

R&S®NGP800

Power Supply Series

User Manual



5601561002
Version 11

ROHDE & SCHWARZ
Make ideas real



This manual describes the following R&S®NGP800 models with firmware version 2.025 or higher:

- R&S®NGP802 Two-channel 32V/20A Power Supply 400 W (5601.4007.05)
- R&S®NGP822 Two-channel 64V/10A Power Supply 400 W (5601.4007.06)
- R&S®NGP804 Four-channel 32V/20A Power Supply 800 W (5601.4007.02)
- R&S®NGP824 Four-channel 64V/10A Power Supply 800 W (5601.4007.03)
- R&S®NGP814 Four-channel 32V/20A & 64V/10A Power Supply 800 W (5601.4007.04)

In addition to the base unit, the following options are described:

- R&S®NG-B105 Option IEEE-488 (GPIB) Interface (5601.6000.02)
- ¹ R&S®NGP-K102 Option Wireless LAN (5601.6400.03)
- R&S®NGP-K103 Option Digital I/O (5601.6300.03)
- R&S®NGP-K107 Option Analog Input (5601.6200.03)

¹ Only available for instrument with serial number below 110000

© 2023 Rohde & Schwarz GmbH & Co. KG
Muehldorfstr. 15, 81671 Muenchen, Germany
Phone: +49 89 41 29 - 0
Email: info@rohde-schwarz.com
Internet: www.rohde-schwarz.com

Subject to change – data without tolerance limits is not binding.

R&S® is a registered trademark of Rohde & Schwarz GmbH & Co. KG.

Trade names are trademarks of the owners.

5601.5610.02 | Version 11 | R&S®NGP800

Throughout this manual, products from Rohde & Schwarz are indicated without the ® symbol, e.g. R&S®NGP800 is indicated as R&S NGP800.

Contents

1	Safety and regulatory information.....	9
1.1	Safety instructions.....	9
1.2	Labels on R&S NGP800.....	12
1.3	Warning messages in the documentation.....	13
1.4	Korea certification class A.....	14
2	Documentation overview.....	15
2.1	Manuals.....	15
2.2	Data sheet.....	15
2.3	Calibration certificate.....	16
2.4	Release notes, open source acknowledgment (OSA).....	16
3	Conventions used in the documentation.....	17
3.1	Typographical conventions.....	17
3.2	Conventions for procedure descriptions.....	17
3.3	Notes on screenshots.....	17
4	Welcome to R&S NGP800.....	18
5	Getting started.....	20
5.1	Preparing for use.....	20
5.1.1	Lifting and carrying.....	20
5.1.2	Unpacking and checking.....	20
5.1.2.1	Delivery package.....	20
5.1.3	Choosing the operating site.....	21
5.1.4	Setting up the R&S NGP800.....	21
5.1.4.1	Placing the R&S NGP800 on a bench top.....	21
5.1.4.2	Mounting the R&S NGP800 in a rack.....	22
5.1.5	Considerations for test setup.....	23
5.1.6	Connecting to power.....	25
5.1.7	Switching on or off.....	26
5.1.8	Connecting to LAN.....	27
5.1.9	Connecting USB devices.....	28
5.2	Instrument tour.....	28

5.2.1	Front panel.....	28
5.2.2	Rear panel.....	30
5.3	Trying out the instrument.....	33
5.3.1	Selecting the channels.....	33
5.3.2	Setting the output voltage and current limit.....	33
5.3.3	Activating the channels output.....	35
5.3.4	Saving/Recalling of instrument settings.....	36
5.4	Instrument control.....	37
5.4.1	Ways to operate the instrument.....	37
5.4.2	Means of manual interaction.....	37
5.4.2.1	Understanding the display information.....	38
5.4.2.2	Accessing the functionality.....	48
5.4.2.3	Entering data.....	49
5.4.3	Remote control.....	51
6	Operating basics.....	52
6.1	Using the touchscreen.....	52
6.1.1	Accessing functionality in the home window.....	52
6.1.1.1	Settings button.....	52
6.1.1.2	Voltage and current inputs.....	53
6.1.1.3	Expand/Collapse button.....	54
6.1.2	Input data.....	55
6.2	Front panel keys.....	56
6.2.1	Menu controls.....	56
6.2.1.1	Home key.....	56
6.2.1.2	Settings key.....	56
6.2.1.3	User key.....	62
6.2.2	Navigation controls.....	62
6.2.3	Output and channel controls.....	62
6.3	Output power auto ranging.....	63
6.4	Operation modes.....	64
7	Instrument functions.....	65
7.1	Setting the channels voltage and current.....	65
7.2	Activating the channel output.....	66

7.3	Output setting	67
7.3.1	Delay.....	68
7.3.2	Remote sensing.....	70
7.3.3	High impedance mode.....	71
7.3.4	Slew rate control.....	71
7.4	Analog input	72
7.5	Protection	74
7.5.1	Overcurrent protection (OCP).....	74
7.5.2	Overvoltage protection (OVP).....	76
7.5.3	Overpower protection (OPP).....	77
7.5.4	Safety limits.....	78
7.6	Tracking function	80
7.7	Digital trigger I/O	81
7.8	Advanced features	86
7.8.1	QuickArb.....	86
7.8.2	EasyRamp.....	92
7.9	User key	94
7.10	Screenshot	95
7.11	Data logging	96
7.12	CSV settings	99
7.13	Graphical view window	101
7.14	File manager	104
7.15	Save and recall	106
7.16	Interfaces	109
7.16.1	Network connection.....	110
7.16.2	LAN connection.....	112
7.16.3	Wireless LAN connection.....	115
7.16.4	VNC.....	117
7.16.5	FTP.....	120
7.16.6	USB connection.....	122
7.16.7	GPIB address.....	123
7.17	General instrument settings	125
7.17.1	Licenses management.....	125

7.17.2	Appearance settings.....	127
7.17.3	Sound settings.....	128
7.17.4	Date and time.....	129
7.17.5	Device information.....	130
7.17.6	Update device.....	131
7.18	Adjustment.....	133
7.18.1	Analog In adjustment.....	133
7.18.2	Channel adjustment.....	137
8	Remote control commands.....	142
8.1	Common setting commands.....	142
8.2	System settings commands.....	145
8.3	Display commands.....	153
8.4	Trigger commands.....	154
8.5	Configuration commands.....	158
8.5.1	Channel selection.....	158
8.5.2	Safety limit setting.....	160
8.5.3	Remote sense setting.....	164
8.5.4	Voltage setting.....	166
8.5.5	Current setting.....	169
8.5.6	Combined setting of voltage and current settings.....	172
8.5.7	Output setting.....	173
8.5.8	OCP setting.....	177
8.5.9	OVP setting.....	182
8.5.10	OPP setting.....	185
8.5.11	Reset protection tripped state.....	188
8.5.12	Tracking setting.....	189
8.5.13	Interface setting.....	190
8.6	Measurement commands.....	190
8.7	Advanced operating commands.....	195
8.7.1	Arbitrary.....	195
8.7.2	EasyRamp.....	204
8.7.3	Analog input.....	205
8.7.4	Adjustment.....	207

8.8	Data and file management commands	212
8.9	Status reporting commands	219
8.9.1	STATus:OPERation registers	219
8.9.2	STATus:QUESTionable registers	221
9	Troubleshooting	224
9.1	Displaying status information	224
9.2	Problems during firmware update	224
9.3	Problems with remote control over LAN	225
9.3.1	Cannot establish a LAN connection	225
9.3.2	Cannot communicate over LAN	225
9.4	Contacting customer support	225
10	Transport	227
11	Maintenance, storage and disposal	228
11.1	Cleaning	228
11.2	Changing fuses	228
11.3	Internal battery replacement	228
11.4	Storage	229
11.5	Disposal	229
12	Applications	230
12.1	Parallel and series mode	230
12.1.1	Series mode	230
12.1.2	Parallel mode	231
Annex		232
A	Additional basics on remote control	232
A.1	Messages and SCPI command structure	232
A.1.1	Messages	232
A.1.2	SCPI command structure	233
A.1.3	SCPI parameters	235
A.1.4	Overview of syntax elements	237
A.1.5	Responses to queries	238
A.2	Command sequence and synchronization	238

A.2.1	Preventing overlapping execution.....	239
A.3	Status reporting system.....	240
A.3.1	Structure of a SCPI status register.....	241
	Glossary.....	246
	List of commands.....	247
	Index.....	252

1 Safety and regulatory information

The product documentation helps you use the product safely and efficiently. Follow the instructions provided here and in the following chapters.

Intended use

The product is intended for the development, production and verification of electronic components and devices in industrial, administrative, and laboratory environments by personnel familiar with the potential risks of measuring electrical quantities.

Use the product only for its designated purpose. Observe the operating conditions and performance limits stated in the data sheet.

Target audience

Only connect, set up and use a power supply if you are an electrically skilled person. Electrically skilled persons have the relevant education and experience to enable them to perceive risks and to avoid hazards that electricity can cause.

This document targets at all users, including installers, operators, technicians, maintenance and service personnel.

Follow the safety instructions provided in [Chapter 1.1, "Safety instructions"](#), on page 9 and the additional information provided during setup or operation procedures.

Where do I find safety information?

Safety information is part of the product documentation. It warns you of potential dangers and gives instructions on how to prevent personal injury or damage caused by dangerous situations. Safety information is provided as follows:

- In [Chapter 1.1, "Safety instructions"](#), on page 9. The same information is provided in many languages as printed "Safety Instructions". The printed "Safety Instructions" are delivered with the product.
- Throughout the documentation, safety instructions are provided when you need to take care during setup or operation.

1.1 Safety instructions

Products from the Rohde & Schwarz group of companies are manufactured according to the highest technical standards. To use the products safely, follow the instructions provided here and in the product documentation. Keep the product documentation nearby and offer it to other users.

Use the product only for its intended use and within its performance limits. Intended use and limits are described in the product documentation such as the data sheet, manuals and the printed "Safety Instructions". If you are unsure about the appropriate use, contact Rohde & Schwarz customer service.

Only people skilled in electrical work should connect, set up and use the product. Such persons have the education and experience needed to recognize risks and avoid hazards of working with electricity. These users also need sound knowledge of at least one of the languages in which the user interfaces and the product documentation are available.

Reconfigure or adjust the product only as described in the product documentation or the data sheet. Any other modifications can affect safety and are not permitted.

Never open the casing of the product. Only service personnel authorized by Rohde & Schwarz are allowed to repair the product. If any part of the product is damaged or broken, stop using the product. Contact Rohde & Schwarz customer service at <https://www.rohde-schwarz.com/support>.

Lifting and carrying the product

Look up the maximum weight in the data sheet. A single person can only carry a maximum of 18 kg safely depending on age, gender and physical condition. If your product is heavier than 18 kg, do not move or carry it by yourself.

To move the product safely, you can use lifting or transporting equipment such as lift trucks and forklifts. Follow the instructions provided by the equipment manufacturer.

Choosing the operating site

Only use the product indoors. The product casing is not waterproof. Water that enters can electrically connect the casing to live parts, which can lead to electric shock, serious personal injury or death if you touch the casing.

Unless otherwise specified, you can operate the product up to an altitude of 2000 m above sea level. The product is suitable for pollution degree 2 environments where nonconductive contamination can occur. For more information on environmental conditions such as ambient temperature and humidity, see the data sheet.

Setting up the product

Always place the product on a stable, flat and level surface with the bottom of the product facing down. If the product is designed for different positions, secure the product so that it cannot fall over.

If the product has foldable feet, always fold the feet completely in or out to ensure stability. The feet can collapse if they are not folded out completely or if the product is moved without lifting it. The foldable feet are designed to carry the weight of the product, but not an extra load.

If stacking is possible, keep in mind that a stack of products can fall over and cause injury.

If you mount products in a rack, ensure that the rack has sufficient load capacity and stability. Observe the specifications of the rack manufacturer. Always install the products from the bottom shelf to the top shelf so that the rack stands securely. Secure the product so that it cannot fall off the rack.

Connecting to power

The product is an overvoltage category II product. Connect the product to a fixed installation used to supply energy-consuming equipment such as household appliances and similar loads. Keep in mind that electrically powered products have risks, such as electric shock, fire, personal injury or even death. Replace parts that are relevant to safety only by original parts, e.g. power cables or fuses.

Take the following measures for your safety:

- Before switching on the product, ensure that the voltage and frequency indicated on the product match the available power source. If the power adapter does not adjust automatically, set the correct value and check the rating of the fuse.
- If a product has an exchangeable fuse, its type and characteristics are indicated next to the fuse holder. Before changing the fuse, switch off the product and disconnect it from the power source. How to change the fuse is described in the product documentation.
- Only use the power cable delivered with the product. It complies with country-specific safety requirements. Only insert the plug into an outlet with protective conductor terminal.
- Only use intact cables and route them carefully so that they cannot be damaged. Check the power cables regularly to ensure that they are undamaged. Also ensure that nobody can trip over loose cables.
- Only connect the product to a power source with the safety fuse specified in the data sheet.
- Ensure that you can disconnect the product from the power source at any time. Pull the power plug to disconnect the product. The power plug must be easily accessible. If the product is integrated into a system that does not meet these requirements, provide an easily accessible circuit breaker at the system level.

Working with hazardous voltages

Voltages higher than 30 V RMS, or 42 V peak, or 60 V DC are regarded as hazardous contact voltages. Direct contact with them can cause serious injuries.

When working with hazardous contact voltages, use protective measures to preclude direct contact with the measurement setup:

- Before each measurement, inspect all components for damage and replace them if necessary.
- Do not touch exposed connections and components when power is applied.
- Casing, chassis and all measuring terminals are connected to a grounding connection. Never disconnect a grounding connection on the product.
- Switch off the power before connecting or disconnecting the terminal block to the rear panel connector. Tighten all wires connected to the terminal block.
- Only use the wires and terminal blocks delivered with the product.
- Only use insulated wires, not stripped wires, for the terminal connections.
- Turn the mains switch off when the product is not in use.

- When operating measuring accessories, only use the cables delivered with the accessory. If you have to use cables from other manufacturers, make sure that they are of the required overvoltage category.

Do not operate the product in series or parallel unless that setup is supported. If accessories are provided for a product, only use them for that product. See the data sheet.

In series or parallel setups, protect yourself against electric shock before connecting access ports such as the Ethernet port or the USB port using one of the following measures:

- Ensure that all products are grounded by connecting them to the AC power.
- Disconnect all power connections to the product, including outputs.

Measurement categories

IEC 61010-2-030 defines measurement categories that rate products on their ability to resist short transient overvoltages that occur in addition to the working voltage.





This product is designed for measuring within measurement category 0 only. Measurements in this category are performed on circuits not directly connected to mains, such as electronics, battery powered circuits, and specially protected secondary circuits. This measurement category is also known as CAT I.

Cleaning the product

Use a dry, lint-free cloth to clean the product. When cleaning, keep in mind that the casing is not waterproof. Do not use liquid cleaning agents.

Meaning of safety labels

Safety labels on the product warn against potential hazards.

	Potential hazard Read the product documentation to avoid personal injury or product damage.
	Electrical hazard Indicates live parts. Risk of electric shock, fire, personal injury or even death.
	Hot surface Do not touch. Risk of skin burns. Risk of fire.
	Protective conductor terminal Connect this terminal to a grounded external conductor or to protective ground. This connection protects you against electric shock if an electric problem occurs.





1.2 Labels on R&S NGP800

Labels on the casing inform about:

- Personal safety, see "[Meaning of safety labels](#)" on page 12.

- Product and environment safety, see [Table 1-1](#).
- Device information is provided on a sticker attached to the [rear panel](#) of R&S NGP800. The sticker contains a barcode and the device ID. The device ID is a combination of the order number and the serial number.

Table 1-1: Labels regarding R&S NGP800 and environment safety

	Labeling in line with EN 50419 for disposal of electrical and electronic equipment after the product has come to the end of its service life. For more information, see " Disposing electrical and electronic equipment " on page 229.
	Grounding terminal (earth ground contact)
	ON (supply voltage)
	OFF (supply voltage)
	Chassis grounding terminal

1.3 Warning messages in the documentation

A warning message points out a risk or danger that you need to be aware of. The signal word indicates the severity of the safety hazard and how likely it will occur if you do not follow the safety precautions.

DANGER

Imminently hazardous situation. Will result in death or serious injury if not avoided.

WARNING

Potentially hazardous situation. Could result in death or serious injury if not avoided.

CAUTION

Potentially hazardous situation. Could result in minor or moderate injury if not avoided.

NOTICE

Potential risks of damage. Could result in damage to the supported product or to other property.

1.4 Korea certification class A



이 기기는 업무용(A급) 전자파 적합기기로서 판매자 또는 사용자는 이 점을 주의하시기
바라며, 가정외의 지역에서 사용하는 것을 목적으로 합니다.

2 Documentation overview

This section provides an overview of the R&S NGP800 user documentation.

2.1 Manuals

You find the documents on the R&S NGP800 product page at:

www.rohde-schwarz.com/product/ngp800

Getting started

Introduces the R&S NGP800 power supply series and describes how to set up and start working with the instrument. The printed document is delivered with the instrument.

User manual

Contains the description of all instrument modes and functions. It also provides an introduction to remote control, a complete description of the remote control commands with programming examples, and information on maintenance and instrument interfaces. Includes the contents of the getting started manual.

The *online version* of the user manual provides the complete contents for immediate display on the internet.

Basic safety instructions

Contains safety instructions, operating conditions and further important information. The printed document is delivered with the instrument.

Instrument security procedures manual

Deals with security issues when working with the R&S NGP800 in secure areas. It is available for download on the internet.

2.2 Data sheet

The datasheet contains the technical specifications of the R&S NGP800 power supply series. It also lists all options with their order numbers and accessories.

See www.rohde-schwarz.com/brochure-datasheet/ngp800

2.3 Calibration certificate

The document is available on <https://gloris.rohde-schwarz.com/calcert>. You need the device ID of your instrument, which you can find on a label on the rear panel.

2.4 Release notes, open source acknowledgment (OSA)

The release notes list new features, improvements and known issues of the current firmware version, and describe the firmware installation. The open source acknowledgment document provides verbatim license texts of the used open source software. It can also be read directly on the instrument.

See www.rohde-schwarz.com/firmware/ngp800.

3 Conventions used in the documentation

3.1 Typographical conventions

The following text markers are used throughout this documentation:

Convention	Description
"Graphical user interface elements"	All names of graphical user interface elements on the screen, such as dialog boxes, menus, options, buttons, and softkeys are enclosed by quotation marks.
[Keys]	Key and knob names are enclosed by square brackets.
Filenames, commands, program code	Filenames, commands, coding samples and screen output are distinguished by their font.
<i>Input</i>	Input to be entered by the user is displayed in italics.
Links	Links that you can click are displayed in blue font.
"References"	References to other parts of the documentation are enclosed by quotation marks.

3.2 Conventions for procedure descriptions

When operating the instrument, several alternative methods may be available to perform the same task. In this case, the procedure using the touchscreen is described. Any elements that can be activated by touching can also be clicked using an additionally connected mouse. The alternative procedure using the keys on the instrument or the on-screen keyboard is only described if it deviates from the standard operating procedures.

The term "select" may refer to any of the described methods, i.e. using a finger on the touchscreen, a mouse pointer in the display, or a key on the instrument or on a keyboard.

3.3 Notes on screenshots

When describing the functions of the product, we use sample screenshots. These screenshots are meant to illustrate as many as possible of the provided functions and possible interdependencies between parameters. The shown values may not represent realistic usage scenarios.

The screenshots usually show a fully equipped product, that is: with all options installed. Thus, some functions shown in the screenshots may not be available in your particular product configuration.

4 Welcome to R&S NGP800

The two or four-channel power supply series are based on a primary switched-mode regulator with power factor correction. This concept allows the instrument to achieve highest accuracy and lowest residual ripple.

The R&S NGP800 power supply series feature galvanically isolated, overload and short-circuit proof outputs. The outputs can be connected in parallel and serial to achieve higher currents or voltages.

Multi-purpose protection functions, such as overcurrent protection (OCP), overvoltage protection (OVP) and overpower protection (OPP) can be set separately for each channel. If the set limit is reached, the affected output channel is automatically turned off and an indicator icon (🔴, 🟡, 🟢) flashes on the display. The overcurrent protection can also be linked to the other channels. If the current exceeds the limit on the affected channel, all linked channels will be switched off.

The R&S NGP800 power supply series are also protected from overheating. Each channel is equipped with a temperature sensor that monitors the channel operating temperature for controlling the fan speed and overtemperature protection. If the safe limit is exceeded, the output of the affected channel is switched off. The channel must cool down to a defined threshold before the output can be switched on again. Operations of the other channels are not affected. Also, the actual operating speed of the fans is monitored. If a fan is not running, e.g. rotor locked condition, all the outputs will be switched off to prevent overheating.

The R&S QuickArb function allows freely definable voltage and current sequences with a timeframe as short as 1 ms, e.g. to simulate different charging conditions of a battery. The voltage and current points can also be grouped in different blocks which can be sequenced and repeated independently to achieve a flexible arbitrary function generation.

With the R&S EasyRamp function, the R&S NGP800 power supply provides the operating condition to ramp up the supply voltage within a defined timeframe up to 10 s with 1 ms step size and it can be set independently for each channel. Furthermore, the channels can be sequenced to ramp up the voltage output applied at different times. With different slew rates and delays between channel outputs, it is easy to test multi-voltage systems reliability. For the four-channel power supplies, the outputs can also be arranged into two independent subgroups.

The analog input and digital I/O interfaces at the rear panel can be activated with an option key. The analog input allows you to control the output directly using voltage signals (0 V to 5 V analog input corresponds to 0 to V_{max} or I_{max}) and can be set independently for each channel. The analog inputs are galvanically isolated from the channel outputs, making the connection simpler. The digital I/O provides an 8-bit control port for various control functions. Each pin can be configured as input or output port, to control any output channel, trigger an event, e.g. start arbitrary or to indicate various conditions, e.g. over current protections.

The R&S NGP800 power supplies are equipped with a color 800 x 480 5" TFT LCD touch screen and a USB and LAN interfaces to control the instrument remotely. The R&S NGP800 power supplies can also be remote-controlled using the GPIB option.

The user manual describes all instrument functionalities. The latest version is available for download from the product homepage (<http://www.rohde-schwarz.com/product/ngp800>).

5 Getting started

5.1 Preparing for use

Here, you can find basic information about setting up the product for the first time.

5.1.1 Lifting and carrying

See "[Lifting and carrying the product](#)" on page 10.

5.1.2 Unpacking and checking

1. Unpack the R&S NGP800 carefully.
2. Retain the original packing material. Use it when transporting or shipping the R&S NGP800 later.
3. Using the [delivery package](#) list, check the equipment for completeness.
4. Check the equipment for damage and loose parts.

If the delivery is incomplete or equipment is damaged, contact Rohde & Schwarz.

See also [Chapter 10, "Transport"](#), on page 227.

5.1.2.1 Delivery package

The delivery package contains the following items:

- R&S NGP800 power supply
- Four power cables
- Depending on the power supply models:
 - For two-channel models: one 8-pin terminal block plug (P/N: 3639.1025.00) for output connections
 - For four-channel models: two 8-pin terminal block plugs (P/N: 3639.1025.00) for output connections
- One printed Getting Started manual
- One document folder with multilingual safety instruction and CE certificate

5.1.3 Choosing the operating site

Specific operating conditions ensure proper operation and avoid damage to the product and connected devices. For information on environmental conditions such as ambient temperature and humidity, see the data sheet.

See also "[Choosing the operating site](#)" on page 10.

Electromagnetic compatibility classes

The electromagnetic compatibility (EMC) class indicates where you can operate the product. The EMC class of the product is given in the data sheet.

- Class B equipment is suitable for use in:
 - Residential environments
 - Environments that are directly connected to a low-voltage supply network that supplies residential buildings
- Class A equipment is intended for use in industrial environments. It can cause radio disturbances in residential environments due to possible conducted and radiated disturbances. It is therefore not suitable for class B environments. If class A equipment causes radio disturbances, take appropriate measures to eliminate them.

5.1.4 Setting up the R&S NGP800

Adequate air circulation must be ensured during operation. For continuous operation, a horizontal or inclined position (integrated stand) is preferable.

See also:

- "[Setting up the product](#)" on page 10
- "[Intended use](#)" on page 9

5.1.4.1 Placing the R&S NGP800 on a bench top

To place the product on a bench top

1. Place the product on a stable, flat and level surface. Ensure that the surface can support the weight of the product. For information on the weight, see the data sheet.
2. **CAUTION!** Foldable feet can collapse. See "[Setting up the product](#)" on page 10. Always fold the feet completely in or out. With folded-out feet, do not place anything on top or underneath the product.
3. **WARNING!** A stack of products can fall over and cause injury. Never stack more than three products on top of each other. Instead, mount them in a rack.

Stack as follows:

- If the products have foldable feet, fold them in completely.

- All products must have the same dimensions (width and length).
- Do not exceed a total load of 50 kg placed on the product at the bottom of the stack.

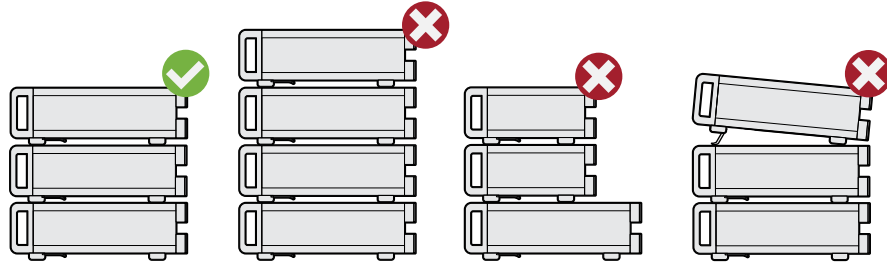

Left = Stacked correctly
 Middle left = Stacked incorrectly, too many products
 Middle right = Stacked incorrectly, different dimensions
 Right = Stacked incorrectly, folded-out feet

4. **NOTICE!** Overheating can damage the product.

Prevent overheating as follows:

- Keep a minimum distance of 10 cm between the fan openings of the product and any object in the vicinity to provide sufficient airflow and ventilation.
- Do not place the product next to heat-generating equipment such as radiators or other products.

5.1.4.2 Mounting the R&S NGP800 in a rack

To prepare the rack

1. Observe the requirements and instructions in "[Setting up the product](#)" on page 10.

2. **NOTICE!** Insufficient airflow can cause overheating and damage the product.

The heat produced inside the instrument is guided to the exterior via temperature-controlled fan. The R&S NGP800 has multiple temperature sensors which check the heat generation in the instrument and control the fan speed.

It is necessary to ensure that there is sufficient space around the instrument sides for heat exchange. Ensure that fan openings and ventilation holes are unobstructed and airflow vents are unimpeded.

If the temperature inside the instrument increases more than the allowed limit, over-temperature protection is triggered and the affected outputs are switched off automatically.

To mount the R&S NGP800 in a rack

1. Use an adapter kit that fits the dimensions of the R&S NGP800 to prepare the R&S NGP800 for rack mounting.

- a) Order the R&S ZZA-GE23 rack adapter kit (P/N: 5601.4059.00) designed for the R&S NGP800.

- b) Mount the adapter kit. Follow the assembly instructions provided with the adapter kit.
2. Lift the R&S NGP800 to shelf height.
3. Push the R&S NGP800 onto the shelf until the rack brackets fit closely to the rack.
4. Tighten all screws at the rack brackets with a tightening torque of 1.2 Nm to secure the R&S NGP800 at the rack.

To unmount the R&S NGP800 from a rack

1. Loosen the screws at the rack brackets.
2. Remove the R&S NGP800 from the rack.
3. If placing the R&S NGP800 on a bench top again, unmount the adapter kit from the R&S NGP800. Follow the instructions provided with the adapter kit.

5.1.5 Considerations for test setup

The product is built in compliance with DIN EN 61010-1 (VDC 0411 part 1), EN 61010-1 and IEC 61010-1. It is designed with the regulations of protection class 1, for supplying power-on circuits that are only indirectly connected to the low voltage mains or not connected at all.

The instrument is not intended for measurements within the measurement categories II, III or IV; the maximum potential against earth generated by the user must not exceed 250 VDC in this application.

See also "[Measurement categories](#)" on page 12.

General instrument specification

See [Table 5-1](#) for the general data on the instrument specification. Refer to the instrument datasheet for details.

Table 5-1: General data on instrument specification

General data	
Mains nominal voltage	100 VAC to 250 VAC 50 Hz / 60 Hz
Maximum input power	650 W for 2 channels 1125 W for 4 channels
Mains fuses	Internal 16 A 250 V IEC 60127-2/7 fast-acting Not user accessible
Operating temperature range	+5 °C to +40 °C
Storage temperature range	-20 °C to +70 °C
Humidity noncondensing	5 % to 95 %
Display	TFT 5" 800 pixels x 480 pixels WVGA Touch

General data		
Rack installation	R&S ZZA-GE23 rack adapter 2U (P/N: 5601.4059.00)	
Dimensions (W x H x D)	362 mm x 100 mm x 451 mm (14.25" x 3.94" x 17.76")	
Weight	R&S NGP802/822 (2-channel)	7.5 kg (16.5 lb)
	R&S NGP804/814/824 (4-channel)	8.0 kg (17.6 lb)

Operating limits

The R&S NGP800 is equipped with a protective overload feature. The protective overload feature prevents damage to the instrument and is intended to protect against a possible electrical shock. The maximum values for the instrument must not be exceeded. The protection limits are listed on the front panel of the R&S NGP800 to ensure safe operation of the instrument.

See [Table 5-2](#) for protection limits of the R&S NGP800.

Table 5-2: Protection limits for R&S NGP800

Specification	Limits
Maximum output voltage	32 V module: 32 VDC 64 V module: 64 VDC
Maximum output current	32 V module: 20 ADC 64 V module: 10 ADC
Maximum voltage against earth	250 VDC
Maximum counter-voltage (same polarity)	32 V module: 35 VDC 64 V module: 70 VDC
Maximum reverse voltage (opposite polarity)	0.4 VDC
Maximum reverse Current (through protection diode, instrument must be operating)	20 A
AC input	100 VAC to 250 VAC, 50 Hz / 60 Hz
Maximum power output	400W for NGP802 & NGP822 800W for NGP804, NGP814 & NGP824

Cable selection and electromagnetic interference (EMI)

Electromagnetic interference (EMI) can affect the measurement results.

To suppress electromagnetic radiation during operation:

- Use high-quality shielded cables, for example double shielded USB and LAN cables.
- Use at least a CAT6+ LAN cables with a length \leq 3 m and passive USB cable with a length \leq 1m.
- Use insulated wires for output supply/terminal connections.
- Always terminate open cable ends.
- Ensure that connected external devices comply with EMC regulations.

- Check regularly that all cables, including power cables are in perfect conditions.

Signal input and output levels

Information on voltage levels is provided in the data sheet. Keep the voltage levels within the specified ranges to avoid damage to the product and connected devices.

See also "Output terminals" on page 33.

5.1.6 Connecting to power

For safety information, see "Connecting to power" on page 11 and "Working with hazardous voltages" on page 11.

Before connecting the instrument to the mains, check whether the mains voltage conforms to the mains voltage range specified on the label located below the [AC power connector](#).

The power supply module covers a wide power supply range and normally does not require adjustment. See [Table 5-1](#) for the supported mains voltage and the corresponding fuse types and ratings. If the power supply exceeds the permissible range, contact Rohde & Schwarz customer service.

1. Ground the R&S NGP800 using the ground terminal on the rear panel. See "[Ground terminal](#)" on page 25.
2. Plug the AC power cable into the AC power connector.
Use power cable that complies with the IEC 60320-1 standard.
3. Plug the AC power cable into a power outlet with ground contact.
The required ratings are listed next to the AC connector and in the data sheet.

Replacing the power fuse

- ▶ The instrument is protected by internal fuses which are not user accessible. If the instrument is not powering on, this may indicate an open fuse.
Send the instrument for servicing.

Ground terminal

If necessary, ground the instrument using the grounding connection  located at the [rear panel](#):

1. Unscrew the screw of the ground terminal using a cross-recess screw driver.
2. Attach a ground cable with a ring terminal and pass the screw through it.
3. Fasten the screw with a tightening torque of 1.2 Nm.
4. Connect the cable to ground.

5.1.7 Switching on or off



Specifications with tolerance data apply after a warm-up period of at least 30 minutes at a temperature of 23 °C (tolerance -3 °C / +7 °C).

See also [Chapter 5.1.6, "Connecting to power"](#), on page 25.

Switching on the product

The product is off but connected to power.

1. Set the switch on the power supply to position [I].
For the location of the switch, see [Chapter 5.2.2, "Rear panel"](#), on page 30.

The LED of the [Power] key is lighted red.

2. Press the [Power] key on the [front panel](#) of the R&S NGP800.

The LED of the [Power] key turns off.

The instrument performs a system check, boots the operating system and starts the R&S NGP800 firmware.

By default, the output channel is turned off when the instrument is switched on to prevent connected loads from being damaged unintentionally.

During startup, the R&S NGP800 is loaded with the last saved instrument settings from internal memory and auto saved parameters. See [Chapter 7.15, "Save and recall"](#), on page 106 in the user manual.

To shut down the product

- ▶ Press the [Power] key.

All current settings are saved and the operating system shuts down. The LED of the power key changes to red.

To disconnect from power

The product is in the standby state.

1. **NOTICE!** Risk of data loss. If you disconnect the product from power when it is in the ready state, you can lose settings and data. Shut it down first.

Set the switch on the power supply to position [0].

The LED of the [Power] key is switched off.

2. Disconnect the product from the power source.

5.1.8 Connecting to LAN

Establishing the LAN connection

The R&S NGP800 provides Ethernet (LAN) connectivity. Provided the corresponding rights are assigned, you can use these interfaces for remote control and data transfer from a controller PC. The controller PC must also be connected in the network.

The LAN connector is at the [rear panel](#) of R&S NGP800.

To connect R&S NGP800 to the LAN:

1. **NOTICE!** Recommendation on secure operation. The R&S NGP800 is designed to operate at local workplaces or in secured networks (LAN). It should not be accessible from the internet because of a potential security risk, e.g. attackers could misuse or damage your device.

Please always install the latest firmware.

By default, the R&S NGP800 configuration uses [DHCP](#) that assigns the IP address automatically.

2. Connect the LAN socket using an RJ-45 cable to the LAN.
3. **NOTICE!** If the R&S NGP800 cannot obtain an IP address automatically, or cannot establish the connection, the LAN interface icon,  in the status bar turns red. Possible reasons are that the LAN does not support DHCP or requires a specific TCP/IP configuration, or that the connection is missing.

To troubleshoot the problem, proceed as follows:

- a) Check if you have connected both, the R&S NGP800 and the controller PC to the LAN.
- b) Consult your network administrator to request support for an IP address, if necessary.
- c) If necessary, assign the IP address manually as described in [Chapter 7.16.2, "LAN connection"](#), on page 112.

If switched on and connected, the R&S NGP800 indicates the address information and LAN parameters in the LAN setting dialog. See [Figure 5-1](#).

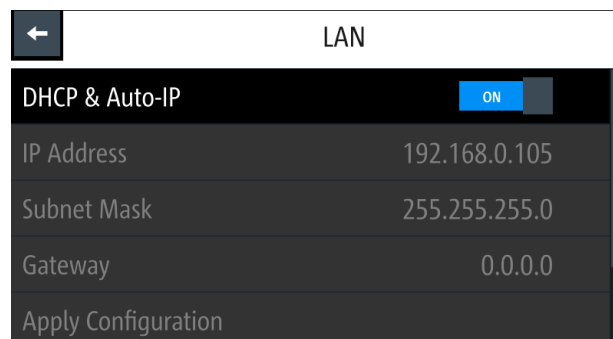

Figure 5-1: LAN settings dialog

5.1.9 Connecting USB devices

The USB Type-A connector is at the [front panel](#). You can connect or disconnect all USB devices from the R&S NGP800 during operation. But do not remove an external USB memory stick while the instrument is performing firmware update, data logging and storing of screen captures, since it leads to unsuccessful updates and loss of data.

To connect USB storage devices

USB storage devices, such as memory sticks, allow easy data transfer from or to the R&S NGP800. You can also use them for firmware updates.

- ▶ Connect the USB storage device to the USB type A connector.
If you use the front panel connectors, connect the USB storage device directly, without connecting cable. Connecting cables can cause electromagnetic radiation and impair the measurement result.

5.2 Instrument tour

The following sections help you to get familiar with the instrument and perform the first steps:

- [Chapter 5.2.1, "Front panel"](#), on page 28
- [Chapter 5.2.2, "Rear panel"](#), on page 30

These sections explain the controls and connections on the front and rear panel of the R&S NGP800. For specifications of the interfaces, see the data sheet.

The meanings of the labels on the R&S NGP800 are described in [Chapter 1.2, "Labels on R&S NGP800"](#), on page 12.

5.2.1 Front panel

The front panel of the R&S NGP800 power supply is shown in [Figure 5-2](#). The function keys and navigation controls are located beside the display. The various connectors are located at the right of the display.

The following power supply models are available:

Table 5-3: Power supply models

Models	Number of output channels
R&S NGP802, R&S NGP822	2
R&S NGP804, R&S NGP814, R&S NGP824	4



Figure 5-2: Front panel of R&S NGP800 power supply

- 1 = Menu control keys
- 2 = Display with touch screen
- 3 = Rotary knob and back key
- 4 = Output and channel keys
- 5 = Chassis ground terminal (4mm socket)
- 6 = Output terminals (see [Table 5-3](#))
- 7 = USB connector
- 8 = Power key

Menu control keys (1)

The menu control keys include the [Home], [Settings] and [User] keys. These keys allow you to access to the home window, instrument menu window and user-defined functions in the instrument, respectively.

For a detailed description on menu control keys, see section "Menu Controls" in the User Manual.

Display (2)

The display is a color TFT touch screen. Depending on the instrument models, up to four channels are shown on the display. The respective measurement settings and menu settings are displayed in the individual channel display area.

Two information status bars, providing the overall device operating mode and channel settings of the instrument are located respectively at the device level (top-right hand corner of the display area) and channel level (on top of individual channel display area) of the instrument.

For a detailed description on-screen layout, see [Chapter 5.4.2.1, "Understanding the display information"](#), on page 38.

Rotary knob and back key (3)

The rotary knob and back key are used for menu navigation and value adjustment in the instrument.

For a detailed description on navigation, see ["To enter values by using the front panel controls"](#) on page 50.

Output and channel keys (4)

Depending on the instrument models, up to four channels and one output key are provided to select individual channel and enable/disable the output(s).

Chassis ground terminal (5)

A 4 mm socket protective ground terminal is provided for the user to connect to earth ground through the instrument ground/chassis, see [Chapter 1.2, "Labels on R&S NGP800"](#), on page 12.

Output terminals (6)

Two-channel instrument models: R&S NGP802 and R&S NGP822 are equipped with 8 terminals for outputs and remote sense connections. Four-channel instrument models: R&S NGP804, R&S NGP814 and R&S NGP824 are equipped with 16 terminals for outputs and remote sense connections.

For 32 V models, each output is capable to source 200 W of power at 0 V to 32 V and maximum current of 20 A.

For 64 V models, each output is capable to source 200 W of power at 0 V to 64 V and maximum current of 10A.

See also ["Output terminals"](#) on page 33.

USB connector (7)

USB Type-A connector is provided for connecting a USB flash drive to perform software update, store logging data or screen captures. It can also be used for an external USB mouse connector. See also [Chapter 5.1.9, "Connecting USB devices"](#), on page 28.

Power key (8)

The [Power] key toggles the instrument between standby state and normal state. In standby state, the key is illuminated in red and the instrument internal circuits are operated in powered down state. In normal state, all the internal modules are powered up and the instrument will startup to operate normally. The LED illumination is turned off in this state. See also [Chapter 5.1.7, "Switching on or off"](#), on page 26.

5.2.2 Rear panel

[Figure 5-3](#) shows the rear panel of the R&S NGP800 power supply with its connectors.

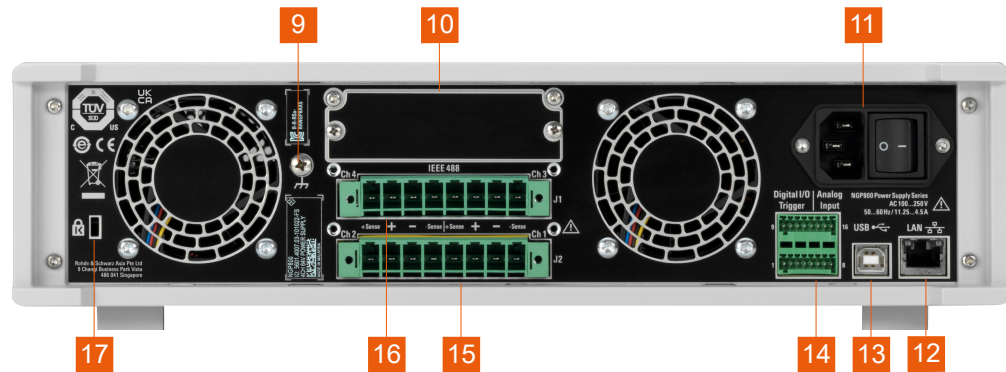

Figure 5-3: Rear panel of R&S NGP800 power supply

- 9 = Ground terminal
- 10 = IEEE-488 (GPIB) interface
- 11 = AC inlet with integrated 2-pole rocker switch
- 12 = Ethernet (LAN) connector
- 13 = USB-B connector (device)
- 14 = Analog input and digital I/O connector
- 15 = Channel 1 and 2 rear panel connector
- 16 = Channel 3 and 4 rear panel connector (for R&S NGP804, R&S NGP814 and R&S NGP824 models only)
- 17 = Kensington lock

Ground terminal (9)

Protective ground terminal to secure the R&S NGP800, e.g. with a ground external conductor, see [Chapter 1.2, "Labels on R&S NGP800"](#), on page 12.

IEEE-488 (GPIB) interface (10)

Option: R&S NG-B105 provides an IEEE-488 (GPIB) bus interface.

AC inlet with integrated 2-pole rocker switch (11)



Main supply cord

Use a detachable mains supply cord according to IEC60320-1 standard.
Never use the product if the power cable is damaged.

The built-in 2-pole rocker switch is the main power switch of the instrument which connects/disconnects the R&S NGP800 from the AC supply, see [Chapter 5.1.6, "Connecting to power"](#), on page 25.

Ethernet connector (12)

This connector is used for establishing remote control via SCPI. For more information on the connection setup, see [Chapter 5.1.8, "Connecting to LAN"](#), on page 27.

USB connector (13)

The USB connector is a Type-B connector for remote control operation via USB TMC or USB VCP.

For more information, see [Chapter 7.16.6, "USB connection"](#), on page 122 in the user manual.

Digital I/O & analog input connector (14)

NOTICE

Risk of instrument damage

Do not exceed the maximum voltage rating of the digital I/O pins (5.25 V max) when supplying voltages to the pins.

For more information, see the instrument datasheet (P/N: 3609.1927.32).

A 16-pin terminal block provides connection to both digital I/O (option R&S NGP-K103) and analog input (option R&S NGP-K107). See [Table 5-4](#).

Table 5-4: Pin configurations

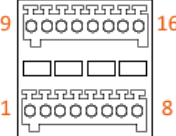
DIO & analog input connector	Signal	Logical name	Value range	Pin number
	Analog input 1 to 4	ANA1	0 Vdc to 5 Vdc	16
		ANA2		8
		ANA3		15
		ANA4		7
	Analog ground	GND	0 Vdc	6, 14
	Digital ground	GND	0 Vdc	5, 13
	Digital trigger 1 to 8	DIO1	TTL	12
		DIO2		4
		DIO3		11
		DIO4		3
		DIO5		10
		DIO6		2
DIO7		9		
DIO8		1		

For more information, see [Chapter 7.7, "Digital trigger I/O"](#), on page 81 and [Chapter 7.18.1, "Analog In adjustment"](#), on page 133.

Rear panel connectors (15, 16)

NOTICE

Output terminals

Either the output terminals at the front panel or the rear panel connector at the back panel can be used.

Both terminals cannot be used at the same time as it can cause the instrument to malfunction.

The rear panel connector contains both outputs ("+", "-") and remote sense ("Sense+", "Sense-"). Connectors for channel 3 and channel 4 are only available for the 4-channel instrument.

1. **DANGER!** Shock Hazard. Risk of electric shock if AC power is turned on when connecting wires to the rear panel connector.
Turn off AC power when connecting wires to the rear panel connector.
2. Insert shielded wire to the pluggable terminal block.
3. Tightened all the wires with the screw on the pluggable terminal block.
4. Connect the pluggable terminal block to the output terminal.

Kensington security slot (17)

A Kensington lock can be anchored to the R&S NGP800 power supply housing to secure it to a workstation mechanically.

5.3 Trying out the instrument

This chapter describes some basic functions that you can perform with the R&S NGP800 power supply series.

5.3.1 Selecting the channels

To select a channel, press the corresponding channel key. The selected channel key illuminates.

5.3.2 Setting the output voltage and current limit

1. Press [Home]  key.
The R&S NGP800 power supply displays the home window.

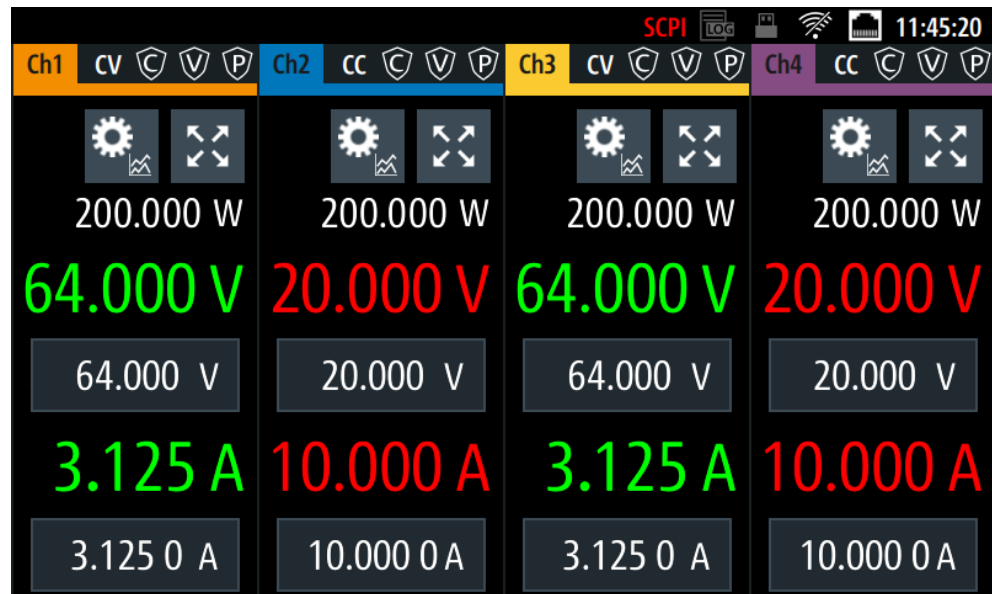
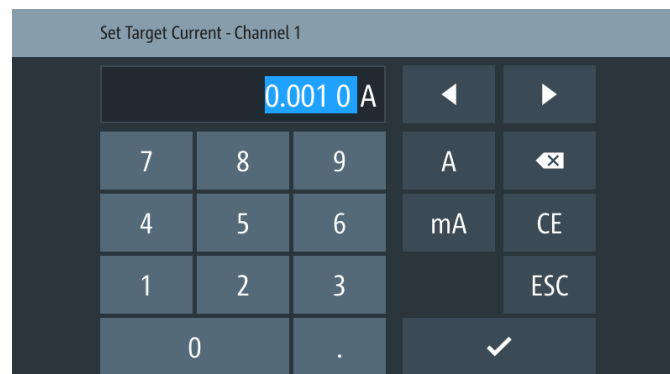
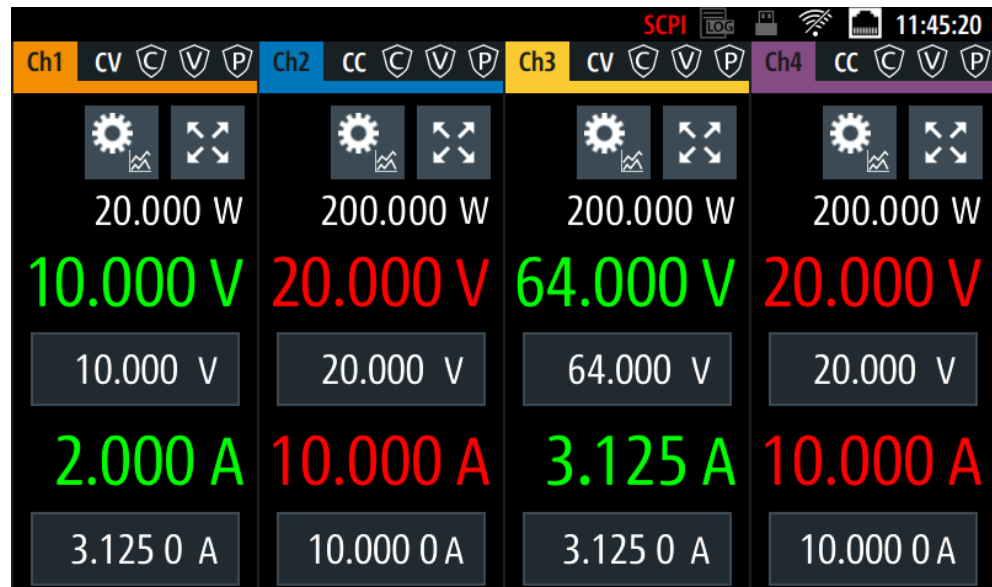

Figure 5-4: Home window

- Select voltage or current parameter of the desired channel.
The R&S NGP800 power supply displays an on-screen keypad to set the value.



- Enter the required value.
- Confirm value with either a unit key or enter key, .
The home window shows the updated voltage and current settings (see changes of voltage and current values in "Ch1").



5. Repeat for other channel if desired.

5.3.3 Activating the channels output

The output voltages can be switched on or off regardless of the instrument's operating mode.

To activate the channel output, press the [Output] key on the front panel followed by the desired channel key or vice versa.

The R&S NGP800 power supply displays the actual voltage on the output channel and the actual current drawn by the load connected to the output. Depending on the instrument operating mode, the display font color changes to green in CV (constant voltage) mode and red in CC (constant current) mode.

By default, the output is turned off when the instrument is switched on.

See the highlighted areas in [Figure 5-5](#).

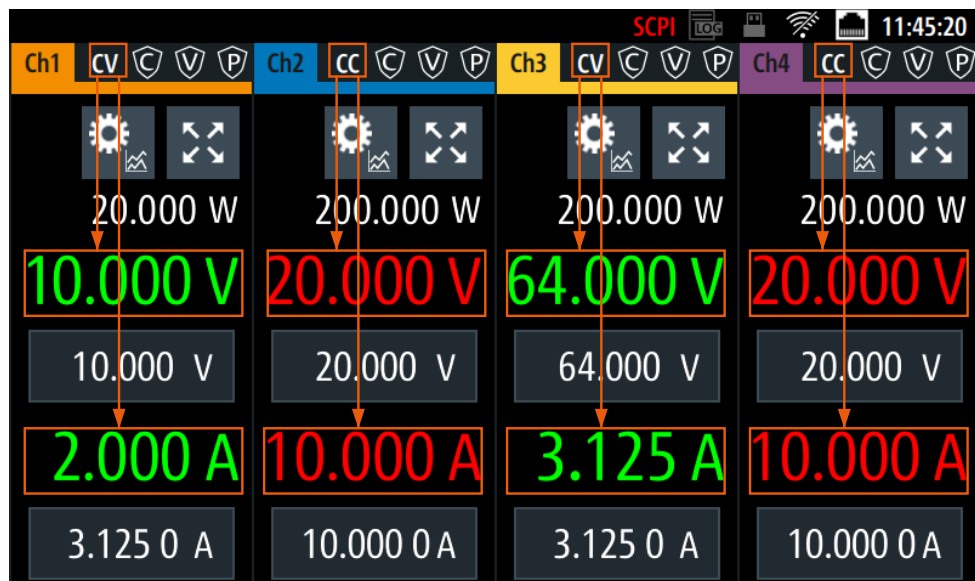

Figure 5-5: Font color in highlighted areas changes to green or red depending on the different operating modes of the instrument

5.3.4 Saving/Recalling of instrument settings

The R&S NGP800 can save instrument settings and screenshots. Both instrument settings and screenshots can be saved on a USB stick or internally in the instrument to non-volatile storage media.

1. Press [Settings] > "Device" > "Save/Recall Device Settings" > "Save Settings to File" to save current instrument settings.
2. Select the desired storage location and filename.
Default location and filename `/int/settings/newSetting.rds` are used if no location and filename are entered.
3. Confirm the selection by selecting the "SAVE" softkey.
The instrument settings are saved.
4. Press [Settings] > "Device" > "Save/Recall Device Settings" > "Recall Settings from File" to load instrument settings.
5. Select the desired file location and filename.
The filemanager dialog of the selection location is displayed.
6. Select "Load" to load the instrument settings.
The selected instrument settings are loaded.

To retrieve the factory default settings, press [Settings] > "Device" > "Save/Recall Device Settings" > "Default Settings" to load back the factory default settings.

For more information, see [Chapter 7.15, "Save and recall"](#), on page 106.

See also [Chapter 7.10, "Screenshot"](#), on page 95.

5.4 Instrument control

This chapter provides an overview on how to work with the R&S NGP800. It introduces the possibilities for operating the instrument and describes the basic functionality of the control elements. If a measurement configuration requires specific operating steps, the corresponding settings description in the user manual points it out separately.

- [Ways to operate the instrument](#)..... 37
- [Means of manual interaction](#)..... 37
- [Remote control](#)..... 51

5.4.1 Ways to operate the instrument

You can operate an R&S NGP800 in two ways:

- **Manual operation**
Use the touchscreen and front panel controls to configure the R&S NGP800 settings.
See [Chapter 5.4.2, "Means of manual interaction"](#), on page 37 for basic information on manual operation of the instrument.
- **Remote control**
Create programs to automatize repeating settings, tests and measurements. A controller PC with remote access to the instrument runs the programs.
See [Chapter 5.4.3, "Remote control"](#), on page 51 for an overview of the interfaces provided for remote control.

5.4.2 Means of manual interaction

For manual interaction with the R&S NGP800, you have several methods that you can use as an alternative to perform a task:

- **Touchscreen**
Touchscreen operation is the most direct way to interact with the instrument. Almost all control elements and actions on the screen are based on the standard operating system concept. You can tap any user interface element, set parameters in dialogs, enter data using online keypads and swipe to scroll within a dialog.

- **Tapping**



Tap on the screen to select or toggle the value.

- **Swipe up and down**



Swipe up to scroll down and swipe down to scroll up the content in the menu or dialog box.

For more information on touchscreen behavior, see chapter [Chapter 6.1, "Using the touchscreen"](#), on page 52 in the user manual.

- **Menu control, channel and output keys**
The menu control keys provide you with quick access to home window, instrument menu and shortcut key to user-defined functions. You can also access to the instrument menu via the channel display area in the home window, see [Table 5-5](#). Instrument channel selection and output activation are only accessible via the respective front panel keys, these keys illuminate when activated. For a detailed description on the front panel keys, see [Chapter 6.2.1, "Menu controls"](#), on page 56.
- **Navigation controls**
The navigation controls include a rotary knob and [Back] key which allow you to navigate in the home window, instrument menus or dialogs and also make value adjustment in the entry field.

This manual describes the manual interaction with the instrument using the touchscreen. It mentions the alternative methods using the keys on the instrument or the on-screen keypads if it deviates from the standard operating procedures.



Throughout the manual, the term "select" refers to any of the described methods, i.e. using a finger on the touchscreen or a key on the instrument or on a keyboard.

For basic instructions on how to control the R&S NGP800, see [Chapter 5.4.2.2, "Accessing the functionality"](#), on page 48.

5.4.2.1 Understanding the display information



Depending on the instrument models, up to two or four home windows are shown on the screen layout. The respective channel settings and device status are displayed for each channel.

The home window of R&S NGP800 shows the [channel display area](#) and [status bar information](#). With the access of "Expand/Collapse" softkey in the channel display area, the [historical channel information](#) of respective channel is displayed.

The channel display area shows the output voltage, current level and [operating mode](#) of the output.

For detailed information, see [Chapter 6.4, "Operation modes"](#), on page 64.

Table 5-5: Home window of R&S NGP800 models

Two-channel models: R&S NGP802, R&S NGP822	Four-channel models: R&S NGP804, R&S NGP824, R&S NGP814
	
<ul style="list-style-type: none"> • 1 = Device status bar • 2 = Channel status bar • 3 = Expand/Collapse softkey • 4 = Settings softkey • 5 = Channel display area of Ch1 • 6 = Channel display area of Ch2 • 7 = Channel display area of Ch3 • 8 = Channel display area of Ch4 	

The following sections explain the information areas as labeled.

Status bar information

There are two types of status bar information located at the top of the screen layout:

- Device status
- Channel status



Device status







The device status displays the state of the functions activated in the device.



Figure 5-6: Device status bar

Table 5-6: Device status bar information

Function	Description
 Touchscreen	If touch input is disabled, the icon is displayed and highlighted in yellow. See Chapter 6.2.1.3, "User key" , on page 62.
 Virtual networking computing, VNC	If VNC is enabled, the icon is highlighted in white. See Chapter 7.16.4, "VNC" , on page 117
 File transfer protocol, FTP	If FTP is enabled, the icon is highlighted in white. See Chapter 7.16.5, "FTP" , on page 120.

Function	Description
SCPI command 	<p>If a SCPI command is received successfully, the icon blinks once in white.</p> <p>If an error is in the SCPI error queue, the icon is highlighted in red.</p> <p>If no activity, icon is displayed in gray.</p> <p>See Chapter 8, "Remote control commands", on page 142.</p>
Trigger event 	<p>Icon blinks once in white when a trigger event occurs.</p> <p>See Chapter 7.7, "Digital trigger I/O", on page 81.</p>
Data logging 	<p>If data logging is present, the icon is highlighted in white.</p> <p>If an error is present, the icon is highlighted in red.</p> <p>See Chapter 7.11, "Data logging", on page 96.</p>
USB 	<p>If USB device is busy, the icon is highlighted in white.</p> <p>If USB device is idle, the icon is highlighted in gray.</p> <p>See Chapter 7.16.6, "USB connection", on page 122.</p>
WLAN 	<p>Only visible if software option Wireless LAN is active and instrument with serial number below 110000.</p> <p>If connection is present, the icon is highlighted in white. If both WLAN and LAN connection are present, the icon is highlighted with a line cross over.</p> <p>If no connection or WLAN is disabled, the icon is highlighted in gray.</p> <p>See Chapter 7.16.3, "Wireless LAN connection", on page 115.</p>
LAN interface 	<p>If connected, the icon is highlighted in white.</p> <p>If no connection or an error is present in connection, the icon is highlighted in red.</p> <p>See Chapter 7.16, "Interfaces", on page 109.</p>
Time 	<p>Time displays in hh:mm:ss format.</p> <p>See Chapter 7.17.4, "Date and time", on page 129.</p>

Channel status



The channel status displays the state of the indicators available in the device channel.



Figure 5-7: Channel status bar

Table 5-7: Channel status bar information

Function	Description
Channel number	Channel number indication.
Operation mode	The R&S NGP800 has two operating modes: <ul style="list-style-type: none"> CV: Constant voltage mode CC: Constant current mode See Chapter 6.4, "Operation modes" , on page 64.
OCP 	If enabled, the icon is highlighted in white. If triggered, the icon blinks. See Chapter 7.5.1, "Overcurrent protection (OCP)" , on page 74.
OVP 	If enabled, the icon is highlighted in white. If triggered, the icon blinks. See Chapter 7.5.2, "Overvoltage protection (OVP)" , on page 76.
OPP 	If enabled, the icon is highlighted in white. If triggered, the icon blinks. See Chapter 7.5.3, "Overpower protection (OPP)" , on page 77.
Arbitrary mode 	If enabled, the icon is highlighted in white. If active, the icon blinks. See Chapter 7.8.1, "QuickArb" , on page 86.
Ramp mode 	If enabled, the icon is highlighted in white. If active, the icon blinks. See Chapter 7.8.2, "EasyRamp" , on page 92.
"Safety Limits" 	If enabled, the icon is highlighted in white. See Chapter 7.5.4, "Safety limits" , on page 78.
"Output Delay" 	If enabled, the icon is highlighted in white. The delay is the time between activation of the output and applying voltage to the output. See Chapter 7.3.1, "Delay" , on page 68.
Adjustment mode 	If user adjustment is active, the icon is highlighted in red. See Chapter 7.18, "Adjustment" , on page 133.
Sense connection 	If sense connection is detected, the icon is highlighted in white. See Chapter 7.3.2, "Remote sensing" , on page 70.
High impedance 	If enabled, the icon is highlighted in white. See Chapter 7.3.3, "High impedance mode" , on page 71.

Function	Description
Reduce slew rate 	If enabled, the icon is highlighted in white. See Chapter 7.3.4, "Slew rate control" , on page 71.
Tracking 	If tracking is enabled, the icon is highlighted in white. See Chapter 7.6, "Tracking function" , on page 80.

Settings softkey

The "Settings" softkey, , navigates to the instrument menu window. Alternate access to instrument menu is via the [Settings] key on the front panel. See also [Chapter 6.2.1.2, "Settings key"](#), on page 56 in user manual.

Long press on the "Settings" softkey navigates to the graphical view window. For details, see chapter [Chapter 7.13, "Graphical view window"](#), on page 101 in the user manual.

For more information on "Settings" softkey behavior, see chapter [Chapter 6.1, "Using the touchscreen"](#), on page 52 in the user manual.

Expand/Collapse softkey

The "Expand/Collapse" softkey opens the detailed channel display area window with additional information, such as the channel historical information and the optional digital I/O trigger configuration. See [Figure 5-9](#).

For more information on "Expand/Collapse" softkey behavior, see chapter [Chapter 6.1, "Using the touchscreen"](#), on page 52 in the user manual.

Channel display area

The channel display area shows the output power, voltage and current values and the corresponding operating mode (CC, CV) of the R&S NGP800 when the device output is turned on. See ["Operating mode"](#) on page 44 for the different operating modes that the R&S NGP800 supported.

Each channel display area contains the [Settings](#) softkey which provides you the access to instrument menu and [Expand/Collapse](#) softkey which extended the channel display area with additional information, such as the channel historical information and digital I/O trigger configuration. See ["Historical channel information"](#) on page 43.

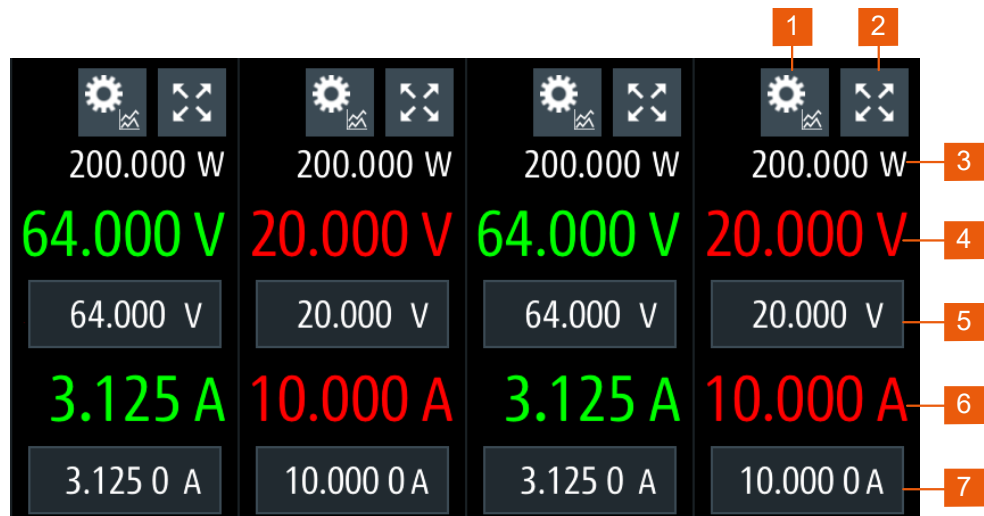



Figure 5-8: Channel display area for 4-channel model

- 1 = "Settings" softkey opens instrument menu window.
- 2 = "Expand/Collapse" softkey toggles between home window and the detailed channel display area window, see [Figure 5-9](#)
- 3 = Output power displays in watt
- 4 = Output voltage displays in volt with display resolution of three decimal points
- 5 = Set voltage level
- 6 = Output current displays in ampere with display resolution of up to four decimal points
- 7 = Set current level

Historical channel information

In the detailed channel display area window, the respective historical channel information displays on the right of the window shows the minimum, maximum and average values for power ("W"), voltage ("V") and current ("A") values. It also performs the calculation of energy result ("mWh") and number of samples collected for the result. To reset the historical channel information to zero value, select the reset softkey, . The statistics provides valid data for up to 365 days of continuous operation, after which the statistics is reset to zero.

With option R&S NGP-K103, the digital I/O trigger configuration of the instrument is available on the left of the window. See also "[Digital I/O & analog input connector \(14\)](#)" on page 32.

Select the "Expand/Collapse" softkey to revert to home window.

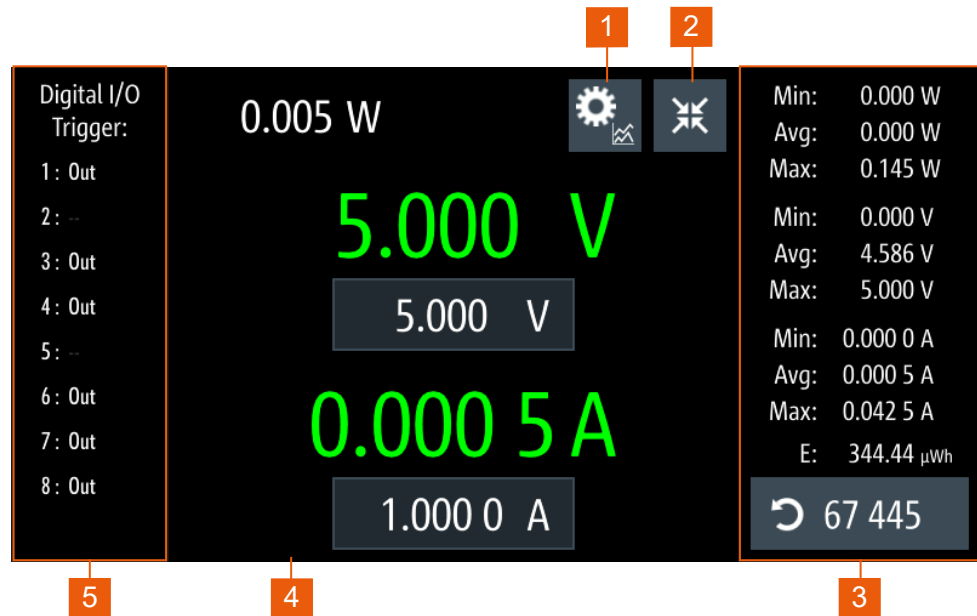

Figure 5-9: Detailed channel display area of a 4-channel instrument model

- 1 = Settings softkey
- 2 = Expand/Collapse softkey
- 3 = Historical channel information
- 4 = Channel display area of respective channel
- 5 = Digital I/O trigger configuration

To change the voltage or current value, see "[Entering numeric parameters](#)" on page 50.

Operating mode

Different font colors on the screen are used to differentiate the various output status and operating conditions of the instrument. It is easy to know and confirm the different output status and operating conditions of the instrument by looking at the colors.

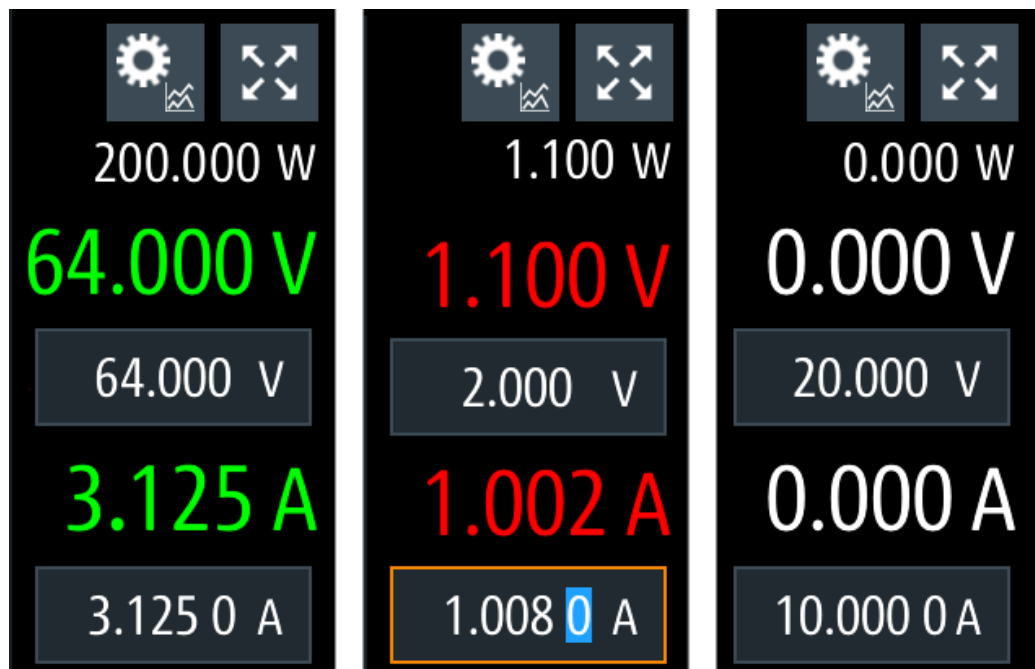

Figure 5-10: Color coding of difference operating conditions

Color	Operating mode	Description
□	OFF mode	Output is OFF.
■	Editing mode	A solid blue cursor is shown when an item is selected.
■	CV mode	Active outputs are operated in a constant voltage mode.
■	CC mode	Active outputs are operated in a constant current mode.

Additional display characteristics

The following section provides a short insight on the indication of the screen in general in dialogs or settings.

- Appearance of active elements
 - Active elements like On/Off switches, selected softkeys have a blue background. In channel display area, the selected element (Voltage or Current) is in editing mode.
 - Selected element is framed or highlighted orange.
 - Inactive elements are gray.



Figure 5-11: Appearance of active elements

- Menus and dialogs

Both, menus and dialogs appear similar, and contain selection lists. Throughout this manual, a list of functions which lead you to the settings of this function is referred to as menu. The term dialog refers to the views that cover the parameters of a certain function. Some dialogs are divided into tabs with logically grouped parameters.

The instrument functions are grouped into the various menus based on the categories of "Device" and respective channel menus (i.e. "Ch 1", "Ch 2", "Ch 3", "Ch 4"). For more information, see [Chapter 6.2.1.2, "Settings key"](#), on page 56.



Figure 5-12: Example of a menu

The term dialog refers to the views that cover the parameters of a certain function.

#	Voltage	Current	Duration	Interpolation
1	1.000 V	1.000 0 A	1.000 s	<input type="checkbox"/>
2	2.000 V	1.000 0 A	1.000 s	<input checked="" type="checkbox"/>
3	5.000 V	1.000 0 A	1.000 s	<input checked="" type="checkbox"/>

Figure 5-13: Example of a dialog

- Wizards

The measurement wizard is provided to perform a sequence of standardized and recurring measurements with guided instructions during the measurement. All relevant parameters are set before the actual measurements and cannot be changed once the actual measurement procedure has begun. For more information, see chapter [Chapter 7.18, "Adjustment"](#), on page 133 in user manual.

About Adjustment	This wizard will guide you through the process of adjustment.
Connection Setup	Please note that a multimeter with sufficient precision is needed to achieve satisfying results.
Pin 1 Adjustment	Factory adjustment can be restored at any time.
Pin 2 Adjustment	Press [Proceed] when ready.
Pin 3 Adjustment	Last date of adjustment: 21-11-2019 Number of times adjusted: 4
Pin 4 Adjustment	
Finish	Back Proceed

Figure 5-14: Example of an analog in adjustment wizard

- On-screen keypad

The on-screen keypad appears if alphanumeric or numeric entry field is required. See ["Entering alphanumeric parameters"](#) on page 51. For alphanumeric entry, you can select "_&123" or "ABC" on the on-screen keypad to toggle between the numeric and alphabetical entry.



Figure 5-15: On-screen keyboard for alphanumeric and numeric entry field

- Info dialogs
An "Info dialog" appears when an event generates a message. The generically assigned header shows the affected topic. The message describes the event, and short instructions lead you through the next steps.
- Scroll bar
Appears when the list of selection parameters exceeds the size of the screen. Touch and swipe on the screen to scroll up and down.

5.4.2.2 Accessing the functionality

The master output control of respective channels is only possible via the front panel keys, all other instrument functionalities are provided in dialogs, menus or keypads, as known from computer programs. You can control the instrument intuitively with the touchscreen. This section provides an overview of the accessing methods.

Apart from the instrument menus, we use the term "dialog" to refer the editable windows in the instrument.

To open the menu

1. Press [Settings] key at the front panel or select the "Settings" softkey in the channel display area.
 - If selection is via [Settings] key, the "Device" menu is displayed.
 - If selection is via the "Settings" softkey from the channel display area window, the respective channel menu is displayed.
2. To alternate between the "Device" and respective channel menu, select the corresponding tab on the top of the screen.
The selection leads you either to a settings parameter directly, or to a dedicated dialog.

To open the dialog

- ▶ Select the corresponding menu item from the displayed menu, i.e. "Interfaces" > "USB Class"
The corresponding dialog is displayed.

To close or exit a dialog or menu

To close or exit a dialog or menu, you have several options.

1. To return to the home window, press the [Home] key.
2. To return to previous menu level or exit the menu if it is already at the main menu level, the R&S NGP800 provides several methods:
 - Softkey that prompts you to confirm or abort your selection, e.g. "Set" or "Cancel" automatically closes a dialog.
 - Select the "Back" softkey,  in the left upper corner of the menu.
 - Press [Back] key or the rotary knob at the front panel.

To select a parameter in a dialog

If many parameters available, they are often provided in a list:

1. If necessary, scroll through the list.
Tip: You do not need the focus exactly on the bar, touch and swipe the list.
2. As an alternative, you can use the rotary knob:
 - a) Turn the rotary knob to select the parameter.
 - b) Press the rotary knob to confirm your selection.

5.4.2.3 Entering data

For data input in dialogs, the instrument provides on-screen keypads for entering numeric and alphanumeric values. Thus, you can always set the parameters using the touchscreen. However, if the touchscreen is locked, data entry via navigation controls at the front panel works only in the home window and the detailed channel area display window, see ["To enter values by using the front panel controls"](#) on page 50.

Data can be entered using one of the following methods:

To correct an entry

1. To delete an entry, set the cursor to the right of the entry you want to delete.
To select the position:
 - a) Select it in the entry field directly.
 - b) Use the cursor softkeys of the on-screen keypad.
2. On the on-screen keypad, select "Back" key, .
The R&S NGP800 deletes the entry to the left of the cursor.
3. Enter your correction.

To complete an entry

To confirm the entry:

- ▶ On the on-screen keypad, confirm your entry with the "Enter" key, .

Alternatively, you can also confirm your entry with the respective unit key (if any) on the on-screen keypad.

Pressing the rotary knob also confirms the data entry.

To abort an entry

- ▶ On the on-screen keypad, select "ESC".
Pressing the [Back] key on the front panel also abort the data entry.
The on-screen keypad closes without changing the settings.

Entering numeric parameters

To enter values with the on-screen keypad

For numeric settings, the instrument displays the numeric keypad. The units specified correspond to the units of the parameter.

1. Enter the numeric value.
2. Select the unit (if any) to complete the entry.
The value changed accordingly to the unit entry.
If entry does not require a unit, confirm the value with the "Enter" key, .
See also ["To complete an entry"](#) on page 49.

To enter values by using the front panel controls

You can also change the parameters with the navigation controls on the front panel, e.g if you have locked the touchscreen. However, these front panel controls work only in the home window and detailed channel display area window.

For details on locking and unlocking touchscreen, see [Chapter 7.9, "User key"](#), on page 94 in the user manual.

1. Navigates to the corresponding entry (voltage or current) by rotating the rotary knob on the front panel.
Selected entry field is highlighted with an orange frame.
2. Press the rotary knob to select the entry.
The on-screen keypad opens.
3. Press again the rotary knob to go into edit mode.
The R&S NGP800 returns to home screen.
To enter a value, use the controls as follows:
 - a) Turning the rotary knob decreases or increases the currently selected digit (highlighted in blue).
 - b) Pressing the rotary knob again switches to the next digit.
4. Press the [Back] key to complete the entry.

Entering alphanumeric parameters

If a field requires alphanumeric input, you can use the on-screen keyboard to enter letters and (special) characters.

Access and control are similar as described above, see ["To enter values with the on-screen keypad"](#) on page 50.

5.4.3 Remote control

In addition to operating the R&S NGP800 directly on the instrument, it is also possible to operate and control it from a remote PC.

Remote control interfaces

The R&S NGP800 provides several interfaces for remote control:

- Ethernet (LAN) interface
- USB standard interface
- IEEE-488 bus interface (GPIB) (option: R&S NG-B105)

For detailed information on how to configure the remote control interfaces, see [Chapter 7.16, "Interfaces"](#), on page 109.

See [Chapter 5.1.8, "Connecting to LAN"](#), on page 27 for an example of how to set up LAN connection for remote control.

6 Operating basics

6.1 Using the touchscreen

The R&S NGP800 provides a touch-sensitive screen. Touch can be disabled (see [Chapter 7.9, "User key"](#), on page 94) in the instrument settings. The following illustrates the touchscreen gestures and highlight the different touchscreen features that can be performed on the instrument.

See also [Chapter 5.4.2, "Means of manual interaction"](#), on page 37.

6.1.1 Accessing functionality in the home window

The following illustrates various ways of accessing functions in the home window.

6.1.1.1 Settings button

The "Settings" button navigates to the device/channel menu window where you can set device or individual channel settings on the instrument.

Long-press on the "Settings" button brings you to the [graphical view window](#) for measurements. For more information, see [Chapter 7.13, "Graphical view window"](#), on page 101.

1. Select the "Settings" button.
The R&S NGP800 displays device/channel menu window.
2. Select "Device" or respective channel tab ("Ch 1", "Ch 2", "Ch 3" or "Ch 4") to open the menu.
3. Swipe up or down for the available items in the menu.
4. Select the required items to configure the settings.
5. Select the back arrow key or press [Back] key to close the menu.



Figure 6-1: Navigation on home window > device/channel menu window

6.1.1.2 Voltage and current inputs

You can directly change the voltage and current level in the respective channel display area.

1. Select the voltage or current field in the channel display area to set value.
The R&S NGP800 displays the on-screen keypad to enter value.
2. Set the required value.
See [Chapter 6.1.2, "Input data"](#), on page 55.
Note: The value is set within the value configured in the "Safety Limits" dialog.
3. Confirm value by selecting a unit key.
Alternatively, select the enter key  to confirm your value.

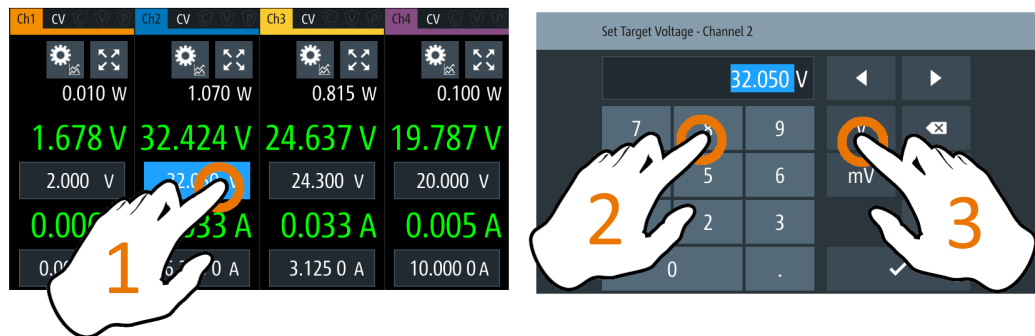



Figure 6-2: Set voltage and current in home window

6.1.1.3 Expand/Collapse button

You can expand the selected channel window by using the "Expand/Collapse" button. The "Expand/Collapse" icon changed when toggled.

1. Select the "Expand/Collapse" button.
The R&S NGP800 expands the selected channel to a full screen displaying the statistics ("Min", "Avg" and "Max" values of power, voltage and current readings, energy calculation and count of samples recorded).
2. To reset the statistics, select the reset button, .
The statistics values are reset to zero.
Note: The statistics provides valid data for up to 365 days of continuous operation, after which the statistics are reset to zero.
3. Select the "Expand/Collapse" button to revert to the home window.

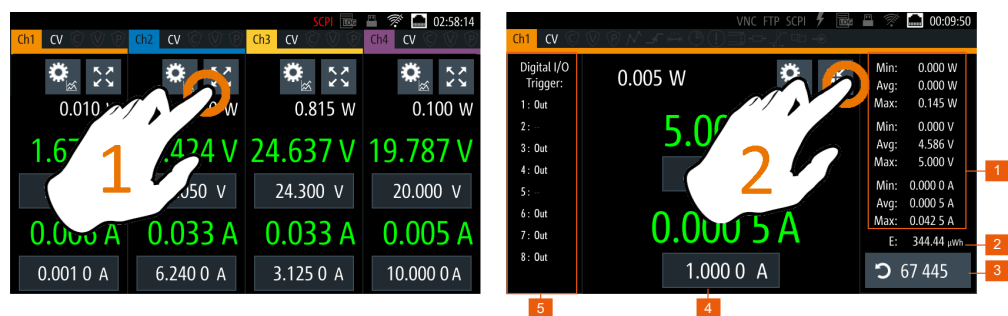



Figure 6-3: Display of channel overview window

- 1 = Minimum, maximum and average values for power, voltage and current
- 2 = Calculation of energy result
- 3 = Number of samples collected
- 4 = Channel display area of selected channel
- 5 = Digital I/O trigger of selected channel

6.1.2 Input data

The R&S NGP800 provides an on-screen keypad for you to enter numerical values. Use the back key  on the on-screen keypad to cancel input of the numerical entries.

1. Select a menu item to enter the numeric value.
The R&S NGP800 displays the on-screen keypad.
2. Enter the required value.
3. Confirm value with the unit key.
Alternatively, select the enter key  to confirm your value.

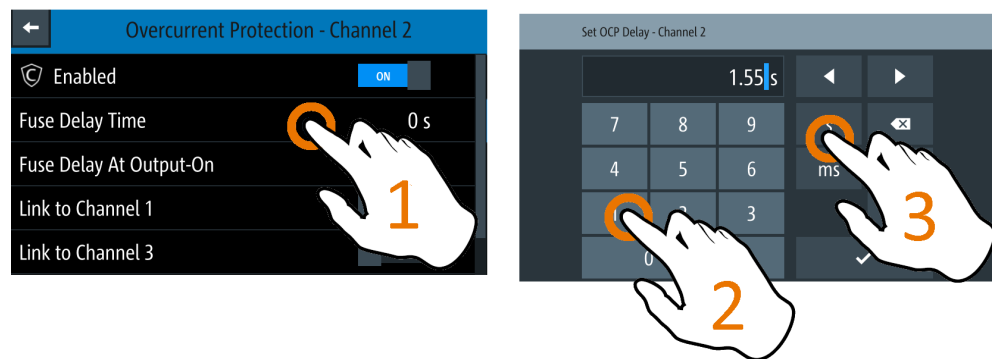



Figure 6-4: Enter numerical value and unit

For alphanumeric input, the on-screen keypad works the same way.

1. Select the "Caps Lock"  key to switch between capital letters and small letters.
The "Caps Lock" key is highlighted in blue.
2. Select "_&123" or "ABC" key to switch between alphabet and numeric input data.

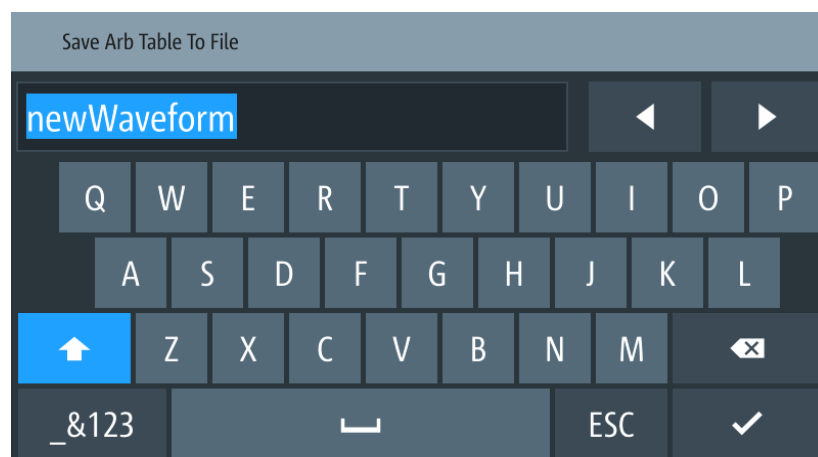

Figure 6-5: Alphanumeric input data

6.2 Front panel keys

For an overview of the front panel keys, see [Figure 5-2](#).

6.2.1 Menu controls

The menu controls keys provide navigation on the available menus in the instrument.

6.2.1.1 Home key



The [Home] key navigates to the instrument home window. See the display of the home window in [Figure 5-4](#).

6.2.1.2 Settings key



The [Settings] key navigates to the device/channel menu window which consists of the "Device" menu and depending on the instrument variants, either two or four channels ("Channel 1", "Channel 2", "Channel 3", "Channel 4") menu.

Long-press on the [Settings] key also navigates to the graphical view window. For more information, see [Chapter 7.13, "Graphical view window"](#), on page 101.

- [Device menu](#)..... 56
- [Channel menu](#)..... 59

Device menu

The "Device" menu provides access to general instrument settings, file arrangement and user key configuration. You can also obtain the instrument information via the menu.

Access:

1. Press [Home] key.
The R&S NGP800 displays the home window.
2. Select the "Settings" button on the required channel display area.
Alternatively, press [Settings] key.
3. Select the "Device" tab to access the device menu.

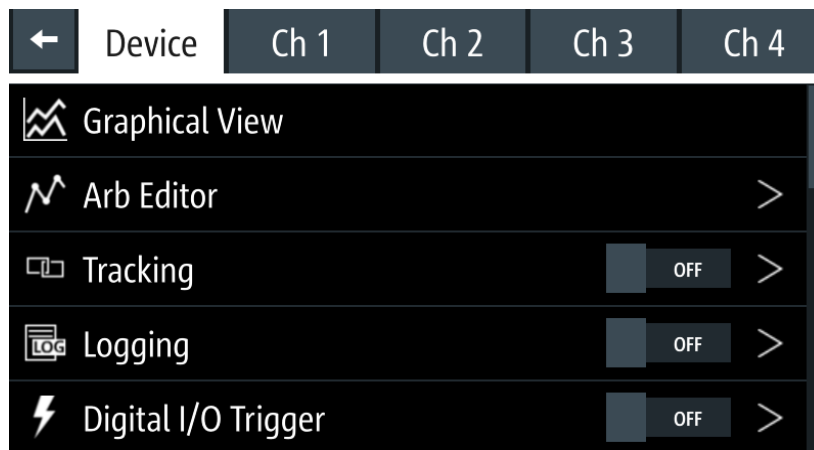

Figure 6-6: Device menu

Device Menu.....	57
L Graphical View.....	57
L Arb Editor.....	57
L Tracking.....	58
L Logging.....	58
L Digital I/O Trigger.....	58
L File Manager.....	58
L Interfaces.....	58
L User Button.....	58
L Screenshot.....	58
L CSV Settings.....	59
L Date & Time.....	59
L Appearance.....	59
L Sound.....	59
L Licenses.....	59
L Device Information.....	59
L Update Device.....	59
L Save/Recall Device Settings.....	59
L Analog In Adjustment.....	59

Device Menu

Provides access to general instrument settings, file arrangement and user key configuration. You can also obtain the instrument information via the menu.

Graphical View ← Device Menu

Graphical display of available data source (e.g. voltage, current, etc.).

See [Chapter 7.13, "Graphical view window"](#), on page 101.

Arb Editor ← Device Menu

Programs the waveform of voltage and current settings for the channel output.

See ["Arbitrary editor"](#) on page 88.

Tracking ← Device Menu

Changes made on voltage and current are applied to the tracked channels.

See [Chapter 7.6, "Tracking function"](#), on page 80.

"ON" Enables tracking.

"OFF" Disables tracking.

Remote command:

[TRACking\[:ENABle\]:GENeral](#) on page 189

Logging ← Device Menu

Logs data such as instrument timestamp, voltage, current and power.

See [Chapter 7.11, "Data logging"](#), on page 96.

"ON" Enables data logging.

"OFF" Disables data logging.

Remote command:

[LOG\[:STATe\]](#) on page 214.

Digital I/O Trigger ← Device Menu

Available only with option R&S NGP-K103.

Configures the digital I/O pins trigger modes and its associated settings.

See [Chapter 7.7, "Digital trigger I/O"](#), on page 81.

"ON" Enables digital I/O trigger.

"OFF" Disables digital I/O trigger.

Remote command:

[TRIGger\[:ENABle\]:GENeral](#) on page 157

File Manager ← Device Menu

Transfers file between instrument internal memory and USB stick.

See [Chapter 7.14, "File manager"](#), on page 104.

Interfaces ← Device Menu

Configures the network (LAN or wireless LAN), USB interface and GPIB (IEEE-488 interface) address.

Wireless LAN is available only with option R&S NGP-K102 and instrument with serial number below 110000.

GPIB interface is available only with option R&S NG-B105.

See [Chapter 7.16, "Interfaces"](#), on page 109.

User Button ← Device Menu

Configures the shortcut key action (e.g. screenshot, trigger, toggle logging, reset statistics, toggle touch).

See [Chapter 7.9, "User key"](#), on page 94.

Screenshot ← Device Menu

Captures screen image of the instrument.

See [Chapter 7.10, "Screenshot"](#), on page 95.

CSV Settings ← Device Menu

Configures the file formatting for CSV file.

See [Chapter 7.12, "CSV settings"](#), on page 99.

Date & Time ← Device Menu

Configures date, time and clock format of the instrument.

See [Chapter 7.17.4, "Date and time"](#), on page 129.

Appearance ← Device Menu

Configures the brightness level of the screen display and front panel keys.

See [Chapter 7.17.2, "Appearance settings"](#), on page 127.

Sound ← Device Menu

Enables or disables beeper for triggered events (e.g. error, fuse tripped, cc-mode continuous).

See [Chapter 7.17.3, "Sound settings"](#), on page 128.

Licenses ← Device Menu

Displays license information and install license options.

See [Chapter 7.17.1, "Licenses management"](#), on page 125.

Device Information ← Device Menu

Displays instrument information.

See [Chapter 7.17.5, "Device information"](#), on page 130.

Update Device ← Device Menu

Performs firmware update on the instrument.

See also [Chapter 7.17.6, "Update device"](#), on page 131.

Save/Recall Device Settings ← Device Menu

Saves, recalls or resets instrument settings.

See [Chapter 7.15, "Save and recall"](#), on page 106.

Analog In Adjustment ← Device Menu

Available only with option R&S NGP-K107.

Provides user adjustment to the analog input connector and restore factory adjustment.

See [Chapter 7.18.1, "Analog In adjustment"](#), on page 133.

Channel menu

The "Ch 1", "Ch 2", "Ch 3" or "Ch 4" menu provides access to settings on channel output, channel trigger conditions and output limit settings.

Access:

1. Press [Home] key.

The R&S NGP800 displays the home window.

2. Select the "Settings" button on the selected channel display area.
Alternatively, press [Settings] key to access the required channel menu.
3. Select the "Settings" button on the channel display area.
Alternatively, press [Settings] key to access the channel menu.

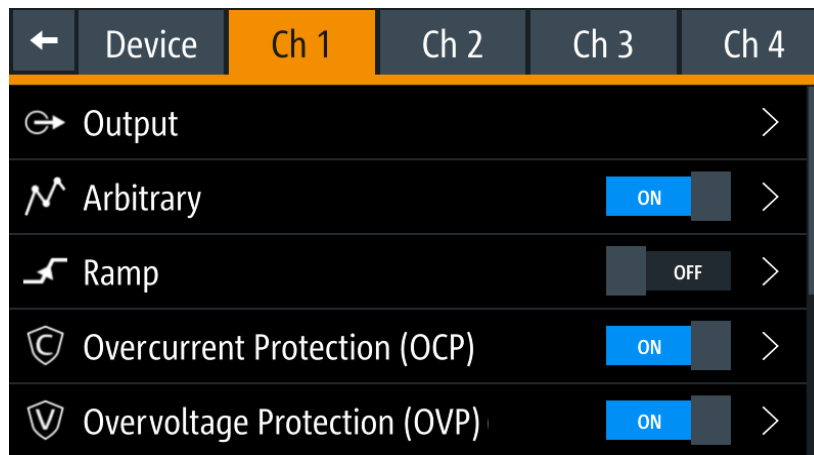

Figure 6-7: Channel 1 menu

Channel menu.....	60
L Output.....	60
L Arbitrary.....	60
L Ramp.....	61
L Overcurrent Protection (OCP).....	61
L Overvoltage Protection (OVP).....	61
L Overpower Protection (OPP).....	61
L Analog Input.....	61
L Adjustment.....	61
L Safety Limit.....	62

Channel menu

Provides access to channel settings.

Output ← Channel menu

Sets the output parameters for the selected channel.

See [Chapter 7.3, "Output setting"](#), on page 67.

Arbitrary ← Channel menu

Configures the arbitrary sequence, sequence repeatability response and the sequence ending behavior.

See [Chapter 7.8.1, "QuickArb"](#), on page 86.

"ON" Enables the QuickArb function.

"OFF" Disables the QuickArb function.

Remote command:

[ARbitrary\[:STATe\]](#) on page 199

Ramp ← Channel menu

Configures the ramping time applied on the channel output.

See [Chapter 7.8.2, "EasyRamp"](#), on page 92.

"ON" Enables the EasyRamp function.

"OFF" Disables the EasyRamp function.

Remote command:

[\[SOURce:\]VOLTage:RAMP\[:STATe\]](#) on page 204

Overcurrent Protection (OCP) ← Channel menu

Configures the OCP protection settings ("Blowing Delay", "Initial Delay" and linking channel) for the instrument.

See [Chapter 7.5.1, "Overcurrent protection \(OCP\)"](#), on page 74.

"ON" Enables the OCP function.

"OFF" Disables the OCP function.

Remote command:

[FUSE\[:STATe\]](#) on page 182

Overvoltage Protection (OVP) ← Channel menu

Configures the OVP protection settings (OVP level) for the instrument.

See also [Chapter 7.5.2, "Overvoltage protection \(OVP\)"](#), on page 76.

"ON" Enables the OVP function.

"OFF" Disables the OVP function.

Remote command:

[\[SOURce:\]VOLTage:PROTection\[:STATe\]](#) on page 184

Overpower Protection (OPP) ← Channel menu

Configures the OPP protection settings (OPP power) for the instrument.

See also [Chapter 7.5.3, "Overpower protection \(OPP\)"](#), on page 77.

"ON" Enables the OPP function.

"OFF" Disables the OPP function.

Remote command:

[\[SOURce:\]POWer:PROTection\[:STATe\]](#) on page 186

Analog Input ← Channel menu

Available only with option R&S NGP-K107.

Regulate the output settings for voltage or current via the applied analog input voltage at the rear panel.

See [Chapter 7.4, "Analog input"](#), on page 72.

Adjustment ← Channel menu

Available only with option R&S NGP-K107.

Performs channel adjustment and restores factory adjustment.

See [Chapter 7.18, "Adjustment"](#), on page 133.

Safety Limit ← Channel menu

Configures the voltage and current limit of the channel output.

See [Chapter 7.5.4, "Safety limits"](#), on page 78.

6.2.1.3 User key



The [*] key provides a shortcut function to one of the followings:

- Screenshot
- Trigger
- Data logging
- Reset statistics
- Toggle touchscreen input

The shortcut key is configurable in the "Device" > "User Button" menu. See [Chapter 7.9, "User key"](#), on page 94.

6.2.2 Navigation controls

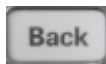

Navigation in the menu and setting of values can be done via rotary knob and [Back] key.

For more information on how to navigate menus, dialogs and data entry in the instrument, see [Chapter 5.4.2.2, "Accessing the functionality"](#), on page 48 and [Chapter 5.4.2.3, "Entering data"](#), on page 49.

6.2.3 Output and channel controls



Depending on the instrument models, up to 4-channel keys control the channel output settings of the instrument.

Function keys	Description
[Ch 1], [Ch 2], [Ch 3], [Ch 4]	Selects the respective channel for output.
[Output]	Master output switch - it turns output for all selected channels on or off.

[Ch 1] / [Ch 2] / [Ch 3] / [Ch 4]

Selects the respective channel for output.

Remote command:

[INSTrument:NSElect](#) on page 159

[INSTrument\[:SElect\]](#) on page 159

[Output]

Master output switch - it turns output for all selected channels on or off.

Remote command:

`OUTPut:GENeral[:STATe]` on page 175

`OUTPut[:STATe]` on page 176

`OUTPut:SElect` on page 177

6.3 Output power auto ranging

The R&S NGP800 power supply series provides a maximum output power of 200 W for each channel. Depending on the power supply models, up to 800 W of output power is provided for models with four identical channels with a continuous voltage range of 0 V to 32 V or 64 V.

Combination of the set voltage and current limit results in the following output performance graph.

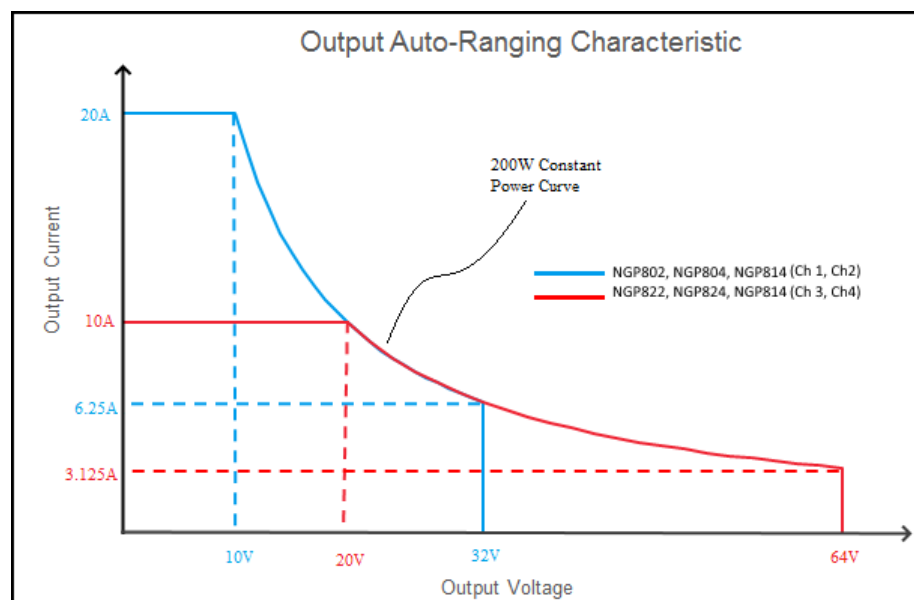

Figure 6-8: Output performance graph

According to the electrical basis formula for power ($P = I \times V$), the following results for the maximum power per channel:

- R&S NGP802, R&S NGP822: 200 W per channel (400 W max for the combination of two channels)
- R&S NGP804, R&S NGP824, R&S NGP814: 200 W per channel (800 W max for the combination of four channels)

For more information on the combination of channels, see [Chapter 12.1, "Parallel and series mode"](#), on page 230.

6.4 Operation modes

The R&S NGP800 operates in two different modes, i.e. CV and CC. The instrument switches automatically between CV and CC depending on the connected load.

CV mode

Figure 6-9 shows that if the instrument is in the range of voltage regulation, the output voltage V_{out} remains constant while the current may increase to its maximum value I_{max} when the connected load is increasing. In CV mode, the font text in the channel display area changes to green.

See Figure 5-10.

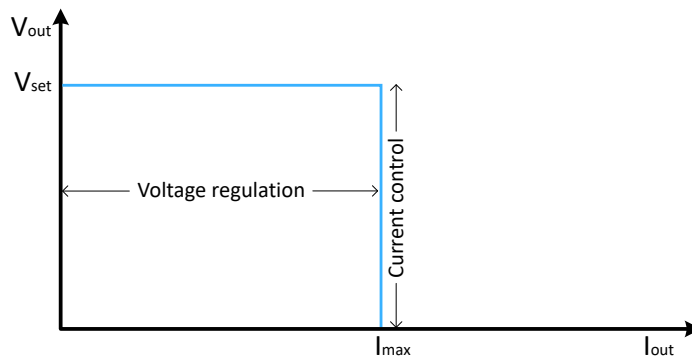

Figure 6-9: Current limit

CC mode

The current I_{max} corresponds to the current setting adjustable in the instrument.

If I_{out} reaches I_{max} , the instrument switches to CC mode, i.e. the output current remains constant and limited to I_{max} even if the load increases. Instead, the output voltage V_{out} decreases below V_{set} . In a short circuit, the output voltage drops towards zero. In CC mode, the font text in the channel display area changes to red.

See Figure 5-10 and Chapter 7.5.1, "Overcurrent protection (OCP)", on page 74.

7 Instrument functions

7.1 Setting the channels voltage and current

The R&S NGP800 comes with the following instrument models:

Models	Channels
R&S NGP802, R&S NGP822	Ch 1, Ch 2
R&S NGP804, R&S NGP824, R&S NGP814	Ch 1, Ch 2, Ch 3, Ch 4

Toggle the respective channel key ([Ch 1], [Ch 2], [Ch 3], [Ch 4]) on the front panel to select these channels. When a channel is selected, the respective channel key illuminates.

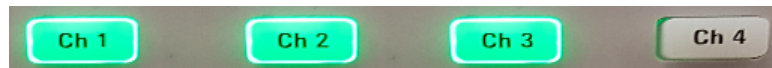

Figure 7-1: Ch 1, Ch 2, and Ch 3 key illuminates when selected

Set output voltage and current



Voltage, current settings

If [Analog input](#) or [QuickArb](#) function of a selected channel is enabled, the respective channel voltage or current setting is disabled.

Depending on the instrument models, the R&S NGP800 adjusts the following voltage and current values with a voltage step size of 1 mV and current step size of 0.5 mA.

Model	Voltage	Current
R&S NGP802, R&S NGP804, R&S NGP814 (Ch 1, Ch 2)	0 V to 32.05 V	0 A to 20.01 A
R&S NGP822, R&S NGP824, R&S NGP814 (Ch 3, Ch 4)	0 V to 64.05 V	0 A to 10.01 A

The setting of current value corresponds to the I_{\max} of the respective channel. It is advisable to set the current limit before operating the instrument to prevent damage to the load and instrument in the case of malfunction such as a short-circuit.

Access:

1. Press [Home] key.
The R&S NGP800 displays the home window.
2. Set voltage or current in the home window.
The R&S NGP800 displays the on-screen keypad to set value.

3. Enter the required voltage or current value.
4. Confirm value with the unit key (V/mV or A/mA).
5. Press the required channel key ([Ch 1], [Ch 2], [Ch 3] or [Ch 4]) on the front panel. The selected channel key is illuminated. See [Figure 7-1](#).
6. Press the [Output] key on the front panel. The R&S NGP800 outputs the set voltage of the selected channel and displays the corresponding values in the home window. For more information on the operation modes, see [Chapter 6.4, "Operation modes"](#), on page 64.



Figure 7-2: Voltage and current settings in the instrument

Set output voltage and current

Set output voltage and current limit for selected channel.

See also [Chapter 7.2, "Activating the channel output"](#), on page 66.

Remote command:

[\[SOURce:\]VOLTage\[:LEVel\] \[:IMMediate\] \[:AMPLitude\]](#) on page 168

[\[SOURce:\]VOLTage\[:LEVel\] \[:IMMediate\]:STEP\[:INCRement\]](#) on page 169

[\[SOURce:\]CURRent\[:LEVel\] \[:IMMediate\] \[:AMPLitude\]](#) on page 171

[\[SOURce:\]CURRent\[:LEVel\] \[:IMMediate\]:STEP\[:INCRement\]](#) on page 171

[APPLY](#) on page 172

7.2 Activating the channel output

The outputs of all the channels (Ch 1, Ch 2, Ch 3, Ch 4) can be switched on or off by toggling the [Output] key on the front panel.

By default, the output is turned off when the instrument is switched on.

Access:

1. Press the required channel key.
Selected channel key ([Ch 1], [Ch 2], [Ch 3], [Ch 4]) illuminates.
2. Press [Output] key.
The R&S NGP800 outputs the set voltage of the selected channel.
Depending on the operating modes, the font text in the channel display area shows green in CV mode and red in CC mode.
See [Chapter 6.4, "Operation modes"](#), on page 64.
See also [Chapter 6.3, "Output power auto ranging"](#), on page 63.

Multiple outputs can be turned on or off at the same time.

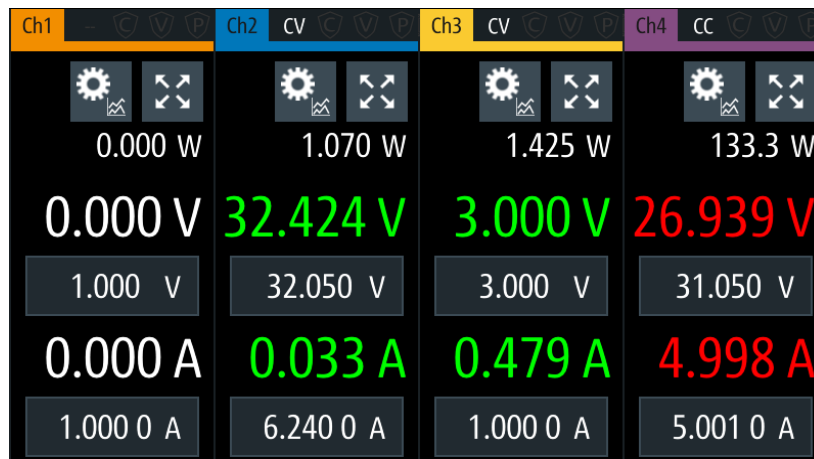

Figure 7-3: Output channels in different operating modes

Activating the channel output

See details in [Chapter 6.2.3, "Output and channel controls"](#), on page 62.

Remote command:

[OUTPut:GENeral\[:STATE\]](#) on page 175

[OUTPut:SELEct](#) on page 177

[OUTPut\[:STATE\]](#) on page 176

7.3 Output setting



The "Output" menu provides the settings for [output delay](#), [remote sensing](#), [high impedance mode](#) and [slew rate](#) control.

Access:

1. Press [Settings] key.
The R&S NGP800 displays the device/channel menu window.

2. Select the required channel tab.
The R&S NGP800 displays the selected channel menu.
3. Select the "Output" menu item.
The R&S NGP800 displays the "Output" dialog.

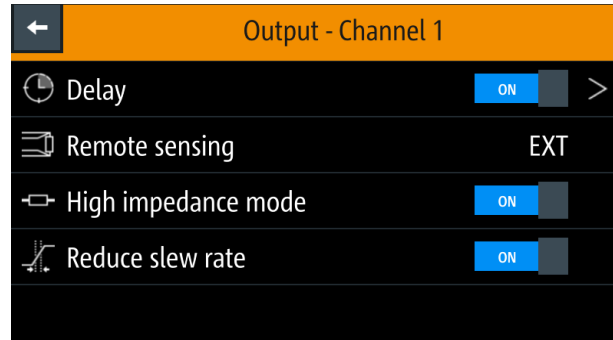

Figure 7-4: Output dialog

7.3.1 Delay

Access:

1. Select the "Delay" menu item to configure the required values.
The R&S NGP800 displays the "Output Delay" dialog.

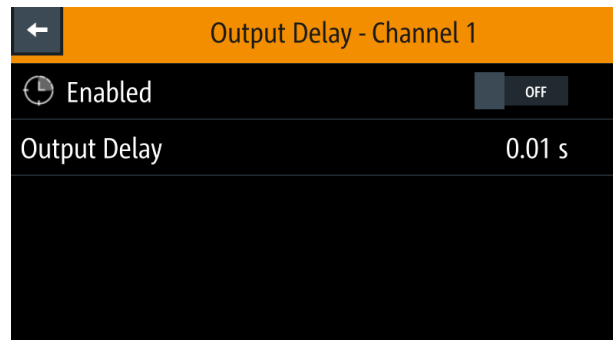

Figure 7-5: Output delay dialog

2. Set the required value.
The R&S NGP800 displays the onscreen keypad for entry.
3. Confirm value with the unit keys.

The output delay is the time between the "Output On" event and the available voltage at the output terminals. See [Figure 7-6](#).

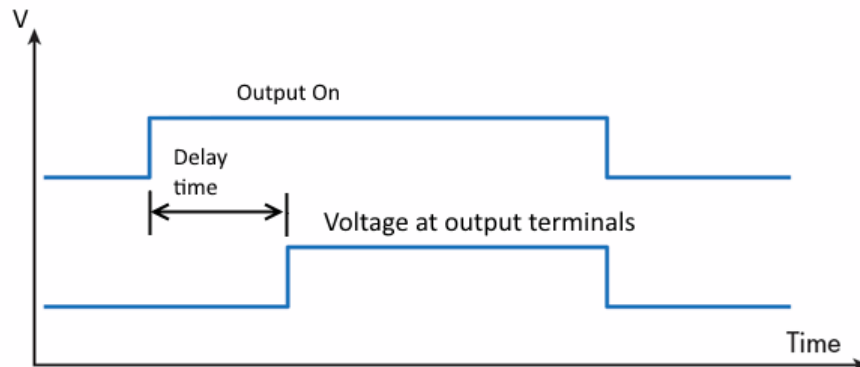

Figure 7-6: Output delay at the output terminals

When the instrument output delay is activated, the front panel of the respective channel key (i.e [Ch 1], [Ch 2], [Ch 3], [Ch 4]) blinks in green and a "DLY" red text is displayed at the channel display area of the respective channel. See [Figure 7-7](#).

These operating behaviors resume to normal after the delay time.

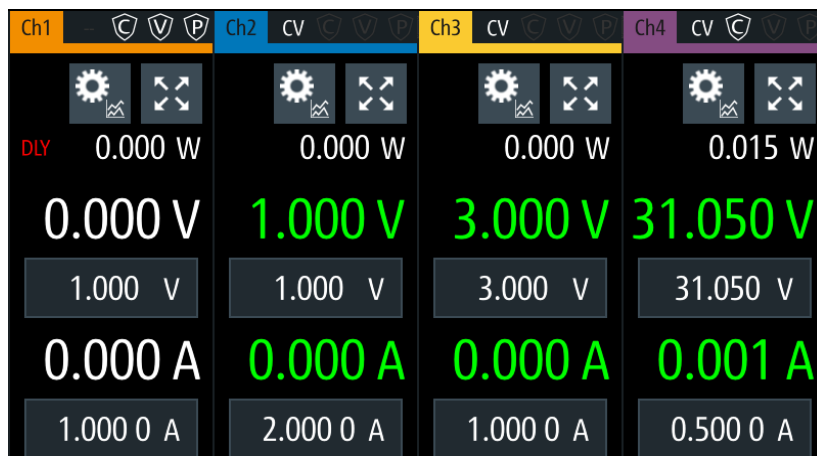

Figure 7-7: Delay text at channel display area

Output Delay

Configures output delay.

Enabled ← Output Delay

Enables or disables output delay.

"ON" Enables output delay.

"OFF" Disables output delay.

Remote command:

[OUTPut:DELay\[:STATe\]](#) on page 177

Delay ← Output Delay

Sets the delay time before voltage is available at the output terminals.

Remote command:

[OUTPut:DELay:DURation](#) on page 176

7.3.2 Remote sensing

The "Remote sensing" is a mechanism used to monitor and compensate the voltage drops on the cables connected to the load.

Access:

1. Select "Remote sensing" menu item to configure the remote sensing mode.
The R&S NGP800 displays the "Select Remote Sense" dialog.

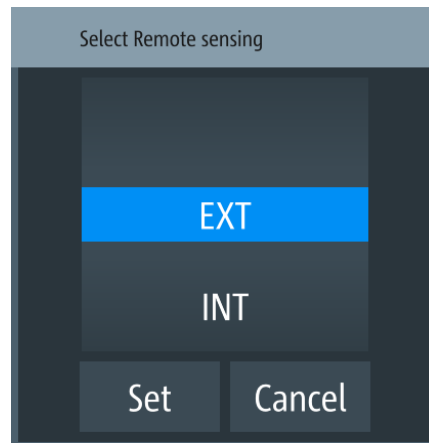

Figure 7-8: Select remote sense dialog

2. Select the required remote sensing mode.
See details in "[Remote sensing](#)" on page 70.
3. Select "Set" to configure the remote sensing mode.

Once the remote sense is activated, it becomes part of the output feedback path for R&S NGP800. Disconnection or shorting of the remote sense lines causes a mismatch in the actual output voltage versus the reported value of the instrument. The error of differences is detected by the instrument and the output is turned off automatically with a corresponding error displayed to instruct the user to check on the connection.



Excessive voltage drop on the loading cables, e.g. using too small wires, can also trigger remote sense protection.

For optimum connection, maintain a maximum voltage drop of 1V on loading cables is recommended.

Remote sensing

Sets remote sense mode for selected channel.

EXT	The internal voltage sense relay in the instrument is switched on and the connection of remote sensing wires (S+, S-) to the input of the load become necessary. Failure to connect remote sense can cause overvoltage or unregulated voltage output from the R&S NGP800. The voltage sensing relay remains switched on even when output is turned off.
INT	The internal voltage sense relay in the instrument is switched off. Remote sense is disabled.

Remote command:

[\[SOURce:\]VOLTage:SENSe\[:SOURce\]](#) on page 164

[\[SOURce:\]VOLTage:SENSe:TRIPped?](#) on page 165

[\[SOURce:\]VOLTage:SENSe:TRIPped:CLEar](#) on page 165

7.3.3 High impedance mode

If "High Impedance Mode" is enabled, the output is turned OFF with the active current sinking circuit disabled. The output capacitors discharge is determined by the instrument internal resistors ($\sim 900 \Omega$ for 32 V models and $\sim 3400 \Omega$ for 64 V models) and the connected load.

The "High Impedance Mode" does not affect the instrument functions when the output is turned ON. Voltage down-programming is still assisted by the active current sinking circuit. If the output is disabled by protection trigger like OVP, OCP, the active current sinking circuit automatically discharges the output capacitors for safety reasons.

Access:

- Select "High Impedance Mode" menu item to activate the high impedance mode. The R&S NGP800 activates the high impedance mode.

High Impedance

Activates or deactivates high impedance mode.

"ON" Activates high impedance mode.

"OFF" Deactivates high impedance mode.

Remote command:

[OUTPut:IMPedance\[:STATe\]](#) on page 175

7.3.4 Slew rate control

The "Reduce Slew Rate" is a mechanism used to control the rate at which the output of voltage changes. If activated, the voltage slew rate up-programming and down-programming are reduced when changing voltage on the fly. The reducing of slew rate control helps to minimize overshoot over wide output and load configuration.

**Slew rate control**

- The slew rate control does not affect the output turn-on slew rate programmed via the [EasyRamp](#) function.
- The slew rate control mode is not compatible with [Analog Input](#) and [QuickArb](#) functions. The reduce slew rate function is automatically disabled if any of these functions is used and vice versa.
- The minimum setting voltage is 0.003 V if "Reduce Slew Rate" is activated, e.g. output voltage is automatically set to 0.003 V if setting value is < 0.003 V.

Access:

- ▶ Select "Reduce Slew Rate" menu item to activate the slew rate control.
The R&S NGP800 activates the slew rate control.

Reduce Slew Rate

Activates or deactivates the slew rate control.

"ON" Activates the slew rate control.

"OFF" Deactivates the slew rate control.

Remote command:

[OUTPut:SRATe\[:STATe\]](#) on page 174

7.4 Analog input

**Instrument option**

R&S NGP-K107 (P/N: 5601.6200.03) option is required for the "Analog Input".

**Analog input**

If "Analog Input" of a selected channel (voltage or current) is enabled, the respective channel voltage or current setting is disabled.

See [Chapter 7.1, "Setting the channels voltage and current"](#), on page 65.

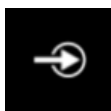

With "Analog Input", you can regulate the channel output (voltage or current) settings with an input voltage of 0 V to 5 V.

Analog input mode	NGP output for 64 V channels	NGP output for 32 V channels
Voltage mode	0 V to 64 V	0 V to 32 V
Current mode	0 A to 10 A	0 A to 20 A

Access:

1. Press [Settings] key.
The R&S NGP800 displays the device/channel menu window.

2. Select the required channel tab to configure the analog input mode.
The R&S NGP800 displays the selected channel menu.
3. Select "Analog Input" from the menu.
The R&S NGP800 displays the selected "Analog Input" dialog.

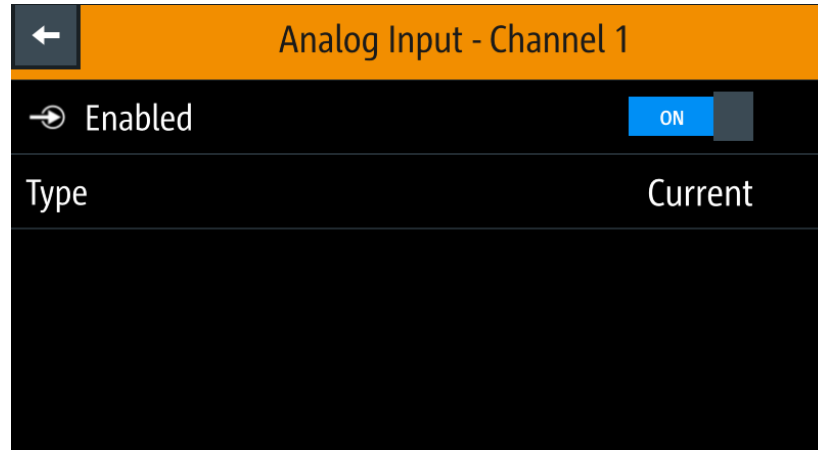

Figure 7-9: Analog input dialog

4. Select the required type to regulate the channel output setting.
The R&S NGP800 displays the "Select Analog Input Type" dialog.
See also "Type" on page 74.

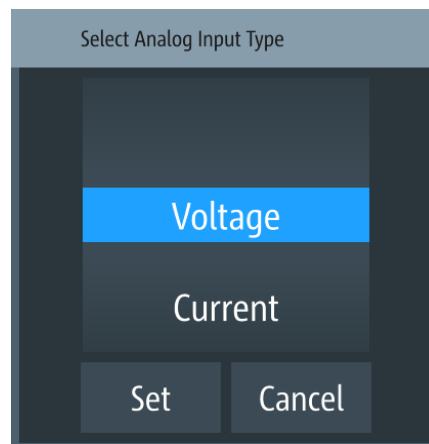

Figure 7-10: Select analog input type dialog

5. Activate the "Enabled" menu item.
The R&S NGP800 enables the "Analog in" input and disables the selected channel settings (voltage or current).

Analog input

Configures the analog input type (voltage or current).

Enabled ← Analog input

Allows configuration of the analog input type.

"ON" Enables the analog input type.

"OFF" Disables the analog input type.

Remote command:

[\[SOURce:\]VOLTage:AINPut\[:STATe\]](#) on page 206

See also [\[SOURce:\]VOLTage:AINPut:TRIGgered\[:STATe\]](#) on page 206

Type ← Analog input

Sets analog input type (voltage or current) when enabled.

"Voltage" Sets the analog input type as "Voltage".

"Current" Sets the analog input type as "Current".

Remote command:

[\[SOURce:\]VOLTage:AINPut:INPut](#) on page 205

Set ← Type ← Analog input

Applies / Cancels the configuration settings.

Cancel ← Type ← Analog input

Cancels the configuration settings.

7.5 Protection

There are various ways in which the R&S NGP800 protects itself and the connected load from damage due to overvoltage, overcurrent and overpower drawn by the load during testing.

Access:

1. Press [Settings] key.
The R&S NGP800 displays the device/channel menu window.
2. Select the required channel tab to configure the various protection dialogs.
The R&S NGP800 displays the selected channel menu.

7.5.1 Overcurrent protection (OCP)



When the drawn current exceeds the limit set for the respective channels, an alert is triggered and the affected channels are turned off according to the settings configured in the [OCP](#) dialog.

Access:

1. Select "Overcurrent Protection (OCP)" from the menu.
The R&S NGP800 displays the OCP dialog.

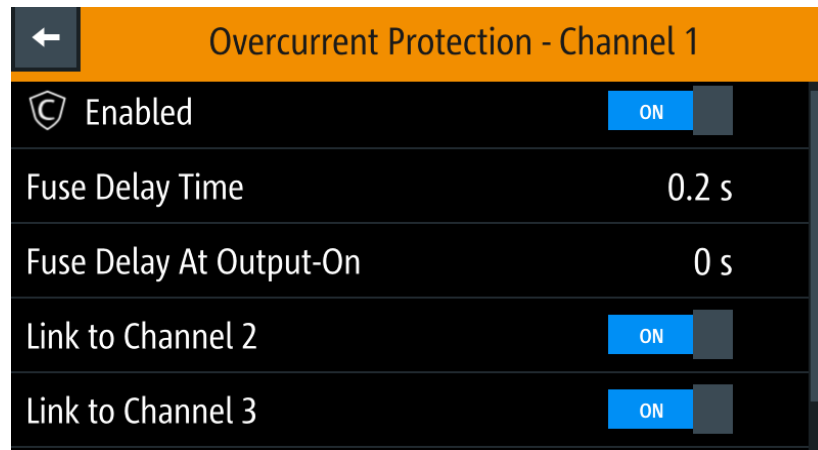

Figure 7-11: Overcurrent protection dialog

2. Activate the "Enabled" menu item.
The R&S NGP800 enables the OCP and displays the OCP icon on the selected channel status bar information.
3. Set the required "Fuse Delay Time" and "Fuse Delay At Output-On".
The R&S NGP800 displays the on-screen keypad to set the values.
4. Confirm value with the unit key (ms or s).
5. Activate the required linked channels for over current protection.

Overcurrent protection (OCP)

Sets [OCP](#) mode and protection parameters for the selected channel.

Enabled ← Overcurrent protection (OCP)

Enables or disables the overcurrent protection feature.

"ON" Enables the OCP and displays the OCP icon on the selected channel status bar information.

"OFF" Disables the OCP feature.

Remote command:

[FUSE\[:STATe\]](#) on page 182

[FUSE:TRIPped?](#) on page 181

[FUSE:TRIPped:CLEAr](#) on page 179

See also [\[SOURce:\]PROTection:CLEAr](#) on page 188

Fuse Delay Time ← Overcurrent protection (OCP)

Time taken to turn off the affected channel after OCP is triggered.

Remote command:

[FUSE:DELay\[:BLOWing\]](#) on page 180

Fuse Delay At Output-On ← Overcurrent protection (OCP)

Time taken after channel output is turned on before OCP is put into operation.

Remote command:

[FUSE:DElay:INITial](#) on page 180

Link to Channel 2 / Link to Channel 3 ← Overcurrent protection (OCP)

Activates the required linked channel when an OCP event is triggered.

"ON" The linked channels are turned off when an OCP event is triggered.

"OFF" The linked channels are not affected when an OCP event is triggered.

Remote command:

[FUSE:LINK](#) on page 181

[FUSE:UNLink](#) on page 181

7.5.2 Overvoltage protection (OVP)



When the output voltage exceeds the limit set for the respective channel, an alert is triggered and the affected channel is turned off according to the settings configured in the [OVP](#) dialog.

Access:

1. Select "Overvoltage Protection (OVP)" from the menu.
The R&S NGP800 displays the OVP dialog.

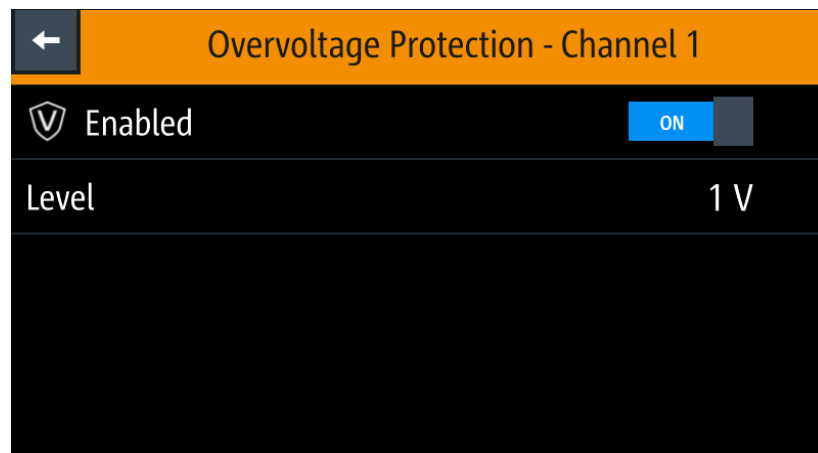

Figure 7-12: Overvoltage protection dialog

2. Activate the "Enabled" menu item.
The R&S NGP800 enables the OVP and displays the OVP icon on the selected channel status bar information.
3. Set the required level for OVP.
The R&S NGP800 displays the on-screen keypad to set the value.
4. Confirm value with the unit key (mV or V).

Overvoltage Protection

Sets [OVP](#) mode and protection parameters for the selected channel.

Enabled ← Overvoltage Protection

Enables or disables the overvoltage protection feature.

"ON" Enables the OVP and displays the OVP icon on the selected channel status bar information.

"OFF" Disables the OVP feature.

Remote command:

[SOURce:]VOLTage:PROTection[:STATe] on page 184

[SOURce:]VOLTage:PROTection:CLEar on page 184

[SOURce:]VOLTage:PROTection:TRIPped? on page 185

See also [SOURce:]PROTection:CLEar on page 188

Level ← Overvoltage Protection

Sets the required level for OVP.

Remote command:

[SOURce:]VOLTage:PROTection:LEVel on page 184

7.5.3 Overpower protection (OPP)

When the output power exceeds the limit set for the respective channels, an alert is triggered and the affected channels are turned off according to the settings configured in the **OPP** dialog.

Access:

1. Select "Overpower Protection (OPP)" menu item.
The R&S NGP800 displays the OPP dialog.

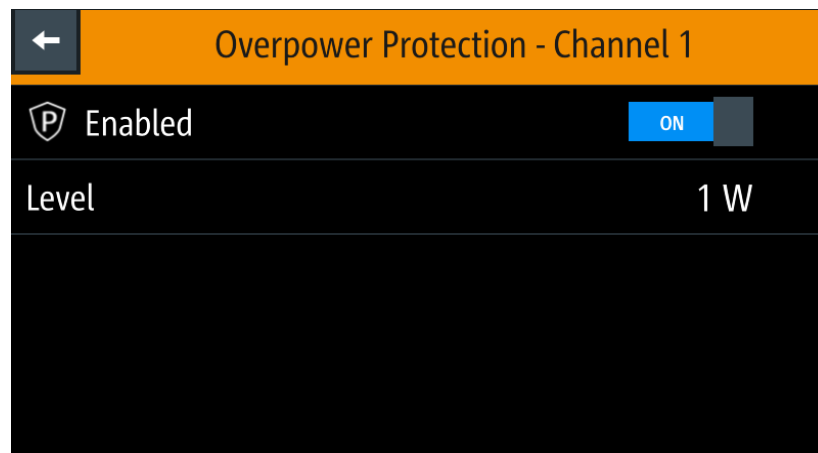

Figure 7-13: Overpower protection dialog

2. Activate the "Enabled" menu item.
The R&S NGP800 enables the OPP and displays the "Overpower Protection (OPP)" icon on the selected channel status bar information.
3. Set the required level for OPP.

The R&S NGP800 displays the on-screen keypad to set the value.

4. Confirm value with the unit key (mW or W).

Overpower Protection

Sets **OPP** mode and protection parameters for the selected channel.

Enabled ← Overpower Protection

Enables or disables the overpower protection feature.

"ON" Enables the OPP and displays the OPP icon on the selected channel status bar information.

"OFF" Disables the OPP feature.

Remote command:

[\[SOURCE:\]POWER:PROTECTION\[:STATE\]](#) on page 186

[\[SOURCE:\]POWER:PROTECTION:CLEAR](#) on page 187

[\[SOURCE:\]POWER:PROTECTION:TRIPPED?](#) on page 188

See also [\[SOURCE:\]PROTECTION:CLEAR](#) on page 188

Level ← Overpower Protection

Sets the required level for OPP.

Remote command:

[\[SOURCE:\]POWER:PROTECTION:LEVEL](#) on page 187

7.5.4 Safety limits



With safety limits set in the instrument, the range of the output voltage and/or output current can be limited. The safety limit prevents inadvertently setting values dangerous for the connected DUT.



The "Safety Limits" function is disabled if [QuickArb](#) function or [Analog input](#) function is in use.

Access:

1. Select "Safety Limits" menu item from the menu.
The R&S NGP800 displays the "Safety Limits" dialog.

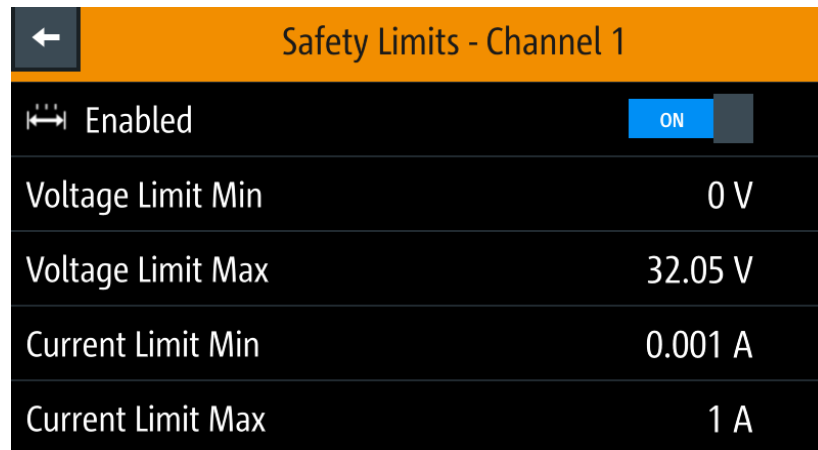

Figure 7-14: Safety limits dialog

2. Activate the "Enabled" menu item.
The R&S NGP800 limits the set voltage and current level and displays the "Safety Limits" icon on the selected channel status bar information.
3. Set the required minimum and maximum value for voltage and current level.
The R&S NGP800 displays an on-screen keypad to set the value.
4. Confirm value with the unit key.

Safety Limits

Sets the maximum and minimum limits of the voltage and current level.

Enabled ← Safety Limits

Enables or disables setting the safety limits of the instrument.

"ON" Limits the set voltage and current level and displays the "Safety Limits" icon on the selected channel status bar information.

"OFF" Disables the safety limit of the instrument.

Remote command:

[\[SOURCE:\]ALIMit\[:STATE\]](#) on page 162

Voltage Limit Min / Voltage Limit Max ← Safety Limits

Sets the maximum or minimum voltage level of the output channels.

Remote command:

[\[SOURCE:\]VOLTage\[:LEVEL\]\[:IMMEDIATE\]:ALIMit:LOWer](#) on page 162

[\[SOURCE:\]VOLTage\[:LEVEL\]\[:IMMEDIATE\]:ALIMit\[:UPPer\]](#) on page 163

Current Limit Min / Current Limit Max ← Safety Limits

Sets the maximum or minimum current level of the output channels.

Remote command:

[\[SOURCE:\]CURRent\[:LEVEL\]\[:IMMEDIATE\]:ALIMit:LOWer](#) on page 163

[\[SOURCE:\]CURRent\[:LEVEL\]\[:IMMEDIATE\]:ALIMit\[:UPPer\]](#) on page 164

7.6 Tracking function

For power supplies with multiple channels, the channels can be linked such that changes made on the selected tracked channel are applied to other channels.

Access:

1. Press [Settings] key.
The R&S NGP800 displays the device/channel menu window.
2. Select the device tab to configure tracking.
The R&S NGP800 displays the "Tracking" dialog.

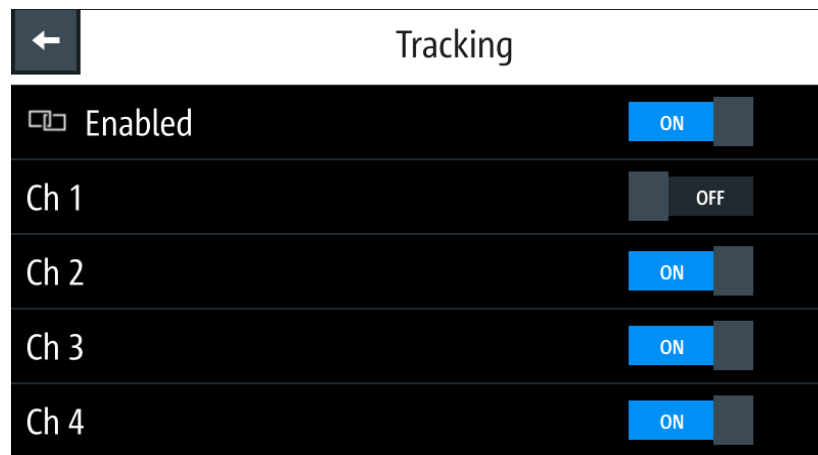

Figure 7-15: Tracking dialog

3. Activate the "Enabled" menu item to enable the tracking function.
4. Set the required channels to be tracked.
The R&S NGP800 tracks the voltage and/or current values to the selected tracked channels.

Tracking

Tracking function settings.

Enabled ← Tracking

Activates tracking function.

"ON" Activates tracking function.

"OFF" Deactivates tracking function.

Remote command:

[TRACking\[:ENable\]:SElect:CH<CHANNEL>](#) on page 189

[TRACking\[:ENable\]:CH<CHANNEL>](#) on page 189

Ch 1 / Ch 2 / Ch 3 / Ch 4 ← Tracking

Sets tracking function for the selected channel.

"ON" Activates tracking function for the selected channel.

"OFF" Deactivates tracking function for the selected channel.

Remote command:

[TRACking\[:ENABle\]:SElect:CH<CHANNEL>](#) on page 189

[TRACking\[:ENABle\]:CH<CHANNEL>](#) on page 189

[TRACking\[:ENABle\]:GENeral](#) on page 189

7.7 Digital trigger I/O

NOTICE

Risk of instrument damage

Do not exceed the maximum voltage rating of the digital I/O pins (5.25 V max) when supplying voltages to the pins.

For more information, see the instrument datasheet (P/N: 3609.1927.32).



Instrument option

R&S NGP-K103 (P/N: 5601.6300.03) option is required for the digital I/O signals.



The eight data lines of the digital I/O interface are mutually independent and can be used as trigger input or trigger output separately. See [Table 5-4](#) and also [Figure 7-16](#).

- **Trigger input**
The data lines of the digital I/O interface receive external trigger signal. The external trigger signal triggers the selected channel ("Ch 1", "Ch 2", "Ch 3", "Ch 4" or "All") with the set response when the trigger condition ("Active High" or "Active Low") is met.
- **Trigger output**
The data lines of the digital I/O interface output an "Active High" or "Active Low" signal when the trigger condition of the selected channel ("Ch 1", "Ch 2", "Ch 3", "Ch 4") is met.

Table 7-1: Trigger in parameters and conditions

Trigger in parameters	Trigger conditions	Description
Channel	"--", "Ch 1", "Ch 2", "Ch 3", "Ch 4" or "All"	Target output channel selected for trigger response. If "--" is selected, no channel is selected for trigger response.
Mode	"Enable"	Selected channel output is turned on when the selected logic level is met.
	"Arb Enable"	Selected channel QuickArb function is enabled when the selected logic level is met.

Trigger in parameters	Trigger conditions	Description
	"Arb Step Point"	Selected channel QuickArb function steps to the next point when the selected logic level is met.
	"Arb Step Group"	Selected channel QuickArb function steps to the next group when the selected logic level is met.
	"Ramp"	Selected channel EasyRamp function is enabled when the selected logic level is met.
	"Logging"	Selected channel logging function is enabled when the selected logic level is met.
	"Statistics"	Selected channel statistics function is enabled when the selected logic level is met.
	"AnalogIn"	Selected channel analog input is enabled when the selected logic level is met.
	"Inhibit"	<p>Selected channel output is inhibited when the selected logic level is met.</p> <p>If the selected channel output is put to inhibit state, manual or remote operation on selected channel output is no longer possible.</p> <p>To reverse the inhibit state, remove the source of the trigger signal. You can either disable the affected DIO interface or remove the source from the affected DIO interface at the rear panel.</p>
Active Level	"High"	Set the logic level of the trigger in signal.
	"Low"	

Table 7-2: Trigger out parameters and conditions

Trigger out parameters	Trigger conditions	Description
Channel	"--", "Ch 1", "Ch 2", "Ch 3", "Ch 4"	<p>Output channel selected to monitor for trigger conditions.</p> <p>If "--" is selected, no channel is selected for trigger response.</p>
Mode	"Output"	Output the selected logic level when the output is turned on at the selected channel.
	"Fuse"	<p>Output the selected logic level when a fuse tripped event occurs on the selected channel.</p> <p>See Chapter 7.5.1, "Overcurrent protection (OCP)", on page 74.</p>

Trigger out parameters	Trigger conditions		Description
	Operation Mode, "OperationMode"		<ul style="list-style-type: none"> "CC": Output the selected logic level when the selected channel operates in the CC mode. See "CC mode" on page 64. "CV": Output the selected logic level when the selected channel operates in the CV mode. See "CV mode" on page 64.
	Voltage Level, "Vset"	>= "Voltage Level"	Output the selected logic level when the voltage level of the selected channel is greater or equal to the set voltage level.
	Current Level, "Iset"	>= "Current Level"	Output the selected logic level when the current level of the selected channel is greater or equal to the set current level.
	Power Level, "Plevel"	>= "Power Level"	Output the selected logic level when the power level of the selected channel is greater or equal to the set power level.
	Critical event	"OVP"	Output the selected logic level when the selected critical event ("OVP", "OPP", "OTP") occurs on the selected channel. See Chapter 7.5, "Protection", on page 74.
		"OPP"	
		"OTP"	
	"Logging"		Output the selected logic level when the logging is enabled.
Active Level	"High"		Set the logic level of the trigger out signal.
	"Low"		

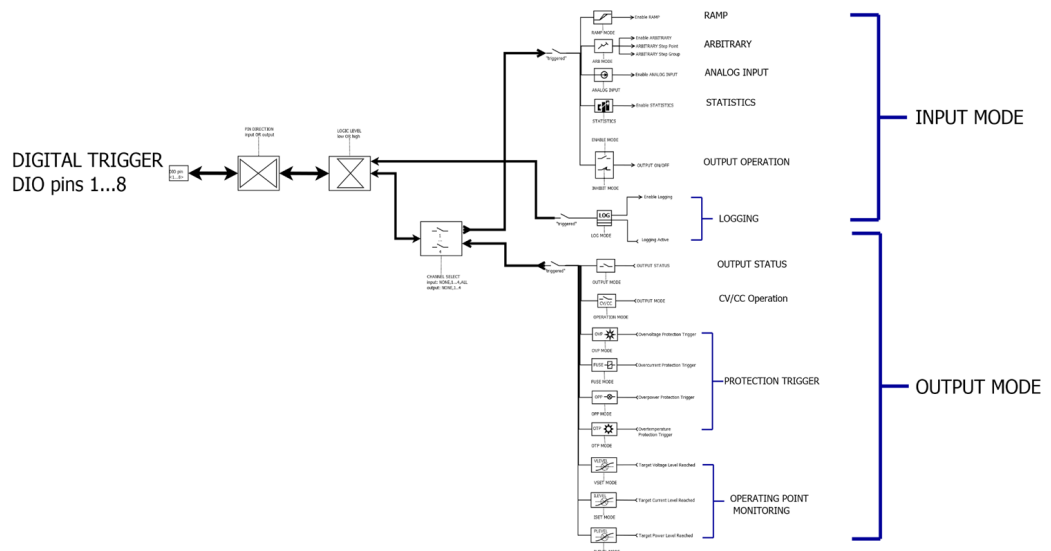

Figure 7-16: DIO trigger block diagram

1. Press [Settings] key.
The R&S NGP800 displays the device/channel menu window.

2. Select the device tab to configure digital I/O trigger.
The R&S NGP800 displays the "Digital Trigger Menu" dialog.

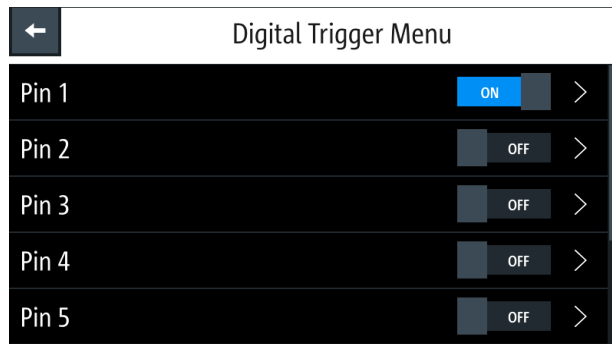

Figure 7-17: Digital trigger menu

3. Set the required pins to "ON" to enable the respective trigger settings for the selected pins.
4. Select the respective pins to configure the trigger settings.
The R&S NGP800 displays the respective pin dialog for configuration.

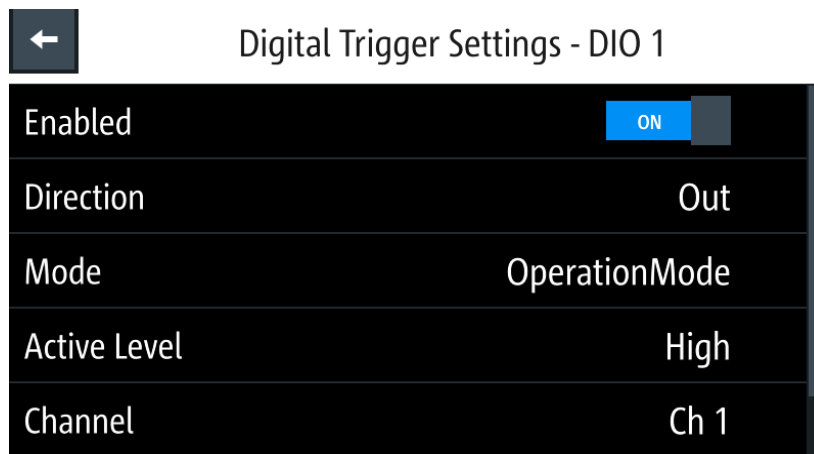

Figure 7-18: Digital trigger settings for pin 1

5. Set the required pin "Direction".
Depending on the pin direction, different operating modes are available for trigger settings.
See [Table 7-1](#) and [Table 7-2](#).
6. Set the required "Active Level" and "Channel" settings.
7. Press the [Settings] key to return to device menu dialog.
8. Set the "Enabled" to "ON" to enable the digital I/O trigger.
The R&S NGP800 monitors the digital I/O trigger conditions and feedback to the respective channels or pins.

[Digital Trigger Menu](#)..... 85

L Pin 1 / ... / Pin 8.....	85
L Enable.....	85
L Direction.....	85
L Mode.....	85
L Active Level.....	85
L Channel.....	86
L Operation Mode.....	86

Digital Trigger Menu

Configures the data lines of the digital I/O interface for up to 8 pins.

Pin 1 / ... / Pin 8 ← Digital Trigger Menu

Sets the selected digital I/O pin settings.

"ON" Enables the selected digital I/O pin setting.

"OFF" Disables the selected digital I/O pin setting.

Remote command:

[TRIGger\[:ENABLE\]:SElect:DIO<IO>](#) on page 158

[TRIGger\[:ENABLE\]:DIO<IO>](#) on page 157

Enable ← Pin 1 / ... / Pin 8 ← Digital Trigger Menu

Enables or disables the digital I/O trigger.

"ON" Activates all digital I/O interface.

"OFF" Deactivates all digital I/O interface.

Remote command:

[TRIGger\[:ENABLE\]:DIO<IO>](#) on page 157

[TRIGger\[:ENABLE\]:SElect:DIO<IO>](#) on page 158

Direction ← Pin 1 / ... / Pin 8 ← Digital Trigger Menu

Sets the trigger direction.

See [Table 7-1](#) and [Table 7-2](#).

Remote command:

[TRIGger:DIRection:DIO<IO>](#) on page 156

Mode ← Pin 1 / ... / Pin 8 ← Digital Trigger Menu

Sets the trigger mode for the selected digital I/O interface.

See [Table 7-1](#) and [Table 7-2](#).

Remote command:

[TRIGger:CONDition:DIO<IO>](#) on page 155

[\[SOURce:\]VOLTage:AINPut:TRIGgered\[:STATe\]](#) on page 206

[LOG:TRIGgered\[:STATe\]](#) on page 218

[ARBITrary:TRIGgered\[:STATe\]](#) on page 203

[ARBITrary:TRIGgered:GROup\[:STATe\]](#) on page 203

[ARBITrary:TRIGgered:POINt\[:STATe\]](#) on page 203

Active Level ← Pin 1 / ... / Pin 8 ← Digital Trigger Menu

Sets the trigger logic of the selected digital I/O interface.

"High" Trigger logic is set to active high for the selected digital I/O interface.

"Low" Trigger logic is set to active low for the selected digital I/O interface.

Remote command:

`TRIGger:LOGic:DIO<IO>` on page 157

Channel ← Pin 1 / ... / Pin 8 ← Digital Trigger Menu

Sets the channel for monitoring of the trigger conditions.

For details, see [Table 7-1](#) and [Table 7-2](#).

Remote command:

`TRIGger:CHANnel:DIO<IO>` on page 154

Operation Mode ← Pin 1 / ... / Pin 8 ← Digital Trigger Menu

Available only for trigger output and "Mode" is set to "OperationMode".

Outputs the selected logic level when the selected channel operates in the CC or CV mode.

See also [Chapter 6.4, "Operation modes"](#), on page 64.

Remote command:

`TRIGger:CONDition:DIO<IO>` on page 155

7.8 Advanced features



QuickArb function

If QuickArb function of a selected channel is enabled, the respective channel voltage, current setting and safety limit settings are disabled.

See [Chapter 7.1, "Setting the channels voltage and current"](#), on page 65.

The QuickArb and EasyRamp are two functions which can be used to control the waveform of voltage and current output.

7.8.1 QuickArb



The QuickArb function allows you to generate freely programmable waveforms which can be reproduced within the [Safety limits](#) for voltage and current.

Access:

1. Press [Settings] key.
The R&S NGP800 displays the device/channel menu window.
2. Select the required channel tab to configure QuickArb function.
The R&S NGP800 displays the selected channel menu.
3. Select "Arbitrary" from the menu.

The R&S NGP800 displays the "Arbitrary" dialog.

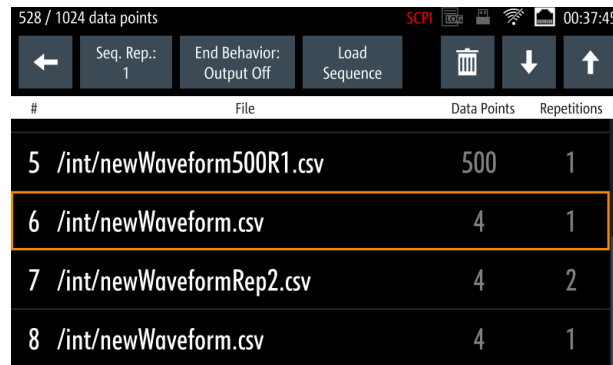

Figure 7-19: Arbitrary dialog

4. Select any of the rows to load or change the arbitrary file in the arbitrary sequence. Up to eight arbitrary files with a maximum of 1024 data points can be loaded. The R&S NGP800 opens a dialog to select the file location.
5. Select the desired file location.
6. Select "Select" to load the selected file. The R&S NGP800 loads the selected arbitrary file.

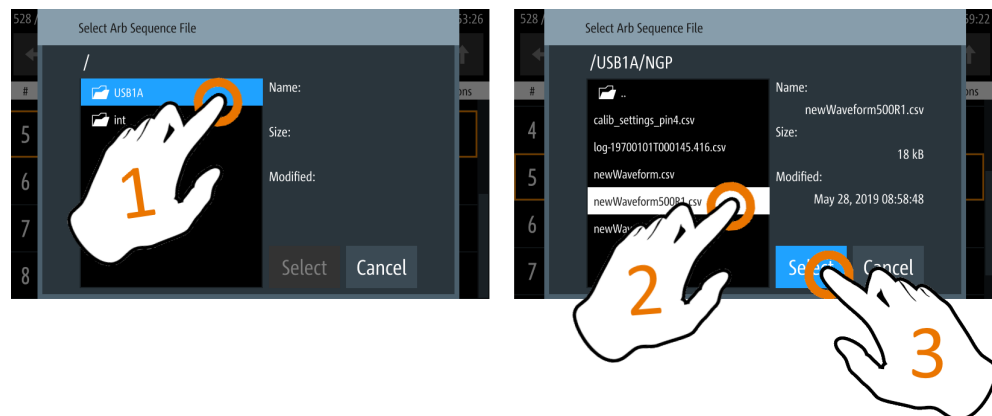



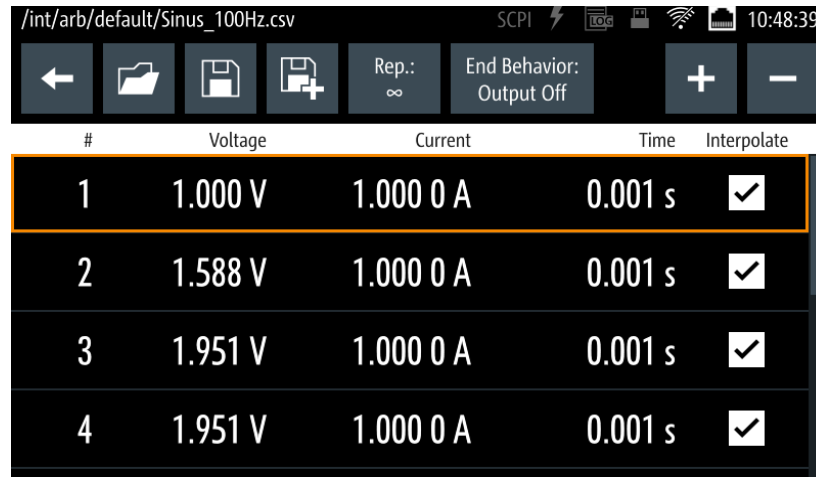

Figure 7-20: Select arbitrary file location

7. Select delete and up/down button    to navigate the arbitrary test sequence.
8. Select "Load Sequence" to load the arbitrary test sequence.
9. Set "Seq. Rep." and "End Behavior" to configure the arbitrary sequence behavior. See details in "Seq. Rep." on page 89 and "End Behavior" on page 90.
10. Select [Back] key to return to channel menu dialog.
11. Activate the "Arbitrary" menu item to enable the QuickArb function. The R&S NGP800 enables the QuickArb function and displays the "Arbitrary" icon on the selected channel status bar information.

Arbitrary editor





The "Arb Editor" dialog allows you to edit the arbitrary profile ("Voltage", "Current", "Time", "Interpolate" status, "Rep." and "End Behavior"). To view or open the list of available arbitrary files, select  to open the arbitrary file.



#	Voltage	Current	Time	Interpolate
1	1.000 V	1.000 0 A	0.001 s	<input checked="" type="checkbox"/>
2	1.588 V	1.000 0 A	0.001 s	<input checked="" type="checkbox"/>
3	1.951 V	1.000 0 A	0.001 s	<input checked="" type="checkbox"/>
4	1.951 V	1.000 0 A	0.001 s	<input checked="" type="checkbox"/>

Figure 7-21: Arbitrary editor dialog

Access:

1. Configure the "Arb Editor" with the required voltage, current and duration. The R&S NGP800 displays the on-screen keypad for data entry.
2. Confirm values with the unit keys.
3. Select the interpolation checkbox to toggle on/off the interpolation function on the arbitrary data.
4. Select the  or  icon to add or delete the arbitrary data from the dialog.
5. Set the "Rep." to configure repetition cycle for the arbitrary data. By default, the repetition cycle is set to infinity. See details in ["Rep."](#) on page 91.
6. Set the "End Behavior" to handle the way to end the automation of the QuickArb function. See details in ["End Behavior"](#) on page 90.
7. Select  (existing file) or  (new file) to save the arbitrary data. The R&S NGP800 displays a popup message to show that file saved successfully.

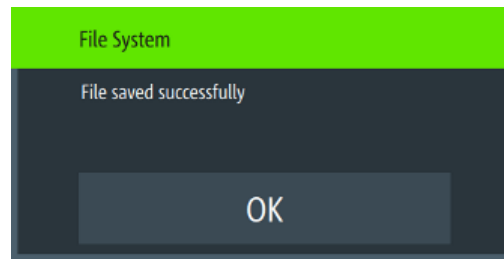

Figure 7-22: File system message

Arbitrary.....	89
L Back.....	89
L Seq. Rep.....	89
L End Behavior.....	90
L Load Sequence.....	90
L Delete 	90
L Up / Down 	90
L <Arbitrary test sequence>.....	90
L #.....	90
L File.....	90
L Data Points.....	90
L Repetitions.....	90
Arbitrary editor.....	91
L Back.....	91
L Open folder.....	91
L Save / Save as.....	91
L Rep.....	91
L End Behavior.....	91
L + 	91
L - 	91
L <Arbitrary data points>.....	91
L #.....	91
L Voltage.....	92
L Current.....	92
L Time.....	92
L Interpolate.....	92

Arbitrary

Configures the arbitrary waveform generator.

Back ← Arbitrary

Returns to the previous menu.

Remote command:

n.a.

Seq. Rep. ← Arbitrary

Sets the number of times the waveform is output in the arbitrary table. If "Seq. Rep." is set to infinity, the waveform is output continuously.

Remote command:

[ARbitrary:SEquence:REPetitions](#) on page 202

End Behavior ← **Arbitrary**

Sets end behavior of the automation of the arbitrary function.

"Off" Output of the selected channel is turned off after performing the arbitrary function.

"Hold" Last voltage and current values output at the instrument.

Remote command:

[ARbitrary:SEquence:BEHavior:END](#) on page 201

Load Sequence ← **Arbitrary**

Loads the selected arbitrary file into the arbitrary test sequence.

Remote command:

[ARbitrary:SEquence:TRANsfer](#) on page 202

Delete ← **Arbitrary**

Delete the selected arbitrary file from the arbitrary test sequence.

Remote command:

[ARbitrary:BLOCK:CLEar](#) on page 197

[ARbitrary:SEquence:CLEar](#) on page 202

Up / Down ← **Arbitrary**

Navigates up and down the rows in the arbitrary test sequence.

Remote command:

n.a.

<Arbitrary test sequence> ← **Arbitrary**

Displays the list of loaded arbitrary files in the arbitrary test sequence.

← **<Arbitrary test sequence>** ← **Arbitrary**

Index numbering of the block in an arbitrary test sequence.

Remote command:

[ARbitrary:BLOCK](#) on page 197

File ← **<Arbitrary test sequence>** ← **Arbitrary**

File directory of the loaded arbitrary file.

Remote command:

[ARbitrary:BLOCK:FNAME](#) on page 198

Data Points ← **<Arbitrary test sequence>** ← **Arbitrary**

Number of data points in an arbitrary file.

Remote command:

n.a.

Repetitions ← **<Arbitrary test sequence>** ← **Arbitrary**

Repetition cycle of the arbitrary file.

Remote command:

[ARbitrary:BLOCK:REPetitions](#) on page 198

Arbitrary editor

Configures the arbitrary points in the loaded arbitrary file.

Back ← Arbitrary editor

Returns to the previous menu.

Remote command:

n.a.

Open folder ← Arbitrary editor

Opens an arbitrary file.

Remote command:

[ARbitrary:LOAD](#) on page 200

[ARbitrary:FNAME](#) on page 200

Save / Save as ← Arbitrary editor

Saves the arbitrary data.

Remote command:

[ARbitrary:SAVE](#) on page 201

Rep. ← Arbitrary editor

Configures the repetition cycle for the loaded arbitrary file.

By default, the repetition cycle is set to infinity.

Remote command:

[ARbitrary:REPetitions](#) on page 201

End Behavior ← Arbitrary editor

See details in "[End Behavior](#)" on page 90.

+ ← Arbitrary editor

Adds a new row of data point at the end of the table. It is initially filled with the data of the currently selected row.

Remote command:

[ARbitrary:DATA](#) on page 199

- ← Arbitrary editor

Removes the currently selected data point from the table.

Remote command:

[ARbitrary:DATA](#) on page 199

<Arbitrary data points> ← Arbitrary editor

Displays the arbitrary data points of the loaded arbitrary file.

← <Arbitrary data points> ← Arbitrary editor

Index numbering of the arbitrary data point in the loaded arbitrary file.

Remote command:

[ARbitrary:DATA](#) on page 199

Voltage ← <Arbitrary data points> ← Arbitrary editor

Data points for voltage in the loaded arbitrary file.

Remote command:

[ARbitrary:DATA](#) on page 199

Current ← <Arbitrary data points> ← Arbitrary editor

Data points for current in the loaded arbitrary file.

Remote command:

[ARbitrary:DATA](#) on page 199

Time ← <Arbitrary data points> ← Arbitrary editor

Duration of the selected data point in the loaded arbitrary file.

Remote command:

[ARbitrary:DATA](#) on page 199

Interpolate ← <Arbitrary data points> ← Arbitrary editor

Check box to enable or disable interpolation for the selected data point.

Remote command:

[ARbitrary:DATA](#) on page 199

7.8.2 EasyRamp



The EasyRamp function configures a constant rise of supply voltage within a set time frame. The output voltage can be increased continuously within a 10 ms to 10 s with 1 ms step size. Each channel has an independent ramp configuration. See [Figure 7-23](#).

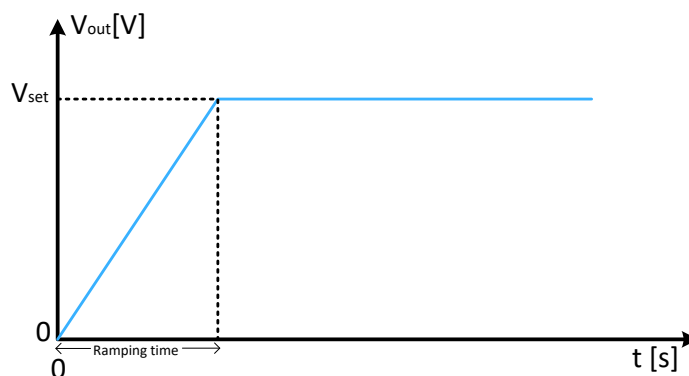

Figure 7-23: Ramping voltage output

Access:

1. Press [Settings] key.

The R&S NGP800 displays the device/channel menu window.

2. Select the required channel tab to configure EasyRamp function.
The R&S NGP800 displays the selected channel menu.
3. Select "Ramp" from the menu.
The R&S NGP800 displays the "Ramp" dialog.

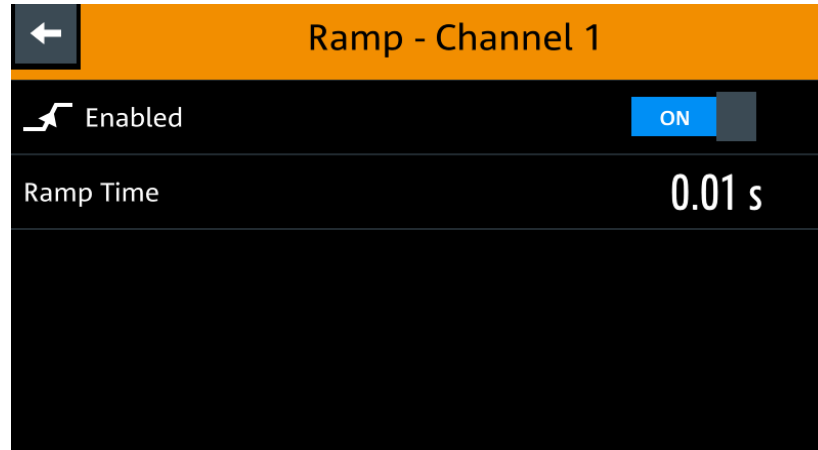

Figure 7-24: Ramp dialog

4. Activate the "Enabled" menu item.
The R&S NGP800 enables the EasyRamp function and displays the "Ramp" icon on the selected channel status bar information.
5. Set the required "Ramp Time".
The R&S NGP800 displays the on-screen keypad to set the value.
6. Confirm value with the unit key.

Ramp.....	93
L Enable.....	93
L Ramp Time.....	93

Ramp

Configures the ramp function.

Enable ← Ramp

Activates or deactivates the ramp function.

"ON" Ramp function activated.

"OFF" Ramp function deactivated.

Remote command:

[SOURce:]VOLTage:RAMP[:STATe] on page 204

Ramp Time ← Ramp

Sets the ramp time.

Remote command:

[SOURce:]VOLTage:RAMP:DURation on page 205

7.9 User key



The R&S NGP800 allows you to configure the user action for one of the following functions:

- Screenshot image from instrument
- Data logging
- Reset statistic (see index 1, 2, 3 of [Figure 6-3](#))
- Enable/Disable touchscreen function

Access:

1. Press [Settings] key.
The R&S NGP800 displays the device/channel menu window.
2. Select the "Device" menu tab to configure user action.
The R&S NGP800 displays the device menu.
3. Select "User Button" from the menu.
Alternatively, long-press on the [*] key to configure the user button action.
The R&S NGP800 displays the "User Button" dialog.

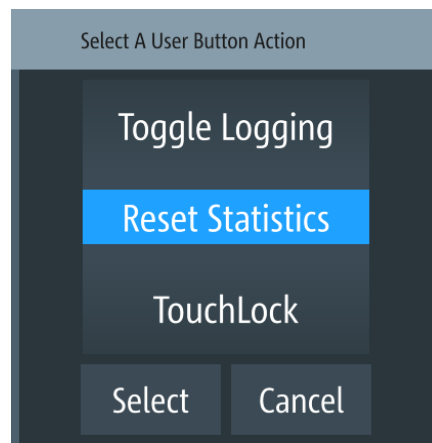

Figure 7-25: User button action

4. Select the "User Button Action" to configure the user action.
The R&S NGP800 displays a dialog to configure the user action.
5. Select the required user action.
6. Select "Select" to confirm the action.

[User Button Action](#)..... 95

L Screenshot.....	95
L Toggle Logging.....	95
L Reset Statistics.....	95
L TouchLock.....	95
L Select.....	95
L Cancel.....	95

User Button Action

Selects a user action.

Screenshot ← User Button Action

Captures the current screen image of the instrument.

Remote command:

n.a.

Toggle Logging ← User Button Action

Enables or disables the data logger function.

Remote command:

[LOG\[:STATe\]](#) on page 214

Reset Statistics ← User Button Action

Resets sample count, energy result, power, voltage and current values.

Remote command:

[MEASure\[:SCALar\]:STATistic:RESet](#) on page 191

TouchLock ← User Button Action

Enables or disables the touchscreen function of the instrument.

Remote command:

[SYSTem:TOUCh\[:STATe\]](#) on page 152

Select ← User Button Action

Applies the configuration.

Remote command:

n.a.

Cancel ← User Button Action

Cancels the configuration.

Remote command:

n.a.

7.10 Screenshot



With screenshot, you can capture image easily from the instrument. The images can be stored in the USB stick or internal memory of the instrument. By default, the screen images are stored in the USB device under the target folder.

Access:

1. Press [Settings] key.
The R&S NGP800 displays the device/channel menu window.
2. Select the "Device" tab to configure screenshot file location.
The R&S NGP800 displays the device menu.
3. Select "Screenshot" from the menu.
The R&S NGP800 displays the "Screenshot" dialog.

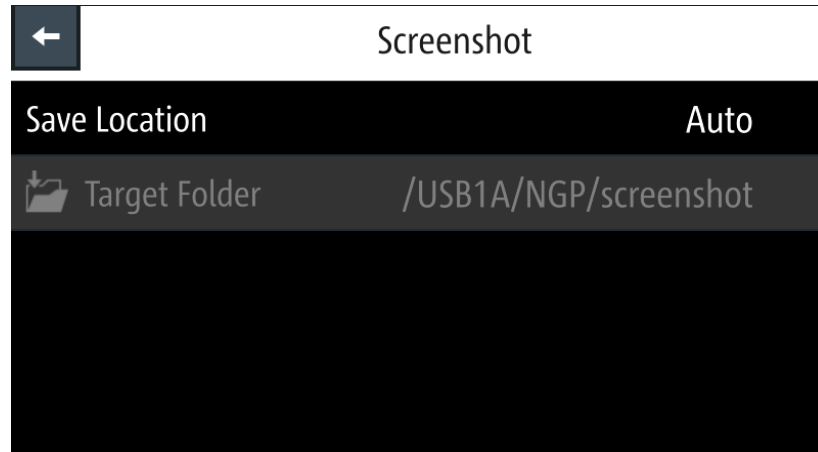

Figure 7-26: Screenshot dialog

4. Select the "Save Location" to configure the screenshot file location.
See details in ["Save Location"](#) on page 96.
5. Select the required save location.

Screenshot

Configures the screenshot setting.

Save Location ← Screenshot

Configures the screenshot file location.

- "Auto" Target folder is set to default file locations:
- With USB stick detected:
/USB1A/NGP/screenshot for R&S NGP models
 - Without USB stick detected:
/int/screenshot

"Manual" Choice of target folder.

Remote command:

n.a.

7.11 Data logging



When data logging is activated, the R&S NGP800 records the voltage, current and power data and stores it in the predefined target folder. The measurement data can be stored on the USB stick or in the instrument internal memory location.

Access:

1. Press [Settings] key.
The R&S NGP800 displays the device/channel menu window.
2. Select the "Device" tab to configure data logger.
The R&S NGP800 displays the device menu.
3. Select "Logging" menu item from the menu.
The R&S NGP800 displays the "Logging" dialog.

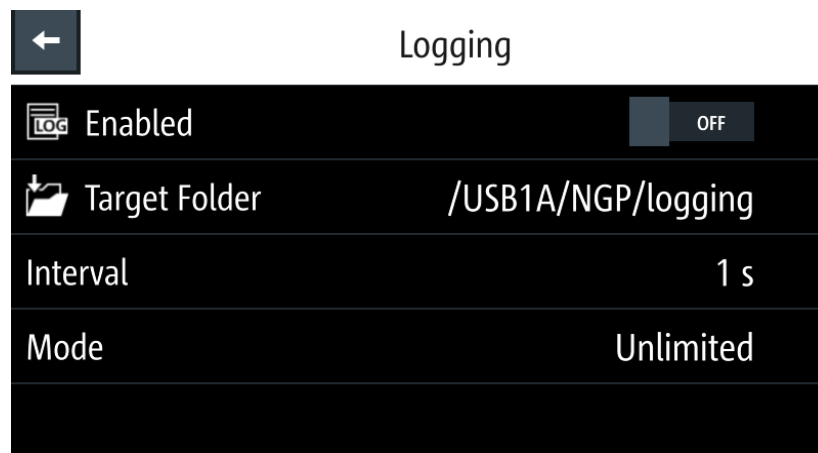

Figure 7-27: Logging dialog

4. Select the "Target Folder" menu item to select the predefined target folder for data logger.
If no USB stick is detected, "Target Folder" is set to internal memory ("int") partition. By default, "USB1A" partition is selected if USB stick is detected.

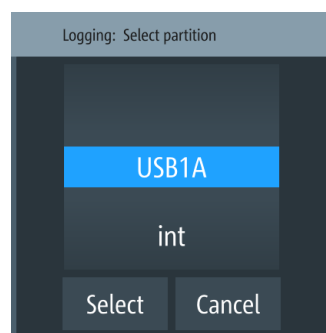

Figure 7-28: Target folder dialog

5. Set the required "Target Folder".
6. Select "Mode" to set logging duration.
See details in ["Mode"](#) on page 98.

7. Depending on the selected mode, configure the required settings for the data logging duration.
8. Activate the "Enabled" menu item.
The R&S NGP800 activates the logging and disables the settings for file saved location and logging mode settings.
9. Configure the "CSV Settings".
See [Chapter 7.12, "CSV settings"](#), on page 99.

Logging.....	98
L Enabled.....	98
L Target Folder.....	98
L Interval.....	98
L Mode.....	98

Logging

Configures the data logging.

Enabled ← Logging

Enables or disables logging events.

"ON" Enables logging.

"OFF" Disables logging.

Remote command:

[LOG\[:STATe\]](#) on page 214

Target Folder ← Logging

Selects the predefined target folder for data logging.

"USB1A" Selects /USB1A/NGP/logging as the target folder.

"int" Selects /int/logging as the target folder.

Remote command:

[LOG:LOCation](#) on page 217

[LOG:FNAME?](#) on page 216

Interval ← Logging

The time interval for data logging.

Remote command:

[LOG:INTerval](#) on page 217

Mode ← Logging

Sets logging duration.

"Duration" Time taken for data logging with duration and time interval setting.

"Span" Time taken for data logging with start time, time interval and duration setting

"Unlimited" Data logging with time interval setting. The data logging continuous until function is deactivated.

"Count" Data logging with number of counts and time interval setting

Remote command:

[LOG:MODE](#) on page 217

[LOG:COUNT](#) on page 215

[LOG:DURation](#) on page 216

[LOG:STIME](#) on page 218

7.12 CSV settings



A CSV file stores tabular data (numbers and text) in plain text. Each line of the file is a data record and each record consists of one or more fields, separated by a file delimiter. The "CSV Settings" provides you ways to format the fields that are stored in the data logging. See [Figure 7-29](#).

#Device	NGP802						
#Calibration Ch1	factory						
#Calibration Ch2	factory						
Timestamp	U1[V]	I1[A]	P1[W]	U2[V]	I2[A]	P2[W]	
12:51.3	5.1801	0.00161	0.00835	11.0004	0.00059	0.00652
12:51.4	5.1801	0.0016	0.00831	11.0003	0.0006	0.00665
12:51.5	5.1801	0.00161	0.00836	11.0004	0.0006	0.00657
12:51.6	5.1801	0.0016	0.0083	11.0004	0.0006	0.00658
12:51.7	5.1801	0.00161	0.00832	11.0004	0.00062	0.00679
12:51.8	5.1801	0.00162	0.00838	11.0003	0.00062	0.00682
12:51.9	5.1801	0.00161	0.00836	11.0003	0.0006	0.00660
12:52.0	5.1801	0.00161	0.00835	11.0004	0.0006	0.00662
12:52.1	5.1801	0.00161	0.00834	11.0004	0.0006	0.00663
12:52.2	5.1801	0.00162	0.00837	11.0004	0.00062	0.00683
12:52.3	5.1801	0.00162	0.00838	11.0004	0.00062	0.00686
12:52.4	5.1801	0.00161	0.00836	11.0004	0.00063	0.00695
12:52.5	5.1801	0.00161	0.00836	11.0004	0.00062	0.00681
12:52.6	5.1801	0.00161	0.00834	11.0004	0.00062	0.00683
12:52.7	5.1801	0.00161	0.00833	11.0004	0.00062	0.00684
12:52.8	5.1801	0.0016	0.00829	11.0003	0.00062	0.00682
12:52.9	5.1801	0.00159	0.00825	11.0004	0.00062	0.00683
12:53.0	nan	nan	nan	nan	nan	nan	
12:53.1	nan	nan	nan	nan	nan	nan	
12:53.2	nan	nan	nan	nan	nan	nan	

Figure 7-29: Sample of data logging

Access:

1. Select "CSV Settings" from "Device" menu.
The R&S NGP800 displays the "CSV Settings" dialog.

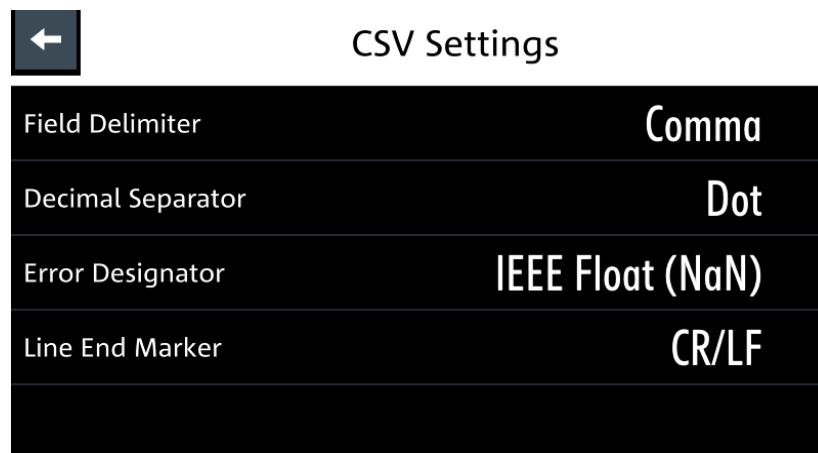

Figure 7-30: CSV Settings dialog

- Set the required CSV parameter.
The R&S NGP800 displays the respective dialog to set the CSV parameter.
See [Table 7-3](#).
- Select "Set" to confirm the value.

Table 7-3: Types of CSV parameters

CSV parameters	Selective fields in the dialog
"Field Delimiter"	"Comma", "Semicolon"
"Decimal Separator"	"Dot", "Comma"
"Error Designator"	"IEEE Float (NaN)", "Empty"
"Line End Marker"	"CR/LF", "LF"

CSV Settings.....	100
L Field Delimiter.....	100
L Decimal Separator.....	100
L Error Designator.....	101
L Line End Marker.....	101

CSV Settings

Configures the CSV parameter.

Field Delimiter ← CSV Settings

Sets the field delimiter.

- "Comma" Use comma as the field separator.
- "Semicolon" Use semicolon as the field separator.

Decimal Separator ← CSV Settings

Sets the decimal separator.

- "Dot" Use dot as the decimal separator.
- "Comma" Use comma as the decimal separator.

Error Designator ← CSV Settings

Sets the error designator.

"IEEE Float (NaN)" Sets IEEE Float (NaN) as the error designator.

"Empty" Sets empty value as the error designator.

Line End Marker ← CSV Settings

Sets the line end marker.

"CR/LF" Sets CR/LF as the line end marker.

"LF" Sets LF as the line end marker.

7.13 Graphical view window



The graphical view measurement is a time-based measurement that allows you to visualize measurements on available data sources.

The graph illustrated below shows the output of voltage "U1" 4.0 V, current "I1" 600 mA at channel 1 with output power of "P1" 2395 mW from 42.5 seconds ago. Each measurement trace is represented with an individual color.

The time-based scale is adjustable with a time duration display from 60 seconds up to the last 12 hours.

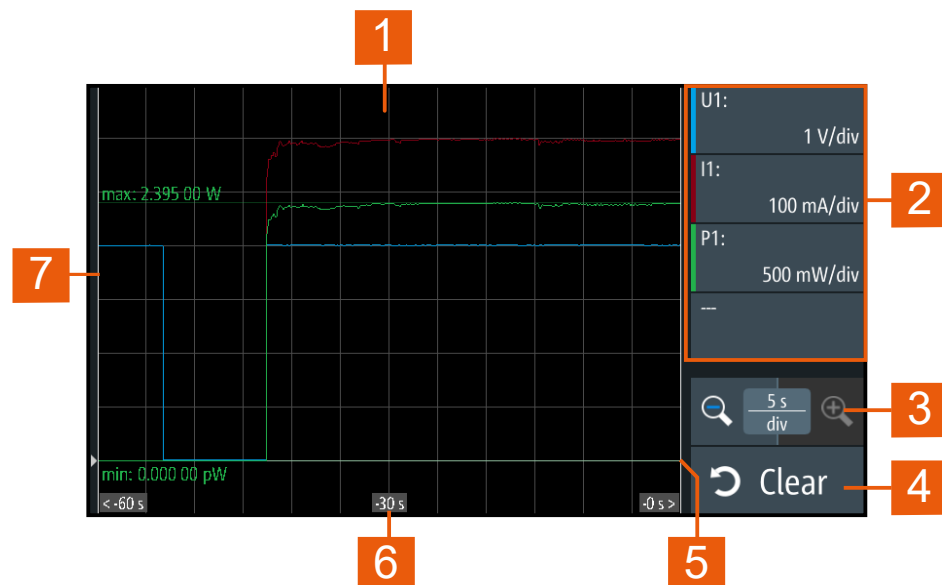

Figure 7-31: Graphical view window

- 1 = Display window for measurement
- 2 = Configuration slot for measurement
- 3 = Adjustable time scale using the "+" and "-" icon

- 4 = Reset measurements in display window
- 5 = Zero-origin of the graph
- 6 = Time axis
- 7 = Measurement axis

Access:

1. Long-press on the [Settings] key or the "Settings" button in "Channel display area" on page 42.
The R&S NGP800 displays the graphical view window. See [Figure 7-31](#).
2. Alternatively, press [Settings] > device menu > "Graphical View" to access graphical view window.

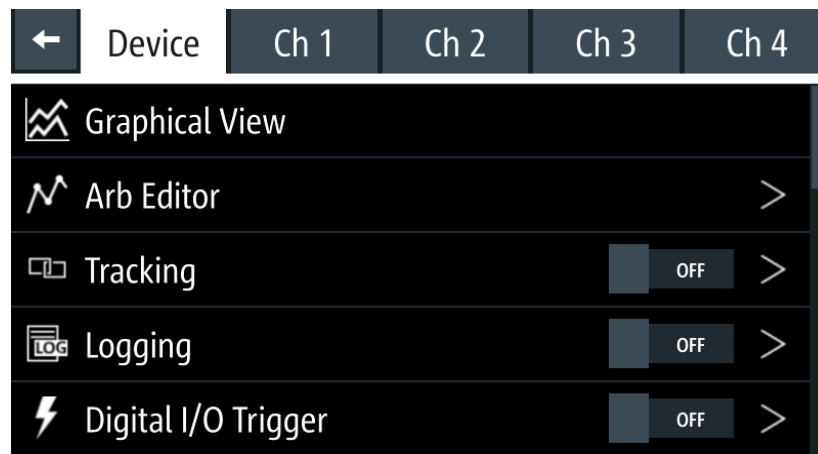

Figure 7-32: Device menu

3. Select any of the configuration slots to configure the measurement parameters.
The R&S NGP800 displays the configuration dialog.

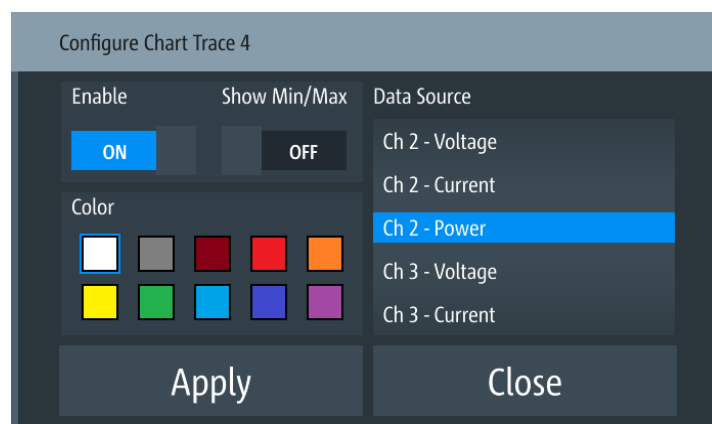

Figure 7-33: Configuration dialog

4. Select the available "Data Source" for configuration.
5. Set "Enable" to "ON" to activate the selected "Data Source" for measurement.

6. Select the available "Color" to configure the "Data Source" measurement trace.
7. Set "Show Min/Max" to "ON" to display the minimum and maximum value of the selected "Data Source".

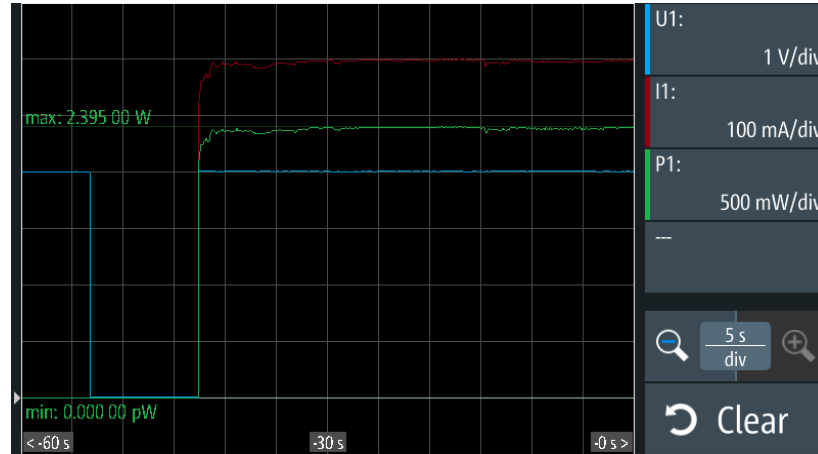

Figure 7-34: Display of minimum and maximum value of selected data source

8. Select "Apply" to confirm the configuration.
9. Select "Close" to exit configuration dialog.

Graphical View.....	103
L Enable.....	103
L Show Min/Max.....	103
L Color.....	104
L Data Source.....	104
L Apply.....	104
L Configuration slot.....	104
L Time scale.....	104
L Clear.....	104
L Close.....	104

Graphical View

Configures and displays graphical view of the measurement.

Enable ← Graphical View

Activates or deactivates the selected "Data Source" for measurement.

- "ON" Activates the selected "Data Source".
 "OFF" Deactivates the selected "Data Source".

Show Min/Max ← Graphical View

Enables displaying the minimum and maximum value of the selected "Data Source".

- "ON" Displays the minimum and maximum value of the selected "Data Source".
 "OFF" Hide the minimum and maximum value of the selected "Data Source".

Color ← Graphical View

Configures the color of the measurement trace.

Data Source ← Graphical View

Selects the data source for measurement.

Apply ← Graphical View

Sets the configuration.

Configuration slot ← Apply ← Graphical View

Configures the selected data source.

Time scale ← Apply ← Graphical View

Configures the time scale on the time axis.

 + Increases the time scale per division.

 - Reduces the time scale per division.

Clear ← Apply ← Graphical View

Resets display to start a new measurement.

Close ← Graphical View

Closes the configuration window.

7.14 File manager



The "File Manager" provides file transfer functions between USB stick and internal memory of the instrument. You can copy and delete files in both USB stick and internal memory of the instrument.

Access:

1. Press [Settings] key.
The R&S NGP800 displays the device/channel menu window.
2. Select the "Device" tab to configure file settings for save and recall function.
The R&S NGP800 displays the device menu.
3. Select "File Manager" from the menu.
The R&S NGP800 displays the file manager dialog.

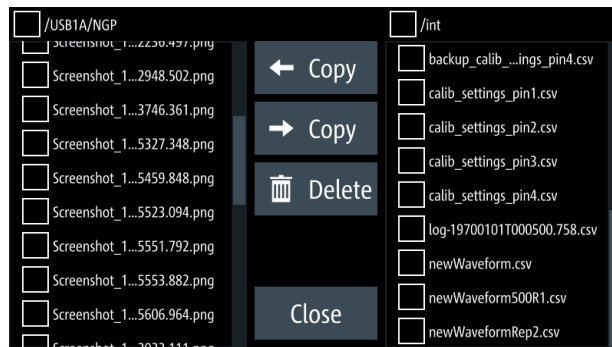

Figure 7-35: File manager dialog

4. Select the file that you want to copy or delete.
5. Select the required action in the file manager dialog.
6. To view the selected file information, long-press on the selected filename in the file manager dialog.
A pop-up message box is displayed with the file information.

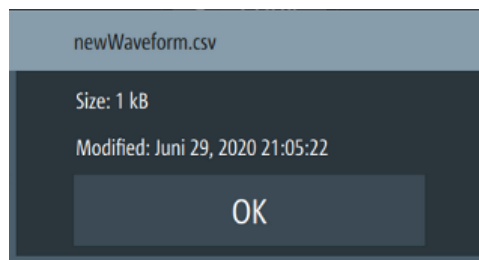

Figure 7-36: File information

File Manager.....	105
L <USB_directory>.....	105
L <Internal_memory>.....	106
L Int to USB copy Copy.....	106
L USB to Int copy Copy.....	106
L Delete.....	106
L Close.....	106

File Manager

Manages file transfer between USB stick and internal memory of the instrument.

Remote command:

[DATA:LIST?](#) on page 213

<USB_directory> ← File Manager

Lists all the files available in the USB stick for file operations. Selected files are marked in the checkbox.

Remote command:

n.a.

<Internal_memory> ← File Manager

Lists all the files available in the internal memory for file operations. Selected files are marked in the checkbox.

Remote command:

n.a.

Int to USB copy ← Copy ← File Manager

Copies from internal memory to USB.

Remote command:

n.a.

USB to Int copy → Copy ← File Manager

Copies from USB to internal memory.

Remote command:

n.a.

Delete ← File Manager

Deletes the selected file.

Remote command:

[DATA:DELeTe](#) on page 213

Close ← File Manager

Closes the file manager dialog

Remote command:

n.a.

7.15 Save and recall



Upon power-up, the instrument loads the last saved settings from internal memory location. Auto saved parameters are also applied during startup.

The R&S NGP800 output states of all channels (Ch 1, Ch 2, Ch 3, Ch 4) are disabled when the recall function is activated.

**Auto saved instrument settings**

Auto saved of the instrument settings is applied when any of the following parameters are changed:

- [Chapter 7.17, "General instrument settings"](#), on page 125
- USB connection mode
- Ethernet settings

In addition of the auto saved instrument settings, the following instrument settings are saved or recalled in the internal memory:

- [Set voltage and current level](#)
- [Settings in the Protection Function, Safety Limits](#)
- [Data Logging settings](#)

Access:

1. Press [Settings] key.
The R&S NGP800 displays the device/channel menu window.
2. Select the "Device" tab to configure file settings for save and recall function.
The R&S NGP800 displays the device menu.
3. Select "Save/Recall Device Settings".
The R&S NGP800 loads the "Save/Recall Device Settings" dialog.

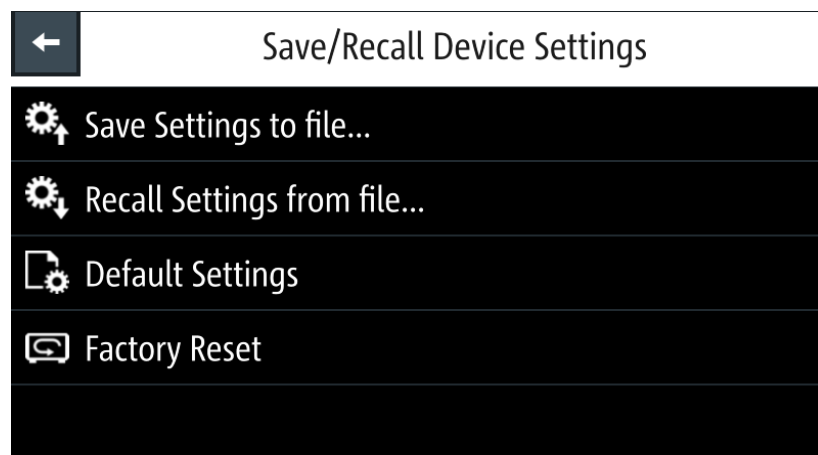

Figure 7-37: Save/Recall device settings dialog

4. Select "Save Settings to file" to save current instrument settings.
The R&S NGP800 opens a dialog to select the file location.
You can save to existing file or create a file for saving.
5. Set the desired file location.
The R&S NGP800 saves the current instrument settings.
6. Similar, you can select "Recall Settings from file" to load instrument settings.
The R&S NGP800 opens a dialog to select the file location.
7. Set the desired file location.
The R&S NGP800 resets the instrument with the loaded instrument settings.

Factory reset

To reset the instrument settings to factory default:

1. Select "Default Settings" from the "Save/Recall Device Settings" dialog.
The R&S NGP800 displays a popup message.

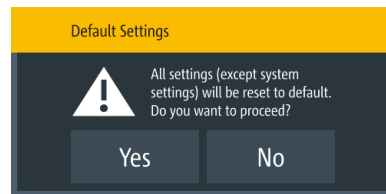

Figure 7-38: Factory reset - default settings message

2. Select "Yes" to overwrite instrument settings to default.
The R&S NGP800 resets current instrument settings to default.
3. The R&S NGP800 displays a popup message to show that all settings reset to default.

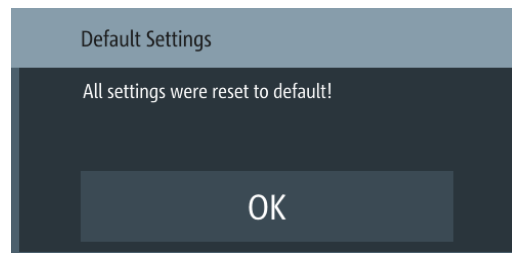

Figure 7-39: Default settings message

4. To proceed to reset instrument settings to factory default with a reboot, select "Factory Reset" from the "Save/Recall Device Settings" dialog.

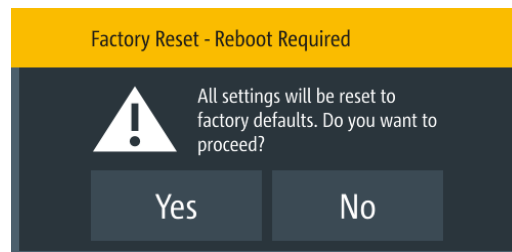

Figure 7-40: Factory reset - reboot message

5. Select "Yes" to proceed factory reset.

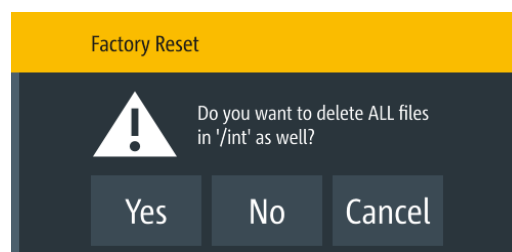

Figure 7-41: Factory reset - all files delete message

6. Select "No" to keep all files in the `/int` directory.

Select "Yes" to remove all files (arbitrary, logging, screenshots, settings) except the files in the documentation folder under the `/int` directory.

Save/Recall Device Settings.....	109
L Save Settings to file.....	109
L Recall Settings from file.....	109
L Default Settings.....	109
L Factory Reset.....	109

Save/Recall Device Settings

Saves or loads instrument settings.

Save Settings to file ← Save/Recall Device Settings

Saves current instrument settings.

Remote command:

*[SAV](#) on page 145

Recall Settings from file ← Save/Recall Device Settings

Loads instrument settings.

Remote command:

*[RCL](#) on page 145

Default Settings ← Save/Recall Device Settings

Overwrites instrument settings to default.

Remote command:

*[RST](#) on page 144

Factory Reset ← Save/Recall Device Settings

Resets instrument to factory default settings, with a reboot.

Remote command:

n.a.

7.16 Interfaces

There are various of ways how the R&S NGP800 can be remotely accessed and controlled.

Access:

1. Press [Settings] key.
The R&S NGP800 displays the device/channel menu window.
2. Select the "Device" tab to configure network connection.
The R&S NGP800 displays the device menu.
3. Select "Interfaces".
The R&S NGP800 displays the "Interfaces" dialog.

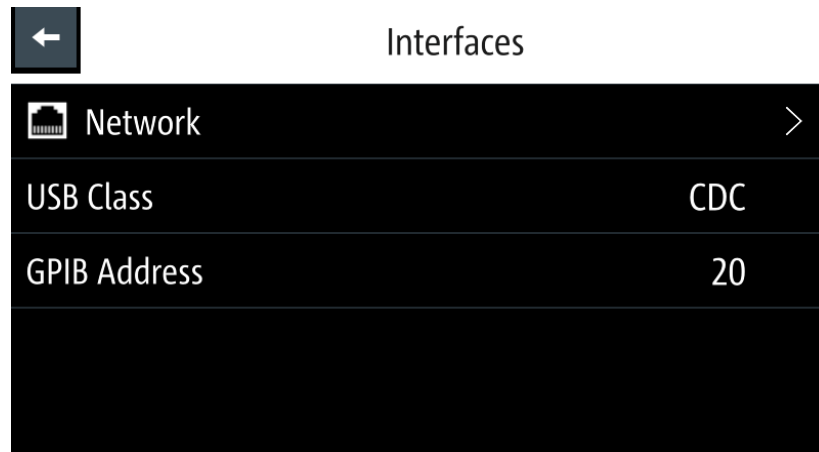

Figure 7-42: Interfaces dialog

4. Select the connected interface ([Network](#), [VNC](#), [FTP](#), [USB Class](#) or [GPIB Address](#)) to configure the necessary parameters required.

• Network connection	110
• LAN connection	112
• Wireless LAN connection	115
• VNC	117
• FTP	120
• USB connection	122
• GPIB address	123

7.16.1 Network connection



The following shows how you can establish a local area network (LAN) connection with the R&S NGP800 for remote control operation.

- [LAN](#)
- [Wireless LAN](#)

Access:

1. Select "Network" from the [Figure 7-42](#).
The R&S NGP800 displays the "Network" dialog.

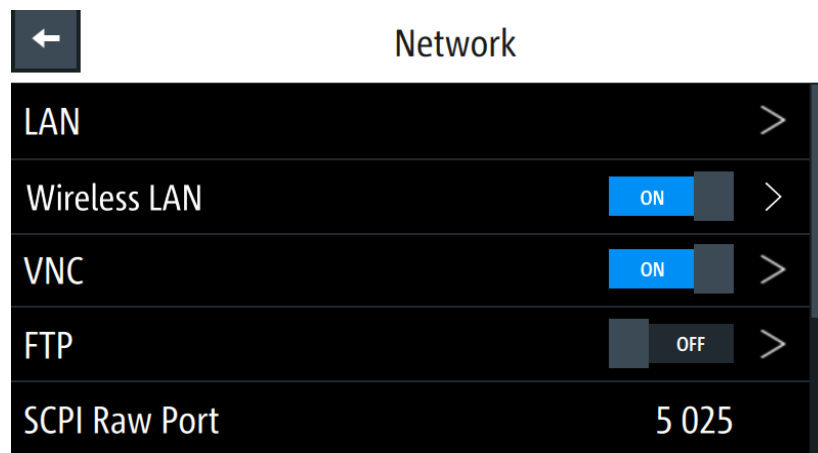

Figure 7-43: Network dialog

- Set the required "SCPI Raw Port" and "Hostname".
The R&S NGP800 displays the on-screen keypad to enter the port number and hostname.

When the connection is available, the network icon is highlighted in white on the device status bar information.

Network.....	111
L LAN.....	111
L Wireless LAN.....	111
L VNC.....	112
L FTP.....	112
L SCPI Raw Port.....	112
L Desired Hostname.....	112
L DNS Hostname / mDNS Hostname.....	112

Network

Sets the network configuration of the instrument.

Remote command:

[SYSTem:INTerface?](#) on page 151

LAN ← Network

Configures LAN network.

See [Chapter 7.16.2, "LAN connection"](#), on page 112.

Remote command:

n.a.

Wireless LAN ← Network

Enables or disables wireless LAN.

See [Chapter 7.16.3, "Wireless LAN connection"](#), on page 115.

"ON" Enables wireless LAN.

"OFF" Disables wireless LAN.

Remote command:

`SYSTem:COMMunicate:WLAN[:STATe]` on page 150

VNC ← Network

Enables or disables VNC connection.

See [Chapter 7.16.4, "VNC"](#), on page 117.

"ON" Enables VNC.

"OFF" Disables VNC.

Remote command:

`SYSTem:VNC:STATe` on page 153

FTP ← Network

Enables or disables FTP connection.

See [Chapter 7.16.5, "FTP"](#), on page 120.

"ON" Enables FTP.

"OFF" Disables FTP.

Remote command:

n.a.

SCPI Raw Port ← Network

A port number used to open a raw TCP/IP connection to send raw SCPI commands to the instrument.

Remote command:

n.a.

Desired Hostname ← Network

The name assigned to the instrument used to identify it in the network.

Remote command:

n.a.

DNS Hostname / mDNS Hostname ← Network

The name assigned to the domain name used to identify it in the network

Remote command:

n.a.

7.16.2 LAN connection

The R&S NGP800 is equipped with a network interface and can be connected to an Ethernet LAN (local area network). A LAN connection is necessary for remote control of the instrument, and for access from a computer using a web browser.



To establish a network connection, connect a commercial RJ-45 cable to the LAN port of the instrument and to a PC or network switch.

Depending on the network capacities, the TCP/IP address information for the instrument can be obtained in different ways.

- If the network supports dynamic TCP/IP configuration using the Dynamic Host Configuration Protocol (DHCP), and a DHCP server is available, all address information can be assigned automatically.
- Otherwise, the address must be set manually. Automatic Private IP Addressing (APIPA) is not supported.

By default, the instrument is configured to use dynamic TCP/IP configuration and obtain all address information automatically. This means that it is safe to establish a physical connection to the LAN without any previous instrument configuration.

Access:

1. **NOTICE!** Risk of network failure. Before connecting the instrument to the network or configuring the network, consult your network administrator. Connection errors may affect the entire network.

If your network does not support DHCP, or if you choose to disable dynamic TCP/IP configuration, you must assign valid address information before connecting the instrument to the LAN. Contact your network administrator to obtain a valid IP address.

2. Connect the LAN cable to the LAN connector at the rear panel of the instrument.
3. Select "LAN" to set LAN connection.

The R&S NGP800 displays the "LAN" dialog.

Note: The "MAC Address" is fixed.

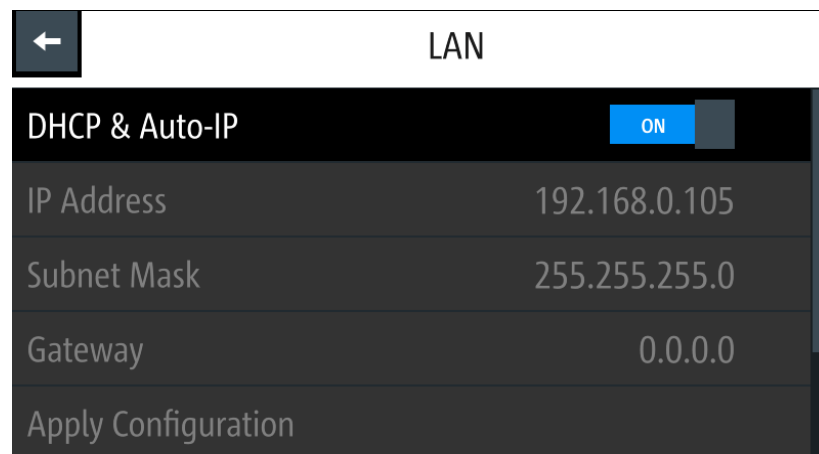

Figure 7-44: Ethernet settings dialog

4. Set the "DHCP & Auto-IP".
See details in "[DHCP & Auto-IP](#)" on page 114.
5. Set the required DHCP mode.
If DHCP mode is set "OFF", the following "Ethernet Settings" are required.
6. Configure the "IP Address", "Subnet Mask" and "Gateway".

The R&S NGP800 displays the IP dialog for configuration.

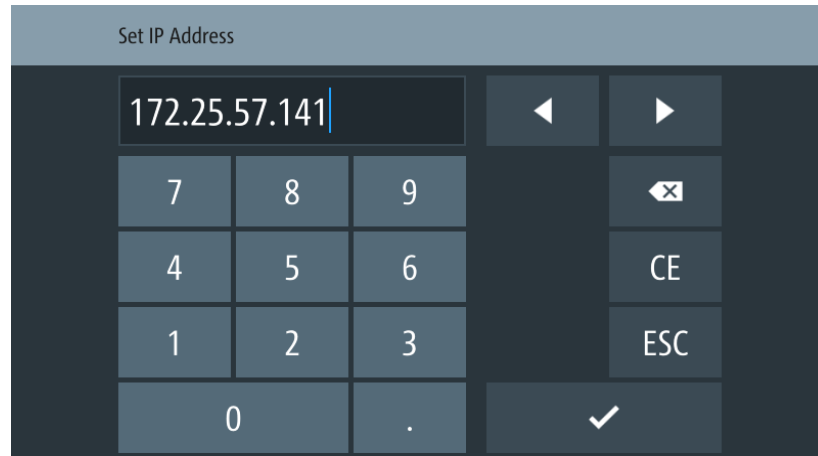

Figure 7-45: IP dialog

7. Set the required IP addresses for "IP Address", "Subnet Mask" and "Gateway"
8. Select "Set" to confirm the value.
9. Select "Apply Configuration" to apply the changes.

LAN.....	114
L DHCP & Auto-IP.....	114
L IP Address.....	114
L Subnet Mask.....	115
L Gateway.....	115
L Apply Configuration.....	115

LAN

Configures LAN connection.

DHCP & Auto-IP ← LAN

Sets IP address via DHCP or manually.

- "ON" Enables DHCP for automatic network parameter distribution and shows the values of the IP Address. By default, the instrument is configured to use dynamic configuration and obtain all address information automatically.
- "OFF" If the network does not support DHCP, the IP addresses must be set manually.

Remote command:

`SYSTem:COMMunicate:SOCKet:DHCP` on page 148

IP Address ← LAN

Address used in communication with the network.

This address is manually configured if "DHCP & Auto-IP" is set "OFF".

Remote command:

[SYSTem:COMMunicate:SOCKet:IPAdDress](#) on page 148

Subnet Mask ← LAN

Secondary address used in communication with the network.

This address is manually configured if "DHCP & Auto-IP" is set "OFF".

Remote command:

[SYSTem:COMMunicate:SOCKet:MASK](#) on page 149

Gateway ← LAN

Gateway address to connect to the network.

This address is manually configured if "DHCP & Auto-IP" is set "OFF".

Remote command:

[SYSTem:COMMunicate:SOCKet:GATeway](#) on page 148

Apply Configuration ← LAN

Applies the changes made to "[IP Address](#)" on page 114, "[Subnet Mask](#)" on page 115 and "[Gateway](#)" on page 115.

Remote command:

[SYSTem:COMMunicate:SOCKet:APPLy](#) on page 147

[SYSTem:COMMunicate:SOCKet:DISCard](#) on page 148

[SYSTem:COMMunicate:SOCKet:RESet](#) on page 149

7.16.3 Wireless LAN connection



Wi-Fi transmitter performance

Frequency range: 2412 MHz to 2472 MHz

Power: 19.5 dBm typical



Instrument option

R&S NGP-K102 (P/N: 5601.6400.03) option is required to connect the R&S NGP800 to a network via wireless LAN connection.

Wireless LAN option is only available for instrument with serial number below 110000.

An alternative to connection in local area network is wireless LAN connection. With the presence of an authenticated Wi-Fi signal, the R&S NGP800 automatically connects to a network and navigation can be made via the web browser according to the WLAN IEEE 802.11 b/g/n standards.

Access:

1. **WARNING!** Risk of RF exposure. This is a class A product. In a domestic environment, this product may cause radio interference in which case the user may be required to take adequate measures.

- When WLAN is active, a minimum separation distance of 20 cm from front panel of the instrument must be observed at all times.
 - When WLAN is active, no operation of antenna or transmitter should be co-located with the instrument.
2. Select "Wireless LAN" to set WLAN connection.
The R&S NGP800 displays the "Wireless LAN Settings" dialog.

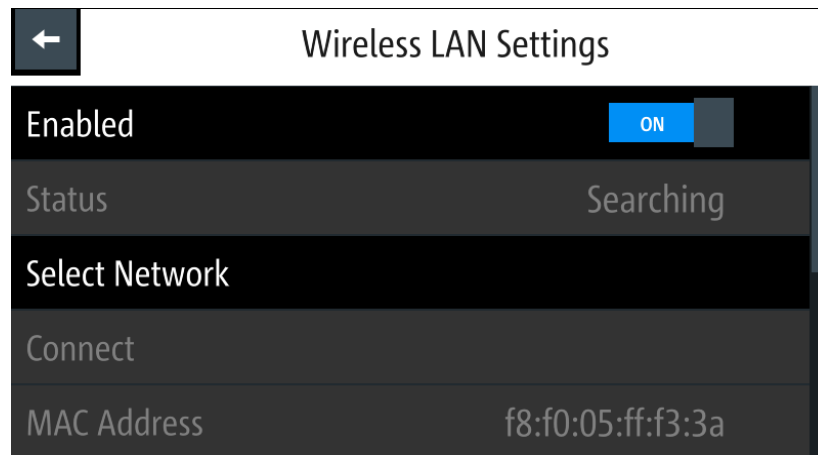

Figure 7-46: WLAN settings dialog

3. Select "Enabled" menu item to set "ON" to enable "Wireless LAN Settings".
The R&S NGP800 began searching available Wi-Fi network and the "Status" shows "Searching".
4. Select the "Select Network" to connect the required Wi-Fi network.
If connection is successful, the "Status" shows "Connected". See [Figure 7-47](#).
When the connection is alive, the WLAN icon turns white on the device status bar. See ["Device status"](#) on page 39.

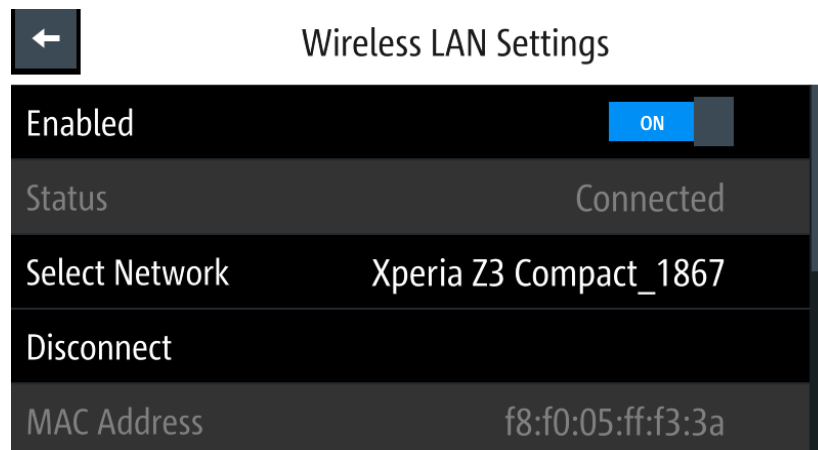

Figure 7-47: WLAN connected

5. To disconnect, select the "Disconnect" in the "Wireless LAN Settings" dialog.

Wireless LAN Settings.....	117
L Enabled.....	117
L Status.....	117
L Select Network.....	117
L Connect / Disconnect.....	117
L MAC Address.....	117

Wireless LAN Settings

Sets WLAN connection.

Enabled ← Wireless LAN Settings

Enables or disables WLAN state.

"ON" Enables WLAN.

"OFF" Disables WLAN.

Remote command:

[SYSTem:COMMunicate:WLAN\[:STATe\]](#) on page 150

Status ← Wireless LAN Settings

Displays the WLAN connection status.

"Searching" The instrument is searching for a WLAN network.

"Connected" The instrument is connected to a WLAN network.

Remote command:

n.a.

Select Network ← Wireless LAN Settings

Selects the Wi-Fi network to connected.

Remote command:

[SYSTem:COMMunicate:WLAN:IPAddress?](#) on page 149

[SYSTem:COMMunicate:WLAN:PASSword](#) on page 150

[SYSTem:COMMunicate:WLAN:SSID](#) on page 150

Connect / Disconnect ← Wireless LAN Settings

Connects or disconnects to the predefined wireless access point.

Remote command:

[SYSTem:COMMunicate:WLAN:CONNECTION\[:STATe\]](#) on page 149

MAC Address ← Wireless LAN Settings

Displays the MAC address of the instrument.

Remote command:

n.a.

7.16.4 VNC

Using a [VNC](#) client tool on a computer, you can control the R&S NGP800 remotely. Alternatively, you can remote access the instrument webpage by using the IP address or hostname in a web browser.

Establish a connection between the computer and R&S NGP800 via same network using [LAN](#) or [WLAN](#).

Access:

1. Select "VNC" to set [VNC](#) connection.
The R&S NGP800 displays the "VNC" settings dialog.

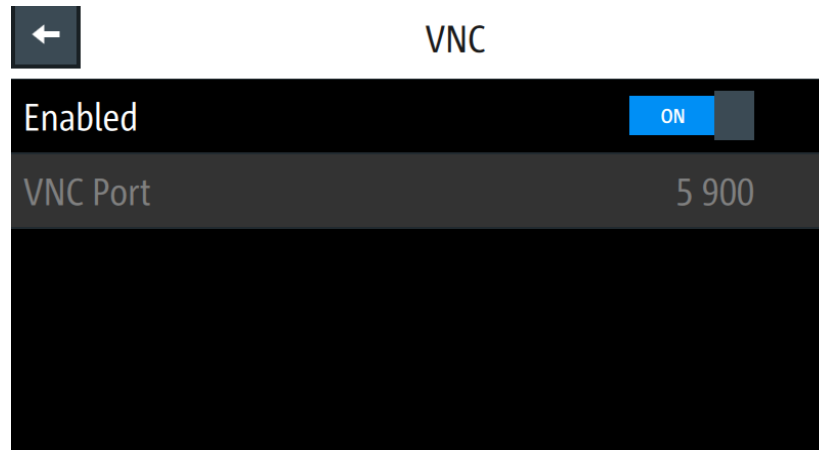

Figure 7-48: VNC settings dialog

2. Select "VNC Port" to set the desired port number.
Setting the "VNC Port" is only possible if "Enabled" is set "OFF".
All settings are reset to default after a factory reset. See ["Factory reset"](#) on page 107.
3. Set "Enabled" to "ON" to enable VNC connection.
4. On the VNC client tool, connect to R&S NGP800 using the device IP address and [VNC](#) port number. If connected successfully, the NGP800 VNC interface is displayed in the VNC client tool.



Figure 7-49: VNC client of respective instrument model

5. Alternatively, connect to the instrument webpage using the IP address or hostname on the web browser URL bar. If connected successfully, the "Instrument Home" webpage is displayed. See [Figure 7-50](#).

Instrument Home

Manufacturer: Rohde&Schwarz
 Device Type: NGP824
 Serial Number: 900207
 Firmware Version: 02.017 00515522C5

Ethernet Port
 Description: RS power supply NGP824-900207
 Host name: RS-NGP824-00207.local
 MAC-Address: 00-90-B8-21-8F-13
 IP Address: 172.25.57.226
 VISA Resource String: TCPIP::172.25.57.226::5025::SOCKET
 TCPIP::172.25.57.226::INSTR

Current Time: 2021-09-23 16:50:21
 Time Source: Operating system

Device Identification: On Off

©2019 ROHDE&SCHWARZ. All rights reserved.

Figure 7-50: Instrument home webpage of a power supply model

6. Select any of the following menus to configure the instrument.
 - "Instrument Home": Displays instrument information (e.g. model, serial number, firmware version). See [Figure 7-50](#).
 - "SCPI Device Control": Displays a command and response text box for sending SCPI commands and provides screenshot capture of the instrument display. To view the latest screen capture, select "Refresh screen data".
 - "VNC Device Control": Displays the virtual instrument for operation. See [Figure 7-49](#).
 By default, the VNC port number is 5900 on the webpage. Set the correct port number if it is different from the default and click "Connect" button. To expand the instrument view, click the "Open in fullscreen" link.
 - "Network Settings": Displays IPv4 configurations and settings dialog. The "Advanced IP configuration" provides setting to enable or disable the "ICMP Ping" service and "mDNS and DNS-SD" service. Click "Submit" to send changes to the instrument.
 - "Change Password": Displays dialog to change access password to instrument webpage.
 - "Documentation": Displays links to Getting Started manual and product homepage.

VNC

A client tool to control the instrument remotely.

Enabled ← VNC

Enables or disables [VNC](#) connection.

"ON" Enables VNC connection.

"OFF" Disables VNC connection.

Remote command:

[SYSTem:VNC:STAtE](#) on page 153

VNC Port ← VNC

Sets the desired VNC port number.

By default, the VNC port is 5900.

Remote command:

`SYSTem:VNC:PORT` on page 152

7.16.5 FTP

FTP (file transfer protocol) provides you with remote file access on the instrument via an ethernet connection. It generally allows you the following operations:

- Download and upload files from the remote instrument.
- Browse the content (file system) on the remote instrument.

Remote access is limited to the content of the instrument file manager section. See [Chapter 7.14, "File manager"](#), on page 104.

Access:

1. Select "FTP" to set **FTP** connection.
The R&S NGP800 displays the "FTP - Remote Access" dialog.

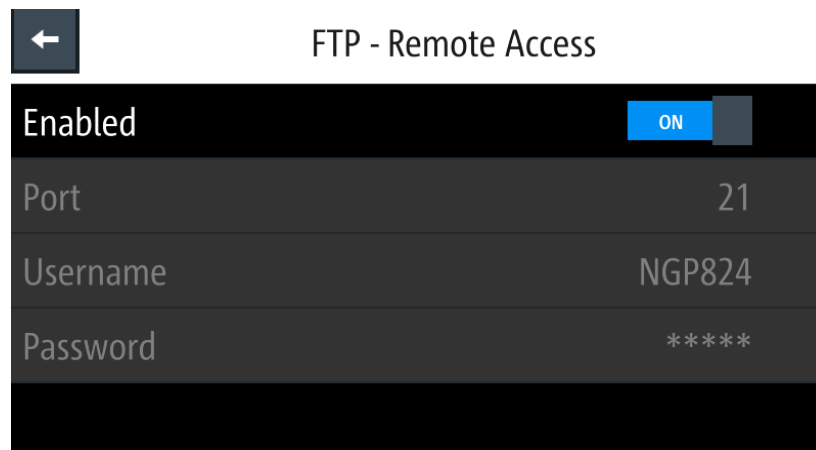

Figure 7-51: FTP settings dialog

2. Set any of the following to configure the **FTP** access:
These settings can only be changed if "Enabled" is set "OFF".
 - FTP "Port": Port number for FTP server.
 - "Username", "Password": User name and password for login access.
Password requirement: Any sequence with at least 1 letter / digit. A valid password is required when using the FTP feature for the first time.

All settings are reset to default after a factory reset. See ["Factory reset"](#) on page 107. Username is reset to device model (e.g. NGP824) and password is reset to device serial number (e.g. 123456).

3. Set "Enabled" to "ON" to enable FTP access.

4. Run the FTP client of your preference and key in the username, password, device IP or hostname and FTP port (default port number: 21) in your FTP client. Some FTP clients (File Explorer, Internet Explorer, etc.) allow connection via a URL-address. The usual syntax for FTP connection is `ftp://<Username>:<Password>@<ip or hostname>[:<port>]`.
If connected successfully, the instrument root directory and USB root directory (if connected) are displayed.

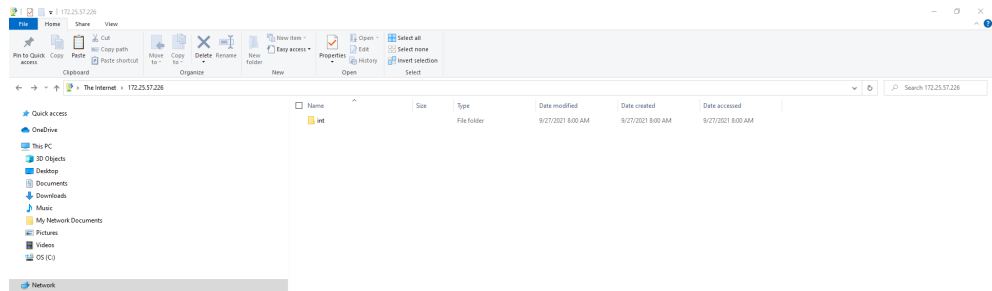

Figure 7-52: Root directory of the instrument using File Explorer

5. For ease of future connections, you can add the connection as a remote network address in the File Explorer.
 - a) Go to the navigation pane on the left side of File Explorer.
 - b) Right-click on "This PC" > "Add a network location".
 - c) Follow the prompt and select a custom network location.
 - d) Enter the URL address mentioned in step 4.
 - e) Enter a name for this new network location, e.g. "FTP Remote Power Supply".
The new network location is created.

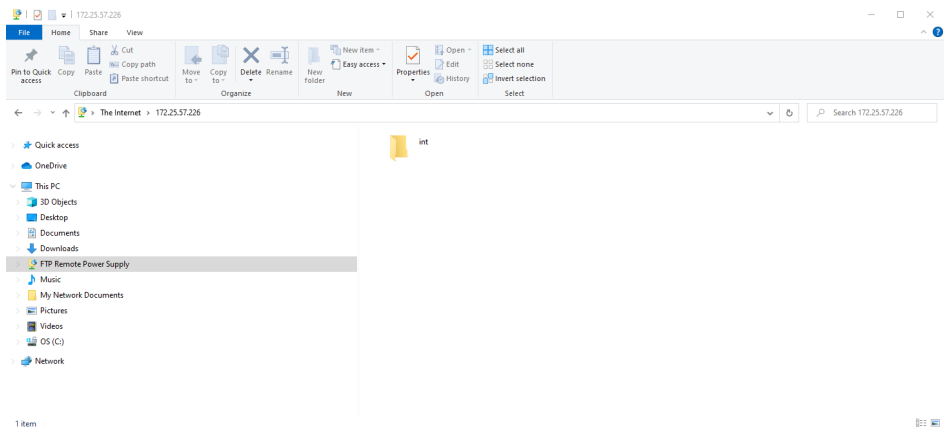

Figure 7-53: New network location

FTP.....	122
L Enabled.....	122
L Port.....	122
L Username.....	122
L Password.....	122

FTP

Configures the [FTP](#) connection.

Enabled ← FTP

Enables or disables FTP access.

"ON" Enables FTP access.

"OFF" Disables FTP access.

Port ← FTP

Sets the port number for FTP server.

Username ← FTP

Sets the user name for login access.

Password ← FTP

Sets the password for login access.

7.16.6 USB connection



Change of USB class

If a change in "USB Class" is detected (i.e. from [TMC](#) to [CDC](#) or vice versa), the rebooting of instrument is necessary to load the correct USB driver.

- A popup message is displayed: "A reboot of the device is required for this setting to take effect."

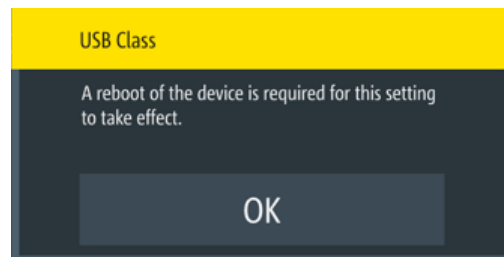

Figure 7-54: USB class - reboot message

Alternatively, connect a USB cable to the USB port (see [Figure 5-3](#)) and PC for a USB connection. The R&S NGP800 supports USB CDC and USB TMC connection.

Access:

1. Select "USB Class" from the "Network Connections" dialog.
The R&S NGP800 displays the USB class dialog to select the USB connection.

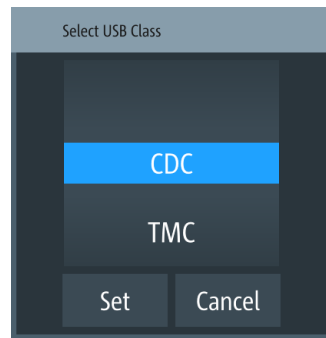

Figure 7-55: USB dialog

2. Set the USB class.
3. Select "Set" to confirm the selection.

USB Class

Configures the USB class.

"CDC" Selects the USB communication device class.

"TMC" Selects the USB test and measurement class.

Remote command:

[INTerfaces:USB:CLASs](#) on page 190

Set ← USB Class

Applies the USB class.

Remote command:

n.a.

Cancel ← USB Class

Cancels the selection and close the window.

Remote command:

n.a.

7.16.7 GPIB address



Instrument option

R&S NG-B105 (P/N: 5601.6000.02) option needs to be installed for the remote command of R&S NGP800 via [GPIB](#) interface.

The GPIB interface, sometimes called the General Purpose Interface Bus (GPIB), is a general purpose digital interface system that can be used to transfer data between two or more devices. Some of its key features are:

- Up to 15 instruments can be connected

- The total cable length is restricted to a maximum of 15 m; the cable length between two instruments should not exceed 2m
- A wired "OR" connection is used if several instruments are connected in parallel

To be able to control the instrument via the GPIB bus, the instrument and the controller must be linked by a GPIB bus cable. A GPIB bus card, the card drivers and the program libraries for the programming language must be provided in the controller. The controller must address the instrument with the GPIB instrument address.

GPIB instrument address

To operate the instrument via remote control, it must be addressed using the **GPIB** address. The default remote control address is factory-set at 20, the addresses of 0 through 30 are allowed.

The GPIB address is maintained after a reset of the instrument settings.

Access:

1. Select "GPIB Address" from the [Figure 7-42](#).
The R&S NGP800 displays an on-screen keypad to set the value.

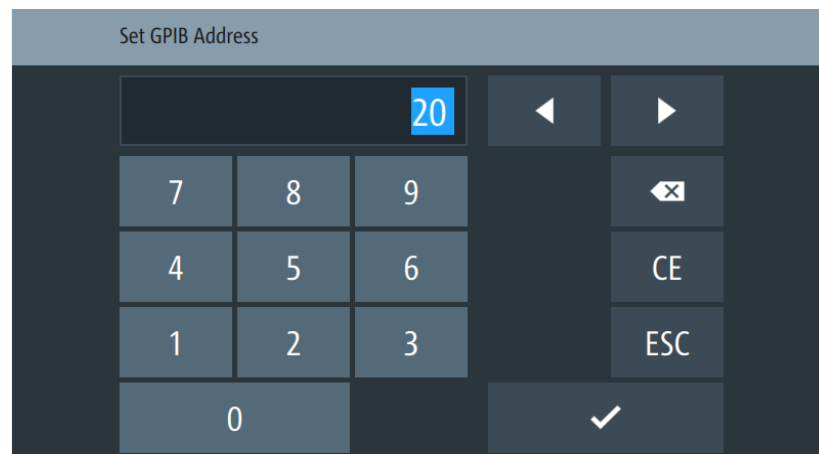



Figure 7-56: On-screen keypad to set GPIB address

2. Enter the required value.
3. Confirm value with the enter key .

GPIB Address

Sets the GPIB address of the instrument.

Remote command:

[SYSTem:INTerface:GPIB?](#) on page 151

7.17 General instrument settings

The following chapters provide the general instrument information and utilities services in "Device" menu.

Access:

1. Press [Settings] key.
The R&S NGP800 displays the device/channel menu window.
2. Select the "Device" tab.
The R&S NGP800 displays the device menu.

7.17.1 Licenses management

Options are enabled by entering a registered license key code.

You may choose to install from an XML file on USB or by manually entering the key code.

Access:

- ▶ Select "Licenses" to install license key code.
The R&S NGP800 displays the license dialog.



Figure 7-57: License dialog

To install an XML file, proceed as follows:

1. Copy the XML file containing the registered key code into the USB flash drive.
2. Connect the USB flash drive to the USB port of the instrument.
3. Select "Load File" to load the license file from the USB stick.
4. Select the license file to install in the instrument.
The R&S NGP800 install the license option accordingly.
If the installation is successful, the option is displayed in the "Active" window.

To enter the key code manually, proceed as follows:

1. Select "Add" key to invoke the license key on-screen keyboard.

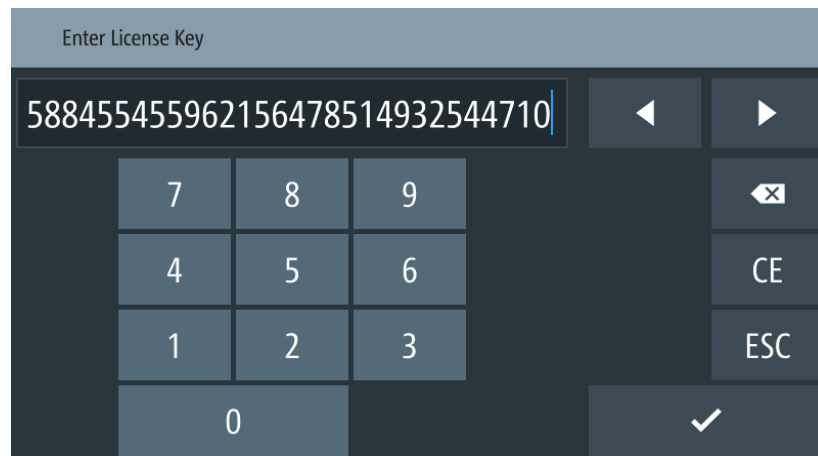

Figure 7-58: License key on-screen keyboard

2. Enter the key code (30-digit number) of the option in the entry box.
3. Confirm entries with the enter key .

If the correct key code is entered, the R&S NGP800 popup a message "Devicekey is installed" and the option is displayed in the "Active" window.
4. To remove the option, select "Remove" from the license dialog.

The R&S NGP800 displays the license key on-screen keyboard. See [Figure 7-58](#).
5. Enter the key code (30-digit number) of the option in the entry box.
6. Confirm entries with the enter key .

If the correct key code is entered, the R&S NGP800 popup a message "Devicekey is removed" and the option is displayed in the "Deactivation" window.

License.....	126
L Active.....	126
L Inactive.....	126
L Deactivation.....	127
L Add.....	127
L Remove.....	127
L Load File.....	127

License

Installation of instrument license key and information display. See also "[Licenses](#)" on page 59.

Active ← License

Displays options that are currently active in the instrument.

Inactive ← License

Displays options that are currently not active in the instrument.

Deactivation ← License

Displays options that are exported or removed in the instrument.

Add ← License

Adds new licenses.

Remove ← License

Removes existing licenses.

Load File ← License

Loads license file from a USB stick.

7.17.2 Appearance settings



Access:

- ▶ Select the "Appearance" to set display and key brightness. The R&S NGP800 displays the appearance dialog.

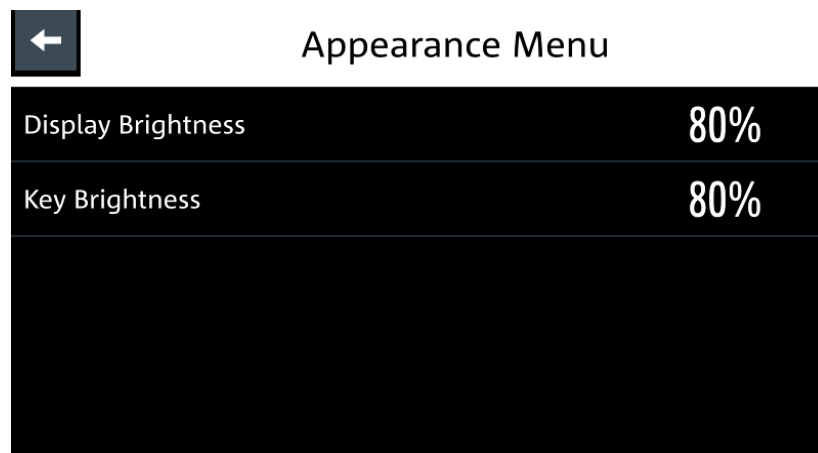

Figure 7-59: Appearance dialog

Appearance

Sets display and key brightness.

Display Brightness ← Appearance

Sets the display brightness.

Remote command:

[DISPlay:BRIGhtness](#) on page 153

Key Brightness ← Appearance

Sets the brightness of the keys.

Remote command:

[SYSTem:KEY:BRIGhtness](#) on page 151

7.17.3 Sound settings



Access:

1. Select the "Sound Settings" to set sound settings.
The R&S NGP800 displays the sound settings dialog.

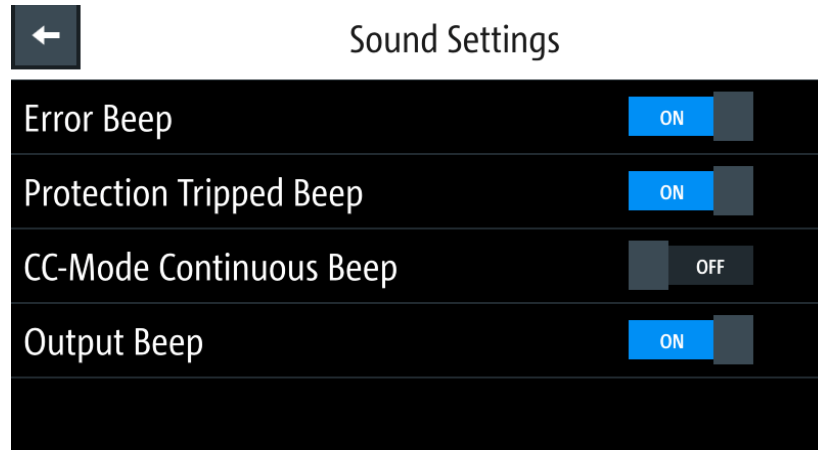

Figure 7-60: Sound settings dialog

2. Select the required fields to set alert.
See "[Sound Settings](#)" on page 128.

Sound Settings

Configures the sound settings of the instrument.

Error Beep ← Sound Settings

Sounds a single beep alert when an error occurs.

"ON" Activates the single beep alert.

"OFF" Deactivates the single beep alert.

Remote command:

[SYSTem:BEEPer:WARNing:STATe](#) on page 147

[SYSTem:BEEPer:WARNing\[:IMMediate\]](#) on page 147

Protection Tripped Beep ← Sound Settings

Sounds a single beep alert when a protection tripped occurs. See [Chapter 7.5, "Protection"](#), on page 74

"ON" Activates the single beep alert.

"OFF" Deactivates the single beep alert.

Remote command:

[SYSTem:BEEPer:PROTection:STATe](#) on page 147

[SYSTem:BEEPer:PROTection\[:IMMediate\]](#) on page 147

CC-Mode Continuous Beep ← Sound Settings

Sounds a continuous beep sound when any channel goes into CC mode. See "[CC mode](#)" on page 64.

"ON" Activates the continuous beep alert.

"OFF" Deactivates the continuous beep alert.

Remote command:

`SYSTem:BEEPer:CURRent:STATe` on page 146

Output Beep ← Sound Settings

Sounds a single beep alert when the output state of any channel changes.

"ON" Activates the single beep alert.

"OFF" Deactivates the single beep alert.

Remote command:

`SYSTem:BEEPer:OUTPut:STATe` on page 146

7.17.4 Date and time



The time is regarded as UTC. There is no timezone selectable.



Access:

1. Select the "Date & Time" to set system date and time.
The R&S NGP800 displays the date and time dialog.

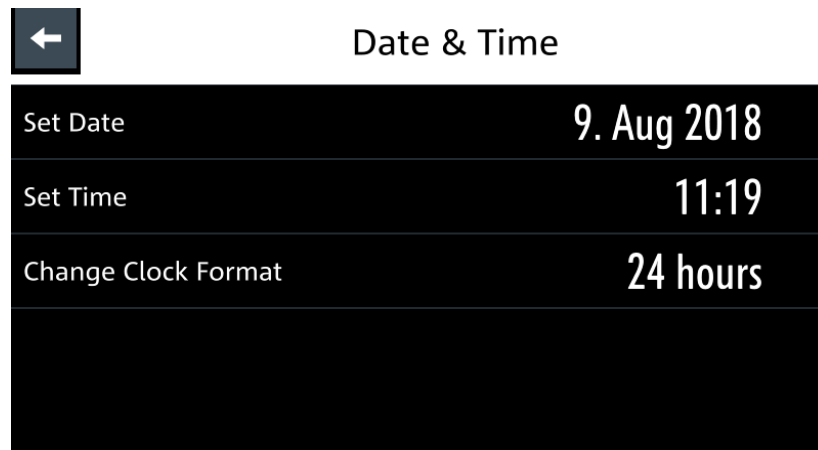

Figure 7-61: Date and time setting dialog

2. Select the required field to configure.
The R&S NGP800 reset the instrument date and time accordingly.

Date & Time

Configures the system date and time.

Set Date ← Date & Time

Sets the system date.

Remote command:

`SYSTem:DATE` on page 150

Set Time ← Date & Time

Sets the system time.

Remote command:

`SYSTem:TIME` on page 152

Change Clock Format ← Date & Time

Switches the clock format between 12 hours and 24 hours.

Remote command:

n.a.

7.17.5 Device information



General instrument information of R&S NGP800.

Access:

- ▶ Select the "Device Information" to display the device information.
The R&S NGP800 displays the device information dialog.

Device Information					
Model:	NGP804	ID: 5601.4007k02	Serial No.:	900100	
Version					
Software:	02.006 01A807C24	Firmware Ch1:	1.141	Firmware Ch3:	1.141
		Firmware Ch2:	1.141	Firmware Ch4:	1.141
Hardware IDs		Temperatures in °C		Misc	
Front:	00.00 900000	Ch1:	25	CPU:	47.69 °C
Ch1&2:	03.03 900005	Ch2:	26	Fan:	20%
Ch3&4:	03.03 900031	Ch3:	26	IP:	172.25.57.170
		Ch4:	26	Memory free:	0 of 975 MB
Close					

Figure 7-62: Device information dialog

Device Information.....	131
L Model.....	131
L ID.....	131
L Serial No.....	131
L Version.....	131
L Hardware IDs.....	131
L Temperatures in °C.....	131
L Misc.....	131

Device Information

Displays instrument information.

Model ← Device Information

Model of the instrument.

Remote command:

[*IDN?](#) on page 143

ID ← Device Information

Instrument orderable part number.

Remote command:

[*IDN?](#) on page 143

Serial No. ← Device Information

Unique identification number for the instrument.

Remote command:

[*IDN?](#) on page 143

Version ← Device Information

Software version that is installed in the instrument.

Remote command:

[*IDN?](#) on page 143

Hardware IDs ← Device Information

Unique serial number of the front and channel boards of the instrument.

Remote command:

n.a.

Temperatures in °C ← Device Information

Temperature in degrees measured in both Ch 1, Ch 2, Ch 3 and Ch 4.

If the temperature exceeded the specification, "Over Temperature Protection" (OTP) is triggered and the respective output channel is turned off.

Remote command:

[CALibration:TEMPerature?](#) on page 211

Misc ← Device Information

Miscellaneous information of the instrument, such as the CPU temperature, instrument IP address, fan speed and memory capacity.

Remote command:

[SYSTem:COMMunicate:SOCKet:IPAddress](#) on page 148

[CALibration:TEMPerature?](#) on page 211

7.17.6 Update device



Latest instrument firmware is available in the R&S NGP800 product homepage.

Access:

1. Select the "Update Device" to update instrument firmware.
The R&S NGP800 displays the update device dialog.

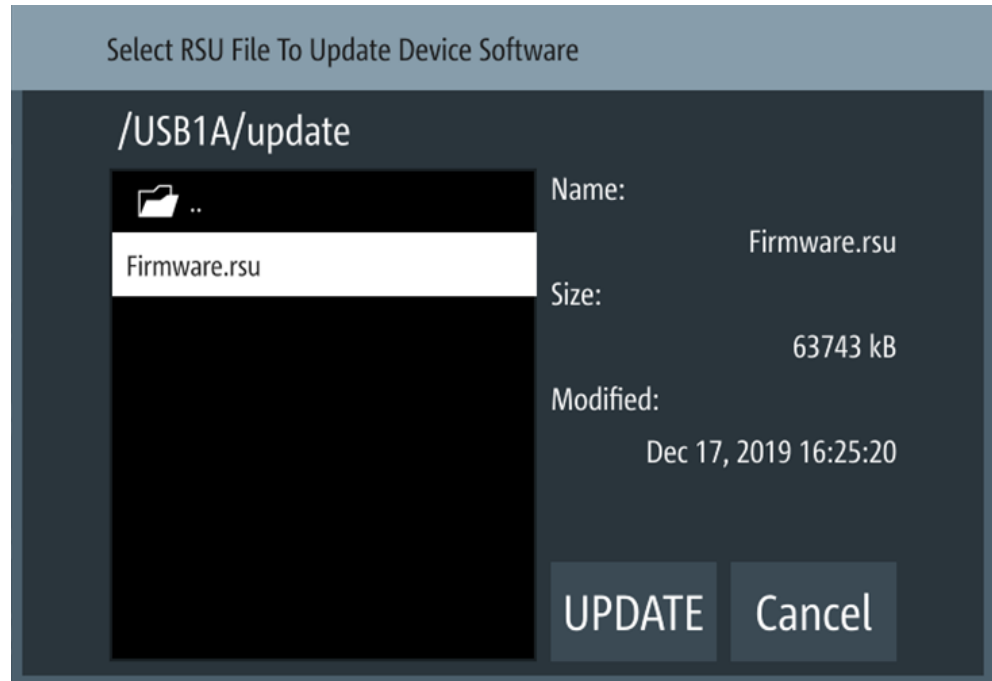

Figure 7-63: Update device dialog

2. Select the file to update instrument firmware.
3. Select "UPDATE" to update the instrument firmware.
The R&S NGP800 updates the instrument firmware accordingly.

Update Device

Displays instrument firmware update information.

<Firmware_list> ← Update Device

Displays all firmware contained in the selected storage location.

UPDATE ← Update Device

Updates the instrument firmware.

Cancel ← Update Device

Cancels the instrument firmware update.

7.18 Adjustment



Adjustment is done at ambient temperature of $25\text{ °C} \pm 2\text{ °C}$.

The instrument must be operated for at least 30 minutes before executing the adjustment.

Thick wires are recommended for connecting the shunt resistor to avoid huge voltage drop and excessive heating.

For ease of maintenance, the R&S NGP800 provides two adjustment procedures which you can apply on the instrument:

- [Chapter 7.18.1, "Analog In adjustment"](#), on page 133
- [Chapter 7.18.2, "Channel adjustment"](#), on page 137

Access:

- ▶ Press [Settings] key.
The R&S NGP800 displays the device/channel menu window.

7.18.1 Analog In adjustment

The "Analog In Adjustment" adjusts the output channel voltage and current when a 0 V to 5 V is applied at the analog input of the terminal block, see ["Digital I/O & analog input connector \(14\)"](#) on page 32.

Depending on the instrument models, up to four analog input pins are adjusted independently.

Table 7-4: Output channel voltage, current for different instrument models

Models	Output channel voltage with 0 V to 5 V applied to analog input pins (ANA IN1, ANA IN2, ANA IN3, ANA IN4)
NGP802, NGP804, NGP814 (Ch 1, Ch 2)	0 V to 32 V, 0A - 20A
NGP822, NGP824, NGP814 (Ch 3, Ch 4)	0 V to 64 V, 0A - 10A

Analog input adjustment setup

Recommended instruments

- Digital multimeter (DMM): 6 ½ digits
- External DC power supply: 1 mV resolution, 0.05 % accuracy with < 500 uVrms ripple
Connect the external DC power supply to the [analog input channel](#) (e.g. ANA_IN1) with respect to the analog ground (AND_GND). Monitor the voltage using digital multimeter.

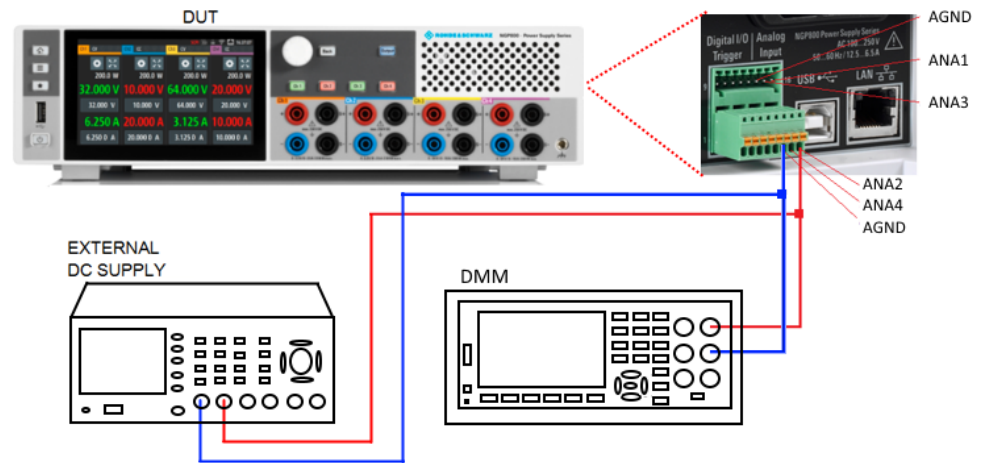

Figure 7-64: Analog input adjustment setup

Access:

1. Select the device tab to perform the analog in adjustment routine.
The R&S NGP800 displays the selected "Adjustment - Analog In" dialog.

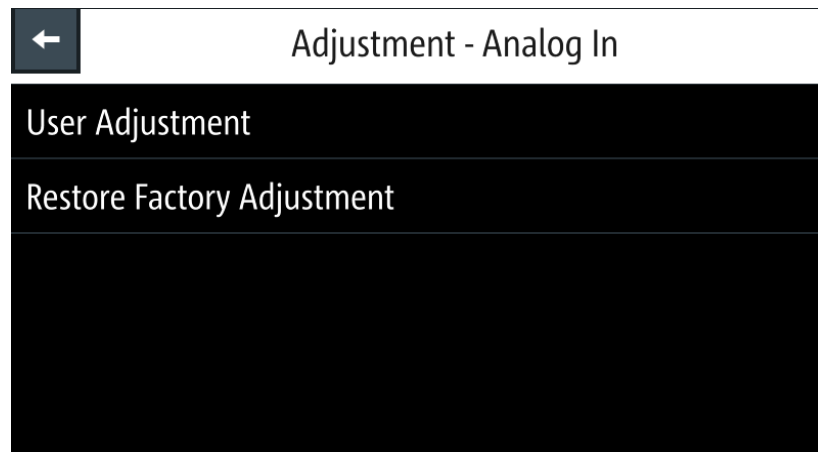

Figure 7-65: Adjustment -Analog In dialog

2. To overwrite user adjustment, select "Restore Factory Adjustment" to restore the analog in factory settings.

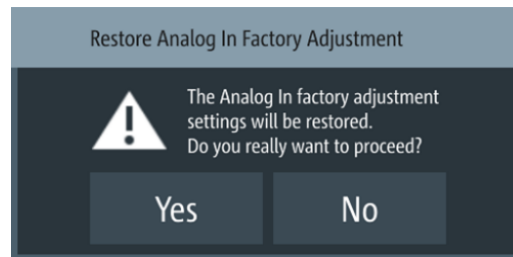

Figure 7-66: Restore analog in factor adjustment message

Select "Yes" to restore factory adjustment.

- To proceed analog in adjustment, select "User Adjustment" in [Figure 7-65](#). The R&S NGP800 displays the "ANALOG IN ADJUSTMENT" wizard to guide the adjustment procedures.

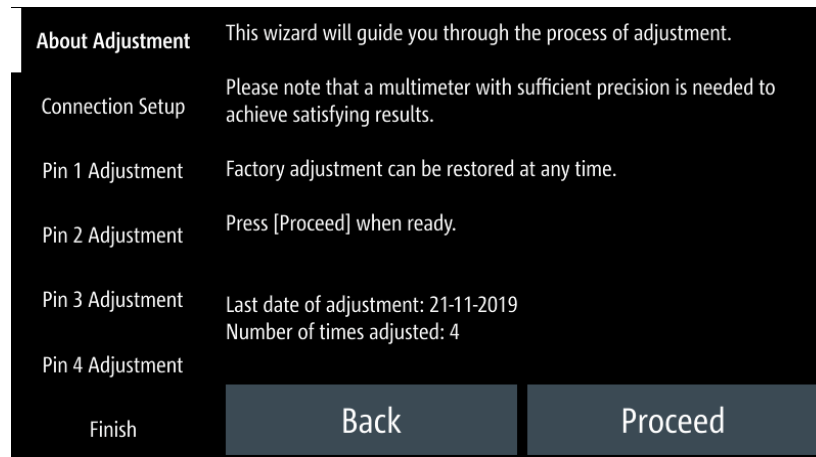

Figure 7-67: Analog in adjustment wizard

- Setup the adjustment with instruments illustrated in [Figure 7-64](#).
- Follow the on-screen instructions displayed in [Figure 7-67](#). Supply the required voltage to the analog input and key in the measured value from DMM using the on-screen keypad. See [Figure 7-68](#).

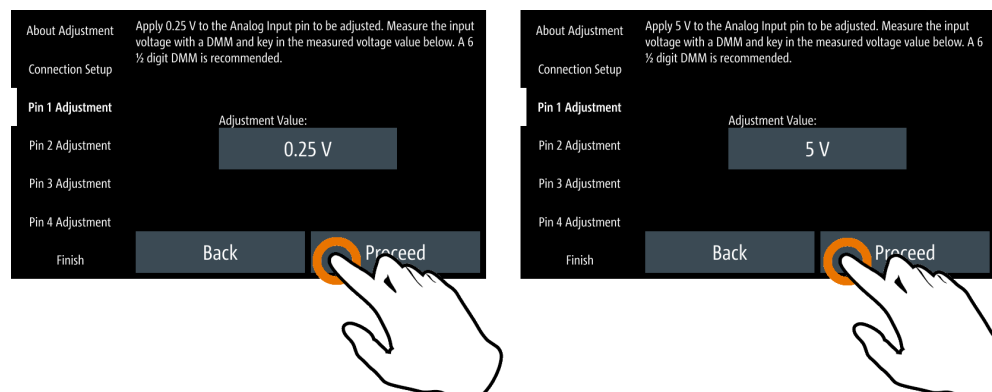



Figure 7-68: Analog in adjustment procedure

6. Confirm the entry with .
7. Leave the setup connections as open.
Select  to start the adjustment automatically.
8. If adjustment is successful, the R&S NGP800 displays a message to indicate that the adjustment is successful.
The R&S NGP800 overwrites the last analog in adjustment.

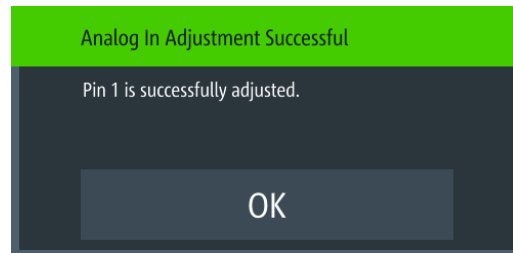

Figure 7-69: Analog in adjustment successful message

9. If adjustment failed after repeated tries, contact your local service partner for support.

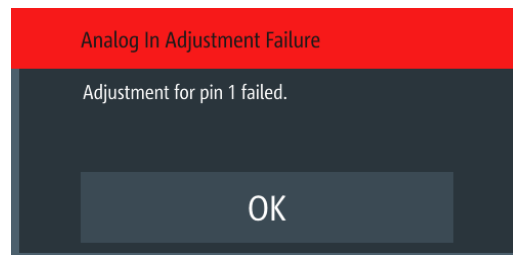

Figure 7-70: Analog in adjustment failure message

Adjustment - Analog In.....	136
L User Adjustment.....	136
L Restore Factory Adjustment.....	137

Adjustment - Analog In

Performs the analog in adjustment procedure.

User Adjustment ← Adjustment - Analog In

Activates user-defined adjustment.

Remote command:

[CALibration:AINPut:DATA](#) on page 208

[CALibration:AINPut:START](#) on page 208

[CALibration:AINPut:COUNT?](#) on page 207

[CALibration:AINPut:SAVE](#) on page 208

[CALibration:AINPut:STATe?](#) on page 209

[CALibration:AINPut:UMAX](#) on page 209

[CALibration:AINPut:UMIN](#) on page 209

[CALibration:AINPut:CANCEl](#) on page 207

[CALibration:AINPut:END](#) on page 208

Restore Factory Adjustment ← Adjustment - Analog In

Restores the analog in factory settings.

Remote command:

[CALibration:AINPut:FACTory:REStore](#) on page 208

7.18.2 Channel adjustment

The "Adjustment" calculates the required adjustment coefficient internally for voltage and current on the selected channel.

Channel adjustment setup

Recommended instruments

- Digital multimeter (DMM): 6 ½ digits
- Shunt resistor: 10 mΩ, at least 25 A rating, 0.02 % accuracy,
- Connect the DMM to the instrument and monitor the measured voltage or current. See [Figure 7-71](#) and [Figure 7-72](#).

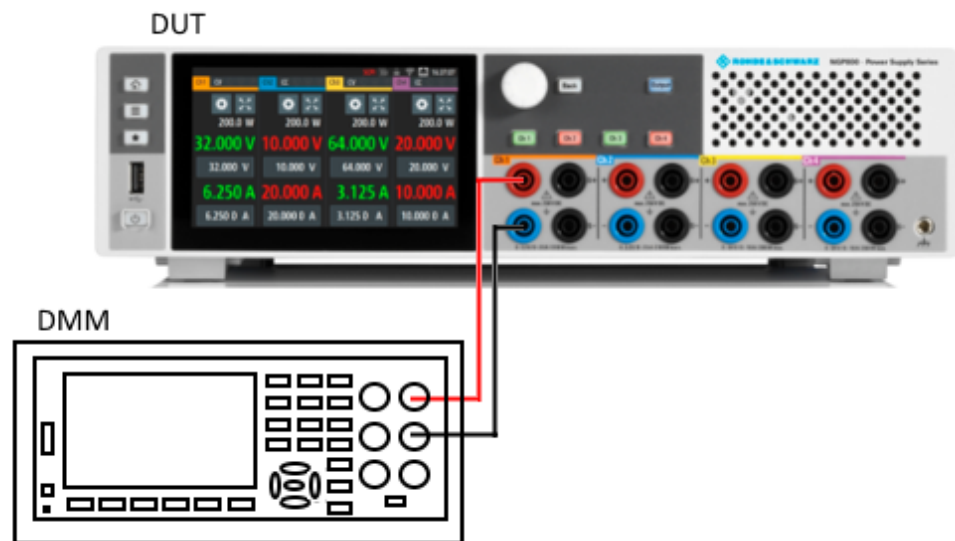

Figure 7-71: Voltage adjustment setup

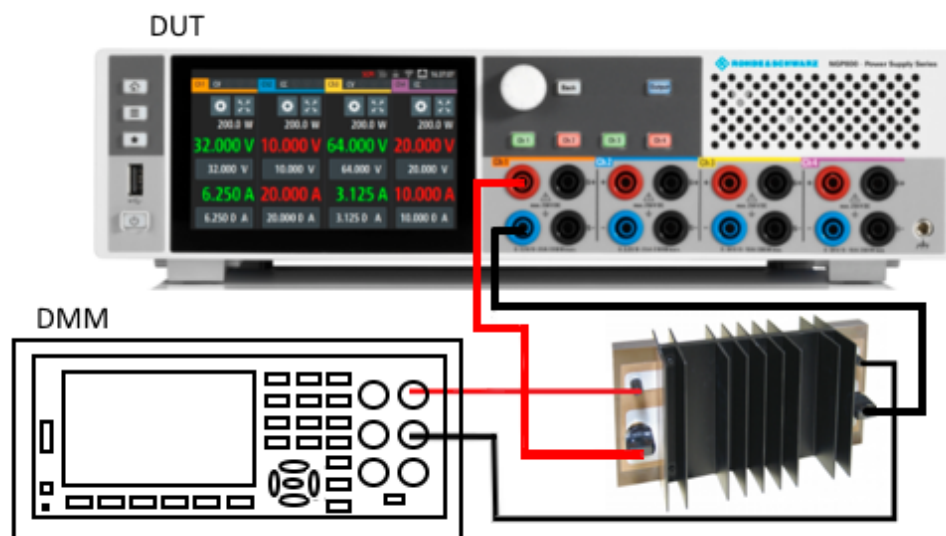

Figure 7-72: Current adjustment setup

Access:

1. Select the desired channel tab to perform the required channel adjustment procedures.

The R&S NGP800 displays the selected channel adjustment dialog.



Figure 7-73: Adjustment dialog

2. To overwrite user adjustment, select "Restore Factory Adjustment" to restore the channel factory settings.

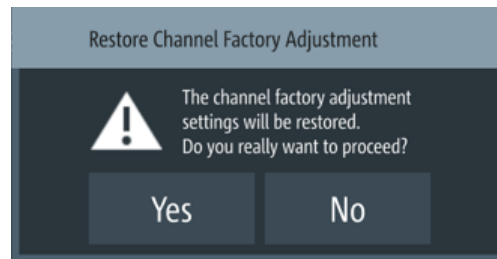

Figure 7-74: Restore channel factory adjustment message

Select "Yes" to restore factory adjustment.

- To proceed channel adjustment, select "User Adjustment" in [Figure 7-73](#). The R&S NGP800 displays the "ADJUSTMENT" wizard to guide the channel adjustment procedures.

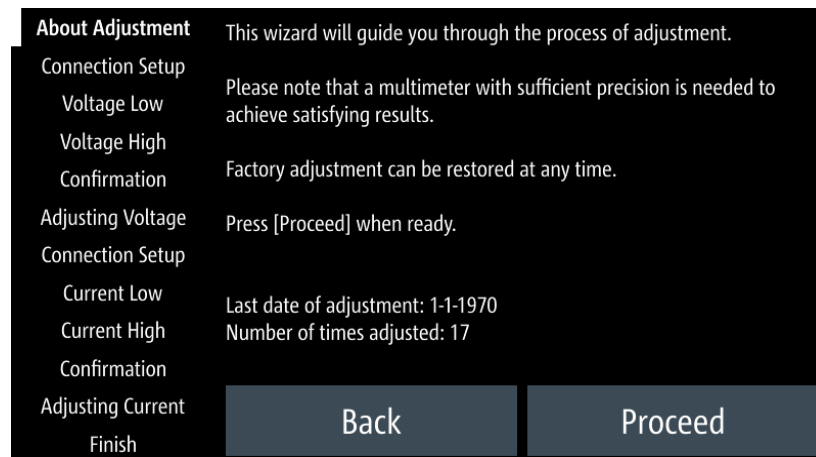

Figure 7-75: Channel adjustment wizard

- Depending on the types of adjustment (voltage or current), setup the instruments illustrated in [Figure 7-71](#) or [Figure 7-72](#).
- Follow the on-screen instructions displayed in the [Figure 7-75](#). The R&S NGP800 applies a low voltage/current followed by a high voltage/current for voltage/current adjustment. Key in the measured value from DMM using the on-screen keypad. See [Figure 7-76](#).

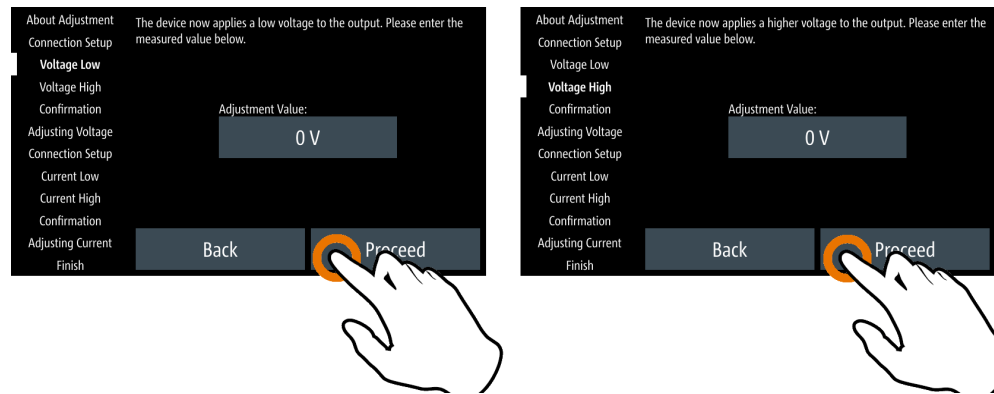

Figure 7-76: Channel adjustment procedure

6. Confirm the entry with .
7. Leave the setup connections as open.
Select to start the voltage adjustment automatically.
8. Follow the on-screen instructions for current adjustment.
9. If adjustment is successful, the R&S NGP800 displays a message to indicate that the adjustment is successful.
The R&S NGP800 overwrites the last channel adjustment.
10. If adjustment failed after repeated tries, contact your local service partner for support.

Adjustment.....	140
↳ User Adjustment.....	140
↳ Restore Factory Adjustment.....	141

Adjustment

Performs the channel adjustment procedure.

User Adjustment ← Adjustment

Activates user-defined adjustment.

Remote command:

- CALibration:USER on page 211
- CALibration:STATe? on page 211
- CALibration:CURREnt:DATA on page 210
- CALibration:VOLTagE:DATA on page 212
- CALibration:VOLTagE:UMIN on page 212
- CALibration:VOLTagE:UMAX on page 212
- CALibration:CURREnt:IMAX on page 210
- CALibration:CURREnt:IMIN on page 210
- CALibration:SAVE on page 211
- CALibration:CANCEL on page 209
- CALibration:COUNT? on page 210

[CALibration:DATE?](#) on page 210

[CALibration:END](#) on page 210

Restore Factory Adjustment ← Adjustment

Restores the factory channel adjustment.

Remote command:

[CALibration:FACTory:REStore](#) on page 211

8 Remote control commands

This chapter provides the description of all remote commands available for the R&S NGP800 series. The commands are sorted according to the menu structure of the instrument. A list of commands in alphabetical order is given in the "List of Commands" at the end of this documentation.

For more information on [Messages and SCPI command structure](#), [Messages and SCPI command structure](#) and [Structure of a SCPI status register](#), see the "Annex" at the end of this documentation.

8.1 Common setting commands

Common commands are described in the IEEE 488.2 (IEC 625-2) standard. These commands have the same effect and are employed in the same way on different devices. The headers of these commands consist of "*" followed by three letters.

Many common commands are related to the Status Reporting System.

*CLS.....	142
*ESE.....	142
*ESR?.....	143
*IDN?.....	143
*OPC.....	143
*OPT?.....	143
*RST.....	144
*SRE.....	144
*STB?.....	144
*TST?.....	144
*WAI.....	144
*SAV.....	145
*RCL.....	145

*CLS

Clear status

Sets the status byte (STB), the standard event register (ESR) and the `EVENT` part of the `QUESTIONABLE` and the `OPERATION` registers to zero. The command does not alter the mask and transition parts of the registers. It clears the output buffer.

Usage: Setting only

*ESE <Value>

Event status enable

Sets the event status enable register to the specified value. The query returns the contents of the event status enable register in decimal form.

Parameters:

<Value> Range: 0 to 255

***ESR?**

Event status read

Returns the contents of the event status register in decimal form and then sets the register to zero.

Return values:

<Contents> Range: 0 to 255

Usage: Query only

***IDN?**

Identification

Returns the instrument identification.

Return values:

<ID> "Rohde&Schwarz,<device type>,<part number>,<serial number>,<firmware version>"

Example: Rohde&Schwarz,NGP802,5601.4007k05/900213,02.02000EEED429B

Manual operation: See "[Model](#)" on page 131
 See "[ID](#)" on page 131
 See "[Serial No.](#)" on page 131
 See "[Version](#)" on page 131

***OPC**

Operation complete

Sets bit 0 in the event status register when all preceding commands have been executed. This bit can be used to initiate a service request. The query writes a "1" into the output buffer when all preceding commands have been executed, which is useful for command synchronization.

The R&S NGP800 does not support parallel processing of remote commands. If the query *OPC? returns a „1“, the device is able to process new commands.

***OPT?**

Option identification query

Queries the options included in the instrument. For a list of all available options and their description, refer to the data sheet.

Usage: Query only

***RST**

Reset

Sets the instrument to a defined default status. The default settings are indicated in the description of commands.

We recommend to start a program by *RST in order to set the instrument to a defined status prior to starting a program.

Usage: Setting only

Manual operation: See "[Default Settings](#)" on page 109

***SRE** <Contents>

Service request enable

Sets the service request enable register to the indicated value. This command determines under which conditions that a service request is triggered.

The SRE is an enable register. Consequently, there are no denotations about the bits. This register conduce for the "OR" combination of the bits in the status byte.

Parameters:

<Contents> Contents of the service request enable register in decimal form.
Bit 6 (MSS mask bit) is always 0.

Range: 0 to 255

***STB?**

Status byte query

Reads the contents of the status byte in decimal form.

Usage: Query only

***TST?**

Self-test query

Initiates self-tests of the instrument and returns an error code.

Return values:

<ErrorCode> **integer > 0 (in decimal format)**

An error occurred.

0

No errors occurred.

Usage: Query only

***WAI**

Wait to continue

Prevents servicing of the subsequent commands until all preceding commands have been executed and all signals have settled (see also command synchronization and *OPC).

Usage: Event

***SAV** <Number>

Save

Stores the current instrument settings under the specified number in an internal memory. The settings can be recalled using the command *RCL with the associated number.

Parameters:

<Number> Range: 0..9

Manual operation: See "Save Settings to file" on page 109

***RCL** <Number>

Recall

Loads the instrument settings from an internal memory identified by the specified number. The instrument settings can be stored to this memory using the command *SAV with the associated number.

Parameters:

<Number> Range: 0..9

Manual operation: See "Recall Settings from file" on page 109

8.2 System settings commands

The SYSTem subsystem contains the commands for general functions, which do not affect signal generation directly.

SYSTem:BEEPer:CURRent:STATe.....	146
SYSTem:BEEPer:OUTPut:STATe.....	146
SYSTem:BEEPer:PROTection:STATe.....	147
SYSTem:BEEPer:PROTection[:IMMediate].....	147
SYSTem:BEEPer:WARning:STATe.....	147
SYSTem:BEEPer:WARning[:IMMediate].....	147
SYSTem:COMMunicate:SOCKet:APPLY.....	147
SYSTem:COMMunicate:SOCKet:DHCP.....	148
SYSTem:COMMunicate:SOCKet:DISCard.....	148
SYSTem:COMMunicate:SOCKet:GATeway.....	148
SYSTem:COMMunicate:SOCKet:IPADdress.....	148
SYSTem:COMMunicate:SOCKet:MASK.....	149
SYSTem:COMMunicate:SOCKet:RESet.....	149
SYSTem:COMMunicate:WLAN:CONNECTION[:STATe].....	149

SYSTem:COMMunicate:WLAN:IPADdress?	149
SYSTem:COMMunicate:WLAN:PASSword	150
SYSTem:COMMunicate:WLAN:SSID	150
SYSTem:COMMunicate:WLAN[:STATe]	150
SYSTem:DATE	150
SYSTem:KEY:BRIGhtness	151
SYSTem:INTerface?	151
SYSTem:INTerface:GPIB?	151
SYSTem:LOCal	151
SYSTem:REMote	152
SYSTem:RWLock	152
SYSTem:TIME	152
SYSTem:TOUCh[:STATe]	152
SYSTem:VNC:PORT	152
SYSTem:VNC:STATe	153
SYSTem:UPTime?	153

SYSTem:BEEPer:CURRent:STATe <arg0>**SYSTem:BEEPer:CURRent:STATe?**

Sets or queries "current control" beeper tone state.

Parameters:

<mode>	1
	Control beeper is activated.
	0
	Control beeper is deactivated.

Example:

```
SYSTem:BEEPer:CURRent:STATe 1
```

The "CC-Mode Continuous Beep" is activated, a continue beep sound alert when any output channel goes into CC mode.

Manual operation: See "[CC-Mode Continuous Beep](#)" on page 128

SYSTem:BEEPer:OUTPut:STATe <arg0>**SYSTem:BEEPer:OUTPut:STATe?**

Sets or queries "output" beeper tone state.

Parameters:

<state>	1
	Output beeper is activated.
	0
	Output beeper is deactivated.

Example:

```
SYSTem:BEEPer:OUTPut:STATe 1
```

The "Output Beep" is activated, a single beep alert when the output state of any channel is changed.

Manual operation: See "[Output Beep](#)" on page 129

SYSTem:BEEPer:PROTection:STATe <arg0>
SYSTem:BEEPer:PROTection:STATe?

Sets or queries "protection" beeper tone state.

Parameters:

<mode> **1**
 Protection beeper is activated.
0
 Protection beeper is deactivated.

Example: SYSTem:BEEPer:PROTection:STATe 1
 The "Protection Tripped Beep" is activated, a single beep alert
 when a protection tripped event occurs.

Manual operation: See "[Protection Tripped Beep](#)" on page 128

SYSTem:BEEPer:PROTection[:IMMEDIATE]

Returns a single "protection" beep immediately.

Usage: Event

Manual operation: See "[Protection Tripped Beep](#)" on page 128

SYSTem:BEEPer:WARNIing:STATe <arg0>
SYSTem:BEEPer:WARNIing:STATe?

Sets or queries "error/warning" beeper tone state.

Parameters:

<state> **1**
 Beep sound for "error/warning" is enabled.
0
 Beep sound for "error/warning" is disabled.

Manual operation: See "[Error Beep](#)" on page 128

SYSTem:BEEPer:WARNIing[:IMMEDIATE]

Returns a single "error/warning" beep immediately.

Usage: Event

Manual operation: See "[Error Beep](#)" on page 128

SYSTem:COMMunicate:SOCKet:APPLY

Apply LAN configuration settings.

Usage: Event

Manual operation: See "[Apply Configuration](#)" on page 115

SYSTem:COMMunicate:SOCKet:DHCP <arg0>

Sets the LAN interface mode.

Parameters:

<mode>	1	DHCP is enabled. Automatic IP address from DHCP server.
	0	DHCP is disabled. Manually set IP address.

Manual operation: See "[DHCP & Auto-IP](#)" on page 114

SYSTem:COMMunicate:SOCKet:DISCard

Discards LAN settings.

Usage: Event

Manual operation: See "[Apply Configuration](#)" on page 115

SYSTem:COMMunicate:SOCKet:GATeway <arg0>**SYSTem:COMMunicate:SOCKet:GATeway?**

Sets or queries gateway for LAN.

Parameters:

<address> Gateway address.

Example: SYSTem:COMMunicate:SOCKet:GATeway?
Return gateway address from LAN.

Manual operation: See "[Gateway](#)" on page 115

SYSTem:COMMunicate:SOCKet:IPADdress <arg0>**SYSTem:COMMunicate:SOCKet:IPADdress?**

Sets or queries IP address of the LAN interface.

Parameters:

<address> IP address.

Example: SYSTem:COMMunicate:SOCKet:IPADdress
"192.168.1.128"
Set IP address 192.168.1.128 for the LAN interface.

Manual operation: See "[IP Address](#)" on page 114
See "[Misc](#)" on page 131

SYSTem:COMMunicate:SOCKet:MASK <arg0>
SYSTem:COMMunicate:SOCKet:MASK?

Sets or queries the subnet mask for LAN.

Parameters:

<address> Subnet address.

Example: SYSTem:COMMunicate:SOCKet:MASK "255.255.0.0"
 Set subnet mask 255.255.0.0

Manual operation: See "[Subnet Mask](#)" on page 115

SYSTem:COMMunicate:SOCKet:RESet

Resets LAN settings.

Usage: Event

Manual operation: See "[Apply Configuration](#)" on page 115

SYSTem:COMMunicate:WLAN:CONNECTION[:STATE] <arg0>
SYSTem:COMMunicate:WLAN:CONNECTION[:STATE]?

Sets or queries WLAN connection state.

Parameters:

<mode> **1**
 Connect WLAN to the predefined wireless access point.
0
 Disconnect WLAN from the predefined wireless access point.

Example: SYSTem:COMMunicate:WLAN:CONNECTION 0
 Disconnect WLAN from the predefined wireless access point.

Options: R&S NGP-K102
 Instrument with serial number below 110000

Manual operation: See "[Connect / Disconnect](#)" on page 117

SYSTem:COMMunicate:WLAN:IPADdress?

Queries IP address for WLAN.

Example: SYSTem:COMMunicate:WLAN:IPADdress?
 Return IP address for WLAN.

Usage: Query only

Options: R&S NGP-K102
 Instrument with serial number below 110000

Manual operation: See "[Select Network](#)" on page 117

SYSTem:COMMunicate:WLAN:PASSword <arg0>

Sets password for WLAN.

Parameters:

<password> WLAN password.

Example:

SYSTem:COMMunicate:WLAN:PASSword "Password01"
Set WLAN password.

Options:

R&S NGP-K102
Instrument with serial number below 110000

Manual operation: See ["Select Network"](#) on page 117

SYSTem:COMMunicate:WLAN:SSID <arg0>**SYSTem:COMMunicate:WLAN:SSID?**

Sets or queries SSID of the access point when wireless interface works as a client.

Parameters:

<ssid> SSID of access point.

Example:

SYSTem:COMMunicate:WLAN:SSID?
Return SSID of access point for WLAN.

Options:

R&S NGP-K102
Instrument with serial number below 110000

Manual operation: See ["Select Network"](#) on page 117

SYSTem:COMMunicate:WLAN[:STATe] <arg0>**SYSTem:COMMunicate:WLAN[:STATe]?**

Sets or queries the WLAN state.

Parameters:

<state> **1**
Enable WLAN.

0
Disable WLAN.

Options:

R&S NGP-K102
Instrument with serial number below 110000

Manual operation: See ["Wireless LAN"](#) on page 111
See ["Enabled"](#) on page 117

SYSTem:DATE <arg0>, <arg1>, <arg2>**SYSTem:DATE?**

Sets or queries the system date.

Parameters:

<year> Sets year of the date.
 <month> Sets month of the date.
 <arg2> Sets day of the date.

Example: `SYSTem:DATE 2018, 10, 15`
`SYSTem:DATE? -> 2018, 10, 15`
 Returns the system date.

Manual operation: See "[Set Date](#)" on page 129

SYSTem:KEY:BRIGhtness <arg0>**SYSTem:KEY:BRIGhtness?**

Sets or queries the front panel key brightness.

Parameters:

<brightness> Sets the key brightness.
 Range: 0.0 to 1.0
 Increment: 0.1
 *RST: 1.0

Example: `SYSTem:KEY:BRIGhtness 1.0`
`SYSTem:KEY:BRIGhtness? -> 1.0`
 Returns key brightness value: 1.0.

Manual operation: See "[Key Brightness](#)" on page 127

SYSTem:INTerface?

Queries the available system interface.

Usage: Query only

Manual operation: See "[Network](#)" on page 111

SYSTem:INTerface:GPIB?

Queries the GPIB interface information.

Usage: Query only

Manual operation: See "[GPIB Address](#)" on page 124

SYSTem:LOCal

Sets the system to front panel control. The front panel control is unlocked. If the front panel control was locked with the SCPI command `SYSTem:RWLock`, the message box of the locked front panel on the instrument display will be disappeared.

Usage: Event

SYSTem:REMOte

Sets the system to remote state. The front panel control is locked. By pushing the soft-key button [*] key, the front panel control will be activated.

Usage: Event

SYSTem:RWLock

Sets the system to remote state. The front panel control is locked and a message box is shown on the instrument display. You are only able to unlock the front panel control via SCPI command `SYSTem:LOCal`.

Usage: Event

SYSTem:TIME <arg0>, <arg1>, <arg2>**SYSTem:TIME?**

Sets or queries the system time.

Parameters:

<hh> Sets the hours of the system time.
 <mm> Sets the minutes of the system time.
 <ss> Sets the seconds of the system time.

Example: `SYSTem:TIME 12, 30, 59`
`SYSTem:TIME? -> 12, 30, 59`
 Returns system time.

Manual operation: See "[Set Time](#)" on page 130

SYSTem:TOUCH[:STATe] <arg0>**SYSTem:TOUCH[:STATe]?**

Sets or queries the touch interface state.

Parameters:

<state> **1**
 Touch interface is activated.
0
 Touch interface is deactivated.

Manual operation: See "[TouchLock](#)" on page 95

SYSTem:VNC:PORT <arg0>**SYSTem:VNC:PORT?**

Sets or queries the VNC port number.

Parameters:

<Port> Range: 100 to 65535

Manual operation: See "VNC Port" on page 120

SYSTem:VNC:STATe <arg0>
SYSTem:VNC:STATe?

Sets or queries the VNC state.

Parameters:

<state> **1**
 Enable VNC.
 0
 Disable VNC.

Manual operation: See "VNC" on page 112
 See "Enabled" on page 119

SYSTem:UPTime?

Queries system uptime.

Usage: Query only

8.3 Display commands

The `DISPlay` subsystem contains the commands for display functions, which do not affect signal generation directly.

<code>DISPlay:BRIGhtness</code>	153
<code>DISPlay[:WINDow]:TEXT:CLEar</code>	154
<code>DISPlay[:WINDow]:TEXT[:DATA]</code>	154

DISPlay:BRIGhtness <arg0>
DISPlay:BRIGhtness?

Sets or queries the display brightness.

Parameters:

<brightness> Displays brightness for the instrument.
 Range: 0.0 to 1.0
 Increment: 0.1
 *RST: 0.8

Example: `DISPlay:BRIGhtness 0.5`
 `DISPlay:BRIGhtness? -> 0.5`
 Returns the display brightness value.

Manual operation: See "Display Brightness" on page 127

DISPlay[:WINDow]:TEXT:CLEar

Clears the text message box on the front display.

Usage: Event

DISPlay[:WINDow]:TEXT[:DATA] <arg0>

Shows the text message box on the front display.

Setting parameters:

<text> New value for text message box.

Usage: Setting only

8.4 Trigger commands

The TRIGger subsystem contains the commands for DIO signal triggering.

TRIGger:CHANnel:DIO<IO>.....	154
TRIGger:CONDition:DIO<IO>.....	155
TRIGger:DIRection:DIO<IO>.....	156
TRIGger:LOGic:DIO<IO>.....	157
TRIGger[:ENABle]:DIO<IO>.....	157
TRIGger[:ENABle]:GENeral.....	157
TRIGger[:ENABle]:SELect:DIO<IO>.....	158

TRIGger:CHANnel:DIO<IO> <arg0>**TRIGger:CHANnel:DIO<IO>?**

Sets or queries the trigger channel of the specified digital I/O line.

Suffix:

<IO> 1..8

Parameters:

<channel> NONE | CH1 | CH2 | CH3 | CH4 | ALL

NONE

No channel is set as the trigger channel.

CH1

Ch 1 is set as the trigger channel.

CH2

Ch 2 is set as the trigger channel.

CH3

Ch 3 is set as the trigger channel.

CH4

Ch 4 is set as the trigger channel.

CHALI

All channels are set as the trigger channel.

Manual operation: See "Channel" on page 86

TRIGger:CONDition:DIO<IO> <arg0>[, <arg1>]
TRIGger:CONDition:DIO<IO>?

Sets or queries the trigger condition of the specified digital I/O line.

Suffix:

<IO> 1..8

Parameters:

<mode> OUTPUT | OVP | FUSE | OTP | OPP | VMODe | CMODe |
 VLEVel | ILEVel | ENABle | INHibit | ARB | ARBPoint |
 ARBGroup | RAMP | ANINput | STATistics | LOG | PLEVel

OUTPUT

Output the selected logic level when the output is turned on at the selected channel.

OVP

Output the selected logic level when the selected critical event (OVP) occurs on the selected channel.

FUSE

Output the selected logic level when a fuse tripped event occurs on the selected channel.

OTP

Output the selected logic level when the selected critical event (OTP) occurs on the selected channel.

OPP

Output the selected logic level when the selected critical event (OPP) occurs on the selected channel.

VMODe

Output the selected logic level when the selected channel operates in the CV mode.

CMODe

Output the selected logic level when the selected channel operates in the CC mode.

VLEVel

Output the selected logic level when the voltage level of the selected channel is greater or equal to the set voltage level, i.e. $V_{set} \geq \text{set value}$.

ILEVel

Output the selected logic level when the current level of the selected channel is greater or equal to the set current level, i.e. $I_{set} \geq \text{set value}$.

ENABle

Selected channel output is turned on when the selected logic level is met.

INHibit

Selected channel output is inhibited when the selected logic level is met.

Note 1: If the selected channel output is put to inhibit state, manual or remote operation on selected channel output is no longer possible.

Note 2: To reverse the inhibit state, remove the source of the trigger signal. You can either disable the affected DIO interface or remove the source from the affected DIO interface at the rear panel.

ARB

Selected channel QuickArb function is enabled when the selected logic level is met.

ARBPoint

Selected channel QuickArb function is stepped to the next point when the selected logic level is met.

ARBGroup

Selected channel QuickArb function is stepped to the next group when the selected logic level is met.

RAMP

Selected channel ramp is enabled when the selected logic level is met.

ANINput

Selected channel analog input is enabled when the selected logic level is met.

STATistics

Selected channel statistic is enabled when the selected logic level is met.

LOG

For output mode - output the selected logic level when logging is enabled.

For input mode - Logging is enabled when the selected logic level is met.

PLEVel

Output the selected logic level when the power level of the selected channel is greater or equal to the set power level, i.e. PLEVel >= set value.

<value>

Mode value.

Manual operation: See "[Mode](#)" on page 85
See "[Operation Mode](#)" on page 86

TRIGger:DIRection:DIO<IO> <arg0>

TRIGger:DIRection:DIO<IO>?

Sets or queries the specified digital I/O line to function as trigger input/output.

Suffix:
 <IO> 1..8

Parameters:
 <logic> OUTPut | INPut
 *RST: OUTPut

Example: TRIGger:DIRection:DIO2 OUT

Manual operation: See "[Direction](#)" on page 85

TRIGger:LOGic:DIO<IO> <arg0>
 TRIGger:LOGic:DIO<IO>?

Sets or queries the trigger logic ("Active High" / "Active Low") of the specified digital I/O line.

Suffix:
 <IO> 1..8

Parameters:
 <logic> LOW | HIGH
 *RST: HIGH

Manual operation: See "[Active Level](#)" on page 85

TRIGger[:ENABle]:DIO<IO> <arg0>
 TRIGger[:ENABle]:DIO<IO>?

Sets or queries the enable state of the specified digital I/O line.

Suffix:
 <IO> 1..8

Parameters:
 <state> 1
 Selected digital I/O line is enabled.
 0
 Selected digital I/O line is disabled.
 *RST: 0

Manual operation: See "[Pin 1 / ... / Pin 8](#)" on page 85
 See "[Enable](#)" on page 85

TRIGger[:ENABle]:GENeral <arg0>
 TRIGger[:ENABle]:GENeral?

Sets or queries the enable state of the master on/off of digital I/O trigger.

Parameters:
 <master_state> 1
 Master state of digital I/O trigger is enabled.

0

Master state of digital I/O trigger is disabled.

*RST: 0

Manual operation: See "Digital I/O Trigger" on page 58**TRIGger[:ENABLE]:SElect:DIO<IO> <arg0>****TRIGger[:ENABLE]:SElect:DIO<IO>?**

Sets or queries the enable state of the specified digital I/O line.

Suffix:

<IO> 1..8

Parameters:<state> **1**
The specified digital I/O line is enabled.**0**

The specified digital I/O line is disabled.

Manual operation: See "Pin 1 / ... / Pin 8" on page 85
See "Enable" on page 85

8.5 Configuration commands

The following subsystems contain the commands for channel selection, voltage and current settings for the instrument.

8.5.1 Channel selection

The `INSTRument:Select` subsystem contains the commands for selecting the output channels.

Each channel of the power supply is considered as separate "instrument", which is required by the SCPI standard. Therefore, the SCPI commands use the `INSTRument` node to select a channel.



You can only address the number of channels a device is equipped with, e.g. a maximum of four channels for the NGP804, NGP824, NGP814 or two channels for the NGP802, NGP822.

Example: Selecting a channel

You can select a channel either with an `OUTput` parameter, or just by the channel number. This example lists all ways how you can select and query a selected channel.

```
// *****
// Select a channel
// *****
// selects channel 1
INST OUT1
// queries the channel selection
INST?
// response: "OUT1"
// *****
// Select a channel by its number
// *****
// selects channel number 1
INST:NSEL 1
// queries number of the channel selection
INST:NSEL?
// response: 1
```

[INSTrument:NSElect](#)..... 159
[INSTrument\[:SElect\]](#)..... 159

INSTrument:NSElect <arg0>
INSTrument:NSElect?

Selects or queries the channel by number.

Setting parameters:

<channel> 1 | 2 | 3 | 4
 Range: 1 to 4

Example: See [Example "Selecting a channel"](#) on page 159.

Manual operation: See "[\[Ch 1\] / \[Ch 2\] / \[Ch 3\] / \[Ch 4\]](#)" on page 62

INSTrument[:SElect] <arg0>
INSTrument[:SElect]?

Selects or queries the channel by keyword.

Setting parameters:

<channel> OUT1 | OUTP1 | OUTPut1 | CH1 | OUT2 | OUTP2 | OUTPut2 |
 CH2 | OUT3 | OUTP3 | OUTPut3 | CH3 | OUT4 | OUTP4 |
 OUTPut4 | CH4
 OUT1 | OUTP1 | OUTPut1 | CH1
 Selects Channel 1 (Ch 1)
 OUT2 | OUTP2 | OUTPut2 | CH2
 Selects Channel 2 (Ch 2)

OUT3 | OUTP3 | OUTPut3 | CH3

Selects Channel 3 (Ch 3)

OUT4 | OUTP4 | OUTPut4 | CH4

Selects Channel 4 (Ch 4)

Example: See [Example"Selecting a channel"](#) on page 159.

Manual operation: See "[Ch 1] / [Ch 2] / [Ch 3] / [Ch 4]" on page 62

8.5.2 Safety limit setting

The `SOURCE:ALIM` subsystem contains the commands for setting the safety limits of the output channels.

Example: Configuring the safety limit

This example contains all commands to configure and query the voltage and current safety limit.

```
// *****
// Select the channel
// *****
// selects channel 1
INST OUT1
// *****
// Set upper or lower voltage safety limit
// *****
//sets the safety limits to enable
ALIM 1
//queries the safety limits state
ALIM?
//response: "1"
//sets the safety limits for the upper voltage
VOLT:ALIM 15
//queries the safety limits for the upper voltage
VOLT:ALIM?
//reponse: "15.000"
//sets the safety limits for the lower voltage
VOLT:ALIM:LOW 0
//queries the safety limits for the lower voltage
VOLT:ALIM:LOW?
//reponse: "0.000"
*****
// Set upper or lower current safety limit
// *****
//sets the safety limits for the upper current
CURR:ALIM 3
//queries the safety limits for the upper current
CURR:ALIM?
//reponse: "3.0000"
//sets the safety limits for the lower current
CURR:ALIM:LOW 0
//queries the safety limits for the lower current
CURR:ALIM:LOW?
//reponse: "0.0000"
```

[SOURCE:]ALIMit[:STATe].....	162
[SOURCE:]VOLTage[:LEVel][:IMMediate]:ALIMit:LOWer.....	162
[SOURCE:]VOLTage[:LEVel][:IMMediate]:ALIMit:UPPer.....	163
[SOURCE:]CURRent[:LEVel][:IMMediate]:ALIMit:LOWer.....	163
[SOURCE:]CURRent[:LEVel][:IMMediate]:ALIMit:UPPer.....	164

[SOURCE:]ALIMit[:STATe] <arg0>[, <Channel list>
[SOURCE:]ALIMit[:STATe]? [<Channel list>]

Sets or queries the safety limit state.

Parameters:

<state> **1**
 Activates the safety limit.

0
 Deactivates the safety limit.

Parameters for setting and query:

<Channel list> <list>

Example: ALIM 1, (@1)
 Activates the safety limit state at channel 1

Example: See [Example"Configuring the safety limit"](#) on page 161.

Manual operation: See "[Enabled](#)" on page 79

[SOURCE:]VOLTage[:LEVel][:IMMediate]:ALIMit:LOWer <arg0>[, <Channel list>
[SOURCE:]VOLTage[:LEVel][:IMMediate]:ALIMit:LOWer? [<Channel list>]

Sets or queries the lower safety limit for voltage.

Setting parameters:

<voltage> <numeric value> | MIN | MINimum | MAX | MAXimum
 <numeric value>
 Numeric value for safety limit.

MIN | MINimum
 Min value for lower safety limit.

MAX | MAXimum
 Max value for lower safety limit.

 Range: For up to 32 V models: 0.000 to 32.050. For up to
 64 V models: 0.000 to 64.050.

 Increment: 0.001

 *RST: 0.000

Parameters for setting and query:

<Channel list> <list>

Example: VOLT:ALIM:LOW? (@1)
 Queries the lower safety limit for voltage at channel 1

Example: See [Example"Configuring the safety limit"](#) on page 161.

Manual operation: See "[Voltage Limit Min / Voltage Limit Max](#)" on page 79

```
[SOURce:]VOLTage[:LEVel][:IMMediate]:ALIMit[:UPPer] <arg0>[, <Channel list>]
[SOURce:]VOLTage[:LEVel][:IMMediate]:ALIMit[:UPPer]? [<Channel list>]
```

Sets or queries the upper safety limit for voltage.

Setting parameters:

```
<voltage>          <numeric value> | MIN | MINimum | MAX | MAXimum
                    <numeric value>
                    Numeric value for upper safety limit.
                    MIN | MINimum
                    Min value for upper safety limit.
                    MAX | MAXimum
                    Max value for upper safety limit.
                    Range:      For up to 32 V models: 0.000 to 32.050. For up to
                               64 V models: 0.000 to 64.050.
                    Increment:  0.001
                    *RST:      32.050 or 64.050
```

Parameters for setting and query:

```
<Channel list>    <list>
```

Example: `VOLT:ALIM:UPP? (@1)`
Queries the upper safety limit for voltage at channel 1.

Example: See [Example "Configuring the safety limit"](#) on page 161.

Manual operation: See ["Voltage Limit Min / Voltage Limit Max"](#) on page 79

```
[SOURce:]CURRent[:LEVel][:IMMediate]:ALIMit:LOWer <arg0>[, <Channel list>]
[SOURce:]CURRent[:LEVel][:IMMediate]:ALIMit:LOWer? [<Channel list>]
```

Sets or queries the lower safety limit for current.

Setting parameters:

```
<current>         <numeric value> | MIN | MINimum | MAX | MAXimum
                    <numeric value>
                    Numeric value for lower safety limit.
                    MIN | MINimum
                    Min value for lower safety limit.
                    MAX | MAXimum
                    Max value for lower safety limit.
                    Range:      For up to 32 V models: 0.001 to 20.010. For up to
                               64 V models: 0.001 to 10.010.
                    Increment:  0.001
                    *RST:      0.001
```

Parameters for setting and query:

```
<Channel list>    <list>
```

Example: `CURR:ALIM:LOW? (@1)`
Queries the lower safety limit for current at channel 1.

Example: See [Example"Configuring the safety limit"](#) on page 161.

Manual operation: See ["Current Limit Min / Current Limit Max"](#) on page 79

**[SOURce:]CURRENT[:LEVel][:IMMediate]:ALIMit[:UPPer] <arg0>[, <Channel list>]
[SOURce:]CURRENT[:LEVel][:IMMediate]:ALIMit[:UPPer]? [<Channel list>]**

Sets or queries the upper safety limit for current.

Setting parameters:

<current> <numeric value> | MIN | MINimum | MAX | MAXimum

<numeric value>

Numeric value for upper safety limit.

MIN | MINimum

Min value for upper safety limit.

MAX | MAXimum

Max value for upper safety limit.

Range: For up to 32 V models: 0.001 to 20.010. For up to 64 V models: 0.001 to 10.010.

Increment: 0.001

*RST: 20.010 or 10.010

Parameters for setting and query:

<Channel list> <list>

Example: CURR:ALIM:UPP? (@1)

Queries the upper safety limit for current at channel 1.

Example: See [Example"Configuring the safety limit"](#) on page 161.

Manual operation: See ["Current Limit Min / Current Limit Max"](#) on page 79

8.5.3 Remote sense setting

The VOLTage:SENSe subsystem contains the command for setting the remote sense for the instrument.

[SOURce:]VOLTage:SENSe[:SOURce]..... 164

[SOURce:]VOLTage:SENSe:TRIPped?..... 165

[SOURce:]VOLTage:SENSe:TRIPped:CLEar..... 165

[SOURce:]VOLTage:SENSe[:SOURce] <arg0>[, <Channel list>]

[SOURce:]VOLTage:SENSe[:SOURce]? [<Channel list>]

Sets and queries the remote sense tripped state of the selected channel.

Parameters:

<arg0> INT | EXT | <list>

INT

If remote sense detection is set to "INT", the voltage sense relay is disabled.

For query returns:

INT - Remote sense is disabled.

EXT

If remote sense detection is set to "EXT", internal voltage sense relay in the instrument is switched on and the connection of remote sense wires (S+, S-) to the input of the load become necessary. Failure to connect remote sense can cause overvoltage or unregulated voltage output from the R&S NGP800.

For query returns:

EXT - External, remote sense is activated manually.

Query parameters:

<Channel list> <list>

Example:

VOLT:SENS? (@1) -> EXT

Queries the remote sense detection at channel 1.

Manual operation: See "[Remote sensing](#)" on page 70

[SOURce:]VOLTage:SENSe:TRIPped? [<Channel list>]

Queries the remote sense tripped state of the selected channel.

Query parameters:

<Channel list> <list>

Example:

VOLT:SENS:TRIP? (@1)

Queries the remote sense tripped status at channel 1.

If response is 1, the remote sense is tripped. If response is 0, the remote sense is not tripped.

Usage:

Query only

Manual operation: See "[Remote sensing](#)" on page 70

[SOURce:]VOLTage:SENSe:TRIPped:CLEar [<Channel list>]

Resets the remote sense tripped state of the selected channel. If the remote sense tripped event has occurred before, the reset also erases the message on the display.

Setting parameters:

<Channel list> <list>

Example:

VOLT:SENS:TRIP:CLE (@1)

Resets remote sense tripped state at channel 1.

Usage:

Setting only

Manual operation: See "[Remote sensing](#)" on page 70

8.5.4 Voltage setting

The `SOURCE:VOLTage` subsystem contains the commands for setting the voltage of the output channels. The default unit is V.

Example: Configuring the output voltage

This example contains all commands to configure and query the output voltage.

```
// *****
// Select the channel
// *****
INST OUT1
// *****
// Set upper or lower voltage safety limit
// *****
//sets the safety limits to enable
ALIM 1
//queries the safety limits state
ALIM?
//response: "1"
//sets the safety limits for the upper voltage
VOLT:ALIM 15
//queries the safety limits for the upper voltage
VOLT:ALIM?
//response: "15.000"
//sets the safety limits for the lower voltage
VOLT:ALIM LOW 0
//queries the safety limits for the lower voltage
VOLT:ALIM?
//response: "0.000"
// *****
// Set the voltage value
// *****
// selects a channel and sets the voltage
VOLT 10
// sets the voltage to maximum or minimum respectively
VOLT MAX
VOLT MIN
// queries the output voltage of a channel
VOLT?
// response: "10.000"
// *****
// Query the range of the voltage values
// *****
// queries the upper and lower limit of the output voltage
VOLT? MIN
// response: "0.000"
VOLT? MAX
// response: "64.050"
// *****
// Increase or decrease the voltage stepwise
// *****
// selects the output channel, sets the step width
// and increases the voltage in the selected channel
// from 4 Volts
```

```

INST OUT1
VOLT:STEP 4
VOLT UP
// decreases the voltage in the selected channel
// from 4 Volts
VOLT DOWN
// queries the voltage step size
VOLT:STEP?
// response: "4.000"

```

[\[SOURce:\]VOLTage\[:LEVel\]\[:IMMediate\]\[:AMPLitude\]](#)..... 168

[\[SOURce:\]VOLTage\[:LEVel\]\[:IMMediate\]:STEP\[:INCRement\]](#)..... 169

[SOURce:]VOLTage[:LEVel][:IMMediate][:AMPLitude] <arg0>[, <Channel list>]

[SOURce:]VOLTage[:LEVel][:IMMediate][:AMPLitude]? [<Channel list>]

Sets or queries the voltage value of the selected channel.

Parameters:

<voltage> <numeric value> | MIN | MINimum | MAX | MAXimum | UP |
DOWN | <list>

<numeric value>

Numeric value in V.

MIN | MINimum

Minimum voltage at 0.000 V.

MAX | MAXimum

Maximum voltage at 64.050 V.

UP

Increases voltage by a defined step size. See [\[SOURce:\]VOLTage\[:LEVel\]\[:IMMediate\]:STEP\[:INCRement\]](#) on page 169.

DOWN

Decreases voltage by a defined step size. See [\[SOURce:\]VOLTage\[:LEVel\]\[:IMMediate\]:STEP\[:INCRement\]](#) on page 169.

Range: 0.000 to 64.050

Parameters for setting and query:

<Channel list> <list>

Example:

VOLT? (@1)

Queries the voltage at channel 1.

Example:

See [Example"Configuring the output voltage"](#) on page 167.

Manual operation:

See ["Set output voltage and current"](#) on page 66

[SOURce:]VOLTage[:LEVel][:IMMediate]:STEP[:INCRement] <arg0>[, <arg1>]
[SOURce:]VOLTage[:LEVel][:IMMediate]:STEP[:INCRement]? [<arg1>]

Sets or queries the incremental step size for the [VOLT UP](#) | [VOLT DOWN](#) command.

Setting parameters:

<stepsize> <numeric value> | DEF | DEFault

<numeric value>

Step value in V.

DEF | DEFault

Default value of stepsize.

Range: 0.001 to 5.000

Increment: 0.001

*RST: 0.100

Default unit: V

Parameters for setting and query:

<stepsize> DEF | DEFault

Queries the default voltage step size.

Example:

INST OUT1

VOLT:STEP 0.001

VOLT:STEP DEF

VOLT:STEP? DEF -> 0.10

Returns the default stepsize voltage.

See also [Example"Configuring the output voltage"](#) on page 167.

Manual operation: See ["Set output voltage and current"](#) on page 66

8.5.5 Current setting

The `SOURce:CURRent` subsystem contains the commands for setting the current limit of the output channels. The default unit is A.

Example: Configuring the current output

```
// *****
// Select the channel
// *****
INST OUT1
// *****
// Set upper or lower current safety limit
// *****
//sets the safety limits to enable
ALIM 1
//queries the safety limits state
ALIM?
//response: "1"
//sets the safety limits for the upper current
CURR:ALIM 3
//queries the safety limits for the upper current
CURR:ALIM?
//reponse: "3.0000"
//sets the safety limits for the lower current
CURR:ALIM LOW 0.0010
//queries the safety limits for the lower current
CURR:ALIM?
//response: "0.0010"
// *****
// Set the current value
// *****
// selects a channel and sets the current
CURR 2
// queries the current of the selected channel
CURR?
// response: 2.0000
// *****
// Query the range of the current values
// *****
// queries the upper and lower limit of the current
CURR? MIN
// response: 0.0001
CURR? MAX
// response: 20.0000
// *****
// Increase or decrease the current stepwise
// *****
// selects the output channel, sets the step width
// and decreases the current in the selected channel
// by the set 1 Ampere
INST OUT1
CURR:STEP 1
CURR DOWN
// increases the current in the selected channel
// by the set 1 Ampere
```

```
CURR UP
// queries the current step size
CURR:STEP?
// response: 1.0000
```

[SOURce:]CURRent[:LEVel][:IMMediate][:AMPLitude]..... 171
[SOURce:]CURRent[:LEVel][:IMMediate]:STEP[:INCRement]..... 171

[SOURce:]CURRent[:LEVel][:IMMediate][:AMPLitude] <arg0>[, <Channel list>]
[SOURce:]CURRent[:LEVel][:IMMediate][:AMPLitude]? [<Channel list>]

Sets or queries the current value of the selected channel.

Parameters:

<current> <numeric value> | MIN | MINimum | MAX | MAXimum | UP | DOWN | <list>

<numeric value>
Numeric value in the range of 0.001 to 20.0100.

MIN | MINimum
Minimum current at 0.001 A.

MAX | MAXimum
Depending on the set voltage level, the maximum set current is 20.0100 A.
For voltage range up to 32 V, maximum set current is 20.0100 A.
For voltage range up to 64 V, maximum set current is 10.0100 A.

UP
Increases current by a defined step size. See [SOURce:]CURRent[:LEVel][:IMMediate]:STEP[:INCRement] on page 171.

DOWN
Decreases current by a defined step size. See [SOURce:]CURRent[:LEVel][:IMMediate]:STEP[:INCRement] on page 171.

Parameters for setting and query:

<Channel list> <list>

Example: CURR? (@1)
Queries the current at channel 1.

Example: See [Example"Configuring the current output"](#) on page 170.

Manual operation: See ["Set output voltage and current"](#) on page 66

[SOURce:]CURRent[:LEVel][:IMMediate]:STEP[:INCRement] <arg0>[, <arg1>]
[SOURce:]CURRent[:LEVel][:IMMediate]:STEP[:INCRement]? [<arg1>]

Sets or queries the incremental step size for the CURR UP | CURR DOWN command.

Setting parameters:

<stepsize> <numeric value> | DEF | DEFault

<numeric value>

Step value in A.

DEF | DEFault

Default value of stepsize.

Range: 0.0001 to 2.000

Increment: 0.0001

*RST: 0.010

Default unit: A

Parameters for setting and query:

<Optional default step DEF | DEFault

query>

Queries the default voltage step size.

Example:

INST OUT1

CURR:STEP 0.005

CURR:STEP DEF

VOLT:STEP? DEF -> 0.1000E+00

Returns the default stepsize for current.

See [Example "Configuring the current output"](#) on page 170.**Manual operation:** See ["Set output voltage and current"](#) on page 66

8.5.6 Combined setting of voltage and current settings

The `APPLY` subsystem provides a command that enables you to set the current and voltage of a channel in one step.



The combined voltage and current setting command takes approximately 100 ms, i.e. longer than the setting of a single value.

APPLY <arg0>[, <arg1>, <arg2>]**APPLY?**

Sets or queries the voltage and current value of the selected channel.

Parameters:

<voltage>

numeric | MIN | MINimum | MAX | MAXimum | DEF | DEFault

numeric

Numeric value for voltage in the range of 0.000 to 64.050.

MIN | MINimum

Min voltage at 0.000 V.

MAX | MAXimum

Max value for voltage at 64.050V.

DEF | DEFault

Default voltage.

*RST: 1.000

Default unit: V

<current>

numeric | MIN | MINimum | MAX | MAXimum | DEF | DEFault

numeric

Numeric value for current in the range of 0.001 to 20.0100.

MIN | MINimum

Min current at 0.001 A.

MAX | MAXimum

Max value for current at 20.01 A.

DEF | DEFault

Numeric value for current.

*RST: 1.000

Default unit: A

<output>

OUT1 | OUTP1 | OUTPut1 | CH1 | OUT2 | OUTP2 | OUTPut2 |
CH2 | OUT3 | OUTP3 | OUTPut3 | CH3 | OUT4 | OUTP4 |
OUTPut4 | CH4

OUT1 | OUTP1 | OUTPut1 | CH1

Selects output for channel 1.

OUT2 | OUTP2 | OUTPut2 | CH2

Selects output for channel 2.

OUT3 | OUTP3 | OUTPut3 | CH3

Selects output for channel 2.

OUT4 | OUTP4 | OUTPut4 | CH4

Selects output for channel 4.

Example:

```
INST OUT1
```

```
APPL 6,2
```

Sets 6 V and 2 A to output of channel 1.

```
APPL? -> 6.000, 2.000
```

Queries the voltage and current of the selected channel.

Manual operation: See "[Set output voltage and current](#)" on page 66

8.5.7 Output setting

The `OUTPut` subsystem contains the commands for activating the output channels.

Example: Activating the channels

You can activate a selected channel and turn on or off the outputs either individually or all outputs simultaneously. This example lists all ways how you can activate and query the outputs.

```
// *****
// Activate a channel
// *****
INST OUT1
// activates the selected channel
OUTP:SEL 1
// activates channel 1 and its output
OUTP 1
// queries the output state
OUTP?
// response: 1
// *****
// Turn on all selected channels simultaneously
// *****
// selects channels 1 and 2
// sets the voltage and current values for both channels
// activates both channels
INST:OUT1
VOLT 12
CURR 0.1
OUTP:SEL 1
INST:OUT2
VOLT 12
CURR 0.2
OUTP:SEL 1
// turns on the output of both channels
OUTP:GEN 1
```

OUTPut:SRATe[:STATe]	174
OUTPut:IMPedance[:STATe]	175
OUTPut:GENeral[:STATe]	175
OUTPut[:STATe]	176
OUTPut:DELay:DURation	176
OUTPut:DELay[:STATe]	177
OUTPut:SELect	177

OUTPut:SRATe[:STATe] <arg0>[, <Channel list>]

OUTPut:SRATe[:STATe]? [<Channel list>]

Sets or queries the reduce slew rate option for the selected channel.

Parameters:

<state>	1	Activates reduce slew rate option for the selected channel.
	0	Deactivates reduce slew rate option for the selected channel.

Parameters for setting and query:

<Channel list> <list>

Example: `OUTPut:SRATe 1`
 `OUTPut:SRATe? -> 1`
 Returns reduce slew rate option as on.

Example: `OUTPut:SRATe? (@1)`
 Returns reduce slew rate option at channel 1.

Manual operation: See "[Reduce Slew Rate](#)" on page 72

OUTPut:IMPedance[:STATe] <arg0>[, <Channel list>]

OUTPut:IMPedance[:STATe]? [<Channel list>]

Sets or queries the output impedance state for the selected channel.

Parameters:

<state> **0**
 Deactivates output impedance for the selected channel.

1
 Activates output impedance for the selected channel.

Parameters for setting and query:

<Channel list> <list>

Example: `OUTPut:IMPedance 1`
 `OUTPut:IMPedance:STAT? -> 1`
 Returns output impedance state as on.

Example: `OUTPut:IMPedance? (@1)`
 Returns output impedance state at channel 1.

Manual operation: See "[High Impedance](#)" on page 71

OUTPut:GENeral[:STATe] <arg0>

OUTPut:GENeral[:STATe]?

Sets or queries the master output state.

Parameters:

<state> **0**
 Switches off the master output.

1
 Switches on the master output.

Example: See [Example"Activating the channels"](#) on page 174.

Manual operation: See "[\[Output\]](#)" on page 63
 See "[Activating the channel output](#)" on page 67

OUTPut[:STATe] <arg0>[, <Channel list>]

OUTPut[:STATe]? [<Channel list>]

Sets or queries the output state of the previous selected channels.

Parameters:

<state> **0**
 Switches off previous selected channels.

1
 Switches on previous selected channels.

Parameters for setting and query:

<Channel list> <list>

Example: OUTP? (@1)
 Queries the output state at channel 1.

Example: See [Example "Activating the channels"](#) on page 174.

Manual operation: See ["\[Output\]"](#) on page 63
 See ["Activating the channel output"](#) on page 67

OUTPut:DELaY:DURation <arg0>[, <Channel list>]

OUTPut:DELaY:DURation? [<Channel list>]

Sets or queries the duration for output delay.

Setting parameters:

<duration> <numeric value> | MIN | MINimum | MAX | MAXimum

<numeric value>
 Numeric value of the duration in seconds.

MIN | MINimum
 Minimum value of the duration at 0 seconds.

MAX | MAXimum
 Maximum value of the duration at 10 seconds.

 Range: 0, 0.01 to 10
 *RST: 0
 Default unit: s

Parameters for setting and query:

<Channel list> <list>

Example: OUTPut:DELaY:DURation 1
 OUTPut:DELaY:DURation? -> 1
 Returns output delay of 1 s.

Example: OUTPut:DELaY:DURation? (@1)
 Returns output delay at channel 1.

Manual operation: See ["Delay"](#) on page 70

OUTPut:DElay[:STATe] <arg0>[, <Channel list>]
OUTPut:DElay[:STATe]? [<Channel list>]

Sets or queries the output delay state for the selected channel.

Parameters:

<state> **0**
 Deactivates output delay for the selected channel.
 1
 Activates output delay for the selected channel.

Parameters for setting and query:

<Channel list> <list>

Example: OUTPut:DElay 1
 OUTPut:DElay? -> 1
 Returns output delay state as on.

Example: OUTPut:DElay? (@1)
 Returns output delay state at channel 1.

Manual operation: See ["Enabled"](#) on page 69

OUTPut:SElect <arg0>[, <Channel list>]
OUTPut:SElect? [<Channel list>]

Sets or queries the output state of selected channel.

Parameters:

<state> **0**
 Deactivates the selected channel.
 1
 Activates the selected channel.
 *RST: 0

Parameters for setting and query:

<Channel list> <list>

Example: OUTPut:SEL? (@1)
 Queries output state at channel 1.

Example: See [Example"Activating the channels"](#) on page 174.

Manual operation: See ["\[Output\]"](#) on page 63
 See ["Activating the channel output"](#) on page 67

8.5.8 OCP setting

The FUSE subsystem contains the commands for overcurrent protection parameters such as activating fuses and setting fuse parameters of the output channels. The default unit is A.



The delay function of the fuses takes effect when the corresponding channel is activated (output on).

Example: Configuring fuses

This example contains all commands to configure and query the fuse states and settings.

```
// *****
// Activate a fuse
// *****
INST OUT1
// selects a channel and activates the overcurrent protection
FUSE 1
// queries the state of the overcurrent protection in the selected channel
FUSE?
// response: 1
// *****
// Set a delay time for the overcurrent protection. The delay time
// takes effect when the channel output is turned on.
// *****
// sets 0.05 s delay for the overcurrent protection
FUSE:DEL 0.05
// queries the currently set delay time of the overcurrent protection
// in the selected channel
FUSE:DEL?
// response: 0.05
// sets the delay time to maximum, minimum respectively
FUSE:DEL MAX
FUSE:DEL MIN
// *****
// Query the range of the overcurrent protection delay time
// *****
// queries the upper and lower limit of the
// overcurrent protection delay time in ms
FUSE:DEL? MIN
// response: 0
FUSE:DEL? MAX
// response: 10
// *****
// Set a initial delay time for the overcurrent protection. During
// the timeframe, overcurrent protection tripping is inhibited.
// *****
// sets 0.1 s for the initial overcurrent protection delay
FUSE:DEL:INIT 0.1
// queries the currently set initial overcurrent protection delay
// in the selected channel
FUSE:DEL:INIT?
// response: 0.1
// sets the initial overcurrent protection delay to maximum, minimum respectively
```

```

FUSE:DEL:INIT MAX
FUSE:DEL:INIT MIN
// *****
// Query a tripped overcurrent protection
// *****
INST OUT1
//queries whether the OCP in channel 1 has tripped
FUSE:TRIP?
//response: 1 OCP is tripped
//response: 0 OCP is not tripped
//resets a tripped OCP in the selected channel
FUSE:TRIP:CLEAr
// *****
// Link the electronic overcurrent protection of the channels logically
// *****
INST OUT1
// links the overcurrent protection of channel 1 with channel 2
FUSE:LINK 2
// queries the combined overcurrent protection of the selected channel
FUSE:LINK?
// *****
// Unlink linked overcurrent protection
// *****
FUSE:UNLink 2
// queries the combined overcurrent protection of the selected channel
FUSE:LINK?
//response 0

```

FUSE:TRIPped:CLEAr.....	179
FUSE:DELAy:INITial.....	180
FUSE:DELAy[:BLOWing].....	180
FUSE:LINK.....	181
FUSE:TRIPped?.....	181
FUSE:UNLink.....	181
FUSE[:STATe].....	182

FUSE:TRIPped:CLEAr [<Channel list>]

Resets the OCP state of the selected channel. If an OCP event has occurred before, the reset also erases the message on the display.

Setting parameters:

<Channel list> <list>

Example: FUSE:TRIP:CLE (@1)
Reset OCP state at channel 1.

Example: See [Example"Configuring fuses"](#) on page 178.

Usage: Setting only

Manual operation: See ["Enabled"](#) on page 75

FUSE:DElay:INITial <arg0>[, <Channel list>]

FUSE:DElay:INITial? [<Channel list>]

Sets or queries the initial fuse delay time once output turns on.

Parameters:

<duration> <numeric value> | MIN | MINimum | MAX | MAXimum

<numeric value>

Numeric value for initial fuse delay.

MIN | MINimum

Min value for initial fuse delay.

MAX | MAXimum

Max value for initial fuse delay.

Range: 0, 0.01 to 60

*RST: 0

Default unit: s

Parameters for setting and query:

<Channel list> <list>

Example: FUSE:DEL:INIT? (@1)

Queries initial fuse delay time at channel 1.

Example: See [Example"Configuring fuses"](#) on page 178.

Manual operation: See ["Fuse Delay At Output-On"](#) on page 75

FUSE:DElay[:BLOWing] <arg0>[, <Channel list>]

FUSE:DElay[:BLOWing]? [<Channel list>]

Sets or queries the fuse delay time.

Parameters:

<duration> <numeric value> | MIN | MINimum | MAX | MAXimum

<numeric value>

Numeric value for the initial fuse delay.

MIN | MINimum

Min value for initial fuse delay.

MAX | MAXimum

Max value for initial fuse delay.

Range: 0, 0.01 to 10

*RST: 0

Default unit: s

Parameters for setting and query:

<Channel list> <list>

Example: FUSE:DEL? (@1)

Queries fuse delay time at channel 1.

Example: See [Example"Configuring fuses"](#) on page 178.

Manual operation: See ["Fuse Delay Time"](#) on page 75

FUSE:LINK <arg0>...

FUSE:LINK? <arg0>...

Sets or queries the fuses of several selected channels (fuse linking).

Parameters for setting and query:

<arg0> 0 | 1 | 2 | 3 | 4

0 - Link all other channels to the previously selected channel.

Example:

INST OUT1; :FUSE:LINK 2

Channel 2 is linked with channel 1.

INST OUT1; :FUSE:LINK?

Returns a comma-separated list of all channels linked to channel 1.

See [Example"Configuring fuses"](#) on page 178.

Manual operation: See ["Link to Channel 2 / Link to Channel 3"](#) on page 76

FUSE:TRIPped? [<Channel list>]

Queries the OCP state of the selected channel.

Query parameters:

<Channel list> <list>

Example:

FUSE:TRIP?

Response 1, the OCP is tripped.

Response 0, the OCP is not tripped.

Example:

FUSE:TRIP? (@1)

Queries fuse tripped status at channel 1.

Usage:

Query only

Manual operation: See ["Enabled"](#) on page 75

See [Example"Configuring fuses"](#) on page 178.

FUSE:UNLink <arg0>...

Unlinks fuse linking from the other channels (Ch 1, Ch 2, Ch 3 or Ch 4).

See [Example"Configuring fuses"](#) on page 178.

Parameters:

<arg0> 0 | 1 | 2 | 3 | 4

0 - Unlink all other channels to the previously selected channel.

Example:

FUSE:UNL 1

Fuse linking is unlinked from channel 1.

Usage:

Setting only

Manual operation: See "[Link to Channel 2 / Link to Channel 3](#)" on page 76

FUSE[:STATe] <arg0>[, <Channel list>]

FUSE[:STATe]? [<Channel list>]

Sets or queries the state for over current protection (OCP).

See [Example"Configuring fuses"](#) on page 178.

Parameters:

<arg0>	1 0
	1
	Activates the OCP state.
	0
	Deactivates the OCP state.

Parameters for setting and query:

<Channel list>	<list>
----------------	--------

Example: FUSE 1
Activates the OCP.

Example: FUSE? (@1)
Queries fuse state at channel 1.

Manual operation: See "[Overcurrent Protection \(OCP\)](#)" on page 61
See "[Enabled](#)" on page 75

8.5.9 OVP setting

The `VOLTage:PROTection` subsystem contains the commands for setting the over-voltage protection parameters for the output channels. The default unit is V.

Example: Configuring the overvoltage protection

```

// *****
// Set the overvoltage protection value
// *****
INST OUT1
//activates the OVP of the previous selected channel
VOLT:PROT 1
// selects a channel and sets the OVP
VOLT:PROT:LEV 5
// queries the output overvoltage value of a channel
VOLT:PROT:LEV?
// response: 5
// queries the OVP state of the previous selected channel
VOLT:PROT?
// response: 1
// sets the overvoltage protection to maximum,
// or minimum respectively
VOLT:PROT:LEV MAX
VOLT:PROT:LEV MIN
// *****
// Query the range of the overvoltage protection values
// *****
// queries the upper and lower limit
VOLT:PROT:LEV? MIN
// response: 0.100
VOLT:PROT:LEV? MAX
// response: 64.050
// *****
// Query a tripped overvoltage protection
// *****
INST OUT1
// queries whether the OVP in channel 1 has tripped
VOLT:PROT:TRIP?
// response: 1 OVP is tripped
// response: 0 OVP is not tripped
// resets a tripped OVP in the selected channel
VOLT:PROT:CLEAr
// *****
// Set the overvoltage protection mode
// *****
INST OUT1
// sets OVP protected mode for channel1
VOLT:PROT:MODE PROT
// queries the OVP mode
VOLT:PROT:MODE PROT?
// response: "protected"

```

[SOURce:]VOLTage:PROTection[:STATe].....	184
[SOURce:]VOLTage:PROTection:CLEar.....	184
[SOURce:]VOLTage:PROTection:LEVel.....	184
[SOURce:]VOLTage:PROTection:TRIPped?.....	185

[SOURce:]VOLTage:PROTection[:STATe] <arg0>[, <Channel list>]

[SOURce:]VOLTage:PROTection[:STATe]? [<Channel list>]

Sets or queries the OVP state of the previous selected channel.

Parameters:

<state>	0	OVP is deactivated.
	1	OVP is activated.

Parameters for setting and query:

<Channel list>	<list>
----------------	--------

Example: VOLT:PROT? (@1)
Queries OVP state at channel 1.

Example: See [Example"Configuring the overvoltage protection"](#)
on page 183.

Manual operation: See "[Overvoltage Protection \(OVP\)](#)" on page 61
See "[Enabled](#)" on page 77

[SOURce:]VOLTage:PROTection:CLEar [<Channel list>]

Resets the OVP state of the selected channel. If an OVP event has occurred before, the reset also erases the message on the display.

Setting parameters:

<Channel list>	<list>
----------------	--------

Example: VOLT:PROT:CLEAR (@1)
Resets OVP state at channel 1.

Example: See [Example"Configuring the overvoltage protection"](#)
on page 183.

Usage: Setting only

Manual operation: See "[Enabled](#)" on page 77

[SOURce:]VOLTage:PROTection:LEVel <arg0>[, <Channel list>]

[SOURce:]VOLTage:PROTection:LEVel? [<Channel list>]

Sets or queries the overvoltage protection value of the selected channel.

Parameters:

<voltage>	<numeric value> MIN MINimum MAX MAXimum DEF DEFault
-----------	-----------------------------------------------------------------

<numeric value>

Numeric value for the overvoltage protection value in V.

MIN | MINimum

Minimum value for the overvoltage protection value at 0.000 V.

MAX | MAXimum

Maximum value for the overvoltage protection value at 32.050 V (for up to 32 V models) or 64.050 V (for up to 64 V models).

Range: 0.000 to 32.050 or 0.000 to 64.050

*RST: 32.050 or 64.050

Default unit: V

Parameters for setting and query:

<Channel list> <list>

Example: VOLT:PROT:LEV? (@1)

Queries overvoltage protection value at channel 1.

Example: See [Example"Configuring the overvoltage protection"](#) on page 183.

Manual operation: See ["Level"](#) on page 77

[SOURce:]VOLTage:PROTection:TRIPped? [<Channel list>]

Queries the OVP state of the selected channel.

Query parameters:

<Channel list> <list>

Example: VOLT:PROT:TRIP?

Response 1, the OVP is tripped.

Response 0, the OVP is not tripped.

Example: VOLT:PROT:TRIP? (@1)

Queries OVP state at channel 1.

Usage: Query only

Manual operation: See ["Enabled"](#) on page 77

See [Example"Configuring the overvoltage protection"](#) on page 183.

8.5.10 OPP setting

The POWer:PROTection subsystem contains the commands for setting the over-power protection parameters for the output channels. The default unit is W.

Example: Configuring the overpower protection

```
// *****
// Set the overpower protection value
// *****
INST OUT1
//activates the OPP of the previous selected channel
POW:PROT 1
// selects a channel and sets the OPP
POW:PROT:LEV 5
// queries the output overvoltage value of a channel
POW:PROT:LEV?
// response: 5
// queries the OPP state of the previous selected channel
POW:PROT?
// response: 1
// sets the overvoltage protection to maximum,
// or minimum respectively
POW:PROT:LEV MAX
POW:PROT:LEV MIN
// *****
// Query the range of the overpower protection values
// *****
// queries the upper and lower limit
POW:PROT:LEV? MIN
// reponse: 0.0
POW:PROT:LEV? MAX
// reponse: 60.0
// *****
// Query a tripped overpower protection
// *****
INST OUT1
// queries whether the OPP in channel 1 has tripped
POW:PROT:TRIP?
// response: 1 OPP is tripped
// response: 0 OPP is not tripped
// resets a tripped OPP in the selected channel
POW:PROT:CLEAr
```

[SOURce:]POWer:PROTection[:STATe].....	186
[SOURce:]POWer:PROTection:CLEAr.....	187
[SOURce:]POWer:PROTection:LEVel.....	187
[SOURce:]POWer:PROTection:TRIPped?.....	188

[SOURce:]POWer:PROTection[:STATe] <arg0>[, <Channel list>]

[SOURce:]POWer:PROTection[:STATe]? [<Channel list>]

Sets or queries the OPP state of the previous selected channel.

Parameters:

<state>

0
OPP is deactivated.

1
OPP is activated.

Parameters for setting and query:

<Channel list> <list>

Example: POW:PROT? (@1)
Queries OPP state at channel 1.

Example: See [Example"Configuring the overpower protection"](#)
on page 186.

Manual operation: See ["Overpower Protection \(OPP\)"](#) on page 61
See ["Enabled"](#) on page 78

[SOURce:]POWER:PROTECTION:CLEAR [<Channel list>]

Resets the OPP state of the selected channel. If an OPP event has occurred before, the reset also erases the message on the display.

Setting parameters:

<Channel list> <list>

Example: POW:PROT:CLEAR (@1)
Resets OPP state at channel 1.

Example: See [Example"Configuring the overpower protection"](#)
on page 186.

Usage: Setting only

Manual operation: See ["Enabled"](#) on page 78

[SOURce:]POWER:PROTECTION:LEVEL <arg0>[, <Channel list>]

[SOURce:]POWER:PROTECTION:LEVEL? [<Channel list>]

Sets or queries the overvoltage protection value of the selected channel.

Parameters:

<power> <numeric value> | MIN | MINimum | MAX | MAXimum | DEF |
DEFault

<numeric value>

Numeric value of the power protection level in watts.

MIN | MINimum

Minimum value of the power protection level at 1.00 W.

MAX | MAXimum

Maximum value of the power protection level at 200.00 W.

DEF | DEFault

Default value of the power protection level at 200.00 W.

Range: 1.00 to 200.00

*RST: 200.00
Default unit: W

Parameters for setting and query:

<Channel list> <list>

Example: POW:PROT:LEV? (@1)
Queries OPP value at channel 1.

Example: See [Example"Configuring the overpower protection"](#) on page 186.

Manual operation: See ["Level"](#) on page 78

[SOURce:]POWER:PROTECTION:TRIPPed? [<Channel list>]

Queries the OPP state of the selected channel.

Query parameters:

<Channel list> <list>

Example: POW:PROT:TRIP?
Response 1, the OPP is tripped.
Response 0, the OPP is not tripped.

Example: POW:PROT:TRIP? (@1)
Queries OPP state at channel 1.

Usage: Query only

Manual operation: See ["Enabled"](#) on page 78

See [Example"Configuring the overpower protection"](#) on page 186.

8.5.11 Reset protection tripped state

The `Protection` subsystem contains the command to reset the protection tripped state.

[SOURce:]PROTECTION:CLEAR [<Channel list>]

Reset protection tripped state.

Setting parameters:

<Channel list> <list>

Example: PROT:CLEAR (@1)
Reset protection tripped state at channel 1.

Usage: Setting only

Manual operation: See ["Enabled"](#) on page 75
See ["Enabled"](#) on page 77
See ["Enabled"](#) on page 78

8.5.12 Tracking setting

The TRACking subsystem contains the commands for changes made on reference channel are applied to the tracked channels.

TRACking[:ENABle]:CH<CHANNEL>.....	189
TRACking[:ENABle]:GENeral.....	189
TRACking[:ENABle]:SELect:CH<CHANNEL>.....	189

TRACking[:ENABle]:CH<CHANNEL> <arg0>
TRACking[:ENABle]:CH<CHANNEL>?

Sets or queries the tracking status on selected channel.

Suffix:

<CHANNEL> 1..4

Parameters:

<arg0> **0**
 Tracking is disabled on specified channel.

1
 Tracking is enabled on specified channel.

Manual operation: See "Enabled" on page 80
 See "Ch 1 / Ch 2 / Ch 3 / Ch 4" on page 80

TRACking[:ENABle]:GENeral <arg0>
TRACking[:ENABle]:GENeral?

Sets or queries the status of the master tracking state.

Parameters:

<arg0> **0**
 Master tracking is disabled.

1
 Master tracking is enabled.

Manual operation: See "Tracking" on page 58
 See "Ch 1 / Ch 2 / Ch 3 / Ch 4" on page 80

TRACking[:ENABle]:SELect:CH<CHANNEL> <arg0>
TRACking[:ENABle]:SELect:CH<CHANNEL>?

Sets or queries the status of tracking soft enable on specific channel.

Suffix:

<CHANNEL> 1..4

Parameters:

<arg0> **0**
 Tracking is disabled.

1

Tracking is enabled.

Manual operation: See "Enabled" on page 80
See "Ch 1 / Ch 2 / Ch 3 / Ch 4" on page 80

8.5.13 Interface setting

The `Interface` subsystem contains the commands for changes made on the USB class.

INTERfaces:USB:CLASs <arg0>

INTERfaces:USB:CLASs?

Sets or queries the USB class.

Parameters:

<USB class> CDC | TMC
CDC
 USB CDC connection.
TMC
 USB TMC connection.

Manual operation: See "USB Class" on page 123

8.6 Measurement commands

The `MEASure` subsystem provides commands to query the voltage and current values of a channel.

<code>READ?</code>	191
<code>MEASure[:SCALar]:ENERgy?</code>	191
<code>MEASure[:SCALar]:STATistic:COUNT?</code>	191
<code>MEASure[:SCALar]:STATistic:RESet</code>	191
<code>MEASure[:SCALar]:CURRent[:DC]?</code>	191
<code>MEASure[:SCALar]:CURRent[:DC]:AVG?</code>	192
<code>MEASure[:SCALar]:CURRent[:DC]:MAX?</code>	192
<code>MEASure[:SCALar]:CURRent[:DC]:MIN?</code>	192
<code>MEASure[:SCALar]:CURRent[:DC]:STATistic?</code>	192
<code>MEASure[:SCALar]:POWer?</code>	193
<code>MEASure[:SCALar]:POWer:AVG?</code>	193
<code>MEASure[:SCALar]:POWer:MAX?</code>	193
<code>MEASure[:SCALar]:POWer:MIN?</code>	193
<code>MEASure[:SCALar]:POWer:STATistic?</code>	194
<code>MEASure[:SCALar][:VOLTage][:DC]?</code>	194
<code>MEASure[:SCALar][:VOLTage][:DC]:AVG?</code>	194
<code>MEASure[:SCALar][:VOLTage][:DC]:MAX?</code>	194
<code>MEASure[:SCALar][:VOLTage][:DC]:MIN?</code>	194
<code>MEASure[:SCALar][:VOLTage][:DC]:STATistic?</code>	195

READ?

Queries for the next available readback for voltage and current of the selected channel.

Example: `READ? -> 1.001000E+00,0.000000E+00`

Usage: Query only

MEASure[:SCALar]:ENERgy? [<Channel list>]

Queries the measured the current released energy value of the previous selected channel.

Query parameters:

<Channel list> <list>

Example: `MEAS:ENER? -> 5.382E+00` (value in Wh)

Example: `MEAS:ENER? (@1)`
Queries the measured accumulated energy value at channel 1.

Usage: Query only

MEASure[:SCALar]:STATistic:COUNt? [<Channel list>]

Returns the number of samples measured in the statistics for voltage/current/power

Query parameters:

<Channel list> <list>

Example: `MEAS:STAT:COUN? (@1)`
Queries the number of measurements at channel 1.

Usage: Query only

MEASure[:SCALar]:STATistic:RESet [<Channel list>]

Resets the minimum, maximum and average statistic values for voltage, current, and power.

Additionally this command resets the measured energy.

Setting parameters:

<Channel list> <list>

Example: `MEAS:STAT:RES (@1)`
Resets all the statistic values at channel 1.

Usage: Setting only

Manual operation: See "[Reset Statistics](#)" on page 95

MEASure[:SCALar]:CURRent[:DC]? [<Channel list>]

Queries the currently measured current of the selected channel.

Query parameters:

<Channel list> <list>

Example: MEAS:CURR? -> 1.000E +00**Example:** MEAS:CURR? (@1)
Queries the currently measured current at channel 1.**Usage:** Query only**MEASure[:SCALar]:CURRent[:DC]:AVG? [<Channel list>]**

Queries the average measured output current.

Query parameters:

<Channel list> <list>

Example: MEAS:CURR? (@1)
Queries the currently measured current at channel 1.**Usage:** Query only**MEASure[:SCALar]:CURRent[:DC]:MAX? [<Channel list>]**

Queries the maximum measured output current.

Query parameters:

<Channel list> <list>

Example: MEAS:CURR:DC:MAX? (@1)
Queries the maximum measured output current at channel 1.**Usage:** Query only**MEASure[:SCALar]:CURRent[:DC]:MIN? [<Channel list>]**

Queries the minimum measured output power.

Query parameters:

<Channel list> <list>

Example: MEAS:CURR:DC:MIN? (@1)
Queries the minimum measured output current at channel 1.**Usage:** Query only**MEASure[:SCALar]:CURRent[:DC]:STATistic? [<Channel list>]**

Queries the current statistics of the selected channel.

Query parameters:

<Channel list> <list>

Example: MEAS:CURR:DC:STAT? (@1)
Queries the current statistics at channel 1.

Usage: Query only

MEASure[:SCALar]:POWER? [<Channel list>]

Queries the currently emitted power of the selected channel.

Query parameters:

<Channel list> <list>

Example: MEAS:POW? -> 3.00E+00

Example: MEAS:POW? (@1)
Queries the currently supplied power at channel 1.

Usage: Query only

MEASure[:SCALar]:POWER:AVG? [<Channel list>]

Queries the average measured output power.

Query parameters:

<Channel list> <list>

Example: MEAS:POW:AVG? (@1)
Queries the average measured output power at channel 1.

Usage: Query only

MEASure[:SCALar]:POWER:MAX? [<Channel list>]

Queries the maximum measured output power.

Query parameters:

<Channel list> <list>

Example: MEAS:POW:MAX? (@1)
Queries the maximum measured output power at channel 1.

Usage: Query only

MEASure[:SCALar]:POWER:MIN? [<Channel list>]

Queries the minimum measured output power.

Query parameters:

<Channel list> <list>

Example: MEAS:POW:MIN? (@1)
Queries the minimum measured output power at channel 1.

Usage: Query only

MEASure[:SCALar]:POWER:STATistic? [<Channel list>]

Queries the power statistics of the selected channel.

Query parameters:

<Channel list> <list>

Example: MEAS:POW:STAT? (@1)
Queries the power statistics at channel 1.

Usage: Query only

MEASure[:SCALar][:VOLTage][:DC]? [<Channel list>]

Queries the currently measured voltage of the selected channel.

Query parameters:

<Channel list> <list>

Example: MEAS:VOLT? -> 1.000E+00

Example: MEAS:VOLT? (@1)
Queries the currently measured voltage at channel 1.

Usage: Query only

MEASure[:SCALar][:VOLTage][:DC]:AVG? [<Channel list>]

Queries the average measured output voltage.

Query parameters:

<Channel list> <list>

Example: MEAS:VOLT:AVG? (@1)
Queries the average measured output voltage at channel 1.

Usage: Query only

MEASure[:SCALar][:VOLTage][:DC]:MAX? [<Channel list>]

Queries the maximum measured output voltage.

Query parameters:

<Channel list> <list>

Example: MEAS:VOLT:MAX? (@1)
Queries the maximum measured output voltage at channel 1.

Usage: Query only

MEASure[:SCALar][:VOLTage][:DC]:MIN? [<Channel list>]

Queries the minimum measured output voltage.

Query parameters:

<Channel list> <list>

Example:

MEAS:VOLT:MIN? (@1)

Queries the maximum measured output voltage at channel 1.

Usage:

Query only

MEASure[:SCALar][:VOLTage][:DC]:STATistic? [<Channel list>]

Queries the voltage statistics of the selected channel.

Query parameters:

<Channel list> <list>

Example:

MEAS:VOLT:STAT? (@1)

Queries the voltage statistics at channel 1.

Usage:

Query only

8.7 Advanced operating commands

The following shows the subsystem that contains the commands for configuring the [QuickArb](#), [EasyRamp](#), [Analog Input](#) and [Adjustment](#) functions.

8.7.1 Arbitrary

The `ARBITrary` subsystem contains the commands for configuring an arbitrary sequence for the output channels.

Example: Configuring an arbitrary sequence

This programming example generates an arbitrary sequence for a selected channel. The sequence starts at 1 V and 1 A for 1 sec, and both values are incremented each second by 1. The generated arbitrary waveform is transferred to Ch1. When activated, the R&S NGP800 provides the arbitrary waveform at the output of the selected channel, and repeats it 10 times.

```
// *****
// Define and start the arbitrary sequence
// *****
// selects channel 1
INST OUT1
// defines the sequence, i.e. starting at 1V, 1A for 1sec,
// and increments the voltage and current each second by 1
ARB:BLOC:DATA 1,1,1,0,2,2,1,0,3,3,1,0
// ARB:BLOC:DATA? queries the arb data
// sets the repetition rate
ARB:BLOC:REP 1
// queries the set number of repetitions
// ARB:BLOC:REP?
//sets the sequence repetition
ARB:SEQ:REP 10
// queries the set number of sequence repetitions
//ARB:SEQ:REP?
//sets the arbitrary endpoint behavior, when the QuickArb function is finished
ARB:SEQ:BEH:END HOLD
// queries the endpoint behaviour
//ARB:SEQ:BEH:END?
// transfers the arbitrary points to channel
ARB:SEQ:TRAN
//Enable the arbitrary sequence
ARB ON
//ARB? queries the arb status
// starts the sequence in channel 1
//turns on the output
OUTP ON
```

ARbitrary:BLOCK:CLEAr.....	197
ARbitrary:BLOCK.....	197
ARbitrary:BLOCK:DATA.....	197
ARbitrary:BLOCK:ENDPoint?.....	198
ARbitrary:BLOCK:FNAME.....	198
ARbitrary:BLOCK:REPetitions.....	198
ARbitrary[::STATe].....	199
ARbitrary:CLEAr.....	199
ARbitrary:DATA.....	199
ARbitrary:SEQuence:ENDPoint?.....	200
ARbitrary:FNAME.....	200
ARbitrary:LOAD.....	200
ARbitrary:REPetitions.....	201

ARbitrary:SAVE.....	201
ARbitrary:SEquence:BEHavior:END.....	201
ARbitrary:SEquence:CLEar.....	202
ARbitrary:SEquence:REPetitions.....	202
ARbitrary:SEquence:TRANsfer.....	202
ARbitrary:TRIGgered:GROup[:STATe].....	203
ARbitrary:TRIGgered:POINt[:STATe].....	203
ARbitrary:TRIGgered[:STATe].....	203

ARbitrary:BLOCK:CLEar

Clears a file selected for the block under channel arbitrary settings.

See also [ARbitrary:BLOCK](#) on page 197.

Example:

```
INST OUT1
ARB:BLOC 1
ARB:BLCK:CLE
Clear the file in block 1 for Ch 1.
```

Usage: Event

Manual operation: See "[Delete](#)" on page 90

ARbitrary:BLOCK <arg0>

ARbitrary:BLOCK?

Sets or queries block number between 1 to 8 in an arbitrary sequence.

Parameters:

<block> 1..8

Manual operation: See "<#>" on page 90

ARbitrary:BLOCK:DATA <arg0>

ARbitrary:BLOCK:DATA?

Sets or queries the data points for a whole block.

Parameters:

<data> voltage1, current1, time1, interpolation mode1, voltage2, current2, time2, interpolation mode2, ...

Voltage and current settings depending on the instrument type. If the interpolation mode is sets to 1, it indicates that the mode is activated. If the interpolation mode is sets to 0, it indicates that the mode is not activated.

Example:

```
INST OUT1
ARB:BLOC 1
ARB:BLOC:DATA 1,1,1,0,2,2,1,0,3,3,1,0
3 data points (voltage, current, time, interpolation) are written to
data block 1, Ch 1.
```

ARbitrary:BLOCK:ENDPoint?

Queries the number of data points of the block of arbitrary data.

Example: INST OUT1
 ARB:BLOC 1
 ARB:BLOC:ENDP?
 Return the number of data points for block 1 of Ch 1.

Usage: Query only

ARbitrary:BLOCK:FNAME <arg0>[, <arg1>]**ARbitrary:BLOCK:FNAME?**

Sets or queries the filename for block of arbitrary data.

Parameters for setting and query:

<filename> Filename of the QuickArb function.

<location> INT | EXT | DEF

INT

Internal memory

EXT

USB stick

DEF

Internal memory

Example: INST OUT1
 ARB:BLOC 1
 ARB:BLOC:FNAME "01.CSV"
 ARB:BLOC:FNAME? -> "01.CSV", INT

Manual operation: See "[File](#)" on page 90

ARbitrary:BLOCK:REPetitions <arg0>**ARbitrary:BLOCK:REPetitions?**

Sets or queries the number of repetitions of the block of arbitrary data.

Parameters:

<repetitions> Repetition of the block of arbitrary data.

Example: INST OUT1
 ARB:BLOC 1
 ARB:BLOC:REP 0
 Set repetition of infinity to block 1 of Ch 1.

Manual operation: See "[Repetitions](#)" on page 90

ARbitrary:STATe] <arg0>[, <Channel list>]
ARbitrary:STATe]? [<Channel list>]

Sets or queries the QuickArb function for the previous selected channel.

Parameters:

<state> **1**
 QuickArb function is activated.
 0
 QuickArb function is deactivated.
 *RST: 0

Parameters for setting and query:

<Channel list> <list>

Example: ARB ON
 ARB? -> 1
 QuickArb function of Ch1 is activated.
 See [Example"Configuring an arbitrary sequence"](#) on page 196.

Example: ARB ON, (@1)
 ARB? (@1)
 Sets and queries the state of QuickArb function at channel 1.

Manual operation: See ["Arbitrary"](#) on page 60

ARbitrary:CLEar

Clears the previous defined arbitrary waveform data for the selected channel.

Example: See [Example"Configuring an arbitrary sequence"](#) on page 196.

Usage: Event

ARbitrary:DATA <arg0>

ARbitrary:DATA?

Sets or queries the arbitrary points for the previous selected channel. Max. 1024 arbitrary points can be defined. The dwell time between 2 arbitrary points is specified from 1 ms to 60 ms.

Parameters:

<data> voltage1, current1, time1, interpolation mode1, voltage2, current2, time2, interpolation mode2, ...
 Voltage and current settings depending on the instrument type. If the interpolation mode is sets to 1, it indicates that the mode is activated. If the interpolation mode is sets to 0, it indicates that the mode is not activated.

- Example:** `ARB:DATA 10,1,0.5,0`
 Defines one arbitrary point with: Voltage1 = 10 V and Current1 = 1 A, Time1 = 500 ms and Interpolation mode1 = 0 (disabled).
`ARB:DATA? -> 10.000, 1.000, 0.50, 1`
 Returns defined arbitrary points for the previous selected channel.
 See [Example "Configuring an arbitrary sequence"](#) on page 196.
- Manual operation:** See ["+ #"](#) on page 91
 See ["- #"](#) on page 91
 See ["#"](#) on page 91
 See ["Voltage"](#) on page 92
 See ["Current"](#) on page 92
 See ["Time"](#) on page 92
 See ["Interpolate"](#) on page 92

ARbitrary:SEquence:ENDPoint?

Queries the total number of points of the arbitrary sequence.

Usage: Query only

ARbitrary:FNAME <arg0>[, <arg1>]**ARbitrary:FNAME?**

Sets or queries the file name and storage location for the QuickArb function.

Parameters for setting and query:

<filename> Filename of the QuickArb function.

<location> INT | EXT | DEF

INT

Internal memory

EXT

USB stick

DEF

Internal memory

Example: `ARB:FNAME "01.CSV"`
`ARB:FNAME? -> "01.CSV", INT`

Manual operation: See ["Open folder"](#) on page 91

ARbitrary:LOAD

Loads an arbitrary table from a file (filename specified with `ARB:FNAME`).

Example: ARB:DATA 10,1,0.5,0
 ARB:REP 10
 ARB:FNAM "ARB03.CSV",INT
 ARB:SAVE
 ARB:LOAD
 Loads an arbitrary data from filename ARB03.CSV.

Usage: Event

Manual operation: See "[Open folder](#)" on page 91

ARbitrary:REPetitions <arg0>

ARbitrary:REPetitions?

Sets or queries the repetition rate of the defined arbitrary waveform for the previous selected channel. Up to 65535 repetitions are possible. If the repetition rate "0" is selected the arbitrary waveform of the previous selected channel is repeated infinitely.

Parameters:

repetition_rate Range: 0 to 65535
 The "0" indicates infinite repetition.

Example: ARB:REP 10
 ARB:REP? -> 10
 The returned repetition rate of the Ch1 arbitrary waveform is 10.

Manual operation: See "[Rep.](#)" on page 91

ARbitrary:SAVE

Saves the current arbitrary table to a file (filename specified with ARB:FNAM).

Example: ARB:DATA 10,1,0.5,0
 ARB:REP 10
 ARB:FNAM "ARB03.CSV",INT
 ARB:SAVE
 Saves a predefined arbitrary data to a filename ARB03.CSV in the internal memory location.

Usage: Event

Manual operation: See "[Save / Save as](#)" on page 91

ARbitrary:SEquence:BEHavior:END <arg0>

ARbitrary:SEquence:BEHavior:END?

Sets or queries the arbitrary endpoint behavior, when QuickArb function is finished.

Parameters:

<> HOLD | OFF
 <state> HOLD | OFF

OFF

If the QuickArb function is finished, the respective channel is deactivated automatically.

HOLD

If the QuickArb function is finished, the last arbitrary point of the user-defined arbitrary list is held.

*RST: OFF

Example: See [Example "Configuring an arbitrary sequence"](#) on page 196.

Manual operation: See ["End Behavior"](#) on page 90

ARbitrary:SEquence:CLEar

Clears the arbitrary sequence.

Usage: Event

Manual operation: See ["Delete"](#) on page 90

ARbitrary:SEquence:REPetitions <arg0>**ARbitrary:SEquence:REPetitions?**

Sets or queries the number of repetitions of the arbitrary sequence.

Parameters:

<repetition_rate> Range: 0 to 65535
The "0" indicates infinite repetition.

Example: See also [ARbitrary:REPetitions](#) on page 201.

Manual operation: See ["Seq. Rep."](#) on page 89

ARbitrary:SEquence:TRANSfer

Transfers the defined arbitrary table to the selected channel.

Parameters:

<channel> 1 | 2 | 3 | 4

Example: See [Example "Configuring an arbitrary sequence"](#) on page 196.

Usage: Event

Manual operation: See ["Load Sequence"](#) on page 90

ARbitrary:TRIGgered:GROup[:STATe] <arg0>
ARbitrary:TRIGgered:GROup[:STATe]?

Sets or queries the trigger condition of the arbitrary step group for the selected channel.

Parameters:

<condition> OFF | 1 | 2 | 3 | 4 | 5 | 6 | 7 | 8

OFF

There is no DIO pin that has a mode set to arbitrary step group for the selected channel.

1 | 2 | 3 | 4 | 5 | 6 | 7 | 8

DIO pin/s are enabled with a mode set to arbitrary step group for the selected channel.

When DIO pin is enabled with arbitrary step point mode, Quick-Arb function will step to the next point when the correct voltage is applied to the DIO pin.

Manual operation: See "[Mode](#)" on page 85

ARbitrary:TRIGgered:POINt[:STATe] <arg0>
ARbitrary:TRIGgered:POINt[:STATe]?

Sets or queries the trigger condition of the arbitrary step point for the selected channel.

Parameters:

<condition> OFF | 1 | 2 | 3 | 4 | 5 | 6 | 7 | 8

OFF

There is no DIO pin that has a mode set to arbitrary step point for the selected channel.

1 | 2 | 3 | 4 | 5 | 6 | 7 | 8

DIO pin/s are enabled with a mode set to arbitrary step point for the selected channel.

When DIO pin is enabled with arbitrary step point mode, Quick-Arb function will step to the next point when the correct voltage is applied to the DIO pin.

Manual operation: See "[Mode](#)" on page 85

ARbitrary:TRIGgered[:STATe] <arg0>
ARbitrary:TRIGgered[:STATe]?

Sets or queries the trigger condition of the arbitrary for the selected channel.

Parameters:

<condition> OFF | 1 | 2 | 3 | 4 | 5 | 6 | 7 | 8

OFF

There is no DIO pin that has a mode set to arbitrary for the selected channel.

1 | 2 | 3 | 4 | 5 | 6 | 7 | 8

DIO pin/s are enabled with a mode set to arbitrary for the selected channel.

When DIO pin is enabled with arbitrary mode, QuickArb function of the channel assigned to that pin will be enabled when the correct voltage is applied to the DIO pin.

Manual operation: See "[Mode](#)" on page 85

8.7.2 EasyRamp

The `VOLTage:RAMP` subsystem contains the commands for configuring the EasyRamp function for the output channels.

[SOURce:]VOLTage:RAMP[:STATe].....	204
[SOURce:]VOLTage:RAMP:DURation.....	205

[SOURce:]VOLTage:RAMP[:STATe] <arg0>[, <Channel list>]
[SOURce:]VOLTage:RAMP[:STATe]? [<Channel list>]

Sets or queries the state of ramp function for the previous selected channel.

Parameters:

<state> 0 | 1
0
 EasyRamp function is deactivated.
1
 EasyRamp function is activated.
 *RST: 0

Parameters for setting and query:

<Channel list> <list>

Example: INST OUT1
 VOLT:RAMP ON
 VOLT:RAMP? -> 1
 EasyRamp function of Ch1 is activated.

Example: VOLT:RAMP ON, (@1)
 VOLT:RAMP? (@1)
 Sets and queries the state of ramp function at channel 1.

Manual operation: See "[Ramp](#)" on page 61
 See "[Enable](#)" on page 93

[SOURce:]VOLTage:RAMP:DURation <arg0>[, <Channel list>]
[SOURce:]VOLTage:RAMP:DURation? [<Channel list>]

Sets or queries the duration of the voltage ramp.

Parameters:

<duration> <numeric value> | MIN | MINimum | MAX | MAXimum | DEF | DEFault

<numeric value>

Duration of the ramp function in seconds.

MIN | MINimum

Minimum duration of the ramp function at 0.00 s.

MAX | MAXimum

Maximum duration of the ramp function at 60.00 s.

DEF | DEFault

Default duration of the ramp function at 0 s.

Range: 0, 0.01 to 60

*RST: 0

Default unit: s

Parameters for setting and query:

<Channel list> <list>

Example:

VOLT:RAMP:DUR 4

VOLT:RAMP:DUR? -> 4

Duration of the ramp function is set at 4 s.

Example:

VOLT:RAMP:DUR 4, (@1)

VOLT:RAMP:DUR? (@1)

Sets and queries the duration of ramp function at channel 1.

Manual operation: See "[Ramp Time](#)" on page 93

8.7.3 Analog input

The VOLTage:AINPut subsystem contains the commands for configuring the analog input.

[SOURce:]VOLTage:AINPut:INPut.....	205
[SOURce:]VOLTage:AINPut:TRIGgered[:STATe].....	206
[SOURce:]VOLTage:AINPut[:STATe].....	206

[SOURce:]VOLTage:AINPut:INPut <arg0>[, <Channel list>]
[SOURce:]VOLTage:AINPut:INPut? [<Channel list>]

Sets or queries the analog input mode.

Parameters:

<input> VOLT | CURR | <list>

VOLT

Voltage mode.

CURR

Current mode.

Parameters for setting and query:

<Channel list> <list>

Example:

VOLT:AINP:INP? (@1)

Queries the analog input mode at channel 1.

Manual operation: See "Type" on page 74**[SOURce:]VOLTage:AINPut:TRIGgered[:STATe] <arg0>****[SOURce:]VOLTage:AINPut:TRIGgered[:STATe]?**

Sets or queries the trigger condition of the analog input for the selected channel.

Parameters:

<condition> OFF | 1 | 2 | 3 | 4 | 5 | 6 | 7 | 8

OFF

There is no DIO pin that has a mode set to Analog In for the selected channel.

1 | 2 | 3 | 4 | 5 | 6 | 7 | 8

DIO pin/s are enabled with a mode set to Analog In for the selected channel.

When DIO pin is enabled with Analog In mode, analog input of the channel assigned to that pin will be enabled when the correct voltage is applied to the DIO pin.

Manual operation: See "Enabled" on page 73

See "Mode" on page 85

[SOURce:]VOLTage:AINPut[:STATe] <arg0>[, <Channel list>]**[SOURce:]VOLTage:AINPut[:STATe]? [<Channel list>]**

Enables or disables the analog input for the selected channel.

Parameters:<arg0> **1**
Analog input for selected channel is enabled.**0**
Analog input for selected channel is disabled.**Parameters for setting and query:**

<Channel list> <list>

Example:

VOLT:AINP? (@1)

Queries the analog input state at channel 1.

Manual operation: See "Enabled" on page 73

8.7.4 Adjustment

The CALibration subsystem contains the commands for analog input and channel adjustment.

CALibration:AINPut:CANCel.....	207
CALibration:AINPut:COUNT?.....	207
CALibration:AINPut:DATA.....	208
CALibration:AINPut:DATE?.....	208
CALibration:AINPut:END.....	208
CALibration:AINPut:FACTory:REStore.....	208
CALibration:AINPut:SAVE.....	208
CALibration:AINPut:STARt.....	208
CALibration:AINPut:STATe?.....	209
CALibration:AINPut:UMAX.....	209
CALibration:AINPut:UMIN.....	209
CALibration:CANCel.....	209
CALibration:COUNT?.....	210
CALibration:CURRent:DATA.....	210
CALibration:CURRent:IMAX.....	210
CALibration:CURRent:IMIN.....	210
CALibration:DATE?.....	210
CALibration:END.....	210
CALibration:FACTory:REStore.....	211
CALibration:SAVE.....	211
CALibration:STATe?.....	211
CALibration:TEMPerature?.....	211
CALibration:USER.....	211
CALibration:VOLTage:DATA.....	212
CALibration:VOLTage:UMAX.....	212
CALibration:VOLTage:UMIN.....	212

CALibration:AINPut:CANCel

Cancels the analog input adjustment.

Usage: Event

Manual operation: See "[User Adjustment](#)" on page 136

CALibration:AINPut:COUNT?

Queries the number of counts performed for analog input adjustment.

Usage: Query only

Manual operation: See "[User Adjustment](#)" on page 136

CALibration:AINPut:DATA <arg0>**CALibration:AINPut:DATA?**

Sets or queries the analog input adjustment data.

Parameters:

<data> Measured value from DMM.

Manual operation: See "[User Adjustment](#)" on page 136

CALibration:AINPut:DATE?

Returns the analog input adjustment date ("DD-MM-YY").

Usage: Query only

CALibration:AINPut:END

Ends the analog input adjustment.

Usage: Event

Manual operation: See "[User Adjustment](#)" on page 136

CALibration:AINPut:FACTory:RESTore

Restores the analog input factory adjustment.

Usage: Event

Manual operation: See "[Restore Factory Adjustment](#)" on page 137

CALibration:AINPut:SAVE

Saves the analog input adjustment.

Usage: Event

Manual operation: See "[User Adjustment](#)" on page 136

CALibration:AINPut:START <arg0>

Selects the analog input pin for adjustment.

Setting parameters:

<pin> Input pin for adjustment.

Range: 1 to 4

Manual operation: See "[User Adjustment](#)" on page 136

CALibration:AINPut:STATe?

Queries the analog input adjustment state.

State	Descriptions
0-15	0x0 - 0xF (0b0000 - 0b1111) bit3 bit2 bit1 bit0 bit0 - pin 1 of analog input bit1 - pin 2 of analog input bit2 - pin 3 of analog input bit3 - pin 4 of analog input e.g. 15 - All analog input pins are adjusted. e.g. 9 - Pin 1 and pin 4 are adjusted.
16	Idle
17	Busy
18	Waiting

Example:

```
CAL:AINP:STAT? -> 9
```

Pin 1 and pin 4 are adjusted successful.

Usage: Query only

Manual operation: See "[User Adjustment](#)" on page 136

CALibration:AINPut:UMAX

Sets output voltage to high value 100 % of Vmax for analog input pin during adjustment.

Usage: Event

Manual operation: See "[User Adjustment](#)" on page 136

CALibration:AINPut:UMIN

Sets the output voltage to low value 1 % of Vmax for analog input pin during adjustment.

Usage: Event

Manual operation: See "[User Adjustment](#)" on page 136

CALibration:CANCel

Cancels the channel adjustment.

Usage: Event

Manual operation: See "[User Adjustment](#)" on page 140

CALibration:COUNT?

Queries the number of counts that the channel adjustment performed successfully.

Usage: Query only

Manual operation: See "[User Adjustment](#)" on page 140

CALibration:CURRENT:DATA <arg0>**CALibration:CURRENT:DATA?**

Sets or queries the DMM reading after setting the output current level in channel adjustment process.

Parameters:

<current> Measured value from DMM.

Manual operation: See "[User Adjustment](#)" on page 140

CALibration:CURRENT:IMAX

Sets the output current to high value 100 % of I_{max} during current adjustment.

Usage: Event

Manual operation: See "[User Adjustment](#)" on page 140

CALibration:CURRENT:IMIN

Sets the output current to low value 1 % of I_{max} during current adjustment.

Usage: Event

Manual operation: See "[User Adjustment](#)" on page 140

CALibration:DATE?

Returns the channel adjustment date.

Usage: Query only

Manual operation: See "[User Adjustment](#)" on page 140

CALibration:END

Ends the channel adjustment.

Usage: Event

Manual operation: See "[User Adjustment](#)" on page 140

CALibration:FACTory:REStore

Restores the factory channel adjustment.

Usage: Event

Manual operation: See "[Restore Factory Adjustment](#)" on page 141

CALibration:SAVE

Saves the channel adjustment.

Usage: Event

Manual operation: See "[User Adjustment](#)" on page 140

CALibration:STATe?

Returns the current state of channel adjustment.

State	Descriptions
0	Idle
1	Busy
2	Waiting
12	Voltage adjustment completed
13	Current adjustment completed
16	Successful channel adjustment
17	Failed channel adjustment

Example: CAL:STAT? -> 12
Voltage adjustment is completed.

Usage: Query only

Manual operation: See "[User Adjustment](#)" on page 140

CALibration:TEMPerature?

Returns the temperature of selected channel.

Usage: Query only

Manual operation: See "[Temperatures in °C](#)" on page 131
See "[Misc](#)" on page 131

CALibration:USER

Starts the channel adjustment process.

Usage: Event

Manual operation: See "User Adjustment" on page 140

CALibration:VOLTage:DATA <arg0>

CALibration:VOLTage:DATA?

Sets or queries the DMM reading after setting the output voltage level in channel adjustment process.

Parameters:

<voltage> Measured value from DMM.

Manual operation: See "User Adjustment" on page 140

CALibration:VOLTage:UMAX

Sets the output voltage to high value 100 % of Vmax during voltage adjustment.

Usage: Event

Manual operation: See "User Adjustment" on page 140

CALibration:VOLTage:UMIN

Sets the output voltage to low value 1 % of Vmax during voltage adjustment.

Usage: Event

Manual operation: See "User Adjustment" on page 140

8.8 Data and file management commands

The `DATA` and `HCOPY` subsystem contains commands for managing the files in the instrument and external USB stick.

The `LOG` subsystem contains the commands for managing the data logging of the instrument.

<code>DATA:DATA?</code>	213
<code>DATA:DELeTe</code>	213
<code>DATA:LIST?</code>	213
<code>DATA:POINts?</code>	214
<code>HCOPY:DATA?</code>	214
<code>HCOPY:SIZE:X?</code>	214
<code>HCOPY:SIZE:Y?</code>	214
<code>LOG[:STATe]</code>	214
<code>LOG:COUNT</code>	215
<code>LOG:DATA?</code>	215
<code>LOG:DURation</code>	216
<code>LOG:FNAME?</code>	216

LOG:INTerval.....	217
LOG:LOCation.....	217
LOG:MODE.....	217
LOG:STIMe.....	218
LOG:TRIGgered[:STATe].....	218

DATA:DATA? <arg0>

Returns the logging file data of the selected file.

If manual trigger mode (trigger via TRIG function) is used, the logging function has to be activated. Without activating the logging function in the manual trigger mode, the instrument is not able to save a logging file internally or on the USB stick.

Query parameters:

<filepath> Filepath of the logging file data.

Example: DATA:DATA?
 "/int/logging/log-20201203T095013.965.csv" ->
 #Device,NGP802
 #Calibration Ch1,factory
 Timestamp,U1[V],I1[A],P1[W]
 09:50:14.078,2.0003,0.00007,0.00013
 09:50:14.177,2.0003,0.00007,0.00014
 09:50:14.278,2.0003,0.00007,0.00014
 09:50:14.376,2.0003,0.00008,0.00016
 09:50:14.477,2.0003,0.00008,0.00015
 09:50:14.575,2.0003,0.00008,0.00017

Usage: Query only

DATA:DELeTe <arg0>

Deletes the specified file from memory.

Setting parameters:

<filepath> Filepath of the file.

Example: DATA:DEL
 "/int/logging/log-20201203T095013.965.csv"
 Deletes internal logging file 'log-20201203T095013.965.csv'

Usage: Setting only

Manual operation: See "[Delete](#)" on page 106

DATA:LIST?

Queries all files in internal memory ('/int/') and external memory ('/USB').

Example: DATA:LIST? -> "/USB1A/NGP/logging/
 log-20201203T101025.829.csv", "/int/arb/
 newWaveform.csv", "/int/logging/log-20201203T101129.818.csv"

Usage: Query only

Manual operation: See "[File Manager](#)" on page 105

DATA:POINts? <arg0>

Queries the number of measurements from the selected logging file.

If manual trigger mode (trigger via TRIG function) is used, the logging function has to be activated. Without activating the logging function in the manual trigger mode, the instrument is not able to save a logging file internally or on the USB stick.

Query parameters:

<filepath> Filepath of the logging file data.

Example: DATA:POIN?
 "/USB1A/NGP/logging/log-20201203T101025.829.csv"
 -> 5
 Returns 5 log files counts from "/USB1A/NGP/logging/
 log-20201203T101025.829.csv".

Usage: Query only

HCOPY:DATA?

Returns the actual display content (screenshot).

Usage: Query only

HCOPY:SIZE:X?

Returns the horizontal dimension of the screenshots.

Usage: Query only

HCOPY:SIZE:Y?

Returns the vertical dimension of the screenshots.

Usage: Query only

LOG[:STATe] <arg0>

LOG[:STATe]?

Sets or queries the data logging state.

Parameters:

<state> **1**
 Data logging function is enabled.
0
 Data logging function is disabled.
 *RST: 0

Example: LOG ON
 LOG? -> 1
 Data logging function is activated.

Manual operation: See "[Logging](#)" on page 58
 See "[Toggle Logging](#)" on page 95
 See "[Enabled](#)" on page 98

LOG:COUNT <Set new value>[, <Return min or max>]

LOG:COUNT? [<Return min or max>]

Sets or queries the number of measurement values to be captured.

Setting parameters:

<count> <numeric value> | MIN | MINimum | MAX | MAXimum

<numeric value>

Number of measurement values to be captured is set in the range of 1 to 10000000.

MIN | MINimum

Minimum number of measurement values to be captured is set at 1.

MAX | MAXimum

Maximum number of measurement values to be captured is set at 10000000.

Parameters for setting and query:

<count> MIN | MINimum | MAX | MAXimum

Returns the number of measurement values.

Example: LOG:COUNT MAX
 LOG:COUNT? MAX -> 10000000

Manual operation: See "[Mode](#)" on page 98

LOG:DATA?

Returns 12 sets of latest logging data with minimum logging interval (8 ms).

Depending on the models, the data is returned in the following format for a 2-channel models: <Ch1_voltage>, <Ch1_current>,<Ch1_power>,<Ch2_voltage>, <Ch2_current>,<Ch2_power>, <Ch1_voltage>, <Ch1_current>,<Ch1_power>, <Ch2_voltage>, <Ch2_current>,<Ch2_power>...

Example: 2-channel models with 5 V set on Ch1 and 10V set on Ch2
 LOG:DATA? ->
 "5.000,0.0000,0.000,10.000,0.0000,0.000,5.000,0.0000,0.000,1
 0.000,0.0000,0.000,5.000,0.0000,0.000,10.000,0.0000,0.000,5.
 000,0.0000,0.000,10.000,0.0000,0.000,5.000,0.0000,0.000,10.0
 00,0.0000,0.000,5.000,0.0000,0.000,10.000,0.0000,0.000,
 5.000,0.0000,0.000,10.000,0.0000,0.000,5.000,0.0000,0.000,
 10.000,0.0000,0.000,5.000,0.0000,0.000,10.000,0.0000,0.000,
 5.000,0.0000,0.000,10.000,0.0000,0.000,5.000,0.0000,0.000,10
 .000,0.0000,0.000,5.000,0.0000,0.000,10.000,0.0000,0.000"

Usage: Query only

LOG:DURation <Set new value>[, <Return min or max>]

LOG:DURation? [<Return min or max>]

Sets or queries the duration of the data logging.

Setting parameters:

<Set new value> <numeric value> | MIN | MINimum | MAX | MAXimum

<numeric value>

Duration of the data logging captured in the range of 0 s to $3.49 \cdot 10^5$ s.

MIN | MINimum

Minimum duration of the data logging captured at 0 s.

MAX | MAXimum

Maximum duration of the data logging captured at $3.49 \cdot 10^5$ s.

Default unit: s

Parameters for setting and query:

 MIN | MINimum | MAX | MAXimum

Returns the duration of the data logging.

Example: LOG:DUR MAX
 LOG:DUR? MAX -> 349000

Manual operation: See "[Mode](#)" on page 98

LOG:FNAME?

Queries the filename and storage location for the data logging.

Example: LOG 0
 LOG:FNAME? -> ""
 LOG 1
 LOG:FNAME? -> "/int/logging/log-20190318T1141853.407.csv"
 Enables the data logging and queries the data log filename.

Usage: Query only

Manual operation: See "[Target Folder](#)" on page 98

LOG:INTerval <Set new value>[, <Return min or max>]
LOG:INTerval? [<Return min or max>]

Sets or queries the data logging measurement interval. The measurement interval describes the time between the recorded measurements.

Setting parameters:

<interval> <numeric value> | MIN | MINimum | MAX | MAXimum

<numeric value>

Measurement interval in the range of 0.008 s to 600 s.

MIN | MINimum

Minimum measurement interval is set at 0.008 s.

MAX | MAXimum

Maximum measurement interval is set at 600 s.

Default unit: s

Parameters for setting and query:

<Return min or max> MIN | MINimum | MAX | MAXimum

Returns the measurement interval.

Example:

LOG:INT 10

LOG:INT? -> 10

Manual operation: See "[Interval](#)" on page 98

LOG:LOCation [<>]

LOG:LOCation? [<>]

Sets or queries the logging location.

Parameters for setting and query:

<location?> INT | EXT | DEF

INT

Internal location, i.e. "int/logging".

EXT

External location, i.e. "USB1A/NGP/logging".

DEF

Default location, i.e. "int/logging".

Manual operation: See "[Target Folder](#)" on page 98

LOG:MODE <arg0>

LOG:MODE? <arg0>

Sets or queries the data logging mode.

Parameters for setting and query:

<mode> UNLimited | COUNT | DURation | SPAN

UNLimited

Infinite data capture.

COUNT

Number of measurement values to be captured.

DURation

Duration of the measurement values capture.

SPAN

Interval of the measurement values capture.

Example: LOG:MODE DUR
LOG:MODE? -> DUR

Manual operation: See "[Mode](#)" on page 98

LOG:STIMe <Year>, <Month>, <Day>, <Hour>, <Minute>, <Second>
LOG:STIMe?

Sets or queries the start time of the data logging function.

Setting parameters:

<Year> Sets the year for the data logging function.
<Month> Sets the month for the data logging function.
<Day> Sets the day for the data logging function.
<Hour> Sets the hour for the data logging function.
<Minute> Sets the minute for the data logging function.
<Second> Sets the second for the data logging function.

Example: LOG:STIM 2018,08,18,08,18,18
LOG:STIM? -> 2018,08,18,08,18,18

Manual operation: See "[Mode](#)" on page 98

LOG:TRIGgered[:STATe] <arg0>
LOG:TRIGgered[:STATe]?

Sets or queries the trigger conditions for logging.

Parameters:

<condition> OFF | 1 | 2 | 3 | 4 | 5 | 6 | 7 | 8

OFF

There is no DIO pin that has a mode set to logging.

1 | 2 | 3 | 4 | 5 | 6 | 7 | 8

DIO pin/s are enabled with a mode set to logging.

When DIO pin is enabled with logging mode, logging of the channel assigned to that pin will be enabled when the correct voltage is applied to the DIO pin.

Manual operation: See "[Mode](#)" on page 85

8.9 Status reporting commands

The status reporting system stores all information on the present operating state of the instrument, and on errors which have occurred. This information is stored in the status registers and in the error queue. The `STATUS:OPERation` and `STATUS:QUESTIONable` subsystems contains commands to control the status reporting structure of the instrument.

See [Chapter A.3.1, "Structure of a SCPI status register"](#), on page 241.

8.9.1 STATUS:OPERation registers

The commands of the `STATUS:OPERation` subsystem control the status reporting structures of the `STATUS:OPERation` register.

The suffix at `<Channel>` selects the instrument channel. Depending on the instrument models, the range is `<1...4>`.

<code>STATUS:OPERation:INSTrument:CONDition?</code>	219
<code>STATUS:OPERation:INSTrument:ISUMmary<Channel>:CONDition?</code>	219
<code>STATUS:OPERation:INSTrument:ENABle</code>	220
<code>STATUS:OPERation:INSTrument:ISUMmary<Channel>:ENABle</code>	220
<code>STATUS:OPERation:INSTrument[:EVENT]?</code>	220
<code>STATUS:OPERation:INSTrument:ISUMmary<Channel>[:EVENT]?</code>	220
<code>STATUS:OPERation:INSTrument:NTRansition</code>	220
<code>STATUS:OPERation:INSTrument:ISUMmary<Channel>:NTRansition</code>	220
<code>STATUS:OPERation:INSTrument:PTRansition</code>	221
<code>STATUS:OPERation:INSTrument:ISUMmary<Channel>:PTRansition</code>	221

STATUS:OPERation:INSTrument:CONDition?

STATUS:OPERation:INSTrument:ISUMmary<Channel>:CONDition?

Returns the contents of the `CONDition` part of the status register to check for operation instrument or measurement states. Reading the `CONDition` registers does not delete the contents.

Suffix:

`<Channel>` 1..n

Return values:

`<Condition>` Condition bits in decimal representation.

Range: 1 to 65535

Usage:

Query only

STATus:OPERation:INSTRument:ENABle <arg0>

STATus:OPERation:INSTRument:ENABle?

STATus:OPERation:INSTRument:ISUMmary<Channel>:ENABle <arg0>

STATus:OPERation:INSTRument:ISUMmary<Channel>:ENABle?

Controls or queries the ENABle part of the STATus:OPERation register. The ENABle defines which events in the EVENT part of the status register are forwarded to the OPERation summary bit (bit 7) of the status byte. The status byte can be used to create a service request.

Suffix:

<Channel> 1..n

Parameters:

<Enable> Range: 1 to 65535
Increment: 1

Example:

STATus:OPERation:INSTRument:ISUMmary1:ENABle?
Reads the enable register for the Standard Operation Register group.

STATus:OPERation:INSTRument[:EVENT]?

STATus:OPERation:INSTRument:ISUMmary<Channel>[:EVENT]?

Returns the contents of the EVENT part of the status register to check whether an event has occurred since the last reading. Reading an EVENT register deletes its contents.

Suffix:

<Channel> 1..n

Return values:

<Event> Range: 1 to 65535

Usage: Query only

STATus:OPERation:INSTRument:NTRansition <arg0>

STATus:OPERation:INSTRument:NTRansition?

STATus:OPERation:INSTRument:ISUMmary<Channel>:NTRansition <arg0>

STATus:OPERation:INSTRument:ISUMmary<Channel>:NTRansition?

Sets or queries the negative transition filter. Setting a bit in the negative transition filter shall cause a 1 to 0 transition in the corresponding bit of the associated condition register to cause a 1 to be written in the associated bit of the corresponding event register.

Suffix:

<Channel> 1..n

Parameters:

<NegativeTransition> Range: 1 to 65535

Example:

STATus:OPERation:INSTRument:ISUMmary1:
NTRansition?
Query for negative transition.

STATus:OPERation:INSTRument:PTRansition <arg0>

STATus:OPERation:INSTRument:PTRansition?

STATus:OPERation:INSTRument:ISUMmary<Channel>:PTRansition <arg0>

STATus:OPERation:INSTRument:ISUMmary<Channel>:PTRansition?

Sets or queries the positive transition filter. Setting a bit in the positive transition filter shall cause a 0 to 1 transition in the corresponding bit of the associated condition register to cause a 1 to be written in the associated bit of the corresponding event register.

Suffix:

<Channel> 1..n

Parameters:

<PositiveTransition> Range: 1 to 65535

Example:

```
STATus:OPERation:INSTRument:ISUMmary1:
PTRansition?
Query for positive transition.
```

8.9.2 STATus:QUEStionable registers

The commands of the `STATus:QUEStionable` subsystem control the status reporting structures of the `STATus:QUEStionable` registers.

The suffix at <Channel> selects the instrument channel. Depending on the instrument models, the range is <1...4>.

<code>STATus:QUEStionable:INSTRument:CONDition?</code>	221
<code>STATus:QUEStionable:INSTRument:ISUMmary<Channel>:CONDition?</code>	221
<code>STATus:QUEStionable:INSTRument:ENABLE</code>	222
<code>STATus:QUEStionable:INSTRument:ISUMmary<Channel>:ENABLE</code>	222
<code>STATus:QUEStionable:INSTRument[:EVENT]?</code>	222
<code>STATus:QUEStionable:INSTRument:ISUMmary<Channel>[:EVENT]?</code>	222
<code>STATus:QUEStionable:INSTRument:NTRansition</code>	222
<code>STATus:QUEStionable:INSTRument:ISUMmary<Channel>:NTRansition</code>	222
<code>STATus:QUEStionable:INSTRument:PTRansition</code>	223
<code>STATus:QUEStionable:INSTRument:ISUMmary<Channel>:PTRansition</code>	223

STATus:QUEStionable:INSTRument:CONDition?

STATus:QUEStionable:INSTRument:ISUMmary<Channel>:CONDition?

Returns the contents of the `CONDition` part of the status register to check for questionable instrument or measurement states. Reading the `CONDition` registers does not delete the contents.

Suffix:

<Channel> 1..n

Return values:

<Condition> Condition bits in decimal representation
 Range: 0 to 65535

Usage: Query only

STATus:QUESTIONable:INSTrument:ENABle <arg0>

STATus:QUESTIONable:INSTrument:ENABle?

STATus:QUESTIONable:INSTrument:ISUMmary<Channel>:ENABle <arg0>

STATus:QUESTIONable:INSTrument:ISUMmary<Channel>:ENABle?

Sets or queries the enable mask that allows true conditions in the EVENT part to be reported in the summary bit.

If a bit in the ENABle part is 1, and the corresponding EVENT bit is true, a positive transition occurs in the summary bit. This transition is reported to the next higher level.

Suffix:

<Channel> 1..n

Parameters:

<Enable_Value> Bit mask in decimal representation
Range: 0 to 65535

Example:

```
STATus:QUESTIONable:INSTrument:ISUMmary1:
ENABle?
```

Queries the event register for the Standard QUESTIONable Register group.

STATus:QUESTIONable:INSTrument[:EVENT]?

STATus:QUESTIONable:INSTrument:ISUMmary<Channel>[:EVENT]?

Returns the contents of the EVENT part of the status register to check whether an event has occurred since the last reading. Reading an EVENT register deletes its contents.

Suffix:

<Channel> 1..n

Return values:

<Event> Event bits in decimal representation
Range: 0 to 65535

Usage: Query only

STATus:QUESTIONable:INSTrument:NTRansition <arg0>

STATus:QUESTIONable:INSTrument:NTRansition?

STATus:QUESTIONable:INSTrument:ISUMmary<Channel>:NTRansition <arg0>

STATus:QUESTIONable:INSTrument:ISUMmary<Channel>:NTRansition?

Sets or queries the negative transition filter. Setting a bit in the negative transition filter shall cause a 1 to 0 transition in the corresponding bit of the associated condition register to cause a 1 to be written in the associated bit of the corresponding event register.

Suffix:

<Channel> 1..n

Parameters:

<NegativeTransition> Range: 1 to 65535

Example: `STATus:QUESTionable:INSTrument:ISUMmary1:
NTRansition?`
Query for negative transition.

`STATus:QUESTionable:INSTrument:PTRansition <arg0>`
`STATus:QUESTionable:INSTrument:PTRansition?`
`STATus:QUESTionable:INSTrument:ISUMmary<Channel>:PTRansition <arg0>`
`STATus:QUESTionable:INSTrument:ISUMmary<Channel>:PTRansition?`

Sets or queries the positive transition filter. Setting a bit in the positive transition filter shall cause a 0 to 1 transition in the corresponding bit of the associated condition register to cause a 1 to be written in the associated bit of the corresponding event register.

Suffix:
<Channel> 1..n

Parameters:
<PositiveTransition> Range: 1 to 65535

Example: `STATus:QUESTionable:INSTrument:ISUMmary1:
PTRansition?`
Query for positive transition.

9 Troubleshooting

- [Displaying status information](#)..... 224
- [Problems during firmware update](#)..... 224
- [Problems with remote control over LAN](#)..... 225
- [Contacting customer support](#)..... 225

9.1 Displaying status information

The R&S NGP800 displays notifications to inform you on current settings and states. It distinguishes between status, information, and warning and error notifications.

Some information and messages are entered in the error/event queue of the status reporting system, see [Chapter A.3, "Status reporting system"](#), on page 240.

9.2 Problems during firmware update

The firmware update is described in [Chapter 7.17.6, "Update device"](#), on page 131.

Solutions for potential problems that can occur during firmware update are described in the following sections.

Firmware update was interrupted

If, for example, a power cut happens during the firmware update, problems can occur.

1. Perform the firmware update again. Sometimes, a further update fixes the problems.
2. If you nevertheless cannot update the R&S NGP800, contact the local service representative, see [Chapter 9.4, "Contacting customer support"](#), on page 225.

Firmware update was aborted

If there is not enough free memory space, the firmware update aborts. The instrument displays an error message.

- ▶ Start the firmware update again.

9.3 Problems with remote control over LAN

9.3.1 Cannot establish a LAN connection

If you have problems to establish a LAN connection as described in [Chapter 7.16.2, "LAN connection"](#), on page 112:

1. Check if the TCP/IP address information is valid.
2. Assign the IP address manually, e.g. if the network does not support DHCP configuration.

9.3.2 Cannot communicate over LAN

If you have problems to establish the LAN communication:

1. Refer to the application note [1SL374: How to communicate with R&S devices using VISA](#), that provides comprehensive information on configuring the interfaces, required drivers, and testing the communication.
2. If you still have problems, contact the customer support.

9.4 Contacting customer support

Technical support – where and when you need it

For quick, expert help with any Rohde & Schwarz product, contact our customer support center. A team of highly qualified engineers provides support and works with you to find a solution to your query on any aspect of the operation, programming or applications of Rohde & Schwarz products.

Contact information

Contact our customer support center at www.rohde-schwarz.com/support, or follow this QR code:



Figure 9-1: QR code to the Rohde & Schwarz support page

10 Transport

Lifting and carrying

See "[Lifting and carrying the product](#)" on page 10.

Packing

Use the original packaging material. It consists of antistatic wrap for electrostatic protection and packing material designed for the product.

If you do not have the original packaging, use similar materials that provide the same level of protection.

Securing

When moving the product in a vehicle or using transporting equipment, make sure that the product is properly secured. Only use items intended for securing objects.

Transport altitude

Unless otherwise specified in the data sheet, the maximum transport altitude without pressure compensation is 4500 m above sea level.

11 Maintenance, storage and disposal

The product does not require regular maintenance. It only requires occasional cleaning. It is however advisable to check the nominal data from time to time.

- [Cleaning](#)..... 228
- [Changing fuses](#)..... 228
- [Internal battery replacement](#)..... 228
- [Storage](#)..... 229
- [Disposal](#)..... 229

11.1 Cleaning

How to clean the product is described in "[Cleaning the product](#)" on page 12.

Do not use any liquids for cleaning. Cleaning agents, solvents, acids and bases can damage the front panel labeling, plastic parts and display.

11.2 Changing fuses

If the product does not start, it is possible that a blown fuse is the cause. The fuse is located in the socket of the power supply.

For details on changing fuses, see "[Replacing the power fuse](#)" on page 25.

11.3 Internal battery replacement

An internal CR2032 coin cell battery powers the real-time clock circuit which provides continuous time stamp for the instrument. If the battery fails, the system clock and time stamp for the logging function are not available but other instrument functions are not affected.

Under normal usage at room temperature, the battery is expected to last up to 10 years. However, the battery life expectancy is reduced if the device is stored at temperature above 40°C for an extended period of time.



If the instrument cannot retain the date and time settings after turning off the AC input, the battery is discharged.

Contact your local service partner for battery replacement.

11.4 Storage

Protect the product against dust. Ensure that the environmental conditions, e.g. temperature range and climatic load, meet the values specified in the data sheet.

11.5 Disposal

Rohde & Schwarz is committed to making careful, ecologically sound use of natural resources and minimizing the environmental footprint of our products. Help us by disposing of waste in a way that causes minimum environmental impact.

Disposing electrical and electronic equipment

A product that is labeled as follows cannot be disposed of in normal household waste after it has come to the end of its service life. Even disposal via the municipal collection points for waste electrical and electronic equipment is not permitted.



Figure 11-1: Labeling in line with EU directive WEEE

Rohde & Schwarz has developed a disposal concept for the eco-friendly disposal or recycling of waste material. As a manufacturer, Rohde & Schwarz completely fulfills its obligation to take back and dispose of electrical and electronic waste. Contact your local service representative to dispose of the product.

12 Applications

12.1 Parallel and series mode

To increase output voltage and currents, it is possible to operate the channels in series or parallel mode. In general, the output voltages of R&S NGP800 to be combined are independent.

For safety information, see [Chapter 5.1.6, "Connecting to power"](#), on page 25.

12.1.1 Series mode

This type of interconnection adds the individual output voltages. The same current flows through all outputs. The current limits for the outputs wired in series should be set to the identical value. If one of the outputs exceeded the current limit, the total voltage will naturally collapse. See [Chapter 6.4, "Operation modes"](#), on page 64.

It is advisable to set the voltages of all connected channels voltages to a similar value to distribute the loads evenly (not absolutely necessary). When all four channels are connected in a series mode and if a (low resistance) load is connected; there is a chance of damaging a channel when that channel is switched off. This is due to the protection diode working as a bypass to connect the other channel in a series mode. Once the protection diode is shorted, the channel will be defective.

Therefore, it is necessary to always have all channels or no channel at all switched on.



If the instrument switches to constant current (CC) mode during a series connection, the voltage display becomes inaccurate.

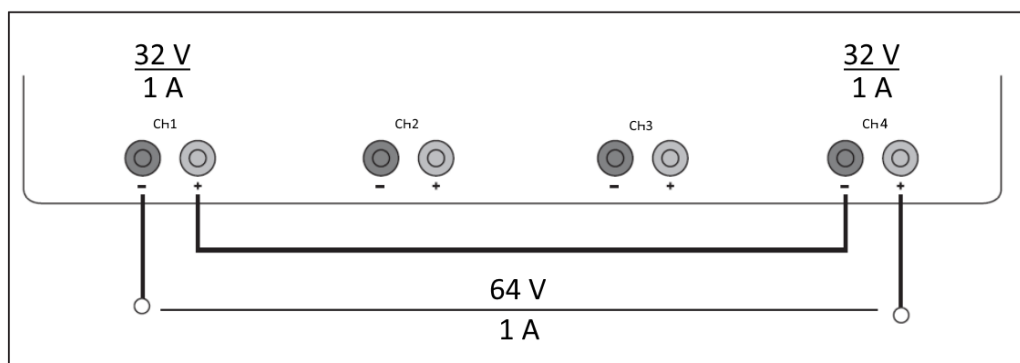

Figure 12-1: Example of series connection

12.1.2 Parallel mode

If it is necessary to increase the total current, the power supply outputs must be wired in parallel. The maximum total current is the sum of the individual currents of all sources connected in parallel. The output voltages for the individual outputs should be set to the same voltage value as precisely as possible. For slight voltage differences, it is common in this operating mode to first charge a voltage output up to the current limit; the other voltage output provides the remaining current. See "[Principles of operation in parallel mode](#)" on page 231.

For power supplies that are connected in parallel, it is possible that compensating currents flow within the power supplies. The use of power supplies by other manufacturers, which are potentially not overload proof, can cause destruction of these units as currents may be distributed unevenly.

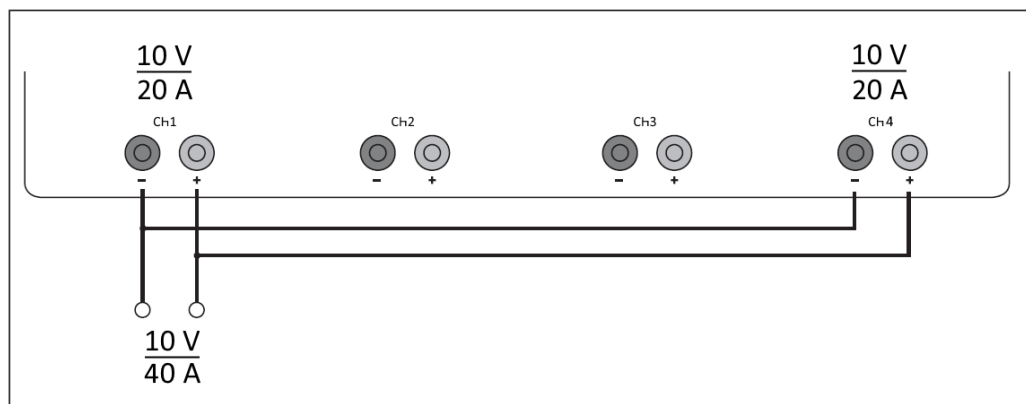

Figure 12-2: Example of parallel connection

Principles of operation in parallel mode

Generally, a higher current is first supplied from the channel with the higher output voltage. Once this channel reaches its power limit, the remaining current is made available by the channel that is connected in parallel. In this scenario, it is unpredictable which channel supplies the higher current because it is also possible for channels with identical voltage values to display a low voltage difference.

By increasing the voltage slightly, the load distribution can be manipulated. If the voltage for a channel is to be increased by 50 mV, for instance (by a set of identical cables), the current will initially be provided by this channel.

If you wish to distribute the load to multiple channels, it is recommended to set the current limit of the channel that is to supply the main current to a fraction of the current. This approach handles the semiconductor with care and improves the heat dissipation, as the power loss is distributed more evenly.

Annex

A Additional basics on remote control

A.1 Messages and SCPI command structure

A.1.1 Messages

Instrument messages are employed in the same way for all interfaces, if not indicated otherwise in the description.

- Structure and syntax of the instrument messages: [Chapter A.1.2, "SCPI command structure"](#), on page 233
- Detailed description of all messages: [Chapter 8, "Remote control commands"](#), on page 142

There are different types of instrument messages:

- Commands
- Instrument responses

Commands

Commands (program messages) are messages which the controller sends to the instrument. They operate the instrument functions and request information. The commands are subdivided according to two criteria:

Effects on the instrument:

- Setting commands cause instrument settings such as a reset of the instrument or setting the output voltage.
- Queries return data for remote control, e.g. for identification of the instrument or polling a parameter value. Queries are formed by appending a question mark to the command header.

Applied standards:

- The function and syntax of the common commands are precisely defined in standard IEEE 488.2. If implemented, they are used identically on all instruments. They refer to functions such as management of the standardized status registers, reset and self-test.
- Instrument control commands refer to functions depending on the features of the instrument such as voltage settings. Many of these commands have also been standardized by the SCPI committee. These commands are marked as "SCPI compliant" in the command reference chapters. Commands without this SCPI label

are device-specific, however, their syntax follows SCPI rules as permitted by the standard.

Instrument responses

Instrument responses (response messages and service requests) are messages which the instrument sends to the controller after a query. They can contain measurement results, instrument settings and information on the instrument status.

GPIB Interface Messages

Interface messages are transmitted to the instrument on the data lines with the attention line (ATN) being active (LOW). They are used for communication between the controller and the instrument and can only be sent by a PC which has the function of a GPIB bus controller. GPIB interface messages can be further subdivided into:

- **Universal commands** act on all instruments connected to the GPIB bus without previous addressing; universal commands are encoded in the range 0x10 through 0x1F. They affect all instruments connected to the bus and do not require addressing.
- **Addressed commands** only act on instruments previously addressed as listeners; addressed commands are encoded in the range 0x00 through 0x0F. They only affect instruments addressed as listeners.

A.1.2 SCPI command structure

SCPI commands consist of a so-called header and, usually, one or more parameters. The header and the parameters are separated by a whitespace. The headers can consist of several mnemonics (keywords). Queries are formed by appending a question mark directly to the header. The commands can be either device-specific or device-independent (common commands). Common and device-specific commands differ in their syntax.

Syntax for common commands

Common (= device-independent) commands consist of a header preceded by an asterisk (*) and possibly one or more parameters.

Table A-1: Examples of common commands

Command	Command name	Description
*RST	Reset	Resets the instrument.
*ESE	Event Status Enable	Sets the bits of the event status enable registers.
*ESR?	Event Status Query	Queries the content of the event status register.
*IDN?	Identification Query	Queries the instrument identification string.

Syntax for device-specific commands

For demonstration purposes only, assume the existence of the following commands for this section:

- MEASure:CURRent[:DC]?
- MEASure:VOLTage[:DC]?
- FUSE[:STATe] {0 | 1}
- FUSE[:STATe]?

Long and short form

The mnemonics feature a long form and a short form. The short form is marked by uppercase letters, the long form corresponds to the complete word. You can enter either the short form or the long form; other abbreviations are not permitted.

Example:

MEASure:CURRent? is equivalent to MEAS:CURR?.



Case-insensitivity

Uppercase and lowercase notation only serves to distinguish the two forms in the manual, the instrument itself is case-insensitive.

Numeric suffixes

If a command can be applied to multiple instances of an object, e.g. specific channels or sources, the required instances can be selected by a suffix added to the command. Numeric suffixes are indicated by angular brackets (<1...4>, <n>, <i>). They are replaced by a value without brackets in the command.

SCPI prescribes that suffix counting starts with 1. Suffix 1 is the default state and used when no suffix is specified.

Example:

Definition: CHANnel<n>:LIMit<n>:SOURCE?

Command: CHAN:LIM2:SOUR?

This command queries the 2nd limit in channel 1.

Optional mnemonics

Some command systems permit inserting or omitting certain mnemonics in the header. These mnemonics are marked by square brackets. The instrument must recognize the long command to comply with the SCPI standard. Some commands are shortened by these optional mnemonics.



Optional mnemonics with numeric suffixes

Do not omit an optional mnemonic if it includes a numeric suffix that is relevant for the effect of the command.

Example:

CHANnel<n>[:ACQuistion]:MODE?

CHAN:ACQ:MODE? is equivalent to CHAN:MODE?.

Note that an optional mnemonic with a numeric suffix automatically selects 1 if you omit the optional part of the command, e.g.:

Definition: CHANnel<n>:MEASurement:FUNCtions? [<n>]

Command: CHAN:MEAS:FUNC? queries the list of all function names in channel 1.

To query a single function, e.g. at index 3 in channel 2, include the optional CHANnel suffix and the index of the function.

Command: CHAN2:MEAS:FUNC? 3

FUSE[:STATe] { ON }

FUSE:STAT ON is equivalent to FUSE ON.

Syntax for channel list commands

For demonstration purposes only, assume the existence of the following commands for this section:

- VOLT? (@2)
- OUTP (@2)
- VOLT? (@1, 3)
- VOLT? (@1:4)
- VOLT 5, (@1:4)

When adding a channel list parameter to a query, there must be a space character between the query indicator (?) and the channel list parameter. Otherwise an error -103, invalid separator occurs.

Table A-2: Special characters

@	The "@" sign-in parameter definition indicates in the sense of "at", which is part of the channel list command syntax. Example: <ul style="list-style-type: none"> • VOLT? (@2) queries the voltage at CH2 • OUTP 1, (@3) turns on the output at CH3
,	The comma sign-in parameter definition indicates in the sense of separator for additional channels definition. Example: <ul style="list-style-type: none"> • VOLT? (@1, 3) queries the voltage at CH1 and CH3 • VOLT? (@1, 3, 4) is equivalent to query the voltage at CH1, CH3 and CH4
:	The colon sign-in parameter definition indicates the definition of channel range for additional channel definition. Example: <ul style="list-style-type: none"> • VOLTage? (@1:3) queries the voltage at CH1, CH2, CH3 • VOLTage 5, (@1:3) configures CH1, CH2 and CH3 to 5 V

A.1.3 SCPI parameters

Many commands are supplemented by a parameter or a list of parameters. The parameters must be separated from the header by a whitespace (ASCII code 0 to 9, 11

to 32 decimal, e.g. blank). If several parameters are specified in a command, they are separated by a comma ",".

Allowed parameters are:

- Numeric values
- Special numeric values
- Boolean parameters
- Text
- Character strings
- Block data

The required parameters and the allowed value range are specified in the command description.

Numeric values

You can enter numeric values either with sign, decimal point or exponentially ("E" or "e"). The mantissa range is up to 255 characters, the value range of the exponent is -32000 to 32000. Values exceeding the resolution of the instrument are rounded up or down.

Example:

```
VOLT 10V = VOLT 10
```

```
VOLT 100mV = VOLT 0.1
```

```
VOLT 500mV is equivalent to VOLT 500e-3.
```

Special numeric values

The text listed below are interpreted as special numeric values. In the case of a query, the numeric value is provided.

- MIN/MAX
- MINimum and MAXimum denote the minimum and maximum value

Example:

```
VOLT:PROT? MAX
```

Returns the maximum numeric value.

Boolean parameters

Boolean parameters represent two states:

- **On** (logically true), is represented by "On" or the numeric value "1"
- **Off** (logically false), is represented by "Off" or the numeric value "0"

The instrument returns the numerical value when queried.

Example:

```
OUTP:STAT ON
```

```
OUTP:STAT? -> 1
```

Text

Text parameters observe the syntactic rules for key words, i.e. they can be entered using a short or long form. Like any parameter, they have to be separated from the header by a white space.

Example:

```
ARBitrary:TRIGgered:MODE
ARBitrary:TRIGgered:MODE SING
ARBitrary:TRIGgered:MODE? -> "SINGLE"
```

Character strings

Strings must always be entered in quotation marks (' or ").

Example:

```
SYSTem:COMMunicate:SOCKet:IPAdDress "192.168.1.128"
SYSTem:COMMunicate:SOCKet:IPAdDress '192.168.1.128'
```

Block data

Block data is a transmission format which is suitable for the transmission of large amounts of data. A command using a block data parameter has the following structure:

Example:

```
HEADer:HEADer #45168xxxxxxxx
```

ASCII character # introduces the data block. The next number indicates how many of the following digits describe the length of the data block. In the example, the four following digits indicate the length to be 5168 bytes. The data bytes follow. During the transmission of these data bytes all end or other control signs are ignored until all bytes are transmitted.

#0 specifies a data block of indefinite length. The use of the indefinite format requires a `NL^END` message to terminate the data block. This format is useful when the length of the transmission is not known or if speed or other considerations prevent segmentation of the data into blocks of definite length.

A.1.4 Overview of syntax elements

The following tables provide an overview of the syntax elements and special characters.

Table A-3: Syntax elements

:	A colon separates the mnemonics of a command.
;	The semicolon separates two commands within a program message. It does not alter the path.
,	A comma separates several parameters of a command.
?	A question mark forms a query.

*	An asterisk marks a common command.
"	Quotation marks introduce a string and terminate it.
	A whitespace (ASCII-Code 0 to 9, 11 to 32 decimal, e.g. blank) separates the header from the parameters.

Special characters

Table A-4: Special characters

	A vertical stroke in parameter definition indicates alternative possibilities in the sense of "or". The effect of the command differs, depending on the used parameter. Example: <ul style="list-style-type: none"> • FUSE:LINK {1 2 3} • FUSE:LINK 1 sets the fuse link CH 1 for the selected channel FUSE:LINK 2 sets the fuse link of CH 2 for the selected channel
[]	Mnemonics in square brackets are optional and can be inserted into the header or be omitted. Example: <ul style="list-style-type: none"> • FUSE[:STATe] { ON } • FUSE:STAT ON is equivalent to FUSE ON
{ }	Parameters in curly brackets are optional and can be inserted once or several times, or be omitted. Example: <ul style="list-style-type: none"> • VOLTage[:LEVel][:IMMediate][:AMPLitude] {<voltage> MIN MAX UP DOWN } <p>The following are valid commands:</p> <ul style="list-style-type: none"> – VOLT MAX – VOLT MIN – VOLT 10

A.1.5 Responses to queries

A query is defined for each setting command unless otherwise specified. The query is set by the question mark at the end of the header. According to SCPI, the responses to some query commands are subject to stricter rules than in defined standard IEEE 488.2.

- The requested parameter is transmitted without a header.
ARBitrary:TRIGgered:MODE? -> "SINgle"
- Maximum values, minimum values and all other quantities that are requested via a special text parameter are returned as numeric values.
VOLT:PROT? MAX -> 32.500
- Boolean values are returned as 0 (for Off) and 1 (for On).
OUTPut:STATe? -> 1

A.2 Command sequence and synchronization

A sequential command finishes the execution before the next command is starting. To make sure that commands are actually carried out in a certain order, each command must be sent in a separate command line.



As a general rule, send commands and queries in different program messages.

A.2.1 Preventing overlapping execution

To prevent an overlapping execution of commands the commands `*OPC`, `*OPC?` or `*WAI` can be used. All three commands cause a certain action only to be carried out after the hardware has been set. The controller can be forced to wait for the corresponding action.



The R&S NGP800 series does not support parallel processing of remote commands. If `OPC?` returns a "1", the device is able to process new commands.

Table A-5: Synchronization using `*OPC`, `*OPC?` and `*WAI`

Command	Action	Programming the controller
<code>*OPC</code>	Sets the Operation Complete bit in the ESR after all previous commands have been executed.	<ul style="list-style-type: none"> Setting bit 0 in the ESE Setting bit 5 in the SRE Waiting for service request (SRQ)
<code>*OPC?</code>	Stops command processing until 1 is returned. It occurs after the Operation Complete bit has been set in the ESR. This bit indicates that the previous setting has been completed.	Sending <code>*OPC?</code> directly after the command whose processing should be terminated before other commands can be executed.
<code>*WAI</code>	Stops further command processing until all commands have been executed before <code>*WAI</code> .	Sending <code>*WAI</code> directly after the command whose processing should be terminated before other commands are executed

Command synchronization using `*WAI` or `*OPC?` is a good choice if the overlapped command takes only little time to process. The two synchronization commands simply block overlapped execution of the command. Append the synchronization command to the overlapping command, for example:

```
SINGLE; *OPC?
```

For time consuming overlapped commands, you can allow the controller or the instrument to do other useful work while waiting for command execution. Use one of the following methods:

***OPC with a service request**

1. Set the OPC mask bit (bit no. 0) in the ESE: `*ESE 1`
2. Set bit no. 5 in the SRE: `*SRE 32` to enable ESB service request.
3. Send the overlapped command with `*OPC` .

4. Wait for a service request.

The service request indicates that the overlapped command has finished.

***OPC? with a service request**

1. Set bit no. 4 in the SRE: `*SRE 16` to enable MAV service request.
2. Send the overlapped command with `*OPC?`.
3. Wait for a service request.

The service request indicates that the overlapped command has finished.

Event status register (ESE)

1. Set the OPC mask bit (bit no. 0) in the ESE: `*ESE 1`
2. Send the overlapped command without `*OPC`, `*OPC?` or `*WAI`.
3. Poll the operation complete state periodically (with a timer) using the sequence:
`*OPC; *ESR?`

A return value (LSB) of 1 indicates that the overlapped command has finished.

***OPC? with a short timeout**

1. Send the overlapped command without `*OPC`, `*OPC?` or `*WAI`.
2. Poll the operation complete state periodically (by means of a timer) using the sequence: (short timeout); `*OPC?`.
3. A return value (LSB) of 1 indicates that the overlapped command has finished. In case of a timeout, the operation is ongoing.
4. Reset timeout to former value
5. Clear the error queue with `SYStem:ERRor?` to remove the "-410, Query interrupted" entries.

Using several threads in the controller application

Provided the programming environment of the controller application supports threads, you can use separate threads for the application GUI and for controlling the instrument using SCPI commands. A thread waiting for an `*OPC?` response does not block the GUI or the communication with other instruments.

A.3 Status reporting system

The status reporting system stores all information on the current operating state of the instrument and errors which have occurred. This information is stored in the status registers and in the error queue. You can query both via RS-232, USB, GPIB or LAN interface (`STATus...` commands).

A.3.1 Structure of a SCPI status register

Each standard SCPI register consists of 2 or 3 parts (Event, Condition and Enable register). Each part has a width of 16 bits and has different functions. The individual bits are independent of each other, i.e. each hardware status is assigned a bit number which is valid for all 2 or 3 parts. Bit 15 (the most significant bit) is set to zero for all parts. Thus the controller can process contents of the register parts as positive integers.

`STATUS:QUESTIONABLE:INSTRUMENT:ISUMmary1` exists as often as device channels are available (e.g. R&S NGP802/R&S NGP822 = 2 channels = 2 status register). Accordingly, the description text of the channel information changes in [Figure A-1](#) (e.g. instrument 1 = channel 1, instrument 2 = channel 2 etc.).



Depending on the value of the read register, you can draw conclusions on the current status of the device. For example, when the unit operates in constant voltage, the result of the returned ISUM register is a decimal "2" which corresponds the binary value of "0000000000000010".

Any part of a status register system can be read by query commands. A decimal value is returned and represents the bit pattern of the requested register. Each SCPI register is 16 bits wide and has various functions. The individual bits are independent, i.e. each hardware status is assigned to a bit number.

Bits 9 to 12 are still "free" resp. unused (always return a "0"). Certain areas of the registers are not used. The SCPI standard defines only the "basic functions". Some devices offer an advanced functionality.

Each channel of the power supply is considered as separate "instrument" (SCPI standard definition). Therefore, e.g. the register

`STATUS:QUESTIONABLE:INSTRUMENT:ISUMmary` of the R&S NGP802/R&S NGP822/R&S NGP804/R&S NGP824/R&S NGP814 is also present four times (Isummary1 - Isummary4).

Description of the status register parts

The SCPI standard provides two different status registers:

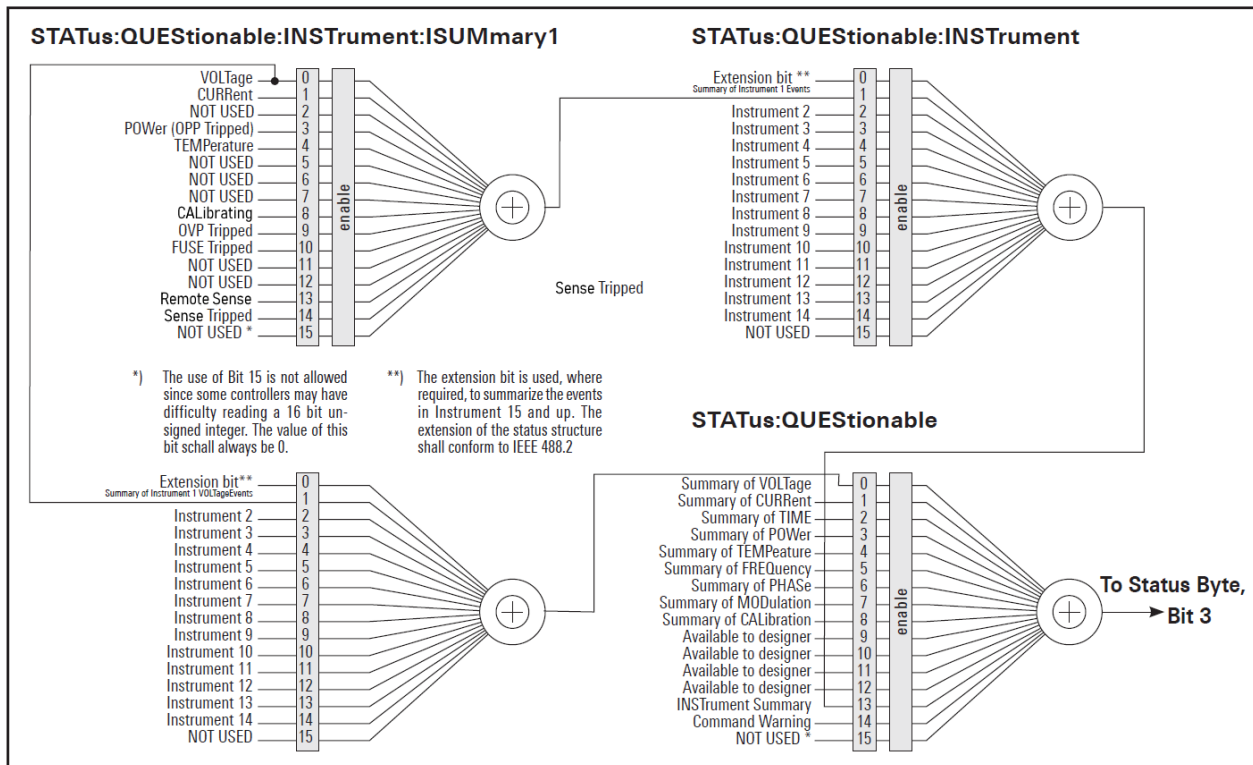

Figure A-1: Structure of the STATUS:QUESTIONABLE register

CONDition

- The CONDition register queries the actual state of the instrument. If you want to query the constant voltage or current mode, you have to use the CONDition register.



The CONDition register delivers a "1" (first bit set) in constant current mode (CC) and a "2" (second bit set) in constant voltage mode (CV).

If the correct channel is selected and the red LED of the channel button lights up (CC mode), the query of the CONDition register must deliver a "1".

Example:

```
STAT:QUES:INST:ISUM1:COND?
```

EVENT

- The EVENT status register is set (1) until it is queried. After reading (query), the EVENT status register is set to zero.



The description of registers is only used for general explanation. Due to the complexity, we recommend the general accessible SCPI standard document for more detailed information.

For further description of the status register, see [Chapter 8.9, "Status reporting commands"](#), on page 219.

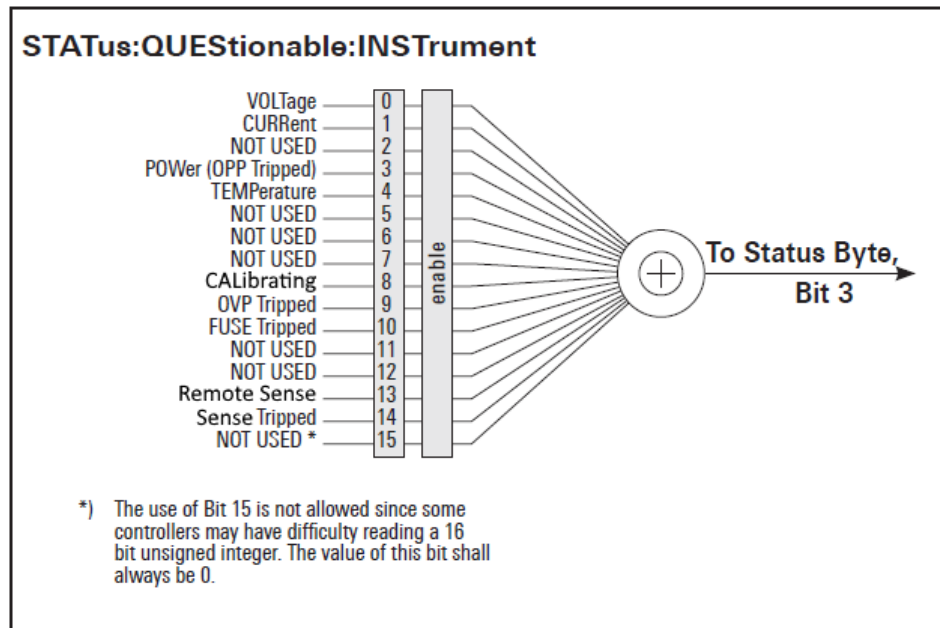

Figure A-2: Structure of the status:QUESTIONable:INSTRument register

Event Status Register (ESR) and Event Status Enable Register (ESE)

The ESR is defined in IEEE 488.2. It can be compared with the `EVENT` part of a SCPI register. The event status register can be read out using the command `*ESR?`. The ESE corresponds to the `ENABLE` part of a SCPI register. If a bit is set in the ESE and the associated bit in the ESR changes from 0 to 1, the ESB bit in the STB is set. The ESE register can be set using the command `*ESE` and read using the command `*ESE?`.

STATUS:OPERation Register

In the `CONDition` part, this register contains information on which actions the instrument is being executing or, in the `EVENT` part, information on which actions the instrument has executed since the last reading. It can be read using the commands `STATUS:OPERation:CONDition?` or `STATUS:OPERation[:EVENT]?`.

Bit No.	Meaning
0	Not used
1 to 3	Not used
4	MEASuring This bit is set on event new measurement available.
5 to 9	Not used

Bit No.	Meaning
10	Logging This bit is set as long as "Logging" is enabled
11	Not used
12	Not used
13 to 14	Not used
15	This bit is always 0

STATus:QUEStionable Register

This register contains information about different states which can occur. It can be read using the commands `STATus:QUEStionable:CONDition?` and `STATus:QUEStionable[:EVENT]?`. See [Figure A-1](#).

Table A-6: Bits of the STATus:QUEStionable register

Bit No.	Meaning
0	Voltage This bit is set while the instrument is in constant current mode (CC). The voltage is regulated and the current is constant.
1	Current This bit is set while the instrument is in constant voltage mode (CV). The current is variable and the voltage is constant.
2	Not used
3	POWER (OPP Tripped) This bit is set if an over power protection has tripped.
4	Temperature Overrange This bit is set if an over temperature occurs.
5 to 7	Not used
8	CALibrating This bit is set when instrument is performing calibration.
9	OVP Tripped This bit is set if the over voltage protection has tripped.
10	Fuse Tripped This bit is set if the fuse protection has tripped.
11 to 12	Not used
13	Remote Sense This bit is set if EXT sense mode is enabled.
14	Sense Tripped This bit is set if the remote sense has tripped
15	This bit is always 0

Query of an instrument status

Each part of any status register can be read using queries.

There are two types of commands:

- The common commands `*ESR?`, `*IDN?`, `*STB?` query the higher-level registers.
- The commands of the `STATus` system query the SCPI registers (`STATus:QUEStionable`)

The returned value is always a decimal number that represents the bit pattern of the queried register. This number is evaluated by the controller program.

Decimal representation of a bit pattern (binary weights)

The STB and ESR registers contain 8 bits, the status registers 16 bits. The contents of a status register are specified and transferred as a single decimal number. To make this possible, each bit is assigned a weighted value. The decimal number is calculated as the sum of the weighted values of all bits in the register that are set to 1.

Bits	0	1	2	3	4	5	6	7	...
Weight	1	2	4	8	16	32	64	128	...

Figure A-3: Decimal representation of a bit pattern

Error Queue

Each error state in the instrument leads to an entry in the error queue. The entries of the error queue are detailed plain text error messages. You can look them up in the error log or via remote control using `SYSTem:ERRor[:NEXT]?`. Each call of `SYSTem:ERRor[:NEXT]?` provides one entry from the error queue. If no error messages are stored, the instrument responds with 0, "No error".

For further description of the error queue and the device error codes, please refer to [Chapter 8.1, "Common setting commands"](#), on page 142.

Glossary

C

CDC: USB communications device class. A composite universal serial bus device class.

D

DHCP: Dynamic host configuration protocol. A type of network management protocol used for automatically assigning IP addresses and other communication parameters to devices connected to the network.

F

FTP: File transfer protocol. A network protocol for file transfer between computers over [TCP/IP](#).

G

GPIOB: General purpose interface bus, also known as IEEE 488. It is a short-range digital communications 8-bit parallel multi-master interface bus.

O

OCP: Overcurrent protection refers to a type of protection circuit that shuts down the instrument when the current exceeds the rated ampere capacity of a circuit or the connected equipment on that circuit.

OPP: Overpower protection refers to a type of protection circuit that shuts down the instrument when the output power exceeds its maximum rating.

OVP: Overvoltage protection refers to a type of protection circuit that shuts down the instrument when the voltage exceeds a preset level.

T

TCP/IP: Transmission control protocol/internet protocol connection. An internet protocol suite that allows devices in a network to communicate.

TMC: USB test and measurement class. Supports communications with test and measurement equipment.

V

VNC: Virtual network computing. A graphical desktop sharing system that uses the remote frame buffer protocol to remotely control another computer.

List of commands

[SOURce:]ALIMit[:STATe].....	162
[SOURce:]CURRent[:LEVel][:IMMediate]:ALIMit:LOWer.....	163
[SOURce:]CURRent[:LEVel][:IMMediate]:ALIMit[:UPPer].....	164
[SOURce:]CURRent[:LEVel][:IMMediate]:STEP[:INCRement].....	171
[SOURce:]CURRent[:LEVel][:IMMediate][:AMPLitude].....	171
[SOURce:]POWer:PROTection:CLEar.....	187
[SOURce:]POWer:PROTection:LEVel.....	187
[SOURce:]POWer:PROTection:TRIPped?.....	188
[SOURce:]POWer:PROTection[:STATe].....	186
[SOURce:]PROTection:CLEar.....	188
[SOURce:]VOLTage:AINPut:INPut.....	205
[SOURce:]VOLTage:AINPut:TRIGgered[:STATe].....	206
[SOURce:]VOLTage:AINPut[:STATe].....	206
[SOURce:]VOLTage:PROTection:CLEar.....	184
[SOURce:]VOLTage:PROTection:LEVel.....	184
[SOURce:]VOLTage:PROTection:TRIPped?.....	185
[SOURce:]VOLTage:PROTection[:STATe].....	184
[SOURce:]VOLTage:RAMP:DURation.....	205
[SOURce:]VOLTage:RAMP[:STATe].....	204
[SOURce:]VOLTage:SENSe:TRIPped:CLEar.....	165
[SOURce:]VOLTage:SENSe:TRIPped?.....	165
[SOURce:]VOLTage:SENSe[:SOURce].....	164
[SOURce:]VOLTage[:LEVel][:IMMediate]:ALIMit:LOWer.....	162
[SOURce:]VOLTage[:LEVel][:IMMediate]:ALIMit[:UPPer].....	163
[SOURce:]VOLTage[:LEVel][:IMMediate]:STEP[:INCRement].....	169
[SOURce:]VOLTage[:LEVel][:IMMediate][:AMPLitude].....	168
*CLS.....	142
*ESE.....	142
*ESR?.....	143
*IDN?.....	143
*OPC.....	143
*OPT?.....	143
*RCL.....	145
*RST.....	144
*SAV.....	145
*SRE.....	144
*STB?.....	144
*TST?.....	144
*WAI.....	144
APPLy.....	172
ARBitrary:BLOCK.....	197
ARBitrary:BLOCK:CLEar.....	197
ARBitrary:BLOCK:DATA.....	197
ARBitrary:BLOCK:ENDPoint?.....	198
ARBitrary:BLOCK:FNAME.....	198
ARBitrary:BLOCK:REPetitions.....	198
ARBitrary:CLEar.....	199

ARbitrary:DATA.....	199
ARbitrary:FNAME.....	200
ARbitrary:LOAD.....	200
ARbitrary:REPetitions.....	201
ARbitrary:SAVE.....	201
ARbitrary:SEQuence:BEHavior:END.....	201
ARbitrary:SEQuence:CLEar.....	202
ARbitrary:SEQuence:ENDPoint?.....	200
ARbitrary:SEQuence:REPetitions.....	202
ARbitrary:SEQuence:TRANsfer.....	202
ARbitrary:TRIGgered:GROup[:STATe].....	203
ARbitrary:TRIGgered:POINt[:STATe].....	203
ARbitrary:TRIGgered[:STATe].....	203
ARbitrary[:STATe].....	199
CALibration:AINPut:CANCel.....	207
CALibration:AINPut:COUNT?.....	207
CALibration:AINPut:DATA.....	208
CALibration:AINPut:DATE?.....	208
CALibration:AINPut:END.....	208
CALibration:AINPut:FACTory:RESTore.....	208
CALibration:AINPut:SAVE.....	208
CALibration:AINPut:START.....	208
CALibration:AINPut:STATe?.....	209
CALibration:AINPut:UMAX.....	209
CALibration:AINPut:UMIN.....	209
CALibration:CANCel.....	209
CALibration:COUNT?.....	210
CALibration:CURREnt:DATA.....	210
CALibration:CURREnt:IMAX.....	210
CALibration:CURREnt:IMIN.....	210
CALibration:DATE?.....	210
CALibration:END.....	210
CALibration:FACTory:RESTore.....	211
CALibration:SAVE.....	211
CALibration:STATe?.....	211
CALibration:TEMPerature?.....	211
CALibration:USER.....	211
CALibration:VOLTage:DATA.....	212
CALibration:VOLTage:UMAX.....	212
CALibration:VOLTage:UMIN.....	212
DATA:DATA?.....	213
DATA:DELeTe.....	213
DATA:LIST?.....	213
DATA:POINts?.....	214
DISPlay:BRIGhtness.....	153
DISPlay[:WINDow]:TEXT:CLEar.....	154
DISPlay[:WINDow]:TEXT[:DATA].....	154
FUSE:DELay:INITial.....	180
FUSE:DELay[:BLOWing].....	180
FUSE:LINK.....	181

FUSE:TRIPped:CLEar.....	179
FUSE:TRIPped?.....	181
FUSE:UNLink.....	181
FUSE[:STATe].....	182
HCOPy:DATA?.....	214
HCOPy:SIZE:X?.....	214
HCOPy:SIZE:Y?.....	214
INSTRument:NSElect.....	159
INSTRument[:SElect].....	159
INTerfaces:USB:CLASs.....	190
LOG:COUNT.....	215
LOG:DATA?.....	215
LOG:DURation.....	216
LOG:FNAME?.....	216
LOG:INTerval.....	217
LOG:LOCation.....	217
LOG:MODE.....	217
LOG:STIme.....	218
LOG:TRIGgered[:STATe].....	218
LOG[:STATe].....	214
MEASure[:SCALar]:CURRent[:DC]:AVG?.....	192
MEASure[:SCALar]:CURRent[:DC]:MAX?.....	192
MEASure[:SCALar]:CURRent[:DC]:MIN?.....	192
MEASure[:SCALar]:CURRent[:DC]:STATistic?.....	192
MEASure[:SCALar]:CURRent[:DC]?.....	191
MEASure[:SCALar]:ENERgy?.....	191
MEASure[:SCALar]:POWER:AVG?.....	193
MEASure[:SCALar]:POWER:MAX?.....	193
MEASure[:SCALar]:POWER:MIN?.....	193
MEASure[:SCALar]:POWER:STATistic?.....	194
MEASure[:SCALar]:POWER?.....	193
MEASure[:SCALar]:STATistic:COUNT?.....	191
MEASure[:SCALar]:STATistic:RESet.....	191
MEASure[:SCALar][:VOLTage][:DC]:AVG?.....	194
MEASure[:SCALar][:VOLTage][:DC]:MAX?.....	194
MEASure[:SCALar][:VOLTage][:DC]:MIN?.....	194
MEASure[:SCALar][:VOLTage][:DC]:STATistic?.....	195
MEASure[:SCALar][:VOLTage][:DC]?.....	194
OUTPut:DELay:DURation.....	176
OUTPut:DELay[:STATe].....	177
OUTPut:GENeral[:STATe].....	175
OUTPut:IMPedance[:STATe].....	175
OUTPut:SElect.....	177
OUTPut:SRATe[:STATe].....	174
OUTPut[:STATe].....	176
READ?.....	191
STATus:OPERation:INSTRument:CONDition?.....	219
STATus:OPERation:INSTRument:ENABLE.....	220
STATus:OPERation:INSTRument:ISUMmary<Channel>:CONDition?.....	219
STATus:OPERation:INSTRument:ISUMmary<Channel>:ENABLE.....	220

STATus:OPERation:INSTrument:ISUMmary<Channel>:NTRansition.....	220
STATus:OPERation:INSTrument:ISUMmary<Channel>:PTRansition.....	221
STATus:OPERation:INSTrument:ISUMmary<Channel>[:EVENT]?.....	220
STATus:OPERation:INSTrument:NTRansition.....	220
STATus:OPERation:INSTrument:PTRansition.....	221
STATus:OPERation:INSTrument[:EVENT]?.....	220
STATus:QUEStionable:INSTrument:CONDition?.....	221
STATus:QUEStionable:INSTrument:ENABle.....	222
STATus:QUEStionable:INSTrument:ISUMmary<Channel>:CONDition?.....	221
STATus:QUEStionable:INSTrument:ISUMmary<Channel>:ENABle.....	222
STATus:QUEStionable:INSTrument:ISUMmary<Channel>:NTRansition.....	222
STATus:QUEStionable:INSTrument:ISUMmary<Channel>:PTRansition.....	223
STATus:QUEStionable:INSTrument:ISUMmary<Channel>[:EVENT]?.....	222
STATus:QUEStionable:INSTrument:NTRansition.....	222
STATus:QUEStionable:INSTrument:PTRansition.....	223
STATus:QUEStionable:INSTrument[:EVENT]?.....	222
SYSTem:BEEPer:CURRent:STATe.....	146
SYSTem:BEEPer:OUTPut:STATe.....	146
SYSTem:BEEPer:PROTection:STATe.....	147
SYSTem:BEEPer:PROTection[:IMMediate].....	147
SYSTem:BEEPer:WARNIing:STATe.....	147
SYSTem:BEEPer:WARNIing[:IMMediate].....	147
SYSTem:COMMunicate:SOCKet:APPLY.....	147
SYSTem:COMMunicate:SOCKet:DHCP.....	148
SYSTem:COMMunicate:SOCKet:DISCard.....	148
SYSTem:COMMunicate:SOCKet:GATeway.....	148
SYSTem:COMMunicate:SOCKet:IPADdress.....	148
SYSTem:COMMunicate:SOCKet:MASK.....	149
SYSTem:COMMunicate:SOCKet:RESet.....	149
SYSTem:COMMunicate:WLAN:CONNection[:STATe].....	149
SYSTem:COMMunicate:WLAN:IPADdress?.....	149
SYSTem:COMMunicate:WLAN:PASSword.....	150
SYSTem:COMMunicate:WLAN:SSID.....	150
SYSTem:COMMunicate:WLAN[:STATe].....	150
SYSTem:DATE.....	150
SYSTem:INTerface:GPIB?.....	151
SYSTem:INTerface?.....	151
SYSTem:KEY:BRIGHtness.....	151
SYSTem:LOCal.....	151
SYSTem:REMote.....	152
SYSTem:RWLock.....	152
SYSTem:TIME.....	152
SYSTem:TOUCH[:STATe].....	152
SYSTem:UPTime?.....	153
SYSTem:VNC:PORT.....	152
SYSTem:VNC:STATe.....	153
TRACking[:ENABle]:CH<CHANNEL>.....	189
TRACking[:ENABle]:GENeral.....	189
TRACking[:ENABle]:SELect:CH<CHANNEL>.....	189
TRIGger:CHANnel:DIO<IO>.....	154

TRIGger:CONDition:DIO<IO>.....	155
TRIGger:DIRection:DIO<IO>.....	156
TRIGger:LOGic:DIO<IO>.....	157
TRIGger[ENABLE]:DIO<IO>.....	157
TRIGger[ENABLE]:GENeral.....	157
TRIGger[ENABLE]:SELect:DIO<IO>.....	158

Index

Symbols

*OPC	239
*OPC?	239
*WAI	239

A

Access	
Instrument	48
Activate channel output	66
Active elements	45
Adjustment	133
Analog in adjustment	133
Channel adjustment	137
Advanced features	
EasyRamp	86
QuickArb	86
Advanced operating commands	
Adjustment	207
Analog input	205
Arbitrary	195
EasyRamp	204
Alert beep	128
Alphanumeric parameters	51
Analog input	72

B

Bench top, placing the R&S NGP800	21
Block data	
SCPI parameters	237
Boolean	
SCPI parameters	236

C

Calibration certificate	16
Carrying the instrument	20
Channel adjustment	
Current adjustment	137
Voltage adjustment	137
Character strings	
SCPI parameters	237
Checking the instrument	20
Clear status	
Remote	142
Command sequence	
Remote	144
Remote control basics	238
Commands	
Remote control basics	232
Common commands	
SCPI syntax	233
Configuration commands	
Channel selection	158
Combined setting of voltage and current settings	172
Current setting	169
OCP setting	177
OPP setting	185
Output setting	173
OVP setting	182
Reset protection tripped state	188
Safety limit setting	160

Tracking setting	189
USB class setting	190
Voltage setting	166
Connecting	
Memory stick	28
Power	25
USB devices	28
Considerations	
EMI	24
Test setup	23
CSV settings	99
Customer support	225

D

Data entry	49
Data logging	96
CSV settings	96
Data sheet	15
Date	129
Default values	
Remote	144
Device-specific commands	
SCPI syntax	234
Device/Channel menu window	56
Digital trigger I/O	81
Display	
Active elements	45
On-screen keypad	45
Display brightness	127
Display information	38
Expand/Collapse softkey	42
Settings softkey	42
Documentation overview	15

E

EasyRamp	92
EMI	
Considerations	24
Event status enable register (ESE)	
Remote	142
Event status register (ESR)	
Remote	143

F

Factory default settings	106
File manager	
Copy	104
Delete	104
Firmware update	
Notifications	224
Front panel	
Back key	29
Chassis ground terminal	30
Display	29
Menu control keys	29
Output and channel keys	30
Output terminals	30
Power key	30
Rotary knob	29
USB connector	30

Front panel keys	56	Keyboard	
Menu controls	56	On-screen	49
Navigation controls	62	Keypad	
Output and channel controls	62	On-screen	49
Settings key	56	L	
Usage	38	LAN communication	
Fuses		Problems	225
How to replace the power fuse	25	LAN connection	
G		Problems	225
General instrument settings	125	Lifting the instrument	20
Appearance settings	127	Long and short form	
Date and time	129	SCPI syntax	234
Device information	130	M	
Licenses management	125	Maintenance, storage and disposal	228
Sound settings	128	Changing fuses	228
Update device	131	Cleaning	228
Getting started	15	Disposal	229
GPIB interface messages		Internal battery replacement	228
Remote control basics	233	Storage	229
Graphical view window	101	Manual interaction	37
Ground terminal		Manual operation	37
How to:	25	Menu	
Ground terminal:		Channel menu	59
How to ground terminal	25	Device menu	56
H		Menu controls	56
Help	15	Home key	56
Historical channel information	43	Settings key	56
How to:		User key	62
Access settings	48	Messages	
Connect to LAN	27	Remote control basics	232
Connect USB storage device	28	Mode	
Enter data	50	Operation modes	64
Ground terminal	25	Mounting, in a rack	22
Mount the instrument in a rack	22	N	
Replace the power fuse	25	Navigation controls	62
Switch on	26	Rotary knob	62
Unmount the instrument from a rack	23	Network	
I		FTP	120
Identification		GPIB	123
Remote	143	LAN	112
Instrument		USB	122
Carrying	20	VNC	117
Checking	20	Wireless LAN	115
Lifting	20	Network connection	110
Operating site	21	Numeric data entry	49
Unpacking	20	Numeric parameters	50
Instrument control	37	Numeric suffixes	
Manual operation	37	SCPI syntax	234
Remote control	37	Numeric values	
Ways of operation	37	SCPI parameters	236
Instrument responses		O	
Remote control basics	233	On-screen keyboard	51
Instrument security procedures	15	On-screen keypad	45
Instrument tour	28	Open source acknowledgment (OSA)	16
Front panel	28	Operating mode	44
Rear panel	30	Operating site	
Interfaces	109	Choosing	21
K		Setting up the instrument	21
Key brightness	127		

- Operation
 - Manually 37
 - Remotely 51
 - Operation complete
 - Remote 143
 - Operation modes
 - Constant current (CC) 64
 - Constant voltage (CV) 64
 - Optional mnemonics
 - SCPI syntax 234
 - Options
 - Identification (remote) 143
 - Output
 - Delay 68
 - High impedance mode 71
 - Output delay 68
 - Remote sensing 70
 - Slew rate control 71
 - Output and channel controls 62
 - Output auto-ranging 63
 - Output setting 67
 - Overcurrent protection 74
 - Overlapping commands
 - Preventing 239
 - Overpower protection 77
 - Overvoltage protection 76
- P**
- Parameters
 - Entering 50, 51
 - SCPI 235
 - Power
 - Connecting the instrument 25
 - Power states 26
 - Preparing for use 20
 - Protection
 - Fuse linking 74
 - Overcurrent protection 74
 - Overpower protection 74
 - Overvoltage protection 74
 - Safety limits 74
- Q**
- QuickArb 86
- R**
- Rack, mounting 22
 - Rear panel
 - AC inlet with integrated 2-pole rocker switch 31
 - Analog input connector 32
 - Channel connectors 33
 - Digital I/O connector 32
 - Ethernet connector 31
 - Ground terminal 31
 - IEEE-488 (GPIB) interface 31
 - Kensington security slot 33
 - USB connectors 32
 - Recall 106
 - Release notes 16
 - Remote command
 - Status reporting commands 219
 - Remote control 37, 51
 - Interfaces 51
 - Remote control basics
 - Command sequence 238
 - Commands 232, 233
 - GPIB interface messages 233
 - Messages 232
 - Responses to queries 238
 - SCPI command structure 233
 - SCPI parameters 235
 - Synchronization 238
 - Remote control commands 142
 - Advanced operating commands 195
 - Common setting commands 142
 - Configuration commands 158
 - Data and file management commands 212
 - Display commands 153
 - Measurement commands 190
 - Remote sense commands 164
 - Status reporting commands 219
 - System settings commands 145
 - Trigger commands 154
 - Replace the power fuse
 - How to: 25
 - Reset values
 - Remote 144
 - Responses to queries
 - Remote control basics 238
- S**
- Safety instructions 9, 15
 - Safety limits 78
 - Save 106
 - SCPI command structure
 - Remote control basics 233
 - SCPI parameters 235
 - Block data 237
 - Boolean 236
 - Character strings 237
 - Numeric values 236
 - Special numeric values 236
 - Text 237
 - SCPI programmers manual 15
 - SCPI syntax
 - Common commands 233
 - Device-specific commands 234
 - Long and short form 234
 - Numeric suffixes 234
 - Optional mnemonics 234
 - Special characters 238
 - Syntax elements 237
 - Screenshot 95
 - Security procedures 15
 - Selecting channels 65
 - Self-test
 - Remote 144
 - Service request enable register (SRE)
 - Remote 144
 - Set voltage and current 65
 - Special characters
 - SCPI syntax 238
 - Special numeric values
 - SCPI parameters 236
 - Status bar information
 - Channel status 40
 - Device status 39
 - Status byte
 - Remote 142, 144

Status information	
Notifications	224
Status reporting system	240
Structure of a SCPI status register	241
Switching on or off	26
Synchronization	
Remote control basics	238
Syntax elements	
SCPI syntax	237

T

Test setup	
Considerations	23
Text	
SCPI parameters	237
Text entry	49
Time	129
Tracking function	80
Troubleshooting	224
Firmware update notifications	224
LAN communication problems	225
LAN connection problems	225
Status notifications	224
Trying out the instrument	
Activating the channels output	35
Selecting the channels	33
Setting the output voltage and current limit	33
Storing/Recalling of instrument settings	36

U

Unpacking the instrument	20
User button key	94
User manual	15
Using the front panel keys	38
Using the touchscreen	37, 52
Accessing functionality using shortcuts	53
Accessing functionality using the settings button	52
Expand/Collapse button	54
Input data	55

W

Wait	
Remote	144
Ways of operation	37
Welcome to R&S NGP800	18