

R&S® RTO6

Oscilloscope

User Manual



1801668702
Version 10

ROHDE & SCHWARZ
Make ideas real



This manual describes the following R&S®RTO6 models with firmware version 5.40:

- R&S®RTO64 (1802.0001K04)

© 2024 Rohde & Schwarz

Muehldorfstr. 15, 81671 Muenchen, Germany

Phone: +49 89 41 29 - 0

Email: info@rohde-schwarz.com

Internet: www.rohde-schwarz.com

Subject to change – data without tolerance limits is not binding.

R&S® is a registered trademark of Rohde & Schwarz GmbH & Co. KG.

The terms HDMI, HDMI High-Definition Multimedia Interface, HDMI trade dress and the HDMI Logos are trademarks or registered trademarks of HDMI Licensing Administrator, Inc.

TEKTRONIX, TEK, and TEKPROBE are registered trademarks of Tektronix, Inc.

All other trademarks are the properties of their respective owners.

1801.6687.02 | Version 10 | R&S®RTO6

Throughout this document, R&S® is indicated as R&S.

Contents

1	Safety and regulatory information.....	11
1.1	Safety instructions.....	11
1.2	Labels on the product.....	16
1.3	Warning messages in the documentation.....	17
1.4	Where to find key documents on Rohde & Schwarz.....	17
1.5	Korea certification class A.....	18
2	Preface.....	19
2.1	Key features.....	19
2.2	Documentation overview.....	19
2.3	Options described in this document.....	21
2.4	Conventions used in the documentation.....	23
3	Getting started.....	24
3.1	Preparing for use.....	24
3.2	Instrument tour.....	30
3.3	Operating the instrument.....	42
4	Instrument setup.....	68
4.1	System settings.....	68
4.2	Option settings.....	72
4.3	Appearance settings.....	75
4.4	Display settings.....	90
4.5	Frontpanel settings.....	94
4.6	Preset setup.....	98
4.7	Maintenance settings.....	100
4.8	Save / recall.....	104
5	Acquisition and waveform setup.....	109
5.1	Basics.....	109
5.2	Horizontal.....	119
5.3	Horizontal accuracy.....	123
5.4	Acquire settings.....	126
5.5	Vertical setup.....	138

5.6	Probes.....	145
5.7	R&S RT-ZVC probe.....	175
5.8	Differential signals.....	184
5.9	Setting up the waveform.....	189
6	Triggers.....	194
6.1	Basics of triggering.....	194
6.2	Setting up the trigger.....	195
6.3	Trigger types.....	197
6.4	Mode / Holdoff.....	224
6.5	Conditioning.....	226
6.6	Actions on trigger.....	228
6.7	Qualification.....	230
6.8	Sequence.....	233
6.9	Zone trigger.....	236
6.10	External trigger input.....	240
7	Waveform analysis.....	243
7.1	Zoom.....	243
7.2	Reference waveforms.....	253
7.3	Mathematics.....	261
7.4	History.....	283
7.5	XY-diagram.....	289
8	Measurements.....	293
8.1	Cursor measurements.....	293
8.2	Automatic measurements.....	304
8.3	Quick measurements.....	374
9	Spectrum analysis.....	376
9.1	FFT analysis.....	376
9.2	Spectrum analysis (option R&S RTO6-K37).....	396
10	Mask testing.....	400
10.1	About mask testing.....	400
10.2	Mask test settings.....	402
10.3	Mask testing on eye diagrams.....	414

10.4	Working with masks.....	417
11	Search functions.....	425
11.1	Overview: search definition and results.....	425
11.2	Search setup.....	426
11.3	Search gate.....	441
11.4	Search display presentation.....	444
12	Data and file management.....	449
12.1	Save and recall user settings.....	449
12.2	Save and recall waveform data and results.....	458
12.3	Screenshots.....	483
12.4	Reports.....	488
12.5	File selection dialog.....	490
13	Signal configuration.....	492
13.1	Signal configuration setup.....	492
13.2	Signal flow overview.....	494
13.3	Signal and reference levels for NRZ signals.....	495
13.4	Signal configuration for PAM-N signals (R&S RTO6-K135).....	505
14	Protocol analysis.....	510
14.1	Basics of protocol analysis.....	510
14.2	I ² C (option R&S RTO6-K510).....	520
14.3	SPI bus (option R&S RTO6-K510).....	535
14.4	UART/RS-232/RS-422/RS-485 (option R&S RTO6-K510).....	546
14.5	Audio signals (option R&S RTO6-K510).....	556
14.6	Custom: Manchester / NRZ (option R&S RTO6-K510).....	574
14.7	CAN and CAN FD (option R&S RTO6-K520).....	606
14.8	LIN (option R&S RTO6-K520).....	632
14.9	FlexRay (option R&S RTO6-K520).....	646
14.10	SENT (option R&S RTO6-K520).....	662
14.11	CXPI (option R&S RTO6-K520).....	694
14.12	MIL-1553 (option R&S RTO6-K530).....	713
14.13	ARINC 429 (option R&S RTO6-K530).....	730
14.14	SpaceWire (option R&S RTO6-K530).....	742

14.15	Ethernet 10BASE-T and 100BASE-TX (option R&S RTO6-K540).....	754
14.16	MDIO (option R&S RTO6-K540).....	769
14.17	RFFE (option R&S RTO6-K550).....	782
14.18	Ethernet 100BASE-T1 (option R&S RTO6-K560).....	803
14.19	Ethernet 1000BASE-T1 (option R&S RTO6-K560).....	821
14.20	USB (option R&S RTO6-K570).....	839
14.21	USB 3.1 (option R&S RTO6-K570).....	867
14.22	USBPD (option R&S RTO6-K570).....	888
14.23	D-PHY (option R&S RTO6-K580).....	901
14.24	M-PHY and USB SSIC (option R&S RTO6-K580 and K570).....	918
14.25	8b/10b (option R&S RTO6-K590).....	948
14.26	PCIe (option R&S RTO6-K72).....	961
14.27	DDR (option R&S RTO6-K91).....	991
15	Mixed signal option (MSO, R&S RTO6-B1).....	1000
15.1	Digital channels and parallel buses.....	1001
15.2	Display.....	1010
15.3	Trigger.....	1012
15.4	Measurements on digital channels.....	1025
15.5	Data export.....	1026
15.6	Mathematics.....	1027
15.7	Search.....	1027
16	Waveform generator (option R&S RTO6-B6).....	1029
16.1	Setup of the waveform generator.....	1029
16.2	Setup of the pattern generator.....	1048
16.3	Output.....	1051
16.4	Coupling settings.....	1054
16.5	Sync settings.....	1056
16.6	Configuring the waveform generator.....	1056
17	Pulse source and TDR/TDT analysis (options R&S RTO6-B7/K130)	1060
17.1	Pulse source (option R&S RTO6-B7).....	1060
17.2	TDR/TDT analysis (option R&S RTO6-K130).....	1062

18	I/Q software interface (option R&S RTO6-K11)	1074
18.1	I/Q mode.....	1074
18.2	I/Q sampling setup.....	1074
18.3	I/Q data output.....	1079
18.4	NFC trigger.....	1081
19	Jitter analysis and clock data recovery	1083
19.1	Jitter measurements (options R&S RTO6-K12/K13).....	1084
19.2	Advanced jitter and noise (option R&S RTO6-K133/K134).....	1094
19.3	Clock data recovery.....	1135
20	Advanced eye diagram analysis (option R&S RTO6-K136)	1145
20.1	Calculation and display of advanced eye diagrams.....	1145
20.2	Eye diagram setup.....	1146
20.3	Measurements and zoom on eye diagrams.....	1168
20.4	Mask Testing on Eye Diagrams.....	1169
21	Power analysis (option R&S RTO6-K31)	1170
21.1	Power measurement selection.....	1170
21.2	Overview of power measurement setup.....	1182
21.3	Input.....	1185
21.4	Control loop.....	1199
21.5	Power path.....	1213
21.6	Output.....	1232
22	Deembedding (option R&S RTO6-K121)	1248
22.1	Configuring the measurement setup for deembedding.....	1248
22.2	Deembedding settings.....	1249
22.3	Responses.....	1258
22.4	Proven probe, proven cable.....	1259
23	Embedding and equalization (option R&S RTO6-K126)	1265
23.1	Equalization basics.....	1265
23.2	Signal lanes settings.....	1267
23.3	Transmitter feed forward equalization (TxFFE).....	1273
23.4	Embedding.....	1278
23.5	Equalization settings.....	1282

24	Compliance tests.....	1302
24.1	USB compliance test.....	1302
24.2	Ethernet compliance tests (options R&S RTO6-K22/K23/K24/K87/K88/K89)....	1303
24.3	D-PHY compliance tests (option R&S RTO6-K26).....	1306
24.4	eMMC compliance tests (option R&S RTO6-K92).....	1306
24.5	PCIe compliance tests (option R&S RTO6-K81).....	1307
24.6	DDR3 compliance tests (option R&S RTO6-K91).....	1308
25	Network operation and remote control.....	1309
25.1	Operating system.....	1309
25.2	Setting up a network (LAN) connection.....	1314
25.3	Web interface.....	1319
25.4	Remote Desktop connection.....	1324
25.5	Remote control.....	1326
26	Maintenance and support.....	1341
26.1	Cleaning.....	1341
26.2	Contacting customer support.....	1341
26.3	Information for technical support.....	1342
26.4	Data security.....	1342
26.5	Transporting.....	1342
26.6	Storage.....	1343
26.7	Disposal.....	1343
27	Remote control commands.....	1344
27.1	Conventions used in remote command description.....	1344
27.2	Finding the appropriate command.....	1344
27.3	Programming examples.....	1345
27.4	Frequently used parameters and suffixes.....	1366
27.5	Common commands.....	1374
27.6	General remote settings.....	1379
27.7	Instrument setup.....	1384
27.8	Acquisition and setup.....	1414
27.9	Trigger.....	1484
27.10	Waveform analysis.....	1536

27.11	Cursor measurements.....	1570
27.12	Automatic measurements.....	1583
27.13	Spectrum analysis.....	1673
27.14	Mask testing.....	1691
27.15	Search.....	1715
27.16	Data management.....	1756
27.17	Signal configuration.....	1788
27.18	Protocols.....	1812
27.19	Mixed signal option (MSO, R&S RTO6-B1).....	2607
27.20	Waveform generator (option R&S RTO6-B6).....	2631
27.21	Pulse Source and TDR/TDT Analysis (options R&S RTO6-B7/K130).....	2654
27.22	I/Q software interface (option R&S RTO6-K11).....	2663
27.23	Jitter analysis and clock data recovery.....	2670
27.24	Eye diagram analysis.....	2732
27.25	Power analysis (option R&S RTO6-K31).....	2756
27.26	Deembedding (option R&S RTO6-K121).....	2798
27.27	Embedding and equalization (option R&S RTO6-K126).....	2810
27.28	Maintenance.....	2849
27.29	Status reporting.....	2851
27.30	Remote trace.....	2857
27.31	Deprecated commands.....	2860
	List of commands.....	2863
	Index.....	2952

1 Safety and regulatory information

The product documentation helps you to use the product safely and efficiently.

Where do I find safety information?

Safety information is part of the product documentation. It warns you of potential dangers and gives instructions on how to prevent personal injury or damage caused by dangerous situations. Safety information is provided as follows:

- In [Chapter 1.1, "Safety instructions"](#), on page 11. The same information is provided in many languages in printed format. The printed "Safety Instructions" for "Oscilloscopes and Accessories" are delivered with the product.
- Throughout the documentation, safety instructions are provided when you need to take care during setup or operation.

Intended use

The R&S RTO6 oscilloscope is designed for measurements on circuits that are only indirectly connected to the mains or not connected at all. It is not rated for any measurement category.

The product is intended for the development, production and verification of electronic components and devices in industrial, administrative, and laboratory environments. Use the product only for its designated purpose. Observe the operating conditions and performance limits stated in the data sheet.

Target audience

The target audience of this document includes developers and technicians, administrators and maintenance personnel using oscilloscopes and probes. The required skills and experience of the users depend on the test setup and application of the product.

1.1 Safety instructions

Products from the Rohde & Schwarz group of companies are manufactured according to the highest technical standards. To use the products safely, follow the instructions provided here and in the product documentation. Keep the product documentation nearby and offer it to other users.

Use the product only for its intended use and within its performance limits. Intended use and limits are described in the product documentation such as the specifications document, manuals and the printed "Safety Instructions" document. If you are unsure about the appropriate use, contact Rohde & Schwarz customer support.

Using the product requires specialists or specially trained personnel. These users also need sound knowledge of at least one of the languages in which the user interfaces and the product documentation are available.

Reconfigure or adjust the product only as described in the product documentation or the specifications document. Any other modifications can affect safety and are not permitted.

Never open the casing of the product. Only service personnel authorized by Rohde & Schwarz are allowed to repair the product. If any part of the product is damaged or broken, stop using the product. Contact Rohde & Schwarz customer support at <https://www.rohde-schwarz.com/support>.

In these safety instructions, the term "product" covers instruments (oscilloscopes), probes and their accessories.

Lifting and carrying the instrument

Check the specifications document for the maximum weight of the instrument. A single person can only carry a maximum of 18 kg safely depending on age, gender and physical condition. If your instrument is heavier than 18 kg, do not move or carry it by yourself.

Use the instrument handles to move or carry the instrument. Do not use the mounted accessories instead of the handles. Accessories are not designed to carry the weight of the instrument.

To move the instrument safely, you can use lifting or transporting equipment such as lift trucks and forklifts. Follow the instructions provided by the equipment manufacturer.

Choosing the operating site

Only use the product indoors. The product casing is not waterproof. Water that enters can electrically connect the casing with live parts, which can lead to electric shock, serious personal injury or death if you touch the casing.

If Rohde & Schwarz provides accessories designed for outdoor use of your product, e.g. a protective cover, you can use the product outdoors.

You can operate the product up to an altitude of 2000 m above sea level. If a higher altitude is permissible, the value is provided in the specifications document. The product is suitable for pollution degree 2 environments where nonconductive contamination can occur. For more information on environmental conditions such as ambient temperature and humidity, see the specifications document.

Setting up the product

Always place the product on a stable, flat and level surface with the bottom of the product facing down. If the product is designed for different positions, secure the product so that it cannot fall over.

If the product has foldable feet, always fold the feet completely in or out to ensure stability. The feet can collapse if they are not folded out completely or if the product is moved without lifting it. The foldable feet are designed to carry the weight of the product, but not an extra load.

If stacking is possible, keep in mind that a stack of products can fall over and cause injury.

If you mount products in a rack, ensure that the rack has sufficient load capacity and stability. Observe the specifications of the rack manufacturer. Always install the products from the bottom shelf to the top shelf so that the rack stands securely. Secure the product so that it cannot fall off the rack.

Connecting the product

Before connecting the interfaces and measuring inputs of the product to other products or electrical circuits, make sure that the other products or electrical circuits provide special protection against electric shock. This protection principle is referred to as SELV (safety extra-low voltage) and is based on a low voltage level and increased insulation. Exceptions are indicated by a measurement category on the product and given in the specifications document.

Connecting to power and grounding

The mains power supply input of the instrument complies with overvoltage category II. Connect the product to a fixed installation used to supply energy-consuming equipment such as household appliances and similar loads. Keep in mind that electrically powered products have risks, such as electric shock, fire, personal injury or even death.

Take the following measures for your safety:

- Do not use an isolating transformer to connect the instrument to the mains power supply.
- Before switching on the product, ensure that the voltage and frequency indicated on the product match the available power source. If the power adapter does not adjust automatically, set the correct value and check the rating of the fuse.
- If a product has an exchangeable fuse, its type and characteristics are indicated next to the fuse holder. Before changing the fuse, switch off the product and disconnect it from the power source. How to change the fuse is described in the product documentation.
- Only use the power cable delivered with the product. It complies with country-specific safety requirements. Only insert the plug into an outlet with protective conductor terminal.
- Only use intact cables and route them carefully so that they cannot be damaged. Check the power cables regularly to ensure that they are undamaged. Also ensure that nobody can trip over loose cables.
- If you connect the product to an external power supply, use the one delivered with the product or recommended in the product documentation. The external power supply must conform to the country-specific regulations.
- Ensure that you can disconnect the product from the power source at any time. Pull the power plug to disconnect the product. The power plug must be easily accessible. If the product is integrated into a system that does not meet these requirements, provide an easily accessible circuit breaker at the system level.
- Replace parts that are relevant to safety only by original parts, e.g. power cables or fuses.

Performing measurements

Take the following measures for your safety:

- To ascertain a voltage-free state, use an appropriate voltage tester. Any measurement setup including an oscilloscope is not suitable for this purpose.
- The maximum input voltage on channel inputs and the external trigger input must not exceed the value specified in the specifications document.
- Observe all voltage and current ratings of the instrument, the probes, and the accessories. Exceeding the allowed voltages can lead to an electric shock. Limits and ratings are marked on the products and listed in the specifications documents.
Consider that the rated voltage depends on the frequency. The voltage limitation curves or values are provided in the specifications document.
- Never cause any short circuits when measuring sources with high output currents.
- Use only probes and accessories that comply with the measurement category (CAT) of your measurement task. If the product is rated for any measurement category, the permitted category is indicated on the product and in the specifications document. If you use other than Rohde & Schwarz accessories, make sure that they are suitable for the instrument and the measurement task.
- Set the correct attenuation factor on the instrument according to the probe being used. Otherwise, the measurement results do not reflect the actual voltage level, and you might misjudge the actual risk.
- When working with high voltages and current probes, observe the additional operating conditions specified in these safety instructions.
- The probe pins are extremely pointed and can easily penetrate clothes and the skin. Handle the probe pins with great care. To exchange a probe pin, use tweezers or pliers to avoid injuries. When transporting the accessories, always use the box supplied with the probe.
- Prevent the probe from receiving mechanical shock. Avoid putting excessive strain on the probe cable or exposing it to sharp bends. Touching a broken cable during measurements can cause injuries.
- Set up all probe connections to the instrument before applying power.

Working with hazardous voltages

Voltages higher than 30 V RMS, or 42 V peak, or 60 V DC are regarded as hazardous contact voltages. Direct contact with them can cause serious injuries.

Make sure that only electrically skilled persons use the products for measurements on hazardous contact voltages. These working conditions require special education and experience to perceive risks and to avoid hazards which electricity can create.

When working with hazardous contact voltages, use protective measures to preclude direct contact with the measurement setup:

- Do not touch exposed connections and components when power is applied.
- Switch off the test circuit while connecting and disconnecting probe leads.
- Use only insulated voltage probes, test leads and adapters.
- Make sure that the input leads fulfill the safety requirements for your measurement.

The delivered input leads might have a jacket wear indicator that indicates a worn jacket by different jacket color. In this case, do not use the input lead. Replace it with a new one.

- When connecting to the DUT, keep your fingers behind finger guard. Remove jewelry, watches, and other metallic objects. Only use 4 mm safety banana plugs.

Working with current probes

When working with current probes, you can measure high-frequency currents or currents that contain high-frequency components.

- Switch off the test circuit while connecting the probe.
- Do not attach the clamp to bare unisolated conductors. To avoid injury from a short circuit, measure at a location on an insulated wire where the insulation is sufficient for the circuit voltage.
- Connect the probe only to the secondary side of a breaker. With this measure, you can avoid injury if a short circuit occurs.
- The following effects can cause burns and fire or damage to the measurement site:
 - Eddy current loss can cause heating of the sensor head.
 - Dielectric heating can cause heating of cord insulation and other materials.
- When measuring current that includes a high-frequency component, consider the derating characteristics of the probe. Do not measure any current that exceeds the rated current.
- Using the probes with high frequencies or strong magnetic fields may cause the device to become abnormally hot, resulting in fire, equipment damage, or burns.

Measurement categories

IEC 61010-2-030 defines measurement categories that rate instruments on their ability to resist short transient overvoltages that occur in addition to the working voltage. Use the measurement setup only in electrical environments for which they are rated.

- 0 - Instruments without rated measurement category
For measurements performed on circuits not directly connected to mains, for example, electronics, circuits powered by batteries, and specially protected secondary circuits. This measurement category is also known as CAT I.
- CAT II:
For measurements performed on circuits directly connected to the low-voltage installation by a standard socket outlet, for example, household appliances and portable tools.
- CAT III:
For measurements performed in the building installation, such as junction boxes, circuit breakers, distribution boards, and equipment with permanent connection to the fixed installation.
- CAT IV:
For measurements performed at the source of the low-voltage installation, such as electricity meters and primary overcurrent protection devices.

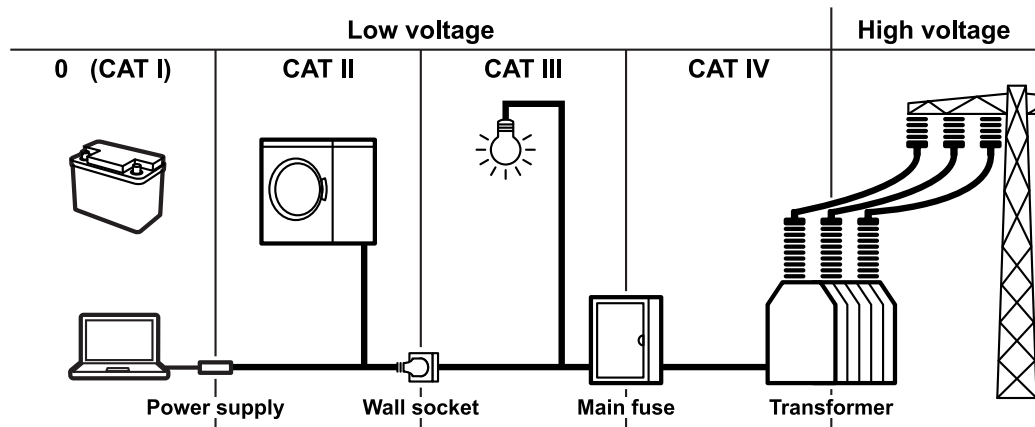

Cleaning the product

Use a dry, lint-free cloth to clean the product. When cleaning, keep in mind that the casing is not waterproof. Do not use liquid cleaning agents.

Meaning of safety labels

Safety labels on the product warn against potential hazards.



	<p>Potential hazard</p> <p>Read the product documentation to avoid personal injury or product damage.</p>
	<p>Electrical hazard</p> <p>Indicates live parts. Risk of electric shock, fire, personal injury or even death.</p>
	<p>Protective conductor terminal</p> <p>Connect this terminal to a grounded external conductor or to protective ground. This connection protects you against electric shock if an electric problem occurs.</p>

1.2 Labels on the product

Labels on the casing inform about:

- Personal safety, see ["Meaning of safety labels"](#) on page 16
- Product and environment safety, see [Table 1-1](#)
- Identification of the product

Table 1-1: Labels regarding product and environment safety

	Chassis grounding terminal
	Take care when handling electrostatic sensitive devices.
	Labeling in line with EN 50419 for disposal of electrical and electronic equipment after the product has come to the end of its life. For more information, see " Disposing of electrical and electronic equipment " on page 1343.

1.3 Warning messages in the documentation

A warning message points out a risk or danger that you need to be aware of. The signal word indicates the severity of the safety hazard and how likely it will occur if you do not follow the safety precautions.

WARNING

Potentially hazardous situation. Could result in death or serious injury if not avoided.

CAUTION

Potentially hazardous situation. Could result in minor or moderate injury if not avoided.

NOTICE

Potential risks of damage. Could result in damage to the supported product or to other property.

1.4 Where to find key documents on Rohde & Schwarz

Certificates issued to Rohde & Schwarz that are relevant for your country are provided at www.rohde-schwarz.com/key-documents, e.g. concerning:

- Quality management
- Environmental management
- Information security management
- Accreditations

1.5 Korea certification class A



이 기기는 업무용(A급) 전자파 적합기기로서 판매자 또는 사용자는 이 점을 주의하시기
바라며, 가정외의 지역에서 사용하는 것을 목적으로 합니다.

2 Preface

2.1 Key features

The R&S RTO6 oscilloscope provides fast signal acquisition and analysis:

- 1 million waveforms per second waveform acquisition rate
- Highly accurate digital trigger system
- Very low noise floor
- Precise measurements due to single-core A/D converter
- High measurement speed, even for complex analysis functions
- High-quality line of probes

For a detailed specification refer to the data sheet.

The R&S RTO6 oscilloscope brings various benefits in your daily work. It helps you to:

- Find signal anomalies quickly with unparalleled update rate
- Capture all signal details with excellent signal integrity
- See more with up to 16-bit resolution
- Find complex signal details with advanced trigger capabilities
- Measure more with deep and responsive memory

The large 15,6" touchscreen and the streamlined user interface of R&S RTO6 oscilloscopes help you quickly solve circuit issues from simple to complex.

2.2 Documentation overview

This section provides an overview of the R&S RTO6 user documentation.

2.2.1 Manuals and instrument help

You find the manuals on the product page at:

www.rohde-schwarz.com/manual/rto6

Getting started manual

Introduces the R&S RTO6 and describes how to set up and start working with the instrument, and describes basic operations. A printed English version is included in the delivery. Editions in other languages are available on the product website.

Instrument help

The help offers quick, context-sensitive access to the complete information for the firm-ware basic functionality and applications.

User manual (Instrument)

Describes all instrument functions in detail. It also provides an introduction to remote control, a complete description of the remote control commands with programming examples, and information on maintenance and instrument interfaces. Includes the contents of the getting started manual.

The *online version* of the user manual provides the complete contents for immediate display on the internet.

Manuals for compliance test options

For compliance test options, extra test procedure manuals are available. Test fixtures are described in printed manuals, which are delivered with the fixture.

- The following test procedure manuals are available:
 - USB 2.0 Compliance Test Procedures
 - Ethernet Compliance Tests Procedures
 - MIPI D-PHY Compliance Tests Procedures
 - eMMC Compliance Tests Procedures
 - PCIe Compliance Tests Procedures
 - DDR3 Compliance Tests Procedures
 - ScopeSuite Automation
- The following test fixture manuals are available:
 - R&S RT-ZF1 USB 2.0 Compliance Test Fixture Set
 - R&S RT-ZF2 Ethernet Compliance Test Fixture Set
 - R&S RT-ZF3 Frequency Converter Board (100BASE-T1)
 - R&S RT-ZF4 10BASE-T_e Test Fixture
 - R&S RT-ZF5 Ethernet Probing Fixture
 - R&S RT-ZF6 Frequency Converter Board (1000BASE-T1)
 - R&S RT-ZF7 Automotive Ethernet T&D Fixture
 - R&S RT-ZF7A and R&S RT-ZF7P SMA Adaptors
 - R&S RT-ZF8 Automotive Ethernet Compliance Test Fixture

Safety instructions

Provides safety information in many languages. The printed document is delivered with the product.

Instrument security procedures manual

Deals with security issues when working with the R&S RTO6 in secure areas. It is available for download on the internet.

Service Manual

Describes the performance test for checking the rated specifications, module replacement, firmware update, troubleshooting and fault elimination, and contains mechanical drawings and spare part lists. The service manual is available for registered users on

the global Rohde & Schwarz information system (GLORIS, <https://gloris.rohde-schwarz.com>).

2.2.2 Data sheet and brochure

The specifications document, also known as the data sheet, contains the technical specifications of the R&S RTO6. It also lists the firmware applications and their order numbers, and optional accessories. The product brochure provides an overview of the instrument and deals with the specific characteristics.

www.rohde-schwarz.com/brochure-datasheet/rto6

2.2.3 Release notes, open source acknowledgment

The release notes list new features, improvements and known issues of the current firmware version, and describe the firmware installation. The open source acknowledgment document provides verbatim license texts of the used open source software. It can also be read directly on the instrument.

www.rohde-schwarz.com/firmware/rto6

2.2.4 Application notes, application cards, videos

These documents deal with special applications or background information on particular topics.

- [Application notes](#)
- [Media Center](#)

2.3 Options described in this document

In addition to the base unit, the following options are described in this documentation:

Type	Designation	Order No.
R&S RTO6-B1	MSO	1801.6741.02
R&S RTO6-B6	Waveform and pattern generator	1801.6758.02
R&S RTO6-B7	Pulse source	1801.6764.02
R&S RTO6-K11	I/Q software interface	1801.6812.02
R&S RTO6-K12	Jitter analysis	1801.6829.02
R&S RTO6-K13	Clock data recovery	1801.6835.02
R&S RTO6-K133	Advanced jitter analysis	1801.6906.02
R&S RTO6-K134	Advanced noise analysis	1801.7677.02

Options described in this document

Type	Designation	Order No.
R&S RTO6-K37	Spectrum analysis	1801.6870.02
R&S RTO6-K31	Power analysis	1801.6858.02
R&S RTO6-K39	User defined math (Python scripting interface)	1803.6778.02
R&S RTO6-K121	Deembedding base option	1801.6887.02
R&S RTO6-K126	Embedding and equalization	1801.8109.02
R&S RTO6-K130	TDR/TDT analysis (requires pulse source option R&S RTO6-B7) For R&S RTO6 with at least 2 GHz bandwidth	1801.6893.02
R&S RTO6-K135	PAM-N analysis	1801.8050.02
R&S RTO6-K500	Bus analysis for I2C, SPI, UART, CAN/CAN-FD, LIN, SENT Ethernet(10BASE-T/100BASE-Tx), RFFE, Automotive Ethernet (100BASE-T1/1000BASE-T1) Requires corresponding protocol decoding option.	1801.6864.02
R&S RTO6-510	Triggering and decoding Low-speed Serial Buses: I2C , SPI, UART/RS-232/RS-422/RS-485, Audio I2S, Custom Manchester / NRZ	1801.7019.02
R&S RTO6-520	Triggering and decoding Automotive Protocols: LIN, CAN / CAN-FD, FlexRay, SENT, CXPI	1801.7025.02
R&S RTO6-530	Triggering and decoding Aerospace Protocols: MIL-STD-1553, ARINC 429, SpaceWire	1801.7031.02
R&S RTO6-540	Triggering and decoding Ethernet Protocols: 10BASE-T / 100BASE-Tx, MDIO	1801.7048.02
R&S RTO6-550	Triggering and decoding MIPI RFFE	1801.7054.02
R&S RTO6-560	Triggering and decoding Automotive Ethernet: 100BASE-T1, 1000BASE-T1	1801.7060.02
R&S RTO6-570	Triggering and decoding USB Protocols: USB 1.0/1.1/2.0, USB 3.1 Gen 1, USB Power Delivery (USB-PD), USB 3.1 SSIC	1801.7077.02
R&S RTO6-580	Triggering and decoding MIPI M-PHY, D-PHY	1801.7083.02
R&S RTO6-590	Triggering and decoding 8b10b, PCI Express 1.1 / 2.0	1801.7090.02

Type	Designation	Order No.
R&S RTO6-- TDBDL	Trigger and decode bundle. Includes options: R&S RTO6- -K500,-K510, -K520, -K530, -K540, -K550, -K560, -K570, -K580, -K590	1801.7725.02
R&S RTO6-K91	DDR3/DDR3L/LPDDR3 debug & compliance test. Decode and debug is described in this user manual. The compliance test is described in a separate manual.	1801.6993.02

2.4 Conventions used in the documentation

2.4.1 Typographical conventions

The following text markers are used throughout this documentation:

Convention	Description
"Graphical user interface elements"	All names of graphical user interface elements on the screen, such as dialog boxes, menus, options, buttons, and softkeys are enclosed by quotation marks.
[Keys]	Key and knob names are enclosed by square brackets.
Filenames, commands, program code	Filenames, commands, coding samples and screen output are distinguished by their font.
<i>Input</i>	Input to be entered by the user is displayed in italics.
Links	Links that you can click are displayed in blue font.
"References"	References to other parts of the documentation are enclosed by quotation marks.

2.4.2 Conventions for procedure descriptions

When operating the instrument, several alternative methods may be available to perform the same task. In this case, the procedure using the touchscreen is described. Any elements that can be activated by touching can also be clicked using an additionally connected mouse. The alternative procedure using the keys on the instrument or the on-screen keyboard is only described if it deviates from the standard operating procedures.

The term "select" may refer to any of the described methods, i.e. using a finger on the touchscreen, a mouse pointer in the display, or a key on the instrument or on a keyboard.

3 Getting started

Note: the following chapters are identical to those in the R&S RTO6 Getting Started manual for R&S RTO6 instruments.

- [Preparing for use](#).....24
- [Instrument tour](#).....30
- [Operating the instrument](#).....42

3.1 Preparing for use

Here, you can find basic information about setting up the instrument for the first time or when changing the operating site.

3.1.1 Lifting and carrying

See: "[Lifting and carrying the instrument](#)" on page 12.

3.1.2 Unpacking and checking

1. Unpack the product carefully.
2. Retain the original packing material. Use it when transporting or shipping the product later.
3. Using the delivery notes, check the equipment for completeness.
4. Check the equipment for damage.

If the delivery is incomplete or equipment is damaged, contact Rohde & Schwarz.

3.1.3 Choosing the operating site

Specific operating conditions ensure proper operation and avoid damage to the product and connected devices. For information on environmental conditions such as ambient temperature and humidity, see the specifications document.

For safety information, see "[Choosing the operating site](#)" on page 12.

Electromagnetic compatibility classes

The electromagnetic compatibility (EMC) class indicates where you can operate the product. The EMC class of the product is given in the specifications document.

- Class B equipment is suitable for use in:
 - Residential environments

- Environments that are directly connected to a low-voltage supply network that supplies residential buildings
- Class A equipment is intended for use in industrial environments. It can cause radio disturbances in residential environments due to possible conducted and radiated disturbances. It is therefore not suitable for class B environments. If class A equipment causes radio disturbances, take appropriate measures to eliminate them.

3.1.4 Setting up the product

When setting up the instrument, follow the safety instructions:

- ["Setting up the product"](#) on page 12
- ["Intended use"](#) on page 11

3.1.4.1 Placing the product on a bench top

For standalone operation, place the instrument on a horizontal bench with even, flat surface. The instrument can be used in horizontal position, standing on its feet, or with the support feet on the bottom extended.

To place the product on a bench top

1. Place the product on a stable, flat and level surface.
2. **CAUTION!** The top surface of the product is too small for stacking. If you stack another product on top of the product, the stack can fall over and cause injury. If you want to save space, mount several products in a rack.

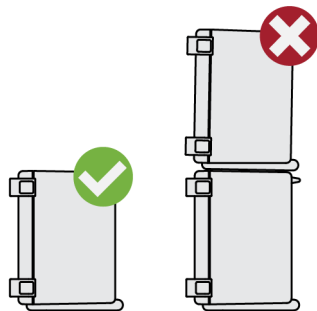

3. **CAUTION!** Foldable feet can collapse. For safety information, see ["Setting up the product"](#) on page 12.

Always fold the feet completely in or out. With folded-out feet, do not place anything on top or underneath.

4. **NOTICE!** Overheating can damage the product.

Prevent overheating as follows:

- Keep a minimum distance of 10 cm between the fan openings of the product and any object in the vicinity to provide sufficient airflow and ventilation.

- Do not place the product next to heat-generating equipment such as radiators or other products.

3.1.4.2 Mounting the product in a rack

To prepare the rack

1. Observe the requirements and instructions in "[Setting up the product](#)" on page 12.
2. **NOTICE!** Insufficient airflow can cause overheating and damage the product. Design and implement an efficient ventilation concept for the rack.

To mount the oscilloscope in a rack

1. Use a rackmount kit to prepare the instrument for rack mounting.
 - a) Order the rackmount kit designed for your oscilloscope. For the order number, see specifications document.
 - b) Mount the rackmount kit. Follow the assembly instructions provided with the rackmount kit.
2. Lift the product to shelf height. If the rack is high, use a safe climbing aid when placing on upper shelves.
3. Grip the product by the handles. Slide the product onto the shelf until the rack brackets fit closely to the rack.
4. Tighten all screws at the rack brackets with a tightening torque of 1.2 Nm to secure the product at the rack.

To unmount the product from a rack

1. Loosen the screws at the rack brackets.
2. Remove the product from the rack.
3. If placing the product on a bench top again, unmount the rackmount kit from the product. Follow the instructions provided with the rackmount kit.

3.1.5 Considerations for test setup

Observe safety instructions, see "[Performing measurements](#)" on page 14.

Cable selection and electromagnetic interference (EMI)

Electromagnetic interference (EMI) can affect the measurement results.

To suppress electromagnetic radiation during operation:

- Use high-quality shielded cables, for example, double-shielded RF and LAN cables.
- Always terminate open cable ends.

- Ensure that connected external devices comply with EMC regulations.

Measuring accessories

Use only probes and measuring accessories that comply with IEC 61010-031.

Signal input and output levels

Information on signal levels is provided in the specifications document. Keep the signal levels within the specified ranges to avoid damage to the product and connected devices.

During operation, if the firmware observes a serious unexpected disturbance (e.g. due to ESD), it resets some hardware components and initiates a new alignment to ensure proper instrument functioning. Then it restores the user settings to the state before the disturbance.

3.1.6 Connecting to power

For safety information, see "[Connecting to power and grounding](#)" on page 13.

The R&S RTO6 can be used with different AC power voltages and adapts itself automatically to it.

The nominal ranges are the following. They are also indicated on a label near the power connector on the instrument and in the specifications document.

- 100 V to 240 V AC at 50 Hz to 60 Hz and 400 Hz, with maximal 10% voltage fluctuation on line
- max. 6.2 A to 4.1 A

1. Plug the AC power cable into the AC power connector on the rear panel of the product. Only use the AC power cable that is delivered with the product.
2. Plug the AC power cable into a power outlet with ground contact.

3.1.7 Switching on or off

The instrument is switched on or off with the power switch and the [Power] key. The [Power] key is located in the bottom left corner of the front panel. The power switch is located at the rear panel of the instrument.

Table 3-1: Overview of power states

Status	LED	Power switch
Off	● (unlighted)	[0] (off)
Standby	● yellow	[!] (on)
Ready	● green	[!] (on)

To switch on the product

The product is off but connected to power.

1. Set the switch on the power supply to position [I].

The power key on the front panel lights up.

2. Press the [Power] key on the front panel.

The instrument performs a system check, boots the operating system, and then starts the R&S RTO6 firmware.

The [Power] key turns green and the illuminated keys on the front panel light up. If the previous session was terminated regularly, the oscilloscope uses the last settings.

Before you start measurements, be sure to comply with the warm-up phase specified in the specifications document.

To shut down the product

The product is in the ready state.

- ▶ Press the [Power] key.

All current settings are saved, and the software shuts down. The [Power] key turns yellow. The standby power supplies only the power switch circuits.

The  "Power" icon in the "Menu" shuts down only the firmware application. To shut down the instrument completely, use the [Power] key.

Remote command for firmware shutdown: [SYSTem:EXIT](#) on page 1384.

To disconnect from power

The product is in the standby state.

1. **NOTICE!** Risk of data loss. If you disconnect the product from power when it is in the ready state, you can lose settings and data. Shut it down first.

Set the switch on the power supply to position [0].

The LED of the [Power] key is switched off.

2. Disconnect the product from the power source.

3.1.8 Connecting external devices

The following interfaces for external devices are provided:

- USB connectors at the front and rear panel of the instrument
- Monitor connectors HDMI and DisplayPort at the rear panel of the instrument

3.1.8.1 Connecting USB devices

You can connect USB flash drives to save screenshots and measurement results, and keyboard and/or mouse to simplify the operation and the entry of data. You can connect or disconnect all USB devices during operation of the instrument. The number of USB connectors can be increased by using USB hubs.

USB devices are plug&play, the operating system automatically uses the suitable device driver. If the operating system does not find a suitable driver, it prompts you to specify a directory that contains the driver software. If the driver software is on a storage media, connect the appropriate drive to the instrument before proceeding. If the instrument is integrated in a network, you can also install driver data stored in a network directory.

When a USB device is disconnected from the R&S RTO6, Windows immediately detects the change in hardware configuration and deactivates the corresponding driver.

The properties of external USB devices are configured in the operating system, not in the instrument's firmware. We recommended using mouse and keyboard to access and modify the settings of the Windows operating system.

To access Windows, press the Windows key on the external keyboard, or select "Menu" > "Minimize Application" on the R&S RTO6 menu.

Connecting a keyboard or mouse

1. Connect the keyboard or mouse.

The device is detected automatically. The default input language of the keyboard is English – US.

2. To configure the keyboard properties, press the Windows key on the external keyboard.
3. Tap the "Find" icon (magnifier) on the Windows taskbar.
4. To configure the keyboard:
 - a) Type *keyboard*.
 - b) Select "Edit language and keyboard options".
5. To configure the mouse:
 - a) Type *mouse*.
 - b) Select "Mouse settings".

3.1.8.2 Connecting external monitors

You can connect one or two external monitors or projectors to the R&S RTO6. The following connectors are available:

- "HDMI" on page 34
- "DisplayPort" on page 34

1. Ensure that the monitors and the R&S RTO6 are connected to a ground contact. Otherwise the instrument can be damaged.
2. Check the input type of the monitors. Make sure to select the correct cable. If the connectors do not match, use an appropriate adapter.
3. You can configure the displays directly in the instrument's setup. Open "Menu" > "Settings" > "Display".
4. Select the "Monitors" tab.
5. Select how to display the screen. Select "Extend" to arrange dialogs and result boxes on different displays.
6. To move the main firmware window to an external monitor, press F11 on the keyboard.
Now the firmware shows a soft frontpanel together with the usual display in a window. You can move this window to an external monitor.
7. To access Windows display settings, tap "Additional settings".
8. To adjust the touch functionality, tap "Tablet PC settings".

The touchscreen of the R&S RTO6 has a screen resolution of 1920x1080 pixels pixel. Many external monitors have a higher screen resolution. If the screen resolution of the monitor is set higher than the instrument's resolution, the firmware window uses a 1920x1080 pixels area of the monitor display. For full screen display, adjust the monitor's screen resolution using "Additional settings".

3.2 Instrument tour

This chapter describes the front and rear panels of the instrument including all function keys and connectors.

3.2.1 Front panel

The front panel of the R&S RTO6 is shown in [Figure 3-1](#). The function keys are grouped in functional blocks to the right of the touchscreen. Below the screen, various connectors are located.



Figure 3-1: Front panel of R&S RTO6

- 1 = Touchscreen
- 2 = [Trigger] controls
- 3 = [Horizontal] controls
- 4 = [Vertical] controls
- 5 = [Analysis] keys
- 6 = Input channels
- 7 = [Aux Out] connector
- 8 = Connectors for probe compensation and grounding
- 9 = USB connectors
- 10 = [Power] key

3.2.1.1 Input connectors

The R&S RTO6 has four channel inputs to connect the input signals using active and passive probes.

The input connectors are provided with a special Rohde & Schwarz active probe interface, and they are BNC compatible. Thus, the instrument can automatically detect passive probes with standard BNC connector and active Rohde & Schwarz probes having the Rohde & Schwarz probe interface.

The input impedance is selectable, the values are 50 Ω and 1 M Ω .

The maximum input voltage is 200 V peak, 150 V RMS at 1 M Ω input impedance and 5 V RMS at 50 Ω input impedance.

3.2.1.2 Other front panel connectors



Besides the input connectors, the instrument has USB connectors and probe compensation connectors at the front panel.

[USB]

Two USB type A connectors that comply with standard USB 2.0. They are used to connect devices like keyboard, mouse and USB flash drive.

Probe Compensation

Probe compensation terminal to support adjustment of passive probes to the oscilloscope channel.

- | | |
|---|---|
|  | Protective earth conductor, 4 mm banana jack to connect ground of DUT and test fixtures, and wrist strap. |
|  | Square wave signal for probe compensation, 1 kHz and 1 V _{pp} . |
|  | Ground connector for probes. |

[Aux Out]

Output of the internal calibration signal, if the signal is configured to external destination.

3.2.2 Rear panel

The rear panel of the R&S RTO6 is shown in [Figure 3-2](#).

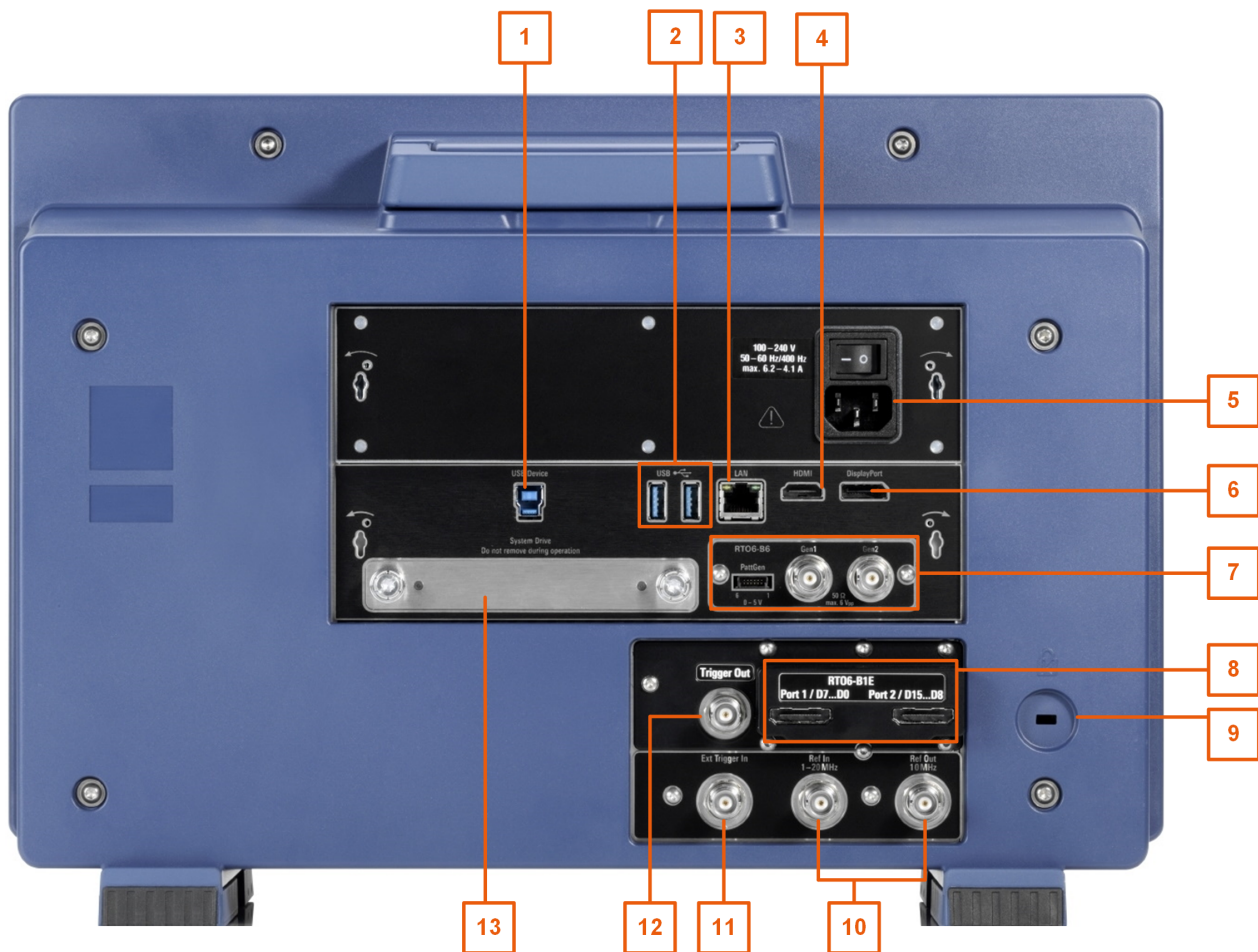

Figure 3-2: Rear panel of R&S RTO6

- 1 = USB device connector, type B
- 2 = USB connectors, type A
- 3 = LAN connector
- 4 = HDMI connector for external monitor
- 5 = AC power supply connector and main power switch
- 6 = DisplayPort connector
- 7 = Option slot for R&S RTO6-B6 (waveform generator, shown in figure) or R&S RTO6-B7 (pulse source)
- 8 = Option slot for R&S RTO6-B1 (MSO, shown in figure) or R&S RTO6-B1E (for R&S RT-ZVC), or R&S RTO6-B10 (GPIB)
- 9 = Kensington lock slot to secure the instrument against theft
- 10 = Ref In, Ref Out: reference input, and output of the OCXO reference signal
- 11 = External trigger input
- 12 = External trigger output
- 13 = Slot for optional exchangeable solid state disk (option R&S RTO6-B19)

AC power supply connector and mains power switch

Connection to the AC power line. The R&S RTO6 can be used with different AC power voltages and adapts itself automatically to it. The nominal voltage and frequency ranges are displayed on the rear panel and quoted in the specifications document.

If grounding is *not* ensured by the mains system, ground the oscilloscope using the protective earth conductor on the front panel and an appropriate cable.

The AC mains power switch also interrupts the power supply of the OCXO.

When you power up the instrument, be sure to comply with the warm-up phase specified in the specifications document before you start measurements.

See also: [Chapter 3.1.6, "Connecting to power"](#), on page 27.

USB Device

USB 3.0 interface of type B (device USB), to be used for remote control of the instrument.

USB

Two USB type A connectors that comply with standard USB 3.1 gen 1. They are used to connect devices like keyboard, mouse and flash drive to store and reload instrument settings and measurement data.

Note: Electromagnetic interference (EMI) can affect the measurement results. To avoid any impact, do not use USB connecting cables exceeding 1 m.

LAN

8-pin RJ-45 connector used to connect the instrument to a Local Area Network (LAN). It supports up to 1000 Mbit/s (10/100/1000BASE-T Ethernet).

HDMI

HDMI Version 2.0 connector for an external monitor or projector. The monitor shows the complete content of the instrument's screen.

See also: [Chapter 3.1.8.2, "Connecting external monitors"](#), on page 29.

DisplayPort

DisplayPort connector for an external monitor or projector. It supports DisplayPort++ version 1.3.

Ext Trigger In

The BNC connector for external trigger input is used to control the measurement by an external signal. The input impedance can be selected in the trigger configuration, the values are 50 Ω and 1 M Ω . The trigger level can be set from -5 V to 5 V. The maximum input voltage is 30 V RMS at 1 M Ω input impedance and 7 V RMS at 50 Ω input impedance.

Trigger Out

The BNC connector for external trigger output is used to provide the internal trigger signal of the oscilloscope to trigger other instruments for synchronized measurements.

When a trigger occurs, the R&S RTO6 creates a pulse of 5 V with a source impedance of 50 Ω and delivers it to the external trigger output. The instrument can also send the pulse on mask test violation or violation of measurement limits and margins.

If the connector is terminated with 50 Ω , the signal level is 2.5 V (50 mA). With 1 M Ω termination, the level is 5 V. A short-circuit of the connector to ground creates current of 100 mA.

To enable the trigger out signal, select the "Trigger out" action for the trigger or test. You can adjust polarity and length of the pulse. The default is a positive pulse of 100 ns. The delay is 800 ns.

Mixed signal option R&S RTO6-B1 / digital extension port R&S RTO6-B1E

The mixed signal option R&S RTO6-B1 provides logic analyzer functionality and 16 digital channels. It also can connect the R&S RT-ZVC multi-channel power probe. The connectors are used to connect two logical probes with 8 digital channels each (D0 to D7 and D8 to D15), or two flat interface cables of R&S RT-ZVC.

The digital extension port R&S RTO6-B1E provides the connectors for the R&S RT-ZVC multi-channel power probe without MSO. The connectors are used to connect two flat interface cables of R&S RT-ZVC.

One of the options can be installed in the option slot at the rear panel.

The maximum input voltage is 40 V peak at 100 k Ω input impedance. The maximum input frequency for a signal with the minimum input voltage swing of 500 mV (V_{pp}) is 400 MHz. For detailed specifications, refer to the specifications document.

Waveform generator option R&S RTO6-B6

The waveform generator generates various function and arbitrary waveforms, sweeps, and parallel patterns. For detailed specifications, refer to the specifications document.

The option can be installed in the option slot at the rear panel.

The module provides the following connectors:

- [Gen1, Gen2] BNC connectors
- [PattGen] Connector for the pattern generator

Pulse source option R&S RTO6-B7

The pulse source outputs a symmetrical differential pulse signal. For detailed specifications, refer to the specifications document.

The option can be installed in the option slot at the rear panel.

The module has four connectors.

- Out, $\overline{\text{Out}}$: 2.92 mm connectors (K type) for pulse signal output
- Ref, $\overline{\text{Ref}}$: 2.92 mm connectors (K type) for reference signal output

GBIP option R&S RTO6-B10

The GBIP option provides a GBIP interface and connector for remote control. For detailed specifications, refer to the data sheet.

3.2.3 Keys and controls

3.2.3.1 Power key

The [Power] key is located on the lower left corner of the front panel. It starts up and shuts down the instrument's software.

The light of the key shows the instrument state, see [Chapter 3.1.7, "Switching on or off"](#), on page 27.

3.2.3.2 Trigger controls

The keys and knob in the Trigger functional block adjust the trigger and start or stop acquisition.



[Level]

The rotary knob sets the trigger level for all trigger types. Turn clockwise to move up the trigger level. Press the knob to set the trigger level to 50% of the signal amplitude.

[Auto Norm]

Toggles the trigger mode between "Auto" and "Normal". The current setting is shown on the trigger label.

- | | |
|------|---|
| Auto | The instrument triggers repeatedly after a time interval if the trigger conditions are not fulfilled. |
| Norm | The instrument acquires a waveform only if a trigger occurs. The "Norm" LED lights up in green. |

Remote command:

[TRIGger<m>:MODE](#) on page 1528

[Source]

Opens a dialog box where you can select the trigger source. Press the key again to switch the source. The key lights up in the color of the selected trigger source.

Remote command:

[TRIGger<m>:SOURce\[:SElect\]](#) on page 1485

[Slope]

Toggles the trigger slope or trigger polarity, dependent on the trigger type. The current setting is shown on the trigger label.

[Run Stop]

Starts and stops the continuous acquisition. The [Run Stop] key lights green when the acquisition is running. When the acquisition is stopped, the key lights red.

Remote command:

[RUN](#) on page 1414

[STOP](#) on page 1415

[Single]

Starts a defined number of acquisitions. The [Single] key lights green when the acquisition is running. When the acquisition is stopped, the key lights red.

To set the number of acquisitions, select "Menu" > "Acquire" > "Setup" tab, and set "N-single count".

Remote command:

[SINGle](#) on page 1415

[Zone]

Opens the overlay menu to configure the zone trigger. A zone trigger combines the trigger condition with the intersection or non-intersection of one or more zones or masks.

Remote command:

[TRIGger<m>:ZONE:EXPReSSion\[:DEFine\]](#) on page 1531

3.2.3.3 Horizontal controls

The rotary knobs in the Horizontal functional block adjust the horizontal parameters. These settings are effective for all channel waveforms. In addition, a [Zoom] is available.

**[Position]**

The rotary knob changes the horizontal position of the waveform or the position of the reference point on the screen. To set the value to zero, press the knob. The current value is shown in the input box in the upper right corner of the screen.

You can select if the knob changes the position or the reference point in "Menu" > "Settings" > "Frontpanel" > "Knobs".

"Horizontal position" defines the time distance of the reference point from the zero point of the diagram. Turn clockwise to move the waveform to the right.

"Reference point" defines the position of the reference point on the screen. Turn clockwise to move it to the right. The reference point marks the rescaling center of the time scale. If you modify the time scale, the reference point remains fixed on the screen, and the scale is stretched or compressed to both sides of the reference point.

Remote command:

[TIMEbase:HORizontal:POSition](#) on page 1416

[TIMEbase:REFerence](#) on page 1417

[Scale]

The rotary knob adjusts the time scale for all signals. The time scale is also known as timebase.

Turn clockwise to stretch the waveforms. Doing so, the scale value *time/div* decreases. Press the knob to toggle between coarse and fine scale adjustment.

[Zoom]

Displays a zoom diagram for the active diagram. The key is illuminated if at least one zoom is active. If you press the key while the zoom function is on, the "Zoom" dialog box opens, where you can configure several zoom areas for detailed signal observation.

3.2.3.4 Vertical controls

The keys and knobs in the Vertical functional block select a signal and adjust the vertical scale and position of the selected signal.



[C<n>]

Turns on and selects a channel. If the channel is active, the key lights up in the corresponding channel color.

The effect of the keypress depends on state of the channel:

- If channel is off: turns on the channel and selects it.
- If the channel is on and in focus (selected): opens the corresponding channel dialog.
- If the channel is on, but not in focus (not selected): selects the channel waveform.
- If the channel is selected, and the dialog is open: turns off the channel, and closes the dialog.

The vertical rotary knobs are focused on the selected waveform. They are illuminated in the color of the selected waveform.

Remote command:

[CHANnel<m>:STATe](#) on page 1427

[Ref]

Opens the "Reference" dialog box, where you can configure and display reference waveforms. Press the key repeatedly to switch the reference waveform.

If a reference waveform is selected, the vertical rotary knobs are illuminated in white or light gray (default colors), depending on the selected waveform.

[Gen]

Opens the "Waveform Generator" dialog, if option R&S RTO6-B6 is installed.

The waveform generator can generate various function and arbitrary waveforms, sweeps, and parallel patterns. For detailed characteristics, refer to the specifications document.

[Logic]

Opens the "Logic" dialog to configure and enable the logic buses L1 to L4. A logic bus (or parallel bus) has up to 16 logic (digital) channels. If logic buses are active, pressing the key toggles these buses.

The key lights up if at least one logic bus is enabled.

[Bus]

Opens and closes the "Protocol" tab in the "Apps" dialog, where you can select the required serial protocol and proceed to the protocol setup. The key lights up if the decoding of a serial bus is active.

If serial buses are active, pressing the key toggles these buses when the "Apps" dialog or the "Serial Bus" dialog is open.

[FFT]

Opens and closes the "Math" dialog with FFT settings. The key lights up if an FFT is active.

[Math]

Opens the "Math" dialog, where you can configure the calculation of mathematical waveforms using various mathematic operations on other waveforms. Press the key repeatedly to toggle the selected math waveform. If no math waveform is active, the key closes the dialog.

If a math waveform is selected, the vertical rotary knobs are illuminated in light brown (default color), the brightness of the color depends on the selected waveform.

[Position]

The vertical [Position] knob changes the vertical offset or the position of the selected waveform. The horizontal axis and the selected waveform are moved vertically. You can select whether the knob changes the offset or the position in the "Menu" > "Settings" > "Frontpanel" > "Knobs" dialog.

- Position indicates the vertical location in divisions.
- Offset moves the vertical center of the selected channel to the offset value.

If the selected waveform is a math or reference waveform, serial bus, or logic channel, the knob changes its vertical position.

The knob lights up in the color of the selected waveform. Turn clockwise to move up the waveform. To set the value to zero, press the knob.

The current value is shown in the input box in the upper right corner of the screen.

Remote command:

[CHANnel<m>:POSition](#) on page 1429

[CHANnel<m>:OFFSet](#) on page 1429

[Scale]

Sets the vertical scale, which defines the displayed amplitude of the selected waveform.

The knob lights up in the color of the selected waveform. Turn clockwise to stretch the waveform. Doing so, the scale value V/div decreases. Press the knob to toggle between coarse and fine scale adjustment. For analog waveforms, the scale value is shown in the signal icon.

To get the maximum resolution of the waveform amplitude, make sure that the waveforms cover most of the diagram's height.

Remote command:

`CHANnel<m>:SCALE` on page 1428

3.2.3.5 Analysis keys

The keys in the Analysis functional block provide direct access to measurement and analyzing functions.

The rotary knob provides an alternative way to navigate in dialog boxes and to enter numeric data.

**[Multiuse]**

The multiuse knob has various functions. It lights up when a function is active on the knob.

- In numeric entry fields: turn to increase or decrease the value.
- To set cursor positions, histogram areas, and mask points in input boxes: press to toggle the parameter, turn clockwise to increase the value or turn counterclockwise to decrease it.
- To move zoom area, cursor line, or gate in diagrams: Turn to move the element that has the focus, and press to toggle the focus.
- In tables: press to activate the edit mode, turn clockwise to increase the value or turn counterclockwise to decrease it, and press to enter the value and move to the next cell.
- To change the intensity: Press the [Intensity] key and turn the knob.

[Intensity]

Adjusts the intensity of the waveforms on the screen, or the background transparency of dialog boxes, or the transparency of result boxes.

Press the [Intensity] key and turn the [Multiuse] knob. Press the [Intensity] key again to toggle between the three settings. The controlled parameter and its value are shown in the input box in the upper right corner of the screen.

[Cursor]

Starts a cursor measurement: displays vertical and horizontal cursor lines in the active diagram, and the results of the cursor measurement.

If you press the key while a cursor measurement is enabled, the "Cursors" dialog opens. The next press closes the dialog.

Cursors are markers which are placed at points of interest on a waveform. The instrument measures the cursor positions and delta values between parallel cursors.

[Measure]

Opens and closes the "Measurements" dialog and the subtab of the last used measurement. In the dialog, you can configure and start automatic measurements.

[History]

Opens and closes the history player. The history shows stored acquisitions that were acquired before the current one.

The key is illuminated as long as history acquisitions are displayed.

[HD]

Activates the high definition mode and opens the "HD Mode" dialog box.

[Autoset]

The instrument analyzes the enabled channel signals, and adjusts appropriate horizontal, vertical, and trigger settings to display stable waveforms.

[Preset]

Resets the instrument to a predefined state and starts the continuous acquisition. All measurements, mask tests, zoom, and most individual settings are deleted, and all channels except for channel 1 are disabled. You can define preset configurations and save them to a file. The [Preset] key can be configured to set either factory defaults or a user-defined preset configuration.

Camera 

Performs the action that is assigned to the key in "Menu" > "Settings" > "Frontpanel" > "Hardkeys". By default, the key saves a screenshot of the waveform display.

See also: [Chapter 4.5.1, "Hardkeys: function assignment"](#), on page 94

[Touch Lock]

Locks the touchscreen to prevent unintended use. When the touchscreen is off, the key is illuminated. Press again to unlock the touchscreen.

[Clear]

Deletes all measurement results including long-term measurement and statistics, all waveforms, and the history.

App Cockpit 

Opens the "Apps" dialog, where you can start an application, serial protocol or another analysis function.

3.3 Operating the instrument

There are three ways to operate the R&S RTO6.

Manual operation

Use the touchscreen, keys and rotary knobs, or an optional mouse and/or keyboard. The principles of manual operation are explained in this section.

Remote control

Create programs to automatize repeating settings, tests, and measurements. The instrument is connected to a computer that runs the program.

This way of operation is described in: [Chapter 27, "Remote control commands"](#), on page 1344

Remote operation

The remote desktop connection of Windows can be used for instrument control and file transfer. Even on computers with non-Windows operating systems, a remote desktop connection is possible using RDP applications.

For details, refer to the user manual, chapter "Remote Desktop Connection".

Remote monitoring and control of the instrument from a connected computer is also possible with a standard web browser and a LAN connection.

For details, refer to the user manual, chapter "Web Control".

Alternatively, you can use Virtual Network Computing (VNC), which requires installation of the VNC server on the R&S RTO6. Installation and configuration are described in the application note "Remote Monitoring and Control of the R&S RTO6 with a Web Browser", available on the Rohde & Schwarz internet site.

3.3.1 Means of manual interaction

The R&S RTO6 provides the following means of manual interaction, which you can use alternatively or complementary:

- **Touchscreen:**
Using the touchscreen allows for direct interaction with the instrument. Use your finger to place waveforms on the screen, mark areas for zoom, set parameters in dialogs, enter data, and much more. The control elements and actions on the screen are based on common concepts, and you easily become familiar with the user interface.

Tapping the screen works like clicking mouse buttons:

- Tap = click: Selects a waveform or parameter, or provokes an action.
- Double-tap = double-click: Has the same effect as touch and hold, it opens the on-screen keyboard or keypad, or a specific editor if available.

Use gestures to scale the waveform:

- Spread or pinch two fingers horizontally to change the time scale.
- Spread or pinch two fingers vertically to change the vertical scale of the active waveform.
- Function keys and rotary knobs:
The front panel provides frequently used functions and controls to operate the instrument. Use knobs to set levels and scales, and keys to initiate actions and to open dialogs.
- Optional mouse and/or keyboard
These devices work in the normal manner.

3.3.2 Touchscreen display

3.3.2.1 Information on the display

The touchscreen of the instrument shows the waveforms and measurement results, and also information and everything that you need to control the instrument. All waveform-related display elements are shown in [Figure 3-3](#). An overview of control elements - like dialog box, toolbar - is given in [Chapter 3.3.2.2, "Control elements on the touchscreen"](#), on page 47.



Figure 3-3: Display information

- 1 = Diagram
- 2 = Grid
- 3 = Trigger position
- 4 = Reference point (distance from trigger position to reference point = horizontal position)
- 5 = Trigger, horizontal and acquisition label
- 6 = Notifications
- 7 = Zoom area
- 8 = Zoom diagram
- 9 = Trigger level
- 10 = Signal bar with inactive waveforms (10a), minimized live waveform (10b) and signal icon with vertical settings (10c)
- 11 = Histogram area
- 12 = Histogram

Diagram

A diagram shows one or more waveforms: channel, reference, and math waveforms together with histograms, masks etc. Zoom details, XY-waveforms, spectra and other special waveforms are shown in separate diagrams.

By default, the diagram name contains the diagram number and the short names of the waveforms shown inside. To change the diagram name, touch and hold the tab name. The on-screen keyboard opens to enter the new name. Names must be unique.

To arrange the diagrams on the screen, the Rohde & Schwarz SmartGrid function helps you to find the target place simply and quickly. For details, see [Chapter 3.3.5, "Rohde & Schwarz SmartGrid"](#), on page 51. You can also adjust the diagram size by dragging the diagram border.

Grid

The grid shows the vertical and horizontal divisions. The division lines are labeled with the correspondent values. The grid labels have the color of the waveform to which they belong. If several waveforms are shown in one diagram, the grid has the color of the selected waveform.

Trigger position and trigger level

The blue markers show the horizontal position of the trigger and the vertical trigger level. You can touch and move the trigger markers in the diagram to set the positions. The trigger point is the zero point of the diagram.

The trigger position can be moved outside the diagram. A red trigger position marker indicates that the trigger position is not visible.

Trigger, Horizontal, Acquisition

The "Trigger", "Horizontal" and "Acquisition" labels show the main timebase and trigger settings. If you tap a label, the relevant dialog box opens.

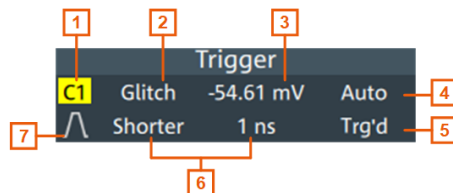

Figure 3-4: Trigger label on the toolbar

- 1 = Trigger source
- 2 = Trigger type
- 3 = Trigger level
- 4 = Trigger mode
- 5 = Trigger state
- 6 = Trigger slope

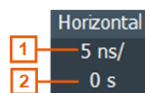

Figure 3-5: Horizontal label on the toolbar

- 1 = Time scale
- 2 = Horizontal position

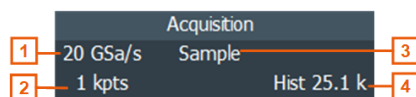

Figure 3-6: Acquisition label on the toolbar

- 1 = Sample rate
- 2 = Record length
- 3 = Decimation
- 4 = Number of acquired waveforms

Reference point

The reference point marks the rescaling center. If you modify the time scale, the reference point remains fixed on the screen, and the scale is stretched or compressed to both sides of the reference point.

You can define the position of the reference point ("Menu" > "Horizontal" > "Reference point"), and also its time distance from the trigger point of the diagram (Position knob).

Notification

The "Notification" button on the toolbar points to the status messages of the instrument. To open the message box, tap the button. See also: [Chapter 3.3.10, "Instrument information and notifications"](#), on page 64.

Zoom diagram and zoom area

Zoomed waveforms are shown in separate zoom diagrams, in addition to the waveform diagrams. On the original waveform diagram, a rectangle indicates the zoomed section of the waveform - this is the zoom area. You can modify the zoom area by dragging the rectangle as a whole, and by dragging its edges. To toggle between these modes, tap the zoom area. You can also set exact positions.

The frames of the zoom area and of the associated zoom diagram have the same color, different zooms are marked with different colors. So it is easy to assign zoom area and zoom diagram.

As for waveform diagrams, you can change the name of the zoom diagram. A zoom in a zoom and coupled zooms are also possible.

For details, see [Chapter 7.1, "Zoom"](#), on page 243.

Signal bar

The signal bar is the control center for all waveforms. All enabled waveforms are shown on the left side of the signal bar. On the right side of the signal bar, you see the signal activators of inactive waveforms. Tap a signal activator to enable the waveform.

Each waveform is represented by a signal icon. If the waveform is shown in a diagram, the signal icon displays its main vertical and acquisition settings. If you tap a signal icon, the dialog with vertical settings for this waveform opens. If you tap the "Minimize" icon on the signal icon, the waveform switches from the diagram area to the signal icon: the icon shows the real-time signal preview. See [Chapter 3.3.4, "Working with waveforms"](#), on page 49 for a detailed description.

In [Figure 3-3](#), the signal icons C1 and C2 show the main settings, and the waveforms are displayed in diagrams. Other waveforms are minimized and shown as signal preview.

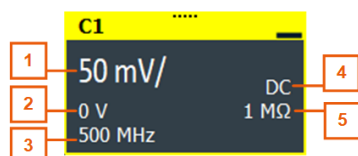

Figure 3-7: Signal label

- 1 = Vertical scale
- 2 = Offset
- 3 = Bandwidth
- 4 = Coupling
- 5 = Termination

If the signal bar contains many signal icons, and not all icons are visible, touch one of the icons and scroll left or right until the required icon appears.

You can also switch off the signal bar: "Menu" > "Settings" > "Appearance" > "Diagram" > "Show signal bar".

Histogram and histogram area

A histogram shows the frequency of occurrence of voltage or time values in a bar chart directly in the diagram. The rectangular histogram area indicates the part of the waveform that is considered in the histogram. The vertical histogram counts the voltage values, and the horizontal histogram counts time values. You can switch between vertical and horizontal mode, and modify the histogram area by dragging the rectangle as a whole, by dragging its edges, or by setting exact positions.

3.3.2.2 Control elements on the touchscreen

The touchscreen provides everything you need to control the instrument, to analyze waveforms, and to get measurement results. [Figure 3-8](#) shows the control elements at a glance.



Figure 3-8: Control elements on the touchscreen

- 1 = Toolbar
- 2 = Tab in a dialog box
- 3 = Dialog box
- 4 = Result table (docked)
- 5 = Signal bar
- 6 = Menu
- Not shown = Input box

Toolbar (1)

The icons on the toolbar provide quick and easy access to the most important functionality. For a detailed description, refer to [Chapter 3.3.6, "Toolbar"](#), on page 53.

If you adjust the settings of an analyzing function, e.g., cursor measurement, the overlay menu is shown instead of the icons. The overlay menu provides the most important settings of the current action. If you need more settings, "Advanced Setup" opens the corresponding dialog box.

Dialog box (2, 3)

The tabs of the dialog boxes contain all task-oriented settings and operations, and black buttons for calling related tabs. The usage of dialog boxes is described in [Chapter 3.3.8, "Using dialogs"](#), on page 61.

Result table (4)

If you perform cursor or automatic measurements, mask testing, or a search, the result table shows the results of the action. The position of the result table is adjustable. It can be docked (default for measurements), floating, minimized to a result icon on the signal bar, or displayed in a separate diagram on the screen.

See also: [Chapter 3.3.7, "Displaying results"](#), on page 59.

Signal bar (5)

The signal bar summarizes all waveforms as described in ["Signal bar"](#) on page 46.

Menu (6)

The menu provides access to the complete functionality of the R&S RTO6.

Input box

The input box appears if you adjust a value using one of the rotary knobs, or if you drag an element on the screen, for example, a cursor line. The input box shows the current value of the modified parameter. You can enter the exact numerical value, change the step size, and - if available - autoselect the value directly in the input box. The box title shows the name of the currently adjusted parameter.

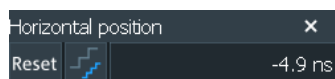

See also: [Chapter 3.3.9, "Entering data"](#), on page 62.

3.3.3 Applications

All available applications for special tasks are provided in the "Apps" dialog.

- ▶ To open the "Apps" dialog:
 - Open "Menu" > "Apps".
 - Press the  app key on the frontpanel.

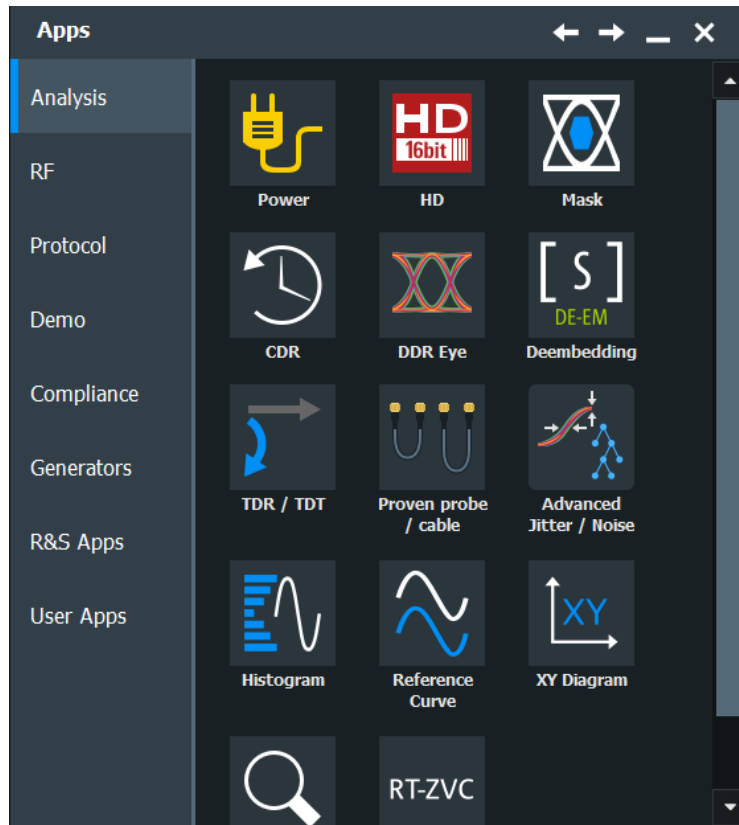

3.3.4 Working with waveforms

The R&S RTO6 can create and display many waveform types. The most important are:

- Channel waveforms:
Up to three waveforms per input channel can be shown. For a four-channel instrument, 12 channel waveforms are available.
- Reference waveforms:
Four waveforms can be used as reference for comparison and analysis.
- Math waveforms:
Eight mathematic waveforms can be created with mathematic operations performed on channel, reference, and other math waveforms.
- Zoom waveforms:
Show the details of waveforms.
- XY-waveforms:
Four XY-waveforms can be created. Each XY-waveform is built from the voltage values of two source waveforms.

- Digital waveforms:
The Mixed Signal Option R&S RTO6-B1 provides 16 digital channels grouped in two logic probes (pods) with 8 channels each.

Waveform handling

The R&S RTO6 can show and analyze many waveforms. To handle this multitude while keeping track of it, the R&S RTO6 provides intelligent support:

- The color system helps to distinguish the waveforms. The color of the vertical rotary knobs indicates the signal that is focused (selected). The color of each waveform can be changed, the color of its signal icon and of the illuminated keys is adjusted to the new color. Alternatively, a color table can be assigned to a waveform.
Settings: "Menu" > "Settings" > "Appearance" > "Colors" tab.
- Waveforms can be minimized to signal icons showing a real-time signal preview. Thus, more space in the diagram area is available without switching off waveforms.
- Diagrams are displayed on tabs – you can arrange them side by side or one above the other. To change the diagram name, double-tap the tab name.
- The Rohde & Schwarz SmartGrid function helps to arrange the diagrams.

Waveform states

Depending on its place on the screen and the effect of settings, a waveform has one of the following states:

- Off
- Active: The waveform is shown in a diagram.
- Selected:
One of the active waveforms that has the focus. In each diagram, one of the assigned waveforms is selected – it appears "on top" in the diagram, and the grid labels have the color of the selected waveform. Some of the toolbar functions, like cursor and histogram measurements, are performed on the selected waveform. All waveform-specific settings are applied to the selected waveform of the selected diagram.
The vertical [Position] and the [Scale] knobs are illuminated in the color of the selected waveform.
In [Figure 3-3](#), C2 is the selected waveform: The frame of the diagram and the signal icon are highlighted.
- Minimized:
The waveform is shown as real-time signal preview in its signal icon.

To switch a waveform on

A channel waveform is activated as soon as you connect the probe. You can switch it on and off according to your needs.

- ▶ Choose one of the following ways:
 - Press the channel key.
 - Tap the signal activator on the right side of the signal bar.
 - In the "Vertical" dialog box, select the channel and tap "Channel" > "On".

The waveform is now active, selected, and is shown in the diagram.

Remote command: [CHANnel<m>:STATe](#) on page 1427

To select a waveform

- ▶ Choose one of the following ways:
 - Tap the waveform in the waveform diagram.
 - To select a channel, reference, or math waveform, press the corresponding key.
 - Tap the signal icon.

Note: Zoom waveforms in zoom diagrams cannot be selected.

To minimize a waveform

- ▶ Choose on of the following ways:
 - Tap the "Minimize" icon in the upper right corner of the waveform's signal label in the signal bar.
 - Drag the waveform from the diagram to the signal bar.

The waveform disappears from the diagram and the signal preview is shown in the signal icon.

Remote command: [LAYout:SIGNal:UNASsign](#) on page 1394

- ▶ To set the waveform back to its previous diagram immediately, use "Undo".

To arrange a waveform using the SmartGrid

See [Chapter 3.3.5, "Rohde & Schwarz SmartGrid"](#), on page 51.

To switch off a waveform

- ▶ Do one of the following:
 - To switch off a signal preview, tap the "Close" icon in the upper right corner of the minimized signal view.
 - Disable "Channel" in the "Vertical" > "Setup" tab.
 - Tap the "Delete" icon (Recycle bin) in the toolbar, and then the waveform.
If several waveforms overlap or lie close together, the upper (selected) waveform is switched off.

Remote command: [CHANnel<m>:STATe](#) on page 1427

3.3.5 Rohde & Schwarz SmartGrid

The Rohde & Schwarz SmartGrid helps to create and arrange the diagrams on the screen with drag&drop. The diagram layout depends on the position where you drop the signal icon, in relation to an existing diagram.

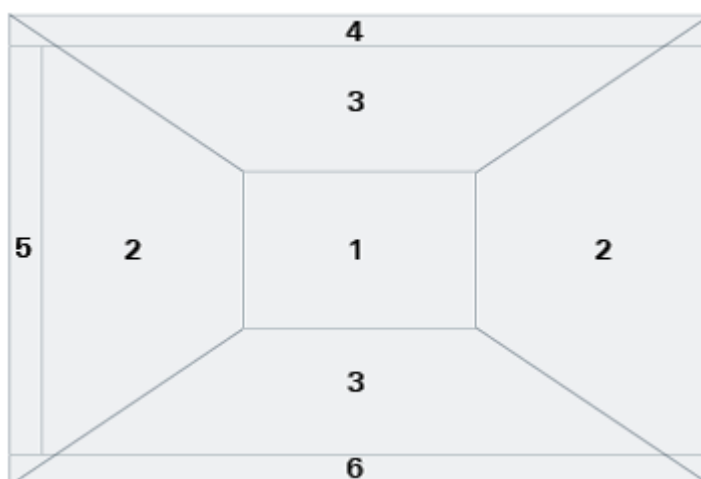

Figure 3-9: SmartGrid positions

- 1 = In the existing diagram, overlay of signal
- 2 = New diagram on the left or right
- 3 = New diagram above or below
- 4 = New diagram on top of the existing diagram
- 5 = XY-diagram
- 6 = YX-diagram

The diagram configuration is deleted when you use [Preset] and *RST.

To arrange a waveform using the SmartGrid

You can arrange waveforms in one of the existing diagrams, or in a new diagram.

1. Drag the signal icon to the diagram area, and move it around.
The Rohde & Schwarz SmartGrid appears and a blue area shows where the waveform will be placed.
2. Drop the waveform in the target area.
The waveform appears in an existing or in a new diagram, and it is selected for further actions.

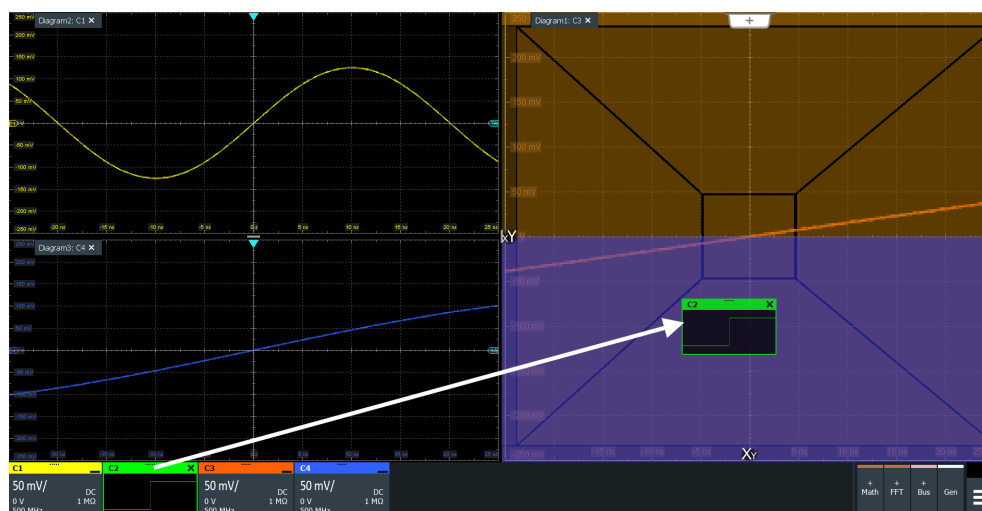

3. To change the size of a diagram, tap the handle between two diagram frames and drag it to the required position.

Remote commands: see [Chapter 27.7.2.4, "Smartgrid"](#), on page 1390.

3.3.6 Toolbar

The toolbar provides direct access to important control and measurement functions.



By default, the toolbar shows the most frequently used functions. You can configure the content of the toolbar, see [Chapter 3.3.6.2, "Configuring the toolbar"](#), on page 54.

3.3.6.1 Using the toolbar

Using the toolbar is easy and straightforward.

Some of the toolbar functions are one-click actions. These actions are performed immediately when you tap the icon.

Other toolbar functions are analyzing functions. These functions are interactive actions.

To use analyzing functions (interactive actions)

1. If several waveforms are shown in the diagram, select the waveform that you want to analyze.
See: ["To select a waveform"](#) on page 51
2. Tap the icon of the function in the toolbar.
If there are many functions on the toolbar, and not all icons are visible, scroll the toolbar using the arrow on the right end of the toolbar.
3. Check and adjust the settings in the overlay menu.

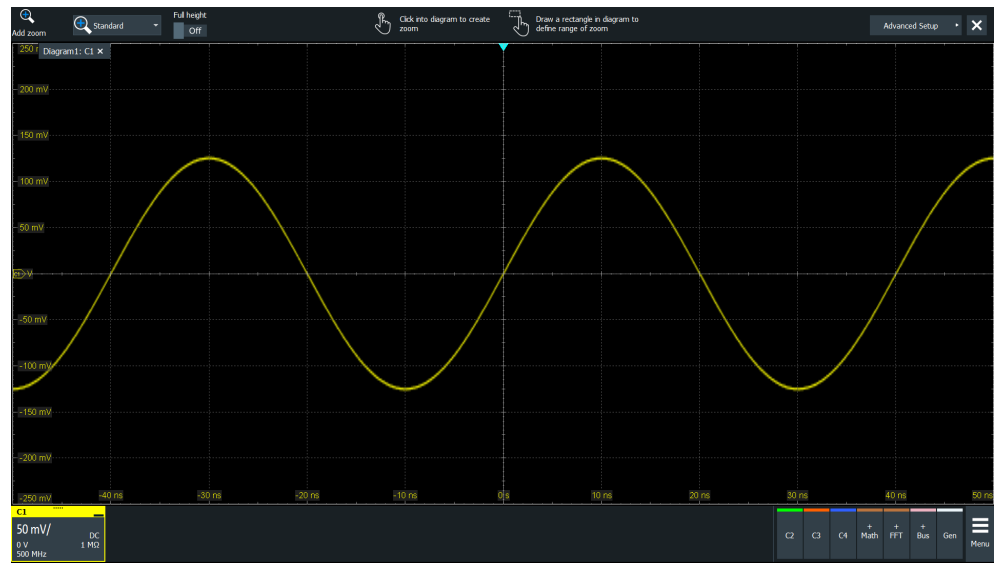

4. To define the analyzed area, do one of the following:
 - Tap the required diagram.
 - Drag a rectangle on the diagram.

3.3.6.2 Configuring the toolbar

You can configure the content of the toolbar so that only the required functions are displayed. The toolbar configuration is part of the user preferences. It is retained when you switch off and on the instrument, and you can save it in the user preferences and user-defined preset.

1. To open the toolbar configuration, tap the icon in the toolbar:



2. Select the required toolbar functions:
 - Disable the functions that you do not need.
 - Enable the functions that you want to add to the toolbar.
3. Close the dialog.

A detailed description of the toolbar functions is given in [Chapter 3.3.6.3, "Toolbar functions"](#), on page 54.

3.3.6.3 Toolbar functions

This section describes all toolbar functions in detail.

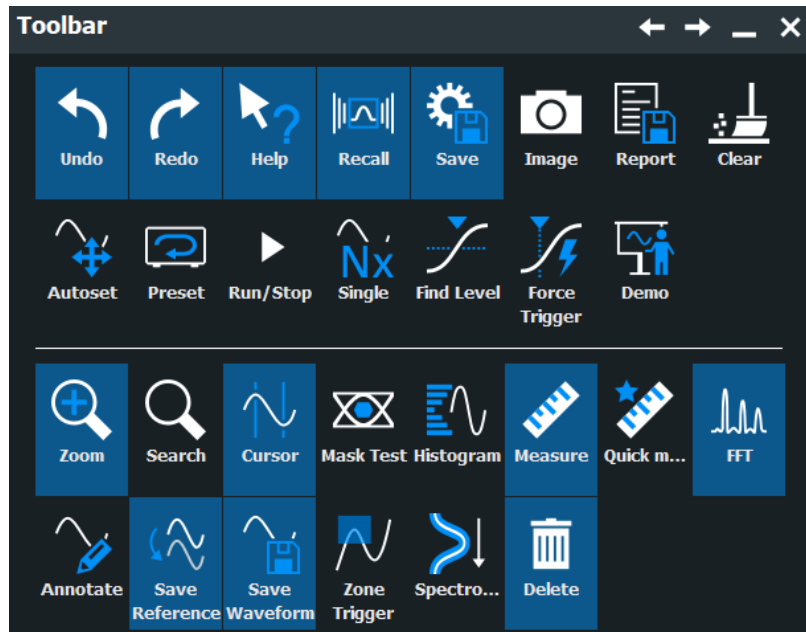

One-click actions	Interactive actions
Undo	Zoom
Redo	Search
Help	Cursor
Recall	Mask Test
Save	Histogram
Image	Measure
Report	Quick meas
Clear	FFT
Autoset and Preset	Annotate
Run / Stop and Single	Save Reference
Find Level	Save Waveform
Force Trigger	Zone trigger
Demo	Spectrogram (option R&S RTO6-K37)



You can configure the content of the toolbar, see [Chapter 3.3.6.2, "Configuring the toolbar"](#), on page 54.

The following list describes at first the default toolbar functions and then the additional functions.

**Undo**

Undoes the last setting actions step by step. Some actions cannot be revoked: locking the touchscreen with [Touch Lock], and saving data. The undo stack is deleted during the following actions: Reloading settings from file, reference waveform actions (save, load and preset with active reference waveform), and some actions that require an internal realignment to ensure correct measurements.

**Redo**

Recovers the undo steps in reverse order.

**Help**

Enables the tooltip display. A short description appears when you tap a parameter in a dialog. To open the corresponding help topic, tap the "Show Help" button in the lower right corner of the tooltip. See also: [Chapter 3.3.11, "Getting help"](#), on page 65.

**Recall**

Opens a window to select and load instrument settings that were previously stored in a saveset. A graphical preview helps you to find the required settings.

**Save**

Saves the current instrument settings in a saveset.

You can reload the saveset using the "Recall" toolbar icon, or using "Menu" > "Save/Recall" > "Recall" tab > "Saveset with preview".

The filename is created according to the autonaming pattern, defined in "Menu" > "Settings" > "Save/Recall" > "Autonaming" tab.

**Image**

Saves a screenshot of the current display using the settings defined in "Menu" > "Save/Recall" > "Save" tab > "Screenshot".

**Report**

Creates a report of the current measurement settings and results using the settings defined in "Menu" > "Save/Recall" > "Save" tab > "Report".

**Clear**

Deletes all measurement results including long term measurement and statistics, all waveforms, and the history.

Remote command:

[DISPlay:CLR](#) on page 1410

**Autoset and Preset**

Performs an autoset, or a preset to a default state. The icons have the same functionality as the corresponding keys on the front panel. They are useful when you operate the instrument remotely.

**Run / Stop and Single**

Starts and stops the continuous acquisition, or starts a defined number of acquisition cycles. The icons have the same functionality as the corresponding keys on the front panel. They are useful when you control the instrument remotely.



Find Level

Analyses the signal and sets the trigger level to the middle of the signal peaks.



Force Trigger

Starts an immediate single acquisition. If the acquisition is running in normal mode and no valid trigger occurs, use "Force Trigger" to confirm that a signal is available. Then you can use the displayed waveform to determine how to trigger on it.



Demo

Opens the "Demo" dialog, where you can find examples of operating the R&S RTO6.



Zoom

Creates a zoom. Tapping the icon opens the overlay menu, where you select one of the four zoom types: standard zoom, hardware zoom, coupled zoom, fingertip zoom.



Standard zoom ← Zoom

Displays a magnified section of the diagram in an additional zoom diagram. It is a display zoom, instrument settings are not changed.

Touch and hold the zoom area to open the "Zoom" dialog box.

Remote command:

[LAYout:ZOOM:ADD](#) on page 1537



Hardware zoom ← Zoom

Changes the instrument settings - horizontal and vertical scales as well as trigger level and offset - to display a part of the diagram in greater detail.



Coupled zoom ← Zoom

Creates a coupled zoom area and its related zoom diagram. If you change the size of one zoom area, the size of all coupled zoom areas is changed as well.

Remote command:

[LAYout:ZOOM:ADDCoupled](#) on page 1537



Fingertip zoom ← Zoom

Magnifies the waveforms around your fingertip.

Tap the icon and put your finger on the waveform. The touched part of the waveform is displayed in a magnifier. Drag your finger on the screen to move the magnifier. You can change the zoom factor using the [Multiuse] knob.



Search

Performs a search according to the settings in the "Search Setup" dialog box. Tap the icon and then tap the diagram with the waveform to be searched, or drag a rectangle to define a search gate. The search is performed on the selected waveform.



Cursor

Performs a cursor measurement. Tapping the icon opens the overlay menu, where you select the cursor type and source.

Tap the diagram where you want to set the cursors, or draw a rectangle in the diagram to position the cursor lines. The resulting cursor lines measure the selected waveform, and the results are shown.



Mask Test

Starts the on-screen mask definition and the testing against the defined mask.

Tap the icon and then tap the points that build the mask. To finish the shape definition, tap "Finish segment" in the overlay menu. To create a rectangular mask, draw a rectangle on the screen. You can add more segments to the test, and add another test. You can also move the mask segments on the screen.

To configure the mask test settings, tap the  icon in the "Mask" result box.



Histogram

Creates a histogram. Tapping the icon opens the overlay menu, where you select the histogram type and source.

Drag a rectangle on the diagram to define the histogram area. The histogram for the selected waveform appears.

To change settings, touch and hold the histogram area, and the histogram overlay menu opens.



Measure

Performs automatic measurements. Tapping the icon opens the overlay menu, where you select the category, the measurement types and measured waveform. Tap the diagram with the waveform to be measured. To define a measurement gate, draw a rectangle on the screen.

You can run up to 8 automatic measurement groups in parallel. The "Measure" icon starts the measurement groups one after the other. A measurement group consists of minimum one measurement, and can consist of many measurements of the same category.

To modify the measurement, double-tap one of the result values.



Quick meas

Performs a set of measurements on the selected waveform or on the selected gate. You can configure up to 8 measurements to be included in quick measurement.

Tap the icon and then tap the waveform to be measured or draw a rectangle to define the gate.



FFT

Transforms a waveform to the frequency spectrum by fast Fourier transform (FFT). The FFT trace is shown in a new diagram.

Tap the icon and adjust the settings in the overlay menu. Select the source of the spectrum in the overlay menu. The FFT diagram is created from the selected waveform.

To adjust FFT settings, double-tap the FFT diagram.



Annotate

Defines a waveform label that names or explains the waveform. Tap the icon and then tap the waveform to be labeled. Enter the label text using the on-screen keyboard. The text is shown in the same color as the waveform. If you tap the display background, the label is assigned to the focused waveform. You can drag the label to another position.



Save Reference

Copies the selected source waveform with all its settings to the reference waveform. If the acquisition is running, the reference waveform is a snapshot. You can configure up to four reference waveforms.

Tap the icon, and select the required reference waveform (R1 to R4) in the overlay menu. Tap the waveform to be copied.



Save Waveform

Exports the waveform data to file using the settings defined in "Menu" > "Save/Recall" > "Save" tab > "Waveform" > "Setup" tab.

The filename is created according to the autonaming pattern.

Tap the icon and then tap the waveform to be exported. If you tap the display background, the focused waveform is exported, or a multichannel export is performed if configured.



Zone trigger

Defines a zone trigger, which combines the trigger condition with the intersection or non-intersection of one or more zones or masks.

Tap the icon and then tap the corner points of the zone on the screen. Tap "Finish zone". You can add more zones to the trigger condition.



Spectrogram (option R&S RTO6-K37)

Starts an FFT and the spectrogram. The FFT trace and the spectrogram are shown in separate diagrams.

Tap the icon. Select the source in the sidebar, or tap diagram with the waveform to be transformed. The diagrams are created from the selected waveform.



Delete

Removes waveforms, measurements, zoom, histograms, mask segments and other elements from the display.

Tap the icon and then tap the element to be deleted, or the waveform to be switched off.

3.3.7 Displaying results

The results of measurements, mask tests, searches, protocol decoding and others are displayed immediately. There are several places to display the results:

- In a table that is docked below the diagram (only for measurement and decode results)
- In a floating result box in front of the diagrams, which you can move on the display

- In a minimized view (result icon) on the signal bar
- In a separate tab that can be arranged similar to a diagram

The default position and the font size can be adjusted.

To define the default position of measurement results

For results of automatic, cursor and protocol measurements and for decode results, the docked table below the diagram is the initial default position.

To change the default position of the results:

- ▶ Open the "Menu" > "Settings" > "Appearance" dialog.
 - Automatic measurements: select "Measurement" tab > "Result position".
 - Cursor measurements: select "Cursor" tab > "Result position".
 - Protocols: select "Protocol" tab > "Result position".

Mask test and search results are always shown in a floating result box, which you can drag to a convenient position using the SmartGrid.

To arrange the results on the display

1. If the results are listed in a docked table, touch and hold a result line and drag it.

The results are now shown in a floating result box.

Note: Once you undock the measurement results, you cannot move the result box back to the docked position.

2. Touch and hold the title of the result box and drag the box on the screen. The SmartGrid indicates where the result box will be placed.

- If you drop the box on one of the buttons, the results are shown in a separate tab besides, above, or below the diagram.
- If you drop the box on the signal bar, a result icon is created.
- If you drop the box somewhere else, the floating result box is placed there.

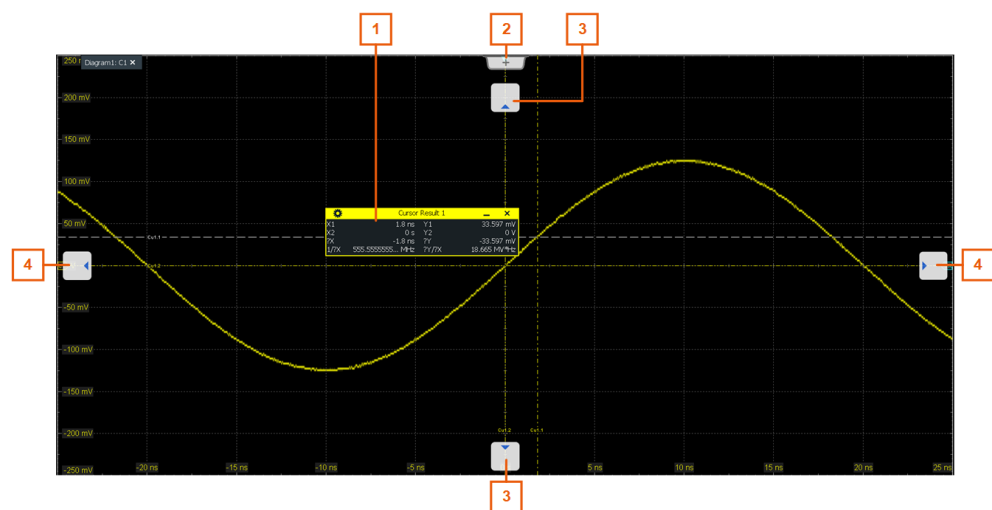

- 1 = Floating result box
- 2 = New tab
- 3 = Table in a tab above or below
- 4 = Table in a tab on the left or right

To open the corresponding settings

1. Double-tap one of the result values.
If a result box is shown, you can also tap the  icon.
The overlay menu appears and provides the most important settings.
2. In the overlay menu, tap "Advanced Setup".
The corresponding dialog opens.

To adjust the font size of results

1. Open the "Menu" > "Settings" > "Appearance" dialog.
2. Select the "Dialogs" tab.
3. Set the "Result dialog" > "Font size".

3.3.8 Using dialogs

Dialogs provide groups of related settings and allow to make selections and enter data in an organized way.



To open a dialog



- ▶ Perform one of the following actions:
 - Open the "Menu", and select the menu entry.
 - Press the function key on the front panel.
 - If the signal bar is open, tap "Advanced Setup".
 - To open the "Vertical" dialog of a waveform, tap the signal icon.
 - Tap the "Horizontal", "Acquisition" or "Trigger" label to open the corresponding dialog.



For direct access to important control and measurement functions, use the toolbar, see [Chapter 3.3.6, "Toolbar"](#), on page 53.

Each dialog has four icons in the upper right corner:

	Go back: opens the previously opened dialog box.
	Go forward: opens the next dialog box.

	Minimizes the dialog box to a small box that only contains the last selected function.
	Closes the dialog box.

To minimize a dialog

If you want to change only one setting during analysis, and you need to change it often, you can display a small box that only contains the required setting.

1. Open the dialog.
2. Tap the setting that you need to modify.
3. Tap the "Minimize" icon in the upper right corner of the dialog box.



The dialog box turns into a small box that contains only the setting, that was last selected.

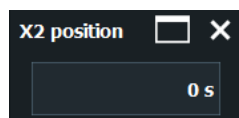

4. To restore the complete dialog box, tap the "Maximize" icon in the small box.



3.3.9 Entering data

To set parameter values and enter other data, you use the various knobs and the on-screen keypad or keyboard.

Using scale, position and level knobs

The instrument has dedicated rotary knobs to set vertical and horizontal positions and scales, and the trigger level. When you turn a knob, the input box opens in the upper right corner of the screen, showing the parameter name and current value.

1. Turn the knob to change the value.
2. Press the knob:
 - [Scale]: toggles the increment.
 - [Position]: sets to zero.
 - [Level]: sets the trigger level to 50% of the signal.
3. The input box also has settings:
 - Tap the "Steps" icon to toggle the increment.
 - Tap the "Reset" icon to set the parameter to the autoselected value (if available).

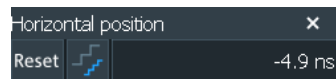

To enter values with the on-screen keypad

To enter numeric values and units in dialogs, the touchscreen provides an on-screen keypad. For text input, the on-screen keyboard with English key layout is used.

1. Double-tap the entry field.
The on-screen keypad opens.

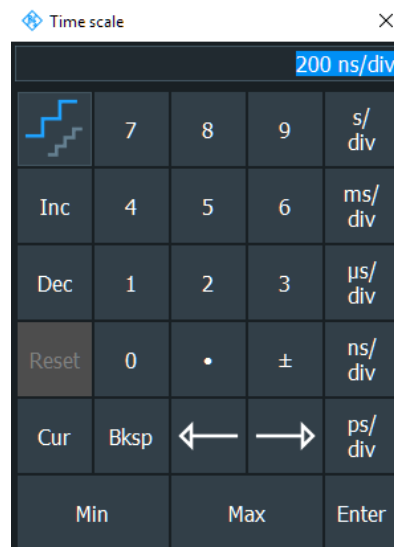

2. Enter the numeric value using one of the following methods:
 - To use the default value, tap "Reset" (if available).
 - To use the minimum or maximum value, tap "Min" or "Max", respectively.
 - To increase the displayed value in fixed steps, tap "Inc".
To decrease the value in fixed steps, tap "Dec".
To toggle between small steps and large steps, tap the "Steps" icon.
 - To get the value that was used before the keypad opened, tap "Cur".
 - To enter a user-defined value, tap the numbers and complete the entry by tapping the unit button.
 - The arrow buttons move the cursor left or right.
 - "Bksp" deletes the last character before the cursor.
 - "±" changes the sign of the value.

To enter data with the on-screen keyboard

1. Double-tap the entry field to open the on-screen keyboard.
If available, you can also tap the keyboard icon on the right of the entry field.

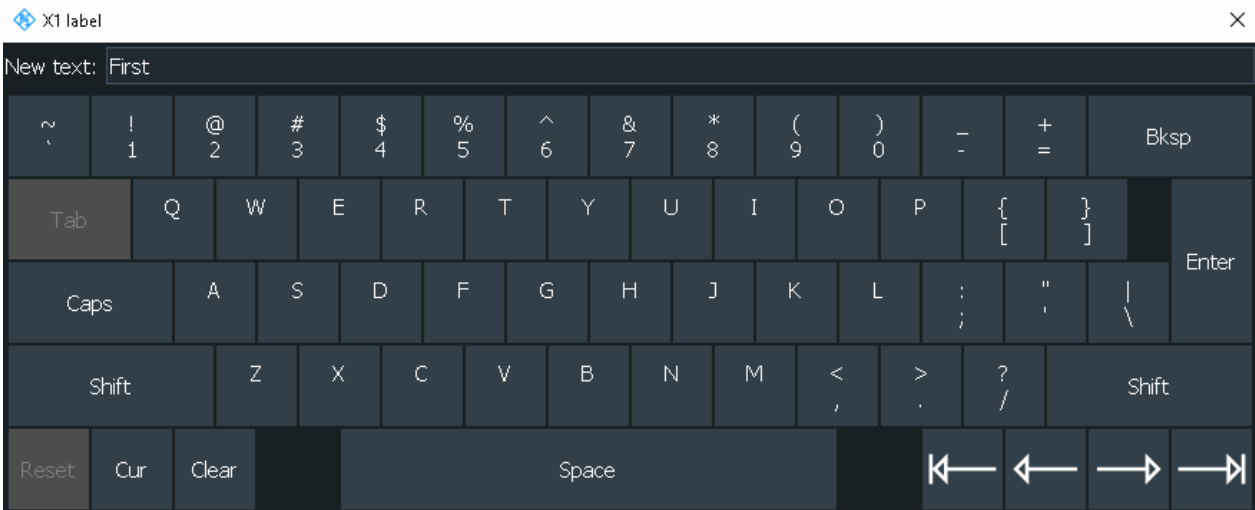



2. Enter the text as you would do on a normal keyboard.
 - To enter a series of capital characters, tap "Caps".
To enter one capital character, tap "Shift".
 - To get the value that was used before the keyboard opened, tap "Cur".
 - The arrow buttons move the cursor left or right.
 - "Bksp" deletes the last character before the cursor.
3. Tap "Enter" to complete the entry.

3.3.10 Instrument information and notifications

In the upper right corner of the screen, you see the Rohde & Schwarz logo, date and time, the symbolic information on LAN connection and the notifications status.

- To see the instrument information, tap the Rohde & Schwarz logo.

Info	2021-02-24 10:46:03	
1		
Notification		
Model:	R&S RTO6 6 GHz	
Analog Bandwidth:	6 GHz	
Firmware Version:	5.0.12.122 Beta	
Serial Number:	900999	
Device ID:	1802.0001k04	
Ethernet:	Connected	
IP address:	10.111.1.27	
Operating time:	00:04:41	

Notifications are status messages, information on mismatching settings and similar information. They are displayed for a few seconds and saved.

The color of the dot before the text indicates the severity: gray for information, orange for warnings, and red for errors.

- ▶ To read the notifications, tap "Notification".
You can also delete the list of notifications.

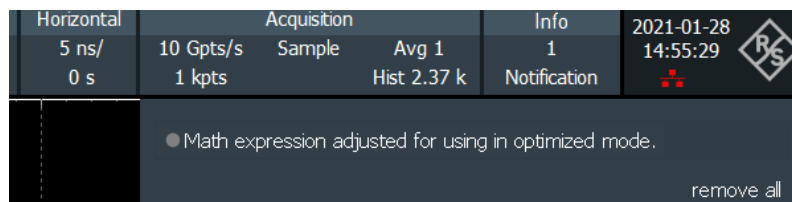

1. To hide the date and time, open "Menu" > "Settings" > "Appearance" > "Diagram" tab.
2. Disable "Show date / time".

3.3.11 Getting help

If you need information on the instrument's functionality, you can use the following sources:

- Tooltips give a short description of the parameter.
- The context help provides functional description on a setting, and the corresponding remote command.
- The general help opens the help window with a table of contents, where you can browse and search for information.

3.3.11.1 Displaying help

To display tooltips and context help

1. Enable the "Help" icon on the toolbar.



2. Tap the parameter for which you need information.
The tooltip opens.
3. To open the corresponding help topic, tap the "Show Help" button in the lower right corner of the tooltip.

The "Help" window opens and displays the comprehensive description and the corresponding remote command. You can browse the help for further information.

Note: The "Help" icon disables automatically when you tap a parameter. To show another tooltip, tap the "Help" icon again.

To open general help

1. Open the "Menu".
2. Tap the  "Help" icon.

The help window opens with the "Contents" page, where you can select the topics.

3.3.11.2 Using the Help window

The Help window contains several tabs:

- "View" - shows the selected help topic
- "Contents" - contains a table of help contents
- "Index" - contains index entries to search for help topics
- "Search" - provides text search



The Help toolbar provides some buttons:

- To browse the topics in the order of the table of contents: up arrow = previous topic, down arrow = next topic
- To browse the topics visited before: left arrow = back, right arrow = forward
- To increase or decrease the font: magnifier with + or - sign, respectively



To navigate the Help, use the touchscreen.

To search for a topic in the index

The index is sorted alphabetically. You can browse the list, or search for entries in the list.

1. Switch to the "Index" tab.
2. Select the "Keyboard" icon besides the entry field.
3. Enter the first characters of the keyword you are interested in.
The entries containing these characters are displayed.
4. Double-tap the suitable index entry.
The "View" tab with the corresponding help topic is displayed.

To search topics for a text string

1. Switch to the "Search" tab.
2. Select the "Keyboard" icon besides the entry field.
3. Enter the string you want to find.
If you enter several strings with blanks between, topics containing all words are found (same as AND operator).

For advanced search, consider the following:

- To find a defined string of several words, enclose it in quotation marks. For example, a search for *"trigger qualification"* finds all topics with exactly *"trigger qualification"*. A search for *trigger qualification* finds all topics that contain the words *trigger* and *qualification*.
- Use "Match whole word" and "Match case" to refine the search.
- Use operators AND, OR, and NOT.

To close the Help window

- ▶ Select the "Close" icon in the upper right corner of the help window.

4 Instrument setup

Access: "Settings" menu > "Settings" dialog.

In the "Settings" dialog, you can adapt various instrument settings to your requirements, such as language, display appearance, and assign functions to some keys.

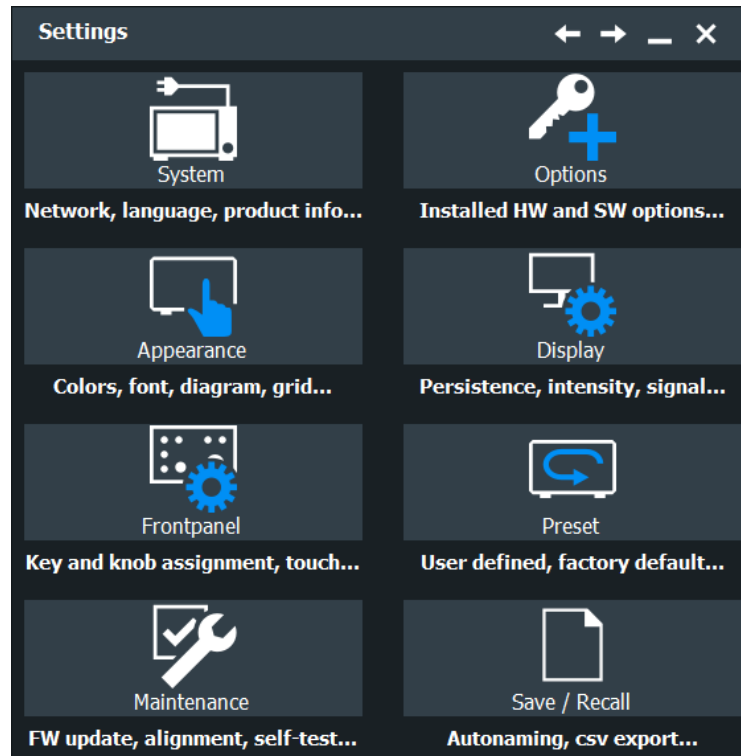

The following settings and procedures are described in the current chapter:

• System settings	68
• Option settings	72
• Appearance settings	75
• Display settings	90
• Frontpanel settings	94
• Preset setup	98
• Maintenance settings	100
• Save / recall	104

4.1 System settings

In the "Settings" > "System" dialog box, you find all instrument, firmware and network related information. Here you can also set the language that is used in the dialogs.

4.1.1 About settings

Access: "Menu" > "Settings" > "System" > "About"

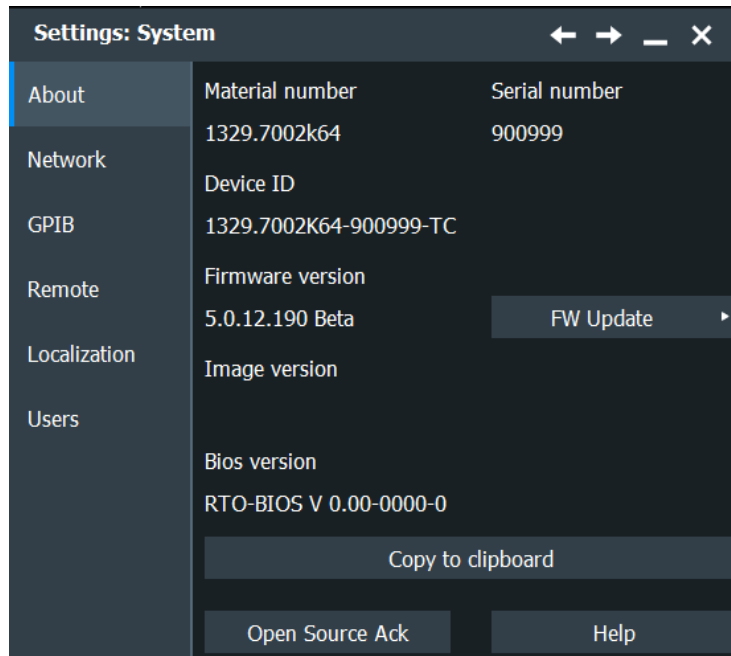

FW Update

Opens the [Firmware update](#) dialog box.

Copy to clipboard

Copies the instrument information, which you see in the dialog box, to the clipboard.

Open Source Ack

Opens the open source acknowledgment document, which provides verbatim license texts of the used open source software.

Help

Opens the help window with a table of contents, where you can browse and search for information.

4.1.2 Network settings

Access: "Menu" > "Settings" > "System" > "Network"

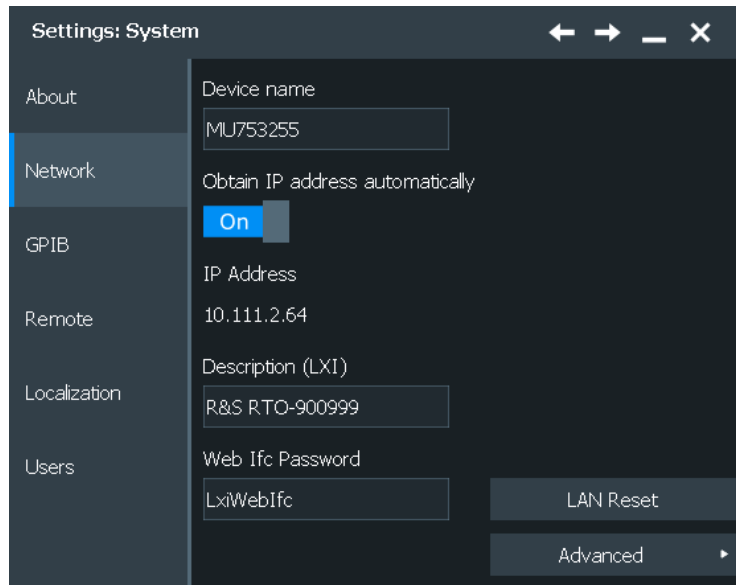

Device name

Indicates the currently defined computer name, the defined IP address and DHCP address enabling. These values are required to configure the instrument for work in a network.

NOTICE! Risk of network problems. All parameters can be edited here; however, beware that changing the device name has major effects in a network. For details, see [Chapter 25.2, "Setting up a network \(LAN\) connection"](#), on page 1314.

Remote command:

`DIAGnostic:SERVice:COMPutername` on page 1385

Obtain IP address automatically

If enabled, the IP address of the oscilloscope is obtained automatically.

IP Address

Indicates the currently defined computer name, the defined IP address and DHCP address enabling. These values are required to configure the instrument for work in a network.

Description (LXI)

Instrument description of the R&S RTO6.

Web Ifc Password

Password for LAN configuration. The default password is *LxiWebIfc*.

LAN Reset

Resets the LAN configuration to its default settings using the network configuration reset mechanism (LCI) for the instrument. The following parameters are reset:

Parameter	Value
TCP/IP mode	DHCP + auto IP address
Dynamic DNS	Enabled
ICMP ping	Enabled
Password for LAN configuration	LxiWebIfc

The LAN settings are configured using the instrument's web browser.

Advanced

Opens the standard Windows "Network Connections" dialog box to configure a network connection. Only users with administrator rights can fulfill this task.

4.1.3 GPIB settings

For a description of the GPIB settings, see: [Chapter 25.5.2.2, "Remote settings"](#), on page 1329.

4.1.4 Remote settings

For a description of the remote settings, see: [Chapter 25.5.2.2, "Remote settings"](#), on page 1329.

4.1.5 Localization settings

Access: "Menu" > "Settings" > "System" > "Localization"

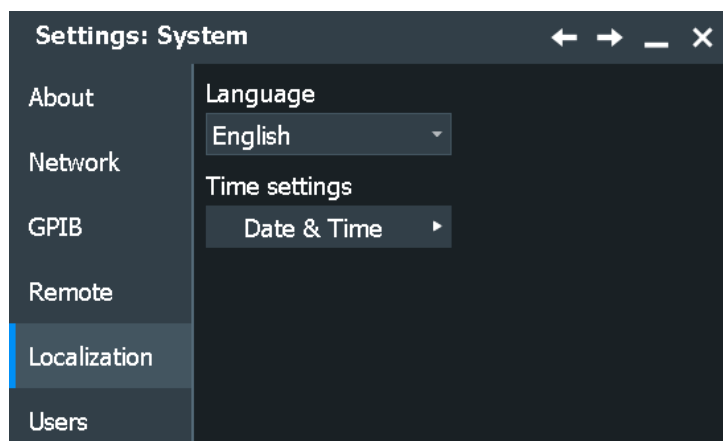

Language

Selects the language in which the dialog boxes, result boxes and other screen information is displayed.

Time settings

Opens the standard Windows "Date and Time Properties" dialog box to set the correct date and time. Only users with administrator rights can fulfill this task.

Note: Usually date and time are set correctly. To adjust your regional time, select the correct time zone rather than changing the time.

Remote command:

[SYSTem:DATE](#) on page 1384

[SYSTem:TIME?](#) on page 1385

4.1.6 Users settings

Access: "Menu" > "Settings" > "System" > "Users"

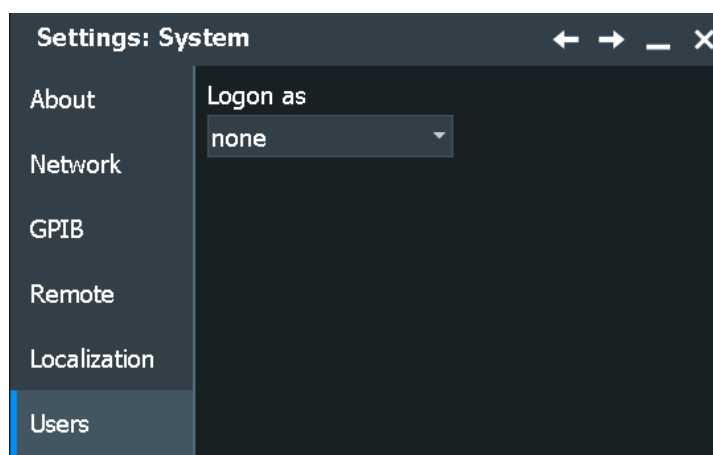
**Log on as**

Sets the user that is automatically logged on during the startup process of the instrument. The change of this setting takes effect at the next instrument startup.

See [Chapter 25.1.1, "Logon"](#), on page 1310 for restrictions of the standard user and how to change the auto-logon.

"User autologon"	Auto-logon as standard user with limited access. Enter the "User name": <i>NormalUser</i> and the "Password" of the standard user.
"Admin autologon"	Auto-logon with unrestricted access to the instrument and network. The setting is only available for administrators. Enter the "User name": <i>Instrument</i> and the administrator's "Password" to enable the auto-logon.
"None"	No auto-logon, user name and password are requested at instrument startup.

4.2 Option settings

Additional options for the R&S RTO6 are enabled using a license key. To obtain the license key, consult your sales representative.

The license type defines the duration of applicability and the portability of a license. The following license types are provided: evaluation, permanent, portable, quantified, timed with duration of 1, 3, 6 or 12 months. A license can also be in the states deactivated and expired.



Unregistered licenses

Unregistered licenses are not assigned to a particular instrument. The instrument accepts only registered licenses. If your license is delivered unregistered, use the online tool R&S License Manager to register the license for your instrument. The registration of a permanent license is irreversible, so ensure that you register it for the correct instrument. The address of the tool is <https://extranet.rohde-schwarz.com/service>. For registration, you need the device ID of the instrument on which the option will be installed.

The R&S License Manager also allows you to move a portable license to another instrument.

4.2.1 Software options settings

Access: "Menu" > "Settings" > "Options" > "Software"

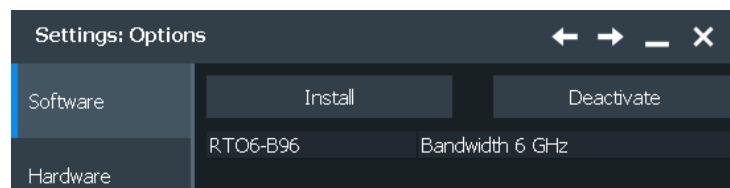

In this dialog, you can access settings for installing and deactivating options.

4.2.1.1 Install options

Access: "Menu" > "Settings" > "Options" > "Software" > "Install"

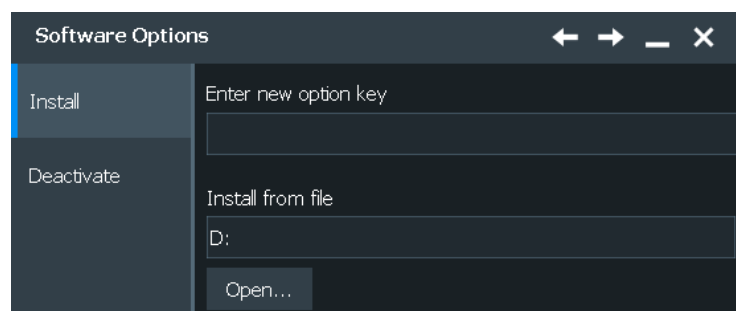

In the "Install" tab, you can install new options or deactivate existing options using license keys.

Enter new option key

Enter the license key here to activate the option. For license keys delivered as a file, use [Install from file](#). Only users with administrator rights can activate options.

Install from file

If you got a license file, install the license here.

Tap "Open" to open the file selection dialog, or enter the complete path and filename. For details, see [Chapter 12.5, "File selection dialog"](#), on page 490. Only users with administrator rights can activate options.

When you move a portable license, use this function to import the deactivation key that is generated by the "R&S License Manager". See also [Chapter 4.2.1.3, "Using a license server"](#), on page 74.

4.2.1.2 Deactivate options

Access: "Menu" > "Settings" > "Options" > "Software" > "Deactivate"

In the "Deactivate" tab, you can export the deactivation response.

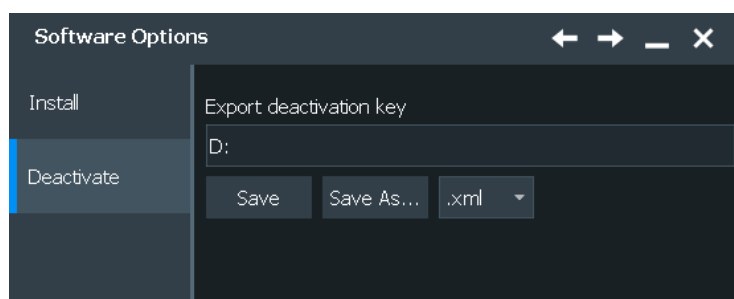
**Export deactivation key**

When you move a portable license, or deactivate an option, you have to note the response key, or to save the response to a file. The "R&S License Manager" needs the response key.

4.2.1.3 Using a license server



Software licenses can also be provided by the R&S®License Server. In this case, all available licenses are stored on a specified server. When you need a particular application, you can obtain a license from the server. When you no longer need the license, you return it to the server and it becomes available to other users again. These licenses are also referred to as *floating licenses*, as opposed to permanent licenses.



The R&S®License Server must be set up as described in the R&S®License Server - Managing Floating Licenses - User Manual.

You can find the manual in the Windows menu of your instrument: "Start > All Programs > R&S License Server > Open License Server Manual".

To open the License Server

- ▶ In the Windows notification area, select , and then  "Open Manager".

- a) Optional: If the status icon (🟢, 🟡 or 🔴) in the Windows notification area is not shown yet, click "Start > All Programs > R&S License Server > License Server Manager".

The icon is now available in the Windows notification area.

- b) Optional: If the status is 🟡 (stopped), select the icon, and then select ▶ "Start License Server". Then, select 🟢 > 🟡 again.

The license server opens in the default web browser. The program adds all available Rohde & Schwarz products (smart cards or devices) to a list and automatically shows the first product that is detected. By default, the "Licenses" list opens with an initial filtering for showing only active licenses.

4.2.2 HW options settings

This tab informs about the availability of hardware options.

4.3 Appearance settings

In the "Settings" > "Appearance" dialog box, you define the look and feel of the display element, e.g. waveform colors, result position, or grid behavior.

4.3.1 Color settings

Access: "Settings" > "Appearance" > "Colors"

By default, various colors are assigned to the different waveform types for better visibility and distinguishability. You can change the color assignment and assign another color or a color table to waveforms.

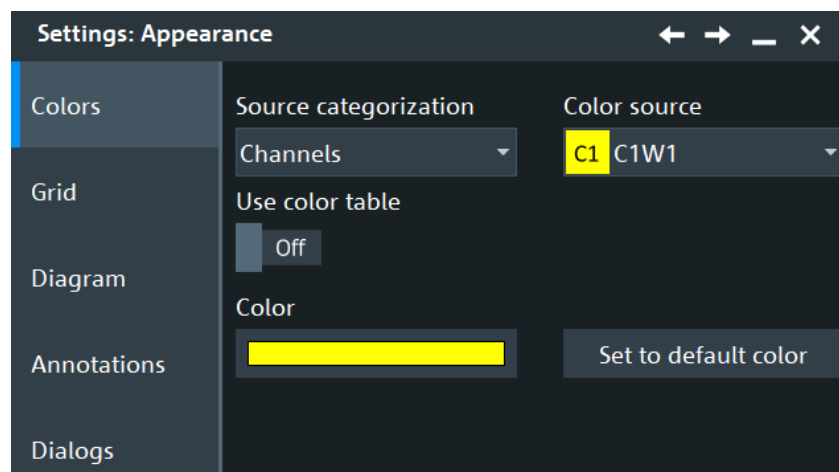

Source categorization

Selects the category of the waveform, e.g. "Channels", "Math", "Reference".

You can then select one of the waveforms of the selected category with "Color source".

Color source

Selects the waveform to which the color table and the labels are assigned.

A spectrogram (option R&S RTO6-K37) always has the same color as the math (spectrum) waveform from which it is created.

Use color table

If enabled, the selected waveform is displayed according to its assigned color table.

If this option is disabled, the selected color is displayed, and the intensity of the specific signal color varies according to the cumulative occurrence of the values.

Remote command:

`DISPlay:COLor:SIGNal<m>:USE` on page 1386

Color

Shows the current color of the selected waveform. To change the color, tap the button and select a color. The color of the waveform, its signal icon, channel icon, and of the illuminated keys is adjusted to the new color.

Remote command:

`DISPlay:COLor:SIGNal<m>:COLor` on page 1386

Assigned color table

Adjust the waveform colors to suit your preferences. For each of the following waveform types you can assign a suitable color table:

- Analog and digital channels
- Reference waveforms
- Results of a mathematical function, also for FFT and derived spectrogram.
- Measurements and tracks
- XY-traces
- Serial buses if a protocol option is activated
- Parallel buses if MSO option is installed

See also: [Chapter 4.3.2, "Color tables"](#), on page 76

Remote command:

`DISPlay:COLor:SIGNal<m>:ASSign` on page 1386

Set to default color

Resets the color of the selected waveform to the factory default.

4.3.2 Color tables

Access: "Settings" > "Appearance" > "Color" > "Edit Color Table"

Color tables define the color of the waveform pixels depending on the cumulative occurrence of the associated values. By default, the intensity of the specific waveform color varies according to the cumulative occurrence of the values. The more often a value occurs, the darker the color of the data point is displayed.

The following color tables are provided:

- "False colors": color changes gradually in a wide color spectrum.
- "M-Hot"
- "M-Hsv"
- "M-Jet"
- "Spectrum": colors display the wave lengths of the light. Low cumulative occurrence is displayed blue like high wave length.
- "Single Event": single events and very seldom events appear yellow, a higher cumulative occurrence is shown with blue color. This view helps to identify specific events.
- "Temperature": color changes gradually from blue (low temperature) to red (high temperature) with increasing cumulative occurrence.

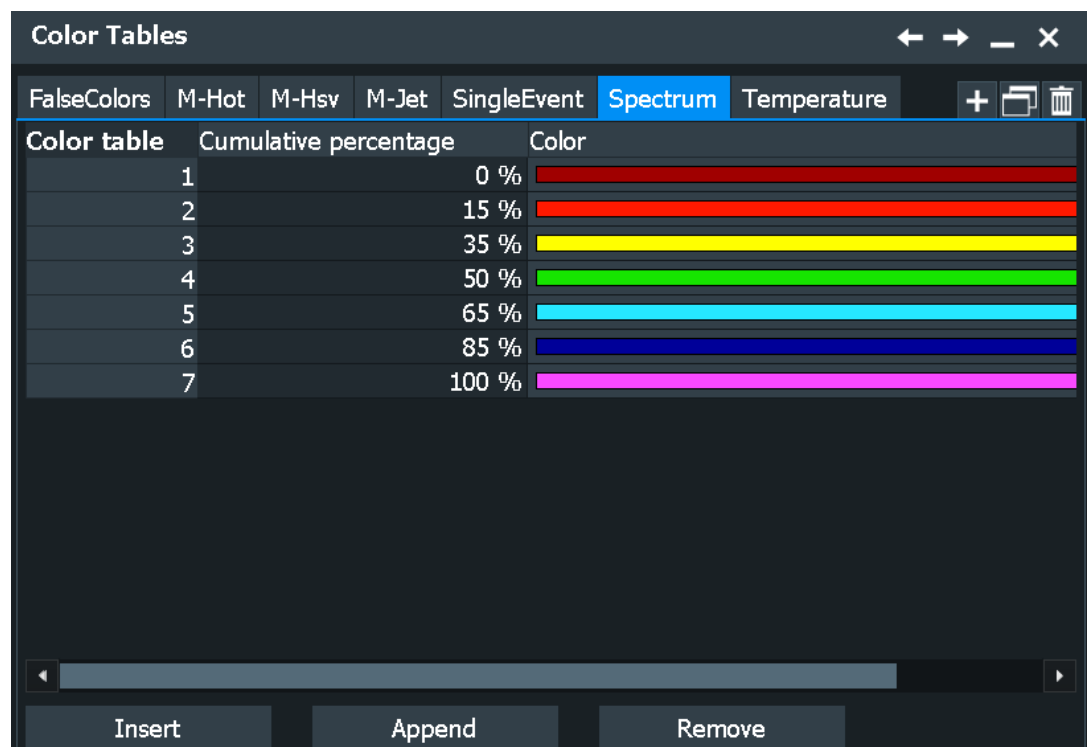

The editing table allows you to edit existing color tables or add new ones that can then be assigned to the waveforms.

See also:

- ["Assigned color table"](#) on page 76

Remote commands

The following remote commands are used to configure color tables:

`DISPlay:COLor:PALette:COUNT?` on page 1387

`DISPlay:COLor:PALette:ADD` on page 1387

`DISPlay:COLor:PALette:REMove` on page 1387

[DISPlay:COLor:PALETTE:POINT:INSert](#) on page 1387

[DISPlay:COLor:PALETTE:POINT:ADD](#) on page 1387

[DISPlay:COLor:PALETTE:POINT\[:VALue\]](#) on page 1388

[DISPlay:COLor:PALETTE:POINT:COUNT?](#) on page 1388

[DISPlay:COLor:PALETTE:POINT:REMOve](#) on page 1387

[DISPlay:COLor:PALETTE:COUNT?](#) on page 1387

4.3.3 Grid appearance settings

Access: "Settings" > "Appearance" > "Grid"

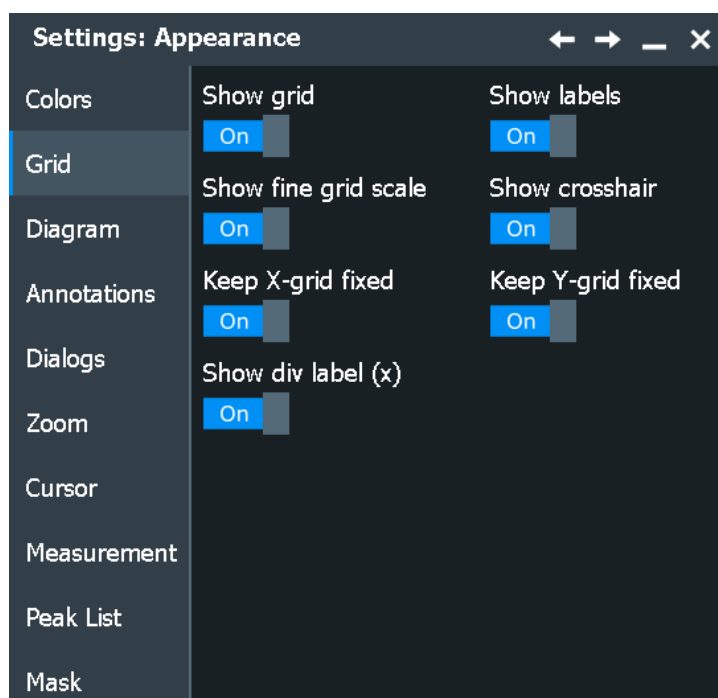

Show grid

If selected, a grid is displayed in the diagram area. A grid helps you associate a specific data point to its exact value on the x- or y-axis.

Remote command:

[DISPlay:DIAGram:GRID](#) on page 1389

Show labels

If selected, labels mark values on the x- and y-axes in specified intervals in the diagram.

Remote command:

[DISPlay:DIAGram:LABels](#) on page 1389

Show fine grid scale

If selected, the crosshair is displayed as a ruler with scale markers. If disabled, the crosshair is shown as dashed lines.

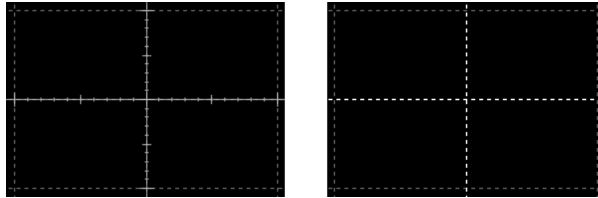

Remote command:

[DISPlay:DIAGram:FINegrid](#) on page 1389

Show crosshair

If selected, a crosshair is displayed in the diagram area. A crosshair allows you to select a specific data point by its co-ordinates.

Remote command:

[DISPlay:DIAGram:CROShair](#) on page 1389

Keep X-grid fixed

If enabled, the vertical grid lines remain in their position when the horizontal position is changed. Only the values at the grid lines are adapted.

Remote command:

[DISPlay:DIAGram:XFIXed](#) on page 1390

Keep Y-grid fixed

If enabled, the horizontal grid lines remain in their position when the position of the curve is changed. Only the values at the grid lines are adapted. Fixed horizontal grid lines correspond to the behavior of traditional oscilloscopes.

Remote command:

[DISPlay:DIAGram:YFIXed](#) on page 1389

Show div label (x)

If selected, the time scale value is shown at the diagram bottom instead of the horizontal grid labels. For example, 10 ns/div is shown instead of the values 0, 10, 20, 30... ns.

4.3.4 Diagram appearance settings

Access: "Settings" > "Appearance" > "Diagram" tab

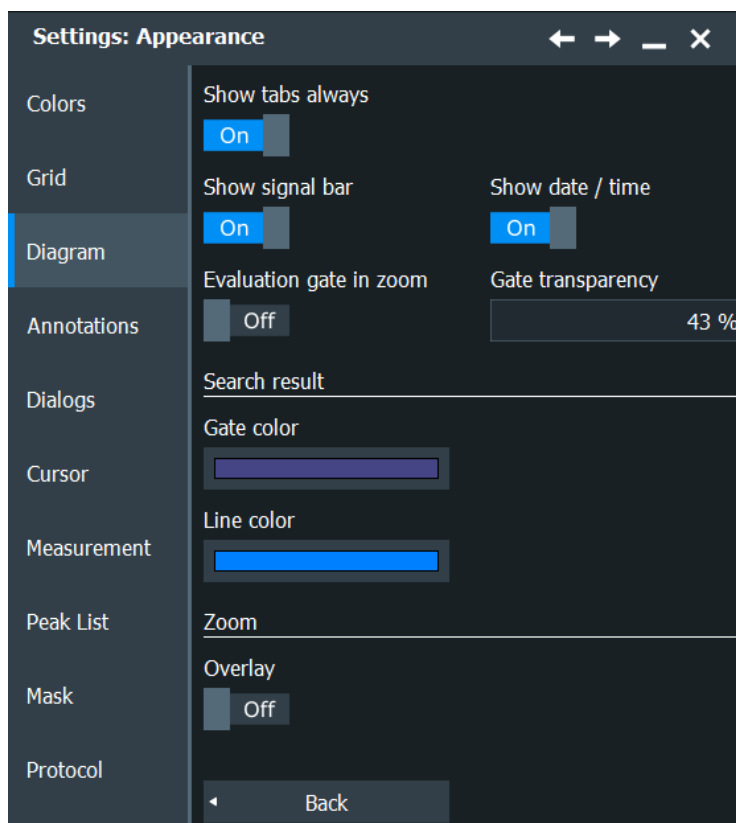

Show tabs always

If selected, the tab titles of all diagrams are displayed: "Diagram1", "Diagram2" ...

If cleared, the tab titles are not shown except for titles in a tabbed diagram. In tabbed diagrams, the tab titles are required to change the tabs.

Remote command:

[DISPlay:DIAGram:TITLe](#) on page 1394

Show signal bar

If enabled, the signal bar is displayed on the right of the diagram area.

Remote command:

[DISPlay:SIGBar\[:STATE\]](#) on page 1394

Show date / time

If enabled, the date and time are shown near to the Rohde & Schwarz logo at the upper right corner of the screen.

Evaluation gate in zoom

If enabled, the available histogram areas, masks, and measurement gates are shown in the zoom diagrams. If the evaluation gate is within the zoom area, the display helps to move or modify the evaluation gates in the zoom window.

Make sure that the option is disabled if the zoom area and the evaluation gate are of nearly the same size to avoid conflicts in operation.

Gate transparency

Sets the transparency of the area that is defined as measurement or search gate. The setting only takes effect if "Show gate" is enabled.

Remote command:

[DISPlay:GATE:TRANsparency](#) on page 1394

Search result gate symbol color

Sets the color of the search zoom area. The search zoom area is displayed if "Show search zoom windows" is enabled.

See also: [Chapter 11.4.2, "Display zoom settings"](#), on page 446.

Search result line color

Sets the color of the search result markers. The markers are displayed if "Show search zoom windows" is enabled.

Zoom overlay

Shows all zooms of a diagram in one zoom window. The zoomed areas are overlaid for better comparison of the zoomed waveforms.

The setting affects all zoom diagrams.

See also: [Chapter 7.1, "Zoom"](#), on page 243

Remote command:

[LAYout:ZOOM:ONEDiagram](#) on page 1395

4.3.5 Annotations appearance settings

Access: "Settings" > "Appearance" > "Annotations" tab

Using labels, you can annotate the waveforms to name or explain each waveform. The text is shown in the same color as the assigned waveform. Each label has its individual position.

You can enter exact positions in the dialog box, or drag the labels on the screen to the required position. The position can be a fixed one (relative to the screen), or a flexible position (absolute, assigned to the axes).



To add labels quickly, you can add the "Label" icon to the toolbar and use it.

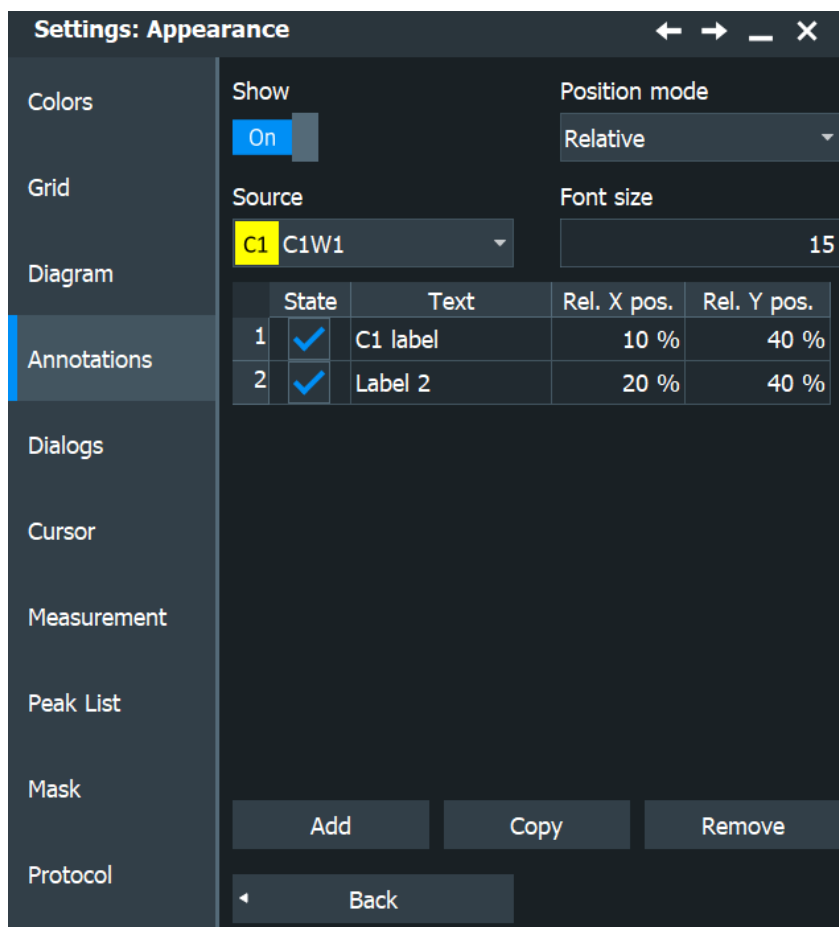

Show / Source

Selects the source of the label and enables the display.

Remote command:

[DISPlay:SIGNal:LABel:SHOW](#) on page 1399

Position mode

Defines the label position either relative to the diagram or with absolute values according to the units of the waveform. Relative positions are fixed, whereas absolute positions move with the waveform display when the scales, the vertical position or offset, or the reference point are changed.

The position mode applies to all labels of the selected waveform. For different waveforms, different position modes can be selected.

"Relative" Sets a fixed position in percent of the screen counting from the upper left corner.

"Absolute" Sets the position in time and voltage values, or in other units depending on the waveform character.

Remote command:

[DISPlay:SIGNal:LABel:POSMode](#) on page 1396

Font size

Defines the size of the labels in the diagram.

Remote command:

[DISPlay:SIGNal:LABel:FONTsize](#) on page 1396

Labels

For each waveform, the "Labels" table shows the defined labels with their visibility state, label texts and positions. The labels belong to the selected waveform.

Enter the label text and the horizontal and vertical positions for each label. Enable "State" to show the label on the screen. The individual state of the labels takes effect if "Show" is active.

"Add" Adds a line at the end of the list.

"Copy" Copies the selected line in a new line.

"Remove" Deletes the selected line. Only single lines can be removed.
You can also delete a label by using the toolbar: Tap the "Delete" icon and then the label.

Remote command:

[DISPlay:SIGNal:LABel:ADD](#) on page 1396

[DISPlay:SIGNal:LABel:STATE](#) on page 1400

[DISPlay:SIGNal:LABel:IDSList](#) on page 1398

[DISPlay:SIGNal:LABel:REMOve](#) on page 1398

[DISPlay:SIGNal:LABel:TEXT](#) on page 1400

[DISPlay:SIGNal:LABel:HORIZontal:ABSolute:POSition](#) on page 1400

[DISPlay:SIGNal:LABel:VERTical:ABSolute:POSition](#) on page 1400

[DISPlay:SIGNal:LABel:HORIZontal:RELative:POSition](#) on page 1401

[DISPlay:SIGNal:LABel:VERTical:RELative:POSition](#) on page 1401

4.3.6 Dialogs appearance settings

Access: "Settings" > "Appearance" > "Dialogs" tab

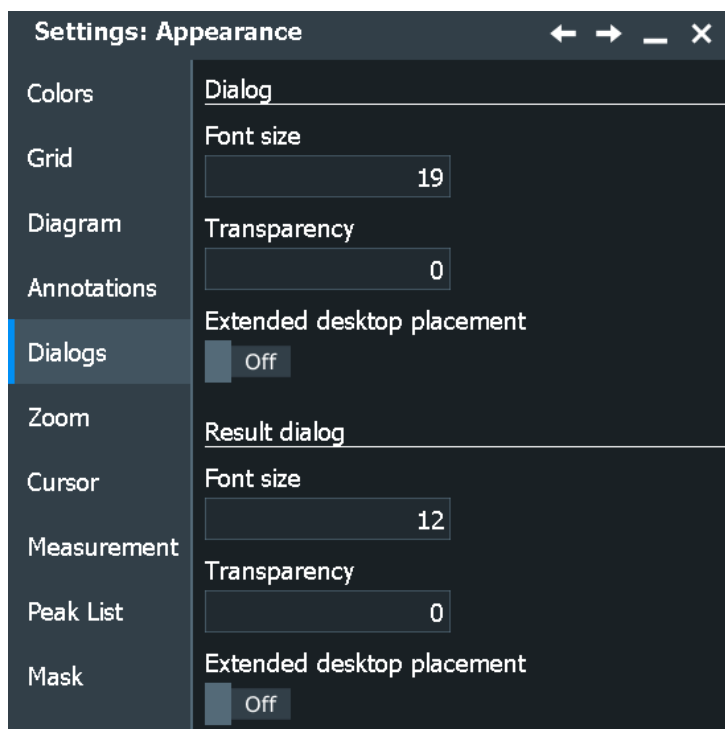

Dialog

With these settings, you can change the appearance of the dialogs.

Font size ← Dialog

Defines the font size of the text in dialog boxes.

Dialog transparency ← Dialog

Defines the transparency of the dialog box background. For high transparency values, you can see the waveform display in the background, and possibly check the effect of the changed setting. For lower transparency values, readability in the dialog box improves.

Result dialog

With these settings, you can change the appearance of the result dialogs.

Font size ← Result dialog

Defines the font size of the text in result boxes. The size of the result box is adapted to the font size.

Transparency ← Result dialog

Defines the transparency of the measurement result boxes in the same way as [Dialog transparency](#).

Extended desktop placement

If an external monitor is connected to the instrument, you can enable these settings to display dialog boxes and/or result boxes on the external monitor. Thus, the boxes do not cover the waveforms on the instrument display.

Remote command:

[DISPlay:EXTended:POrDialogs](#) on page 1401

[DISPlay:EXTended:POSDialogs](#) on page 1402

4.3.7 Cursor appearance settings

Access: "Settings" > "Appearance" > "Cursor" tab

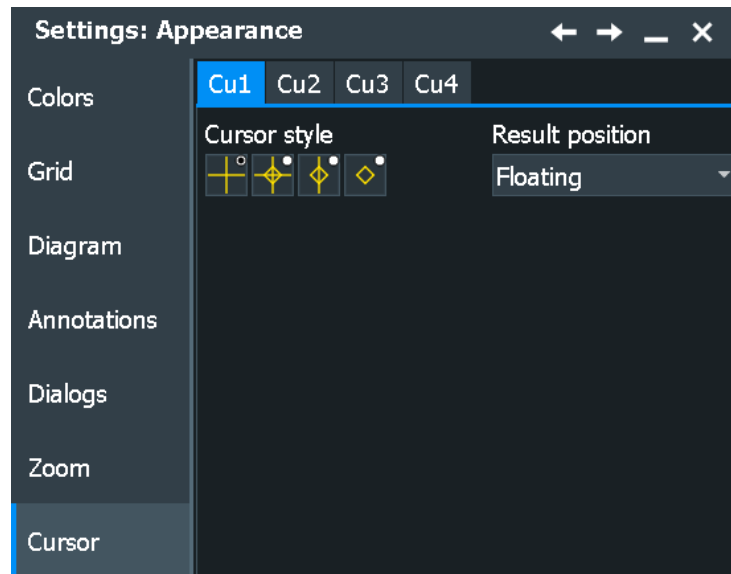

Cursor style

Defines how the cursor is displayed in the diagram.

"Lines"	The cursors are displayed as lines.
"Line & Rhombus"	The cursors are displayed as lines. The intersections of the cursors with the waveforms are displayed by rhombus-shaped points.
"Vertical line and rhombus"	The cursors are displayed as vertical lines. The intersections of the cursors with the waveforms are displayed by rhombus-shaped points.
"Rhombus"	The intersections of the cursors with the waveforms are displayed by rhombus-shaped points.

Remote command:

[CURSor<m>:STYLE](#) on page 1402

Result position

Defines the position of the cursor measurement results.

"Floating"	Floating result box in front of the diagrams.
"Preview"	Result icon on the signal bar.
"Docked"	Fixed tab below the diagrams.

Remote command:

[DISPlay:RESultboxes:CUPosition](#) on page 1402

4.3.8 Measurement appearance settings

Access: "Settings" > "Appearance" > "Measurement" tab

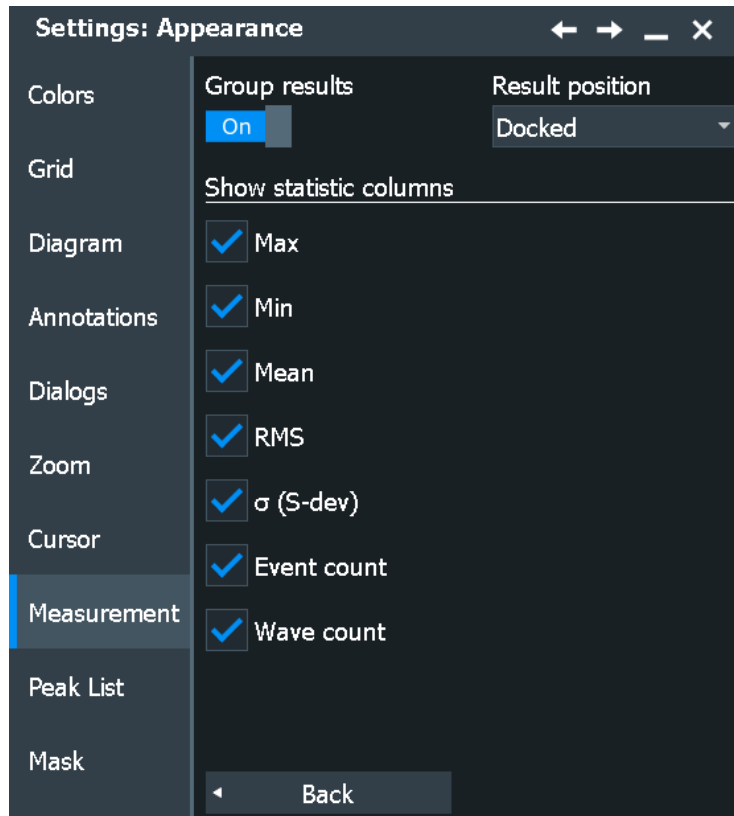

Group results

If enabled, all results are shown in one result box (default).

If disabled, the results of each measurement group are shown in a separate result box. The default position is ignored.

The setting affects all measurements except for the peak list.

Remote command:

[MEASurement<m>:DISPlay:GROuping](#) on page 1403

Result position

Defines the default position of the result table, when a new measurement is started:

- "Docked": fixed tab below the diagrams
- "Preview": result icon on the signal bar
- "Floating": floating result box in front of the diagrams

The setting affects only grouped results.

Remote command:

[DISPlay:RESultboxes:MEPosition](#) on page 1403

Show statistic columns

Select the statistical values that you want to see in the results table.

4.3.9 Peak list appearance settings

Access: "Settings" > "Appearance" > "Peak List" tab

For peak lists measurements only. You can enable the "Peak list" for "Spectrum" measurements, see [Chapter 8.2.6, "Spectrum measurements"](#), on page 341.

In this dialog, you can configure the look of the labels for peaks in the spectrum diagram.

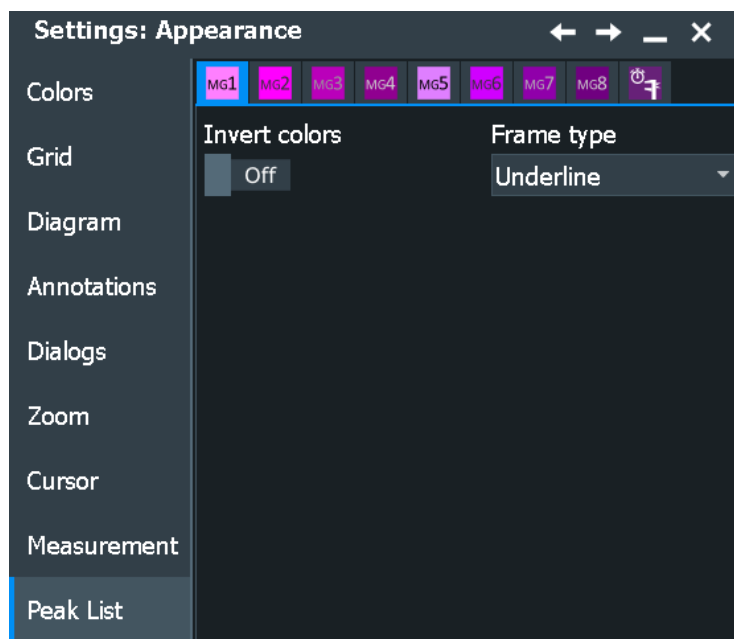

Frame type

Defines the layout of the labels (full border, underline, or none).

Remote command:

[MEASurement<m>:RESult:LABorder](#) on page 1404

Invert

Displays black font on white background using the "Full border" frame type.

Remote command:

[MEASurement<m>:RESult:INVerse](#) on page 1404

4.3.10 Mask appearance settings

Access: "Settings" > "Appearance" > "Mask"

In this dialog, you can define the settings for mask and hit display. See also [Chapter 10, "Mask testing"](#), on page 400.

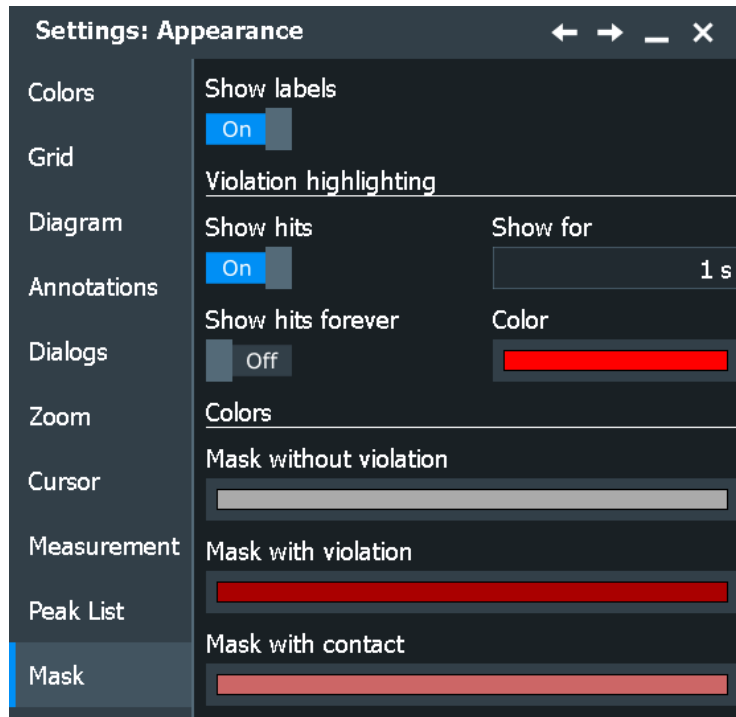

Show labels

Switches the display of the mask test name on or off.

To change the name of the mask test, open the "Mask Test" dialog > "Define Mask" tab. Double-tap the mask test subtab and enter the new mask test name.

Remote command:

[MTEST:LABEL](#) on page 1405

[MTEST:REName](#) on page 1405

Show hits

If selected, the mask hits are highlighted on the screen. You can define the color and the time of the hit display.

These settings are not applied to trigger zones, which are based on masks.

Remote command:

[MTEST:HIGHLIGHT:STATE](#) on page 1406

Show for

Sets the time for which the mask hits are shown.

Remote command:

[MTEST:HIGHLIGHT:TIME](#) on page 1406

Show hits forever

If selected, the mask hits are shown for an unlimited period of time.

Remote command:

[MTEST:HIGHLIGHT:INFinite](#) on page 1405

Color

Sets the color of samples that violated the mask.

Remote command:

[MTESt:COLor:MATCh](#) on page 1407

Mask without violation

Sets the color of masks segments that were not hit.

Remote command:

[MTESt:COLor:UNMatch](#) on page 1406

Mask with violation

Sets the color of mask segments the signal has entered into.

Remote command:

[MTESt:COLor:INTerior](#) on page 1407

Mask with contact

Sets the color of masks segments that were touched at the border. In this case, the resolution is not sufficient to detect if the mask was hit or not. Zoom into the concerned area to see the actual result.

Remote command:

[MTESt:COLor:BORDER](#) on page 1407

4.3.11 Protocol appearance settings

Access: "Settings" > "Appearance" > "Protocol"

In this dialog, you can define the position of the result table for the protocol analysis.

See also [Chapter 14, "Protocol analysis"](#), on page 510.

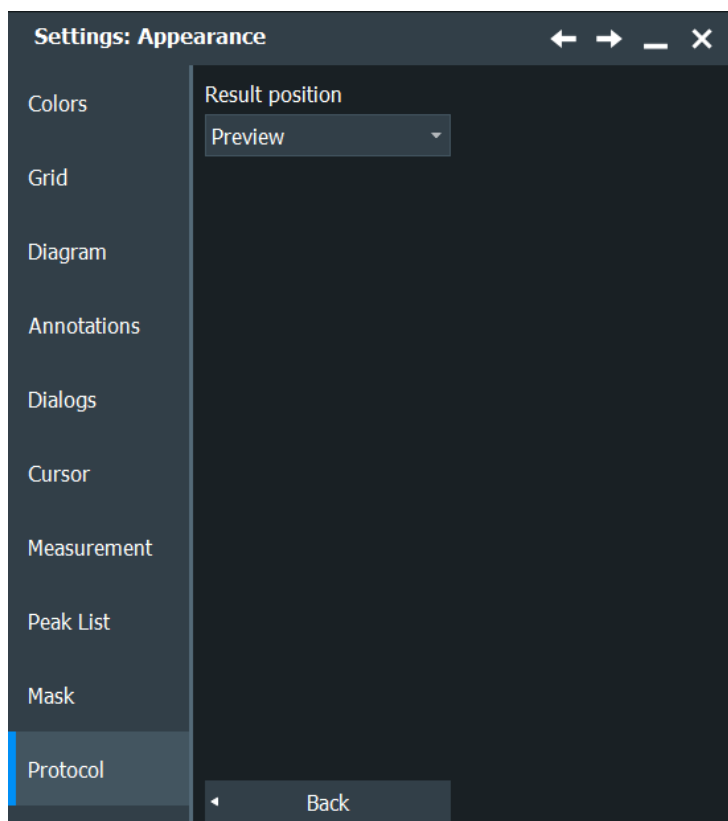

Table position

Defines the position of the decode table on the screen.

"Floating" Floating result box in front of the diagrams.

"Preview"" Result icon on the sidebar.

"Docked" Fixed tab below the diagrams.

Remote command:

[DISPlay:RESultboxes:DEPosition](#) on page 1816

4.4 Display settings

In the "Settings" > "Display" dialog box, you can define the display settings like brightness and signal intensity. Yo can also set up an external monitor.

4.4.1 Persistence settings

Access: "Menu" > "Settings" > "Display" > "Persistence"

The settings in this dialog do not apply to eye diagrams.

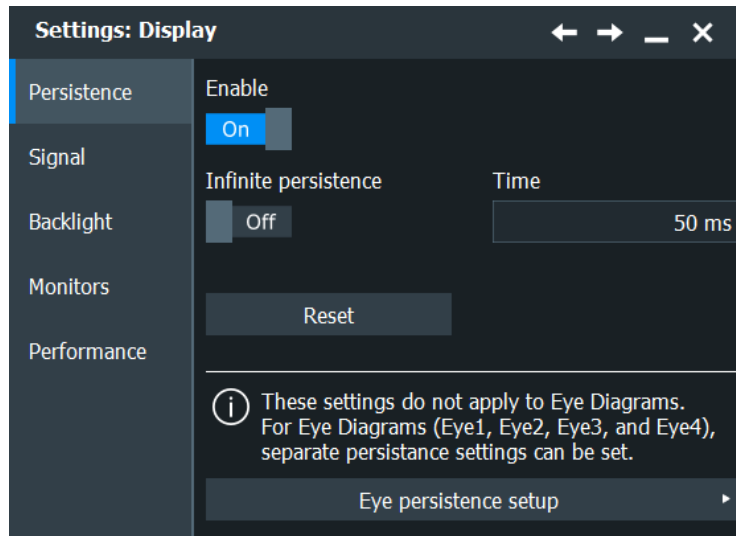
**Enable**

If enabled, each new data point in the diagram area remains on the screen for the duration that is defined using **Time**, or as long as **Infinite persistence** is selected.

If disabled, the waveform points are displayed only for the current acquisition.

Remote command:

`DISPlay:PERStence[:STATe]` on page 1408

Infinite persistence

If infinite persistence is enabled, each new waveform point remains on the screen until this option is disabled. Use infinite persistence to display rare events in the signal.

Remote command:

`DISPlay:PERStence:INFinite` on page 1408

Time

Sets a time factor that controls how long the waveforms points fade away from the display. Thus, the R&S RTO6 emulates the persistence of analog phosphor screens.

Remote command:

`DISPlay:PERStence:TIME` on page 1409

Reset

Resets the display, removing persistent all waveform points.

Remote command:

`DISPlay:PERStence:RESet` on page 1409

Eye persistence setup

Opens the dialog for defining the persistence settings for the eye diagram settings, see [Chapter 20.2.3, "Display settings"](#), on page 1153.

4.4.2 Signal settings

Access: "Menu" > "Settings" > "Display" > "Signal"

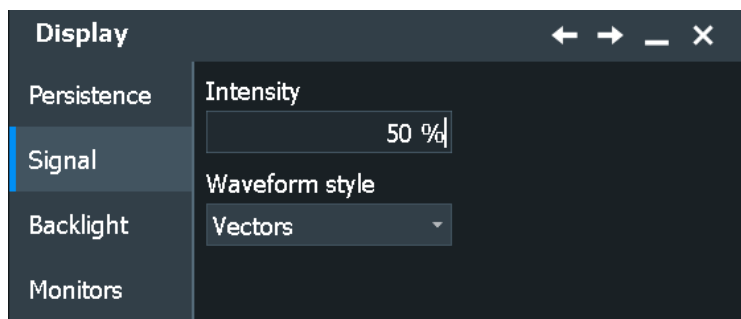

Intensity

This value determines the strength of the waveform line in the diagram. Enter a percentage between 0 (not visible) and 100% (strong). The default value is 50%.

You can also use the [Intensity] knob on the left side of the screen to adjust the waveform intensity directly.

Note: Use of color tables. The exact mapping of the cumulative value occurrences according to the assigned color table is guaranteed only if the intensity is set to 50%. All other intensity values falsify the mapping but can improve the visibility of the signal.

Remote command:

[DISPlay:INTensity](#) on page 1409

Waveform style

Select the style in which the waveform is displayed:

- "Vectors" The individual waveform points are connected by a line. Define the strength of the line using the [Intensity] knob.
- "Dots" Only the individual waveform points are displayed. Waveform sample points are the ADC sample points and additional interpolated points if "Interpolated time" is used for resolution enhancement. To see the dots of one waveform, perform one acquisition with [Single] and N=1 ("Average count" = 1). During continuous acquisition, or a [Single] acquisition with N > 1, the dots of multiple subsequent waveforms are displayed on the screen, and the waveform looks like a line. Consider also the "[Interpolation](#)" on page 127.

Remote command:

[DISPlay:DIAGram:STYLE](#) on page 1409

4.4.3 Backlight settings

Access: "Menu" > "Settings" > "Display" > "Backlight"

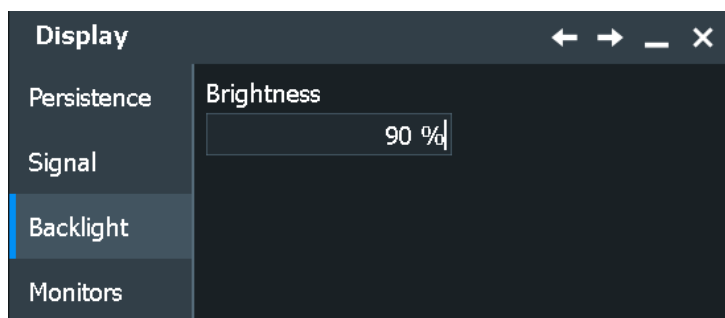

Brightness

Changes the background luminosity of the touchscreen.

4.4.4 Monitors settings

Access: "Menu" > "Settings" > "Display" > "Monitors"

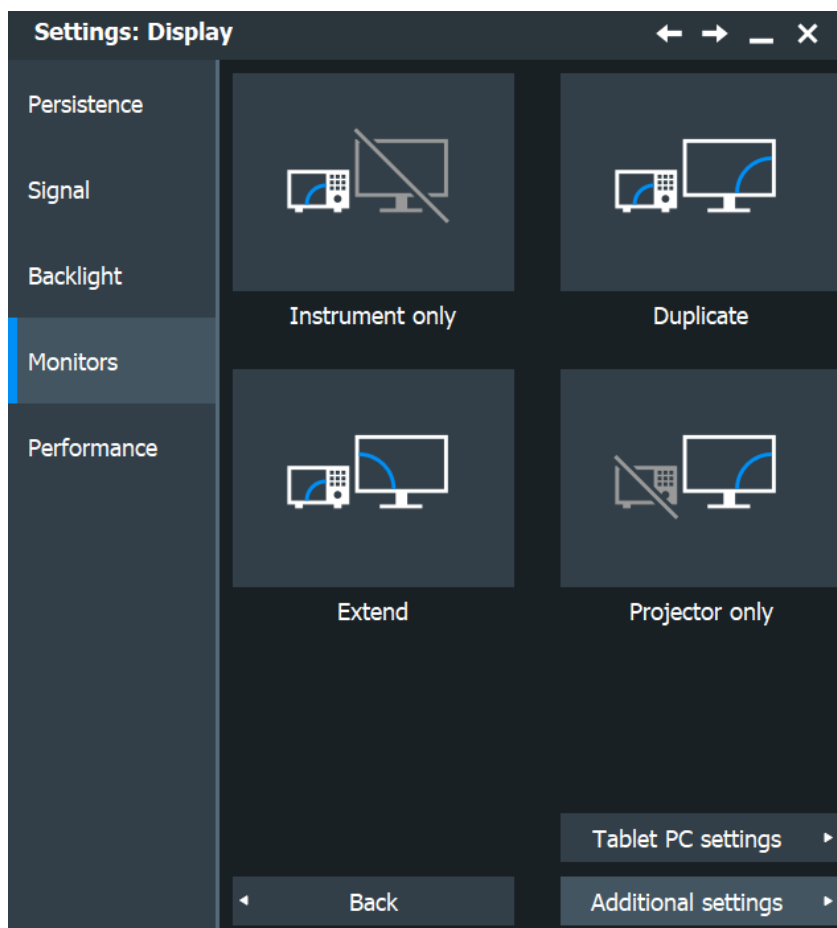

In the "Monitors" tab you can extend or duplicate the instrument display to a second monitor or projector (external display). The following options are available:

- "Instrument only": the instrument display is on, the external display is off.

- "Duplicate": the external display shows the same content as the instrument display.
- "Extend": the instrument display and the external display show different content.
- "Projector only": the instrument's user interface is only shown on the external display, the instrument display is off.
- "Tablet PC settings": opens the Windows setup for touch display to adjust the touch functionality when an additional monitor is in use.
- "Additional settings": opens the Windows configuration for display settings.

4.4.5 Performance settings

Access: "Menu" > "Settings" > "Display" > "Performance"

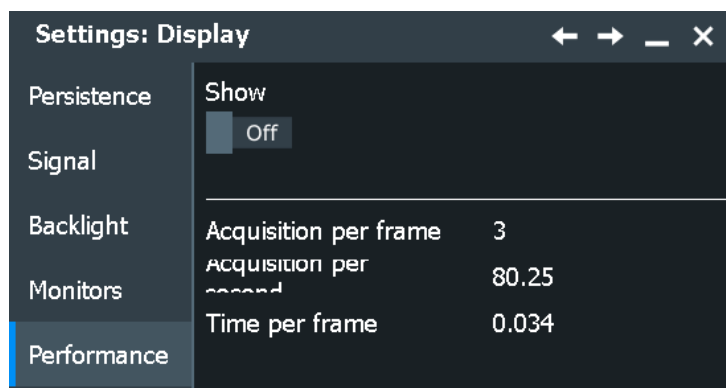

Show

Displays the "Performance" results box.

The "Performance" result box shows information on the current acquisition performance values of the R&S RTO6.

The instrument groups acquired waveforms together in a frame, and displays the frame content. The maximum number of frames displayed per second is about 30. The current number of frames per second is indicated as reciprocal "Time per frame". If the time scale decreases, and thus the number of acquisitions per second also decreases, the number of acquisitions per frame can drop to 1.

4.5 Frontpanel settings

In the "Frontpanel" dialog box, you can assign functions to keys and knobs, adjust the Multiuse knob and adjust the brightness of the keys.

4.5.1 Hardkeys: function assignment

Access: "Settings" > "Frontpanel" > "Hardkeys"

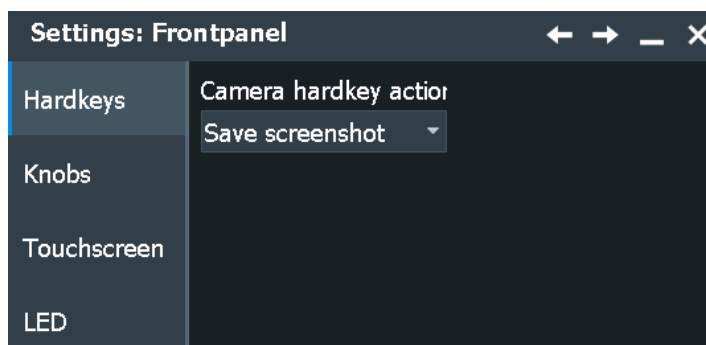

Camera hardkey action

The Camera key on the left side of the display is a shortcut key that initiates an associated action.

You can assign one of the following actions:

- Save a screenshot
- Open screenshot setup
- Save a report
- Open report setup

Configure the settings for the selected action.

- Screenshots: "Save/Recall" key > "Save" tab > "Screenshot", see [Chapter 12.3.1, "Screenshot settings"](#), on page 484.
- Report: "Save/Recall" key > "Save" tab > "Report", see [Chapter 12.4.1, "Report settings"](#), on page 488.

4.5.2 Knobs

Access: "Settings" > "Frontpanel" > "Knobs"

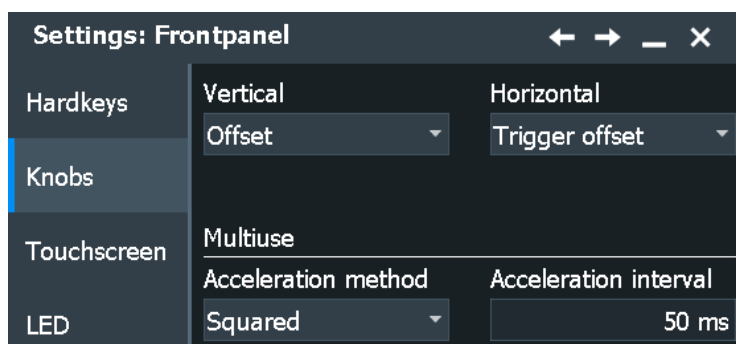

Vertical	95
Horizontal	96
Acceleration method	96
Acceleration interval	96

Vertical

Selects the action that you want to perform with the vertical [Position] knob. It can change the offset or the waveform position of the selected waveform.

See also: "[Position]" on page 39.

Horizontal

Selects the action that you want to perform with the horizontal [Position] knob. It can change the horizontal position of the trigger point (trigger offset), or the reference point.

See also: "[Position]" on page 37.

Acceleration method

Selects a method to accelerate the movement of the element on the screen compared to the actual movement of the [Multiuse] knob.

Acceleration is useful if you need to move from one end of the screen to the other, for example. Without acceleration, you have to turn the knob quite a while to reach the other end. But acceleration can make precise selection difficult, because a small movement of the knob causes a relatively large movement on the screen.

"None"	No acceleration method used.
"Squared"	Moderate acceleration method used.
"Exponential"	Strong acceleration method used.

Acceleration interval

Defines the delay time during which the movement of the [Multiuse] knob is analyzed before acceleration is applied. For short intervals, acceleration sets in quickly, but is not as effective. For long intervals, acceleration is more effective. However, it takes longer until the instrument reacts on the knob's input.

Furthermore, when you turn the knob slowly during fine-tuning, subsequent movements that occur during the same interval are accelerated, making precise selection difficult.

4.5.3 Touchscreen

Access: "Settings" > "Frontpanel" > "Touchscreen".

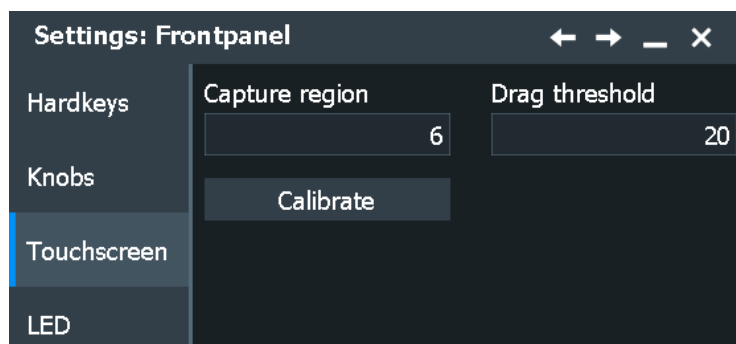

Capture region

Defines the number of pixels around each element (e.g. button, icon, data point) that create a capture region. If you tap your finger or click the mouse pointer within this capture region, this element is considered to be selected. If you tap or click outside this area, a different or no element is selected.

The larger the region, the easier is it to select an element. However, when selecting data points, for example, a large frame does not allow you to select precisely.

Drag threshold

Defines the maximum number of pixels around an element (e.g. data point) within which your pointing device must stay to "click" the element. When you tap or click a specific element and move your finger or the mouse outside this range, it is considered to be a "dragging" or "moving" operation.

Calibration

Opens the touchscreen calibration application. Only users with administrator rights can fulfill this task.

4.5.4 LED

Access: "Settings" > "Frontpanel" > "LED".

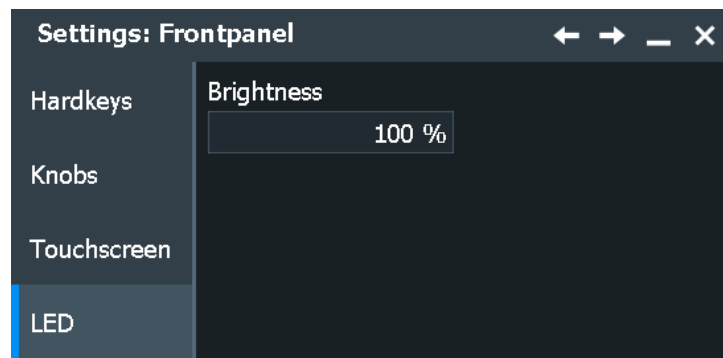

Brightness

Defines the luminosity of illuminated front panel keys and knobs.

4.5.5 Aligning the touchscreen

When the device is delivered, the touchscreen is initially calibrated. However, to ensure that the touchscreen responds to the finger contact correctly, a touchscreen alignment is required. Only users with administrator rights can fulfill this task.

Alignment of the touchscreen is useful:

- At first use
- If the position of the instrument has been changed, and you cannot look straight on the screen
- If another person operates the instrument
- If you notice, that touching a specific point on the screen does not achieve the correct response

1. In the "Menu" > "Settings" menu, select "Frontpanel".

2. Select the "Touchscreen" tab.
3. Tap "Calibrate".
A blinking cross appears in the lower left corner of the screen.
4. Touch and hold the cross until "OK" is shown.
5. Repeat this action for the crosses in the other corners.
6. Tap the Rohde & Schwarz logo to display the instrument's user interface.

4.6 Preset setup

A user-defined preset contains the complete instrument setup including display settings. You can save the current configuration to a preset file, and load a previously saved preset file. You can then specify that these settings are to be applied with the [Preset] key.

4.6.1 User-defined preset

Access: "Menu" > "Settings" > "Preset" > "Settings" tab

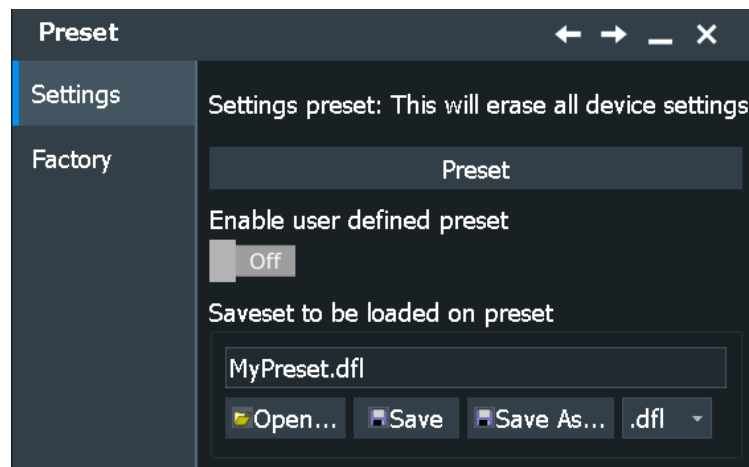

Preset

Performs a user-defined preset of the instrument.

Enable user defined preset

If enabled, the settings from the selected preset file are restored when the [Preset] key is pressed.

If disabled, [Preset] sets the instrument to the factory defaults.

The setting is available if the indicated user-defined saveset file exists, see [Saveset to be loaded on preset](#).

Remote command:

`USRDefined:RST[:ENABLE]` on page 1411

Saveset to be loaded on preset

Enter the filename to load or to save a user-defined preset. The file format is `.df1` and cannot be changed.

"Open"	Loads the indicated file. The settings from this file are applied when "Enable user defined preset" is enabled and you press the [Preset] key.
"Save"	Saves the settings to the file with the indicated name.
"Save As"	Opens the file selection dialog box and saves the settings to the selected file.

Remote command:

[USRDefined:RST:NAME](#) on page 1410

[USRDefined:RST:SAVE](#) on page 1410

[USRDefined:RST:OPEN](#) on page 1410

4.6.2 Factory preset

Access: "Menu" > "Settings" > "Preset" > "Factory"

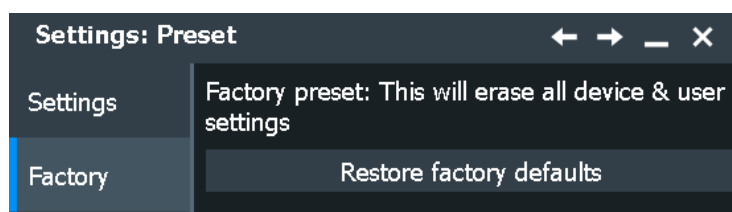
**Restore factory defaults**

Resets the instrument to the factory default settings, to the initial state. Factory settings comprise all instrument settings, including display, intensity and transparency settings. After loading factory defaults, perform a self-alignment to synchronize the signal data.

Remote command:

[Chapter 27.7.1, "System"](#), on page 1384

4.6.3 Restoring settings

When you have changed many settings and are not sure which settings are causing which effect in the measurement, you can restore the default settings and start anew. The following methods are available:

- Saving instrument settings to a user-defined preset and restoring the instrument settings to user-defined default values
- Restoring all settings on the R&S RTO6 to the factory-defined values
- Restoring settings from a file (see ["To load settings from a saveset file"](#) on page 457)

For details on save/recall instrument settings and associated remote commands, see [Chapter 12.1.1, "Savesets"](#), on page 451.

To save a user-defined preset

1. Open the "Menu" > "Settings" > "Preset" tab.
2. Enter a name for the preset file. Select the file format.
3. Tap Save.

Note: If you want to store the file in another directory than the default one, select "Save As". See also: [Chapter 12.5, "File selection dialog"](#), on page 490

To restore the instrument settings to user-defined default values

1. Open the "Menu" > "Settings" > "Preset" tab.
2. Tap "Open" and select the preset file that contains the required settings.
The instrument settings are restored to values that are stored in the file.
3. To use these settings as preset values, select "Enable user-defined preset".
4. Press the [Preset] key.

To restore all settings to the factory defaults

1. Open the "Menu" > "Settings" > "Preset" > "Factory" tab.
2. Tap the "Restore factory defaults" button.

All settings on the R&S RTO6 are reset to their factory-defined values. As long as no user-defined preset file is loaded and "Enable user defined preset" is disabled, the [Preset] key also resets the instrument settings to factory defaults.

4.7 Maintenance settings

In the "Settings" > "Maintenance" dialog box, you define the the look and feel of the display element, e.g. waveform colors, result position, or grid behavior.

4.7.1 Firmware update

Access: "Menu" > "Settings" > "Maintenance" > "FW Update"

Your instrument is delivered with the latest firmware version. Firmware updates are provided on the internet at:

www.rohde-schwarz.com/firmware/rto6.

The "Release Notes" describe the improvements and modifications of all firmware versions. They also explain how to update the firmware. They are available along with the firmware on the same web page.

4.7.2 Alignment

When data from several input channels is displayed at the same time, it may be necessary to align the data vertically or horizontally to synchronize the time bases or amplitudes and positions. This is the case, for example, when strong temperature changes occur ($> 5^\circ$).

4.7.2.1 Control

Access: "Menu" > "Settings" > "Maintenance" > "Alignment"

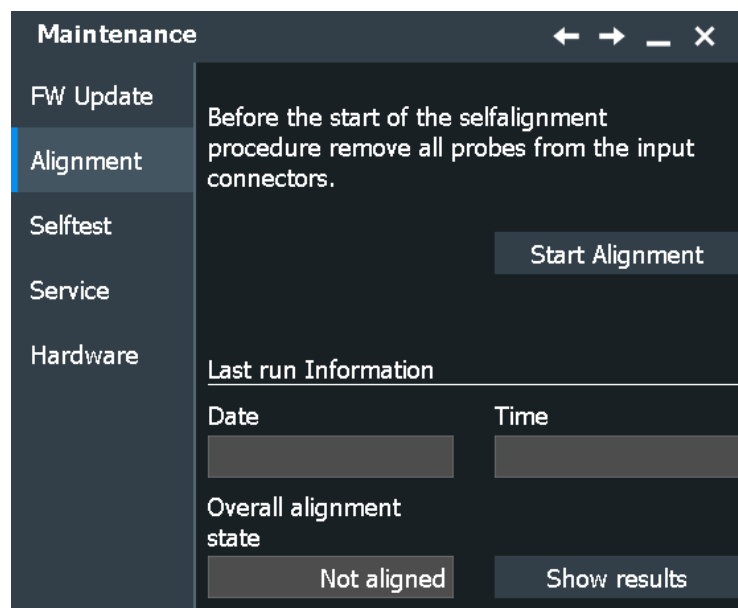

Start Alignment

Starts the self-alignment procedure for all channels.

Remote command:

[*CAL?](#) on page 1375

Date / Time / Overall alignment state

Show the date, time and the summary result of the self-alignment process: not aligned, passed or failed. Detailed results are provided on the "Results" tab.

Remote command:

[CALibration:DATE?](#) on page 1411

[CALibration:TIME?](#) on page 1411

[CALibration:RESult?](#) on page 1412

4.7.2.2 Results

For each channel, the results of the individual alignment steps are shown for all technical channel component. In case you require support, you may be asked to provide this information.

Access: "Settings" > "Maintenance" > "Alignment" > "Show results"

Self alignment step	Alignment step results
THA offset	Init
THA gain	Init
Spc	Init
Deskew	Init
Deskew interleaved	Init
VarGain 50	Init
FixGain 50	Init
Offset 50	Init
BufFixGain	Init
BufVarGain 1M	Init
BufVarGain20dB1M	Init
FixGain 1M	Init
Offset 1M	Init
Frequency Response	Init
External Trigger	Init
Input Signal	Init

4.7.2.3 Performing a self-alignment

The self-alignment aligns the data from several input channels vertically and horizontally to synchronize the timebases, amplitudes and positions. The self-alignment process includes a basic hardware check.

Recommendation on performing the self-alignment:

- When putting the instrument into operation for the first time
 - After a firmware update
 - Once a week
 - When major temperature changes occur (> 5°)
1. Warm up the instrument before you start the self-alignment. The minimum warm-up time is indicated in the data sheet.
 2. Remove the probes from the input connectors.
 3. In the "Menu" > "Settings" menu, select "Maintenance".
 4. In the "Alignment" tab, tap "Start Alignment".

The alignment is performed, the process might take several minutes. A message box informs you about the running process, wait until this message box closes. The overall pass/fail result is shown in the "Overall alignment state" field. The results of the individual alignment steps for each input channel are indicated in the "Results" tab. This information is required if problems arise.

4.7.3 Self-test

The instrument's self-test checks the hardware for correct operation. Perform the self-test if you suspect problems in hardware operation.

Access: "Settings" > "Maintenance" > "Selftest"

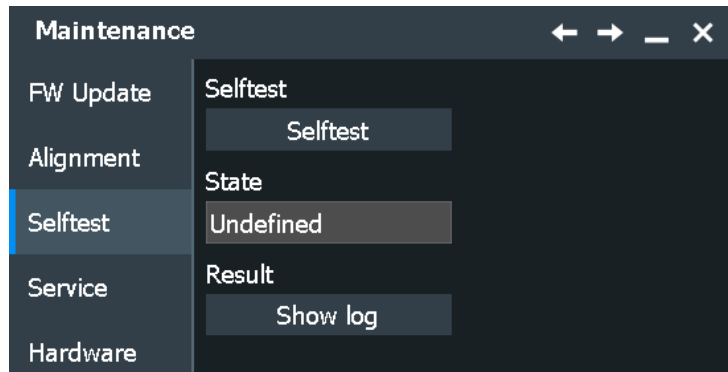

The test can take several minutes. The summary result is shown in the "State" field, which can be helpful in case you need support.

Selftest

Starts the self-test.

Remote command:

[*TST?](#) on page 1379

State

Shows the summary result of the self-test: Pass or Fail.

Remote command:

[DIAGnostic:SERVice:STST:STATe?](#) on page 1412

Result

Opens a log file with detailed information on the self-test steps and operation of hardware components, which can be helpful in case you need support.

4.7.4 Maintenance information

Access: "Settings" > "Maintenance" > "Hardware" tab > "Advanced"

The "Maintenance" dialog box provides information on your R&S RTO6 configuration, which can be helpful in case you need support.

System Info

This tab provides general information on the hardware configuration, and indicates where system information can be found on the instrument. Here you can also show the content of the device footprint file.

Remote command:

[DIAGnostic:SERVice:PARTnumber](#) on page 1413

[DIAGnostic:SERVice:SERialnumber?](#) on page 1413

[SYSTem:DFPPrint](#) on page 1412

Mainboard

This tab provides information on the mainboard configuration in your instrument.

Frontend

This tab provides information on the frontend configuration in your instrument.

Frontpanel

This tab provides information on the front panel module installed in your instrument.

MSO

This tab is only relevant if the MSO option R&S RTO6-B1 is installed. The tab provides information on the MSO hardware module that is installed in your instrument.

AWG

This tab is only relevant if the waveform generator option R&S RTO6-B6 is installed. The tab provides information on the generator hardware module that is installed in your instrument.

PSC

This tab is only relevant if the pulse source option R&S RTO6-B7 is installed. The tab provides information on the pulse source hardware module that is installed in your instrument.

Service

This tab allows the service personnel to enter a password that activates further service functions.

Remote command:

- [DIAGnostic:SERVice:PWD](#) on page 2851

4.8 Save / recall

4.8.1 Autonaming

Access:"Menu" > "Settings" key > "Maintenance" > "Autonaming" tab.

4.8.1.1 Autonoming settings

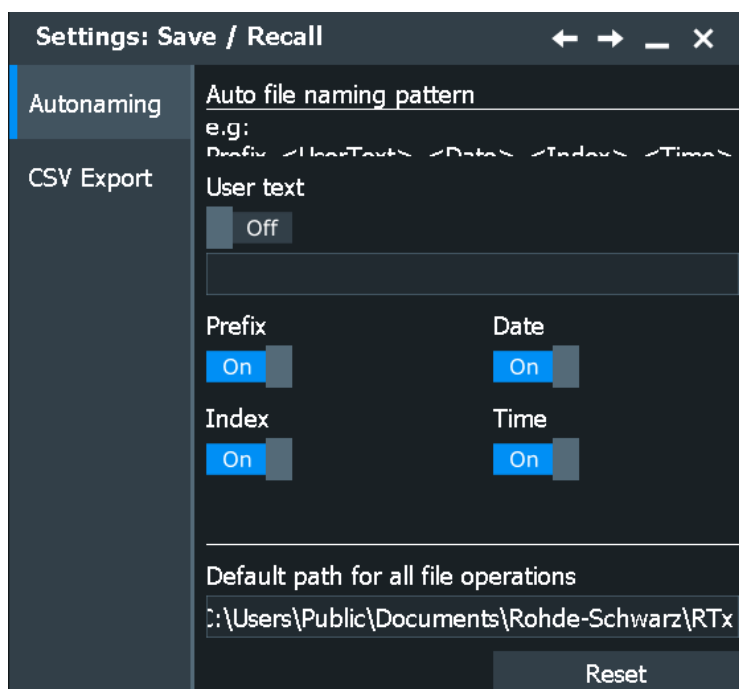

In this tab, you can define the pattern for automatic file name generation. This name is used as the default file name. The default path is the storage location for all saved files and their subdirectories.

Prefix

If enabled, inserts the default prefix in the file name. The prefix indicates the type of data that is saved, for example, Histogram, RefCurve, Settings.

Remote command:

[MMEMory:AUTonaming:PREFix](#) on page 1785

User text (enable)

If enabled, inserts the specified user text after the prefix.

Remote command:

[MMEMory:AUTonaming:USERtext](#) on page 1785

Text input

User-defined text to be inserted after the prefix.

Remote command:

[MMEMory:AUTonaming:TEXT](#) on page 1786

Date

If enabled, inserts the current date.

Remote command:

[MMEMory:AUTonaming:DATE](#) on page 1785

Index

If enabled, inserts an index.

Remote command:

[MMEMory:AUTonaming:INDEX](#) on page 1785

Time

If enabled, inserts the current time.

Remote command:

[MMEMory:AUTonaming:TIME](#) on page 1785

Default path for all file operations

Defines the default path displayed in the file selection dialog box for loading and storing operations. If a USB flash drive is connected, the path is set automatically to the drive letter of the USB flash drive.

To switch the directory quickly, double-tap the input field. Use the symbols on the left of the file explorer box to change the directory.

Remote command:

[MMEMory:AUTonaming:DEFaultpath](#) on page 1786

Reset

Resets the default file path to the factory default.

Remote command:

[MMEMory:AUTonaming:RESPath](#) on page 1786

[MMEMory:AUTonaming:RESall](#) on page 1786

4.8.1.2 Defining default file paths and names

When a save or load operation is performed, a default file name and path is provided. You can configure which path is used and how the file name is generated. In the file selection dialog box, you can change the folder and name as desired.

To define the default file path

1. Tap "Menu" > "Settings".
2. Select the "Save /Recall" tab.
3. Select the "Autonaming" tab.
4. Double-tap the "Default path for all file operations" field.
The directory selection dialog box is opened.
5. Select the folder in which the data is stored by default. Use the symbols on the left of the file explorer box to switch to often used directories.
6. To restore the factory-set default path, tap "Reset" next to the path field.

To define the automatic file name pattern

The automatic file name pattern can consist of the following elements:

<Prefix>_<UserText>_<Date>_<Index>_<Time>

The prefix depends on the data type to be stored and cannot be changed by the user. The other elements can be enabled or disabled as required.

1. Tap "Menu" > "Settings".
2. Select the "Save /Recall" tab.
3. Select the "Autonaming" tab.
4. To insert a user-defined text after the prefix, enter the text in the edit field. and enable "User text".
5. If you want to exclude the prefix, current date, time or an index (serial number), disable the corresponding option.

The specified elements are used to generate the default file name for the next storage operation.

4.8.2 CSV export

Access: "Menu" > "Settings" key > "Save /Recall" > "CSV Export" tab.

In this dialog, you can define the format of your CSV file.

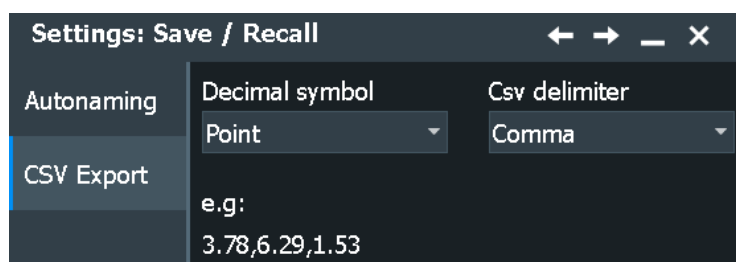

Decimal symbol

Selects if point or comma is used as a decimal symbol in the exported CSV file.

Remote command:

[EXPort:RESult:DECSymbol](#) on page 1787

Csv delimiter

Selects the list separator symbol from a list. Available are semicolon, comma, space, tab and colon.

Remote command:

[EXPort:RESult:DELimiter](#) on page 1787

4.8.3 External application

The R&S RTO6 can start an external application on the instrument or in the network (if connected) when an event occurs.

The following events can start an application:

- Trigger event
- Mask violation
- Successful completion of mask test
- Limit or margin violation of measurements
- Successful completion of limit and margin tests

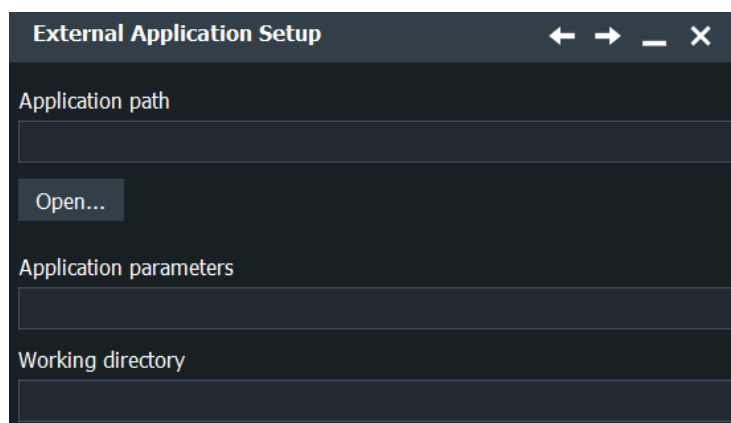

Set the path of the application executable, optional parameters, and the working directory as in a Windows shortcut definition. The setup is valid for all events.

Remote commands:

- [EXECutable:NAME](#) on page 1787
- [EXECutable:PARAMeter](#) on page 1787
- [EXECutable:WDIRECTory](#) on page 1788

5 Acquisition and waveform setup

This chapter describes the horizontal and vertical settings as well as the acquisition and probe setup.

5.1 Basics

This chapter provides background information on the essential settings in the vertical and horizontal systems, on acquisition setup and probing.

5.1.1 Vertical system

The controls and parameters of the vertical system are used to scale and position the waveform vertically.

5.1.1.1 Input coupling

The input coupling influences the signal path between input connector and the following internal signal stage. The coupling can be set to DC, AC, or ground.

- DC coupling shows all parts of an input signal. DC coupling is available with 1 M Ω input impedance to connect standard passive probes. DC 50 Ω coupling is the default for 50 Ω input impedance to connect, for example, active probes.
- AC coupling is useful if the DC component of a signal is of no interest. AC coupling blocks the DC component of the signal so that the waveform is centered on zero volts.
- Ground coupling disconnects the input signal from the vertical system to see the ground level (zero volts) on the screen. Ground coupling is useful for reference purposes.

5.1.1.2 Vertical scale and position

Vertical scale and vertical position directly affect the resolution of the waveform amplitude. The vertical scale corresponds to the ADC input range. To get the full resolution of the ADC, set up the waveforms to cover most of the height of the diagram.

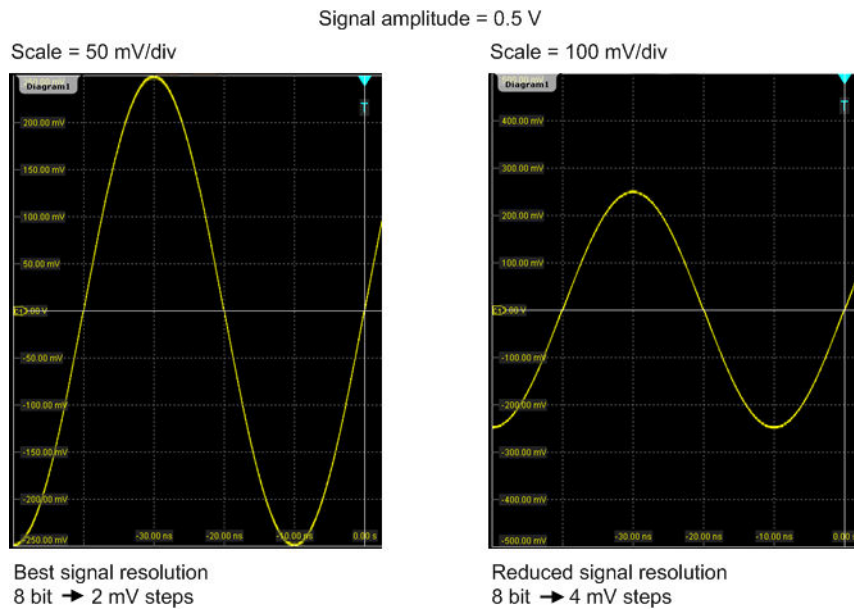

Figure 5-1: Input range and resolution of the ADC

With R&S RTO6, you can work with multiple diagrams, and each diagram obtains the full vertical resolution, no matter where the diagram is placed. Therefore, use a separate diagram for each waveform instead of the traditional setup that arranges the waveforms side by side in one diagram.

Signal amplitude: 0.5 V
Scale/div = 100 mV/div
Reduced signal resolution: 4 mV steps

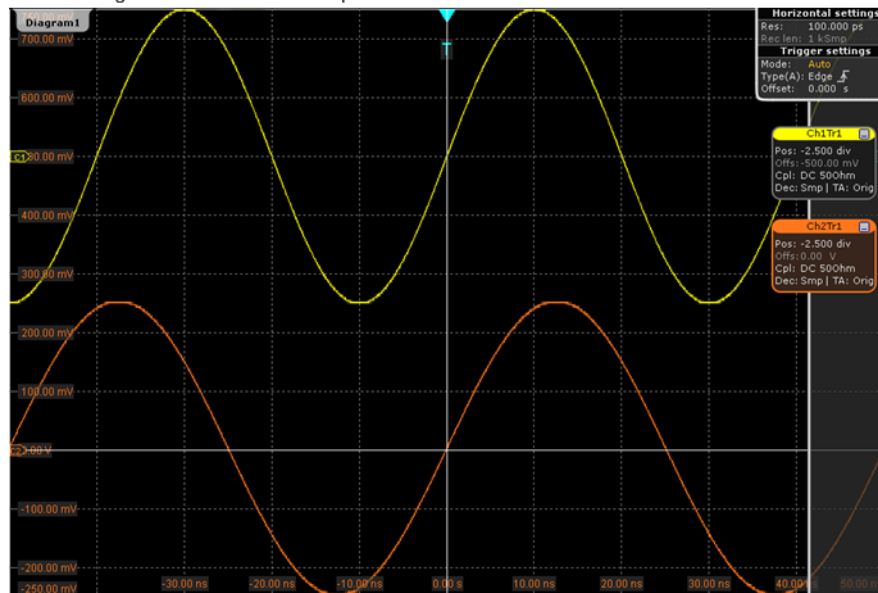

Figure 5-2: Traditional setup of multiple waveforms in one diagram: reduced resolution

Signal amplitude: 0.5 V
 Scale = 50 mV/div
 Best signal resolution: 2 mV steps

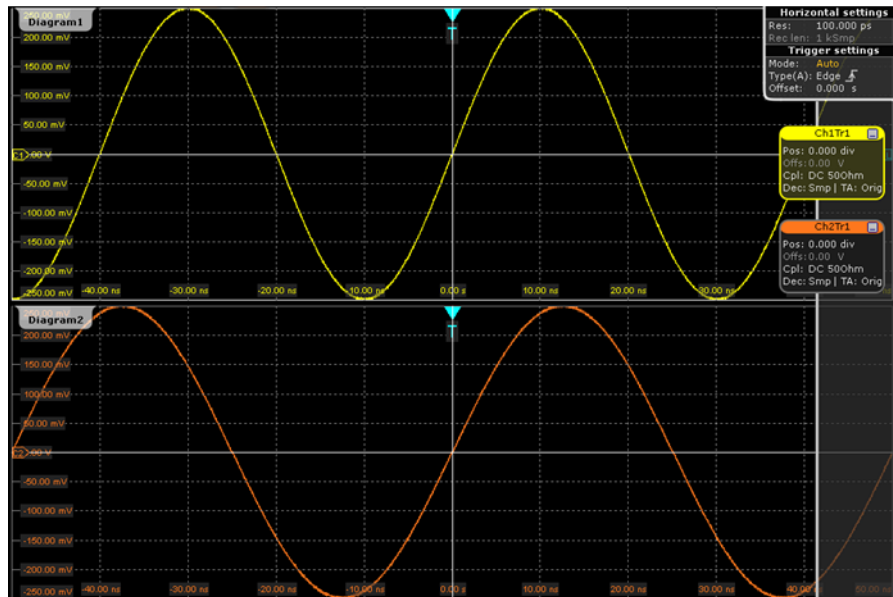

Figure 5-3: R&S RTO6 setup of multiple waveforms in separate diagrams: best resolution

5.1.1.3 Bandwidth

For analog applications, the highest signal frequency determines the required oscilloscope bandwidth. The oscilloscope bandwidth should be slightly higher than the maximum frequency included in the analog test signal to measure the amplitude with very little measurement error.

Most test signals are more complex than a simple sine wave and include several spectral components. A digital signal, for example, is built up of several odd harmonics. As a rule, for digital signals the oscilloscope bandwidth should be 5 times higher than the clock frequency to be measured.

The oscilloscope is not a stand-alone system. You need a probe to measure the signal of interest, and the probe has a limited bandwidth, too. The combination of oscilloscope and probe creates a *system bandwidth*. To reduce the effect of the probe on the system bandwidth, the probe bandwidth must exceed the bandwidth of the oscilloscope, the recommended factor is 1.5 x oscilloscope bandwidth. See also: [Chapter 5.1.4.1, "Voltage probes"](#), on page 116

5.1.2 Sampling and acquisition

The vertical system of a digital oscilloscope conditions the test signal in a way that the following A/D converter (ADC) can transform the measured voltage into digital data.

5.1.2.1 Sampling and processing

The A/D converter samples the continuous signal under test at specific points in time and delivers digital values called **ADC samples**. The rate at which the converter is working is the **ADC sample rate**, a constant value specified in GHz: $f_{ADC} = 1 / T_I$

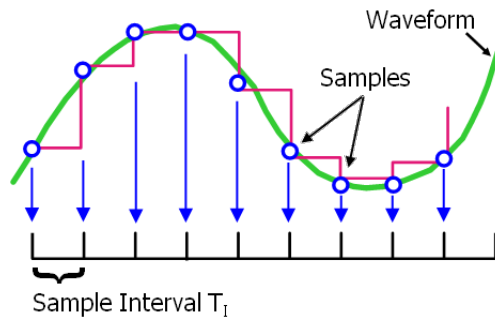

The digital ADC samples are processed according to the acquisition settings. The result is a waveform record that contains **waveform samples** and is stored in the **waveform memory**. The waveform samples are displayed on the screen and build up the waveform.

The number of waveform samples in one waveform record is called **record length**. The rate of recording waveform samples - the number of waveform samples per second - is the **sample rate**. The higher the sample rate, the better the resolution is and the more details of the waveform are visible.

A sufficient resolution is essential for correct reconstruction of the waveform. If the signal is undersampled, aliasing occurs - a false waveform is displayed. To avoid aliasing and accurately reconstruct a signal, Nyquist theorem postulates that the sample rate must be at least twice as fast as the highest frequency component of the signal. However, the theorem assumes ideal conditions, so the Nyquist sample rate is usually not sufficient.

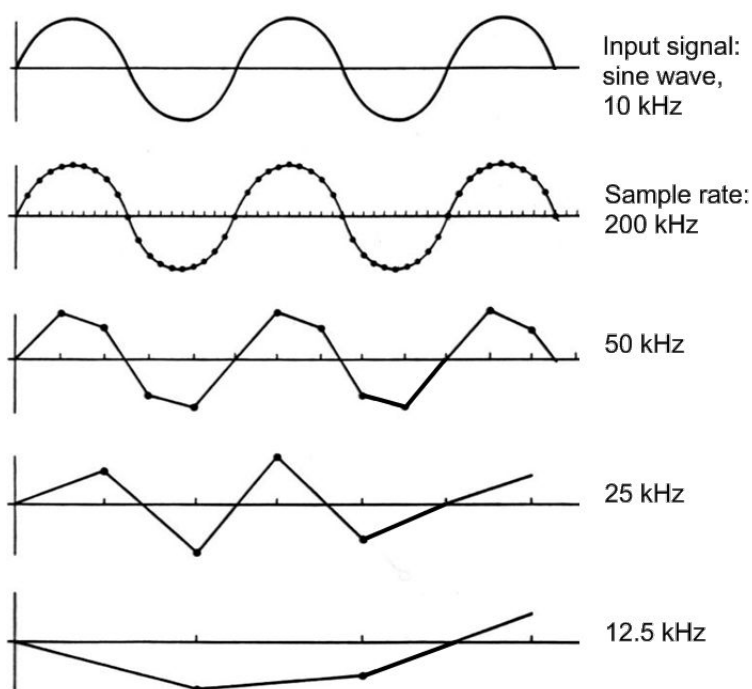

Figure 5-4: Waveforms acquired with different sample rates

To avoid aliasing, the sample rate must be set to a value 3 to 5 times the fastest frequency component of the signal. A higher sample rate increases signal fidelity, increases the chance to capture glitches and other signal anomalies, and improves the zoom-in capabilities.

5.1.2.2 Acquisition settings

The sample rate can be the same as the constant ADC sample rate, or higher, or lower. To get a higher sample rate, interpolation as method of **resolution enhancement** is used. To reduce the sample rate, **decimation** methods help: sample, peak detect, high resolution and RMS.

As digital waveform data is stored in the memory, and the memory can save many waveform records, further **waveform arithmetic** processing is possible: average and envelope waveforms are resulting waveforms, created from a composite of sample points taken from multiple acquisitions.

You can display up to three waveforms from one input signal and apply different decimation and arithmetic to each waveform.

5.1.2.3 Acquisition control

You can run the R&S RTO6 in two ways:

- Run Stop: the instrument acquires data until you stop it manually.
- Single: the instrument samples and processes a specified number of acquisitions.

The determining point of an acquisition is the trigger. The instrument acquires continuously and keeps the sample points to fill the pre-trigger part of the waveform record. When the trigger occurs, the instrument continues acquisition until the post-trigger part of the waveform record is filled. Then it stops acquiring and waits for the next trigger. When a trigger is recognized, the instrument does not accept another trigger until the acquisition is complete.

The trigger modes define how the instrument triggers:

- Normal: The instrument acquires a waveform only if a real trigger occurs, that is, if all trigger conditions are fulfilled.
- Auto: The instrument triggers repeatedly after a fixed time interval if the trigger conditions are not fulfilled. If a real trigger occurs, it takes precedence. If the real trigger is faster than the auto trigger, both modes are virtually the same.

In practice, both trigger modes are useful: The auto mode lets you see the signal with little adjustment, while the normal mode selects the interesting part of the waveform. If you want to acquire a specified number of waveforms, make sure to select the normal trigger mode. Thus you get only the required number of interesting acquisitions.

See also: [Chapter 6, "Triggers"](#), on page 194.

5.1.3 Horizontal system

5.1.3.1 Parameters of the horizontal system

The control parameters of the horizontal system are tightly connected. Thus, changing one parameter affects the other parameters as well.

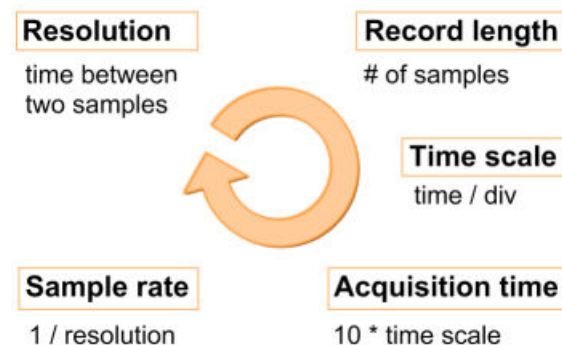

The mathematical dependencies can be summarized as follows:

$$\frac{\text{Sample rate}}{1 / \text{Resolution}} \times \frac{\text{Acquisition time}}{\text{Time scale} \times \# \text{ of div}} = \text{Record length}$$

The number of divisions is 10, which is the only constant parameter.

When you set up horizontal parameters, you can choose whether the record length or the resolution remains constant.

- With constant resolution, increasing the time scale also increases the record length, and vice versa. You can limit the record length to a maximum value.
- With constant record length, increasing the time scale coarsens the resolution, that is, the time between two waveform samples gets longer.

For both settings, the "Auto adjustment" ensures a sufficient resolution to prevent undersampling.

5.1.3.2 Horizontal position

As described before in [Chapter 5.1.2.3, "Acquisition control"](#), on page 113, the trigger is the determining point of the waveform record.

In many scenarios, you want to analyze the waveform some time before or after the trigger. To adjust the horizontal acquisition window to the waveform section of interest, you can use the following parameters:

- The **horizontal position** defines the time distance from the trigger point (the zero point of the diagram) to the reference point. Changing the horizontal position, you can move the trigger point, even outside the screen.
- The **reference point** is the rescaling center of the time scale on the screen. If you modify the time scale, the reference point remains fixed on the screen, and the scale is stretched or compressed to both sides of the reference point.

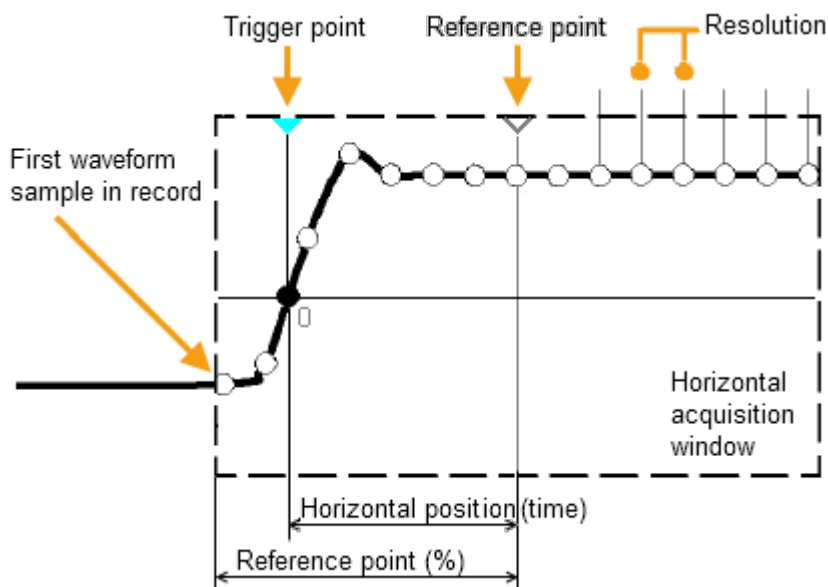

5.1.4 Probes

A probe connects the signal source (DUT) to the oscilloscope, and delivers the signal to be measured. It is the essential first link in the measurement chain.

An ideal probe fulfills the following requirements:

- Safe and reliable contacts
- Infinite bandwidth
- The probe should not load the signal source and thus impact the circuit operation.
- The connection should not introduce or suppress signal components (hum, noise, filter) and thus degrade or distort the transferred signal.

In reality, the probe can never be an ideal one, it always affects the signal transmission and the signal source, and thus the measured signal. It depends on the frequency to be measured and on the signal source to determine the acceptable loading, and to determine which kind of probe delivers good results.

The solution depends on the quantity to be measured regarding:

- Signal type: voltage, current, power, pressure, optical, etc.
- Signal amplitude: The oscilloscope itself can only display voltages in a limited range. Most probes can adjust the dynamic range to amplitudes from a few mV to 10 V. Smaller or much larger signals require specialized equipment.
- Signal frequency: High frequencies require advanced equipment to get correct results.
- Source characteristic: The source impedance is the decisive factor when choosing the suitable connection.

5.1.4.1 Voltage probes

The following table provides an overview on common voltage probes and their usage.

Table 5-1: Voltage probes overview

Probe type	Attenuation	Typical bandwidth range	Oscilloscope input	Usage
Passive, high impedance	1:1	10 MHz	1 M Ω	Low-speed signals, low-level signals
Passive, high impedance	10:1	500 MHz	1 M Ω	General purpose
Passive, low impedance	10:1	up to 10 GHz	50 Ω	High frequency
Active, single-ended	10:1	up to 10 GHz	50 Ω	High speed
Active, differential	10:1		50 Ω	Floating

For a list of recommended probes, refer to the R&S RTO6 product brochure.

Besides the possible input voltage range, two factors are important when selecting a voltage probe: Bandwidth and impedance over frequency.

- **Bandwidth:**
The combination of probe and oscilloscope builds up a system. The resulting system bandwidth is approximately determined with:

$$\frac{1}{BW_{system}} = \sqrt{\left(\frac{1}{BW_{probe}}\right)^2 + \left(\frac{1}{BW_{scope}}\right)^2}$$

To measure the signal with low measurement error, the system bandwidth should be higher than the highest frequency component of the signal. The probe bandwidth must be even higher than the system bandwidth.

- **Impedance:**

A minimum impedance is required to keep the circuit loading low. Over frequency, the impedance decreases, in particular with passive probes. The probe impedance should be approximately 10 times the impedance of the circuit test point at the highest signal frequency.

Passive voltage probes

Passive probes have the following qualities:

- No active components inside
- BNC connector for universal use
- Compensate the probe when it is connected to a scope input: LF compensation matches the probe (mainly cable) capacitance to the oscilloscope input capacitance.
- With high impedance probes, the impedance varies significantly over frequency.
- With low impedance probes, the impedance variation over frequency is low, but the load on the source is high.

If you use passive probes, remember some recommendations:

- Use a probe recommended for your oscilloscope model.
- Use a ground lead as short as possible to minimize the effect of ground lead inductance. The resonance frequency can be much lower than the system bandwidth and thus can affect the measurement results, in particular, if you measure steep edge rise times.
- Select a probe that has a bandwidth of 5 to 10 times the highest frequency being measured. This bandwidth preserves the harmonics and thus the waveform integrity.

Active voltage probes - general

Active probes require operating power from the instrument and have a proprietary interface to the instrument. Their main qualities are:

- Low loading on signal source
- The probe is automatically recognized by the instrument, no adjustment is required.
- Adjustable DC offset at probe tip allows for high resolution on small AC signals which are superimposed on DC levels.
- Connections should be as short as possible to keep the usable bandwidth high.
- Observe the operating voltage range.
- The probe impedance depends on the signal frequency.

RT-ZS single-ended active probes and RT-ZD differential active probes provide special features for easier use and precise measurements. These special features are not available on RT-ZSxxE probes.

- The micro button on the probe head remotely controls important functions on the instrument, like running and stopping the acquisition, autose, AutoZero and setting the offset to mean value.
- The R&S ProbeMeter measures DC voltages between the probe tip and the ground connection with very high precision. The result is displayed on the instrument's screen. So you can check DC voltages with different levels without having to adjust the measurement range of the oscilloscope. The R&S ProbeMeter also measures the zero error of the probe to optimize measurement results at small signal levels.

When you connect an R&S RT-ZSxx active probe to a channel input of the R&S RTO6, the oscilloscope recognizes the probe. It reads the identification and calibration data from the probe box and shows the result in the "Setup" and "Probe Attributes" tabs. This data together with the deskew time for a given channel is stored and processed by the R&S RTO6. If you connect the probe the next time to the same channel, the information is fetched and used.

Differential active probes

Differential active probes are designed to measure signals that are referenced against each other, and voltages that are not references to ground, for example twisted-pair signal lines. The R&S RT-ZD probes are differential probes with high input impedance, they can be used to measure voltages between any two test points.

Compared with two-channel measurement setup with single-ended probes, the measurement with differential probes is symmetric due to the same amplification and cable length on both paths. It is also immune to interference and noise and occupies only one input channel.

A differential probe has three sockets: the positive signal socket (+), the negative signal socket (-), and the ground socket.

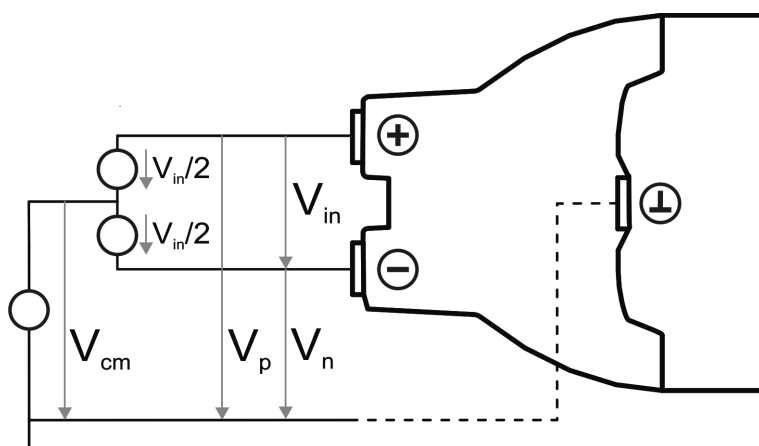

Multiple input voltages can be defined for a differential probe:

- Differential mode input voltage (V_{in} , V_{dm})

Voltage between the positive and negative signal sockets

- Positive single-ended input voltage (V_p)
Voltage between the positive signal socket and the ground socket
- Negative single-ended input voltage (V_n)
Voltage between the negative signal socket and the ground socket
- Common mode input voltage (V_{cm})
Mean voltage of positive and negative signal sockets referred to the ground socket, respectively

Two of these voltages are independent values, the other two can be calculated:

$$V_{in} = V_p - V_n$$

$$V_{cm} = \frac{V_p + V_n}{2}$$

R&S RT-ZD probes detect only differential input voltages and provide it to the oscilloscope. Common mode signals are suppressed by the probe. This characteristic is described by the common mode rejection ratio (CMRR):

$$CMRR = \frac{\text{DifferentialGain}}{\text{CommonModeGain}}$$

In addition, the R&S ProbeMeter of R&S RT-ZD differential probes can measure differential and common mode DC voltages. The measurement result is displayed on the oscilloscope's screen. The common mode measurement of the R&S ProbeMeter allows you to check the input voltage relative to ground. Thus, the CM measurement is a convenient way to detect breaches of the operating voltage window, and the reason of unwanted clippings.

5.2 Horizontal

The "Horizontal" dialog provides the time base configuration for channel and spectrum waveforms.

5.2.1 Setup settings

Access: "Menu" > "Horizontal" > "Setup" tab.

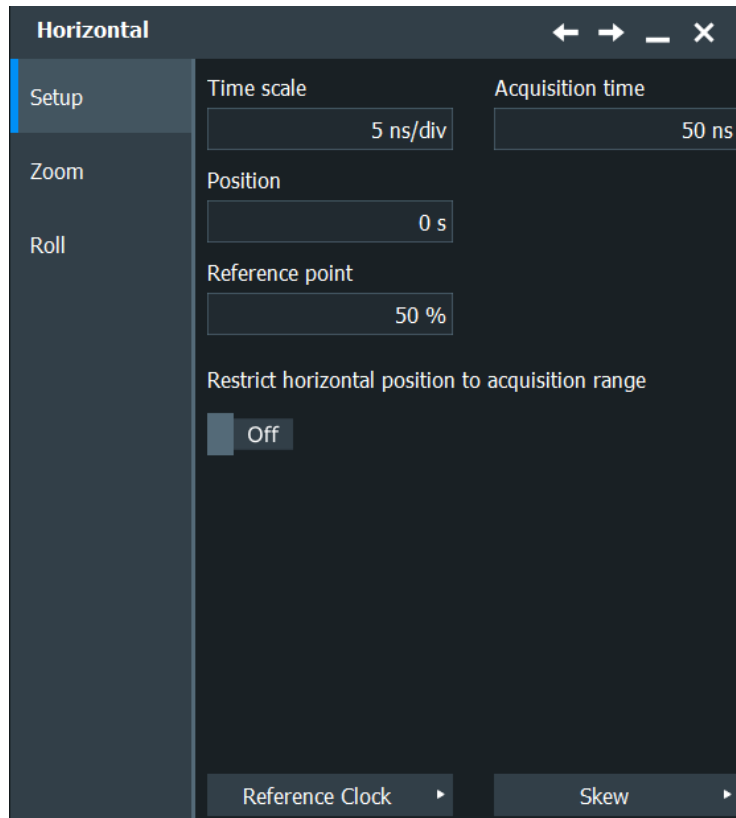

Time scale

Sets the horizontal scale for all channel and math waveforms in seconds per division. Increase the scale to see a longer time interval of the waveform. Decrease the scale to see it in more detail. The scale has a point that remains fixed on the screen when the scale value is changing - the reference point.

Remote command:

[TIMEbase:SCALE](#) on page 1415

Acquisition time

Shows the time of one acquisition, that is the time across the 10 divisions of the diagram:

Acquisition time = Time scale * 10 divisions

Changing the acquisition time changes the time scale too.

Remote command:

[TIMEbase:RANGe](#) on page 1416

Position

Defines the time distance between the reference point and the trigger point (the zero point of the diagram). If you want to see a section of the waveform some time before or after the trigger, enter this time as horizontal position. The requested waveform section is shown around the reference point. Use positive values to see waveform sections after the trigger - the waveform and the diagram origin move to the left.

See also "[Reference point](#)" on page 121.

Remote command:

[TIMEbase:HORizontal:POSition](#) on page 1416

Reference point

Sets the position of the reference point in % of the screen. The reference point marks the rescaling center of the time scale. It is indicated by a grey triangle outline at the top of the diagram. If you modify the time scale, the reference point remains fixed on the screen, and the scale is stretched or compressed to both sides of the reference point.

Remote command:

[TIMEbase:REFerence](#) on page 1417

Restrict horizontal position to acquisition range

If enabled, the horizontal position cannot be set outside the visible waveform diagram.

Remote command:

[TRIGger<m>:OFFSet:LIMited](#) on page 1417

Refence Clock

Opens a dialog for configuring the "Refence Clock" settings, see [Chapter 5.3.2, "Reference clock \(OCXO\)"](#), on page 124.

Skew

Opens a dialog for configuring the "Skew" settings, see [Chapter 5.3.1, "Skew"](#), on page 123.

5.2.2 Zoom settings

The zoom settings are described in [Chapter 7.1, "Zoom"](#), on page 243.

5.2.3 Roll settings

Access: "Menu" > "Horizontal" > "Roll" tab.

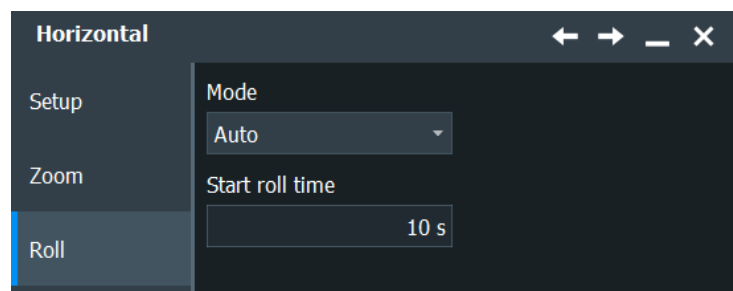

In this dialog, you can define the roll mode.

Roll mode

Selects, if the roll mode is set automatically by the instrument or if it is turned off.

In roll mode, the instrument shows the waveforms immediately, without waiting for the complete acquisition of the waveform record. If the time base is slow - at long time scale values - the roll mode saves waiting for the waveform display. The instrument displays newly acquired waveform points at the right edge of the display and moves the waveform to the left.

The roll mode has following restrictions:

- Roll mode disables persistence
- History is not available
- Event actions are not possible

The instrument activates the roll mode automatically if the following conditions are fulfilled:

- Acquisition time exceeds the defined "Minimum acquisition time"
- Waveform arithmetic is disabled ("Off")
- All channel waveforms are set to the same decimation mode, and only to one of these values: "Sample", "Peak detect", or "High res"
- All mask tests are disabled
- Fast segmentation is disabled
- Event actions are disabled
- FFT is disabled
- All serial buses are disabled
- All digital channels are disabled (MSO option R&S RTO6-B1)
- No CDR jitter data is acquired
- No zone trigger is active

The roll mode depends also on sample rate and record length. In roll mode, the sample rate limit is 20 MSample/s. At 50 s, the resulting record length limit is 1000 MSample.

If the acquisition time is >50 s, the record length limit is effective, and the maximum sample rate depends on the acquisition time:

$$\text{Sample rate} \leq 1000 \text{ MSample} / \text{Acquisition time.}$$

If the acquisition time is <50 s, the maximum sample rate in roll mode depends on the number of active channels:

$$\text{Sample rate} = 20 \text{ MSample/s} / \text{Number of active wfms.}$$

The corresponding maximum record length is:

$$\text{Record length} \leq 20 \text{ MSample/s} * \text{Acquisition time} / \text{Number of active wfms.}$$

Thus, the roll mode switches off, or it does not activate automatically if:

- The record length exceeds the limit at acquisition times >50 s.
- The sample rate exceeds the limit.
- Too many waveforms are active.

Remote command:

[TIMEbase:ROLL:ENABLE](#) on page 1420

[TIMEbase:ROLL:STATE?](#) on page 1420

Start roll time

The instrument can activate the roll mode automatically if the [Acquisition time](#) exceeds the value given here.

Remote command:

[TIMEbase:ROLL:MTIME](#) on page 1421

5.3 Horizontal accuracy

Access: "Menu" > "Horizontal" > "Setup" tab > "Skew".

The "Horizontal Accuracy" dialog box contains standard and optional settings to improve measurement and analysis accuracy and to reduce jitter effects.

5.3.1 Skew

Access: "Menu" > "Horizontal" > "Setup" tab > "Skew" > "Skew" tab.

Skew compensates signal propagation differences between channels caused by the different length of cables, probes, and other sources. Correct skew values are important for accurate triggering and timing relations between channels.

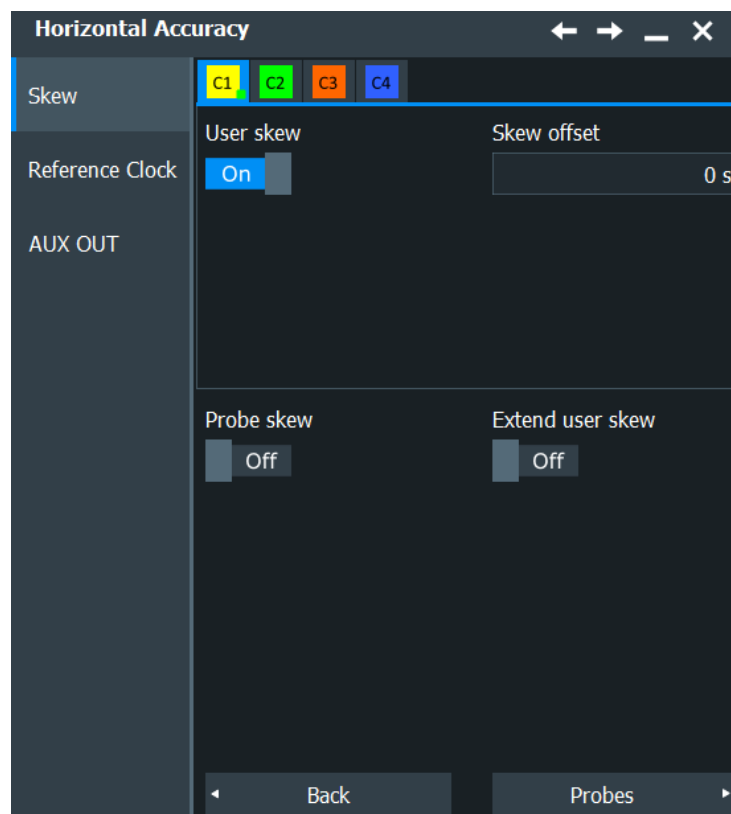

Make sure that the correct channel tab is selected.

User skew

If enabled, the "Skew offset" value is used for compensation.

Remote command:

[CHANnel<m>:SKEW:MANual](#) on page 1479

Skew offset

Sets a delay value, which is known from the circuit specifics but cannot be compensated by the instrument automatically. It affects only the selected input channel.

The offset range and possible values depend on [Extend user skew](#).

Remote command:

[CHANnel<m>:SKEW:TIME](#) on page 1480

Probe skew

Measures the skew of all connected active probes and includes it in the total skew offset. The setting affects all active channels.

If an active probe is detected, the following information is shown:

"Active probe"	Shows the type of the probe that is connected to the selected channel.
"Probe group delay"	Shows the result of the probe skew measurement on the selected channel.
"Total skew offset"	If Extend user skew is disabled, the sum of the measured "Probe group delay" and the "Skew offset" is shown. If "Use skew offset" is disabled, the skew offset is ignored. If Extend user skew is enabled, only the probe skew is shown, and the skew offset is always ignored.

Remote command:

[PROBe<m>:SKEState](#) on page 1480

Extend user skew

Allows you to set higher value in "Skew offset" to compensate for the delay of the measurement setup. Without extension, the deskew range is ± 100 ns, and delays shorter than the sample interval can be compensated.

With extension, the maximum delay is ± 1 s, and the instrument can compensate complete samples. Compensation takes effect after the trigger. The maximum number of acquisitions in the memory is reduced.

Use the extended skew range to compare signals: One signal goes directly from the generator to the scope, and the other signal goes from the generator through the DUT to the scope. The delay of the DUT is higher than ± 100 ns.

Remote command:

[CHANnel<m>:SKEW:EXTended](#) on page 1480

5.3.2 Reference clock (OCXO)

Access: "Menu" > "Horizontal" > "Setup" tab > "Skew" > "Reference clock" tab.

The oven-controlled crystal oscillator (OCXO) produces a 10 MHz internal reference signal with precise and stable frequency. With OCXO, you can also use an external reference signal. The input and output connectors for the external reference signal are on the rear panel.

Oven hot

Indicates when the oven has reached its nominal temperature and is operating with the specified accuracy. Otherwise, "Oven cold" indicates that the operating temperature is not yet reached.

Use external reference

Enables the use of the external reference signal instead of the internal OCXO reference.

If an external input reference is used, no signal is output at Ref Out. Without external reference, the 10 MHz frequency of the OCXO is output at Ref Out.

Remote command:

[SENSe\[:ROSCillator\]:SOURce](#) on page 1483

External reference

Sets the frequency of an external reference input signal that is connected to the external reference input on the rear panel of R&S RTO6. A frequency range from 1 MHz to 20 MHz is supported.

Remote command:

[SENSe\[:ROSCillator\]:EXTernal:FREQuency](#) on page 1484

5.3.3 AUX OUT

Access: "Menu" > "Horizontal" > "Setup" tab > "Skew" > "AUX OUT" tab.

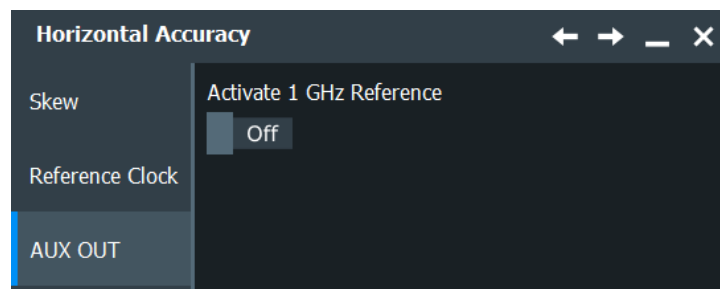

Activate 1GHz Reference

Enables the 1 GHz reference signal and sends it to the [Aux Out] connector. The signal is required for performance test to measure the frequency of the internal calibration signal.

Remote command:

[CALibration:SOURce:FREQuency](#) on page 1481

[CALibration:SOURce:STATe](#) on page 1481

5.4 Acquire settings

The "Acquire" dialog provides the acquisition configuration for channel and spectrum waveforms.

5.4.1 Setup settings

The "Setup" tab in the "Acquire" dialog provides the settings for the time axis.

For background information, see [Chapter 5.1.3, "Horizontal system"](#), on page 114.

Access: "Menu" > "Acquire" > "Setup" tab.

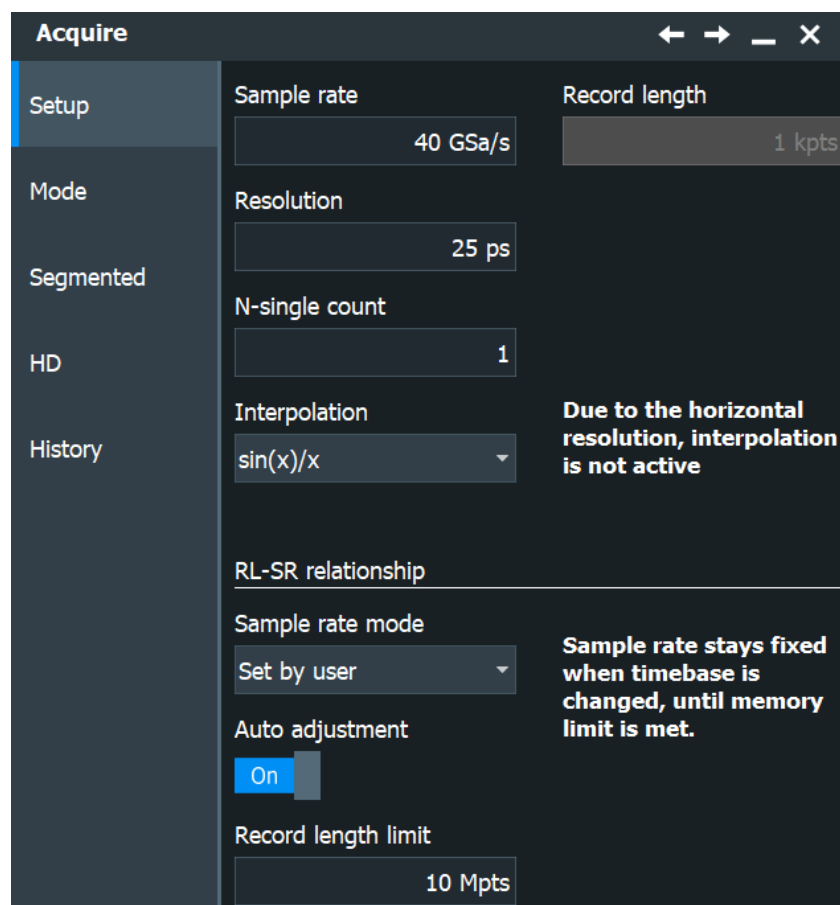

Sample rate

Sets the number of captured waveform points per second. It considers the samples of the ADC, and the reduction of waveform points by decimation.

If interpolation is not active, the sample rate is the reciprocal value of the resolution, and thus also depends on the acquisition time and the record length.

If interpolation is active, the sample rate is limited to the ADC sample rate.

See also:

- [Chapter 5.1.2, "Sampling and acquisition"](#), on page 111

- [Chapter 5.1.3, "Horizontal system"](#), on page 114

Remote command:

[ACQUIRE:SRReal](#) on page 1419

Record length

Indicates the number of waveform samples that build the waveform across the acquisition time.

Remote command:

[ACQUIRE:POINTS\[:VALue\]](#) on page 1420

Resolution

Sets the time between two waveform samples. A fine resolution with low values produces a more precise waveform record.

Remote command:

[ACQUIRE:RESolution](#) on page 1420

Average count (N-single count)

Access:

- "Menu" > "Acquire" > "Setup" tab > "N-single count"
- "Menu" > "Acquire" > "Mode" tab > "Average count"
- "Menu" > "Acquire" > "Segmented" tab > disable "Acquire maximum" > "Required"
- [Math] > "Arithmetic" tab > "Mode" is not "Off" > "Average count"

The acquisition and average count has several effects:

- It sets the number of waveforms acquired with [Single]
- It defines the number of waveforms used to calculate the average waveform. Thus, the instrument acquires sufficient waveforms to calculate the correct average if "Average" is enabled for waveform arithmetic. The higher the value is, the better the noise is reduced.
- It sets the number of acquisitions to be acquired in a fast segmentation acquisition series. Thus, you can acquire exactly one fast segmentation acquisition series with [Single].
If fast segmentation is enabled and configured to acquire the maximum number of acquisitions, the acquisition count is set to that maximum number and cannot be changed.
See also ["Number of acquisitions"](#) on page 132.
- It is the "Finished" criteria for the state of a mask test.

Remote command:

[ACQUIRE:COUNT](#) on page 1424

Interpolation

Selects the interpolation method. If the defined "Sample rate" is higher than the ADC sample rate, interpolation adds points between the captured samples of the waveform by various mathematic methods.

"Linear" Two adjacent ADC sample points are connected by a straight line, the interpolated points are located on the line. You see a polygonal waveform similar to the real signal, and also the ADC sample points as vertexes.

"sin (x)/x"	Two adjacent ADC sample points are connected by a sin(x)/x curve, and also the adjoining sample points are considered by this curve. The interpolated points are located on the resulting curve. This interpolation method is precise and shows the best signal curve.
"Sample/Hold"	The ADC sample points are displayed like a histogram. For each sample interval, the voltage is taken from the sample point and considered as constant, and the intervals are connected with vertical lines. Thus, you see the discrete values of the ADC - the measured samples.

Remote command:

[ACQUIRE:INTerpolate](#) on page 1421

Sample rate mode

You can choose to keep constant either the sample rate or the record length when you adjust the time scale or acquisition time.

See also: [Chapter 5.1.3, "Horizontal system"](#), on page 114

"Set by user"	With constant sample rate and resolution, increasing the time scale also increases the record length, and vice versa. You can limit the record length to a maximum value.
"Fixed record length"	With constant record length, increasing the time scale reduces the sample rate and coarsens the resolution, that is, the time between two waveform samples gets longer.

Remote command:

[ACQUIRE:POINTs:AUTO](#) on page 1418

Auto adjustment

Prevents undersampling and ensures a sufficient resolution to acquire the correct waveform if the time scale is changed. The setting takes effect if the changed parameter - resolution or record length - reaches a limit. The instrument automatically keeps this parameter constant at its limit, and changes the other parameter regardless of the "Resolution / Record length" setting.

See also: [Record length limit](#)

Remote command:

[ACQUIRE:POINTs:AADJust](#) on page 1418

Record length limit

Sets a limit for the record length to prevent very large records. This value is only available if "Auto adjustment" is on and a constant resolution is selected. If you increase the time scale, the resolution remains constant, and the record length increases until the limit is reached. Further increase of the time scale changes the resolution and keeps the record length limit.

See also:

- [Record length](#)
- [Auto adjustment](#)

Remote command:

[ACQUIRE:POINTs:MAXimum](#) on page 1418

5.4.2 Mode settings

Access: "Menu" > "Acquire" > "Mode" tab.

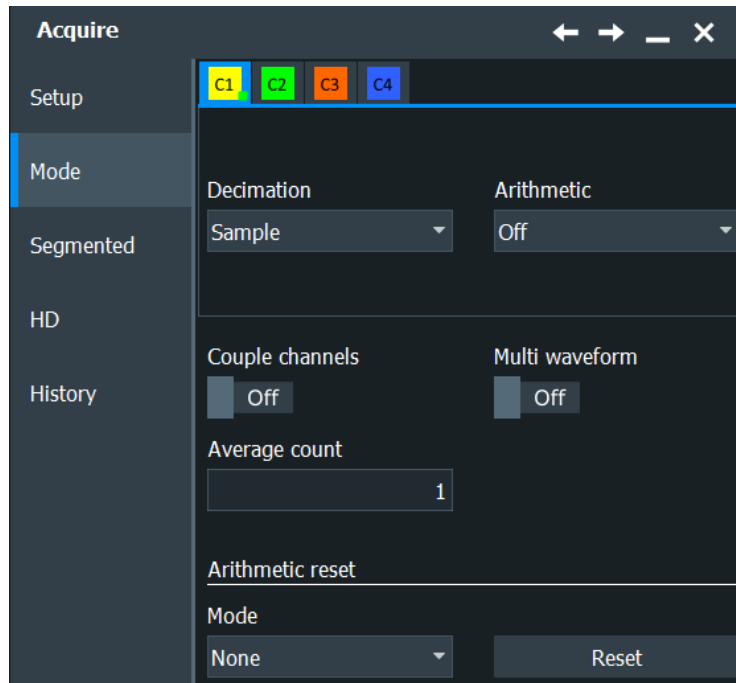

Decimation

Selects the decimation mode. Decimation reduces the data stream of the ADC to a stream of waveform points with lower sample rate and a less precise time resolution. The R&S RTO6 uses decimation, if the waveform "Sample rate" is less than the ADC sample rate. In this case, interpolation is not possible.

There are different methods to define the recorded waveform point out of n sample points:

- | | |
|---------------|--|
| "Sample" | One of n samples in a sample interval of the ADC is recorded as waveform point, the other samples are discarded. The time between the two adjacent waveform points is exactly the resolution. Very short glitches might remain undiscovered by this method. |
| "Peak detect" | The minimum and the maximum of n samples in a sample interval are recorded as waveform points, the other samples are discarded. |
| "High res" | The average of n sample points is recorded as one waveform sample. Averaging reduces the noise, the result is a more precise waveform with higher vertical resolution. In "High res" mode, decoding of serial protocols does not work. |
| "RMS" | The waveform point is the root mean square of n sample values. Thus, the RMS value reflects the instantaneous power. This arithmetic mode is used to average a measured power waveform. Linear averaging of power signals causes an error dependent on the noise of the signal to be averaged. |

Remote command:

[CHANnel<m>\[:WAVeform<n>\]:TYPE](#) on page 1423

Arithmetic

Waveform arithmetic builds the resulting waveform from several consecutive acquisitions of the signal. The arithmetic works with interpolated and decimated waveforms.

This setting is waveform-specific.

The methods are:

- | | |
|------------|--|
| "Off" | The data of only one acquisition is recorded according to the decimation settings. In effect, no waveform arithmetic is processed. |
| "Envelope" | <p>Detects the minimum and maximum values in a sample interval over several acquisitions. Each acquisition is done in the "Peak detect" decimation mode, and the most extreme values for all acquisitions build the envelope. The resulting diagram shows two envelope waveforms: the minimums (floor) and maximums (roof).</p> <p>The envelope is built until the restart criterion is reached, see "Arithmetic Reset > Mode" on page 131.</p> <p>Note: If you change from "Envelope" to "Off", make sure to set also the "Decimation" to the required value.</p> |
| "Average" | <p>The average is calculated from the data of the current acquisition and several acquisitions before. The method reduces random noise and other heterodyne signals. It requires a stable, triggered and periodic signal for correct function.</p> <p>The number of acquisitions for average calculation is defined with "Average count"</p> <p>The "Auto reset mode" defines the restart condition.</p> |

Remote command:

[CHANnel<m>\[:WAVeform<n>\]:ARITHmetics](#) on page 1423

Couple channels

Sets the acquisition mode and the waveform arithmetic of all channels to the last set value.

If the acquisition settings are coupled, "Multi waveform" is not available, only one waveform per channel can be used.

Remote command:

[ACQUIRE:CDTA](#) on page 1422

Multi waveform

For each channel, up to three waveforms can be shown and analyzed. The decimation mode and the waveform arithmetic are specific for each waveform. So you can analyze several aspects of the signal: For example, waveform1 shows the peaks, and waveform2 shows the average of the signal.

Remote command:

[ACQUIRE:MUWaveform](#) on page 1422

Average count (N-single count)

Access:

- "Menu" > "Acquire" > "Setup" tab > "N-single count"
- "Menu" > "Acquire" > "Mode" tab > "Average count"
- "Menu" > "Acquire" > "Segmented" tab > disable "Acquire maximum" > "Required"
- [Math] > "Arithmetic" tab > "Mode" is not "Off" > "Average count"

The acquisition and average count has several effects:

- It sets the number of waveforms acquired with [Single]
- It defines the number of waveforms used to calculate the average waveform. Thus, the instrument acquires sufficient waveforms to calculate the correct average if "Average" is enabled for waveform arithmetic. The higher the value is, the better the noise is reduced.
- It sets the number of acquisitions to be acquired in a fast segmentation acquisition series. Thus, you can acquire exactly one fast segmentation acquisition series with [Single].
If fast segmentation is enabled and configured to acquire the maximum number of acquisitions, the acquisition count is set to that maximum number and cannot be changed.
See also ["Number of acquisitions"](#) on page 132.
- It is the "Finished" criteria for the state of a mask test.

Remote command:

[ACQUIRE:COUNT](#) on page 1424

Arithmetic Reset > Mode

Defines when the envelope and average evaluation restarts.

"None"	No restart, the number of acquisitions considered by the waveform arithmetics is not limited.
"Time"	Restarts the envelope and average calculation after the time defined in "Time".
"Waveforms"	Restarts the envelope and average calculation after a number of acquired waveforms defined in "Count".

Remote command:

[ACQUIRE:ARESet:MODE](#) on page 1425

[ACQUIRE:ARESet:TIME](#) on page 1425

[ACQUIRE:ARESet:COUNT](#) on page 1425

Reset

Forces the immediate restart of the envelope and average calculation for all waveforms.

Remote command:

[ACQUIRE:ARESet:IMMediate](#) on page 1424

5.4.3 Segmented settings

Access: "Menu" > "Acquire" > "Segmented" tab.

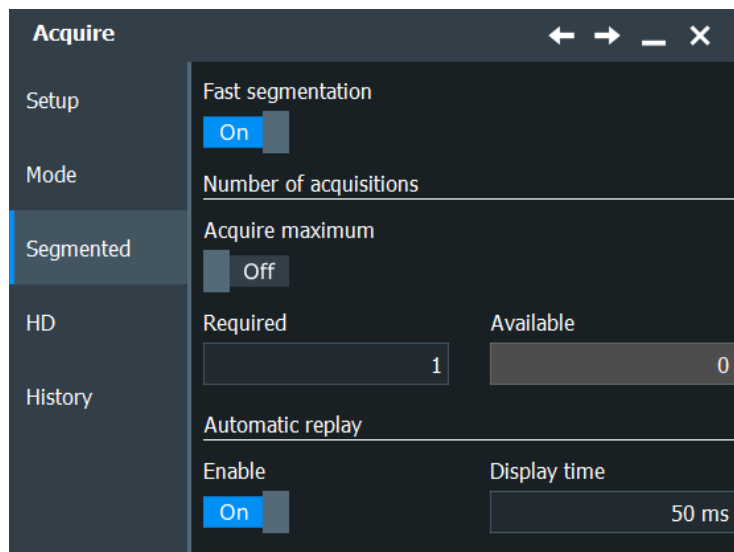

Fast segmentation

Switches the fast segmentation mode on and off.

Remote command:

[ACQUIRE:SEGMENTED:STATe](#) on page 1426

Number of acquisitions

You can define the number of acquisitions to be stored in a fast segmentation acquisition series:

- Acquire the maximum number of acquisitions that can be stored in the sample memory.
To acquire the maximum number, enable "Acquire maximum". The maximum number of acquisitions is shown in the "Required" field.
- Acquire a given number of acquisitions.
Enter the number in the "Required" field.

The acquisition count ([Average count \(N-single count\)](#)) is always set to the required number of acquisitions. Thus you can acquire exactly one fast segmentation acquisition series with [Single]. The [Run Stop] key works in the same way as [Single], it stops acquisition when the series is completed.

You can stop the running acquisition before the series is completed.

The number of acquired waveforms is shown in "Available" and can be displayed with "Show history".

Remote command:

[ACQUIRE:SEGMENTED:MAX](#) on page 1426

Enable automatic replay

If enabled, the instrument starts processing and displaying the data when the acquisition series is captured completely. Depending on the number of acquisitions, it can take some time until the acquisition series is displayed. If the setting is disabled, the instrument only captures the data and stores it in the sample memory.

Remote command:

[ACQUIRE:SEGMENTED:AUTOreplay](#) on page 1426

Display time

Defines the display speed of the fast segmentation acquisition series. Display starts after the series has been captured completely.

5.4.4 High definition mode

The high definition mode offers up to 16 bits of vertical resolution. Higher vertical resolution reduces quantization noise and acquires waveforms of higher accuracy with finer details of the signal to be seen.

The number of vertical resolution bits defines the number of vertical levels that the acquisition samples are mapped to (quantization). 16 bits of resolution represent 65536 voltage quantization levels, while 8 bits of resolution represent only 256 voltage levels. The waveform values are recorded with 16 bit word length, except for peak detect decimation.

The higher vertical resolution is achieved by applying a digital lowpass filter (DSP filter) to the output of the ADC, which reduces the bandwidth of the signal. Increasing the bandwidth reduces the resulting digital resolution. The high definition is also applied to the digital trigger, thus the R&S RTO6 can trigger with the same high resolution with which they can display signals.

High definition can be used, for example, to measure slow pulses with high accuracy, or to analyze AM signals with very low modulation index, as used in radar.

Restriction: When high definition mode is active, differential signals are not available.

See also:

- [Chapter 5.1.1, "Vertical system"](#), on page 109
- [Chapter 5.1.2, "Sampling and acquisition"](#), on page 111

5.4.4.1 High definition settings

Access: [HD]

High definition is a special acquisition mode of the oscilloscope. This mode has only one setting - the filter bandwidth.

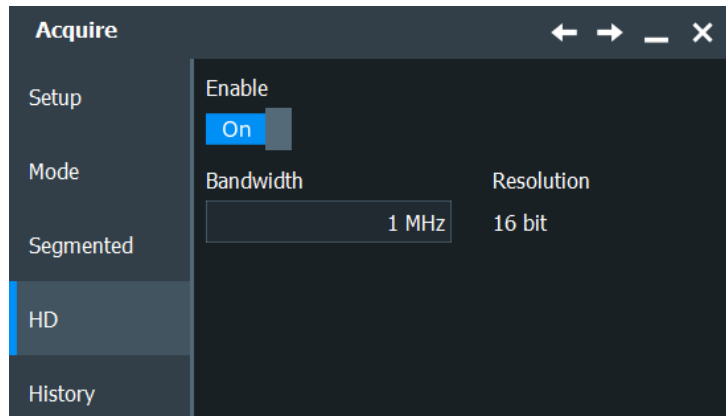

Figure 5-5: Setting the instrument into high definition mode

Enable

Enables the higher digital resolution, up to 16 bit.

Remote command:

[HDEFinition:STATE](#) on page 1482

Bandwidth

Sets the filter bandwidth for the high definition mode. The lower the filter bandwidth, the higher the resulting resolution.

Bandwidth all R&S RTO6 except for R&S RTO6-B96 on 2 channels	Bandwidth R&S RTO6-B96 on 2 channels	Resolution
≤ 50 MHz	≤ 200 MHz	16 bit
100 MHz		14 bit
200 MHz		13 bit
300 MHz, 500 MHz	300 MHz, 500 MHz	12 bit
	1 GHz	11 bit
1 GHz	2 GHz	10 bit

The maximum filter bandwidth depends on the instrument bandwidth.

Instrument bandwidth	Maximum filter bandwidth
600 MHz	500 MHz
≥ 1 GHz and < 6 GHz	1 GHz
6 GHz (R&S RTO6-B96 on 2 channels)	2 GHz

Remote command:

[HDEFinition:BWIDth](#) on page 1482

Resolution

Shows the resulting vertical resolution in high definition mode. The resolution depends on the selected [Bandwidth](#).

Remote command:

[HDEFinition:RESolution?](#) on page 1482

5.4.4.2 Effects of the high definition mode

The high definition mode has several effects:

Acquisition

The active high definition mode is indicated in the "Acquisition" label, and the actual resolution is shown.

Acquisition		
10 GSa/s	HD-Mode	
1 kpts	16 bit	Hist 0

The high definition mode works with half the real-time sample rate. For FFT, the instrument halves this sample rate again.

The waveform values are recorded with 16-bit word length, except for peak detect decimation (2 values with 8 bit).

Vertical system

The current bandwidth is shown in the channel label.

In the "Vertical" > "Bandwidth" dialog (C<x>), the "Bandwidth" setting is not available because the bandwidth is set by the high definition filter.

The minimum vertical scale is 500 μ V/div instead of 1 mV/div in normal mode.

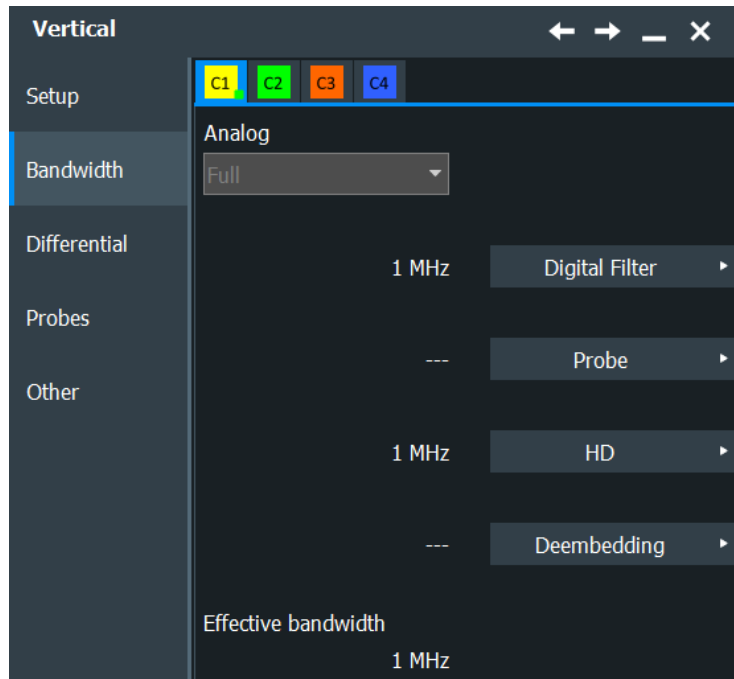

Digital filter

The digital filter settings are set automatically.

You can change the high definition "Bandwidth" in the "Acquire" > "HD" dialog.

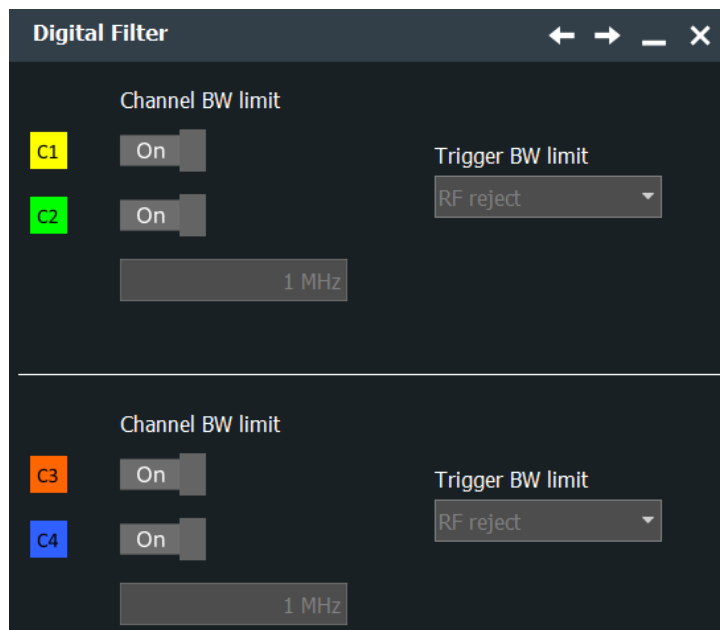

History

Due to the 16-bit word length, the history depth is reduced, less waveforms are saved than in normal mode.

Export

In high definition mode, waveform data in raw format is exported to file with 16-bit word length, except for peak detect decimation (2 values with 8 bit). In addition, you can define the byte order of the data words.

You can define additional export settings in the "Menu" key >"Save/Recall" key > "Save" tab > "Waveform" > "Setup" tab.

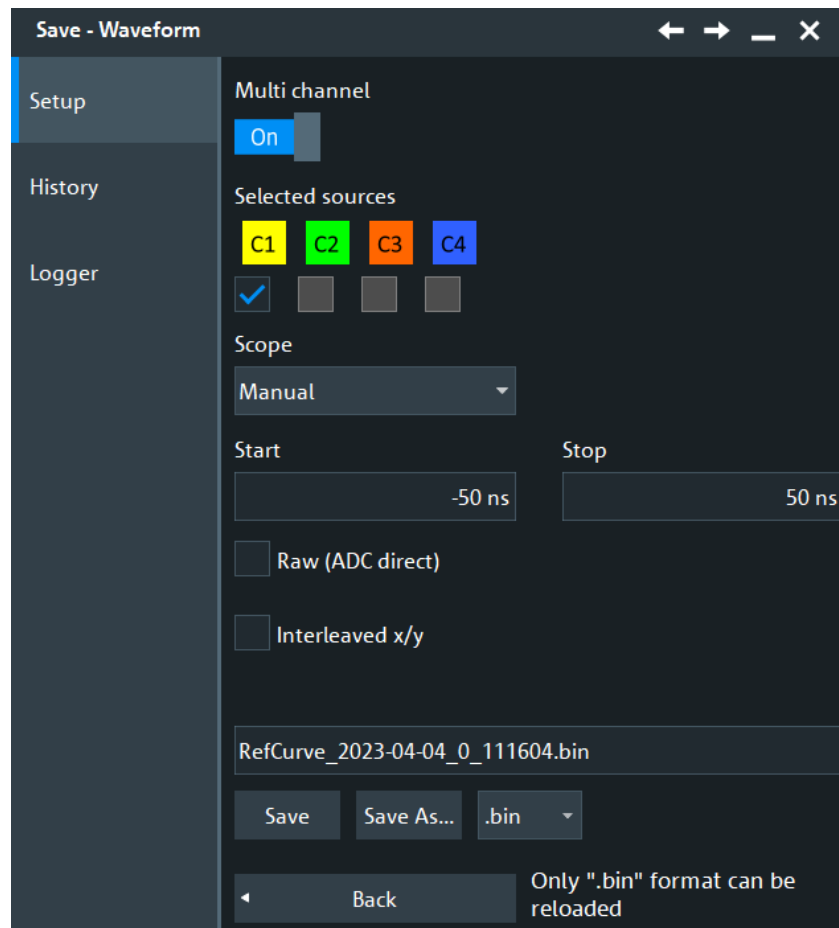

See:

- ["Raw \(ADC direct\)"](#) on page 469
- ["Interleaved x/y"](#) on page 470
- ["Byte order"](#) on page 1330

If you use remote control commands to transfer data to a controlling computer, set the data format to `INT, 16` to transfer the complete data words (see [FORMat \[: DATA \]](#) on page 1380).

Further restrictions

The I/Q mode (option R&S RTO6-K11) is not available if high definition mode is active.

5.4.5 History settings

The history settings are described in [Chapter 7.4.2, "History setup"](#), on page 285.

5.5 Vertical setup

The "Vertical" dialog box contains all channel-dependent settings and information.

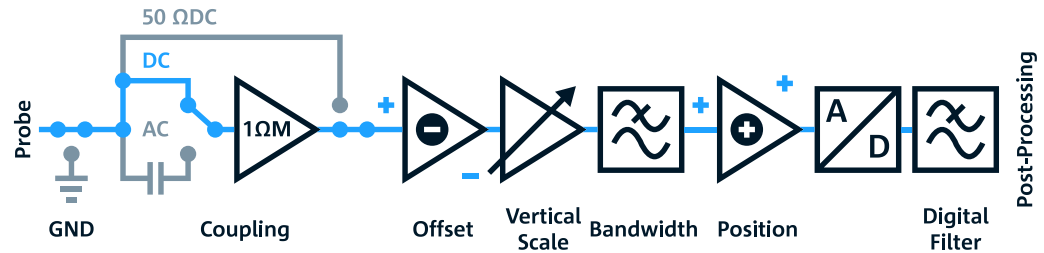
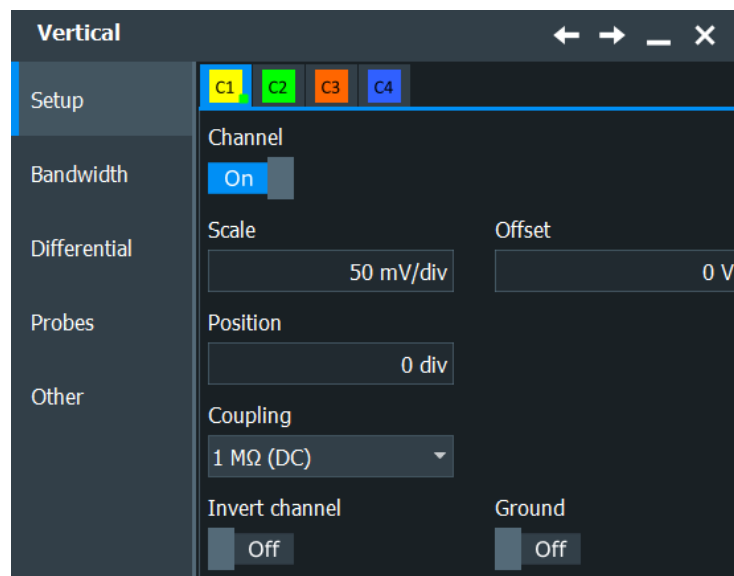

Figure 5-6: Signal path in the vertical system of R&S RTO6

5.5.1 Setup settings

Access: "Menu" > "Vertical" > "Setup"

The "Setup" tab provides all basic vertical settings. The channels are listed in horizontal subtabs. Make sure to select the correct channel tab before you enter the settings.



Channel On/Off	139
Scale	139
Offset	139
Position	139

Coupling.....	140
Invert channel.....	140
Ground.....	140

Channel On/Off

Switches the channel signal on or off. The signal icon appears on the signal bar. The waveform of the last acquisition is displayed in the diagram.

Remote command:

`CHANnel<m>:STATe` on page 1427

Scale

Defines the vertical scale in Volts per division. Increasing the scale compresses the display of the signal.

Remote command:

`CHANnel<m>:SCALE` on page 1428

Offset

The offset voltage is subtracted to correct a signal with DC offset. The vertical center of the selected channel is shifted by the offset value and the signal is repositioned within the diagram area. Negative offset values move up the waveform, positive values move it down.

The offset of a signal is determined and set by the autosegment procedure. The current value is shown in the waveform label, and it is marked by a small triangle in the grid.

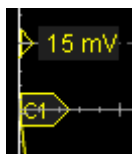

If a Rohde & Schwarz differential probe is connected, the offset is the differential offset.

If a Rohde & Schwarz modular probe is connected, the offset of the selected probe mode is used. For example, in CM mode, the offset is the common mode offset.

By default, the horizontal grid axis remains in the center when the offset is changed. To shift the axis together with the waveform, disable `Keep Y-grid fixed` in ""Settings" > Appearance > Grid".

Remote command:

`CHANnel<m>:OFFSet` on page 1429

Position

Moves the selected signal up or down in the diagram. The visual effect is the same as for `Offset` but the waveform is adjusted later in the signal flow. While the offset sets a voltage, position is a graphical setting given in divisions.

By default, the horizontal grid axis remains in the center when the offset is changed. To shift the axis together with the waveform, disable `Keep Y-grid fixed` in ""Settings" > Appearance > Grid".

Remote command:

`CHANnel<m>:POSition` on page 1429

Coupling

Selects the connection of the channel signal. The coupling determines what part of the signal is used for waveform analysis and triggering.

In addition to coupling, the signal can be filtered for high frequency rejection, see [Chapter 5.5.5, "Digital filter setup"](#), on page 143.

"50 Ω (DC)"	Connection with 50 Ω termination, passes both DC and AC components of the signal.
"1 M Ω (DC)"	Connection with 1 M Ω termination, passes both DC and AC components of the signal.
"1 M Ω (AC)"	Connection with 1 M Ω termination through DC capacitor, removes DC and very low-frequency components. If AC coupling is set, the attenuation of passive probes has no effect, and voltage is applied to the instrument with factor 1:1. Observe the voltage limits, otherwise you can damage the instrument.

Remote command:

[CHANnel<m>:COUPling](#) on page 1427

Invert channel

Turns the inversion of the signal amplitude on or off. To invert means to reflect the voltage values of all signal components against the ground level. If the inverted channel is the trigger source, the instrument triggers on the inverted signal.

You can use inversion, for example, to switch the polarity of a differential signal without changing the probe connections.

Remote command:

[CHANnel<m>:INVert](#) on page 1429

Ground

Connects the input to the ground.

Remote command:

[CHANnel<m>:GND](#) on page 1428

5.5.2 Bandwidth settings

Access: "Menu" > "Vertical" > "Bandwidth"

The "Bandwidth" tab provides all settings that affect the bandwidth of the measurement system. The channels are listed in horizontal subtabs. Make sure to select the correct channel tab before you enter the settings.

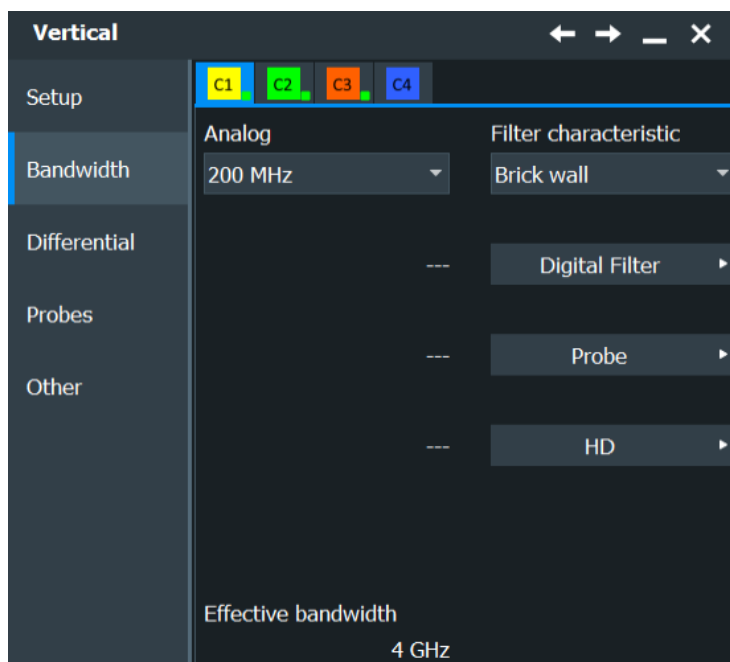

Analog

Selects the bandwidth limit.

The specified bandwidth indicates the range of frequencies that the instrument can acquire and display accurately with less than 3dB attenuation. The probe has also a limited bandwidth and thus affects the resulting system bandwidth.

At full bandwidth, all frequencies in the specified range are acquired and displayed.

"20 MHz, 200 MHz, 800 MHz": Frequencies above the selected limit are removed to reduce noise at different levels. The "800 MHz" filter is available for 50 Ω coupling on scopes with ≥ 1 GHz instrument bandwidth.

See also: [Chapter 5.1.1.3, "Bandwidth"](#), on page 111

Remote command:

[CHANnel<m>:BANDwidth](#) on page 1430

Filter characteristic

Selects the filter that is used to reduce the bandwidth.

"Brick wall" The result is a maximally flat step response.

"Gaussian" The result is step-response optimized.

Effective bandwidth

Displays the effective bandwidth.

5.5.3 Probes settings

See [Chapter 5.6, "Probes"](#), on page 145.

5.5.4 Other settings

Access: "Menu" > "Vertical" > "Other"

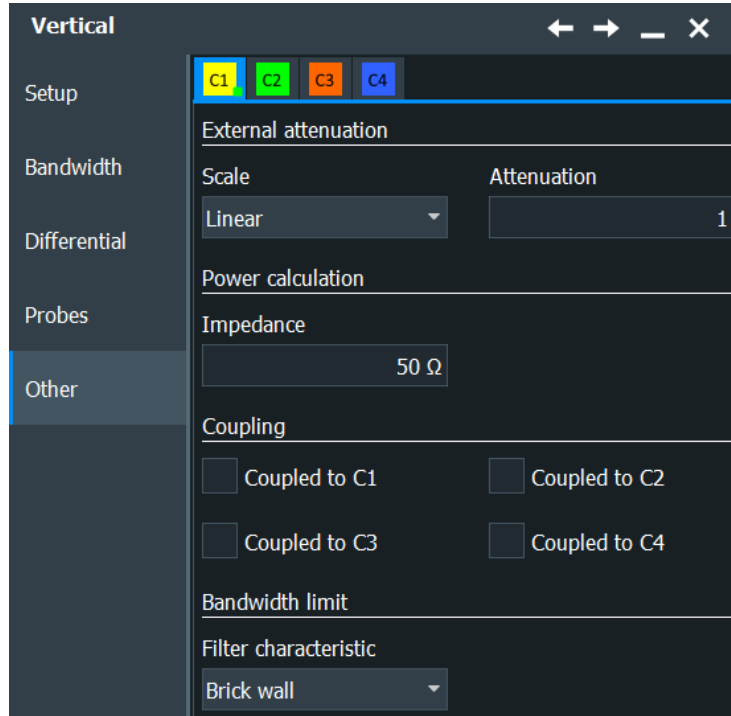

External attenuation: Scale, Attenuation

Consider a voltage divider that is part of the DUT before the measuring point. The external attenuation is included in the measurement, and the instrument shows the results that would be measured before the divider. External attenuation can be used with all probes.

"Scale" Select linear or logarithmic attenuation scale.

"Attenuation" Enter the attenuation of the voltage divider according to the selected scale. The conversion from linear to logarithmic values depends on the "Vertical unit" of the probe:

For voltage-based unit (V and A):

$$\text{attenuation (dB)} = 20 * \log_{10}(\text{attenuation factor})$$

For power-based unit (W):

$$\text{attenuation (dB)} = 10 * \log_{10}(\text{attenuation factor})$$

Remote command:

[CHANnel<m>:EATScale](#) on page 1436

[CHANnel<m>:EATTenuation](#) on page 1437

Impedance

Sets the impedance of the channel for power calculations and measurements.

Remote command:

[CHANnel<m>:IMPedance](#) on page 1431

Coupled to C1 / C2 / C3 / C4

Channel coupling sets the vertical settings of the coupled channels to the values of the active channel. If you want to have the same vertical settings for two or more channels, you can set them at once by coupling these channels.

Channel coupling affects all vertical settings that are adjusted in the "Settings" tab: vertical scale, position, offset, coupling, and ground.

Remote command:

[CHANnel<m>:CPLing](#) on page 1430

Filter characteristics

Selects the type of filter that is used. In the acquisition system, you can define the roll-off of the frequency response of the instrument.

Note: This setting does not apply to oscilloscopes with 4 GHz bandwidth.

"Brick wall"	Ensures a maximally flat frequency response up to the instrument bandwidth. Also a maximally sharp rolloff above the instrument bandwidth to minimize the noise level.
"Gaussian"	Ensures minimum overshoots in the recorded waveforms. Also a more flat rolloff above the instrument bandwidth with a slightly higher noise level than the Brick wall characteristic.

Remote command:

[CHANnel<m>:FILDesign](#) on page 1431

5.5.5 Digital filter setup

Access: "Menu" > "Vertical" > "Bandwidth" tab > "Digital Filter"

After processing by the A/D converter, the channel and trigger signals are digitized signals. These digitized signals can be filtered to reject high frequency - also known as Digital Signal Processing (DSP). You can filter the acquisition channels and the trigger channel signal.

One filter is applied to a pair of channels. If you filter only on the input channels, you can apply different filters to the channels - one filter for channels 1 and 2 and another filter for channels 3 and 4.

If you filter the trigger channel, the same filter must be used for the input channels to ensure that all signals suit for analysis. The instrument offers only permitted combinations and triggers on the filtered signal.

In high definition mode, digital filter settings are enabled automatically. You can change the high definition bandwidth in the "Digital Filter" setup, which is applied to the channels.

Example:

"RF reject" for the trigger signal ensures that triggering is not caused by unexpected glitches.

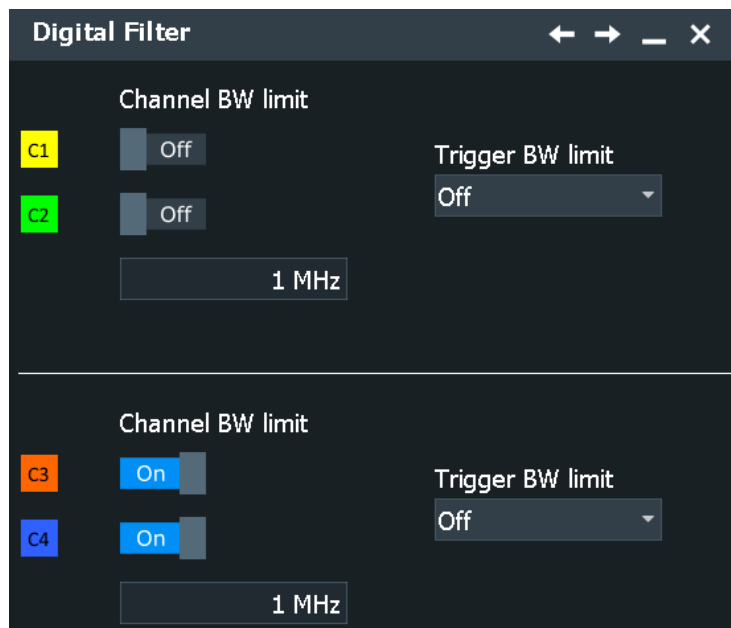

Channel BW limit (On/Off)

Enables the DSP filter for the corresponding input channel.

Remote command:

[CHANnel<m>:DIGFilter:STATe](#) on page 1478

Channel BW limit

If "Trigger BW limit" is "Off", it sets the limit frequency of the lowpass filter for input channels. One filter is applied to a pair of channels.

If "Trigger BW limit" is "RF reject", it sets the limit frequency that is applied to the trigger channel and to the input channels enabled for filtering.

Remote command:

[CHANnel<m>:DIGFilter:CUToff](#) on page 1478

[TRIGger<m>:RFReject](#) on page 1479

Trigger BW limit

Selects the filter for the trigger channel. Other channels must use the same filter, or proceed unfiltered.

"Off" The trigger signal is not filtered, and the acquisition channels can be filtered independently.

"RF reject" Frequencies higher than the "Channel BW limit" are rejected, lower frequencies pass the filter.

Remote command:

[TRIGger<m>:COUpling](#) on page 1478

5.6 Probes

With R&S RTO6 digital oscilloscopes, you can use various probe types. Mostly these probes are passive and active voltage probes. The "Probes" dialog provides all probe-relevant information.

The instrument can detect many probes and read out the probe-specific parameters, for example, bandwidth and attenuation.

In the "Probes" tab, you find all settings that are relevant for the connected probe.

Access: "Menu" > "Vertical" > "Probes"

The functionality on the "Probes" tab changes according to the type of the attached probe. Probes with Rohde & Schwarz probe interface (probe box), and also many other passive voltage probes, are recognized by the instrument. The R&S RTO6 reads out the main characteristics of the probe and displays them. Other probes cannot be detected, but their characteristics are known to the instrument. These known probes are called "Predefined probes". Probes that are not recognized automatically and not predefined are unknown probes, they require manual setting of measurement unit and attenuation.



Before you adjust the settings, select the correct channel tab.

Additional information is given in the "Probe Attributes" and "Calibration Results" tabs. For background information, see [Chapter 5.1.4, "Probes"](#), on page 115.

This chapter has the following sections:

• Shared probe settings	145
• Settings for the R&S probe interface (voltage probes)	147
• Setup for passive probes	150
• Setup for active voltage probes	152
• Setup for modular probes	157
• Setup for predefined probes	162
• Setup for current probes	164
• Setup for optical isolated probe systems	167
• Setup for unknown probes	171
• Probes info	171
• Probe adapter R&S RT-Z2T	173

5.6.1 Shared probe settings

Some of the settings in the "Probes" tab are available for all probes.

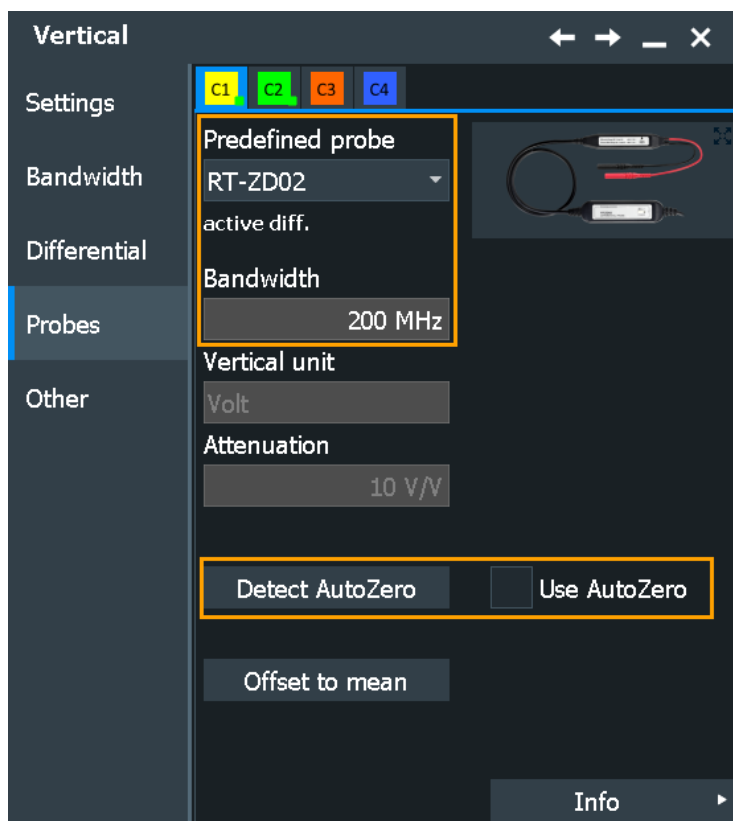

An external attenuation can be set on the "Other" tab, see ["External attenuation: Scale, Attenuation"](#) on page 142.

The shared probe settings are:

Type, Name, Bandwidth	146
Detect AutoZero, Use AutoZero	146

Type, Name, Bandwidth

The fields show the characteristics of a recognized or predefined probe for information. The bandwidth is the effective bandwidth.

If the instrument cannot recognize the probe, and the probe is not known, the "Type" is "None", and the other fields are empty.

Remote command:

[PROBe<m>:SETup:TYPE?](#) on page 1434

[PROBe<m>:SETup:NAME?](#) on page 1435

[PROBe<m>:SETup:BANDwidth?](#) on page 1435

Detect AutoZero, Use AutoZero

Differences in DUT and oscilloscope ground levels can cause larger zero errors, which affect the waveform. If the DUT is ground-referenced, the AutoZero function corrects the zero error of the probe to optimize measurement results at small signal levels. The validation limit depends on the probe attenuation because probes with high attenuation often have to compensate high offsets. AutoZero detects offset values even when the signal is out of the current measurement range.

To correct the zero error of voltage probes, short the signal pin and the ground pin together and connect them to the ground of the DUT. Then tap "Detect AutoZero". While the alignment is running, the instrument switches to DC coupling to display the waveform correctly.

To include the measured offset in measurement results, enable "Use AutoZero".

If a current probe is connected, the function demagnetizes the probe's sensor head and sets the waveform to zero position. See "Detect AutoZero" on page 167.

Remote command:

`PROBe<m>:SETup:OFFSet:AZERo` on page 1436

`PROBe<m>:SETup:OFFSet:USEautozero` on page 1436

5.6.2 Settings for the R&S probe interface (voltage probes)

Active voltage probes with Rohde & Schwarz probe interface provide special features: the micro button and the ProbeMeter. Furthermore, the R&S RTO6 can read out the attenuation of the probe.

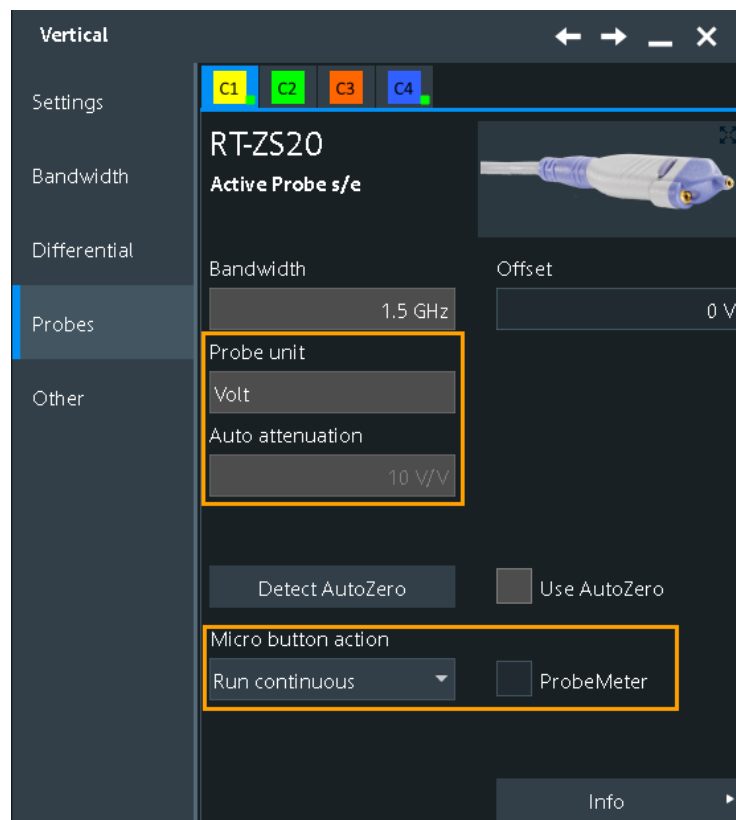

The settings for active voltage probes with Rohde & Schwarz probe interface are:

Probe unit, Auto attenuation	148
Micro button action	148
ProbeMeter	149
ProbeMeter results	149

Probe unit, Auto attenuation

If the probe is recognized by the R&S RTO6, the instrument reads the attenuation unit and value from the probe and displays them.

Remote command:

`PROBe<m>:SETup:ATTenuation[:AUTO]?` on page 1435

Micro button action

Active voltage probes with Rohde & Schwarz probe interface have a configurable micro button on the probe head. Pressing this button, you start an action on the instrument directly from the probe. The button is disabled during internal automatic processes, for example, during self-alignment, autose, and find level.

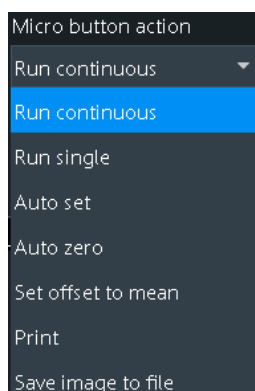

Select the action that you want to start from the probe:

"Run Continuous"

Default assignment. Starts or stops the acquisition (same as Run Stop key).

"Run single" Starts a defined number of acquisitions (same as [Single] key).

"Auto set" Starts the autose procedure (same as Autose key).

"AutoZero" Starts an auto zero measurement, see ["Detect AutoZero, Use AutoZero"](#) on page 146.

"Set offset to mean"

Performs an automatic compensation for a DC component of the input signal using the result of a background mean measurement. See: ["Offset to mean"](#) on page 164.

"Save image to file"

Saves the current display as image according to the image settings. See also [Chapter 12.3, "Screenshots"](#), on page 483.

"No action" Select this option to prevent unwanted actions due to unintended usage of the micro button.

"Find trigger level" Sets the trigger level automatically to $0.5 * (MaxPeak - MinPeak)$.

"Create report" Creates and saves a report using the report settings. See also [Chapter 12.4.1, "Report settings"](#), on page 488.

"Probe mode" Only available if a R&S RT-ZM modular probe is connected. Sets the measurement mode of the modular probe. See also "Probe mode" on page 158.

"Probe Setup" Opens the "Probes Setup" dialog box.

Remote command:

`PROBe<m>:SETup:MODE` on page 1437

ProbeMeter

Activates the integrated R&S ProbeMeter.

For active single-ended, differential and modular probes, the measured voltages are displayed in the "ProbeMeter" result box on the screen.

For optical isolated probes, you can set the measured value to be used as offset.

Remote command:

`PROBe<m>:PMETer:VISibility` on page 1439

ProbeMeter results

The integrated R&S ProbeMeter of active voltage probes with Rohde & Schwarz probe interface is a voltmeter. It measures DC voltages between the probe tip and ground connection or between the probe sockets with very high precision. The R&S ProbeMeter enables ground-referenced measurements of voltages. The measurement is performed continuously and in parallel to the measurements of the oscilloscope.

The measured voltages are displayed in the "ProbeMeter" result box on the screen.

- **ProbeMeter measurement results of single-ended active R&S probes**
Measures the voltage between the probe tip and the ground.

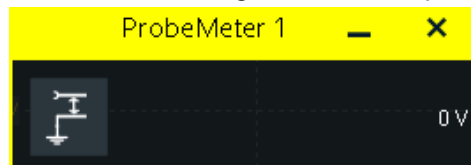

- **ProbeMeter measurement results of differential and modular R&S probes**

You can select the voltage to be measured by the differential active probe:

- "Differential / Common Mode":

Differential voltage is the voltage between the positive and negative signal sockets.

Common mode voltage is the mean voltage between the signal sockets and the ground socket. It measures the voltage level relative to ground, for example, to check the operating voltage window.

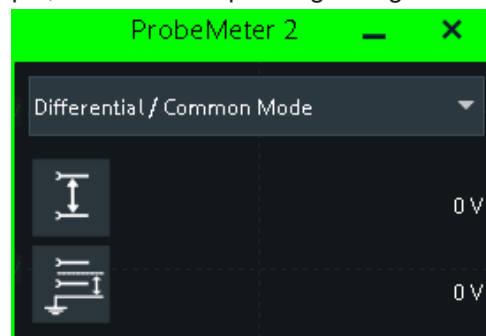

- "Single Ended Pos/Neg": Measures the voltage between the positive/negative signal socket and the ground.

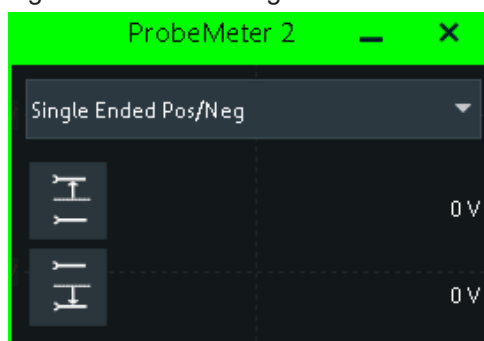

The ProbeMeter always measures the common mode and differential voltages. Single-ended voltages are calculated values:

$$V_p = V_{cm} + 0.5 * V_{in} \text{ and } V_n = V_{cm} - 0.5 * V_{in}$$

Remote command:

[PROBe<m>:SETup:DISPlaydiff](#) on page 1439

[PROBe<m>:PMETer:RESults:SINGle?](#) on page 1439

[PROBe<m>:PMETer:RESults:POSitive?](#) on page 1441

[PROBe<m>:PMETer:RESults:NEGative?](#) on page 1441

[PROBe<m>:PMETer:RESults:DIFFerential?](#) on page 1440

[PROBe<m>:PMETer:RESults:COMMon?](#) on page 1440

5.6.3 Setup for passive probes

Passive probes are the most widely used probes for oscilloscope measurements. Passive probes require compensation.

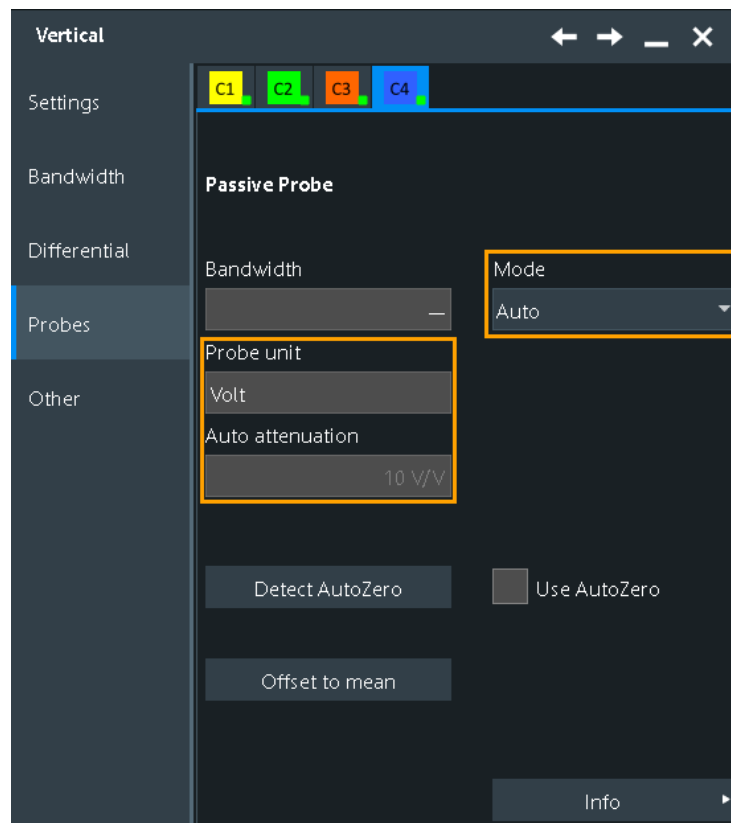

Figure 5-7: Probe setup for passive probe

The following shared probe settings are available:

- ["Type, Name, Bandwidth"](#) on page 146
- ["Detect AutoZero, Use AutoZero"](#) on page 146

If a passive probe is connected, the probe attenuation is read out and shown in the "Setup" tab:

- ["Probe unit, Auto attenuation"](#) on page 148

If you need to change the unit or attenuation, change the "Mode" to "Manual" and enter the correct values.

Mode	151
Vertical unit, Attenuation, Gain	152

Mode

Defines how the attenuation of a passive probe is set.

"Auto" The instrument uses the values that are read out from the probe.

"Manual" You can define the attenuation unit and value.
See: ["Vertical unit, Attenuation, Gain"](#) on page 152

Remote command:

`PROBe<m>:SETup:ATTenuation:MODE` on page 1442

Vertical unit, Attenuation, Gain

If a predefined probe is connected and selected, the attenuation or gain values are shown.

For unknown probes and passive probes in manual mode, you can set user-defined values for unit, gain and attenuation.

If AC coupling is set, the attenuation of passive probes has no effect, and voltage is applied to the instrument with factor 1:1. Observe the voltage limits, otherwise you can damage the instrument.

Remote command:

`PROBe<m>:SETup:ATTenuation:UNIT` on page 1442

`PROBe<m>:SETup:ATTenuation:MANual` on page 1442

`PROBe<m>:SETup:GAIN:MANual` on page 1443

5.6.4 Setup for active voltage probes

Active voltage probes with Rohde & Schwarz probe interface have an integrated data memory that contains identification data and individual probe correction parameters. The R&S RTO6 can detect these probes and read out the data. Furthermore, these probes have a micro button and a ProbeMeter.



Active voltage probes that are offered by Rohde & Schwarz but not equipped with a Rohde & Schwarz probe interface are known to the R&S RTO6 as predefined probes, see [Chapter 5.6.6, "Setup for predefined probes"](#), on page 162.

The following shared probe settings are available:

- ["Type, Name, Bandwidth"](#) on page 146
- ["Detect AutoZero, Use AutoZero"](#) on page 146

Special features of the Rohde & Schwarz probe interface are described in these sections:

- ["Probe unit, Auto attenuation"](#) on page 148
- ["Micro button action"](#) on page 148
- ["ProbeMeter results"](#) on page 149

The specific settings of Rohde & Schwarz active probes are described in the following chapters:

- [R&S RT-ZS single-ended probes](#)..... 153
- [R&S RT-ZD differential probes](#)..... 154
- [R&S RT-ZPR power rail probes](#)..... 155
- [R&S RT-ZHD high-voltage differential probes](#)..... 156

5.6.4.1 R&S RT-ZS single-ended probes

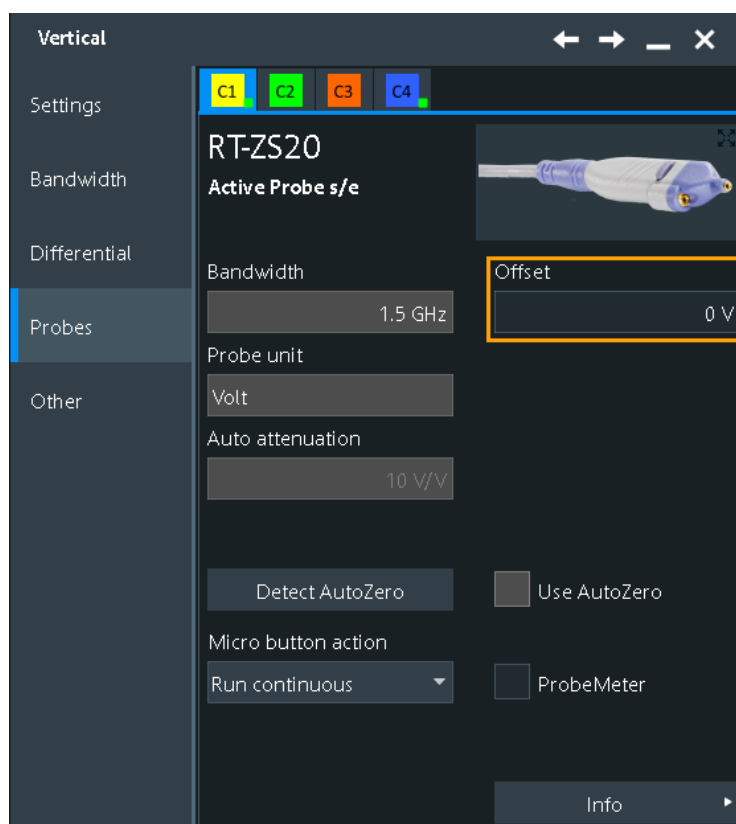

Figure 5-8: Probe setup for active single-ended probe R&S RT-ZS20

The only setting for R&S RT-ZS probes is the channel offset. See ["Offset"](#) on page 139.

5.6.4.2 R&S RT-ZD differential probes

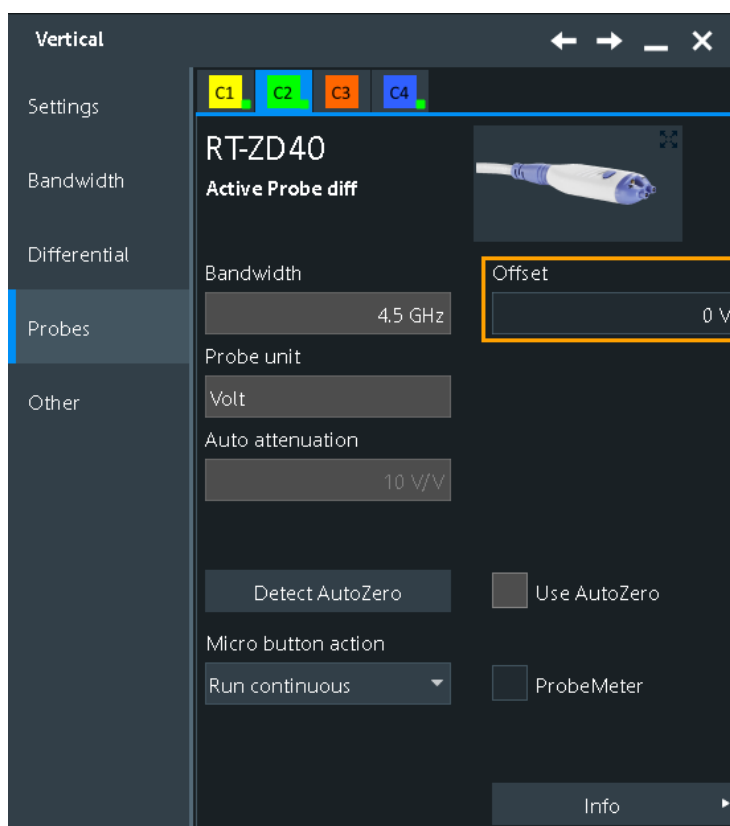

Figure 5-9: Probe setup for active differential probe R&S RT-ZD40

The offset is the differential offset. See "Offset" on page 139.

Specific settings for R&S RT-ZD probes are the following:

CM offset

Sets the common-mode offset to compensate for a common DC voltage applied to both input sockets (referenced to the ground socket). Offset compensation is particularly helpful for measurements on differential signals with high common mode levels, for example, current measurements using a shunt resistor. You can measure the common mode input voltage using the R&S ProbeMeter.

The setting is available for Rohde & Schwarz differential probes, and for modular probes in DM or CM mode (see "DM Offset, CM Offset, P Offset, N Offset" on page 159).

Remote command:

`PROBe<m>:SETup:CMOffset` on page 1443

Probe attenuator RT-ZA15

If you use the external attenuator R&S RT-ZA15 together with one of the differential active probes R&S RT-ZD10/20/30, enable RT-ZA15 to include the external attenuation in the measurements.

Remote command:

`PROBe<m>:SETup:ZAXV` on page 1443

5.6.4.3 R&S RT-ZPR power rail probes

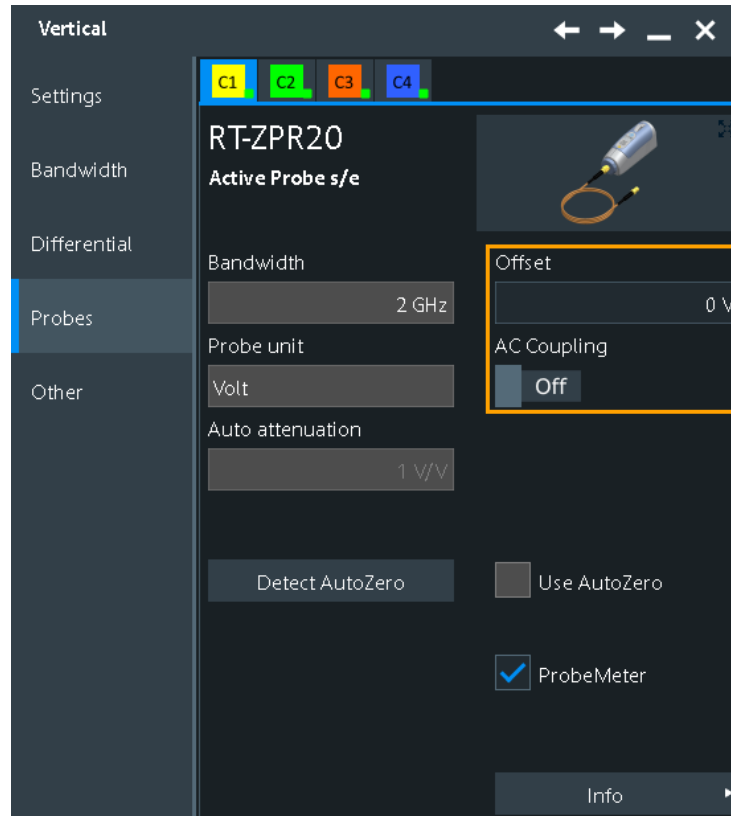

Figure 5-10: Probe setup for power rail probe R&S RT-ZPR

The offset is the channel offset. See "Offset" on page 139.

If the ProbeMeter is active, an additional function is provided in the "ProbeMeter" result box:

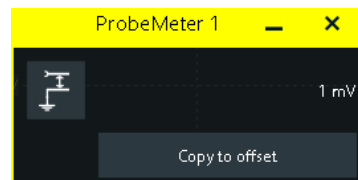

Figure 5-11: ProbeMeter result box for

Specific settings for R&S RT-ZPR probes are the following:

AC Coupling

Enables AC coupling in the R&S RT-ZPR power rail probes, which removes DC and very low-frequency components. The R&S RT-ZPR probe requires 50 Ω input termination, for which the channel AC coupling is not available. The probe setting allows AC coupling also at 50 Ω inputs.

Remote command:

`PROBe<m>:SETup:ACCoupling` on page 1444

Copy to offset

Sets the measured R&S ProbeMeter value as offset. Thus, the value is considered in measurements.

Remote command:

`PROBe<m>:SETup:ADVanced:PMToffset` on page 1444

5.6.4.4 R&S RT-ZHD high-voltage differential probes

Figure 5-12: Probe setup for R&S RT-ZHD probes

The offset is the differential offset. See "[Offset](#)" on page 139.

Specific settings for R&S RT-ZHD probes are the following:

Range

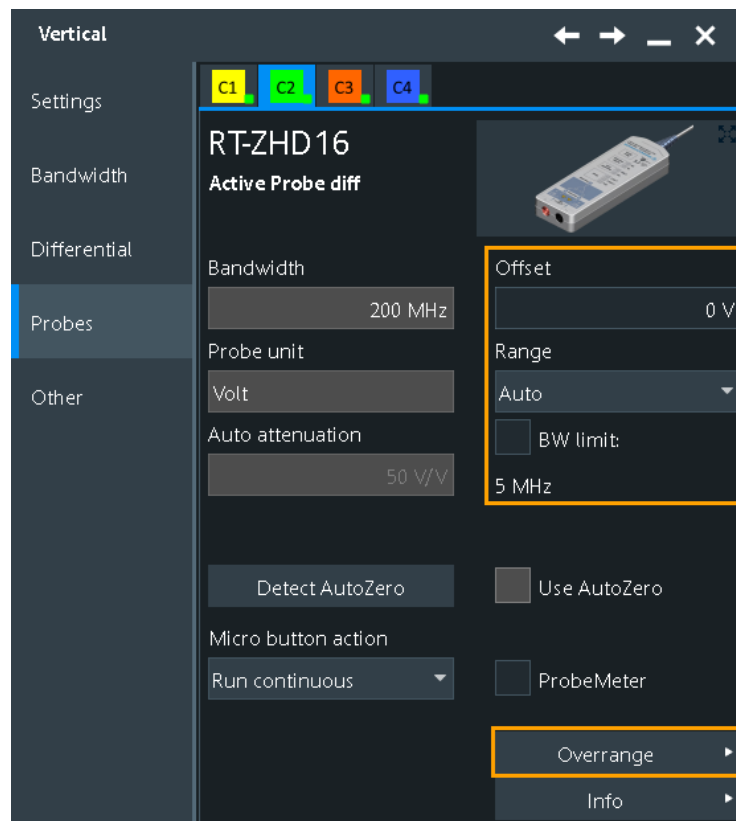
Sets the voltage range of a R&S RT-ZHD probe. You can set the range on the probe control box or at the oscilloscope.

"Auto"	The voltage range is set only at the oscilloscope with "Vertical scale".
"Low"	Sets the lower voltage range of the connected probe. The selected value is shown in "Auto Attenuation".
"High"	Sets the higher voltage range of the connected probe. The selected value is shown in "Auto Attenuation".

Remote command:

[PROBe<m>:SETup:ADVanced:RANGe](#) on page 1444

BW limit

Activates the lowpass filter in the probe control box and displays the used limit. You can also set the filter directly on the probe control box.

Remote command:

[PROBe<m>:SETup:ADVanced:FILTer](#) on page 1445

Buzzer

Activates the acoustic overrange warning in the probe control box. You can also activate the sound directly on the probe control box.

Remote command:

[PROBe<m>:SETup:ADVanced:AUDioverload](#) on page 1445

Negative, Positive, Differential Overage

The color turns red if the voltage exceeds the probe range. The indicators are also available on the probe control box.

5.6.5 Setup for modular probes

The probes of the R&S RT-ZM family are modular probes. They have a probe head and a probe amplifier connected by a cable, and various probe tip modules and tip cables for different applications. R&S RT-ZM probes are equipped with Rohde & Schwarz probe interface, and provide special features: R&S ProbeMeter, micro button, and a wide offset compensation range.

The following shared probe settings are available:

- ["Type, Name, Bandwidth"](#) on page 146
- ["Detect AutoZero, Use AutoZero"](#) on page 146

Special features of the Rohde & Schwarz probe interface are described in these sections:

- ["Probe unit, Auto attenuation"](#) on page 148
- ["Micro button action"](#) on page 148
- ["ProbeMeter results"](#) on page 149

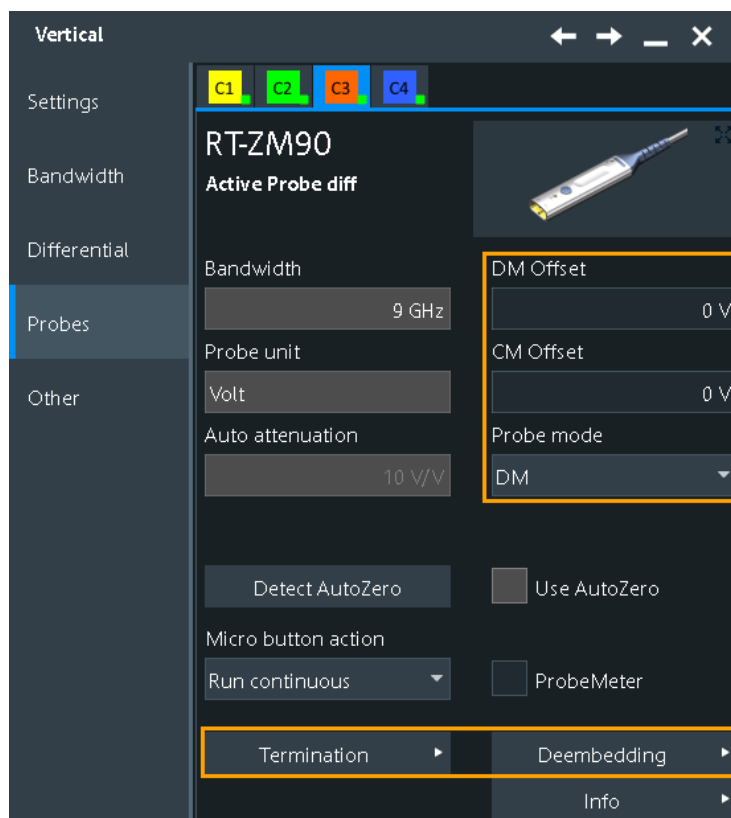

- [Setup parameters of modular probes](#).....158
- [Deembedding for modular probes](#).....159
- [Termination voltage with R&S RT-ZMA40 SMA module](#)..... 161

5.6.5.1 Setup parameters of modular probes

The basic setup parameters of all modular probes are the measurement mode and the offset settings.

Access: "Menu" > "Vertical" > "Probes"

Make sure to adjust also the deembedding settings under "Probe Deembedding" (see [Chapter 5.6.5.2, "Deembedding for modular probes"](#), on page 159).

Probe mode

Sets the measurement mode of modular probes.

The modular probes of the R&S RT-ZM family have a multi-mode function. You can switch between single-ended, differential and common mode measurements without reconnecting or resoldering the probe. You can set the probe mode in the dialog box, and you can assign the probe mode setting to the micro button.

If you use the R&S RT-ZMA30 browser module, only DM measurements are possible because this module has no ground connector.

The measurement modes are:

"DM"	Differential mode input voltage (V_{dm}), the voltage between the positive and negative input terminal. $V_{dm} = V_p - V_n$
"CM"	Common mode input voltage (V_{cm}), the mean voltage between the positive and negative input terminal vs. ground. $V_{cm} = \frac{V_p + V_n}{2}$
"P"	Positive single-ended input voltage (V_p). The voltage between the positive input terminal and ground.
"N"	Negative single-ended input voltage (V_N). The voltage between the negative input terminal and ground.

Remote command:

[PROBe<m>:SETup:PRMode](#) on page 1446

DM Offset, CM Offset, P Offset, N Offset

Compensate offset voltages. Available offsets depend on the selected probe mode.

The offset of the selected probe mode is used as channel offset and considered automatically for correction. For example, in CM mode, the common mode offset is used as channel offset. See also: ["Offset"](#) on page 139.

"DM Offset"	Compensates a DC voltage applied between the positive (V_p) and the negative (V_n) input terminal at the probe tip.
"CM Offset"	Compensates a DC voltage applied to both input terminals referenced to ground. See also: "CM offset" on page 154.
"P Offset"	Compensates a DC voltage applied to the positive input terminal (V_p) referenced to ground.
"N Offset"	Compensates a DC voltage applied to the negative input terminal (V_n) referenced to ground.

Remote command:

[PROBe<m>:SETup:DMOffset](#) on page 1446

[PROBe<m>:SETup:CMOffset](#) on page 1443

[PROBe<m>:SETup:NOFFset](#) on page 1447

[PROBe<m>:SETup:POFFset](#) on page 1448

5.6.5.2 Deembedding for modular probes

Deembedding removes the parasitic effects of the measurement setup from the measured signal. These effects are typically increasing when signal frequency increases. Thus, deembedding is useful or even necessary when measuring signals of 4 GHz frequency or higher.

Access: "Vertical" menu > "Probe Setup" > "Probe Deembedding"

Probe tip module, Pin spacing

Selects the tip module that is used for measurement.

If R&S RT-ZMA40 is selected, choose also the used submodule: semi-rigid cables or none.

For the browser module R&S RT-ZMA30, measure the space between the pins, and select the appropriate value.

Remote command:

[PROBe<m>:DEEMbedding:TIPModule\[:SElect\]](#) on page 1450

[PROBe<m>:DEEMbedding:TIPModule:ZMA<n>:SUBModule](#) on page 1450

Probing, Terminating

Sets the probing mode.

Select "Probing" if you use a high-ohmic probe and measure on an existing line in parallel to the load.

Select "Terminating" if the measuring equipment is the load of the line.

Remote command:

[PROBe<m>:DEEMbedding:MODE](#) on page 1451

[DEEMbedding<m>:COMPonent<n>:MODE](#) on page 2804

Effective bandwidth

Sets the maximum bandwidth for probe deembedding until which the signal is corrected. This maximum value is the minimum bandwidth value of the probe bandwidth, tip module bandwidth, and oscilloscope bandwidth. It cannot be higher than the highest frequency in a used S-parameter file.

Consider that most tip modules support the full bandwidth of the probe, but some tip modules have limited bandwidth.

If deembedding option R&S RTO6-K121 is active, the instrument uses the effective bandwidth that is set in the "Deembedding" > "Setup" dialog box.

Remote command:

[PROBe<m>:DEEMbedding:BANDwidth](#) on page 1451

Probe mode

See "[Probe mode](#)" on page 158.

Remove probe load

If "Probing" is selected, you can remove the loading of the probe.

If the probe loading is removed, you see the signal that would be at the measurement point if the probe's input impedance is ideal (infinite impedance).

Without removing the loading, you see the real signal at the measurement point, including the probe loading.

Remote command:

[PROBe<m>:DEEMbedding:REMPobeload](#) on page 1452

[DEEMbedding<m>:COMPonent<n>:LOAD:REMPobeload](#) on page 2805

Source impedance

Shows the source impedance of the DUT. If an R&S RT-ZM probe is connected, the value depends on the selected probe mode: common mode, differential, or single-ended measurement.

Remote command:

[DEEMbedding<m>:COMPONENT<n>:LOAD:IMPedance?](#) on page 2805

[PROBe<m>:DEEMbedding:LOAD:IMPedance](#) on page 1452

5.6.5.3 Termination voltage with R&S RT-ZMA40 SMA module

Termination voltage is relevant if you use the R&S RT-ZMA40 SMA module. The SMA module applies a termination voltage (± 4 V) to the DUT to enable measurements against a common mode DC voltage instead of ground. This measurement is required for many digital signal standards.

The termination voltage can be controlled by the oscilloscope. Therefore, connect the V_T terminal of the R&S RT-ZM probe amplifier to the V_T terminal of the R&S RT-ZMA40 SMA module using the red DC lead (see R&S RT-ZM User Manual). The required termination voltage is measured and adjusted automatically, but can also be set manually.

Access: "Menu" > "Vertical" > "Probes" > "Termination"

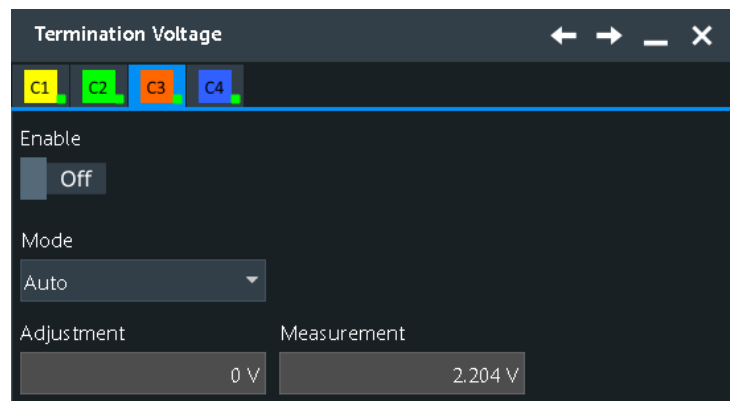

Enable

Activates control of the termination voltage.

Remote command:

[PROBe<m>:SETup:TERM:STATE](#) on page 1448

Mode

In "Auto" mode, the instrument uses the measured common mode voltage for termination.

In "Manual" mode, you can enter the voltage to be used for termination. Use the manual mode if you know the common mode voltage of the DUT.

Remote command:

[PROBe<m>:SETup:TERM:MODE](#) on page 1448

Adjustment

Sets the voltage to be used for termination to DC voltage.

Remote command:

[PROBe<m>:SETup:TERM:ADJust](#) on page 1449

Measurement

Shows the measured common mode voltage.

Remote command:

[PROBe<m>:SETup:TERM:MEASure?](#) on page 1449

5.6.6 Setup for predefined probes

Probes that cannot be detected, but their characteristics are known to the R&S RTO6 are called "Predefined probes".

The following shared probe settings are available:

- "Type, Name, Bandwidth" on page 146
- "Detect AutoZero, Use AutoZero" on page 146

The probe attenuation of the selected probe is also shown in the "Probes" tab:

- "Probe unit, Auto attenuation" on page 148

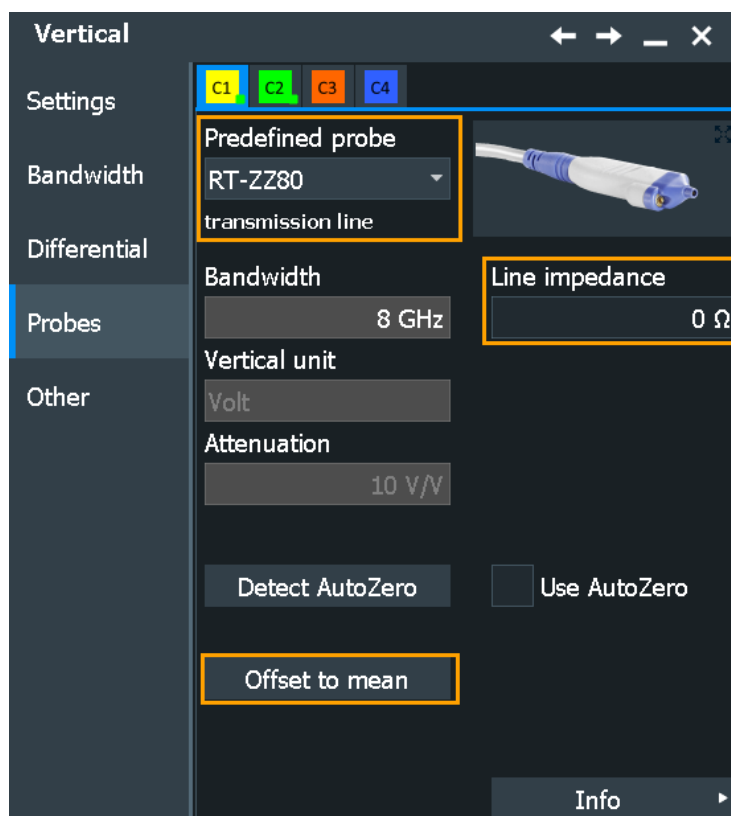

Figure 5-13: Probe setup for transmission line probe R&S RT-ZZ80

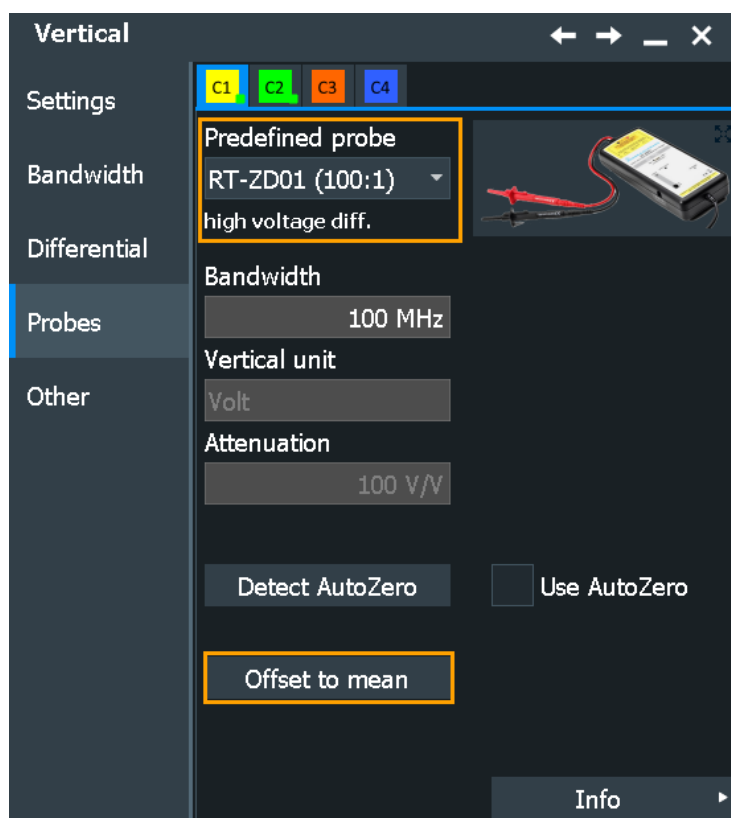

Figure 5-14: Probe setup for R&S RT-ZD01

Specific settings for predefined probes are the following:

Predefined probe.....	163
Offset to mean.....	164
Line impedance.....	164

Predefined probe

List of probes that are known to the instrument. The instrument lists only probes that match the instrument coupling and, if connected, also the used adapter.

Select the used probe on the list. The corresponding "Vertical unit" and the "Attenuation" or "Gain" are shown.

All other unrecognized probes that are not listed, are unknown probes. For these probes, set "Predefined probe" to "None". See [Chapter 5.6.9, "Setup for unknown probes"](#), on page 171.

Remote command:

`PROBe<m>:SETup:ATTenuation:DEFProbe` on page 1453

Offset to mean

Performs an automatic compensation for a DC component of the input signal using the result of a background mean measurement. The result is shown in "Offset". The function is probe-independent and supports quick and convenient measurements of input signals with different DC offsets. It detects offset values even when the signal is out of the current measurement range. It also sets the zero level to the determined DC offset in the middle of the screen and thus prevents clipping of the waveform.

Remote command:

[PROBe<m>:SETup:OFFSet:TOMean](#) on page 1453

Line impedance

If the transmission line probe R&S RT-ZZ80 is selected, enter the impedance of the measured line.

The actual attenuation of the transmission line probe depends on the impedance of the line Z_0 :

$$\text{Attenuation} = 10 + Z_0 / 100$$

The instrument uses the actual attenuation to determine the measurement values.

5.6.7 Setup for current probes

The setup and adjustment of current probes depends on the output connector of the probe: BNC or Rohde & Schwarz probe box.

The following shared probe settings are available:

- ["Type, Name, Bandwidth"](#) on page 146
- ["Detect AutoZero, Use AutoZero"](#) on page 146

Current probes R&S RT-ZCxx

The current probes **R&S RT-ZCxx** have BNC connectors. They are known to the R&S RTO6 as predefined probes, see [Chapter 5.6.6, "Setup for predefined probes"](#), on page 162. Demagnetizing and zero adjustment is done on the probe, see the probe's User Manual for details. Make sure to demagnetize and adjust the probe before taking measurements.

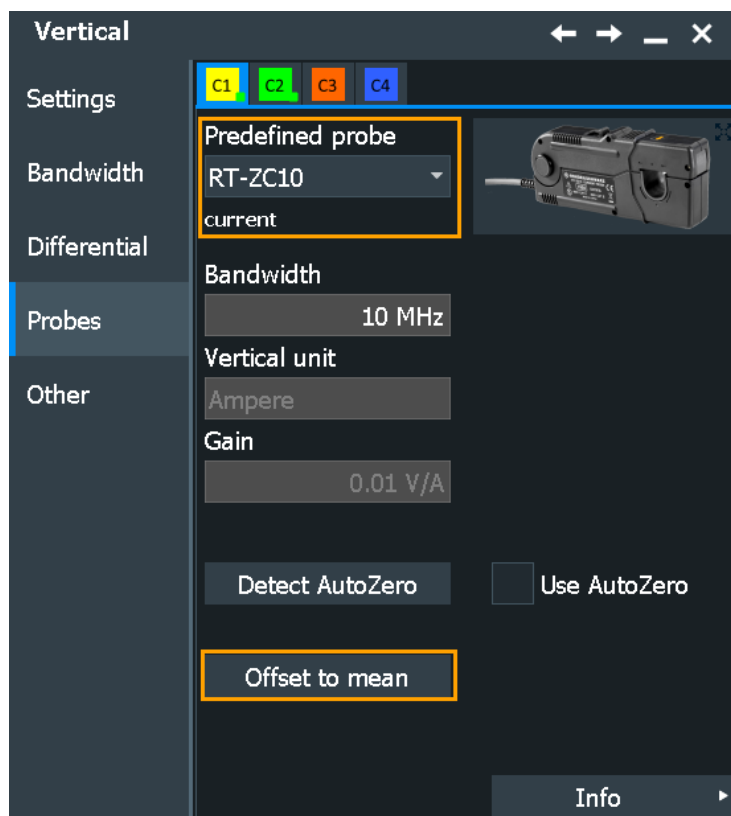

Figure 5-15: Probe setup for current probes R&S RT-ZC10

Current probes R&S RT-ZCxxB

Current probes **R&S RT-ZCxxB** have a Rohde & Schwarz probe interface; they are powered and remotely controlled by the oscilloscope.

When the probe is connected, demagnetization is performed automatically.

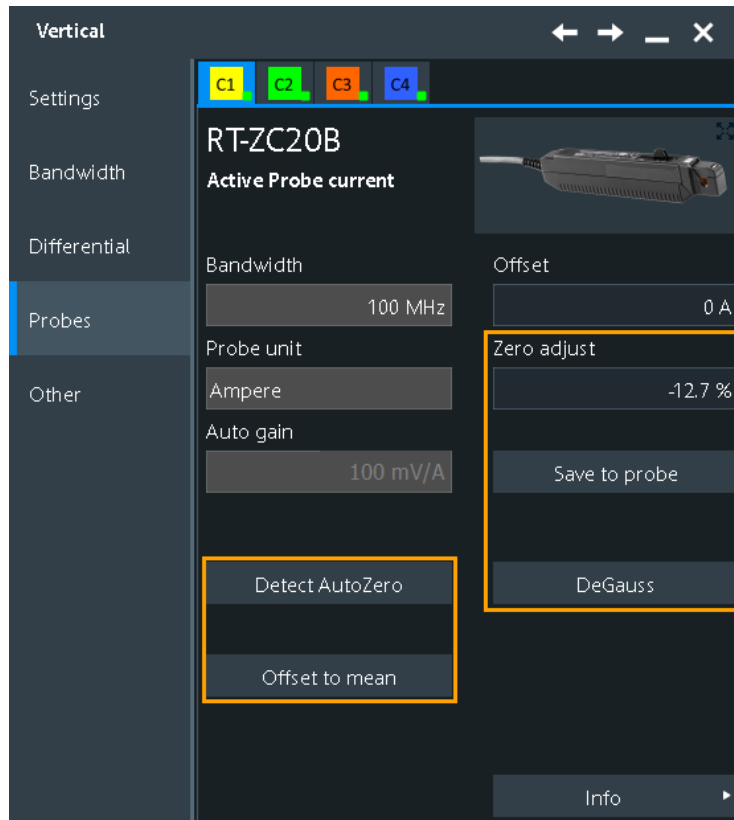

Figure 5-16: Probe setup for current probes R&S RT-ZC20B

For all current probes, attenuation or gain is shown in the "Setup" tab, and you can set the offset to mean:

- ["Probe unit, Auto attenuation"](#) on page 148
- ["Offset to mean"](#) on page 164

Current probes R&S RT-ZCxxB are adjusted by the following functions:

DeGauss	166
Detect AutoZero	167
Zero adjust	167
Save to probe	167

DeGauss

Demagnetizes the core if it has been magnetized by switching the power on and off, or by an excessive input. Always carry out demagnetizing before measurement.

The demagnetizing process takes about one second. During demagnetizing, a demagnetizing waveform is displayed.

Demagnetizing is done automatically when R&S RT-ZCxxB is connected to the oscilloscope, or when "Detect AutoZero" is performed.

Remote command:

[PROBe<m>:SETup:DEGauss](#) on page 1454

Detect AutoZero

If a current probe is connected, the function demagnetizes the probe's sensor head and sets the waveform to zero position to correct the error offset. Thus, it compensates for the remanence and offset caused by temperature drift.

For R&S RT-ZCxxB probes, the determined "Zero adjust" value is displayed and can be saved in the probe head.

See also ["Detect AutoZero, Use AutoZero"](#) on page 146.

Remote command:

`PROBe<m>:SETup:OFFSet:AZERo` on page 1436

Zero adjust

Zero adjust corrects the effect of an offset caused by temperature drift, and compensates for the remanence. The setting is only available if DC coupling is set.

To set the waveform to zero level by the instrument, use "Detect AutoZero". The detected value is displayed.

Alternatively, you can adjust the value manually until the waveform is set to zero level. Make sure to demagnetize the probe before zero adjustment.

The value is given in percent of the maximum range, which is internally defined. The actual setup range depends on the temperature drift, the measured current and other variables, and it can change over time. If you measure high currents, the probe core magnetizes, which impairs the measurement results. Therefore, repeat "Detect AutoZero" before the measurement.

Remote command:

`PROBe<m>:SETup:OFFSet:ZADJust` on page 1454

Save to probe

Saves the "Zero adjust" value in the probe box. If you connect the probe to another channel or to another R&S RTx oscilloscope, the value is read out again, and you can use the probe without further adjustment.

Remote command:

`PROBe<m>:SETup:OFFSet:STPRobe` on page 1454

5.6.8 Setup for optical isolated probe systems

The R&S RT-ZISO is an optical isolated probe system. It consists of the probe head with exchangeable tip module, probe receiver, and scope connector cable. The probe head is permanently connected to the probe receiver by an optical cable, which is an optical isolated cable with multifiber system. To connect the probe receiver to the R&S RTO6, the scope connector cable is used. This cable provides the required supply voltage and transmits the measurement data and control signals simultaneously.

The power consumption of the probes is monitored by the power monitor. See [Chapter 5.6.10.3, "Power monitor"](#), on page 172 for details.

5.6.8.1 Setup parameters of optical isolated probes

Access: "Menu" > "Vertical" > "Probes" > select channel with connected R&S RT-ZISO probe.

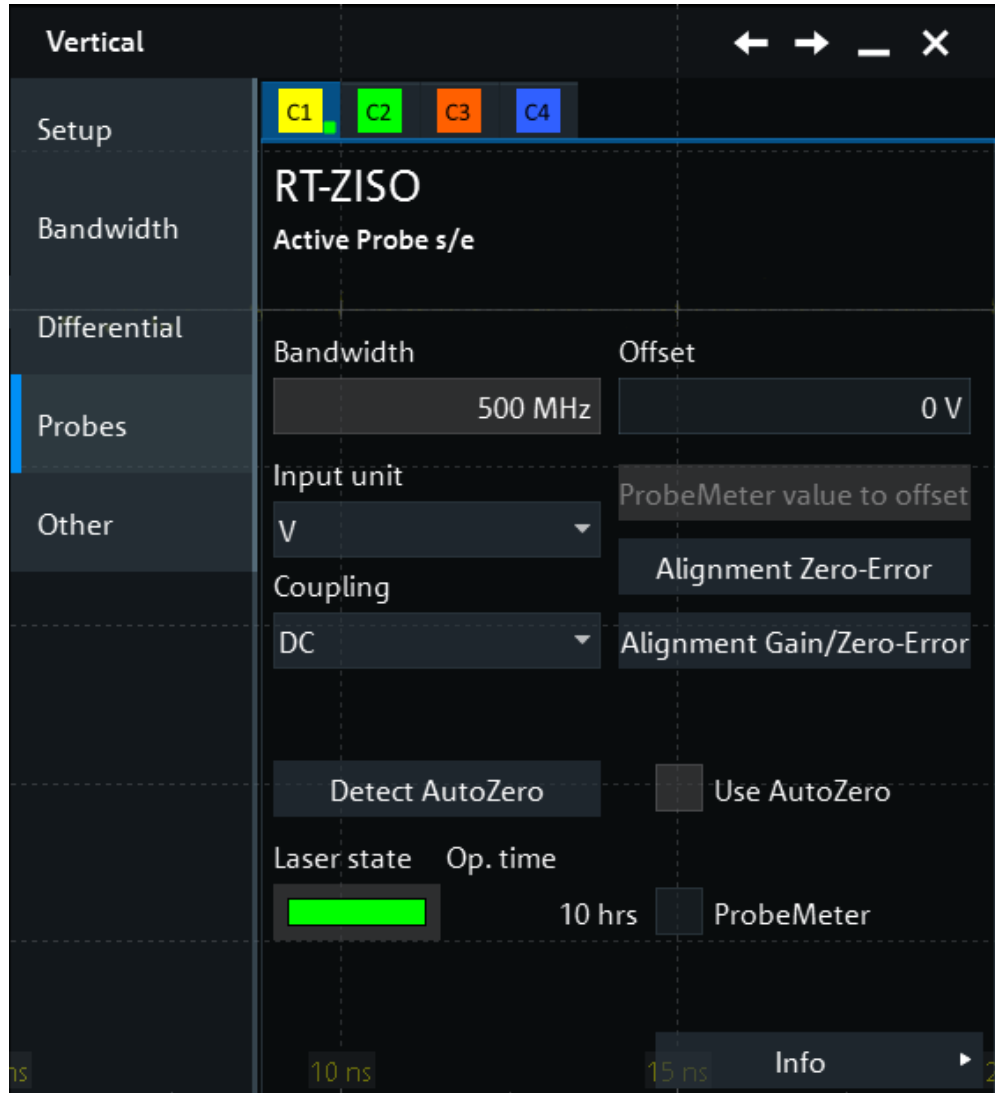

The following shared probe settings are available:

- ["Type, Name, Bandwidth"](#) on page 146
- ["Detect AutoZero, Use AutoZero"](#) on page 146

The dialog also shows the vertical offset. See ["Offset"](#) on page 139 for details.

Set the vertical scale in the "Setup" tab. The probe adjusts its attenuation automatically.

Input unit

Sets the unit of the R&S RT-ZISO signal.

Remote command:

[PROBe<m>:SETup:UNIT](#) on page 1456

Coupling

Selects the coupling of the probe input. The termination of the channel input is always 50 Ω.

The coupling determines the part of the signal that is used for waveform analysis and triggering.

"DC" Both DC and AC components of the signal are passed.

"AC" DC and very low-frequency components of the signal are removed.

ProbeMeter value to offset

Sets the measured R&S ProbeMeter value as offset. Thus, the value is considered in measurements.

The function is available if [ProbeMeter](#) is active.

Remote command:

[PROBe<m>:SETup:ADVanced:PMToffset](#) on page 1444

Alignment Zero-Error

Performs a self-alignment and corrects the zero point error of the R&S RT-ZISO probe.

Tip modules are not affected by the alignment. Attaching or removing the tip module does not change the process or result.

The alignment can take about a minute, the progress is shown in the dialog. Wait until the process has been finished. After successful alignment, the correction data is automatically written to the non-volatile flash of the probe.

Remote command:

[PROBe<m>:SETup:ALIGNment:ZERO:EXECute](#) on page 1456

[PROBe<m>:SETup:ALIGNment:STATe?](#) on page 1457

Alignment Gain/Zero-Error

Corrects the zero point error and the gain error of the R&S RT-ZISO probe.

Tip modules are not affected by the alignment. Attaching or removing the tip module does not change the process or result.

The alignment can take about a minute, the progress is shown in the dialog. Wait until the process has been finished. After successful alignment, the correction data is automatically written to the non-volatile flash of the probe.

Remote command:

[PROBe<m>:SETup:ALIGNment:GAIN:EXECute](#) on page 1456

[PROBe<m>:SETup:ALIGNment:STATe?](#) on page 1457

Laser state

The color indicates the current status of the laser:

- Green: the laser is working.
- Yellow: the laser needs service, but is still working.
- Red: defective laser, send it to your Rohde & Schwarz service center.

Remote command:

`PROBe<m>:SETup:LASTate?` on page 1455

Op. time

Indicates the operating hours of the R&S RT-ZISO laser since the first use or last service.

Remote command:

`PROBe<m>:SETup:LAOPerhours?` on page 1455

TIP Info

Opens the "ZISO tip" dialog. See [Chapter 5.6.8.2, "TIP Info dialog"](#), on page 170.

Info

Opens the "Probes Info" dialog. See [Chapter 5.6.10, "Probes info"](#), on page 171.

5.6.8.2 TIP Info dialog

Access: "Menu" > "Vertical" > "Probes" > select channel with connected R&S RT-ZISO probe > "TIP Info"

The dialog shows the characteristics of the tip modules that are connected to the probes.

ZISO Tip				
Tip Attributes	c1 Channel 1	c2 Channel 2	c3 Channel 3	c4 Channel 4
Name	ZISO-Z301			
Type	BROWSER			
Part number	1803.4500.02			
Serial number	100611			
Production date	2023-11-06			
Production time	10:00:00			
Input impedance	10 MΩ	0 Ω	0 Ω	0 Ω
Input capacity	12 pF	0 F	0 F	0 F
Input min [V]	-300 V	0 V	0 V	0 V
Input max [V]	300 V	0 V	0 V	0 V
Offset min [V]	-300 V	0 V	0 V	0 V
Offset max [V]	300 V	0 V	0 V	0 V
Unit	---	0 V	0 V	0 V
Bandwidth	500 MHz	0 Hz	0 Hz	0 Hz
Attenuation	10	0	0	0

5.6.9 Setup for unknown probes

If the R&S RTO6 cannot detect the probe, and the probe is not a predefined one, you can set the probe parameters manually.

The following shared probe settings are available:

- "Type, Name, Bandwidth" on page 146
- "Detect AutoZero, Use AutoZero" on page 146

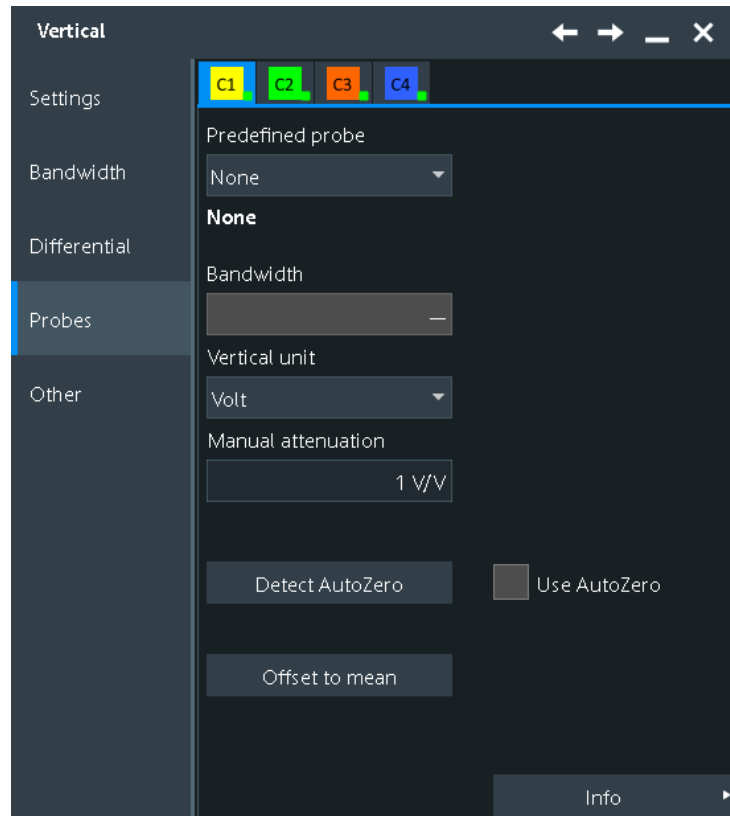

Figure 5-17: Probe setup for an unknown probe

Set the unit and the attenuation or gain of the probe: "Vertical unit, Attenuation, Gain" on page 152.

5.6.10 Probes info

5.6.10.1 Probe attributes

To check the attributes of the connected probes, select "Info" in the "Vertical" > "Probes" tab.

For a specification of the probe parameters, refer to the data sheet.

Probes: Info					
Attributes	Attributes	Channel 1	Channel 2	Channel 3	Channel 4
Type		active single-en	active differenti	active modular	Passive Probe
Name		RT-ZS20	RT-ZD40	RT-ZM90	
Ext. Attenuator		—	—	—	—
Serial No		101534	101678	101475	—
Probe attenuation		10:1	10:1	10:1	10:1
Part number		1410.3502.02	1410.5205.02	1419.3205K02	—
Software version		2.4.19850.10446	2.4.19850.10446	2.7.22331.13362	—
Input unit		V	V	V	V
Bandwidth		1.5 GHz	4.5 GHz	9 GHz	—
Input capacitance		800 fF	400 fF	—	—
Input impedance		1 MΩ	1 MΩ	—	—
Dynamic DC range max		8 V	5 V	2.5 V	—
Dynamic DC range min		-8 V	-5 V	-2.5 V	—
Offset range max		12 V	5 V	16 V	—
Offset range min		-12 V	-5 V	-16 V	—
Sensitivity		2.5 mV	3 mV	4.5 mV	—
CM Offset max.		—	—	16 V	—
CM Offset min.		—	—	-16 V	—
OVW upper value		—	5 V	7 V	—
OVW lower value		—	-5 V	-7 V	—

Remote commands:

- `PROBE<m>:ID:SWVersion?` on page 1457
- `PROBE<m>:ID:PRDate?` on page 1457
- `PROBE<m>:ID:PARTnumber?` on page 1458
- `PROBE<m>:ID:SRNumber?` on page 1458
- `PROBE<m>:SETup:CAPacitance?` on page 1458
- `PROBE<m>:SETup:IMPedance?` on page 1459

5.6.10.2 Calibration results

To check the attributes of the connected probes, select "Info" > "Cal Results" in the "Probes" tab.

Probes: Info					
Attributes	Calibration	Channel 1	Channel 2	Channel 3	Channel 4
Probe group delay		5.409 ns	5.3583 ns	5.5472 ns	0 s
Attenuation		10.5803625:1	10.40935:1	10.7777:1	10:1

5.6.10.3 Power monitor

The power monitor informs about the connected probes and their power consumption.

If you use several R&S RT-ZISO probes, the power of the instrument can be insufficient to power all probes. The power monitor notifies you of insufficient power. To solve the problem, you can remove redundant probes, or use the external power supplies to power the R&S RT-ZISO probes.

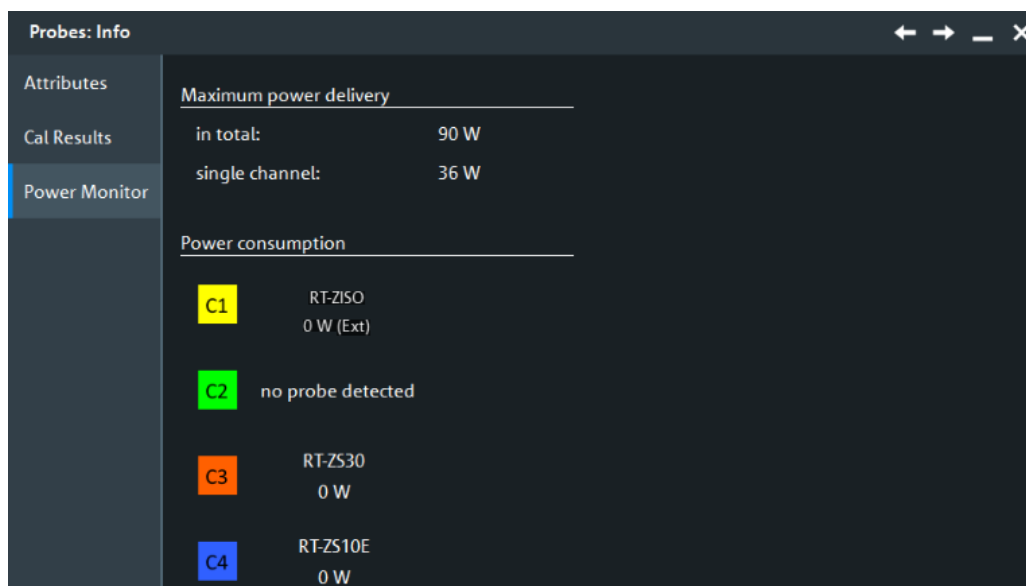

5.6.11 Probe adapter R&S RT-Z2T

Using the R&S RT-Z2T probe interface adapter, you can connect selected Tektronix active probes with TekProbe BNC™ level II interface.

1. Connect the R&S RT-Z2T adapter to the channel input.
2. Connect the probe to the adapter.
The instrument identifies the adapter. The R&S RTO6 lists the supported Tektronix probes as "Predefined probe".
3. Select "Menu" > "Vertical" > "Probes".
The dialog shows that the R&S RT-Z2T probe interface adapter is connected.

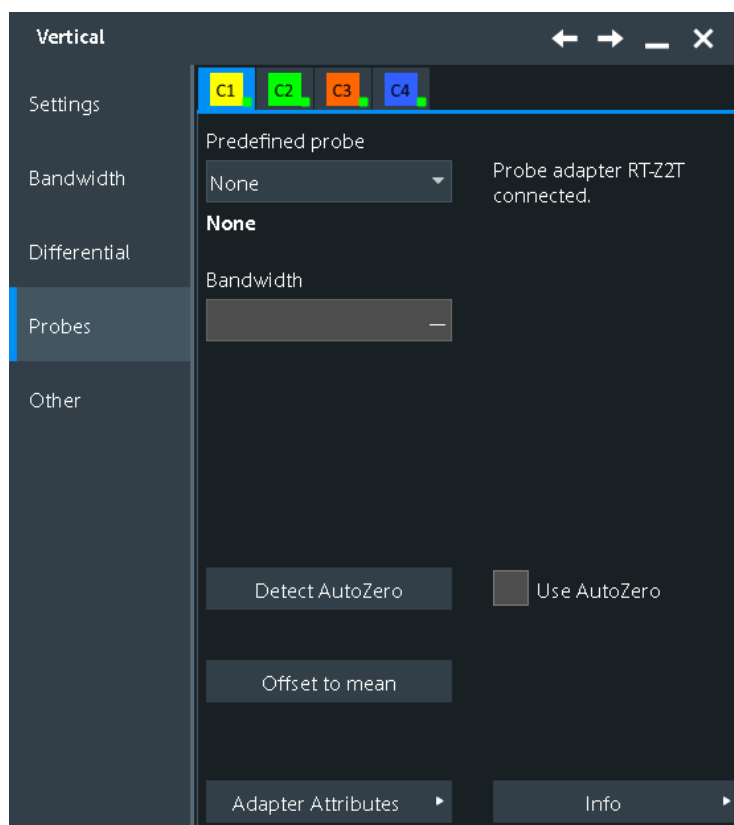

- To see the information on the adapter, select "Adapter Attributes".

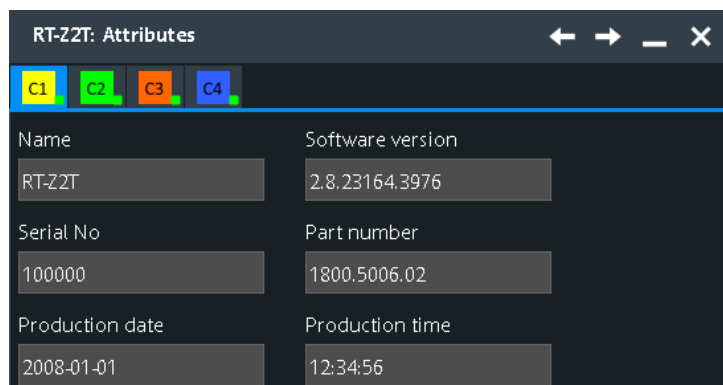

- Select the "Predefined probe" in the "Probes" tab.
See also: [Chapter 5.6.6, "Setup for predefined probes"](#), on page 162.

Remote commands:

- `PROBe<m>:SETup:ADAPter?` on page 1459
- `PROBe<m>:SETup:ATTenuation:TDEFprobe` on page 1459

5.7 R&S RT-ZVC probe

With the R&S RTO6 and option R&S RTO6-B1E, you can use the R&S RT-ZVC multi-channel power probe. It has an integrated 2- or 4-channel amperemeter and 2- or 4-channel voltmeter. The probe provides parallel measurements of analog or digital, voltage/current signals with excellent 18-bit resolution.

For more information on the R&S RT-ZVC probe, see also its user manual.

Source Channels



You can simultaneously connect a R&S RT-ZVC and a R&S RT-ZL04 to the R&S RTO6, but no parallel operation on screen is possible.

You can acquire and measure the R&S RT-ZVC or R&S RT-ZL04 together with the analog input channels. They are running on the same horizontal scale.

If an amperemeter or voltmeter channel is activated, it can be displayed on the screen and used as a source for:

- Cursor measurements
- Automatic measurements, and also histogram, limit checks, longterm, track, quick measurements
- Mask testing
- Basic and advanced maths
- Reference waveform
- Trigger type "Edge"
- Search: all search events
- XY diagrams
- Data export

All features of the base unit and the R&S RTO6-K37 option are supported.

Data export

You can save the data of the amperemeter and voltmeter channels to an XML, CSV, or BIN file. One channel per file can be saved. Files in BIN format can be reloaded to the R&S RTO6 as reference waveforms.

See also:

- [Chapter 12.2.7, "Saving and loading waveform data"](#), on page 481
- [Chapter 12.2.1, "Waveform export files"](#), on page 459

Remote commands for export to file:

- `EXPort:WAVeform:SOURce` on page 1766
- `EXPort:WAVeform:NAME` on page 1768
- `EXPort:WAVeform:SAVE` on page 1769

5.7.1 R&S RT-ZVC overview

5.7.1.1 Setup

Access: [App Cockpit]> "Analysis" > "Multi-channel probe" > "Setup" tab



Make sure that the tab of the correct probe is selected on the left side.

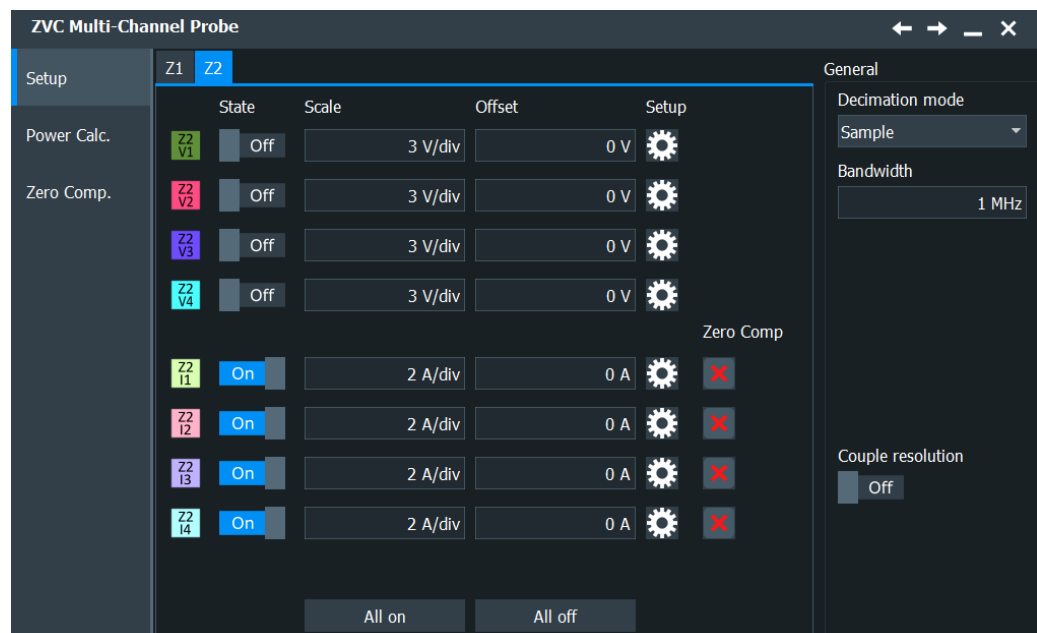

State

Enables the corresponding channel of the probe. The number of available channels depend on the characteristics of your multi-channel power probe.

Remote command:

[ZVC:Z<m>:V<n>\[:STATE\]](#) on page 1470

[ZVC:Z<m>:I<n>\[:STATE\]](#) on page 1467

Scale

Defines the vertical scale for the channel in Volts per division. Increasing the scale compresses the display of the signal. Within a given operation range, modifying the scale is equivalent to scaling a display range.

For the voltmeter channels, the [Scale](#), the [Offset](#) and the "Position" specify the operating range of the voltmeter.

Remote command:

[ZVC:Z<m>:V<n>:SCALE](#) on page 1469

[ZVC:Z<m>:I<n>:SCALE](#) on page 1464

Offset

The vertical center of the selected channel is shifted by the offset value and the signal is repositioned within the diagram area. Negative offset values move up the waveform, positive values move it down.

Within a given operation range, modifying the offset is equivalent to moving vertically the display range. The offset can only be modified such that the display range reaches at most the limits of the operation range.

For the voltmeter channels, the [Scale](#), the [Offset](#) and the "Position" specify the operating range of the voltmeter.

Remote command:

[ZVC:Z<m>:V<n>:OFFSet](#) on page 1468

[ZVC:Z<m>:I<n>:OFFSet](#) on page 1462

Setup

Opens the voltage or current settings for the selected channel. See [Chapter 5.7.2, "ZVC voltage settings"](#), on page 180 and [Chapter 5.7.3, "ZVC current settings"](#), on page 181.

Zero Comp

Shows the status of the zero compensation of each current channel. The green check-mark indicates that the zero offset is compensated automatically. To adjust the settings, tap the icon. For details, see [Chapter 5.7.1.3, "Zero compensation"](#), on page 179.

Remote command:

[ZVC:Z<m>:I<n>:ZERComp:STATe?](#) on page 1472

All on

Enables all available channels.

All off

Disables all available channels.

Decimation mode

Selects the decimation mode for all R&S RT-ZVC probes. Decimation reduces the data stream of the ADC to a stream of waveform points with lower sample rate and a less precise time resolution.

"Sample"	One of n samples in a sample interval of the ADC is recorded as waveform point, the other samples are discarded. The time between the two adjacent waveform points is exactly the resolution. Very short glitches might remain undiscovered by this method.
"Peak detect"	The minimum and the maximum of n samples in a sample interval are recorded as waveform points, the other samples are discarded.
"High res"	The average of n sample points is recorded as one waveform sample. Averaging reduces the noise, the result is a more precise waveform with higher vertical resolution. The high measurement resolution is suitable for high accuracy measurements of instantaneous values.

Remote command:

[ZVC:TYPE](#) on page 1461

Bandwidth

Sets the bandwidth limit of all R&S RT-ZVC probes. The bandwidth specifies the maximum frequency at which a purely sinusoidal signal is still transferred at 89 % (1 dB) of its amplitude.

The bandwidth of some current channels is restricted to 300 KHz due to their vertical settings.

Remote command:

[ZVC:BANDwidth](#) on page 1461

Couple resolution

Sets the resolution of all R&S RT-ZVC channels.

"On" The resolution of the analog channels is applied to R&S RT-ZVC channels. The signal is automatically interpolated or decimated to get the analog resolution.

"Off" The resolution of R&S RT-ZVC channels is set in a way so that the record length of the waveforms is minimum 1000 samples.

Remote command:

[ZVC:RESCoupled](#) on page 1463

5.7.1.2 Power calculation

Access: [App Cockpit]> "Analysis" > "Multi-channel probe" > "Power Cal." tab

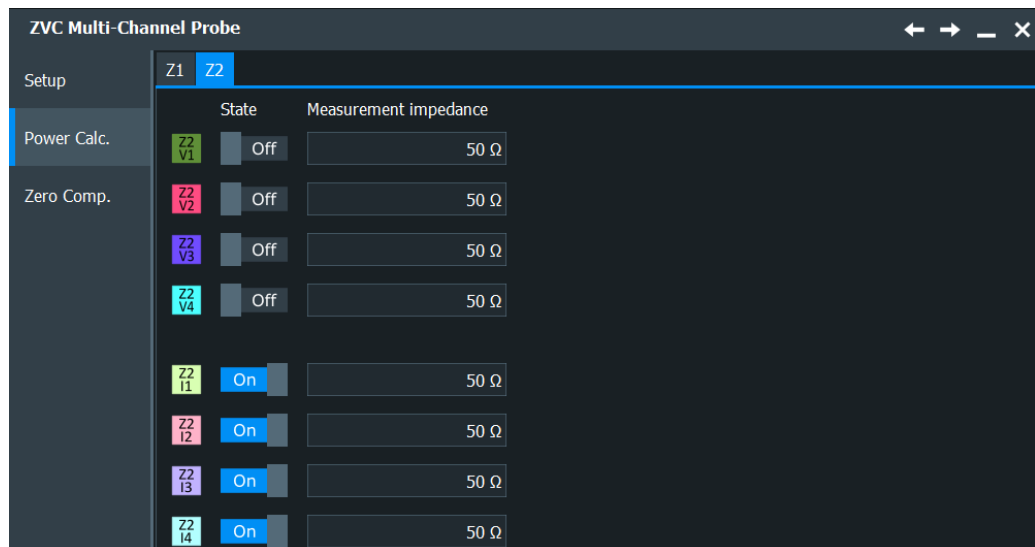
**State**

Enables the corresponding channel of the probe. The number of available channels depend on the characteristics of your multi-channel power probe.

Remote command:

[ZVC:Z<m>:V<n>\[:STATe\]](#) on page 1470

[ZVC:Z<m>:I<n>\[:STATe\]](#) on page 1467

Measurement Impedance

Sets the impedance of the probe channel for power calculations and measurements.

Remote command:

[ZVC:Z<m>:V<n>:IMPedance](#) on page 1468

[ZVC:Z<m>:I<n>:IMPedance](#) on page 1462

5.7.1.3 Zero compensation

Access: [App Cockpit]> "Analysis" > "Multi-channel probe"> "ZeroComp" tab

Zero compensation is used to avoid negative currents in measurement results, and to improve the measurement accuracy. The determined compensation is valid as long as the temperature is constant and the probe settings are unchanged.

1. Disconnect the DUT from the power supply.
2. Adjust the current settings, in particular, the shunt settings. See [Chapter 5.7.3, "ZVC current settings"](#), on page 181.
3. Connect one probe tip of the R&S RT-ZVC probe to the high voltage pin of the DUT. Disconnect the other probe tip from the DUT.
4. Open the "ZeroComp" settings: [App Cockpit]> "Analysis" > "Multi-channel probe"> "ZeroComp" tab
5. Tap "ZeroComp" to determine the zero offset.
6. Enable "Use" to compensate for the zero offset.

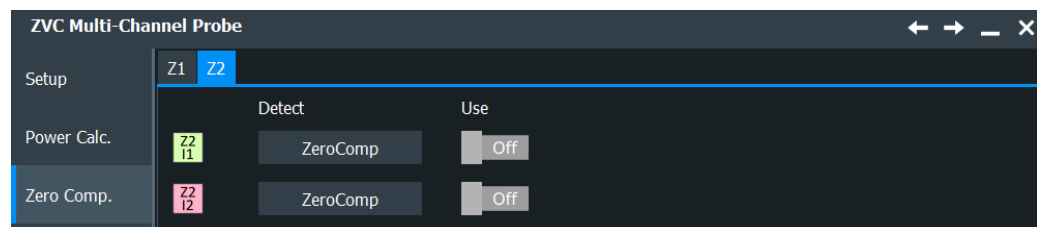

ZeroComp

Measures the zero offset, the mean value on a currentless DUT. If temperature changes, or if you change the shunt or other probe settings, repeat the measurement.

Remote command:

[ZVC:Z<m>:I<n>:ZERComp:DETECT](#) on page 1471

Use

If enabled, the measured "ZeroComp" offset value is compensated automatically.

Remote command:

[ZVC:Z<m>:I<n>:ZERComp:USE](#) on page 1471

5.7.2 ZVC voltage settings

Access: [App Cockpit]> "Analysis" > "Multi-channel probe"> "Setup" tab > "Setup" icon of voltage channel

See also:

- [Scale](#)
- [Offset](#)

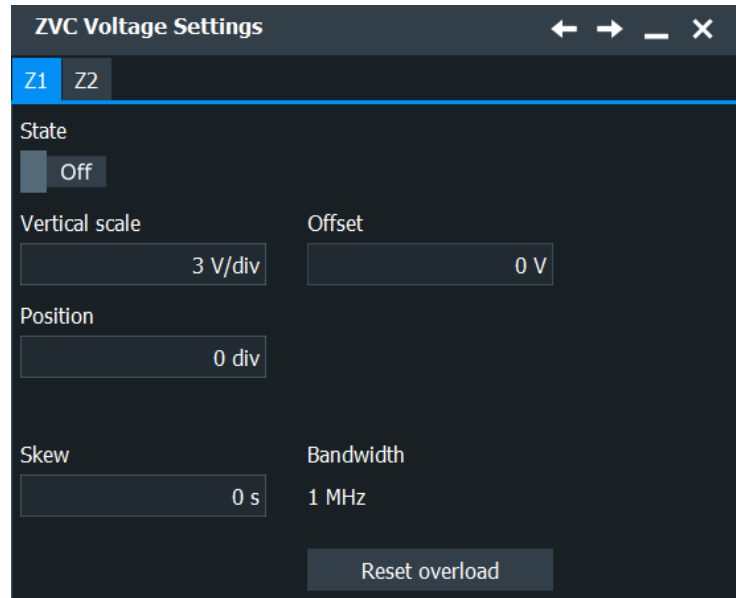

Channel

Selects the voltmeter channel to be configured.

State

Enables the corresponding voltage channel of the probe. The number of available channels depend on the characteristics of your multi-channel power probe.

Remote command:

`ZVC:Z<m>:V<n>[:STATe]` on page 1470

Position

Moves the selected signal up or down in the diagram. The visual effect is the same as for [Offset](#). While the offset sets a voltage, position is a graphical setting given in divisions. Within a given operation range, modifying the position is equivalent to moving vertically the display range. The position can only be modified such that the display range reaches at most the limits of the operation range.

For the voltmeter channels, the [Scale](#), the [Offset](#) and the "Position" specify the operating range of the voltmeter.

Remote command:

`ZVC:Z<m>:V<n>:POSition` on page 1469

Bandwidth

Displays the bandwidth of the current channel. You can set the probe bandwidth in the "Setup" dialog.

Remote command:

[ZVC:Z<m>:V<n>:BANDwidth?](#) on page 1467

Skew

Sets the skew, a delay value, that is known from the circuit specifics but cannot be compensated by the instrument automatically.

Remote command:

[ZVC:Z<m>:V<n>:SKEW](#) on page 1470

Reset Overload

Resets the overload indication at the probe.

Remote command:

[ZVC:Z<m>:V<n>:OVERload:RSTO](#) on page 1468

5.7.3 ZVC current settings

Access: [App Cockpit]> "Analysis" > "Multi-channel probe"> "Setup" tab > "Setup" icon of current channel

See also:

- [Scale](#)
- [Offset](#)

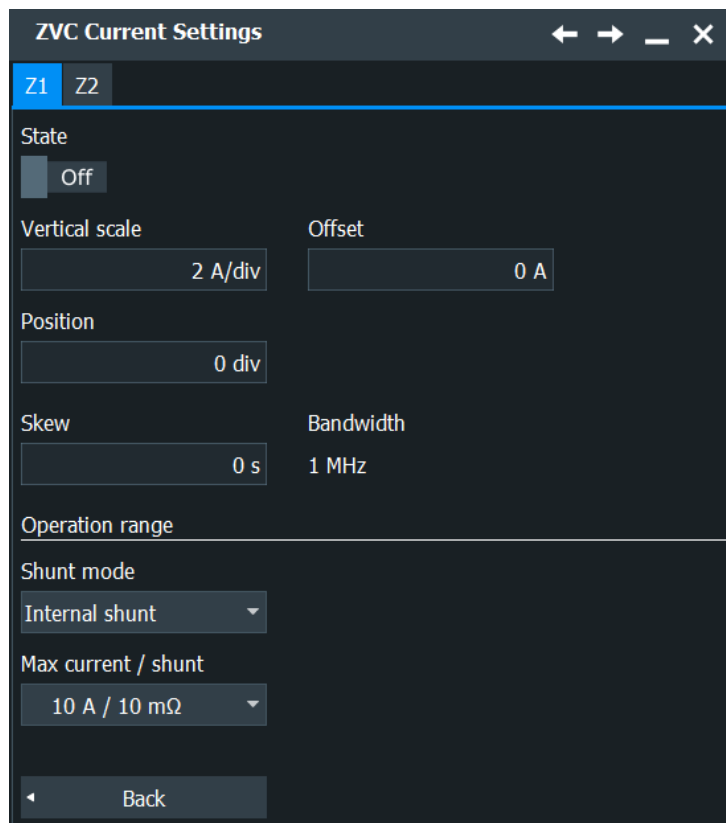

Channel

Selects the amperemeter channel to be configured.

State

Enables the corresponding current channel of the probe. The number of available channels depend on the characteristics of your multi-channel power probe.

Remote command:

[ZVC:Z<m>:I<n>\[:STATe\]](#) on page 1467

Bandwidth

Displays the bandwidth of the current channel. You can set the probe bandwidth in the "Setup" dialog.

Remote command:

[ZVC:Z<m>:I<n>:BANDwidth?](#) on page 1461

Position

Moves the selected signal up or down in the diagram. The visual effect is the same as for [Offset](#). While the offset sets a current, position is a graphical setting given in divisions. Within a given operation range, modifying the position is equivalent to moving vertically the display range. The position can only be modified such that the display range reaches at most the limits of the operation range.

Remote command:

[ZVC:Z<m>:I<n>:POSition](#) on page 1464

Skew

Sets the skew, a delay value, that is known from the circuit specifics but cannot be compensated by the instrument automatically.

Remote command:

`ZVC:Z<m>:I<n>:SKEW` on page 1467

Shunt mode

Selects the internal or external shunt mode.

Regarding the shunt selection, i.e. the burden voltage level, there is a trade-off between the burden of the circuit under test and the SNR at the frontend input. The burden voltage is the DUT circuit loading caused by leads, connectors and the amperemeter circuit.

From the DUT perspective, the burden voltage has to be kept low not to distort the device operation. In contrast, from the probe's view the voltage has to be as large as possible to obtain a good SNR. For that reason, the external shunt can be applied to get the best compromise of both for a specific measurement range.

Remote command:

`ZVC:Z<m>:I<n>:SHUNt:MODE` on page 1465

Internal Shunt Mode

If **Shunt mode** is set to "Internal shunt", include the settings for the internal shunt mode.

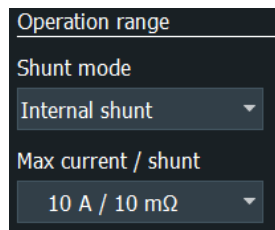
**Max current / shunt ← Internal Shunt Mode**

Selects the maximum current and the internal shunt value.

With the maximum current and the internal shunt selection, the operating range of the amperemeter is specified. At the same time, the burden voltage at the amperemeter input can be estimated. For values of the total round-trip resistance that can be seen at the test lead ends, consider the specifications.

For using internal shunts, the circuit under test needs to be interrupted so that the current can flow through the probe.

Remote command:

`ZVC:Z<m>:I<n>:SHUNt:MAXCurrent` on page 1465

External shunt mode

If **Shunt mode** is set to "External shunt", include the settings for the external shunt mode.

Operation range	
Shunt mode	Shunt value
External shunt	1 Ω
Max voltage	Max current
450 mV	450 mA
Back	Reset overload

Max voltage ← External shunt mode

Selects the maximum voltage at the external shunt.

Remote command:

[ZVC:Z<m>:I<n>:SHUNT:MAXVoltage](#) on page 1466

Shunt value ← External shunt mode

Sets the shunt value of the external shunt resistor.

Remote command:

[ZVC:Z<m>:I<n>:SHUNT:EVALue](#) on page 1465

Max current ← External shunt mode

Displays the maximum current.

Remote command:

[ZVC:Z<m>:I<n>:SHUNT:MXCValue?](#) on page 1466

Reset Overload ← External shunt mode

Resets the overload indication at the probe.

Remote command:

[ZVC:Z<m>:I<n>:OVERload:RSTO](#) on page 1463

5.8 Differential signals

With R&S RTO6, you can easily analyze differential signals using single-ended probes, or even cables. The instrument processes the input of single-ended probes on analog channels and creates the differential and common mode waveforms. Similar to Rohde & Schwarz modular probes, you can display the waveforms of differential voltage, common mode voltage, positive single-ended voltage and negative single-ended voltage. Triggering on differential signals is also possible.

Deembedding is possible if the option R&S RTO6-K121 is installed.

Deembedding is applied to the two single-ended captured signals, resulting in deembedded differential waveform, common mode waveform, positive single-ended waveform and negative single-ended waveform. Deembedding also considers cross-couplings.

Restriction: Differential signals are not available when high definition mode is active.

5.8.1 Settings of differential signals

Access: "Menu" > "Vertical" > "Differential"

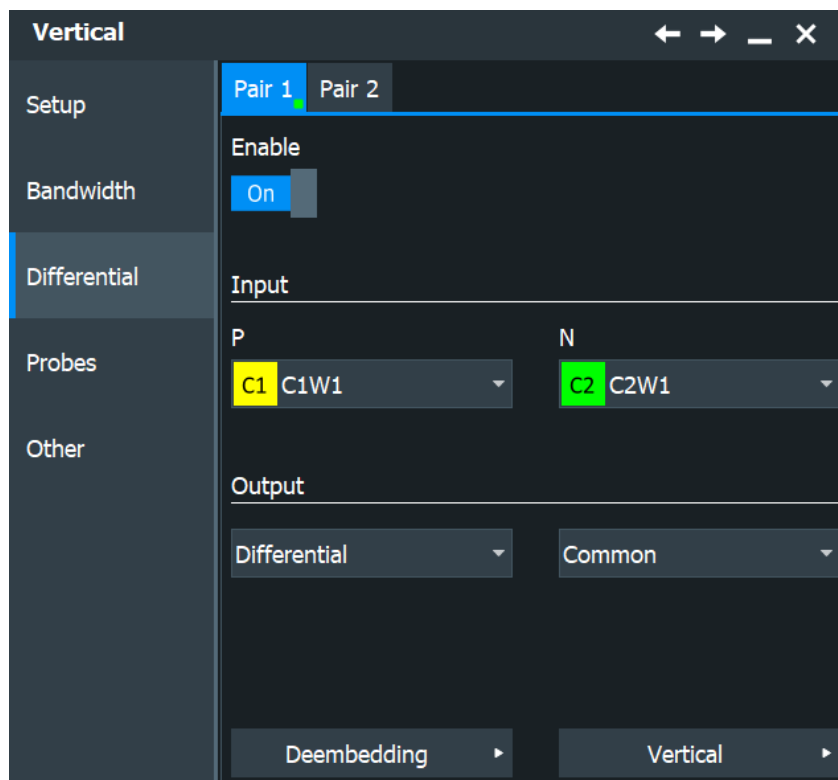

Figure 5-18: Setup of differential signals without deembedding

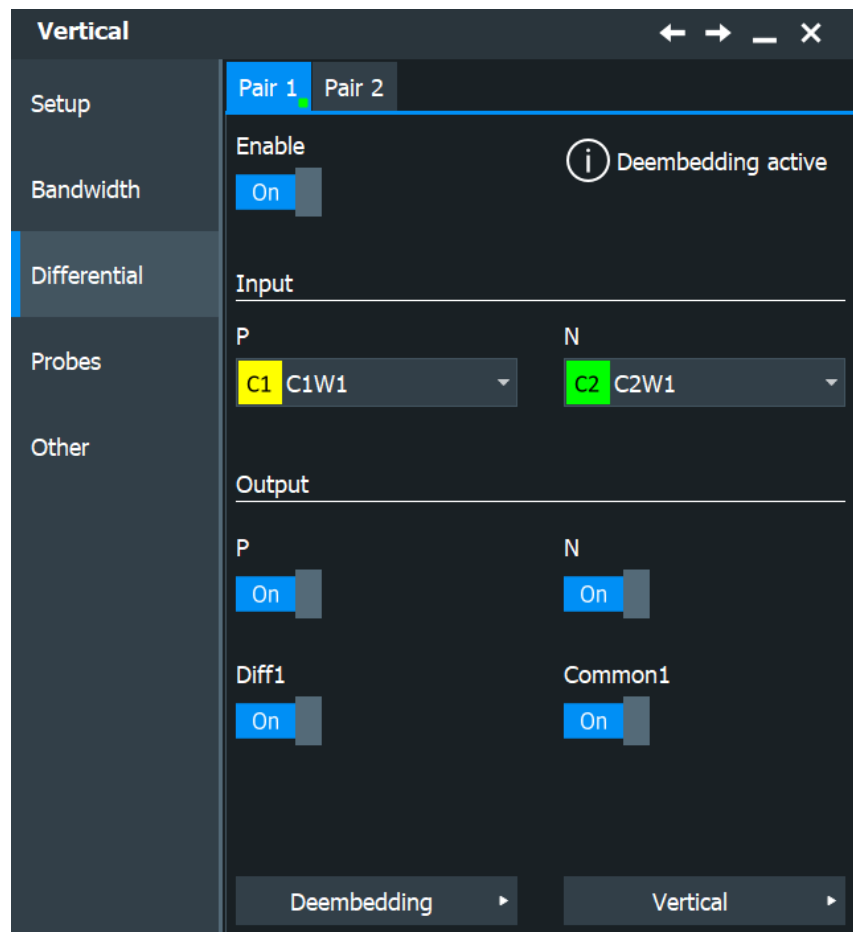

Figure 5-19: Setup of deembedded differential signals

Enable

Activates the differential signal.

Remote command:

[DIFFerential<m>:STATe](#) on page 1475

P, N

Select the analog input channel of the positive and negative signal.

Remote command:

[DIFFerential<m>:PSIGNAL\[:SElect\]](#) on page 1475

[DIFFerential<m>:NSIGNAL\[:SElect\]](#) on page 1475

Output: P, N, Diff, Common

Select the waveforms that are displayed as result of differential processing.

The number of output waveforms per differential signal depends on the deembedding:

- No deembedding: 2 output waveforms.
- With deembedding: up to 4 output waveforms. All output waveforms can be displayed at the same time.

In the diagram, you see the output waveforms, and the signal icons of the input channels are grayed out. The input channels are only visible if "P" or "N" are selected as output.

- "P", "N" Displays the waveform of the positive or negative input signal. Without deembedding, the input channel is shown directly, no additional waveform is created. If differential deembedding is active, you always see the deembedded waveforms, but never the captured input signal.
- "Differential" Displays the differential signal as a new waveform.
- "Common" Displays the common mode signal as a new waveform.

Remote command:

[DIFFerential<m>:AOUTput](#) on page 1475

[DIFFerential<m>:BOUtput](#) on page 1475

If deembedding by software is active, use the following commands:

[DIFFerential<m>:COMMon:STATe](#) on page 1476

[DIFFerential<m>:DIFFerential:STATe](#) on page 1476

[DIFFerential<m>:NSIGNAL:STATe](#) on page 1476

[DIFFerential<m>:PSIGNAL:STATe](#) on page 1476

5.8.2 Vertical setup of differential signals

Access: "Menu" > "Vertical" > "Differential" > "Vertical Setup"

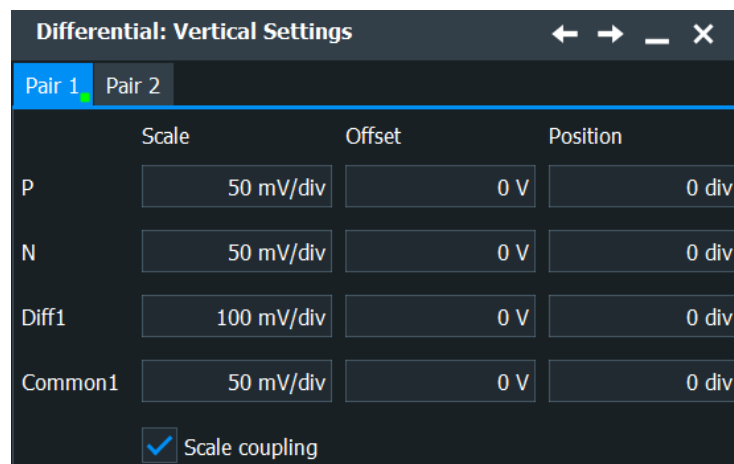

Scale

Sets the vertical scale of differential and common mode waveforms.

Vertical settings of P and N output are the vertical settings of the input channels.

Remote command:

[DIFFerential<m>:COMMon:SCALe](#) on page 1476

[DIFFerential<m>:DIFFerential:SCALe](#) on page 1476

Scale coupling

If enabled, the vertical scales of P, N, differential and common mode waveforms are coupled. The scales are related as follows:

$$VertScale_P = VertScale_N = VertScale_{CM} = VertScale_{Diff}/2$$

You can disable the scale coupling and set an individual scale for each waveform.

Remote command:

[DIFFerential<m>:COUPling](#) on page 1476

Offset

Sets the offset of differential and common mode waveforms.

Vertical settings of P and N output are the vertical settings of the input channels.

Remote command:

[DIFFerential<m>:COMMon:OFFSet](#) on page 1477

[DIFFerential<m>:DIFFerential:OFFSet](#) on page 1477

Position

Sets the vertical position of differential and common mode waveforms.

Vertical settings of P and N output are the vertical settings of the input channels.

Remote command:

[DIFFerential<m>:COMMon:POSition](#) on page 1477

[DIFFerential<m>:DIFFerential:POSition](#) on page 1477

5.8.3 Deembedding of differential signals

To remove the parasitic effects of the measurement setup from the measured signal, you can use deembedding for differential signals. Deembedding requires the option R&S RTO6-K121.

The deembedding of differential signals is represented by one or more 4-port input components. You can activate deskewing, and set a skew time.

See also: [Chapter 22, "Deembedding \(option R&S RTO6-K121\)"](#), on page 1248.

1. On the "Vertical" menu, select "Differential Signals".
2. Select the input channels of the positive and negative signal.
3. Enable the differential signal.
4. Select "Deembedding".
5. Select the channel subtab of the positive input.
6. On the "Setup" tab, enable deembedding for the channel.
7. On the "Input" component, select "Configure".
8. If necessary, activate "Use skew offset". Use the deskewing if the P and N waveforms are not correctly aligned.

When you disable a deembedded differential signal in "Vertical" > "Differential Signals", deembedding is also disabled. When you enable the differential signal again, repeat the deembedding and output settings.

5.8.4 Analysis of differential signals

Before analyzing the output waveforms of differential signals, make sure that the P and N signals are correctly aligned. Without deembedding, use "Horizontal" > "Skew" to deskew the input waveforms if necessary. For deembedded waveforms, the skew setting is in the deembedding configuration.

For all output waveforms of differential signals (differential, common mode, P, N), the usual analysis methods are available:

- Trigger on differential, common mode, P, and N waveforms.
If the differential signal is enabled ("Enable" = on), all possible output waveforms are available as trigger source, even if they are not selected and not displayed.
- Zoom
- Cursor measurements
- Automatic measurements
- Histogram
- Mathematics. In formulas, use DIFF1, DIFF2, COMMON1, COMMON2.
- FFT, spectrogram
- Mask test
- Export of waveform data. You can export the differential and common waveforms if they are selected as output and displayed. Raw data is not available.
Without deembedding, P and N waveforms can be exported if they are selected as output and displayed (source = input channel). With software deembedding, only differential and common waveforms are available for export.



Search on differential signals and their input channels is not supported.

5.9 Setting up the waveform

This chapter contains the fundamental procedures for setting up the acquisition and adjusting the channel waveforms.

5.9.1 Adjusting passive probes

When using a passive probe, you have to compensate it when you connect it to the instrument the first time. Compensation matches the probe cable capacitance to the oscilloscope input capacitance to assure good amplitude accuracy from DC to upper bandwidth limit frequencies. A poorly compensated probe reduces the performance of the probe-oscilloscope system and introduces measurement errors resulting in distorted waveforms and inaccurate results.

Two connector pins are located on the front panel. The  pin is on ground level. The  pin supplies a square wave signal with 1 kHz for low frequency probe compensation.

1. Connect the BNC connector of the probe to one of the channel inputs.
2. Connect the probe's ground connector to the ground compensation pin, and the probe tip to the signal pin.
3. Press [Autoset].
A square wave appears on the display.
4. Adjust the compensation trimmer of the probe to optimum square wave response. For details, refer to the documentation of your probe.

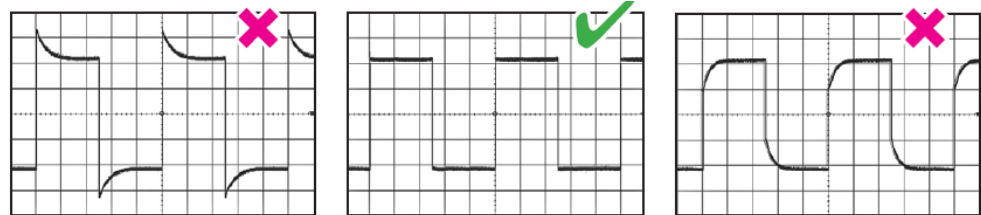

5.9.2 Setting up the signal input with autoset

Autoset is the solution for the major part of routine test-setup. It is also a good start if you need to use more complex trigger settings. Autoset finds appropriate horizontal and vertical scales, vertical offset, and trigger conditions to present a stable waveform.

1. Connect the probe to the input connector [C<n>].
The instrument recognizes the probe and turns on the channel.
2. Press the [Autoset] key.

5.9.3 Adjusting the signal input manually

1. Connect the probe to the input connector [C<n>].
The instrument recognizes the probe and turns on the channel.
2. Open "Menu" > "Horizontal" > "Setup" tab.
3. Set the "Time scale".
4. If you want to analyze the signal some time before or after the trigger, use the "Position" and "Reference point" to adjust the visible section of the waveform.
5. Press the channel button corresponding to the input channel. It is illuminated with the color of the channel waveform.
6. Open the "Menu" > "Vertical" > "Setup" tab.

7. Select the "Coupling".
8. Adjust the vertical "Scale", and the vertical "Position".
9. Proceed with the acquisition setup, see [Chapter 5.9.4, "Setting the acquisition"](#), on page 191.

5.9.4 Setting the acquisition

Prerequisites:

- Probes are connected.
- Vertical and horizontal settings are adjusted.

The settings are described in [Chapter 5.4.2, "Mode settings"](#), on page 129.

1. Open "Menu" > "Acquire" > "Mode" tab.
2. To configure the waveform-specific acquisition settings, enable "Multi waveform". Activate the waveforms "W1"/"W2"/"W3" you need. You can set up and display up to three waveforms per channel.
3. Select the "Decimation" - for example, Peak detect or High res.
4. Select the "Arithmetic" - for example, Average or Envelope. The instrument precludes incompatible combinations, like "Peak detect" with "Average".
5. If "Arithmetic"="Average" is selected for a waveform, enter the "Average count", that is the number of waveforms used for average calculation.
6. Set the arithmetic reset condition for the average and envelope calculation:
 - a) If "Arithmetic Reset > Mode"="Time" is selected, enter the "Time".
 - b) If "Arithmetic Reset > Mode"="Waveforms" is selected, enter the "Count".

5.9.5 Starting and stopping acquisition

You can control the acquisition in two ways:

- Running continuous acquisition until you stop it.
- Running one acquisition or a given number of acquisitions. If "Envelope" or "Average" is selected in the "Acquisition" tab, one acquisition means a cycle containing as many acquired waveforms as required to satisfy the reset conditions.

Prerequisites:

- Probes are connected.
- Vertical and horizontal settings are adjusted.
- Triggering is set.
- Channels to be acquired are turned on.

To start and stop continuous acquisition

1. Check if the trigger mode is set to "Norm". The trigger mode is shown in the trigger label in the upper right corner of the screen.
If not, press the trigger [Auto Norm] key on the front panel to toggle the setting.
2. Press the [Run Stop] key to start acquisition.
The acquisition starts if a trigger occurs.
3. To stop , press the [Run Stop] key again.
The acquisition stops immediately.

To acquire a limited number of acquisitions

1. Check if the trigger mode is set to "Norm". The trigger mode is shown in the trigger label in the upper right corner of the screen.
If not, press the trigger [Auto Norm] key on the front panel to toggle the setting.
2. Open "Menu" > "Acquire" > "Mode" tab.
3. Enter the number of acquisitions in the "Average count" field.
4. Press the [Single] key on the front panel.
You can stop the running acquisition before it is finished by pressing the key again.

5.9.6 Using the roll mode

The roll mode can be used if the acquisition process is slow - that is if the time scale is large. In roll mode, the instrument shows the waveform immediately and saves waiting for the waveform display. The roll mode can be activated by the instrument if several conditions are fulfilled.

To set the roll mode manually

1. Make sure that all requirements for the roll mode are fulfilled: see [Chapter 5.2, "Horizontal"](#), on page 119.
2. Open "Menu" > "Horizontal" > "Roll" tab.
3. Set "Mode" to "Auto".
4. Set the "Start roll time", the acquisition time at which the instrument starts the roll mode.

5.9.7 Using fast segmentation

Fast Segmentation reduces the dead time between two waveform acquisition cycles. The settings are described in [Chapter 5.4.3, "Segmented settings"](#), on page 131.

1. Open "Menu" > "Acquire" > "Segmented" tab.

2. Tap "Fast segmentation" to activate the fast segmentation mode.
3. If you want to sample the maximum number of acquisitions in a series, enable "Acquire maximum".
If you want to capture a defined number of acquisitions, disable "Acquire maximum" and enter the "Required" number of acquisitions.
4. Set the "Display time".

5.9.8 Using digital filters

Before using digital filters, you determine if you want to filter input channels only or if the trigger signal is filtered too. The filter settings depend on this decision.

For details on filter settings and dependencies, see [Chapter 5.5.5, "Digital filter setup"](#), on page 143.

To filter the input channels only

1. Open "Menu" > "Vertical" > "Bandwidth" tab > "Digital Filter".
2. Set the "Trigger BW limit" to "Off".
3. Enter the "Channel BW limit" frequency for each filter.
4. Enable "Channel BW limit (On/Off)" for each channel to be filtered.

To filter the trigger signal

1. Open "Menu" > "Vertical" > "Bandwidth" tab > "Digital Filter".
2. Set the "Trigger BW limit" to "RF Reject".
3. Set the frequency limit for the filter: "Channel BW limit".
4. To filter the input channels too, enable "Channel BW limit (On/Off)" for each channel to be filtered.
The trigger filter settings are applied also to these input channels.

6 Triggers

6.1 Basics of triggering

Triggering means to capture the interesting part of the relevant waveforms. Choosing the right trigger type and configuring all trigger settings correctly allows you to detect various incidents in analog, digital, and protocol signals.

Trigger

A trigger occurs if the complete set of trigger conditions is fulfilled. The trigger is the determining point in the waveform record. The instrument acquires continuously and keeps the sample points to fill the pre-trigger part of the waveform record. When the trigger occurs, the instrument continues acquisition until the post-trigger part of the waveform record is filled. Then it stops acquiring and waits for the next trigger. When a trigger is recognized, the instrument does not accept another trigger until the acquisition is complete, and the holdoff time has expired.

Trigger setup

A simple trigger setup includes:

- Source of the trigger signal, its coupling and filtering
- Trigger type selection and setup
- Horizontal position of the trigger: see: [Chapter 5.1.3.2, "Horizontal position"](#), on page 115
- Trigger mode

The R&S RTO6 provides various trigger types for troubleshooting and signal analysis, for example, edge trigger, glitch trigger, interval trigger, pattern trigger, and much more.

For complex tasks like verifying and debugging designs, advanced trigger settings are available:

- Hysteresis: rejection of noise to avoid unwanted trigger events caused by noise
- Holdoff to define exactly which trigger event causes the trigger
- Qualification to consider the states of digital signals on other input channels and their logical combination
- Trigger sequences to combine two trigger type conditions

Action on trigger

A trigger can initiate one or more actions, for example, saving a screenshot or saving waveform data. All available actions can be initiated at the same time.

Trigger sequence

A complex trigger sequence joins two or more separate trigger conditions with an optional delay time and an optional reset time or reset condition. Similar setups are also known as multi-step trigger or A/B trigger.

Trigger information

Information on the most important trigger settings is shown in the trigger label on top of the signal bar. If you double-tap the trigger label, the "Trigger" dialog box opens. The label shows:

- Trigger mode
- Trigger type, edge/polarity and trigger source, for A- and B-trigger

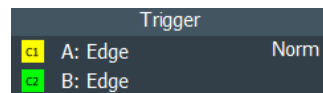

6.2 Setting up the trigger

This chapter provides step-by-step procedures for the important stages of trigger setup.

6.2.1 Configuring a simple trigger

Prerequisites:

- Horizontal and vertical settings are set appropriately to the signals.
- The acquisition is running, the [Run Stop] key lights green.

For details on settings, see [Chapter 6.3, "Trigger types"](#), on page 197.

Proceed as follows:

1. Open the "Menu">"Trigger" dialog.
The "Trigger" dialog box opens with the "Setup" tab.
2. Tap the "Source" button and select the trigger source.
3. Tap the "Type" button and select the trigger type.
4. Under "Trigger type dependent settings", configure the settings for the selected trigger type.
See: [Chapter 6.3, "Trigger types"](#), on page 197
5. To set the trigger level automatically, tap "Find level".
6. Set the normal trigger mode. Do one of the following:
 - Press the [Auto Norm] key on the front panel until "Normal" is shown in the trigger label.
 - In the "Mode / Holdoff" tab, set the "Trigger mode" to "Normal".

6.2.2 Positioning the trigger

By positioning the trigger on the time axis, you define which part of the waveform is displayed: mainly the pre-trigger part, or the post-trigger part, or the part around the trigger point.

For details on position settings, see [Chapter 5.4, "Acquire settings"](#), on page 126.

1. Open the "Menu"> "Horizontal" dialog.
2. Set the "Reference point" and the "Position".
If you want to set the trigger position outside the waveform display, make sure that "Restrict horizontal position to acquisition range" is disabled.

6.2.3 Using holdoff

For details on holdoff settings, see [Chapter 6.4, "Mode / Holdoff"](#), on page 224.

1. Open the "Menu">"Trigger" dialog.
2. Select the "Mode / Holdoff" tab.
3. Select the "Holdoff mode".
4. Enter the "Holdoff settings" belonging to the selected mode.

6.2.4 Setting up an A → B → R trigger sequence

The complete configuration of a complex "A → B → R" trigger sequence consists of:

- A-trigger condition
- B-trigger condition in the same way as for the A-trigger, and optional delay time between the two triggers
- Optional reset by timeout and/or R-trigger

For details on sequence settings, see [Chapter 6.8, "Sequence"](#), on page 233.

1. Open the "Menu" > "Trigger" dialog.
2. Set "Trigger on" = "Sequence".
3. Select the type of "Sequence": "A → B → R".
4. Tap "Setup A trigger".
A dialog opens where you can configure the first event.
See: [Chapter 6.2.1, "Configuring a simple trigger"](#), on page 195.
5. Tap "Setup B trigger" and configure the B-trigger condition.
A dialog opens where you can configure the second event.

6. Optionally, set the "After 1st event wait" that the instrument waits after an A-trigger until it recognizes B-triggers.
7. Set the "2nd event count". The last B-trigger causes the trigger.
8. You can also define a reset condition. If no B-trigger occurs and the reset condition is fulfilled, the sequence restarts with the A-trigger.
 - a) To specify a reset by timeout, enable "Reset on timeout", and enter the "Rest timeout".
 - b) To specify a reset trigger type condition, enable "Reset event" and configure the reset trigger type.

The trigger types and settings depend on the A and B trigger settings. The instrument provides only possible, reasonable combinations.

6.2.5 Qualifying the trigger

Qualification considers the states of digital signals on other input channels and their logical combination as an additional trigger condition. For example, an edge trigger is configured for channel 1, and the instrument triggers only if the signal on channel 2 is high.

For details on qualification settings and restrictions, see [Chapter 6.7, "Qualification"](#), on page 230.

1. On the "Menu", select "Trigger" > "Qualify" tab.
2. Set one or more channels with the input signal to be used as qualifying signals to "On".

The channel that is the trigger source is not available for qualification.
3. Check and set the threshold levels for all used channels, that is, the thresholds for digitization of analog signals.
4. Set the signal state for each channel: high or low.
5. If more than one channel is selected, set the logical combination of the channel states.
6. If not yet enabled, tap "Qualify" to enable the qualification.

6.3 Trigger types

The setup of the trigger type is the most important part of the trigger definition. It determines the method to identify specific signal phenomena. Almost all trigger types are available for all conditions in a trigger sequence, that is, you can combine different types in the sequence. The instrument checks the trigger settings for compatibility and feasibility, and disables settings that do not fit the previous settings in the sequence.

The settings in the tab are:

• Basic trigger settings.....	198
• Edge.....	200
• Glitch.....	201
• Width.....	202
• Runt.....	203
• Window.....	205
• Timeout.....	207
• Interval.....	208
• Slew rate.....	209
• Setup & Hold.....	211
• State.....	213
• Pattern.....	214
• Serial pattern.....	217
• TV/Video trigger.....	219
• NFC trigger.....	223
• CDR trigger.....	223
• Triggering on serial buses.....	223
• Triggering on parallel buses and digital channels.....	224

6.3.1 Basic trigger settings

Access: "Menu" > "Trigger" > "Setup" tab

The basic trigger settings are the trigger source and the trigger type, including the trigger level. These settings are specific for each condition in a trigger sequence. To set the trigger level automatically, use "Find level".

Depending on the trigger type, additional settings are available. They are explained in the type-specific section.

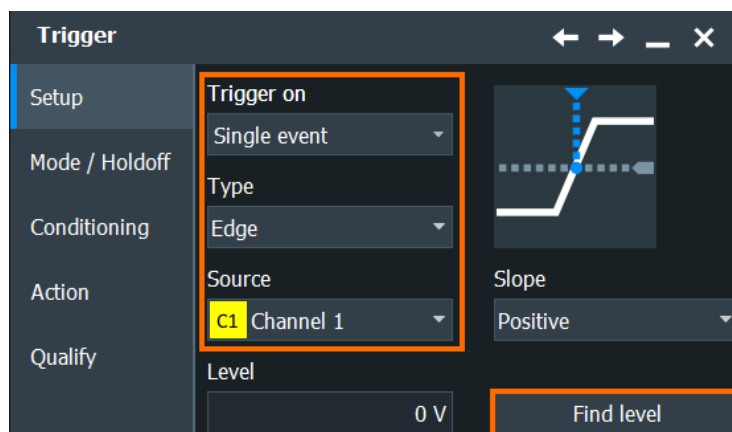

Trigger on

Selects, if you want to trigger on a single event, or on a series of events.

Remote command:

`TRIGGER<m>:EVENT[:EVENT]` on page 1524

Source

Selects the source of the trigger signal for the current trigger condition. The trigger source works even if it is not displayed in a diagram. It must be synchronized to the signal to be displayed and analyzed.

The trigger source can be:

- Channel 1...4: An analog input channel
- Extern: External analog signal connected to the external trigger input
The external trigger source is supported for the "Single event" sequence. It is not available if a longer trigger sequence is selected, or if qualification is enabled.
- Serial bus, D0...D15, Logic, Parallel bus 1...4:
If options with trigger functionality are installed, the variety of trigger sources is enhanced with specific trigger sources.

Available sources depend on the trigger sequence setting. If "Single event" is selected, all inputs (analog input channels, serial and parallel buses, digital channels) can be used as trigger source. If any other trigger sequence is selected, only channel inputs Ch1...4 can be set as trigger source, and all other input sources are disabled.

See also: [Chapter 6.8, "Sequence"](#), on page 233

Remote command:

[TRIGger<m>:SOURce\[:SElect\]](#) on page 1485

Type

Selects the trigger type specific for each condition in a trigger sequence. The current trigger type is shown on the button.

The following trigger types are available:

- [Edge, see page 200](#)
- [Glitch, see page 201](#)
- [Width, see page 202](#)
- [Runt, see page 203](#)
- [Window, see page 205](#)
- [Timeout, see page 207](#)
- [Interval, see page 208](#)
- [Slew rate, see page 209](#)
- [Setup & Hold, see page 211](#)
- [State, see page 213](#)
- [Pattern, see page 214](#)
- [Serial pattern, see page 217](#)
- [TV/Video trigger, see page 219](#)
- [CDR trigger, see page 1142](#) (requires option R&S RTO6-K13)

Restrictions:

- If the external trigger input is used as trigger source, the analog edge trigger is the only available trigger type.
- For the R-trigger (reset), the trigger types and settings are restricted dependent on the A and B trigger settings. The instrument provides only possible, reasonable combinations.

Remote command:

[TRIGger<m>:TYPE](#) on page 1486

Find level

Sets the trigger level automatically to $0.5 * (MaxPeak - MinPeak)$. The function is not available for an external trigger source and the TV trigger.

Remote command:

[TRIGger<m>:FINDlevel](#) on page 1488

6.3.2 Edge

Access: "Menu" > "Trigger" > "Setup" tab > "Type = Edge"

The edge trigger is the most common trigger type. It is well known from analog oscilloscopes; and you can use it for analog and digital signals.

The trigger condition is fulfilled when the signal from the trigger source passes the specified threshold voltage in the specified direction (slope).

If the trigger source is a channel signal, the edge trigger uses the digitized trigger signal. This signal can be qualified and filtered with the DSP filter. If the trigger source is the external trigger input, the coupling and filter for this signal is set directly in the trigger setup.

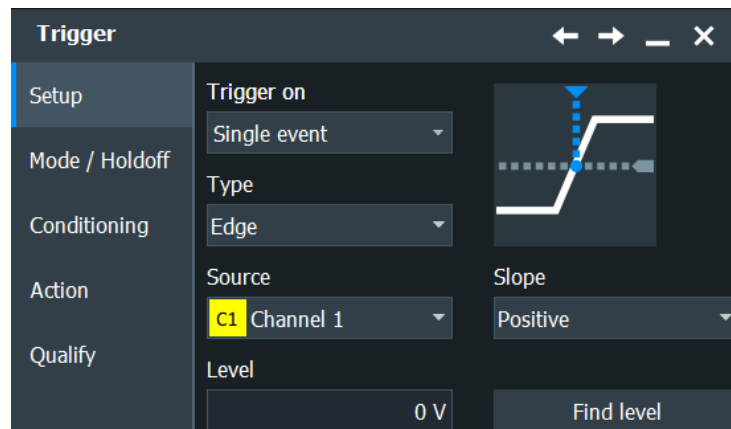
**Slope**

Sets the edge type for the trigger condition.

- "Positive" Selects the rising edge, which is a positive voltage change.
- "Negative" Selects the falling edge, which is a negative voltage change.
- "Both" Selects the rising as well as the falling edge. This option is not available if the trigger source is the external trigger input.

Remote command:

[TRIGger<m>:EDGE:SLOPe](#) on page 1488

[TRIGger<m>:ANEDge:SLOPe](#) on page 1535

[TRIGger<m>:SLEW:SLOPe](#) on page 1499

Level

Sets the voltage level for the trigger condition. You can also drag the trigger level marker on the display (TA or TB on the right edge of the display).

Remote command:

[TRIGger<m>:LEVel<n>\[:VALue\]](#) on page 1487

6.3.3 Glitch

Access: "Menu" > "Trigger" > "Setup" tab > "Type = Glitch"

The glitch trigger detects pulses shorter or longer than a specified time. It identifies deviation from the nominal data rate and helps to analyze causes of even rare glitches and their effects on other signals.

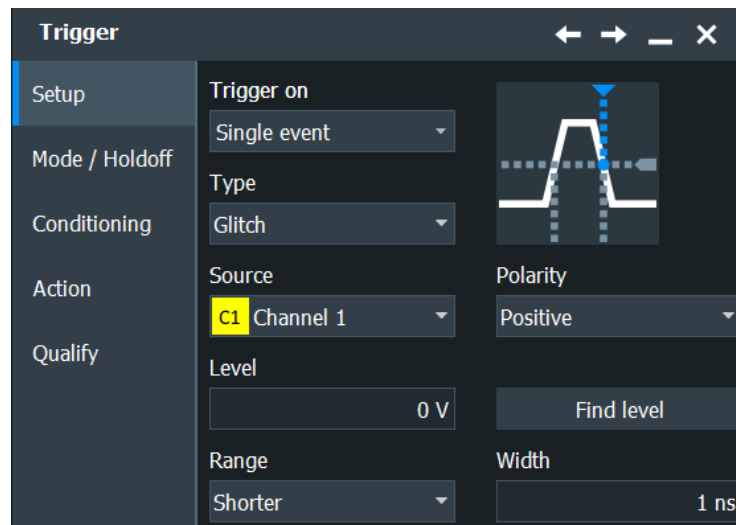

Polarity

Indicates the polarity of a pulse, which is the direction of the first pulse slope.

- "Positive" Selects positive-going pulses.
- "Negative" Selects negative-going pulses.
- "Either" Selects both positive-going and negative-going pulses.

Remote command:

[TRIGger<m>:GLITCh:POLArity](#) on page 1489

[TRIGger<m>:RUNT:POLArity](#) on page 1492

Range

Selects which glitches are identified: shorter or longer than the specified "Width".

Remote command:

[TRIGger<m>:GLITCh:RANGe](#) on page 1489

Width

Sets the length of a glitch. The instrument triggers on pulses shorter or longer than this value. The minimum width is 100 ps.

You need to know the expected pulse widths of the circuit to set the glitch width correctly.

Remote command:

[TRIGger<m>:GLITCh:WIDTh](#) on page 1489

Trigger level

Sets the voltage level for the trigger condition. You can also drag the trigger level marker on the display (TA or TB on the right edge of the display). The range of the trigger level is limited in a way so that always a hysteresis for stable trigger conditions is available.

Remote command:

[TRIGger<m>:LEVel<n>\[:VALue\]](#) on page 1487

6.3.4 Width

Access: "Menu" > "Trigger" > "Setup" tab > "Type = Width"

The width trigger compares the pulse width (duration of a pulse) with a given time limit. It detects pulses with an exact pulse width, pulses shorter or longer than a given time, and pulses inside or outside the allowable time range. The pulse width is measured at the trigger level.

Using the width trigger, you can define the pulse width more precisely than with the glitch trigger. However, using the range settings "Shorter" and "Longer", you can also trigger on glitches.

The width trigger can only analyze **either** positive **or** negative polarity, but searching for a width is also possible for both polarities at the same time ("Either").

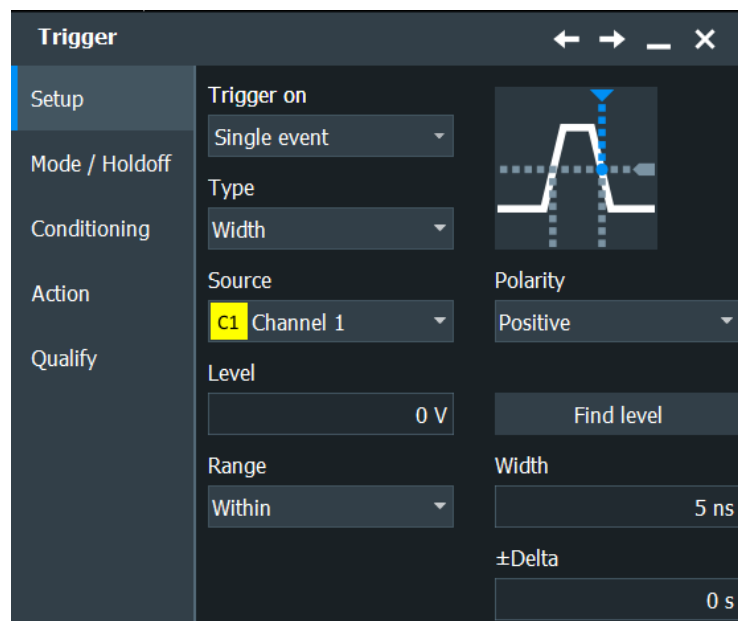

Polarity

Indicates the polarity of a pulse, which is the direction of the first pulse slope.

"Positive" Triggers on positive-going pulses.

"Negative" Triggers on negative-going pulses.

Remote command:

[TRIGger<m>:WIDTh:POLarity](#) on page 1490

Range

Selects how the range of a pulse width is defined:

"Within" Triggers on pulses inside a given range. The range of the pulse width is defined by " $\pm\Delta$ " related to "Width".

"Outside" Triggers on pulses outside a given range. The range definition is the same as for "Within" range.

"Shorter" Triggers on pulses shorter than the given "Width".

"Longer" Triggers on pulses longer than the given "Width".

Remote command:

[TRIGger<m>:WIDTh:RANGe](#) on page 1490

Width

For the ranges "Within" and "Outside", the width defines the center of a range which is defined by the limits $\pm\Delta$.

For the ranges "Shorter" and "Longer", the width defines the maximum and minimum pulse width, respectively.

Remote command:

[TRIGger<m>:WIDTh:WIDTh](#) on page 1491

$\pm\Delta$

Defines a range around the given width value.

The combination "Range = Within" and " $\pm\Delta$ " = 0 triggers on pulses with a pulse width that equals "Width".

The combination "Range = Outside" and " $\pm\Delta$ " = 0 means to trigger on pulse widths \neq "Width".

Trigger level

Sets the voltage level for the trigger condition. You can also drag the trigger level marker on the display (TA or TB on the right edge of the display). The range of the trigger level is limited in a way so that always a hysteresis for stable trigger conditions is available.

Remote command:

[TRIGger<m>:LEVel<n>\[:VALue\]](#) on page 1487

6.3.5 Runt

Access: "Menu" > "Trigger" > "Setup" tab > "Type = Runt"

A runt is a pulse lower than normal in amplitude. The amplitude crosses the first threshold twice in succession without crossing the second one. In addition to the threshold amplitudes, you can define a time limit for the runt in the same way as for width triggers. For example, this trigger can detect logic, digital, and analog signals

remaining below a specified threshold amplitude because I/O ports are in undefined state.

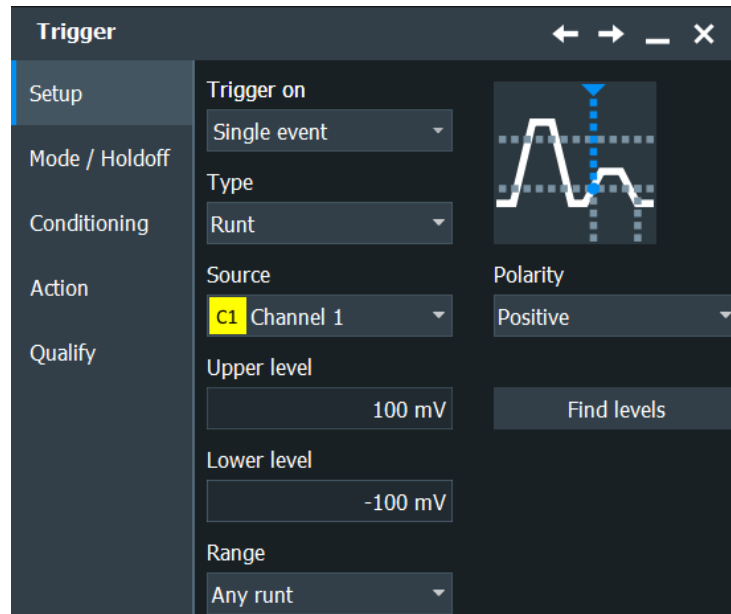

Polarity

Indicates the polarity of a pulse, which is the direction of the first pulse slope.

- "Positive" Selects positive-going pulses.
- "Negative" Selects negative-going pulses.
- "Either" Selects both positive-going and negative-going pulses.

Remote command:

[TRIGger<m>:GLITCh:POLarity](#) on page 1489

[TRIGger<m>:RUNT:POLarity](#) on page 1492

Upper level

Sets the upper voltage threshold.

Remote command:

[TRIGger<m>:LEVel<n>:RUNT:UPPer](#) on page 1492

Lower level

Sets the lower voltage threshold.

Remote command:

[TRIGger<m>:LEVel<n>:RUNT:LOWer](#) on page 1492

Range

Selects how the time limit of the runt pulse is defined:

- "Any runt" Triggers on all runts fulfilling the level condition, without time limitation.
- "Longer" Triggers on runts longer than the given "Runt width".
- "Shorter" Triggers on runts shorter than the given "Runt width".

"Within" Triggers if the runt length is inside a given time range. The range is defined by "Runt width" and " \pm Delta".

"Outside" Triggers if the runt length is outside a given time range. The range definition is the same as for "Within" range.

Remote command:

[TRIGger<m>:RUNT:RANGe](#) on page 1493

Runt width

For the ranges "Shorter" and "Longer", the runt width defines the maximum and minimum pulse width, respectively.

For the ranges "Within" and "Outside", the runt width defines the center of a range which is defined by " \pm Delta".

Remote command:

[TRIGger<m>:RUNT:WIDTh](#) on page 1493

\pm Delta

Defines a range around the given runt width.

Remote command:

[TRIGger<m>:RUNT:DELTa](#) on page 1494

6.3.6 Window

Access: "Menu" > "Trigger" > "Setup" tab > "Type = Window"

The window trigger checks the signal run in relation to a "window". The window is formed by the upper and lower voltage levels. The trigger condition is fulfilled, if the waveform enters or leaves the window, or if the waveform stays inside or outside for a time longer or shorter than specified.

With the window trigger, you can display longer transient effects.

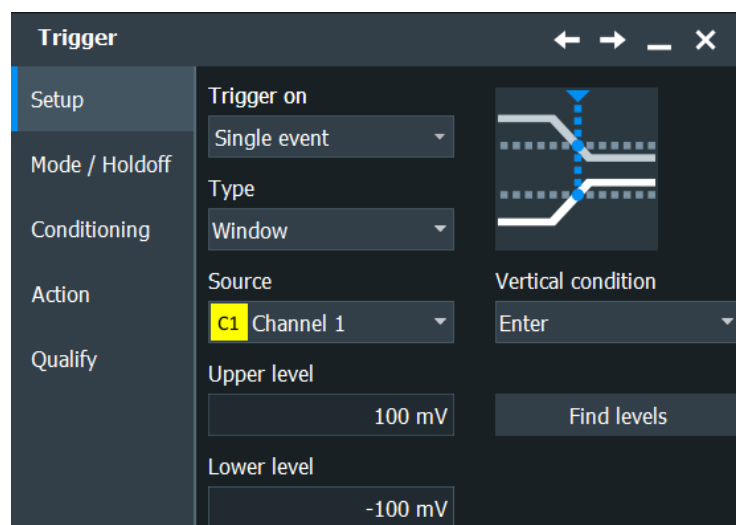

Vertical condition

Selects how the signal run is compared with the window:

"Enter"	Triggers when the signal crosses the upper or lower level and thus enters the window made up of these two levels.
"Exit"	Triggers when the signal leaves the window.
"Stay within"	Triggers if the signal stays between the upper and lower level for a specified time. The time is defined in various ways by the Time condition .
"Stay outside"	Triggers if the signal stays above the upper level or below the lower level for a specified time. The time is also defined by the "Time condition".

Remote command:

[TRIGger<m>:WINDow:RANGe](#) on page 1495

Upper level

Sets the upper voltage limit for the window.

Remote command:

[TRIGger<m>:LEVel<n>:WINDow:UPPer](#) on page 1494

Lower level

Sets the lower voltage limit for the window.

Remote command:

[TRIGger<m>:LEVel<n>:WINDow:LOWer](#) on page 1494

Time condition

Selects how the time limit of the window is defined. Time conditioning is available for the vertical conditions "Stay within" and "Stay outside".

"Within"	Triggers if the signal stays inside or outside the vertical window limits at least for the time $Width - Delta$ and for $Width + Delta$ at the most.
"Outside"	"Outside" is the opposite definition of "Within". The instrument triggers if the signal stays inside or outside the vertical window limits for a time shorter than $Width - Delta$ or longer than $Width + Delta$.
"Shorter"	Triggers if the signal crosses vertical limits before the specified "Width" time is reached.
"Longer"	Triggers if the signal crosses vertical limits after the specified "Width" time is reached.

Remote command:

[TRIGger<m>:WINDow:TIME](#) on page 1495

Width

For the ranges "Within" and "Outside", the width defines the center of a time range which is defined by the limits " $\pm Delta$ ".

For the ranges "Shorter" and "Longer", it defines the maximum and minimum time lapse, respectively.

Remote command:

[TRIGger<m>:WINDow:WIDTh](#) on page 1496

±Delta

Defines a range around the "Width" value.

Remote command:

[TRIGger<m>:WINDow:DELTA](#) on page 1496

6.3.7 Timeout

Access: "Menu" > "Trigger" > "Setup" tab > "Type = Timeout"

The timeout trigger checks if the signal stays above or below the threshold voltage for a specified time lapse. In other words, the trigger occurs if the trigger source does not have the expected transition within the specified time.

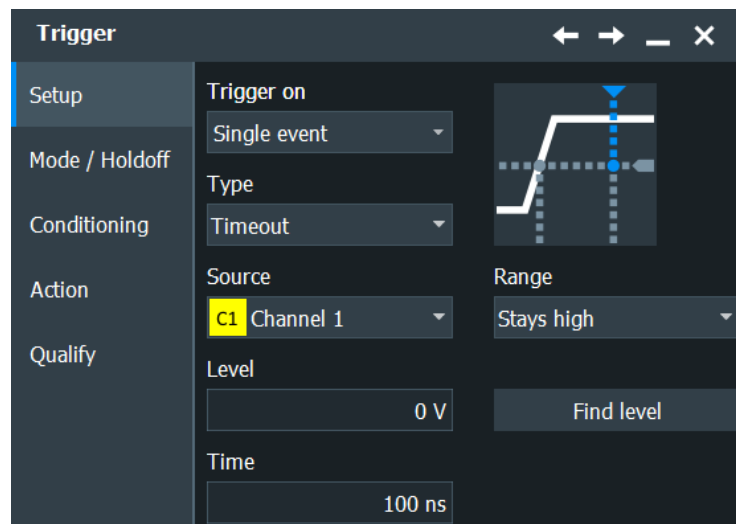

Trigger level

Sets the voltage level for the trigger condition. You can also drag the trigger level marker on the display (TA or TB on the right edge of the display). The range of the trigger level is limited in a way so that always a hysteresis for stable trigger conditions is available.

Remote command:

[TRIGger<m>:LEVel<n>\[:VALue\]](#) on page 1487

Range

Selects the relation of the signal level to the trigger level:

"Stays high" The signal level stays above the trigger level.

"Stays low" The signal level stays below the trigger level.

"High or low" The signal level stays above or below the trigger level.

Remote command:

[TRIGger<m>:TIMEout:RANGe](#) on page 1497

Time

Defines the time limit for the timeout at which the instrument triggers.

Remote command:

[TRIGger<m>:TIMEout:TIME](#) on page 1497

6.3.8 Interval

Access: "Menu" > "Trigger" > "Setup" tab > "Type = Interval"

The interval trigger analyzes the time between two pulses.

The interval trigger can analyze either rising or falling edges, but searching for an interval is also possible for both edges at the same time ("Either").

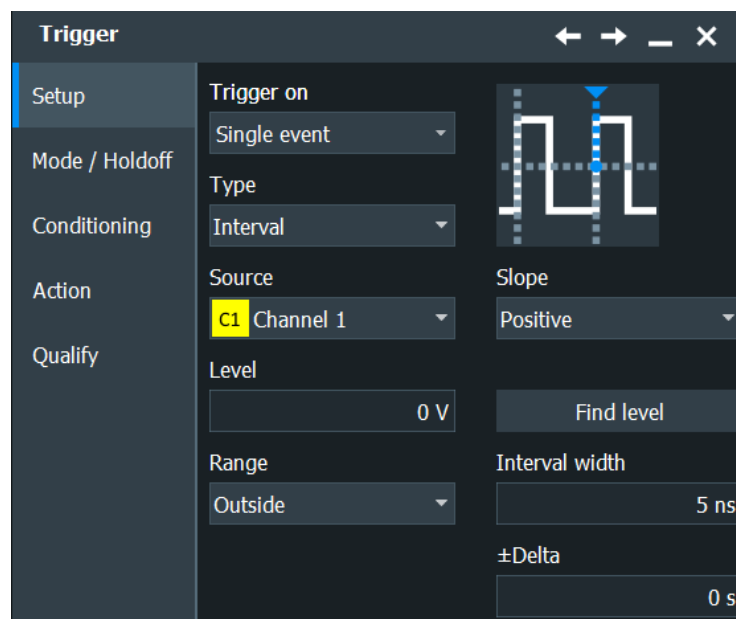
**Slope**

Sets the edge for the trigger. You can analyze the interval between positive edges or between negative edges.

Remote command:

[TRIGger<m>:INTerval:SLOPe](#) on page 1498

Trigger level

Sets the voltage level for the trigger condition. You can also drag the trigger level marker on the display (TA or TB on the right edge of the display). The range of the trigger level is limited in a way so that always a hysteresis for stable trigger conditions is available.

Remote command:

[TRIGger<m>:LEVel<n>\[:VALue\]](#) on page 1487

Range

Selects how the range of an interval is defined:

"Within"	Triggers on pulse intervals inside a given range. The range is defined by "Interv. width" and "±Delta".
"Outside"	Triggers on intervals outside a given range. The range definition is the same as for "Within" range.
"Shorter"	Triggers on intervals shorter than the given "Interv. width".
"Longer"	Triggers on intervals longer than the given "Interv. width".

Remote command:

[TRIGger<m>:INTerval:RANGe](#) on page 1498

Interv. width

Defines the time between two pulses.

Remote command:

[TRIGger<m>:INTerval:WIDTh](#) on page 1498

±Delta

Defines a range around the "Interval width" value.

Remote command:

[TRIGger<m>:INTerval:DELTA](#) on page 1499

6.3.9 Slew rate

Access: "Menu" > "Trigger" > "Setup" tab > "Type = Slew rate"

The slew rate trigger is also known as transition trigger. It triggers if the transition time from the lower to higher voltage level (or vice versa) is shorter or longer as defined, or outside or inside a specified time range.

The slew rate trigger finds slew rates faster than expected or permissible to avoid overshooting and other interfering effects. It also detects slow edges violating the timing in pulse series.

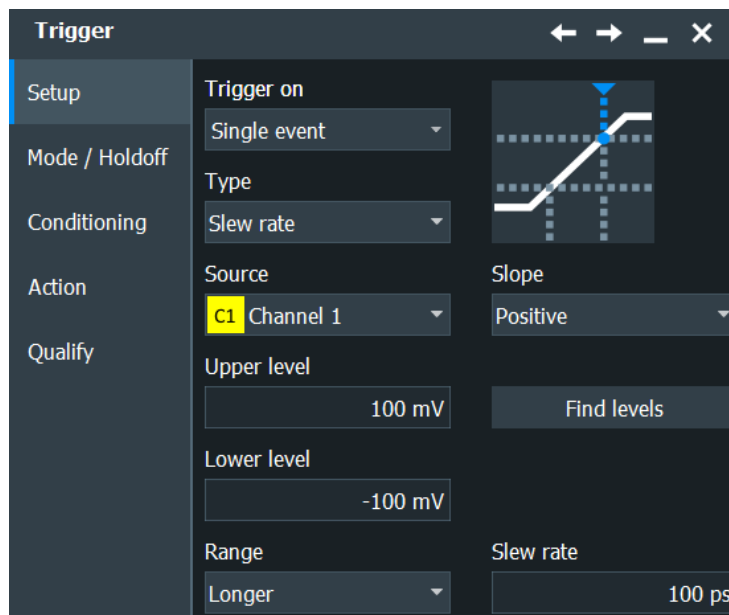

Slope

Sets the edge type for the trigger condition.

- "Positive" Selects the rising edge, which is a positive voltage change.
- "Negative" Selects the falling edge, which is a negative voltage change.
- "Both" Selects the rising as well as the falling edge. This option is not available if the trigger source is the external trigger input.

Remote command:

[TRIGger<m>:EDGE:SLOPe](#) on page 1488

[TRIGger<m>:ANEDge:SLOPe](#) on page 1535

[TRIGger<m>:SLEW:SLOPe](#) on page 1499

Upper level

Sets the upper voltage threshold. When the signal crosses this level, the slew rate measurement starts or stops depending on the selected slope.

Remote command:

[TRIGger<m>:LEVel<n>:SLEW:UPPer](#) on page 1500

Lower level

Sets the lower voltage threshold. When the signal crosses this level, the slew rate measurement starts or stops depending on the selected slope.

Remote command:

[TRIGger<m>:LEVel<n>:SLEW:LOWer](#) on page 1500

Range

Selects how the time limit for the slew rate is defined. The time measurement starts when the signal crosses the first trigger level - the upper or lower level depending on the selected slope. The measurement stops when the signal crosses the second level.

"Within"	Triggers on slew rates inside a given time range. The range is defined by "Slew rate" and " $\pm\Delta$ ".
"Outside"	Triggers on slew rates outside a given time range. The range definition is the same as for "Within" range.
"Shorter"	Triggers on slew rates shorter than the given "Slew rate" limit.
"Longer"	Triggers on slew rates longer than the given "Slew rate" limit.

Remote command:

[TRIGger<m>:SLEW:RANGe](#) on page 1500

Slew rate

For the ranges "Within" and "Outside", the slew rate defines the center of a range which is defined by the limits " $\pm\Delta$ ".

For the ranges "Shorter" and "Longer", the slew rate defines the maximum and minimum slew rate limits, respectively.

Remote command:

[TRIGger<m>:SLEW:RATE](#) on page 1501

$\pm\Delta$

Defines a time range around the given slew rate.

Remote command:

[TRIGger<m>:SLEW:DELTA](#) on page 1501

6.3.10 Setup & Hold

Access: "Menu" > "Trigger" > "Setup" tab > "Type = Setup & Hold"

With the Setup & Hold trigger you can analyze the relative timing between two signals: a data signal and the synchronous clock signal. Many systems require, that the data signal must be steady for some time before and after the clock edge, for example, the data transmission on parallel interfaces. With this trigger type, you can also test the time correlation of sideband and in-band signals.

The trigger occurs if the data signal crosses the data level during the setup and hold time. The reference point for the time measurement is defined by clock level and clock edge.

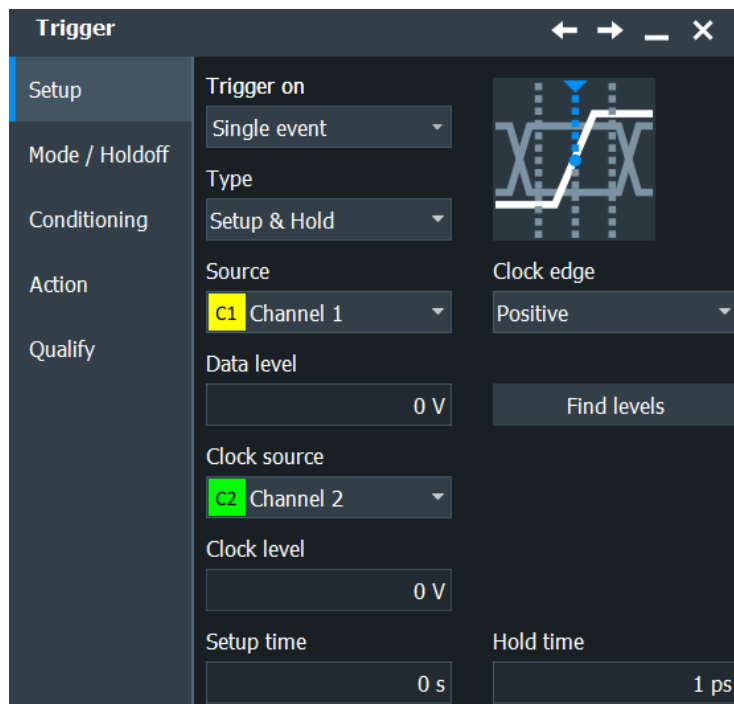

Clock source

Selects the input channel of the clock signal.

Remote command:

[TRIGger<m>:SETHold:CSOURCE\[:VALUE\]](#) on page 1502

[TRIGger<m>:SPATtern:CSOURCE\[:VALUE\]](#) on page 1508

Clock edge

Sets the edge of the clock signal to define the time reference point for the setup and hold time:

- "Positive" Rising edge, a positive voltage change.
- "Negative" Falling edge, a negative voltage change.
- "Both" Both the rising and the falling edge.

Remote command:

[TRIGger<m>:SETHold:CSOURCE:EDGE](#) on page 1502

Clock level

Sets the voltage level for the clock signal. Both "Clock level" and "Clock edge" define the starting point for calculation of the setup and hold time.

Remote command:

[TRIGger<m>:SETHold:CSOURCE:LEVEL](#) on page 1502

Data level

Sets the voltage level for the data signal. At this level, the setup time and hold time are measured.

Remote command:

[TRIGger<m>:LEVEL<n>\[:VALUE\]](#) on page 1487

Use data level for clock level

Sets the trigger levels and hysteresis values for all channels to the values of the currently selected trigger source. The function affects only the levels defined for the selected condition. The hysteresis of the external trigger input is an independent value, and it is not affected by level coupling.

Remote command:

[TRIGger<m>:SCOupling](#) on page 1504

Setup time

Sets the minimum time **before** the clock edge while the data signal must stay steady above or below the data level.

The setup time can be negative. In this case, the hold time is always positive. If you set a negative setup time, the hold time is adjusted by the instrument.

Remote command:

[TRIGger<m>:SETHold:STIME](#) on page 1503

Hold time

Sets the minimum time **after** the clock edge while the data signal must stay steady above or below the data level.

The hold time can be negative. In this case, the setup time is always positive. If you set a negative hold time, the setup time is adjusted by the instrument.

Remote command:

[TRIGger<m>:SETHold:HTIME](#) on page 1503

6.3.11 State

The state trigger is a qualified edge trigger. It combines the edge trigger settings with trigger qualification.

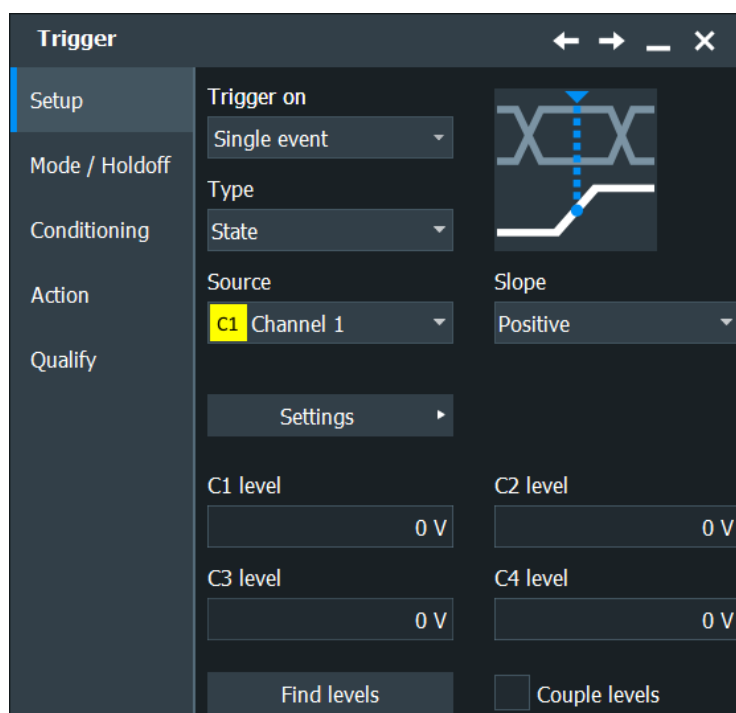

The individual settings are:

- ["Slope"](#) on page 200
- ["Pattern"](#) on page 215
- ["Trigger Levels"](#) on page 216
- ["Find level"](#) on page 200
- ["Use data level for clock level"](#) on page 213

6.3.12 Pattern

Access: "Menu" > "Trigger" > "Setup" tab > "Type = Pattern"

The pattern trigger is a logic trigger. It provides logical combination of the input channels and supports you in verifying the operation of digital logic. In addition to the pattern and the trigger levels, you can define a timing condition.

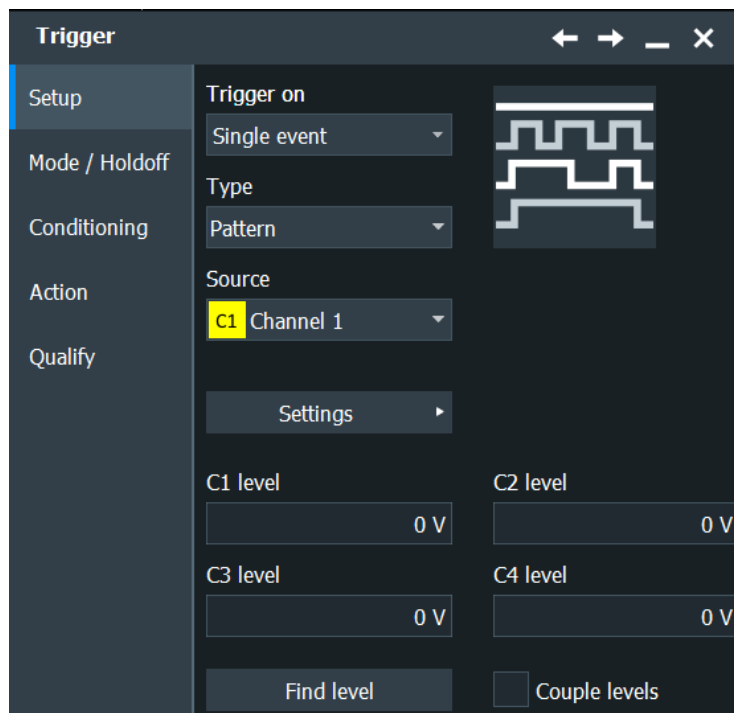

Pattern

The pattern contains the channel selection, and the logical operations structure of hardware-based Boolean logic.

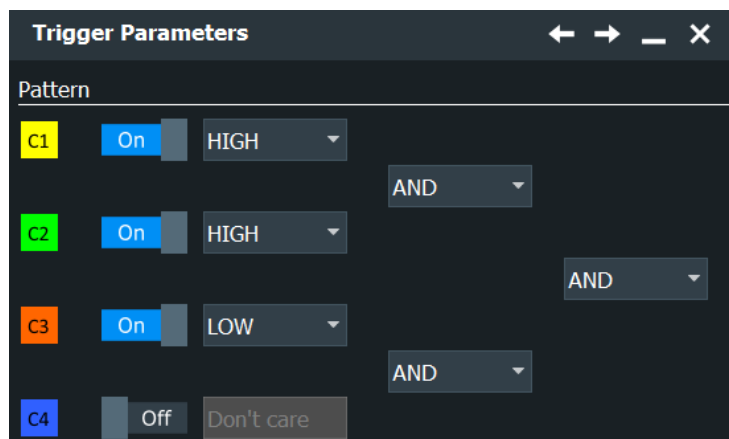

Channel "On", "Off" Select the channels to be considered. For qualification, you can select all channel signals except for the trigger source. In pattern trigger setup, the trigger source channel is selected by default, and you can select all other channel signals.

Channel operators Defines the logical operation on the digital signal resulting from the comparison with the trigger level.

- "HIGH": leaves the input value unchanged
- "LOW": inverts the input value

Logic operators Defines the logic combination of two sources. The sources are channel 1/2 and channel 3/4 on the first step, and in the second step the logical combination resulting from the first step.

- "AND": logical AND, conjunctive combination
- "NAND": logical NOT AND
- "OR": logical OR, disjunctive combination
- "NOR": logical NOT OR

Remote command:

Select channels:

[TRIGger<m>:QUALify<n>:A\[:ENABLE\]](#) on page 1516

[TRIGger<m>:QUALify<n>:B\[:ENABLE\]](#) on page 1516

[TRIGger<m>:QUALify<n>:C\[:ENABLE\]](#) on page 1516

[TRIGger<m>:QUALify<n>:D\[:ENABLE\]](#) on page 1516

Channel operators:

[TRIGger<m>:QUALify<n>:A:LOGic](#) on page 1516

[TRIGger<m>:QUALify<n>:B:LOGic](#) on page 1516

[TRIGger<m>:QUALify<n>:C:LOGic](#) on page 1516

[TRIGger<m>:QUALify<n>:D:LOGic](#) on page 1516

Logic operators:

[TRIGger<m>:QUALify<n>:AB:LOGic](#) on page 1517

[TRIGger<m>:QUALify<n>:CD:LOGic](#) on page 1517

[TRIGger<m>:QUALify<n>:ABCD:LOGic](#) on page 1517

Trigger Levels

Define the trigger level for each input channel. For state and pattern trigger, the trigger level is a decision threshold: If the signal value is higher than the trigger level, the signal state is high (1 or true for the Boolean logic). Otherwise, the signal state is considered low (0 or false) if the signal value is below the trigger level.

You can set the trigger levels for all channels to the same value, see ["Use data level for clock level"](#) on page 213.

Additional settings: Timing

"Timing" adds time limitation to the pattern condition.

- | | |
|-----------|---|
| "Off" | No time limitation. The trigger occurs if the pattern condition is fulfilled. |
| "Timeout" | Defines how long the result of the pattern condition must be true or false. |
| "Width" | Defines a time range for keeping up the true result of the pattern condition. The range is defined in the same way as for width and interval triggers, see "Range" on page 203. |

Remote command:

[TRIGger<m>:PATTern:MODE](#) on page 1505

[TRIGger<m>:PATTern:TIMEout:MODE](#) on page 1505

[TRIGger<m>:PATTern:TIMEout\[:TIME\]](#) on page 1506

[TRIGger<m>:PATTern:WIDTh:DELTA](#) on page 1507

[TRIGger<m>:PATTern:WIDTh:RANGe](#) on page 1506

[TRIGger<m>:PATTern:WIDTh\[:WIDTh\]](#) on page 1507

6.3.13 Serial pattern

Access: "Menu" > "Trigger" > "Setup" tab > "Type = Serial Pattern"

The serial pattern is used to trigger on signals with serial data patterns in relation to a clock signal - for example, on bus signals like the I²C bus.

The instrument expects the bits coming in LSB first order. A triggered waveform in the diagram shows the LSB on the left and the MSB on the right side.

For convenient and comprehensive triggering on specific serial data, options for serial protocol analysis are provided.

If option R&S RTO6--K13 is installed, you can use the recovered clock signal for the serial pattern trigger instead of a real clock signal, see [Chapter 19.3.2.3, "Serial pattern trigger using CDR"](#), on page 1143.

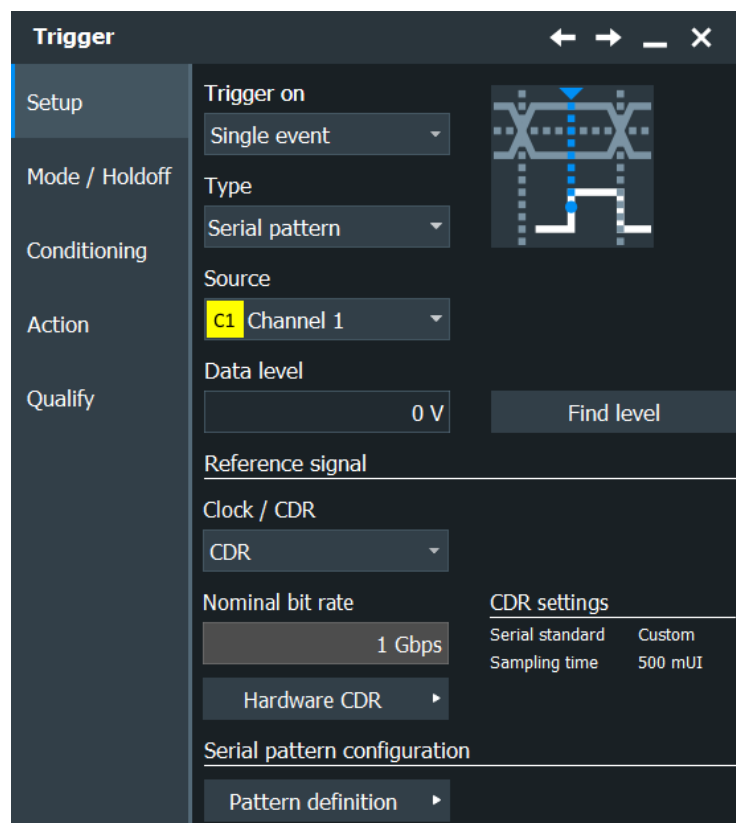

Data level

Sets the voltage level for the data signal.

If the signal value is higher than the data level, the state is 1. Below the level, the signal state is 0.

Remote command:

[TRIGger<m>:LEVel<n>\[:VALue\]](#) on page 1487

Clock / CDR

Selects if an explicit clock or a CDR signal is used as a reference signal for the serial pattern trigger.

- "CDR" Uses clock data recovery. See [Chapter 19.3.2.3, "Serial pattern trigger using CDR"](#), on page 1143.
- "Clock" Uses an explicit clock signal, see [Explicit clock](#).

Remote command:

[TRIGger<m>:SPATtern:REFSource](#) on page 1509

Explicit clock

Opens a dialog to define the settings of the explicit clock settings.

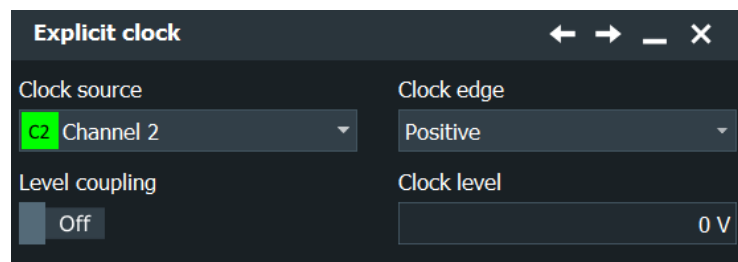
**Clock source ← Explicit clock**

Selects the input channel of the clock signal.

Remote command:

[TRIGger<m>:SETHold:CSOURCE\[:VALUE\]](#) on page 1502

[TRIGger<m>:SPATtern:CSOURCE\[:VALUE\]](#) on page 1508

Clock edge ← Explicit clock

Together with the clock level, the clock edge sets the point in time when the state of the data signal is checked:

- "Positive" Rising edge, a positive voltage change.
- "Negative" Falling edge, a negative voltage change.
- "Both" Both the rising and the falling edge.

Remote command:

[TRIGger<m>:SPATtern:CSOURCE:EDGE](#) on page 1508

Clock level ← Explicit clock

Sets the voltage level for the clock signal.

Remote command:

[TRIGger<m>:SPATtern:CSOURCE:LEVEL](#) on page 1508

Use data level for clock level ← Explicit clock

Sets the trigger levels and hysteresis values for all channels to the values of the currently selected trigger source. The function affects only the levels defined for the selected condition. The hysteresis of the external trigger input is an independent value, and it is not affected by level coupling.

Remote command:

[TRIGger<m>:SCOupling](#) on page 1504

Pattern

The pattern contains the bits of the serial data to be found in the data stream. The maximum length of the pattern is 128 bit. Touch and hold the "Pattern" field to open the "Bit Pattern Editor" where you can enter the pattern in various formats.

See also: [Chapter 14.1.7, "Bit pattern editor"](#), on page 519.

In binary format, an X indicates that the logical level for the bit is not relevant (do not care).

Remote command:

[TRIGger<m>:SPATtern:PATtern](#) on page 1509

6.3.14 TV/Video trigger

Access: "Menu" > "Trigger" > "Setup" tab > "Type = TV"

The TV or video trigger is used to analyze analog baseband video signals. You can trigger on baseband video signals from standard definition and high definition standards, and also on user-defined signals.

The instrument triggers on the line start - the horizontal sync pulse. You can trigger on all lines, or specify a line number. You can also trigger on the field or frame start.

Also, a delay can be set: Set the "Holdoff events" in the "Mode / Holdoff" tab to the number of fields to be skipped.

For details on holdoff settings, see [Chapter 6.4, "Mode / Holdoff"](#), on page 224.

Make sure that the trigger level crosses the synchronizing pulses of the video signal, see ["Trigger level"](#) on page 221.





Most video signals have an output impedance of 75 Ω . The channel inputs of the R&S RTO6 have an input impedance of 50 Ω or 1 M Ω . Make sure to provide the adequate matching to ensure amplitude fidelity. A simple 75 Ω feed-through termination combined with 1 M Ω oscilloscope inputs is suitable for most applications.

Once the trigger is set correctly, you can use cursor and automatic measurements to perform amplitude and timing measurements.

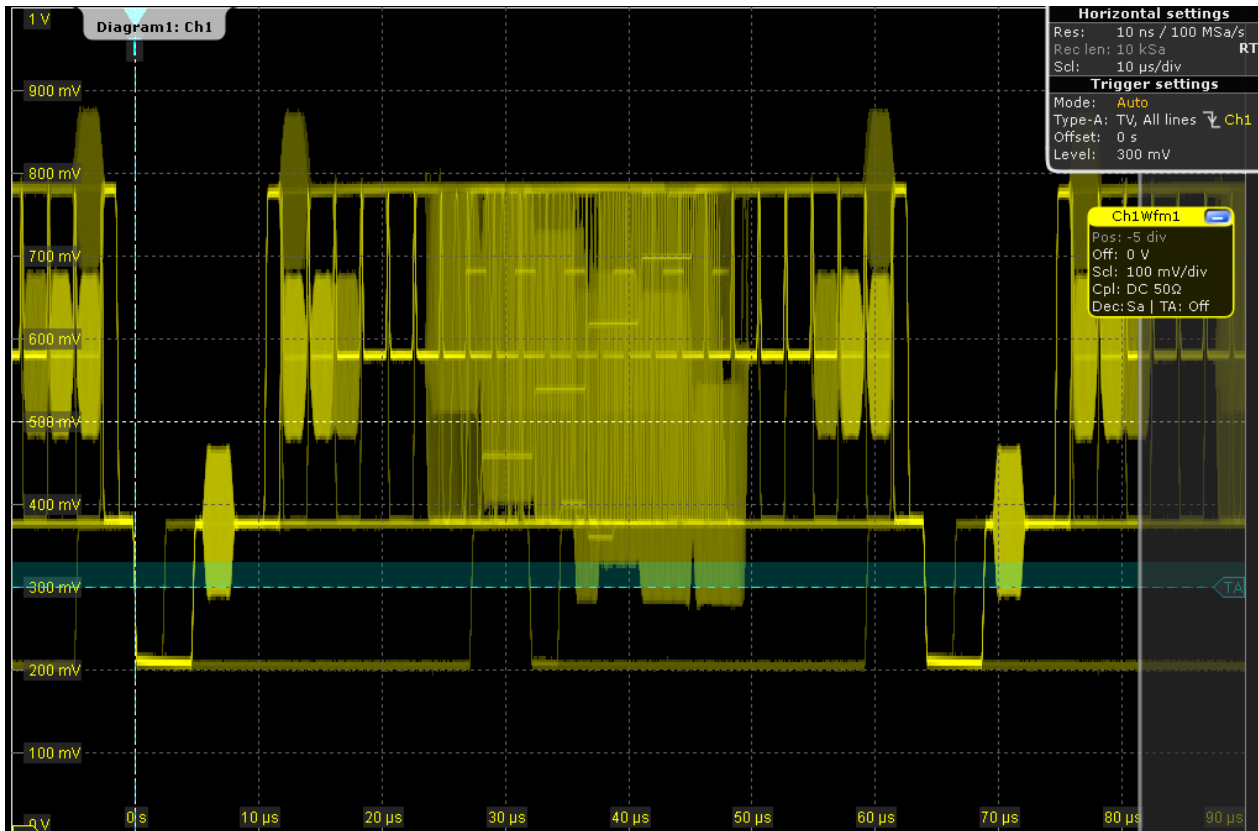

Figure 6-1: Trigger on all lines of a PAL signal with positive signal polarity, trigger level = 300 mV

Standard

Selects the TV standard or "Custom" for user-defined signals.

HDTV standards are indicated by the number of active lines, the scanning system (p for progressive scanning, i for interlaced scanning) and the frame rate. For interlaced scanning, the field rate is used instead of the frame rate. 1080p/24sF is an HDTV standard using progressive segmented frame scanning.

"Custom" can be used for signals of other video systems, for example, medical displays, video monitors, and security cameras. To trigger on these signals, you have to define the pulse type and length of the sync pulse, the scanning system and the line period.

Remote command:

[TRIGger<m>:TV:STANdard](#) on page 1510

Mode

Selects the lines or fields on which the instrument triggers. Available modes depend on the scanning system of the selected standard.

- "All fields" Triggers on the first video line of the frame (progressive scanning) or field (interlaced scanning), for example, to find amplitude differences between the fields.
- "Odd fields / Even fields" Triggers on the first video line of the odd or even field. These modes are available for interlaced scanning (PAL, PAL-M, SECAM, NTSC, 1080i) and progressive segmented frame scanning (1080p/24sF). They can be used, for example, to analyze the components of a video signal.
- "All lines" Triggers on the line start of all video lines, for example, to find maximum video levels.
- "Line number" Triggers on a specified line. Enter the line number in "Line #".

Remote command:

[TRIGger<m>:TV:MODE](#) on page 1510

Line #

Sets the number of the line to be triggered on if "Mode" is set to "Line number". Usually the lines of the frame are counted, beginning from the frame start.

For NTSC signals, the lines are counted per field, not per frame. Therefore, you have to set the "Field" (odd or even), and the line number in the field.

Remote command:

[TRIGger<m>:TV:LINE](#) on page 1511

[TRIGger<m>:TV:LFIeld](#) on page 1512

Trigger level

Sets the trigger level as threshold for the sync pulse. Make sure that the trigger level crosses the synchronizing pulses of the video signal.

The hysteresis is set according to the settings in the "Noise Reject" tab.

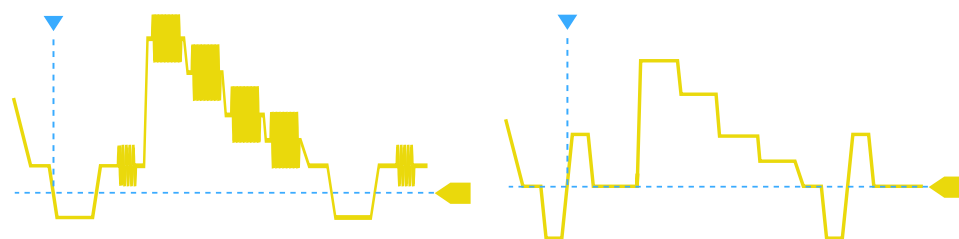

Remote command:

[TRIGger<m>:LEVel<n>\[:VALue\]](#) on page 1487

Signal polarity

Sets the polarity of the signal. Note that the sync pulse has the opposite polarity, for example, a positive signal has a negative sync pulse.

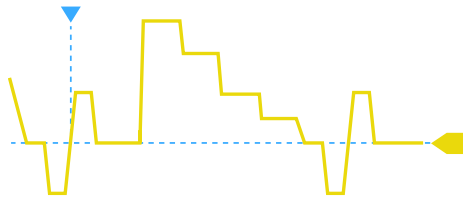

Figure 6-2: Signal with positive polarity and tri-level sync pulse

Remote command:

[TRIGger<m>:TV:POLarity](#) on page 1511

Pulse type

Sets the type of the sync pulse, either bi-level sync pulse (used in SDTV signals), or tri-level sync pulse (used in HDTV signals).

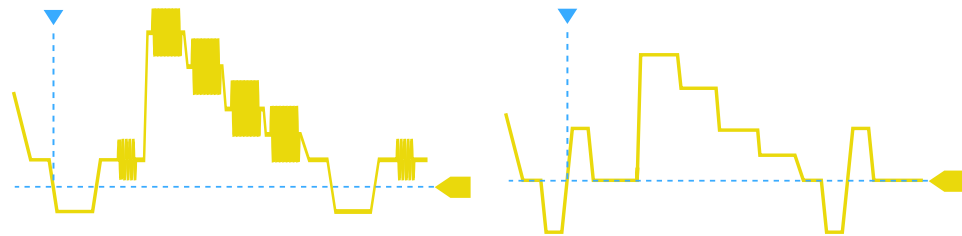

Figure 6-3: Bi-level (left) and tri-level (right) sync pulses

This setting is available for user-defined video signals if "Standard" is set to "Custom".

Remote command:

[TRIGger<m>:TV:CUSTom:STYPe](#) on page 1513

Line period

Sets the duration of a single video line, the time between two successive sync pulses.

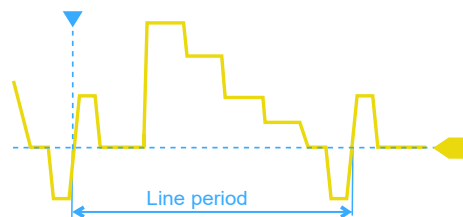

This setting is available for user-defined video signals if "Standard" is set to "Custom".

Remote command:

[TRIGger<m>:TV:CUSTom:LDURation](#) on page 1513

Pulse width

Sets the width of the sync pulse.

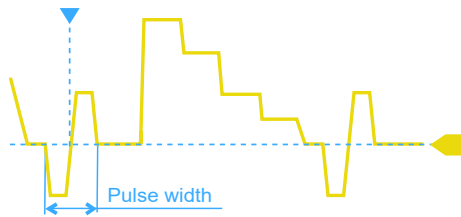

This setting is available for user-defined video signals if "Standard" is set to "Custom".

Remote command:

[TRIGger<m>:TV:CUSTom:SDURation](#) on page 1514

Scan

Sets the scanning system.

This setting is available for user-defined video signals if "Standard" is set to "Custom".

- "Interlaced" Interlace scanning uses two fields to create a frame. One field contains all the odd lines (odd, first, or upper field), the other contains all the even lines of the image (even, second, or lower field). First the lines of the odd field are processed, then the lines of the even field.
- "Progressive" Progressive scanning is a method to capture, transmit and display all lines of a frame in sequence.
- "Segmented" Progressive segmented frame uses progressive scanning to capture the frame, and interlaced scanning for transmission and display.

Remote command:

[TRIGger<m>:TV:CUSTom:SCANmode](#) on page 1513

6.3.15 NFC trigger

The near field communication (NFC) trigger identifies characteristic events of NFC signals. This trigger type requires option R&S RTO6--K11 "I/Q software interface".

For details, see [Chapter 18.4, "NFC trigger"](#), on page 1081.

6.3.16 CDR trigger

The clock data recovery (CDR) trigger triggers on the edges of a clock edge stream that is recovered from a data signal using the hardware CDR. This trigger type requires option R&S RTO6--K13 "CDR".

For details, see [Chapter 19.3.2.2, "CDR trigger"](#), on page 1142.

6.3.17 Triggering on serial buses

Protocol analysis including configuration, triggering, and decoding is described in [Chapter 14, "Protocol analysis"](#), on page 510.

For information on triggering on serial buses, see the "Trigger" chapter of the relevant protocol.

6.3.18 Triggering on parallel buses and digital channels

Triggering on digital signals requires the mixed signal option. The option is described in [Chapter 15, "Mixed signal option \(MSO, R&S RTO6-B1\)"](#), on page 1000.

For information on triggering, see [Chapter 15.3.1, "Trigger settings for digital signals and parallel buses"](#), on page 1013.

6.4 Mode / Holdoff

Access: "Trigger" menu > "Mode / Holdoff" tab

Holdoff conditions define a waiting time after the current trigger until the next trigger can be recognized.

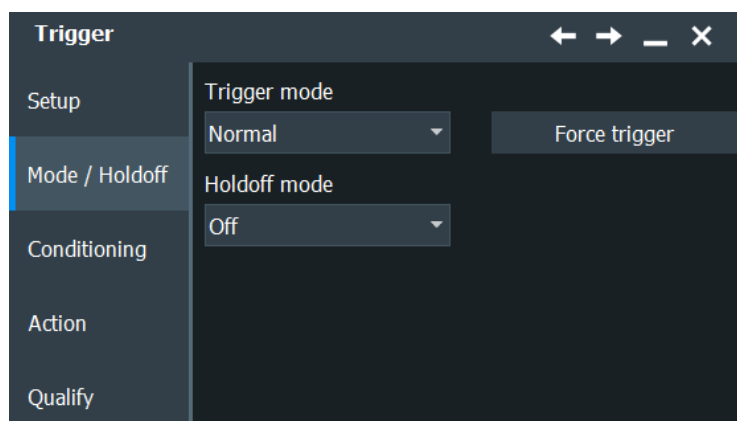

[Run Stop]/[Single]

Front panel keys to start and stop a continuous acquisition or a defined number of acquisition cycles, respectively. The number of acquisitions is set with "Average count".

Remote command:

[RUN](#) on page 1414

[SINGLe](#) on page 1415

[STOP](#) on page 1415

Trigger mode

Sets the trigger mode which determines the behavior of the instrument if no trigger occurs. The current setting is shown on the trigger label on top of the signal bar.

To toggle quickly between "Auto" and "Normal" mode, use the [Auto Norm] key on the front panel (in "Trigger" section).

"Auto"	The instrument triggers repeatedly after a time interval if the trigger conditions are not fulfilled. If a real trigger occurs, it takes precedence. This mode helps to see the waveform even before the trigger conditions are set correctly. The waveform on the screen is not synchronized, and successive waveforms are not triggered at the same point of the waveform. The time interval depends on the timebase settings.
"Normal"	The instrument acquires a waveform only if a trigger occurs, that is, if all trigger conditions are fulfilled. If no trigger occurs, no waveform is acquired and the last acquired waveform is displayed. If no waveform was captured before, none is displayed. When no trigger has been found for longer than one second, a message box appears that shows the time elapsed since the last trigger.
"Free run"	The instrument starts acquisition immediately and triggers after a short time interval independent of the timebase settings and faster than in "Auto" mode. Real triggers are ignored. Use this mode if the "Auto" mode is too slow.

Remote command:

[TRIGger<m>:MODE](#) on page 1528

Force Trigger

If the acquisition is running in normal mode and no valid trigger occurs, forcing the trigger provokes an immediate single acquisition. Thus you can confirm that a signal is available and use the waveform display to determine how to trigger on it.

If you need this function frequently, you can add the "Force Trigger" icon to the toolbar.

Remote command:

[TRIGger<m>:FORCe](#) on page 1528

Holdoff mode

Selects the method to define the holdoff condition.

The trigger holdoff defines when the next trigger after the current will be recognized. Thus, it affects the next trigger to occur after the current one. Holdoff helps to obtain stable triggering when the oscilloscope is triggering on undesired events.

Holdoff settings are not available if the trigger source is an external trigger input or serial bus. For the TV trigger, only the "Events" mode is useful.

Example:

You want to analyze the first pulse in a burst of several pulses. At first, you select a sufficiently slow timebase to display the entire burst. Then, you set the holdoff time a little longer than the length of the burst. Now, each trigger corresponds to the first pulse in successive bursts, and you can change the timebase to display the waveform in more detail.

The following methods are available:

"Time"	Defines the holdoff directly as a time period. The next trigger occurs only after the "Holdoff time" has passed.
--------	--

"Events"	Defines the holdoff as a number of trigger events. The next trigger only occurs when this number of events is reached. The number of triggers to be skipped is defined in "Holdoff events".
"Random"	Defines the holdoff as a random time limited by "Minimum time" and "Maximum time". For each acquisition cycle, the instrument selects a new random holdoff time from the specified range. Random holdoff prevents synchronization to discover effects invisible with synchronized triggering, for example, the features of a pulse train.
"Auto"	The holdoff time is calculated automatically based on the current horizontal scale. "Auto time scaling" defines the factor that the horizontal scale is multiplied with. "Auto time" shows the resulting holdoff time: <i>Auto time = Auto time scaling * Horizontal scale</i> .
"Off"	No holdoff

Remote command:

[TRIGger<m>:HOLDoff:MODE](#) on page 1518

[TRIGger<m>:HOLDoff:TIME](#) on page 1519

[TRIGger<m>:HOLDoff:EVENTs](#) on page 1519

[TRIGger<m>:HOLDoff:MAX](#) on page 1520

[TRIGger<m>:HOLDoff:MIN](#) on page 1520

[TRIGger<m>:HOLDoff:AUTotime?](#) on page 1521

[TRIGger<m>:HOLDoff:SCALing](#) on page 1521

6.5 Conditioning

The rejection of noise by setting a hysteresis avoids unwanted trigger events caused by noise oscillation around the trigger level.

You can select the hysteresis mode and value for each channel separately, or couple the trigger levels and set the same hysteresis for channels. The hysteresis of the external trigger input is an independent value, and it is not affected by level coupling.

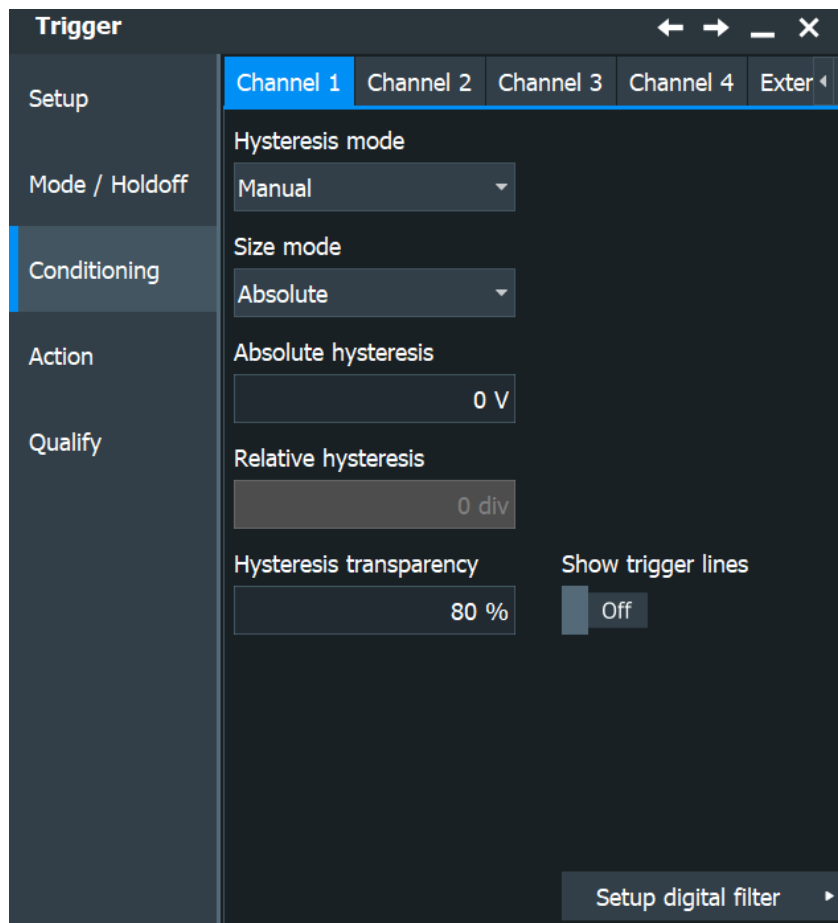

Hysteresis mode

Selects how the hysteresis is set.

- "Auto" Automatic hysteresis is the recommended mode. The hysteresis is set by the instrument to reject the internal noise of the instrument.
- "Manual" The hysteresis is defined directly in absolute or relative values.

Remote command:

[TRIGger<m>:LEVel<n>:NOISe\[:STATe\]](#) on page 1522

Size mode

Selects whether the hysteresis is defined in absolute or relative values. The setting is available only in manual hysteresis mode.

Remote command:

[TRIGger<m>:LEVel<n>:NOISe:MODE](#) on page 1522

Absolute hysteresis

Defines a range in absolute values around the trigger level. If the signal jitters inside this range and crosses the trigger level, no trigger event occurs.

Remote command:

[TRIGger<m>:LEVel<n>:NOISe:ABSolute](#) on page 1523

Relative hysteresis

Defines a range in divisions around the trigger level. If the signal oscillates inside this range and crosses the trigger level, no trigger event occurs.

Remote command:

[TRIGger<m>:LEVel<n>:NOISe:PERDivision](#) on page 1523

[TRIGger<m>:LEVel<n>:NOISe:RELative](#) on page 1524

Show trigger lines

Displays the trigger levels and the hysteresis in the diagrams until you disable this option.

Remote command:

[DISPlay:TRIGger:LINes](#) on page 1488

Hysteresis transparency

Defines the transparency of the hysteresis area above or below the trigger level.

Only visible if [Show trigger lines](#) is enabled.

Hysteresis

Displays the automatic hysteresis value for "Hysteresis mode" = "Auto".

6.6 Actions on trigger

Access: "Menu" > "Trigger" > "Action" tab

The action settings define what happens when a trigger occurs. All available actions can be initiated at the same time.

The R&S RTO6 can provide an external trigger signal to synchronize the measurements of other instruments. The trigger out signal is also adjusted and enabled in the "Action" tab.

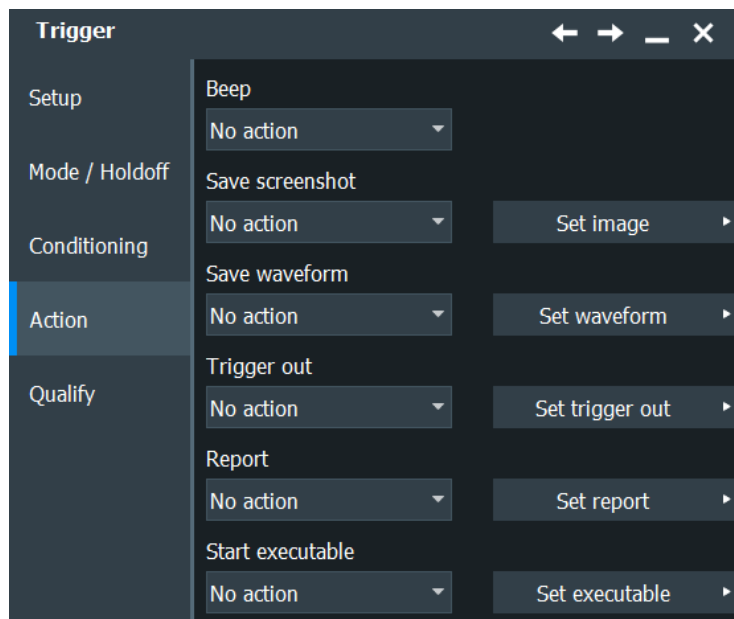

Actions on trigger

The trigger can initiate several actions, each time a trigger occurs. To activate an action, set it to "On trigger". The following actions are available:

"Beep"	Generates a beep sound.
"Save screenshot"	Saves a screenshot according to settings in "Menu" > "Save/Recall" > "Save" tab > "Screenshot".
"Save Waveform"	Saves the waveform data to a file according to settings in "Menu" > "Save/Recall" > "Save" tab > "Waveforms".
"Trigger out"	Selects, if a pulse is provided to the [Trigger Out] connector on the rear panel. Adjust the pulse with "Set trigger out", see "Trigger out signal setup" on page 229.
"Report"	Creates and saves a report using the settings defined in "Menu" key > "Save/Recall" key > "Save" tab > "Report".
"Start executable"	Starts an external application. Tap "Set executable" to set the application path and parameters. See: Chapter 4.8.3, "External application" , on page 107.

Remote command:

[TRIGger<m>:EVENT: BEEP](#) on page 1530

[TRIGger<m>:EVENT: PRINT](#) on page 1530

[TRIGger<m>:EVENT: WFMSave](#) on page 1531

[TRIGger<m>:EVENT: RUNexec](#) on page 1530

[TRIGger<m>:EVENT: TRIGgerout](#) on page 1531

Trigger out signal setup

Defines the pulse that is provided to the [Trigger Out] connector on the rear panel.

A trigger out pulse can be provided either when a trigger occurs, or when a mask test violation occurs, or when a limit check violation in a measurement occurs.

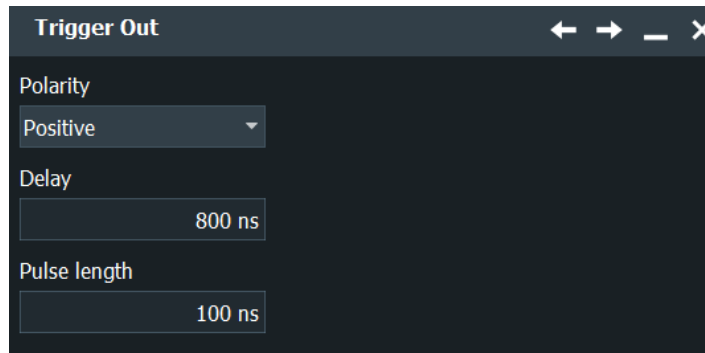

- "Polarity" Sets the polarity of the trigger out pulse, which is the direction of the first pulse edge.
- "Delay" Only available if "Trigger out" is set to "On trigger". The setting defines the delay of the first pulse edge to the trigger point. The minimum delay is 800 ns.
- "Pulse length" Sets the length of the trigger out pulse.

Remote command:

[TRIGGER<m>:OUT:POLarity](#) on page 1529

[TRIGGER<m>:OUT:PLENgtH](#) on page 1529

[TRIGGER<m>:OUT:DELay](#) on page 1529

6.7 Qualification

Access: "Menu" > "Trigger" > "Qualify" tab

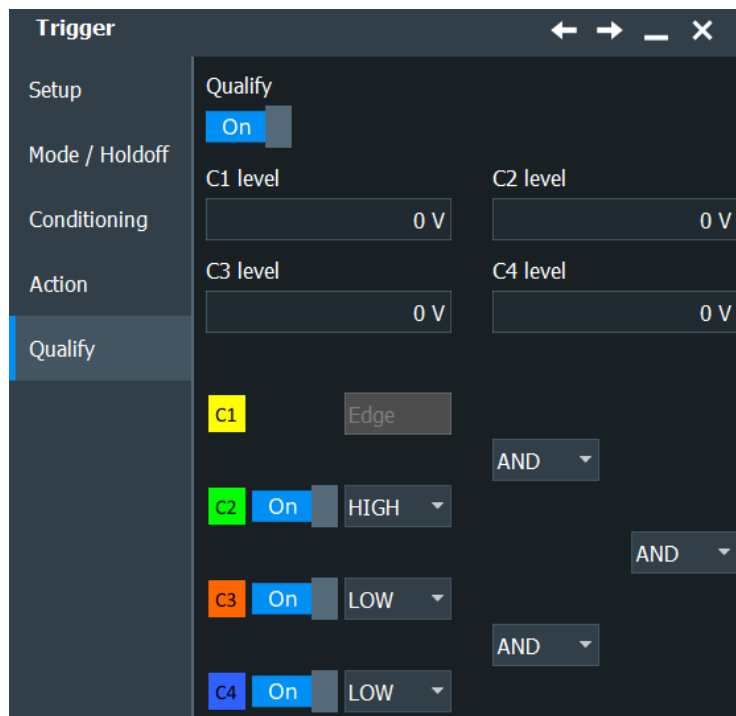

By qualifying a trigger event, you can logically combine the trigger signal with the state of other analog channel signals.

The instrument triggers if both of the following apply:

- The basic conditions of the trigger event definition are fulfilled.
- The logical conditions of the trigger qualification are true.

Qualification is only available for the A-event.

Qualification is not supported if:

- The trigger source is "Extern".
- One of the following trigger types is selected: slew rate, Setup & Hold, serial pattern, TV, and NFC.

► To enable the qualification settings, select [Qualify](#).

Example: Trigger on write access of a specific device of a bus system

In circuits using SPI, several secondary devices use the same lines for reading and writing data, and each secondary device has its own select line. To trigger on write access of specific secondary device, the write line is the trigger source and the select line of the secondary device is set as qualifying condition.

Qualify

Enables the settings for trigger qualification that are defined in the "Qualification" tab. Qualification adds additional trigger conditions considering the logic states of other digital channel signals.

The checkmark is only active if at least one qualification channel is selected.

Qualification is available for many trigger types: Edge, glitch, width, runt, window, time-out, and interval.

Qualification is not possible for the R-event.

See also: [Chapter 6.7, "Qualification"](#), on page 230.

Pattern

The pattern contains the channel selection, and the logical operations structure of hardware-based Boolean logic.

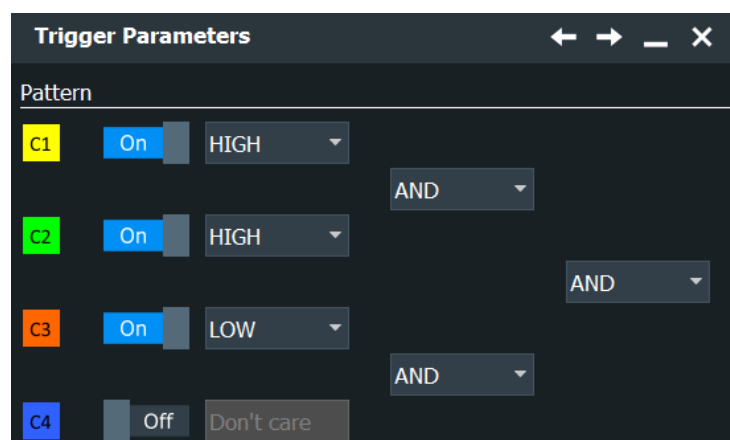

Channel "On", "Off"	Select the channels to be considered. For qualification, you can select all channel signals except for the trigger source. In pattern trigger setup, the trigger source channel is selected by default, and you can select all other channel signals.
Channel operators	<p>Defines the logical operation on the digital signal resulting from the comparison with the trigger level.</p> <ul style="list-style-type: none"> • "HIGH": leaves the input value unchanged • "LOW": inverts the input value
Logic operators	<p>Defines the logic combination of two sources. The sources are channel 1/2 and channel 3/4 on the first step, and in the second step the logical combination resulting from the first step.</p> <ul style="list-style-type: none"> • "AND": logical AND, conjunctive combination • "NAND": logical NOT AND • "OR": logical OR, disjunctive combination • "NOR": logical NOT OR

Remote command:

Select channels:

[TRIGger<m>:QUALify<n>:A\[:ENABLE\]](#) on page 1516

[TRIGger<m>:QUALify<n>:B\[:ENABLE\]](#) on page 1516

[TRIGger<m>:QUALify<n>:C\[:ENABLE\]](#) on page 1516

[TRIGger<m>:QUALify<n>:D\[:ENABLE\]](#) on page 1516

Channel operators:

[TRIGger<m>:QUALify<n>:A:LOGic](#) on page 1516

[TRIGger<m>:QUALify<n>:B:LOGic](#) on page 1516

[TRIGger<m>:QUALify<n>:C:LOGic](#) on page 1516

[TRIGger<m>:QUALify<n>:D:LOGic](#) on page 1516

Logic operators:

[TRIGger<m>:QUALify<n>:AB:LOGic](#) on page 1517

[TRIGger<m>:QUALify<n>:CD:LOGic](#) on page 1517

[TRIGger<m>:QUALify<n>:ABCD:LOGic](#) on page 1517

Trigger Levels

Define the trigger level for each input channel. For state and pattern trigger, the trigger level is a decision threshold: If the signal value is higher than the trigger level, the signal state is high (1 or true for the Boolean logic). Otherwise, the signal state is considered low (0 or false) if the signal value is below the trigger level.

You can set the trigger levels for all channels to the same value, see "[Use data level for clock level](#)" on page 213.

Use data level for clock level

Sets the trigger levels and hysteresis values for all channels to the values of the currently selected trigger source. The function affects only the levels defined for the selected condition. The hysteresis of the external trigger input is an independent value, and it is not affected by level coupling.

Remote command:

[TRIGger<m>:SCOupling](#) on page 1504

6.8 Sequence

A trigger sequence consists of at least one trigger condition and additional conditions defining when the trigger occurs.

The trigger sequence "A → B → R", for example, consists of two subsequent conditions: A-trigger and B-trigger with optional B-trigger delay and count. In addition, a reset condition R can be configured: timeout or R-trigger condition. A-, B-, and R-triggers are configured in the same way.

The instrument checks all trigger settings for compatibility and disables settings that do not fit the previous settings in the sequence.

After the A-trigger conditions have been met, and an optional delay has passed, the B-trigger with independent conditions is enabled. The instrument waits until one or a specified number of B-trigger conditions occur. If the reset condition is not fulfilled, the latest B-trigger causes the trigger event, and then the sequence starts again. The B-trigger can only cause the trigger event if it occurs after the A-trigger and after the delay time.

If you expect, for example, an irregular B-trigger, you can configure a reset condition to restart the sequence. The reset condition can be a simple timeout, and/or a reset event that is defined in the same way as the A- and B-trigger conditions.

All trigger sequences require that input channels CH1...4 are set as trigger sources for all conditions. All other input sources are disabled. Trigger sequences are not available if one of the following trigger types is set as A-trigger:

- Setup & Hold
- TV
- NFC
- CDR

For the zone trigger, more trigger sequences are available, see [Chapter 6.9, "Zone trigger"](#), on page 236.

6.8.1 Sequence setup

Access: "Menu">"Trigger" > "Setup" tab > "Trigger on" = "Sequence"

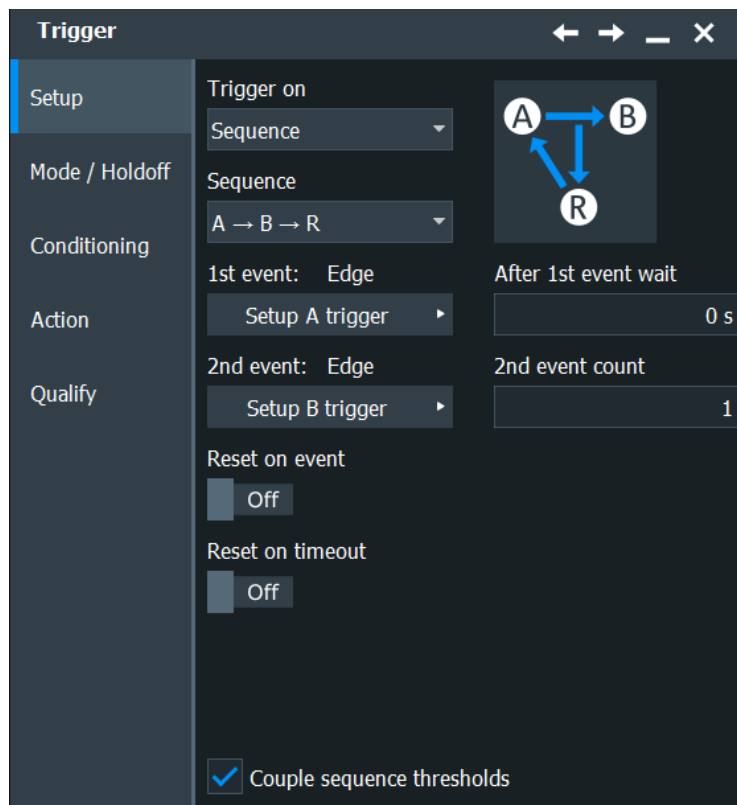

The B-trigger is the second condition of the trigger sequence. You can configure a delay between the A- and B-trigger, and define a number of fulfilled B-trigger conditions to be ignored. The B-trigger condition is configured in the same way as the A-trigger. The instrument disables settings that do not fit the previous settings in the sequence.

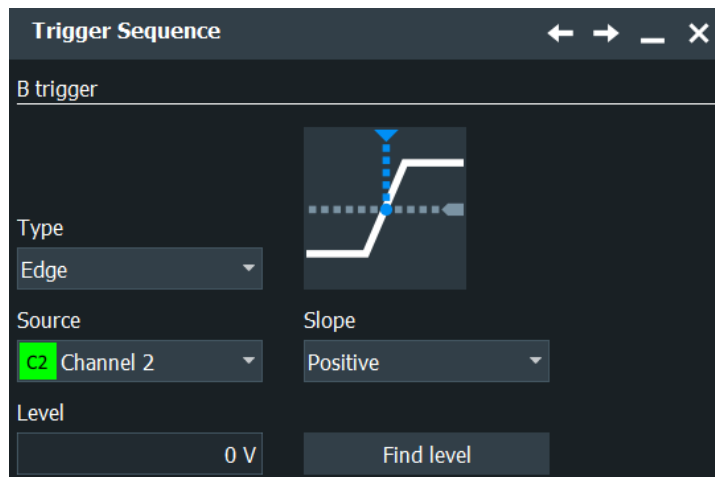

The reset condition R can be a timeout or a trigger condition, or a combination of both.

Sequence

Selects the type of the sequence.

"A → B → R" Triggers if all conditions of A- and B-events, as well as additional delay and reset timeout or R-event (reset) conditions are fulfilled.

"A → Zone"	Triggers if the conditions of the A-event and the zone trigger are fulfilled. A holdoff condition also can be set.
"A → B → R → Zone"	Triggers if all conditions of A- and B-events, reset timeout or R-event (reset) conditions are fulfilled for the defined zone.
"A OR B"	Triggers if the conditions of A-event or the conditions of the B-event are fulfilled.
"A OR B → Zone"	Triggers if the conditions of A-event or the conditions of the B-event are fulfilled for the defined zone. A holdoff condition also can be set.

Remote command:

[TRIGger<m>:SEQuence:TYPE](#) on page 1525

After 1st event wait

Sets the time that the instrument waits after an A-trigger until it recognizes B-triggers.

Remote command:

[TRIGger<m>:SEQuence:DELay](#) on page 1526

2nd event count

Sets the number of B-trigger conditions to be fulfilled after an A-trigger. The last B-trigger causes the trigger event.

The waiting time for B-triggers can be restricted with a reset condition: timeout or reset event.

Remote command:

[TRIGger<m>:SEQuence:COUNt](#) on page 1526

Reset on event/Reset event

If enabled, the trigger sequence is restarted by the R-trigger condition if the specified number of B-triggers does not occur before the trigger conditions are fulfilled.

The R-trigger condition is configured in the same way as the A-trigger. The instrument disables settings that do not fit the previous settings in the sequence.

Remote command:

[TRIGger<m>:SEQuence:RESet:EVENT](#) on page 1526

Reset on timeout/Reset timeout

If timeout is enabled, the instrument waits for the "Timeout" time for the specified number of B-triggers. If no trigger occurs during that time, the sequence is restarted with the A-trigger.

Remote command:

[TRIGger<m>:SEQuence:RESet:TIMEout\[:ENABLE\]](#) on page 1527

[TRIGger<m>:SEQuence:RESet:TIMEout:TIME](#) on page 1527

Couple sequence thresholds

Sets the trigger levels to the values of the latest configured trigger condition. Each channel has its own trigger level.

Example:

You have configured the A-trigger at last, and the trigger level for C1 is 70 mV. Enabling the coupling sets the trigger levels for C1 in the B- and R trigger also to 70 mV. If the B-trigger and/or R-trigger use another source as the A-trigger, the level remains unchanged.

Remote command:

`TRIGger<m>:ECOupling` on page 1525

6.9 Zone trigger

The zone trigger triggers on the intersection or non-intersection of the signal and one or more zones or masks. The zone can be applied to any active input signal, math waveform including FFT, and XY-waveform.

You can use the zone trigger, for example, to solve the following tasks:

- Trigger if a peak in the spectrum occurs: define a zone in the FFT diagram to filter amplitude peaks. In the same way, you can filter harmonics.
- Separate rising and falling edges: define a zone around the base or top of the data signal.
- Separate read/write cycles: define a zone in the eye diagram.
- Identify a tube violation of signals with an infrequent non-monotonic edge.
- Filter events in the history, after acquisition has finished

To document the trigger events, use the actions on trigger. For example, create a report when the instrument triggers, or save the waveform.

Zone trigger is not available for serial protocol triggers.

Trigger sequence with zone trigger

You can combine the zone trigger with common trigger conditions and use one of the following trigger sequences:

- "A → Zone"
- "A → B → R → Zone"
- "(A OR B) → ZoneTrigger"

In a sequence, the zone trigger acts like a filter on previous acquisitions. Previous conditions and then the zone condition must be fulfilled. For example, in an "A → Zone" sequence, the trigger marker is set to the A event, and a corresponding trigger-out signal is sent when the zone condition is fulfilled.

6.9.1 About trigger zones

A zone is a mask without result box. You can adjust the shape of the zone in the same way as mask segments, graphically by dragging the corner points, or numerically in the

"Masks" > "Mask Definition" dialog box. You can also use existing masks in the zone trigger. The zone trigger and usual mask tests run in parallel.

If you switch off a mask test that is used by the zone trigger, the mask is removed from the zone trigger expression automatically.

All zones and masks that are included in the zone trigger expression are indicated with yellow color.

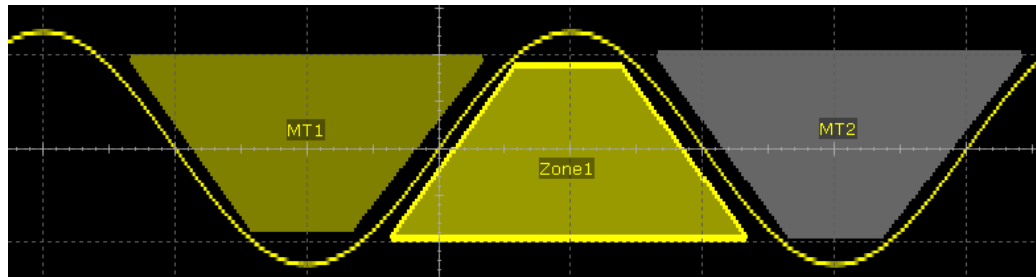

Figure 6-4: Indication of trigger zones

MT1 = Mask is included in zone trigger. Trigger if signal hits the mask (must intersect).

MT2 = Mask is not included in zone trigger.

Zone1 = Zone is included in zone trigger. Trigger if signal does not hit the zone (must not intersect).

If average or envelope acquisition is enabled, only triggered waveforms are used for envelope and average calculation on channel and math waveforms.

6.9.2 Creating trigger zones

You can define the trigger zones on the display, or use existing mask definitions as trigger zones.

Define trigger zones

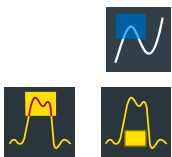

1. Tap the "Zone trigger" icon on the toolbar.
2. In the signal bar, select if the signal must violate the zone to cause a trigger (must intersect), or vice versa (must not intersect).
3. Tap the corner points of the zone on the screen.
4. If all points are set, tap "Finish zone" in the signal bar.
"Zone1" is shown in the expression field.
5. If you want to define another zone, select the logic combination of the zones AND (both zones) or OR (either zone).
6. To create the second zone, repeat steps 3 and 4.
7. To define more zones, repeat steps 5 and 6.

AND

OR

Use existing masks for zone trigger

Prerequisites: At least one mask is created and visible on the display.

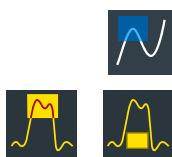

1. Tap the "Zone trigger" icon on the toolbar.
2. In the signal bar, select if the signal must violate the zone to cause a trigger ("Must Intersect"), or vice versa ("Must Not Intersect").
3. Tap the mask on the display.
4. Tap "Use selected mask" in the signal bar.
"MT1" is shown in the expression field.
5. If you want to add another mask test or zone, select the logic combination of the zones AND (both zones) or OR (either zone).
6. To add another mask, tap the mask on the display.
Tap "Use selected mask" in the signal bar.
7. To add another zone, tap the corner points of the zone on the screen.
If all points are set, tap "Finish zone" in the signal bar.



If a zone trigger is already defined, you can also add a new mask to the zone trigger when creating the mask.

Intersect

Defines if the signal must intersect the zone to allow the instrument to trigger, or if it must not intersect the zone.

Combine

Sets the logic combination of two zones.

Use selected mask

Includes the selected zone or mask in the zone expression.

Clear Expr

Deletes the zone trigger expression. The zones are not deleted, they remain as usual masks, and the result boxes of the mask test appear.

Delete all

Deletes the zone trigger expression and the zones.

6.9.3 Advanced setup and analysis with zone trigger

Access: overlay menu for zone trigger > "Advanced Setup", or "Trigger" menu > "Setup" > select sequence with zone trigger > "Setup Z trigger" dialog

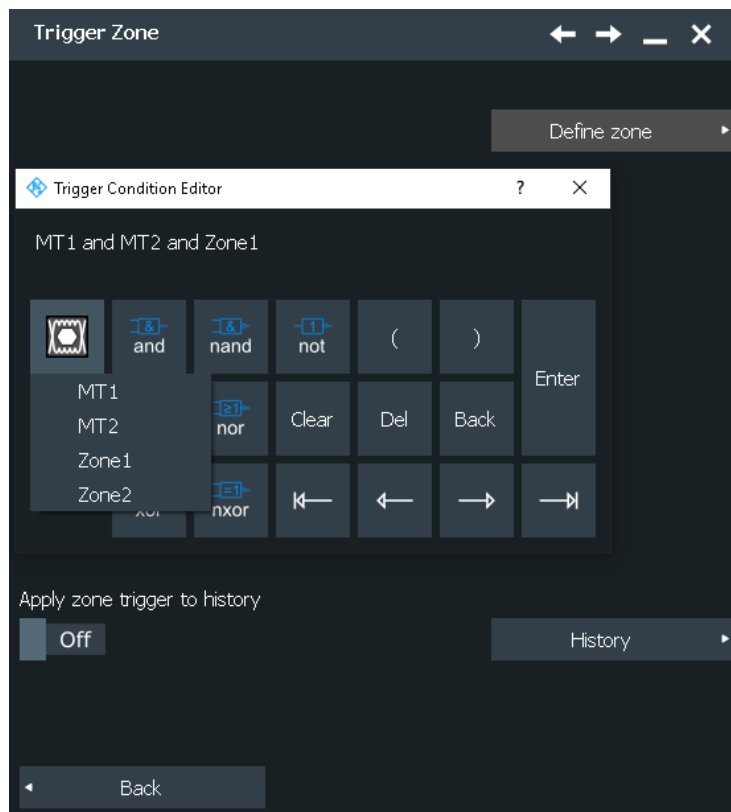

Logical trigger condition

If all required mask tests and zones are defined, you can type the logical expression directly, or use the trigger condition editor. All logical combinations are available in the editor. To express the "Must Not Intersect" condition, use the logic NOT.

Remote command:

[TRIGGER<m>:ZONE:EXPRESSION\[:DEFINE\]](#) on page 1531

Apply zone trigger to history

Applies the zone trigger condition to the acquisitions in the history memory.

The history saves all acquisitions that fulfill the trigger condition that is set during acquisition (zone trigger condition, or another trigger condition). If "Apply zone trigger to history" is disabled, the history "Play" reads and displays all saved acquisitions from the memory.

If the setting is enabled, the zone trigger is applied to the history replay. "Play" displays only acquisitions that fulfill the zone trigger condition.

Using "Apply zone trigger to history", you can:

- Acquire waveforms with high speed and filter them afterwards in the history.
- Change the zone trigger condition after acquisition.

Remote command:

[SWTRIGGER:HISTORY](#) on page 1532

6.10 External trigger input

Except for using analog or digital input channels as trigger source, you can also use external signals as trigger source. The external signal is connected to the external trigger input, which has a BNC connector. The only trigger type to trigger on external signals is the edge trigger.

1. Connect the external trigger signal to the external trigger input.
2. Set up the trigger:
 - a) Select the "Trigger" > "Setup" tab.
 - b) Select the source: "Extern"
 - c) Adjust the trigger settings.
See [Chapter 6.10.1, "External trigger setup"](#), on page 240.

If the trigger source is a channel input, the trigger system uses the digitized signal. The trigger system of the instrument is a separate system, thus the signal processing by enhancement, decimation and arithmetic has no impact on the trigger signal. Most of the R&S RTO6 trigger types use the digitized trigger signal.

If the trigger source is the external trigger input, the trigger comparator uses the analog input signal. For the external trigger signal, only the edge trigger of the A-trigger is available. Trigger sequence is not supported.

Qualification of the external trigger signal is not available.

6.10.1 External trigger setup

Access: "Menu" > "Trigger" > "Setup" tab > "Source = Extern"

External trigger signals, which are connected to the external trigger input, can be triggered with an edge trigger. The "Find level" function is not available for external trigger signals.

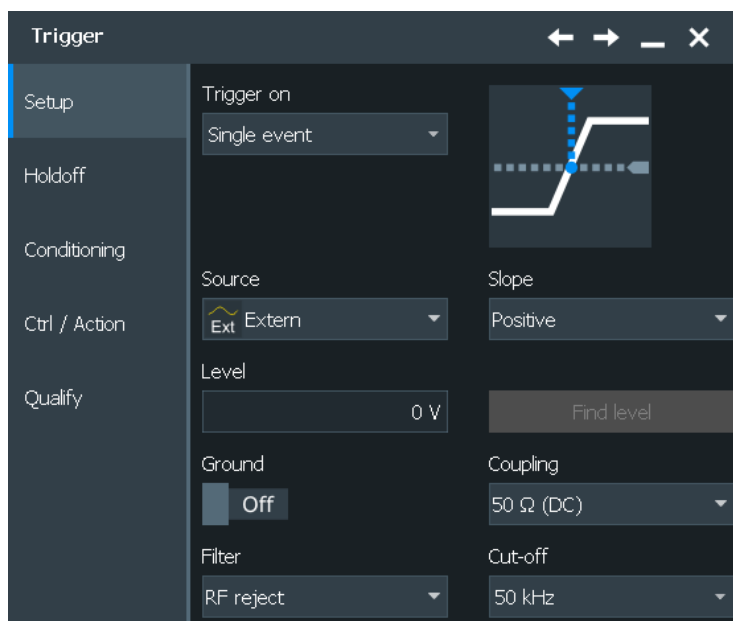

Ground

If the selected trigger source is the external trigger input, you can connect the trigger input to the ground.

Remote command:

[TRIGger<m>:ANEDge:GND](#) on page 1534

Coupling

You can set the coupling in the trigger configuration.

- | | |
|-------------|--|
| "50 Ω (DC)" | Direct connection with 50 Ω termination, passes both DC and AC components of the trigger signal. |
| "1 MΩ (DC)" | Direct connection with 1 MΩ termination, passes both DC and AC components of the trigger signal. |
| "1 MΩ (AC)" | Connection through capacitor, removes unwanted DC and very low-frequency components. |

Remote command:

[TRIGger<m>:ANEDge:COUpling](#) on page 1532

Filter

If the selected trigger source is "Extern" (external trigger input), you can directly select a filter to reject high or low frequencies.

For all other trigger sources, you can add a digital filter using the "Digital Filter" setup.

- | | |
|-------------|--|
| "Off" | The trigger signal is not filtered. |
| "LF reject" | Frequencies below the "Cut-off" frequency are rejected, higher frequencies pass the filter. You can adjust the "Cut-off" frequency, the default is 50 kHz. |

"RF reject" Frequencies higher than the "Cut-off" frequency are rejected, lower frequencies pass the filter. You can adjust the "Cut-off" frequency, the default is 50 kHz.

Remote command:

[TRIGger<m>:ANEDge:FILTer](#) on page 1533

[TRIGger<m>:ANEDge:CUToff:HIGHpass](#) on page 1533

[TRIGger<m>:ANEDge:CUToff:LOWPass](#) on page 1534

Slope

Sets the edge type for the trigger condition.

"Positive" Selects the rising edge, which is a positive voltage change.

"Negative" Selects the falling edge, which is a negative voltage change.

"Both" Selects the rising as well as the falling edge. This option is not available if the trigger source is the external trigger input.

Remote command:

[TRIGger<m>:EDGE:SLOPe](#) on page 1488

[TRIGger<m>:ANEDge:SLOPe](#) on page 1535

[TRIGger<m>:SLEW:SLOPe](#) on page 1499

Trigger level

Sets the voltage level for the trigger condition. You can also drag the trigger level marker on the display (TA or TB on the right edge of the display). The range of the trigger level is limited in a way so that always a hysteresis for stable trigger conditions is available.

Remote command:

[TRIGger<m>:LEVel<n>\[:VALue\]](#) on page 1487

7 Waveform analysis

This chapter describes general methods to check and analyze waveforms. These are:

• Zoom	243
• Reference waveforms	253
• Mathematics	261
• History	283
• XY-diagram	289

7.1 Zoom

The zoom functions allow you to magnify a specific section of the diagram in order to view more details. You can define several zoom areas for the same diagram and even couple them, or you use the hardware zoom.

7.1.1 Methods of zooming

The R&S RTO6 provides various ways of zooming: You define the section of a diagram that you want to magnify, and the zoomed view is shown in a separate zoom diagram. Additionally, you can magnify the diagram directly: The hardware zoom changes the horizontal and vertical scales of the diagram so that you see the selected section.

There are different ways to initiate and configure the zoom function:

- **Fingertip zoom:** magnifies the waveforms around your fingertip. When you drag your finger, the magnifier moves, too. You can convert the fingertip zoom into a standard zoom diagram.
- **Graphical method:** you draw, move and adjust the zoom area on the touchscreen – a very quick and simple method for standard zoom and hardware zoom.
- **Numeric method:** you enter x- and y-values in a dialog box or adjust them using navigation controls. These are precise ways which can be used to optimize a graphically defined zoom.

With the numeric method there are two ways of defining the zoom area:

- Specifying **start and stop values** for the x- and y-axes; the acquired data within those values is zoomed.

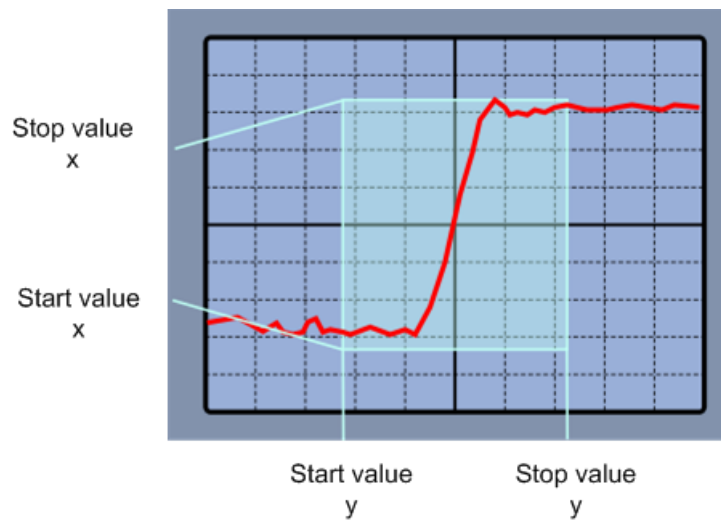

Figure 7-1: Numeric zoom using start and stop values

- Specifying the x- and y-**position** of the centerpoint of the area plus a **range** for the x- and y-axes; the area defined by that centerpoint and the ranges is zoomed.

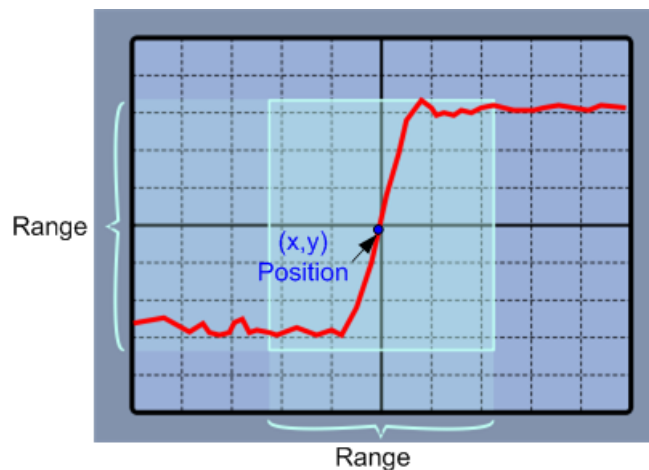

Figure 7-2: Numeric zoom using position and range

- **Coupled zoom** creates a copy of the selected zoom area. Coupled zoom areas always have the same size (size coupling). They can be positioned separately or together (position coupling).

Zoom areas can be used for gating, for example, to define a measurement gate. You can set the gate exactly to the limits of the zoom.



Evaluation gates - available histogram areas, masks, and measurement gates - can be displayed in zoom diagrams to simplify the graphical gate adjustment on the touch-screen.

See: [Chapter 7.1.3, "Zooming for details"](#), on page 249.

7.1.2 Zoom settings

The zoom area, i.e. the section to be enlarged, can be defined using two different methods:

- Using the zoom functions on the toolbar and draw the zoom area on the touch-screen
- Specifying numeric values:
 - start and stop values for the x- and y-axes
 - x and y position of one point in the diagram plus a range for the x- and y-axes

See also: [Chapter 7.1.1, "Methods of zooming"](#), on page 243.

- [Zoom functions on the toolbar](#).....245
- [Zoom settings](#).....245

7.1.2.1 Zoom functions on the toolbar

The zoom icon on the toolbar shows the last selected zoom type. A short tap on the icon activates the selected zoom. If you touch the icon and drag your finger down, a menu opens where you can select another zoom type.



Standard zoom

Displays a magnified section of the diagram in an additional zoom diagram. It is a display zoom, instrument settings are not changed.

Touch and hold the zoom area to open the "Zoom" dialog box.

Remote command:

[LAYout : ZOOM : ADD](#) on page 1537



Hardware zoom

Changes the instrument settings - horizontal and vertical scales as well as trigger level and offset - to display a part of the diagram in greater detail.



Coupled zoom

Creates a coupled zoom area and its related zoom diagram. If you change the size of one zoom area, the size of all coupled zoom areas is changed as well.

Remote command:

[LAYout : ZOOM : ADDCoupled](#) on page 1537



Fingertip zoom

Magnifies the waveforms around your fingertip.

Tap the icon and put your finger on the waveform. The touched part of the waveform is displayed in a magnifier. Drag your finger on the screen to move the magnifier. You can change the zoom factor using the [Multiuse] knob.

7.1.2.2 Zoom settings

Access: "Menu" > "Horizontal" > "Zoom" tab.

The "Zoom" tab allows you to specify start and stop values for the x- and y-axes. The acquired data within these ranges is zoomed.

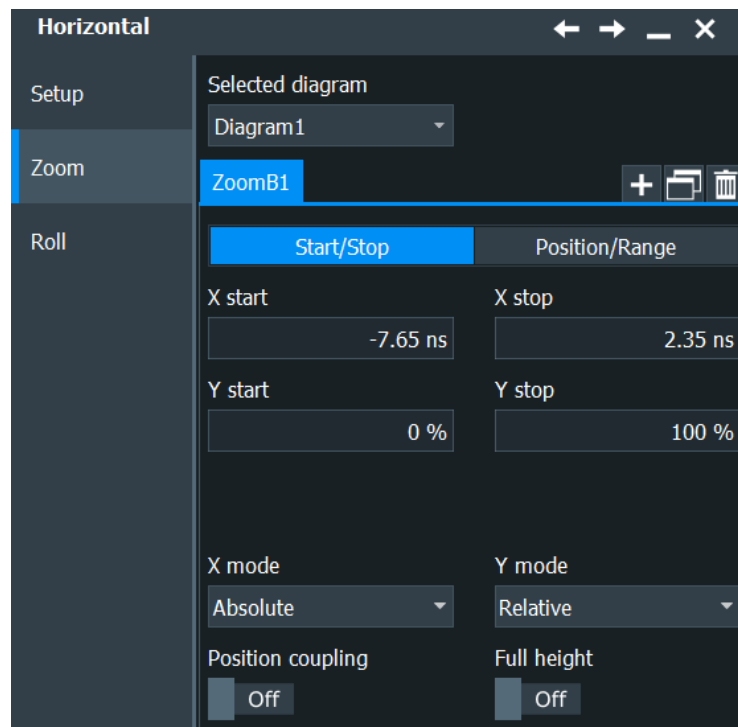

Additionally, you can enable a "Zoom Overlay" in the "Menu" > "Settings" > "Appearance" > "Diagram", see [Chapter 4.3.4, "Diagram appearance settings"](#), on page 79.

Selected diagram

Indicates which of the waveform diagrams is selected for zooming.

Mode

Selects how the window for the zoom diagram is defined. You can select between defining "Start/Stop" values or "Position/Range".

Start/Stop

The "Start/Stop" tab allows you to specify start and stop values for the x- and y-axes. The acquired data within these ranges is zoomed.

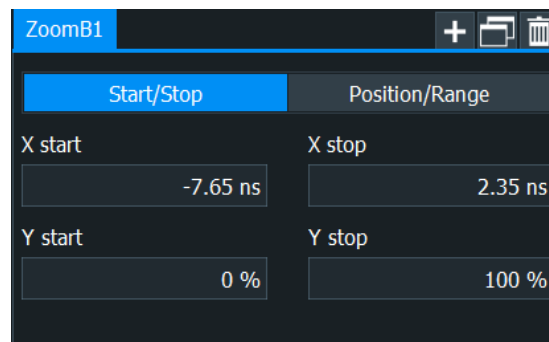

X start ← Start/Stop

Defines the lower limit of the zoom area on the x-axis.

Remote command:

[LAYout:ZOOM:HORIZ:ABSolute:START](#) on page 1539

[LAYout:ZOOM:HORIZ:RELative:START](#) on page 1541

X stop ← Start/Stop

Defines the upper limit of the zoom area on the x-axis.

Remote command:

[LAYout:ZOOM:HORIZ:ABSolute:STOP](#) on page 1539

[LAYout:ZOOM:HORIZ:RELative:STOP](#) on page 1541

Y start ← Start/Stop

Defines the lower limit of the zoom area on the y-axis.

Remote command:

[LAYout:ZOOM:VERTical:RELative:START](#) on page 1544

[LAYout:ZOOM:VERTical:ABSolute:START](#) on page 1543

Y stop ← Start/Stop

Defines the upper limit of the zoom area on the y-axis.

Remote command:

[LAYout:ZOOM:VERTical:RELative:STOP](#) on page 1545

[LAYout:ZOOM:VERTical:ABSolute:STOP](#) on page 1543

Position/Range

In the "Position/Range" tab, you specify the x and y position of center point of the zoom area plus a range for the x- and y-axes; the area defined by that point and the ranges is zoomed.

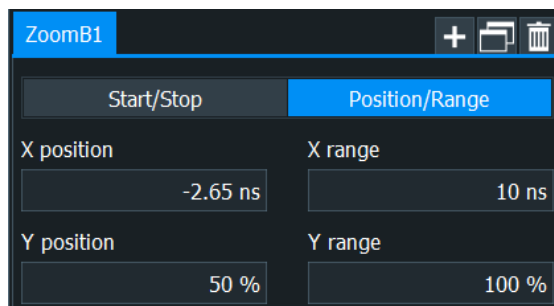
**X position ← Position/Range**

Defines the x-value of the centerpoint of the zoom area.

Remote command:

[LAYout:ZOOM:HORIZ:ABSolute:POSition](#) on page 1538

[LAYout:ZOOM:HORIZ:RELative:POSition](#) on page 1540

[SEARch:RESDiagram:HORIZ:ABSolute:POSition](#) on page 1751

[SEARch:RESDiagram:HORIZ:RELative:POSition](#) on page 1752

X range ← Position/Range

Defines the width of the zoom area.

Remote command:

[LAYout:ZOOM:HORIZ:ABSolute:SPAN](#) on page 1539

[LAYout:ZOOM:HORIZ:RELative:SPAN](#) on page 1540

[SEARCh:RESDiagram:HORIZ:ABSolute:SPAN](#) on page 1751

[SEARCh:RESDiagram:HORIZ:RELative:SPAN](#) on page 1752

Y position ← Position/Range

Defines the y-value of the centerpoint of the zoom area.

Remote command:

[LAYout:ZOOM:VERTical:ABSolute:POSition](#) on page 1542

[LAYout:ZOOM:VERTical:RELative:POSition](#) on page 1543

[SEARCh:RESDiagram:VERT:ABSolute:POSition](#) on page 1753

[SEARCh:RESDiagram:VERT:RELative:POSition](#) on page 1753

Y range ← Position/Range

Defines the height of the zoom area.

Remote command:

[LAYout:ZOOM:VERTical:RELative:SPAN](#) on page 1544

[LAYout:ZOOM:VERTical:ABSolute:SPAN](#) on page 1542

[SEARCh:RESDiagram:VERT:ABSolute:SPAN](#) on page 1753

[SEARCh:RESDiagram:VERT:RELative:SPAN](#) on page 1754

X mode

Defines whether absolute or relative values are used to specify the x-axis values.

Remote command:

[LAYout:ZOOM:HORIZ:MODE](#) on page 1538

[SEARCh:RESDiagram:HORIZ:MODE](#) on page 1751

Y mode

Defines whether absolute or relative values are used to specify the y-axis values.

Remote command:

[LAYout:ZOOM:VERTical:MODE](#) on page 1541

[SEARCh:RESDiagram:VERT:MODE](#) on page 1753

Position coupling

Enables or disables the position coupling of coupled zooms. If position coupling is enabled and you move one zoom area, the other coupled zoom areas are moved, too, and keep their distance.

Remote command:

[LAYout:ZOOM:POSCoupling](#) on page 1538

Full height

Uses the full diagram height for the zoom area. Only horizontal zoom settings can be changed.

7.1.3 Zooming for details

The usage of the various zoom methods is described in the following procedures:

- [To define the zoom area graphically on the touchscreen](#)
- [To define the zoom area numerically using start/stop values](#)
- [To define the zoom area numerically using position and range values](#)
- [To define multiple zoom areas](#)
- [To define coupled zoom areas](#)

To define the zoom area graphically on the touchscreen

For graphical zooming, you use your finger on the screen.

1. On the toolbar, tap the "Standard Zoom" icon.



2. Touch the position that you want to define as one corner of the zoom area. Then drag your finger to the opposite corner of the zoom area. While you drag your finger on the touchscreen, a dotted rectangle indicates the current zoom area. When the rectangle covers the required zoom area, remove your finger.

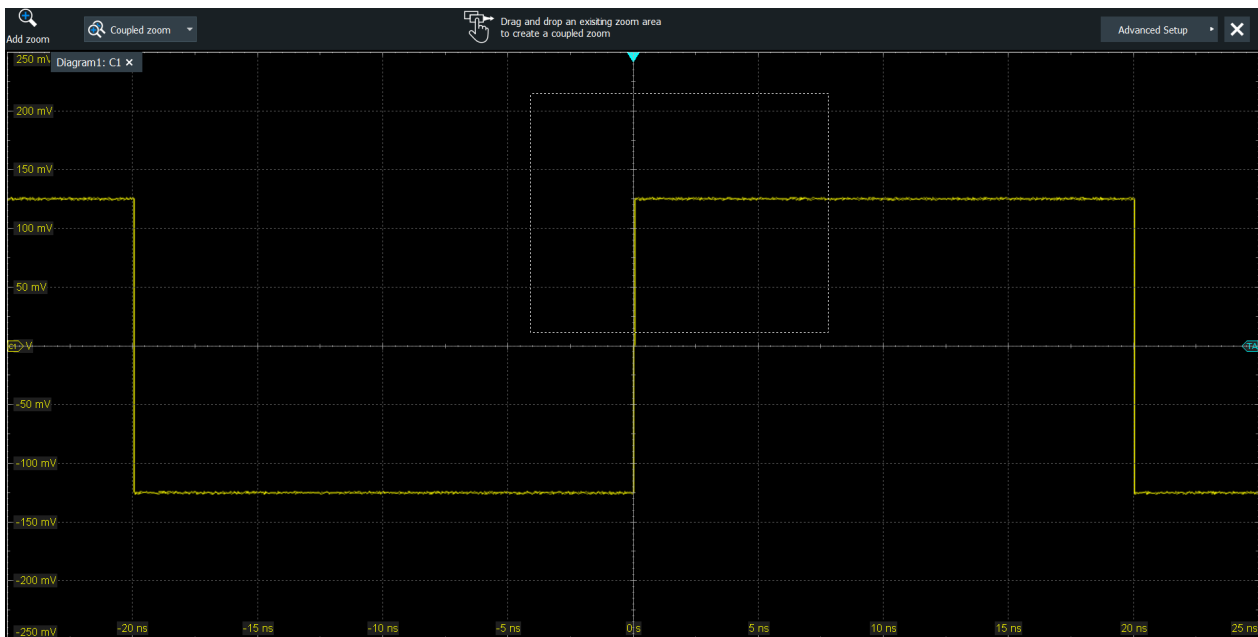

The indicated area is magnified in a new zoom diagram. The original diagram is displayed with the zoom area indicated as a rectangle.

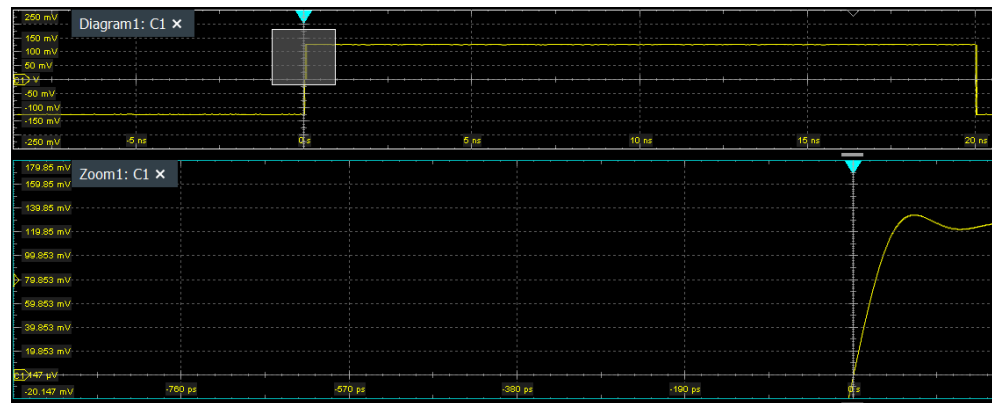

Figure 7-3: Zoom diagram and overview diagram

3. If the position of the zoom area is not correct, drag the rectangle in the overview to the correct position.
4. If the size of the zoom area is not yet ideal, tap the rectangle in the overview diagram. Now, 4 red lines indicate the edges of the zoom area. A dashed red line indicates the selected edge, which you can adjust.
5. Touch the edge that you want to move, and drag it to the required position.



To optimize the zoom definition of an active zoom diagram, double-tap the zoom diagram. The "Zoom" dialog box for numeric definition is opened.

To create a new zoom using the Zoom dialog box

1. There are two ways to create a new zoom:
 - If you want to create a new, unconfigured zoom, tap the "Add" icon.



- If you want to create zoom based on an existing one, tap the "Copy" icon.



2. Enter a name for the zoom using the on-screen keyboard.

To define the zoom area numerically using start/stop values

1. On the "Menu" menu, tap "Horizontal".
2. In the "Zoom" tab, select "Start/Stop".
3. Select "X mode" to define "Absolute" or "Relative" x-axis values. Relative values cause the zoom area to adapt to the input values dynamically.
4. Define the "X start" and "X stop" values that define the lower and upper borders of the zoom area on the x-axis (see [Figure 7-1](#)).

5. Select the "Y mode" to define "Absolute" or "Relative" y-axis values.
6. Define the "Y start" and "Y stop" values that define the lower and upper borders (respectively) of the zoom area on the y-axis.

When you close the dialog box, the specified area is magnified in a new zoom diagram. The original diagram is displayed with the zoom area indicated as a rectangle (see [Figure 7-3](#)).

To define the zoom area numerically using position and range values

1. On the "Menu" menu, tap "Horizontal".
2. In the "Zoom" tab, select "Position/Range".
3. Select "X mode" to define "Absolute" or "Relative" x-axis values. Relative values cause the zoom area to adapt to the input values dynamically.
4. Under "X position", define the x-value of the center point of the zoom area (see [Figure 7-2](#)).
5. Under "X range", define the width of the zoom area.
6. Select the "Y mode" to define "Absolute" or "Relative" y-axis values.
7. Under "Y position", define the y-value of the center point of the zoom area.
8. Under "Y range", define the height of the zoom area.

When you close the dialog box, the specified area is magnified in a new zoom diagram. The original diagram is displayed with the zoom area indicated as a rectangle.

To define multiple zoom areas

You can define more than one zoom area for the same diagram, for example to compare several peaks in a measurement. These zoom areas can be displayed in separate zoom diagrams, or together in one zoom diagram.

To define multiple zoom areas graphically, simply repeat the steps described in [To define the zoom area graphically on the touchscreen](#) - for each area. Numerically, proceed as follows:

1. On the "Menu" menu, tap "Horizontal".
2. Select the "Zoom" tab.
3. Select the required tab according to the method you want to use to define the zoom area.
4. To copy the current zoom area definition, tap the "Copy" icon. Alternatively, tap the "Add" icon to add a new zoom area.
5. Enter a name for the new zoom diagram using the displayed on-screen keyboard.
6. Define the zoom area as described for the first zoom.

An additional zoom diagram is displayed for the new zoom area, and another rectangle in the original diagram indicates the new zoom area. Each rectangle in the overview has the same color as the corresponding zoom diagram frame.

- Alternatively, you can overlay the zoom areas: The zooms are shown in the same zoom diagram, as if the zoom areas are overlaid:

In the "Settings" > "Appearance" dialog > "Diagram" tab, enable "Zoom > Overlay".

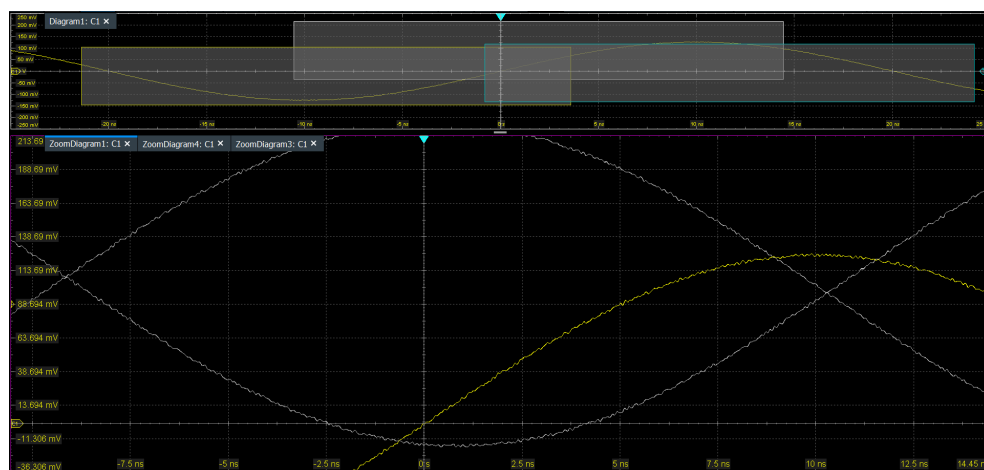

Figure 7-4: Multiple zoom diagrams. Left: separate zoom diagrams. Right: overlaid zoom

To define coupled zoom areas

You can define multiple zoom areas for one diagram that are coupled. If you change the size of one zoom area, the size of all coupled zoom areas is changed as well. Furthermore, you can couple also the position in order to move all coupled zooms at once. Coupling is useful, for example, if you want to compare recurring peaks in a signal.

- On the toolbar, tap the "Coupled Zoom" icon.



- In the diagram overview, tap an existing zoom area.

The selected zoom area is duplicated.

- Drag the duplicate zoom area to the required position.

- To create further coupled zooms, repeat the steps above.

Now, if you change the zoom area size of any of the coupled zoom areas in the "Zoom" dialog box, the settings are changed for all coupled zoom areas.

- In the "Zoom" dialog box, select the diagram that contains the coupled zooms.
- Select a zoom tab.
- Enable "Position coupling".

If you move one of the coupled zoom areas in the diagram, all other coupled zooms are moved as well, and their distance is kept unchanged.

To use the hardware zoom

In contrast to the normal zoom, the hardware zoom changes the instrument settings - horizontal and vertical scales, and also the trigger level and offset. Thus, the selected area is displayed in the diagram instead of the original waveform. No additional zoom diagram is opened.

1. On the toolbar, tap the "Hardware Zoom" icon.



2. Drag your finger on the touch screen to mark the zoom area. A dotted rectangle indicates the current zoom area. When the rectangle covers the required zoom area, remove your finger. The diagram changes and shows the magnified area.

Tip: To return to the previous display, use the "Undo" icon.

Note: You can combine hardware zoom and normal zoom - first use the hardware zoom, then the zoom into the display. The reverse approach is also possible: Create a zoom diagram, and then apply the hardware zoom to the waveform diagram. Both the waveform and the zoom diagrams are changed.

7.2 Reference waveforms

You can configure up to four reference waveforms to display stored waveforms. Any active signal or mathematical waveform can be stored as a reference waveform. It can then be loaded again later to restore the waveform on the screen.

7.2.1 Working with reference waveforms

Reference waveforms can be displayed in addition to the signal waveforms, saved to file, and loaded back for further analysis. Reference waveforms can be loaded only from BIN files.

Note: Saving and loading reference waveforms, and preset with active reference waveform delete the undo stack. After these actions, undo is not possible.

To update a reference waveform using the toolbar icon

If you often need to update a reference waveform, you can use the "Save Reference" toolbar icon.

1. Add the "Save Reference" icon to the toolbar, see [Chapter 3.3.6.2, "Configuring the toolbar"](#), on page 54 .



2. Tap the icon.
The overlay menu opens.

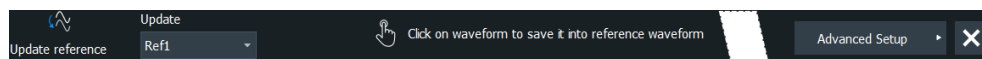

3. Set "Update" to the reference waveform to be used.
4. Tap the waveform to be used as reference waveform.

To display a reference waveform

1. In the "Menu" > "Apps" > "Analysis" tab, select "Reference Curve".
Alternatively, press the [Ref] key.
2. Select the tab for the reference waveform you want to display ("R1"- "R4").
3. Load a stored reference waveform as described in ["To load a reference waveform"](#) on page 255, or select a source to be displayed as a reference:
 - a) In the "Setup" tab, select "Signal".
 - b) Select the "Source" from the selection list. The source can be any active signal, math, or other reference waveform.
 - c) Tap the "Update" button to update the current reference waveform with the source data.
4. Tap the "Show" button.
The reference waveform is displayed on the screen.
5. A reference waveform can have its own scaling settings or it can be scaled according to the source settings. By default, the scaling of the reference waveform is coupled to the source settings. Additionally, it can be stretched or compressed in vertical and horizontal direction.
If necessary, change the settings on the "Vertical" and "Rescale" tabs of the "Reference Waveform" dialog boxes.
To restore the original settings, tap the "Restore settings" in the "Vertical" tab.
For a description of the scaling settings, see [Chapter 7.2.2.4, "Rescale"](#), on page 259

To save a reference waveform

1. In the "Save/Recall" dialog, select "Save > Waveform".
Tip: You can also save a waveform as a reference waveform in the "File" dialog box, see [Chapter 12.2.7, "Saving and loading waveform data"](#), on page 481. Here, you can also save multiple waveforms in one file.
2. Select the tab for the reference waveform you want to store ("Ref1"- "Ref4").
3. Display and configure the reference waveform as described in ["To display a reference waveform"](#) on page 254.

4. Select the file format.

Note: Reference waveforms can be loaded only from BIN files. XML and CSV formats are meant for further processing in other applications.

5. To save the waveform to the currently selected file, tap "Save". By default, the prefix for reference waveform files is "RefCurve".

To save the waveform to another file, select "Save As".

Enter a file name and select the directory. The file type is already defined according to the selection in the previous step. In order to load the reference waveform on the instrument again later, use the file type BIN.

The source settings of the reference waveform and the current scaling settings are stored to the specified file.

To load a reference waveform

Note: Reference waveforms can be loaded only from BIN files.

1. Press the [Ref] key.
2. Select the tab for the reference waveform you want to load ("Ref1" - "Ref4").
3. In the "Setup" tab, select "File".
4. To load the waveform from the specified file, tap "Open".

To load the waveform from a different file, tap "Open". Select the file from the file selection dialog box. Only BIN files are displayed in the file list.

The selected waveform is loaded as the specified reference waveform.

If multiple waveforms are saved in the file, you are asked to assign each waveform to a reference waveform. All waveforms are loaded together.

To view a reference waveform

- ▶ You can view a reference waveform, using the "Saveset with preview" function. For details, see: [Chapter 12.1.4, "Saveset with preview function"](#), on page 455.

7.2.2 Settings for reference waveforms

To compare waveforms and analyze differences between waveforms, you can use up to four reference waveforms R1 to R4. Each reference waveform has its own memory on the instrument. You can also save an unlimited number of reference waveforms and load them for further use.

The display of a reference waveform is independent from the display of the source waveform; you can move, stretch and compress the curve vertically and horizontally.

7.2.2.1 Reference waveform setup

Access: [Ref] key > "Setup" tab

In the "Setup" tab, you select the reference waveform and its source. The source can be an active waveform - trace of an input channel, math waveform or another reference waveform - or a stored waveform.

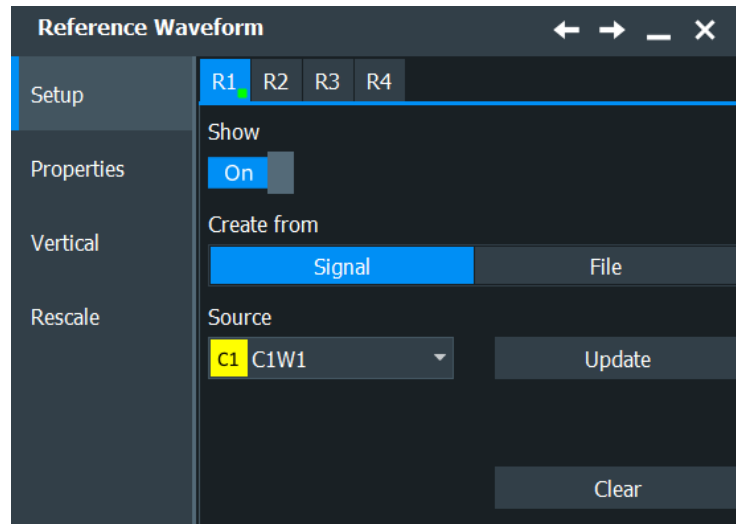

R1/2/3/4.....	256
Show.....	256
Signal.....	256
Source.....	256
Update.....	257
File.....	257
Clear.....	257

R1/2/3/4

Each tab contains the settings for one of the four available reference waveforms.

Show

Displays the reference waveform in the diagram.

Remote command:

[REFCurve<m>:STATe](#) on page 1546

Signal

Selects a signal as the reference waveform.

Source

Selects the source signal from the active waveforms of input channels, math signals and other reference waveforms.

If the selected source is defined as average or envelope waveform, make sure that all required acquisitions ("Average count") are done before you create the reference waveform. Otherwise, the resulting reference waveform is not correct.

Remote command:

[REFCurve<m>:SOURce](#) on page 1546

Update

Copies the selected source waveform with all its settings to the memory of the reference waveform. If the acquisition is running, the reference waveform is a snapshot.

Remote command:

[REFCurve<m>:UPDate](#) on page 1547

File

Opens a file selection dialog box and loads the selected reference waveform file.

Double-tap the filename to open the file selection dialog box, see also [Chapter 12.5, "File selection dialog"](#), on page 490.

Note: Note that reference waveforms can be loaded from BIN files only. XML and CSV formats are meant for further processing in other applications.

Remote command:

[REFCurve<m>:OPEN](#) on page 1547

[REFCurve<m>:SAVE](#) on page 1547

[REFCurve<m>:DELeTe](#) on page 1547

Clear

The selected reference waveform disappears, its memory is deleted.

Remote command:

[REFCurve<m>:CLEAr](#) on page 1548

7.2.2.2 Properties

Access: [Ref] key > "Properties" tab

A reference waveform can be scaled, stretched and positioned in the diagram. The "Original Attributes" tab shows the original settings of the reference waveform, which are stored together with the waveform data.

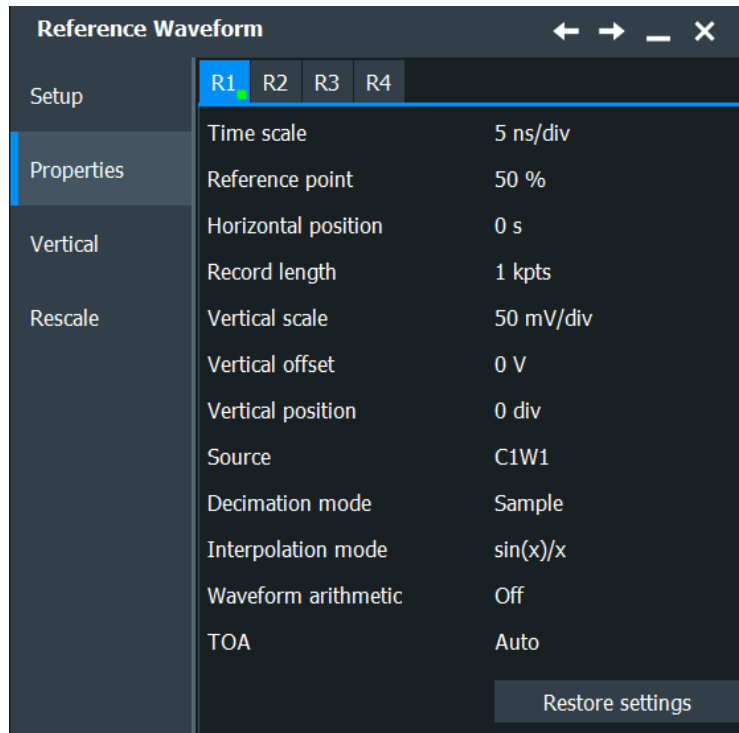

Restore Settings

Resets the time scale and the reference point to the original values of the reference waveform.

Remote command:

[REFCurve<m>:RESTore](#) on page 1548

7.2.2.3 Vertical

Access: [Ref] key > "Vertical" tab

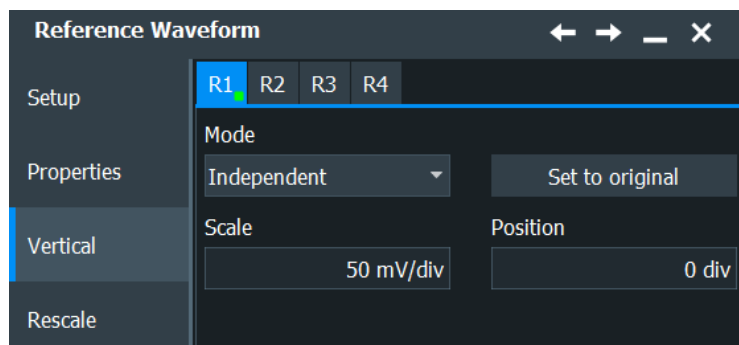

Mode

Selects the type of vertical settings:

"Coupled to source" Vertical position and scale of the source are used.

"Independent" Scaling and position can be set specific to the reference waveform.

Remote command:

[REFCurve<m>:VMODE](#) on page 1548

Set to original

Restores the original vertical settings of the reference waveform (vertical scale, position, and offset), if vertical scaling is set to "Independent".

Remote command:

[REFCurve<m>:TOORignal](#) on page 1550

Scale

Sets the vertical scale for the reference waveform, if vertical scaling is set to "Independent". You can also use the vertical [Scale] knob to adjust this value.

Remote command:

[REFCurve<m>:SCALE](#) on page 1549

Position

Moves the reference waveform up or down in the diagram, if vertical scaling is set to "Independent". If "Position" is assigned to the vertical [Position] knob, you can also use this knob to adjust the "Vertical position"

Remote command:

[REFCurve<m>:POSition](#) on page 1549

7.2.2.4 Rescale

Access: [Ref] key > "Rescale" tab

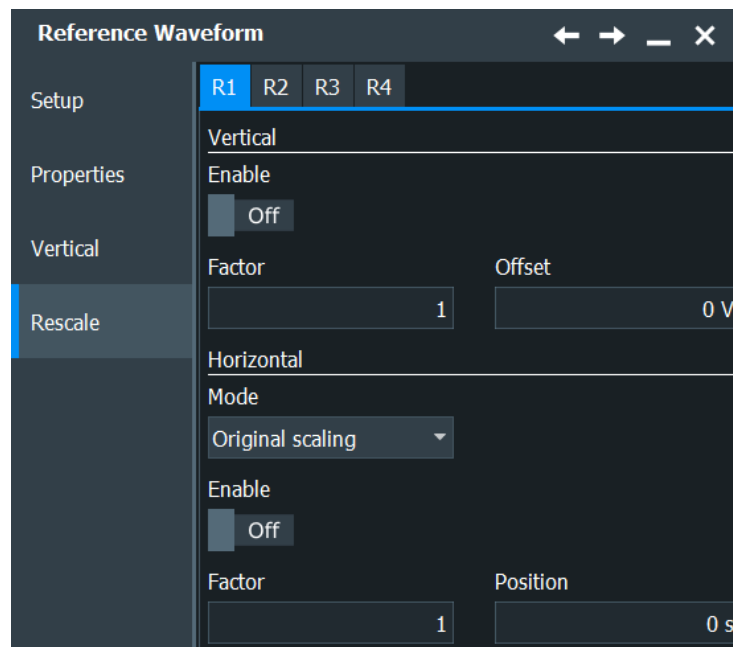

Vertical Rescaling

Stretching and offset change the display of the waveform independent of the vertical scale and position.

Enable ← Vertical Rescaling

If enabled, the vertical offset and factor are applied to the reference waveform.

Remote command:

[REFCurve<m>:RESCale:VERTical:STATe](#) on page 1550

Factor ← Vertical Rescaling

A factor greater than 1 stretches the waveform vertically, a factor lower than 1 compresses the curve.

Remote command:

[REFCurve<m>:RESCale:VERTical:FACTor](#) on page 1550

Offset ← Vertical Rescaling

Moves the reference waveform vertically. Enter a value with the unit of the waveform. Like vertical offset of a channel waveform, the offset of a reference waveform is subtracted from the measured value. Negative values shift the waveform up, positive values shift it down.

Note: As for all waveforms, a vertical offset of a reference waveform can be set using the vertical [Position] knob. This offset is independent from the reference scaling offset, which is described here. If both offsets are set, their values are added up.

Remote command:

[REFCurve<m>:RESCale:VERTical:OFFSet](#) on page 1550

Mode ← Vertical Rescaling

Selects the type of horizontal settings:

"Adjust to X Axis" The current horizontal settings of the diagram are used.

"Original Scaling" Horizontal scaling and reference point of the source waveform are used.

Remote command:

[REFCurve<m>:HMODE](#) on page 1551

Horizontal Rescaling ← Vertical Rescaling

Stretching and offset change the display of the waveform independent of the horizontal settings of the source waveform and of the horizontal diagram settings.

Enable ← Horizontal Rescaling ← Vertical Rescaling

If enabled, the horizontal offset and factor are applied to the reference waveform.

Remote command:

[REFCurve<m>:RESCale:HORizontal:STATe](#) on page 1551

Factor ← Horizontal Rescaling ← Vertical Rescaling

A factor greater than 1 stretches the waveform horizontally, a factor lower than 1 compresses the curve.

Remote command:

[REFCurve<m>:RESCale:HORizontal:FACTor](#) on page 1552

Position ← Horizontal Rescaling ← Vertical Rescaling

Moves the waveform horizontally. Enter a value with a time unit suitable for the time scale of the diagram. Positive values shift the waveform to the right, negative values shift it to the left.

Remote command:

[REFCurve<m>:RESCale:HORizontal:POSition](#) on page 1552

7.3 Mathematics

Math waveforms are calculated waveforms. You can define up to eight math waveforms and display them on the screen, and use it as source for further analysis.

Math waveforms are defined by mathematical expressions (formulas). You can enter mathematical expressions using different methods:

- "Operator" tab: you define a simple math function in a graphical editor by selecting the source waveforms and the operator.
- "Equation" tab: you define sophisticated math functions in a formula editor, as required to your needs.

The result of an FFT analysis is a specific math waveform. For information on FFT and spectrograms, see [Chapter 9, "Spectrum analysis"](#), on page 376.

The vertical scale of a math waveform is adapted automatically to the measurement results to ensure optimal display. Furthermore, you can scale each math waveform manually in vertical direction like a channel waveform.

As for channel waveforms, you can also change the arithmetic mode for the waveform to display the envelope or an average over several calculations.

You can store a math waveform as a reference waveform and restore it later, see ["To save a reference waveform"](#) on page 254.

- [Displaying math waveforms](#)..... 261
- [Math setup - general settings](#).....262
- [Operator editor](#).....264
- [Equation](#).....266
- [Filters](#)..... 274
- [Script \(option R&S RTO6-K39\)](#)..... 277
- [Math scale settings](#)..... 280
- [Math arithmetic](#).....281

7.3.1 Displaying math waveforms

Math waveforms can be displayed in addition to the channel and other waveforms. They also can be used for analysis, e.g. measurements, even if the math waveform is not active.

1. In the "Math" menu, select "Math Setup".
Alternatively, press the [Math] key.
2. Define the math expression for calculation in one of the following ways:
 - [Chapter 7.3.3.2, "Defining a formula in the Operator editor"](#), on page 265
 - [Chapter 7.3.4, "Equation"](#), on page 266
 - [Chapter 9.1.2, "Configuring spectrum waveforms"](#), on page 380
3. In the "Math Setup" dialog box, in the "Setup" tab, tap the "Enable math signal".
The math waveform is displayed on the screen.
4. To change the vertical scaling of the math waveform, tap the "Manual" icon.
5. Enter the "Vertical scale" factor (per division). If necessary, add a "Vertical offset".
By default the instrument performs an automatic scaling.
Tip: You can also use the vertical [Scale] rotary knob for scaling. In this case, the scale mode is set to "Manual" temporarily.
6. If you need the envelope or average of the math waveform over several calculations, change the arithmetic mode for the waveform as for channel waveforms.
See also: ["Arithmetic"](#) on page 130.
7. Close the "Math Setup" dialog box.

7.3.2 Math setup - general settings

You can define up to eight different math waveforms. Each waveform is defined in a separate tab in the "Math" dialog box ("M1" to "M8").

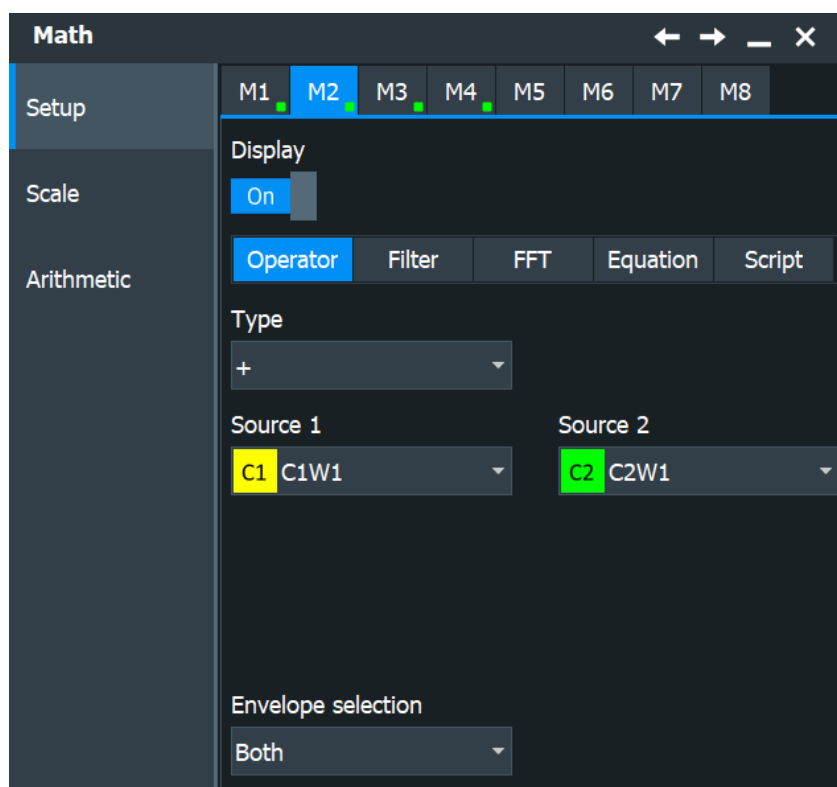

The settings for input of mathematical formulas are described in separate chapters:

- [Chapter 7.3.3.1, "Settings in the Operator editor"](#), on page 264
- [Chapter 7.3.5, "Filters"](#), on page 274
- [Chapter 9.1.3, "FFT configuration settings"](#), on page 384
- [Chapter 7.3.4, "Equation"](#), on page 266

Display	263
Envelope selection	263

Display

If activated, a diagram for the defined math waveform is displayed on the touchscreen.

Remote command:

`CALCulate:MATH<m>:STATe` on page 1558

Envelope selection

Selects the upper or lower part of the waveform for mathematic calculation, or a combination of both.

The setting is relevant for waveforms with waveform arithmetic mode "Envelope" or with "Peak detect" decimation. All mathematic operations - except for derivation - can be applied to envelope waveforms and waveforms with "Peak detect" decimation.

Remote command:

`CALCulate:MATH<m>:ENVSelection` on page 1559

7.3.3 Operator editor

In the Operator editor, you can define the most common mathematical formulas without knowing their correct syntax.

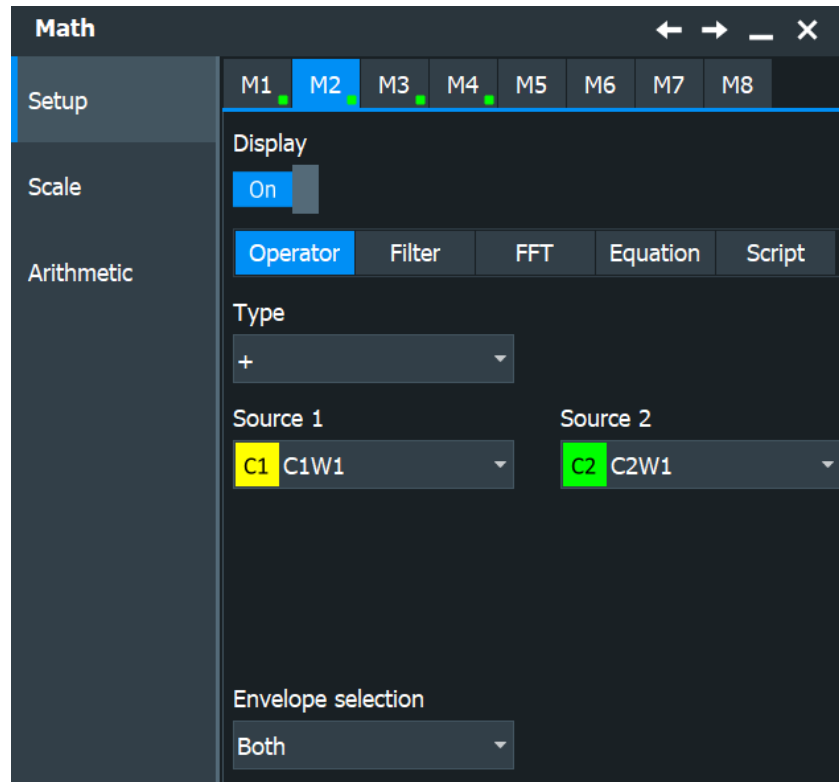

Remote command:

- `CALCulate:MATH<m>[:EXPRession][:DEFine]` on page 1558

7.3.3.1 Settings in the Operator editor

Source 1 / 2.....	264
Type.....	264
Noise reject.....	265
a / b.....	265

Source 1 / 2

Defines the signal source to be evaluated by the math function. Waveform 1 of channel signals can be selected.

Note: If you require other signal sources not listed here, use the formula editor provided in the Equation tab. Any waveform of any input channel can be used as a source. See: [Chapter 7.3.4, "Equation"](#), on page 266.

Type

Defines the type of operation to be performed on the selected signal sources. The following functions are available:

Note: If you require other operators not listed here, use the formula editor provided in the "Equation" tab. See: [Chapter 7.3.4, "Equation"](#), on page 266.

"+"	Adds up the sources
"-"	Subtracts source 2 from source 1.
"x"	Multiplies source 1 by source 2.
" x "	Determines the absolute value of the source.
"dx/dt"	Differentiates the source value with respect to the time value. Not possible on envelope waveforms and waveforms with "Peak detect" decimation.
"log(x)"	Calculates the logarithm of the source value based on 10.
"ln(x)"	Calculates the natural logarithm of the source value (based on e).
"ld(x)"	Calculates the binary logarithm of the source value (binary logarithm, based on 2).
"Rescale"	Rescales the source values by a factor "a" and an offset "b": $ax+b$. See also: "a / b" on page 265.

Noise reject

Only available for "Type" = "dx/dt".

Sets the number of neighboring samples that are skipped for differentiation.

To suppress noise effects during differentiation, it can be useful not to consider two directly neighboring points to calculate dx ($x_n - x_{n-1}$). Instead, some samples in-between are skipped and a point a few samples further is used (e.g. $x_n - x_{n-3}$).

a / b

Defines the values for the "Rescale" function ($ax+b$).

"a"	Multiplication factor
"b"	Offset of the signal source on the y-axis.

7.3.3.2 Defining a formula in the Operator editor

1. Open the "Menu" > "Math" dialog.
Alternatively, press the [Math] key.
2. In the "Setup" tab, select the "Operator" tab.
3. Tap the "Source 1" and "Source 2" icons and select the signal sources to which the math function is applied. For details on available signal sources, see ["Source 1 / 2"](#) on page 264.
4. Tap the "Type" icon and select the mathematical function.
For details on available operators, see ["Type"](#) on page 264.
5. If the operator requires additional parameters, enter them in the input fields.

7.3.4 Equation

In the Equation tab, you can enter complex formulas to define a math waveform. The formula editor helps to enter formulas easily with correct syntax, using a large selection of operators and signal sources.



All formulas in the formula editor are linear regardless whether a [dB] is set or not.

- Double-tap the Equation tab to display the formula editor.

7.3.4.1 Formula editor

Using the formula editor you can define math functions freely, using a large selection of operators and signal sources. For a procedure on using the editor, see [Chapter 7.3.4.11, "Defining a formula in the formula editor"](#), on page 273.

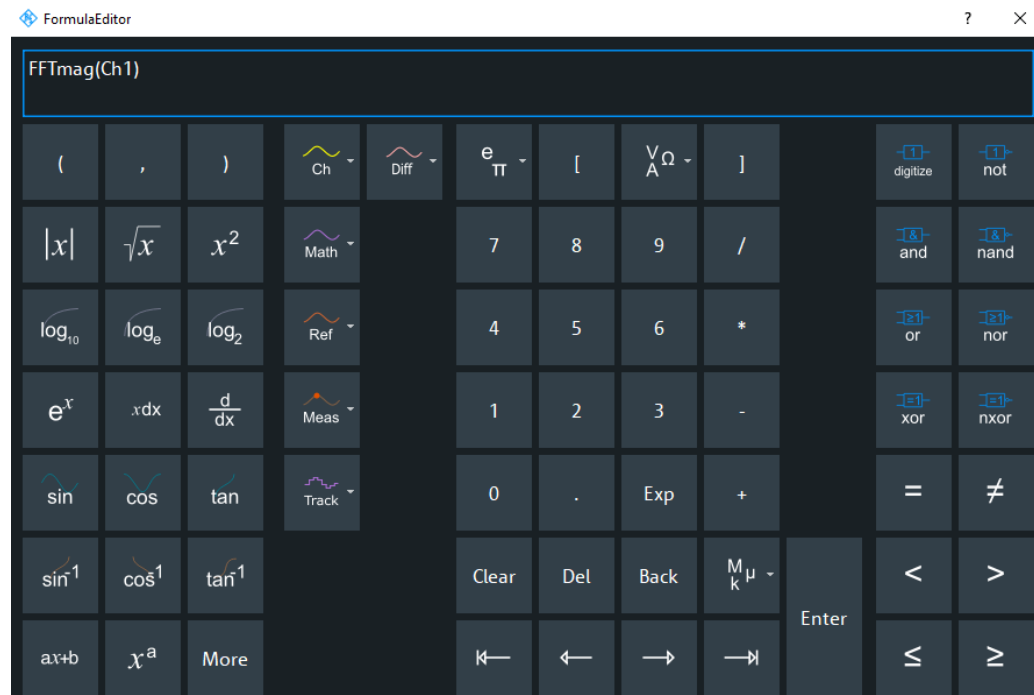

Remote command:

- [CALCulate:MATH<m>\[:EXPRession\] \[:DEFine\]](#) on page 1558

Buttons of the formula editor and their usage

Table 7-1: Basics

Icon	Description	Usage/Comment, <i>FormulaEditor</i> expression
(Left bracket	Enclose operands
,	Comma	Separates operands

Icon	Description	Usage/Comment, <i>FormulaEditor</i> expression
)	Right bracket	Enclose operands
e / π	Math. constants	e: Euler number: 2.7182... Pi: 3.1415...
[Left square bracket	Enclose unit
V / A / Ω	Units	[<unit>]
]	Right square bracket	Enclose unit
x^a	Exponentiation with base x	x: base, a: exponent x^a
/	Division	
*	Multiplication	
-	Subtraction	
+	Addition	
0...9	Numeric characters	
.	Decimal point	
Exp	Exponentiation with base 10	e
Enter	Expression complete	Insert expression in "Setup" dialog and close the formula editor
Clear	Clear expression in editor	Restart editing
Del	Delete	Remove selected part of expression
Back	Backspace	Remove last symbol, operator or operand to the left of the cursor
M / k / μ	SI-prefix for unit	<SI-prefix>[<unit>]

Table 7-2: Signal sources

Icon	Description	Usage/Comment, <i>FormulaEditor</i> expression
Ch	Signal waveform	<i>Ch</i> <1...4> <i>Wfm</i> <1...3>
Math	Math waveform	<i>Math</i> <1...8>
Ref	Reference waveform	<i>Ref</i> <1...4>
Meas	Measurement waveform	<i>Meas</i> <1...8>
Track	Track waveform	<i>Track</i> <1...8>
Diff	Differential and common mode waveforms Waveforms of differential deembedding	<i>Diff</i> <1...2> <i>Common</i> <1...2>

Table 7-3: Cursor keys

Icon	Description	Usage/Comment, <i>FormulaEditor</i> expression
←	Move cursor to beginning	
←	Move cursor 1 step to the left	
→	Move cursor 1 step to the right	
→	Move cursor to end	

7.3.4.2 Math functions: algebra

Table 7-4: Algebra

Icon	Description	Usage/Comment, <i>FormulaEditor</i> expression
x	Absolute x value	<i>abs(x)</i>
\sqrt{x}	Square root of x	<i>sqrt(x)</i>
x^2	$x*x$	<i>pow(x)</i>
\log_{10}	Decimal logarithm (base 10)	<i>log(x)</i>
\log_e	Natural logarithm (base e)	<i>ln(x)</i>
\log_2	Binary logarithm (base 2)	<i>ld(x)</i>
e^x	Exponentiation with base e	<i>exp(x)</i>
$\int x dx$	Integral of x	<i>integral(x)</i>
d/dx	Derivation of x	<i>derivation(x,y)</i> With x = waveform and y = number of skipped samples (noise reject)
ax+b	Scaling of x	<i>rescale(x,a,b)</i>

7.3.4.3 Math functions: trigonometry

Table 7-5: Trigonometry (More keys)

Icon	Description	Usage/Comment, <i>FormulaEditor</i> expression
sinh	Hyperbolic sine	<i>sinh(x)</i>
cosh	Hyperbolic cosine	<i>cosh(x)</i>
tanh	Hyperbolic tangent	<i>tanh(x)</i>

7.3.4.4 Math functions: bit operations

Table 7-6: Bit operations

Icon	Description	Usage/Comment, <i>FormulaEditor</i> expression
digitize	Convert to 0 or 1	<i>digitize(x)</i> The function uses the middle reference level and the hysteresis, which are set in "Menu" > "Measure" > "Advanced" tab > "Reference Level".
not	Negation	<i>not(x)</i>
and		<i>and</i>
nand	Negation of and	<i>nand</i>
or		<i>or</i>
nor	Negation of or	<i>nor</i>
xor	Exclusive or	<i>xor</i>
nxor	Negation of exclusive or	<i>nxor</i>

7.3.4.5 Math functions: comparison

Table 7-7: Comparison

Icon	Description	Usage/Comment, <i>FormulaEditor</i> expression
=	Equal	=
≠	Not equal	<>
<	Smaller	<
>	Greater	>
≤	Smaller or equal	<=
≥	Greater or equal	>=
More	Display additional keys	



7.3.4.6 Math functions: FFT

Table 7-8: FFT (More keys)

Icon	Description	Usage/Comment, <i>FormulaEditor</i> expression
FFT	Magnitude of FFT value	<i>fftmag(x)</i>
FFT (φ)	FFT phase value	<i>fftphi(x)</i>
FFT -dφ*df	FFT group delay	<i>fftgroupdelay(x)</i>
FFT (re)	Real part of FFT value	<i>fftre(x)</i>
FFT (im)	imag part of FFT value	<i>fftim(x)</i>

7.3.4.7 Math functions: correlation

Table 7-9: Correlation (More keys)

Icon	Description	Usage/Comment, FormulaEditor expression
	<p>Cross-correlation function of two waveforms</p> <p>Measures the similarity of two waveforms as a function of a time-lag applied to one of them.</p> <p>Function limits the maximum record length to 4 Msample.</p> <p>Two modes of normalization are supported: biased and unbiased.</p> <p>The length of the correlation buffer is $N_0 + N_1 - 1$ samples. The length of the first input signal is N_0 samples and the length of the second signal is N_1 samples.</p>	<p><i>correlation(x1, x2, biased)</i></p> <p><i>correlation(x1, x2, unbiased)</i></p> <p>with x1 = waveform 1 and x2 = waveform 2</p> <p><i>correlation(x1, x2)</i> performs an unbiased correlation</p>
	<p>Auto correlation</p> <p>Used to find repeating patterns, for example, a periodic signal obscured by noise.</p> <p>The length of the auto correlation buffer is $2N - 1$ samples, if the length of the input signal is N samples.</p> <p>Two modes of normalization are supported: biased and unbiased.</p>	<p><i>autocorrelation(x, biased)</i></p> <p><i>autocorrelation(x, unbiased)</i></p> <p>with x = channel waveform</p> <p><i>autocorrelation(x)</i> performs an unbiased autocorrelation</p>
	Biased / unbiased normalization for correlation and auto correlation	see above

Mathematic background for correlation:

$$Temp1_R_{xy}(m) = \sum_{n=0}^{N1} y_n^* x_{n+m} \quad m \in [0; N1[$$

$$Temp0_R_{xy}(m) = \sum_{n=1}^{N0} x_n^* y_{n+m} \quad m \in [1; N0[$$

The R&S RTO6 uses only the real part of the signal. Two modes of normalization are supported: biased and unbiased.

$$R_{xy}(m) = \begin{cases} \frac{1}{\min(N_0, N_1)} Temp1_R_{xy}(m) & m \in [N_0 - 1; N_1 + N_0 - 1[\\ \frac{1}{\min(N_0, N_1)} Temp0_R_{xy}^*(-m) & m \in [0; N_0 - 1[\end{cases}$$

Equation 7-1: Biased correlation

$$R_{xy}(m) = \begin{cases} \frac{1}{a(m)} \text{Temp1_}R_x(m) & m \in [N_0 - 1; N_1 + N_0 - 1] \\ \frac{1}{a(m)} \text{Temp0_}R_x^*(-m) & m \in [0; N_0 - 1] \end{cases}$$

Equation 7-2: Unbiased correlation

Mathematic background for auto correlation:

$$R_{xx}(m) = \begin{cases} \frac{1}{N} \sum_{n=0}^{N-m-1} x_n x_{n+m}^* & m \geq 0 \\ R_{xx}^*(-m) & m < 0 \end{cases}$$

Equation 7-3: Biased auto correlation



$$R_{xx}(m) = \begin{cases} \frac{1}{N-|m|} \sum_{n=0}^{N-m-1} x_n x_{n+m}^* & m \geq 0 \\ R_{xx}^*(-m) & m < 0 \end{cases}$$



Equation 7-4: Unbiased auto correlation

The R&S RTO6 uses only the real part of the signal.

7.3.4.8 Math functions: filter and power

Table 7-10: Filter and power (More keys)

Icon	Description	Usage, comment, <i>FormulaEditor</i> expression
	Electric power	Electric power is calculated from voltage, based on measurement impedance (see Impedance) <i>elecpower(x) = U²/R</i>
	Finite impulse response (FIR) filter	<i>FIR(tpye,source,limit,shape)</i> or <i>FIR(userdef,source,path)</i> See Chapter 7.3.5.2, "FIR filter in the formula editor" , on page 276
	Type of FIR filter	<i>highpass</i> or <i>lowpass</i> , see FIR filter

Icon	Description	Usage, comment, <i>FormulaEditor</i> expression
	Characteristics of FIR filter	<i>gaussian</i> or <i>rectangle</i> , see FIR filter
	Moving average	Calculates a mean value of several adjacent sample points. The result is a smoothed waveform. The moving average uses the full data and can be used for non-periodic signals. It works like a lowpass filter and increases the vertical resolution at the expense of bandwidth reduction. <i>MovingAverage(x,y)</i> with: x = source (channels only), y = number of samples to be averaged Example: <i>MovingAverage(Ch1Wfm1,1000)</i> Averages 1000 subsequent samples of the channel 1 waveform

7.3.4.9 Math functions: CDR

The clock data recovery function requires at least one of the options R&S RTO6-K12, or R&S RTO6-K133, or R&S RTO6-K134.

Hardware CDR requires option R&S RTO6--K13.

Table 7-11: Clock data recovery (More keys)

Icon	Description	Usage/Comment, <i>FormulaEditor</i> expression
	CDR: displays the generated clock signal as math waveform	Hardware: <i>CDR(hw)</i> Software 1: <i>CDR(sw1,<x>)</i> Software 2: <i>CDR(sw2,<x>)</i> where <x> is the signal from which the clock is recovered Reference n: <i>CDR(R<n>)</i> where <n> = 1 to 4 is a loaded reference file that contains CDR information Example: <i>CDR(sw1,CH2Wfm1)</i> See also: Chapter 19.3.3, "Displaying the recovered clock signal" , on page 1144

7.3.4.10 Transfer functions of a step-like signal

The R&S RTO6 provides two functions to calculate the transfer function of a system out of its step response. These functions are not supported by the formula editor, but you can enter them directly in the "Advanced" tab in the "Math Setup" dialog box. To enter the formula, you need a keyboard (on-screen keyboard or a connected usual one).

Math expression	Description
$Step2FreqRespNormMag(x,points)$ Where: <ul style="list-style-type: none"> • x is the waveform (channel, math, reference) • points are the number of points in the resulting math waveform (min. 1000 points) 	Normalized magnitude of transfer function in frequency domain Example: $Step2FreqRespNormMag(Ch1,2000)$
$Step2FreqRespNormPhi(x,points,time\ offset)$ Where: <ul style="list-style-type: none"> • x is the waveform (channel, math, reference) • points are the number of points in the resulting math waveform (min. 1000 points) • Time offset in s 	Normalized phase of transfer function in frequency domain Example: $Step2FreqRespNormPhi(Ch1,2000,2e-9)$

The calculation of transfer functions has several steps:

- Calculate the frequency domain representation of a step-like signal. A detailed description is given in: A. M. Nicolson, „Forming the fast Fourier Transform of a step response in Time-Domain Metrology,“ in Electronic letters, Bd. 9, Nr. 14, p. 317, 1973.
- Calculate the derivative to convert the result to the transfer function.
- Normalize the result at DC to a magnitude of 1 V and subtract specified time offset from phase.

The step-like signal to be analyzed is a time domain waveform, and the result is a math waveform in the frequency domain.

To get useful results, check and adjust the following settings:

1. Place the analyzed step of the signal in the left half of the time domain diagram. Use the "Reference point" or the horizontal "Position" of the trigger to move the signal.
See also: [Chapter 5.4, "Acquire settings"](#), on page 126.
2. Adjust the record lengths of the source signal and the math signal. The "Record length" of the step-like source signal must be shorter than the number of points in the resulting math function, which is set in the formula. See also: ["Record length"](#) on page 127.
3. If the resulting math waveform is noisy, increase the "Average count" for the source signal until the waveform is clear.
See also: [Chapter 5.4.2, "Mode settings"](#), on page 129.

7.3.4.11 Defining a formula in the formula editor

1. Open the "Menu" > "Math" dialog.
2. Select the Equation tab.
3. Double-tap the editing area.
The "Formula Editor" is displayed.

4. Enter the math formula including all required signal sources and operators by selecting the corresponding keys in the editor. For details on the available keys, see [Chapter 7.3.4.1, "Formula editor"](#), on page 266.
5. To insert a physical unit in the formula, proceed as follows:
 - a) If necessary, insert a decimal prefix using the "M/k/μ" key.
 - b) Insert an opening square bracket using the "[" key.
 - c) Insert the physical unit using the "V/A/Ω" key.
 - d) Insert a closing square bracket using the "]" key.

The resulting expression could be, for example: `m[V]`
6. To perform a rescaling function, proceed as follows:
 - a) Select the rescaling function using the "ax+b" key.
 - b) Behind the left bracket, insert the signal source using one of the following keys:
 - "Ch" for a channel
 - "Math" for a math function
 - "Ref" for a reference waveform
 - "Meas" for a measurement
 - c) Insert a comma using the "," key.
 - d) Insert the "a" value, i.e. the scaling factor, using the number keys.
 - e) Insert a comma using the "," key.
 - f) Insert the "b" value, i.e. the scaling offset, using the number keys.
 - g) Insert the closing bracket using the ")" key.

The resulting expression could be, for example: `rescale(Ch1Wfm1,3,4)`

7.3.5 Filters

The R&S RTO6 provides several ways to filter the input signal:

- Lowpass filter by selecting a bandwidth limit in the acquisition path (vertical channel settings)
See ["Analog"](#) on page 141
- Digital lowpass filter
See [Chapter 5.5.5, "Digital filter setup"](#), on page 143
- FIR filter to create a filtered math waveform (lowpass, highpass, bandpass)
You can set up a FIR-filtered math waveform in the basic math editor, or in the advanced editor. Both ways are described below in this chapter.

7.3.5.1 FIR filter in the math setup

Access: "Math" > "Setup" tab > "Filter" tab.

The finite impulse response filter is a filter to create filtered waveforms with lowpass, highpass, or bandpass. The filter requires additional settings.

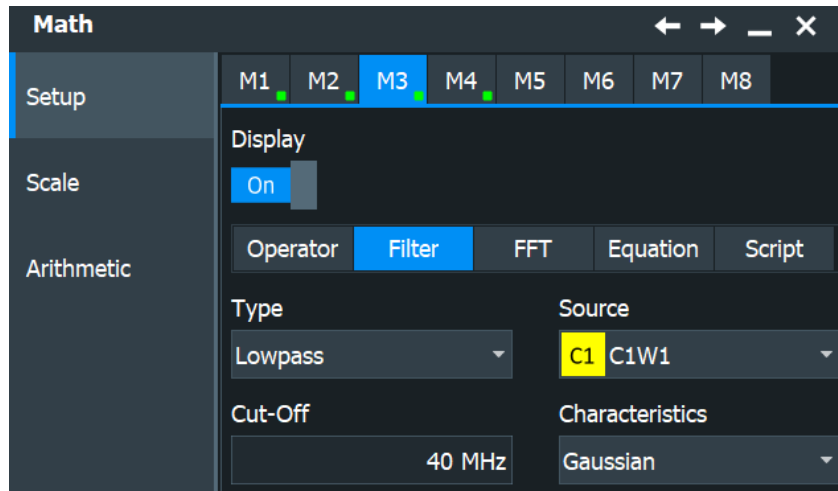

- "Type": defines whether the FIR filter is a highpass, lowpass, or bandpass/band-stop (= "User defined") filter.
- "Cut-Off": sets the limit frequency for the highpass or lowpass FIR filter.
- "Characteristics": defines if the filter has a Gaussian or a rectangular shape.
- "Select filter file": relevant for bandpass/bandstop filter. Opens a file dialog to select the file with the filter coefficients.

Cutoff frequency for lowpass FIR filter

The cutoff frequency depends on the horizontal resolution and the filter characteristics. The frequency for the lowpass filter can only be set in this range:

$$f_{g_3dB} = (0.001 \dots 0.2) * f_{a_in} \text{ for Gaussian FIR filter}$$

$$f_{g_3dB} = (0.001 \dots 0.4) * f_{a_in} \text{ for rectangular FIR filter}$$

Where: f_{g_3dB} = cutoff frequency to be set for the lowpass filter, and f_{a_in} = reciprocal of the resolution, or sample rate.

Cutoff frequency for highpass FIR filter

To check limit frequency for the highpass filter, convert it to an equivalent lowpass frequency:

$$f_{LP} = f_{a_in}/2 - f_{HP}$$

Where f_{HP} is the requested highpass limit frequency and f_{LP} the equivalent lowpass frequency that has to comply with the limits given above.

Bandpass and bandstop FIR filter: CSV file

To define a bandpass or bandstop, you need a CSV file that contains the comma-separated filter coefficients. The maximum number of filter coefficients is 2 048 000 taps. No other parameters are allowed in the file.

To create the CSV file, we recommend using the Matlab Filter Design & Analysis tool. In the tool, enter the filter type, filter order and filter frequencies. Make sure to set the

sample frequency in MATLAB® and the sample rate at the oscilloscope to the same value. If the values differ, the filter is shifted in frequency.

In R&S RTO6, in the "Math" > "Setup" > "Filter", select the filter "Type" = "User defined", and load the CSV file.

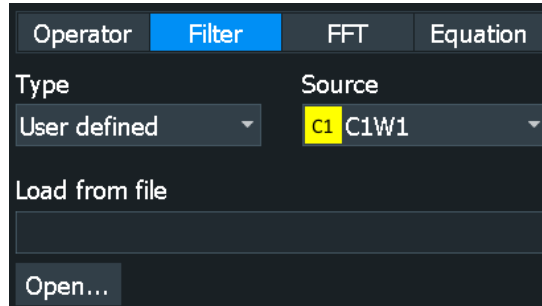

7.3.5.2 FIR filter in the formula editor

You can type the FIR filter formula directly in the "Equation" tab, or open the formula editor and use the buttons to create the formula.

Highpass and lowpass FIR filter

The general syntax for highpass and lowpass filters is:

FIR(tpye,source,limit,shape)

- Type is *lowpass* or *highpass*
- Source is the input channel of the signal.
- Limit is the cutoff frequency. Consider the range of possible values, see ["Cutoff frequency for lowpass FIR filter"](#) on page 275.
- Shape is *gaussian* or *rectangle* for the lowpass and highpass filter.

- ▶ For example, to set a rectangle lowpass filter on channel 1 with 10 MHz cutoff frequency, enter:

FIR(lowpass,Ch1,1e+07,rectangle)

- ▶ For example, to set a Gaussian highpass filter on channel 2 with 3 GHz cutoff frequency, enter:

FIR(highpass,Ch2,3e+09,gaussian)

Bandpass and bandstop FIR filter

The syntax for the bandpass filter is:

FIR(userdef,source,path)

- Source is the input channel of the signal.
- Path is a string containing the path and filename of the filter file. The file contains the comma-separated filter coefficients.

- ▶ For example, to set a bandpass on channel 1 with filter coefficients saved in the `bandpass.csv` file, enter:
`FIR(userdef,Ch1,"C:\Users\Public\Documents\Rohde-Schwarz\RTx\bandpass.csv")`

7.3.6 Script (option R&S RTO6-K39)

The user-defined math option R&S RTO6-K39 provides a Python interface to apply Python scripts to the waveform processing. The script replaces the math function and calculates the math waveform, which can be displayed. The scripts are executed whenever a trigger occurs.

Scripts can provide solutions that exceed the scope of the math functionality, for example, display the Allen variance of a chirped radar signal to verify the clock stability.

For script-created math waveforms, scaling in the "Scale" tab is not available. The scaling is defined in the script.

7.3.6.1 Script settings

Access: "Math" > "Setup" tab > "Script" tab.

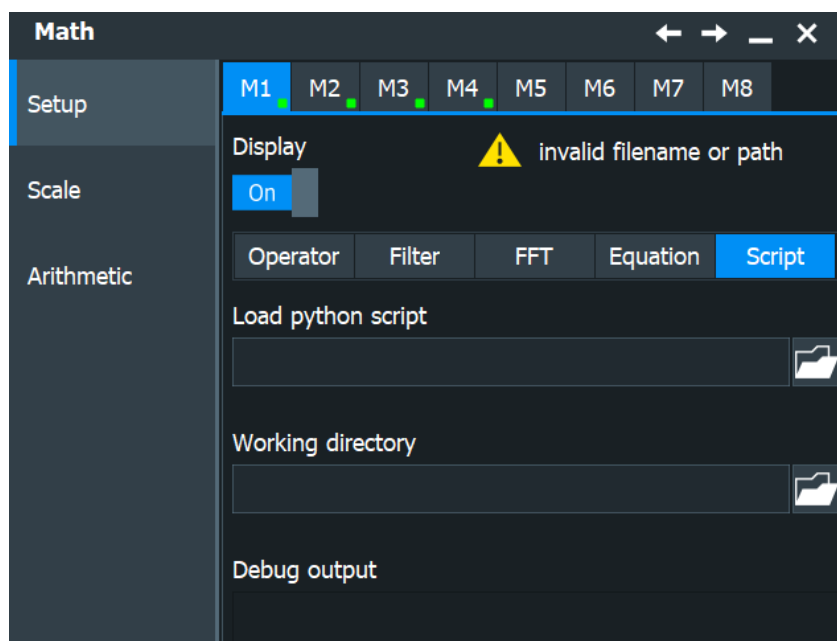

Load Python script

Opens a file explorer, where you select the script file to be executed. The script is loaded. To reload the script, e.g. after changing it, select the Operator tab, and then again the "Script" tab.

Working directory

Opens a file explorer, where you select a folder to save result and temporary data.

Debug output

Shows information on errors and problems in the script. The debug output is also the console output of the script, e.g. print commands are displayed here.

7.3.6.2 Python scripts

To create Python scripts that can run on R&S RTO6, consider the following rules and requirements.

Basics

Each script requires as a minimum the import of ctypes, array, and numpy:

```
import ctypes as ct
import array
import numpy as np
```

The class name must be the same as the filename. Special characters are forbidden. Example: if the filename is addC1C2.py, the class is declared as `class addC1C2:`

Each script requires the `__init__`, `setup`, `execute`, `teardown`, and `requirements` functions:

```
def __init__(self):
    print('__init__ called')

def setup(self):
    print('setup called')

def execute(self):
    # executed at trigger event

def teardown(self):
    print('teardown called')
    # reset of variables, called when output math waveform is deactivated

def requirements(self):
    # input and output variables
```

Requirements

In the requirements part, the variables for the execute part are defined, and also the settings of the output math waveform. The output settings are mandatory, even if they are not needed, e.g. if the resulting waveform is saved to file.

```
def requirements(self):
    return {
        "input" : {
            "sources" : {SignalSource.C2, SignalSource.C1},
        },
        "output" : {
            "domain" : "time",
```



```
        "unit" : "V",
        "verticalScale" : 0.08,
        "verticalOffset" : 0.01,
    }
}
```

Execute

The execute part is called every time when a trigger occurs. The main functions in math scripts are:

```
getInput(SignalSource.Cx) # e.g. SignalSource.C1
getOutput()
getHorizontalSetting() # e.g. xStart, xStop, Resolution
getSystemSettings() # e.g. IP, DeviceID, FW Version
```

The waveforms must be declared as numpy arrays, e.g.

```
ch1 = np.array(view.cast('f'), copy=False)
```

To write the script results to a file, use the following:

```
np.savetxt('C1_waveform.csv', ch1, delimiter=',')
```

Script handling

The script is executed when a trigger occurs AND the last script execution has finished.

Bugs in the script can cause long calculation times or infinite loops. To prevent a blocking of the oscilloscope, the script is closed after a time limit of 10 s.

When you have changed a loaded script, you must reload the script. Select the Operator tab, and then again the "Script" tab.

Example:

The script adds C1 and C2 and displays the result as math waveform M1.

```
import ctypes as ct
import array
import numpy as np

class addC1C2:

    def __init__(self):
        print('__init__ called')

    def setup(self):
        print('setup called')

    def execute(self):
        (type, view) = getInput(SignalSource.C1)
        ch1 = np.array(view.cast('f'), copy=False)
        (type, view) = getInput(SignalSource.C2)
        ch2 = np.array(view.cast('f'), copy=False)
        (type, view) = getOutput()
        M1[:] = ch1 + ch2

    def teardown(self):
        print('teardown called')

    def requirements(self):
        return {
            "input" : {
                "sources" : {SignalSource.C2, SignalSource.C1},
            },
            "output" : {
                "domain" : "time",
                "unit" : "V",
                "verticalScale" : 0.08,
                "verticalOffset" : 0.01,
            }
        }
```

7.3.7 Math scale settings

Access: [Math] > "Scale" tab.

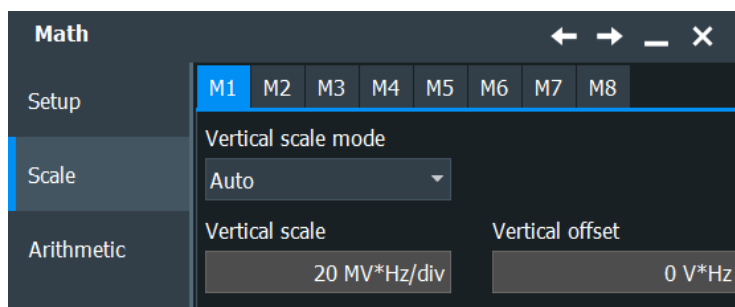

In this tab, you can find functions to set the vertical parameters of the math waveform.

For FFT scale settings, see [Chapter 9.1.4, "FFT scale settings"](#), on page 393.

Vertical scaling mode (Manual/Auto)

By default, the vertical scale is adapted to the current measurement results automatically to provide an optimal display. However, if necessary, you can define scaling values manually to suit your requirements.

Note: When you change the scaling values manually using the "Scale" rotary knob, the scale mode is set to "Manual" temporarily. When you edit the math function, scaling is automatically set back to "Auto" mode. "Manual" mode is only maintained during math function changes if you select it yourself.

"Manual" Enter the required values for "Vertical scale" and "Vertical offset". For FFT, set "Vertical range" and "Vertical maximum".

"Auto" "Vertical scale" and "Vertical offset" are read-only. For FFT, only the "Vertical maximum" is read-only.

Vertical Scale

Defines the scale of the y-axis in the math function diagram. The value is defined as "<unit> per division", e.g. *50m V/div*. In this case, the horizontal grid lines are displayed in intervals of 50 mV.

If the "[Vertical scaling mode \(Manual/Auto\)](#)" on page 281 is set to "Auto", this setting is read-only.

Remote command:

`CALCulate:MATH<m>:VERTical:SCALE` on page 1561

Vertical Offset

Sets a voltage offset to adjust the vertical position of the math function on the screen. Negative values move the waveform, positive values move it down.

If the "[Vertical scaling mode \(Manual/Auto\)](#)" on page 281 is set to "Auto", this setting is read-only.

Remote command:

`CALCulate:MATH<m>:VERTical:OFFSet` on page 1560

7.3.8 Math arithmetic

Access: [Math] > "Arithmetic" tab.

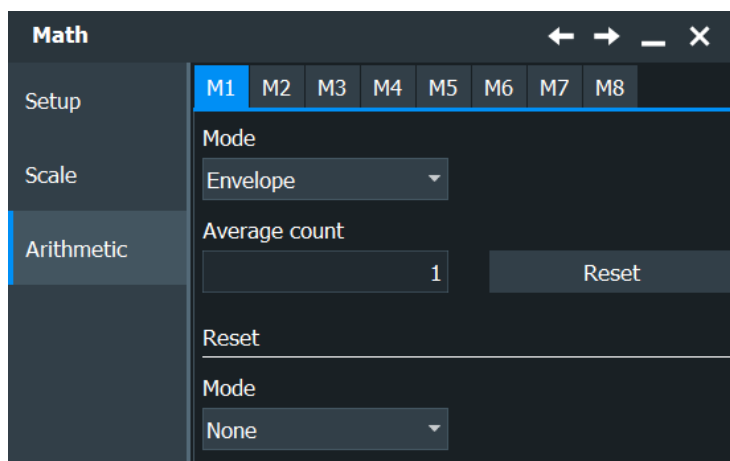

In this tab you can specify the waveform arithmetic for the math waveforms.

Mode

Waveform arithmetic builds the resulting waveform from several consecutive acquisitions and subsequent math calculations of the signal. For details, see ["Arithmetic"](#) on page 130.

"Original"	The original results are displayed.
"Envelope"	The envelope curve of all acquired and calculated results is displayed.
"Average"	The average of all acquired and calculated results is displayed.
"RMS"	The root mean square of the math data is displayed. The result is the average power spectrum. If you measure the channel power on this RMS spectrum, you get the same result as for the average channel power measurement on waveforms.
"MinHold"	Determines the minimum result for each input value from the data of the current acquisition and some acquisitions before.
"MaxHold"	Determines the maximum result for each input value from the data of the current acquisition and some acquisitions before.

Remote command:

[CALCulate:MATH<m>:ARITHmetics](#) on page 1559

Average count (N-single count)

Access:

- "Menu" > "Acquire" > "Setup" tab > "N-single count"
- "Menu" > "Acquire" > "Mode" tab > "Average count"
- "Menu" > "Acquire" > "Segmented" tab > disable "Acquire maximum" > "Required"
- [Math] > "Arithmetic" tab > "Mode" is not "Off" > "Average count"

The acquisition and average count has several effects:

- It sets the number of waveforms acquired with [Single]
- It defines the number of waveforms used to calculate the average waveform. Thus, the instrument acquires sufficient waveforms to calculate the correct average if "Average" is enabled for waveform arithmetic. The higher the value is, the better the noise is reduced.

- It sets the number of acquisitions to be acquired in a fast segmentation acquisition series. Thus, you can acquire exactly one fast segmentation acquisition series with [Single].
If fast segmentation is enabled and configured to acquire the maximum number of acquisitions, the acquisition count is set to that maximum number and cannot be changed.
See also "[Number of acquisitions](#)" on page 132.
- It is the "Finished" criteria for the state of a mask test.

Remote command:

[ACQUIRE:COUNT](#) on page 1424

Reset

Forces the immediate restart of the envelope and average calculation for all waveforms.

Remote command:

[ACQUIRE:ARESet:IMMediate](#) on page 1424

Arithmetic Reset > Mode

Defines when the envelope and average evaluation restarts.

"None"	No restart, the number of acquisitions considered by the waveform arithmetics is not limited.
"Time"	Restarts the envelope and average calculation after the time defined in "Time".
"Waveforms"	Restarts the envelope and average calculation after a number of acquired waveforms defined in "Count".

Remote command:

[ACQUIRE:ARESet:MODE](#) on page 1425

[ACQUIRE:ARESet:TIME](#) on page 1425

[ACQUIRE:ARESet:COUNT](#) on page 1425

7.4 History

The history accesses the data of previous acquisitions and provides them for further analysis.

7.4.1 About history

If a continuous acquisition runs, the captured data is stored in the sample memory and the current acquisition is processed and shown on the display. After the acquisition was stopped, the history accesses the captured samples that were stored, displays these samples as history waveforms, and makes them available for further analysis. It considers all channels that were enabled during the running acquisition. When a new acquisition is started with [Run Stop] or [Single], the memory is cleared and written anew.

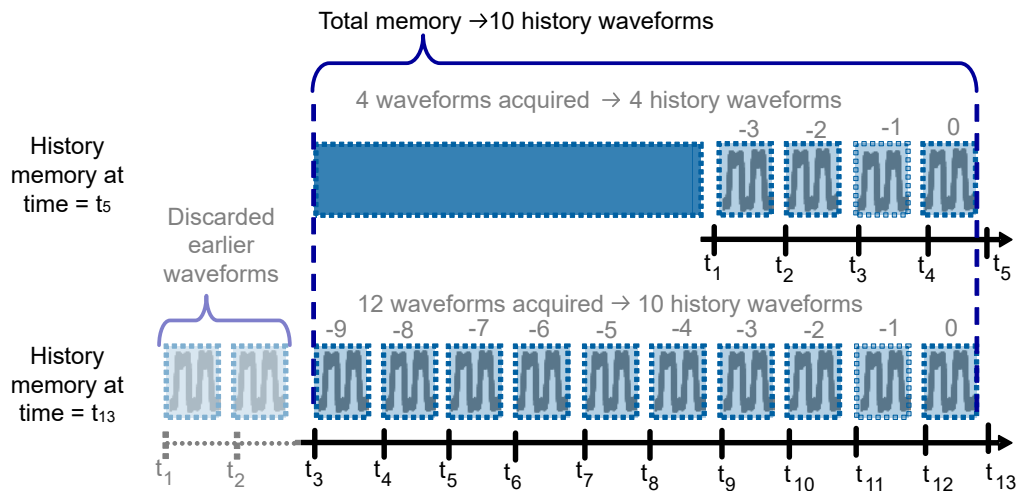

Figure 7-5: History memory. In this example, the memory can store 10 waveforms.

You can work with history waveforms in the same way as with the waveform of the latest acquisition: use zoom, cursor measurements, and automatic measurements, create math waveforms, perform mask testing and so on. Saving the history data is also possible, either completely or a part of the data.

The number of stored history waveforms depends on the memory size, the number of enabled channels, and the record length. The shorter the record length, the less the number of channels, and the larger the memory, the more history waveforms are saved.

Quick-access History dialog box

When you press the [History] key on the front panel or tap "Display" menu > "Show history", the history mode is enabled and the quick-access "History" dialog box is displayed. A running acquisition stops immediately.

The small quick-access "History" dialog box can remain visible on the screen during history replay, so that the history can be replayed at any time by a simple tap on the "Play" button. Closing the quick-access "History" dialog box, or starting a new acquisition disables the history mode.

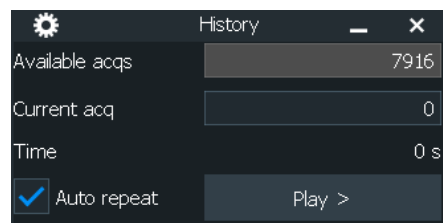

Export of history waveforms

7.4.2 History setup

The "History" dialog contains the complete functionality on history viewing and information.

The most important information and functions are also provided in the quick-access history dialog box.

Access: "Menu" > "Acquire" > "History" tab.

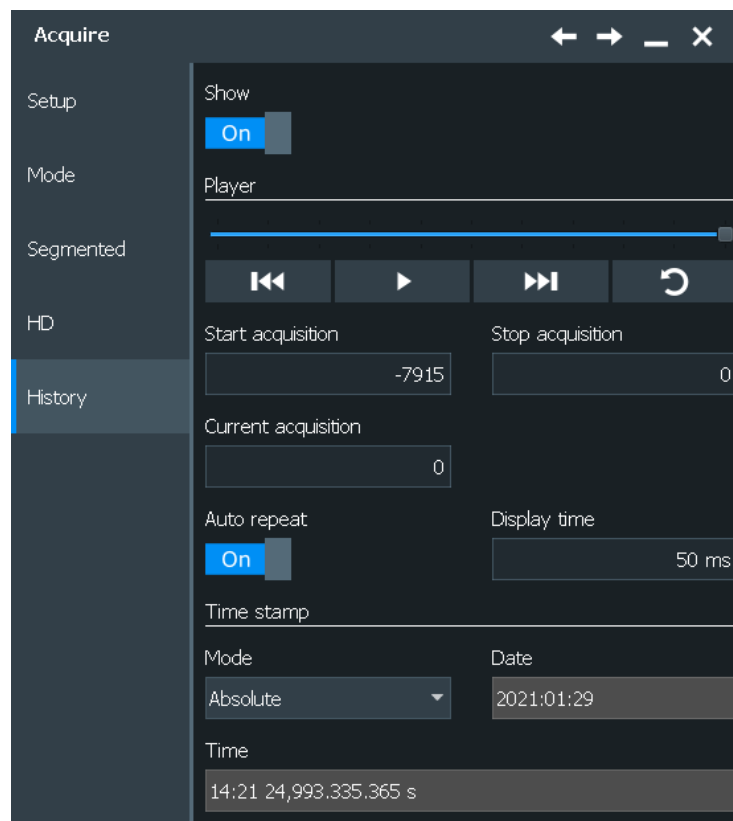

Show history / Export history

Enables the history mode and allows you to save history waveforms to file.

The history display is enabled automatically when you press the [History] button. It is disabled when you close the quick-access "History" dialog box.





For details on data export, see [Chapter 12.2.2.2, "Waveform history settings"](#), on page 470.

Remote command:

`CHANnel<m>[:WAVEform<n>]:HISTORY[:STATe]` on page 1563

Player

The player can be used to control the playback of the history waveforms.

	Sets the oldest acquisition in the sample memory as "Start acquisition" and "Current acquisition".
	Starts and stops the replay of the history waveforms from "Start acquisition" to "Stop acquisition".
	Sets the newest acquisition in the sample memory as "Stop acquisition" and "Current acquisition". The newest acquisition always has the index "0".
	Resets the "Stop acquisition" to 0 and the "Start acquisition" to the number of saved acquisitions. Thus, the history viewer shows all acquisitions.

Start acquisition

Sets the index of the first (oldest) acquisition to be displayed or exported. The index is always negative.

Remote command:

[CHANnel<m>\[:WAVeform<n>\]:HISTory:STARt](#) on page 1564

Stop acquisition

Sets the index of the last (newest) acquisition to be displayed or exported. The newest acquisition of the complete acquisition series always has the index "0".

Remote command:

[CHANnel<m>\[:WAVeform<n>\]:HISTory:STOP](#) on page 1565

Current acquisition

Accesses a particular acquisition in the memory to display it, or to save it. The newest acquisition always has the index "0". Older acquisition have a negative index.

If a history replay is running, the field shows the number of the currently shown acquisition.

Remote command:

[CHANnel<m>\[:WAVeform<n>\]:HISTory:CURRent](#) on page 1564

Auto repeat

If selected, the replay of the history waveform sequence repeats automatically. Otherwise, the replay stops at the "Stop acquisition".

Remote command:

[CHANnel<m>\[:WAVeform<n>\]:HISTory:REPLay](#) on page 1566

Display time

Sets the display time for one acquisition. The shorter the time, the faster the replay is. The setting takes effect for history replay and the display of a Fast Segmentation series, see [Chapter 5.4.3, "Segmented settings"](#), on page 131.

Remote command:

[CHANnel<m>\[:WAVeform<n>\]:HISTory:TPACq](#) on page 1565

Time stamp

The time stamp shows the time of the currently displayed history acquisition. Thus, the time relation between acquisitions is always available.

The time stamp "Mode" can be absolute or relative:

- In "Absolute" mode, the instrument shows the date and the daytime of the current acquisition.
- In "Relative" mode, the time difference to the newest acquisition (index = 0) is shown.

The time stamp can be included in waveform data export, see ["Time stamps"](#) on page 471.

During history replay, the time value is displayed and updated if the replay speed ("Display time") is slow enough, that is 40 ms or slower.

The quick-access history dialog box always shows the relative time. In the "History Viewer" tab, you can select the time mode.

Remote command:

[CHANnel<m>\[:WAVeform<n>\]:HISTory:TSDate?](#) on page 1566

[CHANnel<m>\[:WAVeform<n>\]:HISTory:TSABsolute?](#) on page 1566

[CHANnel<m>\[:WAVeform<n>\]:HISTory:TSRelative?](#) on page 1567

[CHANnel<m>\[:WAVeform<n>\]:HISTory:TSReference?](#) on page 1567

7.4.3 Using history

You can access the history waveforms in two ways:

- Display a particular acquisition.
- Replay all or a part of the saved waveforms to track the signal run.

Furthermore, you can export history data to a file.

- ["To open the history and get information"](#) on page 287
- ["To display a particular acquisition"](#) on page 288
- ["To replay history waveforms"](#) on page 288
- ["To exit the history"](#) on page 288
- ["To save the history data"](#) on page 289

To open the history and get information

1. Press the [History] key on the front panel.

A running acquisition is stopped, the history mode is enabled and the quick-access "History" dialog box is displayed. The [History] key lights up as long as the history mode is active.

2. Open the full configuration dialog box:
 - Tap the  icon.
 - Open "Menu" > "Acquire" dialog > "History" tab.

To display a particular acquisition



1. In the quick-access "History" dialog box, enter the number of the required acquisition in the "Current acq" field. The newest acquisition always has the index "0", older acquisitions have a negative index.
2. Tap "Play" to start.

Alternatively, you can configure and start the history display from the "History" configuration dialog box:

1. Open the "History" configuration tab.
2. If the history mode is off (the [History] key is not illuminated), select "Show".
The quick-access dialog box is displayed.
3. Drag the slider to the required acquisition. The current number is shown in the "Current acquisition" field.
Alternatively, enter the number of the required acquisition in the "Current acquisition" field.
4. Tap "Play" to start.

To replay history waveforms

If you want to see the complete acquisition series without any setup, simply tap "Play" in the quick-access "History" dialog box. For specific analysis of history data, use the history "Viewer" setup.

1. Open the "History" configuration dialog tab.
2. If the history mode is off (the [History] key is not illuminated), enable "Show".
The quick-access dialog box is displayed.
3. Define the part of the history you want to see by doing one of the following:
 - Tap  to see the complete history.
 - Enter the "Start acquisition" of the oldest acquisition to display and the "Stop acquisition" of the newest acquisition to display. All waveforms between the two indexes are displayed.
To enter the oldest or newest acquisition for either index, tap the appropriate button. The newest acquisition always has the index "0". The "Start acquisition" is always negative.
4. Tap  to start.

To exit the history

- ▶ Choose one of the following ways:
 - Close the quick-access "History" dialog box.
 - In the "History" configuration tab, disable "Show".
 - Start the acquisition.

To save the history data

You can save the complete history, or some subsequent waveforms from the history, or a single history waveform. You can also decide to save the complete waveforms, or a part of each waveform.

1. Open the "Menu" > "Save/Recall" dialog.
2. Select the "Save/Recall" tab.
3. In the "Save " tab, press "Waveform".
4. In the "Setup" tab, tap the source icon to select the waveform you want to save.
5. If you want to save only a part of each waveform, set the "Scope".
For settings, see ["Scope"](#) on page 468.
6. Select the "History" tab.
7. Enable "Export history".
8. If you want to write the timestamps into the data file, enable "Time stamps".
9. To save one waveform out of the history memory:
 - a) Make sure that "Multiple acquisitions in one file" is disabled.
 - b) Enter the number of the required acquisition in "Acquisition index".
The newest acquisition in the memory always has the index "0". Older acquisitions have a negative index.
 - c) Tap "Save" or "Save As" to save the waveform data to the specified file.
10. To save several subsequent history waveforms:
 - a) Enable "Multiple acquisitions in one file".
 - b) Define the range of the waveforms to be saved with "Start acquisition" and "Stop acquisition".
 - c) Tap "Start export" to play the history and to save the history data to the specified file.

See also [Chapter 12.2.2.2, "Waveform history settings"](#), on page 470.

7.5 XY-diagram

XY-diagrams combine the voltage levels of two waveforms in one diagram. They use the voltage level of a second waveform as the x-axis, rather than a time base. This allows you to perform phase shift measurements, for example. You can display up to four different XY-diagrams.

XY-diagrams can be used to display the IQ representation of a signal.

7.5.1 Settings for XY-diagrams

Access: [App Cockpit]>"Analysis" tab > "XY-Diagram"

You can display up to four different XY-diagrams that use the voltage level of a waveform as the x-axis, rather than a time base.



Make sure to select the tab of the required XY-diagram.

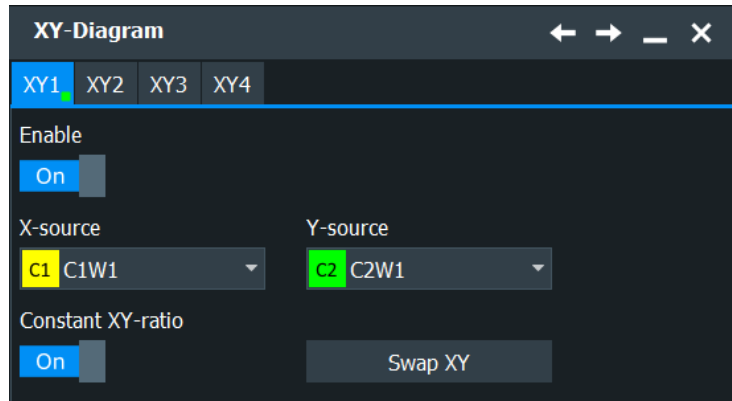

Enable

If activated, the XY-waveform is active and shown in a diagram, or it is minimized in a signal icon.

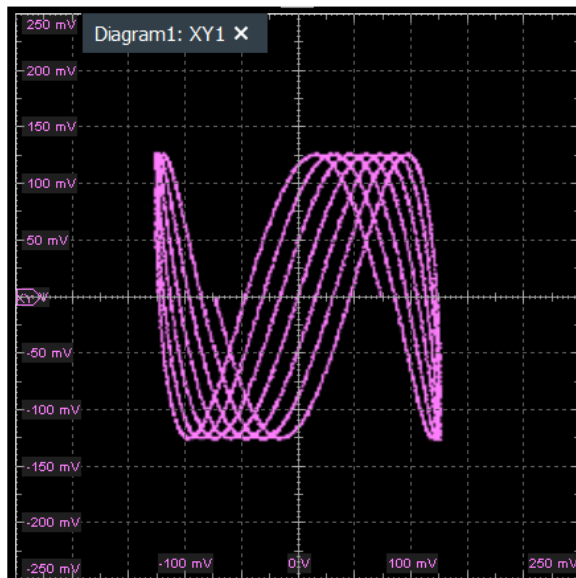

Remote command:

[WAVeform<m>:XYCurve:STATe](#) on page 1568

X-source

Defines the signal source that supplies the x-values of the XY-diagram. Select one of the following:

- One of the waveforms of any channel
- A reference waveform

- The results of a mathematical function

Remote command:

[WAVeform<m>:XYCurve:XSource](#) on page 1569

Y-source

Defines the source to be used as the y-axis of the XY-diagram. Select one of the following:

- One of the waveforms of any channel
- A reference waveform
- The results of a mathematical function

Remote command:

[WAVeform<m>:XYCurve:YSource](#) on page 1570

Constant XY-ratio

If enabled, the x- and y-axes maintain a constant ratio in the diagram.

Remote command:

[WAVeform<m>:XYCurve:RATio](#) on page 1568

Swap XY

Replaces the source of the x-axis with the source of the y-axis and vice versa.

Remote command:

[WAVeform<m>:XYCurve:SWAP](#) on page 1569

7.5.2 Displaying an XY-diagram

You can create the diagram from active waveforms with drag&drop, or use the dialog box for setup.

To display an XY-diagram with drag&drop

Prerequisites: The source waveform for the y-axis is active in a diagram, the source waveform for the x-axis is either active or minimized.

1. Drag the x-axis waveform to the lower middle of the diagram with the y-axis waveform.
2. Drop the icon when it overlaps with the Xy shown in the middle of the diagram.

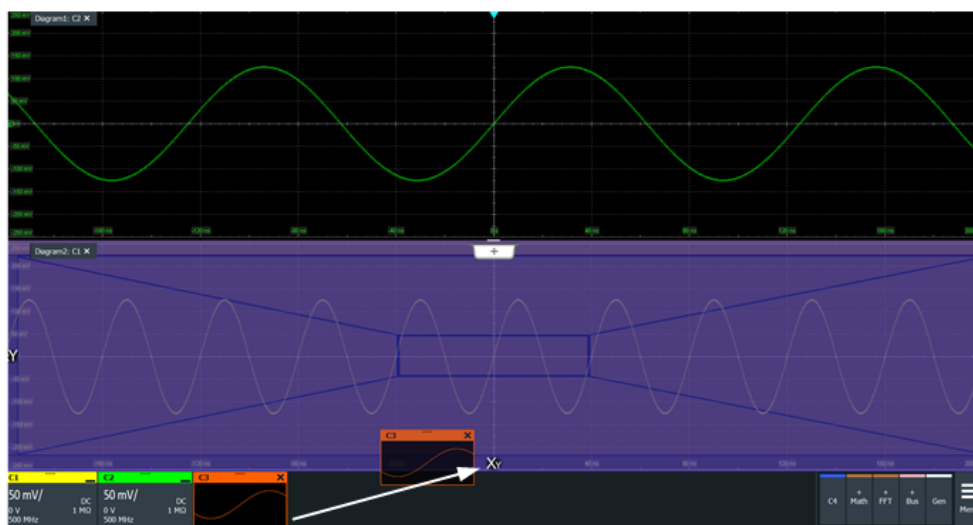

The diagram is converted into an XY-diagram.

To set up an XY-diagram

1. Press the [App Cockpit] key.
2. In the >"Analysis" tab, tap the "XY-Diagram".
3. Enable the "XY-diagram".
4. In the "X-source" field, define the signal source that supplies the x-values of the XY-diagram. Select one of the following:
 - One of the waveforms of any channel
 - A reference waveform
 - The results of a mathematical function
5. In the "Y-source" field, define the signal source that supplies the y values of the XY-diagram.
6. To switch the x- and y-values quickly, tap the "Swap XY" button.
7. To maintain a constant ratio while the x- and y-axes are adapted to the acquired data dynamically, activate the "Constant XY-ratio" option.



If the XY-diagram is active or minimized, touch and hold the signal icon to open the "XY-diagram" tab.

8 Measurements

Using the R&S RTO6 you can perform and display different measurements simultaneously, based on the active signal or math waveforms. The color of the results in the result table corresponds with the source waveform color.

The following measurement methods are available:

- **Cursor measurements:** measurements can be configured for up to 4 cursor sets to determine specific results at the manually defined cursor positions of an active waveform; the results are displayed in a result box.
- **Automatic measurements:** up to eight measurements can be configured and performed simultaneously on different sources; the results of each measurement are displayed in a result box.
- **Quick measurements:** performs a set of automatic measurements on the selected waveform at the push of a button. You can configure the set of measurements.

8.1 Cursor measurements

- [Cursors and results of cursor measurements](#)..... 293
- [Using cursors](#)..... 294
- [Settings for cursor measurements](#)..... 297

8.1.1 Cursors and results of cursor measurements

Cursor measurements determine the results at the current cursor positions. The cursors can be positioned manually, or can be configured to follow the waveform. You can measure on one waveform, or on two different waveforms (sources).

Up to 4 cursor sets can be configured and displayed. Each cursor set consists of a pair of horizontal or vertical cursors, or both. Cursor lines can be coupled so that the initially defined distance is always maintained.

The cursors are displayed in the diagrams of the source waveform only, or in all diagrams. For each measurement, labels can be defined for the cursors. By default, the cursors are labeled as Cu1.1, Cu1.2, Cu2.1, Cu2.2, Cu3.1, Cu3.2, Cu4.1, Cu4.2.

How to set up cursor measurements is described in [Chapter 8.1.2, "Using cursors"](#), on page 294. The [Chapter 8.1.3, "Settings for cursor measurements"](#), on page 297 provides a detailed description of all settings.

Cursors can also define a gate to limit the measurement to the section of the waveform between the cursor lines. See [Chapter 8.2.3.2, "Gate settings for measurements"](#), on page 314.

The result display of cursor measurements is configurable. Results can be shown in a docked table, or in floating result boxes for each measurement. Similar to waveform diagrams, you can also minimize the result box to a result icon on the signal bar.

For details on using the result box, see [Chapter 3.3.7, "Displaying results"](#), on page 59 and ["Result position"](#) on page 85.

8.1.1.1 Cursor measurements on time-based waveforms

The cursor for measurement on time-based waveforms returns the following results. The results are displayed automatically when a cursor measurement is enabled.

Cu	1	2	X1	X2	ΔX	$1/\Delta X$	Y1	Y2	ΔY	$\Delta Y/\Delta X$
1	ca	ca	-92.2 ns	-52.2 ns	40 ns	25 MHz	128 mV	159.3 mV	31.298 mV	---
2	ca	ca	7.8 ns	47.8 ns	40 ns	25 MHz	146.63 mV	96.63 mV	-50 mV	---

Figure 8-1: Measurement results of a cursor measurement in time domain

Label	Description
X1, X2	Time at the position of the vertical cursors.
Y1, Y2	Vertical values of the waveform at the position of the horizontal cursors in V or A.
ΔX	Difference between the vertical cursor (time) values
ΔY	Difference between the horizontal cursor values
$1/\Delta X$	Inverse time difference
$\Delta Y/\Delta X$	Slope of the waveform between the cursors (if measured on one source)

8.1.1.2 Cursor measurements on spectrum waveforms

If the measurement source is a spectrum waveform, the results have a different meaning. Measurement on 2 spectrum waveforms is not possible.

The result box for measurement on spectrum waveforms shows the following information.

Label	Description
X1, X2	Frequency at the position of the vertical cursors
Y1, Y2	Vertical values of the waveform at the position of the horizontal cursors in dB.
Bw	Difference between the vertical cursor (frequency) values
ΔY	Difference between the horizontal cursor values

To set the cursor lines to the peaks, various functions are available in the "Peak Search" tab, see [Chapter 8.1.3.3, "Peak Search tab"](#), on page 302.

8.1.2 Using cursors

You can start cursor measurements by using the "Cursor" icon on the toolbar, or using the [Cursor] key. For detailed configuration, use the "Cursor" dialog box.

- [Starting a simple cursor measurement](#)..... 295
- [Configuring a cursor measurement](#).....295
- [Configuring the cursor display](#).....297
- [Saving measurement results to file](#).....297

8.1.2.1 Starting a simple cursor measurement

To display cursors using the toolbar

1. Tap the "Cursor" icon on the toolbar.



2. Tap the waveform that you want to measure. Alternatively, you can draw a rectangle in the diagram to position the cursor lines.

The cursor lines appear and the cursor results are displayed in a table or result box.

To display cursors using the [Cursor] key

1. Select the waveform that you want to measure.
2. Press the [Cursor] key.

The cursor lines and the measurement results are displayed.

To disable one cursor measurement

1. Tap the "Delete" icon on the toolbar.
2. Tap a cursor line.

The cursor set and its measurement results are deleted.

To disable all cursor measurements

1. Tap the "Delete" icon on the toolbar.
2. Tap the results table.

All cursor sets and measurement results are deleted.

8.1.2.2 Configuring a cursor measurement

To modify the position of the cursor lines, you can drag the lines on the screen. In addition, various settings are possible to refine the measurement.

The complete configuration of cursor measurements is provided in the "Cursors" dialog.

1. To open the "Cursors" dialog, use one of these ways:
 - Open the "Menu", and select "Cursor".

- Press the [Cursor] key.
 - Use the overlay menu:
 - Double-tap a measurement result in the results table.
 - Adjust source, type, and positions of the cursor lines in the overlay menu.
 - Tap "Advanced Setup" to open the "Cursors" dialog.
 - If the results are shown in a floating result box, tap the  icon in the result box.
2. Select the "Setup" tab.
 3. Select the subtab for the cursor set that you want to use.
 4. Select the source - the measured waveform. You can select any input channel, or various other active waveforms. Available sources are shown in the source list.
 5. If necessary, enable and select a 2nd waveform.
 6. Select the cursor type: horizontal, vertical, or both.
 7. Define the position of the cursors:
 - a) To define exact positions of the cursor lines, enter the X-position for each vertical cursor and the Y-position for each horizontal cursor. If it is not possible to set horizontal cursors, disable "Track waveform".
 - b) To position the horizontal cursors automatically, select "Track waveform".
In this case, cursor 1 indicates the current maximum, cursor 2 indicates the current minimum. If both horizontal and vertical cursors are displayed, the horizontal cursors are placed at the crossing points of the vertical cursors with the waveform. Adjust the vertical cursors manually, and the horizontal cursors follow.
 - c) If the waveform arithmetics are set to "Envelope", and "Track waveform" is active, select which horizontal cursor is positioned to the maximum and which to the minimum envelope values.
 - d) To keep the distance between the vertical cursors when one cursor is moved, select "Coupling (2 follows 1)".
 8. Optionally, select "Show in all diagrams" in the "Advanced" tab. This setting enables the cursor display in all diagrams that are in the same domain as the selected source (time or spectrum).
 9. To set the cursors for a spectrum measurement to peak values, select the "Peak Search" tab.
Tap one of the buttons to place the cursors on the selected peak value. For details, see [Chapter 8.1.3.3, "Peak Search tab"](#), on page 302.
 10. Tap the "Cursor On/Off" button in the "Setup" tab to activate the cursor measurement.

The cursors lines and the results are displayed. For details on cursor measurement results, see [Chapter 8.1.1, "Cursors and results of cursor measurements"](#), on page 293.

8.1.2.3 Configuring the cursor display

By default, the cursors are displayed as lines in the diagrams and labeled according to the syntax: Cu<cursor set number>.<1|2>

For example, the cursors for the cursor set 2 are labeled 2.1 and 2.2. The horizontal and the vertical cursors lines have the same labels.

You can change the default cursor display and labels.

To set the cursor style

1. Open the "Menu" and select "Settings".
2. Select "Appearance".
3. Select the "Cursor" tab.
4. Select the cursor style. See also: "[Cursor style](#)" on page 85.

To add labels to cursor lines

1. Open the "Cursors" dialog box, for example, with "Menu" > "Cursor".
2. Select the subtab for the cursor set you want to configure.
3. Select the "Advanced" tab.
4. For each vertical and horizontal cursor, enter a label.
5. Select "Show labels".

8.1.2.4 Saving measurement results to file

1. Open the "Menu" and select "Save/Recall".
2. Select the "Save" tab.
3. Select "Results".
4. Select the results that you want to export.
5. Save the file.

8.1.3 Settings for cursor measurements

Cursor measurements are configured in the "Cursors" dialog box.

8.1.3.1 Setup tab

The "Setup" tab contains the settings for cursor measurements.

The cursor style and position of the measurement results is defined in the "Settings" > "Appearance" > "Cursor" dialog box.

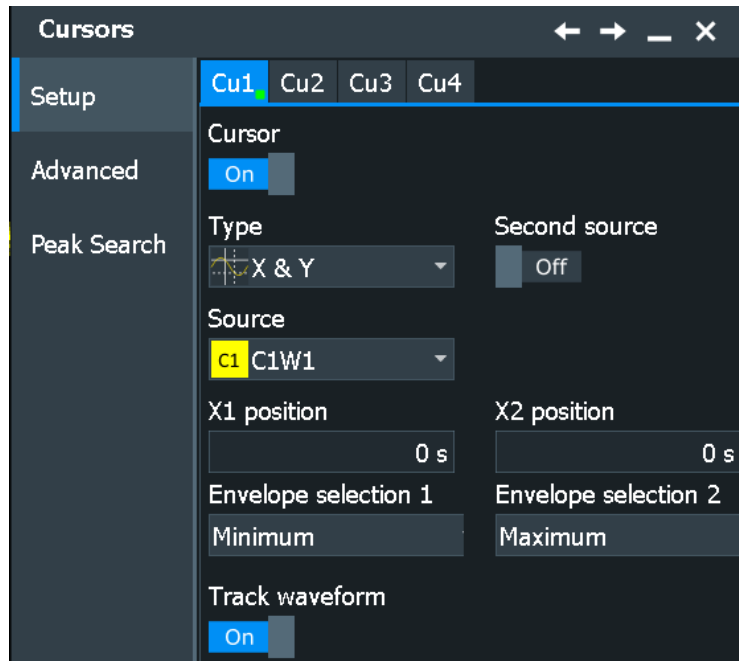

Figure 8-2: Setup for cursor on 1 source, with waveform tracking

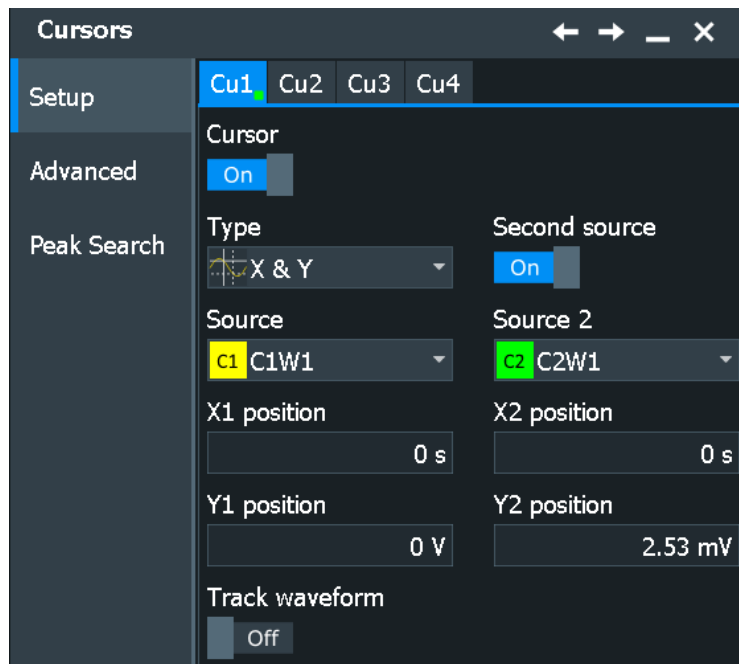

Figure 8-3: Setup for cursor on 2 sources

Cu1, Cu2, Cu3, Cu4

The settings for each cursor measurement (or cursor set) are configured on separate tabs. For each cursor set, a horizontal pair of cursors, a vertical pair of cursors, or both can be displayed.

Cursor On/Off

Enables the selected cursor measurement.

Remote command:

[CURSor<m>:STATe](#) on page 1571

Type

Defines the cursor type to be used for the measurement.

- Horizontal cursors (Y-cursors)
Horizontal cursors are positioned automatically along the waveform and can be adjusted manually
- Vertical cursors (X-cursors)
Both vertical cursor lines are set automatically to the trigger position, and you can reposition them manually.
- Both vertical and horizontal cursors (X&Y-cursors)
Horizontal cursors are positioned automatically along the waveform and vertical cursors are set to the trigger position. You can reposition all cursor lines manually.

Remote command:

[CURSor<m>:FUNctIon](#) on page 1572

Source

Defines the source of the cursor measurement. Any of the input signal, math, reference or XY waveforms can be selected.

Remote command:

[CURSor<m>:SOURce](#) on page 1572

Second source, Source 2

Enables and selects a second source for the cursor measurements. If enabled, the second cursor lines Cx.2 measure on the second source. Using a second source, you can measure differences between two channels with cursors.

Remote command:

[CURSor<m>:USSource](#) on page 1574

[CURSor<m>:SSource](#) on page 1573

X1 position, X2 position

Defines the position of the vertical cursors.

Remote command:

[CURSor<m>:X1Position](#) on page 1575

[CURSor<m>:X2Position](#) on page 1575

Y1 position, Y2 position

Defines the position of the horizontal cursor lines. The setting corresponds to the V1 and V2 values in the "Cursor Results" box.

If "Track waveform" is enabled, the user setting is disabled and the measurement results are displayed in the "Cursor Results" box.

Remote command:

[CURSor<m>:Y1Position](#) on page 1576

[CURSor<m>:Y2Position](#) on page 1577

Envelope selection 1|2

Envelope selection is effective under the following conditions:

- The waveform arithmetic of the cursor source waveform is set to envelope waveform (see ["Arithmetic"](#) on page 130)
- "Track waveform" is enabled.
- Both horizontal and vertical cursors are enabled ("Type" = *Both*).

The setting defines which horizontal cursor is positioned to the maximum and which to the minimum envelope values.

"Minimum" The horizontal cursor is set to the crossing point of the vertical cursor with the minimum waveform envelope.

"Maximum" The horizontal cursor is set to the crossing point of the vertical cursor with the maximum waveform envelope.

Remote command:

[CURSor<m>:X1ENvelope](#) on page 1577

[CURSor<m>:X2ENvelope](#) on page 1578

Track waveform

The horizontal cursors track the waveform. The first cursor line indicates the current vertical minimum, and the second cursor line indicates the maximum. If the waveform changes, e.g. during a running measurement, the cursors move along with it. If both horizontal and vertical cursors are displayed, the horizontal cursors are positioned to the crossing points of the vertical cursors with the waveform. The measurement results are displayed in the "Cursor Results" box.

Tracking disables the Y-coupling (coupling of horizontal cursor lines) and the Y user position settings.

Remote command:

[CURSor<m>:TRACking\[:STATe\]](#) on page 1575

8.1.3.2 Advanced settings

Access: [Cursor] key > "Advanced" tab

The settings in the "Advanced" cursor tab configure the behavior and display of cursor lines, and labels for the lines.

The cursor style and position of the measurement results is defined in the "Settings" > "Appearance" > "Cursor" dialog box. See [Chapter 4.3.7, "Cursor appearance settings"](#), on page 85.

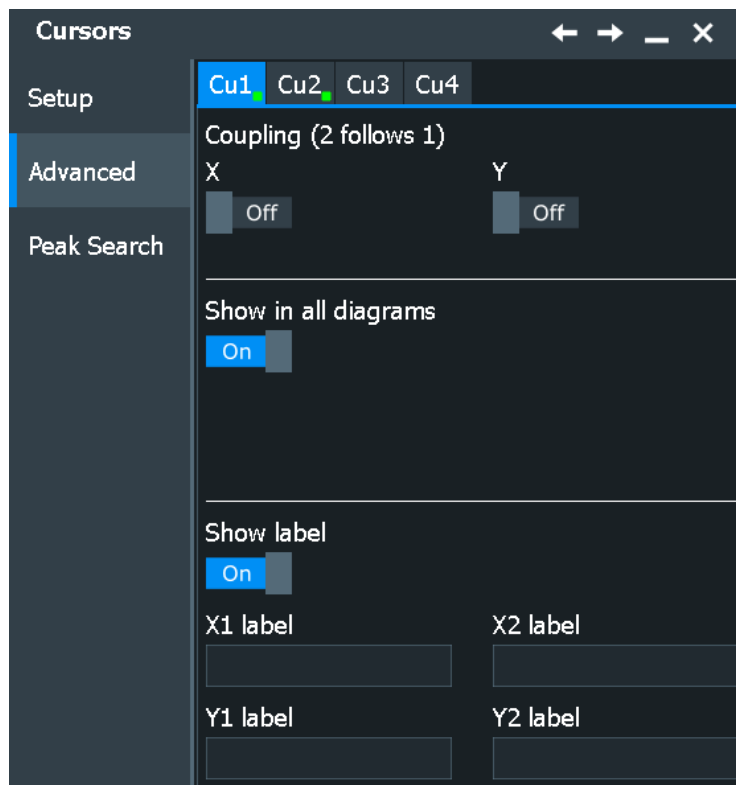

Cu1, Cu2, Cu3, Cu4

The settings for each cursor measurement (or cursor set) are configured on separate tabs. For each cursor set, a horizontal pair of cursors, a vertical pair of cursors, or both can be displayed.

Coupling (2 follows 1)

Couple the horizontal and vertical cursor lines so that the distance between the two lines remains the same if one cursor is moved.

Remote command:

[CURSor<m>:YCOupling](#) on page 1577

[CURSor<m>:XCOupling](#) on page 1576

Show in all diagrams

Shows the cursor lines of the selected cursor set in all active diagrams of the same (time/spectrum) domain.

Remote command:

[CURSor<m>:SIAD](#) on page 1579

Show label

Shows the cursor labels in the diagram.

Remote command:

[CURSor<m>:LAbel \[:LAbel\]](#) on page 1578

X1 label, X2 label

Defines a label to be displayed with the vertical cursors.

By default, the cursors are labeled as Cu1.X1, Cu1.X2, Cu2.X1, Cu2.X2, Cu3.X1, Cu3.X2, Cu4.X1, Cu4.X2.

Remote command:

`CURSor<m>:LAbel:X<1..2>` on page 1579

Y1 label, Y2 label

Defines a label to be displayed with the horizontal cursors. By default, these cursors are labeled as Cu1.Y1, Cu1.Y2, Cu2.Y1, Cu2.Y2, Cu3.Y1, Cu3.Y2, Cu4.Y1, Cu4.Y2.

Remote command:

`CURSor<m>:LAbel:Y<1..2>` on page 1579

8.1.3.3 Peak Search tab

Access: [Cursor] key > "Peak Search" tab

The settings on this tab are only available in spectrum mode, i.e. the source of the cursor measurement is an FFT math waveform. In this case, the cursors can indicate the results of a peak search on the waveform. You can define which peaks the instrument determines by defining the noise reject settings.

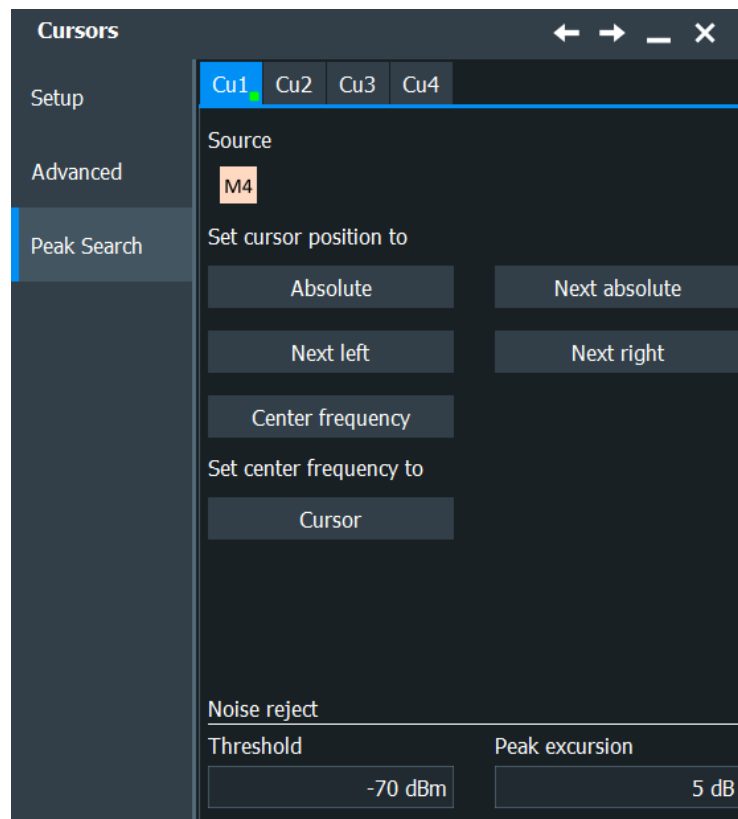

Cu1, Cu2, Cu3, Cu4

The settings for each cursor measurement (or cursor set) are configured on separate tabs. For each cursor set, a horizontal pair of cursors, a vertical pair of cursors, or both can be displayed.

Source

Defines the source of the cursor measurement. Any of the input signal, math, reference or XY waveforms can be selected.

Remote command:

`CURSor<m>:SOURce` on page 1572

Absolute

Both cursors are set to the absolute peak value.

Remote command:

`CURSor<m>:MAXimum[:PEAK]` on page 1582

Next absolute

Cursor 2 is set to the next smaller absolute peak from the current position.

Remote command:

`CURSor<m>:MAXimum:NEXT` on page 1582

Next left

Cursor 2 is set to the next peak to the left of the current position.

Remote command:

`CURSor<m>:MAXimum:LEFT` on page 1582

Next right

Cursor 2 is set to the next peak to the right of the current position.

Remote command:

`CURSor<m>:MAXimum:RIGHT` on page 1582

Center frequency

Sets the vertical cursor line Cu1 to the center frequency.

Remote command:

`CURSor<m>:FFT:TOCenter` on page 1581

Set center frequency to Cursor

Sets the center frequency to the frequency value that is measured at cursor line Cu1.

Remote command:

`CURSor<m>:FFT:SETCenter` on page 1581

Threshold

Defines an absolute threshold as an additional condition for the peak search. Only peaks that exceed the threshold are detected.

This setting is only available for spectrum waveforms. It is valid for cursor measurements, spectrum measurements and peak search.

Remote command:

[CURSor<m>:THReshold](#) on page 1745

[MEASurement<m>:SPECTrum:ATHReshold](#) on page 1632

Peak excursion

Defines a relative threshold, the minimum level value by which the waveform must rise or fall to be considered as a peak. To avoid identifying noise peaks, enter a peak excursion value that is higher than the noise levels.

This setting is only available for spectrum waveforms. It is valid for cursor measurements, spectrum measurements and peak search.

The following figure shows a cursor measurement on a spectrum waveform:

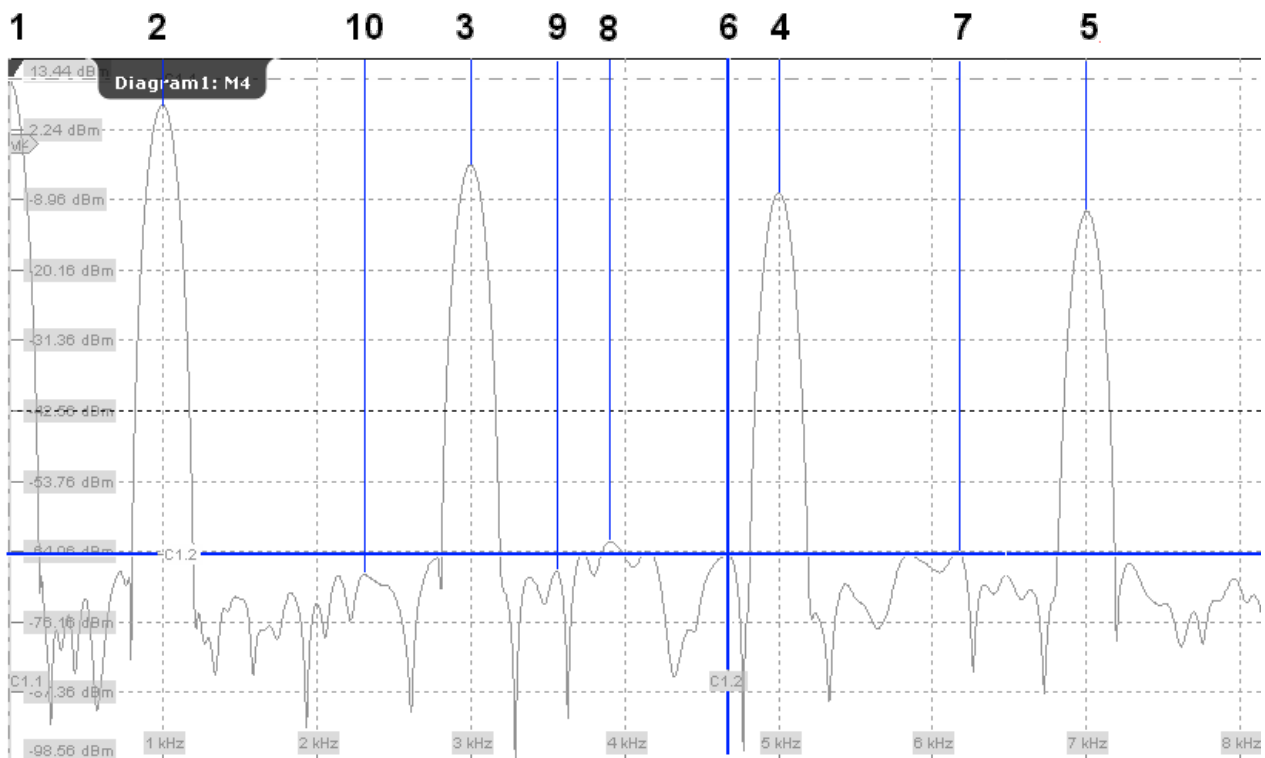

If "Peak excursion" is 30 dB, the peaks 1 to 5 are found. If "Peak excursion" is 20 dB, also the peaks 6 to 10 are found. The cursor position is on peak 6.

Remote command:

[CURSor<m>:PEXCursion](#) on page 1744

[MEASurement<m>:SPECTrum:PEXCursion](#) on page 1632

8.2 Automatic measurements

The R&S RTO6 can perform many measurements in parallel. The measurements are combined in up to 8 measurement groups. In addition, you can run the quick measurement.

The basic measurement settings are source, category, and the selection of the measurement. You can refine the setup to get more specific results:

- **Gating**
A gate limits the measurement to a user-defined part of the waveform. See [Chapter 8.2.3, "Measurement gates"](#), on page 313.
- **Statistics and long term measurements**
To evaluate time-dependent behavior of measurement results, you can use statistics, long term measurements, and tracks. You can also decide, how many measurement results per acquisition contribute to the calculation. See: [Chapter 8.2.11, "Result analysis"](#), on page 361.
- **Limit checks and actions on test result**
Limit and margin checks evaluate if the measurement result exceeds a specified value. You can define actions that are performed on limit or margin violation. See: [Chapter 8.2.12, "Limit and margin checks"](#), on page 369.

Measurement categories

The various measurement are grouped in several categories. The category defines which sources can be analyzed.

Time domain:

- Amp/Time: amplitude and time measurements
- Eye: eye diagram measurements
- Histogram: measurements on histograms
- Jitter measurements (available if one of the jitter options is installed)
- Protocol: available for audio signals (option R&S RTO6-K510)
Protocol: advanced analysis (available if option R&S RTO6-K500 is installed)

Frequency domain

- Spectrum: measurements on spectrum waveforms
- Histogram: measurements on histograms

Details on automatic measurements are described in the following chapters:

• Measurement setup in general	306
• Measurement results	310
• Measurement gates	313
• Amplitude/time measurements	316
• Eye diagram measurements	332
• Spectrum measurements	341
• Histograms and histogram measurements	346
• Jitter measurements	353
• Optical measurements	354
• Protocol measurements (option R&S RTO6-K500)	355
• Result analysis	361
• Limit and margin checks	369

8.2.1 Measurement setup in general

Up to 8 measurement groups can be defined. Each measurement group is configured in its own subtab. For each measurement group, the category and the source are defined in the "Setup" tab, and you can also enable statistic evaluation. Available sources and measurements depend on the selected category, for example, histogram measurements need a defined histogram as source. For each measurement group, you select all required measurements. If further settings are available for a measurement, a settings icon is shown beside the measurement's name.

8.2.1.1 Starting an automatic measurement

There are three methods to start an automatic measurement, each with slightly different effects:

- Using the "Measure" icon on the toolbar:
See: ["To start a measurement using the toolbar icon"](#) on page 306.
- Using the "Measure" menu.
Pressing the [Measure] key on the front panel, or using the "Measure" menu.
See: [Chapter 8.2.1.2, "Configuring measurements"](#), on page 306.

To start a measurement using the toolbar icon

1. Tap the "Measurement" icon on the toolbar.



2. On the toolbar assist, select the category, the measurements and the source to be measured.

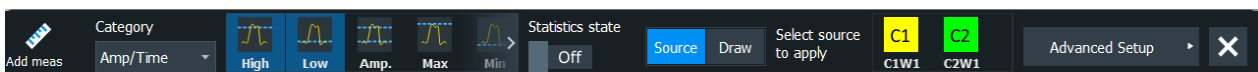

3. Define the measurement range in one of these ways:
 - To measure the complete waveform, tap the diagram with the waveform.
 - To define a gate that limits the measurement, draw a rectangle on the screen.

The "Meas Results" are displayed.

8.2.1.2 Configuring measurements

1. Press the [Measure] key on the front panel, or open the menu and select "Measure".

The "Measurements" dialog box opens.

If you double-tap the title of a result table, the toolbar assist opens. Here you can change the measurement types and enable statistics. If you tap "Advanced Setup", the "Measurements" dialog box opens.

2. Select the subtab for the measurement group that you want to configure.

3. Select the measurement "Category", for example, "Amp/Time".
4. Tap "Source" and select the waveform to be measured. Spectrum measurements require an FFT math waveform as measurement source. Histogram measurements require a histogram as source.
5. Tap "Add / Remove" and select all measurements that you want to include in the measurement group. Tap "Clear" to deselect all settings.



6. Tap "Back" to close the selection box. All selected measurements are displayed in the list of active measurements.
7. A "Settings" icon indicates whether further settings are required. Tap the measurement. A dialog box opens, and you can adjust the measurement. The settings are explained in the following chapters:
 - [Chapter 8.2.4.2, "Settings for amplitude/time measurements"](#), on page 321
 - [Chapter 8.2.5.2, "Settings for eye diagram measurements"](#), on page 335
 - [Chapter 8.2.6.2, "Settings for spectrum measurements"](#), on page 342
 - [Chapter 8.2.7.5, "Settings for histogram measurement"](#), on page 352
8. Optionally, define a gate to restrict the measurement to a part of the waveform. See [Chapter 8.2.3.1, "Using measurement gates"](#), on page 313.

If you enabled the measurement with the toolbar icon and drew a rectangle on the diagram, the gate is already defined and enabled.

9. To compile and display statistics for the measurement, enable "Statistics". See also [Chapter 8.2.11.1, "Statistics"](#), on page 362.
10. Optionally, perform a limit or margin check as described in [Chapter 8.2.12.1, "Performing limit checks"](#), on page 370.
11. "Enable" the measurement group.

The measurement results are displayed by default below the waveform diagram.

8.2.1.3 General measurement settings

Automatic measurements are configured in the "Measurements" dialog box.

Access: [Measure] > "Setup" tab

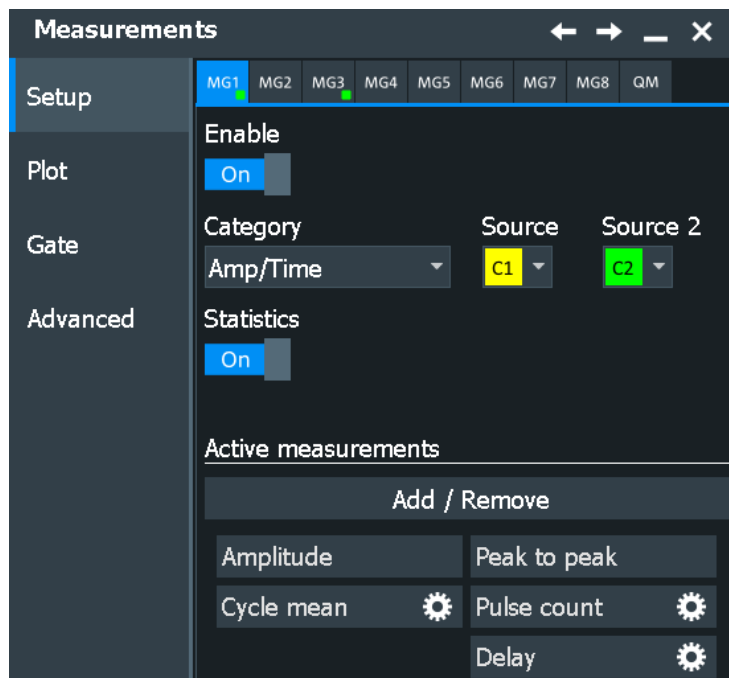

This section describes the settings that relate to all measurements. Specific settings are described in the corresponding category chapters:

- [Chapter 8.2.4.2, "Settings for amplitude/time measurements"](#), on page 321
- [Chapter 19.1, "Jitter measurements \(options R&S RTO6-K12/K13\)"](#), on page 1084
- [Chapter 8.2.5.2, "Settings for eye diagram measurements"](#), on page 335
- [Chapter 8.2.6.2, "Settings for spectrum measurements"](#), on page 342
- [Chapter 8.2.7.5, "Settings for histogram measurement"](#), on page 352

MG 1/2/3/4/5/6/7/8/Quick Meas

Subtabs for each measurement group, and for the quick measurement. The subtabs contain the configuration settings. A green dot on the tab indicates that the measurement group is active.

Enable

Starts the measurements of the selected measurement group.

Remote command:

[MEASurement<m>\[:ENABle\]](#) on page 1584

Category

Measurement category. The following categories are available:

Time domain:

- Amp/Time: amplitude and time measurements
- Eye: eye diagram measurements
- Histogram: measurements on histograms
- Jitter measurements (available if one of the jitter options is installed)
- Protocol: available for audio signals (option R&S RTO6-K510)
Protocol: advanced analysis (available if option R&S RTO6-K500 is installed)

Frequency domain

- Spectrum: measurements on spectrum waveforms
- Histogram: measurements on histograms

Remote command:

[MEASurement<m>:CATegory](#) on page 1586

Source, Source 2

Define the source of the measurement group. The 2nd source is required for amplitude/time measurements that are performed on two waveforms (e.g. delay, phase). Availability of sources depends on the selected category and installed options.

Remote command:

[MEASurement<m>:SOURce](#) on page 1584

Active measurements, Add / Remove

The "Active Measurements" list shows the measurements that are selected for the current category. At least, one measurement must be selected. If further settings are available for a measurement, a settings icon is shown beside the measurement's name.

To change the selection, tap "Add / Remove Measurements".

In the "Add / Remove Measurements" dialog box, select the measurements that you need. Tap "Clear" to disable all selected measurements. Tap "OK" to confirm the selection.

Remote command:

[MEASurement<m>:MAIN](#) on page 1587

[MEASurement<m>:ADDitional](#) on page 1588

Envelope

This setting is only available for measurements on envelope waveforms, see "[Arithmetic](#)" on page 130.

- | | |
|-----------|---|
| "Both" | The upper and the lower envelope are used in measurements. For time measurements, the averages of min and max values are used, that is, the measurement is performed on the average waveform built from the upper and lower envelope. |
| "Maximum" | Measurements are performed on the upper envelope. |

"Minimum" Measurements are performed on the lower envelope.

Remote command:

[MEASurement<m>:ENVSelect](#) on page 1597

Statistics



Enables the calculation and display of statistical results.

Remote command:

[MEASurement<m>:STATistics\[:ENABLE\]](#) on page 1653

8.2.2 Measurement results

By default, the results of automatic measurements are displayed below the waveform diagram when an automatic measurement is enabled.

Meas Group 1 		Meas Group 2 	
High	122.53 mV	Rise time	11.847 ns
Low	-124.51 mV	Fall time	---
Amplitude	247.04 mV	Pos. pulse	20.05 ns
Frequency	25 MHz	Neg. pulse	20 ns
Cycle RMS	87.999 mV		



If you want to save space in the display, drag the results to the signal bar. The most important results are displayed and updated in a results icon.

The function "Clear all" in the "Display" menu resets all results including long-term measurement and statistic results, and also deletes all waveforms and the history.

Which results are displayed depends on the selected measurements and is described in detail in the following chapters.

The following additional results are available:

- **Statistics**

You can enable statistical evaluation of the measurement results, and select the statistical results that you want to see. Statistic information is provided in the result box. Stopping and restarting the acquisition does not reset statistics but only stops and continues them.

See [Chapter 8.2.11, "Result analysis"](#), on page 361

- **Measurement histograms**

The results of measurements can be displayed in a histogram which shows the density distribution of the measurement results in a graphic and thus illustrates the statistics of the measurements.

See [Chapter 8.2.7, "Histograms and histogram measurements"](#), on page 346

- **Long-term measurements**

Long-term measurements show the behavior of measurement results over a longer time or for many samples. You can define the number of long-term points and export the long-term data, including statistical results. The measurement histogram is a vertical histogram shown in the long-term diagram.

Long-term measurements are performed on the measurement that is selected for analysis and math on the "Result Analysis" tab.

See: [Chapter 8.2.11, "Result analysis"](#), on page 361

- **Intermediate results**







You can display auxiliary result lines and reference levels in the source diagram, see [Chapter 8.2.2.2, "Configuring the results display"](#), on page 312.

Remote commands:

- [MEASurement<m>:ARES?](#) on page 1590
- [MEASurement<m>:ARNames](#) on page 1591
- [MEASurement<m>:RESult\[:ACTual\]?](#) on page 1591
- [MEASurement<m>:RESult:COUNT?](#) on page 1593

8.2.2.1 Measurement status

The overall status of measurement results is indicated by various icons. In general, a question mark before the result value indicates that the measurement result might not be correct due to insufficient amplitude level. Check your amplitude and reference level settings. The icon colors indicate the state of the limit and margin checks.

Icon	Description
No icon, no result value ("----")	The instrument cannot measure the required value, for example, if the acquisition does not contain at least one complete period for frequency and cycle measurements. Check and adjust the waveform settings to get results.
	The measurement result might not be correct due to insufficient amplitude level. Check your amplitude and reference level settings. Limit and margin checks are disabled.
	Limit and margin checks passed, measurement results are reliable.
	The measurement result might not be correct due to insufficient amplitude level. Check your amplitude and reference level settings. Limit and margin checks passed.
	The measurement result might not be correct due to insufficient amplitude level. Check your amplitude and reference level settings. Margin checks failed.
	Margin checks failed.
	The measurement result might not be correct due to insufficient amplitude level. Check your amplitude and reference level settings. Limit checks failed.
	Limit checks failed.

8.2.2.2 Configuring the results display

The measurement results can be displayed in a table below the waveform diagrams, in a floating result box, or in a minimized result icon on the signal bar.

The display settings for measurements are provided on the "Gate/Display" tab, see [Chapter 8.2.2.3, "Display settings for results"](#), on page 312.

To clear the measurement results

1. On the "Display" menu, tap "Clear all".
2. To restart measurement statistics, without deleting other results, select "Reset" on the "Result Analysis" tab.

The results in the selected measurement result box are cleared and written anew.

8.2.2.3 Display settings for results

Display settings are specific for each measurement group.

Access: [Measure] > "Advanced" tab

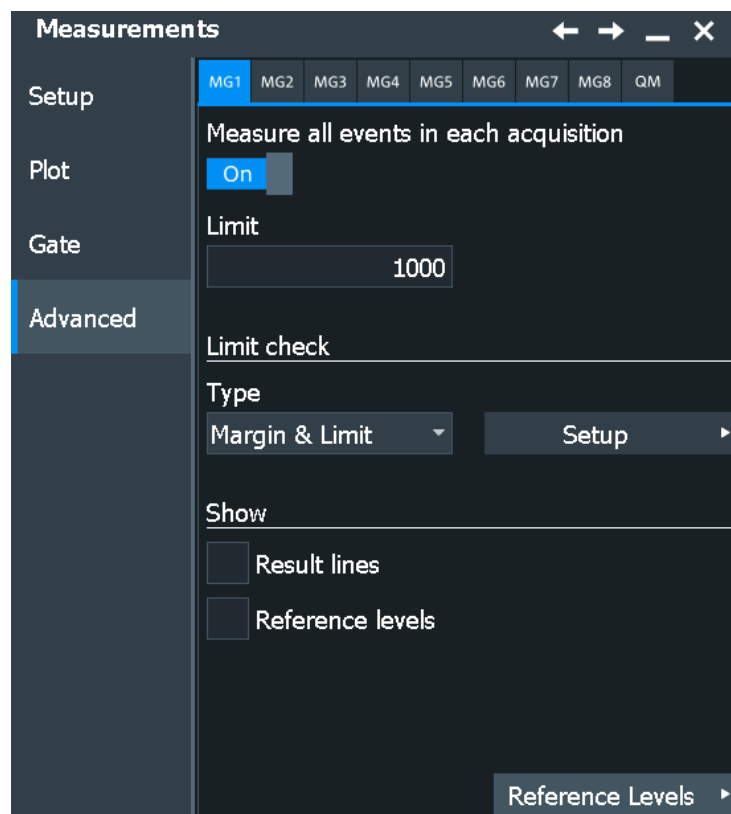

General display setting for measurements are provided in "Settings" > "Appearance" > "Measurements", see [Chapter 4.3.8, "Measurement appearance settings"](#), on page 86.

Result lines

Result lines mark the samples in the waveform that are used to obtain the measurement result. For example, maximum, minimum, high and low values, and mean are marked by horizontal lines; start and end are marked by vertical lines.

Remote command:

[MEASurement<m>:DISPlay:RESults](#) on page 1651

Reference levels

Displays the reference levels used for the measurement in the diagram.

Remote command:

[MEASurement<m>:DISPlay:LEVels](#) on page 1651

Result control panel

Extends the result box of the selected measurement group with the source settings and the statistics enabling. Thus you can check and change the measurement sources directly in the results box, and also enable statistics there. The setting is only available if the result boxes are not grouped ("Group result dialogs" = Off).

8.2.3 Measurement gates

Gate areas limit the measurement to a user-defined range of the waveform. The gate settings are defined on the "Gate" tab.

Each measurement group can use its own gate. Make sure to select the correct measurement group.

8.2.3.1 Using measurement gates

If you have enabled the measurement with the toolbar icon and drew a rectangle on the diagram, the gate is automatically defined and enabled. If you want to create a gate for a running measurement, or if you want to modify the gate area, configuration is done in the "Measurements" > "Gate" dialog box.

1. In the "Measurements" dialog, select the "Gate" tab.
2. Select the subtab for the measurement group you want to configure.
3. To define the gate, use one of the following methods:
 - Define the start value and the stop value of the gate area by entering either absolute or relative values.
 - If a zoom area has already been defined for the waveform, couple the gate area to the zoom area by selecting the "Zoom coupling" option.
 - If a cursor measurement has already been defined for the waveform, couple the gate area to the cursor lines by selecting the "Cursor coupling" option.
4. If you want to use the same gate for all measurement group, enable "Apply to all meas".

5. Tap the "Use gate" icon to enable the gate usage.

The measurement is performed on the selected part of the waveform. The gate is shown in the diagram.

8.2.3.2 Gate settings for measurements

Access: [Measure] > "Gate" tab

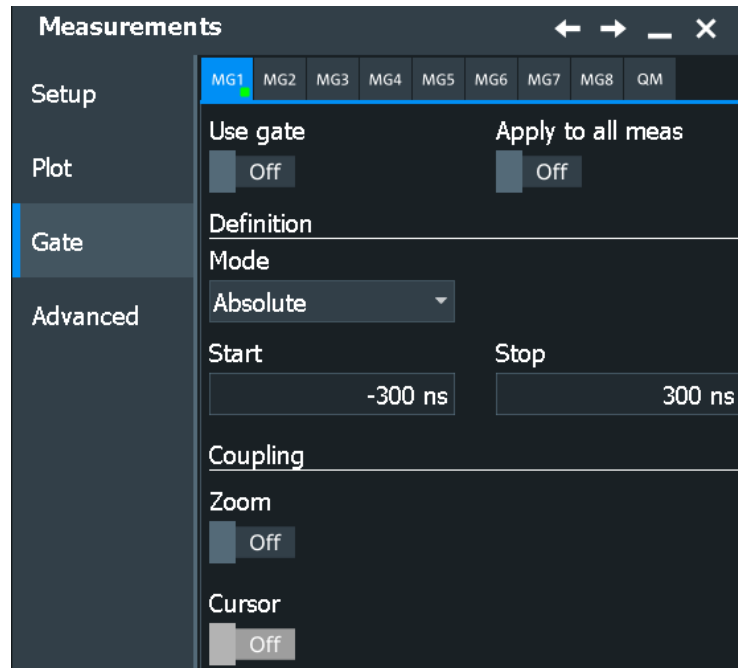

Result display settings are described in [Chapter 8.2.2.3, "Display settings for results"](#), on page 312.

Use gate

Considers the gating settings for the selected measurement and displays the gate.

Remote command:

[MEASurement<m>:GATE\[:STATe\]](#) on page 1667

Apply to all meas

If you enable the gate coupling, the gate settings of the selected measurement are copied to all other measurements. Thus, all measurements use the same gate. If zoom or cursor coupling is active in a measurement, the zoom size and cursor positions are adjusted.

Remote command:

[MEASurement<m>:GATE:GCoupling](#) on page 1670

Gate description

Defines whether the gate settings are configured using absolute or relative values.

"Absolute" The gate is defined by absolute start and stop values.

"Relative" The gate's start and stop values are defined by a percentage of the value range.

Remote command:

[CALCulate:MATH<m>:FFT:GATE:MODE](#) on page 1682

[MEASurement<m>:GATE:MODE](#) on page 1667

[SEARch:GATE:MODE](#) on page 1745

(Relative) Start

Defines the starting value for the gate.

Remote command:

[CALCulate:MATH<m>:FFT:GATE:ABSolute:START](#) on page 1681

[CALCulate:MATH<m>:FFT:GATE:RELative:START](#) on page 1682

[MEASurement<m>:GATE:ABSolute:START](#) on page 1668

[MEASurement<m>:GATE:RELative:START](#) on page 1668

[SEARch:GATE:ABSolute:START](#) on page 1746

[SEARch:GATE:RELative:START](#) on page 1747

(Relative) Stop

Defines the end value for the gate.

Remote command:

[CALCulate:MATH<m>:FFT:GATE:ABSolute:STOP](#) on page 1682

[CALCulate:MATH<m>:FFT:GATE:RELative:STOP](#) on page 1683

[MEASurement<m>:GATE:ABSolute:STOP](#) on page 1668

[MEASurement<m>:GATE:RELative:STOP](#) on page 1668

[SEARch:GATE:ABSolute:STOP](#) on page 1746

[SEARch:GATE:RELative:STOP](#) on page 1747

Zoom

Zoom coupling is available if a zoom is defined. As long as "Zoom coupling" is enabled, the gate area is defined identically to the zoom area - if you change the zoom, the gate changes as well.

If several zoom diagrams are defined, select the zoom diagram to be used for gating. The "Start" and "Stop" values of the gate are adjusted accordingly.

Zoom coupling can be set for measurement gates, FFT gates, and search gates. The zoom must be defined on the diagram that contains the signal source of the measurement, FFT, or search.

Remote command:

[MEASurement<m>:GATE:ZCOupling](#) on page 1669

[MEASurement<m>:GATE:ZDIagram](#) on page 1670

[CALCulate:MATH<m>:FFT:GATE:ZCOupling](#) on page 1683

[SEARch:GATE:ZCOupling](#) on page 1747

[SEARch:GATE:ZDIagram](#) on page 1748

Cursor

If enabled, the gate area is defined by the cursor lines of an active cursor measurement.

If several cursor measurements are enabled, select the cursor set to be used for gating. The "Start" and "Stop" values of the gate are adjusted to the values of the cursor line positions. The measurement is limited to the part of the waveform between the cursor lines.

Remote command:

`MEASurement<m>:GATE:CCOupling` on page 1669

`MEASurement<m>:GATE:CURSor` on page 1668

8.2.4 Amplitude/time measurements

8.2.4.1 Overview of amplitude/time measurements

Access: [Measure] > "Setup" tab > "Amp/Time" category

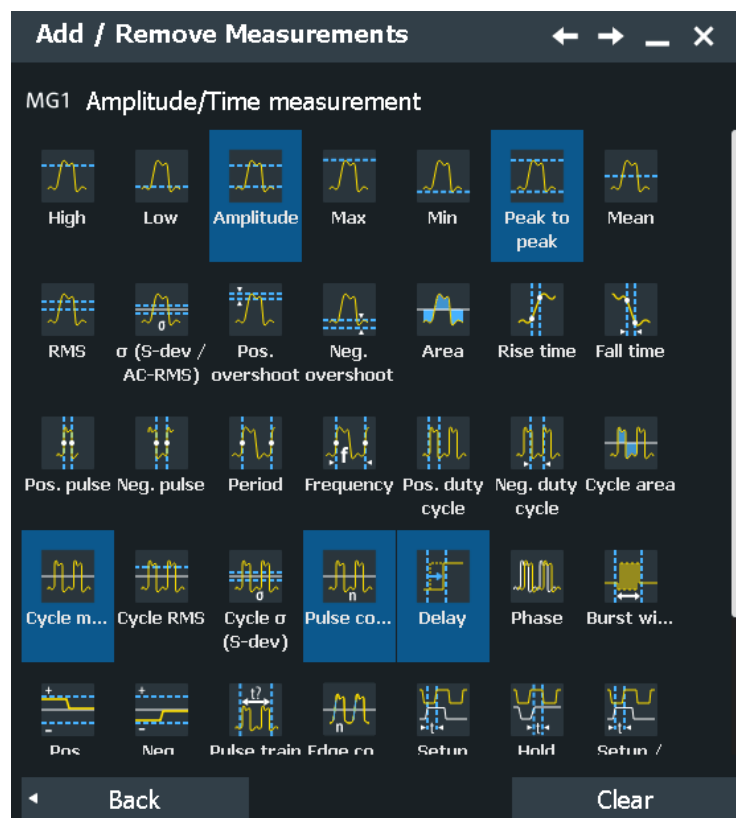

The R&S RTO6 provides various voltage, time, area and counting measurements in the category "Amp/Time". Some measurements require reference levels to be set according to the measurement purpose.











Reference levels are explained in [Chapter 13.3, "Signal and reference levels for NRZ signals"](#), on page 495.











- [Amplitude measurements](#)..... 317
- [Time measurements](#)..... 318
- [Area measurements](#)..... 320
- [Counting](#)..... 321
- [Arithmetic](#)..... 321

Amplitude measurements

Access: [Measure] > "Setup" tab > "Amp/Time" category

Table 8-1: Amplitude measurements

	Meas. type	Symbol	Description/Result
	High	High	High signal level
	Low	Low	Low signal level
	Amplitude	Amp	Amplitude of the signal: the difference of high and low signal levels $X_{Ampl} = X_{High} - X_{Low}$
	Max	Max	Absolute maximum value of the waveform
	Min	Min	Absolute minimum value of the waveform
	Peak to peak	PTP	Peak-to-peak value of the waveform: the difference of maximum and minimum values $X_{Ampl} = X_{Max} - X_{Min}$
	Mean	Mean	Arithmetic average of the waveform voltage values $X_{Mean} = \frac{1}{N_{Eval}} \sum_{i=1}^{N_{Eval}} x(i)$
	RMS	RMS	RMS (root mean square, quadratic mean) of the waveform voltage values $X_{RMS} = \sqrt{\frac{1}{N_{Eval}} \sum_{i=1}^{N_{Eval}} x^2(i)}$
	σ (S-dev)	σ	Standard deviation of the waveform samples $\sigma_x = \sqrt{\frac{1}{N_{Eval}-1} \sum_{i=1}^{N_{Eval}} (x(i) - X_{Mean})^2}$
	Pos. overshoot	P.OS	Positive overshoot of a square wave, calculated from measurement values High, Max, and Amplitude $+Ovr = \frac{V_{top} - V_{P+}}{V_{Amp}} \cdot 100\%$









	Meas. type	Symbol	Description/Result
	Neg. overshoot	N.OS	Negative overshoot of a square wave, calculated from measurement values Min, Low, and Amplitude $-Ovr = \frac{V_{base} - V_{P-}}{V_{Amp}} \cdot 100\%$
	Cycle mean	CMean	The mean value of one cycle
	Cycle RMS	CRMS	The RMS (root mean square) value of one cycle
	Cycle σ (S-dev)	Cyc σ	The standard deviation of one cycle
	Trig. ProbeMeter		The DC voltage from the connected probe. Only available if an active Rohde & Schwarz probe with ProbeMeter is connected.
	Slew rate rising	SRRise	Steepness of the rising edge: voltage difference between the lower and higher reference level, divided by the rise time. Result in V/s = V*Hz (blue vertical lines in the picture below).
	Slew rate falling	SRFall	Steepness of the falling edge: voltage difference between the higher and lower reference level, divided by the fall time. Result in V/s = V*Hz (green vertical lines in the picture below).
	Signal level	SignalLevel	The value of the signal level
	Voltage crossing	Voltage crossing	The point where the waveform crosses a predefined voltage level.
	N-Period	N-Period	The time passed for N consecutive crossings









Time measurements

Access: [Measure] > "Setup" tab > "Amp/Time" category

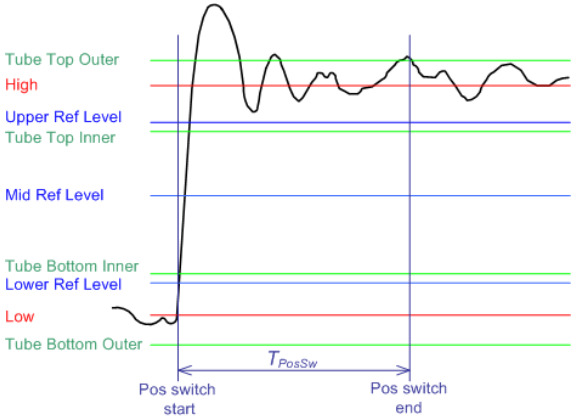
Reference levels are explained in [Chapter 13.3, "Signal and reference levels for NRZ signals"](#), on page 495.

Table 8-2: Time measurements

	Meas. type	Symbol	Description/Result
	Rise time	RTime	Rise time of the first rising edge, the time it takes the signal to rise from the lower reference level to the upper reference level. In manual reference level mode, the high and low reference levels are used. Measurement of all events in the acquisition is possible.
	Fall time	FTime	Fall time of the first falling edge, the time it takes the signal to fall from the upper reference level to the lower reference level. In manual reference level mode, the high and low reference levels are used. Measurement of all events in the acquisition is possible.
	Pos. pulse	PPuls	Duration of the first positive pulse: time between a rising edge and the following falling edge measured on the middle reference level. The measurement requires at least one complete period of a triggered signal. Measurement of all events in the acquisition is possible.
	Neg. pulse	NPuls	Duration of the first negative pulse: time between a falling edge and the following rising edge measured on the middle reference level. The measurement requires at least one complete period of a triggered signal. Measurement of all events in the acquisition is possible.
	Period	Period	Time between two consecutive waveform edges of the same direction, measured on the middle reference level. The measurement requires at least one complete period of a triggered signal. Measurement of all events in the acquisition is possible.
	Frequency	Freq	Frequency of the signal, reciprocal value of the period. $Freq = 1 / Period$
	Pos. duty cycle	PDCyc	Positive duty cycle: Width of a positive pulse in relation to the period in %. The measurement requires at least one complete period of a triggered signal. Multiple measurements are possible. $PDCyc = \frac{T_{PosPulse}}{T_{Period}} \times 100\%$
	Neg. duty cycle	NDCyc	Negative duty cycle: Width of a negative pulse in relation to the period in %. The measurement requires at least one complete period of a triggered signal. Multiple measurements are possible. $PDCyc = \frac{T_{NegPulse}}{T_{Period}} \times 100\%$
	Delay		The measurement result is negative if the edge of the second source comes before the edge of the first source. See: " Settings for delay and phase measurements (analog sources) " on page 323



	Meas. type	Symbol	Description/Result
	Phase		Phase difference between two waveforms. $Phase = Delay / Period * 360$
	Burst width	BWid	Duration of one burst, measured from the first edge to the last
	Pos. switching	PSwit	Settling time at rising edges: Time between crossing the lower reference level and the last return of the signal into the top tolerance tube. See also: Chapter 13.3.4, "Advanced tab" , on page 504 
	Neg. switching	NSwit	Settling time at falling edges: Time between crossing the upper reference level and the last return of the signal into the bottom tolerance tube. See also "Pos. switching" above.
	Pulse train	PulTr	Duration of N positive pulses, measured from the rising edge of the first pulse to the falling edge of the N-th pulse. Define N for the measurement.
	Setup Hold Setup/Hold time	Setup Hold SHT	Setup and Hold time measurement with positive and/or negative clock edge. See: "Setup/Hold measurement settings" on page 324
	Setup/Hold ratio	SHR	Setup/Hold ratio measurement with positive and/or negative clock edge. $SHR = Setup / (Setup + Hold)$ See: "Setup/Hold measurement settings" on page 324
	Delay to trigger	DTO	Time between the trigger event and a following signal slope. High accuracy even if the trigger event is outside the acquisition data. See: • "Delay to trigger measurement settings" on page 326

Area measurements

Access: [Measure] > "Setup" tab > "Amp/Time" category

Area measurements are voltage over time measurements.



Table 8-3: Area measurements

	Meas. type	Symbol	Description/Result
	Area	Area	Area between the waveform and a reference level ("Area level", X_{Ref}). $Area = \frac{T_{Eval}}{N_{Eval}} \times \sum_{k=1}^{N_{Eval}} (x(k) - X_{ref})$ T_{Eval} : Evaluation time, time of a full waveform or limited by a gate
	Cycle area	CArea	Area between the waveform and a reference level ("Area level") measured for one period, see also "Area" measurement. The measurement requires at least one complete period of a triggered signal. Multiple measurements are possible.

Counting

Access: [Measure] > "Setup" tab > "Amp/Time" category

Table 8-4: Counting measurements

	Meas. type	Symbol	Description/Result
	Pulse count	PCount	The number of positive or negative pulses of the waveform, or of both positive and negative pulses. The mean value of the signal is determined. If the signal passes the mean value, an edge is counted. A positive pulse is counted if a rising edge and a following falling edge are detected. A negative pulse is counted if a falling edge and a following rising edge are detected.
	Edge count	EdCo	The number of positive or negative edges, or of both positive and negative edges. The instrument determines the mean value of the signal and counts an edge every time the signal passes the mean value.

Arithmetic

Access: [Measure] > "Setup" tab > "Amp/Time" category

Table 8-5: Arithmetic measurements

	Meas. type	Symbol	Description/Result
	Arithmetic		Allows you to perform basic arithmetic operations between selected measurement values and/or constant.

8.2.4.2 Settings for amplitude/time measurements

Access: [Measure] > "Setup" tab > "Amp/Time" category

Amplitude and time measurements are available for sources in the time domain. For some amplitude/time measurements, such as delay, setup/hold and delay to trigger, further setting are required to get a measurement result.

If further settings are available for a measurement, a settings icon is shown beside the measurement's name in the "Active measurements" list. Tap the icon to configure the measurement.

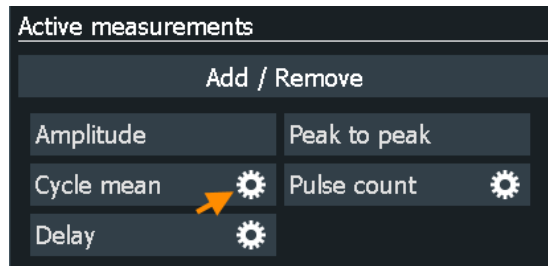

Figure 8-4: Selected active measurements, some have further settings

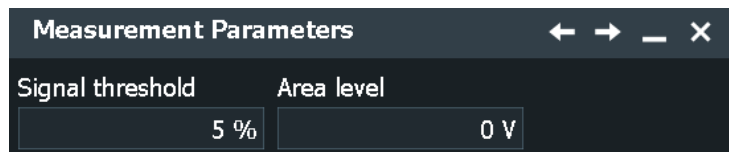

Figure 8-5: Settings for cycle area measurement

This chapter explains all settings for amplitude/time measurements. For a description of available measurement, see [Chapter 8.2.4.1, "Overview of amplitude/time measurements"](#), on page 316.

Signal threshold	322
Area level	322
Pulses slope	323
Measured slope	323
Settings for delay and phase measurements (analog sources)	323
Settings for delay and phase measurements (digital sources)	324
Setup/Hold measurement settings	324
Clock ref level	325
Ref level	326
Pulse count	326
Edges slope	326
Delay to trigger measurement settings	326
Settings for Pos./ Neg. pulse measurements	327
Settings for Voltage crossing	328
Settings for N-Period	329

Signal threshold

The measured signal value must reach a certain voltage or bit to be included in the measurement algorithm. This minimum value is defined in percent of the signal amplitude (difference of high and low signal levels). Values below this value are considered to be noise and they are ignored. The setting is relevant for area, time, and counting measurements.

Remote command:

[MEASurement<m>:DETThreshold](#) on page 1597

Area level

The reference level used to integrate the waveform. The setting is only relevant for area measurements.

Remote command:

[MEASurement<m>:AMPTime:ALEVel](#) on page 1597

Pulses slope

Sets the first slope of the pulses to be counted.

The setting is available only for the "Pulse count" measurement.

"Positive" Positive pulses are counted.

"Negative" Negative pulses are counted.

"Either" Both positive and negative pulses are counted.

Remote command:

[MEASurement<m>:AMPTime:PSLope](#) on page 1598

Measured slope

Selects the slope direction for frequency and period measurements.

"Positive / Negative" Measures the time between rising or falling edges, respectively.

"Either" In multiple measurements, the time is measured both between rising edges and between falling edges.
In single measurements. The first edge is taken for the measurement.

"First edge" Time is measured either between rising edges or between falling edges. The first edge is taken for the measurement. In single measurements, it works the same way as "Either".
Only available for analog measurement sources.

Remote command:

[MEASurement<m>:AMPTime:PFSLope](#) on page 1598

Settings for delay and phase measurements (analog sources)

The specific settings for delay measurement allow you to measure the time between any two slopes at any reference level. Therefore, the reference levels and the slopes must be defined for each source individually. The measurement result is negative if the edge of the second source comes before the edge of the first source.

"Level selection source 1/2": For each measurement source, select the reference level on which the time is measured.

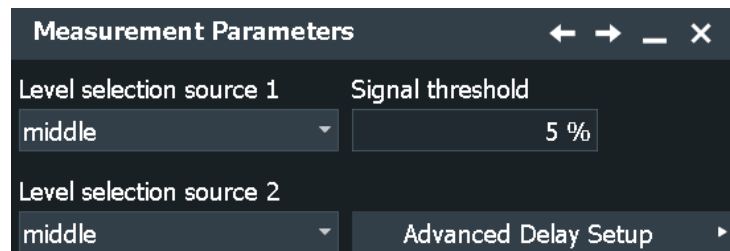

"Advanced Delay Setup":

With the settings shown in the picture, the time between the second and the fifth rising edge is measured.

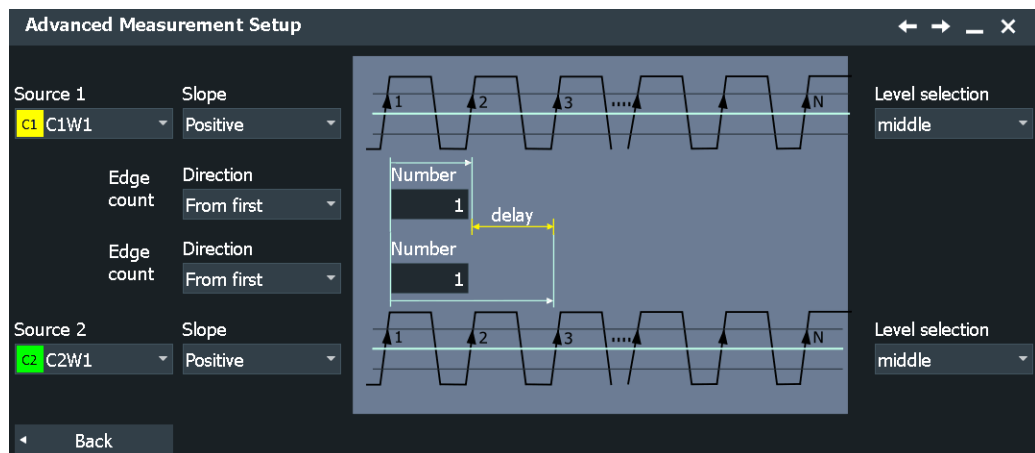

"Level selection" Selects the reference level on which the time is measured.

"Slope" Sets the edge of each source between which the delay is measured: positive, negative, or either of them.

"Direction" Selects the direction for counting slopes for each source: from the beginning of the waveform, or from the end.

"Number" Sets the number of the edge that is relevant for delay measurement.

Remote command:

[MEASurement<m>:AMPTime:DELAy<n>:LSElect](#) on page 1600

[MEASurement<m>:AMPTime:DELAy<n>:SLOPe](#) on page 1600

[MEASurement<m>:AMPTime:DELAy<n>:DIRectiOn](#) on page 1599

[MEASurement<m>:AMPTime:DELAy<n>:ECOunt](#) on page 1599

Settings for delay and phase measurements (digital sources)

Delay measurement on digital channels is reduced to measure the time between two subsequent rising or two subsequent falling edges.

The edge direction is set with [Edges slope](#).

Setup/Hold measurement settings

Setup/Hold measurements analyze the relative timing between two signals: a data signal and the synchronous clock signal. Setup time is the time that the data signal is steady before the clock edge - the time between a data transition and the next specified clock edge. Hold time is the time that the data signal is steady after the clock edge - the time between a data transition and the previous specified clock edge.

"Setup/Hold time" measures and displays the setup and hold durations. "Setup/Hold ratio" measurements return the ratio of the setup time to the sum of hold and setup time: $T_{Setup} / (T_{Setup} + T_{Hold})$.

The clock edge can be defined, the polarity of the data signal does not matter.

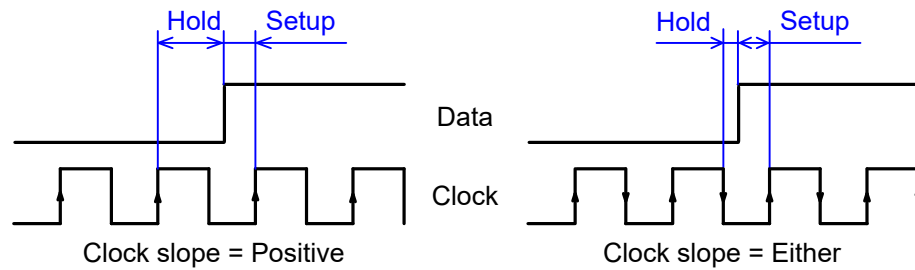

If at least one of the setup/hold measurements is selected, more settings appear to specify the measurement.

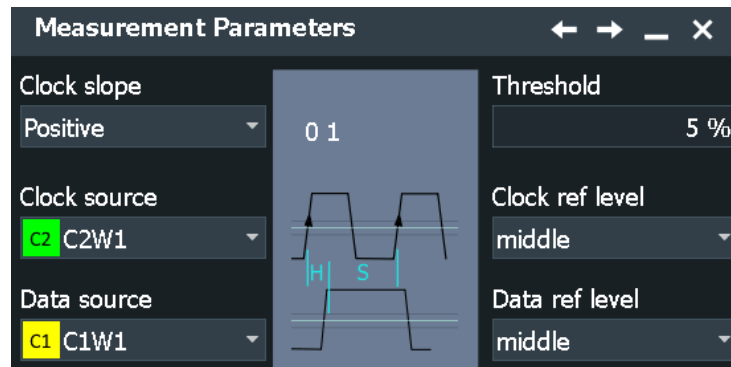

- "Clock slope" Sets the edge of the clock from which the setup and hold times are measured: positive, negative, or either of them. If "Either" is selected, the clock edges next to the data edge are considered regardless of the clock slope.
- "Clock source" The "Clock source" is identical to the measurement "Source". It defines the waveform used as the clock in the setup/hold measurement.
- "Data source" The "Data source" is identical to the "2nd Source" of the measurement. It sets the data signal.
- "Clock ref level" See "Clock ref level" on page 325.
- "Data ref level" See "Ref level" on page 326.
- "Threshold" See "Signal threshold" on page 322.

Remote command:

Clock slope: [MEASurement<m>:AMPTime:CSLope](#) on page 1601

Clock ref level

Selects the reference level of the clock on which the time is measured. The intersection of slope and reference level defines the time point for measurements.

The setting is used for setup and hold measurements, and for jitter measurements (option R&S RTO6-K12).

Remote command:

[MEASurement<m>:AMPTime:CLCK<n>:LSElect](#) on page 1602

Ref level

The setting defines the "Data ref level" for setup and hold measurements, and for time-interval error measurements (option R&S RTO6-K12). It selects the reference level of the data signal on which the time is measured. The intersection of slope and reference level defines the time point for measurements.

For clock jitter measurements (option R&S RTO6-K12), it sets the "Reference level" for the time measurement.

Remote command:

[MEASurement<m>:AMPTime:DATA<n>:LSElect](#) on page 1602

Pulse count

Sets the number N of positive pulses for the "Pulse train" measurement. This measurement measures the duration of N positive pulses from the rising edge of the first pulse to the falling edge of the N-th pulse.

Remote command:

[MEASurement<m>:AMPTime:PTCount](#) on page 1601

Edges slope

Sets the edge direction to be considered. The setting is relevant for edge count measurement and delay measurement on digital channels.

"Positive" Positive edges are considered.

"Negative" Negative edges are considered.

"Either" Both positive and negative edges are counted (edge count). Delay is measured either between rising edges or between falling edges. The first edge is taken for the measurement.

Remote command:

[MEASurement<m>:AMPTime:ESLope](#) on page 1601

Delay to trigger measurement settings

Delay to trigger measures the time between the trigger point and the following slope of a waveform. The delay between the trigger and the slope can be high compared to the accuracy of the acquisition, and the trigger point can even be outside of the current acquisition.

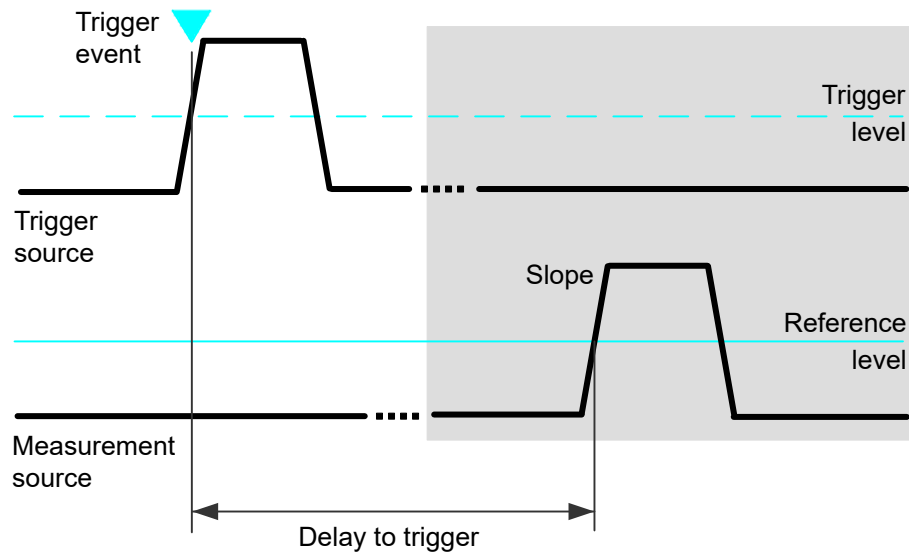

To configure the trigger conditions, use the trigger setup. To set up the slope, additional settings appear in the measurements "Setup" dialog box.



"Edge slope" Sets the edge direction to be used for delay measurement: positive, negative, or either edge.

"Level selection" Selects the reference level of the measurement source on which the delay is measured: upper, middle, or lower level.

"Signal threshold" See ["Signal threshold"](#) on page 322.

Remote command:

[MEASurement<m>:AMPTime:DTOTrigger<n>:SLOPe](#) on page 1603

[MEASurement<m>:AMPTime:DTOTrigger<n>:LSElect](#) on page 1603

Settings for Pos./ Neg. pulse measurements

Defines the settings for the positive and negative pulse measurements.

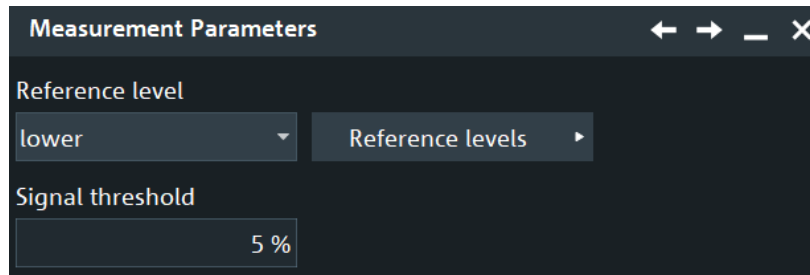

Figure 8-6: Settings for reference level: upper, middle, lower

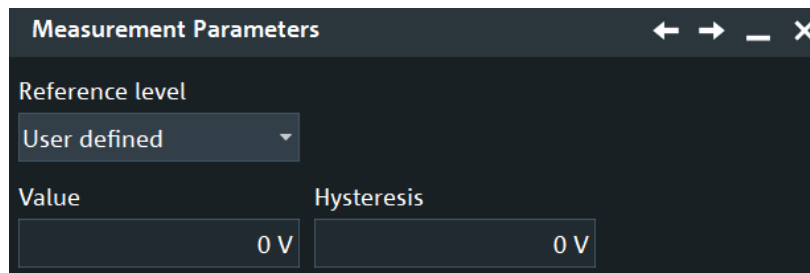

Figure 8-7: Settings for reference level: user defined

- | | |
|--------------------|---|
| "Reference level" | Selects the reference level of the measurement source on which the pulse is measured: upper, middle, lower level or user defined level. |
| "Signal threshold" | Sets a signal value that must be exceeded for the signal value to be included in the measurement. |
| "Value" | Sets the reference level for the measurement for the user defined reference level. |
| "Hysteresis" | Sets a hysteresis value for the measurement. |

Remote command:

[MEASurement<m>:AMPTime:PRLevel](#) on page 1606

[MEASurement<m>:AMPTime:PRLMode](#) on page 1606

[MEASurement<m>:AMPTime:PLHYsteresis](#) on page 1607

Settings for Voltage crossing

Defines the settings for voltage crossing.

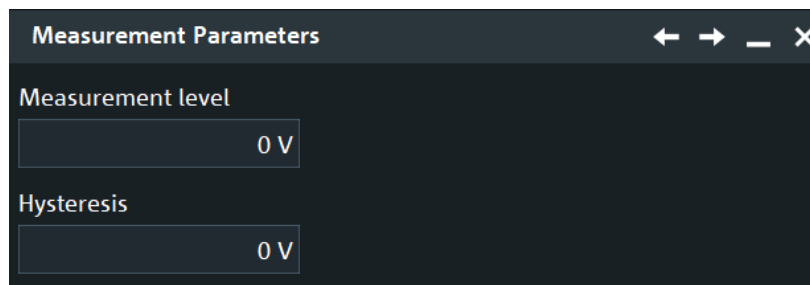

- | | |
|---------------------|--|
| "Measurement level" | Sets the measurement reference level for the voltage crossing calculation. |
|---------------------|--|

"Hysteresis" Sets the minimum level difference between the two sources before the next crossing can be detected.

Remote command:

[MEASurement<m>:AMPTime:VCMLevel](#) on page 1607

[MEASurement<m>:AMPTime:VCHYsteresis](#) on page 1605

Settings for N-Period

Defines the settings for the N-period measurements.

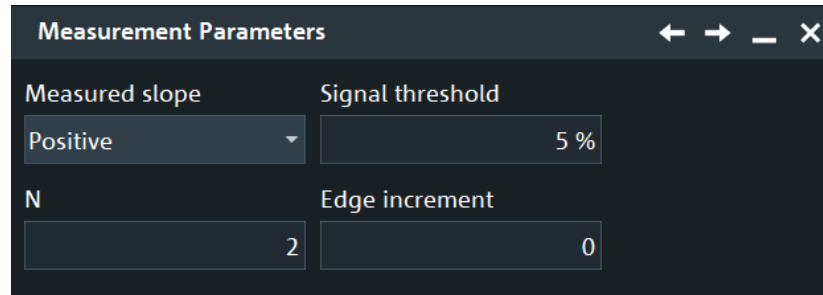

"Measured slope" Sets the slope to be used as the beginning/ end of the measurement. The following values are available:

- "First edge": the measured slope is the polarity of the first edge of the signal.
- "Positive": the measured slope is the rising edge of the signal.
- "Negative": the measured slope is the falling edge of the signal.
- "Either": the rising and falling edges of the signal are measured

"Signal threshold" Sets a signal value in percent that must be exceeded for the signal value to be included in the measurement.

"N" Selects the N-period number, the number of consecutive periods of the waveform.

"Edge increment" Sets the number of edges to be skipped per measurement event.

Remote command:

[MEASurement<m>:AMPTime:EINCrement](#) on page 1606

[MEASurement<m>:AMPTime:NPERiod](#) on page 1605

8.2.4.3 Arithmetic for amplitude/time and spectrum measurements

Access: [Measure] > "Setup" tab > "Amp/Time" or "Spectrum" category > add measurement "Arithmetic" > "Arithmetic".

In this dialog, you can set up basic arithmetic operations between selected measurement values and/or constant.



You can select only measurement groups and measurements that are already enabled.

Type

Selects the type of arithmetic measurement:

"Measurement" Performs an arithmetic operation between two measurement results. You can select from the measurements enabled for "Amp/Time" or "Spectrum".

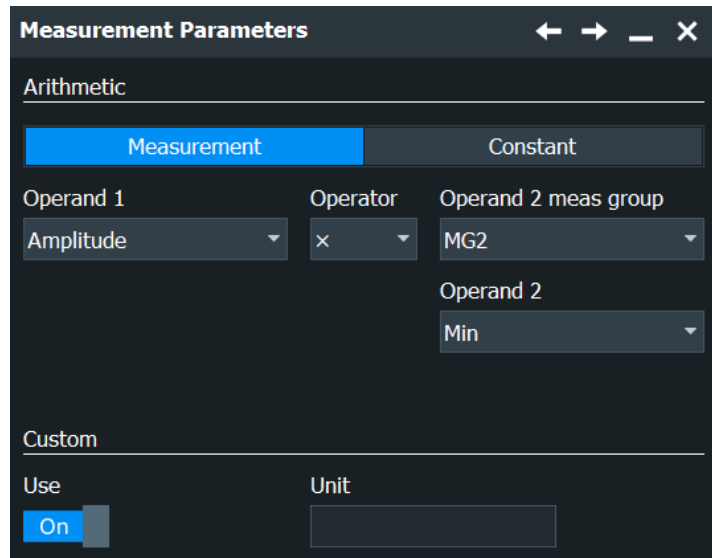

Figure 8-8: Arithmetic with two measurement results

"Constant" Performs an operation between a measurement result and a user defined fixed Constant.

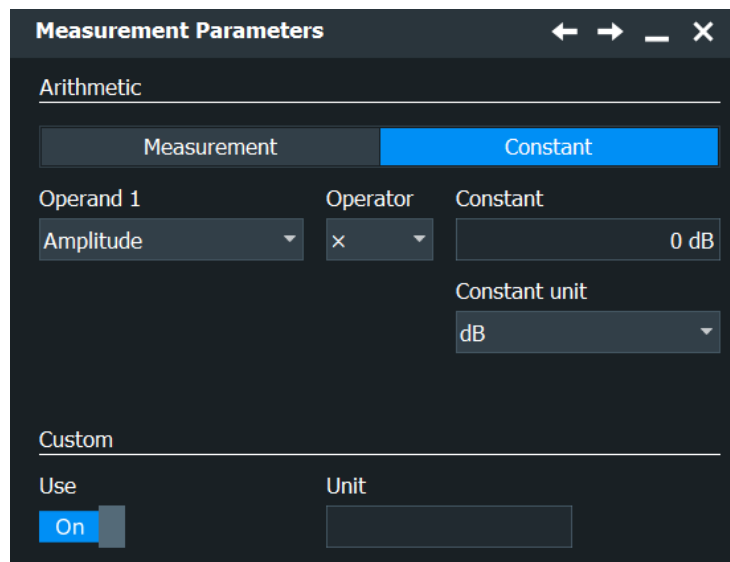

Figure 8-9: Arithmetic with a measurement result and a constant

Remote command:

MEASurement<m>:AMPTime:ARITHmetic:PARAMeter<n>:TYPE on page 1612

Operand 1

Selects the first operand for the arithmetics. You can select one of the measurements, that is enabled for the current measurement group.

Remote command:

[MEASurement<m>:SPECTrum:ARITHmetic:PARAmeter<n>:AMPTime](#)

on page 1614

[MEASurement<m>:AMPTime:ARITHmetic:PARAmeter<n>:AMPTime](#) on page 1610

[MEASurement<m>:AMPTime:ARITHmetic:PARAmeter<n>:SPECTrum](#)

on page 1611

[MEASurement<m>:SPECTrum:ARITHmetic:PARAmeter<n>:SPECTrum](#)

on page 1615

Operand 2 meas group / Operand 2

Selects the measurement group and the measurement result for the second operand. You can select one of the measurements, that is enabled for the selected measurement group.

Remote command:

[MEASurement<m>:AMPTime:ARITHmetic:PARAmeter<n>:GROup](#) on page 1611

[MEASurement<m>:SPECTrum:ARITHmetic:PARAmeter<n>:GROup](#) on page 1615

Operator

Selects the operation type to be performed on the selected operands. You can choose between +, -, * and /.

"+"	Adds up the operands.
"-"	Subtracts "Operand 2"/"Constant" from "Operand 1".
"*"	Multiplies the operands.
"/"	Divides "Operand 1" by "Operand 2"/"Constant".

Remote command:

[MEASurement<m>:AMPTime:ARITHmetic:OPERator](#) on page 1610

[MEASurement<m>:SPECTrum:ARITHmetic:OPERator](#) on page 1614

Custom

Enable "Use" to apply the user-defined value for the "Unit".

Remote command:

[MEASurement<m>:AMPTime:ARITHmetic:CUNState](#) on page 1609

[MEASurement<m>:SPECTrum:ARITHmetic:CUNState](#) on page 1613

Constant

Sets a constant numeric value for the arithmetic operation, for the "Constant" measurement type.

Remote command:

[MEASurement<m>:AMPTime:ARITHmetic:CONStant](#) on page 1608

[MEASurement<m>:SPECTrum:ARITHmetic:CONStant](#) on page 1612

Constant unit

Selects the unit for the [Arithmetic for amplitude/time and spectrum measurements](#).

Remote command:

MEASurement<m>:AMPTime:ARITHmetic:COUNit on page 1608

MEASurement<m>:SPECTrum:ARITHmetic:COUNit on page 1613

8.2.4.4 Measuring the delay to trigger

Delay to trigger measures the time between the trigger point and the following slope of a waveform. If the delay is unknown, it can be measured in two stages - first a coarse and then a precise measurement.

See also: "[Delay to trigger measurement settings](#)" on page 326.

1. Set the horizontal scale and horizontal position so that the trigger point and the slope both are visible on the screen.
2. Select the delay to trigger measurement:
 - a) In the "Setup" dialog, set the "Category" to "Amp/Time".
 - b) Press "Add/ Remove Measurements" button.
 - c) In the dialog, enable "Delay to trigger".
 - d) Tap "Back".
3. Configure the "Delay to trigger" measurement:
 - a) In the "Active Measurements" list, tap the "Delay to trigger" measurement.
 - b) Select the source, that is the waveform with the delayed slope.
 - c) Select the slope and the reference level.
 - d) Check the trigger settings.
4. Enable the measurement. Note the result.
5. Turn the horizontal [Position] knob and enter the measured delay as horizontal position.
Thus, the slope is moved to the center of the screen.
6. Adjust the time scale ("Menu" > "Horizontal" > "Setup" tab) and the sample rate and resolution ("Menu" > "Acquire" > "Setup" tab) to the required resolution.
The trigger is outside the display and is not part of the current acquisition.
7. Repeat the "Delay to trigger" measurement.
Now the delay is measured with high accuracy. You can analyze the variance of delay values using statistical evaluation and histogram functions.

8.2.5 Eye diagram measurements

The eye diagram is a tool for evaluation of signal quality and shows the combined effects of channel noise and intersymbol interference. It is a significant means of visualizing jitter and allows you to analyze the reasons for it. By creating histograms of the eye diagram, important jitter parameters can be determined.

The eye diagrams are a superposition of repetitively sampled waveforms, which have a length of about 1 bit.

There are two ways to generate eye diagrams on the R&S RTO6:

- Standard eye diagrams, which are a superposition of repetitively sampled digital data.
- To use advanced eye diagrams, option R&S RTO6-K136 or R&S RTO6-K91 is required.



The waveform display style must be set to vectors: "Menu" > "Settings" > "Display" > "Signal" > "Waveform style" = "Vectors".

To obtain optimized settings for an eye measurement, use the "Autoset" function that is provided on the right side of the "Eye" tab.

The following characteristic values can be determined:

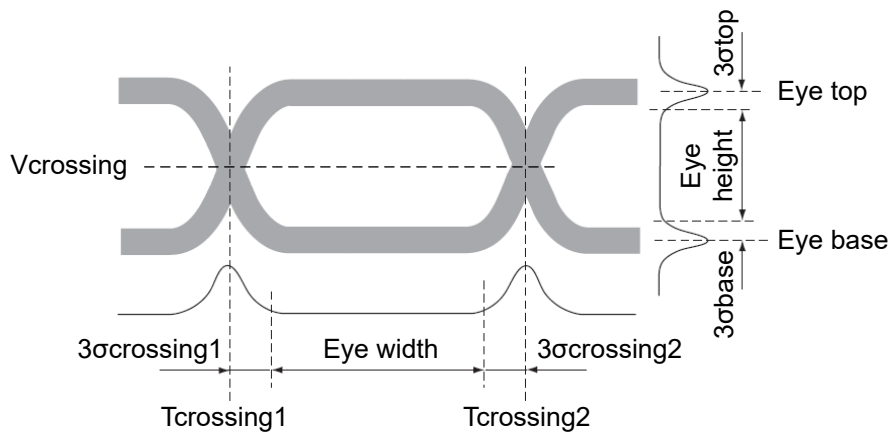

Figure 8-10: Basic eye diagram characteristics

Eye top = Mean of the upper vertical histogram
 σ_{top} = Standard deviation of the upper vertical histogram
 Eye base = Mean of the lower vertical histogram
 σ_{base} = Standard deviation of the lower vertical histogram
 Tcrossing = First and second mean of the horizontal histogram
 $\sigma_{crossing}$ = Standard deviation of the horizontal histogram

8.2.5.1 Overview of eye diagram measurements

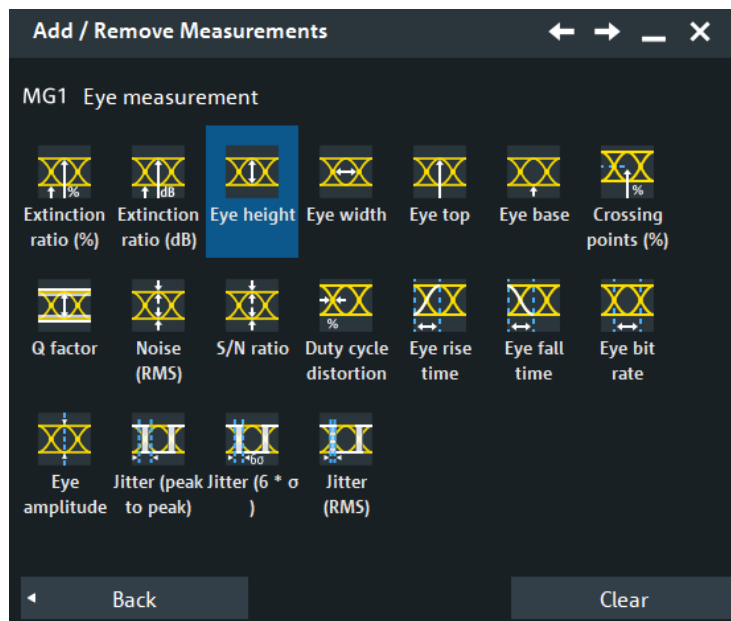













Table 8-6: Eye measurements

	Meas. type	Description/Result
	Extinction ratio (%)	The extinction ratio is an indication of efficiency. It describes the ratio of the power used to transmit a logic level 1, to the energy used to transmit a logic level 0. The R&S RTO6 provides extinction ratio measurements as a percentage, and in decibels: $ER (\%) = \text{Eye base} / \text{Eye top} * 100$ Prerequisite: Eye base > 0 and Eye top > 0 because extinction ratio is defined only for positive values.
	Extinction ratio (dB)	$ER (dB) = 10 * \log (\text{Eye top} / \text{Eye base})$
	Eye height	The vertical eye opening indicates the sensitivity of the transmission to noise. $(\text{Eye top} - 3 * \sigma_{\text{top}}) - (\text{Eye base} + 3 * \sigma_{\text{base}})$
	Eye width	The horizontal eye opening indicates the time range during which the sampling of the logical state is possible. $(T_{\text{crossing2}} - 3 * \sigma_{\text{crossing2}}) - (T_{\text{crossing1}} - 3 * \sigma_{\text{crossing1}})$
	Eye top	Mean of the upper vertical histogram
	Eye base	Mean of the lower vertical histogram
	Q factor	$Q \text{ factor} = (\text{Eye top} - \text{Eye base}) / (\sigma_{\text{top}} + \sigma_{\text{base}})$

	Meas. type	Description/Result
	Noise (RMS)	Quadratic mean of the noise of eye top and eye base Noise (RMS) = $(\sigma_{top} + \sigma_{base})/2$
	S/N ratio	Signal-to-noise ratio SNR = $10 * \log(\text{Eye amplitude} / \text{Noise RMS})$
	Duty cycle distortion	Duty cycle distortion = $20 * \log(\text{Eye amplitude} / \text{Noise RMS})$
	Eye rise time	Duration for signal to rise from 10% to 90% of the high signal level
	Eye fall time	Duration for signal to fall from 90% to 10% of the high signal level
	Eye bit rate	Frequency between two crossings
	Eye amplitude	Eye top - Eye base
	Jitter (peak to peak)	Average of the jitter for both crossing points. Jitter = $(\sigma_{crossing1} + \sigma_{crossing2}) / 2$
	Jitter (6*σ)	Jitter (6*σ) = Jitter * 6
	Jitter (RMS)	Quadratic mean of the jitter at both crossing points
	Crossing points (%)	Percentage of points crossing the eye

8.2.5.2 Settings for eye diagram measurements

Access: [Measure] > "Setup" tab > "Eye" category

Eye diagram measurements are only available for sources in the time domain.

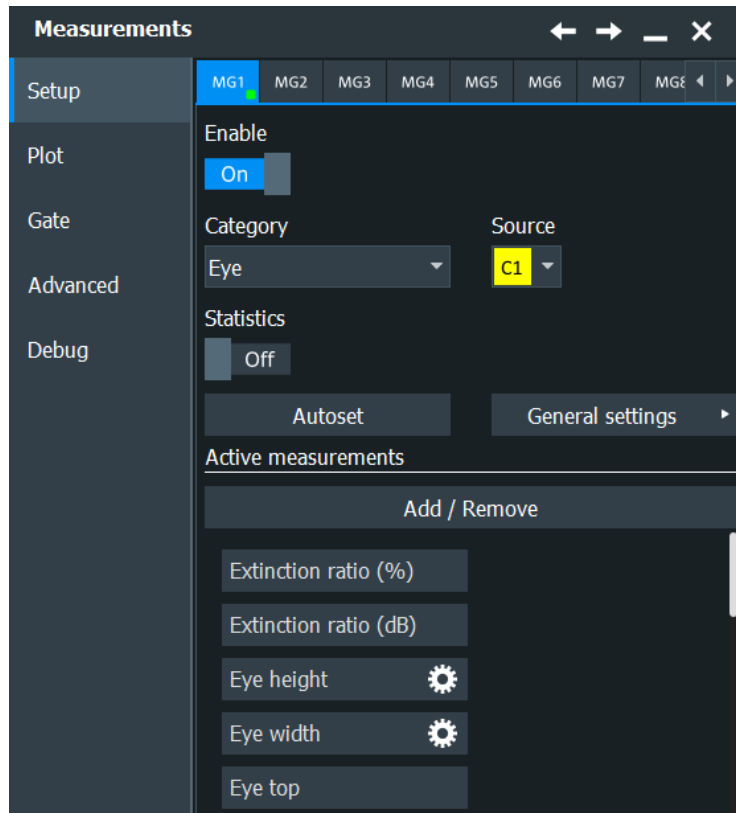

To obtain optimized settings for an eye measurement, use the "Autoset" function that is provided on the right side of the tab.

Autoset

Defines optimized settings for eye diagram measurements on the selected source. "Autoset" is available for analog, differential and common sources.

Remote command:

[MEASurement<m>:EYEJitter:AUToscale](#) on page 1618

General

The settings in this dialog are relevant for the following eye measurements: "Extinction ratio (%)", "Extinction ratio (dB)", "Q factor", "Eye height", "Noise (RMS)", "S/N ratio", "Eye amplitude".

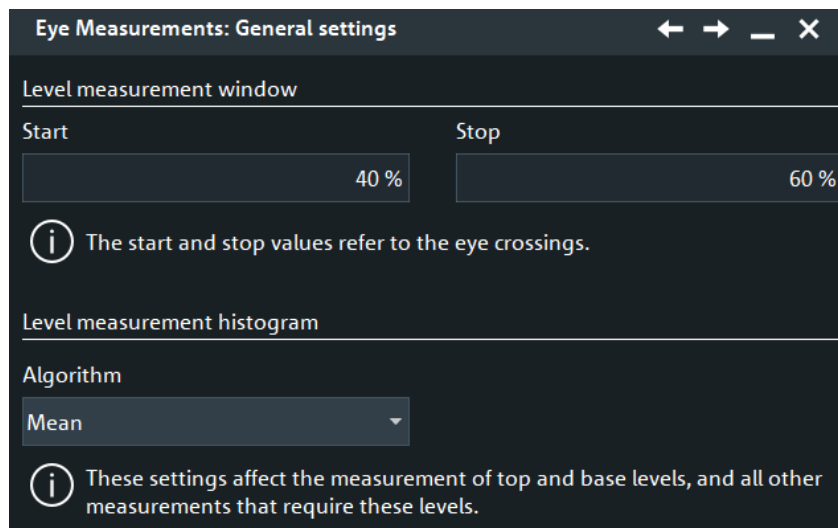

"Start"	Defines the global start for the eye measurements.
"Stop"	Defines the global stop for the eye measurements.
"Algorithm"	Defines how to compute the top/base level and the corresponding sigma values. <ul style="list-style-type: none"> • "Mean": the mean value of the histogram. The Sigma value is the standard deviation of the histogram. • "Peak": the maximal peak of the histogram. Only values corresponding to this peak are used to compute sigma. • "Inner peak": the inner peak of the histogram. Only values corresponding to this peak are used to compute sigma. • "Outer peak": the outer peak of the histogram. Only values corresponding to this peak are used to compute sigma.
"Threshold"	Sets the threshold used to separate peaks: two peaks are separated if they are split by a valley of height $Threshold * Maximal_histogram_value$.

Remote command:

[MEASurement<m>:EY EJitter:GENSettings:RELative:START](#) on page 1621

[MEASurement<m>:EY EJitter:GENSettings:RELative:STOP](#) on page 1621

[MEASurement<m>:EY EJitter:GENSettings:MLEHistogram:ALGORITHM](#) on page 1620

[MEASurement<m>:EY EJitter:GENSettings:MLEHistogram:THReshold](#) on page 1620

Eye height

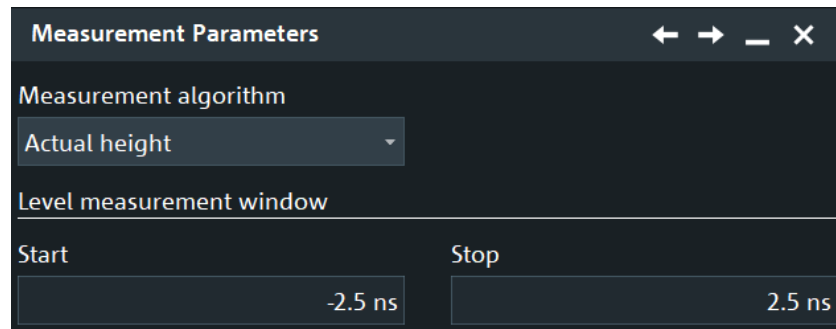

In this dialog, you can define the settings for the eye height measurements.

"Measurement algorithm"	<p>Selects the algorithm for the measurement of the height.</p> <p>The "Actual height" is the vertical distance between the top and the bottom of the eye opening at the sampling point. It represents the range of levels over which the signal can reliably distinguish between logical 1 and logical 0. The default window is 40% - 60% of the eye period.</p> <p>The "Maximum height" is the theoretical maximum vertical distance between the highest possible 1 level and the lowest possible 0 level. The default measurement window is 40% - 60% of the eye period.</p> <p>If "Extrapolate using three sigma" is selected, the eye height is measured with the settings defined in the General dialog.</p> <p>Eye height=(Eye top-3σ_{top})-(Eye base+3σ_{base})</p>
"Mode"	<p>For "2/NRZ" signals, you can additionally select a "Relative" or "Absolute" mode for the values of the measurement window.</p>
"Start"	<p>Defines the start time of the range for the eye measurement height.</p>
"Stop"	<p>Defines the stop time of the range for the eye measurement height.</p>

Remote command:

[MEASurement<m>:EYEJitter:EYEHeight:ALGORITHM](#) on page 1625

[MEASurement<m>:EYEJitter:EYEHeight:MODE](#) on page 1627

[MEASurement<m>:EYEJitter:EYEHeight:RELative:START](#) on page 1626

[MEASurement<m>:EYEJitter:EYEHeight:RELative:STOP](#) on page 1626

[MEASurement<m>:EYEJitter:EYEHeight:ABSolute:START](#) on page 1627

[MEASurement<m>:EYEJitter:EYEHeight:ABSolute:STOP](#) on page 1627

Eye width

In this dialog, you can define the settings for the eye width measurements.

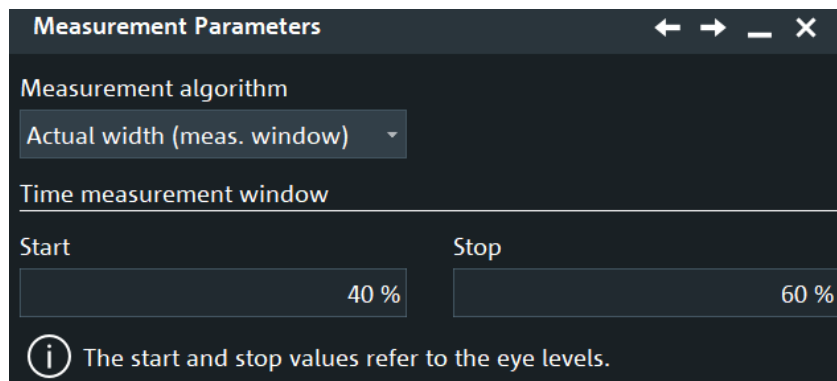

"Measurement algorithm"	<p>Selects the algorithm for the measurement of the height. The following algorithms are available:</p> <ul style="list-style-type: none"> • "Actual width (crossing level)": eye width is measured at crossing level. • The "Maximum width " of an eye diagram is the maximum horizontal distance between the points where the ideal eye opening would cross the decision threshold level, assuming perfect signal timing, no jitter and no distortions. • "Actual width (meas. window)": the horizontal distance between the points where the eye opening crosses the threshold level. • "Extrapolate using three sigma": the eye width is measured at the crossing level: $\text{Eye width} = (\text{Tcrossing2} - 3\sigma_{\text{crossing2}}) - (\text{Tcrossing1} + 3\sigma_{\text{crossing1}})$
"Use measurement level"	If enabled, you can define a user defined "Start" and "Stop" for the eye width measurement.
"Start"	Defines the start time of the range for the eye measurement width.
"Stop"	Defines the stop time of the range for the eye measurement width.

Remote command:

[MEASurement<m>:EYEJitter:EYEWidth:ALGorithm](#) on page 1622

[MEASurement<m>:EYEJitter:EYEWidth:MEASwindow](#) on page 1623

[MEASurement<m>:EYEJitter:EYEWidth:RELative:START](#) on page 1623

[MEASurement<m>:EYEJitter:EYEWidth:RELative:STOP](#) on page 1624

[MEASurement<m>:EYEJitter:EYEWidth:ABSolute:START](#) on page 1624

[MEASurement<m>:EYEJitter:EYEWidth:ABSolute:STOP](#) on page 1625

[MEASurement<m>:EYEJitter:EYEWidth:MODE](#) on page 1625

Eye rise time, Eye fall time

In this dialog, you can define the settings for the "Eye rise time" and "Eye fall time" measurements.

Only values inside the specified horizontal range are considered for the measurements. The range is marked with green lines if the result lines are shown.

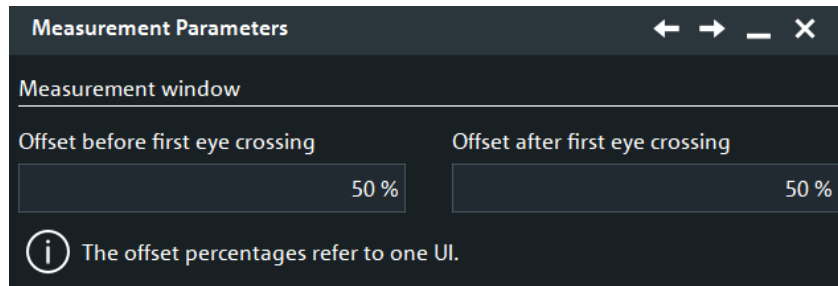

"Offset before first eye crossing" Sets the local start level of the range for eye rise/fall time measurements.

"Offset after first eye crossing" Sets the local stop level of the range for eye rise/fall time measurements.

Remote command:

[MEASurement<m>:EYejitter:RTFTTime:RELative:START](#) on page 1629

[MEASurement<m>:EYejitter:RTFTTime:RELative:STOP](#) on page 1629

Duty cycle distortion

In this dialog, you can define the settings for the duty cycle distortion measurements.

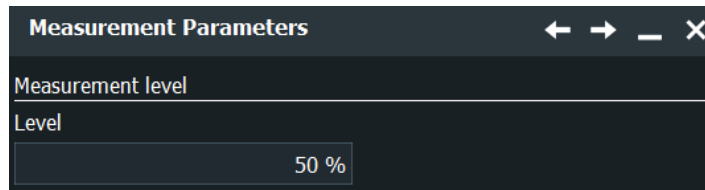

"Level" Defines the level for the eye measurement jitter.

Remote command:

[MEASurement<m>:EYejitter:DCDistortion:RELative:LEVel](#) on page 1622

Jitter

The settings in this dialog are available for "Jitter (peak to peak)", "Jitter (RMS)", "Jitter".

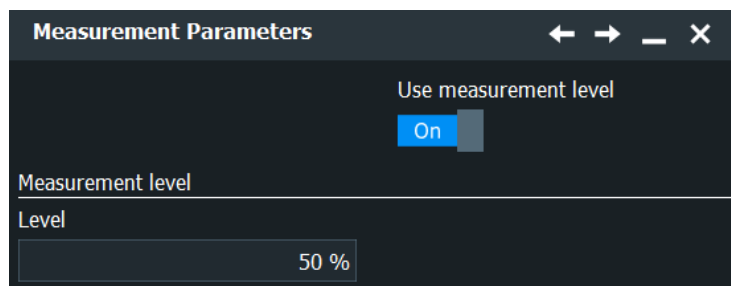

"Use measurement level" If enabled, you can define a user defined "Level" for the eye measurement jitter.

"Level" Defines the level for the eye measurement jitter.

Remote command:

MEASurement<m>:EYElJitter:JITTer:MEASlevel on page 1628

MEASurement<m>:EYElJitter:JITTer:RELative:LEVel on page 1628

8.2.6 Spectrum measurements

Spectrum analysis determines the frequencies of a given input signal over time. Various measurements can then be performed based on the signal spectrum.

8.2.6.1 Overview of spectrum measurements

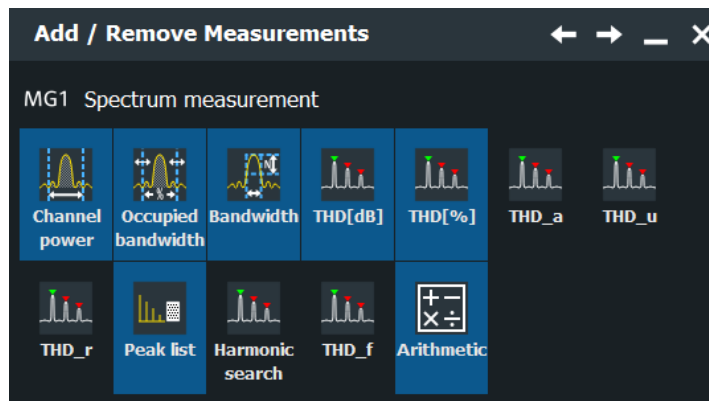









Table 8-7: Spectrum measurements

	Meas. type	Description, result
	Channel power	Power integrated over the sample values defined by a center frequency and a bandwidth; based on a defined impedance. The result is given in dBm. To get best results, enable "Measure all events in each acquisition" on page 368, and set the "Limit" to the maximum value. In particular, these settings are important when measuring pulsed signals.
	Occupied bandwidth	From the defined center frequency, symmetric sample value pairs to the left and right are integrated until a user-defined percentage of the total power is reached. The occupied bandwidth is the difference between the frequencies at which the requested power was reached.
	Bandwidth	n dB down bandwidth; the samples to the left and right of the peak value are analyzed until the n dB threshold is exceeded. The frequencies at which the threshold is exceeded define the limits of the requested bandwidth.
	THD[dB], THD[%] Total harmonic distortion	Power sum of the harmonic waves divided by the power of the fundamental wave: $THD = \frac{\sum_{n=2}^{\infty} P_n}{P_1}$

	Meas. type	Description, result
	THD_f, THD_a, THD_u, THD_r Total harmonic distortion	<p>These measurements require option R&S RTO6-K37 Spectrum analysis.</p> <p>THD_f is the root mean square of the sum of all amplitudes of the harmonic waves in relation to the amplitude at the fundamental frequency (first harmonic):</p> $THD_F = \frac{\sqrt{\sum_{i=2}^n U_i^2}}{U_1}$ <p>THD_a corresponds to THD[dB]:</p> $THD_a = \frac{\sum_{i=2}^n U_i^2}{U_1^2}$ <p>THD_u:</p> $THD_u = \frac{\sqrt{U^2 - U_1^2}}{U_1}$ <p>Distortion factor:</p> $THD_R = \frac{\sqrt{U^2 - U_1^2}}{U}$ <p>Where:</p> <ul style="list-style-type: none"> • U_i: effective value of the harmonic with index i • U_1: effective value of the first harmonic • U: effective value of the signal
	Peak list	Table with measured peaks. For each peak, the frequency and the power value are listed in a table row. The number of determined peaks can be defined. You can sort the results by frequency or power value, and the peak labels are adjusted accordingly.
	Harmonic search	Table with measured harmonics. For each harmonic, the frequency and the value are listed in a table row.
	Arithmetic	<p>Allows you to perform basic arithmetic operations between selected measurement values and/or constant.</p> <p>For details see: Chapter 8.2.4.3, "Arithmetic for amplitude/time and spectrum measurements", on page 329</p>



For remote command parameters and suffix types, see [Table 27-8](#).

8.2.6.2 Settings for spectrum measurements

Access: [Measure] > "Setup" tab > "Spectrum" category

Spectrum measurements require a source in the frequency domain, i.e. a math waveform with an FFT operation.

For spectrum measurements, make sure that the start frequency and other FFT parameters are set correctly, and the fundamentals are not covered by the DC component of the signal. Consider also a gated measurement if the instrument cannot return any result.

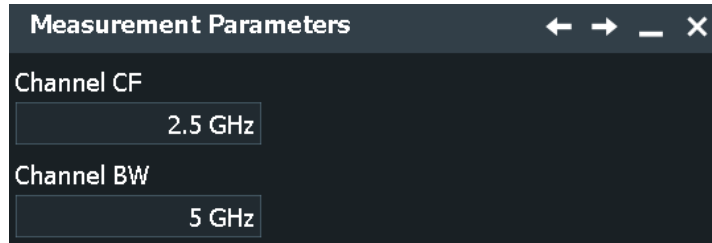

Figure 8-11: Parameters of channel power measurement

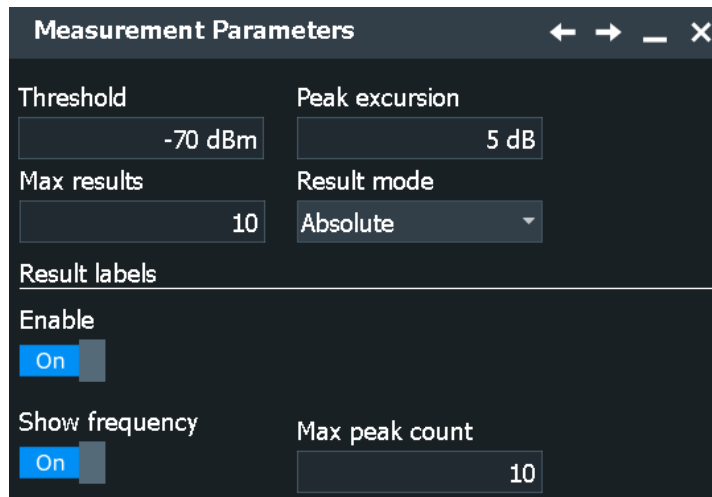

Figure 8-12: Parameters of peak list measurement

Enable

Enables the peak list measurement for the spectrogram.

N db down

The threshold until which the samples to the left and right of the peak value are analyzed to determine the "Bandwidth".

Remote command:

[MEASurement<m>:SPECTrum:NDBDown](#) on page 1632

Channel BW

Bandwidth over which the channel power is calculated.

Remote command:

[MEASurement<m>:SPECTrum:CPOwer:BANDwidth](#) on page 1631

Channel CF

Center frequency from which the channel power is calculated over the specified bandwidth.

Remote command:

[MEASurement<m>:SPECTrum:CPOWer:CFRequency](#) on page 1631

Occup. BW

Percentage of the total power used to determine the occupied bandwidth.

Remote command:

[MEASurement<m>:SPECTrum:OBANdwidth](#) on page 1631

Threshold

Defines an absolute threshold as an additional condition for the peak search. Only peaks that exceed the threshold are detected.

This setting is only available for spectrum waveforms. It is valid for cursor measurements, spectrum measurements and peak search.

Remote command:

[CURSor<m>:THReshold](#) on page 1745

[MEASurement<m>:SPECTrum:ATHReshold](#) on page 1632

Peak excursion

Defines a relative threshold, the minimum level value by which the waveform must rise or fall to be considered as a peak. To avoid identifying noise peaks, enter a peak excursion value that is higher than the noise levels.

This setting is only available for spectrum waveforms. It is valid for cursor measurements, spectrum measurements and peak search.

The following figure shows a cursor measurement on a spectrum waveform:

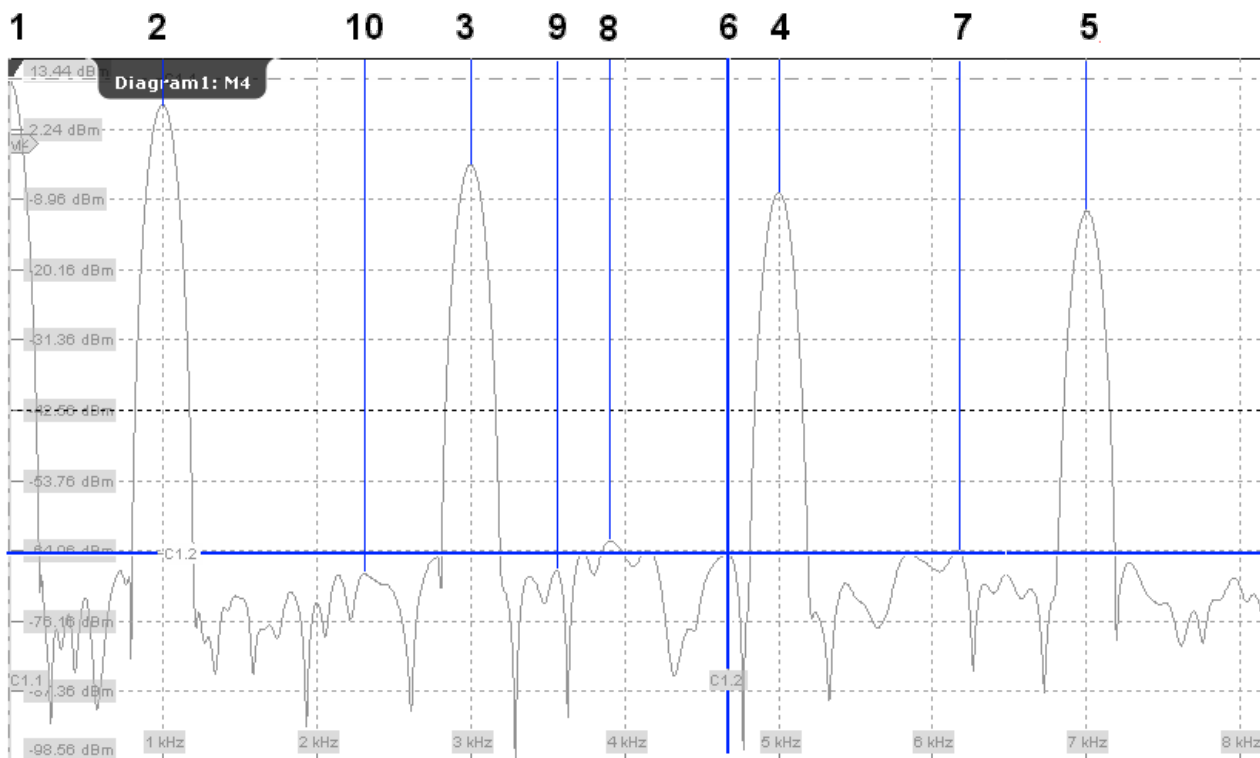

If "Peak excursion" is 30 dB, the peaks 1 to 5 are found. If "Peak excursion" is 20 dB, also the peaks 6 to 10 are found. The cursor position is on peak 6.

Remote command:

[CURSor<m>:PEXCursion](#) on page 1744

[MEASurement<m>:SPECTrum:PEXCursion](#) on page 1632

Max results

Sets the maximum number of measurement results that are listed in the result table. Available for peak list and harmonic search measurements.

Remote command:

[MEASurement<m>:SPECTrum:RESult<n>:COUNT](#) on page 1633

Result mode

Selects the the way the measurement results are displayed. Available for peak list and harmonic search measurements.

"Absolute" The harmonics/peaks are shown in absolute value, dBm.

"Relative" The level of the carrier is shown in absolute value dBm. The values the harmonics/peaks are shown relatively to the carrier in dBc.

Remote command:

[MEASurement<m>:SPECTrum:RESult<n>:MODE](#) on page 1633

Result labels

For peak lists only: Use labels to describe the detected peaks in the spectrum diagram.

You can configure what is displayed in the labels. To change the label design, use "Menu" > "Settings" > "Appearance" > "Peak List", see [Chapter 4.3.9, "Peak list appearance settings"](#), on page 87.

"Enable" Displays a description for each detected peak in the spectrum diagram.

"Show frequency" Includes the frequency of the detected peak in the diagram labels.

"Max. peak count" Defines the maximum number of peaks that are labeled in the diagram. The result table lists all peaks.

Remote command:

[MEASurement<m>:RESult:SHLabels](#) on page 1635

[MEASurement<m>:RESult:LABorder](#) on page 1404

[MEASurement<m>:RESult:INVerse](#) on page 1404

[MEASurement<m>:RESult:MAXCount](#) on page 1634

[MEASurement<m>:RESult:SHFrequency](#) on page 1634

8.2.7 Histograms and histogram measurements

8.2.7.1 Histogram characteristics

Histograms are used to plot density of data, i.e. to display graphically how often which signal values occur. The histogram can be based on the input signal levels (amplitudes) or the timebase in a time domain measurement, or on frequencies or frequency levels in a spectrum measurement. They are a prerequisite for histogram measurements.

Depending on which data the histogram is based on, a vertical or horizontal histogram can be selected. A vertical, or amplitude, histogram displays horizontal bars across amplitude values. A horizontal or time/frequency histogram displays vertical bars over time/frequencies.

You can define up to 8 histograms in a diagram, one of them is displayed. They can be created quickly using toolbar icons, or in the "Meas" menu > "Histogram" dialog box. To switch the histogram display, tap the required histogram area, or select it in the "Histogram" dialog box. For histogram measurements, the measured histogram is selected independently in the measurement setup.

In a histogram, the maximum count of a waveform value is assigned to the full height (histogram peak). All other count values are displayed relative to the maximum.

The following characteristic values can be determined for histograms (illustrated for a vertical histogram):

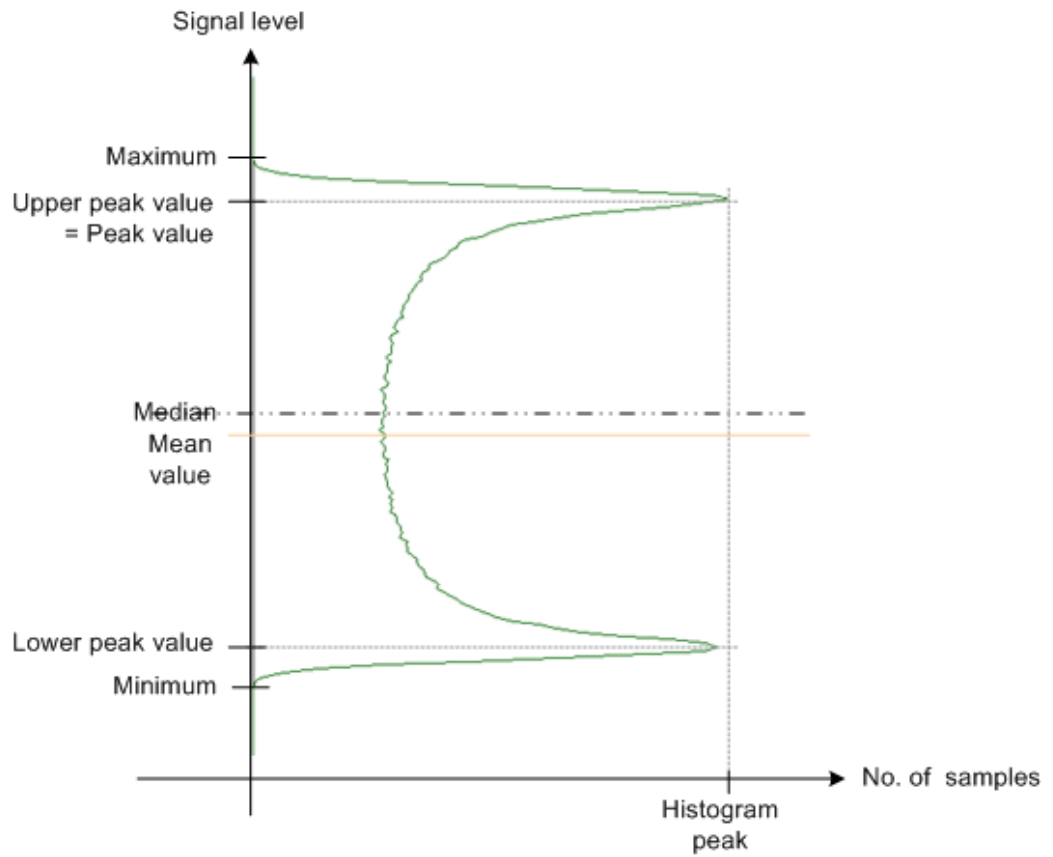

8.2.7.2 Overview of histogram measurements

There are various measurements available to analyze histograms.

Note that graphical changes on the display, e.g. changing the diagram size or the size of the result table, reset the histogram measurements in run mode and also in stop mode.

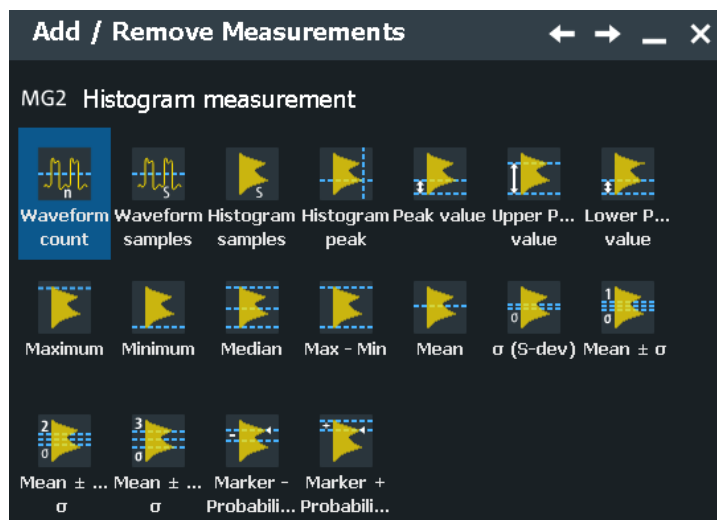



















Table 8-8: Histogram measurements

	Meas. type	Description/Result
	Waveform count	The number of acquisitions (waveforms) the histogram is based on
	Waveform samples	The number of samples from the most recent acquisition included in the current histogram
	Histogram samples	The number of samples from all acquisitions included in the current histogram
	Histogram peak	The maximum count value in the histogram
	Peak value	The signal value at the histogram peak
	Upper peak value	The signal value at the maximum count value in the upper half of the histogram
	Lower peak value	The signal value at the maximum count value in the lower half of the histogram
	Maximum	The highest signal value with a probability > 0
	Minimum	The lowest signal value with a probability > 0
	Median	The signal value for which half the samples lie above, the other half below in the histogram The sample count of one signal value after the other are accumulated until half the total number of samples in the histogram is reached. The signal value for which 50% of the samples are accumulated is the median.
	Max - Min	The range of signal values with a probability > 0
	Mean	The weighted arithmetic average of the histogram
	σ (S-dev)	Standard deviation of the sample numbers

	Meas. type	Description/Result
	Mean $\pm\sigma$	The range between (mean value + standard deviation) and (mean value - standard deviation)
	Mean $\pm 2*\sigma$	The range between (mean value + 3 * standard deviation) and (mean value - 2 * standard deviation)
	Mean $\pm 3*\sigma$	The range between (mean value + 3 * standard deviation) and (mean value - 2 * standard deviation)
	Marker + Probability %	The marker value (according to the selected probability domain marker type) plus the defined limit. Note that the value is restricted to the histogram range.
	Marker - Probability %	The marker value (according to the selected probability domain marker type) minus the defined limit. Note that the value is restricted to the histogram range.



Rough jitter evaluation using a histogram

You can use a horizontal histogram to perform a rough jitter measurement. Define a histogram for a narrow amplitude range close to the trigger time. The "Max-Min" value indicates the peak jitter, while the "StdDev" value indicates the RMS jitter.

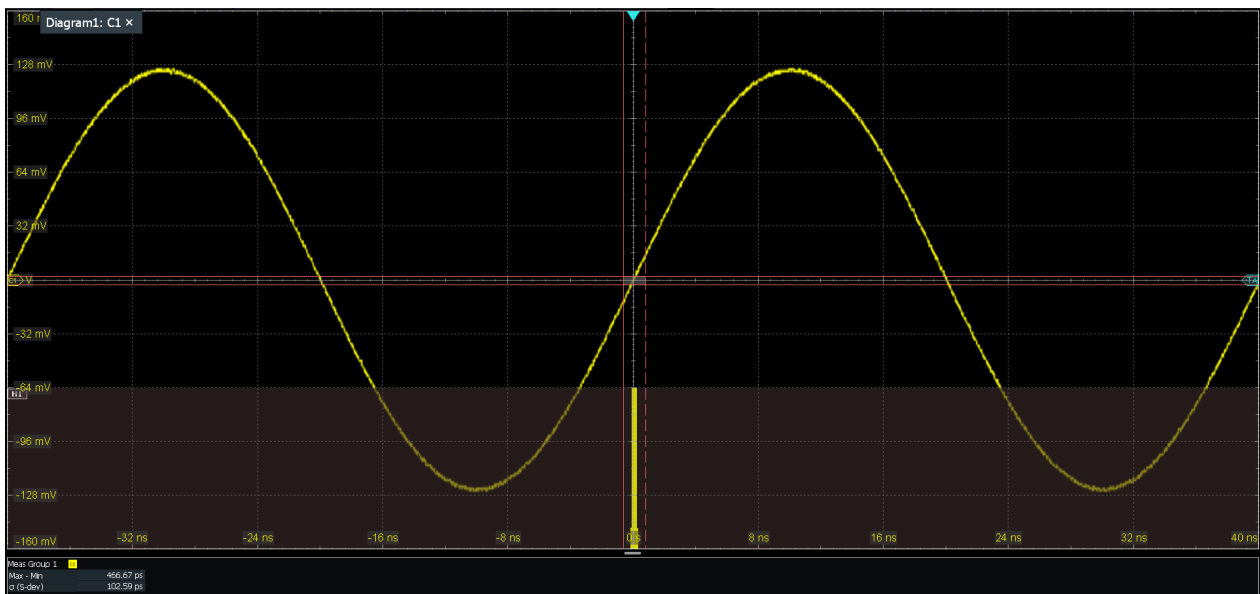

In addition to histograms on channel, math and reference waveforms, histograms can be created based on statistic measurement results. These histograms are enabled in the "Result Analysis" tab, see [Chapter 8.2.11, "Result analysis"](#), on page 361.

8.2.7.3 Creating histograms

Histograms can be used to evaluate the sample value occurrences directly. They are a prerequisite for histogram measurements.

To create a histogram quickly with toolbar icons

1. Select the waveform for which you need a histogram.
2. Tap the histogram icon on the toolbar.
3. Select the histogram type on the overlay menu: "Mode" = vertical for an amplitude histogram, or horizontal for a time-based histogram.

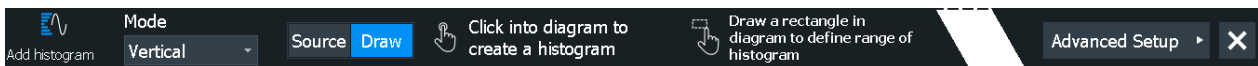

4. Tap the diagram with the waveform to be measured, or draw a rectangle on the screen to define the area for histogram calculation. Alternatively, tap "Source" and select the waveform. The histogram range is indicated in the diagram and a histogram with the selected waveform as a source is defined and displayed.
5. To adjust the histogram range:
 - a) Double-tap the histogram.
 - b) Tap "Advanced Settings" on the overlay menu.
 - c) Adjust the start and stop values.

To create and configure a histogram in the dialog box

1. Select "Menu" > "Apps" > "Analysis" tab > "Histogram". The "Histogram" dialog box is displayed.



2. To create a histogram, tap the "Add" icon in the upper right corner of the dialog box.



3. To copy an existing histogram and configure a new one based on those settings, tap the "Copy" icon.

4. To change the name of a histogram, double-tap the tab label. Enter a name for the histogram using the on-screen keyboard.
5. Select a "Source" for the histogram. The source can be any input signal, math or reference waveform.
6. Define the histogram "Mode": vertical for an amplitude, horizontal for a time-based histogram.
7. Define the range of the waveform for which the histogram is to be generated. Enter the start value and the stop value in x and in y direction, either as absolute or relative values.

8. Enable the histogram.

8.2.7.4 Histogram setup

"Menu" > "Apps" > "Analysis" tab > "Histogram"

In this dialog box, you configure histograms on which you can perform further measurements.

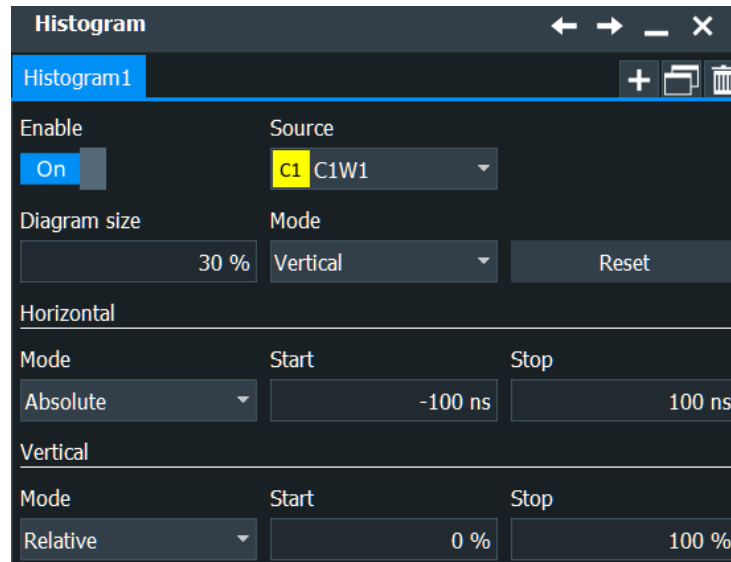

Enable

Enables or disables the histogram evaluation and display. The histogram settings are kept until the histogram is deleted.

Remote command:

[LAYout:HISTogram:ENABle](#) on page 1641

Source

Defines the source of the histogram. Any analog channel waveform, math or reference waveform can be selected. Also measurements can serve as histogram source. In this case, the density distribution of the results of the main measurement is displayed.

Remote command:

[LAYout:HISTogram:SOURce](#) on page 1642

Diagram size

Defines the size of the histogram in percent of the diagram.

Mode

Defines the type of histogram.

- "Vertical" Amplitude histogram (horizontal bars across amplitude)
- "Horizontal" Time histogram (vertical bars over time). For spectrum waveforms, horizontal histograms over spectrum are not available.

Remote command:

[LAYout:HISTogram:MODE](#) on page 1642

Reset

Resets the values to begin a new histogram.

Remote command:

[LAYout:HISTogram:RESet](#) on page 1646

Mode (Horizontal / Vertical)

Defines whether the value range limits are entered as absolute or relative values.

Remote command:

[LAYout:HISTogram:HORZ:MODE](#) on page 1643

[LAYout:HISTogram:VERTical:MODE](#) on page 1644

Start, Stop (Horizontal)

Defines the horizontal value range of the histogram.

Remote command:

[LAYout:HISTogram:HORZ:ABSolute:START](#) on page 1643

[LAYout:HISTogram:HORZ:ABSolute:STOP](#) on page 1643

[LAYout:HISTogram:HORZ:RELative:START](#) on page 1644

[LAYout:HISTogram:HORZ:RELative:STOP](#) on page 1644

Start, Stop (Vertical)

Defines the vertical value range of the histogram.

Remote command:

[LAYout:HISTogram:VERTical:ABSolute:START](#) on page 1645

[LAYout:HISTogram:VERTical:ABSolute:STOP](#) on page 1645

[LAYout:HISTogram:VERTical:RELative:START](#) on page 1645

[LAYout:HISTogram:VERTical:RELative:STOP](#) on page 1646

8.2.7.5 Settings for histogram measurement

Access: [Measure] > "Setup" tab > "Histogram" category

You can perform measurements on histograms. Before, you have to define a histogram, see [Chapter 8.2.7.3, "Creating histograms"](#), on page 350.

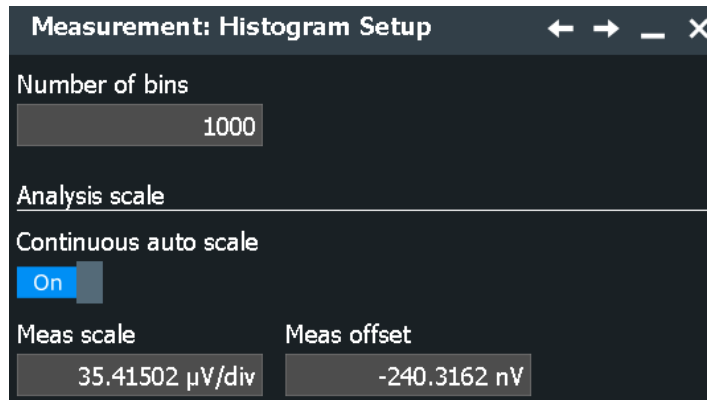

The measurement parameters are common for all histograms measurements, you find them directly on the "Setup" tab.

Source

Selects the histogram on which the measurement is based. Before, you have to define a histogram, see [Chapter 8.2.7.3, "Creating histograms"](#), on page 350.

Remote command:

[MEASurement<m>:HISTogram:SElect](#) on page 1648

Probability domain marker, Reference

Defines the marker reference in the probability domain.

"Peak"	The y-value with the maximum sample value in the histogram
"Upper Peak"	The y-value at the maximum sample value in the upper half of the histogram
"Lower Peak"	The y-value at the maximum sample value in the lower half of the histogram
"Maximum"	The highest y-value with a probability > 0
"Minimum"	The lowest y-value with a probability > 0
"Median"	The y-value for which half the samples lie above, the other half below in the histogram.
"Mean"	The weighted arithmetic average of the histogram

Remote command:

[MEASurement<m>:HISTogram:PROBability:TYPE](#) on page 1648

Probability domain marker, Delta

Defines a range around the marker.

Remote command:

[MEASurement<m>:HISTogram:PROBability:LIMit](#) on page 1649

8.2.8 Jitter measurements

Jitter measurements are available if one of the following options is installed:

- R&S RTO6-K12

- R&S RTO6-K133
- R&S RTO6-K134

See [Chapter 19.1, "Jitter measurements \(options R&S RTO6-K12/K13\)"](#), on page 1084.

8.2.9 Optical measurements

This dialog provides settings for testing optical signals. Optical measurements require an optical power signal provided by an optical probe.



For accurate measurements, a dark calibration of the optical probe is required.

8.2.9.1 Overview of optical measurements

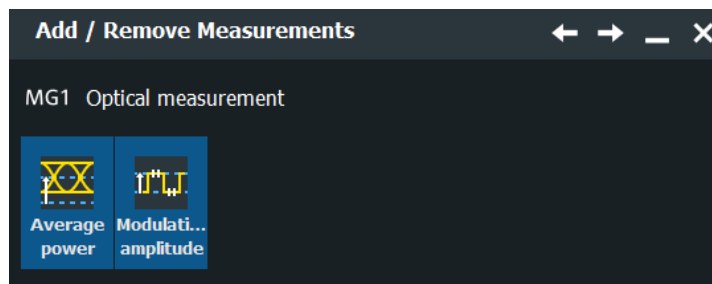



Table 8-9: Optical measurements

	Meas. type	Description/Result
	Average power	Measure for the true average component of an optical signal. $X_{Average} = \frac{1}{N_{Eval}} * \sum_{i=1}^{N_{Eval}} x(i)$
	Optical modulation amplitude (OMA)	Measure of the difference between the optical power of a non-return-to-zero (NRZ) one pulse and the optical power of an NRZ zero pulse. OMA requires an NRZ pattern. The one pulse and zero pulse levels are measured in the level measurement window defined with Start and Stop . OMA is based on norm IEC 61280-2-2.

8.2.9.2 Settings for optical measurements

Access: [Measure] > "Setup" tab > "Optical" category

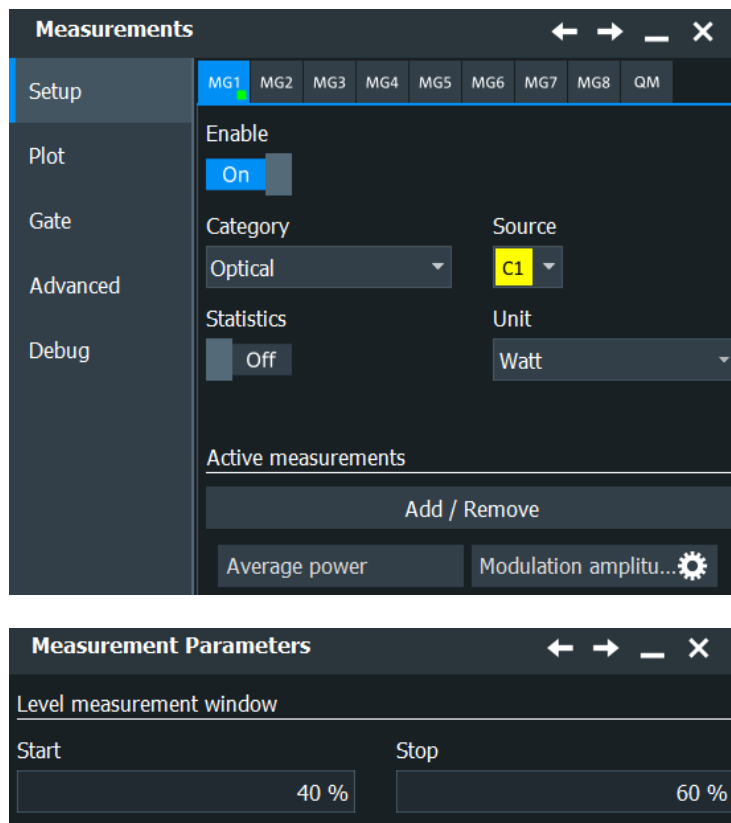

Figure 8-13: Modulation amplitude settings

Unit

Selects the unit of the optical measurement.

Remote command:

[MEASurement<m>:OPTical:UNIT](#) on page 1638

Start

Sets the start value of the range for the optical modulation amplitude.

Remote command:

[MEASurement<m>:OPTical:OMAMplitude:RELative:START](#) on page 1637

Stop

Sets the end value of the range for the optical modulation amplitude.

Remote command:

[MEASurement<m>:OPTical:OMAMplitude:RELative:STOP](#) on page 1638

8.2.10 Protocol measurements (option R&S RTO6-K500)

Option R&S RTO6-K500 provides specific measurements on automotive and Ethernet protocols.

8.2.10.1 Overview of protocol measurements

If option R&S RTO6-K500 is installed, enhanced measurements on the supported serial buses are possible. With it, you can measure various dependencies between the frames.

Additional to option R&S RTO6-K500 you need one of the following serial protocol options:

- I2C (R&S RTO6-K510)
- SPI (R&S RTO6-K510)
- UART/RS232 (R&S RTO6-K510)
- CAN / CAN-FD (R&S RTO6-K520/R&S RTO6-K520)
- LIN (R&S RTO6-K520)
- RFFE (R&S RTO6-K550)
- SENT (R&S RTO6-K520)
- Ethernet (100BASE-Tx) (R&S RTO6-K540)
- 100BASE-T1 (R&S RTO6-K560)

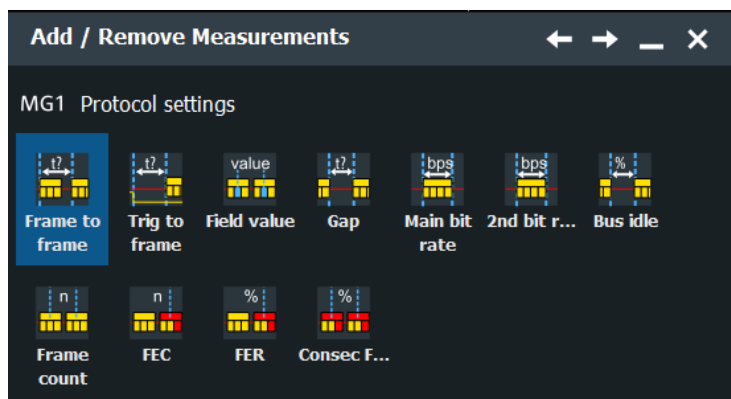

Table 8-10: Protocol measurements

Meas. type	Description / result
Field value	Value of a field over time
Frame to frame	The distance between two frames
Trigger to frame	The distance between a defined frame and the next trigger signal
Gap	Measures a gap, period at which the bus is idle. The distance of a gap can only be measured between two identified frames.
Main bit rate	Bit rate as defined by the standard
2nd bit rate	Additional bit rate, protocol dependent For example: "Data rate" for the CAN-FD protocol.
Bus idle	Calculates the bus idle time
Frame count	Number of all frames within the acquisition window
Frame error count	Sum of all frames with errors within the acquisition window

Meas. type	Description / result
Frame error rate	Sum of all frames with errors divided by all frames within the acquisition window
Consecutive frame error rate	Measures the rate at which at least two consecutive frames have an error rate

8.2.10.2 Settings for protocol measurements

Access: [Measure] > "Setup" tab > "Protocol" category



Protocol measurements require that a supported protocol is enabled first.

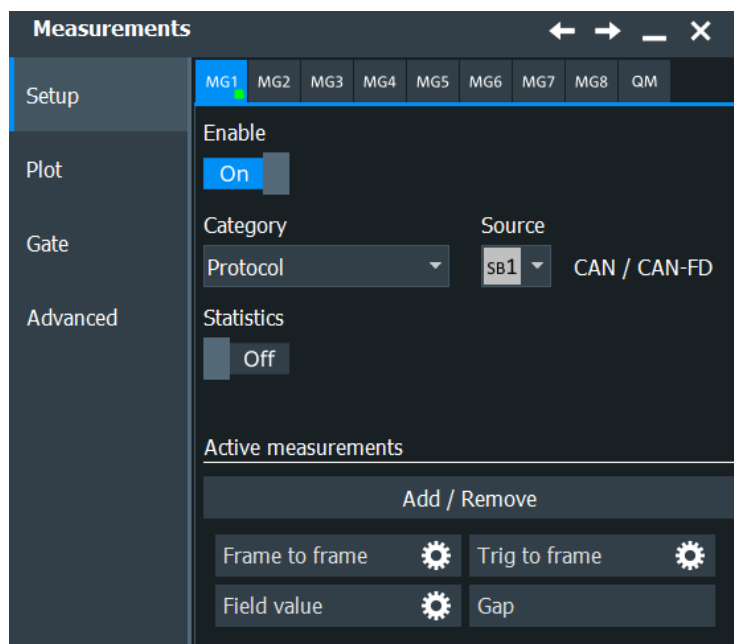

If further settings are available for a measurement, a settings icon is shown beside the measurement's name in the "Active Measurements" list. Tap the icon to configure the measurement.

Frame to frame

Opens a dialog to set up the parameters for the frame to frame measurement. You can define a start frame ("From") and an end frame ("To") for the measurement.

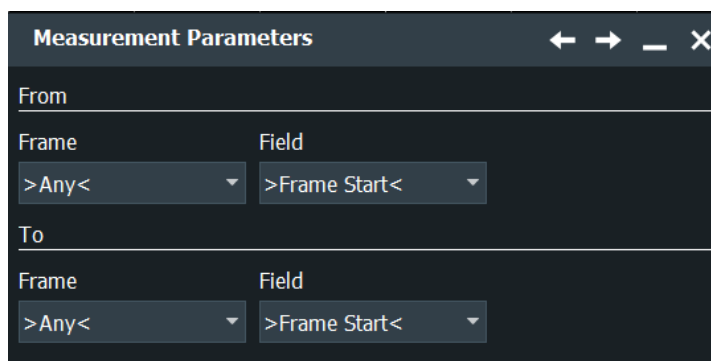

The types of available frames and fields are depending on the enabled protocol.

Table 8-11: Available protocol frames

Protocol	Frame	Field
I2C	W R	Address
		2. Addr
		ACK
		R/W
		Data
SPI	MISO MOSI	Word
CAN/CAN FD	Remote Data	ID FDF BRS ESI DLC SCV P SC Data CRC ACK
	Overload	-
LIN	WAKE	-
	Data	ID Data

Protocol	Frame	Field
RFFE	Register 0 Write	SA
	Register Write	MID
	Register Read	BC
	Extended Register Write	Addr
	Extended Register Read	Mask
	Extended Register Write Long	Data
	Extended Register Read Long	
	Interrupt Summary and Identification	
	Masked Write	
	Master Ownership Handover	
	Master Write	
	Master Read	
	Master Context Transfer Write	
Master Context Transfer Read		
Ethernet	MAC	Preamble
	Sleep	SFD
EOS		Dest
		Src
		Len/Type
		Data
		FCS
	Idle	Triplet
100BASE-T1	MAC	Preamble
	Fill	SFD
		Dest
		Src
		Len/Type
		Data
		FCS
	Idle	Triplet

Also, if a label list is loaded and enabled for the protocol, the symbolic label names can be selected from the "Frame"/"Field" value list.

"Frame" Selects the type of start frame (from) / end frame (to).

"Field" Selects the type of start field (from) / end field (to).

"Value" Sets a value for the selected field.

Remote command:

[MEASurement<m>:PROTOCOL:F2FRAME:FRMFrom](#) on page 1661

[MEASurement<m>:PROTOCOL:F2FRAME:FRMTo](#) on page 1661

[MEASurement<m>:PROTOCOL:F2FRAME:FLDFrom](#) on page 1660

[MEASurement<m>:PROTOCOL:F2FRAME:FLDTo](#) on page 1660

[MEASurement<m>:PROTOCOL:F2FRame:VALFrom](#) on page 1661

[MEASurement<m>:PROTOCOL:F2FRame:VALTo](#) on page 1661

Trigger to frame

Opens a dialog to set up the parameters for the trigger to frame measurement.

The types of available frames are depending on the enabled protocol, see [Table 8-11](#).

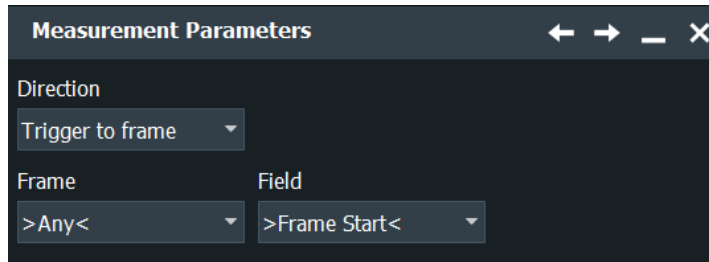

"Direction" Selects the direction for the measurement, from the trigger to the next frame (start),

"Frame" Selects the type of frame.

"Field" Selects the type of field.

"Value" Sets a value for the selected field.

Remote command:

[MEASurement<m>:PROTOCOL:T2FRame:DIRection](#) on page 1664

[MEASurement<m>:PROTOCOL:T2FRame:FLD](#) on page 1665

[MEASurement<m>:PROTOCOL:T2FRame:FRM](#) on page 1665

[MEASurement<m>:PROTOCOL:T2FRame:VALue](#) on page 1665

Field value

Opens a dialog to set up the parameters for the field value measurement. You can first identify a frame with specific field value and then track a selected field of this frame.

The types of available frames and fields depend on the enabled protocol, see [Table 8-11](#).

If a label list is loaded and enabled for the protocol, sometimes there are defined calculations and formatting for the displayed field value. In this case, the measurement displays the value according to the definition in the label list.

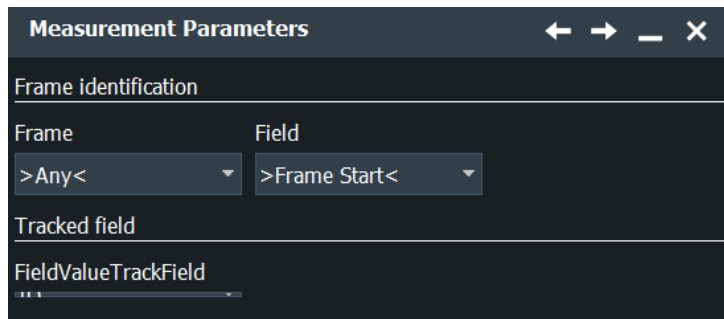

"Frame" Selects the type of frame.

"Field" Selects the type of field.

"Value" Sets a value for the selected field.
 "Field to be tracked" Selects the type of field which value is tracked over time.

Remote command:

[MEASurement<m>:PROTOCOL:FLDValue:FLD](#) on page 1662

[MEASurement<m>:PROTOCOL:FLDValue:FRM](#) on page 1662

[MEASurement<m>:PROTOCOL:FLDValue:TRCK](#) on page 1662

[MEASurement<m>:PROTOCOL:FLDValue:VAL](#) on page 1663

Main bit rate / 2nd bit rate

Opens a dialog to set up the parameters for the main bit rate/ 2nd bit rate measurement. You can identify a frame and a specific field value.

The types of available frames and fields depend on the enabled protocol, see [Table 8-11](#).

If a label list is loaded and enabled for the protocol, sometimes there are defined calculations and formatting for the displayed field value. In this case, the measurement displays the value according to the definition in the label list.

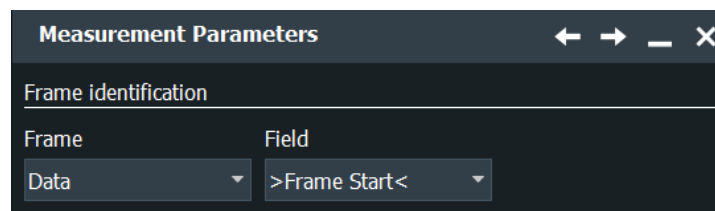

"Frame" Selects the type of frame.
 "Field" Selects the type of field.
 "Value" Sets a value for the selected field.

Remote command:

[MEASurement<m>:PROTOCOL:MBITrate:FLD](#) on page 1663

[MEASurement<m>:PROTOCOL:MBITrate:FRM](#) on page 1663

[MEASurement<m>:PROTOCOL:MBITrate:VAL](#) on page 1663

[MEASurement<m>:PROTOCOL:SBITrate:FLD](#) on page 1664

[MEASurement<m>:PROTOCOL:SBITrate:FRM](#) on page 1664

[MEASurement<m>:PROTOCOL:SBITrate:VAL](#) on page 1664

8.2.11 Result analysis

The behavior of measurement results over time can be evaluated in different ways:

- Statistics
- Long-term measurements
- Histograms on measurement results
- Track

8.2.11.1 Statistics

Statistics can be compiled for each measurement group separately, and also for long-term measurements. If enabled, statistical results are shown in the result box.

By default, all events in each acquisition are measured and included in the statistics: the measurement result is not only determined once within one acquisition, but repeatedly, if available. More results provide a larger basis for statistical evaluation.

To obtain precise results, additional measurement settings can be useful:

- Reference/signal levels: configuring user-defined levels can compensate for irregular data, see [Chapter 13.3, "Signal and reference levels for NRZ signals"](#), on page 495.
 - Gate areas: restricting the waveform range for measurement can eliminate irregular data, see [Chapter 8.2.3, "Measurement gates"](#), on page 313.
 - Defining a "Signal threshold" for time, area and counting measurements can eliminate noise from the evaluation, see ["Signal threshold"](#) on page 322.
 - Spectrum measurements: you can eliminate noise from the evaluation, see [Threshold](#) and ["Peak excursion"](#) on page 304
- To enable statistics, use one of the following ways.
Make sure to select the subtab of the measurement group for which you want to compile statistics.
- On the toolbar assist, enable "Statistics".
 - On the "Setup" tab, enable "Statistics".

If statistics are enabled, the following results are calculated. You can select which results are shown in the result table, see [Chapter 8.2.2.3, "Display settings for results"](#), on page 312.

Label	Description
+Peak	Positive peak value (maximum)
-Peak	Negative peak value (minimum)
μ (Avg)	Average
RMS	Root mean square
σ (S-dev)	Standard deviation
Event count	Number of measured events (e.g. rising edges, pulses etc.)
Wave count	Number of waveforms (acquisitions) the measurement is based on

Remote commands:

- [MEASurement<m>:RESult\[:ACTual\]?](#) on page 1591
- [MEASurement<m>:RESult:AVG?](#) on page 1591
- [MEASurement<m>:RESult:COUNT?](#) on page 1593
- [MEASurement<m>:RESult:EVTCount?](#) on page 1591

- [MEASurement<m>:RESult:NPEak?](#) on page 1591
- [MEASurement<m>:RESult:PPEak?](#) on page 1591
- [MEASurement<m>:RESult:RMS?](#) on page 1591
- [MEASurement<m>:RESult:STDDev?](#) on page 1591
- [MEASurement<m>:RESult:WFMCCount?](#) on page 1591
- [MEASurement<m>:RESult:STARt?](#) on page 1593
- [MEASurement<m>:RESult:STOP?](#) on page 1593
- [MEASurement<m>:ARNames](#) on page 1591
- [MEASurement<m>:ARES?](#) on page 1590

The peak and average values and the standard deviation of the long-term points are also shown in the graph of the long-term measurement.

Stopping and starting the acquisition does not reset statistics but only stops and continues them.

The instrument only resets statistical evaluation if you change measurement setup:

- Select measurement
- Create or modify gate
- Enable/disable long-term measurement and histogram
- Enable continuous autoscale with enabled histogram
- Switch on/off channels
- Enable/disable cursors
- Tap "Reset" or "Clear sreen results"

After a reset, new statistics are compiled beginning with the next acquired waveform.

If limit and margin check is enabled, the icons in the result table indicate if statistical results exceed a limit or margin. These violations do not initiate an action.

8.2.11.2 Long-term measurements

Long-term measurements show the behavior of measurement results over a longer time or for many samples. Therefore the measurement results of a specified time period are summarized into one long-term point. For each point, the current value measured at the end of the time period is written to the long-term waveform. In addition, statistical results for each time period are calculated, saved, and reset. This reset avoids constantly rising maximum or constantly falling minimum values until the end of the measurement.

You can define the number of long-term points and export the long-term data, including statistical results. The measurement histogram is a vertical histogram shown in the long-term diagram.

See also: "[Enable \(Long term\)](#)" on page 366.

Performing long-term measurements

1. On the "Meas" menu, select "Result Analysis".
2. Select the subtab for the measurement group you want to configure.
3. Under "Long term", tap "Enable".
4. Since the waveform can change in the process of time, enable "Continuous auto scale" to adapt the scaling automatically.
Alternatively, tap the "Auto scale" to adjust the scale once and to see the long-term waveform.
5. Tap "Horizontal scaling".
6. Define the "Number of points" to be shown in the long-term diagram.
7. Set the "Scale mode" that defines the period of time from which one long-term point is created.
See ["Scale mode"](#) on page 368 for setting details.
For each long-term measurement point, the current measurement value is added to the long-term waveform.
8. If you need the statistical data of the long-term points:
 - a) Tap "Result Analysis" to return to the measurement settings.
 - b) Enable statistics.
 - c) Let the measurement run and export the data when finished.

8.2.11.3 Histograms on measurement results

Histograms are available not only for channel, math and reference waveforms, but also on measurement results. These histograms cannot be configured, and they are shown in a separate diagram. The source is a measurement, and all events in all acquisitions are measured and included in the histogram. If the histogram is based on long-term measurement, it is shown in the long-term diagram.

See also: ["Enable \(Histogram\)"](#) on page 366.

8.2.11.4 Track

The track is a waveform that shows measurement values in time-correlation to the measured signal. It is the graphical interpretation of all measurement values of a single acquisition.

The track is available for most amplitude/time measurements (except for High, Low, Amplitude, Max, Min, Peak to peak, Mean, RMS, S-dev, Pos. and Neg. overshoot, and Area), and for jitter measurements.

Enabling the track enables also the [Continuous auto scale](#) and [Measure all events in each acquisition](#).

To analyze the track, you can use cursor measurements and zoom.

Creating a track waveform

1. Configure the measurement group.
2. Activate the measurement group.
3. Select the "Result Analysis" tab.
4. Enable the track.

See also: "[Enable \(Track\)](#)" on page 367.

8.2.11.5 Settings for result analysis

The settings in the "Result Analysis" tab activate and configure long-term measurements, statistical calculations, and the histogram of measurement results over a longer period of time.

For scaling settings of the long-term diagram, see [Chapter 8.2.11.6, "Horizontal long-term scaling"](#), on page 368.

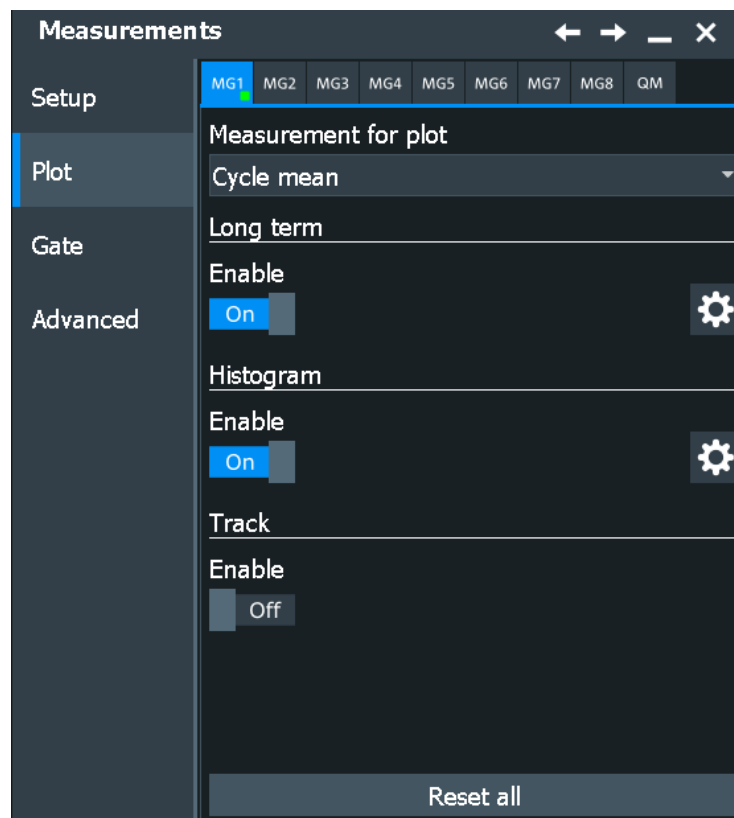

Measurement for plot

Selects the measurement that is used as source for mathematic calculations, long-term measurements, and histograms. These evaluations are performed on one measurement only, not on all measurements of the group. Statistics are calculated for all measurements.

The selected measurement cannot be disabled in the "Add / Remove Measurement" dialog box.

Remote command:

[MEASurement<m>:MAIN](#) on page 1587

Enable (Long term)

Enables long-term measurement of the main measurement.

Long-term measurements are performed on the "Measurement for plot".

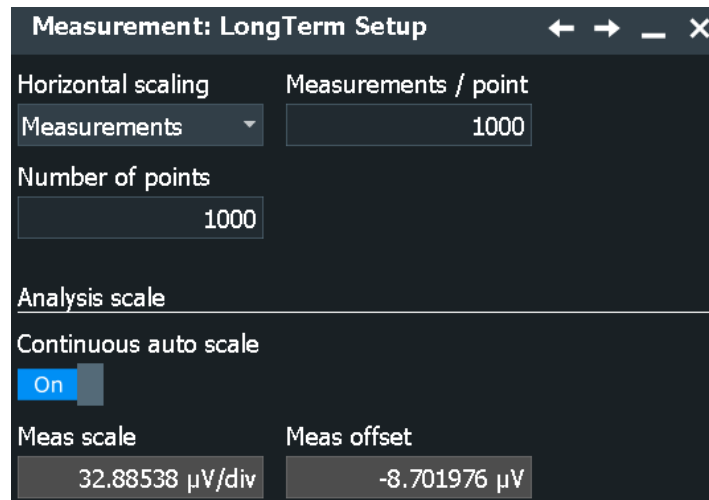

Remote command:

[MEASurement<m>:LTMeas\[:STATe\]](#) on page 1658

Enable (Histogram)

Displays a histogram of measurement results - the cumulative occurrence distribution of measurement results in a graphic. Enabling the histogram enables also the statistics and "Measure all events in each acquisition".

Long-term measurements are performed on the "Measurement for plot".

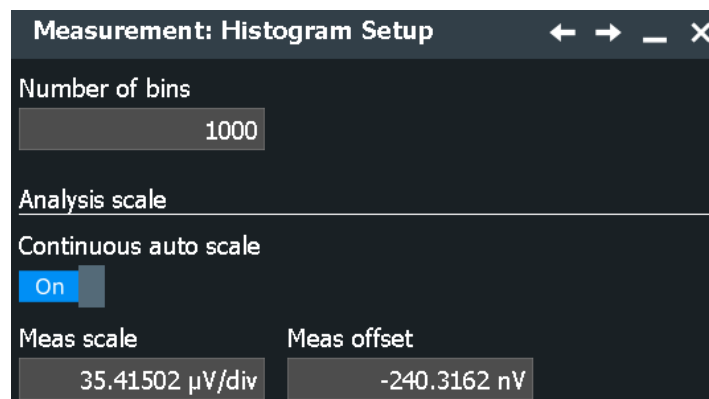

Remote command:

[MEASurement<m>:STATistics:HISTogram](#) on page 1654

Number of bins

Sets the number of bins - the number of vertical bars that build the histogram.

If "Continuous auto scale" is enabled, the instrument determines the number of bins based on the timebase, the current measurements, and other settings. To set the number of bins manually, disable "Continuous auto scale".

Remote command:

[MEASurement<m>:STATistics:HBINs](#) on page 1654

Enable (Track)

Enables the track of measurement results over time and displays the track waveform. It is the graphical interpretation of all measurement values of a single acquisition.

The track is available for most amplitude/time measurements (except for High, Low, Amplitude, Max, Min, Peak to peak, Mean, RMS, S-dev, Pos. and Neg. overshoot, and Area), and for jitter measurements.

Enabling the track enables also the [Continuous auto scale](#) and [Measure all events in each acquisition](#).

Before you can enable the track, activate the appropriate measurement.

Remote command:

[MEASurement<m>:TRACk\[:STATe\]](#) on page 1666

Reset

Immediately resets the histogram, the long-term measurement and the statistics.

Stopping and starting the acquisition does not reset these analyses but only stops and continues them.

To delete all results, waveforms and history, select "Display" menu > "Clear all".

Remote command:

[MEASurement<m>:STATistics:RESet](#) on page 1656

Analysis scale

The measurement scale of a long-term measurement diagram or measurement histogram can be set automatically by the instrument, or manually.

Use automatic scaling if the measurement is running and you cannot see the expected results.

"Continuous auto scale"

Performs an automatic scaling whenever the long-term waveform or the histogram does not fit in the diagram during the measurement period.

"Vertical"

Defines the vertical scaling per division for long-term measurement period and the measurement histogram.

"Offset"

Defines an offset for the long-term measurement and the measurement histogram.

Remote command:

[MEASurement<m>:VERTical:CONT](#) on page 1657

[MEASurement<m>:VERTical:AUTO](#) on page 1657

[MEASurement<m>:VERTical:SCALE](#) on page 1658

[MEASurement<m>:VERTical:OFFSet](#) on page 1657

Measure all events in each acquisition

Normally, only one measurement is performed for each acquired waveform to get best performance. If "Measure all events in each acquisition" is enabled, more than one result is taken from one acquired waveform and the results are included evaluation. For example, the rise time is measured on all pulses in the waveform, not only on the first.

The result box shows only the first result of the waveform, the following results are used only for evaluation.

All event results are also considered in limit and margin checks and can initiate an action. However, the icons in the result box only indicate violations of the first result.

Measuring all events is enabled automatically when calculating statistics and histograms. It can also be useful when generating tracks; however, it reduces the performance of the instrument.

The number of considered results can be restricted: "Limit" sets the maximum number of measurement results per acquisition.

Remote command:

[MEASurement<m>:MULTiple](#) on page 1653

[MEASurement<m>:MNOmeas](#) on page 1654

8.2.11.6 Horizontal long-term scaling

In this dialog box, you define the horizontal scale of long-term measurement diagrams. The length of the long-term measurement is defined by the number of points.

If option R&S RTO6-K510 I²S Audio Signals is installed, the trend diagram is configured here.

Number of points

Defines the total number of points to be displayed in the long-term measurement diagram.

Remote command:

[MEASurement<m>:LTMeas:COUNT](#) on page 1658

Scale mode

Defines when the points of a long-term measurement are created.

If statistics are enabled, each long-term measurement point shows the statistical mean and standard deviation of the results measured during the defined period.

If statistics are disabled, the first measurement result of each period is taken as long-term measurement point.

"Time"	Sets one long-term measurement point for the time defined in "Time/point".
"Waveforms"	Sets one long-term measurement point for several acquired waveforms. The number is defined in "Waveforms/point".

"Measure- Sets one long-term measurement point for several measurement
ments" results. The number is defined in "Measurements/point".

Remote command:

[MEASurement<m>:STATistics:MODE](#) on page 1655

Time / point

Defines the time to create one point of the long-term measurement. The "Time / point" value is a lower time limit. The actual time between two points depends on the acquisition and postprocessing time.

The long-term measurement is not a data logger with equidistant points as the time between two points varies.

This setting is only available if "Scale mode" is set to "Time".

Remote command:

[MEASurement<m>:STATistics:RTIME](#) on page 1656

Measurement time

Defines the total duration of the long-term measurement: *Time/point * Number of points*.

This setting is only available if "Scale mode" is set to "Time".

Remote command:

[MEASurement<m>:LTMeas:TIME](#) on page 1659

Wfms / point

Defines the number of measured waveforms from which one point of the long-term measurement is created.

This setting is only available if "Scale mode" is set to "Waveforms".

Remote command:

[MEASurement<m>:STATistics:RCOunt](#) on page 1655

Measurements / point

Defines the number of measurement results from which one point of the long-term measurement is created.

This setting is only available if "Scale mode" is set to "Measurements".

Remote command:

[MEASurement<m>:STATistics:RMEascount](#) on page 1656

8.2.12 Limit and margin checks

Limit and margin checks evaluate whether the measurement result exceeds a specified value. Violations are indicated by icons in the result box. Furthermore, you can define actions that are performed on limit or margin violation, like saving the waveform or measurement results.

The following results are considered in limit and margin checks:

- All selected measurements.

- All measured events in an acquisition: all results can initiate an action. However, the icons in the result box indicate only violations of the first result.
- Statistical results. Limit and margin violations of statistical results are indicated by icons in the result box. These violations do not initiate an action.

See also: [Chapter 8.2.2.1, "Measurement status"](#), on page 311

8.2.12.1 Performing limit checks

1. Open the menu and select "Measure".
2. Select the "Advanced" tab.
3. Select the subtab of the measurement group that you want to configure.
4. Under "Type", select "Limit only" to distinguish only between valid and non-valid values.
Select "Margin&Limit" to check two values, where the margin is still valid, while the limit is not.
5. Tap "Setup". Define the valid value range for each active measurement.
The margins must always be within the valid value range. If necessary, the limit or margin values are adapted to match the selected valid range.
See also ["Upper limit, Lower limit, Upper margin, Lower margin, Valid range"](#) on page 371
6. Define what happens when the defined limits and margins are exceeded.
For each action, define when the instrument starts it:
 - If the limits or margins are exceeded
 - If the measurement is completed without limit violations
 - Not at all

As a result of the limit check, the specified actions are performed and an icon indicates the status in the result box.

8.2.12.2 Limit and margin settings

Access: [Measure] > "Advanced" tab

If a check is selected, tap "Setup" to set the limit and margin values and the range of valid measurement results.

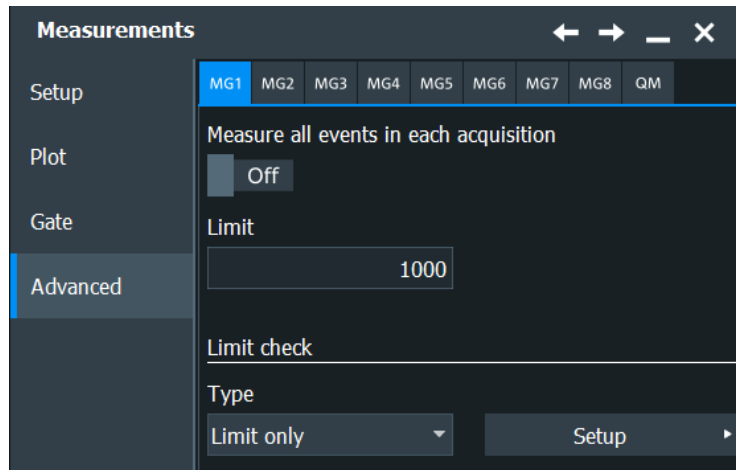

Type

Selects and enables the limit or margin check.

"Off" No limit check is performed.

"Limit only" Limits are checked for violation.

"Margin & Limit" Margins and limits are checked for violation.

Upper limit, Lower limit, Upper margin, Lower margin, Valid range

Set the limits and margins for each measurement, and also specify the valid range.

Measurement: Limit Check			
Amplitude/Time measurement	Upper limit	Lower limit	Valid range
Low	10 μ V	-10 μ V	Within
Amplitude	300 μ V	-300 μ V	Within

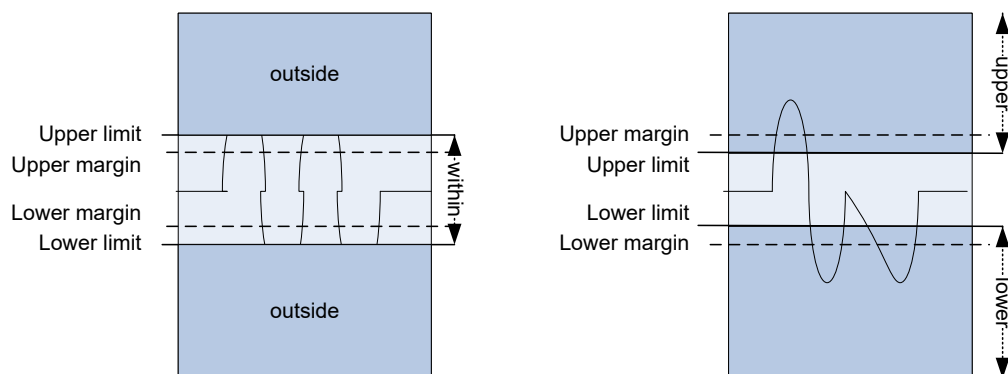

Figure 8-14: Limit and margin definition

Limits are stricter than the margins for the value check. Thus, the margins must be within the valid range. If necessary, the limit and margin values are adapted according to the selected valid range.

The settings are only visible if "Limit check" is enabled.

Remote command:

`MEASurement<m>:AMPTime:LCHeck<n>:LOWer:LIMit` on page 1604

`MEASurement<m>:AMPTime:LCHeck<n>:LOWer:MARGin` on page 1604

`MEASurement<m>:AMPTime:LCHeck<n>:UPPer:LIMit` on page 1604

`MEASurement<m>:AMPTime:LCHeck<n>:UPPer:MARGin` on page 1604

`MEASurement<m>:AMPTime:LCHeck<n>:VALid` on page 1603

To check limits and margins of jitter measurements, use the AMPTime remote commands.

`MEASurement<m>:EYEJitter:LCHeck<n>:LOWer:LIMit` on page 1619

`MEASurement<m>:EYEJitter:LCHeck<n>:LOWer:MARGin` on page 1619

`MEASurement<m>:EYEJitter:LCHeck<n>:UPPer:LIMit` on page 1619

`MEASurement<m>:EYEJitter:LCHeck<n>:UPPer:MARGin` on page 1619

`MEASurement<m>:EYEJitter:LCHeck<n>:VALid` on page 1618

`MEASurement<m>:HISTogram:LCHeck<n>:LOWer:LIMit` on page 1650

`MEASurement<m>:HISTogram:LCHeck<n>:LOWer:MARGin` on page 1650

`MEASurement<m>:HISTogram:LCHeck<n>:UPPer:LIMit` on page 1650

`MEASurement<m>:HISTogram:LCHeck<n>:UPPer:MARGin` on page 1650

`MEASurement<m>:HISTogram:LCHeck<n>:VALid` on page 1649

`MEASurement<m>:SPECTrum:LCHeck<n>:LOWer:LIMit` on page 1636

`MEASurement<m>:SPECTrum:LCHeck<n>:LOWer:MARGin` on page 1636

`MEASurement<m>:SPECTrum:LCHeck<n>:UPPer:LIMit` on page 1636

`MEASurement<m>:SPECTrum:LCHeck<n>:UPPer:MARGin` on page 1636

`MEASurement<m>:SPECTrum:LCHeck<n>:VALid` on page 1635

8.2.12.3 Actions on limit check results

To define what happens when the limits and margins are exceeded, tap Action on limit event below the limit and margin ranges.

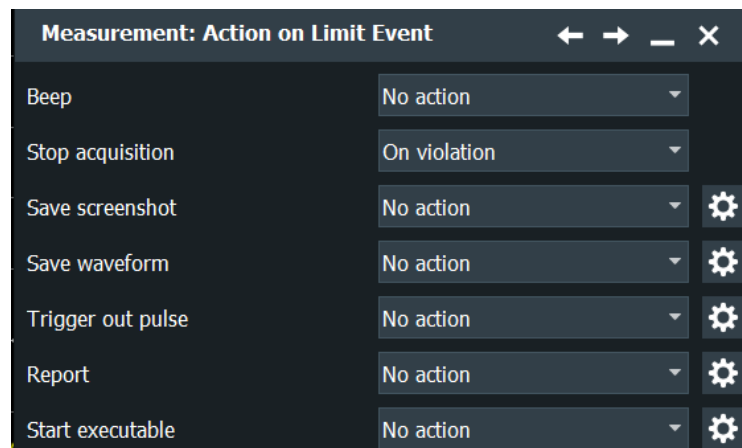

Actions are initiated by all measurements and all results measured on one acquisition.

Note that the violation actions do not distinguish between a margin violation and a limit violation. However, different icons are displayed in the result box.

For each action, you can define the event on which the action is initiated:

- On violation
The action is initiated when the limits or margins are exceeded during the measurement.
- On successful completion
The action is initiated when a defined number of acquisitions has been captured, and the limits or margins were not exceeded.

Independent of these actions, an icon is displayed in the result box, see [Chapter 8.2.2, "Measurement results"](#), on page 310.

Beep

Generates a beep sound.

Remote command:

[MEASurement<m>:ONViolation:BEEP](#) on page 1671

Stop acq

Stops data acquisition on violation.

Remote command:

[MEASurement<m>:ONViolation:ACQStop](#) on page 1671

Save Wfm

Saves the waveform data to the file.

Remote command:

[MEASurement<m>:ONViolation:WFMSave](#) on page 1672

Trigger Out Pulse

Creates a pulse on the Trigger Out connector on limit violation.

When "Trigger Out Pulse" is used, the trigger control option "Enable trigger out" is disabled. Thus, the trigger-out pulse is created only on limit violation but not when a trigger occurs. The pulse is provided always with the minimum delay of 800 ns, the "Delay" cannot be set.

See also: ["Trigger out signal setup"](#) on page 229.

Remote command:

[MEASurement<m>:ONViolation:TRIGgerout](#) on page 1672

Report

Creates and saves a report using the settings defined in "File" menu > "Report Setup".

Remote command:

[MEASurement<m>:ONViolation:REPort](#) on page 1672

Start Executable

Starts an external application. Tap "Config Executable" to set the application path and parameters.

Remote command:

[MEASurement<m>:ONViolation:RUNexec](#) on page 1673

8.3 Quick measurements

Quick measurement performs a set of up to eight amplitude/time measurements on one source, simply by tapping the "Quick measurement" toolbar icon. The results are displayed in a results box. You can configure the measurement to be included in quick measurement. The current configuration can be saved to repeat the measurement quickly.

8.3.1 Starting the quick measurement

If the "Quick meas" icon is not visible on the toolbar, add it to the toolbar: see [Chapter 3.3.6.2, "Configuring the toolbar"](#), on page 54.

1. Tap the waveform that you want to measure.
2. Tap the "Quick measurement" icon on the toolbar.



3. Tap the diagram.

The result box shows the results of the default quick measurement.

QuickMeas	
Source	c1
High	122.53 mV
Low	-126.48 mV
Amplitude	249.01 mV
Max	125.93 mV
Min	-125.81 mV
Peak to peak	251.74 mV
Mean	86.964 μ V
RMS	82.571 mV

8.3.2 Configuring the quick measurement

The default configuration of the quick measurement includes already 8 amplitude measurements. If these measurements do not fit the measurement task, you can modify the selection.

1. Open "Menu" > "Measure" > "Setup".
2. Select the "QM" subtab.



3. Tap "Add/Remove Measurements".
4. Disable all measurements that you do not need.

5. Select the measurements that you want to add to the quick measurement.
6. Tap "OK".
7. A "Settings" icon indicates whether further settings are required. Tap the measurement. A dialog box opens, where you can adjust the measurement.
8. Tap "Set as QuickMeas" to save the setup.
The saved iQuickMeas setup is used when you start a new quick measurement.
9. "Enable" the measurement.

Set as QuickMeas

Saves the current QuickMeas setup. The saved QuickMeas configuration is used when you start a new quick measurement. It remains until you save another QuickMeas setup, or until you reset the instrument to "Factory defaults". The "Set as QuickMeas" is not available if the current configuration already has been saved.

9 Spectrum analysis

The R&S RTO6 provides two ways of spectrum analysis:

- Basic FFT calculation, which is included in the firmware
- Spectrum analysis option R&S RTO6-K37, which provides a wide range of analysis possibilities, for example, spectrogram, cursor and automatic measurements.

9.1 FFT analysis

9.1.1 Fundamentals of FFT analysis

During FFT analysis, a signal in the time domain is converted to a spectrum of frequencies. As a result, either the magnitude or the phase of the determined frequencies can be displayed. FFT analysis can be restricted to an extract of the original time base, and the results display can be restricted to a specified frequency range.

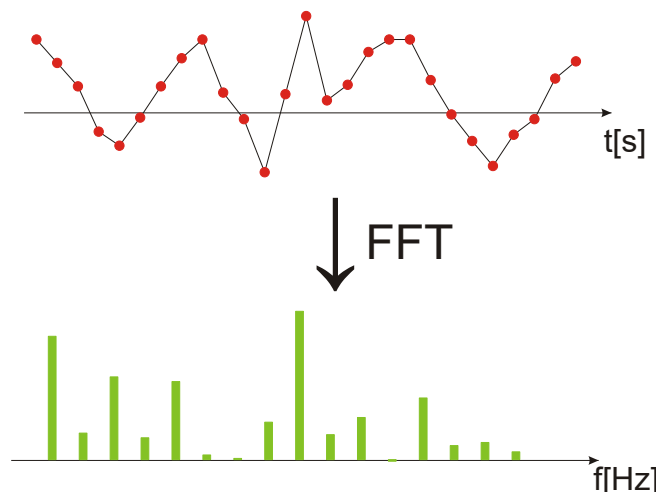

Frames/Segments

To convert the time domain signal to a frequency spectrum, an FFT (Fast Fourier Transformation) unit is used which converts a vector of input values into a discrete spectrum of frequencies.

Conventional oscilloscopes calculate one FFT per capture. The R&S RTO6 can calculate multiple FFTs per capture by dividing one capture into several *segments*, or *frames*. Thus, the R&S RTO6 can visualize how the frequency content of a signal changes over time which helps to detect intermittent or sporadic signal details. Furthermore, the R&S RTO6 allows consecutive frames to overlap. This is especially useful in conjunction with window functions since it enables a gap-free frequency analysis of the signal.

The overlapping factor can be set freely. The higher the overlap factor, the more frames are used. This leads to more individual results and improves detection of transient signal effects. However, it also extends the duration of the calculation. The size of the frame depends on the number of input signal values (record length), the overlap factor, and the FFT size (number of samples used for FFT calculation).

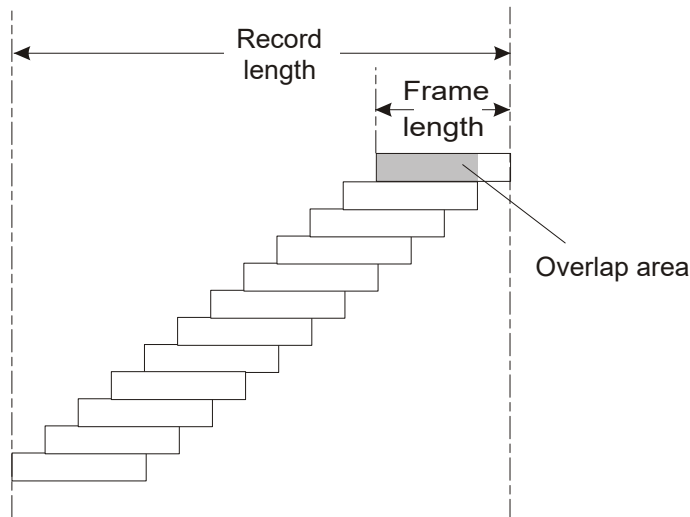

Window functions

Each frame is multiplied with a specific window function after sampling in the time domain. Windowing helps minimize the discontinuities at the end of the measured signal interval and thus reduces the effect of spectral leakage, increasing the frequency resolution.

There are several window functions that can be used in FFT analysis. Each of the window functions has specific characteristics, including some advantages and some trade-offs. Consider these characteristics carefully to find the optimum solution for the measurement task.

For details, see ["Window type"](#) on page 387.

Combining FFT results

After the window function has been applied to the FFT results for each segment, the results for all segments of the data acquisition must be combined to obtain the final waveform. Various arithmetic functions are available for FFT segments, such as averaging, enveloping, or minimum and maximum calculation.

Gating functions

You can restrict the time base of the input signal for which FFT analysis is to be performed. There are various methods to do so:

- Define absolute start and stop times for the time base extract
- Define relative start and stop values that define a percentage of the original time base
- Couple the time base extract for FFT to an active zoom area.

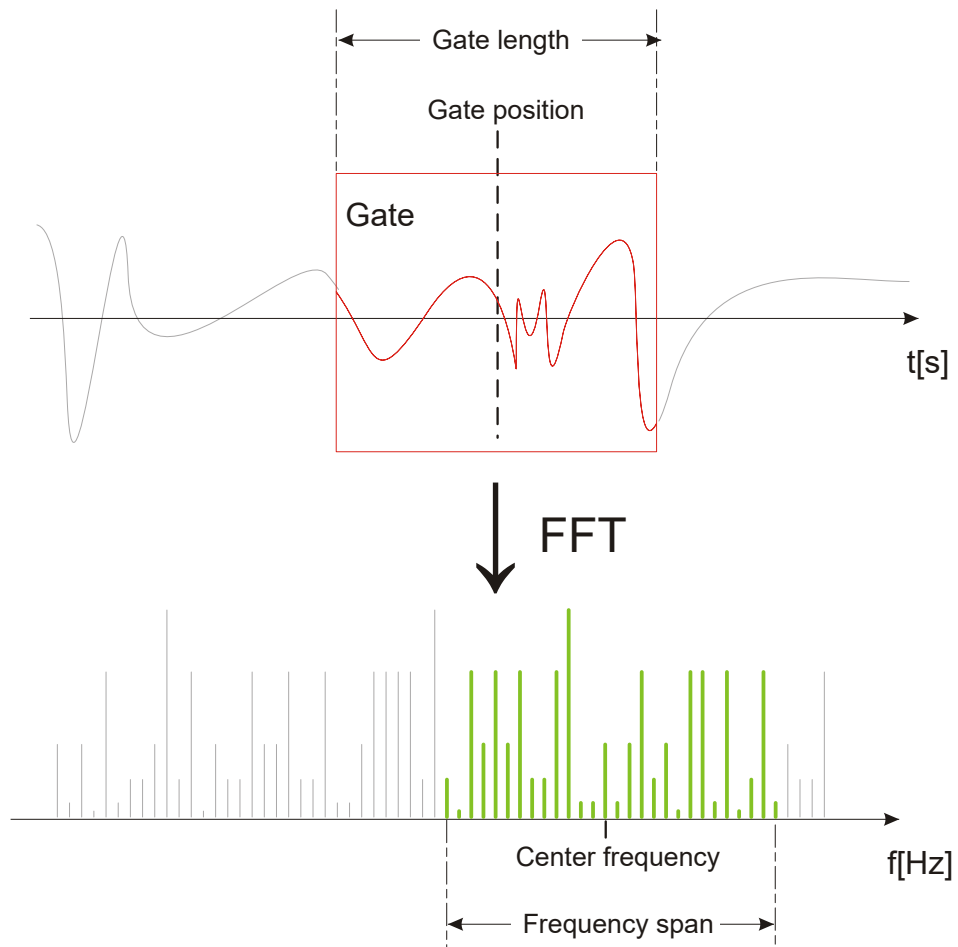

Restricting the result range

You can restrict the results of the FFT analysis to a specified frequency range. The frequency range can be defined in two ways:

- Define a center frequency and frequency span
- Define start and stop frequencies



Using the new cursor functions for spectrum waveforms you can easily determine the results for the current center frequency by moving the cursor to that frequency ("C1 to Center"). If you detect a point of interest in the spectrum diagram, you can place the cursor on it and then move the center frequency to the position of the cursor automatically ("Center to C1").

See [Chapter 8.1, "Cursor measurements"](#), on page 293.

Magnitude vs. phase display

The result of an FFT analysis is a spectrum of frequencies. Either the magnitudes or the phases of those frequencies are displayed, depending on the used FFT function. In "Basic" mode, and for the "Advanced" mode FFT functions |FFT|, FFT (re) and FFT

(**im**), the magnitude is displayed. For the "Advanced" mode FFT (ϕ) function, the phase is displayed.

For magnitude display, you can select the scale and range of magnitudes to be displayed. For linear scaling, the vertical value range of the input signal is used. For logarithmic scaling, the logarithmic power of the frequency is displayed. In this case, the input signal must be given in either Volt or Watt. The resulting value range is defined by a maximum value and a range size. Logarithmic scaling can also be set in relation to a given reference value.

For phase display, you can select the unit and suppress phases beneath a threshold value which are most likely caused by noise. The value range $[-\pi, +\pi]$ or $[-180^\circ, +180^\circ]$ is used. Phase shifts due to a limitation of the value range can be eliminated using the "Unwrap" function.

Dependencies between FFT parameters

FFT analysis in the R&S RTO6 is highly configurable. Several parameters, including the resolution bandwidth, frequency span and center frequency, can be defined according to your requirements. Note, however, that several parameters are correlated and not all can be configured independently of the others.

The **resolution bandwidth** defines the minimum frequency separation at which the individual components of a spectrum can be distinguished. Small values result in high precision, as the distance between two distinguishable frequencies is small. Higher values decrease the precision, but increase measurement speed.

The minimum achievable RBW depends on the integration time which is equivalent to the number of samples available for FFT calculation. If a higher spectral resolution is required, the number of samples must be increased by using a higher sample rate or longer record length. To simplify operation some parameters are coupled and automatically calculated, such as record length and RBW.

The **frequency span** and **center frequency** define the start and stop frequency of the spectral diagram. By default, a suitable frequency range according to the resolution bandwidth is selected, in respect to performance and precision. Span and RBW settings are coupled, so that the parameters can be adjusted automatically as necessary.

With a **Span/RBW ratio** of 100 and a screen resolution of 1000 pixels, each frequency in the spectrum is displayed by 10 pixels. A span/RBW ratio of 1000 provides the highest resolution. For full flexibility, the span/RBW coupling can also be disabled. Note, however, that a higher span/RBW ratio (i.e. low RBW values and large frequency spans) result in large amounts of data and extend the duration of the calculation.

Advanced FFT functions

In "Advanced" math definition mode, other FFT results than the basic frequency magnitude can be displayed.

- **FFT (ϕ)**: phase display
- **FFT (**im**)**: imaginary part of FFT value (magnitude)
- **FFT (**re**)**: real part of FFT value (magnitude)

- **FFT $-d\phi/df$** (group delay): the negative derivative of the phase with respect to frequency; useful to measure phase distortion

9.1.2 Configuring spectrum waveforms

During FFT analysis, a signal in the time domain is converted to a spectrum of frequencies. A basic spectrum waveform can be displayed quickly. By defining additional FFT parameters, the waveform can be configured in more detail.

As a result, either the magnitude or the phase of the determined frequencies can be displayed, or more complex FFT functions. Analysis can be restricted to an extract of the original time base, and the results display can be restricted to a specified frequency range.

To display a basic spectrum waveform using the toolbar

1. Add the "FFT" icon to the toolbar, see [Chapter 3.3.6.2, "Configuring the toolbar"](#), on page 54 .



2. Tap the "FFT" icon on the toolbar.

The FFT overlay menu opens.

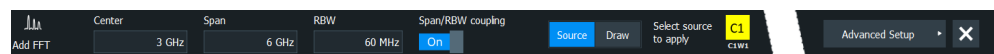

3. Tap the waveform for which the FFT is performed.

The first available math waveform is configured to use the selected waveform as a source and the "Mag(FFT(x))" operator, and is enabled. The spectrum waveform is displayed in a new diagram.

To display a basic spectrum waveform using the [FFT] key

1. Press the [FFT] key.
The "FFT" tab of the "Math" dialog opens.
2. Set the "Source" to the input signal.
3. Enable "Display".
4. If necessary, edit the spectrum waveform parameters as described in the following procedures.

To display advanced spectrum waveforms

Using the "Formula Editor", you can display other FFT results than the basic frequency magnitude, and use more FFT sources.

1. Open the "Menu" > "Math" dialog.
2. Select the Equation tab.

3. Double-tap the editing area.
The "Formula Editor" is displayed.
4. Delete the contents of the edit field.
5. Tap the "More" key to display further functions in the editor.
6. Tap the required FFT function key.
7. Select the source channel.
8. Close the parenthesis.
9. Tap "Enter"
10. Select the "Scale" tab to adjust the vertical and horizontal scale of the spectrum.
11. On the "Setup" tab, select "FFT setup" to configure the spectrum. See ["To configure the spectrum of FFT analysis"](#) on page 381.

To configure the spectrum of FFT analysis

By default, a suitable frequency range for the expected horizontal values according to the resolution bandwidth is selected, in respect to performance and precision. Span and RBW settings are coupled. If a more precise evaluation is required, for example for postprocessing in a different application, disable the coupling and change the frequency ranges and resolution bandwidth values as required.

1. Open [FFT] > "FFT setup".

The "FFT" dialog opens.

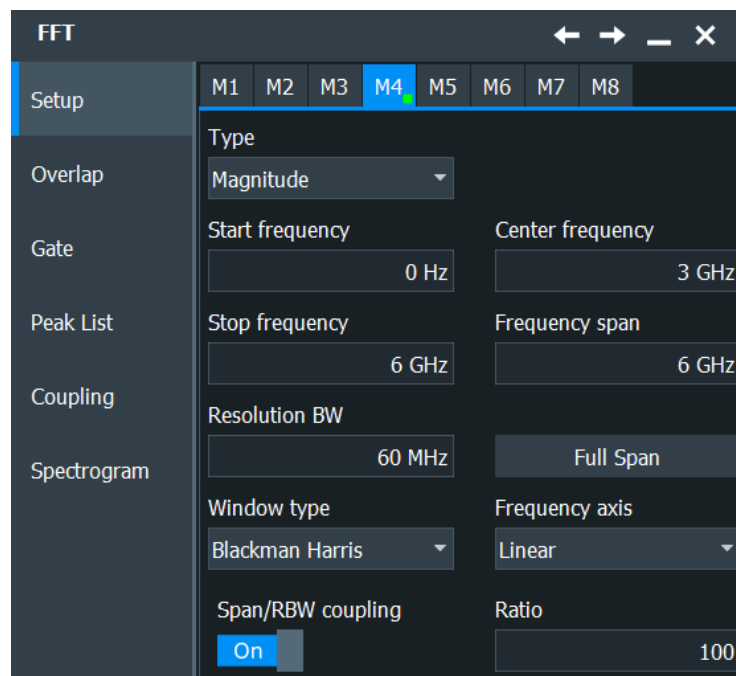

2. In the "Setup" tab, tap the "Frequency axis" button to select the type of scaling you want to use: linear or logarithmic.

3. Disable the "Span/RBW coupling".
4. Specify the frequency range you want to display using one of the following methods:
 - Enter a "Center frequency" and a "Frequency span" that define the spectrum.
 - Enter a "Start frequency" and "Stop frequency" that define the spectrum.
 - Tap the "Full Span" button to display the complete spectrum resulting from the FFT analysis.
5. Define the resolution bandwidth for the FFT result.

The resolution bandwidth defines how precise the results are, i.e. how close together the individual frequencies can be. Small values result in high precision, as the distance between two distinguishable frequencies is small. Higher values decrease the precision, but increase performance.

You can define the RBW manually, or couple it to other FFT settings. Do one of the following:

 - To couple the RBW to the span, enable the "Span/RBW coupling" option and define the "Ratio". The smaller the ratio, the higher the RBW becomes to display the same frequency span.
 - Enter the "Resolution BW" manually. The "Span/RBW coupling" option is automatically disabled.
 - To couple the RBW to the specified record length, in the " Gate" tab of the "Advanced FFT" dialog box, select the "Record length controlled" option. This option is only available if no gate is being used ("Use Gate" disabled).
6. Select the most suitable "Window type" for your source data. Window functions are multiplied with the input values and thus can improve the FFT display. For details, see "[Window type](#)" on page 387.
7. Optionally, select an arithmetic mode for the FFT segments. This mode defines how the individual segment results are combined to a final spectrum waveform. In the "Overlap" tab of the "Advanced FFT" dialog box, tap "Segment arithmetic" and select the required mode from the list.
8. If you use an arithmetic mode, increase the "Overlap factor" for neighboring segments to increase the accuracy of the results.

To restrict the input values (gating)

By default, the FFT is calculated for the entire record length as defined for the data acquisition. However, you can restrict the time range for which the FFT is calculated, resulting in a restricted spectrum. Alternatively, the record length can be determined automatically according to the selected RBW.

1. Open [FFT] > "FFT setup" > "Gate" tab.
2. Determine how the input length is configured by selecting one of the following options:
 - To ensure that the FFT is calculated for the full defined record length, select the "Record length controlled" option. This option is only available if no gate is

being used ("Use Gate" disabled). The RBW is adapted so that the record length can be acquired in the specified acquisition time. However, the RBW is restricted, so that data acquisition may fail if the record length is too long for the specified acquisition time.

- To couple the used record length to the required RBW, select the "RBW controlled" option. This option is only available if no gate is being used ("Use Gate" disabled).

The required acquisition time for the defined RBW value is indicated.

- To restrict the basis of the FFT calculation to a certain time base, configure a time gate, that is: an extract of the time base in the original diagram. To do so, enable the "Use Gate" option, then do one of the following:
 - Select the "Absolute" mode and enter the "Start" and "Stop" times that define the gate area.
 - Select the "Relative" mode and enter the percentages of the total time base that define the "Relative Start" and "Relative Stop" times.
 - If a zoom area has already been defined in the original diagram and you want to use the same time base for FFT analysis, select "Zoom coupling".

The spectrum waveform displays the spectrum for the specified time span.

To configure magnitude results

1. Open [FFT] > "FFT setup" > "Setup" tab.
2. Set "Type" = "Magnitude".
3. In the "Scale" tab of the "Math" dialog, select the "Unit".
4. Select the "Vertical scale mode" to configure the value range manually or use the automatic settings.
5. For "Vertical scale mode" > "Manual", define the size of the "Vertical range" and the "Vertical maximum" to be displayed.
For "Vertical scale mode" > "Auto", define the size of the "Vertical range" to be displayed.
For logarithmic scaling ("Unit = dB"), also define the "Reference level" to be used.

To configure phase results

1. Open [FFT] > "FFT setup" > "Setup" tab.
2. Set "Type" = "Phase".
3. In the "Scale" tab of the "Math" dialog, select the "Unit".
4. To eliminate phase shifts due to a limitation of the value range, enable the "Unwrap" function.
5. To suppress small phase values due to noise, enable the "Suppression" function and enter a "Threshold" value.

To couple spectrum displays

The settings for one or more spectrums can be coupled. Thus, if any FFT setting for any of the coupled spectrums are changed, they are changed for all coupled spectrums.

1. Open [FFT] > "FFT setup" > "Overlap" tab.
2. Select the spectrums that you need to couple. You cannot select the spectrum for the currently selected math waveform. Its settings are applied to the selected spectrums.
3. If necessary, define an FFT function to be used for the coupled math waveforms so that a spectrum is displayed. See [Chapter 7.3.1, "Displaying math waveforms"](#), on page 261.

9.1.3 FFT configuration settings

• FFT setup	384
• FFT overlap	388
• FFT gating	389
• Peak list	392
• FFT coupling	392

9.1.3.1 FFT setup

Access: [FFT] > "FFT setup" > "Setup" tab

In this tab, you define the settings for the FFT window. The display can be restricted to the results for a certain time base extract and to a specified frequency range.



Additional settings are available if the Spectrum analysis option (R&S RTO6-K37) is installed.

See [Chapter 9.2.4, "Spectrogram configuration settings"](#), on page 398.

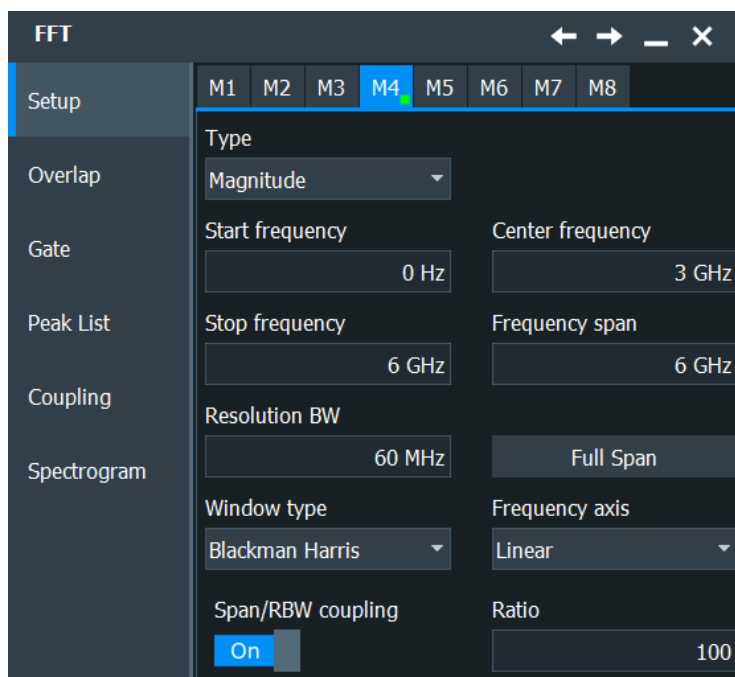

Type.....	385
Display.....	385
Frequency axis.....	385
Center frequency.....	386
Frequency span.....	386
Full span.....	386
Start frequency.....	386
Stop frequency.....	386
Span/RBW Coupling.....	386
Span/RBW Ratio.....	387
Resolution BW.....	387
Window type.....	387
Use color table.....	387

Type

Selects between the magnitude and phase spectrum type.

Remote command:

`CALCulate:MATH<m>:FFT:TYPE` on page 1676

Display

If activated, a diagram for the defined math waveform is displayed on the touchscreen.

Remote command:

`CALCulate:MATH<m>:STATe` on page 1558

Frequency axis

Defines the scaling method for the frequency (x-) axis of the spectrogram.

"Logarithmic" Logarithmic scaling

"Linear Unit" Linear scaling

Remote command:

[CALCulate:MATH<m>:FFT:LOGScale](#) on page 1674

Center frequency

Defines the position of the displayed frequency range, which is (Center - Span/2) to (Center + Span/2). The width of the range is defined using the "Frequency span" setting.

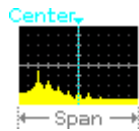

Remote command:

[CALCulate:MATH<m>:FFT:CFrequency](#) on page 1675

Frequency span

The span is specified in Hertz and defines the width of the displayed frequency range, which is (Center - Span/2) to (Center + Span/2). The position of the span is defined using the "Center frequency" setting.

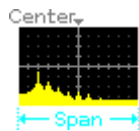

Remote command:

[CALCulate:MATH<m>:FFT:SPAN](#) on page 1676

Full span

Displays the full frequency span.

Remote command:

[CALCulate:MATH<m>:FFT:FULLspan](#) on page 1676

Start frequency

Defines the start frequency of the displayed frequency span.

Remote command:

[CALCulate:MATH<m>:FFT:START](#) on page 1674

Stop frequency

Defines the stop frequency of the displayed frequency span.

Remote command:

[CALCulate:MATH<m>:FFT:STOP](#) on page 1675

Span/RBW Coupling

Couples the frequency span to the "Resolution BW" setting.

Remote command:

[CALCulate:MATH<m>:FFT:BANDwidth\[:RESolution\]:AUTO](#) on page 1677

Span/RBW Ratio

Defines the coupling ratio for Span/RBW. This setting is only available if `CALCulate:MATH<m>:FFT:BANDwidth[:RESolution]:AUTO` is ON.

Remote command:

`CALCulate:MATH<m>:FFT:BANDwidth[:RESolution]:RATio` on page 1677

Resolution BW

Defines the resolution bandwidth. Note that the resolution bandwidth is correlated with the span, record length and acquisition time. If a constant record length is to be used, the RBW may be adapted if the required number of samples cannot be acquired. If span and RBW values are coupled, changing the span will also change the RBW.

For details see [Chapter 9.1.1, "Fundamentals of FFT analysis"](#), on page 376.

Remote command:

`CALCulate:MATH<m>:FFT:BANDwidth[:RESolution][:VALue]` on page 1677

`CALCulate:MATH<m>:FFT:BANDwidth[:RESolution]:ADJusted?` on page 1676

Window type

Windowing helps minimize the discontinuities at the end of the measured signal interval and thus reduces the effect of spectral leakage, increasing the frequency resolution.

Various different window functions are provided in the R&S RTO6 to suit different input signals. Each of the window functions has specific characteristics, including some advantages and some trade-offs. Consider these characteristics carefully, to find the optimum solution for the measurement task.

Window type	Frequency resolution	Magnitude resolution	Measurement recommendation
Rectangular	Best	Worst	Separation of two tones with almost equal amplitudes and a small frequency distance
Hamming Hann	Good	Poor	Frequency response measurements, sine waves, periodic signals and narrow-band noise
Blackman Harris (default)	Worst	Best	Mainly for signals with single frequencies to detect harmonics Accurate single-tone measurements
Gaussian	Good	Good	Weak signals and short duration
FlatTop2	Poor	Best	Accurate single-tone measurements
Kaiser Bessel	Poor	Good	Separation of two tones with differing amplitudes and a small frequency distance

Remote command:

`CALCulate:MATH<m>:FFT:WINDow:TYPE` on page 1678

Use color table

If enabled, the spectrum waveform (and a spectrogram, if available) is displayed according to the assigned color table. For information on the available color tables, see [Chapter 4.3.2, "Color tables"](#), on page 76.

If this option is disabled, the preset color of the selected channel source is displayed, and the intensity of the specific signal color varies according to the cumulative occurrence of the values. For spectrum diagrams, this setting corresponds to the common waveform display. The spectrogram, on the other hand, is then displayed in gray tones, which is not useful.

Remote command:

`CALCulate:MATH<m>:FFT:USEColtab` on page 1689

9.1.3.2 FFT overlap

Access: [FFT] > "FFT setup" > "Overlap" tab

In this tab, you define the settings for the magnitude and phase of the frequencies.

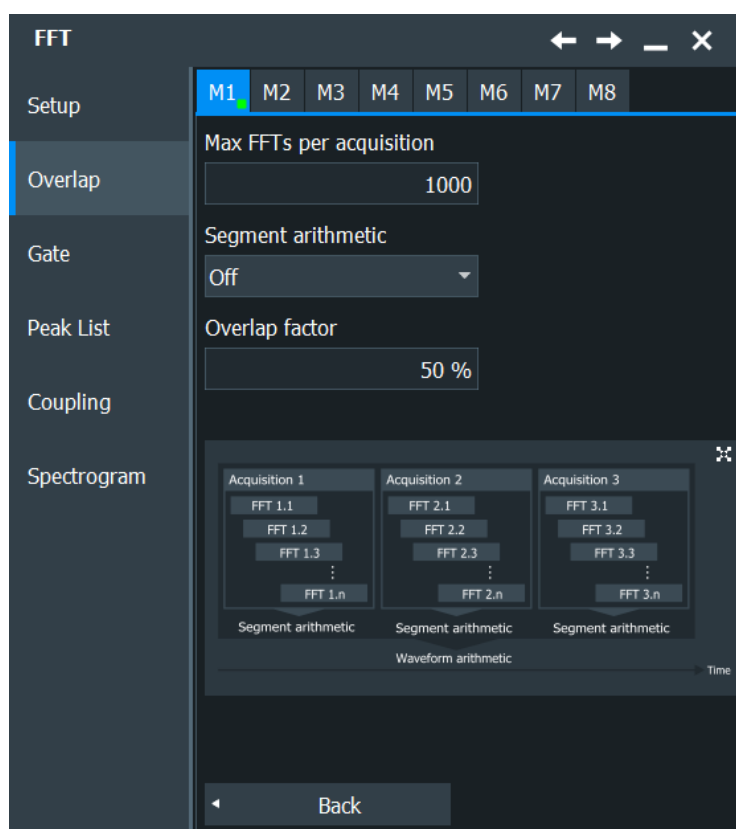

Max FFTs per acquisition	388
Segment arithmetic	389
Overlap Factor	389

Max FFTs per acquisition

Restricts the maximum number of FFTs to be calculated for each data acquisition. Due to the other parameter settings, the required number of FFTs may become very high, thus slowing performance. By restricting the number of FFTs, you can avoid performance loss without changing the other parameters.

However, if the maximum number of FFTs is lower than the required number to cover the entire waveform, the waveform may only be analyzed partially. In this case, the "Frame coverage" indicates the percentage of the waveform that was analyzed, i.e. which part of the data was included in the FFT calculation.

Remote command:

[CALCulate:MATH<m>:FFT:FRAMe:MAXCount](#) on page 1680

[CALCulate:MATH<m>:FFT:FRAMe:COVerge?](#) on page 1679

Segment arithmetic

FFT analysis can only be performed on a maximum number of values at once. If more values must be calculated, the input signal is divided into segments, each of which is calculated separately. The segments need not be disjunct, that is: they may overlap, so that some values have several FFT results. In this case, the arithmetic mode defines how the final result is calculated from the individual results.

The following methods are available:

"Off"	The data of only one segment is considered. In effect, no arithmetics are processed.
"Envelope"	Detects the minimum and maximum values for FFT calculation over all segments. The resulting diagram shows two envelope waveforms: the minimums (floor) and maximums (roof). These envelopes indicate the range of all FFT values that occurred.
"Average"	The average is calculated over all segments.
"RMS"	The root mean square is calculated over all segments. The result is the average power spectrum. If you measure the channel power on this RMS spectrum, you get the same result as for the average channel power measurement on segments.
"MinHold"	Determines the minimum result for each input value from the data of the current acquisition and the acquisitions before.
"MaxHold"	Determines the maximum result for each input value from the data of the current acquisition and the acquisitions before.

Remote command:

[CALCulate:MATH<m>:FFT:FRAMe:ARITHmetics](#) on page 1679

Overlap Factor

Defines the minimum factor by which two neighboring segments overlap. If the required number of segments to cover the input values allows for more overlap, the factor is increased.

The higher the overlap factor, the more segments are used. This leads to more individual results and improves detection of transient signal effects. However, it also extends the duration of the calculation.

Remote command:

[CALCulate:MATH<m>:FFT:FRAMe:OFACTor](#) on page 1680

9.1.3.3 FFT gating

Access: [FFT] > "FFT setup" > "Gate" tab

FFT gating allows you to restrict FFT analysis to a certain time base of the input signal.

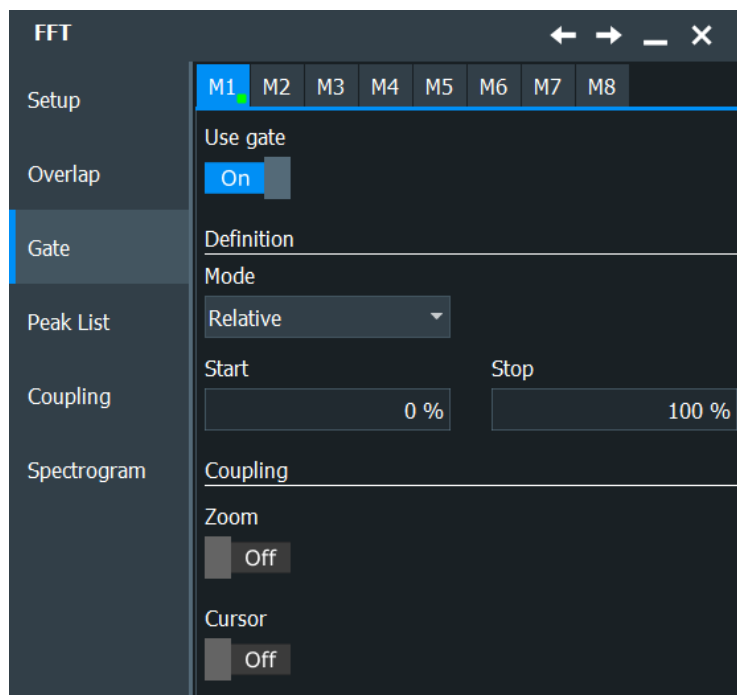

If no gate is used, you can define the record length as dependent on the RBW, or the RBW as dependent on the record length (which is defined by the acquisition time).

Use Gate.....	390
Gate Definition.....	390
L Zoom.....	391
L Gate description.....	391
L (Relative) Start.....	391
L (Relative) Stop.....	391
Record Length/RBW Coupling.....	392
Required acquisition time.....	392

Use Gate

Enables FFT gating and shows the gate.

If enabled, the "Gate Definition" settings are used.

If disabled, the relation between the record length and the RBW can be defined manually in the "Setup" tab instead.

When a gate is used, the RBW is adapted, if necessary. The smaller the gate, the higher the RBW.

For details, see [Chapter 9.1.1, "Fundamentals of FFT analysis"](#), on page 376.

Gate Definition

Defines the gate settings for FFT gating.

Zoom ← Gate Definition

Zoom coupling is available if a zoom is defined. As long as "Zoom coupling" is enabled, the gate area is defined identically to the zoom area - if you change the zoom, the gate changes as well.

If several zoom diagrams are defined, select the zoom diagram to be used for gating. The "Start" and "Stop" values of the gate are adjusted accordingly.

Zoom coupling can be set for measurement gates, FFT gates, and search gates. The zoom must be defined on the diagram that contains the signal source of the measurement, FFT, or search.

Remote command:

[MEASurement<m>:GATE:ZCOupling](#) on page 1669

[MEASurement<m>:GATE:ZDIagram](#) on page 1670

[CALCulate:MATH<m>:FFT:GATE:ZCOupling](#) on page 1683

[SEARch:GATE:ZCOupling](#) on page 1747

[SEARch:GATE:ZDIagram](#) on page 1748

Gate description ← Gate Definition

Defines whether the gate settings are configured using absolute or relative values.

"Absolute" The gate is defined by absolute start and stop values.

"Relative" The gate's start and stop values are defined by a percentage of the value range.

Remote command:

[CALCulate:MATH<m>:FFT:GATE:MODE](#) on page 1682

[MEASurement<m>:GATE:MODE](#) on page 1667

[SEARch:GATE:MODE](#) on page 1745

(Relative) Start ← Gate Definition

Defines the starting value for the gate.

Remote command:

[CALCulate:MATH<m>:FFT:GATE:ABSolute:START](#) on page 1681

[CALCulate:MATH<m>:FFT:GATE:RELative:START](#) on page 1682

[MEASurement<m>:GATE:ABSolute:START](#) on page 1668

[MEASurement<m>:GATE:RELative:START](#) on page 1668

[SEARch:GATE:ABSolute:START](#) on page 1746

[SEARch:GATE:RELative:START](#) on page 1747

(Relative) Stop ← Gate Definition

Defines the end value for the gate.

Remote command:

[CALCulate:MATH<m>:FFT:GATE:ABSolute:STOP](#) on page 1682

[CALCulate:MATH<m>:FFT:GATE:RELative:STOP](#) on page 1683

[MEASurement<m>:GATE:ABSolute:STOP](#) on page 1668

[MEASurement<m>:GATE:RELative:STOP](#) on page 1668

[SEARch:GATE:ABSolute:STOP](#) on page 1746

[SEARch:GATE:RELative:STOP](#) on page 1747

Record Length/RBW Coupling

The record length and resolution bandwidth are coupled during FFT analysis. If you change one value, the other must be adapted accordingly. You can keep either value constant, thus preventing automatic adaptation when the other parameter is changed. However, this may cause the FFT analysis to fail.

This setting is only available if gating is not enabled (otherwise the gate determines the RBW automatically).

For details, see [Chapter 9.1.1, "Fundamentals of FFT analysis"](#), on page 376.

"Record length controlled" The record length remains constant. If not enough samples are available for the selected RBW, the RBW is decreased.

"RBW controlled" The RBW is not adapted, i.e. remains as defined. The required acquisition time for this RBW is indicated. If necessary and possible, the record length is extended to acquire the required number of samples.

Remote command:

[CALCulate:MATH<m>:FFT:GATE:COUPling](#) on page 1681

Required acquisition time

The required acquisition time is calculated for the defined RBW value if "RBW constant" is selected, and is displayed for information only. If the required acquisition time is not available (e.g. because acquisition has already been stopped), an error message is displayed in the [FFT setup](#) tab indicating that not enough samples are available for the defined RBW.

Remote command:

[TIMEbase:RACTime?](#) on page 1681

9.1.3.4 Peak list

For a description of the "Peak List" settings, see [Chapter 8.2.6, "Spectrum measurements"](#), on page 341.

9.1.3.5 FFT coupling

Access: [FFT] > "FFT setup" > "Coupling" tab

Up to four spectrum displays can be shown simultaneously, one for each math waveform. The settings for one or more spectrums can be coupled. Thus, if any FFT setting for any of the coupled spectrums are changed, they are changed for all coupled spectrums.

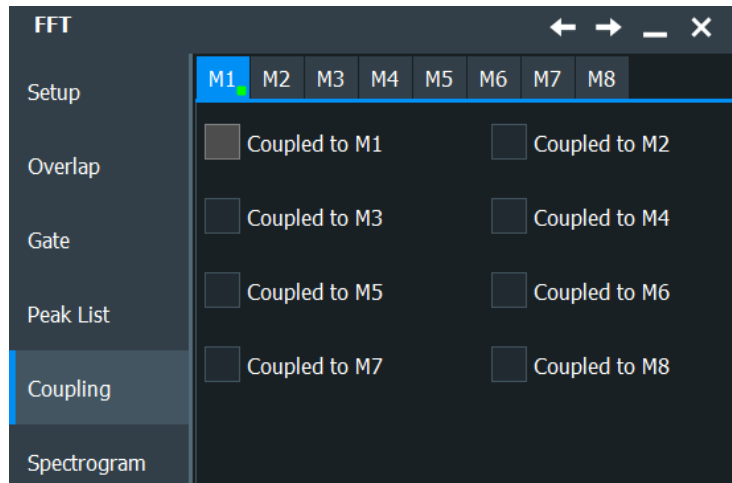

Coupled to M1...M8

Copies the current FFT settings of the selected math waveform (M1...M8) to the other selected math waveforms, and couples those waveforms. Thus, if any FFT setting for any of the coupled spectrums are changed, they are changed for all coupled spectrums.

Two different sets of spectrums can be coupled at the same time, for instance "M1" can be coupled to "M2", while "M3" is coupled to "M4".

Note that the formula of the coupled math waveforms is not changed. If necessary, you must select an FFT function for the math waveform manually before the FFT settings of the coupled waveform are applied. See [Chapter 7.3.1, "Displaying math waveforms"](#), on page 261.

Remote command:

`CALCulate:MATH<m>:FFT:COUPled:WITH<1..8>` on page 1687

9.1.4 FFT scale settings

In this section, you can find functions to set the vertical parameters of the FFT math waveform.

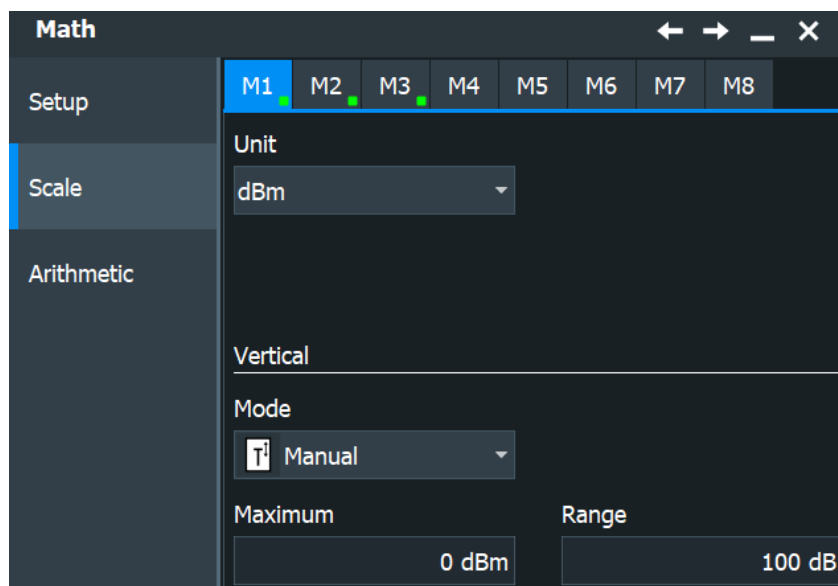

Figure 9-1: Scale settings of magnitude spectrum

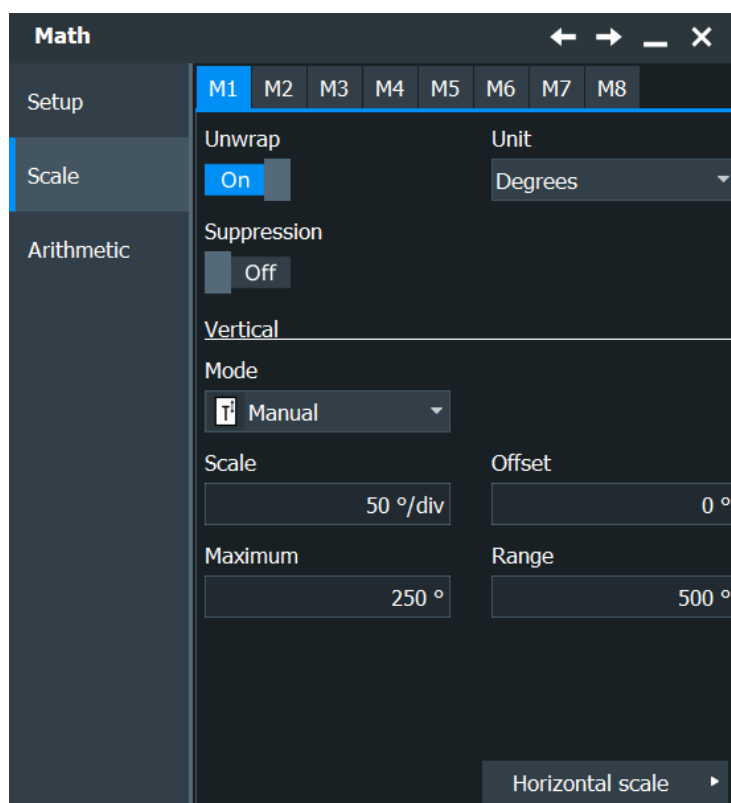

Figure 9-2: Scale settings of phase spectrum

See also:

- [Vertical scaling mode \(Manual/Auto\)](#)
- [Vertical Offset](#)

- [Vertical Scale](#)

Unit

Defines the scaling unit for magnitude display. Available units depend on the unit of the selected source waveform.

"Linear" displays the RMS value of the voltage.

Remote command:

[CALCulate:MATH<m>:FFT:MAGNitude:SCALE](#) on page 1684

Reference level

Defines the reference level if "dB" is the selected unit.

Remote command:

[CALCulate:MATH<m>:FFT:MAGNitude:LEVel](#) on page 1684

Vertical maximum

Defines the maximum value on y-axis for spectrum displays. Only available for "Manual" scale mode.

Remote command:

[CALCulate:MATH<m>:VERTical:MAXimum](#) on page 1561

Vertical range

Defines the range of FFT values to be displayed.

Remote command:

[CALCulate:MATH<m>:VERTical:RANGe](#) on page 1560

Unwrap

If enabled, phase shifts due to a limitation of the value range are eliminated.

Remote command:

[CALCulate:MATH<m>:FFT:PHASe:UNWRap](#) on page 1687

Unit

Defines the scaling unit for phase display.

- Radians
- Degrees

Remote command:

[CALCulate:MATH<m>:FFT:PHASe:SCALE](#) on page 1686

Suppression

Enables noise suppression. Phase calculation is restricted to frequencies with a minimum magnitude, the threshold value.

Remote command:

[CALCulate:MATH<m>:FFT:PHASe:SUPPression](#) on page 1686

Threshold

Defines the minimum frequency magnitude for which phases are calculated. This setting is only available if "Suppression" is enabled.

Remote command:

`CALCulate:MATH<m>:FFT:PHASe:THReshold` on page 1686

9.2 Spectrum analysis (option R&S RTO6-K37)

This chapter describes the Spectrum analysis option R&S RTO6-K37.

9.2.1 Spectrogram display

The Spectrum analysis option provides a new diagram for spectrum waveforms: a spectrogram. When you enable a spectrogram, three windows are displayed: the power vs. time diagram at the top, the spectrogram in the middle (labeled "SG") and the power vs. frequency (=spectrum) diagram at the bottom.

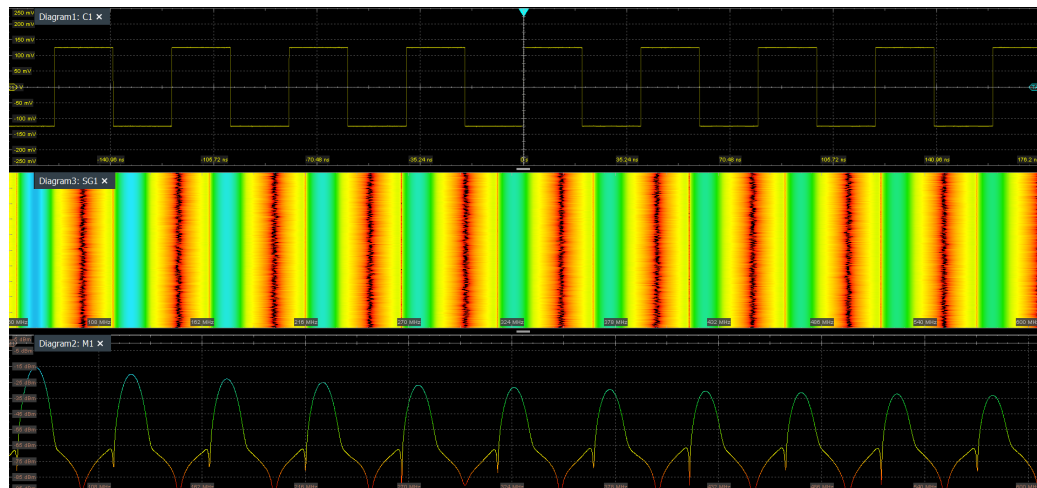

A spectrogram shows how the spectral density of a signal varies over time. The x-axis shows the frequency, the y-axis shows the time. A third dimension, the power level, is indicated by different colors. Thus you can see how the strength of the signal varies over time for different frequencies.

The spectrogram is updated with each data acquisition, from top to bottom, so that the most recent trace is at the bottom. Up to two time lines can be shown at a specified position so that you can analyze the spectrum at a specific point in time.

The spectrum diagram indicates the power vs. frequency values for a single data acquisition. If a time line is enabled, the spectrum shows the results at the selected time. Otherwise, the spectrum shows the results of the most recent data acquisition.

9.2.2 Spectrum analysis functions

In addition to spectrograms, the Spectrum analysis option also provides some new automatic measurements based on spectrum waveforms.

- A peak list measurement detects all peaks above a user-definable threshold and optionally indicates the peaks in the spectrum diagram.

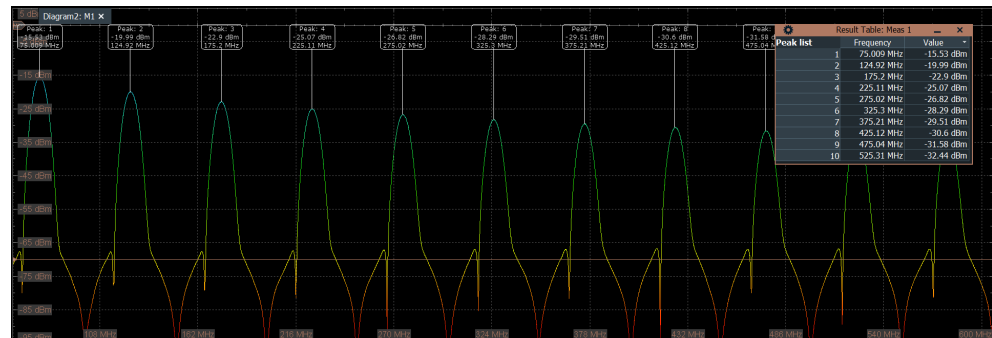

Figure 9-3: Peak list with labels for spectrum waveform

For a description of the measurement settings, see [Chapter 8.2.6.2, "Settings for spectrum measurements"](#), on page 342.

- The THD measurements are an extension to the basic THD measurement. See [Chapter 8.2.6, "Spectrum measurements"](#), on page 341 for details.
- Cursor measurements on spectrum waveforms provide easy center definition and peak search functions, see [Chapter 8.1.1.2, "Cursor measurements on spectrum waveforms"](#), on page 294.

9.2.3 Configuring spectrograms

Spectrograms are only available if the Spectrum analysis option R&S RTO6-K37 is activated.



1. Tap the "Spectrogram" icon on the toolbar.

The "Spectrogram" overlay menu opens.



2. Select the source of the spectrogram.

A spectrogram diagram is displayed. A new signal icon for the spectrogram is displayed on the signal bar ("SGx").

If the selected source is a channel waveform, an FFT is started, on which the spectrogram is created.

Additional settings for time lines become available in the dialog box.

3. Optionally, to display a time line and thus mark a specific waveform in the spectrogram, select "Enable" for one of the two time lines.

A small arrow icon labeled "T1" / "T2" indicates the position of the time line in the spectrogram.

The spectrum diagram displays the results for the selected waveforms. A new signal icon is displayed on the signal bar for each time line ("SGxTL1|2").

- To view the spectrum for each time line in a separate diagram, drag the signal icon for one time line to the diagram area and drop it.

A new window is displayed for the selected time line, and the original diagram displays the other time line.

- To view a different waveform from the spectrogram, move the time lines in the spectrogram.

9.2.4 Spectrogram configuration settings

Access: [FFT] > "FFT setup" > "Spectrogram" tab

Spectrograms are only available if the option R&S RTO6-K37 is activated. Furthermore, a math (FFT) waveform must be configured and enabled.

See [Chapter 9.1.2, "Configuring spectrum waveforms"](#), on page 380.

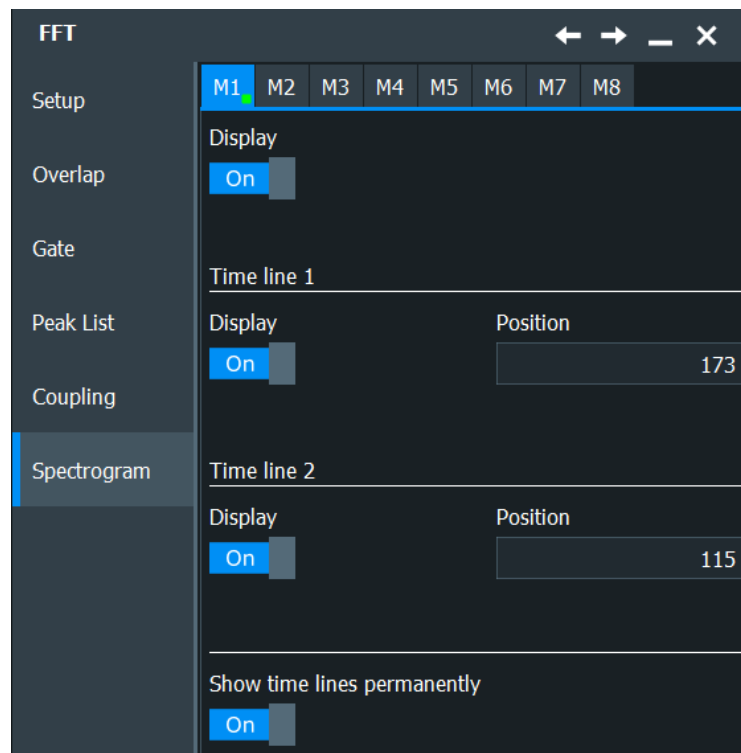

Display.....	399
Time line 1/2.....	399
Show lines permanently.....	399

Display

Enables the spectrogram display.

If enabled, a new signal icon for the spectrogram is displayed on the signal bar ("SGx").

Remote command:

[CALCulate:MATH<m>:FFT:SPECTrogram:STATe](#) on page 1690

Time line 1/2

A time line marks a single spectrum in the spectrogram, that is: the power vs frequency results for the data acquired at a specific time. After enabling a time line, the results for that time are displayed in the spectrum diagram. A small arrow icon labeled "T1" / "T2" indicates the position of the time line in the spectrogram. A new signal icon is displayed on the signal bar for each time line ("SGxTL1|2").

You can enable and display two time lines at the same time. This allows you to compare the results at different times.

The position of the time line is defined by the index of the data acquisition in the history. How many acquisitions are available depends on the history settings.

See "[Player](#)" on page 285.

Remote command:

[CALCulate:MATH<m>:FFT:SPECTrogram:TIMeline<n>:STATe](#) on page 1691

[CALCulate:MATH<m>:FFT:SPECTrogram:TIMeline<n>:POSition](#) on page 1690

Show lines permanently

Displays the spectrogram time lines in the diagrams until you disable this option.

If disabled, only the small arrow icons are permanently visible. The line is only displayed temporarily when you touch the arrow.

10 Mask testing

10.1 About mask testing

Masks are used to determine whether the signal remains within specified limits, e.g. to uncover signal anomalies or test compliance and stability of digital signals. The limits are specified as "mask", which is laid over the input signal in the display. Thus you can easily detect where the signal violates the mask.

Mask testing with R&S RTO6 has only a minor impact on the acquisition rate, thus mask violations are detected fast and reliably.

With R&S RTO6, you can define own masks easily. Specific actions can be executed when mask violations occur. For error analysis, you can stop the acquisition on a failed test and use the history view to look at the previous waveforms.

Mask test

A mask test consists of:

- Mask definition
- Waveform to be tested
- Fail criteria for test
- Actions to be taken on violation or successful completion

Mask Definition

A mask can be created in several ways:

- The individual mask points are defined, either on the touch screen or as numerical values. This mask type is called *user mask*.
For details, see [Chapter 10.2.2.1, "Mask definition: user mask"](#), on page 404
- The mask is derived from an existing waveform. This mask type is called *waveform mask*.
For details, see [Chapter 10.2.2.2, "Mask definition: waveform mask"](#), on page 407.

Fail Criteria for Testing

The fail criteria for a mask test is set by two parameters: "Fail condition" and "Violation tolerance". Fail condition defines if sample hits or the number of acquisitions with sample hits are considered. Violation tolerance sets the number of tolerable sample hits or acquisition hits. A test has failed if the number of sample hits or acquisition hits exceeds the limit of violation tolerance hits.

10.1.1 Results of a mask test

The result box of a mask test shows the following test results:

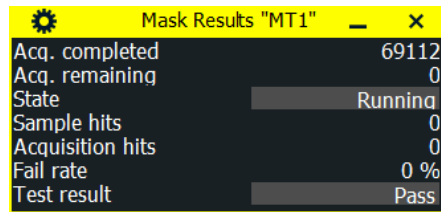

Mask Results "MT1"	
Acq. completed	69112
Acq. remaining	0
State	Running
Sample hits	0
Acquisition hits	0
Fail rate	0 %
Test result	Pass

Acq. completed

Number of tested acquisitions.

Remote command:

[MTESt:RESult:COUNT:WAVeforms?](#) on page 1708

Acq. remaining

Remaining acquisitions until "Average count / Nx Single count" is reached.

The value is useful if you test a specified number of acquisitions with action "Stop acquisition" on violation. Also if the acquisition has been stopped manually before the required number of acquisitions has been acquired.

Remote command:

[MTESt:RESult:COUNT:REMaining?](#) on page 1709

State

Shows if the test has been completed. The state is set to "Finished" when "Nx Single count" acquisitions are tested and the number of "Acq. remaining" is 0. as long as the number of tested acquisitions is less the "Nx Single count" number, the state is "Running".

If you run the acquisition with [Run Stop], or the number of played history acquisitions exceeds "Nx Single count", the mask testing is performed according to fail criteria settings independently of the test state. The testing is not stopped when the state is set to "Finished".

Remote command:

[MTESt:RESult:STATe?](#) on page 1708

Sample hits

Number of samples that hit the mask.

Remote command:

[MTESt:RESult:COUNT:FAILures?](#) on page 1709

Acquisition hits

Number of acquisitions that contained at least one sample hit.

Remote command:

[MTESt:RESult:COUNT:FWAVeforms?](#) on page 1709

Fail rate

Ratio of acquisition hits to the number of tested acquisitions.

Remote command:

[MTESt:RESult:FRATe?](#) on page 1710

Test result

A test has failed if the number of sample hits or acquisition hits exceeds the limit of "Violation tolerance" hits.

Remote command:

[MTESt:RESult\[:RESult\]?](#) on page 1708

10.2 Mask test settings

10.2.1 Define mask

Access: [App Cockpit] > "Analysis" tab > "Mask" > "Define Mask"

The "Define Mask" tab provides all settings for the mask test itself: the waveform to be tested, and saving/loading the mask definition.

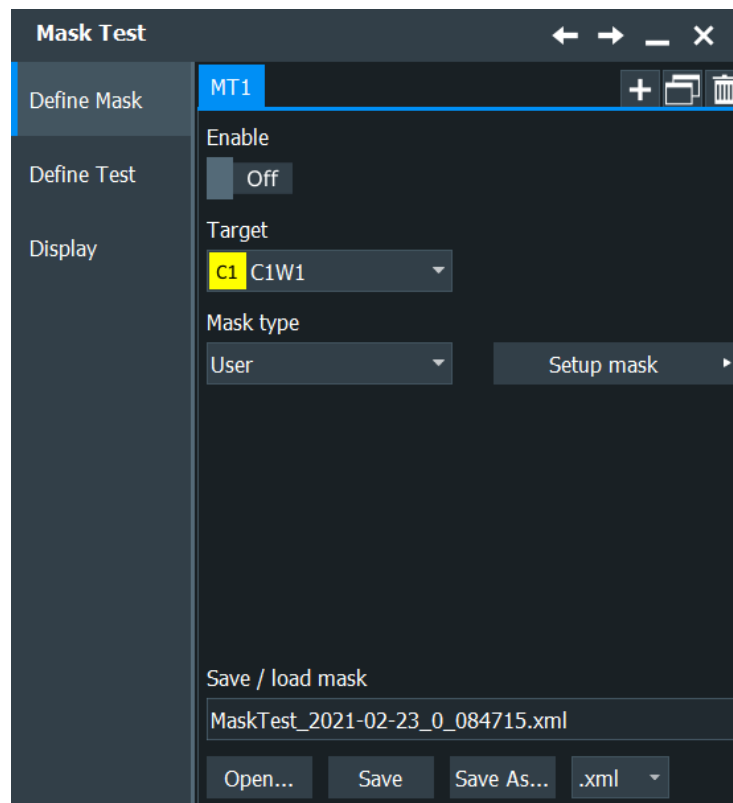

The content of the "Test Definition" tab depends on the selected definition type. If "Waveform" is selected, the main mask settings can be set directly on the "Test Definition" tab. For a description of these settings, see [Chapter 10.2.2.2, "Mask definition: waveform mask"](#), on page 407.



Make sure that the correct "Mask Test" tab is selected on the left side before you enter the settings.

Remote commands:

[MTESt:ADD](#) on page 1692

[MTESt:REMove](#) on page 1692

Enable

Activates and deactivates the mask test. If the acquisition is running, the test starts immediately. Otherwise, the test starts when acquisition is started.

The testing is stopped when acquisition is stopped, or if a stop action is configured with "[Stop acq.](#)" on page 412.

Closing the result box also disables the mask test.

Remote command:

[MTESt\[:STATe\]](#) on page 1692

Target

Selects the waveform to be tested against the mask. All channel waveforms can be tested.

Remote command:

[MTESt:SOURce](#) on page 1693

Mask Type

Sets the method of mask definition.

"User"	The mask is created manually by tapping the mask points on the touch screen and/or by entering the numerical x- and y-values of the mask points.
"Waveform"	The mask is created from an existing waveform. The waveform builds the upper and lower limit line of the mask, and the limits are moved and stretched. The result is a tolerance tube around the waveform that is used as mask.
"Eye"	Requires jitter option R&S RTO6-K12. The mask is created by selecting the shape and setting its dimensions according to the test standard.

Remote command:

[MTESt:CTYPe](#) on page 1694

Setup mask

Opens a dialog for defining the mask. See [Chapter 10.2.2, "Mask definition"](#), on page 404.

Save / load mask

Provides all functions to store and recall a mask test. The mask definition, defined actions and fail conditions are stored in an R&S RTO6-specific .xml file.

"Open" Opens a dialog box where you can select the file name.
See also: [Chapter 12.5, "File selection dialog"](#), on page 490.

"Save, Save As" Stores the specified file.

Remote command:

[MTEST:FILE:NAME](#) on page 1695

[MTEST:FILE:SAVE](#) on page 1695

[MTEST:FILE:OPEN](#) on page 1695

[MTEST:FILE:DELEte](#) on page 1696

10.2.2 Mask definition

With mask definition, you define the shape of the mask - the form and position of its limit lines. The content of the "Mask Definition" tab depends on the selected [Mask Type](#): "User" or "Waveform".

Below, you find the specific settings:

10.2.2.1 Mask definition: user mask

Access: [App Cockpit] > "Analysis" tab > "Define Mask" > "Mask Type" = "User" > "Setup mask"

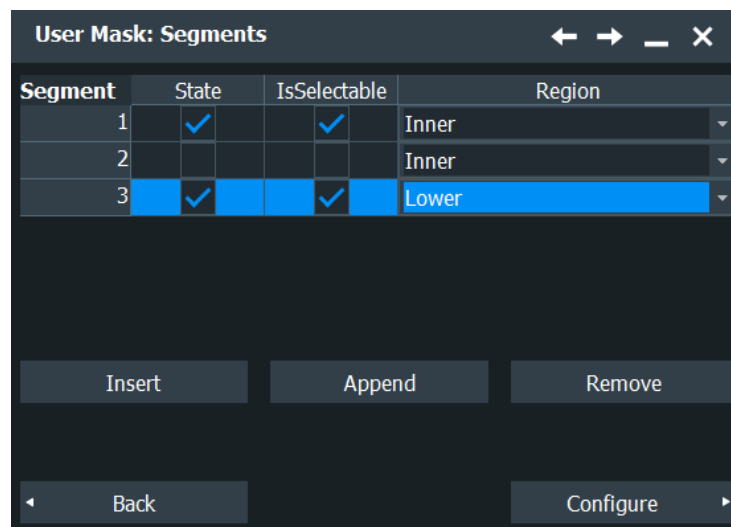

A user mask is defined by entering the time and voltage values for all corner points of the mask segments. A user mask has at least one segment. Complex masks can have up to 16 segments.

An inner segment is an area defined by three or more points. Upper and lower segments limit the signal on top and bottom of the screen. They are defined by a line, the region above or below the line is set automatically as mask segment.

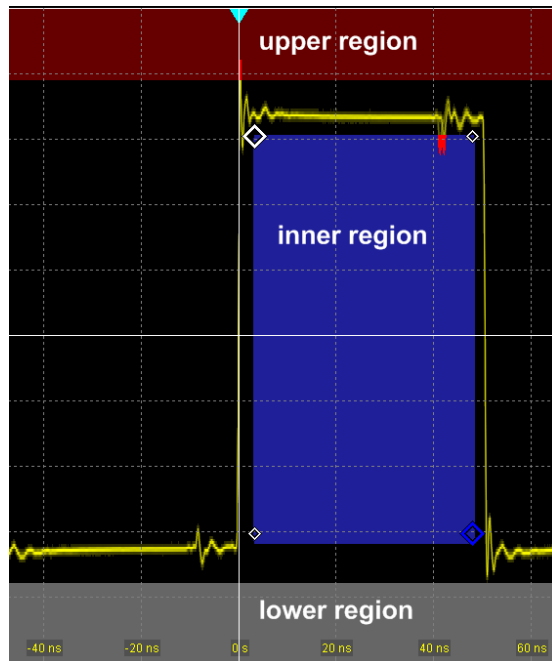

Alternatively, you can set the corner points on the touch screen and adjust the values in the "Mask Definition" tab.

To save the mask, select the "Define Mask" tab and save the mask test.



Make sure that the correct "Mask Test" tab is selected on the left side before you enter the settings.

Mask segments

Defines the number and state of mask segments for the selected mask test. Here you can:

- Insert a new segment before the selected segment.
- Append a new segment at the end of the list.
- Remove the selected mask segment from the list.
- Select the region that builds the mask.
 - Inner region: the segment points form a closed geometrical shape, which is the mask segment.
 - Upper region: the segment points are connected to a line, the display area above this line is the mask segment.
 - Lower region: the segment points are connected to a line, the display area below this line is the mask segment.
- Enable and disable the mask segments individually. Disabled segments are not considered by running tests.

Remote command:

[MTESt:SEGMENT:STATE](#) on page 1697

[MTESt:SEGMENT:ADD](#) on page 1697

[MTESt:SEGMENT:REMOVe](#) on page 1698

[MTESt:SEGMENT:INSert](#) on page 1698

[MTESt:SEGMENT:REGION](#) on page 1698

[MTESt:SEGMENT:COUNT?](#) on page 1697

Configure

Opens a dialog to define the selected segment.

User Mask: Points ← → _ X

Definition of segment:

Point	X	Y
1	44 ns	113 mV
2	19 ns	110 mV
3	42 ns	63 mV
4	62 ns	124 mV

Insert Append Remove

Rescale

Offset X Factor X

Offset Y Factor Y Apply

Back

Definition of segment

The number of the selected segment is shown above the table. In the definition table, the individual points of the selected mask segment are listed with exact horizontal and vertical numerical coordinates. Here you can:

- Insert a new point before the selected point.
- Append a new point at the end of the list.
- Remove the selected point from the list.
- Change the x- and y-values of each point. To scale or move the complete segment, use offset and factor values, see [Rescale](#).

Remote command:

[MTESt:SEGMENT:POINT:ADD](#) on page 1699

[MTESt:SEGMENT:POINT:REMOVe](#) on page 1699

[MTESt:SEGMENT:POINT:INSert](#) on page 1699

[MTESt:SEGMENT:POINT:X](#) on page 1700

[MTESt:SEGMENT:POINT:Y](#) on page 1700

[MTESt:SEGMENT:POINT:COUNT?](#) on page 1700

Rescale

You can rescale and move mask segments by numerical input of factors and offsets.

The values change the selected mask segment and take effect on "Apply".

Offset X ← Rescale

Moves the mask segment horizontally. The specified offset is added to the x-values of all points of the selected mask segment.

To take effect, tap "Apply".

Remote command:

[MTESt:SEGMENT:RESCale:XOFFset](#) on page 1702

Factor X ← Rescale

Stretches or compresses the selected mask segment in horizontal direction. The x-values of all points of the selected mask segment are multiplied with this factor. Factors >1 stretch the mask segment, while factors between 0 and 1 compress it. Negative values are possible and change the algebraic sign.

To take effect, tap "Apply".

Remote command:

[MTESt:SEGMENT:RESCale:XFACTOR](#) on page 1701

Offset Y ← Rescale

Moves the mask segment vertically. The specified offset is added to the y-values of all points of the selected mask segment.

To take effect, tap "Apply".

Remote command:

[MTESt:SEGMENT:RESCale:YOFFset](#) on page 1702

Factor Y ← Rescale

Stretches or compresses the selected mask segment in vertical direction. The y-values of all points of the selected mask segment are multiplied with this factor. Factors >1 stretch the mask segment, while factors between 0 and 1 compress it. Negative values are possible and change the algebraic sign.

To take effect, tap "Apply".

Remote command:

[MTESt:SEGMENT:RESCale:YFACTOR](#) on page 1701

Apply ← Rescale

Multiplies and adds the given x- and y-factors and offsets to the coordinates of all points of the selected mask segment.

Remote command:

[MTESt:SEGMENT:RESCale:RECalculate](#) on page 1701

10.2.2.2 Mask definition: waveform mask

Access: [App Cockpit] > "Analysis" tab > "Define Mask" > "Mask Type" = "Waveform" > "Setup mask"

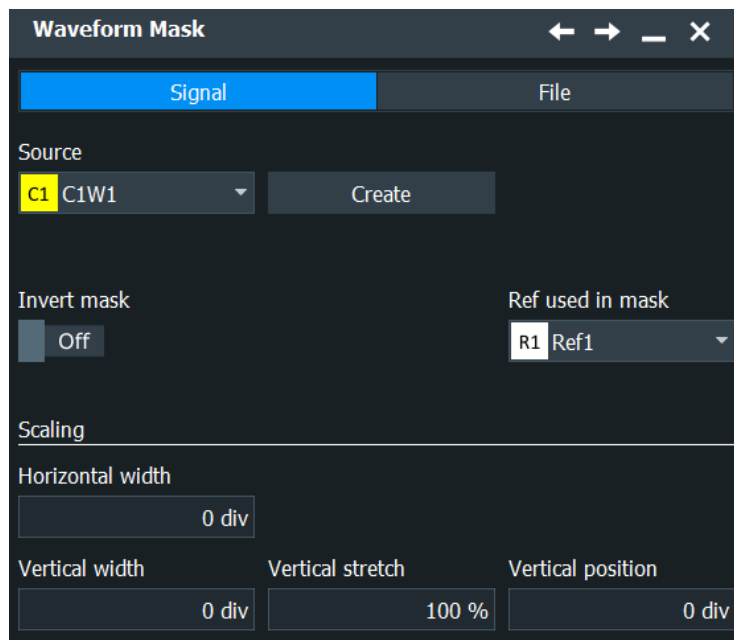

A waveform mask is created from an existing waveform. The waveform builds the upper and lower limit line of the mask, and the limits are moved and stretched. The result is a tolerance tube around the waveform that is used as mask.

During mask testing using a waveform mask, the record length is limited to 1 MSample.

The source for a waveform mask is a reference waveform. The reference waveform can be defined before mask definition, or loaded from a file, or it is created from the waveform to be tested.

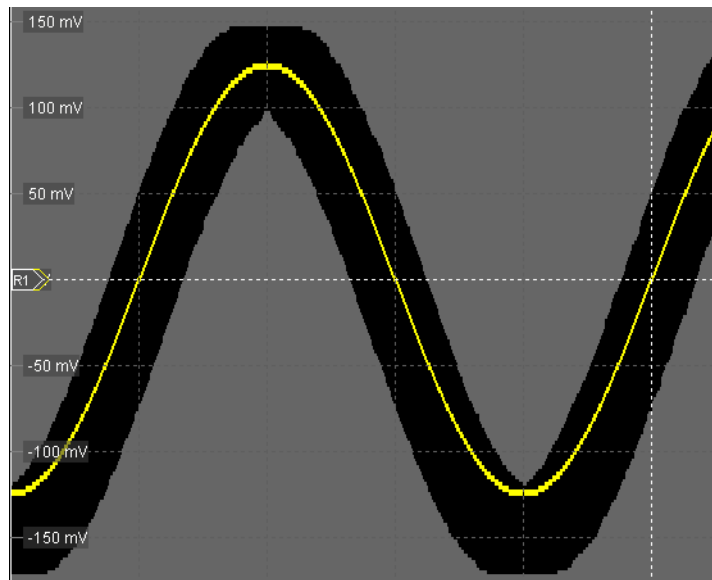

Figure 10-1: Waveform mask

Signal

The reference waveform is created from the selected "Source".

Sets the reference waveform from which the mask is created.

Create ← Signal

Creates the upper and lower mask limit from the "Source" and "Ref used in mark". If the reference waveform was not defined before, it is created automatically from the mask test "Source" waveform.

File

Loads the waveform from the selected file to the "Reference" and creates the mask immediately.

Invert mask

If enabled, the area inside the mask is highlighted, which the signal must not exit. If disabled, the area outside the mask limits is highlighted.

Horizontal width

Sets the width of the mask in horizontal direction. The specified number of divisions is added to the positive x-values and subtracted from the negative x-values of the mask limits in relation to the source waveform of the mask. The overall mask width is twice the specified horizontal width.

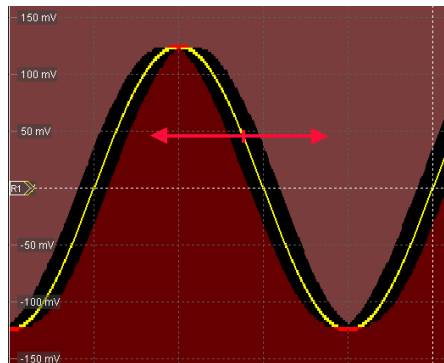

Figure 10-2: Waveform mask with horizontal width = 0.2 div

Remote command:

[MTESt:WFMRescale:XWIDth](#) on page 1703

Vertical width

Sets the width of the waveform mask in vertical direction. The specified number of divisions is added to the y-values of the upper mask limit and subtracted from the y-values of the lower mask limit. Thus, the upper half of the mask is pulled upwards, the lower half is pulled down, and the overall height of the mask is twice the vertical width.

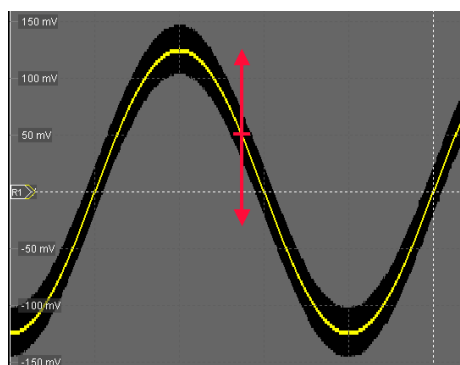

Figure 10-3: Waveform mask with vertical width = 0.5 div

Remote command:

[MTESt:WFMRescale:YWIDTH](#) on page 1704

Vertical stretch

Sets the vertical scaling to stretch the mask in y-direction. The scaling axis is the horizontal line through the lowest value of the lower mask limit. Values > 100% stretch the mask, and values < 100% compress it.

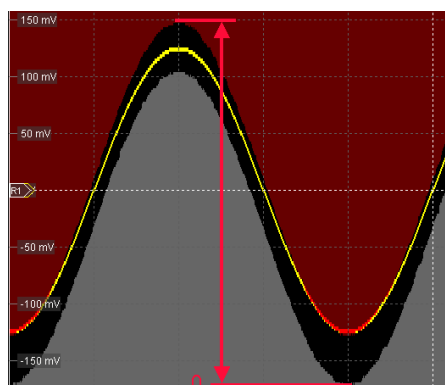

Figure 10-4: Waveform mask with vertical width = 0.5 div, vertical position = -0.5 div, vertical stretch = 110%

Remote command:

[MTESt:WFMRescale:YSTRetch](#) on page 1705

Vertical position

Moves the mask vertically within the display.

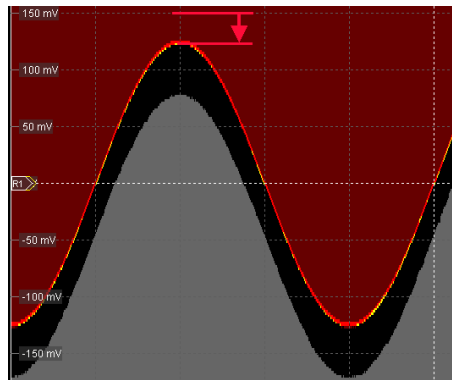

Figure 10-5: Waveform mask with vertical width = 0.5 div and vertical position = -0.5 div

Remote command:

[MTESt:WFMRRescale:YPOSITION](#) on page 1704

10.2.3 Define Test

Access: [App Cockpit] > "Analysis" tab > "Mask" > "Define Test"

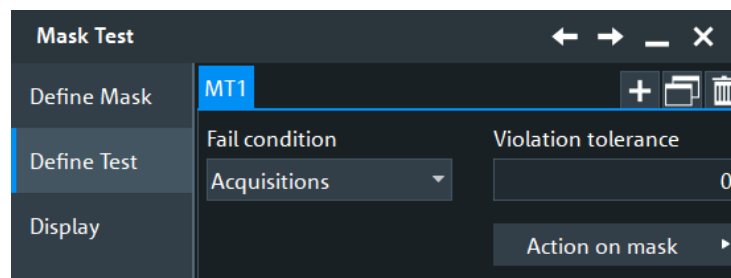

There are two usual test practices:

- Testing a defined number of waveforms against the mask and initiate an action when the acquisition cycle has been completed without failure:
 - Set the number of acquisitions to be tested: "Average count (N-single count)"
 - Start [Single]
- Testing a continuous acquisition or a defined number of waveforms against the mask and initiate an action when the fail criteria is fulfilled.



Make sure that the correct mask test tab is selected before you enter the settings.

Fail condition, Violation tolerance

The fail criteria for a mask test is set by two parameters: "Fail condition" and "Violation tolerance".

"Fail condition" defines the kind of hits to be considered for test evaluation:

- "Samples": Considers the number of samples that hit the mask.

- "Acquisitions": Considers the number of acquisitions that contain at least one sample hit. How many samples hit the mask in that acquisition is not relevant.

"Violation tolerance" sets the number of tolerable sample hits or acquisition hits.

A test has failed if the number of sample hits or acquisition hits exceeds the limit of violation tolerance hits.

Remote command:

[MTESt:CONDition](#) on page 1694

[MTESt:TOLerance](#) on page 1694

Action on mask

The settings in this dialog define what happens when the mask test has failed or when it has passed successfully.

Most actions can be initiated either on failure or on success:

- On violation
The action is initiated when the fail criteria is fulfilled.
- On successful completion
The action is initiated when the [Single] acquisition has finished and the fail criteria is not fulfilled - the fail condition and violation tolerance limit have not been reached.

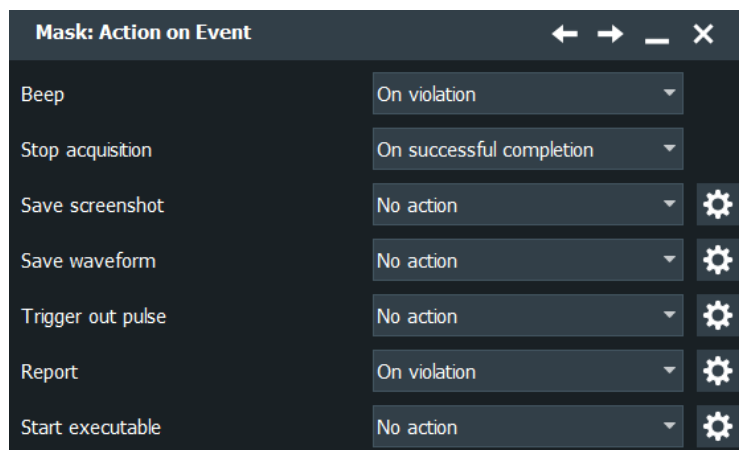

Beep ← Action on mask

Generates a beep sound.

Remote command:

[MTESt:ONViolation:BEEP](#) on page 1705

Stop acq. ← Action on mask

Stops the waveform acquisition on mask violation.

Remote command:

[MTESt:ONViolation:STOP](#) on page 1705

Save screenshot ← Action on mask

Saves a screenshot including the mask test results according to settings in "Menu" > "Save/Recall" > "Save" tab > "Screenshot".

Remote command:

[MTESt:ONViolation:PRINT](#) on page 1706

Save waveform ← Action on mask

Saves the waveform data to a file according to settings in "Menu" > "Save/Recall" > "Save" tab > "Waveforms".

Remote command:

[MTESt:ONViolation:SAVewaveform](#) on page 1706

Trigger out pulse ← Action on mask

Sends a pulse to the [Trigger Out] connector on the rear panel.

You can adjust the pulse by tapping the settings icon, see "[Trigger out signal setup](#)" on page 229.

Remote command:

[MTESt:ONViolation:TRIGgerout](#) on page 1707

Report ← Action on mask

Creates and saves a report using the settings.

Remote command:

[MTESt:ONViolation:REPort](#) on page 1706

Start Executable ← Action on mask

Starts an external application. Tap "Config Executable" to set the application path and parameters.

Remote command:

[MTESt:ONViolation:RUNexec](#) on page 1707

10.2.4 Mask display

Access: [App Cockpit] > "Analysis" tab > "Mask" > "Display".

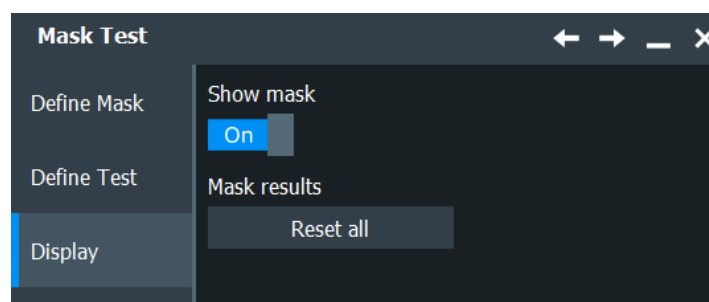

In this dialog, you can reset the mask results and display the mask.

Show mask

Switches the display of all mask segments on or off.

Remote command:

[MTESt:SHOW](#) on page 1693

Mask results > Reset all

Clears all totals and results in all "Mask Test" result boxes.

Remote command:

[MTEST:RST](#) on page 1693

10.2.5 Mask appearance

You can define additional mask appearance settings in the "Settings" > "Appearance" > "Mask" dialog.

See [Chapter 4.3.10, "Mask appearance settings"](#), on page 87

10.3 Mask testing on eye diagrams

To perform mask testing on eye diagrams, the option R&S RTO6-K12 adds a special mask definition type to the common mask definitions: the definition type "Eye".

Using the "Eye" mask type, you can easily define eye masks of various shapes. You can also use "User" masks to define free mask shapes.

10.3.1 Test definition for eye mask tests

Access: [App Cockpit] > "Analysis" tab > "Define Mask" tab

1. Select the "Source": the channel waveform that is analyzed for jitter.
2. Select the "Mask Type" = "Eye".
3. In the "Define Test" tab, adjust the "Fail condition" and "Violation tolerance".
4. Define the eye mask. See [Chapter 10.3.2, "Eye mask definition"](#), on page 414.

The general mask test settings are described in [Chapter 10.2, "Mask test settings"](#), on page 402.

10.3.2 Eye mask definition

Access: [App Cockpit] > "Analysis" tab > "Define Mask" > "Mask Type" = "Eye" > "Setup mask"

The "Eye Mask" dialog provides all settings to define masks of different shapes. It is available if option R&S RTO6-K12 is activated on the instrument.

Shape

Defines the outline of the eye mask: square, diamond, hexagon or octagon.

Remote command:

[MTESt:EYEMask:TYPE](#) on page 1711

PAM eye

Enable if a PAM-N signal is used for the mask.

Remote command:

[MTESt:EYEMask:PAMNeye](#) on page 1715

Vertical data to ref. level

Sets the vertical delta to the reference level for a PAM-N signal eye.

Remote command:

[MTESt:EYEMask:REFDelta](#) on page 1715

Horizontal center/Vertical center

Set the horizontal (time) and vertical (voltage) values of the eye shape enter and thus define the position of the eye shape on the display.

Remote command:

[MTESt:EYEMask:HPOStion](#) on page 1714

[MTESt:EYEMask:VPOStion](#) on page 1714

Main width (W1), Minor width (W2)

Main width defines the width of all eye mask shapes. Minor width defines the secondary width for hexagon and octagon mask shapes.

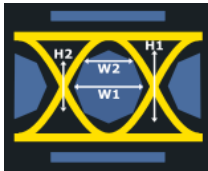

Figure 10-6: Main and minor widths and heights of an octagon eye mask

Remote command:

[MTESt:EYEMask:WIDTh<m>\[:VALue\]](#) on page 1711

Main height (H1), Minor height (H2)

Main height defines the height of all eye mask shapes. Minor height defines the secondary height for octagon mask shapes.

If an octagon shape is selected, and both values are the same, the eye masks looks like a hexagon rather than an octagon.

Remote command:

[MTESt:EYEMask:HEIGht<m>\[:VALue\]](#) on page 1711

Periodicity

Sets the time distance between the shape centers.

Remote command:

[MTESt:EYEMask:HPERiod](#) on page 1712

Top/Bottom setup

Defines the settings for the top and bottom segments of the mask. You have to enable "Top" / "Bottom" for this settings to be relevant.

Symmetric ← Top/Bottom setup

Sets bottom and top offsets to the same value so that the outer regions are symmetric to the eye shape.

Remote command:

[MTESt:EYEMask:TBSYmmetric](#) on page 1713

Width ← Top/Bottom setup

Sets the time width of the outer regions, symmetric to the eye shape center.

Remote command:

[MTESt:EYEMask:TBWidth](#) on page 1714

Offset top, Offset bottom ← Top/Bottom setup

Sets the voltage distance from the eye shape center that limits the upper and lower regions.

Remote command:

[MTESt:EYEMask:BOFFset](#) on page 1713

[MTESt:EYEMask:TOFFset](#) on page 1713

Segments

Enable the different regions of the mask: "Top", "Bottom", "Left", "Right".

The icons copy the eye shape to the left and to the right.

Remote command:

[MTESt:EYEMask:MSKBottom](#) on page 1713

[MTESt:EYEMask:MSKTop](#) on page 1713

[MTESt:EYEMask:MSKLeft](#) on page 1712

[MTESt:EYEMask:MSKRight](#) on page 1712

Convert to user mask

Converts the test and mask definitions of the current mask test to a new mask test of type "User".

The new test is opened in a separate mask test tab, in the "Define Mask" tab.

This is useful, for example, if want to run variants of a mask test in parallel.

Remote command:

[MTESt:CEMask](#) on page 1711

10.4 Working with masks

This chapter explains step-by-step how mask tests are setup and performed. For the explanation of the individual settings, see [Chapter 10.2, "Mask test settings"](#), on page 402.

• Setting up user masks	417
• Setting up a mask test	422
• Configuring the mask and hit display	422
• Running a mask test	423
• Saving and loading masks	423
• Mask testing on history acquisitions	424

10.4.1 Setting up user masks

10.4.1.1 Creating user masks

There are two ways to create a new mask:

- Graphical way by tapping the mask points on the touchscreen,

- Numerical entry of the x- and y-values of the mask points.

You can combine both methods. For example, at first you enter the mask quickly on the touchscreen, and then modify the point coordinates with precise values.

To create a mask graphically on the touch screen

1. Tap the "Masks" icon on the toolbar.



The "Masks" overlay menu opens.

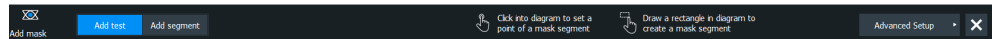

2. Tap the corner points of the mask segment on the touch screen.

Tip: To create an exact rectangle, draw the diagonal of the rectangle on the screen.

3. Tap "Finish segment".

Now you can enter another segment to the current mask test or add a new mask test.

4. To finish the mask definition, close the overlay menu.
If the acquisition is running, the mask test starts automatically and immediately.

To create a mask numerically in the dialog box

The settings mentioned here are described in detail in [Chapter 10.2.1, "Define mask"](#), on page 402.

1. Open [App Cockpit] > "Analysis" tab > "Mask" > "Define Mask" tab.
2. Create a mask test:
 - a) Tap the "+"-icon in the upper right corner.
 - b) Enter a name for the new mask test.

A new, empty tab for the mask test appears.
3. Set "Mask type"= "User".
4. Tap "Setup mask".
5. In the "User Mask: Segments" area, tap "Insert" to create a new mask segment.
6. Set the corner points of the mask segment:
 - a) Select the "Segment".
 - b) Tap "Configure". The "User Mask: Points" dialog opens.
 - c) In the "Definition of segment" area, tap "Insert".
Point 1 appears.
 - d) Tap the X-cell and enter the X-value of the point.
 - e) Tap the Y-cell and enter the Y-value of the point.

- f) To insert the next point:
 - Tap "Insert" to add a point before the selected point.
 - Tap "Append" to add a point at the end of the list.
 - g) Set the X- and Y-values for this point.
 - h) Repeat the last two steps until you define all points.
7. In the "Define Mask" tab, tap "Enable".
 8. Adjust the horizontal and vertical units if necessary.

10.4.1.2 Modifying user masks

To change an existing mask definition, you can also use the graphical method on the touch screen, or the numerical way, or combine both.

With the graphical method, you can:

- Move, add, and delete segments
- Move and delete points

Adding points to an existing segment graphically is not possible.

With the numerical method, in the "Define Mask" tab, you have all modification possibilities. You can delete and add points and segments, change the coordinates, and also stretch a segment, or move it by adding an offset.

To add a mask segment on the touch screen

1. Tap a mask segment of the mask test that you want to complement.
2. Tap the "Masks" icon on the toolbar.



3. Tap the corner points of the new mask segment on the touch screen.
4. To finish the segment and mask definition, double-tap the last point.

To delete a mask segment on the touch screen

1. On the toolbar, tap the "Delete" icon.



2. Tap the mask segment you want to delete.

To delete a point on the touch screen

1. Tap the mask segment from which you want to delete a point.
The selected segment is now in definition mode, shown with blue color.
2. On the toolbar, tap the "Delete" icon.



The "Delete" overlay menu opens.

3. Tap the point you want to delete.

To move a segment on the touch screen

1. Drag&drop the segment to the new position.
2. Tap outside the mask to deselect the mask segment.

To move a point on the touch screen

1. Tap the mask segment that you want to change.
2. Drag&drop the point to the new position.
3. Tap outside the mask to deselect the mask segment.

To change the mask definition numerically

The settings mentioned here are described in detail in [Chapter 10.2.2, "Mask definition"](#), on page 404.

1. Open [App Cockpit] > "Analysis" tab > "Mask" > "Define Mask".
2. At the top, select the mask test for which you want to change the mask definition.
3. To add or delete a mask segment, tap "Setup mask".
Tap the segment's row in the "User Mask: Segments" table and tap the required button below:
 - "Insert": to add a new segment before the selected segment.
 - "Append": to add a new segment at the end of the list.
 - "Remove": to delete the selected mask segment from the list.

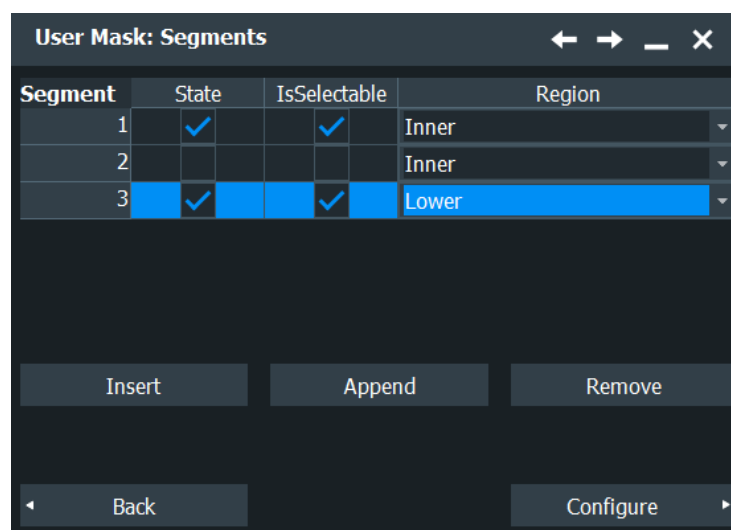

4. To add, delete, or move a point of a segment:

- a) Select the segment in the "User Mask: Segments" table.
- b) Tap "Configure".
- c) Select the point in the "Definition of segment" table.
- d) To add or delete the selected point, use the buttons below the table.
 - "Insert": to add a new point before the selected point.
 - "Append": to add a new point at the end of the list.
 - "Remove": to delete the selected point from the list.
- e) To move the selected point, change the X- and Y-values.

User Mask: Points ← → — ✕

Definition of segment: 3

Point	X	Y
1	44 ns	113 mV
2	19 ns	110 mV
3	42 ns	63 mV
4	62 ns	124 mV

Insert

Append

Remove

Rescale

Offset X 0 s

Offset Y 0 V

Factor X 1

Factor Y 1

Apply

◀ Back

To rescale and move a mask segment

The settings mentioned here are described in detail in [Chapter 10.2.2, "Mask definition"](#), on page 404.

1. Open [App Cockpit] > "Analysis" tab > "Mask" > "Define Mask".
2. At the top, select the mask test for which you want to change the mask definition.
3. Tap "Setup mask" and select the required segment in the "User Mask: Segments" table.
4. Tap "Configure".
5. To stretch or compress the selected mask segment, enter the "Factor X" for horizontal scaling and the "Factor Y" for vertical scaling. The x-values and y-values of all points are multiplied with the corresponding factor. Factors >1 stretch the mask

segment, while factors between 0 and 1 compress it. Negative values are possible and change the algebraic sign.

6. To move the selected mask segment, enter the "Offset X" for horizontal direction and the "Offset Y" for vertical direction. The specified offset is added to the corresponding values of all points.
7. Tap "Apply" to perform the scaling and/or move.

10.4.2 Setting up a mask test

In addition to the mask definition, the mask test contains further settings:

- The waveform to be tested
- The criteria for a failed test
- The actions to be taken if a test has failed or has been completed successfully

1. Open [App Cockpit] > "Analysis" tab > "Mask" > "Define Mask" tab.
2. Select the "Target" to be tested.
3. Select the "Define Test" tab.
4. Set the conditions for a failed test:
 - a) "Fail condition": select if sample hits or the number of acquisitions with sample hits are considered.
 - b) "Violation tolerance": number of tolerable sample hits or acquisition hits.A test has failed if the number of sample hits or acquisition hits exceeds the limit of violation tolerance hits.
5. Tap "Action on mask".
6. For each action, select when the action will be executed:
 - "On violation" if the mask test has failed
 - "On successful completion"

10.4.3 Configuring the mask and hit display

The display of masks and mask violation is the same for all mask tests .

The settings mentioned here are described in detail in [Chapter 10.2.3, "Define Test"](#), on page 411.

1. Open [App Cockpit] > "Analysis" tab > "Mask".
2. Select the "Display" tab.
3. Select "Show mask" to display the masks of all enabled mask tests on the screen.
4. Open "Menu" > "Settings" > "Appearance" dialog.
5. Select the "Mask" tab.

6. Define how the sample hits are displayed:
 - a) Select "Show hits" to display the sample hits.
 - b) Set the "Show for" time or "Show hits forever".
 - c) Set the "Color" of the sample hits.
7. Define the color of the masks segments depending on the violation state:
 - Mask without violation
 - Mask with violation
 - Mask with contact: this color shows that the edge of the mask segment was touched. In this case, the resolution is not sufficient to detect if the mask was really hit or not. Zoom into the concerned area to see the correct result.

10.4.4 Running a mask test

Before you can start a mask test, make sure that the mask setup is complete:

- The mask is defined, see [Chapter 10.4.1.1, "Creating user masks"](#), on page 417 and [Chapter 10.4.1.2, "Modifying user masks"](#), on page 419.
- The mask test is defined, see [Chapter 10.4.2, "Setting up a mask test"](#), on page 422
- The mask display is configured, see [Chapter 10.4.3, "Configuring the mask and hit display"](#), on page 422.

You can perform continuous testing or test a specified number of acquisitions.

1. Open [App Cockpit] > "Analysis" tab > "Mask" > "Define Mask" tab.
2. Select "Enable".
If the acquisition is running, the test starts immediately.
3. If the acquisition is not running, press [Run Stop].
The test starts and runs until you stop the acquisition or the stop action is executed if defined.

10.4.5 Saving and loading masks

Mask test definitions remain on the instrument until they are changed or deleted, or [Preset] is performed. If you want to keep a mask test, you can save and reload them.

To save a mask

1. Open [App Cockpit] > "Analysis" tab > "Mask" > "Define Mask" tab.
2. To save the mask file in the current directory, change the file name if needed, and tap "Save".
You can use the automatic file name generation, see [Chapter 4.8.1, "Autonaming"](#), on page 104.
3. To select the directory and enter the file name, tap "Save As".

To load a mask

1. Tap "Open".
2. Select the file from the file selection dialog box.

10.4.6 Mask testing on history acquisitions

In the same way as for running acquisitions, you can set up and perform the mask testing also on history waveforms.

The requirements for mask testing on history waveforms are also the same:

- The mask is defined, see [Chapter 10.4.1.1, "Creating user masks"](#), on page 417 and [Chapter 10.4.1.2, "Modifying user masks"](#), on page 419.
 - The mask test is defined, see [Chapter 10.4.2, "Setting up a mask test"](#), on page 422
 - The mask display is configured, see [Chapter 10.4.3, "Configuring the mask and hit display"](#), on page 422.
1. Perform and finish the acquisition.
 2. Press [History].
 3. In the quick-access "History" dialog box, tap "Play".

The mask testing is performed on the complete history memory, starting with the oldest acquisition. The state of the mask test is set to "Finished" when "Nx Single count" acquisitions are tested.

For details on history, see [Chapter 7.4.1, "About history"](#), on page 283.

11 Search functions

Search functions allow you to detect and analyze specific events in the acquired data quickly and simply. You can search in various waveforms for several events at once. The search area can be limited by a gate.

The events that can be searched for are basically the same events you can trigger on. Thus, the search parameters are defined in the same way as the trigger conditions. The results are displayed in a result box and optionally shown in a zoom window.

11.1 Overview: search definition and results

11.1.1 Search definition

You can define up to 8 different searches and let them run simultaneously. For each search, you define the criteria, the parameters of each criterion, the gate, and the result display.

The instrument keeps the settings until the next preset. If you save a user-defined preset, the search settings are included in the preset.

Each search is configured in a separate tab and contains:

- *Search control*
If you enable a search and run an acquisition, the search is performed continuously on the acquired data until acquisition is stopped.
If acquisition is stopped and you enable a search, the data of the last acquisition is searched.
Enabling the search zoom window disables the search, stops a running acquisition, and displays the search results of the last acquisition in the zoom window.
- *Source*
Waveform that is searched for one or more events. You can search in analog and digital signals, math or reference waveforms, and tracks. Furthermore, search in decoded data of serial buses is possible.
Search on differential signals and their input channels is not supported.
- *Search criteria and parameters*
Various search criteria are available, depending on the source. Most parameters known from trigger event definition can also be configured as search conditions. Unlike triggering, you can configure several event types to be searched for simultaneously.
If the source is an FFT spectrum, you can perform a frequency marker search by using the cursor measurement and defining the peak excursion. See [Chapter 8.1.3.3, "Peak Search tab"](#), on page 302.
- *Search gate*
Searches can be performed on the entire waveform, or only on a defined area (gate). The gate can be coupled to an existing zoom.

Gating is not available for searches on digital signals and serial buses.

- *Result presentation*

For each search, you define how the search results are displayed: in a result table and/or in a search zoom window.

Remote commands:

- [SEARCH:ADD](#) on page 1716
- [SEARCH:REMove](#) on page 1717

11.1.2 Search results

The results are displayed in a "Search Results" box and optionally in a zoom window.

Search results box

The results of each search are tabulated in a "Search Results" box.

If you search for several event types in parallel, the results are presented in several tabs - one for each search event and one for the combined results. Each tab contains a table with the position and, if available, further parameters for each result. The tables row can be sorted, and you can define a maximum number of table entries in the "Result Presentation" dialog box. As with all result boxes, you can minimize it, display it like a diagram, and define the default position.

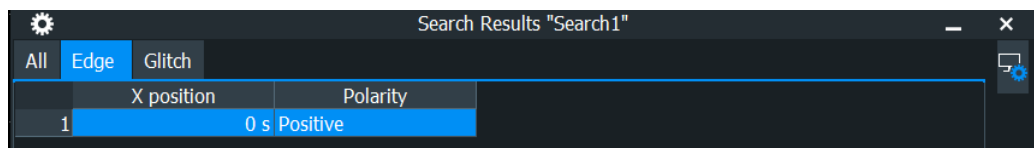

	X position	Polarity
1	0 s	Positive

If "Auto clear" is enabled in the "Display" dialog box, the instrument displays the search results of the last acquisition. If "Auto clear" is disabled, the first result of each acquisition is listed until the maximum number of entries in the table is reached.

Remote commands for result query:

- [SEARCH:RESult\[:ALL\]?](#) on page 1756

11.2 Search setup

Access: "Menu" > "Apps" > "Analysis" tab > "Search"

The search setup includes the source selection, the selection of search events (criteria), event-specific search conditions, and search control.

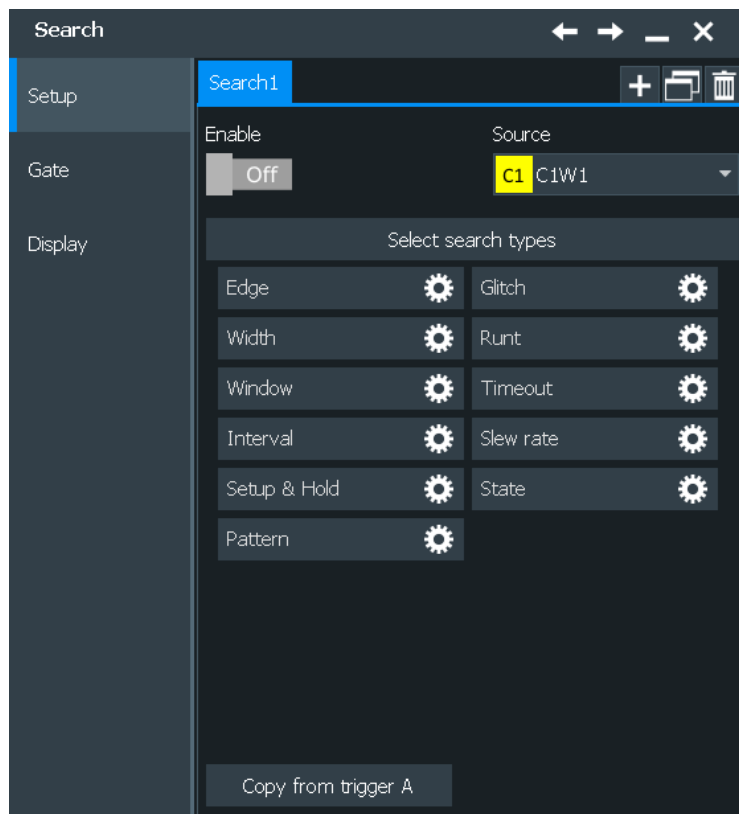

11.2.1 Search criteria

Access: "Menu" > "Apps" > "Analysis" tab > "Search" > "Setup" tab

Enable

If you enable a search and run an acquisition, the search is performed continuously on the acquired data until acquisition is stopped.

If acquisition is stopped and you enable a search, the data of the last acquisition is searched.

Remote command:

[SEARCH:ONLine](#) on page 1717

[SEARCH:ALL](#) on page 1718

Source

Defines the waveform to be searched. The source can be any analog and digital input signal, math or reference waveform, or track. While the instrument triggers only on real input signals, it can search also calculated and restored waveforms.

If the source is an FFT spectrum, you can perform a frequency marker search by using the cursor measurement and defining the peak excursion. See [Chapter 8.1.3.3, "Peak Search tab"](#), on page 302.

For some serial protocol options, search on a serial bus is available. For details, see the relevant chapters of the "Protocol Analysis" chapter.

Depending on the selected source, different search criteria are available.

Remote command:

[SEARCh:SOURce](#) on page 1717

Edge, Glitch, Width, Runt, Window, Timeout, Interval, Slew rate, Setup & Hold, State, Pattern

Search criteria for analog and digital input signals, math and reference waveforms, and tracks. For searching on digital channels, only "Edge", "Width", "Timeout" and "Setup & Hold" criteria are available.

Tap the icon to include or exclude the search criteria in the next search. You can enable several event types for simultaneous search.

Remote command:

[SEARCh:TRIGger:EDGE\[:STATe\]](#) on page 1718

[SEARCh:TRIGger:GLITch\[:STATe\]](#) on page 1718

[SEARCh:TRIGger:WIDTh\[:STATe\]](#) on page 1719

[SEARCh:TRIGger:RUNT\[:STATe\]](#) on page 1719

[SEARCh:TRIGger:WINDow\[:STATe\]](#) on page 1719

[SEARCh:TRIGger:TIMeout\[:STATe\]](#) on page 1719

[SEARCh:TRIGger:INTerval\[:STATe\]](#) on page 1718

[SEARCh:TRIGger:SLEWrate\[:STATe\]](#) on page 1719

[SEARCh:TRIGger:SETHold\[:STATe\]](#) on page 1719

[SEARCh:TRIGger:STATe\[:STATe\]](#) on page 1719

[SEARCh:TRIGger:PATTern\[:STATe\]](#) on page 1718

Copy from trigger A'

Copies the trigger type-specific settings from the A-trigger configuration to the search settings. The source itself is not copied.

Remote command:

[SEARCh:TRIGger:EDGE:ACOPy](#) on page 1720

[SEARCh:TRIGger:GLITch:ACOPy](#) on page 1720

[SEARCh:TRIGger:WINDow:ACOPy](#) on page 1720

[SEARCh:TRIGger:WIDTh:ACOPy](#) on page 1720

[SEARCh:TRIGger:RUNT:ACOPy](#) on page 1720

[SEARCh:TRIGger:WINDow:ACOPy](#) on page 1720

[SEARCh:TRIGger:TIMeout:ACOPy](#) on page 1720

[SEARCh:TRIGger:INTerval:ACOPy](#) on page 1720

[SEARCh:TRIGger:SLEWrate:ACOPy](#) on page 1720

[SEARCh:TRIGger:SETHold:ACOPy](#) on page 1720

[SEARCh:TRIGger:STATe:ACOPy](#) on page 1720

[SEARCh:TRIGger:PATTern:ACOPy](#) on page 1720

11.2.2 Search parameters

Most parameters available for trigger event definition can also be configured as search conditions. Each event type is defined in a separate subtab.

If the source is a spectrum, the instrument performs a frequency marker search.

For serial protocol options, search on a serial bus is available. These searches have protocol-specific search criteria. For details, see the relevant chapters of the "Protocol Analysis" chapter.

• Edge.....	429
• Glitch.....	430
• Width.....	430
• Runt.....	431
• Window.....	432
• Timeout.....	433
• Interval.....	434
• Slew rate.....	435
• Setup & Hold.....	436
• State.....	438
• Pattern.....	438

11.2.2.1 Edge

The edge search works the same way as the edge trigger.

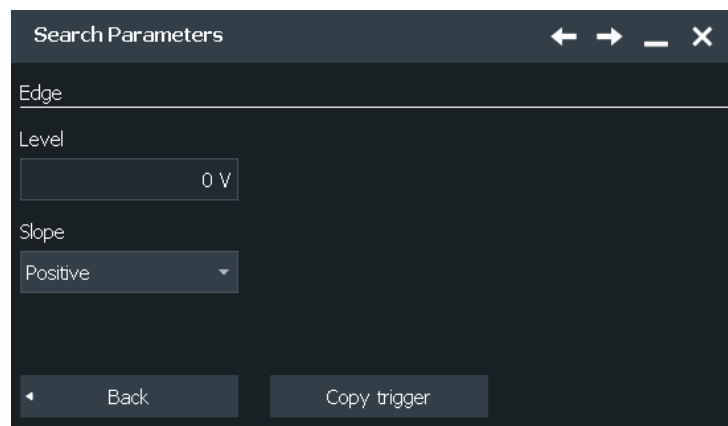

Slope

Sets the edge type: rising edge ("Positive"), falling edge ("Negative"), or both.

Remote command:

[SEARCh:TRIGger:EDGE:SLOPe](#) on page 1720

Level

Sets the voltage level for trigger search. The value is used for all search event types that require one trigger level. The search trigger level is search-specific, you can define different levels in different searches for the same event.

Remote command:

[SEARCh:TRIGger:LEVel\[:VALue\]](#) on page 1719

11.2.2.2 Glitch

The glitch search works the same way as the glitch trigger. To apply the trigger settings to search, tap [Copy from trigger A'](#).

The glitch search is not available if the search source is a digital channel.

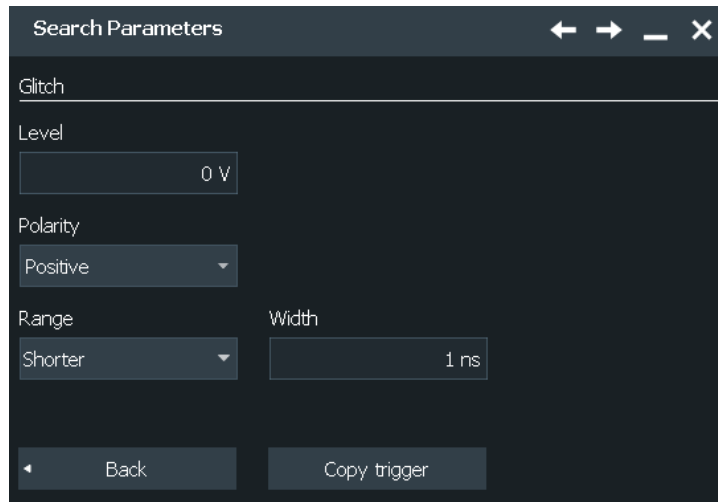

Polarity, Range, Width

See trigger settings:

- ["Range"](#) on page 201
- ["Width"](#) on page 201
- ["Polarity"](#) on page 201

Remote command:

[SEARCH:TRIGGER:GLITCH:POLARITY](#) on page 1721

[SEARCH:TRIGGER:GLITCH:RANGE](#) on page 1721

[SEARCH:TRIGGER:GLITCH:WIDTH](#) on page 1722

Level

Sets the voltage level for trigger search. The value is used for all search event types that require one trigger level. The search trigger level is search-specific, you can define different levels in different searches for the same event.

Remote command:

[SEARCH:TRIGGER:LEVEL\[:VALUE\]](#) on page 1719

11.2.2.3 Width

The width search works the same way as the width trigger. To apply the trigger settings to search, tap [Copy from trigger A'](#).

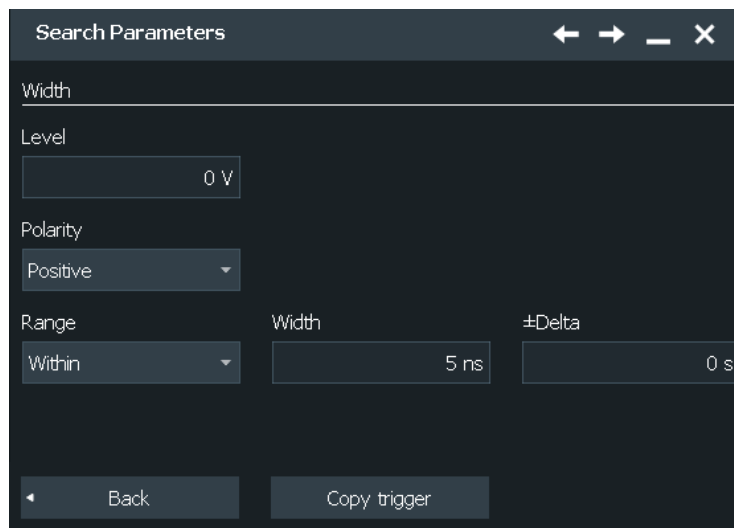

Polarity, Range, Width, \pm Delta

See trigger settings:

- ["Polarity"](#) on page 202
While the width trigger can only analyze positive or negative polarity, searching for a width is also possible for both polarities at the same time ("Either").
- ["Range"](#) on page 203
- ["Width"](#) on page 203
- [" \$\pm\$ Delta"](#) on page 203

Remote command:

[SEARCH:TRIGGER:WIDTH:POLARITY](#) on page 1730

[SEARCH:TRIGGER:WIDTH:RANGE](#) on page 1730

[SEARCH:TRIGGER:WIDTH:WIDTH](#) on page 1731

[SEARCH:TRIGGER:WIDTH:DELTA](#) on page 1730

Level

Sets the voltage level for trigger search. The value is used for all search event types that require one trigger level. The search trigger level is search-specific, you can define different levels in different searches for the same event.

Remote command:

[SEARCH:TRIGGER:LEVEL\[:VALUE\]](#) on page 1719

11.2.2.4 Runt

The runt search settings are the same as the runt trigger settings. To apply the trigger settings to search, tap [Copy from trigger A'](#).

The runt search is not available, if the search source is a digital channel.

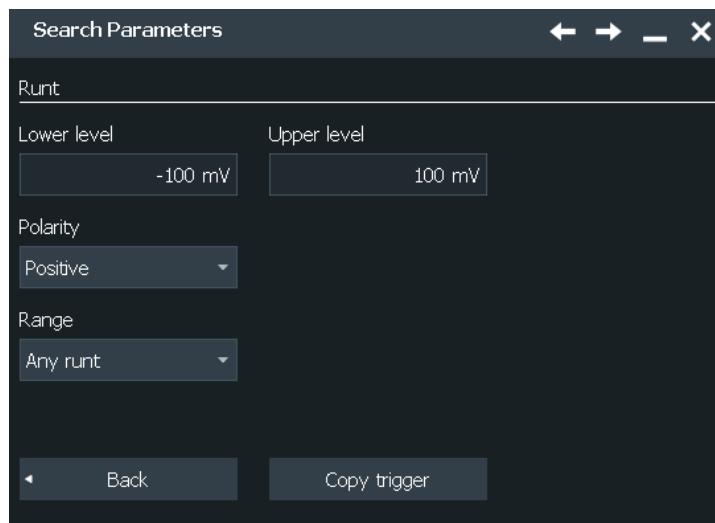

Polarity, Range, Runt width, \pm Delta

Time limit for the runt, see trigger settings:

- "Polarity" on page 201
- "Range" on page 204
- "Runt width" on page 205
- " \pm Delta" on page 205

Remote command:

[SEARCH:TRIGGER:RUNT:POLarity](#) on page 1724

[SEARCH:TRIGGER:RUNT:RANGe](#) on page 1725

[SEARCH:TRIGGER:RUNT:WIDTh](#) on page 1725

[SEARCH:TRIGGER:RUNT:DELTA](#) on page 1724

Upper level, Lower level

Set the upper and lower voltage thresholds. The amplitude of a runt crosses the first threshold twice in succession without crossing the second one.

Remote command:

[SEARCH:TRIGGER:LEVEL:RUNT:UPPer](#) on page 1726

[SEARCH:TRIGGER:LEVEL:RUNT:LOWer](#) on page 1726

11.2.2.5 Window

The window search settings are the same as the window trigger settings. This search type is not available if the search source is a digital channel. To apply the trigger settings to search, tap [Copy from trigger A](#).

The window search is not available if the search source is a digital channel.

The screenshot shows a 'Search Parameters' dialog box with the following settings:

- Lower level:** -100 mV
- Upper level:** 100 mV
- Vertical condition:** Stay within
- Time range:** Within
- Width:** 5 ns
- ±Delta:** 0 s

Buttons at the bottom: Back, Copy trigger.

Vertical condition

Defines the run of the signal relative to the window, see ["Vertical condition"](#) on page 206.

Remote command:

[SEARCH:TRIGGER:WINDOW:RANGE](#) on page 1732

Time condition, Width, ±Delta

Set the time limit for the vertical condition, see:

- ["Time condition"](#) on page 206
- ["Width"](#) on page 206
- ["±Delta"](#) on page 207

Remote command:

[SEARCH:TRIGGER:WINDOW:TIMERange](#) on page 1733

[SEARCH:TRIGGER:WINDOW:WIDTH](#) on page 1733

[SEARCH:TRIGGER:WINDOW:DELTA](#) on page 1732

Upper level, Lower level

Set the upper and lower voltage thresholds. The amplitude of a runt crosses the first threshold twice in succession without crossing the second one.

Remote command:

[SEARCH:TRIGGER:LEVEL:WINDOW:UPPER](#) on page 1734

[SEARCH:TRIGGER:LEVEL:WINDOW:LOWER](#) on page 1734

11.2.2.6 Timeout

The timeout search settings are the same as the timeout trigger settings. To apply the trigger settings to search, tap [Copy from trigger A'](#).

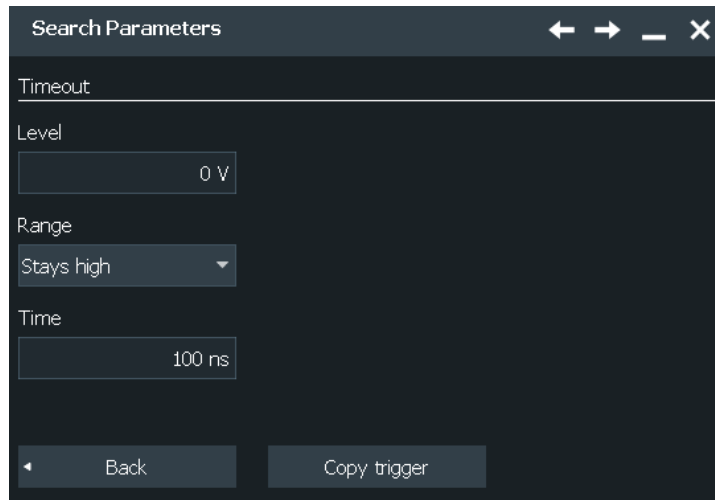

Range, Time

Set the timeout condition, see:

- ["Range"](#) on page 207
- ["Time"](#) on page 208

Remote command:

[SEARCH:TRIGger:TIMEout:RANGe](#) on page 1729

[SEARCH:TRIGger:TIMEout:TIME](#) on page 1729

Level

Sets the voltage level for trigger search. The value is used for all search event types that require one trigger level. The search trigger level is search-specific, you can define different levels in different searches for the same event.

Remote command:

[SEARCH:TRIGger:LEVel\[:VALue\]](#) on page 1719

11.2.2.7 Interval

The interval search settings are the same as the interval trigger settings. To apply the trigger settings to search, tap [Copy from trigger A'](#).

The interval search is not available if the search source is a digital channel.

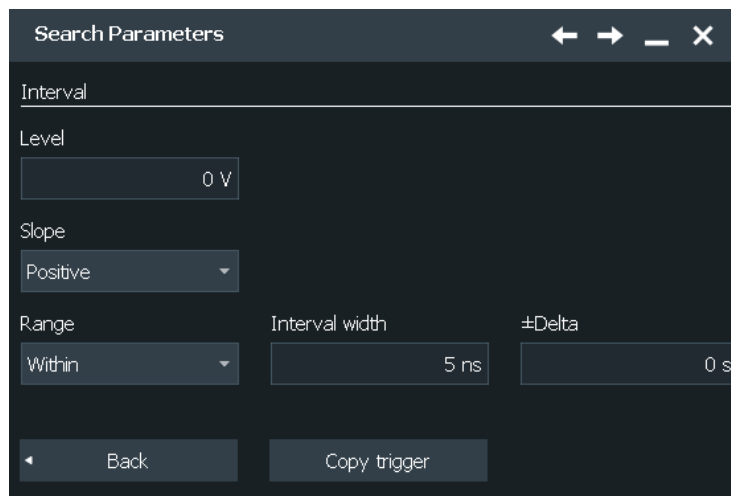

Slope, Range, Interv. width, ±Delta

Set the interval condition, see:

- ["Slope"](#) on page 208
While the interval trigger can only analyze rising or falling edges, searching for a width is possible for both edges at the same time ("Either").
- ["Range"](#) on page 208
- ["Interv. width"](#) on page 209
- ["±Delta"](#) on page 209

Remote command:

[SEARCH:TRIGger:INTerval:SLOPe](#) on page 1722

[SEARCH:TRIGger:INTerval:RANGe](#) on page 1723

[SEARCH:TRIGger:INTerval:WIDTh](#) on page 1723

[SEARCH:TRIGger:INTerval:DELTA](#) on page 1722

Level

Sets the voltage level for trigger search. The value is used for all search event types that require one trigger level. The search trigger level is search-specific, you can define different levels in different searches for the same event.

Remote command:

[SEARCH:TRIGger:LEVel\[:VALue\]](#) on page 1719

11.2.2.8 Slew rate

The slew rate search settings are the same as the slew rate trigger settings. To apply the trigger settings to search, tap [Copy from trigger A'](#).

The slew rate search is not available if the search source is a digital channel.

The screenshot shows a 'Search Parameters' dialog box with the following settings:

- Lower level:** -100 mV
- Upper level:** 100 mV
- Slope:** Positive
- Range:** Longer
- Slew rate:** 100 ps

Buttons at the bottom: Back, Copy trigger.

Polarity, Range, Slew rate, \pm Delta

- "Slope" on page 200
- "Range" on page 210
- "Slew rate" on page 211
- " \pm Delta" on page 211

Remote command:

[SEARCH:TRIGger:SLEWrate:SLOPe](#) on page 1727

[SEARCH:TRIGger:SLEWrate:RANGe](#) on page 1727

[SEARCH:TRIGger:SLEWrate:TIME](#) on page 1728

[SEARCH:TRIGger:SLEWrate:DELTA](#) on page 1726

Upper level, Lower level

Set the upper and lower voltage thresholds. When the signal crosses a level, the slew rate measurement starts or stops depending on the selected slope.

Remote command:

[SEARCH:TRIGger:LEVel:TRANSition:UPPer](#) on page 1728

[SEARCH:TRIGger:LEVel:TRANSition:LOWer](#) on page 1728

11.2.2.9 Setup & Hold

The Setup & Hold search settings are the same as the Setup & Hold trigger settings. To apply the trigger settings to search, tap [Copy from trigger A'](#).

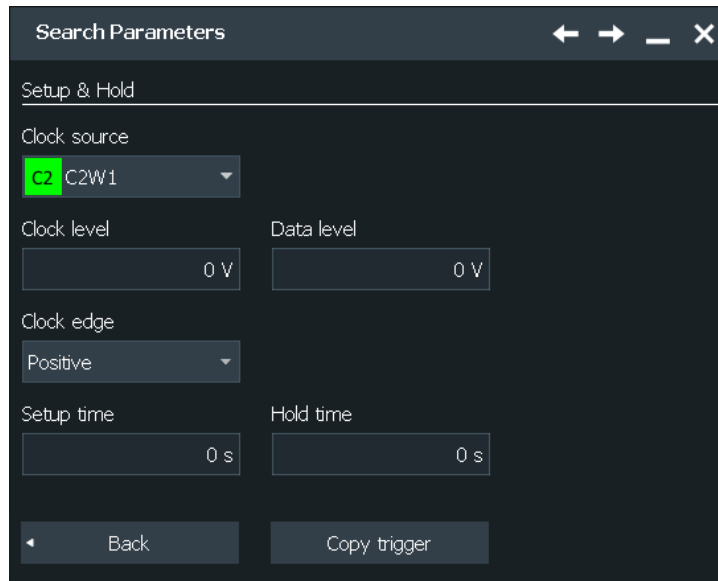

Clock source, Clock edge, Clock level

Set the clock settings. Both "Clock level" and "Clock edge" define the starting point for calculation of the setup and hold time.

Remote command:

[SEARCH:TRIGGER:SETHold:CSOURCE](#) on page 1735

[SEARCH:TRIGGER:SETHold:CEdge](#) on page 1735

[SEARCH:TRIGGER:SETHold:CLEVEL](#) on page 1735

Data level

Sets the voltage level for the data signal. At this level, the setup and hold time are measured.

Remote command:

[SEARCH:TRIGGER:LEVEL\[:VALUE\]](#) on page 1719

Level

Sets the voltage level for trigger search. The value is used for all search event types that require one trigger level. The search trigger level is search-specific, you can define different levels in different searches for the same event.

Remote command:

[SEARCH:TRIGGER:LEVEL\[:VALUE\]](#) on page 1719

Setup time, Hold time

Sets the minimum time **before** (Setup) and **after** (Hold) the clock edge while the data signal must stay steady above or below the data level.

See also: "[Setup time](#)" on page 213 and "[Hold time](#)" on page 213.

Remote command:

[SEARCH:TRIGGER:SETHold:STIME](#) on page 1736

[SEARCH:TRIGGER:SETHold:HTIME](#) on page 1736

11.2.2.10 State

The state search is a qualified edge search. The state search is only available for analog channel sources (Ch1 to Ch4).

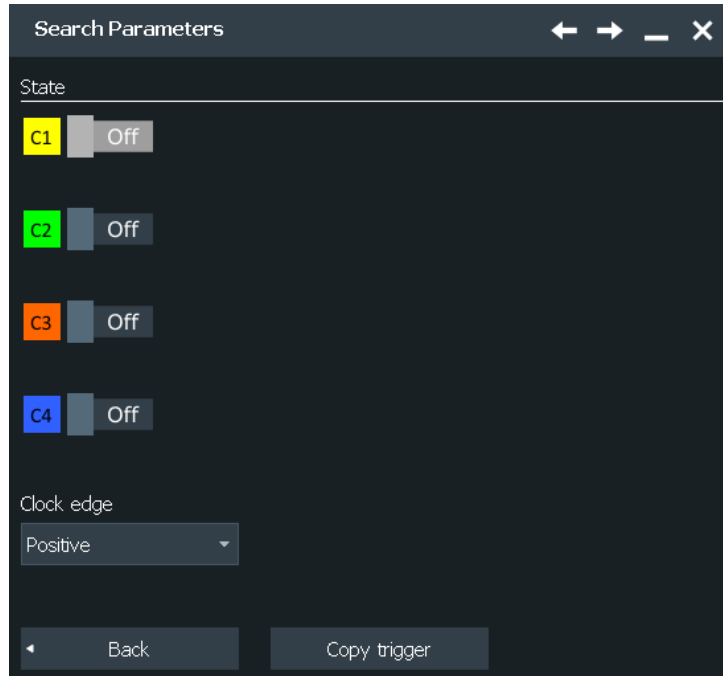

Clock source, Clock edge

Define the clock settings. The clock signal is the waveform to be searched.

Remote command:

[SEARCH:TRIGGER:STATE:CSOURCE](#) on page 1742

[SEARCH:TRIGGER:STATE:CEdge](#) on page 1742

[SEARCH:TRIGGER:STATE:CLEVEL](#) on page 1742

State pattern

State settings are the same as for the state trigger.

See also "[Pattern](#)" on page 215.

Remote command:

[SEARCH:TRIGGER:STATE:A\[:ENABLE\]](#) on page 1743

[SEARCH:TRIGGER:STATE:A:LOGIC](#) on page 1743

[SEARCH:TRIGGER:STATE:AB:LOGIC](#) on page 1744

[SEARCH:TRIGGER:STATE:ABCD:LOGIC](#) on page 1744

11.2.2.11 Pattern

The pattern search combines a logical combination of the input channels with a timing condition. The pattern search is only available for analog channel sources (Ch1 to Ch4).

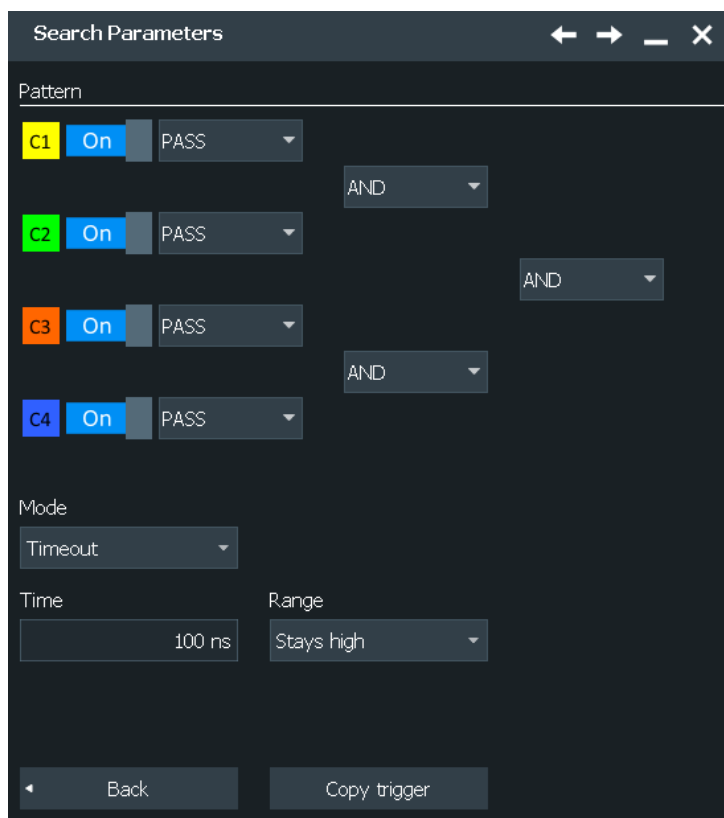

Pattern

Pattern search settings are the same as for the pattern trigger.

See also "[Pattern](#)" on page 215.

Remote command:

[SEARCH:TRIGGER:PATTERN:A\[:ENABLE\]](#) on page 1737

[SEARCH:TRIGGER:PATTERN:A:LOGIC](#) on page 1737

[SEARCH:TRIGGER:PATTERN:AB:LOGIC](#) on page 1738

[SEARCH:TRIGGER:PATTERN:ABCD:LOGIC](#) on page 1738

Timing condition: Mode, Range, Time, Width, \pm Delta

Additional time limitation to the pattern, see "[Additional settings: Timing](#)" on page 216.

Remote command:

[SEARCH:TRIGGER:PATTERN:MODE](#) on page 1739

[SEARCH:TRIGGER:PATTERN:TIMEOUT:MODE](#) on page 1739

[SEARCH:TRIGGER:PATTERN:TIMEOUT\[:TIME\]](#) on page 1740

[SEARCH:TRIGGER:PATTERN:WIDTH:RANGE](#) on page 1740

[SEARCH:TRIGGER:PATTERN:WIDTH\[:WIDTH\]](#) on page 1740

[SEARCH:TRIGGER:PATTERN:WIDTH:DELTA](#) on page 1741

11.2.3 Frequency marker search

When you start a search on a spectrum, a frequency marker search is performed to detect peaks in a spectrum. You can define which peaks the instrument finds by defining the noise reject settings.

Threshold

See "[Threshold](#)" on page 303.

Peak excursion

See "[Peak excursion](#)" on page 304.

11.2.4 Configuring the search setup

There are several ways to create a search:

- Creating a simple default search using the toolbar icon. This method is not available for search on serial buses.
- Setting up a search using the dialog box.

To perform a simple search

1. If more than one waveform is in the diagram, select the waveform to be searched for by tapping it in the diagram.
2. Select the "Search" icon on the toolbar.



The overlay menu opens.

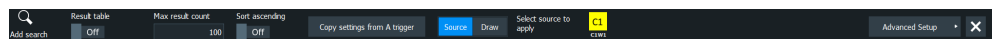

3. Tap the diagram with the waveform to be searched, or drag a rectangle on the diagram to define the search area.
4. Alternatively, use the settings provided in the overlay menu.

The default edge search is configured as "Search<x>" and performed. The "Search Results" box is displayed.

To create a user-defined search

1. Open the search dialog: "Menu" > "Apps" > "Analysis" tab > "Search".
2. There are two ways to create a search:
 - If you want to create a new, unconfigured search, tap the "Add" icon.



- If you want to create a new search based on an existing one, tap the "Copy" icon.



3. Enter a name for the search using the on-screen keyboard.

To configure a user-defined search

1. Open the search dialog: "Menu" > "Apps" > "Analysis" tab > "Search".
2. Select the "Setup" tab and the search that you want to configure.
3. Select the "Source" on which you want to perform the search.
4. Select the events that you want to include in the search.
5. Define the settings of the first search event.
To use the same conditions as defined in the trigger configuration of the A-event, tap "Copy from trigger A". The selected trigger settings are applied to the search settings.
6. Repeat the previous steps to define further events for the same search.
7. To perform the search only on a part of the waveform, configure the gate in the "Gate" tab as described in [Chapter 11.3.2, "Defining the search gate"](#), on page 443.

11.3 Search gate

The gate defines the search area within the source waveform. You can use absolute or relative values to define the gate, or couple it to a previously defined zoom area.

11.3.1 Gate settings

Access: "Menu" > "Apps" > "Analysis" tab > "Search" > "Gate" tab

The search gate settings are identical to those for gate areas for measurements or FFT analysis.

Gating is not available if the search source is a digital channel or a serial bus.

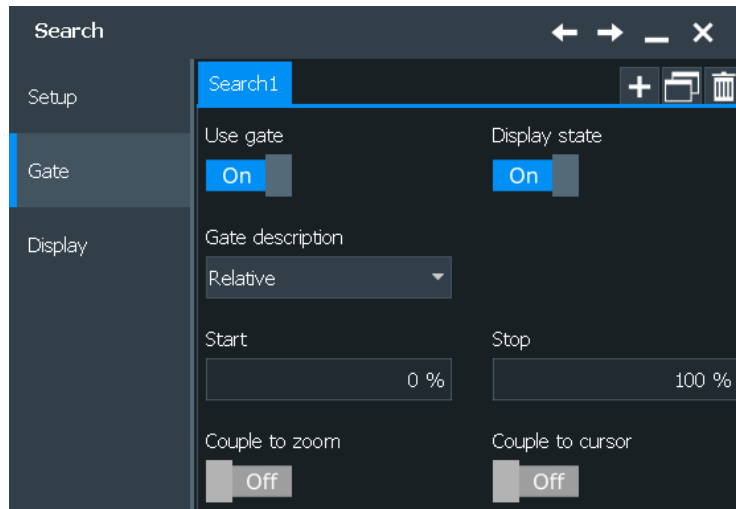

Use gate

Enables the gate settings and shows the gate. Search is only performed on the defined gate area of the source waveform.

Remote command:

[SEARCh:GATE\[:STATe\]](#) on page 1745

Display state

Displays the gate area in the source diagram.

Remote command:

[SEARCh:GATE:SHOW](#) on page 1746

Gate description

Defines whether the gate settings are configured using absolute or relative values.

"Absolute" The gate is defined by absolute start and stop values.

"Relative" The gate's start and stop values are defined by a percentage of the value range.

Remote command:

[CALCulate:MATH<m>:FFT:GATE:MODE](#) on page 1682

[MEASurement<m>:GATE:MODE](#) on page 1667

[SEARCh:GATE:MODE](#) on page 1745

(Relative) Start

Defines the starting value for the gate.

Remote command:

[CALCulate:MATH<m>:FFT:GATE:ABSolute:START](#) on page 1681

[CALCulate:MATH<m>:FFT:GATE:RELative:START](#) on page 1682

[MEASurement<m>:GATE:ABSolute:START](#) on page 1668

[MEASurement<m>:GATE:RELative:START](#) on page 1668

[SEARCh:GATE:ABSolute:START](#) on page 1746

[SEARCh:GATE:RELative:START](#) on page 1747

(Relative) Stop

Defines the end value for the gate.

Remote command:

[CALCulate:MATH<m>:FFT:GATE:ABSolute:STOP](#) on page 1682

[CALCulate:MATH<m>:FFT:GATE:RELative:STOP](#) on page 1683

[MEASurement<m>:GATE:ABSolute:STOP](#) on page 1668

[MEASurement<m>:GATE:RELative:STOP](#) on page 1668

[SEARch:GATE:ABSolute:STOP](#) on page 1746

[SEARch:GATE:RELative:STOP](#) on page 1747

Zoom

Zoom coupling is available if a zoom is defined. As long as "Zoom coupling" is enabled, the gate area is defined identically to the zoom area - if you change the zoom, the gate changes as well.

If several zoom diagrams are defined, select the zoom diagram to be used for gating. The "Start" and "Stop" values of the gate are adjusted accordingly.

Zoom coupling can be set for measurement gates, FFT gates, and search gates. The zoom must be defined on the diagram that contains the signal source of the measurement, FFT, or search.

Remote command:

[MEASurement<m>:GATE:ZCOupling](#) on page 1669

[MEASurement<m>:GATE:ZDIagram](#) on page 1670

[CALCulate:MATH<m>:FFT:GATE:ZCOupling](#) on page 1683

[SEARch:GATE:ZCOupling](#) on page 1747

[SEARch:GATE:ZDIagram](#) on page 1748

Cursor

If enabled, the gate area is defined by the cursor lines of an active cursor measurement.

If several cursor measurements are enabled, select the cursor set to be used for gating. The "Start" and "Stop" values of the gate are adjusted to the values of the cursor line positions. The measurement is limited to the part of the waveform between the cursor lines.

Remote command:

[MEASurement<m>:GATE:CCOupling](#) on page 1669

[MEASurement<m>:GATE:CURSor](#) on page 1668

11.3.2 Defining the search gate

If you create a search using the "Search" toolbar icon, you can directly define the gate by dragging a rectangle on the diagram. Otherwise, you define the gate in the "Gate" tab of the "Search" dialog box.

1. Open the "Menu" > "Apps" > "Analysis" tab > "Search" > "Gate" tab.
2. Select the search for which you want to define the gate.

3. Use one of the following methods:
 - a) Set the absolute or relative "Gate description" . Enter the start and stop values of the gate area.
 - b) If a zoom area has already been defined for the waveform, couple the gate area to the zoom area by selecting the "Couple to zoom" option. If several zoom diagrams are defined, select the zoom diagram you want to use for gating.
4. Tap "Use gate" to enable the gate.
5. Optionally, tap "Display state" to display the gate area in the diagram.

11.4 Search display presentation

Search results are displayed in a table in the "Search Results" box. In addition, a zoom window for a selected search result can be displayed so that you can analyze the result in more detail.

11.4.1 Search display settings

Access: "Menu" > "Apps" > "Analysis" tab > "Search" > "Display"

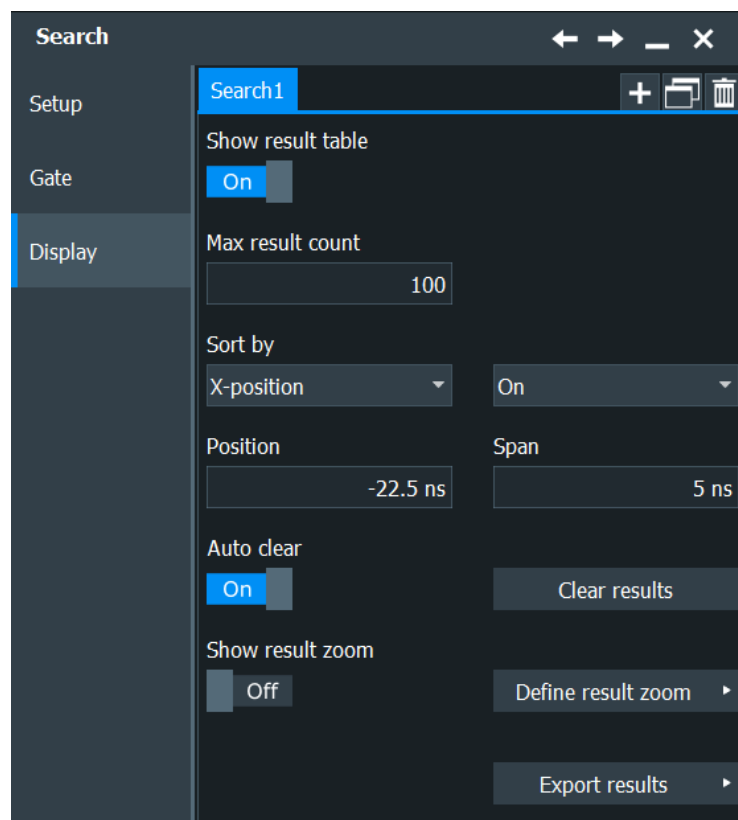

The following settings configure the layout of the result table in the "Search Results" box and the size and position of the search zoom window. The result tables can be sorted by x-position or value. You can define a maximum number of table entries.

Show result table

Displays or hides the search result table.

Remote command:

[SEARCH:RESult:SHOW](#) on page 1755

Max result count

Defines the maximum number of entries in the search result table.

Remote command:

[SEARCH:RESult:LIMit](#) on page 1754

Sort by

Sorts the search results by x-value position or value of the result.

Remote command:

[SEARCH:RESult:SORT\[:MODE\]](#) on page 1755

Sort ascending

By default, the results are listed in descending order, i.e. the largest value at the top. To change the sorting direction, enable "Sort ascending".

Remote command:

[SEARCH:RESult:SORT:ASCending](#) on page 1755

Clear results

Clears the search results once and starts a new search.

Remote command:

[SEARCH:CLEar](#) on page 1716

Auto clear

If "Auto clear" is enabled, the instrument displays the search results of the last acquisition.

If "Auto clear" is disabled, the first result of each acquisition is listed until the maximum number of entries in the table is reached.

Show result zoom

If enabled, a zoom window is displayed for the currently selected search result. The zoom area is indicated in the diagram that displays the source waveform of the search.

Remote command:

[SEARCH:RESDiagram:SHOW](#) on page 1752

Define result zoom

Opens a dialog to define the result zoom display settings.

See [Chapter 11.4.2, "Display zoom settings"](#), on page 446.

Export results

Opens a dialog to define the export results.

See [Chapter 12.2.4, "Results"](#), on page 475.

11.4.2 Display zoom settings

You can display a zoom window for the currently selected search result. The zoom area is indicated in the diagram that displays the source waveform of the search.

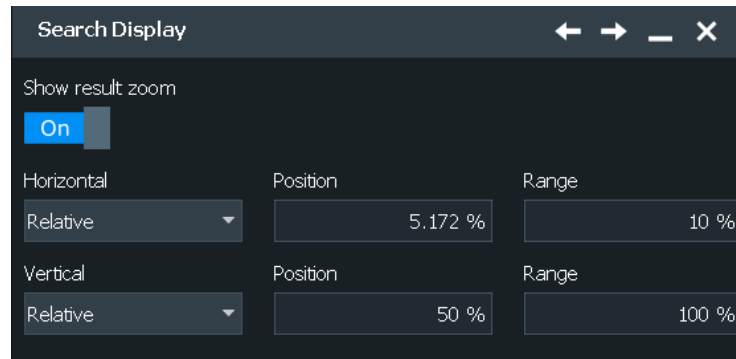
**Show result zoom**

If enabled, a zoom window is displayed for the currently selected search result. The zoom area is indicated in the diagram that displays the source waveform of the search.

Remote command:

[SEARCH:RESDiagram:SHOW](#) on page 1752

Y mode

Defines whether absolute or relative values are used to specify the y-axis values.

Remote command:

[LAYout:ZOOM:VERTical:MODE](#) on page 1541

[SEARCH:RESDiagram:VERT:MODE](#) on page 1753

Y position

Defines the y-value of the centerpoint of the zoom area.

Remote command:

[LAYout:ZOOM:VERTical:ABSolute:POSition](#) on page 1542

[LAYout:ZOOM:VERTical:RELative:POSition](#) on page 1543

[SEARCH:RESDiagram:VERT:ABSolute:POSition](#) on page 1753

[SEARCH:RESDiagram:VERT:RELative:POSition](#) on page 1753

Y range

Defines the height of the zoom area.

Remote command:

[LAYout:ZOOM:VERTical:RELative:SPAN](#) on page 1544

[LAYout:ZOOM:VERTical:ABSolute:SPAN](#) on page 1542

[SEARCH:RESDiagram:VERT:ABSolute:SPAN](#) on page 1753

[SEARCH:RESDiagram:VERT:RELative:SPAN](#) on page 1754

X mode

Defines whether absolute or relative values are used to specify the x-axis values.

Remote command:

[LAYout:ZOOM:HORIZ:MODE](#) on page 1538

[SEARCH:RESDiagram:HORIZ:MODE](#) on page 1751

X position

Defines the x-value of the centerpoint of the zoom area.

Remote command:

[LAYout:ZOOM:HORIZ:ABSolute:POSition](#) on page 1538

[LAYout:ZOOM:HORIZ:RELative:POSition](#) on page 1540

[SEARCH:RESDiagram:HORIZ:ABSolute:POSition](#) on page 1751

[SEARCH:RESDiagram:HORIZ:RELative:POSition](#) on page 1752

X range

Defines the width of the zoom area.

Remote command:

[LAYout:ZOOM:HORIZ:ABSolute:SPAN](#) on page 1539

[LAYout:ZOOM:HORIZ:RELative:SPAN](#) on page 1540

[SEARCH:RESDiagram:HORIZ:ABSolute:SPAN](#) on page 1751

[SEARCH:RESDiagram:HORIZ:RELative:SPAN](#) on page 1752

11.4.3 Configuring the search results presentation

Initially, the "Search Results" box is displayed in front of the other diagrams or as result icon on the signal bar. This depends on the default setting in the "Diagram Layout" tab. Alternatively, you can display it in its own area on the screen, like any other diagram.

For details, see [Chapter 3.3.7, "Displaying results"](#), on page 59.

To configure the result tables

1. Open the search dialog: "Menu" > "Apps" > "Analysis" tab > "Search".
2. Select the tab for the search you want to configure.
3. Select the "Display" tab.
4. Select "Show result table" to display the "Search Results" box.
5. Select the sort mode of the result table.
6. By default, the results are listed in descending order, i.e. the largest value at the top. To change the sorting direction, enable "Sort ascending".
7. Define a maximum number of results to be displayed in the result table in the "Max. result count" field.

To display search zoom windows

1. In the "Search > Display" tab, enable "Show result zoom".

This stops a running search and a running acquisition.

The zoom area is indicated in the diagram that displays the source waveform of the search. The zoom window is displayed for the first result that was found.

2. If you need to adjust the search zoom area, you can drag the area or their edges on the screen. You can also enter the limits of the search zoom window in the "Search > Display > Define result zoom".

Be aware, that the zoom window size is valid for all results of a search definition. If you change the settings drastically for one result, they may not be correct for the next search result you switch to.

See also:

- [Chapter 7.1.3, "Zooming for details"](#), on page 249

12 Data and file management

This chapter describes how to manage instrument settings, and measurement results like waveform data, numeric results and screenshots.

The "Save/Recall" dialog provides functions for saving and restoring data on the instrument. A naming pattern is available and can be adjusted to simplify a clear data storage.

The effect of the [Camera] key can be configured to save screenshots or reports.

- [Save and recall user settings](#).....449
- [Save and recall waveform data and results](#).....458
- [Screenshots](#).....483
- [Reports](#).....488
- [File selection dialog](#).....490

12.1 Save and recall user settings

To repeat measurements at different times or perform similar measurements with different test data, it is useful to save the used instrument settings and load them again later. Furthermore, it can be helpful to refer to the instrument settings of a particular measurement when analyzing the results. Therefore, you can easily save the instrument settings of a measurement. In addition to the measurement-related settings, user-specific display settings and active reference waveforms can also be saved and loaded.

Access: "Menu" key > "Save/Recall" key > "Save" tab > "User settings"

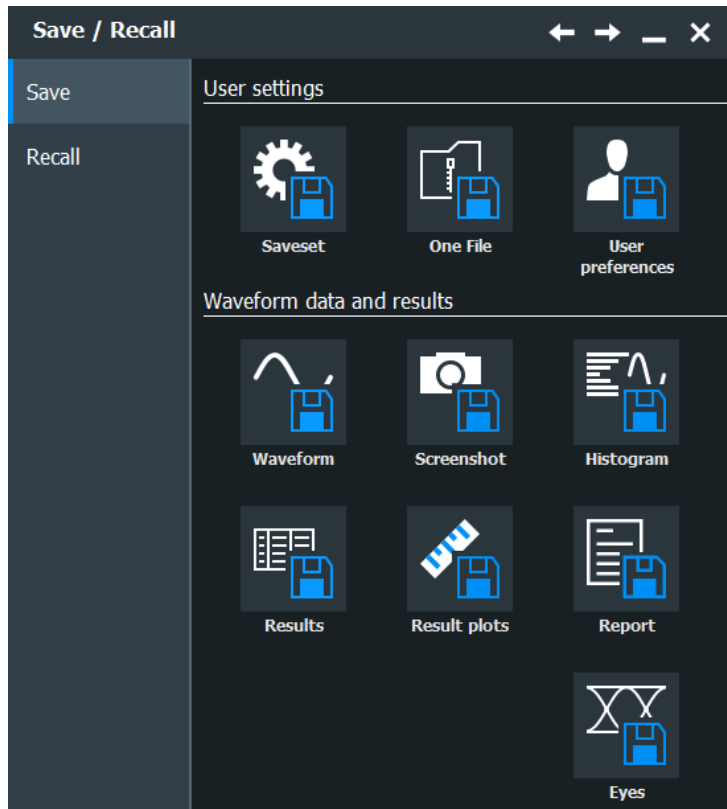

Figure 12-1: Save tab

Access to load instrument settings: "Menu" key > "Save/Recall" key > "Recall" tab > "User settings"

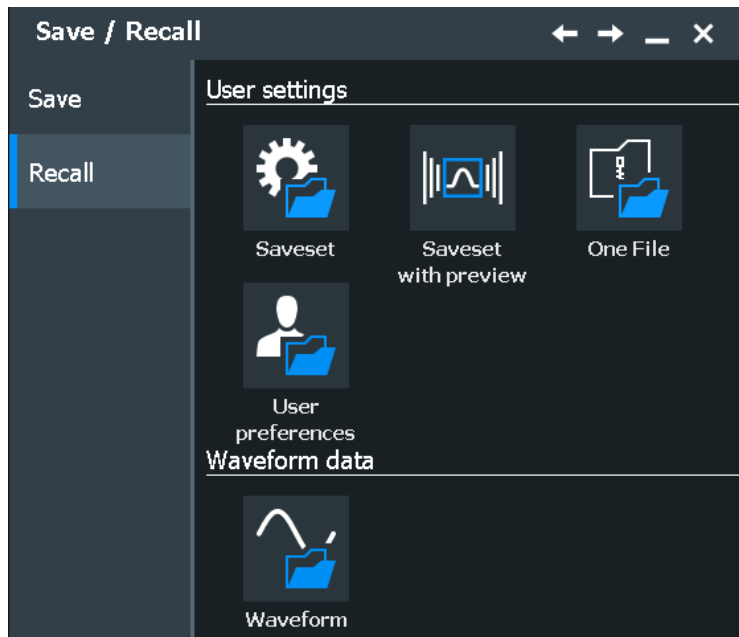

Figure 12-2: Recall tab

The R&S RTO6 provides the following types of saving and restoring settings:

- **Savesets** contain the complete instrument and measurement configuration except for user-specific display settings.
- **One File** contains the saveset and active reference waveform files in a ZIP file.
- **User preferences** contain the user specific display settings.
- **User-defined presets** contain the complete instrument setup including display settings, except for transparency and intensity. These settings can be restored by pressing the [Preset] key. See [Chapter 4.6, "Preset setup"](#), on page 98.

• Savesets	451
• One File	452
• User preferences	454
• Saveset with preview function	455
• Saving and loading settings	456

12.1.1 Savesets

Savesets contain the complete instrument and measurement configuration including a screenshot of the current display, but except for user-specific display settings stored as user preferences. You can save an unlimited number of setting files.

The waveform and pattern generator and the pulse source states are saved as "Off".

To load a saveset quickly, you can use the "Load saveset" function on the toolbar. A graphical preview helps you to find the required settings file.



If you need to store the instrument settings often, you can add the "Save settings" icon to the toolbar and use the icon to store the saveset file.

12.1.1.1 Save saveset settings

Access: "Menu" key > "Save/Recall" key > "Save" tab > "Savesets"

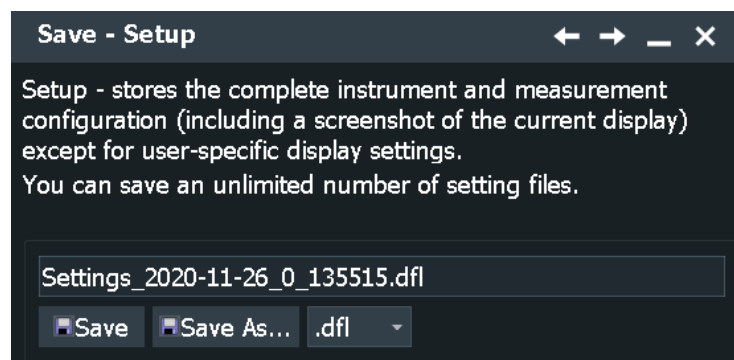

Save to file

Enter the filename to save the setting data to, and select the file format with the format button on the right. Double-tap the filename to open the file selection dialog box. See also: [Chapter 12.5, "File selection dialog"](#), on page 490.

By default, saveset filenames have the prefix "Settings_".

"Save"	Saves the data to the selected file.
"Save As..."	Opens the file selection dialog box and saves the data to the selected file.
".dfi/.xml"	Selects the file format.

Remote command:

[MMEMoRY:SAV](#) on page 1763

12.1.1.2 Load saveset settings

Access: "Menu" key > "Save/Recall" key > "Recall" tab > "Savesets"

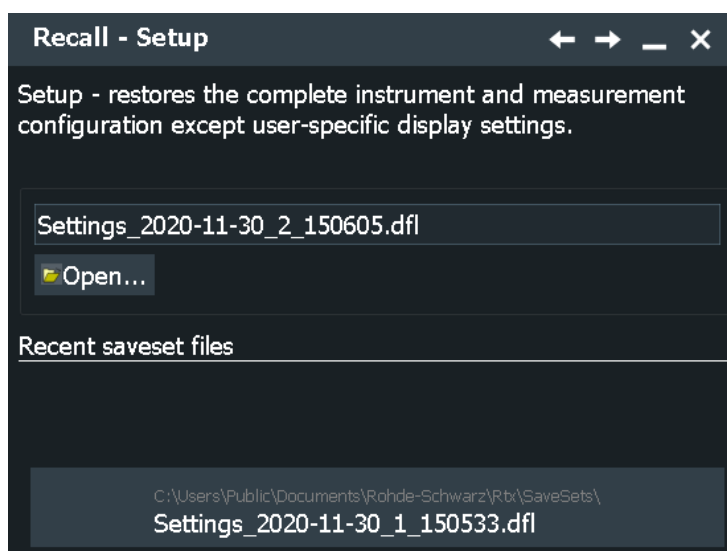
**Load from file**

Enter the filename to load the setting data from, and select the file format with the format button on the right. Double-tap the filename to open the file selection dialog box. See also: [Chapter 12.5, "File selection dialog"](#), on page 490.

By default, saveset filenames have the prefix "Settings_".

"Open" Opens a file selection dialog box and loads the selected file.

Remote command:

[MMEMoRY:RCL](#) on page 1763

12.1.2 One File

The One File function stores the savesets file and the data of active reference waveforms together in a ZIP file. If you want to keep channel waveform data together with

the instrument settings, make sure to create a reference waveform from the channel waveform before you save the One File.

The waveform generator/pattern generator and the pulse source state is saved as "Off".

12.1.2.1 Save One File settings

Access: "Menu" key > "Save/Recall" key > "Save" tab > "One File"

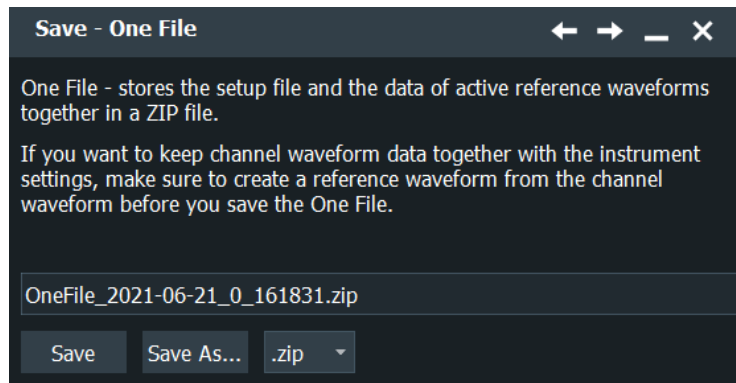

Save to file

Enter the file name to save the One File data to, and select the file format with the format button on the right. Double-tap the file name to open the file selection dialog box. See also: [Chapter 12.5, "File selection dialog"](#), on page 490.

By default, one file names have the prefix "OneFile_".

"Save" Saves the data to the selected file.

"Save As..." Opens the file selection dialog box and saves the data to the selected file.

".zip" Shows the file format.

Remote command:

[SAVeset:ONEFile:NAME](#) on page 1765

[SAVeset:ONEFile:SAVE](#) on page 1765

12.1.2.2 Load One File settings

Access: "Menu" key > "Save/Recall" key > "Recall" tab > "One File"

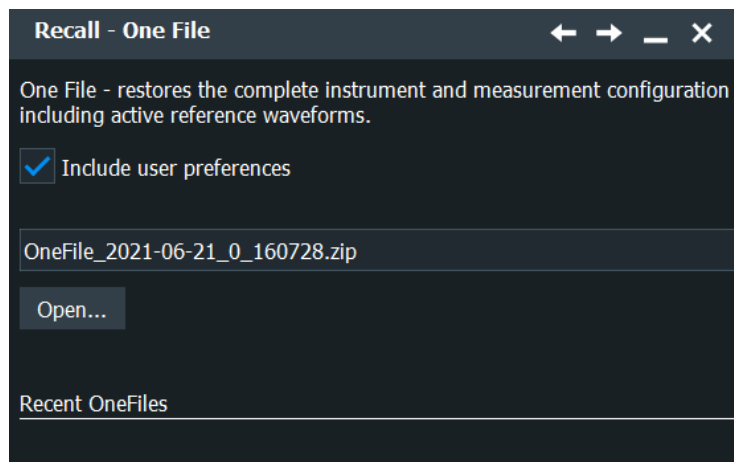

Load from file

Select "Open" to open the file selection dialog box, and to select the required file. See also: [Chapter 12.5, "File selection dialog"](#), on page 490.

By default, one file names have the prefix "OneFile_".

Remote command:

[SAVeset:ONEFile:NAME](#) on page 1765

[SAVeset:ONEFile:OPEN](#) on page 1765

Include user preferences

If enabled, the user preferences settings are also restored together with the saveset and reference waveform. User preferences settings include the user-specific display settings like diagram layout, toolbar, intensity and transparency settings.

Remote command:

[SAVeset:ONEFile:USERpref](#) on page 1765

12.1.3 User preferences

User preferences contain user-specific display settings like diagram layout, toolbar, intensity and transparency settings.

12.1.3.1 Save user preferences settings

Access: "Menu" key > "Save/Recall" key > "Save" tab > "User Preferences"

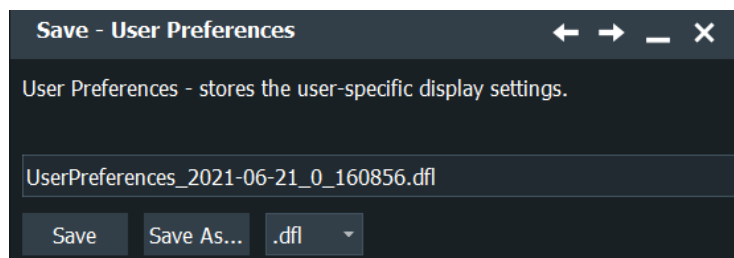

Save to file

The file name to save the data to.

By default, user preference file names have the prefix "UserPreferences_".

"Save" Saves the data to the selected file.

"Save As..." Opens the file selection dialog box and saves the data to the selected file.

".zip" Shows the file format.

12.1.3.2 Load user preference settings

Access: "Menu" key > "Save/Recall" key > "Recall" tab > "User Preferences"

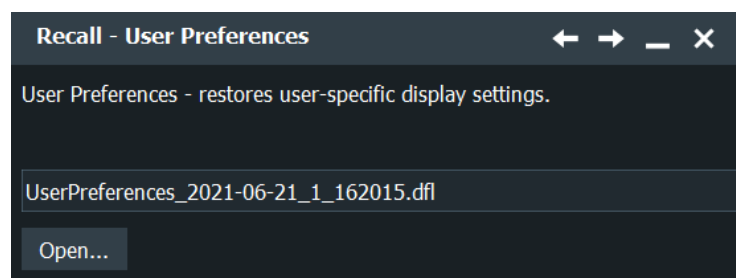
**Load from file**

Enter the file name to load the setting data from, and select the file format with the format button on the right. Double-tap the file name to open the file selection dialog box. See also: [Chapter 12.5, "File selection dialog"](#), on page 490.

By default, user preference file names have the prefix "UserPreferences_".

"Open" Opens a file selection dialog box and loads the selected file.

Remote command:

[MMEMoRY:RCL](#) on page 1763

12.1.4 Saveset with preview function

Access: "Menu" > "Save/Recall" > "Recall" tab > "Saveset with preview"

The graphical preview helps you to find the required settings file or a reference waveform.

The "Saveset with preview" function is also available on the toolbar, see [Chapter 3.3.6.3, "Toolbar functions"](#), on page 54.

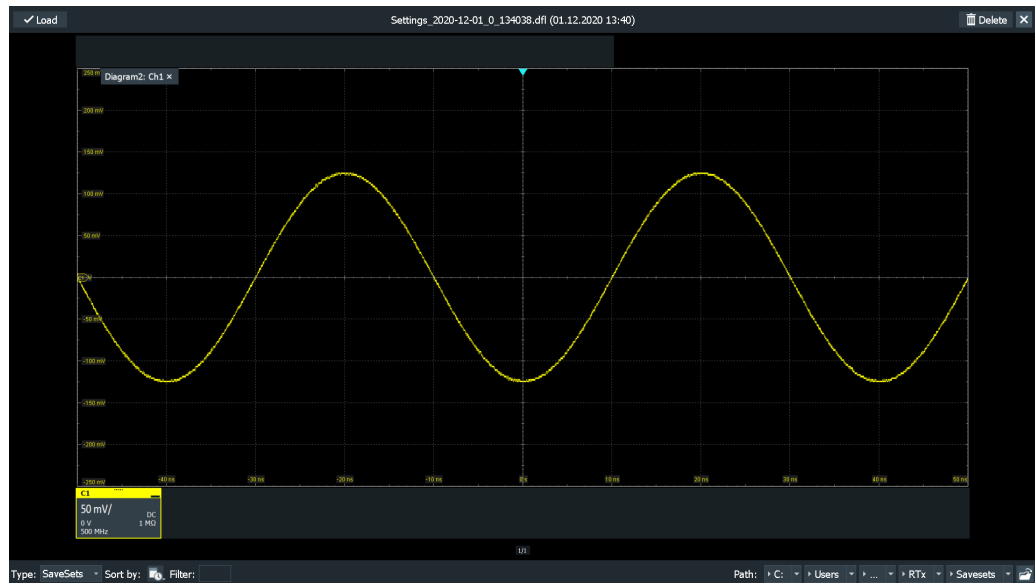

1. On the toolbar, tap the "Saveset with preview" icon.



A window opens and shows the screenshot of the first measurement configuration that is stored in the default directory.

2. Select if you want to display a "SaveSets" file or a reference waveform ("Ref Wfm").
3. Find the required file using one of the following methods:
 - Tap the "Next" icon on the right or the "Previous" icon on the left to scroll the savesets of the directory.
The file name is shown on the top, and the screenshot helps to identify the settings.
 - If the saveset was stored in another directory, use the path buttons at the bottom, or tap "Open" to open the required directory.
 - Tap "Sort by" to sort the files according to the "Last modified" date or the "File-name".
 - Specify a "Filter" name to show only the files containing the filter string.
4. Tap "Load" in the upper left corner to recall the settings of the selected file.

12.1.5 Saving and loading settings

Settings can be stored in a file with user-defined name and location, or in a quick save-set. The settings in a saveset can be saved and retrieved quickly at the touch of a button, so savesets are ideal for frequently used measurements.

For details on save/recall instrument settings and associated remote commands, see [Chapter 12.1.1, "Savesets"](#), on page 451.

To save settings to a saveset file

Alternatively, you can add the " Save settings" icon to the toolbar and use the icon to store the saveset file to the folder and file specified in the "Settings" tab.

See also [Chapter 3.3.6.2, "Configuring the toolbar"](#), on page 54.

1. Tap "Menu" and select "Save/Recall".
2. In the "Save" tab, press the "Saveset" button .
3. Tap "Save" to save the settings to the specified file.
Tap "Save As" to save the settings to a different file. Select the file and directory from the file selection dialog box.

The current settings are saved to the selected file.

To load settings from a saveset file

Alternatively, you can use the "Recall" function on the toolbar.

1. Tap "Menu" and select "Save/Recall".
2. Select the "Recall" tab.
3. Press the "Saveset" button.
4. Tap "Load" to load the settings from the specified file.
Tap "Open" to navigate to a different file. Select the file from the file selection dialog box and tap "Select".

The saved settings are loaded to the R&S RTO6.

To save a One File

1. If you want to save reference waveforms in the One File, create and display the reference waveforms.
2. Tap "Menu" and select "Save/Recall".
3. In the "Save" tab, tap the "One File".
4. Tap "Save" to save the settings to the specified file.
Tap "Save As" to save the settings to a different file. Select the file and directory from the file selection dialog box.

The current settings and the active reference waveforms are saved to the selected file.

To load a One File

1. Tap "Menu" and select "Save/Recall".
2. Press the "One File" button.
3. Tap "Load" to load the settings from the specified file.

Tap "Open" to navigate to a different file. Select the file from the file selection dialog box and tap "Select".

The saved settings and reference waveforms are loaded to the R&S RTO6.

12.2 Save and recall waveform data and results

Access: "Menu" key > "Save/Recall" > "Save" tab

You can export various data to file: waveform data, histograms, and measurement results.

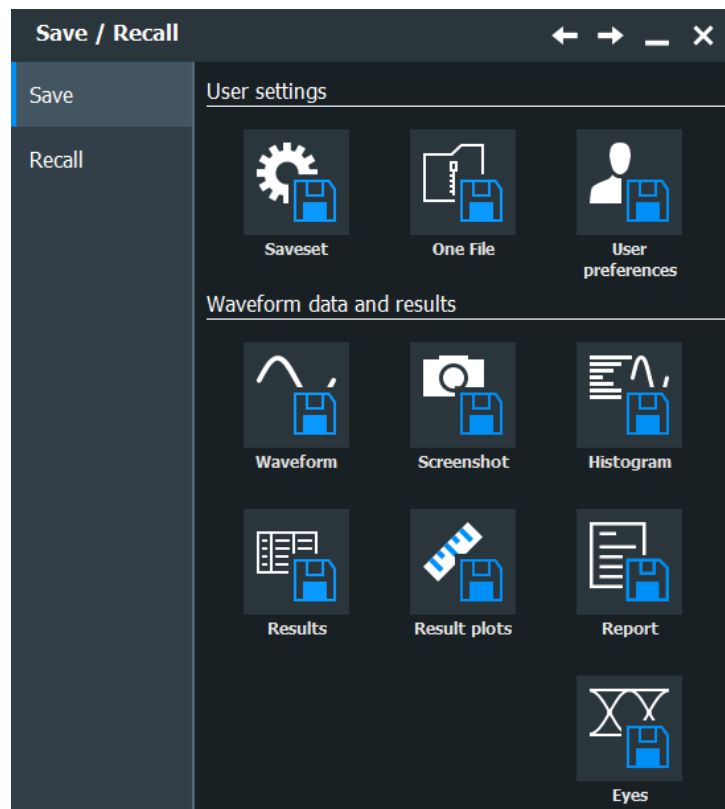

For information on data export in I/Q mode (requires option), see [Chapter 18.3, "I/Q data output"](#), on page 1079.

- [Waveform export files](#)..... 459
- [Waveform settings](#)..... 466
- [Histogram](#)..... 473
- [Results](#)..... 475
- [Result plots analysis](#)..... 476
- [Eyes](#)..... 479
- [Saving and loading waveform data](#)..... 481

12.2.1 Waveform export files

Waveforms can be stored in XML, CSV, or BIN format.



Reloading waveforms: Restrictions

To reload waveform data as a reference waveform, it must be stored in BIN format.

If multiple acquisitions of one waveform are exported (Data logging or Multiple waveforms), only the first acquisition can be reloaded.

If raw data was exported, after reload the waveform position is not the same as for the exported waveform.

If the signal is a spectrum, reloading is only possible for waveforms with "Magnitude unit" = Linear. Waveforms with logarithmic unit cannot be reloaded.

Data of all waveforms is saved in the following files:

- Header file: contains the header data, for example, time scale, vertical scale, vertical and horizontal positions, interpolation mode and much more. Header data is required to restore the waveform from data, or to analyze the data values of the data file.
- Waveform file: indicated by *Wfm.* in the filename. Contains the waveform data.

12.2.1.1 Header files

The header files of XML and BIN waveform files are written in XML format. The header files of CSV waveform files are written in CSV format. You can open the header files and use their information for data analysis.

CSV header files only contain the property names and values, one property per row.

```
Resolution:1e-010:
```

```
RecordLength:1000:
```

XML header files contain more information than CSV header files. The additional information is required to reload the stored waveforms with their correct settings.

```
<Prop Avail="0" ValueKey="" Name="Resolution" Value="1e-010" UserValue="0"
Step="1e-011" Default="0" Min="0" Max="1e+026" StepDefault="1e-011"
StepFactor="10" Resolution="0" UnitId="55" UnitName="s" UnitPowerProduct=""
BitGroupSize="0" Format="0"></Prop>
```

```
<Prop Avail="0" ValueKey="" Name="RecordLength" Value="1000" UserValue="1000"
Step="1" Default="1000" Min="0" Max="4294967295" StepDefault="1" StepFactor="10"
Resolution="1" UnitId="93" UnitName="Sa" UnitPowerProduct="" BitGroupSize="0"
Format="0"></Prop>
```

Header files contain the following properties:

Table 12-1: Header file properties

Value	Description
General	
FirmwareVersion	Firmware version that is installed on the R&S RTO6 (last entry in the header file)
Source	Name of the exported waveform
Resolution	Time between two samples <i>Resolution = 1 / Sample Rate</i>
SignalResolution	Time between two samples in this waveform. The value can differ from Resolution if the source is, for example, a spectrum, a bus signal, a correlation or a measurement. The value is determined automatically considering the waveform parameters and their dependencies. If the signal is a spectrum, the value indicates the frequency range of FFT bins.
EnhancementMode	Method to increase the sample rate if the required sample rate is higher than the ADC sample rate.
InterpolationMode	Interpolation method. The value is relevant when the enhancement mode is interpolated time.
DecimationMode	Method to reduce the number of data samples to achieve the required sample rate
DecimationFactor	Factor to the number of data samples to achieve the required sample rate <i>Decimation factor = ADC sample rate / Sample rate</i>
TraceArithmetics	Off, Envelope, or Average
InterleavedTraceCount	Number of y-values saved at each sampling time. The value is usually 1. The value is 2, if min and max values are saved for each sample, for example, for envelope waveforms.
SignalFormat	Format of the data values: <ul style="list-style-type: none"> • FLOAT: floating point numbers, general export format • INT (8 Bit): Integer 8 bit, used for "Raw (ADC sample)" data export. • INT (16 Bit): Integer 16 bit, used for "Raw (ADC sample)" data export in high definition mode.
Timestamp	Absolute time of the waveform recording
ByteOrder	Endianness, only relevant for raw data export in high definition mode (SignalFormat = INT (16 Bit)). <ul style="list-style-type: none"> • LSB first: little endian, least significant byte first • MSB first: big endian, most significant byte first
NumericFormat	Number format of bus values and digital channel data (bit pattern format)
Record length	
RecordLength	Number of samples in a waveform record of one acquisition
HWRecordLength	Equivalent to the RecordLength
SignalRecordLength	Number of required samples in the waveform. The value can differ from RecordLength and HWRecordLength if the source is, for example, a spectrum, a bus signal, a correlation or a measurement. The value is determined automatically considering the waveform parameters and their dependencies. If the signal is a spectrum, the value indicates the number of FFT bins.

Save and recall waveform data and results

Value	Description
SignalHardwareRecordLength	Number of samples actually available in this waveform, including the number of required samples in the waveform and the additional samples needed for further computation
LeadingSettlingSamples	Relevant only for BIN files. In XML and CSV files, the value is 0. Number of additional samples before the beginning of waveform samples. These additional samples are needed for further computation, for example, for filters.
Horizontal system	
TimeScale	Horizontal scale in seconds per division
HorizontalDivisionCount	Number of horizontal divisions
RescaleCenterTime	Horizontal position, the time distance between the reference point and the zero point of the diagram
RescaleCenterPoint	Position of the reference point in % of the screen
ReferencePoint	Position of the zero point in % of the screen
TriggerOffset	Time distance from the trigger point to the zero point of the diagram
XStart	Horizontal start value of the waveform (time or frequency) *)
XStop	Horizontal stop value of the waveform (time or frequency)
HardwareXStart	Actual horizontal start value of data, including the settling time for further computation *)
HardwareXStop	Actual horizontal stop value of data, including the settling time for further computation
	*) If the waveform is a spectrum, the XStart and HardwareXStart values may be slightly smaller than the specified start frequency, or even get negative. The spectrum is centered on the center frequency, and the frequency range covered by one spectral bin is given by the SignalResolution. Hence, the spectral bin in the center of the spectrum always covers the range [CenterFrequency; CenterFrequency + SignalResolution]. As a result, the range covered by the first spectral bin in the spectrum may reach further than the specified start frequency. It is ensured that the specified start frequency is included in the frequency range.
Vertical system	
If multiple channels are exported, the values of channel1 are delivered, no matter if channel 1 is exported or not.	
VerticalScale	Vertical scale of the waveform in Volts per division, or other unit / division
VerticalDivisionCount	Number of vertical divisions
VerticalPosition	Vertical position of the waveform in divisions
VerticalOffset	Vertical offset of the waveform in Volts, or other unit
NofQuantisationLevels	Theoretical number of quantization levels in the signal. This value depends on the waveform format (8 bit, 16 bit, ...). In case of a math waveform, it depends on the quantization levels of the operands and on the operator type.
BaseYStart	Vertical start value of the waveform

Value	Description
BaseYStop	Vertical stop value of the waveform
Multi channel export	
<p>The header files contain strings like this: <code>MultiChannelVerticalOffset: 4:1.63:1.96:0:0:1e-005:0:-1e+026:1e+026:1e-005:10:0:V:.</code> Only the first 5 values and the unit at the end of the string are relevant for data analysis. All other values are for internal use and not explained here.</p> <p>Examples are in csv format.</p>	
MultiChannelExport	Indication whether multiple channels are exported simultaneously: On Off
MultiChannelExportState	Number of channels and export status of the individual channels, for example, <code>4:On:Off:On:On...</code> : channels 1, 3 and 4 are exported.
MultiChannelVerticalOffset	Number of channels and vertical offset of the individual channels, for example, <code>4:0:0:0.02:0...</code> : channel 3 has an offset of 20 mV.
MultiChannelVerticalPosition	Number of channels and vertical position of the individual channels, for example, <code>4:0:0:0:2...</code> : the position of channel 4 is 2 divisions.
MultiChannelVerticalScale	Number of channels and vertical scale of the individual channels, for example, <code>4:0.05:0:0.03:0.04...</code> : scale of channel is 50 mV/div, channel 3 has 30 mV/div and channel 4 has 40 mV/div.
MultiChannelBaseYStart	Number of channels and minimum value of the vertical range for each individual channel, for example, <code>4:-0.25:0:-0.13:-0.28...</code>
MultiChannelBaseYStop	Number of channels and maximum value of the vertical range for each individual channel, for example, <code>4:0.25:0:0.17:0.12...</code> : The range of channel 1 is -250 mV to 250 mV. The range of channel 3 is -130 mV to 170 mV. The range of channel 4 is -280 mV to 120 mV.
History	
TimestampState	State of the timestamps export. If on, the timestamps of each history waveform are written to the waveform data file.
Math waveform	
BaseUnit	Base unit of a mathematic waveform, for example, linear unit
ViewUnit	User-selected unit of a mathematic waveform, for example, logarithmic unit for a spectrum. The value is only valid if the exported waveform is a math waveform.
ViewUnitRelative	Indication of a relative unit. It is true if the math waveform has the ViewUnit "dB", for example. The value is only valid if the exported waveform is a math waveform.
ViewReferenceLevel	Reference level for a relative unit. The value is only valid if the exported waveform is a math waveform, and the unit is relative.
FFT	
CenterFreq	Center frequency of the spectrum
FreqSpan	Frequency span of the spectrum
FrequencyStart	Start frequency of the spectrum
FrequencyStop	Stop frequency of the spectrum

Save and recall waveform data and results

Value	Description
WindowType	Window used for the spectrum computation
ResolutionBW	Resolution bandwidth of the spectrum
AdjustedResolutionBW	Actual resolution bandwidth of a spectrum waveform. The value is only valid if the exported waveform is a spectrum.
GateRBWCoupling	Indication whether the record length or the resolution bandwidth is a constant for the spectrum computation
Parameters for power calculation	
Impedance	Impedance used for power calculation
NoiseBandwidth	Noise bandwidth of a spectrum waveform, required for power calculation. The value is only valid if the exported waveform is a spectrum.
Parameters for internal use	
SourceType	Source qualifier
TraceType	Waveform qualifier
ValueType	
TOADone	
BaseUnitRelative	Base unit indication
UseInterSampleTriggerOffset	
ISO_TRG SC_POST SC_TRG	

If "Include CDR info" is enabled, additional properties are appended to the header.

Value	Description
AnalogSource	Analog source used for clock recovery
Algorithm	Software algorithm that is used for the hardware clock data recovery: constant frequency or feed forward
Bitrate	Bitrate
UnitIntervalOffset	Unit interval offset, number between 0 and 1
PLLBandwidth	The bandwidth of the feed forward algorithm
PLLRelativeBandwidth	The relative bandwidth, that is the ratio of the nominal bit rate to the PLL bandwidth

Value	Description
SignalFormat	Format of the data values: <ul style="list-style-type: none"> • FLOAT: floating point numbers, general export format • INT (8 Bit): Integer 8 bit, used for "Raw (ADC sample)" data export. • INT (16 Bit): Integer 16 bit, used for "Raw (ADC sample)" data export in high definition mode.
RecordLength	Number of samples in a waveform record of one acquisition

12.2.1.2 Waveform data files

The waveform data files - indicated by **Wfm.** in the filename - contain the actual waveform data. Usually only Y-values - mostly voltage values - are written subsequently. If the signal is a spectrum, the data of the last frame is written.

If the waveform consists of minimum and maximum values, two Y-values per sample are written, and the property `InterleavedTraceCount` in the header file is >1 . This applies to envelope waveforms, for example.

The option "Interleaved X/Y" allows you to include horizontal values into the file.

If multi-channel export is enabled, the Y-values of the selected channels are written in interleaved order.

- One channel, single acquisition export
 - Normal waveform:
Y₀; Y₁; Y₂; Y₃; ...
 - Envelope waveform:
Ymin₀; Ymax₀; Ymin₁; Ymax₁; Ymin₂; Ymax₂; Ymin₃; Ymax₃; ...
 - Normal waveform, interleaved x/y data:
X₀; Y₀; X₁; Y₁; X₂; Y₂; X₃; Y₃; ...
 - Envelope waveform, interleaved x/y data:
X₀; Ymin₀; Ymax₀; X₁; Ymin₁; Ymax₁; X₂; Ymin₂; Ymax₂; X₃; Ymin₃; Ymax₃; ...
- Multi-channel, single acquisition export
In the example, two channels are exported.
 - Normal waveforms:
YCh1₀; YCh2₀; YCh1₁; YCh2₁; YCh1₂; YCh2₂; YCh1₃; YCh2₃; ...
 - Envelope waveforms, channel 1 and channel 2 are envelopes:
YCh1min₀; YCh1max₀; YCh2min₀; YCh2max₀; Ymin₁; Ymax₁; YCh2min₁;
YCh2max₁; Ymin₂; Ymax₂; YCh2min₂; YCh2max₂; Ymin₃; Ymax₃; YCh2min₃;
YCh2max₃; ...
 - Normal waveforms, interleaved x/y data:
X₀; YCh1₀; YCh2₀; X₁; YCh1₁; YCh2₁; X₂; YCh1₂; YCh2₂; X₃; YCh1₃; YCh2₃; ...
 - Envelope waveform and normal waveform, interleaved x/y data:
X₀; YCh1min₀; YCh1max₀; YCh2₀; X₁; YCh1min₁; YCh1max₁; YCh2₁; X₂;
YCh1min₂; YCh1max₂; YCh2₂; X₃; YCh1min₃; YCh1max₃; YCh2₃; ...

In XML and CSV waveform value files, the data of each sample is grouped. The example shows the values of two samples for two waveforms and interleaved x/y data. The first waveform is an envelope, the second one is a normal waveform.

In CSV files, the data values for a given sampling time are written in one row.

```
-1.96e-008    -0.0079051387    -0.0059288535    -0.1027668
-1.95e-008    -0.0098814229    -0.0079051387    -0.10474309
```

In XML format, an empty line marks the beginning of the next sample.

```
<Data>-1.96e-008</Data>
<Data>-0.0079051387 </Data>
<Data>-0.0059288535 </Data>
<Data>-0.1027668 </Data>

<Data>-1.95e-008</Data>
<Data>-0.0098814229 </Data>
<Data>-0.0079051387 </Data>
<Data>-0.1027668 </Data>
```

If multiple acquisitions (Data logging / Multiple waveforms) are exported, the first acquisition is written in the same way as with single acquisition export. The following acquisitions are appended in the same way. If the signal is a spectrum, the last frame of each acquisition is saved.

If the history is exported in one file with timestamps, the timestamp as double float precedes the data of each acquisition. The acquisition data is written in the same way as with single acquisition, according to the selected settings.

```
<timestamp as double float of first acquisition>
<value 1>
<value 2>
<value ...>
<timestamp as double float of second acquisition>
<value 1>
<value 2>
<value ...>
```

In BIN files, the instrument writes some leading and trailing settling samples before and after the waveform data. They ensure that the analysis of the reloaded reference waveform returns the same results as analysis of the original waveform. The number of leading settling samples is provided in the header file.

12.2.1.3 Number of samples in the waveform data file

In this section, a sample is defined as one or more values acquired at a given sampling time. The number of samples for one channel and acquisition is given in the header file by the property `SignalHardwareRecordLength`.

If the waveform has more than one Y-value per sample (e.g. envelope), the property `InterleavedTraceCount` is > 1 , and the number of values in the file for this waveform is:

*No of values per waveform = InterleavedTraceCount * SignalHardwareRecordLength*

If multiple acquisitions are exported, the total number of values in the file is:

*No of values = InterleavedTraceCount * SignalHardwareRecordLength * No of exported acquisitions*

If "Interleaved x/y" is enabled, one horizontal value is added per sample. The total number of values in the file is:

*No of values = (1+ InterleavedTraceCount) * SignalHardwareRecordLength * No of exported acquisitions*

In BIN files, the value `SignalHardwareRecordLength` includes the number of required samples in the waveform and additional samples at the beginning (leading samples) and the end of the file (trailing samples). The number of additional samples is:

No of additional samples = SignalHardwareRecordLength - SignalRecordLength

The number of leading additional samples is given in the header file:

`LeadingSettlingSamples`.

The number of trailing additional samples is:

*No of trailing additional samples = No of additional samples - LeadingSettlingSamples
= SignalHardwareRecordLength - SignalRecordLength - LeadingSettlingSamples*

MSO option R&S RTO6-B1:

If the data of digital channels is stored in BIN format, 1 bit is written for each sample. 8 data samples are written in 1 byte (data word). Thus, the file size is

File size = Number of samples / 8

For example, 100 MSa are written into a 12.5 MByte BIN file. After reading the file, you have to extract the samples from the data words.

12.2.2 Waveform settings

In the "Save - Waveform" dialog, the storage settings for waveform data are defined.

See also: [Chapter 12.2.7, "Saving and loading waveform data"](#), on page 481.

12.2.2.1 Waveform setup settings

Access: "Menu" key > "Save/Recall" key > "Save" tab > "Waveform" > "Setup" tab.

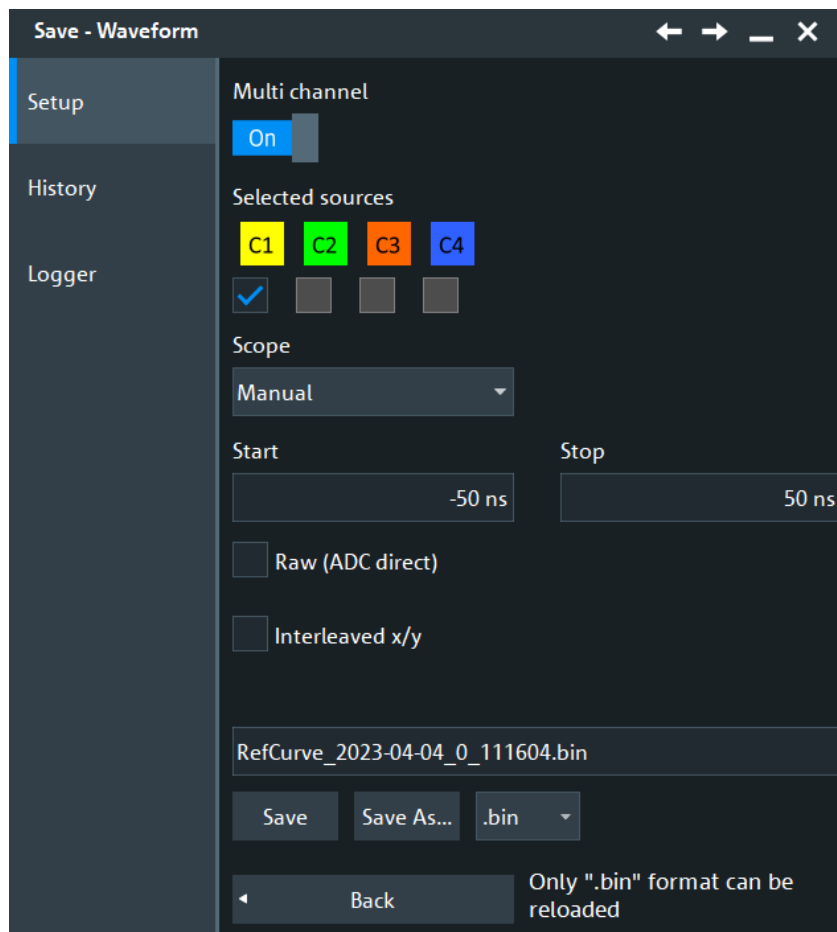

Multi channel

Enables or disables the export of multiple input channels. If enabled, you can export the data of selected input channels ([Selected sources](#)) into one file.

If disabled, you can export one "[Source](#)" on page 468 waveform.

You can reload exported multiple channels if they are stored in BIN format. The import asks you to assign each stored waveform to a reference waveform.

Remote command:

[EXPort:WAVEform:MULTichannel](#) on page 1767

Include CDR info

Available, if all the following conditions are fulfilled:

- [Type](#) = "CDR"
- [State](#) = "On"
- [Clock / CDR / Protocol](#) = "CDR"

Includes the CDR information in a waveform file. If this function is enabled, an additional `RefCurve.CDR.*.bin/*.csv/*.xml` file is created. This file is available in `*.bin`, `*.csv` and `*.xml` format.

The file contains the CDR trigger timestamps corresponding to the waveform data.

The created file can be used as a reference source for math equations and for the advanced eye.

Remote command:

[EXPort:WAVeform:ICDR](#) on page 1774

Source

Selects the waveform to be exported if "Multichannel export" is disabled.

Active waveforms of input channels, math signals, reference waveforms and advanced jitter analysis are available for export.

If the MSO option R&S RTO6-B1 is installed, you can save also digital channels and parallel buses.

If the selected source is defined as average or envelope waveform, make sure that all required acquisitions ("Average count") are done before you save the waveform. Otherwise, the exported waveform data are not correct.

Remote command:

[EXPort:WAVeform:SOURce](#) on page 1766

Selected sources

Select the channels to be included in data export if "Multi channel" is enabled. Waveform1 of up to four input channels can be saved into one file.

If at least one of the selected sources is defined as average or envelope waveform, make sure that all required acquisitions ("Average count") are done before you save the waveforms. Otherwise, the exported waveform data are not correct.

Remote command:

[CHANnel<m>:EXPortstate](#) on page 1768

Scope

Defines the part of the waveform record that has to be stored.

"Full waveform"	Saves the complete waveform record.
"Zoom"	Saves the data included in the zoom area if at least one zoom is defined for the source waveform. The start and stop values of the area are shown. If several zooms are defined, select the "Zoom" to be used for export.
"Cursor"	Saves the data between the cursor lines if at least one cursor measurement is defined for the source waveform. The start and stop values of the area between the cursor lines are shown. If several cursor sets are defined, select the "Cursor set" to be used for export.
"Gate"	Saves the data included in the measurement gate if a gated measurement is defined for the source waveform. Select the "Measurement" for which the required gate is defined. The start and stop values of the gate are shown.
"Manual"	Saves the data between user-defined "Start" and "Stop" values.

Remote command:

[EXPort:WAVeform:SCOPE](#) on page 1769

[EXPort:WAVeform:START](#) on page 1769

[EXPort:WAVeform:STOP](#) on page 1770

[EXPort:WAVeform:ZOOM](#) on page 1770

[EXPort:WAVeform:CURSorset](#) on page 1770

[EXPort:WAVeform:MEAS](#) on page 1771

Raw (ADC direct)

Enables the export of analog channel data in the raw sample format of the ADC. The data format is integer 8 bit (signed 8-bit binary format). This format reduces the file size (1 Byte/sample instead of 4 Bytes/sample in binary files) but decreases the precision of the values.

If the high definition mode is active, the data format is integer 16 bit, except for peak detect decimation (8 bit). See "Export" on page 137.

Only y-values are exported, the "Interleaved x/y" option is not available.

Currently, the setting is not available for the export of digital channel data and data of R&S RT-ZVC channels.

Data conversion:

To convert INT8 or INT16 data to physical quantities, e.g. voltages, use the following formulas:

$$\text{ConversionFactor} = \text{VerticalScale} * \text{VerticalDivisionCount} / \text{NofQuantisationLevels}$$

$$\text{PhysicalQuantity} = (\text{Value_ADC} * \text{ConversionFactor}) + \text{VerticalOffset} - (\text{VerticalScale} * \text{VerticalPosition})$$

The raw values are written in the *.Wfm.* file, all other values can be found in the corresponding header file.

Table 12-2: Example of raw data conversion

	INT8	INT16, HD mode
VerticalScale	110 mV/div	50 mV/div
VerticalPosition	1 div	0
VerticalOffset	50 mV	0
NofQuantisationLevels	253	253 * 256
VerticalDivisionCount	10	10
Value_ADC	13	-61
ConversionFactor	$0.11 * 10 / 253 = 0.004347826086957$	$0.05 * 10 / (253 * 256) = 0.0000771986$
Voltage	$(13 * 0.004347826086957) + 0.05 - (1 * 0.11) = -0.003478260869559 \text{ V} = 3.478260869559 \text{ mV}$	$(-61 * 0.0000771986) + 0 = -4.7091146 \text{ mV}$

When reloading an exported raw BIN waveform, the waveform position after reload is not the same as for the exported waveform.

Remote command:

[EXPort:WAVeform:RAW](#) on page 1773

Interleaved x/y

Includes horizontal values in the export data (time or frequency values, depending on the waveform). X and Y-values are written alternately to the file. If disabled, only Y-values - mostly voltage values - are written.

Interleaved x/y data cannot be exported as raw values, the "Raw (ADC direct)" option is not available.

Remote command:

[EXPort:WAVeform:INCXvalues](#) on page 1772

Save to file

Enter the filename to save the waveform to. Double-tap the filename to open the file selection dialog box.

By default, the filename has the prefix "RefCurves_". You can define a pattern for automatic naming in the "Autonaming" dialog, see [Chapter 4.8.1, "Autonaming"](#), on page 104.

- "Save" Saves the waveform as a reference waveform in the selected file.
- "Save As..." Opens the file selection dialog box and saves the waveform to the selected file. See also [Chapter 12.5, "File selection dialog"](#), on page 490
- ".bin/.xml/.csv" Selects the file format. Note that reference waveforms can be loaded from `.bin` files only.
See also: [Chapter 12.2.1, "Waveform export files"](#), on page 459.

Remote command:

[EXPort:WAVeform:NAME](#) on page 1768

[EXPort:WAVeform:SAVE](#) on page 1769

12.2.2.2 Waveform history settings

Access: "Menu" key > "Save/Recall" key > "Save" tab > "Waveform" > "History" tab.

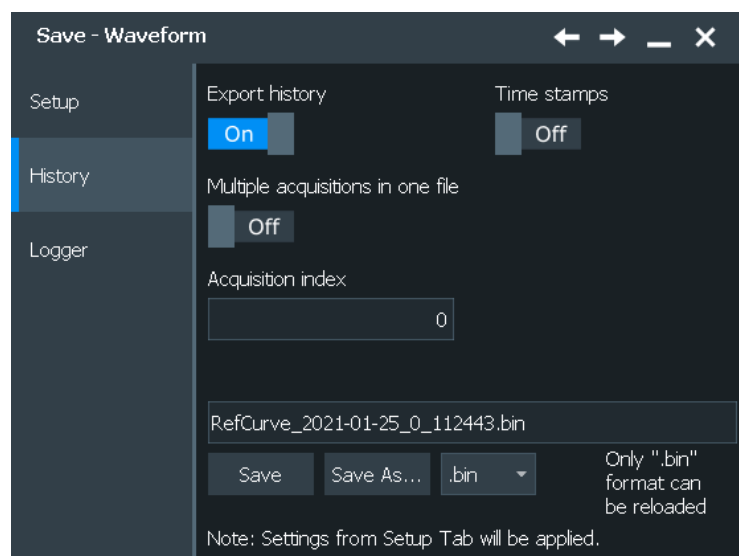

In this dialog you can configure the export of the history waveform data to file. Select the channels and scope in the "Setup" tab.

Export history

Enables the history mode and the export of history waveforms to file.

Remote command:

[CHANnel<m>\[:WAVEform<n>\]:HISTory\[:STATe\]](#) on page 1563

Time stamps

If enabled, the relative timestamps of all history waveforms are written into the waveform data file at the beginning of each waveform record.

The following format is used:

```
<timestamp as double float of first acquisition>
<value 1>
<value 2>
<...>
<timestamp as double float of second acquisition>
<value 1>
<value 2>
<...>
```

You can also select the format of the time stamp in the "Acquire" > "History" dialog.

Remote command:

[EXPort:WAVEform:TIMestamps](#) on page 1772

Multiple acquisitions in one file

If enabled, allows you to save several or all history waveforms. Define the part of the history to be exported using "Start acquisition" and "Stop acquisition".

If multiple acquisitions of one waveform are exported into a BIN file, the first acquisition can be reloaded as reference waveform.

Remote command:

[CHANnel<m>\[:WAVEform<n>\]:HISTory:START](#) on page 1564

[CHANnel<m>\[:WAVEform<n>\]:HISTory:STOP](#) on page 1565

Start export

Starts the history replay and simultaneous saving.

Remote command:

[CHANnel<m>\[:WAVEform<n>\]:HISTory:PLAY](#) on page 1565

Save to file

Enter the filename to save the waveform to. Double-tap the filename to open the file selection dialog box.

By default, the filename has the prefix "RefCurves_". You can define a pattern for automatic naming in the "Autonaming" dialog, see [Chapter 4.8.1, "Autonaming"](#), on page 104.

"Save" Saves the waveform as a reference waveform in the selected file.

- "Save As..." Opens the file selection dialog box and saves the waveform to the selected file. See also [Chapter 12.5, "File selection dialog"](#), on page 490
- ".bin/.xml/.csv" Selects the file format. Note that reference waveforms can be loaded from .bin files only.
See also: [Chapter 12.2.1, "Waveform export files"](#), on page 459.

Remote command:

[EXPort:WAVeform:NAME](#) on page 1768

[EXPort:WAVeform:SAVE](#) on page 1769

12.2.2.3 Waveform logger settings

Access: "Menu" key > "Save/Recall" key > "Save" tab > "Waveform" > "Logger" tab.

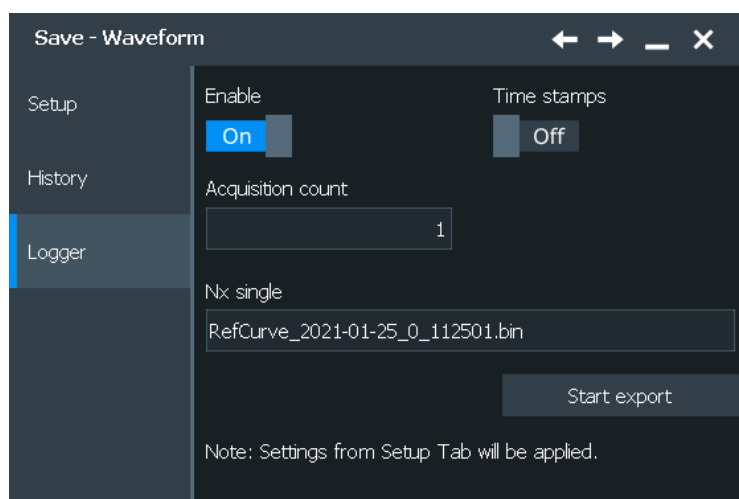

In this dialog, you can configure the export of the data of a running Nx Single acquisition. Select the channels and scope in the "Setup" tab.

Enable

Enables the export of all waveforms of an Nx Single acquisition into one file.

The waveform records are written in historical order one after the other, either the complete records or the sections as defined in [Scope](#). Set the number of acquisitions to be acquired and stored with "Acquisition count". The maximum amount of data that can be written is shown in "Max. file size".

Enabling "Data logging" stops a running acquisition. To start the logging, tap ["Start Export"](#) on page 472 or press [Single].

Pressing "Run cont" disables data logging.

Remote command:

[EXPort:WAVeform:DLOGging](#) on page 1771

Start Export

Starts an Nx Single acquisition series and simultaneously saves the waveform data to a file.

Remote command:

[RUNSingle](#) on page 1415 (Nx Single acquisition)

12.2.3 Histogram

Access: "Menu" key > "Save/Recall" key > "Save" tab > "Histogram"



The waveform histogram export saves data in two files. The `*.Wfm.*` file contains 256 or 512 absolute or relative histogram values. The other file is the header file.

Contents of the header file:

- Source waveform of the histogram
- Histogram mode: vertical or horizontal
- Incidence of exported values: absolute or relative
- Histogram range: XStart, XStop, YStart, YStop
- Name of the exported histogram

Data conversion:

Using the header data, you can calculate the waveform value to which a histogram value belongs:

$$YValue = (YStop - YStart) / HistogramValuesCount * HistogramValueNumber + YStart$$

YStart	-0.25 V
YStop	0.25 V
HistogramValuesCount	256 (total number of written rows in a CSV file)
HistogramValueNumber	68 (number of the row in a CSV file)
Y-Value	$(0.25 - (-0.25)) / 256 * 68 - 0.25 = -0.11719 \text{ V}$

The histograms settings are defined in the "Histogram" dialog box ("Menu" > "Apps" > "Analysis" tab > "Histogram").

See also: [Chapter 8.2.7.4, "Histogram setup"](#), on page 351.

Select

Selects the histogram to be exported. All active waveform histograms are shown in the list.

Measurement histograms can also be exported, see [Chapter 12.2.5, "Result plots analysis"](#), on page 476.

Remote command:

`EXPORT:HISTogram:SElect` on page 1774

Source

Displays the source of the selected histogram.

Incidence

Sets the mode of exported histogram data: relative or absolute count of values. If relative values are exported, the sum of all values is 1, and the count of each value is set in relation to the sum.

Remote command:

`EXPORT:HISTogram:INCidence` on page 1774

Horizontal range, Vertical range

Displays the "Start" and "Stop" limits of the histogram area.

Save to file

Enter the filename to save the waveform histogram to. Double-tap the filename to open the file selection dialog box.

By default, the filename has the prefix "Histogram_". You can define a pattern for automatic naming in the "Autonaming" tab. The default directory is:

`C:\Users\Public\Documents\Rohde-Schwarz\RT06\Histograms`

"Save" Saves the histogram data in the selected file.

"Save As..." Opens the file selection dialog box and saves the histogram data to the selected file. See also [Chapter 12.5, "File selection dialog"](#), on page 490

".bin/.xml/.csv" Selects the file format.

Remote command:

`EXPort:HISTogram:NAME` on page 1774

`EXPort:HISTogram:SAVE` on page 1775

`EXPort:HISTogram:DATA?` on page 1775

12.2.4 Results

In this dialog, you can select the result boxes to be saved, and define the storage settings.

Access: "Menu" key > "Save/Recall" key > "Save" tab > "Results"

Furthermore, you can export the decode result tables of serial protocol analysis.

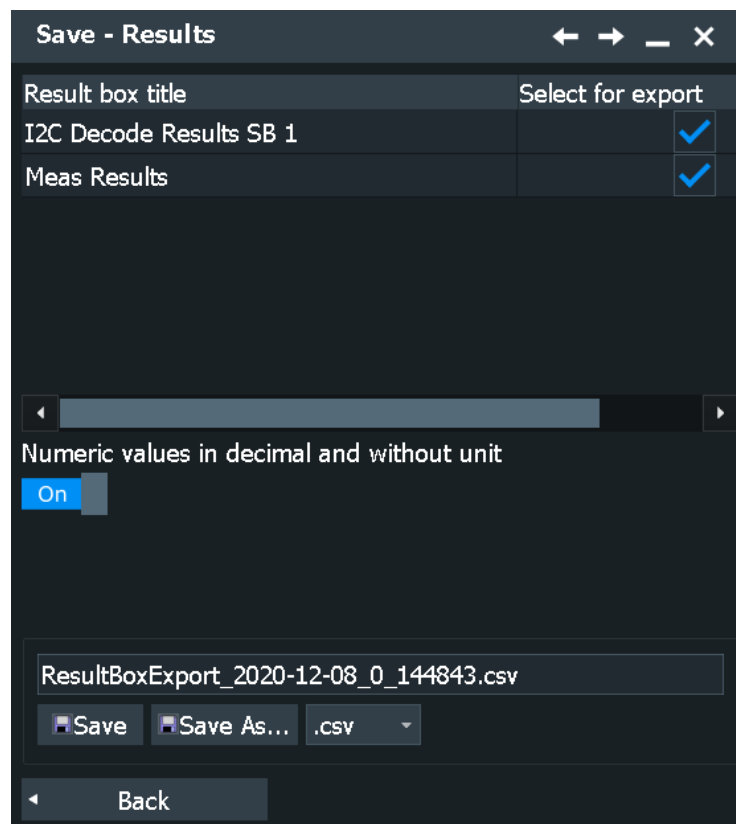

Result selection

The table lists all result boxes and decode tables that are currently open, including minimized boxes and docked boxes. Select the results that you want to save to file. All results are written into one file.

Note: If the result box is minimized, only the columns shown on the result icon are saved (2 columns). Statistical results are not shown on the minimized results icon, and they are not saved.

Numeric values in decimal and without unit

By default, numeric result values are written with their unit to the file. If the option is enabled, the values are saved with more decimal places.

Export results

Enter the filename to save the results to. Double-tap the filename to open the file selection dialog box.

By default, the filename has the prefix "ResultBoxExport_".

You can define a pattern for automatic naming in the "Menu" > "Settings" > "Save/Recall" > "Autonaming".

"Save"	Saves the selected results to the indicated file.
"Save As..."	Opens the file selection dialog box and saves the selected results to the selected file. See also Chapter 12.5, "File selection dialog" , on page 490
".csv/.html"	Selects the file format. <ul style="list-style-type: none"> • CSV: the values are saved in a file You can select the value delimiter and the list separator symbol in the "CSV Export" dialog, see Chapter 4.8.2, "CSV export", on page 107. Tip for using MS Excel: It is recommended that you use the semi-colon as csv decimal symbol. When you open the file with MS Excel, use "File > Open" and follow the wizard to set the separators correctly, or set the separator settings with "Tools > Options > International". • HTML: Results are saved as web page for display in a browser.

12.2.5 Result plots analysis

Access: "Menu" key > "Save/Recall" key > "Save" tab > "Result Plots"

You can export the data of long-term measurements, the measurement histogram and track data to file.

The measurement export saves results in two files. The *.Wfm.* file contains data values, and the other file is the header file.

The header file contains:

- Source waveform of the measurement
- Measurement scale
- Export type = histogram, long term or track
- Exported measurement
- Histogram range: XStart, XStop, YStart, YStop
The range is only relevant for export type = histogram. The measurement axis is the X-axis, which can be a horizontal or vertical axis depending on the histogram mode.

Long-term measurements: The *.Wfm.* file contains one value or value set for each long-term measurement point. The maximum number of points is defined in the "Horizontal scaling" dialog box.

- If statistics are disabled, the current result of the main measurement is written - one double value per long-term point.
- If statistics are enabled, seven values for each long-term point are saved:
 - Upper peak
 - Lower peak
 - RMS
 - Standard deviation
 - Average
 - Event count per point: number of measurement results that creates one long-term point
 - Waveform count per point: number of waveforms included in one long-term point.

Measurement histogram: The *.Wfm.* file contains 1000 absolute or relative histogram values.

Data conversion of measurement histogram data:

Using the header data, you can calculate the measurement value to which a histogram value belongs:

$$\text{MeasValue} = (\text{XStop} - \text{XStart}) / 1000 * \text{HistogramValueNumber} + \text{XStart}$$

Example: The 273rd histogram value is 0.491749. That means, the relative frequency of the measurement value 0.1246 V is 0.491749.

XStart	0.07 V
XStop	0.27 V
HistogramValueNumber	273 (number of the row in a CSV file)
MeasValue	$(0.27 - 0.07) / 1000 * 273 + 0.07 = 0.1246 \text{ V}$

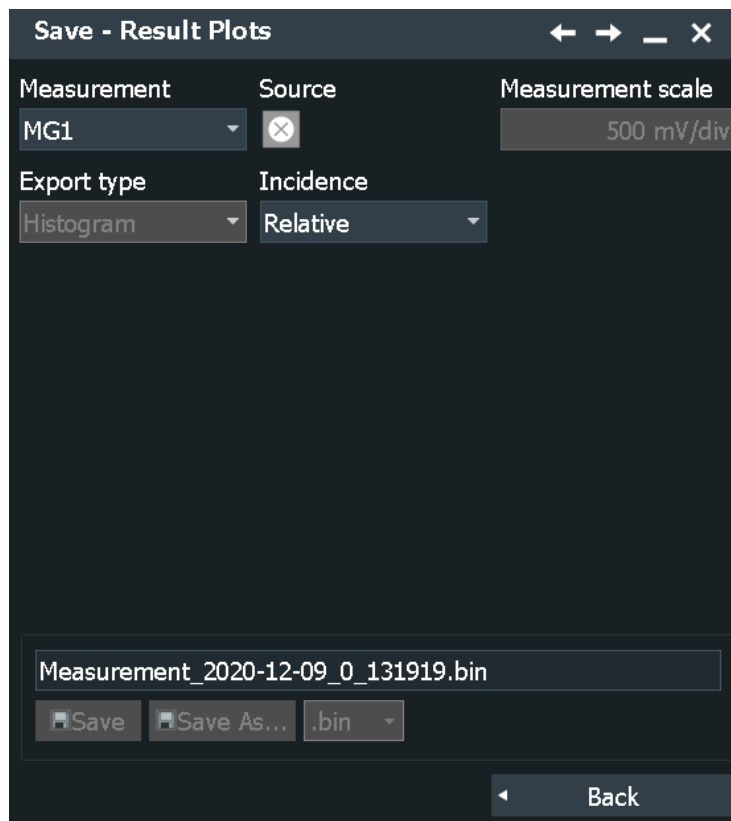
**Measurement**

Selects the measurement to be exported.

Remote command:

[EXPort:MEASurement:SElect](#) on page 1777

Source, Measurement scale

Displays the measurement settings source and scale.

Export type

You can export the result data of the long-term measurement, the measurement histogram or the track.

To export the data, the required type must be enabled in the ""Menu" > "Measure" > "Plot" tab: "Long term > Enable", "Histogram > Enable" or "Track > Enable".

Remote command:

[EXPort:MEASurement:TYPE](#) on page 1777

Incidence

Sets the mode of exported histogram data: relative or absolute count of values. If relative values are exported, the sum of all values is 1, and the count of each value is set in relation to the sum.

Remote command:

[EXPort:HISTogram:INCidence](#) on page 1774

Save to file

Enter the filename to save the measurement data to. Double-tap the filename to open the file selection dialog box.

By default, the filename has the prefix "Measurement_".

You can define a pattern for automatic naming in the "Autonaming" tab, see [Chapter 4.8.1, "Autonaming"](#), on page 104.

The default directory is:

```
C:\Users\Public\Documents\Rohde-Schwarz\RT06\Measurements
```

"Save" Saves the measurement data in the selected file.

"Save As..." Opens the file selection dialog box and saves the measurement data to the selected file. See also [Chapter 12.5, "File selection dialog"](#), on page 490.

".bin/.xml/.csv" Selects the file format.

Remote command:

[EXPort:HISTogram:NAME](#) on page 1774

[EXPort:MEASurement:SAVE](#) on page 1778

[EXPort:MEASurement:DATA?](#) on page 1778

12.2.6 Eyes

Access: "Menu" key > "Save/Recall" key > "Save" tab > "Eyes".

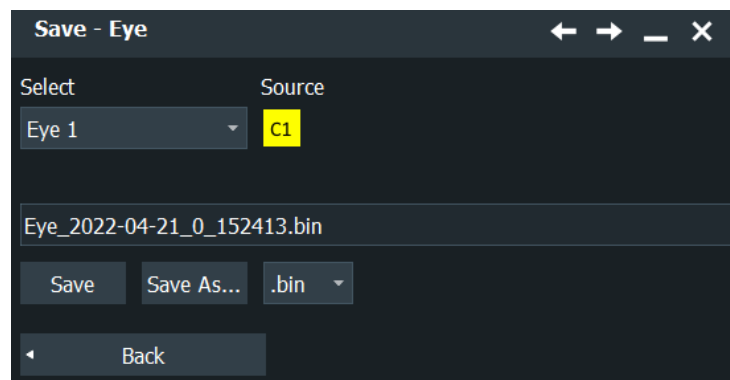

In this dialog, you can select an eye diagram that you want to export.

Eye export saves the accumulated values at each pixel of an eye diagram.

The export supports *.csv and *.bin files. Each export generates a header file and a data file.

Content and format of the CSV files

The header file contains the following values:

- Name of the exported eye (e.g. Eye 1)
- Corresponding source (e.g. C1W1)
- Timestamp

- Image height
- Image width
- Pixel format
- XStart
- XStop
- YStart
- YStop

The data file contains the comma-separated list of the pixel values. The number of lines and columns corresponds to the number of lines and rows of the eye diagram image.

Content and format of the BIN files

The header file contains the following values:

- Name of the exported eye (e.g. Eye 1)
- Corresponding source (e.g. C1W1)
- Timestamp
- Image height
- Image width
- Pixel format
- XStart
- XStop
- YStart
- YStop

The data file contains the following information in the given order.

- Number of bytes per value - uint32
- Number of samples – uint32
- Column wise sorted pixel values – ‘number of samples’ * ‘number of bytes per value’

Select/ Source

Selects the eye measurement to be exported and displays its source.

Remote command:

[EXPort:EYE:SElect](#) on page 1776

[EXPort:EYE:SOURce?](#) on page 1776

Save to file

Enter the filename to save the eye data to. Double-tap the filename to open the file selection dialog box.

By default, the filename has the prefix "Eye_".

You can define a pattern for automatic naming in the "Autonaming" tab, see [Chapter 4.8.1, "Autonaming"](#), on page 104.

The default directory is:

C:\Users\Public\Documents\Rohde-Schwarz\RTO6\Eyes

"Save"	Saves the measurement data in the selected file.
"Save As..."	Opens the file selection dialog box and saves the measurement data to the selected file. See also Chapter 12.5, "File selection dialog" , on page 490
".bin/.csv"	Selects the file format.
Remote command:	
EXPort:EYE:NAME on page 1776	
EXPort:EYE:SAVE on page 1776	
EXPort:EYE:DATA? on page 1775	

12.2.7 Saving and loading waveform data

You can save the data of a channel, math or reference waveform to an `.xml`, `.csv`, or `.bin` file. The data export of several channels into one file is also possible. Files in `.bin` format can be reloaded to the R&S RTO6 as reference waveforms.

Instead of a complete waveform, you can also save a part of it, limited by a previously defined zoom, cursor lines, measurement gate or user-defined time values.



To save waveform data quickly, you can add the "Save Waveform" icon to the toolbar and use it for saving. The icon does not work for saving actions that are started with "Start export" (data logging and multiple history waveforms).

It is also possible to save history data to file. Furthermore, you can save a "live record" of a running Nx Single acquisition to one data file.

For details on waveform save/recall settings, see [Chapter 12.2.2, "Waveform settings"](#), on page 466.

The following procedures are described:

- ["To save a waveform or a part of a waveform to a file"](#) on page 481
- ["To save a waveform using the toolbar icon"](#) on page 482
- ["To export waveform data of a running acquisition"](#) on page 482
- ["To save the history data"](#) on page 289
- ["To load a reference waveform"](#) on page 255
- ["To save a reference waveform"](#) on page 254

To save a waveform or a part of a waveform to a file

1. Open "Menu" and select "Save/Recall" > "Save".
2. Tap the "Waveform" button.
The "Save - Waveform" dialog opens.
3. Select the waveforms to be saved:
 - To save one waveform, tap the "Source" icon. Select the waveform.
 - To save data of several channels, enable "Multi channel" and select the channels.

4. In the "Scope" list, select the part of the waveform record to be saved. Zoom, cursor and gate segments require the same setup for the selected waveform before saving. For "Manual", enter the "Start" and "Stop" time of the section.
5. Check the filename under "Save to file" and change it if needed. Usually, autonaming is used.
6. Check the file format and the "Export format" settings and change them if needed.
7. Tap "Save" to save the waveform data to the specified file.
Tap "Save As" to save the waveform data to a different file or file type. Select the file from the file selection dialog box.

To save a waveform using the toolbar icon

1. Add the "Save Waveform" icon to the toolbar, see [Chapter 3.3.6.2, "Configuring the toolbar"](#), on page 54.
2. Set the scope, export format, and other parameters in "Menu" > "Save/Recall" > "Waveforms".
3. If necessary, adjust the autonaming pattern and the storage path in "Menu" > "Settings" > "Save/Recall" > "Autonaming".
4. To save the waveform data:
 - a) Tap the "Save Waveform" icon on the toolbar. The "Save Waveform" overlay menu opens.

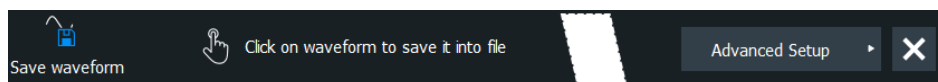

- b) Tap the waveform that you want to save.
If you tap the diagram background, the data of the focused waveform is saved.

To export waveform data of a running acquisition

1. Select the waveform that you want to save and the scope as described in ["To save a waveform or a part of a waveform to a file"](#) on page 481, step 1 to 5.
2. If you want to save only a section of each waveform, set the "Scope".
3. Open the "Logger" tab.
4. Tap "Enable".
5. Enter the number of acquisitions to be acquired and saved in "Acquisition count".
6. Check the filename under "Nx single" and change it, if needed. Usually, autonaming is used.
7. Tap "Start export" to start the acquisition and to save the acquired waveform data to the specified file.

To load waveform data as a reference waveform

To reload waveform data from a previous measurement, the waveform must have been stored as a reference waveform in a BIN file before.

The procedure is described in [Chapter 7.2.1, "Working with reference waveforms"](#), on page 253.

12.3 Screenshots

To store the graphical results of the measurement, you can save a screenshot of the graphic area. To document current settings, the open dialog box can be included in the screenshot.



The "Image" toolbar icon saves the current display to a file according to the settings in "Menu" > "Save/Recall" > "Save" tab > "Screenshot". See also ["Image"](#) on page 56.



You can configure the [Camera] key to save screenshots by a single keypress. See also [Chapter 4.5.1, "Hardkeys: function assignment"](#), on page 94.

If a USB flash drive is connected to the instrument, the default path of the user data directory is set to the USB flash drive. Thus, you save data to USB flash drive automatically, and you can change the directory in the file explorer at any time.

Screenshots on a computer using the Web interface

If the R&S RTO6 is connected to a LAN, you can create and save screenshots of the instrument's display on a computer. See [Chapter 25.3.2, "Web browser"](#), on page 1319.

Meta information in screenshots

The meta data of the screenshot also contains instrument information. In PNG and JPEG files, meta information is saved as EXIF information and can be read, for example, using the ExifTool.

Example:

Reading meta information using the ExifTool.

Command: # exif C:\Screenshot_2020-07-14_0_110551.png

Result:

```
ExifTool Version Number      : 10.20
File Name                    : Screenshot_2016-07-14_0_110551.png
Directory                   : C:/
File Size                    : 37 kB
File Modification Date/Time  : 2020:07:14 11:05:51+02:00
File Access Date/Time       : 2020:07:14 11:05:51+02:00
File Creation Date/Time     : 2020:07:14 11:05:51+02:00
...
Instrument Firmware Version : 3.30.0.46
Instrument Material Number : 1329.7002k44
Instrument Serial Number   : 123456
Image Size                   : 1280x800
Megapixels                   : 1.0
```

12.3.1 Screenshot settings

Access: "Menu" > "Save/Recall" > "Save" tab > "Screenshot"

In the "Screenshot" dialog box, you configure the image to be saved or included in a report. You select the storage location for screenshot files. The image is created when you open the dialog box, and can be updated at any time.

You can also edit the image before saving, and include an open dialog box or the sidebar in the image.

You can save the image in the "Screenshot" dialog box. To save screenshots quickly, use the "Image" toolbar icon, or configure and use the [Camera] key.

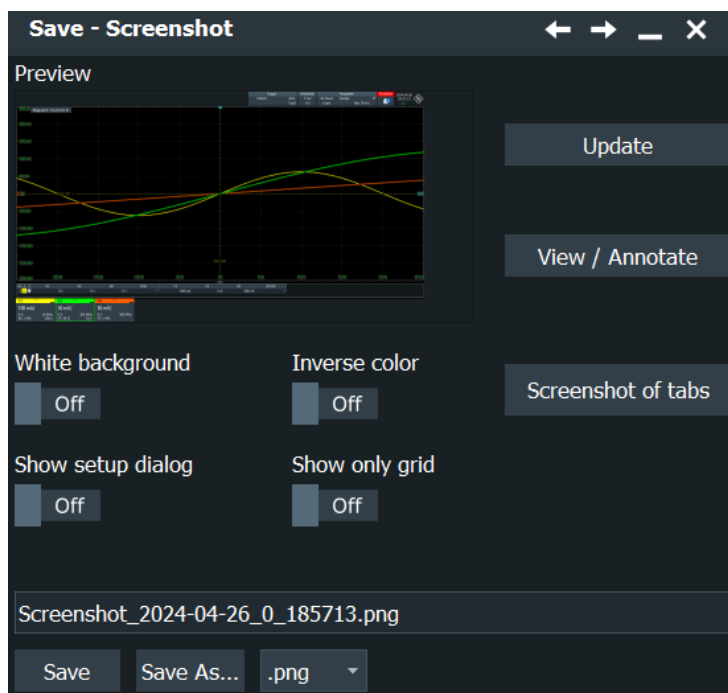

Preview.....	485
Update.....	485
View / Annotate.....	485
White background.....	485
Inverse color.....	486
Show setup dialog.....	486
Show only grid.....	486
Screenshot of tabs.....	486
Save to file.....	486

Preview

Shows a preview of the screenshot. The image is created when the dialog box opens.

Update

Updates the preview of the screenshot with the current display view, e.g. after changes to the settings have been made, or an additional channel has been activated.

View / Annotate

Opens the screenshot in the Paint application. Edit the image as necessary. You can store the file using "Save as". Alternatively, save the file and close the Paint application to return to the "Screenshot" dialog, then save the edited image. The changes are not shown in the preview.

White background

Inverts the background color. So you can picture waveforms with normal waveform colors on white background.

If both "White background" and [Inverse color](#) are enabled, the instrument inverts the background twice, and it appears black.

"White background"	"Inverse color"	Background	Waveform and results
On	Off	White	Screen colors
Off	On	White	Inverted colors
On	On	Black	Inverted colors
Off	Off	Black	Screen colors

Remote command:

[HCOPY:WBKG](#) on page 1781

Inverse color

Inverts the colors of the output, i.e. a dark waveform is shown on a white background.

See also: ["White background"](#) on page 485.

Remote command:

[HCOPY:DEVIce<m>:INVerse](#) on page 1780

Show setup dialog

If you want to save dialog boxes in screenshots, enable "Show setup dialog". The currently open dialog box is included in the screenshot.

Remote command:

[HCOPY:SSD](#) on page 1781

Show only grid

If enabled, the screenshot shows only the grid. The signal bar is not included.

Remote command:

[HCOPY:ISBA](#) on page 1782

Screenshot of tabs

Saves screenshots of all tabs in the diagrams. The instrument creates one screenshot for each tab.

Remote command:

[HCOPY:STABs](#) on page 1783

Save to file

Defines the filename to which screenshot is saved. By default, the filename has the prefix "Screenshot_". Double-tap the filename field to change the name.

If a USB flash drive is connected to the instrument, the default path of the user data directory is set to the USB flash drive. Thus, you save data to USB flash drive automatically, and you can change the directory in the file explorer at any time.

- "Save" Saves the current screenshot to the specified file.
- "Save As..." Opens the file selection dialog box. Here you can adjust the target directory and the file name and save the current screenshot to the file. The symbols of important target folders are listed on the left of the file explorer.
- "Delete" Opens the file selection dialog box and deletes the selected file.

Remote command:

[HCOpy:DEvIce<m>:LANGUage](#) on page 1780

[HCOpy:DESTination<1..2>](#) on page 1779

[MMEMory:NAME](#) on page 1779

[HCOpy:IMMediate<m>\[:DUM\]](#) on page 1782

[HCOpy:IMMediate<m>:NEXT](#) on page 1782

[MMEMory:DELeTe](#) on page 1761

12.3.2 Configuring and saving screenshots

You can edit the image, invert all colors, and set the background color. A preview of the current image is shown for reference.

1. Open the "Menu" > "Save/Recall" > "Save" tab > "Screenshot".
2. To enhance the images for later print on white paper, enable "White background" or "Inverse color". If you print this image later on a monochrome printer, you get a grayscale picture. The contrast of the resulting gray lines depends on waveform colors and the used printer.
3. Select the file format: png, jpg, or another one.
4. To change the directory, tap "Save As" and configure the path.

The symbols of often used target folders are listed on the left of the file explorer. By default, screenshots are saved in the

```
C:\Users\Public\Public Documents\Rohde-Schwarz\RTx\  
ScreenShots directory.
```

5. Tap "Save".
The file is saved and the dialog box closes.
6. Check if the screenshot is saved to the desired directory.
7. To save further screenshots, use one of the following ways:
 - Configure the [Camera] key. Press the key to save a screenshot. See also [Chapter 4.5.1, "Hardkeys: function assignment"](#), on page 94.
 - Add the "Image" icon to the toolbar. Tap the icon to save an image. See also [Chapter 3.3.6.2, "Configuring the toolbar"](#), on page 54.
 - Tap "Save" in the "Screenshot" dialog box to save the image to the specified file.
 - To save the image with a dedicated filename or to another directory, tap "Save As" in the "Screenshot" dialog box. Select the path, enter a filename, and tap "Save".

12.4 Reports

Reports document the current measurement and test results. The report contains general information, current vertical and horizontal settings, trigger settings, active channels and all current results except for zoom and search results. A screenshot is also included.

You can create the report manually, or automatically on defined events:

- Press the [Camera] key.
- Tap the "Create report" toolbar icon.
Before, add the icon to the toolbar, see also [Chapter 3.3.6.2, "Configuring the toolbar"](#), on page 54.
- Action on micro button, available on active Rohde & Schwarz probes
- Action on trigger
- Event action at mask testing

12.4.1 Report settings

Access: "Menu" menu > "Save/Recall" menu > "Save" tab > "Report"

Save - Report

Language: English | Paper size: A4 | Edit before saving: Off

User name: | Comment:

Logo: Rohde & Schwarz

Report_2021-06-21_0_163344.pdf

Save | Save As... | .pdf

Back | Preview

Language

Selects the language to be used in the report. Available languages are listed in the specifications document.

Remote command:

[REPort:LANGuage](#) on page 1783

Paper size

Selects the paper size: A4 or US Letter.

Remote command:

[REPort:PAPersize](#) on page 1783

Edit before saving

Enables you to edit the report info when you save reports using the [Camera] key. When you press the key, a dialog box opens where you can change the user name and the comment.

User name / Comment

Enter information that appears in the general information section at the beginning of the report.

Remote command:

[REPort:USER](#) on page 1784

[REPort:COMMeNt](#) on page 1784

Logo

By default, the Rohde & Schwarz logo is shown in the header of the report pages. You can switch the logo off, or select your logo to be shown. A preview of the selected log file is shown.

Remote command:

[REPort:LOGType](#) on page 1784

[REPort:LOGO](#) on page 1784

Save to file

Select the file format and define the filename of the report file. By default, the filename has the prefix "Report_".

Double-tap the filename to open the file selection dialog box.

"pdf/doc/html" Selects the report format.

"Save" Saves the current report to the specified file.

"Save As..." Opens the file selection dialog box and saves the report to the selected file.

Remote command:

[REPort:FILE:NAME](#) on page 1785

[REPort:FILE:SAVE](#) on page 1785

Preview

Opens the current report in PDF format.

12.5 File selection dialog

The file selection dialog provides a file explorer from which you can select a file to load or to save data to. You can also manage your files in this dialog.

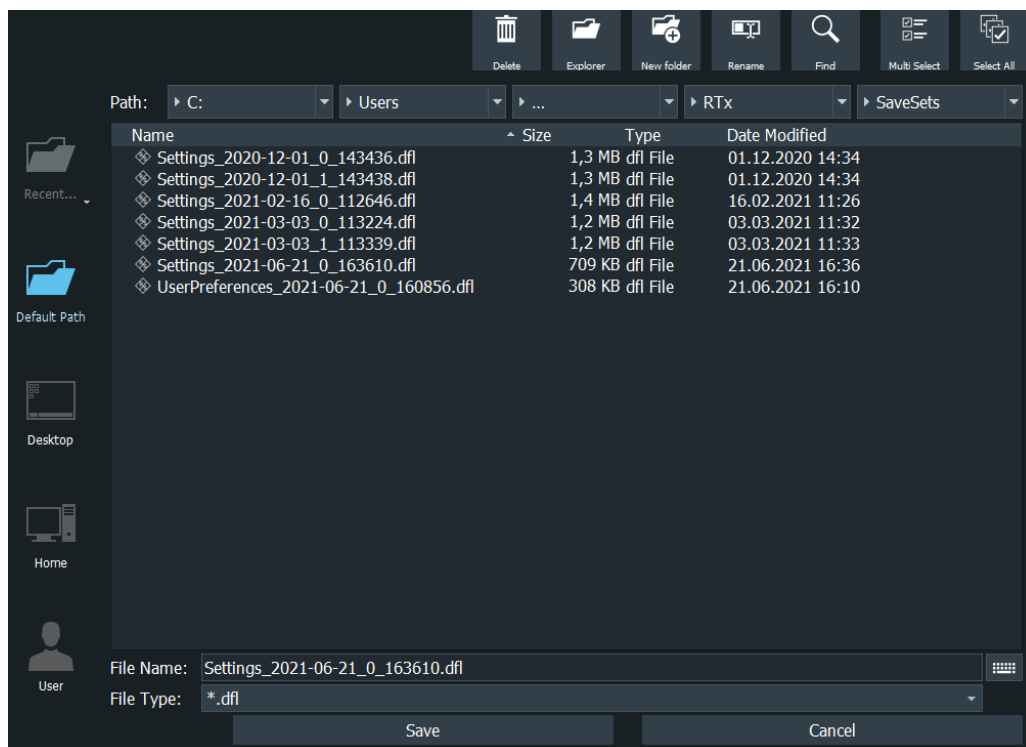

Path

Tap the path elements to change the current folder. The default folder is defined in [Default path for all file operations](#).

You can save the data in a local folder on the instrument, to an external storage device (usually a USB flash drive), or to a folder on a connected network drive. The path list provides all available drives and folders.

On the left, shortcut icons provide access to often used folders.

Toolbar

The toolbar on the top provides various functions for file management.

File Name

The file name to be loaded or stored to. Double-tap the file name, or tap the keyboard icon to enter the file name using the online keyboard.

The default file name for new files is defined in the "Autonaming" tab, see [Chapter 4.8.1, "Autonaming"](#), on page 104.

File Type

The file extension of the file to be loaded or stored to.

Save, Select

Selects the specified file for the open or save operation and closes the dialog box.

Cancel

Closes the dialog box without selecting a file.

13 Signal configuration

In this signal configuration dialog you can setup a signal according to the used serial standard. Also you can set up a user-defined signal up to PAM-8 and define signal and reference levels.

13.1 Signal configuration setup

Access: "Menu" > "Apps" > "Signal Configuration" > "Setup" tab.

The screenshot shows the 'Signal Configuration' dialog box with the 'Setup' tab selected. The main area contains a table with the following data:

	Source	Technology	Serial standard	PAM order	Symbol rate
1	C1W1	Custom	Custom	2/NRZ	125 MBaud
2	C2W1	Ethernet	1000BASE-T	5	125 MBaud

On the right side, the 'Symbol rate estimation' section shows 'Source' set to 'C2W1' and an 'Estimate symbol rate' button. Below this, 'Active measurements:' shows '- Meas. 1'. At the bottom, the 'Signal flow overview' diagram illustrates the signal processing flow: Deembedding (S) → Embedding / Equalization → Eye Analysis → Measurements. An 'Advanced Jitter / Noise' block is also shown in the flow.

Source

Selects a source for the signal that you want to configure. Available sources are analog channels, math waveforms, reference waveforms differential, common. You can define up to 20 sources.

Remote command:

[SIGNalconfig:SETup:SOURce](#) on page 1791

Technology, Serial standard

Selects the technology and the serial standard for the respective lane.

For some serial standards, the bit rate is known to the instrument. If you select the standard, the symbol rate for the analysis is set automatically.

The serial standards are available only if the instrument is able to support its maximum symbol rate.

Table 13-1: Technology and serial standard properties

Technology	Serial standard	PAM order	Symbol rate
USB	USB 2.0	2/NRZ	480 MBaud
	USB 3.2 Gen 1	2/NRZ	5 GBaud
DisplayPort	Displayport 1.1	2/NRZ	1.296 GBaud
	Displayport 1.2	2/NRZ	4.32 GBaud
Fibre Channel	Fibre Channel 1x	2/NRZ	1 GBaud
	Fibre Channel 2x	2/NRZ	2 GBaud
	Fibre Channel 4x	2/NRZ	4 GBaud
HDMI	HDMI 1.2	2/NRZ	1.32 GBaud
	HDMI 1.4	2/NRZ	3.4 GBaud
	HDMI 2.0	2/NRZ	4.8 GBaud
PCIe	PCIe Gen 1	2/NRZ	2.5 GBaud
	PCIe Gen 2	2/NRZ	5 GBaud
SATA	SATA Gen 1 (1/500)	2/NRZ	1.5 GBaud
	SATA Gen 1 (1/1667)	2/NRZ	1.5 GBaud
	SATA Gen 1	2/NRZ	1.5 GBaud
	SATA Gen 2 (1/500)	2/NRZ	3 GBaud
	SATA Gen 2 (1/1667)	2/NRZ	3 GBaud
	SATA Gen 2	2/NRZ	3 GBaud
SAS	SAS Gen 1	2/NRZ	3 GBaud
	SAS Gen 2	2/NRZ	6 GBaud
XAUI	XAUI	2/NRZ	3.75 GBaud
Ethernet	100Base-T	2/NRZ	125 MBaud
	1000Base-T	5	125 MBaud

Remote command:

[SIGNalconfig:SETup:SETTing<m>:SERStandard](#) on page 1789

PAM order

Available for option R&S RTO6-K135.

Selects the PAM order. You can select a value up to 8. For some serial standards there is a pre defined value for the PAM order, see [Technology and serial standard properties](#).

Remote command:

[SIGNalconfig:SETup:SETTing<m>:PAMorder](#) on page 1789

Symbol rate

Sets/ displays the symbol rate. Most standards have a pre-defined symbol rate, see [Technology and serial standard properties](#).

Remote command:

`SIGNalconfig:SETup:SETTING<m>:SYMBOLrate` on page 1790

Add

Adds a new signal to be configured. You can define up to 20 sources.

Remote command:

`SIGNalconfig:SETup:ADD` on page 1788

`SIGNalconfig:SETup:COUNT?` on page 1789

Remove

Removes the last signal from the table.

Remote command:

`SIGNalconfig:SETup:REMOve` on page 1789

Symbol rate estimation

Starts a software algorithm for the automatic determination of the symbol rate for the selected "Source".

Remote command:

`SIGNalconfig:SETup:SOURce` on page 1791

`SIGNalconfig:SETup:SREStimation` on page 1791

13.2 Signal flow overview

The signal flow overview displays further analysis that can be done on your signal. Also, it provides a shortcut to the respective setup dialogs.

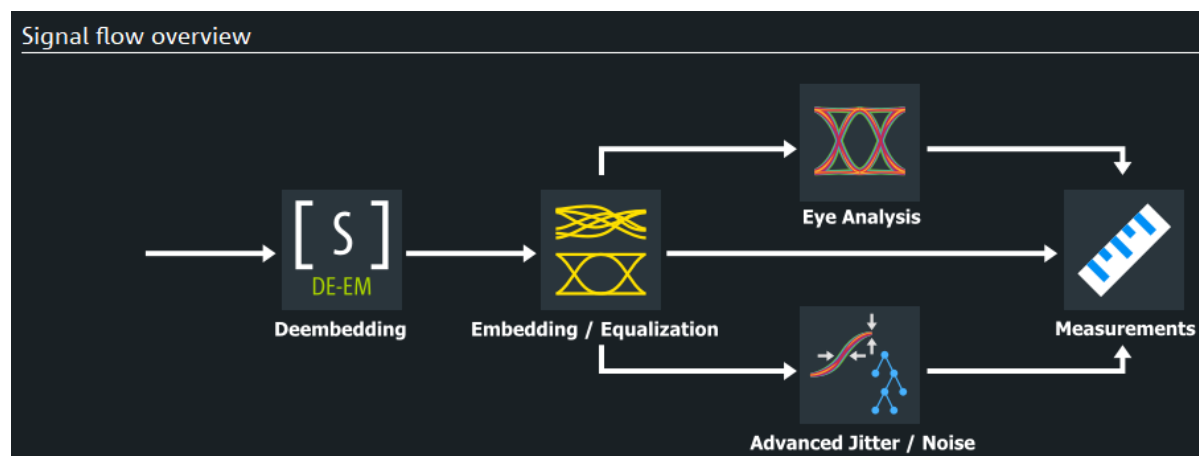

Depending on your available options, you can perform:

- Deembedding (option R&S RTO6-K121), see [Chapter 22, "Deembedding \(option R&S RTO6-K121\)"](#), on page 1248.

- Embedding / Equalization (option R&S RTO6-K126), see [Chapter 23, "Embedding and equalization \(option R&S RTO6-K126\)"](#), on page 1265.
- Advanced Jitter / Noise (option R&S RTO6-K133 or R&S RTO6-K134), see [Chapter 19.2, "Advanced jitter and noise \(option R&S RTO6-K133/K134\)"](#), on page 1094.
- Measurements, see [Chapter 8.2, "Automatic measurements"](#), on page 304.

13.3 Signal and reference levels for NRZ signals

Some measurement require reference levels to obtain the measurement points, e.g. time measurements or pulse count. Reference levels are referred to the signals, for each waveform you can define specific reference levels. Thus, for all measurements on a waveform the same reference levels are used.

Usually, reference levels are determined automatically. The instrument determines the high and low signal levels based on amplitude and histogram measurements of the acquisition. The reference levels are set relatively to the determined signal levels.

However, for irregular data and in special measurement setups it may be useful to configure the levels manually:

- Data signals can contain intervals where no data is transmitted, so that a high and low state cannot be determined for each acquisition. In this case, you can define the high and low signal levels manually to evaluate other measurement results.
- If the signal levels vary strongly or have large overshoots, the rise and fall levels may be difficult to determine.
- If fixed levels are defined for the DUT, you can configure the reference levels in the R&S RTO6 correspondingly and analyze the resulting measurement data.

In manual configuration, the reference levels can be set relatively to defined signal levels or as absolute values. You can also set the reference levels directly.

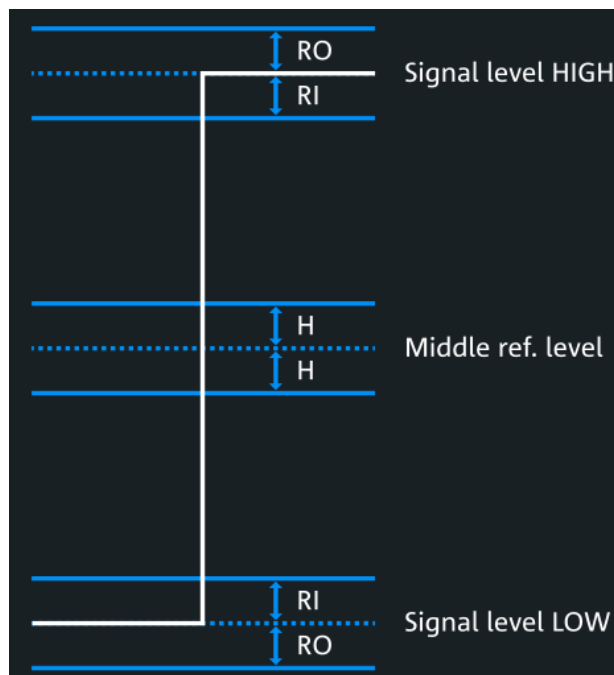

In addition to reference and signal levels, you can define a hysteresis for the middle reference level and tubes for signal levels. Hysteresis is useful for measurements that determine zero-crossings. Period, frequency, and pulse measurements are based on hysteresis - the instrument returns results if the amplitude of the signal exceeds the hysteresis. Thus, measurement during the transient oscillation is also possible. Tubes define evaluation ranges for measurements that require detection of the high level or low level. If the signal value remains within the defined tubes, it is considered to be high or low.

Reference levels and result lines can be displayed in the diagram, see ["To display reference levels and result lines"](#) on page 498.

13.3.1 Configuring reference levels

To determine reference and signal levels automatically

By default, the histogram of the measurement data is evaluated to determine the required levels automatically. However, you can define several parameters to adapt the evaluation to your data.

1. Open "Menu" > "Apps" > "Signal Configuration" > "Setup" tab.
2. Define the "Source", the waveform for which the reference is defined. The source can be any signal input, math or reference waveform.
3. In the "Signal levels" tab, select "Level detection mode" = "Auto" .
4. Define the "Auto level mode", the method which is used to determine the signal levels. For details, see ["Signal level"](#) on page 500.

5. By default, the lower reference level is defined at 10% of the signal amplitude, the middle reference level at 50% and the upper reference level at 90%.
In the "Ref. levels" tab, you can select other "Relative levels" to be used for evaluation.
If default percentages do not fit, select "User defined" and enter the percentages for the upper, middle, and lower reference levels.
The signal levels are determined by the instrument.
6. To determine the reference levels using average values from several histograms, enable the "Histogram averaging" option and define an "Average Count" to define how many histograms are averaged.
Averaging is not available if "Absolute peak" are selected as the "Signal level".

To determine reference levels manually

You can configure the reference levels manually as fixed absolute or relative values.

1. Open "Menu" > "Apps" > "Signal Configuration" > "Setup" tab.
2. Define the "Source", the waveform for which the reference levels are defined. The source can be any signal input, math or reference waveform.
3. In the "Signal levels" tab, select "Level detection mode" = "Manual" .
4. Open the "Ref. levels" tab.
5. Under "Level mode", select whether you want to define the levels using absolute or relative values.
6. Under "User level", select whether you want to configure the high and low signal levels ("Signal") or the lower, middle and upper reference levels ("Reference").
7. To define high and low signal levels if "Signal" is selected:
 - a) If "Level mode" is relative, select one of the predefined "Relative levels". If default percentages do not fit, select "User defined" and enter the percentages for the upper, middle, and lower reference levels.
The upper and lower reference levels are computed from the signal level values and the percentage values.
 - b) If "Level mode" is absolute, set the absolute "Top distance" and "Bottom distance" values, the differences between signal and reference levels.
The upper and lower reference levels are computed from the signal level values and the distances.
 - c) Open the "Signal levels" tab.
 - d) Enter the absolute high and low signal levels.
8. To define lower, middle and upper reference levels if "User level" = "Referene" is selected:
 - a) Enter the absolute upper and lower reference levels.

- b) If "Level mode" is relative, select one of the predefined "Relative levels". If default percentages do not fit, select "User defined" and enter the percentages for the upper, middle, and lower reference levels.
The high and low signal levels are computed from the reference level values and the percentage values.
- c) If "Level mode" is absolute, set the absolute "Top distance" and "Bottom distance" values, the differences between signal and reference levels.
The high and low signal levels are computed from the reference level values and the distances.

To define hysteresis and tubes

1. To define a hysteresis for the middle reference level:
 - a) In the "Signal configuration" dialog, select the "Advanced" tab.
 - b) In the "Hysteresis (H)" field, enter a percentage of the selected signal level.
A rise or fall from the middle reference value that does not exceed the hysteresis is rejected and not considered a zero-crossing.
2. To define a tube for the high and low signal levels:
 - a) Set the "Level definition" to "Relative".
 - b) In the "Relative outer (RO)" field, define a percentage of the signal level by which the absolute signal level may be larger than high signal level or lower than the low signal level.
 - c) In the "Relative inner (RI)" field, define a percentage of the signal level by which the absolute signal level may be higher than the low signal level or lower than the high signal level.

To display reference levels and result lines

1. Open "Menu" > "Measure" > "Advanced" tab.
2. Select the tab for the measurement you want to configure.
3. Enable "Result lines" or "Reference levels" option, or both.

The reference levels and intermediate results are displayed in the waveform diagram.

13.3.2 Signal level settings

Access: "Menu" > "Apps" > "Analysis" tab > "Signal Configuration" > "Signal level" tab.

Automatic level detection mode

In automatic level detection mode, the reference levels are always relative values. You can select one of the predefined sets, or define individual percentage values.

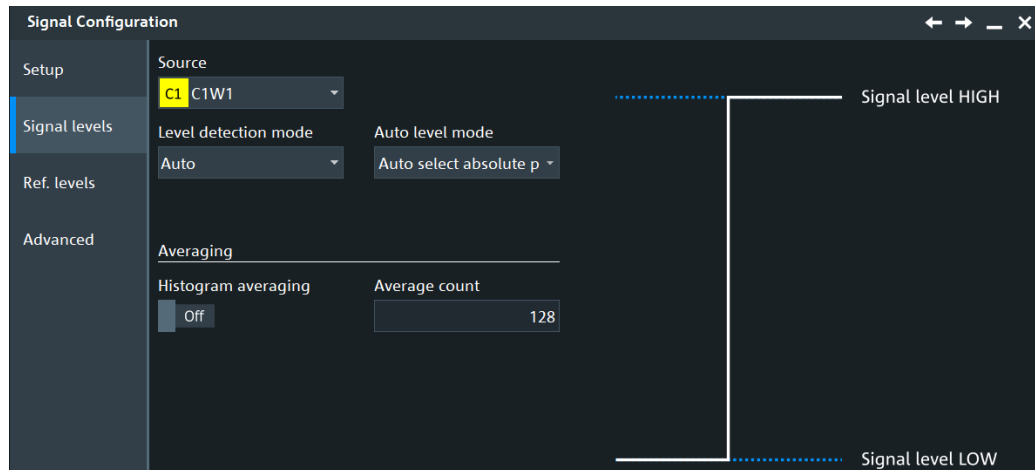

Figure 13-1: Automatic signal level definition

Manual reference level mode

In manual reference level mode, relative and absolute level definitions are possible.

In manual reference level mode with relative level definition, you define the absolute values of high and low signal levels or reference levels, and the reference levels as percentages of the signal amplitude.

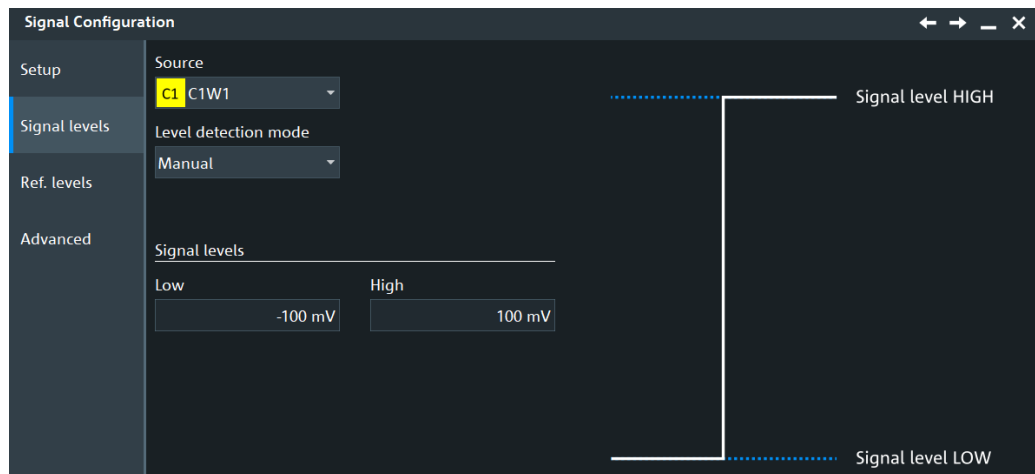

Figure 13-2: Manual signal level definition

Source

Defines the source for which the reference levels are defined. The source can be any signal input, math or reference waveform.

Remote command:

Source is defined by suffix <m> in "REFLevel" subsystem, see [Chapter 27.17.2, "Signal and reference levels for NRZ signals"](#), on page 1791.

Mode

Defines whether the reference level is configured manually or automatically.

Remote command:

[REFLevel<m>:LDEtection](#) on page 1792

Signal level

Defines the computation method for high and low signal levels. The instrument analyzes the signal, performs amplitude and histogram measurements, and defines the signal levels using the selected method.

The selected method is used to compute the signal levels for determination of reference levels in automatic reference level mode. It is also used for high, low, and amplitude measurements in automatic and manual reference level modes.

See also: [Chapter 8.2.7, "Histograms and histogram measurements"](#), on page 346

"Auto select absolute probability"	The most suitable signal levels for the selected measurement are used.
"Peak probability"	The signal levels with the highest probability values are used. These are the upper peak value and the lower peak value of the histogram measurement.
"Mean probability"	The signal levels with mean probabilities are used.
"Absolute peak"	The absolute peak signal levels are used. These are the maximum and minimum signal values of the amplitude measurement.
"Upper absolute peak - Lower mean probability"	The high signal level is the upper absolute peak (the maximum signal level), and the low signal level is the level with the mean probability in the lower half of the histogram.
"Upper mean probability - Lower absolute peak"	The high signal level is the level with mean probability in the upper half of the histogram, and the low signal level is the lower absolute peak (the minimum signal level).
"Upper absolute peak - Lower manual"	The high signal level is the maximum result value of the amplitude measurement. The low signal level is manually set using "Low".
"Upper manual - Lower absolute peak"	The high signal level is set manually using "High". The low signal level is the minimum result value of the amplitude measurement.

Remote command:

[REFLevel<m>:AUTO:MODE](#) on page 1794

High

Sets the high signal level.

The high signal level is set in manual reference level mode, for absolute level definition and user signal level selection.

Remote command:

[REFLevel<m>:ABSolute:HIGH](#) on page 1796

Low

Sets the low signal level.

The low signal level is set in manual reference level mode, for absolute level definition and user signal level selection.

Remote command:

`REFLevel<m>:ABSolute:LOW` on page 1796

Histogram averaging

Enables averaging over several histograms to determine the reference levels.

This function is only available in automatic level mode.

Remote command:

`REFLevel<m>:AUTO[:STATE]` on page 1795

Average Count

Defines the number of histograms to calculate the average from.

This function is only available in automatic level mode.

Remote command:

`REFLevel<m>:AUTO:COUNT` on page 1795

13.3.3 Reference level settings

Access: "Menu" > "Apps" > "Analysis" tab > "Signal Configuration" > "Ref.levels" tab.

The following setups are available, according to the selected "Level detection mode":

Automatic reference level mode

In automatic reference level mode, the reference levels are always relative values. You can select one of the predefined sets, or define individual percentage values.

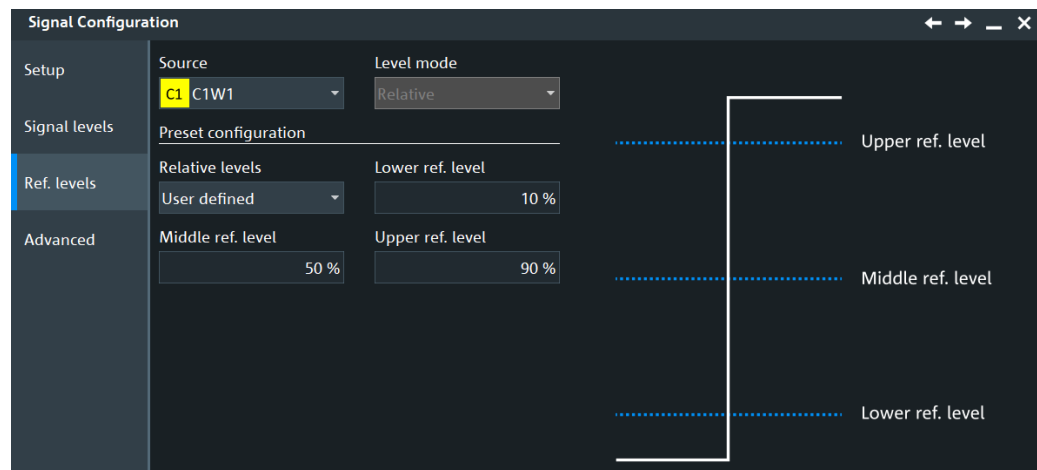

Figure 13-3: Automatic reference level definition

Manual reference level mode

In manual reference level mode, relative and absolute level definitions are possible.

In manual reference level mode with relative level definition, you define the absolute values of high and low signal levels or reference levels, and the reference levels as percentages of the signal amplitude.

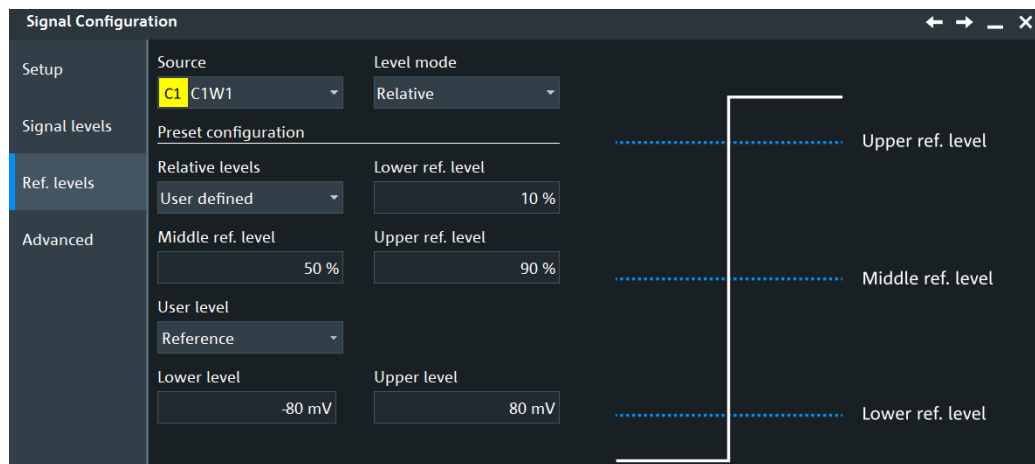

Figure 13-4: Automatic level detection mode, relative reference level definition

In manual reference level mode with absolute level definition, you define the absolute values of high and low signal levels or reference levels, and the distances between reference and signal levels.

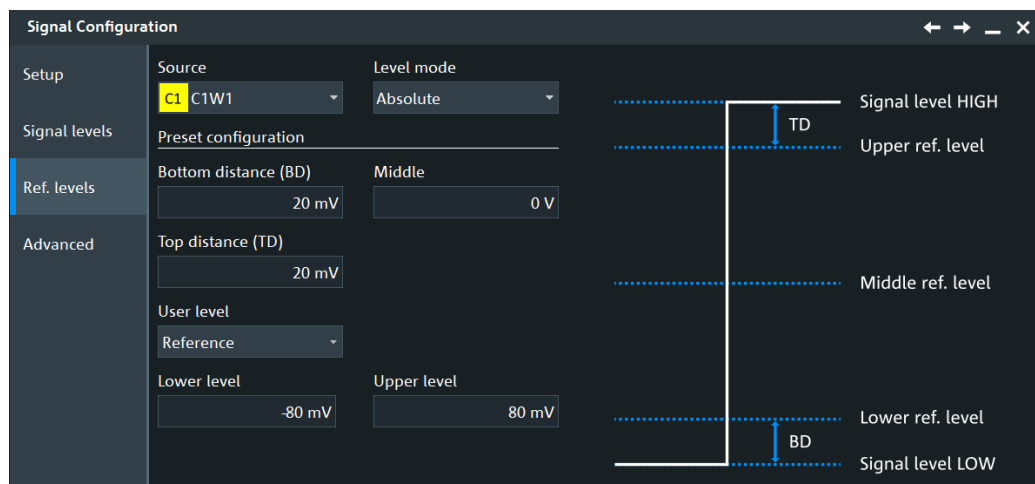

Figure 13-5: Automatic level detection mode, absolute reference level definition

Source

Defines the source for which the reference levels are defined. The source can be any signal input, math or reference waveform.

Remote command:

Source is defined by suffix <m> in "REFLevel" subsystem, see [Chapter 27.17.2, "Signal and reference levels for NRZ signals"](#), on page 1791.

Level mode

For manual "Level detection mode", the setting defines whether the reference is configured using absolute or relative values.

Remote command:

`REFLevel<m>:LMODe` on page 1792

Relative levels

Sets the lower, middle and upper reference levels, defined as percentages of the signal amplitude.

Available relative levels:

- 5/50/95
- 10/50/90
- 20/50/80
- User defined: Enter "Upper ref level", "Middle ref level", and "Lower ref level".

For example, for "5/50/95" the levels are set to the following values:

- Lower reference level = 5% of the signal amplitude
- Middle reference level = 50% of the signal amplitude
- Upper reference level = 95% of the signal amplitude

Remote command:

[REFLevel<m>:RELative:MODE](#) on page 1793

Upper ref level, Middle ref level, Lower ref level

Define the reference levels in percent, if "Relative levels" is set to "User-defined".

Remote command:

[REFLevel<m>:RELative:UPPer](#) on page 1799

[REFLevel<m>:RELative:MIDDLE](#) on page 1800

[REFLevel<m>:RELative:LOWer](#) on page 1800

User level

In manual reference level mode, the setting defines whether the user-defined signal levels or user-defined reference levels are used for the measurements.

"Signal" You can define the high and low signal levels.

"Reference" You can define the reference levels.

Remote command:

[REFLevel<m>:USRLevel](#) on page 1793

Upper level

The upper reference level required, for example, to determine a rise - for manual reference level mode, absolute level definition and user reference level.

Remote command:

[REFLevel<m>:ABSolute:ULEVel](#) on page 1798

Lower level

The lower reference level required, for example, to determine a fall - for manual reference level mode, absolute level definition and user reference level.

Remote command:

[REFLevel<m>:ABSolute:LLEVel](#) on page 1799

Bottom distance

The distance between the lower reference level and the low signal value - for manual reference level mode and absolute level definition.

Remote command:

[REFLevel<m>:ABSolute:BDIStance](#) on page 1797

Top distance

The distance between the high signal level and the upper reference level - for manual reference level mode and absolute level definition.

Remote command:

[REFLevel<m>:ABSolute:TDistance](#) on page 1797

Middle

For user signal level selection, the level is the middle level between high and low signal level. The value is adjusted automatically if you change the high or low signal levels. Vice versa, if you change the middle level, the high and low signal levels are adjusted.

For user reference level selection, the level is the middle level between upper and lower reference level. The value is adjusted automatically if you change the upper or lower reference levels. Vice versa, if you change the middle level, the upper and lower reference levels are adjusted.

Remote command:

[REFLevel<m>:ABSolute:MLevel](#) on page 1798

13.3.4 Advanced tab

Access: "Menu" > "Apps" > "Analysis" tab > "Signal Configuration" > "Advanced" tab.

This tab allows you to define evaluation tubes for measurements that require high-level or low-level detection. If the signal value remains within the defined tubes, it is considered to be high or low.

The screenshot shows the 'Signal Configuration' window with the 'Advanced' tab selected. The configuration is as follows:

Field	Value
Source	C1 C1W1
Hysteresis (H)	20 %
Level definition	Absolute
Tube	
Top outer (TO)	12.8 mV
Top inner (TI)	12.8 mV
Bottom outer (BO)	12.8 mV
Bottom inner (BI)	30.495 mV

The diagram on the right illustrates the signal levels and reference levels. It shows three horizontal lines representing signal levels: 'Signal level HIGH', 'Middle ref. level', and 'Signal level LOW'. Vertical double-headed arrows indicate the distances between these levels and the reference levels: TO (Top Outer) and TI (Top Inner) for the high signal level; H (Hysteresis) for the middle reference level; and BI (Bottom Inner) and BO (Bottom Outer) for the low signal level.

See also: [Source](#) and [Level mode](#).

Hysteresis

Defines a hysteresis for the middle reference level. A rise or fall from the middle reference value that does not exceed the hysteresis is rejected as noise.

Remote command:

[REFLevel<m>:RELative:HYSTeresis](#) on page 1801

Top outer

Defines an area above the high signal level which is still considered to be high level.

Remote command:

[REFLevel<m>:ABSolute:TOTube](#) on page 1802

[MEASurement<m>:REFLevel:RESult:TOUTer?](#) on page 1805

Top inner

Defines an area beneath the high signal level which is still considered to be high level.

Remote command:

[REFLevel<m>:ABSolute:TITube](#) on page 1802

[MEASurement<m>:REFLevel:RESult:TINNER?](#) on page 1805

Bottom inner

Defines an area above the low signal level which is still considered to be low level.

Remote command:

[REFLevel<m>:ABSolute:BITube](#) on page 1803

[MEASurement<m>:REFLevel:RESult:BINNer?](#) on page 1804

Bottom outer

Defines an area beneath the low signal level which is still considered to be low level.

Remote command:

[REFLevel<m>:ABSolute:BOTube](#) on page 1803

[MEASurement<m>:REFLevel:RESult:BOUTer?](#) on page 1804

Relative outer

Defines a percentage of the signal level by which the absolute signal level may be larger than the high signal level or lower than the low signal level to be considered high or low, respectively.

Remote command:

[REFLevel<m>:RELative:OTUBe](#) on page 1801

Relative inner

Defines a percentage of the signal level by which the absolute signal level may be higher than the low signal level or lower than the high signal level to be considered low or high, respectively.

Remote command:

[REFLevel<m>:RELative:ITUBe](#) on page 1802

13.4 Signal configuration for PAM-N signals (R&S RTO6-K135)

Requires option R&S RTO6-K135.

Signal configuration for PAM-N signals (R&S RTO6-K135)

The following chapters describe the signal and reference level definition signals of signals with PAM order > 2.

Pulse Amplitude Modulation (PAM) enables higher data rates on interfaces such as Ethernet, Fibre Channels or PCI express. It is a way to pack more bits into the same amount of time on a serial channel. The traditional mechanism for serial communication is the binary Non-Return-to-Zero (NRZ) using two voltage levels to transmit bit information.

PAM-4 in contrast uses four voltage level and can therefore transmit the double amount of data with the same baud rate therefore the same bandwidth of a signal channel.

With the R&S RTO6 and option R&S RTO6-K135 extend the following base measurements and applications.

- Basic Jitter option R&S RTO6-K12
- Advanced Jitter & Noise option R&S RTO6-K133/R&S RTO6-K134

13.4.1 Signal levels

Access: "Menu" > "Apps" > "Signal Configuration" > "Signal levels" tab.

In this dialog you can configure a number of signal levels depending on the PAM order of your signal. The signal levels, refer to the discrete amplitudes that the PAM signal can take based on the digital data being transmitted.

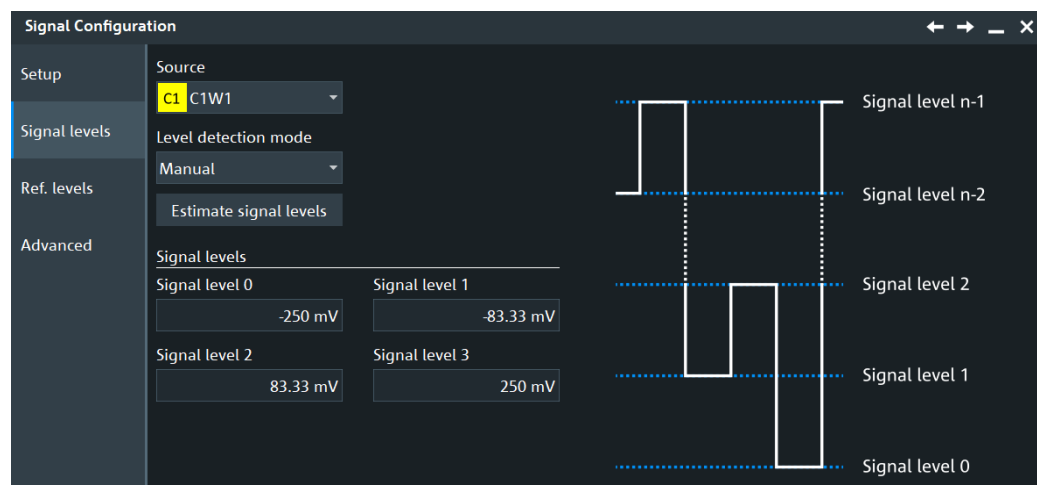

Figure 13-6: Signal levels settings for PAM order = 4 signals

Source

Defines the source for which the reference levels are defined. The source can be any signal input, math or reference waveform.

Remote command:

Source is defined by suffix <m> in "REFLevel" subsystem, see [Chapter 27.17.2, "Signal and reference levels for NRZ signals"](#), on page 1791.

Signal configuration for PAM-N signals (R&S RTO6-K135)

Level detection algorithm

Selects the algorithm that defines how the signal levels are detected.

Remote command:

[REFLevel<m>:PAMSignal:LVLalgorithm](#) on page 1812

Estimate signal levels

Starts a software algorithm for the automatic determination of the signal level. The values are displayed in "Signal level n".

Remote command:

[REFLevel<m>:PAMSignal:ESTimate](#) on page 1811

Signal levels

Sets the signal levels for the discrete amplitudes that the PAM signal can take based on the digital data being transmitted. The number of signal levels available depends on the PAM order of the signal.

For example, in a 4-PAM, there are four signal levels: "Signal level 0", "Signal level 1", "Signal level 2", "Signal level 3", "Signal level 4".

Remote command:

[REFLevel<m>:PAMSignal:LEVel<0..7>](#) on page 1811

13.4.2 Reference levels

Access: "Menu" >"Apps" > "Signal Configuration" > "Reference levels" tab.

In this dialog you can set reference levels of the signal. For each waveform you can define specific reference levels. Thus, for all measurements on a waveform the same reference levels are used.

The reference levels can be set relatively to defined signal levels or as absolute values. You can also set the reference levels directly.

Threshold	Lower	Middle	Upper
1 0 <-> 1	10 %	50 %	90 %
2 1 <-> 2	10 %	50 %	90 %
3 2 <-> 3	10 %	50 %	90 %
4 3 <-> 4	10 %	50 %	90 %

Figure 13-7: Reference levels settings for PAM order = 4 signals

Source

Defines the source for which the reference levels are defined. The source can be any signal input, math or reference waveform.

Remote command:

Source is defined by suffix <m> in "REFLevel" subsystem, see [Chapter 27.17.2, "Signal and reference levels for NRZ signals"](#), on page 1791.

Referenc level mode

Selects if the level jump height dependent reference levels are defined in absolute or relative values.

Remote command:

[REFLevel<m>:PAMReference:LVLDef](#) on page 1806

Preset levels

Sets the lower, middle and upper reference levels, defined as percentages of the signal amplitude.

Available relative levels:

- 5/50/95
- 10/50/90
- 20/50/80
- User-defined: Enter "Upper ref level", "Middle ref level", and "Lower ref level".

For example, for "5/50/95" the levels are set to the following values:

- Lower reference level = 5% of the signal amplitude
- Middle reference level = 50% of the signal amplitude
- Upper reference level = 95% of the signal amplitude

Remote command:

[REFLevel<m>:PAMReference:RELevel](#) on page 1810

Upper ref level, Middle ref level, Lower ref level

Define the reference levels in percent, if "Preset levels" is set to "User-defined".

Remote command:

[REFLevel<m>:PAMReference:UPPer](#) on page 1810

[REFLevel<m>:PAMReference:MIDDLE](#) on page 1809

[REFLevel<m>:PAMReference:LOWer](#) on page 1806

Preset

Presets the levels in the "Level jump height dependent reference levels" according to the value of the selected "Preset levels".

Remote command:

[REFLevel<m>:PAMReference:PRESet](#) on page 1810

Level jump height dependent reference levels

Sets the reference level of the signal for each transition ("Threshold").

At the upper tab, you can select the height of the level jump.

Remote command:

[REFLevel<m>:PAMSignal:LEVel<0..7> on page 1811](#)

[REFLevel<m>:PAMReference:LVLJumphgt<n>:THReshold<o>:ABSLower on page 1807](#)

[REFLevel<m>:PAMReference:LVLJumphgt<n>:THReshold<o>:ABSMiddle on page 1807](#)

[REFLevel<m>:PAMReference:LVLJumphgt<n>:THReshold<o>:ABSupper on page 1807](#)

[REFLevel<m>:PAMReference:LVLJumphgt<n>:THReshold<o>:RELLower on page 1808](#)

[REFLevel<m>:PAMReference:LVLJumphgt<n>:THReshold<o>:RELMiddle on page 1808](#)

[REFLevel<m>:PAMReference:LVLJumphgt<n>:THReshold<o>:RELupper on page 1809](#)

13.4.3 Advanced tab

Access: "Menu" > "Apps" > "Signal Configuration" > "Reference levels" tab.

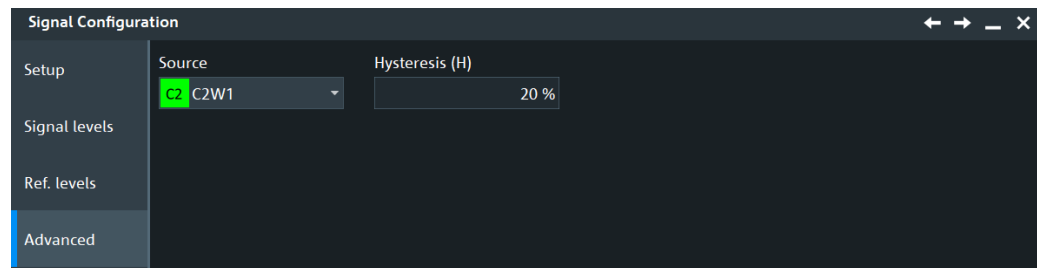

Source

Defines the source for which the reference levels are defined. The source can be any signal input, math or reference waveform.

Remote command:

Source is defined by suffix <m> in "REFLevel" subsystem, see [Chapter 27.17.2, "Signal and reference levels for NRZ signals"](#), on page 1791.

Hysteresis

Defines a hysteresis for the middle reference level. A rise or fall from the middle reference value that does not exceed the hysteresis is rejected as noise.

Remote command:

[REFLevel<m>:RELative:HYSTeresis on page 1801](#)

14 Protocol analysis

Using the serial protocol options for the R&S RTO6, you can analyze various serial protocols.

• Basics of protocol analysis.....	510
• I ² C (option R&S RTO6-K510).....	520
• SPI bus (option R&S RTO6-K510).....	535
• UART/RS-232/RS-422/RS-485 (option R&S RTO6-K510).....	546
• Audio signals (option R&S RTO6-K510).....	556
• Custom: Manchester / NRZ (option R&S RTO6-K510).....	574
• CAN and CAN FD (option R&S RTO6-K520).....	606
• LIN (option R&S RTO6-K520).....	632
• FlexRay (option R&S RTO6-K520).....	646
• SENT (option R&S RTO6-K520).....	662
• CXPI (option R&S RTO6-K520).....	694
• MIL-1553 (option R&S RTO6-K530).....	713
• ARINC 429 (option R&S RTO6-K530).....	730
• SpaceWire (option R&S RTO6-K530).....	742
• Ethernet 10BASE-T and 100BASE-TX (option R&S RTO6-K540).....	754
• MDIO (option R&S RTO6-K540).....	769
• RFFE (option R&S RTO6-K550).....	782
• Ethernet 100BASE-T1 (option R&S RTO6-K560).....	803
• Ethernet 1000BASE-T1 (option R&S RTO6-K560).....	821
• USB (option R&S RTO6-K570).....	839
• USB 3.1 (option R&S RTO6-K570).....	867
• USBPD (option R&S RTO6-K570).....	888
• D-PHY (option R&S RTO6-K580).....	901
• M-PHY and USB SSIC (option R&S RTO6-K580 and K570).....	918
• 8b/10b (option R&S RTO6-K590).....	948
• PCIe (option R&S RTO6-K72).....	961
• DDR (option R&S RTO6-K91).....	991

14.1 Basics of protocol analysis

Before you can analyze a serial signal, the bus has to be configured according to the protocol and specifics of the signal. The configuration contains:

- Assignment of the data and clock lines to the input channels
- Logical thresholds
- Protocol-specific settings

Serial data can be analyzed in several ways:

- Triggering: You can trigger on various events that are typical for the selected protocol type, for example, on start and stop of messages, or on specified data patterns in the message.

Triggering on a trigger event sequence is not supported, and holdoff settings are not available.

- Protocol decoding: The digitized signal data is displayed on the screen together with the decoded content of the messages in readable form, and the decode results are listed in a table.
- Search on decoded signal data: For most serial protocols, you can find various events in the decoded data. You can find the same events that you can trigger on, and even many more, because several event types can be combined. Thus, you get the results for the complete acquisition cycle.

Restrictions:

- Protocol analysis does not work if the "Decimation" is set to "High res".
- All serial protocols are disabled in roll mode.

14.1.1 Setup - general settings

For all protocols, configuration starts with the selection of the serial bus and the protocol.

Table 14-1: Configuration settings are protocol-specific. They are described in the related chapters:

K510 Low speed serial buses	I ² C	Chapter 14.2.2, "I²C configuration", on page 522
	Custom: Manchester / NRZ	Chapter 14.6.2, "Custom: Manchester / NRZ configuration", on page 576
	UART	Chapter 14.4.2.1, "UART configuration settings", on page 547
	SPI	Chapter 14.3.2, "SPI configuration", on page 536
	Audio	Chapter 14.5.2, "Audio configuration", on page 558
K520 Automotive serial buses low speed	CAN, CAN FD	Chapter 14.7.2, "CAN and CAN FD configuration", on page 607
	LIN	Chapter 14.8.2, "LIN configuration", on page 634
	FlexRay	Chapter 14.9.1.1, "FlexRay configuration", on page 646
	CXPI	Chapter 14.11.2, "CXPI configuration", on page 695
	SENT	Chapter 14.10.2.1, "SENT configuration", on page 667
RTO6-K530 Aerospace buses	MIL-1553	Chapter 14.12.2, "MIL-STD-1553 configuration", on page 716
	ARINC 429	Chapter 14.13.2, "ARINC 429 configuration", on page 731

	SpaceWire	Chapter 14.14.2, "SpaceWire configuration", on page 743
RTO6-K540 Ethernet buses	Ethernet 10BASE-T and 100BASE-TX	Chapter 14.15.2, "Ethernet configuration", on page 755
	MDIO	Chapter 14.16.2, "MDIO configuration", on page 771
RTO6-K550 MIPI low speed buses	MIPI RFFE	Chapter 14.17.2, "RFFE configuration", on page 785
RTO6-K560 Automotive ethernet	Ethernet 100BASE-T1	Chapter 14.18.2, "100BASE-T1 configuration", on page 804
RTO6-K570 USB buses	USB	Chapter 14.20.2, "USB 2.0 configuration", on page 845
	USB 3.1	Chapter 14.21.2, "USB 3.1 configuration", on page 875
	USB PD	Chapter 14.22.2, "USBPD configuration", on page 890
	USB SSIC	Chapter 14.24.2, "M-PHY configuration", on page 920
RTO6-K580 MIPI M-PHY, D-PHY, C-PHY Buses	MIPI D-PHY	Chapter 14.23.2, "D-PHY configuration", on page 902
	MIPI M-PHY	Chapter 14.24, "M-PHY and USB SSIC (option R&S RTO6-K580 and K570)", on page 918
RTO6-K590 PCI express	8b/10b	Chapter 14.25.2, "8b/10b configuration", on page 949
	PCIe	Chapter 14.26.2, "PCIe configuration", on page 964

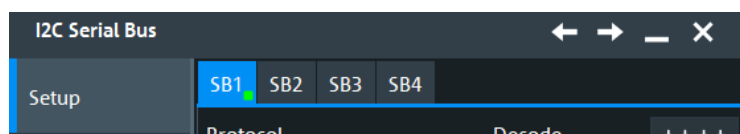

Make sure that the tab of the correct serial bus is selected.

Protocol

Defines the protocol type of the selected serial bus.

Remote command:

`BUS<m>:TYPE` on page 1813

Decode

Enables the decoding of the selected bus. The signal icon of the bus appears on the signal bar.

Remote command:

`BUS<m> [:STATe]` on page 1813

14.1.2 Autosest for protocols

If you want to perform a quick protocol measurement, you can use the "Autosest" function. It allows you to find the correct instrument settings for the desired protocol. It displays at least one decoded frame after the execution.

Performing a protocol autosest

1. Press [Bus] on the front panel.
2. Select the bus you want to configure.
3. Select the "Setup" tab.
4. Tap the "Protocol" you want to configure.
5. Assign the sources for the input channels.
6. Press the "Autosest" button.

"Autosest" performs the following steps:

- Executes "Autosest" for the horizontal and vertical scale.
- Adjusts the horizontal scale to display at least one frame or packet .
- Executes "Find thresholds" to determine the thresholds.
- If necessary, performs bit rate estimation.
- Sets default protocol trigger (frame start) .
- Turns on the protocol decoder.

Remote command:

`BUS<m> :FAUTosest` on page 1814

There are some limitations for the autosest:

- It is not available, if the digital MSO channels are selected as a source for the waveform.
- Signals with longer idle phases might not find horizontal adjustment.
- On duplex signals, different forward/reverse amplitudes can fail to determine thresholds.

14.1.3 Display

For all protocols, you can select to display the decoded signal as a table and to show the binary signal on the screen.

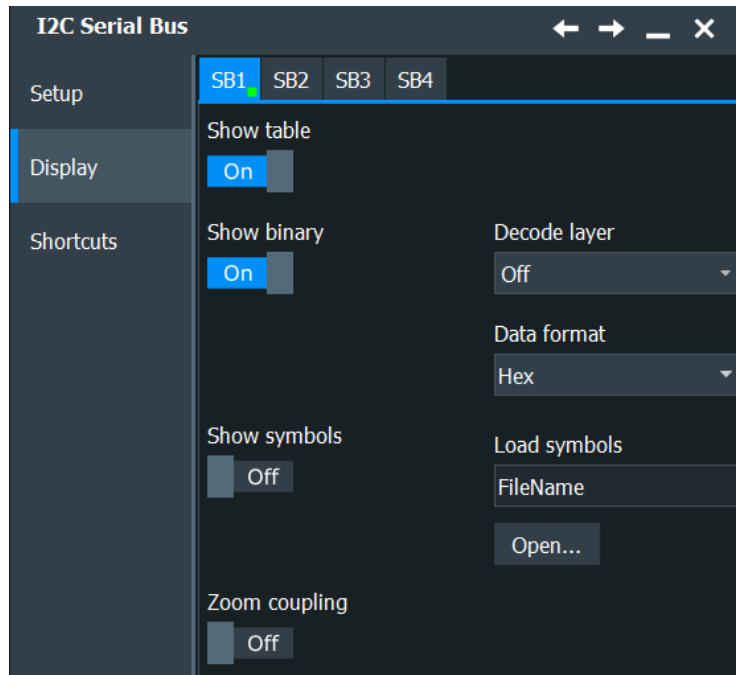

For some protocols, the result table provides a button to show the details of the selected frame.

Label Lists

For all protocols using ID or address identification, it is possible to create label lists containing addresses or IDs, a symbolic name for each node (symbolic label), and some protocol-specific information.

You can load label lists, and activate its usage for decoding. As a result, an additional "Label" column appears in the "Decode results" table, containing the symbolic label. The frame captions of the decoded signal show the symbolic label instead of the ID or address values. Hence it is easy to identify the messages of the different bus nodes.

You can also use the label list to trigger on an identifier or address. Instead of entering the value, you select the name, which is defined in the label list.

Show table

Opens a table with decoded data of the serial signal. The function requires the option for the analyzed protocol.

Decode results are protocol-specific. They are described in the "Decode Results" chapter of each protocol.

Remote command:

`BUS<m>:RESult` on page 1814

Show binary

For each configured line, the binary signal is also displayed.

Data format

Sets the data format for the values displayed in the decode table and in the combs of the decoded signal.

Remote command:

[BUS<m>:FORMat](#) on page 1815

Show symbols

Activates the symbols list to be used for decoding. The "Label" appear in the "Decode results" table and in the frame captions of the decoded signal.

Remote command:

[BUS<m>:SYMBols](#) on page 1815

Load symbols

Selects and loads a label list file. Available file formats are PTT, CSV, DBC (CAN only), and XML (FIBEX files, FlexRay only).

Label lists are protocol-specific. Their contents are described in the corresponding protocol chapters.

Remote command:

[BUS<m>:NEWLisT](#) on page 1815

Zoom coupling

If enabled, the decode zoom and result table are synchronized. If you select a row in the result table, this result is shown in the decode zoom.

With "Zoom window", you can also select the zoom used for coupling.

For an introduction to zoom settings and setup, see:

- [Chapter 7.1.2, "Zoom settings"](#), on page 245
- [Chapter 7.1.3, "Zooming for details"](#), on page 249

Remote command:

[BUS<m>:ZCOupling](#) on page 1816

14.1.4 Content and format of the PTT file

Label lists are stored as PTT (protocol translation table) files. The PTT file format is an extension of the CSV format (comma-separated values). You can edit it with standard editors, for example, with MS Excel or a text editor.

The PTT file has three types of lines:

- Comment lines begin with a hash character #. A hash character at any other position in the line is treated like a standard character.
- Command lines begin with a commercial at character @. An @ character at any other position in the line is treated like a standard character.
- Standard lines are the lines that not qualify as comment or command lines. They build the core of the label list.

Command lines

Command lines define the version of the PTT file and the protocol name:

- @FILE_VERSION: must appear exactly once in the file
- @PROTOCOL_NAME: must appear at least once in the file. Thus, one file can contain several label lists for different protocols.

```
# --- Start of PTT file
@FILE_VERSION = 1.0
@PROTOCOL_NAME = i2c
[... Label list for I2C]
@PROTOCOL_NAME = can
[... Label list for CAN]
# --- End of PTT file
```

Standard lines

Standard lines define the contents of the label list. The rules for standard lines follow the csv convention, they are:

- Values are separated by commas
- Space characters following a delimiter are ignored
- Values with a special character (comma, newline, or double quote) must be enclosed in double quotes
- Text in double quotes must be escaped by double quote characters

The format of the numeric value is indicated by a suffix. The following formats are supported:

Format	Suffix	Example
Decimal	<empty> d	106, DeviceName 106d, DeviceName
Hexadecimal	h	6Ah, DeviceName or prefix: 0x6A, DeviceName
Octal	o	152o, DeviceName
Binary	b	01101010b, DeviceName

The maximum supported word size for (unsigned) integers is 64 bits.

```
# --- Start of PTT file
@FILE_VERSION = 1.0
@PROTOCOL_NAME = i2c
#   Following two lines are equal:
7,01h, Temperature
7,01h, Temperature
#   A comma must be enclosed in double quotes:
7,01h, "Temperature, Pressure, and Volume"
#   A double quote must also be enclosed in double quotes:
7,7Fh, "Highspeed ""Master"" 01"
```

```
#    Following lines yield the same result:
7d,0x11,Pressure
7h,11h,Pressure
0x7,17d,Pressure
7,17,Pressure
```

14.1.5 Shortcuts

The "Shortcuts" tab gives quick access to other dialogs with protocol relevant settings. The availability depends on the functions supported by the protocol.

If you access a dialog from the "Shortcuts" tab, some settings are already predefined.

- "Trigger" dialog: you can trigger on various events that are typical for the selected protocol type, for example, on start and stop of messages, or on specified data patterns in the message.
- "Search" dialog: here you can configure protocol-specific search settings.
- In the "Measurements" dialog, you can perform additional measurements for some protocols. See [Chapter 8.2.10, "Protocol measurements \(option R&S RTO6-K500\)"](#), on page 355.
- "Export results": in the "Save Results" dialog, you can select the decode results you want to export, the file format, and the delimiter. For details, see [Chapter 12.2.4, "Results"](#), on page 475.
- "Export full results": in this dialog, you can select the decode results you want to export and the protocol-specific details to be included.

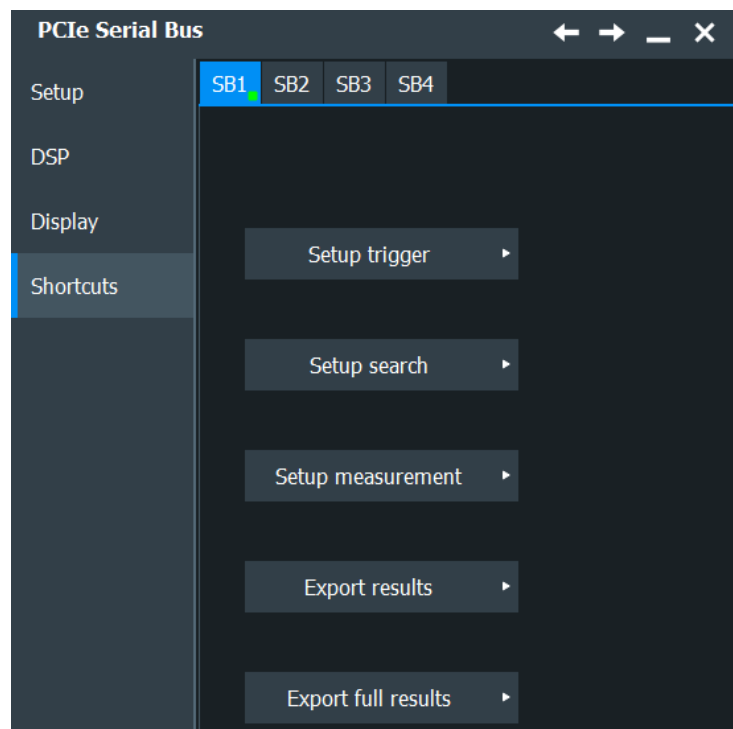

14.1.6 Export protocol results

In the "Export Protocol Results" dialog, you can export the results and all details of the selected protocol.

This is available for the following protocols:

- ARINC 429
- CAN, CAN FD
- USB 3.1
- Ethernet 10BASE-T and 100BASE-TX
- Ethernet 100BASE-T1
- Ethernet 1000BASE-T1
- LIN
- MIL-1553
- MIPI D-PHY
- SPI
- UART

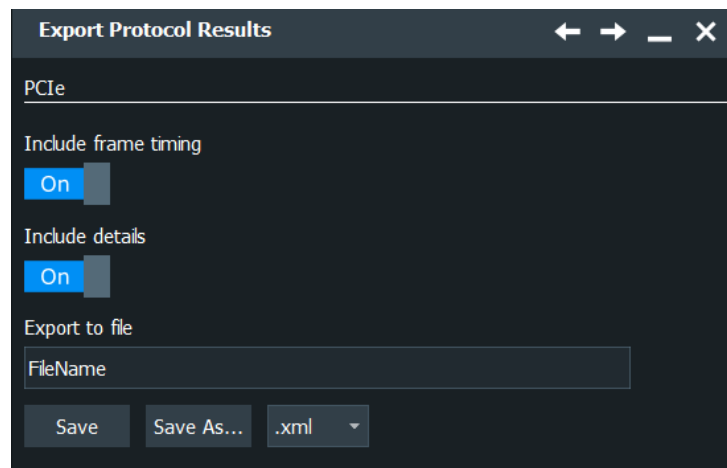

Include frame timing

Includes the frame timing.

Remote command:

[BUS<m>:EXPResult:TIME](#) on page 1817

Include details

Includes the detailed results for all frames.

Remote command:

[BUS<m>:EXPResult:DETail](#) on page 1816

Export to file

Enter the filename to save the results to. Double-tap the filename to open the file selection dialog box.

"Save" Saves the selected results to the indicated file.

- "Save As..." Opens the file selection dialog box and saves the selected results to the selected file. See also [Chapter 12.5, "File selection dialog"](#), on page 490
- File format Selects the file format.
- ".csv": the values are saved in a file.
You can select the value delimiter and the list separator symbol in the "CSV Export" dialog, see [Chapter 4.8.2, "CSV export"](#), on page 107.
Tip for using MS Excel: It is recommended that you use the semi-colon as csv decimal symbol. When you open the file with MS Excel, use "File > Open" and follow the wizard to set the separators correctly, or set the separator settings with "Tools > Options > International".
 - ".html": the results are saved as web page for display in a browser.
 - ".xml": the results are saved in an xml compatible file format.
 - ".py": the values are saved in a python compatible file format.

Remote command:

[BUS<m>:EXPResult:SAVE](#) on page 1817

14.1.7 Bit pattern editor

If you want to enter a specified address or data pattern, the bit pattern editor helps you to enter the pattern in various formats - decimal, hexadecimal, octal, binary and ASCII.

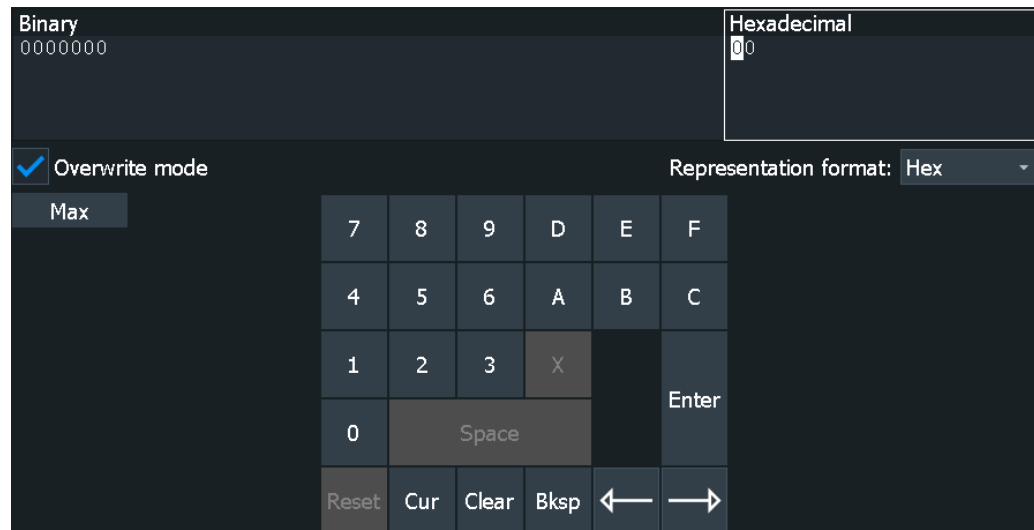

The editor displays the pattern in two columns. The left column always shows binary data. For the right column, you can select the format, the default depends on the data specifics. You can edit data in the left or right column. The keypad adapts itself to the column format, only keys appropriate to the format are enabled.

The data is grouped and converted in bit groups. The size of a bit group depends on the address or data specifics and is set by the instrument. Groups are automatically

separated by blanks. The maximum size of a bit group is 64 bit, the most common group size is 1 byte.

"Overwrite mode": If disabled, the data behind the new digit is shifted to the right. Bit groups are rearranged automatically.

Format-specific information:

- Unsigned: Decimal data format without sign. It is available for I²C, SPI, UART, CAN, LIN and FlexRay protocols. If you enter a decimal number that is too large for the defined bit group, the number is truncated and a message appears. X (do not care) in the decimal column sets all binary digits of the bit group to X.
- Signed: Signed decimal format, available for audio protocols. The first bit represents the sign. You can use the 2's complement or 1's complement format.
- Binary: 0, 1 and X (do not care) is allowed.
- Hex: most common format in the right column.
- Octal: Each digit represents 3 bit.
- ASCII: In the ASCII column, "X" is the character X. The binary X (do not care) is not allowed. If an X is included in the binary value in the left column, the ASCII column displays "\$" to indicate that the value is not defined.

Where applicable, frequently used values are provided in a "Predefined values" list below the pattern table, for example, reserved end words of data packets in the UART protocol.

14.2 I²C (option R&S RTO6-K510)

The Inter-Integrated Circuit is a simple, low-bandwidth, low-speed protocol used for communication between on-board devices.

- [About the I²C protocol](#)..... 520
- [I²C configuration](#).....522
- [I²C trigger](#)..... 525
- [I²C decode results](#)..... 531
- [Search on decoded I²C data](#)..... 532

14.2.1 About the I²C protocol

This chapter provides an overview of protocol characteristics, data format, address types and trigger possibilities. For detailed information, read the "I²C-bus specification and user manual" available on the NXP manuals webpage at <http://www.nxp.com/>.

I²C characteristics

The main characteristics of I²C are:

- Two-wire design: serial clock (SCL) and serial data (SDA) lines

- Controller/ target communication: the controller generates the clock and addresses the targets. Targets receive the address and the clock. Both controller and targets can transmit and receive data.
- Addressing scheme: each target device is addressable by a unique address. Multiple target devices can be linked together and can be addressed by the same controller.
- Read/write bit: specifies if the controller reads (=1) or writes (=0) the data.
- Acknowledge: takes place after every byte. The receiver of the address or data sends the acknowledge bit to the transmitter.

The R&S RTO6 supports all operating speed modes: high-speed, fast mode plus, fast mode, and standard mode.

Data transfer

The format of a simple I²C message (frame) with 7-bit addressing consists of the following parts:

- Start condition: a falling slope on SDA while SCL is high
- 7-bit address of the target device that is either written to or read from
- R/W bit: specifies if the data is written to or read from the target
- ACKnowledge bits: is issued by the receiver of the previous byte if the transfer was successful
Exception: At read access, the controller terminates the data transmission with a NACK bit after the last byte.
- Data: several data bytes with an ACK bit after every byte
- Stop condition: a rising slope on SDA while SCL is high

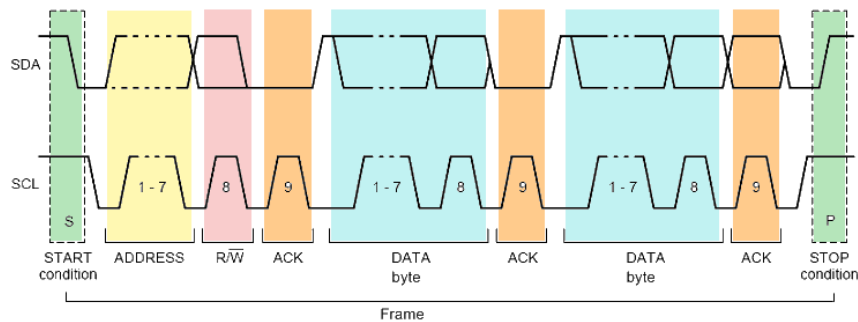

Figure 14-1: I²C write access with a 7-bit address

Address types: 7-bit and 10-bit

Target addresses can be 7 bits or 10 bits long. A 7-bit address requires 1 byte, 7 bits for the address followed by the R/W bit.

A 10-bit address for write access requires 2 bytes: the first byte starts with the reserved sequence 11110, followed by the two MSB of the address and the write bit. The second byte contains the remaining 8 LSB of the address. The target acknowledges each address byte.



Figure 14-2: 10-bit address, write access

A 10-bit address for read access requires 3 bytes. The first 2 bytes are identical to the write access address. The third byte repeats the address bits of the first byte and sets the read bit.

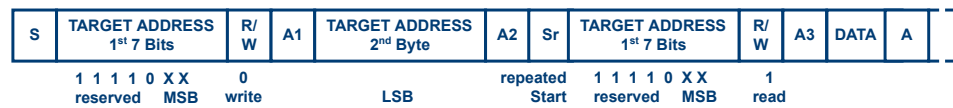

Figure 14-3: 10-bit address, read access

Trigger

The R&S RTO6 can trigger on various parts of I²C messages. The data and clock lines must be connected to the input channels, triggering on math and reference waveforms is not possible.

You can trigger on:

- Start or stop condition
- Repeated start condition
- Transfer direction (read or write)
- Bytes with missing acknowledge bit
- Specific target address or address range
- Specific data pattern in the message

14.2.2 I²C configuration

14.2.2.1 I²C configuration settings

Access: [Bus] > "I2C" > "Setup" tab



Make sure that the tab of the correct serial bus is selected.

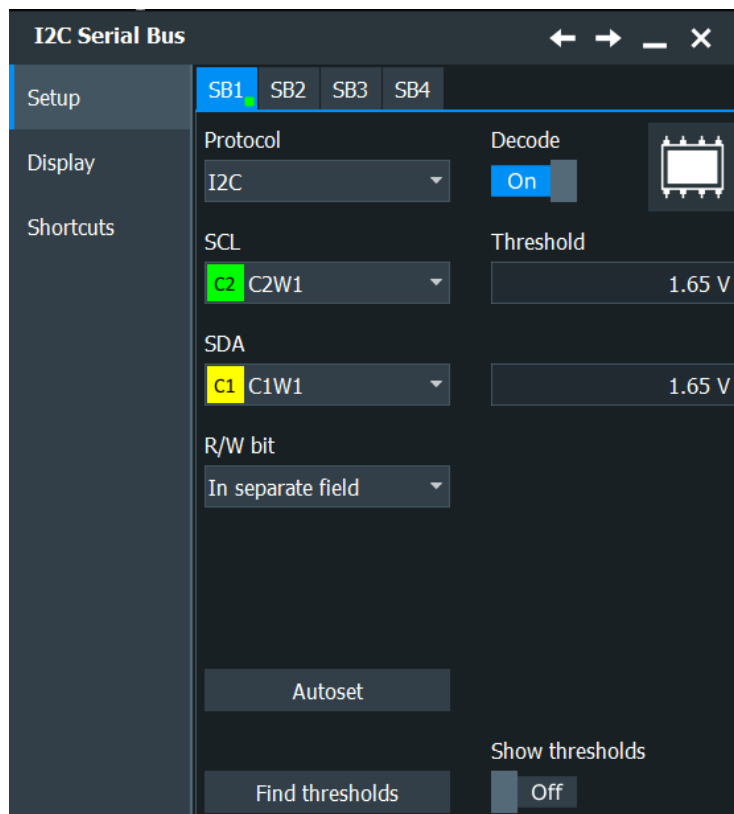

See also: [Chapter 14.1.1, "Setup - general settings"](#), on page 511

SDA, SCL

Set the waveforms of the data line (SDA) and clock line (SCL).

Usually, the source is one of the analog channels. Reference and math waveforms are available as source if the trigger source is one of the analog channels but not the serial bus.

Do not combine a reference waveform with channel or math waveform because the time correlation of these waveforms might differ.

Alternatively, digital channels can be used if MSO option R&S RTO6-B1 is installed. Digital and analog channels cannot be used at the same time.

For triggering on a serial bus, analog or digital channel sources are required.

Remote command:

[BUS<m>: I2C: SDA: SOURce](#) on page 1820

[BUS<m>: I2C: SCL: SOURce](#) on page 1820

R/W bit

Defines if the R/W bit is considered separately or as part of the address. The setting affects the [Adress Type](#) of the trigger conditions.

Remote command:

[BUS<m>: I2C: RWBit](#) on page 1822

Threshold

Sets the threshold value for digitization of signals for each line. If the signal value on the line is higher than the threshold, the signal state is high (1 or true for the Boolean logic). Otherwise, the signal state is considered low (0 or false) if the signal value is below the threshold.

There are several ways to set the threshold:

- "Threshold"
Enter the value directly in the field.
- "Autoset"
Starts software algorithms for determining the signal threshold levels and bitrate.
- "Find thresholds"
Executes the measurement of reference levels and sets the thresholds to the middle reference level of the measured amplitude.

Note: If the sources are digital channels, the same threshold values are used for the parallel and the serial buses. You can set the thresholds either in the parallel bus configuration or in the serial bus configuration.

Remote command:

[BUS<m>:I2C:SCL:THReshold](#) on page 1820

[BUS<m>:I2C:SDA:THReshold](#) on page 1821

[BUS<m>:I2C:TECHnology](#) on page 1821

[BUS<m>:SETReflevels](#) on page 1814

[BUS<m>:FAUToset](#) on page 1814

Show thresholds

If enabled, the threshold levels are displayed in the diagram.

Remote command:

[BUS<m>:THReshold](#) on page 1815

14.2.2.2 Display settings

Access: [Bus] > "Display" tab.

For common display settings, see [Chapter 14.1.3, "Display"](#), on page 513.

I²C Specific Label Settings

Label lists are protocol-specific. Label lists for I²C are available in CSV and PTT format.

An I²C label file contains three values for each address:

- Address type, 7-bit or 10-bit long
- Address value
- Symbolic label: name of the address, specifying its function in the bus network.

Example: I²C PTT file

```
# -----
@FILE_VERSION = 1.00
@PROTOCOL_NAME = i2c
```

```

# -----
# Labels for I2C protocol
#   Column order: Identifier type, Identifier value, Label
# -----
7,0x1E,Voltage
7,38h,Pressure
7,2Ah,Temperature
7,16h,Speed
7,118,Acceleration
7,07h,HighSpeed_Master_0x3
7,51h,EEPROM
10,3A2h,DeviceSetup
10,1A3h,GatewayStatus
10,06Eh,LeftSensor
# -----

```

14.2.2.3 Configuring I²C protocol

The configuration of the I²C is simple - assign the two lines to input channels, and set the thresholds.

For details on configuration settings, see [Chapter 14.2.2, "I²C configuration"](#), on page 522.

1. Press the [Bus] key on the front panel.
2. Select the tab of the bus you want to set up, for example "SB1".
3. Select the "Setup" tab.
4. Tap the "Protocol" button and select the protocol: "I2C".
5. Tap the "SDA" button, and select the waveform of the data line.
6. Tap the "SCL" button, and select the waveform of the clock line.
7. Set the logical thresholds.
8. Enable "Decode".

14.2.3 I²C trigger

14.2.3.1 I²C trigger settings

Access: [Bus] > "Shortcuts" tab > "Setup trigger"

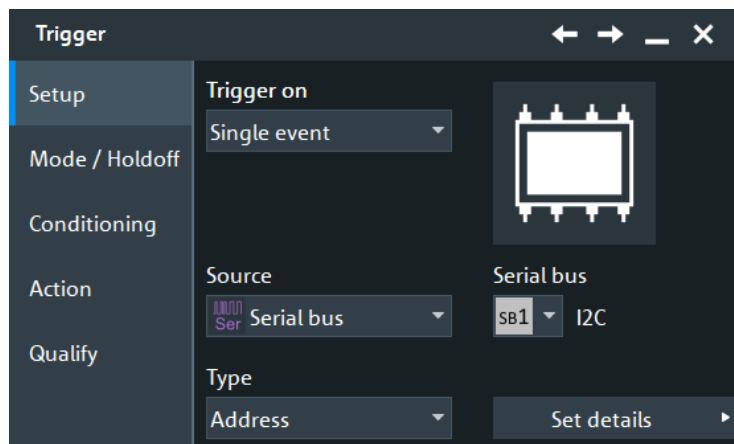

Make sure that:

- In the [Bus] > "Setup" tab:
 - The correct "Protocol" is selected.
 - The data sources of the serial bus are channel signals.
- In the "Trigger" > "Setup" tab:
 - The "Trigger on" = "Single event"
 - The trigger "Source" = "Serial bus".
 - The correct "Serial bus" is selected.

Serial bus

Selects the serial bus to be triggered on. Make sure to select the correct bus before you enter the settings.

To trigger on a serial bus, the signals sources must be channel signals. If the data or clock source is a math or reference waveform, you cannot trigger on that bus.

Remote command:

[TRIGger<m>:SOURce:SBSelect](#) on page 1818

Trigger type

Selects the trigger type for I²C analysis.

Some trigger types have additional settings that can be defined. In this case, the "Define trigger details" button appears next to the "Type" function. Open it for a detailed definition of the trigger conditions.

Remote command:

[TRIGger<m>:I2C:TYPE](#) on page 1823

Start ← Trigger type

Sets the trigger to the start of the message. The start condition is a falling edge on SDA while SCL is high. The trigger instant is the falling edge of the SDA line.

You can change the SDA and SCL lines here if necessary.

Repeated start ← Trigger type

Sets the trigger to a repeated start - when the start condition occurs without previous stop condition. Repeated start conditions occur when a primary exchanges multiple messages with a secondary without releasing the bus.

Stop ← Trigger type

Sets the trigger to the end of the message. The stop condition is a rising slope on SDA while SCL is high.

No Ack (Missing Ack) ← Trigger type

Missing acknowledge bit: the instrument triggers if the data line remains HIGH during the clock pulse following a transmitted byte.

You can also localize specific missing acknowledge bits by setting the [No Ack conditions](#).

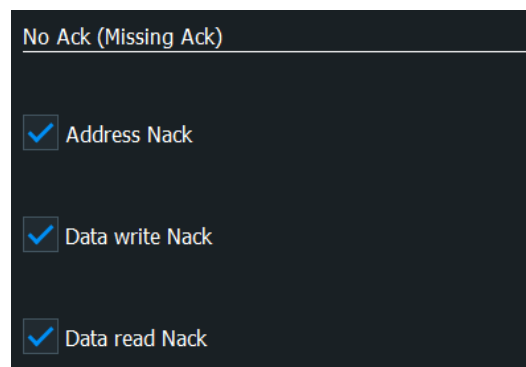
**Address ← Trigger type**

Sets the trigger to one specific address condition or a combination of address conditions. The trigger time is the falling clock edge of the acknowledge bit after the address. You can specify:

- [Address Type](#)
- ["Address"](#) on page 529
- [R/W bit](#)

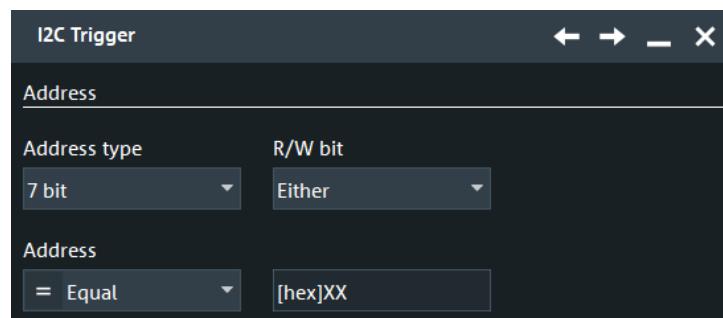
**Address OR ← Trigger type**

Triggers on one to four address conditions. Each enabled condition requires an exact address. You can specify:

For each condition to be used, select "Monitor"

- ["OR x"](#) on page 530

- [Adress Type](#)
- ["Address"](#) on page 529
- [R/W bit](#)

	Adress type	Adress	R/W bit
<input checked="" type="checkbox"/> OR 1	7 bit	[hex]XX	Either
<input type="checkbox"/> OR 2	7 bit	[hex]XX	Either
<input type="checkbox"/> OR 3	7 bit	[hex]XX	Either
<input type="checkbox"/> OR 4	7 bit	[hex]XX	Either

Address and data ← Trigger type

Sets the trigger to a combination of address and data condition. You can specify:

- [Adress Type](#)
- [R/W bit](#)
- ["Address"](#) on page 529
- ["Position"](#) on page 530
- ["Data"](#) on page 530

The address conditions are the same as for the "Address" trigger type and ["Data"](#) on page 530.

Address and data

Address type: 7 bit R/W bit: Either

Address: [-] In range [hex]00 .. [hex]00

Data: [-] Out of range [hex]XX .. [hex]XX

Position: ... Any

No Ack conditions

Selects which missing acknowledge bits is detected if the trigger type is set to "Missing Ack".

"Address Nack"

No secondary recognizes the address.

"Data write Nack"

The addressed secondary does not accept the data.

"Data read Nack"

Marks the end of the read process when the primary reads data from the secondary. This Nack is sent according to the protocol definition, it is not an error.

Remote command:

[TRIGger<m>:I2C:ADNack](#) on page 1824

[TRIGger<m>:I2C:DWNack](#) on page 1824

[TRIGger<m>:I2C:DRNack](#) on page 1824

Address Type

Sets the address length to be triggered on: 7 bit, 7+1 bit, or 10 bit. Available settings depend on the [R/W bit](#) setting of the bus configuration.

For "7 bit" and "10 bit", enter the address bits in the [Address](#) field, and use the ["R/W bit"](#) on page 529 field to select the transfer direction.

For "7+1 bit", enter the seven address bits and also the R/W bit in the "Address" field.

If the trigger type is "Address + data", you can set the address type "Any" to trigger on data only, regardless of the address.

Remote command:

[TRIGger<m>:I2C:AMODe](#) on page 1824

[TRIGger<m>:I2C:ADOR<n>:ADRTYPE](#) on page 1826

Address

The trigger address setup consists of a comparison condition and one or two address patterns.

Defines the bit pattern of the secondary device address. The length of the entry is adjusted to the selected address type.

In binary format, use the following characters: 1; 0; or X (do not care). To enter the pattern in other formats use the bit pattern editor, see [Chapter 14.1.7, "Bit pattern editor"](#), on page 519.

"Condition" Sets the comparison condition to a specific value or a range.

"Min" Specifies the value or sets the start value of a range.

"Max" Sets the maximum value of a range for "Condition" = "In range"/"Out of range".

Remote command:

[TRIGger<m>:I2C:ADDRess](#) on page 1825

[TRIGger<m>:I2C:ADDTo](#) on page 1825

[TRIGger<m>:I2C:ADOR<n>\[:VALue\]](#) on page 1826

R/W bit

Toggles the trigger condition between read and write access of the primary. Select "Either" if the transfer direction is not relevant for the trigger condition.

Remote command:

[TRIGger<m>:I2C:ACCess](#) on page 1823

[TRIGger<m>:I2C:ADOR<n>:RWBit](#) on page 1826

OR x

Enables each selected condition, for "Trigger Type" = "Address OR".

Remote command:

[TRIGger<m>:I2C:ADOR<n>:ENABle](#) on page 1825

Position

Sets the number of data bytes to be skipped after the address. You can define an exact position, or a position range. The index 0 is associated with the first data byte.

"Condition" Sets the comparison condition to a specific value or a range.

"Index min" Specifies the value or sets the start value of a range.

" Index max" Sets the maximum value of a range for "Condition" = "In range"/"Out of range".

Remote command:

[TRIGger<m>:I2C:DPOperator](#) on page 1827

[TRIGger<m>:I2C:DPOsition](#) on page 1827

[TRIGger<m>:I2C:DPTO](#) on page 1827

Data

Specifies the trigger conditions for the data bit pattern.

In binary format, use the following characters: 1; 0; or X (do not care). To enter the pattern in other formats use the bit pattern editor, see [Chapter 14.1.7, "Bit pattern editor"](#), on page 519.

"Condition" Sets the comparison condition to a specific value or a range.

"Value min " Specifies the value or sets the start value of a range.
Enter the bytes in msb first bit order. The maximum pattern length is 64 bit. Waveform data is compared with the pattern byte-by-byte.

"Value max " Sets the maximum value of a range for "Condition" = "In range"/"Out of range".

Remote command:

[TRIGger<m>:I2C:DCONdition](#) on page 1828

[TRIGger<m>:I2C:DMIN](#) on page 1828

[TRIGger<m>:I2C:DMAX](#) on page 1828

14.2.3.2 Triggering on I²C signals

Prerequisites: An I²C bus is configured, see [Chapter 14.2.2.3, "Configuring I²C protocol"](#), on page 525.

1. Press the [Bus] key and select the "Shortcuts" tab.
2. Press "Setup trigger".
3. Tap the "Source" button and select the "Serial bus" trigger source.
4. Select the serial bus that is set to I²C.
5. Select the "Trigger type".

- For more complex trigger types, enter the address and/or data conditions: address, acknowledge bits, R/W bit, and data pattern.
For details, see [Chapter 14.2.3, "I²C trigger"](#), on page 525

14.2.4 I²C decode results

When the configuration of the serial bus is complete, the signal can be decoded:

- In the "Serial Bus" dialog > "Setup" tab, enable "Decode".
- In the "Serial Bus" dialog > "Display" tab, select additional result display settings: "Show table" and "Show binary".
- If required, enable "Zoom coupling"

For a description of the display settings, see also [Chapter 14.1.3, "Display"](#), on page 513.

The instrument captures and decodes the signal according to the standard definition and the configuration settings.

The color-coding of the various protocol sections and errors simplifies the interpretation of the visual display. The decode information condenses or expands, depending on the horizontal scale. Various data formats are available to show the result values.

Decode Results Table

The results are shown in two tables:

- "Decode results": contains information about all decoded frames
- "Details frame": contains more detailed information about the selected frame in the "Decode results" table.

State	Frame start	Address type	Address value	Label	R/W bit	Bit rate
1 Ok	47.58 ns	7 bit	[hex] 48	Temperature	Write	4.794 Gbps
2 Ok	35.6 ns	7 bit	[hex] 32	Pressure	Read	4.794 Gbps
3 Ok	23.72 ns	10 bit	[hex] 136		Write	4.794 Gbps
4 Ok	9.51 ns	10 bit	[hex] 24D	Torque	Write	4.794 Gbps
5 Ok	4.49 ns	10 bit	[hex] 24D	Torque	Read	4.827 Gbps
6 Ok	6.99 ns	7 bit	[hex] 54		Write	4.794 Gbps
7 Ok	9.42 ns	7 bit	[hex] 54		Write	4.794 Gbps
8 Ok	18.59 ns	7 bit	[hex] 17		Write	4.794 Gbps
9 Ok	32.45 ns	7 bit	[hex] 48	Temperature	Write	4.794 Gbps
10 Incomplete	44.42 ns	7 bit	[hex] 32	Pressure	Read	4.827 Gbps

Table 14-2: Content of the Details frame table

Column	Description
State	Overall state of the frame. "Insufficient waveform length" indicates that the frame is not completely contained in the acquisition. Change the horizontal scale, or move the reference point to the left to get a longer acquisition.
Frame start	Time of frame start
Address type	Address length, 7 bit or 10 bit
Address value (hex)	Hexadecimal value of the address
Label	Symbolic label name defined in the label list

Column	Description
R/W bit	Value of the R/W bit
Bit rate	Value of the bit rate

Table 14-3: Content of the Decode results table

Column	Description
Formatted	Value of all data bytes of the frame
Ack bit start	Start time of the acknowledge bit
Ack bit	Value of the address acknowledge bit

Tools

Press "Display settings" in the "Decode Results" table to access the "Display" tab.



Remote commands

Remote commands are described in [Chapter 27.18.3.3, "Decode results"](#), on page 1828.

14.2.5 Search on decoded I²C data

Using the search functionality, you can find various events in the decoded data, the same events which you also can trigger on. Before you can start the search, you have to configure the bus correctly and acquire decoded data.

To search on decoded data, set the search "Source" to the serial bus that is configured for the protocol to be analyzed.

See also [Chapter 11, "Search functions"](#), on page 425.

14.2.5.1 I²C search setup

Access: [Bus] > "Shortcuts" tab > "Setup search"

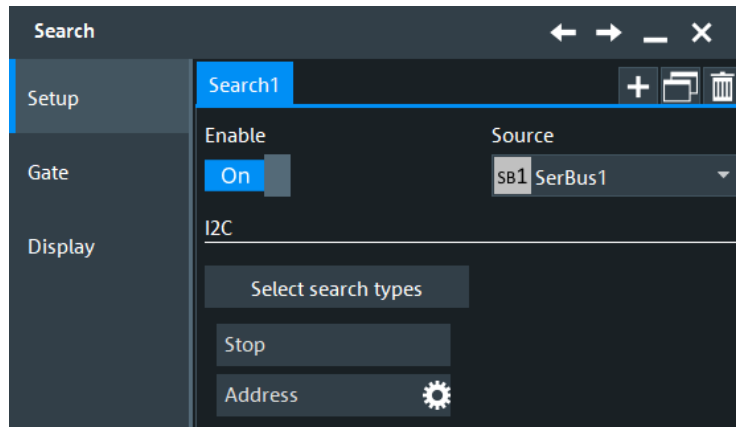

Select search types

Enable the events to be searched for. Unlike triggering, where you can trigger only on one defined event, you can search for various different events in one search.

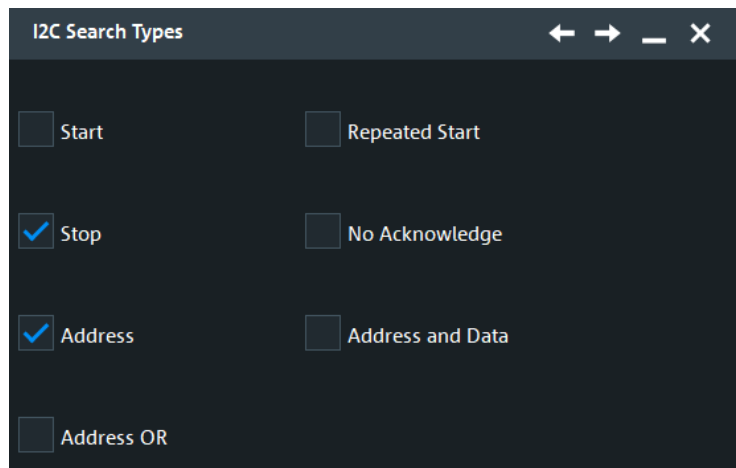

- | | |
|------------------------|--|
| "Start" | Searches for the start of the message. The start condition is a falling edge on SDA while SCL is high. The event is the falling edge of the SDA line.
You can change the SDA and SCL lines here if necessary. |
| "Repeated start" | Searches for a start condition without previous stop condition. Repeated start conditions occur when a master exchanges multiple messages with a slave without releasing the bus. |
| "Stop" | Searches for the end of the message. The stop condition is a rising slope on SDA while SCL is high. |
| "No ACK (Missing ACK)" | Searches for a missing acknowledge bit: an event is found if the data line remains HIGH during the clock pulse following a transmitted byte. |
| "Address" | Searches for one specific address condition or a combination of address conditions. The event is the falling edge of the acknowledge bit after the address. |
| "Address OR" | Searches for one to four address conditions. |

"Address and data" Searches for a combination of address and data conditions.

Remote command:

[SEARCH:TRIGGER:I2C:SCONdition](#) on page 1838

[SEARCH:TRIGGER:I2C:RCONdition](#) on page 1838

[SEARCH:TRIGGER:I2C:STCNdition](#) on page 1838

[SEARCH:TRIGGER:I2C:NACKnowledge](#) on page 1838

[SEARCH:TRIGGER:I2C:SADDRESS](#) on page 1839

[SEARCH:TRIGGER:I2C:ADOR](#) on page 1839

[SEARCH:TRIGGER:I2C:ADData](#) on page 1840

Address setup: Condition, Type, Addr. min, Addr. max, R/W bit

The address setup consists of the condition, type, R/W bit and one or two address patterns.

The address setup settings are the same as in the I2C trigger setup, see ["Address"](#) on page 529.

Remote command:

[SEARCH:TRIGGER:I2C:ACONdition](#) on page 1840

[SEARCH:TRIGGER:I2C:ADDRESS](#) on page 1841

[SEARCH:TRIGGER:I2C:ADDTTo](#) on page 1841

[SEARCH:TRIGGER:I2C:AMODE](#) on page 1840

[SEARCH:TRIGGER:I2C:ACCess](#) on page 1842

Data setup: Condition, Position, Index min, Index max, Value min, Value max

The data setup consists of the condition, position, and one or two index/value patterns.

The data setup settings are the same as in the I2C trigger setup, see ["Data"](#) on page 530.

Remote command:

[SEARCH:TRIGGER:I2C:DPOperator](#) on page 1844

[SEARCH:TRIGGER:I2C:DPOSITION](#) on page 1844

[SEARCH:TRIGGER:I2C:DPTO](#) on page 1844

[SEARCH:TRIGGER:I2C:DCONdition](#) on page 1845

[SEARCH:TRIGGER:I2C:DMIN](#) on page 1845

[SEARCH:TRIGGER:I2C:DMAX](#) on page 1845

Address OR setup: , OR x Address type, Address, R/W bit

The address OR setup consists of the monitor, address type, address and an R/W bit.

The address OR setup settings are the same as in the I2C trigger setup, see [Chapter 14.2.3.1, "I²C trigger settings"](#), on page 525.

Remote command:

[SEARCH:TRIGGER:I2C:ADDO<m>:ENABLE](#) on page 1842

[SEARCH:TRIGGER:I2C:ADDO<m>:ADRTYPE](#) on page 1842

[SEARCH:TRIGGER:I2C:ADDO<m>\[:VALUE\]](#) on page 1843

[SEARCH:TRIGGER:I2C:ADDO<m>:RWBIT](#) on page 1843

No ACK setup: Addr/W/R NACK

The no ACK setup consists of the Addr/W/R NACK.

The no ACK setup settings are the same as in the I2C trigger setup, see "[No Ack conditions](#)" on page 528.

Remote command:

[SEARCH:TRIGger:I2C:DRNack](#) on page 1846

[SEARCH:TRIGger:I2C:DWNack](#) on page 1846

[SEARCH:TRIGger:I2C:NACKnowledge](#) on page 1838

14.2.5.2 I²C search results

To get search results, "Enable" the search. You can minimize, shift or close the search dialog.

The search results are listed in the search result table and marked in the waveform by blue lines.

For an introduction to search results, see:

- [Chapter 11.1.2, "Search results"](#), on page 426
- [Chapter 11.4.2, "Display zoom settings"](#), on page 446

The remote commands for the search results are described in [Chapter 27.18.3.5, "I²C search results"](#), on page 1847.

14.3 SPI bus (option R&S RTO6-K510)

• About the SPI protocol	535
• SPI configuration	536
• SPI trigger	541
• SPI decode results	543
• Search on decoded SPI data	544

14.3.1 About the SPI protocol

A 4-channel instrument is required for full support of the SPI protocol, or the MSO option R&S RTO6-B1.

The Serial Peripheral Interface SPI is used for communication with slow peripheral devices, in particular, for transmission of data streams.

The main characteristics of SPI are:

- Main-subnode communication
- No device addressing. The sub is accessed by a chip select, or sub select line.
- No acknowledgment mechanism to confirm receipt of data
- Duplex capability

Most SPI buses have four lines, two data and two control lines:

- Clock line to all subs (SCLK)
- Sub select or Chip select line (SS or CS)
- Main data output, sub data input (MOSI or SDI)
- Main data input, sub data output (MISO or SDO)

When the main generates a clock and selects a sub device, data can be transferred in either or both directions simultaneously.

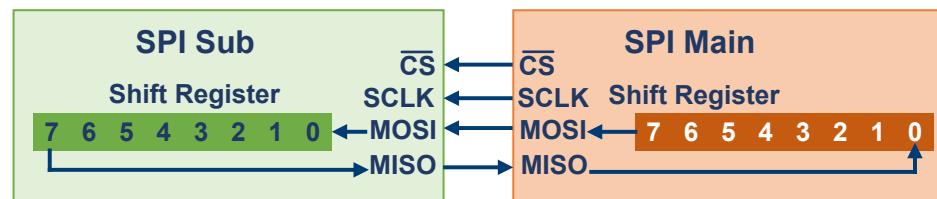

Figure 14-4: Simple configuration of SPI bus

The data bits of a message are grouped by the following criteria:

- A word contains several successive bits. The word length is defined in the protocol configuration.
- A frame contains several successive words, at least one word.

14.3.2 SPI configuration

14.3.2.1 SPI configuration settings

Access: [Bus] > "SPI" > "Setup" tab



Make sure that the tab of the correct serial bus is selected.

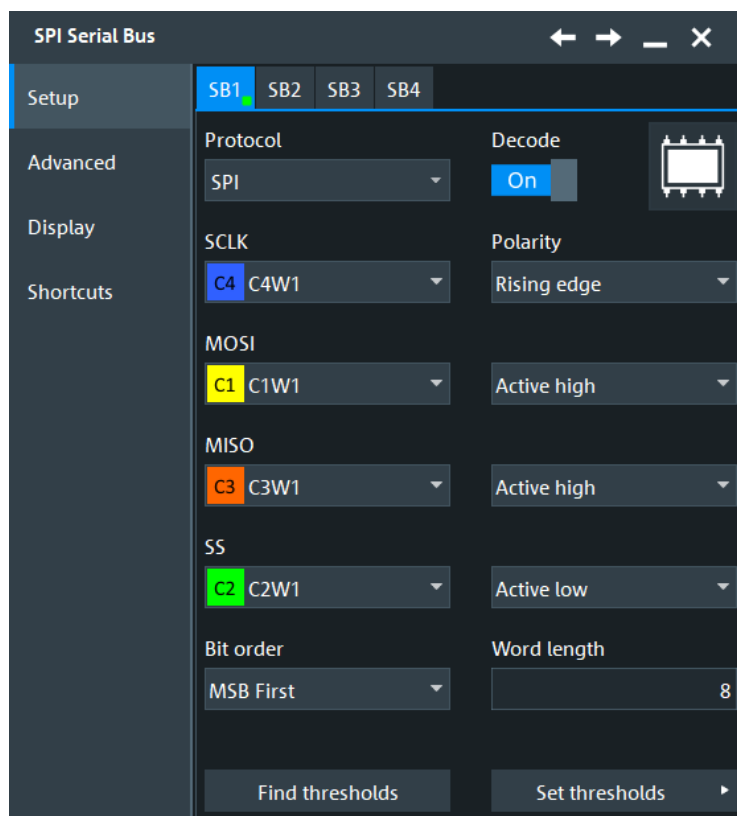

See also: [Chapter 14.1.1, "Setup - general settings"](#), on page 511

SCLK

Defines the settings for the clock line.

SCLK source ← SCLK

Sets the input channel of the clock line. Waveform 1 of channel signals, math waveforms, and reference waveforms can be used for decoding.

Alternatively, digital channels can be used if MSO option R&S RTO6-B1 is installed. Digital and analog channels cannot be used at the same time.

For triggering on a serial bus, analog or digital channel sources are required.

Remote command:

[BUS<m>:SPI:SCLK:SOURce](#) on page 1854

Polarity ← SCLK

Two settings define the clock mode: the clock polarity and the clock phase. Together, they determine the edges of the clock signal on which the data are driven and sampled. A master/slave pair must use the same parameter pair values to communicate.

The clock polarity is "Idle low" (idle = 0) or "Idle high" (idle = 1).

The clock phase defines the slope. It selects if data is stored with the rising or falling slope of the clock. The slope marks the begin of a new bit.

SS, MISO, MOSI

Configures the Slave Select, MISO and MOSI lines.

Source ← SS, MISO, MOSI

Sets the input channel of the selected line.

Usually, the source is one of the analog channels. Reference and math waveforms are available as source if the trigger source is one of the analog channels but not the serial bus.

Do not combine a reference waveform with channel or math waveform because the time correlation of these waveforms might differ.

Alternatively, digital channels can be used if MSO option R&S RTO6-B1 is installed. Digital and analog channels cannot be used at the same time.

For triggering on a serial bus, analog or digital channel sources are required.

Remote command:

[BUS<m>:SPI:SSElect:SOURce](#) on page 1855

[BUS<m>:SPI:MISO:SOURce](#) on page 1856

[BUS<m>:SPI:MOSI:SOURce](#) on page 1856

Polarity ← SS, MISO, MOSI

Selects whether transmitted data or the slave select signal is high active (high = 1) or low active (low = 1).

Remote command:

[BUS<m>:SPI:SSElect:POLarity](#) on page 1855

[BUS<m>:SPI:MISO:POLarity](#) on page 1856

[BUS<m>:SPI:MOSI:POLarity](#) on page 1857

Set Thresholds

Opens a dialog, where you can set the thresholds for digitization of signals for each line. If the signal value on the line is higher than the threshold, the signal state is high. Otherwise, the signal state is considered low if the signal value is below the threshold. The interpretation of HIGH and LOW is defined by the [Polarity](#).

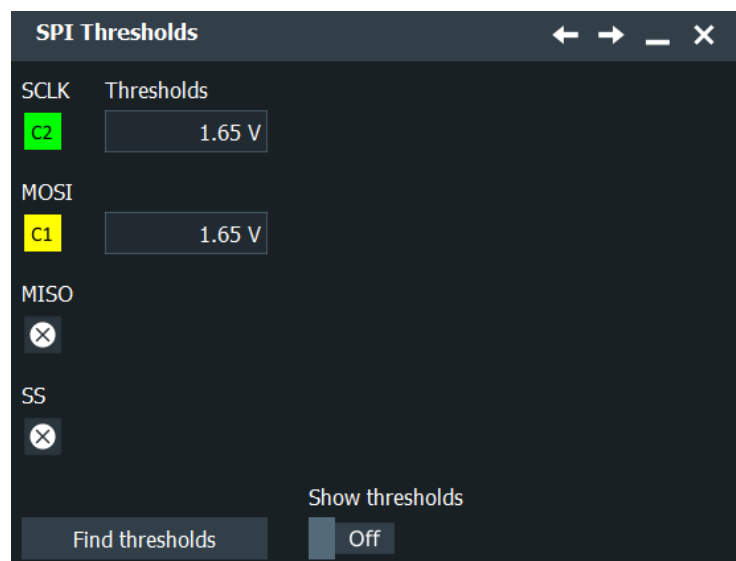

There are several ways to set the threshold:

- "Threshold"
Enter the value directly in the field.
- "Autoset"
Starts software algorithms for determining the signal threshold levels and bitrate.
- "Find thresholds"
Executes the measurement of reference levels and sets the thresholds to the middle reference level of the measured amplitude.

Note: If the sources are digital channels, the same threshold values are used for the parallel and the serial buses. You can set the thresholds either in the parallel bus configuration or in the serial bus configuration.

Remote command:

`BUS<m>:SPI:SCLK:THReshold` on page 1857

`BUS<m>:SPI:MISO:THReshold` on page 1857

`BUS<m>:SPI:MOSI:THReshold` on page 1857

`BUS<m>:SPI:SSElect:THReshold` on page 1857

`BUS<m>:SETReflevels` on page 1814

`BUS<m>:FAUToset` on page 1814

Bit order

Defines if the data of the messages starts with msb (most significant bit) or lsb (least significant bit). The display of the decoded signal considers this setting, results are displayed in the specified order.

Remote command:

`BUS<m>:SPI:BORDER` on page 1854

Word length

Sets the number of bits in a word. The maximum length is 32 bit.

Remote command:

`BUS<m>:SPI:WSIZE` on page 1854

14.3.2.2 Advanced settings

Access: [Bus] > "Advanced" tab.

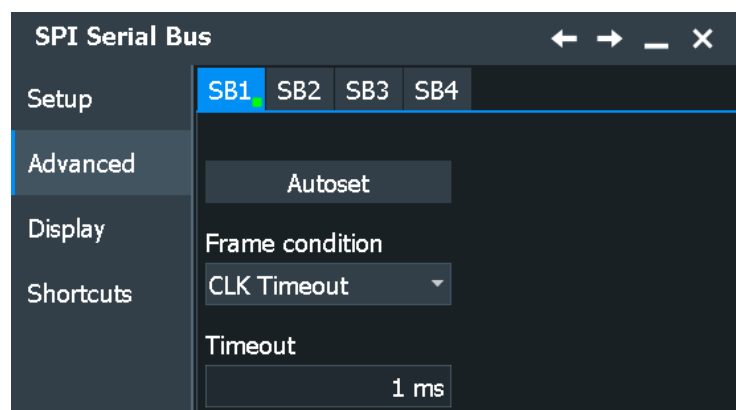

Autoset

Starts software algorithms for determining the signal threshold levels and bitrate.

Remote command:

[BUS<m>:FAUToset](#) on page 1814

Frame condition

Defines the start of a frame. A frame contains a number of successive words, at least one word.

"SS" Start and end of the frame is defined by the active state of the slave select signal.

"CLK timeout" Defines a timeout on the clock line SCLK as limiter between two frames. The timeout condition is used for SPI connections without an SS line. Enter the minimum clock idle time in the field.

Remote command:

[BUS<m>:SPI:FRCondition](#) on page 1857

Timeout

Sets the minimum clock idle time if a timeout on the clock line SCLK is used as limiter between two frames.

See also: "[Frame condition](#)" on page 540.

Remote command:

[BUS<m>:SPI:TIMEout](#) on page 1858

14.3.2.3 Configuring SPI signals

For configuration, assign the lines to the input channels, and define the active states and the logical thresholds.

For details on configuration settings, see [Chapter 14.3.2, "SPI configuration"](#), on page 536.

1. Press the [Bus] key on the front panel.
2. Select the tab of the bus you want to set up, for example "SB1".
3. Tap the "Protocol" button and select the protocol: "SPI".
4. Tap the "SCLK Source" button, and select the waveform of the clock line.
5. Set the polarity (clock mode) for SCLK.
6. For each of the available SS, MISO and MOSI lines, assign the waveform. Define the polarity (active state) of the line.
7. Set the logical thresholds.
8. Set the "Bit order", "Word length", and "Frame condition" according to your signal.
9. Enable "Decode".

14.3.3 SPI trigger

14.3.3.1 SPI trigger

Access: [Bus] > "Shortcuts" tab > "Setup trigger"

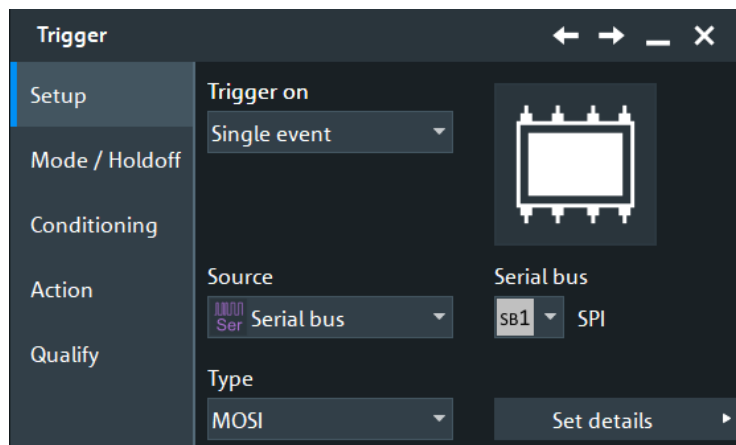

Make sure that:

- In the [Bus] > "Setup" tab:
 - The correct "Protocol" is selected.
 - The data sources of the serial bus are channel signals.
- In the "Trigger" > "Setup" tab:
 - The "Trigger on" = "Single event"
 - The trigger "Source" = "Serial bus".
 - The correct "Serial bus" is selected.

Trigger type

Selects the trigger type for SPI analysis.

"Frame start (SS)"	Trigger on the start of the frame when the slave select signal SS changes to the active state. This trigger type is available if Frame condition is set to "SS".
"Frame start (Timeout)"	Triggers on the start of the frame when the clock idle time exceeds the "Timeout" time. This trigger type is available if Frame condition is set to "CLK timeout".
"MOSI"	Sets the trigger to a specified data pattern expected on the MOSI line. See: "MOSI and MISO data conditions" on page 542.
"MISO"	Sets the trigger to a specified data pattern expected on the MISO line. See: "MOSI and MISO data conditions" on page 542.

"MOSI/MISO" Sets the trigger to specified data patterns expected on the MOSI and MISO lines on the same time.

Remote command:

[TRIGger<m>:SPI:TYPE](#) on page 1859

MOSI and MISO data conditions

The trigger on MOSI and MISO patterns is defined in the same way:

Condition ← MOSI and MISO data conditions

Selects the operator for the "Data" pattern: "Equal" or "Not equal".

Remote command:

[TRIGger<m>:SPI:FCONdition](#) on page 1860

MOSI pattern, MISO pattern ← MOSI and MISO data conditions

Specify the data patterns to be found on the MOSI and/or MISO line.

If the trigger type is "MOSI" or "MISO" (one pattern is defined), the maximum pattern length is 256 bit. If the trigger type is "MOSI/MISO", two patterns must be found at the same time. Thus, both patterns must have the same length, and the maximum pattern length of each pattern is 128 bit.

Enter the words in msb first bit order. The starting point of the pattern is defined by [Index min](#), [Index max](#) and [Search mode](#).

The bit pattern editor helps you to enter the pattern, see [Chapter 14.1.7, "Bit pattern editor"](#), on page 519.

Remote command:

[TRIGger<m>:SPI:MOSIpattern](#) on page 1861

[TRIGger<m>:SPI:MISOpattern](#) on page 1861

Position ← MOSI and MISO data conditions

Operator for the data position. You can define an exact position, a position range, or let the position undefined ("Any").

Remote command:

[TRIGger<m>:SPI:DPOperator](#) on page 1860

Index min, Index max ← MOSI and MISO data conditions

The effect of data positioning depends on the [Search mode](#). It sets the number of bits or words before the first word of interest. These offset bits/words are skipped. If the position operator defines a range, the first and the last bit/word of interest are defined. The index 0 is associated with the first data bit or word.

Remote command:

[TRIGger<m>:SPI:DPOsition](#) on page 1860

[TRIGger<m>:SPI:DPTO](#) on page 1860

Search mode ← MOSI and MISO data conditions

Defines how the specified data pattern is searched:

"Word-aligned" The pattern is matched only at word boundaries.

"Bit-aligned" Bit-by-bit: the pattern can start at any position in the message.

Remote command:

[TRIGger<m>:SPI:PALignment](#) on page 1859

14.3.3.2 Triggering on SPI

Prerequisites: A bus is configured for the SPI signal to be analyzed.

1. Press the [Bus] key and select the "Shortcuts" tab.
2. Press "Setup trigger".
3. Select the serial bus that is set to SPI.
4. Select the "Trigger type".
5. For more complex trigger types, enter the data pattern conditions
For details, see [Chapter 14.3.3, "SPI trigger"](#), on page 541

14.3.4 SPI decode results

When the configuration of the serial bus is complete, the signal can be decoded:

1. In the "Protocol" dialog > "Setup" tab, enable "Decode".
2. In the "Protocol" dialog > "Display" tab, select additional result display settings: "Show decode table" and "Show binary signals".

For a description of the display settings, see also [Chapter 14.1.3, "Display"](#), on page 513.

The instrument captures and decodes the signal according to the standard definition and the configuration settings.

The color-coding of the various protocol sections and errors simplifies the interpretation of the visual display. The decode information condenses or expands, depending on the horizontal scale. Various data formats are available to show the result values.

Decode Results Table

The "Decode results" table contains information about all decoded frames.

SPI Decode Results SB1 ✕						
	State	Frame start	Count	MOSI Values	MISO Values	Bit rate
1	Ok	-19.4536 µs	2	[hex] 6C 55	[hex] 6C 55	7.292 Mbps
2	Ok	-13.648 µs	2	[hex] 6C 55	[hex] 6C 55	7.292 Mbps
3	Ok	-7.8424 µs	2	[hex] 6C 55	[hex] 6C 55	7.292 Mbps
4	Ok	-2.036 µs	2	[hex] 6C 55	[hex] 6C 55	7.292 Mbps
5	Ok	3.7688 µs	2	[hex] 6C 55	[hex] 6C 55	7.292 Mbps
6	Ok	9.5752 µs	2	[hex] 6C 55	[hex] 6C 55	7.292 Mbps
7	Ok	15.3808 µs	2	[hex] 6C 55	[hex] 6C 55	7.292 Mbps

Table 14-4: Content of the "Decode results" table

Column	Description
State	Overall state of the frame
Frame start	Times of frame start and frame end
Count	Number of words in the frame
MOSI values	Value of the MOSI data words. The data format is selected below the table.
MISO values	Value of the MISO data words. The data format is selected below the table.
Bit rate	Value of the bit rate

Tools

Press "Display settings" in the "Decode Results" table to access the "Display" tab.



Remote commands

Remote commands to retrieve decode results are described in [Chapter 27.18.4.3, "SPI decode results"](#), on page 1861.

14.3.5 Search on decoded SPI data

Using the search functionality, you can find various events in the decoded data, the same events which you also can trigger on. Before you can start the search, you have to configure the bus correctly and acquire decoded data.

To search on decoded data, set the search "Source" to the serial bus that is configured for the protocol to be analyzed.

See also [Chapter 11, "Search functions"](#), on page 425.

14.3.5.1 SPI search setup

Access: [Bus] > "Shortcuts" tab > "Setup search"

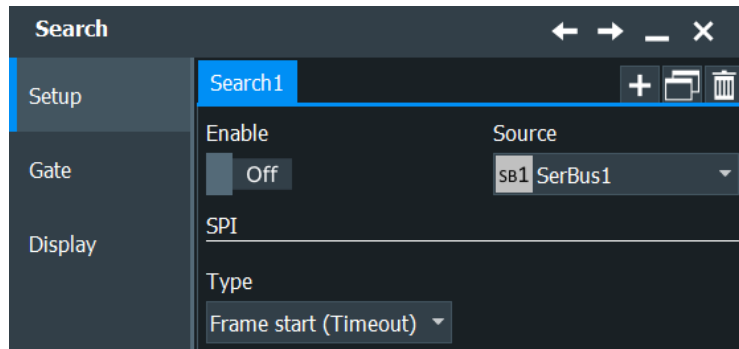

Type

Sets the event to be searched for.

"Frame start (SS)"	Searches for the start of the frame when slave select signal SS changes to the active state. This type is available if the slave select line is configured in the bus setup, and the frame condition is "SS".
"Frame start (Timeout)"	Searches for the start of the frame when the clock idle time exceeds the timeout. This trigger type is available if frame condition is set to "CLK timeout".
"MOSI"	Searches for a specified data pattern expected on the MOSI line.
"MISO"	Searches for a specified data pattern expected on the MISO line.
"MOSI / MISO"	Searches for specified data patterns expected on the MOSI and MISO lines.

Remote command:

[SEARCH:TRIGGER:SPI:TYPE](#) on page 1867

MOSI and MISO data search

The MOSI and MISO setup consists of the condition, position, MOSI pattern, MISO pattern, search mode (word-aligned, bit-aligned) and one or two index patterns.

The MOSI and MISO setup settings are the same as in the SPI trigger setup. For details, see "[MOSI and MISO data conditions](#)" on page 542.

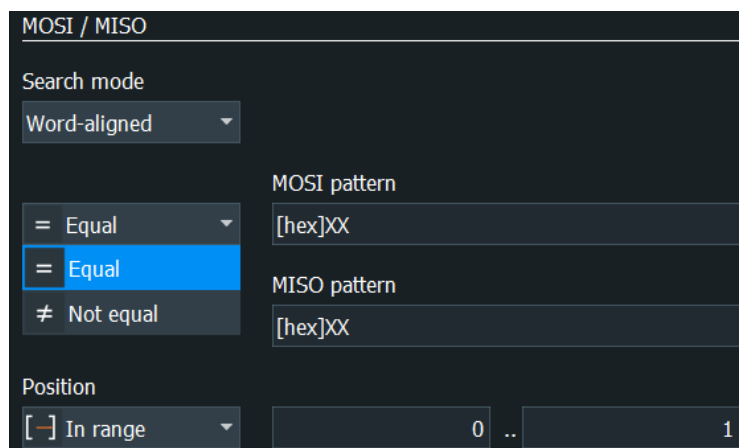

Remote command:

[SEARCh:TRIGGer:SPI:FCONdition](#) on page 1867

[SEARCh:TRIGGer:SPI:MISopattern](#) on page 1868

[SEARCh:TRIGGer:SPI:MOSipattern](#) on page 1868

[SEARCh:TRIGGer:SPI:DPOperator](#) on page 1868

[SEARCh:TRIGGer:SPI:DPOStition](#) on page 1868

[SEARCh:TRIGGer:SPI:DPTO](#) on page 1869

[SEARCh:TRIGGer:SPI:PALignment](#) on page 1869

14.3.5.2 SPI search results

To get search results, "Enable" the search. You can minimize, shift or close the search dialog.

The search results are listed in the search result table and marked in the waveform by blue lines.

For an introduction to search results, see:

- [Chapter 11.1.2, "Search results"](#), on page 426
- [Chapter 11.4.2, "Display zoom settings"](#), on page 446

Remote commands are listed in [Chapter 27.18.4.5, "SPI search results"](#), on page 1869.

14.4 UART/RS-232/RS-422/RS-485 (option R&S RTO6-K510)

14.4.1 About the UART / RS-232 interface

The Universal Asynchronous Receiver/Transmitter UART converts a word of data into serial data, and vice versa. It is the base of many serial protocols such as RS-232.

The UART uses only one line, or two lines for transmitter and receiver.

Data transfer

The data is transmitted in words, also referred to as symbols or characters. Each word consists of a start bit, several data bits, an optional parity bit, and one or more stop bits. Several words can form a package, or frame. The end of a package is marked with a reserved word or by a pause between two words.

Start	Data0	Data1	Data2	Data3	Data4	[Data5]	[Data6]	[Data7]	[Data8]	[Parity]	Stop
-------	-------	-------	-------	-------	-------	---------	---------	---------	---------	----------	------

Figure 14-5: Bit order in a UART word (symbol)

- The start bit is a logic 0.

- The stop bits and the idle state are always logic 1.

The UART protocol has no clock for synchronization. The receiver synchronizes by the start and stop bits, and the bit rate that must be known to the receiver.

Trigger

The R&S RTO6 can trigger on specified parts of UART serial signals:

- Start bit
- Packet start
- Parity errors, and breaks
- Stop errors
- A serial pattern at any or a specified position

14.4.2 UART configuration

14.4.2.1 UART configuration settings

Access: [Bus] > "UART/RS232" > "Setup" tab



Make sure that the tab of the correct serial bus is selected.

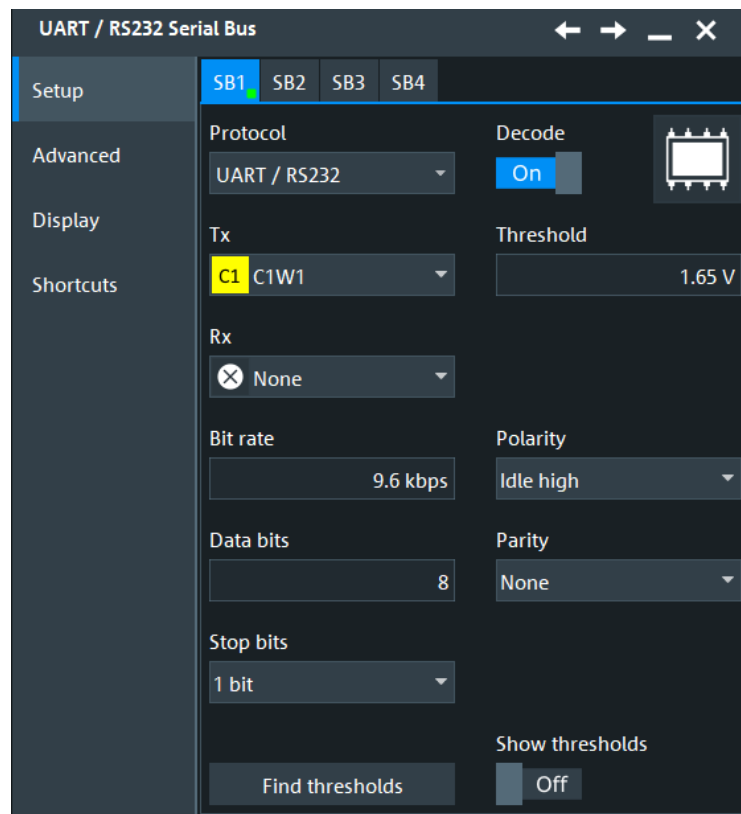

See also: [Chapter 14.1.1, "Setup - general settings"](#), on page 511

Source: Tx, Rx

Select the input channels for the transmitter and receiver signals.

Usually, the source is one of the analog channels. Reference and math waveforms are available as source if the trigger source is one of the analog channels but not the serial bus.

Do not combine a reference waveform with channel or math waveform because the time correlation of these waveforms might differ.

Alternatively, digital channels can be used if MSO option R&S RTO6-B1 is installed. Digital and analog channels cannot be used at the same time.

For triggering on a serial bus, analog or digital channel sources are required.

Remote command:

[BUS<m>:UART:TX:SOURce](#) on page 1874

[BUS<m>:UART:RX:SOURce](#) on page 1874

Threshold

Sets the threshold value for digitization of signals for each line. If the signal value on the line is higher than the threshold, the signal state is high. Otherwise, the signal state is considered low if the signal value is below the threshold. The interpretation of HIGH and LOW is defined by the [Polarity](#).

Note: If the sources are digital channels, the same threshold values are used for the parallel and the serial buses. You can set the thresholds either in the parallel bus configuration or in the serial bus configuration.

"Threshold" Enter the value directly in the field.

"Find thresh- Executes the measurement of reference levels and sets the thresh-
olds" olds to the middle reference level of the measured amplitude.

Remote command:

[BUS<m>:UART:RX:THReshold](#) on page 1874

[BUS<m>:UART:TX:THReshold](#) on page 1875

[BUS<m>:UART:TECHnology](#) on page 1875

[BUS<m>:SETReflevels](#) on page 1814

[BUS<m>:FAUToset](#) on page 1814

Polarity

Defines the logic levels of the bus. The idle state corresponds to a logic 1. the start bit to a logic 0. "Idle high" (high=1) is used, for example, for control signals, while "Idle low" (low=1) is defined for data lines (RS-232).

Remote command:

[BUS<m>:UART:POLarity](#) on page 1877

Bit rate

Sets the number of transmitted bits per second. To select a bit rate from list of predefined values, tap the icon beside the "Bit rate" field. To enter a specific value, open the keypad. The list of predefined values is also available in the keypad.

Remote command:

[BUS<m>:UART:BITRate](#) on page 1876

[BUS<m>:UART:BAUDrate](#) on page 1876

Data bits

Sets the number of data bits of a word in a range from 5 bits to 8 bits. If no parity bit is used, then 9 data bits are possible.

Remote command:

[BUS<m>:UART:SSIZe](#) on page 1877

Stop bits

Sets the number of stop bits: 1 or 1.5 or 2 stop bits are possible.

Remote command:

[BUS<m>:UART:SBIT](#) on page 1877

Parity

Defines the optional parity bit that is used for error detection.

"None" No parity bit is used.

"Odd" The parity bit is set to "1" if the number of data bits set to "1" is even.

"Even" The parity bit is set to "1" if the number of data bits set to "1" is odd.

"Mark" The parity bit is always a logic 1.

"Space" The parity bit is always a logic 0.

"Don't care" The parity is ignored.

Remote command:

`BUS<m>:UART:PARity` on page 1876

14.4.2.2 Advanced settings

Access: [Bus] > "Advanced" tab.

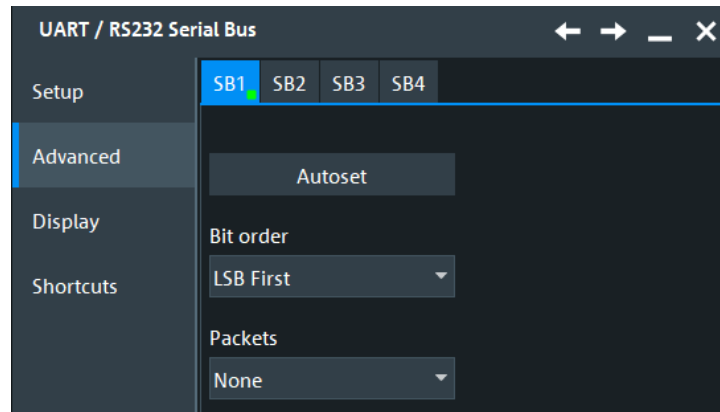

Autoset

Starts software algorithms for determining the signal threshold levels and bitrate.

Remote command:

`BUS<m>:FAUToset` on page 1814

Bit order

Defines if a word starts with msb (most significant bit) or lsb (least significant bit). The display of the decoded signal considers this setting, results are displayed in the specified order.

Packets

Allows you to define packets of several words in the data stream.

"None" Packets are not considered.

"End word" Defines a pattern as end condition of a packet, for example, a reserved word like CR or LF. The bit pattern editor provides frequently used values in the "Predefined values" list below the pattern table. A new packet starts with the first start bit after the defined end pattern.

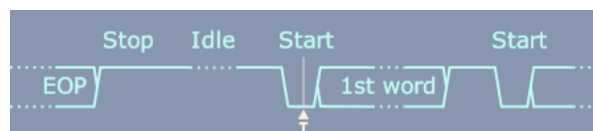

"Timeout" Defines a timeout between a stop bit and the next start bit. Enter the minimum time that marks the end of a packet. A new packet starts with the first start bit after the timeout.

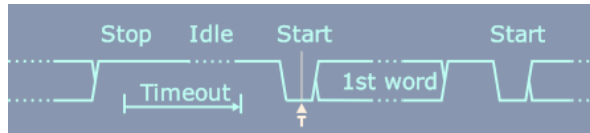

Remote command:

`BUS<m>:UART:PACKets` on page 1878

`BUS<m>:UART:TOUT` on page 1878

`BUS<m>:UART:EWORd` on page 1879

14.4.2.3 Configuring UART protocol

For details on configuration settings, see [Chapter 14.4.2.1, "UART configuration settings"](#), on page 547.

1. Press the [Bus] key on the front panel.
2. At the left-hand side, select the vertical tab of the bus you want to set up.
3. Select the "Setup" tab.
4. Tap the "Protocol" button and select the protocol: "UART".
5. Tap the "TX" button, and select the waveform of the transmitter line.
6. Tap the "Rx" button, and select the waveform of the receiver line.
7. Set the logical thresholds.
8. Set the "Bit rate" and "Stop bits".
9. Set the "Data bits" and "Parity".
10. Set the "Bit order", "Polarity" and "Packets".
11. Enable "Decode".

14.4.3 UART trigger

14.4.3.1 UART trigger settings

Access: [Bus] > "Shortcuts" tab > "Setup trigger"

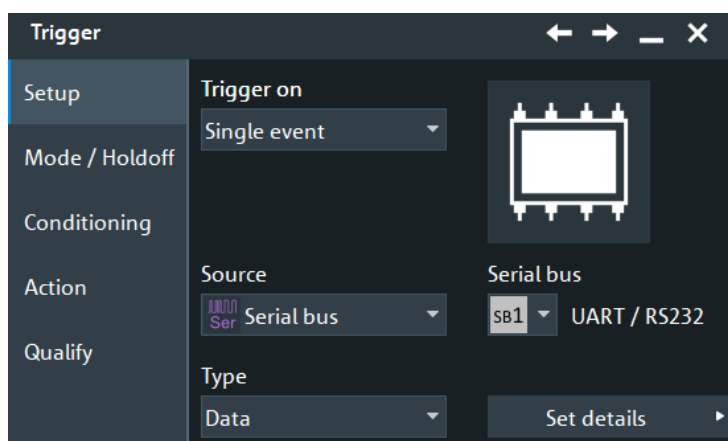

Make sure that:

- In the [Bus] > "Setup" tab:
 - The correct "Protocol" is selected.
 - The data sources of the serial bus are channel signals.
- In the "Trigger" > "Setup" tab:
 - The "Trigger on" = "Single event"
 - The trigger "Source" = "Serial bus".
 - The correct "Serial bus" is selected.

Type

Selects the trigger type for UART analysis.

- "Start bit" Triggers on a start bit. The start bit is the first low bit after a stop bit.
- "Packet start" Triggers on the begin of a data packet.
This trigger type is available, if [Packets](#) is enabled.

"Data" Trigger on a serial pattern at a defined position in the data packet. The pattern can include several subsequent symbols (data frames).

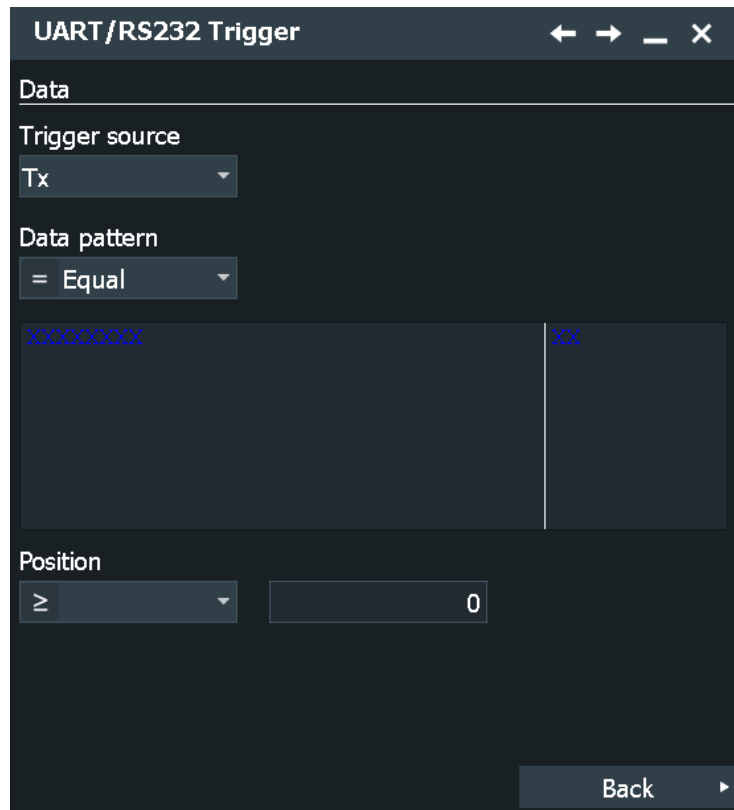

See "Data conditions" on page 553.

"Parity error" Triggers on a parity error indicating a transmission error. This trigger type is only available if a parity is configured for the UART bus.

"Break condition" Triggers if a start bit is not followed by a stop bit, the data line remains at logic 0 for longer than a UART word.

"Stop error" Triggers if the stop bit is a logic 0.

Remote command:

`TRIGger<m>:UART:TYPE` on page 1880

Trigger source

Selects the transmitter or receiver line as trigger source.

Remote command:

`TRIGger<m>:UART:SOURce` on page 1880

Data conditions

Specify the data conditions if the trigger type is set to "Data".

Condition ← Data conditions

Selects the operator for the "Data" pattern: "Equal" or "Not equal".

Remote command:

`TRIGger<m>:UART:FCONdition` on page 1881

Pattern ← Data conditions

Specifies the data pattern to be found on the specified trigger source, in binary or hex format. Enter the words in msb first bit order. The starting point of the pattern is defined by [Position](#) and [Index min](#), [Index max](#).

In binary format, use the following characters: 1; 0; or X (do not care). To enter the pattern in other formats use the bit pattern editor, see [Chapter 14.1.7, "Bit pattern editor"](#), on page 519.

Remote command:

[TRIGger<m>:UART:DATA](#) on page 1881

Position ← Data conditions

Operator for the data position. You can define an exact position, or a position range.

The setting is available if [Packets](#) is enabled in the protocol configuration.

Remote command:

[TRIGger<m>:UART:DPOperator](#) on page 1880

Index min, Index max ← Data conditions

Sets the number of words before the first word of interest. These offset words are ignored. If the [Position](#) defines a range, the first and the last words of interest are defined.

The setting is available if packet detection is enabled in the protocol configuration.

Remote command:

[TRIGger<m>:UART:DPOsition](#) on page 1880

[TRIGger<m>:UART:DPTO](#) on page 1881

14.4.3.2 Triggering on UART signals

Prerequisites: An UART bus is configured, see [Chapter 14.4.3.1, "UART trigger settings"](#), on page 551.

1. Press the [Bus] key and select the "Shortcuts" tab.
2. Press "Setup trigger".
3. Tap the "Source" button and select the "Serial bus" trigger source.
4. Select the serial bus that is set to UART.
5. Select the "Trigger type" and "Trigger source".
6. For more complex trigger types, enter the data conditions: pattern, position, index. For details, see [Chapter 14.2.3, "I²C trigger"](#), on page 525

14.4.4 UART decode results

When the configuration of the serial bus is complete, the signal can be decoded:

1. In the "Serial Bus" dialog > "Setup" tab, enable "Decode".

2. In the "Serial Bus" dialog > "Display" tab, select additional result display settings: "Show table" and "Show binary".
3. If required, enable "Zoom coupling"

For a description of the display settings, see also [Chapter 14.1.3, "Display"](#), on page 513.

The instrument captures and decodes the signal according to the standard definition and the configuration settings.

The color-coding of the various protocol sections and errors simplifies the interpretation of the visual display. The decode information condenses or expands, depending on the horizontal scale. Various data formats are available to show the result values.

Decode Results Table

The "Decode results" box shows the detailed decoded data for each word.

UART / RS232 Decode Results SB1 ✕							
	Source	State	Start	Stop	Tx value	Rx value	Bit rate
1	Tx	Ok	-44.3 μ s	-29.3 μ s	[hex] D3	—	666.7 kbps
2	Tx	Ok	-11.4 μ s	3.6 μ s	[hex] FA	—	666.7 kbps
3	Tx	Ok	12.9 μ s	27.9 μ s	[hex] D3	—	666.7 kbps
4	Tx	Incomplete	41.4 μ s	50.4 μ s	[hex] 13	—	1 Mbps

The decoding process considers the "Bit order" configuration setting of the signal and displays the binary result MSB first.

Table 14-5: Content of the Decode results table

Column	Description
Number of Frames	
Source	Line, Tx or Rx
State	Decoding state of the word. "Insufficient waveform length" indicates that the word is not completely contained in the acquisition. Change the horizontal scale, or move the reference point to the left to get a longer acquisition.
Start	Time of the word start (start bit)
Stop	Time of the word stop (stop bit)
Tx value	Value of the Tx word. The data format is selected in the "Display" tab.
Rx value	Value of the Rx word. The data format is selected in the "Display" tab.
Bit rate	Value of the bit rate .

Tools

Press "Display settings" in the "Decode Results" table to access the "Display" tab.



Remote commands

Remote commands to retrieve decode results are described in [Chapter 27.18.5.3, "Decode results"](#), on page 1881.

14.5 Audio signals (option R&S RTO6-K510)

The R&S RTO6 can analyze several standard and de-facto industry standard signals: I²S Inter-IC Sound standard audio format, left justified and right justified data formats and Time Division Multiplexed (TDM) audio format.

• Audio protocols	556
• Audio configuration	558
• Audio trigger	564
• Audio decode results	568
• Track	569
• Trend	572

14.5.1 Audio protocols

All audio protocols use 3 lines:

- The clock line generates the bit clock.
- The word select line (WS, also known as word clock) defines the frame start and the maximum length of the data word.
For pulse code modulated signals (I²S standard, left and right justified data formats), the level of the WS signal assigns the data words to the left and right channels.
TDM uses frame synchronization pulses on the WS line to identify the beginning of a frame.
- The data line transmits the audio data in time-multiplexed data channels.

14.5.1.1 I²S standard

I²S standard interfaces transmit two PCM coded audio channels. The WS line selects the channel being transmitted - left or right channel. Usually, 32 bits are transmitted on each channel. The data word can be shorter than the channel length, and the receiver ignores the remaining bits. The first byte of the audio word is delayed one clock period from the leading edge of the word select pulse. The R&S RTO6 can decode I²S standard signals with MSBF and LSBF bit order.

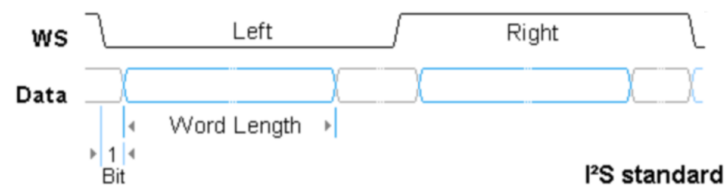

14.5.1.2 Left justified data format

The left justified data format is very similar to the I²S standard, but the first byte of the audio word is aligned with the leading edge of the word select pulse. Thus the audio word is left justified within the frame. The data word can be shorter than the channel length.

In addition to the standard configuration, the R&S RTO6 can analyze also left justified data formats which send the data word with offset to the WS edge. The bit order can be MSBF or LSBF.

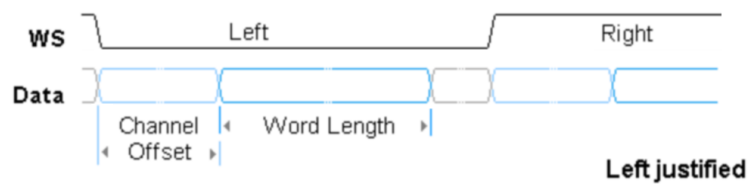

14.5.1.3 Right justified data format

The right-justified data format is similar to the left-justified, but the last byte of the word in the frame is aligned with the trailing edge of the word select pulse. Thus the audio word is right-aligned within the frame.

The R&S RTO6 can decode right justified signals with MSBF and LSBF bit order.

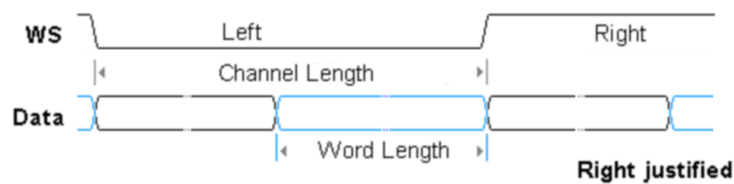

14.5.1.4 TDM

The Time Division Multiplexed (TDM) audio format is not standardized and provides high flexibility for transfer of more than two audio data channels on one line. On the word select line, it uses frame synchronization pulses to identify the beginning of a frame. On the data line, channel blocks of a defined length are transmitted. Each block contains an audio word that can be shorter than the channel length.

Each frame can start with frame offset bits, which precede the first channel. Inside the channel, the audio word also can have an offset to the channel start.

Channel length, channel offset and word length are dependent values:

$$\text{Channel length} \geq \text{Word length} + \text{Channel offset}$$

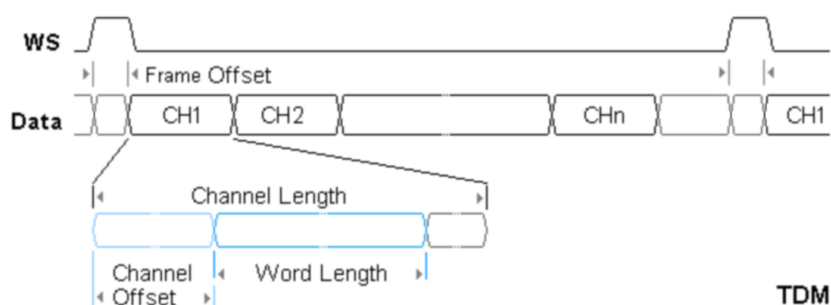

14.5.2 Audio configuration

14.5.2.1 Audio signal configuration

Access: [Bus] > "Audio" > "Setup" tab



Make sure that the tab of the correct serial bus is selected.

In the "Setup" tab, you configure the audio signal. Several audio signal variants are available: the I²S standard signal, the left- and right-justified data formats, and the TDM interface.

For all audio signal variants, you define the line sources and their polarities. Also, if coupling is active, one threshold for all sources; if coupling is not enabled, three thresholds for each source.

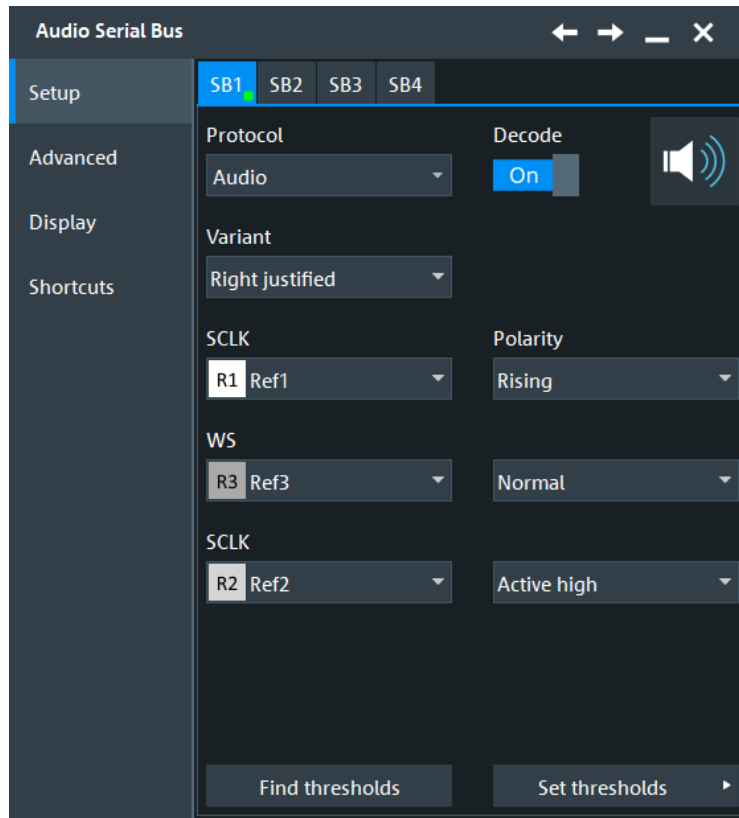

Audio Variant

Selects the protocol variant of the audio signal. The configuration possibilities exceed the definitions of the standards.

- "I2S Standard" Inter-IC sound standard audio format.
It uses the SCLK, WS and SDATA lines. The first byte of the audio word is delayed one clock period from the leading edge of the word select pulse.
- "Left justified" The left-justified data format uses the same lines as I²S standard. The first byte of the audio word is aligned with the leading edge of the word select pulse, or left justified within the frame. The format is word-length independent.
- "Right justified" The right-justified data format is similar to the left-justified, but the last byte of the last word in the frame is aligned with the trailing edge of the word select pulse, or right-aligned within the frame. This format is not word-length independent.
- "TDM" The Time Division Multiplexed audio format is not standardized and provides high flexibility for transfer of up to 8 audio data channels on one line. Instead of words select, it uses frame synchronization pulses to identify the beginning of a frame. On the data line, channel blocks of a defined length are transmitted. Each block contains an audio word followed by several zero bits to complete the block.

Remote command:

[BUS<m>:I2S:AVARiant](#) on page 1884

SCLK

Selects the source of the clock line.

Usually, the source is one of the analog channels. Reference and math waveforms are available as source if the trigger source is one of the analog channels but not the serial bus.

Do not combine a reference waveform with channel or math waveform because the time correlation of these waveforms might differ.

Alternatively, digital channels can be used if MSO option R&S RTO6-B1 is installed. Digital and analog channels cannot be used at the same time.

For triggering on a serial bus, analog or digital channel sources are required.

Remote command:

[BUS<m>:I2S:CLOCK:SOURce](#) on page 1885

SCLK Polarity

Sets the polarity of the clock signal, that is the edge at which the instrument samples the data on the data line. Usually, the rising edge is used. The R&S RTO6 can also analyze the converse setup.

Remote command:

[BUS<m>:I2S:CLOCK:POLarity](#) on page 1885

WS / FSYNC

Selects the source of the word select line for I²S standard, left- and right-justified data formats, or the source of the frame synchronization pulse for TDM audio signals. The same waveforms as for [SCLK](#) are available, and the same restrictions are applied.

Remote command:

[BUS<m>:I2S:WSElect:SOURce](#) on page 1886

WS / FSYNC Polarity

For a word select line, the polarity defines the word select values assigned to the left and right channels.

- "Normal": usually, 0 indicates the left channel, and 1 indicates the right channel.
- "Inverted": 0 indicates the right channel, and 1 the left channel.

For an FSYNC line (TDM), the polarity defines the edge of the FSYNC pulse that identifies the beginning of a frame. The frame starts exactly at the next clock edge following the selected FSYNC edge.

- "Normal": usually, the frame begins with a rising edge.
- "Inverted": the frame begins with a falling edge.

Remote command:

[BUS<m>:I2S:WSElect:POLarity](#) on page 1886

SDATA

Selects the source of the audio data line. The same waveforms as for [SCLK](#) are available, and the same restrictions are applied.

Remote command:

[BUS<m>:I2S:DATA:SOURce](#) on page 1886

SDATA Polarity

Defines the interpretation of high and low signal states.

- "Active high": HIGH (signal level above the threshold level) = 1 and LOW (signal level below the threshold level) = 0
- "Active low": HIGH = 0 and LOW = 1

Remote command:

[BUS<m>:I2S:DATA:POLarity](#) on page 1887

Threshold setup

Opens a dialog to set the thresholds value for digitization of signals for each line.

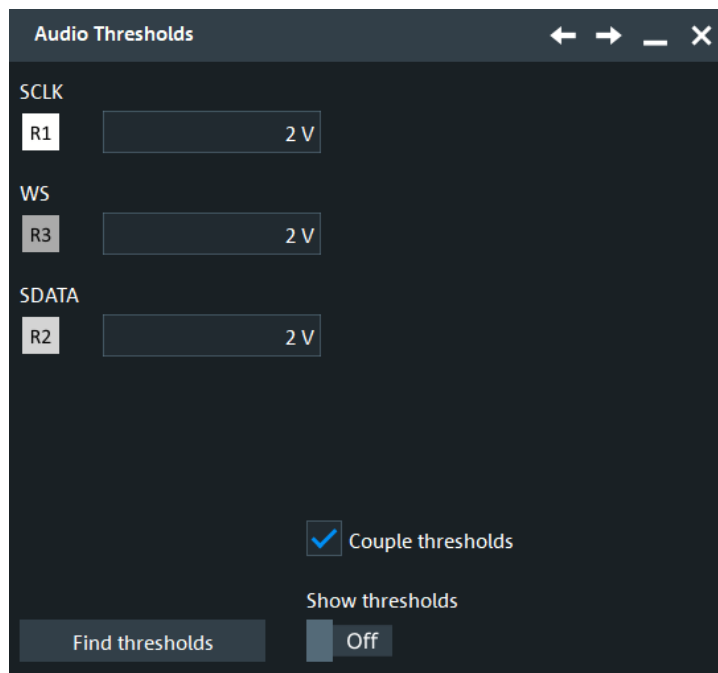

If the signal value on the line is higher than the threshold, the signal state is high. Otherwise, the signal state is considered low if the signal value is below the threshold. The interpretation of HIGH and LOW is defined by the polarity.

There are three ways to set the threshold:

- | | |
|---------------------|---|
| "Threshold" | Enter individual values for each line directly in the fields. |
| "Find thresholds" | Executes the measurement of reference levels and sets the thresholds to the middle reference level of the measured amplitude. This option is only available for analog sources. |
| "Couple thresholds" | Sets all thresholds to the same value. Enter the value in the "Threshold" field. |

Remote command:

[BUS<m>:I2S:TCOupling](#) on page 1887

[BUS<m>:I2S:CLOCK:THReshold](#) on page 1887

[BUS<m>:I2S:DATA:THReshold](#) on page 1888

[BUS<m>:I2S:WSElect:THReshold](#) on page 1888

[BUS<m>:SETReflevels](#) on page 1814

14.5.2.2 Advanced settings

Access: [Bus] > "Advanced" tab.

The settings available in the "Advanced" dialog depend on the selected [Audio Variant](#).

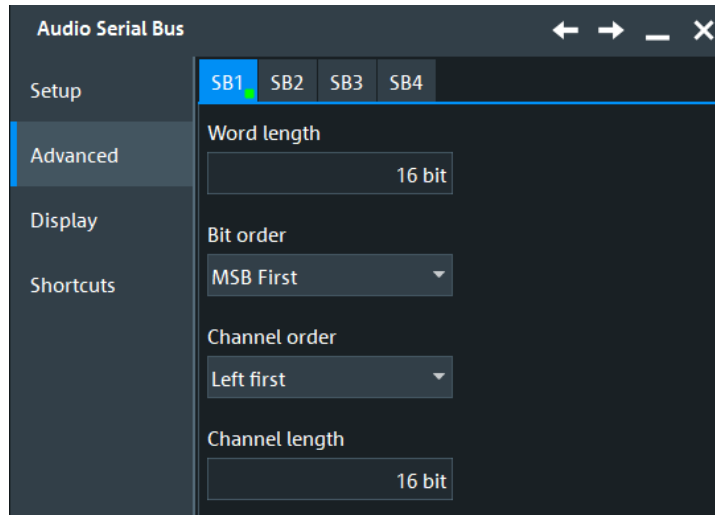

Figure 14-6: Advanced Audio settings for Variant = Right justified

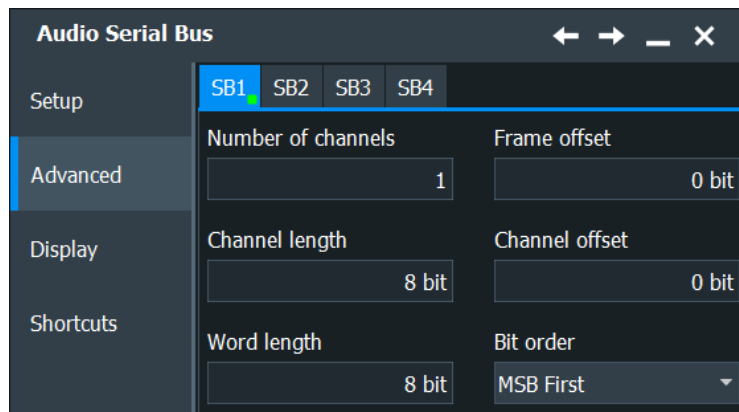

Figure 14-7: Advanced Audio settings for Variant = TDM

Word length

Defines the number of bits in an audio data word. The minimum length is 4 bit, the maximum is 32 bit.

Remote command:

[BUS<m>: I2S: WLENgth](#) on page 1889

Bit order

Sets the bit order in the audio data words. Usually, the MSB is transmitted first.

Remote command:

[BUS<m>: I2S: BORDer](#) on page 1889

Channel order

Defines if the left or the right channel is the first channel in the frame.

The setting is not available for TDM audio signals.

Remote command:

[BUS<m>:I2S:CHANnel:ORDer](#) on page 1888

Channel offset

Available for "Variant" = "Left justified"/ "TDM".

Sets the number of bits between the channel start and the start of the audio word. The setting is available for left-justified data format and TDM audio signals.

For TDM, possible values depend on the channel size and the word size. The maximum delay is *Channel length - Word length*.

Remote command:

[BUS<m>:I2S:CHANnel:OFFSet](#) on page 1889

Number of channels

Available for "Variant" = "TDM".

Sets the number of channels transmitted on the TDM audio line.

Remote command:

[BUS<m>:I2S:CHANnel:TDMCount](#) on page 1890

Frame offset

Available for "Variant" = "TDM".

Sets the number of bits between the frame start and the start of the first channel of a TDM audio line. The maximum offset is 256 bit. Each FSYNC edge restarts the offset count.

Remote command:

[BUS<m>:I2S:FOFFset](#) on page 1890

Channel length

Available for "Variant" = "Left justified" / "Right justified" / "TDM"

Sets the number of bits a frame contains.

Remote command:

[BUS<m>:I2S:CHANnel:LENGth](#) on page 1890

14.5.2.3 Configuring audio protocol

The configuration of the Audio is simple - assign the two lines to input channels, and set the thresholds.

For details on configuration settings, see [Chapter 14.5.2.1, "Audio signal configuration"](#), on page 558.

1. Press the [Bus] key on the front panel.
2. Select the tab of the bus you want to set up, for example "SB1".

3. Select the "Setup" tab.
4. Tap the "Protocol" button and select the protocol: "Audio".
5. Select the "Audio Variant".
6. Set the parameters, as required according to the selected "Audio Variant".
7. Enable "Decode", if available.

14.5.3 Audio trigger

14.5.3.1 Audio trigger

Access: [Bus] > "Shortcuts" tab > "Setup trigger"

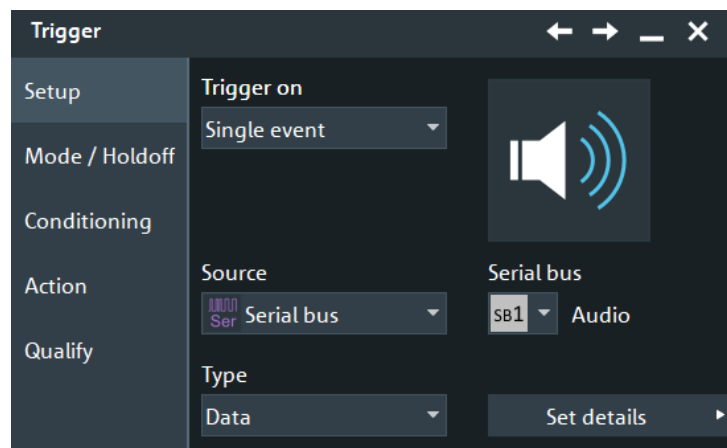

Make sure that:

- In the [Bus] > "Setup" tab:
 - The correct "Protocol" is selected.
 - The data sources of the serial bus are channel signals.
- In the "Trigger" > "Setup" tab:
 - The "Trigger on" = "Single event"
 - The trigger "Source" = "Serial bus".
 - The correct "Serial bus" is selected.

Serial bus

Selects the serial bus to be triggered on. Make sure to select the correct bus before you enter the settings.

To trigger on a serial bus, the signals sources must be channel signals. If the data or clock source is a math or reference waveform, you cannot trigger on that bus.

Remote command:

[TRIGger<m>:SOURce:SBSelect](#) on page 1818

Protocol

Defines the protocol type of the selected serial bus.

Remote command:

[BUS<m>:TYPE](#) on page 1813

Type

Selects the trigger type.

"Data" Sets the trigger on a data word or a data range that occurs on a specified channel or on any channel. The instrument triggers on the last bit of the specified data pattern.



Description of specific trigger type settings:

- ["Channel"](#) on page 566
- ["Data condition"](#) on page 566

"Window"

This trigger checks if the decoded data values stay inside a "window" that is formed by a data range and a time specified by a number of subsequent words. It considers a selected channel or all channels. The instrument triggers at the end of the last word. Thus, for example, you can trigger on a pause.

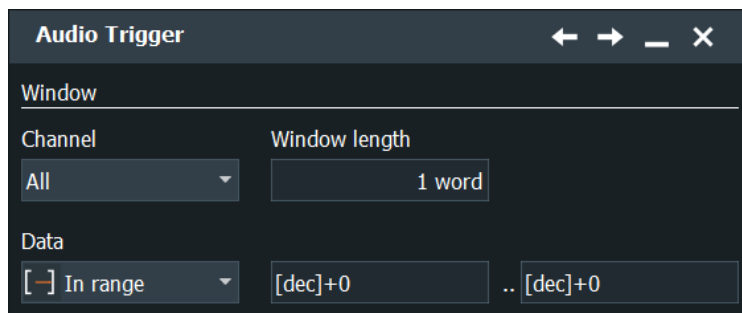

Description of specific trigger type settings:

- ["Channel"](#) on page 566
- ["Data condition"](#) on page 566
- ["Window length"](#) on page 567

"Frame condition" Sets the trigger on an AND combination of data conditions on different channels. The instrument triggers if all conditions are met inside one frame.

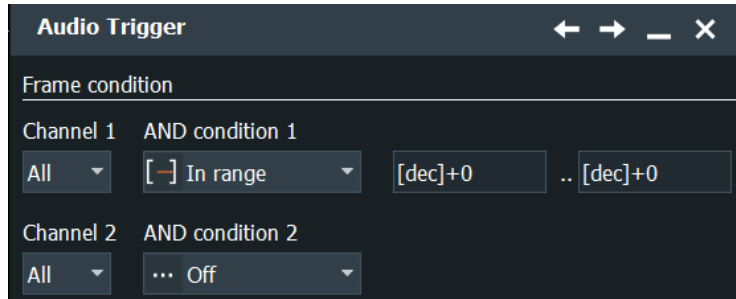

Description of specific trigger type settings:

- "Channel" on page 566
- "Data condition" on page 566

Description of specific trigger type settings: "Channel" on page 566 and .

"Word select" Triggers on the selected edge of the WS line, that is, on the beginning of the left or right channel (I²S, left- and right-justified). For TDM signals, it triggers on the selected edge of the FSYNC line - on the beginning of a TDM frame.

The trigger time is the first clock edge after the selected WS/FSYNC edge.

Description of specific trigger type settings: "Word select: Slope" on page 567.

"Error condition" The oscilloscope uses the WS or FSYNC line to monitor the channel and frame length. An error is detected when two consecutive frames have different length. The instrument triggers on the first clock edge after error detection.

Remote command:

`TRIGger<m>:I2S:TYPE` on page 1891

Channel

Selects the audio channel on which the instrument looks for the specified data condition.

The setting is relevant for trigger types Data, Window and Frame condition.

Note: For TDM signals, the number of available channels depends on the configuration of the audio bus, see [Chapter 14.5.2.2, "Advanced settings"](#), on page 562.

Remote command:

`TRIGger<m>:I2S:TCONdition<n>:CHANnel` on page 1892

Data condition

The data condition setup consists of the operator and one or two data patterns.

The settings are relevant for trigger types Data, Window and Frame condition.

"Operator" Defines the operator to set a specific data word ("Equal" or "Not equal") or a data range.

"Min data" Defines the data pattern. The data length is limited to the word length. Enter the pattern using the bit order defined in the signal configuration. X (don't care) is not allowed.

In binary format, use the following characters: 1; 0; or X (do not care). To enter the pattern in other formats use the bit pattern editor, see [Chapter 14.1.7, "Bit pattern editor"](#), on page 519.

"Max data" The second data pattern is required to specify a range with conditions "In range" and "Out of range".

Remote command:

[TRIGger<m>:I2S:TCONdition<n>:CONDtion](#) on page 1893

[TRIGger<m>:I2S:TCONdition<n>:DMIN](#) on page 1893

[TRIGger<m>:I2S:TCONdition<n>:DMAX](#) on page 1894

Window length

Sets the number of words that is used as time limit for the "Window" trigger type. The instrument triggers if the data condition is fulfilled on the same channel for the given number of subsequent frames.

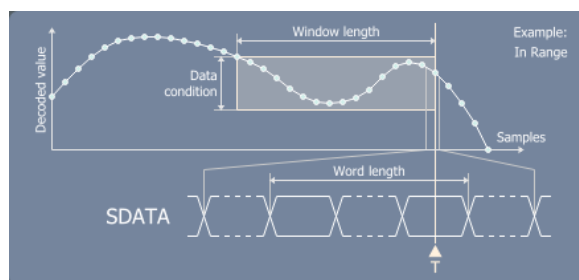

Remote command:

[TRIGger<m>:I2S:SOWords](#) on page 1894

Word select: Slope

Sets the edge of the WS or FSYNC signal as trigger condition. The instrument triggers on the first clock edge after the specified edge.

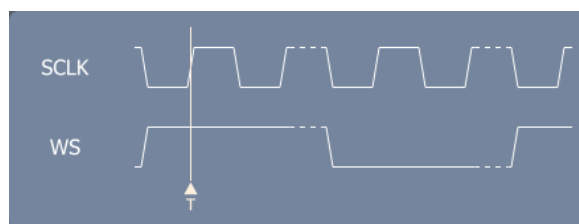

Figure 14-8: Word select trigger on I²S standard signal with clock polarity "Rising" and "Normal" WS polarity (left = 0)

The WS edge indicates the start of the left or right channel. The FSYNC edge indicates the frame start.

Consider the [Audio signal configuration](#) setting in the "Setup" dialog box.

Remote command:

[TRIGger<m>:I2S:WSSlope](#) on page 1894

14.5.3.2 Triggering on audio signals

Prerequisites: An Audio bus is configured, see [Chapter 14.5.2, "Audio configuration"](#), on page 558.

1. Press the [Bus] key and select the "Shortcuts" tab.
2. Press "Setup trigger".
3. Tap the "Source" button and select the "Serial bus" trigger source.
4. Select the serial bus that is set to Audio.
5. Select the "Trigger type".
6. For more complex trigger types, enter the data, frame or word select conditions.
For details, see [Chapter 14.5.3.1, "Audio trigger"](#), on page 564

14.5.4 Audio decode results

When the configuration of the serial bus is complete, the signal can be decoded:

1. In the "Serial Bus" dialog > "Setup" tab, enable "Decode".
2. In the "Serial Bus" dialog > "Display" tab, select additional result display settings: "Show table" and "Show binary".
3. If required, enable "Zoom coupling"

For a description of the display settings, see also [Chapter 14.1.3, "Display"](#), on page 513.

The instrument captures and decodes the signal according to the standard definition and the configuration settings.

The color-coding of the various protocol sections and errors simplifies the interpretation of the visual display. The decode information condenses or expands, depending on the horizontal scale. Various data formats are available to show the result values.

Decode Results Table

The results are shown in two tables:

- "Decode results": contains information about all decoded frames
- "Details frame": contains more detailed information about the selected frame in the "Decode results" table.

	Start	State	Left Value	Right Value
1	-46.793 µs	Ok	54	7F
2	-36.376 µs	Ok	20	60
3	-25.959 µs	Ok	3B	68
4	-15.543 µs	Ok	6F	26
5	-5.126 µs	Ok	4A	3D
6	5.291 µs	Ok	60	13
7	15.707 µs	Ok	08	0B
8	26.124 µs	Ok	05	46
9	36.541 µs	Ok	2D	74
10	46.957 µs	Incomplete	7F	—

The results are shown in the "Decode results" table.

Table 14-6: Content of the Decode results table

Column	Description
Start	Time of the frame start
State	Overall state of the frame. "Insufficient waveform length" indicates that the frame is not completely contained in the acquisition.
Left Value	Data value of the left channel
Right Value	Data value of the right channel

Table 14-7: Content of the Decode results table

Column	Description
Frame Start	Time of the frame start
Frame State	Overall state of the frame. "Insufficient waveform length" indicates that the frame is not completely contained in the acquisition.
TDM<x> Value	Data value of the TDM channel

Remote commands

Remote commands are described in [Chapter 27.18.6.3, "Decode results"](#), on page 1895.

14.5.5 Track

The track is a waveform that shows measurement values in time-correlation to the audio signal. It is the graphical interpretation of all measurement values of a single acquisition. For audio signals, the measurement values on the vertical axis are the decoded values of the audio channels, the time scale is equivalent to the scale of the source waveforms.

You can display the values of several channels in one track, or create one track for each channel and display them in parallel.

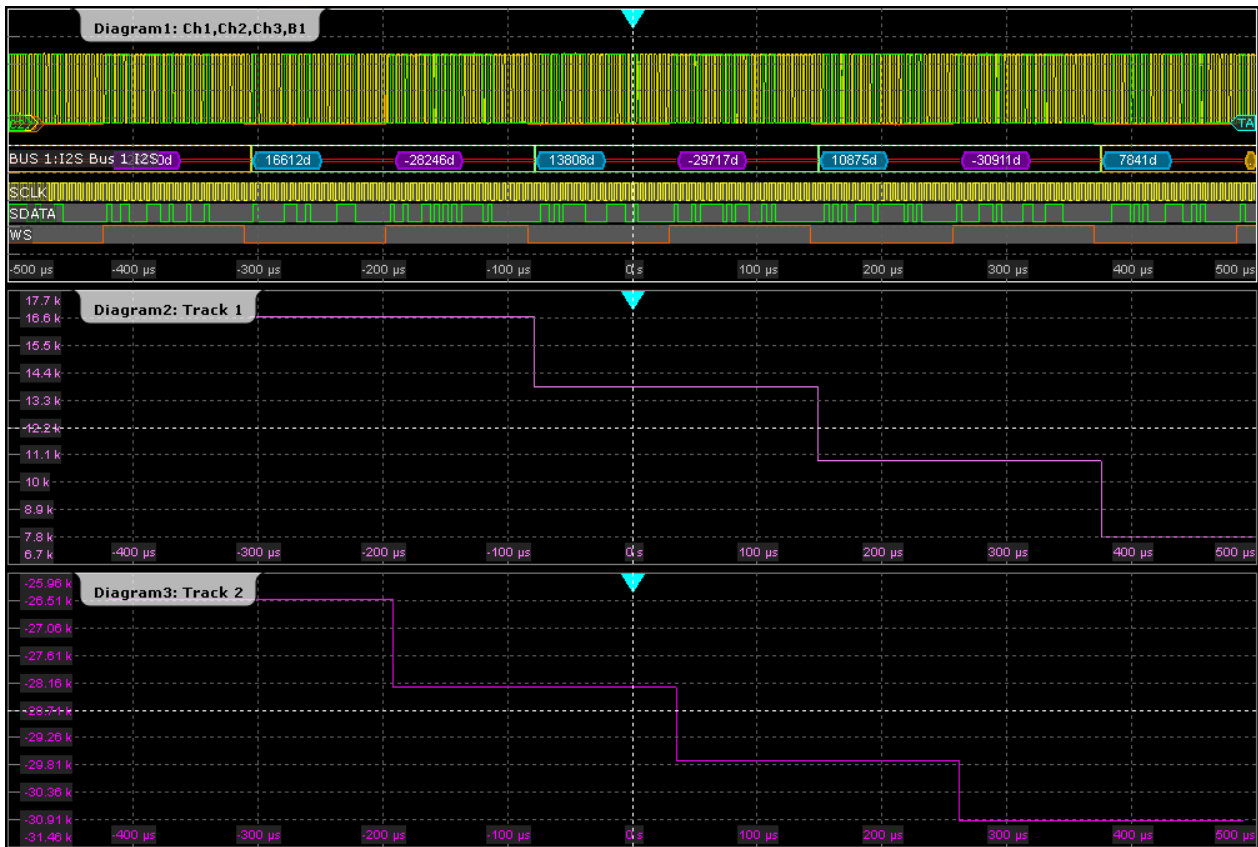

Figure 14-9: Tracks of left and right channel of I²S standard signal

The track is a special measurement waveform, so it can be used for further analysis like cursor measurements and zoom.

The instrument uses the bus data format to interpret audio data ("Display" tab > "Data format"). ASCII format is not supported.

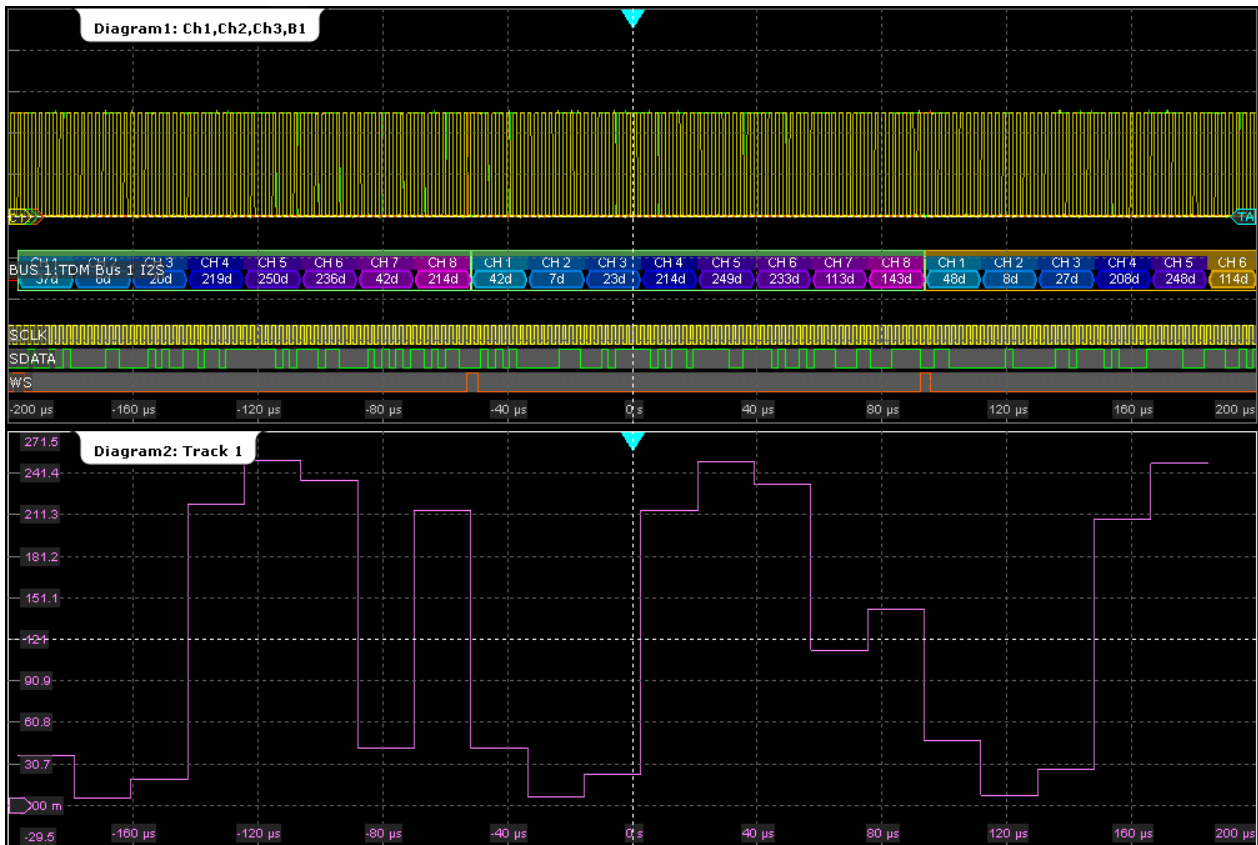

Figure 14-10: Track of all 8 channels of a TDM signal

14.5.5.1 Track settings in protocol setup

You can enable the track waveforms in the protocol settings.



Show Track Waveform(s)

Enables and displays the tracks for the selected channels of the decoded bus using continuous auto scale.

See also: [Chapter 14.5.5, "Track"](#), on page 569.

Remote command:

`BUS<m>:I2S:TRACk:LEFt` on page 1898

`BUS<m>:I2S:TRACk:RIGHT` on page 1898

`BUS<m>:I2S:TRACk:TD1Ch` on page 1898

[BUS<m>:I2S:TRACk:TD2Ch](#) on page 1898

[BUS<m>:I2S:TRACk:TD3Ch](#) on page 1898

[BUS<m>:I2S:TRACk:TD4Ch](#) on page 1898

[BUS<m>:I2S:TRACk:TD5Ch](#) on page 1898

[BUS<m>:I2S:TRACk:TD6Ch](#) on page 1898

[BUS<m>:I2S:TRACk:TD7Ch](#) on page 1898

[BUS<m>:I2S:TRACk:TD8Ch](#) on page 1898

14.5.5.2 Track enabling in measurement setup

As the track is based on measurement, it can be set up in the "Result Analysis" tab of the "Measurement" dialog box. Alternatively, you can enable the track in the protocol display settings, see [Chapter 14.5.5.1, "Track settings in protocol setup"](#), on page 571.

To set the vertical scale of the track waveform, use analysis scale settings, see ["Analysis scale"](#) on page 367.

Enable (Track)

Enables the track of measurement results over time and displays the track waveform. It is the graphical interpretation of all measurement values of a single acquisition.

The track is available for most amplitude/time measurements (except for High, Low, Amplitude, Max, Min, Peak to peak, Mean, RMS, S-dev, Pos. and Neg. overshoot, and Area), and for jitter measurements.

Enabling the track enables also the [Continuous auto scale](#) and [Measure all events in each acquisition](#).

Before you can enable the track, activate the appropriate measurement.

Remote command:

[MEASurement<m>:TRACk\[:STATe\]](#) on page 1666

14.5.6 Trend

The trend is a special long-term measurement that shows the evolution of measurement values in a running continuous acquisitions. For audio signals, each decoded channel value is a measurement result that creates a point on the trend curve. You can configure the number of points that builds the complete trend curve.

14.5.6.1 Displaying and configuring the trend

If an audio bus is configured, you can set up the trend measurement for audio channels. The following procedure describes the complete trend setup using the "Setup" dialog.

1. Select "Setup".
2. Select the "Category" = "Protocol".

3. Select the "Source" of the measurement: "Serial bus". Select the bus configured for the audio signal.
4. Enable the measurement.
5. Tap "Add / Remove " and select "Audio".
6. Select the "Audio channel" for which you want to analyze the trend.

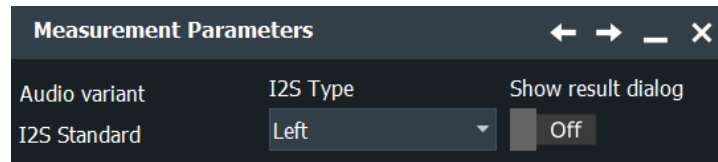

7. In the "Measurements" dialog, select the "Plot" tab.
8. Under "Long term", select "Enable".
An empty trend diagram is displayed.
9. Tap "Settings".
10. In the "Measurement: Long Term Setup", set the "Horizontal scaling" to "Measurements".

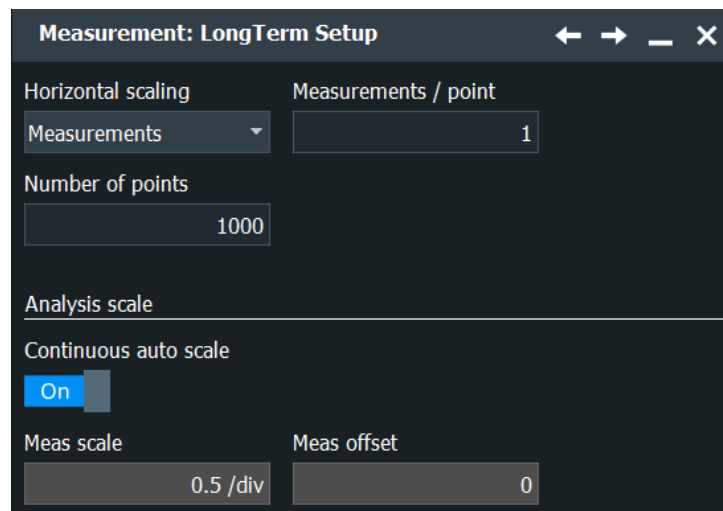

11. Set the number of "Measurements/point" to 1.
12. Enable "Continuous auto scale".
13. Start continuous acquisition.
The trend fills up with measurement points from left to right.

14.6 Custom: Manchester / NRZ (option R&S RTO6-K510)

R&S RTO6-K510 is a firmware option that enables the R&S RTO6 to analyze customizable serial bus signals encoded by the following coding standards:

- Manchester
- Manchester II
- NRZ Clocked
- NRZ Unclocked

For analysis, signals encoded in any of these protocols can be triggered and decoded.

Due to the free format description, no search within the decoded events is available.

This chapter describes:

- [Custom: Manchester / NRZ protocols](#)..... 574
- [Custom: Manchester / NRZ configuration](#)..... 576
- [Custom: Manchester / NRZ trigger](#)..... 595
- [Custom filter](#)..... 600
- [Custom: Manchester / NRZ decode results](#)..... 603
- [Search on decoded custom Manchester / NRZ data](#)..... 604

14.6.1 Custom: Manchester / NRZ protocols

"Manchester" coding is a self-clocked coding scheme also known as phase-shift keying (or phase encoding, PE). It is used in protocols such as Profibus (IEC 61158), DALI (Digital Addressable Lighting Interface, IEC 60929 and IEC 62386), MVB (Multifunction Vehicle Bus, part of IEC 61375 for Train Communication Networks, TCN), and Ethernet 10BASE-T (10 Mbit/s, IEEE 802.3i). In terms of a logical Boolean operation, the Manchester value of each bit (as per G. E. Thomas) is the exclusive disjunction (XOR) of the original data value and the clock value. A "0" is expressed by a high-to-low transition, a "1" by a low-to-high transition. These transitions, which occur at the middle of each bit period, make the signal self-clocked.

"Manchester II" coding (as per IEEE 802.3) is represented by inverted Manchester values: a "0" is expressed by a low-to-high transition, a "1" by a high-to-low transition.

NRZ stands for "non-return-to-zero" coding: Typically a "1" is represented by a positive voltage and a "0" is represented by a negative voltage, with no "zero" voltage state. NRZ code requires only half the bandwidth of Manchester code, and it can either be clocked or unclocked. NRZ unclocked signals require a user-defined bit rate and gap time setting for triggering and decoding.

14.6.1.1 Special features of Manchester coding

In practical protocols, Manchester coding appears in many variations, often employing deliberate coding violations to encode special waveform features, such as unambiguous synchronization and termination patterns. To adapt to these specific Manchester implementations and handle ambiguous signals, the option R&S RTO6-K510 for Cus-

tom Serial Bus uses a combination of automatic algorithms and user configurable parameters.

Quaternary Symbols

The software supports not just traditional binary symbols "0" and "1", but also arbitrary violation waveforms that use two additional symbols, yielding a total of four valid "quaternary bit" values. The two additional violation symbols are "H" (high) and "L" (low). Values of "H" correspond to a waveform lacking a transition in the center of the bit, with a physical high voltage state. Similarly, "L" violations also lack a center transition, but have a physical low voltage state. Most Manchester synchronization and termination conventions, even those containing violations, may be expressed as sequences of these four symbols. R&S RTO6-K510 uses the quaternary notation to support Manchester patterns in the honeycomb display and to describe synchronization and termination patterns in the frame description table.

Idle Conditions

The state of the signal line in between messages is the idle condition. Manchester appears in practical standards with varying idle conditions: it can idle at the high, low, or middle voltage state. High and low idle states correspond to "biphase" Manchester, while the middle voltage (often ground) adds a third state to become "ternary" Manchester. Using ternary Manchester, option R&S RTO6-K510 can usually establish the gaps between messages automatically. Using binary Manchester, the software has no way to automatically discriminate an idling bus from monotonic sequences of "H" or "L" violations. For these biphase situations, R&S RTO6-K510 offers a "Gap Time" detection feature, which allows to distinguish long intervals of non-transitions between bus idling and sequences of violations. Other differences between biphase and ternary Manchester are managed automatically by the software, with no user input required.

Edge Conventions

Most Manchester encodings establish the beginning of the first bit by a first transition, hence an "overhead" edge. The center of the bit is then marked by a second transition, which is a "sampling" edge. Some Manchester implementations, however, sample the first bit on the first edge. The option R&S RTO6-K510 attempts to automatically detect this situation. Unfortunately, it is possible to trick the algorithm with waveforms that contain many (legitimate) violations. In these situations, the user can force a "First Edge" or "Second Edge" convention for handling edges. Edge sampling according to the "First Edge" convention is more likely to appear in biphase Manchester, but the software also supports this setting for ternary Manchester situations.

Bit Rate

Typically, a single bit rate is clearly specified in Manchester protocols; however, some implementations use a variable bit rate. By default, R&S RTO6-K510 automatically determines the bit rate with no user input required. However, there are fundamental ambiguities possible in Manchester, if the bitrate is unknown. In particular, sequences like "0000", "1111", "0101", "1010", and many situations involving "H" and "L" violations, cannot be decoded without a known bit rate. The situation becomes even less defined

with eventual Manchester coding violations. In these situations, a fixed "Bit Rate" setting has to be provided by the user to bypass the software's estimation algorithm.

14.6.2 Custom: Manchester / NRZ configuration

If you need information on how to get started with configuring the custom serial bus setup, see [Chapter 14.6.2.7, "Configuring custom Manchester / NRZ signals"](#), on page 594. Otherwise proceed with the configuration settings.

14.6.2.1 Custom: Manchester / NRZ configuration settings

Access: [Bus] > "Custom" > "Setup" tab



Make sure that the tab of the correct serial bus is selected.

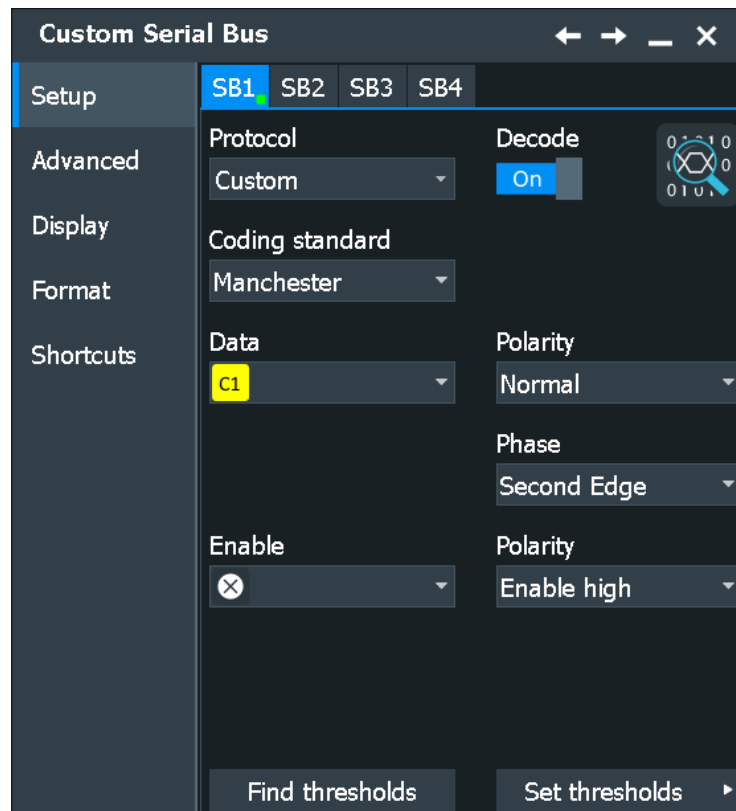

Figure 14-11: Coding standard selection in the serial bus protocol configuration dialog

See also: [Chapter 14.1.1, "Setup - general settings"](#), on page 511

Coding Standard

To define the coding of the custom serial bus to be analyzed, select one of the following standards:

- "Manchester" Selects the coding standard Manchester. Optional "Timing settings" are "Bit Rate" (default: disabled, 10 Mbit/s) and "Gap time" (default: disabled, 10 µs).
- "Manchester II" Selects the coding standard Manchester II, which is the inverted signal of the coding standard Manchester. Optional "Timing settings" are "Bit Rate" (default: disabled, 10 Mbit/s) and "Gap time" (default: disabled, 10 µs).
- "NRZ Clocked" Selects the coding standard NRZ Clocked.
- "NRZ Unclocked" Selects the coding standard NRZ unclocked.

Remote command:

[BUS<m>:CMSB:CODing](#) on page 1901

Data Source

Defines the input source for the custom serial bus data signal.

The data source for Manchester and NRZ coding standards is selected separately, independent of each other. The data source is set to default upon switching the coding standard.

Permitted source selections are:

- For "Manchester"/ "Manchester II":
 - Decoding: the analog, mathematical, and reference channels
 - Triggering: the analog channels
- For "NRZ Clocked":
 - Decoding: the analog, mathematical, reference and digital channels
Digital channels can be only used if MSO option R&S RTO6-B1 is installed.
Digital and analog channels cannot be used at the same time.
 - Triggering: the analog and digital channels
- For "NRZ Unclocked":
 - Decoding: the analog, mathematical, reference and digital channels
Digital channels can be only used if MSO option R&S RTO6-B1 is installed.
Digital and analog channels cannot be used at the same time.
 - Triggering: the analog channels

Remote command:

[BUS<m>:CMSB:MANChester:DATA](#) on page 1901

[BUS<m>:CMSB:NRZ:DATA](#) on page 1904

Clock Source

Defines the source for the custom serial bus clock signal (only available for the coding standard "NRZ Clocked").

Permitted source selections are the analog, mathematical, reference and digital channels.

Digital channels can be only used if MSO option R&S RTO6-B1 is installed. Digital and analog channels cannot be used at the same time.

For triggering on the serial bus, when the NRZ clocked coding standard is selected, analog or digital channel sources are required.

Remote command:

[BUS<m>:CMSB:NRZ:CLCK](#) on page 1904

Data Polarity (Manchester)

Defines the polarity of the custom serial bus data signal in Manchester coding standards. The available settings are "Normal" or "Inverted".

Remote command:

[BUS<m>:CMSB:MANchester:POLarity](#) on page 1902

Data Polarity (NRZ)

Defines the polarity of the custom serial bus data signal in NRZ coding standards. The available settings are:

"Active high" The value "1" is represented by a voltage above the threshold.

"Active low" The value "1" is represented by a voltage below the threshold.

Remote command:

[BUS<m>:CMSB:NRZ:POLarity](#) on page 1907

Data Idle Polarity (NRZ Unclocked)

Defines the idle polarity of the custom serial bus data signal (only available for the coding standard "NRZ Unclocked"). The available settings are:

"Idle low" The base value of the clock is "0"; after an idle period, the data signal starts with a low-to-high transition.

"Idle high" The base value of the clock is "1"; after an idle period, the data signal starts with a high-to-low transition.

Remote command:

[BUS<m>:CMSB:NRZ:IDLPolarity](#) on page 1905

Clock Polarity (NRZ Clocked)

Defines the polarity of the custom serial bus clock signal (only available for the coding standard "NRZ Clocked"). The available settings are:

"Idle low" The base value of the clock is "0".

"Idle high" The base value of the clock is "1".

Remote command:

[BUS<m>:CMSB:NRZ:CPOLarity](#) on page 1905

Clock Phase (Manchester)

Defines the phase of the custom serial bus clock signal for the Manchester coding standards. The available settings are:

"Auto Detect" Lets the decoder automatically select the method ("First Edge" or "Second Edge") for detecting the clock phase.

"First Edge" • At "Idle" = "low": data are captured on the clock's rising edge (low-to-high transition) and propagated on a falling edge.
 • At "Idle" = "high": data are captured on the clock's falling edge (high-to-low transition) and propagated on a rising edge.

- "Second Edge"
- At "Idle" = "low": data are captured on the clock's falling edge (high-to-low transition) and propagated on a rising edge.
 - At "Idle" = "high": data are captured on the clock's rising edge (low-to-high transition) and propagated on a falling edge.

Note: The requirement to specify "First Edge" or "Second Edge" (or let the decoder decide) has the following background: In Manchester coding, an edge is always a transition from high to low (0) or from low to high (1). However, if the signal comes from the idle state, this implies that right before the first valid edge, there is always an overhead transition from idle to high or from idle to low. Some standards may regard this as a valid transition. To avoid a potentially ambiguous situation, a decision has to be made if the first edge is indeed only some overhead transition - or a transition that needs to be sampled. For more details on edge conditions, see [Chapter 14.6.1.1, "Special features of Manchester coding"](#), on page 574.

Remote command:

`BUS<m>:CMSB:MANChester:CPHase` on page 1904

Clock Phase (NRZ Clocked)

Defines the phase of the custom serial bus clock signal for the coding standard "NRZ Clocked", depending on "Clock Polarity". The available settings are:

- "First Edge"
- At "Idle" = "low": data are captured on the clock's rising edge (low-to-high transition) and propagated on a falling edge
 - At "Idle" = "high": data are captured on the clock's falling edge (high-to-low transition) and propagated on a rising edge
- "Second Edge"
- At "Idle" = "low": data are captured on the clock's falling edge (high-to-low transition) and propagated on a rising edge
 - At "Idle" = "high": data are captured on the clock's rising edge (low-to-high transition) and propagated on a falling edge

Remote command:

`BUS<m>:CMSB:NRZ:CPHase` on page 1906

Enable Source (NRZ)

Defines the input source for the custom serial bus enable signal.

If an input is chosen, signals are only decoded when this channel is in the enabled state. This allows you to mark a time when the signal on the selected source is active and when not.

Permitted source selections are the analog, mathematical, and reference channels.

When the serial bus trigger has been selected, the only permitted source selections are the analog channels "C1" – "C4", which are required for triggering.

Math and Reference channels can only be selected, if no serial bus trigger is selected.

Remote command:

`BUS<m>:CMSB:NRZ:ENBL` on page 1906

Enable Polarity (NRZ)

Selects whether the transmitted enable signal is active when the voltage is below the [Set Thresholds](#) ("Enable low") or higher than it ("Enable high").

Remote command:

`BUS<m>:CMSB:NRZ:ENAPolarity` on page 1907

Set Thresholds

Sets the threshold value for the digitization of each signal line and the hysteresis. If the signal voltage on the line is higher than the upper threshold, the signal state is high. Otherwise, if the signal voltage is below the lower threshold, the signal state is considered low.

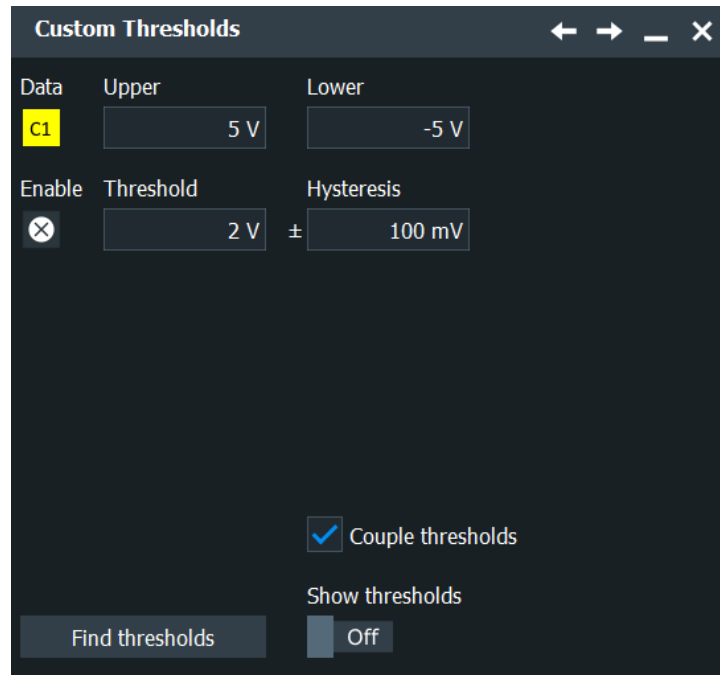

- Manchester coding standards use 3-state signals with an upper and a lower voltage threshold in the range of -25 V to +25 V. A low-to-high transition requires the signal to exceed the upper threshold; a high-to-low transition requires the signal to fall below the lower threshold.
You can set a hysteresis only for the enable signal.
- NRZ coding standards use a single voltage threshold for the data line. The value is in the range of -25 V to +25 V. It is entered into the middle of three available threshold input fields, or into the upper available threshold input field for NRZ Unclocked. You can set the hysteresis for all signal lines.
- In the NRZ Clocked coding standard, there is an additional clock voltage threshold available. This value in the range of -25 V to +25 V is entered into the upper threshold input field.
You can set the hysteresis for the clock line.

There are four ways to set the threshold:

"Threshold"	<p>Directly sets the threshold values.</p> <ul style="list-style-type: none"> • For Manchester: upper threshold in the upper field, lower threshold in the lower field. • For NRZ Clocked: clock threshold in the upper field, data threshold in the middle field and enable threshold in the lower field. Hysteresis values are in the right column. • For NRZ Unclocked: data threshold in the upper field and enable threshold in the lower field. Hysteresis values are in the right column. <p>Remote command:</p> <p>BUS<m>:CMSB:MANChesTer:THReshold:HIGH on page 1902</p> <p>BUS<m>:CMSB:MANChesTer:THReshold:LOW on page 1902</p> <p>BUS<m>:CMSB:NRZ:THReshold:CLCK on page 1907</p> <p>BUS<m>:CMSB:NRZ:THReshold:DATA on page 1908</p> <p>BUS<m>:CMSB:NRZ:THReshold:ENBLE on page 1908</p> <p>BUS<m>:CMSB:NRZ:HYSTeresis:CLCK on page 1907</p> <p>BUS<m>:CMSB:NRZ:HYSTeresis:DATA on page 1908</p> <p>BUS<m>:CMSB:NRZ:HYSTeresis:ENBLE on page 1909</p>
"Find thresholds"	<p>Executes the measurement of reference levels and sets the thresholds to the middle reference level of the measured amplitude.</p> <p>Remote command:</p> <p>BUS<m>:SETReflevels on page 1814</p>
"Couple thresholds"	<ul style="list-style-type: none"> • For Manchester and Manchester II coding, the upper and lower thresholds are coupled to voltage values with the same magnitude but opposite sign (positive for the upper threshold and negative for the lower threshold). However, if the upper threshold is set to a negative voltage or the lower threshold is set to a positive voltage, coupling is disabled, and the other voltage (the one that was not actively set) is automatically adjusted, to avoid an upper threshold below the lower one, or a lower threshold above the upper one. • For NRZ Clocked coding, the clock and data threshold values are coupled to the same voltage. <p>Remote command:</p> <p>BUS<m>:CMSB:MANChesTer:THReshold:COUPling on page 1903</p> <p>BUS<m>:CMSB:NRZ:THReshold:COUPling on page 1909</p>

14.6.2.2 Advanced

Access: [Bus] > "Advanced" tab.

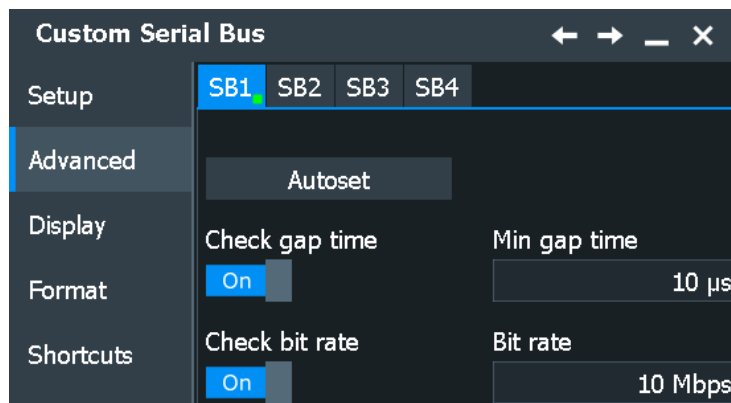

Autoset

Starts software algorithms for determining the signal threshold levels and bitrate.

Remote command:

[BUS<m>:FAUToset](#) on page 1814

Check bit rate

Enables the bit rate setting. In most cases, bit rate is recovered from the signal automatically. You can check the value by enabling this setting.

This setting is not available for "NRZ Clocked".

Remote command:

[BUS<m>:CMSB:BITRate:ENABLE](#) on page 1910

Bit Rate

Defines the transmission speed setting for the data signal. The bit rate is recovered from the signal automatically. However, the parameter can be used as a correction if the signal doesn't have single bit transitions, e.g. a compliance pattern that looks like "110011001100".

A bit rate definition is not available for "NRZ Clocked".

For more information on the bit rate, see [Chapter 14.6.1.1, "Special features of Manchester coding"](#), on page 574.

Remote command:

[BUS<m>:CMSB:BITRate:VALue](#) on page 1910

Check gap time

Enables the gap time settings (always enabled for the coding standard "NRZ Unclocked", and also for triggering on signals in any coding standard).

Remote command:

[BUS<m>:CMSB:GAPTime:ENABLE](#) on page 1910

Min gap time

Specifies a minimum gap time (idle time or timeout) between two frames. A gap time definition is optional for the coding standards "Manchester", "Manchester II" and "NRZ Clocked", but obligatory for "NRZ Unclocked" (and also for triggering on signals in any coding standard). Default gap time is 10 µs, permitted gap times range from 1 ns to 1 s.

For more details on gap time and idle conditions, see [Chapter 14.6.1.1, "Special features of Manchester coding"](#), on page 574.

Remote command:

`BUS<m>:CMSB:GAPTime:VALue` on page 1911

14.6.2.3 Frame format configuration

This dialog enables you to describe the generic format and logical structure of typical protocols by creating customized frame descriptions of various structures and lengths.

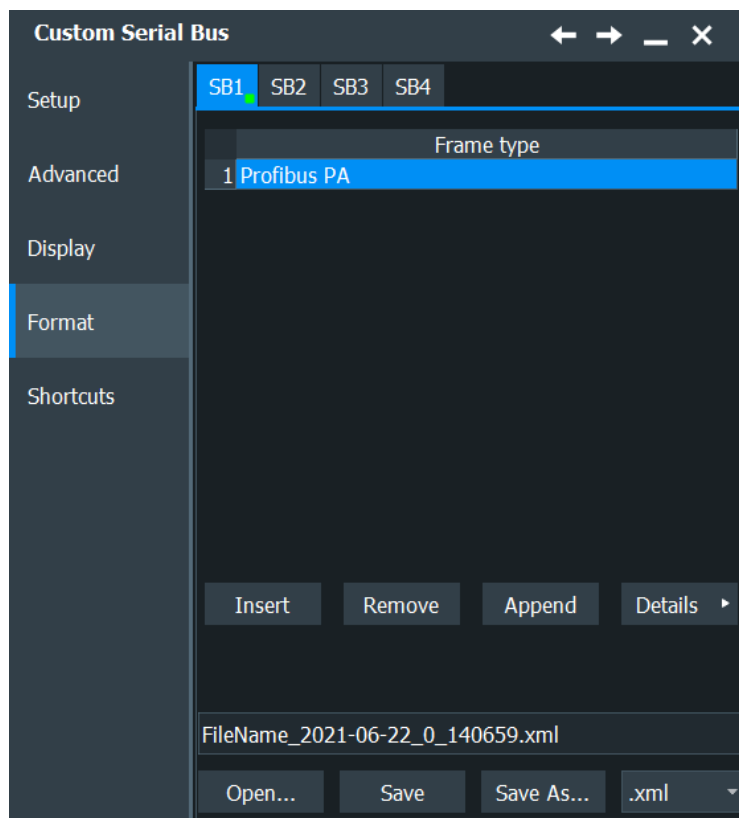

	Field name	Bits	Condition	Format	Bit order	Color	Result
1	Preamble	16	=1010101010101010	Binary	MSB First	Blue	-
2	Start Delim	8	=1LH10HLO	Binary	MSB First	Yellow	-
3	Data Field	32		Binary	MSB First	Orange	1
4	CRC	16		Binary	MSB First	Red	3
5	End Delimiter	8	=1LHLH101	Binary	MSB First	Purple	-

Frames

A frame format description (or *frame description*, for short) is represented by one "page" in this dialog. It can be created by clicking on "Add". If one or several frame descriptions already exist, the new frame description is then created at the end of the frame format description list (or *frame list*, for short). Describing a frame format requires assigning it a name as well as creating [Frame format configuration](#) and specifying cell descriptions. The number of frame descriptions is limited to 100. The frame description that is on display can be deleted from the frame list by clicking "Remove".

The "Frame type" string is intended for the user to label the frame description (typically according to the specifications of the applicable protocol standard). For example, MDIO (Management Data Input/Output) specifies the frames "READ", "WRITE", "ADDRESS".

The frame format dialog also provides the features "Open", "Save", "Save As...", and "Explore...", to store created sets of frame descriptions into files (in ".xml" format), or load existing files of this kind.

The frame identification is executed top down, in the order in which the frame formats are described in the frame list. This provides a hierarchy of criteria for identifying frames.

In case it is required to change the order of previously created frame descriptions, it is recommended to save the set of frame descriptions, and then edit the XML file with any suitable editor. This also allows - with due care - additional editing features, if required.

If no user-defined frame description should be suitable to identify an incoming frame, per default such a "missed" frame is reproduced as "Undescribed Bits" in the honeycomb display. These bits are not shown in the results table.

Note: There may be frame descriptions that positively identifies each kind of frame, e.g. if no **equal** operator is defined for any of the fields. This "catches" every frame, even if there are other frame descriptions to follow in the frame list. Therefore, if a "catch all" frame description is used, it should be placed at the end of the frame list, or

it overwrites any subsequent frame description. However, instead of using a "catch all" frame description, the built-in "undescribed bits" display as mentioned above may be the better approach to create frame descriptions.

It is in the responsibility of the user to define unambiguous settings for each frame type. For a description of these conditions in XML file format and the required XML grammar and syntax, see [Chapter 14.6.2.5, "XML syntax"](#), on page 591.

Remote command:

[BUS<m>:CMSB:FRAMe<n>:TYPE](#) on page 1912

[BUS<m>:CMSB:ADDFrame](#) on page 1911

[BUS<m>:CMSB:CLR](#) on page 1912

[BUS<m>:CMSB:FCOunt?](#) on page 1911

Field name

A field description (which is represented by one row in one frame description) can be created at any position of a frame description by clicking on "Insert". This brings up a new field description in the active frame description, on top of the selected position. The "Append" button adds a cell description at the end of a frame description, below the lowest existing cell description. The number of Field descriptions is not limited. The "Remove" button deletes a selected field description from the active frame description.

The field result can be selected to be displayed in a specified result column of the decode table (see ["Result"](#) on page 590).

Note: The cell descriptions must be sequential and complete. No gaps are allowed, since the "Bis" are used to calculate the start position of the next cell.

A frame type is identified when all user-defined cell conditions are met, which can be regarded as related by the Boolean AND operator.

This can also locate a synchronization pattern, specified by the equal operator in the field. For example, if you define a "Preamble" cell with the condition `=FFFFFFFF`, the decoder scans the data for this pattern, and then synchronize to it.

The field in a frame are described by:

- [Field Name](#)
- ["Bits"](#) on page 586
- ["Condition"](#) on page 586
- ["Format"](#) on page 589
- ["Color"](#) on page 590
- ["Result"](#) on page 590

Remote command:

[BUS<m>:CMSB:FRAMe<n>:CCOunt?](#) on page 1912

[BUS<m>:CMSB:FRAMe<n>:APPend](#) on page 1912

Field Name

The strings in the column title describe cell names. They do not have to be unique; cell names are just for user support.

Remote command:

[BUS<m>:CMSB:FRAMe<n>:CELL<o>:NAME](#) on page 1913

Bits

This crucial information defines the length of the cell and - based on the previous cells - also the cell end position and the next cell start position within a frame.

If, for a given bit count, the **Condition** value is longer, it is truncated. If the condition value is shorter, it is padded with 0. Both truncation and padding occur at the left side of the condition value.

Examples:

- if "Condition" is "=111000" and the "Bit order" is "MSB", then
 - if "Bits" is 4, the truncated condition is "=1000"
 - if "Bits" is 8, the padded condition is "=00111000"
- if "Condition" is "=111000" and the bit order is "LSB" (accordingly, the condition in "MSB" format would be "=000111"), then
 - if "Bit s" is 4, the truncated condition is "=1000" for LSB and "=0001" for MSB
 - if "Bits" is 8, the padded condition is "=00111000" for LSB and "=00011100" for MSB

Remote command:

`BUS<m>:CMSB:FRAMe<n>:CELL<o>:BITCount` on page 1913

Condition

This text field is used to apply various conditions and functionalities for a cell. Among others, it can be used to identify mandatory values (such as CRC checksum or ID) that help to identify a frame. The numeric format and bit order of the condition value has to match up with what is defined in the fields "Format" and "Bit order".

The following conditions are implemented:

"= (equal)"

The **equal** operator (represented by the "=" sign) defines a pattern for the field to match. Valid condition entries are characters that match the cell's defined "Format", "Bit order", and "Bits". In binary format, for example, valid characters are "1", "0", "H" (high), and "L" (low).

Three cases have to be distinguished (cases A, B1, and B2), depending on the presence of a [Variable Length Array: \[\]](#) in the same frame description:

- **Case A:** If there is **no** "Variable Length Array" field, then each field marked with the equal operator acts as a key to identify a frame type. Only if all these fields match up with the expected value, the frame type is identified.
- **Cases B1 and B2:** If there **is** a "Variable Length Array" cell, then the equal operator has two different functionalities, depending on the position of the equal-operator cell within the frame description:
 - **B1:** If the cell is located *anywhere before* the "Variable Length Array" cell, the condition acts as a key to identify a frame type (as in case A).
 - **B2:** If the cell is located *immediately after* the "Variable Length Array" cell, the condition acts as an array delimiter. (Note: If the cell, which is marked with the equal operator, is located after the "Variable Length Array" cell, but *not* immediately after it, the decode result is unpredictable.)

Typically, Manchester protocols use code violations for synchronization. The states "H" and "L", supported by the equal operator in binary [Format](#), mark that a transition is expected at this bit, but only a high or low signal is found.

Examples for the MVB protocol:

Master - Delimiter: "=1LH0LH000"

Slave - Delimiter: "=0000LH0LH"

For more details on the violation symbols "H" and "L", see [Chapter 14.6.1.1, "Special features of Manchester coding"](#), on page 574.

Also, the length of the pattern must correspond to the bit field length (or the results are unpredictable).

"[]" (array)"

The **array** operator (represented by the "[" and "]" bracket signs) defines the number of permissible repetitions of the cell.

Example: Fixed-Length Array: [n]

The length parameter "n" is a decimal number > 0, which determines that the cell is repeated n times within the frame. If, for example, the **Bits** is 8, then the array operator identifies n cells of 8-bit length, and present them in the results table and honeycomb display with the specified name and color.

A fixed-length array is treated the same as other cells, except the real length of such an array is $n \cdot$ bit count.

Example: Variable Length Array: []

This array operator with empty "[" and "]" bracket signs does not determine a fixed size array. The cell could be repeated any number of times, including 0 times. As a result, the cell and the frame are of unspecified length (a situation that covers typical use cases).

The length of the frame is then determined by the end of frame condition, which can be an operator or a gap.

For processing reasons, only one (1) variable length array is supported in a frame, and a delimiter must follow immediately in the next cell after it. This is required to enable the software to correctly terminate the array. Otherwise the bits could not be assigned correctly, and it would not be possible to determine where a repetition starts and where it ends. With an end of frame condition, the software can calculate the length of one single array within a frame. But if there were more arrays, it would be impossible to know which array was how long.

The variable length array can also be the last cell of a frame. In this case, no delimiter is required. If decoded successfully, the detailed view in the results table shows the elements of the array. If the cell name of the array is "Data", then the detail view of result table displays the elements with an array index as "Data: 1", "Data: 2" ... etc. If the variable length array cell is selected, it is shown as array [n], where n is the actual size detected in the waveform.

As an exception to the rule, it is permissible to assign the variable length array to consecutive fields. In this case, the fields are treated as a structure which is repeated. For example, if two consecutive fields are defined as A[] and B[], the decoder creates a sequence of ABABAB until the end condition has been detected.

Note: It is possible to combine check functions in a dynamic array. In the example above, if B[] is extended by odd(1), with "1" being the index of A[], then B checks the parity for each index of A.

"crc5usb(n-m)"	<p>The crc 5-bit operator performs a check for a 5-bit CRC function using the polynomial as defined by the USB standard. n and m define the index range for the CRC check.</p> <p>For example, if the CRC shall check fields 1 to 4, the function shall be written "crc5usb(1-5)".</p> <p>If the range of the CRC check includes an array, all elements in the array is included in the CRC check.</p> <p>If the check fails, the CRC field is marked as "CRC error" in the result details and displayed in the color red in the honeycomb display. The frame that contains the field is marked in the same way, except if another higher priority error is found within this frame.</p>
"odd(n-m), even(n-m)"	<p>The "parity" operators perform checks on odd or even parity in the given index range n to m.</p> <p>Odd parity is fulfilled if the count of "1" bits in the range including the parity bit is odd. Even parity is fulfilled if the count of "1" bits in the range including the parity bit is even.</p> <p>If the parity check fails, the parity field is marked as "CRC error" in the result details and displayed in red color in the honeycomb display. The frame that contains the field is marked in the same way, except if another higher priority error is found within this frame.</p>
"{Block}"	<p>The block operator is represented by the "{" and "}" bracket signs. Consecutive fields marked with "{Block}" and using the same name are displayed in the honeycomb display as a consecutive packet of name "Block" with the first field's color. This feature is a visual effect in the honeycomb only.</p>

Remote command:

[BUS<m>:CMSB:FRAMe<n>:CELL<o>:CONDition](#) on page 1913

Format

Selects from the following numeric data formats for the [Condition](#) value:

- Decimal
- Hexadecimal
- Octal
- Binary

The following rules apply:

- If the condition value contains at least one "H", "h", "L", "l", "X", "x", and the remaining characters only contain "1" and/or "0", the numeric format is automatically interpreted as binary, regardless of its definition.
- The wild-card characters "x" and "X" are only supported in binary format.

Examples: If the numeric format is set to be "HEX", then:

- "=1HL111000" is valid (read as binary)
- "=0x10101" is valid (read as binary, the "x" is interpreted here as a wild card)
- "=1010" is valid (read as HEX, with a total of 16 bits)
- "=0x5A" is valid (read as HEX "5A", since "0x" is a valid HEX prefix; nevertheless, it is recommended to enter "5A" instead)
- "=5X12" is invalid
- "=1H33" is invalid

Remote command:

[BUS<m>:CMSB:FRAMe<n>:CELL<o>:FORMat](#) on page 1914

Bit Order

This defines, in which order the bits of a cell's [Condition](#) value are evaluated: either the most significant bit (MSB) or the least significant bit (LSB) first. Since the bit order is considered for the interpretation of the condition, you should specify MSB or LSB correctly.

Remote command:

[BUS<m>:CMSB:FRAMe<n>:CELL<o>:BITorder](#) on page 1914

Color

Opens a dialog to select the color representation of different cells in the honeycomb display. Assigning user-selected colors helps to interpret the decode results more easily.

In the "Adjust Colors" dialog, you can either select one of the predefined colors or define a new one.

Remote command:

[BUS<m>:CMSB:FRAMe<n>:CELL<o>:CRGB](#) on page 1914

Result

This determines which cells shall be displayed in which result columns of the decode table. No index means that the result is not displayed. The decode table supports three result columns, which have to be unique for each frame type. For different frame types, though, the user can define different result columns, to display unrelated information.

Note: To see more than the three selected results, bring up a full list of the states and values of all cells by activating "Show details" in the decode table dialog.

Remote command:

[BUS<m>:CMSB:FRAMe<n>:CELL<o>:CLMN](#) on page 1915

Open or Save XML File

For efficient working and for convenient exchange of frame descriptions, they can both be loaded ("Open") or saved ("Save" / "Save As...") in XML file format. "Explore..." opens the `SaveXML` folder, which is the "Default Path" for saving frame descriptions.

Remote command:

[BUS<m>:CMSB:LOAD](#) on page 1916

[BUS<m>:CMSB:SAVE](#) on page 1916

14.6.2.4 Shortcuts

The "Shortcuts" tab gives quick access to other dialogs with protocol relevant settings.

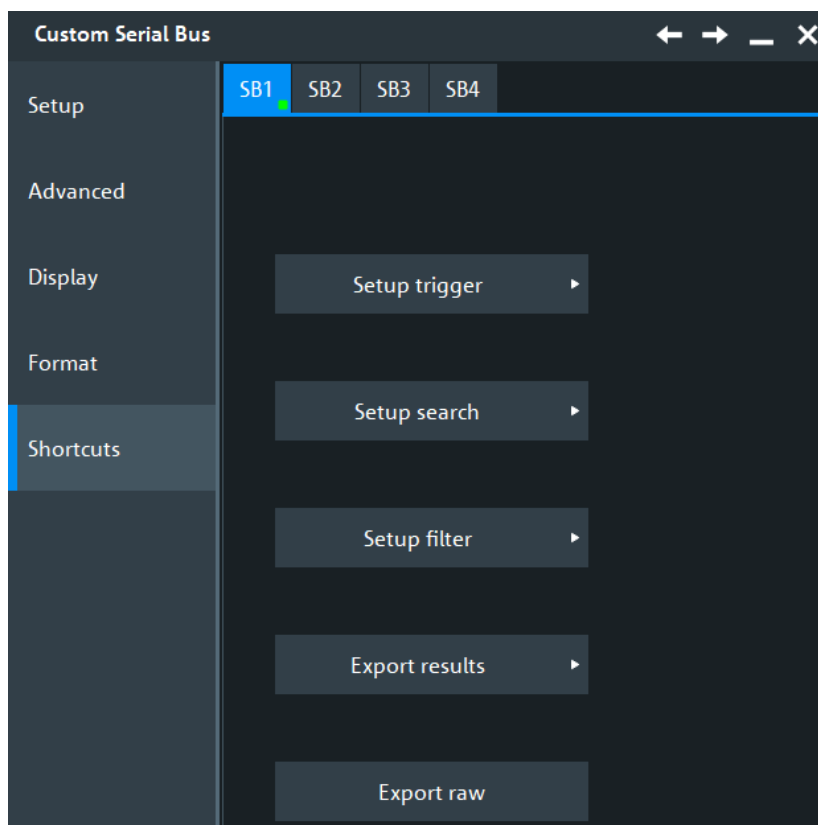

Export Raw

Decodes the data and exports the raw data to an excel file. The file is saved under:

```
c:\\Users\\Public\\Documents\\Rohde-Schwarz\\RTx\\ResultBoxExports\\CustomSBRawBits.csv
```

14.6.2.5 XML syntax

This chapter explains the required grammar and syntax of XML files, which contain custom frames and can be loaded or saved. Below is a typical example of such an XML file:

```

<?xml version="1.0" encoding="utf-8"?>
<FrameDescription xmlns:xsi="http://www.w3.org/2001/XMLSchema-instance" Version="1" xsi:noNamespaceSchemaLocation=".\\Schema\\FrameDescription.xsd">
  <Frame Type="00">
    <Format Name="Start Delim" BitCount="16" Condition="=101010101HL" NumericFormat="Binary" BitOrder="MSB First" ColorRGB="fff00" Column="-"/>
    <Format Name="OP-00" BitCount="8" Condition="=00000000" NumericFormat="Binary" BitOrder="MSB First" ColorRGB="0080ff" Column="1"/>
    <Format Name="data" BitCount="8" Condition="[]" NumericFormat="Hex" BitOrder="MSB First" ColorRGB="10a500" Column="2"/>
    <Format Name="End Delim" BitCount="8" Condition="=1HLHL101" NumericFormat="Binary" BitOrder="MSB First" ColorRGB="fff00" Column="-"/>
  </Frame>
  <Frame Type="01">
    <Format Name="Start Delim" BitCount="16" Condition="=101010101HL" NumericFormat="Binary" BitOrder="MSB First" ColorRGB="fff00" Column="-"/>
    <Format Name="OP-01" BitCount="8" Condition="=00000001" NumericFormat="Binary" BitOrder="MSB First" ColorRGB="0080ff" Column="1"/>
    <Format Name="data" BitCount="8" Condition="[]" NumericFormat="Hex" BitOrder="MSB First" ColorRGB="10a500" Column="2"/>
    <Format Name="CRC" BitCount="16" Condition="" NumericFormat="Hex" BitOrder="MSB First" ColorRGB="fb08080" Column="2"/>
    <Format Name="End Delim" BitCount="8" Condition="=1HLHL101" NumericFormat="Binary" BitOrder="MSB First" ColorRGB="fff00" Column="-"/>
  </Frame>
  <Frame Type="ff">
    <Format Name="Start Delim" BitCount="16" Condition="=101010101HL" NumericFormat="Binary" BitOrder="MSB First" ColorRGB="fff00" Column="-"/>
    <Format Name="OP-ff" BitCount="8" Condition="=11111111" NumericFormat="Binary" BitOrder="MSB First" ColorRGB="0080ff" Column="1"/>
    <Format Name="data" BitCount="8" Condition="[]" NumericFormat="Hex" BitOrder="MSB First" ColorRGB="fb233af" Column="2"/>
    <Format Name="CRC" BitCount="16" Condition="" NumericFormat="Hex" BitOrder="MSB First" ColorRGB="fb08080" Column="2"/>
    <Format Name="End Delim" BitCount="8" Condition="=1HLHL101" NumericFormat="Binary" BitOrder="MSB First" ColorRGB="fff00" Column="-"/>
  </Frame>
</FrameDescription>

```

Figure 14-12: Example of XML file syntax with three custom frame format descriptions

The first out of three XML frames in Figure 14-12 is interpreted by the software in the following way:

A suitable XML file as shown in Figure 14-12 is composed as follows:

Header:

```
<?xml version="1.0" encoding="utf-8"?>
```

Root Element:

```
<FrameDescription xmlns:xsi="http://www.w3.org/2001/XMLSchema-instance"
  Version="1" xsi:noNamespaceSchemaLocation=".\\Schema\\FrameDescription.xsd">
```

The root element contains the "Frame Description" attributes, including a link for the file `FrameDescription.xsd`. This schema file, which is installed in the system, enables the software to validate an XML file before opening it.

Frame:

A frame description must include between 0 and n tags of the following kind:

```
<Frame> </Frame>
```

Frame Type:

Each "<Frame>" tag requires a "Type" attribute in string format:

```
<Frame Type = "string">
```

Tells the software the name of each frame.

Format:

Each frame must include between 1 and n tags of the following kind:

```
<Format> </Format>
```

Together with the attributes, this is written in short form, as in Figure 14-12:

```
<Format attribute... attribute... attribute... />
```

The format describes the fields in each frame. It can have the following attributes:

- "Field Name", in string format.
- "Bit count" specifies the length of bits, in numerical format.
- "Condition" (optional) identifies the bit pattern to match, in string format.
- "Format " allows the following choices:
 - "Decimal"
 - "Hex"
 - "Octal"
 - "Binary"
- "Bit order" allows two alternatives:
 - "MSB First" (most significant bit first)
 - "LSB First" (least significant bit first)
- "Color" allows you to set a user defined ARGB hexadecimal color value.
- The "Result Column" has four options:
 - "-" (none, which is the default)
 - "1"
 - "2"
 - "3"

14.6.2.6 Custom: Manchester / NRZ display settings

Access: [Bus] > "Display" tab.

For common display settings, see [Chapter 14.1.3, "Display"](#), on page 513.

To enhance the decode possibilities of the custom serial protocol, you can use an additional setting in the "Display" tab: "Decode layer".

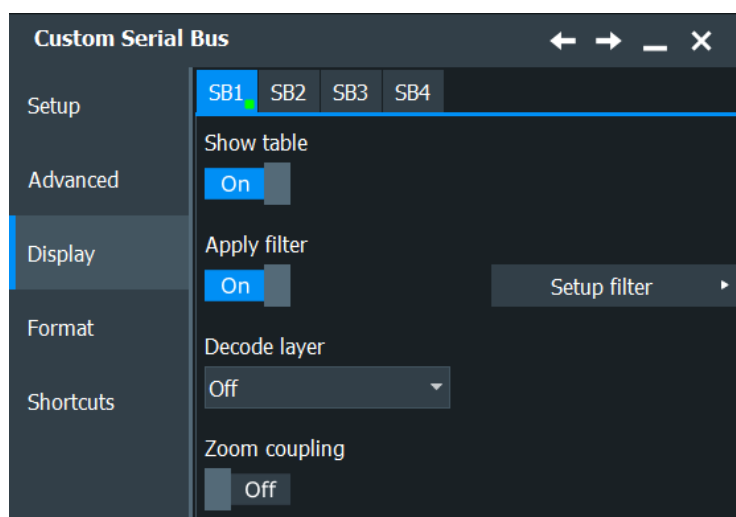

Apply Filter

Enables filtering on a custom serial bus. For details see: [Chapter 14.6.4, "Custom filter"](#), on page 600.

Remote command:

`BUS<m>:CMSB:FILTer:ENABle` on page 1923

Decode layer

Selects the decode layer.

Decoding is performed in several steps, and the end results are presented in the decode table. The decode layer selects an interim step for which the decoding result is shown in the honeycomb display.

"Final"	...
"Edges"	...
"Binary"	...
"Synchroniza- tion"	...

14.6.2.7 Configuring custom Manchester / NRZ signals

For configuration, assign the lines to the input channels, define the active states and the logical thresholds, and specify frame format descriptions.

Serial bus setup

1. Press the [Bus] key on the front panel.
2. Select the tab of the bus you want to set up, for example "SB1".
3. In the "Setup" tab, select the protocol: "Custom".
4. Switch to the "Trigger" tab, tap "Source" and select "Serial bus".
This prevents using digital waveforms (Math and Reference) as channel signals.
Note: For triggering on a custom serial bus, analog input channels are required.
5. Switch back to the "Decode" tab.
6. Tap "Coding Standard" and select the coding ("Manchester", "Manchester II", "NRZ Clocked", or "NRZ Unclocked") you want to set up.
7. Select the polarity and phase of the data signal (and potentially of the clock signal).
8. Set the logical thresholds. See ["Set Thresholds"](#) on page 580.
9. Enable "Decode".
10. Switch to the "Format" tab and open or create frame format descriptions.

For details on configuration settings, see [Chapter 14.6.2.1, "Custom: Manchester / NRZ configuration settings"](#), on page 576.

14.6.3 Custom: Manchester / NRZ trigger

If you need information on how to get started with triggering on Custom serial bus signals, see [Chapter 14.6.3.2, "Triggering on custom Manchester / NRZ serial bus"](#), on page 600. Otherwise proceed with the Custom serial bus trigger settings.

14.6.3.1 Custom: Manchester / NRZ trigger settings

Access: [Bus] > "Trigger" tab > "Source = Serial Bus" > select "Protocol = Custom"



In this section, all trigger settings are described. Their availability on the instrument depends on the selected coding standard and trigger type. The user interface of the instrument displays only appropriate settings and guides you through the trigger setup. You can adjust the "Gap time" and "Bit rate" also in the "Trigger" tab if necessary. For a list of supported trigger conditions, refer to the specifications document.

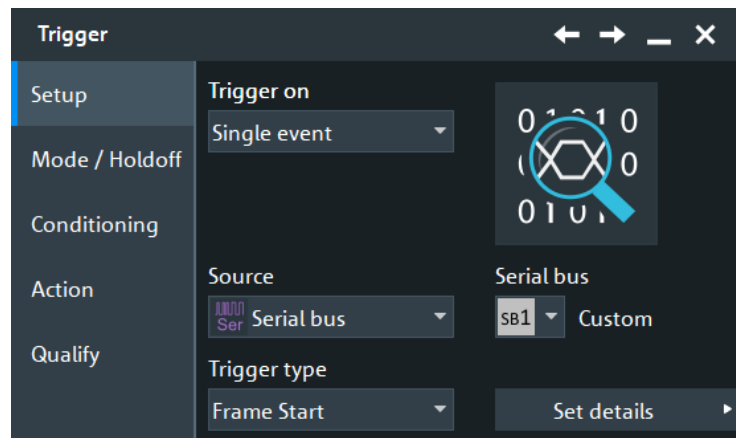

Make sure that:

- In the [Bus] > "Setup" tab:
 - The correct "Protocol" is selected.
 - The data sources of the serial bus are channel signals.
- In the "Trigger" > "Setup" tab:
 - The "Trigger on" = "Single event"
 - The trigger "Source" = "Serial bus".
 - The correct "Serial bus" is selected.

Type

Defines the trigger type for custom serial bus analysis. The available trigger types are "Frame Start", "Pattern" and "Advanced".

Remote command:

`TRIGger<m>:CMSB:TYPE` on page 1917

Frame Start ← Type

For Manchester and NRZ Clocked coding standards, the frame start trigger is set to the end of the gap time. The start of frame (SOF) condition is the first bit after the gap (timeout).

For the NRZ Unclocked coding standard, the trigger requires that the signal contains a start bit. The frame start trigger follows the gap time and is set to the end of the start bit.

Pattern ← Type

Specifies the pattern match conditions for a payload data check. The trigger is set to the first occurrence of a matching data bit pattern (which can be freely specified), starting after the minimum gap time, and after the detected start of the data frame. The trigger instant is after the last bit of the specified data pattern.

The screenshot shows the 'Custom Trigger' configuration window. It has a title bar with navigation icons. The main area is divided into sections: 'Pattern' (empty), 'Gap time' (10 µs), 'Bit rate' (10 Mbps), 'Data pattern' (xxxxxxxx and xx), and 'Bit index' (In range dropdown, 0, and 65535).

- "Data Pattern" Specifies the data pattern that is to be found and triggered. The pattern can be entered in binary or hexadecimal format, maximum pattern length is 256 binary characters or 64 hexadecimal characters.
- "Bit index operator" Sets the operator ("Equal", "Greater or equal", or "In range") to set a specific bit index (data position).
- "Bit index" Sets the bit index (data position), or the start value of a bit index range. Default bit index value is 0, permitted values range from 0 to 65535.
- "Bit index to" Sets the end value of a bit index range (data position range). Available only, if the "Bit index operator" is set to "In range". Default bit index end value is 65535, permitted values range from 0 to 65535.

- "Word Length" Sets the number of bits in an NRZ Unclocked word (hence, the size of the data frame). Default word length is 8 bits, permitted lengths range from 0 bits to 31 bits.
- Note:** The NRZ Unclocked coding standard requires a signal that contains both a start bit and a stop bit:
- The start bit should be opposite in polarity to the idle state of the signal, and it is the first transition detected following the gap time.
 - The stop bit should be the same polarity of the idle state, and it is the last bit in a data frame.
- The end of the stop bit and the detection of the next frame's start bit constitutes the maximum gap time.
- In order for the trigger to operate correctly, **you have to specify** the correct word length in the trigger menu. The trigger then counts the number of bits it decodes, and when the count matches the word length, the next bit is treated as the stop bit.
- "Gap Time" Sets the minimum gap time for synchronization. The trigger is set to a position after the gap time, when the other trigger conditions are met. Default gap time is 10 µs, permitted gap times range from 1 ns to 1 s.
- "Bit Rate" Sets the transmission speed for the data signal. Default bit rate is 10 Mbps, permitted bit rates range from 300 bps to 50 Mbps.

Remote command:

[TRIGger<m>:CMSB:PATtern](#) on page 1917

[TRIGger<m>:CMSB:ICONdition](#) on page 1918

[TRIGger<m>:CMSB:IMIN](#) on page 1918

[TRIGger<m>:CMSB:IMAX](#) on page 1918

[BUS<m>:CMSB:GAPTime:VALue](#) on page 1911

[TRIGger<m>:CMSB:NRZ:WRDLength](#) on page 1919

Advanced

Trigger on various frame types, fields in the frames, and data patterns.

Which settings are available, depends on what you have defined in the "Format" tab.

You can further refine the trigger criteria, selecting which frames you want to select for the triggering and what conditions their field values must fulfill.

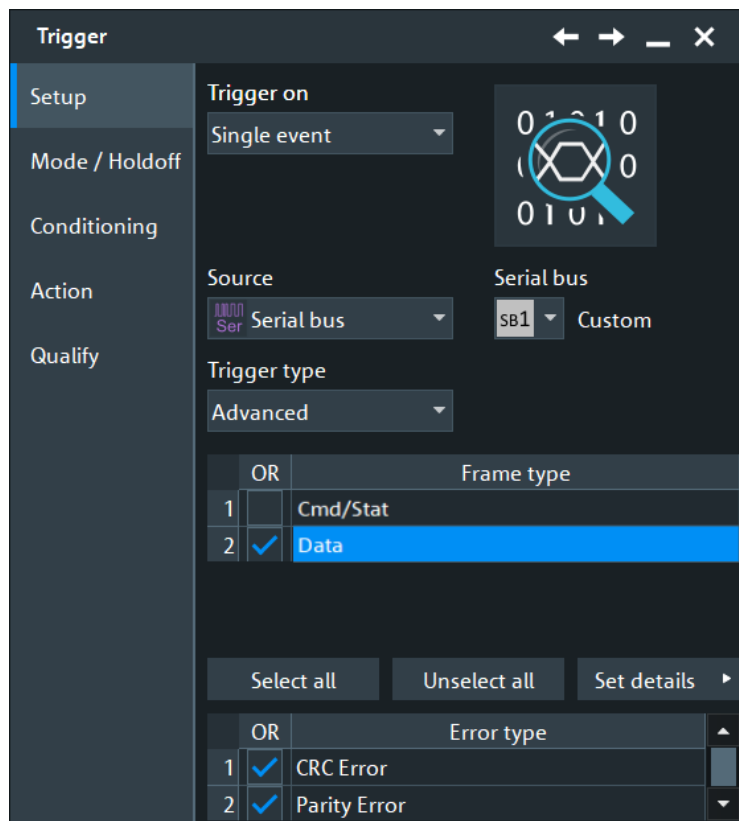

Error types: Item name, Enable ← Advanced

The table lists the error types you can trigger on. Select the required errors in the "Enable" column. Available are "CRC" error and "Parity" error.

Remote command:

[TRIGger<m>:CMSB:ADVanced:ERENable](#) on page 1921

[TRIGger<m>:CMSB:ADVanced:ERRor<n>:ENABle](#) on page 1921

Frame type ← Advanced

Selects the frame type for the custom bus trigger analysis.

You can define individual checking parameters for the fields listed in the "Trigger type dependent settings".

To specify these parameters, select a field from this list and define the data and/or index operators and values, or the bit state.

The trigger instant is the last criterion that is fulfilled.

Remote command:

[TRIGger<m>:CMSB:ADVanced:FRAMe<n>:ENABle](#) on page 1919

Field name / Condition / Enable ← Advanced

This table lists the field numbers and names in the selected frame together with a summary of the user settings of checking conditions for each field and a checkbox to enable the checking.

Select a field in the table to specify the checking conditions for this field in the "Data", "BitState" and/or "Index" dialog (whichever applies). The condition is only applied, and the "Condition" is only shown in the table, if "Enable" is checked.

Remote command:

[TRIGger<m>:CMSB:ADVanced:FRAMe<n>:FLD<o>:ENABLE](#) on page 1919

[TRIGger<m>:CMSB:ADVanced:FIENable](#) on page 1919

BitState ← Advanced

Defines the bit state to be checked for the selected field. Permitted bit states are "1", "0" or "X" (do not care).

Remote command:

[TRIGger<m>:CMSB:ADVanced:FRAMe<n>:FLD<o>:BIT](#) on page 1920

[TRIGger<m>:CMSB:ADVanced:BIT](#) on page 1920

Data ← Advanced

Defines for the selected field, how a data check is executed.

"Condition" Defining specific data or a data range requires to set the operator to one of the following conditions: equal, not equal, less than, less than or equal, greater than, greater than or equal, in range, out of range.

"Min" Specifies data or sets the start value of a data range.

"Max" Sets the end value of a data range, if "Condition" is set to "In range" or "Out of range".

Remote command:

[TRIGger<m>:CMSB:ADVanced:DMAX](#) on page 1920

[TRIGger<m>:CMSB:ADVanced:FRAMe<n>:FLD<o>:DMAX](#) on page 1920

[TRIGger<m>:CMSB:ADVanced:DMIN](#) on page 1920

[TRIGger<m>:CMSB:ADVanced:FRAMe<n>:FLD<o>:DMIN](#) on page 1920

[TRIGger<m>:CMSB:ADVanced:DOPerator](#) on page 1921

[TRIGger<m>:CMSB:ADVanced:FRAMe<n>:FLD<o>:DOPerator](#) on page 1921

Index ← Advanced

Defines for the selected field, how an index check is executed.

"Condition" Defining a specific index or an index range requires to set the operator to one of the following conditions: equal, in range.

"Min" Specifies the index or sets the start value of an index range.

"Max" Sets the end value of an index range, if "Condition" is set to "In range".

Remote command:

[TRIGger<m>:CMSB:ADVanced:IMAX](#) on page 1922

[TRIGger<m>:CMSB:ADVanced:FRAMe<n>:FLD<o>:IMAX](#) on page 1922

[TRIGger<m>:CMSB:ADVanced:IMIN](#) on page 1922

[TRIGger<m>:CMSB:ADVanced:FRAMe<n>:FLD<o>:IMIN](#) on page 1922

[TRIGger<m>:CMSB:ADVanced:IOperator](#) on page 1922

[TRIGger<m>:CMSB:ADVanced:FRAMe<n>:FLD<o>:IOperator](#) on page 1922

14.6.3.2 Triggering on custom Manchester / NRZ serial bus

Prerequisite: A bus is configured for the custom serial bus signal to be analyzed.

For the basic trigger settings, proceed in the following way:

1. Press the [Bus] key and select the "Trigger" tab.
2. Press the "Select" button. The "Source" button is shown.
3. Tap the "Source" button and select the "Serial bus" trigger source.
4. Select the serial bus that is set to Custom.
5. Tap "Type" and select the trigger type to be used for custom serial bus protocol analysis.
6. Depending on the selected custom serial bus coding standard, more setup conditions have to be specified.

For information on how to proceed with the configuration settings, see [Chapter 14.6.3.1, "Custom: Manchester / NRZ trigger settings"](#), on page 595.

14.6.4 Custom filter

With the filter function you can display only selected events in the acquired data. Only one single filter can be enabled on the protocol at a time.

14.6.4.1 Custom filter settings

Access:

1. Press [Bus].
2. Set "Protocol = Custom".
3. In the "Display" tab, enable "Apply filter".
4. Open "Setup filter".

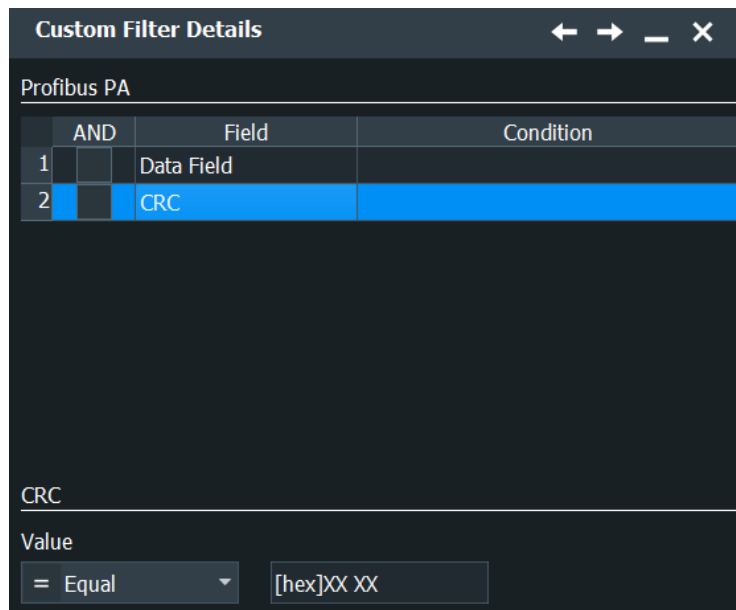
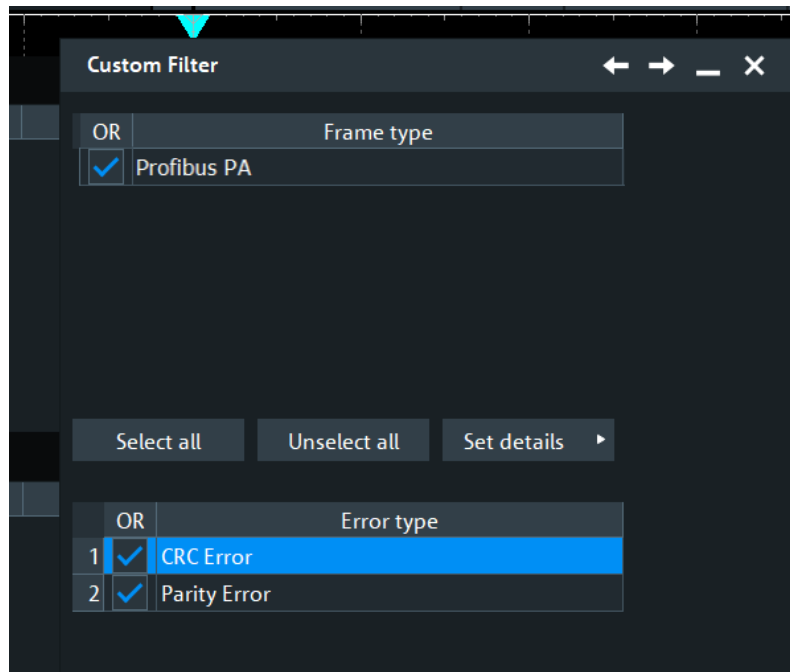

Frame type

Selects the frame type for the custom bus filtering.

You can define individual checking parameters for the fields listed in the "Trigger type dependent settings".

To specify these parameters, select a field from this list and define the data and/or index operators and values, or the bit state.

Remote command:

[BUS<m>:CMSB:FILTer:FRAMe<n>:ENABle](#) on page 1924

Error types: Item name, Enable

The table lists the error types you can filter on. Select the required errors in the "Enable" column. Available are "CRC" error and "Parity" error.

Remote command:

[BUS<m>:CMSB:FILTer:ERRor<n>:ENABle](#) on page 1923

Field name / Condition / Enable

This table lists the field numbers and names in the selected frame together with a summary of the user settings of checking conditions for each field and a checkbox to enable the checking.

Select a field in the table to specify the checking conditions for this field in the "Data", "BitState" and/or "Index" dialog (whichever applies). The condition is only applied, and the "Condition" is only shown in the table, if "Enable" is checked.

Remote command:

[BUS<m>:CMSB:FILTer:FRAMe<n>:FLD<o>:ENABle](#) on page 1926

Bit State

Defines the bit state to be checked for the selected field. Permitted bit states are "1", "0" or "X" (do not care).

Remote command:

[BUS<m>:CMSB:FILTer:FRAMe<n>:FLD<o>:BIT](#) on page 1925

Data

Defines for the selected field, how a data check is executed.

"Condition"	Defining specific data or a data range requires to set the operator to one of the following conditions: equal, not equal, less than, less than or equal, greater than, greater than or equal, in range, out of range.
"Min"	Specifies data or sets the start value of a data range.
"Max"	Sets the end value of a data range, if "Condition" is set to "In range" or "Out of range".

Remote command:

[BUS<m>:CMSB:FILTer:FRAMe<n>:FLD<o>:DMax](#) on page 1925

[BUS<m>:CMSB:FILTer:FRAMe<n>:FLD<o>:DMin](#) on page 1925

[BUS<m>:CMSB:FILTer:FRAMe<n>:FLD<o>:DOPerator](#) on page 1925

Index

Defines for the selected field, how an index check is executed.

This function is available only for array fields.

"Condition"	Defining a specific index or an index range requires to set the operator to one of the following conditions: equal, in range.
"Min"	Specifies the index or sets the start value of an index range.
"Max"	Sets the end value of an index range, if "Condition" is set to "In range".

Remote command:

`BUS<m>:CMSB:FILTer:FRAMe<n>:FLD<o>:IMAX` on page 1926

`BUS<m>:CMSB:FILTer:FRAMe<n>:FLD<o>:IMIN` on page 1926

`BUS<m>:CMSB:FILTer:FRAMe<n>:FLD<o>:IOPerator` on page 1927

14.6.5 Custom: Manchester / NRZ decode results

When the configuration of the serial bus is complete, the signal can be decoded:

1. In the "Serial Bus" dialog > "Setup" tab, enable "Decode".
2. In the "Serial Bus" dialog > "Display" tab, select additional result display settings: "Show table" and "Show binary".
3. If required, enable "Zoom coupling"

For a description of the display settings, see also [Chapter 14.1.3, "Display"](#), on page 513.

The instrument captures and decodes the signal according to the standard definition and the configuration settings.

The color-coding of the various protocol sections and errors simplifies the interpretation of the visual display. The decode information condenses or expands, depending on the horizontal scale. Various data formats are available to show the result values.

In contrast to other protocols, the instrument captures and decodes customizable serial bus signals according to the individual frame configuration.

Decode Results Table

The "Decode results" table contains information about all decoded frames.

State	Start	Type	Result 1	Result 2	Result 3
1 Ok	39.8 µs Cmd/Stat			06h	
2 Ok	59.8 µs Data	129h			
3 Ok	-39.9 µs Data	567h			
4 Ok	15.9 µs Data	9ABCh			
5 Ok	100ms Data	DEFCh			
6 Ok	25.1 µs Cmd/Stat		00h	02h	
7 Ok	50.1 µs Cmd/Stat		083h	01h	
8 Ok	70.1 µs Cmd/Stat		083h	01h	

State	Type	Numeric
1 Ok	Sync	L1Hb
2 Ok	RFA	01h
3 Ok	Info	083h
4 Ok	P	1b

Table 14-8: Content of the "Decode results" table

Column	Description
State	Overall state of the frame: either OK or the relevant error condition (e.g. preamble, length)
Start	Start time of the frame
Type	Frame type as specified in the "Frame type" field of the "Frame Format" description dialog
Result 1	1 st field content as specified in the "Result" of the "Frame Format" description dialog
Result 2	2 nd field content
Result 3	3 rd field content

Table 14-9: Content of the "Decode results details" table

Column	Description
State	Overall state of the cell: either OK or the relevant error condition (e.g. length error)
Type	The type of frame, as specified with the "Frame type"
Numeric	Data content of the cell (e.g. 0x1, 1000LL00L)

Tools

Press "Display settings" in the "Decode Results" table to access the "Display" tab.

**Remote commands**

Remote commands are described in [Chapter 27.18.7.4, "Decode results"](#), on page 1927.

14.6.6 Search on decoded custom Manchester / NRZ data

Using the search functionality, you can find various events in the decoded data. You can find the same events that you can trigger on, and even many more, since several event types can also be combined.

Before you can start the search, you have to configure the bus correctly and acquire decoded data.

To search on decoded data, set the search source to "SerBus" for the configured protocol.

For general information on how to handle the search functionality, see [Chapter 11, "Search functions"](#), on page 425.

If you need information on how to get started with searching custom serial bus data, see [Chapter 14.6.6.3, "Searching custom serial bus data"](#), on page 605. Otherwise proceed with the custom serial bus search setup.

14.6.6.1 Custom Manchester / NRZ search setup

Access: [Bus] > "Shortcuts" tab > "Setup search"

Search criteria

Use the "Search criteria" dialog to define the event types to be searched. Available event types are "Frame" and "Error".

Individual search parameters, which do not depend on the coding standard and trigger settings of the custom serial bus, can be specified in the tabs below the "Search criteria" dialog.

Frame

Searches for four different frame conditions.

Remote command:

[SEARCH:TRIGger:CMSB:ERRor<m>:ENABle](#) on page 1934
[SEARCH:TRIGger:CMSB:FIENable](#) on page 1934
[SEARCH:TRIGger:CMSB:FRAMe<m>:ENABle](#) on page 1937
[SEARCH:TRIGger:CMSB:FRENable](#) on page 1934
[SEARCH:TRIGger:CMSB:FRAMe<m>:FLD<n>:BIT](#) on page 1935
[SEARCH:TRIGger:CMSB:BIT](#) on page 1935
[SEARCH:TRIGger:CMSB:FRAMe<m>:FLD<n>:DMAX](#) on page 1935
[SEARCH:TRIGger:CMSB:DMAX](#) on page 1935
[SEARCH:TRIGger:CMSB:FRAMe<m>:FLD<n>:DMIN](#) on page 1936
[SEARCH:TRIGger:CMSB:DMIN](#) on page 1936
[SEARCH:TRIGger:CMSB:FRAMe<m>:FLD<n>:DOPerator](#) on page 1936
[SEARCH:TRIGger:CMSB:DOPerator](#) on page 1936
[SEARCH:TRIGger:CMSB:FRAMe<m>:FLD<n>:IMAX](#) on page 1937
[SEARCH:TRIGger:CMSB:IMAX](#) on page 1937
[SEARCH:TRIGger:CMSB:FRAMe<m>:FLD<n>:IMIN](#) on page 1937
[SEARCH:TRIGger:CMSB:IMIN](#) on page 1937
[SEARCH:TRIGger:CMSB:FRAMe<m>:FLD<n>:IOPerator](#) on page 1938
[SEARCH:TRIGger:CMSB:IOPerator](#) on page 1938

Error Condition

Searches for two error conditions: "CRC Error" or "Parity Error".

Remote command:

[SEARCH:TRIGger:CMSB:ERRor<m>:ENABle](#) on page 1934

14.6.6.2 Custom serial bus search results

To get search results, "Enable" the search. You can minimize, shift or close the search dialog.

The search results are listed in the search result table and marked in the waveform by blue lines.

For an introduction to search results, see:

- [Chapter 11.1.2, "Search results"](#), on page 426
- [Chapter 11.4.2, "Display zoom settings"](#), on page 446

Remote commands are listed in [Chapter 27.18.7.6, "Search results"](#), on page 1938

14.6.6.3 Searching custom serial bus data

Prerequisite: A serial bus is configured for the custom serial bus signal to be decoded and analyzed.

The search for events is set up in the following way:

1. Press the [Bus] key and select the "Shortcuts" tab.
2. Tap "Setup search".

3. If the dialog box does not contain a search entry, tap the "Add" icon to create one, as described in ["To create a user-defined search"](#) on page 440.
4. Specify search criteria according to [Chapter 14.6.6.1, "Custom Manchester / NRZ search setup"](#), on page 604.
5. To acquire a waveform, press [Single].
The R&S RTO6 performs a custom serial bus decode according to the thresholds and protocol settings of the associated serial bus source (here in our example SB1).
6. To start searching the acquired waveform for specific events, tap "Enable" in the search setup dialog:
The R&S RTO6 displays the "Search Results" box that lists the detected events.

For information on how to configure the search results presentation and how to navigate the search results, see also ["To display search zoom windows"](#) on page 448.

14.7 CAN and CAN FD (option R&S RTO6-K520)

CAN is the Controller Area Network, a bus system designed by Bosch for use within automotive network architecture, for example, for brake, power train and engine management. Today, it is also used in many other systems, for example, in industrial machines, aerospace, subsea, and merchant marine.

More than 20 years after the invention of CAN, communication needs have increased, and CAN has reached its bandwidth limits in some application fields. Therefore, Bosch specified an improved CAN protocol with flexible data rate - CAN FD. It introduces a higher bit rate in the data phase up to 15 Mbit/s and an extended data field from up to 64 bytes.

The R&S RTO6 provides decoding, triggering and searching CAN and CAN FD signals with option R&S RTO6-K520.

14.7.1 The CAN protocol

CAN frame format and in CAN FD frame format can coexist within the same network. CAN FD shares the physical layer, with the CAN protocol as defined in the BOSCH CAN Specification 2.0. The frame format is different. There are two new control bits in the CAN FD frame, the first enabling the new frame format with different data length coding and the second optionally switching to a faster bit rate after the arbitration is decided. New CRC polynomials are introduced to secure the longer CAN FD frames.

14.7.2 CAN and CAN FD configuration

14.7.2.1 CAN and CAN FD configuration settings

Access: [Bus] > "CAN" > "Setup" tab



Make sure that the tab of the correct serial bus is selected.

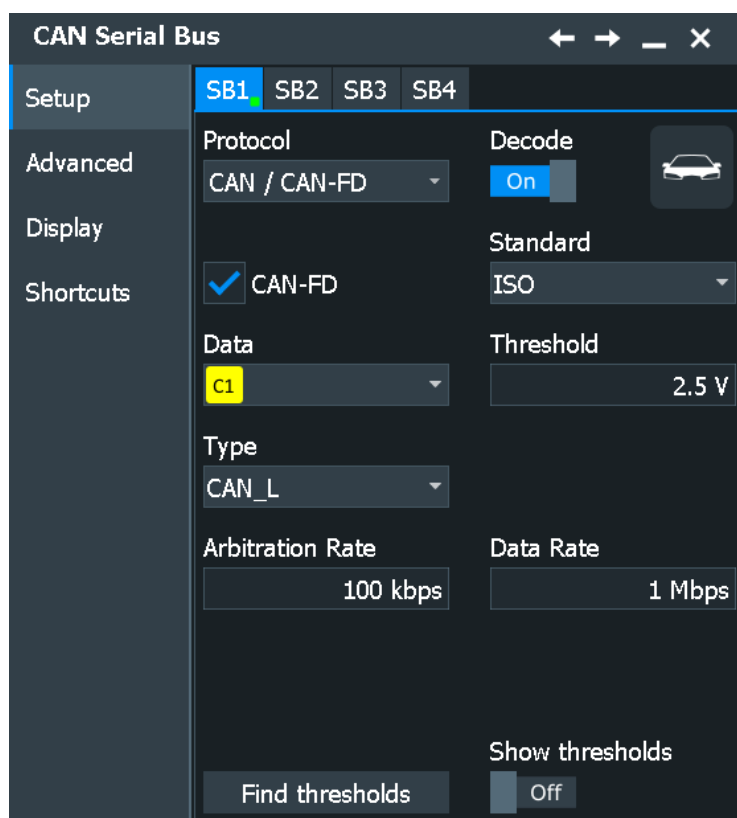

Figure 14-13: Configuration for CAN FD

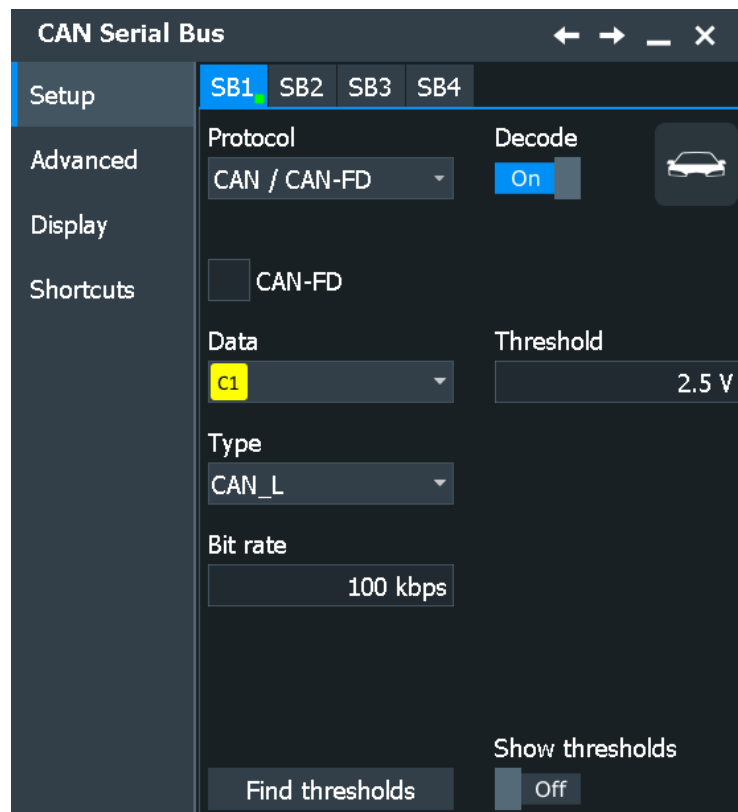

Figure 14-14: Configuration for CAN

See also: [Chapter 14.1.1, "Setup - general settings"](#), on page 511

Protocol

Defines the protocol type of the selected serial bus.

Remote command:

[BUS<m> : TYPE](#) on page 1813

Decode

Enables the decoding of the selected bus. The signal icon of the bus appears on the signal bar.

Remote command:

[BUS<m> \[: STATE\]](#) on page 1813

Data

Sets the source of the selected data line.

Usually, the source is one of the analog channels. Reference and math waveforms are available as source if the trigger source is one of the analog channels but not the serial bus.

Alternatively, digital channels can be used if MSO option R&S RTO6-B1 is installed. Digital and analog channels cannot be used at the same time.

For triggering on a serial bus, analog or digital channel sources are required.

A math waveform can be used, for example, if you probe on CAN-High and CAN-Low using two single-ended probes, and the difference between high and low is calculated and displayed using a math waveform.

Remote command:

[BUS<m>:CAN:DATA:SOURce](#) on page 1945

Type

Selects the CAN-High or CAN-Low line. CAN uses both lines for differential signal transmission.

If you measure with a differential probe, connect the probe to both CAN-H and CAN-L lines, and select the data "Type" = *CAN-H*.

If you use a single-ended probe, connect the probe to either CAN_L or CAN_H, and select the data type accordingly.

Remote command:

[BUS<m>:CAN:TYPE](#) on page 1945

CAN-FD

Enables the CAN FD protocol configuration and displays additional CAN FD parameters.

Remote command:

[BUS<m>:CAN:FDATA:ENABLE](#) on page 1947

[BUS<m>:CAN:FDATA:FRAME<n>:STANdard?](#) on page 1959

Standard

Only available for CAN FD buses.

"Non-ISO" Signals are decoded according to the the Bosch CAN FD protocol.

"ISO" Signals are decoded according to the the ISO CAN FD protocol. This protocol has an additional stuff count field before the CRC sequence.

Remote command:

[BUS<m>:CAN:FDATA:PSTandard](#) on page 1945

Threshold

Sets the threshold value for digitization of the signal. If the signal value on the line is higher than the threshold, the signal state is high (1 or true for the boolean logic). Otherwise, the signal state is considered low (0 or false).

There are several ways to set the threshold:

- "Threshold"
Enter the value directly in the field.
- "Autoset"
Starts software algorithms for determining the signal threshold levels and bitrate.
- "Find thresholds"
Executes the measurement of reference levels and sets the thresholds to the middle reference level of the measured amplitude.

Note: If the sources are digital channels, the same threshold values are used for the parallel and the serial buses. You can set the thresholds either in the parallel bus configuration or in the serial bus configuration.

Remote command:

[BUS<m>:CAN:DATA:THReshold](#) on page 1946

[BUS<m>:CAN:TECHnology](#) on page 1946

[BUS<m>:SETReflevels](#) on page 1814

[BUS<m>:FAUToset](#) on page 1814

Bit rate (CAN) / Arbitration rate (CAN FD)

For CAN buses, the "Bit rate" sets the number of transmitted bits per second.

For CAN FD buses, this parameter is called "Arbitration rate" and sets the bit rate of the arbitration phase.

The maximum value of this rate is 1 Mbit/s. The bit rate is uniform and fixed for a given CAN or CAN FD bus.

To select a bit rate from the list of predefined values, tap the button beside the field. To enter a specific value, open the keypad. The list of predefined values is also available in the keypad.

Remote command:

[BUS<m>:CAN:BITRate](#) on page 1947

Data rate

Sets the bit rate of the data phase. The data rate can be equal or higher than the arbitration rate; and it is uniform and fixed for a given CAN FD bus.

To select a data rate from the list of predefined values, tap the button beside the field. To enter a specific value, open the keypad. The list of predefined values is also available in the keypad.

Remote command:

[BUS<m>:CAN:FDATa:DBITrate](#) on page 1947

14.7.2.2 Advanced settings

Access: [Bus] > "Advanced" tab.

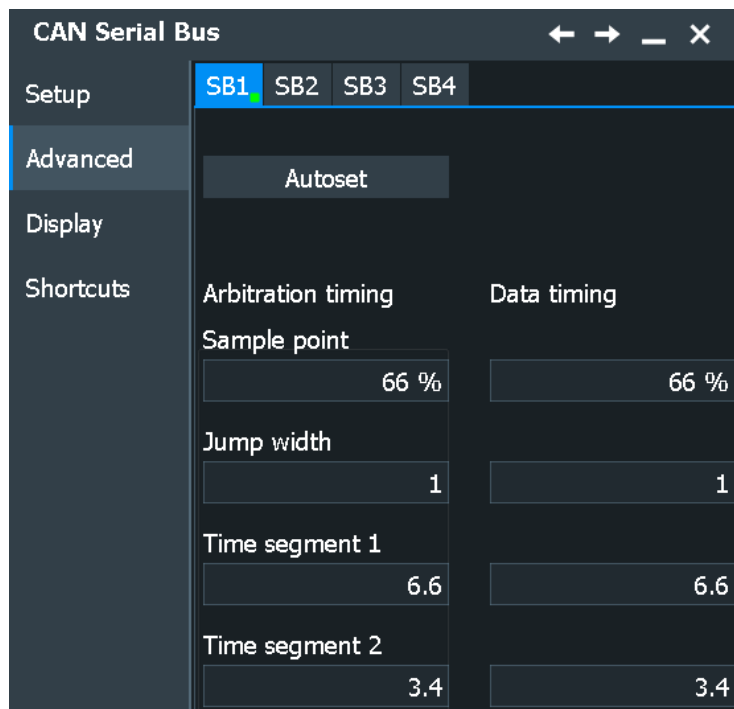

The CAN bus interface uses an asynchronous transmission scheme. The standard specifies a set of rules to resynchronize the local clock of a CAN node to the message.

The sample point divides the nominal bit period into two distinct time segments. The length of the time segments is defined in time quanta according to network and node conditions during CAN development.

For CAN FD signals, you can define the synchronization settings separately for the arbitration phase and data phase.

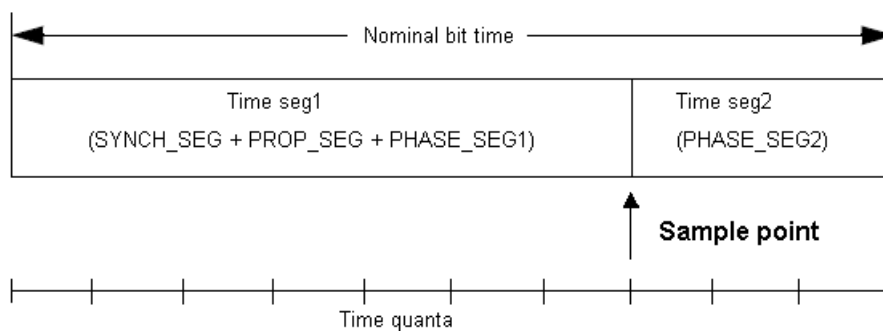

To specify the bit timing, enter either "Time segment1" and "Time segment 2", or directly the "Sample point". Additionally, set the "Jump width".

Autoset

Starts software algorithms for determining the signal threshold levels and bitrate.

Remote command:

`BUS<m>:FAUToset` on page 1814

Time segment1, Time segment2

Set the number of time quanta before the sample point (Time segment 1) and after the sample point (Time segment 2).

The "Sample point" percentage value is adjusted accordingly.

Time segments 1 comprises the segments Synch_seg, Prop_seg, and Phase_seg1 which are specified in the CAN standard. Time seg2 matches Phase_seg2 from the standard.

The maximum sum of Time segment 1 and Time segment 2 is 24.

Remote command:

[BUS<m>:CAN:T1Segment](#) on page 1948

[BUS<m>:CAN:T2Segment](#) on page 1949

[BUS<m>:CAN:FDATa:T1Segment](#) on page 1948

[BUS<m>:CAN:FDATa:T2Segment](#) on page 1949

Sample point

Sets the position of the sample point within the bit in percent of the nominal bit time.

The time quanta values "Time segment1, Time segment2" are adjusted accordingly.

Remote command:

[BUS<m>:CAN:SAMPlepoint](#) on page 1948

[BUS<m>:CAN:FDATa:SAMPlepoint](#) on page 1948

Jump width

Time segment1 may be lengthened or time segment2 may be shortened due to resynchronization. Resynchronization corrects the phase error of an edge caused by the drift of the oscillators. The jump width defines the maximum number of time quanta for phase correction. The maximum value of the jump width is 4, or *Time seg1 - Time seg2* if this difference is lower than 4.

Remote command:

[BUS<m>:CAN:JWIDth](#) on page 1949

[BUS<m>:CAN:FDATa:JWIDth](#) on page 1949

14.7.2.3 Display settings

Access: [Bus] > "Display" tab.

For common display settings, see [Chapter 14.1.3, "Display"](#), on page 513.

DBC Files for CAN / CAN FD

Industry-standard DBC files contain more information than PTT and CSV files and translate the abstract decode results to human language. For each frame, the frame ID and the symbolic name of the ID are given; the frames are also called messages in CAN. The data of a CAN message can consist of several "signals". The DBC file provides the label, unit, start bit, length and other indicators for each signal. For state-encoded signals, the meaning of the states is given.

In the demo example, the message "EngineData" has the decimal ID 2,166,573,756 and consists of 8 data bytes. These 8 bytes are defined as 6 signals. The first one,

"PetrolLevel", starts at bit #24, has a length of 8 bit, and the unit is liter. The signal "IdleRunning" is state-encoded. It has only one bit. The binary value 0 means "Running", and the binary value 1 means "Idle".

Example: CAN DBC file section

```
BO_ 2166573756 EngineData: 8 Engine
SG_ PetrolLevel : 24|8@1+ (1,0) [0|255] "l" ...
SG_ EngPower : 48|16@1+ (0.01,0) [0|350] "kW" ...
SG_ EngForce : 32|10@1+ (1,0) [0|1000] "N" ...
SG_ IdleRunning : 23|1@1+ (1,0) [0|1] "" ...
SG_ EngTemp : 16|7@1+ (2,-50) [-50|150] "degC" ....
SG_ EngSpeed : 0|13@1+ (1,0) [0|8000] "rpm" ...
....
VAL_ 2166573756 IdleRunning 0 "Running" 1 "Idle" ;
```

PTT and CSV Files for CAN / CAN FD

Label list files are protocol-specific. A PTT label file for CAN protocols contains three values for each identifier:

- Identifier type, 11-bit or 29-bit long
- Identifier value
- Label, the symbolic name of the identifier, specifying its function in the bus network.

Example: CAN PTT file

```
# -----
@FILE_VERSION = 1.00
@PROTOCOL_NAME = can
# -----
# Labels for CAN protocol
# Column order: Identifier type, Identifier value, Label
# -----
11,064h,Diag_Response
11,1E5h,EngineData
11,0A2h,Ignition_Info
11,1BCh,TP_Console
11,333h,ABSdata
11,313h,Door_Left
11,314h,Door_Right
29,01A54321h,Throttle
29,13A00FA2h,LightState
29,0630ABCDh,Engine_Status
29,03B1C002h,Airbag_Status
29,01234ABCh,NM_Gateway
# -----
```

Remote command:

- [BUS<m>:CAN:FRAME<n>:SYMBOL?](#) on page 1961

14.7.3 CAN / CAN FD trigger

The R&S RTO6 can trigger on various events in a CAN or CAN FD frame. Trigger conditions include start of frame, frame ID, data pattern, or error conditions.

14.7.3.1 Trigger settings

Access: [Bus] > "Shortcuts" tab > "Setup trigger"

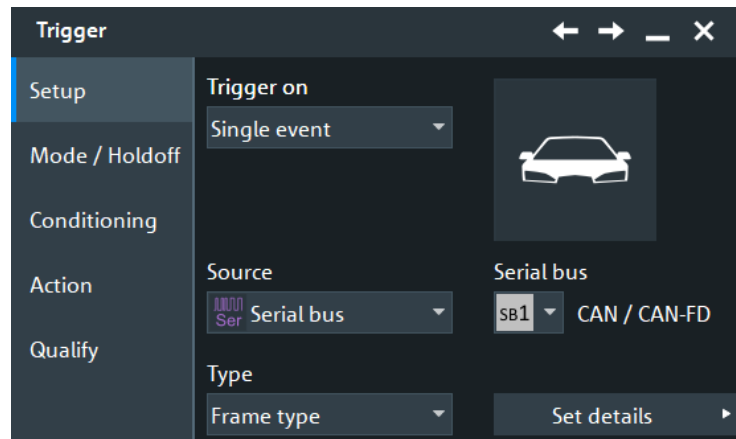

Make sure that:

- In the [Bus] > "Setup" tab:
 - The correct "Protocol" is selected.
 - The data sources of the serial bus are channel signals.
- In the "Trigger" > "Setup" tab:
 - The "Trigger on" = "Single event"
 - The trigger "Source" = "Serial bus".
 - The correct "Serial bus" is selected.

Serial bus

Selects the serial bus to be triggered on. Make sure to select the correct bus before you enter the settings.

To trigger on a serial bus, the signals sources must be channel signals. If the data or clock source is a math or reference waveform, you cannot trigger on that bus.

Remote command:

[TRIGger<m>:SOURce:SBSelect](#) on page 1818

Protocol

Defines the protocol type of the selected serial bus.

Remote command:

[BUS<m>:TYPE](#) on page 1813

Trigger type

Selects the trigger type for CAN analysis.

"Start of frame" Triggers on the first edge of the dominant SOF bit (synchronization bit).

"Frame type"

The screenshot shows a dialog box titled "CAN / CAN-FD Trigger". It has a title bar with navigation icons (back, forward, close). The main content area is titled "Frame type". Under "Standard", there is a dropdown menu set to "Any". Below that, there are two dropdown menus: "Frame type" set to "Data" and "ID type" set to "11 bit".

Triggers on a specified frame type (data, remote, error, or overload). For data and remote frames, also the identifier format is considered.

For details, see:

- ["Frame type"](#) on page 617
- ["ID type"](#) on page 617

"Identifier"

The screenshot shows a dialog box titled "CAN / CAN-FD Trigger". It has a title bar with navigation icons (back, forward, close). The main content area is titled "Identifier". Under "Standard", there is a dropdown menu set to "CAN". Below that, there are two dropdown menus: "Frame type" set to "Data" and "ID type" set to "11 bit". Under "Transfer", there is a dropdown menu set to "Big endian". At the bottom, there are two dropdown menus: the first is set to "= Equal" and the second is a text input field containing "[hex]064".

Sets the trigger to a specific message identifier or an identifier range. See ["Identifier setup: Condition, Identifier min, Identifier max"](#) on page 618.

"Identifier +
Data"

The screenshot shows the 'CAN / CAN-FD Trigger' dialog box with the following settings:

- Standard: CAN
- Frame type: Data
- ID type: 11 bit
- Transfer: Big endian
- DLC: = Equal, 3
- Identifier: = Equal, [hex]064
- Data pattern: = Equal, [hex]00 \$X XX

Sets the trigger to a combination of identifier and data condition. The instrument triggers at the end of the last byte of the specified data pattern.

The identifier conditions are the same as for the "Identifier" trigger type, see ["Identifier setup: Condition, Identifier min, Identifier max"](#) on page 618. Data conditions are set with ["Data setup: DLC, NDB, Transfer, Condition, Data min, Data max"](#) on page 618.

"Error condi-
tion"

Identifies various errors in the frame, see ["Error conditions"](#) on page 620.

The screenshot shows the 'CAN / CAN-FD Trigger' dialog box with the following settings:

- Standard: CAN
- Checksum error:
- Form error:
- Bit stuffing error:
- Ack error:

"Symbolic" The "Symbolic" trigger type is available if a DBC label list file is loaded and applied. It allows you to trigger on a specific data message, or a signal and its value that appears inside the message, see [Chapter 14.7.6.1, "Symbolic trigger"](#), on page 628.

Remote command:

`TRIGger<m>:CAN:TYPE` on page 1950

Standard

Selects the CAN standard: "CAN", "CAN FD", or "Any". Use "Any" to trigger on either CAN or CAN-FD frame. In this case, the trigger configuration provides all possible settings, for CAN as well as for CAN FD.

Remote command:

`TRIGger<m>:CAN:FDATa:STANdard` on page 1951

Frame type

CAN has four frame types which can be used as trigger condition.

For data and remote frames, the identifier format has to be set with [ID type](#).

"Data" The data frame is the only frame for actual data transmission.

"Remote" Remote frames are only available in the CAN protocol. The remote frame initiates the transmission of data by another node. The frame format is the same as of data frames but without the data field.

"Error" When a node recognizes an error, it cancels transmission by sending an error frame. The instrument triggers seven bit periods after the end of the error flag that is marked by a dominant-recessive edge. The ID type is irrelevant for error frames.

"Overload" When a node needs a delay between data and/or remote frames, it sends an overload frame. The instrument triggers seven bit periods after the end of the overload flag that is marked by a dominant-recessive edge. The ID type is irrelevant for overload frames.

Remote command:

`TRIGger<m>:CAN:FTYPE` on page 1952

ID type

Selects the length of the identifier:

"11 bit" Identifier length of the CAN base frame format. The instrument triggers on the sample point of the IDE bit (identifier extension flag).

"29 bit" Identifier length of the CAN extended frame format. The instrument triggers on the sample point of the RTR bit.

"Any" The ID type and ID pattern are not relevant for the trigger condition. If the trigger type is "Identifier", the instrument triggers on any identifier in the specified frame type. If the trigger type is "Identifier + Data", set the "ID type" to "Any" if you want to trigger only on data.

Remote command:

[TRIGger<m>:CAN:ITYPE](#) on page 1952

Identifier setup: Condition, Identifier min, Identifier max

The identifier setup consists mainly of the condition and one or two identifier patterns. Additionally, ID type and frame type may qualify the identifier.

The trigger point depends on the ID type.

- "Frame type" Data frames and remote frames contain an identifier. Select the frame type to be triggered on, or select "Any" if the frame type is not relevant.
In CAN FD, only "Data" frames are available.
- "ID type" See: ["ID type"](#) on page 617.
- "Condition" Defines the operator to set a specific identifier ("Equal" or "Not equal") or an identifier range.
- "Identifier min" In binary format, use the following characters: 1; 0; or X (do not care). To enter the pattern in other formats use the bit pattern editor, see [Chapter 14.1.7, "Bit pattern editor"](#), on page 519.
The length of the bit patterns is restricted to the selected "ID type".
- "Identifier max" The second identifier pattern is required to specify a range with conditions "In range" and "Out of range".
- "FD bits" See: ["FD bits"](#) on page 618.

Remote command:

[TRIGger<m>:CAN:ICONdition](#) on page 1952

[TRIGger<m>:CAN:IMIN](#) on page 1953

[TRIGger<m>:CAN:IMAX](#) on page 1953

FD bits

For standard settings "CAN FD" and "Any", you can trigger on CAN FD-specific bits.

- "FDF" The bit determines whether a frame is CAN or CAN-FD. It corresponds to the EDL bit (extended data length), which only exists in CAN FD format. If you do not know if the signal is CAN or CAN FD, you can use this bit to identify the format: FDF = 1 is CAN FD, and FDF = 0 is CAN. Set "X" if the format is not relevant.
- "BRS" is the bit rate switch bit. Value 1 means that the bit rate switches from the "Arbitration rate" to the faster "Data rate".
- "ESI" is the error state indicator. Set "X" if the bit is not relevant.

Remote command:

[TRIGger<m>:CAN:FDATa:FDF](#) on page 1953

[TRIGger<m>:CAN:FDATa:BRS](#) on page 1954

[TRIGger<m>:CAN:FDATa:ESI](#) on page 1954

Data setup: DLC, NDB, Transfer, Condition, Data min, Data max

The data setup consists of the transfer direction, the number of bytes, the condition, and one or two data patterns.

To trigger only on data, set the "ID type" of the identifier setup to "Any".

"Transfer"	<p>CAN only:</p> <p>Sets the byte order (endianness) of the data transfer. With "Big endian", the data is analyzed and evaluated in the order of reception. With "Little endian", the instrument reads the complete data, reverses the byte order of the data, and compares it with the specified data word.</p>
"DLC, NDB"	<p>"DLC" sets the Data Length Code, which defines the number of data bytes to be found.</p> <p>"NDB" shows the number of data bytes that is set by the DLC. DLC and NDB are different in CAN FD for DLCs > 8.</p> <p>CAN:</p> <p>For Big Endian transfer direction, you can trigger on a number of bytes less than the data length of the frame, that means, on the first bytes that are transmitted. For Little Endian transfer direction, the exact number of data bytes in the frame must be set.</p> <p>Example: The data word to be sent is 12 34 56, and it is sent little endian by the LIN node. With Data length ≥ 2 and Transfer = Big endian, you trigger on the data of the first two bytes, that is 56 34. With Data length = 3 and Transfer = Little endian, you trigger on the required data word 12 34 56.</p> <p>CAN FD:</p> <p>The data field can have up to 64 bytes, the DLC is defined in the standard. For example, DLC = 9 defines that the data field has 12 bytes, and DLC = 15 sets a 64 byte data field.</p>
"Condition"	<p>Sets the operator to set a specific data pattern ("Equal" or "Not equal") or a data range.</p>
"Data min"	<p>Defines the data pattern. The pattern length is adjusted to the DLC setting (and vice versa). Enter the pattern MSB first and with big endian byte order.</p> <p>In binary format, use the following characters: 1; 0; or X (do not care). To enter the pattern in other formats use the bit pattern editor, see Chapter 14.1.7, "Bit pattern editor", on page 519.</p>
"Data max"	<p>The second data pattern is required to specify a range with conditions "In range" and "Out of range".</p>

Remote command:

[TRIGger<m>:CAN:BORDER](#) on page 1955

[TRIGger<m>:CAN:DCONDITION](#) on page 1954

[TRIGger<m>:CAN:DMIN](#) on page 1954

[TRIGger<m>:CAN:DMAX](#) on page 1955

[TRIGger<m>:CAN:DLCCONDITION](#) on page 1955

[TRIGger<m>:CAN:DLC](#) on page 1956

[TRIGger<m>:CAN:NDBYtes?](#) on page 1956

Data position

The data position sets the location in the data field where the instrument looks for the specified data pattern. The position can be defined if the data field of the frame is longer than 8 bytes - if DLC ≥ 9.

"Position"	Sets the operator to define an exact position ("Equal") or a data range. Use "Any", if the data position is not relevant for the trigger condition.
"Data index (min)"	Defines the number of the first data byte at which the data pattern may start.
"Data index (max)"	Sets the number of the last byte at which the required data pattern may start if the "Position" operator is "In range".

Remote command:

[TRIGger<m>:CAN:FDATa:DPOperator](#) on page 1956

[TRIGger<m>:CAN:FDATa:DPOStition](#) on page 1957

[TRIGger<m>:CAN:FDATa:DPTO](#) on page 1957

Error conditions

If a CAN detects an error, it transmits an error flag at the next bit. The R&S RTO6 detects errors in the message and triggers on these errors even if no CAN node sends an error flag.

- **CRC error**
CAN uses the Cyclic Redundancy Check, which is a complex checksum calculation method. The transmitter calculates the CRC and sends the result in the CRC sequence. The receiver calculates the CRC in the same way. A CRC error occurs when the calculated result differs from the received value in the CRC sequence.
- **Bit stuffing error**
The frame segments Start Of Frame, Arbitration Field, Control Field, Data Field and CRC Sequence are coded by the bit stuffing method. The transmitter automatically inserts a complementary bit into the bit stream when it detects five consecutive bits of identical value in the bit stream to be transmitted. A stuff error occurs when the 6th consecutive equal bit level in the mentioned fields is detected.
- **Form error**
A form error occurs when a fixed-form bit field contains one or more illegal bits.
- **Ack error**
An acknowledgement error occurs when the transmitter does not receive an acknowledgment - a dominant bit during the Ack Slot.
- **Stuff count error**
A stuff count error occurs if the received stuff count value does not match the value calculated from the own stuff bit count. Only relevant for CAN FD signals in ISO standard.

Remote command:

[TRIGger<m>:CAN:CRCError](#) on page 1958

[TRIGger<m>:CAN:BITSterror](#) on page 1957

[TRIGger<m>:CAN:FORMerror](#) on page 1958

[TRIGger<m>:CAN:ACKerror](#) on page 1957

[TRIGger<m>:CAN:FDATa:SCERror](#) on page 1958

14.7.3.2 Triggering on CAN FD data

The "Identifier + Data" trigger type supports triggering on data bytes of specific value at specific location in the data field of a frame. The "Data Pattern" field provides 8 data

bytes to define the data pattern. For data fields longer than 8 byte, you can define the position where the specified pattern starts.

The following examples demonstrate how the data pattern and data position are defined.

To set up the trigger

1. Set the basic trigger events:
 - a) Select the source: "Serial bus".
 - b) Select the serial bus.
 - c) Select the protocol: "CAN/CAN FD".
 - d) Select the trigger type: "Identifier + Data".
 - e) Select the standard: "CAN FD" or "Any".
2. In this example, the identifier does not matter. Set the "ID type = Any".
3. Define the data setup as described in the examples.

Example: Triggering on the second data byte

The CAN FD frame has 2 or more data bytes, where the value of the second data byte should be E7.

- Set "DLC ≥ 2".
- Set the data pattern: "= XX E7".

Example: Triggering on the seventh or later data byte

The CAN FD frame has 12 or more data bytes, where the value of the seventh or later data byte should be 17.

- Set "DLC ≥ 9".
- Set the data pattern: "= XX XX XX XX XX XX 17 XX".

Example: Triggering on a data byte at a given position

The CAN FD frame has 12 or more data bytes. the trigger is set at the 8th data byte starting at the 4th data byte or later, with data byte value = 17.

- Set "DLC ≥ 9".
- Set the data pattern: "= XX XX XX XX XX XX XX 17".
- Set the position of the data pattern: "In range", "4" to "12".

The instrument skips the first 3 data bytes and starts comparing the data pattern with the 4th data byte. So, the byte with value 17 can be found between the 11th and the 19th data byte.

14.7.4 CAN and CAN FD decode results

When the configuration of the serial bus is complete, the signal can be decoded:

1. In the "Protocol" dialog > "Setup" tab, enable "Decode".

2. In the "Protocol" dialog > "Display" tab, select additional result display settings: "Show decode table" and "Show binary signals".

For a description of the display settings, see also [Chapter 14.1.3, "Display"](#), on page 513.

The instrument captures and decodes the signal according to the standard definition and the configuration settings.

The color-coding of the various protocol sections and errors simplifies the interpretation of the visual display. The decode information condenses or expands, depending on the horizontal scale. Various data formats are available to show the result values.

The binary results of data bytes are displayed MSB first.

For CAN protocol, the endianness setting ("Transfer") is a trigger setting and not considered for decoding.

You can also load and apply industry-standard DBC files. The symbolic names from the file are applied to the display of the decoded data, see [Chapter 14.7.6.2, "Symbolic decode waveform"](#), on page 629.

State	Frame start	Type	ID type	ID value	Label	DLC	NDB	Data	CRC	Data rate
1 Ok	-12.3 ms	Data	11 bit	64	ABSdata	3	3	[hex] D0 E7 20	35CE	49.27 kbps
2 Ok	-10.42 ms	Data	29 bit	1A54321	GearBoxInfo	5	5	[hex] 07 24 4E 7C CC	3A00	48.0 kbps
3 Ok	-7.8 ms	Remote	11 bit	1E5	EngineStatus	2	2	---	35CE	48.89 kbps
4 Ok	-6.44 ms	Data	11 bit	1E5	EngineStatus	2	2	[hex] 2B 84	45D8	49.18 kbps
5 Ok	-4.76 ms	Data	29 bit	630ABC0	NM_Gateway_PowerTrain	4	4	[hex] 18 46 51 B1	7324	49.48 kbps
6 Ok	-2.95 ms	Remote	29 bit	301C002	Ignition_Info	4	4	---	4E35	48.58 kbps
7 CRC error	-580 µs	Data	11 bit	A2	DiagResponse_Motor	4	4	[hex] 70 61 C3 CB	999	48.59 kbps
8 Ok	840 µs	Error	---	---	---	---	---	---	---	---
9 Ok	1.68 ms	Data	29 bit	1234ABC	EngineData	8	8	[hex] B5 C1 46 AE A7 29 1E 7F	62B6	48.85 kbps
10 Ok	4.344 ms	Overload	---	---	---	---	---	---	---	---

Table 14-10: Content of the Decode results table

Column	Description
State	Overall state of the frame. "Insufficient waveform length" indicates that the frame is not completely contained in the acquisition. Change the horizontal scale, or move the reference point to the left to get a longer acquisition.
Frame start	Time of frame start
Type	Frame type: Data, Remote, Error, or Overload
ID type	11-bit standard format or 29-bit extended format
ID value (hex)	Identifier value, hexadecimal value
Standard	Frame format, CAN or CAN FD.
Label	Symbolic label name defined in the label list
DLC	Data length code, coded number of data bytes
NDB	Actual number of data bytes
Data	Value of the data frame. The data format is selected below the table. Remote frames do not transmit data, therefore "- - -" is displayed.
CRC (hex)	Value of the Cyclic Redundance Check (checksum), hexadecimal value
Data rate	Reason of a form error if a form error occurred

Tools

Press "Display settings" in the "Decode Results" table to access the "Display" tab.



Remote commands

Remote commands are described in [Chapter 27.18.8.3, "Decode results"](#), on page 1958.

14.7.5 Search on decoded CAN or CAN FD data

Using the search functionality, you can find various events in the decoded data. You can find the same events that you can trigger on, and even many more, since several event types can also be combined.

Before you can start the search, you have to configure the bus correctly and acquire decoded data.

To search on decoded data, set the search source to "SerBus" for the configured protocol.

For general information on how to handle the search functionality, see [Chapter 11, "Search functions"](#), on page 425.

14.7.5.1 Search settings

Access: [Bus] > "Shortcuts" tab > "Setup search"

Search Criteria

Sets one criterion or an AND-combination of criteria to be searched for. If more than one criterion is selected, all criteria must be fulfilled by a frame for it to be shown in the search results.

If a DBC label list file is applied, an additional criterion "Symbolic" is provided, see [Chapter 14.7.6.3, "Symbolic search"](#), on page 630.

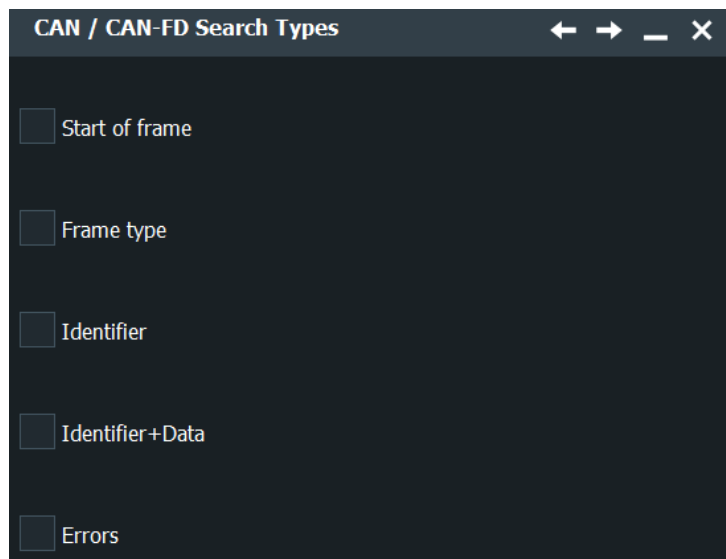

- "Start of frame" Searches for the first edge of the dominant SOF bit (synchronization bit).
- "Frame type" Searches for a specified frame type (data, remote, error, or overload). For data and remote frames, also the identifier format is considered.
For details, see:
- ["Frame type"](#) on page 625
 - ["ID type"](#) on page 625
- "Identifier" Searches for a specific message identifier or an identifier range. See ["Identifier setup: Condition, Identifier min, Identifier max"](#) on page 625.
- "Identifier + Data" Searches for a combination of identifier and data condition. The instrument triggers at the end of the last byte of the specified data pattern.
The identifier conditions are the same as for the "Identifier" search criteria, see ["Identifier setup: Condition, Identifier min, Identifier max"](#) on page 625. Data conditions are set with ["Data setup: DLC, NDB, Condition, Data min, Data max"](#) on page 626.
- "Error condition" Identifies various errors in the frame, see ["Error conditions"](#) on page 620.
- "Symbolic" The "Symbolic" search criteria is available if a DBC label list file is loaded and applied. It allows you to search for specific data messages, or a signal and its value that appears inside the message. Symbolic search is an alternative to the other search criteria, you can either search for symbolic values or for an AND-combination of the other 5 criteria.
For details, see [Chapter 14.7.6.3, "Symbolic search"](#), on page 630.

Remote command:

[SEARCH:TRIGGER:CAN\[:SSOFrame\]](#) on page 1968

[SEARCH:TRIGGER:CAN:SFTYPE](#) on page 1968

[SEARCH:TRIGGER:CAN:SFIDentifier](#) on page 1968

[SEARCH:TRIGGER:CAN:SIDData](#) on page 1969

[SEARCH:TRIGGER:CAN:SERRor](#) on page 1969

[SEARCH:TRIGGER:CAN:SSYMBOLic](#) on page 1986

Standard

Selects the CAN standard: "CAN", "CAN FD", or "Any". Use "Any" to search for both CAN and CAN-FD frames. In this case, the search configuration provides all possible settings, for CAN as well as for CAN FD.

Remote command:

[SEARCH:TRIGGER:CAN:FDATA:STANDARD](#) on page 1969

Frame type

Selects the frame type.

Remote frames are only available in the CAN protocol.

The frame types are the same as in the CAN trigger setup, see ["Frame type"](#) on page 617.

Remote command:

[SEARCH:TRIGGER:CAN:FTYPE](#) on page 1970

ID type

Selects the length of the identifier.

"11 bit" Identifier length of the CAN base frame format. The instrument triggers on the sample point of the IDE bit.

"29 bit" Identifier length of the CAN extended frame format. The instrument triggers on the sample point of the RTR bit.

"Any" The ID type is not relevant. If the trigger type is "Identifier + Data", set the "ID type" to "Any" if you want to search only for data.

Remote command:

[SEARCH:TRIGGER:CAN:ITYPE](#) on page 1970

Identifier setup: Condition, Identifier min, Identifier max

The identifier setup consists mainly of the condition and one or two identifier patterns. Additionally, ID type and frame type may qualify the identifier.

The identifier setup settings are the same as in the CAN trigger setup, see ["Identifier setup: Condition, Identifier min, Identifier max"](#) on page 618.

FD bits: see ["FD bits"](#) on page 626.

Remote command:

[SEARCH:TRIGGER:CAN:ICONdition](#) on page 1970

[SEARCH:TRIGGER:CAN:IMIN](#) on page 1971

[SEARCH:TRIGGER:CAN:IMAX](#) on page 1971

FD bits

For standard settings "CAN FD" and "Any", you can search for CAN FD-specific bits.

For details, see ["FD bits"](#) on page 618.

Remote command:

[SEARCH:TRIGGER:CAN:FDATA\[:FDF\]](#) on page 1976

[SEARCH:TRIGGER:CAN:FDATA:BRS](#) on page 1976

[SEARCH:TRIGGER:CAN:FDATA:ESI](#) on page 1977

Data setup: DLC, NDB, Condition, Data min, Data max

The data setup consists of the number of bytes, the condition, and one or two data patterns.

The data setup settings are the same as in the CAN trigger setup, see ["Data setup: DLC, NDB, Transfer, Condition, Data min, Data max"](#) on page 618.

The data condition setting is also used for symbolic signal search, see [Chapter 14.7.6.3, "Symbolic search"](#), on page 630.

Remote command:

[SEARCH:TRIGGER:CAN:DCondition](#) on page 1971

[SEARCH:TRIGGER:CAN:DMIN](#) on page 1972

[SEARCH:TRIGGER:CAN:DMAX](#) on page 1972

[SEARCH:TRIGGER:CAN:DLCondition](#) on page 1972

[SEARCH:TRIGGER:CAN:DLC](#) on page 1973

[SEARCH:RESULT:CAN:FRAME<m>:NBYTES?](#) on page 1973

Data position

The data position sets the location in the data field where the instrument looks for the specified data pattern. The position can be defined if the data field of the frame is longer than 8 bytes - if DLC \geq 9.

For details, see ["Data position"](#) on page 619.

Remote command:

[SEARCH:TRIGGER:CAN:FDATA:DPOperator](#) on page 1973

[SEARCH:TRIGGER:CAN:FDATA:DPOSITION](#) on page 1974

[SEARCH:TRIGGER:CAN:FDATA:DPTO](#) on page 1974

Error Condition

Selects the error type to be searched for. You can select one or more error types as search condition.

The error types are the same as in the CAN trigger setup, see ["Error conditions"](#) on page 620.

Remote command:

[SEARCH:TRIGGER:CAN:CRCErrror](#) on page 1975

[SEARCH:TRIGGER:CAN:BITSErrror](#) on page 1975

[SEARCH:TRIGGER:CAN:FORMErrror](#) on page 1975

[SEARCH:TRIGGER:CAN:ACKErrror](#) on page 1974

[SEARCH:TRIGGER:CAN:FDATA:SCERRror](#) on page 1976

14.7.5.2 Search results

To get search results, "Enable" the search. You can minimize, shift or close the search dialog.

The search results are listed in the search result table and marked in the waveform by blue lines.

For an introduction to search results, see:

- [Chapter 11.1.2, "Search results"](#), on page 426
- [Chapter 11.4.2, "Display zoom settings"](#), on page 446

Remote commands are listed in [Chapter 27.18.8.5, "Search results"](#), on page 1977.

14.7.5.3 Searching CAN FD data

The "Identifier + Data" search supports the search for data bytes of specific value at a specific location in the data field of a frame. The "Data Pattern" field provides 8 data bytes to define the pattern. For data fields longer than 8 byte, you can define the position where the specified pattern starts.

The following example demonstrates how the data pattern and data position is defined.

To set up the search

1. Set the "Source", the signal to be searched: "SerBus". Select the bus that is configured for CAN FD.
2. Set the search criteria:
 - a) Select the standard: "CAN FD".
 - b) Select the search type: "Identifier + Data".
3. In this example, the identifier does not matter. Set the "ID type = Any".
4. Define the data setup as described in the example.

Example: Searching for a specific byte anywhere in the frame

The CAN FD frame has 8 or more data bytes, containing at least one data byte with value = CB anywhere in the data field.

- Set "DLC ≥ 8".
- Set the data pattern: "= CB".

14.7.6 Symbolic trigger, decode and search

The R&S RTO6 can read and apply industry-standard DBC files to the decoded signal and provides settings for symbolic triggering and symbolic search.

For a description of DBC files, see [Chapter 14.7.2.3, "Display settings"](#), on page 612.

14.7.6.1 Symbolic trigger

The "Symbolic" trigger type is available if a DBC label list file is loaded and applied. It allows you to trigger on a specific data message, or a signal and its value that appears inside the message.

Access:

1. Press [Bus].
2. In the "Setup" tab, set "Protocol = CAN/ CAN-FD".
3. In the "Shortcuts" tab, select "Setup trigger".
4. In the trigger dialog, set the "Type" = "Symbolic".

The "Frame type" is automatically set to "Data", and the "Identifier" is shown for information.

Specific settings for the symbolic trigger are:

Message.....	628
Signal trigger.....	629
Signal.....	629
Condition.....	629
Value, Value min.....	629
Value max.....	629

Message

Sets the message to be triggered or searched for.

The setting is used by symbolic trigger and symbolic search. Thus, you always trigger on and search for the same message if symbolic trigger and symbolic search is used at the same time.

Remote command:

[TRIGger<m>:CAN:SYMBOLic:MSGValue](#) on page 1983

Signal trigger

Enables the trigger on a specific signal value that is part of the selected message.

Remote command:

[TRIGger<m>:CAN:SYMBOLic:TSIGNALs](#) on page 1984

Signal

Sets the signal name to be triggered or searched for.

The setting is used by symbolic trigger and symbolic search. Thus, you always trigger on and search for the same signal if symbolic trigger and symbolic search is used at the same time.

Remote command:

[TRIGger<m>:CAN:SYMBOLic:SIGValue](#) on page 1984

Condition

Sets the operator to set a specific data pattern or symbolic value ("Equal" or "Not equal") or a data range.

Remote command:

[TRIGger<m>:CAN:DCONDITION](#) on page 1954

Value, Value min

Defines the data pattern or selects a symbolic data value.

Remote command:

[TRIGger<m>:CAN:SYMBOLic:DMIN](#) on page 1984

[TRIGger<m>:CAN:SYMBOLic:SGEValue](#) on page 1985

Value max

The second data pattern is required to specify a range with conditions "In range" and "Out of range".

Remote command:

[TRIGger<m>:CAN:SYMBOLic:DMAX](#) on page 1984

14.7.6.2 Symbolic decode waveform

If a DBC file is applied, the symbolic names from the file are applied to the display of the decoded data. The result table lists the signal values and units in the "Symbolic Data" column, and the comb display shows the signal names in addition to the signal values and units.

Remote command:

- [BUS<m>:CAN:FRAME<n>:SDATa?](#) on page 1985

- [BUS<m>:CAN:FRAMe<n>:SDEXport?](#) on page 1966

14.7.6.3 Symbolic search

Access:

1. Press [Bus].
2. In the "Setup" tab, set "Protocol = CAN/ CAN-FD".
3. In the "Shortcuts" tab, select "Setup search".
4. In the search dialog, set the "Type" = "Symbolic".

If a DBC file is applied, the symbolic search for messages and signal, which are defined in the DBC file, is available. Symbolic search is an alternative to the other search criteria, you can either search for symbolic values or for an AND-combination of the other 5 criteria.

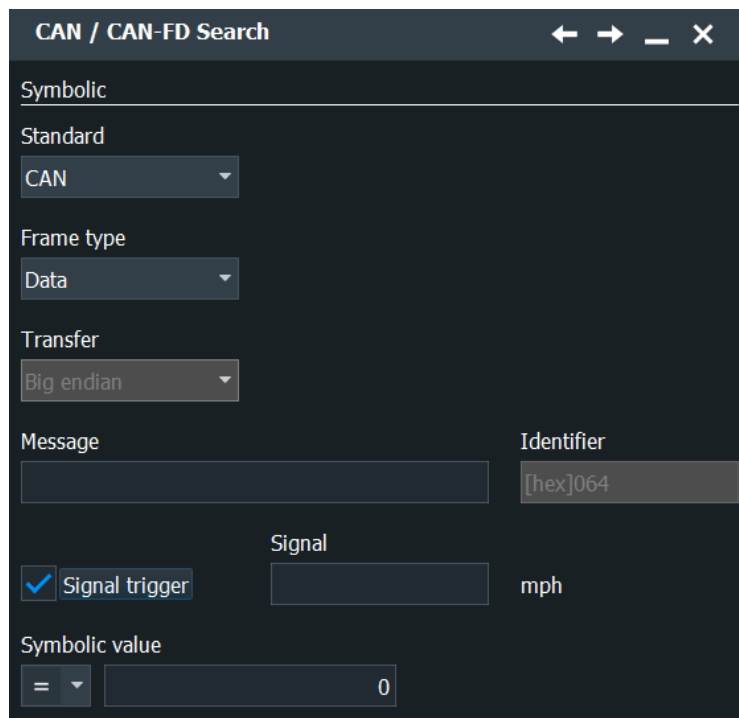

If symbolic search is active, the "Frame type" is automatically set to "Data", and the "Identifier" is shown for information.

Symbolic

Enables the symbolic search and disables all other search criteria.

Remote command:

[SEARCh:TRIGger:CAN:SSYMBOLic](#) on page 1986

Message

Sets the message to be triggered or searched for.

The setting is used by symbolic trigger and symbolic search. Thus, you always trigger on and search for the same message if symbolic trigger and symbolic search is used at the same time.

Remote command:

[SEARCh:TRIGger:CAN:SYMBolic:MSGValue](#) on page 1986

Search signals

Enables the search for a specific signal value that is part of the selected message.

Remote command:

[SEARCh:TRIGger:CAN:SYMBolic:SSIGnals](#) on page 1987

Signal

Sets the signal name to be triggered or searched for.

The setting is used by symbolic trigger and symbolic search. Thus, you always trigger on and search for the same signal if symbolic trigger and symbolic search is used at the same time.

Remote command:

[SEARCh:TRIGger:CAN:SYMBolic:SIGValue](#) on page 1987

Condition

Sets the operator to set a specific data pattern or symbolic value ("Equal" or "Not equal") or a data range.

This condition is also used to search for data, see "[Data setup: DLC, NDB, Condition, Data min, Data max](#)" on page 626.

Remote command:

[SEARCh:TRIGger:CAN:DCONDition](#) on page 1971

Value, Value (min)

Defines the data pattern or selects a symbolic data value.

Remote command:

[SEARCh:TRIGger:CAN:SYMBolic:DMIN](#) on page 1987

[SEARCh:TRIGger:CAN:SYMBolic:SGEValue](#) on page 1988

Value (max)

The second data pattern is required to specify a range with conditions "In range" and "Out of range".

Remote command:

[SEARCh:TRIGger:CAN:SYMBolic:DMAX](#) on page 1988

14.7.6.4 Symbolic search results

If a DBC file is applied, you can search for symbolic messages and signals as described in [Chapter 14.7.6.3, "Symbolic search"](#), on page 630. As usual, the search results

are shown in a table. You can enable the search zoom window to view the frame with the selected result in more detail.

The figure shows the result of a search for an "EngineData" message and the signal "IdleRunning = Running" inside the message. The result marker (blue line) is set to the start of the frame that fulfills the search condition. The search zoom window Search1 is active. It has been moved to the right until the "IdleRunning" bit with value 0 is visible in the zoom.

Remote command:

- `SEARCH:RESult:CAN:FRAMe<m>:SDATa?` on page 1986

14.8 LIN (option R&S RTO6-K520)

The Local Interconnect Network (LIN) is a simple, low-cost bus system used within automotive network architectures. LIN is usually a subnetwork of a CAN bus. The primary purpose of LIN is the integration of uncritical sensors and actuators with low-bandwidth requirements. Common applications in a motor vehicle are the control of doors, windows, wing mirrors, and wipers.

14.8.1 The LIN protocol

This chapter provides an overview of protocol characteristics, frame format, identifiers and trigger possibilities. For detailed information, order the LIN specification on <http://www.lin-subbus.org/> (free of charge).

LIN characteristics

The main characteristics of LIN are:

- Single-wire serial communications protocol, based on the UART byte-word interface
- Single primary, multiple secondaries - usually up to 12 nodes
- Primary-controlled communication: primary coordinates communication with the LIN schedule and sends the identifier to the secondaries
- Synchronization mechanism for clock recovery by secondary nodes without crystal or ceramic resonator

The R&S RTO6 supports several versions of the LIN standard: v1.3, v2.0, v2.1 and the American SAE J2602.

Data transfer

Basic communication concept of LIN:

- Communication in an active LIN network is always initiated by the primary.
- The primary sends a message header including the synchronization break, the synchronization byte, and the message identifier.

- The identified node sends the message response: one to eight data bytes and one checksum byte.
- Header and response form the message frame.

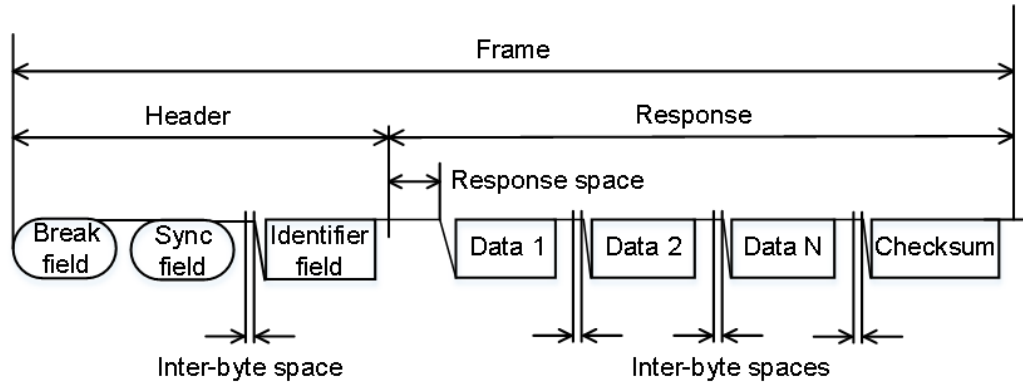

Figure 14-15: LIN frame with header and response

The data is transmitted in bytes using the UART byte-word interface without the parity bit. Each byte consists of a start bit, 8 bits and a stop bit.

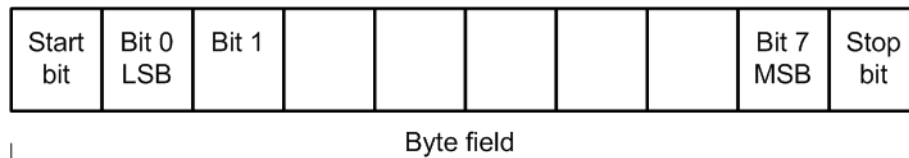

Figure 14-16: Structure of a byte field

Data bytes are transmitted with LSB first.

The identifier byte consists of 6 bits for the frame identifier and two parity bits. This combination is known as protected identifier.

Trigger

The R&S RTO6 can trigger on various parts of LIN frames. The data line must be connected to an input channel, triggering on math and reference waveforms is not possible.

You can trigger on:

- Frame start (synchronization field)
- Specific identifier or identifier range
- Data pattern in the message
- Wake-up signal
- Checksum error (error in data), parity error (error in identifier)

14.8.2 LIN configuration

14.8.2.1 LIN configuration settings

Access: [Bus] > "LIN" > "Setup" tab



Make sure that the tab of the correct serial bus is selected.

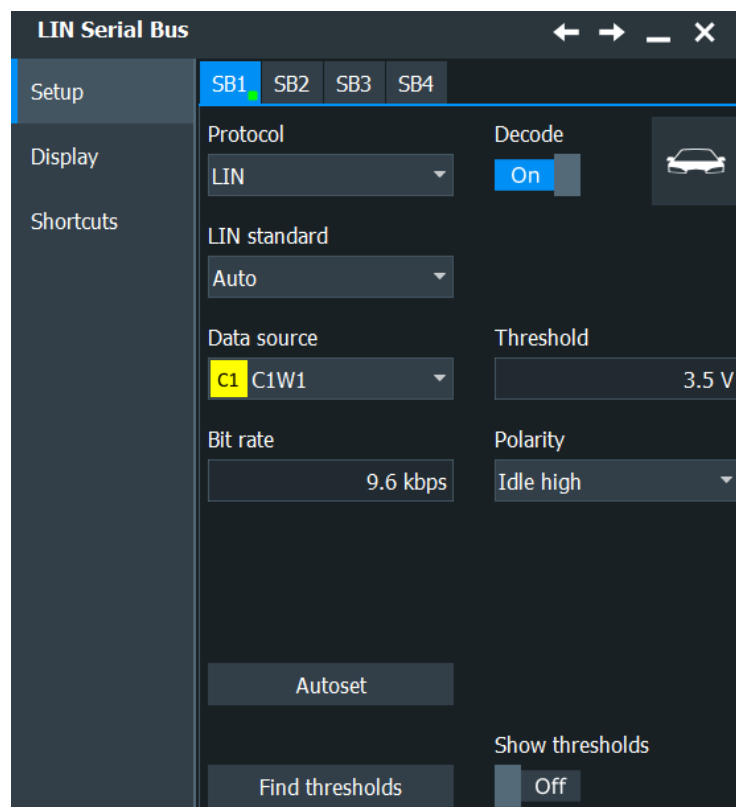

See also: [Chapter 14.1.1, "Setup - general settings"](#), on page 511

LIN standard

Selects the version of the LIN standard that is used in the DUT. The setting mainly defines the checksum version used during decoding.

The most common version is LIN 2.x. For mixed networks, or if the standard is unknown, set the LIN standard to "Auto".

Remote command:

[BUS<m>:LIN:STANdard](#) on page 1990

Data

Sets the source waveform of the data line.

Usually, the source is one of the analog channels. Reference and math waveforms are available as source if the trigger source is one of the analog channels but not the serial bus.

Alternatively, digital channels can be used if MSO option R&S RTO6-B1 is installed. Digital and analog channels cannot be used at the same time.

For triggering on a serial bus, analog or digital channel sources are required.

Remote command:

[BUS<m>:LIN:DATA:SOURce](#) on page 1989

Threshold

Sets the threshold value for digitization of the signal. If the signal value on the line is higher than the threshold, the signal state is high. Otherwise, the signal state is considered low if the signal value is below the threshold. The interpretation of HIGH and LOW is defined by the [Polarity](#).

There are several ways to set the threshold:

- "Threshold"
Enter the value directly in the field.
- "Autoset"
Starts software algorithms for determining the signal threshold levels and bitrate.
- "Find thresholds"
Executes the measurement of reference levels and sets the thresholds to the middle reference level of the measured amplitude.

Note: If the sources are digital channels, the same threshold values are used for the parallel and the serial buses. You can set the thresholds either in the parallel bus configuration or in the serial bus configuration.

Remote command:

[BUS<m>:LIN:DATA:THReshold](#) on page 1989

[BUS<m>:LIN:TECHnology](#) on page 1989

[BUS<m>:SETReflevels](#) on page 1814

[BUS<m>:FAUToset](#) on page 1814

Bit rate

Sets the number of transmitted bits per second. The maximum bit rate for LIN is 20 kbit/s.

To select a bit rate from list of predefined values, tap the icon beside the "Bit rate" field. To enter a specific value, open the keypad. The list of predefined values is also available in the keypad.

If the "LIN standard" is "J2602", the bit rate is 10.417 kbit/s and cannot be changed.

Remote command:

[BUS<m>:LIN:BITRate](#) on page 1990

Polarity

Defines the idle state of the bus. The idle state is the recessive state and corresponds to a logic 1.

Remote command:

[BUS<m>:LIN:POLarity](#) on page 1990

Show thresholds

If enabled, the threshold levels are displayed in the diagram.

Remote command:

`BUS<m>:THReshold` on page 1815

14.8.2.2 LIN display

Access: [Bus] > "Display" tab.

For common display settings, see [Chapter 14.1.3, "Display"](#), on page 513.

LIN Specific Label Settings

Label lists are protocol-specific. Label lists for LIN are available in CSV and PTT format.

You can also apply an existing LIN description file.

A LIN label file contains two values for each identifier:

- Identifier value
- Symbolic name for the identifier

Example of a LIN PTT file

```
# -----
@FILE_VERSION = 1.0
@PROTOCOL_NAME = lin
# -----
# Labels for LIN protocol
#   Column order: Identifier, Label
# -----
# Labels for standard addresses
0x3F, Temperature
1Ch, Left brake
20h, Right brake
# Following ID is provided as integer
33, Mirror
0x37, Indoor lights
# Labels for reserved addresses
0x3C, Master_Request_Frame
0x3D, Slave_Response_Frame
# -----
```

The LIN description file (ldf) contains information about the assignment of the LIN frames to the nodes. The format and syntax are defined in the LIN specification.

A LIN ldf file contains the following sections:

- Header
- Node section
- Signal section
- Frame section

- Schedule table
- Signal encoding section
- Encoding to signal mapping

Example of a LIN LDF file

```

LIN_description_file;
LIN_protocol_version = "2.0";
LIN_language_version = "2.0";
LIN_speed = 19.2 kbps;

Nodes {
    Master: Master1, 10 ms, 0.1 ms;
    Slaves: Slave_Motor, Slave_Sensor;
}

Signals {
    Sensor1:1,0x0,Slave_Sensor, Master1;
    Temperature1:12,0,Slave_Sensor, Master1;
}

Frames {
    Sensor_Frame: {Error,30;
                  Temperature, 20;
                  Status, 0;}
    Master_Frame: {Error,15;
                  Speed, 10;}
}

Schedule_tables {
    Sensor_Frame delay 10.000 ms;
    Master_Frame delay 15.000 ms;
}

Signal_encoding_types {
    Speed {logical_value, 0, "Motor_off";
          logical_value, 1, "Speed1";
          logical_value, 2, "Speed2";
          logical_value, 3, "Speed3";
    }
}

Signal_representation {
    Speed1_encoding:Speed1
    Temperature1_encoding:Temperature1
}

```

Remote commands:

- [BUS<m>:LIN:FRAME<n>:SDATa?](#) on page 1999
- [BUS<m>:LIN:FRAME<n>:SDEXport?](#) on page 2000

14.8.2.3 Configuring LIN signals

For configuration, assign the lines to the input channels, and define the active states and the logical thresholds.

For details on configuration settings, see [Chapter 14.8.2.1, "LIN configuration settings"](#), on page 634.

1. Press the [Bus] key on the front panel.
2. At the left hand-side, select the vertical tab of the bus you want to set up.
3. Select the tab of the bus you want to set up, for example "SB1".
4. Tap the "Protocol" button and select the protocol: "LIN".
5. Set the "Data source".
6. Set the logical thresholds.
7. Set the "LIN standard", "Bit rate" and "Polarity" according to your signal.
8. Enable "Decode".

14.8.3 LIN trigger

14.8.3.1 LIN trigger settings

Access: [Bus] > "Shortcuts" tab > "Setup trigger"

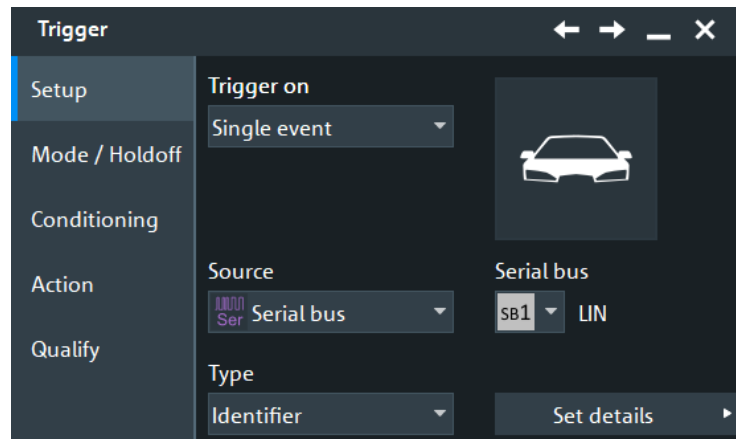



Make sure that:

- In the [Bus] > "Setup" tab:
 - The correct "Protocol" is selected.
 - The data sources of the serial bus are channel signals.
- In the "Trigger" > "Setup" tab:
 - The "Trigger on" = "Single event"
 - The trigger "Source" = "Serial bus".
 - The correct "Serial bus" is selected.

Trigger type

Selects the trigger type for LIN analysis.

"Start of frame (Sync)" Triggers on the stop bit of the sync field.

"Identifier" Sets the trigger to one specific identifier or an identifier range. Enter only the 6-bit identifier without parity bits, not the protected identifier. Description of trigger type specific settings: ["Identifier setup: Condition, Frame ID min, Frame ID max"](#) on page 640.

"Identifier OR" Sets the trigger to a combination of up to four identifiers. Description of trigger type specific settings: ["Identifier OR setup: Monitor, Frame ID"](#) on page 641

"Identifier + Data" Sets the trigger to a combination of identifier and data condition. The instrument triggers at the end of the last byte of the specified data pattern.

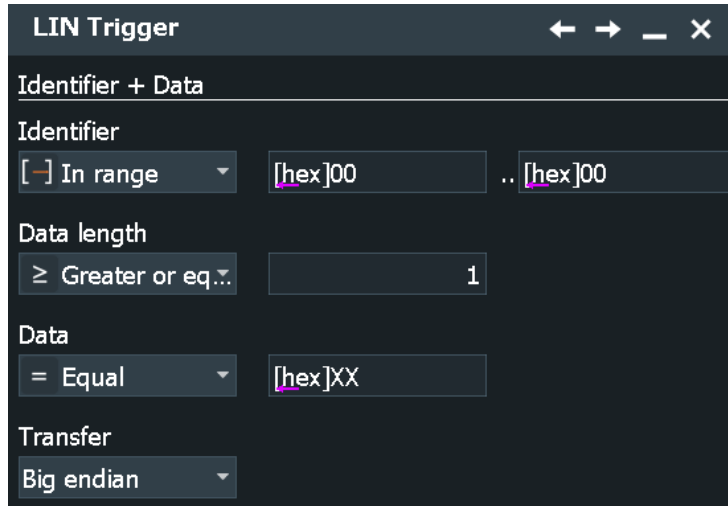

The identifier conditions are the same as for the "Identifier" trigger type, see [Identifier setup: Condition, Frame ID min, Frame ID max](#). Data conditions are set with [Data setup: Data length, Transfer, Condition, Data min, Data max](#).

"Wakeup frame" Triggers after a wakeup frame.

"Error condition" Identifies various errors in the frame, see ["Error conditions"](#) on page 642.

Remote command:

[TRIGger<m>:LIN:TYPE](#) on page 1991

Identifier setup: Condition, Frame ID min, Frame ID max

The identifier setup consists of the condition and one or two identifier pattern.

"Condition" Defines the operator to set a specific identifier ("Equal" or "Not equal") or an identifier range.

"Frame ID min / Frame ID" Defines the bit pattern of the identifier. Enter only the 6-bit identifier without parity bits, not the protected identifier.

In binary format, use the following characters: 1; 0; or X (do not care). To enter the pattern in other formats use the bit pattern editor, see [Chapter 14.1.7, "Bit pattern editor"](#), on page 519.

"Frame ID max" The second identifier pattern is required to specify a range with conditions "In range" and "Out of range".

Remote command:

[TRIGger<m>:LIN:ICONdition](#) on page 1992

[TRIGger<m>:LIN:IMIN](#) on page 1993

[TRIGger<m>:LIN:IMAX](#) on page 1993

Identifier OR setup: Monitor, Frame ID

Sets the trigger to a combination of up to four identifiers. Enter the patterns in the "Frame ID" fields. In binary and hex format, characters 1, 0, and X (do not care) are allowed. For each identifier pattern to be triggered on, enable "Monitor".

Remote command:

[TRIGger<m>:LIN:IDOR<n>:ENABle](#) on page 1995

[TRIGger<m>:LIN:IDOR<n>\[:VALue\]](#) on page 1995

Data setup: Data length, Transfer, Condition, Data min, Data max

The data setup consists of the transfer direction, the number of bytes, the condition, and one or two data patterns.

- "Transfer" Sets the byte order (endianness) of the data transfer. With "Big endian", the data is analyzed and evaluated in the order of reception. With "Little endian", the instrument reads the complete data, reverses the byte order of the data, and compares it with the specified data word.
According to the standard, LIN data is transmitted in little endian transfer order. The "Little endian" setting allows you to enter the required data word directly into "Data min", and the instrument triggers correctly.
- "Data length" Sets the length of the bit pattern to be found, in bytes.
For Big Endian transfer direction, you can trigger on a number of bytes less than the data length of the frame, that means, on the first bytes that are transmitted. For Little Endian transfer direction, the exact number of data bytes in the frame must be set.
Example: The data word to be sent is *12 34 56*, and it is sent little endian by the LIN node. With Data length ≥ 2 and Transfer = Big endian, you trigger on the data of the first two bytes, that is *56 34*. With Data length = 3 and Transfer = Little endian, you trigger on the required data word *12 34 56*.
- "Condition" Sets the operator to define a specific data pattern ("Equal" or "Not equal") or an data range.
- "Data min" Defines the data pattern. The pattern length is adjusted to the data length setting (and vice versa), maximum is 8 bytes.
Enter the pattern MSB first and with big endian byte order, and set the correct "Transfer" direction. The data is compared byte by byte. In binary format, use the following characters: 1; 0; or X (do not care). The use of X is restricted to the operators "Equal" and "Not equal".
- "Data max" The second data pattern is required to specify a range with conditions "In range" and "Out of range".

Remote command:

[TRIGger<m>:LIN:BOReR](#) on page 1994

[TRIGger<m>:LIN:DLECondition](#) on page 1994

[TRIGger<m>:LIN:DLENgth](#) on page 1995

[TRIGger<m>:LIN:DCONdition](#) on page 1993

[TRIGger<m>:LIN:DMIN](#) on page 1993

[TRIGger<m>:LIN:DMAX](#) on page 1994

Error conditions

Triggers if one or more of the following errors occur:

- Checksum error
The checksum verifies the correct data transmission. It is the last byte of the frame response. The checksum includes not only the data but also the protected identifier (PID). To identify checksum errors caused by data, additional settings are required: Enter the bit pattern of the identifier ("Frame ID"), the number of data bytes ("Data length"), and select the used "LIN standard".
See also: [LIN standard](#).
- Identifier parity error
Parity bits are the bits 6 and 7 of the identifier. They verify the correct transmission of the identifier.
- Sync error
Synchronization error

Remote command:

[TRIGger<m>:LIN:CHKSError](#) on page 1996

[TRIGger<m>:LIN:ERRPattern](#) on page 1996

[TRIGger<m>:LIN:CRCDatalen](#) on page 1997

[TRIGger<m>:LIN:STANdard](#) on page 1997

[TRIGger<m>:LIN:IPERror](#) on page 1996

[TRIGger<m>:LIN:SYERror](#) on page 1996

14.8.3.2 Triggering on LIN signals

Prerequisites: An LIN bus is configured, see [Chapter 14.2.2.3, "Configuring I²C protocol"](#), on page 525.

1. Press the [Bus] key and select the "Shortcuts" tab.
2. Press "Setup trigger".
3. Tap the "Source" button and select the "Serial bus" trigger source.
4. Select the serial bus that is set to LIN.
5. Select the "Trigger type".
6. For more complex trigger types, enter the address and/or data conditions: address, identifier, frame ID.
For details, see [Chapter 14.8.3.1, "LIN trigger settings"](#), on page 638.

14.8.4 LIN decode results

When the configuration of the serial bus is complete, the signal can be decoded:

1. In the "Protocol" dialog > "Setup" tab, enable "Decode".
2. In the "Protocol" dialog > "Display" tab, select additional result display settings: "Show decode table" and "Show binary signals".

For a description of the display settings, see also [Chapter 14.1.3, "Display"](#), on page 513.

The instrument captures and decodes the signal according to the standard definition and the configuration settings.

The color-coding of the various protocol sections and errors simplifies the interpretation of the visual display. The decode information condenses or expands, depending on the horizontal scale. Various data formats are available to show the result values.

Decode Results Table

The results are shown in two tables:

- "Decode results": contains information about all decoded frames
- "Details frame": contains more detailed information about the selected frame in the "Decode results" table.

The endianness setting ("Transfer") is a trigger setting and not considered for decoding. The binary results of data bytes are displayed MSB first.

The screenshot shows a software interface with two tables. The left table, titled 'LIN Decode Results SBI x', has columns: State, Frame start, Sync state, Identifier, PID, Checksum, and Bit rate. It lists 10 frames, with frame 3 highlighted in blue. The right table, titled 'Details frame 3', has columns: State and Value, and lists 8 data bytes with their states and hex values. To the right of the details table is a label list for 'Label: HV_Hs_01' with various error codes and their descriptions.

Table 14-11: Content of the Decode results table

Column	Description
State	Overall state of the frame.
Frame start	Time of frame start
Sync state	Result of synchronization
Identifier	Identifier value
Label	Symbolic label name defined in the label list
PID	Protected identifier
Values	Value of the data bytes. The data format is selected below the table.
Checksum	Checksum value
Bit rate	Value of the bit rate

Table 14-12: Content of the Details frame table

Column	Description
State	State of the field
Value	Value of the field
Label	Symbolic label name defined in the label list

Tools

Press "Display settings" in the "Decode Results" table to access the "Display" tab.



Remote commands

Remote commands are described in [Chapter 27.18.9.3, "Decode results"](#), on page 1998.

14.8.5 Search on decoded LIN data

Using the search functionality, you can find various events in the decoded data, the same events which you also can trigger on. Before you can start the search, you have to configure the bus correctly and acquire decoded data.

To search on decoded data, set the search "Source" to the serial bus that is configured for the protocol to be analyzed.

See also [Chapter 11, "Search functions"](#), on page 425.

14.8.5.1 LIN search setup

Access: [Bus] > "Shortcuts" tab > "Setup search"

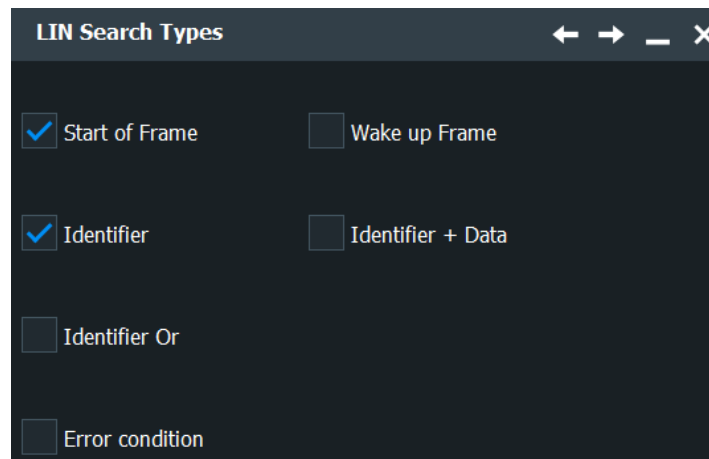

Search types

Sets the type to be searched for.

"Start of frame (Sync)" Searches for the stop bit of the sync field.

"Identifier" Searches for one specific identifier or an identifier range. See ["Identifier setup: Condition, Frame ID min, Frame ID max"](#) on page 645

"Identifier OR" Searches for a combination of up to four identifiers. See ["Identifier OR setup: Monitor, Frame ID"](#) on page 645

"Identifier + Data"	<p>Searches for a combination of identifier and data condition. The instrument triggers at the end of the last byte of the specified data pattern.</p> <p>The identifier conditions are the same as for the "Identifier" trigger type, see "Identifier setup: Condition, Frame ID min, Frame ID max" on page 640.</p> <p>Data conditions are set with "Data setup: Data length, Transfer, Condition, Data min, Data max" on page 641.</p>
"Wakeup frame"	Searches for wakeup frames.
"Error condition"	Identifies various errors in the frame, see "Error conditions" on page 642.

Remote command:

[SEARCH:TRIGger:LIN:SSOFrame](#) on page 2005

[SEARCH:TRIGger:LIN:SFIDentifier](#) on page 2006

[SEARCH:TRIGger:LIN:IDENtifieror](#) on page 2006

[SEARCH:TRIGger:LIN:SIDData](#) on page 2006

[SEARCH:TRIGger:LIN:WUFRame](#) on page 2007

[SEARCH:TRIGger:LIN:SERRor](#) on page 2006

Identifier setup: Condition, Frame ID min, Frame ID max

The identifier setup consists of the condition and one or two frame ID patterns.

The identifier setup settings are the same as in the LIN trigger setup, see ["Identifier setup: Condition, Frame ID min, Frame ID max"](#) on page 640.

Remote command:

[SEARCH:TRIGger:LIN:ICONdition](#) on page 2007

[SEARCH:TRIGger:LIN:IMIN](#) on page 2007

[SEARCH:TRIGger:LIN:IMAX](#) on page 2008

Data setup: Condition, Data min, Data max, Data length, Transfer

The data setup consists of the transfer direction, the data length, the condition, and one or two data patterns.

The data setup settings are the same as in the LIN trigger setup, see ["Data setup: Data length, Transfer, Condition, Data min, Data max"](#) on page 641.

Remote command:

[SEARCH:TRIGger:LIN:DCONdition](#) on page 2009

[SEARCH:TRIGger:LIN:DMIN](#) on page 2009

[SEARCH:TRIGger:LIN:DMAX](#) on page 2009

[SEARCH:TRIGger:LIN:DLECondition](#) on page 2010

[SEARCH:TRIGger:LIN:DLENgth](#) on page 2011

[SEARCH:TRIGger:LIN:BORDER](#) on page 2010

Identifier OR setup: Monitor, Frame ID

The identifier OR setup consists of the monitor and frame ID.

The identifier OR setup settings are the same as in the LIN trigger setup, see ["Identifier OR setup: Monitor, Frame ID"](#) on page 641

Remote command:

[SEARCH:TRIGger:LIN:IDOR<m>:ENABle](#) on page 2008

[SEARCH:TRIGger:LIN:IDOR<m>\[:VALue\]](#) on page 2008

Error Condition

Selects the error type to be searched for. You can select one or more error types as search condition.

The error types are the same as in the LIN trigger setup, see ["Error conditions"](#) on page 642.

Remote command:

[SEARCH:TRIGger:LIN:IPERror](#) on page 2011

[SEARCH:TRIGger:LIN:SYERror](#) on page 2011

[SEARCH:TRIGger:LIN:CHKSError](#) on page 2012

[SEARCH:TRIGger:LIN:ERRPattern](#) on page 2012

[SEARCH:TRIGger:LIN:CRCDatalen](#) on page 2012

[SEARCH:TRIGger:LIN:STANdard](#) on page 2013

14.8.5.2 LIN search results

To get search results, "Enable" the search. You can minimize, shift or close the search dialog.

The search results are listed in the search result table and marked in the waveform by blue lines.

For an introduction to search results, see:

- [Chapter 11.1.2, "Search results"](#), on page 426
- [Chapter 11.4.2, "Display zoom settings"](#), on page 446

Remote commands are listed in [Chapter 27.18.9.5, "LIN search results"](#), on page 2013.

14.9 FlexRay (option R&S RTO6-K520)

FlexRay is designed for use in safety-related distributed applications in the automotive industry. It is applied in real-time applications when higher data rates and reliable communication are required. In particular, FlexRay supports x-by-wire applications, for example, steer-by-wire or brake-by-wire.

14.9.1 FlexRay configuration

14.9.1.1 FlexRay configuration

Access: [Bus] > "Setup" tab > "Protocol" = *FlexRay*



Make sure that the tab of the correct serial bus is selected.

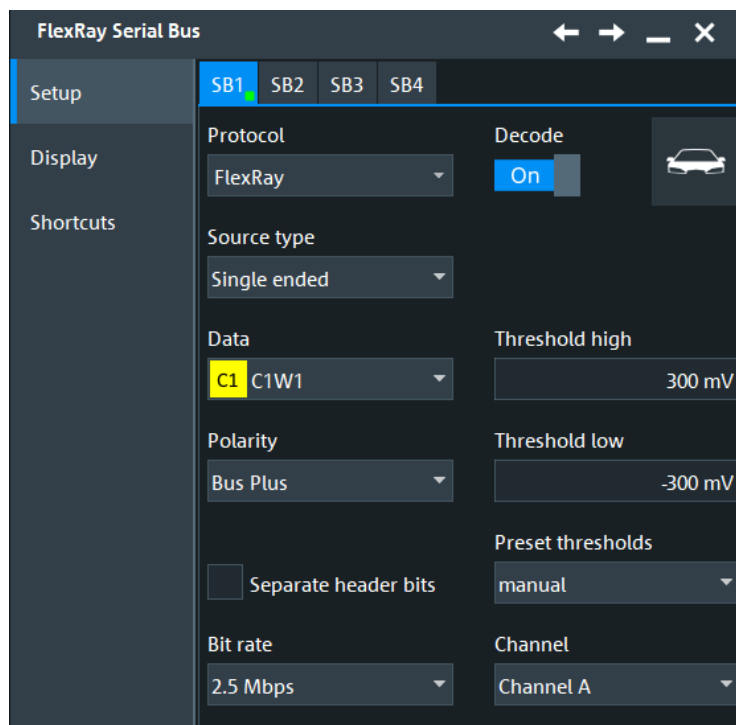

See also: [Chapter 14.1.1, "Setup - general settings"](#), on page 511

Source type

Sets the type of measurement. The instrument adjusts the thresholds to the selected source type.

- "Single-ended" For measurements with single-ended probes, or single-ended voltage measurements with differential probes on the FlexRay bus. Two thresholds have to be defined as absolute voltage levels.
- "Differential" For differential measurements on the FlexRay bus. This is the most common measurement. Two thresholds have to be defined as differential voltages.
- "Logic" For measurements of logic signals, for example, of the logic signal inside the FlexRay node, between the communication controller and the bus driver. If MSO option R&S RTO6-B1 is installed, you can use digital input channels. It is possible to measure simultaneously on a data line and on the enable line. Each line requires its own threshold.

Remote command:

`BUS<m>:FLXRay:SRCType` on page 2019

Data

Sets the input channel of the bus signal, or of the data line for a "Logic" source type. Usually, the source is one of the analog channels. Reference and math waveforms are only available if the trigger source is one of the input channels but not the serial bus.

If the source type is "Logic", digital channels can be used (MSO option R&S RTO6-B1 is required). Digital and analog channels cannot be used at the same time in a bus.

Remote command:

[BUS<m>:FLXRay:SOURce<n>](#) on page 2020

Enable

Sets the input channel of the enable line if there is a "Logic" source type. The enable line transfers the control signal of the bus guardian to the bus driver. None, or one of the analog channels can be used. Reference and math waveforms are only available if the trigger source is one of the input channels but not the serial bus.

Alternatively to analog channels, digital channels can be used if MSO option R&S RTO6-B1 is installed. Digital and analog channels cannot be used at the same time in a bus.

Remote command:

[BUS<m>:FLXRay:SOURce<n>](#) on page 2020

Thresholds

Threshold values are used for digitization of the signal.

For measurements on a FlexRay bus, two thresholds are required to distinguish the three possible states of the signal - high, low and idle. If the signal value on the line is higher than the upper threshold, the signal state is high. Otherwise, the signal state is considered low if the signal value is below the lower threshold. If the value is between the threshold, the signal is in idle state.

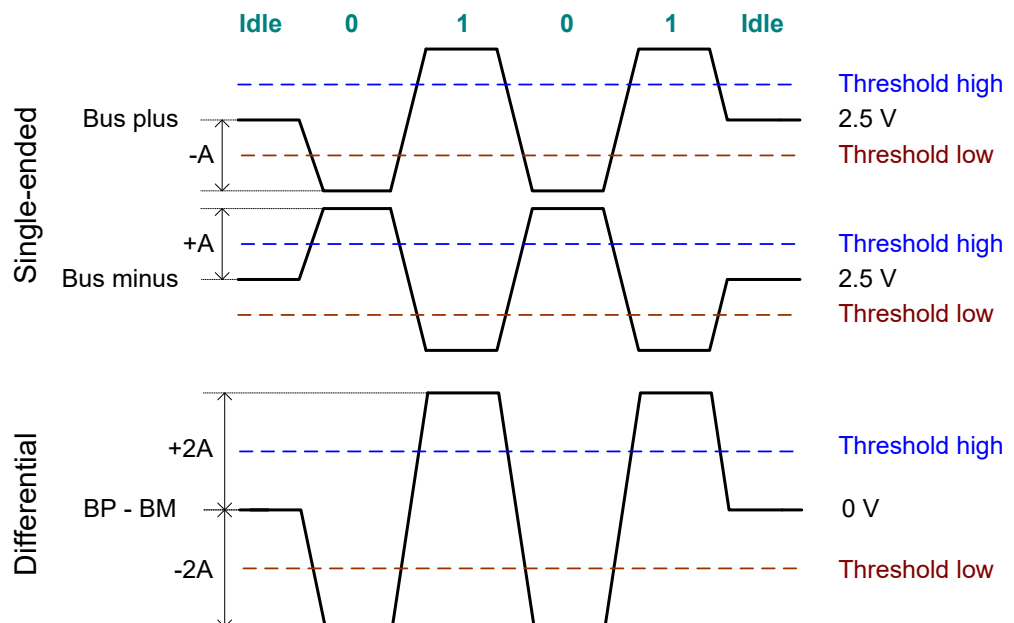

For measurements inside the FlexRay node (with "Source type" = "Logic"), each line requires its threshold level.

There are two ways to set the thresholds: selection of a predefined value, or direct entry of a value.

- "Preset thresholds"

Selects default threshold voltages from a list. The predefined values depend on the selected source type. The value is set to "Manual" if at least one threshold was entered directly.

- "Threshold high" and "Threshold low"
Upper and lower levels for single-ended or differential source types. You can enter the values directly in the fields.
- "Threshold data" and "Threshold enable"
Levels for data and enable line if there is logic source type. You can enter the values directly in the fields.

Note: If the sources are digital channels, the same threshold values are used for the parallel and the serial buses. You can set the thresholds either in the parallel bus configuration or in the serial bus configuration.

Remote command:

[BUS<m>:FLXRay:PRSingle](#) on page 2021

[BUS<m>:FLXRay:PRDiff](#) on page 2022

[BUS<m>:FLXRay:PRLogic](#) on page 2022

[BUS<m>:FLXRay:THReshold<n>](#) on page 2020

[BUS<m>:FLXRay:THData](#) on page 2021

[BUS<m>:FLXRay:THENable](#) on page 2021

[BUS<m>:SETRefllevels](#) on page 1814

Polarity

Selects the wire on which the bus signal is measured if there is "Single-ended" measurement: "Bus plus" or "Bus minus". The setting affects the digitization of the signal.

Remote command:

[BUS<m>:FLXRay:POLarity](#) on page 2022

Bit rate

Selects the number of transmitted bits per second from a list.

Remote command:

[BUS<m>:FLXRay:BITRate](#) on page 2023

Channel

Selects the FlexRay channel on which the signal is measured, either channel A or channel B. The setting is considered in the calculation of the frame CRC.

Remote command:

[BUS<m>:FLXRay:CHTYpe](#) on page 2023

Separate header bits

The setting affects the decoding and its display. If enabled, the leading five indicator bits of the header are decoded as five single bits. Otherwise, the indicator bits are shown as one word with word length 5 bits.

Remote command:

[BUS<m>:FLXRay:SEHB](#) on page 2023

14.9.1.2 Display settings

Access: [Bus] > "Display" tab.

For common display settings, see [Chapter 14.1.3, "Display"](#), on page 513.

FlexRay Specific Label Settings

Label lists are protocol-specific. A FlexRay label file contains four values for each identifier:

- "ID / Addr": number of the slot in which the frame is transmitted
- "Base cycle" and "Repetition": define the cycle indexes for which the identifier applies. Base cycle defines the first applied cycle. There are 64 cycles in a FlexRay communication. The same identifier can be shared by different devices, and each device uses the identifier at different cycles. For example:
 0x0AB,0,2,Ignition_Info: uses cycles 0,2,4,6,...,62
 0x0AB,1,2,GearBoxInfo: uses cycles 1,3,5,7,...,63
- "Symbolic label": symbolic name of the identifier, specifying the device function.

Example: FlexRay PTT file

```
# -----
@FILE_VERSION = 1.0
@PROTOCOL_NAME = flexray
# -----
# Labels for FlexRay protocol
#   Column order: Identifier, Base cycle, Cycle repetition, Label
# -----
# ----Definition----
0x01D,0,2,DriveTrain
0x03D,3,3,EngineData
0x0AB,0,2,Ignition_Info
0x0AB,1,2,GearBoxInfo
0x1C4,1,2,ABSdata
0x1F5,0,1,BrakeControl
0x200,0,1,Engine_Status
0x2BA,0,1,Airbag_Status
0x2D9,0,1,TP_Console
0x340,0,2,CAN_Gateway
0x38B,55,1,MOST_Gateway
0x3EA,0,1,PressureInfo
# -----
```

14.9.1.3 Configuring FlexRay protocol

The configuration of the FlexRay is simple - assign the two lines to input channels, and set the thresholds.

For details on configuration settings, see [Chapter 14.9.1.1, "FlexRay configuration"](#), on page 646.

1. Press the [Bus] key on the front panel.
2. Select the tab of the bus you want to set up, for example "SB1".
3. Select the "Setup" tab.
4. Tap the "Protocol" button and select the protocol: "FlexRay".
5. Select the "Source type".
6. Select the channels for the sources.
7. Adjust other settings, if necessary.
8. Set the logical thresholds.
9. Enable "Decode".

14.9.2 FlexRay trigger

14.9.2.1 FlexRay trigger

Access: [Bus] > "Shortcuts" tab > "Setup trigger"

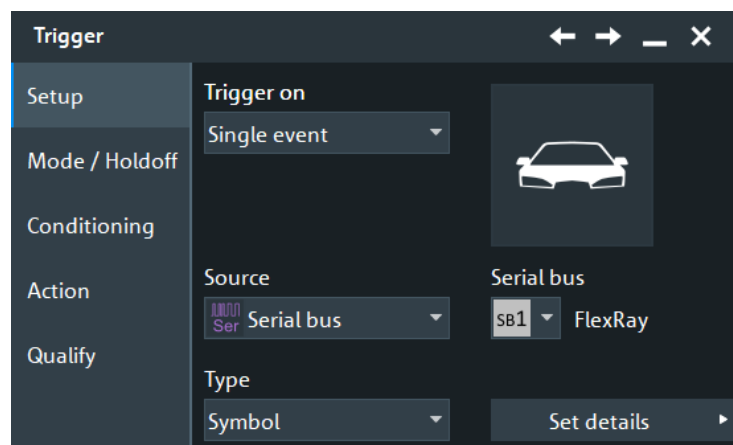

Make sure that:

- In the [Bus] > "Setup" tab:
 - The correct "Protocol" is selected.
 - The data sources of the serial bus are channel signals.
- In the "Trigger" > "Setup" tab:
 - The "Trigger on" = "Single event"
 - The trigger "Source" = "Serial bus".
 - The correct "Serial bus" is selected.

Trigger type

Selects the trigger type for FlexRay analysis.

"Start of frame" Triggers on the first rising edge after the transmission start sequence (TSS).

"Identifier + data"

The screenshot shows the 'FlexRay Trigger' configuration window with the 'Identifier + Data' section selected. The configuration options are as follows:

- Frame ID:** = Equal, [hex]XXX
- Payload length:** [-] In range, 0 .. 0
- Cycle count:** ... Off
- Data:** = Equal, [hex]XX
- Data index:** = Equal, 0
- Payload preamble:** X
- Null frame:** X
- Sync frame:** X
- Startup frame:** X

Triggers on the decoded frame content, on header and payload data:

- Indicator bits, see "[Indicator bits](#)" on page 653
- Frame identifier, see "[Frame ID \(min/max\)](#)" on page 654
- Payload length, see "[Payload length \(min/max\)](#)" on page 654
- Cycle count, see "[Cycle count \(min, max\), Step](#)" on page 654
- Data position, see "[Position, Index \(min, max\) - Data setup](#)" on page 655
- Data bit pattern, see "[Condition, Data \(min, max\) - Data setup](#)" on page 655

"Symbol"

Triggers on a symbol or wakeup pattern, see "[Symbol](#)" on page 656.

The screenshot shows the 'FlexRay Trigger' configuration window with the 'Symbol' section selected. The configuration options are as follows:

- Symbol:** Wakeup Pattern

"Error condition" Triggers on one or more errors that are detected in the decoded data, see "Error conditions" on page 656.

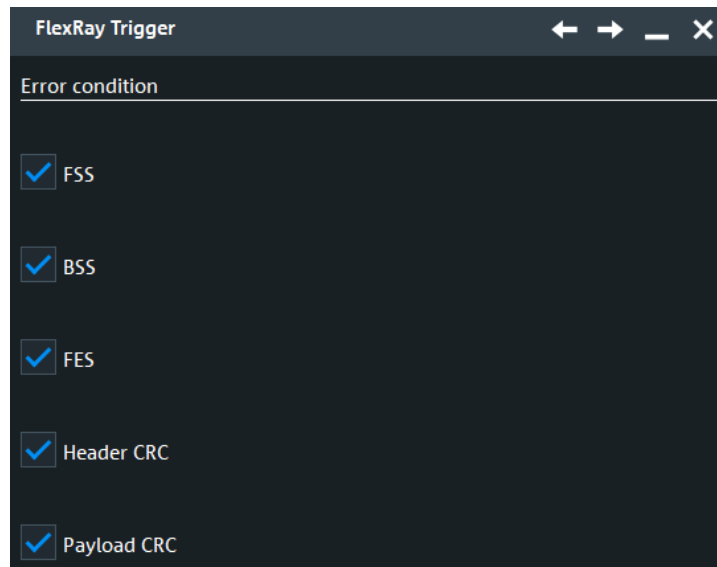

Remote command:

[TRIGger<m>:FLXRay:TYPE](#) on page 2025

Indicator bits

Triggers on one or more indicator bits at the beginning of the header segment. Each bit can be set to 0, 1, or X (do not care).

Trigger type: "Identifier + data"

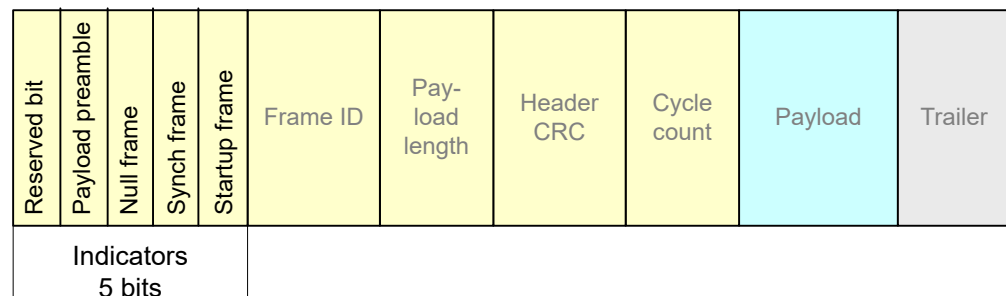

"Payload preamble" Indicates a Network Management Vector in the payload segment. The NMV allows the host processor to send data directly, without processing by the communication controller.

"Null frame" Indicates a frame without usable data.

"Synch frame" Indicates that the frame is used for synchronization of the FlexRay system. Only sync nodes can send this frame type.

"Startup frame" Indicates a startup frame used for startup of the network. Only specific start nodes can send this frame type.

Remote command:

[TRIGger<m>:FLXRay:PLPreamble](#) on page 2026

[TRIGger<m>:FLXRay:NUFRame](#) on page 2026

[TRIGger<m>:FLXRay:SYFrame](#) on page 2026

[TRIGger<m>:FLXRay:STFrame](#) on page 2026

Frame ID (min/max)

The frame ID contains the number of the slot in which the frame is transmitted. Each frame ID occurs only once during a FlexRay cycle.

Indicators	Frame ID	Payload length	Header CRC	Cycle count	Payload	Trailer
5 bits	11 bits	7 bits	11 bits	6 bits		

To trigger on a frame ID, you have to define a condition and one or two identifier patterns. The second identifier pattern is required to specify a range with conditions "In range" and "Out of range". In binary format, use the following characters: 1; 0; or X (any bit). The use of X is restricted to the conditions "Equal" and "Not equal". If the identifier is not relevant for the trigger setup, set it to "Off".

The maximum length of the pattern is 11 bit.

The bit pattern editor helps you to enter the pattern in any format, see [Chapter 14.1.7, "Bit pattern editor"](#), on page 519.

Trigger type: "Identifier + data"

Remote command:

[TRIGger<m>:FLXRay:FCONdition](#) on page 2027

[TRIGger<m>:FLXRay:FMIN](#) on page 2027

[TRIGger<m>:FLXRay:FMAX](#) on page 2027

Payload length (min/max)

The payload length contains the number of words transmitted in the payload segment. Information is transmitted in 2-byte words, so the number of data bytes in the payload segment is twice the payload length.

Indicators	Frame ID	Payload length	Header CRC	Cycle count	Payload	Trailer
5 bits	11 bits	7 bits	11 bits	6 bits		

To trigger on the payload length, you have to define a condition and one or two numbers of words. The second number is required to specify a range with conditions "In range" and "Out of range". If the payload length is not relevant for the trigger setup, set it to "Off".

Trigger type: "Identifier + data"

Remote command:

[TRIGger<m>:FLXRay:PCONdition](#) on page 2028

[TRIGger<m>:FLXRay:PMIN](#) on page 2028

[TRIGger<m>:FLXRay:PMAX](#) on page 2028

Cycle count (min, max), Step

The cycle count contains the number of the current FlexRay cycle.

Indicators	Frame ID	Payload length	Header CRC	Cycle count	Payload	Trailer
5 bits	11 bits	7 bits	11 bits	6 bits		

To trigger on the cycle count, you have to define a condition and one or two numbers. If the condition is a range ("In range" or "Out of range"), a second number "Cycle count max" is required.

Also, you can define a "Step" to trigger on each n-th cycle inside the given range. This allows for specific triggering if slot multiplexing is used.

If the cycle count is not relevant for the trigger setup, set it to "Off".

Trigger type: "Identifier + data"

Remote command:

[TRIGger<m>:FLXRay:CENable](#) on page 2029

[TRIGger<m>:FLXRay:CMIN](#) on page 2029

[TRIGger<m>:FLXRay:CMAX](#) on page 2029

[TRIGger<m>:FLXRay:CSTep](#) on page 2029

Position, Index (min, max) - Data setup

Sets the position of the first byte of data bit pattern within the payload segment. You can define an exact position, or a position range.

Trigger type: "Identifier + data"

"Position" Operator for the data position. Select "Off", if the position of the required pattern is not relevant for the trigger condition.

"Index" Sets the number of data bytes to be skipped after start of the payload segment if "Position" is "Equal" or "Greater or equal". The index 0 is associated with the first data byte.

"Index min, Index max" If the "Position" operator defines a range, the indexes of the first and the last byte are defined between which the required bit pattern may start.

Remote command:

[TRIGger<m>:FLXRay:DPOperator](#) on page 2030

[TRIGger<m>:FLXRay:DPOsition](#) on page 2030

[TRIGger<m>:FLXRay:DPTO](#) on page 2030

Condition, Data (min, max) - Data setup

Specifies the data bit pattern to be found in the payload segment. The starting point of the pattern is defined by "[Position, Index \(min, max\) - Data setup](#)" on page 655. The pattern comparison is byte-aligned, and the instrument triggers at the end of a byte.

"Condition" Sets the operator to set a specific data pattern ("Equal" or "Not equal") or a data range. Select "Off", if the data pattern is not relevant for the trigger condition.

"Data (min/max)" Enter the bytes in msb first bit order. The maximum pattern length is 8 bytes.

In binary format, use the following characters: 1; 0; or X (do not care). To enter the pattern in other formats use the bit pattern editor, see [Chapter 14.1.7, "Bit pattern editor"](#), on page 519.

Remote command:

[TRIGger<m>:FLXRay:DCONdition](#) on page 2031

[TRIGger<m>:FLXRay:DMIN](#) on page 2031

[TRIGger<m>:FLXRay:DMAX](#) on page 2031

Symbol

Triggers on a symbol or on a wakeup pattern.

Trigger type: "Symbol"

"CAS/MTS" Collision Avoidance Symbol / Media access Test Symbol. These symbols are identical and can be sent in the optional symbol window at the end of a communication cycle. They are used to avoid collisions during the system start.

"Wakeup Pattern" The wakeup pattern is sent to activate the nodes of the system.

Remote command:

[TRIGger<m>:FLXRay:SYMBOL](#) on page 2032

Error conditions

Triggers on one or more errors in the frame.

Trigger type: "Error conditions"

"FSS" Error in a Frame Start Sequence. FSS follows the Transmission Start Sequence TSS at the beginning of each frame.

"BSS" Error in a Byte Start Sequence. The BSS is transmitted before each byte.

"FES" Error in Frame End Sequence. FES indicates the end of each frame.

"Header CRC" Error in a cyclic redundancy check code of the header data which covers mainly frame ID and payload length.

"Payload CRC" Error in a cyclic redundancy check code of the complete frame.

Remote command:

[TRIGger<m>:FLXRay:FSSerror](#) on page 2032

[TRIGger<m>:FLXRay:BSSerror](#) on page 2032

[TRIGger<m>:FLXRay:FESerror](#) on page 2032

[TRIGger<m>:FLXRay:HRCerror](#) on page 2033

[TRIGger<m>:FLXRay:PCRCerror](#) on page 2033

14.9.2.2 Triggering on FlexRay signals

Prerequisites: An FlexRay bus is configured, see .

1. Press the [Bus] key and select the "Shortcuts" tab.

2. Press "Setup trigger".
3. Tap the "Source" button and select the "Serial bus" trigger source.
4. Select the serial bus that is set to FlexRay.
5. Select the "Trigger type".
6. For more complex trigger types, enter the address and/or data conditions: address, acknowledge bits, R/W bit, and data pattern.
For details, see [Chapter 14.9.2.1, "FlexRay trigger"](#), on page 651.

14.9.3 FlexRay decode results

When the configuration of the serial bus is complete, the signal can be decoded:

1. In the "Protocol" dialog > "Setup" tab, enable "Decode".
2. In the "Protocol" dialog > "Display" tab, select additional result display settings: "Show decode table" and "Show binary signals".

For a description of the display settings, see also [Chapter 14.1.3, "Display"](#), on page 513.

The instrument captures and decodes the signal according to the standard definition and the configuration settings.

The color-coding of the various protocol sections and errors simplifies the interpretation of the visual display. The decode information condenses or expands, depending on the horizontal scale. Various data formats are available to show the result values.

Decode Results Table

The results are shown in two tables:

- "Decode results": contains information about all decoded frames
- "Details frame": contains more detailed information about the selected frame in the "Decode results" table.

State	Frame start	Type	Flags [hex]	Payload length	Frame ID [hex]	Label	HCRC [hex]	FCRC [hex]	Cycle count	Details frame 1
1 Ok	-217 µs	Static	04	01	B3		E6	1BDEBF	0	
2 Ok	-163.8 µs	Static	04	01	B3		E6	2023E7	1	Value
3 Ok	-110.6 µs	Static	04	01	B3		E6	698D4D	62	1 11
4 Ok	-57.4 µs	Static	04	01	B3		E6	DF6CCC	63	2 11
5 Ok	7.8 µs	Static	04	01	123		5A0	E9D06	7	
6 Ok	61 µs	Static	04	01	123	Count 13 15	5A0	65AB32	13	
7 Ok	114.2 µs	Static	04	01	123	Count 20 1	5A0	324523	30	
8 Ok	167.4 µs	Static	04	01	123	Count 13 15	5A0	3FE0	43	

Table 14-13: Content of the Decode results table

Column	Description
State	Overall state of the frame. "Insufficient waveform length" indicates that the frame is not completely contained in the acquisition. Change the horizontal scale, or move the reference point to the left to get a longer acquisition.
Frame start	Time of frame start

Column	Description
Type	Frame type: Frame of the static segment, frame of the dynamic segment, wakeup frame, symbol in the frame
Flags	State of indicator bits
Payload length	Number of data words in the payload segment.
Frame ID	Value of the frame ID (slot number)
Label	Symbolic label name defined in the label list
HCRC	Value of the header CRC
FCRC	Value of the frame CRC
Cycle count	Number of the current FlexRay cycle
Values	Value of the data bytes. The data format is selected below the table. Wakeup and symbol frames do not transmit data, therefore "- -" is displayed.

Remote commands

Remote commands are described in [Chapter 27.18.10.3, "Decode results"](#), on page 2033.

14.9.4 Search on decoded FlexRay data

Using the search functionality, you can find various events in the decoded data. You can find the same events that you can trigger on, and even many more, since several event types can also be combined.

Before you can start the search, you have to configure the bus correctly and acquire decoded data.

To search on decoded data, set the search source to "SerBus" for the configured protocol.

For general information on how to handle the search functionality, see [Chapter 11, "Search functions"](#), on page 425.

14.9.4.1 FlexRay search setup

Access: [Bus] > "Shortcuts" tab > "Setup search"

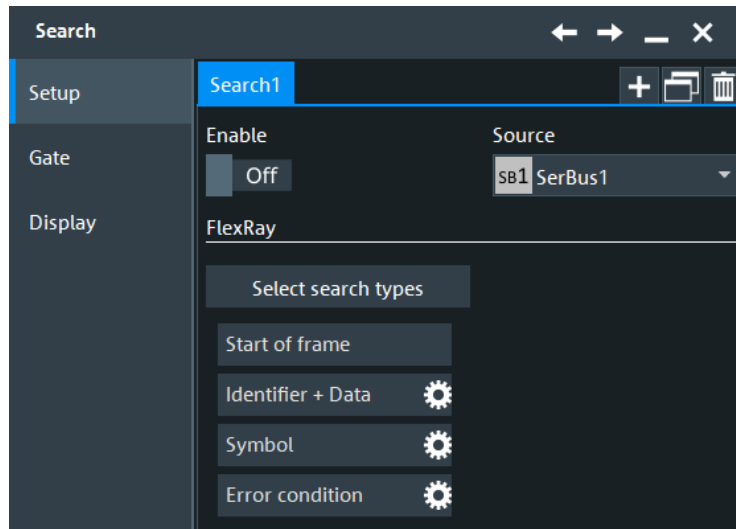

Select Search Types

Selects one criterion or an AND-combination of criteria to be searched for. If more than one criterion is selected, all criteria must be fulfilled by a frame for it to be shown in the search results.

"Start of frame" Searches for the first rising edge after the transmission start sequence (TSS).

"Identifier+data"

Searches for the decoded frame content, on header and payload data:

- Indicator bits, see ["Indicator bits"](#) on page 659
- Frame identifier, see ["Frame ID \(min/max\)"](#) on page 660
- Payload length, see ["Payload length \(min/max\)"](#) on page 660
- Cycle count, see ["Cycle count \(min, max\), Step"](#) on page 660
- Data position, see ["Position, Index \(min, max\) - Data setup"](#) on page 661
- Data bit pattern, see ["Condition, Data \(min, max\) - Data setup"](#) on page 661

"Symbol" Searches for a symbol or wakeup pattern, see ["Symbol"](#) on page 661.

"Error condition"

Searches for one or more errors that are detected in the decoded data, see ["Error Condition"](#) on page 661.

Remote command:

[SEARCH:TRIGGER:FLXRay\[:SSOFrame\]](#) on page 2040

[SEARCH:TRIGGER:FLXRay:SSymbol](#) on page 2040

[SEARCH:TRIGGER:FLXRay:SIDData](#) on page 2040

[SEARCH:TRIGGER:FLXRay:SError](#) on page 2039

Indicator bits

Searches for one or more indicator bits at the beginning of the header segment. Each bit can be set to 0, 1, or X (do not care).

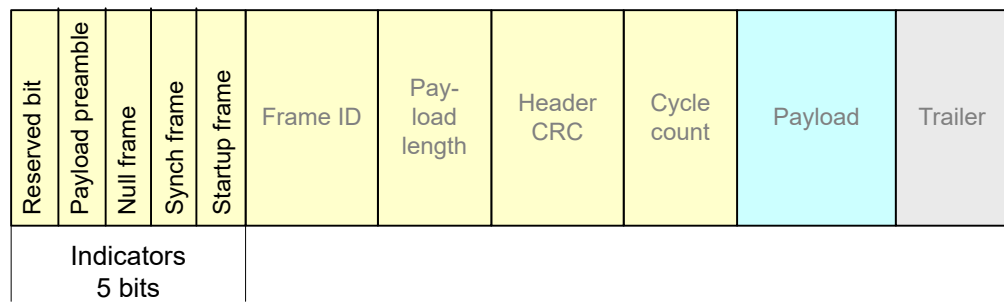

"Payload preamble" Indicates a Network Management Vector in the payload segment. The NMV allows the host processor to send data directly, without processing by the communication controller.

"Null frame" Indicates a frame without usable data.

"Sync frame" Indicates that the frame is used for synchronization of the FlexRay system. Only sync nodes can send this frame type.

"Startup frame" Indicates a startup frame used for startup of the network. Only specific start nodes can send this frame type.

Remote command:

[SEARCH:TRIGGER:FLXRay:PLPreamble](#) on page 2046

[SEARCH:TRIGGER:FLXRay:NUFframe](#) on page 2045

[SEARCH:TRIGGER:FLXRay:SYFrame](#) on page 2047

[SEARCH:TRIGGER:FLXRay:STFrame](#) on page 2047

Frame ID (min/max)

The frame ID contains the number of the slot in which the frame is transmitted. Each frame ID occurs only once during a FlexRay cycle.

The setup conditions are the same as in the FlexRay trigger setup, see "[Frame ID \(min/max\)](#)" on page 654.

Remote command:

[SEARCH:TRIGGER:FLXRay:FCONDITION](#) on page 2044

[SEARCH:TRIGGER:FLXRay:FMIN](#) on page 2045

[SEARCH:TRIGGER:FLXRay:FMAX](#) on page 2045

Payload length (min/max)

The payload length contains the number of words transmitted in the payload segment. Information is transmitted in 2-byte words, so the number of data bytes in the payload segment is twice the payload length.

The setup conditions are the same as in the FlexRay trigger setup, see "[Payload length \(min/max\)](#)" on page 654.

Remote command:

[SEARCH:TRIGGER:FLXRay:PCONdition](#) on page 2046

[SEARCH:TRIGGER:FLXRay:PMIN](#) on page 2047

[SEARCH:TRIGGER:FLXRay:PMAX](#) on page 2046

Cycle count (min, max), Step

The cycle count contains the number of the current FlexRay cycle.

The setup conditions are the same as in the FlexRay trigger setup, see "[Cycle count \(min, max\), Step](#)" on page 654.

Remote command:

[SEARCH:TRIGGER:FLXRay:CENable](#) on page 2041

[SEARCH:TRIGGER:FLXRay:CMIN](#) on page 2041

[SEARCH:TRIGGER:FLXRay:CMAX](#) on page 2041

[SEARCH:TRIGGER:FLXRay:CSTep](#) on page 2042

Position, Index (min, max) - Data setup

Sets the position of the first byte of data bit pattern within the payload segment. You can define an exact position, or a position range.

The setup conditions are the same as in the FlexRay trigger setup, see "[Position, Index \(min, max\) - Data setup](#)" on page 655.

Remote command:

[SEARCH:TRIGGER:FLXRay:DPOperator](#) on page 2043

[SEARCH:TRIGGER:FLXRay:DPOSITION](#) on page 2044

[SEARCH:TRIGGER:FLXRay:DPTO](#) on page 2044

Condition, Data (min, max) - Data setup

Specifies the data bit pattern to be found in the payload segment. The starting point of the pattern is defined by "[Position, Index \(min, max\) - Data setup](#)" on page 661. The pattern comparison is byte-aligned, and the instrument triggers at the end of a byte.

The setup conditions are the same as in the FlexRay trigger setup, see "[Condition, Data \(min, max\) - Data setup](#)" on page 655.

Remote command:

[SEARCH:TRIGGER:FLXRay:DCONDITION](#) on page 2042

[SEARCH:TRIGGER:FLXRay:DMIN](#) on page 2043

[SEARCH:TRIGGER:FLXRay:DMAX](#) on page 2043

Symbol

Searches for a symbol or a wakeup pattern.

"CAS/MTS" Collision Avoidance Symbol / Media access Test Symbol. These symbols are identical and can be sent in the optional symbol window at the end of a communication cycle. They are used to avoid collisions during the system start.

"Wakeup Pattern" The wakeup pattern is sent to activate the nodes of the system.

Remote command:

[SEARCH:TRIGGER:FLXRay:SYMBOL](#) on page 2048

Error Condition

Selects the error type to be searched for. You can select one or more error types as search condition.

The error types are the same as in the FlexRay trigger setup, see "[Error conditions](#)" on page 656.

Remote command:

[SEARCH:TRIGger:FLXRay:BSSerror](#) on page 2048

[SEARCH:TRIGger:FLXRay:FESerror](#) on page 2048

[SEARCH:TRIGger:FLXRay:FSSerror](#) on page 2049

[SEARCH:TRIGger:FLXRay:HRCerror](#) on page 2049

[SEARCH:TRIGger:FLXRay:PCRCerror](#) on page 2049

14.9.4.2 FlexRay search results

To get search results, "Enable" the search. You can minimize, shift or close the search dialog.

The search results are listed in the search result table and marked in the waveform by blue lines.

For an introduction to search results, see:

- [Chapter 11.1.2, "Search results"](#), on page 426
- [Chapter 11.4.2, "Display zoom settings"](#), on page 446

Remote commands:

- [SEARCH:RESult:FLXRay:FCOut?](#) on page 2050
- [SEARCH:RESult:FLXRay:FRAME<m>:ADID?](#) on page 2050
- [SEARCH:RESult:FLXRay:FRAME<m>:CSState?](#) on page 2051
- [SEARCH:RESult:FLXRay:FRAME<m>:CSValue?](#) on page 2051
- [SEARCH:RESult:FLXRay:FRAME<m>:CYCount?](#) on page 2051
- [SEARCH:RESult:FLXRay:FRAME<m>:DATA?](#) on page 2052
- [SEARCH:RESult:FLXRay:FRAME<m>:FCState?](#) on page 2052
- [SEARCH:RESult:FLXRay:FRAME<m>:FCValue?](#) on page 2052
- [SEARCH:RESult:FLXRay:FRAME<m>:FLAGs?](#) on page 2052
- [SEARCH:RESult:FLXRay:FRAME<m>:PAYLength?](#) on page 2053
- [SEARCH:RESult:FLXRay:FRAME<m>:STATus?](#) on page 2053
- [SEARCH:RESult:FLXRay:FRAME<m>:START?](#) on page 2054
- [SEARCH:RESult:FLXRay:FRAME<m>:STOP?](#) on page 2054
- [SEARCH:RESult:FLXRay:FRAME<m>:SYMBOL?](#) on page 2054
- [SEARCH:RESult:FLXRay:FRAME<m>:TYPE?](#) on page 2054

14.10 SENT (option R&S RTO6-K520)

Single Ended Nibble Transmission (SENT) is a serial transmission interface protocol originally specified for the communication of sensors and control units in automotive electronics.

SENT is a protocol standard governed by Society of Automotive Engineers (SAE J2716). For detailed information, refer to the SENT standard specification on <http://www.sae.org>.

The SENT protocol is used exclusively in automotive applications, as for example electrical power steering, advanced driver assistance like parking assist or sensing of pressure, throttle position, pedal position, airflow mass, liquid level, etc.

The R&S RTO6 option R&S RTO6-K520 provides serial triggering, decoding and a highly customizable search on decoded SENT signals.

14.10.1 The SENT protocol

This chapter provides an overview of the protocol characteristics, encoding scheme, identifiers and trigger possibilities.

The SENT protocol transmits signal values point-to-point from a sensor to a controller (electronic control unit ECU), unidirectional. In contrast to conventional measurements, you can receive multiple data parameters via the SENT interface in a single transmission. Nevertheless, SENT is characterized by its simplicity and yet high customizability to meet the individual requirements of the applications.

SENT operates via a three-wire connection, a signal line, a supply voltage line for the sensor and a ground line. It transmits data digitally in variable timing units and evaluates the time between two falling edges (single edges). The signal is amplitude modulated with a constant amplitude voltage. Thus the influences of disturbance signals are not critical.

SENT key features

The main characteristics of SENT are:

- serial communication protocol
- 3 wires: SENT (signal line), 5V (voltage line), GND (ground line)
- output only, from sensor to receiver
- point-to-point transmission, no bus
- digital transmission
- high baud rate
- data transmission in variable timing units of 4 bits (1 nibble) between two falling edges
- transmitter-specific clock period (tick)
- time measured between single falling edges

14.10.1.1 SENT transmission concept

A sensor converts the analog measured data to a digital signal, and thus transmits a series of pulses to the receiver. The receiver, e.g. an ECU processes the received signal also digitally.

The format of a SENT message frame has a fixed pulse order and a transmitter-specific clock period. The total transmission time varies depending on the clock variation of the transmitter and the transmitted data values. The data pulses embedded in the transmission sequence represent one or multiple data parameters to be communicated. The last pulses in a message frame are the CRC check pulse, allowing the receiver to perform some diagnostic tests, and an optional pause pulse.

A SENT transmission starts without a request from the receiver. Consecutive sequences are transmitted continuously after the falling edge of the last pulse.

The SENT protocol distinguishes between two channel types:

- **Fast channel:** transmits primary data, i.e. sensor readings like temperature, pressure, mass air flow, throttle position.
- **Slow channel:** transmits secondary data consisting of transfer characteristics, sensor ID, type, manufacturer diagnostic, etc.
The slow channel transmission provides two serial message formats *Short* and *Enhanced* for customizing the secondary data.

The data of both channels is transmitted simultaneously, by including two bits of a slow channel message in the message frame of the fast channel. Even though it requires many fast channel messages to complete a slow channel message, you can use this function to transmit several slow channel messages with minimal impact on the primary sensor data and the data rate.

14.10.1.2 SENT message definitions

SENT terms

See the specific terms and definitions used in the SENT protocol:

- **Tick (clock tick):** basic unit of time
 - transmitter-specific nominal clock period
 - $3 \mu\text{s} < \text{clock tick} < 90 \mu\text{s}$, with max. 20 % clock variation
- **Nibble:** minimum unit of data
 - used to transmit data
 - variable timing units between two falling edges

SENT fast channel

The SENT protocol enables you to transmit measurements of multiple sensors in one transmission sequence with data signals of varying length. The diagram in [Figure 14-17](#) shows, for example, the encoding scheme for two 12-bit data signals.

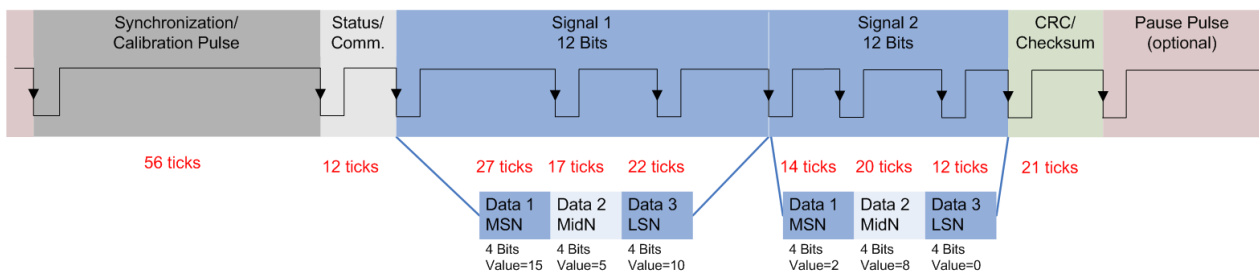

Figure 14-17: Example of a SENT transmission sequence

The format of a SENT transmission sequence consists of the following pulses:

- **Synchronization/Calibration pulse:**
 - initial sequence of the receiver
 - the start condition is the falling edge of the last pulse (CRC or Pause)
 - the nominal pulse period is 56 clock ticks
 - measures the actual clock variation of the transmitter and calculates the tick timing
- **Status/Communication Pulse (Nibble)**
 - one 4 bit pulse
 - communicates status and enables the sensor to include slow channel message bits
 - 0: (LSB) specific application
 - 1: specific application
 - 2: Serial Data message or specific application (e.g. Infineon TLE4998S)
 - 3: (MSB) 1= message start; 0=Serial Data message or specific application (e.g. Infineon TLE4998S)
 - 12 to 27 clock ticks
 - not included in CRC frame calculation
- **Data Pulses (Nibbles)**
 - one up to six 4 bit data nibbles
 - 12 to 27 clock ticks pulse period
 - initial logic 0 time with ≥ 5 ticks, subsequent logical 1 with variable duration
- **CRC/Checksum**
 - one 4 bit pulse
 - used for error checking of data nibbles (status nibble not included)
 - detects single bit, odd number of nonconsecutive and single burst errors
- **Pause Pulse**
 - one optional pulse
 - variable pulse length: 12 to 768 clock ticks
 - can be used to create a transmission with a constant number of clock ticks

SENT slow channel

Short Serial Messages

For transmission of a slow channel message, 2 bits are included in a fast channel message, see the status nibble (Bit 2,3) in Figure 14-18.

A short serial message needs 16 fast channel messages until it is completely transmitted. Prerequisite for the complete transmission of the slow channel message is 16 consecutive error-free fast channel transmissions.

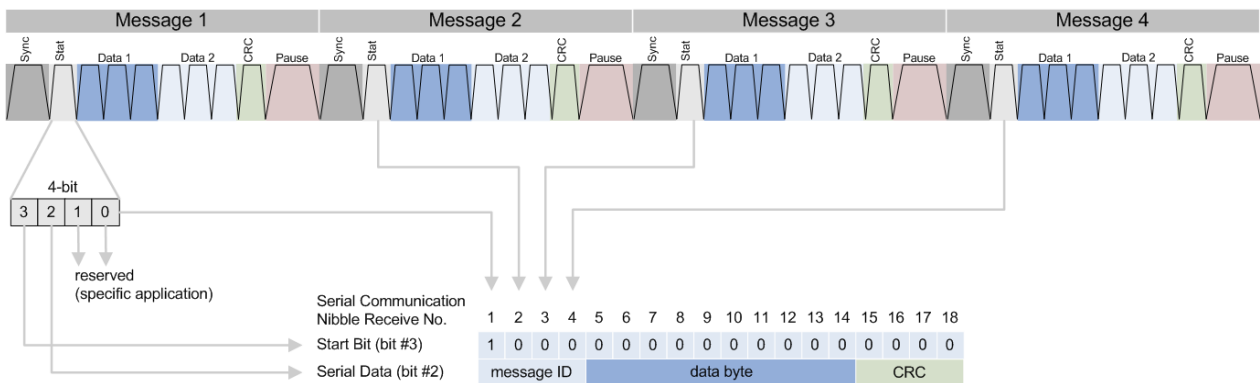

Figure 14-18: One serial message, composed of 16 SENT consecutive fast channel transmissions

Enhanced Serial Messages

The transmission of an enhanced serial message format requires 18 fast channel transmissions. Each slow channel message is assigned a message ID, which is transmitted with the data.

The enhanced serial message format provides two alternatives for configuring the message:

- 4 bit ID and 16 bit data
- 8 bit ID and 12 bit data

The graphs below illustrate the variants.

Table 14-14: Enhanced serial message formats

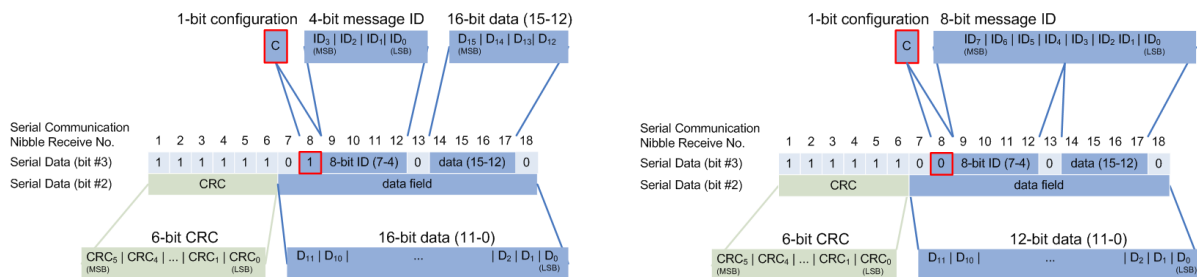

16 bit data and 4 bit message ID

12 bit data and 8 bit message ID

Trigger

The R&S RTO6 can trigger on various parts of SENT pulses. The data line must be connected to an input channel, triggering on math and reference waveforms is not possible.

SENT enables you to trigger on:

- Calibration/synchronization pulse
- Transmission sequence
- Serial messages
- Error conditions

14.10.2 SENT configuration

14.10.2.1 SENT configuration

Access: [Bus] > "Setup" tab > "Protocol" = *SENT*



Make sure that the tab of the correct serial bus is selected.

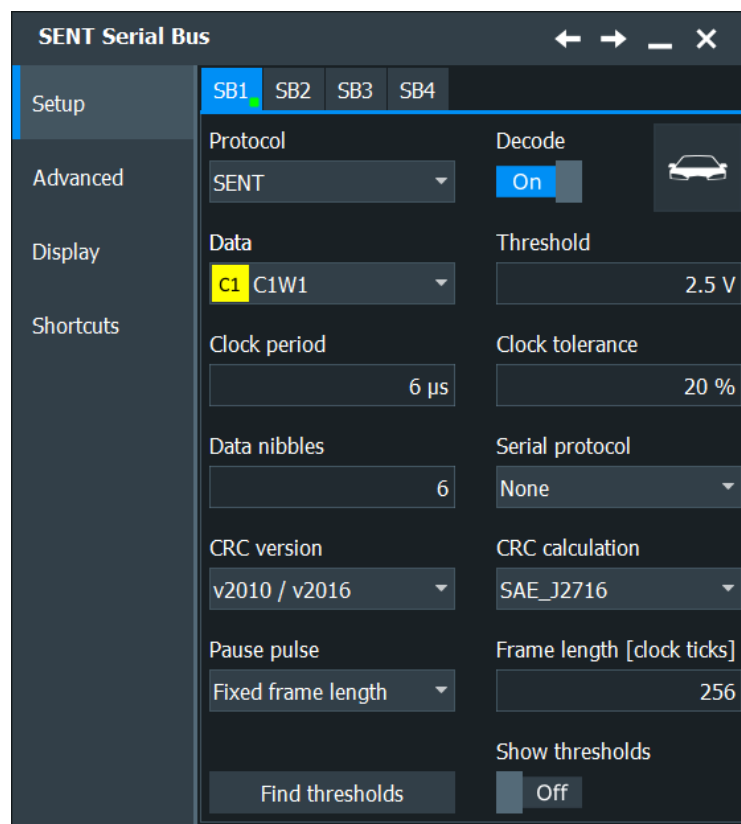

See also: [Chapter 14.1.1, "Setup - general settings"](#), on page 511

Data

Sets the source of the data line.

Usually, the source is one of the analog channels. Reference and math waveforms are available as source if the trigger source is one of the analog channels but not the serial bus.

Remote command:

[BUS<m>:SENT:DATA:SOURce](#) on page 2055

Threshold

Sets the threshold value for digitization of the signal. If the signal value on the line is higher than the threshold, the signal state is high. Otherwise, the signal state is considered low if the signal value is below the threshold.

There are several ways to set the threshold:

- "Threshold"
Enter the value directly in the field.
- "Autoset"
Starts software algorithms for determining the signal threshold levels and bitrate.
- "Find thresholds"
Executes the measurement of reference levels and sets the thresholds to the middle reference level of the measured amplitude.

Remote command:

[BUS<m>:SENT:DATA:THReshold](#) on page 2055

[BUS<m>:SENT:TECHnology](#) on page 2056

[BUS<m>:SETReflevels](#) on page 1814

[BUS<m>:FAUToset](#) on page 1814

Clock Period

Sets the transmitter-specific nominal clock period (clock tick).

The clock period and signal length determine the speed of transmission.

Remote command:

[BUS<m>:SENT:CLKPeriod](#) on page 2056

Clock tolerance

Specifies a tolerated deviation of the clock.

Remote command:

[BUS<m>:SENT:CLKTolerance](#) on page 2056

Data Nibbles

Sets the number of data units in a single transmission sequence.

The maximum number of data nibbles is 6.

Remote command:

[BUS<m>:SENT:DNIBbles](#) on page 2057

Serial protocol

Selects the protocol format in the transmitted signal.

"Short" Short serial messages.

- "Enhanced" Enhanced serial messages.
 "None" No serial messages. Transmission sequences only.

Remote command:

[BUS<m>:SENT:SFORmat](#) on page 2057

CRC version

Selects the version the CRC check is based on.

- "Legacy" Based on the crc calculation version used earlier than 2010.
 "v2010" Based on the recent crc calculation version updated in 2010.

Remote command:

[BUS<m>:SENT:CRCCVersion](#) on page 2057

CRC calculation

Selects the method for CRC calculation.

- "SAE_J2716" Calculates the CRC according to the SAE standard.
 For this method the checksum is calculated over all nibbles except the communication and status nibble.
 "TLE_4998X" Calculates the CRC according to the standard computing method for Infineon TLE_4998X sensors.
 For this method the checksum is calculated over all nibbles except the communication nibble.

Remote command:

[BUS<m>:SENT:CRCCMethod](#) on page 2058

Pause pulse

Determines whether a pause pulse is transmitted after the checksum nibble.

You can use this pulse to create a transmission with a constant number of clock ticks. The pause pulse length can be between a minimum of 12 clock ticks up to 768 (3*256) ticks at a maximum.

- "No" No pause pulse between the transmission sequences.
 "Yes" Pause pulse with fixed length at the end of each transmission sequence.
 The R&S RTO6 computes the length of the pause pulse automatically.
 "For constant frame length" Pause pulse with dynamic length to maintain a fixed transmission sequence length.
 To define the constant frame length, set the number of clock ticks under [Frame length \[clock ticks\]](#).

Remote command:

[BUS<m>:SENT:PPULse](#) on page 2058

Frame length [clock ticks]

Determines the frame length in terms of ticks. The dialog displays this settings parameter, if the signal has a constant frame length.

Remote command:

`BUS<m>:SENT:PPFLength` on page 2059

Show thresholds

If enabled, the threshold levels are displayed in the diagram.

Remote command:

`BUS<m>:THReshold` on page 1815

14.10.2.2 Advanced settings

Access: [Bus] > "Advanced" tab.

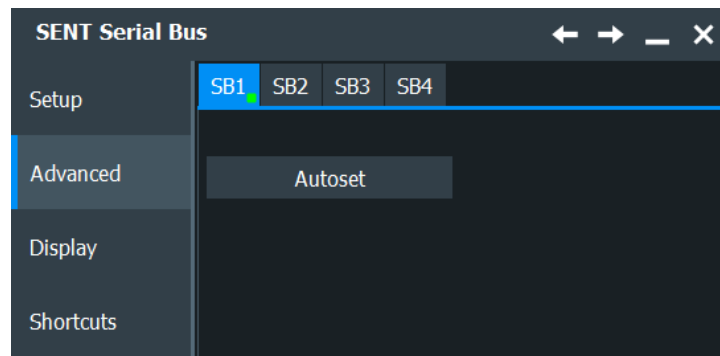

Autoset

Starts software algorithms for determining the signal threshold levels and bitrate.

Remote command:

`BUS<m>:FAUToset` on page 1814

14.10.2.3 Configuring SENT protocol

The configuration of the SENT is simple - assign the two lines to input channels, and set the thresholds.

For details on configuration settings, see [Chapter 14.10.2.1, "SENT configuration"](#), on page 667.

1. Press the [Bus] key on the front panel.
2. Select the tab of the bus you want to set up, for example "SB1".
3. Tap the "Protocol" button and select the protocol: "SPI".
4. Tap the "Data" button, and select the waveform of the data line.
5. If necessary, set the "Transmission Setup" parameters.
6. Set the logical thresholds.
7. Enable "Decode".

14.10.3 SENT trigger

14.10.3.1 SENT trigger settings

Access: [Bus] > "Shortcuts" tab > "Setup trigger"

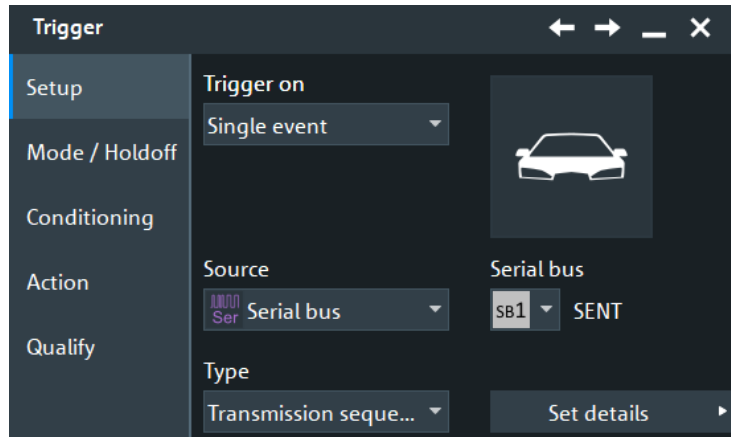

Make sure that:

- In the [Bus] > "Setup" tab:
 - The correct "Protocol" is selected.
 - The data sources of the serial bus are channel signals.
- In the "Trigger" > "Setup" tab:
 - The "Trigger on" = "Single event"
 - The trigger "Source" = "Serial bus".
 - The correct "Serial bus" is selected.

Type

Selects the event of the SENT transmission sequence or message to be triggered on.

The RTO6 triggers always on the falling edge of a pulse, i.e. at the end of the selected type nibble in a transmission sequence.

"Calibration or Sync"

Triggers at the end of the "Synchronization/Calibration" pulse.



This setting does not require any input parameters.

"Transmission Sequence"

Triggering depends on the additional selectable "Sequence" parameter:

- "Sequence > Status": triggers at the end of the "Status" nibble.



- "Sequence > Status+Data": triggers at the end of the last data nibble.



Description of trigger type specific settings: ["Transmission Sequence setup"](#) on page 673

"Serial Message"

Triggering on a serial message depends on the serial protocol selected with [Serial protocol > Short | Enhanced](#) and the associated setting parameters:

- "Short" serial message
 - "Sequence > Identifier": triggers at the end of the "ID".



- "Sequence > ID+Data": triggers at the end of the "ID and Data".



Description of trigger type specific settings: ["Serial Message setup"](#) on page 674

- "Enhanced" serial message
 - "Sequence > Identifier": triggers at the end of the "ID".



- "Sequence > ID+Data": triggers at the end of the "ID and Data".



Description of trigger type specific settings: ["Serial Message setup"](#) on page 674

"Error condition"

Triggers if certain errors occur.

You can select the following error events for triggering:

- "Form Error"
- "Calibration Pulse Error"
- "Pulse Period Error"
- "CRC Error"
- "Irregular Frame Length Error"

Description of error-specific trigger conditions, see ["Error conditions setup"](#) on page 676.

Remote command:

[TRIGger<m>:SENT:TYPE](#) on page 2060

Transmission Sequence setup

Configures the trigger conditions for trigger type transmission sequence.

Note: The displayed parameters depend on the selected "Sequence". The instrument displays the data setting parameters when you select "Status+Data", see ["Type"](#) on page 671.

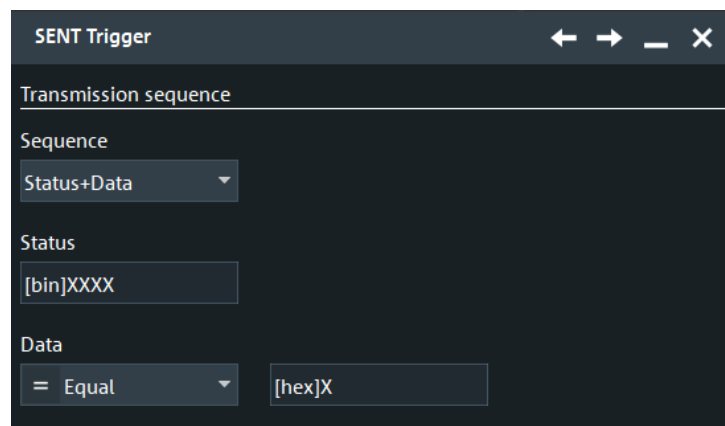
**Sequence ← Transmission Sequence setup**

Selects the condition for triggering in a single transmission sequence.

You can trigger on the end of the status nibble or the combination of the status and data nibbles.

Remote command:

[TRIGger<m>:SENT:TTYPe](#) on page 2060

Status ← Transmission Sequence setup

Defines the data bits for the status nibble.

Remote command:

[TRIGger<m>:SENT:STATus](#) on page 2061

Condition ← Transmission Sequence setup

Selects the operator to define a specific data pattern or a data range.

The available operators:

- Equal, Not equal
- Less than, Greater than
- Less or equal, Greater or equal
- In range, Out of range

Remote command:

[TRIGger<m>:SENT:TDCN](#) on page 2061

Nibbles ← Transmission Sequence setup

Displays the number of data nibbles of the transmission sequence.

Remote command:

[BUS<m>:SENT:DNIBbles](#) on page 2057

Data min ← Transmission Sequence setup

Sets the data pattern. Enter the bytes in msb first bit order. The maximum pattern length is 64 bit. Waveform data is compared with the pattern byte-by-byte.

Remote command:

[TRIGger<m>:SENT:TDMN](#) on page 2061

Data max ← Transmission Sequence setup

The second data pattern is required to specify a range with conditions "In range" and "Out of range".

Remote command:

[TRIGger<m>:SENT:TDMX](#) on page 2062

Serial Message setup

Configures the trigger conditions for a serial message.

Note: The displayed parameters depend on the selected "Sequence". The instrument indicates the data setting parameters when you select "ID+Data", see ["Type"](#) on page 671.

Sequence ← Serial Message setup

Selects the condition for triggering in a serial message.

You can trigger on the end of an identifier nibble or the combination of the identifier and data nibble(s).

Remote command:

[TRIGger<m>:SENT:STYPe](#) on page 2062

ID Type ← Serial Message setup

Selects the message ID format for the enhanced serial message type.

You can select either 4-bit or 8-bit message ID.

Remote command:

[TRIGger<m>:SENT:SIDType](#) on page 2062

Identifier Condition ← Serial Message setup

The available operators:

- Equal, Not equal

- Less than, Greater than
- Less or equal, Greater or equal
- In range, Out of range

Remote command:

`TRIGger<m>:SENT:SICN` on page 2062

Identifier min ← Serial Message setup

Defines the bit pattern of the message identifier.

In binary format, use the following characters: 1; 0; or X (do not care). To enter the pattern in other formats use the bit pattern editor, see [Chapter 14.1.7, "Bit pattern editor"](#), on page 519.

Remote command:

`TRIGger<m>:SENT:SIMN` on page 2063

Identifier max ← Serial Message setup

The second identifier pattern is required to specify a range with conditions "In range" and "Out of range".

Remote command:

`TRIGger<m>:SENT:SIMX` on page 2063

Data Condition ← Serial Message setup

Selects the operator to set a specific data pattern or a data range.

The available operators:

- Equal, Not equal
- Less than, Greater than
- Less or equal, Greater or equal
- In range, Out of range

Remote command:

`TRIGger<m>:SENT:SDCN` on page 2063

Data min ← Serial Message setup

Sets the data pattern. Enter the bytes in msb first bit order. The maximum pattern length is 64 bit. Waveform data is compared with the pattern byte-by-byte.

Remote command:

`TRIGger<m>:SENT:SDMN` on page 2064

Data max ← Serial Message setup

The second data pattern is required to specify a range with conditions "In range" and "Out of range".

Remote command:

`TRIGger<m>:SENT:SDMX` on page 2064

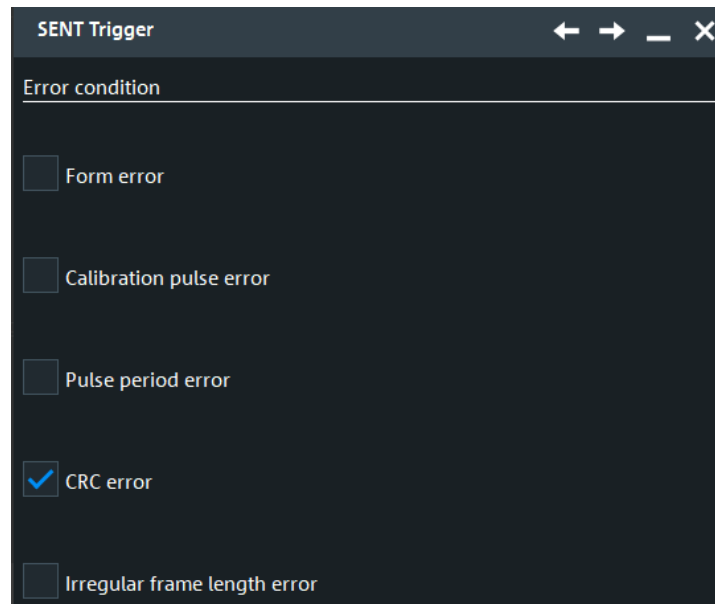
Error conditions setup

Executes a trigger event if one or more of the following errors occur:

- "Form Error"
Detects a form error in serial messages (short and enhanced).
An error occurs when at least one of the transmission sequences that form a serial message has an error.
- "Calibration Pulse Error"
Detects a calibration pulse error in transmission sequences.
An error occurs when:
 - the duration of the "Calibration/Sync" pulse (in ticks) is less than $56 \cdot (1 - \text{clock tolerance})$ or more than $56 \cdot (1 + \text{clock tolerance})$
 - the "Calibration/Sync" pulse duration of frame (–1) varies by more than 1.5625% from the "Calibration/Sync" pulse duration of frame (n)
- "Pulse Period Error"
Detects an error in the "Calibration/Sync" pulse in transmission sequences.
An error occurs when a nibble has any of the following:
 - Number of ticks at low is fewer than 4 ticks.
 - Nibble value < 0 (fewer than 12 ticks) or > 15 (more than 27 ticks).
- "CRC Error"
Detects a checksum error in both, the transmission sequences and serial messages.
The CRC length is 4 bits for transmission sequences and short serial messages, and 6 bit of enhanced serial messages.
- "Irregular Frame Length Error"
Detects frame length errors in transmission sequences when pause pulse mode constant frame length is set, see ["Pause pulse"](#) on page 669.
A frame length error occurs, when the total length of the transmission sequence (including pause pulse) does not match the frame length setting, see ["Frame length \[clock ticks\]"](#) on page 669.

Remote command:

[TRIGger<m>:SENT:FORMerror](#) on page 2064

[TRIGger<m>:SENT:PULSeerror](#) on page 2064

[TRIGger<m>:SENT:PPERioderror](#) on page 2065

[TRIGger<m>:SENT:CRCErrror](#) on page 2065

[TRIGger<m>:SENT:IRFLength](#) on page 2065

14.10.3.2 Triggering on SENT signals

Prerequisites: A SENT bus is configured, see [Chapter 14.10.2.3, "Configuring SENT protocol"](#), on page 670.

1. Press the [Bus] key and select the "Shortcuts" tab.
2. Press "Setup trigger".
3. Tap the "Source" button and select the "Serial bus" trigger source.
4. Select the serial bus that is set to SENT.
5. Select the "Trigger type".
6. For more complex trigger types, set the parameters according to the selected "Trigger type".
For details, see [Chapter 14.10.3.1, "SENT trigger settings"](#), on page 671.

14.10.4 SENT label list

SENT label lists provide a very useful way of translating the decoded data into user format. The label lists are highly customizable. The format of supplying the label list description is through a .xml file and is explained with an example, see ["Label List Structure for SENT Protocol"](#) on page 677.

See also: [Chapter 14.1.4, "Content and format of the PTT file"](#), on page 515.

Label List Structure for SENT Protocol

```
<sb:FRAME NAME="Diagnostic Error Codes" STATE="ON">
  <!-- Start of a Frame Definition -->
  <!-- This block defines the information of a Transmission Sequence
  or Serial Message:
  NAME => Symbolic Label of the Frame
  STATE [ON/OFF] => When ON, this frame Translation is taken into consideration.
  When OFF, this frame Translation is skipped.-->
<sb:DESCRIPTION> used to diagnose the current SENT System</sb:DESCRIPTION>
  <!-- Doesn't affect the Translation -->
<sb:ID-VALUE>01</sb:ID-VALUE>
  <!-- ID Value of the Serial Message (in decimal) -->
  <!-- Absence of the ID-VALUE field implies that the current Frame Translation
  is to be used for Transmission Sequences and not for a Serial Message -->
<sb:ID-LENGTH>8</sb:ID-LENGTH>
```

```

    <!-- ID Length of the Serial Message (in bits) -->
<sb:DATA-SIZE>12</sb:DATA-SIZE>
    <!-- Data Length of the Serial Message (in bits) -->
<sb:SIGNALS>
    <!-- This block defines the information of the Signals embedded
        in the Data Field of the Frame (Transmission Sequence or Serial Message) -->
<sb:SIGNAL ID="Diagnostic">
    <!-- Unique ID of the Signal (no effect on Translation) -->
<sb:SHORT-NAME>Diagnostic Code</sb:SHORT-NAME>
    <!-- Name of the Signal -->
<sb:DESCRIPTION></sb:DESCRIPTION>
    <!-- Info Field (no effect on Translation) -->
<sb:BIT-POSITION>11</sb:BIT-POSITION>
    <!-- Starting Bit position of the Signal
        (The whole Data Field is represented as MSB -> LSB Sequence) -->
<sb:BIT-LENGTH>12</sb:BIT-LENGTH>
    <!-- Number of Bits representing the Signal Value -->
<sb:BYTE-ORDER>MSB</sb:BYTE-ORDER>
    <!-- Byte Order of the Signal Value [MSB or LSB], Default: MSB -->
<sb:VALUE-TYPE>ENUM</sb:VALUE-TYPE>
    <!-- Representation of the Bits [ENUM, UNSIGNED_INT, INT, FLOAT, DOUBLE],
        Default: UNSIGNED_INT
        The Signal Value is calculated according to the following:
        Translated_Value = Encoded_Value * FACTOR + OFFSET -->
<sb:FACTOR>1.0</sb:FACTOR>
    <!-- Signal Factor (decimal value)-->
<sb:OFFSET>0.0</sb:OFFSET>
    <!-- Signal Offset (decimal value)-->
<sb:MIN>0</sb:MIN>
    <!-- Minimum Signal Value (decimal value) -->
<sb:MAX>4096</sb:MAX>
    <!-- Maximum Signal Value (decimal value) -->
<sb:ENUM-VALUES>
    <!-- This block is only valid (and taken into consideration)
        when the VALUE-TYPE is ENUM
        It defines the Enumeration List Translation of the Signal -->
<sb:ENUM INDEX="0" LABEL="No Error"/>
    <!-- INDEX is the Enum Value (corresponds to the Signal Value in decimal),
        LABEL is the matching Translated Signal Value -->
<sb:ENUM INDEX="1" LABEL="Channel 1 out of range high"/>
</sb:ENUM-VALUES>
    <!-- End of Signal Enumeration List Definition -->
</sb:SIGNAL>
    <!-- End of a Signal Definition -->
    <!-- More Signals can be defined here! -->
</sb:SIGNALS>
    <!-- End of list of Signals Definition -->
</sb:FRAME>
    <!-- End of Frame Definition -->

```

For an example to label list translation, see [Chapter 14.10.4.1, "SENT label list translation example"](#), on page 679.

Remote command:

- [BUS<m>:SENT:FRAMe<n>:SYMBol?](#) on page 2071
- [BUS<m>:SENT:FRAMe<n>:SDATa?](#) on page 2070
- [BUS<m>:SENT:FRAMe<n>:SDEXport?](#) on page 2071

14.10.4.1 SENT label list translation example

The example shows the xml sequence for a label list translation in the SENT protocol:

```
<?xml version="1.0" encoding="UTF-8"?>
<sb:LABEL-LIST-FILE>
  <sb:PROJECT ID="SENT-TRANSLATION SYSTEM">
    <sb:SHORT-NAME>SENT</sb:SHORT-NAME>
    <sb:LONG-NAME>SENT-Translation System Demo</sb:LONG-NAME>
    <sb:DESCRIPTION>This is the database for Translation demo for SENT.</sb:DESCRIPTION>
  </sb:PROJECT>
  <sb:FRAMES>
    <sb:FRAME NAME="Air Temperature" STATE="ON">
      <sb:DESCRIPTION></sb:DESCRIPTION>
      <sb:ID-VALUE>0</sb:ID-VALUE>
      <sb:ID-LENGTH>4</sb:ID-LENGTH>
      <sb:DATA-SIZE>16</sb:DATA-SIZE>
    </sb:FRAME>
    <sb:FRAME NAME="Humidity" STATE="OFF">
      <sb:DESCRIPTION></sb:DESCRIPTION>
      <sb:ID-VALUE>2</sb:ID-VALUE>
      <sb:ID-LENGTH>4</sb:ID-LENGTH>
      <sb:DATA-SIZE>16</sb:DATA-SIZE>
    </sb:FRAME>
    <sb:FRAME NAME="Barometric Pressure" STATE="OFF">
      <sb:DESCRIPTION></sb:DESCRIPTION>
      <sb:ID-VALUE>4</sb:ID-VALUE>
      <sb:ID-LENGTH>4</sb:ID-LENGTH>
      <sb:DATA-SIZE>16</sb:DATA-SIZE>
    </sb:FRAME>
    <sb:FRAME NAME="Configuration Code" STATE="OFF">
      <sb:DESCRIPTION></sb:DESCRIPTION>
      <sb:ID-VALUE>04</sb:ID-VALUE>
      <sb:ID-LENGTH>8</sb:ID-LENGTH>
      <sb:DATA-SIZE>12</sb:DATA-SIZE>
    </sb:FRAME>
    <sb:FRAME NAME="Manufacturer Code" STATE="OFF">
      <sb:DESCRIPTION></sb:DESCRIPTION>
      <sb:ID-VALUE>05</sb:ID-VALUE>
      <sb:ID-LENGTH>8</sb:ID-LENGTH>
      <sb:DATA-SIZE>12</sb:DATA-SIZE>
    </sb:FRAME>
  </sb:FRAMES>
</sb:LABEL-LIST-FILE>
```

```

</sb:FRAME>
<sb:FRAME NAME="Sensor Type" STATE="ON">
  <sb:DESCRIPTION>specifies the SENT Sensor Type</sb:DESCRIPTION>
  <sb:ID-VALUE>03</sb:ID-VALUE>
  <sb:ID-LENGTH>8</sb:ID-LENGTH>
  <sb:DATA-SIZE>12</sb:DATA-SIZE>
  <sb:SIGNALS>
    <sb:SIGNAL ID="Sensor Class">
      <sb:SHORT-NAME>Sensor Class</sb:SHORT-NAME>
      <sb:BIT-POSITION>11</sb:BIT-POSITION>
      <sb:BIT-LENGTH>12</sb:BIT-LENGTH>
      <sb:BYTE-ORDER>MSB</sb:BYTE-ORDER>
      <sb:VALUE-TYPE>ENUM</sb:VALUE-TYPE>
      <sb:FACTOR>1.0</sb:FACTOR>
      <sb:OFFSET>0.0</sb:OFFSET>
      <sb:MIN>0</sb:MIN>
      <sb:MAX>32.0</sb:MAX>
      <sb:ENUM-VALUES>
        <sb:ENUM INDEX="0" LABEL="Not Specified"/>
        <sb:ENUM INDEX="1" LABEL="P"/>
        <sb:ENUM INDEX="2" LABEL="P/-"/>
        <sb:ENUM INDEX="3" LABEL="P/S"/>
        <sb:ENUM INDEX="4" LABEL="P/S/Default T"/>
        <sb:ENUM INDEX="5" LABEL="P/S/Sensor-Specific T"/>
        <sb:ENUM INDEX="6" LABEL="P1/P2"/>
        <sb:ENUM INDEX="7" LABEL="P/Default T"/>
        <sb:ENUM INDEX="8" LABEL="P/Sensor-Specific T"/>
        <sb:ENUM INDEX="9" LABEL="P1/P2/Default T"/>
        <sb:ENUM INDEX="10" LABEL="P1/P2/Sensor-Specific T"/>
        <sb:ENUM INDEX="16" LABEL="Not Defined"/>
        <sb:ENUM INDEX="17" LABEL="MAF (hi-res,lin)"/>
        <sb:ENUM INDEX="18" LABEL="MAF (hi-res,non-lin)"/>
        <sb:ENUM INDEX="19" LABEL="MAF (hi-res,lin) / Pressure"/>
        <sb:ENUM INDEX="20" LABEL="MAF (hi-res,non-lin) / Pressure"/>
        <sb:ENUM INDEX="21" LABEL="MAF (lin) / Pressure (hi-res)"/>
        <sb:ENUM INDEX="22" LABEL="MAF (non-lin) / Pressure (hi-res)"/>
      </sb:ENUM-VALUES>
    </sb:SIGNAL>
  </sb:SIGNALS>
</sb:FRAME>
<sb:FRAME NAME="SENT Standard Revision" STATE="ON">
  <sb:SHORT-NAME>SENT Standard</sb:SHORT-NAME>
  <sb:DESCRIPTION>specifies the SENT Standard Revision Number</sb:DESCRIPTION>
  <sb:ID-VALUE>10</sb:ID-VALUE>
  <sb:ID-LENGTH>4</sb:ID-LENGTH>
  <sb:DATA-SIZE>8</sb:DATA-SIZE>
  <sb:SIGNALS>
    <sb:SIGNAL ID="Revision">
      <sb:SHORT-NAME>Revision</sb:SHORT-NAME>
      <sb:DESCRIPTION>SENT-Standard Revision Number</sb:DESCRIPTION>

```

```

<sb:BIT-POSITION>7</sb:BIT-POSITION>
<sb:BIT-LENGTH>8</sb:BIT-LENGTH>
<sb:BYTE-ORDER>MSB</sb:BYTE-ORDER>
<sb:VALUE-TYPE>ENUM</sb:VALUE-TYPE>
<sb:FACTOR>1.0</sb:FACTOR>
<sb:OFFSET>0.0</sb:OFFSET>
<sb:MIN>0</sb:MIN>
<sb:MAX>4.0</sb:MAX>
<sb:ENUM-VALUES>
  <sb:ENUM INDEX="0" LABEL="Not defined"/>
  <sb:ENUM INDEX="1" LABEL="J2716 Rev 1"/>
  <sb:ENUM INDEX="2" LABEL="J2716 Rev 2"/>
  <sb:ENUM INDEX="3" LABEL="J2716 Rev 3"/>
</sb:ENUM-VALUES>
</sb:SIGNAL>
</sb:SIGNALS>
</sb:FRAME>
<sb:FRAME NAME="Diagnostic Error Codes" STATE="ON">
  <sb:DESCRIPTION>used to diagnose the current SENT System</sb:DESCRIPTION>
  <sb:ID-VALUE>01</sb:ID-VALUE>
  <sb:ID-LENGTH>8</sb:ID-LENGTH>
  <sb:DATA-SIZE>12</sb:DATA-SIZE>
  <sb:SIGNALS>
    <sb:SIGNAL ID="Diagnostic">
      <sb:SHORT-NAME>Diagnostic Code</sb:SHORT-NAME>
      <sb:DESCRIPTION></sb:DESCRIPTION>
      <sb:BIT-POSITION>11</sb:BIT-POSITION>
      <sb:BIT-LENGTH>12</sb:BIT-LENGTH>
      <sb:BYTE-ORDER>MSB</sb:BYTE-ORDER>
      <sb:VALUE-TYPE>ENUM</sb:VALUE-TYPE>
      <sb:FACTOR>1.0</sb:FACTOR>
      <sb:OFFSET>0.0</sb:OFFSET>
      <sb:MIN>0</sb:MIN>
      <sb:MAX>4096</sb:MAX>
      <sb:ENUM-VALUES>
        <sb:ENUM INDEX="0" LABEL="No Error"/>
        <sb:ENUM INDEX="1" LABEL="Channel 1 out of range high"/>
        <sb:ENUM INDEX="2" LABEL="Channel 1 out of range low"/>
        <sb:ENUM INDEX="3" LABEL="Initialization Error (Channel 1)"/>
        <sb:ENUM INDEX="4" LABEL="Channel 2 out of range high"/>
        <sb:ENUM INDEX="5" LABEL="Channel 2 out of range low"/>
        <sb:ENUM INDEX="6" LABEL="Initialization Error (Channel 2)"/>
        <sb:ENUM INDEX="7" LABEL="Channel 1 and 2 Rationality Error"/>
        <sb:ENUM INDEX="1025" LABEL="Slow Channel Temperature out of range high"/>
        <sb:ENUM INDEX="1026" LABEL="Slow Channel Temperature out of range low"/>
        <sb:ENUM INDEX="1027" LABEL="Slow Channel Temperature initialization error"/>
        <sb:ENUM INDEX="1028" LABEL="Slow Channel Humidity out of range high"/>
        <sb:ENUM INDEX="1029" LABEL="Slow Channel Humidity out of range low"/>
        <sb:ENUM INDEX="1030" LABEL="Slow Channel Humidity initialization error"/>
        <sb:ENUM INDEX="1031" LABEL="Slow Channel Barometric Pressure out of range high"/>
      </sb:ENUM-VALUES>
    </sb:SIGNAL>
  </sb:SIGNALS>
</sb:FRAME>

```

```

        <sb:ENUM INDEX="1032" LABEL="Slow Channel Barometric Pressure out of range low"/>
        <sb:ENUM INDEX="1033" LABEL="Slow Channel Barometric Pressure initialization error"/>
    </sb:ENUM-VALUES>
</sb:SIGNAL>
</sb:SIGNALS>
</sb:FRAME>
<sb:FRAME NAME="Simu-Dual Throttle Position" STATE="ON">
    <sb:SHORT-NAME>DTP</sb:SHORT-NAME>
    <sb:DATA-SIZE>20</sb:DATA-SIZE>
    <sb:SIGNALS>
        <sb:SIGNAL ID="Channel_1">
            <sb:SHORT-NAME>TPS1</sb:SHORT-NAME>
            <sb:DESCRIPTION>""</sb:DESCRIPTION>
            <sb:BIT-POSITION>19</sb:BIT-POSITION>
            <sb:BIT-LENGTH>12</sb:BIT-LENGTH>
            <sb:BYTE-ORDER>MSB</sb:BYTE-ORDER>
            <sb:VALUE-TYPE>UNSIGNED_INT</sb:VALUE-TYPE>
            <sb:FACTOR>1.0</sb:FACTOR>
            <sb:OFFSET>0.0</sb:OFFSET>
            <sb:MIN>0</sb:MIN>
            <sb:MAX>10000.0</sb:MAX>
            <sb:UNIT></sb:UNIT>
        </sb:SIGNAL>
        <sb:SIGNAL ID="Channel_2">
            <sb:SHORT-NAME>TPS2</sb:SHORT-NAME>
            <sb:DESCRIPTION>""</sb:DESCRIPTION>
            <sb:BIT-POSITION>7</sb:BIT-POSITION>
            <sb:BIT-LENGTH>8</sb:BIT-LENGTH>
            <sb:BYTE-ORDER>LSB</sb:BYTE-ORDER>
            <sb:FACTOR>1.0</sb:FACTOR>
            <sb:OFFSET>0.0</sb:OFFSET>
            <sb:MIN>0</sb:MIN>
            <sb:MAX>10000.0</sb:MAX>
            <sb:UNIT></sb:UNIT>
        </sb:SIGNAL>
    </sb:SIGNALS>
</sb:FRAME>
<sb:FRAME NAME="Dual Throttle Position" STATE="OFF">
    <sb:SHORT-NAME>DTP</sb:SHORT-NAME>
    <sb:DATA-SIZE>24</sb:DATA-SIZE>
    <sb:SIGNALS>
        <sb:SIGNAL ID="Channel_1">
            <sb:SHORT-NAME>TPS1</sb:SHORT-NAME>
            <sb:DESCRIPTION>""</sb:DESCRIPTION>
            <sb:BIT-POSITION>23</sb:BIT-POSITION>
            <sb:BIT-LENGTH>12</sb:BIT-LENGTH>
            <sb:BYTE-ORDER>MSB</sb:BYTE-ORDER>
            <sb:VALUE-TYPE>UNSIGNED_INT</sb:VALUE-TYPE>
            <sb:FACTOR>1.0</sb:FACTOR>
            <sb:OFFSET>0.0</sb:OFFSET>

```

```

    <sb:MIN>0</sb:MIN>
    <sb:MAX>10000.0</sb:MAX>
    <sb:UNIT></sb:UNIT>
  </sb:SIGNAL>
<sb:SIGNAL ID="Channel_2">
  <sb:SHORT-NAME>TPS2</sb:SHORT-NAME>
  <sb:DESCRIPTION>"</sb:DESCRIPTION>
  <sb:BIT-POSITION>11</sb:BIT-POSITION>
  <sb:BIT-LENGTH>12</sb:BIT-LENGTH>
  <sb:BYTE-ORDER>LSB</sb:BYTE-ORDER>
  <sb:FACTOR>1.0</sb:FACTOR>
  <sb:OFFSET>0.0</sb:OFFSET>
  <sb:MIN>0</sb:MIN>
  <sb:MAX>10000.0</sb:MAX>
  <sb:UNIT></sb:UNIT>
</sb:SIGNAL>
</sb:SIGNALS>
</sb:FRAME>
<sb:FRAME NAME="Mass Air Flow (16)" STATE="OFF">
  <sb:SHORT-NAME>MAF/P</sb:SHORT-NAME>
  <sb:DATA-SIZE>24</sb:DATA-SIZE>
  <sb:SIGNALS>
    <sb:SIGNAL ID="Channel_1">
      <sb:SHORT-NAME>MAF</sb:SHORT-NAME>
      <sb:DESCRIPTION>"</sb:DESCRIPTION>
      <sb:BIT-POSITION>23</sb:BIT-POSITION>
      <sb:BIT-LENGTH>16</sb:BIT-LENGTH>
      <sb:BYTE-ORDER>MSB</sb:BYTE-ORDER>
      <sb:FACTOR>1.0</sb:FACTOR>
      <sb:OFFSET>0.0</sb:OFFSET>
      <sb:MIN>0</sb:MIN>
      <sb:MAX>10000.0</sb:MAX>
      <sb:UNIT></sb:UNIT>
    </sb:SIGNAL>
  </sb:SIGNALS>
</sb:FRAME>
<sb:FRAME NAME="Mass Air Flow (16/8)" STATE="OFF">
  <sb:SHORT-NAME>MAF/P</sb:SHORT-NAME>
  <sb:DATA-SIZE>24</sb:DATA-SIZE>
  <sb:SIGNALS>
    <sb:SIGNAL ID="Channel_1">
      <sb:SHORT-NAME>MAF</sb:SHORT-NAME>
      <sb:DESCRIPTION>"</sb:DESCRIPTION>
      <sb:BIT-POSITION>23</sb:BIT-POSITION>
      <sb:BIT-LENGTH>16</sb:BIT-LENGTH>
      <sb:BYTE-ORDER>MSB</sb:BYTE-ORDER>
      <sb:FACTOR>1.0</sb:FACTOR>
      <sb:OFFSET>0.0</sb:OFFSET>
      <sb:MIN>0</sb:MIN>
      <sb:MAX>10000.0</sb:MAX>

```

```

    <sb:UNIT></sb:UNIT>
  </sb:SIGNAL>
<sb:SIGNAL ID="Channel_2">
  <sb:SHORT-NAME>Pressure</sb:SHORT-NAME>
  <sb:DESCRIPTION>"</sb:DESCRIPTION>
  <sb:BIT-POSITION>7</sb:BIT-POSITION>
  <sb:BIT-LENGTH>8</sb:BIT-LENGTH>
  <sb:BYTE-ORDER>LSB</sb:BYTE-ORDER>
  <sb:FACTOR>1.0</sb:FACTOR>
  <sb:OFFSET>0.0</sb:OFFSET>
  <sb:MIN>0</sb:MIN>
  <sb:MAX>10000.0</sb:MAX>
  <sb:UNIT></sb:UNIT>
</sb:SIGNAL>
</sb:SIGNALS>
</sb:FRAME>
<sb:FRAME NAME="Mass Air Flow (14/10)" STATE="OFF">
  <sb:SHORT-NAME>MAF/P</sb:SHORT-NAME>
  <sb:DATA-SIZE>24</sb:DATA-SIZE>
  <sb:SIGNALS>
    <sb:SIGNAL ID="Channel_1">
      <sb:SHORT-NAME>MAF</sb:SHORT-NAME>
      <sb:DESCRIPTION>"</sb:DESCRIPTION>
      <sb:BIT-POSITION>23</sb:BIT-POSITION>
      <sb:BIT-LENGTH>14</sb:BIT-LENGTH>
      <sb:BYTE-ORDER>MSB</sb:BYTE-ORDER>
      <sb:FACTOR>1.0</sb:FACTOR>
      <sb:OFFSET>0.0</sb:OFFSET>
      <sb:MIN>0</sb:MIN>
      <sb:MAX>10000.0</sb:MAX>
      <sb:UNIT></sb:UNIT>
    </sb:SIGNAL>
    <sb:SIGNAL ID="Channel_2">
      <sb:SHORT-NAME>Pressure</sb:SHORT-NAME>
      <sb:DESCRIPTION>"</sb:DESCRIPTION>
      <sb:BIT-POSITION>9</sb:BIT-POSITION>
      <sb:BIT-LENGTH>10</sb:BIT-LENGTH>
      <sb:BYTE-ORDER>LSB</sb:BYTE-ORDER>
      <sb:FACTOR>1.0</sb:FACTOR>
      <sb:OFFSET>0.0</sb:OFFSET>
      <sb:MIN>0</sb:MIN>
      <sb:MAX>10000.0</sb:MAX>
      <sb:UNIT></sb:UNIT>
    </sb:SIGNAL>
  </sb:SIGNALS>
</sb:FRAME>
<sb:FRAME NAME="Single Secure Sensor" STATE="OFF">
  <sb:SHORT-NAME>SSS</sb:SHORT-NAME>
  <sb:DATA-SIZE>24</sb:DATA-SIZE>
  <sb:SIGNALS>

```

```

<sb:SIGNAL ID="Channel_1">
  <sb:SHORT-NAME>Ch1</sb:SHORT-NAME>
  <sb:DESCRIPTION>""</sb:DESCRIPTION>
  <sb:BIT-POSITION>23</sb:BIT-POSITION>
  <sb:BIT-LENGTH>12</sb:BIT-LENGTH>
  <sb:BYTE-ORDER>MSB</sb:BYTE-ORDER>
  <sb:FACTOR>1.0</sb:FACTOR>
  <sb:OFFSET>0.0</sb:OFFSET>
  <sb:MIN>0</sb:MIN>
  <sb:MAX>10000.0</sb:MAX>
  <sb:UNIT></sb:UNIT>
</sb:SIGNAL>
<sb:SIGNAL ID="Channel_2">
  <sb:SHORT-NAME>Counter</sb:SHORT-NAME>
  <sb:DESCRIPTION>""</sb:DESCRIPTION>
  <sb:BIT-POSITION>11</sb:BIT-POSITION>
  <sb:BIT-LENGTH>8</sb:BIT-LENGTH>
  <sb:BYTE-ORDER>MSB</sb:BYTE-ORDER>
  <sb:FACTOR>1.0</sb:FACTOR>
  <sb:OFFSET>0.0</sb:OFFSET>
  <sb:MIN>0</sb:MIN>
  <sb:MAX>256.0</sb:MAX>
  <sb:UNIT></sb:UNIT>
</sb:SIGNAL>
</sb:SIGNALS>
</sb:FRAME>
<sb:FRAME NAME="Pressure Sensor" STATE="OFF">
  <sb:SHORT-NAME>P</sb:SHORT-NAME>
  <sb:DATA-SIZE>24</sb:DATA-SIZE>
  <sb:SIGNALS>
    <sb:SIGNAL ID="Channel_1">
      <sb:SHORT-NAME>Pressure1</sb:SHORT-NAME>
      <sb:DESCRIPTION>""</sb:DESCRIPTION>
      <sb:BIT-POSITION>23</sb:BIT-POSITION>
      <sb:BIT-LENGTH>12</sb:BIT-LENGTH>
      <sb:BYTE-ORDER>MSB</sb:BYTE-ORDER>
      <sb:FACTOR>1.0</sb:FACTOR>
      <sb:OFFSET>0.0</sb:OFFSET>
      <sb:MIN>0</sb:MIN>
      <sb:MAX>10000.0</sb:MAX>
      <sb:UNIT></sb:UNIT>
    </sb:SIGNAL>
    <sb:SIGNAL ID="Channel_2">
      <sb:SHORT-NAME>Pressure2</sb:SHORT-NAME>
      <sb:DESCRIPTION>""</sb:DESCRIPTION>
      <sb:BIT-POSITION>11</sb:BIT-POSITION>
      <sb:BIT-LENGTH>12</sb:BIT-LENGTH>
      <sb:BYTE-ORDER>LSB</sb:BYTE-ORDER>
      <sb:FACTOR>1.0</sb:FACTOR>
      <sb:OFFSET>0.0</sb:OFFSET>

```

```

    <sb:MIN>0</sb:MIN>
    <sb:MAX>10000.0</sb:MAX>
    <sb:UNIT></sb:UNIT>
  </sb:SIGNAL>
</sb:SIGNALS>
</sb:FRAME>
<sb:FRAME NAME="Pressure and Temperature Sensor" STATE="OFF">
  <sb:SHORT-NAME>P/T</sb:SHORT-NAME>
  <sb:DATA-SIZE>24</sb:DATA-SIZE>
  <sb:SIGNALS>
    <sb:SIGNAL ID="Channel_1">
      <sb:SHORT-NAME>Pressure</sb:SHORT-NAME>
      <sb:DESCRIPTION>"</sb:DESCRIPTION>
      <sb:BIT-POSITION>23</sb:BIT-POSITION>
      <sb:BIT-LENGTH>12</sb:BIT-LENGTH>
      <sb:BYTE-ORDER>MSB</sb:BYTE-ORDER>
      <sb:FACTOR>1.0</sb:FACTOR>
      <sb:OFFSET>0.0</sb:OFFSET>
      <sb:MIN>0</sb:MIN>
      <sb:MAX>10000.0</sb:MAX>
      <sb:UNIT></sb:UNIT>
    </sb:SIGNAL>
    <sb:SIGNAL ID="Channel_2">
      <sb:SHORT-NAME>Temperature</sb:SHORT-NAME>
      <sb:DESCRIPTION>"</sb:DESCRIPTION>
      <sb:BIT-POSITION>11</sb:BIT-POSITION>
      <sb:BIT-LENGTH>12</sb:BIT-LENGTH>
      <sb:BYTE-ORDER>LSB</sb:BYTE-ORDER>
      <sb:FACTOR>1.0</sb:FACTOR>
      <sb:OFFSET>0.0</sb:OFFSET>
      <sb:MIN>0</sb:MIN>
      <sb:MAX>10000.0</sb:MAX>
      <sb:UNIT></sb:UNIT>
    </sb:SIGNAL>
  </sb:SIGNALS>
</sb:FRAME>
<sb:FRAME NAME="Pressure and Secure Sensor" STATE="OFF">
  <sb:SHORT-NAME>P/S</sb:SHORT-NAME>
  <sb:DATA-SIZE>24</sb:DATA-SIZE>
  <sb:SIGNALS>
    <sb:SIGNAL ID="Channel_1">
      <sb:SHORT-NAME>Pressure</sb:SHORT-NAME>
      <sb:DESCRIPTION>"</sb:DESCRIPTION>
      <sb:BIT-POSITION>23</sb:BIT-POSITION>
      <sb:BIT-LENGTH>12</sb:BIT-LENGTH>
      <sb:BYTE-ORDER>MSB</sb:BYTE-ORDER>
      <sb:FACTOR>1.0</sb:FACTOR>
      <sb:OFFSET>0.0</sb:OFFSET>
      <sb:MIN>0</sb:MIN>
      <sb:MAX>10000.0</sb:MAX>

```



```

    <sb:UNIT></sb:UNIT>
  </sb:SIGNAL>
<sb:SIGNAL ID="Channel_2">
  <sb:SHORT-NAME>Counter</sb:SHORT-NAME>
  <sb:DESCRIPTION>" "</sb:DESCRIPTION>
  <sb:BIT-POSITION>11</sb:BIT-POSITION>
  <sb:BIT-LENGTH>8</sb:BIT-LENGTH>
  <sb:BYTE-ORDER>MSB</sb:BYTE-ORDER>
  <sb:FACTOR>1.0</sb:FACTOR>
  <sb:OFFSET>0.0</sb:OFFSET>
  <sb:MIN>0</sb:MIN>
  <sb:MAX>10000.0</sb:MAX>
  <sb:UNIT></sb:UNIT>
</sb:SIGNAL>
</sb:SIGNALS>
</sb:FRAME>
</sb:FRAMES>
</sb:LABEL-LIST-FILE>

```

14.10.5 SENT decode results

When the configuration of the serial bus is complete, the signal can be decoded:

1. In the "Protocol" dialog > "Setup" tab, enable "Decode".
2. In the "Protocol" dialog > "Display" tab, select additional result display settings: "Show decode table" and "Show binary signals".

For a description of the display settings, see also [Chapter 14.1.3, "Display"](#), on page 513.

The instrument captures and decodes the signal according to the standard definition and the configuration settings.

The color-coding of the various protocol sections and errors simplifies the interpretation of the visual display. The decode information condenses or expands, depending on the horizontal scale. Various data formats are available to show the result values.

Data is decoded and displayed in the order of its reception. The "Decode results" box shows the detailed decoded data for each frame as it is received.

State	Frame start	Type	Status [bin]	ID value [hex]	Symbolic Data	Translation	CRC [hex]	Bit rate
1 Ok	-53.4534 ms	Transmission Sequence	0011	—	[sym] 1019.000, 3276.000	Dual Throttle Position	0B	200 kbps
2 Pulse Period Error	-52.1724 ms	Transmission Sequence	0011	—	[sym] 1018.000, 4060.000	Dual Throttle Position	0B	200 kbps
3 Ok	-50.8928 ms	Transmission Sequence	0000	—	[sym] 596.000, 1188.000	Dual Throttle Position	0F	200 kbps
4 Ok	-49.6132 ms	Transmission Sequence	0000	—	[sym] 198.000, 1308.000	Dual Throttle Position	4	200 kbps
5 CRC Error	-48.3336 ms	Transmission Sequence	0000	—	[sym] 3902.000, 1567.000	Dual Throttle Position	4	200 kbps
6 Ok	-47.0526 ms	Transmission Sequence	0000	—	[sym] 3535.000, 1668.000	Dual Throttle Position	1	200 kbps
7 Ok	-45.773 ms	Transmission Sequence	0000	—	[sym] 3206.000, 1534.000	Dual Throttle Position	0	200 kbps
8 Ok	-44.4934 ms	Transmission Sequence	0000	—	[sym] 2928.000, 1654.000	Dual Throttle Position	B	200 kbps
9 Ok	-43.2124 ms	Transmission Sequence	0000	—	[sym] 2712.000, 1632.000	Dual Throttle Position	E	200 kbps
10 Ok	-41.9328 ms	Transmission Sequence	0000	—	[sym] 2564.000, 1540.000	Dual Throttle Position	3	200 kbps

Table 14-15: Content of the decode result table

Column	Description
State	Overall state of the frame
Frame start	Time of frame start in relation to the trigger point
Type	Frame type
Status [bin]	Status value
ID Value [hex]	Identifier value
Symbolic Data	Symbolic data value
Translation	Symbolic label name defined in the label list
CRC [hex]	CRC sequence value
Bit rate	Value of the bit rate

Tools

Press "Display settings" in the "Decode Results" table to access the "Display" tab.



Remote commands

Remote commands to retrieve decode results are described in [Chapter 27.18.11.3, "Decode results"](#), on page 2066.

14.10.6 Search on decoded SENT data

Using the search functionality, you can find various events in the decoded data, the same events which you also can trigger on. Before you can start the search, you have to configure the bus correctly and acquire decoded data.

To search on decoded data, set the search "Source" to the serial bus that is configured for the protocol to be analyzed.

See also [Chapter 11, "Search functions"](#), on page 425.

14.10.6.1 SENT search setup

Access: [Bus] > "Shortcuts" tab > "Setup search"

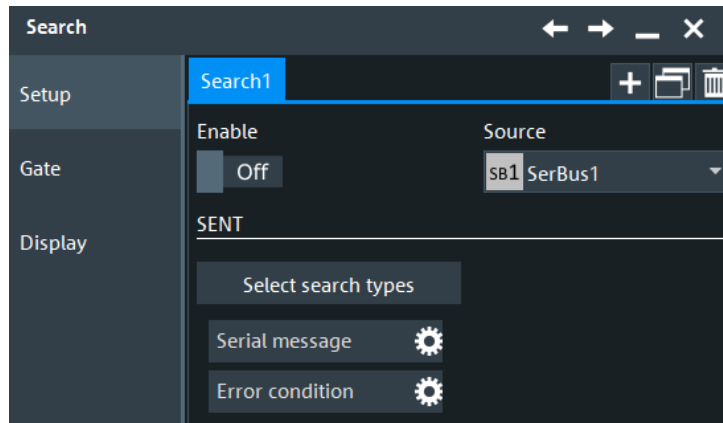

Search types

Enable the events to be searched for.

Unlike triggering, where you can trigger only on one defined event, you can search for various different events in one search.

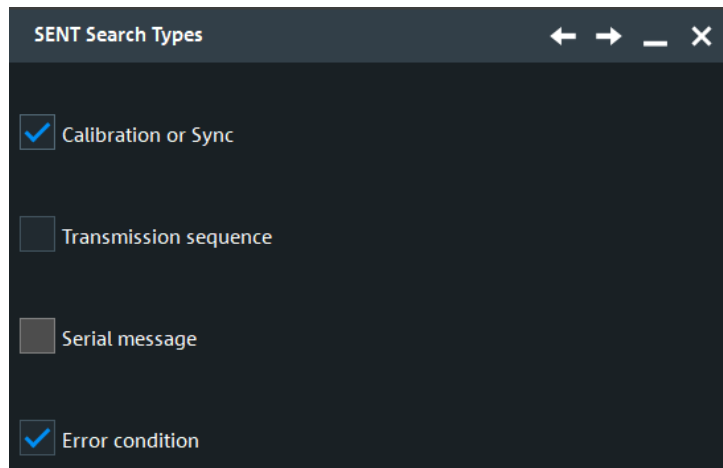

"Calibration Sync"

Searches for the end of the "Calibration/Synchronization" sequence, i.e. the falling edge.

This setting does not require any input parameters.

"Transmission Seq"

Searches for the end of the status nibble in a single transmission sequence, or the end of the combination of the status and data nibble(s).

Description of the specific settings: ["Transmission Sequence setup"](#) on page 690

"Serial Message"

Searching on a serial message depends on the serial protocol selected with [Serial protocol > Short | Enhanced](#) and the associated setting parameters:

- "Sequence > Identifier": searches for the end of the identifier nibble.
- "Sequence > ID+Data": searches for the end of the "ID and Data" nibble.

Description of the serial messages specific settings: ["Serial Message setup"](#) on page 691

"Error Condition"

Searches for the end of certain error events.

Description of trigger type specific settings: ["Error conditions setup"](#) on page 692

Remote command:

[SEARCH:TRIGger:SENT:CALibration](#) on page 2073

[SEARCH:TRIGger:SENT:TRANsmission](#) on page 2074

[SEARCH:TRIGger:SENT:SMSG](#) on page 2074

[SEARCH:TRIGger:SENT:ERRor](#) on page 2074

Transmission Sequence setup

Configures the search conditions for the transmission sequence.

Note: The displayed parameters depend on the selected "Sequence". The instrument displays the data setting parameters when you select "Status+Data", see ["Sequence"](#) on page 690.

The search type specific conditions are the same as for the trigger type, see ["Transmission Sequence setup"](#) on page 673.

Sequence ← Transmission Sequence setup

Selects the condition for searching in a single transmission sequence.

You can search for the end of the status nibble or the combination of the status and data nibble(s).

Remote command:

[SEARCH:TRIGger:SENT:TTYPe](#) on page 2075

Status ← Transmission Sequence setup

Defines the data bits for the status nibble.

Remote command:

[SEARCH:TRIGger:SENT:STATus](#) on page 2075

Condition ← Transmission Sequence setup

Selects the operator to define a specific data pattern or a data range.

The available operators:

- Equal, Not equal
- Less than, Greater than
- Less or equal, Greater or equal
- In range, Out of range

Remote command:

[SEARCH:TRIGGER:SENT:TDCN](#) on page 2076

Data Nibbles ← Transmission Sequence setup

Sets the number of data units in a single transmission sequence.

The maximum number of data nibbles is 6.

Remote command:

[BUS<m>:SENT:DNIBbles](#) on page 2057

Data min ← Transmission Sequence setup

Sets the data pattern. Enter the bytes in msb first bit order. The maximum pattern length is 64 bit. Waveform data is compared with the pattern byte-by-byte.

Remote command:

[SEARCH:TRIGGER:SENT:TDMN](#) on page 2076

Data max ← Transmission Sequence setup

The second data pattern is required to specify a range with conditions "In range" and "Out of range".

Remote command:

[SEARCH:TRIGGER:SENT:TDMX](#) on page 2076

Serial Message setup

Configures the search conditions for a serial message.

Note: The displayed parameters depend on the selected "Sequence". The instrument indicates the data setting parameters when you select "ID+Data", see "[Sequence](#)" on page 691.

The description of the search type specific settings are the same as for the trigger type, see "[Serial Message setup](#)" on page 674.

Sequence ← Serial Message setup

Selects the condition for searching in a serial message.

You can search for the end of an identifier nibble or the combination of the identifier and data nibble(s).

Remote command:

[SEARCH:TRIGGER:SENT:STYPe](#) on page 2077

ID Type ← Serial Message setup

Selects the message ID format for the enhanced serial message type.

You can select either 4 bit or 8 bit message ID.

Remote command:

[SEARCH:TRIGGER:SENT:SIDType](#) on page 2077

Identifier Condition ← Serial Message setup

Selects the operator to set a specific identifier or an identifier range.

The available operators:

- Equal, Not equal

- Less than, Greater than
- Less or equal, Greater or equal
- In range, Out of range

Remote command:

[SEARCh:TRIGger:SENT:SICN](#) on page 2078

Identifier min ← Serial Message setup

Defines the bit pattern of the message identifier.

In binary format, use the following characters: 1; 0; or X (do not care). To enter the pattern in other formats use the bit pattern editor, see [Chapter 14.1.7, "Bit pattern editor"](#), on page 519.

Remote command:

[SEARCh:TRIGger:SENT:SIMN](#) on page 2078

Identifier max ← Serial Message setup

The second identifier pattern is required to specify a range with conditions "In range" and "Out of range".

Remote command:

[SEARCh:TRIGger:SENT:SIMX](#) on page 2078

SSM Data Condition ← Serial Message setup

Selects the operator to set a specific data pattern or a data range.

The available operators:

- Equal, Not equal
- Less than, Greater than
- Less or equal, Greater or equal
- In range, Out of range

Remote command:

[SEARCh:TRIGger:SENT:SDCN](#) on page 2079

Data min ← Serial Message setup

Sets the data pattern. Enter the bytes in msb first bit order. The maximum pattern length is 64 bit. Waveform data is compared with the pattern byte-by-byte.

Remote command:

[SEARCh:TRIGger:SENT:SDMN](#) on page 2079

Data max ← Serial Message setup

The second data pattern is required to specify a range with conditions "In range" and "Out of range".

Remote command:

[SEARCh:TRIGger:SENT:SDMX](#) on page 2079

Error conditions setup

Performs the search on one or more of the following error events:

- "Transmission sequence errors"
 - "Calibration Pulse Error"
Searches for calibration pulse errors.

- "Pulse Period Error"
Searches for pulse period errors in a transmission sequence.
- "Irregular Frame Length Error"
Searches for irregular frame length errors in a transmission sequence if pause pulse mode is set to constant frame length..
- Serial message error
 - "Form Error"
Searches for format errors in serial messages.
- "CRC Error"
Searches for errors in the complete data transmission.

Remote command:

[SEARCH:TRIGGER:SENT:PULSEerror](#) on page 2080

[SEARCH:TRIGGER:SENT:PPERioderror](#) on page 2080

[SEARCH:TRIGGER:SENT:FORMerror](#) on page 2081

[SEARCH:TRIGGER:SENT:CRCErrror](#) on page 2081

[SEARCH:TRIGGER:SENT:IRFLength](#) on page 2080

14.10.6.2 SENT search results

To get search results, "Enable" the search. You can minimize, shift or close the search dialog.

The search results are listed in the search result table and marked in the waveform by blue lines.

For an introduction to search results, see:

- [Chapter 11.1.2, "Search results"](#), on page 426
- [Chapter 11.4.2, "Display zoom settings"](#), on page 446

Remote commands:

- [SEARCH:RESULT:SENT:FCOUNT?](#) on page 2082
- [SEARCH:RESULT:SENT:FRAME<m>:STATUS?](#) on page 2085
- [SEARCH:RESULT:SENT:FRAME<m>:START?](#) on page 2085
- [SEARCH:RESULT:SENT:FRAME<m>:STOP?](#) on page 2085
- [SEARCH:RESULT:SENT:FRAME<m>:DATA?](#) on page 2082
- [SEARCH:RESULT:SENT:FRAME<m>:CSValue?](#) on page 2082
- [SEARCH:RESULT:SENT:FRAME<m>:IDTYpe?](#) on page 2083
- [SEARCH:RESULT:SENT:FRAME<m>:IDValue?](#) on page 2083
- [SEARCH:RESULT:SENT:FRAME<m>:NIBBLE<n>:STATE?](#) on page 2083
- [SEARCH:RESULT:SENT:FRAME<m>:NIBBLE<n>:VALue?](#) on page 2084
- [SEARCH:RESULT:SENT:FRAME<m>:PAPTicks?](#) on page 2084
- [SEARCH:RESULT:SENT:FRAME<m>:SCOM?](#) on page 2084
- [SEARCH:RESULT:SENT:FRAME<m>:SDATA?](#) on page 2085
- [SEARCH:RESULT:SENT:FRAME<m>:SYMBOL?](#) on page 2086
- [SEARCH:RESULT:SENT:FRAME<m>:SYNCDuration?](#) on page 2086

- [SEARCH:RESULT:SENT:FRAME<m>:TYPE?](#) on page 2086

14.11 CXPI (option R&S RTO6-K520)

The Clock Extension Peripheral Interface (CXPI) protocol defines a communication standard for the vehicles electric system. It is developed by the Society of Automotive Engineers of Japan, Inc. (JSAE).

14.11.1 The CXPI protocol

This chapter provides an overview of the protocol characteristics, frame types and frame fields.

CXPI characteristics

Main characteristics of CXPI are:

- Carrier Sense Multiple Access (CSMA) and Collision Resolution (CR)
- The master sends pulse width modulated clock (PWMC)
- Support of the sleep/wake function to reduce power consumption
- Support of two methods for frame transfer management, the event trigger method and the polling method.
The event trigger method can be used when the focus is placed on the responsiveness of the slave node communication. The polling method puts the focus on the communication periodicity.
- Maximum baud rate of 20kbit/s
- Up to 16 nodes connected to a communication bus

Frame types

The CXPI protocol defines three types of frames:

- **Normal frame:** it varies in length according to the frame transfer method. The PTYPE field is only used for the polling method.

The normal frame is used to transfer compact data.

PTYPE		PID		Frame information			Data bytes	CRC
P	Frame Type	P	Frame ID	DLC	NM	CT		

Figure 14-19: CXPI normal frame

- **Sleep frame:** it has a fixed length and fixed values for the PID and data fields. It is sent by the master node to command the slave nodes to change into sleep state.

PID		Frame information			Data bytes	CRC
P	Frame ID	DLC	NM	CT		

Figure 14-20: CXPI sleep frame

- **Long frame:** it varies in length according to the frame transfer method. The PTYPE field is only used for the polling method. The long frame is used to transfer large amount of data.

PTYPE		PID		Frame information				Data bytes	CRC
P	Frame Type	P	Frame ID	DLC	NM	CT	extension DLC		

Figure 14-21: CXPI long frame

During measurements further type of frames may also occur: PTYPE only, PID only and PTYPE + PID only.

Frame fields

The different frames may contain the following fields:

- **PID:** consists of a frame identifier (7 bits) and one parity bit.
- **Protected TYPE (PTYPE):** a special PID field with a frame identifier of 00 (hex) and a parity of 1. It is used only in the polling method.
- **Frame information:** it consists of the following fields:
 - **Data Length Code (DLC):** 4 bits that indicate the length of the data byte of a normal frame.
 - **Network Management (NM):** 2 bits indicating if the frame is in wakeup or sleep mode.
 - **Counter (CT):** 2 bits indicating the continuity of the frame.
 - **extension DLC:** 1 byte that is added to the frame information for long frames. It indicates the length of the data byte field of a long frame.
- **Data byte:** the length of the data byte field depends on the frame type. It contains the actual information of the frame.
- **Cyclic Redundancy Check (CRC):** 1 byte for normal and sleep frames and 2 bytes for long frames. CRC errors can be detected to check if the received data is correct.

14.11.2 CXPI configuration

14.11.2.1 CXPI configuration settings

Access: [Bus] key > "Setup" tab > "Protocol" = "CXPI"



Make sure that the tab of the correct serial bus is selected.

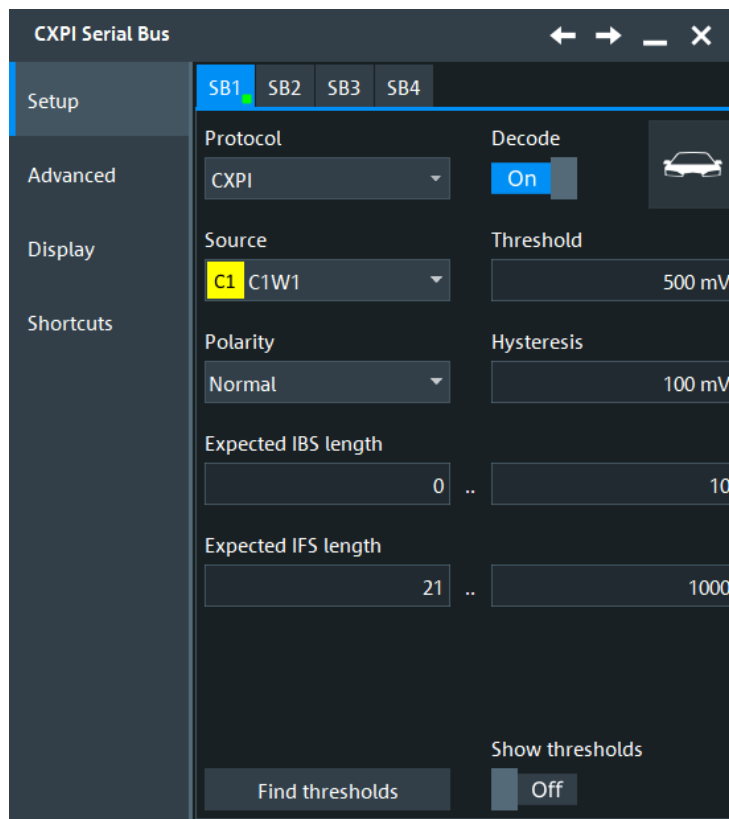

See also: [Chapter 14.1.1, "Setup - general settings"](#), on page 511

Source

Sets the source channel for the signal.

Usually, the source is one of the analog channels. Reference and math waveforms are available as source if the trigger source is one of the analog channels but not the serial bus.

Alternatively, digital channels can be used if MSO option R&S RTO6-B1 is installed. Digital and analog channels cannot be used at the same time.

For triggering on a serial bus, analog or digital channel sources are required.

Remote command:

[BUS<m>:CXPI:SDATa](#) on page 2089

Polarity

Selects if the polarity of the transmitted waveform is normal (high = 1) or inverted (low = 1).

Remote command:

[BUS<m>:CXPI:POLarity](#) on page 2089

Threshold

Sets the threshold value for digitization of the signal. If the signal value on the line is higher than the threshold, the signal state is high. If the signal value on the line is below the threshold, the signal state is low. The interpretation of high and low is defined by the [Polarity](#).

There are two ways to set the threshold:

"Threshold" Enter the value directly in the field.

"Find thresholds" Executes the measurement of reference levels and sets the thresholds to the middle reference level of the measured amplitude.

Remote command:

[BUS<m>:CXPI:THReshold](#) on page 2089

[BUS<m>:SETReflevels](#) on page 1814

Hysteresis

Sets a value for the hysteresis.

The hysteresis is applied as ("Threshold" +"Hysteresis") and ("Threshold" - "Hysteresis").

Remote command:

[BUS<m>:CXPI:HYSTeresis](#) on page 2088

Expected IBS length

Sets a range for the expected inter-byte-space (IBS) length.

The standard has a permissible IBS length. Violation of these limits leads to decoding ambiguities. To test different limits, you can set the expected IBS length value.

Remote command:

[BUS<m>:CXPI:IBS:MAX](#) on page 2090

[BUS<m>:CXPI:IBS:MIN](#) on page 2090

Expected IFS length

Sets a range for the inter-frame-space.

The standard has a permissible IFS length. Violation of these limits leads to decoding ambiguities. To test different limits, you can set the expected IFS length value.

Remote command:

[BUS<m>:CXPI:IFS:MAX](#) on page 2090

[BUS<m>:CXPI:IFS:MIN](#) on page 2090

Show thresholds

If enabled, the threshold levels are displayed in the diagram.

Remote command:

[BUS<m>:THReshold](#) on page 1815

14.11.2.2 Advanced settings

Access: [Bus] > "Advanced" tab.

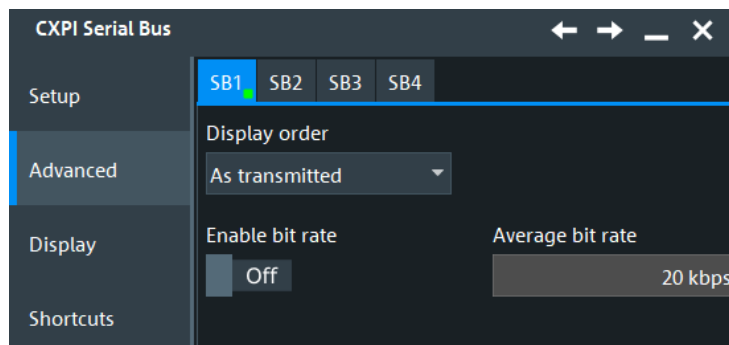

Display order

Selects the order in which the signal is displayed in the honeycomb.

"As transmitted"

The signal is displayed in the order it occurs.

"Logical"

The signal is displayed according to the definition of the standard (MSB bit order).

Remote command:

[BUS<m>:CXPI:DORD](#) on page 2088

Enable bit rate/ Average bit rate

If enabled, sets the number of transmitted bits per second. If disabled, the bit rate is measured and the average bit rate in the acquisition window is displayed.

Remote command:

[BUS<m>:CXPI:BITRate:ENABLE](#) on page 2087

[BUS<m>:CXPI:BITRate:VALue](#) on page 2087

[BUS<m>:CXPI:RESult:BITRate?](#) on page 2088

14.11.2.3 Display settings

Access: [Bus] > "Display" tab.

For common display settings, see [Chapter 14.1.3, "Display"](#), on page 513.

14.11.2.4 Configuring the CXPI signals

For configuration, assign the lines to the input channels and define the logical thresholds and the hysteresis.

1. Press the [Bus] key on the front panel.
2. Select the tab of the bus you want to set up, for example "SB1".
3. Select the "Setup" tab.
4. Tap the "Protocol" button and select the protocol: "CXPI".
5. Tap the "Variant" button, and select the protocol.
6. Select the source and the polarity.

7. Enter the "Threshold" and the "Hysteresis".
8. Enable "Decode".

14.11.3 CXPI trigger

14.11.3.1 CXPI trigger settings

Access: [Bus] > "Shortcuts" tab > "Setup trigger"

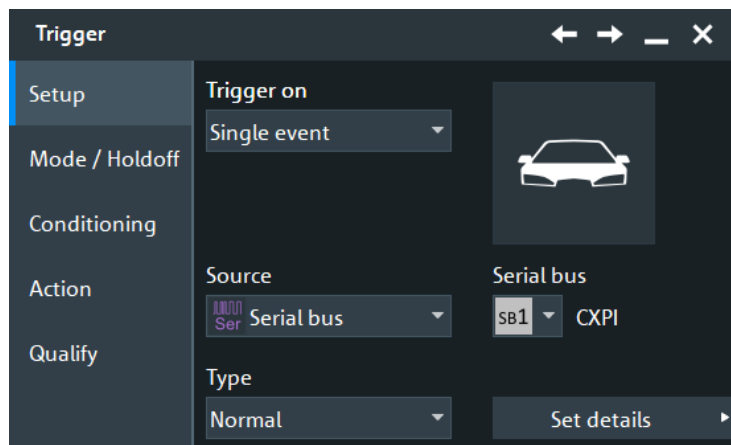

Make sure that:

- In the [Bus] > "Setup" tab:
 - The correct "Protocol" is selected.
 - The data sources of the serial bus are channel signals.
- In the "Trigger" > "Setup" tab:
 - The "Trigger on" = "Single event"
 - The trigger "Source" = "Serial bus".
 - The correct "Serial bus" is selected.

Trigger type

Selects the trigger type for CXPI analysis.

Remote command:

[TRIGger<m>:CXPI:TYPE](#) on page 2098

Frame Start ← Trigger type

Triggers on a frame start.



Normal ← Trigger type

Triggers on a normal frame.

You can refine the trigger condition:

- Set a frame ID pattern or a frame ID range to trigger only on frames that fulfill these conditions.
See: "[Frame ID](#)" on page 704
- Set an NM value expected in the frame.
See "[NM](#)" on page 706.
- Set a CT value expected in the frame.
See: "[CT](#)" on page 706.
- Set a DLC pattern or DLC pattern range to trigger only on frames that fulfill these conditions.
See: "[DLC](#)" on page 705.
- Set a data pattern condition to trigger only on frames that fulfill these conditions.
See: "[Data](#)" on page 705.
- Set an index or index range to trigger only on frames that fulfill these conditions.
See: "[Index](#)" on page 706.

Normal

Frame ID
= Equal [hex]XX

NM [hex]X CT [hex]X

DLC
= Equal [hex]X

Data
... Off

Data index
[-] In range 1 .. 256

Normal Poll ← Trigger type

Triggers on a normal poll frame.

You can refine the trigger condition:

- Set a frame ID pattern or a frame ID range to trigger only on frames that fulfill these conditions.
See: "[Frame ID](#)" on page 704
- Set an NM value expected in the frame.
See "[NM](#)" on page 706.
- Set a CT value expected in the frame.
See: "[CT](#)" on page 706.
- Set a DLC pattern or DLC pattern range to trigger only on frames that fulfill these conditions.
See: "[DLC](#)" on page 705.
- Set a data pattern condition to trigger only on frames that fulfill these conditions.

See: "[Data](#)" on page 705.

- Set an index or index range to trigger only on frames that fulfill these conditions.
See: "[Index](#)" on page 706.

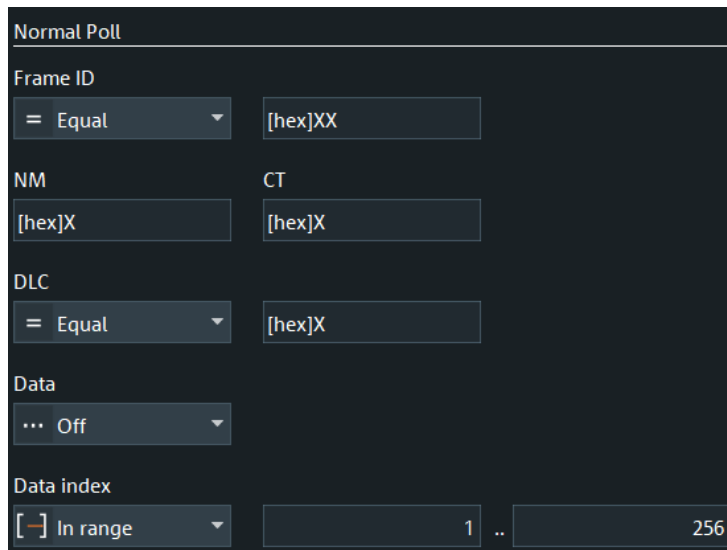

Normal Poll

Frame ID
= Equal [hex]XX

NM [hex]X CT [hex]X

DLC
= Equal [hex]X

Data
... Off

Data index
[-] In range 1 .. 256

Sleep ← Trigger type

Triggers on a sleep frame.

You can refine the trigger condition:

- Set an NM value expected in the frame.
See "[NM](#)" on page 706.
- Set a CT value expected in the frame.
See: "[CT](#)" on page 706.
- Set a data pattern condition to trigger only on frames that fulfill these conditions.
See: "[Data](#)" on page 705.
- Set an index or index range to trigger only on frames that fulfill these conditions.
See: "[Index](#)" on page 706.



Sleep

NM [hex]X CT [hex]X

Data
... Off

Data index
[-] In range 1 .. 256

Long ← Trigger type

Triggers on a long frame.

You can refine the trigger condition:

- Set a frame ID pattern or a frame ID range to trigger only on frames that fulfill these conditions.

- See: "[Frame ID](#)" on page 704
- Set an NM value expected in the frame.
See "[NM](#)" on page 706.
- Set a CT value expected in the frame.
See: "[CT](#)" on page 706.
- Set a DLC extend pattern or DLC extend pattern range to trigger only on frames that fulfill these conditions.
See: "[DLC Extend](#)" on page 705.
- Set a data pattern condition to trigger only on frames that fulfill these conditions.
See: "[Data](#)" on page 705.
- Set an index or index range to trigger only on frames that fulfill these conditions.
See: "[Index](#)" on page 706.

Long

Frame ID

NM CT

DLC Extend

Data

Data index
 ..

Long Poll ← Trigger type

Triggers on a long poll frame.

You can refine the trigger condition:

- Set a frame ID pattern or a frame ID range to trigger only on frames that fulfill these conditions.
See: "[Frame ID](#)" on page 704
- Set an NM value expected in the frame.
See "[NM](#)" on page 706.
- Set a CT value expected in the frame.
See: "[CT](#)" on page 706.
- Set a DLC extend pattern or DLC extend pattern range to trigger only on frames that fulfill these conditions.
See: "[DLC Extend](#)" on page 705.
- Set a data pattern condition to trigger only on frames that fulfill these conditions.
See: "[Data](#)" on page 705.
- Set an index or index range to trigger only on frames that fulfill these conditions.
See: "[Index](#)" on page 706.

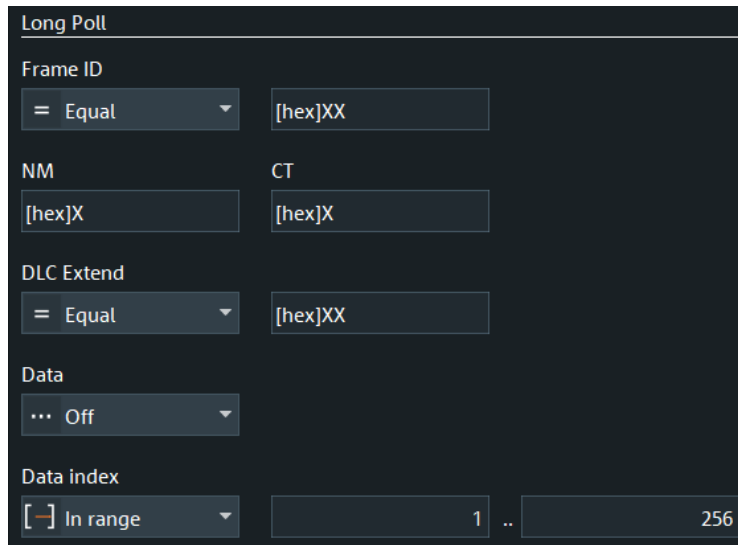

Long Poll

Frame ID
= Equal [hex]XX

NM [hex]X CT [hex]X

DLC Extend
= Equal [hex]XX

Data
... Off

Data index
[-] In range 1 .. 256

PID ← Trigger type

Triggers on a protected ID (PID) field. A PID field consists of a frame identifier and a parity bit.

Optionally, you can define the frame ID pattern or a frame ID range to trigger only on frames that fulfill these conditions.

See: "[Frame ID](#)" on page 704.

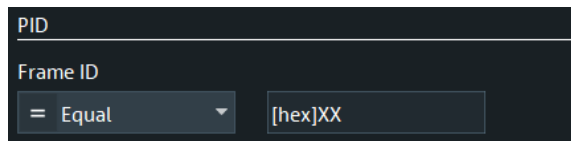

PID

Frame ID
= Equal [hex]XX

PTYPE ← Trigger type

Triggers on a protected TYPE (PTYPE) field, a special PID field with a frame ID of 00 (hex) and a parity of 1. It is used only in the polling method.

PTYPE + PID ← Trigger type

Triggers on a PTYPE field followed by a PID field.

Optionally, you can define a frame ID pattern or a frame ID range to trigger only on frames that fulfill these conditions.

See: "[Frame ID](#)" on page 704.

Error ← Trigger type

Triggers if one or more of the following errors occur:

- "IFS error"
The inter-frame space (IFS) is a bit field after a frame that has a logical value 1. It is used to separate two consecutive frames. IFS errors occur when the length of the IFS field differs from the one defined in the protocol.
- "IBS error"

The inter-byte-space (IBS) is the interval between each byte within a frame. IBS errors occur when the length of the IBS field differs from the one defined in the protocol.

- "Length error"
Length error occurs when there are not enough bits/words to build a frame.
- "DLC error"
Data length code error occurs when the value of the DLC field is different from the data byte field value. If there is a DLC error, it is still possible to build a frame, but there are too many/too few data words.
- "CRC error"
The transmitting node calculates the cyclic redundancy check (CRC) value of a frame and stores it into the CRC field of the frame. CRC error occurs when this CRC field value differs from the value calculated by the receiving node.
- "Parity error"
Triggers on a parity error indicating a transmission error.
- "UART error"
For the CXPI standard, each 8-bit byte is transported as a 10-bit UART word, framed by a start bit (1) and stop bit (0). An UART error occurs if the identified symbol does not follow the described pattern, if it is too short or too long.

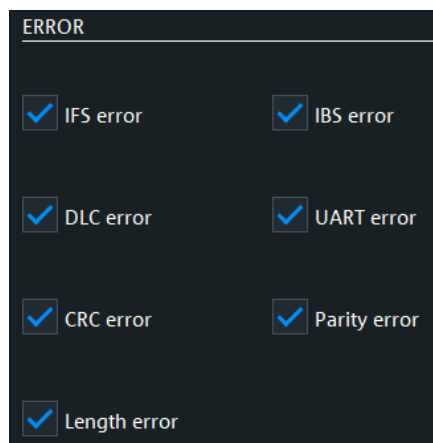

Frame ID

The frame identifier is a 7-bit field. Its setup consists of the condition and one or two frame patterns.

"Condition" Defines the operator to set a specific frame identifier ("Equal" or "Not equal") or a frame identifier range.

"Frame ID Defines the bit pattern of the frame identifier.

min / Frame ID" In binary format, use the following characters: 1; 0; or X (do not care). To enter the pattern in other formats use the bit pattern editor, see [Chapter 14.1.7, "Bit pattern editor"](#), on page 519.

"Frame ID The second frame identifier pattern is required to specify a range with conditions "In range" and "Out of range".

Remote command:

[TRIGger<m>:CXPI:FID:CONDition](#) on page 2097

[TRIGger<m>:CXPI:FID:MAX](#) on page 2098

[TRIGger<m>:CXPI:FID:MIN](#) on page 2098

DLC

Sets the data length code, which indicates the length of the data byte.

The DLC setup consists of the condition and one or two DLC patterns.

"Condition"	Defines the operator to set a specific DLC ("Equal" or "Not equal") or a DLC range.
"DLC min / DLC "	Defines the bit pattern of the DLC. In binary format, use the following characters: 1; 0; or X (do not care). To enter the pattern in other formats use the bit pattern editor, see Chapter 14.1.7, "Bit pattern editor" , on page 519.
"DLC max"	The second DLC pattern is required to specify a range with conditions "In range" and "Out of range".

Remote command:

[TRIGger<m>:CXPI:DLC:CONDition](#) on page 2094

[TRIGger<m>:CXPI:DLC:MAX](#) on page 2095

[TRIGger<m>:CXPI:DLC:MIN](#) on page 2095

DLC Extend

Sets the extension data length code, which indicates the length of the data byte of a long frame.

The DLC extend setup consists of the condition and one or two DLC patterns.

"Condition"	Defines the operator to set a specific DLC extend ("Equal" or "Not equal") or a DLC extend range.
"DLC Extend min / DLC Extend"	Defines the bit pattern of the DLC extend. In binary format, use the following characters: 1; 0; or X (do not care). To enter the pattern in other formats use the bit pattern editor, see Chapter 14.1.7, "Bit pattern editor" , on page 519.
"DLC Extend max"	The second DLC extend pattern is required to specify a range with conditions "In range" and "Out of range".

Remote command:

[TRIGger<m>:CXPI:DEXTension:CONDition](#) on page 2094

[TRIGger<m>:CXPI:DEXTension:MAX](#) on page 2094

[TRIGger<m>:CXPI:DEXTension:MIN](#) on page 2094

Data

The data setup consists of the condition and one or two identifier pattern.

"Condition"	Defines the operator to set a specific data ("Equal" or "Not equal") or a data range.
"Data min / Data"	Defines the bit pattern of the data. In binary format, use the following characters: 1; 0; or X (do not care). To enter the pattern in other formats use the bit pattern editor, see Chapter 14.1.7, "Bit pattern editor" , on page 519.
"Data max"	The second data pattern is required to specify a range with conditions "In range" and "Out of range".

Remote command:

[TRIGger<m>:CXPI:DATA:DCondition](#) on page 2092

[TRIGger<m>:CXPI:DATA:DMax](#) on page 2092

[TRIGger<m>:CXPI:DATA:DMin](#) on page 2092

Index

The data index setup consists of the condition and one or two index patterns.

"Condition"	Defines the operator to set a specific data index ("Equal" or "Not equal") or data index range.
"Index min / Index"	Defines the bit pattern of the data index.
"Index max"	The second data index is required to specify a range with conditions "In range" and "Out of range".

Remote command:

[TRIGger<m>:CXPI:DATA:Icondition](#) on page 2093

[TRIGger<m>:CXPI:DATA:IMax](#) on page 2093

[TRIGger<m>:CXPI:DATA:IMin](#) on page 2093

NM

Sets the value of the network management (NM) field, 2 bits indicating if the frame is in wakeup or sleep mode.

Remote command:

[SEARch:TRIGger:CXPI:NM](#) on page 2111

CT

Sets the value of the counter (CT), 2 bits indicating the continuity of the frame.

Remote command:

[TRIGger<m>:CXPI:CT](#) on page 2091

14.11.3.2 Triggering on CXPI

Prerequisite: A bus is configured for the CXPI signal to be analyzed.

For the basic trigger settings, proceed in the following way:

1. Press the [Bus] key and select the "Shortcuts" tab.
2. Press "Setup trigger".
3. Tap the "Source" button and select the "Serial bus" trigger source.
4. Select the serial bus that is set to CXPI.
5. Tap "Trigger Type" and select the trigger type to be used for CXPI protocol analysis.
6. Depending on the selected trigger type, more setup conditions can be specified.

For information on how to proceed with the configuration settings, see [Chapter 14.11.3.1, "CXPI trigger settings"](#), on page 699.

14.11.4 Search on decoded CXPI data

Using the search functionality, you can find various events in the decoded data, the same events which you also can trigger on. Before you can start the search, you have to configure the bus correctly and acquire decoded data.

To search on decoded data, set the search "Source" to the serial bus that is configured for the protocol to be analyzed.

See also [Chapter 11, "Search functions"](#), on page 425.

14.11.4.1 Search settings

Access: [Bus] > "Shortcuts" tab > "Setup search"

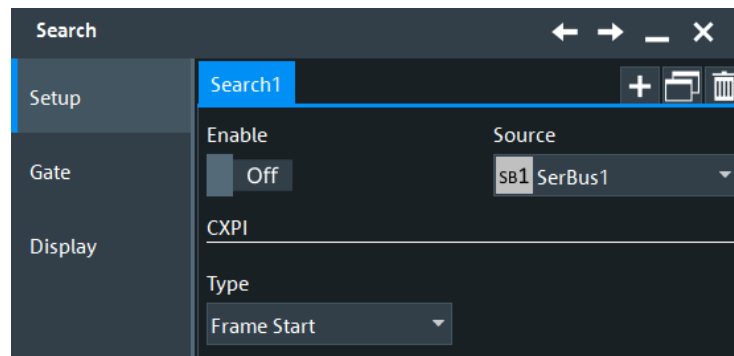

Search type

Selects the condition type for the CXPI search.

"Frame Start" Searches for a frame start.

"Normal" Searches for a normal frame.
You can refine the search condition, see:

- ["Frame ID"](#) on page 708
- ["NM"](#) on page 709
- ["CT"](#) on page 709
- ["DLC"](#) on page 708
- ["Data"](#) on page 709
- ["Index"](#) on page 709

"Normal Poll" Searches for a normal poll frame.

You can refine the search condition, see:

- ["Frame ID"](#) on page 708
- ["NM"](#) on page 709
- ["CT"](#) on page 709
- ["DLC"](#) on page 708
- ["Data"](#) on page 709
- ["Index"](#) on page 709

"Sleep"	Searches for a sleep frame. You can refine the search condition, see: <ul style="list-style-type: none"> • "NM" on page 709 • "CT" on page 709 • "Data" on page 709 • "Index" on page 709
"Long"	Searches for a long frame. You can refine the search condition, see: <ul style="list-style-type: none"> • "Frame ID" on page 708 • "NM" on page 709 • "CT" on page 709 • "DLC Extend" on page 709 • "Data" on page 709 • "Index" on page 709
"Long Poll"	Searches for a long poll frame. You can refine the search condition, see: <ul style="list-style-type: none"> • "Frame ID" on page 708 • "NM" on page 709 • "CT" on page 709 • "DLC Extend" on page 709 • "Data" on page 709 • "Index" on page 709
"PID"	Searches for a PID field. You can refine the frame identifier, see "Frame ID" on page 708.
"PTYPE"	Searches for a PTYPE field
"PTYPE + PID"	Searches for a PTYPE field followed by a PID field. You can refine the frame identifier, see "Frame ID" on page 708.

Remote command:

[SEARCh:TRIGger: CXPI:TYPE](#) on page 2111

Frame ID

Searches for a frame identifier pattern or a frame identifier range. The setup consists of the condition and one or two frame patterns.

The frame identifier setup settings are the same as in the CXPI trigger setup, see "Frame ID" on page 704.

Remote command:

[SEARCh:TRIGger: CXPI:FID:CONDition](#) on page 2110

[SEARCh:TRIGger: CXPI:FID:MAX](#) on page 2110

[SEARCh:TRIGger: CXPI:FID:MIN](#) on page 2110

DLC

Searches for a DLC pattern or a DLC range. The setup consists of the condition and one or two DLC patterns.

The DLC setup settings are the same as in the CXPI trigger setup, see "DLC" on page 705.

Remote command:

[SEARCH:TRIGger:DXPI:DLC:CONDition](#) on page 2107

[SEARCH:TRIGger:DXPI:DLC:MAX](#) on page 2107

[SEARCH:TRIGger:DXPI:DLC:MIN](#) on page 2108

DLC Extend

Searches for a DLC extend pattern or a DLC extend range. The setup consists of the condition and one or two DLC extend patterns.

The DLC extend setup settings are the same as in the CXPI trigger setup, see "[DLC Extend](#)" on page 705.

Remote command:

[SEARCH:TRIGger:DXPI:DEXTension:CONDition](#) on page 2106

[SEARCH:TRIGger:DXPI:DEXTension:MAX](#) on page 2106

[SEARCH:TRIGger:DXPI:DEXTension:MIN](#) on page 2107

Data

Searches for a data pattern or a data range. The setup consists of the condition and one or two data patterns.

The data setup settings are the same as in the CXPI trigger setup, see "[Data](#)" on page 705.

Remote command:

[SEARCH:TRIGger:DXPI:DATA:DCONDition](#) on page 2104

[SEARCH:TRIGger:DXPI:DATA:DMAX](#) on page 2104

[SEARCH:TRIGger:DXPI:DATA:DMIN](#) on page 2105

Index

Searches for a data index pattern or a data index range. The setup consists of the condition and one or two index patterns.

The index setup settings are the same as in the CXPI trigger setup, see "[Index](#)" on page 706.

Remote command:

[SEARCH:TRIGger:DXPI:DATA:ICONDition](#) on page 2105

[SEARCH:TRIGger:DXPI:DATA:IMAX](#) on page 2105

[SEARCH:TRIGger:DXPI:DATA:IMIN](#) on page 2106

NM

Searches for the value of the network management (NM), 2 bits indicating if the frame is in wakeup or sleep mode.

Remote command:

[TRIGger<m>:DXPI:NM](#) on page 2098

CT

Searches for the value of the counter (CT), 2 bits indicating the continuity of the frame.

Remote command:

[SEARCH:TRIGger:DXPI:CT](#) on page 2104

Error

Selects the error type to be searched for. You can select one or more error types as search condition.

The error types are the same as in the CXPI trigger setup, see ["Error"](#) on page 703.

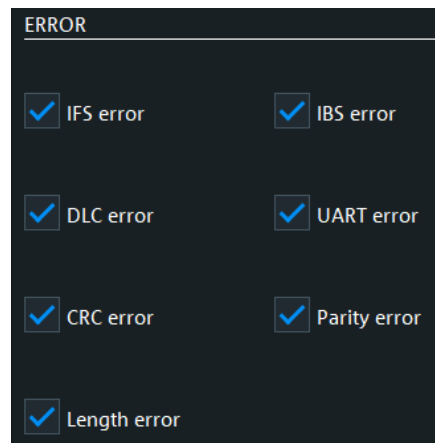
**14.11.4.2 Search results**

To get search results, "Enable" the search. You can minimize, shift or close the search dialog.

The search results are listed in the search result table and marked in the waveform by blue lines.

For an introduction to search results, see:

- [Chapter 11.1.2, "Search results"](#), on page 426
- [Chapter 11.4.2, "Display zoom settings"](#), on page 446

The columns in the search result table are the same as in the decoding table, see [Chapter 14.11.5, "CXPI decode results"](#), on page 711.

Remote commands:

- [SEARCH:RESULT: CXPI: FCOunt?](#) on page 2113
- [SEARCH:RESULT: CXPI: FRAME<m>: STATE?](#) on page 2114
- [SEARCH:RESULT: CXPI: FRAME<m>: START?](#) on page 2113
- [SEARCH:RESULT: CXPI: FRAME<m>: STOP?](#) on page 2114
- [SEARCH:RESULT: CXPI: FRAME<m>: TYPE?](#) on page 2114
- [SEARCH:RESULT: CXPI: FRAME<m>: DATA?](#) on page 2113
- [SEARCH:RESULT: CXPI: FRAME<m>: DLCV?](#) on page 2113
- [SEARCH:RESULT: CXPI: FRAME<m>: WORD<n>: TYPE?](#) on page 2115
- [SEARCH:RESULT: CXPI: FRAME<m>: WORD<n>: VALUE?](#) on page 2115
- [SEARCH:RESULT: CXPI: FRAME<m>: WORD<n>: STATUS?](#) on page 2114

14.11.4.3 Searching CXPI data

Prerequisites: A CXPI bus is configured, see [Chapter 14.11.2, "CXPI configuration"](#), on page 695, and "Decode" is enabled.

1. Press the [Bus] key and select the "Shortcuts" tab.
2. Tap "Setup search".
3. Tap the "Source" button and select the serial bus that is set to CXPI.
"Protocol" shows the CXPI icon.
4. Tap "Type" and select the search type.
All trigger types are also available for search.
5. To refine the search settings, configure additional settings, which are available for many search types.
For details, see [Chapter 14.11.4.1, "Search settings"](#), on page 707.
6. Under "Control", "Enable" the search.
The "Search Results" box opens.
7. Close the "Search" dialog box.
8. Press [Run Stop] to start acquisition.
9. To start searching the acquired waveform for specific events, tap "Enable" in the search setup dialog:
The R&S RTO6 displays the "Search Results" box that lists the detected events.

For information on how to configure the search results presentation and how to navigate the search results, see also ["To display search zoom windows"](#) on page 448.

14.11.5 CXPI decode results

When the configuration of the serial bus is complete, the signal can be decoded:

1. In the "Serial Bus" dialog > "Setup" tab, enable "Decode".
2. In the "Serial Bus" dialog > "Display" tab, select additional result display settings: "Show table" and "Show binary".
3. If required, enable "Zoom coupling"

For a description of the display settings, see also [Chapter 14.1.3, "Display"](#), on page 513.

The instrument captures and decodes the signal according to the standard definition and the configuration settings.

The color-coding of the various protocol sections and errors simplifies the interpretation of the visual display. The decode information condenses or expands, depending on the horizontal scale. Various data formats are available to show the result values.

Decode Results Table

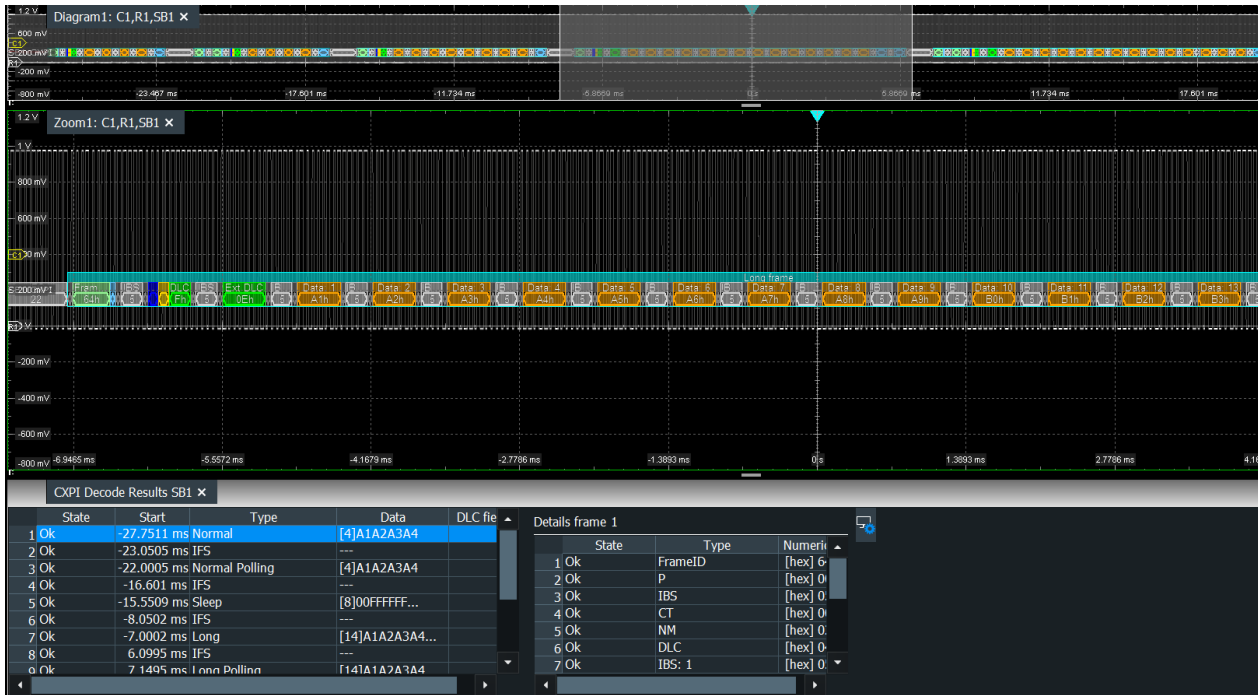

The results are shown in two tables:

- "Decode results": contains information about all decoded frames
- "Details frame": contains more detailed information about the selected frame in the "Decode results" table.

Table 14-16: Content of the Decode results table

Column	Description
State	Overall state of the frame
Start	Time of frame start
Type	Frame type: normal, normal polling, sleep, long, long polling, PID, PTYPE, PTYPE +PID, unknown, inter-frame-space
Data	Displays the first four data words in the frame. More details are displayed in the "Details frame".
DLC field	Data length code, number of data bytes

Table 14-17: Content of the Details frame table

Column	Description
Status	Status of the field: OK or error
Type	Type (name) of field
Numeric value	The numeric value of the field

Tools

Press "Display settings" in the "Decode Results" table to access the "Display" tab.

**Remote commands**

Remote commands are described in [Chapter 27.18.12.3, "Decode results"](#), on page 2099.

14.12 MIL-1553 (option R&S RTO6-K530)

14.12.1 The MIL-STD-1553

The MIL-STD-1553 specification defines the characteristics of a serial data bus originally designed for use in the military avionics. Nowadays it is also used in spacecraft on-board data handling.

The bus is a 2-wire bus that uses differential signals.

A MIL-STD-1553 system consists of the following components:

- Bus Controller (BC): initiates and coordinates the data flow in the system.
- Remote Terminal (RT): interfaces various subsystems with the data bus. A system consists of up to 31 RTs and each RT can have 31 subaddresses. The subaddresses 0 and 31 refer to a mode code command.
- Bus Monitor (BM) (optional): listens to all messages and can record selected data for real-time or off-line analysis.

The information is transmitted over the bus in defined series of words using Manchester code, where each bit is transmitted as high-low for a logical 1 or a low-high for a logical 0. There are three types of words: command, data and status.

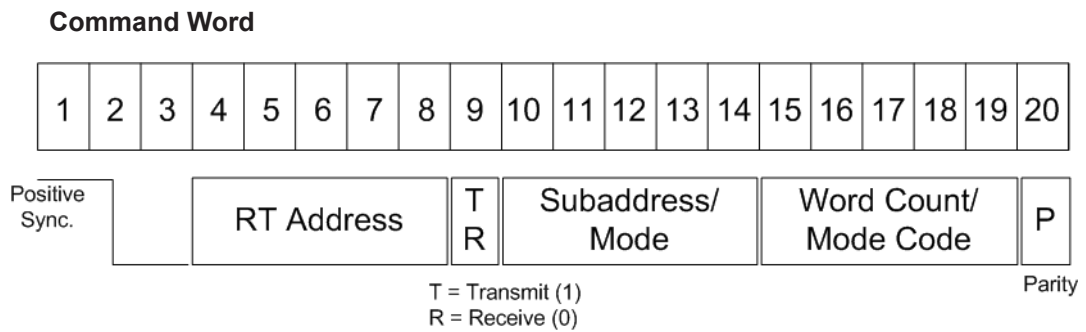

Figure 14-22: Structure of a command word

The format of a command word consists of the following parts (see [Figure 14-22](#)):

- Sync: an invalid Manchester waveform.
- Remote Terminal (RT) Address: the unique address of the corresponding RT.
- Transmit/Receive (T/R): indicates the action required from the RT.
- Subaddress/Mode Code: indicates the RT subaddress. The subaddresses 0 and 31 signalize the transmission of a mode code.
- Data Word Count /Mode Code: indicates the number of words that are sent/received by the RT. A maximum of 32 words is allowed. This field may be used for the transmission of the mode code value.
- Parity: checks if there are bit errors during the transmission. The total number of logic 1 bits for the word (sync bits not included) shall be odd.

Data Word

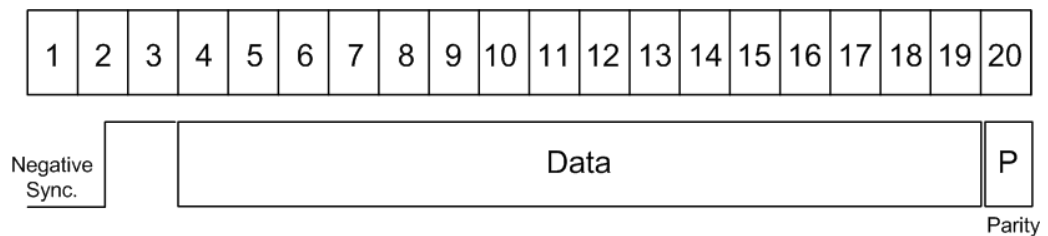
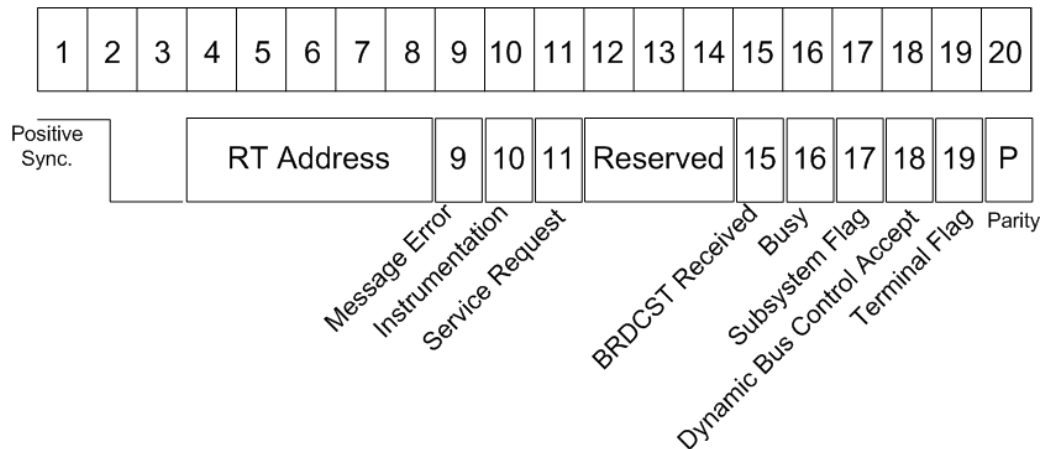

Figure 14-23: Structure of a data word

The format of a data word consists of the following parts (see [Figure 14-23](#)):

- Sync: an invalid Manchester waveform.
- Data: the transferred information (16 bit).
- Parity: checks if there are bit errors during the transmission. The total number of logic 1 bits for the word (sync bits not included) shall be odd.

Status Word**Figure 14-24: Structure of a status word**

The format of a status word consists of the following parts (see [Figure 14-24](#)):

- Sync: an invalid Manchester waveform.
- Remote Terminal (RT) Address: the unique address of the corresponding RT.
- Message error: indicates an error in the command/data word transmission from the BC. A logic 1 indicates presence of a message error and a logic 0 indicates its absence.
- Instrumentation: helps to distinguish between a status word and a command word. The logic state of this bit shall be 0.
- Service Request: indicates that the RT requires service. A logic 1 indicates a presence of a service request and logic 0 indicates its absence.
- Reserved: bits reserved for future uses.
- Broadcast Command: a logic 1 indicates that the preceding valid command word was a broadcast command and a logic 0 that it was not.
- Busy: a busy state indicates that the RT or the subsystem is not able to transfer data. A logic 1 indicates a presence of a busy condition and logic 0 indicates its absence.
- Subsystem Flag: flags a subsystem fault. A logic 1 indicates a presence of a flag and logic 0 indicates its absence.
- Dynamic Bus Control Acceptance: a logic 1 indicates acceptance of a dynamic bus control and a logic 0 a rejection.
- Terminal Flag: flags an RT fault condition. A logic 1 indicates a presence of a flag and logic 0 indicates its absence.
- Parity: checks if there are bit errors during the transmission. The total number of logic 1 bits for the word (sync bits not included) shall be odd.

For comfortable analysis, you can load an editable label list, to interpret transferred numeric values as meaningful text labels.

14.12.2 MIL-STD-1553 configuration

14.12.2.1 MIL-STD-1553 configuration settings

Access: [Bus] > "Decode" tab > "Protocol" = *MIL-STD-1553*

Access: [Bus] > "MIL-1553" > "Setup" tab



Make sure that the tab of the correct serial bus is selected.

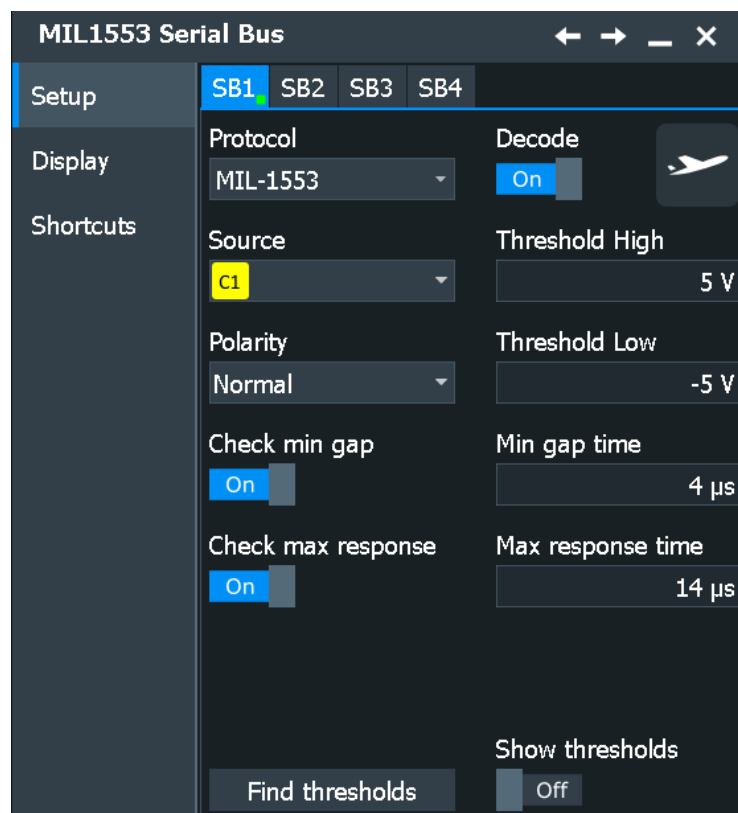

See also: [Chapter 14.1.1, "Setup - general settings"](#), on page 511

Source

Sets the source of the selected data line. Waveform 1 of channel signals, math waveforms, and reference waveforms can be used.

For triggering on a serial bus, a channel signal is required.

Remote command:

`BUS<m>:MILStd:SOURce` on page 2116

Polarity

Selects the wire on which the bus signal is measured : "Normal" or "Inverted". The setting affects the digitization of the signal.

Remote command:

[BUS<m>:MILStd:POLarity](#) on page 2117

Thresholds

Threshold values are used for digitization of the signal.

Sets the threshold value for digitization of signals for each line. If the signal value on the line is higher than the threshold, the signal state is high (1 or true for the Boolean logic). Otherwise, the signal state is considered low (0 or false) if the signal value is below the threshold.

"Threshold high" and "Threshold low" Upper and lower threshold levels. You can enter the values directly in the fields.

"Threshold low"

"Find thresholds" Executes the measurement of reference levels and sets the thresholds to the middle reference level of the measured amplitude.

Remote command:

[BUS<m>:MILStd:THReshold:HIGH](#) on page 2118

[BUS<m>:MILStd:THReshold:LOW](#) on page 2118

[BUS<m>:MILStd:PRESet](#) on page 2118

[BUS<m>:SETReflevels](#) on page 1814

Check min gap

Checks and sets a value for the intermessage gap between the last bit of a message and the following command word sync. The time is measured between the mid bit zero crossings. According to the standard, the minimum idle time is 4 μ s.

The minimum gap time is relevant for protocol configuration and error trigger.

If "Check min gap" is enabled, the instrument detects the specified gap during decoding. If the trigger type "Error condition" is selected in addition, the instrument triggers when the gap is shorter than specified.

Remote command:

[BUS<m>:MILStd:MINGap:BITS](#) on page 2117

[BUS<m>:MILStd:MINGap:SElect](#) on page 2117

[TRIGger<m>:MILStd:MINGap:BITS](#) on page 2127

[TRIGger<m>:MILStd:MINGap:SElect](#) on page 2127

Check max response

Checks and sets a value for the maximum response time between the last bit of a word and the following status word sync. The time is measured between the mid bit zero crossings. According to the standard, the RT shall respond to a valid command word within the time period of 4 to 12 μ s.

The max response time is relevant for protocol configuration and error trigger.

If "Check max response" is enabled, the instrument detects the specified gap during decoding. If the trigger type "Error condition" is selected in addition, the instrument triggers when the response time is longer than specified.

Remote command:

[BUS<m>:MILStd:MAXResponse:BITS](#) on page 2116

[BUS<m>:MILStd:MAXResponse:SElect](#) on page 2116

[TRIGger<m>:MILStd:MAXResponse:BITS](#) on page 2127

[TRIGger<m>:MILStd:MAXResponse:SElect](#) on page 2127

Show thresholds

If enabled, the threshold levels are displayed in the diagram.

Remote command:

[BUS<m>:THReshold](#) on page 1815

14.12.2.2 Display settings

Access: [Bus] > "Display" tab.

For common display settings, see [Chapter 14.1.3, "Display"](#), on page 513.

MIL Specific Label Settings

Label lists are protocol-specific. A MIL-STD-1553 label file contains four values for each identifier:

- "RTA": hexadecimal remote terminal address value
- "Sub Addr": hexadecimal sub address value
- "Sub Address Label Name": the label name corresponding to the value of the sub-address.
- "Symbolic label": symbolic name of addressed device, specifying the device function, and the label of the sub address.

Example: MIL PTT file

```
# -----
# Labels for MIL.1553 protocol
# Column order: RT address, RT label, Subaddress, Subaddress Label
# -----
@PROTOCOL_NAME = mil1553
0Ah,Engine,01h,Thrust
03h,Main panel,07h,Altimeter
03h,Main panel,01h,Speed
0Eh,Only RTA
```

14.12.2.3 Configuring MIL-STD-1553

For configuration assign the line to the input channel, set the threshold and the timing conditions.

For details on configuration settings, see [Chapter 14.12.2.1, "MIL-STD-1553 configuration settings"](#), on page 716.

1. Press the [Bus] key on the front panel.

2. Select the tab of the bus you want to set up, for example "SB1".
3. In the "Setup" tab, select the protocol: "MIL-STD-1553".
4. Tap the "Polarity" button, and select the waveform of the data line.
5. Set the logical thresholds.
6. If necessary, tap the "Check min gap" button to select it and set the minimum gap time.
7. If necessary, tap the "Check max response" button to select it and set the maximum response time.

14.12.3 MIL-STD-1553 trigger

14.12.3.1 Trigger settings MIL-STD-1553

Access: [Bus] > "Shortcuts" tab > "Setup trigger"



Make sure that:

- In the [Bus] > "Setup" tab:
 - The correct "Protocol" is selected.
 - The data sources of the serial bus are channel signals.
- In the "Trigger" > "Setup" tab:
 - The "Trigger on" = "Single event"
 - The trigger "Source" = "Serial bus".
 - The correct "Serial bus" is selected.

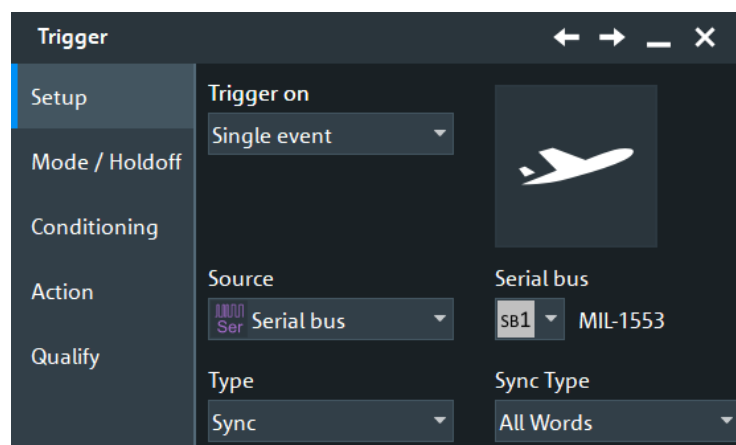

Trigger Type

Selects the trigger type for MIL-STD-1553 analysis.

"Sync" Triggers on a sync impulse.

"Word" Triggers on the selected word type.

"Data Word" Triggers on a specified data word or data word range.

The screenshot shows the 'MIL-1553 Trigger' dialog box with the 'Data Word' section selected. The configuration is as follows:

- Data Word:** (Section header)
- Remote terminal address:** Set to '= Equal' with a value of '[hex]XX'.
- Data pattern:** Set to '= Equal' with a value of '[hex]XXXX'.
- Data index:** Set to '[-] In range' with a range from '1' to '32'.

"Command/ Status Word"

Triggers on a specified command word or on a status word.

The screenshot shows the 'MIL-1553 Trigger' dialog box with the 'Command/Status Word' section selected. The configuration is as follows:

- Command/Status Word:** (Section header)
- Remote terminal address:** Set to '[-] In range' with a range from '[hex]00' to '[hex]00'.
- 11 bit information:** Set to '[-] In range' with a range from '[hex]000' to '[hex]000'.

"Command Word"

Triggers on a specified command word.

The screenshot shows the 'MIL-1553 Trigger' dialog box with the 'Command Word' section selected. The configuration is as follows:

- Command Word:** (Section header)
- Remote terminal address:** Set to '[-] In range' with a range from '[hex]00' to '[hex]00'.
- Subaddress/Mode:** Set to '= Equal' with a value of '[hex]XX'.
- Data word count/Mode code:** Set to '= Equal' with a value of '[hex]XX'.
- T/R flag:** Set to 'X'.

"Status Word" Triggers on a specified status word.

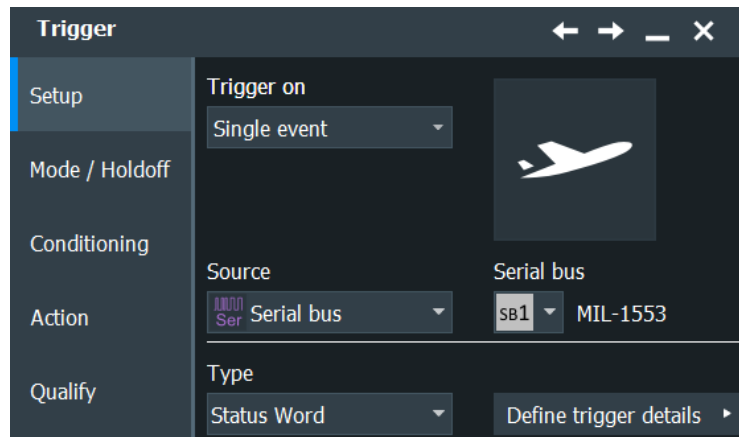

"Error Condition" Triggers on any combination of protocol errors.

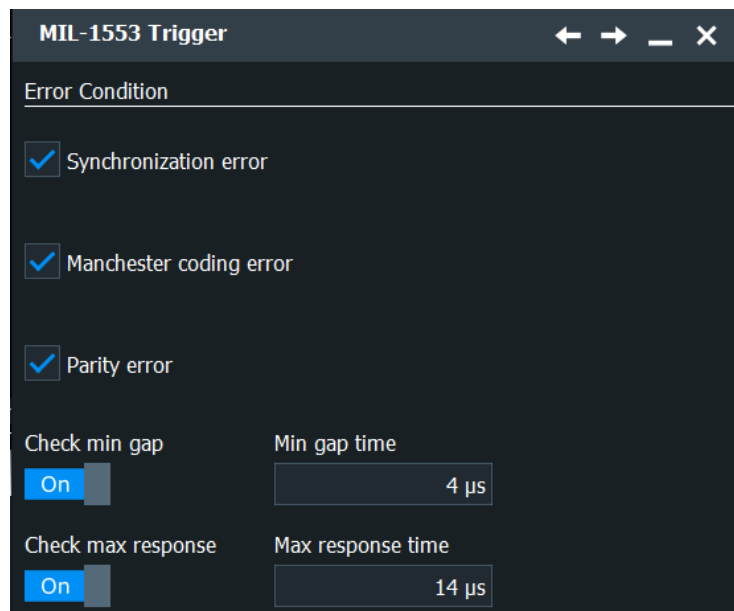

Remote command:

[TRIGger<m>:MILStd:TYPE](#) on page 2119

Sync Type / Word Type

Triggers on a sync impulse or word type. You can select to trigger on "Command/Status", on "All" or on "Data" sync pulses / word types.

Remote command:

[TRIGger<m>:MILStd:TPSPecifier](#) on page 2129

Remote Terminal Address

The RTA setup consists of the condition and one or two RTA patterns.

In binary format, use the following characters: 1; 0; or X (do not care). To enter the pattern in other formats use the bit pattern editor, see [Chapter 14.1.7, "Bit pattern editor"](#), on page 519.

"Condition"	Sets the comparison condition to a specific value or a range.
"RTA Min/ RTA"	Specifies the value or sets the start value of a range.
"RTA Max"	Sets the maximum value of a range for "Condition" = "In range"/"Out of range".

Remote command:

[TRIGger<m>:MILStd:CDST:RCONdition](#) on page 2120

[TRIGger<m>:MILStd:CDST:RMAX](#) on page 2121

[TRIGger<m>:MILStd:CDST:RMIN](#) on page 2121

[TRIGger<m>:MILStd:CMD:RCONdition](#) on page 2120

[TRIGger<m>:MILStd:CMD:RMAX](#) on page 2121

[TRIGger<m>:MILStd:CMD:RMIN](#) on page 2121

[TRIGger<m>:MILStd:DATA:RCONdition](#) on page 2120

[TRIGger<m>:MILStd:DATA:RMAX](#) on page 2121

[TRIGger<m>:MILStd:DATA:RMIN](#) on page 2121

Data Pattern

Sets the data to be triggered on. The trigger data setup consists of a comparison condition and one or two data patterns.

In binary format, use the following characters: 1; 0; or X (do not care). To enter the pattern in other formats use the bit pattern editor, see [Chapter 14.1.7, "Bit pattern editor"](#), on page 519.

"Condition"	Sets the comparison condition to a specific value or a range.
"Data Min/ Data"	Specifies the value or sets the start value of a range.
"Data Max"	Sets the maximum value of a range for "Condition" = "In range"/"Out of range".

Remote command:

[TRIGger<m>:MILStd:DATA:DCONdition](#) on page 2124

[TRIGger<m>:MILStd:DATA:DMAX](#) on page 2125

[TRIGger<m>:MILStd:DATA:DMIN](#) on page 2125

Data Index

The MIL-MIL-STD-1553 standard defines the length of a message to a series of up to 32 words. Data index sets the range within this series of the data words that is considered for the analysis. The data index setup consists of the condition and one or two data index values.

"Condition"	Sets the comparison condition to a specific value or a range.
"Index Min/Index"	Specifies the value or sets the start value of a range.
"Index Max"	Sets the maximum value of a range for "Condition" = "In range"/"Out of range".

Remote command:

[TRIGger<m>:MILStd:DATA:ICONdition](#) on page 2125

[TRIGger<m>:MILStd:DATA:IMAX](#) on page 2125

[TRIGger<m>:MILStd:DATA:IMIN](#) on page 2126

11-Bit Information

The 11-Bit information sets bits 9 to 19 if there is a command or status word. The 11-Bit information consists of the condition and one or two 11-Bit information patterns.

In binary format, use the following characters: 1; 0; or X (do not care). To enter the pattern in other formats use the bit pattern editor, see [Chapter 14.1.7, "Bit pattern editor"](#), on page 519.

"Condition"	Sets the comparison condition to a specific value or a range.
"Info Min/Info"	Specifies the value or sets the start value of a range.
"Info Max"	Sets the maximum value of a range for "Condition" = "In range"/"Out of range".

Remote command:

[TRIGger<m>:MILStd:CDST:ICONdition](#) on page 2123

[TRIGger<m>:MILStd:CDST:IMAX](#) on page 2124

[TRIGger<m>:MILStd:CDST:IMIN](#) on page 2124

Subaddress/ Mode

The subaddress/mode setup consists of the condition and one or two subaddress/mode patterns.

In binary format, use the following characters: 1; 0; or X (do not care). To enter the pattern in other formats use the bit pattern editor, see [Chapter 14.1.7, "Bit pattern editor"](#), on page 519.

"Condition"	Sets the comparison condition to a specific value or a range.
"Subaddress Min / Subaddress/Mode"	Specifies the value or sets the start value of a range.
"Subaddress Max"	Sets the maximum value of a range for "Condition" = "In range"/"Out of range".

Remote command:

[TRIGger<m>:MILStd:CMD:SCONdition](#) on page 2122

[TRIGger<m>:MILStd:CMD:SMAX](#) on page 2123

[TRIGger<m>:MILStd:CMD:SMIN](#) on page 2123

Data Word Count/Mode Code

The data word count/ mode code setup consists of the condition and one or two patterns.

In binary format, use the following characters: 1; 0; or X (do not care). To enter the pattern in other formats use the bit pattern editor, see [Chapter 14.1.7, "Bit pattern editor"](#), on page 519.

"Condition"	Sets the comparison condition to a specific value or a range.
"Word Count Min/ Count Code"	Specifies the value or sets the start value of a range.

"Word Count Max"

Sets the maximum value of a range for "Condition" = "In range"/"Out of range".

Remote command:

[TRIGger<m>:MILStd:CMD:CCONdition](#) on page 2121

[TRIGger<m>:MILStd:CMD:CMAx](#) on page 2122

[TRIGger<m>:MILStd:CMD:CMIN](#) on page 2122

T/R (Transmit/receive)

Toggles the data direction of the selected command: 1 (transmit), 0 (receive), or X (either).

Remote command:

[TRIGger<m>:MILStd:CMD:TR](#) on page 2123

Status Flags

Specifies the values of the status flags. You can use the following characters: 1; 0; or X (do not care).

For details, see ["Status Word"](#) on page 715.

Remote command:

[TRIGger<m>:MILStd:STATus:BCReceived](#) on page 2128

[TRIGger<m>:MILStd:STATus:BUSY](#) on page 2128

[TRIGger<m>:MILStd:STATus:DBCaccept](#) on page 2128

[TRIGger<m>:MILStd:STATus:INSTRument](#) on page 2128

[TRIGger<m>:MILStd:STATus:MERRor](#) on page 2128

[TRIGger<m>:MILStd:STATus:SREQuest](#) on page 2129

[TRIGger<m>:MILStd:STATus:SUBSystem](#) on page 2129

[TRIGger<m>:MILStd:STATus:TERMinal](#) on page 2129

Error Condition

Specify the error conditions to be triggered on.

Synchronization Error ← Error Condition

Triggers if a sync impulse does not fulfill the technical requirements or when the transmission is not valid.

Remote command:

[TRIGger<m>:MILStd:ERRor:SYNC](#) on page 2126

Manchester Coding Error ← Error Condition

Triggers if there is an error in the Manchester coding of the signal.

Remote command:

[TRIGger<m>:MILStd:ERRor:MANChester](#) on page 2126

Parity Error ← Error Condition

Checks the parity of every word and triggers if the parity is even.

Remote command:

[TRIGger<m>:MILStd:ERRor:PARity](#) on page 2126

Check min gap ← Error Condition

Checks and sets a value for the intermessage gap between the last bit of a message and the following command word sync. The time is measured between the mid bit zero crossings. According to the standard, the minimum idle time is 4 μ s.

The minimum gap time is relevant for protocol configuration and error trigger.

If "Check min gap" is enabled, the instrument detects the specified gap during decoding. If the trigger type "Error condition" is selected in addition, the instrument triggers when the gap is shorter than specified.

Remote command:

[BUS<m>:MILStd:MINGap:BITS](#) on page 2117

[BUS<m>:MILStd:MINGap:SElect](#) on page 2117

[TRIGger<m>:MILStd:MINGap:BITS](#) on page 2127

[TRIGger<m>:MILStd:MINGap:SElect](#) on page 2127

Check max response ← Error Condition

Checks and sets a value for the maximum response time between the last bit of a word and the following status word sync. The time is measured between the mid bit zero crossings. According to the standard, the RT shall respond to a valid command word within the time period of 4 to 12 μ s.

The max response time is relevant for protocol configuration and error trigger.

If "Check max response" is enabled, the instrument detects the specified gap during decoding. If the trigger type "Error condition" is selected in addition, the instrument triggers when the response time is longer than specified.

Remote command:

[BUS<m>:MILStd:MAXResponse:BITS](#) on page 2116

[BUS<m>:MILStd:MAXResponse:SElect](#) on page 2116

[TRIGger<m>:MILStd:MAXResponse:BITS](#) on page 2127

[TRIGger<m>:MILStd:MAXResponse:SElect](#) on page 2127

14.12.3.2 Triggering on MIL-STD-1553

Prerequisites: A bus is configured for the MIL-STD-1553 signal to be analyzed.

1. Press the [Bus] key and select the "Shortcuts" tab.
2. Press "Setup trigger".
3. Tap the "Source" button and select the "Serial bus" trigger source.
4. Select the serial bus that is set to MIL-STD-1553.
5. Select the "Trigger type".
6. For more complex trigger types, enter the data pattern conditions.
For details, see [Chapter 14.12.3.1, "Trigger settings MIL-STD-1553"](#), on page 719.

14.12.4 MIL-STD-1553 decode results

When the configuration of the serial bus is complete, the signal can be decoded:

1. In the "Protocol" dialog > "Setup" tab, enable "Decode".
2. In the "Protocol" dialog > "Display" tab, select additional result display settings: "Show decode table" and "Show binary signals".

For a description of the display settings, see also [Chapter 14.1.3, "Display"](#), on page 513.

The instrument captures and decodes the signal according to the standard definition and the configuration settings.

The color-coding of the various protocol sections and errors simplifies the interpretation of the visual display. The decode information condenses or expands, depending on the horizontal scale. Various data formats are available to show the result values.

Decode Results Table

The results are shown in two tables:

- "Decode results": contains information about all decoded frames
- "Details frame": contains more detailed information about the selected frame in the "Decode results" table.

Table 14-18: Content of the decode result table

Column	Description
State	Overall state of the word
Start	Time of word start in relation to the trigger point
Stop	Time of word stop in relation to the trigger point
Type	Word type
RTA	Remote terminal address
Info	The hexadecimal value of the 9th to 1th bit of a command/status word
Label	Symbolic label name defined in the label list
Data	The values of the data bytes

Remote commands

Remote commands to retrieve decode results are described in [Chapter 27.18.13.3, "Decode results"](#), on page 2130.

14.12.5 Search on decoded MIL data

Using the search functionality, you can find various events in the decoded data, the same events which you also can trigger on. Before you can start the search, you have to configure the bus correctly and acquire decoded data.

To search on decoded data, set the search "Source" to the serial bus that is configured for the protocol to be analyzed.

See also [Chapter 11, "Search functions"](#), on page 425.

14.12.5.1 MIL search setup

Access: [Bus] > "Shortcuts" tab > "Setup search"

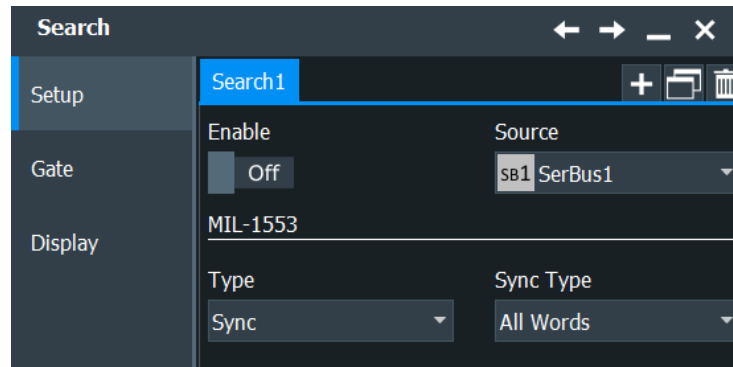

Type

The search criterion is defined by "Type". All trigger types are also available for search. Additional search parameters are provided under "Detailed Search Parameter Setup".

"Sync"	Searches for a sync impulse.
"Word"	Searches for the selected word type.
"Data Word"	Searches for the specified data word. Additional search parameters: remote terminal address, data pattern and data index.
"Command / Status Word"	Searches for command or status words. Additional search parameters: remote terminal address, and 11-bit information.
"Command Word"	Searches for a command word. Additional search parameters: remote terminal address, subaddress / mode, and data word count / mode code.
"Status Word"	Searches for a status word. Additional search parameters: remote terminal address, and status flags.
"Error condition"	Identifies various errors in the frame, see "Error Condition" on page 724.

Remote command:

[SEARCH:TRIGger:MILStd:TYPE](#) on page 2134

Sync Type / Word Type

Searches for a sync impulse/ word type. You can search for "Command/Status", "All" or "Data" sync pulses/ word types.

Remote command:

[SEARCH:TRIGger:MILStd:TPSPecifier](#) on page 2140

Remote terminal address setup: Condition, RTA

The remote terminal address setup consists of the condition and one or two RTA patterns.

The RTA setup settings are the same as in the MIL trigger setup, see ["Remote Terminal Address"](#) on page 721.

Remote command:

[SEARCH:TRIGger:MILStd:CDST:RCONdition](#) on page 2134

[SEARCH:TRIGger:MILStd:CMD:RCONdition](#) on page 2134

[SEARCH:TRIGger:MILStd:DATA:RCONdition](#) on page 2134

[SEARCH:TRIGger:MILStd:CDST:RMIN](#) on page 2135

[SEARCH:TRIGger:MILStd:CMD:RMIN](#) on page 2135

[SEARCH:TRIGger:MILStd:DATA:RMIN](#) on page 2135

[SEARCH:TRIGger:MILStd:CDST:RMAX](#) on page 2136

[SEARCH:TRIGger:MILStd:CMD:RMAX](#) on page 2136

[SEARCH:TRIGger:MILStd:DATA:RMAX](#) on page 2136

Data pattern setup: Condition, Data min, Data max

The data pattern setup consists of the condition and one or two data patterns.

The data pattern setup settings are the same as in the MIL trigger setup, see ["Data Pattern"](#) on page 722.

Remote command:

[SEARCH:TRIGger:MILStd:DATA:DCONdition](#) on page 2136

[SEARCH:TRIGger:MILStd:DATA:DMIN](#) on page 2137

[SEARCH:TRIGger:MILStd:DATA:DMAX](#) on page 2137

Data index setup: Condition, Index min, Index max

The data index setup consists of the condition and one or two index patterns.

The data index setup settings are the same as in the MIL trigger setup, see ["Data Index"](#) on page 722.

Remote command:

[SEARCH:TRIGger:MILStd:DATA:ICONdition](#) on page 2138

[SEARCH:TRIGger:MILStd:DATA:IMIN](#) on page 2138

[SEARCH:TRIGger:MILStd:DATA:IMAX](#) on page 2138

11-Bit information setup: Condition, Info min, Info max

The 11-bit information setup consists of the condition and one or two 11-bit information patterns.

The 11-bit information setup settings are the same as in the MIL trigger setup, see ["11-Bit Information"](#) on page 723.

Remote command:

[SEARCH:TRIGger:MILStd:CDST:ICONdition](#) on page 2136

[SEARCH:TRIGger:MILStd:CDST:IMIN](#) on page 2137

[SEARCH:TRIGger:MILStd:CDST:IMAX](#) on page 2137

Subaddress / Mode setup: Condition, Subaddress min, Subaddress max

The subaddress/mode setup consists of the condition and one or two subaddress/mode patterns.

The subaddress/mode setup settings are the same as in the MIL trigger setup, see "[Subaddress/ Mode](#)" on page 723.

Remote command:

[SEARCH:TRIGger:MILStd:CMD:SCONdition](#) on page 2136

[SEARCH:TRIGger:MILStd:CMD:SMIN](#) on page 2137

[SEARCH:TRIGger:MILStd:CMD:SMAX](#) on page 2137

Data word count / Mode code setup: Condition, Word count min, Word count max

The data word count/mode code setup consists of the condition and one or two patterns.

The subaddress/mode setup settings are the same as in the MIL trigger setup, see "[Data Word Count/Mode Code](#)" on page 723.

Remote command:

[SEARCH:TRIGger:MILStd:CMD:CCONdition](#) on page 2136

[SEARCH:TRIGger:MILStd:CMD:CMIN](#) on page 2137

[SEARCH:TRIGger:MILStd:CMD:CMAX](#) on page 2137

T/R (Transmit/receive)

Specifies the data direction of the selected command.

For details, see "[T/R \(Transmit/receive\)](#)" on page 724.

Remote command:

[SEARCH:TRIGger:MILStd:CMD:TR](#) on page 2139

Status flags setup

Specifies the values (X, 0, 1) of the status flags.

The status flags setup settings are the same as in the MIL trigger setup, see "[Status Flags](#)" on page 724.

Remote command:

[SEARCH:TRIGger:MILStd:STATus:BCReceived](#) on page 2139

[SEARCH:TRIGger:MILStd:STATus:BUSY](#) on page 2139

[SEARCH:TRIGger:MILStd:STATus:DBCaccept](#) on page 2139

[SEARCH:TRIGger:MILStd:STATus:INSTrument](#) on page 2139

[SEARCH:TRIGger:MILStd:STATus:MERRor](#) on page 2139

[SEARCH:TRIGger:MILStd:STATus:SREQuest](#) on page 2140

[SEARCH:TRIGger:MILStd:STATus:SUBSystem](#) on page 2140

[SEARCH:TRIGger:MILStd:STATus:TERMinal](#) on page 2140

Error Condition

Selects the error type to be searched for. You can select one or more error types as search condition.

The error types are the same as in the MIL trigger setup, see "[Error Condition](#)" on page 724

Remote command:

[SEARCH:TRIGger:MILStd:ERRor:MANChester](#) on page 2139

[SEARCH:TRIGger:MILStd:ERRor:PARity](#) on page 2139

[SEARCH:TRIGger:MILStd:ERRor:SYNC](#) on page 2139

[SEARCH:TRIGger:MILStd:ERRor:TIMing](#) on page 2139

14.12.5.2 MIL search results

To get search results, "Enable" the search. You can minimize, shift or close the search dialog.

The search results are listed in the search result table and marked in the waveform by blue lines.

For an introduction to search results, see:

- [Chapter 11.1.2, "Search results"](#), on page 426
- [Chapter 11.4.2, "Display zoom settings"](#), on page 446

The search results are the same as [Chapter 14.12.4, "MIL-STD-1553 decode results"](#), on page 726

Remote commands:

- [SEARCH:RESult:MILStd:WCOunt?](#) on page 2141
- [SEARCH:RESult:MILStd:WORD<m>:INFO?](#) on page 2143
- [SEARCH:RESult:MILStd:WORD<m>:RTADdress?](#) on page 2142
- [SEARCH:RESult:MILStd:WORD<m>:STARt?](#) on page 2141
- [SEARCH:RESult:MILStd:WORD<m>:STATus?](#) on page 2141
- [SEARCH:RESult:MILStd:WORD<m>:STOP?](#) on page 2142
- [SEARCH:RESult:MILStd:WORD<m>:SYMBol?](#) on page 2142
- [SEARCH:RESult:MILStd:WORD<m>:TYPE?](#) on page 2141

14.13 ARINC 429 (option R&S RTO6-K530)

14.13.1 ARINC 429 basics

The ARINC 429 is a specification that defines the characteristics of an avionic data bus used on commercial and transport aircraft.

In an ARINC 429 system, a single transmitter/source is connected to 1 to 20 receivers/sinks on one twisted wire pair. The bus uses differential signals. The ARINC 429 standard uses a simplex communication - data may be transmitted in only one direction. The information is transmitted over the bus in defined series of words.

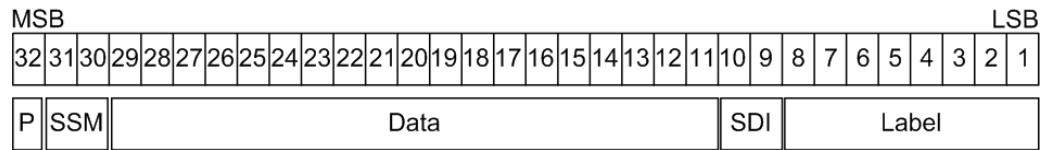
Word Format*Figure 14-25: Structure of an ARINC 429 word*

An ARINC 429 word is 32-bits and consists of the following parts (see [Figure 14-25](#)):

- Parity: the most significant bit (MSB). Checks if there are bit errors during the transmission. The total number of logic 1 bits for the word shall be odd.
- Sign/Status Matrix (SSM): the value of these bits depends on the data type. It may be used to report the status of hardware equipment.
- Data:
 - Binary (BNR): stores the data as a binary number.
 - Binary Coded Decimal (BCD): uses 4 data field bits to represent a decimal digit.
 - Discrete data: a combination of BNR and/ or BCD or individual bits that express specific equipment conditions.
 - Maintenance data and acknowledgment
 - Williamsburg / Buckhorn protocol: a bit-oriented protocol that is used for file transfer.
- Source/Destination Identifier (SDI): indicates the intended receiver or the transmitting subsystem.
- Label: gives information about the word's data type.

For comfortable analysis, you can load an editable label list, to interpret transferred numeric values as meaningful text labels.

14.13.2 ARINC 429 configuration**14.13.2.1 ARINC 429 configuration settings**

Access: [Bus] > "ARINC 429" > "Setup" tab



Make sure that the tab of the correct serial bus is selected.

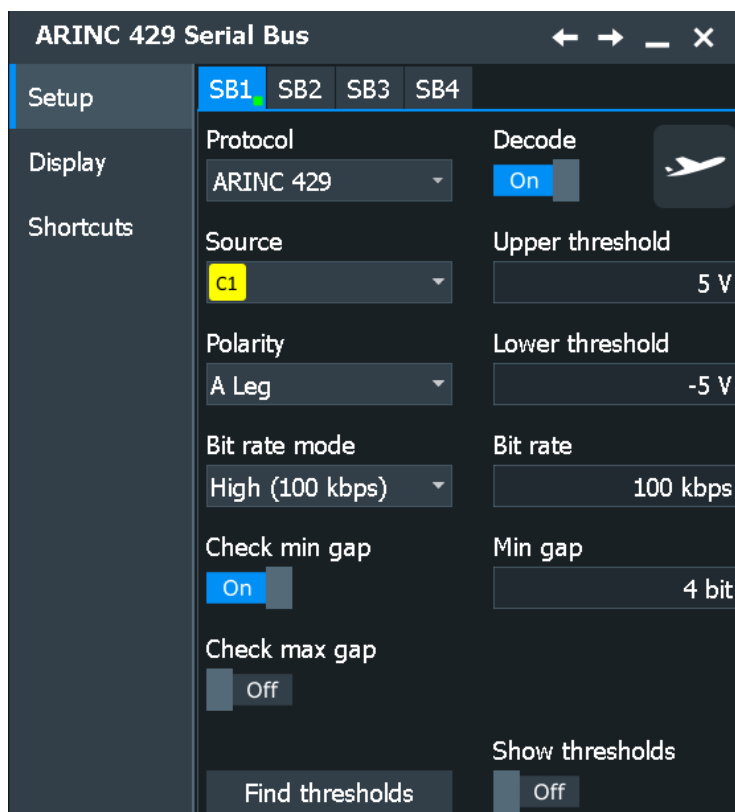

See also: [Chapter 14.1.1, "Setup - general settings"](#), on page 511

Data

Sets the source of the selected data line. Usually, the source is one of the analog channels. Reference and math waveforms are only available if the trigger source is one of the input channels but not the serial bus.

For triggering on a serial bus, a channel signal is required.

Remote command:

[BUS<m>:ARINC:SOURce](#) on page 2144

Polarity

Selects the wire on which the bus signal is measured : "A Leg" or "B Leg". The setting affects the digitization of the signal.

Remote command:

[BUS<m>:ARINC:POLarity](#) on page 2146

Thresholds

Sets the threshold value for digitization of the data signal. If the signal value on the line is higher than the threshold, the signal state is high (1 or true for the Boolean logic). Otherwise, the signal state is considered low (0 or false) if the signal value is below the threshold.

There are several ways to set the thresholds:

- "Upper threshold" and "Lower threshold"
Upper and lower threshold levels. You can enter the values directly in the fields.

- "Find thresholds"

Executes the measurement of reference levels and sets the thresholds to the middle reference level of the measured amplitude.

Remote command:

[BUS<m>:ARINc:THReshold:HIGH](#) on page 2146

[BUS<m>:ARINc:THReshold:LOW](#) on page 2146

[BUS<m>:ARINc:PRESet](#) on page 2146

[BUS<m>:SETReflevels](#) on page 1814

Bit Rate

Selects the number of transmitted bits per second. The value can be set to high speed (100 kbps) or low speed (12.0- 14.5 kbps).

Remote command:

[BUS<m>:ARINc:BRValue](#) on page 2144

[BUS<m>:ARINc:BRMode](#) on page 2144

Timing: Min gap, Max gap

Defines the idle time between two words, which is needed for word synchronization. The beginning of the first bit after the gap marks the start of a new word.

You can define a minimum idle time "Min gap", and/or a maximum time "Max gap". The standard defines a minimum of 4-bit times to separate two subsequent words.

Timing settings are relevant for protocol configuration and error trigger.

If "Min gap" and/or "Max gap" are enabled, the instrument detects the specified gaps during decoding. If the trigger type "Error condition" is selected in addition, the instrument triggers when the gap is shorter or longer than the specified gaps, respectively.

Remote command:

[BUS<m>:ARINc:MAXGap:BITS](#) on page 2145

[BUS<m>:ARINc:MAXGap:SElect](#) on page 2144

[BUS<m>:ARINc:MINGap:BITS](#) on page 2145

[BUS<m>:ARINc:MINGap:SElect](#) on page 2145

[TRIGger<m>:ARINc:MINGap:BITS](#) on page 2150

[TRIGger<m>:ARINc:MINGap:SElect](#) on page 2149

[TRIGger<m>:ARINc:MAXGap:BITS](#) on page 2150

[TRIGger<m>:ARINc:MAXGap:SElect](#) on page 2150

Show thresholds

If enabled, the threshold levels are displayed in the diagram.

Remote command:

[BUS<m>:THReshold](#) on page 1815

14.13.2.2 Display settings

Access: [Bus] > "Display" tab.

For common display settings, see [Chapter 14.1.3, "Display"](#), on page 513.

ARINC 429 Specific Label Settings

Label lists are protocol-specific. An ARINC 429 label file contains two values for each identifier:

- "Arinc Label": the ARINC 429 label value, that identifies the data type and the parameters associated with it. The usual data format is octal.
- "Symbolic label": symbolic name of the label, specifying its function.

Example: ARINC 429 PTT file

```
# -----
@FILE_VERSION = 1.0
@PROTOCOL_NAME = arinc429
# -----
# Labels for ARINC 429 protocol
#   Column order: Arinc Label, Symbolic Label
# -----
# ----Definition----
001o, Distance to Go
002o, Time to Go
010o, Present Position - Latitude
011o, Present Position - Longitude
014o, Magnetic Heading
015o, Wind Speed
075o, Gross Weight
125o, Universal Time Coordinated
# -----
s
```

14.13.2.3 Configuring ARINC 429 signals

For configuration assign the line to the input channel, set the threshold and the timing conditions.

For details on configuration settings, see [Chapter 14.13.2.1, "ARINC 429 configuration settings"](#), on page 731.

1. Press the [Bus] key on the front panel.
2. Select the tab of the bus you want to set up, for example "SB1".
3. In the "Setup" tab, select the protocol: "ARINC 429".
4. Tap the "Polarity" button, and select the waveform of the data line.
5. Set the logical thresholds.
6. Tap the "Bit Rate" button and set it for high or low speed.
7. If necessary, tap the "Min Gap" button to select it and set the minimum gap time.
8. If necessary, tap the "Max Response" button to select it and set the maximum response time.

9. Enable "Decode".

14.13.3 ARINC 429 trigger

14.13.3.1 ARINC 429 trigger settings

Access: [Bus] > "Shortcuts" tab > "Setup trigger"

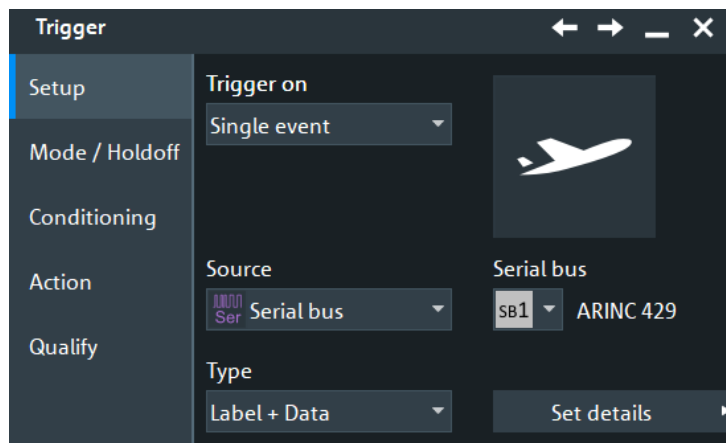

Make sure that:

- In the [Bus] > "Setup" tab:
 - The correct "Protocol" is selected.
 - The data sources of the serial bus are channel signals.
- In the "Trigger" > "Setup" tab:
 - The "Trigger on" = "Single event"
 - The trigger "Source" = "Serial bus".
 - The correct "Serial bus" is selected.

Trigger Type

Selects the trigger type for ARINC 429 analysis.

"Word Start" Sets the trigger to the start of the word.

"Word Stop" Sets the trigger to the stop of the word.

"Label + Data" Sets the trigger on a defined word format. You can define the label, the data and the SDI / SSM bits separately, see ["Label + Data"](#) on page 736.

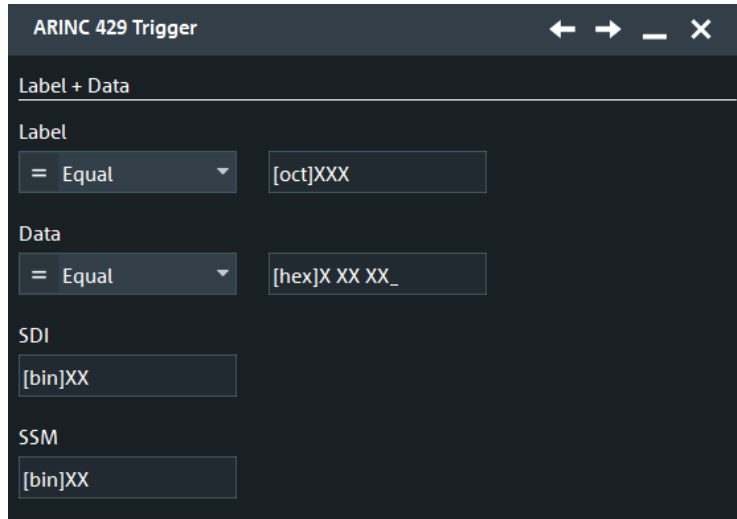

"Error Condition" Identifies various errors in the word, see ["Error Conditions"](#) on page 737.

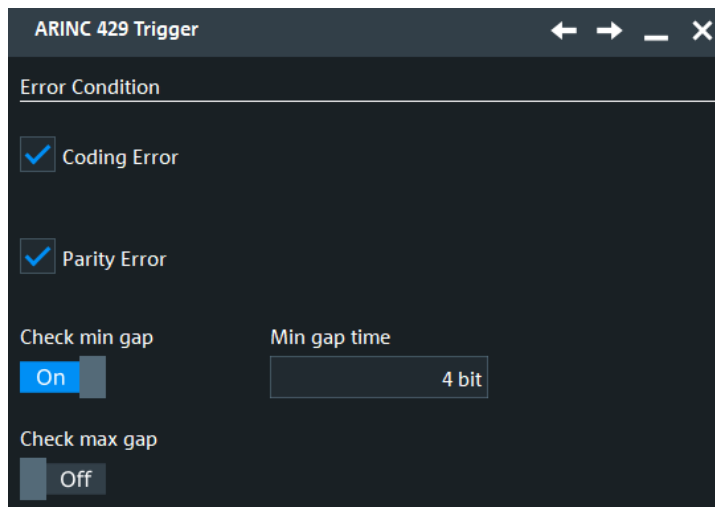

Remote command:

[TRIGger<m>:ARINC:TYPE](#) on page 2147

Label + Data

Sets the trigger on a defined word format. You can define the label, the data and the SDI / SSM bits separately.

Label setup: Condition, Label Min, Label Max ← Label + Data

The label setup consists of the condition and one or two label patterns.

"Condition" Defines the operator to set a specific label ("Equal" or "Not equal") or a label range.

- "Label Min" Defines the bit pattern of the label.
In binary format, use the following characters: 1; 0; or X (do not care). To enter the pattern in other formats use the bit pattern editor, see [Chapter 14.1.7, "Bit pattern editor"](#), on page 519.
- "Label Max" The second label pattern is required to specify a range with conditions "In range" and "Out of range".

Remote command:

[TRIGger<m>:ARINC:LABel:CONDition](#) on page 2149

[TRIGger<m>:ARINC:LABel:MIN](#) on page 2149

[TRIGger<m>:ARINC:LABel:MAX](#) on page 2149

Data setup: Condition, Data Min, Data Max ← Label + Data

The data setup consists of the condition and one or two data patterns.

- "Condition" Defines the operator to set a specific data ("Equal" or "Not equal") or a data range.
- "Data Min" Defines the bit pattern of the data.
In binary format, use the following characters: 1; 0; or X (do not care). To enter the pattern in other formats use the bit pattern editor, see [Chapter 14.1.7, "Bit pattern editor"](#), on page 519.
- "Data Max" The second data pattern is required to specify a range with conditions "In range" and "Out of range".

Remote command:

[TRIGger<m>:ARINC:DATA:CONDition](#) on page 2147

[TRIGger<m>:ARINC:DATA:MIN](#) on page 2148

[TRIGger<m>:ARINC:DATA:MAX](#) on page 2148

SDI / SSM ← Label + Data

Sets the values for the source/destination identifier (SDI) and the sign/status matrix (SSM) bits.

Remote command:

[TRIGger<m>:ARINC:SDI](#) on page 2150

[TRIGger<m>:ARINC:SSM](#) on page 2150

Error Conditions

Specifies the error conditions to be triggered on.

Coding error ← Error Conditions

Triggers on a coding error.

Remote command:

[TRIGger<m>:ARINC:ERRor:CODing](#) on page 2148

Parity Error ← Error Conditions

Checks the parity and triggers if the parity is even.

Remote command:

[TRIGger<m>:ARINC:ERRor:PARity](#) on page 2148

Timing: Min gap, Max gap ← Error Conditions

Defines the idle time between two words, which is needed for word synchronization. The beginning of the first bit after the gap marks the start of a new word.

You can define a minimum idle time "Min gap", and/or a maximum time "Max gap". The standard defines a minimum of 4-bit times to separate two subsequent words.

Timing settings are relevant for protocol configuration and error trigger.

If "Min gap" and/or "Max gap" are enabled, the instrument detects the specified gaps during decoding. If the trigger type "Error condition" is selected in addition, the instrument triggers when the gap is shorter or longer than the specified gaps, respectively.

Remote command:

[BUS<m>:ARINC:MAXGap:BITS](#) on page 2145

[BUS<m>:ARINC:MAXGap:SElect](#) on page 2144

[BUS<m>:ARINC:MINGap:BITS](#) on page 2145

[BUS<m>:ARINC:MINGap:SElect](#) on page 2145

[TRIGger<m>:ARINC:MINGap:BITS](#) on page 2150

[TRIGger<m>:ARINC:MINGap:SElect](#) on page 2149

[TRIGger<m>:ARINC:MAXGap:BITS](#) on page 2150

[TRIGger<m>:ARINC:MAXGap:SElect](#) on page 2150

14.13.3.2 Triggering on ARINC 429

Prerequisites: A bus is configured for the ARINC 429 signal to be analyzed.

1. Press the [Bus] key and select the "Shortcuts" tab.
2. Press "Setup trigger".
3. Tap the "Source" button and select the "Serial bus" trigger source.
4. Select the serial bus that is set to ARINC 429.
5. Select the "Trigger type".
6. For more complex trigger types, enter the data pattern conditions.
For details, see [Chapter 14.13.3.1, "ARINC 429 trigger settings"](#), on page 735.

14.13.4 ARINC 429 decode results

When the configuration of the serial bus is complete, the signal can be decoded:

1. In the "Protocol" dialog > "Setup" tab, enable "Decode".
2. In the "Protocol" dialog > "Display" tab, select additional result display settings: "Show decode table" and "Show binary signals".

For a description of the display settings, see also [Chapter 14.1.3, "Display"](#), on page 513.

The instrument captures and decodes the signal according to the standard definition and the configuration settings.

The color-coding of the various protocol sections and errors simplifies the interpretation of the visual display. The decode information condenses or expands, depending on the horizontal scale. Various data formats are available to show the result values.

Decode Results Table

The "Decode results" table contains information about all decoded frames.

State	Start	Stop	Label [oct]	SDI [bin]	Data [hex]	SSM [bin]	Label name	Data (32 bit)
1 Ok	-1.69 ms	-1.37 ms	101	10	2AAAA	11 Bus		[hex] EAAA AA82
2 Coding Error	-1.32 ms	-1.22 ms	000	00	00	00		[hex] 0000 0000
3 Ok	-950 µs	-630 µs	101	01	54455	11 Bus		[hex] 7511 5582
4 Ok	-580 µs	-260 µs	101	01	C955	11 Bus		[hex] 6325 5582
5 Ok	-210 µs	110 µs	101	10	22222	10 Bus		[hex] 4888 8A82
6 Ok	160 µs	480 µs	102	00	24243	00 Left Wing		[hex] 8909 0C42
7 Ok	530 µs	850 µs	103	10	26263	10 Right Wing		[hex] 4989 8EC2
8 Parity Error	900 µs	1.22 ms	104	00	24683	10		[hex] 491A 0C22

Table 14-19: Content of the Decode results table

Column	Description
State	Overall state of the frame.
Start	Time of word start in relation to the trigger point
Stop	Time of word stop in relation to the trigger point
Label	The value of the label bytes
SDI	The state of the SDI bits
DATA	All 32 bits of the word.
SSM	The state of the SSM bits
Label Name	The label name
Data (32 bit)	The value of the data bytes

Tools

Press "Display settings" in the "Decode Results" table to access the "Display" tab.



Remote commands

Remote commands are described in [Chapter 27.18.14.3, "Decode results"](#), on page 2151.

14.13.5 Search on decoded ARINC 429 data

Using the search functionality, you can find various events in the decoded data, the same events which you also can trigger on. Before you can start the search, you have to configure the bus correctly and acquire decoded data.

To search on decoded data, set the search "Source" to the serial bus that is configured for the protocol to be analyzed.

See also [Chapter 11, "Search functions"](#), on page 425.

14.13.5.1 ARINC 429 search setup

Access: [Bus] > "Shortcuts" tab > "Setup search"

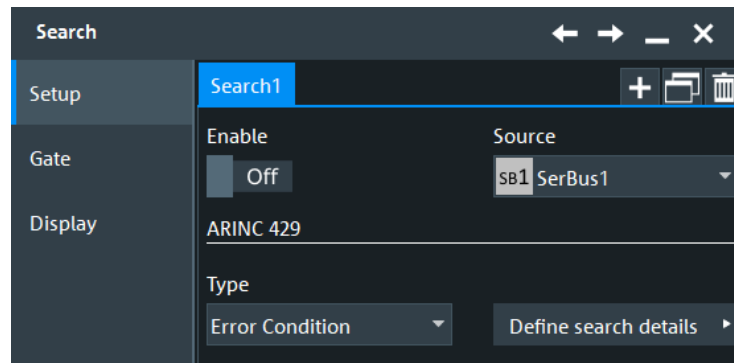

Type

The search criterion is defined by "Type". All trigger types are also available for search. Additional search parameters are provided under "Detailed Search Parameter Setup".

"Word Start" Searches for the start word.

"Word Stop" Searches for the stop word.

"Label + Data" Searches for a defined word format. You can search for the label, the data, the SDI, and SSM bits separately. For details, see ["Label + Data"](#) on page 736.

"Error condition" Identifies various errors in the frame, see ["Error Conditions"](#) on page 737.

Remote command:

[SEARCH:TRIGger:ARINC:TYPE](#) on page 2154

Label setup: Condition, Label min, Label max

The label setup consists of the condition and one or two label patterns.

The label setup settings are the same as in the ARINC trigger setup, see ["Label setup: Condition, Label Min, Label Max"](#) on page 736.

Remote command:

[SEARCH:TRIGger:ARINC:LABel:CONDition](#) on page 2155

[SEARCH:TRIGger:ARINC:LABel:MIN](#) on page 2155

[SEARCH:TRIGger:ARINC:LABel:MAX](#) on page 2156

Data setup: Condition, Data min, Data max

The data setup consists of the condition and one or two data patterns.

The data setup settings are the same as in the ARINC trigger setup, see ["Data setup: Condition, Data Min, Data Max"](#) on page 737.

Remote command:

[SEARCH:TRIGger:ARINc:DATA:CONDition](#) on page 2155

[SEARCH:TRIGger:ARINc:DATA:MIN](#) on page 2155

[SEARCH:TRIGger:ARINc:DATA:MAX](#) on page 2156

SDI / SSM setup: SDI, SSM

The SDI / SSM setup consists of the SDI and SSM.

The SDI / SSM setup settings are the same as in the ARINC trigger setup, see "[SDI / SSM](#)" on page 737.

Remote command:

[SEARCH:TRIGger:ARINc:SDI](#) on page 2156

[SEARCH:TRIGger:ARINc:SSM](#) on page 2156

Error Condition

Selects the error type to be searched for. You can select one or more error types as search condition.

The error types are the same as in the ARINC trigger setup, see "[Error Conditions](#)" on page 737

Remote command:

[SEARCH:TRIGger:ARINc:ERRor:CODing](#) on page 2156

[SEARCH:TRIGger:ARINc:ERRor:PARity](#) on page 2157

[SEARCH:TRIGger:ARINc:ERRor:TIMing](#) on page 2157

14.13.5.2 ARINC search results

To get search results, "Enable" the search. You can minimize, shift or close the search dialog.

The search results are listed in the search result table and marked in the waveform by blue lines.

For an introduction to search results, see:

- [Chapter 11.1.2, "Search results"](#), on page 426
- [Chapter 11.4.2, "Display zoom settings"](#), on page 446

Remote commands:

• [SEARCH:RESult:ARINc:WCOunt?](#) on page 2159

• [SEARCH:RESult:ARINc:WORD<m>:DATA?](#) on page 2158

• [SEARCH:RESult:ARINc:WORD<m>:LABel?](#) on page 2158

• [SEARCH:RESult:ARINc:WORD<m>:PATtern?](#) on page 2158

• [SEARCH:RESult:ARINc:WORD<m>:SDI?](#) on page 2159

• [SEARCH:RESult:ARINc:WORD<m>:SSM?](#) on page 2158

• [SEARCH:RESult:ARINc:WORD<m>:STArT?](#) on page 2160

• [SEARCH:RESult:ARINc:WORD<m>:STATe?](#) on page 2160

• [SEARCH:RESult:ARINc:WORD<m>:STOP?](#) on page 2159

- [SEARCH:RESult:ARINc:WORD<m>:SYMBol?](#) on page 2159

14.14 SpaceWire (option R&S RTO6-K530)

The SpaceWire is a communication network standard used for spacecrafts. It is based on the IEEE 1355 standard of communications and coordinated by the European Space Agency (ESA).

- [SpaceWire basics](#)..... 742
- [SpaceWire configuration](#)..... 743
- [SpaceWire trigger](#)..... 747
- [SpaceWire decode results](#)..... 749
- [Search on decoded SpaceWire data](#)..... 751

14.14.1 SpaceWire basics

The SpaceWire links are a Point-to-point (P2P) connection between a node and another node or a router. The link is full-duplex bidirectional serial data link.

The SpaceWire has two types of characters:

- Data characters containing a parity bit, a data control flag and eight bits of data.

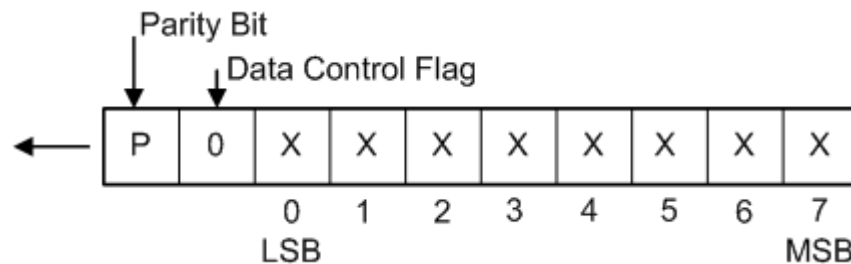

Figure 14-26: SpaceWire data characters

- Control characters containing a parity-bit, a data-control flag and the 2-bit control code. The data control flag is set to 1 and indicates that this is a control character.

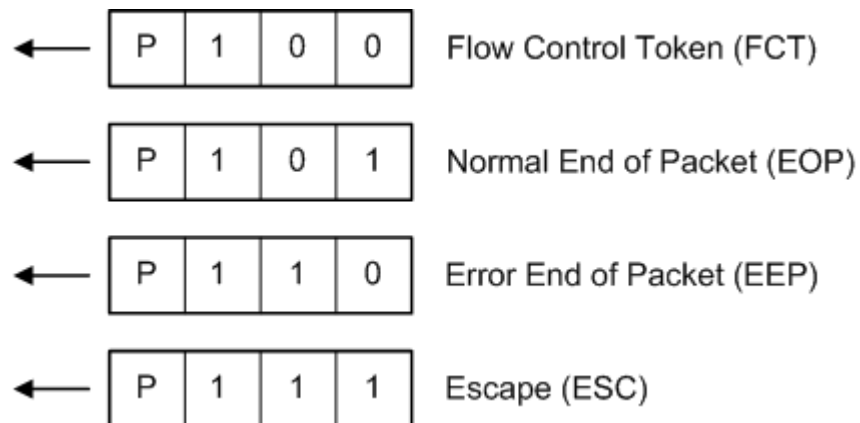

Figure 14-27: SpaceWire control characters

Also there are two control codes:

- NULL code consisting of an Escape (ESC) and a Flow Control Token (FCT)
- Time Code consisting of an ESC followed by a single data character

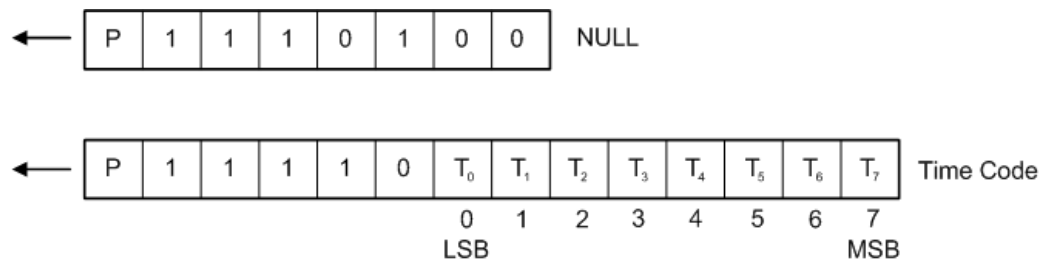

Figure 14-28: SpaceWire control codes

14.14.2 SpaceWire configuration

14.14.2.1 SpaceWire configuration settings

Access: [Bus] > "SpaceWire" > "Setup" tab



Make sure that the tab of the correct serial bus is selected.

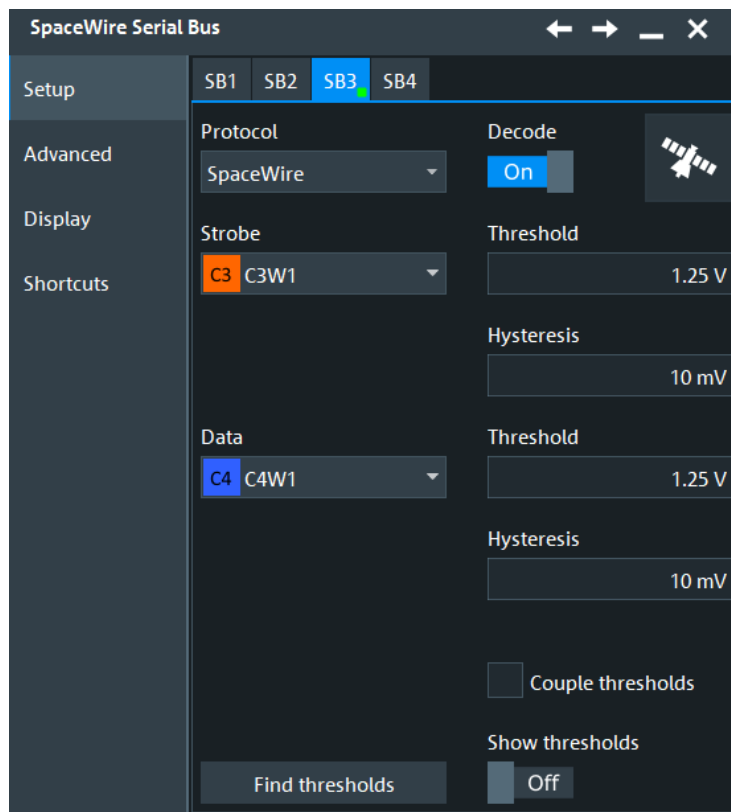

See also: [Chapter 14.1.1, "Setup - general settings"](#), on page 511

Strobe

Selects the source for the strobe signal.

Remote command:

[BUS<m>: SWIRe: STRBe: SOURce](#) on page 2163

Data

Selects the source for the data signal.

Remote command:

[BUS<m>: SWIRe: DATA: SOURce](#) on page 2161

Threshold setup

Sets the threshold value for the strobe/data signal.

"Threshold" Enter individual values for each line directly in the fields.

"Couple thresholds" Enables coupling, i.e. the same threshold and hysteresis value is used for the strobe and data signal.

Remote command:

[BUS<m>: SWIRe: COUPling](#) on page 2163

[BUS<m>: SWIRe: STRBe: THReshold](#) on page 2163

[BUS<m>: SWIRe: DATA: THReshold](#) on page 2162

[BUS<m>: SWIRe: PRESet](#) on page 2164

[BUS<m>: SETRefllevels](#) on page 1814

Hysteresis

Sets a value for the hysteresis of the strobe/data signal.

Remote command:

[BUS<m>:SWIRe:STRBe:HYSTeresis](#) on page 2162

[BUS<m>:SWIRe:DATA:HYSTeresis](#) on page 2161

Show thresholds

If enabled, the threshold levels are displayed in the diagram.

Remote command:

[BUS<m>:THReshold](#) on page 1815

14.14.2.2 Advanced settings

Access: [Bus] > "Advanced" tab.

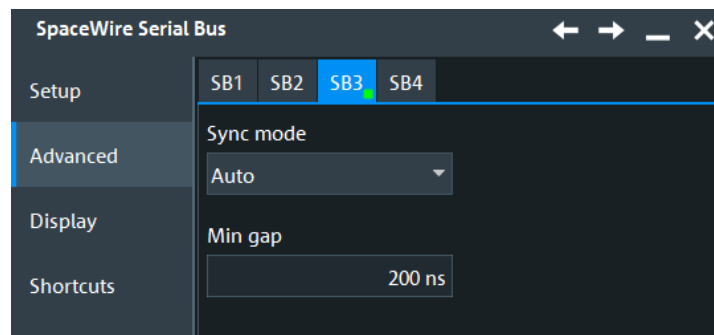
**Bit Position**

Sets the bit position, the align position for the manual synchronization mode. This can be useful when parity errors exist in the signal, and parity check is the main indicator for the decoder to do packet alignment.

Remote command:

[BUS<m>:SWIRe:BPOsition](#) on page 2161

Min Gap

SpaceWire can have idle phases where strobe and data signals are not being sent. These "gaps" are identified to resume decoding after this idle time.

"Min Gap" sets the minimum duration of a gap. Any inactivity greater than this time is interpreted as a gap and lead to a resynchronization to the signal.

Remote command:

[BUS<m>:SWIRe:MGAP](#) on page 2162

Sync Settings

Sets the mode for the synchronization of the signal. In the auto mode, the decoder automatically does the packet align. In the manual mode, you can set the align point manually with the "Bit Position" setting.

Remote command:

[BUS<m>:SWIRe:SYSLect](#) on page 2163

14.14.2.3 Display settings

Access: [Bus] > "Display" tab.

For common display settings, see [Chapter 14.1.3, "Display"](#), on page 513.

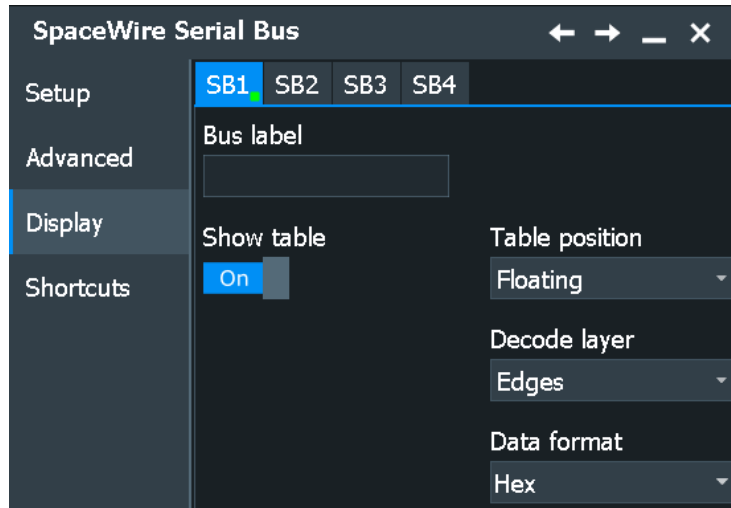

Decode Layer

Selects the decode layer.

Decoding is performed in several steps, and the end results are presented in the decode table. The decode layer selects an interim step for which the decoding result is shown in the honeycomb display.

Available are:

- "Off"
- "Edges"
- "Binary"

14.14.2.4 Configuring the SpaceWire signals

For configuration, assign the lines to the input channels and define the logical thresholds and the hysteresis.

1. Press the [Bus] key on the front panel.
2. Select the tab of the bus you want to set up, for example "SB1".
3. In the "Setup" tab, set "Protocol"="SpaceWire".
4. Select the source and polarity for the strobe and data signals.
5. Enter the "Threshold" and the "Hysteresis" for the strobe and data signals.
6. Set the "Sync Settings" and the "Bit Position" if necessary.
7. Enable "Decode".

14.14.3 SpaceWire trigger

14.14.3.1 SpaceWire trigger settings

Access: [Bus] > "Shortcuts" tab > "Setup trigger"



Make sure that:

- In the [Bus] > "Setup" tab:
 - The correct "Protocol" is selected.
 - The data sources of the serial bus are channel signals.
- In the "Trigger" > "Setup" tab:
 - The "Trigger on" = "Single event"
 - The trigger "Source" = "Serial bus".
 - The correct "Serial bus" is selected.

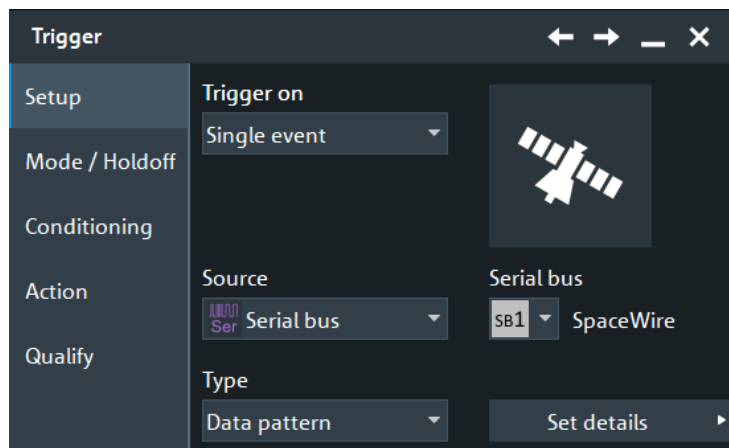

Type

Selects the trigger type for the SpaceWire analysis.

"Control frame" Sets the trigger to the selected control type frame.

"Data Pattern" Sets the trigger to a defined data pattern or pattern range.

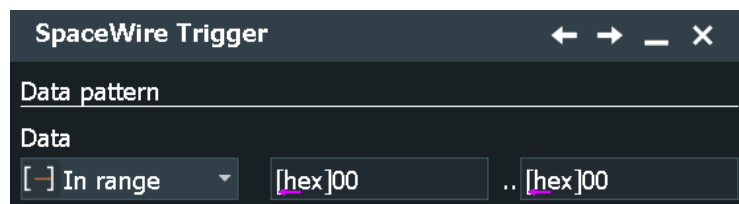

"NULL frame" Sets the trigger to a null frame, a frame without usable data.

"Time Code" Sets the trigger to a time-code control code. You can define the data pattern of the time code to be triggered on.

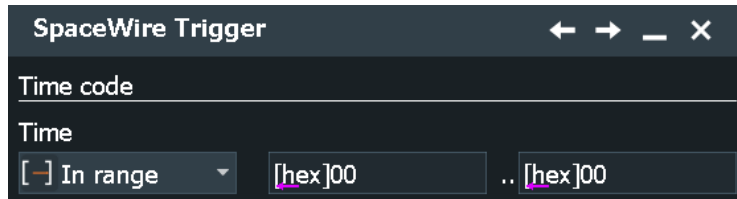

"Errors" Triggers on an enabled error type.

Remote command:

[TRIGger<m>:SWIRe:TYPE](#) on page 2167

Trigger Control Type

Triggers on a specific control type character.

"ANY" Any control type character
 "FCT" Flow control token character
 "EOP" Normal end of packet character
 "EEP" Error end of packet character

Remote command:

[TRIGger<m>:SWIRe:CTYPe](#) on page 2164

Data (Time Code)

Sets the specified data type for the time code to be triggered on. The trigger data setup consists of a comparison condition and one or two data patterns.

In binary format, use the following characters: 1; 0; or X (do not care). To enter the pattern in other formats use the bit pattern editor, see [Chapter 14.1.7, "Bit pattern editor"](#), on page 519.

"Condition" Sets the comparison condition to a specific value or a range.
 "Data Min/Data" Specifies the value or sets the start value of a range.
 "Data Max" Sets the maximum value of a range for "Condition" = "In range"/"Out of range".

Remote command:

[TRIGger<m>:SWIRe:TIME:CONDition](#) on page 2166

[TRIGger<m>:SWIRe:TIME:MAX](#) on page 2167

[TRIGger<m>:SWIRe:TIME:MIN](#) on page 2167

Data (Data Pattern)

Sets the specified data type for the data pattern to be triggered on. The data type setup consists of the condition and one or two data patterns.

In binary format, use the following characters: 1; 0; or X (do not care). To enter the pattern in other formats use the bit pattern editor, see [Chapter 14.1.7, "Bit pattern editor"](#), on page 519.

"Condition" Sets the comparison condition to a specific value or a range.

"Data Min/ Data"	Specifies the value or sets the start value of a range.
"Data Max"	Sets the maximum value of a range for "Condition" = "In range"/"Out of range".

Remote command:

[TRIGger<m>:SWIRe:DATA:CONDition](#) on page 2165

[TRIGger<m>:SWIRe:DATA:MAX](#) on page 2165

[TRIGger<m>:SWIRe:DATA:MIN](#) on page 2165

Parity Error

Checks the parity of every frame and triggers if the parity is even.

Remote command:

[TRIGger<m>:SWIRe:ERRor:PARity](#) on page 2166

ESC Error

Triggers on an escape error.

Remote command:

[TRIGger<m>:SWIRe:ERRor:ESC](#) on page 2166

14.14.3.2 Triggering on SpaceWire

Prerequisite: A bus is configured for the SpaceWire signal to be analyzed.

For the basic trigger settings, proceed in the following way:

1. Press the [Bus] key and select the "Shortcuts" tab.
2. Press "Setup trigger".
3. Tap the "Source" button and select the "Serial bus" trigger source.
4. Select the serial bus that is set to SpaceWire.
5. Select the "Trigger Type" to be used for SpaceWire protocol analysis.
6. To refine the trigger settings, configure additional settings, which are available for some trigger types.
For details, see [Chapter 14.14.3.1, "SpaceWire trigger settings"](#), on page 747.

14.14.4 SpaceWire decode results

When the configuration of the serial bus is complete, the signal can be decoded:

1. In the "Protocol" dialog > "Setup" tab, enable "Decode".
2. In the "Protocol" dialog > "Display" tab, select additional result display settings: "Show decode table" and "Show binary signals".

For a description of the display settings, see also [Chapter 14.1.3, "Display"](#), on page 513.

The instrument captures and decodes the signal according to the standard definition and the configuration settings.

The color-coding of the various protocol sections and errors simplifies the interpretation of the visual display. The decode information condenses or expands, depending on the horizontal scale. Various data formats are available to show the result values.

Decode results table

The results are shown in two tables:

- "Decode results": contains information about all decoded frames
- "Details frame": contains more detailed information about the selected frame in the "Decode results" table.

The screenshot shows a software interface titled "SpaceWire Decode Results SB3 X". It features a main table with columns for State, Start, Type, and Data. The first row is highlighted in blue and shows "1 Ambiguous" state, starting at "-9.45 μs", with an "Escape" type and "[hex] 01" data. To the right, a "Details frame 1" window is open, showing a smaller table with columns for State, Type, Numeric, and Formatted. The details table shows the selected frame's state as "Ambiguous", type as "P", numeric value as "[hex] 00 0", and formatted value as "[hex] 01 1".

Table 14-20: Content of the Decode results table

Column	Description
State	Overall state of the frame
Start	Time of frame start in relation to the trigger point
Stop	Time of frame stop in relation to the trigger point
Type	Frame type
Data	Data value

Table 14-21: Content of the Details frame table

Column	Description
State	State of the field
Type	Field type
Numeric	Hexadecimal value of the field
Formatted	Formatted content of the field

Tools

Press "Display settings" in the "Decode Results" table to access the "Display" tab.



Remote commands

Remote commands to retrieve decode results are described in [Chapter 27.18.15.3, "Decode results"](#), on page 2167.

14.14.5 Search on decoded SpaceWire data

Using the search functionality, you can find various events in the decoded data. You can find the same events that you can trigger on, and even many more, since several event types can also be combined.

Before you can start the search, you have to configure the bus correctly and acquire decoded data.

To search on decoded data, set the search source to "SerBus" for the configured protocol.

For general information on how to handle the search functionality, see [Chapter 11, "Search functions"](#), on page 425.

14.14.5.1 SpaceWire search setup

Access: [Bus] > "Shortcuts" tab > "Setup search"

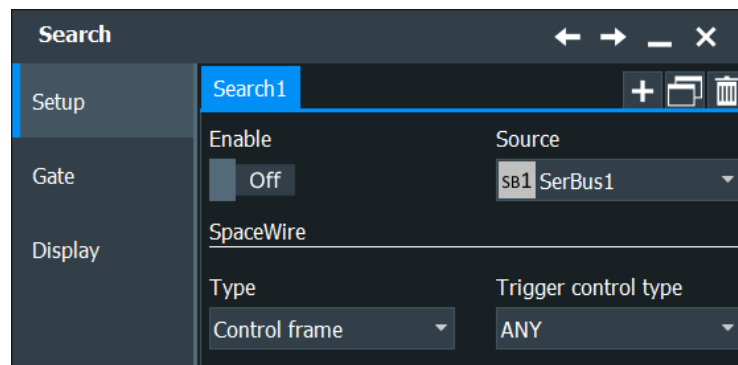

Type

Sets the search type for the SpaceWire analysis.

"Control frame" Searches for the selected control type frame.

"Data Pattern" Searches for a defined data pattern or pattern range.

"NULL frame" Searches for a null frame, a frame without usable data.

"Time Code" Searches for a time-code control code. You can define the data pattern of the time code to be searched for.

"ERRORs" Searches for an enabled error type.

Remote command:

`SEARCH:TRIGger:SWIRE:TYPE` on page 2176

Trigger Control Type

Searches for a specific control type character.

"ANY"	Any control type character
"FCT"	Flow Control Token character
"EOP"	Normal End of Packet character
"EEP"	Error End of Packet character

Remote command:

[SEARCh:TRIGger:SWIRe:CTYPe](#) on page 2173

Data (Time Code)

Sets the specified data type for the time code to be searched for. The data type setup consists of the condition and one or two data patterns.

"Condition"	Defines the operator to set a specific data type ("Equal" or "Not equal") or a data type range.
"Data Min/ Data"	Defines the bit pattern of the data pattern. In binary format, use the following characters: 1; 0; or X (do not care). To enter the pattern in other formats use the bit pattern editor, see Chapter 14.1.7, "Bit pattern editor" , on page 519.
"Data Max"	The second data pattern is required to specify a range with conditions "In range" and "Out of range".

Remote command:

[SEARCh:TRIGger:SWIRe:TIME:CONDition](#) on page 2175

[SEARCh:TRIGger:SWIRe:TIME:MAX](#) on page 2175

[SEARCh:TRIGger:SWIRe:TIME:MIN](#) on page 2176

Data (Data Pattern)

Sets the specified data type for the data pattern to be searched for. The data type setup consists of the condition and one or two data patterns.

"Condition"	Defines the operator to set a specific data type ("Equal" or "Not equal") or a data type range.
"Data Min/ Data"	Defines the bit pattern of the data pattern. In binary format, use the following characters: 1; 0; or X (do not care). To enter the pattern in other formats use the bit pattern editor, see Chapter 14.1.7, "Bit pattern editor" , on page 519.
"Data Max"	The second data pattern is required to specify a range with conditions "In range" and "Out of range".

Remote command:

[SEARCh:TRIGger:SWIRe:DATA:CONDition](#) on page 2173

[SEARCh:TRIGger:SWIRe:DATA:MAX](#) on page 2174

[SEARCh:TRIGger:SWIRe:DATA:MIN](#) on page 2174

Parity Error

Checks the parity of every frame and searches for even parity.

Remote command:

[SEARCh:TRIGger:SWIRe:ERRor:PARity](#) on page 2174

ESC Error

Searches for an escape error.

Remote command:

[SEARCH:TRIGger:SWIRE:ERRor:ESC](#) on page 2174

14.14.5.2 SpaceWire search results

To get search results, "Enable" the search. You can minimize, shift or close the search dialog.

The search results are listed in the search result table and marked in the waveform by blue lines.

For an introduction to search results, see:

- [Chapter 11.1.2, "Search results"](#), on page 426
- [Chapter 11.4.2, "Display zoom settings"](#), on page 446

Remote commands:

- [SEARCH:RESult:SWIRE:FCOunt?](#) on page 2176
- [SEARCH:RESult:SWIRE:FRAMe<m>:DATA?](#) on page 2177
- [SEARCH:RESult:SWIRE:FRAMe<m>:STARt?](#) on page 2177
- [SEARCH:RESult:SWIRE:FRAMe<m>:STATe?](#) on page 2177
- [SEARCH:RESult:SWIRE:FRAMe<m>:STOP?](#) on page 2178
- [SEARCH:RESult:SWIRE:FRAMe<m>:TYPE?](#) on page 2178

14.14.5.3 Searching SpaceWire

Prerequisite: A serial bus is configured for the SpaceWire signal to be decoded and analyzed.

The search for events is set up in the following way:

1. Press the [Bus] key and select the "Shortcuts" tab.
2. Tap "Setup search".
3. If the dialog box does not contain a search entry, tap the "Add" icon to create one, as described in ["To create a user-defined search"](#) on page 440.
4. Tap "Source" and select the serial bus that is set to SpaceWire (e.g. "SB1", unless already selected).
5. Specify search criteria according to [Chapter 14.14.5.1, "SpaceWire search setup"](#), on page 751.
6. To acquire a waveform, press [Single].

The R&S RTO6 performs a SpaceWire decode according to the thresholds and protocol settings of the associated serial bus source.

7. To start searching the acquired waveform for specific events, tap "Enable" in the search setup dialog:

The R&S RTO6 displays the "Search Results" box that lists the detected events.

For information on how to configure the search results presentation and how to navigate the search results, see also ["To display search zoom windows"](#) on page 448.

14.15 Ethernet 10BASE-T and 100BASE-TX (option R&S RTO6-K540)

Twisted-pair Ethernet technologies are based on the family of standards IEEE 802.3, issued by the Institute of Electrical and Electronics Engineers (IEEE).

R&S RTO6-K540 is a firmware option that enables the R&S RTO6 to analyze Ethernet protocol variants 10BASE-T and 100BASE-TX, by decoding the signal and searching within the decoded events. It is possible to trigger on 10BASE-T signals and 100BASE-TX signals. The option is compatible with the standards IEEE 802.3i of 1990 (10BASE-T) and IEEE 802.3u of 1995 (100BASE-TX).

- [The Ethernet protocol](#).....754
- [Ethernet configuration](#).....755
- [Ethernet trigger](#).....760
- [Ethernet decode results](#).....764
- [Search on decoded Ethernet data](#).....765

14.15.1 The Ethernet protocol

The two Ethernet protocol variants that R&S RTO6-K540 can process have the following features:

- 10BASE-T uses Manchester coding (or phase encoding, PE). In terms of a logical Boolean operation, the Manchester value of each bit is the exclusive disjunction (XOR) of the original data value and the clock value. A "0" is expressed by a high-to-low transition, a "1" by a low-to-high transition. These transitions, which occur at the middle of each bit period, make the signal self-clocked.
- 100BASE-TX uses a 4B5B multi-level transmit (MLT-3) encoding. The protocol sequentially cycles through a sequence of the voltage levels -1 V, 0 V, +1 V, and 0 V. To transmit a "1" bit, MLT-3 moves to the next state; to transmit a "0" bit, it stays in the same state. 4B5B block coding is used to map groups of four bits onto groups of five bits. Also, the signal is scrambled.

All Ethernet-over-twisted-pair technologies use wires with four twisted pairs of cables (and 8P8C connectors), but 10BASE-T and 100BASE-TX only require two pairs of wires.

14.15.2 Ethernet configuration

14.15.2.1 Ethernet configuration settings

Access: [Bus] > "Ethernet" > "Setup" tab



Make sure that the tab of the correct serial bus is selected.

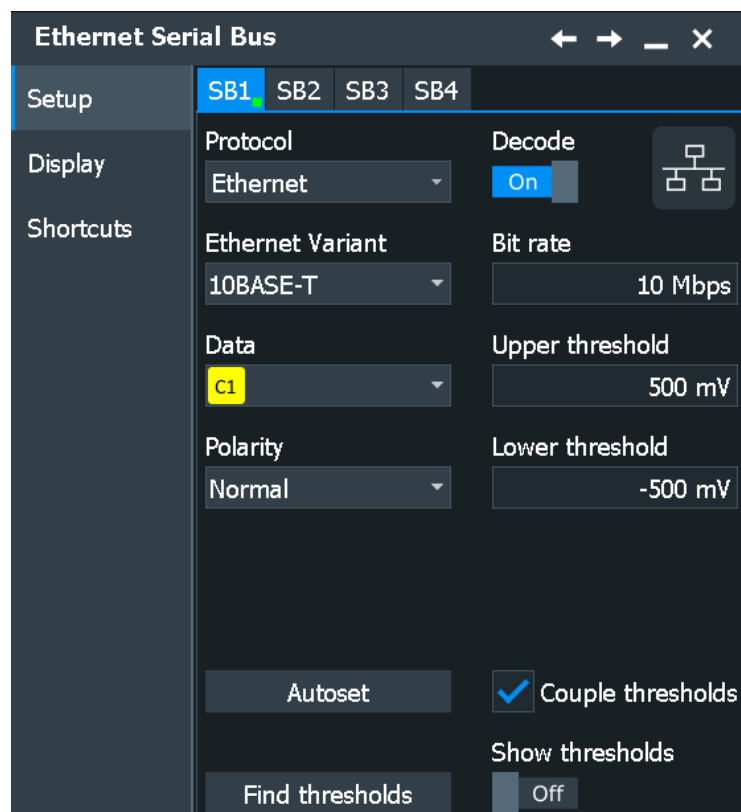

See also: [Chapter 14.1.1, "Setup - general settings"](#), on page 511

Protocol

Defines the protocol type of the selected serial bus.

Remote command:

`BUS<m>:TYPE` on page 1813

Decode

Enables the decoding of the selected bus. The signal icon of the bus appears on the signal bar.

Remote command:

`BUS<m>[:STATE]` on page 1813

Ethernet Variant

Defines the Ethernet protocol variant and transmission speed.

"10BASE-T"

Selects the Ethernet protocol variant 10BASE-T (standard data rate 10 Mbit/s).

"100BASE-TX"

Selects the Ethernet protocol variant 100BASE-TX, which provides 100 Mbit/s use data rate. Due to 4b/5b encoding, the raw data rate on the line is 125 Mbit/s. This value is used by R&S RTO6-K540 as the bit rate default for 100BASE-TX.

Remote command:

[BUS<m>:ETHernet:VARIant](#) on page 2179

Source

Defines the source settings for the data signal.

Permitted source selections are the analog, mathematical, and reference channels.

As soon as the serial bus trigger has been selected, the only permitted source selections are the analog channels "C1" – "C4", which are required for triggering.

Remote command:

[BUS<m>:ETHernet:SOURce](#) on page 2179

Polarity

Defines the polarity ("Normal" or "Inverted") of the data signal. This setting is only available in 10BASE-T.

Remote command:

[BUS<m>:ETHernet:POLarity](#) on page 2180

Thresholds

Sets the threshold value for the digitization of each signal line. If the signal value on the line is higher than the upper threshold, the signal state is high. Otherwise, if the signal value is below the lower threshold, the signal state is considered low.

"Thresholds" Enter the values directly: upper threshold in the upper field, lower threshold in the lower field.

"Autoset" Starts software algorithms for determining the signal threshold levels and bitrate.

"Find thresholds" Executes the measurement of reference levels and sets the thresholds to the middle reference level of the measured amplitude.

"Couple thresholds" Couples threshold settings between upper and lower threshold.

Remote command:

[BUS<m>:ETHernet:THReshold:HIGH](#) on page 2180

[BUS<m>:ETHernet:THReshold:LOW](#) on page 2180

[BUS<m>:ETHernet:PRESet](#) on page 2181

[BUS<m>:SETReflevels](#) on page 1814

[BUS<m>:FAUTOset](#) on page 1814

Bit rate

Defines the transmission speed setting for the data signal:

- 10BASE-T: default bit rate 10 Mbps
- 100BASE-TX: default bit rate 125 Mbps

In both variants, the permitted bit rates range from 10 kbps to 150 Mbps. Switching the variant adjusts the bit rate, independent of the previous setting.

Remote command:

`BUS<m>:ETHernet:BITRate` on page 2181

Show thresholds

If enabled, the threshold levels are displayed in the diagram.

Remote command:

`BUS<m>:THReshold` on page 1815

14.15.2.2 Ethernet display settings

Access: [Bus] > "Display" tab.

For common display settings, see [Chapter 14.1.3, "Display"](#), on page 513.

To enhance the decode possibilities of the Ethernet protocol, you can use an additional setting in the "Display" tab: "Decode layer".

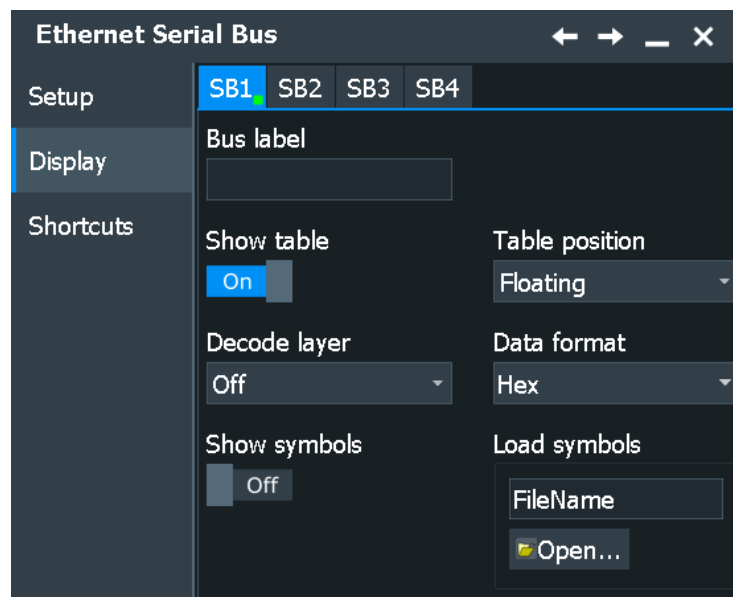
**Ethernet Specific Label Settings**

Label lists are protocol-specific. An Ethernet label file contains two values for each identifier:

- "Ethernet Header Display": the Ethernet header display value (e.g. `FF:FF:FF:FF:FF:FF/48`)
- "Symbolic label": user-defined symbolic name of the header, specifying its function (e.g. `BroadCast`).

For example, an ethernet label list can be a vendor-specific MAC address list:

```
# -----
@FILE_VERSION = 1.00
@PROTOCOL_NAME = ethernet
# -----
# Labels for Ethernet protocol
# Column order: Ethernet Header Display, Label
#-----
# Supported MAC Address Format
# xx:xx:xx standard 24 bit manufactory header
# xx:xx:xx:xx:xx:xx/yy support other length headers
# yy should be the header length in decimal
# yy should be between 24 - 48
# -----
00:00:0C, Cisco
00:01:13, Olympus
00:01:14, KandaTsu
00:04:07, TopconPo
00:0B:64, KiebackP
00:1B:C5:06:C0:00/36, LuxconSy
00:1B:C5:06:D0:00/36, TesElect
00:1B:C5:06:E0:00/36, TwoDimen
00:1B:C5:06:F0:00/36, LlcEmzio
00:1F:BE, Shenzhen
00:21:8F, Avantgar
00:21:90, GoliathS
00:21:91, D-Link
00:21:92, BaodingG
00:50:C2:5F:60:00/36, Cambridg
00:50:C2:5F:70:00/36, Metrolog
00:50:C2:5F:80:00/36, GrupoEpe
18:42:2F, AlcateL
18:44:62, RiavaNet
18:46:17, SamsungE
18:8E:D5, TpVision
18:E7:F4, Apple
40:D8:55:1C:80:00/36, SensataT
40:D8:55:1C:90:00/36, Andy-L
40:D8:55:1C:A0:00/36, RigelEng
40:D8:55:1C:B0:00/36, MgSRL
40:D8:55:1C:D0:00/36, YxlonInt
40:D8:55:1C:E0:00/36, PeterHub
40:D8:55:1C:F0:00/36, OmnikNew
40:D8:55:1D:00:00/36, WebeasyB
FC:F8:B7, TronteqE
FC:FA:F7, Shanghai
FC:FB:FB, Cisco
```

Ethernet 10BASE-T and 100BASE-TX (option R&S RTO6-K540)

FC:FE:77, HitachiR

FF:FF:FF:FF:FF:FF/48, BroadCast

In the figure below, you can see a decoded broadcast symbol. The symbol name is displayed in the "Destination symbol" column of the "Decode results" table.

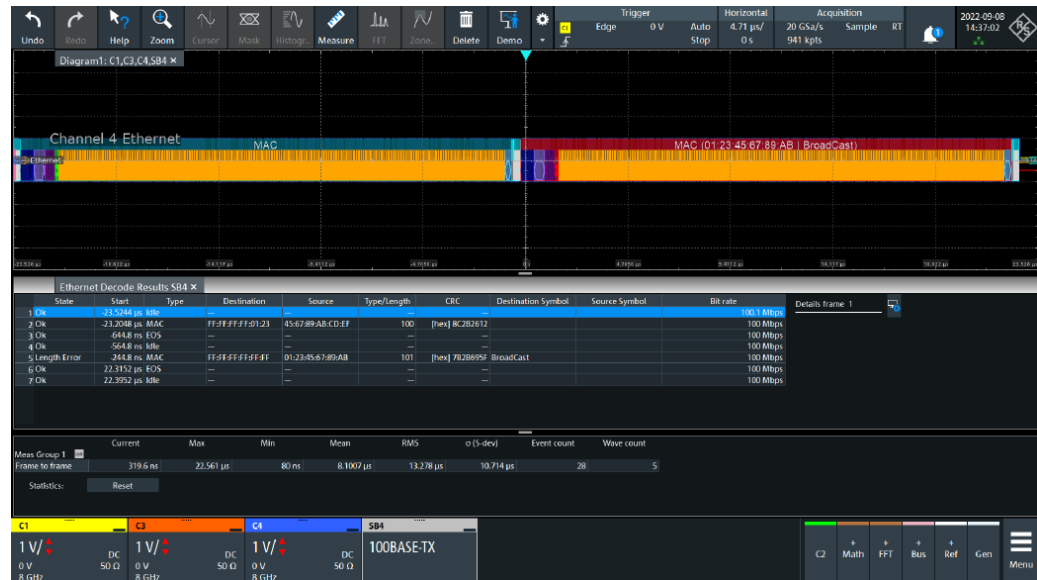

Figure 14-29: Decoded Ethernet results with applied label

Decode layer

Selects the decode layer.

Decoding is performed in several steps, and the end results are presented in the decode table. The decode layer selects an interim step for which the decoding result is shown in the honeycomb display.

Available are:

- "Edges": Shows where the decoder identified transitions through the threshold.
- "Binary": Shows the bits as identified by the decoder.
- "Descramble": Shows the bits after signal has been descrambled.
- "5b Symbol": Shows the symbol values after the 4b/5b decoder.

14.15.2.3 Configuring Ethernet signals

For configuration, assign the lines to the input channels and define the active states and the logical thresholds.

For details on configuration settings, see [Chapter 14.15.2.1, "Ethernet configuration settings"](#), on page 755.

1. Press the [Bus] key on the front panel.
2. Select the tab of the bus you want to set up, for example "SB1".
3. In the "Setup" tab, select the protocol: "Ethernet".

4. Tap "Ethernet Variant" and select the variant ("10BASE-T" or "100BASE-TX") you want to set up.
Note: Note that no triggering on the serial bus is available. To trigger the signal, use the edge trigger on the source channel.
5. For the variant "10BASE-T", select the polarity ("Normal" or "Inverted") of the data signal.
6. Set the logical thresholds.
7. Enable "Decode".

14.15.3 Ethernet trigger

If you need information on how to get started with triggering on Ethernet 10BASE-T signals, see [Chapter 14.15.3.2, "Triggering on Ethernet signals"](#), on page 764. Otherwise proceed with the Ethernet trigger settings.

14.15.3.1 Ethernet trigger settings

Access: [Bus] > "Shortcuts" tab > "Setup trigger"

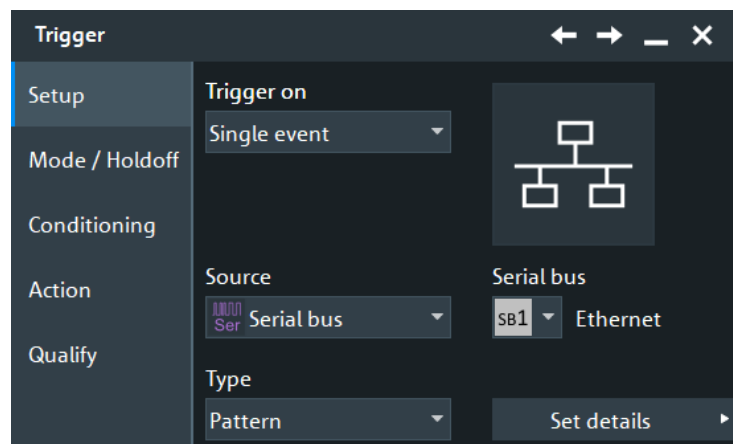

Make sure that:

- In the [Bus] > "Setup" tab:
 - The correct "Protocol" is selected.
 - The data sources of the serial bus are channel signals.
- In the "Trigger" > "Setup" tab:
 - The "Trigger on" = "Single event"
 - The trigger "Source" = "Serial bus".
 - The correct "Serial bus" is selected.

Type

Selects the trigger type for the Ethernet analysis.

Ethernet 10BASE-T and 100BASE-TX (option R&S RTO6-K540)

- "Frame Start" Available only for "Variant > 10BASE-T".
Sets the trigger to the start frame delimiter (SFD). The start of frame (SOF) condition is the occurrence of the preamble; the trigger instant is after the SFD.
- "Pattern" Available only for "Variant > 10BASE-T".
Sets the trigger to any bit pattern (data) that can be freely specified, starting from the beginning of the frame. The trigger instant is after the last bit of the specified data pattern.
- "Adv frame "

The screenshot shows the 'Ethernet Trigger' dialog box with the 'Adv frame' tab selected. It contains four configuration sections, each with a dropdown menu set to 'Equal' and a text input field containing '[hex]XX':

- Destination address
- Source address
- Length/Type
- Frame check

- "Adv error" Triggers on any selected errors.

The screenshot shows the 'Ethernet Trigger' dialog box with the 'Adv error' tab selected. It contains three checked checkboxes:

- Preamble error
- Length error
- CRC error

Remote command:

[TRIGger<m>:ETHernet:TYPE](#) on page 2182

Ethernet Variant

Defines the Ethernet protocol variant and transmission speed.

"10BASE-T"

Selects the Ethernet protocol variant 10BASE-T (standard data rate 10 Mbit/s).

"100BASE-TX"

Selects the Ethernet protocol variant 100BASE-TX, which provides 100 Mbit/s use data rate. Due to 4b/5b encoding, the raw data rate on the line is 125 Mbit/s. This value is used by R&S RTO6-K540 as the bit rate default for 100BASE-TX.

Remote command:

`BUS<m>:ETHernet:VARIant` on page 2179

Data Pattern

Specifies the data pattern that is to be triggered on.

Remote command:

`TRIGger<m>:ETHernet:PATTern` on page 2183

Bit rate

Defines the transmission speed setting for the data signal:

- 10BASE-T: default bit rate 10 Mbps
- 100BASE-TX: default bit rate 125 Mbps

In both variants, the permitted bit rates range from 10 kbps to 150 Mbps. Switching the variant adjusts the bit rate, independent of the previous setting.

Remote command:

`BUS<m>:ETHernet:BITRate` on page 2181

Bit index

Defines the position of the first bit of the data pattern.

"Bit index operator" Sets the operator ("Equal", "Greater or equal", or "In range").

"Bit index" Sets the bit index (data position), or the start value of a bit index range.

"Bit index to" Sets end value of a bit index range (data position range). Available only, if the "Bit index operator" is set to "In range".

Destination Address

Defines the destination address.

"Condition" Sets the comparison condition to a specific value or a range.

"Destination Address (Min)" Specifies the value or sets the start value of a range.

"Destination Address (Max)" Sets the maximum value of a range for "Condition" = "In range"/"Out of range".

Remote command:

`TRIGger<m>:ETHernet:FRAME:DCONdition` on page 2185

`TRIGger<m>:ETHernet:FRAME:DMAX` on page 2185

`TRIGger<m>:ETHernet:FRAME:DMIN` on page 2185

Source Address

Defines the source address, the physical address of the device that sends the frame.

Ethernet 10BASE-T and 100BASE-TX (option R&S RTO6-K540)

"Condition"	Sets the comparison condition to a specific value or a range.
"Source Address (Min)"	Specifies the value or sets the start value of a range.
"Source Adress (Max)"	Sets the maximum value of a range for "Condition" = "In range"/"Out of range".

Remote command:

[TRIGger<m>:ETHernet:FRAME:SCONdition](#) on page 2185

[TRIGger<m>:ETHernet:FRAME:SMAX](#) on page 2186

[TRIGger<m>:ETHernet:FRAME:SMIN](#) on page 2186

Length/ Type

Defines the length/type field value.

"Condition"	Sets the operator to trigger on a specific address pattern ("Equal" or "Not equal") or an address range.
"Length/Type (Min)"	Defines the length/type pattern for all operators that require one pattern.
"Length/Typ (Max)"	Defines the length/type pattern that is required to specify a range with conditions "In range" and "Out of range".

Remote command:

[TRIGger<m>:ETHernet:FRAME:TCONdition](#) on page 2186

[TRIGger<m>:ETHernet:FRAME:TMAX](#) on page 2187

[TRIGger<m>:ETHernet:FRAME:TMIN](#) on page 2187

Frame check

Defines the frame check sequence value.

"Condition"	Sets the comparison condition to a specific value or a range.
"Frame check (Min)"	Specifies the value or sets the start value of a range.
"Frame check (Max)"	Sets the maximum value of a range for "Condition" = "In range"/"Out of range".

Remote command:

[TRIGger<m>:ETHernet:FRAME:CCONdition](#) on page 2184

[TRIGger<m>:ETHernet:FRAME:CMAX](#) on page 2184

[TRIGger<m>:ETHernet:FRAME:CMIN](#) on page 2184

Error

Triggers on enabled errors.

"Preamble error"	Triggers on a frame with invalid preamble.
"Length error"	Triggers on an incorrect length of the sequence - when additional or missing bits are detected and the sequence of bits is not as expected.
"CRC error"	Triggers on a frame that has a mismatch of the cyclic redundancy check (CRC) value between the transmitting and receiving device.

Remote command:

[TRIGger<m>:ETHernet:ERRor:CRC](#) on page 2183

[TRIGger<m>:ETHernet:ERRor:LENGth](#) on page 2183

[TRIGger<m>:ETHernet:ERRor:PREamble](#) on page 2183

14.15.3.2 Triggering on Ethernet signals

Prerequisite: A bus is configured for the Ethernet signal to be analyzed.

For the basic trigger settings, proceed in the following way:

1. Press the [Bus] key and select the "Shortcuts" tab.
2. Press "Setup trigger".
3. Tap the "Source" button and select the "Serial bus" trigger source.
4. Select the serial bus that is set to Ethernet.
5. Tap "Type" and select the trigger type to be used for Ethernet protocol analysis. Available trigger types are "Frame Start", "Pattern", "Adv frame" and "Adv error".
6. Depending on the selected Ethernet variant, more setup conditions have to be specified.

For information on how to proceed with the configuration settings, see [Chapter 14.15.3.1, "Ethernet trigger settings"](#), on page 760.

14.15.4 Ethernet decode results

When the configuration of the serial bus is complete, the signal can be decoded:

1. In the "Protocol" dialog > "Setup" tab, enable "Decode".
2. In the "Protocol" dialog > "Display" tab, select additional result display settings: "Show decode table" and "Show binary signals".

For a description of the display settings, see also [Chapter 14.1.3, "Display"](#), on page 513.

The instrument captures and decodes the signal according to the standard definition and the configuration settings.

The color-coding of the various protocol sections and errors simplifies the interpretation of the visual display. The decode information condenses or expands, depending on the horizontal scale. Various data formats are available to show the result values.

Decode Results Table

The results are shown in two tables:

- "Decode results": contains information about all decoded frames
- "Details frame": contains more detailed information about the selected frame in the "Decode results" table.

Ethernet 10BASE-T and 100BASE-TX (option R&S RTO6-K540)

State	Start	Type	Destination	Source	Type/length	CRC	Destination Symbol	Source Symbol	Bit rate	Details frame
1 Ok	23.5244 µs	Idle	—	—	—	—	—	—	100.1 Mbps	1 Data
2 Ok	23.3998 µs	MAC	FF:FF:FF:FF:01:23	85:87:89:AB:CD:EF	100	(hex) 8C2B2612	—	100 Mbps	2 (hex) 00	
3 Ok	644.8 ns	EOS	—	—	—	—	—	—	100 Mbps	3 (hex) 01
4 Ok	564.8 ns	Idle	—	—	—	—	—	—	100 Mbps	4 (hex) 02
5 Length Error	284.8 ns	MAC	FF:FF:FF:FF:FF:FF	01:23:45:67:89:AB	101	(hex) 7B2B695F BroadCast	—	—	100 Mbps	5 (hex) 03
6 Ok	22.3152 µs	EOS	—	—	—	—	—	—	100 Mbps	6 (hex) 04
7 Ok	22.3952 µs	Idle	—	—	—	—	—	—	100 Mbps	7 (hex) 05
										8 (hex) 06
										9 (hex) 07
										10 (hex) 08

Table 14-22: Content of the Decode results table

Column	Description
State	Overall state of the frame: either OK or the relevant error condition (preamble, length)
Start	Start time of the frame
Type	Frame type
Destination	Destination address of the frame
Source	Source address of the frame
Type/Length	The subprotocol (e.g. HTML, video, etc.) determines what meaning this field has. Since the content of this data area is not decoded, the interpretation of this field is ambivalent. It could either be the word type (specific for the subprotocol) or the word length.
Data	Values of the data bytes in a frame. The table shows a truncated version; to see all the bytes in a separate data table, activate "Show details". The data format is always hexadecimal.
CRC	FrameCheck (Cyclic Redundancy Code, CRC)
Destination Symbol	Translation (or symbolic label) of the destination address, if the label list is enabled.
Source Symbol	Translation (or symbolic label) of the source address, if the label list is enabled.
Number of Words	Number of words in the frame
Bit rate	Value of the bit rate

Tools

Press "Display settings" in the "Decode Results" table to access the "Display" tab.



Remote commands

Remote commands are described in [Chapter 27.18.16.3, "Decode results"](#), on page 2187.

14.15.5 Search on decoded Ethernet data

Using the search functionality, you can find various events in the decoded data. You can find the same events that you can trigger on, and even many more, since several event types can also be combined.

Before you can start the search, you have to configure the bus correctly and acquire decoded data.

To search on decoded data, set the search source to "SerBus" for the configured protocol.

For general information on how to handle the search functionality, see [Chapter 11, "Search functions"](#), on page 425.

If you need information on how to get started with searching Ethernet data, see [Chapter 14.15.5.3, "Searching Ethernet data"](#), on page 769. Otherwise proceed with the Ethernet search setup.

14.15.5.1 Ethernet search setup

Access: [Bus] > "Shortcuts" tab > "Setup search"

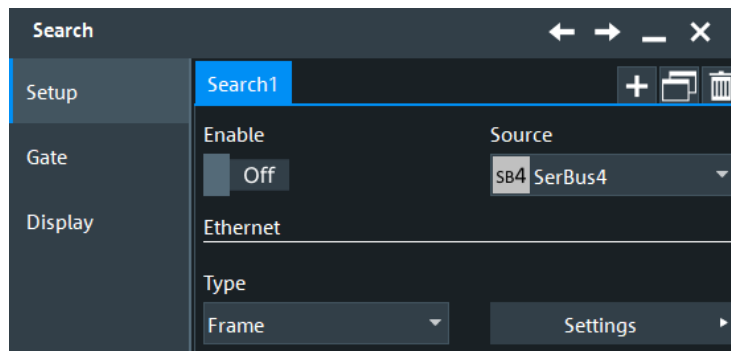

Type

Define the event types to be searched. Available event types are "Frame" and "Error".

Remote command:

[SEARCh:TRIGger:ETHernet:TYPE](#) on page 2193

Frame

Searches for the following frame conditions: "Destination address", "Source address", "Length/Type", or "Frame check".

The screenshot shows a dialog box titled "Ethernet Search". It has a title bar with navigation icons (back, forward, close). The dialog is divided into four sections, each with a dropdown menu and a text input field:

- Destination address:** Dropdown set to "= Equal", input field contains "[hex]XX".
- Source address:** Dropdown set to "= Equal", input field contains "[hex]XX".
- Length/Type:** Dropdown set to "= Equal", input field contains "[hex]XX".
- Frame check:** Dropdown set to "= Equal", input field contains "[hex]XX".

Destination address ← Frame

To search for a destination address, an address pattern or optionally an address range have to be specified.

Remote command:

[SEARCh:TRIGGer:ETHernet:FRAMe:DCONdition](#) on page 2194

[SEARCh:TRIGGer:ETHernet:FRAMe:DMIN](#) on page 2194

[SEARCh:TRIGGer:ETHernet:FRAMe:DMAX](#) on page 2194

Source address ← Frame

To search for a source address, an address pattern or optionally an address range have to be specified.

Remote command:

[SEARCh:TRIGGer:ETHernet:FRAMe:SCONdition](#) on page 2195

[SEARCh:TRIGGer:ETHernet:FRAMe:SMIN](#) on page 2195

[SEARCh:TRIGGer:ETHernet:FRAMe:SMAX](#) on page 2195

Length/Type ← Frame

To search for a frame length or frame type, a type/length pattern or optionally a range of type/length patterns have to be specified.

Remote command:

[SEARCh:TRIGGer:ETHernet:FRAMe:TCONdition](#) on page 2196

[SEARCh:TRIGGer:ETHernet:FRAMe:TMIN](#) on page 2196

[SEARCh:TRIGGer:ETHernet:FRAMe:TMAX](#) on page 2197

Frame check ← Frame

To search for a specific pattern, this pattern or optionally a range of patterns have to be specified.

Remote command:

[SEARCh:TRIGGer:ETHernet:FRAMe:CCONdition](#) on page 2197

[SEARCh:TRIGGer:ETHernet:FRAMe:CMIN](#) on page 2197

[SEARCh:TRIGGer:ETHernet:FRAMe:CMAX](#) on page 2198

Error Condition

Searches for the following error conditions: "Preamble Error" or "Length Error".

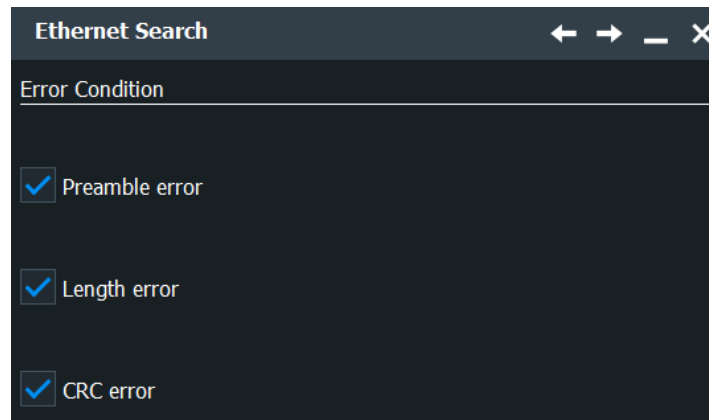
**Preamble Error ← Error Condition**

Searches for any preamble errors.

Remote command:

[SEARCH:TRIGGER:ETHERNET:ERROR:PREAmble](#) on page 2198

Length Error ← Error Condition

Searches for any length errors.

Remote command:

[SEARCH:TRIGGER:ETHERNET:ERROR:LENGTH](#) on page 2198

14.15.5.2 Ethernet search results

To get search results, "Enable" the search. You can minimize, shift or close the search dialog.

The search results are listed in the search result table and marked in the waveform by blue lines.

For an introduction to search results, see:

- [Chapter 11.1.2, "Search results"](#), on page 426
- [Chapter 11.4.2, "Display zoom settings"](#), on page 446

Remote commands:

- [SEARCH:RESULT:ETHERNET:WCount?](#) on page 2199
- [SEARCH:RESULT:ETHERNET:WORD<m>:TYPE?](#) on page 2201
- [SEARCH:RESULT:ETHERNET:WORD<m>:FTYPE?](#) on page 2201
- [SEARCH:RESULT:ETHERNET:WORD<m>:STATE?](#) on page 2199
- [SEARCH:RESULT:ETHERNET:WORD<m>:START?](#) on page 2200
- [SEARCH:RESULT:ETHERNET:WORD<m>:STOP?](#) on page 2200
- [SEARCH:RESULT:ETHERNET:WORD<m>:DESTaddress?](#) on page 2200
- [SEARCH:RESULT:ETHERNET:WORD<m>:SRCaddress?](#) on page 2201

- [SEARCH:RESult:ETHernet:WORD<m>:DATA?](#) on page 2201
- [SEARCH:RESult:ETHernet:WORD<m>:CRC?](#) on page 2202
- [SEARCH:RESult:ETHernet:WORD<m>:DSYMBOL?](#) on page 2202
- [SEARCH:RESult:ETHernet:WORD<m>:SSYMBOL?](#) on page 2202
- [SEARCH:RESult:ETHernet:WORD<m>:BYTE<n>:VALue?](#) on page 2203

14.15.5.3 Searching Ethernet data

Prerequisite: A serial bus is configured for the Ethernet signal to be decoded and analyzed.

The search for events is set up in the following way:

1. Press the [Bus] key and select the "Shortcuts" tab.
2. Tap "Setup search".
3. If the dialog box does not contain a search entry, tap the "Add" icon to create one, as described in ["To create a user-defined search"](#) on page 440.
4. Tap "Source" and select the serial bus that is set to Ethernet (e.g. "SerBus1", unless already selected).

The search dialog for Ethernet protocol analysis is opened.

5. Specify search criteria according to [Chapter 14.15.5.1, "Ethernet search setup"](#), on page 766.
6. To acquire a waveform, press [Single].

The R&S RTO6 performs an Ethernet decode according to the thresholds and protocol settings of the associated serial bus source (here in our example SB1).

7. To start searching the acquired waveform for specific events, tap "Enable" in the search setup dialog:

The R&S RTO6 displays the "Search Results" box that lists the detected events.

For information on how to configure the search results presentation and how to navigate the search results, see also ["To display search zoom windows"](#) on page 448.

14.16 MDIO (option R&S RTO6-K540)

The R&S RTO6-K540 option enables the R&S RTO6 to analyse Management Data Input/Output (MDIO) protocols. The option is compatible with the Ethernet standard IEEE 802.3 (<http://standards.ieee.org/findstds/standard/802.3-2012.html>) and supports simplified triggering and decoding for both variants of MDIO: Clause 22 with basic addressing, and Clause 45 with advanced addressing that meets the requirements of 10 Gigabit Ethernet devices.

- [The MDIO protocol](#).....770
- [MDIO configuration](#).....771
- [MDIO trigger](#).....775
- [MDIO decode results](#).....778
- [Search on decoded MDIO data](#).....780

14.16.1 The MDIO protocol

MDIO is used for bidirectional transfer of control and status information between the physical layer entity (PHY) and the station management entities (STA).

A major application of MDIO is fault detection by interrogating registers of physical devices. Hence, MDIO serial bus visualization helps debugging new products by giving developers a quick insight into the native data on the bus without using a special decoder.

On physical level, MDIO is a clocked non-return-to-zero (NRZ) code similar to SPI. According to the Ethernet standard, the protocol defines two threshold levels, 2 V and 0.8 V, which establish a hysteresis.

On logical level, MDIO is a fairly simple protocol with a fixed word length of 64 bits. The structure of MDIO frames is shown in the following tables:

Table 14-23: MDIO frame structure according to Clause 22

	Management Frame Fields							
Frame	PRE	ST	OP	PHYAD	REGAD	TA	DATA	IDLE
WRITE	1...1	01	01	AAAAA	RRRRR	10	DDDDDDDDDDDDDDDDDD	Z
READ	1...1	01	10	AAAAA	RRRRR	Z0	DDDDDDDDDDDDDDDDDD	Z

Table 14-24: MDIO frame structure according to Clause 45

	Management Frame Fields							
Frame	PRE	ST	OP	PRTAD	DEVAD	TA	ADDRESS / DATA	IDLE
ADDRESS	1...1	00	00	PPPPP	EEEEEE	10	AAAAAAAAAAAAAAAAAAAA	Z
WRITE	1...1	00	01	PPPPP	EEEEEE	10	DDDDDDDDDDDDDDDDDD	Z
READ	1...1	00	11	PPPPP	EEEEEE	Z0	DDDDDDDDDDDDDDDDDD	Z
POST-READ increment address	1...1	00	10	PPPPP	EEEEEE	Z0	DDDDDDDDDDDDDDDDDD	Z

The following abbreviations are used in the tables:

- PRE = preamble, consisting of 32 logic "one" bits ("1...1")
- ST = start of frame code (2 bits), "01" for Clause 22, "00" for Clause 45, "0X" for any, no other options permitted
- OP = operation code or "OpCode" (2 bits). This is a frame type code specifying the type of transaction.

- PHYAD = address of a physical layer entity (in Clause 22)
- PRTAD = address of a port (in Clause 45)
- REGAD = register address within a PHY (in Clause 22)
- DEVAD = device address within a port (in Clause 45)
- TA = turnaround time, a 2-bit time spacing between REGAD/DEVAD and DATA. The turnaround provides the slave some time to answer upon a read command. TA is hard-wired even in write commands, although it is not required there.
- ADDRESS / DATA = address or payload data, 16 bits
- IDLE = A single value (high-impedance state) indicating to the Physical Medium Attachment (PMA) that there is no data to convey

Instead of a specific hardware trigger, the option R&S RTO6-K540 uses a predefined generic serial bus pattern trigger. It simply triggers on a bit pattern in the data stream. This is fast, but limited in the complexity of the conditions.

The MDIO trigger settings allow you to define the MDIO fields individually. The firmware concatenates the settings to a single search pattern that is then used by the serial bus pattern.

While this design is simple, it does not allow triggering on a data range or even inequality. This explains the much simpler structure compared to other protocols.

14.16.2 MDIO configuration

14.16.2.1 MDIO configuration settings

Access: [Bus] > "MDIO" > "Setup" tab



Make sure that the tab of the correct serial bus is selected.

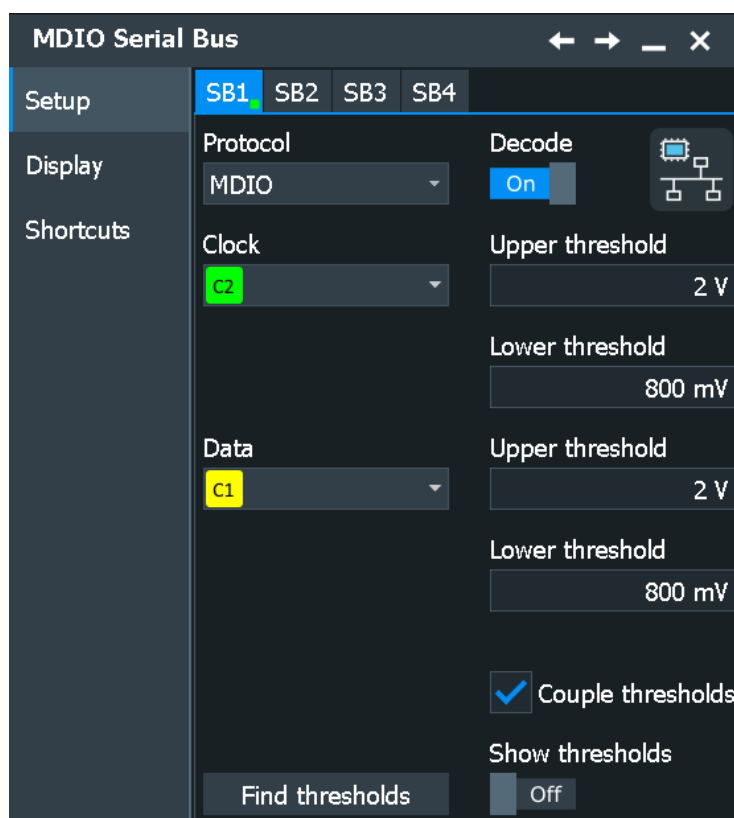

Figure 14-30: Serial bus MDIO protocol configuration dialog

See also: [Chapter 14.1.1, "Setup - general settings"](#), on page 511

Source

MDIO requires two source channels, one for clock and one for data.

- | | |
|---------|---|
| "Clock" | Defines the source settings for the clock line (management data clock, MDC). Typically, select any of the analog channels "C1" – "C4" or digital channels "D0" – "D15", depending on the test application. "Math" or "Ref" waveforms are also permitted. |
| "Data" | Defines the source settings for the data signal. Typically, select any of the analog channels "C1" – "C4" or digital channels "D0" – "D15", depending on your application, but not the same as for "Clock". "Math" or "Ref" waveforms are also permitted. |

Remote command:

[BUS<m>:MDIO:CLOCK:SOURce](#) on page 2203

[BUS<m>:MDIO:DATA:SOURce](#) on page 2204

Thresholds

MDIO defines two thresholds for each source line:

- $V_{ih}(\min)$ is being used for the rising edge evaluation. This "h" (high) threshold is the minimum value for the signal to be identified as "1". If the signal value comes from a low state (hence, rising edge), the state remains to be considered as low ("0"), until it has risen above $V_{ih}(\min)$.

- $V_{il(max)}$ is being used for the falling edge evaluation. This "l" (low) threshold is the maximum level for the signal to be identified as "0". If the signal value comes from a high state (hence, falling edge), the state remains to be considered as high ("1"), until it has fallen below $V_{il(max)}$.

There are four ways to set the thresholds for the digitization of the signal lines:

- "Threshold"
Enter the values directly in the fields.
- "Preset thresholds"
Allows to select the default threshold settings according to the Ethernet standard: 2.0 V and 0.8 V.
- "Auto thresholds"
Executes a measurement of reference levels and sets the thresholds to the middle reference level of the measured amplitude.
- "Couple thresholds"
Overwrites the data thresholds with the clock thresholds.

Remote command:

[BUS<m>:MDIO:CLOCK:THReshold:HIGH](#) on page 2204

[BUS<m>:MDIO:CLOCK:THReshold:LOW](#) on page 2205

[BUS<m>:MDIO:DATA:THReshold:HIGH](#) on page 2205

[BUS<m>:MDIO:DATA:THReshold:LOW](#) on page 2205

[BUS<m>:MDIO:PRESet](#) on page 2205

[BUS<m>:SETReflevels](#) on page 1814

[BUS<m>:MDIO:COUPling](#) on page 2206

14.16.2.2 MDIO display settings

Access: [Bus] > "Setup" tab > "Protocol = MDIO" > "Display" tab

To enhance the decode possibilities of the MDIO protocol, you can use an additional setting in the "Display" tab: "Decode layer".

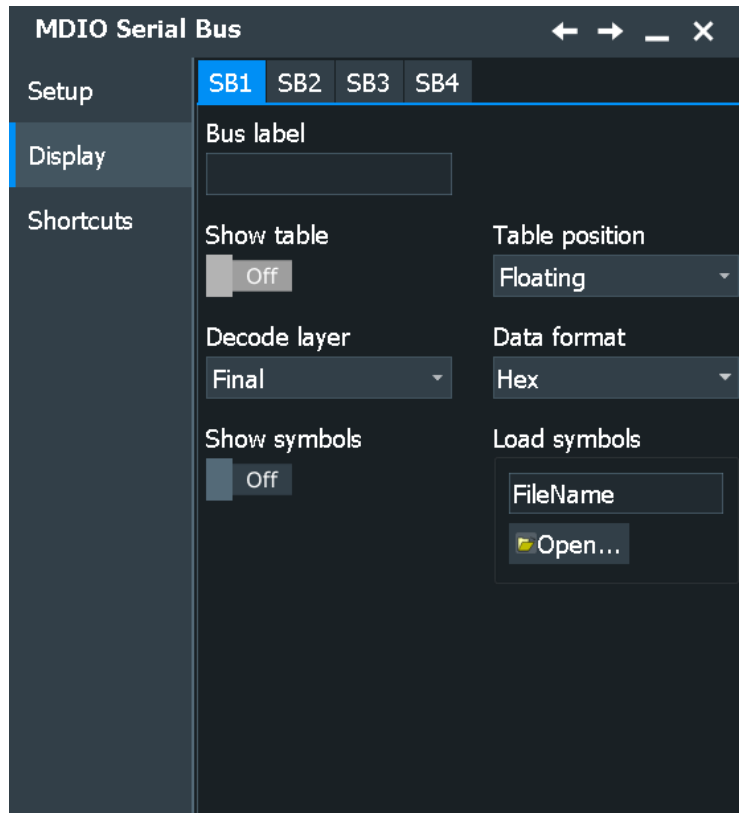

Access: [Bus] > "Display" tab.

For common display settings, see [Chapter 14.1.3, "Display"](#), on page 513.

MDIO Specific Label Settings

Decode layer

Selects the decode layer.

Decoding is performed in several steps, and the end results are presented in the decode table. The decode layer selects an interim step for which the decoding result is shown in the honeycomb display.

Available are:

- "Final"
- "Edges"
- "Binary"

14.16.2.3 Configuring MDIO signals

For configuration, assign the lines to the input channels and define the active states and the logical thresholds.

For details on configuration settings, see [Chapter 14.16.2.1, "MDIO configuration settings"](#), on page 771.

1. Press the [Bus] key on the front panel.

2. Select the tab of the bus you want to set up, for example "SB1".
3. Select the "Setup" tab.
4. In the "Setup" tab, set the "Protocol" > "MDIO".
5. Select the waveform for the "Clock" and "Data" lines.
6. Set the logical thresholds.
7. Enable "Decode".

14.16.3 MDIO trigger

14.16.3.1 MDIO trigger settings

Access: [Bus] > "Shortcuts" tab > "Setup trigger"

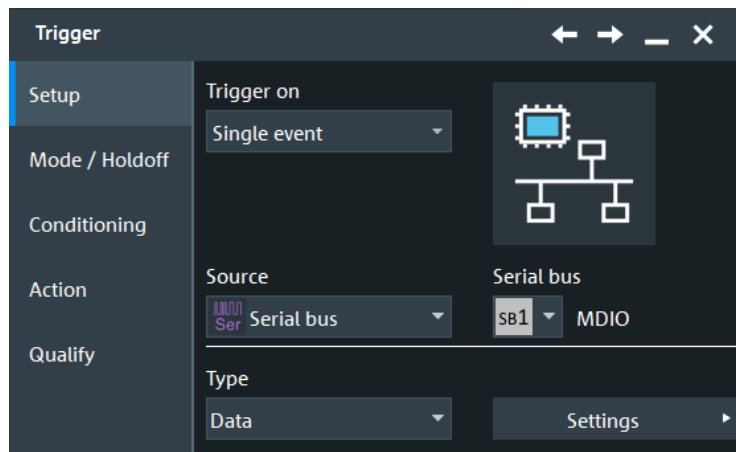

i In this section, all trigger settings are described. The user interface of the instrument displays only appropriate settings and guides you through the trigger setup. For a list of supported trigger conditions, refer to the specifications document.

- i** Make sure that:
- In the [Bus] > "Setup" tab:
 - The correct "Protocol" is selected.
 - The data sources of the serial bus are channel signals.
 - In the "Trigger" > "Setup" tab:
 - The "Trigger on" = "Single event"
 - The trigger "Source" = "Serial bus".
 - The correct "Serial bus" is selected.

Serial bus

Selects the serial bus to be triggered on. Make sure to select the correct bus before you enter the settings.

To trigger on a serial bus, the signals sources must be channel signals. If the data or clock source is a math or reference waveform, you cannot trigger on that bus.

Remote command:

[TRIGger<m>:SOURce:SBSelect](#) on page 1818

Protocol

Defines the protocol type of the selected serial bus.

Remote command:

[BUS<m>:TYPE](#) on page 1813

MDIO Trigger Type

Selects the trigger type for MDIO analysis.

"Frame Start" Sets the trigger to the start of frame (SOF) field. The start of frame condition and the trigger instant is the end of the preamble.
Trigger pattern: preamble (32 bits "1")

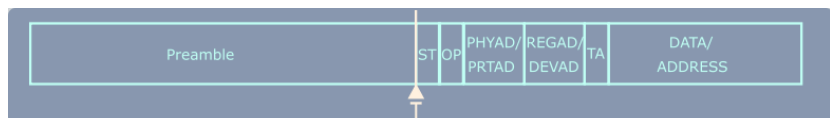

There are no additional parameters to be specified.

"Frame Stop" Sets the trigger to the end of frame (EOF) field. The trigger instant is after the last data bit.
Trigger pattern: preamble (32 bits "1") + 32 bits "X"



There are no additional parameters to be specified.

"Data" Sets the trigger to the data field. For more information on the data condition, see MDIO in the Ethernet standard. The trigger instant is at the end of the frame after the last data bit, as indicated in the GUI.

Note: All data triggers are always at the end of the frame, even if the specified pattern to trigger for is at a different position within the data word.

Trigger pattern: preamble (32 bits "1") + "ST" (2 bits, Start of Frame Code) + "OP" (2 bits, operation code or frame type code) + "PHYAD/PRTAD" (5 bits, Physical Layer Entity Address / Port Address) + "REGAD/DEVAD" (5 bits, Register Address / Device Address) + "TA" (2 "X" bits, turnaround time) + "DATA/ADDRESS" (16 bits)

For the parameters to be specified, see "ST" on page 777, "OP" on page 777, "PHYAD/PRTAD" on page 777, "REGAD/DEVAD" on page 778, and "DATA/ADDRESS" on page 778.

Remote command:

`TRIGger<m>:MDIO:TYPE` on page 2206

ST ← MDIO Trigger Type

Selects the start of frame code of the frame pattern; available only in trigger type "Data". Permissible frame patterns are: Clause 22, Clause 45, or Any

Remote command:

`TRIGger<m>:MDIO:ST` on page 2207

OP ← MDIO Trigger Type

Selects the type of frame code (or OP code, OpCode, operation code); available only in trigger type "Data". Available frame types are: Address, Write, Read, Post Read, or Any

Remote command:

`TRIGger<m>:MDIO:FRAMetype` on page 2207

PHYAD/PRTAD ← MDIO Trigger Type

Sets the physical address or port address (5 bits) of the frame pattern; available only in trigger type "Data".

Remote command:

`TRIGger<m>:MDIO:PHYS` on page 2208

REGAD/DEVAD ← MDIO Trigger Type

Sets the register address or device address (5 bits) of the frame pattern; available only in trigger type "Data".

Remote command:

[TRIGger<m>:MDIO:REGI](#) on page 2208

DATA/ADDRESS ← MDIO Trigger Type

Defines the payload data pattern or address pattern (16 bits); available only in trigger type "Data".

Remote command:

[TRIGger<m>:MDIO:DATA](#) on page 2208

14.16.3.2 Triggering on MDIO

Prerequisite: A serial bus is configured for the MDIO signal to be analyzed.

For the basic trigger settings, proceed in the following way:

1. Press the [Bus] key and select the "Shortcuts" tab.
2. Press "Setup trigger".
3. Tap the "Source" button and select the "Serial bus" trigger source.
4. Tap "Serial bus" and select the serial bus that is set to MDIO.
5. Tap "Trigger Type MDIO" and select the trigger type to be used for MDIO protocol analysis.
6. If the trigger type "Data" is selected, the frame pattern has to be specified.

For information on how to proceed with the configuration settings, see [Chapter 14.16.3.1, "MDIO trigger settings"](#), on page 775.

14.16.4 MDIO decode results

When the configuration of the serial bus is complete, the signal can be decoded:

1. In the "Protocol" dialog > "Setup" tab, enable "Decode".
2. In the "Protocol" dialog > "Display" tab, select additional result display settings: "Show decode table" and "Show binary signals".

For a description of the display settings, see also [Chapter 14.1.3, "Display"](#), on page 513.

The instrument captures and decodes the signal according to the standard definition and the configuration settings.

The color-coding of the various protocol sections and errors simplifies the interpretation of the visual display. The decode information condenses or expands, depending on the horizontal scale. Various data formats are available to show the result values.

Decode Results Table

The "Decode results" table contains information about all decoded frames.

State	Start	Start code	OP code	PHYAD/PRTAD	REGAD/DEVAD	DATA/ADDRESS	Register name
1 Opcode Error	-513.292 µs	[bin] 01	[bin] 11	[hex] 0F	[hex] 1A	[hex] DEAD	KSZ8721SL
2 Ok	-487.275 µs	[bin] 00	[bin] 11	[hex] 0E	[hex] 19	[hex] DEAD	KSZ8721CL
3 Ok	-461.258 µs	[bin] 01	[bin] 01	[hex] 0E	[hex] 15	[hex] A56F	KSZ8721CL
4 Ok	-435.197 µs	[bin] 00	[bin] 01	[hex] 0B	[hex] 15	[hex] A55F	KSZ9031MNX
5 Opcode Error	-409.18 µs	[bin] 01	[bin] 00	[hex] 0C	[hex] 17	[hex] CCAF	KSZ8051MNLU
6 Ok	-383.162 µs	[bin] 00	[bin] 00	[hex] 0E	[hex] 17	[hex] BCAF	KSZ8721CL
7 Ok	-357.145 µs	[bin] 01	[bin] 10	[hex] 1A	[hex] 11	[hex] EEFB	KSZ8721BL
8 Ok	-331.084 µs	[bin] 00	[bin] 10	[hex] 1B	[hex] 12	[hex] EEFB	KSZ8721BT

Table 14-25: Content of the Decode results table

Column	Description
Frame	Number of the acquired frame
State	State of frame, available messages are: <ul style="list-style-type: none"> • OK • Opcode error • Length error • Incomplete frame • Unsynchronized bits
Start	Start time of the frame
Stop	Stop time of the frame
Start code	Start of frame code, 2 bits <ul style="list-style-type: none"> • "01" (Clause 22) • "00" (Clause 45)
OP code	Operation code (= Frame type), 2 bits <ul style="list-style-type: none"> • "00" = Address frame (in Clause 45, only) • "01" = Write frame (in Clause 22 or Clause 45) • "10" = Read frame (in Clause 22) or Post Read frame (in Clause 45) • "11" = Read frame (in Clause 45)
PHYAD/PRTAD	Address field, shown as 2 hex characters (corresponding to 5 binary bits) <ul style="list-style-type: none"> • PHY address (in Clause 22) • Port address (in Clause 45)
REGAD/DEVAD	Address field, shown as 2 hex characters (corresponding to 5 binary bits) <ul style="list-style-type: none"> • Register address (in Clause 22) • Device address (in Clause 45)
DATA/ADDRESS	Payload data field (in Clause 22 or Clause 45), or Address field (in Clause 45, only), shown as 4 hex characters or 16 binary bits
Register Name	Displays a translation of the PHYAD/PRTAD address label in textual form

Tools

Press "Display settings" in the "Decode Results" table to access the "Display" tab.



Remote commands

Remote commands to retrieve decode results are described in [Chapter 27.18.17.3, "Decode results"](#), on page 2208.

14.16.5 Search on decoded MDIO data

Using the search functionality, you can find various events in the decoded data. You can find the same events that you can trigger on, and even many more, since several event types can also be combined.

Before you can start the search, you have to configure the bus correctly and acquire decoded data.

To search on decoded data, set the search source to "SerBus" for the configured protocol.

For general information on how to handle the search functionality, see [Chapter 11, "Search functions"](#), on page 425.

If you need information on how to get started with searching MDIO data, see [Chapter 14.16.5.3, "Searching MDIO data"](#), on page 782. Otherwise proceed with the MDIO search setup.

14.16.5.1 MDIO search setup

Access: [Bus] > "Shortcuts" tab > "Setup search"

Search types

Selects the event types to be searched.

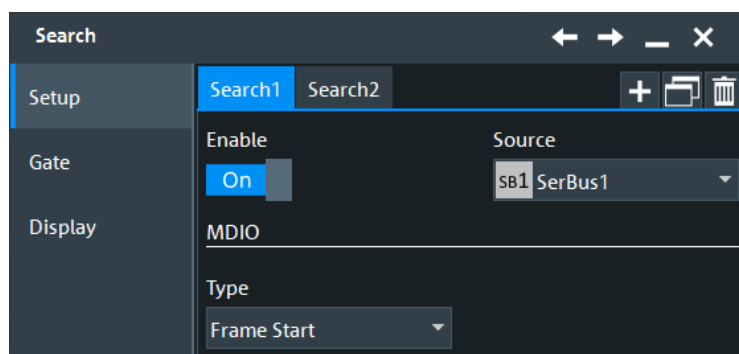

Available event types are "Frame Start", "Frame Stop", and "Data".

Only if search criteria type "Data" is selected, individual search parameters can be specified in the tabs below the "Search criteria" dialog. For these parameters, see ["ST" on page 781](#), ["OP" on page 781](#), ["PHYAD/PRTAD" on page 781](#), ["REGAD/DEVAD" on page 781](#), and ["DATA/ADDRESS" on page 781](#).

Remote command:

[SEARCH:TRIGger:MDIO:TYPE](#) on page 2215

ST

Selects the start of frame code of the frame pattern; available only in search criteria type "Data". Permissible frame patterns are: Clause 22, Clause 45, or Any

Remote command:

[SEARCH:TRIGGER:MDIO:ST](#) on page 2214

OP

Selects the Type of Frame code (or OP code, OpCode, operation code); available only in search criteria type "Data". Available frame types are: Address, Write, Read, Post Read, or Any

Remote command:

[SEARCH:TRIGGER:MDIO:FRAMETYPE](#) on page 2213

PHYAD/PRTAD

Sets the physical address or port address (5 bits) of the frame pattern; available only in search criteria type "Data".

Remote command:

[SEARCH:TRIGGER:MDIO:PHYS](#) on page 2214

REGAD/DEVAD

Sets the register address or device address (5 bits) of the frame pattern; available only in search criteria type "Data".

Remote command:

[SEARCH:TRIGGER:MDIO:REGI](#) on page 2214

DATA/ADDRESS

Defines the payload data pattern or address pattern (16 bits); available only in search criteria type "Data".

Remote command:

[SEARCH:TRIGGER:MDIO:DATA](#) on page 2213

14.16.5.2 MDIO search results

To get search results, "Enable" the search. You can minimize, shift or close the search dialog.

The search results are listed in the search result table and marked in the waveform by blue lines.

For an introduction to search results, see:

- [Chapter 11.1.2, "Search results"](#), on page 426
- [Chapter 11.4.2, "Display zoom settings"](#), on page 446

Remote commands:

- [SEARCH:RESULT:MDIO:WCOUNT?](#) on page 2219
- [SEARCH:RESULT:MDIO:WORD<m>:STATE?](#) on page 2217
- [SEARCH:RESULT:MDIO:WORD<m>:START?](#) on page 2217

- [SEARCH:RESult:MDIO:WORD<m>:STOP?](#) on page 2218
- [SEARCH:RESult:MDIO:WORD<m>:ST?](#) on page 2216
- [SEARCH:RESult:MDIO:WORD<m>:TYPE?](#) on page 2218
- [SEARCH:RESult:MDIO:WORD<m>:PHYS?](#) on page 2216
- [SEARCH:RESult:MDIO:WORD<m>:REGI?](#) on page 2216
- [SEARCH:RESult:MDIO:WORD<m>:DATA?](#) on page 2215
- [SEARCH:RESult:MDIO:WORD<m>:SYMBol?](#) on page 2218

14.16.5.3 Searching MDIO data

Prerequisite: A serial bus is configured for the MDIO signal to be decoded and analyzed.

The search for events is set up in the following way:

1. Press the [Bus] key and select the "Shortcuts" tab.
2. Tap "Setup search".
3. If the dialog box does not contain a search entry, tap the "Add" icon to create one, as described in ["To create a user-defined search"](#) on page 440.
4. Tap "Source" and select the serial bus that is set to MDIO (e.g. "SB1", unless already selected).

The search dialog for MDIO protocol analysis is opened.

There are no additional search criteria to be specified.

5. To acquire a waveform, press [Single].

The R&S RTO6 performs an MDIO decode according to the thresholds and protocol settings of the associated serial bus source (here in our example SB1).

6. To start searching the acquired waveform for specific events, tap "Enable" in the search setup dialog.

The R&S RTO6 displays the "Search Results" box that lists the detected events.

For information on how to configure the search results presentation and how to navigate the search results, see also ["To display search zoom windows"](#) on page 448.

14.17 RFFE (option R&S RTO6-K550)

Radio Frequency Front-End (RFFE) control interface is a serial interface specified by the Mobile Industry Processor Interface (MIPI) alliance. The RFFE interface is designed to control RF front-end components in mobile terminals.

14.17.1 The RFFE protocol

The RFFE interface is specified in the "MIPI® Alliance Specification for RF Front-End Control Interface". The RFFE interface is used by the radio frequency front-end interface chips in most LTE-Advanced platforms and in smart phones in general. RFFE is a replacement for existing standards like SPI and I²C that do not meet performance requirements.

Bus structure

RFFE is a two-wire, serial interface that connects up to 4 main devices (Radio Frequency IC, RFIC) to up to 15 sub devices (front-end modules, FEM) on a single RFFE bus. A sub device has read-write capability, or it is write only. Only one of the main devices is the active main device (bus owner main device, BOM), which can initiate command sequences on the bus.

The interface has two lines: one clock signal (SCLK) controlled by the main device, and a serial bidirectional data signal (SDATA). Furthermore, a VIO supply/reference voltage from a common source is applied to all components on the bus.

Command sequences

Protocol messages are called command sequences in RFFE. The standard defines various command sequences to accomplish read and write access to sub devices and to non-active main devices. Command sequences are initiated by the BOM main device on the SDATA line.

In general, a command sequence consists of:

- Sequence start condition (SSC)
Two bits: 1 followed by 0 on SDATA while SCLK is at logic level zero.
- Command frame
Consist of a 4-bit sub device address field (SA), followed by 8 command payload bits and a single parity bit.
- Address and/or data frames, depending on the command sequence
A frame consists of 8 data bits or 8 register address bits, followed by a single parity bit. The number of address and data frames varies depending on the command sequence type.
- Bus park cycle (BP)
A BP cycle is sent at the end of a command sequence, and when the device transfers control of SDATA to another device.

Between the end of a command sequence and the beginning of a new command sequence, the bus is in idle condition at least for 10 ns.

The bits are sent MSB first.

SSC	Command frame		Address and data frames		BP
	SA 4 bits	Command payload 8 bits + P	[Address frames] 8 bits + P	[Data frames] 8 bits + P	

Figure 14-31: General structure of a RFFE Write command sequence

SSC	Command frame		Address and data frames			BP
	SA 4 bits	Command payload 8 bits + P	[Address frames] 8 bits + P	BP	[Data frames] 8 bits + P	

Figure 14-32: General structure of a RFFE Read command sequence

Trigger

The R&S RTO6 uses a hardware-based trigger to trigger on various parts of sub device messages, to trigger at maximum bus speed and on frame gaps. The data and clock lines must be connected to the input channels. Triggering on math and reference waveforms is not possible.

You can trigger on:

- Start of command sequence (SSC). In addition, you can specify a sub device address.
- End of command sequence). In addition, you can specify a sub device address.
- Various errors, for example, parity and bus park error
- Read and write command sequences between the BOM and the sub devices.

Within a command sequence, you can trigger on specific parts of the message:

- Sub device address
- Byte count
- Register address
- Data word

Search

Using the search functionality, you can find various events in the acquired and decoded data. You can find the same events which you also can trigger on. In addition, you can find command sequences of main device-to main device communication and "interrupt summary and identification" command sequences.

14.17.2 RFFE configuration

14.17.2.1 RFFE configuration settings

Access: [Bus] > "RFFE" > "Setup" tab



Make sure that the tab of the correct serial bus is selected.

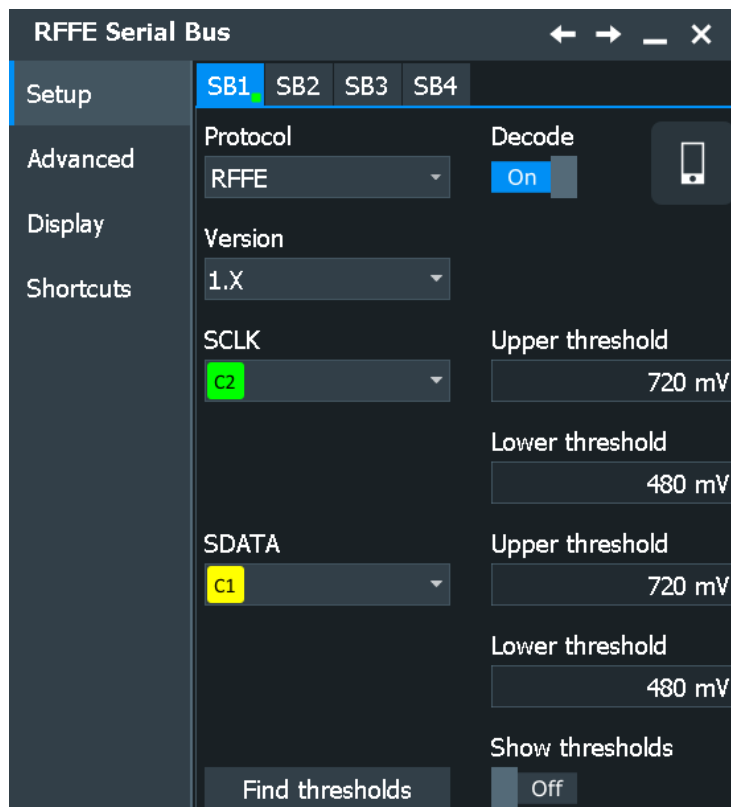

See also: [Chapter 14.1.1, "Setup - general settings"](#), on page 511

Version

Selects the RFFE version. Supported are 1.x, 2.0, 2.1 and 3.0/3.1.

Remote command:

`BUS<m>:RFFE:VERSion` on page 2223

Read mode

Selects, if the standard or synchronous read ("sRead") mode is used. Available for "Version" = 2.0/2.1.

Remote command:

`BUS<m>:RFFE:RDMD` on page 2223

SCLK Source

Sets the source of the clock line.

Usually, the source is one of the analog channels. Reference and math waveforms are available as source if the trigger source is one of the analog channels but not the serial bus.

Alternatively, digital channels can be used if MSO option R&S RTO6-B1 is installed. Digital and analog channels cannot be used at the same time.

For triggering on a serial bus, analog or digital channel sources are required.

Remote command:

[BUS<m>:RFFE:CLOCK:SOURce](#) on page 2219

SDATA Source

Sets the source of the data line.

Usually, the source is one of the analog channels. Reference and math waveforms are available as source if the trigger source is one of the analog channels but not the serial bus.

Alternatively, digital channels can be used if MSO option R&S RTO6-B1 is installed. Digital and analog channels cannot be used at the same time.

For triggering on a serial bus, analog or digital channel sources are required.

Remote command:

[BUS<m>:RFFE:DATA:SOURce](#) on page 2220

Thresholds

Set the threshold values for digitization of signals for each line: the positive going threshold (V_{TP} , upper value), the negative going threshold (V_{TN} , lower value), and the hysteresis. The hysteresis is the difference of V_{TP} and V_{TN} .

If the signal value on the line is higher than the positive going threshold, the signal state is high. Otherwise, the signal state is considered low if the signal value is below the negative going threshold.

There are several ways to set the thresholds

- | | |
|-------------------|---|
| "Threshold" | Enter the value directly in the field. |
| "Find thresholds" | Executes the measurement of reference levels and sets the thresholds to the middle reference level of the measured amplitude. |

Remote command:

[BUS<m>:RFFE:CLOCK:THReshold:HIGH](#) on page 2221

[BUS<m>:RFFE:CLOCK:THReshold:LOW](#) on page 2221

[BUS<m>:RFFE:DATA:THReshold:HIGH](#) on page 2220

[BUS<m>:RFFE:DATA:THReshold:LOW](#) on page 2221

[BUS<m>:SETReflevels](#) on page 1814

[BUS<m>:FAUTOset](#) on page 1814

Show thresholds

If enabled, the threshold levels are displayed in the diagram.

Remote command:

[BUS<m>:THReshold](#) on page 1815

14.17.2.2 Advanced settings

Access: [Bus] > "Advanced" tab.

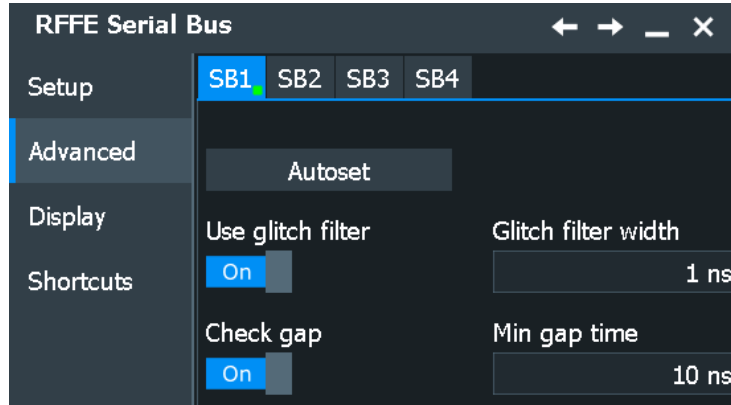

Autoset

Starts software algorithms for determining the signal threshold levels and bitrate.

Remote command:

[BUS<m>:FAUToset](#) on page 1814

Glitch filter

Enables the glitch filter on the SCLK and SDATA lines to improve decode accuracy.

The "Glitch filter width" field sets the maximum glitch width to be ignored.

Remote command:

[BUS<m>:RFFE:GFILter](#) on page 2222

[BUS<m>:RFFE:GFWidth](#) on page 2222

Timing

The gap defines the idle time between the Bus Park Cycle (BP) and Sequence Start Condition (SSC).

You can define a "Min gap time". The standard defines a minimum of 10 ns to separate two subsequent command sequences.

Remote command:

[BUS<m>:RFFE:MINGap:SElect](#) on page 2222

[BUS<m>:RFFE:MINGap:TIME](#) on page 2223

14.17.2.3 Configuring RFFE signals

For details on configuration settings, see [Chapter 14.17.2.1, "RFFE configuration settings"](#), on page 785.

1. Press the [Bus] key on the front panel.
2. Select the tab of the bus you want to set up, for example "SB1".
3. In the "Setup" tab, select the protocol: "RFFE".

4. Select the RFFE "Version".
5. Select the "Read mode".
6. Tap "SCLK", and select the waveform of the clock line.
7. Tap "SDATA", and select the waveform of the data line.
8. Set the logical thresholds.
9. If the signal has glitches which can distort the decoding, enable the glitch filter. Set the glitch width.
10. Enable "Decode".

14.17.3 RFFE trigger

14.17.3.1 RFFE trigger settings

Access: [Bus] > "Shortcuts" tab > "Setup trigger"

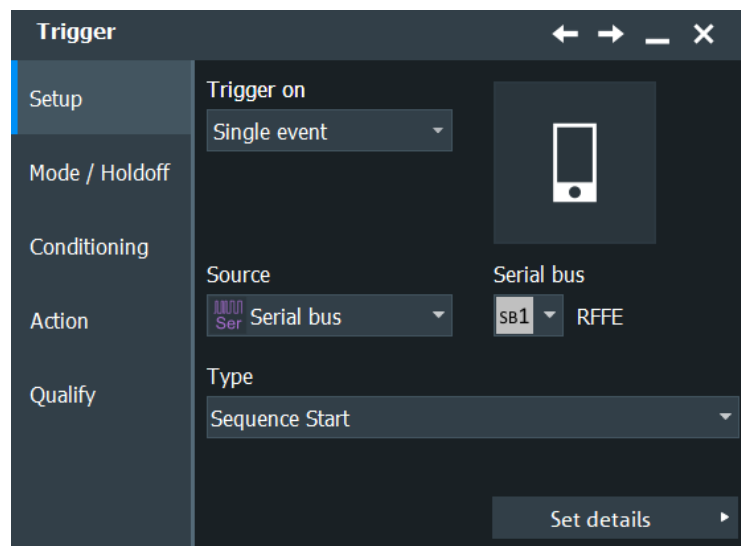

Make sure that:

- In the [Bus] > "Setup" tab:
 - The correct "Protocol" is selected.
 - The data sources of the serial bus are channel signals.
- In the "Trigger" > "Setup" tab:
 - The "Trigger on" = "Single event"
 - The trigger "Source" = "Serial bus".
 - The correct "Serial bus" is selected.

Type

Selects the trigger type for RFFE analysis.

The instrument triggers always at the end of the met trigger criteria.

Remote command:

[TRIGger<m>:RFFE:TYPE](#) on page 2224

Sequence Start ← Type

Triggers on the beginning of a command sequence, after the sub device address. The SSC is a 1 followed by 0 on SDATA line while SCLK is at logic level zero.

Optionally, you can specify a sub device address pattern or a sub device address range to trigger only on command sequences that are sent to these sub devices.

See: ["Sub device addr. /MID "](#) on page 793.

Sequence Stop ← Type

Triggers on the end of a command sequence, on the bus park cycle.

Optionally, you can specify a sub device address pattern or a sub device address range to trigger only on command sequences that are sent to these sub devices.

See: ["Sub device addr. /MID "](#) on page 793.

Register 0 Write ← Type

Triggers on "Register 0 Write" command sequences. This sequence sends 7 data bits in the command payload.

You can refine the trigger condition:

- Set a sub device address condition to trigger only on command sequences that are sent to the specified sub devices.
See: ["Sub device addr. /MID "](#) on page 793.
- Set a data pattern condition to trigger on data patterns expected in the message.
See: ["Data"](#) on page 794.

Register Write ← Type

Triggers on "Register Write" command sequences. This sequence sends the register address in the command payload, and sends one data frame.

You can refine the trigger condition:

- Set a sub device address condition to trigger only on command sequences that are sent to the specified sub devices.
See: ["Sub device addr. /MID "](#) on page 793.
- Set a register address condition to trigger only on command sequences that write data to the specified register.
See: ["Address"](#) on page 793.
- Set a data pattern condition to trigger on data patterns expected in the message.
See: ["Data"](#) on page 794.

Register Read ← Type

Triggers on "Register Read" command sequences. This sequence sends the register address in the command payload, and reads back one data frame.

You can refine the trigger condition using the same settings as for the "Register Write" command sequence, see ["Register Write"](#) on page 789.

Extended Register Write ← Type

Triggers on "Extended Register Write" command sequences. This sequence sends the byte count of data frames in the command payload, followed by one address frame with the address of the first extended register, and up to 16 data frames.

You can refine the trigger condition:

- Set a sub device address condition to trigger only on command sequences that are sent to the specified sub devices.
See: "[Sub device addr. /MID](#)" on page 793
- Set a byte count condition to trigger only on command sequences that send the specified number of data frames.
See: "[Byte count](#)" on page 794
- Set a register address condition to trigger only on command sequences that write data to the specified register.
See: "[Address](#)" on page 793
- Set a data pattern condition to trigger on data patterns expected in the message.
See: "[Data](#)" on page 794 and "[Index](#)" on page 794

Extended Register Read ← Type

Triggers on "Extended Register Read" command sequences. This sequence sends the byte count of data frames in the command payload, followed by one address frame with the address of the first extended register, and reads back up to 16 data frames.

You can refine the trigger condition using the same settings as for the "Extended Register Write" command sequence, see "[Extended Register Write](#)" on page 790.

Extended Register Write Long ← Type

Triggers on "Extended Register Write" command sequences. This sequence sends the byte count of data frames in the command payload, followed by 2 address frames with the address of the first extended register, and up to 8 data frames.

You can refine the trigger condition using the same settings as for the "Extended Register Write" command sequence, see "[Extended Register Write](#)" on page 790.

Extended Register Read Long ← Type

Triggers on "Extended Register Write" command sequences. This sequence sends the byte count of data frames in the command payload, followed by 2 address frames with the address of the first extended register, and reads back up to 8 data frames.

You can refine the trigger condition using the same settings as for the "Extended Register Write" command sequence, see "[Extended Register Write](#)" on page 790.

Interrupt Summary and Notification ← Type

Available only for "Version"= "2.0"/"2.1".

Triggers on "Interrupt Summary and Notification" command sequence.

You can refine the trigger condition:

- Set a sub device address condition to trigger only on command sequences that are sent to the specified MIDs.
See: "[Sub device addr. /MID](#)" on page 793
- Set a bit count condition to trigger only on command sequences that send the specified number of data frames.
See: "[Byte count](#)" on page 794

- Set a data pattern condition to trigger on data patterns expected in the message.
See: "[Data](#)" on page 794

Masked Write ← Type

Available only for "Version"= "2.1".

Triggers on "Masked Write" command sequences. This sequence sends the register address in the command payload, and sends one mask and one data frame.

You can refine the trigger condition:

- Set a sub device address condition to trigger only on command sequences that are sent to the specified MIDs.
See: "[Sub device addr. /MID](#) " on page 793.
- Set a register address condition to trigger only on command sequences that write data to the specified register.
See: "[Address](#)" on page 793.
- Set a mask pattern condition to trigger on a mask expected in the message.
See: "[Mask](#)" on page 795.
- Set a data pattern condition to trigger on data patterns expected in the message.
See: "[Data](#)" on page 794.

Main Ownership Handover ← Type

Available only for "Version"= "2.0"/"2.1".

Triggers on "Main Ownership Handover" command sequences.

Optionally, you can specify an MID pattern or an MID range to trigger only on command sequences that are sent to these sub devices.

Main Device Write ← Type

Available only for "Version"= "2.0"/"2.1".

Triggers on "Main Device Write" command sequences. This sequence sends the register address in the command payload, and sends two data frames.

You can refine the trigger condition:

- Set a MID condition to trigger only on command sequences that are sent to the specified MIDs.
See: "[Sub device addr. /MID](#) " on page 793.
- Set a register address condition to trigger only on command sequences that write data to the specified register.
See: "[Address](#)" on page 793.
- Set a data pattern condition to trigger on data patterns expected in the message.
See: "[Data](#)" on page 794.

Main Device Read ← Type

Available only for "Version"= "2.0"/"2.1".

Triggers on "Main Device Read" command sequences. This sequence sends the register address in the command payload, and reads two data frames.

You can refine the trigger condition:

- Set a MID condition to trigger only on command sequences that are sent to the specified MIDs.
See: "[Sub device addr. /MID](#) " on page 793.

- Set a register address condition to trigger only on command sequences that write data to the specified register.
See: "[Address](#)" on page 793.
- Set a data pattern condition to trigger on data patterns expected in the message.
See: "[Data](#)" on page 794.

Main Device Context Transfer Write ← Type

Available only for "Version"= "2.1".

Triggers on "Main Device Context Transfer Write" command sequences.

You can refine the trigger condition:

- Set an MID condition to trigger only on command sequences that are sent to the specified MIDs.
See: "[Sub device addr. /MID](#) " on page 793
- Set a byte count condition to trigger only on command sequences that send the specified number of data frames.
See: "[Byte count](#)" on page 794
- Set a register address condition to trigger only on command sequences that write data to the specified register.
See: "[Address](#)" on page 793
- Set a data pattern condition to trigger on data patterns expected in the message.
See: "[Data](#)" on page 794 and "[Index](#)" on page 794

Main Device Context Transfer Read ← Type

Available only for "Version"= "2.1"/ "3.0/3.1".

Triggers on "Main Device Context Transfer Read" command sequences.

You can refine the trigger condition:

- Set an MID condition to trigger only on command sequences that are sent to the specified MIDs.
See: "[Sub device addr. /MID](#) " on page 793
- Set a byte count condition to trigger only on command sequences that send the specified number of data frames.
See: "[Byte count](#)" on page 794
- Set a register address condition to trigger only on command sequences that write data to the specified register.
See: "[Address](#)" on page 793
- Set a data pattern condition to trigger on data patterns expected in the message.
See: "[Data](#)" on page 794 and "[Index](#)" on page 794

Error conditions ← Type

Triggers if at least one of the selected errors occurs in a frame. The instrument triggers on the first detected error.

"SSC error"	Triggers when no valid SSC sequence has been found after the idle time. The instrument triggers at the invalid sequence.
"Length error"	Triggers on an incorrect length of the command sequence - when additional or missing bits are detected and the sequence of bits is not as expected.
"No response"	Triggers on any No Response Frame. All 9 bits of a No Response Frame, including the parity bit, are zero.

"Bus park error"	Triggers on an incorrect bus park cycle - when the instrument expects a low bit in bus park but detects high bit.
"Parity error"	Triggers on incorrect parity bits.
"Unknown sequence"	Triggers when the instrument cannot detect any supported command sequence.
"Gap error"	Triggers when timing gap error occurs.
"Version error"	Triggers on any version errors.

Remote command:

[TRIGger<m>:RFFE:ERRor:SSC](#) on page 2233

[TRIGger<m>:RFFE:ERRor:LENGth](#) on page 2232

[TRIGger<m>:RFFE:ERRor:BP](#) on page 2232

[TRIGger<m>:RFFE:ERRor:PARity](#) on page 2233

[TRIGger<m>:RFFE:ERRor:NOResponse](#) on page 2232

[TRIGger<m>:RFFE:ERRor:USEquence](#) on page 2233

[TRIGger<m>:RFFE:ERRor:GAP](#) on page 2233

[TRIGger<m>:RFFE:ERRor:VERSion](#) on page 2233

Sub device addr. /MID

Defines the address of the sub device / main ID. The sub device address setup consists of the condition and one or two address patterns.

"Condition" Sets the operator to trigger on a specific address pattern ("Equal" or "Not equal") or an address range.

"Sub device address (Min)" Defines the sub device address pattern for all operators that require one pattern.

"Sub device address (Max)" Defines the second address pattern that is required to specify a range with conditions "In range" and "Out of range".

Remote command:

[TRIGger<m>:RFFE:SADD:CONDition](#) on page 2230

[TRIGger<m>:RFFE:SADD:MIN](#) on page 2231

[TRIGger<m>:RFFE:SADD:MAX](#) on page 2231

Address

Defines the register address. The register address setup consists of the condition and one or two address patterns.

"Condition" Sets the operator to trigger on a specific address pattern ("Equal" or "Not equal") or an address range.

"Address (Min)" Defines the register address pattern for all operators that require one pattern.

"Adress (Max)" Defines the second address pattern that is required to specify a range with conditions "In range" and "Out of range".

Remote command:

[TRIGger<m>:RFFE:ADDRESS:CONDition](#) on page 2227

[TRIGger<m>:RFFE:ADDRESS:MIN](#) on page 2227

[TRIGger<m>:RFFE:ADDRESS:MAX](#) on page 2227

Byte count

Sets the number of data frames to be read or written in the command sequence. The setting is available for all "Extended Register" command sequences, which can transfer more than one data frame.

"Condition" Sets the operator to trigger on a specific byte count ("Equal" or "Not equal") or a byte count range.

"Byte/Bit count (Min)" Defines the byte count for all operators that require one count setting.

"Byte/Bit count (Max)" Defines the second byte count value that is required to specify a range with conditions "In range" and "Out of range".

Remote command:

[TRIGger<m>:RFFE:BCOunt:CONDition](#) on page 2228

[TRIGger<m>:RFFE:BCOunt:MIN](#) on page 2228

[TRIGger<m>:RFFE:BCOunt:MAX](#) on page 2228

Data

Defines the data trigger condition. The data setup consists of the condition and one or two data patterns.

To define on which data frames of the sequence you want to trigger, use the [Index](#) settings.

"Condition" Sets the operator to trigger on a specific data pattern ("Equal" or "Not equal") or a data range.

"Data (Min)" Defines the data pattern for all operators that require one pattern.

"Data (Max)" Defines the second data pattern that is required to specify a range with conditions "In range" and "Out of range".

Remote command:

[TRIGger<m>:RFFE:DATA:DCON](#) on page 2228

[TRIGger<m>:RFFE:DATA:DMIN](#) on page 2229

[TRIGger<m>:RFFE:DATA:DMAX](#) on page 2229

Index

Defines which data frames are relevant for the trigger. The setting is available for all "Extended Register" command sequences, which can transfer more than one data frame.

The index allows you to check for a certain bit pattern at a certain position in the byte sequence. Furthermore, you can trigger on the occurrence of a certain bit pattern within a data range.

To trigger on any data byte that fulfills the data pattern settings, set the index to XX.

"Condition" Sets the operator to trigger on a specific data frame ("Equal") or a data frame range.

- "Data (Min)" Defines the frame index of the data pattern for all operators that require one index.
- "Data (Max)" Defines the frame index of the last data pattern that is required to specify a range with condition "In range". The instrument adjusts this value, if you enter a data pattern that is longer than the index range.

Remote command:

[TRIGger<m>:RFFE:DATA:ICONdition](#) on page 2229

[TRIGger<m>:RFFE:DATA:IMIN](#) on page 2230

[TRIGger<m>:RFFE:DATA:IMAX](#) on page 2230

Mask

Defines the mask trigger condition. The mask setup consists of the condition and one or two data patterns. The setting is available for "Masked Write" command sequences.

- "Condition" Sets the operator to trigger on a specific mask frame ("Equal") or a mask frame range.
- "Mask (Min)" Defines the mask pattern for all operators that require one pattern.
- "Mask (Max)" Defines the second mask pattern that is required to specify a range with conditions "In range" and "Out of range".

Remote command:

[TRIGger<m>:RFFE:MASK:CONDition](#) on page 2231

[TRIGger<m>:RFFE:MASK:MIN](#) on page 2232

[TRIGger<m>:RFFE:MASK:MAX](#) on page 2231

14.17.3.2 Triggering on RFFE signals

Prerequisites: An RFFE bus is configured, see [Chapter 14.17.2, "RFFE configuration"](#), on page 785, and "Decode" is enabled.

1. Press the [Bus] key and select the "Shortcuts" tab.
2. Press "Setup trigger".
3. Tap the "Source" button and select the "Serial bus" trigger source.
4. Tap "Serial bus" and select the serial bus that is set to RFFE.
5. Select the "Trigger type".
6. To refine the trigger settings, configure additional settings, which are available for many trigger types.
For details, see [Chapter 14.17.3.1, "RFFE trigger settings"](#), on page 788.

14.17.4 RFFE label list

Label lists are protocol-specific. A label list file for RFFE contains sub device addresses and/or register addresses and their symbolic names:

- "SA": sub device address (SID in the label list file)
- Address: register address.

- "Symbolic label": symbolic name as combination of the sub device name (SID text) and the address name (Address text), specifying the device function

Example: RFFE label list file

```
# Labels for RFFE protocol
# Column order: SID, SID text, Address, Address text
# -----
@PROTOCOL_NAME = rffe
0x01,LM8335
0x01,LM8335,0x00,CMTL_REG
0x01,LM8335,0x01,GPO_PULL_DIR
0x01,LM8335,0x02,GPO_PULL_ENABLE
0x01,LM8335,0x03,GPO_OUT_HIGH_CFG
0x01,LM8335,0x04,GPO_OUT_MASK
0x01,LM8335,0x05,GPO_OUT_DATA
0x01,LM8335,0x1C,PM_TRIG
0x01,LM8335,0x1D,PROD_ID
0x01,LM8335,0x1E,MAN_ID
0x01,LM8335,0x1F,USID_REG
0x05,LM3279
0x05,LM3279,0x00,VSET_CTRL
0x05,LM3279,0x01,STATE_CTRL
0x05,LM3279,0x02,GPO_CTRL
0x05,LM3279,0x1C,PM_TRIG
0x05,LM3279,0x1D,PROD_ID
0x05,LM3279,0x1E,MAN_ID
0x05,LM3279,0x1F,USID_REG
0x0A,Test
```

See also: [Chapter 14.1.4, "Content and format of the PTT file"](#), on page 515.

Remote command:

- `BUS<m>:RFFE:SEquence<n>:SYMBOL?` on page 2237

14.17.5 RFFE decode results

When the configuration of the serial bus is complete, the signal can be decoded:

1. In the "Protocol" dialog > "Setup" tab, enable "Decode".
2. In the "Protocol" dialog > "Display" tab, select additional result display settings: "Show decode table" and "Show binary signals".

For a description of the display settings, see also [Chapter 14.1.3, "Display"](#), on page 513.

The instrument captures and decodes the signal according to the standard definition and the configuration settings.

The color-coding of the various protocol sections and errors simplifies the interpretation of the visual display. The decode information condenses or expands, depending on the horizontal scale. Various data formats are available to show the result values.

Decode Results Table

The results are shown in two tables:

- "Decode results": contains information about all decoded frames
- "Details frame": contains more detailed information about the selected frame in the "Decode results" table.

Table 14-26: Content of the Decode results table

Column	Description
State	Overall state of the frame. "Insufficient waveform length" indicates that the frame is not completely contained in the acquisition. Change the horizontal scale, or move the reference point to the left to get a longer acquisition.
Start	Time of command sequence start (SSC)
Type	Type of the command sequence
SA /MID	Address of the SA/ MID
BC	Byte count (decimal value)
Address	Register address (hex value)
Label	Symbolic name of the address if a label list is applied.

Table 14-27: Content of the Details frame table

Column	Description
Parity control	Checks if there an error in the parity
Parity address 0/1	Checks if there an error in the parity address
Read bit rate	Value of the read bit rate
Write bit rate	Value of the write bit rate
Name	Type of the command sequence
State	Overall state of the frame. "Insufficient waveform length" indicates that the frame is not completely contained in the acquisition. Change the horizontal scale, or move the reference point to the left to get a longer acquisition.
Value	Values of the data bytes.

Tools

Press "Display settings" in the "Decode Results" table to access the "Display" tab.



Remote commands

Remote commands to retrieve decode results are described in [Chapter 27.18.18.3, "Decode results"](#), on page 2234.

14.17.6 Search on decoded RFFE data

Using the search functionality, you can find various events in the decoded data, the same events which you also can trigger on. Before you can start the search, you have to configure the bus correctly and acquire decoded data.

To search on decoded data, set the search "Source" to the serial bus that is configured for the protocol to be analyzed.

See also [Chapter 11, "Search functions"](#), on page 425.

14.17.6.1 RFFE search setup

Access: [Bus] > "Shortcuts" tab > "Setup search"

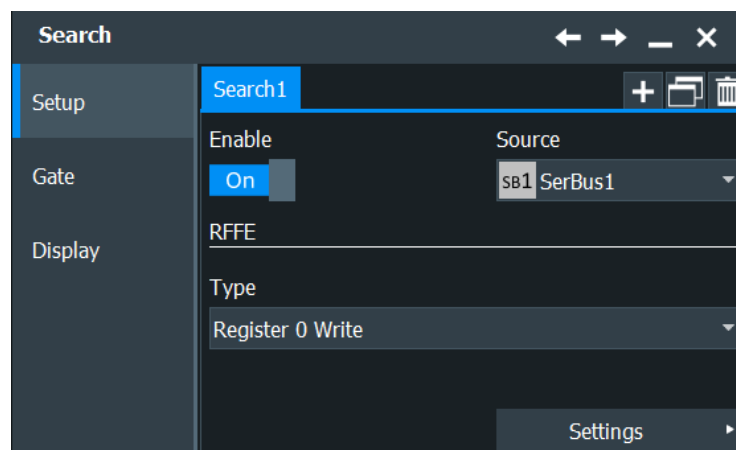

Type

The search criterion is defined by "Type". All trigger types are also available for search. Additional search parameters are provided under "Detailed Search Parameter Setup".

For details, see also ["Type"](#) on page 789.

"Sequence Start"

Searches for SSC.

Additional search parameter: ["Sub device addr."](#) on page 800

"Sequence Stop"

Searches for bus park at the end of a command sequence.

Additional search parameter: ["Sub device addr."](#) on page 800

"Register 0 Write"

Searches for Register 0 Write command sequences. Additional search parameters:

- Sub device address, see ["Sub device addr."](#) on page 800.
- Data pattern, see ["Data"](#) on page 801

"Register Write"

Searches for Register Write command sequences. Additional search parameters:

- Sub device address, see ["Sub device addr."](#) on page 800
- Register address, see ["Address"](#) on page 800
- Data pattern, see ["Data"](#) on page 801

"Register Read"

Searches for Register Read command sequences.

This search uses the same additional parameters as the Register Write search.

"Extended Register Write"

Searches for Extended Register Write command sequences. Additional search parameters:

- Sub device address, see ["Sub device addr."](#) on page 800
- Byte count, see ["Byte count"](#) on page 800
- Register address, see ["Address"](#) on page 800
- Data pattern, see ["Data"](#) on page 801 and ["Index"](#) on page 801

"Extended Register Read"

Searches for Extended Register Read command sequences.

This search uses the same additional parameters as the Extended Register Write search.

"Extended Register Write Long"

Searches for Extended Register Write Long command sequences.

This search uses the same additional parameters as the Extended Register Write search.

"Extended Register Read Long"

Searches for Extended Register Read Long command sequences.

This search uses the same additional parameters as the Extended Register Write search.

"Main device Read"

Searches for Main device Read command sequences. Additional search parameters:

- Address of the non-BOM main device, see ["Sub device addr."](#) on page 800.
- Register address, see ["Address"](#) on page 800.
- Data pattern that is returned by the non-BOM main device, see ["Data"](#) on page 801.

- "Main device Write"
Searches for Main device Write command sequences. Additional search parameters:
- Address of the non-BOM main device, see "[Sub device addr.](#)" on page 800
 - Register address, see "[Address](#)" on page 800
 - Data pattern to be written into the non-BOM, see "[Data](#)" on page 801.
- "Main device Ownership Handover"
Searches for Main device Ownership Handover command sequences. Additional search parameters:
- Address of the BOM-to-be, see "[Sub device addr.](#)" on page 800
 - Data pattern of the confirmation sequence of the new BOM, see "[Data](#)" on page 801.
- "Interrupt Summary and Notification"
Searches for interrupts. Additional search parameters:
- Sub device address, see "[Sub device addr.](#)" on page 800
 - Byte count, see "[Byte count](#)" on page 800
 - Data of the interrupt identification sequence, see
- "Error Condition"
Searches for the selected errors, see "[Error conditions](#)" on page 801.

Remote command:

[SEARCH:TRIGger:RFFE:TYPE](#) on page 2241

Sub device addr.

Searches for a sub device address or a sub device address range.

In command sequences transferred between main devices, this is the non-BOM address.

The sub device address settings are the same as in the RFFE trigger setup, see "[Sub device addr. /MID](#)" on page 793.

Remote command:

[SEARCH:TRIGger:RFFE:SADD:CONDition](#) on page 2243

[SEARCH:TRIGger:RFFE:SADD:MIN](#) on page 2244

[SEARCH:TRIGger:RFFE:SADD:MAX](#) on page 2245

Byte count

Searches for a byte count or a byte count range.

The byte count settings are the same as in the RFFE trigger setup, see "[Byte count](#)" on page 794

Remote command:

[SEARCH:TRIGger:RFFE:BCOunt:CONDition](#) on page 2243

[SEARCH:TRIGger:RFFE:BCOunt:MIN](#) on page 2244

[SEARCH:TRIGger:RFFE:BCOunt:MAX](#) on page 2245

Address

Searches for a register address or an address range.

The register address settings are the same as in the RFFE trigger setup, see ["Address"](#) on page 793.

Remote command:

[SEARCH:TRIGger:RFFE:ADDRESS:CONDition](#) on page 2243

[SEARCH:TRIGger:RFFE:ADDRESS:MIN](#) on page 2244

[SEARCH:TRIGger:RFFE:ADDRESS:MAX](#) on page 2245

Data

Searches for a data pattern or a data word range. The setting is available for all "Extended Register" command sequences, which can transfer more than one data frame.

The data settings are the same as in the RFFE trigger setup, see ["Data"](#) on page 794.

Remote command:

[SEARCH:TRIGger:RFFE:DATA:DCON](#) on page 2243

[SEARCH:TRIGger:RFFE:DATA:DMIN](#) on page 2244

[SEARCH:TRIGger:RFFE:DATA:DMAX](#) on page 2245

Index

Defines which data frames are relevant for the search. The setting is available for all Extended Register command sequences, which can transfer more than one data frame. To search for any data byte that fulfills the data pattern settings, set the index to XX.

Remote command:

[SEARCH:TRIGger:RFFE:DATA:ICONdition](#) on page 2244

[SEARCH:TRIGger:RFFE:DATA:IMIN](#) on page 2244

[SEARCH:TRIGger:RFFE:DATA:IMAX](#) on page 2245

Data

Defines the pattern of the interrupt identification sequence, which consists of interrupt slots 15 to 0. The setting is only available for "Interrupt Summary and Notification" command sequence.

Remote command:

[SEARCH:TRIGger:RFFE:INTerrupt](#) on page 2245

Error conditions

Defines which error conditions are relevant for the search.

Remote command:

[SEARCH:TRIGger:RFFE:ERRor:LENGth](#) on page 2245

[SEARCH:TRIGger:RFFE:ERRor:PARity](#) on page 2246

[SEARCH:TRIGger:RFFE:ERRor:SSC](#) on page 2246

[SEARCH:TRIGger:RFFE:ERRor:GAP](#) on page 2246

[SEARCH:TRIGger:RFFE:ERRor:VERSion](#) on page 2246

14.17.6.2 RFFE search results

To get search results, "Enable" the search. You can minimize, shift or close the search dialog.

The search results are listed in the search result table and marked in the waveform by blue lines.

For an introduction to search results, see:

- [Chapter 11.1.2, "Search results"](#), on page 426
- [Chapter 11.4.2, "Display zoom settings"](#), on page 446

Remote commands:

- [SEARCH:RESult:RFFE:FCOunt?](#) on page 2247
- [SEARCH:RESult:RFFE:SEQuence<m>:TYPE?](#) on page 2247
- [SEARCH:RESult:RFFE:SEQuence<m>:STATe?](#) on page 2248
- [SEARCH:RESult:RFFE:SEQuence<m>:STARt?](#) on page 2248
- [SEARCH:RESult:RFFE:SEQuence<m>:STOP?](#) on page 2249
- [SEARCH:RESult:RFFE:SEQuence<m>:SADD?](#) on page 2248
- [SEARCH:RESult:RFFE:SEQuence<m>:ADDRess?](#) on page 2249
- [SEARCH:RESult:RFFE:SEQuence<m>:BCOunt?](#) on page 2249
- [SEARCH:RESult:RFFE:SEQuence<m>:DATA?](#) on page 2250
- [SEARCH:RESult:RFFE:SEQuence<m>:SYMBol?](#) on page 2250
- [SEARCH:RESult:RFFE:SEQuence<m>:BYTE<n>:STATe?](#) on page 2250
- [SEARCH:RESult:RFFE:SEQuence<m>:BYTE<n>:VALue?](#) on page 2250

14.17.6.3 Searching RFFE data

Prerequisites: An RFFE bus is configured, see [Chapter 14.17.2, "RFFE configuration"](#), on page 785, and "Decode" is enabled.

1. Press the [Bus] key and select the "Shortcuts" tab.
2. Tap "Setup search".
3. If the dialog box does not contain a search entry, tap the "Add" icon to create one, as described in ["To create a user-defined search"](#) on page 440.
4. Tap the "Source" button and select the serial bus that is set to RFFE.
"Protocol" shows the RFFE icon.
5. Tap "Type" and select the search type.
All trigger types are also available for search.
6. To refine the search settings, configure additional settings, which are available for many search types.
For details, see [Chapter 14.17.6.1, "RFFE search setup"](#), on page 798.
7. Under "Control", "Enable" the search.
The "Search Results" box opens.
8. Close the "Search" dialog box.

9. Press [Run Stop] to start acquisition.
10. To start searching the acquired waveform for specific events, tap "Enable" in the search setup dialog:
The R&S RTO6 displays the "Search Results" box that lists the detected events.

For information on how to configure the search results presentation and how to navigate the search results, see also "[To display search zoom windows](#)" on page 448.

14.18 Ethernet 100BASE-T1 (option R&S RTO6-K560)

100BASE-T1 is an Ethernet based protocol specialized for the needs of the automotive industry, such as in the automotive networking applications, enabling advanced safety, comfort and infotainment features within the automobile.

Its specifications, with reference to IEEE Standard 802.3-2012, were developed by the OPEN (One-Pair Ether-Net) alliance under BroadR-Reach®.

BroadR-Reach is a Broadcom® point-to-point Ethernet physical layer (PHY) technology. Therefore, 100BASE-T1 is also known as BroadR-Reach Physical Layer (BR-PHY) or Open Alliance BroadR-Reach PHY (OABR PHY). For more details on the specifications, refer to <http://www.opensig.org/about/specifications/>.

This option is compatible with the MII (IEEE 802.3 Clause 22) and IEEE 802.3 MAC operating at 100Mbps.

- [100BASE-T1 basics](#)..... 803
- [100BASE-T1 configuration](#)..... 804
- [100BASE-T1 trigger](#)..... 809
- [100BASE-T1 decode results](#)..... 814
- [Search on decoded 100BASE-T1 data](#)..... 816

14.18.1 100BASE-T1 basics

The BR-PHY has the following objectives:

- Provides a PHY that supports full duplex operating at 100 Mbps over a pair of unshielded twisted pair (UTP) cable or better cable
- Provides compatibility with the Media Independent Interface (MII) IEEE 802.3 Clause 22 and IEEE 802.3 Media Access Controller (MAC) operating at 100 Mbps
- Achieves bit error rate (BER) of less than $1e^{-10}$

To achieve the above objectives, 100BASE-T1 uses 1000BASE-T PHYs with parts of IEEE 802.3 100BASE-TX in operation at 100 MBps and develops a new solution for the PHY sublayers, i.e. Physical Coding Sublayer (PCS) and Physical Medium Attachment (PMA) sublayer as follows:

- Adopts full duplex communication of 1000BASE-T and therefore echo cancellation on a single twisted-pair channel. This feature reduces cabling while preserving the Ethernet MAC compatibility

- Adopts Pulse Amplitude Modulation (PAM-3) encoding scheme with the following encoding techniques:
 - Data encoding is carried out via a 4b3b encoder that converts the MII data (4B - four bits) with 25 MHz clock to three bits (3B) wide of data that is transmitted during one 33.3 MHz clock period
 - Symbol encoding is carried out via a one-dimensional (1D) PAM-3 encoder that converts the 3-bit groups into pairs of ternary symbols. These symbols are transmitted using three voltage levels (-1 V, 0 V and +1 V). One symbol is transmitted in each symbol period
 - Data scrambling is carried out via a sidestream scramble to randomize the sequence of transmitted symbols and avoid the presence of spectral lines in the signal spectrum

PAM-3 has a higher spectral efficiency that limits the signaling bandwidth to 33.3 MHz instead of 65 MHz to 80 MHz in 100BASE-T and 100BASE-TX such that communication occurs in the best part of a twisted-pair channel. This in turn improves return loss, reduces crosstalk and EMI, allows for a more aggressive Electromagnetic Compatibility (EMC) filtering and lower cost (often lower quality) cabling

In terms of the trigger and decoder development, multiple aspects of this protocol are new, specifically:

- Sidestream descrambler: Descrambles the randomized sequence of received ternary symbols
- 1D PAM-3 decoder: Decodes the received ternary symbols into groups of three bits according to a conversion chart
- 4b/3b line decoder: Decodes the groups of three bits (result of ternary pair) back to groups of four bits of the data stream

14.18.2 100BASE-T1 configuration

14.18.2.1 100BASE-T1 configuration settings

Access: [Bus] > "100BASE-T1" > "Setup" tab



Make sure that the tab of the correct serial bus is selected.

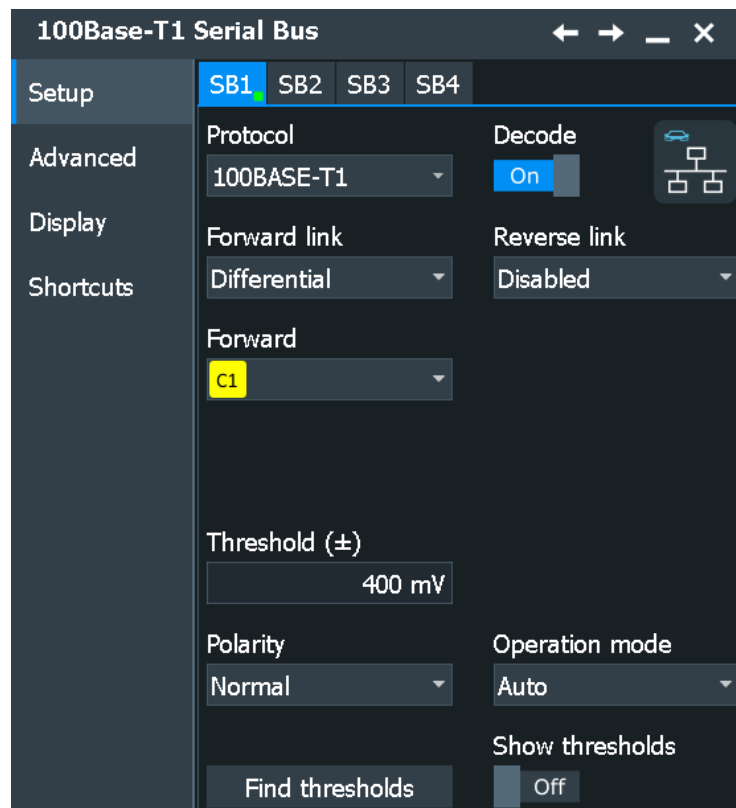

See also: [Chapter 14.1.1, "Setup - general settings"](#), on page 511

Forward

Defines the forward signal settings.

You can choose between a differential and single-ended signal and set the forward source channel for the waveform. Only analog channels are available for selection.

Remote command:

[BUS<m>:HBTO:FTYP](#) on page 2252

[BUS<m>:HBTO:FDIF](#) on page 2252

[BUS<m>:HBTO:FDAP](#) on page 2252

[BUS<m>:HBTO:FDAM](#) on page 2252

Reverse

Defines the reversed signal settings. The reverse direction is optional and can be disabled.

You can choose between a differential and single-ended signal and set the reverse source channel for the waveform. Only analog channels are available for selection.

Remote command:

[BUS<m>:HBTO:RTYP](#) on page 2253

[BUS<m>:HBTO:RDIF](#) on page 2253

[BUS<m>:HBTO:RDAP](#) on page 2253

[BUS<m>:HBTO:RDAM](#) on page 2253

Reverse attenuation

Sets the attenuation factor. It is used to de-amplify the reverse signal before subtracting it from the forward signal.

The effective signal amplitude passed to the decoder is:

$$Amp = (Fwd_+ - Fwd_-) - 10^{\frac{Attn}{20}} (Rev_+ - Rev_-)$$

Remote command:

[BUS<m>:HBTO:ATTN](#) on page 2251

Polarity

Selects the polarity of the data signal. You can select between "Normal" and "Inverted".

For "Normal" polarity, active high is defined as +1 V and active low is defined as -1 V.

For "Inverted" polarity, active high is defined as -1 V and active low is defined as +1 V.

Remote command:

[BUS<m>:HBTO:POLarity](#) on page 2254

Thresholds

Sets the positive and negative thresholds for the digitalization of the signal line.

The signal can have three states:

- High: the signal value is higher than the positive threshold.
- Low: the signal value is below the negative threshold.
- Zero: signal is between the positive and the negative threshold.

"Thresholds" Enter the value directly.

"Find thresh- Executes the measurement of reference levels and sets the thresh-
olds" olds to the middle reference level of the measured amplitude.

Remote command:

[BUS<m>:HBTO:THReshold](#) on page 2254

[BUS<m>:SETReflevels](#) on page 1814

[BUS<m>:FAUTOset](#) on page 1814

Operation mode

Selects the desired direction of the full-duplex signal for analysis. If set to "Auto", the decoder automatically detects the "Master" or "Slave" mode.

Remote command:

[BUS<m>:HBTO:MODE](#) on page 2254

Show thresholds

If enabled, the threshold levels are displayed in the diagram.

Remote command:

[BUS<m>:THReshold](#) on page 1815

14.18.2.2 Advanced settings

Access: [Bus] > "Advanced" tab.

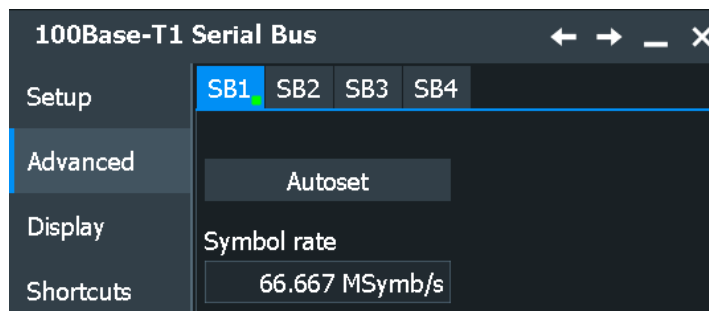

Symbol rate

Defines the transmission rate of ternary symbols which is by default 66.67 MSymb/s. This parameter should be rarely changed.

Remote command:

[BUS<m>:HBTO:SYMRate](#) on page 2254

Autoset

Starts software algorithms for determining the signal threshold levels and bitrate.

Remote command:

[BUS<m>:FAUTOset](#) on page 1814

14.18.2.3 100BASE-T1 display settings

Access: [Bus] > "Display" tab.

For common display settings, see [Chapter 14.1.3, "Display"](#), on page 513.

To enhance the decode possibilities of the 100BASE-T1 protocol, you can use an additional setting in the "Display" tab: "Decode layer".

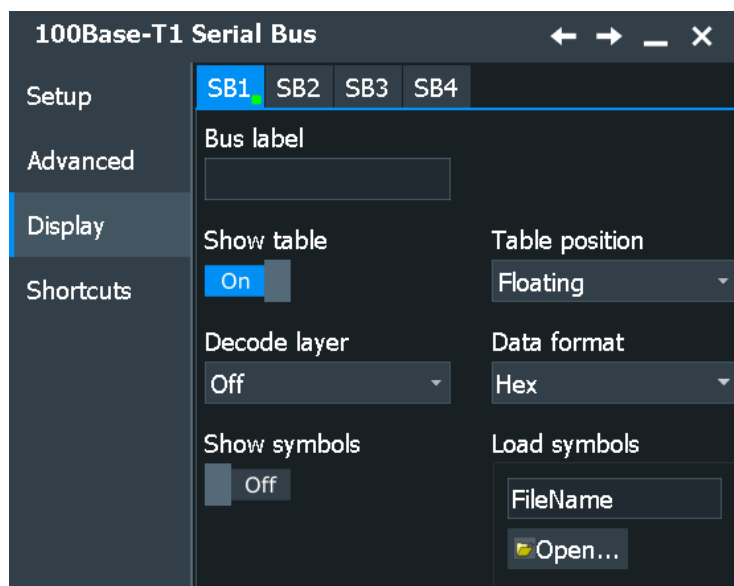

100BASE-T1 Specific Symbol Settings

Label lists are protocol-specific. Label lists for 100BASE-T1 are available in CSV and PTT format.

A 100BASE-T1 label file contains two values for each ethernet header:

- Ethernet Header Display
- Symbolic label: name of the address, specifying its function in the bus network.

Decode layer

Selects the decode layer.

Decoding is performed in several steps, and the end results are presented in the decode table. The decode layer selects an interim step for which the decoding result is shown in the honeycomb display.

"Off"	No decode layer is displayed.
"Ternary symbols"	Decoded ternary symbols.
"Scrambled bits"	Scrambled ternary bits.
"Descrambled bits"	Descrambled ternary bits.
"Reversed Bits"	Reserved bits

14.18.2.4 Configuring 100BASE-T1 signals

For configuration, assign the lines to the input channels and define the active states and the logical thresholds.

For details on configuration settings, see [Chapter 14.18.2.1, "100BASE-T1 configuration settings"](#), on page 804.

Serial bus setup

1. Press the [Bus] key on the front panel.
2. Select the tab of the bus you want to set up, for example "SB1".
3. In the "Setup" tab, select the protocol: "100BASE-T1".
4. Select the type and source for the reversed and forward signal.
5. Select the polarity ("Normal" or "Inverted") of the signal.
6. Set the logical thresholds.
7. Enable "Decode".

14.18.3 100BASE-T1 trigger

14.18.3.1 100BASE-T1 trigger settings

Access: [Bus] > "Shortcuts" tab > "Setup trigger"



In this section, all trigger settings are described. Their availability on the instrument depends on the selected trigger type. The user interface of the instrument displays only appropriate settings and guides you through the trigger setup.

For a list of supported trigger conditions, refer to the specifications document.

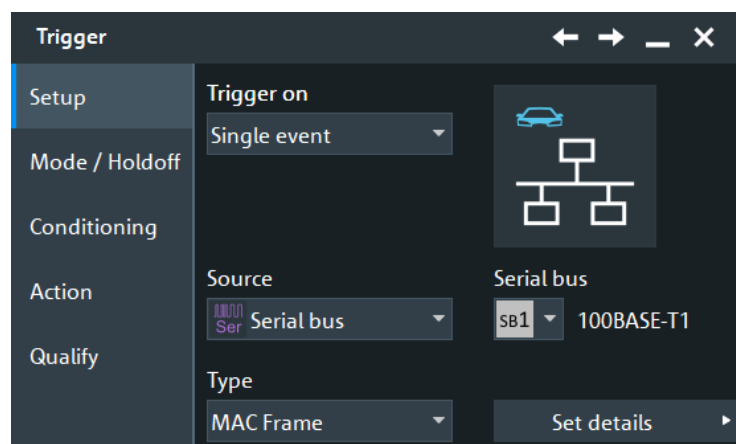

Make sure that:

- In the [Bus] > "Setup" tab:
 - The correct "Protocol" is selected.
 - The data sources of the serial bus are channel signals.
- In the "Trigger" > "Setup" tab:
 - The "Trigger on" = "Single event"
 - The trigger "Source" = "Serial bus".
 - The correct "Serial bus" is selected.

Type

Selects the trigger type for 100BASE-T1 analysis.

Remote command:

[TRIGger<m>:HBTO:TYPE](#) on page 2255

Frame Start ← Type

Triggers on the start of frame.

MAC Frame ← Type

Triggers on a Media Access Control (MAC) frame. You can specify:

- Destination address
- Source address
- Length/Type
- Frame check
- Data
- Index

The frame contains addresses of the devices and MAC control information that define how to go about transmitting and receiving frames.

100BASE-T1 Trigger

MAC Frame

Destination address
= Equal [hex]XX

Source address
= Equal [hex]XX

Length/Type
= Equal [hex]XX

Frame check
= Equal [hex]XX

Data
= Equal [hex]XX

Index
[-] In range 1 .. 65535

Back

IDLE ← Type

Triggers on an idle frame. The frame is used for clock synchronization.

Error ← Type

Triggers on the specified [error](#) frame.

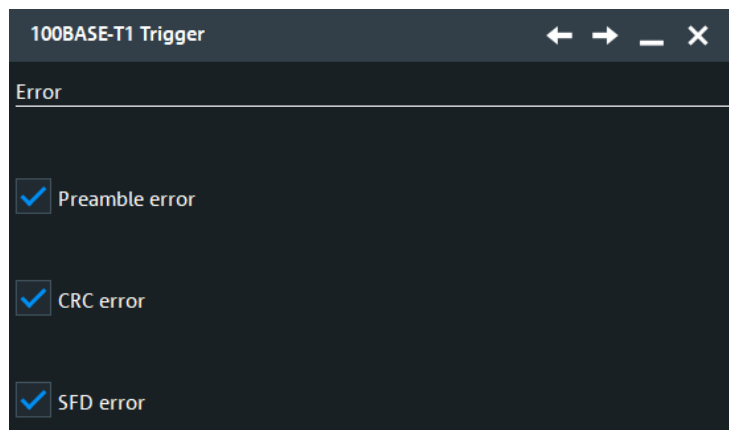

Destination address

Sets the specified destination address to be triggered on. The destination address setup consists of the condition and one or two data patterns.

The destination address corresponds to the address of the interface in the device that receives the frame. If the destination address does not match the interface's own Ethernet address, then the interface is free to ignore the rest of the frame.

"Condition" Defines the operator to set a specific destination address, e.g. "Equal" or "Not Equal") or a range.

"Data Min/Data"

Defines the bit pattern of the destination address pattern.

In binary format, use the following characters: 1; 0; or X (do not care). To enter the pattern in other formats use the bit pattern editor, see [Chapter 14.1.7, "Bit pattern editor"](#), on page 519.

"Data Max"

The second data pattern is required to specify a range with conditions "In range" and "Out of range".

Remote command:

[TRIGger<m>:HBTO:DADDRESS:CONDition](#) on page 2256

[TRIGger<m>:HBTO:DADDRESS:MIN](#) on page 2256

[TRIGger<m>:HBTO:DADDRESS:MAX](#) on page 2257

Source address

Sets the specified source address to be triggered on. The source address setup consists of the condition and one or two data patterns.

The source address is the physical address of the device that sends the frame.

"Condition" Defines the operator to set a specific source address, e.g. "Equal" or "Not Equal") or a range.

"Data Min/Data"

Defines the bit pattern of the source address pattern.

In binary format, use the following characters: 1; 0; or X (do not care). To enter the pattern in other formats use the bit pattern editor, see [Chapter 14.1.7, "Bit pattern editor"](#), on page 519.

"Data Max" The second data pattern is required to specify a range with conditions "In range" and "Out of range".

Remote command:

[TRIGger<m>:HBTO:SADDress:CONDition](#) on page 2257

[TRIGger<m>:HBTO:SADDress:MIN](#) on page 2257

[TRIGger<m>:HBTO:SADDress:MAX](#) on page 2258

Length/Type

Sets the specified Length/Type to be triggered on. The Length/Type setup consists of the condition and one or two data patterns.

The value in this field indicates the manner in which the field is being used, either as a length or type field. As a length field, the value in the field indicates the number of logical link control (LLC) data octets that follow in the data field of the frame. As a type field, the value in the field is used to indicate the type of protocol data being carried in the data field of the frame.

"Condition" Defines the operator to set a specific Length/Type, e.g. "Equal" or "Not Equal") or a range.

"Data Min/Data"

Defines the bit pattern of the Length/Type pattern.

In binary format, use the following characters: 1; 0; or X (do not care). To enter the pattern in other formats use the bit pattern editor, see [Chapter 14.1.7, "Bit pattern editor"](#), on page 519.

"Data Max" The second data pattern is required to specify a range with conditions "In range" and "Out of range".

Remote command:

[TRIGger<m>:HBTO:LENGth:CONDition](#) on page 2258

[TRIGger<m>:HBTO:LENGth:MIN](#) on page 2258

[TRIGger<m>:HBTO:LENGth:MAX](#) on page 2259

Frame check

Sets the specified frame check to be triggered on. The frame check setup consists of the condition and one or two data patterns.

This field contains a value that is used to check the integrity of the various bits in the frame fields (excluding the preamble / SFD).

"Condition" Defines the operator to set a specific frame check, e.g. "Equal" or "Not Equal") or a range.

"Data Min/Data"

Defines the bit pattern of the frame check pattern.

In binary format, use the following characters: 1; 0; or X (do not care). To enter the pattern in other formats use the bit pattern editor, see [Chapter 14.1.7, "Bit pattern editor"](#), on page 519.

"Data Max" The second data pattern is required to specify a range with conditions "In range" and "Out of range".

Remote command:

[TRIGger<m>:HBTO:CRC:CONDition](#) on page 2259

[TRIGger<m>:HBTO:CRC:MIN](#) on page 2259

[TRIGger<m>:HBTO:CRC:MAX](#) on page 2260

Data

Sets the specified data to be triggered on. The data setup consists of the condition and one or two data patterns.

"Condition" Defines the operator to set a specific data, e.g. "Equal" or "Not Equal") or a range.

"Data Min/Data"

Defines the bit pattern of the data pattern.

In binary format, use the following characters: 1; 0; or X (do not care). To enter the pattern in other formats use the bit pattern editor, see [Chapter 14.1.7, "Bit pattern editor"](#), on page 519.

"Data Max" The second data pattern is required to specify a range with conditions "In range" and "Out of range".

Remote command:

[TRIGger<m>:HBTO:DATA:DCONDition](#) on page 2260

[TRIGger<m>:HBTO:DATA:DMIN](#) on page 2260

[TRIGger<m>:HBTO:DATA:DMAX](#) on page 2261

Index

Sets the specified value or range within this series of data that is considered for the analysis. The index setup consists of the condition and one or two index values.

"Condition" Defines the operator to set a specific index, e.g. "Equal" or a range.

"Index Min/Index"

Defines the bit pattern of the index pattern.

In binary format, use the following characters: 1; 0; or X (do not care). To enter the pattern in other formats use the bit pattern editor, see [Chapter 14.1.7, "Bit pattern editor"](#), on page 519.

"Index Max" The second index pattern is required to specify a range with conditions "In range".

Remote command:

[TRIGger<m>:HBTO:DATA:ICONDition](#) on page 2261

[TRIGger<m>:HBTO:DATA:IMIN](#) on page 2261

[TRIGger<m>:HBTO:DATA:IMAX](#) on page 2262

Errors

Sets the type of error events to be triggered on.

Preamble Error ← Errors

Triggers on a frame with invalid preamble.

Remote command:

[TRIGger<m>:HBTO:ERRor:PREamble](#) on page 2262

CRC Error ← Errors

Triggers on a frame that has a mismatch of the Cyclic Redundancy Check (CRC) value between the transmitting and receiving device.

Remote command:

[TRIGger<m>:HBTO:ERRor:CRc](#) on page 2262

SFD Error ← Errors

Triggers on a frame with invalid Start Frame Delimiter (SFD).

Remote command:

[TRIGger<m>:HBTO:ERRor:SFD](#) on page 2263

14.18.3.2 Triggering on 100BASE-T1

Prerequisite: A bus is configured for the 100BASE-T1 signal to be analyzed.

For the basic trigger settings, proceed in the following way:

1. Press the [Bus] key and select the "Shortcuts" tab.
2. Press "Setup trigger".
3. Tap the "Source" button and select the "Serial bus" trigger source.
4. Select the serial bus that is set to 100BASE-T1.
5. Tap "Type" and select the trigger type to be used for 100BASE-T1 protocol analysis.
6. To refine the trigger settings, configure additional settings, which are available for some trigger types.

For details, see [Chapter 14.18.3, "100BASE-T1 trigger"](#), on page 809.

14.18.4 100BASE-T1 decode results

When the configuration of the serial bus is complete, the signal can be decoded:

1. In the "Protocol" dialog > "Setup" tab, enable "Decode".
2. In the "Protocol" dialog > "Display" tab, select additional result display settings: "Show decode table" and "Show binary signals".

For a description of the display settings, see also [Chapter 14.1.3, "Display"](#), on page 513.

The instrument captures and decodes the signal according to the standard definition and the configuration settings.

The color-coding of the various protocol sections and errors simplifies the interpretation of the visual display. The decode information condenses or expands, depending on the horizontal scale. Various data formats are available to show the result values.

Decode Results Table

The results are shown in two tables:

- "Decode results": contains information about all decoded frames
- "Details frame": contains more detailed information about the selected frame in the "Decode results" table.

State	Start	Type	Destination	Source	Type/Length	CRC	Destination Symbol	Source Symbol	Bit rate
1 Ok	-28.3389 µs	Idle	—	—	—	—	—	—	99.98 Mbps
2 Ok	-16.3862 µs	MAC	01:01:01:01:01:01	FF:FF:FF:FF:FF:FF	800	[hex] 49545AF9	BroadCast	100 Mbps	
3 Ok	-10.5362 µs	Idle	—	—	—	—	—	100.1 Mbps	
4 Ok	-8.2287 µs	MAC	02:02:02:02:02:02	FF:FF:FF:FF:FF:FF	800	[hex] E89E2D0F	BroadCast	99.96 Mbps	
5 Ok	-2.3767 µs	Idle	—	—	—	—	—	100 Mbps	
6 Ok	-1.4467 µs	MAC	03:03:03:03:03:03	FF:FF:FF:FF:FF:FF	800	[hex] 16901359	BroadCast	100 Mbps	
7 Ok	4.3911 µs	Filler	—	—	—	—	—	100 Mbps	
8 Ok	4.4911 µs	Idle	—	—	—	—	—	99.97 Mbps	
9 CRC Error	6.7717 µs	MAC	04:04:04:04:04:04	FF:FF:FF:FF:FF:FF	800	[hex] 461CC62	BroadCast	100 Mbps	
10 Ok	12.6315 µs	Filler	—	—	—	—	—	100 Mbps	

Name	Value [hex]	Rcvr status
1 Triplet: 1	03	Not Ok
2 Triplet: 2	05	Not Ok
3 Triplet: 3	05	Not Ok
4 Triplet: 4	00	Not Ok
5 Triplet: 5	02	Not Ok
6 Triplet: 6	00	Not Ok
7 Triplet: 7	05	Not Ok
8 Triplet: 8	02	Not Ok
9 Triplet: 9	06	Not Ok

Table 14-28: Content of the Decode results table

Column	Description
Frame	Frame count
State	Overall state of the frame: either OK or the relevant error condition (preamble, CRC or SFD)
Start	Start time of the frame
Type	Type of frame (e.g. Idle, MAC or data)
Destination	Destination address of the frame
Source	Source address of the frame
Type/Length	The sub-protocol (e.g. HTML, video, etc.) determines what meaning this field has. Since the content of this data area is not decoded, the interpretation of this field is ambivalent. It could either be the word type (specific for the sub-protocol) or the word length.
CRC	Frame Check (Cyclic Redundancy Code, CRC)
Destination symbol	Symbol defined for the respective destination
Source symbol	Symbol defined for the respective source
Bit rate	Value of the bit rate

Table 14-29: Content of the Details frame table

Column	Description
Name	State of the field
Type	Field type
Value	Hexadecimal value of the field
Rcvr status	Receiver status

Tools

Press "Display settings" in the "Decode Results" table to access the "Display" tab.



Remote commands

Remote commands are described in [Chapter 27.18.19.3, "Decode results"](#), on page 2263.

14.18.5 Search on decoded 100BASE-T1 data

Using the search functionality, you can find various events in the decoded data. You can find the same events that you can trigger on, and even many more, since several event types can also be combined.

Before you can start the search, you have to configure the bus correctly and acquire decoded data.

To search on decoded data, set the search source to "SerBus" for the configured protocol.

For general information on how to handle the search functionality, see [Chapter 11, "Search functions"](#), on page 425.

14.18.5.1 100BASE-T1 search setup

Access: [Bus] > "Shortcuts" tab > "Setup search"

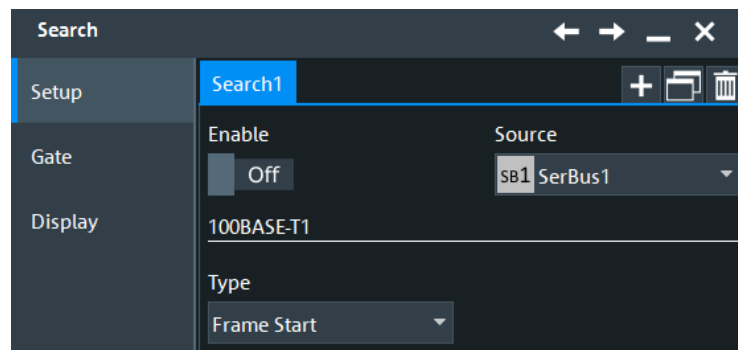

Enable

Enables the search for 100BASE-T1.

Type

Selects the search type for 100BASE-T1 analysis.

Remote command:

[SEARCH:TRIGger:HBTO:TYPE](#) on page 2269

Frame Start ← Type

Searches for the start of frame.

MAC Frame ← Type

Searches for a Media Access Control (MAC) frame that matches the specified [Destination address](#), [Source address](#), [Length/Type](#), [Frame check](#), [Data](#) or [Index](#) condition.

The frame contains addresses of the devices and MAC control information that define how to go about transmitting and receiving frames.

FILLER ← Type

Searches for a Filler frame. The frame is used to maintain transmission activity.

IDLE ← Type

Searches for an idle frame. The frame is used for clock synchronization.

Error ← Type

Searches for the specified [error](#) frame.

Destination address

Sets the specified destination address to be searched for. The destination address setup consists of the condition and one or two data patterns.

The destination address corresponds to the address of the interface in the device that receives the frame. If the destination address does not match the interface's own Ethernet address, then the interface is free to ignore the rest of the frame.

"Condition" Defines the operator to set a specific destination address, e.g. "Equal" or "Not Equal") or a range.

"Data Min/Data" Defines the bit pattern of the destination address pattern.
In binary format, use the following characters: 1; 0; or X (do not care).
To enter the pattern in other formats use the bit pattern editor, see [Chapter 14.1.7, "Bit pattern editor"](#), on page 519.

"Data Max" The second data pattern is required to specify a range with conditions "In range" and "Out of range".

Remote command:

[SEARCh:TRIGger:HBTO:DADDRESS:CONDition](#) on page 2270

[SEARCh:TRIGger:HBTO:DADDRESS:MIN](#) on page 2270

[SEARCh:TRIGger:HBTO:DADDRESS:MAX](#) on page 2270

Source address

Sets the specified source address to be searched for. The source address setup consists of the condition and one or two data patterns.

The source address is the physical address of the device that sends the frame.

"Condition" Defines the operator to set a specific source address, e.g. "Equal" or "Not Equal") or a range.

"Data Min/Data" Defines the bit pattern of the source address pattern.
In binary format, use the following characters: 1; 0; or X (do not care).
To enter the pattern in other formats use the bit pattern editor, see [Chapter 14.1.7, "Bit pattern editor"](#), on page 519.

"Data Max" The second data pattern is required to specify a range with conditions "In range" and "Out of range".

Remote command:

[SEARCh:TRIGGer:HBTO:SADDress:CONDition](#) on page 2271

[SEARCh:TRIGGer:HBTO:SADDress:MIN](#) on page 2271

[SEARCh:TRIGGer:HBTO:SADDress:MAX](#) on page 2271

Length/Type

Sets the specified Length/Type to be searched for. The Length/Type setup consists of the condition and one or two data patterns.

The value in this field indicates the manner in which the field is being used, either as a length or type field. As a length field, the value in the field indicates the number of logical link control (LLC) data octets that follow in the data field of the frame. As a type field, the value in the field is used to indicate the type of protocol data being carried in the data field of the frame.

"Condition" Defines the operator to set a specific Length/Type, e.g. "Equal" or "Not Equal") or a range.

"Data Min/Data" Defines the bit pattern of the Length/Type pattern.
In binary format, use the following characters: 1; 0; or X (do not care). To enter the pattern in other formats use the bit pattern editor, see [Chapter 14.1.7, "Bit pattern editor"](#), on page 519.

"Data Max" The second data pattern is required to specify a range with conditions "In range" and "Out of range".

Remote command:

[SEARCh:TRIGGer:HBTO:LENGth:CONDition](#) on page 2272

[SEARCh:TRIGGer:HBTO:LENGth:MIN](#) on page 2272

[SEARCh:TRIGGer:HBTO:LENGth:MAX](#) on page 2273

Frame check

Sets the specified frame check to be searched for. The frame check setup consists of the condition and one or two data patterns.

This field contains a value that is used to check the integrity of the various bits in the frame fields (excluding the preamble / SFD).

"Condition" Defines the operator to set a specific frame check, e.g. "Equal" or "Not Equal") or a range.

"Data Min/Data" Defines the bit pattern of the frame check pattern.
In binary format, use the following characters: 1; 0; or X (do not care). To enter the pattern in other formats use the bit pattern editor, see [Chapter 14.1.7, "Bit pattern editor"](#), on page 519.

"Data Max" The second data pattern is required to specify a range with conditions "In range" and "Out of range".

Remote command:

[SEARCh:TRIGGer:HBTO:CRC:CONDition](#) on page 2273

[SEARCh:TRIGGer:HBTO:CRC:MIN](#) on page 2273

[SEARCh:TRIGGer:HBTO:CRC:MAX](#) on page 2274

Data

Sets the specified data to be searched for. The data setup consists of the condition and one or two data patterns.

"Condition" Defines the operator to set a specific data, e.g. "Equal" or "Not Equal") or a range.

"Data Min/Data"

Defines the bit pattern of the data pattern.

In binary format, use the following characters: 1; 0; or X (do not care). To enter the pattern in other formats use the bit pattern editor, see [Chapter 14.1.7, "Bit pattern editor"](#), on page 519.

"Data Max" The second data pattern is required to specify a range with conditions "In range" and "Out of range".

Remote command:

[SEARCH:TRIGger:HBTO:DATA:DCondition](#) on page 2274

[SEARCH:TRIGger:HBTO:DATA:DMIN](#) on page 2274

[SEARCH:TRIGger:HBTO:DATA:DMAX](#) on page 2275

Index

Sets the specified value or range within this series of data that is considered for the search. The index setup consists of the condition and one or two index values.

"Condition" Defines the operator to set a specific index, e.g. "Equal" or a range.

"Index Min/Index"

Defines the bit pattern of the index pattern.

In binary format, use the following characters: 1; 0; or X (do not care). To enter the pattern in other formats use the bit pattern editor, see [Chapter 14.1.7, "Bit pattern editor"](#), on page 519.

"Index Max" The second index pattern is required to specify a range with conditions "In range".

Remote command:

[SEARCH:TRIGger:HBTO:DATA:ICONdition](#) on page 2275

[SEARCH:TRIGger:HBTO:DATA:IMIN](#) on page 2275

[SEARCH:TRIGger:HBTO:DATA:IMAX](#) on page 2276

Errors

Sets the type of error events to be searched for.

Preamble Error ← Errors

Searches for a frame with invalid preamble.

Remote command:

[SEARCH:TRIGger:HBTO:ERRor:PREamble](#) on page 2276

CRC Error ← Errors

Searches for a frame that has a mismatch of the Cyclic Redundancy Check (CRC) value between the transmitting and receiving device.

Remote command:

[SEARCH:TRIGger:HBTO:ERRor:CRc](#) on page 2276

SFD Error ← Errors

Searches for a frame with invalid Start Frame Delimiter (SFD).

Remote command:

[SEARCh:TRIGger:HBTO:ERRor:SFD](#) on page 2277

14.18.5.2 100BASE-T1 search results

To get search results, "Enable" the search. You can minimize, shift or close the search dialog.

The search results are listed in the search result table and marked in the waveform by blue lines.

For an introduction to search results, see:

- [Chapter 11.1.2, "Search results"](#), on page 426
- [Chapter 11.4.2, "Display zoom settings"](#), on page 446

Remote commands are described in [Chapter 27.18.19.5, "Search results"](#), on page 2277.

14.18.5.3 Searching 100BASE-T1 data

Prerequisite: A serial bus is configured for the 100BASE-T1 signal to be decoded and analyzed.

The search for events is set up in the following way:

1. Press the [Bus] key and select the "Shortcuts" tab.
2. Tap "Setup search".
3. If the dialog box does not contain a search entry, tap the "Add" icon to create one, as described in ["To create a user-defined search"](#) on page 440.
4. Tap "Source" and select the serial bus that is set to 100BASE-T1 (e.g. "SB1", unless already selected).

The search dialog for 100BASE-T1 protocol analysis opens.

5. Specify search criteria according to [Chapter 14.18.5, "Search on decoded 100BASE-T1 data"](#), on page 816.

6. To acquire a waveform, press [Single].

The R&S RTO6 performs an 100BASE-T1 decode according to the thresholds and protocol settings of the associated serial bus source (here in our example SB1).

7. To start searching the acquired waveform for specific events, tap "Enable" in the search setup dialog.

The R&S RTO6 displays the "Search Results" box that lists the detected events.

For information on how to configure the search results presentation and how to navigate the search results, see also ["To display search zoom windows"](#) on page 448.

14.19 Ethernet 1000BASE-T1 (option R&S RTO6-K560)

1000BASE-T1 is a single pair Ethernet based protocol specialized for the needs of the automotive industry, such as in the automotive networking applications, enabling advanced safety, comfort and infotainment features within the automobile. Its specifications is reference to IEEE P802.3bp.

- [1000BASE-T1 basics](#)..... 821
- [1000BASE-T1 configuration](#)..... 822
- [1000BASE-T1 trigger](#)..... 825
- [1000BASE-T1 decode results](#)..... 831
- [Search on decoded 1000BASE-T1 data](#)..... 833

14.19.1 1000BASE-T1 basics

The 1000BASE-T1 has the following objectives:

- Provides a PHY that supports full duplex operating at 1000 Mbps over a pair of unshielded sheathed twisted-pair cable or better cable.
- Achieves bit error rate (BER) of less than $1e^{-10}$.
- Support for up to at least 15 meters of cable length in the automotive link segment.

To achieve the above objectives, 1000BASE-T1 uses Physical Coding Sublayer (PCS) and Physical Medium Attachment (PMA) sublayer as follows:

- Adopts full duplex communication of 1000BASE-T1 and therefore echo cancellation on a single twisted-pair channel. This feature reduces cabling while preserving the Ethernet MAC compatibility
- Adopts Pulse Amplitude Modulation (PAM-3) encoding scheme with the following encoding techniques:
 - PAM-3 is transmitted at 750 MB data rate.
 - It uses 15-bit scrambler to improve the EMC performance.
 - Data is encoded in 80B/81B blocks.
 - 396 bits of Reed-Solomon forward error correction (FEC) parity is added to each group of 45 80B/81B blocks.
 - 9-bit OAM symbol is added, then 396 bits Reed-Solomon. Together, they shape a PHY frame of 4050 bits, or 450 forward error correction (FEC) symbols of 9 bits. FEC allows for correction of up to 22 FEC symbols per PHY frame.

14.19.2 1000BASE-T1 configuration

14.19.2.1 1000BASE-T1 configuration settings

Access: [Bus] > "1000BASE-T1" > "Setup" tab



Make sure that the tab of the correct serial bus is selected.

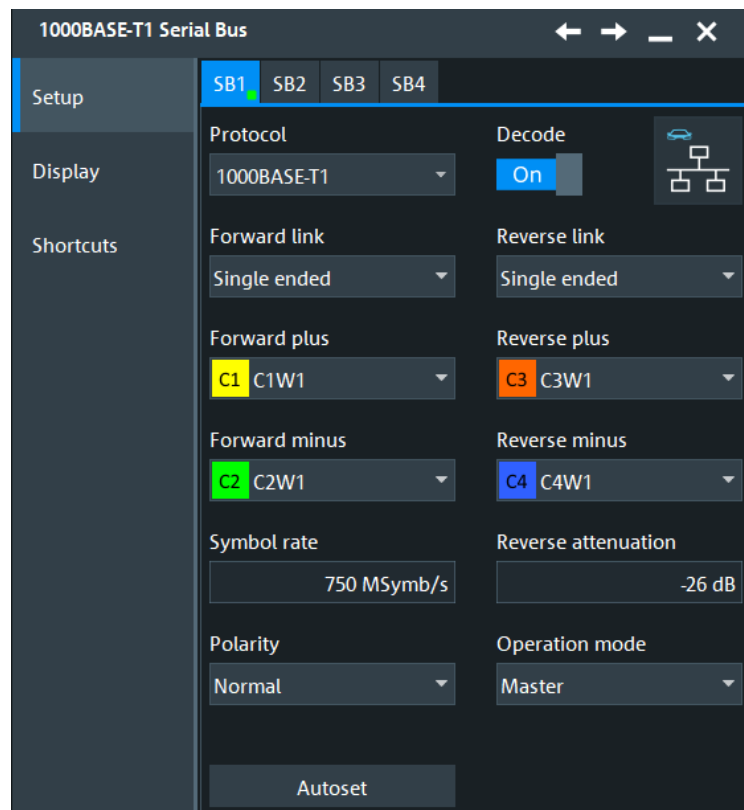

See also: [Chapter 14.1.1, "Setup - general settings"](#), on page 511

Forward

Defines the forward signal settings.

You can choose between a differential and single-ended signal and set the source channel for the waveform. Only analog channels are available for selection.

Remote command:

[BUS<m>: TBTO: FTYP](#) on page 2284

[BUS<m>: TBTO: FDI F](#) on page 2283

[BUS<m>: TBTO: FDAP](#) on page 2283

[BUS<m>: TBTO: FDAM](#) on page 2283

Reverse

Defines the reversed signal settings. The reverse direction is optional and can be disabled.

You can choose between a differential and single-ended signal and set the source channel for the waveform. Only analog channels are available for selection.

Remote command:

[BUS<m>:TBTO:RTYP](#) on page 2285

[BUS<m>:TBTO:RDIF](#) on page 2284

[BUS<m>:TBTO:RDAP](#) on page 2284

[BUS<m>:TBTO:RDAM](#) on page 2284

Reverse attenuation

Sets the attenuation factor. It is used to de-amplify the reverse signal before subtracting it from the forward signal.

The effective signal amplitude passed to the decoder is:

$$Amp = (Fwd_+ - Fwd_-) - 10^{\frac{Attn}{20}} (Rev_+ - Rev_-)$$

Remote command:

[BUS<m>:TBTO:ATTN](#) on page 2282

Polarity

Selects the polarity of the data signal. You can select between "Normal" and "Inverted".

For "Normal" polarity, active high is defined as +1 V and active low is defined as -1 V. For "Inverted" polarity, active high is defined as -1 V and active low is defined as +1 V.

Remote command:

[BUS<m>:TBTO:POLarity](#) on page 2285

Operation mode

Selects the desired direction of the full-duplex signal for analysis. If set to "Auto", the decoder automatically detects the "Master" or "Slave" mode.

Remote command:

[BUS<m>:TBTO:MODE](#) on page 2285

Autoset

Starts software algorithms for determining the signal threshold levels and bitrate.

Remote command:

[BUS<m>:FAUToset](#) on page 1814

14.19.2.2 1000BASE-T1 display settings

Access: [Bus] > "Display" tab.

For common display settings, see [Chapter 14.1.3, "Display"](#), on page 513.

To enhance the decode possibilities of the 1000BASE-T1 protocol, you can use an additional setting in the "Display" tab: "Decode layer".

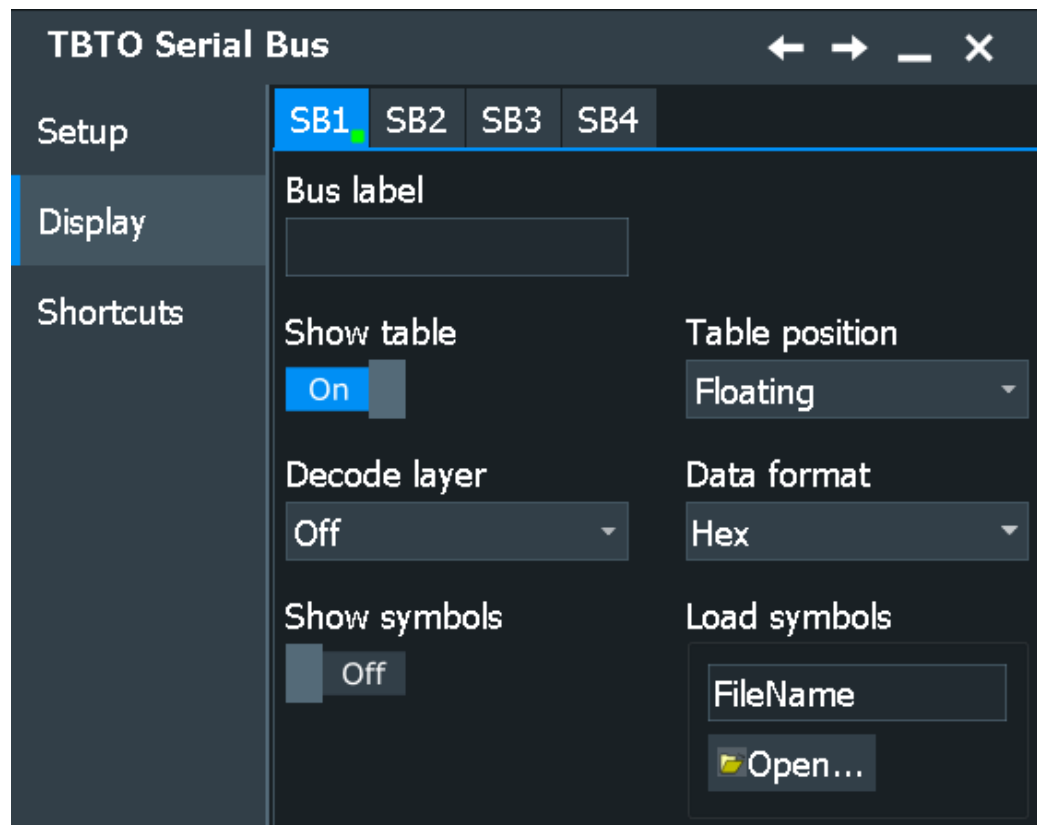

1000BASE-T1 Specific Label Settings

Label lists are protocol-specific. Label lists for 1000BASE-T1 are available in CSV and PTT format.

A 1000BASE-T1 label file contains two values for each ethernet header:

- Ethernet header display
- Symbolic label: name of the address, specifying its function in the bus network.

Decode layer

Selects the decode layer.

Decoding is performed in several steps, and the end results are presented in the decode table. The decode layer selects an interim step for which the decoding result is shown in the honeycomb display.

"Off"	No decode layer is displayed.
"Ternary symbols"	Decoded ternary symbols.
"Scrambled bits"	Scrambled ternary bits.
"Descrambled bits"	Descrambled ternary bits.
"Corrected RS-FEC symbols"	Displays RS-FEC symbols that have been corrected.

14.19.2.3 Configuring 1000BASE-T1 signals

For configuration, assign the lines to the input channels and define the active states and the logical thresholds.

Serial bus setup

1. Press the [Bus] key on the front panel.
2. Select the tab of the bus you want to set up, for example "SB1".
3. In the "Setup" tab, select the protocol: "1000BASE-T1".
4. Select the type and source for the reversed and forward signal.
5. Select the "Polarity" ("Normal" or "Inverted") of the signal.
6. Enable "Decode".

14.19.3 1000BASE-T1 trigger

14.19.3.1 1000BASE-T1 trigger settings

Access: [Bus] > "Shortcuts" tab > "Setup trigger"

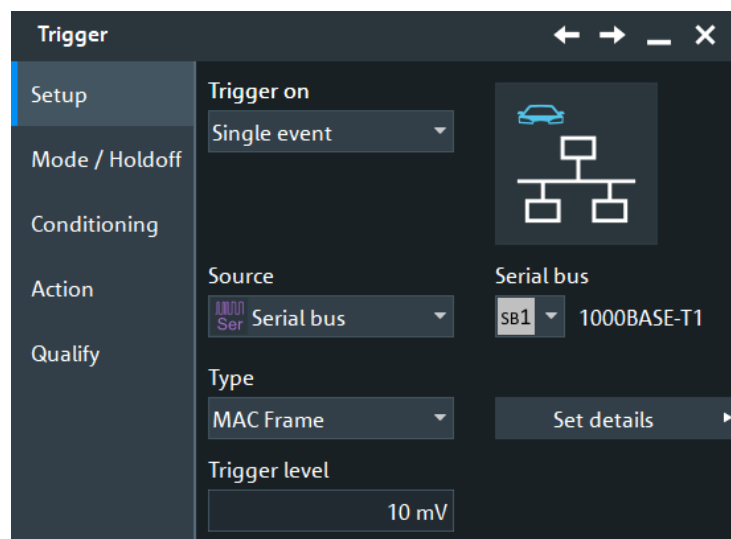



Make sure that:

- In the [Bus] > "Setup" tab:
 - The correct "Protocol" is selected.
 - The data sources of the serial bus are channel signals.
- In the "Trigger" > "Setup" tab:
 - The "Trigger on" = "Single event"
 - The trigger "Source" = "Serial bus".
 - The correct "Serial bus" is selected.

Type

Selects the trigger type for 1000BASE-T1 analysis.

Remote command:

[TRIGger<m>:TBTO:TYPE](#) on page 2293

Frame Start ← Type

Triggers on the start of frame.

MAC Frame ← Type

Triggers on a media access control (MAC) frame. You can specify:

- [Destination address](#)
- [Source address](#)
- [Length/Type](#)
- [Frame check](#)
- [Data](#)
- [Index](#)

The frame contains addresses of the devices and MAC control information that define how to go about transmitting and receiving frames.

MAC Frame

Destination address
= Equal [hex]XX

Source address
= Equal [hex]XX

Length/Type
= Equal [hex]XX

Frame check
= Equal [hex]XX

Data
= Equal [hex]XX

Index
[-] In range 1 .. 65535

IDLE ← Type

Triggers on an idle frame. The frame is used for clock synchronization.

Error ← Type

Triggers on the specified [error](#) frame.

Trigger level

Sets the trigger level.

Remote command:

[TRIGger<m>:TBTO:TRGLevel](#) on page 2293

Destination address

Sets the specified destination address to be triggered on. The destination address setup consists of the condition and one or two data patterns.

The destination address corresponds to the address of the interface in the device that receives the frame. If the destination address does not match the interface's own Ethernet address, then the interface is free to ignore the rest of the frame.

"Condition" Defines the operator to set a specific destination address, e.g. "Equal" or "Not Equal") or a range.

"Data Min/Data"

Defines the bit pattern of the destination address pattern.
In binary format, use the following characters: 1; 0; or X (do not care).
To enter the pattern in other formats use the bit pattern editor, see [Chapter 14.1.7, "Bit pattern editor"](#), on page 519.

"Data Max"

The second data pattern is required to specify a range with conditions "In range" and "Out of range".

Remote command:

[TRIGger<m>:TBTO:DADDRESS:CONDition](#) on page 2294

[TRIGger<m>:TBTO:DADDRESS:MIN](#) on page 2295

[TRIGger<m>:TBTO:DADDRESS:MAX](#) on page 2295

Source address

Sets the specified source address to be triggered on. The source address setup consists of the condition and one or two data patterns.

The source address is the physical address of the device that sends the frame.

"Condition" Defines the operator to set a specific source address, e.g. "Equal" or "Not Equal") or a range.

"Data Min/Data"

Defines the bit pattern of the source address pattern.

In binary format, use the following characters: 1; 0; or X (do not care). To enter the pattern in other formats use the bit pattern editor, see [Chapter 14.1.7, "Bit pattern editor"](#), on page 519.

"Data Max" The second data pattern is required to specify a range with conditions "In range" and "Out of range".

Remote command:

[TRIGger<m>:TBTO:SADDRESS:CONDition](#) on page 2300

[TRIGger<m>:TBTO:SADDRESS:MIN](#) on page 2300

[TRIGger<m>:TBTO:SADDRESS:MAX](#) on page 2300

Length/Type

Sets the specified length/type to be triggered on. The length/type setup consists of the condition and one or two data patterns.

The value in this field indicates the manner in which the field is being used, either as a length or type field. As a length field, the value in the field indicates the number of logical link control (LLC) data octets that follow in the data field of the frame. As a type field, the value in the field is used to indicate the type of protocol data being carried in the data field of the frame.

"Condition" Defines the operator to set a specific Length/Type, e.g. "Equal" or "Not Equal") or a range.

"Data Min/Data"

Defines the bit pattern of the Length/Type pattern.

In binary format, use the following characters: 1; 0; or X (do not care). To enter the pattern in other formats use the bit pattern editor, see [Chapter 14.1.7, "Bit pattern editor"](#), on page 519.

"Data Max" The second data pattern is required to specify a range with conditions "In range" and "Out of range".

Remote command:

[TRIGger<m>:TBTO:LENGTH:CONDition](#) on page 2298

[TRIGger<m>:TBTO:LENGTH:MIN](#) on page 2299

[TRIGger<m>:TBTO:LENGTH:MAX](#) on page 2299

Frame check

Sets the specified frame check to be triggered on. The frame check setup consists of the condition and one or two data patterns.

This field contains a value that is used to check the integrity of the various bits in the frame fields (excluding the preamble / SFD).

"Condition" Defines the operator to set a specific frame check, e.g. "Equal" or "Not Equal") or a range.

"Data Min/Data"

Defines the bit pattern of the frame check pattern.

In binary format, use the following characters: 1; 0; or X (do not care). To enter the pattern in other formats use the bit pattern editor, see [Chapter 14.1.7, "Bit pattern editor"](#), on page 519.

"Data Max" The second data pattern is required to specify a range with conditions "In range" and "Out of range".

Remote command:

[TRIGger<m>:TBTO:CRC:CONDition](#) on page 2293

[TRIGger<m>:TBTO:CRC:MIN](#) on page 2294

[TRIGger<m>:TBTO:CRC:MAX](#) on page 2294

Data

Sets the specified data to be triggered on. The data setup consists of the condition and one or two data patterns.

"Condition" Defines the operator to set a specific data, e.g. "Equal" or "Not Equal") or a range.

"Data Min/Data"

Defines the bit pattern of the data pattern.

In binary format, use the following characters: 1; 0; or X (do not care). To enter the pattern in other formats use the bit pattern editor, see [Chapter 14.1.7, "Bit pattern editor"](#), on page 519.

"Data Max" The second data pattern is required to specify a range with conditions "In range" and "Out of range".

Remote command:

[TRIGger<m>:TBTO:DATA:DCONDition](#) on page 2295

[TRIGger<m>:TBTO:DATA:DMIN](#) on page 2296

[TRIGger<m>:TBTO:DATA:DMAX](#) on page 2296

Index

Sets the specified value or range within this series of data that is considered for the analysis. The index setup consists of the condition and one or two index values.

"Condition" Defines the operator to set a specific index, e.g. "Equal" or a range.

"Index Min/Index"

Defines the bit pattern of the index pattern.

In binary format, use the following characters: 1; 0; or X (do not care). To enter the pattern in other formats use the bit pattern editor, see [Chapter 14.1.7, "Bit pattern editor"](#), on page 519.

"Index Max" The second index pattern is required to specify a range with conditions "In range".

Remote command:

[TRIGger<m>:TBTO:DATA:ICONdition](#) on page 2296

[TRIGger<m>:TBTO:DATA:IMIN](#) on page 2297

[TRIGger<m>:TBTO:DATA:IMAX](#) on page 2297

Errors

Sets the type of error events to be triggered on.

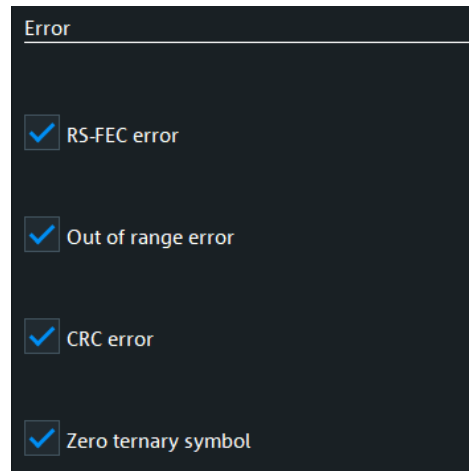

RS-FEC error ← Errors

Triggers, if more than 22 RS-FEC errors are detected.

Remote command:

[TRIGger<m>:TBTO:ERRor:FEC](#) on page 2298

CRC error ← Errors

Triggers on a frame that has a mismatch of the cyclic redundancy check (CRC) value between the transmitting and receiving device.

Remote command:

[TRIGger<m>:TBTO:ERRor:CRc](#) on page 2297

Out of range error ← Errors

Triggers if values are out of range. This can be, for example a preamble error, or invalid symbols in control blocks.

Remote command:

[TRIGger<m>:TBTO:ERRor:OOR](#) on page 2298

Zero ternary symbol ← Errors

Triggers, if a zero ternary symbol pair (0-0) is detected.

Remote command:

[TRIGger<m>:TBTO:ERRor:ZERO](#) on page 2298

14.19.3.2 Triggering on 1000BASE-T1

Prerequisite: A bus is configured for the 1000BASE-T1 signal to be analyzed.

For the basic trigger settings, proceed in the following way:

1. Press the [Bus] key and select the "Shortcuts" tab.
2. Press "Setup trigger".
3. Tap the "Source" button and select the "Serial bus" trigger source.
4. Select the serial bus that is set to 1000BASE-T1.
5. Tap "Type" and select the trigger type to be used for 1000BASE-T1 protocol analysis.
6. To refine the trigger settings, configure additional settings, which are available for some trigger types.

For details, see [Chapter 14.19.3, "1000BASE-T1 trigger"](#), on page 825.

14.19.4 1000BASE-T1 decode results

When the configuration of the serial bus is complete, the signal can be decoded:

1. In the "Serial Bus" dialog > "Setup" tab, enable "Decode".
2. In the "Serial Bus" dialog > "Display" tab, select additional result display settings: "Show table" and "Show binary".
3. If required, enable "Zoom coupling"

For a description of the display settings, see also [Chapter 14.1.3, "Display"](#), on page 513.

The instrument captures and decodes the signal according to the standard definition and the configuration settings.

The color-coding of the various protocol sections and errors simplifies the interpretation of the visual display. The decode information condenses or expands, depending on the horizontal scale. Various data formats are available to show the result values.

Decode Results Table

The example shows decoded signals in 1000BASE-T1.

Ethernet 1000BASE-T1 (option R&S RTO6-K560)

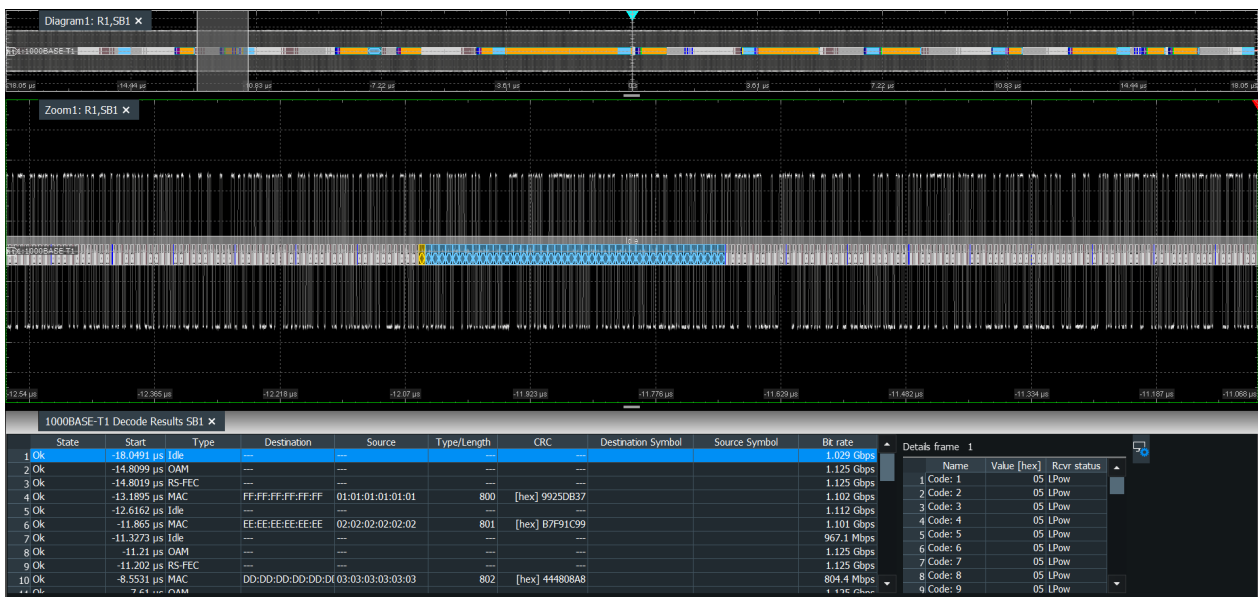

Figure 14-33: 1000BASE-T1 decoded signal

The results are shown in two tables:

- "Decode results": contains information about all decoded frames
- "Details frame": contains more detailed information about the selected frame in the "Decode results" table.

Table 14-30: Content of the Decode results table

Column	Description
Frame	Frame count
State	Overall state of the frame: either OK or the relevant error condition (preamble, CRC or SFD)
Start	Start time of the frame
Type	Type of frame (e.g. Idle, MAC or data)
Destination	Destination symbol of the frame
Source	Source address of the frame
Type/Length	The sub-protocol (e.g. HTML, video, etc.) determines what meaning this field has. Since the content of this data area is not decoded, the interpretation of this field is ambivalent. It could either be the word type (specific for the sub-protocol) or the word length.
CRC	Frame Check (Cyclic Redundancy Code, CRC)
Destination Symbol	Destination address of the frame
Source Symbol	Source symbol of the frame
Data	Values of the data bytes in a frame. The table shows a truncated version; to see all the bytes in a separate data table, activate "Show details". The data format is always hexadecimal.

Column	Description
CRC	Frame Check (Cyclic Redundancy Code, CRC)
Bit rate	Value of the bit rate

Table 14-31: Content of the Details frame table

Column	Description
Name	State of the field
Value [hex]	Hexadecimal value of the field
Rcvr status	Receiver status

Tools

Press "Display settings" in the "Decode Results" table to access the "Display" tab.



Remote commands

Remote commands are described in [Chapter 27.18.20, "Ethernet 1000BASE-T1 \(option R&S RTO6-K560\)"](#), on page 2282.

14.19.5 Search on decoded 1000BASE-T1 data

Using the search functionality, you can find various events in the decoded data. You can find the same events that you can trigger on, and even many more, since several event types can also be combined.

Before you can start the search, you have to configure the bus correctly and acquire decoded data.

To search on decoded data, set the search source to "SerBus" for the configured protocol.

For general information on how to handle the search functionality, see [Chapter 11, "Search functions"](#), on page 425.

14.19.5.1 1000BASE-T1 search setup

Access: [Bus] > "Shortcuts" tab > "Setup search"

Search criteria

Use the "Search criteria" dialog to define the event types to be searched.

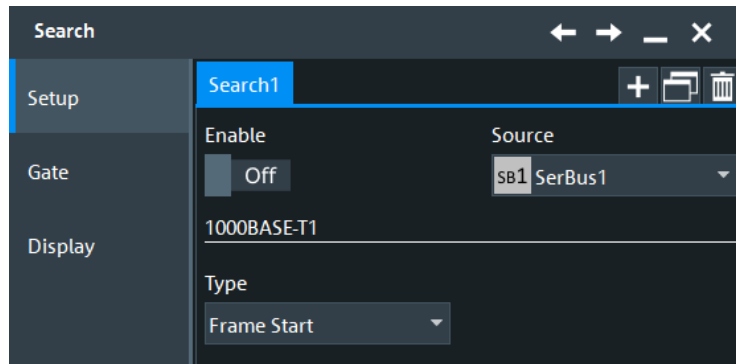
**Type**

Selects the search type for 1000BASE-T1 analysis.

Remote command:

[SEARCH:TRIGger:TBTO:TYPE](#) on page 2309

Frame Start ← Type

Searches for the start of frame.

MAC Frame ← Type

Searches for a Media Access Control (MAC) frame that matches the specified [Destination address](#), [Source address](#), [Length/Type](#), [Frame check](#), [Data](#) or [Index](#) condition.

The frame contains addresses of the devices and MAC control information that define how to go about transmitting and receiving frames.

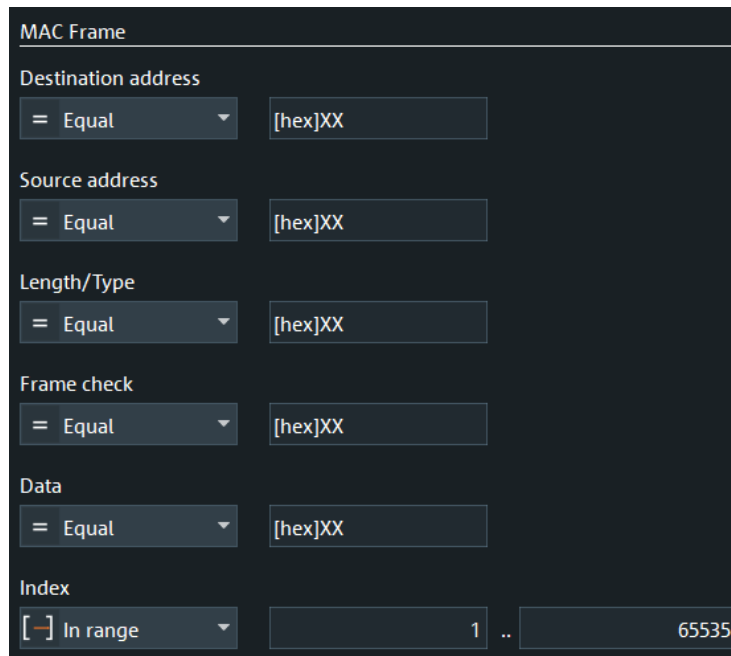
**IDLE ← Type**

Searches for an idle frame. The frame is used for clock synchronization.

Error ← Type

Searches for the specified [error](#) frame.

Destination address

Sets the specified destination address to be searched for. The destination address setup consists of the condition and one or two data patterns.

The destination address corresponds to the address of the interface in the device that receives the frame. If the destination address does not match the interface's own Ethernet address, then the interface is free to ignore the rest of the frame.

"Condition" Defines the operator to set a specific destination address, e.g. "Equal" or "Not Equal") or a range.

"Data Min/Data" Defines the bit pattern of the destination address pattern.
In binary format, use the following characters: 1; 0; or X (do not care). To enter the pattern in other formats use the bit pattern editor, see [Chapter 14.1.7, "Bit pattern editor"](#), on page 519.

"Data Max" The second data pattern is required to specify a range with conditions "In range" and "Out of range".

Remote command:

[SEARCH:TRIGger:TBTO:DADDRESS:CONDition](#) on page 2302

[SEARCH:TRIGger:TBTO:DADDRESS:MIN](#) on page 2303

[SEARCH:TRIGger:TBTO:DADDRESS:MAX](#) on page 2303

Source address

Sets the specified source address to be searched for. The source address setup consists of the condition and one or two data patterns.

The source address is the physical address of the device that sends the frame.

"Condition" Defines the operator to set a specific source address, e.g. "Equal" or "Not Equal") or a range.

"Data Min/Data" Defines the bit pattern of the source address pattern.
In binary format, use the following characters: 1; 0; or X (do not care). To enter the pattern in other formats use the bit pattern editor, see [Chapter 14.1.7, "Bit pattern editor"](#), on page 519.

"Data Max" The second data pattern is required to specify a range with conditions "In range" and "Out of range".

Remote command:

[SEARCH:TRIGger:TBTO:SADDRESS:CONDition](#) on page 2308

[SEARCH:TRIGger:TBTO:SADDRESS:MIN](#) on page 2308

[SEARCH:TRIGger:TBTO:SADDRESS:MAX](#) on page 2308

Length/Type

Sets the specified Length/Type to be searched for. The Length/Type setup consists of the condition and one or two data patterns.

The value in this field indicates the manner in which the field is being used, either as a length or type field. As a length field, the value in the field indicates the number of logical link control (LLC) data octets that follow in the data field of the frame. As a type field, the value in the field is used to indicate the type of protocol data being carried in the data field of the frame.

"Condition" Defines the operator to set a specific Length/Type, e.g. "Equal" or "Not Equal") or a range.

"Data Min/Data" Defines the bit pattern of the Length/Type pattern.
In binary format, use the following characters: 1; 0; or X (do not care). To enter the pattern in other formats use the bit pattern editor, see [Chapter 14.1.7, "Bit pattern editor"](#), on page 519.

"Data Max" The second data pattern is required to specify a range with conditions "In range" and "Out of range".

Remote command:

[SEARCH:TRIGGER:TBTO:LENGTH:CONDITION](#) on page 2307

[SEARCH:TRIGGER:TBTO:LENGTH:MIN](#) on page 2307

[SEARCH:TRIGGER:TBTO:LENGTH:MAX](#) on page 2307

Frame check

Sets the specified frame check to be searched for. The frame check setup consists of the condition and one or two data patterns.

This field contains a value that is used to check the integrity of the various bits in the frame fields (excluding the preamble / SFD).

"Condition" Defines the operator to set a specific frame check, e.g. "Equal" or "Not Equal") or a range.

"Data Min/Data" Defines the bit pattern of the frame check pattern.
In binary format, use the following characters: 1; 0; or X (do not care). To enter the pattern in other formats use the bit pattern editor, see [Chapter 14.1.7, "Bit pattern editor"](#), on page 519.

"Data Max" The second data pattern is required to specify a range with conditions "In range" and "Out of range".

Remote command:

[SEARCH:TRIGGER:TBTO:CRC:CONDITION](#) on page 2301

[SEARCH:TRIGGER:TBTO:CRC:MIN](#) on page 2302

[SEARCH:TRIGGER:TBTO:CRC:MAX](#) on page 2302

Data

Sets the specified data to be searched for. The data setup consists of the condition and one or two data patterns.

"Condition" Defines the operator to set a specific data, e.g. "Equal" or "Not Equal") or a range.

"Data Min/Data"

Defines the bit pattern of the data pattern.

In binary format, use the following characters: 1; 0; or X (do not care).
To enter the pattern in other formats use the bit pattern editor, see [Chapter 14.1.7, "Bit pattern editor"](#), on page 519.

"Data Max"

The second data pattern is required to specify a range with conditions "In range" and "Out of range".

Remote command:

[SEARCH:TRIGger:TBTO:DATA:DCONdition](#) on page 2303

[SEARCH:TRIGger:TBTO:DATA:DMIN](#) on page 2304

[SEARCH:TRIGger:TBTO:DATA:DMAX](#) on page 2304

Index

Sets the specified value or range within this series of data that is considered for the search. The index setup consists of the condition and one or two index values.

"Condition" Defines the operator to set a specific index, e.g. "Equal" or a range.

"Index Min/Index"

Defines the bit pattern of the index pattern.

In binary format, use the following characters: 1; 0; or X (do not care).
To enter the pattern in other formats use the bit pattern editor, see [Chapter 14.1.7, "Bit pattern editor"](#), on page 519.

"Index Max"

The second index pattern is required to specify a range with conditions "In range".

Remote command:

[SEARCH:TRIGger:TBTO:DATA:ICONdition](#) on page 2304

[SEARCH:TRIGger:TBTO:DATA:IMIN](#) on page 2305

[SEARCH:TRIGger:TBTO:DATA:IMAX](#) on page 2305

Errors

Sets the type of error events to be searched for.

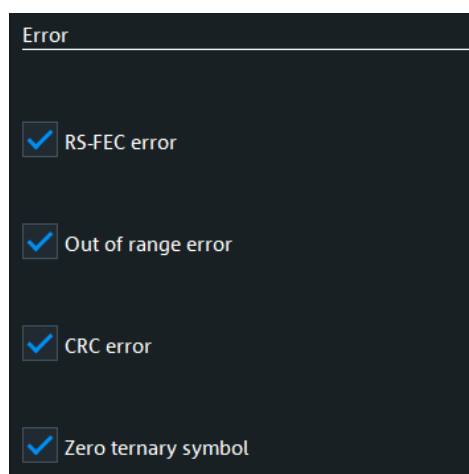
**RS-FEC error ← Errors**

Searches for RS-FEC errors.

Remote command:

[SEARCH:TRIGger:TBTO:ERRor:FEC](#) on page 2306

CRC error ← Errors

Searches for a frame that has a mismatch of the Cyclic Redundancy Check (CRC) value between the transmitting and receiving device.

Remote command:

[SEARCH:TRIGger:TBTO:ERRor:CRC](#) on page 2305

Out of range error ← Errors

Searches for values that are out of range. This can be, for example a preamble error, or invalid symbols in control blocks.

Remote command:

[SEARCH:TRIGger:TBTO:ERRor:OOR](#) on page 2306

Zero ternary symbol ← Errors

Searches for zero ternary symbol pairs (0-0).

Remote command:

[SEARCH:TRIGger:TBTO:ERRor:ZERO](#) on page 2306

14.19.5.2 1000BASE-T1 search results

To get search results, "Enable" the search. You can minimize, shift or close the search dialog.

The search results are listed in the search result table and marked in the waveform by blue lines.

For an introduction to search results, see:

- [Chapter 11.1.2, "Search results"](#), on page 426
- [Chapter 11.4.2, "Display zoom settings"](#), on page 446

Remote commands:

- [SEARCH:RESult:TBTO:FCOunt?](#) on page 2310
- [SEARCH:RESult:TBTO:FRAMe<m>:TYPE?](#) on page 2314
- [SEARCH:RESult:TBTO:FRAMe<m>:STATe?](#) on page 2313
- [SEARCH:RESult:TBTO:FRAMe<m>:START?](#) on page 2313
- [SEARCH:RESult:TBTO:FRAMe<m>:STOP?](#) on page 2313
- [SEARCH:RESult:TBTO:FRAMe<m>:DESTaddress?](#) on page 2310
- [SEARCH:RESult:TBTO:FRAMe<m>:SRCaddress?](#) on page 2312
- [SEARCH:RESult:TBTO:FRAMe<m>:DATA?](#) on page 2310
- [SEARCH:RESult:TBTO:FRAMe<m>:CRC?](#) on page 2310
- [SEARCH:RESult:TBTO:FRAMe<m>:NUMWords?](#) on page 2312
- [SEARCH:RESult:TBTO:FRAMe<m>:FTYPE?](#) on page 2311
- [SEARCH:RESult:TBTO:FRAMe<m>:DSYMBOL?](#) on page 2311

- [SEARCH:RESult:TBTO:FRAMe<m>:SSYMbol?](#) on page 2312
- [SEARCH:RESult:TBTO:FRAMe<m>:WORD<n>:TYPE?](#) on page 2314
- [SEARCH:RESult:TBTO:FRAMe<m>:WORD<n>:VALue?](#) on page 2314
- [SEARCH:RESult:TBTO:FRAMe<m>:WORD<n>:VSTR?](#) on page 2315

14.19.5.3 Searching 1000BASE-T1 data

Prerequisite: A serial bus is configured for the 1000BASE-T1 signal to be decoded and analyzed.

The search for events is set up in the following way:

1. Press the [Bus] key and select the "Shortcuts" tab.
2. Tap "Setup search".
3. If the dialog box does not contain a search entry, tap the "Add" icon to create one, as described in ["To create a user-defined search"](#) on page 440.
4. Tap "Source" and select the serial bus that is set to 1000BASE-T1 (e.g. "SB1", unless already selected).

The search dialog for 1000BASE-T1 protocol analysis opens.

5. Specify search criteria according to [Chapter 14.19.5, "Search on decoded 1000BASE-T1 data"](#), on page 833.
6. To acquire a waveform, press [Single].

The R&S RTO6 performs an 1000BASE-T1 decode according to the thresholds and protocol settings of the associated serial bus source (here in our example SB1).

7. To start searching the acquired waveform for specific events, tap "Enable" in the search setup dialog.

The R&S RTO6 displays the "Search Results" box that lists the detected events.

For information on how to configure the search results presentation and how to navigate the search results, see also ["To display search zoom windows"](#) on page 448.

14.20 USB (option R&S RTO6-K570)

R&S RTO6-K570 is a firmware option that enables the R&S RTO6 to analyze Universal Serial Bus (USB) protocols, by triggering and decoding them. The option is compatible with the standards USB 1.0, USB 1.1, USB 2.0 and USB HSIC (High-Speed Inter-Chip). R&S RTO6-K570 supports the data rates "Low Speed" (1.5 Mbit/s), "Full Speed" (12 Mbit/s) and "High Speed" (480 Mbit/s, available in USB 2.0 and HSIC).

- [The USB protocol](#).....840
- [USB 2.0 configuration](#)..... 845
- [USB 2.0 trigger](#).....851
- [USB 2.0 decode results](#)..... 859
- [Search on decoded USB 2.0 data](#).....860

14.20.1 The USB protocol

The USB protocol was developed, starting in 1996, by the nonprofit organization USB Implementers Forum, Inc. (USB-IF), formed by Compaq, Hewlett-Packard, Intel, Lucent Technologies, Microsoft, NEC, and Philips. The purpose was to provide a common "plug-and-play" solution to replace a multitude of interfaces for the communication between computers and devices. It should allow even unskilled users to easily connect many devices to a PC. USB was originally used for devices that feature low signalling rates (up to 1.5 Mbit/s), especially human interface devices like mouse, joystick or keyboard. With the release of USB 2.0 in April 2000, devices such as printers, cameras and mass storage media were enabled to exchange data at faster rates (up to 480 Mbit/s). Also, the high-speed protocol HSIC (High Speed Inter Chip) is used for the communication between on-board devices.

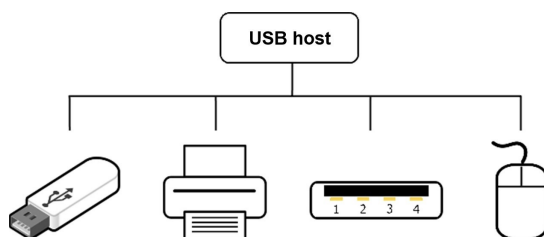

Figure 14-34: USB Topology: mass storage device, printer, USB hub, and mouse (human interface device) connected to a USB host

More information, including the USB specification, is available online within the web domain <http://usb.org>.

This chapter provides an overview of protocol characteristics, data transfer, packet structure, address and endpoint formats of USB and trigger possibilities.

USB characteristics

Main characteristics of USB are:

- **Four-wire design:** USB requires a shielded cable containing four wires. Two of them, called D+ and D-, form a twisted pair (for low speed, they may not be twisted). These data lines transmit differential data signals and single-ended signal states, both referenced to a third wire: the GND or ground. The fourth wire, called VBUS (voltage bus), carries a nominal 5 V supply, which may be used to power a device.
- **Host-to-device communication:** in USBs "speak-when-spoken-to" protocol, communication is always initiated by the host. Consequently, there is no direct communication between USB devices, apart from few exceptions.

- Addressing scheme: a maximum of 127 connected devices can be distinguished, because a packet's address field length is limited to 7 bits. USB devices have up to 16 OUT endpoints (from host to device) and up to 16 IN endpoints (from device to host).
- USB transactions consist of two or three packets: token, data, and typically hand-shake
- Packet type: a packet identifier (PID) is sent as a first byte within the packet and specifies the different packet types.
- NRZI (Non Return to Zero Inverted): a zero (0) is encoded as a transition of the physical level, whereas a one (1) has no transition, thus it is represented by a steady level.

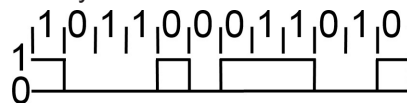

Figure 14-35: Example of an NRZI sequence

- Bit stuffing: a zero (0) is inserted after every 6 consecutive ones (111111). This ensures sufficient transitions to keep the phase-locked loop (PLL) synchronized and locked onto the data stream.
- Little Endian scheme: both multiple bits and multiple bytes are transmitted with the least significant bit/byte (LSB) sent first, while the most significant bit/byte (MSB) is sent last.
- HSIC (High-Speed Inter-Chip): an industry standard for USB chip-to-chip interconnection with a 2-signal (strobe, data) source synchronous serial interface, using 240 MHz DDR signaling to provide only high-speed (480 Mbps) data rate.

Table 14-32: Simplified symbolic representation from the USB standard

Bus State	Protocol	Levels
Differential "1"		D+ High, D- Low
Differential "0"		D+ Low, D- High
Data "J" State	Low speed	D+ Low, D- High (differential "0")
	Full speed	D+ High, D- Low (differential "1")
Data "K" State	Low speed	D+ High, D- Low (differential "1")
	Full speed	D+ Low, D- High (differential "0")

In the example in [Table 14-32](#), High speed can be assumed to be like Full speed. For a complete overview of bus states and for an electrical definition of High and Low speed, refer to chapter 7 of the USB specification.

Data transfer

In contrast to a conventional bus, USB is more like a network protocol, using target addresses and endpoints. However, USB features a bus master, called the host. It transmits packets of data to all devices or hubs connected to the host (or connected to a device or hub, which is in turn connected to the host). All connected devices receive

each data packet, but disregard it unless it carries the correct address. In reply, only the addressed device (one at a time) can send data upstream, to the host.

The USB architecture supports four different kinds of data transfer: control, bulk, interrupt or isochronous transfer. For example, a "bulk OUT" transfer (from host to device) would look like this:

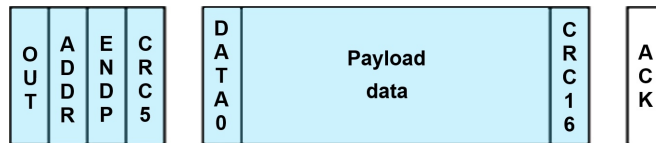

Figure 14-36: Example of a bulk OUT transfer. Blue: host speaks, white: device speaks

Packet structure

All packets must start with a **SYNC** field, also called **SOP** (start of packet), which indicates data transmission. It consists of "KJ" pairs, followed by one "KK". At low speed and full speed (USB 1.x), it is 8 bits long, encoded as "KJKJKJKK". At high speed (USB 2.0 and HSIC), it is up to 32 bits long, encoded as "KJKJKJKJKJK...KK".

The SYNC field is used to synchronize the clock of the receiver with that of the transmitter. The final 2 bits ("KK") indicate where the PID fields starts.

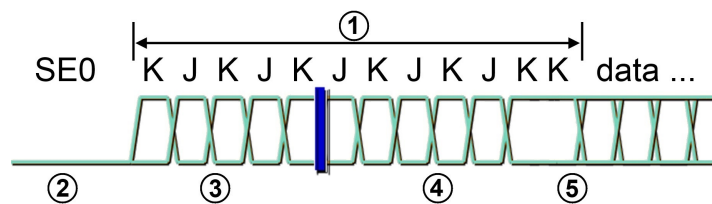

Figure 14-37: Start of a high-speed packet: after an SE0, the packet starts with a SYNC field (or SOP), followed by the data packet

SE0 = Single-ended zero, both D+ and D- wire are on low level

1 = High-speed SYNC field (or SOP), length up to 32 bits

2 = Receiver-squelched differential envelope, below 100 mV

3 = Differential envelope exceeds 150 mV, reception enabled with 4 symbol times

4 = Clock recovery must lock in time to detect end of SYNC

5 = End of SYNC detected, receiver begins data recovery

After the SYNC (or SOP), USB data packets consist of (in this order):

- **PID** (packet identifier): specifies the type of packet. Examples are:
 - Token packets (IN, OUT, SETUP) are always the first packet in a USB transaction, containing the address of the device and its endpoint.
 - Token SOF packets (start of frame) are there to schedule a data transfer.
 - Handshake packets provide the status of the transaction.
 - Data packets are dedicated for the data transfer payload.
 - Various special packets provide special characteristics: for instance, SPLIT packets are used to communicate with low or full speed devices on a high-speed link.

Packet type	Name	PID value	Meaning
	NAK	0x5A	Data not accepted, typically equivalent with some type of EAGAIN, meaning that the data should be resent later
	STALL	0x1E	A severe error has occurred, the target endpoint cannot be addressed until it is explicitly cleared again
	NYET	0x96	Only used in high-speed transfers, meaning ACK, but in the next interval no data can be received, therefore the host should first apply a PING
Special	PRE	0x3C	Starts a low speed transfer via a full speed bus
	ERR	0x3C	Indicates an error in an SPLIT transaction (using the same PID as PRE, however, these cannot be mistaken for each other)
	SPLIT	0x78	Starts an SPLIT transaction (thus: a low speed or full speed transfer via a high-speed bus)
	PING	0xB4	Used for monitoring high-speed data flow

- Token packets (IN, OUT, SETUP) and PING packets have the following format:

SYNC	PID	ADDR	ENDP	CRC5	EOP
------	-----	------	------	------	-----

- Start of frame packets (SOF) have the following format:

SYNC	PID	Frame number	CRC5	EOP
------	-----	--------------	------	-----

- Data packets have the following format:

SYNC	PID	Data	CRC16	EOP
------	-----	------	-------	-----

- Handshake packets have the following format:

SYNC	PID	EOP
------	-----	-----

- SPLIT packets have the following format:

SYNC	PID	ADDR	SC	PORT	S	E	ET	CRC5	EOP
------	-----	------	----	------	---	---	----	------	-----

Trigger possibilities

Signals on the input channels CH1 - CH4 of the R&S RTO6 can be triggered by the option R&S RTO6-K570. The following trigger types are available:

- ANY Packet - Packet Sync: Triggering on the first rising slope after transmission of the packet Sync. Various lengths according to standard (in USB 2.0: 32 bit)
- Any token, OUT, IN, SOF, SETUP, AND-ing with user defined PID check, address, endpoint, CRC5: For OUT, IN, SETUP, the endpoint and CRC5 follow from the bit order, therefore such patterns can be recognized.

- Data Selection: DATA0, DATA1, DATA2, MDATA, (for USB 1.x only: AND-ing with user defined PID check, payload and CRC values)
- Handshake Packet Setup: Triggering on handshake packet, trigger with specific settings: ACK, NAK, NYET, STALL or ERR handshake packet
- Protocol Error: Triggering on PID/check error, CRC5 error, CRC16 (for USB 1.x only), frame length error (for USB 1.x only)
- Bus Event: Triggering on reset, resume, or suspend

14.20.2 USB 2.0 configuration

If you need information on how to get started with configuring the USB 2.0 setup, see [Chapter 14.20.2.2, "Configuring USB signals"](#), on page 850. Otherwise proceed with the configuration settings.

14.20.2.1 USB 2.0 configuration settings

Access: [Bus] > "USB 2.0" > "Setup" tab



Make sure that the tab of the correct serial bus is selected.

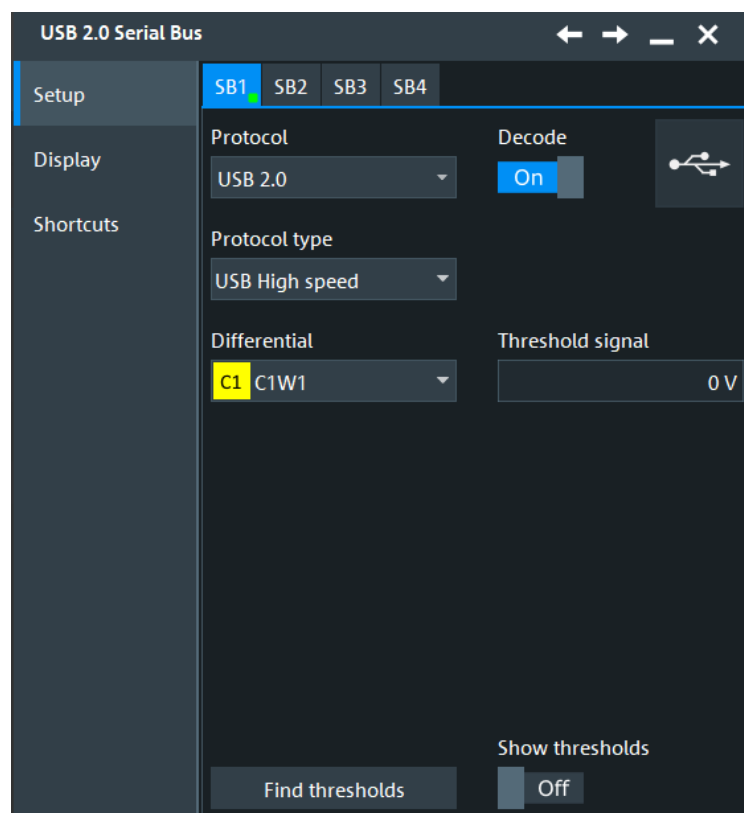

Figure 14-38: Serial bus protocol configuration dialog

See also: [Chapter 14.1.1, "Setup - general settings"](#), on page 511

Protocol type

Defines the USB protocol technology and transmission speed.

"USB Low speed"

Selects USB 2.0 low speed protocol (1.5 Mbit/s).

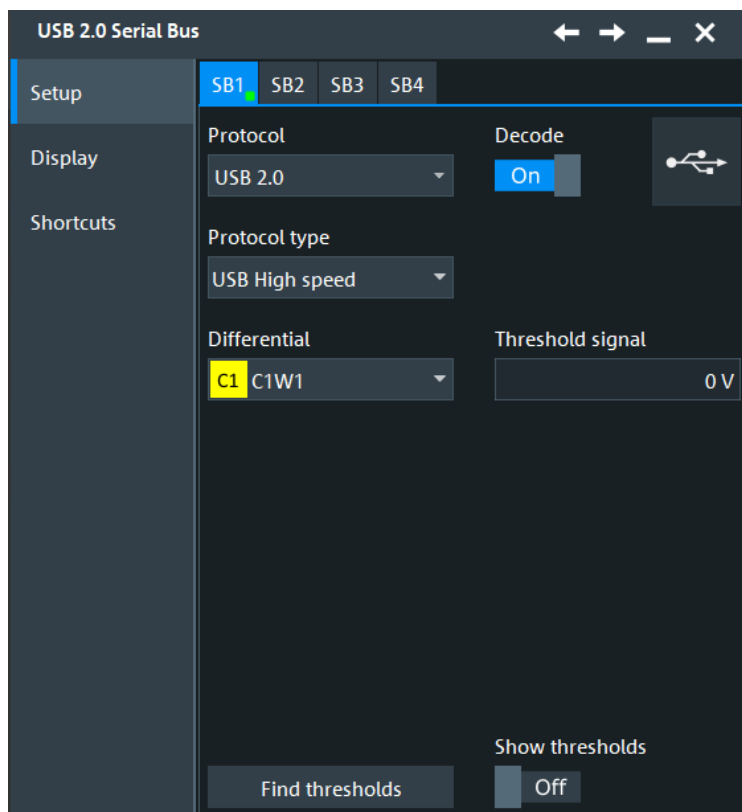

Figure 14-39: USB low speed protocol configuration

"USB Full speed"

Selects USB 2.0 full speed protocol (12 Mbit/s).

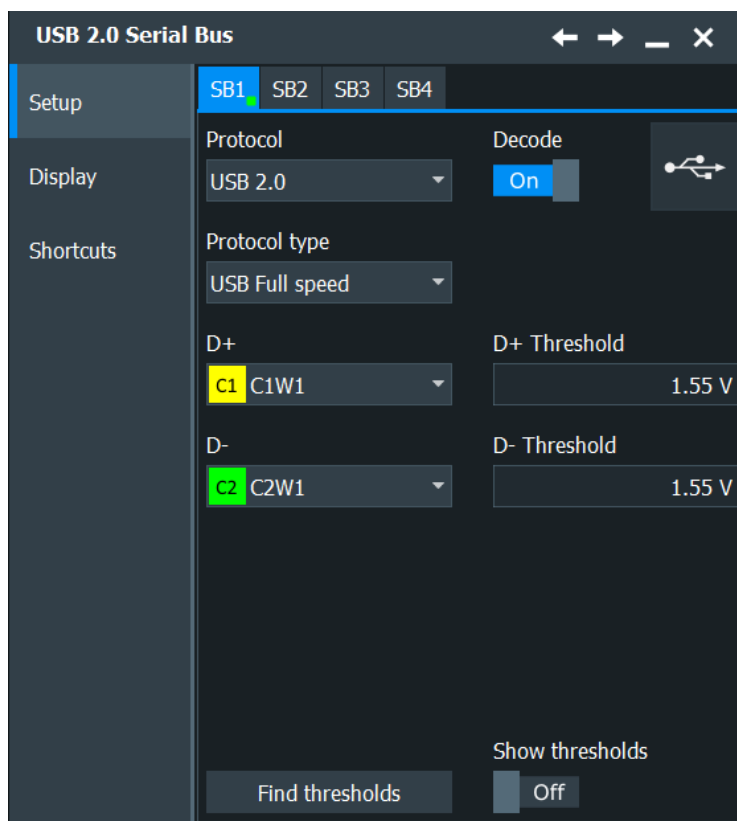

Figure 14-40: USB full speed protocol configuration

"USB High speed"

Selects USB high-speed protocol (480 Mbit/s). As the signal is differential, there is only one source and one threshold to be defined.

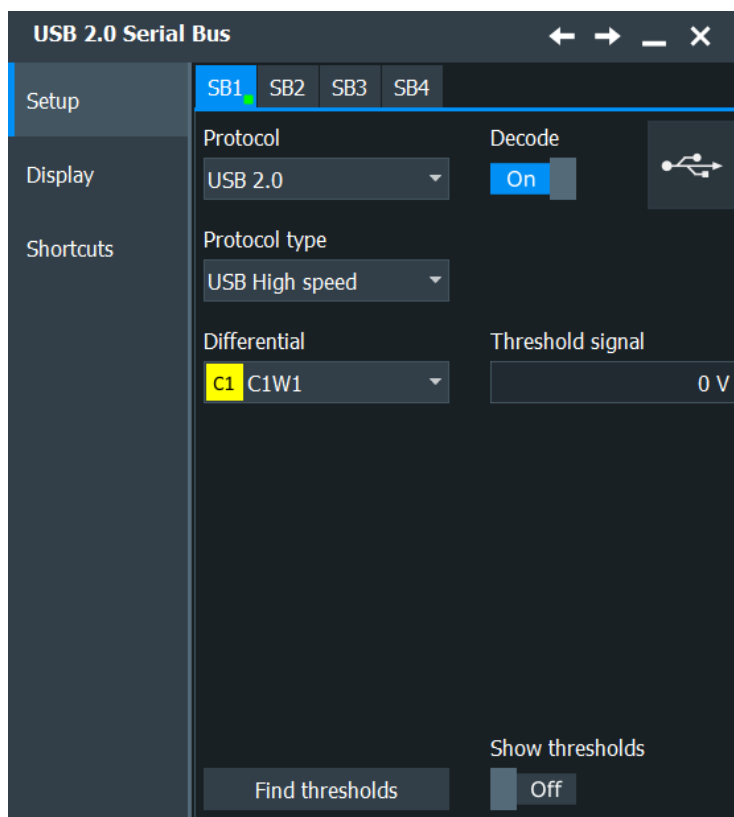

Figure 14-41: USB high-speed protocol configuration

"USB HSIC"

Selects USB high speed inter-chip (HSIC) protocol.

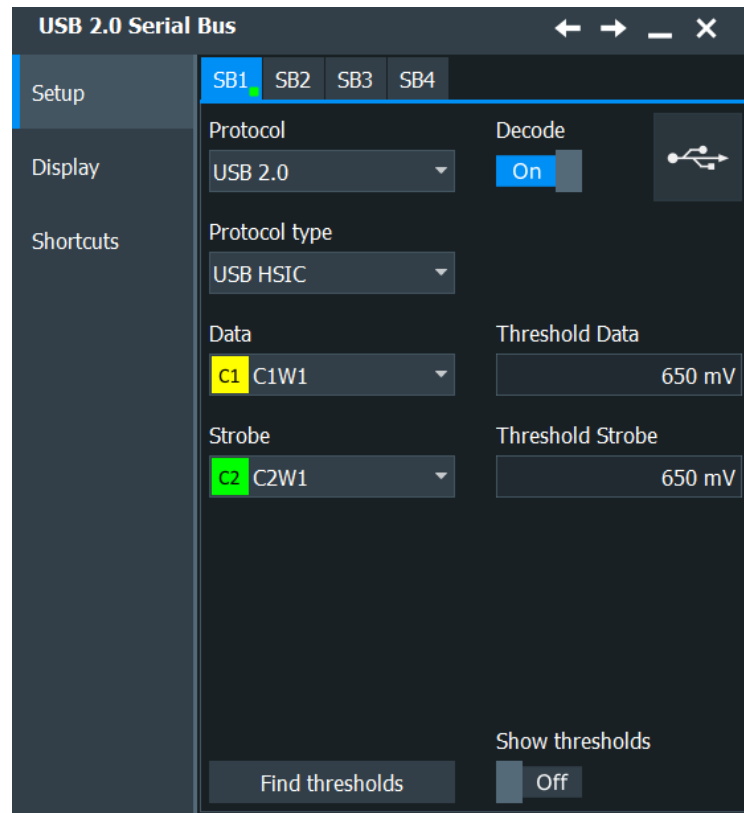

Figure 14-42: USB HSIC protocol configuration

Remote command:

[BUS<m>:USB:TECHnology](#) on page 2316

D+, D-

Define the source settings for the D+ and the D- data signals for USB low speed and USB full speed protocols.

Usually, the source is one of the analog channels. Reference and math waveforms are available as source if the trigger source is one of the analog channels but not the serial bus.

Remote command:

[BUS<m>:USB:DPLus:SOURce](#) on page 2316

[BUS<m>:USB:DMINus:SOURce](#) on page 2316

Differential

Defines the source settings for the differential data signal (in USB high-speed protocol, only). You can select analog channels "C1" to "C4", and also active math and reference waveforms as source. If you want to trigger on the serial bus, analog channel sources are required.

Remote command:

[BUS<m>:USB:DIFFerential:SOURce](#) on page 2317

Data, Strobe

Define the source settings for the data and the strobe signals in USB HSIC protocol. You can select analog channels "C1" to "C4", and also active math and reference waveforms as source. If you want to trigger on the serial bus, analog channel sources are required.

Remote command:

[BUS<m>:USB:DATA:SOURce](#) on page 2317

[BUS<m>:USB:STRobe:SOURce](#) on page 2317

Thresholds

Sets the threshold value for the digitization of each signal line. If the signal value on the line is higher than the threshold, the signal state is high. Otherwise, if the signal value is below the threshold, the signal state is considered low.

"Threshold" Enter the value directly in the field.

"Find thresh-
olds" Executes the measurement of reference levels and sets the thresh-
olds to the middle reference level of the measured amplitude.

Remote command:

[BUS<m>:USB:DPLus:THReshold](#) on page 2318

[BUS<m>:USB:DMINus:THReshold](#) on page 2318

[BUS<m>:USB:DIFFerential:THReshold](#) on page 2318

[BUS<m>:USB:DATA:THReshold](#) on page 2318

[BUS<m>:USB:STRobe:THReshold](#) on page 2319

[BUS<m>:SETReflevels](#) on page 1814

14.20.2.2 Configuring USB signals

For configuration, assign the lines to the input channels and define the active states and the logical thresholds.

For details on configuration settings, see [Chapter 14.20.2.1, "USB 2.0 configuration settings"](#), on page 845.

Serial Bus Setup

1. Press the [Bus] key on the front panel.
2. Select the tab of the bus you want to set up, for example "SB1".
3. In the "Setup" tab, select "Protocol" = "USB 2.0".
4. Tap "Protocol type" and select the protocol type that you want to set up.
5. Depending on the protocol type, select the waveform for each of the available "D+", "D-", "Differential", "Data", and "Strobe" lines.
6. Set the logical thresholds: Either to the middle reference levels with "Find thresholds", or enter a user-defined value directly in the "Threshold" fields.
7. Enable "Decode".

14.20.3 USB 2.0 trigger

If you need information on how to get started with triggering on USB 2.0 signals, see [Chapter 14.20.3.2, "Triggering on USB 2.0"](#), on page 858. Otherwise proceed with the USB 2.0 trigger settings.

14.20.3.1 USB 2.0 trigger settings

Access: [Bus] > "Shortcuts" tab > "Setup trigger"



In this section, all trigger settings are described. Their availability on the instrument depends on the selected USB 2.0 protocol type and trigger type. The user interface of the instrument displays only appropriate settings and guides you through the trigger setup.

For a list of supported trigger conditions, refer to the specifications document.

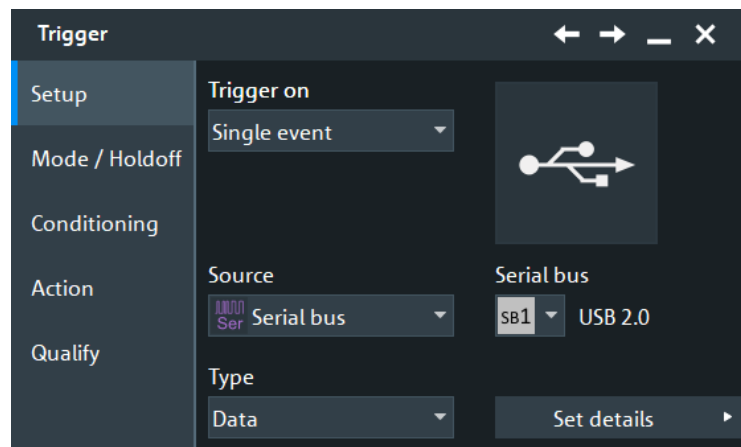

Figure 14-43: USB trigger event settings dialog



Make sure that:

- In the [Bus] > "Setup" tab:
 - The correct "Protocol" is selected.
 - The data sources of the serial bus are channel signals.
- In the "Trigger" > "Setup" tab:
 - The "Trigger on" = "Single event"
 - The trigger "Source" = "Serial bus".
 - The correct "Serial bus" is selected.

Trigger type USB

Selects the trigger type for USB 2.0 analysis. The available trigger types depend on the USB 2.0 protocol type that is selected in the configuration setup, see ["Protocol type"](#) on page 846.

Remote command:

[TRIGger<m>:USB:TYPE](#) on page 2320

Start of packet ← Trigger type USB

Sets the trigger to the SOP (start of packet) field. The start of packet condition is the end of the SYNC field. The trigger instant is the end of the SOP field.

End of packet ← Trigger type USB

Sets the trigger to the EOP (end of packet) field. The trigger instant is the beginning of the EOP field.

Reset ← Trigger type USB

Sets the trigger to the Reset field. For more information on the reset condition, see the USB standard. The trigger instant is the end of the 10 ms period after the SE0 field.

Suspend ← Trigger type USB

Sets the trigger to the Suspend field. For more information on the suspend condition, see the USB standard. The trigger instant will be declared after the defined 3 ms timeout.

Resume ← Trigger type USB

Sets the trigger to the Resume field. For more information on the resume condition, see the USB standard. The trigger instant will be declared after the defined 20 ms timeout.

Token ← Trigger type USB

Sets the trigger to one out of four different token trigger types: OUT, IN, SOF, or SETUP.

See "[Token](#)" on page 853

Data ← Trigger type USB

Sets the trigger to one out of four different data trigger types: DATA0, DATA1, DATA2, or MDATA.

See "[Data](#)" on page 853

Handshake ← Trigger type USB

Sets the trigger to one out of four different handshake trigger types: ACK, NAK, STALL, or NYET.

See "[Handshake](#)" on page 854

Special PID ← Trigger type USB

Sets the trigger to one out of four different Special PID trigger types: PREAMBLE, ERR, SPLIT, or PING.

See "[Special PID](#)" on page 854

Error condition ← Trigger type USB

Sets the trigger to one out of eight different error condition trigger types: Any error, PID error, CRC5 error, CRC16 error, Bitstuff error, Unexpected PID error, SE1 error, or Glitch error.

See ["Error condition"](#) on page 855

Token

Sets the trigger to one out of four different token types:

- "OUT"
- "IN"
- "SOF"
- "SETUP"

If no additional conditions are set, the trigger instant is after the PID.

If the PID error check is selected:

- If an error is found in the PID's complementary form, the trigger is set immediately after the 8th bit of the PID
- If no PID error is found, no trigger is set, even if other selected conditions are met.

Otherwise, the trigger instant is defined by the first occurrence of any of the specified additional conditions.

Remote command:

[TRIGger<m>:USB:TOKen](#) on page 2329

OUT, IN or SETUP ← Token

For the trigger token types "OUT", "IN" or "SETUP", the following conditions can be set:

You can refine the trigger condition:

- See ["PID error"](#) on page 856
- See ["End Point"](#) on page 856
- See ["Address"](#) on page 856

SOF ← Token

For the trigger token type "SOF", the following conditions can be set:

You can refine the trigger condition:

- See ["PID error"](#) on page 856
- See ["Frame number"](#) on page 857

Data

Sets the trigger to one out of four different data types:

- "DATA0"
- "DATA1"
- "DATA2"
- "MDATA"

If no additional conditions are set, the trigger instant is after the PID.

If the PID error check is selected:

- If an error is found in the PID's complementary form, the trigger is set immediately after the 8th bit of the PID
- If no PID error is found, no trigger is set, even if other selected conditions are met.

Otherwise, the trigger instant is defined by the first occurrence of any of the specified additional conditions.

You can refine the trigger condition:

- See "[PID error](#)" on page 856
- See "[Payload](#)" on page 856

Remote command:

[TRIGger<m>:USB:DATA](#) on page 2322

Handshake

Sets the trigger to one out of four different handshake types:

- "ACK"
- "NAK"
- "STALL"
- "NYET"

If no handshake condition is set, the trigger instant is after the PID.

If the PID error check is selected:

- If an error is found in the PID's complementary form, the trigger is set immediately after the 8th bit of the PID.
- If no PID error is found, no trigger is set.

See "[PID error](#)" on page 856

Remote command:

[TRIGger<m>:USB:HAND](#) on page 2326

Special PID

Sets the trigger to one out of four different "Special PID" types:

- "PREamble"
- "ERR"
- "SPLIT"
- "PING"

If no additional conditions are set, the trigger instant is after the PID.

If the PID error check is selected:

- if an error is found in the PID's complementary form, the trigger is set immediately after the 8th bit of the PID

- if no PID error is found, no trigger is set, even if other selected conditions are met. Otherwise, the trigger instant is defined by the first occurrence of any of the specified additional conditions.

Remote command:

[TRIGger<m>:USB:SPEC](#) on page 2328

PREamble or ERR ← Special PID

For the Trigger Special Types "PREamble" and "ERR", the following condition can be set:

See ["PID error"](#) on page 856

SPLIT ← Special PID

For the Trigger Special Type "SPLIT", the following conditions can be set:

You can refine the trigger condition:

- See ["Address"](#) on page 856
- See ["SC"](#) on page 857
- See ["Port"](#) on page 857
- See ["SEU"](#) on page 858
- See ["ET"](#) on page 858
- See ["PID error"](#) on page 856

PING ← Special PID

For the Trigger Special Type "PING", the following conditions can be set:

You can refine the trigger condition:

- See ["Address"](#) on page 856
- See ["End Point"](#) on page 856
- See ["PID error"](#) on page 856

Error condition

Sets the trigger in case of one of the following eight different error condition types.

The trigger instant is the first occurrence of the specified error.

"Any error"	Triggers on any of the errors listed below.
"PID error"	Triggers on any packet identifier error.
"CRC5 error"	Triggers on any CRC5 error event
"CRC16 error"	Triggers on any CRC16 error event
"Bitstuff error"	Triggers in the event of an erroneous or missing bit stuffing sequence (see USB standard).
"Unexpected PID error"	Triggers on any illegal PID. This is a PID that is not allowed in USB low speed and USB full speed protocols, especially PID's announcing packets such as SPLIT, DATA2, MDATA, or other noncompliant packets.
"SE1 error"	Triggers on the illegal bus state Single Ended 1 (SE1 = both lines high).
"Glitch error"	Triggers on an error in the bit period (see USB standard for the definition of glitch).

Remote command:

[TRIGger<m>:USB:ERRC](#) on page 2324

PID error

Defines, whether a packet ID error check is executed or not.

Remote command:

[TRIGger<m>:USB:WPID](#) on page 2331

End Point

Defines, whether an endpoint check that meets specific conditions is executed or not.

"Condition" Defining a specific endpoint or an endpoint range requires to set the operator to one of the following: equal, not equal, less than, less than or equal, greater than, greater than or equal, in range, out of range.

"Min" Specifies an endpoint, or sets the start value of an endpoint range.

"Max" Sets the end value of an endpoint range if "Condition" ([TRIGger<m>:USB:ECONdition](#)) is set to `INRange` or `OORange`.

Remote command:

[TRIGger<m>:USB:WEND](#) on page 2330

[TRIGger<m>:USB:ECONdition](#) on page 2323

[TRIGger<m>:USB:EMIN](#) on page 2324

[TRIGger<m>:USB:EMAX](#) on page 2324

Address

Defines, whether an address check that meets specific conditions is executed or not.

"Condition" Defining a specific address or an address range requires to set the operator to one of the following: equal, not equal, less than, less than or equal, greater than, greater than or equal, in range, out of range.

"Min" Specifies an address, or sets the start value of an address range.

"Max" Sets the end value of an address range if "Condition" ([TRIGger<m>:USB:ACONdition](#)) is set to `INRange` or `OORange`.

Remote command:

[TRIGger<m>:USB:WADD](#) on page 2330

[TRIGger<m>:USB:ACONdition](#) on page 2321

[TRIGger<m>:USB:AMAX](#) on page 2322

[TRIGger<m>:USB:AMIN](#) on page 2322

Payload

Defines, whether a payload check that meets specific conditions is executed or not.

"Condition" Sets the operator "any" or "equal" that allows to trigger for payload data at any position or at a specified position.

"Position" Available only if "Condition" ([TRIGger<m>:USB:DPOperator](#)) is set to *equal*. Specifies the position in which a special data pattern is to be triggered within the payload data packet.

"Data Condition" Sets the operator ("equal" or "unequal", [TRIGger<m>:USB:DCONdition](#)) to set a specific payload data pattern.

"Payload pattern" Specifies the payload data pattern that is to be triggered.

Remote command:

[TRIGger<m>:USB:WPAY](#) on page 2331

[TRIGger<m>:USB:DPOperator](#) on page 2323

[TRIGger<m>:USB:DPOsition](#) on page 2323

[TRIGger<m>:USB:DCONdition](#) on page 2322

[TRIGger<m>:USB:PATT](#) on page 2326

Frame number

Defines, whether a frame number check that meets specific conditions is executed or not.

"Condition" Defining a specific frame number or a frame number range requires to set the operator to one of the following: equal, not equal, less than, less than or equal, greater than, greater than or equal, in range, out of range.

"Min" Specifies a frame number, or sets the start value of a frame number range.

"Max" Sets the end value of a frame number range if "Condition" ([TRIGger<m>:USB:FCONdition](#)) is set to `INRange` or `ORange`.

Remote command:

[TRIGger<m>:USB:WFRN](#) on page 2330

[TRIGger<m>:USB:FCONdition](#) on page 2325

[TRIGger<m>:USB:FMIN](#) on page 2325

[TRIGger<m>:USB:FMAX](#) on page 2325

SC

Defines, whether a Start / Complete SPLIT transaction check is executed or not.

Remote command:

[TRIGger<m>:USB:WSTC](#) on page 2331

[TRIGger<m>:USB:STCO](#) on page 2328

Port

Defines, whether a port check that meets specific conditions is executed or not.

"Condition" Defining a specific port number or a port number range requires to set the operator to one of the following: equal, not equal, less than, less than or equal, greater than, greater than or equal, in range, out of range.

"Min" Specifies a port number, or sets the start value of a port number range.

"Max" Sets the end value of a port number range if "Condition" ([TRIGger<m>:USB:PCONdition](#)) is set to `INRange` or `ORange`.

Remote command:

[TRIGger<m>:USB:WPOR](#) on page 2331

[TRIGger<m>:USB:PCONdition](#) on page 2326

[TRIGger<m>:USB:PMIN](#) on page 2327

[TRIGger<m>:USB:PMAX](#) on page 2327

SEU

Defines, whether an SEU check that meets specific conditions is executed or not. S and E represent the Start and End of a start-split transaction, U represents the reserved/Unused bit of a complete-split transaction. Permissible binary SEU values are 00, 01, 10, and 11.

"Condition"	Defining a specific SEU value or an SEU value range requires to set the operator to one of the following: equal, not equal, less than, less than or equal, greater than, greater than or equal, in range, out of range.
"Min"	Specifies an SEU value, or sets the start value of an SEU value range.
"Max"	Sets the end value of an SEU value range if "Condition" (TRIGger<m>:USB:SCONdition) is set to INRange or OORange.

Remote command:

[TRIGger<m>:USB:WSEU](#) on page 2331

[TRIGger<m>:USB:SCONdition](#) on page 2327

[TRIGger<m>:USB:SMIN](#) on page 2327

[TRIGger<m>:USB:SMAX](#) on page 2328

ET

Defines, whether an Endpoint Type (ET) check that meets specific conditions is executed or not.

"Condition"	Defining a specific endpoint type or an ET range requires to set the operator to one of the following: equal, not equal, less than, less than or equal, greater than, greater than or equal, in range, out of range.
"Min"	Specifies an ET, or sets the start value of an ET range.
"Max"	Sets the end value of an ET range if "Condition" (TRIGger<m>:USB:TCONdition) is set to INRange or OORange.

Remote command:

[TRIGger<m>:USB:WETCheck](#) on page 2330

[TRIGger<m>:USB:TCONdition](#) on page 2329

[TRIGger<m>:USB:TMIN](#) on page 2329

[TRIGger<m>:USB:TMAX](#) on page 2329

14.20.3.2 Triggering on USB 2.0

Prerequisite: A bus is configured for the USB 2.0 signal to be analyzed.

For the basic trigger settings, proceed in the following way:

1. Press the [Bus] key and select the "Shortcuts" tab.
2. Press "Setup trigger".

3. Tap the "Source" button and select the "Serial bus" trigger source.
4. Select the serial bus that is set to USB 2.0.
5. Tap "Trigger Type USB" and select the trigger type to be used for USB protocol analysis.
Available trigger types depend on the USB 2.0 protocol type that is activated in "Protocol type" on page 846.
6. Depending on the selected USB 2.0 protocol type and trigger type, more setup conditions have to be specified.

For information on how to proceed with the configuration settings, see [Chapter 14.20.3.1, "USB 2.0 trigger settings"](#), on page 851.

14.20.4 USB 2.0 decode results

When the configuration of the serial bus is complete, the signal can be decoded:

1. In the "Serial Bus" dialog > "Setup" tab, enable "Decode".
2. In the "Serial Bus" dialog > "Display" tab, select additional result display settings: "Show table" and "Show binary".
3. If required, enable "Zoom coupling"

For a description of the display settings, see also [Chapter 14.1.3, "Display"](#), on page 513.

The instrument captures and decodes the signal according to the standard definition and the configuration settings.

The color-coding of the various protocol sections and errors simplifies the interpretation of the visual display. The decode information condenses or expands, depending on the horizontal scale. Various data formats are available to show the result values.

Decode Results Table

The results are shown in two tables:

- "Decode results": contains information about all decoded frames
- "Details frame": contains more detailed information about the selected frame in the "Decode results" table.

USB 2.0 Decode Results SB1 X								
State	Start	PID	Addr	Endp	Frame	Data	CRC	
1 Ok	-912.8 ns	DATA0	—	—	—	FF	FF00	FF00
2 Ok	-737.8 ns	DATA1	—	—	—	2A 3B	FCA0	
3 Ok	-548.3 ns	DATA2	—	—	—	00 FF 00	CFCF	
4 Ok	-339.9 ns	MDATA	—	—	—	00 FF 11 AA 22 BB 33 CC	5AC5	
5 Ok	-87.2 ns	DATA0	—	—	—	FF	FF00	
6 Ok	262.2 ns	DATA1	—	—	—	2A 3B	FCA0	
7 Ok	451.7 ns	DATA2	—	—	—	00 FF 00	CFCF	
8 Ok	660.1 ns	MDATA	—	—	—	00 FF 11 AA 22 BB 33 CC	5AC5	

Table 14-34: Content of the Decode results table

Column	Description
State	Overall state of the packet: either OK or the relevant error condition (CRC, glitching, ...)
Start	Start time of the packet.
PID	PID type (OUT, IN, DATA0, ...)
Addr	Address of the recipient
Endp	Endpoint of the recipient
Frame	Frame number (in SOF packet)
Data	Values of the payload data bytes. The data format is selected below the table.
CRC	Either CRC5 or CRC16 (data packet PID)

Tools

Press "Display settings" in the "Decode Results" table to access the "Display" tab.

**Remote commands**

Remote commands to retrieve decode results are described in [Chapter 27.18.21.3, "Decode results"](#), on page 2332.

14.20.5 Search on decoded USB 2.0 data

Using the search functionality, you can find various events in the decoded data. You can find the same events that you can trigger on, and even many more, since several event types can also be combined.

Before you can start the search, you have to configure the bus correctly and acquire decoded data.

To search on decoded data, set the search source to "SerBus" for the configured protocol.

For general information on how to handle the search functionality, see [Chapter 11, "Search functions"](#), on page 425.

If you need information on how to get started with searching USB 2.0 data, see [Chapter 14.20.5.3, "Searching USB data"](#), on page 866. Otherwise proceed with the USB 2.0 search setup.

14.20.5.1 USB 2.0 search setup

Access: [Bus] > "Shortcuts" tab > "Setup search"

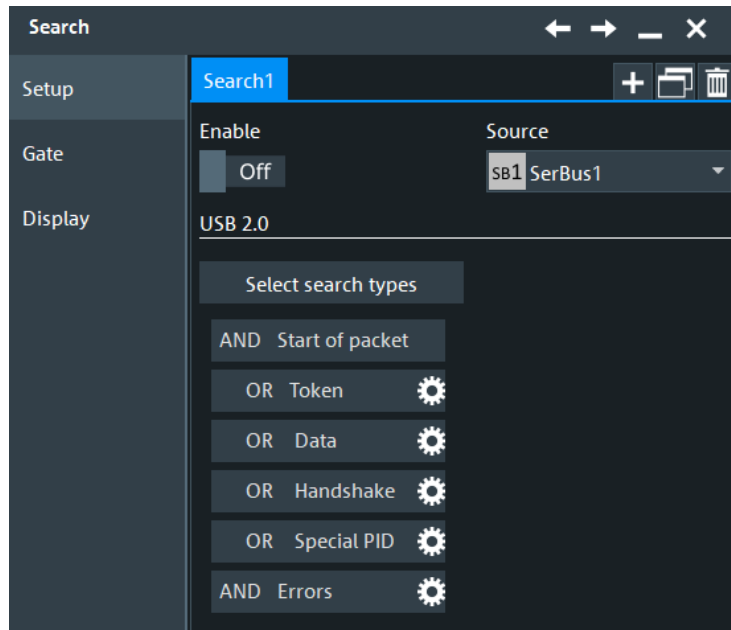

Search types

Use the "Search Types" dialog to define the event types to be searched for.

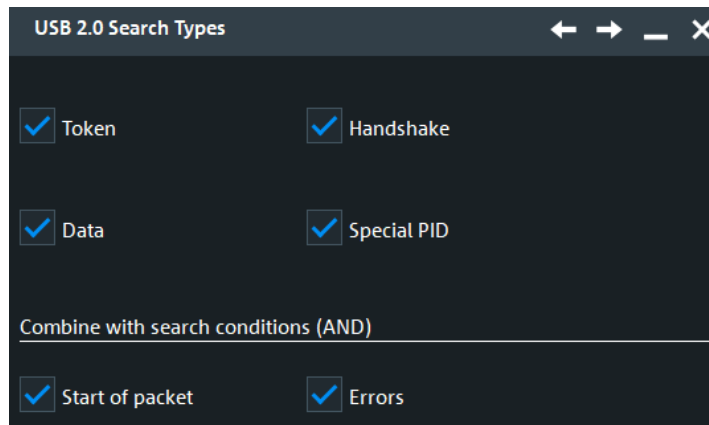

Individual search parameters (which do not depend on the USB protocol type and trigger settings), can be specified in the tabs below the "Search criteria" dialog.

Remote command:

[SEARCH:TRIGger:USB:SSOP](#) on page 2347

[SEARCH:TRIGger:USB:STOKEN](#) on page 2349

[SEARCH:TRIGger:USB:SDATA](#) on page 2347

[SEARCH:TRIGger:USB:SHANDshake](#) on page 2347

[SEARCH:TRIGger:USB:SSPE](#) on page 2348

[SEARCH:TRIGger:USB:SERRor](#) on page 2347

SOP

Searches for any start of packet. There are no additional parameters to be defined.

Token

Searches for four different token types: "OUT", "IN", "SOF", or "SETUP", and "Any" token.

For "Any" token, there are no additional parameters to be defined.

For "OUT", "IN", or "SETUP" tokens, additional search parameters are "Address check" and "End Point check".

You can refine the search condition:

- See ["Address check"](#) on page 863
- See ["End Point check"](#) on page 863

For "SOF" tokens, the additional search parameter is "Frame number check".

You can refine the search condition:

- See ["Frame number check"](#) on page 864

Remote command:

[SEARCH:TRIGger:USB:TOKen](#) on page 2350

Data

Searches for data packets of the following types: DATA0, DATA1, DATA2, or MDATA, and "Any" data packet.

To search for payload in any data packet type, a data pattern and optionally a packet position have to be specified.

You can refine the search condition:

- See ["Payload check"](#) on page 864

Remote command:

[SEARCH:TRIGger:USB:DATA](#) on page 2340

Handshake

Searches for four different handshake packet types: "ACK", "NAK", "STALL", or "NYET", and "Any" handshake packet. There are no additional parameters to be defined.

Remote command:

[SEARCH:TRIGger:USB:HAND](#) on page 2344

Special PID

Searches for four different special packet identifier types: "PREamble", "ERR", "SPLIT", or "PING", and "Any" special PID.

For "Any", "PREamble", or "ERR", there are no additional parameters to be defined.

For "SPLIT", additional search parameters are "Address check", "SC check", "Port check", "SEU check", and "ET check".

You can refine the search condition:

- See ["Address check"](#) on page 863
- See ["SC check"](#) on page 865
- See ["Port check"](#) on page 865
- See ["SEU check"](#) on page 865
- See ["ET check"](#) on page 865

For "PING", additional search parameters are "Address check" and "End Point check".

You can refine the search condition:

- See ["Address check"](#) on page 863
- See ["End Point check"](#) on page 863

Remote command:

[SEARCH:TRIGger:USB:SPEC](#) on page 2348

Error condition

Searches for the following error conditions:

"PID Error"	Searches for packet identifier errors. Remote command: SEARCH:TRIGger:USB:PIDerror on page 2345
"CRC5 Error"	Searches for any CRC5 error event. Remote command: SEARCH:TRIGger:USB:CRC5error on page 2340
"CRC16 Error"	Searches for any CRC16 error event. Remote command: SEARCH:TRIGger:USB:CRC16error on page 2340
"Bitstuff Error"	Searches for bitstuff errors, thus an erroneous or missing bit stuffing sequence (see USB standard). Remote command: SEARCH:TRIGger:USB:BITSterror on page 2339
"Glitch Error"	Searches for glitch errors (errors in the bit period, see USB standard for the definition of glitch). Remote command: SEARCH:TRIGger:USB:GLITCherror on page 2344

Address check

Enables the search for an address that meets specific conditions.

"Condition"	Defining a specific address or an address range requires to set the operator to one of the following: equal, not equal, less than, less than or equal, greater than, greater than or equal, in range, out of range.
"Min"	Specifies an address, or sets the start value of an address range.
"Max"	Sets the end value of an address range if "Condition" (SEARCH:TRIGger:USB:ACONdition) is set to INRange or OORange.

Remote command:

[SEARCH:TRIGger:USB:WADD](#) on page 2351

[SEARCH:TRIGger:USB:ACONdition](#) on page 2338

[SEARCH:TRIGger:USB:AMIN](#) on page 2339

[SEARCH:TRIGger:USB:AMAX](#) on page 2339

End Point check

Enables the search for an endpoint that meets specific conditions.

"Condition"	Defining a specific endpoint or an endpoint range requires to set the operator to one of the following: equal, not equal, less than, less than or equal, greater than, greater than or equal, in range, out of range.
"Min"	Specifies an endpoint, or sets the start value of an endpoint range.
"Max"	Sets the end value of an endpoint range if "Condition" (SEARCH:TRIGGER:USB:ECONdition) is set to <code>INRange</code> or <code>ORange</code> .

Remote command:

[SEARCH:TRIGGER:USB:WEND](#) on page 2351

[SEARCH:TRIGGER:USB:ECONdition](#) on page 2342

[SEARCH:TRIGGER:USB:EMIN](#) on page 2342

[SEARCH:TRIGGER:USB:EMAX](#) on page 2342

Frame number check

Enables the search for a frame number that meets specific conditions.

"Condition"	Defining a specific frame number or a frame number range requires to set the operator to one of the following: equal, not equal, less than, less than or equal, greater than, greater than or equal, in range, out of range.
"Min"	Specifies a frame number, or sets the start value of a frame number range.
"Max"	Sets the end value of a frame number range if "Condition" (SEARCH:TRIGGER:USB:FCONdition) is set to <code>INRange</code> or <code>ORange</code> .

Remote command:

[SEARCH:TRIGGER:USB:WFRN](#) on page 2352

[SEARCH:TRIGGER:USB:FCONdition](#) on page 2343

[SEARCH:TRIGGER:USB:FMIN](#) on page 2343

[SEARCH:TRIGGER:USB:FMAX](#) on page 2343

Payload check

Enables the search for a payload data pattern that meets specific conditions.

"Condition"	Sets the operator "any" or "equal" that allows to search for payload data at any position or at a specified position.
"Position"	Available only if "Condition" (SEARCH:TRIGGER:USB:DPOperator) is set to <i>equal</i> . Specifies the position in which a special data pattern is to be searched within the payload data packet.
"Data Condition"	Sets the operator ("equal" or "unequal", SEARCH:TRIGGER:USB:DCONdition) to set a specific payload data pattern.
"Payload pattern"	Specifies the payload data pattern that is to be searched.

Remote command:

[SEARCH:TRIGGER:USB:WPAY](#) on page 2352

[SEARCH:TRIGGER:USB:DPOperator](#) on page 2341

[SEARCH:TRIGGER:USB:DPOsition](#) on page 2341

[SEARCH:TRIGGER:USB:DCONdition](#) on page 2341

[SEARCH:TRIGGER:USB:PATT](#) on page 2344

SC check

Searches for the selected Start (0) or Complete (1) SPLIT transaction endpoint, or X (do not care).

Remote command:

[SEARCH:TRIGger:USB:WSTC](#) on page 2353

[SEARCH:TRIGger:USB:STCO](#) on page 2349

Port check

Enables the search for a port that meets specific conditions.

"Condition" Defining a specific port number or a port number range requires to set the operator to one of the following: equal, not equal, less than, less than or equal, greater than, greater than or equal, in range, out of range.

"Min" Specifies a port number, or sets the start value of a port number range.

"Max" Sets the end value of a port number range if "Condition" ([SEARCH:TRIGger:USB:PCONdition](#)) is set to INRange or OORange.

Remote command:

[SEARCH:TRIGger:USB:WPOR](#) on page 2352

[SEARCH:TRIGger:USB:PCONdition](#) on page 2344

[SEARCH:TRIGger:USB:PMIN](#) on page 2345

[SEARCH:TRIGger:USB:PMAX](#) on page 2345

SEU check

Enables the search for an SEU that meets specific conditions. (For SEU, see "SEU" on page 858.)

"Condition" Defining a specific SEU value or an SEU value range requires to set the operator to one of the following: equal, not equal, less than, less than or equal, greater than, greater than or equal, in range, out of range.

"Min" Specifies an SEU value, or sets the start value of an SEU value range.

"Max" Sets the end value of an SEU value range if "Condition" ([SEARCH:TRIGger:USB:SCONdition](#)) is set to INRange or OORange.

Remote command:

[SEARCH:TRIGger:USB:WSEU](#) on page 2353

[SEARCH:TRIGger:USB:SCONdition](#) on page 2346

[SEARCH:TRIGger:USB:SMIN](#) on page 2346

[SEARCH:TRIGger:USB:SMAX](#) on page 2346

ET check

Enables the search for an Endpoint Type (ET) that meets specific conditions.

"Condition" Defining a specific endpoint type or an ET range requires to set the operator to one of the following: equal, not equal, less than, less than or equal, greater than, greater than or equal, in range, out of range.

"Min" Specifies an ET, or sets the start value of an ET range.

"Max" Sets the end value of an ET range if "Condition" ([SEARCH:TRIGGER:USB:TCONDITION](#)) is set to INRange or OORange.

Remote command:

[SEARCH:TRIGGER:USB:WETCHECK](#) on page 2351

[SEARCH:TRIGGER:USB:TCONDITION](#) on page 2349

[SEARCH:TRIGGER:USB:TMIN](#) on page 2350

[SEARCH:TRIGGER:USB:TMAX](#) on page 2350

14.20.5.2 USB 2.0 search results

To get search results, "Enable" the search. You can minimize, shift or close the search dialog.

The search results are listed in the search result table and marked in the waveform by blue lines.

For an introduction to search results, see:

- [Chapter 11.1.2, "Search results"](#), on page 426
- [Chapter 11.4.2, "Display zoom settings"](#), on page 446

Remote commands:

- [SEARCH:RESULT:USB:PCOUNT?](#) on page 2358
- [SEARCH:RESULT:USB:PACKET<m>:STATUS?](#) on page 2357
- [SEARCH:RESULT:USB:PACKET<m>:START?](#) on page 2357
- [SEARCH:RESULT:USB:PACKET<m>:STOP?](#) on page 2357
- [SEARCH:RESULT:USB:PACKET<m>:ADDRESS?](#) on page 2354
- [SEARCH:RESULT:USB:PACKET<m>:DATA?](#) on page 2354
- [SEARCH:RESULT:USB:PACKET<m>:CRC?](#) on page 2354
- [SEARCH:RESULT:USB:PACKET<m>:ENDPOINT?](#) on page 2354
- [SEARCH:RESULT:USB:PACKET<m>:ET?](#) on page 2355
- [SEARCH:RESULT:USB:PACKET<m>:FRAME?](#) on page 2355
- [SEARCH:RESULT:USB:PACKET<m>:PID?](#) on page 2355
- [SEARCH:RESULT:USB:PACKET<m>:PORT?](#) on page 2356
- [SEARCH:RESULT:USB:PACKET<m>:SC?](#) on page 2356
- [SEARCH:RESULT:USB:PACKET<m>:SEU?](#) on page 2356

14.20.5.3 Searching USB data

Prerequisite: A serial bus is configured for the USB signal to be decoded and analyzed.

The search for events is set up in the following way:

1. Press the [Bus] key and select the "Shortcuts" tab.
2. Tap "Setup search".

3. If the dialog box does not contain a search entry, tap the "Add" icon to create one, as described in ["To create a user-defined search"](#) on page 440.
4. Tap "Source" and select the serial bus that is set to USB 2.0 (e.g. "SerBus1", unless already selected).
5. Specify search criteria according to [Chapter 14.20.5.1, "USB 2.0 search setup"](#), on page 860.

6. To acquire a waveform, press [Single].

The R&S RTO6 performs a USB 2.0 decode according to the thresholds and protocol settings of the associated serial bus source (here in our example SB1).

7. To start searching the acquired waveform for specific events, tap "Enable" in the search setup dialog.

The R&S RTO6 displays the "Search Results" box that lists the detected events.

For information on how to configure the search results presentation and how to navigate the search results, see also ["To display search zoom windows"](#) on page 448.

14.21 USB 3.1 (option R&S RTO6-K570)

Option R&S RTO6-K570 analyzes Universal Serial Bus (USB) signals encoded by the USB 3.1 Gen1 coding standard. To use the full functionality of the option, you need an instrument that covers the frequency range up to 5 GHz, because the USB 3.1 Gen 1 protocol is defined for data rates up to 5 GHz.

For analysis, USB 3.1 encoded signals can be triggered, decoded and searched.

This chapter describes:

- [The USB 3.1 protocol](#).....867
- [USB 3.1 configuration](#)..... 875
- [USB 3.1 trigger](#).....880
- [USB 3.1 decode results](#)..... 883
- [Search on decoded USB 3.1 data](#).....885

14.21.1 The USB 3.1 protocol

The USB 3.1 protocol standard was published on July 26th, 2013, strongly enhancing the performance of the USB 2.0 protocol. Compared to USB 2.0, USB 3.1 defines a new physical layout, better power distribution and higher data rates.

The USB 3.1 standard features two speed levels (generations):

- **USB 3.1 Gen 1** for 5 Gbps (also labeled "SuperSpeed" or "SS"), encompassing and superseding USB 3.0 (published on November 12th, 2008)
- **USB 3.1 Gen 2** for 10 Gbps (also labeled "SuperSpeedPlus" or "SSP")

While USB 3.1 Gen 2 is not yet very common, you can use a fast oscilloscope (minimum 5 GHz) with option **R&S RTO6-K570** to analyze signals encoded according to the **USB 3.1 Gen 1** protocol.

NOTICE

Oscilloscope must range up to 5 GHz, at least

As the USB 3.1 Gen 1 protocol is defined for data rates up to 5 GHz, option R&S RTO6-K570 requires a fast oscilloscope that covers this frequency range.

USB 3.1 supersedes the USB 3.0 standard but uses, for example, the USB 3.0 Standard-A connector design with 9 pins. Hence, USB 3.1 cables and connectors contain 5 additional wires and pins compared to USB 2.0.



Figure 14-44: USB 3.1 cable cross-section and Standard-A plug - backward compatible with USB 2.0

- A = Shield (braid) / connector shell
 - B = USB 2.0 unshielded twisted pair
 - C = USB 3.0 / USB 3.1 shielded twisted pair
 - D = USB 3.0 / USB 3.1 shielded twisted pair
 - 1 = Voltage bus V_{CC} power supply pin, +5 V
 - 2 = Differential data signal D-
 - 3 = Differential data signal D+
 - 4 = Ground pin for power return
 - 5 = SuperSpeed receiver differential pair Rx-
 - 6 = SuperSpeed receiver differential pair Rx+
 - 7 = Ground drain for signal return
 - 8 = SuperSpeed transmitter differential pair Tx-
 - 9 = SuperSpeed transmitter differential pair Tx+
- * = Connector images courtesy of Wikipedia authors smial and Unconventional2

Table 14-35: Backward compatibility of USB 3.1 connectors

Connector type	USB 3.1	Compatibility	USB 2.0
Standard-A	plug	... is backward compatible with ...	receptacle
	receptacle	... is backward compatible with ...	plug
Standard-B	plug	... is not compatible with ...	receptacle
	receptacle	... is backward compatible with ...	plug
Micro-USB	plug	... is not compatible with ...	receptacle
	receptacle	... is backward compatible with ...	plug

Each item in this list contains:

- the SCPI name of the frame
(hence the name of the frame according to the related [remote control command \(SCPI\)](#))
- the GUI name of the frame, which is sometimes identical with the SCPI name (the GUI names are highlighted in **bold** font and linked to one of [Table 14-36](#) / [Table 14-37](#) / [Table 14-38](#))
- a brief description of the frame type

List of frame types

- ACK - **ACK** = Handshake packet indicating a positive acknowledgment.
- BCNT - **BCNT** = BERT count, with BERT = Bit Error Rate Test. BCNT is a K28.3 sequence followed by the error count symbol EC. See also BEREC.
- BDAT - **BDAT** = BERT data, ordered set of a BERT command. This data sequence (output of the scrambler) is used for BER testing and is equivalent to the logical idle sequence, consisting of scrambled 0.
- BEREC - **BEREC** = BERT error count, ordered set of a BERT command that does not increment the error count register. BEREC is not looped back to the receiver but replaced with BCNT.
- BRST - **BRST** = BERT reset, ordered set of a BERT command. Any time a BRST is received, the error count register EC is set to 0 and the linear feedback shift register (LFSR) for scrambling is set to 0FFFFh. Any number of consecutive BRST ordered sets may be received.
- BIAM - **Bus Interval Adjustment** = The bus interval is the period that establishes the integral boundary of service intervals. It is equivalent to the Microframe interval (THSFRAM) defined in the USB 2.0 specification.
- CP0 - compliance data pattern. Runs in scrambled mode.
- CP1/CP2 - compliance data pattern. Run in unscrambled mode.
- CP3/CP5or6 - compliance data pattern. Run in both scrambled and unscrambled mode.
- DPH - **DPH** = Data Packet Header, containing a type field, the data packet's address, route string, length, and other information about the packet, including a 2-byte checksum (CRC-16).
- DPH n-def - = non-deferred Data Packet Header, containing a type field, the data packet's address, route string, length field replica, and other information about the packet, including a 2-byte checksum (CRC-16). Valid only for USB 3.1 Gen 2.
- DPP - **Data Packet Payload** = The packet's payload data and a 32-bit CRC.
- DPPA - **Data Packet Payload Abort** = Frame ordered set used to abort a data packet payload.
- ERDY - **ERDY** = The Endpoint Ready notification is a handshake packet indicating a positive acknowledgment.
- FWAKE - **Function Wake** = The function wake device notification is sent from a device (that is enabled for remote wakeup) to the host, if it wants to exit from "device suspend" or "function suspend".

- HRR - **Host Role Request** = This notification type is reserved for being issued by a SuperSpeed On-the-Go (SS-OTG) device, if its Role Swap Protocol (RSP) capability has been enabled.
- IDLE - **IDLE** = Logical Idle is a period of one or more symbol periods when no information (packets or link commands) is transferred on the link. The Idle Symbol (IS) is transmitted by a port at any time in the active (U0) state meeting the logical idle definition.
- ITP - **ITP** = Isochronous Timestamp Packet, sent periodically by a host to inform devices on the USB of the current bus time. ITPs are multicast on all active links.
- LTM - **Latency Tolerance** = Latency Tolerance Messaging is an optional normative USB power management feature that utilizes reported BELT (Best Effort Latency Tolerance) values to enable more power efficient platform operation.
- LC - **Link Command** = An eight-symbol sequence used for link-level flow control, retries, power management and device removal.
- LDM - **Link Delay Measurement** = A protocol for determining propagation delays through the USB topology with a high degree of accuracy (sometimes called "Precision Time Measurement").
- NRDY - **NRDY** = The Not Ready response is a handshake packet indicating a negative acknowledgment.
- PING - **PING** = This transaction packet can only be sent by the host, to transition all links, which are in the path to a device, back to the active (U0) state prior to initiating an isochronous transfer.
- PNGR - **PING_RESPONSE** = This transaction packet is sent by a device in response for each PING received from the host.
- PCAP - **Port Capability** = This link management packet describes each port's link capabilities and is sent by both link partners after the successful completion of training and link initialization.
- PCNF - **Port Configuration** = All Enhanced SuperSpeed ports that support downstream port capability can send this link management packet (LMP), which is similar to Port Capability. If a port, which was to be configured in the upstream facing mode, does not receive this LMP within a defined time after link initialization, then the upstream port shall transition to "eSS.Disabled" and a peripheral device shall try to connect at the other speeds this device supports.
- PCNR - **Port Configuration Response** = This link management packet is sent by the upstream port in response to a Port Configuration and indicates its acceptance or rejection.
- SDS - **Start of Data Stream** marks the start of an SDS ordered set. Valid only for USB 3.1 Gen 2.
- SKIP - **SKIP** = SKP compensates for different bit rates between two communicating ports. SKPs may be dynamically inserted or removed from the data stream. SKPEND marks the boundary between SKP symbols and the remainder of the SKP ordered set. (For SuperSpeedPlus operation, unscrambled.)
- STALL - **STALL** = This transaction packet can only be sent by an endpoint on the device. It is used to inform the host that the endpoint is halted or that a control transfer is invalid.

- STATUS - **STATUS** = This transaction packet can only be sent by the host to a control endpoint. It is used to inform a control endpoint that the host has initiated the Status stage of a control transfer.
- SLF - **Set Link Function** = This link management packet is used to configure functionality that can be changed without leaving the active (U0) state.
- SSPD - **Sublink Speed** = Speed of a sublink, which is the collection of receive or transmit lanes between a downstream facing port (DFP) and an upstream facing port (UFP).
- TS1/TS1A/TS1B - **TS1** = Training sequences are ordered sets for initializing bit and symbol alignment and receiver equalization. Examples are TS1, TS2 and TSEQ.
- TS2 - **TS2** = See TS1
- TSEQ - **TSEQ** = See TS1
- U2IT - **U2 Inactivity Timeout** = This link management packet is used to define the timeout from U1 to U2.
- VDT - **Vendor Device Test** = Use of this link management packet is intended for vendor-specific device testing and shall not be used during normal operation of the link.

Other types

- ERRor - **Error** = This is not a frame type, but it is included as an artificial entry in the search and navigate dialog to allow selecting and activating the error search. If the host error bit is set to "1", this state indicates that the host was unable to accept the data. The reason can be a CRC error, length error, value out of range, packet incomplete or unknown error.
- UDEF - **Unknown** = Undefined data cannot be identified as any specific USB 3.1 frame, because the measured signal does not match with the specifications of any defined frame. Therefore, in this case the field is represented by a "?". You cannot search for "Unknown" or trigger on it, but these types are returned, if an unexpected (sub)type has been found. If some rough type identification is possible, the unknown data may fit one of the following descriptions of unknown types.
- UDVN - **Unknown Device Notification** = A Device Notification transaction packet can only be sent by a device, to inform the host of an asynchronous change in a device or interface state (e.g., to identify the function within a device that caused the device to perform a remote wake operation).
- UHP - **Unknown Header Packet** = An undefined header packet that starts with HPSTART, but then the type is invalid.
- ULMP - **Unknown LMP** = A Link Management Packet is a type of header packet primarily used to manage links by communicating information between links partners. LMPs only travel between pairs of directly connected ports.
- UTP - **Unknown TP** = A Transaction Packet is a type of header packet used to communicate information between a device and the host. TPs traverse all the links, directly connecting the host to a device. They have no payload data, instead they are used, e.g., to control the flow of data packets or configure devices and hubs.

The frames listed above consist of individual sets of fields. Some frames only contain one field, others are much longer: up to 29 fields (in case of the "ACK" frame).

We try to represent the structure of these frames. However, one single table that contains all frames and all fields would be very large: 30 by 40 cells. We have therefore split up the full table into the following four smaller tables:

- [Table 14-36](#) contains the **short** frames that end with the "Link Control Word". (This table uses abbreviation, see below.)
- [Table 14-37](#) contains the **long** frames that end with the "Link Control Word". (This table uses abbreviation, see below.)
- [Table 14-38](#) contains the frames that do not end with the "Link Control Word". These frames have no additional fields other than those in the table.
- [Table 14-39](#) contains the types that are no specified USB 3.1 frames.



The frames in both [Table 14-36](#) and [Table 14-37](#) are abbreviated. For the full set of fields, you must add to each frame the 2 fields "HPSTART" and "Type" in the beginning of the frame. Also add a "CRC" field and the 6 fields of the "Link Control Word" at the end of each frame. In [Table 14-39](#), only the "Link Control Word" is abbreviated.

The 2-byte "**Link Control Word**" is used for both link level and end-to-end flow control. The fields in the Link Control Word are detailed in [Table 14-37](#).

Table 14-36: Short frames that start with fields HPSTART and Type and end with CRC and the Link Control Word

Frame	Field3	Field4	Field5	Field6	Field7	Field8	Field9	Field10	Field11
Bus Interval Adjustment	Rsvd	Device Address	SubType	NotType	Rsvd	BusIntAdj	Rsvd		
Function Wake	Rsvd	Device Address	SubType	NotType	Interface	Rsvd	Rsvd		
Host Role Request	Rsvd	Device Address	SubType	NotType	RSP	Rsvd	Rsvd		
ITP	Counter	Delta	Adj Ctrl	Corr	Rsvd	Rsvd			
Latency Tolerance	Rsvd	Device Address	SubType	NotType	BELT	Rsvd	Rsvd		
Link Delay Measurement	SubType	LDM Type	LDMS	Rsvd	Response Delay	Rsvd	Rsvd		
NRDY	Rsvd	Device Address	SubType	Rsvd	D	EPTNum	Rsvd	StreamId	Rsvd
PING	Route String	Device Address	SubType	Rsvd	D	EPTNum	Rsvd	Rsvd	
PING_RESPONSE	Rsvd	Device Address	SubType	Rsvd	D	EPTNum	Rsvd	Rsvd	
Port Configuration	SubType	Link Speed	Rsvd	Rsvd	Rsvd				
Port Configuration Response	SubType	Response Code	Rsvd	Rsvd	Rsvd				
STALL	Rsvd	Device Address	SubType	Rsvd	D	EPTNum	Rsvd	Rsvd	
Set Link Function	SubType	SLF	Rsvd	Rsvd	Rsvd				
U2 Inactivity Timeout	SubType	U2 IT	Rsvd	Rsvd	Rsvd				
Vendor Device Test	SubType	VDT	Rsvd	Vendor Def	... for fields no. 1, 2 and n+x see Table 14-37				

Table 14-37: Long frames that start with fields HPSTART and Type and end with CRC and the Link Control Word

Frame	Fid.3	Field4	Fid.5	Field6	Fid.7	Field8	Field9	F.10	Fid.11	Fid.12	Fid.13	F.14	F.15	Fid.16	F.17	F.18	F.19	F.20	F.21	F.22																												
ACK	Route String	Device Address	Sub-Type	Rsvd	rty	D	EPT-Num	TT	HE	NumP	SeqNum	Rsvd	TPF	StreamId	Rsvd	SSI	WPA	DBI	PP	NBI																												
DPH	Route String	Device Address	Seq-Num	Rsvd	EOB	D	EPT-Num	TT	S	Length	StreamId	Rsvd	SSI	WPA	DBI	PP	NBI																															
ERDY	Rsvd	Device Address	Sub-Type	Rsvd	D	EPT-Num	Rsvd	NumP	Rsvd	StreamId	Rsvd																																					
Port Capability	Sub-Type	Link Speed	Rsvd	Num HP Buf	Rsvd	Dir	OTG	Rsvd	Tie-breaker	Rsvd	Rsvd																																					
STA-TUS	Route String	Device Address	Sub-Type	Rsvd	D	EPT-Num	Rsvd	Rsvd	PP	Rsvd																																						
Sublink Speed	Rsvd	Device Address	Sub-Type	Not-Type	Rsvd	TPF	Rsvd	LSE	ST	Rsvd	Lanes	LP	LSM																																			
Ahead of Field 3, add these two fields (Field1 + Field2):																																																
Field1							Field2							Field3																																		
HPSTART							Type							see above																																		
After the last field (n), add CRC + the "Link Control Word":																																																
Field n+1							Field n+2							Field n+3							Field n+4							Field n+5							Field n+6							Field n+7						
CRC							Hdr#							Rsvd							Hub#							DLY							DFR							CRC						

Table 14-38: Frames without additional fields other than in this table

Frame	Field1	Field2	Field3	Field4	Field5	Field6	F.7	Fld.8	Field9
BCNT	BERC	EC							
BDAT	BDAT								
BERC	BERC								
BRST	COM	BRST							
Data Packet Payload	HPSTART	Data	CRC	DPPEND					
Data Packet Payload Abort	HPSTART	Data	CRC	DPPABORT					
IDLE	Idle								
Link Command	LCSTART	SubType	CRC	SubType	CRC				
SKIP	SKP								
TS1	COM	Rsvd	Train	Rsvd	Loop	Scramble	LL	Rsvd	TS1ID
TS2	COM	Rsvd	Train	Rsvd	Loop	Scramble	LL	Rsvd	TS2ID
TSEQ	COM	Symbol							

And finally the remaining types that are no specified USB 3.1 frames:

Table 14-39: Other types

Type	Field1	Field2	Field3	Field4	Field5	Field6	Field7	Field8	Field9
Error	CRC Error	Length Error	Unknown	Value out of range	Packet Incomplete				
Unknown	?								
Unknown Device Notification	HPSTART	Type	Rsvd	Device Address	SubType	NotType	?	CRC	LCW
Unknown Header Packet	HPSTART	Type	?	?	CRC	LCW			
Unknown LMP	HPSTART	Type	SubType	?	?	CRC	LCW		
Unknown TP	HPSTART	Type	Rsvd	Device Address	SubType	?	?	CRC	LCW

LCW = Link Control Word, see Table 14-37, occupies the last 6 fields.

More information on the USB 3.1 protocol, including all specifications down to the field contents, is available in the "Universal Serial Bus 3.1 Specification" documentation. Refer to the online resources at www.usb.org.

14.21.2 USB 3.1 configuration

If you need information on how to get started with configuring the USB setup, see Chapter 14.21.2.3, "Configuring USB 3.1 signals", on page 879. Otherwise proceed with the configuration settings.

14.21.2.1 USB 3.1 configuration settings

Access: [Bus] > "USB 3.1" > "Setup" tab



Make sure that the tab of the correct serial bus is selected.

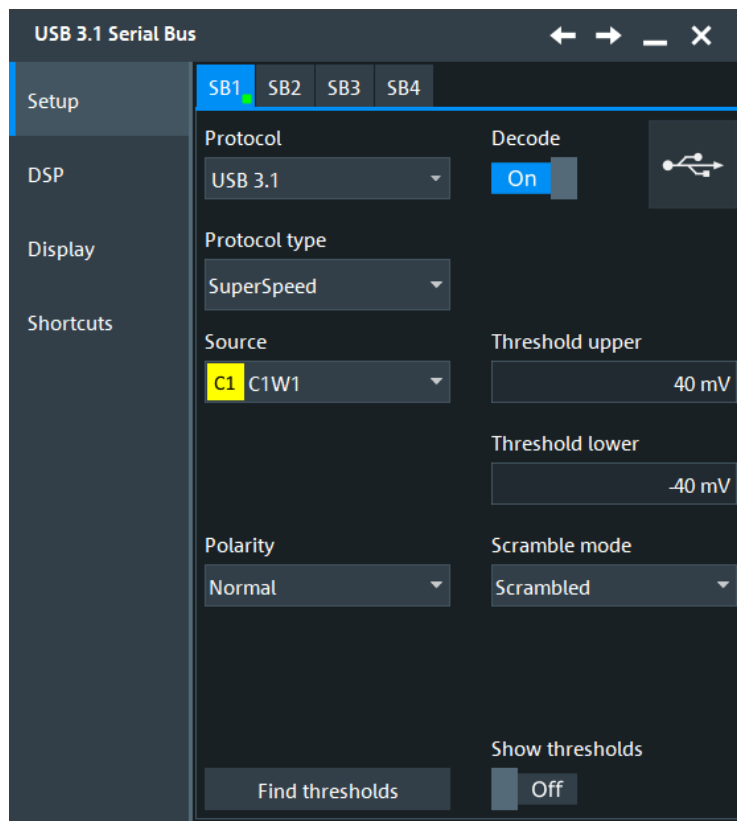

Figure 14-46: Serial bus protocol configuration dialog

See also: [Chapter 14.1.1, "Setup - general settings"](#), on page 511

Protocol type

Selects the USB 3.1 protocol type.

"SuperSpeed"

USB 3.1 Gen 1 with 5 Gbit/s data rate.

Remote command:

`BUS<m>:USBThree:TYPE` on page 2360

Source

Defines the source for the data signal. You can select analog channels "C1" to "C4", and also active math and reference waveforms as source. If you want to trigger on the serial bus, analog channel sources are required.

Remote command:

[BUS<m>:USBThree:SOURce](#) on page 2358

Polarity

Defines the signal polarity settings. Permitted selections are "Normal" and "Inverted".

Remote command:

[BUS<m>:USBThree:POLarity](#) on page 2359

Thresholds

Sets the threshold values for digitization of the analog signals.

The USB 3.1 standard uses 2-state signals with an upper and a lower voltage level. Permitted thresholds values are in the range of -2 V to +2 V, the default is -40 mV to +40 mV.

If the signal value on the line is higher than the upper threshold, the signal state is considered high. Otherwise, if the signal value is below the lower threshold, the signal state is considered low. The two threshold levels allow configuring a hysteresis setting.

There are two ways to set the thresholds:

"Threshold" Enter the upper and lower values directly into the fields.

"Find thresh- Executes the measurement of reference levels and sets the thresh-
olds" olds to the middle reference level of the measured amplitude.

Remote command:

[BUS<m>:USBThree:THRHigh](#) on page 2359

[BUS<m>:USBThree:THRLow](#) on page 2359

[BUS<m>:SETReflevels](#) on page 1814

Scramble Mode

Selects if the data pattern is scrambled or unscrambled. Scrambling as specified in the standard minimizes EMI emissions, the unscrambled mode can simplify testing and debugging.

Remote command:

[BUS<m>:USBThree:SCRMode](#) on page 2360

Show thresholds

If enabled, the threshold levels are displayed in the diagram.

Remote command:

[BUS<m>:THReshold](#) on page 1815

14.21.2.2 USB 3.1 DSP settings

Access: [Bus] > "Setup" tab > "Protocol = USB 3.1" > "DSP" tab

At this tab, you can enable and define the equalization techniques used for the equalization at the receiver side of the signal.

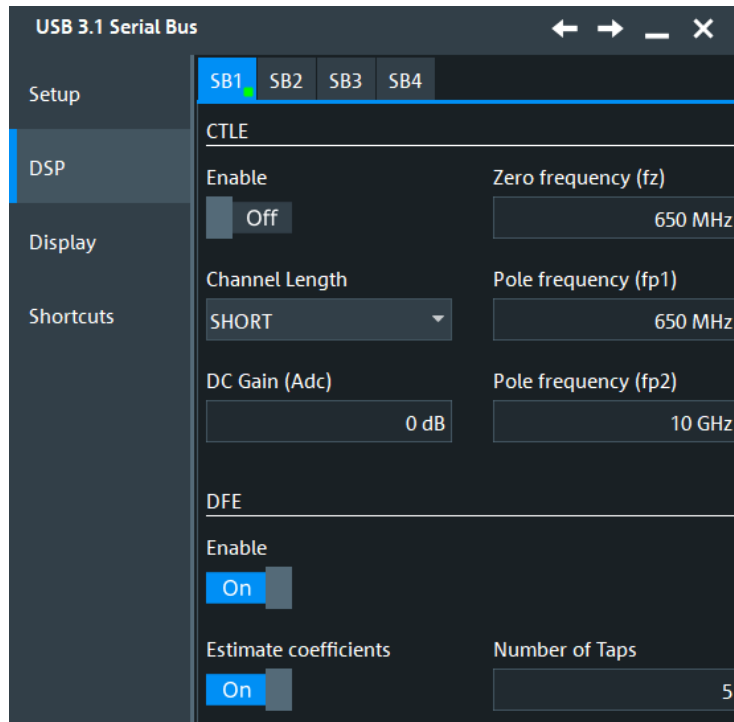

CTLE

Continuous time linear equalization (CTLE) is an equalization that can be used for improving the signal performance. It boosts the high frequency noise and the signal. Thus it helps reduce the inter-symbol interference (ISI) on the receiver side.

Enable ← CTLE

Enables the CTLE equalization.

Remote command:

`BUS<m>:CTLE:ENBLE` on page 2361

Zero frequency (fz) ← CTLE

Sets the zero frequency for the transfer function of the CTLE algorithm.

Remote command:

`BUS<m>:CTLE:Z1FReq` on page 2362

Pole frequency (wp1)/(wp2) ← CTLE

Sets the pole 1/2 frequency for the transfer function of the CTLE algorithm.

Remote command:

`BUS<m>:CTLE:P1FReq` on page 2361

`BUS<m>:CTLE:P2FReq` on page 2361

DC Gain (A_{dc}) ← CTLE

Sets the adjustable DC gain. This value can be chosen according to the channel loss characteristics. For low-loss channels, you can set a value close to 0 dB.

Remote command:

`BUS<m>:CTLE:DCGain` on page 2361

Channel Length ← CTLE

Selects the USB Super Speed channel length.

Remote command:

`BUS<m>:USBThree:PROTOCOL` on page 2363

DFE

Defines the settings of the decision feedback equalization (DFE). DFE correction is needed when the channel is distorted.

Enable ← DFE

Enables the use of the decision feedback equalization.

Remote command:

`BUS<m>:USBThree:DFE:ENABLE` on page 2363

Estimate coefficients ← DFE

Enables the use of estimate coefficients.

Remote command:

`BUS<m>:USBThree:DFE:ESTCOEFF` on page 2363

Coefficient ← DFE

Sets the value of the coefficient.

Remote command:

`BUS<m>:USBThree:DFE:COEFFICIENT` on page 2362

Number of Taps ← DFE

Sets a number of taps for the decision feedback filter.

Remote command:

`BUS<m>:USBThree:DFE:TCONT` on page 2363

14.21.2.3 Configuring USB 3.1 signals

For configuration, assign the lines to the input channels and define the active states and the logical thresholds.

1. Press the [Bus] key on the front panel.
2. Select the tab of the bus you want to set up, for example "SB1".
3. In the "Setup" tab, set "Protocol"="USB3.1".
4. Select the "Protocol type".
5. Switch back to the "Setup" tab.
6. Set the logical thresholds: Either enter user-defined values directly in the "Threshold" fields, or set the thresholds to the middle reference levels with "Auto thresholds".
7. Enable "Decode".

For details on configuration settings, see [Chapter 14.21.2.1, "USB 3.1 configuration settings"](#), on page 876.

14.21.3 USB 3.1 trigger

If you need information on how to get started with triggering on USB 3.1 signals, see [Chapter 14.21.3.2, "Triggering on USB 3.1"](#), on page 883. Otherwise proceed with the USB 3.1 trigger settings.

14.21.3.1 USB 3.1 trigger settings

Access: [Bus] > "Shortcuts" tab > "Setup trigger"

In this section, all trigger settings for USB 3.1 are described. The user interface of the instrument guides you through the trigger setup.

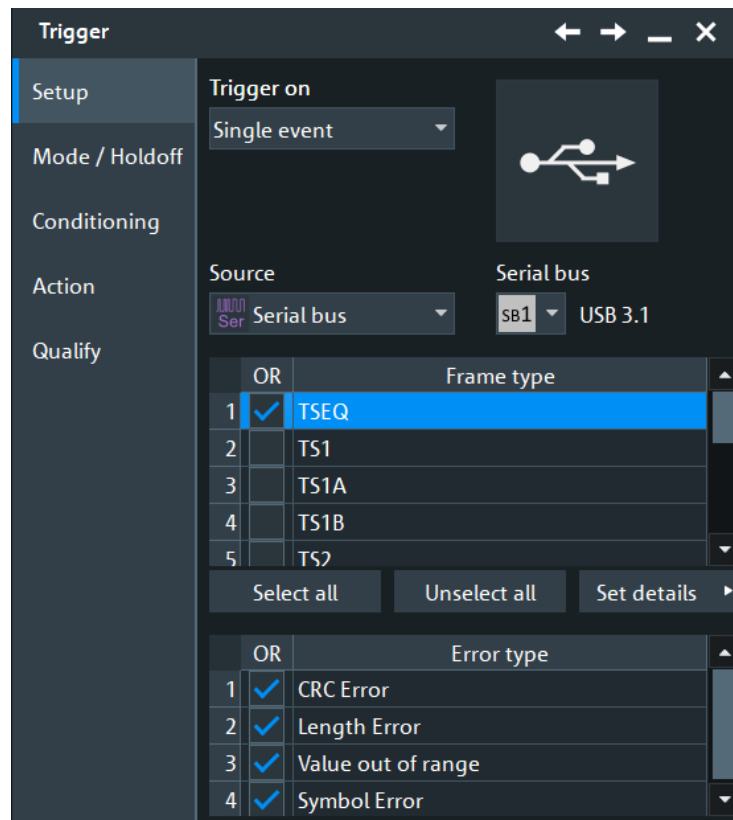



Make sure that:

- In the [Bus] > "Setup" tab:
 - The correct "Protocol" is selected.
 - The data sources of the serial bus are channel signals.
- In the "Trigger" > "Setup" tab:
 - The "Trigger on" = "Single event"
 - The trigger "Source" = "Serial bus".
 - The correct "Serial bus" is selected.

Protocol type

Selects the protocol type for the USB 3.1 analysis.

Frame type

Selects the frame type for USB 3.1 analysis. For the available frame types, see "[Frame types](#)" on page 869.

You can define individual checking parameters for the fields listed in the "Set details" dialog.

The trigger instant is the last criterion that is fulfilled.

Remote command:

[TRIGger<m>:USBThree:FREnable](#) on page 2371

[TRIGger<m>:USBThree:FRAME<n>:ENABLE](#) on page 2371

Error types: Item name, Enable

The table lists the error types you can trigger on: "CRC Error", "Length Error", "Value out of range", "Symbol Error". Enable any error that you want to trigger on in the "OR" column.

Remote command:

[TRIGger<m>:USBThree:ERENable](#) on page 2370

[TRIGger<m>:USBThree:ERRor<n>:ENABLE](#) on page 2370

Set details

Select the frame type first, and then open the "Set details" dialog.

In this dialog to define the individual parameters for the fields of the selected frame.

TS1		
AND	Field	Condition
<input type="checkbox"/>	Train	
<input type="checkbox"/>	Loop	
<input type="checkbox"/>	Scramble	
<input type="checkbox"/>	LL	
<input type="checkbox"/>	Retimer	

Train
Value
X

Field name / Condition Summary / Enable ← Set details

This table lists the field numbers and names in the selected frame together with a summary of the user settings of checking conditions for each field and a checkbox to enable the checking.

It also shows the user settings of checking conditions for each field and a checkbox to enable the checking.

Select a field in the table to specify the checking conditions for this field in the "Set details" dialog.

For an overview of frames and fields, see [Frame types](#).

Remote command:

[TRIGger<m>:USBThree:FIENable](#) on page 2371

[TRIGger<m>:USBThree:FRAMe<n>:FLD<o>:ENABLE](#) on page 2371

Data

Defines for the selected field, how a data check is executed.

"Condition" Sets the comparison condition to a specific value or a range.

"Min" Specifies the value or sets the start value of a range.

"Max" Sets the maximum value of a range for "Condition" = "In range"/"Out of range".

Remote command:

[TRIGger<m>:USBThree:DOPerator](#) on page 2372

[TRIGger<m>:USBThree:FRAMe<n>:FLD<o>:DOPerator](#) on page 2372

[TRIGger<m>:USBThree:DMIN](#) on page 2372

[TRIGger<m>:USBThree:FRAMe<n>:FLD<o>:DMIN](#) on page 2372

[TRIGger<m>:USBThree:DMAX](#) on page 2373

[TRIGger<m>:USBThree:FRAMe<n>:FLD<o>:DMAX](#) on page 2373

Data BitState

Defines the data bit state to be checked for the selected field. Permitted bit states are "1", "0" or "X" (do not care).

Remote command:

[TRIGger<m>:USBThree:BIT](#) on page 2373

[TRIGger<m>:USBThree:FRAMe<n>:FLD<o>:BIT](#) on page 2373

Index

The trigger index setup consists of a comparison condition and one or two address patterns.

"Condition"	Sets the comparison condition to a specific value or a range.
"Min"	Specifies the value or sets the start value of a range.
"Max"	Sets the maximum value of a range for "Condition" = "In range"/"Out of range".

Remote command:

[TRIGger<m>:USBThree:IOPerator](#) on page 2374

[TRIGger<m>:USBThree:FRAMe<n>:FLD<o>:IOPerator](#) on page 2374

[TRIGger<m>:USBThree:IMIN](#) on page 2374

[TRIGger<m>:USBThree:FRAMe<n>:FLD<o>:IMIN](#) on page 2374

[TRIGger<m>:USBThree:IMAX](#) on page 2374

[TRIGger<m>:USBThree:FRAMe<n>:FLD<o>:IMAX](#) on page 2374

14.21.3.2 Triggering on USB 3.1

Prerequisite: A bus is configured for the USB 3.1 signal to be analyzed.

For the basic trigger settings, proceed in the following way:

1. Press the [Bus] key and select the "Shortcuts" tab.
2. Press "Setup trigger".
3. Tap the "Source" button and select the "Serial bus" trigger source.
4. Select the "Protocol Type".
5. If you trigger on errors, enable the error types you want to find.
6. Select the frame types you want to trigger on.
7. For some frame types, you can define the frame fields.
For information on the configuration settings, see [Chapter 14.21.3.1, "USB 3.1 trigger settings"](#), on page 880.

14.21.4 USB 3.1 decode results

When the configuration of the serial bus is complete, the signal can be decoded:

1. In the "Protocol" dialog > "Setup" tab, enable "Decode".

2. In the "Protocol" dialog > "Display" tab, select additional result display settings: "Show decode table" and "Show binary signals".

For a description of the display settings, see also [Chapter 14.1.3, "Display"](#), on page 513.

The instrument captures and decodes the signal according to the standard definition and the configuration settings.

The color-coding of the various protocol sections and errors simplifies the interpretation of the visual display. The decode information condenses or expands, depending on the horizontal scale. Various data formats are available to show the result values.

Decode Results Table

The results are shown in two tables:

- "Decode results": contains information about all decoded frames
- "Details frame": contains more detailed information about the selected frame in the "Decode results" table.

The screenshot shows two tables from the USB 3.1 Decode Results interface. The left table, titled 'USB 3.1 Decode Results S81', has columns: State, Start, Frame type, and Info. The right table, titled 'Details frame 1', has columns: State, Type, Numeric, and Formatted.

State	Start	Frame type	Info
1 Ok	-666.76 ns	TSEQ	---
2 Ok	-602.76 ns	T51	---
3 Ok	-570.76 ns	Skip	---
4 Ok	-566.77 ns	Skip	---
5 Ok	-562.77 ns	T52	---
6 Ok	-530.76 ns	Idle	---
7 Ok	-514.76 ns	Set Link Function	SLF=Assert
8 Ok	-474.76 ns	U2 Inactivity Timeout	U2.IT=05h
9 Ok	-434.76 ns	Vendor Device Test	[2] 600D600D 1CABBA6E
10 Ok	-394.76 ns	Port Capability	Link Speed=01h

State	Type	Numeric	Formatted
1 Ok	COM	[hex] BC	K28.5-
2 Ok	Symbol: 1	[hex] FF	D31.7+
3 Ok	Symbol: 2	[hex] 17	D23.0+
4 Ok	Symbol: 3	[hex] C0	D0.6+
5 Ok	Symbol: 4	[hex] 14	D20.0-
6 Ok	Symbol: 5	[hex] B2	D18.5
7 Ok	Symbol: 6	[hex] E7	D7.7+
8 Ok	Symbol: 7	[hex] 02	D2.0-
9 Ok	Symbol: 8	[hex] 82	D7.4-

Table 14-40: Content of the Decode results table

Column	Description
Frame	Frame number
State	Overall state of the frame, for example "OK" or "Incomplete"
Start	Start time of the frame
Frame Type	Type of the frame
Info	Specific frame information, for example result of the Link Speed Measurement = 5.0 Gb/s, or content of the Data Packet Payload

Enable "Details" in the decode table to display a more detailed analysis of the selected frame.

Table 14-41: Content of the Details frame table

Column	Description
State	Overall state of the field
Start	Start time of the field
Stop	Stop time of the field
Type	Type (name) of field

Column	Description
Numeric value	The numeric value of the field
Formatted	Formatted content of the field, for example HPSTART "F7" = end packet framing (EPF)

Remote commands

Remote control commands for retrieving decode results are described in [Chapter 27.18.22, "USB 3.1 \(option R&S RTO6-K570\)"](#), on page 2358.

Remote command:

- `BUS<m>:USBThree:RESult:FCOunt?` on page 2375
- `BUS<m>:USBThree:RESult:FRAMe<n>:INFO?` on page 2375
- `BUS<m>:USBThree:RESult:FRAMe<n>:TYPE?` on page 2376
- `BUS<m>:USBThree:RESult:FRAMe<n>:STATe?` on page 2376
- `BUS<m>:USBThree:RESult:FRAMe<n>:START?` on page 2377
- `BUS<m>:USBThree:RESult:FRAMe<n>:STOP?` on page 2377
- `BUS<m>:USBThree:RESult:FRAMe<n>:FLD<o>:TYPE?` on page 2377
- `BUS<m>:USBThree:RESult:FRAMe<n>:FLD<o>:STATus?` on page 2378
- `BUS<m>:USBThree:RESult:FRAMe<n>:FLD<o>:START?` on page 2378
- `BUS<m>:USBThree:RESult:FRAMe<n>:FLD<o>:STOP?` on page 2378
- `BUS<m>:USBThree:RESult:FRAMe<n>:FLD<o>:VAL?` on page 2379
- `BUS<m>:USBThree:RESult:FRAMe<n>:FLD<o>:FVAL?` on page 2379

14.21.5 Search on decoded USB 3.1 data

Using the search functionality, you can find various events in the decoded data. You can find the same events that you can trigger on, and even many more, since several event types can also be combined.

Before you can start the search, you have to configure the bus correctly and acquire decoded data.

To search on decoded data, set the search source to "SerBus" for the configured protocol.

For general information on how to handle the search functionality, see [Chapter 11, "Search functions"](#), on page 425.

If you need information on how to get started with searching USB 3.1 data, see [Chapter 14.21.5.3, "Searching USB 3.1 data"](#), on page 887. Otherwise proceed with the USB 3.1 search setup.

14.21.5.1 USB 3.1 search setup

Access: [Bus] > "Shortcuts" tab > "Setup search"

Search criteria

Use the "Search criteria" dialog to define the search type. If you search for frame content, define the frame type in which data is to be searched.

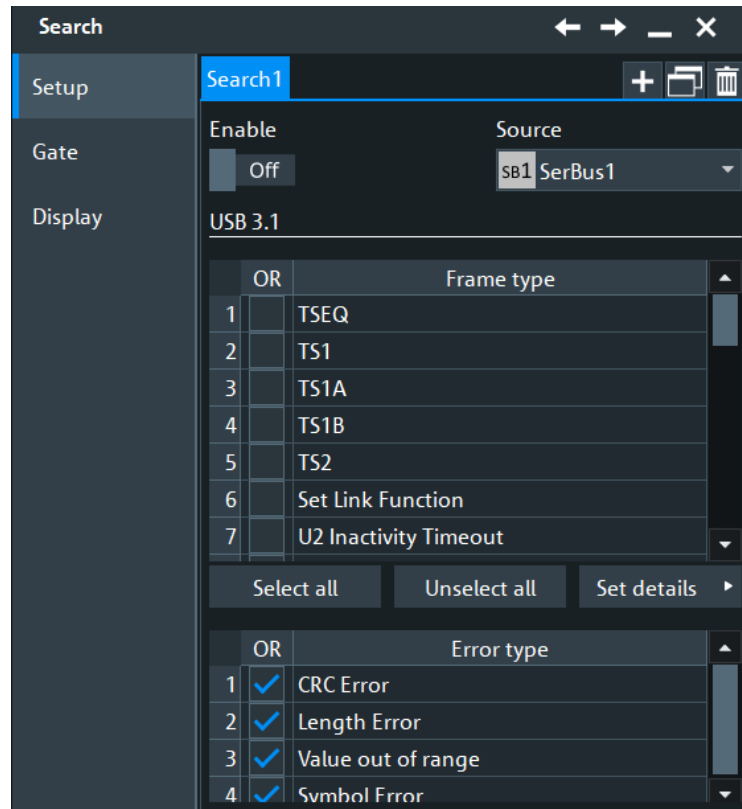

You can define individual search parameters for the fields of the selected frame in the table below the "Search criteria". To specify these parameters, select a field in the table and define the data and/or index operators and values, or the bit state.

For a description of how to set the search conditions, see [Chapter 14.21.3.1, "USB 3.1 trigger settings"](#), on page 880.

Remote command:

[SEARCH:TRIGGER:USBThree:ERENable](#) on page 2380

[SEARCH:TRIGGER:USBThree:ERROR<m>:ENABLE](#) on page 2380

[SEARCH:TRIGGER:USBThree:FRENable](#) on page 2381

[SEARCH:TRIGGER:USBThree:FRAME<m>:ENABLE](#) on page 2381

[SEARCH:TRIGGER:USBThree:FIENable](#) on page 2381

[SEARCH:TRIGGER:USBThree:FRAME<m>:FLD<n>:ENABLE](#) on page 2381

[SEARCH:TRIGGER:USBThree:DOPERator](#) on page 2382

[SEARCH:TRIGGER:USBThree:FRAME<m>:FLD<n>:DOPERator](#) on page 2382

[SEARCH:TRIGGER:USBThree:DMIN](#) on page 2382

[SEARCH:TRIGGER:USBThree:FRAME<m>:FLD<n>:DMIN](#) on page 2382

[SEARCH:TRIGGER:USBThree:DMAX](#) on page 2383

[SEARCH:TRIGGER:USBThree:FRAME<m>:FLD<n>:DMAX](#) on page 2383

[SEARCH:TRIGGER:USBThree:BIT](#) on page 2383

[SEARCH:TRIGGER:USBThree:FRAME<m>:FLD<n>:BIT](#) on page 2383

[SEARCh:TRIGGer:USBThree:IOPerator](#) on page 2384
[SEARCh:TRIGGer:USBThree:FRAMe<m>:FLD<n>:IOPerator](#) on page 2384
[SEARCh:TRIGGer:USBThree:IMIN](#) on page 2384
[SEARCh:TRIGGer:USBThree:FRAMe<m>:FLD<n>:IMIN](#) on page 2384
[SEARCh:TRIGGer:USBThree:IMAX](#) on page 2385
[SEARCh:TRIGGer:USBThree:FRAMe<m>:FLD<n>:IMAX](#) on page 2385

14.21.5.2 USB 3.1 search results

To get search results, "Enable" the search in the "Control" section of the "Search Setup" dialog. You can minimize, shift or close the search dialog to better see the "Search Results" table.

To get search results, "Enable" the search. You can minimize, shift or close the search dialog.

The search results are listed in the search result table and marked in the waveform by blue lines.

For an introduction to search results, see:

- [Chapter 11.1.2, "Search results"](#), on page 426
- [Chapter 11.4.2, "Display zoom settings"](#), on page 446

Remote commands:

- [SEARCh:RESult:USBThree:FCOunt?](#) on page 2386
- [SEARCh:RESult:USBThree:FRAMe<m>:TYPE?](#) on page 2386
- [SEARCh:RESult:USBThree:FRAMe<m>:INFO?](#) on page 2386
- [SEARCh:RESult:USBThree:FRAMe<m>:STATe?](#) on page 2387
- [SEARCh:RESult:USBThree:FRAMe<m>:START?](#) on page 2387
- [SEARCh:RESult:USBThree:FRAMe<m>:STOP?](#) on page 2387
- [SEARCh:RESult:USBThree:FRAMe<m>:FLD<n>:TYPE?](#) on page 2388
- [SEARCh:RESult:USBThree:FRAMe<m>:FLD<n>:STATus?](#) on page 2388
- [SEARCh:RESult:USBThree:FRAMe<m>:FLD<n>:START?](#) on page 2388
- [SEARCh:RESult:USBThree:FRAMe<m>:FLD<n>:STOP?](#) on page 2389
- [SEARCh:RESult:USBThree:FRAMe<m>:FLD<n>:VAL?](#) on page 2389
- [SEARCh:RESult:USBThree:FRAMe<m>:FLD<n>:FVAL?](#) on page 2389

14.21.5.3 Searching USB 3.1 data

Prerequisite: A serial bus is configured for the USB 3.1 signal to be decoded and analyzed.

The search for events is set up in the following way:

1. Press the [Bus] key and select the "Shortcuts" tab.
2. Tap "Setup search".

3. If the dialog box does not contain a search entry, tap the "Add" icon to create one, as described in ["To create a user-defined search"](#) on page 440.
4. Tap "Source" and select the serial bus that is set to USB 3.1 (e.g. "SB1", unless already selected).
The search dialog for USB3 protocol analysis is opened.
5. Specify search criteria according to [Chapter 14.21.5.1, "USB 3.1 search setup"](#), on page 885.
6. To acquire a waveform, press [Single].
The R&S RTO6 performs a USB 3.1 decode according to the thresholds and protocol settings of the associated serial bus source (here in our example SB1).
7. To start searching the acquired waveform for specific events, tap "Enable" in the search setup dialog:
The R&S RTO6 displays the "Search Results" box that lists the detected events.

For information on how to configure the search results presentation and how to navigate the search results, see also ["To display search zoom windows"](#) on page 448.

14.22 USBPD (option R&S RTO6-K570)

R&S RTO6-K570 is a firmware option that enables the R&S RTO6 to analyze Universal Serial Bus Power Delivery (USBPD) signals.

For analysis, USBPD encoded signals can be triggered, decoded and searched.

This chapter describes:

- [The USB power delivery protocol](#).....888
- [USBPD configuration](#)..... 890
- [USBPD trigger](#).....893
- [USBPD decode results](#)..... 897
- [Search on decoded USBPD data](#).....899

14.22.1 The USB power delivery protocol

The requirements on the USB have changed in the last years with the need of providing power through the USB port additionally to the data transfer. The USBPD specification aims to define standard for optimizing the power usage through the USB for the needs of the users.

USBPD characteristics

Main characteristics of USBPD are:

- Power direction is not fixed
- Negotiation of required power amount between devices

- Alternate modes can be defined through vendor defined messages, which allows for USB connector pins to be used for purposes other than USB

Message types

In the USBPD protocol, a power delivery connection can be made between a port that supplies power (source) and a port that consumes power (sink). They communicate with each other through messages. The USBPD specification defines three message types:

- Control messages: 16-bit messages used to control the messages between the port partners or transfer messages with no extra data. A control message consists of a message header and a CRC.
- Data messages: 48 bit to 240 bit messages used to transfer information between port partners. A data message consists of a message header and several data objects. The information that a data object carries is defined by the message type of the message header, see [Table 14-42](#).
- Extended messages: can have a different length up to the defined maximum length of an extended message. It is used to transfer information between port partners. The information that the extended message carries is defined by the message type of the message header, see [Table 14-42](#).

Frame packet types

All frame types are listed below. The frames listed above consist of individual sets of fields. Some frames only contain one field, others are much longer.

The frame types are sorted according to the message type.

Table 14-42: Frame packet types

SCPI	Description	Message type
ALRT	Alert message	Data
BATT	Battery status	Data
BIST	Built in self-test	Data
RQST	Request	Data
SINK	Sink capabilities message	Data
SRC	Source capabilities message	Data
VEND	Vendor defined message	Data
CTRL	Control	Control
DATA	Data	Data
LOWP	Low power	Low power
TEST	Test frame	Test
RESet	Reset frame	Reset
XBAC	Battery capabilities	Extended
XFRS	Firmware update response	Extended

SCPI	Description	Message type
XFRQ	Firmware update request	Extended
XGBC	Get battery cap	Extended
XGMI	Get manufacturer info	Extended
XGBS	Get battery status	Extended
XMFI	Manufacturer info	Extended
XMSG	Message	Extended
XSRC	Sources capabilities message	Extended
XRSR	Security response	Extended
XSRQ	Security request	Extended
XSTA	Status	Extended

More information on the USBPD protocol, including all specifications down to the field contents, is available in the "Universal Serial Bus Power Delivery Specification" documentation. Refer to the online resources at www.usb.org.

14.22.2 USBPD configuration

14.22.2.1 USBPD configuration settings

Access: [Bus] > "USBPD" > "Setup" tab



Make sure that the tab of the correct serial bus is selected.

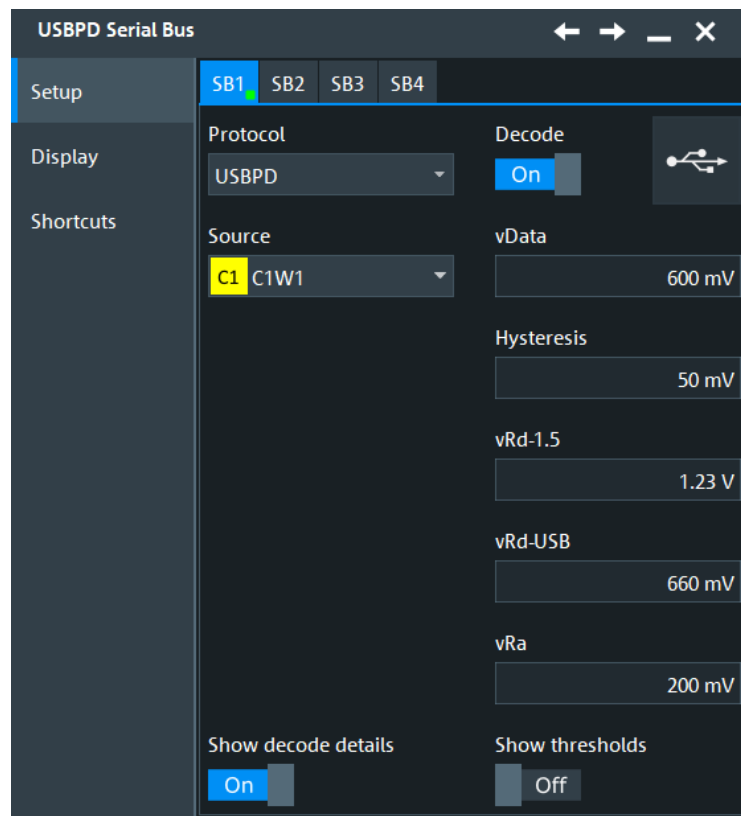

See also: [Chapter 14.1.1, "Setup - general settings"](#), on page 511

Data

Defines the source settings for the data signal. You can select analog channels "C1" to "C4", and also active math and reference waveforms as source. If you want to trigger on the serial bus, analog channel sources are required.

Remote command:

[BUS<m>:USBPd:SOURce](#) on page 2391

vData

Sets the threshold value of the data.

Remote command:

[BUS<m>:USBPd:THReshold](#) on page 2391

Hysteresis

Sets a value for the hysteresis of the data.

Remote command:

[BUS<m>:USBPd:HYSTeresis](#) on page 2390

Current advertisement thresholds

The signal level provides information about the current advertisement between the bursts. These thresholds determine the levels at which the current advertisement modes are defined.

"vRd-1.5" Sets the threshold at USB Type-C current of 1.5 A.

"vRd-USB" Sets the threshold at default USB Type-C current.

"vRa" Sets the threshold for the low current.

Remote command:

[BUS<m>:USBPd:THRBottom](#) on page 2391

[BUS<m>:USBPd:THRMid](#) on page 2392

[BUS<m>:USBPd:THRTop](#) on page 2392

Show decode detail

If enabled, the data words are broken down into subframes. If not enabled the data words are displayed as 32-bit data words.

If the "Show decode detail" is enabled, you cannot do a search and trigger on USBPD frames.

Remote command:

[BUS<m>:USBPd:DETail](#) on page 2390

Show thresholds

If enabled, the threshold levels are displayed in the diagram.

Remote command:

[BUS<m>:THReshold](#) on page 1815

14.22.2.2 Display settings

Access: [Bus] > "Display" tab.

For common display settings, see [Chapter 14.1.3, "Display"](#), on page 513.

To enhance the decode possibilities of the USBPD protocol, you can use an additional setting in the "Display" tab: "Decode layer".

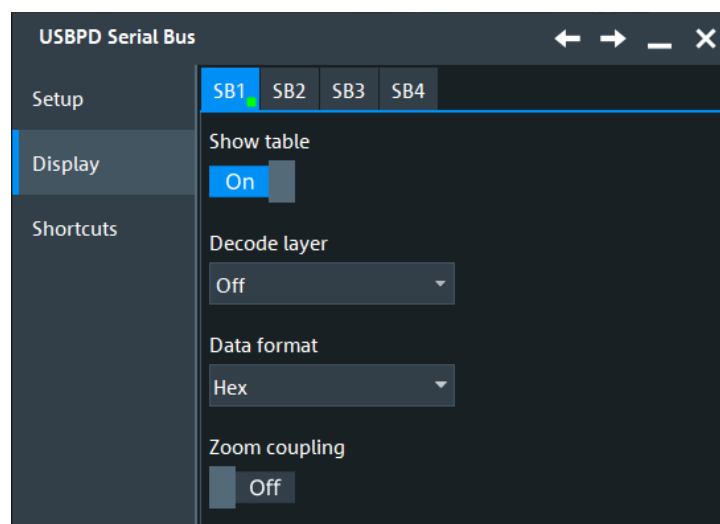

Decode layer

Selects the decode layer.

Decoding is performed in several steps, and the end results are presented in the decode table. The decode layer selects an interim step for which the decoding result is shown in the honeycomb display.

Available are:

- "Edges"
- "Bits"
- "4b5b Symbols"

14.22.2.3 Configuring the USBPD signals

For configuration, assign the lines to the input channels and define the logical thresholds and the hysteresis.

1. Press the [Bus] key on the front panel.
2. Select the tab of the bus you want to set up, for example "SB1".
3. In the "Setup" tab, set "Protocol"="USBPD".
4. Select the data source.
5. Enter the "Thresholds".
6. Enable "Decode".

14.22.3 USBPD trigger

If you need information on how to get started with triggering on USBPD signals, see [Chapter 14.22.3.2, "Triggering on USBPD"](#), on page 896. Otherwise proceed with the USBPD trigger settings.

14.22.3.1 USBPD trigger settings

Access: [Bus] > "Shortcuts" tab > "Setup trigger"

In this section, all trigger settings for USBPD are described. The user interface of the instrument guides you through the trigger setup.

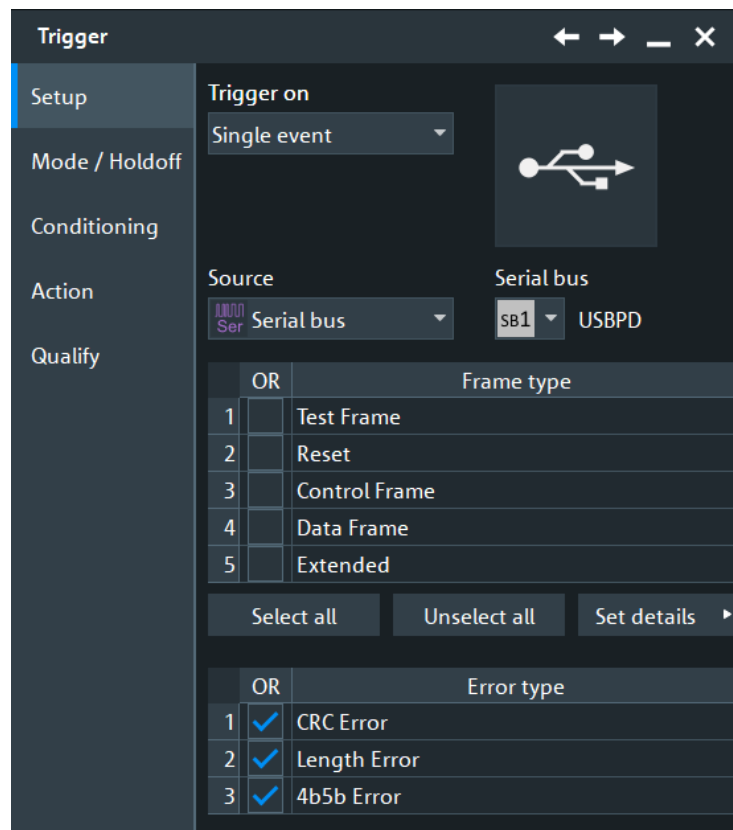

Make sure that:

- In the [Bus] > "Setup" tab:
 - The correct "Protocol" is selected.
 - The data sources of the serial bus are channel signals.
- In the "Trigger" > "Setup" tab:
 - The "Trigger on" = "Single event"
 - The trigger "Source" = "Serial bus".
 - The correct "Serial bus" is selected.

Frame Type

Selects the frame type for the USBPD analysis. For the available packet types, see ["Frame packet types"](#) on page 889.

You can define individual checking parameters for the fields listed of the frame.

To specify these parameters, select a field from this list and open "Set details". You can define the data and/or index operators and values, or the bit state.

The trigger instant is the last criterion that is fulfilled.

Remote command:

[TRIGGER<m>:USBPD:FRENable](#) on page 2395

[TRIGGER<m>:USBPD:FRAME<n>:ENABLE](#) on page 2395

Set details

Select the frame type first, and then open the "Set details" dialog.

In this dialog to define the individual parameters for the fields of the selected frame.

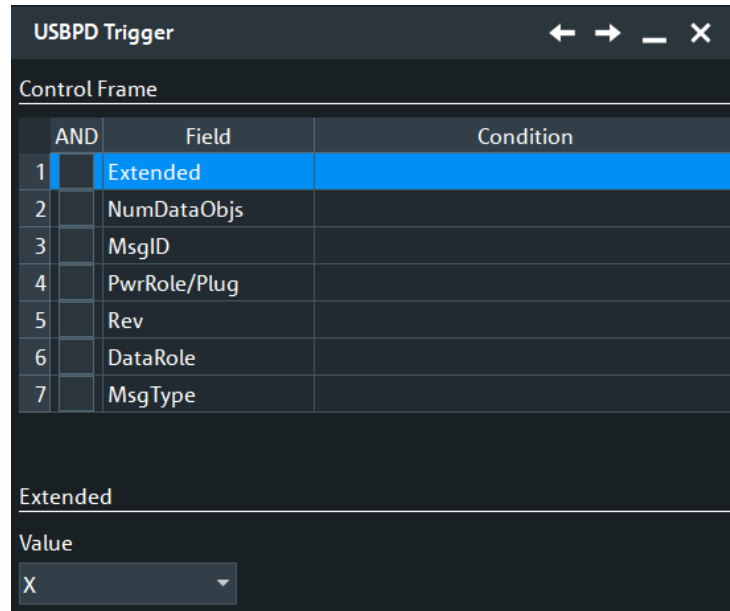

Enable/ Field name/ Condition ← Set details

This table lists the field numbers and names in the selected frame together with a summary of the user settings of checking conditions for each field and a checkbox to enable the checking.

Select a field in the table to specify the checking conditions for this field in the "Data", "BitState" and/or "Index" dialog (whichever applies). The condition is only applied, and the "Condition Summary" is only shown in the table, if "Enable" is checked.

For an overview of frames and fields, see ["Frame packet types"](#) on page 889.

Remote command:

[TRIGger<m>:USBPd:FIENable](#) on page 2395

[TRIGger<m>:USBPd:FRAMe<n>:FLD<o>:ENABLe](#) on page 2395

Error > Enable /Item

The table lists the error types you can trigger on: "CRC Error", "Length Error", "4b5b Error". Enable any error that you want to trigger on in the "OR" column.

Remote command:

[TRIGger<m>:USBPd:ERENable](#) on page 2394

[TRIGger<m>:USBPd:ERRor<n>:ENABLe](#) on page 2394

Data

Sets the data to be triggered on. The trigger data setup consists of a comparison condition and one or two data patterns.

"Condition" Sets the comparison condition to a specific value or a range.

"Min" Specifies the value or sets the start value of a range.

"Max" Sets the maximum value of a range for "Condition" = "In range"/"Out of range".

Remote command:

[TRIGger<m>:USBPd:DOPerator](#) on page 2397

[TRIGger<m>:USBPd:FRAMe<n>:FLD<o>:DOPerator](#) on page 2397

[TRIGger<m>:USBPd:DMAX](#) on page 2396

[TRIGger<m>:USBPd:FRAMe<n>:FLD<o>:DMAX](#) on page 2396

[TRIGger<m>:USBPd:DMIN](#) on page 2397

[TRIGger<m>:USBPd:FRAMe<n>:FLD<o>:DMIN](#) on page 2397

Data BitState

Defines the bit state to be checked for the selected field. Permitted bit states are "1", "0" or "X" (do not care).

Remote command:

[TRIGger<m>:USBPd:BIT](#) on page 2396

[TRIGger<m>:USBPd:FRAMe<n>:FLD<o>:BIT](#) on page 2396

Index

Defines for the selected field, how an index check is executed.

"Condition" Defining a specific index or an index range requires to set the operator to one of the following conditions: equal, in range.

"Min" Specifies the index or sets the start value of an index range.

"Max" Sets the the end value of an index range, if "Condition" is set to INRange.

Remote command:

[TRIGger<m>:USBPd:IOperator](#) on page 2398

[TRIGger<m>:USBPd:FRAMe<n>:FLD<o>:IOperator](#) on page 2398

[TRIGger<m>:USBPd:IMAX](#) on page 2397

[TRIGger<m>:USBPd:FRAMe<n>:FLD<o>:IMAX](#) on page 2397

[TRIGger<m>:USBPd:IMIN](#) on page 2398

[TRIGger<m>:USBPd:FRAMe<n>:FLD<o>:IMIN](#) on page 2398

14.22.3.2 Triggering on USBPD

Prerequisite: A bus is configured for the USBPD signal to be analyzed.

In order to be able to trigger on an USBPD data, the "Show decode detail" field in the "Configuration" tab of the protocol setup should be disabled.

For the basic trigger settings, proceed in the following way:

1. Press the [Bus] key and select the "Shortcuts" tab.
2. Press "Setup trigger".
3. Tap the "Source" button and select the "Serial bus" trigger source.
4. Tap "Serial bus" and select the serial bus that is set to USBPD.

5. If you trigger on errors, enable the error types you want to find.
6. Select the frame types you want to trigger on.
7. For some frame types, you can define the frame fields.
For information on how to proceed with the configuration settings, see [Chapter 14.22.3.1, "USBPD trigger settings"](#), on page 893.

14.22.4 USBPD decode results

When the configuration of the serial bus is complete, the signal can be decoded:

1. In the "Serial Bus" dialog > "Setup" tab, enable "Decode".
2. In the "Serial Bus" dialog > "Display" tab, select additional result display settings: "Show table" and "Show binary".
3. If required, enable "Zoom coupling"

For a description of the display settings, see also [Chapter 14.1.3, "Display"](#), on page 513.

The instrument captures and decodes the signal according to the standard definition and the configuration settings.

The color-coding of the various protocol sections and errors simplifies the interpretation of the visual display. The decode information condenses or expands, depending on the horizontal scale. Various data formats are available to show the result values.

Decode Results Table

The example in [Figure 14-47](#) shows a simulated USBPD message. Among the long line of decoded frames, the zoom has selected a "Control" frame.

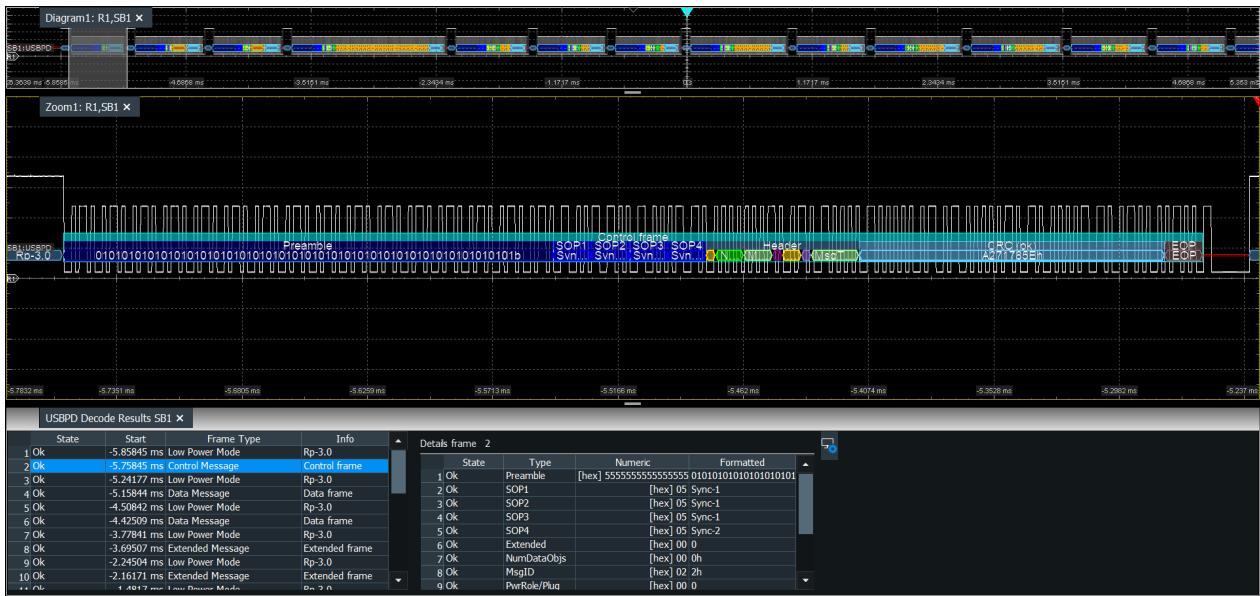

Figure 14-47: USBPD protocol: decoded signal

The results are shown in two tables:

- "Decode results": contains information about all decoded frames
- "Details frame": contains more detailed information about the selected frame in the "Decode results" table.

Table 14-43: Content of the Decode results table

Column	Description
State	Overall state of the frame
Start	Time of frame start
Frame Type	Type of the frame
Info	Information about the frame

Table 14-44: Content of the Details frame table

Column	Description
State	Overall state of the field
Start	Start time of the field
Type	Type (name) of field
Numeric value	The numeric value of the field
Formatted	Formatted content of the field

Remote commands

Remote commands are described in [Chapter 27.18.23.3, "Decode results"](#), on page 2399.

14.22.5 Search on decoded USBPD data

Using the search functionality, you can find various events in the decoded data. You can find the same events that you can trigger on, and even many more, since several event types can also be combined.

Before you can start the search, you have to configure the bus correctly and acquire decoded data.

To search on decoded data, set the search source to "SerBus" for the configured protocol.

For general information on how to handle the search functionality, see [Chapter 11, "Search functions"](#), on page 425.

If you need information on how to get started with searching USBPD data, see [Chapter 14.22.5.3, "Searching USBPD data"](#), on page 901. Otherwise proceed with the USBPD search setup.

14.22.5.1 USBPD search setup

Access: [Bus] > "Shortcuts" tab > "Setup search"

Search

In the "Search" dialog to define the frame type in which data is to be searched.

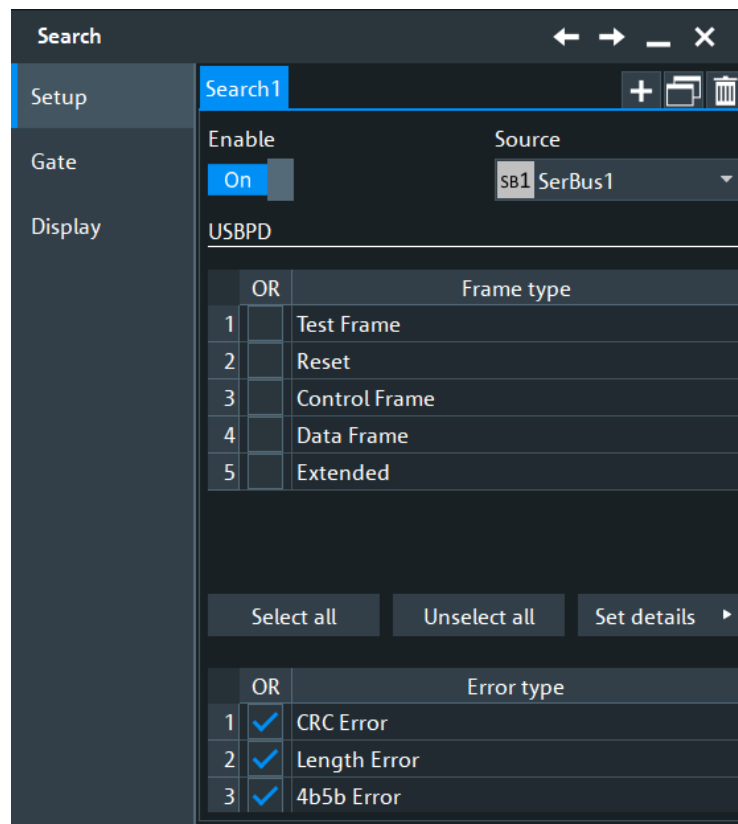

You can define individual search parameters for individual fields in the "Set details" dialog. To specify these parameters, select a field in this table and define the data and/or index operators and values, or the bit state.

For a description of how to set the search conditions, see [Chapter 14.22.3.1, "USBPD trigger settings"](#), on page 893.

Remote command:

[SEARCH:TRIGger:USBPd:ERENable](#) on page 2405
[SEARCH:TRIGger:USBPd:ERRor<m>:ENABLE](#) on page 2405
[SEARCH:TRIGger:USBPd:BIT](#) on page 2406
[SEARCH:TRIGger:USBPd:FRAMe<m>:FLD<n>:BIT](#) on page 2406
[SEARCH:TRIGger:USBPd:DMAX](#) on page 2407
[SEARCH:TRIGger:USBPd:FRAMe<m>:FLD<n>:DMAX](#) on page 2407
[SEARCH:TRIGger:USBPd:DMIN](#) on page 2407
[SEARCH:TRIGger:USBPd:FRAMe<m>:FLD<n>:DMIN](#) on page 2407
[SEARCH:TRIGger:USBPd:DOPerator](#) on page 2408
[SEARCH:TRIGger:USBPd:FRAMe<m>:FLD<n>:DOPerator](#) on page 2408
[SEARCH:TRIGger:USBPd:IMAX](#) on page 2408
[SEARCH:TRIGger:USBPd:FRAMe<m>:FLD<n>:IMAX](#) on page 2408
[SEARCH:TRIGger:USBPd:IMIN](#) on page 2409
[SEARCH:TRIGger:USBPd:FRAMe<m>:FLD<n>:IMIN](#) on page 2409
[SEARCH:TRIGger:USBPd:IOPerator](#) on page 2409
[SEARCH:TRIGger:USBPd:FRAMe<m>:FLD<n>:IOPerator](#) on page 2409

14.22.5.2 USBPD search results

To get search results, "Enable" the search. You can minimize, shift or close the search dialog to better see the "Search Results" table.

To get search results, "Enable" the search. You can minimize, shift or close the search dialog.

The search results are listed in the search result table and marked in the waveform by blue lines.

For an introduction to search results, see:

- [Chapter 11.1.2, "Search results"](#), on page 426
- [Chapter 11.4.2, "Display zoom settings"](#), on page 446

Remote commands:

- [SEARCH:RESult:USBPd:FCOunt?](#) on page 2410
- [SEARCH:RESult:USBPd:FRAMe<m>:DATA?](#) on page 2410
- [SEARCH:RESult:USBPd:FRAMe<m>:TYPE?](#) on page 2414
- [SEARCH:RESult:USBPd:FRAMe<m>:INFO?](#) on page 2413
- [SEARCH:RESult:USBPd:FRAMe<m>:STATe?](#) on page 2414
- [SEARCH:RESult:USBPd:FRAMe<m>:START?](#) on page 2413
- [SEARCH:RESult:USBPd:FRAMe<m>:STOP?](#) on page 2414
- [SEARCH:RESult:USBPd:FRAMe<m>:FLD<n>:TYPE?](#) on page 2412

- [SEARCH:RESult:USBPd:FRAMe<m>:FLD<n>:STATus?](#) on page 2411
- [SEARCH:RESult:USBPd:FRAMe<m>:FLD<n>:START?](#) on page 2412
- [SEARCH:RESult:USBPd:FRAMe<m>:FLD<n>:STOP?](#) on page 2412
- [SEARCH:RESult:USBPd:FRAMe<m>:FLD<n>:VAL?](#) on page 2413
- [SEARCH:RESult:USBPd:FRAMe<m>:FLD<n>:FVAL?](#) on page 2411

14.22.5.3 Searching USBPD data

Prerequisite: A serial bus is configured for the USBPD signal to be decoded and analyzed.

To be able to search for a USBPD data, the "Show decode detail" field in the "Configuration" tab of the protocol setup should be disabled. If "Show decode detail" is enabled, the "Enable" search button is disabled.

The search for events is set up in the following way:

1. Press the [Bus] key and select the "Shortcuts" tab.
2. Tap "Setup search".
3. If the dialog box does not contain a search entry, tap the "Add" icon to create one, as described in ["To create a user-defined search"](#) on page 440.
4. Tap "Source" and select the serial bus that is set to USBPD (e.g. "SerBus1", unless already selected).

The search dialog for USBPD protocol analysis is opened.

5. Specify search criteria according to [Chapter 14.22.5.1, "USBPD search setup"](#), on page 899.
6. To acquire a waveform, press [Single].

The R&S RTO6 performs a USBPD decode according to the thresholds and protocol settings of the associated serial bus source (here in our example SB1).

7. To start searching the acquired waveform for specific events, tap "Enable" in the search setup dialog:

The R&S RTO6 displays the "Search Results" box that lists the detected events.

For information on how to configure the search results presentation and how to navigate the search results, see also ["To display search zoom windows"](#) on page 448.

14.23 D-PHY (option R&S RTO6-K580)

The D-PHY is a specification developed by the Mobile Industry Processor Interface (MIPI) alliance as a standard for the communication of high-speed components, like cameras and displays, within mobile devices.

• D-PHY basics.....	902
• D-PHY configuration.....	902
• D-PHY trigger.....	906
• D-PHY decode results.....	912
• Search on decoded D-PHY data.....	913

14.23.1 D-PHY basics

A D-PHY interface consists of one clock lane and up to four data lanes. The D-PHY data lanes have two operational modes:

- A high speed mode (HS): differential signal with a data rate of 80 Mbps to 1.5GHz. This mode is used for the transmission of large volumes of information.
- A low power mode (LP): single-ended signal with a data rate < 10 Mbps. This mode is used for conserving power .

D-PHY provides a framework for other protocols such as the Display Serial Interface (DSI) and Camera Serial Interface (CSI-2).

14.23.2 D-PHY configuration

14.23.2.1 D-PHY configuration settings

Access: [Bus] > "D-PHY" > "Setup" tab



Make sure that the tab of the correct serial bus is selected.

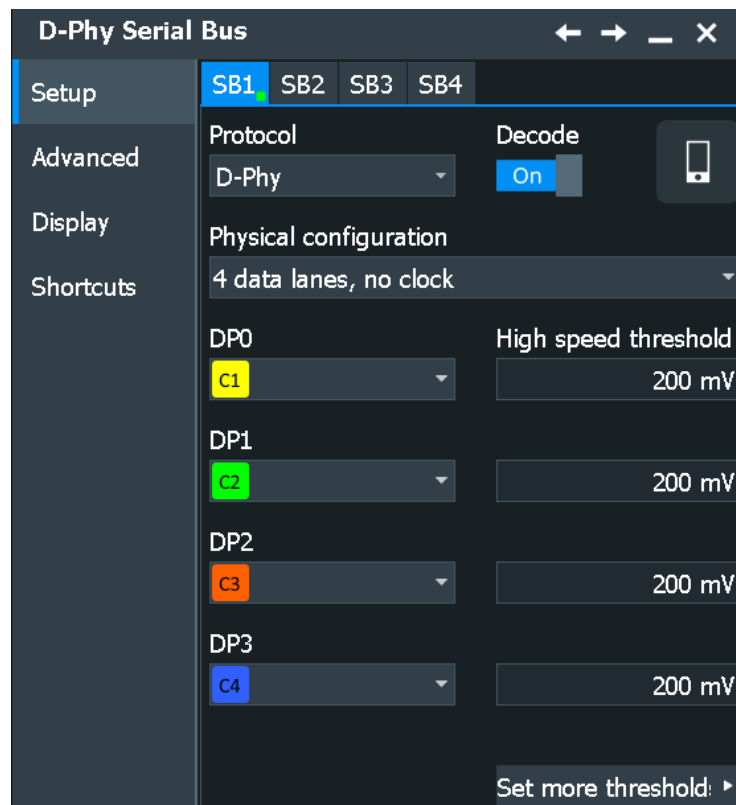

See also: [Chapter 14.1.1, "Setup - general settings"](#), on page 511

Variant

Selects the protocol running on the interface. You can select between the Display Serial Interface (DSI) and Camera Serial Interface (CSI-2).

Remote command:

`BUS<m>:DPHY:VARIant` on page 2418

Physical configuration

Selects the number of data lanes and if the clock lane and low power are available.

Remote command:

`BUS<m>:DPHY:CONFIg` on page 2416

Source Connection

Defines the source and the type of probe used for the respective lane.

Permitted source selections are none, the analog, mathematical, and reference channels.

CP ← Source Connection

Sets the source of the clock lane.

Remote command:

`BUS<m>:DPHY:CP:SOURce` on page 2416

DP0/DN0 ← Source Connection

Selects the source of the low-power data lanes.

The "DP0" lane has to be present all the time, hence "Source DP0">"None" is not allowed.

Remote command:

[BUS<m>:DPHY:DPZero:SOURce](#) on page 2419

[BUS<m>:DPHY:DNZero:SOURce](#) on page 2419

DP1/DP2/DP3 ← Source Connection

Selects the source of the high-speed data lanes.

Remote command:

[BUS<m>:DPHY:DPONe:SOURce](#) on page 2419

[BUS<m>:DPHY:DPTWo:SOURce](#) on page 2419

[BUS<m>:DPHY:DPTHree:SOURce](#) on page 2419

Probe ← Source Connection

Selects the type of probe used for the respective lane. The D-PHY low-power mode uses a single-ended signal, while the high-speed mode signaling is differential.

Remote command:

[BUS<m>:DPHY:CP:PROBe](#) on page 2416

[BUS<m>:DPHY:DNZero:PROBe](#) on page 2419

[BUS<m>:DPHY:DPZero:PROBe](#) on page 2419

[BUS<m>:DPHY:DPONe:PROBe](#) on page 2420

[BUS<m>:DPHY:DPTWo:PROBe](#) on page 2420

[BUS<m>:DPHY:DPTHree:PROBe](#) on page 2420

Data Rate

Sets a data rate.

Remote command:

[BUS<m>:DPHY:DRATe](#) on page 2417

[BUS<m>:DPHY:DSPData](#) on page 2417

HS Threshold

Sets the threshold value for the digitization of high-speed data line.

Remote command:

[BUS<m>:DPHY:DPZero:HSPeed:THReshold](#) on page 2420

[BUS<m>:DPHY:DPONe:HSPeed:THReshold](#) on page 2420

[BUS<m>:DPHY:DPTWo:HSPeed:THReshold](#) on page 2420

[BUS<m>:DPHY:DPTHree:HSPeed:THReshold](#) on page 2420

Set thresholds

Opens a dialog to set the threshold values.

HS Hysteresis ← Set thresholds

Sets a value for the hysteresis of the respective lane.

Remote command:

[BUS<m>:DPHY:CP:HSPeet:HYSTeresis](#) on page 2420

[BUS<m>:DPHY:DPZero:HSPeet:HYSTeresis](#) on page 2420

[BUS<m>:DPHY:DPONe:HSPeet:HYSTeresis](#) on page 2420

[BUS<m>:DPHY:DPTWo:HSPeet:HYSTeresis](#) on page 2420

[BUS<m>:DPHY:DPTHree:HSPeet:HYSTeresis](#) on page 2420

Low power thresholds ← Set thresholds

Sets the thresholds for the low-power mode.

DP0 High / DN0 High ← Low power thresholds ← Set thresholds

Sets the high-power threshold value for the respective lane.

Remote command:

[BUS<m>:DPHY:DNZero:LPOWer:THUPper](#) on page 2418

[BUS<m>:DPHY:DPZero:LPOWer:THUPper](#) on page 2418

DP0 Low / DN0 Low ← Low power thresholds ← Set thresholds

Sets the low-power threshold value for the respective lane.

Remote command:

[BUS<m>:DPHY:DNZero:LPOWer:THLower](#) on page 2419

[BUS<m>:DPHY:DPZero:LPOWer:THLower](#) on page 2419

Couple thresholds ← Set thresholds

Enables coupling, i.e. the same threshold and hysteresis value is used for all lanes.

Remote command:

[BUS<m>:DPHY:THCoupling](#) on page 2417

14.23.2.2 Display settings

Access: [Bus] > "Configuration" tab > "Protocol = D-PHY" > "Display" tab

To enhance the decode possibilities of the D-PHY protocol, you can use an additional setting in the "Display" tab: "Decode layer".

Access: [Bus] > "Display" tab.

For common display settings, see [Chapter 14.1.3, "Display"](#), on page 513.

Decode layer

Selects the decode layer.

Decoding is performed in several steps, and the end results are presented in the decode table. The decode layer selects an interim step for which the decoding result is shown in the honeycomb display.

"HS Edges"	The high-speed edges of each lane, showing the transitions in high-speed mode.
"HS Binary"	All high-speed bits of each lane, whether they are part of a burst or not.

"HS Burst Bits"	The filtered high-speed bits of each lane , including only bits that are part of a burst.
"HS Burst Words"	8 bits per word in a high-speed burst of each lane.
"HS Merged Bytes"	The words from the previous layer after they have been merged into one honeycomb.
"HS Merged Words"	The bytes that are combined/split into words.
"LP Edges"	The combined edge display of DP0 and DN0.
"LP States"	The low-power states LP00, LP01, LP10, LP11 of DP0 and DN0.

Show multiple lanes

Enables the display of the results in multiple lanes.

Remote command:

[BUS<m>:DPHY:SMLanes](#) on page 2421

14.23.2.3 Configuring the D-PHY signals

For configuration, assign the lines to the input channels and define the logical thresholds and the hysteresis.

1. Press the [Bus] key on the front panel.
2. Select the tab of the bus you want to set up, for example "SB1".
3. In the "Setup" tab, select the protocol: "D-PHY".
4. Tap the "Variant" button, and select the protocol.
5. Enter the number of "Data Lanes".
6. Select the source and type of "Probe", for each lane.
7. Enter the "HS threshold" and the "Hysteresis" for each data lane.
8. Enter the low-power thresholds.
9. Enable "Decode".

14.23.3 D-PHY trigger**14.23.3.1 D-PHY trigger settings**

Access: [Bus] > "Shortcuts" tab > "Setup trigger"



In this section, all trigger settings are described. Their availability on the instrument depends on the selected USB protocol type and trigger type. The user interface of the instrument displays only appropriate settings and guides you through the trigger setup. For a list of supported trigger conditions, refer to the specifications document.

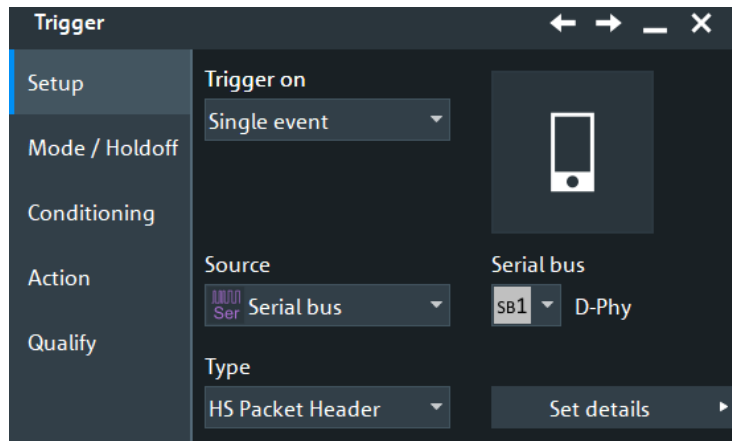

Make sure that:

- In the [Bus] > "Setup" tab:
 - The correct "Protocol" is selected.
 - The data sources of the serial bus are channel signals.
- In the "Trigger" > "Setup" tab:
 - The "Trigger on" = "Single event"
 - The trigger "Source" = "Serial bus".
 - The correct "Serial bus" is selected.

Serial bus

Selects the serial bus to be triggered on. Make sure to select the correct bus before you enter the settings.

To trigger on a serial bus, the signals sources must be channel signals. If the data or clock source is a math or reference waveform, you cannot trigger on that bus.

Remote command:

[TRIGger<m>:SOURce:SBSelect](#) on page 1818

Protocol

Defines the protocol type of the selected serial bus.

Remote command:

[BUS<m>:TYPE](#) on page 1813

Type

Selects the trigger type for the D-PHY analysis.

Remote command:

[TRIGger<m>:DPHY:TYPE](#) on page 2422

HS Start of Packet ← Type

Sets the trigger to the transmission start of a high-speed packet.

**HS End of Packet ← Type**

Sets the trigger to the transmission end of a high-speed packet.

**HS Packet Header ← Type**

Sets the trigger to a packet header of a high-speed package. The header consists of a data identifier (containing the [Virtual Channel](#) and the [Data Type](#)) and a [Word Count](#). You can specify the values each part of the packet header.

D-Phy Trigger
← → - X

HS Packet Header

Virtual channel

Data type
[-] In range ▾ ..

Word count
[-] In range ▾ ..

HS Data ← Type

Sets the trigger to a specified high-speed data.

D-Phy Trigger
← → _ X

HS Data

Virtual channel
[hex]X

Data type
[-] In range ▾ [hex]XX .. [hex]XX

Word count
[-] In range ▾ [hex]XXXX .. [hex]XXXX

Data value
= Equal ▾ [hex]XX

Data index
[-] In range ▾ [] 0 .. [] 65535

LP Escape Mode ← Type

Sets the trigger to an escape mode event.

D-Phy Trigger
← → _ X

LP Escape Mode

Escape mode
[-] In range ▾ [hex]XX .. [hex]XX

Data value
[-] In range ▾ [hex]XX .. [hex]XX

Data index
[-] In range ▾ [] 0 .. [] 65535

LP Lane Turnaround ← Type

Sets the trigger to a low-power turnaround, a reversion of the transmission direction.

**LP HS Request ← Type**

Sets the trigger to a high-speed request.



Virtual Channel

Triggers on a specific virtual channel, an independent data stream for up to four peripherals.

Remote command:

[TRIGger<m>:DPHY:HSVC](#) on page 2427

Data Type

Sets the specified data type to be triggered on. The data type setup consists of the condition and one or two data patterns.

In binary format, use the following characters: 1; 0; or X (do not care). To enter the pattern in other formats use the bit pattern editor, see [Chapter 14.1.7, "Bit pattern editor"](#), on page 519.

"Condition"	Sets the comparison condition to a specific value or a range.
"Data Min/ Data"	Specifies the value or sets the start value of a range.
"Data Max"	Sets the maximum value of a range for "Condition" = "In range"/"Out of range".

Remote command:

[TRIGger<m>:DPHY:DTYPe:CONDition](#) on page 2424

[TRIGger<m>:DPHY:DTYPe:MAX](#) on page 2424

[TRIGger<m>:DPHY:DTYPe:MIN](#) on page 2425

Word Count

Sets the specified specific word count to be triggered on. The word count setup consists of the condition and one or two data patterns.

In binary format, use the following characters: 1; 0; or X (do not care). To enter the pattern in other formats use the bit pattern editor, see [Chapter 14.1.7, "Bit pattern editor"](#), on page 519.

"Condition"	Sets the comparison condition to a specific value or a range.
"Data Min/ Data"	Specifies the value or sets the start value of a range.
"Data Max"	Sets the maximum value of a range for "Condition" = "In range"/"Out of range".

Remote command:

[TRIGger<m>:DPHY:WCOunt:CONDition](#) on page 2428

[TRIGger<m>:DPHY:WCOunt:MAX](#) on page 2428

[TRIGger<m>:DPHY:WCOunt:MIN](#) on page 2428

Data Value

Set the specified data value to be triggered on. The data value setup consists of the condition and one or two data value patterns.

In binary format, use the following characters: 1; 0; or X (do not care). To enter the pattern in other formats use the bit pattern editor, see [Chapter 14.1.7, "Bit pattern editor"](#), on page 519.

"Condition"	Sets the comparison condition to a specific value or a range.
-------------	---

"Data Min/ Data"	Specifies the value or sets the start value of a range.
"Data Max"	Sets the maximum value of a range for "Condition" = "In range"/"Out of range".

Remote command:

For "Type">"HS Data":

[TRIGger<m>:DPHY:DATA:CONDition](#) on page 2422

[TRIGger<m>:DPHY:DATA:MAX](#) on page 2423

[TRIGger<m>:DPHY:DATA:MIN](#) on page 2423

For "Type">"LP Escape Mode":

[TRIGger<m>:DPHY:ESDTa:CONDition](#) on page 2426

[TRIGger<m>:DPHY:ESDTa:MAX](#) on page 2426

[TRIGger<m>:DPHY:ESDTa:MIN](#) on page 2426

Data Index

Data index sets the range within this series of the data value that is considered for the analysis. The data index setup consists of the condition and one or two data index values.

"Condition"	Sets the comparison condition to a specific value or a range.
"Index Min/Index"	Specifies the value or sets the start value of a range.
"Index Max"	Sets the maximum value of a range for "Condition" = "In range"/"Out of range".

Remote command:

For "Type">"HS Data":

[TRIGger<m>:DPHY:DIDX:CONDition](#) on page 2423

[TRIGger<m>:DPHY:DIDX:MAX](#) on page 2423

[TRIGger<m>:DPHY:DIDX:MIN](#) on page 2424

For "Type">"LP Escape Mode":

[TRIGger<m>:DPHY:ESINDEX:CONDition](#) on page 2427

[TRIGger<m>:DPHY:ESINDEX:MAX](#) on page 2427

[TRIGger<m>:DPHY:ESINDEX:MIN](#) on page 2427

Escape mode

The escape mode setup consists of the condition and one or two data patterns.

In binary format, use the following characters: 1; 0; or X (do not care). To enter the pattern in other formats use the bit pattern editor, see [Chapter 14.1.7, "Bit pattern editor"](#), on page 519.

"Condition"	Sets the comparison condition to a specific value or a range.
"Data Min/ Data"	Specifies the value or sets the start value of a range.
"Data Max"	Sets the maximum value of a range for "Condition" = "In range"/"Out of range".

Remote command:

[TRIGger<m>:DPHY:ESCMODE:CONDition](#) on page 2425

[TRIGger<m>:DPHY:ESCMODE:MAX](#) on page 2425

[TRIGger<m>:DPHY:ESCMODE:MIN](#) on page 2425

14.23.3.2 Triggering on D-PHY

Prerequisite: A bus is configured for the D-PHY signal to be analyzed.

For the basic trigger settings, proceed in the following way:

1. Press the [Bus] key and select the "Shortcuts" tab.
2. Press "Setup trigger".
3. Tap the "Source" button and select the "Serial bus" trigger source.
4. Tap "Serial bus" and select the serial bus that is set to D-PHY.
5. Select the "Trigger Type" to be used for D-PHY protocol analysis.
6. To refine the trigger settings, configure additional settings, which are available for some trigger types.

For details, see [Chapter 14.23.3.1, "D-PHY trigger settings"](#), on page 906.

14.23.4 D-PHY decode results

When the configuration of the serial bus is complete, the signal can be decoded:

1. In the "Serial Bus" dialog > "Setup" tab, enable "Decode".
2. In the "Serial Bus" dialog > "Display" tab, select additional result display settings: "Show table" and "Show binary".
3. If required, enable "Zoom coupling"

For a description of the display settings, see also [Chapter 14.1.3, "Display"](#), on page 513.

The instrument captures and decodes the signal according to the standard definition and the configuration settings.

The color-coding of the various protocol sections and errors simplifies the interpretation of the visual display. The decode information condenses or expands, depending on the horizontal scale. Various data formats are available to show the result values.

If a frame is marked red, some kind of error occurred. To analyze the error, see the indication of the corresponding frame in the result table.

ECC checks are supported. ECC can correct a certain number of bit errors in the header. If the errors can be fixed, the status is an ECC warning. If there are too many errors, an ECC error is shown.

Decode Results Table

The results are shown in two tables:

- "Decode results": contains information about all decoded frames
- "Details frame": contains more detailed information about the selected frame in the "Decode results" table.

The screenshot shows a software interface for D-Phy Decode Results. The main table lists 10 frames with columns for State, Start, Packet type, VC, DT, and WC / Data. Frame 4 is highlighted as a 'Checksum Error' for an 'HS Long Packet' at -5.388 μs. To the right, the 'Details frame 4' view shows 'User Defined 8-bit Data Type 1' with a word count of 20, ECC of 03, and a check sum of A185. A 'Data bytes' table shows 8 bytes of hex data from 00 to 07.

State	Start	Packet type	VC	DT	WC / Data
1 Ok	-8.724 μs	LP HS Request	—	—	—
2 Ok	-8.189 μs	HS Short Packet	0	00	[hex] 00
3 Ok	-5.925 μs	LP HS Request	—	—	—
4 Checksum Error	-5.388 μs	HS Long Packet	0	30	[dec] 20
5 Ok	-2.684 μs	LP HS Request	—	—	—
6 Ok	-2.148 μs	HS Short Packet	1	00	[hex] 00
7 Ok	115 ns	LP HS Request	—	—	—
8 Checksum Error	652 ns	HS Long Packet	1	30	[dec] 21
9 Ok	3.395 μs	LP HS Request	—	—	—
10 Checksum Error	3.931 μs	HS Long Packet	0	12	[dec] 22

Table 14-45: Content of the Decode results table

Column	Description
State	Overall state of the frame
Start	Time of frame start in relation to the trigger point
Packet Type	Packet type
VC	Number of virtual channels
DT	Data type
WC/ Data	Word count or data value
Number of Packets	Number of packets in the frame

Tools

Press "Display settings" in the "Decode Results" table to access the "Display" tab.



Remote commands

Remote commands are described in [Chapter 27.18.24.3, "D-PHY decode results"](#), on page 2428.

14.23.5 Search on decoded D-PHY data

Using the search functionality, you can find various events in the decoded data. You can find the same events that you can trigger on, and even many more, since several event types can also be combined.

Before you can start the search, you have to configure the bus correctly and acquire decoded data.

To search on decoded data, set the search source to "SerBus" for the configured protocol.

For general information on how to handle the search functionality, see [Chapter 11, "Search functions"](#), on page 425.

14.23.5.1 D-PHY search setup

Access: [Bus] > "Shortcuts" tab > "Setup search"

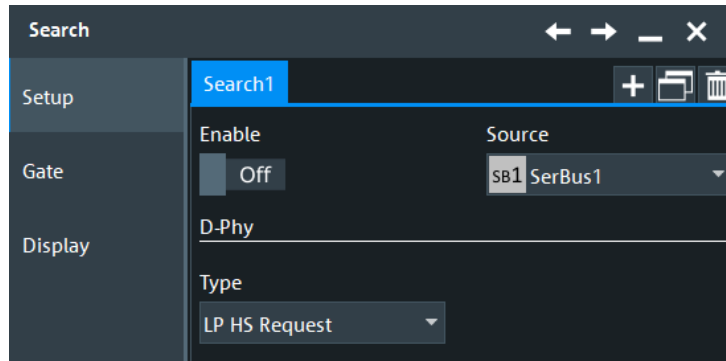

Type

Searches for the selected D-PHY type.

Remote command:

[SEARCH:TRIGger:DPHY:TYPE](#) on page 2435

HS Start of Packet ← Type

Searches for a transmission start of a high-speed packet.

HS End of Packet ← Type

Searches for a transmission end of a high-speed packet.

HS Packet Header ← Type

Searches for a packet header of a high-speed package. The header consists of a data identifier (containing the [Virtual Channel](#) and the [Data Type](#)) and a [Word Count/ Data](#). You can specify the values each part of the packet header.

HS Data ← Type

Searches for a specified high-speed data.

LP Escape Mode ← Type

Searches for an escape mode event.

LP Lane Turnaround ← Type

Searches for a low-power turnaround, a reversion of the transmission direction.

LP HS Request ← Type

Searches for a high-speed request.

Virtual Channel

Searches for a specific virtual channel, an independent data stream for up to four peripherals.

Remote command:

[SEARCH:TRIGger:DPHY:HSVC](#) on page 2442

Data Type

Searches for a specific data type. The data type setup consists of the condition and one or two data patterns.

"Condition" Defines the operator to set a specific data type ("Equal" or "Not equal") or a data type range.

"Data Min/Data"

Defines the bit pattern of the data pattern.

In binary format, use the following characters: 1; 0; or X (do not care). To enter the pattern in other formats use the bit pattern editor, see [Chapter 14.1.7, "Bit pattern editor"](#), on page 519.

"Data Max" The second data pattern is required to specify a range with conditions "In range" and "Out of range".

Remote command:

[SEARCH:TRIGger:DPHY:DTYPe:CONDition](#) on page 2438

[SEARCH:TRIGger:DPHY:DTYPe:MAX](#) on page 2438

[SEARCH:TRIGger:DPHY:DTYPe:MIN](#) on page 2438

Word Count/ Data

Searches for a specific word count /data. The word count setup consists of the condition and one or two data patterns.

"Condition" Defines the operator to set a specific word count ("Equal" or "Not equal") or a word count range.

"Data Min/Data"

Defines the bit pattern of the word pattern.

In binary format, use the following characters: 1; 0; or X (do not care). To enter the pattern in other formats use the bit pattern editor, see [Chapter 14.1.7, "Bit pattern editor"](#), on page 519.

"Data Max" The second word pattern is required to specify a range with conditions "In range" and "Out of range".

Remote command:

[SEARCH:TRIGger:DPHY:WCOunt:CONDition](#) on page 2442

[SEARCH:TRIGger:DPHY:WCOunt:MAX](#) on page 2443

[SEARCH:TRIGger:DPHY:WCOunt:MIN](#) on page 2443

Data Value

Searches for a specific data value. The data value setup consists of the condition and one or two data value patterns.

"Condition" Defines the operator to set a specific data value ("Equal" or "Not equal") or a data value range.

"Data Min/Data"

Defines the bit pattern of the data value pattern.

In binary format, use the following characters: 1; 0; or X (do not care).

To enter the pattern in other formats use the bit pattern editor, see [Chapter 14.1.7, "Bit pattern editor"](#), on page 519.

"Data Max"

The second data value pattern is required to specify a range with conditions "In range" and "Out of range".

Remote command:

For "Type">"HS Data":

[SEARCH:TRIGger:DPHY:DATA:CONDition](#) on page 2435

[SEARCH:TRIGger:DPHY:DATA:MAX](#) on page 2436

[SEARCH:TRIGger:DPHY:DATA:MIN](#) on page 2436

For "Type">"LP Escape Mode":

[SEARCH:TRIGger:DPHY:ESDTa:CONDition](#) on page 2440

[SEARCH:TRIGger:DPHY:ESDTa:MAX](#) on page 2440

[SEARCH:TRIGger:DPHY:ESDTa:MIN](#) on page 2441

Data Index

Data index sets the range within this series of the data value to be searched for. The data index setup consists of the condition and one or two data index values.

"Condition" Defines the operator to set a specific data ("Equal") or a data range.

"Index Min/Index"

Defines the minimum index.

"Index Max"

The second index pattern is required to specify a range with conditions "In range".

Remote command:

For "Type">"HS Data":

[SEARCH:TRIGger:DPHY:DIDX:CONDition](#) on page 2437

[SEARCH:TRIGger:DPHY:DIDX:MAX](#) on page 2437

[SEARCH:TRIGger:DPHY:DIDX:MIN](#) on page 2437

For "Type">"LP Escape Mode":

[SEARCH:TRIGger:DPHY:ESINDEX:CONDition](#) on page 2441

[SEARCH:TRIGger:DPHY:ESINDEX:MAX](#) on page 2441

[SEARCH:TRIGger:DPHY:ESINDEX:MIN](#) on page 2442

Escape mode

Searches for an escape mode event. The escape mode setup consists of the condition and one or two data patterns.

"Condition" Defines the operator to set a specific word count ("Equal" or "Not equal") or a word count range.

"Data Min/Data"

Defines the bit pattern of the data pattern.

In binary format, use the following characters: 1; 0; or X (do not care).

To enter the pattern in other formats use the bit pattern editor, see [Chapter 14.1.7, "Bit pattern editor"](#), on page 519.

"Data Max" The second data pattern is required to specify a range with conditions "In range" and "Out of range".

Remote command:

[SEARCH:TRIGger:DPHY:ESCMode:CONDition](#) on page 2439

[SEARCH:TRIGger:DPHY:ESCMode:MAX](#) on page 2439

[SEARCH:TRIGger:DPHY:ESCMode:MIN](#) on page 2439

14.23.5.2 D-PHY search results

To get search results, "Enable" the search. You can minimize, shift or close the search dialog.

The search results are listed in the search result table and marked in the waveform by blue lines.

For an introduction to search results, see:

- [Chapter 11.1.2, "Search results"](#), on page 426
- [Chapter 11.4.2, "Display zoom settings"](#), on page 446

Remote commands:

• [SEARCH:RESult:DPHY:FCOunt?](#) on page 2444

• [SEARCH:RESult:DPHY:FRAMe<m>:CS?](#) on page 2444

• [SEARCH:RESult:DPHY:FRAMe<m>:DATA?](#) on page 2444

• [SEARCH:RESult:DPHY:FRAMe<m>:DTName?](#) on page 2444

• [SEARCH:RESult:DPHY:FRAMe<m>:DTYPe?](#) on page 2445

• [SEARCH:RESult:DPHY:FRAMe<m>:ECC?](#) on page 2445

• [SEARCH:RESult:DPHY:FRAMe<m>:PACKet<n>:IDX?](#) on page 2445

• [SEARCH:RESult:DPHY:FRAMe<m>:PACKet<n>:VALue?](#) on page 2446

• [SEARCH:RESult:DPHY:FRAMe<m>:START?](#) on page 2446

• [SEARCH:RESult:DPHY:FRAMe<m>:STATe?](#) on page 2446

• [SEARCH:RESult:DPHY:FRAMe<m>:STOP?](#) on page 2447

• [SEARCH:RESult:DPHY:FRAMe<m>:TYPE?](#) on page 2447

• [SEARCH:RESult:DPHY:FRAMe<m>:VCHannel?](#) on page 2448

14.23.5.3 Searching D-PHY

Prerequisite: A serial bus is configured for the D-PHY signal to be decoded and analyzed.

The search for events is set up in the following way:

1. Press the [Bus] key and select the "Shortcuts" tab.
2. Tap "Setup search".
3. If the dialog box does not contain a search entry, tap the "Add" icon to create one, as described in ["To create a user-defined search"](#) on page 440.

4. Tap "Source" and select the serial bus that is set to D-PHY (e.g. "SB1", unless already selected).
5. Specify search criteria according to [Chapter 14.23.5.1, "D-PHY search setup"](#), on page 914.
6. To acquire a waveform, press [Single].
The R&S RTO6 performs a D-PHY decode according to the thresholds and protocol settings of the associated serial bus source.
7. To start searching the acquired waveform for specific events, tap "Enable" in the search setup dialog:
The R&S RTO6 displays the "Search Results" box that lists the detected events.

For information on how to configure the search results presentation and how to navigate the search results, see also ["To display search zoom windows"](#) on page 448.

14.24 M-PHY and USB SSIC (option R&S RTO6-K580 and K570)

The M-PHY® is a serial communication protocol. Its specifications were developed by the Mobile Industry Processor Interface (MIPI) alliance as standards for the communication of high-speed components, like smartphones and tablets, within mobile devices. For more details on the specifications, refer to <http://mipi.org/specifications/physical-layer#M-PHY Specification>.

This protocol is the foundation for several upper layer protocols, such as UniProSM (Unified Protocol), which manage complex data transfer functions. Each of these protocols is optimized for its particular purpose, such as data storage, data transfer, display, camera, memory sharing and radio interface.

When implemented together with the MIPI UniPro, defined as UniPort-M, they deliver high speed, low power, scalable and flexible data transport solutions.

The super speed inter-chip (SSIC) was developed by the USB standards committee based on USB3.1 G1 (SuperSpeed). It is developed to support the chip to chip communication of USB3 components. The lower communication layers are using M-PHY as the encoder platform and use a multilane distribution similar to UniPro. The higher communication layers (above 8b/10b) are almost identical to USB3.1 G1.

- [M-PHY basic](#)..... 919
- [M-PHY configuration](#)..... 920
- [M-PHY trigger](#)..... 923
- [M-PHY decode results](#)..... 938
- [Search on decoded M-PHY data](#)..... 939

14.24.1 M-PHY basic

This chapter provides an overview of the characteristics of the M-PHY and UniPro protocols.

14.24.1.1 Data transfer

M-PHY words are always 10 bits long (both data and control words). For UniPro, they have variable lengths that depend on the frame type. For example, control words have 8 bits, data words have 16 bits and reserved words have 3 bits.

To achieve power efficiency and high-performance transmissions, multiple power-saving states and recovery times are utilized. Scalability and flexibility are achieved through the various transmission speed ranges and rates.

Different modes of operations:

- Disable mode: lowest power mode entered into once the power supply is turned on
- Hibernate (Hibern8): ultra low-power state, which can be used without configuration loss
- High-speed mode (HS): supports three gears with predefined data rates. This mode is used during high-speed transmission for transporting large volume of data. This mode utilizes the power-saving Stall state to reduce power consumption while offering a fast state transition in the range of nanoseconds
- Low-power mode (PWM): supports seven gears with predefined frequency ranges. This mode is used during low-speed transmission for power conservation. This mode utilizes the power-saving Sleep state with a state transition time typically in the range of microseconds

The R&S RTO6 supports all operating speed modes: high-speed and low-power mode. The gear settings of these modes are auto detected by the instrument.

14.24.1.2 Data analysis

The M-PHY and UniPro decoding process involves several stages, similar to D-PHY.

The stages are as the following:

- Stage 1: involves two substages:
 - Stage 1a: converts the three stage cross points into bit and attempts a HS-Sync. This stage involves the Hibern8-Detection/Filter, NRZ Unclocked Decoder and Burst Detection.
 - Stage 1b is only involved if Stage 1a burst detection fails, assuming using PWM. Input is from the bits from stage 1a. This stage involves the PWM Decoder, Line CFG Decoder and Burst Detection.
- Stage 2: performs the 8b/10b decoding of bits from stage 1 into Bytes and identifies the 8b/10b control words. This stage involves the 8b/10b Decoder and Shift-decoder to Bytes.
- Stage 3: starts decoding the Bytes from stage 2. This stage involves the Descrambler and 17-bit Shift Decoder.

- Stage 4: merges the data lanes and finalizes the decoding to the UniPro data frames. This stage involves the Lane Merger, PDU Sync Detector, Shift Decode and Dynamic Data unit Decoder.

14.24.2 M-PHY configuration

14.24.2.1 M-PHY configuration settings

Access: [Bus] > "M-PHY" > "Setup" tab



Make sure that the tab of the correct serial bus is selected.

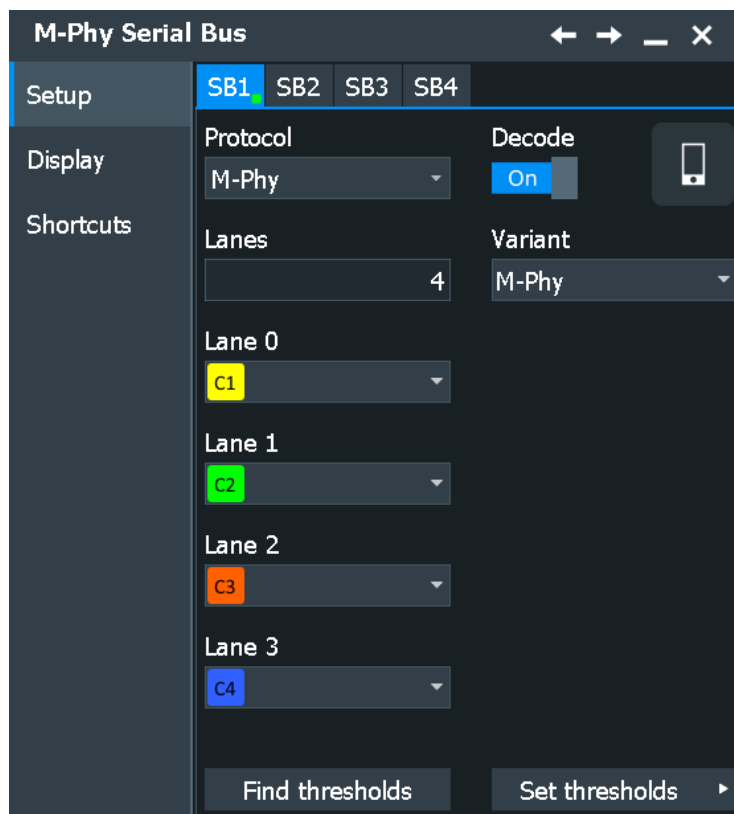

See also: [Chapter 14.1.1, "Setup - general settings"](#), on page 511

Variant

Selects the protocol running on the interface. You can select between the M-PHY, Uni-Pro and SSIC.

Remote command:

`BUS<m>:MPHY:VARIant` on page 2449

Lanes

Sets the number of logical lanes that are mapped to the physical lines. You can select up to four lanes.

Remote command:

[BUS<m>:MPHY:DLANes](#) on page 2449

Lane 0 / Lane 1 / Lane 2 / Lane 3: Channel

Select the signal sources for the logical lanes.

Remote command:

[BUS<m>:MPHY:DZERo:SOURce](#) on page 2449

[BUS<m>:MPHY:DONE:SOURce](#) on page 2450

[BUS<m>:MPHY:DTWO:SOURce](#) on page 2450

[BUS<m>:MPHY:DTHRee:SOURce](#) on page 2450

Threshold setup

Opens a dialog, where you can set the thresholds for digitization of signals for each lane.

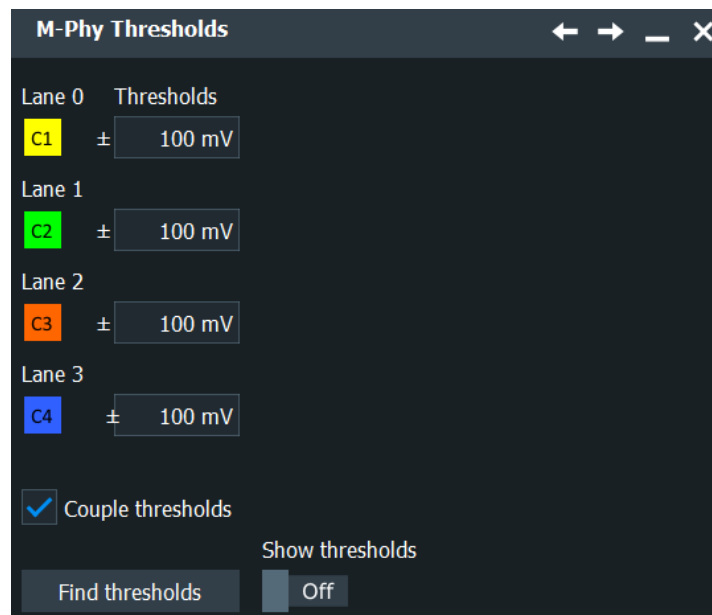

"Thresholds" Enter individual values for each line directly in the fields.

"Couple thresholds" Enables the same threshold value for all lanes.

"Find thresholds" Executes the measurement of reference levels and sets the thresholds to the middle reference level of the measured amplitude.

"Show thresholds" If enabled, the threshold levels are displayed in the diagram.

Remote command:

[BUS<m>:MPHY:DZERo:THReshold](#) on page 2450

[BUS<m>:MPHY:DONE:THReshold](#) on page 2450

[BUS<m>:MPHY:DTWO:THReshold](#) on page 2450

[BUS<m>:MPHY:DTHRee:THReshold](#) on page 2450

[BUS<m>:MPHY:THCoupling](#) on page 2450

Scrambled Mode

Available, if "Variant" = "SSIC".

Selects, if the SSIC data is scrambled or descrambled. Set this parameter according to your signal parameters, to ensure a proper decoding.

Remote command:

[BUS<m>:MPHY:SCRMode](#) on page 2451

14.24.2.2 Display settings

Access: [Bus] > "Display" tab.

For common display settings, see [Chapter 14.1.3, "Display"](#), on page 513.

To enhance the decode possibilities of the M-PHY or UniPro protocol, you can use an additional setting in the "Display" tab: "Decode layer".

Decode layer

Selects the decode layer.

Decoding is performed in several steps, and the end results are presented in the decode table. The decode layer selects an interim step for which the decoding result is shown in the honeycomb display.

"Final"	Final decoded frames of each lane.
"Edges"	All edges of each lane in stage 1 decoding.
"Bits"	All bits of each lane in stage 1 decoding.
"8b/10b Symbols"	8b/10b symbols in stage 2 decoding.
"LCC bits"	LCC bits in stage 3 decoding.
"Filter/descrambler"	UniPro filter/descrambler in stage 3 decoding.
"Lane merge"	UniPro lane merge in stage 4 decoding.
"Bytes"	UniPro bytes in stage 2 decoding.

Show multiple lanes

Enables the display of the results in multiple lanes.

Remote command:

[BUS<m>:MPHY:SMLanes](#) on page 2451

14.24.2.3 Configuring the M-PHY signals

Access: [Bus] > "Setup" tab > "Protocol" = *M-PHY*

Assign the lanes to the channels and define the thresholds:

1. Press [Bus] on the front panel.
2. Select the tab of the bus you want to set up, for example "SB1".
3. In the "Setup" tab, select the protocol: M-PHY.
4. Tap "Variant" and select the protocol.
5. Enter the number of "Lanes".
6. Select the source "Channel" for each lane.
7. Enter the "Thresholds" for each lane.
8. Enable "Decode".

14.24.3 M-PHY trigger

14.24.3.1 M-PHY trigger settings

Access: [Bus] > "Shortcuts" tab > "Setup trigger"

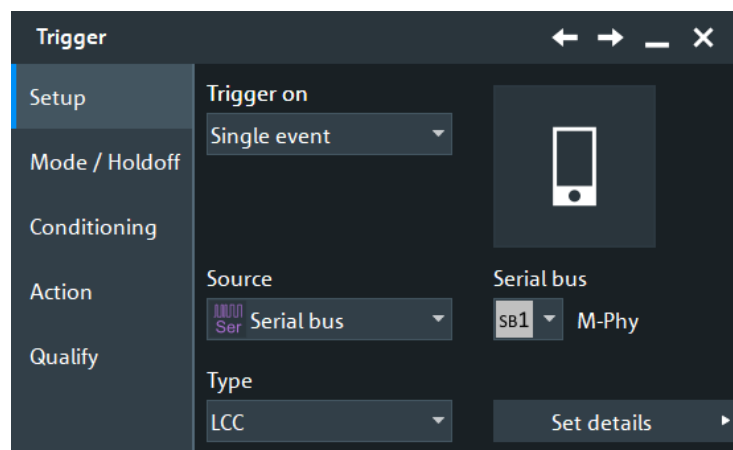

Make sure that:

- In the [Bus] > "Setup" tab:
 - The correct "Protocol" is selected.
 - The data sources of the serial bus are channel signals.
- In the "Trigger" > "Setup" tab:
 - The "Trigger on" = "Single event"
 - The trigger "Source" = "Serial bus".
 - The correct "Serial bus" is selected.

Type

Selects the trigger type for the analysis of the selected protocol.

Remote command:

[TRIGger<m>:MPHY:TYPE](#) on page 2453

Start of frame ← Type

Triggers on the start of an M-PHY or a UniPro frame.

Burst ← Type

Triggers on an M-PHY burst frame.

Adapt ← Type

Triggers on an M-PHY Adapt frame. This control frame is used for clock/bit synchronization.

LCC ← Type

Triggers on an M-PHY Line Control Command (LCC) frame that matches the specified:

- [LCC Type](#)
- [WORD](#)

This control frame is used for configuring the line to a different state or mode depending on the LCC type.

The screenshot shows the 'M-Phy Trigger' configuration window. It has a title bar with navigation icons. The main content is organized as follows:

- LCC**: A section header.
- LCC Type**: A dropdown menu currently showing 'Any LCC Com...'.
- WORD 1**: A dropdown menu showing '[-] In range', followed by two input fields containing '[hex]00' and '.. [hex]00'.
- WORD 2**: A dropdown menu showing '[-] In range', followed by two input fields containing '[hex]00' and '.. [hex]00'.
- WORD 3**: A dropdown menu showing '[-] In range', followed by two input fields containing '[hex]00' and '.. [hex]00'.
- WORD 4**: A dropdown menu showing '[-] In range', followed by two input fields containing '[hex]00' and '.. [hex]00'.

DL PDU SOF ← Type

Triggers on a UniPro Downlink Protocol Data Unit (DL PDU) Start Of Frame (SOF) that matches the specified:

- [Prepare length](#)
- [TC](#)
- [Data](#)
- [Index](#)

The screenshot shows the 'M-Phy Trigger' configuration window for 'DL PDU SOF'. The window has a title bar with navigation icons (back, forward, home, close). The configuration fields are as follows:

- DL PDU SOF**: Title of the trigger configuration.
- Prepare Length**: A text input field containing '5 ns'.
- TC**: A text input field containing '[bin]XX'.
- Data**: A dropdown menu set to 'In range', followed by two text input fields containing '[hex]0000' and '.. [hex]0000'.
- Index**: A dropdown menu set to 'In range', followed by two text input fields containing '1' and '65535'.

DL PDU COF ← Type

Triggers on a UniPro DL PDU Continuation Of Pre-empted Frame (COF) that matches the specified:

- Prepare length
- TC
- Data
- Index

The screenshot shows the 'M-Phy Trigger' configuration window for 'DL PDU COF'. The window has a title bar with navigation icons (back, forward, home, close). The configuration fields are as follows:

- DL PDU COF**: Title of the trigger configuration.
- Prepare Length**: A text input field containing '5 ns'.
- TC**: A text input field containing '[bin]XX'.
- Data**: A dropdown menu set to '= Equal', followed by a text input field containing '[hex]XXXX'.
- Index**: A dropdown menu set to 'In range', followed by two text input fields containing '1' and '65535'.

DL PDU EOF ← Type

Triggers on a UniPro DL PDU End Of Frame (EOF) frame that matches the specified conditions:

- Prepare length
- FSN
- CRC

The screenshot shows the 'M-Phy Trigger' configuration window. The title bar includes navigation icons (back, forward, home, close). The main content area is titled 'DL PDU EOF'. It contains three sections: 'Prepare Length' with a text input field containing '5 ns'; 'FSN' with a dropdown menu set to '= Equal' and a text input field containing '[hex]XX'; and 'CRC' with a dropdown menu set to '= Equal' and a text input field containing '[hex]XX XX'.

DL PDU NAC ← Type

Triggers on a UniPro DL PDU Negative Acknowledgment Control (NAC) frame that matches the specified conditions:

- Prepare length
- RReq
- CRC

The screenshot shows the 'M-Phy Trigger' configuration window. The title bar includes navigation icons (back, forward, home, close). The main content area is titled 'DL PDU NAC'. It contains three sections: 'Prepare Length' with a text input field containing '5 ns'; 'RReq' with a dropdown menu set to 'X'; and 'CRC' with a dropdown menu set to '= Equal' and a text input field containing '[hex]XX XX'.

DL PDU AFC ← Type

Triggers on a UniPro DL PDU Acknowledgement and L2 Flow Control (AFC) frame that matches the specified conditions:

- Prepare length
- TC
- CReq
- FSN
- Credit
- CRC

M-Phy Trigger

DL PDU AFC

Prepare Length
5 ns

TC
[bin]XX

CReq
X

FSN
= Equal [hex]XX

Credit
= Equal [hex]XX

CRC
= Equal [hex]XX XX

PACP ← Type

Triggers on a UniPro PHY Adapter Control Protocol (PACP) frame that matches the specified condition:

- Prepare length
- PACP Begin
- PACP Function ID
- Data
- Index
- CRC

This control frame is used mainly for power mode change and L1.5 link management. It is also used in scrambling request.

M-Phy Trigger

PACP

Prepare Length
5 ns

PACP begin
= Equal [hex]XX

PACP function ID
= Equal [hex]XX XX

Data
[-] In range [hex]0000 .. [hex]0000

Index
[-] In range 1 .. 65535

CRC
= Equal [hex]XX XX

Trigger Upr0 ← Type

Triggers on a UniPro Trigger Upper0 frame. This control frame is used for link startup sequence.

Trigger Upr1 ← Type

Triggers on a UniPro Trigger Upper1 frame. This control frame is used for link startup sequence.

Trigger Upr2 ← Type

Triggers on a UniPro Trigger Upper2 frame. This control frame is used for link startup sequence.

Errors ← Type

Triggers on the specified M-PHY or UniPro [error](#) frame.

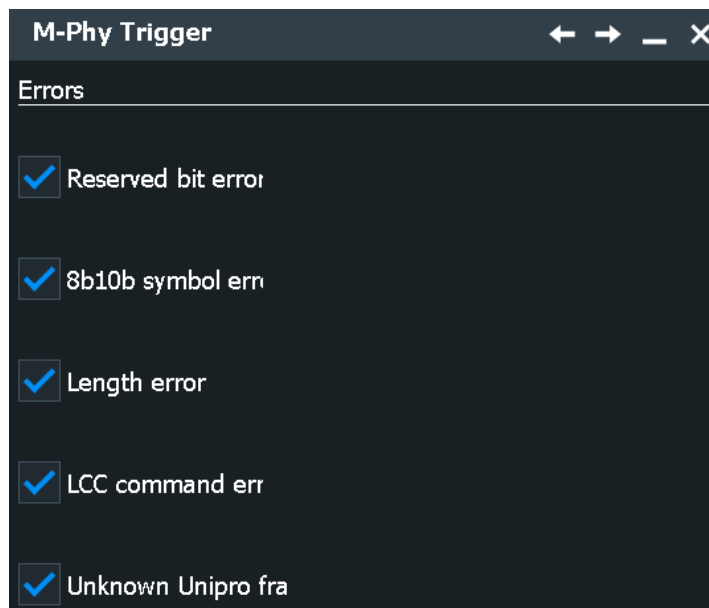
**Prepare length**

Sets the prepare length.

LCC Type

Selects the type of LCC command to be triggered on.

"Any LCC Command"

All the available LCC commands

"HIBERN8-SLEEP"

Switches the power-saving state to ultra-low power without configuration loss. This state saves up to 90% power and is used with PWM burst.

"HIBERN8-STALL"

Switches the power-saving state to ultra-low power without configuration loss. This state saves up to 75% power and is used with HS burst.

"READ-CAPABILITY"

Recovers data about the Optical Media Converter (OMC) capabilities

"READ-MFG-INFO"

Retrieves manufacturing ID and vendor-specific information

"READ-VEND-INFO"

Retrieves the additional four delimited bytes containing vendor-specific information

"WRITE-ATTRIBUTE"

Sets the configuration parameters required for lane operation

"PWM-G0/PWM-G1/PWM-G2/PWM-G3/PWM-G4/PWM-G5/PWM-G6/PWM-G7"

Switches the transmission mode to the selected low-power gear

"HS-G1A/HS-G2A/HS-G3A/HS-G4A/HS-G1B/HS-G2B/HS-G3B/HS-G4B"

Switches the transmission mode to the selected high-speed gear

"Reserved"

Reserved bit command. These bits are reserved for future use.

Remote command:

[TRIGger<m>:MPHY:LCCType](#) on page 2453

WORD 1/WORD 2/WORD 3/WORD 4

Sets the specified words to be triggered on. The setup for a word consists of the condition and one or two word patterns.

"Condition" Sets the comparison condition to a specific value or a range.

"Data Min/Data"

Specifies the value or sets the start value of a range.

In binary format, use the following characters: 1; 0; or X (do not care). To enter the pattern in other formats use the bit pattern editor, see [Chapter 14.1.7, "Bit pattern editor"](#), on page 519.

"Data Max" Sets the maximum value of a range for "Condition" = "In range"/"Out of range".

Remote command:

For " WORD 1":

[TRIGger<m>:MPHY:LWONe:CONDition](#) on page 2454

[TRIGger<m>:MPHY:LWONe:MIN](#) on page 2455

[TRIGger<m>:MPHY:LWONe:MAX](#) on page 2455

For " WORD 2":

[TRIGger<m>:MPHY:LWTWo:CONDition](#) on page 2455

[TRIGger<m>:MPHY:LWTWo:MIN](#) on page 2456

[TRIGger<m>:MPHY:LWTWo:MAX](#) on page 2456

For " WORD 3":

[TRIGger<m>:MPHY:LWTHree:CONDition](#) on page 2456

[TRIGger<m>:MPHY:LWTHree:MIN](#) on page 2457

[TRIGger<m>:MPHY:LWTHree:MAX](#) on page 2457

For " WORD 4":

[TRIGger<m>:MPHY:LWFour:CONDition](#) on page 2457

[TRIGger<m>:MPHY:LWFour:MIN](#) on page 2458

[TRIGger<m>:MPHY:LWFour:MAX](#) on page 2458

TC

Sets the specified Traffic Class (TC) to be triggered on.

TC is used for classifying the traffic flow based on protocol and port number, e.g. TC0 and TC1 are two priority classes with guaranteed link reliability defined and used in L2.

"Data" Defines the bit pattern of the TC pattern.

In binary format, use the following characters: 1; 0; or X (do not care). To enter the pattern in other formats use the bit pattern editor, see [Chapter 14.1.7, "Bit pattern editor"](#), on page 519.

Remote command:

[TRIGger<m>:MPHY:TC](#) on page 2458

Data

Sets the data to be triggered on. The trigger data setup consists of a comparison condition and one or two data patterns.

"Condition" Sets the comparison condition to a specific value or a range.

"Data Min/Data"

Specifies the value or sets the start value of a range.

In binary format, use the following characters: 1; 0; or X (do not care). To enter the pattern in other formats use the bit pattern editor, see [Chapter 14.1.7, "Bit pattern editor"](#), on page 519.

"Data Max" Sets the maximum value of a range for "Condition" = "In range"/"Out of range".

Remote command:

[TRIGger<m>:MPHY:DATA:DCON](#) on page 2459

[TRIGger<m>:MPHY:DATA:DMIN](#) on page 2459

[TRIGger<m>:MPHY:DATA:DMAX](#) on page 2459

Index

The trigger index setup consists of a comparison condition and one or two address patterns.

"Condition" Sets the comparison condition to a specific value or a range.

"Index Min/Index"

Specifies the value or sets the start value of a range.

In binary format, use the following characters: 1; 0; or X (do not care). To enter the pattern in other formats use the bit pattern editor, see [Chapter 14.1.7, "Bit pattern editor"](#), on page 519.

"Index Max" Sets the maximum value of a range for "Condition" = "In range"/"Out of range".

Remote command:

[TRIGger<m>:MPHY:DATA:ICONdition](#) on page 2460

[TRIGger<m>:MPHY:DATA:IMIN](#) on page 2460

[TRIGger<m>:MPHY:DATA:IMAX](#) on page 2460

FSN

Sets the specified Frame Sequence Number (FSN) to be triggered on. The FSN setup consists of the condition and one or two FSN patterns.

"Condition" Defines the operator to set a specific FSN, e.g. "Equal" or "Not Equal" or a range.

"Data Min/Data"

Defines the bit pattern of the FSN pattern.

In binary format, use the following characters: 1; 0; or X (do not care). To enter the pattern in other formats use the bit pattern editor, see [Chapter 14.1.7, "Bit pattern editor"](#), on page 519.

"Data Max" The second FSN pattern is required to specify a range with conditions "In range" and "Out of range".

Remote command:

[TRIGger<m>:MPHY:FSNumber:CONDition](#) on page 2461

[TRIGger<m>:MPHY:FSNumber:MIN](#) on page 2461

[TRIGger<m>:MPHY:FSNumber:MAX](#) on page 2461

CRC

Sets the specified Cyclic Redundancy Check (CRC) to be triggered on. The CRC setup consists of the condition and one or two CRC patterns.

CRC is an error detecting code to detect accidental changes to raw data.

"Condition" Defines the operator to set a specific CRC, e.g. "Equal" or "Not Equal" or a range.

"Data Min/Data"

Defines the bit pattern of the CRC pattern.

In binary format, use the following characters: 1; 0; or X (do not care). To enter the pattern in other formats use the bit pattern editor, see [Chapter 14.1.7, "Bit pattern editor"](#), on page 519.

"Data Max" Sets the maximum value of a range for "Condition" = "In range"/"Out of range".

Remote command:

[TRIGger<m>:MPHY:CRC:CONDition](#) on page 2462

[TRIGger<m>:MPHY:CRC:MIN](#) on page 2462

[TRIGger<m>:MPHY:CRC:MAX](#) on page 2462

Req

Sets the specified Reset Link Request (RReq) or Credit Transmit Request (CReq) to be triggered on.

RReq is used for requesting the remote end to reinitialize its Transmit (TX) Physical Layer (PHY) while CReq is used for requesting flow control information for the corresponding [TC](#) from the remote end.

"Data" Defines the bit pattern of the RReq pattern.

In binary format, use the following characters: 1; 0; or X (do not care). To enter the pattern in other formats use the bit pattern editor, see [Chapter 14.1.7, "Bit pattern editor"](#), on page 519.

Remote command:

[TRIGger<m>:MPHY:RREQ](#) on page 2463

[TRIGger<m>:MPHY:CREQ](#) on page 2463

Credit

Sets the specified credit to be triggered on. The credit setup consists of the condition and one or two credit patterns.

Credit represents the total number of credits available since boot time.

"Condition" Defines the operator to set a specific credit, e.g. "Equal" or "Not Equal" or a range.

"Data Min/Data"

Defines the bit pattern of the credit pattern.

In binary format, use the following characters: 1; 0; or X (do not care).

To enter the pattern in other formats use the bit pattern editor, see [Chapter 14.1.7, "Bit pattern editor"](#), on page 519.

"Data Max"

The second credit pattern is required to specify a range with conditions "In range" and "Out of range".

Remote command:

[TRIGger<m>:MPHY:CREDit:CONDition](#) on page 2463

[TRIGger<m>:MPHY:CREDit:MIN](#) on page 2464

[TRIGger<m>:MPHY:CREDit:MAX](#) on page 2464

PACP Begin

Sets the specified PACP Begin to be triggered on. The PACP Begin setup consists of the condition and one or two PACP Begin patterns.

"Condition"

Defines the operator to set a specific PACP Begin, e.g. "Equal" or "Not Equal" or a range.

"Data Min/Data"

Defines the bit pattern of the data value pattern.

In binary format, use the following characters: 1; 0; or X (do not care).

To enter the pattern in other formats use the bit pattern editor, see [Chapter 14.1.7, "Bit pattern editor"](#), on page 519.

"Data Max"

The second PACP Begin pattern is required to specify a range with conditions "In range" and "Out of range".

Remote command:

[TRIGger<m>:MPHY:PBEGin:CONDition](#) on page 2464

[TRIGger<m>:MPHY:PBEGin:MIN](#) on page 2465

[TRIGger<m>:MPHY:PBEGin:MAX](#) on page 2465

PACP Function ID

Sets the specified PACP Function ID to be triggered on. The PACP Function ID setup consists of the condition and one or two PACP Function ID patterns.

"Condition"

Defines the operator to set a specific PACP Function ID, e.g. "Equal" or "Not Equal" or a range.

"Data Min/Data"

Defines the bit pattern of the PACP Function ID pattern.

In binary format, use the following characters: 1; 0; or X (do not care).

To enter the pattern in other formats use the bit pattern editor, see [Chapter 14.1.7, "Bit pattern editor"](#), on page 519.

"Data Max"

The second PACP Function ID pattern is required to specify a range with conditions "In range" and "Out of range".

Remote command:

[TRIGger<m>:MPHY:PFID:CONDition](#) on page 2465

[TRIGger<m>:MPHY:PFID:MIN](#) on page 2466

[TRIGger<m>:MPHY:PFID:MAX](#) on page 2466

Errors

Sets the type of error events to be triggered on.

Reserved Bit Error ← Errors

Triggers on reserved bit error.

This error means that the waveform violates the reserved field according to the specification. For example, a DL_PDU_AFC frame requires that the two bits before and three bits after the FSN field to be reserved and set as 0. If the waveform carries 1 in these positions instead, it is marked as this error.

Remote command:

[TRIGger<m>:MPHY:ERRor:REServed](#) on page 2467

LCC Command Error ← Errors

Triggers on LCC command error.

This error is marked when the Command field in the LCC packet is not a known command defined in the specification.

Remote command:

[TRIGger<m>:MPHY:ERRor:LCMD](#) on page 2467

8b10b Symbol Error ← Errors

Triggers on 8b10b symbol error.

For example, some of the 10-bit combinations that do not map to 8-bit according to the specification are invalid 10-bit and therefore marked as this error.

Remote command:

[TRIGger<m>:MPHY:ERRor:SYMBOL](#) on page 2467

Unknown Unipro Frame ← Errors

Triggers on unidentified UniPro frame error. This error is marked when the end mark on UniPro packets is undetected.

Remote command:

[TRIGger<m>:MPHY:ERRor:UNKNown](#) on page 2468

Length Error ← Errors

Triggers on frames that violate the length according to the specification.

Remote command:

[TRIGger<m>:MPHY:ERRor:LENGth](#) on page 2467

14.24.3.2 Triggering on M-PHY

Prerequisite: A bus is configured for the M-PHY signal to be analyzed.

For the basic trigger settings, proceed in the following way:

1. Press the [Bus] key and select the "Trigger" tab.
2. Press the "Select" button. The "Source" button is shown.
3. Tap the "Source" button and select the "Serial bus" trigger source.

4. Tap "Serial bus" and select the serial bus that is set to M-PHY, e.g.:



The "Protocol" selection is then automatically set to "M-PHY".

5. Select the "Type" to use in the M-PHY protocol analysis.
6. To refine the trigger settings, configure additional settings, which are available for some trigger types.
For details, see [Chapter 14.24.3.1, "M-PHY trigger settings"](#), on page 923.

14.24.3.3 SSIC trigger settings

The setting is available for SSIC option R&S RTO6-K570.

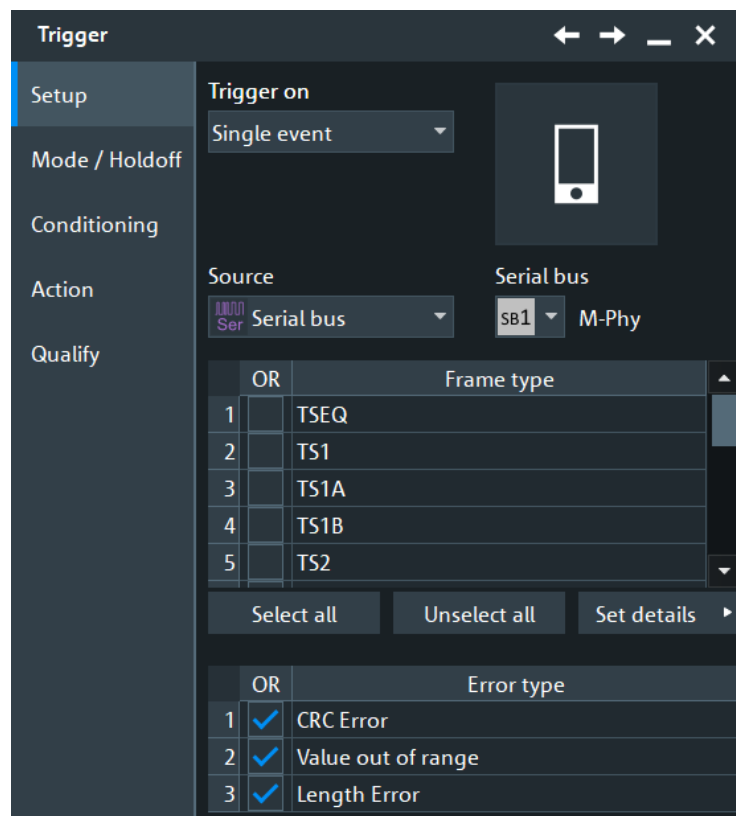

Frame type

Selects the frame type for the M-PHY SSIC.

The SSIC trigger frames and fields are the same as for USB3.1, see ["Frame types"](#) on page 869.

Error types, Enable

The table lists the error types you can trigger on. Select the required errors in the "OR" column.

Remote command:

[TRIGger<m>:MPHY:SSIC:DOPerator](#) on page 2500

[TRIGger<m>:MPHY:SSIC:FRAMe<n>:FLD<o>:DOPerator](#) on page 2500

[TRIGger<m>:MPHY:SSIC:DMIN](#) on page 2500

[TRIGger<m>:MPHY:SSIC:FRAMe<n>:FLD<o>:DMIN](#) on page 2500

[TRIGger<m>:MPHY:SSIC:DMAX](#) on page 2499

[TRIGger<m>:MPHY:SSIC:FRAMe<n>:FLD<o>:DMAX](#) on page 2499

BitState

Defines the bit state to be checked for the selected field. Permitted bit states are "1", "0" or "X" (do not care).

Remote command:

[TRIGger<m>:MPHY:SSIC:BIT](#) on page 2499

[TRIGger<m>:MPHY:SSIC:FRAMe<n>:FLD<o>:BIT](#) on page 2499

Index

Defines for the selected field, how an index check is executed.

"Condition"	Defining a specific index or an index range requires to set the operator to one of the following conditions: equal, in range.
"Min"	Specifies the index or sets the start value of an index range.
"Max"	Sets the end value of an index range, if "Condition" is set to "In range".

Remote command:

[TRIGger<m>:MPHY:SSIC:IOPerator](#) on page 2502

[TRIGger<m>:MPHY:SSIC:FRAMe<n>:FLD<o>:IOPerator](#) on page 2502

[TRIGger<m>:MPHY:SSIC:IMIN](#) on page 2501

[TRIGger<m>:MPHY:SSIC:FRAMe<n>:FLD<o>:IMIN](#) on page 2501

[TRIGger<m>:MPHY:SSIC:IMAX](#) on page 2501

[TRIGger<m>:MPHY:SSIC:FRAMe<n>:FLD<o>:IMAX](#) on page 2501

14.24.3.4 Triggering on SSIC

Prerequisite: A bus is configured for the "M-PHY" > "Variant" = "SSIC" signal to be analyzed.

For the basic trigger settings, proceed in the following way:

1. Press the [Bus] key and select the "Shortcuts" tab.
2. Press "Setup trigger".
3. Tap the "Source" button and select the "Serial bus" trigger source.
4. Tap "Serial bus" and select the serial bus that is set to SSIC.
5. If you trigger on errors, select the error types you want to find.
6. Select the frame type to be used for SSIC protocol analysis.
7. For some frame types, you can define the frame fields.

For details, see [Chapter 14.24.3.3, "SSIC trigger settings"](#), on page 935.

14.24.4 M-PHY decode results

When the configuration of the serial bus is complete, the signal can be decoded:

1. In the "Protocol" dialog > "Setup" tab, enable "Decode".
2. In the "Protocol" dialog > "Display" tab, select additional result display settings: "Show decode table" and "Show binary signals".

For a description of the display settings, see also [Chapter 14.1.3, "Display"](#), on page 513.

The instrument captures and decodes the signal according to the standard definition and the configuration settings.

The color-coding of the various protocol sections and errors simplifies the interpretation of the visual display. The decode information condenses or expands, depending on the horizontal scale. Various data formats are available to show the result values.

Decode Results Table

The results are shown in two tables:

- "Decode results": contains information about all decoded frames
- "Details frame": contains more detailed information about the selected frame in the "Decode results" table.

State	Start	Name	Info
3 Ok	-315 ns	Skip	---
4 Ok	-305 ns	Skip	---
5 Ok	-305 ns	Skip	---
6 Ok	-295 ns	Skip	---
7 Ok	-295 ns	TS2	---
8 Ok	-255 ns	TS1A	---
9 Ok	-215 ns	TS1B	---
10 Ok	-175 ns	Port Capability	Link Speed=01h
11 Ok	-124.9 ns	Link Delay Meas	LDM Type=1
12 Ok	-75 ns	ACK	---

State	Type	Numeric	Formatted
1 Ok	HPSTART: 1	[hex] FB	SHP
2 Ok	HPSTART: 2	[hex] FB	SHP
3 Ok	HPSTART: 3	[hex] FB	SHP
4 Ok	HPSTART: 4	[hex] F7	EPF
5 Ok	Type	[hex] 04	TP
6 Ok	Route String	[hex] F233D	F233Dh
7 Ok	Device Address	[hex] 12	12h
8 Ok	SubType	[hex] 01	ACK
9 Ok	Rsvd	[hex] 00	0h

Table 14-46: Content of the Decode results table

Column	Description
Frame	Frame count
State	Overall state of the frame indicating, for example, if the frame is valid or invalid
Start	Time of frame start in relation to the trigger point
Info	Label on top of the frame

Table 14-47: Content of the Details frame table

Column	Description
State	State of the field
Type	Frame identifier specifying the data or control frame name

Column	Description
Numeric	Hexadecimal value of the field
Formatted	Formatted content of the field

Tools

Press "Display settings" in the "Decode Results" table to access the "Display" tab.



Remote commands

Remote commands are described in [Chapter 27.18.25.3, "Decode results M-PHY"](#), on page 2468.

14.24.5 Search on decoded M-PHY data

Using the search functionality, you can find various events in the decoded data. You can find the same events that you can trigger on, and even many more, since several event types can also be combined.

Before you can start the search, you have to configure the bus correctly and acquire decoded data.

To search on decoded data, set the search source to "SerBus" for the configured protocol.

For general information on how to handle the search functionality, see [Chapter 11, "Search functions"](#), on page 425.

14.24.5.1 M-PHY search setup

Access: [Bus] > "Shortcuts" tab > "Setup search"

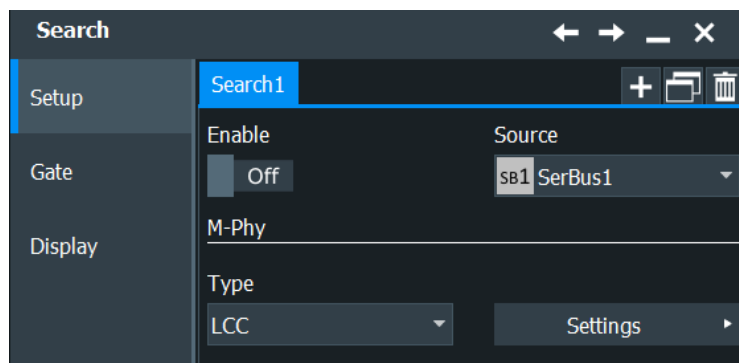

Type

Selects the search type for the selected protocol.

Remote command:

[SEARCH:TRIGGER:MPHY:TYPE](#) on page 2476

Start of frame ← Type

Searches for the start of an M-PHY or a UniPro frame.

Burst ← Type

Searches for an M-PHY burst.

Adapt ← Type

Searches for an M-PHY Adapt frame. This control frame is used for clock/bit synchronization.

LCC ← Type

Searches for an M-PHY Line Control Command (LCC) frame that matches the specified [LCC Type](#) or any [WORD](#) condition.

This control frame is used for configuring the line to a different state or mode depending on the LCC type.

DL PDU SOF ← Type

Searches for a UniPro Downlink Protocol Data Unit (DL PDU) Start Of Frame (SOF) that matches the specified [TC](#), [Data](#) or [Index](#) condition.

DL PDU COF ← Type

Searches for a UniPro DL PDU Continuation Of Pre-empted Frame (COF) that matches the specified [TC](#), [Data](#) or [Index](#) condition.

DL PDU EOF ← Type

Searches for a UniPro DL PDU End Of Frame (EOF) that matches the specified [FSN](#) or [CRC](#) condition.

DL PDU NAC ← Type

Searches for a UniPro DL PDU Negative Acknowledgment Control (NAC) frame that matches the specified [RReq](#) or [CRC](#) condition.

DL PDU AFC ← Type

Searches for a UniPro DL PDU Acknowledgement and L2 Flow Control (AFC) frame that matches the specified [TC](#), [CReq](#), [FSN](#), [Credit](#) or [CRC](#) condition.

PACP ← Type

Searches for a UniPro PHY Adapter Control Protocol (PACP) frame that matches the specified [PACP Begin](#), [PACP Function ID](#), [Data](#), [Index](#) or [CRC](#) condition.

This control frame is used mainly for power mode change and L1.5 link management. It is also used in scrambling request.

Trigger Upper0 ← Type

Searches for a Trigger Upper0 frame. This control frame is used for link startup sequence.

Trigger Upper1 ← Type

Searches for a Trigger Upper1 frame. This control frame is used for link startup sequence.

Trigger Upper2 ← Type

Searches for a Trigger Upper2 frame. This control frame is used for link startup sequence.

Errors ← Type

Searches for the specified [error](#) frame.

LCC Type

Selects the type of LCC command to be searched for.

"Any LCC Command"

All the available LCC commands

"HIBERN8-SLEEP"

Switches the power-saving state to ultra-low power without configuration loss. This state saves up to 90% power and is used with PWM burst.

"HIBERN8-STALL"

Switches the power-saving state to ultra-low power without configuration loss. This state saves up to 75% power and is used with HS burst.

"READ-CAPABILITY"

Recovers data about the Optical Media Converter (OMC) capabilities

"READ-MFG-INFO"

Retrieves manufacturing ID and vendor-specific information

"READ-VEND-INFO"

Retrieves the additional four delimited bytes containing vendor-specific information

"WRITE-ATTRIBUTE"

Sets the configuration parameters required for lane operation

"PWM-G0/PWM-G1/PWM-G2/PWM-G3/PWM-G4/PWM-G5/PWM-G6/PWM-G7"

Switches the transmission mode to the selected low-power gear

"HS-G1A/HS-G2A/HS-G3A/HS-G4A/HS-G1B/HS-G2B/HS-G3B/HS-G4B"

Switches the transmission mode to the selected high-speed gear

"Reserved"

Reserved bit command. These bits are reserved for future use.

Remote command:

[SEARCH:TRIGGER:MPHY:LCCType](#) on page 2476

WORD 1/WORD 2/WORD 3/WORD 4

Sets the specified words to be searched for. The setup for a word consists of the condition and one or two word patterns.

"Condition"

Defines the operator to set a specific word, e.g. "Equal" or "Not Equal" or a range.

"Data Min/Data"

Defines the bit pattern of the word pattern.

In binary format, use the following characters: 1; 0; or X (do not care).

To enter the pattern in other formats use the bit pattern editor, see [Chapter 14.1.7, "Bit pattern editor"](#), on page 519.

"Data Max"

The second word pattern is required to specify a range with conditions "In range" and "Out of range".

Remote command:

For " WORD 1":

[SEARCH:TRIGger:MPHY:LWONe:CONDition](#) on page 2477

[SEARCH:TRIGger:MPHY:LWONe:MIN](#) on page 2478

[SEARCH:TRIGger:MPHY:LWONe:MAX](#) on page 2478

For " WORD 2":

[SEARCH:TRIGger:MPHY:LWTWo:CONDition](#) on page 2478

[SEARCH:TRIGger:MPHY:LWTWo:MIN](#) on page 2479

[SEARCH:TRIGger:MPHY:LWTWo:MAX](#) on page 2479

For " WORD 3":

[SEARCH:TRIGger:MPHY:LWTHree:CONDition](#) on page 2480

[SEARCH:TRIGger:MPHY:LWTHree:MIN](#) on page 2480

[SEARCH:TRIGger:MPHY:LWTHree:MAX](#) on page 2480

For " WORD 4":

[SEARCH:TRIGger:MPHY:LWFour:CONDition](#) on page 2481

[SEARCH:TRIGger:MPHY:LWFour:MIN](#) on page 2481

[SEARCH:TRIGger:MPHY:LWFour:MAX](#) on page 2481

TC

Sets the specified Traffic Class (TC) to be searched for.

TC is used for classifying the traffic flow based on protocol and port number, e.g. TC0 and TC1 are two priority classes with guaranteed link reliability defined and used in L2.

"Data"

Defines the bit pattern of the TC pattern.

In binary format, use the following characters: 1; 0; or X (do not care).

To enter the pattern in other formats use the bit pattern editor, see [Chapter 14.1.7, "Bit pattern editor"](#), on page 519.

Remote command:

[SEARCH:TRIGger:MPHY:TC](#) on page 2482

Data

Sets the specified data to be searched for. The data setup consists of the condition and one or two data patterns.

"Condition"

Defines the operator to set a specific data, e.g. "Equal" or "Not Equal") or a range.

"Data Min/Data"

Defines the bit pattern of the data pattern.

In binary format, use the following characters: 1; 0; or X (do not care).

To enter the pattern in other formats use the bit pattern editor, see [Chapter 14.1.7, "Bit pattern editor"](#), on page 519.

"Data Max" The second data pattern is required to specify a range with conditions "In range" and "Out of range".

Remote command:

[SEARCH:TRIGger:MPHY:DATA:DCondition](#) on page 2482

[SEARCH:TRIGger:MPHY:DATA:DMIN](#) on page 2482

[SEARCH:TRIGger:MPHY:DATA:DMAX](#) on page 2483

Index

Index sets the range within this series of data that is considered for the search. The index setup consists of the condition and one or two data index values.

"Condition" Defines the operator to set a specific index, e.g. "Equal" or a range.

"Index Min/Index"

Defines the bit pattern of the index pattern.

In binary format, use the following characters: 1; 0; or X (do not care).

To enter the pattern in other formats use the bit pattern editor, see

[Chapter 14.1.7, "Bit pattern editor"](#), on page 519.

"Index Max" The second index pattern is required to specify a range with conditions "In range".

Remote command:

[SEARCH:TRIGger:MPHY:DATA:ICONdition](#) on page 2483

[SEARCH:TRIGger:MPHY:DATA:IMIN](#) on page 2484

[SEARCH:TRIGger:MPHY:DATA:IMAX](#) on page 2484

FSN

Sets the specified Frame Sequence Number (FSN) to be searched for. The FSN setup consists of the condition and one or two FSN patterns.

"Condition" Defines the operator to set a specific FSN, e.g. "Equal" or "Not Equal" or a range.

"Data Min/Data"

Defines the bit pattern of the FSN pattern.

In binary format, use the following characters: 1; 0; or X (do not care).

To enter the pattern in other formats use the bit pattern editor, see

[Chapter 14.1.7, "Bit pattern editor"](#), on page 519.

"Data Max" The second FSN pattern is required to specify a range with conditions "In range" and "Out of range".

Remote command:

[SEARCH:TRIGger:MPHY:FSNumber:CONDition](#) on page 2484

[SEARCH:TRIGger:MPHY:FSNumber:MIN](#) on page 2485

[SEARCH:TRIGger:MPHY:FSNumber:MAX](#) on page 2485

CRC

Sets the specified Cyclic Redundancy Check (CRC) to be searched for. The CRC setup consists of the condition and one or two CRC patterns.

CRC is an error detecting code to detect accidental changes to raw data.

- "Condition" Defines the operator to set a specific CRC, e.g. "Equal" or "Not Equal" or a range.
- "Data Min/Data" Defines the bit pattern of the CRC pattern.
In binary format, use the following characters: 1; 0; or X (do not care).
To enter the pattern in other formats use the bit pattern editor, see [Chapter 14.1.7, "Bit pattern editor"](#), on page 519.
- "Data Max" The second CRC pattern is required to specify a range with conditions "In range" and "Out of range".

Remote command:

[SEARCH:TRIGGER:MPHY:CRC:CONDITION](#) on page 2485

[SEARCH:TRIGGER:MPHY:CRC:MIN](#) on page 2486

[SEARCH:TRIGGER:MPHY:CRC:MAX](#) on page 2486

Req

Sets the specified Reset Link Request (RReq) or Credit Transmit Request (CReq) to be searched for.

RReq is used for requesting the remote end to reinitialize its Transmit (TX) Physical Layer (PHY) while CReq is used for requesting flow control information for the corresponding **TC** from the remote end.

- "Data" Defines the bit pattern of the RReq pattern.
In binary format, use the following characters: 1; 0; or X (do not care).
To enter the pattern in other formats use the bit pattern editor, see [Chapter 14.1.7, "Bit pattern editor"](#), on page 519.

Remote command:

For "RReq":

[SEARCH:TRIGGER:MPHY:RREQ](#) on page 2487

For "CReq"

[SEARCH:TRIGGER:MPHY:CREQ](#) on page 2486

Credit

Sets the specified credit to be searched for. The credit setup consists of the condition and one or two credit patterns.

Credit represents the total number of credits available since boot time.

- "Condition" Defines the operator to set a specific credit, e.g. "Equal" or "Not Equal" or a range.
- "Data Min/Data" Defines the bit pattern of the credit pattern.
In binary format, use the following characters: 1; 0; or X (do not care).
To enter the pattern in other formats use the bit pattern editor, see [Chapter 14.1.7, "Bit pattern editor"](#), on page 519.
- "Data Max" The second credit pattern is required to specify a range with conditions "In range" and "Out of range".

Remote command:

[SEARCH:TRIGger:MPHY:CREDit:CONDition](#) on page 2487

[SEARCH:TRIGger:MPHY:CREDit:MIN](#) on page 2488

[SEARCH:TRIGger:MPHY:CREDit:MAX](#) on page 2488

PACP Begin

Sets the specified PACP Begin to be searched for. The PACP Begin setup consists of the condition and one or two PACP Begin patterns.

"Condition" Defines the operator to set a specific PACP Begin, e.g. "Equal" or "Not Equal" or a range.

"Data Min/Data"

Defines the bit pattern of the data value pattern.

In binary format, use the following characters: 1; 0; or X (do not care). To enter the pattern in other formats use the bit pattern editor, see [Chapter 14.1.7, "Bit pattern editor"](#), on page 519.

"Data Max" The second PACP Begin pattern is required to specify a range with conditions "In range" and "Out of range".

Remote command:

[SEARCH:TRIGger:MPHY:PBEGin:CONDition](#) on page 2488

[SEARCH:TRIGger:MPHY:PBEGin:MIN](#) on page 2489

[SEARCH:TRIGger:MPHY:PBEGin:MAX](#) on page 2489

PACP Function ID

Sets the specified PACP Function ID to be searched for. The PACP Function ID setup consists of the condition and one or two PACP Function ID patterns.

"Condition" Defines the operator to set a specific PACP Function ID, e.g. "Equal" or "Not Equal" or a range.

"Data Min/Data"

Defines the bit pattern of the PACP Function ID pattern.

In binary format, use the following characters: 1; 0; or X (do not care). To enter the pattern in other formats use the bit pattern editor, see [Chapter 14.1.7, "Bit pattern editor"](#), on page 519.

"Data Max" The second PACP Function ID pattern is required to specify a range with conditions "In range" and "Out of range".

Remote command:

[SEARCH:TRIGger:MPHY:PFID:CONDition](#) on page 2489

[SEARCH:TRIGger:MPHY:PFID:MIN](#) on page 2490

[SEARCH:TRIGger:MPHY:PFID:MAX](#) on page 2490

Errors

Sets the type of error events to be searched for.

Reserved Bit Error ← Errors

Searches for reserved bit error.

This error means that the waveform violates the reserved field according to the specification. For example, a DL_PDU_AFC frame requires that the two bits before and three bits after the FSN field to be reserved and set as 0. If the waveform carries 1 in these positions instead, it is marked as this error.

Remote command:

[SEARCH:TRIGGER:MPHY:ERROR:RESERVED](#) on page 2490

LCC Command Error ← Errors

Searches for LCC command error.

This error is marked when the Command field in the LCC packet is not a known command defined in the specification.

Remote command:

[SEARCH:TRIGGER:MPHY:ERROR:LCMD](#) on page 2491

8b10b Symbol Error ← Errors

Searches for 8b10b symbol error.

For example, some of the 10-bit combinations that do not map to 8-bit according to the specification are invalid 10-bit and therefore marked as this error.

Remote command:

[SEARCH:TRIGGER:MPHY:ERROR:SYMBOL](#) on page 2491

Unknown Unipro Frame ← Errors

Searches for unidentified UniPro frame error. This error is marked when the end mark on Unipro packets is undetected.

Remote command:

[SEARCH:TRIGGER:MPHY:ERROR:UNKNOWN](#) on page 2491

Length Error ← Errors

Searches for frames that violate the length according to the specification.

Remote command:

[SEARCH:TRIGGER:MPHY:ERROR:LENGTH](#) on page 2491

14.24.5.2 M-PHY search results

To get search results, "Enable" the search. You can minimize, shift or close the search dialog.

The search results are listed in the search result table and marked in the waveform by blue lines.

For an introduction to search results, see:

- [Chapter 11.1.2, "Search results"](#), on page 426
- [Chapter 11.4.2, "Display zoom settings"](#), on page 446

Remote commands:

- [SEARCH:RESULT:MPHY:FCOUNT?](#) on page 2492
- [SEARCH:RESULT:MPHY:FRAME<m>:CCOUNT?](#) on page 2492

- [SEARCH:RESult:MPHY:FRAMe<m>:CELL<n>:DATA?](#) on page 2493
- [SEARCH:RESult:MPHY:FRAMe<m>:CELL<n>:TYPE?](#) on page 2493
- [SEARCH:RESult:MPHY:FRAMe<m>:CELL<n>:START?](#) on page 2493
- [SEARCH:RESult:MPHY:FRAMe<m>:CELL<n>:STOP?](#) on page 2494
- [SEARCH:RESult:MPHY:FRAMe<m>:CELL<n>:STATe?](#) on page 2494
- [SEARCH:RESult:MPHY:FRAMe<m>:DATA?](#) on page 2494
- [SEARCH:RESult:MPHY:FRAMe<m>:FTYPE?](#) on page 2495
- [SEARCH:RESult:MPHY:FRAMe<m>:START?](#) on page 2496
- [SEARCH:RESult:MPHY:FRAMe<m>:STATe?](#) on page 2495
- [SEARCH:RESult:MPHY:FRAMe<m>:STOP?](#) on page 2497

14.24.5.3 Searching M-PHY

Prerequisite: A serial bus is configured for the M-PHY signal to be decoded and analyzed.

The search for events is set up in the following way:

1. Press the [Bus] key and select the "Shortcuts" tab.
2. Tap "Setup search".
3. If the dialog box does not contain a search entry, tap the "Add" icon to create one, as described in ["To create a user-defined search"](#) on page 440.
4. Specify the search criteria according to [Chapter 14.24.5.1, "M-PHY search setup"](#), on page 939.
5. To acquire a waveform, press [Single].

The R&S RTO6 performs an M-PHY decode according to the thresholds and protocol settings of the associated serial bus source.

6. To start searching the acquired waveform for specific events, tap "Enable" in the search setup dialog:

The R&S RTO6 displays the "Search Results" box that lists the detected events.

For information on how to configure the search results presentation and how to navigate the search results, see also ["To display search zoom windows"](#) on page 448.

14.24.5.4 SSIC search setup

Access: [Bus] > "Shortcuts" tab > "Setup search"

Search criteria

Use the "Search criteria" dialog to define the search type. If you search for frame content, define the frame type in which data is to be searched.

You can define individual search parameters for the fields of the selected frame in the table below the "Search criteria". To specify these parameters, select a field in the table and define the data and/or index operators and values, or the bit state.

For a description of how to set the search conditions, see [Chapter 14.24.3.3, "SSIC trigger settings"](#), on page 935.

Remote command:

[SEARCH:TRIGger:MPHY:SSIC:ERRor<m>:ENABle](#) on page 2503
[SEARCH:TRIGger:MPHY:SSIC:FIENable](#) on page 2504
[SEARCH:TRIGger:MPHY:SSIC:FRAMe<m>:ENABle](#) on page 2503
[SEARCH:TRIGger:MPHY:SSIC:FRAMe<m>:FLD<n>:BIT](#) on page 2505
[SEARCH:TRIGger:MPHY:SSIC:BIT](#) on page 2505
[SEARCH:TRIGger:MPHY:SSIC:FRAMe<m>:FLD<n>:DMAX](#) on page 2505
[SEARCH:TRIGger:MPHY:SSIC:DMAX](#) on page 2505
[SEARCH:TRIGger:MPHY:SSIC:FRAMe<m>:FLD<n>:DMIN](#) on page 2506
[SEARCH:TRIGger:MPHY:SSIC:DMIN](#) on page 2506
[SEARCH:TRIGger:MPHY:SSIC:FRAMe<m>:FLD<n>:DOPerator](#) on page 2506
[SEARCH:TRIGger:MPHY:SSIC:DOPerator](#) on page 2506
[SEARCH:TRIGger:MPHY:SSIC:FRAMe<m>:FLD<n>:ENABle](#) on page 2504
[SEARCH:TRIGger:MPHY:SSIC:FRENable](#) on page 2503
[SEARCH:TRIGger:MPHY:SSIC:FRAMe<m>:FLD<n>:IMAX](#) on page 2507
[SEARCH:TRIGger:MPHY:SSIC:IMAX](#) on page 2507
[SEARCH:TRIGger:MPHY:SSIC:FRAMe<m>:FLD<n>:IMIN](#) on page 2508
[SEARCH:TRIGger:MPHY:SSIC:IMIN](#) on page 2508
[SEARCH:TRIGger:MPHY:SSIC:FRAMe<m>:FLD<n>:IOPerator](#) on page 2508
[SEARCH:TRIGger:MPHY:SSIC:IOPerator](#) on page 2508

14.25 8b/10b (option R&S RTO6-K590)

The 8b/10b coding scheme is used for high-speed serial data transmission, used by different standards, like fibre channel, PCIe, DVI and USB 3.0. Also the MIPI UniPro M-PHY interface in smartphones and display interfaces such as HDMI use 8b/10b encoding, as do base stations based on the Common Public Radio Interface (CPRI).

The R&S RTO6 can decode differential and single-ended 8b/10b signals. Furthermore, you can search the decoded data to isolate data contents and error states such as disparity violations.

You can also trigger on defined data contents and on error states.

- [The 8b/10b code](#)..... 949
- [8b/10b configuration](#)..... 949
- [8b/10b trigger](#)..... 954
- [8b/10b decode results](#)..... 957
- [Search on decoded 8b/10b data](#)..... 958

14.25.1 The 8b/10b code

The 8b/10b is a code where an 8-bit parallel data input is mapped into a 10-bit output. This code achieves a DC-balance and bounded disparity and simultaneously allows a reasonable clock recovery.

In the coding scheme, the original 8 bits are split into two blocks, three most significant bits and five least significant bits, see [Figure 14-48](#). After that the 3-bit block is encoded into 4 bits and the 5-bit block into 6 bits. The 4-bit and the 6-bit blocks are then combined into a 10-bit.

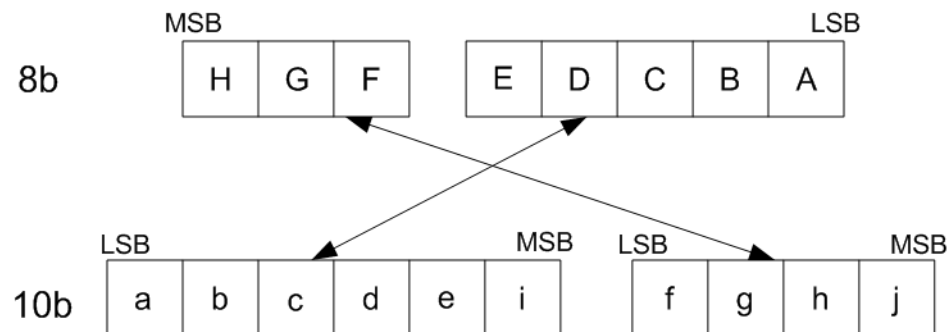

Figure 14-48: Coding scheme of the 8b/10b

The additional two bits i and j that join the stream are variable and ensure the running disparity.

There are two types of characters used in the 8b/10b coding, special characters Kx.y and data characters Dx.y. x denotes the decimal value of EDCBA and is within the range from 0 to 31. y denotes the decimal value of HGF and is within the range 0 to 7.

14.25.2 8b/10b configuration

14.25.2.1 8b/10b configuration settings

Access: [Bus] > "8b/10b" > "Setup" tab



Make sure that the tab of the correct serial bus is selected.

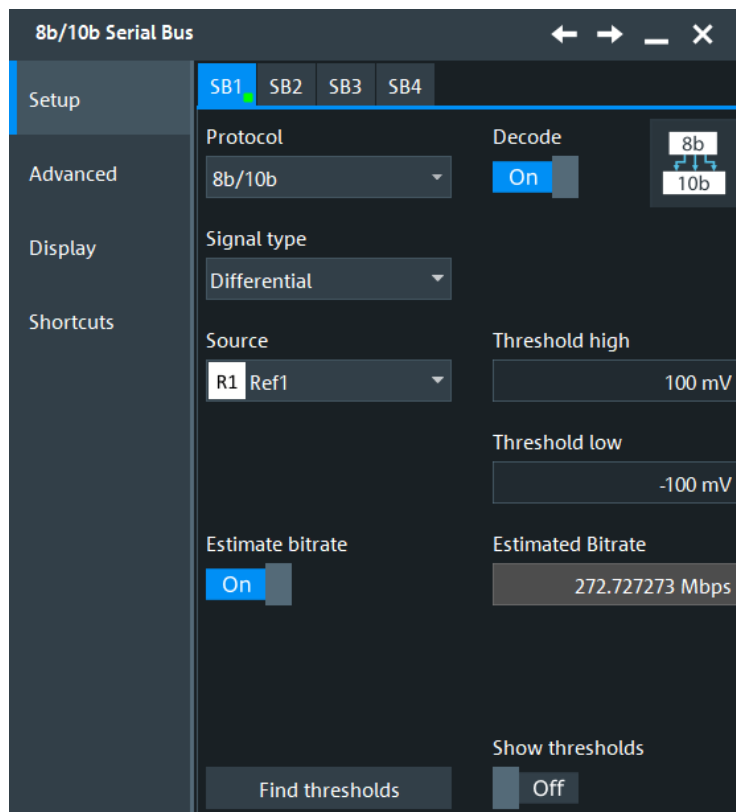

See also: [Chapter 14.1.1, "Setup - general settings"](#), on page 511

Signal type

Selects the signal type that is used for the decoding. You can choose between a differential and single-ended signal.

Remote command:

`BUS<m>:EBTB:TYPE` on page 2513

Source

Selects the source of the provided differential signal , if "Signal type" > "Differential".

Remote command:

`BUS<m>:EBTB:DIFFerential:SOURce` on page 2510

Source D+

Selects the source of the provided single ended signal, if "Signal type" > "Single ended".

Remote command:

`BUS<m>:EBTB:DPLus:SOURce` on page 2512

Source D-

Selects the source of the provided single ended signal , if "Signal type" > "Single ended".

Remote command:

`BUS<m>:EBTB:DMINus:SOURce` on page 2511

Threshold High

Sets the threshold high of the signal, if "Signal type" > "Differential".

Remote command:

[BUS<m>:EBTB:DIFFerential:THRHigh](#) on page 2510

Threshold Low

Sets the threshold low of the signal, if "Signal type" > "Differential".

Remote command:

[BUS<m>:EBTB:DIFFerential:THRLow](#) on page 2511

Threshold D+

Sets the high threshold (D+) of the signal, if "Signal type" > "Single ended".

Remote command:

[BUS<m>:EBTB:DPLus:THReshold](#) on page 2512

Threshold D-

Sets the high threshold (D-) of the signal, if "Signal type" > "Single ended".

Remote command:

[BUS<m>:EBTB:DMINus:THReshold](#) on page 2511

Find thresholds

Executes the measurement of reference levels and sets the thresholds to the middle reference level of the measured amplitude.

Remote command:

[BUS<m>:SETReflevels](#) on page 1814

Bitrate

Sets the number of transmitted bits per second.

Remote command:

[BUS<m>:EBTB:BITRate](#) on page 2509

Estimate Bitrate

Starts a software algorithm for the automatic determination of the bitrate. The value is displayed in the "Estimated Bitrate".

Remote command:

[BUS<m>:EBTB:BITDetermi](#) on page 2514

[BUS<m>:EBTB:EBTRate?](#) on page 2510

Show thresholds

If enabled, the threshold levels are displayed in the diagram.

Remote command:

[BUS<m>:THReshold](#) on page 1815

14.25.2.2 Advanced settings

Access: [Bus] > "Advanced" tab.

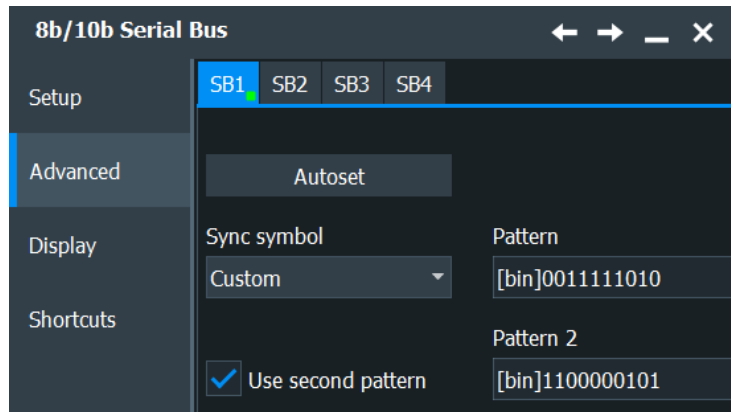

Autoset

Starts software algorithms for determining the signal threshold levels and bitrate.

Remote command:

`BUS<m>:FAUToset` on page 1814

Sync symbol

Selects the sync symbol, a control symbol used for low-level control functions. You can select one of the comma control symbols (K28.1, K28.5, K28.7) used for synchronization or you can enter a pattern.

Remote command:

`BUS<m>:EBTB:SYNC` on page 2513

Pattern

Selects a pattern that serves as a sync symbol.

Remote command:

`BUS<m>:EBTB:FCSY` on page 2512

Pattern 2

Enables a second pattern that serves as a sync symbol and sets its value.

Remote command:

`BUS<m>:EBTB:SCSY` on page 2513

`BUS<m>:EBTB:USCS` on page 2514

14.25.2.3 Display settings

Access: [Bus] > "Display" tab.

For common display settings, see [Chapter 14.1.3, "Display"](#), on page 513.

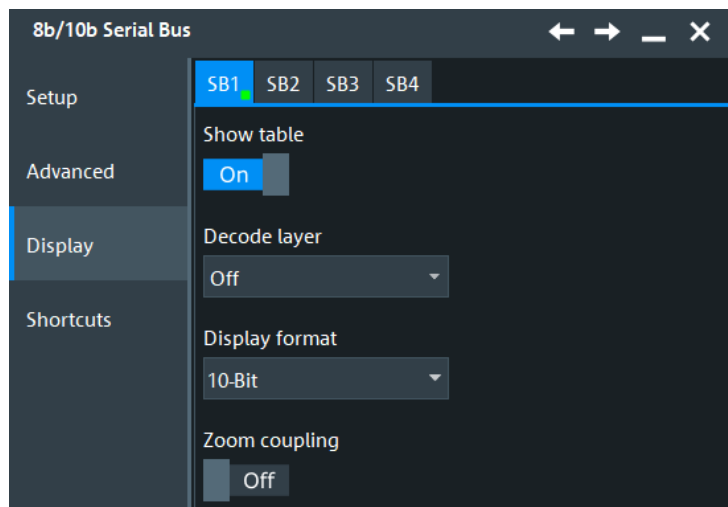

Display Format

Selects the display format for the results of the display table.

Remote command:

`BUS<m>:EBTB:DISF` on page 2511

14.25.2.4 Configuring 8b/10b

For configuration, you assign the line to the input channel, set the threshold, the bitrate, and the sync symbol.

For details on configuration settings, see [Chapter 14.25.2.1, "8b/10b configuration settings"](#), on page 949.

1. Press the [Bus] key on the front panel.
2. Select the tab of the bus you want to set up, for example "SB1".
3. In the "Setup" tab, set "Protocol"="8b/10b".
4. Tap the "Signal type" button, and select the used signal type for the measurement.
5. Select the source for the signal type.
6. Tap "Autoset".
7. Check the threshold and bitrate settings. Adjust the values if necessary.
8. Select the "Sync symbol" to be used for decoding.
9. Enable "Decode".

14.25.3 8b/10b trigger

If you need information on how to get started with triggering on 8b/10b signals, see [Chapter 14.25.3.2, "Triggering on 8b/10b data"](#), on page 957. Otherwise proceed with the 8b/10b trigger settings.

14.25.3.1 8b/10b trigger setup

Access: [Bus] > "Shortcuts" tab > "Setup trigger"

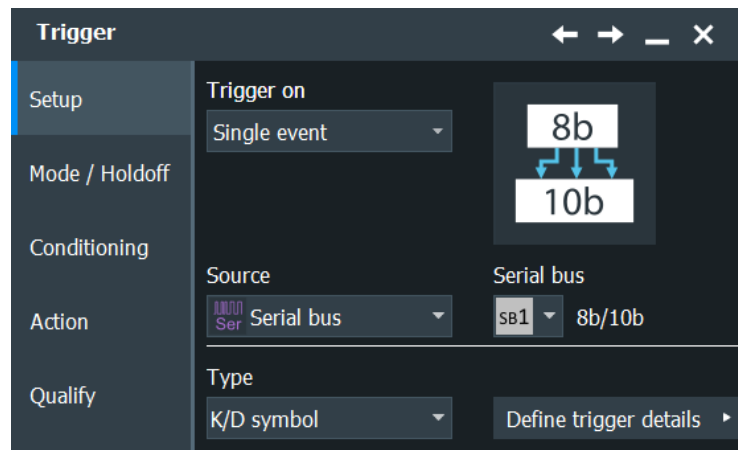

Type 8b/10b

Selects the type of condition to be triggered on. Available are:

- "K/D symbol"
- "8 bit pattern"
- "10 bit pattern"
- "Expression"
- "Error Condition"

Press "Define trigger details" to open a dialog for defining trigger type dependent settings.

Remote command:

[TRIGger<m>:EBTB:STYPe](#) on page 2517

K/D symbol

Selects the data character (Dx.y) or control character to be triggered on.

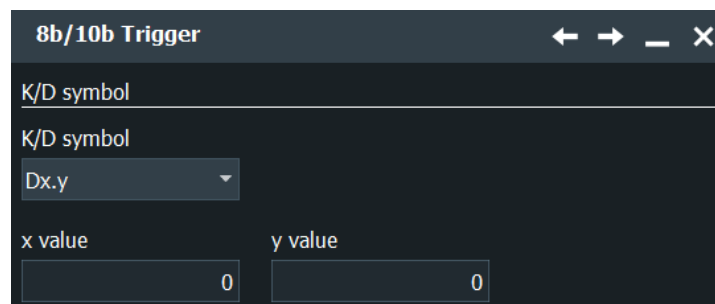

K/D Codes Symbol ← K/D symbol

Selects the control character.

Remote command:

[TRIGger<m>:EBTB:SYMType](#) on page 2516

x value ← K/D symbol

Sets the x value of the data character Dx.y to be triggered on, if "K/D symbol" > "Dx.y".

Remote command:

[TRIGger<m>:EBTB:DX](#) on page 2515

y value ← K/D symbol

Sets the y value of the data character Dx.y to be triggered on, if "K/D symbol" > "Dx.y".

Remote command:

[TRIGger<m>:EBTB:DY](#) on page 2515

8 bit pattern

Sets the 8-bit pattern to be triggered on, if "Trigger Type" > "8 bit pattern".

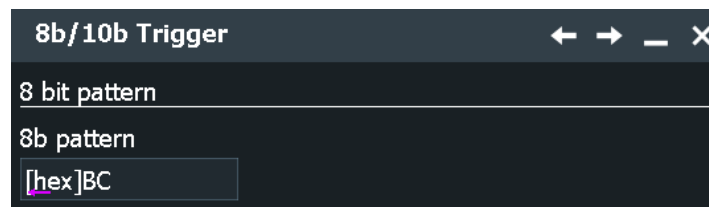

Remote command:

[TRIGger<m>:EBTB:EBPA](#) on page 2515

10 bit pattern

Sets the 10-bit pattern to be triggered on, if "Trigger Type" > "10 bit pattern".

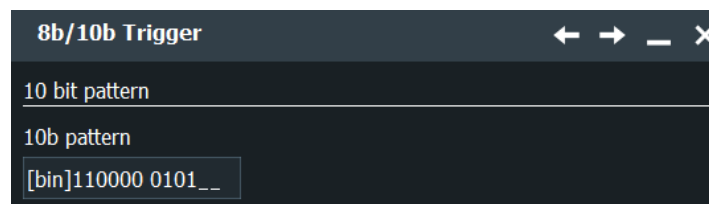

Remote command:

[TRIGger<m>:EBTB:TBPA](#) on page 2516

Expression

Defines the expression to be triggered on, if "Trigger Type" > "Expression".

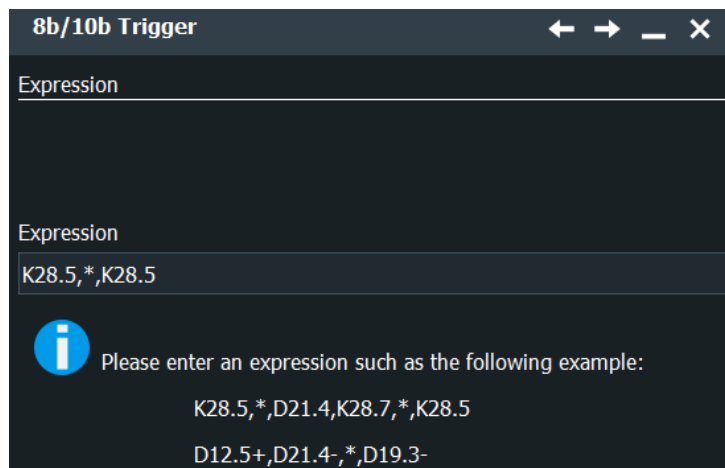

Remote command:

[TRIGger<m>:EBTB:SYME](#) on page 2516

Error Condition

Triggers on the selected error conditions.

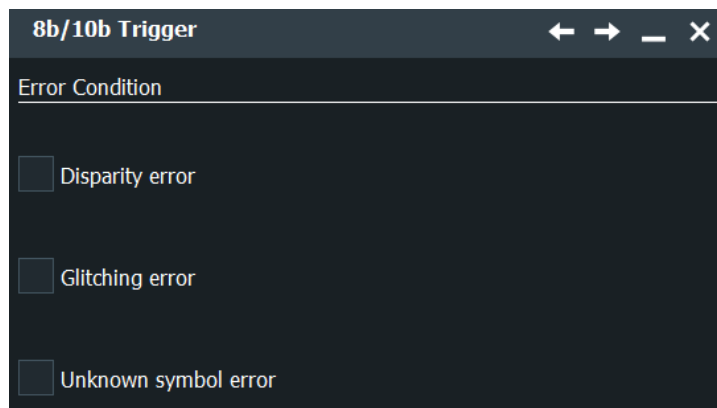

Disparity error ← Error Condition

Triggers on disparity errors.

Remote command:

[TRIGger<m>:EBTB:DISParityerr](#) on page 2515

Glitching error ← Error Condition

Triggers on glitch errors.

Remote command:

[TRIGger<m>:EBTB:GLITCherror](#) on page 2516

Unknown symbol error ← Error Condition

Triggers on a symbol that is not defined by the 8b/10b.

Remote command:

[TRIGger<m>:EBTB:UNK](#) on page 2517

14.25.3.2 Triggering on 8b/10b data

Prerequisite: A bus is configured for the 8b/10b signal to be analyzed.

For the basic trigger settings, proceed in the following way:

1. Press the [Bus] key and select the "Shortcuts" tab.
2. Press "Setup trigger".
3. Tap the "Source" button and select the "Serial bus" trigger source.
4. Tap "Serial bus" and select the serial bus that is set to 8b/10b.
5. Tap "Type" and select the trigger type to be used for 8b/10b protocol analysis.
6. Depending on the selected trigger type, more setup conditions have to be specified.

For information on how to proceed with the configuration settings, see [Chapter 14.25.3.1, "8b/10b trigger setup"](#), on page 954.

14.25.4 8b/10b decode results

When the configuration of the serial bus is complete, the signal can be decoded:

1. In the "Protocol" dialog > "Setup" tab, enable "Decode".
2. In the "Protocol" dialog > "Display" tab, select additional result display settings: "Show decode table" and "Show binary signals".

For a description of the display settings, see also [Chapter 14.1.3, "Display"](#), on page 513.

The instrument captures and decodes the signal according to the standard definition and the configuration settings.

The color-coding of the various protocol sections and errors simplifies the interpretation of the visual display. The decode information condenses or expands, depending on the horizontal scale. Various data formats are available to show the result values.

Decode Results Table

The results are shown in two tables:

- "Decode results": contains information about all decoded frames
- "Details frame": contains more detailed information about the selected frame in the "Decode results" table.

Symbol	State	Start	K/D Code	8-bit	10-bit
1	Ok	-128 ns	K28.5-	[hex] BC	0011111010
2	Ok	-119.9 ns	K23.7+	[hex] F7	0001010111
3	Ok	-112 ns	K23.7+	[hex] F7	0001010111
4	Ok	-103.9 ns	D10.0+	[hex] 0A	0101010100
5	Ok	-95.9 ns	D2.0-	[hex] 02	1011010100
6	Ok	-87.9 ns	D0.0-	[hex] 00	1001110100
7	Ok	-79.9 ns	D10.2-	[hex] 4A	0101010101
8	Ok	-71.9 ns	D10.2-	[hex] 4A	0101010101
9	Ok	-63.9 ns	D10.2-	[hex] 4A	0101010101
10	Ok	-56 ns	D10.2-	[hex] 4A	0101010101

Table 14-48: Content of the decode result table

Column	Description
Symbol	Shows the index number of the symbol
State	Overall state of the symbol
Start	Time of the symbol start in relation to the trigger point
K/D Code	The K/D code
8-bit	The 8-bit value
10-bit	10-bit output value

Tools

Press "Display settings" in the "Decode Results" table to access the "Display" tab.



Remote commands

Remote commands are described in [Chapter 27.18.26.3, "Decode results"](#), on page 2517.

14.25.5 Search on decoded 8b/10b data

Using the search functionality, you can find various events in the decoded data, the same events which you also can trigger on. Before you can start the search, you have to configure the bus correctly and acquire decoded data.

To search on decoded data, set the search "Source" to the serial bus that is configured for the protocol to be analyzed.

See also [Chapter 11, "Search functions"](#), on page 425.

14.25.5.1 8b/10b search setup

Access: [Bus] > "Shortcuts" tab > "Setup search"

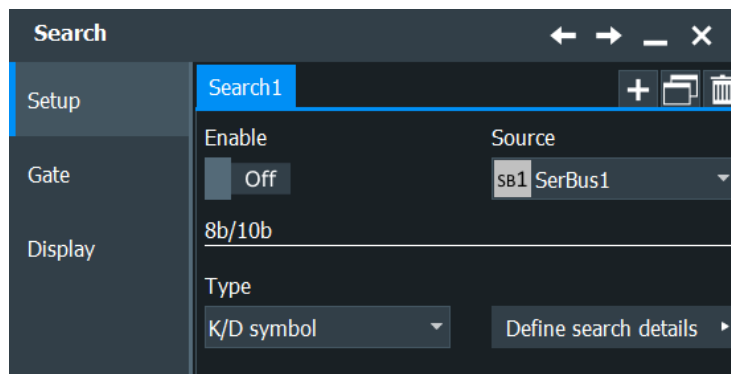

Type

Selects the type of condition to be searched for. Available are:

- "K/D symbol"
- "8 bit pattern"
- "10 bit pattern"
- "Expression"
- "Error Condition"

Press "Define search details" to open a dialog for defining search type dependent settings.

Remote command:

[TRIGger<m>:EBTB:STYPe](#) on page 2517

K/D symbol

Selects the data character (Dx.y) or control character to be searched for.

K/D Codes Symbol ← K/D symbol

Selects the data character (Dx.y) or control character to be searched for. You can specify the value of the data character to be searched for with "Dx Value" and "Dy Value".

Remote command:

[SEARCh:TRIGger:EBTB:SYMType](#) on page 2522

y value ← K/D symbol

Sets the y value of the data character Dx.y to be searched for, if "K/D symbol" > "Dx.y".

Remote command:

[SEARCh:TRIGger:EBTB:DY](#) on page 2521

x value ← K/D symbol

Sets the x value of the data character Dx.y to be searched for, if "K/D symbol" > "Dx.y".

Remote command:

[SEARCh:TRIGger:EBTB:DX](#) on page 2520

Error Condition

Searches for the selected error conditions.

Disparity error

Searches for disparity errors.

Remote command:

[SEARCH:TRIGger:EBTB:DISParityerr](#) on page 2520

Glitching error

Searches for glitching errors.

Remote command:

[SEARCH:TRIGger:EBTB:GLITCherror](#) on page 2521

Unknown symbol error

Searches for a symbol that is not defined by the the 8b/10b.

Remote command:

[SEARCH:TRIGger:EBTB:UNK](#) on page 2523

8b Pattern

Sets the 8-bit pattern to be searched for, if "Type" > "8-bit".

Remote command:

[SEARCH:TRIGger:EBTB:EBPA](#) on page 2521

10b Pattern

Sets the 10-bit pattern to be searched for, if "Type" > "10-bit".

Remote command:

[SEARCH:TRIGger:EBTB:TBPA](#) on page 2522

Expression

Defines the expression to be searched for, if "Type" > "Expression".

Remote command:

[SEARCH:TRIGger:EBTB:SYME](#) on page 2522

14.25.5.2 8b/10b search results

To get search results, "Enable" the search. You can minimize, shift or close the search dialog.

The search results are listed in the search result table and marked in the waveform by blue lines.

For an introduction to search results, see:

- [Chapter 11.1.2, "Search results"](#), on page 426
- [Chapter 11.4.2, "Display zoom settings"](#), on page 446

Remote Commands:

- [SEARCH:RESult:EBTB:SCOunt?](#) on page 2523
- [SEARCH:RESult:EBTB:SYMBol<m>:DATA?](#) on page 2523
- [SEARCH:RESult:EBTB:SYMBol<m>:START?](#) on page 2524
- [SEARCH:RESult:EBTB:SYMBol<m>:STATus?](#) on page 2524

- [SEARCH:RESult:EBTB:SYMBOL<m>:STOP?](#) on page 2524

14.25.5.3 Searching 8b/10b data

Prerequisite: A serial bus is configured for the 8b/10b signal to be decoded and analyzed.

The search for events is set up in the following way:

1. Press the [Bus] key and select the "Shortcuts" tab.
2. Tap "Setup search".
3. If the dialog box does not contain a search entry, tap the "Add" icon to create one, as described in ["To create a user-defined search"](#) on page 440.
4. Tap "Source" and select the serial bus that is set to 8b/10b (e.g. "SB1", unless already selected).

The search dialog for 8b/10b protocol analysis is opened.

There are no additional search criteria to be specified.

5. Tap "Source" and select the serial bus that is set to 8b/10b (e.g. "SB1", unless already selected).
6. Specify search criteria according to [Chapter 14.25.5.1, "8b/10b search setup"](#), on page 958.
7. To acquire a waveform, press [Single].

The R&S RTO6 performs a 8b/10b decode according to the thresholds and protocol settings of the associated serial bus source (here in our example SB1).

8. To start searching the acquired waveform for specific events, tap "Enable" in the search setup dialog:

The R&S RTO6 displays the "Search Results" box that lists the detected events.

For information on how to configure the search results presentation and how to navigate the search results, see also ["To display search zoom windows"](#) on page 448.

14.26 PCIe (option R&S RTO6-K72)

R&S RTO6-K590 is a firmware option that enables the R&S RTO6 to analyze Peripheral Component Interconnect Express (PCIe) signals encoded by the PCIe standard, generation 1 and 2.

For analysis, PCIe encoded signals can be triggered, decoded and searched.

- [The PCIe protocol](#)..... 962
- [PCIe configuration](#).....964
- [PCIe digital signal processing \(DSP\) settings](#).....967

- [PCIe trigger](#).....969
- [PCIe Gen 1/2 decode results](#).....979
- [PCIe Gen 1/2 search](#).....980

14.26.1 The PCIe protocol

The PCIe is a high-speed serial computer expansion bus standard.

The communication between two PCIe devices is performed through logical connections called links. Each link consists of several lanes. The lanes contain one differential signaling pair for receiving data and the other for transmitting it.

PCIe logical layers

The PCIe has three logical layers:

- Transaction layer: assembles and disassembles transaction layer packets (TLPs). TLP transfer information like read and write and some event types.
- Data link layer: used for link management and data integrity. Error detection and correction are also done in this layer. The data link layer produces data link layer packets (DLLP).
- Physical layer: includes the circuitry for the interface operation.

PCIe Packet Types

The communication between the layers is done through packets. All packet types that can be decoded by the R&S RTO6 are listed below.

SCPI name	Description	Type
MRD32 / MRD64	Memory Read Request for 32 bit/ 64-bit addressing packet format	TLP
MRDLK32 / MRDLK64	Memory Read Request-Locked for 32 bit/ 64-bit addressing packet format	TLP
MWR32 / MWR64	Memory Write Request for 32 bit/ 64-bit addressing packet format	TLP
IORD	I/O Read Request	TLP
IOWR	I/O Write Request	TLP
CFGRD0 / CFGRD1	Configuration Read Type 0/1	TLP
CFGWR0 / CFGWR1	Configuration Write Type 0/1	TLP
TCfgRd / TCfgWr	Deprecated TLP Type	TLP
MSG	Message Request	TLP
MSGD	Message Request with data payload	TLP
CPL	Completion without Data	TLP
CPLD	Completion with Data	TLP

SCPI name	Description	Type
CPLLK	Completion for Locked Memory Read without Data	TLP
CPLDLK	Completion for Locked Memory Read	TLP
FA32 / FA64	Fetch and Add AtomicOp Request for 32 bit/ 64-bit addressing packet format	TLP
SWP32 / SWP64	Unconditional Swap AtomicOp Request for 32 bit/ 64-bit addressing packet format	TLP
CAS32 / CAS64	Compare and Swap AtomicOp Request for 32 bit/ 64-bit addressing packet format	TLP
LPRFX	Local TLP Prefix	TLP
EPRFX	End-End TLP Prefix	TLP
EDB		TLP
ACK	Acknowledgement	DLLP
NAK	Negative acknowledgment	DLLP
PMEL1 / PMEL23	Power management Enter L1/ L23	DLLP
PMASRL1	Power management Active State Request L1	DLLP
PMRA	Power management request acknowledgment	DLLP
VENDS	Vendor Specific	DLLP
IFC1P / IFC2P	Initialization flow control 1/2 posted requests	DLLP
IFC1NP / IFC2NP	Initialization flow control 1/2 non posted requests	DLLP
IFC1CPL / IFC2CPL	Initialization flow control 1/2 completions	DLLP
UPDFCP	Update flow control 1/2 posted requests	DLLP
UPDFCNP	Update flow control non posted requests	DLLP
UPDFCCPL	Update flow control completions	DLLP
SKPOS	SKP ordered set	Ordered Set
TS1OS / TS2OS	Training sequence 1/2 ordered set	Ordered Set
FTSOS	Fast training sequence ordered set	Ordered Set
EIOS	Electrical idle ordered set	Ordered Set
EIEOS	Electrical idle exit ordered set	Ordered Set
COMPL	Compliance pattern	Ordered Set
MCOMPL	Modified Compliance pattern	Ordered Set

14.26.2 PCIe configuration

14.26.2.1 PCIe configuration settings

Access: [Bus] > "PCIe" > "Setup" tab



Make sure that the tab of the correct serial bus is selected.

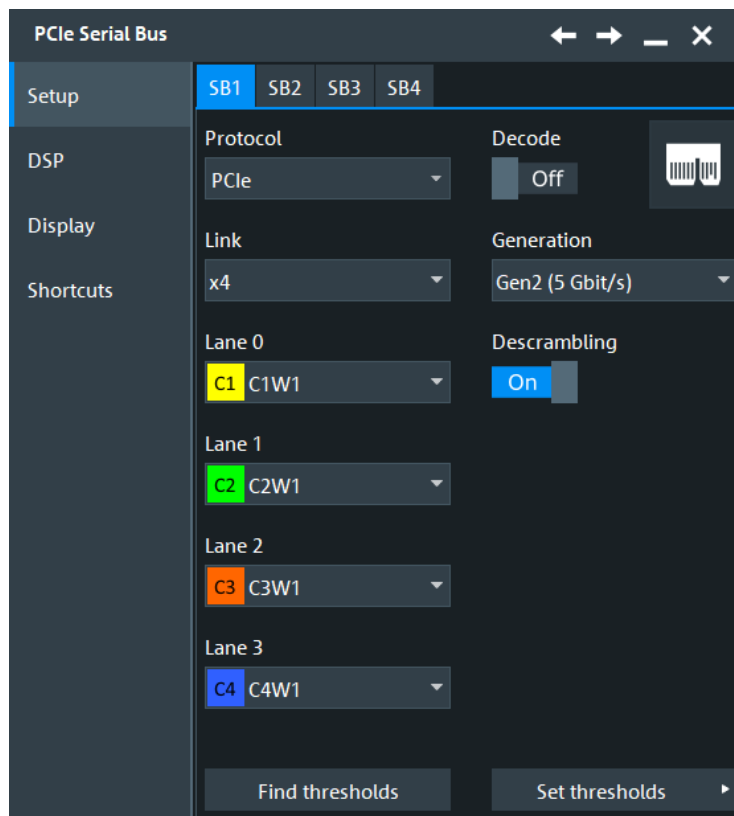

See also: [Chapter 14.1.1, "Setup - general settings"](#), on page 511

Generation

Selects the generation of the PCIe technology.

"PCIe Gen1 (2.5 Gbit/s)" Selects the PCIe generation 1.0, standard introduced in 2003. It has a transfer rate of 2.5 Gbit/s.

"PCIe Gen2 (5 Gbit/s)" Selects the PCIe generation 2.0, standard introduced in 2007. It has a transfer rate of 5 Gbit/s.

Remote command:

`BUS<m> : PCIE : GEN` on page 2526

Link

Selects the link width, the number of lanes that are used for the transmission of the data.

Remote command:

[BUS<m>:PCIe:LNKW](#) on page 2526

Descrambling

Enables descrambling of the data.

Remote command:

[BUS<m>:PCIe:DSCRambling](#) on page 2525

Lane 0/1/2/3

Select the signal sources for the logical lanes.

Usually, the source is one of the analog channels. Reference and math waveforms are available as source if the trigger source is one of the analog channels but not the serial bus.

Remote command:

[BUS<m>:PCIe:LZER:SOURce](#) on page 2527

[BUS<m>:PCIe:LONE:SOURce](#) on page 2527

[BUS<m>:PCIe:LTWO:SOURce](#) on page 2527

[BUS<m>:PCIe:LTHRee:SOURce](#) on page 2527

Thresholds

Sets the threshold value for digitization of signals for each line.

Lane	Low threshold	High threshold
Lane 0 C1	-20 mV	20 mV
Lane 1 C2	-20 mV	20 mV
Lane 2 C3	-20 mV	20 mV
Lane 3 C4	-20 mV	20 mV

Couple thresholds

Show thresholds: Off

Find thresholds

Back

Couple thresholds ← Thresholds

Enables the same threshold value for all lanes.

Find thresholds ← Thresholds

Executes the measurement of reference levels and sets the thresholds to the middle reference level of the measured amplitude.

Remote command:

`BUS<m>:SETReflevels` on page 1814

Low threshold ← Thresholds

Sets the lower threshold value for the respective lane.

Remote command:

`BUS<m>:PCIE:LONE:THRLow` on page 2527

`BUS<m>:PCIE:LTHRee:THRLow` on page 2528

`BUS<m>:PCIE:LTWO:THRLow` on page 2527

`BUS<m>:PCIE:LZER:THRLow` on page 2527

High threshold ← Thresholds

Sets the high threshold value for the respective lane.

Remote command:

`BUS<m>:PCIE:LONE:THRHigh` on page 2527

`BUS<m>:PCIE:LTHRee:THRHigh` on page 2527

`BUS<m>:PCIE:LTWO:THRHigh` on page 2527

`BUS<m>:PCIE:LZER:THRHigh` on page 2527

14.26.2.2 Display settings

Access: [Bus] > "Display" tab.

For common display settings, see [Chapter 14.1.3, "Display"](#), on page 513.

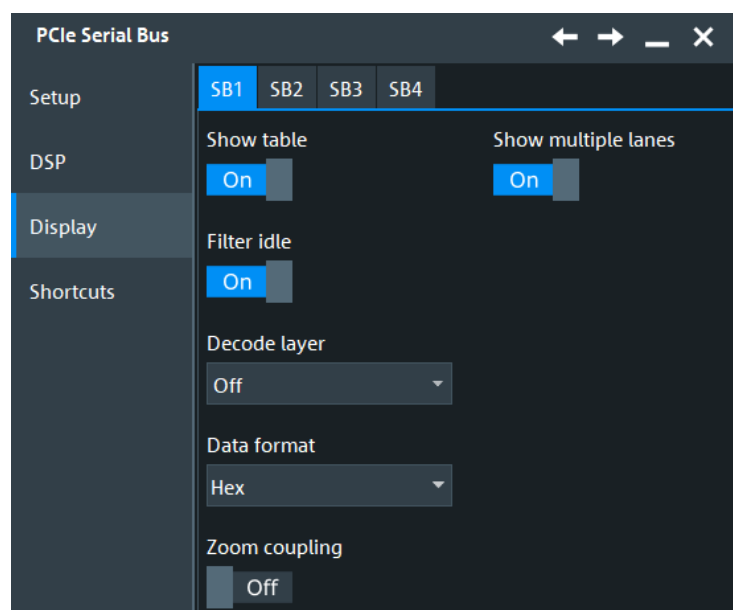

Decode layer

Selects the decode layer.

Decoding is performed in several steps, and the end results are presented in the decode table. The decode layer selects an interim step for which the decoding result is shown in the honeycomb display.

Available are:

- "Off"
- "Edges"
- "Binary"

Filter Idle

Enables the filtering of idle packets.

Remote command:

[BUS<m>:PCIe:FIDLe](#) on page 2526

Show multiple lanes

Displays the result in multiple lanes.

Remote command:

[BUS<m>:PCIe:SMLanes](#) on page 2528

14.26.2.3 Configuring PCIe Gen 1/2

For configuration, you assign the line to the input channel, set the threshold, the bitrate, and the sync symbol.

For details on configuration settings, see [Chapter 14.26.2.1, "PCIe configuration settings"](#), on page 964.

1. Press the [Bus] key on the front panel.
2. Select the tab of the bus you want to set up.
3. In the "Setup" tab, select the protocol: "PCIe".
4. Tap the "Generation" button and select the PCIe protocol.
5. Tap the "Link" button and chose the link width.
6. Select the source for of the signal for each lane.
7. Check the threshold settings for each lane. Adjust the values if necessary.

14.26.3 PCIe digital signal processing (DSP) settings

14.26.3.1 PCIe Gen 1/2 CDR configuration settings

The process of clock data recovery (CDR) generates a reference clock from a high-speed serial data stream that is sent without a dedicated clock signal. The generated

clock signal matches the frequency and is aligned to the phase of the data stream. The recovered clock can be used to sample the data stream and to obtain the sequence of transmitted bits.

Access: [Bus] > "Setup" tab > "Protocol = PCIe" = "Generation = Gen1/Gen2" > "DSP" tab

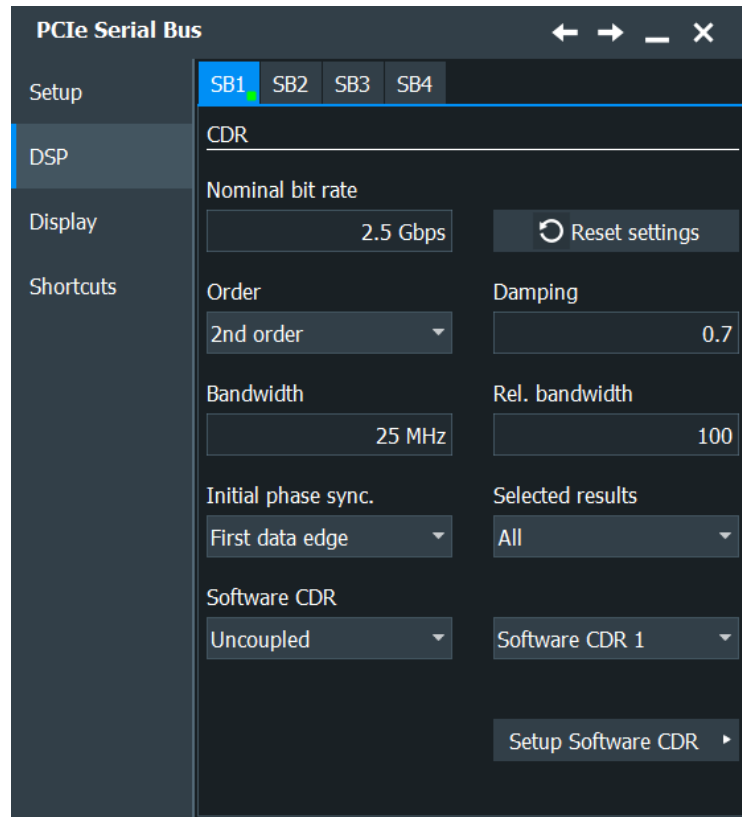

Nominal bit rate

Sets the quiescent frequency of the PLL. It corresponds to the data rate of the data stream from which the clock is to be recovered.

Remote command:

[BUS<m>:CDR:BITRate](#) on page 2528

PLL settings

Phase-locked loop parameters are listed below.

Note: Nomial bit rate, bandwidth and relative bandwidth are interacting settings. Modifying one parameter also changes one of the dependent parameters.

"Order"	Sets the order of the PLL: first or second order. PLL of higher order can compensate for more complex jitter behavior.
"Bandwidth"	Sets the PLL bandwidth. It defines the part of the spectrum that the PLL can follow during synchronization. The PLL bandwidth is usually defined by the transmission standard.
"Rel. bandwidth"	Sets the relative bandwidth, that is the ratio of the nominal bit rate to the PLL bandwidth.

"Damping" Sets the damping factor, which is only relevant for second order PLL.

Remote command:

[BUS<m>:CDR:PLL:ORDer](#) on page 2529

[BUS<m>:CDR:PLL:BWIDth](#) on page 2528

[BUS<m>:CDR:PLL:RELBwidth](#) on page 2529

[BUS<m>:CDR:PLL:DAMPing](#) on page 2529

Initial phase sync.

Defines the phase reference for the first clock edge.

"First sample" The first clock edge matches the first sample of the waveform at the left border of the display.

"First data edge" The first clock edge matches the first edge of the data signal.

Remote command:

[BUS<m>:CDR:SYNC](#) on page 2530

Selected results

The PLL requires some time to synchronize to the phase of the data stream. You can select when the CDR algorithm returns clock edges:

"After initial sync." The clock edges of the synchronization time are discarded; results are gathered after initial synchronization of the CDR. Thus, meaningful TIE measurement results can be obtained.

"All" All clock edges are used.

Remote command:

[BUS<m>:CDR:RESults](#) on page 2530

Software CDRs

Couples the protocol CDR to the selected software CDR. For more information about it see, [Chapter 19.3, "Clock data recovery"](#), on page 1135.

14.26.4 PCIe trigger

14.26.4.1 PCIe trigger settings

Access: [Bus] > "Shortcuts" tab > "Setup trigger"

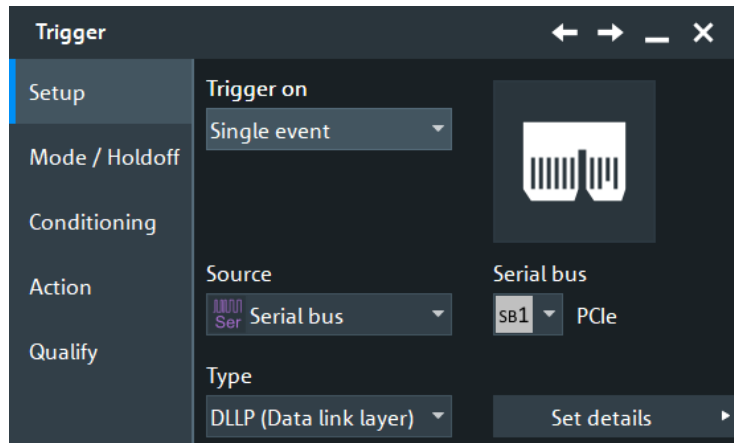

Make sure that:

- In the [Bus] > "Setup" tab:
 - The correct "Protocol" is selected.
 - The data sources of the serial bus are channel signals.
- In the "Trigger" > "Setup" tab:
 - The "Trigger on" = "Single event"
 - The trigger "Source" = "Serial bus".
 - The correct "Serial bus" is selected.

Trigger type PCI express

Selects the trigger type for the PCI express analysis.

"TLP (Transaction layer)" Sets the trigger on a defined type of the transaction layer packet.

"DLLP (Data link layer)" Sets the trigger on a defined type of the data link layer packet.

"Ordered Sets" Sets the trigger on a defined ordered set.

"Error Condition" Sets the trigger on a selection of error conditions.

Remote command:

[TRIGger<m>:PCIE:TYPE](#) on page 2539

TLP (Transaction layer)

Specifies the trigger conditions for the transaction layer type trigger.

TLP ← TLP (Transaction layer)

Triggers on a transaction type.

TLP (Transaction layer)	
TLP	Sequence Number
Any Type ▾	[hex]XXX
TC	Requester ID
Any ▾	[hex]XXXX
Ordering	Snoop
Any ▾	Any ▾

"Any type"	Triggers on any transaction type.
"Mem"	Triggers on memory transaction type used for data transfers to memory-mapped locations.
"IO"	Triggers on I/O transaction type used for data transfers to I/O-mapped locations.
"Cfg"	Triggers on configuration transaction type used to set up the device functions.
"Msg"	Triggers on message transaction type used for transmitting diverse messages.
"Cpl"	Triggers on completion without data.
"FetchAdd"	Triggers on fetch and add atomic op request.
"Swap"	Triggers on unconditional swap atomic op request.
"CAS"	Triggers on compare and swap atomic op request transaction type.

Remote command:

[TRIGger<m>:PCIE:TLP:TYPE](#) on page 2539

Sequence Number ← TLP (Transaction layer)

Triggers on a sequence number, which indicates if any TLPs have been lost.

Remote command:

[TRIGger<m>:PCIE:TLP:SNUM](#) on page 2539

TC ← TLP (Transaction layer)

Triggers on a traffic class which is mapped on a specific virtual channel. The TC label is transmitted unmodified through the fabric.

Remote command:

[TRIGger<m>:PCIE:TLP:TCHN](#) on page 2539

Ordering ← TLP (Transaction layer)

Triggers on an ordering. The ordering can be relaxed or strong.

Remote command:

[TRIGger<m>:PCIE:TLP:ORDE](#) on page 2538

Snoop ← TLP (Transaction layer)

Triggers on a snoop state.

Remote command:

[TRIGger<m>:PCIE:TLP:SNOO](#) on page 2539

Requester ID ← TLP (Transaction layer)

Triggers on a requester ID, consisting of the requester's bus number, device number, and function number.

Remote command:

[TRIGger<m>:PCIE:TLP:REID](#) on page 2538

Device ID ← TLP (Transaction layer)

Triggers on a device ID, a field that can be assigned a value by the vendor for classifying root complex register blocks (RCRB). The Device ID is only valid for Configuration transaction. It is composed of 8-bit bus number, 5-bit device number and a 3-bit function number.

Remote command:

[TRIGger<m>:PCIE:TLP:DEID](#) on page 2537

Read/Write ← TLP (Transaction layer)

Triggers on a read and/ or write state.

Remote command:

[TRIGger<m>:PCIE:TLP:MERW](#) on page 2538

Address Type ← TLP (Transaction layer)

Triggers on an address type. The address type can be 32 bit or 64 bit.

Remote command:

[TRIGger<m>:PCIE:TLP:ADRT](#) on page 2537

Type ← TLP (Transaction layer)

Triggers on a configuration type.

Remote command:

[TRIGger<m>:PCIE:TLP:CFGT](#) on page 2537

Routing ← TLP (Transaction layer)

Triggers on a selected message routing type.

Remote command:

[TRIGger<m>:PCIE:TLP:MSGR](#) on page 2538

Message Code ← TLP (Transaction layer)

Triggers on a specific message code.

Remote command:

[TRIGger<m>:PCIE:TLP:MSGC](#) on page 2538

Status ← TLP (Transaction layer)

Triggers on a completion status.

Remote command:

[TRIGger<m>:PCIE:TLP:CPLS](#) on page 2537

Completer ID ← TLP (Transaction layer)

Triggers on a completer ID, consisting of the completer's bus number, device number, and function number.

Remote command:

[TRIGger<m>:PCIE:TLP:CPID](#) on page 2537

DLLP Type

Sets the trigger to the type of DLLP. You can refine the settings for the different types according to their specifications.

Remote command:

[TRIGger<m>:PCIE:DLLP:TYPE](#) on page 2535

DLLP Any Type conditions

Sets the trigger to any type of DLLP.

DLLP MRDLLP conditions

Specifies the conditions for the multi-root trigger.

DLLP (Data link layer)

DLLP
MRDLLP

MR DLLP
MRInit

Phase
Any

VH FC
Any

Mixed Type
Any

Authorized
Any

Device/Port Type
Any

MR DLLP ← DLLP MRDLLP conditions

Triggers on a multi-root type for the data link layer.

Remote command:

[TRIGger<m>:PCIE:DLLP:MULT:TYPE](#) on page 2533

MRInit ← DLLP MRDLLP conditions

Specifies the conditions for the multi-root initialization protocol trigger.

The screenshot shows a configuration window titled "MR DLLP". It contains several dropdown menus:

- MRInit**: Set to "MRInit"
- Phase**: Set to "Any"
- VH FC**: Set to "Any"
- Mixed Type**: Set to "Any"
- Authorized**: Set to "Any"
- Device/Port Type**: Set to "Any"

Phase ← MRInit ← DLLP MRDLLP conditions

Triggers on a phase state.

Remote command:

[TRIGger<m>:PCIE:DLLP:MULT:PHAS](#) on page 2533

VH FC ← MRInit ← DLLP MRDLLP conditions

Triggers on a virtual hierarchies flow control presence.

Remote command:

[TRIGger<m>:PCIE:DLLP:MULT:VHFC](#) on page 2534

Mixed Type ← MRInit ← DLLP MRDLLP conditions

Triggers on a mixed type presence.

Remote command:

[TRIGger<m>:PCIE:DLLP:MULT:MIXT](#) on page 2532

Authorized ← MRInit ← DLLP MRDLLP conditions

Triggers on an authorized state presence.

Remote command:

[TRIGger<m>:PCIE:DLLP:MULT:AUTH](#) on page 2532

Device/Port Type ← MRInit ← DLLP MRDLLP conditions

Triggers on an device/port type.

Remote command:

[TRIGger<m>:PCIE:DLLP:MULT:DVPT](#) on page 2532

MRInitFC1/InitFC2/UpdateFC ← DLLP MRDLLP conditions

Specifies the conditions for the multi-root initialization flow control protocol trigger.

DLLP (Data link layer)

DLLP
MRDLLP ▾

MR DLLP
MRUpdateFC ▾

VL Number ▾ VH Absent ▾
Any Any

TLP Type ▾ Credit Type ▾
Any Any

VL Number ← MRInitFC1/InitFC2/UpdateFC ← DLLP MRDLLP conditions
Triggers on a virtual link (VL) number.

Remote command:

[TRIGger<m>:PCIE:DLLP:MULT:VLNR](#) on page 2534

VH Absent ← MRInitFC1/InitFC2/UpdateFC ← DLLP MRDLLP conditions
Triggers on absent virtual hierarchies (VH).

Remote command:

[TRIGger<m>:PCIE:DLLP:MULT:HABS](#) on page 2532

TLP Type ← MRInitFC1/InitFC2/UpdateFC ← DLLP MRDLLP conditions
Triggers on a transaction layer type for a multi-root data link layer trigger type.

"Any" Any transaction layer type.

"P" Posted credit.

"N" Non posted credit.

"Cpl" Completion credit.

Remote command:

[TRIGger<m>:PCIE:DLLP:MULT:TLPT](#) on page 2533

Credit Type ← MRInitFC1/InitFC2/UpdateFC ← DLLP MRDLLP conditions
Triggers on any, data or header credit type.

Remote command:

[TRIGger<m>:PCIE:DLLP:MULT:CRET](#) on page 2532

MRRReset ← DLLP MRDLLP conditions

Specifies the conditions for the multi-root reset protocol trigger.

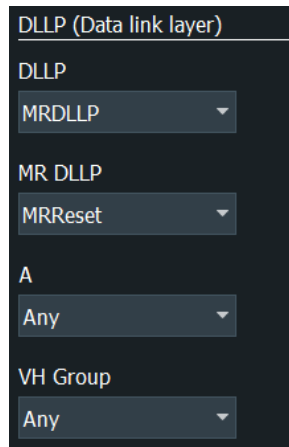

A ← MRReset ← DLLP MRDLLP conditions

Triggers on the value of the A bit (Ack/Request).

Remote command:

[TRIGger<m>:PCIE:DLLP:MULT:RESA](#) on page 2533

VH Group ← MRReset ← DLLP MRDLLP conditions

Triggers on the selected virtual hierarchies group.

Remote command:

[TRIGger<m>:PCIE:DLLP:MULT:VHGR](#) on page 2534

DLLP ACK/NAK conditions

Triggers on an acknowledgement (ACK)/ negative acknowledgment (NAK).

Sequence ← DLLP ACK/NAK conditions

Triggers on the sequence field indicating what TLPs are affected by the ACK/NAK.

Remote command:

[TRIGger<m>:PCIE:DLLP:SEQ](#) on page 2534

DLLP Init FC1/InitFC2/UpdateFC conditions

Triggers on flow control initialization/update conditions.

Credit Type ← DLLP Init FC1/InitFC2/UpdateFC conditions

Triggers on a credit type value.

"Any"	Triggers on any credit type.
"P"	Triggers on posted requests.
"NP"	Triggers on non posted requests.
"CPL"	Triggers on completions.

Remote command:

[TRIGger<m>:PCIE:DLLP:FCTL:CRET](#) on page 2531

VC ID ← DLLP Init FC1/InitFC2/UpdateFC conditions

Triggers on a virtual channel ID value.

Remote command:

[TRIGger<m>:PCIE:DLLP:FCTL:VCID](#) on page 2531

DLLP PM conditions

Triggers on a specified power management conditions.

PM Type ← DLLP PM conditions

Triggers on a power management type.

Remote command:

[TRIGger<m>:PCIE:DLLP:POWM](#) on page 2534

DLLP Vendor conditions

Triggers on a specified vendor conditions.

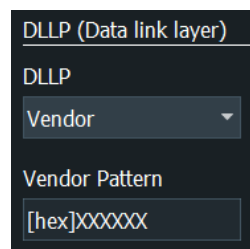

Vendor Pattern ← DLLP Vendor conditions

Triggers on a vendor pattern.

Remote command:

[TRIGger<m>:PCIE:DLLP:VPAT](#) on page 2535

Ordered set condition

Triggers on an ordered set.

"SKP OS"	Triggers on an SKP ordered sets.
"Training Seq 1/2"	Triggers on a training sequence ordered set.
"Fast Training Seq"	Triggers on a fast training sequence ordered set.
"Electrical Idle OS"	Triggers on an electrical idle ordered set that must be send by the transmitter before it can enter the electrical idle.
"Electrical Idle Exit OS"	Triggers on an electrical idle exit ordered set.
"Compliance Pattern"	Triggers on a compliance pattern ordered set.

Remote command:

[TRIGger<m>:PCIE:OSET:TYPE](#) on page 2536

Error Condition PCIe Gen 1/2

Triggers on enabled error condition.

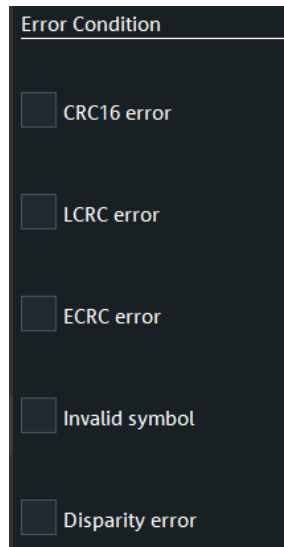

"CRC16 error"	Triggers on 16-bit cyclic redundancy check (CRC) errors.
"LCRC error"	Triggers on link cyclic redundancy check (LCRC) errors.
"ECRC error"	Triggers on end-to-end cyclic redundancy checksum (ECRC) errors.
"Invalid symbol"	Triggers on invalid symbol errors.
"Disparity error"	Triggers on disparity errors.

Remote command:

[TRIGger<m>:PCIE:ERRC:CRC](#) on page 2535

[TRIGger<m>:PCIE:ERRC:DISP](#) on page 2535

[TRIGger<m>:PCIE:ERRC:ECRC](#) on page 2535

[TRIGger<m>:PCIE:ERRC:INVP](#) on page 2536

[TRIGger<m>:PCIE:ERRC:LCRC](#) on page 2536

14.26.4.2 Triggering on PCIe Gen 1/2

Prerequisite: A bus is configured for the PCIe Gen 1/2 signal to be analyzed.

For the basic trigger settings, proceed in the following way:

1. Press the [Bus] key and select the "Shortcuts" tab.
2. Press "Setup trigger".
3. Tap the "Source" button and select the "Serial bus" trigger source.
4. Tap "Serial bus" and select the serial bus that is set to PCIe Gen 1/2.
5. Tap "Trigger Type PCI express" and select the trigger type to be used for PCIe Gen 1/2 protocol analysis.
6. Depending on the selected trigger type, more setup conditions can be specified.

For information on how to proceed with the configuration settings, see [Chapter 14.26.4.1, "PCIe trigger settings"](#), on page 969.

14.26.5 PCIe Gen 1/2 decode results

When the configuration of the serial bus is complete, the signal can be decoded:

1. In the "Serial Bus" dialog > "Setup" tab, enable "Decode".
2. In the "Serial Bus" dialog > "Display" tab, select additional result display settings: "Show table" and "Show binary".
3. If required, enable "Zoom coupling"

For a description of the display settings, see also [Chapter 14.1.3, "Display"](#), on page 513.

The instrument captures and decodes the signal according to the standard definition and the configuration settings.

The color-coding of the various protocol sections and errors simplifies the interpretation of the visual display. The decode information condenses or expands, depending on the horizontal scale. Various data formats are available to show the result values.

Decode results table

The screenshot shows a software interface with two tables. The main table, titled 'PCIe Decode Results 581', has columns: State, Start, Type, Seq Cnt, Tag, Length, Address, HdrFC, DataFC, Compl, Requester ID, Completer ID, and Bit rate. It lists several decoded frames, with frame 8 selected. The 'Details frame 8' table provides a breakdown of frame 8, with columns: State, Type, Numeric, and Formatted. It shows fields like SDP, Type, VC ID, R, HdrFC, DataFC, and CRC.

The results are shown in two tables:

- "Decode results": contains information about all decoded frames
- "Details frame": contains more detailed information about the selected frame in the "Decode results" table.

Table 14-49: Content of the Decode results table

Column	Description
State	Overall state of the packet
Start	Start time of the packet
Type	Type of packet
Sequence count	Sequence count
Tag	Tag of the packet
Length	Length of packet
Address	Value of the address
HdrFC	Credit value of the header

Column	Description
DataFC	Credit value of the payload data
Completion status	Completion status field value
Requester ID	Requester ID
Completer ID	Completer ID
Bit rate	The bit rate of the packet

Table 14-50: Content of the Details frame table

Column	Description
State	State of the field
Type	Field type
Numeric	Hexadecimal value of the field
Formatted	Formatted content of the field

Tools

Press "Display settings" in the "Decode Results" table to access the "Display" tab.



Remote commands

Remote commands to retrieve decode results are described in [Chapter 27.18.27.4, "Decode results"](#), on page 2540.

14.26.6 PCIe Gen 1/2 search

14.26.6.1 PCIe Gen 1/2 search settings

Access: [Bus] > "Shortcuts" tab > "Setup search"

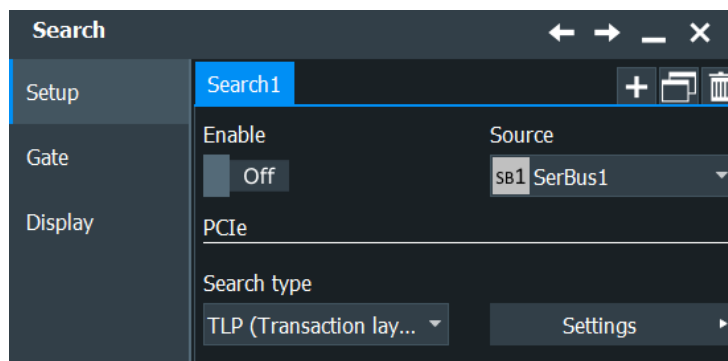



Make sure that:

- In the [Bus] > "Setup" tab:
 - The correct "Protocol" is selected.
 - The data sources of the serial bus are channel signals.
- In the "Trigger" > "Setup" tab:
 - The "Trigger on" = "Single event"
 - The trigger "Source" = "Serial bus".
 - The correct "Serial bus" is selected.

Serial bus

Selects the serial bus to be triggered on. Make sure to select the correct bus before you enter the settings.

To trigger on a serial bus, the signals sources must be channel signals. If the data or clock source is a math or reference waveform, you cannot trigger on that bus.

Remote command:

[TRIGger<m>:SOURce:SBSelect](#) on page 1818

Protocol

Defines the protocol type of the selected serial bus.

Remote command:

[BUS<m>:TYPE](#) on page 1813

Searches for PCI express

Selects the search type for the PCI express analysis.

"TLP (Transaction layer)" Sets the search on a defined type of the transaction layer packet.

"DLLP (Data link layer)" Sets the search on a defined type of the data link layer packet.

"Ordered Sets" Sets the search on a defined ordered set.

"Error Condition" Sets the search on a selection of error conditions.

Remote command:

[SEARCH:TRIGger:PCIE:TYPE](#) on page 2561

TLP (Transaction layer)

Specifies the search conditions for the transaction layer type search.

TLP ← TLP (Transaction layer)

Searches for a transaction type.

TLP (Transaction layer)	
TLP	Sequence Number
Any Type ▾	[hex]XXX
TC	Requester ID
Any ▾	[hex]XXXX
Ordering	Snoop
Any ▾	Any ▾

"Any type"	Searches for any transaction type.
"Mem"	Searches for memory transaction type used for data transfers to memory-mapped locations.
"IO"	Searches for I/O transaction type used for data transfers to I/O-mapped locations.
"Cfg"	Searches for configuration transaction type used to setup the device functions.
"Msg"	Searches for message transaction type used for transmitting diverse messages.
"Cpl"	Searches for completion without data.
"FetchAdd"	Searches for fetch and add atomic op request.
"Swap"	Searches for unconditional swap atomic op request.
"CAS"	Searches for compare and swap atomic op request transaction type.

Remote command:

[SEARCh:TRIGger:PCIE:TLP:TYPE](#) on page 2561

Sequence Number ← TLP (Transaction layer)

Searches for a sequence number, which indicates if any TLPs have been lost.

Remote command:

[SEARCh:TRIGger:PCIE:TLP:SNUM](#) on page 2560

TC ← TLP (Transaction layer)

Searches for a traffic class which is mapped on a specific virtual channel. The TC label is transmitted unmodified through the fabric.

Remote command:

[SEARCh:TRIGger:PCIE:TLP:TCHN](#) on page 2560

Ordering ← TLP (Transaction layer)

Searches for an ordering. The ordering can be relaxed or strong.

Remote command:

[SEARCh:TRIGger:PCIE:TLP:ORDE](#) on page 2559

Snoop ← TLP (Transaction layer)

Searches for a snoop state.

Remote command:

[SEARCh:TRIGger:PCIE:TLP:SNOO](#) on page 2560

Requester ID ← TLP (Transaction layer)

Searches for a requester ID, consisting of the requester's bus number, device number, and function number.

Remote command:

[SEARCh:TRIGger:PCIE:TLP:REID](#) on page 2560

Device ID ← TLP (Transaction layer)

Searches for a device ID, a field that can be assigned a value by the vendor for classifying root complex register blocks (RCRB). The Device ID is only valid for Configuration transaction. It is composed of 8-bit Bus number, 5-bit Device number and a 3-bit Function number.

Remote command:

[SEARCh:TRIGger:PCIE:TLP:DEID](#) on page 2558

Read/Write ← TLP (Transaction layer)

Searches for a read and/ or write state.

Remote command:

[SEARCh:TRIGger:PCIE:TLP:MERW](#) on page 2558

Address Type ← TLP (Transaction layer)

Searches for an address type. The address type can be 32 bit or 64 bit.

Remote command:

[SEARCh:TRIGger:PCIE:TLP:ADRT](#) on page 2557

Type ← TLP (Transaction layer)

Searches for a configuration type.

Remote command:

[SEARCh:TRIGger:PCIE:TLP:CFGT](#) on page 2557

Routing ← TLP (Transaction layer)

Searches for a selected message routing type.

Remote command:

[SEARCh:TRIGger:PCIE:TLP:MSGR](#) on page 2559

Message Code ← TLP (Transaction layer)

Searches for a specific message code.

Remote command:

[SEARCh:TRIGger:PCIE:TLP:MSGC](#) on page 2559

Status ← TLP (Transaction layer)

Searches for a completion status.

Remote command:

[SEARCh:TRIGger:PCIE:TLP:CPLS](#) on page 2558

Completer ID ← TLP (Transaction layer)

Searches for a completer ID, consisting of the completer's bus number, device number, and function number.

Remote command:

[SEARCH:TRIGger:PCIE:TLP:CPID](#) on page 2558

DLLP Type

Sets the trigger to the type of DLLP. You can refine the settings for the different types according to their specifications.

Remote command:

[SEARCH:TRIGger:PCIE:DLLP:TYPE](#) on page 2553

DLLP Any Type conditions

Sets the trigger to any type of DLLP.

DLLP MRDLLP conditions

Specifies the conditions for the multi-root trigger.

The screenshot shows a configuration window titled "MR DLLP". It contains several dropdown menus:

- MRInit**: Set to "Any"
- Phase**: Set to "Any"
- VH FC**: Set to "Any"
- Mixed Type**: Set to "Any"
- Authorized**: Set to "Any"
- Device/Port Type**: Set to "Any"

MR DLLP ← DLLP MRDLLP conditions

Searches for a multi-root type for the data link layer.

Remote command:

[SEARCH:TRIGger:PCIE:DLLP:MULT:TYPE](#) on page 2552

MRInit ← DLLP MRDLLP conditions

Specifies the conditions for the multi-root initialization protocol search.

The screenshot shows a configuration window titled "MR DLLP". It contains several dropdown menus:

- MRInit**: Set to "MRInit"
- Phase**: Set to "Any"
- VH FC**: Set to "Any"
- Mixed Type**: Set to "Any"
- Authorized**: Set to "Any"
- Device/Port Type**: Set to "Any"

Phase ← MRInit ← DLLP MRDLLP conditions

Searches for a phase state.

Remote command:

[SEARCH:TRIGGER:PCIE:DLLP:MULT:PHAS](#) on page 2551

VH FC ← MRInit ← DLLP MRDLLP conditions

Searches for a virtual hierarchies flow control presence.

Remote command:

[SEARCH:TRIGGER:PCIE:DLLP:MULT:VHFC](#) on page 2552

Mixed Type ← MRInit ← DLLP MRDLLP conditions

Searches for a mixed type presence.

Remote command:

[SEARCH:TRIGGER:PCIE:DLLP:MULT:MIXT](#) on page 2550

Authorized ← MRInit ← DLLP MRDLLP conditions

Searches for an authorized state presence.

Remote command:

[SEARCH:TRIGGER:PCIE:DLLP:MULT:AUTH](#) on page 2549

Device/Port Type ← MRInit ← DLLP MRDLLP conditions

Searches for an device/port type.

Remote command:

[SEARCH:TRIGGER:PCIE:DLLP:MULT:DVPT](#) on page 2550

MRInitInit FC1/InitFC2/UpdateFC ← DLLP MRDLLP conditions

Specifies the conditions for the multi-root initialization flow control protocol search.

DLLP (Data link layer)	
DLLP	
MRDLLP	
MR DLLP	
MRUpdateFC	
VL Number	VH Absent
Any	Any
TLP Type	Credit Type
Any	Any

VL Number ← **MRInitInit FC1/InitFC2/UpdateFC** ← **DLLP MRDLLP conditions**
Searches for a virtual link (VL) number.

Remote command:

[SEARCH:TRIGGER:PCIE:DLLP:MULT:VLNR](#) on page 2552

VH Absent ← **MRInitInit FC1/InitFC2/UpdateFC** ← **DLLP MRDLLP conditions**
Searches for absent virtual hierarchies (VH).

Remote command:

[SEARCH:TRIGGER:PCIE:DLLP:MULT:HABS](#) on page 2550

TLP Type ← **MRInitInit FC1/InitFC2/UpdateFC** ← **DLLP MRDLLP conditions**
Searches for a transaction layer type for a multi-root data link layer trigger type.

"Any" Any transaction layer type.

"P" Posted credit.

"N" Non posted credit.

"Cpl" Completion credit.

Remote command:

[SEARCH:TRIGGER:PCIE:DLLP:MULT:TLPT](#) on page 2551

Credit Type ← **MRInitInit FC1/InitFC2/UpdateFC** ← **DLLP MRDLLP conditions**
Searches for any, data or header credit type.

Remote command:

[SEARCH:TRIGGER:PCIE:DLLP:FCTL:CRET](#) on page 2549

MRRReset ← **DLLP MRDLLP conditions**

Specifies the conditions for the multi-root reset protocol search.

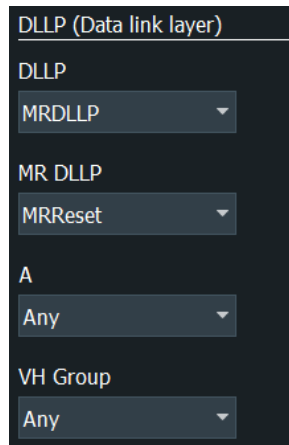
**A ← MRRReset ← DLLP MRDLLP conditions**

Searches for the value of the A bit (Ack/ Request).

Remote command:

[SEARCH:TRIGGER:PCIE:DLLP:MULT:RESA](#) on page 2551

VH Group ← MRRReset ← DLLP MRDLLP conditions

Searches for the selected virtual hierarchies group.

Remote command:

[SEARCH:TRIGGER:PCIE:DLLP:MULT:VHGR](#) on page 2552

DLLP ACK/NAK conditions

Searches for an acknowledgement (ACK)/ negative acknowledgment (NAK).

Sequence ← DLLP ACK/NAK conditions

Searches for the sequence field indicating what TLPs are affected by the ACK/NAK.

Remote command:

[SEARCH:TRIGGER:PCIE:DLLP:SEQ](#) on page 2553

DLLP Init FC1/InitFC2/UpdateFC conditions

Searches for flow control initialization/update conditions.

Credit Type ← DLLP Init FC1/InitFC2/UpdateFC conditions

Searches for a credit type value.

"Any"	Searches for any credit type.
"P"	Searches for posted requests.
"NP"	Searches for non posted requests.
"CPL"	Searches for completions.

Remote command:

[SEARCH:TRIGGER:PCIE:DLLP:FCTL:CRET](#) on page 2549

VC ID ← DLLP Init FC1/InitFC2/UpdateFC conditions

Searches for a virtual channel ID value.

Remote command:

[SEARCH:TRIGGER:PCIE:DLLP:FCTL:VCID](#) on page 2549

DLLP PM conditions

Searches for a specified power management conditions.

PM Type ← DLLP PM conditions

Searches for a power management type.

Remote command:

[SEARCH:TRIGGER:PCIE:DLLP:POWM](#) on page 2553

DLLP Vendor conditions

Searches for a specified vendor conditions.

Vendor Pattern ← DLLP Vendor conditions

Searches for a vendor pattern.

Remote command:

[SEARCH:TRIGGER:PCIE:DLLP:VPAT](#) on page 2554

Ordered set condition

Searches for the enabled ordered sets.

"SKP OS"	Searches for an SKP ordered sets.
"Training Seq 1/2"	Searches for a training sequence ordered set.
"Fast Training Seq"	Searches for a fast training sequence ordered set.
"Electrical Idle OS"	Searches for an electrical idle ordered set that must be send by the transmitter before it can enter the electrical idle.
"Electrical Idle Exit OS"	Searches for an electrical idle exit ordered set.
"Start of data sequence OS"	Available for PCIe "Generation" = " Gen 3 (8 Gbit/s)" Searches for a start of data sequence order set.
"Compliance Pattern"	Searches for a compliance pattern ordered set.

Remote command:

[SEARCH:TRIGGER:PCIE:OSET:COMP](#) on page 2555

[SEARCH:TRIGGER:PCIE:OSET:EIDE](#) on page 2555

[SEARCH:TRIGGER:PCIE:OSET:EIDL](#) on page 2556

[SEARCH:TRIGGER:PCIE:OSET:FTS](#) on page 2556

[SEARCH:TRIGGER:PCIE:OSET:SKIP](#) on page 2556

[SEARCH:TRIGGER:PCIE:OSET:TSONe](#) on page 2557

[SEARCH:TRIGGER:PCIE:OSET:TSTWo](#) on page 2557

Error Condition

Searches for enabled error conditions.

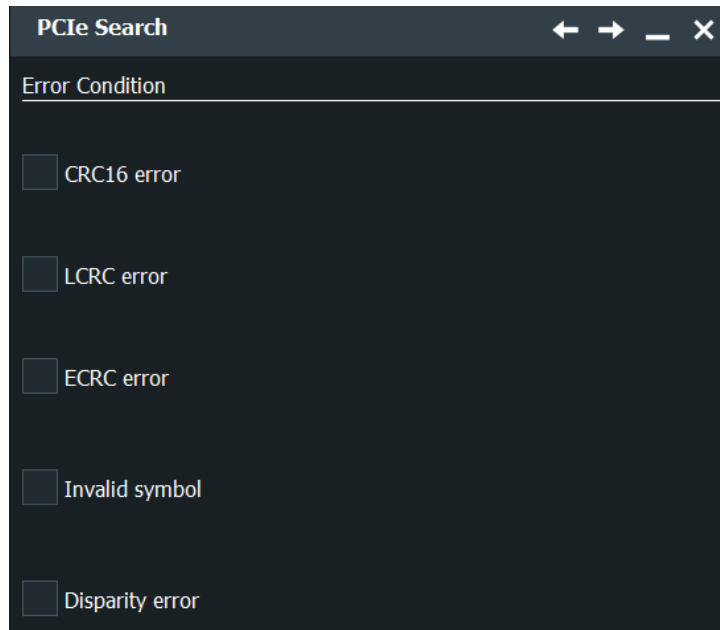

"CRC16 error"	Searches for 16-bit cyclic redundancy check (CRC) errors.
"LCRC error"	Searches for link cyclic redundancy check (LCRC) errors.
"ECRC error"	Searches for end-to-end cyclic redundancy checksum (ECRC) errors.
"Invalid symbol"	Searches for invalid symbol errors.
"Disparity error"	Searches for disparity errors.

Remote command:

[SEARCH:TRIGGER:PCIE:ERRC:CRC](#) on page 2554
[SEARCH:TRIGGER:PCIE:ERRC:DISP](#) on page 2554
[SEARCH:TRIGGER:PCIE:ERRC:ECRC](#) on page 2554
[SEARCH:TRIGGER:PCIE:ERRC:INVP](#) on page 2555
[SEARCH:TRIGGER:PCIE:ERRC:LCRC](#) on page 2555

14.26.6.2 PCIe Gen 1/2 search results

To get search results, "Enable" the search. You can minimize, shift or close the search dialog.

The search results are listed in the search result table and marked in the waveform by blue lines.

For an introduction to search results, see:

- [Chapter 11.1.2, "Search results"](#), on page 426
- [Chapter 11.4.2, "Display zoom settings"](#), on page 446

The results of the search are the same as for decoding, see [Chapter 14.27.3, "DDR decode results"](#), on page 998.

Remote Commands:

- [SEARCH:RESult:PCIE:PCOunt?](#) on page 2567
- [SEARCH:RESult:PCIE:PACKet<m>:ADDR?](#) on page 2562
- [SEARCH:RESult:PCIE:PACKet<m>:CPID?](#) on page 2562
- [SEARCH:RESult:PCIE:PACKet<m>:CPS?](#) on page 2562
- [SEARCH:RESult:PCIE:PACKet<m>:DATA?](#) on page 2563
- [SEARCH:RESult:PCIE:PACKet<m>:DFC?](#) on page 2563
- [SEARCH:RESult:PCIE:PACKet<m>:FCOunt?](#) on page 2563
- [SEARCH:RESult:PCIE:PACKet<m>:HFC?](#) on page 2565
- [SEARCH:RESult:PCIE:PACKet<m>:LEN?](#) on page 2565
- [SEARCH:RESult:PCIE:PACKet<m>:RQID?](#) on page 2565
- [SEARCH:RESult:PCIE:PACKet<m>:SEQN?](#) on page 2565
- [SEARCH:RESult:PCIE:PACKet<m>:START?](#) on page 2566
- [SEARCH:RESult:PCIE:PACKet<m>:STATe?](#) on page 2566
- [SEARCH:RESult:PCIE:PACKet<m>:STOP?](#) on page 2566
- [SEARCH:RESult:PCIE:PACKet<m>:TAG?](#) on page 2567
- [SEARCH:RESult:PCIE:PACKet<m>:TYPE?](#) on page 2567
- [SEARCH:RESult:PCIE:PACKet<m>:FCOunt?](#) on page 2563
- [SEARCH:RESult:PCIE:PACKet<m>:FLD<n>:FVAL?](#) on page 2563
- [SEARCH:RESult:PCIE:PACKet<m>:FLD<n>:STATus?](#) on page 2564
- [SEARCH:RESult:PCIE:PACKet<m>:FLD<n>:TYPE?](#) on page 2564
- [SEARCH:RESult:PCIE:PACKet<m>:FLD<n>:VAL?](#) on page 2564

14.26.6.3 Searching for PCIe Gen 1/2

Prerequisite: A serial bus is configured for the PCIe signal to be decoded and analyzed.

The search for events is set up in the following way:

1. Press the [Bus] key and select the "Shortcuts" tab.
2. Tap "Setup search".
3. If the dialog box does not contain a search entry, tap the "Add" icon to create one, as described in ["To create a user-defined search"](#) on page 440.
4. Tap "Source" and select the serial bus that is set to PCIe (e.g. "SB1").
5. Specify the search criteria according to [Chapter 14.26.6.1, "PCIe Gen 1/2 search settings"](#), on page 980.
6. To acquire a waveform, press [Single].

The R&S RTO6 performs an PCIe decode according to the thresholds and protocol settings of the associated serial bus source.

7. To start searching the acquired waveform for specific events, tap "Enable" in the search setup dialog:

The R&S RTO6 displays the "Search Results" box that lists the detected events.

For information on how to configure the search results presentation and how to navigate the search results, see also ["To display search zoom windows"](#) on page 448.

14.27 DDR (option R&S RTO6-K91)

Double Data Rate Type 3 (DDR3) is a type of Synchronous Dynamic Random Access Memory (SDRAM). With option R&S RTO6-K91 you can perform the following analysis on DDR3 data:

- Decode the signal.
See: [Chapter 14.27.1, "DDR configuration"](#), on page 991
- Create and analyze an eye diagram. This helps to separate the read and write cycle.
See [Chapter 20, "Advanced eye diagram analysis \(option R&S RTO6-K136\)"](#), on page 1145.
- Together with the R&S ScopeSuite software you can perform a compliance test on the signal.
For details refer to:
 - "DDR3 Compliance Tests, Test Procedures Manual"

14.27.1 DDR configuration

14.27.1.1 DDR configuration settings

Access: [Bus] > "DDR" > "Setup" tab



Make sure that the tab of the correct serial bus is selected.

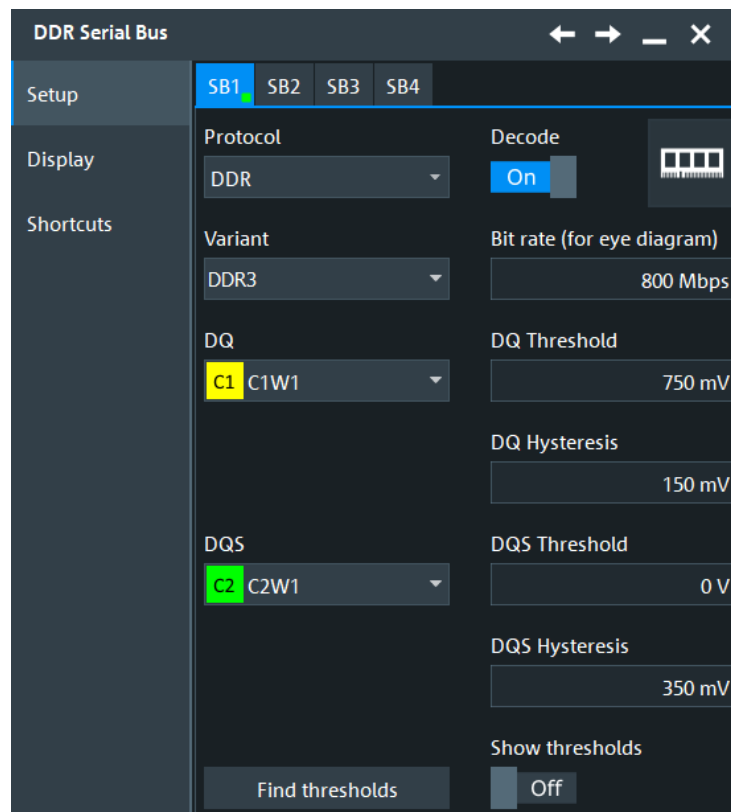

See also: [Chapter 14.1.1, "Setup - general settings"](#), on page 511

Variant

Selects the DDR standard.

"DDR3" Requires option R&S RTO6-K91.

Remote command:

[BUS<m>:DDR:STANdard](#) on page 2568

DQ

Sets the channel for the data output signal.

You can select analog channels "C1" to "C4", and also active math and reference waveforms as source.

Remote command:

[BUS<m>:DDR:DATA:SOURce](#) on page 2569

DQS

Sets the channel for the data strobe signal.

You can select analog channels "C1" to "C4", and also active math and reference waveforms as source.

Remote command:

[BUS<m>:DDR:STRBe:SOURce](#) on page 2569

Threshold

Sets the threshold value for the digitization of the DQ/DQS lane.

There are two ways to set the thresholds:

- "Threshold"
Enter individual values for each line directly in the fields.
- "Find thresholds"
Executes the measurement of reference levels and sets the thresholds to the middle reference level of the measured amplitude.

Remote command:

[BUS<m>:DDR:DATA:THReshold](#) on page 2569

[BUS<m>:DDR:STRBe:THReshold](#) on page 2570

[BUS<m>:SETReflevels](#) on page 1814

Hysteresis

Sets a value for the hysteresis of the respective lane.

Remote command:

[BUS<m>:DDR:DATA:HYSTeresis](#) on page 2568

[BUS<m>:DDR:STRBe:HYSTeresis](#) on page 2569

Bit rate (for eye diagram)

Declares the nominal bit rate of the data signal for the DDR eye diagram analysis.

See also, [Range UI](#), [Position UI](#).

Remote command:

[BUS<m>:DDR:BITRate](#) on page 2570

Show thresholds

If enabled, the threshold levels are displayed in the diagram.

Remote command:

[BUS<m>:THReshold](#) on page 1815

14.27.1.2 Display settings

Access: [Bus] > "Display" tab.

For common display settings, see [Chapter 14.1.3, "Display"](#), on page 513.

To enhance the decode possibilities of the DDR protocol, you can use an additional setting in the "Display" tab: "Decode layer".

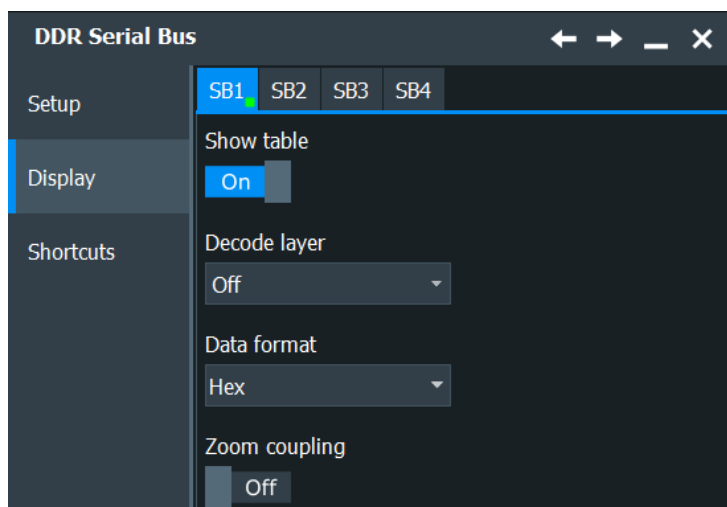

Decode layer

Selects the decode layer.

Decoding is performed in several layers, and the end results are presented in the decode table. The decode layer selects an interim step for which the decoding result is shown in the honeycomb display.

"Edges"	All edges of each lane in stage 1 decoding.
"Bits"	All bits of each lane in stage 1 decoding.
"Word"	All words of each lane in stage 1 decoding.

14.27.1.3 Configuring the DDR signals

For configuration, assign the lanes to the input channels and define the logical thresholds and the hysteresis.

1. Press the [Bus] key on the front panel.
2. Select the tab of the bus you want to set up, for example "SB1".
3. In the "Setup" tab, set "Protocol"="DDR".
4. Optionally, you can enter a "Bus label" on the "Display" tab.
5. Set the channels for the "DS" and "DQS".
6. Set the "Threshold" and "Hysteresis" values.
7. Enable "Decode".

14.27.2 Search on decoded DDR data

Using the search functionality, you can find various events in the decoded data. You can find the same events that you can trigger on, and even many more, since several event types can also be combined.

Before you can start the search, you have to configure the bus correctly and acquire decoded data.

To search on decoded data, set the search source to "SerBus" for the configured protocol.

For general information on how to handle the search functionality, see [Chapter 11, "Search functions"](#), on page 425.

If you need information on how to get started with searching for DDR data, see [Chapter 14.27.2.3, "Searching for DDR data"](#), on page 998. Otherwise proceed with the DDR search setup.

14.27.2.1 DDR search setup

Access: [Bus] > "Shortcuts" tab > "Setup search"

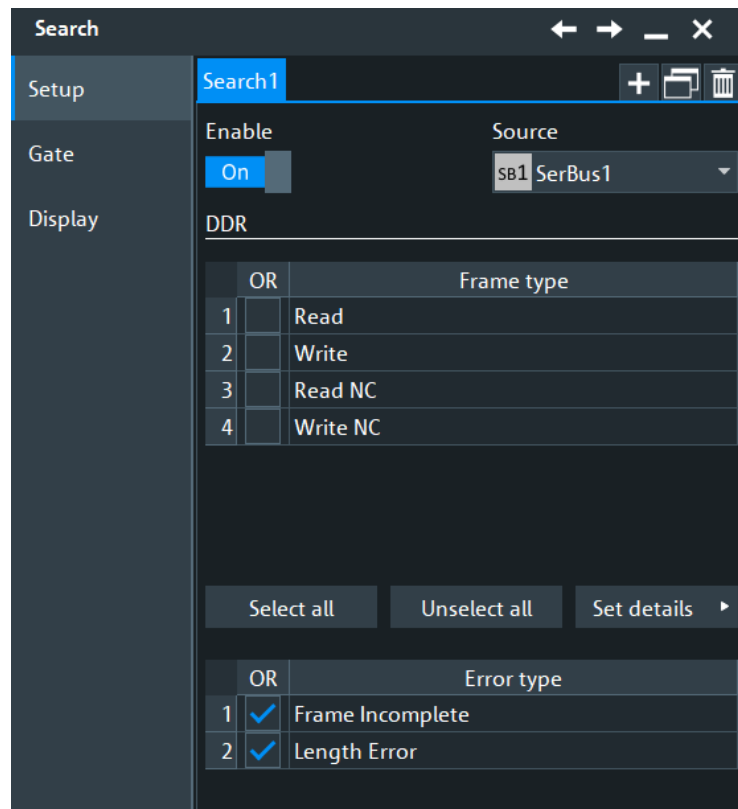

In this dialog, you can define the search type for DDR.

DDR search

You can select one or more frames to be searched for. Available are "Read", "Write", "Read NC" and "Write NC". You can also define the data and/or index operators and values for the field, see [Set details](#).

Remote command:

`SEARCH:TRIGGER:DDR:FRENable` on page 2576

`SEARCH:TRIGGER:DDR:FRAME<m>:ENABLE` on page 2577

Error type

You can search for "Frame Incomplete" and "Length error".

Remote command:

[SEARCH:TRIGGER:DDR:ERROR<m>:ENABLE](#) on page 2575

[SEARCH:TRIGGER:DDR:ERENABLE](#) on page 2575

Set details

In this dialog, you can define the individual search parameters for the fields of the selected frame. Select the frame type first, and then open the "Set details" dialog.

	Field	Condition	AND
1	Data		

Data

Value

= Equal [hex]XX

Index

[-] In range 1 .. 65534

Back

Remote command:

[SEARCH:TRIGGER:DDR:FIENABLE](#) on page 2576

Value ← Set details

Sets the data value of the field to be searched for. The search data setup consists of a comparison condition and one or two data patterns.

"Condition" Sets the comparison condition to a specific value or a range.

"Min" Specifies the value or sets the start value of a range.

"Max" Sets the maximum value of a range for "Condition" = "In range"/"Out of range".

Remote command:

[SEARCH:TRIGGER:DDR:DMAX](#) on page 2576

[SEARCH:TRIGGER:DDR:FRAME<m>:FLD<n>:DMAX](#) on page 2576

[SEARCH:TRIGGER:DDR:DMIN](#) on page 2576

[SEARCH:TRIGger:DDR:FRAMe<m>:FLD<n>:DMIN](#) on page 2576

[SEARCH:TRIGger:DDR:DOPerator](#) on page 2577

[SEARCH:TRIGger:DDR:FRAMe<m>:FLD<n>:DOPerator](#) on page 2577

Index ← Set details

The search index setup consists of a comparison condition and one or two address patterns.

"Condition"	Sets the comparison condition to a specific value or a range.
"Min"	Specifies the value or sets the start value of a range.
"Max"	Sets the maximum value of a range for "Condition" = "In range"/"Out of range".

Remote command:

[SEARCH:TRIGger:DDR:IMAX](#) on page 2578

[SEARCH:TRIGger:DDR:FRAMe<m>:FLD<n>:IMAX](#) on page 2578

[SEARCH:TRIGger:DDR:IMIN](#) on page 2578

[SEARCH:TRIGger:DDR:FRAMe<m>:FLD<n>:IMIN](#) on page 2578

[SEARCH:TRIGger:DDR:IOPerator](#) on page 2579

[SEARCH:TRIGger:DDR:FRAMe<m>:FLD<n>:IOPerator](#) on page 2579

14.27.2.2 DDR search results

To get search results, "Enable" the search. You can minimize, shift or close the search dialog.

The search results are listed in the search result table and marked in the waveform by blue lines.

For an introduction to search results, see:

- [Chapter 11.1.2, "Search results"](#), on page 426
- [Chapter 11.4.2, "Display zoom settings"](#), on page 446

The results of the search are the same as for decoding, see [Chapter 14.27.3, "DDR decode results"](#), on page 998.

Remote commands:

- [SEARCH:RESult:DDR:FCOunt?](#) on page 2580
- [SEARCH:RESult:DDR:FRAMe<m>:FLD<n>:FVAL?](#) on page 2580
- [SEARCH:RESult:DDR:FRAMe<m>:FLD<n>:START?](#) on page 2580
- [SEARCH:RESult:DDR:FRAMe<m>:FLD<n>:STATus?](#) on page 2581
- [SEARCH:RESult:DDR:FRAMe<m>:FLD<n>:STOP?](#) on page 2581
- [SEARCH:RESult:DDR:FRAMe<m>:FLD<n>:VAL?](#) on page 2581
- [SEARCH:RESult:DDR:FRAMe<m>:NWRDs?](#) on page 2582
- [SEARCH:RESult:DDR:FRAMe<m>:START?](#) on page 2582
- [SEARCH:RESult:DDR:FRAMe<m>:STATe?](#) on page 2583
- [SEARCH:RESult:DDR:FRAMe<m>:STOP?](#) on page 2583

- [SEARCH:RESult:DDR:FRAME<m>:TYPE?](#) on page 2583

14.27.2.3 Searching for DDR data

Prerequisite: A serial bus is configured for the DDR signal to be decoded and analyzed.

The search for events is set up in the following way:

1. Press the [Bus] key and select the "Shortcuts" tab.
2. Tap "Setup search".
3. If the dialog box does not contain a search entry, tap the "Add" icon to create one, as described in ["To create a user-defined search"](#) on page 440.
4. Tap "Source" and select the serial bus that is set to DDR (e.g. "SB1", unless already selected).

The search dialog for DDR protocol analysis is opened.

5. Specify search criteria according to [Chapter 14.27.2.1, "DDR search setup"](#), on page 995.

6. To acquire a waveform, press [Single].

The R&S RTO6 performs a DDR decode according to the thresholds and protocol settings of the associated serial bus source (here in our example SB1).

7. To start searching the acquired waveform for specific events, tap "Enable" in the search setup dialog:

The R&S RTO6 displays the "Search Results" box that lists the detected events.

For information on how to configure the search results presentation and how to navigate the search results, see also ["To display search zoom windows"](#) on page 448.

14.27.3 DDR decode results

When the configuration of the serial bus is complete, the signal can be decoded:

1. In the "Protocol" dialog > "Setup" tab, enable "Decode".
2. In the "Protocol" dialog > "Display" tab, select additional result display settings: "Show decode table" and "Show binary signals".

For a description of the display settings, see also [Chapter 14.1.3, "Display"](#), on page 513.

The instrument captures and decodes the signal according to the standard definition and the configuration settings.

The color-coding of the various protocol sections and errors simplifies the interpretation of the visual display. The decode information condenses or expands, depending on the horizontal scale. Various data formats are available to show the result values.

Decode Results Table

The screenshot shows a software interface titled "DDR Decode Results SB1". It contains two tables. The first table, "Decode Results", has columns for State, Start, Frame Type, and Word count. The second table, "Details frame 1", has columns for State, Numeric, and Formatted.

State	Start	Frame Type	Word count
1 Ok	-1.59 μ s	Read Frame	8
2 Ok	-230 ns	Write Frame	8

State	Numeric	Formatted
1 Ok	[hex] B9 B9h	
2 Ok	[hex] 8E 8Eh	
3 Ok	[hex] AA AAh	
4 Ok	[hex] 02 02h	
5 Ok	[hex] F0 F0h	
6 Ok	[hex] 48 48h	
7 Ok	[hex] 42 42h	
8 Ok	[hex] 3A 3Ah	

The results are shown in two tables:

- "Decode results": contains information about all decoded frames
- "Details frame": contains more detailed information about the selected frame in the "Decode results" table.

Table 14-51: Content of the Decode result table

Column	Description
Frame	Frame count
State	Overall state of the frame indicating, for example, if the frame is valid or invalid
Start	Time of frame start in relation to the trigger point
Frame Type	Frame identifier specifying the data or control frame name
Word count	Total number of words in the frame

Table 14-52: Content of the Details frame table

Column	Description
State	State of the field
Numeric	Hexadecimal value of the field
Formatted	Formatted content of the field

Remote commands

Remote commands are described in [Chapter 27.18.28.2, "Decode results"](#), on page 2570.

15 Mixed signal option (MSO, R&S RTO6-B1)

The Mixed Signal Option R&S RTO6-B1 adds logic analyzer functions to the classical oscilloscope functions. Using the MSO option, you can analyze and debug embedded systems with mixed-signal designs that use analog signals and correlated digital signals simultaneously.

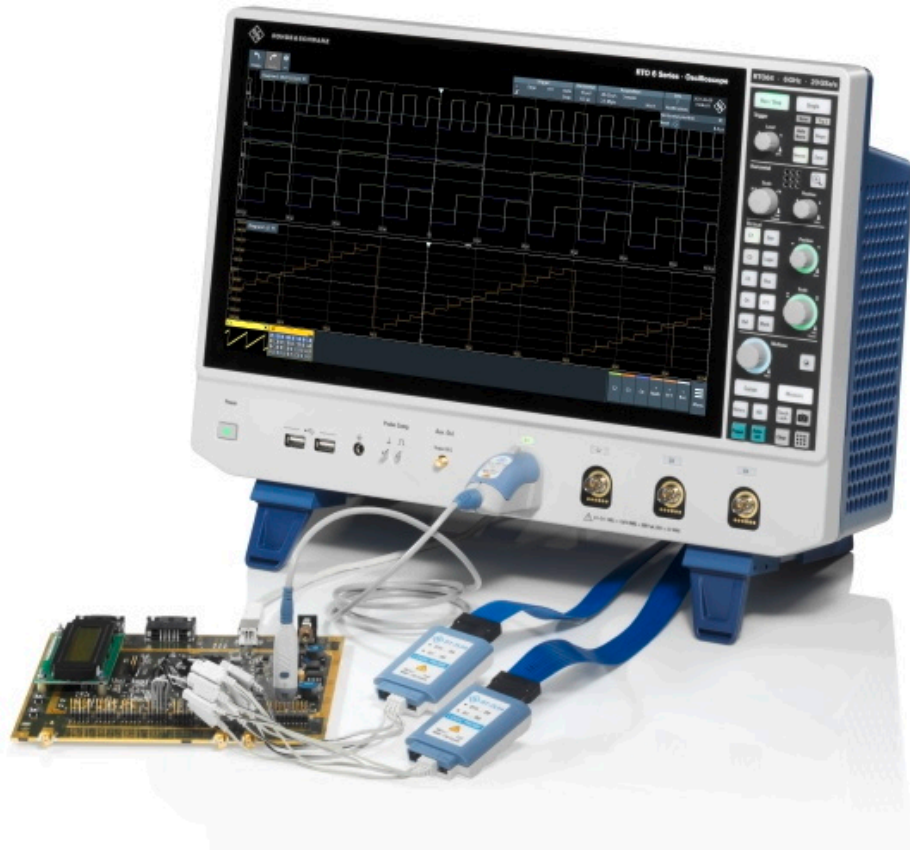

The Mixed Signal Option provides 16 digital channels grouped in two logic probes (pods) with 8 channels each. The instrument ensures that analog and digital waveforms are time-aligned and synchronized so that critical timing interactions between analog and digital signals can be displayed and tested. The automatic alignment compensates the skew between the probe connectors of the analog channels and the probe boxes of the digital channels.

Logic probes provided by Rohde & Schwarz are recognized by the instrument. The information on each recognized probe is shown under "Menu" > "Settings" > "Maintenance" > "Hardware" > "Advanced" > "Logic Probes".

15.1 Digital channels and parallel buses

Each digital channel can be displayed on the screen and used as trigger source. Digital channels can be grouped and displayed as a parallel bus. Up to four parallel buses can be configured; and two bus types are supported: clocked bus and unclocked bus. The clocked bus is available only on parallel bus 1 and 2. Each digital channel can be assigned to one *active* parallel bus only, the instrument disables conflicting buses automatically.

You can display each bus and use it as trigger source, as well. For each active parallel bus, the corresponding signal icon appears on the signal bar and indicates the assigned digital channels. Individual digital channels do not have a signal icon.

If one or more parallel buses are active, the roll mode is not available.

15.1.1 Parallel buses - configuration

Access: "Menu" > "Logic" > "Setup" tab

Digital channels can be displayed individually, and they can be grouped and displayed as a parallel bus. You can configure and enable up to 4 parallel buses. Each digital channel can be assigned to one *active* parallel bus only, the instrument disables conflicting buses automatically.

For clocked buses, you can display the decoded data in a result box.



If you have configured several parallel buses and you want to modify the settings, make sure that the tab of the correct bus is selected, and disable the bus before you change the settings.

15.1.1.1 Setup

Access: "Menu" > "Logic" > "Setup" tab

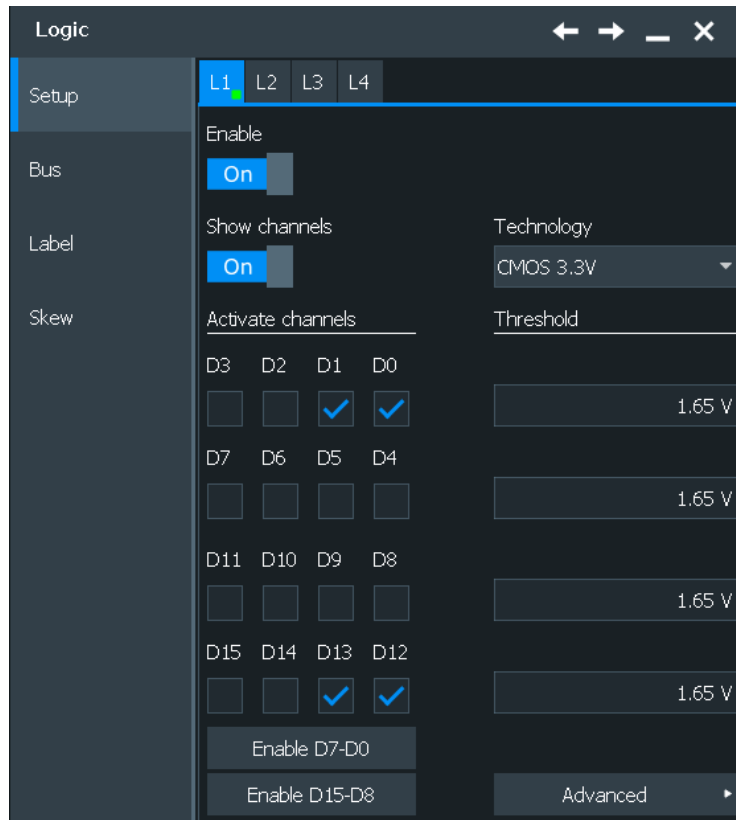

Enable bus

Enables the selected parallel bus. The corresponding signal icon appears on the signal bar.

If another *active* bus already uses the same digital channel, the instrument disables the other bus and shows a message.

Remote command:

[BUS<m>:PARAllel:STATe](#) on page 2611

Show channels

If enabled, the selected digital channels are shown in the diagram. Each channel is displayed as a logic signal.

Remote command:

[BUS<m>:PARAllel:DISPlay:SHDI](#) on page 2615

Technology, Threshold

Sets the logical threshold. For each sample, the instrument compares the input voltage with the threshold value. If the input voltage is above the threshold, the signal state "1" is stored. Otherwise, the signal state "0" is stored if the input voltage is below the threshold.

To avoid the change of signal states due to noise, a hysteresis is considered.

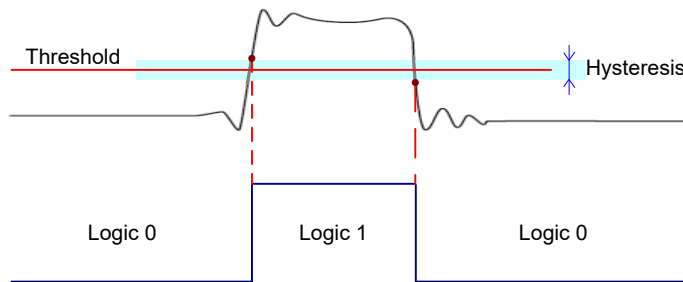

By default, same threshold and hysteresis value are used for all digital channels and all parallel buses: "Couple thresholds" is enabled.

You can also set different thresholds for the individual channel groups. As long as the buses are disabled, you can set different thresholds for each bus. Active buses use the same threshold and hysteresis values, the settings of the last activated bus take effect.

The range of threshold levels and the minimum voltage swing is given in the specifications document.

"Threshold" Enter the value directly in the field.

"Technology" Selects the threshold voltage for various types of integrated circuits from a list and applies it to all digital channels. The value is set to "Manual" if a user-defined threshold was entered directly.

Remote command:

[BUS<m>:PARAllel:TECHnology](#) on page 2612 (all buses)

[DIGital<m>:TECHnology](#) on page 2608 (bus1)

[BUS<m>:PARAllel:THReshold<n>](#) on page 2611 (all buses)

[DIGital<m>:THReshold](#) on page 2608 (bus1)

Advanced

Opens a dialog for advanced threshold and hysteresis settings. You can define them additional to the "Threshold" and "Technology".

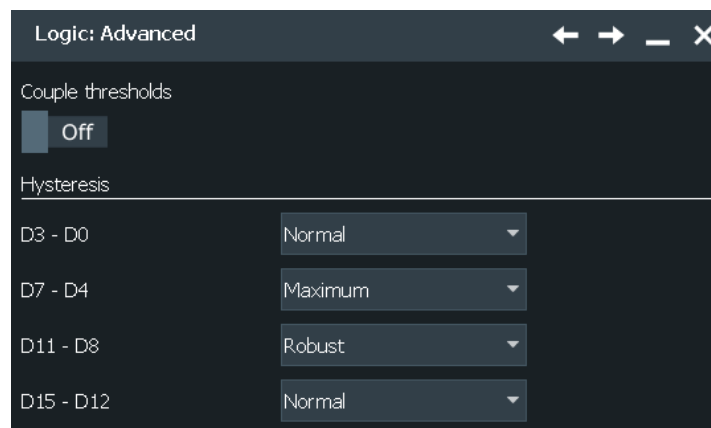

Couple thresholds ← Advanced

Sets the threshold and the hysteresis for all digital channels and all buses to the same value.

Remote command:

[BUS<m>:PARAllel:THCoupling](#) on page 2613 (all buses)

[DIGital<m>:THCoupling](#) on page 2609 (bus1)

Hysteresis ← Advanced

Defines the size of the hysteresis for the respective channels.

- | | |
|-----------|---|
| "Normal" | The instrument sets a small value suitable for the signal and its settings. Use this setting for clean signals. |
| "Maximum" | The instrument sets the maximum value that is possible and useful for the signal and its settings. Use this setting for noisy signals. |
| "Robust" | Sets different hysteresis values for falling and rising edges to avoid an undefined state of the trigger system. Use this setting for very noisy signals. |

Remote command:

[BUS<m>:PARAllel:HYSTeresis<n>](#) on page 2613 (all buses)

[DIGital<m>:HYSTeresis](#) on page 2609 (bus1)

Activate channels

Selects the state of the respective bus channel.

Enable/Disable D7-D0, D15-D18

The buttons select or deselect all digital channels of a pod at once.

15.1.1.2 Bus

Access: "Menu" > "Logic" > "Bus" tab

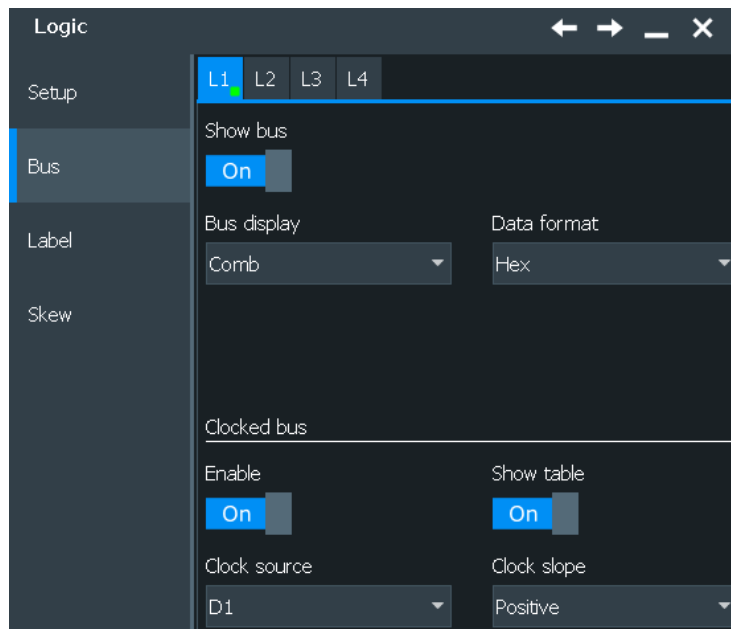

Show bus

If enabled, the resulting bus signal and bus values are displayed in the diagram. Select the presentation type for the bus signal with "Bus display" on page 1005.

Remote command:

`BUS<m>:PARAllel:DISPlay:SHBU` on page 2615

Bus display

Defines how the parallel bus is displayed.

- | | |
|----------|--|
| "Comb" | Displays the decoded bus signal with bus values. When at least one digital channel changes its value, the bus value changes too. |
| "Analog" | Displays the bus values as signal amplitudes, similar to an analog waveform. Thus, a quasi-analog waveform is created. |

Remote command:

`BUS<m>:PARAllel:DISPlay:BTYP` on page 2616

Data format

Sets the data format of bus values, which are displayed in the decode table and on the comb bus display. Available formats are: Hex, ASCII, octal, binary, signed, and unsigned.

Signed and Unsigned are integer data types with maximum 16-bit length. Unsigned is used for positive integers. Signed is used for positive and negative integers.

If the target file format is BIN, you can save only signed and unsigned binary data. The data format "Signed" writes signed data; all other formats are saved as unsigned binary data.

Remote command:

`BUS<m>:PARAllel:DATA:FORMat` on page 2615

Clocked bus

If a bus is a clocked bus, one of the digital channels serves as clock of the bus.

For an unclocked bus, the logical state of the bus is determined for each sample. For a clocked bus, the logical state is determined only at the specified clock edges.

The settings are only available for "Bus1" and "Bus2".

Enable ← Clocked bus

Enable this option for a clocked bus.

Remote command:

`BUS<m>:PARAllel:CLON` on page 2616

Show table ← Clocked bus

The decode table is only available for clocked buses to check the data words.

If enabled, a results box opens with decoded values of the bus signal and its time. Each clock edge corresponds to one row in the table.

Remote command:

`BUS<m>:PARAllel:DECTable<n>:SHOW` on page 2617

`BUS<m>:PARAllel:DECTable<n>:COUNT?` on page 2617

`BUS<m>:PARAllel:DECTable<n>:DATA?` on page 2618

Clock source ← Clocked bus

Selects the digital channel used as clock.

Remote command:

[BUS<m>:PARAllel:CLOCK](#) on page 2616

Clock slope ← Clocked bus

Selects the slope of the clock signal at which all digital channels of the bus are analyzed.

Remote command:

[BUS<m>:PARAllel:CLSLope](#) on page 2617

15.1.1.3 Label settings

Access: "Menu" > "Logic" > "Label" tab

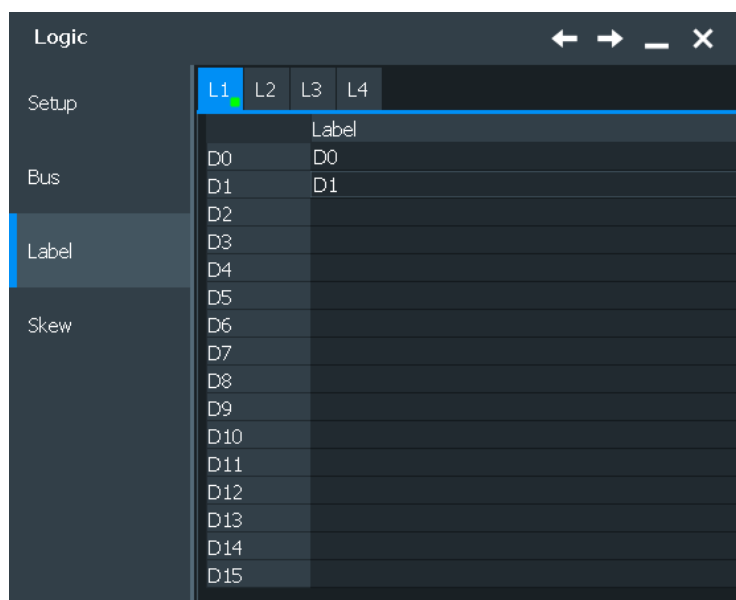

In this tab, you can enter a name for each digital channel. The name is displayed in the diagram.

15.1.1.4 Skew settings

Access: "Menu" > "Logic" > "Skew" tab

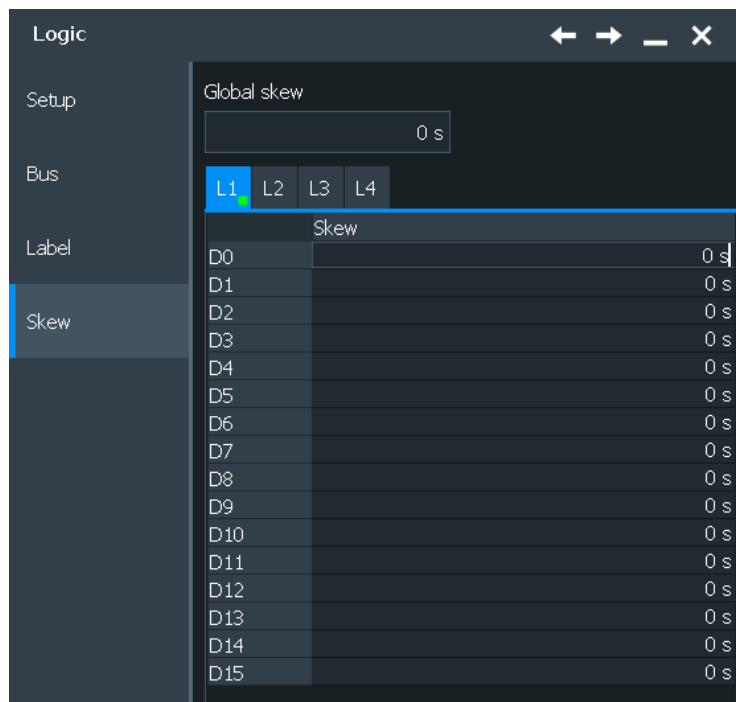
**Global skew**

Sets a general delay for all digital channels. The resulting skew of a digital channel is the sum of the general "Global skew" and the individual "Skew".

Remote command:

[BUS<m>:PARallel:DESoffset](#) on page 2614

Skew

Sets an individual delay for each digital channel to time-align it with other digital channels. The skew value compensates delays that are known from the circuit specifics or caused by the different length of cables. The skew between the probe boxes of the digital channels and the probe connectors of the analog channels is automatically aligned by the instrument.

Remote command:

[BUS<m>:PARallel:BIT<n>:DESKew](#) on page 2614 (all buses)

[DIGital<m>:DESKew](#) on page 2610 (Bus1)

15.1.2 Digital resolution

Access: "Menu" > "Acquire"

If an MSO option is installed and at least one digital channel is active, additional information appears on the "Setup" tab of the "Acquire" dialog box.

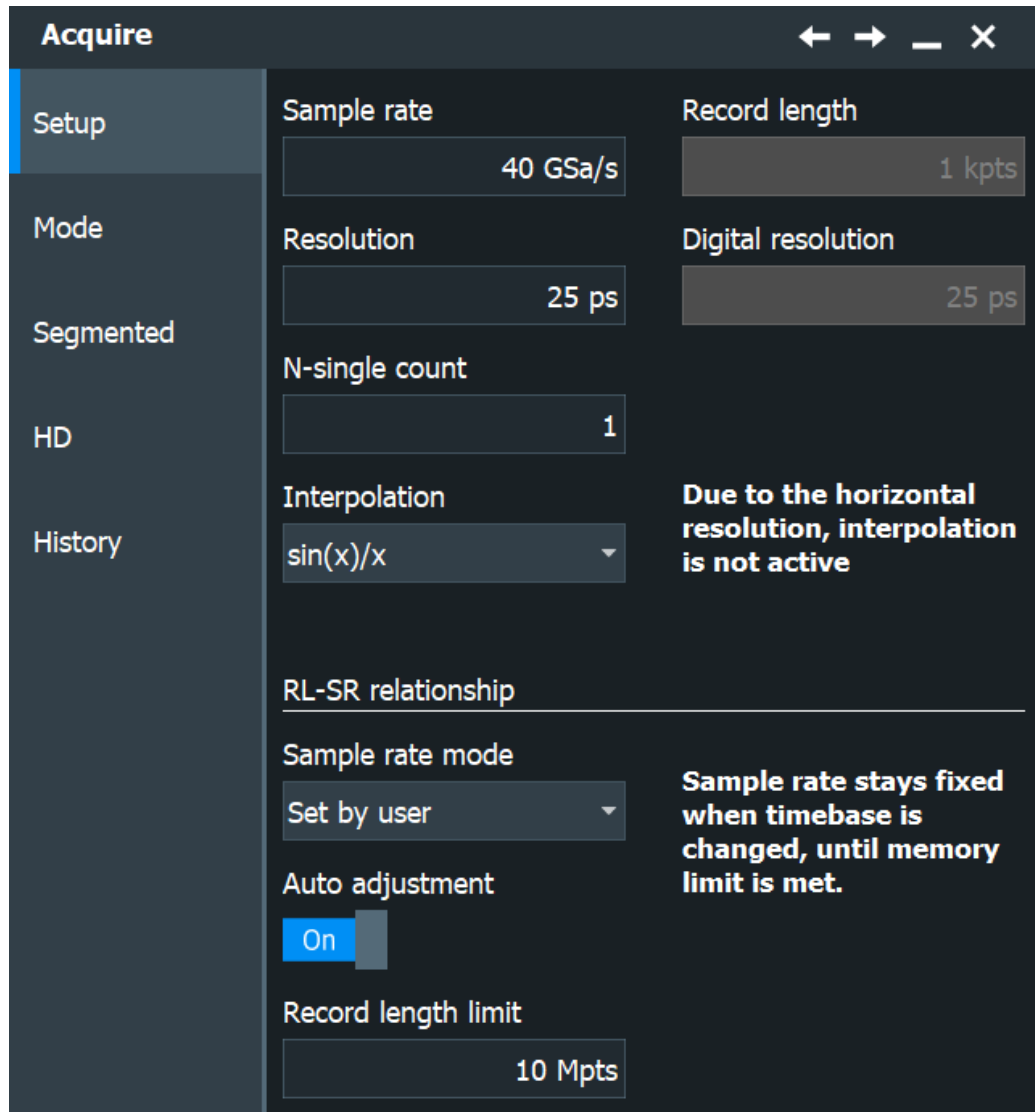
**Dig. resolution**

Shows the current digital resolution of the digital channels. The maximum digital record length is always 200 MSa per digital channel. This number is independent of the installed memory.

Remote command:

[ACquire:DREsolution?](#) on page 2618

15.1.3 Using digital probes

NOTICE

Ensuring accurate measurement results

The mixed-signal-option (MSO, R&S RTO6-B1) with connected probe leads is considered as a test probe, according to EN 61326-2-1, clause 5.2.4.101. Therefore, the measurements are sensitive to electromagnetic interference. Consider additional shielding methods to avoid interference.

Consider the following guidelines for good probing practices:

- The ground lead from each digital channel group (D15–D8 and D7–D0) should be attached to the ground of the DUT if any channel within the group is being used for data capture. The ground lead improves signal fidelity to the oscilloscope, ensuring accurate measurements.
- For high-speed timing measurements (rise time < 3 ns), each digital channel probe should use its own ground.

1. Connect the digital probe cable to any of the MSO connectors on the rear panel of the instrument as shown on the Documentation Card delivered with the digital probe.
2. Connect the ground lead on each set of channels (each pod) with a probe grabber.
3. Connect a grabber to one of the probes leads.
4. Connect the grabber to a node in the circuit that you want to test.
5. For high-speed signals, connect a ground lead to the probe lead. Connect the ground lead to ground in the device under test.
6. Repeat these steps until you have connected all points of interest.

15.1.4 Configuring digital channels and parallel buses

The configuration of a parallel bus includes the selection and setup of the digital channels, the configuration of the bus display, and, if necessary, the clock configuration.

For a detailed description of the settings, see [Chapter 15.1.1, "Parallel buses - configuration"](#), on page 1001.

1. Open "Menu" > "Logic" > "Setup".
2. Enable the digital channels to be displayed and included in the bus.
To enable or disable all channels of a pod at once, tap "Enable D7-D0" or "Enable D15-D8".

Enabling one or more channels also enables the display of the signals - "Show channels", and enables the parallel bus. If another active bus already uses the same digital channel, the instrument disables this bus and shows a message.

The digital signals are shown in the diagram, and the signal icon of the parallel bus appears on the signal bar. Using this bus icon, you can minimize, arrange, and switch off the bus together with its channels in the same way as you do with any waveform.

3. Set the logical thresholds as described in [Chapter 15.1.5, "Setting the logical thresholds"](#), on page 1010.
4. If the bus has a clock signal, open the "Bus" tab.
Enable "Clocked bus" and select the "Clock source" and "Clock slope".
5. If necessary, enter a "Label" for each digital channel in the "Label" tab.
6. If necessary, enter a "Skew" value to time-align the channel in the "Skew" tab.
Now the configuration of the parallel bus is completed.

15.1.5 Setting the logical thresholds

For a detailed description of the settings, see [Chapter 15.1.1.1, "Setup"](#), on page 1001. Threshold settings are the same for all *active* parallel buses.

1. Open "Menu" > "Logic" > "Setup".
2. To set the thresholds, use one of the following ways:
 - a) Use the same value for all digital channels and all parallel buses:
 - In the "Logic: Advanced" dialog, enable "Coupe thresholds".
 - Open the "Setup" tab. To set the threshold, either select a predefined "Technology" value or enter a user-defined value.
 - b) Set different thresholds for the individual channel groups:
 - In the "Logic: Advanced" dialog, disable "Coupe thresholds".
 - Set different thresholds for each bus. Active buses use the same threshold and hysteresis values.
3. In the "Logic: Advanced" dialog, set the "Hysteresis" for each threshold to avoid the change of signal states due to noise.

15.2 Display

You can adjust the display of the parallel bus signals and the individual digital channels to optimize the analysis of bus data:

- Show the digital channels which are assigned to the bus, drag them to the optimal position, and scale them
- Show the decoded bus signal in different ways:
 - comb display with numeric bus values
 - analog display with bus values as amplitudes (quasi-analog waveform)

You can also drag the bus waveforms on the display and scale them.

- Show the result box of the decoded clocked bus signal

Each parallel bus is shown in a separate diagram, and the diagrams can be minimized and arranged as usual.

The signal icon indicates the activities on the digital channels even if they are not displayed in the diagram, or if the acquisition has been stopped:

- Blue: channel is low
- Green: channel is high
- Gray: channel state is changing

L1			
D0	D1	D2	D3
D4	D5	D6	D7
D8	D9	D10	D11
D12	D13	D14	D15

The display update rate of the oscilloscope is adapted to the visual perception of human eyes, and it is slower than the acquisition rate. All analog and digital waveforms that are acquired during one display update cycle are overlapped and displayed at once. Thus you can see the cumulative occurrence of binary states and edge transitions on the screen at once. Bus signals are not overlapped.

The trigger point is always visible on the display, it cannot be moved outside ("Restrict horizontal position to acquisition range" is enabled automatically).

If digital channels are active, the trigger point is always visible on the display, it cannot be moved outside.

To access and analyze one or more specific acquisitions, you can use the History Viewer in the common way.

Furthermore, you can zoom in digital signals and bus signal in the same way as in analog waveforms.

See also:

- [Chapter 7.1, "Zoom"](#), on page 243

15.2.1 Parallel bus - decode table

Decoding is available for clocked parallel buses.

The decode table shows the decoded data words of the bus signal and the corresponding time. Each clock edge corresponds to one row in the table. Below the table, you can select the data format of the bus values.

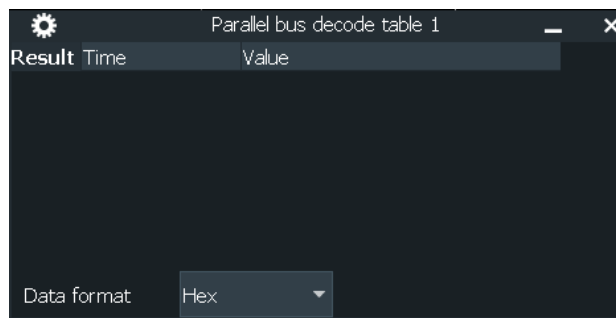

The results can be saved to a `.csv` or `.html` file, see [Chapter 12.2.4, "Results"](#), on page 475.

15.2.2 Adjusting the display of digital channels and parallel buses

The display of digital channels and parallel buses is flexible, you can adjust it to your needs by combining the following settings:

1. Enable "Show bus" if you want to display the bus signal in the diagram. Under "Bus representation", select if you want to display the decoded bus signal with bus values ("Comb"), or show the bus values as amplitudes, similar to an analog waveform ("Analog").
2. Check the signal icon of the bus to monitor the activities on the digital channels even if they are not displayed in the diagram:
 - Blue: channel is low
 - Green: channel is high
 - Gray: channel state is changing
3. In the diagram, you can change the display order of the digital channels by dragging the individual channels to the required position.
4. To adjust the line height and vertical position of all digital channels at once, tap one of the digital channels and turn the vertical [Scale] and [Position] rotary knobs. In the same way, you can move and scale the bus signal.
5. If the bus signal is displayed as quasi-analog waveform, you can double-tap the waveform to open the "Parallel buses" dialog box.
6. To switch off the display of the digital channels, disable "Show signals".

15.3 Trigger

For digital trigger sources are all trigger types useful that require only one trigger level as trigger condition. This level is the logical threshold. Possible trigger sources are the individual digital channels, parallel bus signals, or any logical combination of digital channels. The following trigger types are available:

Table 15-1: Trigger types and digital trigger sources

Trigger type	Trigger source is		
	Digital channel	Logic combination of digital channels	Parallel bus
Edge	X	X	
Width	X	X	
Timeout	X	X	
Setup & Hold	X		X
State		X	X
Pattern (with holdoff)		X	X
Serial Pattern	X	X	

For details, see: [Chapter 15.3.1, "Trigger settings for digital signals and parallel buses"](#), on page 1013.

Also, you can define trigger holdoff conditions. See [Chapter 6.4, "Mode / Holdoff"](#), on page 224.

15.3.1 Trigger settings for digital signals and parallel buses

Depending on the selected source, the instrument provides the appropriate trigger types and the corresponding trigger settings.

The settings in the "Setup" tab are:

- [Basic trigger settings](#)..... 1013
- [Edge](#)..... 1014
- [Width](#)..... 1015
- [Timeout](#)..... 1017
- [Setup & Hold](#)..... 1018
- [State](#)..... 1020
- [Pattern](#)..... 1021
- [Serial pattern](#)..... 1023

15.3.1.1 Basic trigger settings

The basic trigger settings for MSO are the trigger source and the trigger type. They are selected in the upper part of the "Trigger" dialog box.



Make sure that the trigger sequence is set to "A only".

Also, you can define trigger holdoff conditions. See [Chapter 6.4, "Mode / Holdoff"](#), on page 224.

Source

If the Mixed Signal Option is installed, the variety of trigger sources is enhanced with specific digital trigger sources. As a trigger source you can select:

- One of the digital channels "D0" ... "D15"



- A logic combination of digital channels: "Logic"



- One of the parallel buses "Par. bus1" ... "Par. bus4"



Remote command:

`TRIGger<m>:SOURce[:SElect]` on page 1485

Type

Depending on the selected source, the instrument provides the appropriate trigger types and the corresponding trigger settings. For mixed signal analysis, the following trigger types are available:

- [Edge, see page 1014](#)
- [Width, see page 1015](#)
- [Timeout, see page 1017](#)
- [Setup & Hold, see page 1018](#)
- [State, see page 1020](#)
- [Pattern, see page 1021](#)
- [Serial pattern, see page 1023](#)

Remote command:

`TRIGger<m>:PARallel:TYPE` on page 2620

15.3.1.2 Edge

Using the edge trigger, you can also trigger on a single digital channel (a logic bit), and a logical combination of digital channels.

Depending on the selected trigger source, different trigger settings are available. The trigger level is already set - in MSO the logical threshold is used as trigger level.

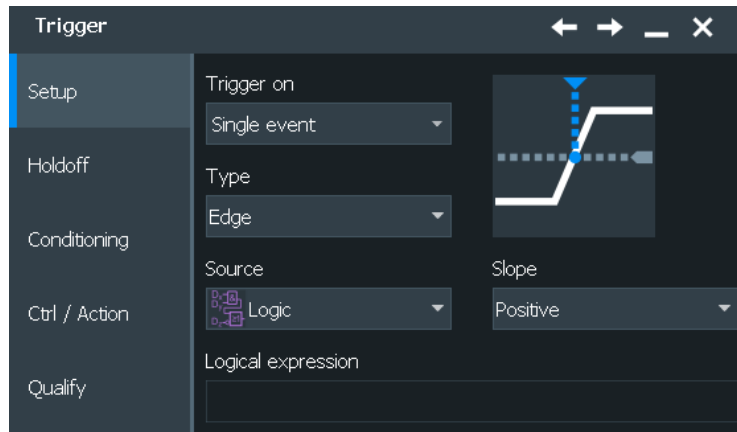

Figure 15-1: Edge trigger settings for trigger source = logical combination of digital channels (Logic)

Slope

Defines the edge - the state transition - of the signal.

"Positive" Means a 0 to 1 transition of the state.

"Negative" Means a 1 to 0 transition of the state.

"Either" Triggers on any activity on the selected trigger source.

Remote command:

[TRIGger<m>:PARAllel:EDGE:SLOPe](#) on page 2621

Logical expression

Defines a logical combination of several digital channels as trigger condition if "Logic" is set for "Source".

If the "Slope" is positive, the trigger occurs when the logical expression becomes true. If the "Slope" is negative, the trigger occurs when the logical expression becomes false.

Remote command:

[TRIGger<m>:PARAllel:EDGE:EXPRession\[:DEFine\]](#) on page 2621

15.3.1.3 Width

The width trigger detects positive and/or negative pulses of a pulse width (duration) inside or outside of a defined time limit. It can trigger on a single digital channel or a logical combination of digital channels.

The instrument triggers at the end of the detected pulse.

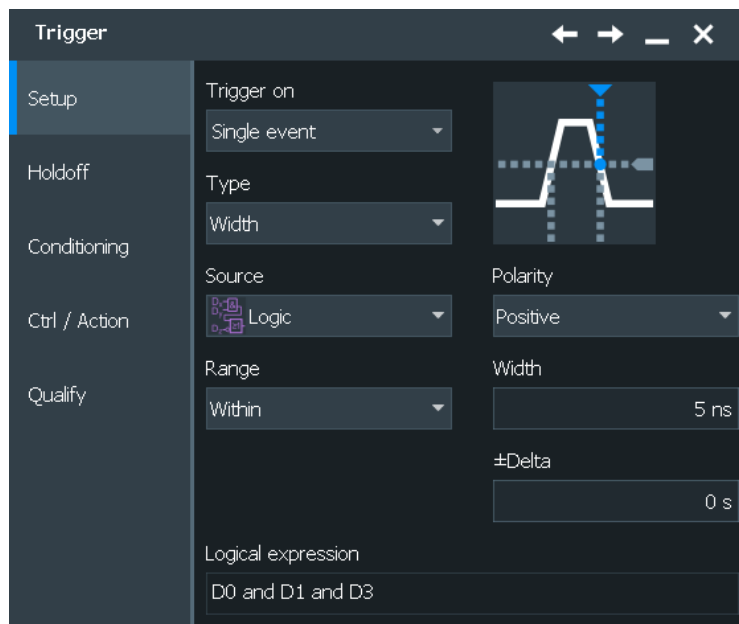

Figure 15-2: Width trigger settings for trigger source = logical combination of digital channels

Polarity

Sets the polarity of a pulse to "Positive", "Negative", or "Both".

When triggering on a positive pulse, the trigger event occurs on the high to low transition of the pulse if the timing condition is true. When triggering on a negative pulse, the trigger event occurs on the low to high transition of the pulse if the timing condition is true.

Remote command:

[TRIGger<m>:PARAllel:WIDTh:POLArity](#) on page 2622

Logical expression

Defines a logical combination of several digital channels as trigger condition if "Logic" is set for "Source". As long as the digital signals match the logical expression (true), the pulse is positive. Otherwise, the pulse is negative.

Remote command:

[TRIGger<m>:PARAllel:WIDTh:EXPReSSion\[:DEFine\]](#) on page 2621

Range

Selects how the range of a pulse width is defined:

- "Within" Triggers on pulses inside a given time range. The time limit is defined by $Width \pm Delta$.
- "Outside" Triggers on pulses shorter or longer than a given time range. The time limit definition is the same as for "Within" range.
- "Shorter" Triggers on pulses shorter than the given "Width".
- "Longer" Triggers on pulses longer than the given "Width".

Remote command:

[TRIGger<m>:PARAllel:WIDTh:RANGe](#) on page 2622

Width

For the ranges "Shorter" and "Longer", the width defines the maximum and minimum pulse width, respectively.

For the ranges "Within" and "Outside", the width defines the center of a range which is defined by the limits " $\pm\Delta$ ".

Remote command:

[TRIGger<m>:PARAllel:WIDTh:WIDTh](#) on page 2622

 $\pm\Delta$

Defines a range around the given width value.

The combination "Range" = Within and " $\pm\Delta$ " = 0 triggers on pulses with a pulse width that equals "Width".

The combination "Range" = Outside and " $\pm\Delta$ " = 0 means to trigger on pulse widths \neq "Width".

Remote command:

[TRIGger<m>:PARAllel:WIDTh:DELTA](#) on page 2623

15.3.1.4 Timeout

The timeout trigger event checks if the trigger source signal stays above or below the threshold voltage for a specified time lapse. In other words, the event occurs if the state condition remains unchanged for the specified time.

You can use the timeout trigger on a single digital channel, or a logical combination of digital channels.

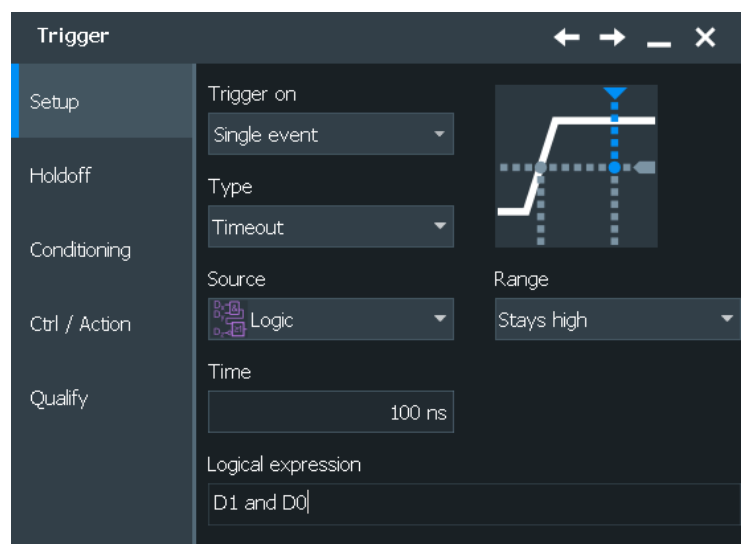

Figure 15-3: Timeout trigger settings for trigger source = logical combination of digital channels

Range

Sets the state condition:

- "Stays high" The level of a digital channel stays above the threshold, or the logical expression for "Logic" trigger source is true.
- "Stays low" The level of a digital channel stays below the threshold, or the logical expression for "Logic" trigger source is false.
- "High or low" The signal state remains unchanged.

Remote command:

[TRIGger<m>:PARallel:TIMEout:RANGe](#) on page 2623

Time

Defines the time limit for the timeout at which the instrument triggers.

Remote command:

[TRIGger<m>:PARallel:TIMEout:TIME](#) on page 2624

Logical expression

Defines a logic combination of several digital channels as trigger condition if "Logic" is set for "Source". The "Qualification Editor" supports the entry of the expression.

Remote command:

[TRIGger<m>:PARallel:TIMEout:EXPReSSion\[:DEFine\]](#) on page 2621

[TRIGger<m>:PARallel:STATe:EXPReSSion\[:DEFine\]](#) on page 2621

[TRIGger<m>:PARallel:PATtern:EXPReSSion\[:DEFine\]](#) on page 2621

[TRIGger<m>:PARallel:SPATtern:EXPReSSion\[:DEFine\]](#) on page 2621

15.3.1.5 Setup & Hold

The Setup & Hold trigger event occurs when the state of the trigger source signal changes inside a given time before the clock edge (setup time) or after the clock edge (hold time). The trigger event occurs at the clock edge for which the setup and/or hold time was violated.

With Setup & Hold trigger, you can trigger on a single digital channel, or a parallel bus to check several digital channels simultaneously. The clock signal is connected to one of the digital channels.

If you configure this trigger type for a parallel bus, the bus configuration is adjusted by the instrument if necessary. The bus is defined as clocked bus, and the clock source of the trigger is set as clock source of the bus.

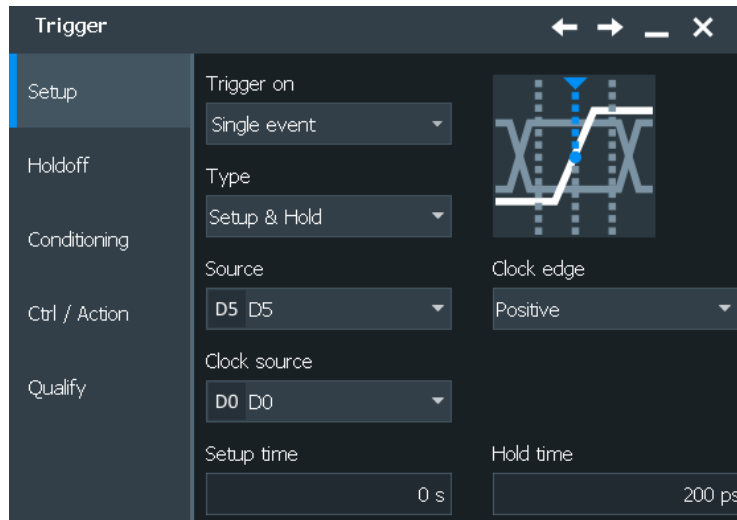

Figure 15-4: Setup & Hold trigger settings

Clock source

Selects the digital channel of the clock signal.

Remote command:

[TRIGger<m>:PARallel:SETHold:CSource\[:VALue\]](#) on page 2621

[TRIGger<m>:PARallel:STATe:CSource:VALue](#) on page 2621

[TRIGger<m>:PARallel:SPATtern:CSource\[:VALue\]](#) on page 2621

Clock edge

Sets the edge of the clock signal. The crossing of the clock edge and the logical threshold defines the time reference point for the setup and hold time measurement.

Remote command:

[TRIGger<m>:PARallel:SETHold:CSource:EDGE](#) on page 2624

Setup time

Sets the minimum time *before* the clock edge while data is stable and not change its state.

The setup time can be negative. In this case, the setup interval starts after the clock edge, and the hold time starts after the setup time has expired. Thus, the hold time is always positive. If you change the negative setup time, the hold time is adjusted by the instrument.

Remote command:

[TRIGger<m>:PARallel:SETHold:STIME](#) on page 2625

Hold time

Sets the minimum time *after* the clock edge while data is stable and not change its state.

The hold time can be negative. In this case, the hold time ends before the clock edge, and the setup interval ends when the hold interval starts. Thus, the setup time is always positive. If you change the negative hold time, the setup time is adjusted by the instrument.

Remote command:

[TRIGger<m>:PARAllel:SETHold:HTIME](#) on page 2624

15.3.1.6 State

The state trigger detects the logical state of several logically combined digital channels at a given clock edge. The trigger source is a logical combination of digital channels or a parallel bus. The trigger occurs at the clock edge at which the state condition is true.

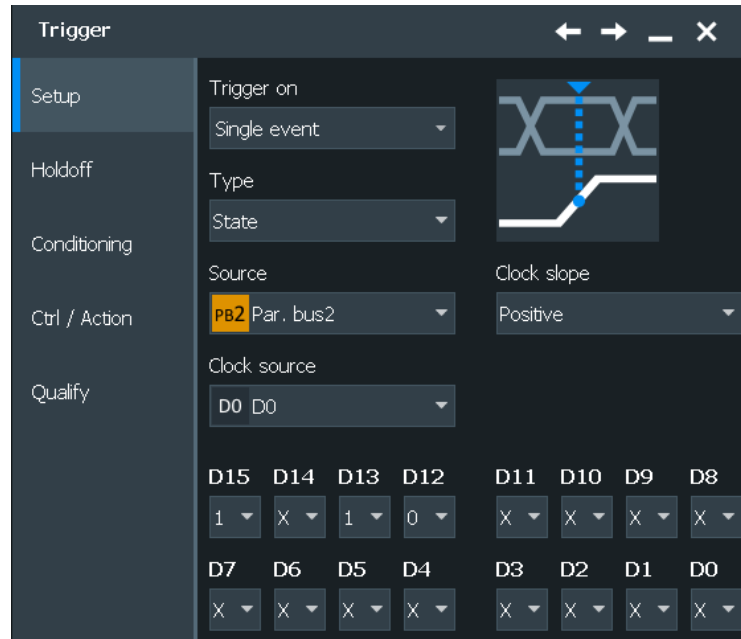

Figure 15-5: State trigger settings for trigger source = parallel bus

Clock source

Selects the digital channel of the clock signal.

Remote command:

[TRIGger<m>:PARAllel:SETHold:CSource\[:VALue\]](#) on page 2621

[TRIGger<m>:PARAllel:STATe:CSource:VALue](#) on page 2621

[TRIGger<m>:PARAllel:SPATtern:CSource\[:VALue\]](#) on page 2621

Clock edge

Sets the edge of the clock signal. The crossing of the clock edge and the logical threshold defines the time at which the logical states and the bus value are analyzed.

Remote command:

[TRIGger<m>:PARAllel:STATe:CSource:EDGE](#) on page 2625

Channel states

Available for "Trigger Source"= "Par. Bus1/2/3/4"

For each digital channel that is used in the bus, set the required state: 1, 0, or X (don't care).

Remote command:

`TRIGger<m>:PARAllel:STATe:BIT<0..15>` on page 2625

Logical expression

Defines a logic combination of several digital channels as trigger condition if "Logic" is set for "Source". The "Qualification Editor" supports the entry of the expression.

Remote command:

`TRIGger<m>:PARAllel:TIMEout:EXPRession[:DEFine]` on page 2621

`TRIGger<m>:PARAllel:STATe:EXPRession[:DEFine]` on page 2621

`TRIGger<m>:PARAllel:PATTern:EXPRession[:DEFine]` on page 2621

`TRIGger<m>:PARAllel:SPATTern:EXPRession[:DEFine]` on page 2621

15.3.1.7 Pattern

The pattern trigger identifies a logical state of several logically combined digital channels (pattern) and a time limitation (holdoff). The pattern definition is defined by the logical expression, if "Logic" is used for trigger source. For a parallel bus trigger source, the pattern is defined by setting the state of each digital channel.

The timing starts when the pattern comes true. The decision level is the logical threshold.

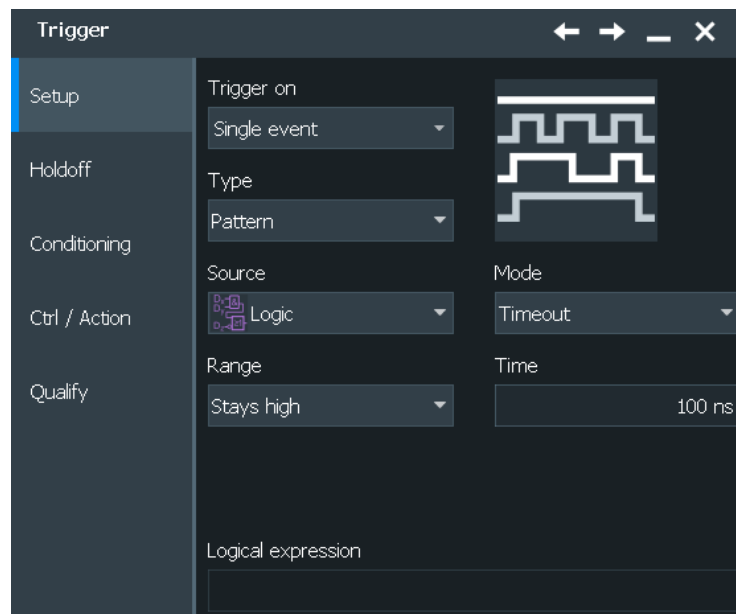

Figure 15-6: Pattern trigger settings for trigger source = parallel bus and timeout

Channel states

Available for "Trigger Source"= "Par. Bus1/2/3/4"

For each digital channel that is used in the bus, set the required state: 1, 0, or X (do not care).

Remote command:

`TRIGger<m>:PARAllel:PATTern:BIT<0..15>` on page 2626

Logical expression

Defines a logic combination of several digital channels as trigger condition if "Logic" is set for "Source". The "Qualification Editor" supports the entry of the expression.

Remote command:

[TRIGger<m>:PARallel:TIMEout:EXPRession\[:DEFine\]](#) on page 2621

[TRIGger<m>:PARallel:STATe:EXPRession\[:DEFine\]](#) on page 2621

[TRIGger<m>:PARallel:PATTern:EXPRession\[:DEFine\]](#) on page 2621

[TRIGger<m>:PARallel:SPATTern:EXPRession\[:DEFine\]](#) on page 2621

Mode: Off, Timeout, Width

Sets the mode of the timing condition.

- | | |
|-----------|--|
| "Off" | No timing condition, only the logical pattern condition is relevant. |
| "Timeout" | <p>Defines a minimum time qualification to avoid triggering on unstable or transitional conditions. Even in best-designed systems, there are slight delays between the signal when digital signals change states. This means that there are always transitional state conditions when signals are switching.</p> <p>See "Timeout settings" on page 1022 for a description of the settings. The trigger event occurs when the pattern stays unchanged for the specified time.</p> |
| "Width" | <p>Sets a pulse width as timing condition, see "Width settings" on page 1023. The pulse starts when the pattern comes true, and the trigger event occurs when the pattern comes false during the specified time limit.</p> <p>Using this mode, you can, for example, trigger exclusively on unstable conditions - if the pattern is present for less than a specified time.</p> |

Remote command:

[TRIGger<m>:PARallel:PATTern:MODE](#) on page 2626

Timeout settings

The timeout settings "Range" and "Time" appear if the timing mode is set to "Timeout".

Range ← Timeout settings

Sets the state condition:

- | | |
|---------------|---|
| "Stays high" | The pattern stays true for the specified time. |
| "Stays low" | The pattern stays false for the specified time. |
| "High or low" | The pattern remains unchanged for the specified time. |

Remote command:

[TRIGger<m>:PARallel:PATTern:TIMEout:MODE](#) on page 2627

Time ← Timeout settings

Defines the time limit for the timeout at which the instrument triggers.

Remote command:

[TRIGger<m>:PARallel:PATTern:TIMEout\[:TIME\]](#) on page 2627

Width settings

The width settings "Range", "Width" and " \pm Delta" appear if the timing mode is set to "Width".

Range ← Width settings

Selects how the range of a pulse width is defined:

"Within"	Triggers when the pattern comes false inside a given time range. The time limit is defined by <i>Width \pm Delta</i> .
"Outside"	Triggers when the pattern comes false before or after the given time range. The time limit definition is the same as for "Within" range.
"Shorter"	Triggers when the pattern comes false before the given "Width" has expired.
"Longer"	Triggers when the pattern comes false after the given "Width" has expired.

Remote command:

[TRIGger<m>:PARallel:PATtern:WIDTh:RANGe](#) on page 2627

Width ← Width settings

For the ranges "Shorter" and "Longer", the width defines the maximum and minimum time limit, respectively.

For the ranges "Within" and "Outside", the width defines the center of a range which is defined by the limits " \pm Delta".

Remote command:

[TRIGger<m>:PARallel:PATtern:WIDTh\[:WIDTh\]](#) on page 2628

 \pm Delta ← Width settings

Defines a range around the given width value.

The combination "Range" = Within and " \pm Delta" = 0 triggers on pulses with a pulse width that equals "Width".

The combination "Range" = Outside and " \pm Delta" = 0 means to trigger on pulse widths \neq "Width".

Remote command:

[TRIGger<m>:PARallel:PATtern:WIDTh:DELTA](#) on page 2628

15.3.1.8 Serial pattern

The serial pattern trigger identifies a serial bit string trigger on a single digital channel, or for a logical combination of digital channels. The trigger requires a clocked bus; the bits are read at the specified clock edge. The trigger event occurs at the last clock edge of the serial bit string.

This trigger type allows you to trigger on specific address or data transmissions in serial input and output signals.

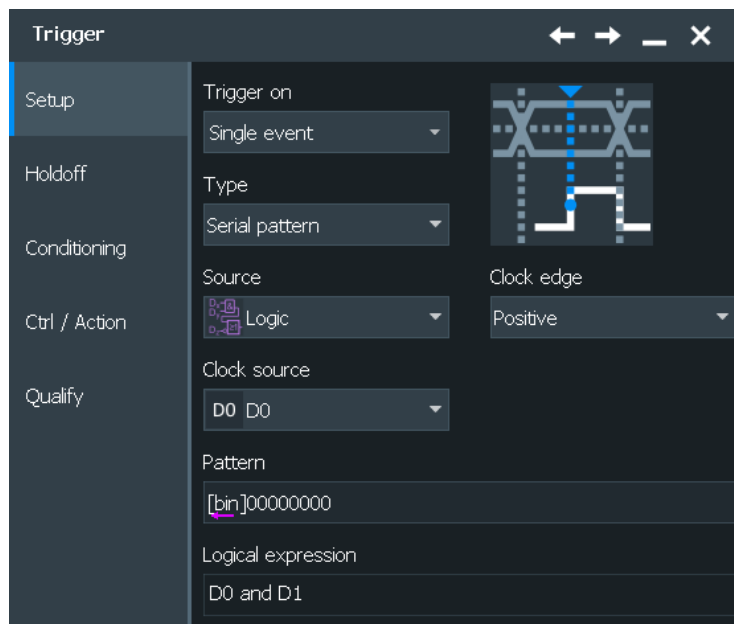

Figure 15-7: Serial pattern trigger settings for trigger source = logical combination of digital channels

Clock edge

Sets the edge of the clock signal. The bit value is determined at the crossing of the clock edge and the logical threshold.

Remote command:

[TRIGger<m>:PARAllel:SPATtern:CSOurce:EDGE](#) on page 2628

Clock source

Selects the digital channel of the clock signal.

Remote command:

[TRIGger<m>:PARAllel:SETHold:CSOurce\[:VALue\]](#) on page 2621

[TRIGger<m>:PARAllel:STATe:CSOurce:VALue](#) on page 2621

[TRIGger<m>:PARAllel:SPATtern:CSOurce\[:VALue\]](#) on page 2621

Logical expression

Defines a logic combination of several digital channels as trigger condition if "Logic" is set for "Source". The "Qualification Editor" supports the entry of the expression.

Remote command:

[TRIGger<m>:PARAllel:TIMEout:EXPReSSion\[:DEFine\]](#) on page 2621

[TRIGger<m>:PARAllel:STATe:EXPReSSion\[:DEFine\]](#) on page 2621

[TRIGger<m>:PARAllel:PATtern:EXPReSSion\[:DEFine\]](#) on page 2621

[TRIGger<m>:PARAllel:SPATtern:EXPReSSion\[:DEFine\]](#) on page 2621

Pattern

Defines the serial bit string on which to trigger. Touch and hold the "Pattern" field to open the "Bit Pattern Editor" where you can enter the pattern in various formats. The pattern has to be defined exactly, X (do not care) is not supported in binary format.

See also: [Chapter 14.1.7, "Bit pattern editor"](#), on page 519

Remote command:

`TRIGger<m>:PARallel:SPATtern:PATtern` on page 2629

15.3.2 Triggering on digital signals and parallel buses

For a detailed description of the settings, see [Chapter 15.3.1, "Trigger settings for digital signals and parallel buses"](#), on page 1013.

1. Open "Menu">"Trigger" > "Setup" tab
2. Select the trigger "Source":
 - One of the digital channels "D0" ... "D15"
 - A logic combination of digital channels: "Logic"
 - One of the parallel buses "Par. bus1" ... "Par. bus4"
3. Select the trigger "Type".
4. Under "Trigger type dependent settings", configure the trigger.
5. For trigger source "Logic", enter the logical expression of the digital channel combination. Tap and hold the "Logical expression" field until the "Qualification Editor" opens. It provides all logic operators that can be used in the expression.

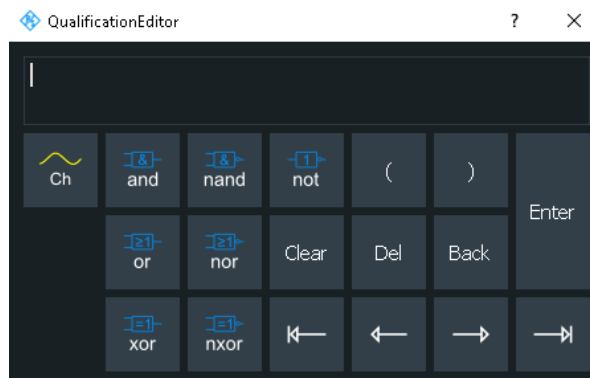

15.4 Measurements on digital channels

For measurements on digital channels, the number of measurement categories and types is reduced to applicable measurement.

These are:

- Period
- Frequency
- Positive and negative pulse
- Pulse count
- Delay
- Phase
- Positive and negative duty cycle
- Burst width
- Edge count

Except for delay measurement, the measurements have the same settings and results for analog and digital sources.

Delay measurement on digital channels is reduced to measure the time between two subsequent rising or two subsequent falling edges.

See also [Chapter 8.2, "Automatic measurements"](#), on page 304.

15.5 Data export

The data of digital channels and parallel buses can be saved to file in the same way as analog waveform data. One digital channel or bus per file can be saved.

The data format of the stored values is defined with Menu > "Logic" > "Bus" tab > "Data format".

If the data is written to XML or CSV files, the selected format is used. If the target file format is BIN, you can save signed and unsigned binary data. The data format "Signed" writes signed data; all other formats are saved as unsigned binary data.

The export of raw data is not available.

Export of a digital channel

If the data of digital channels is stored in BIN format, 1 bit is written for each sample. 8 data samples are written in 1 byte (data word). Thus, the file size is

$$\text{File size} = \text{Number of samples} / 8$$

For example, 100 MSa are written into a 12.5 MByte BIN file. After reading the file, you have to extract the samples from the data words.

If saved to BIN file, the digital channel can be imported as reference waveform.

Export of a parallel bus

A parallel bus can be exported to file if "Enable bus" and "Show bus" are both activated, and the bus representation is "Comb".

All data formats can be saved to XML, CSV, and BIN files. If you save binary format to XML or CSV, you can see the values of each line for each sample.

In BIN files, 4 Bytes are written for each sample.

See also:

- [Chapter 12.2.7, "Saving and loading waveform data"](#), on page 481
- [Chapter 12.2.1, "Waveform export files"](#), on page 459

Remote commands for export to file:

- [EXPort:WAVEform:SOURce](#) on page 1766
- [EXPort:WAVEform:NAME](#) on page 1768
- [EXPort:WAVEform:SAVE](#) on page 1769

Remote commands for remote data transfer:

- [BUS<m>:PARAllel:DATA:FORMat](#) on page 2615
- [BUS<m>:PARAllel:DATA:HEADer?](#) on page 2630
- [BUS<m>:PARAllel:DATA\[:VALues\]?](#) on page 2630
- [DIGital<m>:DATA:HEADer?](#) on page 2629
- [DIGital<m>:DATA\[:VALues\]?](#) on page 2630

15.6 Mathematics

A parallel bus that is displayed as quasi-analog waveform can be analyzed with FFT. To configure the FFT, use the "Advanced" mode and the formula editor.

15.7 Search

Access: "Menu" > "Apps" > "Analysis" tab > "Search".

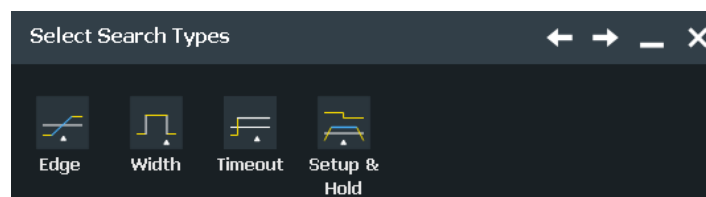
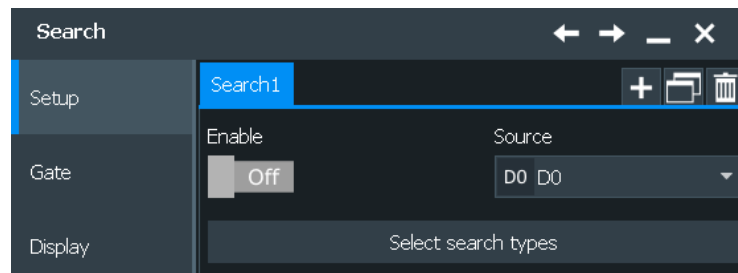

It is also possible to search on digital channels for specified events. Search conditions use the same parameters as the trigger event definition, see [Chapter 15.3.1, "Trigger settings for digital signals and parallel buses"](#), on page 1013.

You can search for edge, width, timeout, and Setup & Hold conditions.

16 Waveform generator (option R&S RTO6-B6)

The R&S RTO6 includes an integrated waveform generator which can generate input signals and patterns during testing. You can setup and output two waveform generators and a pattern generator.

With each of the waveform generators, one can output simple functions, modulated sine waveform, arbitrary waveforms and sweep waveforms. It is possible to couple and synchronize the settings of the waveform generators.

The instrument preset does not affect the generator settings. Each generator has its own preset.

Always use double-shielded cables to prevent electromagnetic interference (EMI) from impairing measurement results.

16.1 Setup of the waveform generator

Access: [Gen] > "Setup" tab

The "Setup" tab is divided into several sections:

- General settings like enabling and presetting the waveform generator
- Signal settings, depending on the selected [Operation mode](#) refer to one of the following:
 - [Chapter 16.1.2, "Function generator"](#), on page 1031
 - [Chapter 16.1.3, "Modulation"](#), on page 1036
 - [Chapter 16.1.4, "Sweep"](#), on page 1042
 - [Chapter 16.1.5, "Arbitrary"](#), on page 1043

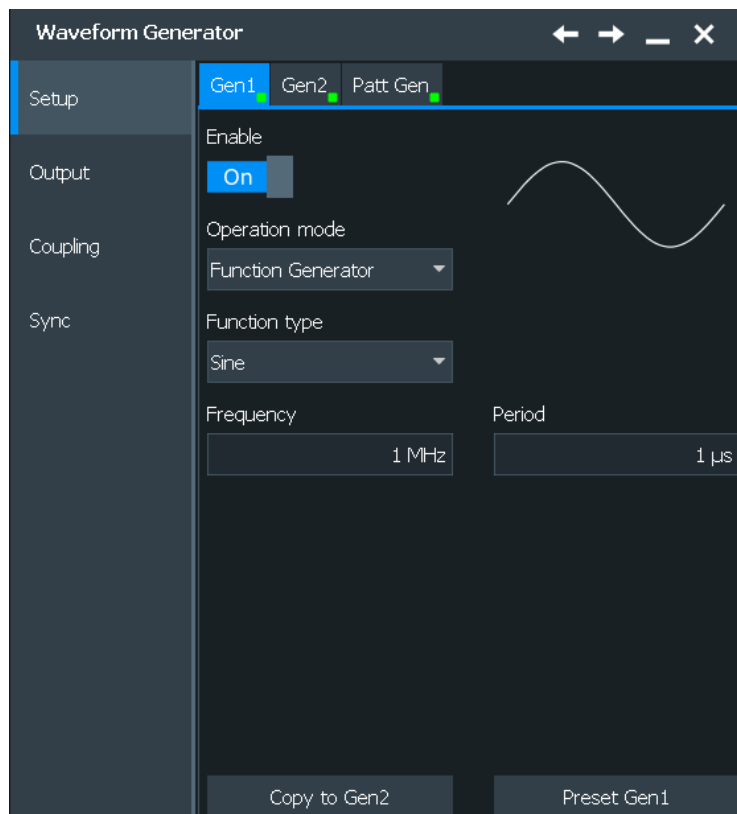

Make sure that the tab of the correct waveform generator is selected on the left side.



The settings of the waveform generators are not affected by an instrument preset. Press "Preset Gen1/2" to preset the settings of the corresponding waveform generator.

16.1.1 General settings

The general waveform generator settings are for enabling and presetting the generator and selecting the "Operation Mode".

Enable

Enables the waveform generator/ pattern generator and outputs the signal to the connectors.

Remote command:

[WGENerator<m>\[:ENABLE\]](#) on page 2631

[PGENerator:ENABLE](#) on page 2646

Operation mode

Selects the operation mode for the waveform generator. The "Signal" settings depend on the selected mode.

For the settings of the different operation modes, refer to:

- [Chapter 16.1.2, "Function generator"](#), on page 1031
- [Chapter 16.1.3, "Modulation"](#), on page 1036
- [Chapter 16.1.4, "Sweep"](#), on page 1042
- [Chapter 16.1.5, "Arbitrary"](#), on page 1043

Remote command:

`WGENerator<m>:SOURce` on page 2632

Copy settings from Gen1/Gen2

Copies all settings from Gen1/Gen2 and applies them to Gen2/Gen1.

Remote command:

`WGENerator<m>:ACOPY` on page 2631

Preset Gen1/Gen2/Patt Gen

Sets the parameters of the generator to their default values. The settings of the generators are not affected by an instrument preset. They are also not stored in the user-defined preset.

Remote command:

`WGENerator<m>:PRESet` on page 2632

`PGENerator:PRESet` on page 2647

Message

Displays relevant messages concerning the coupling and sync settings.

16.1.2 Function generator

The R&S RTO6 function generator can generate input signals during testing. These signals can be used, for example, when testing circuits.

Function type

Selects the type of waveform to be generated for the function generator.

"Sine" Generates a sine wave. You can set its [Frequency](#) and [Period](#).

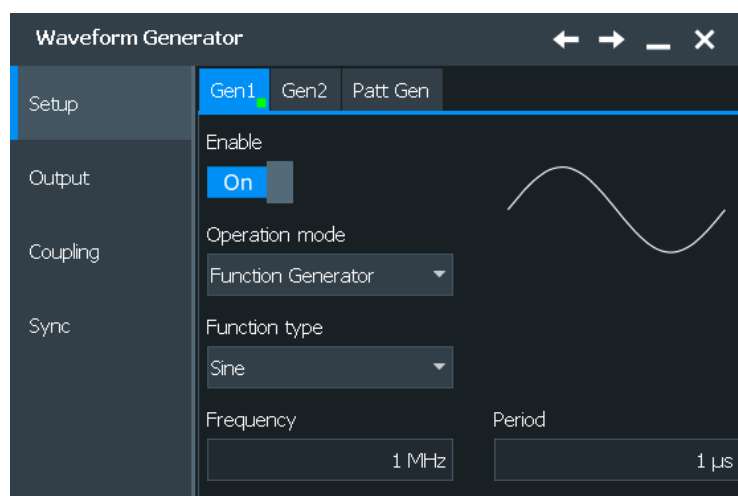

"Square"

Generates a square wave. You can set its [Frequency](#), [Period](#) and [Duty cycle](#).

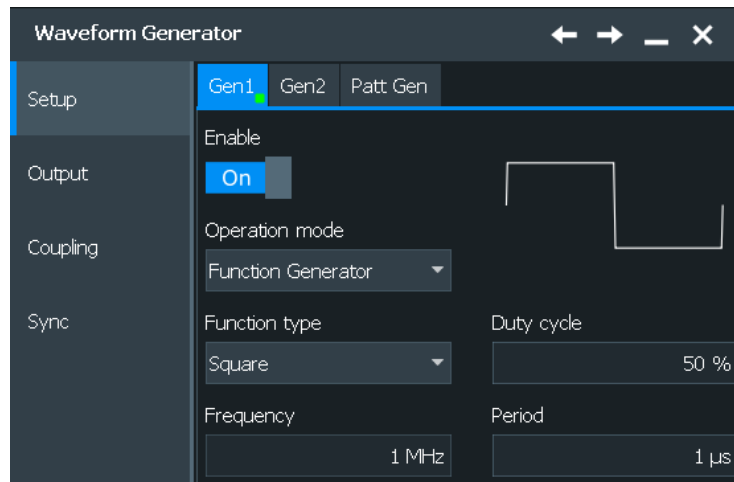

"Ramp"

Generates a ramp signal. You can set its [Frequency](#), [Period](#) and [Symmetry](#).

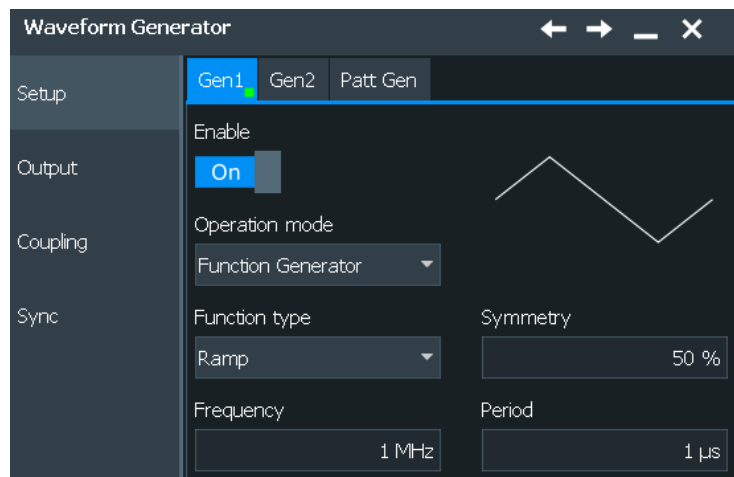

"DC"

Generates a direct current (DC) signal. You can set the ["Absolute level"](#) on page 1053.

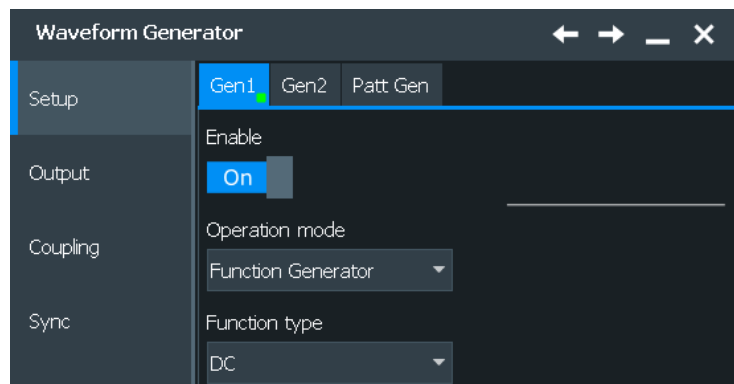

"Pulse" Generates a pulse signal. You can set the [Frequency](#), [Period](#) and [Pulse width](#).

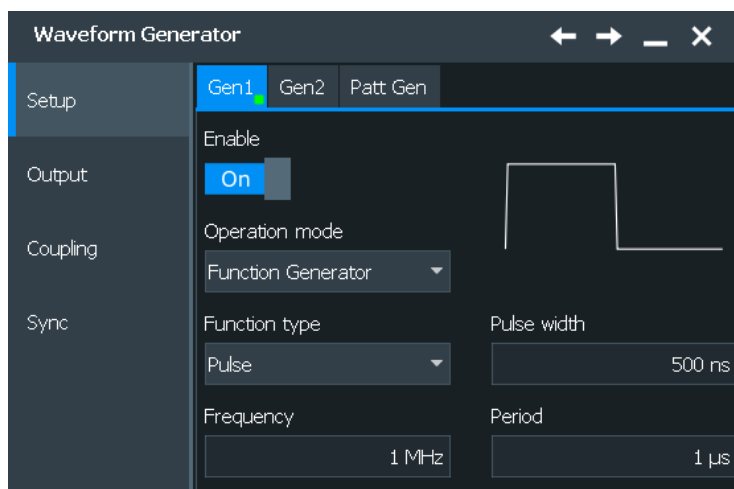

"Cardinal sine" Generates a cardinal sine wave. You can set the [Frequency](#) and [Period](#).

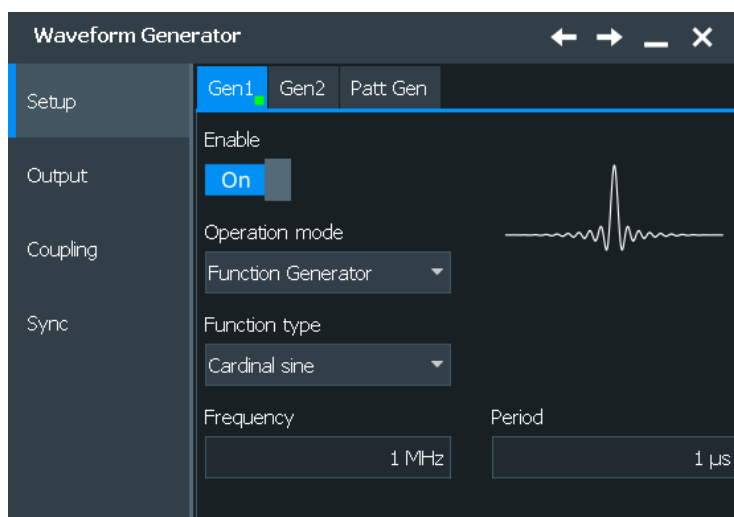

"Cardiac" Generates a cardiac signal. You can set the [Frequency](#) and [Period](#).

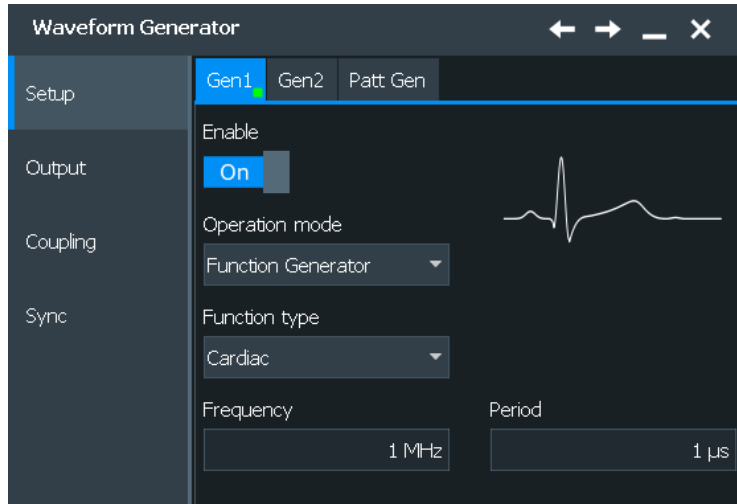

"Gauss" Generates a gauss signal . You can set the [Frequency](#) and [Period](#).

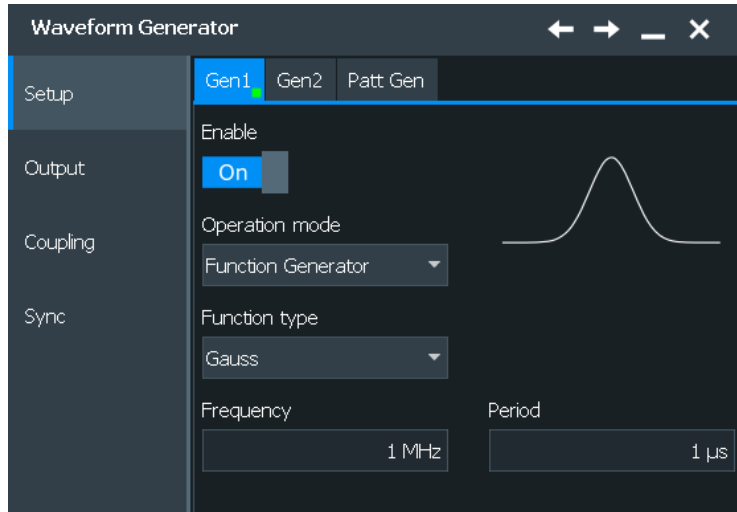

"Lorentz" Generates a Lorentz signal . You can set the [Frequency](#) and [Period](#).

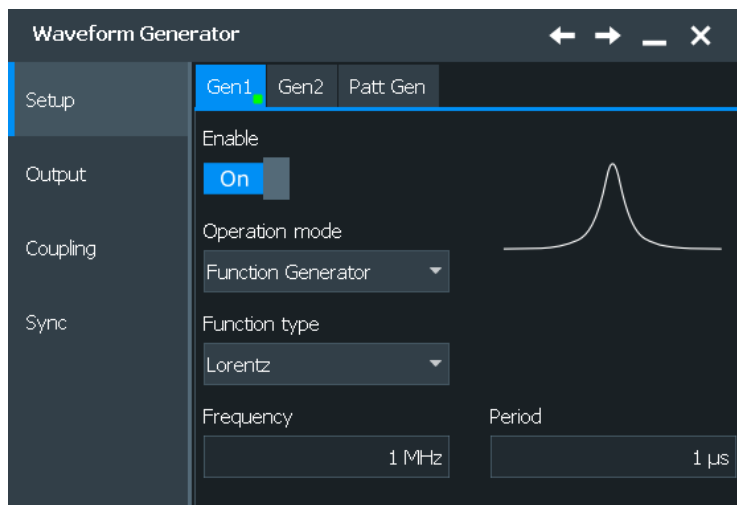

"Exp. rise" Generates an exponential rise signal. You can set the [Frequency](#) and [Period](#).

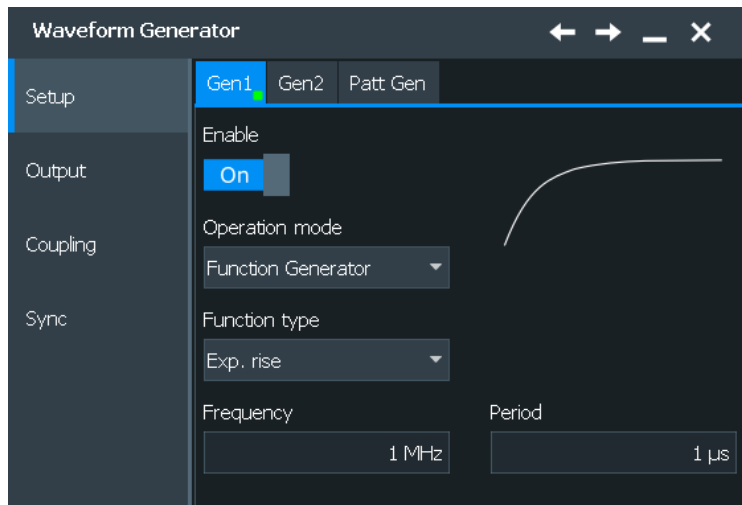

"Exp. fall" Generates an exponential fall signal. You can set the [Frequency](#) and [Period](#).

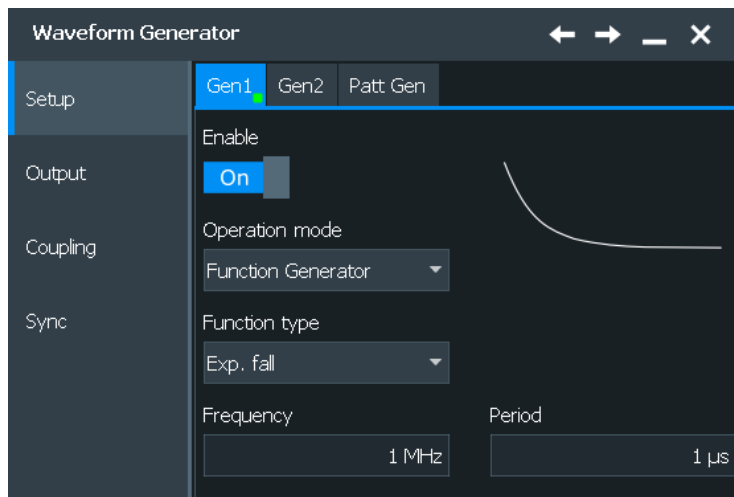

Remote command:

`WGGenerator<m>:FUNCTION[:SElect]` on page 2632

Frequency

Sets the frequency of the waveform. The available frequency range depends on the selected "Function Type", see [Frequency range of the function generator waveforms](#).

Table 16-1: Frequency range of the function generator waveforms

"Function type"	Min frequency	Max frequency
"Sine"	0.001 Hz	100 MHz
"Square"	0.001 Hz	30 MHz
"Ramp"	0.001 Hz	1 MHz
"DC"	-	-

"Function type"	Min frequency	Max frequency
"Pulse"	0.001 Hz	30 MHz
"Cardinal sine"	0.001 Hz	5 MHz
"Cardiac"	0.001 Hz	1 MHz
"Gauss"	0.001 Hz	25 MHz
"Lorentz"	0.001 Hz	10 MHz
"Exp. rise"	0.001 Hz	1 MHz
"Exp. fall"	0.001 Hz	1 MHz

The values of the "Frequency" and "Period" depend on each other, as:

$$\text{Period} = 1 / \text{Frequency}$$

Remote command:

[WGENerator<m>:FREQuency](#) on page 2633

Period

Sets the period of the waveform. The available period range depends on the selected "Function Type".

Remote command:

[WGENerator<m>:PERiod](#) on page 2633

Duty cycle

Sets the duty cycle for a square waveform. The duty cycle expresses for what percentage of the period, the signal state is high.

Remote command:

[WGENerator<m>:FUNction:SQUare:DCYCLE](#) on page 2634

Symmetry

Sets the symmetry of a ramp waveform, the percentage of time the waveform is rising. By changing the symmetry of the ramp, you can create, for example, triangular waveforms.

Remote command:

[WGENerator<m>:FUNction:RAMP\[:SYMMetry\]](#) on page 2633

Pulse width

Sets the pulse width, the pulse duration of the generated pulse waveform.

Remote command:

[WGENerator<m>:FUNction:PULSe\[:WIDTh\]](#) on page 2633

16.1.3 Modulation

Modulation is when properties of an original periodic waveform, the carrier signal, are varied according to a second modulating signal. The type of modulation used determines which properties are changed.

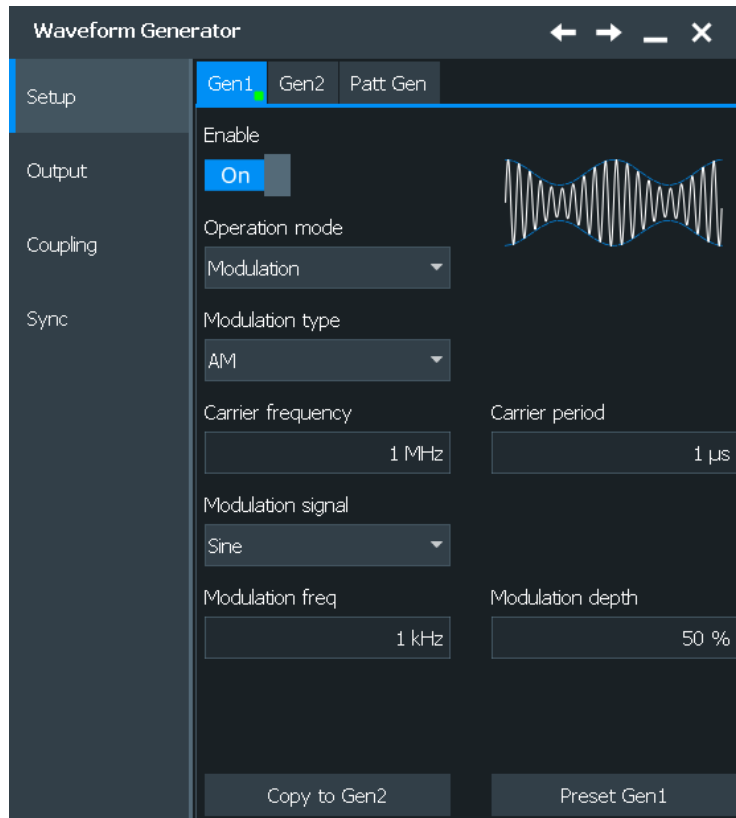

16.1.3.1 General settings

Consists of settings for selecting the modulation type.

Modulation type

Selects the modulation type, which defines how the carrier signal is modified.

"AM"	Amplitude modulation. See: Chapter 16.1.3.2, "AM modulation" , on page 1038.
"FM"	Frequency modulation. See: Chapter 16.1.3.4, "FM modulation" , on page 1040.
"PWM"	Pulse width modulation See: Chapter 16.1.3.3, "PWM modulation" , on page 1039
"FSK"	Frequency shift keying (FSK) modulation. See: Chapter 16.1.3.5, "FSK modulation" , on page 1042.

Remote command:

[WGENerator<m>:MODulation:TYPE](#) on page 2635

Carrier frequency

Sets the frequency of the carrier signal.

Remote command:

[WGENerator<m>:MODulation:CARRier:FREQuency](#) on page 2636

Carrier period

Sets the period of the carrier signal.

Remote command:

[WGEnerator<m>:MODulation:CARRier:PERiod](#) on page 2636

16.1.3.2 AM modulation

For amplitude modulation (AM), the amplitude of the carrier signal is varied according to the modulation signal.

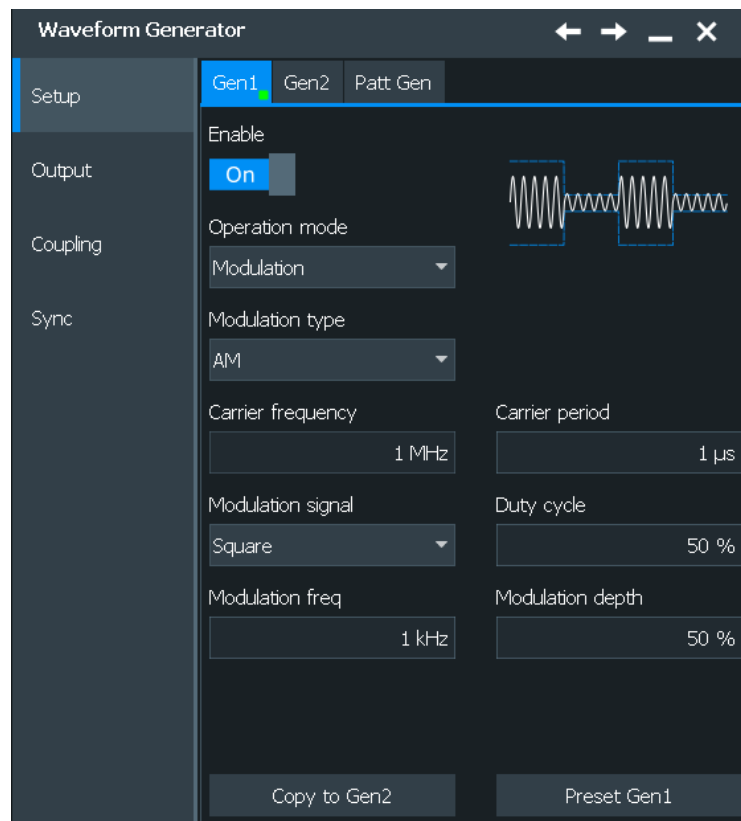
**Modulation signal**

Selects the type of the modulation signal for the AM modulation types.

Remote command:

[WGEnerator<m>:MODulation:AM\[:FUNCTION\]](#) on page 2637

Modulation freq

Sets the frequency of the modulation waveform.

Remote command:

[WGEnerator<m>:MODulation:AM:FREQUENCY](#) on page 2635

Modulation depth

Sets the modulation depth, the percentage of the amplitude range that is used for the modulation.

Remote command:

`WGENerator<m>:MODulation:AM:DEPTH` on page 2635

Symmetry

Sets the symmetry for the ramp modulation waveform, the percentage of time that the waveform is rising.

Remote command:

`WGENerator<m>:MODulation:AM:SYMMetry` on page 2636

Duty cycle

Sets the duty cycle for a square waveform. The duty cycle expresses for what percentage fraction of the period, the waveform is active, i.e. the signal state is high.

Remote command:

`WGENerator<m>:MODulation:AM:DCYCLE` on page 2635

16.1.3.3 PWM modulation

For pulse width modulation (PWM), the time for which the signal is in a high state is varied according to the modulation signal.

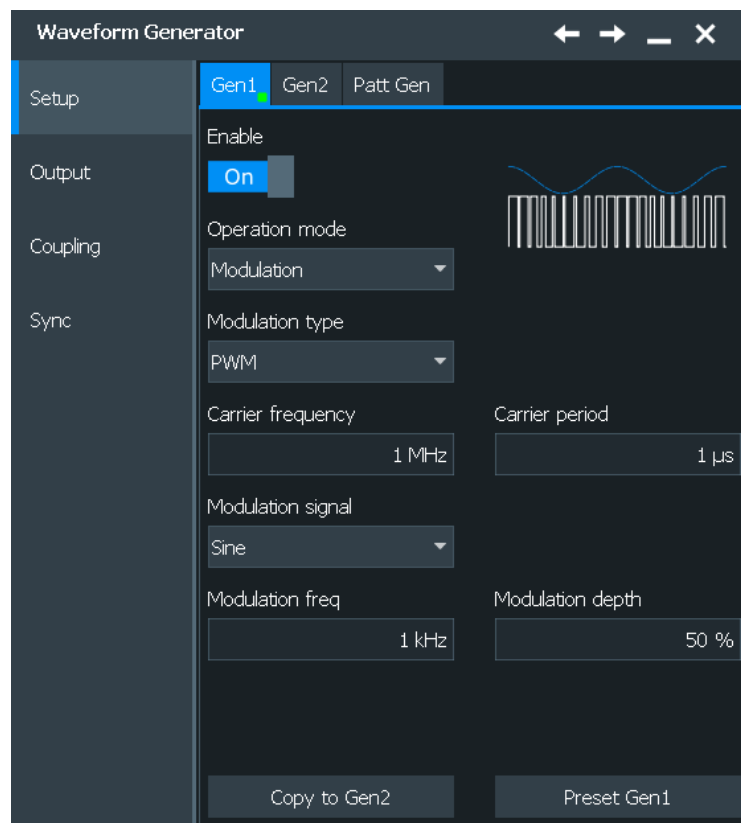

Modulation signal

Selects the type of the modulation signal for the PWM modulation types.

Remote command:

[WGENerator<m>:MODulation:PWM\[:FUNction\]](#) on page 2640

Modulation freq

Sets the frequency of the modulation waveform.

Remote command:

[WGENerator<m>:MODulation:PWM:FREQuency](#) on page 2640

Modulation depth

Sets the modulation depth, the percentage of the pulse width range that is used for the modulation.

Remote command:

[WGENerator<m>:MODulation:PWM:DEPTh](#) on page 2639

Symmetry

Sets the symmetry for the ramp modulation waveform, the percentage of time that the waveform is rising.

Remote command:

[WGENerator<m>:MODulation:PWM:SYMMetry](#) on page 2640

Duty cycle

Sets the duty cycle for a square waveform. The duty cycle expresses for what percentage fraction of the period, the waveform is active, i.e. the signal state is high.

Remote command:

[WGENerator<m>:MODulation:PWM:DCYCLe](#) on page 2639

16.1.3.4 FM modulation

For frequency modulation (FM), the frequency of the carrier signal is varied according to the modulation signal.

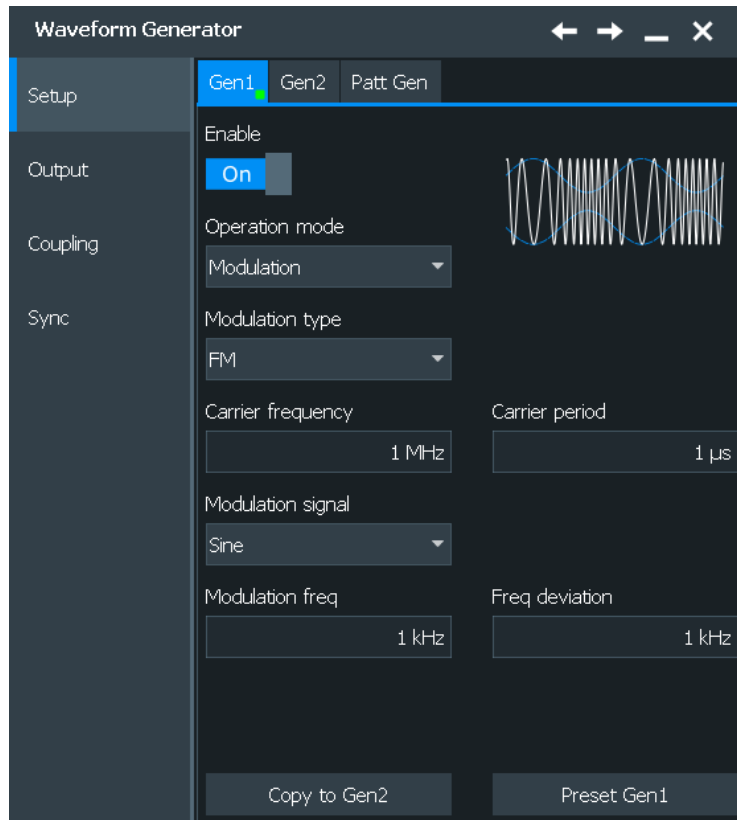

Modulation signal

Selects the type of the modulation signal for the FM modulation types.

Remote command:

[WGENerator<m>:MODulation:FM\[:FUNCTION\]](#) on page 2638

Modulation freq

Sets the frequency of the modulation waveform.

Remote command:

[WGENerator<m>:MODulation:FM:FREQUENCY](#) on page 2637

Symmetry

Sets the symmetry for the ramp modulation waveform, the percentage of time that the waveform is rising.

Remote command:

[WGENerator<m>:MODulation:FM:SYMMetry](#) on page 2638

Freq deviation

Sets the frequency deviation, the maximum difference between and FM modulated signal and the carrier signal.

Remote command:

[WGENerator<m>:MODulation:FM:DEVIation](#) on page 2637

Duty cycle

Sets the duty cycle for a square waveform. The duty cycle expresses the percentage of the period during which the waveform is active, i.e. the signal state is high.

Remote command:

[WGENerator<m>:MODulation:FM:DCYCLE](#) on page 2637

16.1.3.5 FSK modulation

For frequency shift keying (FSK) modulation, the signal switches between [Frequency 1](#) and [Frequency 2](#) at a [Hop rate](#).

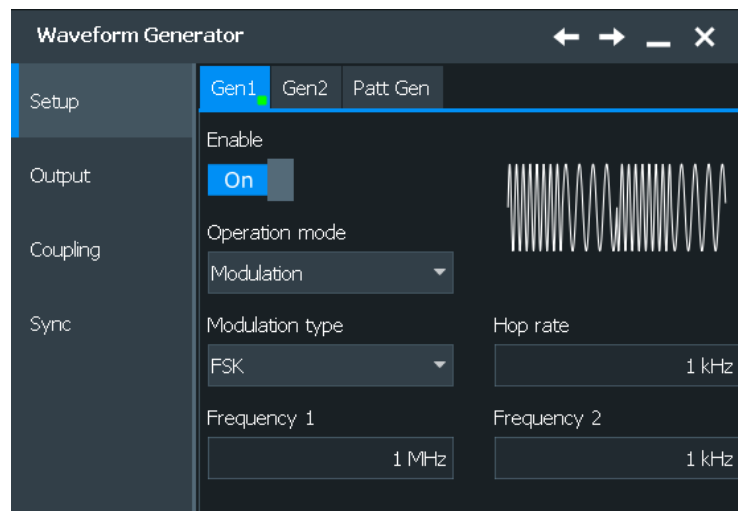
**Frequency 1**

Sets the frequency of the first signal in FSK modulated signal.

Remote command:

[WGENerator<m>:MODulation:FSK:FONE](#) on page 2638

Frequency 2

Sets the frequency of the second signal in FSK modulated signal.

Remote command:

[WGENerator<m>:MODulation:FSK:FTWO](#) on page 2639

Hop rate

Sets the hop rate, the frequency at which signal switches between [Frequency 1](#) and [Frequency 2](#).

Remote command:

[WGENerator<m>:MODulation:FSK\[:RATE\]](#) on page 2639

16.1.4 Sweep

In the sweep mode, the R&S RTO6 generates a signal whose frequency gradually changes from the [Start frequency](#) to the [Stop frequency](#) for a certain [Sweep time](#).

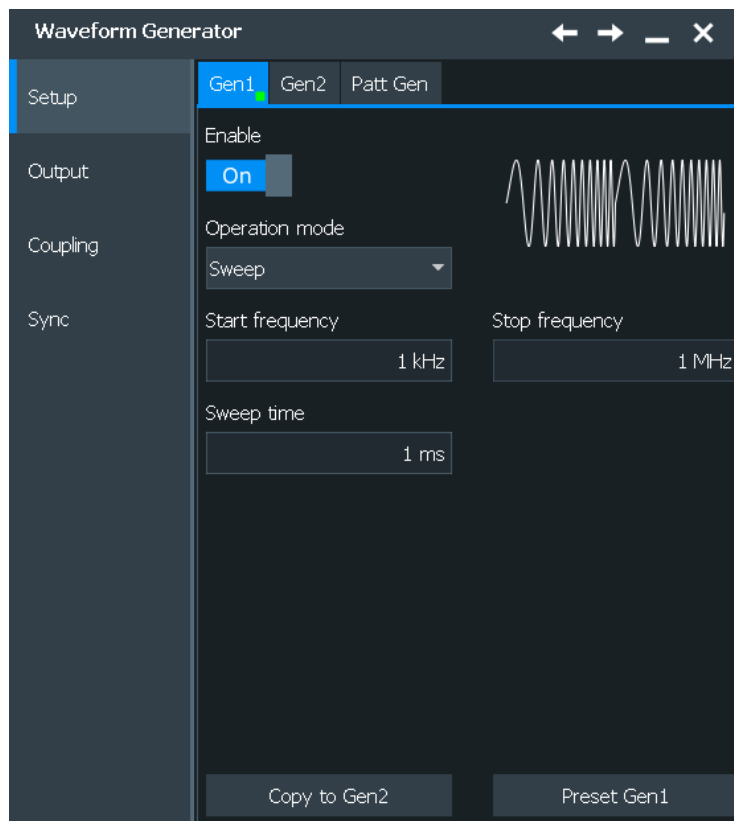
**Start frequency**

Sets the start frequency of the sweep signal.

Remote command:

[WGENerator<m>:SWEep:FStart](#) on page 2641

Stop frequency

Sets the stop frequency of the sweep signal.

Remote command:

[WGENerator<m>:SWEep\[:FEND\]](#) on page 2641

Sweep time

Sets the duration of the sweep.

Remote command:

[WGENerator<m>:SWEep:TIME](#) on page 2641

16.1.5 Arbitrary

The arbitrary waveform generator allows you to output a user-defined waveform for testing your devices. You can output a waveform from a file or from the current R&S RTO6 reference curve format. Files in *.csv and *.bin formats are supported. This files must follow a defined structure. You can load *.csv files in an R&S Wave

Gen format (see ["Content and format of the Rohde & Schwarz arbitrary waveform CSV files"](#) on page 1044), Tektronix AFG format or Keysight WaveGen format.

Content and format of the Rohde & Schwarz arbitrary waveform CSV files

The waveform generator format can contain the following values:

- Rate
- Time value
- Voltage value

If all the values are defined, the file format is as follows:

```
Rate = 5000000           //Sample rate of the arbitrary waveform.
0.000000E+000,-5.995    //Time value 1, Voltage value 1
1.237011E-005,-6.0      //Time value 2, Voltage value 2
.....
```

In this case, the rate is reflected in the "Sample Rate" field of the user interface. The total number of Time/Voltage values is reflected in the "Samples" of the user interface. Anything written after // is ignored as a comment.

You can define only some of the values. According to what you define, the file format looks different and is handled differently:

- With specified *Rate*:
Time values are ignored. You can specify just rate and voltage values as below:

```
Rate = 5000000           //Sample rate of the arbitrary waveform
-5.995                   //Voltage value 1
-6.0                     //Voltage value 2
.....
```

- Without specified *Rate* and without specified *Time* values:
The last user-defined sample rate is used to calculate the waveform. You can change the "Sample rate" in the user interface. The voltage values are then played with this sample rate.

```
-5.995                   //Voltage value 1
-6.0                     //Voltage value 2
.....
```

- Without specified *Rate* and with specified *Time*:
The timing information of the first 2 time values is used to calculate the sample rate.

Example:

Consider the following file:

```
0.000000E+000,-5.995    //Time value 1, Voltage value 1
1.237011E-005,-6.0      //Time value 2, Voltage value 2
```

The sample rate is:

$Sample\ rate = 1 / Time\ between\ first\ two\ samples = 1 / 1.237011E-005 = 80.840K\ Samples/sec$

Content and format of the Rohde & Schwarz arbitrary generator BIN files

The file stream should contain the following information in the given order:

- Sample rate [double format]
- Number of samples [unsigned integer format]
- Samples [double format] * number of samples

16.1.5.1 General settings

Access: [Gen] > "Setup" tab > "Operation mode" = "Arbitrary"

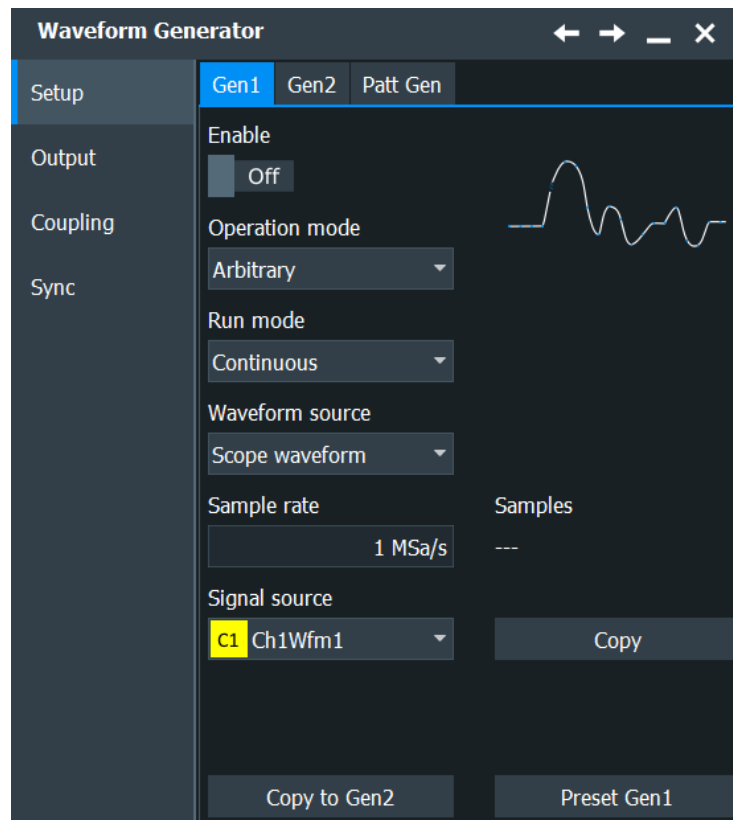

Waveform source

Selects the arbitrary waveform source. You can load an existing file or load the current oscilloscope waveform.

Remote command:

`WGENerator<m>:ARBGen[:SOURce]` on page 2645

Run mode

Selects the duration for which the signal of the arbitrary generator will be output after the trigger event. You can choose between a "Continuous" and "Single period" duration.

Remote command:

[WGENerator<m>:ARBGen:RUNMode](#) on page 2644

Sample rate

Sets the sample rate for the arbitrary waveform.

Remote command:

[WGENerator<m>:ARBGen:SRATe](#) on page 2645

Samples

Displays the number of samples in the loaded waveform.

Remote command:

[WGENerator<m>:ARBGen:SAMPles?](#) on page 2644

Run single

Generates a single period of the arbitrary waveform if "Run mode" is set to "Single period".

Remote command:

[WGENerator<m>:ARBGen:RUNSingle](#) on page 2645

16.1.5.2 Saved waveform

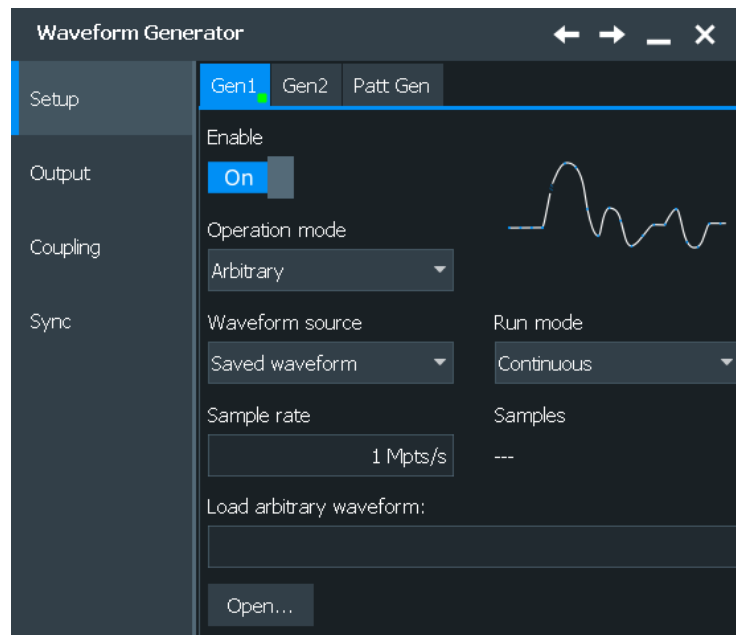

For a saved waveform, the following settings are available:

Load arbitrary waveform

Opens a file selection dialog box and loads the selected file. Supported are `.bin` and `.csv` extension files.

Remote command:

[WGENerator<m>:ARBGen:NAME](#) on page 2643

[WGENerator<m>:ARBGen:OPEN](#) on page 2644

Select waveform

When a multichannel file is loaded into the arbitrary waveform generator, a dialog appears to select which waveform from the file is loaded.

Select the waveform and press "Load" to load it into the arbitrary waveform generator.

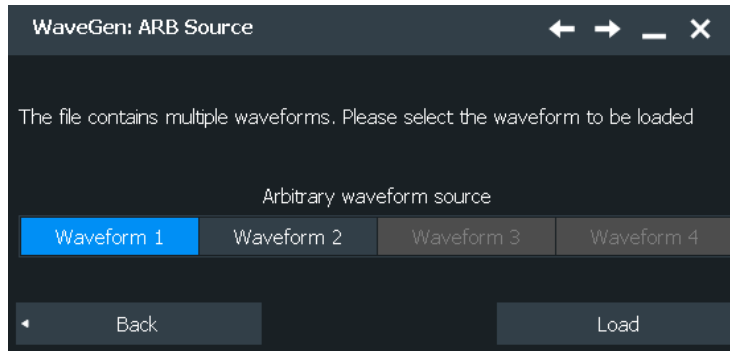

Remote command:

[WGENerator<m>:ARBGen:MULTichannel:NAME](#) on page 2643

[WGENerator<m>:ARBGen:MULTichannel:IMPort](#) on page 2642

[WGENerator<m>:ARBGen:MULTichannel:OPEN](#) on page 2643

16.1.5.3 Scope waveform

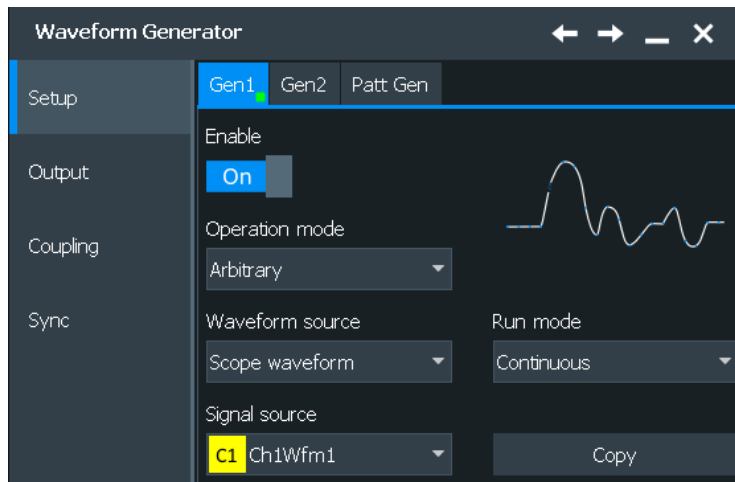

For a scope waveform, the following settings are available:

Signal source

Selects the oscilloscope source, from which the arbitrary signal is loaded.

Remote command:

[WGENerator<m>:ARBGen:SElect](#) on page 2644

Load

Loads the waveform from the selected "Signal source".

Remote command:

[WGGenerator<m>:ARBGen:COPY](#) on page 2642

16.2 Setup of the pattern generator

Access: [Gen] > "Setup" > "Patt Gen" tab

The pattern generator outputs parallel patterns.

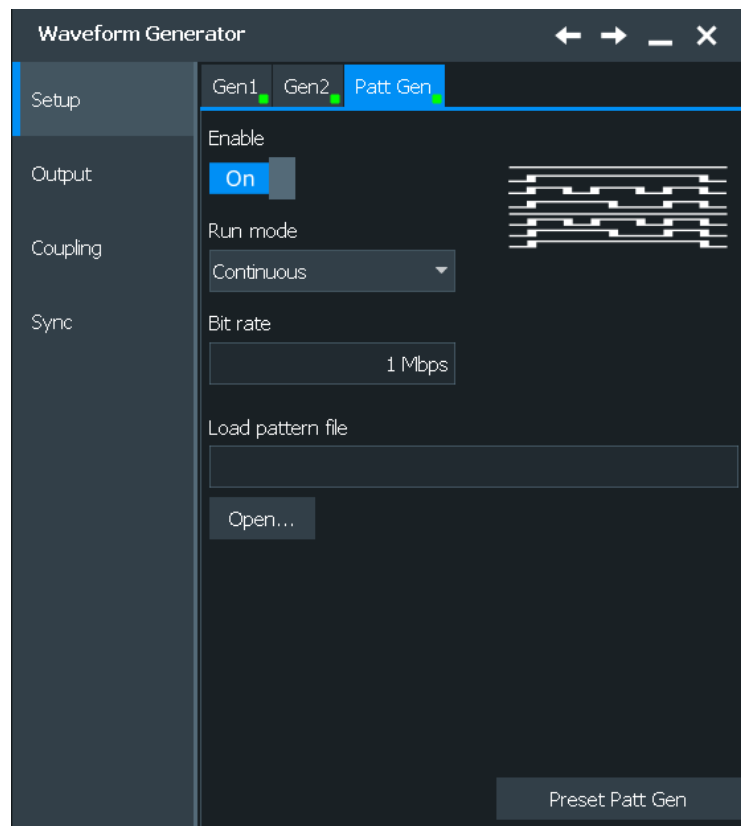

NOTICE

Using pattern generator accessories

The pattern generator with connected Patt Gen Cable and Patt Gen Board (1329.7054.02) is considered as a test probe, EN 61326-2-1, clause 5.2.4.101, note 1. Therefore normal operation may display increased emissions above the limits as specified in EN 55011 and/or reduced interference resistance as required in EN 61326-1, table 1, basic requirements.

If the cable and the board are connected, other surrounding electronic devices may be disturbed. Furthermore, signals at the analog generator outputs Gen1 and Gen2 may be distorted by surrounding devices.



The settings of the pattern generator are not affected by an instrument preset. Press "Preset Patt Gen" to preset the settings of the pattern generator.

16.2.1 Content and format of the pattern generator files

The pattern generator supports `.bin` or `.csv` file formats.

Content and format of the R&S*.csv files

The file's header have the following structure:

- Bit rate [double]: the number of transmitted bits per second. The value is reflected in the user interface.
- High level [double]: the value is reflected in the user interface.
- Mask [string of 8 characters made up of "X"/"1"/"0"] : defines how the output of the pattern generator looks like. The following values are defined:
 - `1`' means that the pin output is always at high level
 - `0`' means that the pin output is always at low level (close to 0V)
 - `X` means that the pin output varies according to the given pattern
- Data sample format [HEX, BIN, OCT, DEC]: indicates how the samples are going to be interpreted. Each sample is represented as 8bit value (corresponding to the 8bit pattern generator) considering the selected format.

Example: Sample format HEX

```
Format= HEX          // Defines the format of the pattern values [HEX, DEC, BIN, OCT]
0F -> Data Sample 1
21 -> Data Sample 2
.....
```

The samples are mapped on the 8 pins of the pattern generator as follows:

```
=> Pattern Samples are:
D7  D6  D5  D4  D3  D2  D1  D0
0   0   0   0   1   1   1   1
0   0   1   0   0   0   0   1
```

Example: .csv pattern generator file

```
R&S Pattern Generator File
Rate= 1000000        // Bit Rate [double]
HLevel= 1.5          // High Voltage Level [double]
Mask= X111000X      // Masks the Pins to be used in the Pattern Generator
                    // [0 => always LOW, 1 => always HIGH, X/x => used in the Pattern]
Format= DEC          // Defines the format of the pattern values [HEX, DEC, BIN, OCT]0
1
2
3
....
200
```

Content and format of the R&S pattern generator *.bin files

For the content of the fields, refer to "[Content and format of the R&S*.csv files](#)" on page 1049.

The file stream should contain the following information in the given order:

- Bit rate [double]
- High level [double]
- Mask [string of 8 characters made up of "X"/"1"/"0"]
- Number of samples [UINT32]
- Data samples [UINT8] * number of samples

16.2.2 Pattern generator settings

Enable

Enables the waveform generator/ pattern generator and outputs the signal to the connectors.

Remote command:

[WGENerator<m>\[:ENABle\]](#) on page 2631

[PGENerator:ENABle](#) on page 2646

Run mode

Selects the duration for which the signal of the generator will be output after the trigger event. You can choose between a "Continuous" and "Single period" duration.

Remote command:

[PGENerator:RUNMode](#) on page 2647

Bit rate

Sets the number of transmitted bits per second for the pattern generator.

Remote command:

[PGENerator:BITRate](#) on page 2646

Run single

Generates a single period of the pattern waveform if "Run mode" is set to "Single period".

Remote command:

[PGENerator:RUNSingle](#) on page 2647

Load pattern file

Opens a dialog for selecting an existing pattern file. It is possible to load `.bin` or `.csv` files, see [Chapter 16.2.1, "Content and format of the pattern generator files"](#), on page 1049.

Remote command:

`PGENERator:FILE:OPEN` on page 2646

`PGENERator:FILE[:NAME]` on page 2646

Preset Gen1/Gen2/Patt Gen

Sets the parameters of the generator to their default values. The settings of the generators are not affected by an instrument preset. They are also not stored in the user-defined preset.

Remote command:

`WGENERator<m>:PRESet` on page 2632

`PGENERator:PRESet` on page 2647

16.3 Output

Access: [Gen] > "Setup" tab

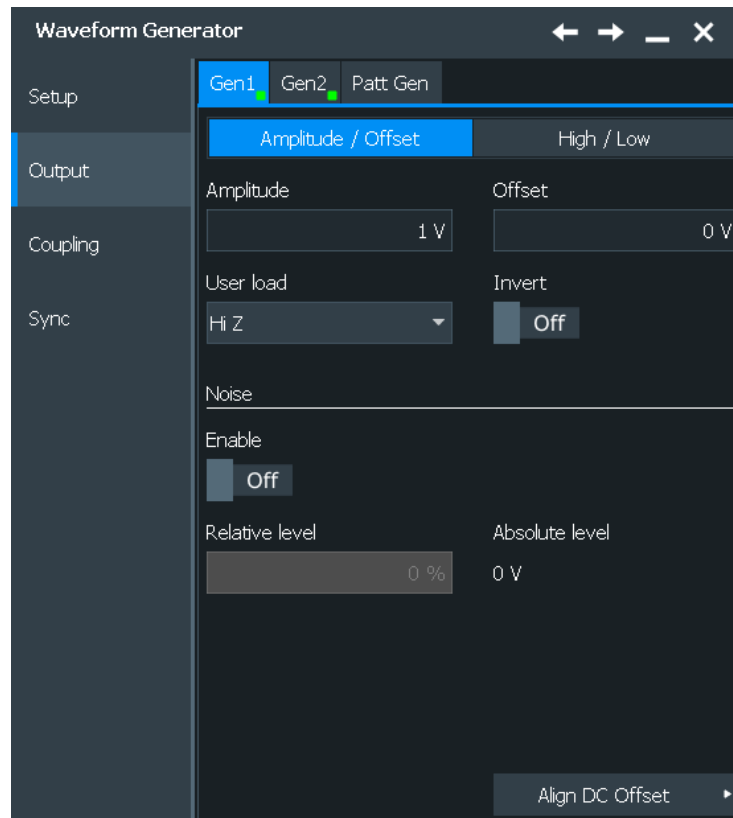

In this tab you can define the generator output and add noise to the waveform.

16.3.1 Output

Amplitude/Offset - High/Low

Selects how the output is defined: with a defined "Amplitude"/ "Offset" or with "High"/"Low" values.

Amplitude

Sets the amplitude, peak to peak voltage, of the output waveform. It is defined as the voltage difference between the maximum ("High") and the minimum ("Low") voltage levels.

The "Amplitude" value is set for the currently selected "User Load". If the "User Load" is changed, the value of "Amplitude" is adapted to this new setting.

Remote command:

[WGENerator<m>:VOLTage\[:VPP\]](#) on page 2648

Offset

Sets a voltage offset.

Remote command:

[WGENerator<m>:VOLTage:OFFSet](#) on page 2649

High

Sets the high signal level of the output waveform.

Remote command:

[WGENerator<m>:VOLTage:HIGH](#) on page 2648

Low

Sets the low signal level of the output waveform.

Remote command:

[WGENerator<m>:VOLTage:LOW](#) on page 2649

Invert

Inverts the waveform at the offset level.

Remote command:

[WGENerator<m>:VOLTage:INVersion](#) on page 2649

User Load

Select the user load, the load of the DUT at its connection. You can select either a "50Ω" or a "HiZ" (high input impedance) load.

Remote command:

[WGENerator<m>:OUTPut\[:LOAD\]](#) on page 2647

DC Level

Sets the voltage DC level for the generated DC signal, for "Operation mode" >"Function Gen." and "Function type"> "DC".

Remote command:

[WGENerator<m>:VOLTage:DCLevel](#) on page 2648

16.3.2 Noise

Enable

Enables the adding of noise to the waveform.

Remote command:

[WGENerator<m>:MODulation:NOISe](#) on page 2651

Relative level

Sets the level of the noise in percentage of the set "Amplitude" output of the signal.

Remote command:

[WGENerator<m>:MODulation:NLPCent](#) on page 2650

Absolute level

Displays the level of the noise in volts.

Remote command:

[WGENerator<m>:MODulation:NLABbsolute?](#) on page 2650

Absolute level

For "Function type">"DC" only.

Sets the level for the DC signal.

Remote command:

[WGENerator<m>:MODulation:NDCLevel](#) on page 2650

16.3.3 DC offset alignment

Access: [Gen] > "Output" > "Align DC Offset"

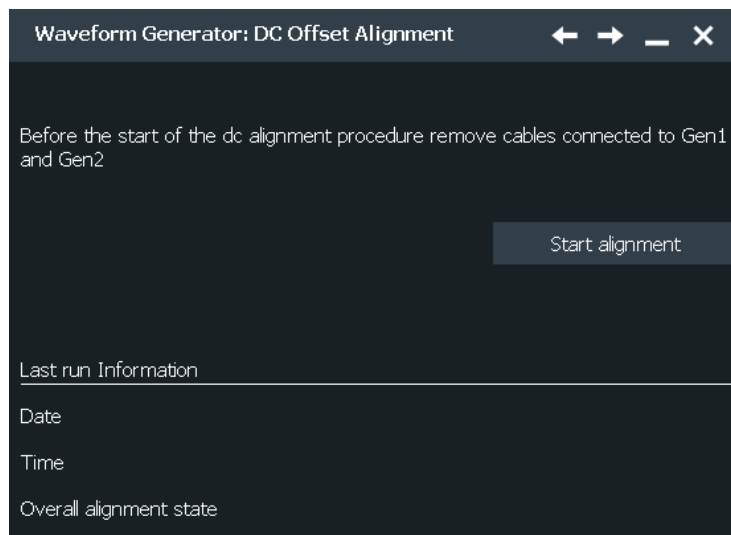

Start Alignment

Starts the alignment of the DC offset.

Remote command:

[GENerator:ALIGNment:DC\[:START\]](#) on page 2652

Date

Displays the date of the last performed DC offset alignment.

Remote command:

[GENerator:ALIGNment:DC:RESult:DATE?](#) on page 2651

Time

Displays the time of the last performed DC offset alignment.

Remote command:

[GENerator:ALIGNment:DC:RESult:TIME?](#) on page 2651

Overall alignment state

Displays the result of the DC offset alignment.

Remote command:

[GENerator:ALIGNment:DC:RESult\[:STATe\]?](#) on page 2651

16.4 Coupling settings

Access: [Gen] > "Coupling"

In the R&S RTO6, you can couple certain settings of the available waveform generators. If one of the available coupling options is enabled for one of the generators, then you cannot change the coupled parameters at the "Setup" tab of the other generator. The values for all coupled parameters are automatically taken from the currently selected generator.

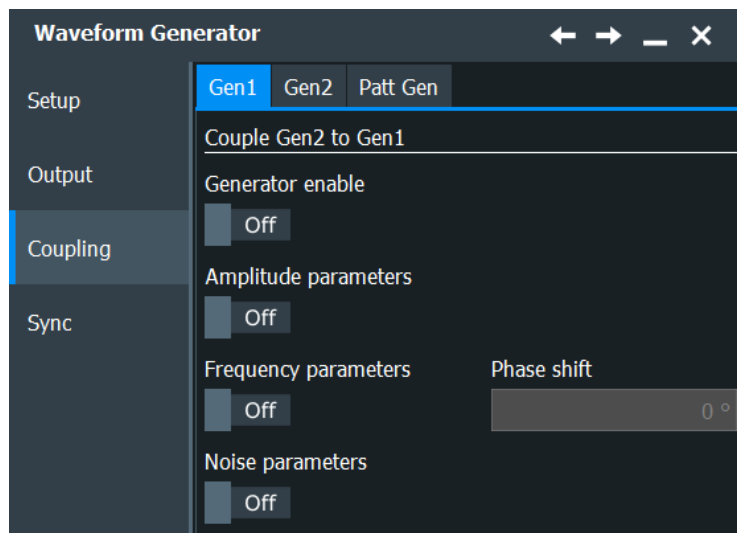

Generator enable

Enables the coupling of the generators, with the selected set of parameters: amplitude, frequency and noise.

Remote command:

[WGENerator<m>:COUPLing:STATe](#) on page 2652

Amplitude parameters

Couples all amplitude parameters of "Gen1" to "Gen2" or "Gen2" to "Gen1" including the load. The values are taken from the currently selected generator.

- For all "Operation Mode": the output settings except of "Load" and "Inversion", "Amplitude", "High", "Offset" and "Low".
- For "Operation Mode" > "Function Gen.": "DC Level"
- For "Operation Mode" > "Modulation": "Modulation depth"

Remote command:

[WGENerator<m>:COUPLing\[:FREQuency\]](#) on page 2653

Frequency parameters

Couples all frequency parameters of "Gen1" to "Gen2" or "Gen2" to "Gen1". The values are taken from the currently selected generator.

- For "Operation Mode" > "Function Gen.": "Frequency" and "Period"
- For "Operation Mode" > "Modulation": "Carrier frequency", "Carrier period", "Modulation freq", "Freq deviation", "Frequency 1", "Frequency 2" and "Hop rate"
- For "Operation Mode" > "Sweep": "Start frequency", "Stop frequency" and "Sweep time".
- For "Operation Mode" > "Arbitrary": "Arb wfm source" and "Signal source".

You can still change the other settings of the generators independently.

Remote command:

[WGENerator<m>:COUPLing:AMPLitude](#) on page 2652

Phase shift

Sets the phase shift between the waveform of "Gen1" and "Gen2" when the frequency parameters of the two waveforms are coupled.

Remote command:

[WGENerator<m>:COUPLing:PHASeshift](#) on page 2653

Noise parameters

Couples all noise parameters of "Gen1" to "Gen2" or "Gen2" to "Gen1". The values are taken from the currently selected generator.

Remote command:

[WGENerator<m>:COUPLing:NOISe](#) on page 2653

Arbitrary waveform

Available for [General settings](#) = "Arbitrary".

Couples the arbitrary waveform "Gen1" to "Gen2" or "Gen2" to "Gen1". The values are taken from the currently selected generator.

Remote command:

[WGENerator<m>:COUPLing:NOISe](#) on page 2653

16.5 Sync settings

Access: [Gen] > "Sync"

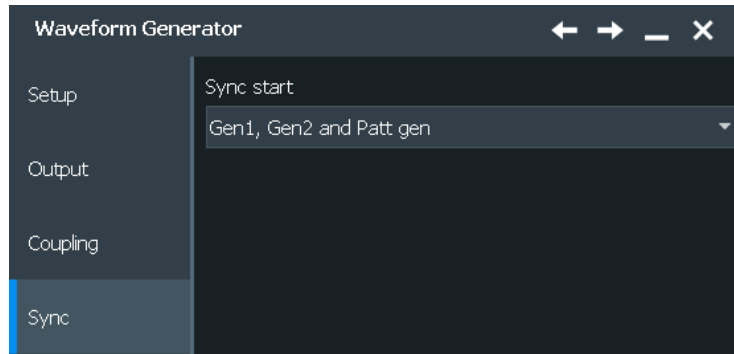

Sync start

Selects, which signals generated from the waveform generator are synchronized.

Selecting one of the sync options indicates that the first samples of those signals are generated at the same time, irrespective of if the generators are on or off. Selecting one of the coupling options automatically syncs the signals generated by the two waveform generators.

Remote command:

`GENerator:SYNC[:COMBination]` on page 2654

16.6 Configuring the waveform generator

This chapter explains step-by-step how to configure the waveform generator.

- [Configuring a function waveform](#).....1056
- [Configuring a modulation waveform](#).....1057
- [Configuring a sweep waveform](#).....1058
- [Configuring an arbitrary waveform](#).....1058
- [Configuring a pattern generator waveform](#).....1059

16.6.1 Configuring a function waveform

1. Press the [Gen] key on the front panel.
2. Select the "Setup" tab.
3. Under "Operation mode", enable the "Function Gen." button.
4. Select the "Function type" that you want to generate, e.g. "Sine".
5. Depending on the selected "Function type", configure the settings of the waveform like "Frequency" and "Period".

6. If necessary, change the "Output" settings or add "Noise" to the waveform.
7. Press the "Enable" button, to output the waveform at the output connector of the waveform generator.

16.6.2 Configuring a modulation waveform

Generating an AM modulated waveform

1. Press the [Gen] key on the front panel.
2. Select the "Setup" tab.
3. Under "Operation mode", enable the "Modulation" button.
4. Tap "Modulation type" and select "AM".
5. Set the "Carrier frequency" and the "Carrier period".
6. Tap "Modulation signal" and select the required waveform.
7. Depending on the selected "Modulation signal", configure the settings of the waveform like "Modulation freq" and "Modulation depth".
8. If necessary, change the "Output" settings or add "Noise" to the waveform.
9. Press the "Enable" button, to output the waveform at the output connector of the waveform generator.

Generating an PWM modulated waveform

1. Press the [Gen] key on the front panel.
2. Select the "Setup" tab.
3. Under "Operation mode", enable the "Modulation" button.
4. Tap "Modulation type" and select "PWM".
5. Set the "Carrier frequency" and the "Carrier period".
6. Tap "Modulation signal" and select the required waveform.
7. Depending on the selected "Modulation signal", configure the settings of the waveform like "Modulation freq" and "Modulation depth".
8. If necessary, change the "Output" settings or add "Noise" to the waveform.
9. Press the "Enable" button, to output the waveform at the output connector of the waveform generator.

Generating an FM modulated waveform

1. Press the [Gen] key on the front panel.
2. Select the "Setup" tab.

3. Under "Operation mode", enable the "Modulation" button.
4. Tap "Modulation type" and select "FM".
5. Set the "Carrier frequency" and the "Carrier period".
6. Tap "Modulation signal" and select the required waveform.
7. Depending on the selected "Modulation signal", configure the settings of the waveform like "Modulation freq" and "Freq deviation".
8. If necessary, change the "Output" settings or add "Noise" to the waveform.
9. Press the "Enable" button, to output the waveform at the output connector of the waveform generator.

Generating an FSK modulated waveform

1. Press the [Gen] key on the front panel.
2. Select the "Setup" tab.
3. Under "Operation mode", enable the "Modulation" button.
4. Tap "Modulation type" and select "FSK".
5. Set the "Frequency 1", "Frequency 2" and the "Hop rate".
6. If necessary, change the "Output" settings or add "Noise" to the waveform.
7. Press the "Enable" button, to output the waveform at the output connector of the waveform generator.

16.6.3 Configuring a sweep waveform

1. Press the [Gen] key on the front panel.
2. Select the "Setup" tab.
3. Under "Operation mode", enable the "Sweep" button.
4. Set the "Start frequency", the "Stop frequency" and the "Sweep time".
5. If necessary, change the "Output" settings or add "Noise" to the waveform.
6. Press the "Enable" button, to output the waveform at the output connector of the waveform generator.

16.6.4 Configuring an arbitrary waveform

Generating an arbitrary waveform from a saved file

1. Press the [Gen] key on the front panel.

2. Select the "Setup" tab.
3. Under "Operation mode", enable the "Arbitrary" button.
4. Set the "Arb wfm source" to "Saved waveform".
5. Select the "Run mode".
6. Press "Open" and set the path to your saved arbitrary waveform.
7. Set the "Sample rate".
8. If necessary, change the "Output" settings or add "Noise" to the waveform.
9. Press the "Enable" button, to output the waveform at the output connector of the waveform generator.

Generating an arbitrary waveform from the scope waveform

1. Press the [Gen] key on the front panel.
2. Select the "Setup" tab.
3. Under "Operation mode", enable the "Arbitrary" button.
4. Set the "Arb wfm source" to "Scope waveform".
5. Select the "Run mode".
6. Press the "Signal source" button and select the channel source for the waveform.
7. Set the "Sample rate".
8. If necessary, change the "Output" settings or add "Noise" to the waveform.
9. Press the "Enable" button, to output the waveform at the output connector of the waveform generator.

16.6.5 Configuring a pattern generator waveform

1. Press the [Gen] key on the front panel.
2. Select the "Setup" tab.
3. Select the "Patt Gen" tab.
4. Select the "Run mode".
5. Press "Open" and set the path to your saved pattern file.
6. Set the "Bit rate" and "High level".
7. Press "Open" and set the path to your saved arbitrary waveform.
8. Press the "Enable" button, to output the pattern at the output connector of the pattern generator.

17 Pulse source and TDR/TDT analysis (options R&S RTO6-B7/K130)

17.1 Pulse source (option R&S RTO6-B7)

The pulse source option R&S RTO6-B7 provides a symmetrical differential pulse signal with steep rise time and configurable parameters. The hardware module of the option features four 2.92 mm connectors (K type), two for signal output (Out, $\overline{\text{Out}}$), and two for reference signal output (Ref, $\overline{\text{Ref}}$).

Typical applications of the pulse source are:

- Stimulus for devices under test, for example, as a precise clock
- Accurate source for deskewing cables and probes for differential measurements
- Analysis of time-transmission characteristics of a differential signal path
- TDR/TDT analysis with option R&S RTO6-K130

The module is installed at the rear panel of the instrument. To ensure correct installation and calibration, send the instrument to a Rohde & Schwarz service center.

Usage of cables

Beside the pulse source module, the option includes several accessories: SMA cables, 50 Ω terminations, adapters, and more. The accessory case provides also space for optional accessories. All included accessories are listed in the specifications document.

NOTICE

When fastening the cable, observe the maximum torque of 0.9 Nm. Therefore, using a 0.9 Nm torque wrench is recommended (optional accessory 1328.8534.35).

To ensure accurate and reliable measurements, connect only cables with a maximum length of 3 m.

Always use double-shielded cables to prevent electromagnetic interference (EMI) from impairing measurement results.

Always use cables to connect the DUT or test fixture to the pulse source outputs. Never connect the DUT or test fixture directly to the outputs.

17.1.1 Settings for the pulse source

Access: [App Cockpit] > "Generators" > "PSC"

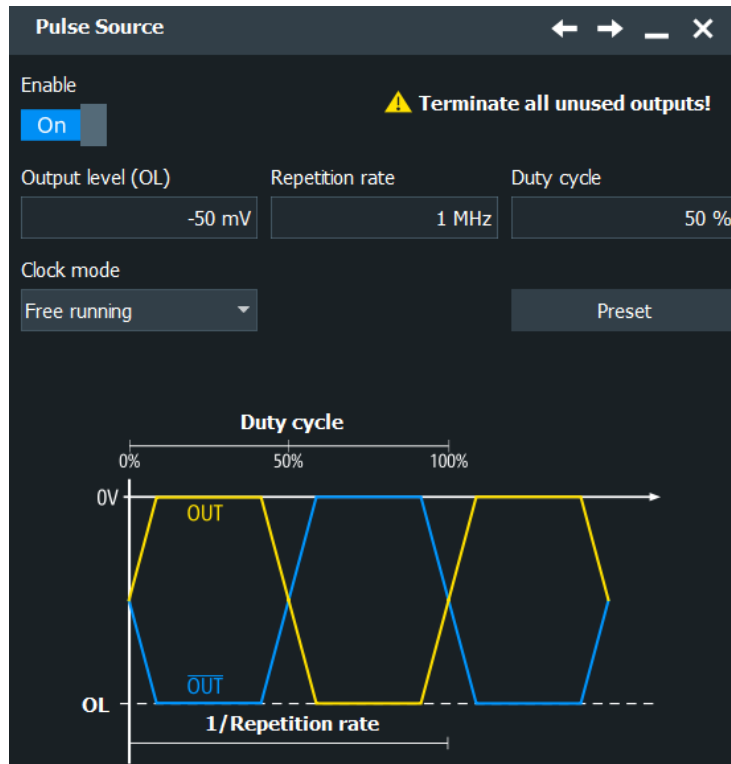

Terminate all unused outputs of the pulse source with 50 Ω terminating resistors.

**Enable**

Switches all four pulse source outputs on and off.

Remote command:

[PSRC\[:STATe\]](#) on page 2654

Output level

Sets the low level of the output pulse. The high level is 0 V and cannot be changed.

Remote command:

[PSRC:OUTPutLow](#) on page 2655

Repetition rate

Sets the pulse frequency, the repetition rate of the pulse. Available values depend on the selected clock mode.

Remote command:

[PSRC:REPRate](#) on page 2655

Duty cycle

Sets the duty cycle of the pulse in %, which is the ratio of the positive pulse width to the period of the signal.

For repetition rates > 5 MHz, the value is fixed at 50 %.

Remote command:

[PSRC:DUTYcycle](#) on page 2655

Clock mode

Sets the dependency of the pulse clock on the instrument's reference clock. The appropriate clock mode depends on the measurement application.

"Free running" The clock of the pulse source is independent. Deviations of the system do not affect the pulse clock, and deterministic conditions are avoided.

If the waveform acquisition is set to "Average", the "free running" clock mode can improve the measurement result. Internal spurious signals of the instrument are reduced by averaging, because they are not coherent to the pulse source signal.

See also: "[Arithmetic](#)" on page 130.

"Locked" The pulse source is locked to the reference clock of the instrument.

Remote command:

[PSRC:CLOCKmode](#) on page 2656

Preset

Resets the pulse source to the default state. Pulse source settings are not affected by an instrument preset. They are also not stored in the user-defined preset.

Remote command:

[PSRC:RST](#) on page 2656

17.2 TDR/TDT analysis (option R&S RTO6-K130)

The option R&S RTO6-K130 provides analysis of time domain reflectometry (TDR) and time domain transmission (TDT) to verify high-speed digital designs. Using the results of the TDR/TDT calibration, the instrument removes the effects of the cables (deembedding), and measures the DUT.

Typical use cases are:

- Locate faults in a circuit
- Measure impedance
- Measure step response of a DUT

17.2.1 About TDR/TDT measurements

Using TDR/TDT measurements, you can analyze the reflections and transmission characteristics of a DUT. With TDR, it is possible to determine the type, magnitude and location of a fault. TDT delivers information on stability, losses and bandwidth of the DUT.

The signal source is the pulse source, and the oscilloscope measures the reflected and transmitted signals.

Requirements

TDR/TDT analysis requires the pulse source option R&S RTO6-B7.

Cabling requirements:

- Use only high-quality double-shielded RF cables. Two suitable cables are delivered with the pulse source option R&S RTO6-B7.
- Use low loss cables with frequency range that fits the oscilloscope bandwidth.
- Consider the recommended cable length: $0.5 \text{ m} < \text{length} < 3 \text{ m}$.

Calibration standards

During calibration, you measure the connecting cables of the measurement setup against standards. Calibration standards assumed to be ideal.

- Short with RF quality: a standard short is delivered with the pulse source option R&S RTO6-B7. You can use other shorts with electrical length $0 \text{ ns} \dots 2 \text{ ns}$. Default value is the R&S RTO6-B7 short.
- Open (DC)
- Match (DC): a standard 50Ω match is delivered with the pulse source option R&S RTO6-B7. You can use another match with $50 \Omega \pm 10\%$.
- Through (RF): the length is assumed to be zero.

Calibration results

After successful calibration, the frequency response of the short and through measurements are displayed. Steep dips in the graph indicate high attenuation within your desired bandwidth, which impairs the performance. To improve the measurement, reduce the bandwidth of the system. To check the impact of the frequency response calibration on the time domain waveform, you can disable the usage ("Use frequency response calibration"). Without frequency response correction, only the rescaling to the TDR/TDT measurements is performed.

The calibration results are used for correction of subsequent measurements and can be saved in a file for later usage.

Correction

Calibration results are used for correction of the signal in two ways:

- DC scaling using results of open, short and match calibration.
- RF correction and deembedding of transmission loss based on short calibration.

The R&S RTO6 corrects for the transmission loss of the system, but not for multiple reflections between DUT and oscilloscope.

17.2.2 Using TDR/TDT

17.2.2.1 Calibrating the setup

Before you can start TDR/TDT measurements, calibrate the used cables.

You can:

- Calibrate the setup using the calibration wizard of the R&S RTO6.
- Load a file with results of a previous calibration of the same setup.
- Use default calibration and correction values.

To calibrate the cables

The calibration procedure is described for single-ended TDR and TDT analysis. If you need only TDR or only TDT, the procedure is the same but with fewer calibration steps and fewer measurements.

1. Open [App Cockpit]> "Analysis" > "TDR / TDT"
2. To start a new calibration, select "Start wizard".
If a calibration was loaded or done before, the calibration steps are skipped, and the measurement dialog box is shown.
3. Select the analysis type: "TDR", "TDT", or "TDR / TDT" (both TDR and TDT measurements).
4. Select "Calibrate setup".
5. Connect the cables, and select the input channels:
 - a) Connect the first cable to the "Ref" connector of the pulse source and to a channel input. This cable is for TDR measurements.
 - b) Select the connected channel in the dialog box.
 - c) Connect the second cable to the "Out" connector. Do not connect the DUT.
 - d) Connect a third cable to a channel input. This cable is for TDT measurements.
 - e) Select the connected channel in the dialog box.
 - f) Terminate all unused connectors of the pulse source.
 - g) Set up the input channels, in particular, the trigger level and vertical settings. These settings must remain unchanged during and after calibration.
 - h) Select "Next".
6. Calibrate with a short:
 - a) Connect a short to the cable that is connected to the "Out" connector.
 - b) To change the short, select the edit icon.
 - c) If you use another short than the delivered standard short, select "User.defined", and enter the electrical length of the used short.
 - d) Select "Calibrate".
7. Calibrate with open cable:
 - a) Remove the short.
 - b) Select "Calibrate".
8. Calibrate with a match:
 - a) Connect a match to the cable that is connected to the "Out" connector.
 - b) Select "Calibrate".
9. Calibrate with a through:

- a) Connect a through to the cable that is connected to the "Out" connector.
 - b) Connect the through to the third cable.
 - c) Select "Calibrate".
10. Select "Next".
 11. Check the graphical calibration result. To see the details, you can display the full-size graphic, zoom in and out, and use the cursor. To see the original plot again, select "Reset".

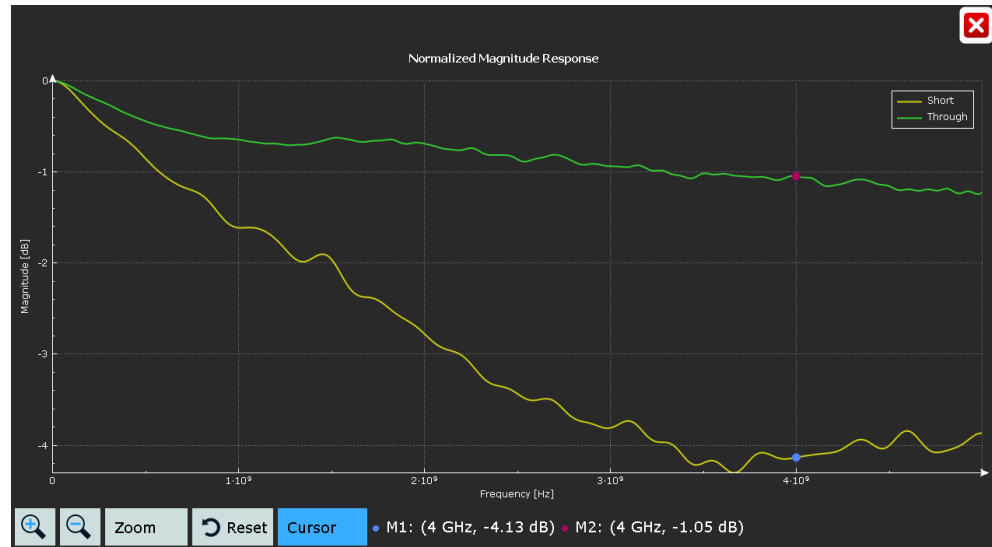

Figure 17-1: Full-size display of calibration results, with cursor

12. Save the calibration results for later measurements.
 13. Select "Next".
- Now you can analyze the DUT.

17.2.2.2 Measuring the DUT

1. Open [App Cockpit]> "Analysis" > "TDR / TDT"
2. Load an existing calibration file, or calibrate the setup as described in [Chapter 17.2.2.1, "Calibrating the setup"](#), on page 1063.
3. Discharge the DUT before connecting.
4. Connect the DUT instead of calibration standards as shown in the dialog.
5. Under "Signals", select the characteristics that you want to analyze.
6. Enter the "Bandwidth" of the DUT.
7. Select whether you want to see the time or the distance on the x-axis: "Domain".
8. If the distance is selected, enter the permittivity of the DUT: " ϵ_r ".

9. To check the impact of the frequency response calibration on the time domain waveform, disable "Use frequency response calibration".
10. Close the dialog box.
11. Set the horizontal time scale so that the complete DUT is captured and visible on the screen.
12. Analyze the selected signals. See also: [Chapter 17.2.6, "Measurement results"](#), on page 1072

17.2.3 Calibration settings

17.2.3.1 Setup: TDR/TDT configuration

Access: [App Cockpit]> "Analysis" > "TDR / TDT"

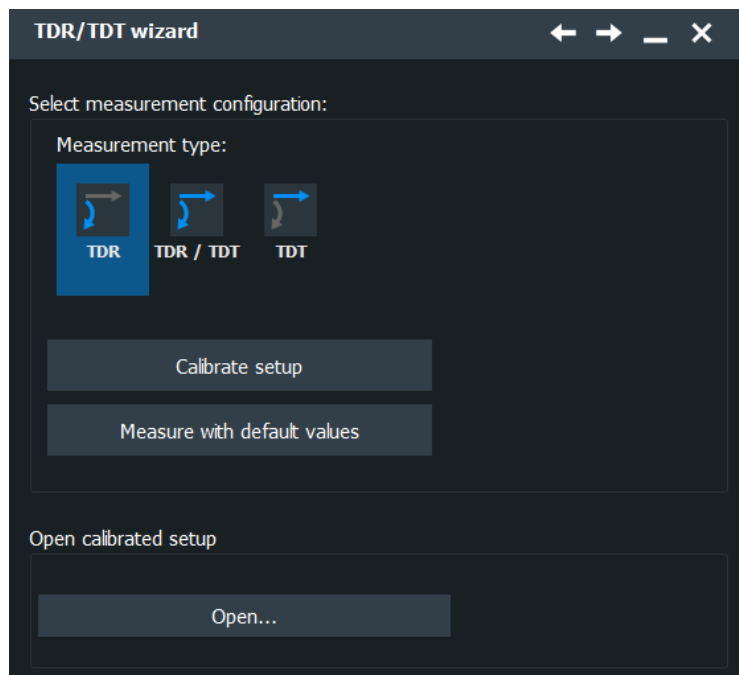

Measurement type

Selects the analysis type: "TDR" (time domain reflectometry), "TDT" (time domain transmission), or "TDR / TDT" (both TDR and TDT).

Remote command:

[TDRT:TYPE](#) on page 2657

Calibrate setup

Starts the wizard for manual calibration. In the next steps, you connect several calibration standards and measure the correction parameters.

Measure with default values

Starts the measurement with default correction values instead of calibrating the setup. Default values are rough values without time reference.

Remote command:

`TDRT:DEFault` on page 2657

Open

Opens a saved calibration file of a previous calibration and starts the measurement.

Remote command:

`TDRT:CALibration:OPEN:NAME` on page 2657

`TDRT:CALibration:OPEN[:EXECute]` on page 2657

17.2.3.2 Setup: channels

Access: [App Cockpit]> "Analysis" > "TDR / TDT" > "Calibrate setup"

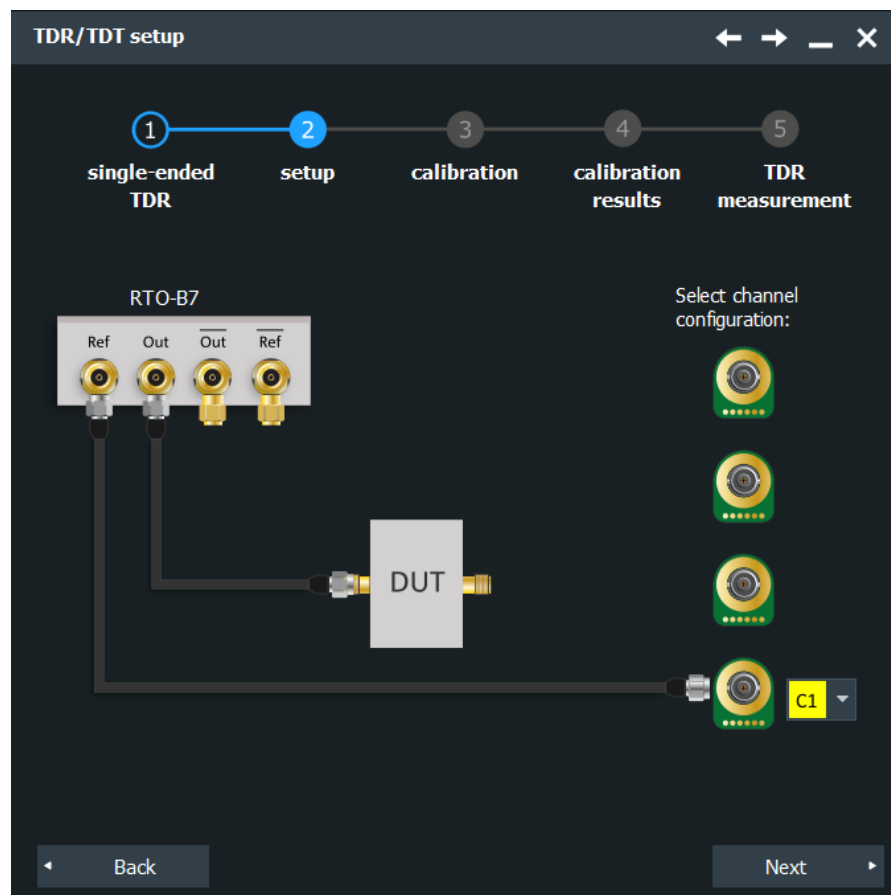

Figure 17-2: Channel setup for single-ended TDR/TDT

Channel

Select the input channels that are connected to the "Ref" connector and the "Out" connector of the pulse source.

Note: The position of the DUT is shown for information only. Do not connect the DUT.

Remote command:

[TDRT:PULSe:OUT](#) on page 2658

[TDRT:PULSe:REFeRence](#) on page 2658

17.2.3.3 Calibration

Access: [App Cockpit]> "Analysis" > "TDR / TDT" > "Calibrate setup" > "Next"



Figure 17-3: Calibration of single-ended TDR/TDT

The used short type is shown in the wizard. To change the short, tap the "Edit" icon.

Short type

Selects whether the short is the Rohde & Schwarz short that is delivered with the pulse source R&S RTO6-B7, or another one.

If you do not use the Rohde & Schwarz short, enter the "Electrical short length" of the used short.

Remote command:

[TDRT:SLENgth](#) on page 2658

Calibrate

Starts the calibration of the current calibration step (short, open, match through).

17.2.4 Calibration results

Access: [App Cockpit]> "Analysis" > "TDR / TDT" > "Calibrate setup" > "Next"



Magnitude response plot

Shows the graph of magnitude over frequency for the short calibration (TDR) and through calibration (TDT).

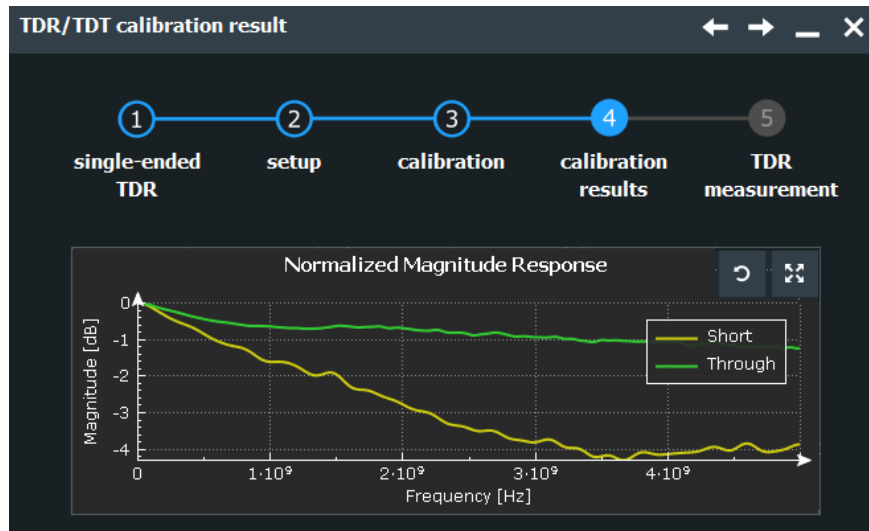

Figure 17-4: Result of TDR and TDT calibration: smooth graph with moderate attenuation

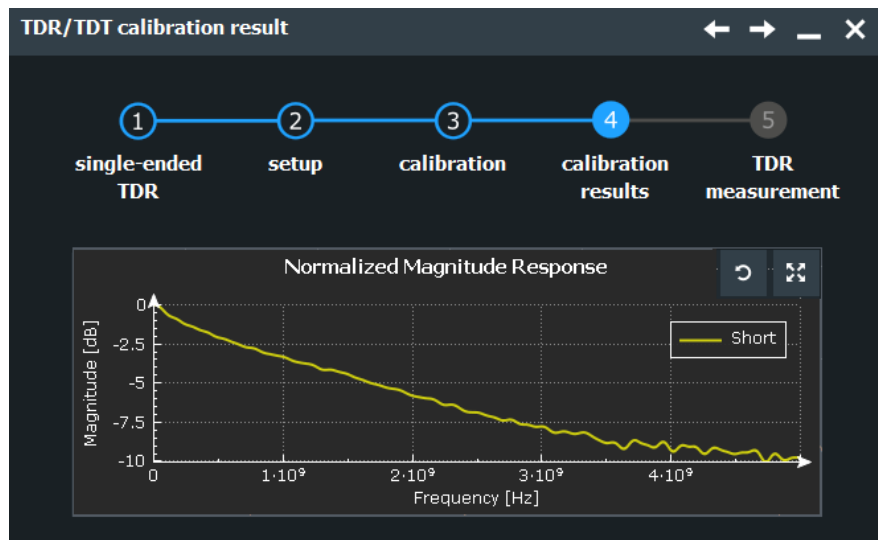

Figure 17-5: Result of TDR calibration: high attenuation and noisy graph at higher frequencies

Save calibration

Saves the current correction values to a file. Using the saved file, you can repeat the measurements at any time.

Remote command:

[TDRT:CALibration:SAVE:NAME](#) on page 2658

[TDRT:CALibration:SAVE\[:EXECute\]](#) on page 2659

17.2.5 Measurement settings

Access: [App Cockpit]> "Analysis" > "TDR / TDT" > "Calibrate setup" > "Next"> "Next" > "Next"

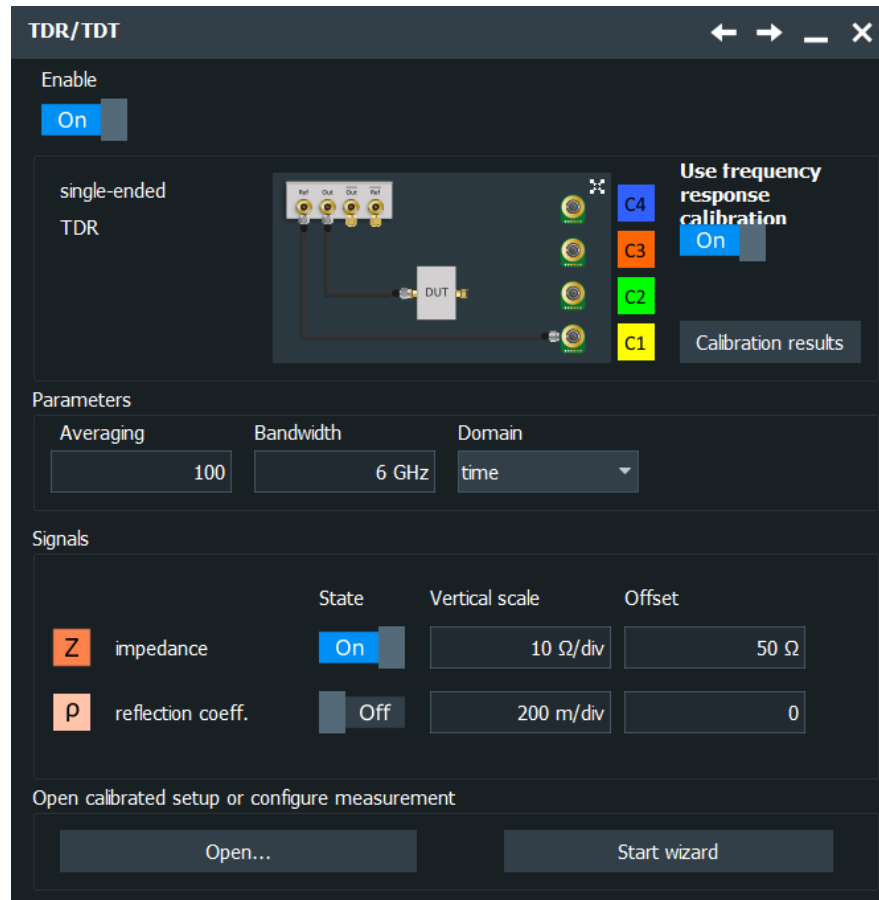
**Enable**

Activates the TDR/TDT measurements.

Remote command:

[TDRT:STATE](#) on page 2659

Use frequency response calibration

Disables the frequency response calibration. Without calibration, the measured signals are only rescaled, and you can see the impact of the frequency response calibration on the time domain waveform.

The setting is not available when measuring with default values.

Remote command:

[TDRT:CALibration:USECaldata](#) on page 2659

Averaging

The "Averaging" value is the "Average count (N-single count)", which you can also set in the acquisition and trigger settings. See ["Average count \(N-single count\)"](#) on page 127.

Increase the value to reduce noise.

Bandwidth

Sets the bandwidth of the DUT.

Remote command:

[TDRT:BW](#) on page 2660

Domain, ϵ_r

Sets the domain of the x-axis: time or distance (in m or inch). If you select distance, enter also the permittivity " ϵ_r " of the used DUT.

Remote command:

[TDRT:DOMain](#) on page 2660

[TDRT:PERMittivity](#) on page 2660

State

Select the TDR/TDT signals to be displayed and analyzed.

TDR delivers the impedance Z and the reflection coefficient ρ .

TDT delivers the normalized and corrected step response.

Remote command:

[TDRT:SIGNal<m>STATe](#) on page 2660

Vertical scale

Set the vertical scale of the TDR/TDT signals.

Remote command:

[TDRT:SIGNal<m>:SCALE](#) on page 2661

Offset

Set the offset of the TDR/TDT signals.

To set the position, assign position to the vertical Position knob ("File" menu > "Front-panel Setup" > "Knobs"). Turn the vertical Position knob to change the position.

Remote command:

[TDRT:SIGNal<m>:OFFSet](#) on page 2661

[TDRT:SIGNal<m>:POSition](#) on page 2661

17.2.6 Measurement results

To get exact measurement results, set the horizontal time scale so that the complete DUT is captured and visible on the screen. Thus, interference between the reflected signals from the DUT is avoided. Interference can occur because the repetition rate of the pulse source is linked to the horizontal scale to maximize measurement speed.

The results of the TDR measurements are the impedance waveform Z and the waveform of the reflection coefficient ρ .

To investigate details of the waveforms, use the zoom function. For further analysis, you can use automatic and cursor measurements, histogram, mathematics and reference waveforms.

Data export

In the same way as channel waveforms, you can export the data of Z , ρ and H waveforms to file (one waveform per file). Raw data is not available.

See also: [Chapter 12.2, "Save and recall waveform data and results"](#), on page 458.

Remote commands:

- [EXPort:WAVEform:SOURce](#) on page 1766
- [TDRT:SIGNAL<m>:DATA:HEADer?](#) on page 2662
- [TDRT:SIGNAL<m>:DATA:VALues?](#) on page 2662

17.2.7 Troubleshooting

If the calibration or measurement does not show meaningful results, the following table helps you to find the cause.

	Issue	Checks
Calibration	No waveform is visible.	Check the cabling. Check the pulse source.
Calibration	Calibration with short failed	Check the cable length: 0.5 m < length < 3 m Use cables with low loss. Use a short that has a low impedance for high frequencies.
Calibration	Calibration with open failed	Use cables with low loss.
Calibration	Calibration with match failed	Use cables with low loss. Use match with $50 \Omega \pm 10\%$ for single-ended measurements.
Calibration	Calibration with through failed	Use cables with low loss. Check the cable length: 0.5 m < length < 3 m
Calibration	Failure after completion of all calibration steps	Use cables with low loss. Check the pulse source.
Measurement	Waveform is noisy or unstable	Evaluate the calibration results for any resonances or high attenuation in frequency response. Increase averaging. Reduce bandwidth. Disable calibration. If noise disappears, reduce attenuation or remove resonances from your setup and recalibrate.

18 I/Q software interface (option R&S RTO6-K11)

The option R&S RTO6-K11 "I/Q software interface" acquires modulated signals and outputs I/Q data for further analysis using other software, for example, MATLAB. Rohde & Schwarz provides the R&S®VSE vector signal explorer for analysis of I/Q data on external computer.

In I/Q mode, the input signal is captured with a sample rate of 10 Gsample/s.

In addition to the I/Q data recording, the option also provides the NFC trigger type, a specific trigger for near field communication analysis.

For specifications, see the R&S RTO6 data sheet.

- [I/Q mode](#)..... 1074
- [I/Q sampling setup](#)..... 1074
- [I/Q data output](#)..... 1079
- [NFC trigger](#)..... 1081

18.1 I/Q mode

The I/Q mode is a special operating mode of R&S RTO6. In this mode, the usual analyzing tools (cursor, zoom, measurements, FFT and so on) of the oscilloscope are deactivated. The instrument displays the magnitude of the I/Q vector to get an impression of the data before it is exported.

Triggering is performed on the input data before conversion to I/Q data, using the usual R&S RTO6 trigger functionality. In case of complex input signals, the instrument triggers on one component of the complex signal (I or Q) depending on the selected trigger source.

To activate the IQ mode

1. Press the [App Cockpit] key on the front panel.
2. In the "RF" tab, select "IQ".
3. In the "IQ Sampling" dialog, tap "Enable".

The instrument switches to I/Q mode, and the setup dialog for I/Q data recording is shown.

18.2 I/Q sampling setup

Access: [App Cockpit] menu > "RF" tab > "IQ" > "IQ Sampling Setup"

In the "IQ Sampling" dialog box, you configure the complete I/Q sampling for real and complex input signals.

If the values in the dialog box result in an unfavorable combination, a note is shown. The note indicates:

- "Undersampling" if the carrier frequency is too fast.
- " $CF + BW/2 > DevBW$ ", where CF is the carrier frequency, BW is the filter bandwidth, and DevBW is the maximum instrument bandwidth.
- Remote commands:
[CHANnel<m>:IQ:WARNing\[:STATe\]? on page 2667](#)
[CHANnel<m>:IQ:WARNing:MESSAge? on page 2668](#)

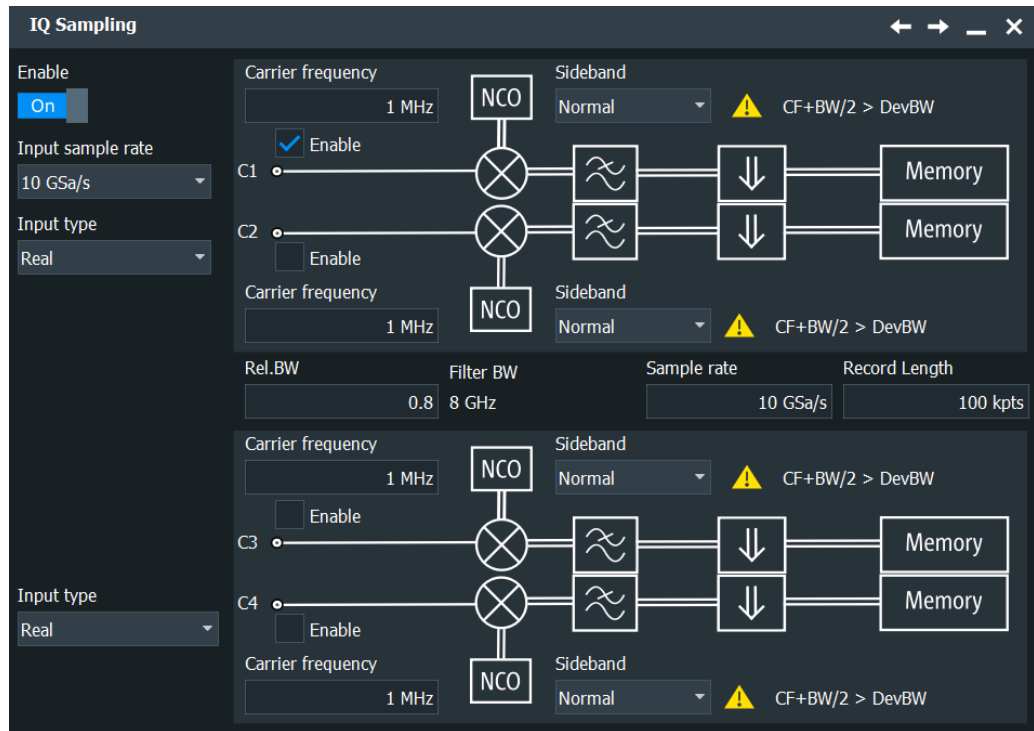

As usual, the signal icons of the enabled channels show the current settings. In I/Q mode, the I/Q settings are shown, see Figure 18-1. The left signal icon shows a complex input signal in IF range with carrier frequency 1 MHz and normal/upper sideband. C1 is the in-phase component, C2 the quadrature component. The right signal icon shows a real input signal with carrier frequency 1 MHz. C1 has inverse sideband, C2 has normal sideband.

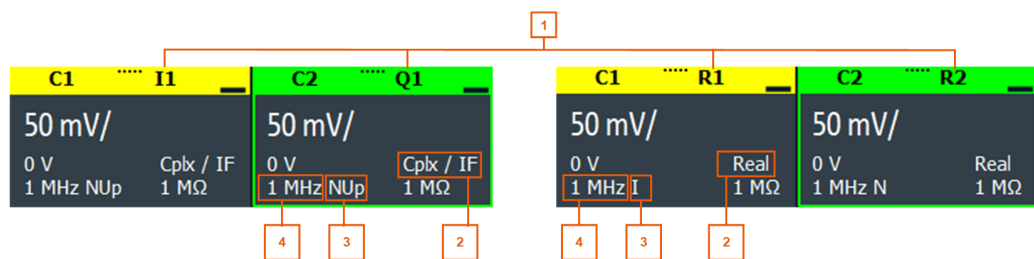

Figure 18-1: Signal icons in I/Q mode

- 1 = Signal component
- 2 = Input type/Input mode
- 3 = Sideband
- 4 = Carrier frequency

Enable

Enables the I/Q mode to record I/Q data.

The analyzing tools on the toolbar are deactivated, and the magnitude of the I/Q vector is displayed.

Remote command:

[IQ:STATe](#) on page 2664

Input sample rate

Shows the sample rate of capturing the input data in I/Q mode: 10 Gsample/s.

Remote command:

[IQ:INSRate](#) on page 2664

Input type, Input mode

"Input type" sets the format of the input signal. "Input mode" selects the frequency band of a complex input signal.

The R&S RTO6 I/Q software interface supports three formats of input signals.

- Real RF signals

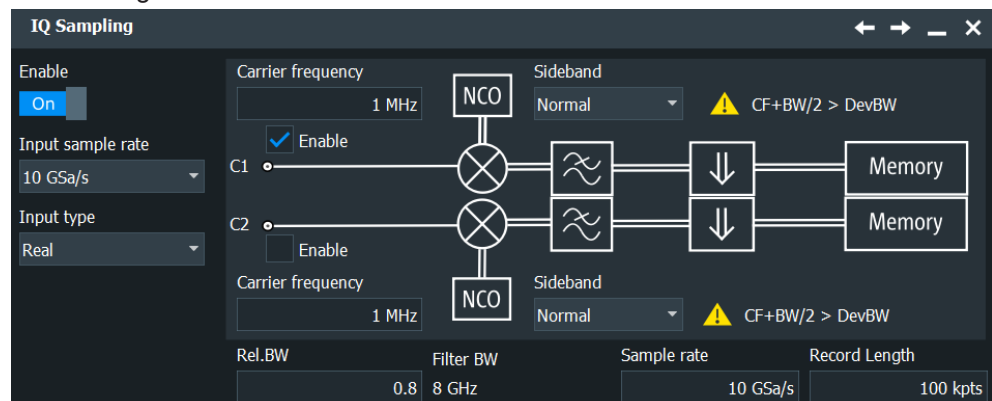

- The input signal is down-converted, filtered and resampled to the sample rate of the output I/Q signal.
- One channel is required for each input signal. Thus up to four real signals can be recorded in parallel.
- Sideband settings: see "[Sideband \(real input\)](#)" on page 1078.
- Complex I/Q baseband signals

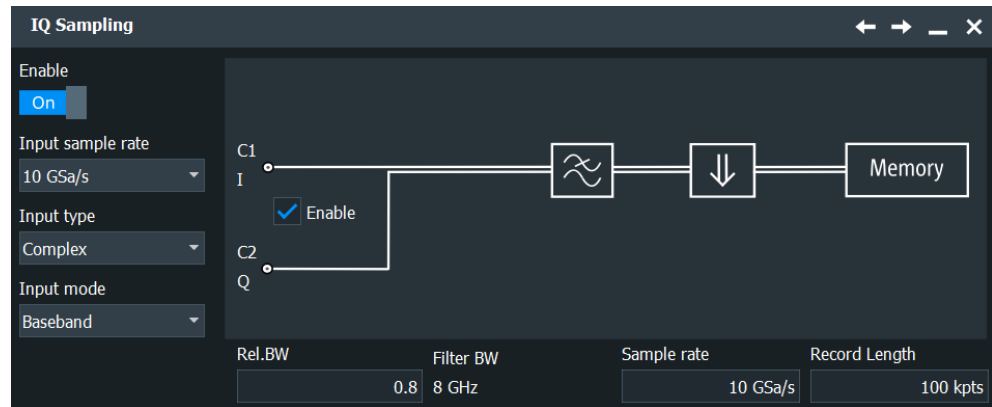

- The input signal is filtered and resampled to the sample rate of the output I/Q signal.
- Two input channels are required for each input signal, one for the in-phase component, and one for the quadrature component. Thus up to two complex input signals can be recorded in parallel.
- Complex I/Q signals in low IF range

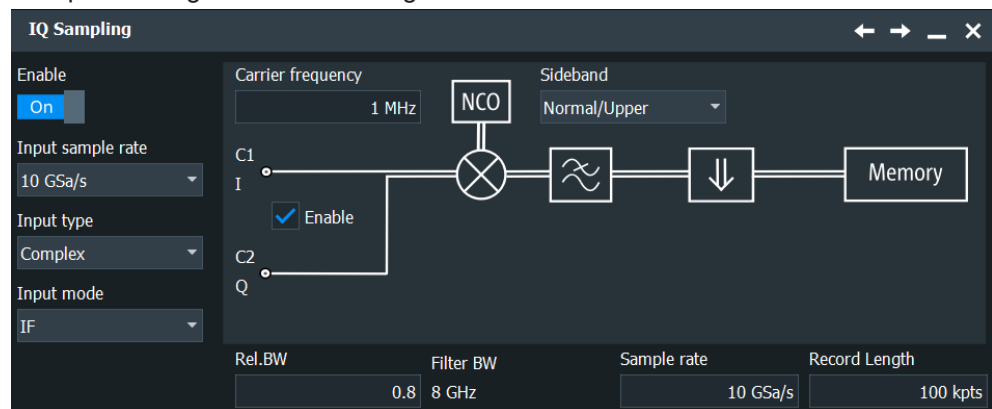

- The input signal is down-converted, filtered and resampled to the sample rate of the output I/Q signal.
- Two input channels are required for each input signal, one for the in-phase component, and one for the quadrature component. Thus up to two complex input signals can be recorded in parallel.
- Sideband settings: see "[Sideband \(complex IF input\)](#)" on page 1079.

Remote command:

[CHANnel<m>: IQ: INPType](#) on page 2664

[CHANnel<m>: IQ: INPMode](#) on page 2664

Rel. BW, Filter BW

"Rel. BW" sets the bandwidth factor to define the filter bandwidth:

$$\text{Filter BW} = \text{Relative BW} * \text{Sample rate}$$

Remote command:

[IQ: RBWidth](#) on page 2665

[IQ: BWIDth?](#) on page 2665

Sample rate

Sets the required sample rate of the output I/Q data.

Remote command:

[IQ:SRATe](#) on page 2665

Record length

Sets the required record length of the output I/Q data. The resulting acquisition time of the I/Q data is:

$$\text{Acquisition time} = \text{Record length} / \text{Sample rate}$$

Remote command:

[IQ:RLENgth](#) on page 2666

Channel On/Off

Switches the channel signal on or off. The signal icon appears on the signal bar. The waveform of the last acquisition is displayed in the diagram.

Remote command:

[CHANnel<m>:STATe](#) on page 1427

Carrier frequency

Sets the carrier frequency of the modulated RF signal or of the complex signal in IF range. The minimum carrier frequency is 10 mHz, the maximum frequency corresponds to the input sample rate.

Remote command:

[CHANnel<m>:IQ:CFRequency](#) on page 2666

Sideband (real input)

Defines the frequency position of the RF spectrum in the input signal: normal or inverse. The position is important for correct down-conversion and filtering.

- "Normal" position of the RF spectrum

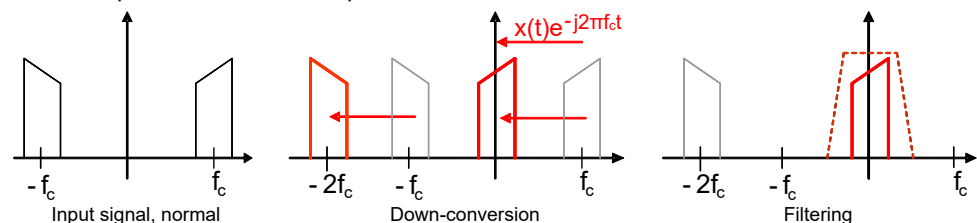

- "Inverse" position of the RF spectrum

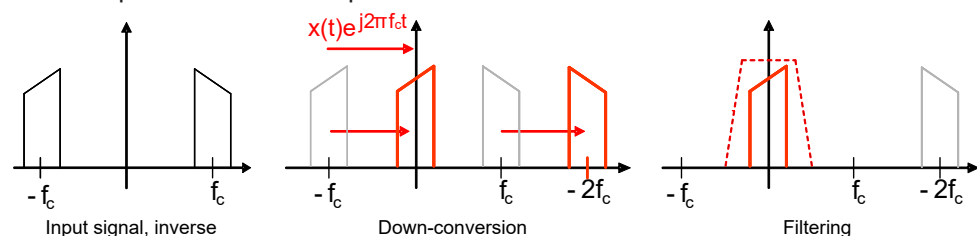

Remote command:

[CHANnel<m>:IQ:SBRF](#) on page 2666

Sideband (complex IF input)

Defines the sideband and the frequency position of complex modulated input signal in IF range.

- "Normal/Upper": Upper sideband in normal position

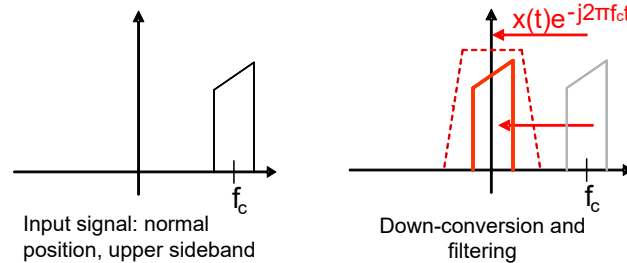

- "Normal/Lower": Lower sideband in normal position

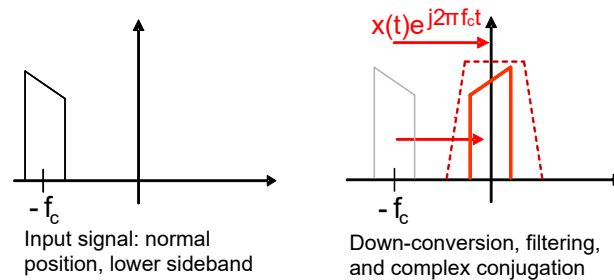

- "Inverse/Upper": Upper sideband in inverse position

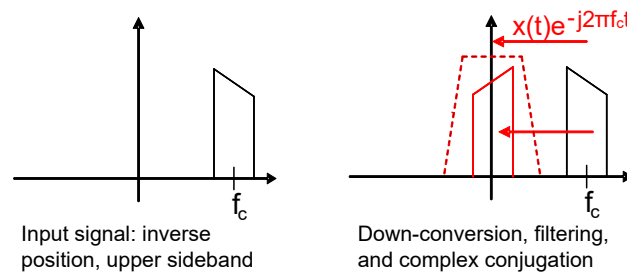

- "Inverse/Lower": Lower sideband in inverse position

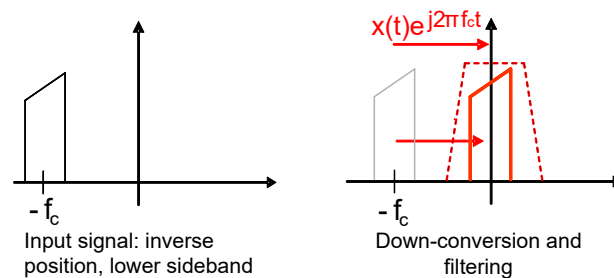

Remote command:

[CHANnel<m>:IQ:SBIF](#) on page 2667

18.3 I/Q data output

The recorded I/Q data can be saved manually on hard disc or USB flash device for further analysis, or extracted using remote control from an external computer. If supported

by the Rohde & Schwarz analysis software, a direct connection and data usage via LAN is also possible.

Access: "Menu" > "Save/Recall" > "Save" tab > "Waveform"

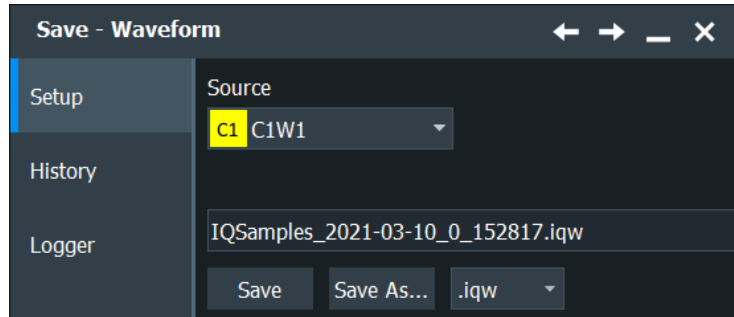

In I/Q mode, the "Save Waveform" dialog provides all functions to save the recorded I/Q data.

Source

Selects the channel for which the I/Q data is saved. For each input channel, a separate output file is written.

In case of a complex input signal that requires two input channels, the results of sources C1W1 and C2W1 are identical, as well as the results of C3W1 and C4W1.

Save IQ data to file

Enter the file name to save the I/Q data to. Double-tap the file name to open the file selection dialog box.

By default, the file name has the prefix "IQSamples_".

You can define a pattern for automatic naming in the "Autonaming" dialog, see [Chapter 4.8.1, "Autonaming"](#), on page 104.

"Save" Saves the I/Q data in the selected file.

"Save As..." Opens the file selection dialog box and saves the I/Q data to the selected file. See also [Chapter 12.5, "File selection dialog"](#), on page 490.

".iqw/.iq.tar/.bin" Selects the file format.

/.xml/.csv" IQW: specific format for analysis with R&S I/Q data analysis software. It contains the I and Q values in interleaved order.

IQ.TAR: iq-tar file format, packed format containing several files: an I/Q parameter XML file, an I/Q data binary file, and an optional I/Q preview XSLT file (style sheet). A detailed specification of the iq-tar file format is given in http://www.rohde-schwarz.com/en/manual/manual-r-s-iq-tar-file-format-specification-manuals-gb1_78701-37313.html.

CSV, XML, and BIN: usual formats, which are also used for common waveform export, see [Chapter 12.2.1, "Waveform export files"](#), on page 459.

Remote command:

[CHANnel<m>:IQ:DATA\[:VALues\]? on page 2668](#)

[CHANnel<m>:IQ:DATA:HEADer? on page 2669](#)

18.4 NFC trigger

The Near Field Communication (NFC) trigger triggers on characteristic events of NFC signals, in particular on polling requests of a device, for example, of a mobile phone.

The trigger source is the NFC signal connected to one of the channel inputs.

You can analyze the triggered signal in two ways:

- In normal instrument mode, you can display and analyze the signal in the time domain.
- In IQ mode, you can acquire and save I/Q data for external analysis on a computer. The R&S RTO6 display shows the magnitude of the I/Q vector.

Access: "Menu">"Trigger" > "Setup" tab > "Type = NFC"

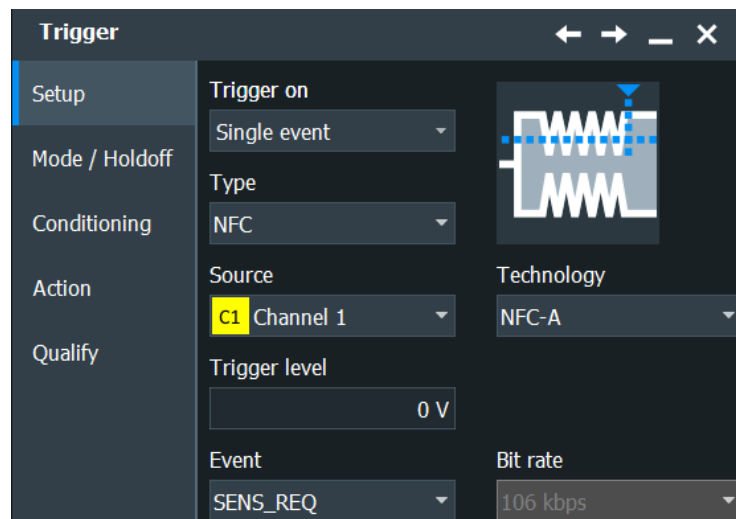

Technology

Selects the NFC technology, the communication protocol used by the input signal.

"NFC-A"	Compatible with ISO/IEC 14443A
"NFC-B"	Compatible with ISO/IEC 14443B
"NFC-F"	Compatible with JIS X6319-4 (FeliCa)

Remote command:

[TRIGger<m>:NFC:TECHnology on page 2669](#)

Bit rate

Sets the bit rate of the signal. For NFC-A and NFC-B, the bit rate is always 106 kBit per second. For NFC-F, the bit rate can be either 212 or 424 kBit per second.

Remote command:

[TRIGger<m>:NFC:BITRate](#) on page 2669

Event

Sets the trigger on:

- NFC-A:
ALL_REQ or SENS_REQ command (polling requests)
- NFC-B:
ALLB_REQ or SENSB_REQ command
- NFC-F:
Start of sequence pattern with 48 bit or 96-bit length

Remote command:

[TRIGger<m>:NFC:EVENT](#) on page 2670

Trigger level

Sets the voltage level for the trigger condition. You can also drag the trigger level marker on the display (TA or TB on the right edge of the display). The range of the trigger level is limited in a way so that always a hysteresis for stable trigger conditions is available.

Remote command:

[TRIGger<m>:LEVel<n>\[:VALue\]](#) on page 1487

19 Jitter analysis and clock data recovery

Jitter describes the timing errors in a system. It is a significant and undesired factor in high-speed serial communication designs because it causes transmission errors.

R&S RTO6 provides different options for analyzing jitter:

General jitter analysis (R&S RTO6-K12)

The jitter analysis option R&S RTO6-K12 provides common analysis and visualization tools for signal integrity analysis and jitter characterization:

- Automated jitter measurements in time domain like period, frequency, cycle-to-cycle jitter and skew
- Track graph of jitter measurement results
- Jitter spectrum
- Eye mask definition and analysis
- Software-based clock data recovery

See: [Chapter 19.1, "Jitter measurements \(options R&S RTO6-K12/K13\)"](#), on page 1084.

Advanced jitter analysis (R&S RTO6-K133)

The advanced jitter analysis option provides tools for detailed analysis including:

- All functionalities provided with option R&S RTO6-K12
- All data for total jitter, random jitter, periodic jitter, data-dependant jitter and deterministic jitter.
- Allows separation into horizontal and vertical components.
- Provides options for extensive result presentation, like histogram, spectrum, track, jitter bathtub graphics and synthetic eye diagram.

See: [Chapter 19.2, "Advanced jitter and noise \(option R&S RTO6-K133/K134\)"](#), on page 1094

Advanced jitter and noise analysis (R&S RTO6-K134)

The advanced noise analysis provides tools for detailed jitter and noise analysis including:

- All functionalities provided with option R&S RTO6-K133
- All data for total noise, random noise, periodic noise, data-dependant noise and deterministic noise.
- Allows separation into horizontal and vertical components.
- Provides options for extensive result presentation, like histogram, spectrum, track, noise bathtub graphics and synthetic eye diagram.

The different ways for analyzing jitter and noise are described in the following chapters.

In addition, the option R&S RTO6-K13 provides hardware-based clock data recovery. The resulting clock edge stream can be used as trigger source for the CDR trigger.

See: [Chapter 19.2, "Advanced jitter and noise \(option R&S RTO6-K133/K134\)"](#), on page 1094.

• Jitter measurements (options R&S RTO6-K12/K13)	1084
• Advanced jitter and noise (option R&S RTO6-K133/K134)	1094
• Clock data recovery	1135

19.1 Jitter measurements (options R&S RTO6-K12/K13)

This chapter describes the measurement setup in the "Jitter" category.

• Jitter measurements	1084
• Jitter measurement settings	1086
• Jitter statistics and histogram	1093
• Track of jitter measurement results	1093
• Jitter spectrum	1094

19.1.1 Jitter measurements









The measurement category "Jitter" gathers all measurements which are useful for jitter analysis. The category contains jitter-specific measurements. In addition, the following amplitude/time measurements are added to the jitter category, because they are useful for jitter analysis:

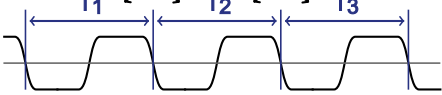

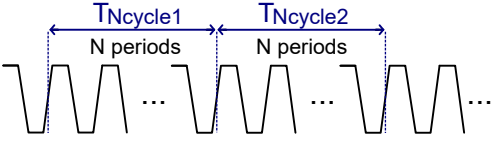

- Period
- Frequency
- Setup time
- Hold time
- Setup/Hold ratio

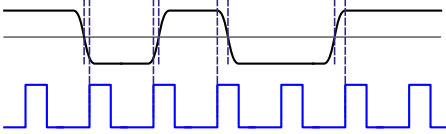
The amplitude/time measurements are described in "[Time measurements](#)" on page 318.

The specific jitter measurements are described in [Table 19-1](#).

Table 19-1: Jitter measurements

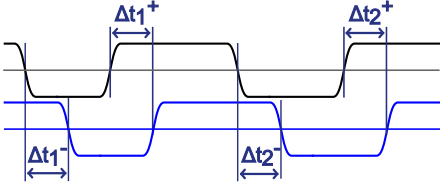
	Measurement	Description/Result
	Cycle-cycle jitter	<p>Difference between the periods of two adjacent cycles. The measurement is based on the period measurement. You can select the slope and the reference level on which the period is measured.</p> $\Delta T_{Period\ k} = T_{Period\ k+1} - T_{Period\ k} \quad \text{for } k = 1, \dots, K-1$ $\Delta T_1 = T_2 - T_1 \quad \Delta T_2 = T_3 - T_2$  <p>See also: Chapter 19.1.2.2, "Settings for clock measurements", on page 1087</p>
	N-cycle jitter	<p>Difference between the time of two adjacent groups of N cycles (periods) each. You can select the slope and the reference level on which the time is measured, and the number of periods in the groups.</p> $\Delta T_{Ncycle\ k} = T_{Ncycle\ k+1} - T_{Ncycle\ k} \quad \text{for } k = \text{cycle group index}$ $\Delta T_{Ncycle1} = T_{Ncycle2} - T_{Ncycle1}$ 
	Cycle-cycle width	<p>Difference between the pulse width of two adjacent cycles. The measurement is based on the pulse width measurement. You can select the pulse polarity to be measured.</p> $\Delta T_{Pulse\ k} = T_{Pulse\ k+1} - T_{Pulse\ k} \quad \text{for } k = 1, \dots, K-1$
	Cycle-cycle duty cycle	<p>Difference between the duty cycle of two adjacent cycles. The measurement is based on the duty cycle measurement. You can select the pulse polarity for the duty cycle measurement.</p> $\Delta R_{Cyc\ k} = R_{Cyc\ k+1} - R_{Cyc\ k} \quad \text{for } k = 1, \dots, K-1$
	Time interval error	<p>Time difference between the slope of the input signal and the slope of a reference signal. The reference signal can be a captured clock waveform, or a clock generated by clock data recovery (CDR, software algorithm or hardware generation). You can select the slope and the reference level on which the TIE is measured.</p> $TIE_k = t_{Signal\ k} - t_{Clock\ k} \quad \text{for } k = 1, \dots, K$  <p>See also: Chapter 19.1.2.3, "Data measurement settings", on page 1089</p>
	Unit interval	<p>Period of the clock signal. If no clock signal is available, it is recovered by CDR. The period is calculated as the time difference between two consecutive clock edges of the same polarity.</p> $UI_k = t_{Clock\ k+1} - t_{Clock\ k} \quad \text{for } k = 1, \dots, K-1$

	Measurement	Description/Result
	Data rate	Frequency of the clock signal. If no clock signal is available, it is recovered by CDR. The measurement is based on the unit interval measurement. $R_{Clock\ k} = 1 / UI_k$ for $k = 1, \dots, K-1$
	Skew delay	Delay between the edges of two interdependent waveforms. The measurement is a simplified variant of the "Delay" measurement assuming that both sources are similar except for the delay. $Skew\ delay = \Delta t_k = t_{Source2} - t_{Source1}$ for $k = 1, \dots, K$ 
	Skew phase	Phase difference between the edges of two waveforms. $Skew\ phase = Skew\ delay / Period * 360^\circ = \Delta t_k / \Delta T_{Period\ k} * 360^\circ$

Limit and margin checks are also available for jitter measurements, see [Chapter 8.2.12, "Limit and margin checks"](#), on page 369. Limit and margin checks are based on the amplitude/time measurements.

19.1.2 Jitter measurement settings

19.1.2.1 Measurement selection

Access: [Measure] > "Setup" tab > "Jitter" category

Jitter measurements are only available for sources in the time domain.

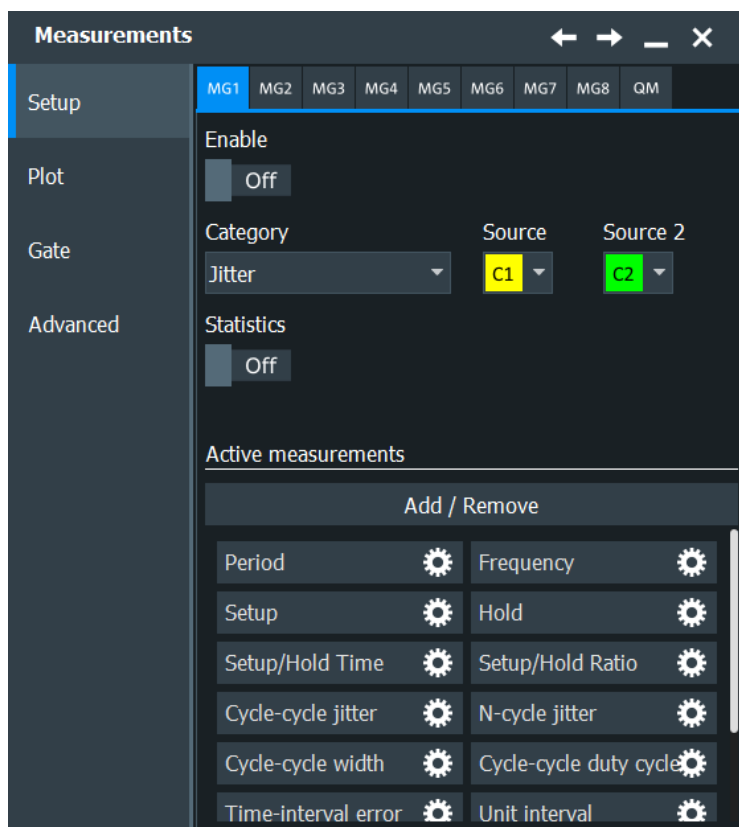

Active Measurements

The "Active Measurements" list shows the measurements that are selected in the selected category. At least, one measurement must be selected. If further settings are available for a measurement, a settings icon is shown beside the measurement's name.

To change the selection, tap "Add / Remove".

For details on the available measurements, see [Chapter 19.1.1, "Jitter measurements"](#), on page 1084.

If option R&S RTO6-K135 you can define signals with higher "PAM order". For signals with a "PAM order" > 2 only the following jitter measurements are available: "Time interval error", "Data rate", "Unit interval".

Remote command:

[MEASurement<m>:MAIN](#) on page 1587

[MEASurement<m>:ADDITIONAL](#) on page 1588

19.1.2.2 Settings for clock measurements

The cycle-cycle measurements are intended to analyze the quality of clock signals. They require a few additional settings for period and pulse width measurement. See also: [Table 19-1](#)

- ▶ To configure a measurement, tap it in the "Active Measurements" list.

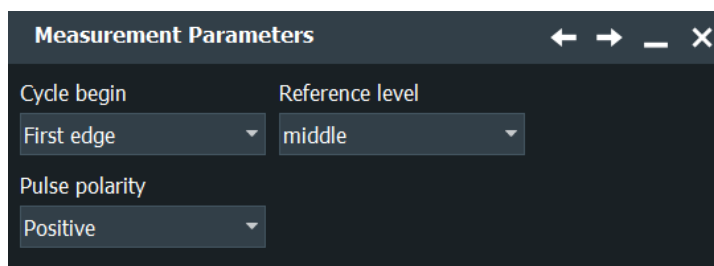

Cycle begin

Selects the slope at which the periods and thus the jitter is measured.

The setting is available for the following measurements: cycle-cycle jitter, N-cycle jitter, and cycle-cycle duty cycle.

"First edge"	Measures the period from the first edge that is found, no matter of its direction.
"Positive"	Measures the period at positive going edges.
"Negative"	Measures the period at negative going edges.
"Either"	Measures the period at both positive and negative going edges. This option is useful, for example, to check the clock stability of a double data rate clock.

Remote command:

[MEASurement<m>:JITTer:CCSLope](#) on page 2672

Ref level

The setting defines the "Data ref level" for setup and hold measurements, and for time-interval error measurements (option R&S RTO6-K12). It selects the reference level of the data signal on which the time is measured. The intersection of slope and reference level defines the time point for measurements.

For clock jitter measurements (option R&S RTO6-K12), it sets the "Reference level" for the time measurement.

Remote command:

[MEASurement<m>:AMPTime:DATA<n>:LSElect](#) on page 1602

Pulse polarity

Sets the polarity of pulses for which the pulse width is measured to obtain the cycle-cycle width and the cycle-cycle duty cycle.

The setting is available for the following measurements: cycle-cycle width and cycle-cycle duty cycle.

"Positive"	Pulse width of positive pulses is measured.
"Negative"	Pulse width of negative pulses is measured.

Remote command:

[MEASurement<m>:JITTer:PULSe](#) on page 2672

Number of cycles

Sets the number of periods (cycles) that are accumulated to measure the N-cycle jitter.

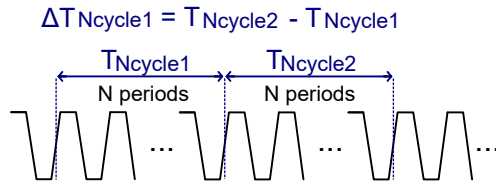

Remote command:

[MEASurement<m>:JITTer:NCYCles](#) on page 2673

19.1.2.3 Data measurement settings

The following measurements are intended to analyze serial data. The clock can be a captured clock signal, or it can be recovered from the data signal using one of the clock recovery algorithms:

- Time interval error
- Unit interval
- Data rate

► To configure a measurement, tap it in the "Active Measurements" list.



Figure 19-1: Settings for time interval error measurement with real clock signal

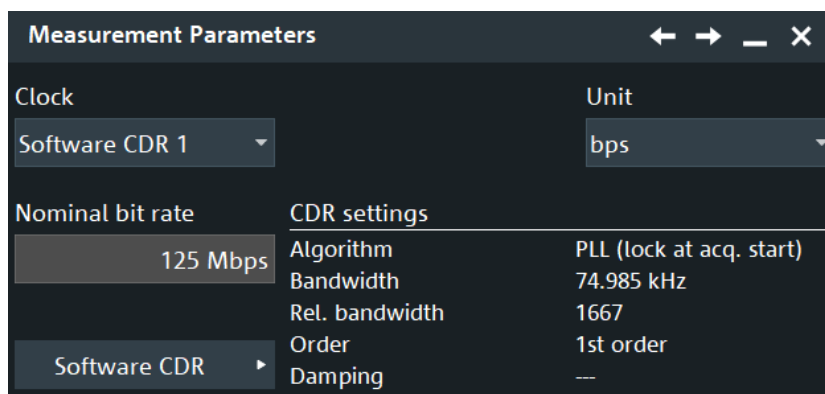

Figure 19-2: Settings for data rate measurement with software clock recovery

Clock

Defines the origin of the clock signal - either an existing clock signal or waveform, or a clock generated using one of the CDR methods.

The setting is available for the following measurements: time-interval error, unit interval and data rate.

- "Explicit signal" The clock is an existing clock signal. Select the clock source, clock slope, and the reference level.
- "Software CDR 1 / 2 / 3 / 4" The clock is generated by a software algorithm. The R&S RTO6 provides two setups for software CDR, which can be configured and used independently. To configure the CDR, tap the "Software CDR" button.
- "Hardware CDR" The clock is generated from the source signal by the integrated CDR circuitry. To configure the CDR, tap the "Hardware CDR setup" button.
The HW CDR must be active to perform the measurement. To activate HW CDR, use the trigger type "CDR", or the trigger type "Serial pattern" with active CDR.

Note: For TIE measurement results with HW CDR, set "UI offset = 0". Other values introduce a timing offset in the results.

Remote command:

[MEASurement<m>:JITTer:CDRMode](#) on page 2673

Slope

Sets the edges that are used for measurements.

For time-interval error measurement, you set the data slope, and the clock slope if the clock is a real signal. For unit interval and data rate measurements, you set only the clock slope if the clock is a real signal.

- "Positive" The positive clock slope can be used, for example, for single data rate (SDR) signals with bit start at the positive clock edge.
- "Negative" The negative clock slope can be used, for example, for SDR signals with bit start at the negative clock edge.

"Either" For clock edges, this option can be used for double data rate (DDR) signals.
For data edges, it is the most common setting.

Remote command:

[MEASurement<m>:JITTer:SOURce<n>:TIESlope](#) on page 2674

Clock ref level

Selects the reference level of the clock on which the time is measured. The intersection of slope and reference level defines the time point for measurements.

The setting is used for setup and hold measurements, and for jitter measurements (option R&S RTO6-K12).

Remote command:

[MEASurement<m>:AMPTime:CLCK<n>:LSElect](#) on page 1602

Ref level

The setting defines the "Data ref level" for setup and hold measurements, and for time-interval error measurements (option R&S RTO6-K12). It selects the reference level of the data signal on which the time is measured. The intersection of slope and reference level defines the time point for measurements.

For clock jitter measurements (option R&S RTO6-K12), it sets the "Reference level" for the time measurement.

Remote command:

[MEASurement<m>:AMPTime:DATA<n>:LSElect](#) on page 1602

Unit

Sets the unit to bps (bit per second), or to Hz for analysis of radar signals. The setting is available for data rate measurements.

Remote command:

[MEASurement<m>:JITTer:DRUNit](#) on page 2675

19.1.2.4 Delay measurement settings

Skew delay and skew phase measurements are intended to measure the time difference between the edges of two waveforms. The measurements are simplified variants of the "Delay" and "Phase" measurements assuming that both sources are similar except for the delay.

See also: [Table 19-1](#)

- ▶ To configure a measurement, tap it in the "Active Measurements" list.

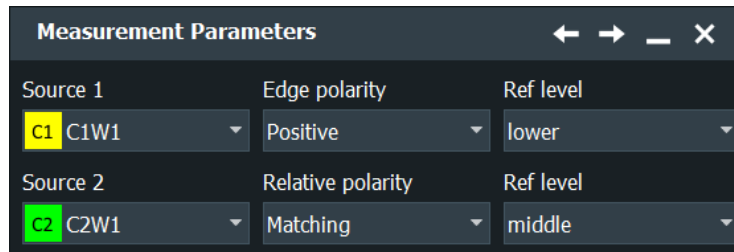
**Source 1, Source 2**

"Source 1" is the reference signal, and "Source 2" is the signal compared to the reference signal.

$$\text{Skew delay} = \Delta t_k = t_{\text{Source2}} - t_{\text{Source1}} \quad \text{for } k = 1, \dots, K$$

Edge polarity

Sets the edge of the first waveform from which the skew delay or phase is measured: positive, negative or both.

Remote command:

[MEASurement<m>:JITTer:SKWSlope](#) on page 2675

Relative polarity

Sets the edge of the second waveform relative to the first waveform.

"Matching" Measures from positive to positive edge or from negative to negative edge.

"Inverse" Measures from positive to negative edge or from negative to positive edge.

Remote command:

[MEASurement<m>:JITTer:SKWRelation](#) on page 2675

Data ref level / Clock ref level

See ["Ref level"](#) on page 326 and ["Clock ref level"](#) on page 325.

19.1.2.5 Example: measuring TIE with HW CDR

To measure the time interval error with hardware-recovered clock, the option R&S RTO6--K13 is required.

1. Configure the HW CDR settings according to the characteristics of the measured signal.
2. Set up the trigger:
 - a) "Menu">"Trigger" > "Setup" > "Source" = channel of the input signal > Trigger type = CDR
 - b) Tap "Find level" to determine the trigger level.
3. Configure the measurement:
 - a) On the "Measure" menu, select "Setup".
 - b) Select the "Jitter" category.

- c) Tap "Add / Remove" and select "Time interval error".
- d) Tap "Time interval error" in the "Active measurements" list.
- e) Select the "Data slope" and the reference level to be used to measure the jitter.
- f) Select the "Clock = Hardware CDR".
- g) In the "Measure" > "Setup" tab, enable the measurement.
- h) Enable "Statistics".

19.1.3 Jitter statistics and histogram

Since jitter is a random component of all signals, statistical measurement results are required to characterize the jitter.

To get measurements statistics of a jitter measurement

Prerequisite: the jitter measurements are selected and configured, and the measurement group is active.

1. Double tap the "Meas Results" box.
The "Measurement" toolbar assist opens.



2. In the overlay menu, enable "Statistics state".
3. Tap "Advanced Setup".
4. On the "Measure" > "Advanced" tab, enable "Measure all events in each acquisition".

The histogram plots the density of data. It shows the frequency of occurrence of the measurement values. The maximum count of a measurement value is assigned to the full height of the histogram diagram (= 1000). All other count values are displayed relative to the maximum.

To enable the histogram

1. On the "Plot" tab, enable the "Histogram".
2. If the histogram is not displayed as expected, disable "Continuous auto scale" and adjust the "Meas scale".

19.1.4 Track of jitter measurement results

A track graph displays the results of the first jitter measurement from a single acquisition as a time-correlated waveform. To generate the track graph, multiple measurement points are required. Thus, enabling the track automatically activates "Measure all events in each acqu.".

You can measure amplitude and time on the track waveform: Configure a new measurement group, e.g. "MG2", that uses the track waveform as measurement source.

You can also zoom into the track waveform, perform cursor measurements on it, and export the track.



Figure 19-3: TIE measurement with CDR trigger, 10 Mbps, with track and histogram

19.1.5 Jitter spectrum

An extension of jitter measurements is the FFT analysis of track waveforms of jitter measurements. The results are displayed in the frequency domain as a jitter spectrum. The modulation frequency is displayed on the horizontal axis, and the amplitude of modulation on the vertical axis. Using FFT, periodic components can be detected.

19.2 Advanced jitter and noise (option R&S RTO6-K133/ K134)

This chapter describes the settings of the advanced jitter option R&S RTO6-K133 and of the advanced noise option R&S RTO6-K134.

19.2.1 About jitter

Jitter typically consists of various jitter components that are caused by different jitter sources, see [Figure 19-4](#).

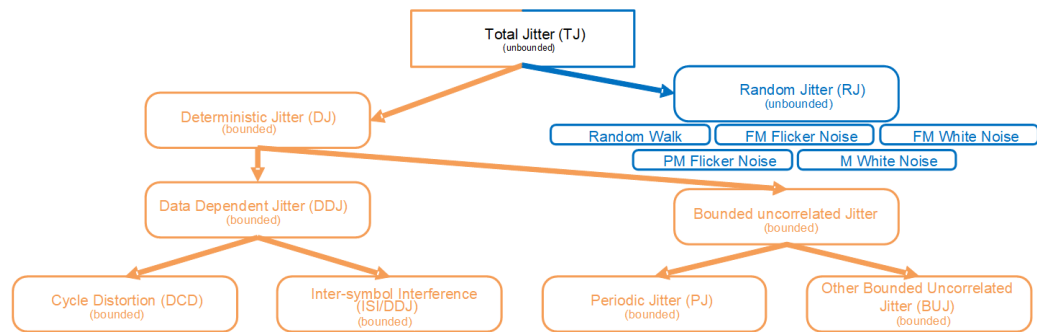

Figure 19-4: Jitter decomposition tree

With the advanced jitter option R&S RTO6-K133, you can perform different measurements for calculating and displaying the different jitter components.

For the analysis of jitter, it is important to understand these sources and the contributions to the total jitter (TJ). For an analytical approach, a jitter model is frequently used, which splits jitter into the two major categories of random and deterministic jitter.

The jitter of the different components has different causes. Knowing what jitter component is influencing your system can help you identify what phenomenon causes the jitter.

Deterministic jitter

Deterministic jitter (DJ), also called systematic jitter, is further broken down into periodic jitter (PJ) and data-dependent jitter (DDJ). Deterministic jitter is bounded and specified as peak-to-peak value.

Periodic jitter

Periodic jitter (PJ) is caused by a periodic disturbance. Though this signal is not necessarily sinusoidal, it is frequently also named sinusoidal jitter. The amplitude of the periodic signal bounds the jitter.

A strong local RF oscillator, a switch-mode power supply, undesired crosstalk or an unstable, oscillating PLL cause period jitter due to an unintentional coupling into the signal.

Data-Dependent jitter

Inter-symbol interference (ISI) causes data-dependent jitter (DDJ). When ISI is present, the signal is disturbed with an attenuated, time-shifted copy of itself or spectral parts of itself.

Random jitter

Random jitter is unbounded and commonly specified by the standard deviation σ . Due to its irregular nature, random jitter (RJ) is uncorrelated to any other signal and unpredictable in timing behavior. Contributions to the random jitter are thermal noise, shot noise, $1/f$ noise and other physical effects.

19.2.2 About noise

Noise describes the amplitude deviation of a data symbol at the sampling time respective to a corresponding reference level. These deviations or level errors (LE) are caused by various sources.

The total noise is split into two main components: random noise (RN) and deterministic noise (DN). DN consists of periodic noise (PN) and non-periodic components.

The advanced noise algorithm enables various selectable result plots of the activated noise components in the results tab.

19.2.3 Configuring the advanced jitter

To perform an advanced jitter analysis:

1. Open the "Analysis" > "Advanced Jitter" menu.
2. In the "Signal" tab, set up the analyzed signal and reference signal.
3. In the "Advanced Settings" tab, configure the "Data dependent" settings.
4. If necessary, enable "Periodic"/"(Other) bounded uncorrelated".
5. In the "Result" tab, enable all general and component-specific results diagrams, that you want to display.
6. In the "Result" tab, "Add/ remove components". A dialog opens, where you can enable all required measurements.
7. Press "Enable" to view all selected measurement results and diagrams.

19.2.4 Signal settings

Access: App Cockpit> "Analysis" > "Advanced Jitter / Noise" > "Signal" tab

In the "Signal" tab, you can set up the signal you want to analyze and define the reference clock signal.

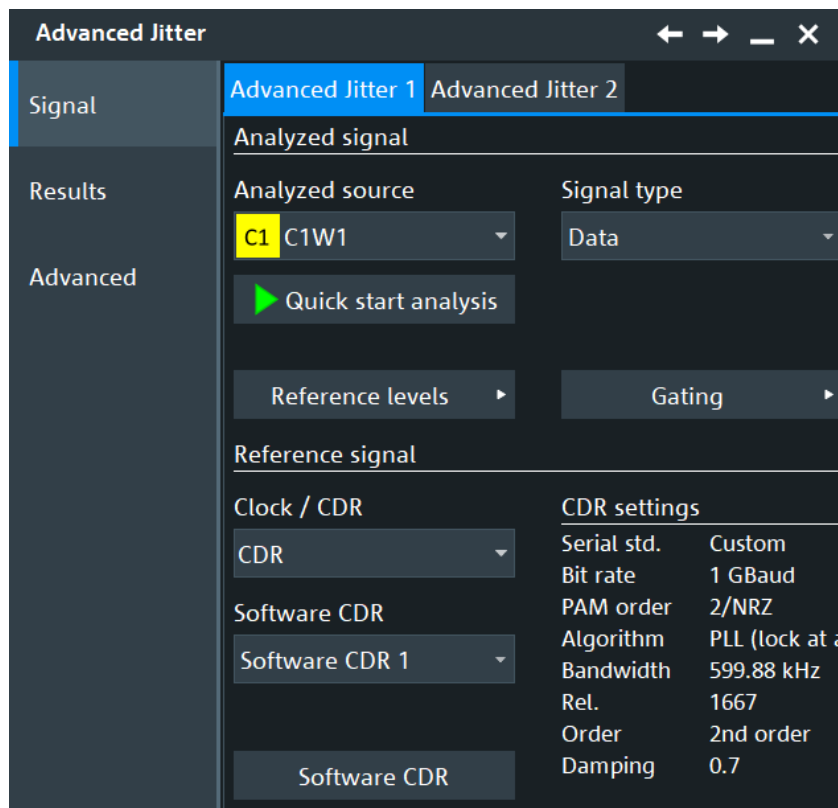

Analyzed source

Selects the source for the advanced jitter analysis.

Remote command:

[ADVJitter<m>:SIGnAl:SOURce](#) on page 2677

Signal Type

Select, if the analyzed signal is a data or clock signal.

Remote command:

[ADVJitter<m>:SIGnAl:TYPE](#) on page 2677

Quick start analysis

Starts a quick advanced jitter analysis.

Before starting the quick start analysis, set the [Analyzed source](#) and the [Signal Type](#).

The quick start analysis performs the following:

- A bit rate estimation is performed on the applied signal.
- A software CDR of second order is used as reference signal for the jitter analysis.
- Enables basic measurement "Event Count" and advanced jitter components: TJ@BER, RJ, TJ, DJ and PJ.
- In the "Result" dialog it enables:
 - "Bathtub" for total jitter @ BER (TJ@BER).
 - "Step response" for the analyzed source signal.
 - "Histogram" for RJ, TJ, DJ, DDJ and PJ.
- Enables the advance jitter measurement analysis.

Remote command:

[ADVJitter<m>:SIGNal:QUICKmeas](#) on page 2677

Reference Level

Opens a dialog to set the reference levels. For details, see [Chapter 13.3, "Signal and reference levels for NRZ signals"](#), on page 495.

Gating

Opens a dialog to set up the gate of the waveform for the advanced jitter analysis. The gate limits the measurement to a user-defined range of the waveform.

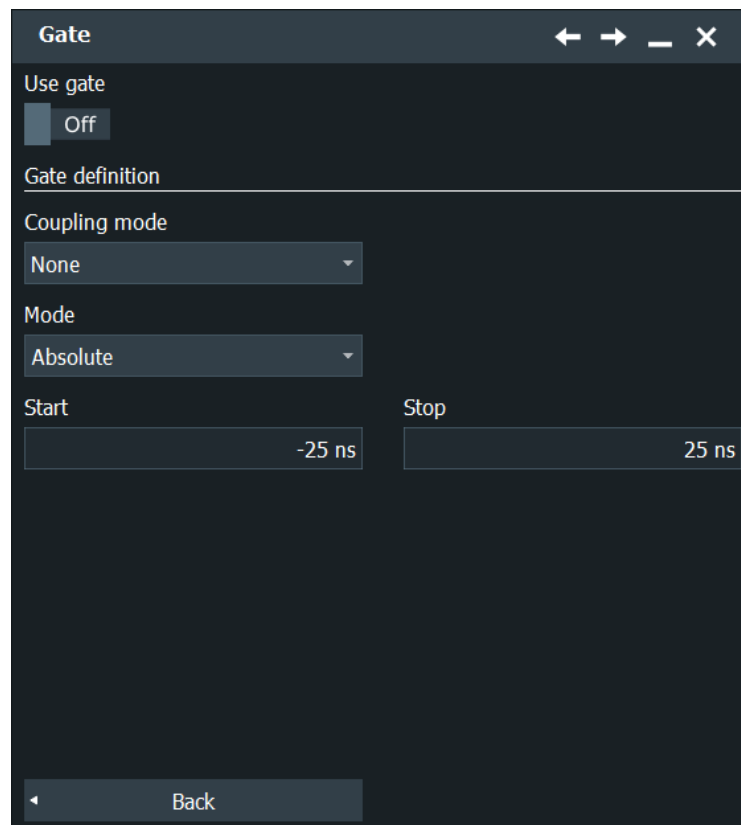

Use gate ← Gating

Enables the gating setup.

Remote command:

[ADVJitter<m>:SIGNal:GATE:STATE](#) on page 2683

Coupling mode ← Gating

Selects if the gate is coupled to the zoom or cursor.

To use the coupling mode, you have to enable a cursor or zoom first.

Remote command:

[ADVJitter<m>:SIGNal:GATE:COUPLing](#) on page 2680

Cursor / Zoom ← Gating

Selects the cursor/ zoom the gate is coupled to, if "Coupling mode" is set to "Cursor"/"Zoom".

Remote command:

[ADVJitter<m>:SIGNal:GATE:CURSor](#) on page 2681

[ADVJitter<m>:SIGNal:GATE:ZDIagram](#) on page 2682

Mode ← Gating

Selects if the gate area is defined in relative values (percent) or absolute.

Remote command:

[ADVJitter<m>:SIGNal:GATE:RANGe:MODE](#) on page 2682

Start / Stop ← Gating

Sets the start/stop time of the gate area.

Remote command:

[ADVJitter<m>:SIGNal:GATE:RANGe:ABSolute:STARt](#) on page 2681

[ADVJitter<m>:SIGNal:GATE:RANGe:ABSolute:STOP](#) on page 2681

Relative start / stop ← Gating

Sets the relative start/stop of the gate area in percent.

Remote command:

[ADVJitter<m>:SIGNal:GATE:RANGe:RELative:STARt](#) on page 2682

[ADVJitter<m>:SIGNal:GATE:RANGe:RELative:STOP](#) on page 2682

Clock / CDR

Selects if a clock or a CDR signal is used as a reference signal.

"CDR" Uses software clock data recovery.

"Clock" Uses an explicit clock signal. The clock must use an extra channel.

Remote command:

[ADVJitter<m>:SIGNal:REFSource](#) on page 2679

Reference source

Selects the reference source for the clock signal.

Remote command:

[ADVJitter<m>:SIGNal:CLKSource](#) on page 2679

Software CDR

Selects the reference software CDR..

Remote command:

[ADVJitter<m>:SIGNal:CDRMode](#) on page 2678

Nominal bit rate / Nominal symbol rate

Sets /displays the nominal bit rate. It corresponds to the data rate of the data stream from which the clock is to be recovered.

Remote command:

[ADVJitter<m>:SIGNal:BITRate](#) on page 2678

[ADVJitter<m>:SIGNal:SYMBOLrate?](#) on page 2678

Software CDR Setup

Opens a dialog for configuring the CDR. For details, see [Chapter 19.3, "Clock data recovery"](#), on page 1135.

Explicit clock

Opens a dialog to define the setting of the explicit clock.

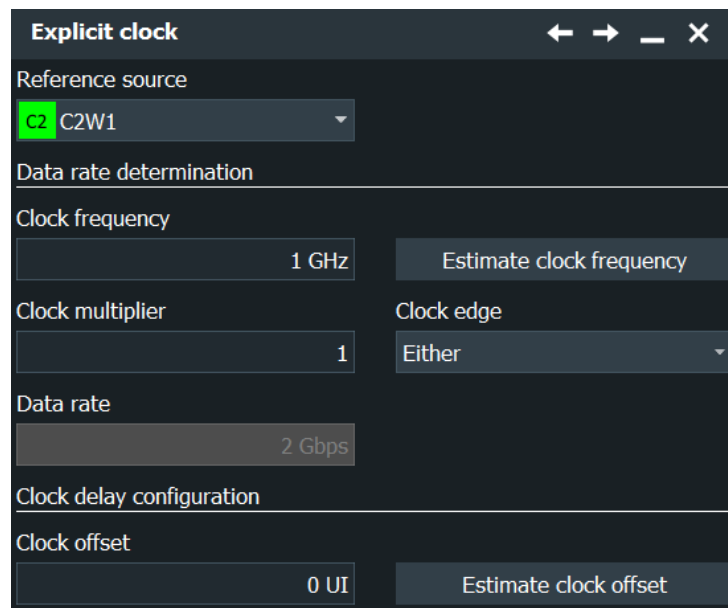

Clock frequency ← Explicit clock

Sets the clock frequency of the explicit clock signal. If this value is unknown, you can use "Estimate clock frequency".

Remote command:

[ADVJitter<m>:SIGNal:CLFRequency](#) on page 2680

Estimate clock frequency ← Explicit clock

Calculates an estimate value for the clock frequency.

Remote command:

[ADVJitter<m>:SIGNal:FREStimation](#) on page 2683

Clock multiplier ← Explicit clock

Sets a value for the clock multiplier, the ratio of an internal clock rate to the externally supplied clock.

Remote command:

[ADVJitter<m>:SIGNal:CLFFactor](#) on page 2679

Clock edge ← Explicit clock

The clock edge sets the point in time when the state of the data signal is checked:

"Positive"	Rising edge, a positive voltage change.
"Negative"	Falling edge, a negative voltage change.
"Either"	Both the rising and the falling edge.

Remote command:

[ADVJitter<m>:SIGNal:EDGE](#) on page 2679

Data rate ← Explicit clock

Displays the calculated data rate. It is calculated as follows:

*"Data rate" = "Clock frequency" * "Clock multiplier"*X*

Where X is:

- 1 for "Clock edge"= "Positive" or "Negative"
- 2 for "Clock edge"= "Either"

Remote command:

[ADVJitter<m>:SIGNal:DATRate?](#) on page 2680

Clock offset ← Explicit clock

Sets a clock offset. If this value is unknown, you can use "Estimate clock offset".

Remote command:

[ADVJitter<m>:SIGNal:CLOffset](#) on page 2680

Estimate clock offset ← Explicit clock

Calculates an estimate value for the clock offset.

Remote command:

[ADVJitter<m>:SIGNal:OFEstimation](#) on page 2683

19.2.5 Results

Access: "Analysis" menu > "Advanced Jitter" > "Result" tab.

In this tab, you can select the jitter components measurements that you want to perform and enable the results.

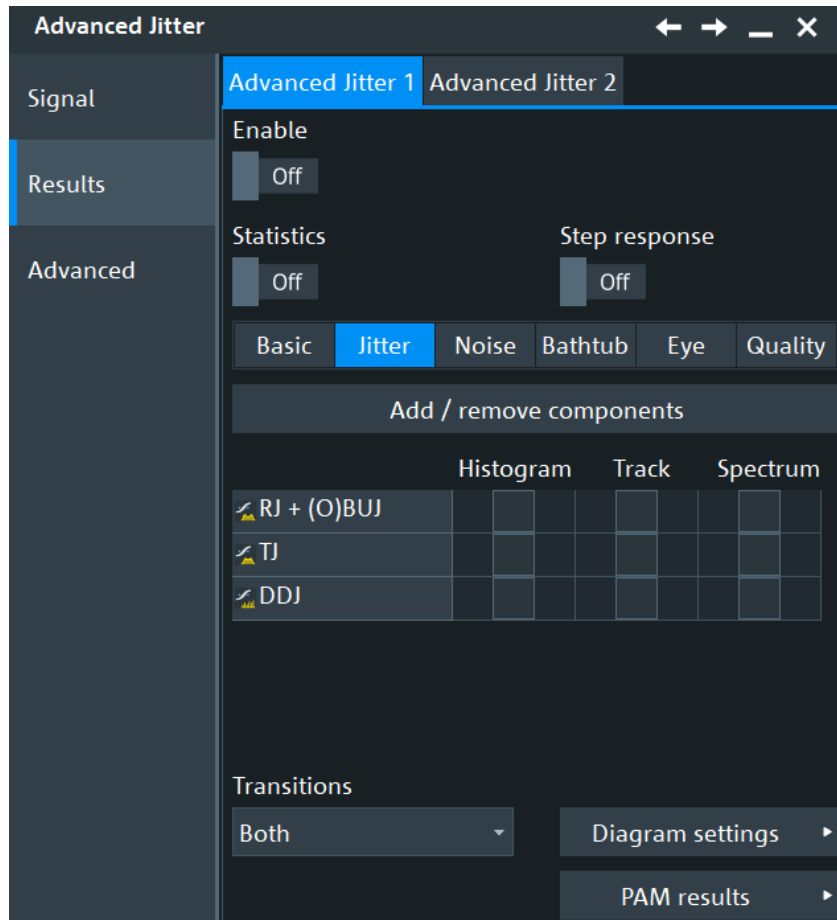

The advanced jitter option provides different ways to display your measurement results. In the "Result" tab, you can select which measurement results you want to display.

[Figure 19-5](#) and [Figure 19-6](#) show an example of the displayed advanced jitter and noise analysis results.

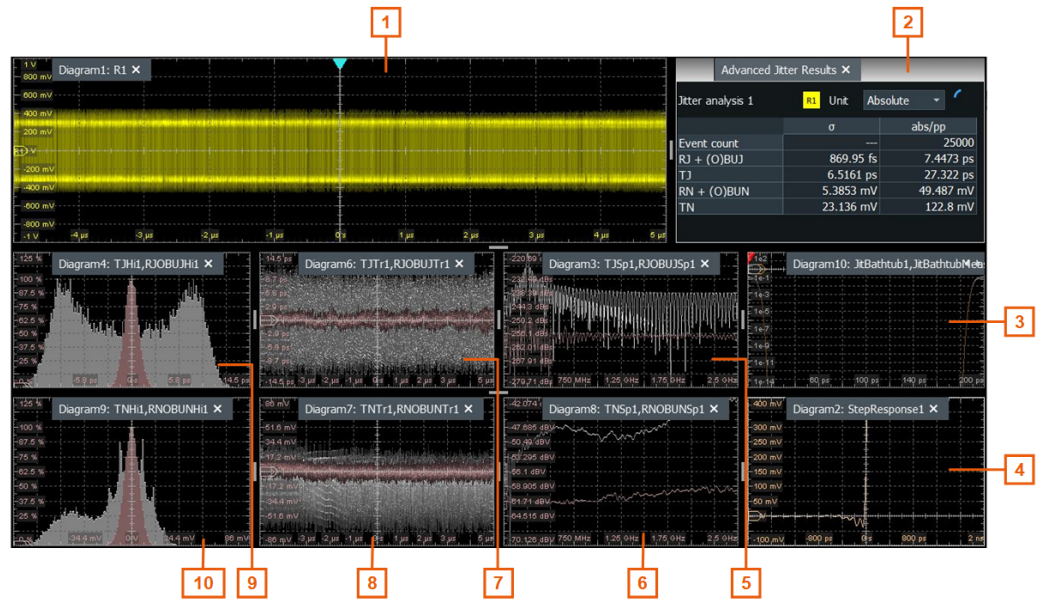

Figure 19-5: Advanced jitter and noise analysis results display

- 1 = Analyzed signal spectrum
- 2 = Advanced jitter results
- 3 = Jitter bathtub
- 4 = Noise bathtub
- 5 = Jitter spectrum
- 6 = Noise spectrum
- 7 = Jitter track
- 8 = Noise track
- 9 = Jitter histogram
- 10 = Noise histogram

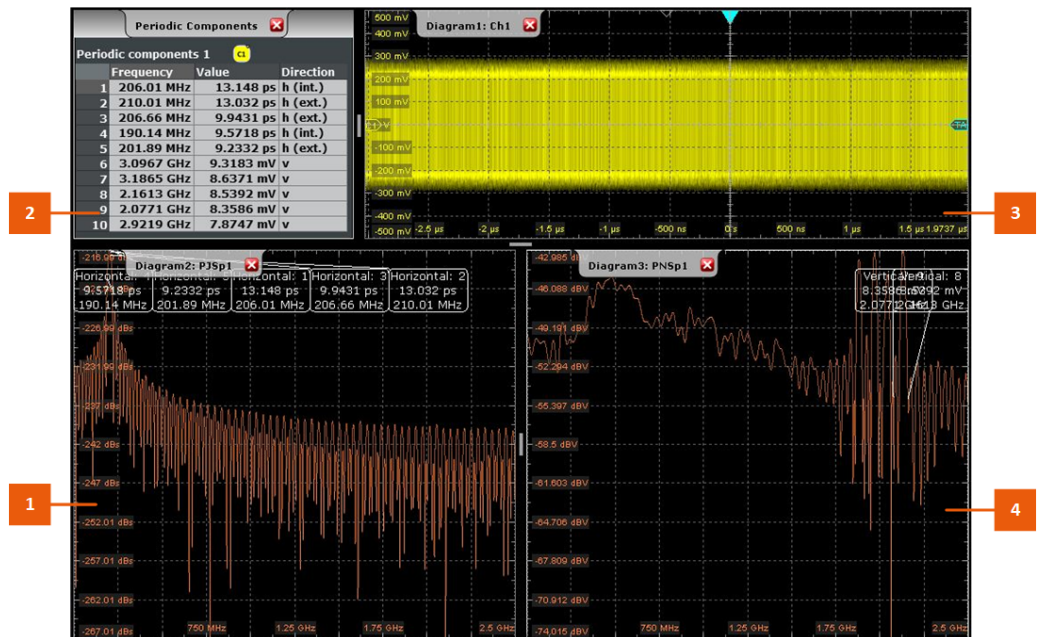

Figure 19-6: Advanced jitter and noise periodic results display

- 1 = Periodic jitter spectrum
- 2 = Periodic components results
- 3 = Analyzed signal spectrum
- 4 = Periodic noise spectrum

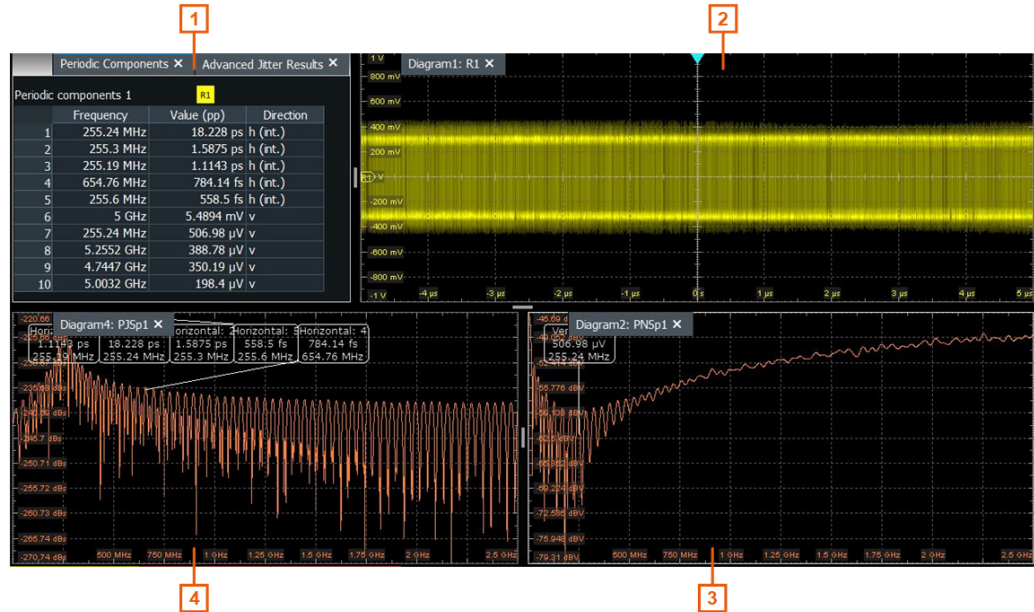

Figure 19-7: Advanced jitter and noise periodic results display

- 1 = Periodic components results
- 2 = Analyzed signal spectrum
- 4 = Periodic jitter spectrum
- 3 = Periodic noise spectrum

19.2.5.1 General settings

In the "General Settings" section of the "Results" dialog, you can enable the advanced jitter analysis, and select which results you want to display.

Enable

Enables the advanced jitter analysis. It displays all enabled diagrams and displays a table with the results for the component measurements. It also displays the measurement results for all enabled [Basic components](#), [Jitter Components](#).

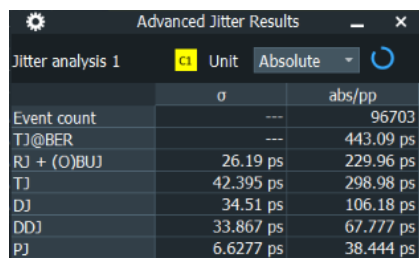

Figure 19-8: Advanced jitter results for NRZ signals

Remote command:

`ADVJitter<m>:RESult:ENABle` on page 2686

Statistics

Enables the calculation and display of statistical results. They include:

- "Min (abs/pp)": absolute minimum value of the component.
- "Max (abs /pp)": absolute maximum value of the component.
- "Min (σ)": minimum value of the standard deviation.
- "Max (σ)": maximum value of the standard deviation.
- "Wave count": The number of waveforms (acquisitions) the measurement is based on.

In the "Advanced Jitter Results" table, you can reset the statistics.

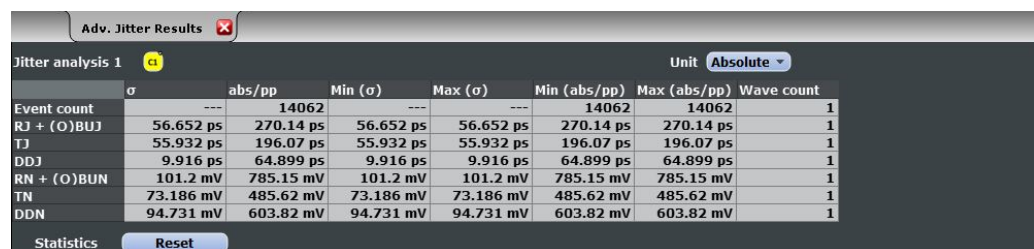

Event count	σ	abs/pp	Min (σ)	Max (σ)	Min (abs/pp)	Max (abs/pp)	Wave count
RJ + (O)BUJ	56.652 ps	270.14 ps	56.652 ps	56.652 ps	270.14 ps	270.14 ps	1
TJ	55.932 ps	196.07 ps	55.932 ps	55.932 ps	196.07 ps	196.07 ps	1
DDJ	9.916 ps	64.899 ps	9.916 ps	9.916 ps	64.899 ps	64.899 ps	1
RN + (O)BUN	101.2 mV	785.15 mV	101.2 mV	101.2 mV	785.15 mV	785.15 mV	1
TN	73.186 mV	485.62 mV	73.186 mV	73.186 mV	485.62 mV	485.62 mV	1
DDN	94.731 mV	603.82 mV	94.731 mV	94.731 mV	603.82 mV	603.82 mV	1

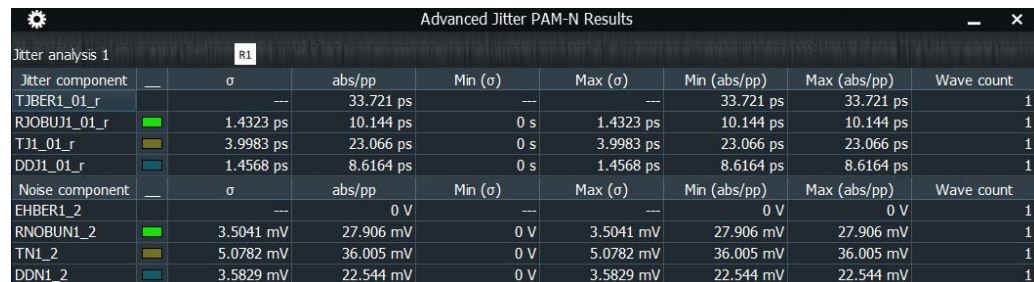

Jitter component	σ	abs/pp	Min (σ)	Max (σ)	Min (abs/pp)	Max (abs/pp)	Wave count
TJBER1_01_r	---	33.721 ps	---	---	33.721 ps	33.721 ps	1
RJOBUI_01_r	1.4323 ps	10.144 ps	0 s	1.4323 ps	10.144 ps	10.144 ps	1
TJ1_01_r	3.9983 ps	23.066 ps	0 s	3.9983 ps	23.066 ps	23.066 ps	1
DDJ1_01_r	1.4568 ps	8.6164 ps	0 s	1.4568 ps	8.6164 ps	8.6164 ps	1
Noise component	σ	abs/pp	Min (σ)	Max (σ)	Min (abs/pp)	Max (abs/pp)	Wave count
EHBER1_2	---	0 V	---	---	0 V	0 V	1
RNOBUN1_2	3.5041 mV	27.906 mV	0 V	3.5041 mV	27.906 mV	27.906 mV	1
TN1_2	5.0782 mV	36.005 mV	0 V	5.0782 mV	36.005 mV	36.005 mV	1
DDN1_2	3.5829 mV	22.544 mV	0 V	3.5829 mV	22.544 mV	22.544 mV	1

Figure 19-9: Advanced jitter results for PAM-N signals

Remote command:

`ADVJitter<m>:RESult:STATistics` on page 2687

Step response

Enables a step response diagram. The diagram displays the time behavior of the system when the inputs change from zero to one or from one to zero within a short time period.

You can set the [Length](#) and the [Step position](#) for the step response diagram in the "Advanced Settings" dialog.

For further analysis of the step response, you can use it as a source for "Amp/Time" measurements. See [Chapter 8.2.4, "Amplitude/time measurements"](#), on page 316.

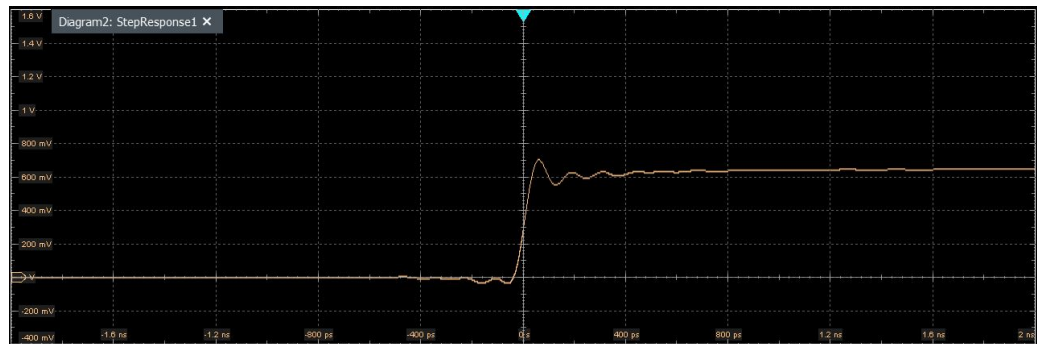

Remote command:

`ADVJitter<m>:REsult:STEPresponse` on page 2687

Component specific results

For the selected jitter component, selected you can display:

- "Histogram": displays a histogram of measurement results for the selected component - the cumulative occurrence distribution of measurement results in a graphic. You can enable a cursor and use it for further analysis.

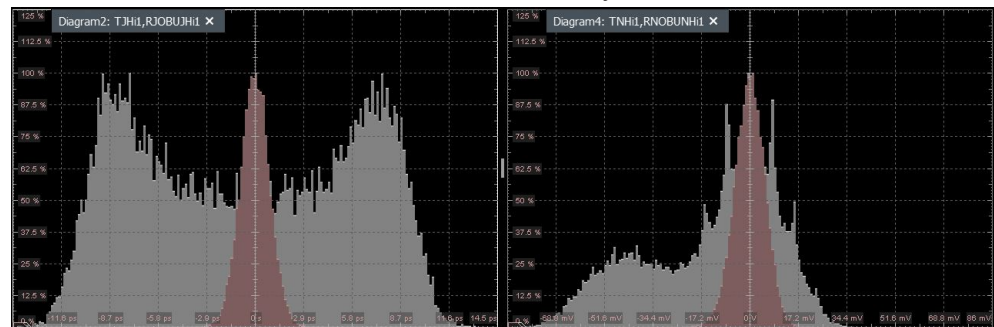

Figure 19-10: Jitter and noise histogram for NRZ signal

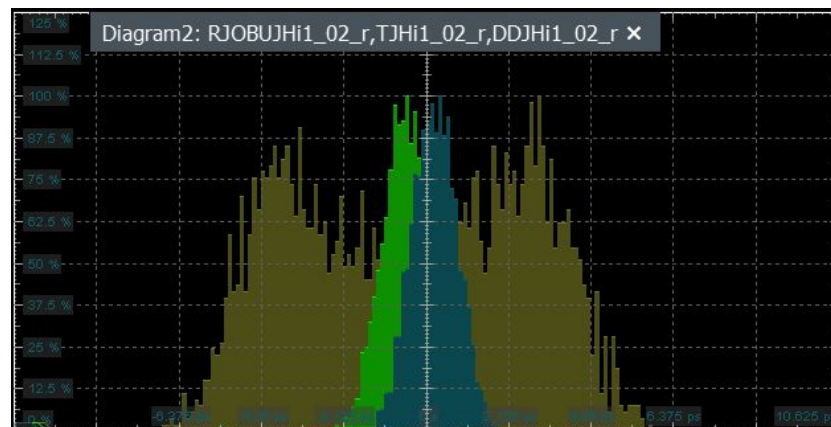

Figure 19-11: Jitter histogram PAM-N signal

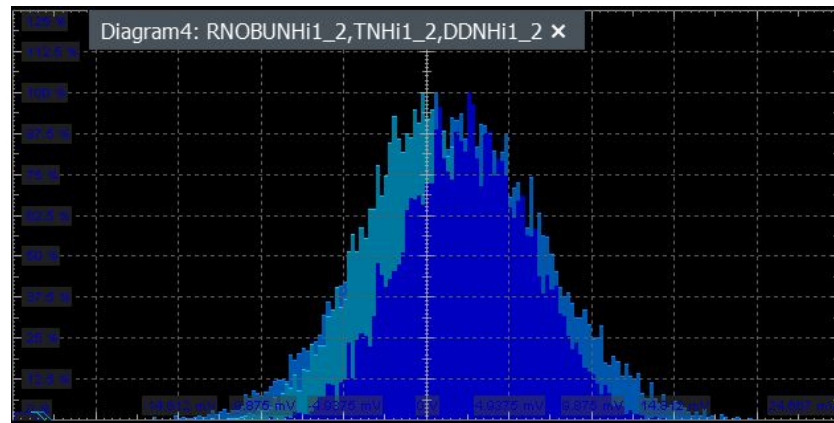

Figure 19-12: Noise histogram PAM-N signal

- "Track": the measurement results over time for an acquired waveform. It is the graphical interpretation of all measurement values of a single acquisition. Unlike the histogram, it reveals trends of change in the analysis and preserves the timing relationship of the measurement results to the signal.

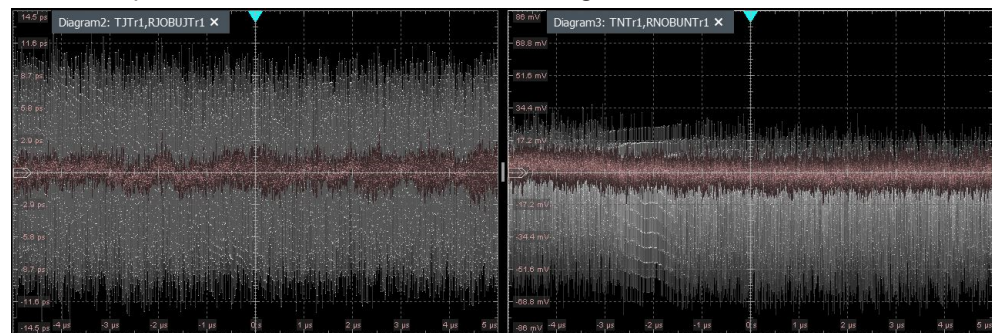

Figure 19-13: Jitter and noise track for NRZ signal

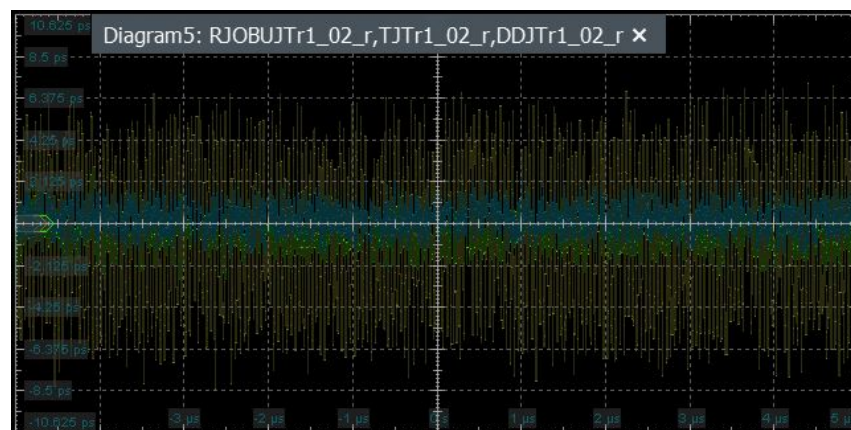

Figure 19-14: Jitter track PAM-N signal

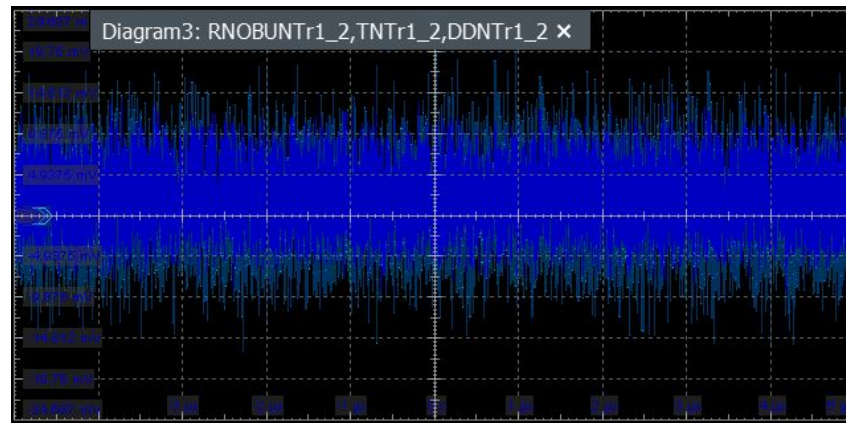
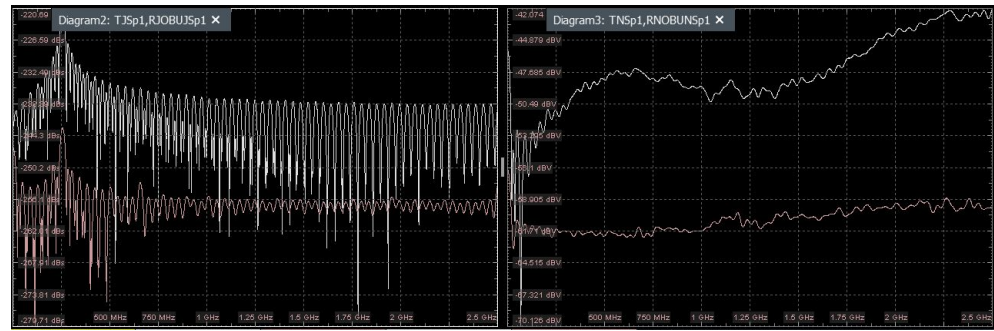

Figure 19-15: Noise track PAM-N signal

- "Spectrum": displays how the power of the signal is distributed over the frequency.



Remote command:

[ADVJitter<m>:RESult:COMPonents<n>:HISTogram](#) on page 2687

[ADVJitter<m>:RESult:COMPonents<n>:TRACk](#) on page 2688

[ADVJitter<m>:RESult:COMPonents<n>:SPECTrum](#) on page 2688

Unit

In the jitter results dialog, you can select the unit for the displayed results. The following values are available:

- For jitter measurements, you can select between absolute (seconds) and relative (unit intervals) values.
- For noise measurements, you can select between absolute (V) and relative (%) values.

Remote command:

[ADVJitter<m>:RESult:UNIT](#) on page 2688

19.2.5.2 Basic measurement settings

Access: "Analysis" menu > "Advanced Jitter" > "Result" tab > "Basic".

In the "Basic" tab, you can add measurements for better understanding of the collected data. You can then enable a histogram or track on them, see [Component specific results](#).

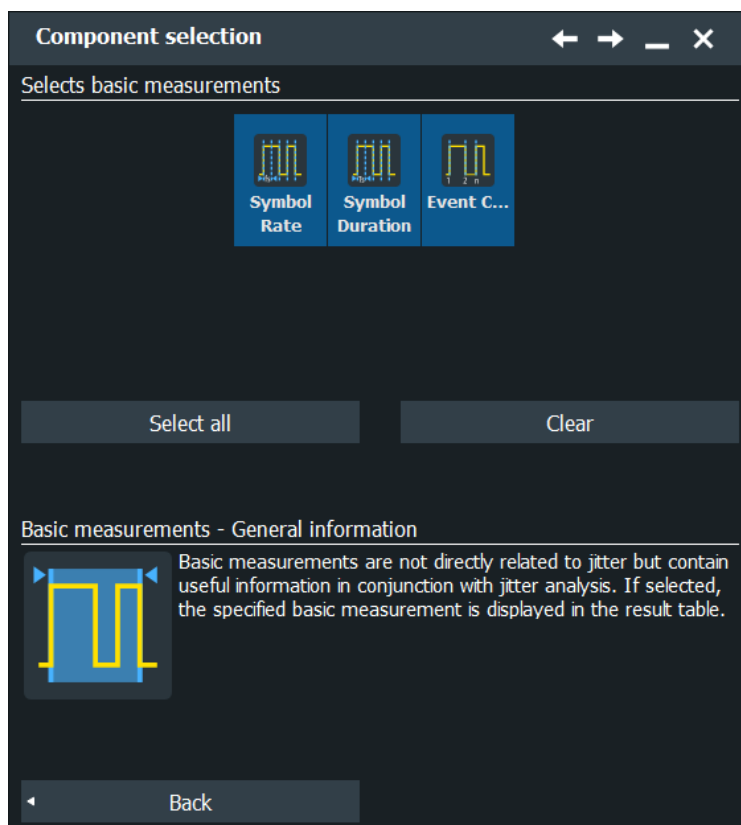

Add / remove components

Opens a dialog to select the jitter and noise components.

Basic components

To display the measurement results, "Enable" the advanced jitter analysis in the "Results" tab.

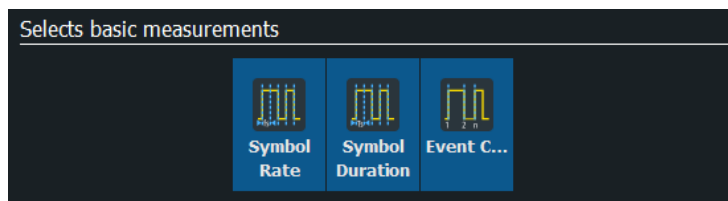

Table 19-2: Advanced jitter basic measurements

Measurement	Abbreviation	Description	S t d D e v	a p / D a t e s	H i s t o g r a m	T r a c k
Symbol rate	f_symb	Number of data symbols per second of the analyzed signal. It is equivalent to the baud rate. For binary signals, the signal rate is equal to the bit rate.		X	X	X
Symbol duration	T_symb	The length of time to transfer one signal symbol. Equals the inverse value of the symbol rate.		X	X	X
Event Count	EC	Number of analyzed data transitions.		X		

Remote command:

[ADVJitter<m>:DCOMposition:COMPONENTs<n>:ENABLE](#) on page 2687

Select all /Clear

Selects/clears all components in the basic dialog.

Remote command:

[ADVJitter<m>:DCOMposition:SELBasicmeas](#) on page 2691

[ADVJitter<m>:DCOMposition:CLEBasicmeas](#) on page 2691

19.2.5.3 Jitter measurement settings

Access: "Analysis" menu > "Advanced Jitter" > "Result" tab > "Jitter".

In the "Jitter" tab, you can add the jitter components you want to measure. You can then enable a histogram, track or spectrum on them, see [Component specific results](#).

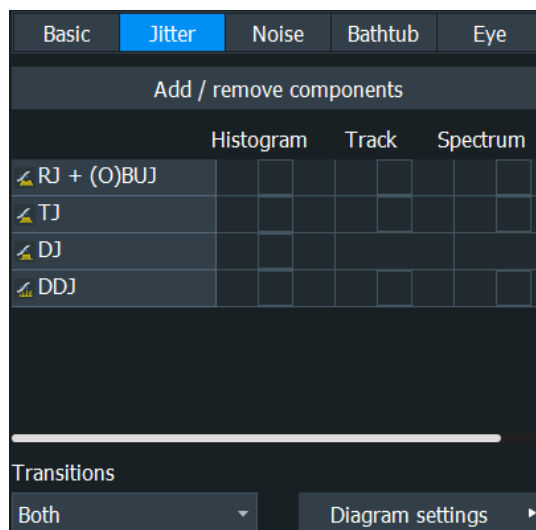

Add / remove components

Opens a dialog to select the jitter components.

Jitter Components

In the "Jitter" tab, you can select which jitter components you want to measure. For the enabled measurements you can display the results in different forms, see [Chapter 19.2.5.1, "General settings"](#), on page 1104.



Table 19-3: Advanced jitter components measurements

Measurement	Abbreviation	Description	Results		Diagram		
			Std Dev	ap/abs	Histogram	Trace	Spectrum
Total jitter at BER	TJ@BER	The eye closure at the user-defined target BER.		x			
Total jitter	TJ	Measures the total Time Interval Error (TIE) of the input signal. It is defined as the time between each transition of the input signal and its corresponding reference clock transition.	x	x	x	x	x
Deterministic jitter	DJ	The reproducible portion of the overall TIE of the input signal. It consists of the Data Dependent Jitter(DDJ), Periodic Jitter (PJ) and the Other Bounded Uncorrelated Jitter (OBUJ) components.		x			
Data-dependent jitter	DDJ	Consists of Inter-symbol Interference (ISI) and Duty Cycle Distortion (DCD). It depends on the symbol sequence. ISI is an effect commonly caused by limited signal bandwidth in the transmitter and transmission line, which forces influence from past symbols onto future symbols. DCD is a mismatch between rising and falling signal transitions due to reference level mismatch or other imbalances between transitions.	x	x	x	x	x
Duty cycle distortion ⁽³⁾	DCD	Measure of the imbalance between rising and falling data transitions. It is defined as the time difference between the average rising and average falling edge.		x			
Random plus (other) bounded uncorrelated jitter	RJ + (O)BUJ	Random jitter plus bounded uncorrelated jitter/ other bounded uncorrelated jitter is the combined effect of both jitter types. If periodic components are activated, RJ + OBUJ is displayed. Otherwise RJ + BUJ. RJ + (O)BUJ is typically used, if track or spectrum plots are desired. Both plots are not available for RJ only or (O)sBUJ only components as the time dependencies of these jitter types are unknown. RJ + (O)BUJ spectrum is a useful approximation of the RJ spectrum for negligible small (O)BUJ.	x	x	x	x	x

(1) Available, if (Other) bounded uncorrelated > "Enabled".

(2) Available, if Periodic > "Enabled".

(3) No results available, if "Transitions" is set to "Rising"/"Falling".

Measurement	Abbreviation	Description	Results		Diagram		
			Std Dev	aps	Histogram	Track	Spectrum
Periodic jitter ⁽²⁾	PJ	Caused by crosstalk from periodic signal sources to the transmitter or transmission line. It represents the harmonic portion of the overall time interval error (TIE).	x	x	x	x	x
Deterministic Dual-Dirac jitter	DJ (δ - δ)	Industry standard approximation to the deterministic jitter measurement, calculated by fitting a model of two overlapping, equally large Gaussian distributions to the observed TJ histogram. The calculated value is the time difference between the two distributions center points.		x			
Inter-Symbol interference	ISI	The time between the earliest and the latest signal transition of a single transition type, i.e. rising and falling edges. The measurement result is the largest value across all transition types.		x			
Data-dependent and periodic jitter ⁽²⁾	DDJ + PJ	Consist of the data-dependent and periodic jitter DDJ+PJ is the same as deterministic jitter minus other bounded uncorrelated jitter. In contrast to deterministic jitter, DDJ+PJ offers track and spectrum plots. DDJ+PJ spectrum is a useful approximation of the deterministic jitter spectrum for negligible small other bounded uncorrelated jitter.	x	x	x	x	x
Other bounded uncorrelated jitter ⁽¹⁾	(O)BUJ	Composite impact of all unknown but deterministic portions of the overall time interval error of the input signal. It consists of any disturbance that comes from a deterministic source but cannot be reproduced from the input signal. Often it is caused by crosstalk from other data signals.	x	x	x		
<p>⁽¹⁾ Available, if (Other) bounded uncorrelated > "Enabled".</p> <p>⁽²⁾ Available, if Periodic > "Enabled".</p> <p>⁽³⁾ No results available, if "Transitions" is set to "Rising"/"Falling".</p>							

Measurement	Abbreviation	Description	Results		Diagram		
			Std Dev	aps	Histogram	Tracks	Spectrum
Other bounded uncorrelated Dual-Dirac jitter ⁽¹⁾	(O)BUJ (δ - δ)	Other bounded uncorrelated Dual-Dirac jitter (O)BUJ (δ - δ) is an industry standard approximation to the other bounded uncorrelated jitter measurement. It is calculated by fitting a model of two overlapping, equally large Gaussian distributions to the observed RJ+(O)BUJ histogram. The calculated value is the amplitude difference between the two distributions center points.		x			
Random jitter ⁽¹⁾	RJ	Consists of any influence that cannot be predicted with model parameters. Usually, this jitter component follows a Gaussian probability distribution. The algorithm computes the standard deviation and the peak-peak value of the TIE caused by RJ within the analyzed waveform.	x		x		

(¹) Available, if (Other) bounded uncorrelated > "Enabled".
(²) Available, if Periodic > "Enabled".
(³) No results available, if "Transitions" is set to "Rising"/"Falling".

To display the measurement results, "Enable" the advanced jitter analysis in the "Results" tab.

Remote command:

[ADVJitter<m>:DCOMposition:COMPonents<n>:ENABle](#) on page 2687

Select all /Clear

Selects/clears all components in the jitter dialog.

Remote command:

[ADVJitter<m>:DCOMposition:CLEJitcomp](#) on page 2691

[ADVJitter<m>:DCOMposition:SELJitcomp](#) on page 2691

Transitions

Selects which transitions are considered for the display of the diagrams, rising, falling or both. This setting is mostly relevant for histograms, tracks and the measurement results.

Remote command:

[ADVJitter<m>:RESult:TRANSitions](#) on page 2692

19.2.5.4 Noise measurement settings

Available for option R&S RTO6- K134.

Access: "Analysis" menu > "Advanced Jitter" > "Result" tab > "Noise".

In the "Noise" tab, you can add the noise components you want to measure. You can then enable a histogram, track or spectrum on them, see [Component specific results](#).

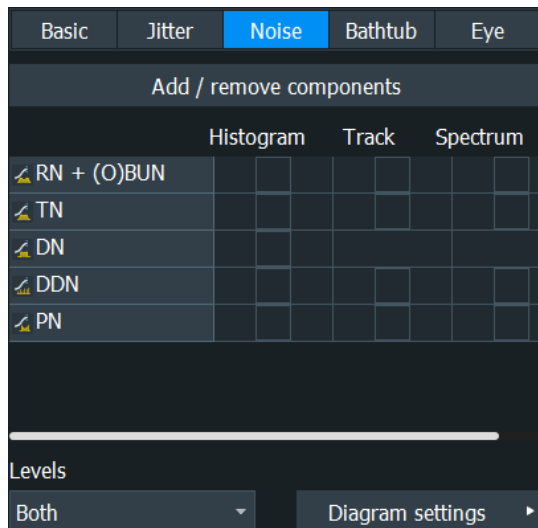

Add / remove components

Opens a dialog to select the noise components.

Noise components

In the "Noise" tab, you can select which jitter noise components you want to measure.

Component selection

← → - ✕

Select noise components

 EH@BER	 RN + (O)BUN	 TN	 DN	 DDN	 LD	 PN
 ISIN	 DDN + PN	 (O)BUN	 (O)BUN (δ - δ)	 RN		

Select all
Clear

 Enable (Other) bounded uncorrelated in tab "Advanced"

Noise - General information



noise describes the amplitude deviation of a data symbol at the sampling time with respect to a corresponding reference level. These deviations or Level Errors (LE) are caused by various sources.

The Total Noise (TN) is split into two main components: Random Noise (RN) and Deterministic Noise (DN). DN consists of Periodic Noise (PN) and non periodic components.

The advanced noise algorithm enables various selectable result

◀ Back

Measurement	Abbreviation	Description	Results		Diagram			
			S t D e v	a p /a b s	H i s t o g r a m	T r a c k	S p e c t r u m	
Eye height @BER ⁽³⁾	EH@BER	Returns the vertical eye opening at the user-defined BER.		x				
Random plus (other) bounded uncorrelated noise	RN+(O)BUN	Random noise plus (other) bounded uncorrelated noise or (other) bounded uncorrelated noise is the combined effect of both noise types. If periodic components are activated RN + OBUN are displayed, otherwise RN + BUN. RN + (O)BUN is typically used, if track or spectrum plots are desired. Both plots are not available for RN only or (O)BUN only components as the time dependencies of these noise types are unknown. RN + (O)BUN spectrum is a useful approximation of the RN spectrum for negligible small (O)BUN.	x	x	x	x	x	x
Total noise	TN	Measures the total level error of the input signal. It is defined as the amplitude deviation between the amplitude of the input signal at the decision time point and its corresponding reference level.	x	x	x	x	x	x
Deterministic noise	DN	The reproducible portion of the overall level error of the input signal. It consists of the data-dependent noise, the periodic noise components and the other bounded uncorrelated jitter components.	x	x	x			
Data-dependent noise	DDN	Consists of inter-symbol interface noise and level distortion. It depends on the symbol sequence. ISIN is an effect whereby past symbols have an influence on future symbols. DCD is a mismatch between rising and falling signal transitions due to reference level mismatch or other imbalances between transitions.	x	x	x	x	x	x
Level distortion ⁽³⁾	LD	A measure of imbalance between different symbol levels. It is defined as the difference between the average level errors of the symbols one and zero.		x				
Periodic noise ⁽²⁾	PN	Periodic noise is typically caused by crosstalk from periodic signal sources to the transmitter or transmission line. It represents the harmonic portion of the overall level error.	x	x	x	x	x	x
<p>⁽¹⁾ Available, if (Other) bounded uncorrelated > "Enabled".</p> <p>⁽²⁾ Available, if Periodic > "Enabled".</p> <p>⁽³⁾ No results available, if "Levels" is set to "Rising"/"Falling".</p>								

Measurement	Abbreviation	Description	Results		Diagram		
			StDev	aps	Histogram	Trace	Spectrum
Inter-symbol interference noise	ISIN	The level difference between the highest and the lowest level error of a symbol, i.e. one or zero. The largest value across all symbols is the measurement result.		x			
Data-dependent noise and periodic noise ⁽²⁾	DDN+PN	Data-dependent noise plus periodic noise is the combined effect of both jitter types. Note that DDN+PN equals deterministic noise minus other bounded uncorrelated noise. DDN+PN spectrum is a useful approximation of the deterministic noise spectrum for negligible small other bounded uncorrelated noise.	x	x	x	x	x
Other bounded uncorrelated noise ⁽¹⁾	(O)BUN	Composite impact of all unknown but deterministic portions of the overall time interval error of the input signal. It consists of any disturbance that comes from a deterministic source but cannot be reproduced from the input signal. Often it is caused by crosstalk from other data signals.	x	x	x		
Other bounded uncorrelated Dual-Dirac noise ⁽¹⁾	(O)BUN (δ - δ)	Other bounded uncorrelated Dual-Dirac noise (O)BUN (δ - δ) is an industry standard approximation to the other bounded uncorrelated jitter measurement. It is calculated by fitting a model of two overlapping, equally large Gaussian distributions to the observed RN+(O)BUN histogram. The calculated value is the amplitude difference between the two distributions center points.		x			
Random noise ⁽¹⁾	RN	Consists of any influence that cannot be predicted with model parameters. Usually, this noise component follows a Gaussian probability distribution. The algorithm computes the standard deviation and the peak-peak value of the level error (LE) caused by RN within the analyzed waveform.	x		x		

(1) Available, if (Other) bounded uncorrelated > "Enabled".
(2) Available, if Periodic > "Enabled".
(3) No results available, if "Levels" is set to "Rising"/"Falling".

Remote command:

`ADVJitter<m>:DCOMposition:COMPONENTS<n>:ENABLe` on page 2687

Select all /Clear

Selects/clears all components in the noise dialog.

Remote command:

[ADVJitter<m>:DCOMposition:CLENoisecomp](#) on page 2692

[ADVJitter<m>:DCOMposition:SELNoisecomp](#) on page 2692

Levels

Selects which levels are considered for the display of the diagrams, rising, falling or both. This setting is mostly relevant for histograms, tracks and the measurement results.

Remote command:

[ADVJitter<m>:RESult:LEVels](#) on page 2692

19.2.5.5 Bathtub settings

Access: "Analysis" menu > "Advanced Jitter" > "Result" tab > "Bathtub".

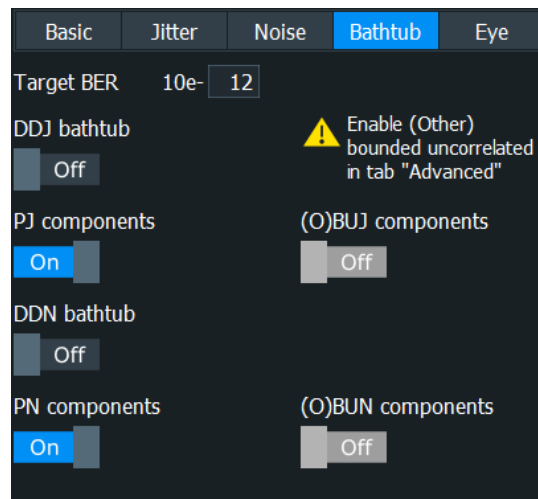

Target BER 10

Sets the target bit error rate.

Remote command:

[ADVJitter<m>:DCOMposition:TARBer](#) on page 2693

DDJ bathtub

Enables a bathtub plot, a graph of BER in a log scale versus data-dependent jitter (DDJ).



Remote command:

[ADVJitter<m>:RESult:BATHtub](#) on page 2693

PJ / (O)BUJ components

Selects which jitter components are considered for the jitter bathtub.

"PJ" is available, if [Periodic](#) > "Enabled".

"(O)BUJ" is available, if [\(Other\) bounded uncorrelated](#) > "Enabled".

Remote command:

[ADVJitter<m>:RESult:PJ](#) on page 2694

[ADVJitter<m>:RESult:OBUJ](#) on page 2694

DDN bathtub

Available for option R&S RTO6- K134.

Enables a noise bathtub plot, a graph of BER in a log scale versus data-dependent jitter (DDN).



Figure 19-16: Bathtub plot for NRZ signals

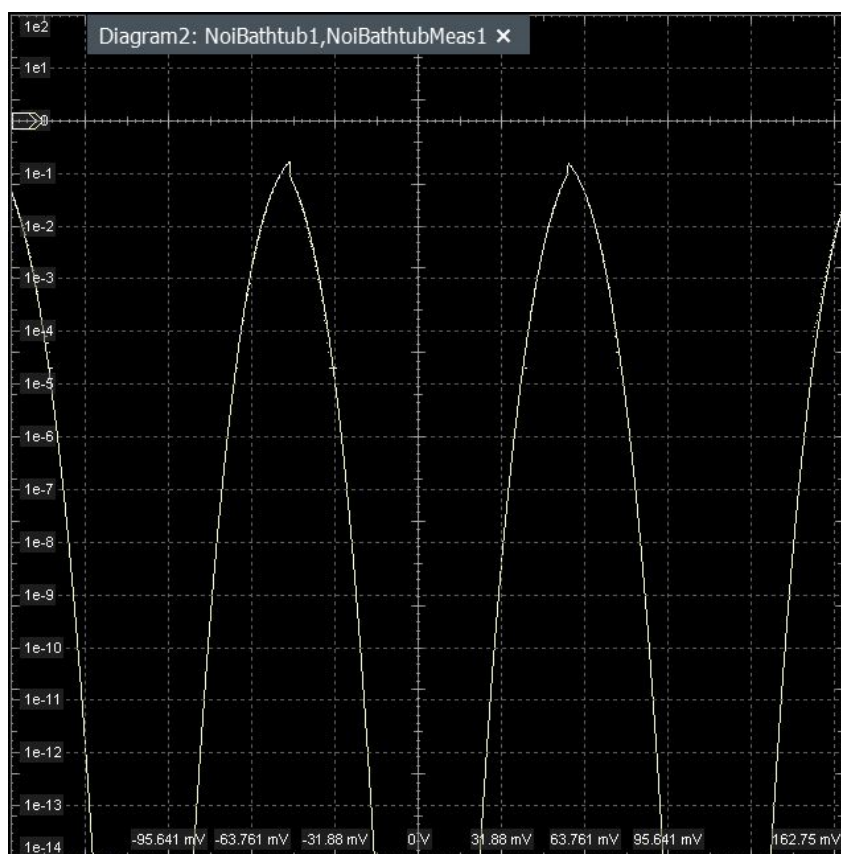

Figure 19-17: Bathtub plot for PAM-N signals

Remote command:

[ADVJitter<m>:RESult:NBAThtub](#) on page 2694

PN / (O)BUN components

Selects which noise components are considered for the noise bathtub.

"PN" is available, if **Periodic** > "Enabled".

"(O)BUN" is available, if **(Other) bounded uncorrelated** > "Enabled".

Remote command:

`ADVJitter<m>:RESult:PN` on page 2694

`ADVJitter<m>:RESult:OBUN` on page 2695

19.2.5.6 Eye settings

Access: "Analysis" menu > "Advanced Jitter" > "Result" tab > "Eye".

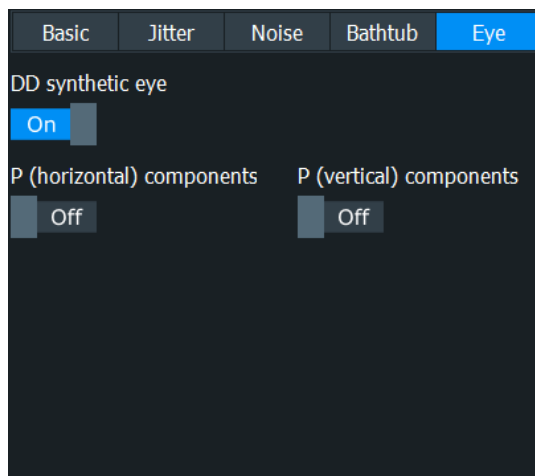
**Synthetic eye**

Enables a synthetic eye plot out of the synthesized data.

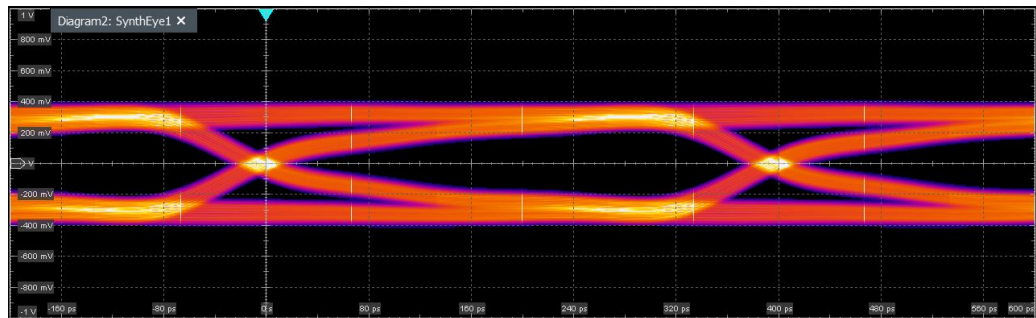

Figure 19-18: Synthetic eye for NRZ signals

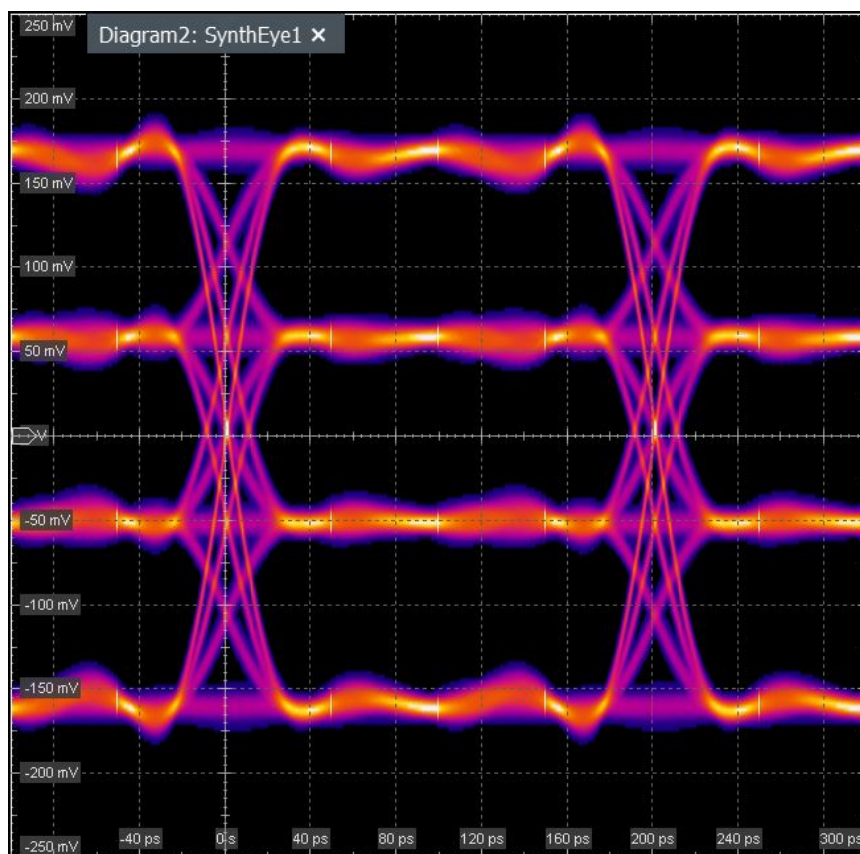

Figure 19-19: Synthetic eye for PAM Order 4 signals

Remote command:

[ADVJitter<m>:RESult:SYNTheticEye](#) on page 2695

Add periodic components to DD synthetic eye

Adds horizontal/vertical periodic components to the data-dependent synthetic eye.

Remote command:

[ADVJitter<m>:RESult:PHORizontal](#) on page 2695

[ADVJitter<m>:RESult:PVERTical](#) on page 2695

19.2.5.7 Quality settings

Access: "Analysis" menu > "Advanced Jitter" > "Result" tab > "Quality".

In the "Quality" tab, you can add signals you want to measure.

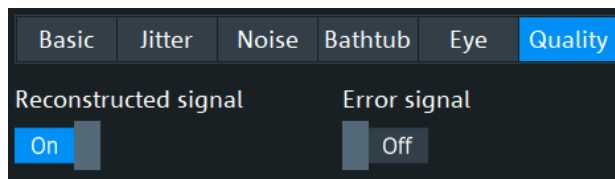

Reconstructed signal

If enabled, shows the reconstructed signal. The reconstructed signal is the signal that results after attempting to correct for jitter. It aims to represent the original transmitted signal as closely as possible, lessening the effects of timing errors or variations introduced by jitter.

Remote command:

[ADVJitter<m>:DCOMposition:RECSignal](#) on page 2696

Error signal

If enabled, shows the error signal. An error signal is the difference between the expected signal and the observed signal, considering the jitter. The error signal quantifies the extent of jitter and other discrepancies from the ideal timing of pulses.

Remote command:

[ADVJitter<m>:DCOMposition:ERRSignal](#) on page 2696

19.2.5.8 Diagram settings

In the diagram settings dialog you can set a separate scale for the basic, jitter and noise parameters.

Settings for histogram and track

Defines the settings for the histogram and track diagrams.

Basic	Jitter	Noise
Settings for histogram		
Interleaved <input type="checkbox"/> Off	Max. num of bins 200	
Settings for track		
Continuous auto scale <input type="checkbox"/> Off	Measurement type Symbol Duration	
Scale 500 ms	Offset 0 s	

Interleaved ← Settings for histogram and track

Displays interleaved histogram values.

Remote command:

[ADVJitter<m>:DCOMposition:JINTerleaved](#) on page 2700

Max. numb of bins ← Settings for histogram and track

Sets the number of bins, the number of data intervals, of the histogram.

Remote command:

[ADVJitter<m>:RESult:VERTical:HBINs](#) on page 2697

Continuous auto scale ← **Settings for histogram and track**

If enabled, the measurement scale for track is set automatically. If disabled you can manually set a [Scale](#) and [Offset](#).

Remote command:

[ADVJitter<m>:RESult:VERTical:CONTinuous](#) on page 2697

[ADVJitter<m>:RESult:VERTical:BHContinuous](#) on page 2698

[ADVJitter<m>:RESult:VERTical:NHContinuous](#) on page 2699

Measurement type ← **Settings for histogram and track**

Selects the basic measurement type to apply the scale to. This is available only for basic measurements.

Remote command:

[ADVJitter<m>:RESult:VERTical:BMTyPe](#) on page 2698

Scale ← **Settings for histogram and track**

Sets a measurement scale. The unit depends on the measurement type.

Remote command:

[ADVJitter<m>:RESult:COMPOnents<n>:SDSCale](#) on page 2703

[ADVJitter<m>:RESult:COMPOnents<n>:SRSCale](#) on page 2704

[ADVJitter<m>:RESult:COMPOnents<n>:HSCale](#) on page 2701

[ADVJitter<m>:RESult:COMPOnents<n>:NSCale](#) on page 2701

Offset ← **Settings for histogram and track**

Sets a measurement offset. The unit depends on the measurement type.

Remote command:

[ADVJitter<m>:RESult:COMPOnents<n>:SDOFFset](#) on page 2702

[ADVJitter<m>:RESult:COMPOnents<n>:SROFFset](#) on page 2703

[ADVJitter<m>:RESult:COMPOnents<n>:HOFFset](#) on page 2700

[ADVJitter<m>:RESult:COMPOnents<n>:NOFFset](#) on page 2701

Settings for spectrum

Defines the settings for the spectrum diagrams.

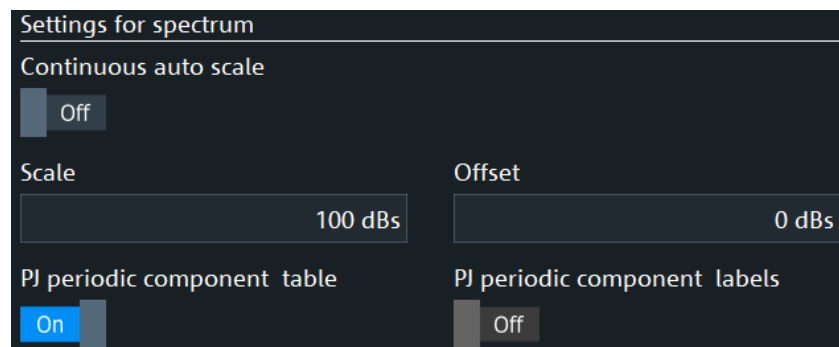
**Continuous auto scale** ← **Settings for spectrum**

If enabled, the measurement scale for the spectrum is set automatically. If disabled you can manually set a [Scale](#) and [Offset](#).

Remote command:

[ADVJitter<m>:RESult:VERTical:JSContinuous](#) on page 2698

[ADVJitter<m>:RESult:VERTical:NSContinuous](#) on page 2699

Scale ← Settings for spectrum

Sets a measurement scale. The unit depends on the measurement type.

Remote command:

[ADVJitter<m>:RESult:COMponents<n>:NSPScale](#) on page 2702

[ADVJitter<m>:RESult:COMponents<n>:SScale](#) on page 2704

Offset ← Settings for spectrum

Sets a measurement offset. The unit depends on the measurement type.

Remote command:

[ADVJitter<m>:RESult:COMponents<n>:SOFFset](#) on page 2703

[ADVJitter<m>:RESult:COMponents<n>:NSPoffset](#) on page 2702

PJ periodic component table ← Settings for spectrum

Enables the display of the periodic jitter components table. The table is displayed after the advanced jitter/ noise analysis is enabled.

The unit of the periodic components depends on the switching between "Absolute" and "Relative". Thus, times are represented in "s" and "UI" and voltages in "V" and "%".

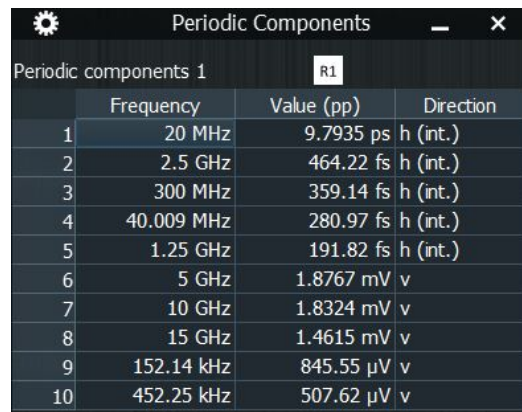

	Frequency	Value (pp)	Direction
1	20 MHz	9.7935 ps	h (int.)
2	2.5 GHz	464.22 fs	h (int.)
3	300 MHz	359.14 fs	h (int.)
4	40.009 MHz	280.97 fs	h (int.)
5	1.25 GHz	191.82 fs	h (int.)
6	5 GHz	1.8767 mV	v
7	10 GHz	1.8324 mV	v
8	15 GHz	1.4615 mV	v
9	152.14 kHz	845.55 μV	v
10	452.25 kHz	507.62 μV	v

Remote command:

[ADVJitter<m>:DCOMposition:SPJTable](#) on page 2699

PJ periodic component labels ← Settings for spectrum

Displays the periodic jitter/noise labels on the spectrum diagrams.

Available, if in the "Result"> "Jitter" tab, "Spectrum" is enabled for the "Periodic Jitter" measurement.

Remote command:

[ADVJitter<m>:DCOMposition:SPJLabels](#) on page 2700

[ADVJitter<m>:DCOMposition:SPNLabels](#) on page 2700

19.2.5.9 PAM results jitter

Requires option R&S RTO6-K135.

For signals with a "PAM order" > 2 you can activate jitter measurements on PAM-N signals.

PAM Results: Jitter

PAM-N results
On

Preset configuration:

Mode: Pre-defined

Component: TJ@BER

Selection mode: Same level height

Level height: 2

Active components:

Num. Results | Histogram | Track

6 of 13 numerical results are activated.

Component	Base	Target	Transition
TJ@BER	0	2	Rising
TJ@BER	1	3	Rising
TJ@BER	2	4	Rising
TJ@BER	3	5	Rising
TJ@BER	4	6	Rising
TJ@BER	5	7	Rising

Preset Add Remove last

Back

PAM-N results

Enables the PAM-N results for jitter measurements.

Jitter component	σ	abs/pp	Min (σ)	Max (σ)	Min (abs/pp)	Max (abs/pp)	Wave count
TJBER1_01_r	---	33.721 ps	---	---	33.721 ps	33.721 ps	1
RJOBUI_01_r	1.4323 ps	10.144 ps	0 s	1.4323 ps	10.144 ps	10.144 ps	1
TJ1_01_r	3.9983 ps	23.066 ps	0 s	3.9983 ps	23.066 ps	23.066 ps	1
DDJ1_01_r	1.4568 ps	8.6164 ps	0 s	1.4568 ps	8.6164 ps	8.6164 ps	1

Remote command:

`ADVJitter<m>:REsult:PAMJitter:CONFig:ENABle` on page 2710

Preset configuration

For easier configuration, you can use some of the pre-defined user configurations. For more specific user cases, you can also define your own settings.

Mode ← Preset configuration

Selects if you want to add "Pre-defined" user configurations to the active components, or defined your own "User-defined" settings.

Remote command:

[ADVJitter<m>:RESult:PAMJitter:CONFig:MODE](#) on page 2711

Component ← Preset configuration

Selects a component from the list of active components for jitter, see [Jitter Components](#).

Remote command:

[ADVJitter<m>:RESult:PAMJitter:CONFig:COMPonent](#) on page 2709

Selection mode ← Preset configuration

Selects how the level difference between the "Base" and "Target" level of the PAM-N signal is defined.

"Same level height" All active components have the same level difference, "Level height", between the "Base" and "Target" level.

"Explicit level" All active components from/to a defined explicit level.

Remote command:

[ADVJitter<m>:RESult:PAMJitter:CONFig:SELMode](#) on page 2711

[ADVJitter<m>:RESult:PAMJitter:CONFig:LVLHeight](#) on page 2710

[ADVJitter<m>:RESult:PAMJitter:CONFig:EXPLicit](#) on page 2710

Preset ← Preset configuration

Available only for "Mode" = "Pre-defined".

Adds a pre-defined preset configuration for the selected component to the "Active components" table.

Remote command:

[ADVJitter<m>:RESult:PAMJitter:CONFig:PRESet](#) on page 2711

Active components

In this table you can select the components for the measurement and their settings.

Category ← Active components

Selects the category of the measurement that you want to define: "Num. Results", "Histogram" or "Track".

Component ← Active components

Selects a component from the list of active components for jitter, see [Jitter Components](#).

Remote command:

[ADVJitter<m>:RESult:PAMJitter:CONFig:CATegory<n>:MEASurement<o>:COMPonent](#) on page 2708

Base ← Active components

Selects the base level. This is the lowest amplitude level used in the modulation. It sets the reference point for the least amount of energy a pulse can carry in the system.

Remote command:

`ADVJitter<m>:RESult:PAMJitter:CONFig:CATegory<n>:MEASurement<o>:
BASE` on page 2707

Target ← Active components

Selects the target level, the higher level a pulse can reach. The different target levels represent the different symbols/data values that are being transmitted.

Remote command:

`ADVJitter<m>:RESult:PAMJitter:CONFig:CATegory<n>:MEASurement<o>:
TARGet` on page 2708

Color ← Active components

Selects the color of the active component.

Remote command:

`ADVJitter<m>:RESult:PAMJitter:CONFig:CATegory<n>:MEASurement<o>:
COLor` on page 2707

Transition ← Active components

Selects which transitions are considered for the display of the diagrams, rising or falling.

Remote command:

`ADVJitter<m>:RESult:PAMJitter:CONFig:CATegory<n>:MEASurement<o>:
TRANsition` on page 2709

Add

Adds a new line to the active components list of the currently selected category.

You can add up to 13 "Numerical results", 8 "Histograms" and 8 "Tracks".

Remote command:

`ADVJitter<m>:RESult:PAMJitter:CONFig:CATegory<n>:ADD` on page 2706

Remove last

Removes the last added line of the currently selected category.

Remote command:

`ADVJitter<m>:RESult:PAMNoise:CONFig:CATegory<n>:REMOve`
on page 2716

19.2.5.10 PAM results noise

Requires option R&S RTO6-K135.

For signals with a "PAM order" > 2 you can activate noise measurements on PAM-N signals.

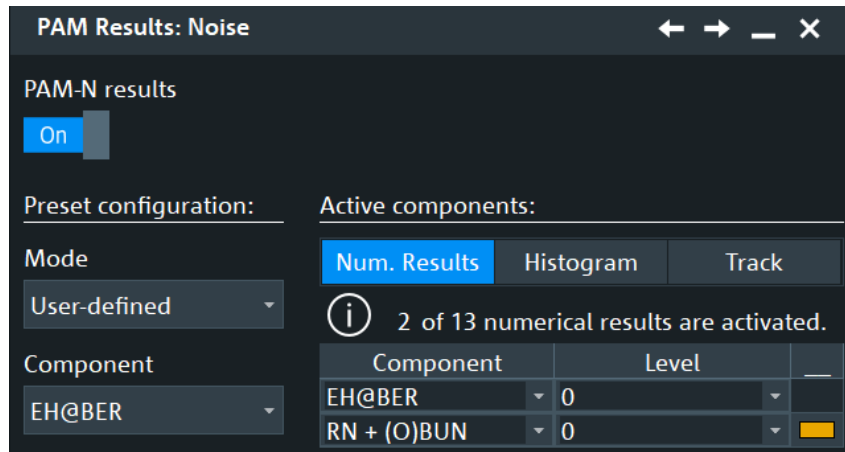

PAM-N results

Enables the PAM-N results for noise measurements.

Noise component	σ	abs/pp	Min (σ)	Max (σ)	Min (abs/pp)	Max (abs/pp)	Wave count
EHBER1_2	---	0 V	---	---	0 V	0 V	1
RNOBUN1_2	3.5041 mV	27.906 mV	0 V	3.5041 mV	27.906 mV	27.906 mV	1
TN1_2	5.0782 mV	36.005 mV	0 V	5.0782 mV	36.005 mV	36.005 mV	1
DDN1_2	3.5829 mV	22.544 mV	0 V	3.5829 mV	22.544 mV	22.544 mV	1

Remote command:

[ADVJitter<m>:RESult:PAMNoise:CONFig:ENABle](#) on page 2717

Preset configuration

For easier configuration, you can use some of the pre-defined user configurations. For more specific user cases, you can also define your own settings.

Mode ← Preset configuration

Selects if you want to add "Pre-defined" user configurations to the active components, or defined your own "User-defined" settings.

Remote command:

[ADVJitter<m>:RESult:PAMNoise:CONFig:MODE](#) on page 2717

Component ← Preset configuration

Selects a component from the list of active components for noise, see [Noise components](#).

Remote command:

[ADVJitter<m>:RESult:PAMNoise:CONFig:COMPonent](#) on page 2717

Level ← Preset configuration

Sets the same base level for all components, if "Component" is set to "All".

Remote command:

[ADVJitter<m>:RESult:PAMNoise:CONFig:BASE](#) on page 2713

Preset ← Preset configuration

Available only for "Mode" = "Pre-defined".

Adds a pre-defined preset configuration for the selected component to the "Active components" table.

Remote command:

`ADVJitter<m>:RESult:PAMNoise:CONFig:PRESet` on page 2718

Active components

In this table you can select the components for the measurement and their settings.

Remote command:

`ADVJitter<m>:RESult:PAMNoise:CONFig:CATegory<n>:ACTive?`
on page 2713

Category ← Active components

Selects the category of the measurement that you want to define: "Num. Results", "Histogram" or "Track".

Component ← Active components

Selects a component from the list of active components for jitter, see [Noise components](#).

Remote command:

`ADVJitter<m>:RESult:PAMNoise:CONFig:CATegory<n>:MEASurement<o>:COMPonent` on page 2715

Level ← Active components

Selects the same base level.

Remote command:

`ADVJitter<m>:RESult:PAMNoise:CONFig:CATegory<n>:MEASurement<o>:BASE` on page 2714

Color ← Active components

Selects the color of the measurement.

Remote command:

`ADVJitter<m>:RESult:PAMNoise:CONFig:CATegory<n>:MEASurement<o>:COLor` on page 2715

Add

Adds a new line to the active components list of the currently selected category.

You can add up to 13 "Numerical results", 8 "Histograms" and 8 "Tracks".

Remote command:

`ADVJitter<m>:RESult:PAMNoise:CONFig:CATegory<n>:ADD` on page 2714

Remove

Removes the last added line of the currently selected category.

Remote command:

`ADVJitter<m>:RESult:PAMNoise:CONFig:CATegory<n>:REMOve`
on page 2716

19.2.6 Advanced settings

Access: "Analysis" menu > "Advanced Jitter" > "Advanced settings" tab.

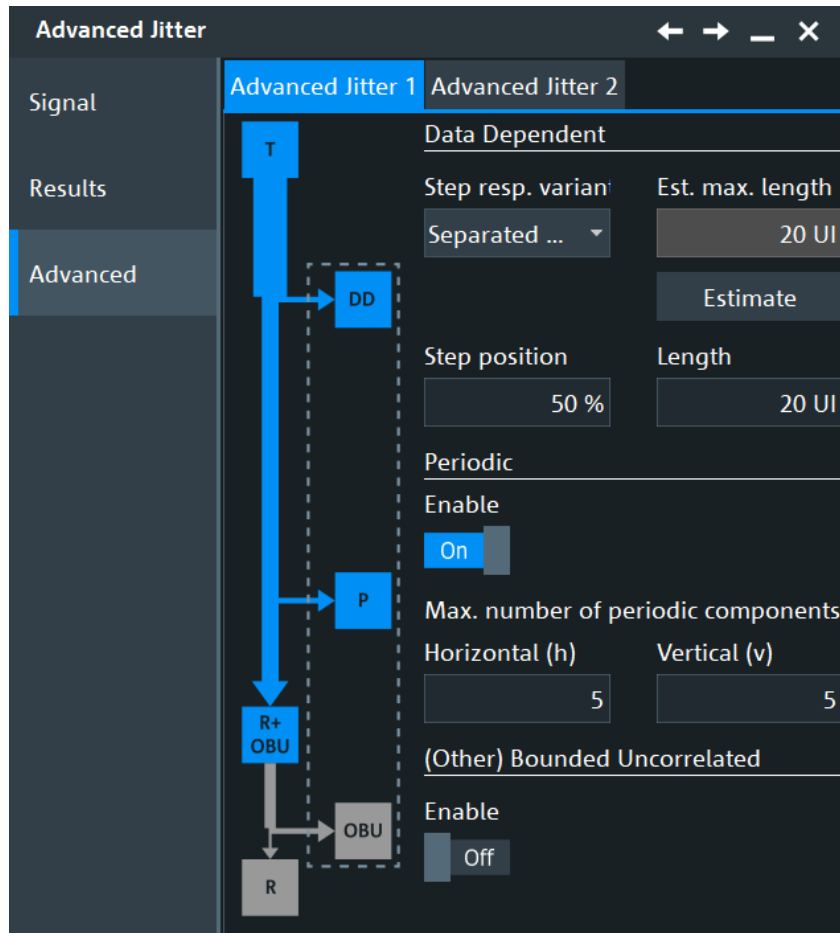

Step response variant

Selects if separated edges or combined edges are used for the step response calculation.

"Combined edges"

The rising and the falling edges of a step input are considered as a single entity. The step response is measured based on the combined effect of the entire step change, without distinguishing between the rising and falling edges.

This is useful for understanding the overall dynamic behavior of the system over a complete cycle or input change.

"Separated edges"

The systems response to the rising edge and falling edge of a step input is analyzed separately.

This is useful for a more detailed understanding of the system's behavior, as it can highlight differences in how the system responds to positive versus negative changes.

Remote command:

[ADVJitter<m>:DCOMposition:STEPresponse](#) on page 2722

Length

Sets the step response length in unit intervals. A higher step response value leads to longer measurement times. Hence it is best to set this value to the number of unit intervals that is roughly needed until the ringing has subsided.

You can set the step response manually or run an estimate.

The "Estimate" sets the maximum feasible value. If it is lower than the set "Length", then the "Length" value is overwritten.

Remote command:

[ADVJitter<m>:DCOMposition:RESplength](#) on page 2720

[ADVJitter<m>:DCOMposition:RLEstimate](#) on page 2720

[ADVJitter<m>:DCOMposition:MRESplength?](#) on page 2720

Step position

Sets the steps position. It defines what percentage of the unit lengths are displayed before the step response.

For example, if the "Length" is set to 20 UI and the "Step position" is set to 75%, the step response diagram displays 15 UI before the step response and 5 UI after it.

Remote command:

[ADVJitter<m>:DCOMposition:POSStep](#) on page 2720

Periodic

If enabled, allows the selection of the "Periodic jitter" / "Periodic noise" components: PJ, DDJ+PJ, PN and DDN+PN.

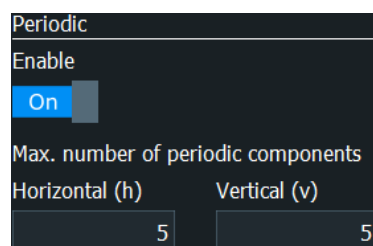
**Enable ← Periodic**

Enables the periodic components.

Remote command:

[ADVJitter<m>:DCOMposition:ENP](#) on page 2721

Horizontal (h) direction ← Periodic

Sets the maximum number of periodic components in the horizontal direction that are considered for the measurement. If the actual number of periodic components is higher than the set value, they are considered for the random jitter component.

The horizontal components also differentiate between intrinsic and extrinsic. Extrinsic periodic horizontal components describe timing variations likely caused by external interference on the clock generation system of the DUT. The interference source is free running and not coupled to the generated clock. Intrinsic periodic horizontal components describe timing variations likely caused by fluctuations within the clock generation system of the DUT. The interference is tightly coupled to the generated clock and follows modulations in data rate, e.g. spread spectrum clocking.

Remote command:

`ADVJitter<m>:DCOMposition:NHORizontal` on page 2721

Vertical (v) direction ← Periodic

Sets the maximum number of periodic components in the vertical direction that are considered for the measurement. If the actual number of periodic components is higher than the set value, they are considered for the random jitter component.

Remote command:

`ADVJitter<m>:DCOMposition:NVERTical` on page 2721

(Other) bounded uncorrelated

If enabled, allows the selection of the (other) bounded uncorrelated jitter/noise: (O)BUJ, (O)BUJ(δ - δ), RJ, (O)BUN, (O)BUN(δ - δ), RN.

The **other** bounded uncorrelated jitter/noise includes the periodic jitter/noise components. It is displayed, if **Periodic** is enabled. Otherwise the bounded uncorrelated jitter/noise is displayed.

Remote command:

`ADVJitter<m>:DCOMposition:ENOBu` on page 2722

19.2.7 Saving the results

Once the advanced jitter analysis is enabled, you can save the results as a report or export the waveforms for future references.

Report

You can save a report of the advanced jitter analysis, which displays the "Adv. Jitter Results" table and the "Periodic components" table.

Advanced Jitter: Results of all Components

	StdDev	abs/pp	Min(StdDev)	Max(StdDev)	Min(abs/pp)	Max(abs/pp)	Wave Count
AdvancedJitterResults1	Analyzed source: Ch1Wfm1 Reference source: CDR Use gate: Off						
Event Count	---	14.2 k	---	---	14.2 k	14.2 k	1
Random Jitter and Other Bounded Uncorrelated Jitter	54.9 ps	237 ps	54.9 ps	54.9 ps	237 ps	237 ps	1
Total Jitter (measured)	55.5 ps	196 ps	55.5 ps	55.5 ps	196 ps	196 ps	1
Data-Dependent Jitter	5.53 ps	53.5 ps	5.53 ps	5.53 ps	53.5 ps	53.5 ps	1
Periodic Jitter	8.4 ps	88.1 ps	8.4 ps	8.4 ps	88.1 ps	88.1 ps	1
Random Noise and Other Bounded Uncorrelated Noise	78.9 mV	605 mV	78.9 mV	78.9 mV	605 mV	605 mV	1
Total Noise	72.9 mV	486 mV	72.9 mV	72.9 mV	486 mV	486 mV	1
Data-Dependent Noise	61.8 mV	372 mV	61.8 mV	61.8 mV	372 mV	372 mV	1
Periodic Noise	18.8 mV	301 mV	18.8 mV	18.8 mV	301 mV	301 mV	1

Advanced Jitter: Periodic Components of Periodic Jitter

	Frequency	Value	Direction
Advanced.JitterPeriodicComponents1 Analyzed source: Ch1Wfm1			
1	206 MHz	13.1 ps	Horizontal (intrinsic)
2	210 MHz	13 ps	Horizontal (extrinsic)
3	207 MHz	9.94 ps	Horizontal (extrinsic)
4	190 MHz	9.57 ps	Horizontal (intrinsic)
5	202 MHz	9.23 ps	Horizontal (extrinsic)
6	3.1 GHz	9.32 mV	Vertical
7	3.19 GHz	8.64 mV	Vertical
8	2.16 GHz	8.54 mV	Vertical
9	2.08 GHz	8.36 mV	Vertical
10	2.92 GHz	7.87 mV	Vertical

See also [Chapter 12.4, "Reports"](#), on page 488.

Exporting the output signal

The following output signals from the advanced jitter analysis can be exported in the file formats *.csv, *.bin and *.xml:

- Step response
- Bathtub
- Histograms
- Tracks
- Spectrum

19.3 Clock data recovery

The process of clock data recovery (CDR) generates a reference clock from a high-speed serial data stream that is sent without a dedicated clock signal. The generated clock signal matches the frequency and is aligned to the phase of the data stream. The recovered clock can be used to sample the data stream, to obtain the sequence of transmitted bits, and to measure jitter parameters.

There are two ways to recover the clock signal:

- Using software algorithms that calculate the clock from data signal edges (option R&S RTO6-K12):
[Chapter 19.3.1, "Software CDR"](#), on page 1135
- Using hardware CDR
Option R&S RTO6-K13:[Chapter 19.3.2, "Hardware CDR \(option R&S RTO6-K13\)"](#), on page 1140

19.3.1 Software CDR

You can define four independent software CDR instances to recover clock signals. These clock signals are used for data timing measurements: time interval error, unit

interval, and data rate (frequency of the clock signal). The lower the signal bandwidth and the higher the relative bandwidth, the longer is the settling time.

Software CDR is based on acquired data, needs a synchronization time to set up the clock. To get correct measurement results, the data acquired during synchronization time has to be discarded.

You can also display the recovered clock signal as a math waveform, see [Chapter 19.3.3, "Displaying the recovered clock signal"](#), on page 1144.

Access: [App Cockpit] > "Analysis" tab > "CDR" > "SW CDR x"

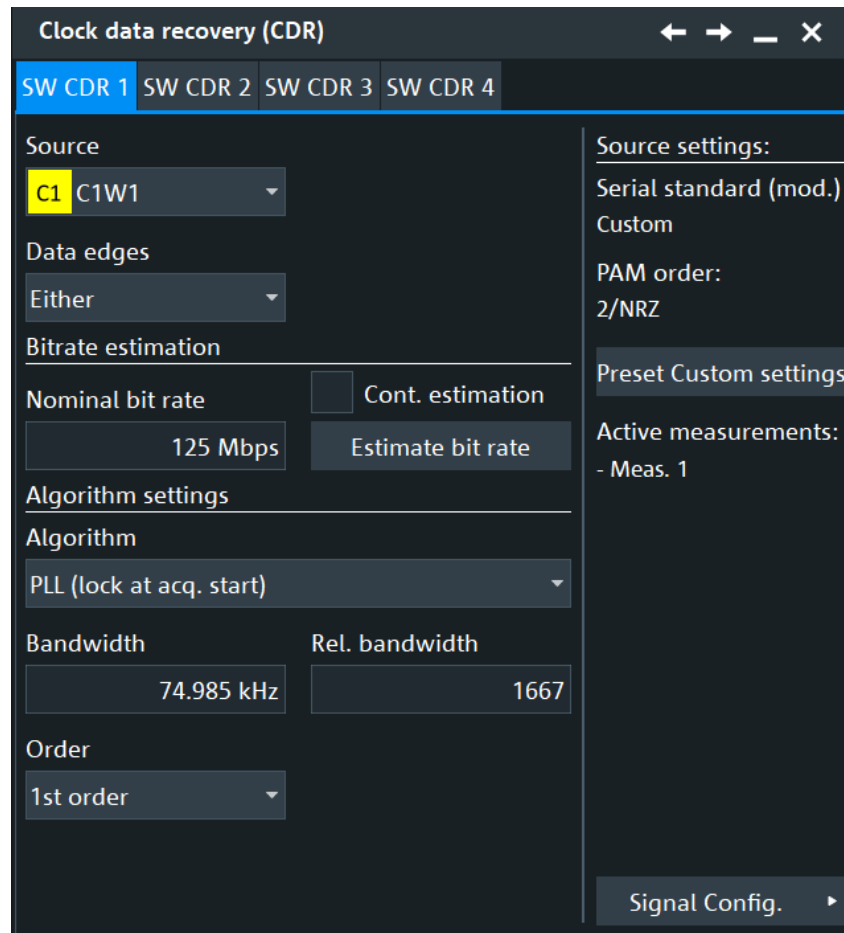

Figure 19-20: Software CDR for NRZ signals

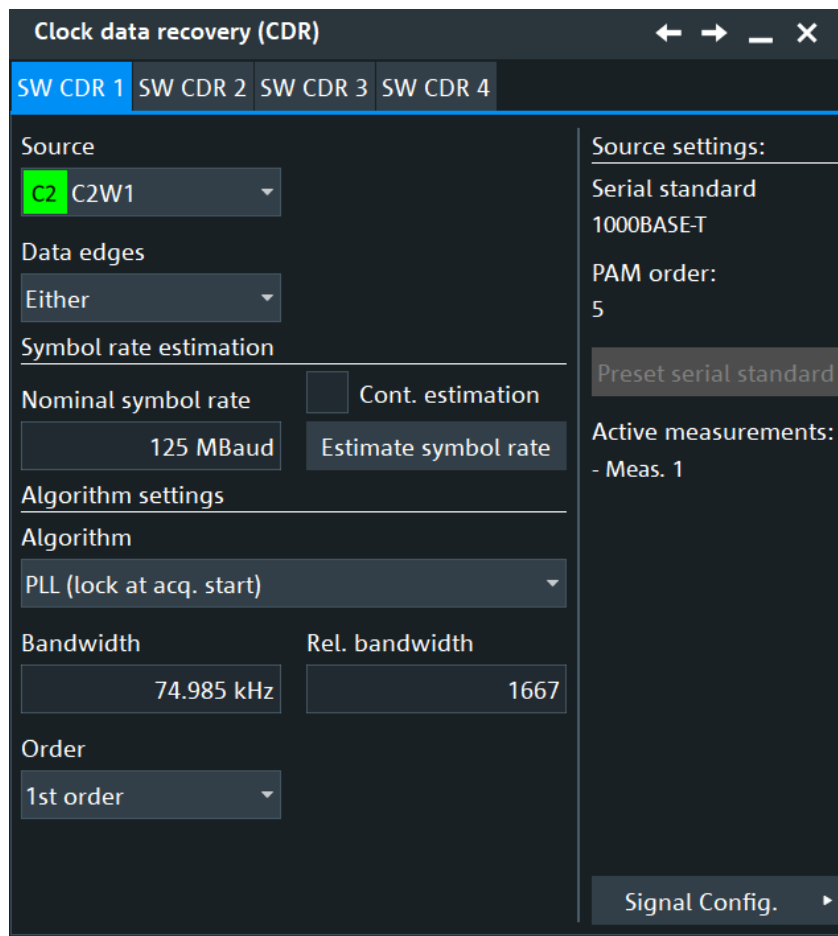

Figure 19-21: Software CDR for PAM-N signals (PAM order > 2)

Source

Selects the source for the bit rate estimation.

Remote command:

`CDR:SOFTware<m>:ESBRate:SOURce` on page 2723

Source settings

In the source settings you can see the currently selected settings for the signal source. The settings can be configured in the "Signal configuration" dialog, see [Chapter 13.1, "Signal configuration setup"](#), on page 492.

The following settings are available:

- [Technology, Serial standard](#)
- [PAM order](#)
- "Preset serial standard": presets the settings to the serial standard selected for the source.
- "Active measurements": displays the currently active measurements, the measurements that are set to use the same source.

Data edges

Selects the edges of the data stream that are used for the clock recovery.

- "Either": Both positive and negative edges are used
- "Positive / Negative": Only one edge direction is used. Use one of these settings if the other edge might deliver unreliable results.

Remote command:

[CDR:SOFTware<m>:ESLope](#) on page 2725

Bit rate estimation/Symbol rate estimation

For NRZ signals, you can do a "Bit rate estimation".

For signals with a "PAM order" > 2, you can do a "Symbol rate estimation".

Bitrate/symbol rate estimation analyzes the source signal based on the given "Nominal bit rate" / "Nominal symbol rate" and corrects the value.

"Cont. estimation" Enables ongoing bit/symbol rate correction.

"Estimate" Estimates the bit/symbol rate once, for the current acquisition.

Remote command:

[CDR:SOFTware<m>:ESSRate:CONTinuous](#) on page 2724

[CDR:SOFTware<m>:ESSRate:SREStimate](#) on page 2724

Nominal bit rate/ Nominal symbol rate

For NRZ signals, you can set a "Nominal bit rate".

For signals with a "PAM order" > 2, you can do a "Nominal symbol rate".

Sets the quiescent frequency of the PLL. It corresponds to the data rate of the data stream from which the clock is to be recovered.

Remote command:

[CDR:SOFTware<m>:BITRate](#) on page 2725

[CDR:SOFTware<m>:SYMRate](#) on page 2728

Algorithm

Sets the software algorithm that is used for clock data recovery.

"Constant freq."	CDR uses the nominal bit rate to generate the clock signal. The method assumes that the frequency of the signal is constant during the complete acquisition.
"PLL"	PLL is the phase-locked loop control system. It can follow slow deviations in the frequency of the data stream. Thus, it acts as highpass filter regarding the jitter that remains on the signal.
"PLL (lock at acq. start)"	PLL is the phase-locked loop control system which is locked at the acquisition start.
"Feed Forward"	The feed forward algorithm is a mathematical optimization method used for clock data recovery. Feed forward is available if none of the listed serial standards is used ("Serial standard" = "Custom"). It is faster than PLL, i.e., the settling time is shorter. Feed forward is also more precise than PLL. To set up the algorithm, set the bandwidth and the relative bandwidth.

"Feed Forward" Feed forward algorithm locked at the acquisition start. (lock at acq. start)"

Remote command:

[CDR:SOFTWARE<m>:ALGORITHM](#) on page 2722

Algorithm settings

Phase-locked loop parameters are listed below.

Note: Nomial bit rate, bandwidth and relative bandwidth are interacting settings. Modifying one parameter also changes one of the dependent parameters.

"Order"	Sets the order of the PLL: first or second order. PLL of higher order can compensate for more complex jitter behavior.
"Damping"	Sets the damping factor, which is only relevant for second order PLL.
"Bandwidth"	Sets the PLL bandwidth. It defines the part of the spectrum that the PLL can follow during synchronization. The PLL bandwidth is usually defined by the transmission standard.
"Rel. bandwidth"	Sets the relative bandwidth, that is the ratio of the nominal bit rate to the PLL bandwidth.

Remote command:

[CDR:SOFTWARE<m>:PLL:ORDER](#) on page 2726

[CDR:SOFTWARE<m>:PLL:BWIDTh](#) on page 2727

[CDR:SOFTWARE<m>:PLL:RELBwidth](#) on page 2727

[CDR:SOFTWARE<m>:PLL:DAMPing](#) on page 2727

Initial phase

Available for "Algorithm" > "PLL".

Defines the phase reference for the first clock edge.

"First sample" The first clock edge matches the first sample of the waveform at the left border of the display.

"First data edge" The first clock edge matches the first edge of the data signal.

Remote command:

[CDR:SOFTWARE<m>:SYNC](#) on page 2726

Selected results

Available for "Algorithm" > "PLL".

The PLL requires some time to synchronize to the phase of the data stream. You can select when the CDR algorithm returns clock edges:

"After initial sync." The clock edges of the synchronization time are discarded; results are gathered after initial synchronization of the CDR. Thus, meaningful TIE measurement results can be obtained.

"All" All clock edges are used.

Remote command:

[CDR:SOFTWARE<m>:RESults](#) on page 2726

19.3.2 Hardware CDR (option R&S RTO6-K13)

Hardware-based clock data recovery uses the digital CDR module to recover the clock edges. The generated clock is acquired similar to a waveform and occupies an adjacent analog channel. If the source is C1, the recovered clock blocks C2, and vice versa. C3 and C4 work in the same way. The occupied channel cannot be displayed, but the generated clock can be displayed as math waveform.

Hardware CDR is a continuous process, the recovered clock is always synchronized. HW CDR is the best way to analyze the jitter and eyes of continuous signals, and of buses that use Spread Spectrum Clocking. The complete data can be used, there is no synchronization time needed as with SW CDR, and no data must be discarded. Even short acquisitions are useable with HW CDR. For burst signals, HW CDR can be used for decoding, but it is inapplicable for eye and jitter measurement.

The recovered clock can be used:

- As trigger source for the CDR trigger, which is the basis for reliable jitter measurements, see [Chapter 19.3.2.2, "CDR trigger"](#), on page 1142.
- For the serial pattern trigger, see [Chapter 19.3.2.3, "Serial pattern trigger using CDR"](#), on page 1143.
- For TIE, unit interval and data rate measurements, see [Chapter 19.1.2.3, "Data measurement settings"](#), on page 1089.
- Display the generated clock as math waveform, see [Chapter 19.3.3, "Displaying the recovered clock signal"](#), on page 1144.

Jitter measurements and the recovered clock math waveform, which are based on HW CDR, interpret and display the acquired jitter data. If you change the HW CDR settings, a new acquisition is required. To acquire jitter data with HW CDR, the trigger type "CDR" or the trigger type "Serial pattern" with active CDR is required.

19.3.2.1 Hardware CDR setup

Access: "Menu" > "Trigger" > "Setup" tab > "Type = Serial Pattern" or "Type = CDR"> "Hardware CDR"

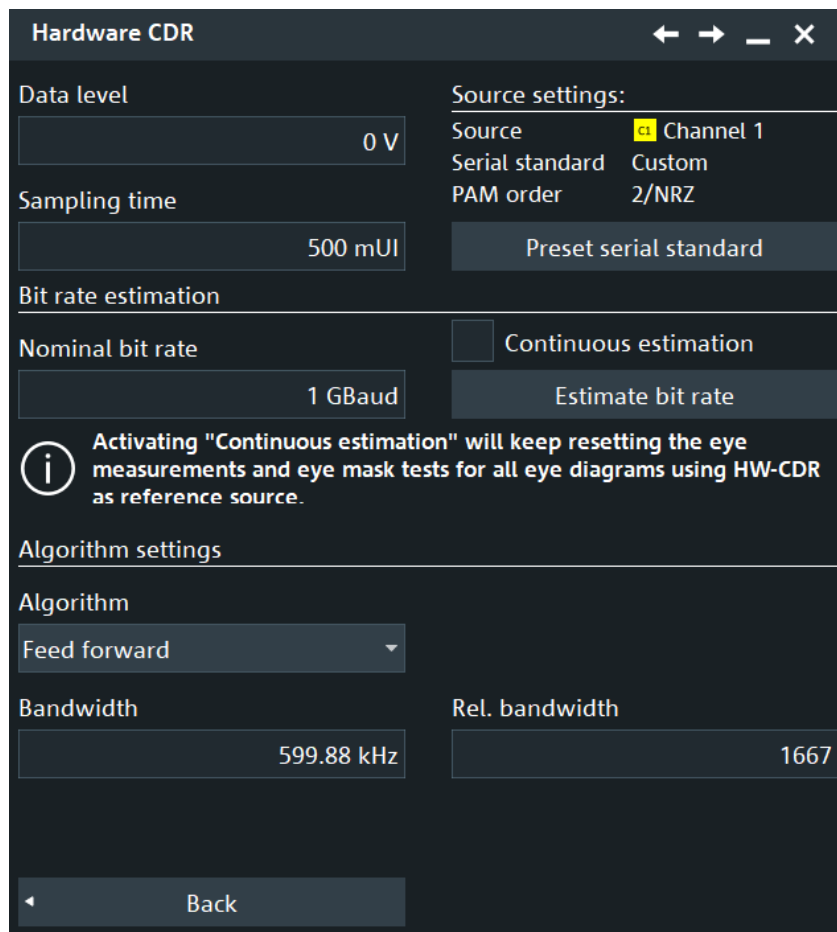

Source

Channel signal that is used for clock recovery.

If the source is selected in the trigger setup, the instrument triggers on the recovered clock; trigger source and CDR source are the same.

Remote command:

[CDR:HARDware:SOURce](#) on page 2728

Data level

Sets the threshold to determine the position of rising and falling edges in the data input signal. The threshold level is also the trigger level for the specified input channel.

Remote command:

[TRIGger<m>:LEVel<n>\[:VALue\]](#) on page 1487

Data edges

Selects the edges of the data stream that are used for the clock recovery.

- "Either": Both positive and negative edges are used
- "Positive / Negative": Only one edge direction is used. Use one of these settings if the other edge might deliver unreliable results.

Remote command:

[CDR:HARDware:ESLope](#) on page 2729

Nominal bit rate

Sets the quiescent frequency of the PLL. It corresponds to the data rate of the data stream from which the clock is to be recovered.

Remote command:

[CDR:HARDware:BITRate](#) on page 2729

Estimate

Estimates the bite rate once, for the current acquisition.

Remote command:

[CDR:HARDware:BREStimate](#) on page 2729

PLL settings

Phase-locked loop parameters are listed below.

Note: Nomial bit rate, bandwidth and relative bandwidth are interacting settings. Modifying one parameter also changes one of the dependent parameters.

"Bandwidth"	Sets the PLL bandwidth. It defines the part of the spectrum that the PLL can follow during synchronization. The PLL bandwidth is usually defined by the transmission standard.
"Rel. band-width"	Sets the relative bandwidth, that is the ratio of the nominal bit rate to the PLL bandwidth.
"Order"	Sets the order of the PLL: first or second order. PLL of higher order can compensate for more complex jitter behavior.
"Damping"	Sets the damping factor, which is only relevant for second order PLL.

Remote command:

[CDR:HARDware:PLL:ORDer](#) on page 2729

[CDR:HARDware:PLL:BWIDth](#) on page 2730

[CDR:HARDware:PLL:RELBwidth](#) on page 2730

[CDR:HARDware:PLL:DAMPing](#) on page 2730

19.3.2.2 CDR trigger

The CDR triggers on the edges of the clock that is recovered from a data signal by the hardware CDR. The CDR trigger is the prerequisite for correct eye formation, and thus for correct jitter measurements and statistics.

The trigger point corresponds to the clock edge that indicates the bit start, and it considers the UI offset.

Access: "Menu" > "Trigger" > "Setup" tab > "Type" = "CDR"

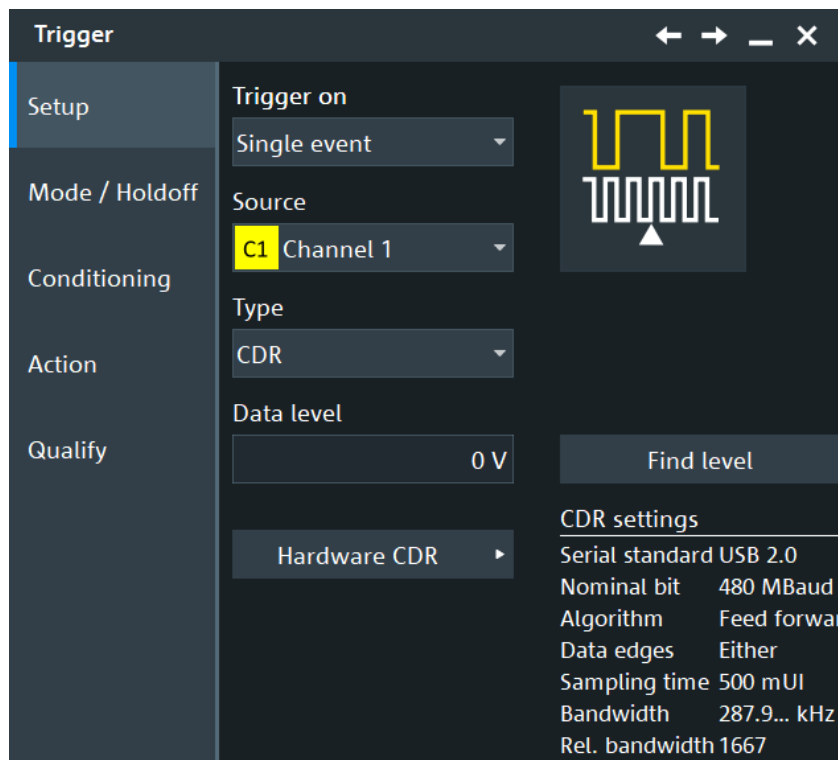
**Data level**

Sets the voltage level for the trigger event. For CDR, the level is the threshold to detect signal edges.

Remote command:

[TRIGger<m>:LEVel<n>\[:VALue\]](#) on page 1487

Hardware CDR

See [Chapter 19.3.2.1, "Hardware CDR setup"](#), on page 1140.

19.3.2.3 Serial pattern trigger using CDR

If option R&S RTO6-K13 is installed, you can use the recovered clock signal for the serial pattern trigger instead of a real clock signal.

1. Select the trigger source and the trigger type "Serial pattern".
2. Set "Clock / CDR" to "CDR".
3. Tap "Hardware CDR" to set up the clock data recovery. See [Chapter 19.3.2.1, "Hardware CDR setup"](#), on page 1140 for details.

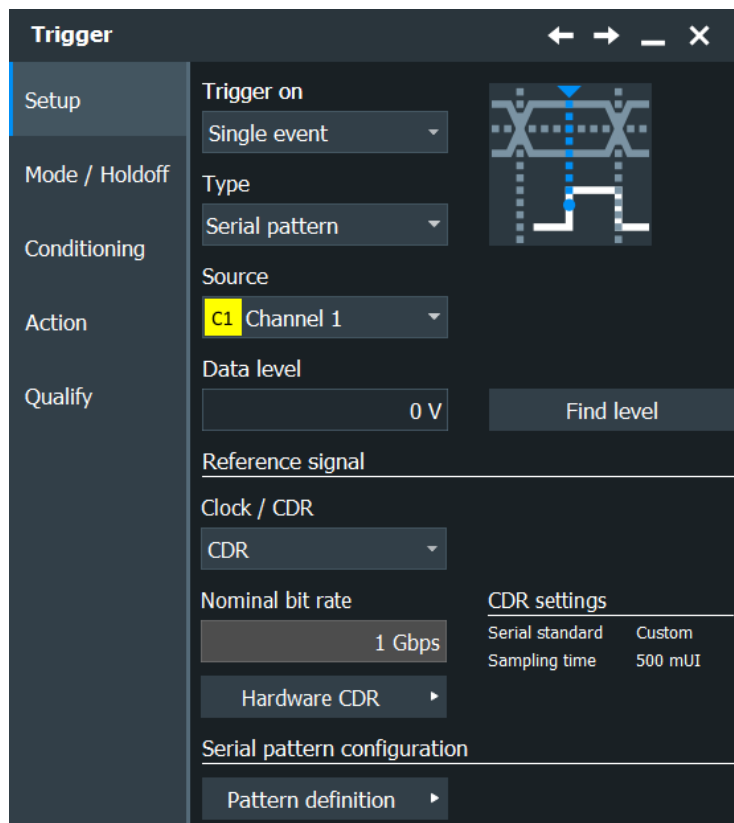

19.3.3 Displaying the recovered clock signal

The clock signal that is recovered by CDR can be displayed as a math waveform. The generated waveform is time-correlated to the data waveform.

1. Prerequisite: Configure the CDR method.
2. Press the [Math] key.
3. On the "Setup" tab, select the "Equation" subtab.
4. Double-tap the entry field to open the formula editor.
5. Tap "More", and again "More".
6. Tap "Clear".
7. Tap "CDR" and select the CDR method.
8. Complete the expression:
 SW CDR: e.g., CDR(sw1,Ch1Wfm1)
 HW CDR: CDR(hw)
9. Tap "Enter".
10. Enable the math signal.

20 Advanced eye diagram analysis (option R&S RTO6-K136)

The main application of eye diagrams is the analysis of signal integrity and signal quality. In particular, eye diagram analysis is used for serial communication standards, for both high-speed serial protocols (e.g. USB) and low-speed serial protocols (e.g. CAN, FlexRay).

There are two ways to generate eye diagrams on the R&S RTO6:

- Standard eye diagrams, which are a superposition of repetitively sampled digital data.
- To use advanced eye diagrams, option R&S RTO6-K136 or R&S RTO6-K91 is required.

20.1 Calculation and display of advanced eye diagrams

The R&S RTO6 generates advanced eye diagrams. To build advanced eyes, the oscilloscope acquires a long waveform containing many bits. The instrument uses a clock reference to cut the waveform into slices of 1-bit length, and superimposes the individual slices. The superimposed slices of consecutive bits build the advanced eye. The clock reference defines the position of the individual data bits on the time axis, and so it provides the necessary timing marks to align and superimpose the waveform slices.

On the contrary, the basic R&S RTO6 without the advanced eye option builds the eye from consecutive acquisitions. The trigger is set in a way that each acquisition is about 1 bit long. With long-persistence display settings, the consecutive acquisitions draw an eye on the screen. The bits that contribute to the eye are always non-consecutive due to the unavoidable oscilloscope's blind time between acquisitions.

The advanced eye approach combines consecutive bits in the eye diagram and does not miss any bit of the acquisition. Advanced eye generation also offers time control over the waveform slices contributing to the eye diagram. For example, you can select the bits contributing to the eye by filtering on dedicated data sequences or by excluding idle sequences.

You can define up to four advanced eye diagrams and configure them independently. Each eye diagram is shown in a separate display diagram, which has its own signal icon. You can move and minimize eye diagrams like any waveform diagram and analyze all eye diagrams in parallel.

The following analysis functions are available for advanced eye diagrams:

- Cursor measurements
- Automatic eye measurements
- Histograms
- Zoom
- Mask testing

20.2 Eye diagram setup

This chapter describes the configuration of eye diagrams.

The configuration of an eye diagram mainly consists of the selection and setup of the input source and timing reference source. You can also adjust display settings and restrict the segments that contribute to the eye generation by various means.

You can configure and analyze up to four independent eye diagrams in parallel.

The "Eye Diagram" dialog box provides four tabs with all settings that are required to configure eye diagrams.

20.2.1 Basic setup

Access: [App Cockpit]> "Analysis" > "Eye Analysis" > "Setup" tab

In the "Setup" tab, you configure the source, the timing reference, and horizontal scale settings of the eye diagram. The vertical scale of the eye diagram is coupled to the vertical scale of the data source.

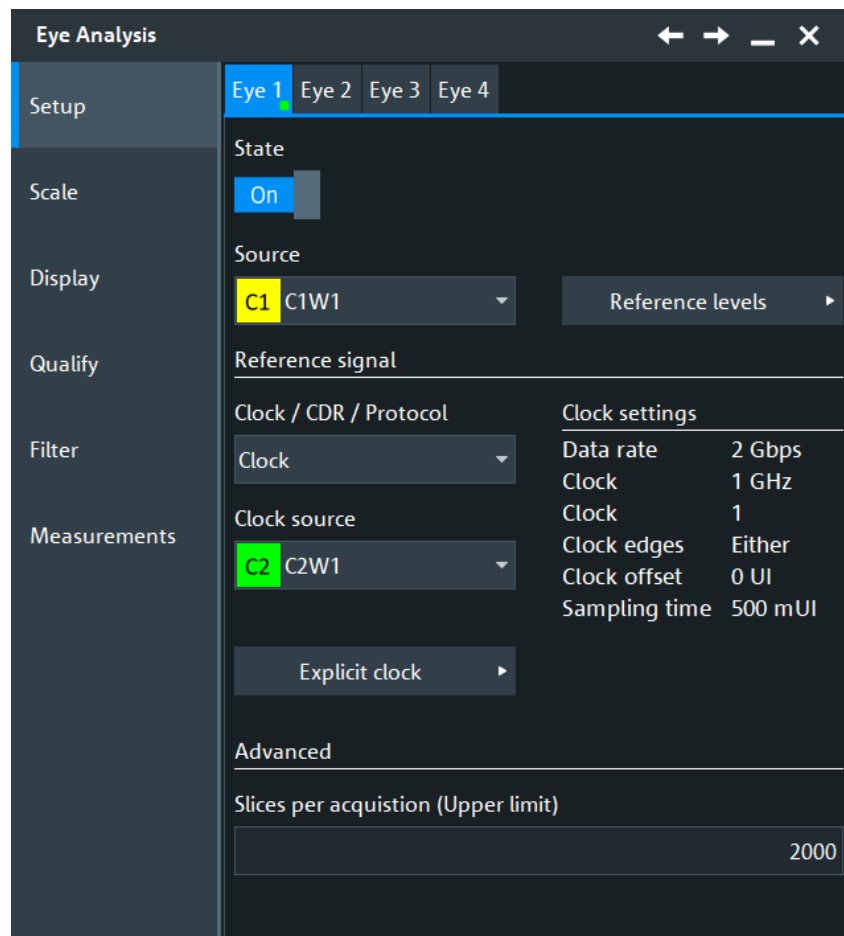

You can configure and analyze up to four independent eye diagrams in parallel (vertical subtabs Eye 1 to Eye 4). Make sure to select the correct eye diagram subtab on the left before you adjust the settings.

State.....	1147
Source.....	1147
Reference signal.....	1147
L Clock / CDR / Protocol.....	1147
L Clock.....	1148
L CDR.....	1148
L Protocol.....	1149
Explicit clock.....	1149
L Vertical reference level.....	1150
L Clock frequency.....	1150
L Estimate clock frequency.....	1150
L Clock multiplier.....	1150
L Clock edge.....	1150
L Data rate.....	1151
L Clock offset.....	1151
L Estimate clock offset.....	1151
Signal Configuration.....	1151
Slices per acquisition (Upper limit).....	1151

State

Activates or deactivates the eye diagram.

Remote command:

`EYE<m> [: STATE]` on page 2584

Source

Selects the waveform from which the eye diagram is generated (data source). You can select analog channels, reference and math waveforms.

If the source waveform is minimized or hidden, no measurement results for the eye diagram are shown.

Select the same channel for the DDR serial bus protocol configuration "DQ" data line and the input for the eye diagram.

Remote command:

`EYE<m> : SOURce` on page 2585

Reference signal

In this section you can define the reference signal used for the eye diagram.

Clock / CDR / Protocol ← Reference signal

Selects the type of waveform that is used to obtain the timing information required to slice the data source waveform.

Remote command:

`EYE<m> : TIMReference [: SOURce]` on page 2589

Clock ← Reference signal

If a clock signal is available, the instrument can use it directly to set the segmentation timestamps. The signal has to be provided on an additional channel.

With "Clock source" you can select the source of the clock signal.

See also [Explicit clock](#).

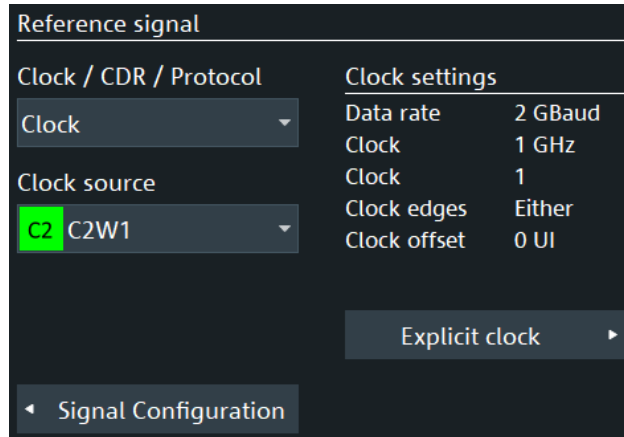

Remote command:

[EYE<m>:TIMReference:CLOCK:SOURce](#) on page 2589

CDR ← Reference signal

Available, if [Type](#) = "CDR".

Uses a hardware or software clock data recovery as a "Reference source".

You can also load a reference waveform that contains CDR information in the "Menu" > "Save/Recall" > "Recall" > "Waveform" dialog.

Option "Reference source" = "Software CDR 1/2/3/4" is only available, if one of the following options is available: R&S RTO6-K12, R&S RTO6-K133 or R&S RTO6-K134.

For "Reference source" = "Software CDR 1/2/3/4" [Software CDR](#).

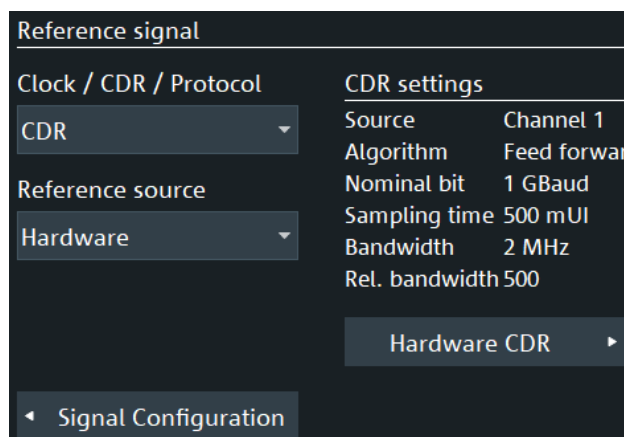

Reference signal	
Clock / CDR / Protocol	CDR settings
CDR	Source C2W1
Reference source	Bit rate 600 Mbps
Software	Algorithm PLL (RL)
Sampling time	Bandwidth 8.995502 MHz
500 mUI	Relative BW 66.7
Software CDR	Software CDR 1
Signal Configuration	Software CDR

Remote command:

[EYE<m>:TIMReference:CDR\[:SElect\]](#) on page 2590

[EYE<m>:TIMReference:CDR:SOFTware](#) on page 2589

[EYE<m>:TIMReference:CDR:SOFTware:SAMTime](#) on page 2591

[REFCurve<m>:CDR:ALGorithm?](#) on page 1555

[REFCurve<m>:CDR:BITRate?](#) on page 1556

[REFCurve<m>:CDR:BWIDth?](#) on page 1556

[REFCurve<m>:CDR:RELBwidth?](#) on page 1557

[REFCurve<m>:CDR:SAMTime?](#) on page 1557

Protocol ← Reference signal

If "Protocol" is selected as the reference type signal, the DDR source signal settings are used for the timing information.

You can select the "Source" of the protocol signal. You can only select the protocols that are enabled.

Also some protocol-specific settings are displayed: "Type", "Bit rate", "Variant".

Reference signal	
Clock / CDR / Protocol	Protocol settings
Protocol	Type DDR
Source	Bit rate 800 Mbps
SerBus1	Variant DDR3
Serial Bus	

Remote command:

[EYE<m>:TIMReference:PROTOcol:SElect](#) on page 2589

Explicit clock

Opens a dialog to define the setting of the explicit clock for "Clock / CDR / Protocol" = "Clock".

Vertical reference level ← Explicit clock

Sets the reference level to define the timestamps for slicing the data waveform. A time-stamp is set each time when the selected slope of the timing waveform crosses the selected reference level.

Remote command:

[EYE<m>:TIMReference:CLOCK:LEVEL](#) on page 2588

Clock frequency ← Explicit clock

Sets the clock frequency of the explicit clock signal. If this value is unknown, you can use "Estimate clock frequency".

Remote command:

[EYE<m>:TIMReference:CLOCK:FREQUENCY](#) on page 2587

Estimate clock frequency ← Explicit clock

Calculates an estimate value for the clock frequency.

Remote command:

[EYE<m>:TIMReference:CLOCK:FREStimation](#) on page 2587

Clock multiplier ← Explicit clock

Sets a value for the clock multiplier, the ratio of an internal clock rate to the externally supplied clock.

Remote command:

[EYE<m>:TIMReference:CLOCK:FACTOR](#) on page 2587

Clock edge ← Explicit clock

The clock edge sets the point in time when the state of the data signal is checked:

"Positive"	Rising edge, a positive voltage change.
"Negative"	Falling edge, a negative voltage change.
"Either"	Both the rising and the falling edge.

Remote command:

[EYE<m>:TIMReference:CLOCK:EDGE](#) on page 2587

Data rate ← Explicit clock

Displays the calculated data rate. It is calculated as follows:

*"Data rate" = "Clock frequency" * "Clock multiplier"*X*

Where X is:

- 1 for "Clock edge"= "Positive" or "Negative"
- 2 for "Clock edge"= "Either"

Remote command:

[ADVJitter<m>:SIGNAL:DATRate?](#) on page 2680

Clock offset ← Explicit clock

Sets a clock offset. If this value is unknown, you can use "Estimate clock offset".

Remote command:

[EYE<m>:TIMReference:CLOCK:OFFSet](#) on page 2588

Estimate clock offset ← Explicit clock

Calculates an estimate value for the clock offset.

Remote command:

[EYE<m>:TIMReference:CLOCK:OFEstimation](#) on page 2588

Signal Configuration

Opens the dialog for configuring the signal lanes, see [Chapter 13, "Signal configuration"](#), on page 492.

Slices per acquisition (Upper limit)

Sets the number of waveform slices for a single acquisition.

Remote command:

[EYE<m>:MSLices](#) on page 2593

20.2.2 Scale settings

Access: [App Cockpit]> "Analysis" > "Eye Analysis" > "Scale" tab.

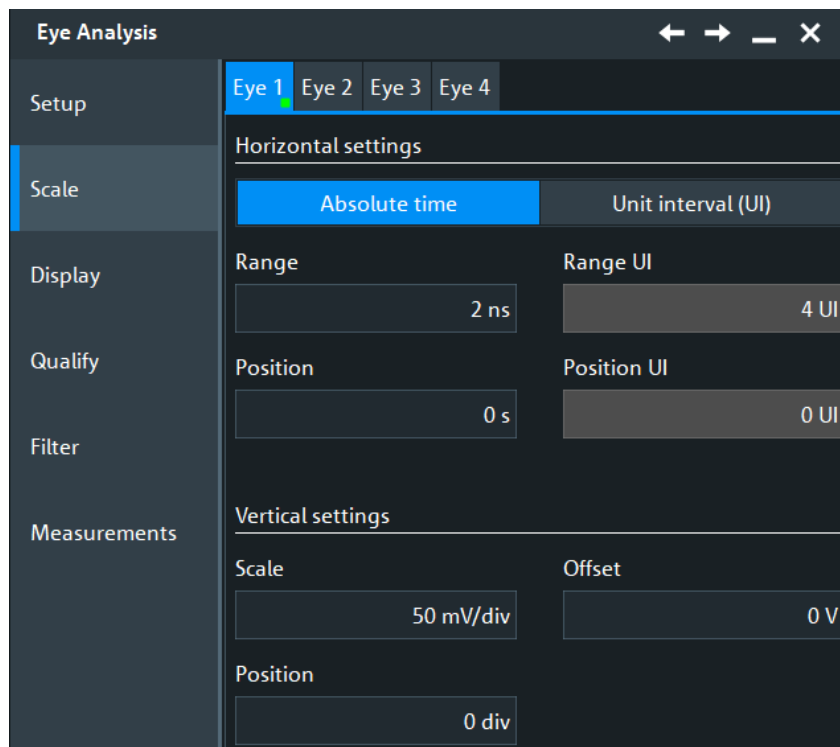

Horizontal settings

Defines the horizontal settings for the eye analysis.

Time units ← Horizontal settings

Sets the method to define the horizontal scale of the eye diagram: as absolute time, or in unit intervals. You can use unit interval, if the nominal frequency of the clock signal is known.

Indirectly, the horizontal scale determines the size of one waveform slice. The waveform slice must be fully contained in the waveform acquisition to contribute to the eye diagram.

The time units value, effect the following parameters:

- The units of the "Eye diagram".
- [Setup tab](#) of the cursor measurements on "Eye diagram".
- Parameters of the eye measurement: "Eye width".
- Masks tests: user and eye
- Histogram: horizontal [Histogram setup](#).
- "Settings" > "Appearance" > "Annotations" > "X position".

Remote command:

`EYE<m>:HORizontal[:UNIT]` on page 2585

Range, Position ← Horizontal settings

Available for [Time units](#) = "Absolute time"

Define the horizontal scale in absolute time.

"Range" Time range that is covered by the eye diagram.

"Position" Place of the zero point in the diagram, in seconds. The zero point is the alignment point on which the slice timestamps are superimposed.

Remote command:

[EYE<m>:HORizontal:ABSolute:RANGe](#) on page 2585

[EYE<m>:HORizontal:ABSolute:POSition](#) on page 2586

Range UI, Position UI ← Horizontal settings

Available for **Time units** = "Unit interval (UI)"

Define the horizontal scale in unit intervals. A unit interval typically corresponds to a bit in the input data signal.

"Range UI" Number of unit intervals that are visible in the eye diagram.

"Position UI" Place of the zero point in the diagram, in unit intervals. The zero point is the alignment point on which the segment timestamps are superimposed.

Remote command:

[EYE<m>:HORizontal:UINterval:RANGe](#) on page 2586

[EYE<m>:HORizontal:UINterval:POSition](#) on page 2586

Vertical settings

Defines the horizontal settings for the eye analysis.

Scale ← Vertical settings

Defines the vertical scale in Volts per division. Increasing the scale compresses the display of the signal.

Remote command:

[EYE<m>:VERTical:SCALE](#) on page 2591

Offset ← Vertical settings

The offset voltage is subtracted to correct a signal with DC offset. The vertical center of the selected channel is shifted by the offset value and the signal is repositioned within the diagram area. Negative offset values move up the waveform, positive values move it down.

Remote command:

[EYE<m>:VERTical:OFFSet](#) on page 2590

Position ← Vertical settings

Moves the selected signal up or down in the diagram. The visual effect is the same as for "Offset" but the waveform is adjusted later in the signal flow. While the offset sets a voltage, position is a graphical setting given in divisions.

Remote command:

[EYE<m>:VERTical:POSition](#) on page 2591

20.2.3 Display settings

Access: [App Cockpit]> "Analysis" > "Eye Analysis" > "Display" tab

In the "Display" tab, you define the appearance of the individual eye diagrams.

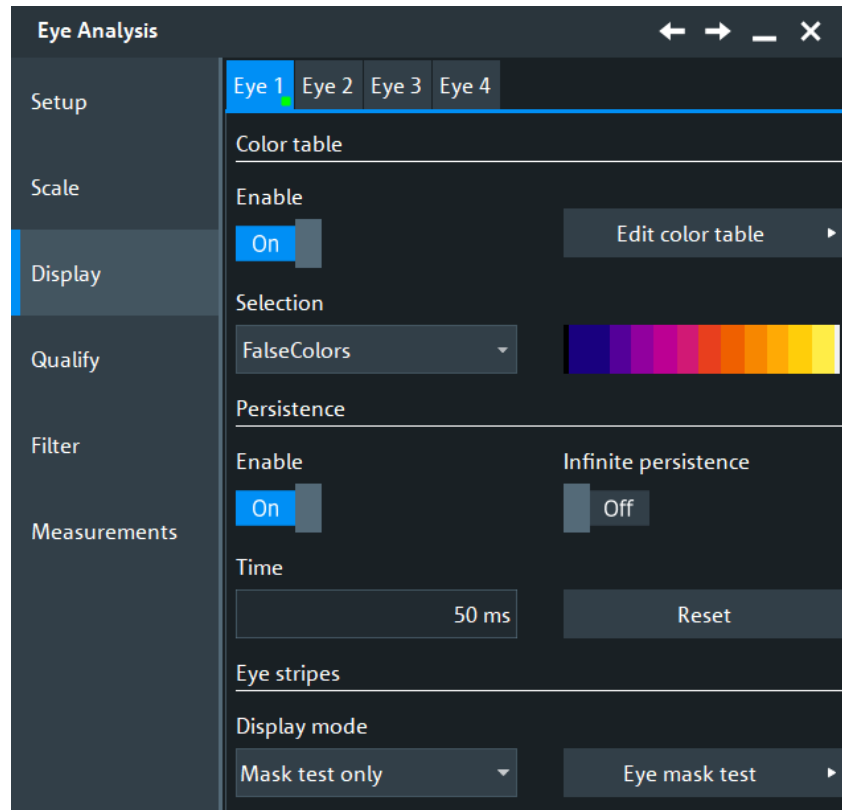

You can configure and analyze up to four independent eye diagrams in parallel (vertical subtabs Eye 1 to Eye 4). Make sure to select the correct eye diagram subtab on the left before you adjust the settings.

Color table

Like any other waveform, you can show the eye waveform in solid color, or apply a color table.

For a description of the color table settings, see [Chapter 4.3.2, "Color tables"](#), on page 76.

Persistence

Each eye diagram has its specific persistence settings, independent of the general waveform persistence.

The persistence settings influence the way that the "Wave Count" and "Event Count" statistics on eye measurements are calculated:

- If "Enable" and "Infinite persistence" are disabled:
 - "Wave Count": for every image used in an eye measurement, sums up the number of acquisitions that contributed to the advanced eye image.
 - "Event Count": the number of UIs of images with successful eye measurement.
- If "Infinite persistence" is enabled:
 - "Wave Count": the number of acquisitions that contributed to the last advanced eye image used in an eye measurement.

- "Event Count": the number of UIs of the last advanced eye image with successful eye measurement.

See also: [Chapter 8.2.11.1, "Statistics"](#), on page 362.

Enable ← Persistence

If enabled, each new data point in the diagram area remains on the screen for the duration that is defined using [Time](#), or as long as [Infinite persistence](#) is selected.

If disabled, the waveform points are displayed only for the current acquisition.

Remote command:

[EYE<m>:DISPlay:PERsistence:STATe](#) on page 2594

Infinite persistence ← Persistence

If infinite persistence is enabled, each new waveform point remains on the screen until this option is disabled. Use infinite persistence to display rare events in the signal.

Remote command:

[EYE<m>:DISPlay:PERsistence:INFinite](#) on page 2593

Time ← Persistence

Sets a time factor that controls how long the waveform points fade away from the display. Thus, the R&S RTO6 emulates the persistence of analog phosphor screens.

Remote command:

[EYE<m>:DISPlay:PERsistence:TIME](#) on page 2594

Reset ← Persistence

Resets the display, removing persistent all waveform points.

Remote command:

[EYE<m>:DISPlay:PERsistence:RESet](#) on page 2594

Display mode

Defines when the eye stripe is shown: always, never, or during mask tests.

The eye stripe is shown at the bottom of the main source waveform. It shows the part of the waveform that contributes to the eye. When a mask test is performed on the eye diagram, the eye stripe shows the position of the mask violations in red color.



Remote command:

[EYE<m>:DISPlay:MODE](#) on page 2593

20.2.4 Qualify settings

Access: [App Cockpit]> "Analysis" > "DDR Eye" > "Qualify" tab

Using the qualification settings, you can restrict the slices that contribute to the eye diagram. The restriction can be in horizontal direction (gate), or in vertical direction using the reference level.

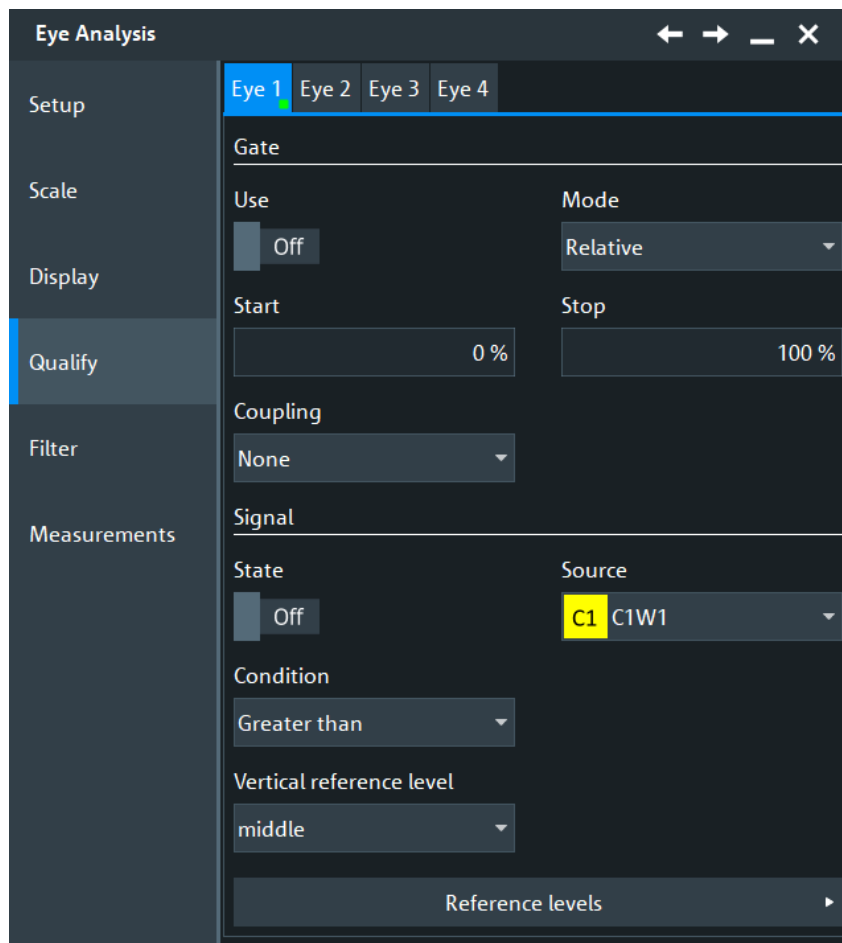

You can configure and analyze up to four independent eye diagrams in parallel (vertical subtabs Eye 1 to Eye 4). Make sure to select the correct eye diagram subtab on the left before you adjust the settings.

Gate

Restricts the contributing slices in horizontal direction. Only the timestamps within the defined horizontal interval qualify for eye generation.

To apply the gate settings, enable the "State".

The gate definition is the same as gate definition for measurements, but the gates are independent. You can define the gate in one of these ways:

- Enter absolute time values for gate start and gate end: "Coupling mode = None" and "Mode = Absolute". Set "Start" and "Stop" time.
- Enter relative values for gate start and gate end: "Coupling mode = None" and "Mode = Relative". Set "Relative start" and "Relative stop" in percent.
- If a cursor measurement is active, you can use the vertical cursor lines as gate limits: "Coupling mode = Cursor". Select the cursor set.
- If a zoom is active, you can use the zoom limits as gate: "Coupling mode = Zoom". Select the zoom.

Remote command:

[EYE<m>:QUALify:GATE\[:STATe\]](#) on page 2595

[EYE<m>:QUALify:GATE:COUPling](#) on page 2595

[EYE<m>:QUALify:GATE:MODE](#) on page 2595

[EYE<m>:QUALify:GATE:ABSolute:STARt](#) on page 2596

[EYE<m>:QUALify:GATE:ABSolute:STOP](#) on page 2596

[EYE<m>:QUALify:GATE:RELative:STARt](#) on page 2596

[EYE<m>:QUALify:GATE:RELative:STOP](#) on page 2596

[EYE<m>:QUALify:GATE:CURSor](#) on page 2596

[EYE<m>:QUALify:GATE:ZDIagram](#) on page 2597

Signal

Sets a waveform-based qualification for the eye generation. The voltage level of a waveform is compared with a threshold, and only if this condition is fulfilled, the slices contribute to the eye generation.

State ← Signal

Applies the signal qualification.

Remote command:

[EYE<m>:QUALify:SIGNal\[:STATe\]](#) on page 2597

Source ← Signal

Selects the waveform to be compared.

Remote command:

[EYE<m>:QUALify:SIGNal:SOURce](#) on page 2598

Condition ← Signal

Selects the comparison condition for the waveform.

Remote command:

[EYE<m>:QUALify:SIGNal:CONDition](#) on page 2598

Vertical reference level ← Signal

Selects the threshold. You can use the lower, middle, or upper reference level. These levels are the reference levels that are defined for measurements.

See [Chapter 13.3, "Signal and reference levels for NRZ signals"](#), on page 495.

Remote command:

[EYE<m>:QUALify:SIGNal:LSElect](#) on page 2598

Reference levels

Opens the reference level dialog. For details, see [Chapter 13.3, "Signal and reference levels for NRZ signals"](#), on page 495.

20.2.5 Filter settings for NRZ signals

Access: [App Cockpit]> "Analysis" > "DDR Eye" > "Filter" tab

Filter settings allow you to select waveform slices for eye generation dependent on the bit status.

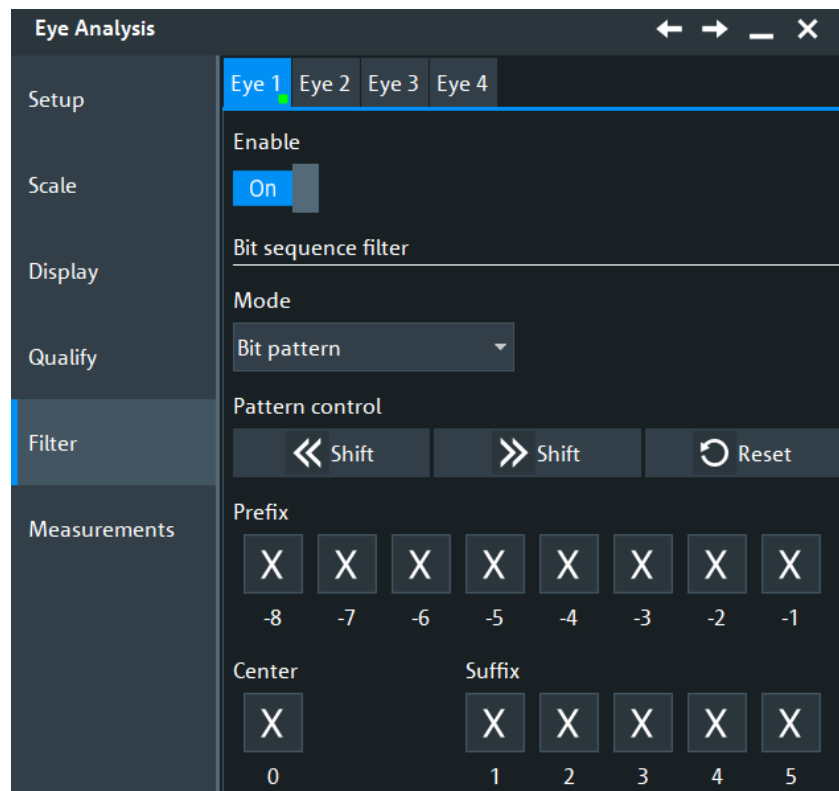

Figure 20-1: Filter settings for NRZ signals

You can configure and analyze up to four independent eye diagrams in parallel (vertical subtabs Eye 1 to Eye 4). Make sure to select the correct eye diagram subtab on the left before you adjust the settings.

Enable

Applies the filter settings.

Remote command:

`EYE<m>:FILTer:STATe` on page 2599

Mode

Selects which bits contribute to the eye generation.

- | | |
|--------------------|---|
| "All bits" | All bits contribute to the eye diagram, same as "State" = off. |
| "Level transition" | Only bits after a signal transition contribute (0 to 1, or 1 to 0). |
| "Constant level" | Only bits without a preceding signal transition contribute (0 to 0, or 1 to 1). |
| "Bit pattern" | Only bits contribute that match the defined pattern before and after the center eye. Use the bit pattern, for example, to measure the effect of data-dependent jitter on the eye diagram. |

Remote command:

`EYE<m>:FILTer:BPATtern:MODE` on page 2599

Pattern

Defines the bit pattern if "Mode" = "Bit pattern". You can set up to 8 bits before and 5 bits after the center eye (reference bit).

Remote command:

`EYE<m>:FILTer:BPATtern:PREFix<1..8>` on page 2600

`EYE<m>:FILTer:BPATtern:CENTer` on page 2600

`EYE<m>:FILTer:BPATtern:SUFFix<1..5>` on page 2600

Pattern control

Shift the pattern bit by bit to the left or to the right, and reset to the default (X for all bits).

Remote command:

`EYE<m>:FILTer:BPATtern:SLEFt` on page 2600

`EYE<m>:FILTer:BPATtern:SRIGHt` on page 2600

`EYE<m>:FILTer:BPATtern:RESet` on page 2600

20.2.6 Protocol filter settings

This setting is only available, if the [Source](#) is set to "SBx" and the "DDR" serial bus analysis is enabled for the same bus.

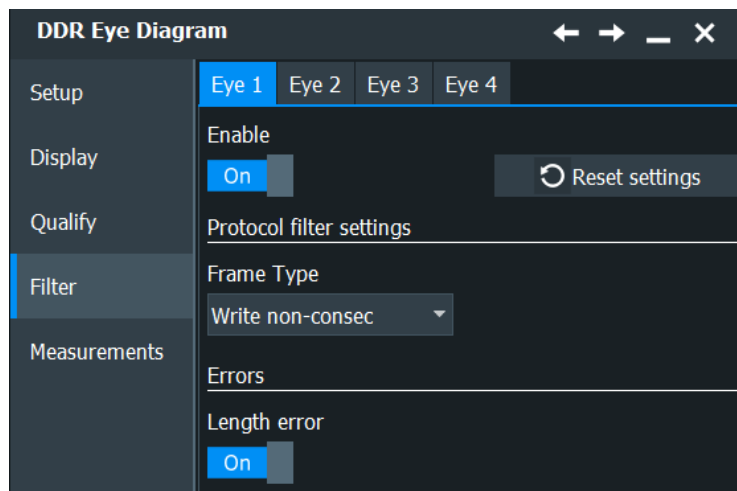

You can configure and analyze up to four independent eye diagrams in parallel (vertical subtabs Eye 1 to Eye 4). Make sure to select the correct eye diagram subtab on the left before you adjust the settings.

Reset settings

Resets the current filter settings.

Frame Type

Selects which frame types contribute to the eye diagram, write frames, read frames or any of them.

Remote command:

`EYE<m>:FILTer:DDR:FTYPE` on page 2601

Length Error

If enabled, the length errors contribute to the eye diagram.

Remote command:

`EYE<m>:FILTer:DDR:LENerror` on page 2601

20.2.7 Filter settings for PAM-N signals

Requires option R&S RTO6-K135.

Access: [App Cockpit]> "Analysis" > "Eye Analysis" > "Filter" tab

These settings are only available for signals with "PAM order" > 2, see [Technology and serial standard properties](#).

The screenshot shows the 'Eye Analysis' software interface. On the left is a vertical sidebar with menu items: Setup, Scale, Display, Qualify, Filter (highlighted), and Measurements. The main area has four tabs: Eye 1, Eye 2, Eye 3, and Eye 4. Under the 'Filter' tab, there are two sections:

- PAM-N diagram filter:** Includes an 'Enable' toggle set to 'Off', a 'Mode' dropdown menu set to 'Whole eye', and a preview window showing an eye diagram with multiple levels labeled 'Eye n-1' and 'Eye 1'. Below the preview, text reads: "Whole eye" displays all level transitions of the selected source.
- Bit sequence filter:** Includes a 'Mode' dropdown menu set to 'Constant level' and a waveform visualization showing a signal with a central burst of blue dots.

You can configure and analyze up to four independent eye diagrams in parallel (vertical subtabs Eye 1 to Eye 4). Make sure to select the correct eye diagram subtab on the left before you adjust the settings.

PAM-N diagram filter mode

Selects which part of the signal is used to build the eye.

"Whole eye" Displays all level transitions of the selected source.

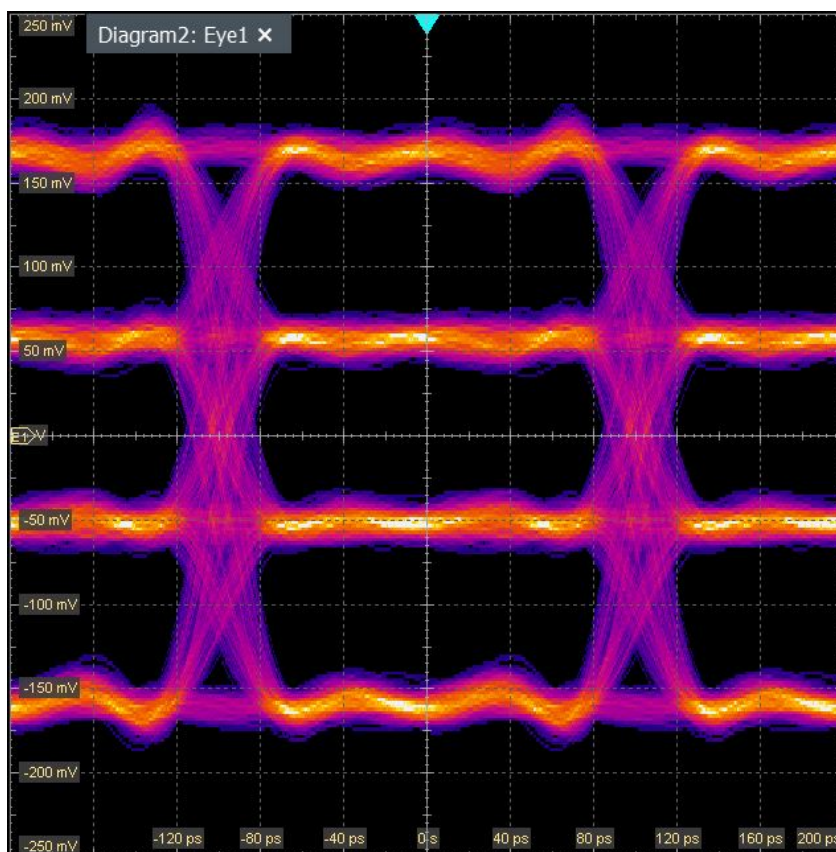
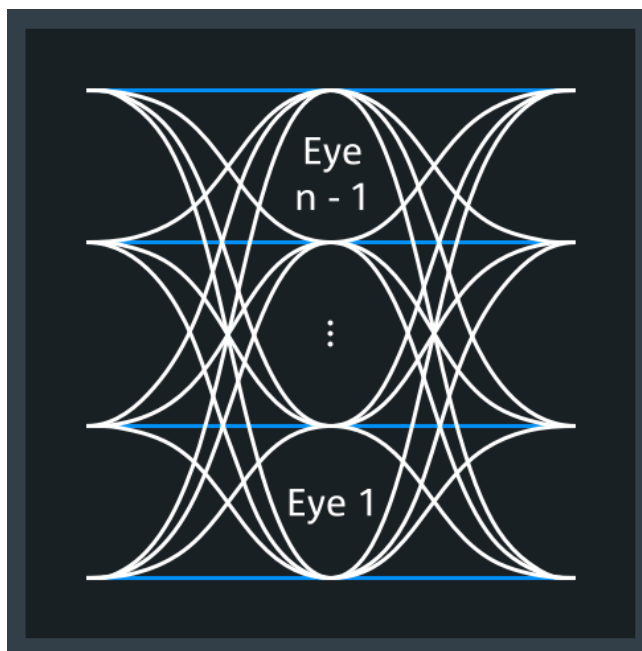

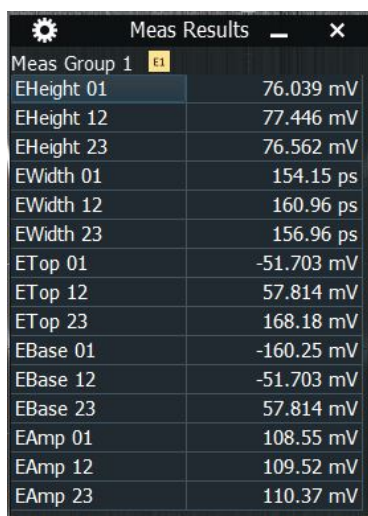

The screenshot shows a window titled "Meas Results" with a gear icon and a close button. It displays a table of measurement results for "Meas Group 1". The table has two columns: the measurement name and the corresponding value with units.

Measurement	Value
EHeight 01	76.039 mV
EHeight 12	77.446 mV
EHeight 23	76.562 mV
EWidth 01	154.15 ps
EWidth 12	160.96 ps
EWidth 23	156.96 ps
ETop 01	-51.703 mV
ETop 12	57.814 mV
ETop 23	168.18 mV
EBase 01	-160.25 mV
EBase 12	-51.703 mV
EBase 23	57.814 mV
EAmplitude 01	108.55 mV
EAmplitude 12	109.52 mV
EAmplitude 23	110.37 mV

"Specific eye" Displays an explicit eye opening (e.g. for level transition 1-2) with all involved level transitions. You can select the eye with "Eye selection".

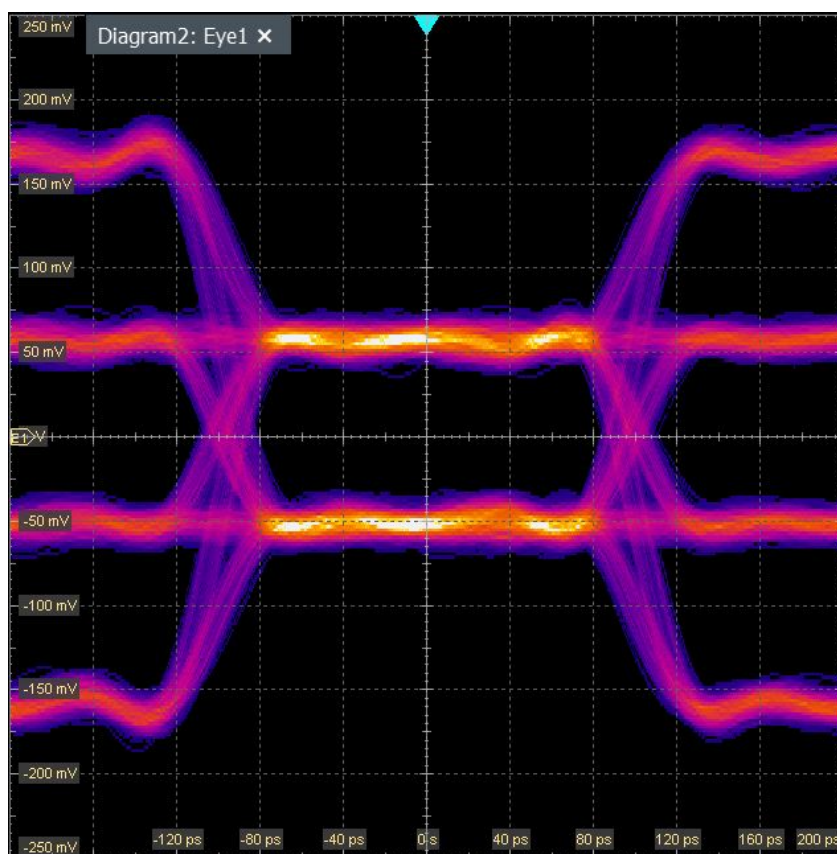
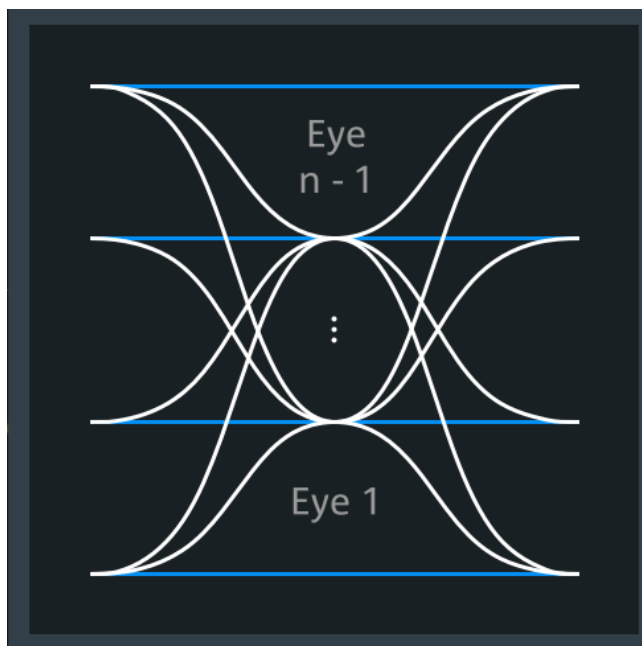

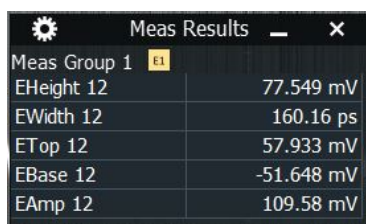

The screenshot shows a window titled "Meas Results" with a gear icon and a close button. It displays a table of measurement results for "Meas Group 1". The table has two columns: the measurement name and the value. The values are: EHeight 12 (77.549 mV), EWidth 12 (160.16 ps), ETop 12 (57.933 mV), EBase 12 (-51.648 mV), and EAmp 12 (109.58 mV).

Measurement	Value
EHeight 12	77.549 mV
EWidth 12	160.16 ps
ETop 12	57.933 mV
EBase 12	-51.648 mV
EAmp 12	109.58 mV

"Selected eye" Displays an explicit eye opening (e.g. for level transition 1-2) with only its own level transitions. You can select the "Base level" and the "Target level".

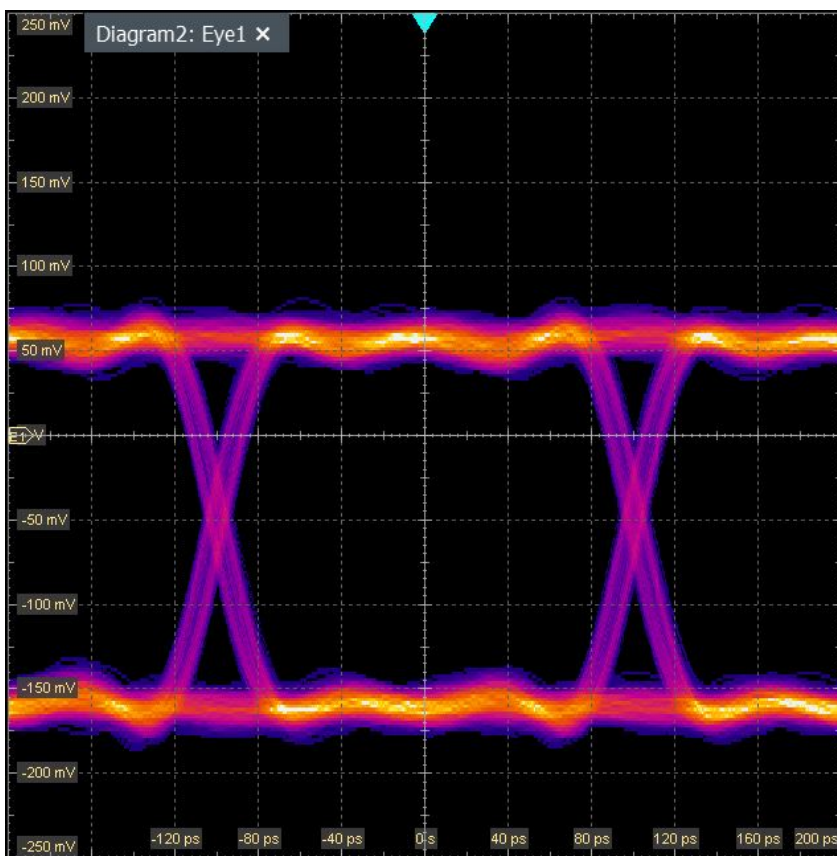
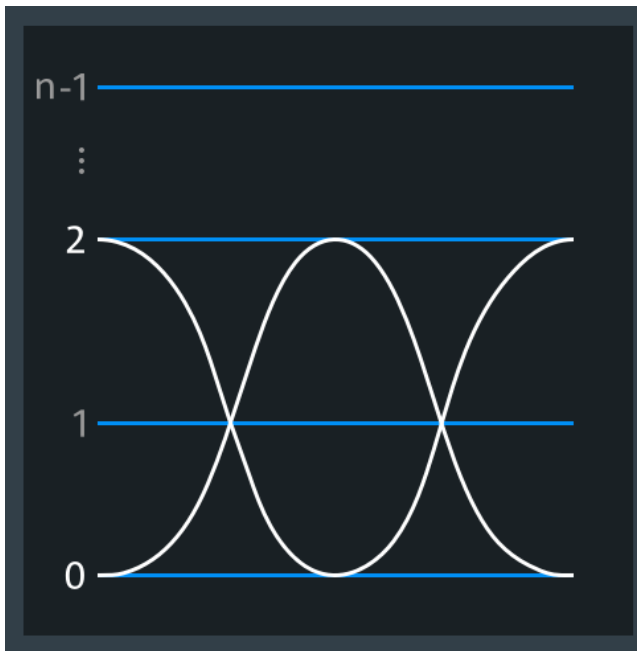

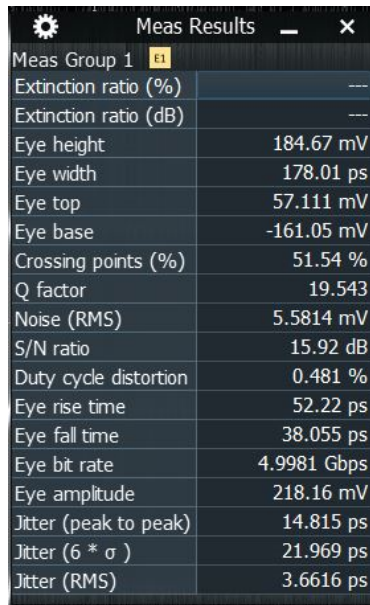

Meas Results	
Meas Group 1	ei
Extinction ratio (%)	---
Extinction ratio (dB)	---
Eye height	184.67 mV
Eye width	178.01 ps
Eye top	57.111 mV
Eye base	-161.05 mV
Crossing points (%)	51.54 %
Q factor	19.543
Noise (RMS)	5.5814 mV
S/N ratio	15.92 dB
Duty cycle distortion	0.481 %
Eye rise time	52.22 ps
Eye fall time	38.055 ps
Eye bit rate	4.9981 Gbps
Eye amplitude	218.16 mV
Jitter (peak to peak)	14.815 ps
Jitter (6 * σ)	21.969 ps
Jitter (RMS)	3.6616 ps

Remote command:

[EYE<m>:FILTer:PAMN:EMODe](#) on page 2602

[EYE<m>:FILTer:PAMN:SEYE](#) on page 2602

[EYE<m>:FILTer:PAMN:BLEVel](#) on page 2601

[EYE<m>:FILTer:PAMN:TLEVel](#) on page 2602

Mode

Selects which bits contribute to the eye generation.

"All bits" All bits contribute to the eye diagram, same as "State" = off.

"Level transition" Only bits after a signal transition contribute (0 to 1, or 1 to 0).

"Constant level" Only bits without a preceding signal transition contribute (0 to 0, or 1 to 1).

Remote command:

[EYE<m>:FILTer:BPATtern:MODE](#) on page 2599

20.2.8 Measurements settings

Access: [App Cockpit]> "Analysis" > "DDR Eye" > "Measurement" tab

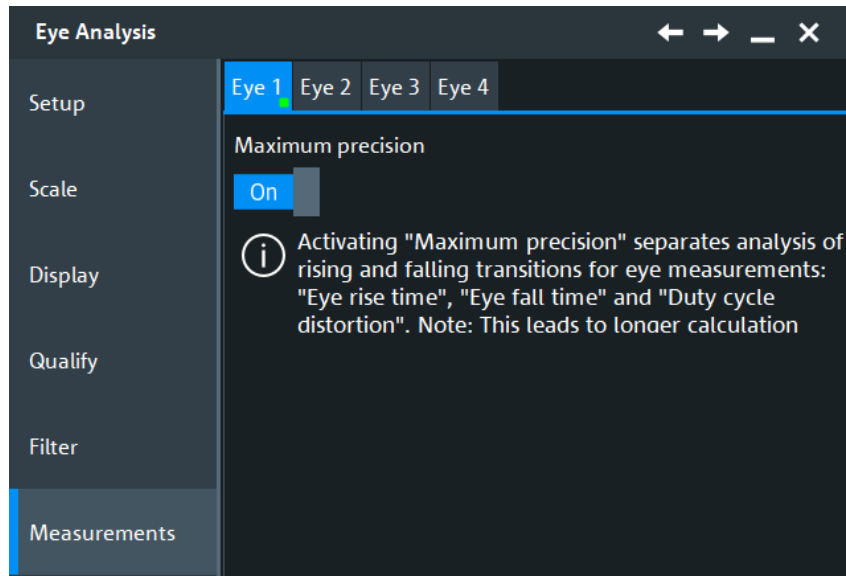

Maximum precision

If this function is enabled, the rising and falling transitions for the eye measurements "Eye rise time", "Eye fall time" and "Duty cycle distortion" are separated. This leads to longer calculation times.

See also: [Chapter 8.2.5, "Eye diagram measurements"](#), on page 332.

Remote command:

`EYE<m>:MEASurement:MAXPrecision` on page 2590

20.3 Measurements and zoom on eye diagrams

To analyze eye diagrams, you can use the following basic functions of the R&S RTO6:

- **Cursor measurements**
Cursors can be used on eye diagrams in the usual way. "Track waveform" is not supported.
For details, see [Chapter 8.1, "Cursor measurements"](#), on page 293.
- **Automatic eye measurements**
Eye measurements can be used on advanced eye diagrams in the usual way.
For details, see [Chapter 8.2.5, "Eye diagram measurements"](#), on page 332.
- **Histograms**
You can create histograms on eye diagrams as usual.
For details, see [Chapter 8.2.7, "Histograms and histogram measurements"](#), on page 346.
- **Zoom**
You can zoom into eye diagrams using the zoom functions.
For details, see [Chapter 7.1, "Zoom"](#), on page 243.

20.4 Mask Testing on Eye Diagrams

Mask testing on eye diagrams allows you to test data signals against eye shapes that are required in the standards.

You can select the shape of the eye, enter its dimensions and position the eye on the display. For mask configuration details, see [Chapter 10.2.2, "Mask definition"](#), on page 404. The fail criteria for the test is defined as usual for R&S RTO6 mask tests, see [Chapter 10.2.3, "Define Test"](#), on page 411.

The eye mask definition cannot be saved as a mask test. You can save the settings as user defined preset and recall them by loading the preset file. See: [Chapter 4.6, "Pre-set setup"](#), on page 98.

21 Power analysis (option R&S RTO6-K31)

With the R&S RTO6 and option R&S RTO6-K31, you can perform power analysis measurements.

The following power measurements are available:

- [Power quality](#)
- [Inrush current](#)
- [Current harmonic](#)
- [Modulation analysis](#)
- [Dynamic on resistance](#)
- [Slew rate](#)
- [Safe operating area \(S.O.A.\)](#)
- [Turn on/off](#)
- [Switching loss](#)
- [Power efficiency](#)
- [Output ripple](#)
- [Transient response](#)
- [Output spectrum](#)

21.1 Power measurement selection

Access: [App Cockpit]> "Analysis" > "Power"

The "Power Menu" is the entry point to all power measurements and the general setting required for them.

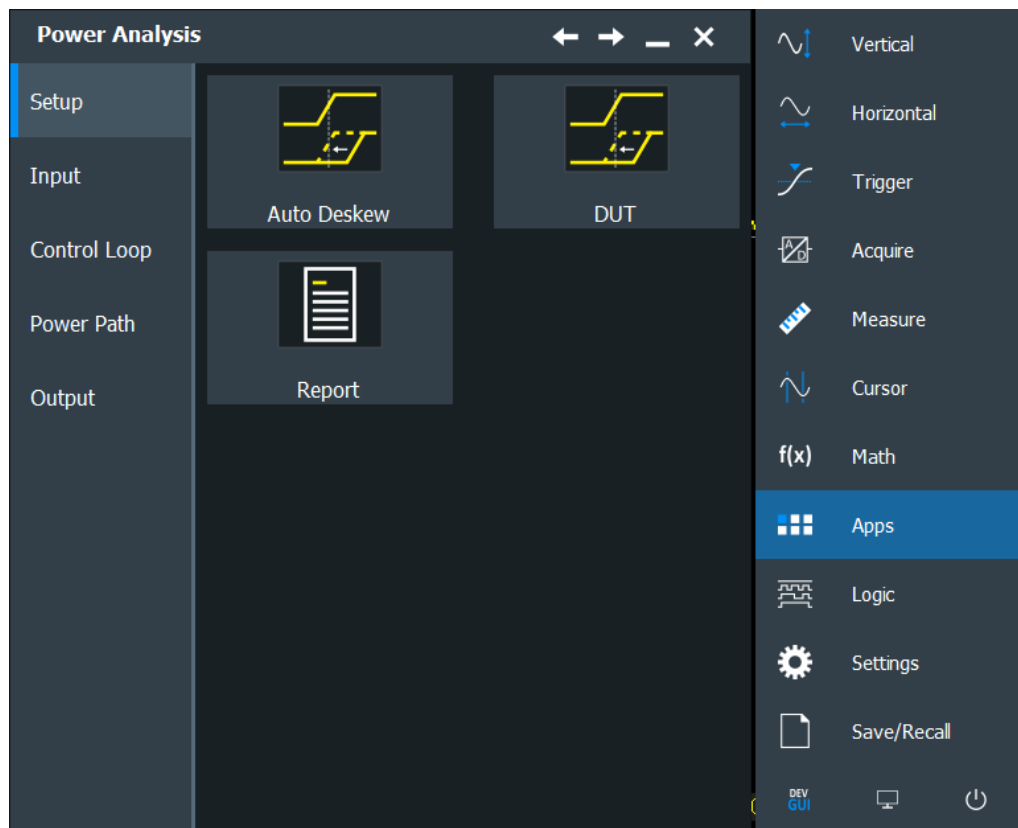

The dialog has several tabs:

- "Setup": general settings, that can be used by all measurements, like deskewing.
- "Input": measurements for performing input line analysis. They are used to measure the characteristics of the input power and the effects the power supply exudes to the input line.
- "Control Loop": measurements for characterizing the switching properties of a device.
- "Power Path": measurements for analyzing the behavior of the devices that control the power flow through the switched-mode power supply (SMPS) circuit, including switching devices and inductors.
- "Output": measurements for characterizing the behavior and quality of the SMPS output voltage.

21.1.1 Setup settings

Access: [App Cockpit]> "Analysis" > "Power" > "Setup"

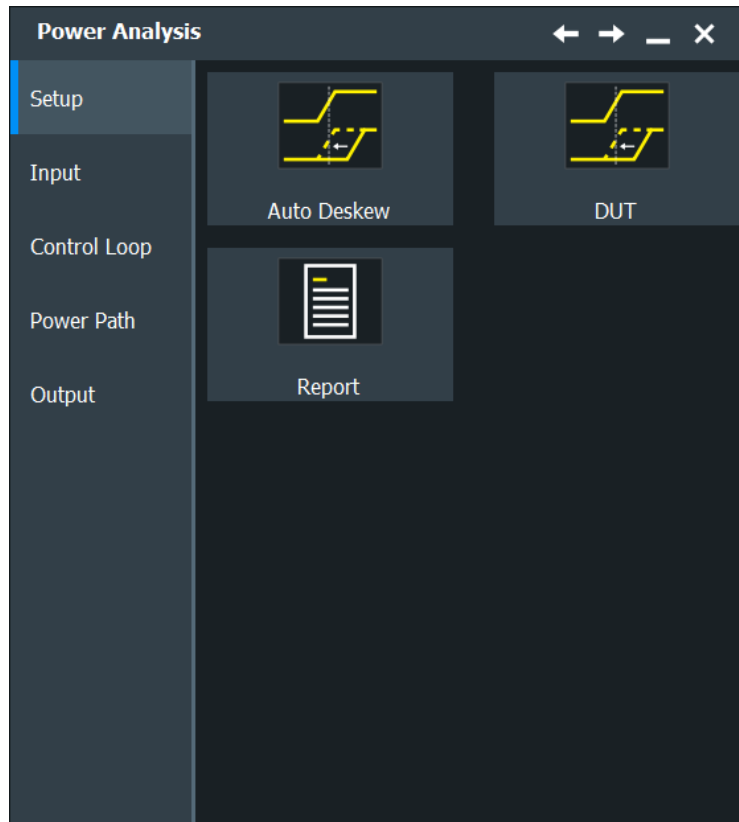

The Setup settings, can be used by all measurements, like deskewing.

21.1.1.1 Auto deskew

The "Auto Deskew" dialog box guides you through the auto deskew of your current and voltage probes.

Required equipment:

- R&S RT-ZF20 power deskew fixture
- Rohde & Schwarz voltage probe
- Rohde & Schwarz current probe

1. Select "Analysis" > "Power".
2. Under "General", select "Auto Deskew".
3. Connect the voltage probe and the current probe to the oscilloscope.
4. Connect the probes to the R&S RT-ZF20 power deskew fixture as shown in the "Channels" tab:

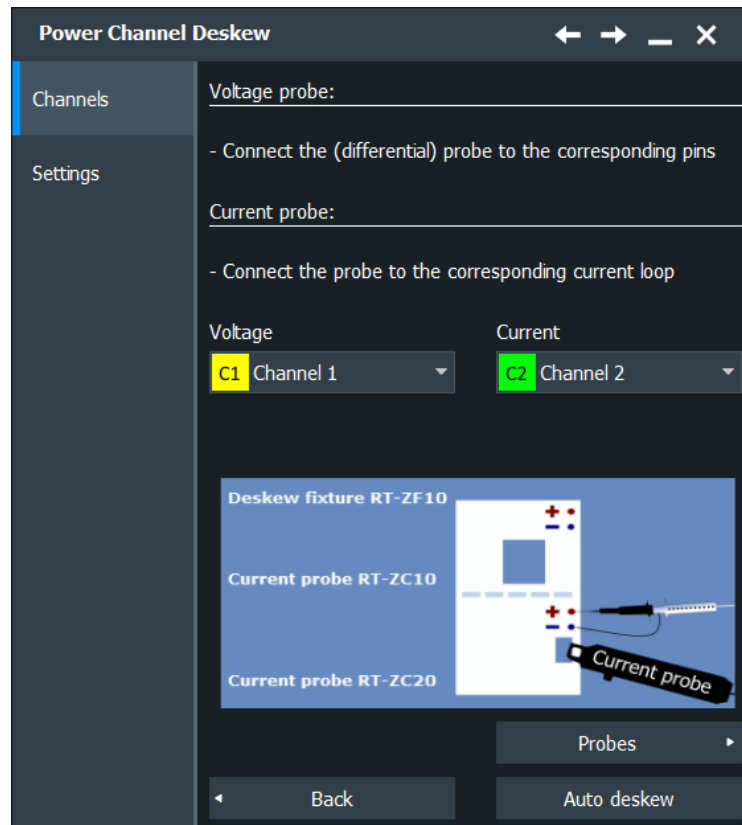

5. Select the correct channels for the "Current Source" and the "Voltage Source".
6. Tap "Next".
7. Check and complete the probe setup in the "Probes" tab.
Current probes and high-voltage differential probes are not automatically detected by the instrument. Tap "Predefined probe" and select the correct probe type.
8. Tap the "Settings" tab.
9. Set the ["Overwrite present skew setup"](#) on page 1175 and ["Activate user defined preset"](#) on page 1176 options. These settings define whether the instrument uses the deskew result for user-defined preset and general skew settings.
10. Tap "Auto deskew".

The probes are deskewed and the measurement can be started.

If no deskew fixture is available, you have to deskew your probes manually, see [Chapter 5.3.1, "Skew"](#), on page 123.

Probes

In the "Probes" tab, you check and set up your voltage and current probes.

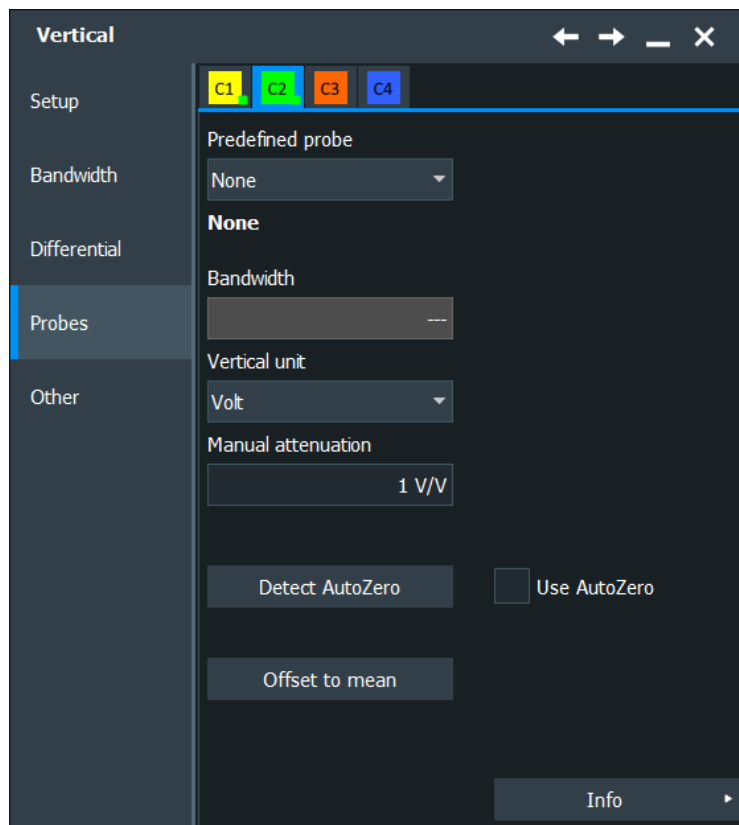

Type, Name, Bandwidth

The fields show the characteristics of a recognized or predefined probe for information. The bandwidth is the effective bandwidth.

If the instrument cannot recognize the probe, and the probe is not known, the "Type" is "None", and the other fields are empty.

Remote command:

[PROBe<m>:SETup:TYPE?](#) on page 1434

[PROBe<m>:SETup:NAME?](#) on page 1435

[PROBe<m>:SETup:BANDwidth?](#) on page 1435

Predefined probe, Vertical unit, Attenuation

Current probes R&S RT-ZCxx, the high-voltage active probe R&S RT-ZD01 and the transmission line probe R&S RT-ZZ80 are not recognized automatically but the parameters of these probes are known to the instrument. Select the correct probe type and enter additional parameters if necessary. The corresponding "Vertical unit" and the "Attenuation" or "Gain" are set.

For an auto deskew, only Rohde & Schwarz probes are supported.

Settings

In this tab, you can define the preset behavior and how the auto deskew results are stored.

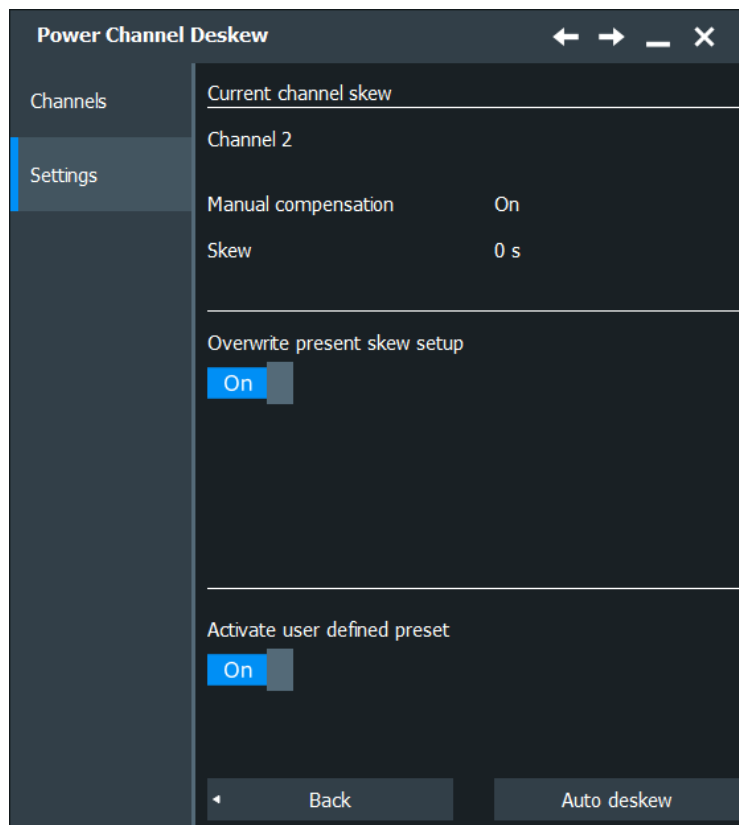

Current channel skew

Shows the skew settings of the channel connected to the current probe. Skew settings are defined in the "Horizontal > Skew" dialog box.

See also: [Chapter 5.3.1, "Skew"](#), on page 123

Overwrite present skew setup

If disabled, the instrument only stores the result of the auto deskew procedure as a separate value and does not use it. This value can be used later for power measurements. The general skew offset under "Current channel skew" remains unchanged.

If enabled, the result of the auto deskew procedure is used for all measurements on the selected channel. It is shown under "Current channel skew".

Remote command:

`POWer:DESKew:RESet` on page 2757

Auto deskew result

Available only if "Overwrite present skew setup" is disabled.

"Deskew value" Result of the auto deskew.

Remote command:

`POWer:DESKew:TIME?` on page 2758

"Apply" Writes the result of the auto deskew to the "Skew offset" of the selected channel.

Remote command:

[POWer:DESKew:CURRent](#) on page 2757

Activate user defined preset

If enabled, the deskew values are written to a user-defined preset file, and the user-defined preset is enabled. Thus, the probe setup and deskew values are not influenced by a manual [Preset].

See also: [Chapter 4.6, "Preset setup"](#), on page 98.

Remote command:

[POWer:DESKew:UDPReset](#) on page 2758

Auto Deskew

Starts an auto deskew.

Make sure that the probes are configured correctly before you start the deskewing.

Remote command:

[POWer:DESKew:EXECute](#) on page 2757

21.1.1.2 DUT

Access: "Analysis" > "Power" > "DUT".

In this dialog, you can describe your device under test (DUT). The information set in this dialog can be used on the title page for a report generated from the "Power Analysis" measurements, see ["Content"](#) on page 1181.

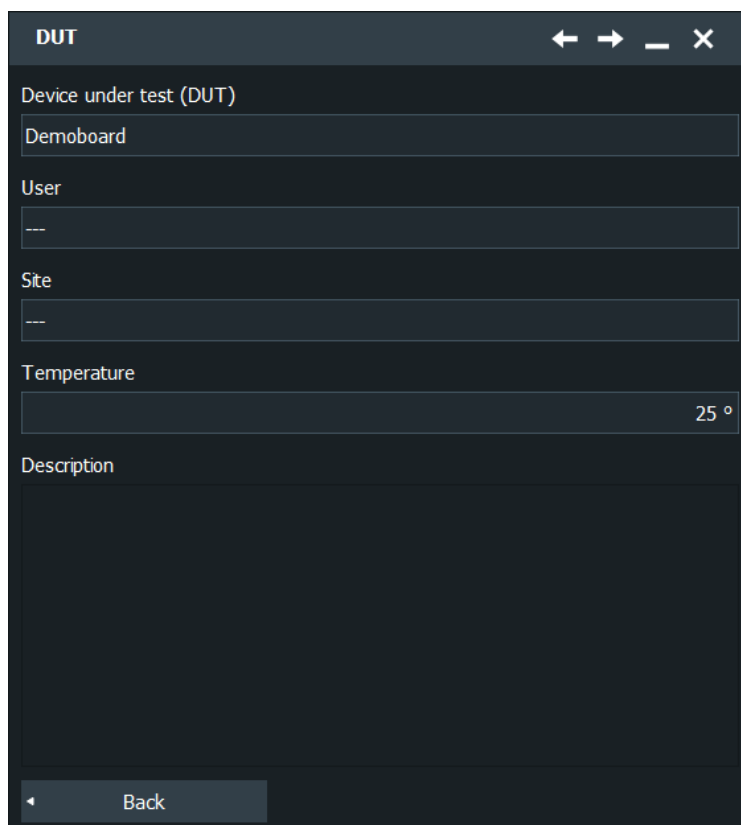

The screenshot shows a configuration window titled "DUT" with a dark background. At the top right of the window are navigation icons: a left arrow, a right arrow, a minus sign, and a close 'X' icon. The main content area contains the following fields:

- Device under test (DUT):** A text input field containing "Demoboard".
- User:** A text input field containing "---".
- Site:** A text input field containing "---".
- Temperature:** A text input field containing "25 °".
- Description:** A large, empty text area.

At the bottom left of the window is a "Back" button with a left-pointing arrow.

Device under test (DUT)

Enter a name for your DUT.

Remote command:

[POWer:REPort:DUT](#) on page 2759

User

Enter a user.

Remote command:

[POWer:REPort:USER](#) on page 2759

Site

Enter a site.

Remote command:

[POWer:REPort:SITE](#) on page 2759

Temperature

Enter the temperature.

Remote command:

[POWer:REPort:TEMPerature](#) on page 2759

Description

Enter a description.

Remote command:

[POWER:REPort:DESCRiption](#) on page 2759

21.1.1.3 Report

Access "Analysis">"Power" > "Report".

Test results

After executing a measurement, you can press "Add to report" and save the results. In this tab, you can manage all saved measurement results.

At the top of the tab, you can switch through the different "Power Analysis" measurements.

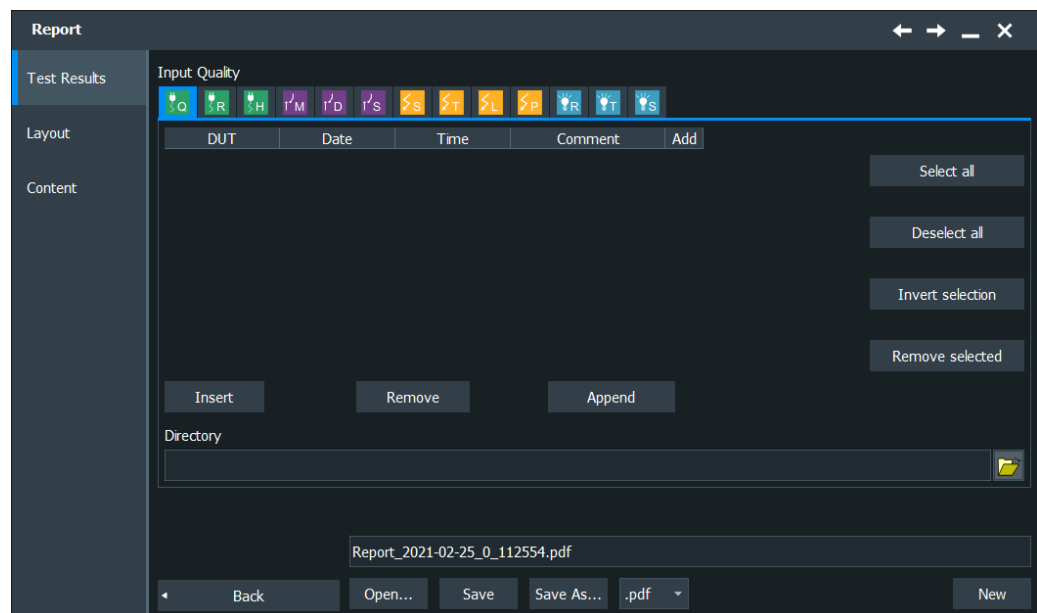

Report Table

Shows a list of the available measurements.

After you select a [Directory](#), you can manage previous report results from this directory. To add a measurement report press "Insert" or "Append". To remove a measurement report press "Remove".

"DUT" Shows the name of the DUT, see [Chapter 21.1.1.2, "DUT"](#), on page 1176.

"Date" Shows the date of the measurement.

"Time" Shows at what time, the measurement result was added to report.

"Comment" Enters a comment.

"Add" Adds the selected measurement to the report.

Remote command:

[POWER:REPort:TEST:ADD](#) on page 2761

[POWER:REPort:TEST:COMMeNT](#) on page 2763

[POWer:REPort:TEST:COUNT](#) on page 2764

[POWer:REPort:TEST:INSert](#) on page 2761

[POWer:REPort:TEST:LSEnd?](#) on page 2764

[POWer:REPort:TEST:REMove](#) on page 2761

Selection

Manages the selection of the result reports.

Select all ← Selection

Selects all result reports.

Remote command:

[POWer:REPort:TEST:SEA](#) on page 2762

Deselect all ← Selection

Deselects all result reports.

Remote command:

[POWer:REPort:TEST:DSEA](#) on page 2762

Invert Selection ← Selection

Inverts the selection of all result reports, meaning that all selected result reports are deselected and vice versa.

Remote command:

[POWer:REPort:TEST:ISE](#) on page 2762

Remove selected ← Selection

Removes the selected result report.

Remote command:

[POWer:REPort:TEST:RSE](#) on page 2762

Directory

Selects the directory, from which previous report results are inserted into the report table. You can use this directory to insert previously recorded report data into the current report.

Remote command:

[POWer:REPort:TEST:DIRectory](#) on page 2763

Report Path

Enter the file name to load or to save the report to, and select the file format with the format button on the right.

"Load"	Loads the most recently created report with the Windows default viewer application for the pdf/rtf file format.
"Open"	Opens a file selection dialog box and loads the selected file.
"Save"	Saves the data to the selected file.
"Save As..."	Opens the file selection dialog box and saves the data to the selected file.
".pdf/.rtf"	Selects the file format.

"New" Creates a new file.

"Delete" Deletes the selected file.

Remote command:

[POWer:REPort:FILE:DELeTe](#) on page 2761

[POWer:REPort:FILE:NAME](#) on page 2761

[POWer:REPort:FILE:NEW](#) on page 2761

[POWer:REPort:FILE:SAVE](#) on page 2761

Layout

In this tab, you can set up a layout for your report.

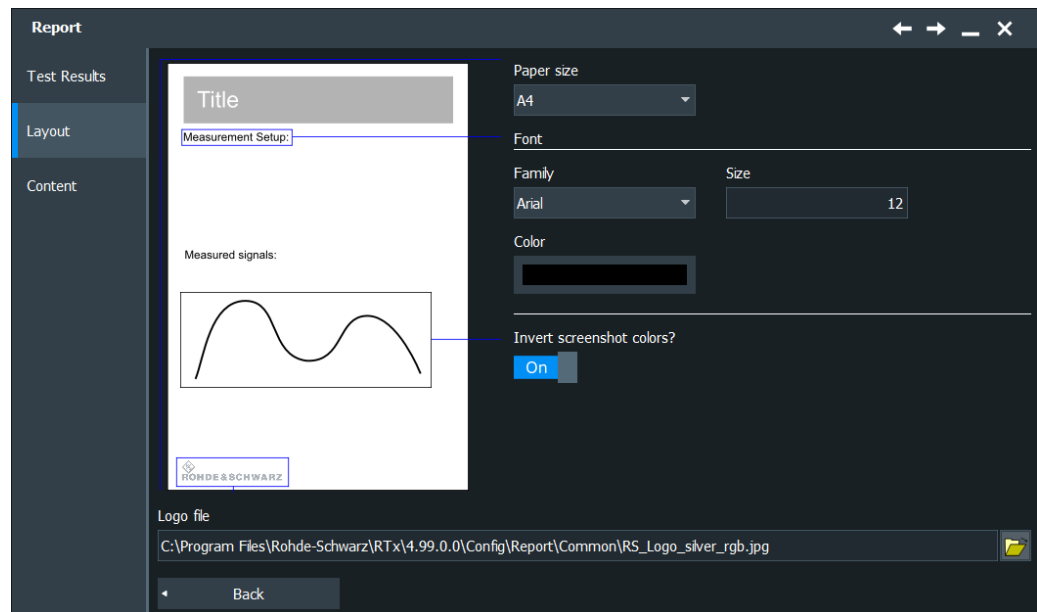

Paper size

Selects the paper size.

"A4" Selects A4.

"US Letter" Selects US Letter.

Remote command:

[POWer:REPort:PAPersize](#) on page 2760

Font

Sets the font for the report

Family ← Font

Selects the font family.

"Arial" Selects the font Arial.

"Helvetica" Selects the font Helvetica.

Remote command:

[POWer:REPort:FONT:FAMI](#) on page 2760

Size ← Font

Sets the font size.

Remote command:

`POWer:REPort:FONT:SIZE` on page 2760

Color ← Font

Sets the font color.

Remote command:

`POWer:REPort:FONT:COLO` on page 2760

Invert Screenshot Colors

Inverts the screenshot colors.

Remote command:

`POWer:REPort:INVert` on page 2762

Logo File

Selects a path to a logo picture file.

Remote command:

`POWer:REPort:LOGO` on page 2760

Content

In this tab, you can select the contents of your report. For each content you can select how often it is included in the report:

- "Always": Shows the respective contents for each measurement.
- "Never": Does not show the respective contents in the report.
- "Once": Shows the respective contents once at the beginning of the report.

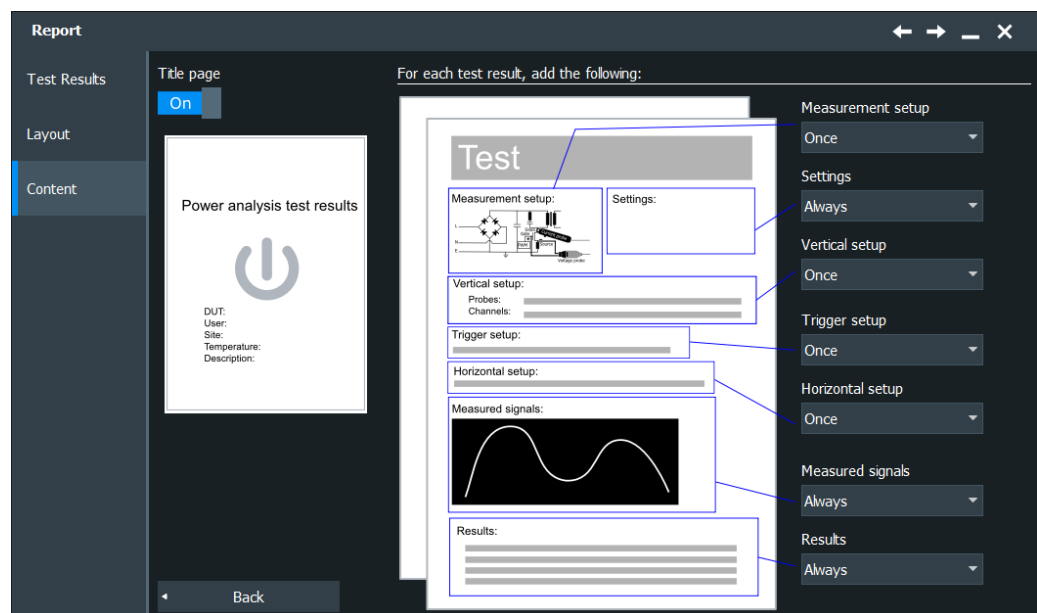

Title Page

Adds a Title page to the report. The contents can be set up in the "DUT" dialog, see [Chapter 21.1.1.2, "DUT"](#), on page 1176.

Remote command:

[POWER:REPort:CONTent:TITLe](#) on page 2759

Measurement Setup

Adds a graphic of the measurement setup.

Remote command:

[POWER:REPort:CONTent:MSETup](#) on page 2759

Settings

Adds the settings of the analysis.

Remote command:

[POWER:REPort:CONTent:SETTings](#) on page 2759

Vertical Setup

Adds the vertical setup settings.

Remote command:

[POWER:REPort:CONTent:VSETup](#) on page 2759

Trigger Setup

Adds the trigger setup settings.

Remote command:

[POWER:REPort:CONTent:TSETup](#) on page 2759

Horizontal Setup

Adds the horizontal setup settings.

Remote command:

[POWER:REPort:CONTent:HSETup](#) on page 2759

Measured signals

Adds a diagram of the measured signal.

Remote command:

[POWER:REPort:CONTent:MSIGNAL](#) on page 2759

Results

Adds the result box.

Remote command:

[POWER:REPort:CONTent:RESU](#) on page 2759

21.2 Overview of power measurement setup

Each power analysis measurement dialog box consists of the following tabs:

- Channels

- Settings
- Details

At the bottom of each tab, you can find two buttons. Tapping "Back", you can return to the power analysis measurement selection. "Execute" starts the power measurement.



21.2.1 Channels tab

In the "Channels" tab, you find information on the experimental setup of the selected power measurement. A short description explains what probes are needed and how to connect them. The description is supported by a block diagram of the experimental setup that shows the connection points for the probes.

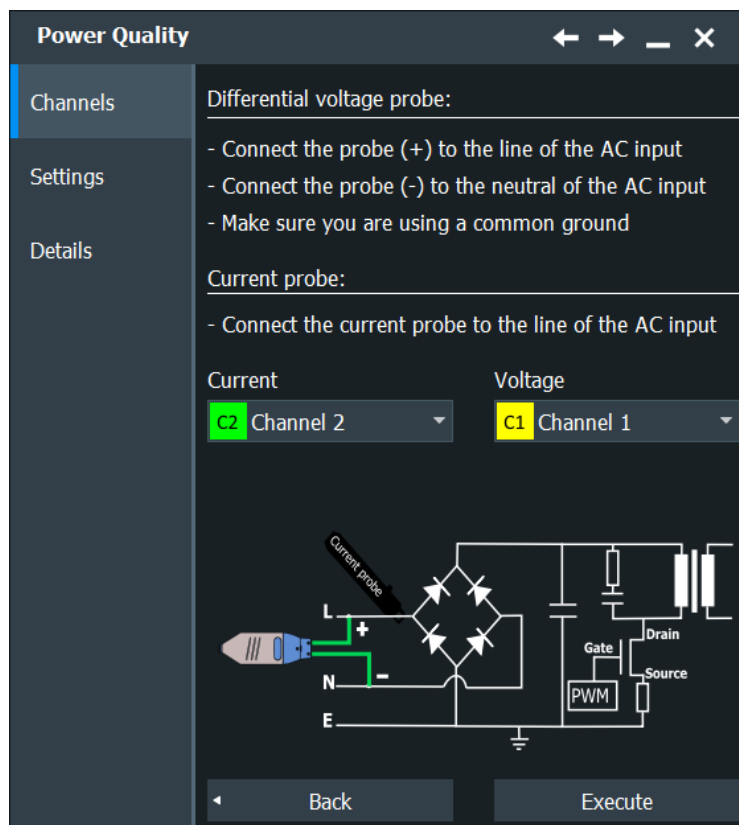

Depending on the selected power measurement, one or two voltage sources and current sources are required.

Current Source

Sets the channel for the current source.

Remote command:

[POWER:SOURce:CURRent<1..2>](#) on page 2756

Voltage Source

Sets the channel for the voltage source input.

Remote command:

`POWer:SOURce:VOLTage<1..4>` on page 2757

21.2.2 Settings tab

In the "Settings" tab, you configure the measurement and display settings. The settings depend on the selected power measurement.

For detailed information, see the "Settings" chapter of the relevant power measurement description.

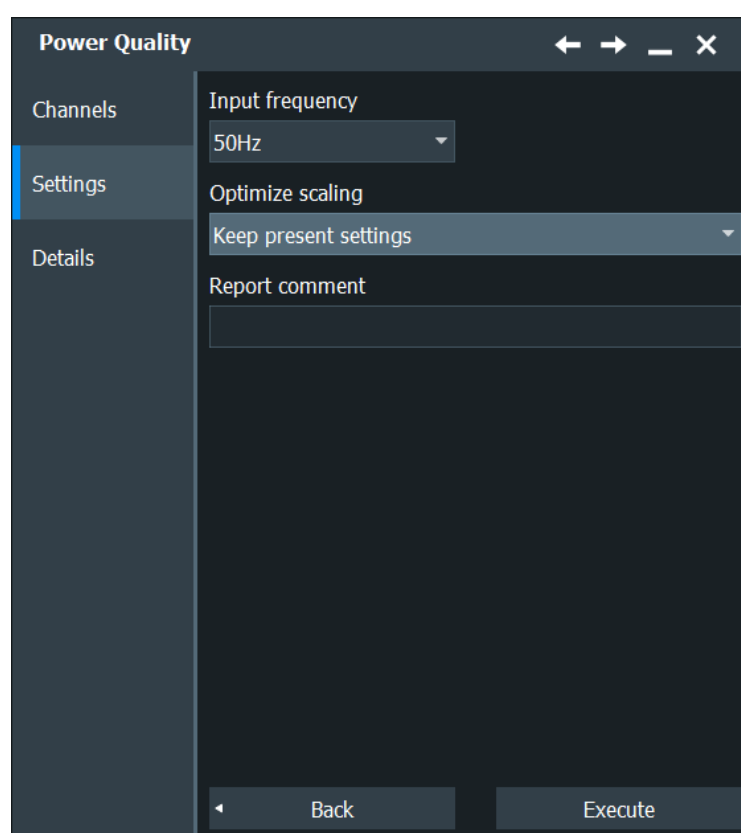

21.2.3 Details tab

In the "Details" tab, you find information on the measurement resources used by the selected power measurement.

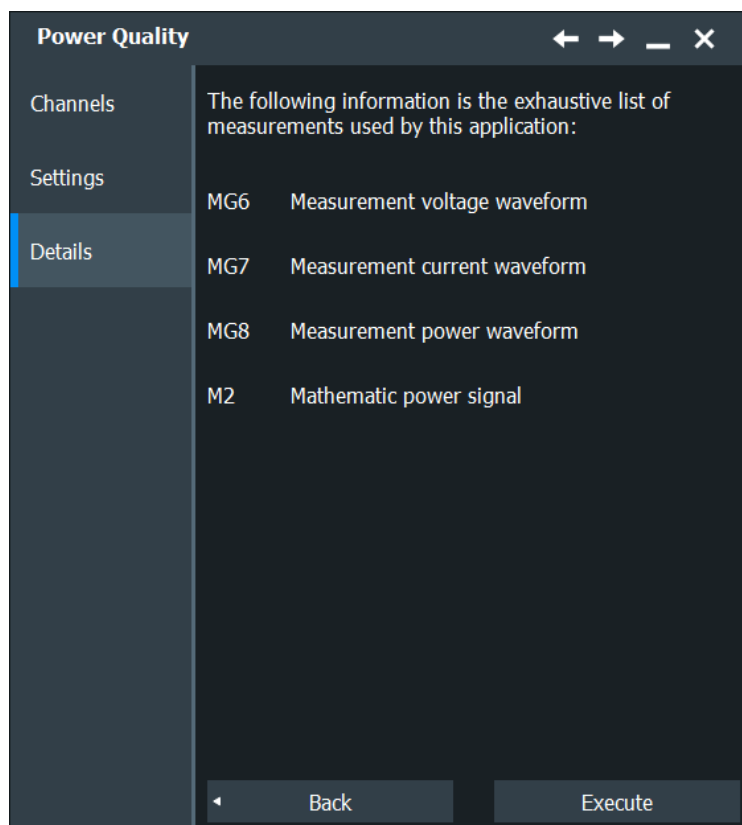

The following resources may be used:

- Measurements
- Mathematic waveforms
- Cursors
- XY-diagrams

The instrument enables the required resources when the power measurement is started.

21.3 Input

Access: [App Cockpit]> "Analysis" > "Power" > "Input"



The "Input" measurements are for performing input line analysis. They are used to measure the characteristics of the input power and the effects the power supply exudes to the input line.

21.3.1 Power quality

In an electric circuit power is a measure for the rate of flow of energy at a certain point of the circuit. The real power of a circuit, or the energy that can be used for work, is the portion of energy that is transferred in one direction over a complete cycle of the AC waveform. In AC circuits, however, inductive and capacitive elements can store energy temporarily. This portion of the power flow known as reactive power is then returned to the source without doing any work.

The "Power Quality" analysis measurements include the real power, the reactive power, the apparent power and the power factor. The crest factors and the phase angle between the current and voltage are also measured. These properties describe the power transfer in the system and allow you to characterize the power quality of the system.

Required probes:

- Differential voltage probe
- Current probe

21.3.1.1 Power quality results

The results of "Power Quality" measurements are provided in two ways:

- The diagram shows the graphical presentation of:
 - the voltage waveform
 - the current waveform
 - the power waveform that is the product of the current and voltage waveforms
- The result box displays the numeric measurement results.

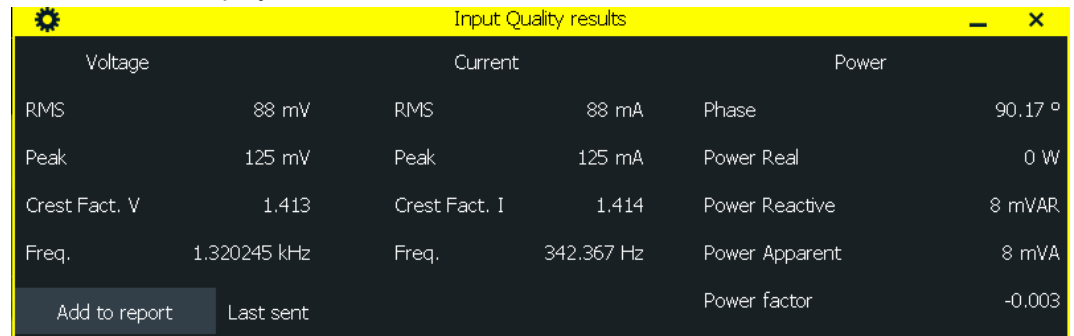

Input Quality results						
Voltage		Current		Power		
RMS	88 mV	RMS	88 mA	Phase	90.17 °	
Peak	125 mV	Peak	125 mA	Power Real	0 W	
Crest Fact. V	1.413	Crest Fact. I	1.414	Power Reactive	8 mVAR	
Freq.	1.320245 kHz	Freq.	342.367 Hz	Power Apparent	8 mVA	
				Power factor	-0.003	

Add to report Last sent

To measure and display the power quality, the instrument uses the following measurements and waveforms:

- "MG 6" to measure the voltage
- "MG 7" to measure the current
- "MG 8" to measure the power
- "M2" "Math 2" to calculate the power

The used resources are listed in the "Details" tab. See also: [Chapter 21.2.3, "Details tab"](#), on page 1184.

Voltage and current results

The voltage and current results are defined as follows:

Result	Description
RMS	Square root of the mean of the square of the current or voltage averaged over N cycles
Peak	Highest measured magnitude value of the voltage or current
Crest factor	Peak value / RMS value
Frequency	Frequency of the signal

Power results

The power in a system is described by several physical quantities: real power, reactive power, complex power, and phase angle. In [Figure 21-1](#), you can see how these quantities are related if the voltage and the current are sinusoidal signals.

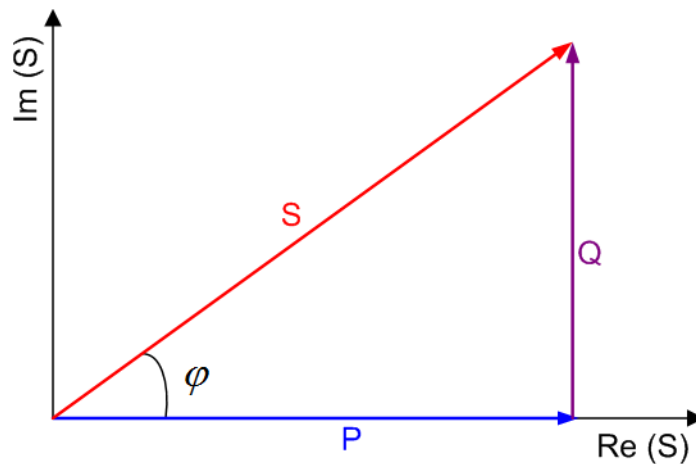

Figure 21-1: Power diagram for sinusoidal signals

P = real power [W]

Q = reactive power [VAR]

S = complex power [VA]

φ = phase angle between the current and the voltage sine waves [°]

The power results are defined as follows:

Result	Unit	Formula	Description
Power factor, P_{Factor}	-	$P_{Factor} = P / S $	Measure of the system efficiency. The value varies between -1 and 1.
Phase, φ	°	$\varphi = \arccos(P_{Factor})$	Phase angle between the current and the voltage sine waves.
Real power, P	W	$P = V_{INSTANTENEOUS} \cdot I_{INSTANTENEOUS}$ (averaged over N cycles)	Energy of the system that can be used to do work.
Reactive power, Q	VAR (Volt-Ampere reactive)	$Q = S \sin \varphi$	Power flow that is temporally stored in a system because of the inductive and capacitive elements.
Apparent power, S	VA	$ S = V_{RMS} \cdot I_{RMS}$ (averaged over N cycles)	S is the magnitude of the vector sum of real and reactive power (the complex power S).

The following remote commands are used for handling the measurement results:

- [POWER:QUALity:RESult:CURRent:CREStfactor?](#) on page 2765
- [POWER:QUALity:RESult:CURRent:FREQuency?](#) on page 2765
- [POWER:QUALity:RESult:CURRent:PEAK?](#) on page 2765
- [POWER:QUALity:RESult:CURRent:RMS?](#) on page 2765
- [POWER:QUALity:RESult:POWer:APParent?](#) on page 2765
- [POWER:QUALity:RESult:POWer:PFACTOR?](#) on page 2765

- [POWER:QUALity:RESult:POWER:PHASe?](#) on page 2765
- [POWER:QUALity:RESult:POWER:REACTive?](#) on page 2765
- [POWER:QUALity:RESult:POWER:REALpower?](#) on page 2766
- [POWER:QUALity:RESult:VOLTage:CREStfactor?](#) on page 2766
- [POWER:QUALity:RESult:VOLTage:FREQuency?](#) on page 2766
- [POWER:QUALity:RESult:VOLTage:PEAK?](#) on page 2766
- [POWER:QUALity:RESult:VOLTage:RMS?](#) on page 2766
- [POWER:QUALity:REPort:ADD](#) on page 2765

21.3.1.2 Configuring power quality

For details of the configuration settings, see [Chapter 21.3.1.3, "Power quality settings"](#), on page 1190.

1. Select "Analysis" > "Power".
2. Under "Input", select "Power Quality".
3. Connect the differential voltage probe and the current probe to the oscilloscope.
4. Deskew the probes as described in [Chapter 21.1.1.1, "Auto deskew"](#), on page 1172.
5. Connect the probes to the DUT as shown in the "Channels" tab:

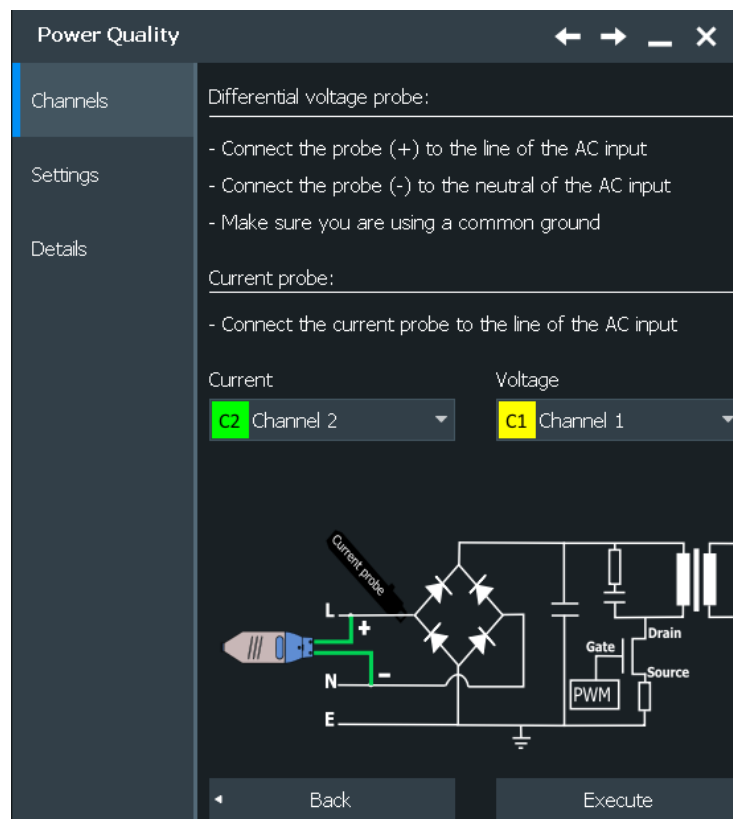

6. Select the correct channels of the "Current Source" and the "Voltage Source".
7. Select the "Settings" tab.
8. Set the "Input frequency" according to your signal.
9. Select an "Optimize Scaling" option.
10. Tap "Execute".

On the screen you can see the measurement waveforms of the current, the voltage and the power. Also, the result box with numeric measurement results is shown. For details, see [Chapter 21.3.1.1, "Power quality results"](#), on page 1187.

21.3.1.3 Power quality settings

In the "Channels" tab, you set the current source and the voltage source, see also: [Chapter 21.2.1, "Channels tab"](#), on page 1183.

In the "Settings" tab, you configure the power measurement parameters and display settings.

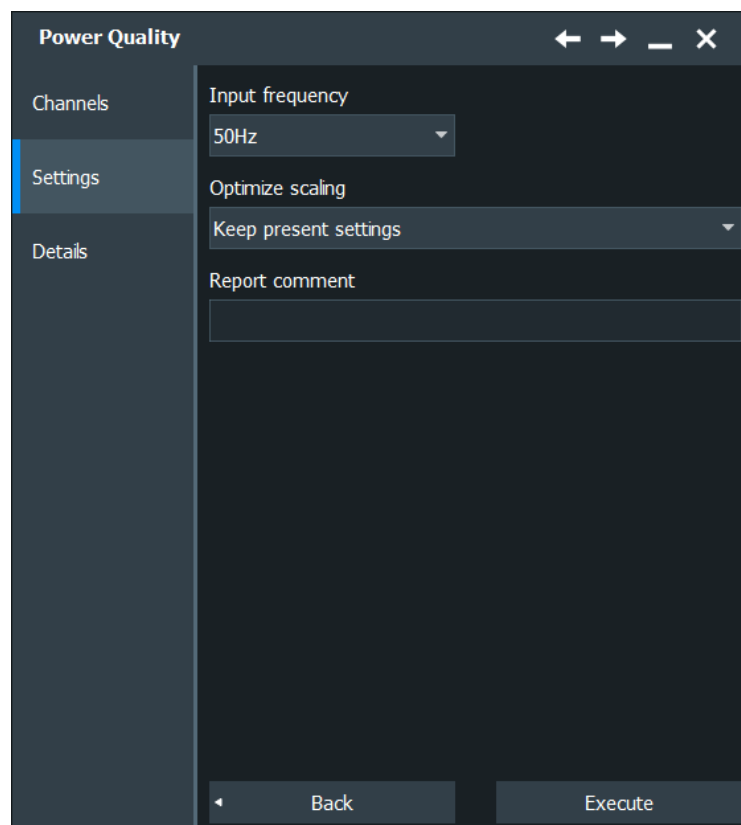

Input frequency

Selects the input frequency of the source signal.

Remote command:

[POWER:QUALity:FREQ](#) on page 2765

Custom frequency

Sets the user-defined frequency if the "Input frequency" is set to "Custom".

Remote command:

[POWER:QUALity:FCUS](#) on page 2765

Optimize scaling

Selects the scaling for the display of the results.

"Autoscale the signals"

Automatically selects the most appropriate scale for the display of the results.

"Keep present settings"

The present display settings are not changed.

Remote command:

[POWER:QUALity:AUTO](#) on page 2764

Report comment

In this field you can write a comment that is displayed in the measurement report, for example, a measurement description.

Execute

Starts the " Power Quality" measurement.

Remote command:

[POWER:QUALity:EXECute](#) on page 2765

21.3.2 Inrush current

The "Inrush Current" analysis measures the peak of the input current that is drawn by the device, when the device is first turned on.

Required probes:

- Current probe

21.3.2.1 Inrush current results

The results of " Inrush Current" measurements are provided in two ways:

- The diagram shows the graphical presentation of:
 - the current waveform
- The result box displays the following numeric measurement results:
 - "Start time" / "Stop time" define the time period for the present gate
 - The "Value" stands for the maximum amplitude of the current for the present time period. This is the inrush current for the correspondent gate.

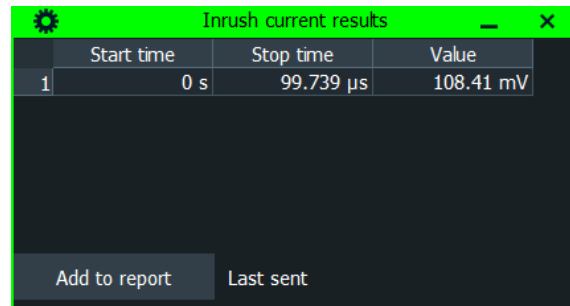

	Start time	Stop time	Value
1	0 s	99.739 µs	108.41 mV

Add to report Last sent

To measure and display the inrush current, the instrument uses the following measurements and waveforms:

- "MG 1" to "MG 5" to measure the inrush current of "Gate 1" to "Gate 5"

The used resources are listed in the "Details" tab. See also: [Chapter 21.2.3, "Details tab"](#), on page 1184.

The following remote commands are used for handling the measurement results:

- `POWer:INRush:GATE<m>:VALue` on page 2767
- `POWer:INRush:REPort:ADD` on page 2768

21.3.2.2 Configuring inrush current

For details of the configuration settings, see [Chapter 21.3.2, "Inrush current"](#), on page 1191.

1. Select "Analysis" > "Power".
2. Under "Input", select "Inrush Current".
3. Connect the current probe to the oscilloscope.
4. Select the correct channel for the "Current Source".
5. Select "Vertical" > "Probe Setup" > "Channel" and set your probe parameters.
6. Connect the probes to the DUT as shown in the "Channels" tab:

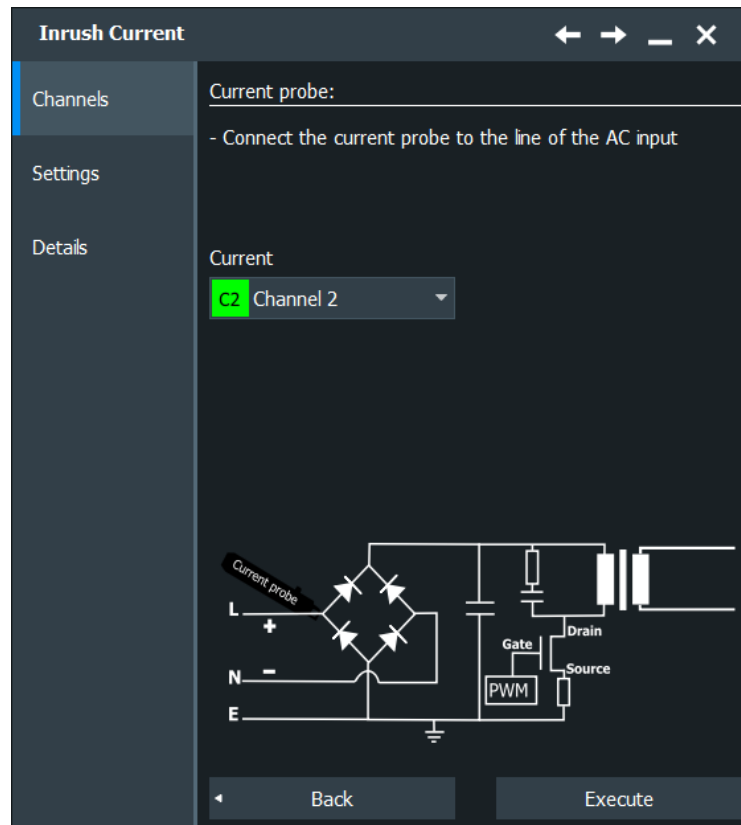

7. Select the "Settings" tab.
8. Set the "Trigger current value".
9. Set the "Maximum current" that should be displayed in the vertical scale.
10. In the "Gate configuration" table, define the different time periods. You can set up to five different gates.
11. Tap "Execute".
12. Start the DUT.

On the screen, you can see the result box with the inrush current of each gate. For details, see [Chapter 21.3.2.1, "Inrush current results"](#), on page 1191.

21.3.2.3 Inrush current settings

In the "Channels" tab, you set the current source, see also: [Chapter 21.2.1, "Channels tab"](#), on page 1183.

In the "Settings" tab, you configure the inrush current measurement parameters and display settings.

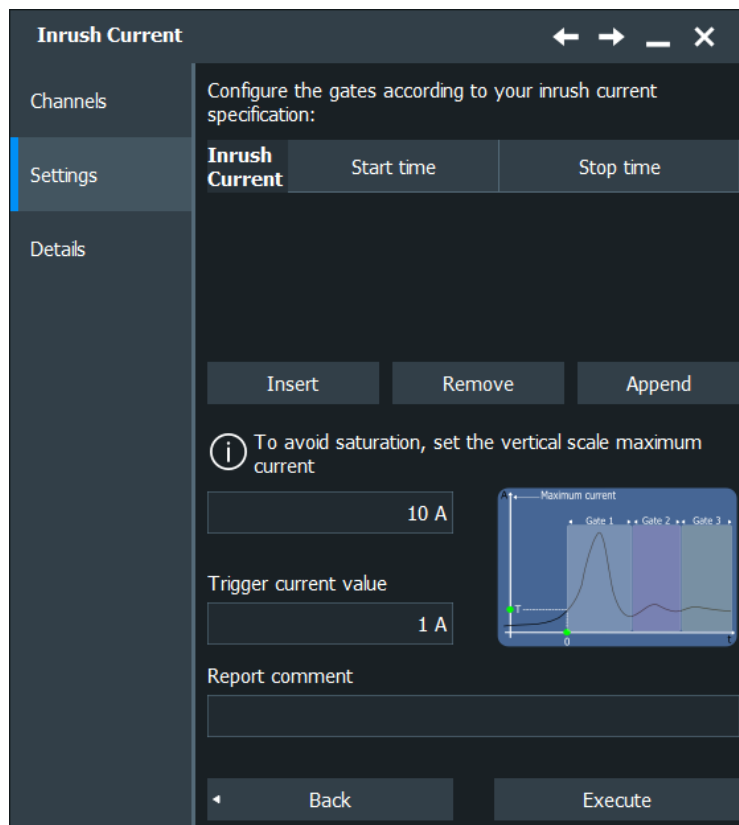

Maximum current

Sets the maximum expected current for the vertical scale. Set the value according to your signal to avoid saturation.

Remote command:

[POWer: INRush:MAXCurrent](#) on page 2768

Trigger current value (T)

Sets the current value for the trigger. The measurement starts after the signal of the DUT reaches this current value.

Remote command:

[POWer: INRush:TRIGger](#) on page 2768

Gate Configuration

In this table, you can configure different gates (time periods). You can configure up to five different gates. The time periods of the defined gates may overlap.

To add a gate press "Insert" or "Append". To remove a gate press "Remove".

Remote command:

[POWer: INRush:ADD](#) on page 2766

[POWer: INRush:INSert](#) on page 2766

[POWer: INRush:REMOve](#) on page 2766

Inrush current ← Gate Configuration

Shows the index of the gate.

Remote command:

`POWer:INRush:COUnT?` on page 2767

Start time ← Gate Configuration

Sets the start measuring time for the selected gate.

Remote command:

`POWer:INRush:GATE<m>:STARt` on page 2767

Stop time ← Gate Configuration

Sets the stop measuring time for the selected gate.

Remote command:

`POWer:INRush:GATE<m>:STOP` on page 2767

Report comment

In this field you can write a comment that is displayed in the measurement report, for example, a measurement description.

Execute

Starts the "Inrush Current" measurement.

Remote command:

`POWer:INRush:EXECute` on page 2767

21.3.3 Current harmonic

Current harmonics appear in an electric power system due to non-linear electric loads. The harmonics can be ejected back into the AC line and disturb other equipment on the grid. To avoid this disturbance, there are often standards of compliance that consumer or industry end-products should meet.

The "Current Harmonic" analysis tests the devices according to the pre-compliance standards EN 61000-3-2, MIL-STD-1399 and RTCA DO-160.

Required probes:

- Differential voltage probe
- Current probe

21.3.3.1 Current harmonic results

The results of "Current Harmonic" measurements are provided in two ways:

- The diagram shows the graphical presentation of:
 - the voltage waveform
 - the current waveform
 - the power waveform
- The result box displays a bar chart or a table with the numerical measurement results up to the 40th harmonics.
To switch the display, tap "Show table" or "Show plot" accordingly

To measure and display the current harmonic, the instrument uses the following measurements and waveforms:

- "MG 6" to measure the power waveform
- "MG 7" to measure the spectrum voltage
- "MG 8" to measure the spectrum current
- "M2" Math 2 to calculate the power
- "M3" Math 3 to calculate the FFT of the voltage
- "M4" Math 4 to calculate the FFT of the current

The used resources are listed in the "Details" tab. See also: [Chapter 21.2.3, "Details tab"](#), on page 1184.

The current harmonic results are defined as follows:

Result Table	Bar Chart Match	Description
Harmonic Index	Value of the X-Axis	The harmonic order
Frequency	-	The frequency value of the signal
Value	Value of the Y-Axis. Shown by a green bar	The present value of the current harmonic
Maximum	Shown by a darkened green bar	The maximum measured value
Standard limit	Shown by a white bar	The maxim allowed value according to the selected standard
"Y max"	"Y max"	Sets the upper limit for the display of the Y scale. This value can be reset with the "Reset Max" button

The following remote commands are used for handling the measurement results:

- `POWer:HARMonics:RESult<m>:FREQuency<n>:VALue?` on page 2770
- `POWer:HARMonics:RESult<m>:MAXValue<n>:VALue?` on page 2770
- `POWer:HARMonics:RESult<m>:STDinuse?` on page 2770
- `POWer:HARMonics:RESult<m>:STDValue<n>:VALue?` on page 2770
- `POWer:HARMonics:RESult<m>:VALue<n>:VALue?` on page 2770
- `POWer:HARMonics:REPort:ADD` on page 2770

21.3.3.2 Configuring current harmonic

For details of the configuration settings, see [Chapter 21.3.3.3, "Current harmonic settings"](#), on page 1197.

1. Select "Analysis">"Power".
2. Under "Power Analysis", select "Current Harmonic".
3. Connect the differential voltage probe and the current probe to the oscilloscope.

4. Deskew the probes as described in [Chapter 21.1.1.1, "Auto deskew"](#), on page 1172.
5. Connect the probes to the DUT as shown in the "Channels" tab:

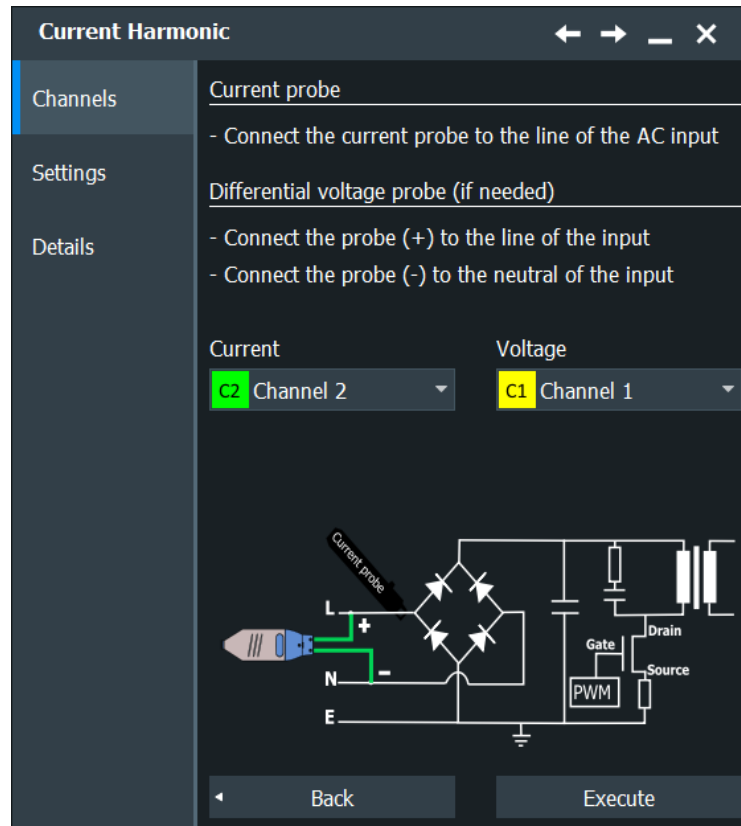

6. Select the correct channels for the "Current Source" and the "Voltage Source".
7. Select the "Settings" tab.
8. Set the "Standard in use"
9. Set the "Frequency" according to your signal.
10. Select an "Optimize Scaling" option.
11. Tap "Execute".

On the screen you can see the measurement of the current, the voltage and the power. Also there is a table giving information about important measurement parameters. For details, see [Chapter 21.3.3.1, "Current harmonic results"](#), on page 1195.

21.3.3.3 Current harmonic settings

In the "Channels" tab, you set the current source and the voltage source, see also: [Chapter 21.2.1, "Channels tab"](#), on page 1183.

In the "Settings" tab, you configure the current harmonic measurement parameters and display settings.

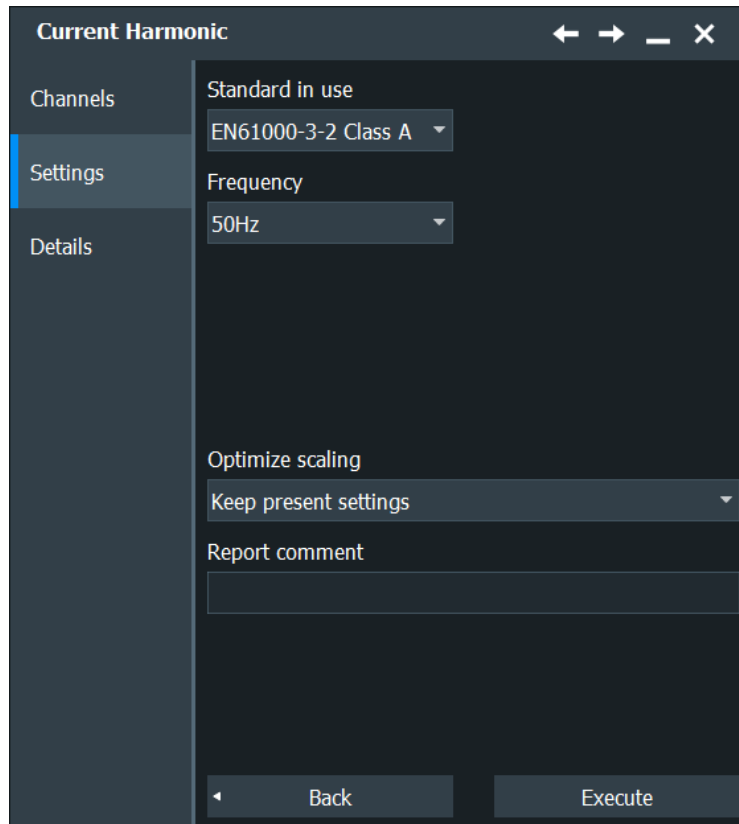

Standard in use

Select the standard in use. For a list of the available standards, see [Table 21-1](#).

Table 21-1: Current Harmonic pre-compliance standards

Standard	Application
EN 61000-3-2 Class A	Balanced 3-phase equipment, household appliances (excluding equipment identified as class D), tools (excluding portable tools), dimmers for incandescent lamps, audio equipment
EN 61000-3-2 Class B	Portable tools, not professional arc welding equipment
EN 61000-3-2 Class C	Lighting equipment
EN 61000-3-2 Class D	PC, PC monitors, radio, or TV receivers with an input power less than or equal to 600W
MIL-STD-1399	Military shipboard user equipment
RTCA DO-160	Environmental tests of avionics hardware

Remote command:

`POWER:HARMonics:STAN` on page 2770

Frequency

Selects the frequency of the input signal.

Remote command:

[POWer:HARMonics:ENFR](#) on page 2769

[POWer:HARMonics:MIFR](#) on page 2769

[POWer:HARMonics:DOFR](#) on page 2769

Revised Current

Available only for "Standard" > "RTCA DO-160".

Selects how the results are evaluated. Available are the following settings:

- Evaluation with current source only
- Evaluation with voltage source and revised current law
 - Display opposite voltage harmonic result chart
 - Do not display voltage result

Remote command:

[POWer:HARMonics:EVAL](#) on page 2769

[POWer:HARMonics:VOLT](#) on page 2771

Optimize scaling

Selects the scaling for the display of the results.

"Autoscale the signals"

Automatically selects the most appropriate scale for the display of the results.

"Keep present settings"

The present display settings are not changed.

Remote command:

[POWer:HARMonics:AUTO](#) on page 2768

Report comment

In this field you can write a comment that is displayed in the measurement report, for example, a measurement description.

Execute

Starts the "Current Harmonics" measurement.

Remote command:

[POWer:HARMonics:EXECute](#) on page 2769

21.4 Control loop

Access: [App Cockpit]> "Analysis" > "Power" > "Control Loop"

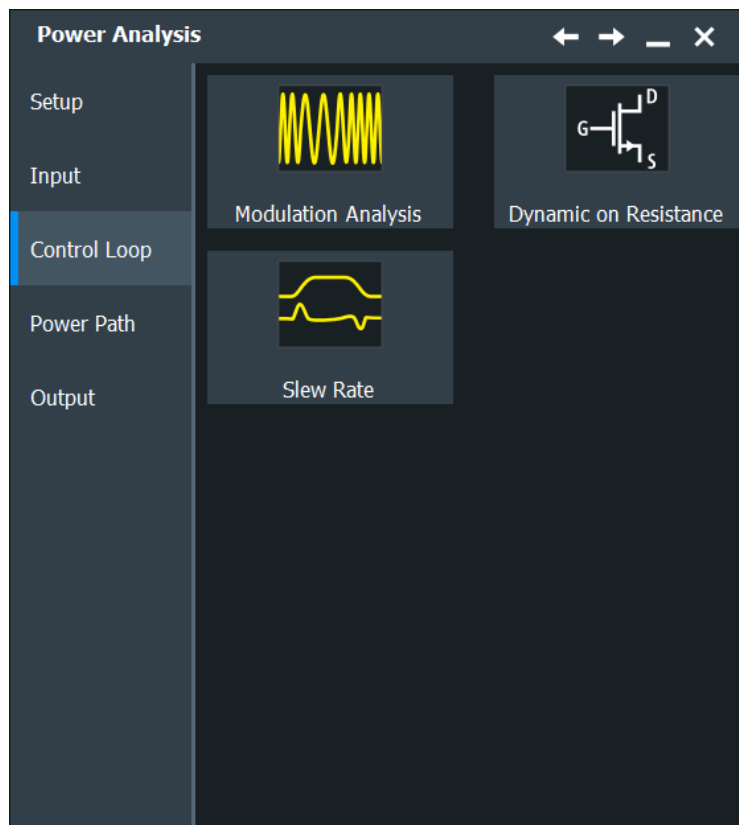

The "Control Loop" measurements are used for characterizing the switching properties of a device.

21.4.1 Modulation analysis

The "Modulation Analysis " measures the control pulse signal to a switching device.

Required probes:

- Differential voltage probe
- Current probe

21.4.1.1 Modulation analysis results

The results of "Modulation Analysis " measurements are provided in two ways:

- The diagram shows the graphical presentation of:
 - the voltage or the current waveform
 - for "Type > Turn on" a track of the frequency and the duty cycle.
- (Optional for "Type > Continuous" measurement) Two histograms display the density distribution of the measurement results in dependence of the frequency and the positive duty cycle.
- The result box displays the numeric measurement results.

The screenshot shows a window titled "Modulation analysis results" with two data tables. The first table, labeled "Amplitude/Time measurement", shows frequency-related metrics. The second table, also labeled "Amplitude/Time measurement", shows duty cycle-related metrics. At the bottom of the window are three buttons: "Reset statistics", "Add to report", and "Last added".

Amplitude/Time measurement	Current	Max	Min	Mean	RMS	σ (S-dev)	Event count	Wave count
Frequency	25.008 MHz	25.057 MHz	24.942 MHz	25 MHz	25 MHz	18.378 kHz	2000	2

Amplitude/Time measurement	Current	Max	Min	Mean	RMS	σ (S-dev)	Event count	Wave count
Pos. duty cycle	50.285 %	50.453 %	50.037 %	50.249 %	50.249 %	0.066 %	2000	2

To measure and display the power quality, the instrument uses the following measurements and waveforms:

- "MG 7" to measure the positive duty cycle
- "MG 8" to measure the frequency

The used resources are listed in the "Details" tab. See also: [Chapter 21.2.3, "Details tab"](#), on page 1184.

Table 21-2: Statistic result parameters

Label	Description
Current	Currently measured value
+Peak	Positive peak value (maximum)
-Peak	Negative peak value (minimum)
μ (Avg)	Average
RMS	Root mean square
σ (S-dev)	Standard deviation
Event count	Number of measured pulses
Wave count	Number of waveforms (acquisitions) the measurement is based on

"Modulation Analysis" is a statistical evaluation that is reset only if the measurement setup is changed or you reset the statistics.

The following remote commands are used for handling the measurement results:

- `POWer:MODulation:RESult:ACTual?` on page 2772
- `POWer:MODulation:RESult:AVG?` on page 2772
- `POWer:MODulation:RESult:EVTCount?` on page 2772
- `POWer:MODulation:RESult:NPEak?` on page 2772
- `POWer:MODulation:RESult:PPEak?` on page 2772
- `POWer:MODulation:RESult:RMS?` on page 2772
- `POWer:MODulation:RESult:STDDev?` on page 2772
- `POWer:MODulation:RESult:WFMCCount?` on page 2772
- `POWer:MODulation:REPort:ADD` on page 2772

21.4.1.2 Configuring modulation analysis

For details of the configuration settings, see [Chapter 21.4.1.3, "Modulation analysis settings"](#), on page 1203.

1. Select "Analysis" > "Power".
2. Under "Switching / Control Loop", select "Modulation Analysis".
3. Connect the differential voltage probe and the current probe to the oscilloscope.
4. Deskew the probes as described in [Chapter 21.1.1.1, "Auto deskew"](#), on page 1172.
5. Connect the probes to the DUT as shown in the "Channels" tab:

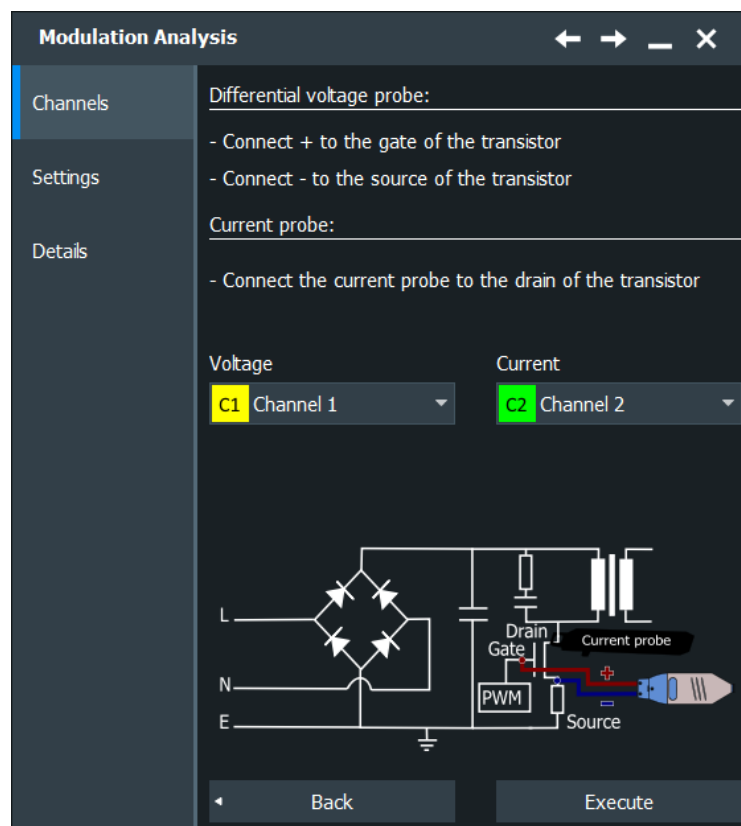

6. Select the correct channels for the "Current Source" and the "Voltage Source".
7. Select the "Settings" tab.
8. Set the "Source" and the "Type" of measurement.
9. Select an "Optimize Scaling" option.

10. Tap "Execute".

On the screen, you can see the measurement waveforms of the current or the voltage. Also, the result box with numeric measurement results is shown. For details, see [Chapter 21.4.1.1, "Modulation analysis results"](#), on page 1200.

21.4.1.3 Modulation analysis settings

In the "Channels" tab, you set the current source and the voltage source, see also: [Chapter 21.2.1, "Channels tab"](#), on page 1183.

In the "Settings" tab, you configure the modulation analysis parameters and display settings.

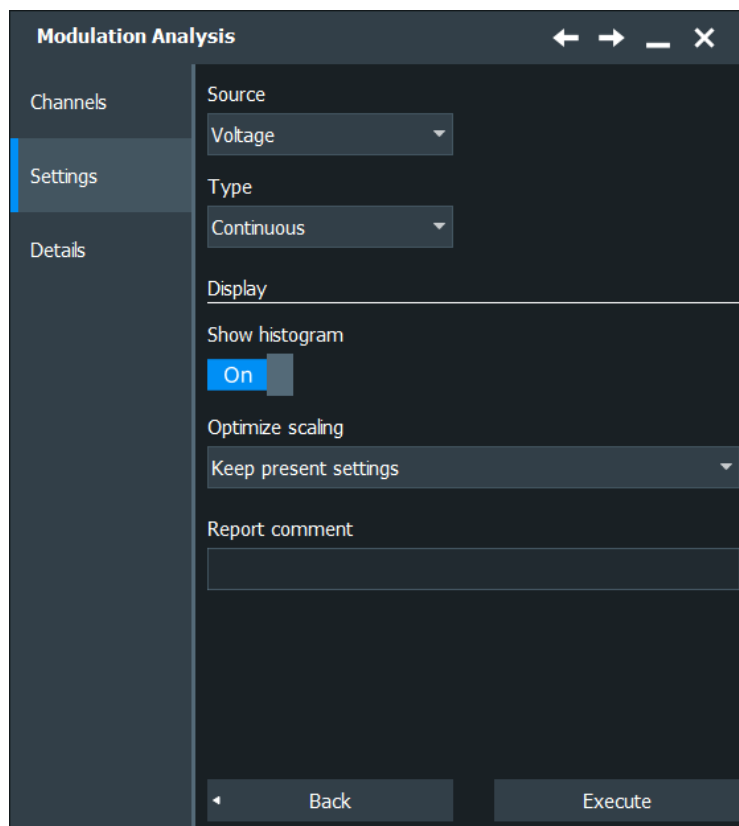

Source

Selects the source for the measurement.

Remote command:

[POWER:MODulation:SOURce](#) on page 2772

Type

Selects the type of signal flow for the measurement

"Continuous" The measurement is running continuously.

"Turn on" The measurement runs once when the DUT is turned on.

Remote command:

`POWer:MODulation:TYPE` on page 2773

Display Histogram

Available only for "Type" > "Continuous".

Enables the display of two histograms after the measurement is executed. The histograms show the density distribution of the measurement results in dependence of the frequency/ duty cycle in a graphic. Thus they illustrate the statistics of the measurements.

Remote command:

`POWer:MODulation:DHISTogram` on page 2771

Optimize scaling

Selects the scaling for the display of the results.

"Autoscale the signals"

Automatically selects the most appropriate scale for the display of the results.

"Keep present settings"

The present display settings are not changed.

Remote command:

`POWer:MODulation:AUTO` on page 2771

Report comment

In this field you can write a comment that is displayed in the measurement report, for example, a measurement description.

Execute

Starts the "Modulation Analysis" measurement.

Remote command:

`POWer:MODulation:EXECute` on page 2772

21.4.2 Dynamic on resistance

The "Dynamic ON Resistance" analysis measures the resistance of a switching device, during operation. Because voltage and current may vary in time, the resistance is not constant, thus it is called dynamic ON resistance. It is defined as the ratio dV/dI .

The resistance-related voltage should be measured during a stable part of the switch node waveform, when the undershoot and ringing have decayed, after the high-to-low voltage transition.

Required probes:

- Differential voltage probe
- Current probe

21.4.2.1 Dynamic on resistance results

The results of "Dynamic on Resistance" measurements are provided in two ways:

- The diagram shows the graphical presentation of:
 - the voltage waveform
 - the current waveform
- The result box displays the dynamic on resistance value.

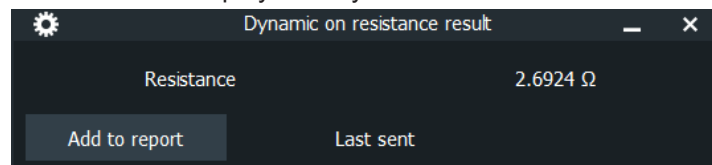

To measure and display the dynamic on resistance, the instrument uses the following measurements and waveforms:

- "MG 5" to measure the amplitude of the voltage
- "MG 6" to measure the amplitude of the voltage
- "MG 7" to measure the amplitude of the current
- "MG 8" to measure the amplitude of the current
- "Cu 1 " Cursor 1 to measure gate ["t₀" , "t₁"]
- "Cu 2 " Cursor 2 to measure gate ["t₂" , "t₃"]

The used resources are listed in the "Details" tab. See also: [Chapter 21.2.3, "Details tab"](#), on page 1184.

The dynamic on resistance displayed as the result is defined as:

$$R = \frac{V(t_2) - V(t_0)}{I(t_3) - I(t_1)}$$

The points "t₀" , "t₁" , "t₂" and "t₃" are defined by the cursor lines displayed in the result diagram of the measurement. You can move the cursor lines to define another area of interest.

The following remote commands are used for handling the measurement results:

- [POWer:DONRes:RESult:RESistance?](#) on page 2774
- [POWer:DONRes:GATE<m>:START](#) on page 2774
- [POWer:DONRes:GATE<m>:STOP](#) on page 2774
- [POWer:DONRes:REPort:ADD](#) on page 2774

21.4.2.2 Configuring dynamic on resistance

For details of the configuration settings, see [Chapter 21.4.2.3, "Dynamic on resistance settings"](#), on page 1207.

1. Select "Analysis" > "Power".
2. Under "Switching / Control Loop", select "Dynamic on Resistance".
3. Connect the differential voltage probe and the current probe to the oscilloscope.
4. Deskew the probes as described in [Chapter 21.1.1.1, "Auto deskew"](#), on page 1172.
5. Connect the probes to the DUT as shown in the "Channels" tab:

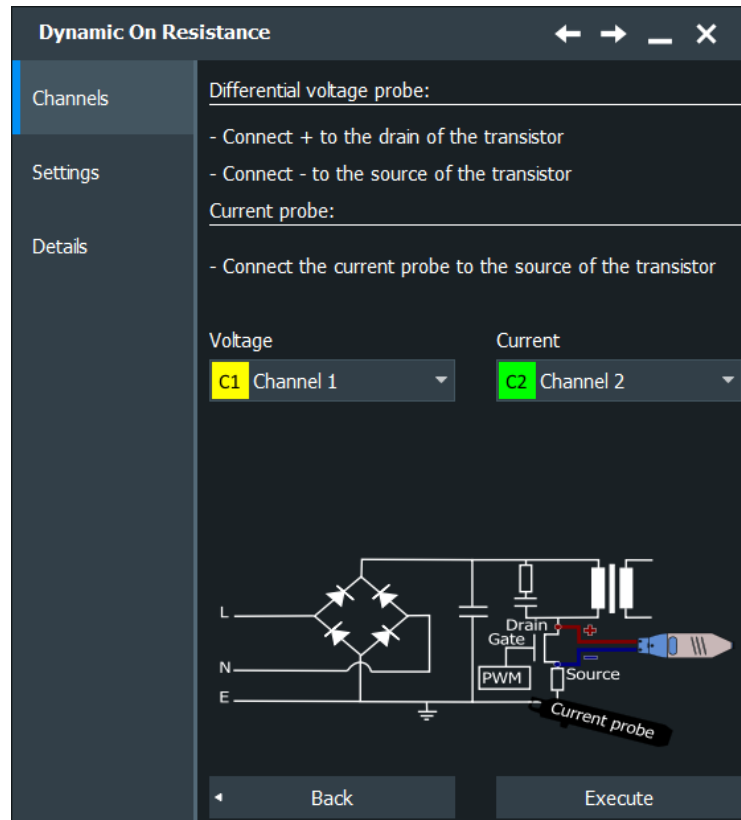

6. Select the correct channels for the "Current Source" and the "Voltage Source".
7. Select the "Settings" tab.
8. If "Average" is selected, enter the "Average count", that is the number of waveforms used for average calculation.
9. Set the reset condition for the average calculation:
 - If "Time" is selected, enter the "Reset time".
 - If "Waveforms" is selected, enter the "Reset count".
10. Select an "Optimize Scaling" option.
11. Tap "Execute".

12. If needed adjust the cursors manually.

On the screen, you can see the measurement waveforms of the current and the voltage. Also, the result box displays the dynamic on resistance. For details, see [Chapter 21.4.2.1, "Dynamic on resistance results"](#), on page 1205.

21.4.2.3 Dynamic on resistance settings

In the "Channels" tab, you set the current source and the voltage source, see also: [Chapter 21.2.1, "Channels tab"](#), on page 1183.

In the "Settings" tab, you configure the power measurement parameters and display settings.

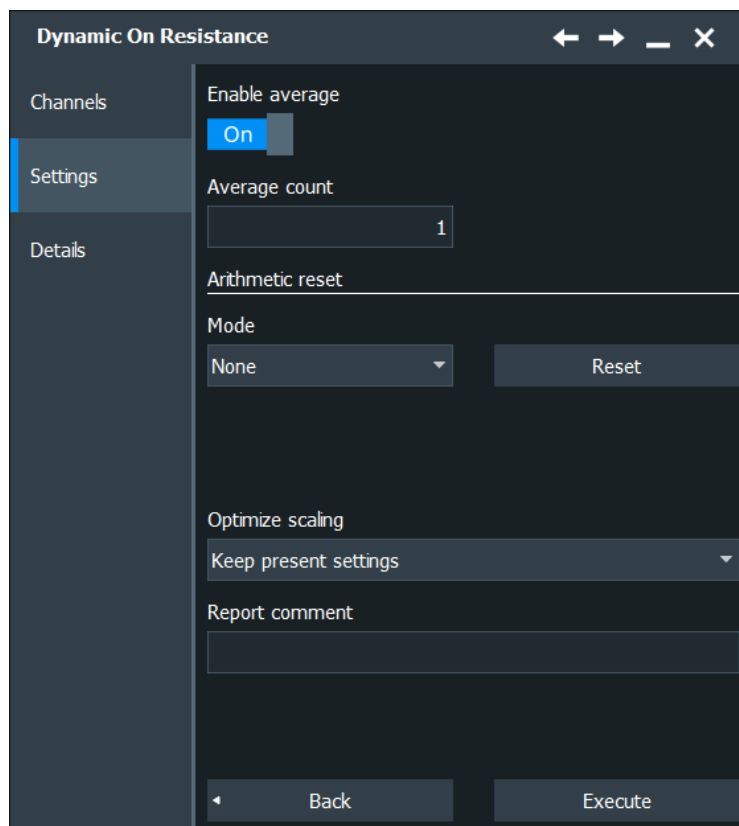

Average

Enables the "Average" method for building the resulting waveform. The average is calculated from the data of the current acquisition and several acquisitions before. The method reduces random noise and other heterodyne signals. It requires a stable, triggered and periodic signal for correct function. The number of acquisitions for average calculation is defined with "Average count", and the "Reset mode" defines the restart condition.

Remote command:

`POWer:DONRes:AVG` on page 2773

Arithmetic Reset > Mode

Defines when the envelope and average evaluation restarts.

"None"	No restart, the number of acquisitions considered by the waveform arithmetics is not limited.
"Time"	Restarts the envelope and average calculation after the time defined in "Time".
"Waveforms"	Restarts the envelope and average calculation after a number of acquired waveforms defined in "Count".

Remote command:

[ACQUIRE:ARESet:MODE](#) on page 1425

[ACQUIRE:ARESet:TIME](#) on page 1425

[ACQUIRE:ARESet:COUNT](#) on page 1425

Reset

Forces the immediate restart of the envelope and average calculation for all waveforms.

Remote command:

[ACQUIRE:ARESet:IMMEDIATE](#) on page 1424

Optimize scaling

Selects the scaling for the display of the results.

"Autoscale the signals"	Automatically selects the most appropriate scale for the display of the results.
"Keep present settings"	The present display settings are not changed.

Remote command:

[POWER:DONRes:AUTO](#) on page 2773

Report comment

In this field you can write a comment that is displayed in the measurement report, for example, a measurement description.

Execute

Starts the "Dynamic on Resistance" measurement.

Remote command:

[POWER:DONRes:EXECute](#) on page 2773

21.4.3 Slew rate

The "Slew Rate" analysis measures the rate of change of the voltage or current waveform during the switching of the switching transistor.

Required probes:

- Differential voltage probe

- Current probe

21.4.3.1 Slew rate results

The results of "Slew Rate" measurements are provided in two ways:

- The diagram shows the graphical presentation of:
 - the voltage waveform
 - the current waveform
 - a waveform of the derivative of voltage and current
- The result box displays the numeric measurement results. For a detailed description, see [Table 21-2](#).

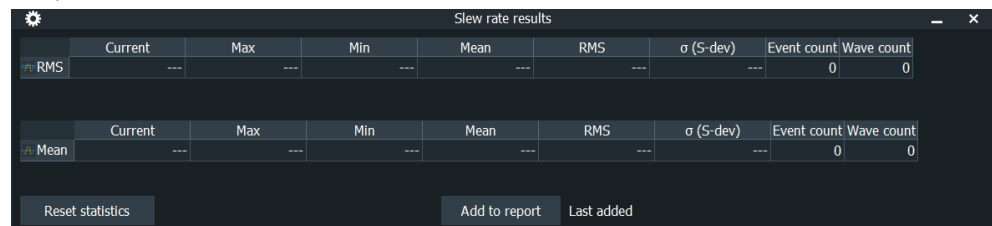

	Current	Max	Min	Mean	RMS	σ (S-dev)	Event count	Wave count
RMS	---	---	---	---	---	---	0	0
Mean	---	---	---	---	---	---	0	0

Buttons: Reset statistics, Add to report, Last added

To measure and display the slew rate, the instrument uses the following measurements and waveforms:

- "MG 8" to measure the amplitude of the current or voltage waveform
- "M2" Math 4 to calculate the time derivative of the current or voltage waveform
- "Cu 1" Cursor 1 to determine the measurement area

The used resources are listed in the "Details" tab. See also: [Chapter 21.2.3, "Details tab"](#), on page 1184.

The following remote commands are used for handling the measurement results:

- [POWER:SLEWrate:RESult:ACTual?](#) on page 2777
- [POWER:SLEWrate:RESult:AVG?](#) on page 2777
- [POWER:SLEWrate:RESult:EVTCount?](#) on page 2777
- [POWER:SLEWrate:RESult:NPEak?](#) on page 2777
- [POWER:SLEWrate:RESult:PPEak?](#) on page 2777
- [POWER:SLEWrate:RESult:RMS?](#) on page 2777
- [POWER:SLEWrate:RESult:STDDev?](#) on page 2777
- [POWER:SLEWrate:RESult:WFMCount?](#) on page 2777
- [POWER:SLEWrate:REPort:ADD](#) on page 2776

21.4.3.2 Configuring slew rate

For details of the configuration settings, see [Chapter 21.4.3.3, "Slew rate settings"](#), on page 1211.

1. Select "Analysis" > "Power".

2. Under "Switching / Control Loop", select "Slew Rate".
3. Connect the differential voltage probe and the current probe to the oscilloscope.
4. Deskew the probes as described in [Chapter 21.1.1.1, "Auto deskew"](#), on page 1172.
5. Connect the probes to the DUT as shown in the "Channels" tab:

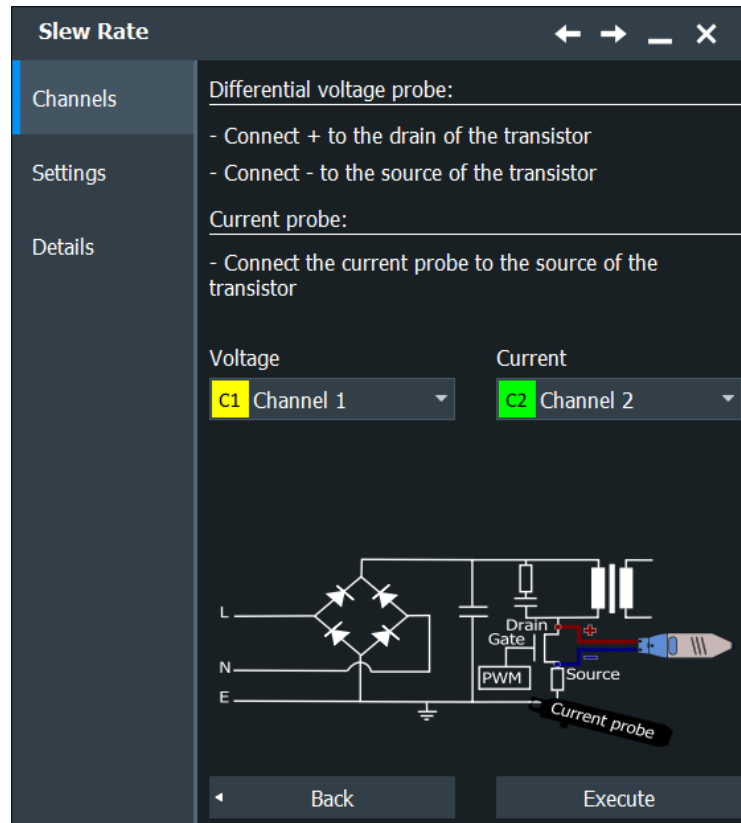

6. Select the correct channels for the "Current Source" and the "Voltage Source".
7. Select the "Settings" tab.
8. Select the "Source".
9. If "Average" is selected, enter the "Average count", that is the number of waveforms used for average calculation.
10. Set the reset condition for the average calculation:
 - If "Time" is selected, enter the "Reset time".
 - If "Waveforms" is selected, enter the "Reset count".
11. Select an "Optimize Scaling" option.

12. Tap "Execute".

On the screen you can see the measurement waveforms of the slew rate, the current and the voltage. The result box with numeric measurement results is shown. For details, see [Chapter 21.4.3.1, "Slew rate results"](#), on page 1209.

21.4.3.3 Slew rate settings

In the "Channels" tab, you set the current source and the voltage source, see also: [Chapter 21.2.1, "Channels tab"](#), on page 1183.

In the "Settings" tab, you configure the slew rate measurement parameters and display settings.

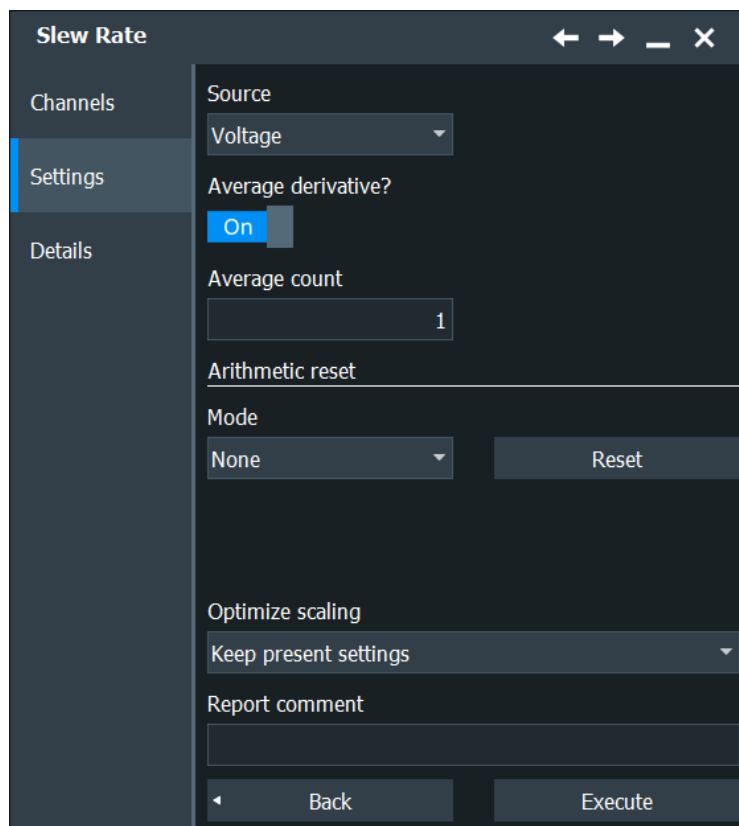

Source

Selects dV/dt or dI/dt as the source of the measurement.

Remote command:

`POWER:SLEWrate:SOURce` on page 2775

Average

Enables the "Average" method for building the resulting waveform. The average is calculated from the data of the current acquisition and several acquisitions before. The method reduces random noise and other heterodyne signals. It requires a stable, triggered and periodic signal for correct function. The number of acquisitions for average calculation is defined with "Average count", and the "Reset mode" defines the restart condition.

Remote command:

[POWER:SLEWrate:AVGDeriv](#) on page 2775

Arithmetic Reset > Mode

Defines when the envelope and average evaluation restarts.

"None"	No restart, the number of acquisitions considered by the waveform arithmetics is not limited.
"Time"	Restarts the envelope and average calculation after the time defined in "Time".
"Waveforms"	Restarts the envelope and average calculation after a number of acquired waveforms defined in "Count".

Remote command:

[ACQUIRE:ARESet:MODE](#) on page 1425

[ACQUIRE:ARESet:TIME](#) on page 1425

[ACQUIRE:ARESet:COUNT](#) on page 1425

Reset

Forces the immediate restart of the envelope and average calculation for all waveforms.

Remote command:

[ACQUIRE:ARESet:IMMediate](#) on page 1424

Optimize scaling

Selects the scaling for the display of the results.

"Autoscale the signals"	Automatically selects the most appropriate scale for the display of the results.
"Keep present settings"	The present display settings are not changed.

Remote command:

[POWER:SLEWrate:AUTO](#) on page 2775

Report comment

In this field you can write a comment that is displayed in the measurement report, for example, a measurement description.

Execute

Starts the "Slew Rate" measurement.

Remote command:

POWer:SLEWrate:EXECute on page 2775

21.5 Power path

Access: [App Cockpit]> "Analysis" > "Power" > "Power Path"

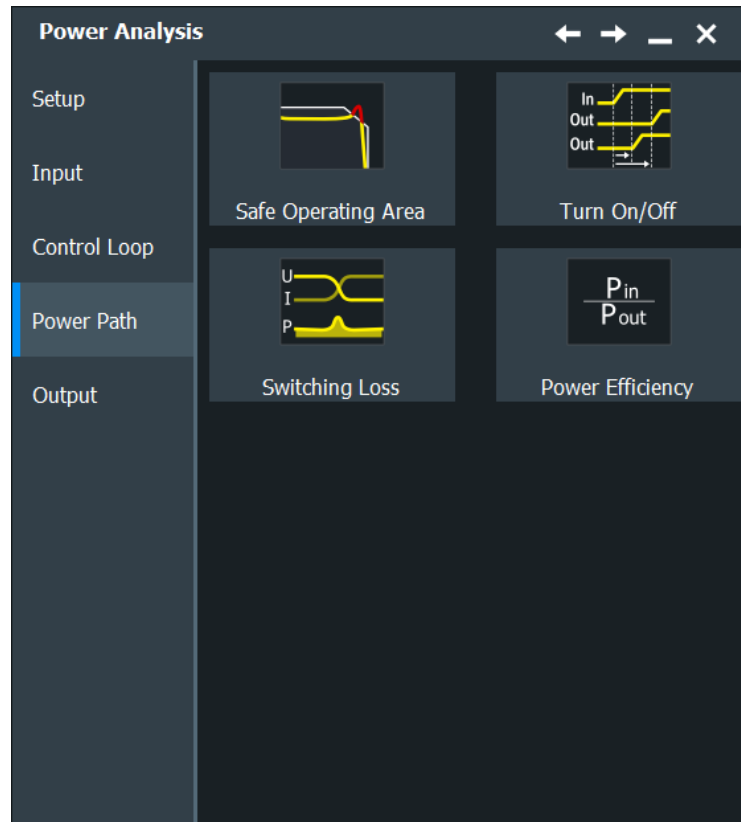

The "Power Path" measurements are used for analyzing the behavior of the devices that control the power flow through the switched-mode power supply (SMPS) circuit, including switching devices and inductors.

21.5.1 Safe operating area (S.O.A.)

The safe operating area is defined by the voltage and current conditions over which a power semiconductor device is expected to operate without self-damage. The "Safe Operating Area" analysis provides a diagram of the safe operating conditions of your device.

Required probes:

- Differential voltage probe
- Current probe

21.5.1.1 Safe operating area results

The results of " Safe Operating Area" measurements are provided in the following ways:

- The diagram shows the graphical presentation of:
 - the voltage waveform
 - the current waveform
- A logarithmic or linear XY diagram of the calculated voltage (x-axis) and current (y-axis) waveforms. This curve is a graphical representation of the power handling capability of the device under various conditions.
- The result box displays the numeric measurement results. Also, you can see the mask definition and change the scale in the "SOA Control" dialog. If the state of "Enable mask test" is "On" an extra result box appears, see also [Table 21-3](#).

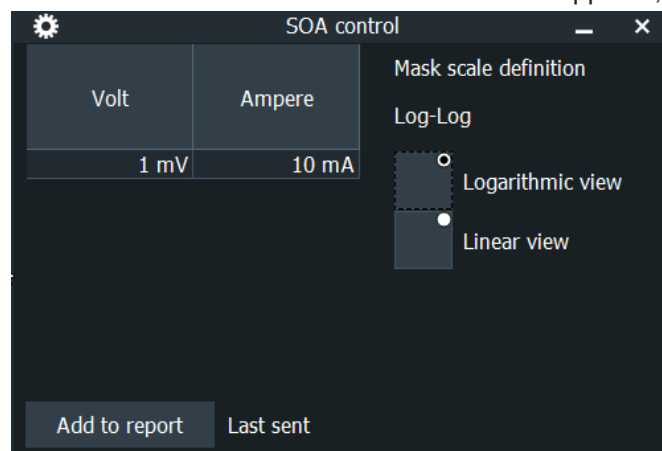

Mask Results "SOA_Log"	
Acq. completed	37
Acq. remaining	0
State	Running
Sample hits	520933
Acquisition hits	37
Fail rate	100 %
Test result	Fail

To measure and display the safe operating area, the instrument uses the following measurements and diagrams:

- "XY1" XY Diagram 1 to measure the logarithmic waveform
- "XY2" XY Diagram 2 to measure the linear waveform
- "M1" Math 1 to calculate the voltage signal
- "M2" Math 2 to calculate the current signal

The used resources are listed in the "Details" tab. See also: [Chapter 21.2.3, "Details tab"](#), on page 1184.

The results of the safe operating area mask test are described in [Table 21-3](#).

Table 21-3: Results of the mask test

Result	Description
Acq. completed	Number of tested acquisitions
Acq. remaining	Remaining acquisitions until "Average count / Nx Single count" is reached
State	Shows if the test has been completed. The state is set to "Finished" when "Nx Single count" acquisitions are tested and the number of "Acq. remaining" is 0. As long as the number of tested acquisitions is less the "Nx Single count" number, the state is "Running". If you run the acquisition with [Run Stop], or the number of played history acquisitions exceeds "Nx Single count", the mask testing is performed according to fail criteria settings independently of the test state. The testing is not stopped when the state is set to "Finished".
Sample hits	Number of samples that hit the mask
Acquisition hits	Number of acquisitions that contained at least one sample hit
Fail rate	Ratio of acquisition hits to the number of tested acquisitions
Test result	A test has failed if the number of sample hits or acquisition hits exceeds the limit of "Violation tolerance" hits

The following remote commands are used for handling the measurement results:

- `POWer:SOA:SWITCh` on page 2780
- `POWer:SOA:REPort:ADD` on page 2779

21.5.1.2 Configuring safe operating area

For details of the configuration settings, see [Chapter 21.5.1.3, "Safe operating area settings"](#), on page 1216.

1. Select "Analysis" > "Power".
2. Under "Power Path", select "Safe Operating Area".
3. Connect the differential voltage probe and the current probe to the oscilloscope.
4. Deskew the probes as described in [Chapter 21.1.1.1, "Auto deskew"](#), on page 1172.
5. Connect the probes to the DUT as shown in the "Channels" tab:

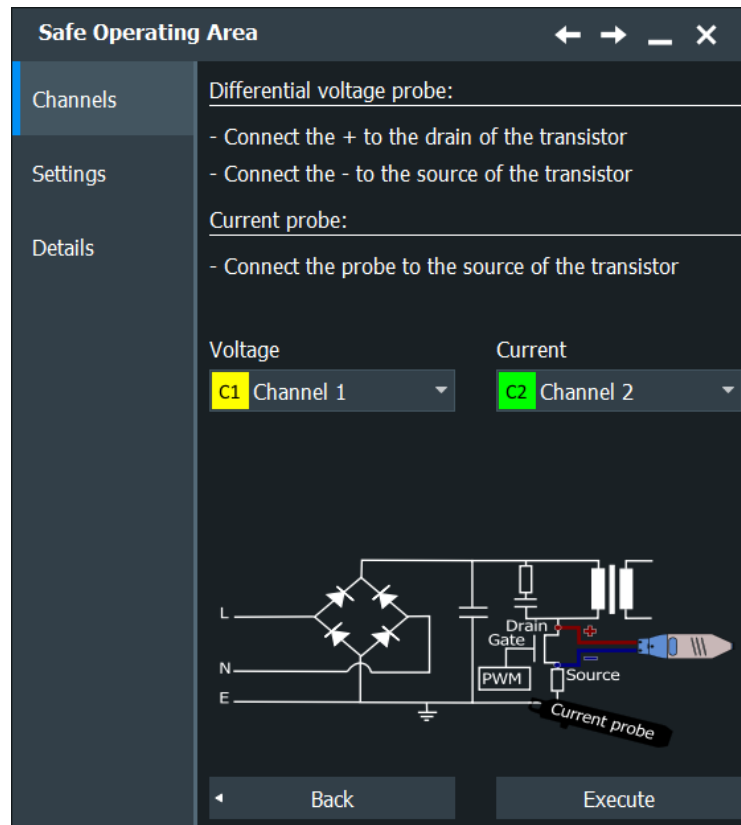

6. Select the correct channels of the "Current Source" and the "Voltage Source".
7. Select the "Settings" tab.
8. Select the state of the "Enable mask test".
9. Select the "Scale".
10. Define the SOA Points.
11. Tap "Execute".

On the screen you can see the measurement waveforms of the Additionally, the result box with numeric measurement results is shown. For details, see [Chapter 21.5.1.1, "Safe operating area results"](#), on page 1214.

21.5.1.3 Safe operating area settings

In the "Channels" tab, you set the current source and the voltage source, see also: [Chapter 21.2.1, "Channels tab"](#), on page 1183.

In the "Settings" tab, you configure the safe operating area parameters and display settings.

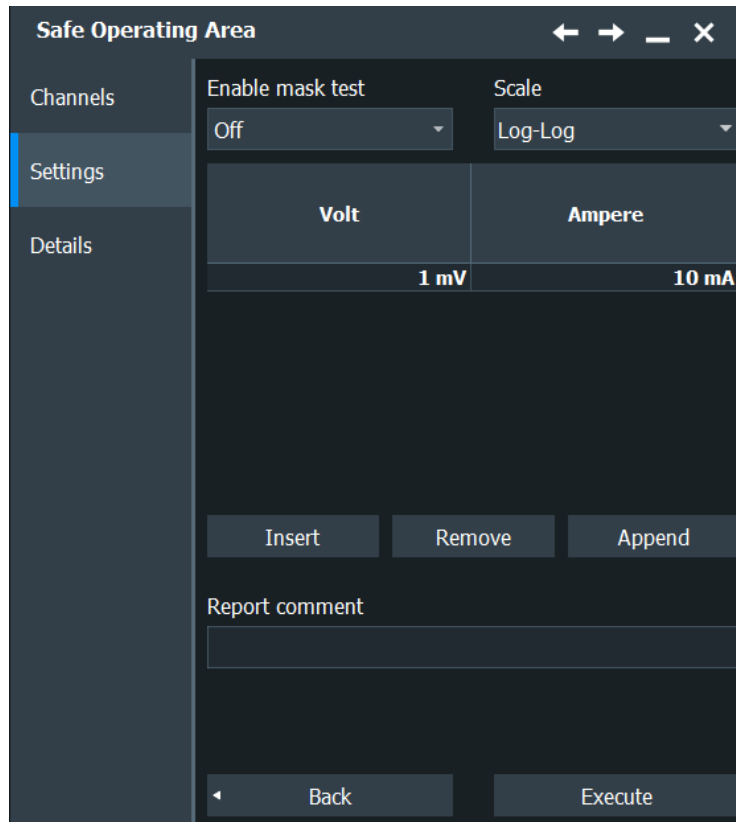
**Enable mask test**

Enables a mask test.

Remote command:

[POWer:SOA:MASK](#) on page 2779

Scale

Selects the scale for the result diagram.

Remote command:

[POWer:SOA:SCALE](#) on page 2779

SOA point definition

In this table, you can set voltage-current points to define a mask for the safe point operating area. If [Enable mask test](#) > "On", you can check whether the signal remains within the specified limits.

To add a point press "Insert" or "Append". To remove a point press "Remove".

Remote command:

[POWer:SOA:LINear:ADD](#) on page 2778

[POWer:SOA:LOGarithmic:ADD](#) on page 2778

[POWer:SOA:LINear:COUNT?](#) on page 2778

[POWer:SOA:LOGarithmic:COUNT?](#) on page 2778

[POWer:SOA:LINear:INSert](#) on page 2778

[POWer:SOA:LOGarithmic:INSert](#) on page 2778

[POWER:SOA:LINear:REMove](#) on page 2778

[POWER:SOA:LOGarithmic:REMove](#) on page 2778

Volt ← SOA point definition

Sets the voltage value of the SOA point.

Remote command:

[POWER:SOA:LINear:POINT<m>:VOLTagE](#) on page 2779

Ampere ← SOA point definition

Sets the current value of the SOA point.

Remote command:

[POWER:SOA:LINear:POINT<m>:CURRent](#) on page 2778

Report comment

In this field you can write a comment that is displayed in the measurement report, for example, a measurement description.

Execute

Starts the "Safe Operating Area" measurement.

Remote command:

[POWER:SOA:EXECute](#) on page 2777

21.5.2 Turn on/off

"Turn On/Off" analysis measures the time that a power supply needs to reach a certain percentage of the steady state output level when initially turned on or turned off.

Common measuring scenarios include:

- Turn on time: measurement of the time it takes for the DC output to reach 90 % of the expected steady state level, after the power supply is initially turned on.
- Turn off time: measurement of the time it takes for the DC output to reach 10 % of the expected steady state level, after the power supply is initially turned off.

Required probes:

- Differential voltage probe
- Passive or differential voltage probe

21.5.2.1 Turn on/off results

The results of "Turn on/off" measurements are provided in two ways:

- The diagram shows the graphical presentation of:
 - the input voltage waveform
 - the output voltage waveform
- The result box displays the "Turn on time" or the "Turn off time".

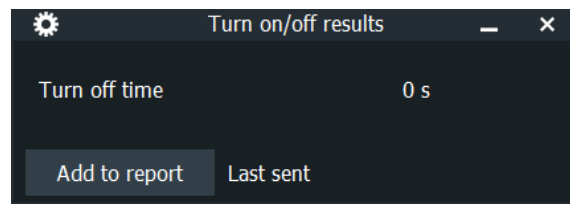

The used resources are listed in the "Details" tab. See also: [Chapter 21.2.3, "Details tab"](#), on page 1184.

The "Turn on time" is measured as the time between the trigger point ("Trigger level on" value is reached) and the time the given percentage of the "Steady state level" is reached.

The "Turn off time" is measured as the time between the trigger point, delayed with the set "Time" ("Trigger level on" value is reached) and the time the given percentage of the "Steady state level" is reached, see

See also [Figure 21-2](#) and [Figure 21-3](#)

The following remote commands are used for handling the measurement results:

- `POWer:ONOFF:RESult:TOFF?` on page 2781
- `POWer:ONOFF:RESult:TON?` on page 2781
- `POWer:ONOFF:REPort:ADD` on page 2781

21.5.2.2 Configuring turn on/ off

For details of the configuration settings, see [Chapter 21.5.2.3, "Turn on/off settings"](#), on page 1221.

1. Select "Analysis">"Power".
2. Under "Power Path", select "Turn on/off".
3. Connect the probes to the DUT as shown in the "Channels" tab:

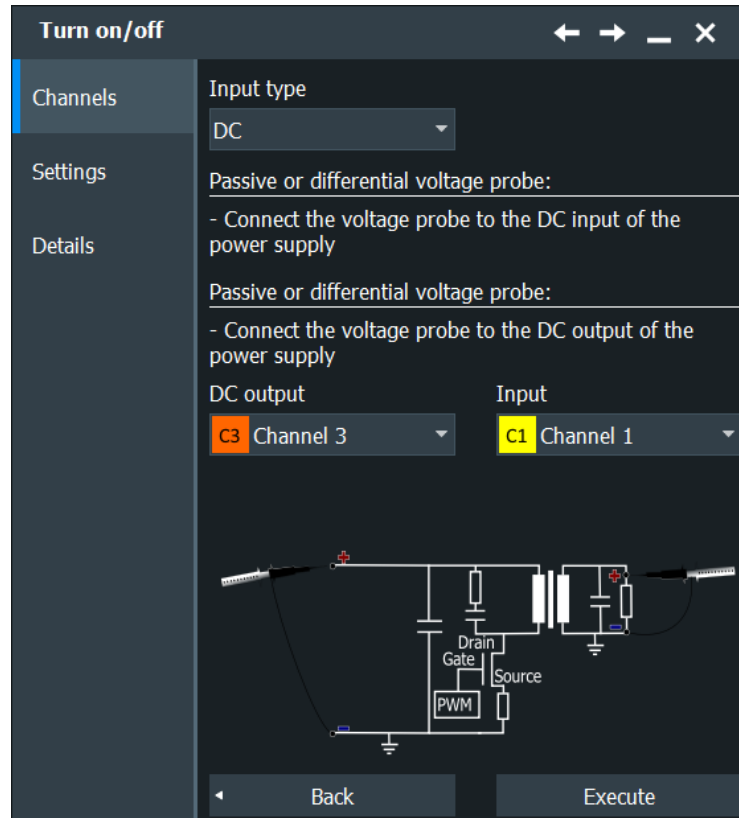
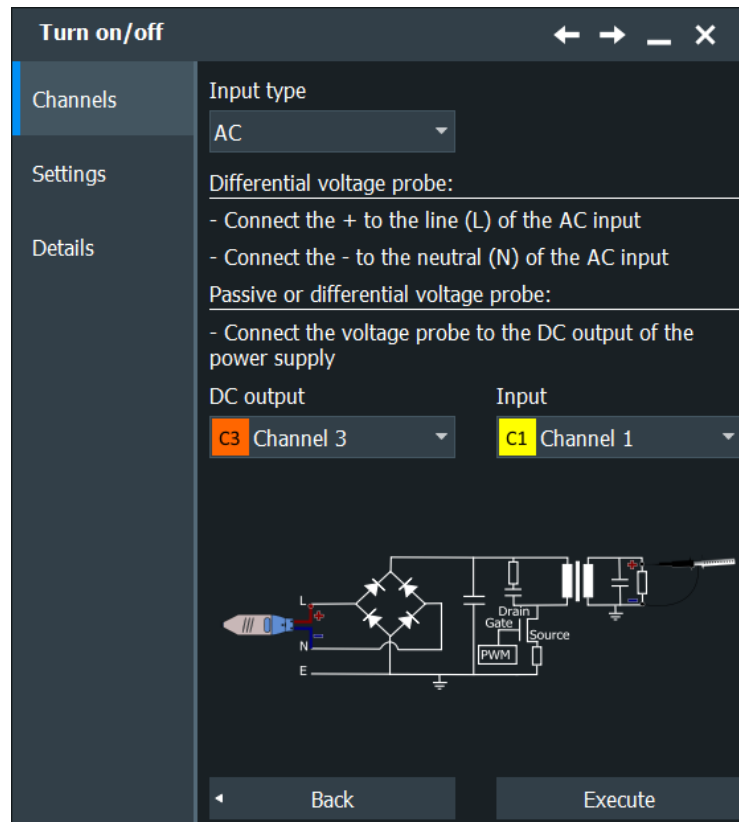

4. Select the correct channels for the "DC output" and the "AC input" or the "DC input".
5. Select the "Settings" tab.
6. Select whether you want to measure "Turn on" or "Turn off".
7. Set the "Steady state level" and the "Trigger level" according to your requirements.
8. Tap "Execute".
9. Turn on/off the DUT.

On the screen, you can see the measurement. Also, the result box displays the turn on or the turn off time. For details, see [Chapter 21.5.2.1, "Turn on/off results"](#), on page 1218.

21.5.2.3 Turn on/off settings

In the "Channels" tab, you set the current source and the voltage source, see also: [Chapter 21.2.1, "Channels tab"](#), on page 1183.

In the "Settings" tab, you configure the turn on and the turn off parameters.

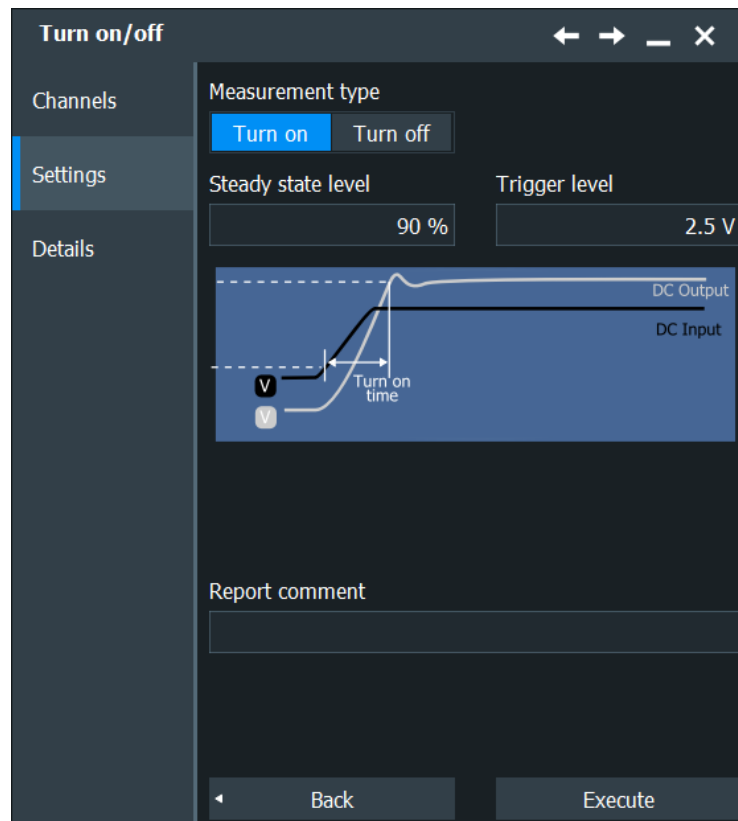

Figure 21-2: Settings turn on time

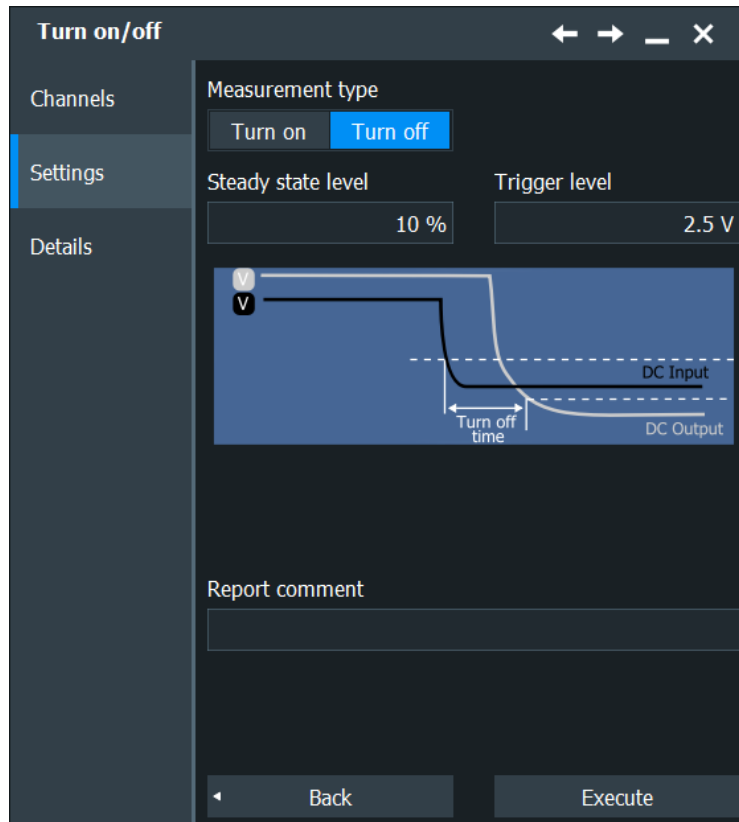

Figure 21-3: Settings turn off time

Input Type

To access this setting, select the "Channels" tab.

Selects the AC or DC input type.

Remote command:

[POWER:ONOFF:INPut](#) on page 2781

Measurement Type

Selects the "Turn on" or the " Turn off " measurement.

Remote command:

[POWER:ONOFF:TYPE](#) on page 2782

Turn on

Enables the configuration of the turn on time measurement.

Steady state level-Turn on ← Turn on

Sets the percentage of the steady state level of the DC output that has to be reached.

Remote command:

[POWER:ONOFF:DSOn](#) on page 2780

Trigger level on ← Turn on

Triggers the beginning of the measurements at the moment the AC or DC input voltage reaches the set value.

Remote command:

[POWer:ONOFF:ATON](#) on page 2780

[POWer:ONOFF:DTON](#) on page 2780

Turn off

Enables the configuration of the turn off time measurement.

Steady state level- Turn off ← Turn off

Sets the percentage of the steady state level of the DC output that has to be reached.

Remote command:

[POWer:ONOFF:DSOFF](#) on page 2780

Trigger level ← Turn off

Triggers the beginning of the measurements at the moment the AC or DC input voltage reaches the set value.

Remote command:

[POWer:ONOFF:ATOFF](#) on page 2780

[POWer:ONOFF:DTOFF](#) on page 2780

Time ← Turn off

Sets the time, the start of the measurement of the turn off time is delayed with, after the trigger point.

Remote command:

[POWer:ONOFF:TIME](#) on page 2781

Report comment

In this field you can write a comment that is displayed in the measurement report, for example, a measurement description.

Execute

Starts the " Power Quality" measurement.

Remote command:

[POWer:ONOFF:EXECute](#) on page 2781

21.5.3 Switching loss

The "Switching Loss" analysis measures the power and energy losses of a switching device, that occur during the switching phases and the conduction phase of the switching transistor.

Required probes:

- Differential voltage probe
- Current probe

21.5.3.1 Switching loss results

The results of "Switching Loss" measurements are provided in two ways:

- The diagram shows the graphical presentation of:
 - the voltage waveform
 - the current waveform
 - the power waveform
- The result box displays the numeric measurement results for the enabled measurement parameters in dependence of the energy and the power. To switch the display, tap "Energy" or "Power" accordingly.

For a detailed description, see [Table 21-2](#).

Switching Loss Results								
	Current	+Peak	-Peak	μ (Avg)	RMS	σ (S-dev)	Event count	Wave count
Switching frequency	0 Hz	0 Hz	0 Hz	0 Hz	0 Hz	0 Hz	0	0
Turn on	0 W	0 W	0 W	0 W	0 W	0 W	0	0
Turn off	0 W	0 W	0 W	0 W	0 W	0 W	0	0
Conduction	0 W	0 W	0 W	0 W	0 W	0 W	0	0
Non conduction	0 W	0 W	0 W	0 W	0 W	0 W	0	0
Total	0 W	0 W	0 W	0 W	0 W	0 W	0	0

Reset statistics Add to report Last sent Energy >

To measure and display the switching loss, the instrument uses the following measurements and cursors:

- "P3"... "P8": "Meas 3" ... "Meas 8" to measure the voltage
- "M4" Math 4 to calculate the power
- "C3" Cursor 3 to define time points " t_0 " and " t_1 "
- "C4" Cursor 4 to define time points " t_2 " and " t_3 "

The used resources are listed in the "Details" tab. See also: [Chapter 21.2.3, "Details tab"](#), on page 1184.

"Switching Loss" is a statistical evaluation that is reset only if the measurement setup is changed or you reset the statistics.

The switching loss phases that can be defined during the measurement are shown in [Figure 21-4](#) and described in [Table 21-4](#).

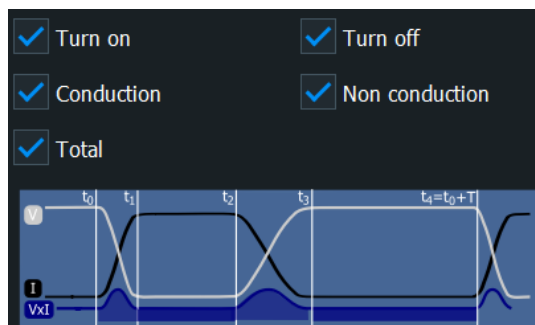

Figure 21-4: Switching loss phases

Table 21-4: Switching loss phases

Phase	Definition Points	Description
Turn on	The area between "t ₀ " and "t ₁ "	The time after switching the device, during which the current rises until it reaches the saturation current level.
Conduction	The area between "t ₁ " and "t ₂ "	The time during which the voltage is at the transistors saturated minimum and the current flows.
Turn off	The area between "t ₂ " and "t ₃ "	The time during which after a short delay time the voltage rises until it reaches its final value.
Non conduction	The area between "t ₃ " and "t ₄ "	The time during current does not flow. The losses during this period should be theoretically zero.
Total	The area between "t ₀ " and "t ₄ "	The period of one switching cycle.

The following remote commands are used for handling the measurement results:

- `POWer:SWITching:GATE:COND:START` on page 2784
- `POWer:SWITching:GATE:COND:STOP` on page 2784
- `POWer:SWITching:GATE:NCON:START` on page 2784
- `POWer:SWITching:GATE:TOFF:START` on page 2784
- `POWer:SWITching:GATE:TOFF:STOP` on page 2784
- `POWer:SWITching:GATE:TON:START` on page 2784
- `POWer:SWITching:GATE:TON:STOP` on page 2784
- `POWer:SWITching:RESult:ENERgy:ACTual?` on page 2784
- `POWer:SWITching:RESult:ENERgy:AVG?` on page 2784
- `POWer:SWITching:RESult:ENERgy:EVTCount?` on page 2784
- `POWer:SWITching:RESult:ENERgy:NPEak?` on page 2784
- `POWer:SWITching:RESult:ENERgy:PPEak?` on page 2784
- `POWer:SWITching:RESult:ENERgy:RMS?` on page 2784
- `POWer:SWITching:RESult:ENERgy:STDDev?` on page 2784
- `POWer:SWITching:RESult:ENERgy:WFMCount?` on page 2784
- `POWer:SWITching:RESult:POWer:ACTual?` on page 2785
- `POWer:SWITching:RESult:POWer:AVG?` on page 2785
- `POWer:SWITching:RESult:POWer:EVTCount?` on page 2785
- `POWer:SWITching:RESult:POWer:NPEak?` on page 2785
- `POWer:SWITching:RESult:POWer:PPEak?` on page 2785
- `POWer:SWITching:RESult:POWer:RMS?` on page 2785
- `POWer:SWITching:RESult:POWer:STDDev?` on page 2785
- `POWer:SWITching:RESult:POWer:WFMCount?` on page 2785
- `POWer:SWITching:REPort:ADD` on page 2783

21.5.3.2 Configuring switching loss

For details of the configuration settings, see [Chapter 21.5.3.3, "Switching loss settings"](#), on page 1227.

1. Select "Analysis" > "Power".
2. Under "Power Path", select "Switching Loss".
3. Connect the differential voltage probe and the current probe to the oscilloscope.
4. Deskew the probes as described in [Chapter 21.1.1.1, "Auto deskew"](#), on page 1172.
5. Connect the probes to the DUT as shown in the "Channels" tab:

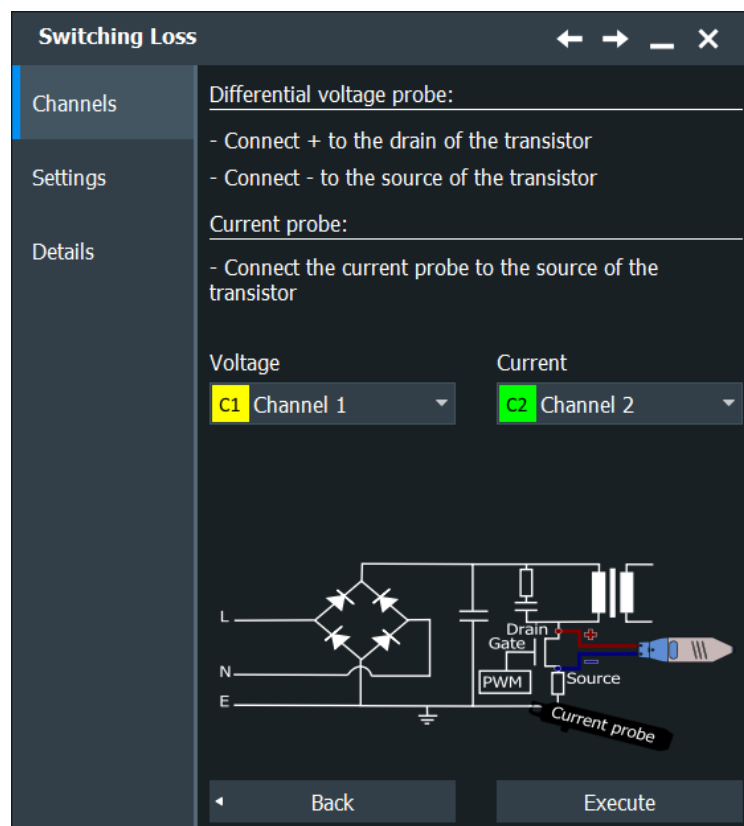

6. Select the correct channels for the "Current Source" and the "Voltage Source".
7. Select the "Settings" tab.
8. Enable the parameters you want to measure.
9. Select an "Optimize Scaling" option.

10. Tap "Execute".

On the screen you can see the measurement waveforms of the current, the voltage and the power. Also, the result box with numeric measurement results is shown. For details, see [Chapter 21.5.3.1, "Switching loss results"](#), on page 1224.

21.5.3.3 Switching loss settings

In the "Channels" tab, you set the current source and the voltage source, see also: [Chapter 21.2.1, "Channels tab"](#), on page 1183.

In the "Settings" tab, you configure the switching loss parameters and display settings.

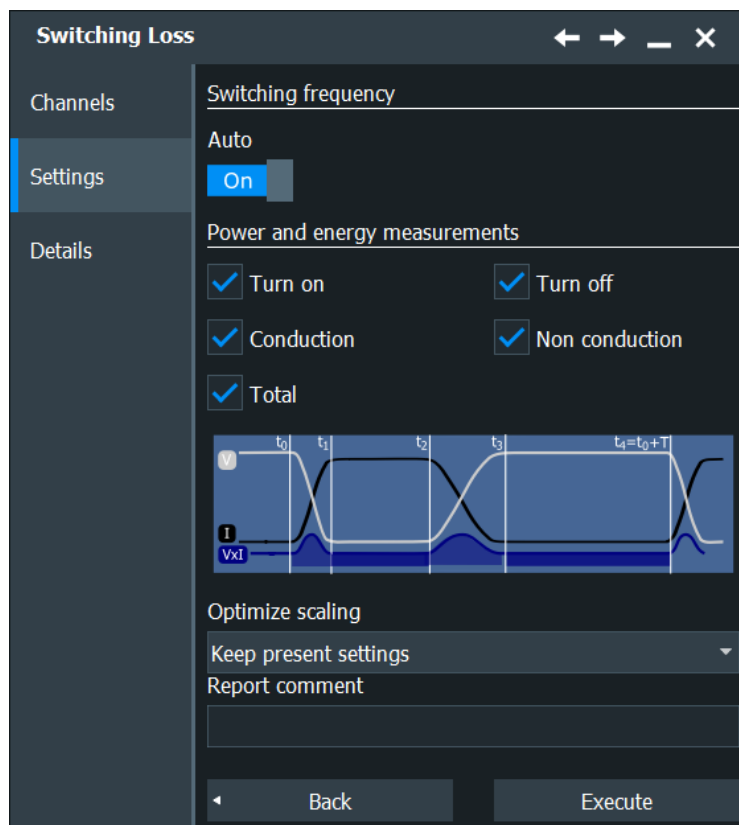

Switching frequency > Auto

Enables the measurements of the switching frequency. If disabled you can enter the value of the switching frequency.

Remote command:

[POWER:SWITching:SWIFrequency](#) on page 2783

[POWER:SWITching:SWIT](#) on page 2783

Turn on

Enables the measurements during the turn on period.

Remote command:

[POWER:SWITching:TON](#) on page 2784

Conduction

Enables the measurements during the conduction period.

Remote command:

`POWer:SWITChing:COND` on page 2784

Turn off

Enables the measurements during the turn off period.

Remote command:

`POWer:SWITChing:TOFF` on page 2784

Non conduction

Enables the measurements during the non conduction period.

Remote command:

`POWer:SWITChing:NCON` on page 2784

Total

Enables the measurements of the total period

Remote command:

`POWer:SWITChing:TOTal` on page 2784

Optimize scaling

Selects the scaling for the display of the results.

"Autoscale the signals"

Automatically selects the most appropriate scale for the display of the results.

"Keep present settings"

The present display settings are not changed.

Remote command:

`POWer:SWITChing:AUTO` on page 2783

Report comment

In this field you can write a comment that is displayed in the measurement report, for example, a measurement description.

Execute

Starts the " Switching Loss" measurement.

Remote command:

`POWer:SWITChing:EXECute` on page 2783

21.5.4 Power efficiency

This measurement requires a 4-channel oscilloscope (R&S RTO6xxx4).

"Power Efficiency" analysis measures the input and the output power of a power supply. The power efficiency of the power supply is then calculated as the ratio of the output power and the input power.

Required probes:

- Two differential voltage probes
- Two current probes

21.5.4.1 Power efficiency results

The results of "Power Efficiency" measurements are provided in two ways:

- The diagram shows the graphical presentation of:
 - the voltage input waveform
 - the current input waveform
 - the voltage output waveform
 - the voltage input waveform
 - the power input waveform
 - the power output waveform
- The result box displays the numeric measurement results of the "Input power", "Output power" and the "Efficiency". For a detailed description, see [Table 21-2](#).

Power efficiency results									
Result	Current	+Peak	-Peak	μ (Avg)	RMS	σ (S-dev)	Event count	Wave count	
Input Power	677.18 pW	677.18 pW	677.18 pW	677.18 pW	677.18 pW	0 W	1	1	
Output Power	3.3023 nW	3.3023 nW	3.3023 nW	3.3023 nW	3.3023 nW	0 W	1	1	
Efficiency	487.65 %	487.65 %	-249020000 %	-94864000 %	153700000 %	123920000 %	1	1	

Reset statistics Add to report Last sent

To measure and display the power quality, the instrument uses the following measurements and waveforms:

- "MG 7" to measure the input power waveform
- "MG 8" to measure the output power waveform
- "M2" Math 2 to calculate the input power
- "M3" Math 3 to calculate the output power

The used resources are listed in the "Details" tab. See also: [Chapter 21.2.3, "Details tab"](#), on page 1184.

"Power Efficiency" is a statistical evaluation that is reset only if the measurement setup is changed or you reset the statistics.

The following remote commands are used for handling the measurement results:

- `POWer:EFFiciency:RESult<m>:ACTual?` on page 2786
- `POWer:EFFiciency:RESult<m>:AVG?` on page 2786
- `POWer:EFFiciency:RESult<m>:EVTCount?` on page 2786
- `POWer:EFFiciency:RESult<m>:NPEak?` on page 2786
- `POWer:EFFiciency:RESult<m>:PPEak?` on page 2786
- `POWer:EFFiciency:RESult<m>:RMS?` on page 2786
- `POWer:EFFiciency:RESult<m>:STDDev?` on page 2786
- `POWer:EFFiciency:RESult<m>:WFMCCount?` on page 2786

- [Power:EFFiciency:REPort:ADD](#) on page 2786

21.5.4.2 Configuring power efficiency

For details of the configuration settings, see [Chapter 21.5.4.3, "Power efficiency settings"](#), on page 1231.

1. Select "Analysis" > "Power".
2. Under "Power Path", select "Power Efficiency".
3. Connect the differential voltage probes and the current probes to the oscilloscope.
4. Deskew the probes as described in [Chapter 21.1.1.1, "Auto deskew"](#), on page 1172.
5. Connect the probes to the DUT as shown in the graphic of the "Channels" tab:

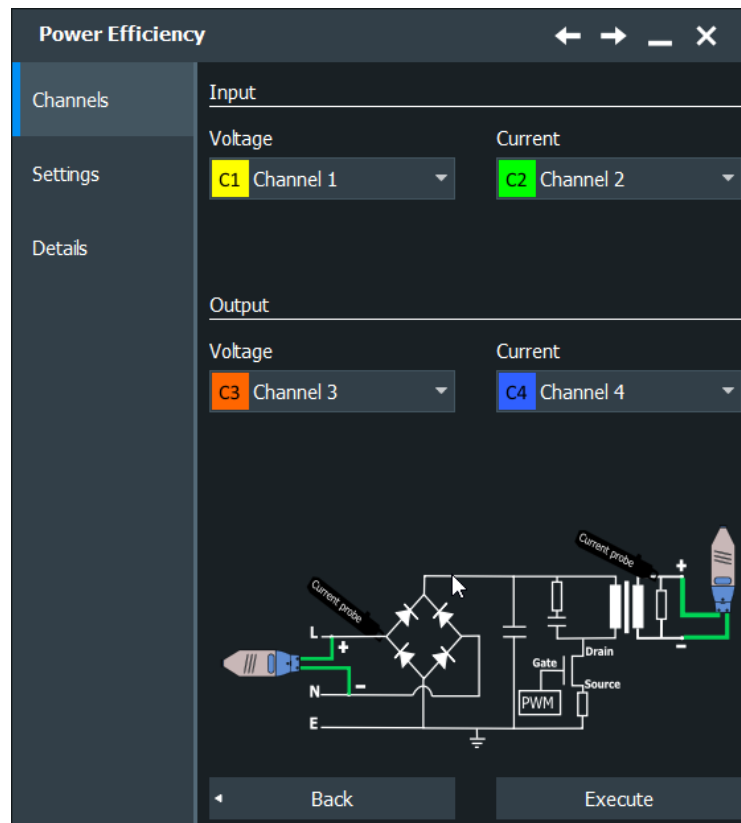

6. Select the correct channels for the "Current Source" and the "Voltage Source" of the input and the output.
7. Select the "Settings" tab.
8. Select an "Optimize Scaling" option.

9. Tap "Execute".

On the screen, you can see the measurement waveforms of the input power and the output power. Also, the result box with numeric measurement results is shown. For details, see [Chapter 21.5.4.1, "Power efficiency results"](#), on page 1229

21.5.4.3 Power efficiency settings

In the "Channels" tab, you set the current source and the voltage source, see also: [Chapter 21.2.1, "Channels tab"](#), on page 1183.

In the "Settings" tab, you configure the power efficiency display settings.

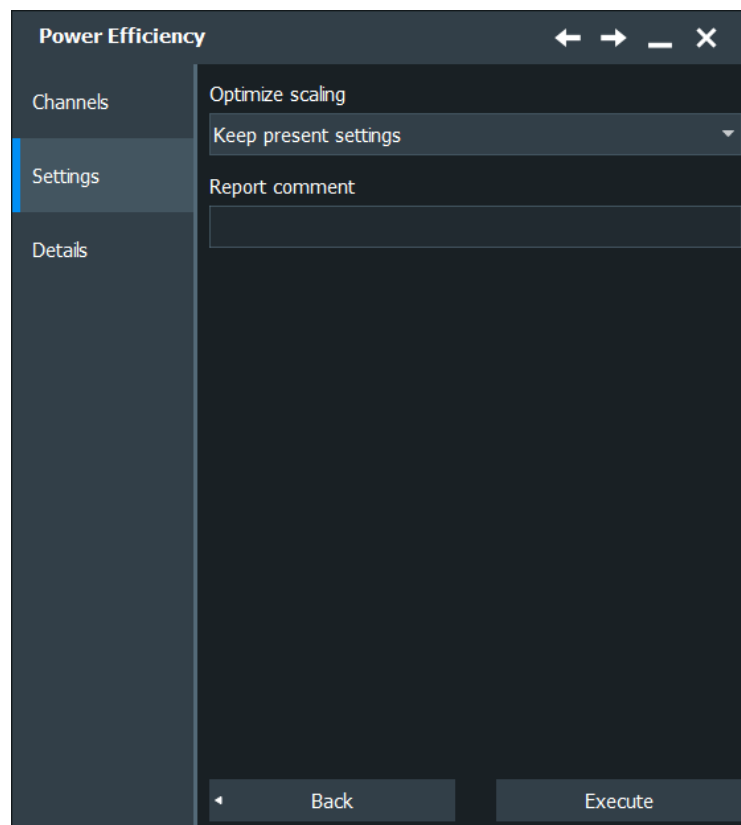

Optimize scaling

Selects the scaling for the display of the results.

"Autoscale the signals"

Automatically selects the most appropriate scale for the display of the results.

"Keep present settings"

The present display settings are not changed.

Remote command:

`POWER:EFFiciency:AUTO` on page 2785

Report comment

In this field you can write a comment that is displayed in the measurement report, for example, a measurement description.

Execute

Starts the " Power Efficiency" measurement.

Remote command:

[POWER:EFFiciency:EXECute](#) on page 2786

21.6 Output

Access: [App Cockpit]> "Analysis" > "Power" > "Output"

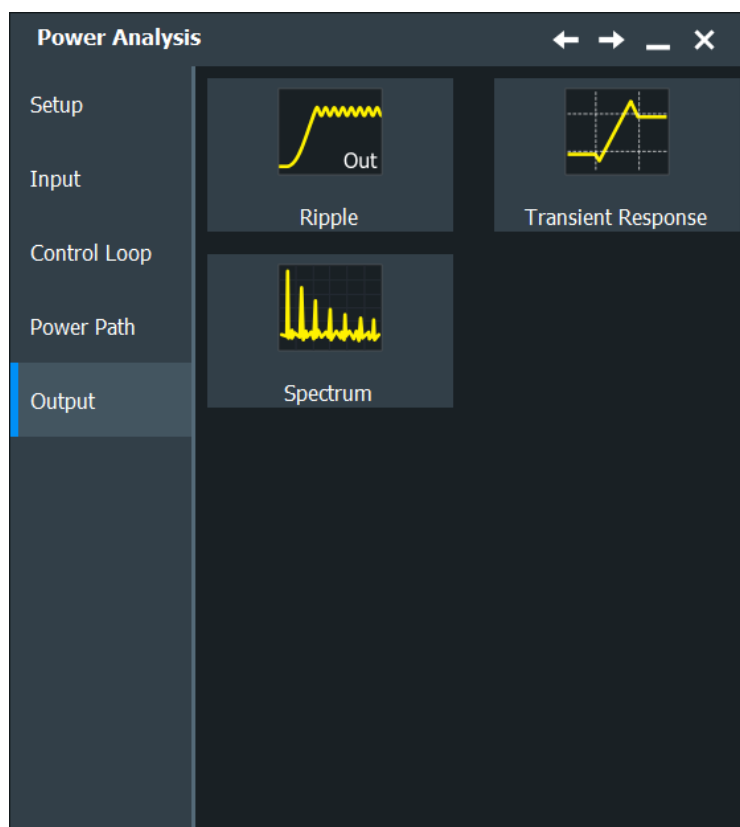

The "Output" measurements are used for characterizing the behavior and quality of the SMPS output voltage.

21.6.1 Output ripple

The "Output Ripple" analysis measures the ripple of the device output. You can measure the voltage ripple alone or the voltage and the current ripple simultaneously. In this measurement, the peak-to-peak extremes of the output DC signal are of interest.

The measurement also includes the AC-RMS of the output DC signal, which is calculated as a standard deviation.

Required probes:

- Voltage probe
- (Optional) Current probe

21.6.1.1 Output ripple results

The results of "Output Ripple" measurements are provided in two ways:

- The diagram shows the graphical presentation of:
 - The voltage waveform
 - (Optional) the current waveform
- The result box displays the numeric measurement results for the voltage and for the current ripple. For details, see [Table 21-5](#) and [Table 21-2](#).



Voltage Channel		Ripple Result							
Result	Current	Max	Min	Mean	RMS	σ (S-dev)	Event count	Wave count	
Max	126 mV	126 mV	126 mV	126 mV	126 mV	0 V	30	30	
Min	-126 mV	-126 mV	-126 mV	-126 mV	126 mV	0 V	30	30	
Peak to peak	251.99 mV	251.99 mV	251.99 mV	251.99 mV	251.99 mV	0 V	30	30	
σ (S-dev/AC-RMS)	88.389 mV	88.39 mV	88.388 mV	88.389 mV	88.389 mV	447 nV	30	30	
Period	39.966 ns	40.075 ns	39.933 ns	40.002 ns	40.002 ns	37.406 ps	30	30	
Frequency	25.021 MHz	25.042 MHz	24.953 MHz	24.999 MHz	24.999 MHz	23.369 kHz	30	30	
Pos. duty cycle	50.359 %	50.398 %	50.082 %	50.248 %	50.248 %	0.088 %	30	30	
Neg. duty cycle	49.641 %	49.918 %	49.602 %	49.752 %	49.752 %	0.088 %	30	30	
Current Channel									
Result	Current	Max	Min	Mean	RMS	σ (S-dev)	Event count	Wave count	
Max	126 mV	126 mV	126 mV	126 mV	126 mV	0 V	25	25	
Min	-126 mV	-126 mV	-126 mV	-126 mV	126 mV	0 V	25	25	
Peak to peak	251.99 mV	251.99 mV	251.99 mV	251.99 mV	251.99 mV	0 V	25	25	
σ (S-dev/AC-RMS)	88.389 mV	88.39 mV	88.388 mV	88.389 mV	88.389 mV	322.15 nV	25	25	
Period	124.93 ns	125.14 ns	124.82 ns	125 ns	125 ns	82.29 ps	25	25	
Frequency	8.0047 MHz	8.0112 MHz	7.9913 MHz	7.9997 MHz	7.9997 MHz	5.2664 kHz	25	25	
Pos. duty cycle	50.236 %	50.37 %	50.166 %	50.251 %	50.251 %	0.059 %	25	25	
Neg. duty cycle	49.764 %	49.834 %	49.63 %	49.749 %	49.749 %	0.059 %	25	25	
Reset statistics		Add to report		Last sent					







To measure and display the output ripple, the instrument uses the following measurements and waveforms:

- "MG 7" to measure the current
- "MG 8" to measure the voltage

The used resources are listed in the "Details" tab. See also: [Chapter 21.2.3, "Details tab"](#), on page 1184.

Table 21-5: Properties output ripple

	Meas. type	Symbol	Description/Result
	Max	X_{Max}	Absolute maximum value of the waveform.
	Min	X_{Min}	Absolute minimum value of the waveform.

	Meas. type	Symbol	Description/Result
	Peak to peak	X_{PkPk}	Peak-to-peak value of the waveform: the difference of maximum and minimum values. $X_{Ampl} = X_{Max} - X_{Min}$
	σ (S-dev/AC-RMS)	σ_X	Standard deviation of the waveform (samples)
	Period	T_{Period}	Time of the left-most signal period of the waveform - the time difference between two consecutive waveform edges measured on the middle reference level. The measurement requires at least one complete period of a triggered signal. Multiple measurements are possible.
	Frequency	f_{Period}	Frequency of the signal, reciprocal value of the period. $f_{Period} = 1 / T_{Period}$
	Pos. duty cycle	R_{PosCyc}	Positive duty cycle: Width of a positive pulse in relation to the period in %. The measurement requires at least one complete period of a triggered signal. Multiple measurements are possible. $PDCyc = \frac{T_{PosPulse}}{T_{Period}} \times 100\%$
	Neg. duty cycle	R_{NegCyc}	Negative duty cycle: Width of a negative pulse in relation to the period in %. The measurement requires at least one complete period of a triggered signal. Multiple measurements are possible. $PDCyc = \frac{T_{NegPulse}}{T_{Period}} \times 100\%$

"Ripple" is a statistical evaluation that is reset only if the measurement setup is changed or you reset the statistics.

The following remote commands are used for handling the measurement results:

- `POWer:RIPPlE:RESult:FREQuency:AVG?` on page 2789
- `POWer:RIPPlE:RESult:FREQuency:EVTCount?` on page 2789
- `POWer:RIPPlE:RESult:FREQuency:NPEak?` on page 2789
- `POWer:RIPPlE:RESult:FREQuency:PPEak?` on page 2789
- `POWer:RIPPlE:RESult:FREQuency:RMS?` on page 2789
- `POWer:RIPPlE:RESult:FREQuency:STDDev?` on page 2789
- `POWer:RIPPlE:RESult:FREQuency:WFMCCount?` on page 2789
- `POWer:RIPPlE:RESult:FREQuency[:ACTual]?` on page 2789
- `POWer:RIPPlE:RESult:MAXimum:AVG?` on page 2789
- `POWer:RIPPlE:RESult:MAXimum:EVTCount?` on page 2789
- `POWer:RIPPlE:RESult:MAXimum:NPEak?` on page 2789
- `POWer:RIPPlE:RESult:MAXimum:PPEak?` on page 2789

- [POWer:RIPPlE:RESult:MAXimum:RMS?](#) on page 2789
- [POWer:RIPPlE:RESult:MAXimum:STDDev?](#) on page 2789
- [POWer:RIPPlE:RESult:MAXimum:WFMCount?](#) on page 2789
- [POWer:RIPPlE:RESult:MAXimum\[:ACTual\]?](#) on page 2789
- [POWer:RIPPlE:RESult:MINimum:AVG?](#) on page 2790
- [POWer:RIPPlE:RESult:MINimum:EVTCount?](#) on page 2790
- [POWer:RIPPlE:RESult:MINimum:NPEak?](#) on page 2790
- [POWer:RIPPlE:RESult:MINimum:PPEak?](#) on page 2790
- [POWer:RIPPlE:RESult:MINimum:RMS?](#) on page 2790
- [POWer:RIPPlE:RESult:MINimum:STDDev?](#) on page 2790
- [POWer:RIPPlE:RESult:MINimum:WFMCount?](#) on page 2790
- [POWer:RIPPlE:RESult:MINimum\[:ACTual\]?](#) on page 2790
- [POWer:RIPPlE:RESult:NDCYcle:AVG?](#) on page 2790
- [POWer:RIPPlE:RESult:NDCYcle:EVTCount?](#) on page 2790
- [POWer:RIPPlE:RESult:NDCYcle:NPEak?](#) on page 2790
- [POWer:RIPPlE:RESult:NDCYcle:PPEak?](#) on page 2790
- [POWer:RIPPlE:RESult:NDCYcle:RMS?](#) on page 2790
- [POWer:RIPPlE:RESult:NDCYcle:STDDev?](#) on page 2791
- [POWer:RIPPlE:RESult:NDCYcle:WFMCount?](#) on page 2791
- [POWer:RIPPlE:RESult:NDCYcle\[:ACTual\]?](#) on page 2790
- [POWer:RIPPlE:RESult:PDCYcle:AVG?](#) on page 2791
- [POWer:RIPPlE:RESult:PDCYcle:EVTCount?](#) on page 2791
- [POWer:RIPPlE:RESult:PDCYcle:NPEak?](#) on page 2791
- [POWer:RIPPlE:RESult:PDCYcle:PPEak?](#) on page 2791
- [POWer:RIPPlE:RESult:PDCYcle:RMS?](#) on page 2791
- [POWer:RIPPlE:RESult:PDCYcle:STDDev?](#) on page 2791
- [POWer:RIPPlE:RESult:PDCYcle:WFMCount?](#) on page 2791
- [POWer:RIPPlE:RESult:PDCYcle\[:ACTual\]?](#) on page 2791
- [POWer:RIPPlE:RESult:PDEL:AVG?](#) on page 2792
- [POWer:RIPPlE:RESult:PDEL:EVTCount?](#) on page 2792
- [POWer:RIPPlE:RESult:PDEL:NPEak?](#) on page 2792
- [POWer:RIPPlE:RESult:PDEL:PPEak?](#) on page 2792
- [POWer:RIPPlE:RESult:PDEL:RMS?](#) on page 2792
- [POWer:RIPPlE:RESult:PDEL:STDDev?](#) on page 2792
- [POWer:RIPPlE:RESult:PDEL:WFMCount?](#) on page 2792
- [POWer:RIPPlE:RESult:PDEL\[:ACTual\]?](#) on page 2792
- [POWer:RIPPlE:RESult:PERiod:AVG?](#) on page 2792
- [POWer:RIPPlE:RESult:PERiod:EVTCount?](#) on page 2792

- [POWer:RIPPlE:RESult:PERiod:NPEak?](#) on page 2792
- [POWer:RIPPlE:RESult:PERiod:PPEak?](#) on page 2792
- [POWer:RIPPlE:RESult:PERiod:RMS?](#) on page 2792
- [POWer:RIPPlE:RESult:PERiod:STDDev?](#) on page 2792
- [POWer:RIPPlE:RESult:PERiod:WFMCCount?](#) on page 2792
- [POWer:RIPPlE:RESult:PERiod\[:ACTual\]?](#) on page 2792
- [POWer:RIPPlE:RESult:STDDev:AVG?](#) on page 2793
- [POWer:RIPPlE:RESult:STDDev:EVTCount?](#) on page 2793
- [POWer:RIPPlE:RESult:STDDev:NPEak?](#) on page 2793
- [POWer:RIPPlE:RESult:STDDev:PPEak?](#) on page 2793
- [POWer:RIPPlE:RESult:STDDev:RMS?](#) on page 2793
- [POWer:RIPPlE:RESult:STDDev:STDDev?](#) on page 2793
- [POWer:RIPPlE:RESult:STDDev:WFMCCount?](#) on page 2793
- [POWer:RIPPlE:RESult:STDDev\[:ACTual\]?](#) on page 2793
- [POWer:RIPPlE:REPort:ADD](#) on page 2789

21.6.1.2 Configuring output ripple

For details of the configuration settings, see [Chapter 21.6.1.3, "Output ripple settings"](#), on page 1237.

1. Select "Analysis" > "Power".
2. Under "Output", select "Ripple".
3. Connect the voltage probe to the oscilloscope.
4. If you want to measure the current ripple, enable the current channel. Connect the current probe to the oscilloscope.
5. If you want to measure both the voltage and the current ripple, deskew the probes. For details, see [Chapter 21.1.1.1, "Auto deskew"](#), on page 1172.
6. Connect the probes to the DUT as shown in the "Channels" tab:

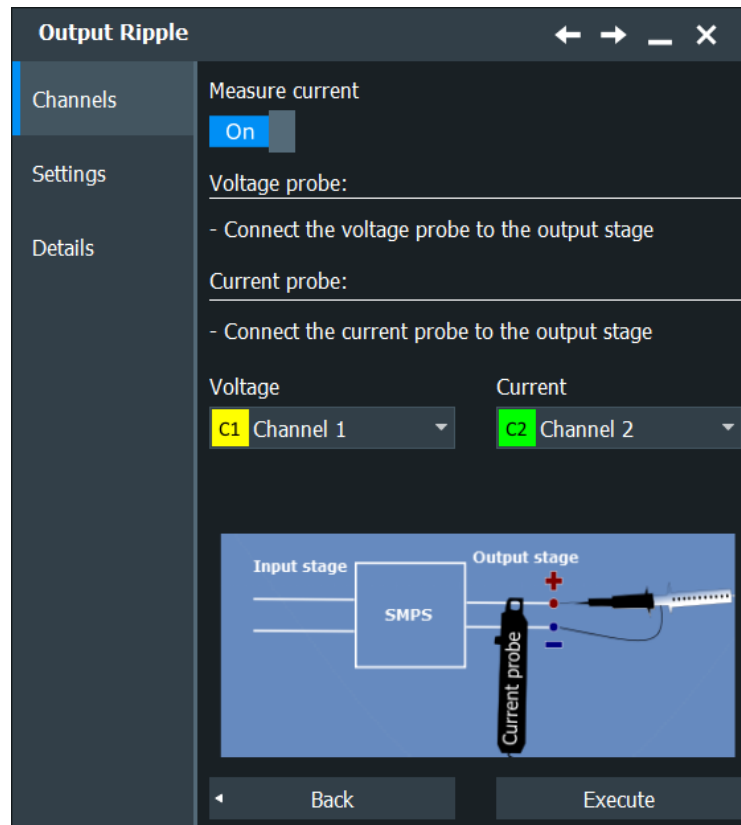

7. Select the correct channels for the "Voltage Source" and the "Current Source".
8. Select the "Settings" tab.
9. Set the "SMPS switching frequency" according to your signal.
10. Select an "Optimize Scaling" option.
11. Tap "Execute".

On the screen, you can see the measurement waveforms of the current and the voltage. Also, the result box with numeric measurement results is shown. For details, see [Chapter 21.6.1.1, "Output ripple results"](#), on page 1233.

21.6.1.3 Output ripple settings

In the "Channels" tab, you set the current source and the voltage source, see also: [Chapter 21.2.1, "Channels tab"](#), on page 1183 and [POWER:RIPPLE:CURRENT](#) on page 2788)

In the "Settings" tab, you configure the ripple parameters and display settings.

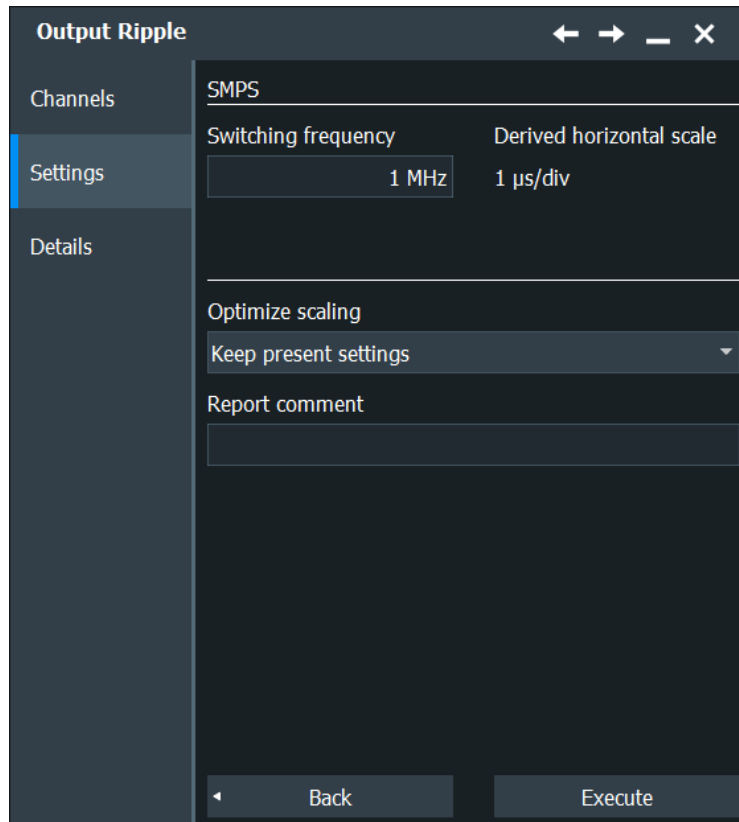

Switching frequency

Sets the SMPS switching frequency. Set the value according to your DUT.

Remote command:

[POWER:RIPPLE:FREQUENCY](#) on page 2788

Derived horizontal scale

Shows the scale of the displayed results. This value is calculated as the inverse of the "SMPS switching frequency".

Optimize scaling

Selects the scaling for the display of the results.

"Autoscale the signals"

Automatically selects the most appropriate scale for the display of the results.

"Keep present settings"

The present display settings are not changed.

Remote command:

[POWER:RIPPLE:AUTOSCALE](#) on page 2788

Report comment

In this field you can write a comment that is displayed in the measurement report, for example, a measurement description.

Execute

Starts the "Output Ripple" measurement.

Remote command:

[POWER:RIPPLE:EXECUTE](#) on page 2788

21.6.2 Transient response

The "Transient Response" analysis measures the response of a system to a change from equilibrium. This response is described by different properties like the rise time, the overshoot, the settling time, the peak time and the delay time.

Required probes:

- One or two voltage probes
- Current probe

21.6.2.1 Transient response results

The results of "Power Quality" measurements are provided in two ways:

- The diagram shows the graphical presentation of:
 - the voltage waveforms
 - the current waveform
- The result box displays the numeric measurement results.

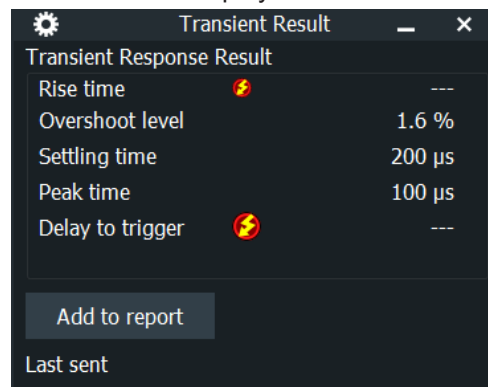

To measure and display the transient response, the instrument uses the following measurements and waveforms:

- MG 8 to measure the rise time, the overshoot and delay to trigger
- "Cu 1" Cursor 3 to measure the peak time
- "Cu 2" Cursor 2 to measure the delay to trigger

The used resources are listed in the "Details" tab. See also: [Chapter 21.2.3, "Details tab"](#), on page 1184.

The results describing the transient response of the system are shown in [Figure 21-5](#) and described in [Table 21-6](#).

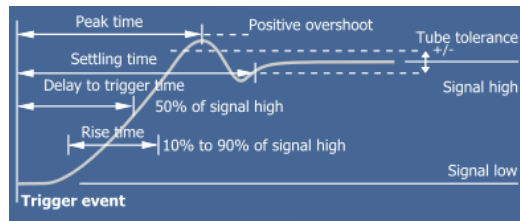

Figure 21-5: Graphical presentation of the transient response properties

Table 21-6: Transient response

Result	Description
Rise time	The time needed for the signal to change from 10% to 90% of the specified signal high.
Overshoot level	The maximum swing level above the signal high.
Settling time	The time elapsed from the trigger event to the time the output enters and remains within the tube tolerance band.
Peak time	The time needed for the response to reach the first peak of the overshoot.
Delay to trigger	The time needed for the response to reach half of the signal high value, after the trigger event.

The following remote commands are used for handling the measurement results:

- `POWer:TRANsient:RESult[:ACTual]?` on page 2795
- `POWer:TRANsient:REPort:ADD` on page 2795

21.6.2.2 Configuring transient response

For details of the configuration settings, see [Chapter 21.6.2.3, "Transient response settings"](#), on page 1241.

1. Select "Analysis" > "Power".
2. Under "Output", select "Transient Response".
3. Connect one or more voltage probes and the current probe to the oscilloscope.
4. Deskew the probes as described in [Chapter 21.1.1.1, "Auto deskew"](#), on page 1172.
5. Connect the probes to the DUT as shown in the "Channels" tab:

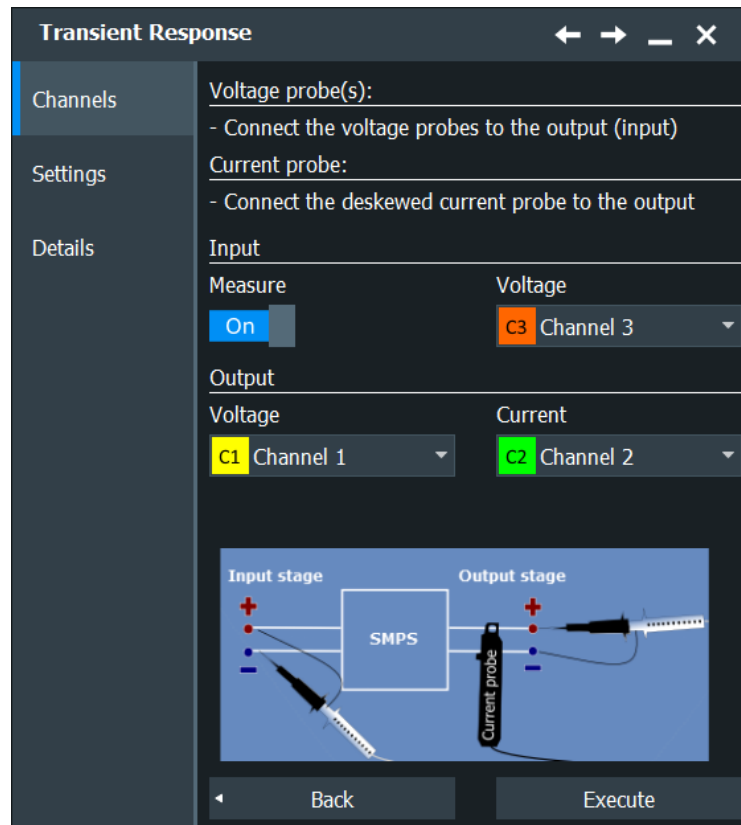

6. Select the correct channels for the "Current Source" and the "Voltage Source".
7. Select the "Settings" tab.
8. Set the "Trigger" settings according to your signal.
9. Set the "Tube tolerance", "Signal high" and "Signal low" according to your requirements.
10. Set the "SMPS switching frequency" according to your device.
11. Select an "Optimize Scaling" option.
12. Tap "Execute".
13. If needed adjust the cursors manually.

On the screen, you can see the measurement of the current and the voltage. Also, there is a table giving information about important measurement parameters. For details, see [Chapter 21.6.2.1, "Transient response results"](#), on page 1239.

21.6.2.3 Transient response settings

In the "Channels" tab, you set the current source and the voltage sources, see also: [Chapter 21.2.1, "Channels tab"](#), on page 1183 and `POWER:TRANSient:INPut` on page 2795.

In the "Settings" tab, you configure the transient response measurement parameters and display settings.

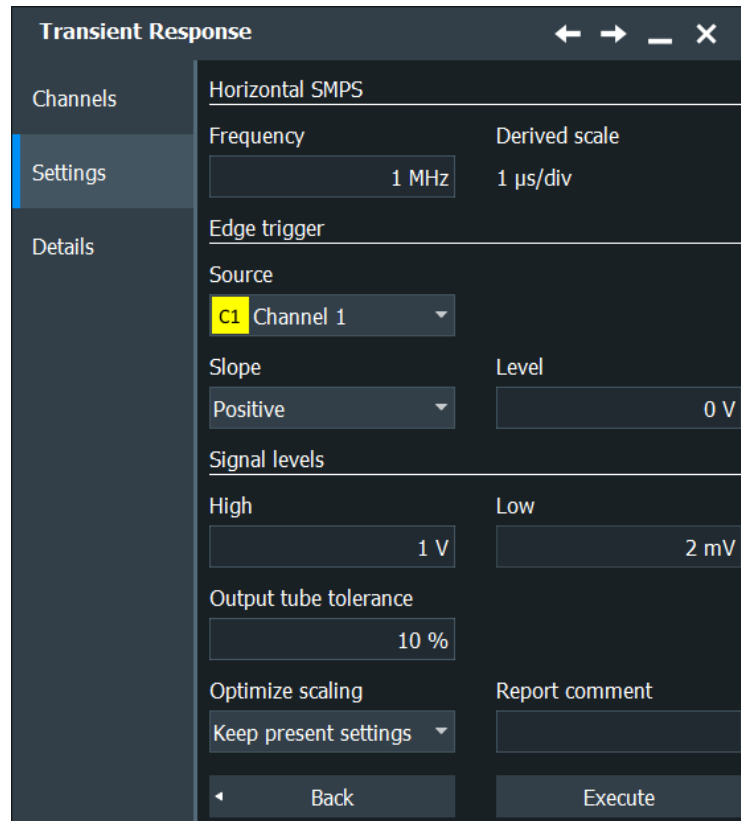

Horizontal SMPS Frequency

Sets the SMPS switching frequency. Set the value according to your DUT.

Remote command:

[POWER:TRANSient:FREQUENCY](#) on page 2794

Derived scale

Shows the scale of the displayed results. This value is calculated as the inverse of the "SMPS switching frequency"

Edge trigger

Sets the properties of the trigger.

Source ← Edge trigger

Sets the source channel of the trigger.

Remote command:

[POWER:TRANSient:TRGChannel](#) on page 2795

Slope ← Edge trigger

Sets the edge type for the trigger event.

"Positive" Selects the rising edge, that is a positive voltage change.

"Negative" Selects the falling edge, that is a negative voltage change.

"Both" Selects the rising as well as the falling edge.

Remote command:

`POWer:TRANsient:TRGSlope` on page 2796

Level ← Edge trigger

Sets the voltage or current level for the trigger event.

Remote command:

`POWer:TRANsient:TRGLevel` on page 2796

Output tube tolerance

Specifies a tolerated error band for the signal level.

Remote command:

`POWer:TRANsient:HYSteresis` on page 2794

High

Sets the expected signal high-voltage value.

Remote command:

`POWer:TRANsient:SIGHigh` on page 2795

Low

Sets the expected signal low voltage value.

Remote command:

`POWer:TRANsient:SIGLow` on page 2795

Optimize scaling

Selects the scaling for the display of the results.

"Autoscale the signals"

Automatically selects the most appropriate scale for the display of the results.

"Keep present settings"

The present display settings are not changed.

Remote command:

`POWer:TRANsient:AUToscale` on page 2794

Report comment

In this field you can write a comment that is displayed in the measurement report, for example, a measurement description.

Execute

Starts the "Transient Response" measurement.

Remote command:

`POWer:TRANsient:EXECute` on page 2794

21.6.3 Output spectrum

"Output Spectrum" analysis measures the spectrum of the output voltage. The results can be applied to see typical side effect problems of the SMPS application, such as switching frequency components of internal SMPS.

Required probes:

- Voltage probe

21.6.3.1 Output spectrum results

After executing the "Output Spectrum" measurement, the following windows are displayed:

The results of "Power Quality" measurements are provided in two ways:

- Two diagrams that show the graphical presentation of:
 - the voltage waveform
 - the spectrum
- The result box displays the positions of the measured peaks. The peaks are found by an automatic peak search.

Note: If no results are found, check and correct the FFT settings.

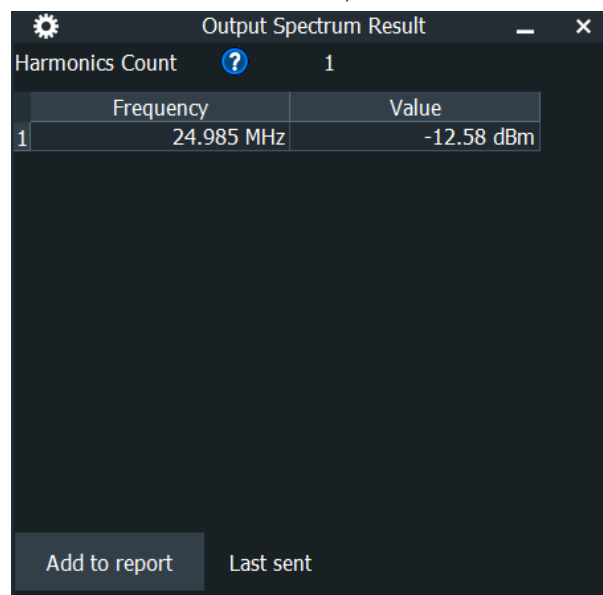

Output Spectrum Result		
Harmonics Count	?	1
	Frequency	Value
1	24.985 MHz	-12.58 dBm

Add to report Last sent

To measure and display the output spectrum, the instrument uses the following measurements and waveforms:

- "M4" Math 4 to calculate the magnitude of the FFT for the voltage source values
- "Cu 1" to "Cu 4": Cursor 1 to Cursor 4 to determine the positions of the peaks

The used resources are listed in the "Details" tab. See also: [Chapter 21.2.3, "Details tab"](#), on page 1184.

The measured peaks have different origin. Analyzing the frequencies gives information about the influences on the output signal.

The following remote commands are used for handling the measurement results:

- `POWer:SPECTrum:RCOut?` on page 2797
- `POWer:SPECTrum:RESult<m>:FREQuency?` on page 2797
- `POWer:SPECTrum:RESult<m>:LEVel?` on page 2797
- `POWer:SPECTrum:REPort:ADD` on page 2797

21.6.3.2 Configuring output spectrum

For details of the configuration settings, see [Chapter 21.6.3.3, "Output spectrum settings"](#), on page 1246.

1. Select "Analysis">"Power".
2. Under "Output", select "Spectrum".
3. Select the "Channels" tab.
4. Connect the probe to the DUT and to the oscilloscope as shown in the graphic:

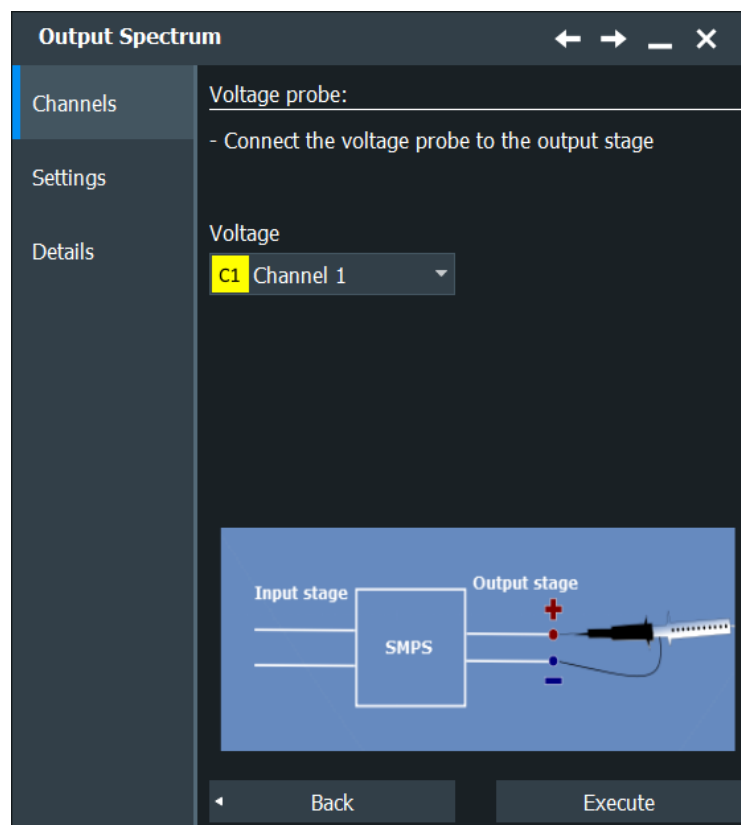

5. Select the correct channel for the "Voltage Source".
6. Select the "Settings" tab.
7. Set the "SMPS switching frequency" according to your signal.
8. Select an "Optimize Scaling" option.

9. Tap "Execute".
10. Set the positions of the cursors according to the measured spectrum.

On the screen, you can see the measurement of the spectrum. Also, the result box shows the position of the peaks. For details, see [Chapter 21.6.3.1, "Output spectrum results"](#), on page 1244.

21.6.3.3 Output spectrum settings

In the "Channels" tab, you set the voltage source, see also: [Chapter 21.2.1, "Channels tab"](#), on page 1183.

In the "Settings" tab, you configure the spectrum measurement parameters and display settings.

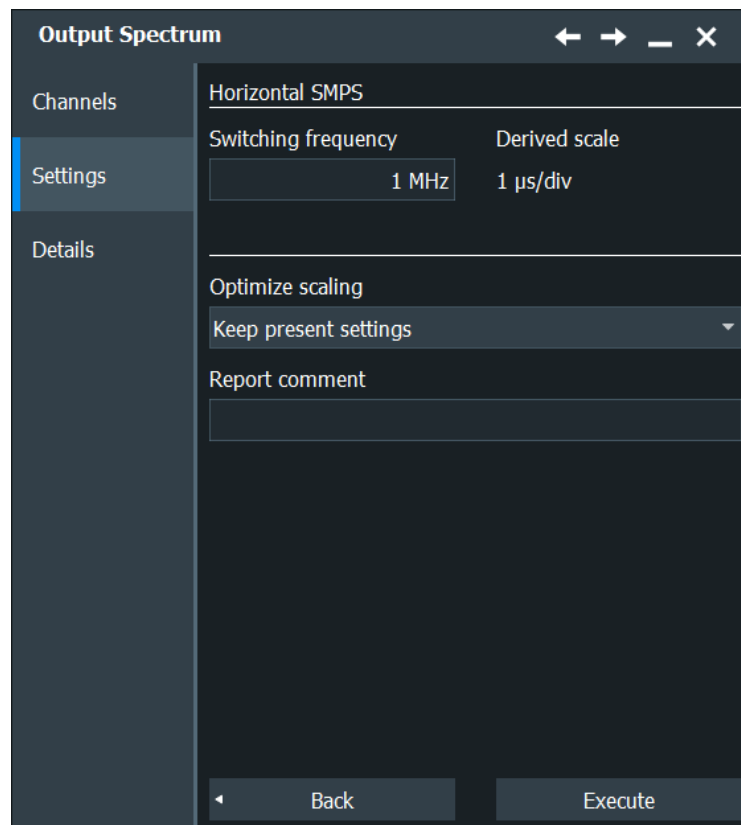

Switching frequency

Sets the SMPS switching frequency. Set the value according to your DUT.

Remote command:

[POWER:SPECTrum:FREQuency](#) on page 2797

Derived horizontal scale

Shows the scale of the displayed results. This value is calculated as the inverse of the "SMPS switching frequency"

Optimize scaling

Selects the scaling for the display of the results.

"Autoscale the signals"

Automatically selects the most appropriate scale for the display of the results.

"Keep present settings"

The present display settings are not changed.

Remote command:

[POWER:SPECTrum:AUToscale](#) on page 2796

Report comment

In this field you can write a comment that is displayed in the measurement report, for example, a measurement description.

Execute

Starts the " Output Spectrum" measurement.

Remote command:

[POWER:SPECTrum:EXECute](#) on page 2797

22 Deembedding (option R&S RTO6-K121)

Deembedding removes the parasitic effects of the measurement setup from the measured signal. A simple measurement setup consists of a probe only, but more complex setups include also cables, fixtures and other components. The effects of these components on the measurement are typically increasing when signal frequency increases. Thus, deembedding is useful or even necessary when measuring signals of 4 GHz frequency or higher. Furthermore, you can virtually move the measurement point to a point in a circuit that cannot be reached by probing. In this case, the effects of the components between the real and ideal probe are deembedded.

The components of a measurement setup are usually multiports, and each multiport can be described by a scattering matrix. The elements of a scattering matrix are the S-parameters. The S-parameters of a multiport are usually measured using vector network analyzers (VNA), and they are saved in Touchstone files.

The R&S RTO6 also can measure probes and cables and determine their S-parameters. These components are called proven probe or proven cable, and their characteristics are saved in *.rs2p files. The measurements require hardware option R&S RTO6-B7. For proven probe, also the R&S RT-ZF30 probe test fixture is needed

From the S-parameters of the measurement components, the deembedding option determines the transfer function for the measurement setup. Based on the transfer function, filter coefficients are calculated, and the filter is applied to the measured signal.

Option R&S RTO6-K121 realizes the deembedding process in software. As the process requires some time, triggering on the corrected signal is not possible, and the acquisition rate decreases.

22.1 Configuring the measurement setup for deembedding

The R&S RTO6 provides an easy way to model the measurement setup on the instrument, and to enter the characteristics of the components. If you use an R&S RT-ZM, R&S RT-ZD or R&S RT-ZS probe with Rohde & Schwarz interface, the setup is easy: The probe is recognized by the oscilloscope, and the oscilloscope knows the characteristics of the probe components.

Before you start, you need to know the following:

- Probing method: probing or terminating
- S-parameter files of the components of the measurement setup (Touchstone files). S-parameters can be listed as complex numbers (real and imaginary parts), or as magnitude and phase in the order of increasing frequency. The phase unit has to be degree (°).

Proceed as follows:

1. Select [App Cockpit] > "Analysis".
2. Select "Deembedding".

3. Select the input channel to which the measurement setup is connected.
4. Add the components of the measurement setup:
 - a) Tap the "+" icon.
 - b) Select the component type.

The component is added to the setup, and it is disabled by default (bypassed). The DUT and a probe or other input component are included by default.
5. Configure each component:
 - a) Tap the "Configure" button.
 - b) Enter the settings as required.

All settings are described in [Chapter 22.2, "Deembedding settings"](#), on page 1249.
 - c) If necessary, tap "Open" and load the S-parameters from file.

As long as the configuration is incomplete or conflicting, the message "Invalid configuration" is shown.
 - d) Enable the component to consider it during deembedding.
 - e) Tap the subtab of the next component, and configure it in the same way.
6. On the "Setup" tab, set the [Effective bandwidth](#) and the [Delay compensation](#).
7. Enable the deembedding.
8. If you want to keep the configuration for later use, save it to file.

22.2 Deembedding settings

22.2.1 Measurement setup

In the "Deembedding" > "Setup" tab, you add all components of the measurement setup and define all settings that are related to the complete path.

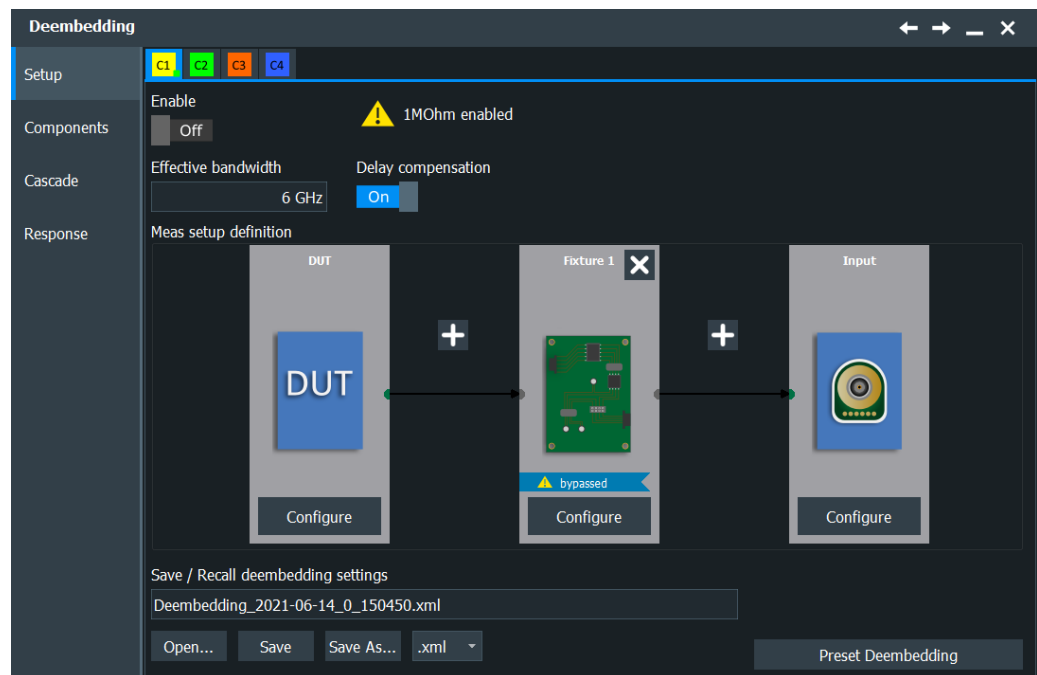

Enable

Activates the deembedding - the correction of parasitic effects of the measurement setup on the measured signal.

Remote command:

[DEEMbedding<m>\[:STATe\]](#) on page 2798

Effective bandwidth

Sets the maximum bandwidth until which the signal is corrected. This maximum value is the minimum bandwidth value of the probe bandwidth, tip module bandwidth (R&S RT-ZM) and oscilloscope bandwidth, and can not be higher than the highest frequency in a used S-parameter file. The setting is also coupled with the digital filter bandwidth if the cut-off frequency of the digital filter is at least 1 GHz.

Remote command:

[DEEMbedding<m>:BANDwidth](#) on page 2800

Delay compensation

Enables the compensation for the group delay of the complete measurement setup. If enabled, the calibration time reference point is the start point of the measurement setup. If disabled, the calibration time reference point is the oscilloscope's channel input.

Remote command:

[DEEMbedding<m>:CMPDelay](#) on page 2800

Meas setup definition

Simulates the complete measurement setup with all components.

To add a component, tap the + icon and select the component type: cable, fixture, adapter, proven probe, proven cable, or others ("Custom"). The DUT component is always included in the deembedding. Also, a connected R&S RT-ZM, R&S RT-ZD or R&S RT-ZS probe with Rohde & Schwarz interface is automatically recognized and included in the deembedding.

The remark "bypassed" indicates that the component is disabled and not considered in the deembedding calculation as long as it is not configured correctly.

Remote command:

[DEEMbedding<m>:ADD](#) on page 2799

[DEEMbedding<m>:REMOve](#) on page 2799

[DEEMbedding<m>:CCOunt?](#) on page 2799

Save / recall deembedding settings

Saves the complete deembedding configuration, or loads a saved deembedding configuration. The file format is XML.

To save the deembedding configuration, enter a filename and tap "Save". Alternatively, tap "Save as" to open the file selection dialog box, see [Chapter 12.5, "File selection dialog"](#), on page 490.

To load a deembedding configuration, tap "Open" and select the required file.

Remote command:

[DEEMbedding<m>:NAME](#) on page 2801

[DEEMbedding<m>:SAVE](#) on page 2801

[DEEMbedding<m>:OPEN](#) on page 2802

[DEEMbedding<m>:DELeTe](#) on page 2802

Preset Deembedding

Sets the complete deembedding configuration to the default values.

Remote command:

[DEEMbedding<m>:PRESet](#) on page 2801

22.2.2 Common settings for components

The "Components" tab has several subtabs to configure each component of the measurement setup that was defined on the "Setup" tab.

Settings that are available on all subtabs are described in this chapter. Other settings are component-specific and explained in the following chapters.

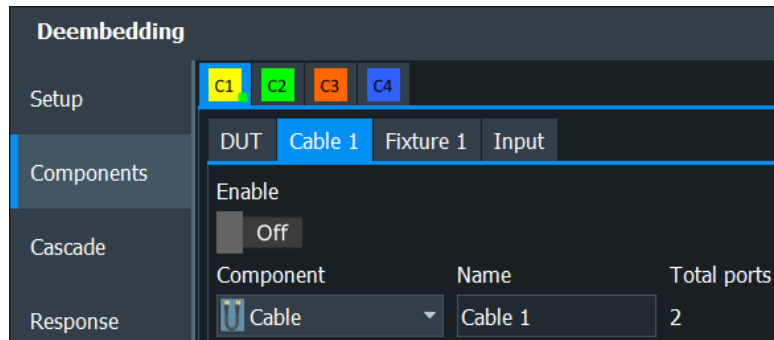

Enable

Enables the component for deembedding. As long as the configuration is incomplete or conflicting, the message "Invalid configuration" is shown, and enabling is not possible.

Remote command:

[DEEMbedding<m>:COMPONENT<n>\[:STATE\]](#) on page 2802

Component

Selects the component type. The "DUT", "Input" and "Probe" types are predefined and shown for information. The other types ("Fixture", "Cable", "Adapter", and "Other") are selectable.

Remote command:

[DEEMbedding<m>:COMPONENT<n>:TYPE](#) on page 2803

Name

Enter a name for the component that helps you identifying it.

Remote command:

[DEEMbedding<m>:COMPONENT<n>:NAME](#) on page 2803

Total ports

Shows the number of all ports of the selected component (input ports and output ports).

The number of ports depends on the attached probe. If a modular probe R&S RT-ZM or differential probe R&S RT-ZD is used, the number of ports is 4. Otherwise, 2 ports are available.

Remote command:

[DEEMbedding<m>:COMPONENT<n>:PCOUNT?](#) on page 2803

22.2.3 DUT settings

In the "Deembedding" > "Components" > "DUT" tab, you set the characteristics of the DUT.

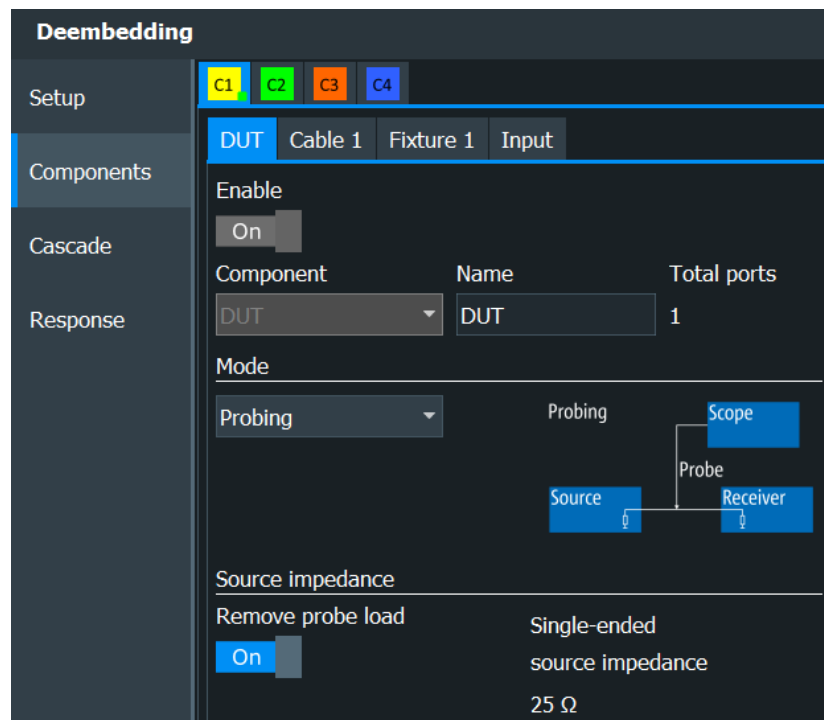

Probing, Terminating

Sets the probing mode.

Select "Probing" if you use a high-ohmic probe and measure on an existing line in parallel to the load.

Select "Terminating" if the measuring equipment is the load of the line.

Remote command:

[PROBe<m>:DEEMbedding:MODE](#) on page 1451

[DEEMbedding<m>:COMPONENT<n>:MODE](#) on page 2804

Remove probe load

If "Probing" is selected, you can remove the loading of the probe.

If the probe loading is removed, you see the signal that would be at the measurement point if the probe's input impedance is ideal (infinite impedance).

Without removing the loading, you see the real signal at the measurement point, including the probe loading.

Remote command:

[PROBe<m>:DEEMbedding:REMProbeload](#) on page 1452

[DEEMbedding<m>:COMPONENT<n>:LOAD:REMProbeload](#) on page 2805

Source impedance

Shows the source impedance of the DUT. If an R&S RT-ZM probe is connected, the value depends on the selected probe mode: common mode, differential, or single-ended measurement.

Remote command:

[DEEMbedding<m>:COMPONENT<n>:LOAD:IMPedance?](#) on page 2805

[PROBe<m>:DEEMbedding:LOAD:IMPedance](#) on page 1452

22.2.4 R&S RT-ZM probe settings

If an R&S RT-ZM modular probe is connected to a channel input, the probe is detected by the oscilloscope and automatically added to the measurement path. The S-parameters of the probe, the tip modules, and the probe group delay are known to the oscilloscope and used for deembedding.

Probe settings that are important for deembedding can be set directly in the deembedding dialog.

To get all probe deembedding settings:

1. In the "Deembedding" > "Components" > "RT-ZMxx" tab, select "More Settings".
2. In the "Probes Setup" dialog box, select "Probe Deembedding".

The "Probe Deembedding" dialog box is described in [Chapter 5.6.5.2, "Deembedding for modular probes"](#), on page 159.

For details on probe parameters, see:

- ["Probe tip module, Pin spacing"](#) on page 159
- ["Probe mode"](#) on page 158
- ["DM Offset, CM Offset, P Offset, N Offset"](#) on page 159

22.2.5 Input settings for other probes

The "Input" component is used for all probes except for R&S RT-ZM, R&S RT-ZD and R&S RT-ZS probes with Rohde & Schwarz interface, and for cables or other components that are used to connect the measurement setup to the oscilloscope. For these input components, the horizontal skew and vertical settings are considered during deembedding. You can set the skew directly in the "Deembedding" > "Components" > "Input" tab, or in "Horizontal" menu > "Skew". The button "More Settings" opens the "Channels" settings.

The input component is also used for deembedded differential signals, see [Chapter 5.8.3, "Deembedding of differential signals"](#), on page 188.

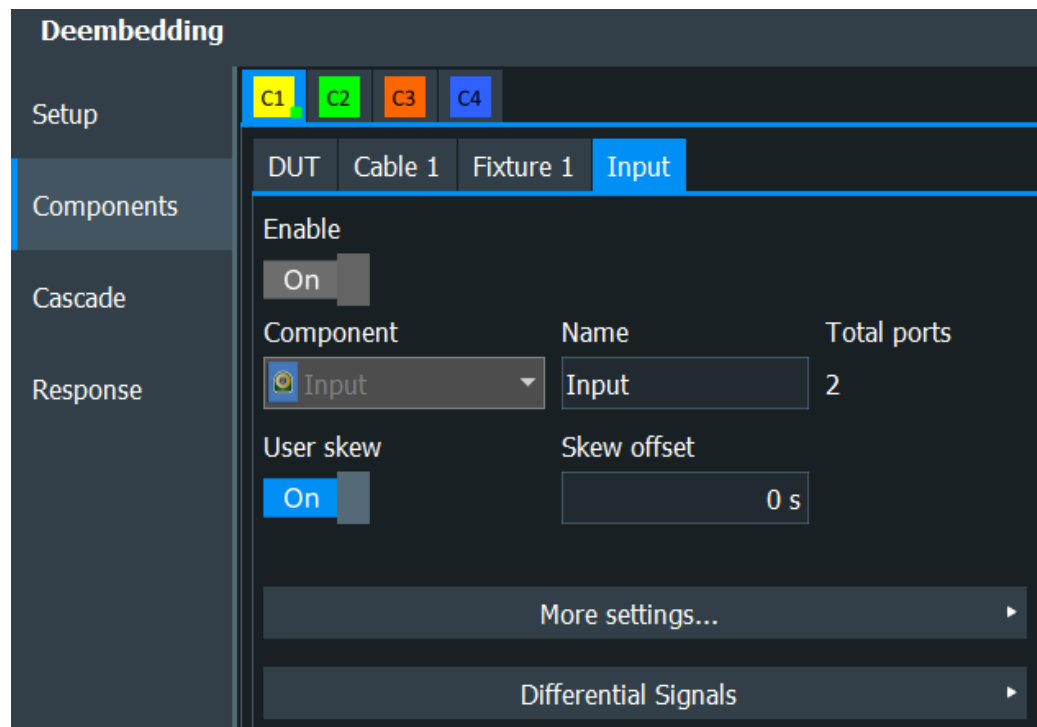

For details, see:

- "User skew" on page 124
- "Skew offset" on page 124

22.2.6 Cable, adapter, fixture and custom settings

If you have added a cable, adapter, test fixture or other component to the measurement setup, you set the characteristics in the corresponding subtabs of the "Deembedding" > "Components" tab.

The characteristics are the same for these component types. Configuration differs between 2-port and 4-port components, because 4-ports need additional settings. Generally, these components are configured by loading S-parameter files and analyzing its characteristics.

To configure a component in a single-ended 2-port setup

1. Tap "Open".
2. Select and load the *.s2p Touchstone file that contains the S-parameters of the component. The filetype is always *.s2p.
3. Assign the ports to the input and output of the component according to the data in the Touchstone file. See also: "Input 1, Input 2, Output 1, Output 2" on page 1257.
4. Analyze the response curves of each S-parameter. The response curves are functions of magnitude, phase, and group delay over frequency.
 - a) Select the S-parameter.

- b) Check the response curves. The display is based on a reference impedance of $Z_0 = 50 \Omega$.

The response curves show:

- The correctness of the S-parameter file.
 - The correct setting of the input and output ports ("Input 1", "Output 1")
 - The characteristics of the component.
5. If the component is configured correctly, tap "Enable" to include it in the deembedding setup.

To configure a component in a single-ended 4-port setup

1. If the component is a 4-port, i.e. a fixture or custom block, load the *.s4p Touchstone file that contains the S-parameters of the component:
 - a) Tap "Open".
 - b) Select and load the *.s4p Touchstone file. The filetype is always *.s4p.
2. If the component is a 2-port, i.e. a cable or adapter, typically 2 cables or adapters are used. These components can be different or identical.
 - a) If the components are identical, enable **"Identical Paths"** on page 1257. You need 1 *.s2p Touchstone file.
If the components are different, disable **"Identical Paths"** on page 1257. You need 2 *.s2p Touchstone files, one for each component.
 - b) Select the filetype *.s2p.
 - c) Tap "Open".
 - d) Select and load the *.s2p Touchstone file.
 - e) If the components are different, load the second *.s2p Touchstone file in the same way.
3. Assign the ports to the input and output of the component according to the data in the Touchstone file. See also: **"Input 1, Input 2, Output 1, Output 2"** on page 1257.
4. Analyze the response curves of each S-parameter. You can analyze magnitude, phase and group delay response, which are functions of frequency.
 - a) Select the S-parameter.
 - b) Check the response curves. The display is based on a reference impedance of $Z_0 = 50 \Omega$.
The response curves show:
 - The correctness of the S-parameter file.
 - The correct setting of the input and output ports ("Input 1", "Output 1")
 - The characteristics of the component.
5. If the component is configured correctly, tap "Enable" to include it in the deembedding setup.

Response curves are described in [Chapter 22.3.1, "Responses of the component cascade"](#), on page 1258.

Input 1, Input 2, Output 1, Output 2

Assign the ports to the input and output of the component according to the data in the Touchstone file. This information is not directly written in the file. You need background information how the S-parameters were determined, i.e. which port was input and which port was output. If in doubt, the response curves help assigning the ports correctly.

Remote command:

`DEEMbedding<m>:COMPONENT<n>:IPONe` on page 2807

`DEEMbedding<m>:COMPONENT<n>:IPTWo` on page 2807

`DEEMbedding<m>:COMPONENT<n>:OPONe` on page 2808

`DEEMbedding<m>:COMPONENT<n>:OPTWo` on page 2808

Identical Paths

The setting is relevant if the measurement setup is a 4-port, and the component is a 2-port. Usually, these components are cables and adapters, which are described by *.s2p files. If there is a 4-port setup, 2 cables or 2 adapters are used. If there is no crosstalk in-between, each cable or adapter can be described by a *.s2p file.

If both components are different, each is described by its own *.s2p file. If they are identical, for example, when a matched-pair cable is used, they can be described by the same file. In this case, enable "Identical Paths".

Remote command:

`DEEMbedding<m>:COMPONENT<n>:IDENTical` on page 2807

S-Parameters, Filetype

Loads the Touchstone file that contains the S-parameters of the component.

If the measurement setup is a 2-port, the filetype is always *.s2p.

If the measurement setup is a 4-port, the selection depends on the component. Fixtures and custom blocks are usually 4-ports, and they are described by *.s4p S-parameter files.

Cables and adapters are usually 2-ports, and they are described by *.s2p S-parameter files. If there is a 4-port setup, 2 cables or 2 adapters are used. You need 2 different files if the components are different, or only 1 file if they are identical (see also "[Identical Paths](#)" on page 1257).

Remote command:

`DEEMbedding<m>:COMPONENT<n>:SPONe` on page 2808

`DEEMbedding<m>:COMPONENT<n>:SPTWo` on page 2808

22.3 Responses

22.3.1 Responses of the component cascade

The "Deembedding" > "Cascade" tab combines the S-parameters of all included components and shows the response curves of the measurement setup for each S-parameter:

- Magnitude response
- Phase response
- Group delay response

While the response curves on the component tabs show the S-parameter characteristics of a single component, the cascade shows the combined characteristics for all components including the mismatch between the components. The DUT is not considered.

Port selection

Selects the S-parameter. The response curves (magnitude, phase, and group delay response) of the setup cascade for the selected parameter are shown. You can refresh each graphic, and display it on full screen.

22.3.2 Responses of the measurement setup

On the "Deembedding" > "Response" tab, you see the resulting transfer function characteristics of the deembedded measurement setup. These response curves include also the characteristics of the DUT and its interaction with the input connector of the oscilloscope.

You can see the following characteristics:

- Magnitude response
- Phase response
- Group delay response
- Step response

Using these response curves, you can assess the correction of the signal by deembedding. In particular, you can compare realtime deembedding with software deembedding and check whether the accuracy of the realtime deembedding is sufficient for the measurement task.

- ▶ To see more details in a response graphic, tap the upper right button in the graphic. The graphic opens in full view, where you can analyze the response function: zoom in and out, use the cursor.

On the "Response" tab, you see also some parameters of the uncorrected measurement setup including the DUT. All parameters are related to a frequency range from DC to the configured effective bandwidth.

Att_{max}

Maximum attenuation of the measurement setup before deembedding, with reference to a frequency response normalized at DC to 0 dB. The deembedding filter must amplify the amplitude response by the "Att_{max}" value, and thus also increases the noise by this value. The value also helps to decide whether deembedding is useful for the defined effective bandwidth.

Remote command:

[DEEMbedding<m>:MATTenuation?](#) on page 2809

Att_{DC}, Gain_{DC}

Maximum attenuation or gain of the measurement setup before deembedding at DC. This value is the expected basic attenuation or gain, which is corrected by deembedding.

Remote command:

[DEEMbedding<m>:CADC?](#) on page 2809

Gain_{max}

Maximum gain of the measurement setup before deembedding, with reference to a frequency response normalized at DC to 0 dB. The deembedding filter must attenuate the amplitude response by this value. The value helps also to avoid an overload of the ADC.

Remote command:

[DEEMbedding<m>:MGain?](#) on page 2809

22.4 Proven probe, proven cable

The R&S RTO6 can measure probes and cables and determine their S-parameters. These components are called proven probe or proven cable, and their characteristics are saved in *.rs2p files. The measurements require hardware option R&S RTO6-B7. For proven probe, also the R&S RT-ZF30 probe test fixture is needed

22.4.1 Characterization of proven probes and cables

To get the S-parameters of proven probes and cable, several measurements are needed. A wizard guides you through the process, and graphics show how to connect the setup. You can also save the result of each step and speed up further measurements by saved step results.

The wizard steps are the following:

- [Proven probe / cable setup](#)..... 1260
- [Normalization](#)..... 1261
- [Measurement](#)..... 1262
- [Response](#)..... 1263

22.4.1.1 Proven probe / cable setup

Access: [App Cockpit] > "Analysis" > "Deembedding" > "Setup" tab: include component "Proven Probe" or "Proven Cable" > "Configure" > "Start wizard"

Depending on the steps that you have done before, you can:

- Start the complete characterization procedure.
- Start the probe or cable measurement in a normalized setup.
- Load measurement results.

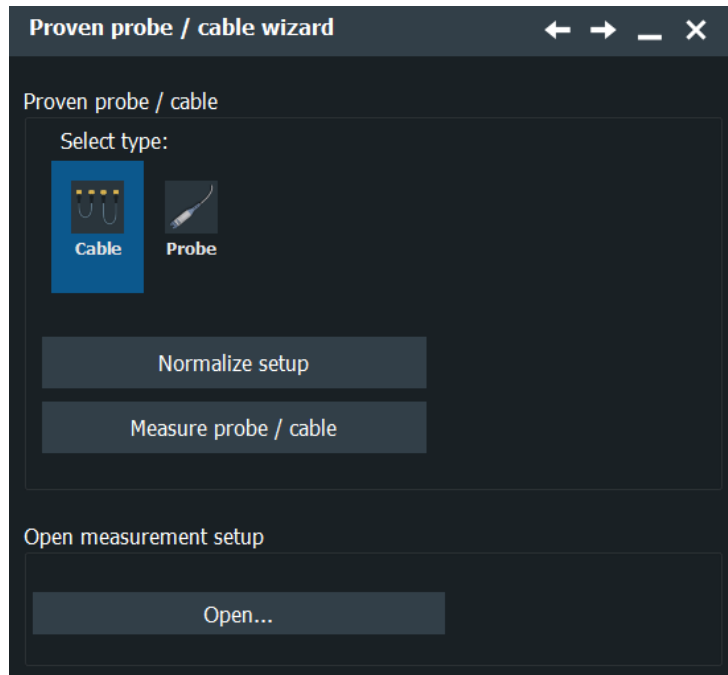

Select type

Select the DUT to be characterized: probe or cable

Normalize setup

Starts the wizard for the complete normalization and measurement procedure.

Measure probe / cable

Starts the measurement of the probe or cable directly. If the measurement setup has been normalized just before, the "Measurement" dialog box opens. Otherwise, you are asked to open a normalization file, or to start with normalization.

Open measurement setup

Opens a file with previously saved measurement results. The "Response" dialog box opens, and you can check the response plots, and save or apply the S-parameters to the deembedding setup.

22.4.1.2 Normalization

Open [App Cockpit]> "Analysis" tab > "Proven Probe / Cable" > "Normalize setup"

1. Connect the cables to the pulse source R&S RTO6-B7 and to the input channels. The probe or cable to be measured is *not* connected. Use only high-quality double-shielded RF cables. Two suitable cables are delivered with the pulse source option R&S RTO6-B7.

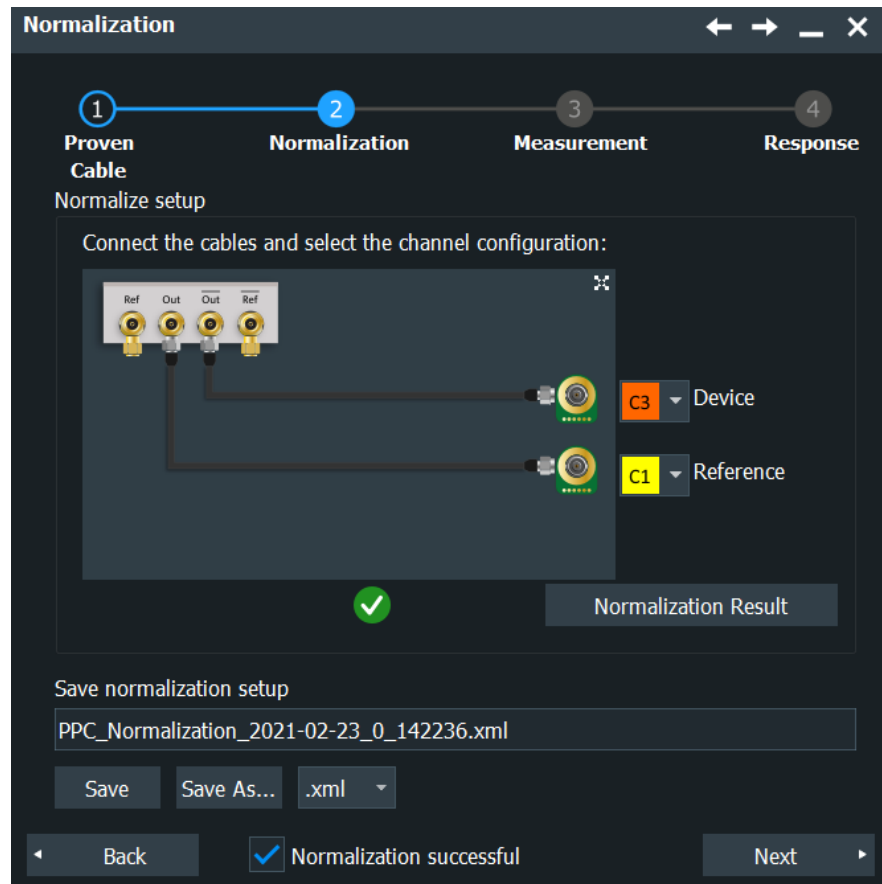

Figure 22-1: Normalization settings

2. Start measurements with "Normalize".
The basic setup is characterized.

Device

Selects the input channel that is connected to the $\overline{\text{Out}}$ connector of the pulse source R&S RTO6-B7 during normalization, and to the measured probe or cable during measurements.

Reference

Selects the input channel that is connected to Out connector of the pulse source.

Normalize

Starts the normalization of the setup without the probe or cable to be measured. The frequency correction and deskew are determined and applied in the next measurement step.

If normalization was successful, it is indicated by an icon, and you can display the "Normalization Result" - the normalized magnitude response.

Save normalization setup

Saves the results of the normalization step to an XML file.

22.4.1.3 Measurement

Open [App Cockpit]> "Analysis" tab > "Proven Probe / Cable" > "Normalize setup"> "Next"

1. To characterize a cable, connect it to the cable coming from the $\overline{\text{Out}}$ connector of the pulse source and the "Device" input channel. Use an adapter if necessary.

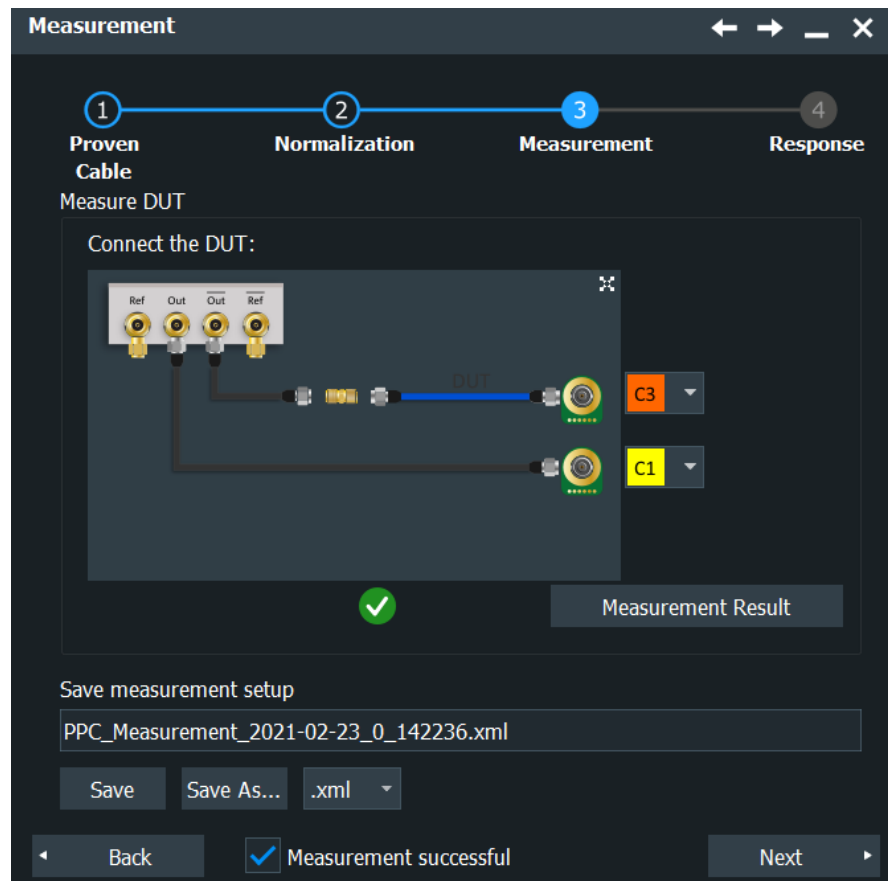

Figure 22-2: Cable measurement

2. To characterize a probe, you need the R&S RT-ZF30 probe test fixture.

- a) Connect the fixture to the cable coming from the $\overline{\text{Out}}$ connector of the pulse source.
 - b) Connect the probe to the fixture.
For details, see the "R&S RT-ZF30 Probe Test Fixture Manual".
 - c) Connect the probe to the "Device" input channel.
3. Select "Measure".

Measure

Starts the measurement of the probe or cable to be characterized.

If the measurement was successful, it is indicated by an icon, and you can display the "Measurement Result" - the magnitude response of the proved probe or cable.

Save measurement setup

Saves the measurement results of the proven probe or cable to an XML file.

22.4.1.4 Response

Open [App Cockpit]> "Analysis" tab > "Proven Probe / Cable" > > "Normalize setup" > "Next" > "Measure" > "Next"

In the last step, you see the response curves, the characteristics of deembedded proven probe or cable. The characteristics are the same as on the "Deembedding Response" tab. For more information, see [Chapter 22.3.2, "Responses of the measurement setup"](#), on page 1258.

Apply result

Includes the proven probe or proven cable component in the deembedding setup, and opens the "Deembedding Components" tab for configuration.

Save result

Saves the S-parameters of the proven probe or cable to a rs2p or rs4p file. Using this file, you can include and configure this proven probe or cable as a component in a deembedded measurement setup.

22.4.2 Deembedding with proven probe or proven cable

If a probe or cable is characterized as described in [Chapter 22.4.1, "Characterization of proven probes and cables"](#), on page 1259, and its S-parameters are saved, you can use this probe or cable in any deembedding measurement setup.

1. In the deembedding measurements setup, add the component "Proven Probe" or "Proven Cable".
2. Select "Configure" on the new component.
3. Load the S-parameters file (*.rs2p).
If no file is available, you can start the characterization wizard here.

See also: [Chapter 22.1, "Configuring the measurement setup for deembedding"](#), on page 1248.

23 Embedding and equalization (option R&S RTO6-K126)

With the R&S RTO6 and option R&S RTO6-K126 you can perform embedding and equalization of your signals.

To achieve a reliable data transmission, techniques such as emphasis (at the transmitter side) and equalization (at the receiver side) are used to compensate for transmission losses and to “reopen” the data eye.

On the transmitter side, FFE (Feed-Forward-Equalization) filters can be applied. On the receiver side, CTLE (Continuous-Time-Linear-Equalization), FFE, and DFE (Decision-Feedback-Equalization) filters can be used.

In addition to the emulation of the transmitter and receiver equalization functions, you can emulate additional signal traces (e.g.: longer cables) “Embedding”.

23.1 Equalization basics

Equalization is an operation that is applied to a pulse-amplitude modulated (PAM) signal (such as a USB or Ethernet signal) that has been distorted by a channel (such as a cable). The equalizer compensates for some of the distortions introduced by the channel and recovers the transmitted PAM symbols.

23.1.1 CTLE

A continuous-time linear equalizer (CTLE) is a continuous-time filter whose zeros and poles lie in the negative real axis of the Laplace domain.

A pole is a value of s (complex frequency) at which the transfer function of the CTLE goes to infinity. Poles have a significant impact on the system's stability and the frequency response's shape. In the time domain, poles are related to the system's natural response and can influence the equalizer's transient and steady-state behavior. In the frequency domain, poles contribute to the roll-off rate of the frequency response and can enhance the low-frequency gain.

A zero is a value of s at which the transfer function becomes zero. Zeros in the transfer function influence the frequency response by creating points where the gain is minimized. They are used to shape the frequency response in a way that compensates for the undesired channel effects, like attenuating certain frequencies or enhancing others.

In a CTLE, the placement of poles and zeros is strategically chosen to achieve a desired frequency response. Typically, the goal is to boost the high-frequency components of the signal more than the low-frequency ones to counteract the channel's high-frequency loss. This is often accomplished by placing zeros at higher frequencies and poles at lower frequencies. The exact placement of these poles and zeros defines the CTLE's ability to equalize the signal effectively, balancing the trade-off between signal enhancement and noise amplification.

It is usually specified by a list of M zero frequencies $f_{\text{zero},m}$, a list of N pole frequencies $f_{\text{pole},n}$ and a DC gain A_{DC} . The actual zeros and poles are at $-2\pi f_{\text{zero},m}$ and $-2\pi f_{\text{pole},n}$.

23.1.2 Feed-forward equalizer (FFE)

A Feed Forward Equalizer (FFE) is a type of digital filter used primarily in communication systems to mitigate the effects of inter-symbol interference (ISI). ISI is a common problem in high-speed data transmission where signals from different symbols interfere with each other, causing distortion and potential errors in the received data.

The FFE works by applying a set of weighted coefficients to the incoming signal, adjusting it to counteract the distortion caused by the channel.

The FFE has multiple "taps," each representing a delayed version of the input signal. Each tap has a corresponding coefficient (weight) that is adjusted during the equalization process. The weighted signals from all the taps are summed together to produce the output signal.

The coefficients are continuously adjusted using an algorithm to minimize the error between the equalized output signal and the desired signal.

23.1.3 Decision feedback equalizer (DFE)

A decision-feedback equalizer has a feedback loop that uses decisions on previous symbols to equalize the current symbol. "Decision" means to find the closest constellation point to each equalized symbol. The advantage of a DFE over an FFE is that the DFE is better at compensating zeros or large dips in the frequency response of the channel without enhancing the noise. For standard cables with a gradually falling frequency response, the advantage of a DFE is small.

Similar to an FFE, the DFE has a feed forward section that processes the incoming signal with a set of weighted coefficients to produce an initial estimate of the current symbol. This section aims to reduce the ISI from future symbols (pre-cursor ISI). The unique feature of the DFE is its feedback section. This part of the equalizer uses the decisions made about previous symbols to cancel out their interference on the current symbol. The previously detected symbols are fed back through a set of taps with their own coefficients, and the resulting signal is subtracted from the output of the feed forward section.

The combined output from the feed forward and feedback sections is then passed through a decision device, which determines the most likely transmitted symbol based on the processed signal. This decision is then fed back into the feedback section for use in subsequent symbol decisions.

The coefficients in both the feed forward and feedback sections are typically adjusted using adaptive algorithms to continually optimize the equalizer's performance based on the channel conditions.

23.1.4 Taps

Taps are the coefficients used in digital signal processing, specifically in an equalizer filter, to adjust the frequency response of a system. These taps are essentially weights applied to different delayed versions of the signal to interfere with certain frequencies, thereby compensating for distortions or attenuations introduced by the communication channel or system.

Taps are used to correct the signal distortion caused by channel impairments, such as multipath fading, which results in intersymbol interference (ISI). An equalizer with a certain number of taps (each corresponding to a particular delay) can be designed to adjust the amplitude and phase of different frequency components of the signal to counteract the channel's effects, thereby improving the quality of the received signal.

The design and optimization of these taps are crucial for achieving the desired equalization effect, which is typically aimed at restoring the original signal or minimizing the error rate in data transmission. The number of taps in an equalizer determines its complexity and the degree of equalization that it can achieve, with more taps generally providing better equalization at the cost of increased computational complexity.

23.2 Signal lanes settings

You can define up to four different signal lanes. Each waveform is defined in a separate tab in the "Signal Lanes" dialog box ("Lane 1" to "Lane 4").

23.2.1 General settings

Access: "Menu" > "Apps" > "Embedding / Equalization" > "Signal Lanes" tab.

In this dialog you can select the input sources and configure the nominal bit rate. You can also access

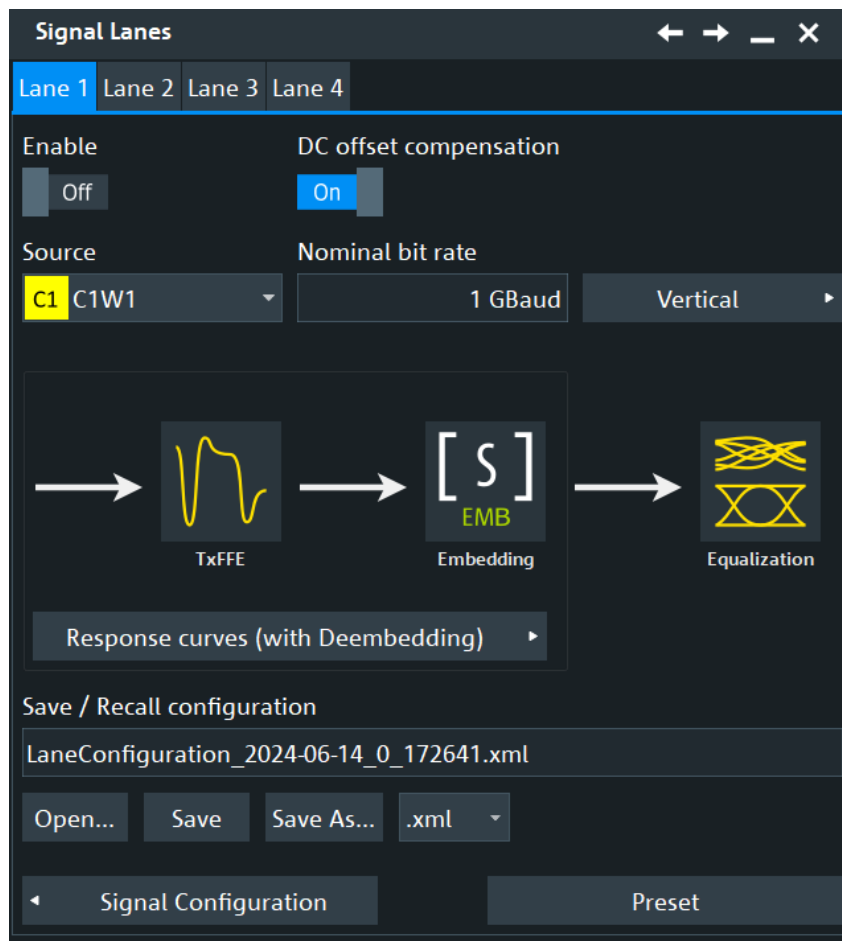
**Lane n**

Selects the lane for the signal configuration. Make sure that the tab of the correct lane is selected.

Enable

Activates the signal.

Remote command:

[LANE<m> : STATE](#) on page 2812

DC offset compensation

Enables the DC offset compensation. If enabled, the application estimates the DC offset of the input signal and removes it prior to training and/or applying equalizers to it. This may improve results, but it is only accurate if the input symbol sequence is balanced (similar number of ones and zeros in NRZ, or symmetric distribution of PAM levels in PAM-N).

If the signal is not balanced, set DC compensation to "Off".

Remote command:

[LANE<m> : CMPO](#) on page 2813

Source

Displays the currently selected source for the equalization.

You can set this up in the "Menu" > "Apps" > "Analysis" > "Embedding / Equalization" > "Signal Lanes" dialog.

Remote command:

`LANE<m> : SOURce` on page 2812

Nominal bit rate

Sets a nominal bit rate for the signal.

Remote command:

`LANE<m> : SYMRate` on page 2812

Vertical

Opens a dialog to see the vertical settings for embedding and equalization, see [Chapter 23.2.3, "Vertical settings"](#), on page 1272.

Signal flow

The signal flow displays the different stages of the signal definition:

- "Response curves (with Deembedding)": you can define a transmitter feed forward equalization (TxFFE) (see [Transmitter feed forward equalization \(TxFFE\)](#)) or add embedding (see [Embedding](#)).
- "Equalization": In this dialog you can configure the equalization settings and select your filter, see [Equalization settings](#).

Save / recall settings

Saves the complete signal lane configuration, or loads a saved configuration. The file format is XML.

To save the signal lane configuration, enter a filename and tap "Save". Alternatively, tap "Save as" to open the file selection dialog box, see [Chapter 12.5, "File selection dialog"](#), on page 490.

To load a signal lane configuration, tap "Open" and select the required file.

Remote command:

`LANE<m> : NAME` on page 2811

`LANE<m> : OPEN` on page 2811

`LANE<m> : SAVE` on page 2812

Preset

Presets the equalization settings.

Remote command:

`LANE<m> : PRESet` on page 2811

23.2.2 Combined filter response curves

In this dialog you can select the filters that are applied to the signal.

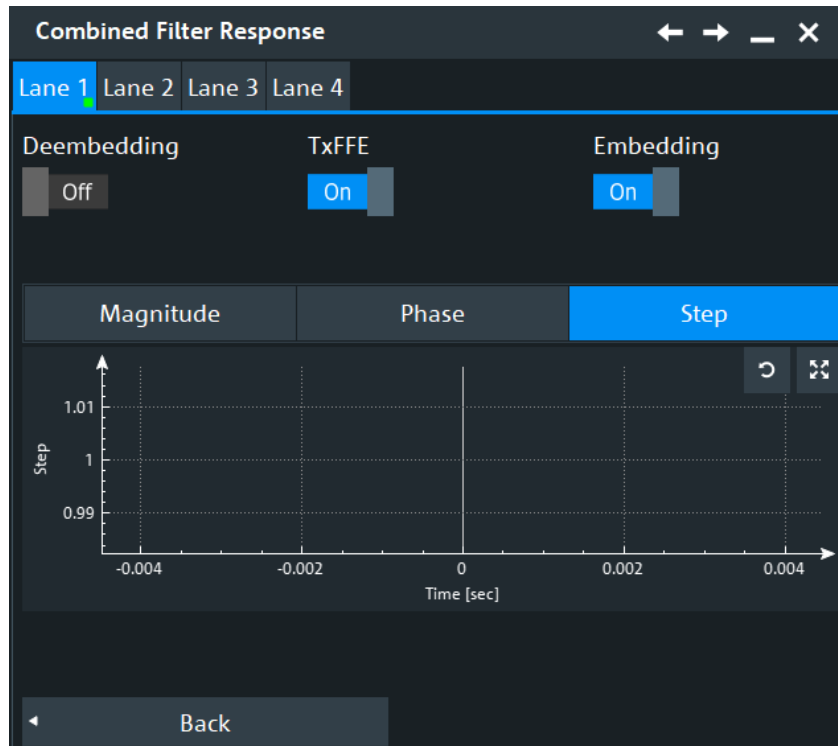

Deembedding

Includes deembedding, see [Chapter 22, "Deembedding \(option R&S RTO6-K121\)"](#), on page 1248.

Remote command:

`LANE<m>:COMFilter:INCLude:DEEMbedding` on page 2813

TxFE

Includes the transmitter feed-forward equalization, see [Chapter 23.3, "Transmitter feed forward equalization \(TxFFE\)"](#), on page 1273.

Remote command:

`LANE<m>:COMFilter:INCLude:TFFE` on page 2814

Embedding

Includes embedding, see [Chapter 23.4, "Embedding"](#), on page 1278.

Remote command:

`LANE<m>:COMFilter:INCLude:EMBedding` on page 2814

Plot

Displays plots for the selected configuration. Using these plots, you can assess the correction of the signal.

You can see the following characteristics:

- "Magnitude"

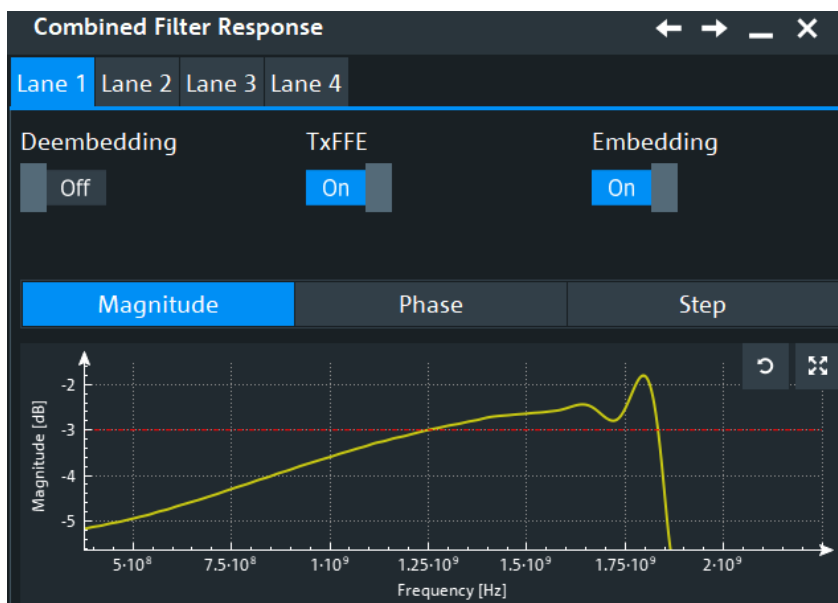

- "Phase"

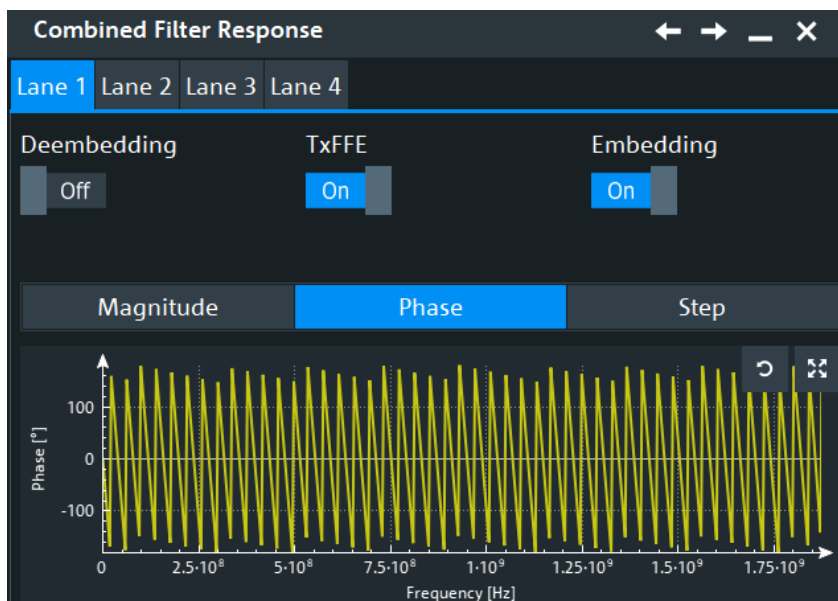

- "Step"

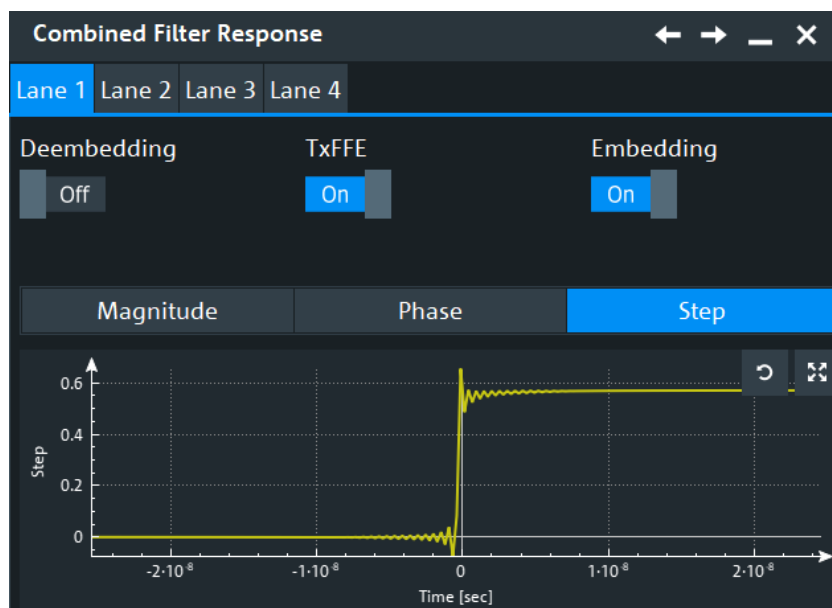

Remote command:

[LANE<m>:TFFE:PSELection](#) on page 2817

23.2.3 Vertical settings

Access: "Embedding / Equalization" > "Signal Lanes" > "Vertical".

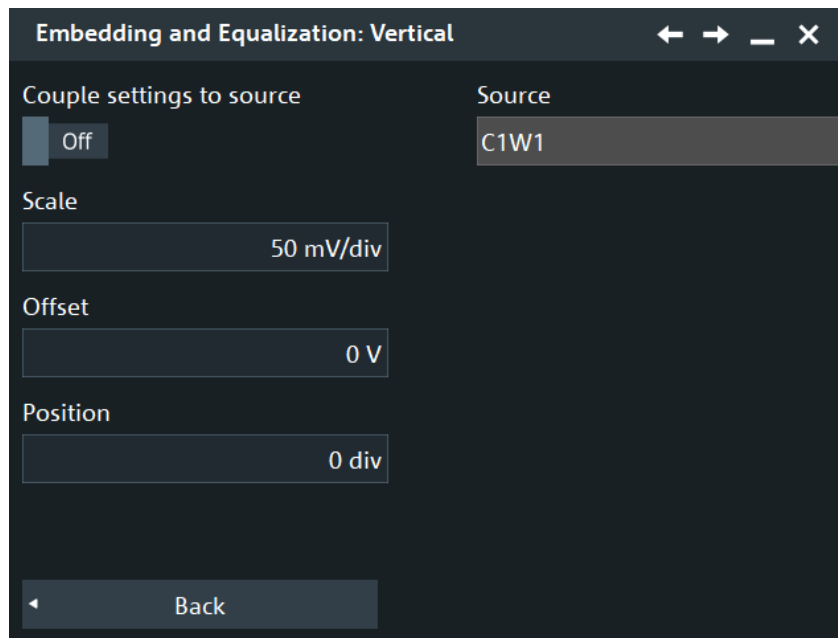

Couple settings to source

Determines how the vertical settings are defined.

If enabled, the vertical settings are coupled to the settings of the respective source. You can then adjust the vertical source settings in the "Vertical" > "Setup" dialog, see [Chapter 5.5.1, "Setup settings"](#), on page 138.

If disabled, the vertical settings for embedding and equalization are set in this dialog.

Remote command:

`LANE<m>:VERTical:COUPle` on page 2816

Scale

Sets the vertical scale for embedding and equalization.

Remote command:

`LANE<m>:VERTical:SCALe` on page 2817

Offset

Sets the offset for embedding and equalization.

Remote command:

`LANE<m>:VERTical:OFFSet` on page 2816

Position

Sets the vertical position for embedding and equalization.

Remote command:

`LANE<m>:VERTical:POSition` on page 2817

23.3 Transmitter feed forward equalization (TxFFE)

The transmitter feed forward equalization (TxFFE) applies a pre-defined set of filters (taps) to the outgoing signal to compensate for the anticipated channel-induced distortion. It is a specific type of FFE filter, which is applied at the transmitter to improve the quality of the signal by reducing ISI before the signal traverses the channel.

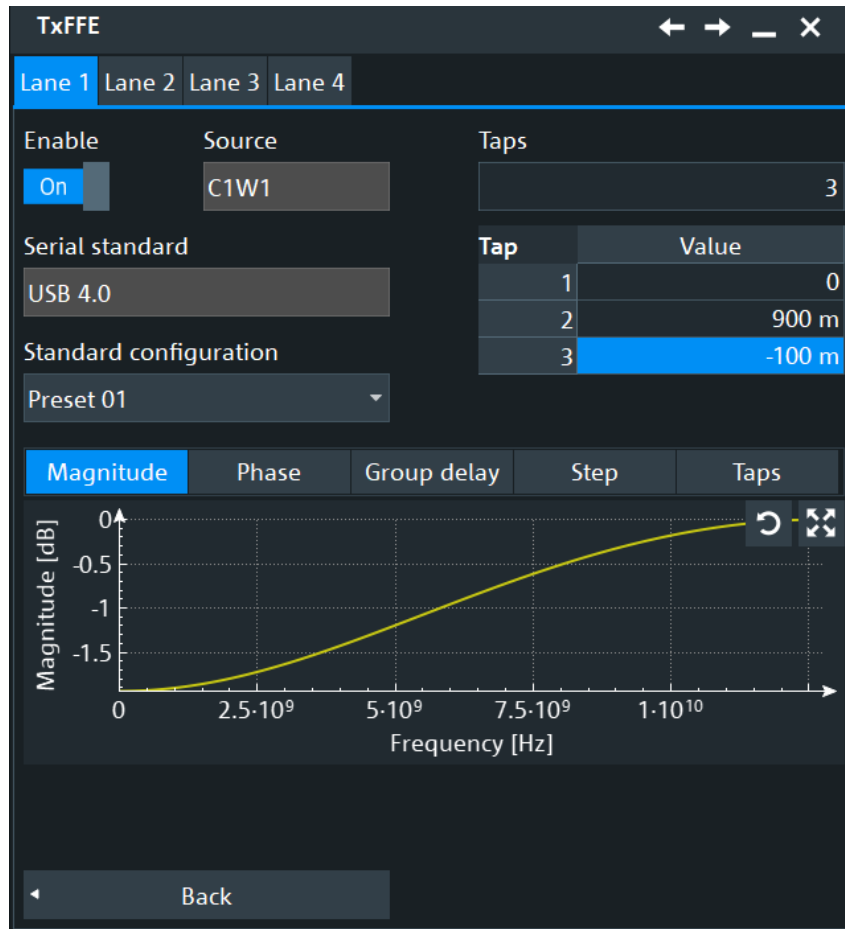
**Enable**

Enables the transmitter feed forward equalization.

Remote command:

[LANE<m>:TFFE:STATe](#) on page 2818

Serial standard

Displays the currently selected serial standard.

You can set this up in the "Menu" > "Apps" > "Analysis" > "Signal Configuration" dialog.

Standard configuration

Selects a preset standard from the list. The available values are dependent on the selected "Serial standard".

Each standard defines its own set of presets. The preset includes the number of filter taps to be used and the taps themselves.

Remote command:

[LANE<m>:TFFE:SCONfig:LIST?](#) on page 2818

[LANE<m>:TFFE:SCONfig\[:SElect\]](#) on page 2818

Taps

Selects the number of taps for the TxFFE. Depending on the selected "Serial standard", there are some predefined presets you can use.

You can also enter your custom number of taps and define a "Value" for each of them. You can enable up to 4 taps.

Remote command:

`LANE<m>:TFFE:TAPS:COUNT` on page 2819

`LANE<m>:TFFE:TAPS:TAP<*>` on page 2819

Plots

Displays plots for the selected TxFFE configuration. Using these plots, you can assess the correction of the signal.

You can see the following characteristics:

- "Magnitude"

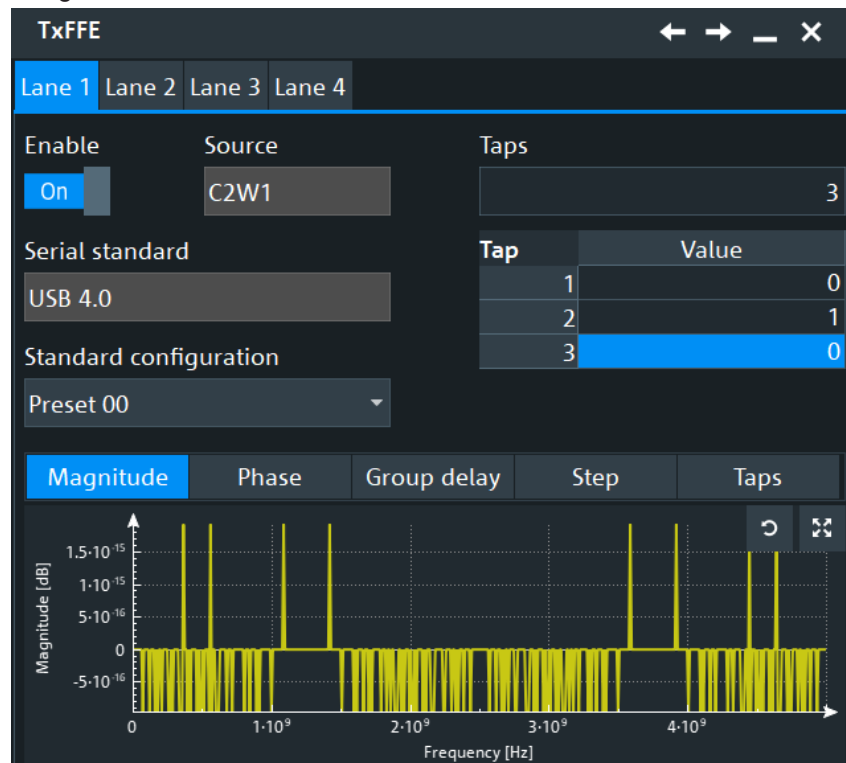

- "Phase"

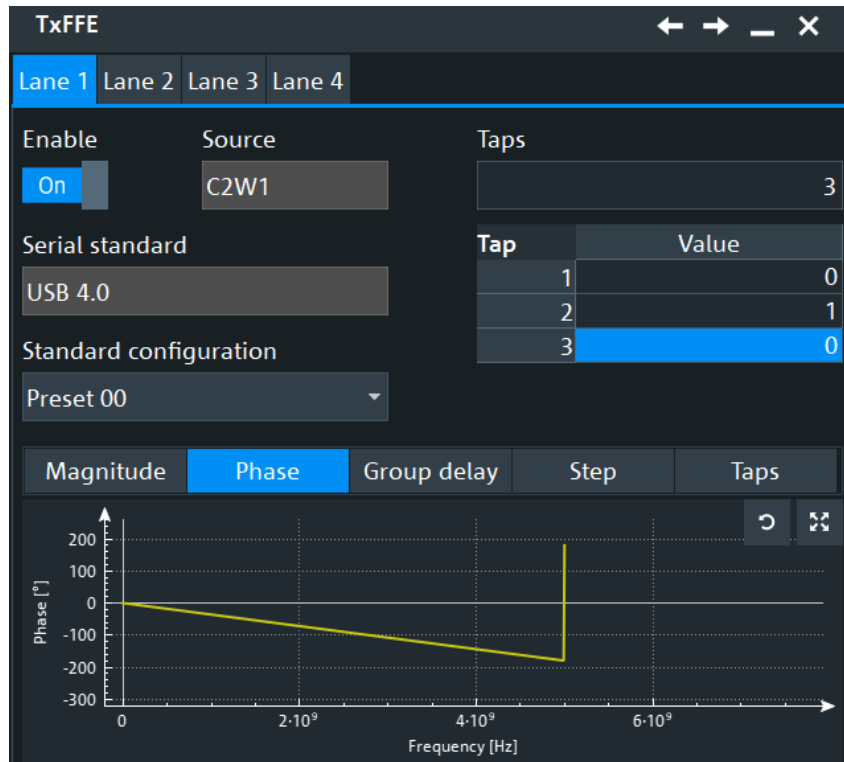

- "Group delay"

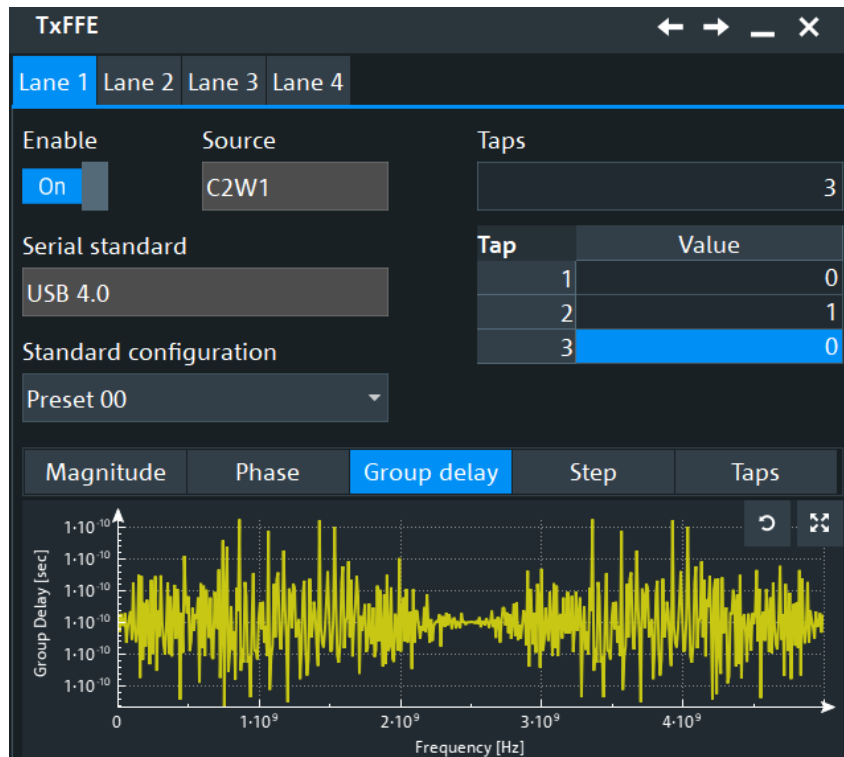

- "Step"

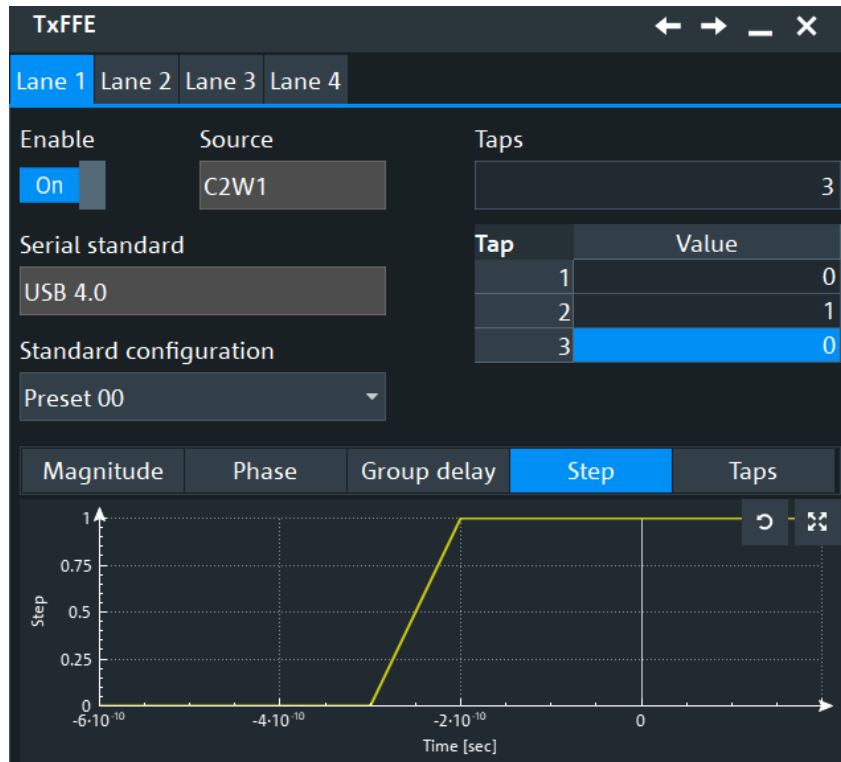

- "Taps"

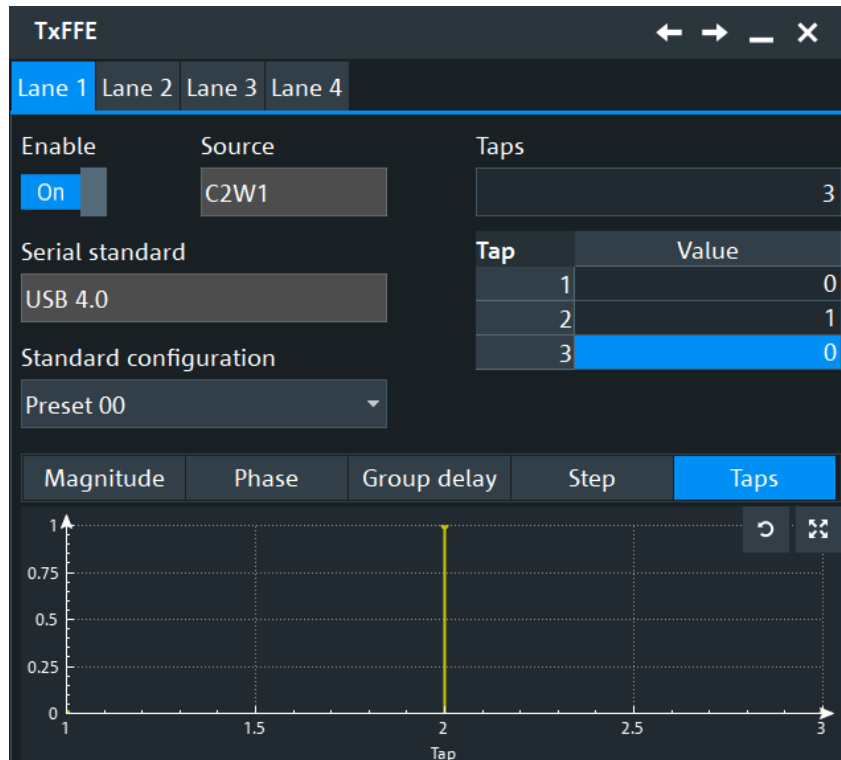

Remote command:

`LANE<m>:TFE:PSElection` on page 2817

23.4 Embedding

Embedding simulates a channel behavior, for example a transmission line. You can choose between different standard channels or set your own embedding filter.

23.4.1 Measurement setup

In the "Embedding" > "Setup" tab, you add all components of the measurement setup and define all settings that are related to the complete path.

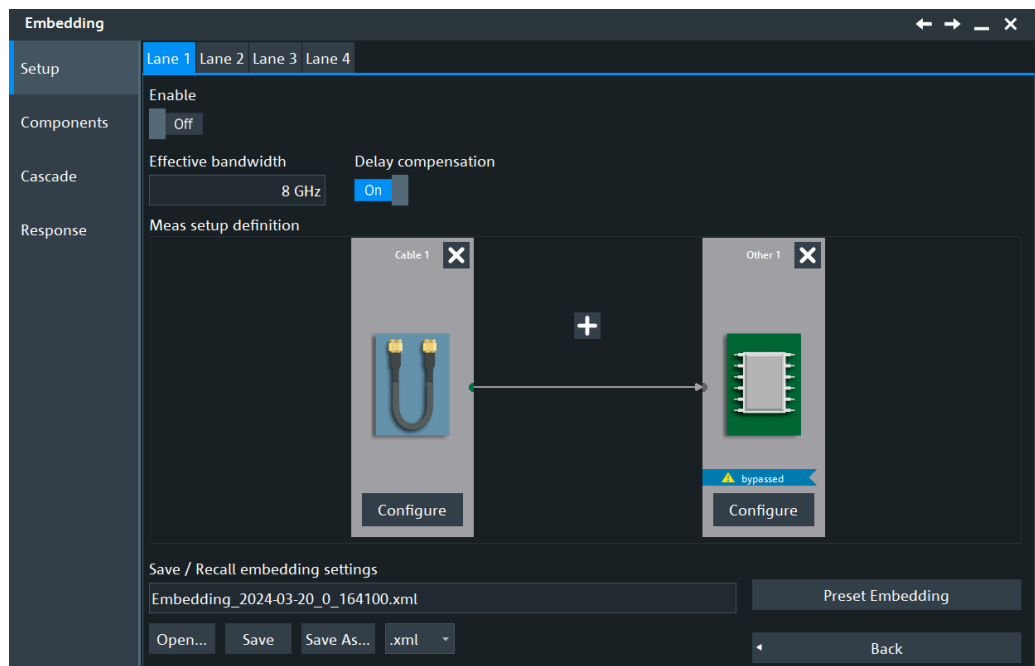

Enable

Activates the embedding - the correction of parasitic effects of the measurement setup on the measured signal.

Remote command:

[LANE<m>:EMBedding:STATe](#) on page 2820

Effective bandwidth

Sets the maximum bandwidth until which the signal is corrected.

Remote command:

[LANE<m>:EMBedding:BANDwidth](#) on page 2821

Delay compensation

Enables the delay compensation.

Remote command:

[LANE<m>:EMBedding:CMPDelay](#) on page 2822

Meas setup definition

Simulates the complete measurement setup with all components.

To add a component, tap the + icon and select the component type: cable, fixture, adapter, or others ("Custom").

The remark bypassed indicates that the component is disabled and not considered in the embedding calculation as long as it is not configured correctly.

Remote command:

[LANE<m>:EMBedding:ADD](#) on page 2821

[LANE<m>:EMBedding:REMove](#) on page 2827

[LANE<m>:EMBedding:CCOunt?](#) on page 2821

Save / recall embedding settings

Saves the complete embedding configuration, or loads a saved embedding configuration. The file format is XML.

To save the embedding configuration, enter a filename and tap "Save". Alternatively, tap "Save as" to open the file selection dialog box, see [Chapter 12.5, "File selection dialog"](#), on page 490.

To load an embedding configuration, tap "Open" and select the required file.

Remote command:

[LANE<m>:EMBedding:NAME](#) on page 2826

[LANE<m>:EMBedding:SAVE](#) on page 2827

[LANE<m>:EMBedding:OPEN](#) on page 2826

Preset Embedding

Sets the complete embedding configuration to the default values.

Remote command:

[LANE<m>:EMBedding:PRESet](#) on page 2826

23.4.2 Components

The "Components" tab has several subtabs to configure each component of the measurement setup that was defined on the "Setup" tab.

Settings that are available on all subtabs are described in this chapter. Other settings are component-specific and explained in the following chapters.

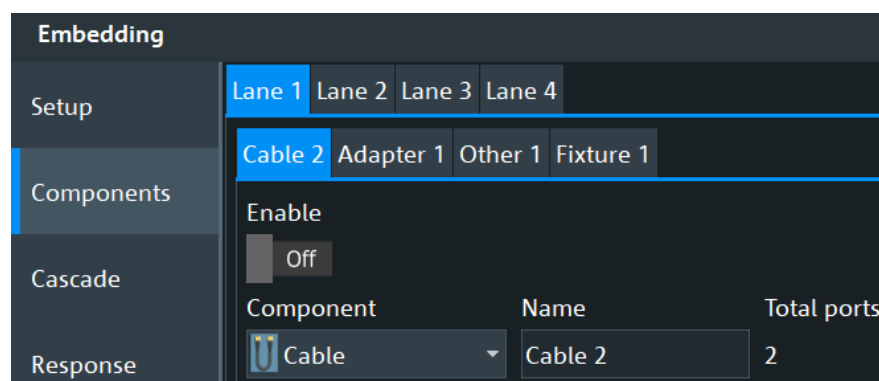

Enable

Enables the component for deembedding. As long as the configuration is incomplete or conflicting, the message "Invalid configuration" is shown, and enabling is not possible.

Remote command:

[LANE<m>:EMBedding:COMPONENT<n>\[:STATe\]](#) on page 2826

Component

Selects the component type.

Remote command:

[LANE<m>:EMBedding:COMPONENT<n>:TYPE](#) on page 2825

Name

Enter a name for the component that helps you identifying it.

Remote command:

[LANE<m>:EMBedding:COMPONENT<n>:NAME](#) on page 2823

Total ports

Shows the number of all ports of the selected component (input ports and output ports).

Remote command:

[LANE<m>:EMBedding:COMPONENT<n>:PCOUNT?](#) on page 2823

Input 1, Input 2, Output 1, Output 2

Assign the ports to the input and output of the component according to the data in the Touchstone file. This information is not directly written in the file. You need background information how the S-parameters were determined, i.e. which port was input and which port was output. If in doubt, the response curves help assigning the ports correctly.

Remote command:

[LANE<m>:EMBedding:COMPONENT<n>:IPONE](#) on page 2823

[LANE<m>:EMBedding:COMPONENT<n>:IPTWO](#) on page 2823

[LANE<m>:EMBedding:COMPONENT<n>:OPONE](#) on page 2823

[LANE<m>:EMBedding:COMPONENT<n>:OPTWO](#) on page 2823

S-Parameters, Filetype

Loads the Touchstone file that contains the S-parameters of the component.

If the measurement setup is a 2-port, the filetype is always *.s2p.

If the measurement setup is a 4-port, the selection depends on the component. Fixtures and custom blocks are usually 4-ports, and they are described by *.s4p S-parameter files.

Cables and adapters are usually 2-ports, and they are described by *.s2p S-parameter files. If there is a 4-port setup, 2 cables or 2 adapters are used.

Remote command:

[LANE<m>:EMBedding:COMPONENT<n>:SPONE](#) on page 2825

[LANE<m>:EMBedding:COMPONENT<n>:SPTWO](#) on page 2825

23.4.3 Responses

23.4.3.1 Responses of the component cascade

The "Embedding" > "Cascade" tab combines the S-parameters of all included components and shows the response curves of the measurement setup for each S-parameter:

- Magnitude response
- Phase response
- Group delay response

While the response curves on the component tabs show the S-parameter characteristics of a single component, the cascade shows the combined characteristics for all components including the mismatch between the components.

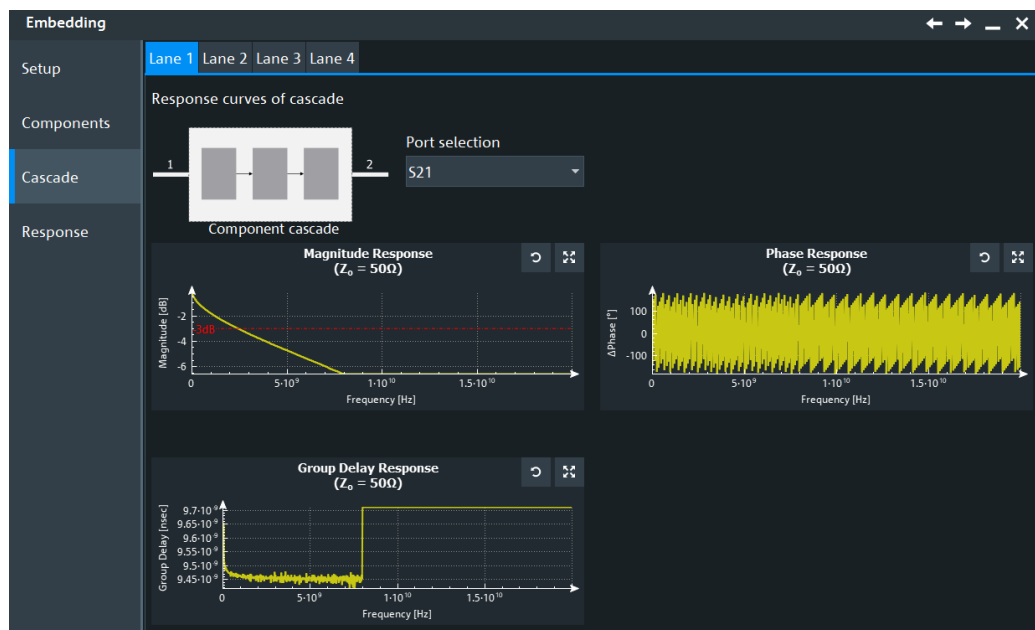

Port selection

Selects the S-parameter. The response curves (magnitude, phase, and group delay response) of the setup cascade for the selected parameter are shown. You can refresh each graphic (↻), and display it on full screen (⌕) to analyze it further: zoom in and out, use the cursor.

23.4.3.2 Responses of the measurement setup

On the "Embedding" > "Response" tab, you see the resulting transfer function characteristics of the embedded measurement setup.

You can see the following characteristics:

- Magnitude response

- Phase response
- Group delay response
- Normalized step response

Using these response curves, you can assess the correction of the signal by embedding.

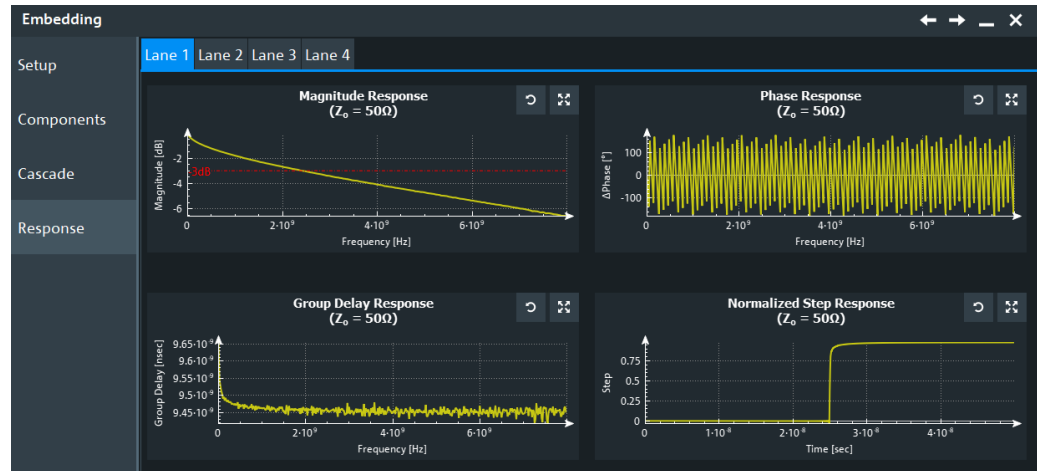

- To see more details in a response graphic, tap the upper right button in the graphic .

The graphic opens in full view, where you can analyze the response function: zoom in and out, use the cursor.

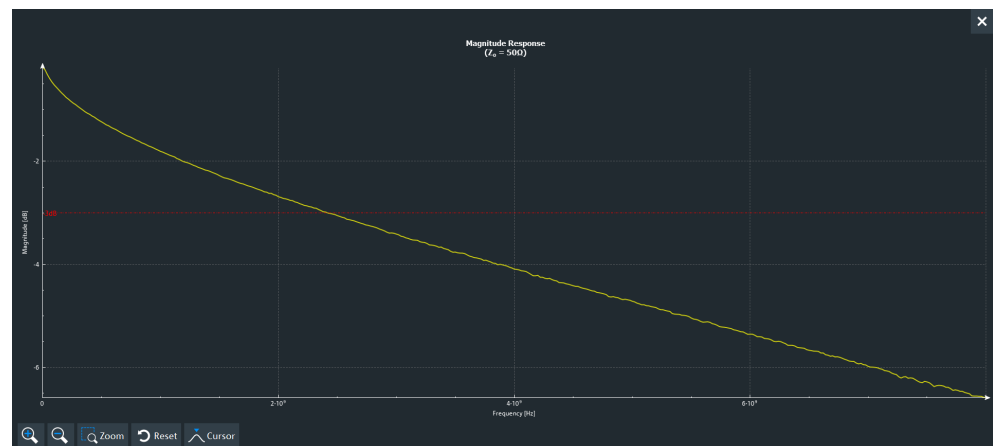

23.5 Equalization settings

Equalization is an operation that is applied to a PAM signal (such as a USB or Ethernet signal) that has been distorted by a channel (such as a cable). The equalizer compensates for some of the distortions introduced by the channel and recovers the transmitted PAM symbols.

23.5.1 Setup

Access: "Menu" > "Apps" > "Embedding / Equalization" > "Signal Lanes" > "Equalization" > "Setup" tab.

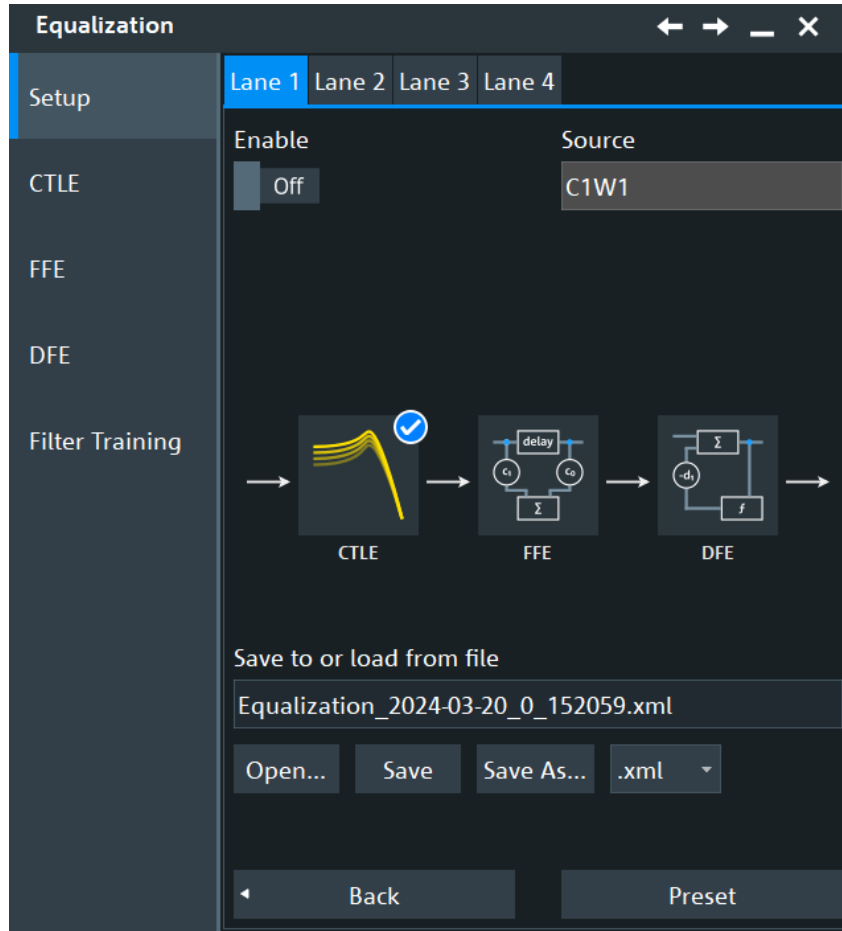

Enable

Enables equalization.

Remote command:

[LANE<m>:EQUalization:STATe](#) on page 2815

Source

Displays the currently selected source for the equalization.

You can set this up in the "Menu" > "Apps" > "Analysis" > "Embedding / Equalization" > "Signal Lanes" dialog.

Remote command:

[LANE<m>:SOURce](#) on page 2812

Filter

The diagram displays which filters are enabled. You can enable each filter in the corresponding tab of the "Equalization" dialog.

If a filter is enabled, a blue circle with a tick appears in the right corner of its icon.

The figure below shows a setup where the CTLE filter is enabled and the FFE and DFE filters are disabled.

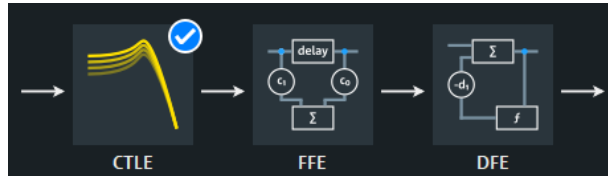

Preset

Presets the equalization settings to their default values.

Note: A preset disables all filters.

Remote command:

[LANE<m>:EQAlization:PRESet](#) on page 2815

Save / open equalization settings

Saves the complete equalization configuration, or loads a saved equalization configuration. The file format is XML.

To save the equalization configuration, enter a filename and tap "Save". Alternatively, tap "Save as" to open the file selection dialog box, see [Chapter 12.5, "File selection dialog"](#), on page 490.

To load an equalization configuration, tap "Open" and select the required file.

Remote command:

[LANE<m>:EQAlization:OPEN](#) on page 2815

[LANE<m>:EQAlization:SAVE](#) on page 2815

[LANE<m>:EQAlization:NAME](#) on page 2814

23.5.2 CTLE

Access: "Menu" > "Apps" > "Embedding / Equalization" > "Signal Lanes" > "Equalization" > "CTLE" tab.

In this dialog, you can define the settings for the continuous time linear equalizer.

For more information, see [Chapter 23.1.1, "CTLE"](#), on page 1265.

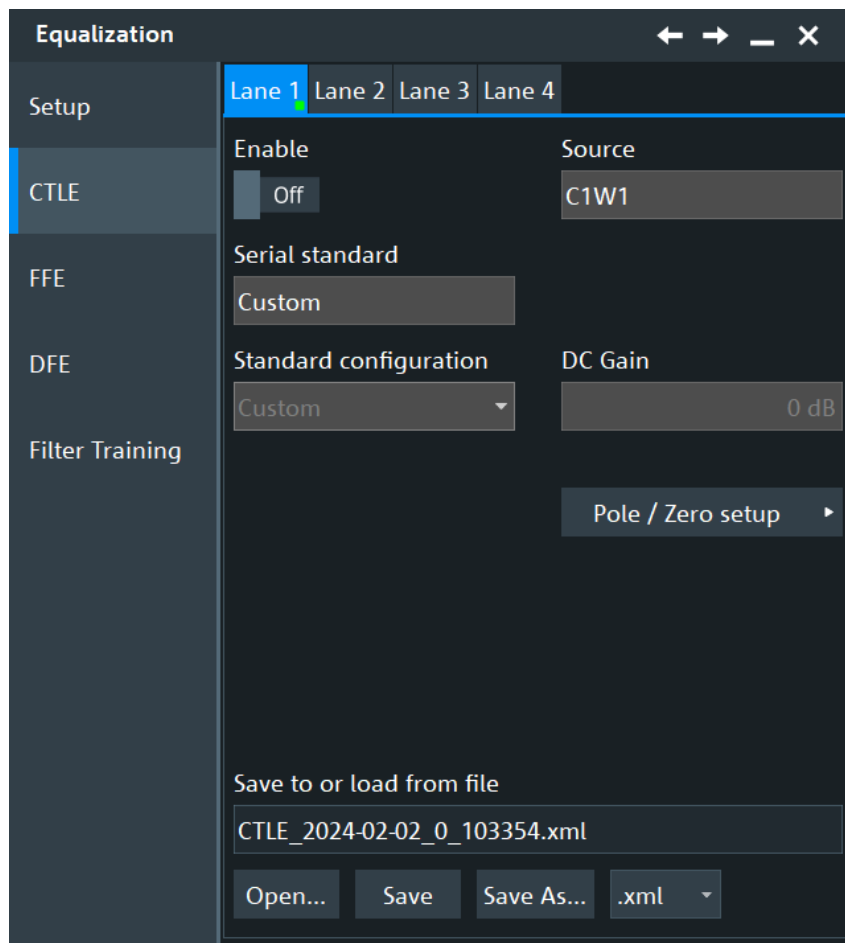
**Enable**

Enables the continuous time linear equalizer (CTLE).

Remote command:

[LANE<m>:EQUalization:CTLE:STATE](#) on page 2830

DC Gain

Sets a DC gain for the CTLE filter. The DC gain determines the level of signal amplification at the low frequency end, thus ensuring that low frequency components are amplified to an adequate level to maintain signal integrity.

Remote command:

[LANE<m>:EQUalization:CTLE:DCGain](#) on page 2828

Serial standard

Displays the currently selected serial standard.

You can set this up in the "Menu" > "Apps" > "Analysis" > "Signal Configuration" dialog.

Standard configuration

Depending on the selected "Serial standard", you can select further standard specific settings.

Remote command:

`LANE<m>:EQUalization:CTLE:SCONfig[:SElect]` on page 2830

`LANE<m>:EQUalization:CTLE:SCONfig:LIST?` on page 2830

Save / recall CTLE settings

Saves the complete CTLE configuration, or loads a saved CTLE configuration. The file format is XML.

To save the CTLE configuration, enter a filename and tap "Save". Alternatively, tap "Save as" to open the file selection dialog box, see [Chapter 12.5, "File selection dialog"](#), on page 490.

To load a CTLE configuration, tap "Open" and select the required file.

Remote command:

`LANE<m>:EQUalization:CTLE:NAME` on page 2828

`LANE<m>:EQUalization:CTLE:OPEN` on page 2828

`LANE<m>:EQUalization:CTLE:SAVE` on page 2829

Pole/ Zero setup

In this dialog you can set up the zero and pole frequencies for the CTLE filter. Depending on the selected [Serial standard](#), standard predefined values are displayed. They can be changed according to your requirements.

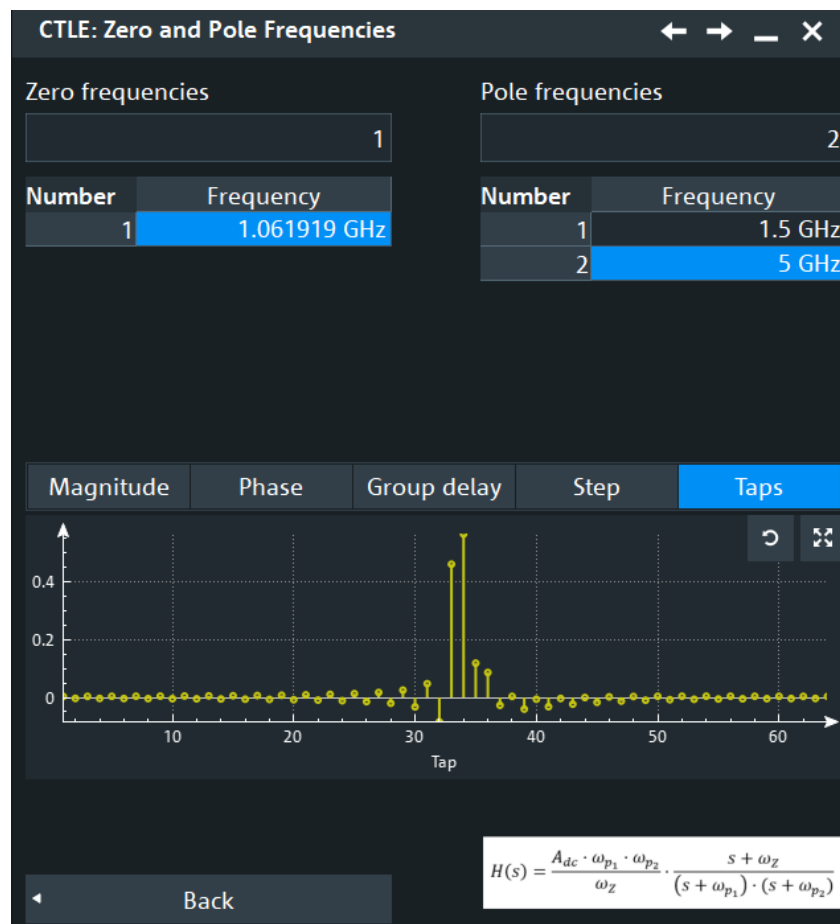

Zero frequencies ← Pole/ Zero setup

Selects the number of zero frequencies for CTLE. Depending on the selected "Serial standard", there are some predefined presets you can use.

You can also enter your custom number of taps and define a "Value" for each of them. You can enter up to 6 zero frequencies.

Remote command:

`LANE<m>:EQUalization:CTLE:ZERO:COUNT` on page 2830

`LANE<m>:EQUalization:CTLE:ZERO:FREQuency<*>` on page 2831

Pole frequencies ← Pole/ Zero setup

Selects the number of pole frequencies for CTLE. Depending on the selected [Serial standard](#), there are some predefined presets you can use.

You can also enter your custom number of taps and define a "Value" for each of them. You can enter up to 6 pole frequencies.

Remote command:

`LANE<m>:EQUalization:CTLE:POLE:COUNT` on page 2828

`LANE<m>:EQUalization:CTLE:POLE:FREQuency<*>` on page 2829

Plot selection ← Pole/ Zero setup

Displays plots for the selected CTLE configurations. Using these plots, you can assess the correction of the signal by CTLE.

You can see the following characteristics:

- "Magnitude"

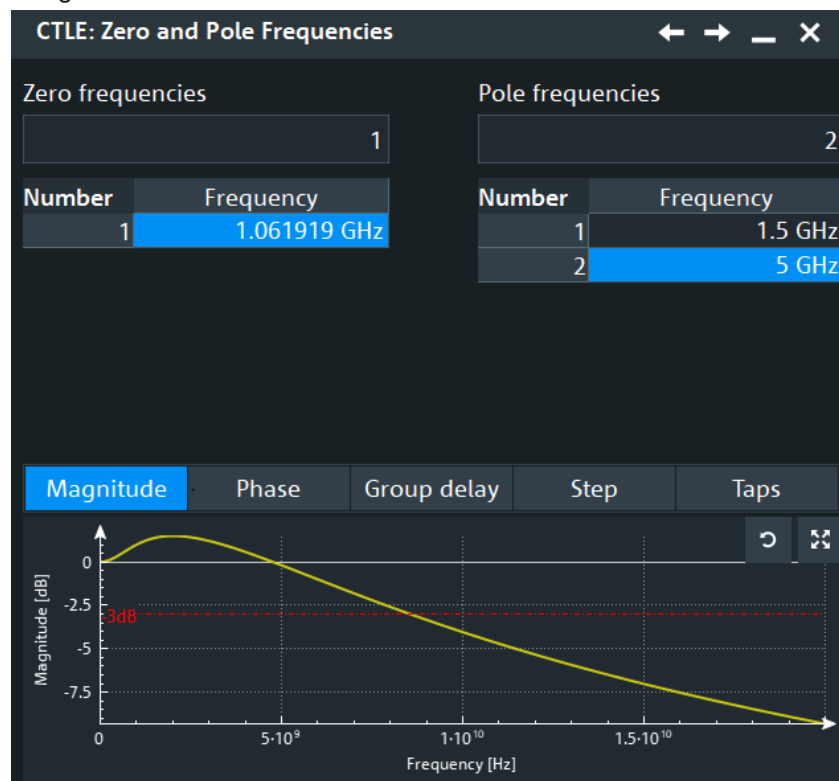

- "Phase"

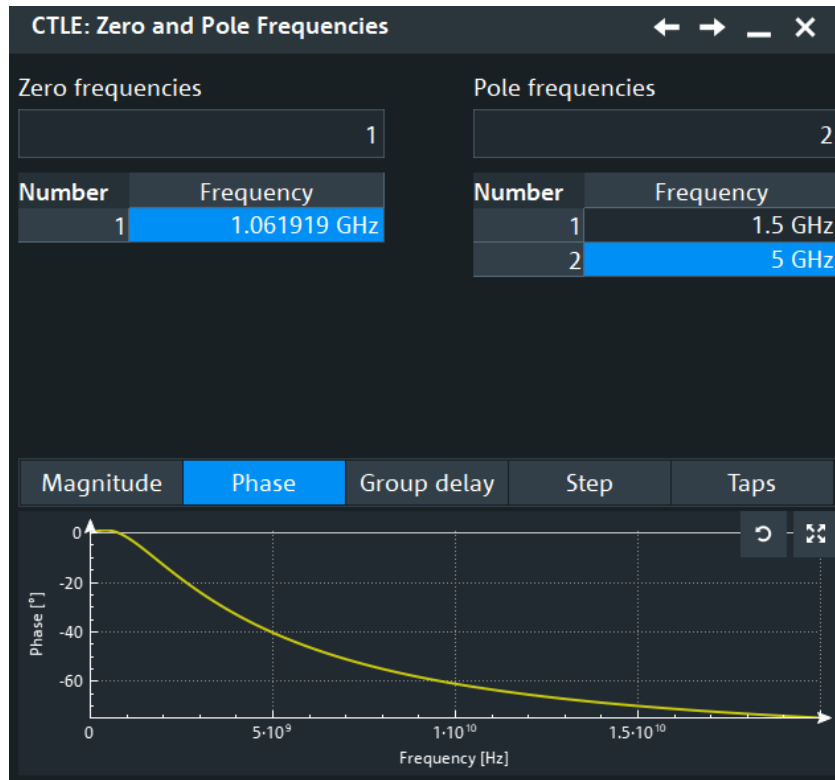

- "Group delay"

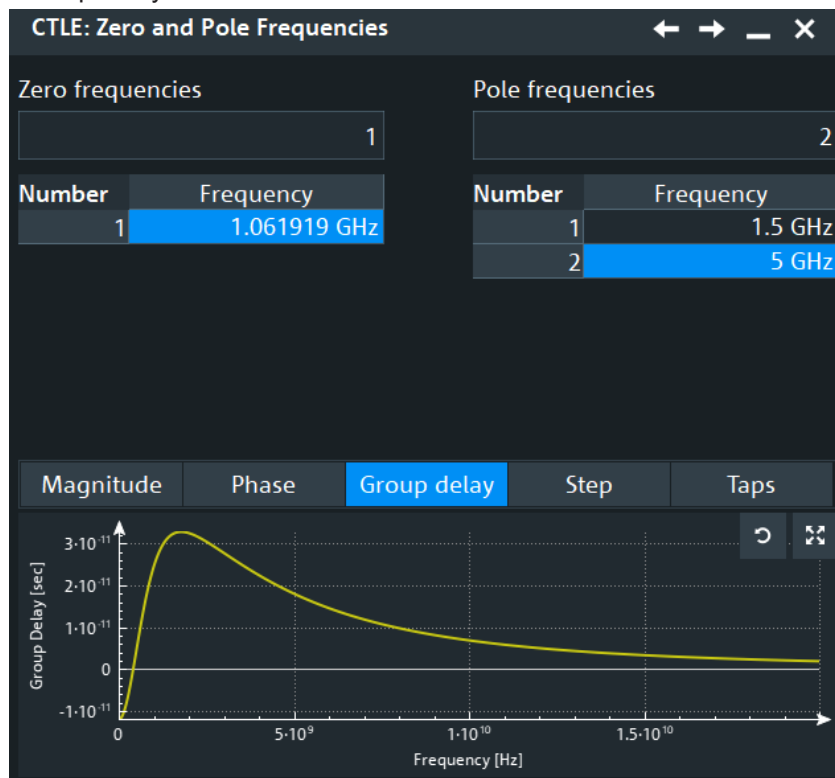

- "Step"

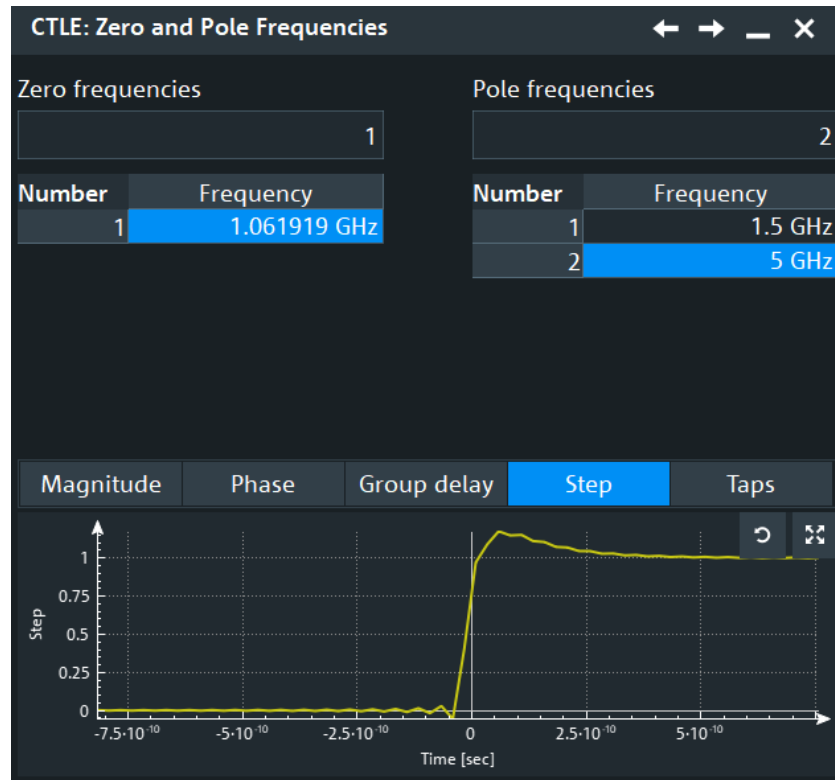

- "Taps"

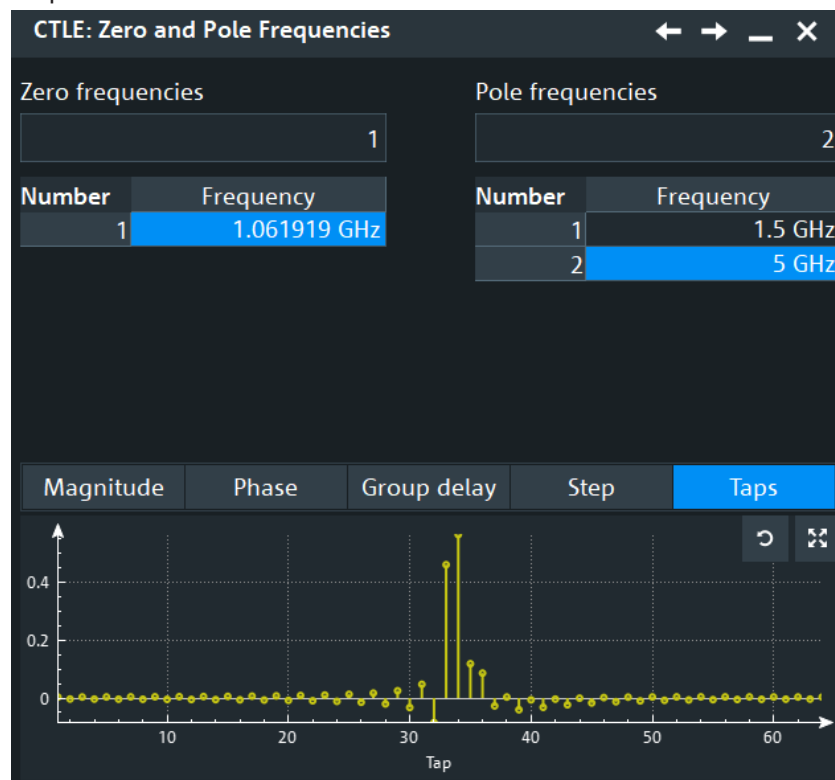

Remote command:

`LANE<m>:EQualization:CTLE:PSElection` on page 2829

23.5.3 FFE

Access: "Menu" > "Apps" > "Embedding / Equalization" > "Signal Lanes" > "Equalization" > "FFE" tab.

In this dialog, you can define the settings for the feed-forward equalizer.

For more information, see [Chapter 23.1.2, "Feed-forward equalizer \(FFE\)"](#), on page 1266.

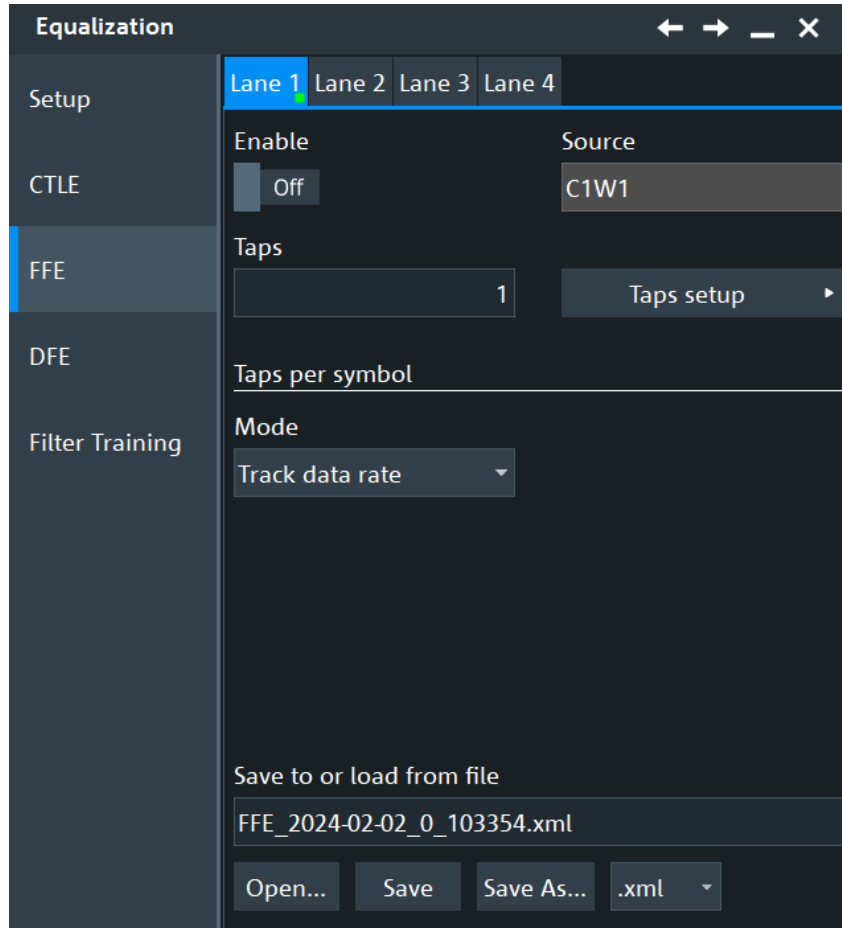

Enable

Enables the feed-forward equalizer (FFE).

Remote command:

[LANE<m>:EQualization:FFE:STATe](#) on page 2832

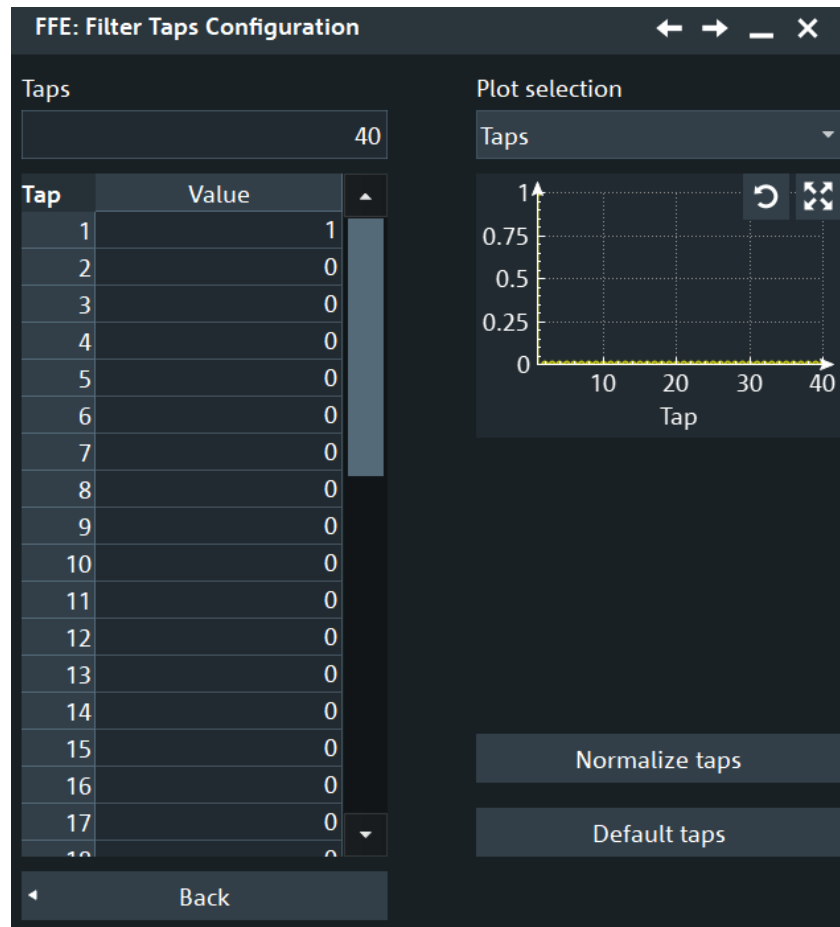
Taps setup**Taps ← Taps setup**

Sets the number of taps. You can also define a "Value" for each tap.

Remote command:

[LANE<m>:EQUalization:FFE:TAPS:COUNT](#) on page 2833

[LANE<m>:EQUalization:FFE:TAPS:TAP<*>](#) on page 2834

Plot selection ← Taps setup

Displays plots for the selected FFE configurations. Using these plots, you can assess the correction of the signal by FFE.

You can see the following characteristics:

- "Magnitude"
- "Phase"
- "Group delay"
- "Step"
- "Taps"

Remote command:

[LANE<m>:EQUalization:FFE:PSElection](#) on page 2832

Normalize taps ← Taps setup

Normalizes the taps so that their sum is 1.0.

Remote command:

[LANE<m>:EQUalization:FFE:TAPS:NORMalize](#) on page 2833

Default taps ← Taps setup

Sets default taps, e.g. 1,0,0,0.

Remote command:

[LANE<m>:EQUalization:FFE:TAPS:PRESet](#) on page 2833

Taps per symbol

Selects how the taps per symbol are determined.

The equalizer can use more than one tap per symbol by sampling at a higher rate than the symbol rate. For example, if the symbol period is T, the equalizer can sample at intervals of T/2 and apply one tap to each sample. Such an equalizer would have two taps per symbol. This can improve results if the clock recovery is not accurate, but requires double the number of taps to be able to compensate the same distortions in frequency.

- | | |
|-------------------|--|
| "Track data rate" | The number of taps tracks the data rate which corresponds to one tap per symbol. |
| "Manual" | If manual is selected, multiple taps per bit are used for the equalization. You can enter the number in the "Value" field. |

Remote command:

[LANE<m>:EQUalization:FFE:TAPS:SYMMode](#) on page 2834

[LANE<m>:EQUalization:FFE:TAPS:SYMValue](#) on page 2834

Save / recall FFE settings

Saves the complete FFE configuration, or loads a saved FFE configuration. The file format is XML.

To save the FFE configuration, enter a filename and tap "Save". Alternatively, tap "Save as" to open the file selection dialog box, see [Chapter 12.5, "File selection dialog"](#), on page 490.

To load an FFE configuration, tap "Open" and select the required file.

Remote command:

[LANE<m>:EQUalization:FFE:NAME](#) on page 2831

[LANE<m>:EQUalization:FFE:OPEN](#) on page 2832

[LANE<m>:EQUalization:FFE:SAVE](#) on page 2832

23.5.4 DFE

Access: "Menu" > "Apps" > "Embedding / Equalization" > "Signal Lanes" > "Equalization" > "DFE" tab.

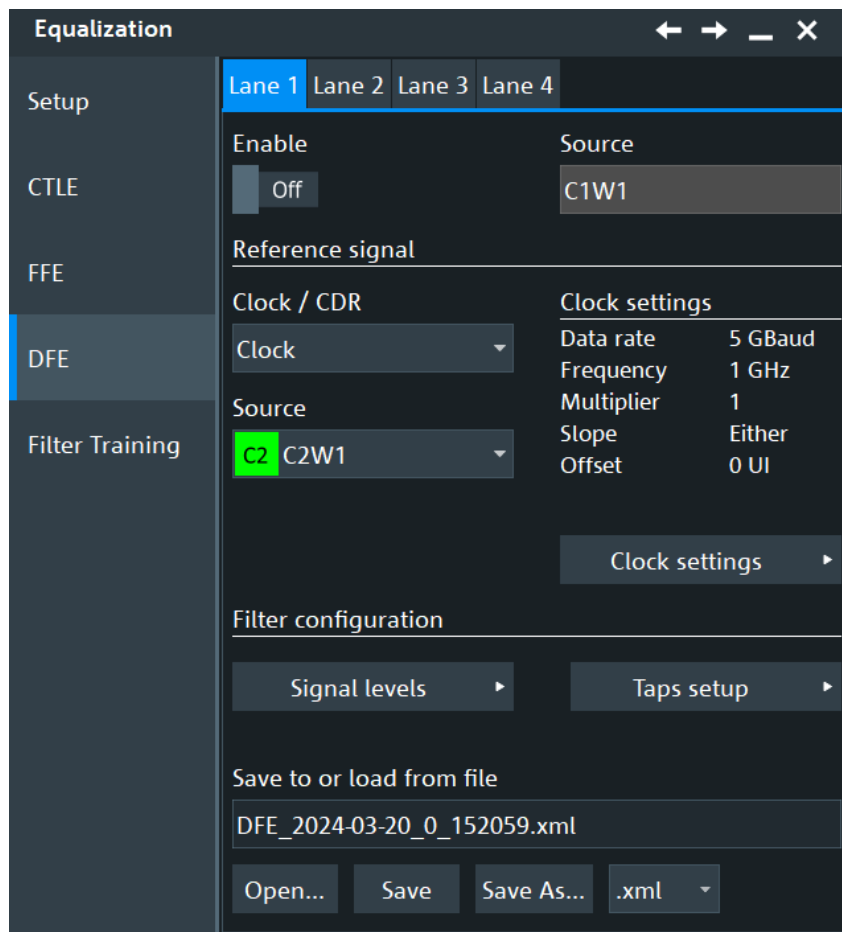
**Enable**

Enables the decision feedback equalization.

Remote command:

[LANE<m>:EQUalization:DFE:STATe](#) on page 2836

Reference signal

In this section you can define the reference signal used for DFE.

Clock / CDR ← Reference signal

Selects the type of waveform that is used to obtain the timing information required to slice the data source waveform.

Remote command:

[LANE<m>:EQUalization:DFE:TIMReference:SOURce](#) on page 2842

Clock ← Reference signal

If a clock signal is available, the instrument can use it directly to set the segmentation timestamps. The signal has to be provided on an additional channel.

With "Source" you can select the source of the clock signal. For the clock settings, see

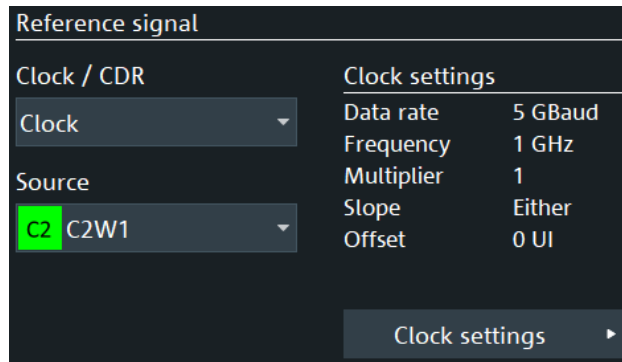

Remote command:

[LANE<m>:EQUalization:DFE:TIMReference:SOURce](#) on page 2842

CDR ← Reference signal

Uses a software clock data recovery.

You can also load a reference waveform that contains CDR information in the "Menu" > "Save/Recall" > "Recall" > "Waveform" dialog.

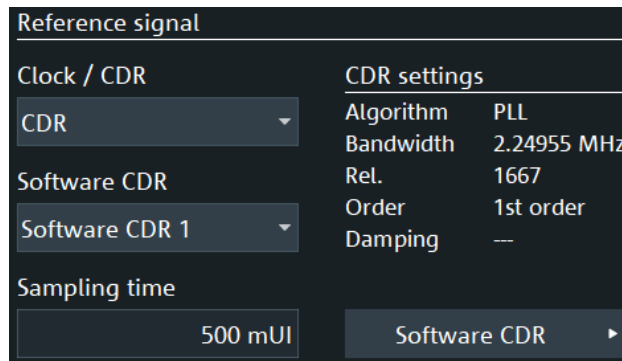

Remote command:

[LANE<m>:EQUalization:DFE:TIMReference:CDR\[:SElect\]](#) on page 2838

[LANE<m>:EQUalization:DFE:TIMReference:CDR:SOFTware](#) on page 2838

[LANE<m>:EQUalization:DFE:TIMReference:CDR:SOFTware:SAMTime](#)
on page 2838

Clock

Opens a dialog to define the setting of the DFE clock.

Source ← Clock

Selects the source for the DFE clock.

Remote command:

[LANE<m>:EQUalization:DFE:TIMReference:CLOCK:SOURce](#) on page 2842

Vertical reference level ← Clock

Sets the reference level to define the timestamps for slicing the data waveform. A time-stamp is set each time when the selected slope of the timing waveform crosses the selected reference level.

Remote command:

[LANE<m>:EQUalization:DFE:TIMReference:CLOCK:LEVEl](#) on page 2840

Frequency ← Clock

Sets the clock frequency of the explicit clock signal. If this value is unknown, you can use "Estimate frequency", to calculate an estimate value.

Remote command:

[LANE<m>:EQUalization:DFE:TIMReference:CLOCK:FREQuency](#) on page 2839

[LANE<m>:EQUalization:DFE:TIMReference:CLOCK:FREStimation](#)

on page 2840

Multiplier ← Clock

Sets a value for the clock multiplier, the ratio of an internal clock rate to the externally supplied clock.

Remote command:

[LANE<m>:EQUalization:DFE:TIMReference:CLOCK:FACTor](#) on page 2839

Slope ← Clock

The clock slope sets the point in time when the state of the data signal is checked:

- "Positive" Rising edge, a positive voltage change.
- "Negative" Falling edge, a negative voltage change.
- "Either" Both the rising and the falling edge.

Remote command:

[LANE<m>:EQUalization:DFE:TIMReference:CLOCK:EDGE](#) on page 2839

Data rate ← Clock

Displays the data rate.

Offset, Estimate offset ← Clock

Sets a clock offset. If this value is unknown, you can use "Estimate offset" to calculate an estimate value for the clock offset.

Remote command:

[LANE<m>:EQUalization:DFE:TIMReference:CLOCK:OFFSet](#) on page 2841

[LANE<m>:EQUalization:DFE:TIMReference:CLOCK:OFEstimation](#)
on page 2840

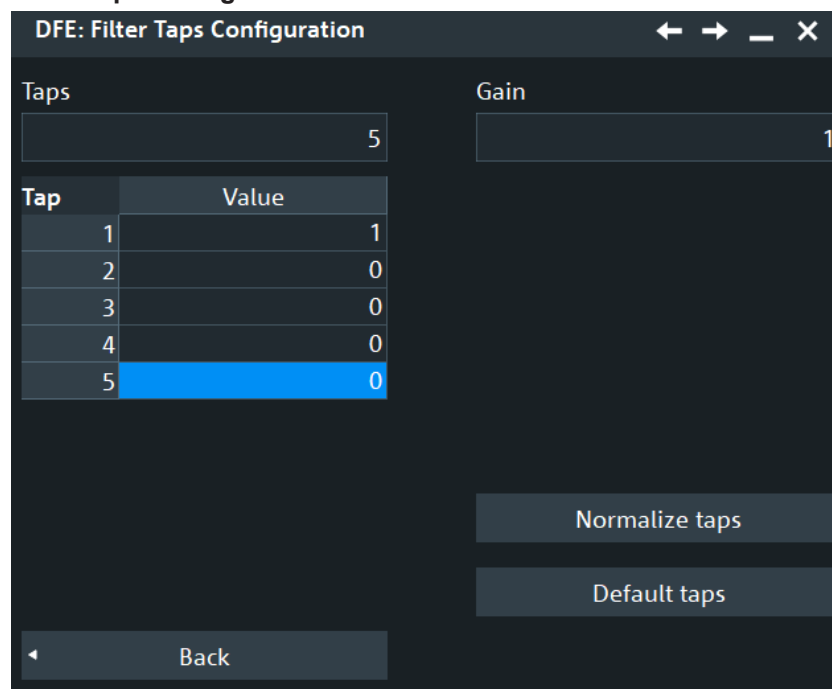
Filter Taps Configuration**Taps ← Filter Taps Configuration**

Selects the number of taps for DFE.

Remote command:

[LANE<m>:EQUalization:DFE:TAPS:COUNT](#) on page 2837

[LANE<m>:EQUalization:DFE:TAPS:TAP<*>](#) on page 2837

Gain ← Filter Taps Configuration

Sets the gain for the DFE filter.

Remote command:

`LANE<m>:EQUalization:DFE:GAIN` on page 2835

Normalize taps

Normalizes the taps.

Remote command:

`LANE<m>:EQUalization:DFE:TAPS:NORMalize` on page 2837

`LANE<m>:EQUalization:DFE:TAPS:TAP<*>` on page 2837

Default taps

Sets default taps.

Remote command:

`LANE<m>:EQUalization:DFE:TAPS:PRESet` on page 2837

Save / recall DFE settings

Saves the complete DFE configuration, or loads a saved DFE configuration. The file format is XML.

To save the DFE configuration, enter a filename and tap "Save". Alternatively, tap "Save as" to open the file selection dialog box, see [Chapter 12.5, "File selection dialog"](#), on page 490.

To load a DFE configuration, tap "Open" and select the required file.

Remote command:

`LANE<m>:EQUalization:DFE:NAME` on page 2835

`LANE<m>:EQUalization:DFE:OPEN` on page 2836

`LANE<m>:EQUalization:DFE:SAVE` on page 2836

23.5.5 Filter training

Filter training for equalization is the process of adapting the coefficients of an equalizer filter to optimize its performance in reducing inter-symbol interference (ISI) and other distortions in a communication channel. The goal is to adjust the filter so that the output closely matches the desired signal.

Access: "Menu" > "Apps" > "Embedding / Equalization" > "Signal Lanes" > "Equalization" > "Filter Training" tab.

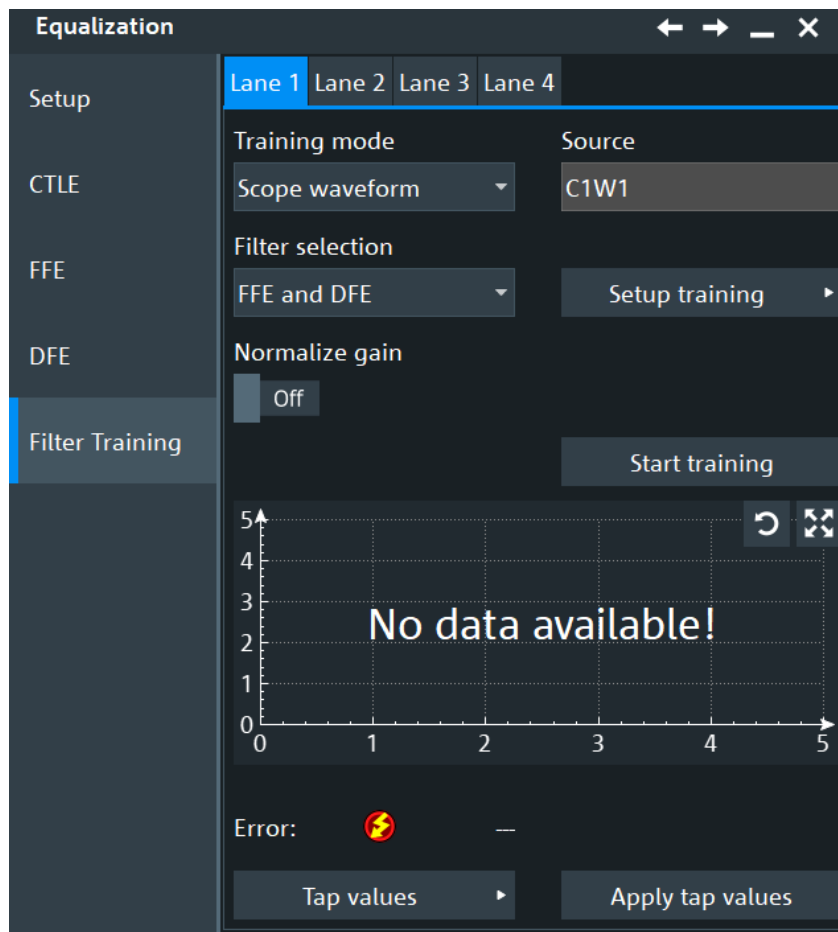

Training mode

Selects the waveform to be trained. You can select a "Scope waveform" or load a "Reference waveform".

Remote command:

[LANE<m>:EQUalization:TRaining:MODE](#) on page 2847

Filter selection

Selects the filter for the filter training. You can select between an FFE filter and a combination of FFE and DFE filter.

Remote command:

[LANE<m>:EQUalization:TRaining:FSElection](#) on page 2847

Normalize gain

Sets this state of the normalize gain for FFE. The gain of a trained DFE is always 1.

If enabled, the gain of the FFE is normalized to 1, such that the signal has a similar amplitude at the input and output of the equalizer.

If disabled, the equalizer is trained such that the output PAM levels are separated by 1 V (e.g., +/- 0.5 V for NRZ).

Remote command:

[LANE<m>:EQUalization:TRaining:NORGain](#) on page 2847

Start training

Starts the filter training.

Remote command:

[LANE<m>:EQUalization:TRaining:STARt](#) on page 2848

Plot

Displays the plots for the selected training configuration.

Error

Shows, if there is an error during the filter training.

Remote command:

[LANE<m>:EQUalization:TRaining:ERRor?](#) on page 2848

Apply tap values

Applies the tap values.

Remote command:

[LANE<m>:EQUalization:TRaining:APPLy](#) on page 2843

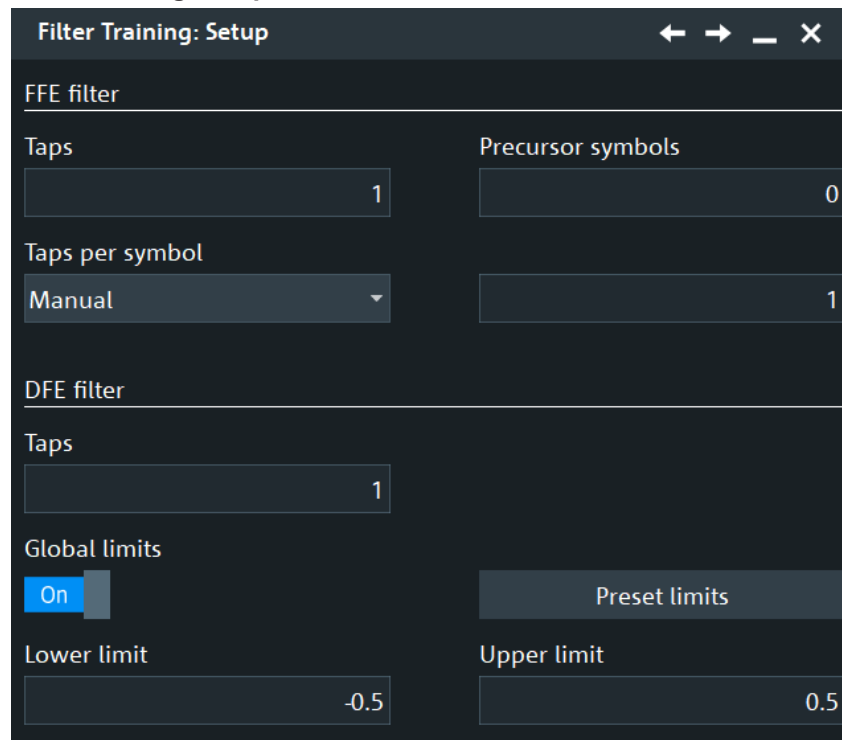
Filter Training Setup : FFE

Filter Training: Setup

FFE filter

Taps: 1

Precursor symbols: 0

Taps per symbol: Manual

DFE filter

Taps: 1

Global limits: On

Preset limits

Lower limit: -0.5

Upper limit: 0.5

Taps ← Filter Training Setup : FFE

Sets the number of taps used for the training of the FFE. You can select up to 40 taps.

Remote command:

[LANE<m>:EQUalization:TRaining:FFE:TAPS:COUNT](#) on page 2845

Precursor symbols ← Filter Training Setup : FFE

Sets a value for the number of the precursor symbols that are used.

FFE uses a linear combination of some past, present and future symbols to estimate the current symbol. The precursor taps determine the number of future symbols that are used to estimate the current symbol. This is also the zero-based index of the strongest tap, and approximately equivalent to the group delay of the equalizer, measured in symbol periods.

Default value is $0.4 * (\text{Number of taps})$. This usually gives good results.

Remote command:

[LANE<m>:EQUalization:TRaining:FFE:TAPS:PRECursor](#) on page 2846

Taps per symbol ← Filter Training Setup : FFE

Selects how the taps per symbol are determined.

"Track data rate" The number of taps tracks the data rate which corresponds to one tap per symbol.

"Manual" If manual is selected, multiple taps per bit are used for the equalization. You can enter the number in the "Value" field.

Remote command:

[LANE<m>:EQUalization:TRaining:FFE:TAPS:SYMMode](#) on page 2846

[LANE<m>:EQUalization:TRaining:FFE:TAPS:SYMValue](#) on page 2846

Filter Training Setup : DFE

The screenshot shows a dialog box titled "Filter Training: Setup" with a dark background. It is divided into two main sections: "FFE filter" and "DFE filter".

FFE filter section:

- Taps:** A text input field containing the value "1".
- Precursor symbols:** A text input field containing the value "0".
- Taps per symbol:** A dropdown menu currently set to "Manual".
- Value field:** A text input field containing the value "1".

DFE filter section:

- Taps:** A text input field containing the value "1".
- Global limits:** A toggle switch is set to "On".
- Preset limits:** A button labeled "Preset limits".
- Lower limit:** A text input field containing the value "-0.5".
- Upper limit:** A text input field containing the value "0.5".

In this dialog you can define the settings of the FFE and DFE filter.

Taps ← Filter Training Setup : DFE

Sets the number of taps used for the training of the DFE. You can select up to 5 taps.

Remote command:

`LANE<m>:EQUalization:TRaining:DFE:TAPS:COUNT` on page 2844

Global limits ← Filter Training Setup : DFE

If enabled, you can define the same "Lower limit" and "Upper limit" limits for all taps. Else, you can define separate values for each tap.

Remote command:

`LANE<m>:EQUalization:TRaining:DFE:TAPS:UGLLimit` on page 2845

Lower limit, Upper limit ← Filter Training Setup : DFE

Sets the lower/upper limit for the DFE filter. The trained/generated filter tap values are within these given limits. The values are constrained between -1 and 1.

Remote command:

`LANE<m>:EQUalization:TRaining:DFE:LIMits:TAP<n>:LLIMit`
on page 2843

`LANE<m>:EQUalization:TRaining:DFE:LIMits:TAP<n>:ULIMit`
on page 2844

`LANE<m>:EQUalization:TRaining:DFE:TAPS:LLIMit<0>` on page 2844

`LANE<m>:EQUalization:TRaining:DFE:TAPS:ULIMit<0>` on page 2845

Preset limits ← Filter Training Setup : DFE

Sets the DFE taps limits to their default values.

Remote command:

`LANE<m>:EQUalization:TRaining:DFE:LIMits:PRESet` on page 2843

24 Compliance tests

Thanks to the high measurement accuracy of the R&S RTO6, the oscilloscope can be used for reliable compliance testing on the physical layer of high-speed bus interfaces. For fast and easy compliance testing, you need the free-of-charge R&S ScopeSuite. The software guides you step-by-step through the test sequences, configures the oscilloscope, automatically performs measurements and compiles the results in a measurement report. Detailed, image-based instructions make it easy to connect the oscilloscope and the probes to the test fixture set and the device under test.

The R&S ScopeSuite can be installed on a test computer or directly on the R&S RTO6. If the R&S ScopeSuite is installed on the oscilloscope, you can start it directly in the firmware menu.

For best operation results, we recommend that the installed firmware versions of the R&S ScopeSuite and the oscilloscope are the same.

Access: [App Cockpit] > "Compliance" tab



24.1 USB compliance test

The R&S RTO6-K21 option enables the automatic testing of USB 2.0 compliance (high-speed) as well as USB 1.1 (full-speed) and USB 1.0 (low-speed).

As an example, the test setup for USB device tests is shown below.

The test fixture and the USB compliance test procedures are described in separate manuals:

- "R&S®RTO-K21, R&S®RTP-K21/-101 R&S®USB 2.0/3.2 Compliance Test, User Manual"
- "R&S®RT-ZF1 USB 2.0 Compliance Test Fixture Set, Manual"

24.1.1 Test equipment

USB 2.0 test equipment

For USB 2.0 compliance tests, the following test equipment is recommended:

- R&S RTO6 oscilloscope with 4 channels and at least 2 GHz bandwidth.
For full speed and low speed compliance tests, a 4-channel R&S RTO with less than 2 GHz bandwidth is sufficient.
- R&S RT-ZF1 USB 2.0 compliance test fixture set, which consists of the load board and the signal quality board.
- Probes:
 - 2x single-ended active probes with at least 2 GHz bandwidth
 - 1x differential active probe with at least 2 GHz bandwidth
- R&S RTO-B6/R&S RTP-B6/Tabor WX2182B/Tabor WX2182C arbitrary waveform generator for automatic receiver sensitivity tests.
For manual receiver sensitivity tests, any AWG can be used.
- R&S ScopeSuite software, which can be installed on a computer or directly on the R&S RTO6.
- R&S RTO6-K21 USB 2.0 compliance test option (required option, installed on the oscilloscope)
- Make sure that you use the latest version of the USBHSET tool. To find downloads, search for *USBHSET* on the following websites:
 - USB 3.0 host: www.usb.org/developers/tools/
 - USB 2.0 host: www.usb.org/developers/tools/usb20_tools/

Regularly check the USB-IF website compliance.usb.org/index.asp?Update-File=Electrical&Format=Standard for USB-IF compliance updates.

24.2 Ethernet compliance tests (options R&S RTO6-K22/K23/K24/K87/K88/K89)

The Ethernet compliance test options enable the automatic testing of various Ethernet standards:

- 10/100/1000BASE-T (R&S RTO6-K22)
- 2.5/5/10GBASE-T (R&S RTO6-K23)

- 100BASE-T1: (R&S RTO6-K24)
- 1000BASE-T1: (R&S RTO6-K87)
- 1000BASE-T1: (R&S RTO6-K88)
- 10BASE-T1: (R&S RTO6-K89)

The test fixture and the Ethernet compliance test procedures are described in the separate manuals:

- R&S®RTO, R&S®RTP Ethernet Compliance Test, User Manual"
- "R&S®RT-ZF2 Ethernet Compliance Test Fixture Set Manual"
- "R&S®RT-ZF3 Frequency Converter Manual"
- "R&S®RT-ZF4 10BASE-Te Fixture Manual"
- R&S®RT-ZF5 Ethernet Probing Fixture Manual"
- R&S®RT-ZF6 Frequency Converter Manual"

24.2.1 Test equipment

For Ethernet compliance tests, the following test equipment is needed:

- The free-of-charge R&S ScopeSuite software, which can be installed on a computer or directly on the oscilloscope.
- **10/100/1000BASE-T Ethernet compliance tests:**
 - R&S RTO/R&S RTP oscilloscope with at least 600 MHz bandwidth
 - Differential probe with at least 1 GHz bandwidth
 - R&S RTO/R&S RTP-K22 10/100/1000BASE-T Ethernet compliance test option (required option, installed on the oscilloscope)
 - R&S RT-ZF2 Ethernet test fixture set
 - For energy-efficient Ethernet tests, in addition:
R&S RT-ZF5 Ethernet test fixture set for 100/1000BASE-T EEE tests
R&S RT-ZF4 test fixture for 10BASE-Te tests
- **2.5GBASE-T Ethernet compliance tests:**
 - R&S RTO/R&S RTP oscilloscope with at least 600 MHz bandwidth
For precise power spectral density and power level measurements up to 1 GHz, it is recommended to use an oscilloscope and a differential probe with 1 GHz bandwidth each.
 - Differential probe with at least 1GHz bandwidth
 - R&S RTO/R&S RTP-K23 GBASE-T Ethernet compliance test option (required option, installed on the R&S RTO6)
 - R&S RT-ZF2 Ethernet test fixture set
- **5GBASE-T Ethernet compliance tests:**
 - R&S RTO/R&S RTP oscilloscope with at least 1 GHz bandwidth
For precise power spectral density and power level measurements up to 1.5 GHz, it is recommended to use an oscilloscope and a differential probe with 1.5 GHz bandwidth each.
 - Differential probe with at least 1.5 GHz bandwidth

Ethernet compliance tests (options R&S RTO6-K22/K23/K24/K87/K88/K89)

- R&S RTO/R&S RTP-K23 GBASE-T Ethernet compliance test option (required option, installed on the R&S RTO6)
- R&S RT-ZF2 Ethernet test fixture set
- **10GBASE-T Ethernet compliance tests:**
 - R&S RTO/R&S RTP oscilloscope with at least 2 GHz bandwidth
For precise power spectral density and power level measurements up to 3 GHz, it is recommended to use an oscilloscope and a differential probe with 3 GHz bandwidth each.
 - Differential probe with at least 3 GHz bandwidth
 - R&S RTO/R&S RTP-K23 GBASE-T Ethernet compliance test option (required option, installed on the R&S RTO6)
 - R&S RT-ZF2 Ethernet test fixture set
- **100BASE-T1 compliance tests:**
 - R&S RTO/R&S RTP oscilloscope with at least 600 MHz bandwidth
 - Differential probe with 1 GHz bandwidth
 - R&S RTO/R&S RTP-K24 100BASE-T1 compliance test option (required option, installed on the R&S RTO6)
 - R&S RT-ZF2 Ethernet test fixture set
 - R&S RT-ZF3 frequency converter for transmitter distortion tests
- **1000BASE-T1 compliance tests:**
 - R&S RTO/R&S RTP oscilloscope with at least 2 GHz bandwidth
 - Differential probe with 2 GHz bandwidth
 - R&S RTO/R&S RTP-K87 1000BASE-T1 compliance test option (required option, installed on the R&S RTO6)
 - R&S RT-ZF2 Ethernet test fixture set
 - R&S RT-ZF6 frequency converter for transmitter distortion tests
- **MGBASE-T1 compliance tests:**
 - R&S RTO / R&S RTO6 /R&S RTP oscilloscope, with a bandwidth of:
 - for 2.5 GBASE-T1 tests: at least 3.5 GHz
 - for 5 GBASE-T1 tests: at least 7 GHz
 - for 10 GBASE-T1 tests: at least 13 GHz
 - 2 BNC/SMA cables
 - R&S RTO/R&S RTP-K88 MGBASE-T1 compliance test option (required option, installed on the R&S RTO6)
- **10BASE-T1 compliance tests:**
 - R&S RTO/R&S RTP oscilloscope
 - Optional Differential probe with 1 GHz bandwidth
 - R&S RTO/R&S RTP-K89 10BASE-T1 compliance test option (required option, installed on the R&S RTO6)
- R&S RTO-B6/R&S RTP-B6/Tabor WX2182B/Tabor WX2182C arbitrary waveform generator for automatic disturber tests. For some disturber tests, also HMF2550 can be used.

- R&S ZNB/ZNC/ZND/ZVL vector network analyzer for automatic return loss measurements. For manual measurements, also other AWGs and VNAs can be used.

24.3 D-PHY compliance tests (option R&S RTO6-K26)

The option R&S RTO6-K26 enables the automatic processing of D-PHY compliance tests.

The D-PHY compliance test procedures are described in a separate manual:

- R&S®RTO-K26, R&S®RTP-K26, D-PHY Compliance Test, User Manual"

24.3.1 Test equipment

For D-PHY compliance tests, the following test equipment is needed:

- R&S RTO6 oscilloscope with 4 channels and at least 4 GHz bandwidth
- For measuring the clock signal (+ and -): either 1 differential probe or 2 single-ended probes with at least 4 GHz bandwidth. However, note that D-PHY Group 2 and Group 4 tests require 2 probes for the clock signal.
- For measuring the data signal (+ and -): 2 probes with at least 4 GHz bandwidth
Available probes: R&S RT-ZD40 or R&S RT-ZM with a different probe tip selection.
- R&S RTO6-K26 D-PHY compliance test option (required option, installed on the oscilloscope)
- R&S RTO6-K27 D-PHY compliance test option (required option, installed on the oscilloscope)
- For Eye Tests, the following options are needed:
For R&S RTO/ R&S RTO6:
 - R&S RTO/R&S RTO6-K91 (DDR3) or R&S RTO/R&S RTO6-K93 (DDR4)
- Recommended test fixture for LP-TX tests: MIPI D-PHY Capacitive Load (C_{LOAD}) fixture from The University of New Hampshire InterOperability Laboratory (UNH-IOL)
- Recommended termination board for HS-TX tests: MIPI D-PHY Reference Termination Board (RTB) from The University of New Hampshire InterOperability Laboratory (UNH-IOL)
- The free-of-charge R&S ScopeSuite software, which can be installed on a computer or directly on the oscilloscope.

24.4 eMMC compliance tests (option R&S RTO6-K92)

The option R&S RTO6-K92 enables the automatic processing of eMMC compliance tests.

The eMMC compliance test procedures are described in a separate manual:

- eMMC Compliance Tests, Test Procedures Manual"

24.4.1 Test equipment

For eMMC compliance tests, the following test equipment is needed:

- R&S RTO6 oscilloscope with at least 1 GHz bandwidth
- A probe with at least 1.5 GHz bandwidth
- R&S RTO6-K92 eMMC compliance test option (required option, installed on the R&S RTO6)
- The free-of-charge R&S ScopeSuite software, which can be installed on a computer or directly on the R&S RTO6.

24.5 PCIe compliance tests (option R&S RTO6-K81)

The option R&S RTO6-K81 enables the automatic processing of PCIe 1.1 / PCIe 2.0 compliance tests.

The PCIe compliance test procedures are described in a separate manual:

- R&S®RTO-K81, R&S®RTP-K81/-K83, PCIe Compliance Test, User Manual"

24.5.1 Test equipment

PCIe 1.1 / PCIe 2.0 Test Equipment

For PCIe compliance tests, the following test equipment is needed:

- R&S RTO6 oscilloscope with at least 6 GHz bandwidth, 2 channels and 20 GS/s available
- Probes/cables:
 - Two SMP to SMA cables or
 - Two single-ended probes with at least 6GHz bandwidth bandwidth or
 - One differential probe with at least 6GHz bandwidth bandwidth
- R&S RTO6-K81 PCIe compliance test option (required option, installed on the oscilloscope)
- Recommended test fixture:
 - For Add-In card testing: PCI Express Compliance Base Board (CBB2.0) from PCI-SIG
 - For System Board testing: PCI Express Compliance Load Board (CLB2.0) from PCI-SIG
- The free-of-charge R&S ScopeSuite software, which can be installed on a computer or directly on the oscilloscope.

24.6 DDR3 compliance tests (option R&S RTO6-K91)

The option R&S RTO6-K91 enables the automatic processing of DDR3 compliance tests.

The DDR3 compliance test procedures are described in a separate manual:

- R&S®RTO-K91, R&S®RTP-K91 DDR3 Compliance Test, User Manual"

24.6.1 Test equipment

For DDR3 compliance tests, the following test equipment is needed:

- R&S RTP with 4 channels and minimum 8 GHz bandwidth, or R&S RTO2000 with 4 channels and minimum 4 GHz bandwidth
R&S RTO6 with 4 channels and minimum 4 GHz bandwidth
- R&S RTO6-K91 DDR3 compliance test option (required option, installed on the R&S RTO6)
- 4 modular probes, R&S ZM90 with 9 GHz bandwidth. See also [Chapter 24.6.1.1, "Soldering guide for modular probes"](#), on page 1308.
- 4 modular probe tips R&S RT-ZMA10 or R&S RT-ZMA14
- The free-of-charge R&S ScopeSuite software, which can be installed on a computer or directly on the R&S RTO6.

24.6.1.1 Soldering guide for modular probes

All single-ended signals such as ADD, CMD, DQ, DM, CS, CKE should be soldered in such a way that the signal is connected to the + part on the probe tip. The ground of the signal is connected to the - part on the same probe tip.

All differential signals such as CK, DQS should be soldered differentially:

- The + signal is connected to the + part on the probe tip.
- The - signal is connected to the - part on the same probe tip.
- The ground of the signal is connected to the ground of the same probe tip.

25 Network operation and remote control

The operating system is the basis of the instrument's firmware, it provides basic functions such as logon, password protection, virus protection, and connection to a network.

In addition to working with the R&S RTO6 directly, using the touchscreen and the keys, you can also operate the instrument from a remote PC. Various methods of remote control are supported:

- Using the web interface in a LAN network
- Using Remote Desktop Connection in a LAN network
- Remote control with SCPI commands
- [Operating system](#)..... 1309
- [Setting up a network \(LAN\) connection](#)..... 1314
- [Web interface](#)..... 1319
- [Remote Desktop connection](#)..... 1324
- [Remote control](#)..... 1326

25.1 Operating system

The R&S RTO6 has a Windows 10 operating system.

The operating system has been configured according to the instrument's features and needs. To ensure that the instrument software functions properly, certain rules must be observed when using the operating system.

NOTICE

Risk of rendering instrument unusable

The instrument is equipped with the Windows operating system. You can install additional software on the instrument, however, additional software can impair instrument function. Thus, run only programs that Rohde & Schwarz has tested for compatibility with the instrument software.

The drivers and programs used on the instrument under Windows are adapted to the instrument. Only install update software released by Rohde & Schwarz to modify existing instrument software.

Changes in the system setup are only required if the network configuration does not comply with the default settings (see [Chapter 25.2.1, "Connecting the instrument to the network"](#), on page 1314).

25.1.1 Logon

Windows requires that users identify themselves by entering a user name and password in a logon window.

If the instrument is connected to the network, you are automatically logged on to the network when you log on to the operating system. As a prerequisite, the user name and the password must be identical under Windows and on the network. The instrument provides an auto-logon function that can be configured for standard user and administrator access. The configuration requires the user name and password.

See also: "[Log on as](#)" on page 72.

The R&S RTO6 provides two user accounts:

- "Instrument": an administrator account with unrestricted access to the computer/domain (default user)
- "NormalUser": a standard user account with limited access

For both users, the initial password is "894129". It is recommended that you change the password for both users after initial logon. You can change the password in the Windows configuration :

"Start" menu > "Settings" > "Accounts" > "Sign-in options".

Make sure to change the password also in the auto-logon of the R&S RTO6, see below.

By default, the instrument logs on with administrator account and standard password. To restrict the access to system functions, you can change the autologon to "Normal-User".

The following tasks require administrator rights:

- Configuration of a LAN settings, network connection, and firewall settings
- Date and time setup
- Printer installation
- Firmware update
- BIOS update
- Using the web browser
- Touchscreen calibration
- Installation of options
- Moving portable licenses

To configure the auto-logon for a standard user

Default situation: the auto-logon is configured for the administrator ("Instrument").

1. Open "Menu" > "Settings" > "System" > "Users"
2. Set "Logon as" to "User autologon".
3. Enter the "User name": *NormalUser*.
4. Enter the password of the standard user.

5. Restart the instrument.

To configure the auto-logon for administrator

Starting situation: the auto-logon is configured for a standard user ("NormalUser").

1. Open "Menu" > "Settings" > "System" > "Users"
2. Set "Logon as" to "None".
3. Exit the firmware.
4. Sign out from the operating system.
5. Log on as administrator ("Instrument").
6. Set the "Logon as" to "Admin autologon". Enter the "User name": *Instrument* and the administrator's password.
7. Restart the instrument.

25.1.2 Service packs and updates

Microsoft regularly creates security updates and other patches to protect Windows-based operating systems. These are released through the Microsoft Update website and associated update server. Instruments using Windows, especially those that connect to a network, should be updated regularly.

For details and recommendations, see the following Rohde & Schwarz white paper:

- [1EF96: Malware Protection Windows 10](#)

25.1.3 Virus protection

Take appropriate steps to protect your instruments from infection. Use strong firewall settings and scan any removable storage device used with a Rohde & Schwarz instrument regularly. It is also recommended that you install anti-virus software on the instrument. Rohde & Schwarz does NOT recommend running anti-virus software in the background ("on-access" mode) on Windows-based instruments, due to potentially degrading instrument performance. However, Rohde & Schwarz does recommend running it during non-critical hours.

For details and recommendations, see the following Rohde & Schwarz white paper:

- [1EF96: Malware Protection Windows 10](#)

25.1.4 Backup and recovery

The R&S RTO6 has a backup partition with an application for backup and restore the firmware. The backup of the factory default state is always available. You can save additional backups, for example, before a firmware update or to provide different system configurations for different environments.

The backup saves the current instrument installation and its configuration. Data are not saved in the backup.

To save a system backup

1. Before starting the backup, unplug the LAN cable and USB storage devices to minimize the risk of computer virus attacks.
2. Restart the R&S RTO6.
The boot screen is displayed for about 2 seconds.
3. When the boot screen is displayed, immediately select "Backup", and press [ENTER].
4. Select "Create Backup".
5. Enter a name for the backup and the date. If necessary, you can add information to the description. By default, the description contains the current version of the firmware.
6. Select "Start Backup".
A progress information dialog is displayed. You can terminate at any time with "Cancel". After the process has been finished, the dialog is closed automatically, and the main dialog is displayed again.
7. In the main dialog, select "Exit and Reboot".
The backup and restore application is closed, and the R&S RTO6 is restarted.

To restore a backup version



When restoring a backup, the Windows operating system and installed anti-malware software are probably outdated. To minimize the risk of malware threats after restoring a backup, verify and adjust the "Windows Update" settings. Follow the recommendations from Rohde & Schwarz applicable to your instrument. Also, install all Windows security updates that have been published in the meanwhile.

1. Before starting the recovery, unplug the LAN cable and USB storage devices to minimize the risk of computer virus attacks.
2. Restart the R&S RTO6.
The boot screen is displayed for about 2 seconds.
3. When the boot screen is displayed, immediately select "Backup", and press [ENTER].
4. Select the backup that you want to restore.
5. Select "Restore Selected".
6. Confirm with "Yes".

A progress information dialog is displayed. You can terminate at any time with "Cancel".

During the restore process, the system partition is deleted, formatted and written newly. The data partition is not affected. After the process has been finished, the application is closed automatically, and the R&S RTO6 is restarted.

To delete a backup version

To provide space for new backups, you can remove older backups. The factory default cannot be deleted.

1. Restart the R&S RTO6.
2. When the boot screen is displayed, immediately select "Backup", and press [ENTER].
3. Select the backup that you want to delete.
4. Select "Delete Selected".
5. Confirm with "Yes".
6. In the main dialog, select "Exit and Reboot", or continue with ["To save a system backup"](#) on page 1312.

25.1.5 Accessing windows functionality

All required Windows settings can be changed using the touchscreen and the on-screen keyboard that is part of the Windows system. However, modification is easier if you connect a mouse and/or keyboard to the instrument.

To access Windows

- ▶ Open "Menu" > .

The application is minimized to the taskbar and the "Start" menu becomes available.

To access Windows using an external keyboard

1. To open the "Start" menu, press the Windows key or the CTRL + ESC key combination on your keyboard.
2. To access the desktop, press the Windows key + D on your keyboard.

25.2 Setting up a network (LAN) connection

Network environment

Before connecting the product to a LAN, consider the following:

- Install the latest firmware to reduce security risks.
- For internet or remote access, use secured connections if applicable.
- Ensure that the network settings comply with the security policies of your company. Contact your local system administrator or IT department before connecting your product to your company LAN.
- When connected to the LAN, the product may potentially be accessed from the internet, which may be a security risk. For example, attackers might misuse or damage the product.

Applications of LAN

The LAN connection settings can be configured directly in the Windows operating system. Provided the network administrator has assigned you the appropriate rights and adapted the Windows firewall configuration, you can use the interface, for example:

- To transfer data between a controlling device and the test device, e.g. to run a remote control program.
- To access or control the measurement from a remote computer using the "Remote Desktop" application (or a similar tool)
- To transfer data from a remote computer and back, e.g. using network folders

This section describes how to configure the LAN interface. It includes the following topics:

- [Chapter 25.2.1, "Connecting the instrument to the network"](#), on page 1314
- [Chapter 25.2.2, "Assigning the IP address"](#), on page 1315

Note that only user accounts with administrator rights can configure LAN networks.

25.2.1 Connecting the instrument to the network

There are two methods to establish a LAN connection to the instrument:

- A non-dedicated network (Ethernet) connection from the instrument to an existing network.
 - A dedicated network connection (Point-to-point connection) between the instrument and a single computer.
- ▶ To establish a non-dedicated network connection, connect a commercial RJ-45 cable to one of the LAN ports.
To establish a dedicated connection, connect a (crossover) RJ-45 cable between the instrument and a single PC.

If the instrument is connected to the LAN, Windows automatically detects the network connection and activates the required drivers.

The network card can be operated with a 10/100/1000 Mbps Ethernet IEEE 802.3u interface.

25.2.2 Assigning the IP address

Depending on the network capacities, the TCP/IP address information for the instrument can be obtained in different ways.

- If the network supports dynamic TCP/IP configuration using the Dynamic Host Configuration Protocol (DHCP), all address information can be assigned automatically.
- If the network does not support DHCP, or if the instrument is set to use alternate TCP/IP configuration, the addresses must be set manually.

By default, the instrument is configured to use dynamic TCP/IP configuration and obtain all address information automatically. This means that it is safe to establish a physical connection to the LAN without any previous instrument configuration.

NOTICE

Risk of network errors

Connection errors can affect the entire network. If your network does not support DHCP, or if you choose to disable dynamic TCP/IP configuration, you must assign valid address information before connecting the instrument to the LAN. Contact your network administrator to obtain a valid IP address.

Assigning the IP address on the instrument

1. Open "Menu" > "Settings".
2. Select the "System" tab.
3. In the "Network" tab, select "Advanced".
4. Select "Ethernet".
5. Select "Properties".
6. On the "Networking" tab, select "Internet Protocol Version 4 (TCP/IPv4)", and then select "Properties".
7. Select "Use the following IP address".
8. Enter the address information as obtained from the network administrator.

25.2.3 Using computer names

In a LAN that uses a DNS server (Domain Name System server), each computer and instrument in the LAN can be accessed via an unambiguous host name (or computer name) instead of the IP address. The DNS server translates the host name to the IP address. Host names are useful when a DHCP server is used, as a new IP address can be assigned each time the instrument is restarted.

Each instrument is delivered with an assigned computer name, but this name can be changed.

The default instrument name is a non-case-sensitive string with the following syntax:

<Type><variant>-<serial_number>

The serial number can be found on the rear panel of the instrument. It is the third part of the device ID printed on the bar code sticker:



To change the device name

1. Open the "Menu" > "Settings" dialog.
2. Open the "System" dialog.
3. Select the "Network" tab.
4. Enter the new "Device name" and confirm the entry.

Using a DNS server to determine the IP address

If a DNS server is configured on the R&S RTO6, the server can determine the current IP address for the connection using the permanent computer name.

1. Obtain the name of your DNS domain and the IP addresses of the DNS and WINS servers on your network.
2. Open the "Menu" > "Settings" dialog.
3. Select the "System" tab.
4. Tap "Network".
5. Select "Ethernet".

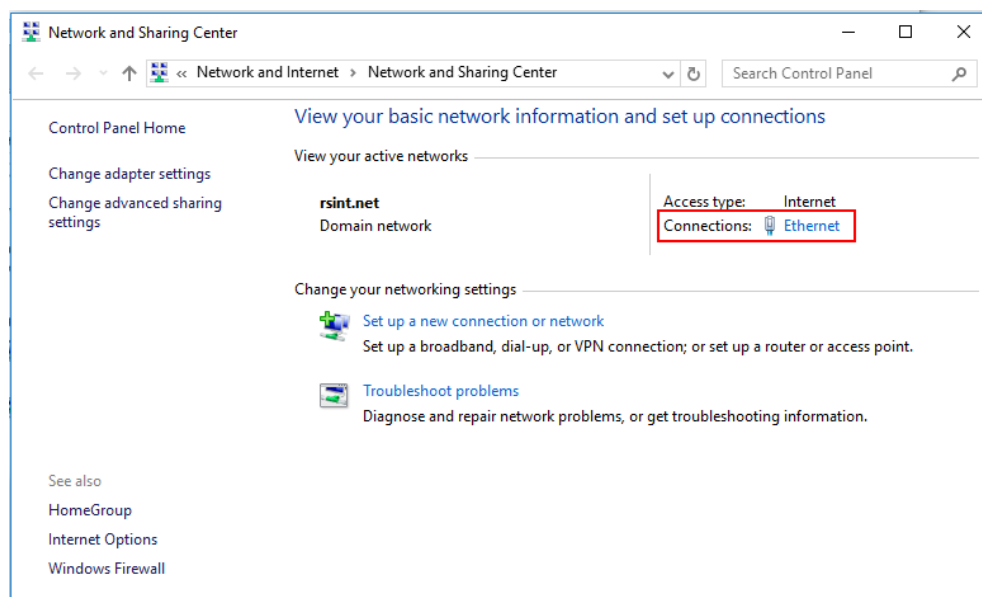

6. On the "Networking" tab, select "Internet Protocol Version 4 (TCP/IPv4)", and then select "Properties".

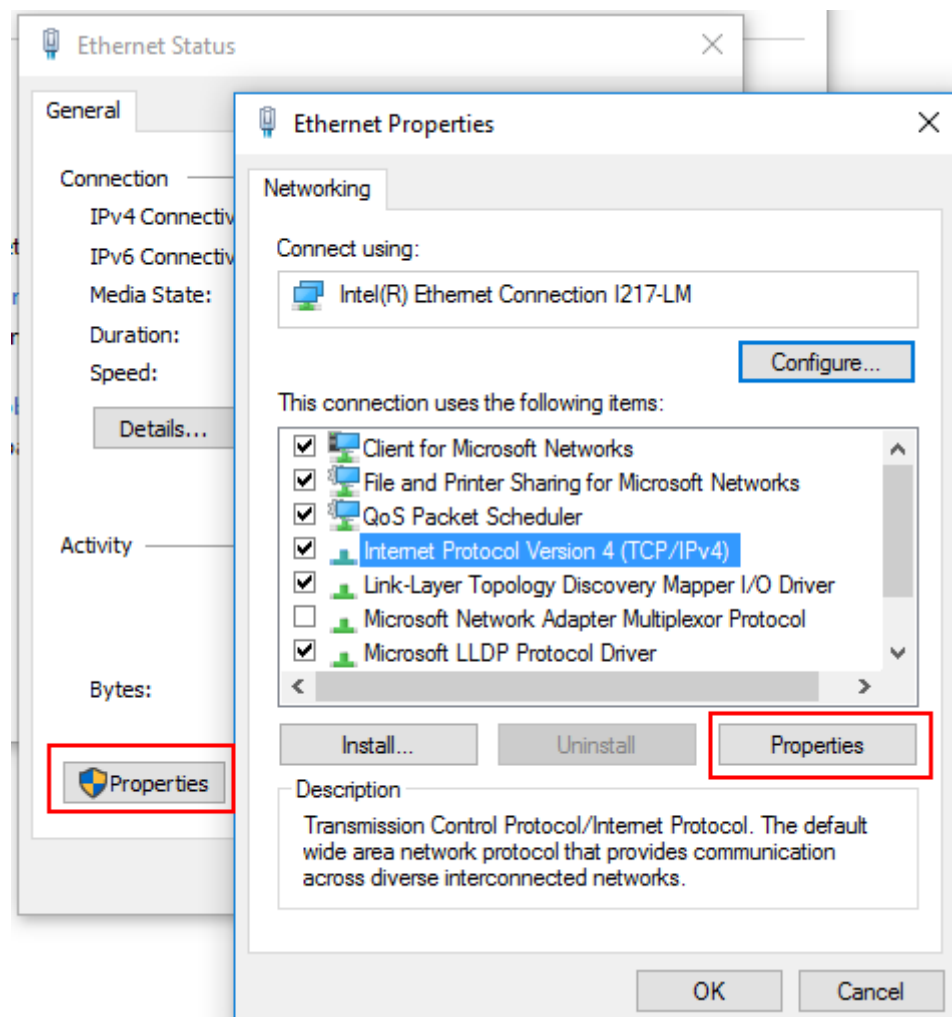

- On the "General" tab, select "Use the following DNS server addresses" and enter your own DNS addresses.

For more information, refer to the Windows operating system help.

25.2.4 Changing the windows firewall settings

A firewall protects an instrument by preventing unauthorized users from gaining access to it through a network. Rohde & Schwarz highly recommends the use of the firewall on your instrument. Rohde & Schwarz instruments are shipped with the Windows firewall enabled and preconfigured in such a way that all ports and connections for remote control are enabled.

For more details on firewall configuration, see the following Rohde & Schwarz White Paper:

- [1EF96: Malware Protection Windows 10](#)

Note that changing firewall settings requires administrator rights.

25.3 Web interface

If the R&S RTO6 is connected to a computer via LAN, you can operate the instrument from a computer. No additional tools are required, you need only a web browser.

25.3.1 Settings on the R&S RTO6



Access: "Menu" > "Settings" > "System" > "Network"



The LAN status icon on the toolbar of the R&S RTO6 indicates the status of the LAN connection. A green icon indicates that the instrument is connected to the LAN; a red symbol indicates an error - mostly the LAN cable is not connected.

The "Network" tab of the "System" dialog box provides network information. See [Chapter 4.1.2, "Network settings"](#), on page 69.



Only users with administrator rights can change LAN settings.

25.3.2 Web browser

The instrument's web interface works with all W3C compliant browsers. Only users with administrator rights on the instrument can use the web interface.

1. Open a web browser on the computer.
2. Type the instrument's host name or IP address in the address field of the browser on your PC, e.g. "http://10.113.10.203".

The instrument home page opens.

The screenshot shows the Rohde & Schwarz web interface for the RTO6 instrument. The left sidebar contains navigation options: LAN (Home, Lan Configuration, Utilities), Instrument Control (Web Control), Diagnostics (Device Screenshot, Health & Utilization), and Help (Glossary, www.rohde-schwarz.com). The main content area is titled 'Instrument Properties' and lists the following information:

Instrument Model	RT06064
Manufacturer	Rohde & Schwarz GmbH & Co. KG
Serial Number	900999
Description	R&S RTO-900999
DNS Host Name(s)	RT06.local.
MAC Address	08:00:27:FF:C8:FF
IP Address	10.111.1.64
Firmware Revision	5.0.12.117 Beta
Current Time	Monday, 2021/02/08, 09:00:41
Current Time source	Operating System
VISA resource string	TCPIP::10.111.1.64::inst0::INSTR TCPIP::10.111.1.64::hislip0::INSTR
Device Indicator	<input type="button" value="INACTIVE (press to toggle)"/>

The instrument home page displays the device information required by the LAN standard including the VISA resource string in read-only format.

- ▶ To update the "Host Name", press the "Device Indicator" button. The "Device Indicator" is not password-protected.

The most important items in the navigation menu of the browser interface are the following:

- "LAN Configuration" opens the menu with configuration pages.
- "Utilities > Logging" shows log messages and provides buttons to download or clear the logfile.
- "Web Control" emulates the front panel and shows the instrument display. You see a live image of the instrument, and you can operate the instrument remotely. You can use the keys, the knobs and the menus in the same way as directly on the instrument.
- "Device Screenshot": creates a screenshot of the display.
- "Health & Utilization": not yet supported
- "Help" provides a glossary of terms related to the standard, and a link to the Rohde & Schwarz Internet site.

25.3.2.1 LAN configuration

The LAN configuration consists of three parts:

- "IP configuration" provides all mandatory LAN parameters.
- "Advanced LAN Configuration" provides LAN settings that are not declared mandatory by the standard.

- "Ping Client" provides the ping utility to verify the connection between the instrument and other devices.

IP configuration

The "LAN Configuration > IP configuration" web page displays all mandatory LAN parameters and allows their modification.

The screenshot shows the "LAN Parameters" configuration page. On the left is a navigation menu with categories: LAN (Home, Lan Configuration, IP Configuration, Advanced Config, Ping Client), Utilities, Instrument Control (Web Control), Diagnostics (Device Screenshot), and Help (Glossary, www.rohde-schwarz.com). The main content area is titled "LAN Parameters" and contains the following fields:

Hostname	<input type="text" value="RTO6"/>	Attention! Changing the hostname reboots the device!
DNS Hostname(s)	<input type="text" value="RTO6.local."/>	
Domain	<input type="text" value="rsint.net"/>	
Description	<input type="text" value="R&S RTO-900999"/>	
IP Address Mode	<input type="text" value="DHCP + Auto IP Address"/>	
IP Address	<input type="text" value="10.111.2.64"/>	
Subnet Mask	<input type="text" value="255.255.252.0"/>	
Default Gateway	<input type="text" value="10.110.0.1"/>	
Obtain DNS Server Address automatically	<input checked="" type="checkbox"/>	
DNS Server(s)	<input type="text" value="10.0.1.166"/>	<input type="text" value="10.0.23.159"/>
Register Device at DNS Server dynamically	<input checked="" type="checkbox"/>	
HiSLIP Port	<input type="text" value="4880"/>	

At the bottom right, there is a "Submit" button and a password field with the label "(Password required)".

The "TCP/IP Mode" configuration field controls how the IP address for the instrument gets assigned (see also [Chapter 25.2.2, "Assigning the IP address"](#), on page 1315). For the manual configuration mode, the static IP address, subnet mask, and default gateway are used to configure the LAN. The automatic configuration mode uses DHCP server or Dynamic Link Local Addressing (automatic IP) to obtain the instrument IP address.



Changing the LAN configuration is password protected. The password is *LxiWebIfc* (notice upper and lower case characters). This password cannot be changed in the current firmware version.

Advanced config

The screenshot shows the "LAN Parameters - Advanced Config" page. The navigation menu is the same as in the previous screenshot. The main content area is titled "LAN Parameters" and contains the following fields:

mDNS and DNS-SD	<input type="text" value="mDNS & DNS-SD"/>	
ICMP Ping enabled	<input checked="" type="checkbox"/>	
VXI-11 Discovery	<input checked="" type="checkbox"/>	

At the bottom right, there is a "Submit" button and a password field with the label "(Password required)".

The "LAN Configuration > Advanced Config" parameters are used as follows:

- mDNS and DNS-SD are two additional protocols: Multicast DNS and DNS Service Discovery. They are used for device communication in zero configuration networks working without DNS and DHCP
- "ICMP Ping" must be enabled to use the ping utility.

- "VXI-11" is the protocol that is used to detect the instrument in the LAN.

Ping client

Ping is a utility that verifies the connection between the instrument and another device. The ping command uses the ICMP echo request and echo reply packets to determine whether the LAN connection is functional. Ping is useful for diagnosing IP network or router failures. The ping utility is not password-protected.

To initiate a ping between the compliant instrument and a second connected device:

1. Enable "ICMP Ping" on the "Advanced Config" page (enabled by default).
2. On the "Ping Client" page, enter the IP address of the second device **without the ping command and without any further parameters** into the "Destination Address" field (e.g. *10.113.10.203*).
3. Click "Submit".

Ping Parameter

Destination Address

Result

```
Pinging 10.113.30.15 with 32 bytes of data:
Reply from 10.113.30.15: bytes=32 time<1ms TTL=128
Reply from 10.113.30.15: bytes=32 time<1ms TTL=128
Reply from 10.113.30.15: bytes=32 time<1ms TTL=128
Reply from 10.113.30.15: bytes=32 time<1ms TTL=128

Ping statistics for 10.113.30.15:
    Packets: Sent = 4, Received = 4, Lost = 0 (0%
loss),
```

25.3.2.2 Web control

"Web Control" emulates the front panel and shows the instrument display. You see a live image of the instrument, and you can operate the instrument remotely. You can use the keys, the knobs and the menus in the same way as directly on the instrument. The Web control replaces VNC as control tool for remote operation.

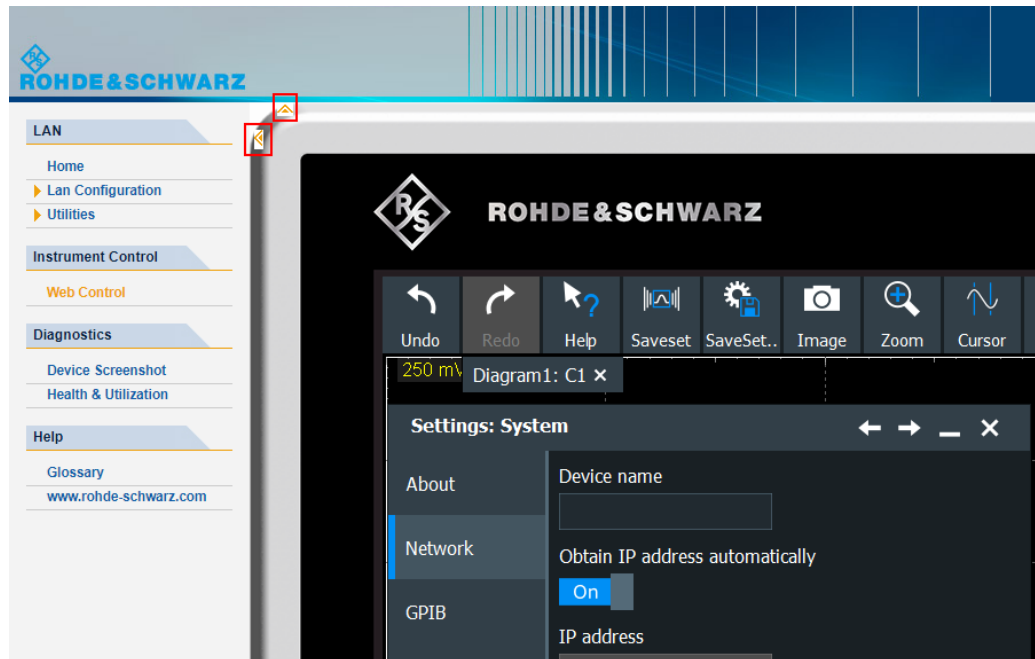

In the upper left corner of the emulated display, you see two arrows:

- The up/down arrow hides or shows the front panel.
- The left/right arrow hides or shows the menu.

25.3.2.3 Device screenshot

If you click "Device Screenshot", a screenshot of the current instrument display is shown on the computer.

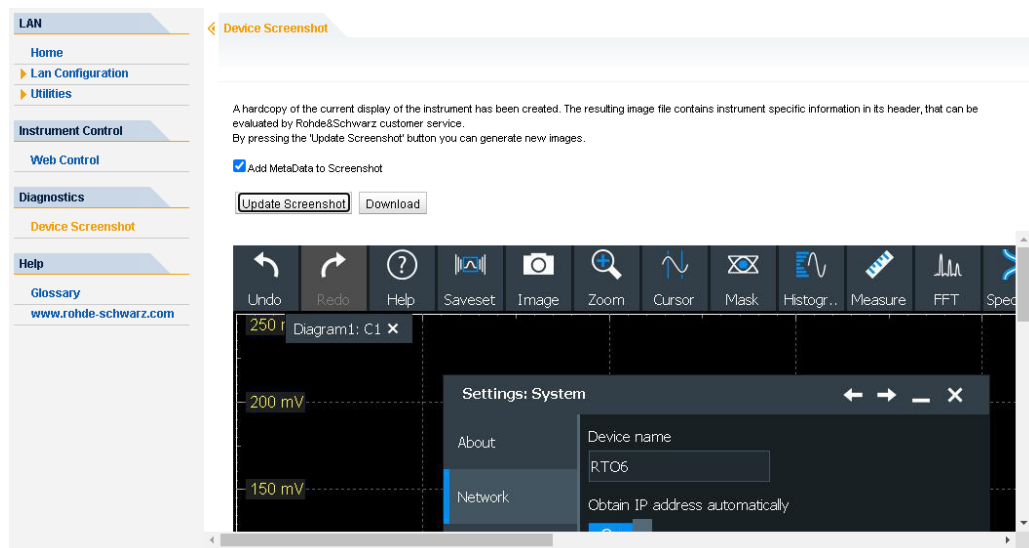

Add MetaData to Screenshot

Adds the instrument information to PNG and JPG files. Meta information is saved as EXIF information and can be read, for example, using the ExifTool, see "[Meta information in screenshots](#)" on page 483.

Update Screenshot

Updates the display.

Download

Saves the screenshot to the download directory of the computer. By default, JPG format is saved.

To save the screenshot in PNG format, select "Save as", select "All files" as type, and enter the filename with extension *.png*.

25.4 Remote Desktop connection

Remote Desktop is a Windows application, which can be used to access and control the instrument from a remote computer through a LAN connection. While the instrument is in operation, the contents of the instrument screen are displayed on the remote computer. Remote Desktop provides access to all applications, files, and network resources of the instrument. Thus, remote operation of the instrument is possible.

NOTICE**Risk of unauthorized access**

If you enable the Windows Remote Desktop application on the instrument, anyone using the network who knows the computer name and login data can access it. To prevent unauthorized access, make sure that the Remote Desktop application on the instrument is disabled: "Start" > "Settings" > "Control Panel" > "System"

To set up a Remote Desktop connection

1. Enable remote desktop control on the instrument. See "[Enabling remote desktop control on the instrument](#)" on page 1324 for details.
2. Connect the instrument and the remote computer to a LAN. See [Chapter 25.2.1, "Connecting the instrument to the network"](#), on page 1314 for details.
3. Set up the Remote Desktop connection between the remote computer and the instrument.

Remote Desktop Connection is part of the operating system and can be accessed via "Start > Windows Accessories > Remote Desktop Connection."

Enabling remote desktop control on the instrument

1. Press the [Setup] key and select the "System" tab.

2. Tap "System".
3. Select "Remote settings".
The "Remote" tab of the "System Properties" is shown.
4. Under "Remote Desktop", activate "Allow remote connections to this computer".
Note: Remote Desktop access and firewall settings.
When you enable or disable the Windows Remote Desktop option (in the "System Properties"), the associated firewall settings are adapted automatically.
5. If necessary, click "Select Users" and select users who are allowed to access the R&S RTO6 via Remote Desktop.
The user account under which configuration is carried out is automatically enabled for Remote Desktop.

Setting up the Remote Desktop connection on the remote computer

1. On the remote computer, select "Start > Windows Accessories > Remote Desktop Connection".
2. Enter the instrument's name or IP address in the dialog box.
See also [Chapter 25.2.2, "Assigning the IP address"](#), on page 1315.
3. Enter the user ID and password for the instrument. See [Chapter 25.1, "Operating system"](#), on page 1309 for details.
4. Click "Connect".
When the connection has been set up, the instrument's screen appears on the remote computer.

For detailed information about Remote Desktop and the connection, refer to the Windows Help.

Helpful settings for Remote Desktop

The following settings for the Remote Desktop connection can make working on the remote PC more convenient.

1. When setting up the connection to the instrument, you can configure the connection settings in the "Remote Desktop Connection" dialog box.
Click the "Show Options".
The dialog box is expanded to display the configuration data.
2. Customize the settings:
 - a) On the "Experience" tab, select the appropriate connection to optimize the connection speed.

- b) On the "Local Resources" tab:
- To use printers connected to the remote PC while accessing them from the instrument, activate "Printers" under "Local devices and resources".
 - If you want access drives of the remote PC from the instrument, e.g. to store settings or to copy files from the PC to the instrument:
 - Select "More" under "Local devices and resources".
 - Select the "Drives" that are needed.
 Windows maps the selected drives of the remote PC to corresponding network drives. When a connection is established, a warning on the PC indicates that the drives are enabled for access from the instrument.
- c) On the "Display" tab:
- Use the slider to set the size of the R&S RTO6 window on the remote PC desktop.
 - Activate "Display the connection bar when in full screen mode".
A bar with the network address of the instrument is displayed on the screen, which you can use to reduce, minimize or close the window.
- d) On the "General" tab, you can save the connection settings for later use: click "Save As".

Terminating Remote Desktop Control

A Remote Desktop connection can be terminated either on the R&S RTO6 or on the remote PC. The connection can be established again any time as long as remote control is enabled on the instrument. Consider the notice "[Risk of unauthorized access](#)" on page 1324.

- ▶ To terminate the connection on the remote PC, close the "Remote Desktop" window, or select "Start > Disconnect".

25.5 Remote control

Remote control automates the operation of the instrument using SCPI commands, scripts and programs.

For general information on remote control of Rohde & Schwarz products via SCPI, refer to www.rohde-schwarz.com/rc-via-scp.

The following sections describe the instrument-specific basics of remote control. SCPI commands are listed described in chapter "Remote Control Commands".

- [Remote control interfaces and protocols](#).....1327
- [Remote settings](#)..... 1328
- [Starting and stopping remote control](#)..... 1330
- [Remote control - status reporting system](#)..... 1331

25.5.1 Remote control interfaces and protocols

The instrument supports different interfaces for remote control. The following table gives an overview.

Table 25-1: Remote control interfaces and protocols

Interface	Protocols, VISA address string	Remarks
Local Area Network (LAN)	<p>Protocol HiSLIP</p> <p>VISA address string: TCPIP::<host address="">::hislip0[, <port>] [::INSTR]</host></p> <p>Protocol VXI-11</p> <p>VISA address string: TCPIP::<host address="">[::inst0] [::INSTR]</host></p>	<p>The LAN connector is located on rear panel of the instrument.</p> <p>The interface is based on TCP/IP and supports various protocols.</p>
GPIB (IEC/IEEE Bus Interface)	<p>VISA address string: GPIB::primary address[::INSTR] (no secondary address)</p>	<p>The GPIB bus interface according to standard IEC 625.1/IEEE 488.1 is located on the rear panel of the instrument.</p> <p>The GPIB bus interface requires option R&S RTO6-B10.</p>

Within this interface description, the term GPIB is used as a synonym for the IEC/IEEE bus interface.

25.5.1.1 LAN interface

To be integrated in a LAN, the instrument is equipped with a LAN interface, consisting of a connector, a network interface card and protocols. The interface details are given in the specifications.

For remote control via a network, the PC and the instrument must be connected via the LAN interface to a common network with TCP/IP network protocol. They are connected using a commercial RJ45 cable (shielded or unshielded twisted pair category 5). The TCP/IP network protocol and the associated network services are preconfigured on the instrument. Software for instrument control and the VISA program library must be installed on the controller.

IP address

Only the IP address or a valid DNS host name is required to set up the connection. The host address is part of the "VISA resource string" used by programs to identify and control the instrument. The VISA resource string has the form:

TCPIP::::hislip0[, <port>] [::INSTR] for HiSLIP protocol

TCPIP::[::inst0] [::INSTR] for VXI-11 protocol

Where:

- `host address` identifies the instrument in the network, usually the IP address. If the LAN is supported by a DNS server, the host name can be used instead of the IP address. The DNS server (Domain Name System server) translates the host name to the IP address.

- `hislip0` indicates the HiSLIP protocol
- `inst0` is the default LAN device name. VISA supports several devices running on the instrument. On R&S RTO6, only one device is configured, so the LAN device name can be omitted.
- `INSTR` specifies a VISA resource of the type INSTR. By default, the VISA resource name control is set to the INSTR class.

Example: HiSLIP

IP address is *192.1.2.3*: the valid resource string is: `TCPIP::192.1.2.3::hislip0`

Instrument name is *RSRT1*: the valid resource string is: `TCPIP::RSRT1::hislip0`.

DNS host name is *RTO6-123456*: the valid resource string is:

`TCPIP::RTO6-123456::hislip0`.

Example: VXI-11

IP address is *192.1.2.3*: the valid resource string is: `TCPIP::192.1.2.3`

Instrument name is *RSRT1*: the valid resource string is: `TCPIP::RSRT1`.

DNS host name is *RTO6-123456*: the valid resource string is: `TCPIP::RTO6-123456`.

See also:

- Find IP address: "Menu" > "Settings" > "System" tab, see ["IP Address"](#) on page 70
- [Chapter 25.2.2, "Assigning the IP address"](#), on page 1315

25.5.1.2 GPIB interface (IEC/IEEE bus interface)

A GPIB interface is provided with option R&S RTO6-B10.

To control the instrument remotely via GPIB, the instrument and the controller must be connected by a GPIB bus cable. The total cable length is restricted to a maximum of 15 m; the cable length between two instruments should not exceed 2m.

GPIB instrument address

The GPIB address is set on the instrument, see [Chapter 25.5.2.1, "GPIB settings"](#), on page 1328.

25.5.2 Remote settings

The settings on this tab are required for remote control of the instrument via a connected computer.

25.5.2.1 GPIB settings

Access: "Menu" > "Settings" > "System" > "Remote"

Displays the GPIB settings of the instrument.

It requires an optional GPIB bus card, option R&S RTO6-B10.

Address

Indicates the GPIB address of the instrument if an optional GPIB bus card is installed.

The remote control address is factory-set to 20, but it can be changed if it does not fit in the network environment. For remote control, addresses 0 through 30 are allowed. The GPIB address is maintained after a reset of the instrument settings. Be aware that changing the address has major effects on the communication to the remote computer.

Remote command:

`GPIB:ADDRes` on page 1382

Terminator

Specifies the symbol that is used as a terminator in GPIB communication.

Remote command:

`GPIB:TERMinator` on page 1382

25.5.2.2 Remote settings

Access: "Menu" > "Settings" > "System" > "Remote"

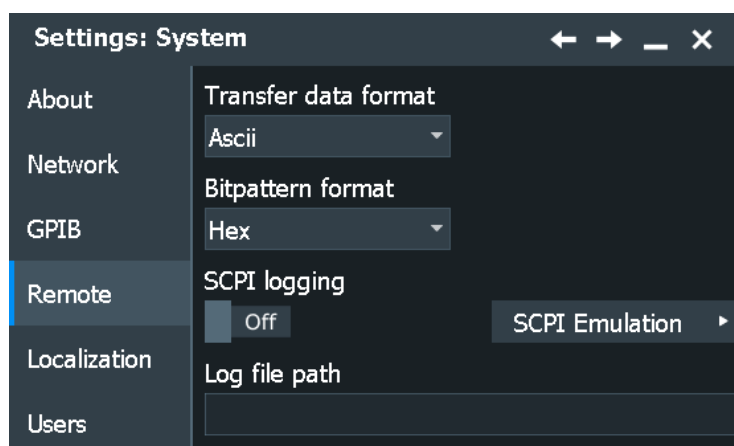

The following settings are required for remote control of the instrument via a connected computer.

Transfer data format

Selects the data format that is used for transmission of waveform data from the instrument to the controlling computer.

Waveform data can be retrieved using the following commands:

- `CHANnel<m>[:WAVEform<n>]:DATA[:VALues]?`
- `CALCulate:MATH<m>:DATA[:VALues]?`
- `REFCurve<m>:DATA[:VALues]?`
- `DIGital<m>:DATA[:VALues]?`

The content of the data stream can be defined with "Menu" > "Save/Recall" > "Save > Waveforms > Interleaved X/Y" (or `EXPort:WAVEform:INCXvalues`).

"Ascii" Data values are returned in ASCII format as a list of comma separated values in floating point format.

"FLOAT"	Binary format. The data is stored as binary data (Definite Length Block Data according to IEEE 488.2).
"INT8"	Signed integer data with length 8 bit.
"INT16"	Signed integer data with length 16 bit. The Byte order can be set using . For details on the formats, refer to the description of the remote command.

Remote command:

[FORMat \[: DATA \]](#) on page 1380

Byte order

Sets the endianness for INT16 data:

- LSB first: little endian, least significant byte first
- MSB first: big endian, most significant byte first

Remote command:

[FORMat : BORDer](#) on page 1381

Bit pattern format

Sets the format for all bit pattern queries.

Remote command:

[FORMat : BPATtern](#) on page 1381

SCPI logging

If enabled, all received remote commands are written into a text file. Enter the path and filename with extension (log, txt, or csv) in "Log file path".

SCPI emulation

Not available for R&S RTO6

25.5.3 Starting and stopping remote control

25.5.3.1 Starting a remote control session

When you switch on the instrument, it is always in manual operation state ("local" state). It can be operated via the front panel, the touch screen and external keyboard and/or mouse.

► To start remote control:

- Send a command from the controller.
- VXI-11 protocol (LAN or USB interface): Use `>R` interface message.

While remote control is active, the instrument settings are optimized for maximum measurement speed; the display is switched off. Operation via the front panel is disabled.

On the touch screen, two buttons appear in the upper left corner: "Local" and "View".

25.5.3.2 Using the display during remote control

You can observe the screen while a remote control script is executed. This is helpful for program test purposes but tends to slow down the measurement. Therefore it is recommended that you switch off the display in real measurement applications where a tested program script is to be executed repeatedly.

- ▶ To switch on the display, do one of the following:
 - Tap the "View" button in the upper left corner of the touch screen.
 - Use the `SYSTem:DISPlay:UPDate ON` command.
- ▶ To switch off the display, do one of the following:
 - Tap the "View" button again.
 - Use the `SYSTem:DISPlay:UPDate OFF` command.

25.5.3.3 Returning to manual operation

The instrument switches back to manual operation when the remote connection is closed. Besides, you can return to manual operation manually or via remote control.

- ▶ To return to manual operation:
 - Tap the "Local" button in the upper left corner of the touch screen.
 - VXI-11 protocol: Use `>L` interface message.

25.5.4 Remote control - status reporting system

The status reporting system stores all information on the current operating state of the instrument, and on errors which have occurred. This information is stored in the status registers and in the error queue. Both can be queried via `STATus...` commands.

25.5.4.1 Hierarchy of status registers

As shown in the following figure, the status information is of hierarchical structure.

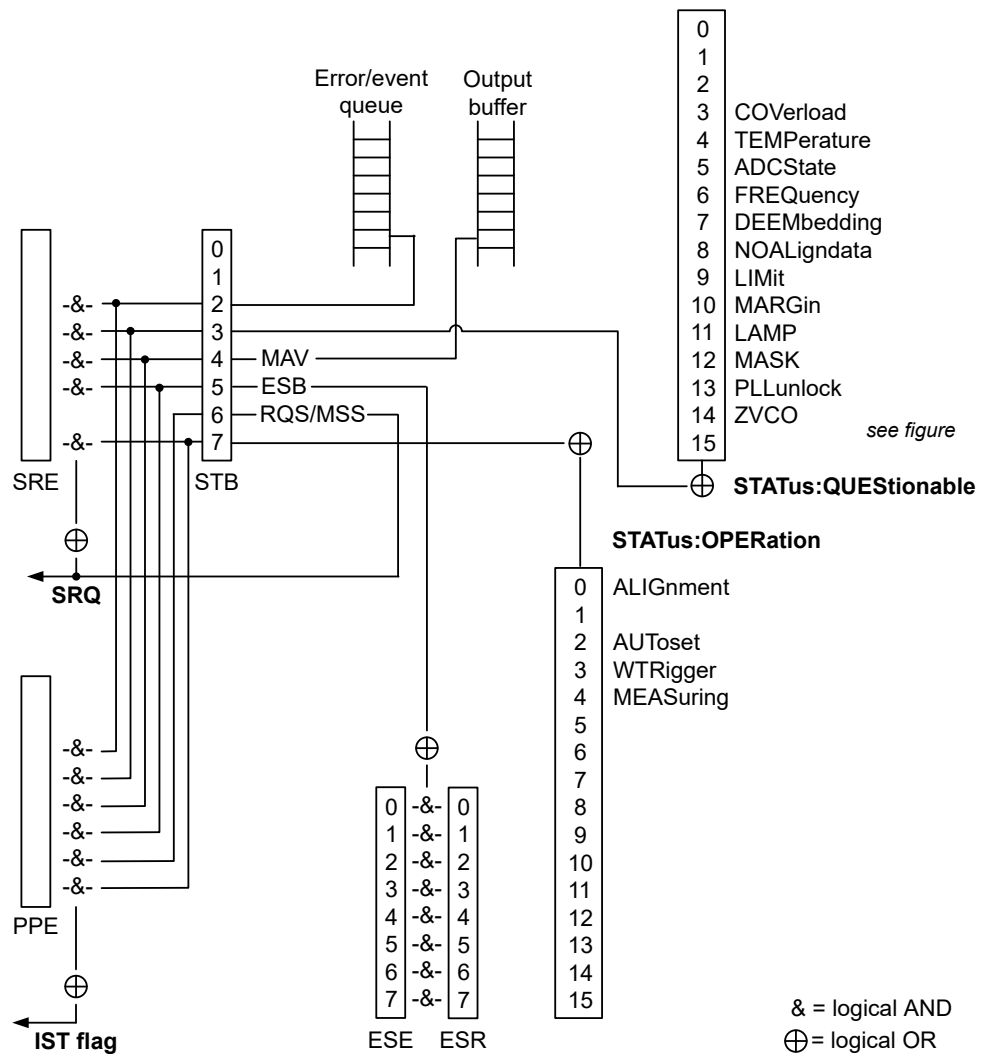

Figure 25-1: Overview of the status registers hierarchy

All status registers have the same internal structure.

25.5.4.2 Contents of the status registers

STATUS:OPERation register

In the **CONDition** part, this register contains information on which actions the instrument is executing. In the **EVENT** part, it contains information on which actions the instrument has executed since the last reading.

It can be read using the commands `STATUS:OPERation:CONDition?` or `STATUS:OPERation[:EVENT]?`, see also [Chapter 27.29.1, "STATUS:OPERation register"](#), on page 2851.

Table 25-2: Bits in the STATus:OPERation register

Bit No.	Meaning
0	ALIGnment This bit is set as long as the instrument is performing a self-alignment.
1	Not used
2	AUToset This bit is set while the instrument is performing an auto setup.
3	WTRigger The wait for trigger status bit indicates that the instrument is ready to trigger, and the pre-trigger time is expired. The bit is set if the instrument did not trigger for more than 10 ms. The bit is only valid if the instrument is operated in a single acquisition mode and in normal trigger mode but not in auto mode.
4	MEASuring The bit is set as long as an acquisition - sampling and postprocessing - is running. In run continuous mode, the bit is always set.
5 - 15	Not used

STATus:QUEStionable register

This register contains information about indefinite states which can occur if the unit is operated without meeting the specifications. It can be read using the commands `STATus:QUEStionable:CONDition?` and `STATus:QUEStionable[:EVENT]?`.

The remote commands for the STATus:QUEStionable register are described in [Chapter 27.29.2, "STATus:QUEStionable registers"](#), on page 2852.

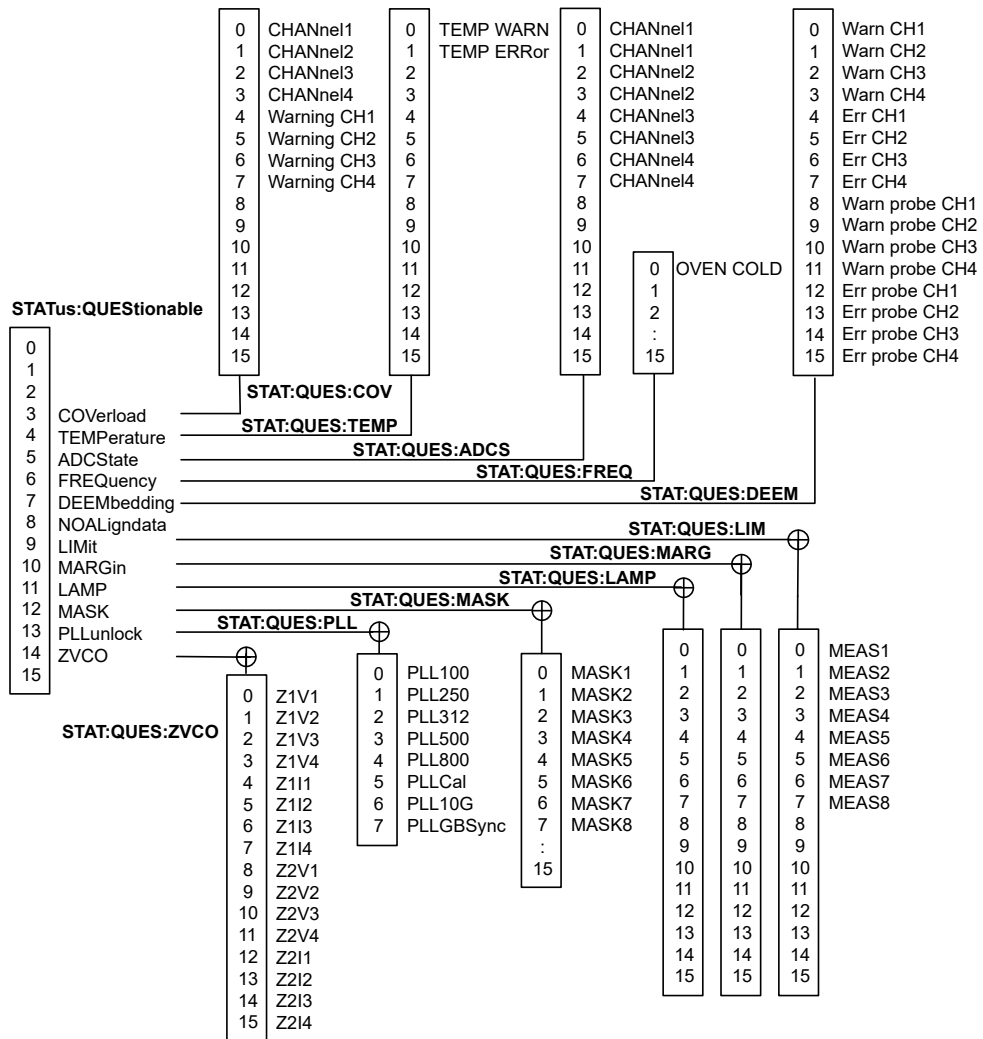

Figure 25-2: Overview of the STATUS:QUESTIONABLE register

Table 25-3: Bits in the STATUS:QUESTIONABLE register

Bit No.	Meaning
0 to 2	not used
3	COVerload This bit is set if a questionable channel overload occurs (see "STATUS:QUESTIONABLE:COVerload register" on page 1335).
4	TEMPerature This bit is set if a questionable temperature occurs (see "STATUS:QUESTIONABLE:TEMPerature register" on page 1336).
5	ADCState The bit is set if the signal is clipped on the upper or lower edge of the screen, if an overflow of the ADC occurs (see "STATUS:QUESTIONABLE:ADCState register" on page 1336).

Bit No.	Meaning
6	FREQuency This bit is set if there is anything wrong with the frequency of the local oscillator or the reference frequency (see " STATUS:QUESTIONable:FREQuency register " on page 1336).
7	DEEMbedding The bit is set if a warning or an error occurs during deembedding (see " STATUS:QUESTIONable:DEEMbedding register " on page 1337).
8	NOALigndata This bit is set if no alignment data is available - the instrument is uncalibrated.
9	LIMit This bit is set if a limit value is violated (see " STATUS:QUESTIONable:LIMit , STATUS:QUESTIONable:MARGIN registers " on page 1337).
10	MARGIN This bit is set if a margin value is violated, and the limit value is not violated (see " STATUS:QUESTIONable:LIMit , STATUS:QUESTIONable:MARGIN registers " on page 1337).
11	LAMP (Low AMPLitude) This bit is set if the magnitude of the signal is too low to get reliable measurement results. See " STATUS:QUESTIONable:LAMP register " on page 1338.
12	MASK This bit is set if a mask value is violated (see " STATUS:QUESTIONable:MASK register " on page 1338).
13	PLLunlock See " STATUS:QUESTIONable:PLLunlock register " on page 1338.
14	ZVCO : This bit is set if a channel overload occurs at one or more input channels of the R&S RT-ZVC multi-channel power probe. See " STATUS:QUESTIONable:ZVCO register " on page 1339.
15	This bit is always 0.

STATUS:QUESTIONable:COVERload register

This register contains all information about overload of the channels. The bit is set if the assigned channel is overloaded, or if an overload risk occurred (overload warning).

Table 25-4: Bits in the STATUS:QUESTIONable:COVERload register

Bit No.	Meaning
0	Overload on CHANne11
1	Overload on CHANne12
2	Overload on CHANne13
3	Overload on CHANne14
4	Overload warning for CHANne11
5	Overload warning for CHANne12
6	Overload warning for CHANne13
7	Overload warning for CHANne14

Bit No.	Meaning
8	Overload on external trigger input
9	Overload warning for external trigger input

STATUS:QUESTIONable:TEMPerature register

This register contains information about the instrument's temperature.

Table 25-5: Bits in the STATUS:QUESTIONable:TEMPerature register

Bit No.	Meaning
0	TEMP WARN This bit is set if a temperature warning on channel 1, 2, 3 or 4 occurred.
1	TEMP ERRor This bit is set if a temperature error on channel 1, 2, 3 or 4 occurred.

STATUS:QUESTIONable:ADCState register

This register contains all information about overflow of the ADC.

The bit is set if the assigned channel signal is clipped on the upper or lower edge of the screen. In this case, the signal does not fit in the range of the ADC and overflow occurs.

Table 25-6: Bits in the STATUS:QUESTIONable:ADCState register

Bit No.	Meaning
0	CHANnel1, clipping on the upper limit
1	CHANnel1, clipping on the lower limit
2	CHANnel2, clipping on the upper limit
3	CHANnel2, clipping on the lower limit
4	CHANnel3, clipping on the upper limit
5	CHANnel3, clipping on the lower limit
6	CHANnel4, clipping on the upper limit
7	CHANnel4, clipping on the lower limit

STATUS:QUESTIONable:FREQuency register

Table 25-7: Bits in the STATUS:QUESTIONable:FREQuency register

Bit No.	Meaning
0	Oven cold. This bit is set if the reference oscillator has not yet attained its operating temperature.

STATus:QUESTionable:DEEMbedding register**Table 25-8: Bits in the STATus:QUESTionable:DEEMbedding register**

Bit No.	Meaning
0 1 2 3	Warning for channel 1, 2, 3, 4 accordingly. The bits are set if there are problems in the deembedding configuration of the assigned channel.
4 5 6 7	Error for channel 1, 2, 3, 4 accordingly. The bits are set if the deembedding configuration of the assigned channel causes an error.
8 9 10 11	Warning for channel 1, 2, 3, 4 accordingly. The bits are set if there are problems in the probe deembedding of the assigned channel.
12 13 14 15	Error for channel 1, 2, 3, 4 accordingly. The bits are set if the probe deembedding of the assigned channel causes an error.

STATus:QUESTionable:LIMit, STATus:QUESTionable:MARGin registers

These registers contain information about the observance of the limits or margins of measurements.

The LIMit bit is set if the limit of the assigned measurement is violated. The MARGin bit is set if the margin of the assigned measurement is violated but not the limit (the limit bit is not set).

The status bits are set if the limits or margins of one or more assigned measurements are violated.

If multiple measurements are active, all measurement results affect the status bits. Statistical results do not change the status bits.

Table 25-9: Bits in the STATus:QUESTionable:LIMit and STATus:QUESTionable.MARGin registers

Bit No.	Meaning
0	MEAS1
1	MEAS2
2	MEAS3
3	MEAS4
4	MEAS5
5	MEAS6

Bit No.	Meaning
6	MEAS7
7	MEAS8

STATUS:QUESTIONABLE:LAMP register

The LAMP (Low AMPlitude) bit is set if the magnitude of the signal is too low to get reliable measurement results.

Table 25-10: Bits in the STATUS:QUESTIONABLE:LAMP register

Bit No.	Meaning
0	MEAS1
1	MEAS2
2	MEAS3
3	MEAS4
4	MEAS5
5	MEAS6
6	MEAS7
7	MEAS8

STATUS:QUESTIONABLE:MASK register

This register contains information about the violation of masks. This bit is set if the assigned mask is violated.

Table 25-11: Bits in the STATUS:QUESTIONABLE:MASK register

Bit No.	Meaning
0	MASK1
1	MASK2
2	MASK3
3	MASK4
4	MASK5
5	MASK6
6	MASK7
7	MASK8

STATUS:QUESTIONABLE:PLLunlock register

This register contains information on the phase-locked loop process status. An unlocked status sets the bit true.

Table 25-12: Bits in the STATus:QUEStionable:PLLunlock register

Bit No.	Meaning
0	PLL100: indicates if the frequency reference is locked. The frequency reference is usually the OCXO. It can also be an external reference if it is connected and activated.
1	not used
2	PLL312: internal use
3	not used
4	PLL800: internal use
5	PLLCal: internal use
6	PLL10G: internal use
7	PLLGBSync: internal use

STATus:QUEStionable:ZVCO register

This register contains all information about overload of the R&S RT-ZVC input channels. The bit is set if the assigned channel is overloaded.

Table 25-13: Bits in the STATus:QUEStionable:ZVCO register

Bit No.	Meaning
0	Overload on Z1V1
1	Overload on Z1V2
2	Overload on Z1V3
3	Overload on Z1V4
4	Overload on Z1I1
5	Overload on Z1I2
6	Overload on Z1I3
7	Overload on Z1I4
8	Overload on Z2V1
9	Overload on Z2V2
10	Overload on Z2V3
11	Overload on Z2V4
12	Overload on Z2I1
13	Overload on Z2I2
14	Overload on Z2I3
15	Overload on Z2I4

25.5.4.3 Reset values of the status reporting system

The following table contains the different commands and events causing the status reporting system to be reset. None of the commands, except *RST and SYSTem:PRESet, influence the functional instrument settings. In particular, DCL does not change the instrument settings.

Table 25-14: Resets of the status reporting system

Event	Switching on supply voltage Power-On-Status-Clear		DCL, SDC (Device Clear, Selected Device Clear)	*RST or SYS- Tem:PRE Set	STA- Tus:PRE- Set	*CLS
	0	1				
Clear STB, ESR	-	yes	-	-	-	yes
Clear SRE, ESE	-	yes	-	-	-	-
Clear PPE	-	yes	-	-	-	-
Clear EVENT parts of the registers	-	yes	-	-	-	yes
Clear ENABLE parts of all OPERation and QUESTionable registers; Fill ENABLE parts of all other registers with "1".	-	yes	-	-	yes	-
Fill PTRansition parts with "1"; Clear NTRansition parts	-	yes	-	-	yes	-
Clear error queue	yes	yes	-	-	-	yes
Clear output buffer	yes	yes	yes	1)	1)	1)
Clear command processing and input buffer	yes	yes	yes	-	-	-

1) The first command in a command line that immediately follows a <PROGRAM MESSAGE TERMINATOR> clears the output buffer.

26 Maintenance and support

The instrument does not need periodic maintenance. Only the cleaning of the instrument is essential.

To protect the front panel and to transport the instrument to another workplace safely and easily, various accessories are provided. Refer to the specifications document for available covers and cases and their order numbers.

The adjustment of the OCXO oscillator is described in the service manual.

26.1 Cleaning

How to clean the product is described in "[Cleaning the product](#)" on page 16.

Do not use any liquids for cleaning. Cleaning agents, solvents, acids and bases can damage the front panel labeling, plastic parts and display.

26.2 Contacting customer support

Technical support – where and when you need it

For quick, expert help with any Rohde & Schwarz product, contact our customer support center. A team of highly qualified engineers provides support and works with you to find a solution to your query on any aspect of the operation, programming or applications of Rohde & Schwarz products.

Contact information

Contact our customer support center at www.rohde-schwarz.com/support, or follow this QR code:



Figure 26-1: QR code to the Rohde & Schwarz support page

26.3 Information for technical support

If you encounter problems that you cannot solve yourself, contact your Rohde & Schwarz support center, see [Contacting customer support](#).

The support center finds solutions more quickly and efficiently, if you provide them with information on the instrument and an error description. To create, collect and save the required information, you can create a service report.

The service report is a ZIP file with a complete bug report, all relevant setup information, reporting and log files, alignment files, and the instrument configuration.

1. Open the "Settings" > "Maintenance" dialog.
2. Select the "Service" tab.
3. Tap "Service reporter: Start".

The service reporter creates the report and saves it as ZIP file directly on the Windows desktop.

4. Create a support ticket that describes the problem, and attach the report file.

On the instrument, you can find log files, the device footprint and report files, and other information in the "AppData" folder on the Windows desktop

(C:\ProgramData\Rohde-Schwarz\RTx). The "Maintenance" dialog box also provides information on your instrument configuration which can be helpful in case you need support.

26.4 Data security

If you have to send the instrument to the service, or if the instrument is used in a secured environment, consider the document "Instrument Security Procedures" that is delivered on the R&S RTO6 webpage.

Instrument configuration data and user data are stored on a removable hard disk only. Thus it is sufficient to remove the hard disk before the instrument leaves a secured environment. Details are given in the document mentioned above.

26.5 Transporting

Lifting and carrying

See: "[Lifting and carrying the instrument](#)" on page 12

Packing

Use the original packaging material. It consists of antistatic wrap for electrostatic protection and packing material designed for the product.

If you do not have the original packaging, use similar materials that provide the same level of protection. You can also contact your local Rohde & Schwarz service center for advice.

Securing

When moving the R&S RTO6 in a vehicle or using transporting equipment, make sure that the R&S RTO6 is properly secured. Only use items intended for securing objects.

Transport altitude

Unless otherwise specified in the specifications document, the maximum transport altitude without pressure compensation is 4500 m above sea level.

26.6 Storage

Protect the product against dust. Ensure that the environmental conditions, e.g. temperature range and climatic load, meet the values specified in the specifications document.

26.7 Disposal

Rohde & Schwarz is committed to making careful, ecologically sound use of natural resources and minimizing the environmental footprint of our products. Help us by disposing of waste in a way that causes minimum environmental impact.

Disposing of electrical and electronic equipment

A product that is labeled as follows cannot be disposed of in normal household waste after it has come to the end of its life. Even disposal via the municipal collection points for waste electrical and electronic equipment is not permitted.



Figure 26-2: Labeling in line with EU directive WEEE

Rohde & Schwarz has developed a disposal concept for the eco-friendly disposal or recycling of waste material. As a manufacturer, Rohde & Schwarz completely fulfills its obligation to take back and dispose of electrical and electronic waste. Contact your local service representative to dispose of the product.

27 Remote control commands

This chapter describes all remote commands available for R&S RTO6 and provides examples and information how to use the commands.

For further information on remote control, see [Chapter 25.5, "Remote control"](#), on page 1326.

27.1 Conventions used in remote command description

The following conventions are used in the remote command descriptions:

- *Command usage*
If not specified otherwise, commands can be used both for setting and for querying parameters.
If a command can be used for setting or querying only, or if it initiates an event, the usage is stated explicitly.
- *Parameter usage*
If not specified otherwise, a parameter can be used to set a value, and it is the result of a query.
Parameters required only for setting are indicated as "Setting parameters".
Parameters required only to refine a query are indicated as "Query parameters".
Parameters that are only returned as the result of a query are indicated as "Return values".
- *Conformity*
Commands that are taken from the SCPI standard are indicated as "SCPI confirmed". All commands used by the R&S RTO6 follow the SCPI syntax rules.
- *Asynchronous commands*
A command which does not automatically finish executing before the next command starts executing (overlapping command) is indicated as an "Asynchronous command".
- *Reset values (*RST)*
Default parameter values that are used directly after resetting the instrument (*RST command) are indicated as "*RST" values, if available.
- *Default unit*
The default unit is used for numeric values if no other unit is provided with the parameter.

27.2 Finding the appropriate command

In the following chapters, the commands are sorted according to the menu and dialog structure of the instrument.

A list of all commands in alphabetical order is given in the "List of Commands" at the end of this documentation.

To find the appropriate command for a setting easily, you can use the context help:

1. Enable the "Help" icon on the toolbar.



2. Tap the parameter for which you need information.
The tooltip opens.
3. Tap the "Show Help" button in the lower right corner of the tooltip.
The "Help" window opens and displays the comprehensive description and the corresponding remote command.
4. Tap the remote command link to open the command description.

27.3 Programming examples

Some of the commands in the following chapter are asynchronous. An overlapping or asynchronous command does not automatically finish executing before the next command starts executing. If overlapping commands must be executed in a defined order, e.g. to avoid wrong measurement results, they must be serviced sequentially.

To prevent an overlapping execution of commands, one of the commands `*OPC`, `*OPC?` or `*WAI` can be used after the command or a command set.

For more information, see:

- www.rohde-schwarz.com/rc-via-sdpi, chapter "Command sequence and synchronization"
- [Chapter 27.3, "Programming examples"](#), on page 1345

27.3.1	Display.....	1346
27.3.1.1	Creating diagrams (SmartGrid).....	1346
27.3.1.2	Creating zoom diagrams.....	1347
27.3.2	Automatic measurements.....	1347
27.3.2.1	Performing amplitude/time measurements.....	1347
27.3.2.2	Setting reference levels.....	1348
27.3.2.3	Waveform histograms.....	1349
27.3.2.4	Long-term measurements.....	1350
27.3.2.5	Measurement limits.....	1351
27.3.3	Mask testing.....	1351
27.3.3.1	Creating a user mask.....	1351
27.3.4	Search.....	1352
27.3.4.1	Searching for a pulse of a specified width.....	1352

27.3.5	Data management.....	1352
27.3.5.1	Saving a screenshot to file.....	1353
27.3.5.2	Exporting waveform data to file.....	1353
27.3.5.3	Exporting measurement results to file.....	1359
27.3.6	Deembedding.....	1359
27.3.6.1	Adding cables to the measurement setup.....	1359
27.3.7	Protocol analysis.....	1360
27.3.7.1	RFFE (option R&S RTO6-K550).....	1360
27.3.7.2	SENT (option R&S RTO6-K520).....	1361
27.3.8	Power analysis (option R&S RTO6-K31).....	1363
27.3.8.1	Auto deskew.....	1363
27.3.8.2	Transient response measurement.....	1365

27.3.1 Display

- [Creating diagrams \(SmartGrid\)](#)..... 1346
- [Creating zoom diagrams](#)..... 1347

27.3.1.1 Creating diagrams (SmartGrid)

The example creates 3 diagrams at different positions on the screen, and a zoom diagram. It also minimizes a waveform and adds it to another diagram.

Command description in: [Chapter 27.7.2.4, "Smartgrid"](#), on page 1390

In the following example *OPC prevents overlapping execution of asynchronous commands.

```
// Turn on display update
:SYSTem:DISPlay:UPDate ON
// Turn on Channel 2
:CHANnel2:STATe 1
// Create new diagram 'MyDiag2' below existing 'Diagram1' with waveform C2W1 in it
:LAYout:ADD 'Diagram1',VERTical,OFF,C2W1,'MyDiag2'
// Turn on Channel 3
:CHANnel3:STATe 1
// Create new diagram 'MyDiag3' right of existing 'MyDiag2'
:LAYout:ADD 'MyDiag2',HORizontal,OFF,C3W1,'MyDiag3'
// Turn on Channel 4
:CHANnel4:STATe 1
// Create new diagram 'MyDiag4' tabbed to existing 'Diagram1'
:LAYout:ADD 'Diagram1',TAB,OFF,C4W1,'MyDiag4'
// Select 'Diagram1'
:LAYout:SHOW 'Diagram1'
```

```
// Create zoom window of 'Diagram1'
:LAYout:ZOOM:ADD 'Diagram1',VERT,OFF,-10e-9,10e-9,-0.05,0.04,'MyZoom1'
// Minimize Channel 2 (Wfml)
:LAYout:SIGNal:UNAssign C2W1
// Add Channel 2 (Wfml) to Diagram1
:LAYout:SIGNal:ASSign 'Diagram1', C2W1

*OPC?
```

27.3.1.2 Creating zoom diagrams

The example creates a zoom diagram, sets the relative size of the zoom area, and removes the zoom diagram.

Command description in: [Chapter 27.10.1, "Zoom"](#), on page 1536.

In the following example *OPC prevents overlapping execution of asynchronous commands.

```
// Create an new zoom diagram for Diagram1
LAYout:ZOOM:ADD 'Diagram1', VERT, OFF, -10e-9, 20e-9, -0.1, 0.05, 'MyZoom1'
// Query the horizontal zoom mode, return value: ABS
LAYout:ZOOM:HORIZ:MODE? 'Diagram1', 'MyZoom1'
<--ABS
// Set horizontal zoom mode to relative
LAYout:ZOOM:HORIZ:MODE 'Diagram1', 'MyZoom1', REL
// Set horizontal zoom span in percent
LAYout:ZOOM:HORIZ:REL:SPAN 'Diagram1', 'MyZoom1', 10
// Set horizontal zoom position in percent
LAYout:ZOOM:HORIZ:REL:POS 'Diagram1', 'MyZoom1', 15
*OPC?
// Remove zoom diagram
LAYout:ZOOM:REM 'Diagram1', 'MyZoom1'
*OPC?
```

27.3.2 Automatic measurements

- [Performing amplitude/time measurements](#)..... 1347
- [Setting reference levels](#).....1348
- [Waveform histograms](#)..... 1349
- [Long-term measurements](#).....1350
- [Measurement limits](#)..... 1351

27.3.2.1 Performing amplitude/time measurements

Command description is given in [Chapter 27.12.1, "General settings"](#), on page 1584 and [Chapter 27.12.2, "Results"](#), on page 1589.

In the following example *OPC prevents overlapping execution of asynchronous commands.

Simple frequency and amplitude measurement

```
SING;*OPC?
MEAS1:SOUR C1W1          // Configure frequency measurement
MEAS1:MAIN FREQ
MEAS1 ON
*OPC?
MEAS2:SOUR C1W1          // Configure amplitude measurement
MEAS2:MAIN AMPL
MEAS2 ON
*OPC?
MEAS1:RES:ACT?           // Get frequency result
MEAS2:RES:ACT?           // Get amplitude result
*OPC?
```

27.3.2.2 Setting reference levels

Command description in [Chapter 27.17.2, "Signal and reference levels for NRZ signals"](#), on page 1791.

In the following example *OPC prevents overlapping execution of asynchronous commands.

Manual reference level definition using relative values

Reference levels are set to 15%, 50%, and 85% of the high signal level for waveform C2W1 (= suffix 5).

```
REFLevel5:LDEtection MANual
REFLevel5:LMOde REL
REFLevel5:RELative:MOde USER
REFLevel5:RELative:LOWer 15
REFLevel5:RELative:MIDDLE 50
REFLevel5:RELative:UPPer 85
*OPC?
```

Manual reference level definition using absolute values

Set reference levels manually for waveform C1W1 (= suffix 2), defining high and low signal levels and the distances between signal and reference levels.

```
REFLevel2:LDEtection MANual
REFLevel2:LMOde ABS
REFLevel2:ABSolute:HIGH 0.12
REFLevel2:ABSolute:TDistance 0.03
REFLevel2:ABSolute:Low -0.12
REFLevel2:ABSolute:BDistance 0.04
*OPC?
```

```
REFLevel2:ABSolute:MLeVel?
<-- 0
```

Set reference levels manually for waveform C1W1 (= suffix 2) by defining upper and lower reference levels and the distances between signal and reference levels.

```
REFLevel2:LDEtection MANual
REFLevel2:LMODe ABS
REFLevel2:USRLevel UREF
REFLevel2:ABSolute:LLeVel 0
REFLevel2:ABSolute:BDIStance 0.02
REFLevel2:ABSolute:ULeVel 0.2
REFLevel2:ABSolute:TDIStance 0.03
*OPC?
REFLevel2:ABSolute:MLeVel?
<-- 0.1
```

Automatic level detection, peak probability

Reference levels are set to the signal levels with the highest probability values for waveform C3W1 (= suffix 8).

```
REFLevel8:LDEtection Auto
REFLevel8:AUTO:MODE PPRobability
*OPC?
```

27.3.2.3 Waveform histograms

In the following example *OPC prevents overlapping execution of asynchronous commands.

- [Creating and reading histograms](#)..... 1349
- [Exporting histogram data to file](#)..... 1350
- [Transferring histogram data](#)..... 1350

Creating and reading histograms

The example creates a histogram, activates two measurements (mean and standard deviation measurements of Histogram1), and queries the results of both measurements.

Command description in:

- [Chapter 27.12.1, "General settings"](#), on page 1584
- [Chapter 27.12.8.2, "Histogram measurement"](#), on page 1646
- [Chapter 27.12.2, "Results"](#), on page 1589

```
LAY:HIST:ADD 'Histogram1', C1W1, -2.5E-007, 2.5E-007, -1.32, 5.35, OFF, VERT *OPC?

MEAS1 ON
MEAS1:HIST:SEL 'Histogram1'
MEAS1:CAT HIST
MEAS1:MAIN HME
*OPC?
```

```

MEAS2 ON
MEAS2:HIST:SEL 'Histogram1'
MEAS2:CAT HIST
MEAS2:MAIN HSTD
*OPC?

MEAS1:RES:ACT?
MEAS2:RES:ACT?

```

Exporting histogram data to file

The example writes the absolute data values of Histogram1 to C:\Histograms\Hist1.xml in XML format.

Command description in [Chapter 27.16.5, "Waveform histogram export to file"](#), on page 1774.

```

EXPort:HISTogram:SElect 'Histogram1'
EXPort:HISTogram:INCidence ABS
EXPort:HISTogram:NAME 'C:\Histograms\Hist1.xml'
EXPort:HISTogram:SAVE
*OPC?

```

Transferring histogram data

The example transfers the absolute values of Histogram1 to a controlling computer in ASCII format.

Command description in [Chapter 27.16.5, "Waveform histogram export to file"](#), on page 1774.

```

EXP:HIST:SEL 'Histogram1'
EXP:HIST:INC ABS
*OPC?
FORM ASC
EXP:HIST:DATA?
<--0,0,0,0,0,2037,5754804,4683496,3100169,2874565,...

```

27.3.2.4 Long-term measurements

In the following example *OPC prevents overlapping execution of asynchronous commands.

- [Exporting long-term measurement data to file](#)..... 1350
- [Transferring long-term measurement data](#)..... 1351

Exporting long-term measurement data to file

The example writes the long-term data of Meas1 to C:\Measurements\Meas1.csv in CSV format.

Command description in [Chapter 27.16.7, "Long term measurement results and measurement histogram export to file"](#), on page 1777.

```

EXPort:MEASurement:SEL MEAS1
EXPort:MEASurement:TYPE LONGTERM
EXPort:MEASurement:NAME 'C:\Measurements\Meas1.csv'
EXPort:MEASurement:SAVE
*OPC?

```

Transferring long-term measurement data

The example transfers the long-term data of Meas1 to a controlling computer in ASCII format.

Command description in [Chapter 27.16.7, "Long term measurement results and measurement histogram export to file"](#), on page 1777.

```

MEASurement:LTM ON
MEASurement:STAT ON
EXPort:MEASurement:SElect MEAS1
EXPort:MEASurement:TYPE LONGTERM
*OPC?
FORM ASC
EXPort:MEASurement:DATA?
<--50,0.24901185771,0.24731225296,0.24703557312,0.00069270717936,0,50,....

```

27.3.2.5 Measurement limits

The example configures the limit check for measurement group 4. The LCHeck suffix determines the measurement type, here: 7 = MEAN.

Command description in [Chapter 27.12.3, "Amplitude/time measurements"](#), on page 1594.

```

MEASurement4:AMPtime:LCHeck7:LOWer:LIMit <Value> // Define lower limit
MEASurement4:AMPtime:LCHeck7:UPPer:LIMit <Value> // Define upper limit
MEASurement4:AMPtime:LCHeck7:VALid ILIMit // Define valid range for limits
MEASurement4:LCHeck LIMit' // Enable limit check

```

27.3.3 Mask testing

- [Creating a user mask](#)..... 1351

27.3.3.1 Creating a user mask

Creates new user mask "MyMask" with one inner segment, and turns on the mask test.

Command description in: [Chapter 27.14, "Mask testing"](#), on page 1691.

In the following example *OPC prevents overlapping execution of asynchronous commands.

```

MTEST:ADD 'MyMask'
MTEST:SEGM:ADD 'MyMask'
MTEST:SEGM:POIN:ADD 'MyMask', 0

```

```

MTEST:SEGM:POIN:X 'MyMask', 0, 0, -20e-9
MTEST:SEGM:POIN:Y 'MyMask', 0, 0, -0.1
MTEST:SEGM:POIN:ADD 'MyMask', 0
MTEST:SEGM:POIN:X 'MyMask', 0, 1, -20e-9
MTEST:SEGM:POIN:Y 'MyMask', 0, 1, 0.1
MTEST:SEGM:POIN:ADD 'MyMask', 0
MTEST:SEGM:POIN:X 'MyMask', 0, 2, 20e-9
MTEST:SEGM:POIN:Y 'MyMask', 0, 2, 0.1
MTEST:SEGM:POIN:ADD 'MyMask', 0
MTEST:SEGM:POIN:X 'MyMask', 0, 3, 20e-9
MTEST:SEGM:POIN:Y 'MyMask', 0, 3, -0.1
MTEST:SEGM:REG 'MyMask', 0, INNER
MTEST:STAT 'MyMask', ON
*OPC?

```

27.3.4 Search

- [Searching for a pulse of a specified width](#).....1352

27.3.4.1 Searching for a pulse of a specified width

In the following example *OPC prevents overlapping execution of asynchronous commands.

Search for positive pulses with pulse width $12 \pm 10 \mu\text{s}$ ($2 \mu\text{s}$ to $22 \mu\text{s}$).

Command description in: [Chapter 27.15, "Search"](#), on page 1715.

The usage of asynchronous commands is described in www.rohde-schwarz.com/rc-via-scpi, chapter "Command Sequence and Synchronization".

```

SEAR:ADD 'MySearch' // Create a new search
SEAR:TRIG:WIDT:STAT 'MySearch',1 // Configure search type
SEAR:SOUR 'MySearch',M1 // Configure search source - here Math1
SEAR:TRIG:WIDT:RANG 'MySearch',WITH // Configure search parameters
SEAR:TRIG:WIDT:WIDT 'MySearch',5e-4 // Configure search parameters
SEAR:TRIG:WIDT:DELT 'MySearch',5e-6 // Configure search parameters
SEAR:RES:LIM 'MySearch',1 // Set number of result lines in table to 1
*OPC?
SEAR:ALL 'MySearch'; // Initiate search for all events, asynchr. command

```

27.3.5 Data management

- [Saving a screenshot to file](#)..... 1353
- [Exporting waveform data to file](#)..... 1353
- [Exporting measurement results to file](#)..... 1359

27.3.5.1 Saving a screenshot to file

Saves three display images in png format to the files `Print.png`, `Print_001.png`, and `Print_002.png` in the directory `C:\Temp`. To get a correct screenshot, turn on the display first.

Command description in: [Chapter 27.16.8, "Screenshots"](#), on page 1779.

In the following example `*OPC` prevents overlapping execution of asynchronous commands.

```
SYST:DISP:UPD ON
HCOP:DEST 'MMEM'
HCOP:DEV:LANG PNG
*OPC?
MMEM:NAME 'C:\Temp\Print.png'
HCOP:IMMEDIATE; *OPC?
HCOP:IMM:NEXT; *OPC?
HCOP:IMM:NEXT; *OPC?
```

27.3.5.2 Exporting waveform data to file

Command description in:

- [Chapter 27.16.4, "Waveform data export to file"](#), on page 1766
- [Chapter 27.16.1, "Instrument settings"](#), on page 1757
- [Chapter 27.10.4, "History"](#), on page 1563

In the following example `*OPC` prevents overlapping execution of asynchronous commands.

- [Exporting a single waveform to an XML file](#)..... 1353
- [Exporting raw data of a single waveform to a BIN file](#)..... 1354
- [Exporting raw data of a measurement gate to a BIN file](#)..... 1354
- [Exporting interleaved x/y data of a single waveform to a CSV file](#)..... 1355
- [Exporting interleaved x/y data of a zoom to CSV file](#)..... 1355
- [Exporting multiple running acquisitions of a single waveform to an XML file](#)..... 1356
- [Exporting a single acquisition of the history to a BIN file](#)..... 1356
- [Exporting multiple acquisitions of the history to an XML file](#)..... 1357
- [Exporting and reconstructing multiple raw acquisitions of the history file](#)..... 1357

Exporting a single waveform to an XML file

Saves a single analog waveform completely to an XML file. Data logging is off.

The usage of asynchronous commands is described in www.rohde-schwarz.com/rc-via-scp, chapter "Command Sequence and Synchronization".

```
STOP;*OPC?
EXPort:WAVEform:FASTexport ON
CHANnel:WAVEform1:STATe 1
*OPC?
RUNSingle;*OPC?
```

```

EXPort:WAVeform:SOURce C1W1
EXPort:WAVeform:SCOPE WFM
EXPort:WAVeform:NAME 'C:\Data\DataExportWfm_analog.xml'
EXPort:WAVeform:RAW OFF
EXPort:WAVeform:INCXvalues OFF
EXPort:WAVeform:DLOGging OFF
MMEM:DEL 'C:\Data\DataExportWfm_analog.*'
EXPort:WAVeform:SAVE
*OPC?
MMEM:DATA? 'C:\Data\DataExportWfm_analog.xml'
MMEM:DATA? 'C:\Data\DataExportWfm_analog.wfm.xml'

```

Exporting raw data of a single waveform to a BIN file

Saves the data of a single analog waveform in integer 8-bit format (raw data) to a BIN file. Data logging is off.

Data conversion is described in "[Raw \(ADC direct\)](#)" on page 469.

In the following example *OPC prevents overlapping execution of asynchronous commands.

```

STOP;*OPC?
EXPort:WAVeform:FASTexport ON
CHANnel1:WAVeform1:STATe 1
RUNSingle; *OPC?
EXPort:WAVeform:SOURce C1W1
EXPort:WAVeform:SCOPE WFM
EXPort:WAVeform:NAME 'C:\Data\DataExportWfm_analog.bin'
EXPort:WAVeform:RAW ON
EXPort:WAVeform:INCXvalues OFF
EXPort:WAVeform:DLOGging OFF
MMEM:DEL 'C:\Data\DataExportWfm_analog.*'
EXPort:WAVeform:SAVE
*OPC?
MMEM:DATA? 'C:\Data\DataExportWfm_analog.bin'
MMEM:DATA? 'C:\Data\DataExportWfm_analog.wfm.bin'

```

Exporting raw data of a measurement gate to a BIN file

Saves the data of a measurement gate in integer 8-bit format (raw data) to a BIN file. Data logging is off.

In the following example *OPC prevents overlapping execution of asynchronous commands.

```

STOP;*OPC?
EXPort:WAVeform:FASTexport ON
CHANnel1:WAVeform1:STATe 1
MEASurement2:CATegory AMPT
MEASurement2:MAIN MEAN
MEASurement2:ENABle 1
MEASurement2:SOURce C1W1

```

```

MEASurement2:GATE:MODE ABS
MEASurement2:GATE:ABS:START -0.00012
MEASurement2:GATE:ABS:STOP -5e-06
MEASurement2:GATE:STATE On
EXPort:WAVeform:SOURce C1W1
EXPort:WAVeform:SCOPE GATE
EXPort:WAVeform:MEAS Meas2
*OPC?
RUNSingle;*OPC?
EXPort:WAVeform:NAME 'C:\Data\DataExportWfm_analog.bin'
EXPort:WAVeform:RAW ON
EXPort:WAVeform:INCXvalues OFF
EXPort:WAVeform:DLOGging OFF
MME:DEL 'C:\Data\DataExportWfm_analog.*'
EXPort:WAVeform:SAVE
*OPC?
MME:DATA? 'C:\Data\DataExportWfm_analog.bin'
MME:DATA? 'C:\Data\DataExportWfm_analog.wfm.bin'

```

Exporting interleaved x/y data of a single waveform to a CSV file

Saves the x- and y-values of a single analog waveform to a CSV file. Data logging is off.

In the following example *OPC prevents overlapping execution of asynchronous commands.

```

STOP;*OPC?
EXPort:WAVeform:FASTexport ON
CHANnel:WAVeform1:STATE 1
*OPC?
RUNSingle;*OPC?
EXPort:WAVeform:SOURce C1W1
EXPort:WAVeform:SCOPE WFM
EXPort:WAVeform:NAME 'C:\Data\DataExportWfm_analog.csv'
EXPort:WAVeform:RAW OFF
EXPort:WAVeform:INCXvalues ON
EXPort:WAVeform:DLOGging OFF
MME:DEL 'C:\Data\DataExportWfm_analog.*'
EXPort:WAVeform:SAVE
*OPC?
MME:DATA? 'C:\Data\DataExportWfm_analog.csv'
MME:DATA? 'C:\Data\DataExportWfm_analog.wfm.csv'

```

Exporting interleaved x/y data of a zoom to CSV file

Saves the x- and y-values that are displayed in a zoom diagram to a CSV file. Data logging is off.

In the following example *OPC prevents overlapping execution of asynchronous commands.

```

STOP;*OPC?
EXPort:WAVeform:FASTeXport ON
CHANnel:WAVeform1:STATe 1
LAYout:ZOOM:ADD 'Diagram1',HORIZONTAL,OFF,-0.00012,-5e-06,0.308,-0.092,'ExportAreaZoom'
*OPC?
RUNSingle;*OPC?
EXPort:WAVeform:SOURce C1W1
EXPort:WAVeform:SCOPE ZOOM
EXPort:WAVeform:ZOOM 'Diagram1', 'ExportAreaZoom'
EXPort:WAVeform:NAME 'C:\Data\DataExportWfm_analog.csv'
EXPort:WAVeform:RAW OFF
EXPort:WAVeform:INCXvalues ON
EXPort:WAVeform:DLOGging OFF
MMEM:DEL 'C:\Data\DataExportWfm_analog.*'
EXPort:WAVeform:SAVE
*OPC?
MMEM:DATA? 'C:\Data\DataExportWfm_analog.csv'
MMEM:DATA? 'C:\Data\DataExportWfm_analog.wfm.csv'

```

Exporting multiple running acquisitions of a single waveform to an XML file

Saves the data of 5 subsequent acquisitions of a single analog waveform to an XML file. Data logging is on.

In the following example *OPC prevents overlapping execution of asynchronous commands.

```

STOP;*OPC?
EXPort:WAVeform:FASTeXport ON
CHANnel:WAVeform1:STATe 1
EXPort:WAVeform:SOURce C1W1
EXPort:WAVeform:SCOPE WFM
EXPort:WAVeform:NAME 'C:\Data\DataExportWfm_analog.xml'
EXPort:WAVeform:RAW OFF
EXPort:WAVeform:INCXvalues OFF
*OPC?
ACQuire:COUNT 5
EXPort:WAVeform:DLOGging ON
MMEM:DEL 'C:\Data\DataExportWfm_analog.*'
RUNSingle;*OPC?
MMEM:DATA? 'C:\Data\DataExportWfm_analog.xml'
MMEM:DATA? 'C:\Data\DataExportWfm_analog.wfm.xml'

```

Exporting a single acquisition of the history to a BIN file

Saves the oldest acquisition of the history to a BIN file. Data logging is off.

In the following example *OPC prevents overlapping execution of asynchronous commands.

```

STOP;*OPC?
EXPort:WAVeform:FASTeXport ON
CHANnel:WAVeform1:STATe 1

```

```

EXPort:WAVeform:SOURce C1W1
EXPort:WAVeform:SCOpe WFM
EXPort:WAVeform:NAME 'C:\Data\DataExportWfm_analog.bin'
EXPort:WAVeform:RAW OFF
EXPort:WAVeform:INCXvalues OFF
EXPort:WAVeform:DLOGging OFF
*OPC?
MMEM:DEL 'C:\Data\DataExportWfm_analog.*'
ACQuire:COUNT 5 //Acquire 5 waveforms
RUNSingle;*OPC?
CHANnel:WAV1:HISTory:STATE ON
CHANnel:WAV1:HISTory:CURRENT -4;*OPC? //Oldest waveform of 5 has index -4
EXPort:WAVeform:SAVE
*OPC?
MMEM:DATA? 'C:\Data\DataExportWfm_analog.bin'
MMEM:DATA? 'C:\Data\DataExportWfm_analog.wfm.bin'

```

Exporting multiple acquisitions of the history to an XML file

Saves the data of 5 subsequent acquisitions of the history to an XML file. Data logging is on.

In the following example *OPC prevents overlapping execution of asynchronous commands.

```

STOP;*OPC?
EXPort:WAVeform:FASTexport ON
CHANnel:WAVeform1:STATE 1
EXPort:WAVeform:SOURce C1W1
EXPort:WAVeform:SCOpe WFM
EXPort:WAVeform:NAME 'C:\Data\DataExportWfm_analog.xml'
EXPort:WAVeform:RAW OFF
EXPort:WAVeform:INCXvalues OFF
EXPort:WAVeform:DLOGging ON
*OPC?
MMEM:DEL 'C:\Data\DataExportWfm_analog.*'
ACQuire:COUNT 5 //Acquire 5 waveforms
RUNSingle;*OPC?
CHANnel:WAV1:HISTory:STATE ON
CHANnel:WAV1:HISTory:START -4
CHANnel:WAV1:HISTory:STOP 0
CHANnel:WAV1:HISTory:REPLAY OFF
CHANnel:WAV1:HISTory:PLAY
*OPC?
MMEM:DATA? 'C:\Data\DataExportWfm_analog.xml'
MMEM:DATA? 'C:\Data\DataExportWfm_analog.wfm.xml'

```

Exporting and reconstructing multiple raw acquisitions of the history file

This example captures and exports 100 waveforms acquired in fast segmentation mode (minimize blind time). The data is transferred in blocks using SCPI commands.

In the following example *OPC prevents overlapping execution of asynchronous commands.

```
// --- Set data format to signed integers, 1 byte
FORMat:DATA INT,8

// --- Create history data (assuming on channel 1) ---
CHANnel:WAVeform1:STATe 1           //turn on channel 1
ACQuire:COUNt 100                   //acquire 100 waveforms
ACQuire:SEGmented:STATe ON; *OPC?
//turn on fast segmentation, acquisition is started and data is stored in the memory

// --- Set Export variables and export data ---
EXPort:WAVeform:SOURce C1W1         //specify source for data export
EXPort:WAVeform:SCOpe WFM           //specify range: complete acq. time
MMEM:DEL "C:\Users\Public\Documents\Rohde-Schwarz\RTx\Temp\DataExportWfm_analog.*"
//delete data from previous runs of this script
EXPort:WAVeform:NAME "C:\Users\Public\Documents\Rohde-Schwarz\RTx\Temp\DataExpWfm.bin"
//store data in this path and filename
EXPort:WAVeform:RAW ON
//export as raw ADC integer values (saves memory) --> data needs to be converted later
EXPort:WAVeform:INCXvalues OFF
//disable time values in data file. Time can be constructed from the header file
CHANnel:WAV1:HISTory:STATe ON       //switch to history view
EXPort:WAVeform:DLOGging ON        //enable data logging & history
EXPort:WAVeform:TIMestamps ON      //enable relative time stamp for each acq.
CHANnel:WAV1:HISTory:START -99     //oldest waveform of n acq. has index = (-1)*(n-1)
CHANnel:WAV1:HISTory:STOP 0        //newest waveforms has index 0
CHANnel:WAV1:HISTory:REPLay OFF
CHANnel:WAV1:HISTory:PLAY; *OPC?   //exports waveforms to defined file location.
//2 files are created: header file *.bin and waveform data file *.Wfm.bin

// --- Put files into output buffer of scope and collect ---
// The following code lines are mostly Pseudo Code.
//Sorting out the binary waveform data is more complex and require additional coding
binaryFormat = '1 byte'
//Pseudo Code, tell your language how to interpret the binary data,
//e.g. 'int8' for MATLAB
MMEM:DATA? "C:\Users\Public\Documents\Rohde-Schwarz\RTx\Temp\DataExpWfm.bin"
//Put header file into output buffer
header = readSCPIBinary(visaInstrument, binaryFormat);
//Pseudo Code, use appropriate command from your programming language,
//e.g. binblockread in MATLAB
MMEM:DATA? "C:\Users\Public\Documents\Rohde-Schwarz\RTx\Temp\DataExpWfm.Wfm.bin"
//Put data file into output buffer
//(your input buffer of the VISA resource might need to be increased)
wfmRaw = readSCPIBinary(visaInstrument, binaryFormat)
//Pseudo Code, use appropriate command from your programming language,
```



```
//e.g. binblockread in MATLAB.
//Note: Sort different acquisitions into an array separately after file transfer.

// --- Convert raw ADC values into voltage floating point values ---
// header is assumed to be a struct and the members are accessed via "." syntax.
vertOffsetByPosition = header.VerticalScale * header.VerticalPosition
conversionFactor = (1/header.NofQuantisationLevels) *
    header.VerticalScale * header.VerticalDivisionCount
for(i = 0; i<100; i++){
    wfmVolt(i) = wfmRaw(i) * conversionFactor +
        header.VerticalOffset - vertOffsetByPosition
}
// Note: Depending on settings, the waveform can contain more samples than the
//record length. Remove leading and trailing samples from the waveform.
```

27.3.5.3 Exporting measurement results to file

See:

- ["Exporting histogram data to file"](#) on page 1350
- ["Transferring histogram data"](#) on page 1350
- ["Exporting long-term measurement data to file"](#) on page 1350
- ["Transferring long-term measurement data"](#) on page 1351

27.3.6 Deembedding

27.3.6.1 Adding cables to the measurement setup

The example adds a cable to each channel and assigns an S-parameter file for each cable. Commands are explained in [Chapter 27.26, "Deembedding \(option R&S RTO6-K121\)"](#), on page 2798.

```
// Preset de-embedding, because *RST does not affect de-embedding
:DEEMbedding1:PRESet // Ch1
:DEEMbedding2:PRESet // Ch2
:DEEMbedding3:PRESet // Ch3
:DEEMbedding4:PRESet // Ch4

// Add cables to each channel, cable is added next to DUT at index 2 (DUT = index 1)
:DEEMbedding1:ADD 2,cabl // Ch1
:DEEMbedding2:ADD 2,cabl // Ch2
:DEEMbedding3:ADD 2,cabl // Ch3
:DEEMbedding4:ADD 2,cabl // Ch4

// Assign corresponding S2P file to channel
:DEEMbedding1:COMPONENT2:SPONE 'C:\Rtx\Deembedding\RT-ZA17-1806671-0005-A.s2p'
```

```
:DEEMbedding2:COMPonent2:SPONE 'C:\Rtx\Deembedding\RT-ZA17-1806671-0005-B.s2p'
:DEEMbedding3:COMPonent2:SPONE 'C:\Rtx\Deembedding\RT-ZA17-1806671-0006-A.s2p'
:DEEMbedding4:COMPonent2:SPONE 'C:\Rtx\Deembedding\RT-ZA17-1806671-0006-B.s2p'
```

27.3.7 Protocol analysis

27.3.7.1 RFFE (option R&S RTO6-K550)

Configuring RFFE bus

Example 1: 1.8 V bus

In the following example *OPC prevents overlapping execution of asynchronous commands.

```
//Configure source and thresholds for 1.8 V bus
STOP;*OPC?
BUS1:TYPE RFFE
BUS1:LABel "RFFE Test 2"
BUS1:RFFE:CLOCK:SOUR C2W1
BUS1:RFFE:DATA:SOUR C1W1
BUS:RFFE:PRESet V18

//Load a label list and switch on
BUS1:NEWList 'C:\Protocols\RFFE.csv'
BUS1:SYMBOLs ON

//Initiate single sweep
CHANnel1:STATe ON
CHANnel2:STATe ON
BUS1 ON
RUNSingle;*OPC?
```

Example 2: User-defined thresholds with threshold coupling

```
//Configure source and user-defined thresholds
STOP;*OPC?
BUS1:TYPE RFFE
BUS1:LABel "RFFE Test 1"
BUS1:RFFE:CLOCK:SOUR C2W1
BUS1:RFFE:DATA:SOUR C1W1
BUS1:RFFE:COUPling ON
BUS1:RFFE:CLOCK:THReshold:HYSteresis 0.2
BUS1:RFFE:CLOCK:THReshold:HIGH 0.72
BUS1:RFFE:CLOCK:THReshold:LOW 0.48
```

Triggering on RFFE bus

Trigger on sequence start of sequences that have the slave address 0010, 0011, or 0100.

```
//Set trigger source to serial bus
TRIGger1:SOURce SBUS
TRIGger:MODE NORMAl

//Trigger on sequence start of all sequences with slave address range
TRIGger1:RFFE:TYPE START
TRIG1:RFFE:SADD:CONDition INR
TRIG1:RFFE:SADD:MIN #H2 //SAD = 0010
TRIG1:RFFE:SADD:MAX #H4 //SAD = 0100
```

Searching RFFE data

Search for sequence ends of sequences if the last bit of slave address is 1.

```
STOP;*OPC?
SEARch:ADD 'RFFESearch1'
SEARch:SOURce 'RFFESearch1',SBUS1
SEARch:TRIGger:RFFE:TYPE 'RFFESearch1',STOP
SEARch:TRIGger:RFFE:SADD:COND 'RFFESearch1', EQU
SEARch:TRIGger:RFFE:SADD:MIN 'RFFESearch1', 'XXX1'
RUNSingle;*OPC? //asynchronous command
SEARch:ALL 'RFFESearch1';*OPC?
SEARch:RESult:RFFE:FCount? 'RFFESearchCh1'

SEARch:RESult:RFFE:SEQuence1:STATE? 'RFFESearchCh1'
<--OK //First sequence is valid
SEARch:RESult:RFFE:SEQuence1:TYPE? 'RFFESearchCh1'
<--ERRL //Extended Register Read Long sequence
```

27.3.7.2 SENT (option R&S RTO6-K520)

Configuring SENT bus

```
// Set protocol parameters
//*****
STOP;*OPC?
BUS:TYPE SENT
BUS:LABel "Bus 1 SENT"
BUS:SENT:DATA:SOURce C1W1
BUS:SENT:DATA:THReshold 2.0
BUS:SENT:CLKPeriod 0.000005
BUS:SENT:CLKTolerance 20.0
BUS:SENT:CRCVersion V2010
BUS:SENT:CRCMethod TLE
BUS:SENT:DNIBbles 5
```

```

BUS:SENT:PPULse NPP
BUS ON

//*****
// Load a label list and switch on
BUS:NEWList 'C:\Protocols\SENT_Labels.xml'
BUS:SYMBOLs ON
RUNSingle;*OPC?           //asynchronous command

//*****
// Display all results
BUS:SENT:RDSL ALL

//*****
// Display the fast channel transmission sequence
BUS:SENT:RDSL TRSQ

//*****
// Display the short serial message of slow channel
BUS:SENT:RDSL MSG

```

Triggering on SENT bus

```

//Set trigger source to serial bus
TRIGger1:SOURce SBUS
TRIGger:MODE NORMAL

//Trigger on the fast channel transmission sequence
TRIGger1:SENT:TYPE TSEQ
TRIGger1:SENT:TTYPE STDA
TRIGger1:SENT:statbit #H2
TRIGger1:SENT:DCondition INR
BUS1:SENT:DNibbles 5
TRIGger1:SENT:DMIN #H2 //Data MIN = 0010
TRIGger1:SENT:DMAX #H4 //Data MAX = 0100

```

Searching SENT data

```

// Search for all frames with sync/calibration pulse
SEARCH:TRIGger:SENT:CALibration 'Search1', ON
SEARCH:ONLine 'Search1',ON
SEARCH:RESult:SORT:ASCending 'Search1', ON
SEARCH:RESult:SENT:FCOunt? 'Search1'
SEARCH:RESult:SENT:FRAMe1:STAT? 'Search1'
SEARCH:RESult:SENT:FRAMe1:START? 'Search1'
SEARCH:RESult:SENT:FRAMe1:STOP? 'Search1'
SEARCH:RESult:SENT:FRAMe1:DATA? 'Search1'
SEARCH:RESult:SENT:FRAMe1:NIBB1:VALue? 'Search1'
SEARCH:RESult:SENT:FRAMe1:NIBB2:VALue? 'Search1'
SEARCH:RESult:SENT:FRAMe1:CSValue? 'Search1'

```

```

SEARCh:RESult:SENT:FRAMe1:SCOM? 'Search1'
SEARCh:TRIGger:SENT:CALibration 'Search1', OFF

//*****
// Search Short serial message
SEARCh:TRIGger:SENT:SHORT 'Search1', ON
SEARCh:RESult:SENT:FCOunt? 'Search1'

SEARCh:RESult:SENT:FRAMe1:STAT? 'Search1'
SEARCh:RESult:SENT:FRAMe1:IDValue? 'Search1'
SEARCh:RESult:SENT:FRAMe1:NIBB1:VALue? 'Search1'
SEARCh:RESult:SENT:FRAMe1:NIBB2:VALue? 'Search1'
SEARCh:RESult:SENT:FRAMe1:CSValue? 'Search1'

SEARCh:TRIGger:SENT:SHORT 'Search1', OFF

//*****
// Search Enhanced serial message
SEARCh:TRIGger:SENT:ENHanced 'Search1', ON

SEARCh:RESult:SENT:FCOunt? 'Search1'

SEARCh:RESult:SENT:FRAMe1:STAT? 'Search1'
SEARCh:RESult:SENT:FRAMe1:IDValue? 'Search1'
SEARCh:RESult:SENT:FRAMe1:NIBB1:VALue? 'Search1'
SEARCh:RESult:SENT:FRAMe1:NIBB2:VALue? 'Search1'
SEARCh:RESult:SENT:FRAMe1:CSValue? 'Search1'

SEARCh:TRIGger:SENT:ENHanced 'Search1', OFF

```

27.3.8 Power analysis (option R&S RTO6-K31)

27.3.8.1 Auto deskew

Configures the voltage and current probes for power measurements and executes the auto deskew.

Command description in [Chapter 27.25.1, "General"](#), on page 2756 and [Chapter 27.25.2, "Deskew"](#), on page 2757.



If the instrument refuses to accept `POWer` commands, activate the power mode with `:POWer:ENABle`.

In the following example `*OPC` prevents overlapping execution of asynchronous commands.

```
*RST; *OPC?
STOP;*OPC?
```

```

//Activate two channels
:CHANnel1:STATe 1
:CHANnel2:STATe 1

//Activate power
:POWer:ENABle

//Select current and voltage sources
:POWer:SOURce:VOLTage1 CHANnel1
:POWer:SOURce:CURRent1 CHANnel2
*OPC?

//Configure voltage probe on CH1 manually
//Not necessary if you use an active R&S voltage probe that is recognized by the instrument
:PROBe1:SETup:ATTenuation:MODE Manual
:PROBe:SETup:ATTenuation:DEFProbe ZD01a100
*OPC?
//selected high voltage differential probe 1:100

//Configure current probe on CH2 manually
//Always required because R&S current probes are not recognized automatically
PROBe2:SETup:ATTenuation:MODE Manual
PROBe2:SETup:ATTenuation:DEFProbe ZC20
*OPC?
//select 20MHz current probe ZC10 also possible

//Start deskew
//Overwrites the skew offset of CH2 (current probe), because :POWer:DESKew:RESet? == 1
//writes a user-defined preset file (UserDefinedPreset_AutoDeskew.dfl) and
//activates the user defined preset, because :POWer:DESKew:UDPReset? == 1
:POWer:DESKew:EXECute;

//Check result
CHANnel2:SKew:MAN?
CHANnel2:SKew:TIME?
POWer:DESKew:TIME?
*OPC?

```

Effect of *RST and loading user-defined preset

Note that *RST resets the deskew values.

You can reload the deskew values as follows:

```

*RST;*OPC?
STOP;*OPC?
:POWer:ENABle
//Select voltage and current sources
:POWer:SOURce:VOLTage1 CHANnel1
:POWer:SOURce:CURRent1 CHANnel2

```

```

*OPC?
//Reload deskew values
:POWer:DESKew:CURRent
*OPC?
//Load default saveset after FW restart
MMEM:RCL 'C:\Users\Public\Documents\Rohde-Schwarz\RTx\SaveSets
\UserDefinedPreset_AutoDeskew.dfl'

```

27.3.8.2 Transient response measurement

Configures and executes a transient response measurement.

Command description in [Chapter 27.25.15, "Transient response"](#), on page 2793.

Make sure to configure and deskew the probes before the measurement, see [Chapter 27.3.8.1, "Auto deskew"](#), on page 1363.

```

//Activate power
*RST; *OPC?
:POWer:ENABle

//Expected smps frequency
:POW:TRANsient:FREQ          12500000

:POWer:TRANsient:AUToscale AUTO

:POWer:TRANsient:SIGHHigh 0.1
:POWer:TRANsient:SIGLow 0.025
:POWer:TRANsient:HYSTeresis 20

//Trigger channel
:POWer:TRANsient:TRGC CHAN2

//Edge trigger slope
:POWer:TRANsient:TRGS POS

//Trigger level
:POWer:TRANsient:TRGL 0.08

//Run measurement
:POWer:TRANsient:EXECute;*OPC?

//Query results
:POWer:TRANsient:RESult? SETTling
:POWer:TRANsient:RESult? PEAKtime
:POWer:TRANsient:RESult? DELay
:POWer:TRANsient:RESult? RTIME
:POWer:TRANsient:RESult? OVERshoot

```

```
//Add to report
:Power:TRANsient:REPort:Add
```

27.4 Frequently used parameters and suffixes

This chapter describes in general those parameters and suffixes that are used in several subsystems.

27.4.1 Waveform suffix

The numeric waveform suffix is used in some commands, for example, to indicate the source waveform number from which the reference level is taken, and to assign color tables to waveforms.



Depending on the command, not all suffix values are supported. For example, in REFLevel commands, only suffixes 2 to 21 are allowed. The range of supported suffix numbers is indicated in the description of the individual commands.

NOTICE

Suffix 1

Suffix 1 means that no waveform is assigned. The first waveform C1W1 corresponds to suffix number 2.

Waveform number	Description
1	None
2	C1W1 (channel 1, waveform 1)
3	C1W2 (channel 1, waveform 2)
4	C1W3 (channel 1, waveform 3)
5	C2W1 (channel 2, waveform 1)
6	C2W2 (channel 2, waveform 2)
7	C2W3 (channel 2, waveform 3)
8	C3W1 (channel 3, waveform 1)
9	C3W2 (channel 3, waveform 2)
10	C3W3 (channel 3, waveform 3)
11	C4W1 (channel 4, waveform 1)
12	C4W2 (channel 4, waveform 2)
13	C4W3 (channel 4, waveform 3)

Frequently used parameters and suffixes

Waveform number	Description
14 to 17	Math waveforms: M1, M2, M3, M4 M5 to M8: suffixes 119 to 122
18 to 21	Reference waveforms: R1, R2, R3, R4
22 to 25	XY-waveforms: XY1, XY2, XY3, XY4
26 to 33	Measurement results: MRESult1, MRESult2, MRESult3, MRESult4, MRESult5, MRESult6, MRESult7, MRESult8 MRESult1 are the results of measurement group 1 and so on.
34 to 35	not used
36 to 39	Serial buses: SBUS1, SBUS2, SBUS3, SBUS4
40 to 55	Digital channels: D0 to D15 (option R&S RTO6-B1)
56 to 59	Digital buses: MSO1, MSO2, MSO3, MSO4 (option R&S RTO6-B1)
60	not used
61 to 68	Track waveforms: TRK1, TRK2, TRK3, TRK4, TRK5, TRK6, TRK7, TRK8
69 to 71	not used
72 to 75	Spectrograms: SG1, SG2, SG3, SG4. Available for option R&S RTO6-K37. SG5 to SG8: suffixes 119 to 122. Available for option R&S RTO6-K133.
76 to 83	Timeline spectrums: SG1TL1, SG1TL2, SG2TL1, SG2TL2, SG3TL1, SG3TL2, SG4TL1, SG4TL2. Available for option R&S RTO6-K37 TL1 is timeline 1, TL2 is timeline 2 SG5TL1 to SG8TL2: suffixes 123 to 130. Available for option R&S RTO6-K133.
84 to 87	Eye diagrams: EYE1, EYE2, EYE3, EYE4 Available for eye diagram analysis with option R&S RTO6-K91
88 to 91	Voltage input channels of multi-channel probe R&S RT-ZVC (probe 1) R&S RT-ZVC04: Z1V1 Z1V2 Z1V3 Z1V4 R&S RT-ZVC02: Z1V1 Z1V2. Suffixes 90 to 91 are not available.
92 to 95	Current input channels of multi-channel probe R&S RT-ZVC (probe 1) R&S RT-ZVC04: Z1I1 Z1I2 Z1I3 Z1I4 R&S RT-ZVC02: Z1I1 Z1I2. Suffixes 94 to 95 are not available.
96 to 99	Voltage input channels of multi-channel probe R&S RT-ZVC (probe 2) R&S RT-ZVC04: Z2V1 Z2V2 Z2V3 Z2V4 R&S RT-ZVC02: Z2V1 Z2V2. Suffixes 98 to 99 are not available.
100 to 103	Current input channels of multi-channel probe R&S RT-ZVC (probe 2) R&S RT-ZVC04: Z2I1 Z2I2 Z2I3 Z2I4 R&S RT-ZVC02: Z2I1 Z2I2. Suffixes 102 to 103 are not available.
104 to 107	not used
108 to 111	Resulting waveforms of differential deembedding: DIFF1 DIFF2 COMMON1 COMMON2

Frequently used parameters and suffixes

Waveform number	Description
112 to 114	Resulting waveforms of TDR/TDT analysis (option R&S RTO6-K130): TDRZ TDRH TDRR
115 to 118	Math waveforms: M5, M6, M7, M8 M1 to M4: suffixes 14 to 17
119 to 122	Spectrograms: SG5, SG6, SG7, SG8. Available for option R&S RTO6-K133. SG1 to SG4: suffixes 72 to 75. Available for option R&S RTO6-K37.
123 to 130	Timeline spectrums: SG5TL1, SG5TL2, SG6TL1, SG6TL2, SG7TL1, SG7TL2, SG8TL1, SG8TL2. Available for option R&S RTO6-K133. TL1 is timeline 1, TL2 is timeline 2 SG1TL1 to SG4TL2: suffixes 76 to 83. Available for option R&S RTO6-K37.
131 to 140	HP1 HP2 HP3 HP4 HP5 HP6 HP7 HP8 HP9 HP10 Available for option R&S RTO6-K133.
141	not used
142 to 144	BATHtub1 BMEas1 SRESponse1 Bathtub diagram, bathtub measurement, and step response of 1st advanced jitter measurement, option R&S RTO6-K133/K134.
145 to 151	SRHist1 SDHist1 TJHist1 DJHist1 DDJHist1 PJHist1 RJOHist1 Histograms of 1st advanced jitter measurement, option R&S RTO6-K133/K134. SR: symbol rate, SD: symbol duration, TJ: total jitter, DDJ: data-dependent jitter, PJ: periodic jitter, RJO: random jitter.
152, 154- 158	SRTRack1 TJTRack1 DJTRack1 DDJTrack1 PJTRack1 RJOTrack1 Tracks of 1st advanced jitter measurement, option R&S RTO6-K133/K134.
153	not used
159 to 163	TJSpectrum1 DDJSpectrum1 PJOSpectrum1 RJOSEpectrum1 SEYE1 Spectrograms and synthetic eye diagram of 1st advanced jitter measurement, option R&S RTO6-K133/K134.
164	not used
165 to 167	BATHtub2 BMEas2 SRESponse2 Bathtub diagram, bathtub measurement, and step response of 2nd advanced jitter measurement, option R&S RTO6-K133/K134.
168 to 174	SRHist2 SDHist2 TJHist2 DJHist2 DDJHist2 PJOHist2 RJOHist2 Histograms of 2nd advanced jitter measurement, option R&S RTO6-K133/K134.
175-177, 179-181	SRTRack2 SDTRack2 TJTRack2 DDJTrack2 PJOTrack2 RJOTrack2 Tracks of 1st advanced jitter measurement, option R&S RTO6-K133/K134.
178	not used
182 to 186	TJSpectrum2 DDJSpectrum2 PJOSpectrum2 RJOSEpectrum2 SEYE2 Spectrograms and synthetic eye diagram of 2nd advanced jitter measurement, option R&S RTO6-K133/K134.

Frequently used parameters and suffixes

Waveform number	Description
187 to 188	NBATHtub1 NBMeas1 Noise bathtub diagram and noise bathtub measurement of 1st noise measurement, option R&S RTO6-K134.
189 to 193	TNHist1 DNHist1 DDNHist1 PNHist1 RNOHist1 Histograms of 1st noise measurement, option R&S RTO6-K134. TN: total noise, DN: deterministic noise, DDN: data-dependent noise, PJ: periodic noise, RNO: random noise.
194, 196 to 198	TNTRack1 DDNTrack1 PNTRack1 RNOTRack1 Tracks of 1st noise measurement, option R&S RTO6-K134.
195	not used
199 to 202	TNSpectrum1 DDNSpectrum1 PNSpectrum1 RNOSpectrum1 Spectrograms of 1st noise measurement, option R&S RTO6-K134.
203 to 204	NBATHtub2 NBMeas2 Noise bathtub diagram and noise bathtub measurement of 2nd noise measurement, option R&S RTO6-K134.
205 to 209	TNHist2 DNHist2 DDNHist2 PNHist2 RNOHist2 Histograms of 2nd noise measurement, option R&S RTO6-K134.
210, 212 to 214	TNTRack2 DDNTrack2 PNTRack2 RNOTRack2 Tracks of 2nd noise measurement, option R&S RTO6-K134.
211	not used
215 to 218	TNSpectrum2 DDNSpectrum2 PNSpectrum2 RNOSpectrum2 Spectrograms eye diagram of 2nd noise measurement, option R&S RTO6-K134.
219 to 221	PJDHist1 BUJHist1 RJHist1 Histograms of 1st jitter measurement, option R&S RTO6-K134. BUJ: (Other) bounded uncorrelated jitter.
222	PJDTrack1 Tracks of 1st data dependent and periodic jitter noise measurement, option R&S RTO6-K134.
223	PJDSpectrum1 Spectrograms of 1st data dependent and periodic jitter noise measurement, option R&S RTO6-K134.
224 to 226	PJDHist2 BUJHist2 RJHist2 Histograms of 2nd noise measurement, option R&S RTO6-K134.
227	PJDTrack2 Tracks of 2nd data dependent and periodic jitter noise measurement, option R&S RTO6-K134.
228	PJDSpectrum2 Spectrograms of 2nd data dependent and periodic jitter measurement, option R&S RTO6-K134.

Frequently used parameters and suffixes

Waveform number	Description
229 to 231, 234 to 236	PNDHist1 BUNHist1 RNHist1 PNDHist2 BUNHist2 RNHist2 Histograms of noise measurement, option R&S RTO6-K134. BUN: (Other) bounded uncorrelated noise.
232	PNDTrack1 Tracks of 1st data dependent and periodic noise measurement, option R&S RTO6-K134.
233	PNDSpectrum1 Spectrograms of 1st data dependent and periodic noise measurement, option R&S RTO6-K134.
237	PNDTrack2 Tracks of 2nd data dependent and periodic noise measurement, option R&S RTO6-K134.
238	PNDSpectrum2 Spectrograms of 2nd data dependent and periodic noise measurement, option R&S RTO6-K134.
243-250	JHI1_1, JHI1_2, JHI1_3, JHI1_4, JHI1_5, JHI1_6, JHI1_7, JHI1_8, Jitter histograms for PAM-N signals, option R&S RTO6-K133 and option R&S RTO6-K135
250-258	JTR1_1, JTR1_2, JTR1_3, JTR1_4, JTR1_5, JTR1_6, JTR1_7, JTR1_8 Jitter tracks for PAM-N signals, option R&S RTO6-K133 and option R&S RTO6-K135
259-266	NHI1_1, NHI1_2, NHI1_3, NHI1_4, NHI1_5, NHI1_6, NHI1_7, NHI1_8, Noise histograms for PAM-N signals, option R&S RTO6-K134 and option R&S RTO6-K135
267-274	NTR1_1, NTR1_2, NTR1_3, NTR1_4, NTR1_5, NTR1_6, NTR1_7, NTR1_8 Noise tracks for PAM-N signals, option R&S RTO6-K134 and option R&S RTO6-K135
275-282	JHI2_1, JHI2_2, JHI2_3, JHI2_4, JHI2_5, JHI2_6, JHI2_7, JHI2_8 Jitter histograms for PAM-N signals, option R&S RTO6-K133 and option R&S RTO6-K135
283-290	JTR2_1, JTR2_2, JTR2_3, JTR2_4, JTR2_5, JTR2_6, JTR2_7, JTR2_8 Jitter tracks for PAM-N signals, option R&S RTO6-K133 and option R&S RTO6-K135
291-298	NHI2_1, NHI2_2, NHI2_3, NHI2_4, NHI2_5, NHI2_6, NHI2_7, NHI2_8, Noise histograms for PAM-N signals, option R&S RTO6-K134 and option R&S RTO6-K135
299-306	NTR2_1, NTR2_2, NTR2_3, NTR2_4, NTR2_5, NTR2_6, NTR2_7, NTR2_8 Noise tracks for PAM-N signals, option R&S RTO6-K134 and option R&S RTO6-K135
307-308	CDRSW3, CDRSW4

Waveform number	Description
309-312	LPDFE1, LPDFE2, LPDFE3, LPDFE4 Embedding and equalization signal lanes including TxFFE, Embedding, CTLE and FFE(option R&S RTO6-K126)
313-316	LANE1, LANE2, LANE3, LANE4 Embedding and equalization signal lanes including TxFFE, Embedding, CTLE, FFE and DFE (option R&S RTO6-K126)

27.4.2 Waveform parameter

Many commands requires one of the waveforms to be specified as source. The following table lists all waveforms. For each command using a waveform parameter, the available waveforms are specified in the command description.

Waveform	Description
C1W1 C1W2 C1W3	Channel 1 waveforms
C2W1 C2W2 C2W3	Channel 2 waveforms
C3W1 C3W2 C3W3	Channel 3 waveforms
C4W1 C4W2 C4W3	Channel 4 waveforms
M1 M2 M3 M4 M5 M6 M7 M8	Math waveforms
R1 R2 R3 R4	Reference waveforms
XY1 XY2 XY3 XY4	XY-waveforms
MRESult1 MRESult2 MRESult3 MRESult4 MRESult5 MRESult6 MRESult7 MRESult8	Measurement results
SBUS1 SBUS2 SBUS3 SBUS4	Serial buses
D0 D1 D2 D3 D4 D5 D6 D7 D8 D9 D10 D11 D12 D13 D14 D15	Digital channels (option R&S RTO6-B1)
MSOB1 MSOB2 MSOB3 MSOB4	Digital buses (option R&S RTO6-B1)
TRK1 TRK2 TRK3 TRK4 TRK5 TRK6 TRK7 TRK8	Track waveforms
CDRSW1 = CDRSw1, CDRSW2 = CDRSw2, CDRSW3 = CDRSw3, CDRSW4 = CDRSw4 CDRHW = CDRhw	Generated clock signals
SG1 SG2 SG3 SG4	Spectrograms (option R&S RTO6-K37)
SG5 SG6 SG7 SG8	Advanced jitter analysis (option R&S RTO6-K133)
SG1TL1, SG1TL2, SG2TL1, SG2TL2, SG3TL1, SG3TL2, SG4TL1, SG4TL2	Spectrograms (option R&S RTO6-K37)
SG5TL1, SG5TL2, SG6TL1, SG6TL2, SG7TL1, SG7TL2, SG8TL1, SG8TL2	Advanced jitter analysis (option R&S RTO6-K133)
EYE1 EYE2 EYE3 EYE4	Available for eye diagram analysis with option R&S RTO6-K91

Frequently used parameters and suffixes

Waveform	Description
Z1V1 Z1V2 Z1V3 Z1V4 Z1I1 Z1I2 Z1I3 Z1I4 Z2V1 Z2V2 Z2V3 Z2V4 Z2I1 Z2I2 Z2I3 Z2I4 Z1V1 Z1V2 Z1I1 Z1I2 Z2V1 Z2V2 Z2I1 Z2I2	Input channels of multi-channel probe R&S RT-ZVC04 Input channels of multi-channel probe R&S RT-ZVC02
DIFF1 DIFF2 COMMON1 COMMON2	Resulting waveforms of differential deembedding
TDRZ TDRH TDRR	Resulting waveforms of TDR/TDT analysis (option R&S RTO6-K130)
SEYE1 SEYE2	Available for synthetic eye diagram analysis with option R&S RTO6-
TJSpectrum1 TJSpectrum2 DDJSpectrum1 DDJSpectrum2 PJSpectrum1 PJSpectrum2 RJOSSpectrum RJOSSpectrum1	Spectrograms of the advanced jitter analysis components (option R&S RTO6-K133/K134) TJ: total jitter DDJ: data-dependent jitter PJ: periodic jitter RJO: random jitter
BATHtub1 BATHtub2	Bathtub diagrams of the advanced jitter analysis components (option R&S RTO6-K133/K134)
BMEas1 BMEas2	Bathtub measurements of the advanced jitter analysis components (option R&S RTO6-K133/K134)
SRTRack1 SRTRack2 SDTRack1 SDTRack2 TJTRack1 TJTRack2 DJTRack1 DJTRack2 DDJTrack1 DDJTrack2 PJOTrack1 PJOTrack2 RJOTrack1 RJOTrack2	Tracks of the advanced jitter analysis components (option R&S RTO6-K133/K134) SR: Symbol rate SD: Symbol duration
SRESponse1 SRESponse2	Step response of the advanced jitter analysis (option R&S RTO6-K133/K134)
TNSpectrum1 TNSpectrum2 DDNSpectrum1 DDNSpectrum2 PNSpectrum1 PNSpectrum2 RNOSpectrum1 RNOSpectrum2	Spectrograms of the advanced jitter analysis components (option R&S RTO6-K134) TN: total noise DDN: data-dependent noise PN: periodic noise RNO: random noise
NBAThtub1 NBAThtub2	Bathtub diagrams of the noise analysis components (option R&S RTO6-K134)
NBMeas1 NBMeas2	Bathtub measurements of the noise analysis components (option R&S RTO6-K134)
TNTRack1 TNTRack2 DNTRack1 DNTRack2 DDNTrack1 DDNTrack2 PNTRack1 PNTRack2 RNOTrack1 RNOTrack2	Tracks of the noise analysis components (option R&S RTO6-K134)
LPDFE1 LPDFE2 LPDFE3 LPDFE4	Signal lanes pre-DFE (option R&S RTO6-K126)
LANE1 LANE2 LANE3 LANE4	Signal lanes (option R&S RTO6-K126)

27.4.3 Slope parameter

The slope parameter is used with several trigger and search condition commands.

Slope	Description
POSitive	Rising edge, that is a positive voltage change.
NEGative	Falling edge, that is a negative voltage change
EITHer	rising as well as the falling edge.

27.4.4 Polarity parameter

The polarity parameter is used with several trigger and search condition commands.

Polarity	Description
POSitive	Positive going pulses.
NEGative	Negative going pulses.
EITHer	Both positive and negative going pulses.

27.4.5 Event parameter

The event parameter is used with commands defining an action for mask testing, limit checks and margin checks.

Event	Description
NOAction	The action is not initiated.
SUCCESS	The action is initiated if the operation finished successfully: <ul style="list-style-type: none"> • Limits or margins were not exceeded during the entire measurement • Mask test passed
VIOLation	The action is initiated if the operation finished with error: <ul style="list-style-type: none"> • Limits or margins were violated during the measurement • Mask test failed

27.4.6 Bit pattern parameter

Bit pattern parameter are required with commands triggering on address, identifier, or data pattern.

To set the pattern value, you can use either a numeric parameter as defined in the SCPI standard, or a string parameter.

Bit pattern in numeric parameter

In a numeric parameter, the values are listed byte-by-byte, with bytes separated by commas and MSB first. The default numeral format is decimal, other formats can be

indicated by a format identifier (#B = binary, #H = hexadecimal, #Q = octal). Currently, no format for signed values is available.

Example: Parameter with three bytes, decimal byte values are 10, 20, 30. The examples are given for CAN, the bit pattern in other commands is defined in the same way.

- TRIGger:CAN:DMIN 10,20,30
- TRIGger:CAN:DMIN #B00001010,#B00010100,#B00011110
- TRIGger:CAN:DMIN #H0A,#H14,#H1E
- TRIGger:CAN:DMIN #Q012,#Q024,#Q036

Bit pattern in string parameter

In a string, the complete binary pattern is written without separation of bytes, for example:

```
TRIGger:CAN:DMIN '000010100001010000011110'
```

Unlike a numeric parameter, the string parameter accepts wildcards for single bits (X = don't care). Whether wildcards can be used or not depends on the remote command. Usually, address and identifier parameter require unique patterns while data parameters may contain wildcards.

Mostly the length of the bit pattern is defined, for example, by the I²C address type, the CAN identifier type, or the data length code. In these cases, it is recommended that you enter the complete bit pattern. If you enter a shorter pattern, the instrument fills up the pattern with X bits to the right of the defined pattern.

Example: You want to trigger on an 11 bit CAN address and enter the bit pattern '11100011' (8 bits only). The instrument uses the pattern '11100011XXX' for triggering.

Query for a pattern

The pattern format for the return value of a pattern is defined by the [FORMat:BPATtern](#) command.

27.5 Common commands

Common commands are described in the IEEE 488.2 (IEC 625-2) standard. These commands have the same effect and are employed in the same way on different devices. The headers of these commands consist of "*" followed by three letters. Many common commands are related to the Status Reporting System.

Available common commands:

*CAL?	1375
*CLS	1375
*ESE	1375
*ESR?	1376
*IDN?	1376
*IST?	1376
*OPC	1376

*OPT?	1376
*PCB	1377
*PRE	1377
*PSC	1377
*RCL	1377
*RST	1378
*SAV	1378
*SRE	1378
*STB?	1378
*TRG	1378
*TST?	1379
*WAI	1379

***CAL?**

Starts a self-alignment of the instrument, and then queries a status response. Return values $\neq 0$ indicate an error.

Return values:

<State>

- 0: no error
- 1: alignment failed
- 2: not aligned, e.g. init
- 3: device needs longer warmup time before selfalignment can start
- 4: input signal connected during selfalignment

Usage: Query only

Manual operation: See "[Start Alignment](#)" on page 101

***CLS**

Clear status

Sets the status byte (STB), the standard event register (ESR) and the `EVENT` part of the `QUESTIONABLE` and the `OPERATION` registers to zero. The command does not alter the mask and transition parts of the registers. It clears the output buffer.

Usage: Setting only

***ESE <Value>**

Event status enable

Sets the event status enable register to the specified value. The query returns the contents of the event status enable register in decimal form.

Parameters:

<Value> Range: 0 to 255

***ESR?**

Event status read

Returns the contents of the event status register in decimal form and then sets the register to zero.

Return values:

<Contents> Range: 0 to 255

Usage: Query only

***IDN?**

Identification

Returns the instrument identification.

Return values:

<ID> "Rohde&Schwarz,<device type>,<part number>/<serial number>,<firmware version>"

Example: Rohde&Schwarz, RT06, 1802.0001k04/200153, 5.0.0.2
Model assignment:

Usage: Query only

***IST?**

Individual status query

Returns the contents of the IST flag in decimal form. The IST flag is the status bit which is sent during a parallel poll.

Return values:

<ISTflag> 0 | 1

Usage: Query only

***OPC**

Operation complete

Sets bit 0 in the event status register when all preceding commands have been executed. This bit can be used to initiate a service request. The query writes a "1" into the output buffer when all preceding commands have been executed, which is useful for command synchronization.

***OPT?**

Option identification query

Queries the options included in the instrument. For a list of all available options and their description, refer to the specifications document.

Return values:

<Options>

The query returns a list of options. The options are returned at fixed positions in a comma-separated string. A zero is returned for options that are not installed.

Usage:

Query only

***PCB <Address>**

Pass control back

Indicates the controller address to which remote control is returned after termination of the triggered action.

Setting parameters:

<Address> Range: 0 to 30

Usage:

Setting only

***PRE <Value>**

Parallel poll register enable

Sets parallel poll enable register to the indicated value. The query returns the contents of the parallel poll enable register in decimal form.

Parameters:

<Value> Range: 0 to 255

***PSC <Action>**

Power on status clear

Determines whether the contents of the `ENABLE` registers are preserved or reset when the instrument is switched on. Thus a service request can be triggered when the instrument is switched on, if the status registers ESE and SRE are suitably configured. The query reads out the contents of the "power-on-status-clear" flag.

Parameters:

<Action> 0 | 1

0

The contents of the status registers are preserved.

1

Resets the status registers.

***RCL <Number>**

Recall

Loads the instrument settings from an intermediate memory identified by the specified number. The instrument settings can be stored to this memory using the command

`*SAV` with the associated number.

It also activates the instrument settings which are stored in a file and loaded using [MMEMoRY:LOAD:STATe](#).

*RST

Reset

Sets the instrument to a defined default status. The default settings are indicated in the description of commands.

Usage: Setting only

*SAV <Number>

Save

Stores the current instrument settings under the specified number in an intermediate memory. The settings can be recalled using the command [*RCL](#) with the associated number.

To transfer the stored instrument settings to a file, use [MMEMoRY:STORe:STATe](#).

*SRE <Contents>

Service request enable

Sets the service request enable register to the indicated value. This command determines under which conditions a service request is triggered.

Parameters:

<Contents> Contents of the service request enable register in decimal form.
 Bit 6 (MSS mask bit) is always 0.
 Range: 0 to 255

*STB?

Status byte query

Reads the contents of the status byte in decimal form.

Usage: Query only

*TRG

Trigger

Triggers all actions waiting for a trigger event. In particular, *TRG generates a manual trigger signal. This common command complements the commands of the [TRIGger](#) subsystem.

*TRG corresponds to the [INITiate:IMMediate](#) command.

Usage: Event

***TST?**

Self-test query

Initiates self-tests of the instrument and returns an error code.

Return values:

<ErrorCode>

integer > 0 (in decimal format)

An error occurred.

(For details, see the Service Manual supplied with the instrument).

0

No errors occurred.

Usage: Query only

Manual operation: See "[Selftest](#)" on page 103

***WAI**

Wait to continue

Prevents servicing of the subsequent commands until all preceding commands have been executed and all signals have settled (see also command synchronization and [*OPC](#)).

Usage: Event

27.6 General remote settings

This chapter describes commands that have effect on many other remote commands in different applications of the instrument.

FORMat[:DATA]	1380
FORMat:BORDER	1381
FORMat:BPATtern	1381
SYSTem:DISPlay:UPDate	1382
SYSTem:KLOCK	1382
GPIB:ADDRess	1382
GPIB:TERMinator	1382
SYSTem:DISPlay:MESSage:STATe	1383
SYSTem:DISPlay:MESSage[:TEXT]	1383
SYSTem:LANGuage	1383

FORMat[:DATA] <Format>, [<Length>]

Selects the data type that is used for transmission of data from analog channels, math and reference waveforms, and some measurement results from the instrument to the controlling computer.

The command sets the data format for the following query commands:

- [CHANnel<m>\[:WAVEform<n>\]:DATA\[:VALues\]?](#)
- [CALCulate:MATH<m>:DATA\[:VALues\]?](#)
- [REFCurve<m>:DATA\[:VALues\]?](#)
- [EXPort:HISTogram:DATA?](#) on page 1775
- [EXPort:MEASurement:DATA?](#) on page 1778
- [MEASurement<m>:TRACk:DATA\[:VALues\]?](#) on page 1666

Parameters:

<Format>,<Length>] ASCII | REAL,32 | INT,8 | INT,16

ASCII

Data values are returned in ASCII format as a list of comma-separated values in floating point format. The length can be omitted. It is 0 which means that the instrument selects the number of digits to be returned. The query returns both values (ASC, 0).

REAL,32

The data is stored as binary data (Definite Length Block Data according to IEEE 488.2). Each waveform value is formatted in 32-Bit IEEE 754 Floating Point Format.

The schema of the result string is as follows:

#41024<value1><value2>...<value n> with:

#4 = number of digits (= 4 in the example) of the following number

1024 = number of following data bytes (= 1024 in the example)

<value> = 4-byte floating point values

For large data (≥ 1 GB), the result string starts with "#(data length)". The number inside the parentheses indicates the real data length in bytes.

INT,8 | INT,16

Signed integer data with length 8 bit or 16 bit. It defines that `CHANnel<m>[:WAVEform<n>]:DATA[:VALues]?` returns the raw sample data of the ADC as integers. If format of the waveform data differs from the defined export format, the instrument converts the data to the required length.

The result string has the same schema as the REAL format.

For INT,16 you can set the byte order using the `FORMat: BORDer` command.

Data conversion is described in "Raw (ADC direct)" on page 469.

For digital channel data, math and histogram data, INT formats are not available.

`EXPort:WAVEform:INCXvalues` must be set OFF.

*RST: ASCII

Example:

```
FORMat:DATA REAL,32
FORMat:DATA?
REAL,32
```

Usage:

SCPI confirmed

Manual operation:

See "Transfer data format" on page 1329

FORMat:BORDer <ByteOrder>

Sets the endianness.

The command is only relevant for raw data export in high definition mode (16 bit word length).

Parameters:

<ByteOrder>

LSBFirst | MSBFirst

LSB first: little endian, least significant byte first

MSB first: big endian, most significant byte first

*RST: LSBFirst

Usage:

Asynchronous command

Manual operation:

See "Byte order" on page 1330

FORMat:BPATtern <BitPatternFormat>

Sets the number format for remote bit pattern queries on serial protocols.

Parameters:

<BitPatternFormat>

DEC | HEX | OCT | BIN | ASCII | ASCII | STRG

ASCII = ASCII

*RST: HEX

Usage:

Asynchronous command

Manual operation: See ["Bit pattern format"](#) on page 1330

SYSTem:DISPlay:UPDate <Enable>

Defines whether the display is updated while the instrument is in the remote state. If the display is switched off, the normal GUI is replaced by a static image while the instrument is in the remote state. Switching off the display can speed up the measurement. This is the recommended state.

See also: [Chapter 25.5.3.2, "Using the display during remote control"](#), on page 1331

Parameters:

<Enable> **ON | 1:** Display is shown and updated during remote control
OFF | 0: Display shows static image during remote control

Example:

SYSTem:DISPlay:UPDate 1
 Switch on the display update.

SYSTem:KLOCK <Enable>

Locks or unlocks the local controls of the instrument. This includes the front panel keys, the keyboard, or other local interfaces. except for the "View" button on the display.

Parameters:

<Enable> **ON | 1:** Locks the local keys
OFF | 0: Keys are unlocked

Usage: SCPI confirmed

GPIB:ADDRess <Address>

Sets the GPIB address of the instrument. Changing the address has major effects on the communication to the remote computer.

Parameters:

<Address> Range: 0 to 30
 Increment: 1
 *RST: 20

Usage: Asynchronous command

Manual operation: See ["Address"](#) on page 1329

GPIB:TERMinator <Terminator>

Specifies the symbol that is used as a terminator in GPIB communication.

Parameters:

<Terminator> LFEoi | EOI
 *RST: EOI

Usage: Asynchronous command

Manual operation: See "Terminator" on page 1329

SYSTem:DISPlay:MESSage:STATe <DispMessState>

Enables and disables the display of an additional text in remote control.

To define the text, use `SYSTem:DISPlay:MESSage[:TEXT]`.

Parameters:

<DispMessState> ON | OFF
 *RST: OFF

Usage: Asynchronous command

Firmware/software: Version 2.70

SYSTem:DISPlay:MESSage[:TEXT] <DisplayMessage>

Defines an additional text that is displayed during remote control operation.

To enable the text display, use `SYSTem:DISPlay:MESSage:STATe` on page 1383.

Parameters:

<DisplayMessage> String that contains the text.

Usage: Asynchronous command

Firmware/software: Version 2.70

SYSTem:LANGUage <Language>

Defines the remote control behavior of the instrument and sets the remote control command set.

Parameters:

<Language> String value. Available values:
 'SCPI': R&S RTO6 remote command set is used.
 "DPO7000" or 'TDS540': Compatible remote command set of Tektronix oscilloscopes DPO7000 or TDS540 is used.
 If one of these emulation modes is used, you can define alternative responses to the `IDN*?` and `OPT*?` commands on the "Menu" > "Settings" > "System" > "Remote" > "SCPI Emulation" tab.

Usage: Asynchronous command

Options: R&S RTO6--K301

27.7 Instrument setup

27.7.1 System

SYSTem:EXIT.....	1384
SYSTem:SHUTdown.....	1384
SYSTem:PRESet.....	1384
SYSTem:DATE.....	1384
SYSTem:TIME?.....	1385
SYSTem:DEVIce:ID?.....	1385
DIAGnostic:SERVice:COMPutername.....	1385

SYSTem:EXIT

Starts the shutdown of the firmware.

Usage: Event
 Asynchronous command

SYSTem:SHUTdown

Starts the shutdown of the instrument (firmware and operating system).

Usage: Event
 Asynchronous command

SYSTem:PRESet

Resets the instrument to the factory default settings, to the initial state. Factory settings comprise all instrument settings, including display, intensity and transparency settings. After loading factory defaults, perform a self-alignment to synchronize the signal data.

Usage: Event

SYSTem:DATE <Year>, <Month>, <Day>

Sets the date of the internal calendar.

Parameters:

<Year> Year, to be entered as a four-digit number (including the century and millennium information)

<Month> Month, 1 (January) to 12 (December)

<Day> Day, 1 to the maximum number of days in the specified month

*RST: does not affect the date settings

Example: SYSTem:DATE?
 Returned value: 2011,09,13

Usage: SCPI confirmed
Manual operation: See "Time settings" on page 72

SYSTem:TIME? <Hour>, <Minute>, <Second>

Returns the UTC (Universal Time Coordinated) of the internal clock. To define the current local time, use the time zone setting of the operating system

Example: SYSTem:TIME?
 Returned value: 15,09,20. UTC is 15:09:20.

Usage: Query only
 SCPI confirmed

Manual operation: See "Time settings" on page 72

SYSTem:DEvice:ID?

Returns the instrument ID - that is the part number and the serial number.

Return values:
 <ID> String containing the part number and the serial number

Example: 1316.1000K24-001122-jT

Usage: Query only

DIAGnostic:SERvice:COMPUtername <ComputerName>

The query returns the computer name that is currently defined. The computer name is required when configuring a network.

The setting command changes the computer name. The change takes effect after the next reboot of the computer.

Parameters:
 <ComputerName> Name string

Usage: Asynchronous command

Manual operation: See "Device name" on page 70

27.7.2 Appearance

27.7.2.1 Colors appearance

DISPlay:COLor:SIGNa<m>:COLor.....	1386
DISPlay:COLor:SIGNa<m>:ASSign.....	1386
DISPlay:COLor:SIGNa<m>:USE.....	1386

DISPlay:COLor:SIGNal<m>:COLor <Value>**Suffix:**

<m> 1...218
Waveform number, see [Chapter 27.4.1, "Waveform suffix"](#), on page 1366.

Parameters:

<Value> Decimal value of the ARGB color. Use the color dialog box on the instrument to get the hex value of the color, and convert the hex value to a decimal value.
0 is fully transparent black.
4278190080 (dec) = FF000000 (hex) is opaque black.
4294967295 (dec) = FFFFFFFF (hex) is opaque white.

Manual operation: See ["Color"](#) on page 76

DISPlay:COLor:SIGNal<m>:ASSign <ColorTable>

Assigns the color table to the specified signal.

Suffix:

<m> 1...218
Waveform number, see [Chapter 27.4.1, "Waveform suffix"](#), on page 1366.

Parameters:

<ColorTable> Color table name to be assigned to the signal.

Manual operation: See ["Assigned color table"](#) on page 76

DISPlay:COLor:SIGNal<m>:USE <State>

If enabled, the selected waveform is displayed according to its assigned color table.

If this option is disabled, the default color table is used, i.e. the intensity of the specific signal color varies according to the cumulative occurrence of the values.

Suffix:

<m> 1...218
Waveform number, see [Chapter 27.4.1, "Waveform suffix"](#), on page 1366.

Parameters:

<State> ON | OFF

Manual operation: See ["Use color table"](#) on page 76

27.7.2.2 Color tables

DISPlay:COLor:PALette:ADD	1387
DISPlay:COLor:PALette:REMove	1387
DISPlay:COLor:PALette:COUnT?	1387

DISPlay:COLor:PALette:POINt:ADD.....	1387
DISPlay:COLor:PALette:POINt:INSert.....	1387
DISPlay:COLor:PALette:POINt:REMOve.....	1387
DISPlay:COLor:PALette:POINt[:VALue].....	1388
DISPlay:COLor:PALette:POINt:COUNt?.....	1388

DISPlay:COLor:PALette:ADD <Name>

Adds a new color table with the specified name.

Setting parameters:

<Name> color table

Usage: Setting only

DISPlay:COLor:PALette:REMOve <Name>

Removes the specified color table.

Setting parameters:

<Name> color table

Usage: Setting only

DISPlay:COLor:PALette:COUNt?

Queries the number of configured color maps.

Usage: Query only

DISPlay:COLor:PALette:POINt:ADD <PaletteName>

Appends a new row at the end of the color table.

Setting parameters:

<PaletteName> color table

Usage: Setting only

DISPlay:COLor:PALette:POINt:INSert <PaletteName>, <PointIndex>

Inserts the entry at the specified index in the color table.

Setting parameters:

<PaletteName> color table

<PointIndex> row number in the color table

Usage: Setting only

DISPlay:COLor:PALette:POINt:REMOve <PaletteName>, <PointIndex>

Removes the entry with the specified index from the color table.

Setting parameters:

<PaletteName> color table
 <PointIndex> row number in the color table

Usage: Setting only

DISPlay:COLor:PALette:POINT[:VALue] <ColorTableName>, <Index>,<Position>,
 <Color>

DISPlay:COLor:PALette:POINT[:VALue]? <ColorTableName>, <Index>

Inserts a new entry or queries the specified entry in the specified color table.

Parameters:

<Position> Cumulative occurrence value
 Range: 0 to 100
 Increment: 1
 *RST: 50
 Default unit: %

<Color> ARGB value of the color to be used for the table entry.
 ARGB=<Opacity(alpha) value><red value><green value><blue value>, in hexadecimal or decimal format.
 Range: 0 to 4294967295
 Increment: 1
 *RST: 0

Parameters for setting and query:

<ColorTableName> Color table to be edited
 <Index> Index (row number) of the new entry in the color table

Usage: Asynchronous command

DISPlay:COLor:PALette:POINT:COUNT? <PaletteName>

Queries the number of entries in the color table.

Query parameters:

<PaletteName> color table

Usage: Query only

27.7.2.3 Grid appearance

DISPlay:DIAGram:GRID.....	1389
DISPlay:DIAGram:LABels.....	1389
DISPlay:DIAGram:FINegrid.....	1389
DISPlay:DIAGram:CROSShair.....	1389
DISPlay:DIAGram:YFIXed.....	1389
DISPlay:DIAGram:XFIXed.....	1390

DISPlay:DIAGram:GRID <Show>

If enabled, a grid is displayed in the diagram area.

Parameters:

<Show> ON | OFF

Usage: Asynchronous command

Manual operation: See ["Show grid"](#) on page 78

DISPlay:DIAGram:LABels <ShowLabels>

If enabled, labels mark values on the x- and y-axes in specified intervals in the diagram.

Parameters:

<ShowLabels> ON | OFF

Usage: Asynchronous command

Manual operation: See ["Show labels"](#) on page 78

DISPlay:DIAGram:FINegrid <ShowFineScale>

If ON, the crosshair is displayed as a ruler with scale markers. If OFF, the crosshair is shown as dashed lines.

Parameters:

<ShowFineScale> ON | OFF

Usage: Asynchronous command

Manual operation: See ["Show fine grid scale"](#) on page 79

DISPlay:DIAGram:CROSShair <Crosshair>

If selected, a crosshair is displayed in the diagram area. A crosshair allows you to select a specific data point by its co-ordinates.

Parameters:

<Crosshair> ON | OFF

Usage: Asynchronous command

Manual operation: See ["Show crosshair"](#) on page 79

DISPlay:DIAGram:YFIXed <YGridFixed>

If enabled, the horizontal grid lines remain in their position when the position of the curve is changed. Only the values at the grid lines are adapted. This reflects the behavior of traditional oscilloscopes.

Parameters:

<YGridFixed> ON | OFF

Usage: Asynchronous command
Manual operation: See "[Keep Y-grid fixed](#)" on page 79

DISPlay:DIAGram:XFIXed <XGridFixed>

If enabled, the vertical grid lines remain in their position when the horizontal position is changed. Only the values at the grid lines are adapted.

Parameters:

<XGridFixed> ON | OFF
 *RST: OFF

Usage: Asynchronous command
Manual operation: See "[Keep X-grid fixed](#)" on page 79

27.7.2.4 Smartgrid

The following `LAYout` commands configure the SmartGrid: add and remove diagrams, and assign signals to the diagrams. In manual operation, you configure the SmartGrid by drag and drop.

<code>LAYout:ADD</code>	1390
<code>LAYout:REMove</code>	1392
<code>LAYout:SHOW</code>	1392
<code>LAYout:SIGNal:ASSign</code>	1392
<code>LAYout:SIGNal:UNASSign</code>	1394

LAYout:ADD <NodeName>, <ParentType>, <InsertBefore>, <FirstSource>, <DiagramName>

Adds a new diagram with a waveform on the screen, in relation to an existing diagram.

Setting parameters:

<NodeName> String with the name of the existing diagram
 <ParentType> HORIZONTAL | VERTICAL | TAB
 Position of the new diagram in relation to the existing one.
HORIZONTAL
 Besides the existing diagram
VERTICAL
 Above or below the existing diagram
TAB
 In a new tab in the existing diagram
 <InsertBefore> ON | OFF
 If on, the new diagram is inserted to the left (for HORIZONTAL), above (for VERTICAL) or in a tab in front the existing diagram.
 HOR, ON = left to the existing diagram, defined in <NodeName>
 HOR, OFF = right to the existing diagram

VERT, ON = above the existing diagram

VERT, OFF = below the existing diagram

<FirstSource>

C1W1 | C1W2 | C1W3 | C2W1 | C2W2 | C2W3 | C3W1 | C3W2 |
 C3W3 | C4W1 | C4W2 | C4W3 | M1 | M2 | M3 | M4 | M5 | M6 |
 M7 | M8 | R1 | R2 | R3 | R4 | XY1 | XY2 | XY3 | XY4 |
 MRESult1 | MRESult2 | MRESult3 | MRESult4 | MRESult5 |
 MRESult6 | MRESult7 | MRESult8 | SBUS1 | SBUS2 | SBUS3 |
 SBUS4 | D0 | D1 | D2 | D3 | D4 | D5 | D6 | D7 | D8 | D9 | D10 |
 D11 | D12 | D13 | D14 | D15 | MSOB1 | MSOB2 | MSOB3 |
 MSOB4 | TRK1 | TRK2 | TRK3 | TRK4 | TRK5 | TRK6 | TRK7 |
 TRK8 | Z1V1 | Z1V2 | Z1V3 | Z1V4 | Z1I1 | Z1I2 | Z1I3 | Z1I4 |
 Z2V1 | Z2V2 | Z2V3 | Z2V4 | Z2I1 | Z2I2 | Z2I3 | Z2I4 | DIFF1 |
 DIFF2 | COMMON1 | COMMON2 | BATHtub1 | BMEas1 |
 SRESponse1 | SRHist1 | SDHist1 | TJHist1 | DJHist1 |
 DDJHist1 | PJHist1 | RJOHist1 | SRTRack1 | SDTRack1 |
 TJTRack1 | DJTRack1 | DDJTrack1 | PJTRack1 | RJOTrack1 |
 TJSpectrum1 | DDJSpectrum1 | PJSpectrum1 |
 RJOspectrum1 | SEYE1 | BATHtub2 | BMEas2 | SRESponse2 |
 SRHist2 | SDHist2 | TJHist2 | DJHist2 | DDJHist2 | PJHist2 |
 RJOHist2 | SRTRack2 | SDTRack2 | TJTRack2 | DJTRack2 |
 DDJTrack2 | PJTRack2 | RJOTrack2 | TJSpectrum2 |
 DDJSpectrum2 | PJSpectrum2 | RJOspectrum2 | SEYE2 |
 NBATHtub1 | NBMeas1 | TNHist1 | DNHist1 | DDNHist1 |
 PNHist1 | RNOHist1 | TNTRack1 | DNTRack1 | DDNTrack1 |
 PNTRack1 | RNOTrack1 | TNSpectrum1 | DDNSpectrum1 |
 PNSpectrum1 | RNOSpectrum1 | NBATHtub2 | NBMeas2 |
 TNHist2 | DNHist2 | DDNHist2 | PNHist2 | RNOHist2 |
 TNTRack2 | DNTRack2 | DDNTrack2 | PNTRack2 |
 RNOTrack2 | TNSpectrum2 | DDNSpectrum2 | PNSpectrum2 |
 RNOSpectrum2 | PJDHist1 | BUJHist1 | RJOHist1 | PJDTrack1 |
 PJDSpectrum1 | PJDHist2 | BUJHist2 | RJOHist2 | PJDTrack2 |
 PJDSpectrum2 | PNDHist1 | BUNHist1 | RNOHist1 |
 PNDTrack1 | PNDSpectrum1 | PNDHist2 | BUNHist2 |
 RNOHist2 | PNDTrack2 | PNDSpectrum2 | LANE1 | LANE2 |
 LANE3 | LANE4

Waveform to be displayed in the new diagram, see [Chapter 27.4.2, "Waveform parameter"](#), on page 1371.

Spectrum analysis, option R&S RTO6-K37: Spectrograms and timeline spectrums are automatically displayed in their own diagrams.

Eye diagram analysis with option R&S RTO6-K91: Eye diagrams are automatically displayed in their own diagrams.

TDR/TDT analysis with option R&S RTO6-K130: Measurement waveforms are automatically displayed in their own diagrams.

Advanced jitter analysis with option R&S RTO6-K133: Jitter analysis waveforms are automatically displayed in their own diagrams.

Advanced noise analysis with option R&S RTO6-K134 : Noise analysis waveforms are automatically displayed in their own diagrams.

<DiagramName> String with the name of the new diagram.

Example: `LAYout:ADD 'Diagram2',TAB,ON,C4W1,'MyDiagram3'`
Creates a new diagram 'MyDiagram3' with waveform C4W1 in a new tab that in front of 'Diagram2'.

Example: See [Chapter 27.3.1.1, "Creating diagrams \(SmartGrid\)"](#), on page 1346.

Usage: Setting only
Asynchronous command

LAYout:REMOve <DiagramName>

Closes the specified diagram. The waveforms are displayed as minimized waveforms in their signal icons on the signal bar.

Setting parameters:

<DiagramName> String with the name of the diagram

Usage: Setting only
Asynchronous command

LAYout:SHOw <DiagramName>

Selects the specified diagram.

Setting parameters:

<DiagramName> String with the name of the diagram

Example: See [Chapter 27.3.1.1, "Creating diagrams \(SmartGrid\)"](#), on page 1346.

Usage: Setting only
Asynchronous command

LAYout:SIGNal:ASSign <DiagramName>, <Source>

Shows the specified waveform in the selected diagram.

Setting parameters:

<DiagramName>	String with the diagram name
<Source>	<p>C1W1 C1W2 C1W3 C2W1 C2W2 C2W3 C3W1 C3W2 C3W3 C4W1 C4W2 C4W3 M1 M2 M3 M4 M5 M6 M7 M8 R1 R2 R3 R4 XY1 XY2 XY3 XY4 MRESult1 MRESult2 MRESult3 MRESult4 MRESult5 MRESult6 MRESult7 MRESult8 SBUS1 SBUS2 SBUS3 SBUS4 D0 D1 D2 D3 D4 D5 D6 D7 D8 D9 D10 D11 D12 D13 D14 D15 MSOB1 MSOB2 MSOB3 MSOB4 TRK1 TRK2 TRK3 TRK4 TRK5 TRK6 TRK7 TRK8 Z1V1 Z1V2 Z1V3 Z1V4 Z1I1 Z1I2 Z1I3 Z1I4 Z2V1 Z2V2 Z2V3 Z2V4 Z2I1 Z2I2 Z2I3 Z2I4 DIFF1 DIFF2 COMMON1 COMMON2 BATHtub1 BMEas1 SRESponse1 SRHist1 SDHist1 TJHist1 DJHist1 DDJHist1 PJHist1 RJOHist1 SRTRack1 SDTRack1 TJTRack1 DJTRack1 DDJTrack1 PJTRack1 RJOTrack1 TJSPpectrum1 DDJSpectrum1 PJSpectrum1 RJOspectrum1 BATHtub2 BMEas2 SRESponse2 SRHist2 SDHist2 TJHist2 DJHist2 DDJHist2 PJHist2 RJOHist2 SRTRack2 SDTRack2 TJTRack2 DJTRack2 DDJTrack2 PJTRack2 RJOTrack2 TJSPpectrum2 DDJSpectrum2 PJSpectrum2 RJOspectrum2 NBATHtub1 NBMeas1 TNHist1 DNHist1 DDNHist1 PNHist1 RNOHist1 TNTRack1 DNTRack1 DDNTrack1 PNTRack1 RNOTrack1 TNSpectrum1 DDNSpectrum1 PNSpectrum1 RNOSpectrum1 NBATHtub2 NBMeas2 TNHist2 DNHist2 DDNHist2 PNHist2 RNOHist2 TNTRack2 DNTRack2 DDNTrack2 PNTRack2 RNOTrack2 TNSpectrum2 DDNSpectrum2 PNSpectrum2 RNOSpectrum2 PJDHist1 BUJHist1 RJHist1 PJDTrack1 PJDSpectrum1 PJDHist2 BUJHist2 RJHist2 PJDTrack2 PJDSpectrum2 PNDHist1 BUNHist1 RNHist1 PNDTrack1 PNDspectrum1 PNDHist2 BUNHist2 RNHist2 PNDTrack2 PNDspectrum2 LANE1 LANE2 LANE3 LANE4</p> <p>Waveform to be assigned, see Chapter 27.4.2, "Waveform parameter", on page 1371</p> <p>Spectrum analysis, option R&S RTO6-K37: Spectrograms and timeline spectrums are automatically displayed in their own diagrams.</p> <p>Eye diagram analysis with option R&S RTO6-K91: Eye diagrams are automatically displayed in their own diagrams.</p> <p>TDR/TDT analysis with option R&S RTO6-K130: Measurement waveforms are automatically displayed in their own diagrams.</p> <p>Advanced jitter and noise analysis with option R&S RTO6-K133/K134</p>
Example:	See Chapter 27.3.1.1, "Creating diagrams (SmartGrid)" , on page 1346.

Usage: Setting only
Asynchronous command

LAYout:SIGNal:UNASsign <Source>

Minimizes the specified waveform, i.e. removes it from the diagram and shows it in the signal icon.

Setting parameters:

<Source> See [LAYout:SIGNal:ASSign](#) on page 1392 and [Chapter 27.4.2, "Waveform parameter"](#), on page 1371

Example: See [Chapter 27.3.1.1, "Creating diagrams \(SmartGrid\)"](#), on page 1346.

Usage: Setting only
Asynchronous command

27.7.2.5 Diagram appearance

DISPlay:DIAGram:TITLe	1394
DISPlay:SIGBar[:STATe]	1394
DISPlay:GATE:TRANsparency	1394
LAYout:ZOOM:ONEDiagram	1395

DISPlay:DIAGram:TITLe <DiagTitleSt>

If enabled, the tab titles of all diagrams are displayed: "Diagram1", "Diagram2" ...

If disabled, the tab titles are not shown except for those in a tabbed diagram. In tabbed diagrams, the tab titles are required to change the tabs.

Parameters:

<DiagTitleSt> ON | OFF

Usage: Asynchronous command

Manual operation: See ["Show tabs always"](#) on page 80

DISPlay:SIGBar[:STATe] <State>

If enabled, the signal bar is displayed.

Parameters:

<State> ON | OFF

Usage: Asynchronous command

Manual operation: See ["Show signal bar"](#) on page 80

DISPlay:GATE:TRANsparency <Transparency>

Sets the transparency of the area that is defined as measurement or search gate.

Parameters:

<Transparency> Range: 0 to 100
 Increment: 1
 *RST: 43
 Default unit: %

Usage: Asynchronous command

Firmware/software: FW 3.20

Manual operation: See "[Gate transparency](#)" on page 81

LAYout:ZOOM:ONEDiagram <ShowInOne>

Shows all zooms of a diagram in one zoom window. The zoomed areas are overlaid for better comparison of the zoomed waveforms.

The command takes effect on all zoom diagrams.

Parameters:

<ShowInOne> ON | OFF
 *RST: OFF

Usage: Asynchronous command

Manual operation: See "[Zoom overlay](#)" on page 81

27.7.2.6 Annotations

To create an annotation (or waveform label), use `DISPlay:SIGNal:LABel:ADD`. Using the other `DISP:SIGN:LAB:...` commands, you can query the text and position of a label, and modify the initial settings. The <LabelID> and <Source> parameters identify each label uniquely. You can query the <LabelID> with `DISPlay:SIGNal:LABel:IDSList`.

<code>DISPlay:SIGNal:LABel:POSMode</code>	1396
<code>DISPlay:SIGNal:LABel:FONTsize</code>	1396
<code>DISPlay:SIGNal:LABel:ADD</code>	1396
<code>DISPlay:SIGNal:LABel:REMove</code>	1398
<code>DISPlay:SIGNal:LABel:IDSList</code>	1398
<code>DISPlay:SIGNal:LABel:SHOW</code>	1399
<code>DISPlay:SIGNal:LABel:STATe</code>	1400
<code>DISPlay:SIGNal:LABel:TEXT</code>	1400
<code>DISPlay:SIGNal:LABel:HORIZontal:ABSolute:POSition</code>	1400
<code>DISPlay:SIGNal:LABel:VERTical:ABSolute:POSition</code>	1400
<code>DISPlay:SIGNal:LABel:HORIZontal:RELative:POSition</code>	1401
<code>DISPlay:SIGNal:LABel:VERTical:RELative:POSition</code>	1401

DISPlay:SIGNal:LABel:POSMode <Source>, <PositionMode>
DISPlay:SIGNal:LABel:POSMode? <Source>

Modifies or queries the position mode: either relative to the diagram or with absolute values according to the units of the waveform. The position mode applies to all labels of the selected source. For different sources, different position modes can be selected.

Parameters:

<PositionMode> ABS | REL

ABS

Position in time and voltage values, or in other units depending on the waveform character. Absolute positions move with the waveform display when the scales, the vertical position or offset, or the reference point are changed.

Use `DISPlay:SIGNal:LABel:HORizontal:ABSolute:POSition` and `DISPlay:SIGNal:LABel:HORizontal:RELative:POSition` to set the position.

REL

Fixed label position in percent of the screen counting from the upper left corner.

Use `DISPlay:SIGNal:LABel:HORizontal:RELative:POSition` and `DISPlay:SIGNal:LABel:VERTical:RELative:POSition` to set the position.

Parameters for setting and query:

<Source> All waveforms that can be displayed, see `DISPlay:SIGNal:LABel:ADD`

Usage: Asynchronous command

Manual operation: See "Position mode" on page 82

DISPlay:SIGNal:LABel:FONTsize <FontSize>

Sets the font size of waveform labels.

Parameters:

<FontSize> Range: 7 to 30
 Increment: 1
 *RST: 15

Usage: Asynchronous command

Manual operation: See "Font size" on page 83

DISPlay:SIGNal:LABel:ADD <LabelID>, <Source>, <LabelText>, <PositionMode>, <XPositon>, <YPositon>

Creates a new waveform label for the specified source waveform.

Setting parameters:

<LabelID>	String with the label identifier. The <LabelID> and <Source> parameters identify each label uniquely, so the label ID must be unique for the given waveform. Note the <LabelID> because it is not possible to query it, or to read it on the user interface.
<Source>	C1W1 C1W2 C1W3 C2W1 C2W2 C2W3 C3W1 C3W2 C3W3 C4W1 C4W2 C4W3 M1 M2 M3 M4 M5 M6 M7 M8 R1 R2 R3 R4 XY1 XY2 XY3 XY4 MRESult1 MRESult2 MRESult3 MRESult4 MRESult5 MRESult6 MRESult7 MRESult8 QUICK QUICK SBUS1 SBUS2 SBUS3 SBUS4 D0 D1 D2 D3 D4 D5 D6 D7 D8 D9 D10 D11 D12 D13 D14 D15 MSOB1 MSOB2 MSOB3 MSOB4 TRK1 TRK2 TRK3 TRK4 TRK5 TRK6 TRK7 TRK8 SG1 SG2 SG3 SG4 SG5 SG6 SG7 SG8 SG1TL1 SG1TL2 SG2TL1 SG2TL2 SG3TL1 SG3TL2 SG4TL1 SG4TL2 SG5TL1 SG5TL2 SG6TL1 SG6TL2 SG7TL1 SG7TL2 SG8TL1 SG8TL2 Z1V1 Z1V2 Z1V3 Z1V4 Z1I1 Z1I2 Z1I3 Z1I4 Z2V1 Z2V2 Z2V3 Z2V4 Z2I1 Z2I2 Z2I3 Z2I4 DIFF1 DIFF2 COMMON1 COMMON2 BATHtub1 BMEas1 SRESponse1 SRHist1 SDHist1 TJHist1 DJHist1 DDJHist1 PJHist1 RJOHist1 SRTRack1 SDTRack1 TJTRack1 DJTRack1 DDJTrack1 PJTrack1 RJOTrack1 TJSPpectrum1 DDJSpectrum1 PJSPpectrum1 RJOspectrum1 SEYE1 BATHtub2 BMEas2 SRESponse2 SRHist2 SDHist2 TJHist2 DJHist2 DDJHist2 PJHist2 RJOHist2 SRTRack2 SDTRack2 TJTRack2 DJTRack2 DDJTrack2 PJTrack2 RJOTrack2 TJSPpectrum2 DDJSpectrum2 PJSPpectrum2 RJOspectrum2 SEYE2 NBATHtub1 NBMeas1 TNHist1 DNHist1 DDNHist1 PNHist1 RNOHist1 TNTRack1 DNTRack1 DDNTrack1 PNTRack1 RNOTrack1 TNSpectrum1 DDNSpectrum1 PNSpectrum1 RNOSpectrum1 NBATHtub2 NBMeas2 TNHist2 DNHist2 DDNHist2 PNHist2 RNOHist2 TNTRack2 DNTRack2 DDNTrack2 PNTRack2 RNOTrack2 TNSpectrum2 DDNSpectrum2 PNSpectrum2 RNOSpectrum2 PJDHist1 BUJHist1 RJOHist1 PJDTrack1 PJDSpectrum1 PJDHist2 BUJHist2 RJOHist2 PJDTrack2 PJDSpectrum2 PNDHist1 BUNHist1 RNOHist1 PNDTrack1 PNDSpectrum1 PNDHist2 BUNHist2 RNOHist2 PNDTrack2 PNDSpectrum2 LPDFE1 LPDFE2 LPDFE3 LPDFE4 LANE1 LANE2 LANE3 LANE4 Waveform to that the label belongs, see Chapter 27.4.1, "Waveform suffix" , on page 1366.
<LabelText>	String with the label text that is shown on the display
<PositionMode>	ABS REL

ABS

Position in time and voltage values, or in other units depending on the waveform character. Absolute positions move with the waveform display when the scales, the vertical position or offset, or the reference point are changed.

REL

Fixed label position in percent of the screen counting from the upper left corner.

<XPositon>	Horizontal position of the label text. Values, range and unit depend on the position mode, the waveform position and scaling. For relative position mode, the range is 0 to 100 %.
<YPositon>	Vertical position of the label text. Values, range and unit depend on the position mode, the waveform position and scaling. For relative position mode, the range is 0 to 100 %.

Usage: Setting only
Asynchronous command

Manual operation: See "[Labels](#)" on page 83

DISPlay:SIGNaL:LABel:REMOve <LabelID>, <Source>

Deletes the specifies waveform label.

Setting parameters:

<LabelID>	String with the label identifier.
<Source>	All waveforms that can be displayed, see DISPlay:SIGNaL:LABel:ADD

Example: `DISPlay:SIGNaL:LABel:REMOve 'Label1', C1W1`

Usage: Setting only
Asynchronous command

Manual operation: See "[Labels](#)" on page 83

DISPlay:SIGNaL:LABel:IDSList <Source>

Returns a list of label IDs for the specified source. Labels that are defined in the user interface get an automatic label "DiagramText<No>".

Parameters:

<Source>	See DISPlay:SIGNaL:LABel:ADD .
----------	--

Usage: Asynchronous command

Manual operation: See "[Labels](#)" on page 83

DISPlay:SIGNal:LABel:SHOW <Source>, <State>

DISPlay:SIGNal:LABel:SHOW? <Source>

Selects the source for the label display and displays all labels for that source that have state = ON in [DISPlay:SIGNal:LABel:STATe](#) on page 1400.

Parameters:

<State> OFF | ON

Parameters for setting and query:

<Source> C1W1 | C1W2 | C1W3 | C2W1 | C2W2 | C2W3 | C3W1 | C3W2 | C3W3 | C4W1 | C4W2 | C4W3 | M1 | M2 | M3 | M4 | M5 | M6 | M7 | M8 | R1 | R2 | R3 | R4 | XY1 | XY2 | XY3 | XY4 | MRESult1 | MRESult2 | MRESult3 | MRESult4 | MRESult5 | MRESult6 | MRESult7 | MRESult8 | QUICK | QUICK | SBUS1 | SBUS2 | SBUS3 | SBUS4 | D0 | D1 | D2 | D3 | D4 | D5 | D6 | D7 | D8 | D9 | D10 | D11 | D12 | D13 | D14 | D15 | MSOB1 | MSOB2 | MSOB3 | MSOB4 | TRK1 | TRK2 | TRK3 | TRK4 | TRK5 | TRK6 | TRK7 | TRK8 | SG1 | SG2 | SG3 | SG4 | SG5 | SG6 | SG7 | SG8 | SG1TL1 | SG1TL2 | SG2TL1 | SG2TL2 | SG3TL1 | SG3TL2 | SG4TL1 | SG4TL2 | SG5TL1 | SG5TL2 | SG6TL1 | SG6TL2 | SG7TL1 | SG7TL2 | SG8TL1 | SG8TL2 | Z1V1 | Z1V2 | Z1V3 | Z1V4 | Z1I1 | Z1I2 | Z1I3 | Z1I4 | Z2V1 | Z2V2 | Z2V3 | Z2V4 | Z2I1 | Z2I2 | Z2I3 | Z2I4 | DIFF1 | DIFF2 | COMMON1 | COMMON2 | BATHtub1 | BMEas1 | SRESponse1 | SRHist1 | SDHist1 | TJHist1 | DJHist1 | DDJHist1 | PJHist1 | RJOHist1 | SRTRack1 | SDTRack1 | TJTRack1 | DJTRack1 | DDJTrack1 | PJTrack1 | RJOTrack1 | TJSPpectrum1 | DDJSpectrum1 | PJSPpectrum1 | RJOspectrum1 | SEYE1 | BATHtub2 | BMEas2 | SRESponse2 | SRHist2 | SDHist2 | TJHist2 | DJHist2 | DDJHist2 | PJHist2 | RJOHist2 | SRTRack2 | SDTRack2 | TJTRack2 | DJTRack2 | DDJTrack2 | PJTrack2 | RJOTrack2 | TJSPpectrum2 | DDJSpectrum2 | PJSPpectrum2 | RJOspectrum2 | SEYE2 | NBAThtub1 | NBMeas1 | TNHist1 | DNHist1 | DDNHist1 | PNHist1 | RNOHist1 | TNTRack1 | DNTRack1 | DDNTrack1 | PNTRack1 | RNOTrack1 | TNSpectrum1 | DDNSpectrum1 | PNSpectrum1 | RNOspectrum1 | NBAThtub2 | NBMeas2 | TNHist2 | DNHist2 | DDNHist2 | PNHist2 | RNOHist2 | TNTRack2 | DNTRack2 | DDNTrack2 | PNTRack2 | RNOTrack2 | TNSpectrum2 | DDNSpectrum2 | PNSpectrum2 | RNOspectrum2 | PJDHist1 | BUJHist1 | RJOHist1 | PJDTrack1 | PJDSpectrum1 | PJDHist2 | BUJHist2 | RJOHist2 | PJDTrack2 | PJDSpectrum2 | PNDHist1 | BUNHist1 | RNOHist1 | PNDTrack1 | PNDspectrum1 | PNDHist2 | BUNHist2 | RNOHist2 | PNDTrack2 | PNDspectrum2 | LPDFE1 | LPDFE2 | LPDFE3 | LPDFE4 | LANE1 | LANE2 | LANE3 | LANE4

Usage: Asynchronous command

Manual operation: See "[Show / Source](#)" on page 82

DISPlay:SIGNal:LABel:STATe <LabelID>, <Source>, <State>
DISPlay:SIGNal:LABel:STATe? <LabelID>, <Source>

Displays or hides a single label that is identified by the signal source and label ID.

Parameters:

<State> OFF | ON
 ON: shows the label on the screen.
[DISPlay:SIGNal:LABel:SHOW](#) must be set to ON for the source.

Parameters for setting and query:

<LabelID> String with the label identifier.
 <Source> See [DISPlay:SIGNal:LABel:ADD](#).

Usage: Asynchronous command

Manual operation: See "[Labels](#)" on page 83

DISPlay:SIGNal:LABel:TEXT <LabelID>, <Source>, <LabelText>
DISPlay:SIGNal:LABel:TEXT? <LabelID>, <Source>

Modifies or queries the text of the specified label.

Parameters:

<LabelText> String with the label text that is shown

Parameters for setting and query:

<LabelID> String with the label identifier.
 <Source> All waveforms that can be displayed, see [DISPlay:SIGNal:LABel:ADD](#)

Usage: Asynchronous command

Manual operation: See "[Labels](#)" on page 83

DISPlay:SIGNal:LABel:HORizontal:ABSolute:POSition <LabelID>, <Source>, <Position>

DISPlay:SIGNal:LABel:HORizontal:ABSolute:POSition? <LabelID>, <Source>

DISPlay:SIGNal:LABel:VERTical:ABSolute:POSition <LabelID>, <Source>, <Position>

DISPlay:SIGNal:LABel:VERTical:ABSolute:POSition? <LabelID>, <Source>

Modifies or queries the absolute horizontal and vertical positions of the specified label if [DISPlay:SIGNal:LABel:POSMode](#) is set to ABS.

Parameters:

<Position> Range: Depends on waveform position and scaling
 Default unit: s and V, or in other units depending on the waveform character

Parameters for setting and query:

<LabelID> String with the label identifier.

<Source> All waveforms that can be displayed, see [DISPlay:SIGNal:LABel:ADD](#)

Example: `:DISPlay:SIGNal:LABel:POSMode C2W1, ABS`
`DISPlay:SIGNal:LABel:HORizontal:ABSolute:POSITION 'Label1', C2W1, 5e-09`
`DISPlay:SIGNal:LABel:VERTical:ABSolute:POSITION 'Label1', C2W1, -0.1`

Move the label to 5 ns and -0.1 V.

Manual operation: See "[Labels](#)" on page 83

DISPlay:SIGNal:LABel:HORizontal:RELative:POSition <LabelID>, <Source>, <Position>

DISPlay:SIGNal:LABel:HORizontal:RELative:POSition? <LabelID>, <Source>

DISPlay:SIGNal:LABel:VERTical:RELative:POSition <LabelID>, <Source>, <Position>

DISPlay:SIGNal:LABel:VERTical:RELative:POSition? <LabelID>, <Source>

Modifies or queries the relative horizontal and vertical positions of the specified label if [DISPlay:SIGNal:LABel:POSMode](#) is set to REL.

Parameters:

<Position> Position in percent of the screen counting from the upper left corner.

Range: 0 to 100

Default unit: %

Parameters for setting and query:

<LabelID> String with the label identifier.

<Source> All waveforms that can be displayed, see [DISPlay:SIGNal:LABel:ADD](#)

Example: `:DISPlay:SIGNal:LABel:POSMode C2W1, REL`
`DISPlay:SIGNal:LABel:HORizontal:RELative:POSITION 'Label1', C2W1, 30`
`DISPlay:SIGNal:LABel:VERTical:RELative:POSITION 'Label1', C2W1, 70`

Move the label to new relative position: horizontal at 30 % and vertical at 70 % of the screen.

Manual operation: See "[Labels](#)" on page 83

27.7.2.7 Dialog appearance

DISPlay:EXTended:PORDialogs <PopOutResDialogs>

If an external monitor is connected to the instrument, enables the display of result boxes on the external monitor.

Parameters:

<PopOutResDialogs> ON | OFF

*RST: OFF

Manual operation: See "[Extended desktop placement](#)" on page 84

DISPlay:EXTended:POSDialogs <PopOutSettDialogs>

If an external monitor is connected to the instrument, enables the display of dialog boxes on the external monitor.

Parameters:

<PopOutSettDialogs> ON | OFF

*RST: OFF

Manual operation: See "[Extended desktop placement](#)" on page 84

27.7.2.8 Cursor appearance

CURSor<m>:STYLe <Style>

Defines how the cursor is displayed in the diagram.

Suffix:

<m> 1..4
Selects the cursor set.

Parameters:

<Style> LINes | LRHombus | VLRHombus | RHOMbus

LINes

The cursors are displayed as lines.

LRHombus

The cursors are displayed as lines. The intersections of the cursors with the waveforms are displayed by rhombus-shaped points.

VLRHombus

The cursors are displayed only as vertical lines. The intersections of the cursors with the waveforms are displayed by rhombus-shaped points.

RHOMbus

The intersections of the cursors with the waveforms are displayed by rhombus-shaped points.

*RST: LINes

Usage: Asynchronous command

Manual operation: See "[Cursor style](#)" on page 85

DISPlay:RESUltboxes:CUPosition <Position>

Defines the position of the cursor measurement results on the screen.

Parameters:

<Position> PREV | FLOA | DOCK

PREV

Preview: result icon on the signal bar.

FLOA

Floating result box in front of the diagrams.

DOCK

Docked: fixed tab below the diagrams.

*RST: DOCK

Usage: Asynchronous command

Manual operation: See "[Result position](#)" on page 85

27.7.2.9 Measurement appearance

MEASurement<m>:DISPlay:GROUping <GroupResDialogs>

If ON, all measurement results are shown in one result box. If disabled, the results of each measurement group are shown in a separate result box. The default position is ignored.

Suffix:

<m>

1..10

The suffix is irrelevant. The setting affects all measurements except for the peak list.

Parameters:

<GroupResDialogs> ON | OFF

*RST: ON

Usage: Asynchronous command

Manual operation: See "[Group results](#)" on page 86

DISPlay:RESultboxes:MEPosition <Position>

Defines the position of the measurement results on the display.

Parameters:

<Position>

PREV | FLOA | DOCK

PREV

Preview: result icon on the signal bar

FLOA

Floating: floating result box in front of the diagrams

DOCK

Docked: fixed tab below the diagrams

*RST: DOCK

Usage: Asynchronous command

Manual operation: See "[Result position](#)" on page 86

27.7.2.10 Peak list appearance

MEASurement<m>:RESult:LABorder <MeasType>, <FrameType>
MEASurement<m>:RESult:LABorder? <MeasType>

Defines the layout of the labels.

Suffix:

<m> 1..10
 See "[Selection of the measurement group: MEASurement<m>](#)" on page 1583.

Parameters:

<FrameType> NOBorder | UNDERLINE | FULL

NOBorder

Label without border or lines.

UNDERLINE

The label is underlined.

FULL

The label is surrounded by a frame.

Parameters for setting and query:

<MeasType> PLISt
 Only for peaklist measurements. For other measurements, this command returns an error.

Manual operation: See "[Frame type](#)" on page 87

MEASurement<m>:RESult:INVerse <MeasType>, <State>
MEASurement<m>:RESult:INVerse? <MeasType>

Displays labels with black font on white background using the "Full frame" label type (if [MEASurement<m>:RESult:LABorder=ON](#)).).

Suffix:

<m> 1..10
 See "[Selection of the measurement group: MEASurement<m>](#)" on page 1583.

Parameters:

<State> ON | OFF

Parameters for setting and query:

<MeasType> PLISt
 Only for peaklist measurements. For other measurement, this command returns an error.

Example: Display labels.
 MEAS:RES:SHL PLIS,ON
 Select inverted labels.
 MEAS:RES:INV PLIS,ON
 Query the type of labels for peak lists.
 MEAS:RES:INV? PLIS
 //Result: ON

Manual operation: See "Invert" on page 87

27.7.2.11 Mask appearance

| | |
|------------------------------|------|
| MTES:LABel..... | 1405 |
| MTES:REName..... | 1405 |
| MTES:HIGHlight:INFinite..... | 1405 |
| MTES:HIGHlight:STATE..... | 1406 |
| MTES:HIGHlight:TIME..... | 1406 |
| MTES:COLor:UNMatch..... | 1406 |
| MTES:COLor:MATCh..... | 1407 |
| MTES:COLor:BORDer..... | 1407 |
| MTES:COLor:INTerior..... | 1407 |

MTES:LABel <LabelState>

Switches the display of the mask test name on or off.

To change the name of the mask test, use [MTES:REName](#) on page 1405.

Parameters:

<LabelState> ON | OFF
 *RST: ON

Usage: Asynchronous command

Manual operation: See "Show labels" on page 88

MTES:REName <MaskTestName>, <NewName>

MTES:REName? <MaskTestName>

Changes the name of the mask test.

Parameters:

<NewName> String with the new mask test name.

Parameters for setting and query:

<MaskTestName> String with the existing mask test name.

Manual operation: See "Show labels" on page 88

MTES:HIGHlight:INFinite <State>

If ON, the mask hits are highlighted for an unlimited period of time.

Parameters:

<State> ON | OFF
 *RST: OFF

Usage: Asynchronous command

Manual operation: See ["Show hits forever"](#) on page 88

MTESst:HIGHlight:STATe <HighlightHits>

If ON, the mask hits are highlighted on the screen. You can define the color and the time of the hit display.

Parameters:

<HighlightHits> ON | OFF
 *RST: ON

Usage: Asynchronous command

Manual operation: See ["Show hits"](#) on page 88

MTESst:HIGHlight:TIME <HighlightTime>

Sets the time how long the mask hits are highlighted.

Parameters:

<HighlightTime> Range: 0.05 to 50
 Increment: 0.1
 *RST: 1
 Default unit: s

Usage: Asynchronous command

Manual operation: See ["Show for"](#) on page 88

MTESst:COLor:UNMatch <ClrUnmatchedMsk>

Sets the color of masks segments that were not hit.

Parameters:

<ClrUnmatchedMsk> Decimal value corresponding to the ARGB hex value that is shown in the "Color" dialog box. ARGB is a 32-bit unsigned integer with alpha, red, green, blue word order. Alpha defines the transparency.
 To get the value, convert the hex value from the dialog to decimal value.
 Range: 0 (black) to 4294967295 (white)
 Increment: 1
 *RST: 2578098858

Usage: Asynchronous command

Manual operation: See ["Mask without violation"](#) on page 89

MTESt:COLor:MATCh <ClrMatchedPixel>

Sets the color of samples that violated the mask.

Parameters:

<ClrMatchedPixel> Decimal value corresponding to the ARGB hex value that is shown in the "Color" dialog box. ARGB is a 32-bit unsigned integer with alpha, red, green, blue word order. Alpha defines the transparency.

To get the value, convert the hex value from the dialog to decimal value.

Range: 0 (black) to 4294967295 (white)

Increment: 1

*RST: 4294901760

Usage: Asynchronous command

Manual operation: See "[Color](#)" on page 89

MTESt:COLor:BORDeR <ClrMatchedMskBorder>

Sets the color of masks segments that were touched at the border. In this case, the resolution is not sufficient to detect if the mask was really hit or not. Zoom into the concerned area to see the actual result.

Parameters:

<ClrMatchedMskBorder> Decimal value corresponding to the ARGB hex value that is shown in the "Color" dialog box. ARGB is a 32-bit unsigned integer with alpha, red, green, blue word order. Alpha defines the transparency.

To get the value, convert the hex value from the dialog to decimal value.

Range: 0 (black) to 4294967295 (white)

Increment: 1

*RST: 2580309606

Usage: Asynchronous command

Manual operation: See "[Mask with contact](#)" on page 89

MTESt:COLor:INTerior <ClrMatchedMskInterior>

Sets the color of mask segments the signal has entered into.

Parameters:

<ClrMatchedMskInterior> Decimal value corresponding to the ARGB hex value that is shown in the "Color" dialog box. ARGB is a 32-bit unsigned integer with alpha, red, green, blue word order. Alpha defines the transparency.

To get the value, convert the hex value from the dialog to decimal value.

Range: 0 (black) to 4294967295 (white)

Increment: 1

*RST: 2578055168

Usage:

Asynchronous command

Manual operation: See "[Mask with violation](#)" on page 89

27.7.3 Display

27.7.3.1 Persistence

| | |
|--|------|
| DISPlay:PERStence[:STATe] | 1408 |
| DISPlay:PERStence:INFinite | 1408 |
| DISPlay:PERStence:TIME | 1409 |
| DISPlay:PERStence:RESet | 1409 |

DISPlay:PERStence[:STATe] <State>

If enabled, each new data point in the diagram area remains on the screen for the duration defined using [DISPlay:PERStence:TIME](#), or as long as [DISPlay:PERStence:INFinite](#) is enabled.

If disabled, the signal value is only displayed as long as it actually occurs.

Parameters:

<State> ON | OFF
*RST: ON

Usage:

Asynchronous command

Manual operation: See "[Enable](#)" on page 91

DISPlay:PERStence:INFinite <State>

If persistence is enabled ([DISPlay:PERStence\[:STATe\]](#)), each new data point in the diagram area remains on the screen infinitely until this command is set to "OFF".

Parameters:

<State> ON | OFF
*RST: OFF

Usage:

Asynchronous command

Manual operation: See ["Infinite persistence"](#) on page 91

DISPlay:PERSiStence:TIME <Time>

If persistence is enabled (`DISPlay:PERSiStence[:STATe]`), each new data point in the diagram area remains on the screen for the duration defined here.

Parameters:

<Time> Range: 0.05 to 50
 Increment: 0.05
 *RST: 0.05
 Default unit: s

Usage: Asynchronous command

Manual operation: See ["Time"](#) on page 91

DISPlay:PERSiStence:RESet

Resets the display, removing persistent values.

Usage: Event
 Asynchronous command

Manual operation: See ["Reset"](#) on page 91

27.7.3.2 Signal

DISPlay:INTensity <Intensity>

This value determines the strength of the waveform line in the diagram. Enter a percentage between 0 (not visible) and 100% (very strong).

The exact mapping of the cumulative value occurrences according to the assigned color table is guaranteed only if the intensity is set to 50% (default). All other intensity values falsify the mapping but may improve the visibility of the signal.

Parameters:

<Intensity> Range: 0 to 100
 Increment: 1
 *RST: 50
 Default unit: %

Usage: Asynchronous command

Manual operation: See ["Intensity"](#) on page 92

DISPlay:DIAGram:STYLe <Style>

Select the style in which the waveform is displayed.

Parameters:

<Style> VECTors | DOTS

VECTors

The individual data points are connected by a line.

DOTS

Only the individual data points are displayed.

*RST: VECTors

Usage: Asynchronous command

Manual operation: See "[Waveform style](#)" on page 92

27.7.3.3 Clear results**DISPlay:CLR**

Deletes all measurement results including long term measurement and statistics, all waveforms, and the history.

Usage: Event
Asynchronous command

Manual operation: See "[Clear](#)" on page 56

27.7.4 User-defined preset**USRDefined:RST:NAME <Name>**

Sets the path and file name of a user-defined preset file.

Parameters:
<Name> String parameter

Manual operation: See "[Save set to be loaded on preset](#)" on page 99

USRDefined:RST:OPEN

opens and loads a user-defined preset file. Name and path of the preset file are defined with [USRDefined:RST:NAME](#).

Usage: Event

Manual operation: See "[Save set to be loaded on preset](#)" on page 99

USRDefined:RST:SAVE

Saves the current instrument settings to a user-defined preset file. Name and path of the preset file are defined with [USRDefined:RST:NAME](#).

Usage: Event

Manual operation: See "[Save set to be loaded on preset](#)" on page 99

USRDefined:RST[:ENABLE] <Name>

If ON, the settings from a previously defined preset file are restored when the [Preset] key is pressed. The preset file is defined with [USRDefined:RST:NAME](#).

If OFF, [Preset] sets the instrument to the factory defaults.

Parameters:

<Name> ON | OFF
*RST: OFF

Manual operation: See ["Enable user defined preset"](#) on page 98

27.7.5 Save / recall

See the following chapters:

- [Chapter 27.16.10, "Autonaming"](#), on page 1785
- [Chapter 27.16.11, "CSV export"](#), on page 1786
- [Chapter 27.16.12, "External application"](#), on page 1787

27.7.6 Maintenance**27.7.6.1 Self-alignment**

| | |
|---|------|
| CALibration:DATE? | 1411 |
| CALibration:TIME? | 1411 |
| CALibration:RESult? | 1412 |

CALibration:DATE?

Returns the date of the last selfalignment.

Return values:

<Date>

Usage: Query only
Asynchronous command

Manual operation: See ["Date / Time / Overall alignment state"](#) on page 101

CALibration:TIME?

Returns the time of the last selfalignment.

Return values:

<Time>

Usage: Query only
Asynchronous command

Manual operation: See ["Date / Time / Overall alignment state"](#) on page 101

CALibration:RESult?

Returns the result of the last selfalignment and the current alignment status. In remote mode, *CAL? provides more detailed information.

Return values:

<ResultState> PASSEd | FAILed | NOALigndata
 *RST: FAILed

Usage: Query only
 Asynchronous command

Manual operation: See ["Date / Time / Overall alignment state"](#) on page 101

27.7.6.2 Self-test

DIAGnostic:SERvice:STST:STATE?

Returns the summary result of the selftest.

Return values:

<State> PSSD | FAILed | UNDEfined
 *RST: UNDEfined

Usage: Query only
 Asynchronous command

Manual operation: See ["State"](#) on page 103

27.7.6.3 Hardware

SYSTem:DFPRint [<Path>]

The device footprint contains the configuration of the instrument, installed modules, installed software and software licenses. This information is written in the device footprint xml file might be useful in case of maintenance or support request.

The query returns the information as block data. The setting command saves the device footprint xml file in the specified path.

It is also possible to access the device footprint xml file via the instrument's web browser. Therefore, the directory containing the xml file must be enabled for sharing.

Setting parameters:

<Path> String parameter, specifying the target path of the footprint file.

Return values:

<DeviceFootprint> Content of the device footprint xml file as block data

Manual operation: See ["System Info"](#) on page 103

DIAGnostic:SERVice:FWVersion?

Returns the firmware version that is currently installed on the instrument.

Return values:

<FirmwareVersion> Version string

Usage: Query only
Asynchronous command

DIAGnostic:SERVice:PARTnumber <Number>

Returns the part number (order number) of your instrument. This number is required to order a new option, and in case of service.

Parameters:

<Number> Number string

Usage: Asynchronous command

Manual operation: See "[System Info](#)" on page 103

DIAGnostic:SERVice:SERialnumber?

Returns the serial number of your instrument. This number is required to order a new option, and in case of service.

Return values:

<SerialNumber> Number string

Usage: Query only
Asynchronous command

Manual operation: See "[System Info](#)" on page 103

DIAGnostic:SERVice:CHANnelcount?

Queries the number of available channels.

Return values:

<ChannelCount> Range: 0 to 4
Increment: 1
*RST: 0

Usage: Query only
Asynchronous command

Firmware/software: V 2.00

27.8 Acquisition and setup

Some of the commands in the following chapter are asynchronous. An overlapping or asynchronous command does not automatically finish executing before the next command starts executing. If overlapping commands must be executed in a defined order, e.g. to avoid wrong measurement results, they must be serviced sequentially.

To prevent an overlapping execution of commands, one of the commands `*OPC`, `*OPC?` or `*WAI` can be used after the command or a command set.

For more information, see:

- www.rohde-schwarz.com/rc-via-scp, chapter "Command sequence and synchronization"
- Chapter 27.3, "Programming examples", on page 1345
- [Starting and stopping acquisition](#)..... 1414
- [Time base](#)..... 1415
- [Acquisition](#)..... 1421
- [Fast segmentation](#)..... 1426
- [Vertical](#)..... 1427
- [Waveform data](#)..... 1432
- [Probes](#)..... 1434
- [R&S RT-ZVC probe](#)..... 1460
- [Differential signals](#)..... 1474
- [Digital filter](#)..... 1478
- [Skew](#)..... 1479
- [AUX OUT](#)..... 1481
- [High definition mode](#)..... 1482
- [Reference clock](#)..... 1483

27.8.1 Starting and stopping acquisition

| | |
|-------------------------------------|------|
| RUNContinuous | 1414 |
| RUN | 1414 |
| RUNSingle | 1415 |
| SINGle | 1415 |
| STOP | 1415 |

RUNContinuous

RUN

Starts the continuous acquisition.

Usage: Event
 Asynchronous command

Manual operation: See "[Run Stop]" on page 36

RUNSingle SINGLE

Starts a defined number of acquisition cycles. The number of cycles is set with [ACQUIRE:COUNT](#).

Usage: Event
Asynchronous command

Manual operation: See "[Single]" on page 37

STOP

Stops the running acquisition.

Usage: Event
Asynchronous command

Manual operation: See "[Run Stop]" on page 36

27.8.2 Time base

| | |
|---|------|
| TIMEbase:SCALE | 1415 |
| TIMEbase:RANGE | 1416 |
| TIMEbase:DIVisions? | 1416 |
| TIMEbase:HORizontal:POSition | 1416 |
| TIMEbase:REFerence | 1417 |
| TRIGger<m>:OFFSet:LIMited | 1417 |
| AUToscale | 1417 |
| ACQUIRE:POINTS:AUTO | 1418 |
| ACQUIRE:POINTS:AADJust | 1418 |
| ACQUIRE:POINTS:MAXimum | 1418 |
| ACQUIRE:POINTS:ARATe? | 1419 |
| ACQUIRE:SRATe | 1419 |
| ACQUIRE:SRReal | 1419 |
| ACQUIRE:RESolution | 1420 |
| ACQUIRE:POINTS[:VALue] | 1420 |
| TIMEbase:ROLL:ENABLE | 1420 |
| TIMEbase:ROLL:STATe? | 1420 |
| TIMEbase:ROLL:MTIME | 1421 |

TIMEbase:SCALE <TimeScale>

Sets the horizontal scale - the time per division on the x-axis - for all channel and math waveforms.

The setting accuracy depends on the current resolution (sample rate).

- No interpolation:
The resolution is an integer multiple of the ADC sample rate.
- With interpolation:
Any value for the horizontal scale can be set.

Parameters:

<TimeScale> Range: 25E-12 to 10000 (RTO, RTP) | 5000 (RTE)
 Increment: 1E-12
 *RST: 10E-9
 Default unit: s/div

Usage: Asynchronous command

Manual operation: See "[Time scale](#)" on page 120

TIMEbase:RANGe <AcquisitionTime>

Defines the time of one acquisition, that is the time across the 10 divisions of the diagram: *TimeScale*10*.

Parameters:

<AcquisitionTime> Range: 250E-12 to 100E+3 (RTO, RTP) | 50E+3 (RTE)
 Increment: 1E-12
 *RST: 0.5
 Default unit: s

Usage: Asynchronous command

Manual operation: See "[Acquisition time](#)" on page 120

TIMEbase:DIVisions?

Queries the number of horizontal divisions on the screen. The number cannot be changed.

Return values:

<HorizDivCnt> Range: 4 to 20
 Increment: 2
 *RST: 10

Usage: Query only
 Asynchronous command

TIMEbase:HORizontal:POSition <RescalCenterTime>

Defines the time distance between the reference point and the trigger point (the zero point of the diagram). The reference point marks the rescaling center of the time scale.

Parameters:

<RescalCenterTime> Range: -100E+24 to 100E+24
 Increment: 1E-12
 *RST: 0
 Default unit: s

Usage: Asynchronous command

Manual operation: See "[\[Position\]](#)" on page 37

ACQUIRE:POINTS:AUTO <ReclgthManual>

Selection to keep constant either the resolution or the record length when you adjust the time scale ([TIMEbase:SCALE](#)) or acquisition time ([TIMEbase:RANGE](#)).

Parameters:

<ReclgthManual> RESolution | RECLength

RESolution

Resolution is kept constant. Set the required resolution value with [ACQUIRE:RESolution](#).

RECLength

The record length is kept constant. Set the required record length value with [ACQUIRE:POINTS\[:VALue\]](#).

*RST: RESolution

Usage: Asynchronous command

Manual operation: See "[Sample rate mode](#)" on page 128

ACQUIRE:POINTS:AADJUST <AutoAdjust>

Prevents undersampling and ensures a sufficient resolution to acquire the correct waveform if the time scale is changed. The setting takes effect if the changed parameter - resolution or record length - reaches a limit. The instrument automatically keeps this parameter constant at its limit, and changes the other parameter regardless of the [ACQUIRE:POINTS:AUTO](#) setting.

Parameters:

<AutoAdjust> ON | OFF

*RST: ON

Usage: Asynchronous command

Manual operation: See "[Auto adjustment](#)" on page 128

ACQUIRE:POINTS:MAXIMUM <ReclgthLim>

Sets a limit for the record length to prevent very large records. This value only takes effect if a constant resolution is selected with [ACQUIRE:POINTS:AUTO](#). If you increase the time scale, the resolution remains constant and the record length increases until the limit is reached. Further increase of the time scale changes the resolution and keeps the record length limit.

Parameters:

<ReclgthLim> Range: 1000 to 800 MSa. The actual maximum can be lower depending on the installed options, number of active channels, measurements and math waveforms.
 Increment: 2
 *RST: 10E+6
 Default unit: pts

Usage: Asynchronous command

Manual operation: See "[Record length limit](#)" on page 128

ACQUIRE:POINTS:ARATE?

Retrieves the sample rate of the ADC, that is the number of points that are sampled by the ADC in one second.

Return values:

<ADCSampleRate> Range: 10 Gsample/s
Default unit: Sa/s

Usage: Query only
Asynchronous command

ACQUIRE:SRATE <SampleRate>

Defines the sample rate, that is the number of recorded waveform samples per second.

Parameters:

<SampleRate> Range: 10 Gsample/s
Increment: 1
*RST: 10 Gsample/s
Default unit: Sa/s

Usage: Asynchronous command

ACQUIRE:SRReal <RealSampleRate>

Sets the number of captured waveform points per second. It considers the samples of the ADC, and the reduction of waveform points by decimation.

If interpolation is not active, the sample rate is the reciprocal value of the resolution and thus also depends on the acquisition time and the record length.

If interpolation is active, the sample rate is limited to the ADC sample rate.

Parameters:

<RealSampleRate> Range: 10 Gsample/s
Increment: 1
*RST: 10 Gsample/s
Default unit: Sa/s

Usage: Asynchronous command

Firmware/software: FW 3.40

Manual operation: See "[Sample rate](#)" on page 126

ACquire:RESolution <Resolution>

Indicates the time between two waveform points in the record.

Parameters:

<Resolution> A fine resolution with low values produces a more precise waveform record.
Range: 1E-15 to 0.5
Increment: 10E-12
*RST: 100E-12
Default unit: s

Usage: Asynchronous command

Manual operation: See "[Resolution](#)" on page 127

ACquire:POINts[:VALue] <RecordLength>

Indicates the record length, the number of recorded waveform points that build the waveform across the acquisition time. [:VALue] can be omitted.

Parameters:

<RecordLength> Number of recorded waveform points.
Range: 1000 to 1000000000
Increment: 2
*RST: 1000
Default unit: pts

Usage: Asynchronous command

Manual operation: See "[Record length](#)" on page 127

TIMEbase:ROLL:ENABLE <Mode>

Activates the automatic roll mode.

Parameters:

<Mode> AUTO | OFF
AUTO: the instrument activates the roll mode under specific conditions.
See also "[Roll mode](#)" on page 121.
*RST: AUTO

Usage: Asynchronous command

Manual operation: See "[Roll mode](#)" on page 121

TIMEbase:ROLL:STATe?

Returns the status of the roll mode.

Return values:

<State> ON | OFF
 *RST: OFF

Usage:

Query only
 Asynchronous command

Manual operation: See ["Roll mode"](#) on page 121

TIMEbase:ROLL:MTIME <MinHorizGain>

The roll mode is enabled automatically if the acquisition time exceeds the given value, and if [TIMEbase:ROLL:ENABLE](#) is set to AUTO.

Parameters:

<MinHorizGain> Threshold value for roll mode enabling.
 Range: 1 to 600
 Increment: 1
 *RST: 10
 Default unit: s

Usage:

Asynchronous command

Manual operation: See ["Start roll time"](#) on page 122

27.8.3 Acquisition

| | |
|--|------|
| ACQUIRE:INTERPOLATE | 1421 |
| ACQUIRE:CDTA | 1422 |
| ACQUIRE:MUWAVEFORM | 1422 |
| CHANNEL<m>[:WAVEFORM<n>][:STATE] | 1422 |
| CHANNEL<m>[:WAVEFORM<n>]:TYPE | 1423 |
| CHANNEL<m>[:WAVEFORM<n>]:ARITHMETICS | 1423 |
| ACQUIRE:COUNT | 1424 |
| ACQUIRE:ARESET:IMMEDIATE | 1424 |
| ACQUIRE:ARESET:MODE | 1425 |
| ACQUIRE:ARESET:TIME | 1425 |
| ACQUIRE:ARESET:COUNT | 1425 |

ACQUIRE:INTERPOLATE <IntpolMd>

Selects the interpolation method.

See also: ["Interpolation"](#) on page 127.

Parameters:

<IntpolMd> LINear | SINX | SMHD
LINear
 Linear interpolation between two adjacent sample points
SINX
 Interpolation by means of a $\sin(x)/x$ curve.

SMHD

Sample/Hold causes a histogram-like interpolation.

*RST: SINX

Usage: Asynchronous command

Manual operation: See "[Interpolation](#)" on page 127

ACQuire:CDTA <CoupleAcquSet>

Sets the acquisition mode and the waveform arithmetic of all channels to the last set value.

If the acquisition settings are coupled, [ACQuire:MUWaveform](#) is not relevant, only one waveform per channel can be used.

Parameters:

<CoupleAcquSet> ON | OFF

*RST: ON

Usage: Asynchronous command

Firmware/software: FW 3.30
Substitutes [ACQuire:CMODode](#)

Manual operation: See "[Couple channels](#)" on page 130

ACQuire:MUWaveform <MultiWaveform>

For each channel, up to three waveforms can be shown and analyzed. The decimation mode and the waveform arithmetic are specific for each waveform. So you can analyze several aspects of the signal: For example, waveform1 shows the peaks, and waveform2 shows the average of the signal.

Parameters:

<MultiWaveform> ON | OFF

*RST: OFF

Usage: Asynchronous command

Firmware/software: FW 3.20

Manual operation: See "[Multi waveform](#)" on page 130

CHANnel<m>[:**WAVE**form<n>][:**STATE**] <State>

Activates or deactivates a waveform. [:**STATE**] can be omitted.

Suffix:

<m> 1..4

Selects the input channel.

<n> 1..3
Selects the waveform. If [:WAVEform<n>] is omitted, waveform 1 is addressed.

Parameters:

<State> ON | OFF
*RST: OFF

Usage: Asynchronous command

CHANnel<m>[:WAVEform<n>]:TYPE <DecimationMode>

Selects the method to reduce the data stream of the ADC to a stream of waveform points with lower sample rate.

See also: "[Decimation](#)" on page 129.

Suffix:

<m> 1..4
Selects the input channel.

<n> 1..3
Selects the waveform. If [:WAVEform<n>] is omitted, waveform 1 is addressed.

Parameters:

<DecimationMode> SAMPLE | PDETECT | HRESOLUTION | RMS

SAMPLE

One of n samples in a sample interval of the ADC is recorded as waveform point.

PDETECT

Peak Detect: the minimum and the maximum of n samples in a sample interval are recorded as waveform points.

HRESOLUTION

High resolution: The average of n sample points is recorded as waveform point.

RMS

The waveform point is the root mean square of n sample values.

*RST: SAMPLE

Usage: Asynchronous command

Manual operation: See "[Decimation](#)" on page 129

CHANnel<m>[:WAVEform<n>]:ARITHmetics <Arithmetics>

Selects the method to build the resulting waveform from several consecutive acquisitions of the signal. To define the number of acquisitions, use [ACQUIRE:COUNT](#).

See also: "[Arithmetic](#)" on page 130.

Suffix:

| | |
|-----|--|
| <m> | 1..4
Selects the input channel. |
| <n> | 1..3
Selects the waveform. If [:WAVEform<n>] is omitted, waveform 1 is addressed. |

Parameters:

| | |
|---------------|--|
| <Arithmetics> | OFF ENVELOpe AVERAge
OFF
The data of the current acquisition is recorded according to the decimation settings.
ENVELOpe
Detects the minimum and maximum values in an sample interval over a number of acquisitions. To define the reset method, use ...
AVERAge
Calculates the average from the data of the current acquisition and a number of acquisitions before.
*RST: OFF |
|---------------|--|

Usage: Asynchronous command

Manual operation: See "[Arithmetic](#)" on page 130

ACQUIRE:COUNT <MaxAcqCnt>

The acquisition and average count has a double effect:

- It sets the number of waveforms acquired with RUNSingle.
- It defines the number of waveforms used to calculate the average waveform.

Parameters:

| | |
|-------------|--|
| <MaxAcqCnt> | Range: 1 to 16777215
Increment: 10
*RST: 1 |
|-------------|--|

Usage: Asynchronous command

Manual operation: See "[Average count \(N-single count\)](#)" on page 127

ACQUIRE:ARESet:IMMEDIATE

Forces the immediate restart of the envelope and average calculation for all waveforms.

Usage: Event
Asynchronous command

Manual operation: See "[Reset](#)" on page 131

ACQUIRE:ARESet:MODE <ArMSt>

Defines when the envelope and average evaluation restarts.

Parameters:

<ArMSt> NONE | TIME | WFMS

TIME

Restarts the envelope and average calculation after the time defined with [ACQUIRE:ARESet:TIME](#).

WFMS

Restarts the envelope and average calculation after a number of acquired waveforms defined with [ACQUIRE:ARESet:COUNT](#) on page 1425.

*RST: NONE

Usage: Asynchronous command

Manual operation: See "[Arithmetic Reset > Mode](#)" on page 131

ACQUIRE:ARESet:TIME <EnvelopeTimeout>

Defines the time after which the envelope and average evaluation restarts.

The setting is relevant if [ACQUIRE:ARESet:MODE](#) is set to TIME.

Parameters:

<EnvelopeTimeout> Range: 0.1 to 10000
Increment: 0.01
*RST: 0.1
Default unit: s

Usage: Asynchronous command

Manual operation: See "[Arithmetic Reset > Mode](#)" on page 131

ACQUIRE:ARESet:COUNT <NofWaveforms>

Defines the number of acquired waveforms after which the envelope and average evaluation restarts.

The setting is relevant if [ACQUIRE:ARESet:MODE](#) is set to WFMS.

Parameters:

<NofWaveforms> Range: 2 to 16777215
Increment: 10
*RST: 1000

Usage: Asynchronous command

Manual operation: See "[Arithmetic Reset > Mode](#)" on page 131

27.8.4 Fast segmentation

| | |
|---------------------------------|------|
| ACQUIRE:SEGMENTED:STATE..... | 1426 |
| ACQUIRE:SEGMENTED:MAX..... | 1426 |
| ACQUIRE:SEGMENTED:AUTOPLAY..... | 1426 |

ACQUIRE:SEGMENTED:STATE <State>

Switches the fast segmentation mode on and off.

Parameters:

<State> ON | OFF
 *RST: OFF

Usage: Asynchronous command

Manual operation: See "[Fast segmentation](#)" on page 132

ACQUIRE:SEGMENTED:MAX <MaxAcquisitions>

The number of acquisitions in a fast segmentation acquisition series depends on the record length.

Parameters:

<MaxAcquisitions> ON | OFF
 ON
 Acquires the maximum possible number of acquisitions in a series.
 OFF
 Acquires the number of acquisitions defined using [ACQUIRE:COUNT](#).
 *RST: OFF

Usage: Asynchronous command

Manual operation: See "[Number of acquisitions](#)" on page 132

ACQUIRE:SEGMENTED:AUTOPLAY <ReplayAfterAcq>

If enabled, the instrument starts processing and displaying the data as soon as the acquisition series is captured completely. Depending on the number of acquisitions, it may take some time until the acquisition series is displayed. If the setting is disabled, the instrument only captures the data and stores it in the sample memory.

Parameters:

<ReplayAfterAcq> ON | OFF
 *RST: ON

Usage: Asynchronous command

Manual operation: See "[Enable automatic replay](#)" on page 132

27.8.5 Vertical

| | |
|---------------------------|------|
| CHANnel<m>:STATe..... | 1427 |
| CHANnel<m>:COUPling..... | 1427 |
| CHANnel<m>:GND..... | 1428 |
| CHANnel<m>:SCALe..... | 1428 |
| CHANnel<m>:RANGe..... | 1428 |
| CHANnel<m>:POSition..... | 1429 |
| CHANnel<m>:OFFSet..... | 1429 |
| CHANnel<m>:INVert..... | 1429 |
| CHANnel<m>:BANDwidth..... | 1430 |
| CHANnel<m>:CPLing..... | 1430 |
| CHANnel<m>:IMPedance..... | 1431 |
| CHANnel<m>:OVERload..... | 1431 |
| CHANnel<m>:FILDesign..... | 1431 |

CHANnel<m>:STATe <State>

Switches the channel signal on or off.

Suffix:

<m> 1..4
Selects the input channel.

Parameters:

<State> ON | OFF
*RST: OFF

Usage: Asynchronous command

Manual operation: See "[C<n>]" on page 38

CHANnel<m>:COUPling <Value>

Selects the connection of the indicated channel signal.

Suffix:

<m> 1..4
Selects the input channel.

Parameters:

<Value> DC | DCLimit | AC

DC
Direct connection with 50 Ω termination, passes both DC and AC components.

DCLimit
Direct connection with 1 MΩ termination, passes both DC and AC components.

AC
Connection with 1 MΩ termination, removes DC and very low-frequency components.

Manual operation: See "[Coupling](#)" on page 140

CHANnel<m>:GND <State>

Connects the signal to the ground.

Suffix:

<m> 1..4

Parameters:

<State> ON | OFF
*RST: OFF

Manual operation: See "[Ground](#)" on page 140

CHANnel<m>:SCALE <Scale>

Sets the vertical scale for the indicated channel.

Suffix:

<m> 1..4
Selects the input channel.

Parameters:

<Scale> Scale value, given in Volts per division.
Range: Depends on attenuation factors, coupling, and instrument model, see below.
Increment: Depends on vertical and probe settings
*RST: 0.05
Default unit: V/div

Usage: Asynchronous command

Manual operation: See "[\[Scale\]](#)" on page 40

CHANnel<m>:RANGe <Range>

Sets the voltage range across the 10 vertical divisions of the diagram. Use the command alternatively instead of [CHANnel<m>:SCALE](#).

Suffix:

<m> 1..4
Selects the input channel.

Parameters:

<Range> Voltage range value
Range: Dependencies see below.
Increment: Depends on vertical and probe settings
*RST: 0.5
Default unit: V/div

Usage: Asynchronous command

CHANnel<m>:POSition <Position>

Sets the vertical position of the indicated channel as a graphical value.

Suffix:

<m> 1..4
Selects the input channel.

Parameters:

<Position> Positive values move the waveform up, negative values move it down.
Range: -5 to 5
Increment: 0.01
*RST: 0
Default unit: div

Usage: Asynchronous command

Manual operation: See "[Position]" on page 39

CHANnel<m>:OFFSet <Offset>

The offset voltage is subtracted to correct an offset-affected signal. The offset of a signal is determined and set by the autose procedure.

See also: "Offset" on page 139.

Suffix:

<m> 1..4
Selects the input channel.

Parameters:

<Offset> Negative values move the waveform up, positive values move it down.
Range: Depends on attenuation factors, input coupling, and the offset compensation range of active probes. The nominal offset range for 1:1 attenuation and probe offset compensation = 0 is specified in the specifications document.
Increment: Depends on vertical and probe settings
*RST: 0
Default unit: V

Usage: Asynchronous command

Manual operation: See "[Position]" on page 39

CHANnel<m>:INVert <InvertChannel>

Turns the inversion of the signal amplitude on or off. To invert means to reflect the voltage values of all signal components against the ground level. If the inverted channel is the trigger source, the instrument triggers on the inverted signal.

Suffix:

<m> 1..4
Selects the input channel.

Parameters:

<InvertChannel> ON | OFF
*RST: OFF

Usage: Asynchronous command

Firmware/software: FW 3.30

Manual operation: See "[Invert channel](#)" on page 140

CHANnel<m>:BANDwidth <BandwidthLimit>

Selects the bandwidth limit for the indicated channel.

Suffix:

<m> 1..4
Selects the input channel.

Parameters:

<BandwidthLimit> FULL | B800 | B200 | B20

FULL

Use full bandwidth.

B200 | B20

Limit to 200 MHz or 20 MHz.

B800

Limit to 800 MHz. Available for 50 Ω coupling on scopes with ≥ 1 GHz instrument bandwidth.

*RST: FULL

Usage: Asynchronous command

Manual operation: See "[Analog](#)" on page 141

CHANnel<m>:CPLing <Channel>, <State>**CHANnel<m>:CPLing? <Channel>**

Sets the vertical settings of the coupled channel to the values of the active channel.

Suffix:

<m> 1..4
Active channel

Parameters:

<State> OFF | ON

Parameters for setting and query:

<Channel> CHAN1 | C1 | CHAN2 | C2 | CHAN3 | C2 | CHAN4 | C4

CHAN1 = C1, CHAN2 = C2, CHAN3 = C2, CHAN4 = C4

Input channel that takes the vertical settings of CHANnel<m>.

Usage: Asynchronous command
Manual operation: See "[Coupled to C1 / C2 / C3 / C4](#)" on page 143

CHANnel<m>:IMPedance <Impedance>

Sets the impedance of the channel for power calculations and measurements.

Suffix:

<m> 1..4
 Selects the input channel.

Parameters:

<Impedance> Range: 0.1 to 100E+3
 Increment: 1
 *RST: 50
 Default unit: Ω

Usage: Asynchronous command
Manual operation: See "[Impedance](#)" on page 142

CHANnel<m>:OVERload <Overload>

Retrieves the overload status of the specified channel from the status bit. When the overload problem is solved, the command resets the status bit.

The overload status is returned asynchronously. Therefore, it is not possible to assign an overload to a specific acquisition during continuous acquisition. This assignment is only possible for a single acquisition.

Suffix:

<m> 1..4
 Selects the input channel.

Parameters:

<Overload> ON | OFF
 Use OFF to reset the overload status bit.
 *RST: OFF

Example:

```
ACQuire:COUNT 1
SINGle
CHANnel2:OVERload?
Queries the overload status of channel 2 after a single acquisition.
CHANnel2:OVERload OFF
Resets the overload status bit.
```

Usage: Asynchronous command

CHANnel<m>:FILDesign <FilterDesignTyp>

Selects the type of filter to be used.

Suffix:

<m> 1..4

Parameters:

<FilterDesignTyp> WALL | GAUSSian
 WALL: Brick wall filter
 *RST: WALL

Usage: Asynchronous command**Manual operation:** See "Filter characteristics" on page 143

27.8.6 Waveform data

To set the export data format, see [FORMat \[:DATA\]](#) on page 1380.

[CHANnel<m>\[:WAVEform<n>\]:DATA:HEADer?](#)..... 1432
[CHANnel<m>\[:WAVEform<n>\]:DATA\[:VALues\]?](#)..... 1433

CHANnel<m>[:WAVEform<n>]:DATA:HEADer?

Returns the header of channel waveform data.

Table 27-1: Header data

| Position | Meaning | Example |
|----------|---|--------------------------|
| 1 | XStart in s | -9.477E-008 = - 94,77 ns |
| 2 | XStop in s | 9.477E-008 = 94,77 ns |
| 3 | Record length of one waveform | 200000 |
| 4 | Number of values per sample interval. For most waveforms the result is 1, for peak detect and envelope waveforms it is 2. If the number is 2, the number of returned values is twice the number of samples (record length). | 1 |

If multichannel export is enabled, the number of returned samples is *Record length * Number of exported waveforms*. See also [EXPort:WAVEform:MULTichannel](#).

Suffix:

<m> 1..4
 Selects the input channel.

<n> 1..3
 Selects the waveform. If [:WAVEform<n>] is omitted, waveform 1 is addressed.

Example: CHAN1:WAV1:DATA:HEAD?
 -9.477E-008,9.477E-008,200000,1

Usage: Query only

CHANnel<m>[:WAVeform<n>]:DATA[:VALues]? [<Offset>], [<Length>]

Returns the data of the channel waveform points for transmission from the instrument to the controlling computer. The data can be used in MATLAB, for example.

Without parameters, the complete waveform is retrieved. Using the offset and length parameters, data can be retrieved in smaller portions, which makes the command faster.

To set the export format, use `FORMat [:DATA]`.

You can retrieve only Y-values (usually voltage values), or X- and Y-values. Use `EXPort:WAVeform:INCXvalues` to define which values are retrieved.

If multichannel export is active (`EXPort:WAVeform:MULTichannel`), the channel suffix is ignored. To select the channels to be exported, use `CHANnel<m>:EXPortstate`. The Y-values are written in interleaved order, for example, YCh1₀; YCh2₀; YCh1₁; YCh2₁... for a 2-channel instrument.

Suffix:

| | |
|-----|--|
| <m> | 1..4
Selects the input channel. |
| <n> | 1..3
Selects the waveform. If [:WAVeform<n>] is omitted, waveform 1 is addressed. |

Query parameters:

| | |
|------------|--|
| [<Offset>] | Number of offset waveform points.
Range: 0 to m. Limit: n + m <= record length |
| [<Length>] | Number of waveform points to be retrieved.
Range: 1 to n. Limit: n + m <= record length |

Return values:

| | |
|--------|--|
| <Data> | List of values according to the format and content settings. |
|--------|--|

Example:

Retrieve the complete channel 1 waveform, only Y-values:

```
FORM ASC
EXP:WAV:INCX OFF
CHAN1:WAV1:DATA?
<-- -0.125000,-0.123016,-0.123016,-0.123016,-0.123016,-0.123016,...
```

Example:

Retrieve the first 10 values of the waveform:

```
CHANnel:WAVeform:DATA:VALues? 0,10
<-- -0.10079051554203,-0.098814234137535,-0.098814234137535,
-0.096837945282459,-0.094861663877964,-0.094861663877964,
-0.092885382473469,-0.090909093618393,-0.090909093618393,
-0.088932812213898
```

Example:

Skip 5 samples and retrieve the next 5 samples:

```
CHANnel:WAVeform:DATA:VALues? 5,5
<-- -0.094861663877964,-0.092885382473469,-0.090909093618393,
-0.090909093618393,-0.088932812213898
```

Usage: Query only

27.8.7 Probes

TRPProbe: . . . command are dedicated commands for the external trigger input.

- [Common probe settings](#)..... 1434
- [Micro button and R&S ProbeMeter](#)..... 1437
- [Passive probes](#)..... 1441
- [Active voltage probes](#)..... 1443
- [Modular probes](#)..... 1446
- [Modular probes, deembedding](#)..... 1449
- [Predefined probes](#)..... 1452
- [Current probes](#)..... 1454
- [Optical isolated probes](#)..... 1455
- [Probe attributes](#)..... 1457
- [Probe adapter R&S RT-Z2T](#)..... 1459

27.8.7.1 Common probe settings

| | |
|--|------|
| PROBe<m>:SETup:STATe? | 1434 |
| PROBe<m>:SETup:TYPE? | 1434 |
| PROBe<m>:SETup:NAME? | 1435 |
| PROBe<m>:SETup:BANDwidth? | 1435 |
| PROBe<m>:SETup:ATTenuation[:AUTO]? | 1435 |
| PROBe<m>:SETup:OFFSet:AZERo | 1436 |
| PROBe<m>:SETup:OFFSet:USEautozero | 1436 |
| CHANnel<m>:EATScale | 1436 |
| CHANnel<m>:EATTenuation | 1437 |

PROBe<m>:SETup:STATe?

Queries if the probe at the specified input channel is active (detected) or not active (not detected). To switch the probe on, use [CHANnel<m>:STATe](#).

Suffix:

<m> 1..4

Return values:

<State> DETected | NDETECTED
*RST: NDETECTED

Usage:

Query only
Asynchronous command

PROBe<m>:SETup:TYPE?

Queries the type of the probe.

Suffix:

<m> 1..4
Selects the input channel.

Return values:

<Type> String containing one of the following values:
– None (no probe detected)
– Passive Probe
– active single-ended

Usage:

Query only
Asynchronous command

Manual operation: See "[Type, Name, Bandwidth](#)" on page 146

PROBe<m>:SETup:NAME?

Queries the name of the probe.

Suffix:

<m> 1..4
Selects the input channel.

Return values:

<Name> Name string

Usage:

Query only
Asynchronous command

Manual operation: See "[Type, Name, Bandwidth](#)" on page 146

PROBe<m>:SETup:BANDwidth?

Queries the bandwidth of the probe.

Suffix:

<m> 1..4
Selects the input channel.

Return values:

<Bandwidth> Range: 10000 to 20E+9
*RST: 1E+9
Default unit: Hz

Usage:

Query only
Asynchronous command

Manual operation: See "[Type, Name, Bandwidth](#)" on page 146

PROBe<m>:SETup:ATTenuation[:AUTO]?

Queries the attenuation of the probe.

Suffix:

<m> 1..4
Selects the input channel.

Return values:

<PrbAttMdAuto> Range: 1E-3 to 1000
*RST: 1
Default unit: V/V

Usage:

Query only
Asynchronous command

Manual operation: See "[Probe unit, Auto attenuation](#)" on page 148

PROBe<m>:SETup:OFFSet:AZERo

Performs an automatic correction of the zero error. If the DUT is ground-referenced, the AutoZero function can improve the measurement results.

See also: "[Detect AutoZero, Use AutoZero](#)" on page 146

Suffix:

<m> 1..4
Selects the input channel.

Usage:

Event
Asynchronous command

Manual operation: See "[Detect AutoZero, Use AutoZero](#)" on page 146

PROBe<m>:SETup:OFFSet:USEautozero <AutoZeroOffset>

Includes the AutoZero offset in measurement results. The auto zero error is detected with `PROBe<m>:SETup:OFFSet:AZERo`.

Suffix:

<m> 1..4
Selects the input channel.

Parameters:

<AutoZeroOffset> ON | OFF
*RST: OFF

Usage:

Asynchronous command

Firmware/software: Version 2.70

Manual operation: See "[Detect AutoZero, Use AutoZero](#)" on page 146

CHANnel<m>:EATScale <ExtAttScI>

Sets the attenuation scale for an external divider.

Suffix:

<m> 1..4
Selects the input channel.

Parameters:

<ExtAttScl> LIN | LOG
*RST: LIN

Usage: Asynchronous command

Manual operation: See "[External attenuation: Scale, Attenuation](#)" on page 142

CHANnel<m>:EATTenuation <ExtAtt>

Sets the attenuation of an external voltage divider that is part of the DUT before the measuring point. The external attenuation is included in the measurement, and the instrument shows the results that would be measured before the divider.

Suffix:

<m> 1..4
Selects the input channel.

Parameters:

<ExtAtt> Values and unit depend on the selected scale ([CHANnel<m>:EATScale](#)).

Range: Linear scale: 1E-3 to 1E+6, logarithmic scale: -60 dB to 120 dB
Increment: 0.01
*RST: 1

Usage: Asynchronous command

Manual operation: See "[External attenuation: Scale, Attenuation](#)" on page 142

27.8.7.2 Micro button and R&S ProbeMeter

| | |
|---|------|
| PROBe<m>:SETup:MODE | 1437 |
| PROBe<m>:SETup:DISPlaydiff | 1439 |
| PROBe<m>:PMETer:VISibility | 1439 |
| PROBe<m>:PMETer:RESults:SINGle? | 1439 |
| PROBe<m>:PMETer:RESults:COMMon? | 1440 |
| PROBe<m>:PMETer:RESults:DIFFerential? | 1440 |
| PROBe<m>:PMETer:RESults:NEGative? | 1441 |
| PROBe<m>:PMETer:RESults:POSitive? | 1441 |

PROBe<m>:SETup:MODE <Mode>

Select the action that is started when you press the micro button on the probe head.

See also: "[Micro button action](#)" on page 148.

Suffix:

<m>

1..4

Selects the input channel.

Parameters:

<Mode>

RCONtinuous | RSINgle | AUToset | AZERo | SEToffsettomean | SITFile | NOACtion | FINDtriglevel | REPort | PROBemode | PRSetup

RCONtinuous

Run continuous: The acquisition is running as long as the probe button is pressed.

RSINgle

Run single: Starts a defined number of acquisitions (same as [Single] key).

AUTOSET

Starts the autosegment procedure.

AZero

AutoZero: performs an automatic correction of the zero error.

SEToffsettomean

Set offset to mean: performs an automatic compensation for a DC component of the input signal.

SITFile

Save Image To File:

Directs the display image to a file. The `MMEMory:NAME` command defines the file name. The file format is defined with `HCOpy:DEvIce<m>:LANGuage`.**NOACtion**

Nothing is started on pressing the micro button.

FINDtriglevelSets the trigger level automatically to $0.5 * (MaxPeak - MinPeak)$. The function is not available for an external trigger source.**REPort**

Creates and saves a report of the current results.

PROBemode

Only available for R&S RT-ZM probes. Changes the measurement mode of the probe.

PRSetup

Opens the "Probes Setup" dialog box.

*RST: RCONtinuous

Usage:

Asynchronous command

Manual operation:See "[Micro button action](#)" on page 148

PROBe<m>:SETUp:DISPlaydiff <DisplayDiff>

Selects the input voltages to be measured by the ProbeMeter of an R&S differential active probe.

See also: "[Differential active probes](#)" on page 118.

Suffix:

<m> 1..4
Selects the input channel.

Parameters:

<DisplayDiff> DIFFerential | SINGleended
DIFFerential
Measures differential and common mode voltages
SINGleended
Measures the voltage between the positive/negative signal socket and the ground.
 *RST: DIFFerential

Usage: Asynchronous command

Manual operation: See "[ProbeMeter results](#)" on page 149

PROBe<m>:PMETer:VISibility <Visibility>

Activates the integrated R&S ProbeMeter of active R&S probes.

Suffix:

<m> 1..4
Selects the input channel.

Parameters:

<Visibility> ON | OFF
 *RST: OFF

Usage: Asynchronous command

Firmware/software: FW 2.25

Manual operation: See "[ProbeMeter](#)" on page 149

PROBe<m>:PMETer:RESults:SINGle?

Returns the ProbeMeter measurement result of single-ended active R&S probes, the voltage measured between the probe tip and the ground.

Suffix:

<m> 1..4
Selects the input channel.

Return values:

<Result> Range: -100E+24 to 100E+24
 Increment: 1E-3
 *RST: 0
 Default unit: V

Usage:

Query only
 Asynchronous command

Firmware/software: FW 2.25

Manual operation: See "[ProbeMeter results](#)" on page 149

PROBe<m>:PMETer:RESults:COMMon?

Returns the ProbeMeter measurement result of differential active R&S probes: the common mode voltage, which is the mean voltage between the signal sockets and the ground socket.

Suffix:

<m> 1..4
 Selects the input channel.

Return values:

<Result> Range: -100E+24 to 100E+24
 Increment: 1E-3
 *RST: 0
 Default unit: V

Usage:

Query only
 Asynchronous command

Firmware/software: FW 2.25

Manual operation: See "[ProbeMeter results](#)" on page 149

PROBe<m>:PMETer:RESults:DIFFerential?

Returns the ProbeMeter measurement result of differential active R&S probes, the differential voltage - the voltage between the positive and negative signal sockets.

Suffix:

<m> 1..4
 Selects the input channel.

Return values:

<DiffMeasRes> Range: -100E+24 to 100E+24
 Increment: 1E-3
 *RST: 0
 Default unit: V

Usage:

Query only
 Asynchronous command

Firmware/software: FW 2.25

Manual operation: See ["ProbeMeter results"](#) on page 149

PROBe<m>:PMETer:RESults:NEGative?

Returns the ProbeMeter measurement result of differential active R&S probes, the voltage that is measured between the negative signal socket and the ground.

Suffix:

<m> 1..4
Selects the input channel.

Return values:

<SgEndNegMeasRes>Range: -100E+24 to 100E+24
Increment: 1E-3
*RST: 0
Default unit: V

Usage: Query only
Asynchronous command

Firmware/software: FW 2.25

Manual operation: See ["ProbeMeter results"](#) on page 149

PROBe<m>:PMETer:RESults:POSitive?

Returns the ProbeMeter measurement result of differential active R&S probes, the voltage that is measured between the negative signal socket and the ground.

Suffix:

<m> 1..4
Selects the input channel.

Return values:

<Result> Range: -100E+24 to 100E+24
Increment: 1E-3
*RST: 0
Default unit: V

Usage: Query only
Asynchronous command

Firmware/software: FW 2.25

Manual operation: See ["ProbeMeter results"](#) on page 149

27.8.7.3 Passive probes

| | |
|--|------|
| PROBe<m>:SETup:ATTenuation:MODE..... | 1442 |
| PROBe<m>:SETup:ATTenuation:UNIT..... | 1442 |
| PROBe<m>:SETup:ATTenuation:MANual..... | 1442 |
| PROBe<m>:SETup:GAIN:MANual..... | 1443 |

PROBe<m>:SETup:ATTenuation:MODE <PrbAttMd>

Set the mode to MANual if the instrument does not detect the probe.

Suffix:

<m> 1..4
Selects the input channel.

Parameters:

<PrbAttMd> AUTO | MANual
*RST: AUTO

Usage: Asynchronous command

Manual operation: See "[Mode](#)" on page 151

PROBe<m>:SETup:ATTenuation:UNIT <AttenuationUnit>

Sets the unit for the connected probe type if [PROBe<m>:SETup:ATTenuation:MODE](#) on page 1442 is set to MANual.

Suffix:

<m> 1..4
Selects the input channel.

Parameters:

<AttenuationUnit> V | A | W
Voltage probe (V), current probe (A), power probe (W)
*RST: V

Usage: Asynchronous command

Manual operation: See "[Vertical unit, Attenuation, Gain](#)" on page 152

PROBe<m>:SETup:ATTenuation:MANual <ManualAttenuation>

Sets the attenuation for the connected probe if [PROBe<m>:SETup:ATTenuation:MODE](#) on page 1442 is set to MANual.

Suffix:

<m> 1..4
Selects the input channel.

Parameters:

<ManualAttenuation> Range: 100E-6 to 10000
Increment: 0.1
*RST: 1
Default unit: Depends on the selected unit

Usage: Asynchronous command

Manual operation: See "[Vertical unit, Attenuation, Gain](#)" on page 152

PROBe<m>:SETup:GAIN:MANual <GainManual>

Sets the gain of a current probe.

Suffix:

<m> 1..4
Selects the input channel. The number of channels depends on the instrument.

Parameters:

<GainManual> Range: 100E-6 to 10000
Increment: 100E-6
*RST: 1
Default unit: V/A

Usage: Asynchronous command

Manual operation: See "[Vertical unit, Attenuation, Gain](#)" on page 152

27.8.7.4 Active voltage probes

| | |
|--|------|
| PROBe<m>:SETup:CMOffset | 1443 |
| PROBe<m>:SETup:ZAXV | 1443 |
| PROBe<m>:SETup:ACCoupling | 1444 |
| PROBe<m>:SETup:ADVanced:PMOffset | 1444 |
| PROBe<m>:SETup:ADVanced:RANGe | 1444 |
| PROBe<m>:SETup:ADVanced:FILTer | 1445 |
| PROBe<m>:SETup:ADVanced:AUDioverload | 1445 |

PROBe<m>:SETup:CMOffset <CMOffset>

Sets the common-mode offset. The setting is only available for differential probes.

Suffix:

<m> 1..4
Selects the input channel.

Parameters:

<CMOffset> Range: -100E+24 to 100E+24
Increment: 1E-3
*RST: 0
Default unit: V

Usage: Asynchronous command

Manual operation: See "[CM offset](#)" on page 154

PROBe<m>:SETup:ZAXV <ExtAttRTZA15>

If you use the external attenuator R&S RT-ZA15 together with one of the differential active probes R&S RT-ZD10/20/30, enable it to include the external attenuation in the measurements.

Suffix:

<m> 1..4
Selects the input channel.

Parameters:

<ExtAttRTZA15> ON | OFF
*RST: OFF

Usage: Asynchronous command

Manual operation: See "[Probe attenuator RT-ZA15](#)" on page 154

PROBe<m>:SETup:ACCoupling <ProbeCouplingAC>

Enables AC coupling in the R&S RT-ZPR20 probe, which removes DC and very low-frequency components. The R&S RT-ZPR20 probe requires 50 Ω input termination, for which the channel AC coupling is not available. The probe setting allows AC coupling also at 50 Ω inputs.

Suffix:

<m> 1..4
Selects the input channel.

Parameters:

<ProbeCouplingAC> ON | OFF
*RST: OFF

Usage: Asynchronous command

Manual operation: See "[AC Coupling](#)" on page 156

PROBe<m>:SETup:ADVanced:PMToffset

Sets the measured R&S ProbeMeter value as offset. Make sure that the R&S ProbeMeter is active before you use this command.

Available for power rail probes R&S RT-ZPR and optical isolated probes R&S RT-ZISO.

Suffix:

<m> 1..4
Selects the input channel.

Usage: Event
Asynchronous command

Manual operation: See "[Copy to offset](#)" on page 156

PROBe<m>:SETup:ADVanced:RANGe <ProbeRange>

Sets the voltage range of a R&S RT-ZHD probe.

Suffix:

<m> 1..4
Selects the input channel.

Parameters:

<ProbeRange> AUTO | MHIGH | MLOW

AUTO

The voltage range is set with `CHANnel<m>:SCALE`.

MHIGH

Sets the higher voltage range of the connected probe. To query the value, use `PROBe<m>:SETup:ATTenuation[:AUTO]?`.

MLOW

Sets the lower voltage range of the connected probe. To query the value, use `PROBe<m>:SETup:ATTenuation[:AUTO]?`.

*RST: AUTO

Usage: Asynchronous command

Manual operation: See "Range" on page 157

PROBe<m>:SETup:ADVanced:FILTer <BwFilterSt>

Enables the lowpass filter in the probe control box.

Suffix:

<m> 1..4
Selects the input channel.

Parameters:

<BwFilterSt> ON | OFF

*RST: OFF

Usage: Asynchronous command

Manual operation: See "BW limit" on page 157

PROBe<m>:SETup:ADVanced:AUDioverload <Sound>

Activates the acoustic overrange warning in the probe control box.

Suffix:

<m> 1..4
Selects the input channel.

Parameters:

<Sound> ON | OFF

*RST: OFF

Usage: Asynchronous command

Manual operation: See "Buzzer" on page 157

27.8.7.5 Modular probes

The commands of this chapter are relevant for R&S RT-ZM modular probes. The commands are available in firmware version 3.40 and higher.

The suffix <m> selects the input channel to which the probe is connected.

| | |
|-----------------------------------|------|
| PROBe<m>:SETup:PRMode..... | 1446 |
| PROBe<m>:SETup:DMOOffset..... | 1446 |
| PROBe<m>:SETup:CMOOffset..... | 1447 |
| PROBe<m>:SETup:NOFFset..... | 1447 |
| PROBe<m>:SETup:POFFset..... | 1448 |
| PROBe<m>:SETup:TERM:STATe..... | 1448 |
| PROBe<m>:SETup:TERM:MODE..... | 1448 |
| PROBe<m>:SETup:TERM:MEASure?..... | 1449 |
| PROBe<m>:SETup:TERM:ADJust..... | 1449 |

PROBe<m>:SETup:PRMode <MeasMode>

Sets the measurement mode of the modular probe.

Suffix:

<m> 1..4

Parameters:

<MeasMode> DMODE | CMODE | PMODE | NMODE

DMODE

Differential mode input voltage (V_{dm}), the voltage between the positive and negative input terminal.

CMODE

Common mode input voltage (V_{cm}), the mean voltage between the positive and negative input terminal vs. ground.

PMODE

Positive single-ended input voltage (V_p). the voltage between the positive input terminal and ground.

NMODE

Negative single-ended input voltage (V_N). the voltage between the negative input terminal and ground.

*RST: DMODE

Usage:

Asynchronous command

Manual operation: See "Probe mode" on page 158

PROBe<m>:SETup:DMOOffset <DMOOffset>

Sets the differential offset to compensate a DC voltage applied to the positive and the negative input terminal.

Suffix:

<m> 1..4

Parameters:

<DMOffset> In "DM" probe mode (DMODE), this offset is used as channel offset and considered automatically for correction.

Range: -100E+24 to 100E+24

Increment: 1E-3

*RST: 0

Default unit: V

Usage:

Asynchronous command

Manual operation: See "[DM Offset](#), [CM Offset](#), [P Offset](#), [N Offset](#)" on page 159

PROBe<m>:SETup:CMOffset <CMOffset>

Sets the common-mode offset. The setting is only available for differential probes.

Suffix:

<m> 1..4

Selects the input channel.

Parameters:

<CMOffset> Range: -100E+24 to 100E+24

Increment: 1E-3

*RST: 0

Default unit: V

Usage:

Asynchronous command

Manual operation: See "[CM offset](#)" on page 154

PROBe<m>:SETup:NOFFset <NOffset>

Sets the negative offset to compensate a DC voltage applied to the negative input terminal (Vp) referenced to ground.

Suffix:

<m> 1..4

Parameters:

<NOffset> In "N" probe mode (NMODE), this offset is used as channel offset and considered automatically for correction.

Range: -100E+24 to 100E+24

Increment: 1E-3

*RST: 0

Default unit: V

Usage:

Asynchronous command

Manual operation: See "[DM Offset](#), [CM Offset](#), [P Offset](#), [N Offset](#)" on page 159

PROBe<m>:SETup:POFFset <POffset>

Sets the positive offset to compensate a DC voltage applied to the positive input terminal (Vp) referenced to ground.

Suffix:

<m> 1..4

Parameters:

<POffset> In "P" probe mode (PMODE), this offset is used as channel offset and considered automatically for correction.

Range: -100E+24 to 100E+24

Increment: 1E-3

*RST: 0

Default unit: V

Usage: Asynchronous command

Manual operation: See "[DM Offset, CM Offset, P Offset, N Offset](#)" on page 159

PROBe<m>:SETup:TERM:STATe <VoltageState>

Activates the instrument control of the termination voltage.

Suffix:

<m> 1..4

Parameters:

<VoltageState> ON | OFF

*RST: OFF

Usage: Asynchronous command

Manual operation: See "[Enable](#)" on page 161

PROBe<m>:SETup:TERM:MODE <Mode>

Setting the termination voltage is relevant if you use the R&S RT-ZMA40 SMA module.

You can set a termination voltage to correct the internal 50 Ω termination of the SMA module by the common mode voltage. To control the termination voltage by the instrument, connect the VT terminal of the R&S RT-ZM probe amplifier to the VT terminal of the SMA module using the red DC lead (see R&S RT-ZM User Manual).

Suffix:

<m> 1..4

Parameters:

<Mode> AUTO | MANual

AUTO

The instrument uses the measured common mode voltage to control the termination.

MANual

Enter the voltage to be used for termination.

*RST: AUTO

Usage: Asynchronous command

Manual operation: See "[Mode](#)" on page 161

PROBe<m>:SETup:TERM:MEASure?

Returns the measured common mode voltage.

Suffix:

<m> 1..4

Return values:

<VoltageMeas> Common mode voltage
 Range: -100E+24 to 100E+24
 Increment: 1E-3
 *RST: 0
 Default unit: V

Usage: Query only
 Asynchronous command

Manual operation: See "[Measurement](#)" on page 162

PROBe<m>:SETup:TERM:ADJust <VoltageAdjust>

Sets the voltage to be used for termination correction.

Suffix:

<m> 1..4

Parameters:

<VoltageAdjust> Correction voltage
 Range: -100E+24 to 100E+24
 Increment: 1E-3
 *RST: 0
 Default unit: V

Usage: Asynchronous command

Manual operation: See "[Adjustment](#)" on page 161

27.8.7.6 Modular probes, deembedding

The commands of this chapter are relevant for R&S RT-ZM modular probes when used for measurements on signal frequencies of 4 GHz and higher. The commands are available in firmware version 4.00 and higher.

See also: [PROBe<m>:SETup:PRMode](#) on page 1446

| | |
|--|------|
| PROBe<m>:DEEMbedding:PMODE..... | 1450 |
| PROBe<m>:DEEMbedding:TIPModule[:SElect]..... | 1450 |
| PROBe<m>:DEEMbedding:TIPModule:ZMA<n>:SUBModule..... | 1450 |
| PROBe<m>:DEEMbedding:BANDwidth..... | 1451 |
| PROBe<m>:DEEMbedding:MODE..... | 1451 |
| PROBe<m>:DEEMbedding:REMProbeload..... | 1452 |
| PROBe<m>:DEEMbedding:LOAD:IMPedance..... | 1452 |

PROBe<m>:DEEMbedding:PMODE <MeasMode>

Suffix:

<m> 1..4

Parameters:

<MeasMode> DMODE | CMODE | PMODE | NMODE
 See [PROBe<m>:SETup:PRMode](#) on page 1446.
 *RST: DMODE

Usage: Asynchronous command

PROBe<m>:DEEMbedding:TIPModule[:SElect] <ProbeTipZMA>

Selects the tip module that is used for measurement.

Suffix:

<m> 1..4
 Selects the channel to which the probe is connected.

Parameters:

<ProbeTipZMA> NONE | ZMA10 | ZMA12 | ZMA14 | ZMA15 | ZMA30 | ZMA40 | ZMA50
 *RST: ZMA10

Usage: Asynchronous command

Manual operation: See "[Probe tip module, Pin spacing](#)" on page 159

PROBe<m>:DEEMbedding:TIPModule:ZMA<n>:SUBModule <Value>

Defines additional settings for some tip modules:

For the browser module R&S RT-ZMA30, measure the space between the pins, and select the appropriate value.

If R&S RT-ZMA40 is selected, choose the used submodule: semi-rigid cables or none.

Suffix:

<m> 1..4
 Selects the channel to which the probe is connected.

<n> 30 (R&S RT-ZMA30) or 40 (R&S RT-ZMA40)

Parameters:

<Value> D16 | D25 | D45 | D75 | NONE | SRCS

For R&S RT-ZMA30:

D16 = 1.6 mm

D25 = 2.5 mm

D45 = 4.5 mm

D75 = 7.5 mm

For R&S RT-ZMA40:

NONE = no submodule

SRCS = semi-rigid cables

Usage: Asynchronous command**Manual operation:** See "[Probe tip module, Pin spacing](#)" on page 159**PROBe<m>:DEEMbedding:BANDwidth <ProbeBandwidth>**

Sets the maximum bandwidth until which the signal is corrected. This maximum value is the minimum bandwidth value of probe, probe tip and oscilloscope bandwidth, and can not be higher than the highest frequency in a used S-parameter file. Consider that most tip modules support the full bandwidth of the probe amplifier, but some tip modules have limited bandwidth.

Suffix:

<m> 1..4
Selects the channel to which the probe is connected.

Parameters:

<ProbeBandwidth> Range: 10000 to 16E+9
Increment: 10
*RST: 4E+9
Default unit: Hz

Usage: Asynchronous command**Manual operation:** See "[Effective bandwidth](#)" on page 160**PROBe<m>:DEEMbedding:MODE <Mode>**

Sets the probing mode.

Suffix:

<m> 1..4
Selects the channel to which the probe is connected.

Parameters:

<Mode> PROBing | TERMinating

PROBing

For measurements with a high-ohmic probe and measure on an existing line in parallel to the load.

TERMinating

For measurements if the measuring equipment is the load of the line.

*RST: PROBing

Usage: Asynchronous command
Manual operation: See "Probing, Terminating" on page 160

PROBe<m>:DEEMbedding:REMProbeLoad <RemoveProbeLoad>

Removes the loading of the probe if `DEEMbedding<m>:COMPONENT<n>:MODE` is set to `PROBing`.

If the probe loading is removed, you see the signal that would be at the measurement point if the probe's input impedance is ideal (infinite impedance).

Without removing the loading, you see the real signal at the measurement point, including the probe loading.

Suffix:

<m> 1..4
 Selects the channel to which the probe is connected.

Parameters:

<RemoveProbeLoad> ON | OFF
 *RST: ON

Usage: Asynchronous command
Manual operation: See "Remove probe load" on page 160

PROBe<m>:DEEMbedding:LOAD:IMPedance <SourceImpedance>

Shows the source impedance of the DUT. If an R&S RT-ZM probe is connected, the value depends on the selected probe mode: common mode, differential, or single-ended measurement.

Suffix:

<m> 1..4
 Selects the channel to which the probe is connected.

Parameters:

<SourceImpedance> Range: 100E-15 to 1E+9
 Increment: 1
 *RST: 50
 Default unit: Ω

Usage: Asynchronous command
Manual operation: See "Source impedance" on page 160

27.8.7.7 Predefined probes

| | |
|--|------|
| <code>PROBe<m>:SETup:ATTenuation:DEFProbe</code> | 1453 |
| <code>PROBe<m>:SETup:OFFSet:TOMean</code> | 1453 |

PROBe<m>:SETup:ATTenuation:DEFProbe <PredefinedProbe>

Selects a predefined probe. These are probes that are not recognized automatically but the parameters of the probe are known to the instrument.

Suffix:

<m> 1..4
Selects the input channel.

Parameters:

<PredefinedProbe> ZC10 | ZC20 | ZC30 | ZD01A100 | ZD01A1000 | ZZ80 | FREE | ZS10L | ZD02 | ZD08 | ZC02100 | ZC021000 | ZC03 | ZD002A10 | ZD002A100 | ZD003A20 | ZD003A200 | ZC3110 | ZC311 | ZC3101

ZC10 | ZC20 | ZC30 | ZZ80 | ZS10L | ZD02 | ZD08 | ZC03

Type of the probe

ZD01A100 | ZD01A1000 | ZD002A10 | ZD002A100 | ZD003A20 | ZD003A200

High voltage differential probes R&S RT-ZD0xx, attenuation ratio according to the setting on the probe.

A10 = 10:1

A20 = 20:1

A100 = 100:1

A200 = 200:1

A1000 = 1000:1

ZC02100 | ZC021000

Current probes 100 A or 1000 A according to the setting on the probe.

FREE

Any other probe that is not recognized by the instrument.

*RST: FREE

Usage: Asynchronous command

Manual operation: See "[Predefined probe](#)" on page 163

PROBe<m>:SETup:OFFSet:TOMean

Performs an automatic compensation for a DC component of the specified input signal using the result of a background mean measurement.

Suffix:

<m> 1..4
Selects the input channel.

Usage: Event
Asynchronous command

Manual operation: See "[Offset to mean](#)" on page 164

27.8.7.8 Current probes

To set up R&S RT-ZC10 and R&S RT-ZC20, use `PROBe<m>:SETup:ATTenuation:DEFProbe`.

| | |
|---|------|
| <code>PROBe<m>:SETup:DEGauss</code> | 1454 |
| <code>PROBe<m>:SETup:OFFSet:STPProbe</code> | 1454 |
| <code>PROBe<m>:SETup:OFFSet:ZADJust</code> | 1454 |

`PROBe<m>:SETup:DEGauss`

Demagnetizes the core if it has been magnetized by switching the power on and off, or by an excessive input. Always carry out demagnetizing before measurement. The demagnetizing process takes about one second.

Suffix:

<m> 1..4
Selects the input channel.

Usage:

Event
Asynchronous command

Firmware/software: FW 2.50

Manual operation: See "[DeGauss](#)" on page 166

`PROBe<m>:SETup:OFFSet:STPProbe`

Saves the zero adjust value in the probe box. If you connect the probe to another channel or to another R&S RTx oscilloscope, the value is read out again.

Suffix:

<m> 1..4
Selects the input channel.

Usage:

Event
Asynchronous command

Manual operation: See "[Save to probe](#)" on page 167

`PROBe<m>:SETup:OFFSet:ZADJust <ZroAdjVal>`

set the waveform to zero position. It corrects the effect of a voltage offset or temperature drift. To set the value by the instrument, use `PROBe<m>:SETup:OFFSet:AZERo`.

Suffix:

<m> 1..4
Selects the input channel.

Parameters:

<ZroAdjVal> Range: -100 to 100
Increment: 0.1
*RST: 0
Default unit: %

Usage: Asynchronous command
Firmware/software: FW 2.50
Manual operation: See "[Zero adjust](#)" on page 167

27.8.7.9 Optical isolated probes

The commands of this chapter are relevant for optical isolated probes. The commands are available in firmware version 5.40 and higher.

The suffix <m> selects the input channel to which the probe is connected.

| | |
|---|------|
| PROBe<m>:SETup:LAOPerhours? | 1455 |
| PROBe<m>:SETup:LASTate? | 1455 |
| PROBe<m>:SETup:UNIT | 1456 |
| PROBe<m>:SETup:ALIGnment:GAIN:EXECute | 1456 |
| PROBe<m>:SETup:ALIGnment:ZERO:EXECute | 1456 |
| PROBe<m>:SETup:ALIGnment:STATe? | 1457 |
| PROBe<m>:SETup:ALIGnment:WRITe | 1457 |

PROBe<m>:SETup:LAOPerhours?

Returns the operating hours of the R&S RT-ZISO laser since the first use or last service.

Suffix:

<m> 1..4

Return values:

<LaserOperatingHours>
 Range: 0 to 1000000
 Increment: 1
 *RST: 0
 Default unit: hrs

Usage: Query only
 Asynchronous command

Manual operation: See "[Op. time](#)" on page 170

PROBe<m>:SETup:LASTate?

Returns the current status of the laser.

Suffix:

<m> 1..4

Return values:

<LaserState> GOOD | WARNing | CRITical

GOOD

The laser is working.

WARNing

The laser needs service, but is still working.

CRITICAL

Defective laser, send to your Rohde & Schwarz service center.

*RST: GOOD

Usage: Query only
Asynchronous command

Manual operation: See "[Laser state](#)" on page 169

PROBe<m>:SETup:UNIT <SelectUnit>

Sets the unit of the R&S RT-ZISO signal.

Suffix:

<m> 1..4

Parameters:

<SelectUnit> V | A | W

*RST: V

Usage: Asynchronous command

Manual operation: See "[Input unit](#)" on page 168

PROBe<m>:SETup:ALIGNment:GAIN:EXECute

Corrects the zero point error and the gain error of the R&S RT-ZISO probe.

To write the alignment result to the non-volatile flash of the probe, use [PROBe<m>:SETup:ALIGNment:WRITe](#).

Suffix:

<m> 1..4

Usage: Event
Asynchronous command

Manual operation: See "[Alignment Gain/Zero-Error](#)" on page 169

PROBe<m>:SETup:ALIGNment:ZERO:EXECute

Performs a self-alignment and corrects the zero point error of the R&S RT-ZISO probe.

To write the alignment result to the non-volatile flash of the probe, use [PROBe<m>:SETup:ALIGNment:WRITe](#).

Suffix:

<m> 1..4

Usage: Event
Asynchronous command

Manual operation: See "[Alignment Zero-Error](#)" on page 169

PROBe<m>:SETup:ALIGNment:STATe?

Returns the result of the probe alignment.

Suffix:

<m> 1..4

Return values:

<AlignmentState> PASS | FAIL
*RST: FAIL

Usage:

Query only
Asynchronous command

Manual operation: See "[Alignment Zero-Error](#)" on page 169

PROBe<m>:SETup:ALIGNment:WRITe

The command writes the alignment result to the non-volatile flash of the probe.

Suffix:

<m> 1..4

Usage:

Event
Asynchronous command

27.8.7.10 Probe attributes

| | |
|---|------|
| PROBe<m>:ID:SWVersion? | 1457 |
| PROBe<m>:ID:PRDate? | 1457 |
| PROBe<m>:ID:PARTnumber? | 1458 |
| PROBe<m>:ID:SRNumber? | 1458 |
| PROBe<m>:SETup:CAPacitance? | 1458 |
| PROBe<m>:SETup:IMPedance? | 1459 |

PROBe<m>:ID:SWVersion?

Queries the version of the probe firmware.

Suffix:

<m> 1..4
Selects the input channel.

Return values:

<Softwareversion> Version number in a string.

Usage:

Query only
Asynchronous command

PROBe<m>:ID:PRDate?

Queries the production date of the probe.

Suffix:
 <m> 1..4
 Selects the input channel.

Return values:
 <ProductionDate> Date in a string.

Usage:
 Query only
 Asynchronous command

PROBe<m>:ID:PARTnumber?

Queries the R&S part number of the probe.

Suffix:
 <m> 1..4
 Selects the input channel.

Return values:
 <PartNumber> Part number in a string.

Usage:
 Query only
 Asynchronous command

PROBe<m>:ID:SRNumber?

Queries the serial number of the probe.

Suffix:
 <m> 1..4
 Selects the input channel.

Return values:
 <SerialNo> Serial number in a string.

Usage:
 Query only
 Asynchronous command

PROBe<m>:SETup:CAPacitance?

Queries the input capacitance of the probe.

Suffix:
 <m> 1..4
 Selects the input channel.

Return values:
 <InputCapacity> Range: 100E-15 to 1E-9
 *RST: 10E-12
 Default unit: F

Usage:
 Query only
 Asynchronous command

PROBe<m>:SETup:IMPedance?

Queries the termination of the probe.

Suffix:

<m> 1..4
Selects the input channel.

Return values:

<InputImpedance> Range: 0 to 1E+9
*RST: 50
Default unit: Ω

Usage: Query only
Asynchronous command

27.8.7.11 Probe adapter R&S RT-Z2T

[PROBe<m>:SETup:ADAPter?](#)..... 1459

[PROBe<m>:SETup:ATTenuation:TDEFprobe](#)..... 1459

PROBe<m>:SETup:ADAPter?

Queries the adapter status, whether the instrument identified the adapter.

Suffix:

<m> 1..4
Selects the input channel.

Return values:

<Type> NONE | Z2T
*RST: NONE

Usage: Query only
Asynchronous command

PROBe<m>:SETup:ATTenuation:TDEFprobe <TekPredefProbe>

Selects the Tektronix probe that is connected to the R&S RT-Z2T adapter.

Suffix:

<m> 1..4

Parameters:

<TekPredefProbe> NONE | P5205A50 | P5205A500 | P5210A100 | P5210A1000 |
P6205 | P6241 | P6243 | P6245 | P6246A1 | P6246A10 |
P6247A1 | P6247A10 | P6248A1 | P6248A10 | P6249 |
P6250A5 | P6250A50 | P6251A5 | P6251A50 | P6701B |
P6703B | P6711 | P6713 | TCP202
*RST: NONE

| | |
|-----------------|--|
| Example: | <pre>PROBe2:SETup:ADAPter <-- Z2T PROBe2:SETup:ATTenuation:TDEFprobe P5205A50</pre> <p>Checks the adapter state on channel 2, and selects the probe P5205A50.</p> |
| Usage: | Asynchronous command |

27.8.8 R&S RT-ZVC probe

- [Probe setup](#)..... 1460
- [Resolution and data](#)..... 1472

27.8.8.1 Probe setup

In the `ZVC:Z<m>`: commands, the following suffixes are used:

- `<m>` selects the multi-channel probe. The available range is 1..2
- `<n>` selects the voltage or current channel. The available range depends on the probe characteristics and is 1..2 or 1..4

Some of the commands in the following chapter are asynchronous. An overlapping or asynchronous command does not automatically finish executing before the next command starts executing. If overlapping commands must be executed in a defined order, e.g. to avoid wrong measurement results, they must be serviced sequentially.

To prevent an overlapping execution of commands, one of the commands `*OPC`, `*OPC?` or `*WAI` can be used after the command or a command set.

For more information, see:

- www.rohde-schwarz.com/rc-via-scpj, chapter "Command sequence and synchronization"
- [Chapter 27.3, "Programming examples"](#), on page 1345

ZVC:BANDwidth	1461
ZVC:TYPE	1461
ZVC:Z<m>:I<n>:BANDwidth?	1461
ZVC:Z<m>:I<n>:IMPedance	1462
ZVC:Z<m>:I<n>:OFFSet	1462
ZVC:RESCoupled	1463
ZVC:Z<m>:I<n>:OVERload:RSTO	1463
ZVC:Z<m>:I<n>:OVERload:VALue?	1464
ZVC:Z<m>:I<n>:POSition	1464
ZVC:Z<m>:I<n>:SCALe	1464
ZVC:Z<m>:I<n>:SHUNT:EVALue	1465
ZVC:Z<m>:I<n>:SHUNT:MODE	1465
ZVC:Z<m>:I<n>:SHUNT:MAXCurrent	1465
ZVC:Z<m>:I<n>:SHUNT:MXCValue?	1466
ZVC:Z<m>:I<n>:SHUNT:MAXVoltage	1466
ZVC:Z<m>:I<n>:SKEW	1467

ZVC:Z<m>:I<n>[:STATe].....	1467
ZVC:Z<m>:V<n>:BANDwidth?	1467
ZVC:Z<m>:V<n>:IMPedance.....	1468
ZVC:Z<m>:V<n>:OFFSet.....	1468
ZVC:Z<m>:V<n>:OVERload:RSTO.....	1468
ZVC:Z<m>:V<n>:OVERload:VALue?	1469
ZVC:Z<m>:V<n>:POSition.....	1469
ZVC:Z<m>:V<n>:SCALe.....	1469
ZVC:Z<m>:V<n>:SKEW.....	1470
ZVC:Z<m>:V<n>[:STATe].....	1470
ZVC:Z<m>:ID:NAME?	1470
ZVC:Z<m>:ID:PARTnumber?	1470
ZVC:Z<m>:ID:SRNumber?	1471
ZVC:Z<m>:ID:SWVersion?	1471
ZVC:Z<m>:I<n>:ZERComp:DETECT.....	1471
ZVC:Z<m>:I<n>:ZERComp:USE.....	1471
ZVC:Z<m>:I<n>:ZERComp:STATe?	1472

ZVC:BANDwidth <Bandwidth>

Sets the bandwidth limit of the probe. The bandwidth specifies the maximum frequency at which a purely sinusoidal signal is still transferred at 89 % (0.1 dB) of its amplitude.

Parameters:

<Bandwidth> Range: 5000 to 1E+6
 Increment: 5000
 *RST: 1E+6
 Default unit: Hz

Usage: Asynchronous command

Manual operation: See "[Bandwidth](#)" on page 178

ZVC:TYPE <DecimationMode>

Sets the decimation mode for the R&S RT-ZVC probe. Decimation reduces the data stream of the ADC to a stream of waveform points with lower sample rate and a less precise time resolution.

Parameters:

<DecimationMode> SAMPLE | PDETECT | HRESOLUTION
 *RST: SAMPLE

Usage: Asynchronous command

Manual operation: See "[Decimation mode](#)" on page 177

ZVC:Z<m>:I<n>:BANDwidth?

Queries the bandwidth of the current channel. You can set the probe bandwidth with [ZVC:BANDwidth](#).

The bandwidth of some current channels is restricted to 300KHz due to their vertical settings.

Suffix:

<m> 1..2

<n> 1..4

Return values:

<Bandwidth> Range: 5000 to 1E+6
 Increment: 5000
 *RST: 1E+6
 Default unit: Hz

Usage: Query only
 Asynchronous command

Manual operation: See "[Bandwidth](#)" on page 182

ZVC:Z<m>:I<n>:IMPedance <MeasImp>

Sets the current impedance of the probe channel for power calculations and measurements.

Suffix:

<m> 1..2

<n> 1..4

Parameters:

<MeasImp> Range: 1 to 100E+3
 Increment: 1
 *RST: 50
 Default unit: Ω

Usage: Asynchronous command

Manual operation: See "[Measurement Impedance](#)" on page 179

ZVC:Z<m>:I<n>:OFFSet <VerticalOffset>

Sets the offset current for the current channel.

Suffix:

<m> 1..2

<n> 1..4

Parameters:

<VerticalOffset> Range: -1 to 1
 Increment: 0.01
 *RST: 0
 Default unit: V

Usage: Asynchronous command

Manual operation: See ["Offset"](#) on page 177

ZVC:RESCoupled <CoupleToAnalog>

Sets the resolution of all R&S RT-ZVC channels.

Parameters:

<CoupleToAnalog> ON | OFF

ON

The resolution of the analog channels is applied to R&S RT-ZVC channels. The signal is automatically interpolated or decimated to get the analog resolution.

OFF

The resolution of R&S RT-ZVC channels is set in a way so that the record length of the waveforms is minimum 1000 samples.

*RST: OFF

Usage: Asynchronous command

Manual operation: See ["Couple resolution"](#) on page 178

ZVC:Z<m>:I<n>:OVERload:RSTO <Settings>

Resets the overload indication at the probe.

In internal shunt mode ([ZVC:Z<m>:I<n>:SHUNt:MODE](#) is set to INTShunt), chooses whether to keep the operation range adjusted by the R&S RT-ZVC during overload or to restore the original settings for the given current channel.

In external shunt mode ([ZVC:Z<m>:I<n>:SHUNt:MODE](#) is set to EXTShunt), there is no adjustment of the operation range during overload.

Suffix:

<m> 1..2

<n> 1..4

Setting parameters:

<Settings> ADJusted | ORIGinal

ADJusted

The operation range that is automatically adjusted by the probe during overload is kept.

In internal shunt mode, during an overload at a current channel, the probe switches automatically to the next higher range. If the 10A range is also exceeded, the amperemeter switches to external shunt mode to protect the probe against permanent damage.

ORIGinal

The original operation range is restored as before the overload and the adjustment of the operation range.

Usage: Setting only
Asynchronous command

Manual operation: See "[Reset Overload](#)" on page 184

ZVC:Z<m>:I<n>:OVERload:VALue?

Queries if an overload of the current channel was detected.

Suffix:

<m> 1..2

<n> 1..4

Return values:

<Overload> ON | OFF

*RST: OFF

Usage:

Query only

Asynchronous command

ZVC:Z<m>:I<n>:POSition <VertPosi>

Sets the vertical position of the indicated current channel as a graphical value.

Suffix:

<m> 1..2

<n> 1..4

Parameters:

<VertPosi> Range: -5 to 5

Increment: 0.02

*RST: 0

Default unit: div

Usage:

Asynchronous command

Manual operation: See "[Position](#)" on page 182

ZVC:Z<m>:I<n>:SCALE <VerticalScale>

Sets the vertical scale for the current channel in Volts per division. Increasing the scale compresses the display of the signal.

Suffix:

<m> 1..2

<n> 1..4

Parameters:

<VerticalScale> Range: 1E-15 to 10E+24

Increment: 10E-6

*RST: 3

Default unit: V/div

Usage:

Asynchronous command

Manual operation: See ["Scale"](#) on page 176

ZVC:Z<m>:I<n>:SHUNT:EVALue <ExtShuntVal>

Defines the value of the external shunt resistor to calculate the correct current values.

Suffix:

<m> 1..2

<n> 1..4

Parameters:

<ExtShuntVal> Range: 10E-6 to 10000
 Increment: 0.02
 *RST: 1
 Default unit: Ω

Usage: Asynchronous command

Manual operation: See ["Shunt value"](#) on page 184

ZVC:Z<m>:I<n>:SHUNT:MODE <ShuntMode>

Sets the internal or external shunt mode.

Suffix:

<m> 1..2

<n> 1..4

Parameters:

<ShuntMode> INTShunt | EXTShunt
 *RST: INTShunt

Usage: Asynchronous command

Manual operation: See ["Shunt mode"](#) on page 183

ZVC:Z<m>:I<n>:SHUNT:MAXCurrent <IntShuntMeasRg>

Sets the maximum current and the internal shunt value.

The internal shunt and maximum current parameter pairs are defined as described in the table below.

Parameter	Internal shunt	Maximum current
A100r01	10 A	10 mΩ
A40R01	4.5 A	10 mΩ
A45M10r	45 mA	10 Ω
A4M510r	4.5 mA	10 Ω

Parameter	Internal shunt	Maximum current
A45u10k	45 μ A	10 K Ω
A4U510k	4.5 μ A	10 K Ω

Suffix:

<m> 1..2

<n> 1..4

Parameters:

<IntShuntMeasRg> A100r01 | A40R01 | A45M10r | A4M510r | A45u10k | A4U510k
 *RST: A100r01

Usage: Asynchronous command**Manual operation:** See "[Max current / shunt](#)" on page 183**ZVC:Z<m>:I<n>:SHUNT:MXCValue?**

Queries the maximum current.

Suffix:

<m> 1..2

<n> 1..4

Return values:

<MaxCurrentValue> Default unit: A

Usage: Query only
Asynchronous command**Manual operation:** See "[Max current](#)" on page 184**ZVC:Z<m>:I<n>:SHUNT:MAXVoltage <ExtShuntMeasRg>**

Sets the maximum voltage for the external shunt.

Suffix:

<m> 1..2

<n> 1..4

Parameters:

<ExtShuntMeasRg> V450m | V045m
 V450m: 450 mV
 V045m: 45 mV
 *RST: V450m

Usage: Asynchronous command**Manual operation:** See "[Max voltage](#)" on page 184

ZVC:Z<m>:I<n>:SKEW <DeskewOffset>

Sets the skew offset value for the current probe channel. This is a delay value, that is known from the circuit specifics but cannot be compensated by the instrument automatically.

Suffix:

<m> 1..2
<n> 1..4

Parameters:

<DeskewOffset> Range: -6E-6 to 6E-6
Increment: 200E-9
*RST: 0
Default unit: s

Usage: Asynchronous command

Manual operation: See "[Skew](#)" on page 183

ZVC:Z<m>:I<n>[:STATe] <State>

Enables the corresponding current channel of the probe.

Suffix:

<m> 1..2
<n> 1..4

Parameters:

<State> ON | OFF
*RST: OFF

Usage: Asynchronous command

Manual operation: See "[State](#)" on page 176

ZVC:Z<m>:V<n>:BANDwidth?

Queries the bandwidth of the voltage channel. You can set the probe bandwidth with [ZVC:BANDwidth](#).

Suffix:

<m> 1..2
<n> 1..4

Return values:

<Bandwidth> Range: 5000 to 1E+6
Increment: 5000
*RST: 1E+6
Default unit: Hz

Usage: Query only
Asynchronous command

Manual operation: See ["Bandwidth"](#) on page 181

ZVC:Z<m>:V<n>:IMPedance <MeasImp>

Sets the voltage impedance of the probe channel for power calculations and measurements.

Suffix:

<m> 1..2

<n> 1..4

Parameters:

<MeasImp> Range: 1 to 100E+3
 Increment: 1
 *RST: 50
 Default unit: Ω

Usage: Asynchronous command

Manual operation: See ["Measurement Impedance"](#) on page 179

ZVC:Z<m>:V<n>:OFFSet <VerticalOffset>

Sets the vertical offset for the voltage channel.

Suffix:

<m> 1..2

<n> 1..4

Parameters:

<VerticalOffset> Range: -1 to 1
 Increment: 0.01
 *RST: 0
 Default unit: V

Usage: Asynchronous command

Manual operation: See ["Offset"](#) on page 177

ZVC:Z<m>:V<n>:OVERload:RSTO

Resets the overload indication at the probe.

Suffix:

<m> 1..2

<n> 1..4

Usage:

Event
 Asynchronous command

Manual operation: See ["Reset Overload"](#) on page 181

ZVC:Z<m>:V<n>:OVERload:VALue?

Queries if an overload of the voltage channel was detected.

Suffix:

<m> 1..2

<n> 1..4

Return values:

<Overload> ON | OFF

*RST: OFF

Usage:

Query only

Asynchronous command

ZVC:Z<m>:V<n>:POSition <VertPosi>

Sets the vertical position of the indicated voltage channel as a graphical value.

Suffix:

<m> 1..2

<n> 1..4

Parameters:

<VertPosi> Range: -5 to 5

Increment: 0.02

*RST: 0

Default unit: div

Usage:

Asynchronous command

Manual operation: See "[Position](#)" on page 180

ZVC:Z<m>:V<n>:SCALe <VerticalScale>

Sets the vertical scale for the voltage channel in Volts per division. Increasing the scale compresses the display of the signal.

Suffix:

<m> 1..2

<n> 1..4

Parameters:

<VerticalScale> Range: 1E-15 to 10E+24

Increment: 10E-6

*RST: 3

Default unit: V/div

Usage:

Asynchronous command

Manual operation: See "[Scale](#)" on page 176

ZVC:Z<m>:V<n>:SKEW <DeskewOffset>

Sets the skew offset value for the voltage probe channel. This is a delay value, that is known from the circuit specifics but cannot be compensated by the instrument automatically.

Suffix:

<m> 1..2
<n> 1..4

Parameters:

<DeskewOffset> Range: -6E-6 to 6E-6
Increment: 200E-9
*RST: 0
Default unit: s

Usage: Asynchronous command

Manual operation: See "[Skew](#)" on page 181

ZVC:Z<m>:V<n>[:STATe] <State>

Enables the corresponding voltage channel of the probe.

Suffix:

<m> 1..2
<n> 1..4

Parameters:

<State> ON | OFF
*RST: OFF

Usage: Asynchronous command

Manual operation: See "[State](#)" on page 176

ZVC:Z<m>:ID:NAME?

Queries the name of the probe.

Suffix:

<m> 1..2

Return values:

<Name>

Usage: Query only
Asynchronous command

ZVC:Z<m>:ID:PARTnumber?

Queries the R&S part number of the probe.

Suffix:

<m> 1..2

Return values:

<PartNumber>

Usage:Query only
Asynchronous command**ZVC:Z<m>:ID:SRNumber?**

Queries the serial number of the probe.

Suffix:

<m> 1..2

Return values:

<SerialNo>

Usage:Query only
Asynchronous command**ZVC:Z<m>:ID:SWVersion?**

Queries the version of the probe firmware.

Suffix:

<m> 1..2

Return values:

<Softwareversion>

Usage:Query only
Asynchronous command**ZVC:Z<m>:I<n>:ZERComp:DETECT**

Measures the zero offset, the mean value on a currentless DUT. If temperature changes, or if you change the shunt or other probe settings, repeat the measurement.

Suffix:

<m> 1..2

<n> 1..4

Usage:Event
Asynchronous command**Manual operation:** See "[ZeroComp](#)" on page 179**ZVC:Z<m>:I<n>:ZERComp:USE <UseZeroComp>**

Enables the automatic compensation of the measured zero offset.

Suffix:

<m> 1..2

<n> 1..4

Parameters:

<UseZeroComp> ON | OFF

*RST: OFF

Usage: Asynchronous command**Manual operation:** See "Use" on page 179**ZVC:Z<m>:I<n>:ZERComp:STATe?**

Returns the status of the zero compensation of the indicated current channel.

Suffix:

<m> 1..2

<n> 1..4

Return values:

<ZeroCompState> ON | OFF

ON: Zero compensation is used

Off: Zero Compensation is not used

*RST: OFF

Usage: Query only
Asynchronous command**Manual operation:** See "Zero Comp" on page 177**27.8.8.2 Resolution and data**

ACQuire:POINts:ZVALue?.....	1472
ACQuire:ZRESolution?.....	1473
ZVC:Z<m>:I<n>:DATA:HEADer?.....	1473
ZVC:Z<m>:V<n>:DATA:HEADer?.....	1473
ZVC:Z<m>:I<n>:DATA[:VALues]?.....	1473
ZVC:Z<m>:V<n>:DATA[:VALues]?.....	1473

ACQuire:POINts:ZVALue?

Returns the current record length used by the R&S RT-ZVCmulti-channel power probe channel.

Return values:

<ZUIRecordLength> Range: 1000 to 400E6

Increment: 2

*RST: 1000

Default unit: pts

Usage: Query only
Asynchronous command

ACQUIRE:ZRESolution?

Returns the current resolution of the R&S RT-ZVCmulti-channel power probe channel.

Return values:

<ZUIResolution> Range: 1E-15 to 0.5
Increment: 10E-12
*RST: 500E-6
Default unit: s

Usage: Query only
Asynchronous command

ZVC:Z<m>:I<n>:DATA:HEADer?

ZVC:Z<m>:V<n>:DATA:HEADer?

Return the header of amperemeter and voltmeter waveform data.

Table 27-2: Header data

Position	Meaning	Example
1	Start time in s	-0.0001
2	Stop time in s	0.0001
3	Number of values in one waveform (record length)	1000
4	Number of values per sample interval. For most waveforms the result is 1, for peak detect and envelope waveforms it is 2. If the number is 2, the number of returned values is twice the number of values (record length)..	1

Suffix:

<m> 1..2

<n> 1..4

Example:

```
ZVC:Z2:V2:DATA:HEADer?
<-- -0.0001,0.0001,1000,1
```

Usage: Query only

ZVC:Z<m>:I<n>:DATA[:VALues]?

ZVC:Z<m>:V<n>:DATA[:VALues]?

Return the waveform data of the amperemeter and voltmeter for transmission from the instrument to the controlling computer. The data can be used in MATLAB, for example.

Set the export format to ASCII or REAL,32 using `FORMat [:DATA]`. Export of raw data is not supported.

Suffix:

<m> 1..2

<n> 1..4

Return values:

<Data> Liste of values according to the format setting.

Example:

```

FORMat:DATA ASCii
ZVC:Z2:V2:DATA:HEADer?
<-- -0.0001,0.0001,1000,1
ZVC:Z2:V2:DATA:VaLues?
<-- 0.00083049136446789,-0.0042279558256269,-0.0076707201078534,
-0.011294682510197,-0.015915233641863,-0.018905002623796,
-0.022423267364502, ...

```

1000 values are returned.

Usage: Query only

27.8.9 Differential signals

Some of the commands in the following chapter are asynchronous. An overlapping or asynchronous command does not automatically finish executing before the next command starts executing. If overlapping commands must be executed in a defined order, e.g. to avoid wrong measurement results, they must be serviced sequentially.

To prevent an overlapping execution of commands, one of the commands *OPC, *OPC? or *WAI can be used after the command or a command set.

For more information, see:

- www.rohde-schwarz.com/rc-via-scpj, chapter "Command sequence and synchronization"
- Chapter 27.3, "Programming examples", on page 1345

DIFFerential<m>:STATe.....	1475
DIFFerential<m>:PSIGnal[:SElect].....	1475
DIFFerential<m>:NSIGnal[:SElect].....	1475
DIFFerential<m>:AOUtput.....	1475
DIFFerential<m>:BOUtput.....	1475
DIFFerential<m>:COMMon:STATe.....	1476
DIFFerential<m>:DIFFerential:STATe.....	1476
DIFFerential<m>:NSIGnal:STATe.....	1476
DIFFerential<m>:PSIGnal:STATe.....	1476
DIFFerential<m>:COMMon:SCALe.....	1476
DIFFerential<m>:DIFFerential:SCALe.....	1476
DIFFerential<m>:COUPling.....	1476
DIFFerential<m>:COMMon:OFFSet.....	1477
DIFFerential<m>:DIFFerential:OFFSet.....	1477
DIFFerential<m>:COMMon:POSition.....	1477
DIFFerential<m>:DIFFerential:POSition.....	1477

DIFFerential<m>:STATe <State>

Activates the differential signal. Two differential signals are available.

Suffix:

<m> 1..2
Differential signal

Parameters:

<State> ON | OFF
*RST: OFF

Usage: Asynchronous command

Manual operation: See "Enable" on page 186

DIFFerential<m>:PSIGnal[:SELEct] <Signal>**DIFFerential<m>:NSIGnal[:SELEct]** <Signal>

Select the analog input channel of the positive and negative signal.

Suffix:

<m> 1..2
Differential signal

Parameters:

<Signal> C1W1 | C2W1 | C3W1 | C4W1
*RST: C1W1

Usage: Asynchronous command

Manual operation: See "P, N" on page 186

DIFFerential<m>:AOUTput <Output>**DIFFerential<m>:BOUTput** <Output>

Select the waveform that is the result of differential processing. 2 output waveforms per digital signal can be defined.

Suffix:

<m> 1..2
Differential signal

Parameters:

<Output> P | N | DIFF | COM
P | N
Positive or negative waveform.
DIFF
Differential waveform.
COM
Common mode waveform.
*RST: COM

Usage: Asynchronous command

Manual operation: See ["Output: P, N, Diff, Common"](#) on page 186

DIFFerential<m>:COMMon:STATe <State>

DIFFerential<m>:DIFFerential:STATe <State>

DIFFerential<m>:NSIGnal:STATe <State>

DIFFerential<m>:PSIGnal:STATe <State>

The commands enable the output waveforms if deembedding by software is active. In this case, all output waveforms can be displayed at the same time, and each output is enabled separately.

Suffix:

<m> 1..2
Differential signal

Parameters:

<State> ON | OFF
*RST: OFF

Usage: Asynchronous command

Manual operation: See ["Output: P, N, Diff, Common"](#) on page 186

DIFFerential<m>:COMMon:SCALE <Scale>

DIFFerential<m>:DIFFerential:SCALE <Scale>

Set the vertical scale of differential and common mode waveforms, respectively.

Vertical settings of P and N output are the vertical settings of the input channels.

Suffix:

<m> 1..2
Differential signal

Parameters:

<Scale> Scale value, given in Volts per division.
Range: 1E-3 to 100
Increment: 1E-3
*RST: 0.05
Default unit: V/div

Usage: Asynchronous command

Manual operation: See ["Scale"](#) on page 187

DIFFerential<m>:COUPling <ScaleCoupling>

If enabled for a differential signal, the vertical scales of P, N, differential and common mode waveforms are coupled. The scales are related as follows:

$$VertScale_P = VertScale_N = VertScale_{CM} = VertScale_{Diff}/2$$

You can disable the scale coupling and set an individual scale for each waveform.

Suffix:

<m> 1..2
Differential signal

Parameters:

<ScaleCoupling> ON | OFF
*RST: ON

Usage: Asynchronous command

Manual operation: See "[Scale coupling](#)" on page 188

DIFFerential<m>:COMMON:OFFSet <Offset>

DIFFerential<m>:DIFFerential:OFFSet <Offset>

Set the offset of differential and common mode waveforms.

Vertical settings of P and N output are the vertical settings of the input channels.

Suffix:

<m> 1..2
Differential signal

Parameters:

<Offset> Offset value
Range: -1 to 1
Increment: 0.01
*RST: 0
Default unit: V

Usage: Asynchronous command

Manual operation: See "[Offset](#)" on page 188

DIFFerential<m>:COMMON:POSition <Position>

DIFFerential<m>:DIFFerential:POSition <Position>

Set the vertical position of differential and common mode waveforms.

Vertical settings of P and N output are the vertical settings of the input channels.

Suffix:

<m> 1..2
Differential signal

Parameters:

<Position> Position value
Range: -5 to 5
Increment: 0.02
*RST: 0
Default unit: div

Usage: Asynchronous command

Manual operation: See ["Position"](#) on page 188

27.8.10 Digital filter

CHANnel<m>:DIGFilter:STATe	1478
CHANnel<m>:DIGFilter:CUToff	1478
TRIGger<m>:COUPling	1478
TRIGger<m>:RFReject	1479

CHANnel<m>:DIGFilter:STATe <State>

Enables the DSP filter for input channels.

Suffix:

<m> 1..4

Parameters:

<State> ON | OFF
*RST: OFF

Usage: Asynchronous command

Manual operation: See ["Channel BW limit \(On/Off\)"](#) on page 144

CHANnel<m>:DIGFilter:CUToff <CutOffLP>

Sets the limit frequency of the lowpass filter for input channels.

Suffix:

<m> 1..4

Selects the input channel. One filter is applied to a pair of channels - one filter for channels 1 and 2 and another filter for channels 3 and 4 (only 4-channel models).

Parameters:

<CutOffLP> Range: 100E+3 to instrument bandwidth
*RST: 1E+6
Default unit: Hz
Available filter values are:
100E+3, 200E+3, 300E+3, 500E+3, 1.0E+6, 2.0E+6, 3.0E+6,
5.0E+6, 10E+6, 20E+6, 30E+6, 50E+6, 100E+6, 500E+6, 1.0E+9,
1.5E+9, 2.0E+9, 2.5E+9, 3.0E+9, 3.5E+9, 4.0E+9, 4.5E+9,
5.0E+9, 5.5E+9, 6.0E+9

Usage: Asynchronous command

Manual operation: See ["Channel BW limit"](#) on page 144

TRIGger<m>:COUPling <DigTrigCpl>

Selects the filter for the trigger channel(s). Other channels must use the same filter, or proceed unfiltered.

Suffix:

<m> 1..3
Irrelevant, omit the suffix.

Parameters:

<DigTrigCpl> OFF | RFReject
OFF
The trigger signal is not filtered.
RFReject
Frequencies higher a given limit are rejected, lower frequencies pass the filter. The limit is set with `TRIGger<m>:RFReject`.
*RST: OFF

Usage: Asynchronous command

Manual operation: See "Trigger BW limit" on page 144

TRIGger<m>:RFReject <Bandwidth>**Suffix:**

<m> 1..3
Irrelevant, omit the suffix.

Parameters:

<Bandwidth> Range: 100E+3 to 2E+9
Increment: 1000
*RST: 1E+6
Default unit: Hz

Usage: Asynchronous command

Manual operation: See "Channel BW limit" on page 144

27.8.11 Skew

<code>CHANnel<m>:SKEW:MANual</code>	1479
<code>CHANnel<m>:SKEW:TIME</code>	1480
<code>PROBe<m>:SKEState</code>	1480
<code>CHANnel<m>:SKEW:EXTended</code>	1480

CHANnel<m>:SKEW:MANual <ManualCompens>

If enabled, the skew offset value (`CHANnel<m>:SKEW:TIME`) is used for compensation. This improves horizontal and trigger accuracy.

Suffix:

<m> 1..4
Selects the input channel.

Parameters:

<ManualCompens> ON | OFF
 *RST: ON

Usage: Asynchronous command

Manual operation: See "[User skew](#)" on page 124

CHANnel<m>:SKEW:TIME <Offset>

Sets an delay value, that is known from the circuit specifics but cannot be compensated by the instrument automatically. It affects only the selected input channel.

Suffix:

<m> 1..4
 Selects the input channel.

Parameters:

<Offset> Range: -100E-9 to 100E-9
 Increment: 10E-15
 *RST: 0
 Default unit: s

Usage: Asynchronous command

Manual operation: See "[Skew offset](#)" on page 124

PROBe<m>:SKEState <ProbeSkew>

If enabled, the skew of all connected active probes is measured, displayed, and used for deskewing.

Suffix:

<m> 1..4
 The suffix is irrelevant. The setting affects all active channels.

Parameters:

<ProbeSkew> ON | OFF
 *RST: OFF

Usage: Asynchronous command

Manual operation: See "[Probe skew](#)" on page 124

CHANnel<m>:SKEW:EXTended <ExtendSkew>

Enables a higher skew value range that can be set with [CHANnel<m>:SKEW:TIME](#) on page 1480. The skew extension reduces the maximum number of acquisitions in the memory.

Suffix:

<m> 1..4
 The suffix is irrelevant. The setting affects all active channels.

Parameters:

<ExtendSkew> ON | OFF
 *RST: OFF

Usage: Asynchronous command

Manual operation: See "[Extend user skew](#)" on page 124

27.8.12 AUX OUT

[CALibration:SOURce:FREQuency](#)..... 1481

[CALibration:SOURce:STATe](#).....1481

CALibration:SOURce:FREQuency <Frequency>

Frequency value and waveform type of the internal calibration source, which is output at the [Aux Out] connector.

Parameters:

<Frequency> KHZ7900 | MHZ10 | KHZ15800 | MHZ31_25 | KHZ31600 |
 KHZ63200 | GHZ1 | MHZ250MB | MHZ250mb | GHZ1_20DB |
 MHZ62 | MHZ125 | MHZ250 | MHZ500 | KHZ505500 | MHZ1R |
 MHZ31R | MHZ31_25R | MHZ498S | MHZ1257_2S |
 MHZ2491S | MHZ4060S | MHZ4350S | MHZ4810S |
 MHZ4991S | MHZ5940S | MHZ1000S | MHZ10 | MHZ31_25 |
 MHZ250MB | MHZ250mb | GHZ1_20DB | GHZ1

MHZ10

10 MHz square wave

MHZ31_25 | GHZ1 | MHZ250MB

31.25 MHz, 1 GHz, 250 MHz sine waves generated by the mainboard.

MHZ250MB = MHZ250mb

GHZ1_20DB

Clinched sine wave with indicated frequency, generated by the frontend.

GHZ1

1 GHz sine wave generated by the mainboard.

*RST: GHZ1

Example:

CAL:SOUR:FREQ GHZ1

CAL:SOUR:STAT ON

The commands activate the 1 GHz reference frequency.

Usage:

Asynchronous command

Manual operation: See "[Activate 1GHz Reference](#)" on page 125

CALibration:SOURce:STATe <State>

Defines the state of the internal calibration source.

Parameters:

<State> ON | OFF
 *RST: OFF

Usage: Asynchronous command

Manual operation: See "[Activate 1GHz Reference](#)" on page 125

27.8.13 High definition mode

HDEFinition:STATe	1482
HDEFinition:BWIDth	1482
HDEFinition:RESolution?	1482
FORMat:BORDER	1483

HDEFinition:STATe <State>

Activates the high definition mode of the instrument.

Parameters:

<State> ON | OFF
 ON: high definition mode, up to 16 bit digital resolution
 OFF: normal oscilloscope mode
 *RST: OFF

Usage: Asynchronous command

Manual operation: See "[Enable](#)" on page 134

HDEFinition:BWIDth <Bandwidth>

Sets the filter bandwidth for the high definition mode.

Parameters:

<Bandwidth> Range: 10000 to max. 2 GHz, depending on the instrument bandwidth.
 Increment: 1000
 *RST: 1E+6
 Default unit: Hz

Usage: Asynchronous command

Manual operation: See "[Bandwidth](#)" on page 134

See "[Bandwidth](#)" on page 134 for bandwidth limits.

HDEFinition:RESolution?

Returns the resulting digital resolution in high definition mode.

Return values:

<Resolution> Range: 0 to 16
 Increment: 0.1
 *RST: 0
 Default unit: bit

Usage:

Query only
 Asynchronous command

Manual operation: See "[Resolution](#)" on page 135

FORMat:BORDER <ByteOrder>

Sets the endianness.

The command is only relevant for raw data export in high definition mode (16 bit word length).

Parameters:

<ByteOrder> LSBFirst | MSBFirst
 LSB first: little endian, least significant byte first
 MSB first: big endian, most significant byte first
 *RST: LSBFirst

Usage:

Asynchronous command

Manual operation: See "[Byte order](#)" on page 1330

27.8.14 Reference clock

Commands are related to the external reference input on the rear panel, and the output of the OCXO reference signal.

[SENSe\[:ROSCillator\]:SOURce](#)..... 1483
[SENSe\[:ROSCillator\]:EXTernal:FREQuency](#)..... 1484

SENSe[:ROSCillator]:SOURce <RefSource>

Enables the use of the external reference signal instead of the internal OCXO reference.

Parameters:

<RefSource> INTernal | EXTernal
 *RST: INTernal

Usage:

Asynchronous command

Manual operation: See "[Use external reference](#)" on page 125

- [Zone trigger](#)..... 1531
- [External trigger input](#)..... 1532
- [Acquisition info](#)..... 1535

27.9.1 Basic trigger settings

TRIGger<m>:SOURce[:SElect]	1485
TRIGger<m>:TYPE	1486
TRIGger<m>:LEVel<n>[:VALue]	1487
TRIGger<m>:FINDlevel	1488
DISPlay:TRIGger:LINes	1488

TRIGger<m>:SOURce[:SElect] <SourceDetailed>

Selects the source of the trigger signal.

Suffix:

<m> 1..3
 1 = A-trigger, 2 = B-trigger, 3 = R-trigger
 Available values depend on the selected trigger source. For input channels CHAN1...4, a trigger sequence can be configured.
 For all other trigger sources, only suffix 1 is allowed.

Parameters:

<SourceDetailed> CHAN1 | CHANnel1 | CHAN2 | CHANnel2 | CHAN3 | CHANnel3 | CHAN4 | CHANnel4 | EXTeranalog | SBUS | D0 | D1 | D2 | D3 | D4 | D5 | D6 | D7 | D8 | D9 | D10 | D11 | D12 | D13 | D14 | D15 | LOGIC | MSOB1 | MSOB2 | MSOB3 | MSOB4 | Z1V1 | Z1V2 | Z1V3 | Z1V4 | Z1I1 | Z1I2 | Z1I3 | Z1I4 | Z2V1 | Z2V2 | Z2V3 | Z2V4 | Z2I1 | Z2I2 | Z2I3 | Z2I4 | DIFF1 | DIFF2 | COMMON1 | COMMON2

CHAN1 = CHANnel1, CHAN2 = CHANnel2, CHAN3 = CHANnel3, CHAN4 = CHANnel4
 Input channels

EXTeranalog
 External analog signal connected to the External Trigger Input. For this source, only the analog edge trigger is available.

SBUS
 Serial bus

D0...D15
 Digital channels (option R&S RTO6-B1)
 See also: [Chapter 27.19.4, "Trigger settings for digital signals and parallel buses"](#), on page 2619

LOGic
 Logic combination of digital channels, used as trigger source (option R&S RTO6-B1)

MSOB1 | MSOB2 | MSOB3 | MSOB4

Parallel bus (option R&S RTO6-B1)

Z1V1 | Z1V2 | Z1V3 | Z1V4 | Z1I1 | Z1I2 | Z1I3 | Z1I4 | Z2V1 | Z2V2 | Z2V3 | Z2V4 | Z2I1 | Z2I2 | Z2I3 | Z2I4

Input channels of R&S RT-ZVC multi-channel power probe. Only available in the A-trigger with trigger type EDGE.

DIFF1 | DIFF2 | COMMON1 | COMMON2

Differential signals

*RST: CHAN1

Usage: Asynchronous command

Manual operation: See "[Source]" on page 36

TRIGger<m>:TYPE <Type>

Selects the trigger type to trigger on analog channels or the external trigger input.

See also: [Chapter 6.3, "Trigger types"](#), on page 197.To trigger on digital channels and parallel buses, use **TRIGger<m>:PARAllel:TYPE**.**Suffix:**

<m> 1..3
 1 = A-trigger, 2 = B-trigger, 3 = R-trigger
 For suffixes 2 and 3, the following trigger types are available:
 EDGE, GLITCh, WIDTH, RUNT, WINDow, TIMEout, INTerval, SLEWrate.

Parameters:

<Type> EDGE | GLITCh | WIDTH | RUNT | WINDow | TIMEout | INTerval | SLEWrate | STATE | PATtern | ANEDge | SERPattern | TV | | SETHold | | NFC | CDR

Most of the type values are self-explanatory.

SETHoldSETHold: analyzes the relative timing between a data signal and the synchronous clock signal. For trigger settings, see [Chapter 27.9.10, "Setup & Hold"](#), on page 1501.**ANEDge**Edge trigger for external trigger input. Only available if the trigger source is the external trigger input. This trigger type uses the analog input signal. For trigger settings, see [Chapter 6.10.1, "External trigger setup"](#), on page 240.**SERPattern**Serial pattern for signals with serial data patterns in relation to a clock signal. For trigger settings, see [Chapter 27.9.13, "Serial pattern trigger"](#), on page 1507

NFC

Specific trigger for Near Field Communication testing, requires option R&S RTO6--K11. For NFC trigger settings, see [Chapter 27.22.3, "NFC trigger"](#), on page 2669.

CDR

Trigger on the edges of a recovered clock signal, requires option R&S RTO6--K13. The CDR also uses the trigger level as threshold to detect signal edges. For CDR trigger settings, see [Chapter 27.23.4, "Clock data recovery \(hardware-based, option R&S RTO6-K13\)"](#), on page 2728.

*RST: EDGE

Usage: Asynchronous command

Manual operation: See ["Type"](#) on page 199

TRIGger<m>:LEVel<n>[:VALue] <Level>

Sets the trigger level for the specified event and source.

If the trigger source is serial bus, the trigger level is set by the thresholds in the protocol configuration.

Suffix:

<m> 1..3
1 = A-trigger, 2 = B-trigger, 3 = R-trigger

<n> 1..31
Indicates the trigger source:
1...4 = channel 1 to 4
5 = external trigger input
6...11 = not available
12...27 = R&S RT-ZVC input channels
28...31 = differential signals Diff1, Diff2 and Common1, Common2

Parameters:

<Level> Voltage for the trigger level.
Range: Depends on vertical scale, channel offset and other settings. The trigger level must be within the current display range.
Increment: 1E-3
*RST: 0
Default unit: V

Example:

```
TRIG:LEV5 0.01
```

Sets the trigger level for the external trigger signal to 10 mV.

```
TRIG2:LEV3 0.2
```

Sets the trigger level for the B-event and B-trigger source channel 3 to 200 mV.

Usage: Asynchronous command

Manual operation: See ["Level"](#) on page 200

TRIGger<m>:FINDlevel

Sets the trigger level automatically. The command is only relevant if the trigger source is an analog channel CHAN1...4.

Suffix:

<m> 1..3
1 = A-trigger, 2 = B-trigger, 3 = R-trigger

Usage:

Event
Asynchronous command

Manual operation: See ["Find level"](#) on page 200

DISPlay:TRIGger:LINEs <State>

Hides or shows the trigger levels in the diagrams.

Parameters:

<State> ON | OFF
*RST: OFF

Usage:

Asynchronous command

Manual operation: See ["Show trigger lines"](#) on page 228

27.9.2 Edge trigger

[TRIGger<m>:EDGE:SLOPe.....](#) 1488

TRIGger<m>:EDGE:SLOPe <Slope>

Defines the edge for the edge trigger event.

Suffix:

<m> 1..3
1 = A-trigger, 2 = B-trigger, 3 = R-trigger

Parameters:

<Slope> POSitive | NEGative | EITHer
See [Chapter 27.4.3, "Slope parameter"](#), on page 1373.
*RST: POSitive

Usage:

Asynchronous command

Manual operation: See ["Slope"](#) on page 200

27.9.3 Glitch trigger

TRIGger<m>:GLITCh:POLarity.....	1489
TRIGger<m>:GLITCh:RANGe.....	1489
TRIGger<m>:GLITCh:WIDTh.....	1489

TRIGger<m>:GLITCh:POLarity <Polarity>

Defines the polarity of a pulse, that is the direction of the first pulse slope.

Suffix:

<m> 1..3
1 = A-trigger, 2 = B-trigger, 3 = R-trigger

Parameters:

<Polarity> POSitive | NEGative | EITHer
See [Chapter 27.4.4, "Polarity parameter"](#), on page 1373.
*RST: POSitive

Usage: Asynchronous command

Manual operation: See ["Polarity"](#) on page 201

TRIGger<m>:GLITCh:RANGe <RangeMode>

Selects which glitches are identified: shorter or longer than the width specified using [TRIGger<m>:GLITCh:WIDTh](#).

Suffix:

<m> 1..3
1 = A-trigger, 2 = B-trigger, 3 = R-trigger

Parameters:

<RangeMode> SHORter | LONGer
SHORter
Glitches shorter than the specified width are identified.
LONGer
Glitches longer than the specified width are identified.
*RST: SHORter

Usage: Asynchronous command

Manual operation: See ["Range"](#) on page 201

TRIGger<m>:GLITCh:WIDTh <Width>

Sets the length of a glitch. The instrument triggers on pulses shorter or longer than this value, depending on the [TRIGger<m>:GLITCh:RANGe](#) command.

You need to know the expected pulse widths of the circuit to set the glitch width correctly.

Suffix:	
<m>	1..3 1 = A-trigger, 2 = B-trigger, 3 = R-trigger
Parameters:	
<Width>	Range: 100E-12 to 10000 Increment: 100E-6 *RST: 1E-9 Default unit: s
Usage:	Asynchronous command
Manual operation:	See " Width " on page 201

27.9.4 Width trigger

TRIGger<m>:WIDTh:POLarity	1490
TRIGger<m>:WIDTh:RANGe	1490
TRIGger<m>:WIDTh:WIDTh	1491
TRIGger<m>:WIDTh:DELTA	1491

TRIGger<m>:WIDTh:POLarity <Polarity>

Suffix:	
<m>	1..3 1 = A-trigger, 2 = B-trigger, 3 = R-trigger
Parameters:	
<Polarity>	POSitive NEGative See Chapter 27.4.4, "Polarity parameter" , on page 1373. *RST: POSitive
Usage:	Asynchronous command
Manual operation:	See " Polarity " on page 202

TRIGger<m>:WIDTh:RANGe <RangeMode>

Defines how the range of a pulse width is defined in relation to the width and delta specified using [TRIGger<m>:WIDTh:WIDTh](#) and [TRIGger<m>:WIDTh:DELTA](#), respectively.

Suffix:	
<m>	1..3 1 = A-trigger, 2 = B-trigger, 3 = R-trigger
Parameters:	
<RangeMode>	WITHin OUTSide SHORter LONGer WITHin Triggers on pulses inside a given range. The range is defined by the width \pm delta.

OUTSide

Triggers on pulses outside a given range. The range is defined by the width $\pm\delta$.

SHORter

Triggers on pulses shorter than the given width.

LONGer

Triggers on pulses longer than the given width.

*RST: WITHin

Usage: Asynchronous command

Manual operation: See "Range" on page 203

TRIGger<m>:WIDTh:WIDTh <Width>

For the ranges "Within" and "Outside" (defined using [TRIGger<m>:WIDTh:RANGe](#)), the width defines the center of a range which is defined by the limits " $\pm\Delta$ " (see [TRIGger<m>:WIDTh:DELTA](#) on page 1491).

For the ranges "Shorter" and "Longer", the width defines the maximum and minimum pulse width, respectively.

Suffix:

<m> 1..3
1 = A-trigger, 2 = B-trigger, 3 = R-trigger

Parameters:

<Width> Range: 100E-12 to 10000
Increment: 100E-9
*RST: 5E-9
Default unit: s

Usage: Asynchronous command

Manual operation: See "Width" on page 203

TRIGger<m>:WIDTh:DELTA <WidthDelta>

Defines a range around the width value specified using [TRIGger<m>:WIDTh:WIDTh](#).

Suffix:

<m> 1..3
1 = A-trigger, 2 = B-trigger, 3 = R-trigger

Parameters:

<WidthDelta> Range: 0 to 432
Increment: 500E-12
*RST: 0
Default unit: s

Usage: Asynchronous command

27.9.5 Runt trigger

TRIGger<m>:RUNT:POLarity.....	1492
TRIGger<m>:LEVel<n>:RUNT:LOWer.....	1492
TRIGger<m>:LEVel<n>:RUNT:UPPer.....	1492
TRIGger<m>:RUNT:RANGe.....	1493
TRIGger<m>:RUNT:WIDTh.....	1493
TRIGger<m>:RUNT:DELTA.....	1494

TRIGger<m>:RUNT:POLarity <Polarity>

Suffix:

<m> 1..3
1 = A-trigger, 2 = B-trigger, 3 = R-trigger

Parameters:

<Polarity> POSitive | NEGative | EITHer
See [Chapter 27.4.4, "Polarity parameter"](#), on page 1373.
*RST: POSitive

Usage: Asynchronous command

Manual operation: See ["Polarity"](#) on page 201

TRIGger<m>:LEVel<n>:RUNT:LOWer <Level>

TRIGger<m>:LEVel<n>:RUNT:UPPer <Level>

Set the lower and upper voltage thresholds.

Suffix:

<m> 1..3
1 = A-trigger, 2 = B-trigger, 3 = R-trigger

<n> 1..31
Indicates the trigger source:
1...4 = channel 1...4
5...27 = not available
28...31 = differential signals Diff1, Diff2 and Common1, Common2

Parameters:

<Level> Range: -10 to 10
Increment: 1E-3
*RST: Lower = -0.1, upper = 0.1
Default unit: V

Usage: Asynchronous command

Manual operation: See ["Upper level"](#) on page 204

TRIGger<m>:RUNT:RANGe <Mode>

Defines the time limit of the runt pulse in relation to the `TRIGger<m>:RUNT:WIDTh` and `TRIGger<m>:RUNT:DELTA` settings.

Suffix:

<m> 1..3
1 = A-trigger, 2 = B-trigger, 3 = R-trigger

Parameters:

<Mode> ANY | LONGer | SHORter | WITHin | OUTSide

ANY

Triggers on all runts fulfilling the level condition, without time limitation.

LONGer

Triggers on runts longer than the given "Runt width".

SHORter

Triggers on runts shorter than the given "Runt width".

WITHin

Triggers if the runt length is inside a given time range. The range is defined by "Runt width" and " \pm Delta".

OUTSide

Triggers if the runt length is outside a given time range. The range is defined by "Runt width" and " \pm Delta".

*RST: ANY

Usage: Asynchronous command

Manual operation: See "[Range](#)" on page 204

TRIGger<m>:RUNT:WIDTh <Width>

Defines the upper or lower voltage threshold. This command is not available if `TRIGger<m>:RUNT:RANGe` is set to "ANY".

Suffix:

<m> 1..3
1 = A-trigger, 2 = B-trigger, 3 = R-trigger

Parameters:

<Width> Range: 100E-12 to 10000
Increment: 100E-9
*RST: 5E-9
Default unit: s

Usage: Asynchronous command

Manual operation: See "[Runt width](#)" on page 205

TRIGger<m>:RUNT:DELTA <WidthDelta>

Defines a range around the runt width specified using `TRIGger<m>:RUNT:WIDTh`. This command is only available if `TRIGger<m>:RUNT:RANGe` is set to "WITHin" or "OUTSide".

Suffix:

<m> 1..3
1 = A-trigger, 2 = B-trigger, 3 = R-trigger

Parameters:

<WidthDelta> Range: 100E-12 to 864
Increment: 100E-9
*RST: 100E-12
Default unit: s

Usage: Asynchronous command

Manual operation: See "[±Delta](#)" on page 205

27.9.6 Window trigger

<code>TRIGger<m>:LEVel<n>:WINDow:LOWer</code>	1494
<code>TRIGger<m>:LEVel<n>:WINDow:UPPer</code>	1494
<code>TRIGger<m>:WINDow:RANGe</code>	1495
<code>TRIGger<m>:WINDow:TIME</code>	1495
<code>TRIGger<m>:WINDow:WIDTh</code>	1496
<code>TRIGger<m>:WINDow:DELTA</code>	1496

TRIGger<m>:LEVel<n>:WINDow:LOWer <Level>**TRIGger<m>:LEVel<n>:WINDow:UPPer <Level>**

Set the lower and upper voltage limits for the window.

Suffix:

<m> 1..3
1 = A-trigger, 2 = B-trigger, 3 = R-trigger

<n> 1..31
Indicates the trigger source:
1...4 = channel 1...4
5...27 = not available
28...31 = differential signals Diff1, Diff2 and Common1, Common2

Parameters:

<Level> Range: -10 to 10
Increment: 1E-3
*RST: Lower = -0.1, upper = 0.1
Default unit: V

Usage: Asynchronous command

Manual operation: See "[Upper level](#)" on page 206

TRIGger<m>:WINDow:RANGe <RangeMode>

Defines the signal run in relation to the window:

Suffix:

<m> 1..3
1 = A-trigger, 2 = B-trigger, 3 = R-trigger

Parameters:

<RangeMode> ENTer | EXIT | WITHin | OUTSide

ENTer

Triggers when the signal crosses the upper or lower level and thus enters the window made up of these two levels.

EXIT

Triggers when the signal leaves the window.

WITHin

Triggers if the signal stays between the upper and lower level for a specified time. The time is defined using the [TRIGger<m>:WINDow:TIME](#) command.

OUTSide

Triggers if the signal stays above the upper level or below the lower level for a specified time. The time is defined using the [TRIGger<m>:WINDow:TIME](#) command.

*RST: ENTer

Usage: Asynchronous command

Manual operation: See "[Vertical condition](#)" on page 206

TRIGger<m>:WINDow:TIME <TimeRangeMode>

Defines the limit of the window in relation to the time specified using [TRIGger<m>:WINDow:WIDTh](#) and [TRIGger<m>:WINDow:DELTA](#). Time conditioning is available for [TRIGger<m>:WINDow:RANGe](#)= "WITHin" and "OUTSide".

Suffix:

<m> 1..3
1 = A-trigger, 2 = B-trigger, 3 = R-trigger

Parameters:

<TimeRangeMode> WITHin | OUTSide | SHORter | LONGer

WITHin

Triggers if the signal stays inside or outside the vertical window limits at least for the time *Width - Delta* and for *Width + Delta* at the most.

OUTSide

"Outside" is the opposite definition of "Within". The instrument triggers if the signal stays inside or outside the vertical window limits for a time shorter than *Width - Delta* or longer than *Width + Delta*.

SHORter

Triggers if the signal crosses vertical limits before the specified "Width" time is reached.

LONGer

Triggers if the signal crosses vertical limits before the specified "Width" time is reached.

*RST: WITHin

Usage: Asynchronous command

Manual operation: See "[Time condition](#)" on page 206

TRIGger<m>:WINDow:WIDTh <Width>

For the ranges "Within" and "Outside" (defined using [TRIGger<m>:WINDow:RANGe](#)), the width defines the center of a time range which is defined by the limits " \pm Delta" (see [TRIGger<m>:WINDow:DELTA](#) on page 1496).

For the ranges "Shorter" and "Longer", it defines the maximum and minimum time lapse, respectively.

Suffix:

<m> 1..3
1 = A-trigger, 2 = B-trigger, 3 = R-trigger

Parameters:

<Width> Range: 100E-12 to 10000
Increment: 100E-9
*RST: 5E-9
Default unit: s

Usage: Asynchronous command

Manual operation: See "[Width](#)" on page 206

TRIGger<m>:WINDow:DELTA <WidthDelta>

Defines a range around the "Width" value specified using [TRIGger<m>:WINDow:WIDTh](#).

Suffix:

<m> 1..3
1 = A-trigger, 2 = B-trigger, 3 = R-trigger

Parameters:

<WidthDelta> Range: 0 to 432
Increment: 500E-12
*RST: 0
Default unit: s

Usage: Asynchronous command

Manual operation: See "[±Delta](#)" on page 207

27.9.7 Timeout trigger

TRIGger<m>:TIMEout:RANGe.....	1497
TRIGger<m>:TIMEout:TIME.....	1497

TRIGger<m>:TIMEout:RANGe <TimeoutMode>

Defines the relation of the signal level to the trigger level.

Suffix:

<m> 1..3
1 = A-trigger, 2 = B-trigger, 3 = R-trigger

Parameters:

<TimeoutMode> HIGH | LOW | EITHer

HIGH

The signal level stays above the trigger level.

LOW

The signal level stays below the trigger level.

EITHer

The signal level stays above or below the trigger level.

*RST: HIGH

Usage: Asynchronous command

Manual operation: See "Range" on page 207

TRIGger<m>:TIMEout:TIME <Time>

Defines the time limit for the timeout at which the instrument triggers.

Suffix:

<m> 1..3
1 = A-trigger, 2 = B-trigger, 3 = R-trigger

Parameters:

<Time> Range: 100E-12 to 10000
Increment: 100E-9
*RST: 100E-9
Default unit: s

Usage: Asynchronous command

Manual operation: See "Time" on page 208

27.9.8 Interval trigger

TRIGger<m>:INTerval:SLOPe.....	1498
TRIGger<m>:INTerval:RANGe.....	1498
TRIGger<m>:INTerval:WIDTh.....	1498
TRIGger<m>:INTerval:DELTA.....	1499

TRIGger<m>:INTerval:SLOPe <Slope>

Sets the edge for the trigger. You can analyze the interval between positive edges or between negative edges.

Suffix:

<m> 1..3
1 = A-trigger, 2 = B-trigger, 3 = R-trigger

Parameters:

<Slope> POSitive | NEGative
See [Chapter 27.4.3, "Slope parameter"](#), on page 1373.
*RST: POSitive

Usage: Asynchronous command

Manual operation: See ["Slope"](#) on page 208

TRIGger<m>:INTerval:RANGe <RangeMode>

Defines the range of an interval in relation to the interval width specified using [TRIGger<m>:INTerval:WIDTh](#) and [TRIGger<m>:INTerval:DELTA](#).

Suffix:

<m> 1..3
1 = A-trigger, 2 = B-trigger, 3 = R-trigger

Parameters:

<RangeMode> WITHin | OUTSide | SHORter | LONGer

WITHin

Triggers on pulses inside a given range. The range is defined by the interval width $\pm\delta$.

OUTSide

Triggers on pulses outside a given range. The range is defined by the interval width $\pm\delta$.

SHORter

Triggers on pulses shorter than the given interval width.

LONGer

Triggers on pulses longer than the given interval width.

*RST: OUTSide

Usage: Asynchronous command

Manual operation: See ["Range"](#) on page 208

TRIGger<m>:INTerval:WIDTh <Width>

Defines the time between two pulses.

Suffix:

<m> 1..3
1 = A-trigger, 2 = B-trigger, 3 = R-trigger

Parameters:

<Width> Range: 100E-12 to 10000
 Increment: 100E-9
 *RST: 5E-9
 Default unit: s

Usage: Asynchronous command

Manual operation: See "[Interv. width](#)" on page 209

TRIGger<m>:INTerval:DELTA <WidthDelta>

Defines a range around the "Interval width" value specified using [TRIGger<m>:INTerval:WIDTH](#) on page 1498.

Suffix:

<m> 1..3
 1 = A-trigger, 2 = B-trigger, 3 = R-trigger

Parameters:

<WidthDelta> Range: 0 to 10
 Increment: 100E-9
 *RST: 0
 Default unit: s

Usage: Asynchronous command

Manual operation: See "[±Delta](#)" on page 209

27.9.9 Slew rate trigger

TRIGger<m>:SLEW:SLOPe	1499
TRIGger<m>:LEVel<n>:SLEW:LOWer	1500
TRIGger<m>:LEVel<n>:SLEW:UPPer	1500
TRIGger<m>:SLEW:RANGe	1500
TRIGger<m>:SLEW:RATE	1501
TRIGger<m>:SLEW:DELTA	1501

TRIGger<m>:SLEW:SLOPe <Slope>

Selects the edge type for the trigger event.

Suffix:

<m> 1..3
 1 = A-trigger, 2 = B-trigger, 3 = R-trigger

Parameters:

<Slope> POSitive | NEGative | EITHer
 See [Chapter 27.4.3, "Slope parameter"](#), on page 1373.
 *RST: POSitive

Usage: Asynchronous command

Manual operation: See "[Slope](#)" on page 200

TRIGger<m>:LEVel<n>:SLEW:LOWer <Level>

TRIGger<m>:LEVel<n>:SLEW:UPPer <Level>

Set the lower and upper voltage thresholds. When the signal crosses a level, the slew rate measurement starts or stops depending on the selected slope.

Suffix:

<m> 1..3
1 = A-trigger, 2 = B-trigger, 3 = R-trigger

<n> 1..31
Indicates the trigger source:
1...4 = channel 1...4
5...27 = not available
28...31 = differential signals Diff1, Diff2 and Common1, Common2

Parameters:

<Level> Range: -10 to 10
Increment: 1E-3
*RST: Lower = -0.1, upper = 0.1
Default unit: V

Usage: Asynchronous command

Manual operation: See "[Upper level](#)" on page 210

TRIGger<m>:SLEW:RANGe <RangeMode>

Defines the time limit for the slew rate in relation to the upper or lower trigger level (see [TRIGger<m>:SLEW:RATE](#) on page 1501 and [TRIGger<m>:SLEW:DELTA](#) on page 1501). The time measurement starts when the signal crosses the first trigger level - the upper or lower level depending on the selected slope - and stops when the signal crosses the second level.

Suffix:

<m> 1..3
1 = A-trigger, 2 = B-trigger, 3 = R-trigger

Parameters:

<RangeMode> INSRange | OUTRange | LTHan | GTHan

INSRange

Triggers on pulses inside a given range. The range is defined by the slew rate $\pm\delta$.

OUTRange

Triggers on pulses outside a given range. The range is defined by the slew rate $\pm\delta$.

LTHan

Triggers on pulses shorter than the given slew rate.

GTHan

Triggers on pulses longer than the given slew rate.

*RST: GTHan

Usage: Asynchronous command

Manual operation: See "[Range](#)" on page 210

TRIGger<m>:SLEW:RATE <Time>

For the ranges "Within" and "Outside", the slew rate defines the center of a range which is defined by the limits " $\pm\Delta$ ".

For the ranges "Shorter" and "Longer", the slew rate defines the maximum and minimum slew rate limits, respectively. When the signal crosses this level, the slew rate measurement starts or stops depending on the selected slope (see [TRIGger<m>:SLEW:SLOPe](#) on page 1499).

Suffix:

<m> 1..3
1 = A-trigger, 2 = B-trigger, 3 = R-trigger

Parameters:

<Time> Range: 100E-12 to 10000
Increment: 100E-9
*RST: 100E-12
Default unit: s

Usage: Asynchronous command

Manual operation: See "[Slew rate](#)" on page 211

TRIGger<m>:SLEW:DELTA <TimeDelta>

Defines a time range around the slew rate specified using [TRIGger<m>:SLEW:RATE](#).

Suffix:

<m> 1..3
1 = A-trigger, 2 = B-trigger, 3 = R-trigger

Parameters:

<TimeDelta> Range: 0 to 10
Increment: 100E-9
*RST: 0
Default unit: s

Usage: Asynchronous command

Manual operation: See "[±Delta](#)" on page 211

27.9.10 Setup & Hold

The Setup & Hold trigger is only available for the A-event (Suffix = 1).

TRIGger<m>:SETHold:CSOource:EDGE.....	1502
TRIGger<m>:SETHold:CSOource:LEVel.....	1502
TRIGger<m>:SETHold:CSOource[:VALue].....	1502
TRIGger<m>:SETHold:HTIME.....	1503
TRIGger<m>:SETHold:STIME.....	1503
TRIGger<m>:SCOupling.....	1504

TRIGger<m>:SETHold:CSOource:EDGE <ClockEdge>

Sets the edge of the clock signal to define the time reference point for the setup and hold time.

Suffix:

<m> 1..3
Only 1 = A-trigger, 2 | 3 = not available. Can be omitted.

Parameters:

<ClockEdge> POSitive | NEGative | EITHer
See [Chapter 27.4.3, "Slope parameter"](#), on page 1373.
*RST: POSitive

Usage: Asynchronous command

Manual operation: See ["Clock edge"](#) on page 212

TRIGger<m>:SETHold:CSOource:LEVel <ClockLevel>

Sets the voltage level for the clock signal. Both this command and [TRIGger<m>:SETHold:CSOource:EDGE](#) define the starting point for calculation of the setup and hold time.

Suffix:

<m> 1..3
Only 1 = A-trigger, 2 | 3 = not available. Can be omitted.

Parameters:

<ClockLevel> Range: -10 to 10
Increment: 1E-3
*RST: 0
Default unit: V

Usage: Asynchronous command

Manual operation: See ["Clock level"](#) on page 212

TRIGger<m>:SETHold:CSOource[:VALue] <ClockSource>

Selects the source of the clock signal.

Suffix:

<m> 1..3
Only 1 = A-trigger, 2 | 3 = not available. Can be omitted.

Parameters:

<ClockSource> CHAN1 | CHANnel1 | CHAN2 | CHANnel2 | CHAN3 |
 CHANnel3 | CHAN4 | CHANnel4
 CHAN1 = CHANnel1, CHAN2 = CHANnel2, CHAN3 = CHAN-
 nel3, CHAN4 = CHANnel4
 Input channel of the clock signal
 *RST: CHAN1

Usage: Asynchronous command

Manual operation: See "[Clock source](#)" on page 212

TRIGger<m>:SETHold:HTIME <HoldTime>

Sets the minimum time **after** the clock edge while the data signal must stay steady above or below the data level.

The hold time can be negative. In this case, the setup time is always positive. The setup/hold interval starts before the clock edge (setup time) and ends before the clock edge (hold time). If you change the negative hold time, the setup time is adjusted by the instrument.

Suffix:

<m> 1..3
 Only 1 = A-trigger, 2 | 3 = not available. Can be omitted.

Parameters:

<HoldTime> Range: -99.999E-9 to 100E-9
 Increment: 1E-9
 *RST: 0
 Default unit: s

Usage: Asynchronous command

Manual operation: See "[Hold time](#)" on page 213

TRIGger<m>:SETHold:STIME <SetupTime>

Sets the minimum time **before** the clock edge while the data signal must stay steady above or below the data level.

The setup time can be negative. In this case, the hold time is always positive. The setup/hold interval starts after the clock edge (setup time) and ends after the clock edge (hold time). If you change the negative setup time, the hold time is adjusted by the instrument.

Suffix:

<m> 1..3
 Only 1 = A-trigger, 2 | 3 = not available. Can be omitted.

Parameters:

<SetupTime> Range: -99.999E-9 to 100E-9
 Increment: 1E-9
 *RST: 0
 Default unit: s

Usage: Asynchronous command

Manual operation: See "[Setup time](#)" on page 213

TRIGger<m>:SCOupling <TrigLevSrcCpl>

Sets the trigger levels of all used channels to the level of the data line (Setup & Hold and serial pattern trigger), clock line (state trigger) or source line (pattern trigger).

Suffix:

<m> 1..3
 Only 1 = A-trigger, 2 | 3 = not available. Can be omitted.

Parameters:

<TrigLevSrcCpl> ON | OFF
 *RST: OFF

Usage: Asynchronous command

Manual operation: See "[Use data level for clock level](#)" on page 213

27.9.11 State trigger

The state trigger combines the edge trigger settings with trigger qualification. It is only available for the A-event (Suffix = 1).

Use the following commands:

- [TRIGger<m>:EDGE:SLOPe](#) on page 1488
- [TRIGger<m>:LEVel<n>\[:VALue\]](#) on page 1487
- [TRIGger<m>:SCOupling](#) on page 1504
- To define the state, use the `TRIG:QUAL...[ENABLE]` and `TRIG:QUAL...LOGic` commands, which are described in [Chapter 27.9.15, "Trigger qualification"](#), on page 1514.

27.9.12 Pattern trigger

The pattern trigger is only available for the A-event (Suffix = 1).

The pattern is defined using the commands:

- [TRIGger<m>:QUALify<n>:A\[:ENABLE\]](#) on page 1516
- [TRIGger<m>:QUALify<n>:A:LOGic](#) on page 1516
- [TRIGger<m>:QUALify<n>:AB:LOGic](#) on page 1517

These are the commands for channel 1, use the similar commands for channels 2, 3, and 4.

TRIGger<m>:PATtern:MODE.....	1505
TRIGger<m>:PATtern:TIMEout:MODE.....	1505
TRIGger<m>:PATtern:TIMEout[:TIME].....	1506
TRIGger<m>:PATtern:WIDTH:RANGe.....	1506
TRIGger<m>:PATtern:WIDTH[:WIDTH].....	1507
TRIGger<m>:PATtern:WIDTH:DELTA.....	1507

TRIGger<m>:PATtern:MODE <Mode>

Adds additional time limitation to the pattern definition.

Suffix:

<m> 1..3
Only 1 = A-trigger, 2 | 3 = not available. Can be omitted.

Parameters:

<Mode> OFF | TIMEout | WIDTH

OFF
No time limitation. The event occurs if the pattern condition is fulfilled.

TIMEout
Defines how long the result of the pattern condition must be true or false. The duration of the timeout is defined using [TRIGger<m>:PATtern:TIMEout\[:TIME\]](#).

WIDTH
Defines a time range for keeping up the true result of the pattern condition. The range is defined using [TRIGger<m>:PATtern:WIDTH:RANGe](#).

*RST: OFF

Usage: Asynchronous command

Manual operation: See "[Additional settings: Timing](#)" on page 216

TRIGger<m>:PATtern:TIMEout:MODE <TimeoutMode>

Defines the condition for the timeout.

Suffix:

<m> 1..3
Only 1 = A-trigger, 2 | 3 = not available. Can be omitted.

Parameters:

<TimeoutMode> HIGH | LOW

HIGH
The result stays high.

LOW
The result stays low.

*RST: HIGH

Usage: Asynchronous command

Manual operation: See ["Additional settings: Timing"](#) on page 216

TRIGger<m>:PATtern:TIMEout[:TIME] <Time>

Defines how long the result of the pattern condition must be true or false.

Suffix:

<m> 1..3
Only 1 = A-trigger, 2 | 3 = not available. Can be omitted.

Parameters:

<Time> Range: 100E-12 to 10000
Increment: 100E-9
*RST: 100E-9
Default unit: s

Usage: Asynchronous command

Manual operation: See ["Additional settings: Timing"](#) on page 216

TRIGger<m>:PATtern:WIDTh:RANGe <WidthRangeMode>

Defines how the range of a pulse width is defined for keeping up the true result of the pattern condition. The width and delta are specified using `TRIGger<m>:PATtern:WIDTh[:WIDTh]` and `TRIGger<m>:PATtern:WIDTh:DELTA`, respectively.

Suffix:

<m> 1..3
Only 1 = A-trigger, 2 | 3 = not available. Can be omitted.

Parameters:

<WidthRangeMode> WITHin | OUTSide | SHORter | LONGer

WITHin

Triggers on pulses inside a given range. The range is defined by the width \pm delta.

OUTSide

Triggers on pulses outside a given range. The range is defined by the width \pm delta.

SHORter

Triggers on pulses shorter than the given width.

LONGer

Triggers on pulses longer than the given width.

*RST: WITHin

Usage: Asynchronous command

Manual operation: See ["Additional settings: Timing"](#) on page 216

TRIGger<m>:PATTern:WIDTh[:WIDTh] <Width>

For the ranges "Within" and "Outside" (defined using [TRIGger<m>:PATTern:WIDTh:RANGe](#)), the width defines the center of a range which is defined by the limits "±Delta" (see [TRIGger<m>:PATTern:WIDTh:DELTA](#) on page 1507).

For the ranges "Shorter" and "Longer", the width defines the maximum and minimum pulse width, respectively.

Suffix:

<m> 1..3
Only 1 = A-trigger, 2 | 3 = not available. Can be omitted.

Parameters:

<Width> Range: 100E-12 to 10000
Increment: 100E-9
*RST: 5E-9
Default unit: s

Usage: Asynchronous command

Manual operation: See "[Additional settings: Timing](#)" on page 216

TRIGger<m>:PATTern:WIDTh:DELTA <WidthDelta>

Defines a range around the width value specified using [TRIGger<m>:PATTern:WIDTh\[:WIDTh\]](#).

Suffix:

<m> 1..3
Only 1 = A-trigger, 2 | 3 = not available. Can be omitted.

Parameters:

<WidthDelta> Range: 0 to 432
Increment: 500E-12
*RST: 0
Default unit: s

Usage: Asynchronous command

Manual operation: See "[Additional settings: Timing](#)" on page 216

27.9.13 Serial pattern trigger

The serial pattern trigger is only available for the A-event (Suffix = 1).

TRIGger<m>:SPATtern:CSOurce[:VALue]	1508
TRIGger<m>:SPATtern:CSOurce:EDGE	1508
TRIGger<m>:SPATtern:CSOurce:LEVel	1508
TRIGger<m>:SPATtern:PATTern	1509
TRIGger<m>:SPATtern:REFSource	1509

TRIGger<m>:SPATtern:CSource:VALue <ClockSource>

Defines the source of the clock signal.

Suffix:

<m> 1..3
Only 1 = A-trigger, 2 | 3 = not available. Can be omitted.

Parameters:

<ClockSource> CHAN1 | CHANNEL1 | CHAN2 | CHANNEL2 | CHAN3 |
CHANNEL3 | CHAN4 | CHANNEL4
CHAN1 = CHANnel1, CHAN2 = CHANnel2, CHAN3 = CHAN-
nel3, CHAN4 = CHANnel4
Input channel of the clock signal
*RST: CHAN1

Usage: Asynchronous command

Manual operation: See "[Clock source](#)" on page 212

TRIGger<m>:SPATtern:CSource:EDGE <ClockEdge>

Together with the clock level (see [TRIGger<m>:SPATtern:CSource:LEVel](#) on page 1508), the clock edge defines the point in time when the state of the data signal is checked.

Suffix:

<m> 1..3
Only 1 = A-trigger, 2 | 3 = not available. Can be omitted.

Parameters:

<ClockEdge> POSitive | NEGative | EITHer
See [Chapter 27.4.3, "Slope parameter"](#), on page 1373.
*RST: POSitive

Usage: Asynchronous command

Manual operation: See "[Clock edge](#)" on page 218

TRIGger<m>:SPATtern:CSource:LEVel <ClockLevel>

Defines the voltage level for the clock signal.

Suffix:

<m> 1..3
Only 1 = A-trigger, 2 | 3 = not available. Can be omitted.

Parameters:

<ClockLevel> Range: -10 to 10
Increment: 1E-3
*RST: 0
Default unit: V

Usage: Asynchronous command
Manual operation: See "Clock level " on page 218

TRIGger<m>:SPATtern:PATtern <Pattern>

The pattern contains the bits of the serial data to be found in the data stream. The maximum length of the pattern is 128 bit.

Suffix:
 <m> 1..3
 Only 1 = A-trigger, 2 | 3 = not available. Can be omitted.

Parameters:
 <Pattern> Numeric or string pattern, see [Chapter 27.4.6, "Bit pattern parameter"](#), on page 1373. The string parameter accepts the bit value X (don't care).

Usage: Asynchronous command
Manual operation: See "Pattern" on page 219

TRIGger<m>:SPATtern:REFSource <ReferenceSource>

Selects if an explicit clock or a CDR signal is used as a reference signal.

Suffix:
 <m> 1..3

Parameters:
 <ReferenceSource> CLOCK | CDR
 *RST: CDR

Usage: Asynchronous command
Manual operation: See "Clock / CDR" on page 218

27.9.14 TV/Video trigger

The TV or video trigger requires a channel input as trigger source ([TRIGger<m>:SOURCE\[:SElect\]](#)). It is only available for the A-event (Suffix = 1).

Make sure to set the trigger level - the threshold of the sync pulse - with [TRIGger<m>:LEVel<n>\[:VALue\]](#).

TRIGger<m>:TV:STANdard	1510
TRIGger<m>:TV:MODE	1510
TRIGger<m>:TV:POLarity	1511
TRIGger<m>:TV:LINE	1511
TRIGger<m>:TV:LFIeld	1512
TRIGger<m>:TV:CUSTom:SCANmode	1513

TRIGger<m>:TV:CUSTom:LDURation.....	1513
TRIGger<m>:TV:CUSTom:STYPe.....	1513
TRIGger<m>:TV:CUSTom:SDURation.....	1514

TRIGger<m>:TV:STANdard <Standard>

Sets the TV standard.

Suffix:

<m> 1..3
Only 1 = A-trigger, 2 | 3 = not available. Can be omitted.

Parameters:

<Standard> CUSTom | PAL | PALM | NTSC | SECam | P480L60HZ |
P720L30HZ | P720L50HZ | P720L60HZ | I1080L50HZ |
I1080L60HZ | P1080L24HZ | P1080L24HZSF | P1080L25HZ |
P1080L30HZ | P1080L50HZ | P1080L60HZ

CUSTom

User-defined signal. Configure the signal using:

TRIGger<m>:TV:CUSTom:SCANmode
TRIGger<m>:TV:CUSTom:STYPe
TRIGger<m>:TV:CUSTom:LDURation
TRIGger<m>:TV:CUSTom:SDURation

PAL | PALM | NTSC | SECam

SDTV standards. PALM = PAL-M

PxxxxLyyHZ

HDTV standards using progressive scanning (P). xxxx indicates the number of active lines, yy is the frame rate.

IxxxxLxxHZ

HDTV standards using interlaced scanning (I). xxxx indicates the number of active lines, yy is the field rate.

P1080L24HZSF

1080p/24sF is a HDTV standard using progressive segmented frame scanning.

*RST: PAL

Usage: Asynchronous command

Manual operation: See "[Standard](#)" on page 220

TRIGger<m>:TV:MODE <Mode>

Selects the lines or fields on which the instrument can trigger. Available modes depend on the scanning system.

Suffix:

<m> 1..3
Only 1 = A-trigger, 2 | 3 = not available. Can be omitted.

Parameters:

<Mode> ALL | ODD | EVEN | ALINe | LINE

ALL

All fields, triggers on the frame start (progressive scanning) or field start (interlaced and progressive segmented frame scanning)

ODD | EVEN

Only available for interlaced scanning and progressive segmented frame scanning. Triggers on the field start of the odd or even field.

ALINe

All lines, triggers on all line starts.

LINE

Triggers on a specified line. To set the line number, use `TRIGger<m>:TV:LINE`. For NTSC signals, set also the field with `TRIGger<m>:TV:LFIeld`.

*RST: ALL

Usage: Asynchronous command

Manual operation: See "[Mode](#)" on page 221

TRIGger<m>:TV:POLarity <Polarity>

Sets the polarity of the *signal*. Note that the sync pulse has the opposite polarity, for example, a positive signal has a negative sync pulse.

Suffix:

<m> 1..3
Only 1 = A-trigger, 2 | 3 = not available. Can be omitted.

Parameters:

<Polarity> POSitive | NEGative
*RST: POSitive

Usage: Asynchronous command

Manual operation: See "[Signal polarity](#)" on page 221

TRIGger<m>:TV:LINE <LineNumber>

Specifies the line number to trigger on. The command is relevant if `TRIGger<m>:TV:MODE` is set to `LINE`.

Usually the lines of the frame are counted beginning from the frame start. For NTSC signals, the lines are counted per field, not per frame. For these signals, set also the field with `TRIGger<m>:TV:LFIeld`.

Suffix:

<m> 1..3
Only 1 = A-trigger, 2 | 3 = not available. Can be omitted.

Parameters:

<LineNumber> Range: Depends on the standard, see table below
 Increment: 1
 *RST: 1

Usage: Asynchronous command

Manual operation: See "[Line #](#)" on page 221

Standard	Minimum value	Maximum value
PAL	1	625
PAL-M	1	525
NTSC	1	263 in odd field 262 in even field
SECAM	1	625
480p/60 (P480L60HZ)	1	525
720p/30 (P720L30HZ) 720p/50 (P720L50HZ) 720p/60 (P720L60HZ)	1	750
1080i/50 (I1080L50HZ) 1080i/60 (I1080L60HZ) 1080p/24 (P1080L24HZ) 1080p/24sF (P1080L24HZSF) 1080p/25 (P1080L25HZ) 1080p/30 (P1080L30HZ) 1080p/50 (P1080L50HZ) 1080p/60 (P1080L60HZ)	1	1125

TRIGger<m>:TV:LField <LineField>

The commands is only relevant for NTSC signals and sets the field in which the line number is counted.

Suffix:

<m> 1..3
 Only 1 = A-trigger, 2 | 3 = not available. Can be omitted.

Parameters:

<LineField> FIELD1 | FIELD2
 FIELD1 = odd field
 FIELD2 = even field
 *RST: FIELD1

Usage: Asynchronous command

Manual operation: See "[Line #](#)" on page 221

TRIGger<m>:TV:CUSTom:SCANmode <ScanMode>

Sets the scanning system. Only relevant if **TRIGger<m>:TV:STANdard** is set to **CUSTom**.

See also: "[Scan](#)" on page 223.

Suffix:

<m> 1..3
Only 1 = A-trigger, 2 | 3 = not available. Can be omitted.

Parameters:

<ScanMode> INTerlaced | PROGressive | SEGmented
SEGmented: Progressive segmented frame uses progressive scanning to capture the frame, and interlaced scanning for transmission and display.
*RST: INTerlaced

Usage: Asynchronous command

Manual operation: See "[Scan](#)" on page 223

TRIGger<m>:TV:CUSTom:LDURATION <LinePeriod>

Sets the duration of a line, the time between two successive sync pulses. Only relevant if **TRIGger<m>:TV:STANdard** is set to **CUSTom**.

Suffix:

<m> 1..3
Only 1 = A-trigger, 2 | 3 = not available. Can be omitted.

Parameters:

<LinePeriod> Range: 1E-6 to 500E-6
Increment: 100E-9
*RST: 64E-6
Default unit: s

Usage: Asynchronous command

Manual operation: See "[Line period](#)" on page 222

TRIGger<m>:TV:CUSTom:STYPe <SyncPulseType>

Sets the type of the sync pulse. Only relevant if **TRIGger<m>:TV:STANdard** is set to **CUSTom**.

Suffix:

<m> 1..3
Only 1 = A-trigger, 2 | 3 = not available. Can be omitted.

Parameters:

<SyncPulseType> BIlevel | TRIlevel

BIlevel

Bi-level sync pulse, usually used in SDTV signals

TRILevel

Tri-level sync pulse, used in HDTV signals

*RST: BIlevel

Usage: Asynchronous command**Manual operation:** See "Pulse type" on page 222**TRIGger<m>:TV:CUSTom:SDURation <SyncPulseDurat>**Sets the width of the sync pulse. Only relevant if `TRIGger<m>:TV:STANdard` is set to `CUSTom`.**Suffix:**

<m>

1..3

Only 1 = A-trigger, 2 | 3 = not available. Can be omitted.

Parameters:

<SyncPulseDurat> Range: 100E-9 to 100E-6
 Increment: 100E-9
 *RST: 4.7E-6
 Default unit: s

Usage: Asynchronous command**Manual operation:** See "Pulse width" on page 222

27.9.15 Trigger qualification

The A-event can have its own trigger qualification. Qualification is not available for B- and R-events (event suffix `m = 2 | 3`) and some trigger types.

A suffix defines the trigger type to which the qualification belongs.

Table 27-3: Trigger type suffixes

Suffix	Trigger type
1	EDGE
2	GLITCh
3	WIDTh
4	RUNT
5	WINDow
6	TIMeout
7	INTerval
8	Qualification is not supported (SLEWrate)
9	Qualification is not supported (SETHold)

Suffix	Trigger type
10	STATe
11	PATtern
12	qualification is not supported (ANEDge, ext. trigger input)
13	Currently not used
14	Currently not used
15	Qualification is not supported (SERPattern)
16	Qualification is not supported (NFC)
17	Qualification is not supported (TV)
18	Qualification is not supported (CDR)

TRIGger<m>:QUALify<n>:STATe.....	1515
TRIGger<m>:QUALify<n>:A[:ENABLE].....	1516
TRIGger<m>:QUALify<n>:B[:ENABLE].....	1516
TRIGger<m>:QUALify<n>:C[:ENABLE].....	1516
TRIGger<m>:QUALify<n>:D[:ENABLE].....	1516
TRIGger<m>:QUALify<n>:A:LOGic.....	1516
TRIGger<m>:QUALify<n>:B:LOGic.....	1516
TRIGger<m>:QUALify<n>:C:LOGic.....	1516
TRIGger<m>:QUALify<n>:D:LOGic.....	1516
TRIGger<m>:QUALify<n>:AB:LOGic.....	1517
TRIGger<m>:QUALify<n>:CD:LOGic.....	1517
TRIGger<m>:QUALify<n>:ABCD:LOGic.....	1517

TRIGger<m>:QUALify<n>:STATe <AddTrigLogi>

Enables the use of the qualification definition for the selected trigger event.

Suffix:

<m>	1..3 Only 1 = A-trigger, 2 3 = not available. Can be omitted.
<n>	1..18 Defines the trigger type, see Table 27-3 .

Parameters:

<AddTrigLogi>	ON OFF
	ON The qualification expression is considered for the trigger event.
	OFF The qualification expression is ignored for the trigger event.
*RST:	OFF

Usage: Asynchronous command

TRIGger<m>:QUALify<n>:A[:ENABLE] <State>
TRIGger<m>:QUALify<n>:B[:ENABLE] <State>
TRIGger<m>:QUALify<n>:C[:ENABLE] <State>
TRIGger<m>:QUALify<n>:D[:ENABLE] <State>

The command is relevant for qualification, for pattern trigger and for state trigger.

Select the channels to be considered:

- A[:ENABLE]: C1
- B[:ENABLE]: C2
- C[:ENABLE]: C3
- D[:ENABLE]: C4

The trigger source cannot be enabled.

Suffix:

<m> 1..3
 Only 1 = A-trigger, 2 | 3 = not available. Can be omitted.
 <n> 1..18
 Trigger type, see [Table 27-3](#).

Parameters:

<State> ON | OFF
ON
 The qualification expression is considered.
OFF
 The qualification expression is ignored.
 *RST: OFF

Usage: Asynchronous command

Manual operation: See "[Pattern](#)" on page 215

TRIGger<m>:QUALify<n>:A:LOGic <Operator>
TRIGger<m>:QUALify<n>:B:LOGic <Operator>
TRIGger<m>:QUALify<n>:C:LOGic <Operator>
TRIGger<m>:QUALify<n>:D:LOGic <Operator>

Defines the logic for the indicated channel:

- A: C1
- B: C2
- C: C3
- D: C4

Suffix:

<m> 1..3
 Only 1 = A-trigger, 2 | 3 = not available. Can be omitted.

<n> 1..18
Trigger type, see [Table 27-3](#).

Parameters:

<Operator> DIRect | HIGH | NOT | LOW
DIRect
Input value remains unchanged
NOT
Input value is inverted
*RST: DIRect

Usage: Asynchronous command

Manual operation: See "[Pattern](#)" on page 215

TRIGger<m>:QUALify<n>:AB:LOGic <Operator>

TRIGger<m>:QUALify<n>:CD:LOGic <Operator>

TRIGger<m>:QUALify<n>:ABCD:LOGic <Operator>

Defines the logical combination of the indicated channels after evaluating the previous logical operations:

- AB: CH1 and CH2
- CD: CH3 and CH4
- ABCD: result of AB and CD

Suffix:

<m> 1..3
Only 1 = A-trigger, 2 | 3 = not available. Can be omitted.

<n> 1..18
Trigger type, see [Table 27-3](#).

Parameters:

<Operator> AND | NAND | OR | NOR
AND
logical AND, conjunctive combination
NAND
logical NOT AND
OR
logical OR, disjunctive combination
NOR
logical NOT OR
*RST: AND

Usage: Asynchronous command

Manual operation: See "[Pattern](#)" on page 215

27.9.16 Holdoff

TRIGger<m>:HOLDoff:MODE.....	1518
TRIGger<m>:HOLDoff:TIME.....	1519
TRIGger<m>:HOLDoff:EVENTs.....	1519
TRIGger<m>:HOLDoff:MIN.....	1520
TRIGger<m>:HOLDoff:MAX.....	1520
TRIGger<m>:HOLDoff:AUTotime?.....	1521
TRIGger<m>:HOLDoff:SCALing.....	1521

TRIGger<m>:HOLDoff:MODE <Mode>

Selects the method to define the holdoff condition.

The trigger holdoff defines when the next trigger after the current will be recognized. Thus, it affects the next trigger to occur after the current one. Holdoff helps to obtain stable triggering when the oscilloscope is triggering on undesired events.

Suffix:

<m> 1..3
Only 1 = A-trigger, 2 | 3 = not available. Can be omitted.

Parameters:

<Mode> TIME | EVENTs | RANDom | AUTO | OFF

TIME

Defines the holdoff directly as a time period. The next trigger occurs only after the "Holdoff time" has passed (defined using [TRIGger<m>:HOLDoff:TIME](#)).

EVENTs

Defines the holdoff as a number of trigger events. The next trigger occurs only when this number of events is reached. The number of triggers to be skipped is defined using [TRIGger<m>:HOLDoff:EVENTs](#).

RANDom

Defines the holdoff as a random time limited by [TRIGger<m>:HOLDoff:MIN](#) on page 1520 and [TRIGger<m>:HOLDoff:MAX](#) on page 1520. For each acquisition cycle, the instrument selects a new random holdoff time from the specified range.

AUTO

The holdoff time is calculated automatically based on the current horizontal scale.

OFF

No holdoff

*RST: OFF

Usage: Asynchronous command

Manual operation: See "[Holdoff mode](#)" on page 225

TRIGger<m>:HOLDoff:TIME <Time>

Defines the holdoff time period. The next trigger occurs only after this time has passed. The setting is relevant if the holdoff mode is set to TIME.

See also:

- [TRIGger<m>:HOLDoff:MODE](#)

Suffix:

<m> 1..3
Only 1 = A-trigger, 2 | 3 = not available. Can be omitted.

Parameters:

<Time> Range: 100E-9 to 10
Increment: 200E-6
*RST: 1E-3
Default unit: s

Example:

```
TRIGger:HOLDoff:MODE TIME
TRIGger:HOLDoff:TIME 1ms
The holdoff time is set to 1 ms.
```

Usage: Asynchronous command

Manual operation: See "[Holdoff mode](#)" on page 225

TRIGger<m>:HOLDoff:EVENTs <Events>

Defines the number of triggers to be skipped. The next trigger only occurs when this number of events is reached. The setting is relevant if the holdoff mode is set to EVENTS.

See also:

- [TRIGger<m>:HOLDoff:MODE](#)

Suffix:

<m> 1..3
Only 1 = A-trigger, 2 | 3 = not available. Can be omitted.

Parameters:

<Events> Range: 1 to 2147483647
Increment: 1
*RST: 1

Example:

```
TRIGger:HOLDoff:MODE EVENTs
TRIGger:HOLDoff:EVENTs 5
```

Usage: Asynchronous command

Manual operation: See "[Holdoff mode](#)" on page 225

TRIGger<m>:HOLDoff:MIN <RandomMinTime>

Defines the lower limit for the random time holdoff. The setting is relevant if the holdoff mode is set to RANDOM.

See also:

- [TRIGger<m>:HOLDoff:MODE](#)
- [TRIGger<m>:HOLDoff:MAX](#)

Suffix:

<m> 1..3
Only 1 = A-trigger, 2 | 3 = not available. Can be omitted.

Parameters:

<RandomMinTime> Range: 100E-9 to 5
Increment: 200E-6
*RST: 1E-3
Default unit: s

Example:

```
TRIGger:HOLDoff:MODE RANDOM
TRIGger:HOLDoff:MIN 1ms
TRIGger:HOLDoff:MAX 2ms
```

The holdoff time is set randomly between 1 ms and 2 ms.

Usage: Asynchronous command

Manual operation: See "[Holdoff mode](#)" on page 225

TRIGger<m>:HOLDoff:MAX <RandomMaxTime>

Defines the upper limit for the random time holdoff. The setting is relevant if the holdoff mode is set to RANDOM.

See also:

- [TRIGger<m>:HOLDoff:MODE](#)
- [TRIGger<m>:HOLDoff:MIN](#)

Suffix:

<m> 1..3
Only 1 = A-trigger, 2 | 3 = not available. Can be omitted.

Parameters:

<RandomMaxTime> Range: 100E-9 to 10
Increment: 200E-6
*RST: 2E-3
Default unit: s

Usage: Asynchronous command

Manual operation: See "[Holdoff mode](#)" on page 225

TRIGger<m>:HOLDoff:AUTotime?

Returns the resulting holdoff time if the holdoff mode is set to AUTO: $Auto\ time = Auto\ time\ scaling * Horizontal\ scale$. The auto time scaling factor is defined with [TRIGger<m>:HOLDoff:SCALing](#).

See also: [TRIGger<m>:HOLDoff:MODE](#)

Suffix:

<m> 1..3
Only 1 = A-trigger, 2 | 3 = not available. Can be omitted.

Return values:

<AutoTime> Holdoff time
Range: 100E-9 to 10
*RST: 1E-3
Default unit: s

Example:

```
TRIGger:HOLDoff:MODE AUTO
TRIGger:HOLDoff:SCALing 0.5
TRIGger:HOLDoff:AUTotime?
1ms
Result if the horizontal scale is 1 ns/div
```

Usage:

Query only
Asynchronous command

Manual operation: See "[Holdoff mode](#)" on page 225

TRIGger<m>:HOLDoff:SCALing <AutoTimeScaling>

Sets the auto time scaling factor the horizontal scale is multiplied with: $Auto\ time = Auto\ time\ scaling * Horizontal\ scale$. The setting is relevant if the holdoff mode is set to AUTO.

See also:

- [TRIGger<m>:HOLDoff:MODE](#)
- [TRIGger<m>:HOLDoff:AUTotime?](#) on page 1521

Suffix:

<m> 1..3
Only 1 = A-trigger, 2 | 3 = not available. Can be omitted.

Parameters:

<AutoTimeScaling> Range: 1E-3 to 1000
Increment: 1
*RST: 0.5

Usage:

Asynchronous command

Manual operation: See "[Holdoff mode](#)" on page 225

27.9.17 Conditioning

TRIGger<m>:LEVel<n>:NOISe[:STATe].....	1522
TRIGger<m>:LEVel<n>:NOISe:MODE.....	1522
TRIGger<m>:LEVel<n>:NOISe:ABSolute.....	1523
TRIGger<m>:LEVel<n>:NOISe:PERDivision.....	1523
TRIGger<m>:LEVel<n>:NOISe:RELative.....	1524

TRIGger<m>:LEVel<n>:NOISe[:STATe] <HysteresisMode>

Selects how the hysteresis is set.

Suffix:

<m>	1..3 Irrelevant, omit the suffix.
<n>	1..31 Indicates the trigger source: 1...4 = channel 1 to 4 5 = external trigger input 6...11 = not available 12...27 = R&S RT-ZVC input channels 28...31 = differential signals Diff1, Diff2 and Common1, Common2

Parameters:

<HysteresisMode>	AUTO MANual
	AUTO This is the recommended mode. The hysteresis is set by the instrument to reject at least the internal noise of the instrument. You can define a higher minimum value using TRIGger<m>:LEVel<n>:NOISe:ABSolute .
	MANual The hysteresis is defined directly with TRIGger<m>:LEVel<n>:NOISe:ABSolute .
*RST:	AUTO

Usage: Asynchronous command

Manual operation: See "[Hysteresis mode](#)" on page 227

TRIGger<m>:LEVel<n>:NOISe:MODE <HystMode>

Selects how the hysteresis is set.

Suffix:

<m>	1..3 Irrelevant, omit the suffix.
-----	--------------------------------------

<n> 1..31
Indicates the trigger source: see [TRIGger<m>:LEVel<n>:NOISe\[:STATE\]](#) on page 1522.

Parameters:

<HystMode> ABS | REL
ABS
The hysteresis is set in absolute values (voltage).
REL
The hysteresis is defined in relative values (div).
*RST: ABS

Usage: Asynchronous command

Manual operation: See "[Size mode](#)" on page 227

TRIGger<m>:LEVel<n>:NOISe:ABSolute <HystAbs>

Defines a range in absolute values around the trigger level. If the signal oscillates inside this range and crosses the trigger level thereby, no trigger event occurs.

Suffix:

<m> 1..3
Irrelevant, omit the suffix.

<n> 1..31
Indicates the trigger source: see [TRIGger<m>:LEVel<n>:NOISe\[:STATE\]](#) on page 1522.

Parameters:

<HystAbs> Range: 0 to The value corresponding to full division range.
The exact maximum value depends on the selected vertical scale.
Increment: 1E-3
*RST: 0
Default unit: V

Usage: Asynchronous command

Manual operation: See "[Absolute hysteresis](#)" on page 227

TRIGger<m>:LEVel<n>:NOISe:PERDivision <HystInDivs>

Defines a range in divisions around the trigger level. If the signal oscillates inside this range and crosses the trigger level thereby, no trigger event occurs.

Suffix:

<m> 1..3
Irrelevant, omit the suffix.

<n> 1..31
Indicates the trigger source: see [TRIGger<m>:LEVel<n>:NOISe\[:STATE\]](#) on page 1522.

Parameters:

<HystInDivs> Hysteresis size in divisions
 Range: 0 to 5
 Increment: 0.01
 *RST: 0
 Default unit: div

Usage: Asynchronous command

Manual operation: See "[Relative hysteresis](#)" on page 228

TRIGger<m>:LEVel<n>:NOISe:RELative <HystRel>

Defines a range in percent around the trigger level. If the signal oscillates inside this range and crosses the trigger level thereby, no trigger event occurs.

Suffix:

<m> 1..3
 Irrelevant, omit the suffix.

<n> 1..31
 Indicates the trigger source: see [TRIGger<m>:LEVel<n>:NOISe\[:STATE\]](#) on page 1522.

Parameters:

<HystRel> Hysteresis in %. 10% = 1 div
 Range: 0 to 50
 Increment: 1
 *RST: 0
 Default unit: %

Usage: Asynchronous command

Manual operation: See "[Relative hysteresis](#)" on page 228

27.9.18 Trigger sequence

TRIGger<m>:EVENT[:EVENT]	1524
TRIGger<m>:SEQUence:TYPE	1525
TRIGger<m>:ECOupling	1525
TRIGger<m>:SEQUence:DELay	1526
TRIGger<m>:SEQUence:COUnt	1526
TRIGger<m>:SEQUence:RESet:EVENT	1526
TRIGger<m>:SEQUence:RESet:TIMEout[:ENAbLe]	1527
TRIGger<m>:SEQUence:RESet:TIMEout:TIME	1527

TRIGger<m>:EVENT[:EVENT] <Class>

Selects, if you want to trigger on a single event, or on a series of events.

Suffix:

<m> 1..3

Parameters:

<Class> SINGle | SEQuence
 *RST: SINGle

Usage: Asynchronous command

Manual operation: See ["Trigger on"](#) on page 198

TRIGger<m>:SEQuence:TYPE <Sequence>

Selects the type of the sequence. All trigger sequences require that input channels CH1...4 are set as trigger sources for all conditions.

See also: [Chapter 6.8, "Sequence"](#), on page 233.

Suffix:

<m> 1..3
 Irrelevant, omit the suffix.

Parameters:

<Sequence> ABR | AZ | ABRZ | AORB | AORBZ

ABR

Triggers if all conditions of A- and B-events, as well as additional delay and reset timeout or R-event (reset) conditions are fulfilled.

AZ

Triggers if the conditions of the A-event and the zone trigger are fulfilled. Additionally, a holdoff condition can be set.

ABRZ

Triggers if all conditions of A- and B-events, reset timeout or R-event (reset) conditions are fulfilled for the defined zone.

AORB

Triggers if the conditions of A-event or the conditions of the B-event are fulfilled.

AORBZ

Triggers if the conditions of A-event or the conditions of the B-event are fulfilled for the defined zone. Additionally, a holdoff condition can be set.

*RST: ABR

Usage: Asynchronous command

Manual operation: See ["Sequence"](#) on page 234

TRIGger<m>:ECOupling <TrigLevEvtCpl>

Event coupling of trigger levels: Sets the trigger levels to the values of the indicated event. Thus, channel 1 has one trigger level for all events, channel 2 has one trigger level and so on.

Suffix:

<m> 1..3
1 = A-trigger, 2 = B-trigger, 3 = R-trigger

Parameters:

<TrigLevEvtCpl> ON | OFF
*RST: ON

Usage: Asynchronous command

Manual operation: See "[Couple sequence thresholds](#)" on page 235

TRIGger<m>:SEQUence:DELay <Delay>

Sets the time the instrument waits after an A-event until it recognizes B-events.

Suffix:

<m> 1..3
Irrelevant, omit the suffix.

Parameters:

<Delay> Range: 0 to 50
Increment: 1E-12
*RST: 0
Default unit: s

Usage: Asynchronous command

Manual operation: See "[After 1st event wait](#)" on page 235

TRIGger<m>:SEQUence:COUNT <Events>

Sets the number of B-events to be fulfilled after an A-event. The last B-event causes the trigger.

Suffix:

<m> 1..3
Irrelevant, omit the suffix.

Parameters:

<Events> Range: 1 to 2147483647
Increment: 1
*RST: 1

Usage: Asynchronous command

Manual operation: See "[2nd event count](#)" on page 235

TRIGger<m>:SEQUence:RESet:EVENT <EnabRstEvt>

If set to ON, the trigger sequence is restarted by the R-event if the specified number of B-event does not occur.

Suffix:

<m> 1..3
Irrelevant, omit the suffix.

Parameters:

<EnabRstEvt> ON | OFF
*RST: OFF

Usage: Asynchronous command

Manual operation: See "[Reset on event/Reset event](#)" on page 235

TRIGger<m>:SEQuence:RESet:TIMEout[:ENABle] <State>

If set to ON, the instrument waits for the time defined using [TRIGger<m>:SEQuence:RESet:TIMEout:TIME](#) for the specified number of B-events. If no trigger occurs during that time, the sequence is restarted with the A-event.

Suffix:

<m> 1..3
Irrelevant, omit the suffix.

Parameters:

<State> ON | OFF
*RST: OFF

Usage: Asynchronous command

Manual operation: See "[Reset on timeout/Reset timeout](#)" on page 235

TRIGger<m>:SEQuence:RESet:TIMEout:TIME <ResetTimeout>

The time the instrument waits for the number of B-events specified using [TRIGger<m>:SEQuence:COUNT](#) before the sequence is restarted with the A-event.

Suffix:

<m> 1..3
Irrelevant, omit the suffix.

Parameters:

<ResetTimeout> Range: 0 to 50
Increment: 1E-12
*RST: 0
Default unit: s

Usage: Asynchronous command

Manual operation: See "[Reset on timeout/Reset timeout](#)" on page 235

27.9.19 Trigger control

TRIGger<m>:MODE.....	1528
TRIGger<m>:FORCe.....	1528
TRIGger<m>:OUT:POLarity.....	1529
TRIGger<m>:OUT:PLENght.....	1529
TRIGger<m>:OUT:DELay.....	1529

TRIGger<m>:MODE <TriggerMode>

Sets the trigger mode which determines the behaviour of the instrument if no trigger occurs.

Suffix:

<m> 1..3
Irrelevant, omit the suffix.

Parameters:

<TriggerMode> AUTO | NORMal | FREerun

AUTO

The instrument triggers repeatedly after a time interval if the trigger conditions are not fulfilled. If a real trigger occurs, it takes precedence. The time interval depends on the time base.

NORMal

The instrument acquires a waveform only if a trigger occurs.

FREerun

The instrument triggers after a very short time interval - faster than in AUTO mode. Real triggers are ignored.

*RST: AUTO

Usage: Asynchronous command

Manual operation: See "[Auto Norm]" on page 36

TRIGger<m>:FORCe

If the acquisition is running in normal mode and no valid trigger occurs, forcing the trigger provokes an immediate single acquisition. Thus you can confirm that a signal is available and use the waveform display to determine how to trigger on it.

Suffix:

<m> 1..3
Irrelevant, omit the suffix.

Usage: Event
Asynchronous command

Manual operation: See "Force Trigger" on page 225

TRIGger<m>:OUT:POLarity <Polarity>

Sets the polarity of the trigger out pulse.

Suffix:

<m> 1..3
Irrelevant, omit the suffix.

Parameters:

<Polarity> POSitive | NEGative
*RST: POSitive

Usage: Asynchronous command

Manual operation: See ["Trigger out signal setup"](#) on page 229

TRIGger<m>:OUT:PLENght <PulseLength>

Sets the length of the trigger out pulse.

Suffix:

<m> 1..3
Irrelevant, omit the suffix.

Parameters:

<PulseLength> Range: 4E-9 to 0.06
Increment: 20E-9
*RST: 100E-9
Default unit: s

Usage: Asynchronous command

Manual operation: See ["Trigger out signal setup"](#) on page 229

TRIGger<m>:OUT:DELay <Delay>

Sets the delay of the first pulse edge to the trigger point.

The setting is not available if a mask test or measurement is running and the on-violation event is set to trigger out pulse.

Suffix:

<m> 1..3
Irrelevant, omit the suffix.

Parameters:

<Delay> Range: 800E-9 to 1
Increment: 1E-9
*RST: 800E-9
Default unit: s

Usage: Asynchronous command

Manual operation: See ["Trigger out signal setup"](#) on page 229

27.9.20 Actions on trigger

TRIGger<m>:EVENT:BEEP.....	1530
TRIGger<m>:EVENT:PRINT.....	1530
TRIGger<m>:EVENT:RUNexec.....	1530
TRIGger<m>:EVENT:TRIGgerout.....	1531
TRIGger<m>:EVENT:WFMSave.....	1531

TRIGger<m>:EVENT:BEEP <Beep>

Generates a beep sound if the command is set to TRIGger.

Suffix:

<m> 1..3
The suffix is irrelevant.

Parameters:

<Beep> NOAction | TRIGger
*RST: NOAction

Usage: Asynchronous command

Manual operation: See ["Actions on trigger"](#) on page 229

TRIGger<m>:EVENT:PRINT <Print>

Saves a screenshot at each trigger if the command is set to TRIGger.

For screenshot settings, see [Chapter 27.16.8, "Screenshots"](#), on page 1779.

Suffix:

<m> 1..3
The suffix is irrelevant.

Parameters:

<Print> NOAction | TRIGger
*RST: NOAction

Usage: Asynchronous command

Manual operation: See ["Actions on trigger"](#) on page 229

TRIGger<m>:EVENT:RUNexec <RunExecutable>

Starts an external application if the command is set to TRIGger.

Use the following commands to set up the application:

- [EXECutable:NAME](#) on page 1787
- [EXECutable:PARAMeter](#) on page 1787
- [EXECutable:WDIRectory](#) on page 1788

Suffix:

<m> 1..3
The suffix is irrelevant.

Parameters:

<RunExecutable> NOAction | TRIGger
*RST: NOAction

Usage:

Asynchronous command

Manual operation: See ["Actions on trigger"](#) on page 229

TRIGger<m>:EVENT:TRIGgerout <TriggerOutPulse>

Sends the trigger out signal to the [Trigger Out] connector if the command is set to TRIGger and a trigger occurs.

Suffix:

<m> Irrelevant, omit the suffix.

Parameters:

<TriggerOutPulse> NOAction | TRIGger
*RST: NOAction

Usage:

Asynchronous command

Manual operation: See ["Actions on trigger"](#) on page 229

TRIGger<m>:EVENT:WFMSave <SaveWfm>

Saves the waveform data to file at each trigger if the command is set to TRIGger.

For data export settings, see [Chapter 27.16.4, "Waveform data export to file"](#), on page 1766

Suffix:

<m> 1..3
The suffix is irrelevant.

Parameters:

<SaveWfm> NOAction | TRIGger
*RST: NOAction

Usage:

Asynchronous command

Manual operation: See ["Actions on trigger"](#) on page 229

27.9.21 Zone trigger

TRIGger<m>:ZONE:EXPRession[:DEFine] <LogiExpr>

Defines the zone trigger.

Suffix:	
<m>	1..3 The suffix is irrelevant.
Parameters:	
<LogiExpr>	String with the logical expression
Example:	Prerequisite: mask tests MT1 and MT2 are defined, and also Zone1. TRIGger:ZONE:EXPRession 'MT1 and MT2 and Zone1' TRIGger:ZONE:EXPRession? <-- MT1 and MT2 and Zone1
Usage:	Asynchronous command
Firmware/software:	FW 3.20
Manual operation:	See "[Zone]" on page 37

SWTRigger:HISTory <ApplyZnTrigHistory>

Applies the zone trigger condition to the acquisitions in the history memory during history replay.

See: "[Apply zone trigger to history](#)" on page 239.

Parameters:

<ApplyZnTrigHistory> ON | OFF
*RST: OFF

Usage: Asynchronous command

Manual operation: See "[Apply zone trigger to history](#)" on page 239

27.9.22 External trigger input

External trigger signals, which are connected to the external trigger input, can be triggered with an edge trigger.

TRIGger<m>:ANEDge:COUPling <Coupling>

Sets the coupling for the external trigger signal.

Suffix:

<m> 1..3
Only 1 = A-trigger, 2 | 3 = not available. Can be omitted.

Parameters:

<Coupling> DC | DCLimit | AC
DC
Direct connection with 50 Ω termination, passes both DC and AC components of the trigger signal.

DCLimit

Direct connection with 1 MΩ termination, passes both DC and AC components of the trigger signal.

AC

Connection through DC capacitor, removes DC and very low-frequency components.

Usage: Asynchronous command
Manual operation: See "[Coupling](#)" on page 241

TRIGger<m>:ANEDge:FILTer <Filter>

Sets a filter for the external trigger signal to reject high or low frequencies.

Suffix:

<m> 1..3
 Only 1 = A-trigger, 2 | 3 = not available. Can be omitted.

Parameters:

<Filter> OFF | LFReject | RFReject

OFF

The trigger signal is not filtered.

LFReject

Frequencies higher than the "Cut-off" frequency are rejected, lower frequencies pass the filter.

You can adjust the "Cut-off" frequency using the [TRIGger<m>:ANEDge:CUToff:LOWPass](#) command, the default is 50 kHz.

RFReject

Frequencies below the "Cut-off" frequency are rejected, higher frequencies pass the filter.

You can adjust the "Cut-off" frequency using the [TRIGger<m>:ANEDge:CUToff:HIGHPass](#) command, the default is 50 kHz.

*RST: OFF

Usage: Asynchronous command
Manual operation: See "[Filter](#)" on page 241

TRIGger<m>:ANEDge:CUToff:HIGHPass <AnalogCutOffHP>

Frequencies below the "Cut-off" frequency are rejected, higher frequencies pass the filter.

Suffix:

<m> 1..3
 Only 1 = A-trigger, 2 | 3 = not available. Can be omitted.

Parameters:

<AnalogCutOffHP> KHZ5 | KHZ50 | MHZ50
 Cut-off frequency

KHZ5

5 kHz

KHZ50

50 kHz

MHZ50

50 MHz

*RST: KHZ50

Usage: Asynchronous command**Manual operation:** See "[Filter](#)" on page 241**TRIGger<m>:ANEDge:CUToff:LOWPass <AnalogCutOffLP>**

Frequencies higher than the "Cut-off" frequency are rejected, lower frequencies pass the filter.

Suffix:

<m> 1..3
Only 1 = A-trigger, 2 | 3 = not available. Can be omitted.

Parameters:

<AnalogCutOffLP> KHZ5 | KHZ50 | MHZ50

KHZ5

5 kHz

KHZ50

50 kHz

MHZ50

50 MHz

*RST: KHZ50

Usage: Asynchronous command**Manual operation:** See "[Filter](#)" on page 241**TRIGger<m>:ANEDge:GND <Ground>**

Connects the analog signal to the ground.

Suffix:

<m> 1..3
Only 1 = A-trigger, 2 | 3 = not available. Can be omitted.

Parameters:

<Ground> ON | OFF

*RST: OFF

Usage: Asynchronous command**Manual operation:** See "[Ground](#)" on page 241

TRIGger<m>:ANEDge:SLOPe <Slope>

Sets the edge for the trigger event.

Suffix:

<m> 1..3
Only 1 = A-trigger, 2 | 3 = not available. Can be omitted.

Parameters:

<Slope> POSitive | NEGative
See [Chapter 27.4.3, "Slope parameter"](#), on page 1373.
*RST: POSitive

Usage: Asynchronous command

Manual operation: See ["Slope"](#) on page 200

TRIGger<m>:EXTern:OVERload <Overload>

The query returns the overload status of the external trigger input.

:TRIGger:EXTern:OVERload 0 confirms the information in the message box, it has same effect as OK.

Suffix:

<m> 1..3
Only 1 = A-trigger, 2 | 3 = not available. Can be omitted.

Parameters:

<Overload> ON | OFF
ON | 1
Indicates an overload of the probe
OFF | 0
In a query: no overlaod.
Setting: confirms the information in the message box
*RST: OFF

Usage: Asynchronous command

27.9.23 Acquisition info

ACQuire:CURRent?

Shows the current number of acquisitions that have been acquired.

Return values:

<CurrAcqCnt> Range: 0 to 4294967295
Increment: 1
*RST: 0

Usage: Query only
Asynchronous command

27.10 Waveform analysis

Some of the commands in the following chapter are asynchronous. An overlapping or asynchronous command does not automatically finish executing before the next command starts executing. If overlapping commands must be executed in a defined order, e.g. to avoid wrong measurement results, they must be serviced sequentially.

To prevent an overlapping execution of commands, one of the commands *OPC, *OPC? or *WAI can be used after the command or a command set.

For more information, see:

- www.rohde-schwarz.com/rc-via-scp, chapter "Command sequence and synchronization"
- Chapter 27.3, "Programming examples", on page 1345
- [Zoom](#)..... 1536
- [Reference waveforms](#)..... 1545
- [Mathematics](#)..... 1558
- [History](#)..... 1563
- [XY-Diagram](#)..... 1568

27.10.1 Zoom

LAYout:ZOOM:ADD	1537
LAYout:ZOOM:ADDCoupled	1537
LAYout:ZOOM:POSCoupling	1538
LAYout:ZOOM:HORIZ:MODE	1538
LAYout:ZOOM:HORIZ:ABSolute:POSition	1538
LAYout:ZOOM:HORIZ:ABSolute:SPAN	1539
LAYout:ZOOM:HORIZ:ABSolute:START	1539
LAYout:ZOOM:HORIZ:ABSolute:STOP	1539
LAYout:ZOOM:HORIZ:RELative:POSition	1540
LAYout:ZOOM:HORIZ:RELative:SPAN	1540
LAYout:ZOOM:HORIZ:RELative:START	1541
LAYout:ZOOM:HORIZ:RELative:STOP	1541
LAYout:ZOOM:VERTical:MODE	1541
LAYout:ZOOM:VERTical:ABSolute:POSition	1542
LAYout:ZOOM:VERTical:ABSolute:SPAN	1542
LAYout:ZOOM:VERTical:ABSolute:START	1543
LAYout:ZOOM:VERTical:ABSolute:STOP	1543
LAYout:ZOOM:VERTical:RELative:POSition	1543
LAYout:ZOOM:VERTical:RELative:SPAN	1544
LAYout:ZOOM:VERTical:RELative:START	1544
LAYout:ZOOM:VERTical:RELative:STOP	1545
LAYout:ZOOM:REMove	1545

LAYout:ZOOM:ADD <NodeName>, <ParentType>, <InsertBefore>, <XStart>, <XStop>, <YStart>, <YStop>, <NewZoomName>

Adds a new zoom diagram based on the specified waveform.

For numerical values, the input of a unit is not supported for this command.

Setting parameters:

<NodeName>	String with the name of diagram to be zoomed
<ParentType>	VERTical, OFF The new zoom diagram is displayed below the original one.
<InsertBefore>	OFF Position of the zoom diagram, depending on ParentType
<XStart>	Defines the x-value at the beginning of the zoom area.
<XStop>	Defines the x-value at the end of the zoom area.
<YStart>	Defines the y-value at the beginning of the zoom area.
<YStop>	Defines the y-value at the end of the zoom area.
<NewZoomName>	String with the name of the new zoom diagram.

Example: LAYout:ZOOM:ADD 'Diagram1', VERT, OFF, -10e-9, 20e-9, -0.1, 0.05, 'MyZoom1'
Creates the zoom diagram 'MyZoom1' for 'Diagram1'.

Example: See [Chapter 27.3.1.2, "Creating zoom diagrams"](#), on page 1347

Usage: Setting only
Asynchronous command

Manual operation: See ["Standard zoom"](#) on page 57

LAYout:ZOOM:ADDCoupled <ZoomName>, <XOffset>, <YOffset>, <NewZoomName>

Creates a new zoom diagram based on the settings of an existing zoom area for the same source.

For numerical values, the input of a unit is not supported for this command.

Parameters:

<NewZoomName> Defines the name of the new zoom diagram.

Setting parameters:

<ZoomName>	Defines the name of the zoom diagram to be copied.
<XOffset>	Defines an offset to the existing zoom area in x direction.
<YOffset>	Defines an offset to the existing zoom area in y direction.

Usage: Asynchronous command

Manual operation: See ["Coupled zoom"](#) on page 57

Parameters for setting and query:

<DiagramName> Name of the diagram on which the zoom area is based.

<ZoomName> Name of the zoom diagram

Usage: Asynchronous command

Manual operation: See "[X position](#)" on page 247

LAYout:ZOOM:HORIZ:ABSolute:SPAN <DiagramName>, <ZoomName>,

LAYout:ZOOM:HORIZ:ABSolute:SPAN? <DiagramName>, <ZoomName>

Defines the width of the zoom area.

For numerical values, the input of a unit is not supported for this command.

Parameters:

 Range: 0 to 100E+24
Increment: 0.01
*RST: 0.01

Parameters for setting and query:

<DiagramName> Name of the diagram on which the zoom area is based.

<ZoomName> Name of the zoom diagram

Usage: Asynchronous command

Manual operation: See "[X range](#)" on page 248

LAYout:ZOOM:HORIZ:ABSolute:START <DiagGroupNme>,
<ZoomDiagramName>,<Start>

LAYout:ZOOM:HORIZ:ABSolute:START? <DiagGroupNme>, <ZoomDiagramName>

Defines the lower limit of the zoom area on the x-axis.

For numerical values, the input of a unit is not supported for this command.

Parameters:

<Start> Range: -100E+24 to 100E+24
Increment: 0.01
*RST: 0

Parameters for setting and query:

<DiagGroupNme> Name of the diagram on which the zoom area is based.

<ZoomDiagramName>Name of the zoom diagram

Usage: Asynchronous command

Manual operation: See "[X start](#)" on page 247

LAYout:ZOOM:HORIZ:ABSolute:STOP <DiagramName>, <ZoomName>,<Stop>

LAYout:ZOOM:HORIZ:ABSolute:STOP? <DiagramName>, <ZoomName>

Defines the upper limit of the zoom area on the x-axis.

For numerical values, the input of a unit is not supported for this command.

Parameters:

<Stop> Range: -100E+24 to 100E+24
 Increment: 0.01
 *RST: 0.01

Parameters for setting and query:

<DiagramName> Name of the diagram on which the zoom area is based.

<ZoomName> Name of the zoom diagram

Usage: Asynchronous command

Manual operation: See "[X stop](#)" on page 247

LAYout:ZOOM:HORIZ:RELative:POSition <DiagramName>,
 <ZoomName>,<RelPosi>

LAYout:ZOOM:HORIZ:RELative:POSition? <DiagramName>, <ZoomName>

Defines the x-value of the centerpoint of the zoom area.

Parameters:

<RelPosi> Relative position of the centerpoint (x-value)
 Range: 0 to 100
 Increment: 0.1
 *RST: 100
 Default unit: %

Parameters for setting and query:

<DiagramName> Name of the diagram on which the zoom area is based.

<ZoomName> Name of the zoom diagram

Example: See [Chapter 27.3.1.2, "Creating zoom diagrams"](#), on page 1347

Usage: Asynchronous command

Manual operation: See "[X position](#)" on page 247

LAYout:ZOOM:HORIZ:RELative:SPAN <DiagramName>,
 <ZoomName>,<RelativeSpan>

LAYout:ZOOM:HORIZ:RELative:SPAN? <DiagramName>, <ZoomName>

Defines the width of the zoom area.

Parameters:

<RelativeSpan> Range: 1E-15 to 100
 Increment: 0.1
 *RST: 1
 Default unit: %

Parameters for setting and query:

<DiagramName> Name of the diagram on which the zoom area is based.

<ZoomName> Name of the zoom diagram

- Example:** See [Chapter 27.3.1.2, "Creating zoom diagrams"](#), on page 1347
- Usage:** Asynchronous command
- Manual operation:** See ["X range"](#) on page 248

LAYout:ZOOM:HORZ:RELative:START <DiagramName>,
 <ZoomName>,<RelativeStart>
LAYout:ZOOM:HORZ:RELative:START? <DiagramName>, <ZoomName>

Defines the lower limit of the zoom area on the x-axis.

Parameters:

<RelativeStart> Range: 0 to 100
 Increment: 0.1
 *RST: 0
 Default unit: %

Parameters for setting and query:

<DiagramName> Name of the diagram on which the zoom area is based.
 <ZoomName> Name of the zoom diagram

Usage: Asynchronous command

Manual operation: See ["X start"](#) on page 247

LAYout:ZOOM:HORZ:RELative:STOP <DiagramName>,
 <ZoomName>,<RelativeStop>
LAYout:ZOOM:HORZ:RELative:STOP? <DiagramName>, <ZoomName>

Defines the upper limit of the zoom area on the x-axis.

Parameters:

<RelativeStop> Range: 0 to 100
 Increment: 0.1
 *RST: 100
 Default unit: %

Parameters for setting and query:

<DiagramName> Name of the diagram on which the zoom area is based.
 <ZoomName> Name of the zoom diagram

Usage: Asynchronous command

Manual operation: See ["X stop"](#) on page 247

LAYout:ZOOM:VERTical:MODE <DiagramName>, <ZoomName>,<Mode>
LAYout:ZOOM:VERTical:MODE? <DiagramName>, <ZoomName>

Defines whether absolute or relative values are used to specify the y-axis values. Since the zoom area refers to the active signal, relative values ensure that the zoom area remains the same.

Parameters:

<Mode> ABS | REL
 Mode used to specify the y-axis values of the zoom area.
 *RST: ABS

Parameters for setting and query:

<DiagramName> Name of the diagram on which the zoom area is based.
 <ZoomName> Name of the zoom diagram

Usage: Asynchronous command

Manual operation: See "[Y mode](#)" on page 248

LAYout:ZOOM:VERTical:ABSolute:POSition <DiagramName>, <ZoomName>, <Position>

LAYout:ZOOM:VERTical:ABSolute:POSition? <DiagramName>, <ZoomName>

Defines the y-value of the centerpoint of the zoom area.

For numerical values, the input of a unit is not supported for this command.

Parameters:

<Position> Range: -100E+24 to 100E+24
 Increment: 0.01
 *RST: 0.01

Parameters for setting and query:

<DiagramName> Name of the diagram on which the zoom area is based.
 <ZoomName> Name of the zoom diagram

Usage: Asynchronous command

Manual operation: See "[Y position](#)" on page 248

LAYout:ZOOM:VERTical:ABSolute:SPAN <DiagramName>, <ZoomName>,

LAYout:ZOOM:VERTical:ABSolute:SPAN? <DiagramName>, <ZoomName>

Defines the height of the zoom area.

For numerical values, the input of a unit is not supported for this command.

Parameters:

 Range: 0 to 100E+24
 Increment: 0.01
 *RST: 0.01

Parameters for setting and query:

<DiagramName> Name of the diagram on which the zoom area is based.
 <ZoomName> Name of the zoom diagram

Usage: Asynchronous command

Manual operation: See "[Y range](#)" on page 248

LAYout:ZOOM:VERTical:ABSolute:START <DiagGroupNme>, <ZoomDiagramName>, <Start>

LAYout:ZOOM:VERTical:ABSolute:START? <DiagGroupNme>, <ZoomDiagramName>

Defines the lower limit of the zoom area on the y-axis.

For numerical values, the input of a unit is not supported for this command.

Parameters:

<Start> Range: -100E+24 to 100E+24
 Increment: 0.01
 *RST: 0

Parameters for setting and query:

<DiagGroupNme> Name of the diagram on which the zoom area is based.

<ZoomDiagramName> Name of the zoom diagram

Usage: Asynchronous command

Manual operation: See "[Y start](#)" on page 247

LAYout:ZOOM:VERTical:ABSolute:STOP <DiagramName>, <ZoomName>, <Stop>

LAYout:ZOOM:VERTical:ABSolute:STOP? <DiagramName>, <ZoomName>

Defines the upper limit of the zoom area on the y-axis.

For numerical values, the input of a unit is not supported for this command.

Parameters:

<Stop> Range: -100E+24 to 100E+24
 Increment: 0.01
 *RST: 0.01

Parameters for setting and query:

<DiagramName> Name of the diagram on which the zoom area is based.

<ZoomName> Name of the zoom diagram

Usage: Asynchronous command

Manual operation: See "[Y stop](#)" on page 247

LAYout:ZOOM:VERTical:RELative:POSition <DiagramName>, <ZoomName>, <RelPosi>

LAYout:ZOOM:VERTical:RELative:POSition? <DiagramName>, <ZoomName>

Defines the y-value of the centerpoint of the zoom area.

Parameters:

<RelPosi> Relative position of the centerpoint (y-value)
 Range: 0 to 100
 Increment: 0.1
 *RST: 100
 Default unit: %

Parameters for setting and query:

<DiagramName> Name of the diagram on which the zoom area is based.
 <ZoomName> Name of the zoom diagram

Usage: Asynchronous command

Manual operation: See "[Y position](#)" on page 248

LAYout:ZOOM:VERTical:RELative:SPAN <DiagramName>,
 <ZoomName>,<RelativeSpan>

LAYout:ZOOM:VERTical:RELative:SPAN? <DiagramName>, <ZoomName>

Defines the height of the zoom area.

Parameters:

<RelativeSpan> Range: 1E-15 to 100
 Increment: 0.1
 *RST: 1
 Default unit: %

Parameters for setting and query:

<DiagramName> Name of the diagram on which the zoom area is based.
 <ZoomName> Name of the zoom diagram

Usage: Asynchronous command

Manual operation: See "[Y range](#)" on page 248

LAYout:ZOOM:VERTical:RELative:START <DiagramName>,
 <ZoomName>,<RelativeStart>

LAYout:ZOOM:VERTical:RELative:START? <DiagramName>, <ZoomName>

Defines the lower limit of the zoom area on the y-axis.

Parameters:

<RelativeStart> Range: 0 to 100
 Increment: 0.1
 *RST: 0
 Default unit: %

Parameters for setting and query:

<DiagramName> Name of the diagram on which the zoom area is based.
 <ZoomName> Name of the zoom diagram

Usage: Asynchronous command

Manual operation: See "Y start" on page 247

LAYout:ZOOM:VERTical:RELative:STOP <DiagramName>, <ZoomName>, <RelativeStop>

LAYout:ZOOM:VERTical:RELative:STOP? <DiagramName>, <ZoomName>

Defines the upper limit of the zoom area on the y-axis.

Parameters:

<RelativeStop> Range: 0 to 100
 Increment: 0.1
 *RST: 100
 Default unit: %

Parameters for setting and query:

<DiagramName> Name of the diagram on which the zoom area is based.
 <ZoomName> Name of the zoom diagram

Usage: Asynchronous command

Manual operation: See "Y stop" on page 247

LAYout:ZOOM:REMOve <DiagramName>, <ZoomName>

Removes the specified zoom diagram.

Setting parameters:

<DiagramName> Name of the diagram on which the zoom area is based.
 <ZoomName> Name of the zoom diagram

Example: See [Chapter 27.3.1.2, "Creating zoom diagrams"](#), on page 1347

Usage: Setting only
 Asynchronous command

27.10.2 Reference waveforms

- [Reference](#)..... 1545
- [Scaling](#)..... 1548
- [Waveform data export](#)..... 1553
- [Import of multichannel waveform data](#)..... 1554
- [CDR reference files](#)..... 1555

27.10.2.1 Reference

REFCurve<m>:SOURce	1546
REFCurve<m>:STATe	1546
REFCurve<m>:NAME	1546
REFCurve<m>:OPEN	1547
REFCurve<m>:UPDate	1547

REFCurve<m>:SAVE.....	1547
REFCurve<m>:DELeTe.....	1547
REFCurve<m>:CLEAr.....	1548

REFCurve<m>:SOURce <Source>

Selects the source waveform to be used as a reference.

Suffix:

<m> 1..4
Reference waveform

Parameters:

<Source> C1W1 | C1W2 | C1W3 | C2W1 | C2W2 | C2W3 | C3W1 | C3W2 |
C3W3 | C4W1 | C4W2 | C4W3 | M1 | M2 | M3 | M4 | R1 | R2 |
R3 | R4 | TRK1 | TRK2 | TRK3 | TRK4 | TRK5 | TRK6 | TRK7 |
TRK8 | Z1V1 | Z1V2 | Z1V3 | Z1V4 | Z1I1 | Z1I2 | Z1I3 | Z1I4 |
Z2V1 | Z2V2 | Z2V3 | Z2V4 | Z2I1 | Z2I2 | Z2I3 | Z2I4 | DIFF1 |
DIFF2 | COMMON1 | COMMON2 | LANE1 | LANE2 | LANE3 |
LANE4

Source of the reference waveform, see [Chapter 27.4.2, "Waveform parameter"](#), on page 1371

*RST: C1W1

Usage: Asynchronous command

Manual operation: See "[Source](#)" on page 256

REFCurve<m>:STATe <State>

If enabled, the reference waveform is displayed in the diagram.

Suffix:

<m> 1..4
Reference waveform

Parameters:

<State> ON | OFF
*RST: OFF

Usage: Asynchronous command

Manual operation: See "[Show](#)" on page 256

REFCurve<m>:NAME <Name>

Defines the name of the reference waveform file to be loaded, saved or deleted.

Suffix:

<m> 1..4
Reference waveform

Parameters:

<Name> Path and name of the file that contains the reference waveform or to which the reference waveform is to be stored (.xml or .bin format), enclosed in single quotes.

Usage: Asynchronous command

REFCurve<m>:OPEN

Loads the reference waveform file selected by [REFCurve<m>:NAME](#) on page 1546.

Suffix:

<m> 1..4
Reference waveform

Usage: Event

Manual operation: See "[File](#)" on page 257

REFCurve<m>:UPDate

Copies the selected source waveform (see [REFCurve<m>:SOURce](#) on page 1546) with all its settings to the memory of the reference waveform.

Suffix:

<m> 1..4
Reference waveform

Usage: Event

Manual operation: See "[Update](#)" on page 257

REFCurve<m>:SAVE

Saves the reference waveform to the file selected by [REFCurve<m>:NAME](#) on page 1546.

Suffix:

<m> 1..4
Reference waveform

Usage: Event

Manual operation: See "[File](#)" on page 257

REFCurve<m>:DELeTe

Deletes the reference waveform file selected by [REFCurve<m>:NAME](#) on page 1546.

Suffix:

<m> 1..4
Reference waveform

Usage: Event

Manual operation: See ["File"](#) on page 257

REFCurve<m>:CLEar

The selected reference waveform is no longer displayed, its memory is deleted.

Suffix:

<m> 1..4
Reference waveform

Usage:

Event
Asynchronous command

Manual operation: See ["Clear"](#) on page 257

27.10.2.2 Scaling

REFCurve<m>:REStore.....	1548
REFCurve<m>:VMODE.....	1548
REFCurve<m>:SCALe.....	1549
REFCurve<m>:POSition.....	1549
REFCurve<m>:TOORignal.....	1550
REFCurve<m>:RESCale:VERTical:STATe.....	1550
REFCurve<m>:RESCale:VERTical:FACTor.....	1550
REFCurve<m>:RESCale:VERTical:OFFSet.....	1550
REFCurve<m>:HMODE.....	1551
REFCurve<m>:RESCale:HORizontal:STATe.....	1551
REFCurve<m>:RESCale:HORizontal:FACTor.....	1552
REFCurve<m>:RESCale:HORizontal:OFFSet.....	1552
REFCurve<m>:RESCale:HORizontal:POSition.....	1552

REFCurve<m>:REStore

Resets the time scale and the reference point to the original values of the reference waveform.

Suffix:

<m> 1..4
Reference waveform

Usage:

Event
Asynchronous command

Manual operation: See ["Restore Settings"](#) on page 258

REFCurve<m>:VMODE <VerticalMode>

Selects the coupling of vertical settings.

Suffix:

<m> 1..4
Reference waveform

Parameters:

<VerticalMode> COUPlEd | INDePendent
COUPlEd
 Vertical position and scale of the source are used.
INDePendent
 Scaling and position can be set specific to the reference waveform.
 *RST: INDePendent

Usage: Asynchronous command

Manual operation: See "[Mode](#)" on page 258

REFCurve<m>:SCALe <VerticalScale>

Sets the scale factor for the reference waveform if vertical scaling is set to "Independent" (see [REFCurve<m>:VMODE](#) on page 1548).

Suffix:

<m> 1..4
Reference waveform

Parameters:

<VerticalScale> Range: 1E-15 to 100E+24
 Increment: 10E-6
 *RST: 0.5
 Default unit: V/div

Usage: Asynchronous command

Manual operation: See "[Scale](#)" on page 259

REFCurve<m>:POSition <VertPosi>

Moves the reference waveform and its horizontal axis up or down in the diagram, if vertical scaling is set to "Independent" (see [REFCurve<m>:VMODE](#) on page 1548).

Suffix:

<m> 1..4
Reference waveform

Parameters:

<VertPosi> Range: -100E+24 to 100E+24
 Increment: 0.02
 *RST: 0
 Default unit: div

Usage: Asynchronous command

Manual operation: See "[Position](#)" on page 259

REFCurve<m>:TOORignal

Restores the original vertical settings of the reference waveform (vertical scale, position, and offset), if vertical scaling is set to independent (see [REFCurve<m>:VMODE](#) on page 1548).

Suffix:

<m> 1..4

Usage:

Event
Asynchronous command

Manual operation: See ["Set to original"](#) on page 259

REFCurve<m>:RESCale:VERTical:STATe <State>

Enables and disables the vertical stretching. Stretching changes the display of the waveform independent of the vertical scale and position.

Suffix:

<m> 1..4
Reference waveform

Parameters:

<State> ON | OFF
*RST: OFF

Usage:

Asynchronous command

Manual operation: See ["Enable"](#) on page 260

REFCurve<m>:RESCale:VERTical:FACTor <ScaleFactor>

Defines the vertical stretching factor. A factor greater than 1 stretches the waveform vertically, a factor lower than 1 compresses the curve.

Suffix:

<m> 1..4
Reference waveform

Parameters:

<ScaleFactor> Range: -1E+6 to 1E+6
Increment: 0.1
*RST: 1

Usage:

Asynchronous command

Manual operation: See ["Factor"](#) on page 260

REFCurve<m>:RESCale:VERTical:OFFSet <Offset>

Moves the reference waveform vertically. Like vertical offset of channel waveforms, the offset of a reference waveform is subtracted from the measured value.

Suffix:

<m> 1..4
Reference waveform

Parameters:

<Offset> Negative values shift the waveform up, positive values shift it down.
Range: -100E+24 to 100E+24
Increment: 1E-6
*RST: 0
Default unit: V

Usage: Asynchronous command

Manual operation: See "Offset" on page 260

REFCurve<m>:HMODe <HorizontalMode>

Selects the coupling of horizontal settings.

Suffix:

<m> 1..4
Reference waveform

Parameters:

<HorizontalMode> ORIGINAL | COUPled
ORIGINAL
Horizontal scaling and reference point of the source waveform are used.
COUPled
The current horizontal settings of the diagram are used.
*RST: ORIGINAL

Usage: Asynchronous command

Manual operation: See "Mode" on page 260

REFCurve<m>:RESCale:HORizontal:STATe <State>

Enables and disables the horizontal stretching.

Stretching changes the display of the waveform independent of the horizontal settings of the source waveform and of the horizontal diagram settings.

Suffix:

<m> 1..4
Reference waveform

Parameters:

<State> ON | OFF
*RST: OFF

Usage: Asynchronous command

Manual operation: See "Enable" on page 260

REFCurve<m>:RESCale:HORizontal:FACTor <ScaleFactor>

A factor greater than 1 stretches the waveform horizontally, a factor lower than 1 compresses the curve.

Suffix:

<m> 1..4
Reference waveform

Parameters:

<ScaleFactor> Range: 1E-6 to 1E+6
Increment: 0.1
*RST: 1

Usage: Asynchronous command

Manual operation: See "Factor" on page 260

REFCurve<m>:RESCale:HORizontal:OFFSet <Offset>

Moves the waveform horizontally. Positive values shift the waveform to the right, negative values shift it to the left.

Suffix:

<m> 1..4
Reference waveform

Parameters:

<Offset> Range: -100E+24 to 100E+24
Increment: 0.01
*RST: 0
Default unit: s

Usage: Asynchronous command

REFCurve<m>:RESCale:HORizontal:POSition <Offset>

Moves the waveform horizontally. Enter a value with a time unit suitable for the time scale of the diagram. Positive values shift the waveform to the right, negative values shift it to the left.

Suffix:

<m> 1..4

Parameters:

<Offset> Range: -100E+24 to 100E+24
Increment: 0.01
*RST: 0
Default unit: s

Usage: Asynchronous command

Manual operation: See "Position" on page 261

27.10.2.3 Waveform data export

Commands for saving waveform data to file are described in [Chapter 27.16.4, "Waveform data export to file"](#), on page 1766.

Commands for reference waveforms are listed below.

REFCurve<m>:DATA:STYPe?	1553
REFCurve<m>:DATA:HEADer?	1553
REFCurve<m>:DATA[:VALues]?	1554

REFCurve<m>:DATA:STYPe?

Returns the signal type of the source of the reference waveform.

Suffix:

<m> 1..4
Reference waveform

Return values:

<SignalType> SOUR | SPEC | CORR | NONE
SOURce = normal signal
SPECTrum = FFT spectrum, specific math signal
CORRelation = correlated signal, specific math signal
NONE = undefined

Usage: Query only

REFCurve<m>:DATA:HEADer?

Returns information on the reference waveform.

Table 27-4: Header data

Position	Meaning	Example
1	XStart in s	-9.477E-008 = - 94,77 ns
2	XStop in s	9.477E-008 = 94,77 ns
3	Record length of the waveform in Samples	200000
4	Number of values per sample interval. For reference waveforms the number is always 1.	1

Suffix:

<m> 1..4
Reference waveform

Example:

REFC:DATA:HEAD?
-9.477E-008,9.477E-008,200000,1

Usage: Query only

REFCurve<m>:DATA[:VALues]?

Returns the data of the channel waveform points for transmission from the instrument to the controlling computer. The data can be used in MATLAB, for example.

To set the export format, use [FORMat \[:DATA\]](#).

You can retrieve only Y-values, or X- and Y-values. Use [EXPort:WAVeform:INCXvalues](#) to define this.

Suffix:

<m> 1..4
Reference waveform

Return values:

<Data> List of values according to the format and content settings.

Usage: Query only

27.10.2.4 Import of multichannel waveform data

Commands for saving waveform data to file are described in [Chapter 27.16.4, "Waveform data export to file"](#), on page 1766.

Commands for reference waveforms are listed below.

REFCurve<m>:MULTichannel:NAME	1554
REFCurve<m>:MULTichannel:IMPort	1554
REFCurve<m>:MULTichannel:OPEN	1555

REFCurve<m>:MULTichannel:NAME <MltChImptPath>

Defines the path and the file to be imported. If not path is given, the default path `C:\Users\Public\Public Documents\Rohde-Schwarz\RTx\RefWaveforms` is used.

Suffix:

<m> 1..4
The suffix is irrelevant.

Parameters:

<MltChImptPath> String with path and filename

Example: See [REFCurve<m>:MULTichannel:IMPort](#) on page 1554.

Usage: Asynchronous command

REFCurve<m>:MULTichannel:IMPort <MltChImptWfmSel>

Assigns a waveform from the multichannel file to a reference waveform. To import all waveforms that are in the file, you must assign each waveform to another reference waveform.

Suffix:

<m> 1..4
Selects the reference waveform.

Parameters:

<MitChImpWfmSel> NONE | NONE | WF1 | WAVEform1 | WF2 | WAVEform2 | WF3 | WAVEform3 | WF4 | WAVEform4
WF1 = WAVEform1, WF2 = WAVEform2, WF3 = WAVEform3, WF4 = WAVEform4
Selects the waveform in the export file.
*RST: NONE

Example:

Prerequisite: file RefCurve_2016-02-16_01.bin is a multi-channel export with at least WF1, WF3 and WF4.

```
REFCurve:MULTichannel:NAME 'RefCurve_2016-02-16_01.bin'
REFCurve1:MULTichannel:IMPort WF1
REFCurve2:MULTichannel:IMPort WF3
REFCurve3:MULTichannel:IMPort WF4
REFCurve:MULTichannel:OPEN
```

Usage: Asynchronous command

Firmware/software: FW 3.20

REFCurve<m>:MULTichannel:OPEN

Loads the waveform data to the reference waveforms.

Suffix:

<m> 1..4
The suffix is irrelevant.

Example: See [REFCurve<m>:MULTichannel:IMPort](#) on page 1554.

Usage: Event
Asynchronous command

27.10.2.5 CDR reference files

The following commands query the settings of the reference waveform, after a RefCurve.CDR.* file has been recalled.

```
REFCurve<m>:CDR:ALGorithm?..... 1555
REFCurve<m>:CDR:BITRate?..... 1556
REFCurve<m>:CDR:BWIDth?..... 1556
REFCurve<m>:CDR:RELBwidth?..... 1557
REFCurve<m>:CDR:SAMTime?..... 1557
REFCurve<m>:CDR:SOURce?..... 1557
```

REFCurve<m>:CDR:ALGorithm?

Queries the algorithm of the CDR reference waveform.

Suffix:
 <m> 1..4
 Reference waveform

Return values:
 <Algorithm> CFRequency | FF
 CFRequency: constant frequency
 FF: feed forward
 *RST: FF

Usage: Query only
 Asynchronous command

Manual operation: See "CDR" on page 1148

REFCurve<m>:CDR:BITRate?

Queries the bit rate of the CDR reference waveform.

Suffix:
 <m> 1..4
 Reference waveform

Return values:
 <Bitrate> Range: 1000 to 40E+9
 Increment: 10
 *RST: 1E+9
 Default unit: bps

Usage: Query only
 Asynchronous command

Manual operation: See "CDR" on page 1148

REFCurve<m>:CDR:BWIDth?

Queries the bandwidth of the CDR reference waveform.

Suffix:
 <m> 1..4
 Reference waveform

Return values:
 <Bandwidth> Range: 20E+3 to 10E+6
 Increment: 10
 *RST: 599.88E+3
 Default unit: Hz

Usage: Query only
 Asynchronous command

Manual operation: See "CDR" on page 1148

REFCurve<m>:CDR:RELBwidth?

Queries the relative bandwidth of the CDR reference waveform.

Suffix:

<m> 1..4
Reference waveform

Return values:

<RelBw> Range: 500 to 3000
Increment: 1
*RST: 1667

Usage: Query only
Asynchronous command

Manual operation: See "CDR" on page 1148

REFCurve<m>:CDR:SAMTime?

Queries the sampling time of the CDR reference waveform.

Suffix:

<m> 1..4
Reference waveform

Return values:

<SamplingTime> Range: 0 to 1
Increment: 0.01
*RST: 0.5
Default unit: UI

Usage: Query only
Asynchronous command

Manual operation: See "CDR" on page 1148

REFCurve<m>:CDR:SOURce?

Queries the analog source of the CDR reference waveform.

Suffix:

<m> 1..4
Reference waveform

Return values:

<AnalogSource> C1 | C2 | C3 | C4 | DIFF1 | DIFF2 | COMMON1 | COMMON2
*RST: C1

Usage: Query only
Asynchronous command

27.10.3 Mathematics

CALCulate:MATH<m>[:EXPRession][:DEFine].....	1558
CALCulate:MATH<m>:STATe.....	1558
CALCulate:MATH<m>:ENVSelection.....	1559
CALCulate:MATH<m>:ARITHmetics.....	1559
CALCulate:MATH<m>:VERTical:OFFSet.....	1560
CALCulate:MATH<m>:VERTical:RANGe.....	1560
CALCulate:MATH<m>:VERTical:SCALe.....	1561
CALCulate:MATH<m>:VERTical:MAXimum.....	1561
CALCulate:MATH<m>:DATA:STYPe?.....	1561
CALCulate:MATH<m>:DATA:HEADer?.....	1562
CALCulate:MATH<m>:DATA[:VALues]?.....	1562

CALCulate:MATH<m>[:EXPRession][:DEFine] <RemComplExpr>

Defines the math expression to be calculated for the specified math channel.

For an overview of corresponding expressions for the available keys in the formula editor, see [Chapter 7.3.4, "Equation"](#), on page 266.

Suffix:

<m> 1..8
Selects the math waveform.

Parameters:

<RemComplExpr> String with regular expression for calculation

Example:

CALC:MATH 'Ch1Wfm1*Ch2Wfm1 '
Defines the multiplication of waveforms Ch1Wfm1 and Ch2Wfm1.

Usage:

Asynchronous command

CALCulate:MATH<m>:STATe <State>

Enables the math waveform display.

Suffix:

<m> 1..8
math waveform

Parameters:

<State> ON | OFF
*RST: OFF

Usage:

Asynchronous command

Manual operation: See ["Display"](#) on page 263

CALCulate:MATH<m>:ENVSelection <EnvelopeCurve>

Selects the upper or lower part of the waveform for mathematic calculation, or a combination of both.

The setting is relevant for waveforms with waveform arithmetic mode "Envelope" or with "Peak detect" decimation. All mathematic operations - except for derivation - can be applied to envelope waveforms and waveforms with "Peak detect" decimation.

Suffix:

<m> 1..8
Selects the math waveform.

Parameters:

<EnvelopeCurve> MIN | MAX | BOTH
*RST: BOTH

Usage: Asynchronous command

Firmware/software: FW 2.25

Manual operation: See ["Envelope selection"](#) on page 263

CALCulate:MATH<m>:ARITHmetics <Arithmetics>

Selects the method to build the resulting math waveform from consecutive acquisitions. The processing is similar to the waveform arithmetics - instead of the acquired waveforms the results of the mathematic formula are used to create envelope, average and RMS.

To define the reset condition for arithmetics calculation, use [ACQUIRE:ARESet:MODE](#).

Suffix:

<m> 1..8
Selects the math waveform.

Parameters:

<Arithmetics> OFF | ENvelope | AVERage | RMS | MINHold | MAXHold
Waveform arithmetic mode

OFF

The math waveform is built according to the mathematic formula.

ENvelope

Detects the minimum and maximum math values in a sample interval over a number of acquisitions.

AVERage

Calculates the average from the math data of the current acquisition and a number of acquisitions before. To define the number of acquisitions, use [ACQUIRE:COUNT](#).

RMS

The resulting math waveform is the root mean square of the current acquisition and a number of acquisitions before. The result is the average power spectrum. Number of acquisitions:

[ACQUIRE:COUNT](#)

MAXHold

Determines the maximum result for each input value from the math data of the current acquisition and a number of acquisitions before. To define the number of acquisitions, use

[ACQUIRE:COUNT](#).

MINHold

Determines the minimum result for each input value from the math data of the current acquisition and a number of acquisitions before. To define the number of acquisitions, use

[ACQUIRE:COUNT](#).

*RST: OFF

Usage: Asynchronous command

Manual operation: See "[Mode](#)" on page 282

CALCulate:MATH<m>:VERTical:OFFSet <VerticalOffset>

Sets a voltage offset to adjust the vertical position of the math function on the screen.

Suffix:

<m> 1..8
Math waveform

Parameters:

<VerticalOffset> Negative values move the waveform up, positive values move it down.

Range: -100E+12 to 100E+12

Increment: 0.01

*RST: 0

Default unit: div

Usage: Asynchronous command

Manual operation: See "[Vertical Offset](#)" on page 281

CALCulate:MATH<m>:VERTical:RANGe <VerticalRange>

Defines the range of FFT values to be displayed.

Suffix:

<m> 1..8
Math waveform

Parameters:

<VerticalRange> Range: 0 to 1E+15
 Increment: 0.01
 *RST: 0
 Default unit: div

Usage: Asynchronous command

Manual operation: See "[Vertical range](#)" on page 395

CALCulate:MATH<m>:VERTical:SCALE <VerticalScale>

Defines the scale of the y-axis in the math function diagram. The value is defined as "V per division", e.g. *50V/div*. In this case, the horizontal grid lines are displayed in intervals of 50 V.

Suffix:

<m> 1..8
 Math waveform

Parameters:

<VerticalScale> Range: 1E-12 to 100E+12
 Increment: 10E-6
 *RST: 0.5
 Default unit: V/div

Usage: Asynchronous command

Manual operation: See "[Vertical Scale](#)" on page 281

CALCulate:MATH<m>:VERTical:MAXimum <VerticalMax>

Defines the maximum value on y-axis for spectrum displays.

Suffix:

<m> 1..8

Parameters:

<VerticalMax> Range: -1E+15 to 1E+15
 Increment: 0.01
 *RST: 0
 Default unit: div

Usage: Asynchronous command

Manual operation: See "[Vertical maximum](#)" on page 395

CALCulate:MATH<m>:DATA:STYPe?

Returns the signal type of the source of the math waveform.

Suffix:

<m> 1..8
Selects the math waveform.

Return values:

<SignalType> SOUR | SPEC | CORR | MEAS | NONE
 SOURce = normal signal
 SPECTrum = FFT spectrum, specific math signal
 CORRelation = correlated signal, specific math signal
 MEAsurement = result of a measurement
 NONE = undefined

Usage:

Query only
Asynchronous command

CALCulate:MATH<m>:DATA:HEADer?

Returns the header of math waveform data. The header contains attributes of the waveform.

Table 27-5: Header data

Position	Meaning	Example
1	XStart in s	-9.477E-008 = - 94,77 ns
2	XStop in s	9.477E-008 = 94,77 ns
3	Record length of the waveform in Samples	200000
4	Number of values per sample interval. For most waveforms the result is 1, for peak detect and envelope waveforms it is 2. If the number is 2, the number of returned values is twice the number of samples (record length).	1

Suffix:

<m> 1..8
Selects the math waveform.

Example:

CALC:MATH1:DATA:HEAD?
-9.477E-008,9.477E-008,200000,1

Usage:

Query only

CALCulate:MATH<m>:DATA[:VALues]?

Returns the data of the math waveform points for transmission from the instrument to the controlling computer. The data can be used in MATLAB, for example.

To set the export format, use [FORMat \[:DATA\]](#).

You can retrieve only Y-values, or X- and Y-values. Use [EXPort:WAVeform:INCXvalues](#) to define this.

Suffix:

<m> 1..8
Selects the math waveform.

Return values:

<Data> List of values according to the format and content settings.

Usage: Query only

27.10.4 History

CHANnel<m>[:WAVEform<n>]:HISTory[:STATe].....	1563
ACQuire:AVAIlable?.....	1563
CHANnel<m>[:WAVEform<n>]:HISTory:CURRent.....	1564
CHANnel<m>[:WAVEform<n>]:HISTory:START.....	1564
CHANnel<m>[:WAVEform<n>]:HISTory:STOP.....	1565
CHANnel<m>[:WAVEform<n>]:HISTory:TPACq.....	1565
CHANnel<m>[:WAVEform<n>]:HISTory:PLAY.....	1565
CHANnel<m>[:WAVEform<n>]:HISTory:REPLay.....	1566
CHANnel<m>[:WAVEform<n>]:HISTory:TSDate?.....	1566
CHANnel<m>[:WAVEform<n>]:HISTory:TSABsolute?.....	1566
CHANnel<m>[:WAVEform<n>]:HISTory:TSRelative?.....	1567
CHANnel<m>[:WAVEform<n>]:HISTory:TSRReference?.....	1567

CHANnel<m>[:WAVEform<n>]:HISTory[:STATe] <State>

Enables or disables the history display.

Suffix:

<m> 1..4
Selects the input channel.

<n> 1..3
Selects the waveform. If [:WAVEform<n>] is omitted, waveform 1 is addressed.

Parameters:

<State> ON | OFF
*RST: OFF

Usage: Asynchronous command

Manual operation: See "[Show history / Export history](#)" on page 285

ACQuire:AVAIlable?

Returns the number of acquisitions that is saved in the memory. This number of acquisitions is available for history viewing. It is also the number of acquisitions in a fast segmentation acquisition series.

Return values:

<AcquisitionCount> Range: 0 to 4294967295

Usage: Query only
Asynchronous command

CHANnel<m>[:WAVEform<n>]:HISTory:CURRent <CurrAcqIdx>

Accesses a particular acquisition in the memory to display it. The query returns the index of the segment that is shown.

Suffix:

<m> 1..4

Selects the input channel.

<n> 1..3

Selects the waveform. If [:WAVEform<n>] is omitted, waveform 1 is addressed.

Parameters:

<CurrAcqIdx>

History index: the newest segment has the index "0", older segments have a negative index: -(n-1), -1 , 0 where n is the number of acquired segments.

Range: 0 to -(n-1)

Increment: 1

Example:

```
CHAN2:HIST:STAT ON
CHAN2:HIST:CURR -1
*OPC
```

Displays the acquisition before last from the history.

Usage: Asynchronous command

Manual operation: See "[Current acquisition](#)" on page 286

CHANnel<m>[:WAVEform<n>]:HISTory:STARt <StrtAcqIdx>

Sets the index of the oldest history acquisition for the history viewing.

Suffix:

<m> 1..4

Selects the input channel.

<n> 1..3

Selects the waveform. If [:WAVEform<n>] is omitted, waveform 1 is addressed.

Parameters:

<StrtAcqIdx>

The start index is always negative.

Range: 0 to -(n-1)

Increment: 1

Usage: Asynchronous command

Manual operation: See "[Start acquisition](#)" on page 286

CHANnel<m>[:WAVEform<n>]:HISTory:STOP <StpAcqIdx>

Sets the index of the latest segment to be displayed in the history viewer.

Suffix:

<m> 1..4

Selects the input channel.

<n> 1..3

Selects the waveform. If [:WAVEform<n>] is omitted, waveform 1 is addressed.

Parameters:

<StpAcqIdx> Index of the stop acquisition. The newest acquisition always has the index "0".

Range: 0 to -(n-1)

Increment: 1

Usage: Asynchronous command

Manual operation: See ["Stop acquisition"](#) on page 286

CHANnel<m>[:WAVEform<n>]:HISTory:TPACq <TimePerAcq>

Sets the display time for one acquisition. The shorter the time, the faster is the replay.

Suffix:

<m> 1..4

Selects the input channel.

<n> 1..3

Selects the waveform. If [:WAVEform<n>] is omitted, waveform 1 is addressed.

Parameters:

<TimePerAcq> Range: 40E-6 to 10

Increment: 1

*RST: 0.05

Default unit: s

Usage: Asynchronous command

Manual operation: See ["Display time"](#) on page 286

CHANnel<m>[:WAVEform<n>]:HISTory:PLAY

Starts and stops the replay of the history waveforms.

Suffix:

<m> 1..4

Selects the input channel.

<n> 1..3

Selects the waveform. If [:WAVEform<n>] is omitted, waveform 1 is addressed.

Usage: Event
Asynchronous command

Manual operation: See ["Start export"](#) on page 471

CHANnel<m>[:WAVEform<n>]:HISTory:REPLay <AutoRepeat>

If ON, the replay of the history waveform sequence repeats automatically. Otherwise, the replay stops at the stop index set with [CHANnel<m>\[:WAVEform<n>\]:HISTory:STOP](#).

Suffix:

<m> 1..4

Selects the input channel.

<n> 1..3

Selects the waveform. If [:WAVEform<n>] is omitted, waveform 1 is addressed.

Parameters:

<AutoRepeat> ON | OFF

*RST: OFF

Usage: Asynchronous command

Manual operation: See ["Auto repeat"](#) on page 286

CHANnel<m>[:WAVEform<n>]:HISTory:TSDate?

Returns the date of the current acquisition that is shown in the history viewer ([CHANnel<m>\[:WAVEform<n>\]:HISTory:CURRENT](#)).

Suffix:

<m> 1..4

Selects the input channel.

<n> 1..3

Selects the waveform. If [:WAVEform<n>] is omitted, waveform 1 is addressed.

Return values:

<DateAbsString> String with date of the current acquisition (absolute time)

Usage: Query only
Asynchronous command

Manual operation: See ["Time stamp"](#) on page 287

CHANnel<m>[:WAVEform<n>]:HISTory:TSABsolute?

Returns the absolute daytime of the current acquisition that is shown in the history viewer ([CHANnel<m>\[:WAVEform<n>\]:HISTory:CURRENT](#)).

Suffix:

<m>	1..4 Selects the input channel.
<n>	1..3 Selects the waveform. If [:WAVEform<n>] is omitted, waveform 1 is addressed.

Return values:

<TimeAbsString> String containing the time and unit

Usage:

Query only
Asynchronous command

Manual operation: See ["Time stamp"](#) on page 287

CHANnel<m>[:WAVEform<n>]:HISTory:TSRelative?

Returns the relative time of the current acquisition - the time difference to the newest acquisition (index = 0).

See also: ([CHANnel<m>\[:WAVEform<n>\]:HISTory:CURRENT](#)).

Suffix:

<m>	1..4 Selects the input channel.
<n>	1..3 Selects the waveform. If [:WAVEform<n>] is omitted, waveform 1 is addressed.

Return values:

<TimeRelativ> Range: -100E+24 to 100E+24
Default unit: s

Usage:

Query only
Asynchronous command

Manual operation: See ["Time stamp"](#) on page 287

CHANnel<m>[:WAVEform<n>]:HISTory:TSReference?

Returns the relative time of the currently selected acquisition and the internal reference time (horizontal alignment) in history view with respect to the acquisition with index 0.

Suffix:

<m>	1..4 Selects the input channel.
<n>	1..3 Selects the waveform. If [:WAVEform<n>] is omitted, waveform 1 is addressed.

Return values:

<TimeRelIntRef> Range: -100E+24 to 100E+24
 Increment: 1
 *RST: 0
 Default unit: s

Usage:

Query only
 Asynchronous command

Firmware/software: Version 2.70

Manual operation: See ["Time stamp"](#) on page 287

27.10.5 XY-Diagram

WAVeform<m>:XYCurve:RATio	1568
WAVeform<m>:XYCurve:STATe	1568
WAVeform<m>:XYCurve:SWAP	1569
LAYout:SIGNal:AXIS	1569
WAVeform<m>:XYCurve:XSource	1569
WAVeform<m>:XYCurve:YSource	1570

WAVeform<m>:XYCurve:RATio <ConstantXYRatio>

If enabled, the x- and y-axes maintain a constant ratio in the diagram.

Suffix:

<m> 1..4
 XY-diagram

Parameters:

<ConstantXYRatio> ON | OFF
 *RST: ON

Usage:

Asynchronous command

Manual operation: See ["Constant XY-ratio"](#) on page 291

WAVeform<m>:XYCurve:STATe <State>

Activates an XY-waveform.

Suffix:

<m> 1..4
 XY-diagram

Parameters:

<State> ON | OFF
 *RST: OFF

Usage:

Asynchronous command

Manual operation: See ["Enable"](#) on page 290

WAVeform<m>:XYCurve:SWAP

Replaces the source of the x-axis with the source of the y-axis and vice versa.

Suffix:

<m> 1..4
XY-diagram

Usage:

Event
Asynchronous command

Manual operation: See "[Swap XY](#)" on page 291

LAYout:SIGNal:AXIS <DiagramName>, <Source>, <XSource>

Creates an XY-diagram by adding a second waveform to a diagram.

Setting parameters:

<DiagramName> String with the name of the diagram where the waveform is added.

<Source> C1W1 | C1W2 | C1W3 | C2W1 | C2W2 | C2W3 | C3W1 | C3W2 | C3W3 | C4W1 | C4W2 | C4W3 | M1 | M2 | M3 | M4 | M5 | M6 | M7 | M8 | R1 | R2 | R3 | R4 | TRK1 | TRK2 | TRK3 | TRK4 | TRK5 | TRK6 | TRK7 | TRK8 | SG1TL1 | SG1TL2 | SG2TL1 | SG2TL2 | SG3TL1 | SG3TL2 | SG4TL1 | SG4TL2 | SG5TL1 | SG5TL2 | SG6TL1 | SG6TL2 | SG7TL1 | SG7TL2 | SG8TL1 | SG8TL2 | Z1V1 | Z1V2 | Z1V3 | Z1V4 | Z1I1 | Z1I2 | Z1I3 | Z1I4 | Z2V1 | Z2V2 | Z2V3 | Z2V4 | Z2I1 | Z2I2 | Z2I3 | Z2I4 | DIFF1 | DIFF2 | COMMON1 | COMMON2

Waveform to be added, see [Chapter 27.4.2, "Waveform parameter"](#), on page 1371

<XSource>

ON | OFF

If on, the added waveform is assigned to the x-axis.
If off, it is assigned to the y-axis.

Usage:

Setting only
Asynchronous command

WAVeform<m>:XYCurve:XSource <XSource>

Defines the signal source that supplies the x-values of the XY-diagram.

Suffix:

<m> 1..4
XY-diagram

Parameters:

<XSource>

C1W1 | C1W2 | C1W3 | C2W1 | C2W2 | C2W3 | C3W1 | C3W2 | C3W3 | C4W1 | C4W2 | C4W3 | M1 | M2 | M3 | M4 | M5 | M6 | M7 | M8 | R1 | R2 | R3 | R4 | SG1TL1 | SG1TL2 | SG2TL1 | SG2TL2 | SG3TL1 | SG3TL2 | SG4TL1 | SG5TL1 | SG5TL2 | SG6TL1 | SG6TL2 | SG7TL1 | SG7TL2 | SG8TL1 | SG8TL2 | SG4TL2 | Z1V1 | Z1V2 | Z1V3 | Z1V4 | Z1I1 | Z1I2 | Z1I3 | Z1I4 | Z2V1 | Z2V2 | Z2V3 | Z2V4 | Z2I1 | Z2I2 | Z2I3 | Z2I4 | DIFF1 | DIFF2 | COMMON1 | COMMON2 | LANE1 | LANE2 | LANE3 | LANE4

Source of x-values, see [Chapter 27.4.2, "Waveform parameter"](#), on page 1371

*RST: C1W1

Usage:

Asynchronous command

Manual operation:

See ["X-source"](#) on page 290

WAVeform<m>:XYCurve:YSource <YSource>

Defines the signal source that supplies the y-values of the XY-diagram.

Suffix:

<m>

1..4

XY-diagram

Parameters:

<YSource>

C1W1 | C1W2 | C1W3 | C2W1 | C2W2 | C2W3 | C3W1 | C3W2 | C3W3 | C4W1 | C4W2 | C4W3 | M1 | M2 | M3 | M4 | M5 | M6 | M7 | M8 | R1 | R2 | R3 | R4 | SG1TL1 | SG1TL2 | SG2TL1 | SG2TL2 | SG3TL1 | SG3TL2 | SG4TL1 | SG4TL2 | SG5TL1 | SG5TL2 | SG6TL1 | SG6TL2 | SG7TL1 | SG7TL2 | SG8TL1 | SG8TL2 | Z1V1 | Z1V2 | Z1V3 | Z1V4 | Z1I1 | Z1I2 | Z1I3 | Z1I4 | Z2V1 | Z2V2 | Z2V3 | Z2V4 | Z2I1 | Z2I2 | Z2I3 | Z2I4 | DIFF1 | DIFF2 | COMMON1 | COMMON2 | LANE1 | LANE2 | LANE3 | LANE4

Source of y-values, see [Chapter 27.4.2, "Waveform parameter"](#), on page 1371

*RST: C2W1

Usage:

Asynchronous command

Manual operation:

See ["Y-source"](#) on page 291

27.11 Cursor measurements

Some of the commands in the following chapter are asynchronous. An overlapping or asynchronous command does not automatically finish executing before the next command starts executing. If overlapping commands must be executed in a defined order, e.g. to avoid wrong measurement results, they must be serviced sequentially.

To prevent an overlapping execution of commands, one of the commands *OPC, *OPC? or *WAI can be used after the command or a command set.

For more information, see:

- www.rohde-schwarz.com/rc-via-scpi, chapter "Command sequence and synchronization"
- [Chapter 27.3, "Programming examples"](#), on page 1345

27.11.1	Cursor setup.....	1571
27.11.2	Cursor results.....	1580
27.11.3	Peak search using cursors.....	1581

27.11.1 Cursor setup

CURSor<m>:STATe.....	1571
CURSor<m>:AOFF.....	1572
CURSor<m>:FUNctIon.....	1572
CURSor<m>:SOURce.....	1572
CURSor<m>:SSource.....	1573
CURSor<m>:USSource.....	1574
CURSor<m>:TRACking[:STATe].....	1575
CURSor<m>:X1Position.....	1575
CURSor<m>:X2Position.....	1575
CURSor<m>:XCOupling.....	1576
CURSor<m>:Y1Position.....	1576
CURSor<m>:Y2Position.....	1577
CURSor<m>:YCOupling.....	1577
CURSor<m>:X1ENvelope.....	1577
CURSor<m>:X2ENvelope.....	1578
CURSor<m>:LABel[:LABel].....	1578
CURSor<m>:LABel:X<1..2>.....	1579
CURSor<m>:LABel:Y<1..2>.....	1579
CURSor<m>:SIAD.....	1579

CURSor<m>:STATe <State>

Switches the indicated cursor on or off.

Suffix:

<m> 1..4
Selects the cursor set.

Parameters:

<State> ON | OFF
*RST: OFF

Usage: Asynchronous command

Manual operation: See "[Cursor On/Off](#)" on page 299

CURSor<m>:AOFF

This command switches all cursors off.

Suffix:

<m> The numeric suffix is irrelevant.

Usage:

Event
Asynchronous command

CURSor<m>:FUNcTion <Type>

Defines the type of the indicated cursor set.

Suffix:

<m> 1..4
Selects the cursor set.

Parameters:

<Type> HORizontal | VERTical | PAIRed

HORizontal

A pair of horizontal cursor lines.

VERTical

A pair of vertical cursor lines.

PAIRed

Both vertical and horizontal cursor line pairs.

*RST: PAIRed

Usage:

Asynchronous command

Manual operation: See "[Type](#)" on page 299

CURSor<m>:SOURce <Source>

Defines the source of the cursor measurement.

Suffix:

<m> 1..4
Selects the cursor set.

Parameters:

<Source>

C1W1 | C1W2 | C1W3 | C2W1 | C2W2 | C2W3 | C3W1 | C3W2 |
 C3W3 | C4W1 | C4W2 | C4W3 | M1 | M2 | M3 | M4 | M5 | M6 |
 M7 | M8 | R1 | R2 | R3 | R4 | XY1 | XY2 | XY3 | XY4 | D0 | D1 |
 D2 | D3 | D4 | D5 | D6 | D7 | D8 | D9 | D10 | D11 | D12 | D13 |
 D14 | D15 | MSOB1 | MSOB2 | MSOB3 | MSOB4 | TRK1 |
 TRK2 | TRK3 | TRK4 | TRK5 | TRK6 | TRK7 | TRK8 | SG1 |
 SG2 | SG3 | SG4 | SG5 | SG6 | SG7 | SG8 | SG1TL1 | SG1TL2 |
 SG2TL1 | SG2TL2 | SG3TL1 | SG3TL2 | SG4TL1 | SG4TL2 |
 SG5TL1 | SG5TL2 | SG6TL1 | SG6TL2 | SG7TL1 | SG7TL2 |
 SG8TL1 | SG8TL2 | Z1V1 | Z1V2 | Z1V3 | Z1V4 | Z1I1 | Z1I2 |
 Z1I3 | Z1I4 | Z2V1 | Z2V2 | Z2V3 | Z2V4 | Z2I1 | Z2I2 | Z2I3 |
 Z2I4 | DIFF1 | DIFF2 | COMMON1 | COMMON2

Source of the cursor measurement, see [Chapter 27.4.2, "Waveform parameter"](#), on page 1371

*RST: C1W1

Usage:

Asynchronous command

Manual operation:

See "[Source](#)" on page 299

CURSor<m>:SSource <Source2>

Selects the second cursor source.

Suffix:

<m>

1..4

Selects the cursor set.

Parameters:

<Source2>

C1W1 | C1W2 | C1W3 | C2W1 | C2W2 | C2W3 | C3W1 | C3W2 | C3W3 | C4W1 | C4W2 | C4W3 | M1 | M2 | M3 | M4 | M5 | M6 | M7 | M8 | R1 | R2 | R3 | R4 | XY1 | XY2 | XY3 | XY4 | D0 | D1 | D2 | D3 | D4 | D5 | D6 | D7 | D8 | D9 | D10 | D11 | D12 | D13 | D14 | D15 | MSOB1 | MSOB2 | MSOB3 | MSOB4 | TRK1 | TRK2 | TRK3 | TRK4 | TRK5 | TRK6 | TRK7 | TRK8 | SG1 | SG2 | SG3 | SG4 | SG5 | SG6 | SG7 | SG8 | SG1TL1 | SG1TL2 | SG2TL1 | SG2TL2 | SG3TL1 | SG3TL2 | SG4TL1 | SG4TL2 | SG5TL1 | SG5TL2 | SG6TL1 | SG6TL2 | SG7TL1 | SG7TL2 | SG8TL1 | SG8TL2 | Z1V1 | Z1V2 | Z1V3 | Z1V4 | Z1I1 | Z1I2 | Z1I3 | Z1I4 | Z2V1 | Z2V2 | Z2V3 | Z2V4 | Z2I1 | Z2I2 | Z2I3 | Z2I4 | DIFF1 | DIFF2 | COMMON1 | COMMON2 | EYE1 | EYE2 | EYE3 | EYE4 | TDRZ | TDRH | TDRR | BATHtub1 | BMEas1 | SRESponse1 | SRTRack1 | SDTRack1 | TJTRack1 | DJTRack1 | DDJTrack1 | PJTRack1 | RJOTRack1 | TJSPpectrum1 | DDJSpectrum1 | PJOSpectrum1 | RJSPpectrum1 | BATHtub2 | BMEas2 | SRESponse2 | SRTRack2 | SDTRack2 | TJTRack2 | DJTRack2 | DDJTrack2 | PJTRack2 | RJTORack2 | TJSPpectrum2 | DDJSpectrum2 | PJSPpectrum2 | RJOSpectrum2 | SEYE1 | SEYE2 | SDHist1 | TJHist1 | DJHist1 | DDJHist1 | PJHist1 | RJOHist1 | SRHist2 | SDHist2 | TJHist2 | DJHist2 | DDJHist2 | PJHist2 | RJOHist2 | NBATHtub1 | NBMeas1 | TNHist1 | DNHist1 | DDNHist1 | PNHist1 | RNOHist1 | TNTRack1 | DNTRack1 | DDNTrack1 | PNTRack1 | RNOTRack1 | TNSpectrum1 | DDNSpectrum1 | PNSpectrum1 | RNSpectrum1 | NBATHtub2 | NBMeas2 | TNHist2 | DNHist2 | DDNHist2 | PNHist2 | RNHist2 | TNTRack2 | DNTRack2 | DDNTrack2 | PNTRack2 | RNOTRack2 | TNSpectrum2 | DDNSpectrum2 | PNSpectrum2 | RNOSpectrum2 | LANE1 | LANE2 | LANE3 | LANE4

Second source of the cursor measurement, see [Chapter 27.4.2, "Waveform parameter"](#), on page 1371

*RST: C2W1

Usage: Asynchronous command

Firmware/software: FW 3.60

Manual operation: See ["Second source, Source 2"](#) on page 299

CURSor<m>:USSource <UseSource2>

Enables the second cursor source. To select the second source, use [CURSor<m>:SSource](#) on page 1573.

If enabled, the second cursor lines Cx.2 measure on the second source. Using a second source, you can measure differences between two channels with cursors.

Suffix:

<m> 1..4
Selects the cursor set.

Parameters:

<UseSource2> ON | OFF
*RST: OFF

Usage: Asynchronous command

Firmware/software: FW 3.60

Manual operation: See "[Second source, Source 2](#)" on page 299

CURSor<m>:TRACking[:STATe] <TrackCurve>

If set to ON, the horizontal cursor lines follow the waveform.

Suffix:

<m> 1..4
Selects the cursor set.

Parameters:

<TrackCurve> ON | OFF
*RST: OFF

Usage: Asynchronous command

Manual operation: See "[Track waveform](#)" on page 300

CURSor<m>:X1Position <XPosition1>

Defines the position of the left vertical cursor line.

Suffix:

<m> 1..4
Selects the cursor set.

Parameters:

<XPosition1> Range: 0 to 500
Increment: 0.1
*RST: 0
Default unit: s

Usage: Asynchronous command

Manual operation: See "[X1 position, X2 position](#)" on page 299

CURSor<m>:X2Position <XPosition2>

Defines the position of the right vertical cursor line.

Suffix:

<m> 1..4
Selects the cursor set.

Parameters:

<XPosition2> Range: 0 to 500
Increment: 0.1
*RST: 0
Default unit: s

Usage: Asynchronous command

Manual operation: See "[X1 position, X2 position](#)" on page 299

CURSor<m>:XCOupling <Coupling>

Defines the positioning mode of the vertical cursor.

Suffix:

<m> 1..4
Selects the cursor set.

Parameters:

<Coupling> ON | OFF
ON
Moving one cursor line moves the other cursor line too. The cursor lines always remain a fixed distance.
OFF
Each cursor line is positioned independently.
*RST: OFF

Usage: Asynchronous command

Manual operation: See "[Coupling \(2 follows 1\)](#)" on page 301

CURSor<m>:Y1Position <YPosition1>

Defines the position of the lower horizontal cursor line.

If [CURSor<m>:TRACking\[:STATe\]](#) is enabled, the query returns the measurement result - the lower vertical value of the waveform.

Suffix:

<m> 1..4
Selects the cursor set.

Parameters:

<YPosition1> Range: -50 to 50
Increment: 0.01
*RST: 0
Default unit: The unit depends on the type of the waveform.

Usage: Asynchronous command

Manual operation: See "[Y1 position, Y2 position](#)" on page 299

CURSor<m>:Y2Position <YPosition2>

Defines the position of the upper horizontal cursor line.

If [CURSor<m>:TRACking\[:STATe\]](#) is enabled, the query returns the measurement result - the upper vertical value of the waveform.

Suffix:

<m> 1..4
Selects the cursor set.

Parameters:

<YPosition2> Range: -50 to 50
Increment: 0.01
*RST: 0
Default unit: The unit depends on the type of the waveform.

Usage: Asynchronous command

Manual operation: See "[Y1 position, Y2 position](#)" on page 299

CURSor<m>:YCOupling <Coupling>

Defines the positioning mode of the horizontal cursor. If the horizontal cursor lines track the waveform, the y-coupling is irrelevant ([CURSor<m>:MODE TRACK](#)).

Suffix:

<m> 1..4
Selects the cursor set.

Parameters:

<Coupling> ON | OFF
ON
Moving one cursor line moves the other cursor line too. The cursor lines always remain a fixed distance.
OFF
Each cursor line is positioned independently.
*RST: OFF

Usage: Asynchronous command

Manual operation: See "[Coupling \(2 follows 1\)](#)" on page 301

CURSor<m>:X1ENvelope <EnvelopeCurve1>

If the waveform arithmetics are set to envelope curve (see [CHANnel<m>\[:WAVEform<n>\]:ARITHmetics](#) on page 1423) and [CURSor<m>:TRACking\[:STATe\]](#) is set to "ON", this setting defines how the first horizontal cursor is positioned.

Suffix:

<m> 1..*
Selects the cursor set. 4 cursor sets are available.

Parameters:

<EnvelopeCurve1> MIN | MAX
MIN
The horizontal cursor is set to the crossing point of the vertical cursor with the minimum waveform envelope.
MAX
The horizontal cursor is set to the crossing point of the vertical cursor with the maximum waveform envelope.
*RST: MIN

Usage: Asynchronous command

Manual operation: See "[Envelope selection 1|2](#)" on page 300

CURSor<m>:X2ENvelope <EnvelopeCurve2>

If the waveform arithmetics are set to envelope curve (see [CHANnel<m>\[:WAVEform<n>\]:ARITHmetics](#) on page 1423) and [CURSor<m>:TRACking\[:STATe\]](#) is set to "ON", this setting defines how the second horizontal cursor is positioned.

Suffix:

<m> 1..*
Selects the cursor set. 4 cursor sets are available.

Parameters:

<EnvelopeCurve2> MIN | MAX
MIN
The horizontal cursor is set to the crossing point of the vertical cursor with the minimum waveform envelope.
MAX
The horizontal cursor is set to the crossing point of the vertical cursor with the maximum waveform envelope.
*RST: MAX

Usage: Asynchronous command

Manual operation: See "[Envelope selection 1|2](#)" on page 300

CURSor<m>:LABel[:LABel] <ShowLabel>

Shows the cursor labels in the diagram.

Suffix:

<m> 1..4
Selects the cursor set.

Parameters:

<ShowLabel> ON | OFF
 *RST: ON

Usage: Asynchronous command

Manual operation: See ["Show label"](#) on page 301

CURSor<m>:LABel:X<1..2> <Name>

Defines a label to be displayed with the vertical cursors. X1 is the left cursor line, and X2 the right one. By default, the cursors are labeled as Cu1.X1, Cu1.X2, Cu2.X1, Cu2.X2, Cu3.X1, Cu3.X2, Cu4.X1, Cu4.X2.

Suffix:

<m> 1..4
 Selects the cursor set.

Parameters:

<Name> String with the cursor label

Usage: Asynchronous command

Manual operation: See ["X1 label, X2 label"](#) on page 302

CURSor<m>:LABel:Y<1..2> <Name>

Defines a label to be displayed with the vertical cursors. Y1 is the lower cursor line, and Y2 the upper one. By default, the cursors are labeled as Cu1.Y1, Cu1.Y2, Cu2.Y1, Cu2.Y2, Cu3.Y1, Cu3.Y2, Cu4.Y1, Cu4.Y2.

Suffix:

<m> 1..4
 Selects the cursor set.

Parameters:

<Name> String with the cursor label

Usage: Asynchronous command

Manual operation: See ["Y1 label, Y2 label"](#) on page 302

CURSor<m>:SIAD <ShwInAllDiags>

Shows the cursor lines of the selected cursor set in all active diagrams of the same (time/spectrum) domain.

Suffix:

<m> 1..*
 Selects the cursor set.

Parameters:

<ShowInAllDiagr> ON | OFF
 *RST: ON

Usage: Asynchronous command

Manual operation: See ["Show in all diagrams"](#) on page 301

Note: the behavior of the command has been changed. In firmware versions 5.35. and older, the command affected all cursor sets, and the suffix was ignored. From FW version 5.40 on, the command affects only the cursor set that is selected by the suffix. If your script was written before the change and contains a deactivation of the cursor line display, you replace the single command by a loop over all cursor sets.

27.11.2 Cursor results

CURSor<m>:XDELta[:VALue]?	1580
CURSor<m>:XDELta:INVerse?	1580
CURSor<m>:YDELta[:VALue]?	1580
CURSor<m>:YDELta:SLOPe	1581

CURSor<m>:XDELta[:VALue]?

Queries the delta value (distance) of two vertical cursor lines.

Suffix:

<m> 1..4
Selects the cursor set.

Return values:

<Delta> Range: -100E+24 to 100E+24
 *RST: 0
 Default unit: s

Usage: Query only
Asynchronous command

CURSor<m>:XDELta:INVerse?

Queries the inverse value of the delta value (distance) of the two vertical cursor lines.

Suffix:

<m> 1..4
Selects the cursor set.

Return values:

<DeltaInverse> Range: -100E+24 to 100E+24
 *RST: 0
 Default unit: Hz

Usage: Query only
Asynchronous command

CURSor<m>:YDELta[:VALue]?

Queries the delta value (distance) of the two horizontal cursor lines.

Suffix:

<m> 1..4
Selects the cursor set.

Return values:

<Delta> Range: -100E+24 to 100E+24
*RST: 0

Usage:

Query only
Asynchronous command

CURSor<m>:YDELta:SLOPe <DeltaSlope>

Returns the inverse value of the voltage difference - the reciprocal of the vertical distance of two horizontal cursor lines: $1/\Delta V$.

Suffix:

<m> 1..4
Selects the cursor set.

Parameters:

<DeltaSlope> Range: -100E+24 to 100E+24
Increment: 0
*RST: 0

Usage:

Asynchronous command

27.11.3 Peak search using cursors

CURSor<m>:FFT:SETCenter.....	1581
CURSor<m>:FFT:TOCenter.....	1581
CURSor<m>:MAXimum[:PEAK].....	1582
CURSor<m>:MAXimum:LEFT.....	1582
CURSor<m>:MAXimum:RIGHT.....	1582
CURSor<m>:MAXimum:NEXT.....	1582

CURSor<m>:FFT:SETCenter

Sets the center frequency to the frequency value that is measured at cursor line c1.

Suffix:

<m> The suffix is irrelevant.

Usage:

Event
Asynchronous command

Manual operation: See "[Set center frequency to Cursor](#)" on page 303

CURSor<m>:FFT:TOCenter

Sets the vertical cursor line c1 to the center frequency.

Suffix:
 <m> The suffix is irrelevant.

Usage: Event
 Asynchronous command

Manual operation: See "[Center frequency](#)" on page 303

CURSor<m>:MAXimum[:PEAK]

Sets both cursors to the absolute peak value.

Suffix:
 <m> 1..4
 Selects the cursor set.

Usage: Event

Manual operation: See "[Absolute](#)" on page 303

CURSor<m>:MAXimum:LEFT

Sets cursor 2 to the next maximum to the left of the current position.

Suffix:
 <m> 1..4
 Selects the cursor set.

Usage: Event

Manual operation: See "[Next left](#)" on page 303

CURSor<m>:MAXimum:RIGHT

Sets cursor 2 to the next peak to the right (from the current position).

Suffix:
 <m> 1..4
 Selects the cursor set.

Usage: Event

Manual operation: See "[Next right](#)" on page 303

CURSor<m>:MAXimum:NEXT

Sets cursor 2 to the next smaller peak (from the current position).

Suffix:
 <m> 1..4
 Selects the cursor set.

Usage: Event

Manual operation: See "[Next absolute](#)" on page 303

27.12 Automatic measurements

This chapter contains all remote commands to set up automatic measurements and to analyze the measurement results.

Selection of the measurement group: MEASurement<m>

With R&S RTO6, you can configure up to eight simultaneous measurement groups. In manual operation, these eight measurement groups are represented by subtabs "MG1" to "MG8" in the "Measurements" dialog box. For remote operation, the measurement group is indicated by the suffix MEAS<m>, containing the number of the measurement group.

Remote control: measurement suffix <m>	Manual operation: "MG" subtab
1 to 8 correspond to	"MG1" to "MG8"
9, 10: do not use	Not available

Some of the commands in the following chapter are asynchronous. An overlapping or asynchronous command does not automatically finish executing before the next command starts executing. If overlapping commands must be executed in a defined order, e.g. to avoid wrong measurement results, they must be serviced sequentially.

To prevent an overlapping execution of commands, one of the commands *OPC, *OPC? or *WAI can be used after the command or a command set.

For more information, see:

- www.rohde-schwarz.com/rc-via-scpi, chapter "Command sequence and synchronization"
- [Chapter 27.3, "Programming examples"](#), on page 1345
- [General settings](#)..... 1584
- [Results](#)..... 1589
- [Amplitude/time measurements](#)..... 1594
- [Arithmetic for amplitude/time and spectrum measurements](#)..... 1607
- [Eye diagram measurements](#)..... 1616
- [Spectrum](#)..... 1629
- [Optical measurements](#)..... 1637
- [Histograms](#)..... 1640
- [Display](#)..... 1651
- [Statistics and long-term measurements](#)..... 1652
- [Protocol](#)..... 1659
- [Track](#)..... 1666
- [Gating](#)..... 1667
- [Limit check and event actions](#)..... 1670

27.12.1 General settings

MEASurement<m>[:ENABLE].....	1584
MEASurement<m>:SOURce.....	1584
MEASurement<m>:FSRC.....	1586
MEASurement<m>:SSRC.....	1586
MEASurement<m>:CATegory.....	1586
MEASurement<m>:MAIN.....	1587
MEASurement<m>:ADDITIONal.....	1588
MEASurement<m>:AON.....	1589
MEASurement<m>:AOFF.....	1589

MEASurement<m>[:ENABLE] <State>

Switches the indicated measurement on or off.

Suffix:

<m> 1..10
See "[Selection of the measurement group: MEASurement<m>](#)" on page 1583.

Parameters:

<State> ON | OFF
*RST: OFF

Example: See "[Simple frequency and amplitude measurement](#)" on page 1348.

Usage: Asynchronous command

Manual operation: See "[Enable](#)" on page 309

MEASurement<m>:SOURce <SignalSource>, [<SignalSource2>]

Defines the source of the measurement. Availability of sources depends on the selected category and installed options.

Suffix:

<m> 1..10
See "[Selection of the measurement group: MEASurement<m>](#)" on page 1583.

Parameters:

<SignalSource>

C1W1 | C1W2 | C1W3 | C2W1 | C2W2 | C2W3 | C3W1 | C3W2 | C3W3 | C4W1 | C4W2 | C4W3 | M1 | M2 | M3 | M4 | M5 | M6 | M7 | M8 | R1 | R2 | R3 | R4 | SBUS1 | SBUS2 | SBUS3 | SBUS4 | D0 | D1 | D2 | D3 | D4 | D5 | D6 | D7 | D8 | D9 | D10 | D11 | D12 | D13 | D14 | D15 | TRK1 | TRK2 | TRK3 | TRK4 | TRK5 | TRK6 | TRK7 | TRK8 | SG1TL1 | SG1TL2 | SG2TL1 | SG2TL2 | SG3TL1 | SG3TL2 | SG4TL1 | SG4TL2 | SG5TL1 | SG5TL2 | SG6TL1 | SG6TL2 | SG7TL1 | SG7TL2 | SG8TL1 | SG8TL2 | Z1V1 | Z1V2 | Z1V3 | Z1V4 | Z1I1 | Z1I2 | Z1I3 | Z1I4 | Z2V1 | Z2V2 | Z2V3 | Z2V4 | Z2I1 | Z2I2 | Z2I3 | Z2I4 | DIFF1 | DIFF2 | COMMON1 | COMMON2 | | SRESponse1 | SRTRack1 | SDTRack1 | TJTRack1 | DJTRack1 | DDJTrack1 | PJTRack1 | RJTRack1 | SRESponse2 | SRTRack2 | SDTRack2 | TJTRack2 | DJTRack2 | DDJTrack2 | PJTRack2 | RJTRack2 | SEYE1 | SEYE2 | TNTRack1 | DNTRack1 | DDNTrack1 | PNTRack1 | RNOTrack1 | TNTRack2 | DNTRack2 | DDNTrack2 | PNTRack2 | RNOTrack2 | PJDTrack1 | PJDTrack2 | PNDTrack1 | PNDTrack2 | LANE1 | LANE2 | LANE3 | LANE

First source of the measurement, see [Chapter 27.4.2, "Waveform parameter"](#), on page 1371

<SignalSource2>

C1W1 | C1W2 | C1W3 | C2W1 | C2W2 | C2W3 | C3W1 | C3W2 | C3W3 | C4W1 | C4W2 | C4W3 | M1 | M2 | M3 | M4 | M5 | M6 | M7 | M8 | R1 | R2 | R3 | R4 | D0 | D1 | D2 | D3 | D4 | D5 | D6 | D7 | D8 | D9 | D10 | D11 | D12 | D13 | D14 | D15 | TRK1 | TRK2 | TRK3 | TRK4 | TRK5 | TRK6 | TRK7 | TRK8 | Z1V1 | Z1V2 | Z1V3 | Z1V4 | Z1I1 | Z1I2 | Z1I3 | Z1I4 | Z2V1 | Z2V2 | Z2V3 | Z2V4 | Z2I1 | Z2I2 | Z2I3 | Z2I4 | DIFF1 | DIFF2 | COMMON1 | COMMON2 | | SRESponse1 | SRTRack1 | SDTRack1 | TJTRack1 | DJTRack1 | DDJTrack1 | PJTRack1 | RJTRack1 | SRESponse2 | SRTRack2 | SDTRack2 | TJTRack2 | DJTRack2 | DDJTrack2 | PJTRack2 | RJTRack2 | SEYE1 | SEYE2 | TNTRack1 | DNTRack1 | DDNTrack1 | PNTRack1 | RNOTrack1 | TNTRack2 | DNTRack2 | DDNTrack2 | PNTRack2 | RNOTrack2 | PJDTrack1 | PJDTrack2 | PNDTrack1 | PNDTrack2

Second measurement source. The 2nd source is required for amplitude/time measurements that are performed on two waveforms (e.g. delay, phase).

Digital channels are only available if <SignalSource> is a digital channel.

Step response, advanced jitter track components and synthetic eye sources are available for amplitude/time measurements only.

*RST: C1W1,C2W1

Example:

See "[Simple frequency and amplitude measurement](#)" on page 1348.

Manual operation: See "Source, Source 2" on page 309

MEASurement<m>:FSRC <Source>

Defines the first measurement source.

The command is an alternative to [MEASurement<m>:SOURce](#).

Suffix:

<m> 1..10
See "Selection of the measurement group: MEASurement<m>" on page 1583.

Parameters:

<Source> Source of the measurement, see [MEASurement<m>:SOURce](#) on page 1584.
*RST: C1W1

Usage: Asynchronous command

MEASurement<m>:SSRC <Source2>

Defines the second measurement source.

The command is an alternative to [MEASurement<m>:SOURce](#).

Suffix:

<m> 1..10
See "Selection of the measurement group: MEASurement<m>" on page 1583.

Parameters:

<Source2> Second source of the measurement, see [MEASurement<m>:SOURce](#) on page 1584.
Digital channels are only available if a digital channel is set as first measurement source using [MEASurement<m>:FSRC](#).
*RST: C2W1

Usage: Asynchronous command

MEASurement<m>:CATegory <Category>

Defines the measurement category.

Suffix:

<m> 1..10
See "Selection of the measurement group: MEASurement<m>" on page 1583.

Parameters:

<Category> AMPTime | JITTER | EYEJitter | SPECTrum | HISTogram | PROTocol | OPTical

AMPTime

Amplitude and time measurements

JITTer

Jitter measurements, available if one of the jitter options is installed.

EYEJitter

Eye diagram measurements

SPECTrum

Spectrum measurements

HISTogram

Histogram measurements

PROTOcol

Protocol measurements

OPTical

Optical measurements

*RST: AMPTime

Example: See ["Creating and reading histograms"](#) on page 1349**Usage:** Asynchronous command**Manual operation:** See ["Category"](#) on page 309**MEASurement<m>:MAIN <MeasType>**

Defines the measurement that is used as a source for math calculations and result analysis. This measurement is mandatory in the measurement group. Further measurements are added to the measurement group with [MEASurement<m>:ADDITIONal](#).

Suffix:

<m>

1..10

See ["Selection of the measurement group: MEASurement<m>"](#) on page 1583.**Parameters:**

<MeasType>

Amplitude/time measurements

HIGH | LOW | AMPLitude | MAXimum | MINimum | PDELta | MEAN | RMS | STDDev | POVershoot | NOVershoot | AREA | RTIME | FTIME | PPULse | NPULse | PERiod | FREQUENCY | PDCYcle | NDCYcle | CYCarea | CYCMean | CYCRms | CYCStddev | PULCnt | DELay | PHASe | BWIDth | PSWitching | NSWitching | PULSetrain | EDGecount | SHT | SHR | DTOTrigger | PROBemeter | SLERising | SLEFalling | ATAR | SIGNallV | VOCrossing | NPERiod

See [Chapter 27.12.3, "Amplitude/time measurements"](#), on page 1594.

*RST value for amplitude/time measurements: AMPLitude.

Jitter measurements

CCJitter | NCJitter | CCWidth | CCDutycycle | TIE | UINterval | DRATe | SKWDelay | SKWPhase

Only available if option R&S RTO6-K12 is installed. See [Chapter 27.23.1, "Jitter measurements \(option R&S RTO6-K12\)"](#), on page 2671.

Eye diagram measurements

ERPercent | ERDB | EHEight | EWIDth | ETOP | EBASe | QFACtor | RMSNoise | SNRatio | DCDistortion | ERTime | EFTime | EBRate | EAMplitude | PPJitter | STDJitter | RMSJitter

See [Chapter 27.12.5, "Eye diagram measurements"](#), on page 1616

*RST value for eye/jitter measurements: ERPercent.

Spectrum measurements

CPOWer | OBWidth | SBWidth | THD | THDPCT | THDA | THDU | THDR | PLISt | HAR | THDF | SPAR

See [Chapter 27.12.6, "Spectrum"](#), on page 1629.

*RST value for spectrum measurements: CPOWer.

Histogram measurements

WCOunt | WSAMples | HSAMples | HPEak | PEAK | UPEakvalue | LPEakvalue | HMAXimum | HMINimum | MEDian | MAXMin | HMEan | HSTDdev | M1STddev | M2STddev | M3STddev | MKPositive | MKNegative

See [Chapter 27.12.8.2, "Histogram measurement"](#), on page 1646.

*RST value for histogram measurements: WCOunt.

Protocol measurements

NONE | AUDio | F2F | F2A | FLDValue | GAP | MBITrate | SBITrate | BIDLe | FCNT | FEC | FER | CFER

Requires option R&S RTO6-K500

See [Chapter 27.12.11, "Protocol"](#), on page 1659

Optical measurements

OAP | OMA

See [Chapter 27.12.7, "Optical measurements"](#), on page 1637.

Example: See ["Simple frequency and amplitude measurement"](#) on page 1348.

See ["Creating and reading histograms"](#) on page 1349

Usage: Asynchronous command

Manual operation: See ["Active measurements, Add / Remove"](#) on page 309

MEASurement<m>:ADDITIONal <MeasType>, <State>

MEASurement<m>:ADDITIONal? <MeasType>

Adds additional measurements to the indicated measurement group. Only one measurement can be enabled or disabled per command. The query returns the state of the specified measurement.

Note that each measurement group must contain measurements from the same category. For example, if the main measurement of measurement group 1 is amplitude, then you cannot enable an eye width measurement in the same measurement group.

Suffix:

<m> 1..10
See "[Selection of the measurement group: MEASurement<m>](#)" on page 1583.

Parameters:

<State> ON | OFF
Enables or disables the measurement.

Parameters for setting and query:

<MeasType> See [MEASurement<m>:MAIN](#) on page 1587.

Usage: Asynchronous command

Manual operation: See "[Active measurements, Add / Remove](#)" on page 309

MEASurement<m>:AON

Enables all additional measurements in all categories of the indicated measurement.

Suffix:

<m> 1..10
See "[Selection of the measurement group: MEASurement<m>](#)" on page 1583.

Usage: Event
Asynchronous command

MEASurement<m>:AOFF

Disables all additional measurements in all categories of the indicated measurement.

Suffix:

<m> 1..10
See "[Selection of the measurement group: MEASurement<m>](#)" on page 1583.

Usage: Event
Asynchronous command

27.12.2 Results

MEASurement<m>:ARES?	1590
MEASurement<m>:ARNames	1591
MEASurement<m>:RESult[:ACTual]?	1591
MEASurement<m>:RESult:AVG?	1591
MEASurement<m>:RESult:EVTCount?	1591
MEASurement<m>:RESult:NPEak?	1591

MEASurement<m>:RESult:PPEak?.....	1591
MEASurement<m>:RESult:RELiability?.....	1591
MEASurement<m>:RESult:RMS?.....	1591
MEASurement<m>:RESult:WFMCount?.....	1591
MEASurement<m>:RESult:STDDev?.....	1591
MEASurement<m>:RESult:START?.....	1593
MEASurement<m>:RESult:STOP?.....	1593
MEASurement<m>:RESult:COUNt?.....	1593

MEASurement<m>:ARES?

Returns the results of all active measurements for the selected measurement group. If statistics are enabled, the instrument returns also statistical results.

Suffix:

<m> 1..10

See "[Selection of the measurement group: MEASurement<m>](#)" on page 1583.

Return values:

<sData> Result string

Example: :MEASurement:ARES?
2.351778656126e-001,1.343873517787e-001,
-1.343873517787e-001

Example: :MEASurement:ARNames 1
:MEASurement:ARES?
Amplitude: 2.351778656126e-001,Max:
1.343873517787e-001,Min: -1.343873517787e-001

Example: :MEASurement:ARNames 1
:MEASurement:STATistics:ENABLE 1
:MEASurement:ARES?
Amplitude:
2.312252964427e-001,2.608695652174e-001,
2.292490118577e-001,2.391822576775e-001,
2.392462568683e-001,5.533663458383e-003,12447,
12447,Max: 1.343873517787e-001,
1.343873517787e-001,1.324110671937e-001,
1.340297640714e-001, 1.340319233732e-001,
7.608360495310e-004,12447,12447, Min:
-1.324110671937e-001,-1.324110671937e-001,
-1.343873517787e-001,-1.340169449387e-001,
1.340191641476e-001,7.712812700636e-004,12447,
12447
Results: current, peak+, peak-, average, RMS,
standard deviation, event count, waveform count

Usage:

Query only
Asynchronous command

MEASurement<m>:ARNames <Identifier>

Enables a prefix that indicates the measurement in the result string of the [MEASurement<m>:ARES?](#) command.

Suffix:

<m> 1..10
See "[Selection of the measurement group: MEASurement<m>](#)" on page 1583.

Parameters:

<Identifier> ON | OFF
*RST: OFF

Example:

```
:MEASurement:ARNames 1
:MEASurement:ARES?
Low: -1.185770750988e-001,Amplitude:
2.371541501976e-001,Max: 1.343873517787e-001
```

Usage:

Asynchronous command

MEASurement<m>:RESult[:ACTual]? [<MeasType>], [<BaseLevel>], [<TargetLevel>]

MEASurement<m>:RESult:AVG? [<MeasType>], [<BaseLevel>], [<TargetLevel>]

**MEASurement<m>:RESult:EVTCount? [<MeasType>], [<BaseLevel>],
[<TargetLevel>]**

MEASurement<m>:RESult:NPEak? [<MeasType>], [<BaseLevel>], [<TargetLevel>]

MEASurement<m>:RESult:PPEak? [<MeasType>], [<BaseLevel>], [<TargetLevel>]

**MEASurement<m>:RESult:RELiability? [<MeasType>], [<BaseLevel>],
[<TargetLevel>]**

MEASurement<m>:RESult:RMS? [<MeasType>], [<BaseLevel>], [<TargetLevel>]

**MEASurement<m>:RESult:WFMCCount? [<MeasType>], [<BaseLevel>],
[<TargetLevel>]**

MEASurement<m>:RESult:STDDev? [<MeasType>], [<BaseLevel>], [<TargetLevel>]

Return the statistic results of the specified measurement. If no parameter is specified, the result of the main measurement is returned. The main measurement is defined using [MEASurement<m>:MAIN](#).

- [:ACTual]: current measurement result
- AVG: average of the long-term measurement results
- EVTCount: number of measurement results in the long-term measurement
- NPEak: negative peak value of the long-term measurement results
- PPEak: positive peak value of the long-term measurement results
- RELiability: reliability of the measurement result
- RMS: RMS value of the long-term measurement results
- STDDev: standard deviation of the long-term measurement results

For a detailed description of the results, see "[Selection of the measurement group: MEASurement<m>](#)" on page 1583.

Suffix:

<m>

1..10

See ["Selection of the measurement group: MEASurement<m>"](#) on page 1583.

Query parameters:

<MeasType>

Amplitude/time measurements

HIGH | LOW | AMPLitude | MAXimum | MINimum | PDELta | MEAN | RMS | STDDev | POVershoot | NOVershoot | AREA | RTIME | FTIME | PPULse | NPULse | PERiod | FREQuency | PDCYcle | NDCYcle | CYCarea | CYCMean | CYCRms | CYCStddev | PULCnt | DELay | PHASe | BWIDth | PSWitching | NSWitching | PULSetrain | EDGecount | SETup | HOLD | SHR | DTOTrigger | PROBemeter | SLERising | SLEFalling | ATAR | SIGNallvl | VOCrossing | NPERiod

See [Chapter 27.12.3, "Amplitude/time measurements"](#), on page 1594.

Jitter measurements (option R&S RTO6-K12)

CCJitter | NCJitter | CCWidth | CCDutycycle | TIE | UINterval | DRATe | SKWDelay | SKWPhase

See [Chapter 27.23.1, "Jitter measurements \(option R&S RTO6-K12\)"](#), on page 2671

Eye diagram measurements

ERPercent | ERDB | EHEight | EWIDth | ETOP | EBASe | QFACtor | RMSNoise | SNRatio | DCDistortion | ERTime | EFTime | EBRate | EAMPLitude | PPJitter | STDJitter | RMSJitter | CPPercent

See [Chapter 27.12.5, "Eye diagram measurements"](#), on page 1616.

Spectrum measurements

CPOWer | OBWidth | SBWidth | THD | THDPCT | THDA | THDU | THDR | PLISt | HAR | THDF | SPAR

See [Chapter 27.12.6, "Spectrum"](#), on page 1629.

Histogram measurements

WCOunt | WSAMples | HSAMples | HPEak | PEAK | UPEakvalue | LPEakvalue | HMAXimum | HMINimum | MEDian | MAXMin | HMEan | HSTDdev | M1STddev | M2STddev | M3STddev | MKPositive | MKNegative

See [Chapter 27.12.8.2, "Histogram measurement"](#), on page 1646.

Protocol measurements

NONE | AUDio | F2F | T2F | FLDValue | GAP | MBITrate | SBITrate | BIDLe | FCNT | FEC | FER | CFER

Requires option R&S RTO6-K510 for type AUDio, or option R&S RTO6-K500.

Optical measurements

OAP | OMA

See [Chapter 27.12.7, "Optical measurements"](#), on page 1637.

<BaseLevel>	Sets the base level for signals with PAM order > 2
<TargetLevel>	Sets the target level for signals with PAM order > 2
Example:	See " Simple frequency and amplitude measurement " on page 1348. See " Creating and reading histograms " on page 1349
Usage:	Query only

MEASurement<m>:RESult:START? [<MeasType>], [<BaseLevel>], [<TargetLevel>]
MEASurement<m>:RESult:STOP? [<MeasType>], [<BaseLevel>], [<TargetLevel>]

Return the start and stop times of the specified measurement. The parameter defines the measurement. If no parameter is specified, the result of the main measurement is returned. The main measurement is defined using [MEASurement<m>:MAIN](#).

Suffix:

<m>	1..10 See " Selection of the measurement group: MEASurement<m> " on page 1583.
-----	---

Query parameters:

<MeasType>	See MEASurement<m>:RESult:STDDev? on page 1591.
<BaseLevel>	Sets the base level for signals with PAM order > 2
<TargetLevel>	Sets the target level for signals with PAM order > 2
Usage:	Query only

MEASurement<m>:RESult:COUNT? [<MeasType>], [<BaseLevel>]

Returns the number of result groups that are returned by [MEASurement:RESult:ACTual?](#) HAR.

Suffix:

<m>	1..10 See " Selection of the measurement group: MEASurement<m> " on page 1583.
-----	---

Query parameters:

<MeasType>	HAR The command is only relevant for harmonic search.
<BaseLevel>	Sets the base level for signals with PAM order > 2

Return values:

<TargetLevel>	Sets the target level for signals with PAM order > 2
---------------	--

Example:

```
:MEASurement:RESult:ACTual? HAR
99.9;-6.000139236;199.8;-80.701713562;299.7;-15.528377533;
:MEASurement:RESult:COUNT? HAR
4
```

Usage:	Query only
---------------	------------

Firmware/software: Version 2.70

27.12.3 Amplitude/time measurements

The following table lists the <MeasType> parameter values with a short description.

In addition, the suffixes <n> for limit-check remote commands are listed.

For a detailed description, see [Chapter 8.2.4.1, "Overview of amplitude/time measurements"](#), on page 316.

Table 27-6: Amplitude and time measurements

<MeasType> parameter value (remote control)	Measurement (manual operation)	Description, result	Suffix <n>
HIGH	High	High signal level	1
LOW	Low	Low signal level	2
AMPLitude	Amplitude	Amplitude of the signal	3
MAXimum	Max	Maximum value of the waveform	4
MINimum	Min	Minimum value of the waveform	5
PDELta	Peak to peak	Peak-to-peak value of the waveform	6
MEAN	Mean	Mean value of the waveform	7
RMS	RMS	RMS (Root Mean Square) value of the voltage	8
STDDev	σ (S-dev)	Standard deviation of the waveform	9
POVershoot	Pos. overshoot	Positive overshoot of a square wave	10
NOVershoot	Neg. overshoot	Negative overshoot of a square wave	11
AREA	Area	Area beneath the waveform (integral)	12
RTIME	Rise time	Rise time of the left-most rising edge of the waveform.	13
FTIME	Fall time	Falling time of the left-most falling edge of the waveform.	14
PPULse	Pos. pulse	Width of a positive pulse – a rising edge followed by a falling edge. The measurement requires at least one complete period of a triggered signal.	15
NPULse	Neg. pulse	Width of a negative pulse – a falling edge followed by a rising edge. The measurement requires at least one complete period of a triggered signal.	16
PERiod	Period	Length of the left-most signal period of the waveform	17
FREQUENCY	Frequency	Frequency of the signal. The result is based on the period measurement.	18
PDCYcle	Pos. duty cycle	Positive duty cycle. The measurement requires at least one complete period of a triggered signal.	19
NDCYcle	Neg. duty cycle	Negative duty cycle. The measurement requires at least one complete period of a triggered signal.	20

<MeasType> parameter value (remote control)	Measurement (manual operation)	Description, result	Suffix <n>
CYCare	Cycle area	Area (integral) beneath one cycle	21
CYCMean	Cycle mean	Mean value of one cycle	22
CYCRms	Cycle RMS	The RMS (Root Mean Square) value of one cycle	23
CYCStddev	Cycle σ (S-dev)	Standard deviation of one cycle	24
PULCnt	Pulse count	Number of positive or negative pulses of the waveform, or both	25
DELay	Delay	Time difference between any edges of two measurement sources at any reference level. The measurement result is negative if the edge of the second source comes before the edge of the first source.	26
PHASe	Phase	Phase difference between two waveforms	27
BWIDth	Burst width	Duration of one burst, measured from the first edge to the last	28
PSWitching	Pos. switching	Settling time at rising edges	29
NSWitching	Neg. switching	Settling time at falling edges	30
PULSetrain	Pulse train	Duration of N positive pulses, measured from the rising edge of the first pulse to the falling edge of the N-th pulse. N has to be configured.	31
EDGecount	Edge count	Number of positive or negative edges of the waveform, or both	32
SETup	Setup time	Parameters to query the setup and hold times. Use these parameters only in following queries: <ul style="list-style-type: none"> • <code>MEASurement<m>:ARES?</code> • <code>MEASurement<n>:RESult:..</code> commands 	33
HOLD	Hold time		
SHT	Setup/Hold time	Setting parameter to enable Setup/Hold time measurements. Use this parameter only as setting in: <ul style="list-style-type: none"> • <code>MEASurement<m>:MAIN</code> on page 1587 • <code>MEASurement<m>:ADDITIONal</code> on page 1588 	35
SHR	Setup/Hold ratio	Setup/Hold ratio measurement. Setup/Hold ratio is the ratio of the setup time to the sum of hold and setup time: $T_{Setup} / (T_{Setup} + T_{Hold})$ Use this parameter as setting to activate the Setup/Hold ratio measurement in: <ul style="list-style-type: none"> • <code>MEASurement<m>:MAIN</code> on page 1587 • <code>MEASurement<m>:ADDITIONal</code> on page 1588 It is also used in the following queries: <ul style="list-style-type: none"> • <code>MEASurement<m>:ARES?</code> • <code>MEASurement<n>:RESult:..</code> Used also in queries with and commands.	36
Used for jitter measurements (limit checks) see Chapter 27.23.1, "Jitter measurements (option R&S RTO6-K12)" , on page 2671.			37 to 45

<MeasType> parameter value (remote control)	Measurement (manual operation)	Description, result	Suffix <n>
DTOTrigger	Delay to trigger	Time between the trigger event and a following signal slope. High accuracy even if the trigger event is outside the acquisition data.	46
PROBemeter	Trig. ProbeMeter	DC voltage measured by the connected active R&S probe	47
SLE Rising	Slew rate on rising edge	Steepness of the rising edge: voltage difference between the lower and higher reference level, divided by the rise time.	48
SLE Falling	Slew rate on falling edge	Steepness of the falling edge: voltage difference between the higher and lower reference level, divided by the fall time.	49
ATAR	Arithmetic for amplitude/time measurements	Basic arithmetic calculations with measurement values and scalars.	50
SIGNallvl	Signal level	The value of the signal level	51
VOCrossing	Voltage crossing	The point where the waveform crosses a predefined voltage level.	52
NPERiod	N-period	The time passed for N consecutive crossings	53

MEASurement<m>:ENVSelect.....	1597
MEASurement<m>:DETThreshold.....	1597
MEASurement<m>:AMPTime:ALEVel.....	1597
MEASurement<m>:AMPTime:PFSlope.....	1598
MEASurement<m>:AMPTime:PSlope.....	1598
MEASurement<m>:AMPTime:DElay<n>:DIRection.....	1599
MEASurement<m>:AMPTime:DElay<n>:ECOunt.....	1599
MEASurement<m>:AMPTime:DElay<n>:LSElect.....	1600
MEASurement<m>:AMPTime:DElay<n>:SLOPe.....	1600
MEASurement<m>:AMPTime:PTCount.....	1601
MEASurement<m>:AMPTime:ESlope.....	1601
MEASurement<m>:AMPTime:CSlope.....	1601
MEASurement<m>:AMPTime:CLCK<n>:LSElect.....	1602
MEASurement<m>:AMPTime:DATA<n>:LSElect.....	1602
MEASurement<m>:AMPTime:DTOTrigger<n>:SLOPe.....	1603
MEASurement<m>:AMPTime:DTOTrigger<n>:LSElect.....	1603
MEASurement<m>:AMPTime:LCHeck<n>:VALid.....	1603
MEASurement<m>:AMPTime:LCHeck<n>:LOWer:LIMit.....	1604
MEASurement<m>:AMPTime:LCHeck<n>:UPPer:LIMit.....	1604
MEASurement<m>:AMPTime:LCHeck<n>:LOWer:MARGin.....	1604
MEASurement<m>:AMPTime:LCHeck<n>:UPPer:MARGin.....	1604
MEASurement<m>:AMPTime:NPERiod.....	1605
MEASurement<m>:AMPTime:VCHYsteresis.....	1605
MEASurement<m>:AMPTime:EINCrement.....	1606
MEASurement<m>:AMPTime:PRLevel.....	1606

MEASurement<m>:AMPTime:PRLMode.....	1606
MEASurement<m>:AMPTime:PLHYsteresis.....	1607
MEASurement<m>:AMPTime:VCMLLevel.....	1607

MEASurement<m>:ENVSelect <EnvelopeCurve>

The command is only relevant for measurements on envelope waveforms. It selects the envelope to be used for measurement.

Suffix:

<m> 1..10
See "[Selection of the measurement group: MEASurement<m>](#)" on page 1583.

Parameters:

<EnvelopeCurve> MIN | MAX | BOTH
MIN: measures on the lower envelope
MAX: measures on the upper envelope
BOTH: the envelope is ignored and the waveform measured as usual
*RST: BOTH

Usage: Asynchronous command

Manual operation: See "[Envelope](#)" on page 309

MEASurement<m>:DETThreshold <SignDetectThres>

The measured signal value must reach a certain voltage or bit to be included in the measurement algorithm. This minimum value is defined in percent of the signal amplitude (difference of high and low signal levels). Values below this value are considered to be noise and they are ignored. The setting is relevant for area, time, and counting measurements.

Suffix:

<m> 1..10
irrelevant

Parameters:

<SignDetectThres> Range: 0 to 50
Increment: 1
*RST: 5
Default unit: %

Usage: Asynchronous command

Manual operation: See "[Signal threshold](#)" on page 322

MEASurement<m>:AMPTime:ALEVEL <AreaLevel>

Defines the reference level used to integrate the waveform.

Suffix:

<m>

1..10

See "[Selection of the measurement group: MEASurement<m>](#)" on page 1583.**Parameters:**

<AreaLevel>

Range: -100E+24 to 100E+24

Increment: 0

*RST: 0

Default unit: V

Usage:

Asynchronous command

Manual operation: See "[Area level](#)" on page 322**MEASurement<m>:AMPTime:PFSlope <PeriodSlope>**

Selects the slope direction for frequency and period measurements.

Suffix:

<m>

1..10

See "[Selection of the measurement group: MEASurement<m>](#)" on page 1583.**Parameters:**

<PeriodSlope>

FIRSt | POSitive | NEGative | EITHer

POSitive | NEGative

Measures the time between rising or falling edges, respectively.

EITHer

In multiple measurements, the time is measured both between rising edges and between falling edges.

In single measurements, the first edge is taken for the measurement.

FIRSt

Time is measured either between rising edges or between falling edges. The first edge is taken for the measurement. In single measurements, it works the same way as "Either".

Only available for analog measurement sources.

*RST: FIRSt (analog source), POSitive (digital source)

Usage:

Asynchronous command

Manual operation: See "[Measured slope](#)" on page 323**MEASurement<m>:AMPTime:PSLope <PulsesSlope>**

Sets the first slope of the pulses to be counted. The setting is only relevant for pulse count measurement (MEASurement<m>:MAIN PULCnt or MEASurement<m>:ADDITIONAL PULCnt, ON).

Suffix:

<m> 1..10
See "[Selection of the measurement group: MEASurement<m>](#)" on page 1583.

Parameters:

<PulsesSlope> POSitive | NEGative | EITHer
Count either positive or negative pulses, or both.
*RST: POSitive

Usage: Asynchronous command

Manual operation: See "[Pulses slope](#)" on page 323

MEASurement<m>:AMPTime:DELay<n>:DIRection <EdgeCntDirct>

Selects the direction for counting slopes for each source: from the beginning of the waveform, or from the end.

Suffix:

<m> 1..10
See "[Selection of the measurement group: MEASurement<m>](#)" on page 1583.

<n> 1..2
Selects the source number.

Parameters:

<EdgeCntDirct> FRFI | FRLA
FRFI - FRom FirSt, counting starts with the first edge of the waveform.
FRLA - FRom LAsT, counting starts with the last edge of the waveform.
*RST: FRFI

Usage: Asynchronous command

Manual operation: See "[Settings for delay and phase measurements \(analog sources\)](#)" on page 323

MEASurement<m>:AMPTime:DELay<n>:ECOunt <EdgeIndex>

Sets the number of the edge that is relevant for delay measurement for each source.

Suffix:

<m> 1..10
See "[Selection of the measurement group: MEASurement<m>](#)" on page 1583.

<n> 1..2
Selects the source number.

Parameters:

<EdgeIndex> Edge number
 Range: 1 to 100000
 Increment: 1
 *RST: 1

Usage: Asynchronous command

Manual operation: See "[Settings for delay and phase measurements \(analog sources\)](#)" on page 323

MEASurement<m>:AMPTime:DELay<n>:LSElect <DlyLevSel>

Selects the reference level on which the time is measured for each source.

Suffix:

<m> 1..10
 See "[Selection of the measurement group: MEASurement<m>](#)" on page 1583.

<n> 1..2
 Selects the source number.

Parameters:

<DlyLevSel> UPPer | MIDDle | LOWer
 *RST: MIDDle

Usage: Asynchronous command

Manual operation: See "[Settings for delay and phase measurements \(analog sources\)](#)" on page 323

MEASurement<m>:AMPTime:DELay<n>:SLOPe <Slope>

Sets the edge of each source, between which the delay is measured.

Suffix:

<m> 1..10
 See "[Selection of the measurement group: MEASurement<m>](#)" on page 1583.

<n> 1..2
 Selects the source number.

Parameters:

<Slope> POSitive | NEGative | EITHer
 *RST: POSitive

Usage: Asynchronous command

Manual operation: See "[Settings for delay and phase measurements \(analog sources\)](#)" on page 323

MEASurement<m>:AMPTime:PTCount <PulseCount>

Sets the number of positive pulses for the pulse train measurement. It measures the duration of N positive pulses from the rising edge of the first pulse to the falling edge of the N-th pulse.

Suffix:

<m> 1..10

See "[Selection of the measurement group: MEASurement<m>](#)" on page 1583.

Parameters:

<PulseCount> Range: 1 to 2147483647
Increment: 1
*RST: 1

Usage: Asynchronous command

Manual operation: See "[Pulse count](#)" on page 326

MEASurement<m>:AMPTime:ESLope <EdgesSlope>

Sets the edge direction to be counted: rising edges, falling edges, or both. The setting is only relevant for edge count measurement (MEASurement<m>:MAIN EDGecount or MEASurement<m>:ADDITIONAL EDGecount, ON).

Suffix:

<m> 1..10

See "[Selection of the measurement group: MEASurement<m>](#)" on page 1583.

Parameters:

<EdgesSlope> POSitive | NEGative | EITHer
*RST: POSitive

Usage: Asynchronous command

Manual operation: See "[Edges slope](#)" on page 326

MEASurement<m>:AMPTime:CSLope <SetHoldClkSlp>

Sets the edge of the clock from which the setup and hold times are measured.

Suffix:

<m> 1..10

See "[Selection of the measurement group: MEASurement<m>](#)" on page 1583.

Parameters:

<SetHoldClkSlp> POSitive | NEGative | EITHer

EITHer

The clock edges next to the data edge are considered regardless of the clock slope.

*RST: POSitive

Usage:

Asynchronous command

Manual operation: See ["Setup/Hold measurement settings"](#) on page 324

MEASurement<m>:AMPTime:CLCK<n>:LSElect <ClkLevSel>

Selects the reference level of the clock on which the time is measured. Reference level and clock slope define the time point for setup and hold measurements.

Suffix:

<m> 1..10

See ["Selection of the measurement group: MEASurement<m>"](#) on page 1583.

<n> 1..2

The suffix is irrelevant, omit it.

Parameters:

<ClkLevSel> UPPer | MIDDle | LOWer

*RST: MIDDle

Usage:

Asynchronous command

Manual operation: See ["Clock ref level"](#) on page 325

MEASurement<m>:AMPTime:DATA<n>:LSElect <DatLevSel>

Selects the reference level of the data on which the setup and hold time are measured.

Suffix:

<m> 1..10

See ["Selection of the measurement group: MEASurement<m>"](#) on page 1583.

<n> 1..2

The suffix is irrelevant, omit it.

Parameters:

<DatLevSel> UPPer | MIDDle | LOWer

*RST: MIDDle

Usage:

Asynchronous command

Manual operation: See ["Ref level"](#) on page 326

MEASurement<m>:AMPTime:DTOTrigger<n>:SLOPe <DlyTrigSlp>

Sets the edge direction to be used for delay measurement.

Suffix:

<m>	1..10 See " Selection of the measurement group: MEASurement<m> " on page 1583.
<n>	1..2 The suffix is irrelevant.

Parameters:

<DlyTrigSlp>	POSitive NEGative EITHER *RST: POSitive
--------------	--

Usage: Asynchronous command

Manual operation: See "[Delay to trigger measurement settings](#)" on page 326

MEASurement<m>:AMPTime:DTOTrigger<n>:LSElect <DlyTrigLevSel>

Selects the reference level of the measurement source on which the delay is measured.

Suffix:

<m>	1..10 See " Selection of the measurement group: MEASurement<m> " on page 1583.
<n>	1..2 The suffix is irrelevant.

Parameters:

<DlyTrigLevSel>	UPPer MIDDle LOWer *RST: MIDDle
-----------------	--

Usage: Asynchronous command

Manual operation: See "[Delay to trigger measurement settings](#)" on page 326

MEASurement<m>:AMPTime:LCHeck<n>:VALid <ValidRange>

Selects the limit range for each measurement.

Suffix:

<m>	1..10 See " Selection of the measurement group: MEASurement<m> " on page 1583.
<n>	1..53 Number of the amplitude/time measurement, see Table 27-6 .

Parameters:

<ValidRange>	ILIMit ULIMit LLIMit OLIMit
--------------	-----------------------------------

ILIMit

Inside (within) limit; between the upper and lower limit values

ULIMit

Upper limit; above the upper limit value

LLIMit

Lower limit; below the lower limit value

OLIMit

Outside limit; above the upper limit or below the lower limit values

*RST: ILIMit

Usage: Asynchronous command

Manual operation: See "[Upper limit, Lower limit, Upper margin, Lower margin, Valid range](#)" on page 371

MEASurement<m>:AMPTime:LCHeck<n>:LOWer:LIMit <LowerLimit>

MEASurement<m>:AMPTime:LCHeck<n>:UPPer:LIMit <UpperLimit>

Define the lower and upper limit for limit checking, respectively. The valid range is defined using the [MEASurement<m>:AMPTime:LCHeck<n>:VALid](#) command.

Suffix:

<m> 1..10

See "[Selection of the measurement group: MEASurement<m>](#)" on page 1583.

<n> 1..53

Number of the amplitude/time measurement, see [Table 27-6](#).

Parameters:

<UpperLimit> Range: -100 to 100

Increment: 10E-6

*RST: 0

Usage: Asynchronous command

Manual operation: See "[Upper limit, Lower limit, Upper margin, Lower margin, Valid range](#)" on page 371

MEASurement<m>:AMPTime:LCHeck<n>:LOWer:MARGin <LowerMargin>

MEASurement<m>:AMPTime:LCHeck<n>:UPPer:MARGin <UpperMargin>

Define the lower and upper margins for the limit check, respectively. Margins are not as strict as limits and must be within the valid value range. The valid range is defined using the [MEASurement<m>:AMPTime:LCHeck<n>:VALid](#) command.

Suffix:

<m> 1..10

See "[Selection of the measurement group: MEASurement<m>](#)" on page 1583.

<n> 1..53
Number of the amplitude/time measurement type, see [Table 27-6](#).

Parameters:

<UpperMargin> Range: -100 to 100
Increment: 10E-6
*RST: 0

Usage: Asynchronous command

Manual operation: See "[Upper limit, Lower limit, Upper margin, Lower margin, Valid range](#)" on page 371

MEASurement<m>:AMPTime:NPPeriod <PeriodNNum>

Selects the N-period number, the number of consecutive periods of the waveform for N-period measurements.

Suffix:

<m> 1..10
See "[Selection of the measurement group: MEASurement<m>](#)" on page 1583.

Parameters:

<PeriodNNum> Range: 1 to 2147483647
Increment: 1
*RST: 2

Usage: Asynchronous command

Manual operation: See "[Settings for N-Period](#)" on page 329

MEASurement<m>:AMPTime:VCHYsteresis <VoltageCrossingHyst>

Sets the minimum level difference between the two sources before the next crossing can be detected.

Suffix:

<m> 1..10
See "[Selection of the measurement group: MEASurement<m>](#)" on page 1583.

Parameters:

<VoltageCrossingHyst> Range: 0 to 100E+24
Increment: 0.01
*RST: 0
Default unit: V

Usage: Asynchronous command

Manual operation: See "[Settings for Voltage crossing](#)" on page 328

MEASurement<m>:AMPTime:EIIncrement <PeriodNEdgeIncrement>

Sets the number of edges to be skipped per measurement event for N-period measurements.

Suffix:

<m> 1..10

See "[Selection of the measurement group: MEASurement<m>](#)" on page 1583.

Parameters:

<PeriodNEdgeIncrement> Range: 0 to 2147483647
Increment: 1
*RST: 0

Usage: Asynchronous command

Manual operation: See "[Settings for N-Period](#)" on page 329

MEASurement<m>:AMPTime:PRLLevel <PlsRefLevManual>

Available only if [MEASurement<m>:AMPTime:PRLMode](#) is set to USER.

Sets the reference level for the positive and negative pulse measurements for the user defined reference level.

Suffix:

<m> 1..10

See "[Selection of the measurement group: MEASurement<m>](#)" on page 1583.

Parameters:

<PlsRefLevManual> Range: -100E+24 to 100E+24
Increment: 0.01
*RST: 0
Default unit: V

Usage: Asynchronous command

Manual operation: See "[Settings for Pos./ Neg. pulse measurements](#)" on page 327

MEASurement<m>:AMPTime:PRLMode <PlsRefLevMd>

Selects the reference level of the measurement source on which the pulse is measured: upper, middle, lower level or user defined level.

This command is relevant for the positive and negative pulse measurements.

Suffix:

<m> 1..10

See "[Selection of the measurement group: MEASurement<m>](#)" on page 1583.

Parameters:

<PlsRefLevMd> UPPer | MIDDle | LOWer | USER
 *RST: MIDDle

Usage: Asynchronous command

Manual operation: See "[Settings for Pos./ Neg. pulse measurements](#)" on page 327

MEASurement<m>:AMPTime:PLHYsteresis <PlsManualHyst>

Available only if [MEASurement<m>:AMPTime:PRLMode](#) is set to USER.

Sets a hysteresis value for the measurement.

Suffix:

<m> 1..10
 See "[Selection of the measurement group: MEASurement<m>](#)" on page 1583.

Parameters:

<PlsManualHyst> Range: 0 to 100E+24
 Increment: 0.01
 *RST: 0
 Default unit: V

Usage: Asynchronous command

Manual operation: See "[Settings for Pos./ Neg. pulse measurements](#)" on page 327

MEASurement<m>:AMPTime:VCMLLevel <VoltageCrossingMeasLev>

Sets the measurement reference level for the voltage crossing calculation.

Suffix:

<m> 1..10
 See "[Selection of the measurement group: MEASurement<m>](#)" on page 1583.

Parameters:

<VoltageCrossingMeasLev> Range: -100E+24 to 100E+24
 Increment: 0.01
 *RST: 0
 Default unit: V

Usage: Asynchronous command

Manual operation: See "[Settings for Voltage crossing](#)" on page 328

27.12.4 Arithmetic for amplitude/time and spectrum measurements

MEASurement<m>:AMPTime:ARITHmetic:CONStant	1608
MEASurement<m>:AMPTime:ARITHmetic:COUNit	1608
MEASurement<m>:AMPTime:ARITHmetic:CUNState	1609

MEASurement<m>:AMPTime:ARITHmetic:CUUNit.....	1609
MEASurement<m>:AMPTime:ARITHmetic:CUUState.....	1610
MEASurement<m>:AMPTime:ARITHmetic:OPERator.....	1610
MEASurement<m>:AMPTime:ARITHmetic:PARAmeter<n>:AMPTime.....	1610
MEASurement<m>:AMPTime:ARITHmetic:PARAmeter<n>:GROup.....	1611
MEASurement<m>:AMPTime:ARITHmetic:PARAmeter<n>:SPECtrum.....	1611
MEASurement<m>:AMPTime:ARITHmetic:PARAmeter<n>:TYPE.....	1612
MEASurement<m>:SPECtrum:ARITHmetic:CONStant.....	1612
MEASurement<m>:SPECtrum:ARITHmetic:COUNit.....	1613
MEASurement<m>:SPECtrum:ARITHmetic:CUNState.....	1613
MEASurement<m>:SPECtrum:ARITHmetic:CUUNit.....	1614
MEASurement<m>:SPECtrum:ARITHmetic:CUUState.....	1614
MEASurement<m>:SPECtrum:ARITHmetic:OPERator.....	1614
MEASurement<m>:SPECtrum:ARITHmetic:PARAmeter<n>:AMPTime.....	1614
MEASurement<m>:SPECtrum:ARITHmetic:PARAmeter<n>:GROup.....	1615
MEASurement<m>:SPECtrum:ARITHmetic:PARAmeter<n>:SPECtrum.....	1615
MEASurement<m>:SPECtrum:ARITHmetic:PARAmeter<n>:TYPE.....	1616

MEASurement<m>:AMPTime:ARITHmetic:CONStant <ArithConstant>

Sets a constant numeric value as the second operand of the amplitude/time arithmetic measurement.

Suffix:

<m> 1..10
See "[Selection of the measurement group: MEASurement<m>](#)" on page 1583.

Parameters:

<ArithConstant> Range: 0 to 0
Increment: 1
*RST: 0

Usage: Asynchronous command

Manual operation: See "[Constant](#)" on page 331

MEASurement<m>:AMPTime:ARITHmetic:COUNit <ArithCstUnt>

Selects the operation type to be performed on the selected operands for the amplitude/time arithmetic measurement.

Suffix:

<m> 1..10
See "[Selection of the measurement group: MEASurement<m>](#)" on page 1583.

Parameters:

<ArithCstUnt> DBM | DB | DB_HZ | DB_GHZ | DBC | DBC_HZ | DBPW_HZ | DBW | DBPW | DBM_HZ | DBMW | W | MW | W_HZ | J | V_S | A_S | DBV | DBMV | DBMV_HZ | DBMV_MHZ | DBUV | DBUV_HZ | DBUV_SQRT_HZ | DBUV_MHZ | DBUV_M | DBMV_M_HZ | DBUV_M_MHZ | V | MV | UV | VPP | VV | UV_HZ | UV_M_HZ | V_SQRT_HZ | DBA | DBMA | DBMA_HZ | DBMA_MHZ | DBUA | DBUA_HZ | DBUA_SQRT_HZ | DBUA_MHZ | DBUA_M | DBUA_M_HZ | DBUA_M_MHZ | A | UA_HZ | UA_M_HZ | A_SQRT_HZ | PCT | DBPT | DBPT_HZ | H | PH_GHZ | F | FF_GHZ | OHM | SIEMENS | S | DBPS | DBNS | DBUS | DBMS | DBS | HZ | DBHZ | DBKHZ | DBMHZ | DBGHZ | M | IN | DEG | RAD | PCT | SYMB | VA_LIN | VA_LOG | NONE | IRE | MILES | SYMB_S | MSYMB_S | MBIT_S | BIT_S | BIT | WORD | PPM | DB | PER_SEC | S_DIV | HZ_DIV | V_DIV | A_DIV | OHM_DIV | NONE_DIV | DIV | BER | S | S_S | BAUD | TDEG | VS | USER | UINV | W_DIV | V_V | A_V | W_V | BYTS | V_A | V_W | VA | VAR | UI | LN | HRS | MIN

*RST: NONE

Usage: Asynchronous command

Manual operation: See ["Constant unit"](#) on page 331

MEASurement<m>:AMPTime:ARITHmetic:CUNState <ArithCustomNmeSt>

Enables the use of user-defined custom name for the amplitude/time arithmetic measurement.

Suffix:

<m> 1..10
See ["Selection of the measurement group: MEASurement<m>"](#) on page 1583.

Parameters:

<ArithCustomNmeSt> ON | OFF

*RST: OFF

Usage: Asynchronous command

Manual operation: See ["Custom"](#) on page 331

MEASurement<m>:AMPTime:ARITHmetic:CUUnit <ArithCustomUnit>

Sets a user-defined value of the unit for the amplitude/time arithmetic measurement.

Suffix:

<m> 1..10
See ["Selection of the measurement group: MEASurement<m>"](#) on page 1583.

Parameters:

<ArithCustomUnit>

Usage: Asynchronous command**MEASurement<m>:AMPTime:ARITHmetic:CUUState <ArithCustomUntSt>**

Enables the use of user-defined custom unit for the amplitude/time arithmetic measurement. You can set the unit with [MEASurement<m>:AMPTime:ARITHmetic:CUUNit](#).

Suffix:

<m> 1..10

See "[Selection of the measurement group: MEASurement<m>](#)" on page 1583.

Parameters:

<ArithCustomUntSt> ON | OFF

*RST: OFF

Usage: Asynchronous command**MEASurement<m>:AMPTime:ARITHmetic:OPERator <ArithOperator>**

Selects the operation type to be performed on the selected operands for the amplitude/time arithmetic measurement.

Suffix:

<m> 1..10

See "[Selection of the measurement group: MEASurement<m>](#)" on page 1583.

Parameters:

<ArithOperator> ADD | SUB | MUL | DIV

*RST: ADD

Usage: Asynchronous command**Manual operation:** See "[Operator](#)" on page 331**MEASurement<m>:AMPTime:ARITHmetic:PARAmeter<n>:AMPTime
<ArithOp1MeasAmplitudeTime>**

Selects the amplitude/time arithmetics measurements for the measurement group.

Suffix:

<m> 1..10

See "[Selection of the measurement group: MEASurement<m>](#)" on page 1583.

<n> 1..2

Selects the operand.

Parameters:

<Op1MeasAmpTime> HIGH | LOW | AMPLitude | MAXimum | MINimum | PDELta | MEAN | RMS | STDDev | POVershoot | NOVershoot | AREA | RTIME | FTIME | PPULse | NPULse | PERiod | FREQuency | PDCYcle | NDCYcle | CYCarea | CYCMean | CYCRms | CYCStddev | PULCnt | DELay | PHASe | BWIDth | PSWitching | NSWitching | PULSetrain | EDGecount | SETup | HOLD | SHT | SHR | CCJitter | NCJitter | CCWidth | CCDutycycle | TIE | UINterval | DRATe | SKWDelay | SKWPhase | DTOTrigger | PROBemeter | SLERising | SLEFalling | ATAR | SIGNallvl | VOCCrossing | NPERiod

See [Table 27-6](#).

*RST: HIGH

Usage: Asynchronous command

Manual operation: See "[Operand 1](#)" on page 331

MEASurement<m>:AMPTime:ARITHmetic:PARAmeter<n>:GROup
 <ArithOp2MeasGroup>

Sets the measurement group for the second operand of the amplitude/time arithmetic measurement.

Suffix:

<m> 1..10

See "[Selection of the measurement group: MEASurement<m>](#)" on page 1583.

<n> 2

Parameters:

<Op2MeasGroup> MEAS1 | MEAS2 | MEAS3 | MEAS4 | MEAS5 | MEAS6 | MEAS7 | MEAS8 | IMEAS | IMEAs | QUICK | QUICK

*RST: MEAS1

Usage: Asynchronous command

Manual operation: See "[Operand 2 meas group / Operand 2](#)" on page 331

MEASurement<m>:AMPTime:ARITHmetic:PARAmeter<n>:SPECTrum
 <ArithOp1MeasSpectrum>

Selects the spectrum arithmetics measurements for the measurement group.

Suffix:

<m> 1..10

See "[Selection of the measurement group: MEASurement<m>](#)" on page 1583.

<n> 1..2
 Selects the operand.

Parameters:

<Op1MeasSpectrum> CPOWer | ACPower | OBWidth | SBWidth | TOI | AMMod |
 THD | THDPCT | THDPct | THDA | THDU | THDR | PLISt |
 HAR | THDF | SPAR
 *RST: CPOWer

Usage: Asynchronous command

Manual operation: See "[Operand 1](#)" on page 331

MEASurement<m>:AMPTime:ARITHmetic:PARAmeter<n>:TYPE <ArithOp2Type>

Sets the type of amplitude arithmetic measurement.

Suffix:

<m> 1..10
 See "[Selection of the measurement group: MEASurement<m>](#)"
 on page 1583.

<n> 2

Parameters:

<ArithOp2Type> MEASurement | CONStant

MEASurement

Performs an arithmetic operation between two measurement results.

CONStant

Performs an operation between a measurement result and a user defined fixed constant.

*RST: MEASurement

Usage: Asynchronous command

Manual operation: See "[Type](#)" on page 330

MEASurement<m>:SPECTrum:ARITHmetic:CONStant <ArithConstant>

Sets a constant numeric value as the second operand of the spectrum arithmetic measurement.

Suffix:

<m> 1..10
 See "[Selection of the measurement group: MEASurement<m>](#)"
 on page 1583.

Parameters:

<ArithConstant> Range: - 3.4 e38 to + 3.4 e38
 Increment: 1
 *RST: 0

Usage: Asynchronous command

Manual operation: See "[Constant](#)" on page 331

MEASurement<m>:SPECtrum:ARITHmetic:COUNit <ArithCstUnt>

Sets the unit for the constant, set with [MEASurement<m>:SPECtrum:ARITHmetic:CONStant](#).

Suffix:

<m> 1..10

See "[Selection of the measurement group: MEASurement<m>](#)" on page 1583.

Parameters:

<ArithCstUnt>

DBM | DB | DB_HZ | DB_GHZ | DBC | DBC_HZ | DBPW_HZ | DBW | DBPW | DBM_HZ | DBMW | W | MW | W_HZ | J | V_S | A_S | DBV | DBMV | DBMV_HZ | DBMV_MHZ | DBUV | DBUV_HZ | DBUV_SQRT_HZ | DBUV_MHZ | DBUV_M | DBMV_M_HZ | DBUV_M_MHZ | V | MV | UV | VPP | VV | UV_HZ | UV_M_HZ | V_SQRT_HZ | DBA | DBMA | DBMA_HZ | DBMA_MHZ | DBUA | DBUA_HZ | DBUA_SQRT_HZ | DBUA_MHZ | DBUA_M | DBUA_M_HZ | DBUA_M_MHZ | A | UA_HZ | UA_M_HZ | A_SQRT_HZ | PCT | DBPT | DBPT_HZ | H | PH_GHZ | F | FF_GHZ | OHM | SIEMENS | S | DBPS | DBNS | DBUS | DBMS | DBS | HZ | DBHZ | DBKHZ | DBMHZ | DBGHZ | M | IN | DEG | RAD | PCT | SYMB | VA_LIN | VA_LOG | NONE | IRE | MILES | SYMB_S | MSYMB_S | MBIT_S | BIT_S | BIT | WORD | PPM | DB | PER_SEC | S_DIV | HZ_DIV | V_DIV | A_DIV | OHM_DIV | NONE_DIV | DIV | BER | S | S_S | BAUD | TDEG | VS | USER | UINV | W_DIV | V_V | A_V | W_V | BYTS | V_A | V_W | VA | VAR | UI | LN | HRS | MIN
*RST: NONE

Usage: Asynchronous command

Manual operation: See "[Constant unit](#)" on page 331

MEASurement<m>:SPECtrum:ARITHmetic:CUNState <ArithCustomNmeSt>

Enables the use of user-defined custom name for the spectrum arithmetic measurement.

Suffix:

<m> 1..10

See "[Selection of the measurement group: MEASurement<m>](#)" on page 1583.

Parameters:

<ArithCustomNmeSt> ON | OFF

*RST: OFF

Usage: Asynchronous command

Manual operation: See "[Custom](#)" on page 331

MEASurement<m>:SPECtrum:ARITHmetic:CUUNit <ArithCustomUnit>

Sets a user-defined value of the unit for the spectrum arithmetic measurement.

Suffix:

<m> 1..10

See "[Selection of the measurement group: MEASurement<m>](#)" on page 1583.

Parameters:

<ArithCustomUnit>

Usage:

Asynchronous command

MEASurement<m>:SPECtrum:ARITHmetic:CUUState <ArithCustomUntSt>

Enables the use of user-defined custom unit for the amplitude/time arithmetic measurement. You can set the unit with [MEASurement<m>:AMPTime:ARITHmetic:CUUNit](#).

Suffix:

<m> 1..10

Parameters:

<ArithCustomUntSt> ON | OFF

*RST: OFF

Usage:

Asynchronous command

MEASurement<m>:SPECtrum:ARITHmetic:OPERator <ArithOperator>

Selects the operation type to be performed on the selected operands for the spectrum arithmetic measurement.

Suffix:

<m> 1..10

See "[Selection of the measurement group: MEASurement<m>](#)" on page 1583.

Parameters:

<ArithOperator> ADD | SUB | MUL | DIV

*RST: ADD

Usage:

Asynchronous command

Manual operation: See "[Operator](#)" on page 331

MEASurement<m>:SPECtrum:ARITHmetic:PARAmeter<n>:AMPTime
<ArithOp1MeasAmplitudeTime>

Selects the amplitude/time arithmetics measurements for the measurement group.

Suffix:

<m> 1..10
See "[Selection of the measurement group: MEASurement<m>](#)" on page 1583.

<n> 1..2
Selects the operand.

Parameters:

<Op1MeasAmpTime> HIGH | LOW | AMPLitude | MAXimum | MINimum | PDELta | MEAN | RMS | STDDev | POVershoot | NOVershoot | AREA | RTIME | FTIME | PPULse | NPULse | PERiod | FREQuency | PDCYcle | NDCYcle | CYCarea | CYCMean | CYCRms | CYCStddev | PULCnt | DELay | PHASe | BWIDth | PSWitching | NSWitching | PULSetrain | EDGecount | SETup | HOLD | SHT | SHR | CCJitter | NCJitter | CCWidth | CCDutycycle | TIE | UINterval | DRATe | SKWDelay | SKWPhase | DTOTrigger | PROBemeter | SLERising | SLEFalling | ATAR | SIGNallvl | VOCrossing | NPERiod
*RST: HIGH

Usage: Asynchronous command

Manual operation: See "[Operand 1](#)" on page 331

MEASurement<m>:SPECTrum:ARITHmetic:PARAmeter<n>:GROup
<ArithOp2MeasGroup>

Sets the measurement group for the second operand of the spectrum arithmetic measurement.

Suffix:

<m> 1..10
See "[Selection of the measurement group: MEASurement<m>](#)" on page 1583.

<n> 2

Parameters:

<ArithOp2MeasGroup> MEAS1 | MEAS2 | MEAS3 | MEAS4 | MEAS5 | MEAS6 | MEAS7 | MEAS8 | IMEAS | IMEAs | QUICK | QUICK
*RST: MEAS1

Usage: Asynchronous command

Manual operation: See "[Operand 2 meas group / Operand 2](#)" on page 331

MEASurement<m>:SPECTrum:ARITHmetic:PARAmeter<n>:SPECTrum
<ArithOp1MeasSpectrum>

Selects the first operand for the sepctrum arithmetics measurements.

Suffix:

<m> 1..10
See "[Selection of the measurement group: MEASurement<m>](#)" on page 1583.

<n> 1..2
Selects the operand.

Parameters:

<Op1MeasSpectrum> CPOWer | ACPower | OBWidth | SBWidth | TOI | AMMod | THD | THDPCT | THDPct | THDA | THDU | THDR | PLISt | HAR | THDF | SPAR

See [Table 27-8](#).

*RST: CPOWer

Usage: Asynchronous command

Manual operation: See "[Operand 1](#)" on page 331

MEASurement<m>:SPECtrum:ARITHmetic:PARAmeter<n>:TYPE <ArithOp2Type>

Sets the type of spectrum arithmetic measurement.

Suffix:

<m> 1..10
See "[Selection of the measurement group: MEASurement<m>](#)" on page 1583.

<n> 2

Parameters:

<ArithOp2Type> MEASurement | CONSTant

MEASurement

Performs an arithmetic operation between two measurement results.

CONSTant

Performs an operation between a measurement result and a user defined fixed constant.

*RST: MEASurement

Usage: Asynchronous command

27.12.5 Eye diagram measurements

The following table lists the <MeasType> parameter values with a short description.

In addition, the suffixes <n> for limit-check remote commands are listed.

For a detailed description, see [Chapter 8.2.5.1, "Overview of eye diagram measurements"](#), on page 334.

Table 27-7: Eye diagram measurements

<MeasType> parameter value (remote control)	Measurement (man- ual operation)	Description/Result	Suffix <n>
		not used	1
ERPercent	Extinction ratio (%)	Eye base / Eye top *100 Prerequisite: Eye base > 0 and Eye top > 0	2
ERDB	Extinction ratio (dB)	10*log (Eye top / Eye base)	3
EHEight	Eye height	Vertical eye opening	4
EWIDth	Eye width	Horizontal eye opening	5
ETOP	Eye top	Mean of the upper vertical histogram	6
EBASe	Eye base	Mean of the lower vertical histogram	7
		not used	8
CPPercent		Crossing points percentage	9
QFACtor	Q factor	(Eye top – Eye base) / (σ_{top} + σ_{base})	10
		not used	11...13
RMSNoise	Noise (RMS)	Quadratic mean of the noise of eye top and eye base	14
SNRatio	S/N ratio	Signal-to-noise ratio 10 * log (Eye amplitude / Noise RMS)	15
DCDistortion	Duty cycle distortion	20 * log (Eye amplitude / Noise RMS)	16
ERTime	Eye rise time	Duration for signal to rise from 10% to 90% of the high signal level	17
EFTime	Eye fall time	Duration for signal to fall from 90% to 10% of the high signal level	18
EBRate	Eye bit rate	Frequency between two crossings	19
EAMplitude	Eye amplitude	Eye top - Eye base	20
		not used	21...27
PPJitter	Jitter (peak to peak)	Average of the jitter for both crossing points ($\sigma_{crossing1}$ + $\sigma_{crossing2}$) / 2	28
STDJitter	Jitter (6* σ)	Jitter *6	29
RMSJitter	Jitter (RMS)	Quadratic mean of the jitter at both crossing points	30

MEASurement<m>:EYEJitter:AUToscale.....	1618
MEASurement<m>:EYEJitter:LCHeck<n>:VALid.....	1618
MEASurement<m>:EYEJitter:LCHeck<n>:LOWer:LIMit.....	1619
MEASurement<m>:EYEJitter:LCHeck<n>:UPPer:LIMit.....	1619
MEASurement<m>:EYEJitter:LCHeck<n>:LOWer:MARGin.....	1619
MEASurement<m>:EYEJitter:LCHeck<n>:UPPer:MARGin.....	1619
MEASurement<m>:EYEJitter:GENSettings:MLEHistogram:ALGorithm.....	1620

MEASurement<m>:EYEJitter:GENSettings:MLEHistogram:THReshold.....	1620
MEASurement<m>:EYEJitter:GENSettings:RElative:START.....	1621
MEASurement<m>:EYEJitter:GENSettings:RElative:STOP.....	1621
MEASurement<m>:EYEJitter:GENSettings:ABSolute:START.....	1621
MEASurement<m>:EYEJitter:GENSettings:ABSolute:STOP.....	1622
MEASurement<m>:EYEJitter:DCDistortion:RElative:LEVel.....	1622
MEASurement<m>:EYEJitter:EYEWIdth:ALGorithm.....	1622
MEASurement<m>:EYEJitter:EYEWIdth:MEASwindow.....	1623
MEASurement<m>:EYEJitter:EYEWIdth:RElative:START.....	1623
MEASurement<m>:EYEJitter:EYEWIdth:RElative:STOP.....	1624
MEASurement<m>:EYEJitter:EYEWIdth:ABSolute:START.....	1624
MEASurement<m>:EYEJitter:EYEWIdth:ABSolute:STOP.....	1625
MEASurement<m>:EYEJitter:EYEWIdth:MODE.....	1625
MEASurement<m>:EYEJitter:EYEHeight:ALGorithm.....	1625
MEASurement<m>:EYEJitter:EYEHeight:RElative:START.....	1626
MEASurement<m>:EYEJitter:EYEHeight:RElative:STOP.....	1626
MEASurement<m>:EYEJitter:EYEHeight:ABSolute:START.....	1627
MEASurement<m>:EYEJitter:EYEHeight:ABSolute:STOP.....	1627
MEASurement<m>:EYEJitter:EYEHeight:MODE.....	1627
MEASurement<m>:EYEJitter:JITTer:MEASlevel.....	1628
MEASurement<m>:EYEJitter:JITTer:RElative:LEVel.....	1628
MEASurement<m>:EYEJitter:RTFTime:RElative:STOP.....	1629
MEASurement<m>:EYEJitter:RTFTime:RElative:START.....	1629

MEASurement<m>:EYEJitter:AUToscale

Defines optimized settings to perform an eye diagram measurement for the selected source. This is available, if the measurement source set with [MEASurement<m>:SOURCE](#) is analog, differential and common source.

Suffix:

<m> 1..10
See "[Selection of the measurement group: MEASurement<m>](#)" on page 1583.

Usage:

Event
Asynchronous command

Manual operation: See "[Autoset](#)" on page 336

MEASurement<m>:EYEJitter:LCHeck<n>:VALid <ValidRange>

Enables or disables limit checking for eye/jitter measurements in the specified measurement channel.

Suffix:

<m> 1..10
See "[Selection of the measurement group: MEASurement<m>](#)" on page 1583.

<n> 1..30
Number of the eye/jitter measurement, see [Table 27-7](#).

Parameters:

<ValidRange> ILIMit | ULIMit | LLIMit | OLIMit

ILIMit
Inside (within) limit; between the upper and lower limit values

ULIMit
Upper limit; above the upper limit value

LLIMit
Lower limit; below the lower limit value

OLIMit
Outside limit; above the upper limit or below the lower limit values

*RST: ILIMit

Usage: Asynchronous command

Manual operation: See "[Upper limit, Lower limit, Upper margin, Lower margin, Valid range](#)" on page 371

MEASurement<m>:EYEJitter:LCHeck<n>:LOWer:LIMit <LowerLimit>

MEASurement<m>:EYEJitter:LCHeck<n>:UPPer:LIMit <UpperLimit>

Define the lower and upper limit for the limit check, respectively. The valid range is defined using the [MEASurement<m>:EYEJitter:LCHeck<n>:VALid](#) command.

Suffix:

<m> 1..10
See "[Selection of the measurement group: MEASurement<m>](#)" on page 1583.

<n> 1..30
Number of the eye/jitter measurement, see [Table 27-7](#).

Parameters:

<UpperLimit> Range: -100 to 100
Increment: 10E-6
*RST: 0
Default unit: The unit depends on the selected measurement.

Usage: Asynchronous command

Manual operation: See "[Upper limit, Lower limit, Upper margin, Lower margin, Valid range](#)" on page 371

MEASurement<m>:EYEJitter:LCHeck<n>:LOWer:MARGin <LowerMargin>

MEASurement<m>:EYEJitter:LCHeck<n>:UPPer:MARGin <UpperMargin>

Defines the upper margin for the limit check. Margins are not as strict as limits and must be within the valid value range. The valid range is defined using the [MEASurement<m>:EYEJitter:LCHeck<n>:VALid](#) command.

Suffix:

<m> 1..10
See "[Selection of the measurement group: MEASurement<m>](#)" on page 1583.

<n> 1..30
Number of the eye/jitter measurement, see [Table 27-7](#).

Parameters:

<UpperMargin> Range: -100 to 100
Increment: 10E-6
*RST: 0
Default unit: The unit depends on the selected measurement.

Usage: Asynchronous command

Manual operation: See "[Upper limit, Lower limit, Upper margin, Lower margin, Valid range](#)" on page 371

MEASurement<m>:EYejitter:GENSettings:MLEHistogram:ALGORITHM
<Algorithm>

Defines how to compute the top/base level and the corresponding sigma values.

Suffix:

<m> 1..10

Parameters:

<Algorithm> MEAN | PEAK | INNPeark | OUTPeak
*RST: MEAN

Usage: Asynchronous command

Manual operation: See "[General](#)" on page 336

MEASurement<m>:EYejitter:GENSettings:MLEHistogram:THRESHOLD
<Threshold>

Sets the threshold used to separate peaks: two peaks are separated if they are split by a valley of height *Threshold * Maximal_histogram_value*.

Suffix:

<m> 1..10

Parameters:

<Threshold> Range: 1 to 99
Increment: 0.1
*RST: 50
Default unit: %

Usage: Asynchronous command

Manual operation: See "[General](#)" on page 336

MEASurement<m>:EYEJitter:GENSettings:RELative:START <RelativeStart>

Defines the start of the measurement window in relative values.

This settings is relevant, if **MEASurement<m>:MAIN** is set to one of the following: ERPercent, ERDB, EHeight, QFactor, RMSNoise, SNRatio, EAmplitude.

Suffix:

<m> 1..10
See "[Selection of the measurement group: MEASurement<m>](#)" on page 1583.

Parameters:

<RelativeStart> Range: 1 to 99
Increment: 0.1
*RST: 40
Default unit: %

Usage: Asynchronous command

Manual operation: See "[General](#)" on page 336

MEASurement<m>:EYEJitter:GENSettings:RELative:STOP <RelativeStop>

Defines the stop of the measurement window in relative values.

This settings is relevant, if **MEASurement<m>:MAIN** is set to one of the following: ERPercent, ERDB, EHeight, QFactor, RMSNoise, SNRatio, EAmplitude .

Suffix:

<m> 1..10
See "[Selection of the measurement group: MEASurement<m>](#)" on page 1583.

Parameters:

<RelativeStop> Range: 1 to 99
Increment: 0.1
*RST: 60
Default unit: %

Usage: Asynchronous command

Manual operation: See "[General](#)" on page 336

MEASurement<m>:EYEJitter:GENSettings:ABSolute:START <AbsoluteStart>

Defines the start of the measurement window in absolute values.

This settings is relevant, if **MEASurement<m>:MAIN** is set to one of the following: ERPercent, ERDB, EHeight, QFactor, RMSNoise, SNRatio, EAmplitude.

Suffix:

<m> 1..10

Parameters:

<AbsoluteStart> Range: -100E+24 to 100E+24
 Increment: 0.01
 *RST: -1.25E-9
 Default unit: s

Usage:

Asynchronous command

MEASurement<m>:EYEJitter:GENSettings:ABSolute:STOP <AbsoluteStop>

Defines the stop of the measurement window in absolute values.

This settings is relevant, if [MEASurement<m>:MAIN](#) is set to one of the following:
 ERPercent, ERDB, EHeight, QFACTOR, RMSNoise, SNRatio,
 EAmplitude .

Suffix:

<m> 1..10

Parameters:

<AbsoluteStop> Range: -100E+24 to 100E+24
 Increment: 0.01
 *RST: 1.25E-9
 Default unit: s

Usage:

Asynchronous command

MEASurement<m>:EYEJitter:DCDistortion:RELative:LEVel <RelLevel>

Defines the level of the measurement window in relative values.

This settings is relevant, if [MEASurement<m>:MAIN](#) is set to DCDistortion.

Suffix:

<m> 1..10

See "[Selection of the measurement group: MEASurement<m>](#)"
 on page 1583.

Parameters:

<RelLevel> Range: 1 to 99
 Increment: 0.1
 *RST: 50
 Default unit: %

Usage:

Asynchronous command

Manual operation: See "[Duty cycle distortion](#)" on page 340

MEASurement<m>:EYEJitter:EYEWIdth:ALGorithm <Algorithm>

Selects the algorithm for the measurement of the width.

This settings is relevant, if `MEASurement<m>:MAIN` is set to `EWIDth`.

Suffix:

<m> 1..10
See "[Selection of the measurement group: MEASurement<m>](#)" on page 1583.

Parameters:

<Algorithm>

ACTWidth | AWMWindow | MAXWidth | TSIGma

ACTWidth

Measure actual width at crossing level.

AWMWindow

Measure actual width (meas. window)

MAXWidth

Maximum width

TSIGma

Extrapolate using three sigma. The eye width is measured at the crossing level.

*RST: TSIGma

Usage:

Asynchronous command

Manual operation: See "[Eye width](#)" on page 338

MEASurement<m>:EYEJitter:EYEWidth:MEASwindow <UseWindow>

If enabled, you can define a user defined start and stop values for the eye width measurement.

Suffix:

<m> 1..10
See "[Selection of the measurement group: MEASurement<m>](#)" on page 1583.

Parameters:

<UseWindow>

ON | OFF

*RST: OFF

Usage:

Asynchronous command

Manual operation: See "[Eye width](#)" on page 338

MEASurement<m>:EYEJitter:EYEWidth:RELative:STARt <RelativeStart>

Sets the start of the measurement window in relative values.

This settings is relevant, if `MEASurement<m>:MAIN` is set to `EWIDth`.

Suffix:

<m> 1..10
See "[Selection of the measurement group: MEASurement<m>](#)" on page 1583.

Parameters:

<RelativeStart> Range: 1 to 99
 Increment: 0.1
 *RST: 40
 Default unit: %

Usage: Asynchronous command

Manual operation: See "Eye width" on page 338

MEASurement<m>:EYEJitter:EYEWIdth:RELative:STOP <RelativeStop>

Sets the stop of the measurement window in relative values.

This settings is relevant, if [MEASurement<m>:MAIN](#) is set to EWIDth.

Suffix:

<m> 1..10
 See "[Selection of the measurement group: MEASurement<m>](#)" on page 1583.

Parameters:

<RelativeStop> Range: 1 to 99
 Increment: 0.1
 *RST: 60
 Default unit: %

Usage: Asynchronous command

Manual operation: See "Eye width" on page 338

MEASurement<m>:EYEJitter:EYEWIdth:ABSolute:START <AbsoluteStart>

Sets the start of the measurement window in absolute value, if [MEASurement<m>:EYEJitter:EYEWIdth:MODE](#) is set to ABSolute.

This settings is relevant, if [MEASurement<m>:MAIN](#) is set to EWIDth.

Suffix:

<m> 1..10
 See "[Selection of the measurement group: MEASurement<m>](#)" on page 1583.

Parameters:

<AbsoluteStart> Range: -100E+24 to 100E+24
 Increment: 0.01
 *RST: -0.05
 Default unit: V

Usage: Asynchronous command

Manual operation: See "Eye width" on page 338

MEASurement<m>:EYEJitter:EYEWIdth:ABSolute:STOP <AbsoluteStop>

Defines the stop of the measurement window in absolute values, if [MEASurement<m>:EYEJitter:EYEHeight:MODE](#) is set to ABSolute.

This settings is relevant, if [MEASurement<m>:MAIN](#) is set to EHeight.

Suffix:

<m> 1..10
See "[Selection of the measurement group: MEASurement<m>](#)" on page 1583.

Parameters:

<AbsoluteStop> Range: -100E+24 to 100E+24
Increment: 0.01
*RST: 0.05
Default unit: V

Usage: Asynchronous command

Manual operation: See "[Eye width](#)" on page 338

MEASurement<m>:EYEJitter:EYEWIdth:MODE <Mode>

Selects, if the measurement window is defined in absolute or relative values.

This settings is relevant, if [MEASurement<m>:MAIN](#) is set to EWIDth.

Suffix:

<m> 1..10
See "[Selection of the measurement group: MEASurement<m>](#)" on page 1583.

Parameters:

<Mode> ABS | REL
*RST: REL

Usage: Asynchronous command

Manual operation: See "[Eye width](#)" on page 338

MEASurement<m>:EYEJitter:EYEHeight:ALGORITHM <Algorithm>

Selects the algorithm for the measurement of the height.

This settings is relevant, if [MEASurement<m>:MAIN](#) is set to EHeight.

Suffix:

<m> 1..10
See "[Selection of the measurement group: MEASurement<m>](#)" on page 1583.

Parameters:

<Algorithm> ACTHeight | MAXHeight | TSIGma

ACTHeight

Measure actual height. You can define a measurement window for the measurement.

MAXHeight

Measure maximum height. You can define a measurement window for the measurement.

TSIGma

Extrapolate using three sigma. The eye height is measured with the settings defined with the general commands.

*RST: TSIGma

Usage: Asynchronous command

Manual operation: See ["Eye height"](#) on page 338

MEASurement<m>:EYEJitter:EYEHeight:RELative:START <RelativeStart>

Defines the start of the measurement window in relative values.

This settings is relevant, if [MEASurement<m>:MAIN](#) is set to [EHEight](#).

Suffix:

<m> 1..10
See ["Selection of the measurement group: MEASurement<m>"](#) on page 1583.

Parameters:

<RelativeStart> Range: 1 to 99
Increment: 0.1
*RST: 40
Default unit: %

Usage: Asynchronous command

Manual operation: See ["Eye height"](#) on page 338

MEASurement<m>:EYEJitter:EYEHeight:RELative:STOP <RelativeStop>

Defines the start of the measurement window in relative values.

This settings is relevant, if [MEASurement<m>:MAIN](#) is set to [EHEight](#).

Suffix:

<m> 1..10
See ["Selection of the measurement group: MEASurement<m>"](#) on page 1583.

Parameters:

<RelativeStop> Range: 1 to 99
Increment: 0.1
*RST: 60
Default unit: %

Usage: Asynchronous command

Manual operation: See ["Eye height"](#) on page 338

MEASurement<m>:EYEJitter:EYEHeight:ABSolute:START <AbsoluteStart>

Defines the start of the measurement window in absolute values, if [MEASurement<m>:EYEJitter:EYEHeight:MODE](#) is set to ABSolute.

This settings is relevant, if [MEASurement<m>:MAIN](#) is set to EHEight.

Suffix:

<m> 1..10
See ["Selection of the measurement group: MEASurement<m>"](#) on page 1583.

Parameters:

<AbsoluteStart> Range: -100E+24 to 100E+24
Increment: 0.01
*RST: -2.5E-9
Default unit: s

Usage: Asynchronous command

Manual operation: See ["Eye height"](#) on page 338

MEASurement<m>:EYEJitter:EYEHeight:ABSolute:STOP <AbsoluteStop>

Defines the stop of the measurement window in relative values, if [MEASurement<m>:EYEJitter:EYEHeight:MODE](#) is set to ABSolute.

This settings is relevant, if [MEASurement<m>:MAIN](#) is set to one of the following: ERPercent, ERDB, EHEight, QFACTOR, RMSNoise, SNRatio, EAMPLitude .

Suffix:

<m> 1..10
See ["Selection of the measurement group: MEASurement<m>"](#) on page 1583.

Parameters:

<AbsoluteStop> Range: -100E+24 to 100E+24
Increment: 0.01
*RST: 2.5E-9
Default unit: s

Usage: Asynchronous command

Manual operation: See ["Eye height"](#) on page 338

MEASurement<m>:EYEJitter:EYEHeight:MODE <Mode>

Selects, if the start and stop values of the measurement window is defined in absolute or relative values.

This settings is relevant, if [MEASurement<m>:MAIN](#) is set to EHEight.

Suffix:
 <m> 1..10
 See "[Selection of the measurement group: MEASurement<m>](#)" on page 1583.

Parameters:
 <Mode> ABS | REL
 *RST: REL

Usage: Asynchronous command

Manual operation: See "[Eye height](#)" on page 338

MEASurement<m>:EYEJitter:JITTer:MEASlevel <UseLevel>

If enabled, you can define a user defined level for the eye measurement jitter.

Suffix:
 <m> 1..10
 See "[Selection of the measurement group: MEASurement<m>](#)" on page 1583.

Parameters:
 <UseLevel> ON | OFF
 *RST: OFF

Usage: Asynchronous command

Manual operation: See "[Jitter](#)" on page 340

MEASurement<m>:EYEJitter:JITTer:RELative:LEVel <RelLevel>

Defines the level of the measurement window in relative values.

This settings is relevant, if [MEASurement<m>:MAIN](#) is set to one of the following measurements: [PPJitter](#), [STDJitter](#), [RMSJitter](#).

Suffix:
 <m> 1..10
 See "[Selection of the measurement group: MEASurement<m>](#)" on page 1583.

Parameters:
 <RelLevel> Range: 1 to 99
 Increment: 0.1
 *RST: 50
 Default unit: %

Usage: Asynchronous command

Manual operation: See "[Jitter](#)" on page 340

MEASurement<m>:EYEJitter:RTFTTime:RELative:STOP <Stop>

Sets the local stop level of range for eye measurements rise/fall time.

Suffix:

<m> 1..10

Parameters:

<Stop> Range: 1 to 99
Increment: 0.1
*RST: 50
Default unit: %

Usage: Asynchronous command

Manual operation: See "[Eye rise time, Eye fall time](#)" on page 339

MEASurement<m>:EYEJitter:RTFTTime:RELative:START <Start>

Sets the local start level of range for eye measurements rise/fall time.

Suffix:

<m> 1..10

Parameters:

<Start> Range: 1 to 99
Increment: 0.1
*RST: 50
Default unit: %

Usage: Asynchronous command

Manual operation: See "[Eye rise time, Eye fall time](#)" on page 339

27.12.6 Spectrum

The following table lists the <MeasType> parameter values with a short description.

In addition, the suffixes <n> for limit-check remote commands are listed.

For a detailed description, see [Chapter 8.2.6.1, "Overview of spectrum measurements"](#), on page 341.

Table 27-8: Spectrum measurements

<MeasType> parameter value (remote control)	Measurement (manual operation)	Description/Result	Suffix <n>
CPOWer	Channel power	Power integrated over the sample values defined by a center frequency and a bandwidth; based on a defined impedance; the result is given in mW	1
		not used	2

<MeasType> parameter value (remote control)	Measurement (manual operation)	Description/Result	Suffix <n>
OBWidth	Occupied bandwidth	From the defined center frequency, symmetric sample value pairs to the left and right are integrated until a user-defined percentage of the total power is reached	3
SBWidth	Bandwidth	n dB down bandwidth. The samples to the left and right of the peak value are analyzed until the n dB threshold is exceeded. Frequencies at which the threshold is exceeded define the limits of the requested bandwidth.	4
		not used	5, 6
THD	THD[dB]	Total harmonic distortion in dB	7
THDPCT	THD[%]	Total harmonic distortion in %	8
THDA	THD_a	Is equivalent to THD. Requires option R&S RTO6-K37.	9
THDU	THD_u	Requires option R&S RTO6-K37.	10
THDR	THD_r	Distortion factor. Requires option R&S RTO6-K37.	11
PLISt	Peak list	List of frequency and peak power value pairs.	12
HAR	Harmonic search	Returns the measured harmonics. For each harmonic, the frequency and the value are listed. To get the number of result pairs (= harmonics), use MEASurement<m>:RESult:COUNT? .	13
THDF	THD_f	Root mean square of the sum of all amplitudes of the harmonic waves in relation to the amplitude at the fundamental frequency (first harmonic). Requires option R&S RTO6-K37.	14
SPAR	Arithmetic for spectrum measurements	Basic arithmetic calculations with measurement values and scalars.	15

MEASurement<m>:SPEctrum:CPOwer:BANDwidth	1631
MEASurement<m>:SPEctrum:OBANdwidth	1631
MEASurement<m>:SPEctrum:CPOwer:CFRequency	1631
MEASurement<m>:SPEctrum:NDBDown	1632
MEASurement<m>:SPEctrum:PEXCursion	1632
MEASurement<m>:SPEctrum:ATHReshold	1632
MEASurement<m>:SPEctrum:RESult<n>:COUNT	1633
MEASurement<m>:SPEctrum:RESult<n>:MODE	1633
MEASurement<m>:RESult:MAXCount	1634
MEASurement<m>:RESult:SHFRequency	1634
MEASurement<m>:RESult:SHLabels	1635
MEASurement<m>:SPEctrum:LCHeck<n>:VALid	1635
MEASurement<m>:SPEctrum:LCHeck<n>:LOWer:LIMit	1636
MEASurement<m>:SPEctrum:LCHeck<n>:UPPer:LIMit	1636
MEASurement<m>:SPEctrum:LCHeck<n>:LOWer:MARGin	1636
MEASurement<m>:SPEctrum:LCHeck<n>:UPPer:MARGin	1636

MEASurement<m>:SPECtrum:CPOWer:BANDwidth <ChPowBw>

Defines the bandwidth over which the channel power is calculated.

Suffix:

<m> 1..10
See "[Selection of the measurement group: MEASurement<m>](#)" on page 1583.

Parameters:

<ChPowBw> Range: 0 to 4E+9
Increment: 1
*RST: 0
Default unit: Hz

Usage: Asynchronous command

Manual operation: See "[Channel BW](#)" on page 343

MEASurement<m>:SPECtrum:OBANdwidth <OccupiedBW>

Defines the percentage of the total power used to determine the occupied bandwidth.

Suffix:

<m> 1..10
See "[Selection of the measurement group: MEASurement<m>](#)" on page 1583.

Parameters:

<OccupiedBW> Range: 0.1 to 99.9
Increment: 1
*RST: 20
Default unit: %

Usage: Asynchronous command

Manual operation: See "[Occup. BW](#)" on page 344

MEASurement<m>:SPECtrum:CPOWer:CFRequency <ChPowCtrFreq>

Defines the center frequency from which the channel power is calculated over the specified bandwidth.

Suffix:

<m> 1..10
See "[Selection of the measurement group: MEASurement<m>](#)" on page 1583.

Parameters:

<ChPowCtrFreq> Range: 0 to 6E+9
Increment: 1
*RST: 0
Default unit: Hz

Usage: Asynchronous command

Manual operation: See "[Channel CF](#)" on page 343

MEASurement<m>:SPECTrum:NDBDown <NDbDown>

Defines the threshold until which the samples to the left and right of the peak value are analyzed in order to determine the "N dB down bandwidth".

Suffix:

<m> 1..10

See "[Selection of the measurement group: MEASurement<m>](#)" on page 1583.

Parameters:

<NDbDown> Range: 0 to 100
 Increment: 1
 *RST: 20
 Default unit: dB

Usage: Asynchronous command

Manual operation: See "[N db down](#)" on page 343

MEASurement<m>:SPECTrum:PEXCursion <Value>

Defines a relative threshold, the minimum level value by which the waveform must rise or fall to be considered as a peak. To avoid identifying noise peaks, enter a peak excursion value that is higher than the noise levels.

Suffix:

<m> 1..10

The suffix is irrelevant.

Parameters:

<Value>

Usage: Asynchronous command

Firmware/software: Version 2.70

Manual operation: See "[Peak excursion](#)" on page 304

MEASurement<m>:SPECTrum:ATHReshold <Value>

Defines an absolute threshold as an additional condition for the peak search. Only peaks that exceed the threshold are detected.

This setting is only available for spectrum waveforms. It is valid for cursor measurements, spectrum measurements and peak search.

Suffix:

<m> 1..10
See "[Selection of the measurement group: MEASurement<m>](#)" on page 1583.

Parameters:

<Value> numeric value
Default unit: dBm

Usage: Asynchronous command

Manual operation: See "[Threshold](#)" on page 303

MEASurement<m>:SPECTrum:RESult<n>:COUNT <MaxNoOfResults>

Sets the maximum number of measurement results that are listed in the result table. Available for peak list and harmonic search measurements (MEASurement:MAIN is set to PLISt or HAR).

Suffix:

<m> 1..10
See "[Selection of the measurement group: MEASurement<m>](#)" on page 1583.

<n> 12 | 13
12: Peak list measurements
13: Harmonic search measurements

Parameters:

<MaxNoOfResults> Range: 1 to 1000
Increment: 1
*RST: 10

Usage: Asynchronous command

Manual operation: See "[Max results](#)" on page 345

MEASurement<m>:SPECTrum:RESult<n>:MODE <ResultMode>

Sets the way how the measurement results are displayed. Available only if MEASurement:MAIN is set to PLISt or HAR.

Suffix:

<m> 1..10
<n> 12 | 13
12: Peak list measurements
13: Harmonic search measurements

Parameters:

<ResultMode> ABS | REL
ABS
The harmonics/peaks are shown in absolute value, dBm.

REL

The level of the carrier is shown in absolute value dBm. The values the harmonics/peaks are shown relatively to the carrier in dBc.

*RST: ABS

- Example:** :MEASurement1:SPECTrum:RESult13:MODE ABS
The harmonic measurements are shown in absolute value, dBm.
- Usage:** Asynchronous command
- Manual operation:** See "[Result mode](#)" on page 345

MEASurement<m>:RESult:MAXCount <Number>

MEASurement<m>:RESult:MAXCount? <MeasType>, <Number>, [<BaseLevel>]

Defines the maximum number of peaks that are labeled in the diagram.

Suffix:

<m> 1..10
See "[Selection of the measurement group: MEASurement<m>](#)" on page 1583.

Query parameters:

<MeasType> PLISt
Only for peaklist measurements. For other measurement, this command returns an error.

<BaseLevel> Sets the base level for signals with PAM order > 2

Parameters for setting and query:

<Number> Maximum number of peaks

Return values:

<TargetLevel> Sets the target level for signals with PAM order > 2

Manual operation: See "[Result labels](#)" on page 345

MEASurement<m>:RESult:SHFRequency <MeasType>, <State>

MEASurement<m>:RESult:SHFRequency? <MeasType>

Includes the frequency of the detected peak in the diagram labels (if [MEASurement<m>:RESult:LABorder=ON](#)).

Suffix:

<m> 1..10
See "[Selection of the measurement group: MEASurement<m>](#)" on page 1583.

Parameters:

<State> ON | OFF

Parameters for setting and query:

<MeasType> PLISt
 Only for peaklist measurements. For other measurements, this command returns an error.

Example:

Display labels.
 MEAS:RES:SHL PLIS,ON
 Show frequency in labels.
 MEAS:RES:SHFR PLIS,ON
 Query the type of labels for peak lists.
 MEAS:RES:SHFR? PLIS
 //Result: ON

Manual operation: See "[Result labels](#)" on page 345

MEASurement<m>:RESult:SHLabels <MeasType>, <State>

MEASurement<m>:RESult:SHLabels? <MeasType>

Defines whether a description (label) is displayed for each detected peak in the spectrum diagram.

The layout of the label is defined by [MEASurement<m>:RESult:LABorder](#).

Suffix:

<m> 1..10
 See "[Selection of the measurement group: MEASurement<m>](#)" on page 1583.

Parameters:

<State> ON | OFF

Parameters for setting and query:

<MeasType> PLISt
 Only for peaklist measurements. For other measurements, this command returns an error.

Example:

Display labels.
 MEAS:RES:SHL PLIS,ON

Manual operation: See "[Result labels](#)" on page 345

MEASurement<m>:SPECTrum:LCHeck<n>:VALid <ValidRange>

Enables or disables limit checking for spectrum measurements in the specified measurement channel.

Suffix:

<m> 1..10
 See "[Selection of the measurement group: MEASurement<m>](#)" on page 1583.

<n> 1..15
Number of the spectrum measurement, see [Table 27-8](#).

Parameters:

<ValidRange>

ILIMit | ULIMit | LLIMit | OLIMit

ILIMit

Inside (within) limit; between the upper and lower limit values

ULIMit

Upper limit; above the upper limit value

LLIMit

Lower limit; below the lower limit value

OLIMit

Outside limit; above the upper limit or below the lower limit values

*RST: ILIMit

Usage:

Asynchronous command

Manual operation:See "[Upper limit, Lower limit, Upper margin, Lower margin, Valid range](#)" on page 371**MEASurement<m>:SPECTrum:LCHeck<n>:LOWer:LIMit** Value**MEASurement<m>:SPECTrum:LCHeck<n>:UPPer:LIMit** ValueDefine the lower and upper limits for the limit check, respectively. The valid range is defined using the [MEASurement<m>:SPECTrum:LCHeck<n>:VALid](#) command.**Suffix:**

<m>

1..10

See "[Selection of the measurement group: MEASurement<m>](#)" on page 1583.

<n>

1..15

Number of the spectrum measurement, see [Table 27-8](#).**Parameters:**

Value

Range: -100 to 100

Increment: 10E-6

*RST: 0

Usage:

Asynchronous command

Manual operation:See "[Upper limit, Lower limit, Upper margin, Lower margin, Valid range](#)" on page 371**MEASurement<m>:SPECTrum:LCHeck<n>:LOWer:MARGin** <LowerMargin>**MEASurement<m>:SPECTrum:LCHeck<n>:UPPer:MARGin** <UpperMargin>Define the lower and upper margins for the limit check, respectively. Margins are not as strict as limits and must be within the valid value range. The valid range is defined using the [MEASurement<m>:SPECTrum:LCHeck<n>:VALid](#) command.

Suffix:

<m> 1..10
See "[Selection of the measurement group: MEASurement<m>](#)" on page 1583.

<n> 1..15
Number of the spectrummeasurement, see [Table 27-8](#).

Parameters:

<UpperMargin> Range: -100 to 100
Increment: 10E-6
*RST: 0

Usage: Asynchronous command

Manual operation: See "[Upper limit, Lower limit, Upper margin, Lower margin, Valid range](#)" on page 371

27.12.7 Optical measurements

The following table lists the <MeasType> parameter values with a short description.

In addition, the suffixes <n> for limit-check remote commands are listed.

Table 27-9: Optical measurements

<MeasType> parameter value (remote control)	Measurement (manual operation)	Description/Result	Suffix <n>
OAP	Average power	True average component of an optical signal. $X_{Average} = \frac{1}{N_{Eval}} * \sum_{i=1}^{N_{Eval}} x(i)$	1
OMA	Modulation amplitude	Measure of the difference between the optical power of a non-return-to-zero (NRZ) one pulse and the optical power of an NRZ zero pulse. OMA requires an NRZ pattern.	2

MEASurement<m>:OPTical:OMAMplitude:RELative:START	1637
MEASurement<m>:OPTical:OMAMplitude:RELative:STOP	1638
MEASurement<m>:OPTical:UNIT	1638
MEASurement<m>:OPTical:LCHeck<n>:LOWer:LIMit	1639
MEASurement<m>:OPTical:LCHeck<n>:UPPer:LIMit	1639
MEASurement<m>:OPTical:LCHeck<n>:LOWer:MARGin	1639
MEASurement<m>:OPTical:LCHeck<n>:UPPer:MARGin	1639
MEASurement<m>:OPTical:LCHeck<n>:VALid	1639

MEASurement<m>:OPTical:OMAMplitude:RELative:START <Start>

Sets the start value of the range for the optical modulation amplitude.

Suffix:

<m> 1..10
See "[Selection of the measurement group: MEASurement<m>](#)" on page 1583.

Parameters:

<Start> Range: 1 to 99
Increment: 0.1
*RST: 40
Default unit: %

Usage: Asynchronous command

Manual operation: See "[Start](#)" on page 355

MEASurement<m>:OPTical:OMAMplitude:RELative:STOP <Stop>

Sets the end value of the range for the optical modulation amplitude.

Suffix:

<m> 1..10
See "[Selection of the measurement group: MEASurement<m>](#)" on page 1583.

Parameters:

<Stop> Range: 1 to 99
Increment: 0.1
*RST: 60
Default unit: %

Usage: Asynchronous command

Manual operation: See "[Stop](#)" on page 355

MEASurement<m>:OPTical:UNIT <Unit>

Selects the unit for the optical measurements.

Suffix:

<m> 1..10
See "[Selection of the measurement group: MEASurement<m>](#)" on page 1583.

Parameters:

<Unit> WATT | DBM
*RST: WATT

Usage: Asynchronous command

Manual operation: See "[Unit](#)" on page 355

MEASurement<m>:OPTical:LCHeck<n>:LOWer:LIMit <LowerLimit>

MEASurement<m>:OPTical:LCHeck<n>:UPPer:LIMit <UpperLimit>

Define the lower/ upper limit for limit checking of the optical measurements.

The range is defined with [MEASurement<m>:OPTical:LCHeck<n>:VALid](#).

Suffix:

<m> 1..10

See "[Selection of the measurement group: MEASurement<m>](#)" on page 1583.

<n> 1..2

Parameters:

<UpperLimit> Range: -100 to 100
Increment: 10E-6
*RST: 0

Usage: Asynchronous command

MEASurement<m>:OPTical:LCHeck<n>:LOWer:MARGIN <LowerMargin>

MEASurement<m>:OPTical:LCHeck<n>:UPPer:MARGIN <UpperMargin>

Define the lower/ upper margin for limit checking of the optical measurements.

The range is defined with [MEASurement<m>:OPTical:LCHeck<n>:VALid](#).

Suffix:

<m> 1..10

See "[Selection of the measurement group: MEASurement<m>](#)" on page 1583.

<n> 1..2

Parameters:

<UpperMargin> Range: -100 to 100
Increment: 10E-6
*RST: 0

Usage: Asynchronous command

MEASurement<m>:OPTical:LCHeck<n>:VALid <ValidRange>

Selects the condition for the limit check of the optical measurement.

Suffix:

<m> 1..10

See "[Selection of the measurement group: MEASurement<m>](#)" on page 1583.

<n> 1..2

Parameters:

<ValidRange> ILIMit | ULIMit | LLIMit | OLIMit

ILIMit: Inside (within) limit; between the upper and lower limit values

ULIMit: Upper limit; above the upper limit value

LLIMit : Lower limit; below the lower limit value

OLIMit: Outside limit; above the upper limit or below the lower limit values

*RST: ILIMit

Usage: Asynchronous command

27.12.8 Histograms

See also: [Chapter 27.16.5, "Waveform histogram export to file"](#), on page 1774.

- [Histogram display](#)..... 1640
- [Histogram measurement](#)..... 1646

27.12.8.1 Histogram display

LAYout:HISTogram:ADD	1640
LAYout:HISTogram:ENABLE	1641
LAYout:HISTogram:SOURce	1642
LAYout:HISTogram:MODE	1642
LAYout:HISTogram:HORIZ:MODE	1643
LAYout:HISTogram:HORIZ:ABSolute:START	1643
LAYout:HISTogram:HORIZ:ABSolute:STOP	1643
LAYout:HISTogram:HORIZ:RELative:START	1644
LAYout:HISTogram:HORIZ:RELative:STOP	1644
LAYout:HISTogram:VERTical:MODE	1644
LAYout:HISTogram:VERTical:ABSolute:START	1645
LAYout:HISTogram:VERTical:ABSolute:STOP	1645
LAYout:HISTogram:VERTical:RELative:START	1645
LAYout:HISTogram:VERTical:RELative:STOP	1646
LAYout:HISTogram:RESet	1646
LAYout:HISTogram:REMove	1646

LAYout:HISTogram:ADD <HistogramName>, <Source>, <XStart>, <XStop>, <YStart>, <YStop>, <Relative>, <Orientation>

Defines and displays a new histogram for the specified source.

Note: To define the mode of the histogram (vertical or horizontal), use the [LAYout:HISTogram:MODE](#) command.

For numerical values, the input of a unit is not supported for this command.

Setting parameters:

<HistogramName> String defining the histogram name which is used to refer to the histogram by other functions.

<Source>	C1W1 C1W2 C1W3 C2W1 C2W2 C2W3 C3W1 C3W2 C3W3 C4W1 C4W2 C4W3 M1 M2 M3 M4 M5 M6 M7 M8 R1 R2 R3 R4 MRESult1 MRESult2 MRESult3 MRESult4 MRESult5 MRESult6 MRESult7 MRESult8 SG1TL1 SG1TL2 SG2TL1 SG2TL2 SG3TL1 SG3TL2 SG4TL1 SG4TL2 SG5TL2 SG6TL1 SG6TL2 SG7TL1 SG7TL2 SG8TL1 SG8TL2 Z1V1 Z1V2 Z1V3 Z1V4 Z1I1 Z1I2 Z1I3 Z1I4 Z2V1 Z2V2 Z2V3 Z2V4 Z2I1 Z2I2 Z2I3 Z2I4 DIFF1 DIFF2 COMMON1 COMMON2 EYE1 EYE2 EYE3 EYE4 SRHist1 SDHist1 TJHist1 DJHist1 DDJHist1 PJOHist1 RJOHist1 SEYE1 SRHist2 SDHist2 TJHist2 DJHist2 DDJHist2 PJHOist2 RJOHist2 SEYE2 TNHist1 DNHist1 DDNHist1 PNHist1 RNOHist1 TNHist2 DNHist2 DDNHist2 PNHist2 RNOHist2 PJDHist1 BUJHist1 RJHist1 PJDHist2 BUJHist2 RJHist2 PNDHist1 BUNHist1 RNHist1 PNDHist2 BUNHist2 RNHist2 LANE1 LANE2 LANE3 LANE4 Data source of the histogram, see Chapter 27.4.2, "Waveform parameter" , on page 1371
<XStart>	Defines the start value of the x-value range.
<XStop>	Defines the stop value of the x-value range.
<YStart>	Defines the start value of the y-value range.
<YStop>	Defines the stop value of the y-value range.
<Relative>	ON OFF Defines whether relative or absolute values are used for the value range definition.
<Orientation>	VERTical HORizontal
Example:	See " Creating and reading histograms " on page 1349
Usage:	Setting only Asynchronous command

LAYout:HISTogram:ENABLE <HistogramName>,<State>

LAYout:HISTogram:ENABLE? <HistogramName>

Enables or disables the histogram evaluation and display.

Parameters:

<State> ON | OFF
*RST: ON

Parameters for setting and query:

<HistogramName> String parameter, name of the histogram as defined with [LAYout:HISTogram:ADD](#).

Usage: Asynchronous command

Manual operation: See "[Enable](#)" on page 351

LAYout:HISTogram:SOURce <HistogramName>,<Source>

LAYout:HISTogram:SOURce? <HistogramName>

Defines the waveform which is the source of the histogram.

Parameters:

<Source> C1W1 | C1W2 | C1W3 | C2W1 | C2W2 | C2W3 | C3W1 | C3W2 | C3W3 | C4W1 | C4W2 | C4W3 | M1 | M2 | M3 | M4 | M5 | M6 | M7 | M8 | R1 | R2 | R3 | R4 | MRESult1 | MRESult2 | MRESult3 | MRESult4 | MRESult5 | MRESult6 | MRESult7 | MRESult8 | SG1TL1 | SG1TL2 | SG2TL1 | SG2TL2 | SG3TL1 | SG3TL2 | SG4TL1 | SG4TL2 | SG5TL2 | SG6TL1 | SG6TL2 | SG7TL1 | SG7TL2 | SG8TL1 | SG8TL2 | Z1V1 | Z1V2 | Z1V3 | Z1V4 | Z1I1 | Z1I2 | Z1I3 | Z1I4 | Z2V1 | Z2V2 | Z2V3 | Z2V4 | Z2I1 | Z2I2 | Z2I3 | Z2I4 | DIFF1 | DIFF2 | COMMON1 | COMMON2 | EYE1 | EYE2 | EYE3 | EYE4 | SRHist1 | SDHist1 | TJHist1 | DJHist1 | DDJHist1 | PJOHist1 | RJOHist1 | SEYE1 | SRHist2 | SDHist2 | TJHist2 | DJHist2 | DDJHist2 | PJOHist2 | RJOHist2 | SEYE2 | TNHist1 | DNHist1 | DDNHist1 | PNHist1 | RNOHist1 | TNHist2 | DNHist2 | DDNHist2 | PNHist2 | RNOHist2 | PJDHist1 | BUJHist1 | RJHist1 | RJHist2 | PNDHist1 | BUNHist1 | RNHist1 | PNDHist2 | BUNHist2 | RNHist2 | LANE1 | LANE2 | LANE3 | LANE4

Waveform source of the histogram, see [Chapter 27.4.2, "Waveform parameter"](#), on page 1371.

If the histogram source is a measurement, the histogram shows the density distribution of the results for the selected measurement (MEAS<m>:MAIN).

Parameters for setting and query:

<HistogramName> String parameter

Usage: Asynchronous command

Manual operation: See "[Source](#)" on page 351

LAYout:HISTogram:MODE <HistogramName>,<Mode>

LAYout:HISTogram:MODE? <HistogramName>

Defines or queries the type of histogram.

Parameters:

<Mode> VERTical | HORizontal

VERTical

Amplitude histogram (horizontal bars across amplitude)

HORizontal

Time or frequency histogram (vertical bars over time/frequencies)

*RST: VERTical

Parameters for setting and query:

<HistogramName> The name of the histogram as defined using [LAYout: HISTogram:ADD](#) on page 1640.

Usage: Asynchronous command

Manual operation: See "[Mode](#)" on page 351

LAYout:HISTogram:HORZ:MODE <HistogramName>,<Mode>

LAYout:HISTogram:HORZ:MODE? <HistogramName>

Defines or queries whether the value range limits are entered as absolute or relative values.

Parameters:

<Mode> ABS | REL
*RST: ABS

Parameters for setting and query:

<HistogramName>

Usage: Asynchronous command

Manual operation: See "[Mode \(Horizontal / Vertical\)](#)" on page 352

LAYout:HISTogram:HORZ:ABSolute:START <HistogramName>,<Start>

LAYout:HISTogram:HORZ:ABSolute:START? <HistogramName>

Defines the horizontal start value of the histogram.

For numerical values, the input of a unit is not supported for this command.

Parameters:

<Start> Range: -100E+24 to 100E+24
Increment: 0.01
*RST: 0

Parameters for setting and query:

<HistogramName>

Usage: Asynchronous command

Manual operation: See "[Start, Stop \(Horizontal\)](#)" on page 352

LAYout:HISTogram:HORZ:ABSolute:STOP <HistogramName>,<Stop>

LAYout:HISTogram:HORZ:ABSolute:STOP? <HistogramName>

Defines the horizontal stop value of the histogram.

For numerical values, the input of a unit is not supported for this command.

Parameters:

<Stop> Range: -100E+24 to 100E+24
Increment: 0.01
*RST: 0.01

Parameters for setting and query:

<HistogramName>

Usage: Asynchronous command**Manual operation:** See "[Start, Stop \(Horizontal\)](#)" on page 352**LAYout:HISTogram:HORZ:RELative:START** <HistogramName>,<RelativeStart>**LAYout:HISTogram:HORZ:RELative:START?** <HistogramName>

Defines the horizontal start value of the histogram.

Parameters:

<RelativeStart>	Range:	0 to 100
	Increment:	0.1
	*RST:	0
	Default unit:	%

Parameters for setting and query:

<HistogramName>

Usage: Asynchronous command**Manual operation:** See "[Start, Stop \(Horizontal\)](#)" on page 352**LAYout:HISTogram:HORZ:RELative:STOP** <HistogramName>,<RelativeStop>**LAYout:HISTogram:HORZ:RELative:STOP?** <HistogramName>

Defines the horizontal stop value of the histogram.

Parameters:

<RelativeStop>	Range:	0 to 100
	Increment:	0.1
	*RST:	100
	Default unit:	%

Parameters for setting and query:

<HistogramName>

Usage: Asynchronous command**Manual operation:** See "[Start, Stop \(Horizontal\)](#)" on page 352**LAYout:HISTogram:VERTical:MODE** <HistogramName>,<Mode>**LAYout:HISTogram:VERTical:MODE?** <HistogramName>

Defines or queries whether the value range limits are entered as absolute or relative values.

Parameters:

<Mode>	ABS REL
	*RST: ABS

Parameters for setting and query:

<HistogramName>

Usage: Asynchronous command**Manual operation:** See "[Mode \(Horizontal / Vertical\)](#)" on page 352**LAYout:HISTogram:VERTical:ABSolute:START** <HistogramName>,<Start>**LAYout:HISTogram:VERTical:ABSolute:START?** <HistogramName>

Defines the vertical start value of the histogram.

For numerical values, the input of a unit is not supported for this command.

Parameters:

<Start>	Range:	-100E+24 to 100E+24
	Increment:	0.01
	*RST:	0

Parameters for setting and query:

<HistogramName>

Usage: Asynchronous command**Manual operation:** See "[Start, Stop \(Vertical\)](#)" on page 352**LAYout:HISTogram:VERTical:ABSolute:STOP** <HistogramName>,<Stop>**LAYout:HISTogram:VERTical:ABSolute:STOP?** <HistogramName>

Defines the vertical stop value of the histogram.

For numerical values, the input of a unit is not supported for this command.

Parameters:

<Stop>	Range:	-100E+24 to 100E+24
	Increment:	0.01
	*RST:	0.01

Parameters for setting and query:

<HistogramName>

Usage: Asynchronous command**Manual operation:** See "[Start, Stop \(Vertical\)](#)" on page 352**LAYout:HISTogram:VERTical:RELative:START** <HistogramName>,<RelativeStart>**LAYout:HISTogram:VERTical:RELative:START?** <HistogramName>

Defines the vertical start value of the histogram.

Parameters:

<RelativeStart>	Range:	0 to 100
	Increment:	0.1
	*RST:	0
	Default unit:	%

Parameters for setting and query:

<HistogramName>

Usage: Asynchronous command**Manual operation:** See "[Start, Stop \(Vertical\)](#)" on page 352**LAYout:HISTogram:VERTical:RELative:STOP** <HistogramName>,<RelativeStop>**LAYout:HISTogram:VERTical:RELative:STOP?** <HistogramName>

Defines the vertical stop value of the histogram.

Parameters:

<RelativeStop>	Range:	0 to 100
	Increment:	0.1
	*RST:	100
	Default unit:	%

Parameters for setting and query:

<HistogramName>

Usage: Asynchronous command**Manual operation:** See "[Start, Stop \(Vertical\)](#)" on page 352**LAYout:HISTogram:RESet** <HistogramName>

Resets the values to begin a new histogram.

Setting parameters:

<HistogramName>

Usage: Setting only
Asynchronous command**Manual operation:** See "[Reset](#)" on page 352**LAYout:HISTogram:REMove** <Name>

Removes the specified histogram.

Setting parameters:

<Name>

Usage: Setting only
Asynchronous command**27.12.8.2 Histogram measurement**

This chapter lists commands to set up measurements on histograms.

Note that the R&S RTO6 performs histogram measurements on the measurement that is defined with `MEASurement<m>:MAIN`. Other measurements are not considered.

See also: "[Creating and reading histograms](#)" on page 1349.

The following table lists the <MeasType> parameter values with a short description.

In addition, the suffixes <n> for limit-check remote commands are listed.

For a detailed description, see [Table 8-8](#).

Table 27-10: Histogram measurements

<MeasType> parameter value (remote control)	Measurement (manual operation)	Description/Result	Suffix <n>
WCOunt	Waveform count	Number of acquisitions (waveforms) the histogram is based on	1
WSAMples	Waveform samples	Number of samples from the most recent acquisition included in the current histogram	2
HSAMples	Histogram samples	Number of samples from all acquisitions included in the current histogram	3
HPEak	Histogram peak	Maximum sample value in the histogram	4
PEAK	Peak value	Signal value at the histogram peak	5
UPEakvalue	Upper peak value	Signal value at the maximum sample value in the upper half of the histogram	6
LPEakvalue	Lower peak value	Signal value at the maximum sample value in the lower half of the histogram	7
HMAXimum	Maximum	Highest signal value with a probability > 0	8
HMINimum	Minimum	Lowest signal value with a probability > 0	9
MEDian	Median	Signal value for which half the samples lie above, the other half below in the histogram	10
MAXMin	Max - Min	Range of signal values with a probability > 0	11
HMEan	Mean	Weighted arithmetic average of the histogram	12
HSTDdev	σ (S-dev)	Standard deviation of the sample numbers	13
M1STddev	Mean $\pm\sigma$	Range between (mean value + standard deviation) and (mean value - standard deviation)	14
M2STddev	Mean $\pm 2*\sigma$	Range between (mean value + 3 * standard deviation) and (mean value - 2 * standard deviation)	15
M3STddev	Mean $\pm 3*\sigma$	Range between (mean value + 3 * standard deviation) and (mean value - 2 * standard deviation)	16
MKPositive	Marker + Probability %	Marker value (according to the selected probability domain marker type) plus the defined limit. Note that the value is restricted to the histogram range.	17
MKNegative	Marker - Probability %	Marker value (according to the selected probability domain marker type) minus the defined limit. Note that the value is restricted to the histogram range.	18

MEASurement<m>:HISTogram:SElect.....	1648
MEASurement<m>:HISTogram:PROBability:TYPE.....	1648
MEASurement<m>:HISTogram:PROBability:LIMit.....	1649
MEASurement<m>:HISTogram:LCHeck<n>:VALid.....	1649
MEASurement<m>:HISTogram:LCHeck<n>:LOWer:LIMit.....	1650
MEASurement<m>:HISTogram:LCHeck<n>:UPPer:LIMit.....	1650
MEASurement<m>:HISTogram:LCHeck<n>:LOWer:MARGin.....	1650
MEASurement<m>:HISTogram:LCHeck<n>:UPPer:MARGin.....	1650

MEASurement<m>:HISTogram:SElect <HistgRef>

Selects the histogram on which the measurement is based.

Suffix:

<m> 1..10
See "[Selection of the measurement group: MEASurement<m>](#)" on page 1583.

Parameters:

<HistgRef> String with the name of the histogram

Example: See "[Creating and reading histograms](#)" on page 1349

Usage: Asynchronous command

Manual operation: See "[Source](#)" on page 353

MEASurement<m>:HISTogram:PROBability:TYPE <HistgPrbDomMark>

Defines the marker reference in the probability domain.

Suffix:

<m> 1..10
See "[Selection of the measurement group: MEASurement<m>](#)" on page 1583.

Parameters:

<HistgPrbDomMark> PEAK | UPPK | LWPK | MAXimum | MINimum | MEDian | MEAN

PEAK

The y-value with the maximum sample value in the histogram

UPPK

The y-value at the maximum sample value in the upper half of the histogram

LWPK

The y-value at the maximum sample value in the lower half of the histogram

MAXimum

The highest y-value with a probability > 0

MINimum

The lowest y-value with a probability > 0

MEDian

The y-value for which half the samples lie above, the other half below in the histogram

MEAN

The weighted arithmetic average of the histogram

*RST: PEAK

Usage: Asynchronous command

Manual operation: See ["Probability domain marker, Reference"](#) on page 353

MEASurement<m>:HISTogram:PROBability:LIMit <HistgPrbDomLim>

Defines a range around the probability marker.

Suffix:

<m> 1..10

See ["Selection of the measurement group: MEASurement<m>"](#) on page 1583.

Parameters:

<HistgPrbDomLim> Range: 0 to 100
Increment: 10
*RST: 10
Default unit: %

Usage: Asynchronous command

Manual operation: See ["Probability domain marker, Delta"](#) on page 353

MEASurement<m>:HISTogram:LCHeck<n>:VALid <ValidRange>

Enables or disables limit checking for histogram measurements in the specified measurement channel.

Suffix:

<m> 1..10

See ["Selection of the measurement group: MEASurement<m>"](#) on page 1583.

<n> 1..18

Number of the histogram measurement, see [Table 27-10](#).

Parameters:

<ValidRange> ILIMit | ULIMit | LLIMit | OLIMit

ILIMit

Inside (within) limit; between the upper and lower limit values

ULIMit

Upper limit; above the upper limit value

LLIMit

Lower limit; below the lower limit value

OLIMit

Outside limit; above the upper limit or below the lower limit values

*RST: ILIMit

Usage: Asynchronous command

Manual operation: See "[Upper limit, Lower limit, Upper margin, Lower margin, Valid range](#)" on page 371

MEASurement<m>:HISTogram:LCHeck<n>:LOWer:LIMit <LowerLimit>

MEASurement<m>:HISTogram:LCHeck<n>:UPPer:LIMit <UpperLimit>

Define the lower and upper limits for the limit check, respectively. The valid range is defined using the [MEASurement<m>:HISTogram:LCHeck<n>:VALid](#) command.

Suffix:

<m> 1..10

See "[Selection of the measurement group: MEASurement<m>](#)" on page 1583.

<n> 1..18

Number of the histogram measurement, see [Table 27-10](#).

Parameters:

<UpperLimit> Range: -100 to 100

Increment: 10E-6

*RST: 0

Usage: Asynchronous command

Manual operation: See "[Upper limit, Lower limit, Upper margin, Lower margin, Valid range](#)" on page 371

MEASurement<m>:HISTogram:LCHeck<n>:LOWer:MARGIN <LowerMargin>

MEASurement<m>:HISTogram:LCHeck<n>:UPPer:MARGIN <UpperMargin>

Define the lower and upper margins for the limit check, respectively. Margins are not as strict as limits and must be within the valid value range. The valid range is defined using the [MEASurement<m>:HISTogram:LCHeck<n>:VALid](#) command.

Suffix:

<m> 1..10

See "[Selection of the measurement group: MEASurement<m>](#)" on page 1583.

<n> 1..18

Number of the histogram measurement, see [Table 27-10](#).

Parameters:

<UpperMargin> Range: -100 to 100

Increment: 10E-6

*RST: 0

Usage:	Asynchronous command
Manual operation:	See " Upper limit, Lower limit, Upper margin, Lower margin, Valid range " on page 371

27.12.9 Display

MEASurement<m>:DISPlay:LEVels.....	1651
MEASurement<m>:DISPlay:RESults.....	1651
MEASurement<m>:DISPlay:STYLe.....	1652
MEASurement<m>:DISPlay:HISTogram.....	1652

MEASurement<m>:DISPlay:LEVels <DisplayLevels>

If enabled, the reference levels used for the measurement are displayed in the diagram.

Suffix:

<m> 1..10
See "[Selection of the measurement group: MEASurement<m>](#)" on page 1583.

Parameters:

<DisplayLevels> ON | OFF
*RST: OFF

Usage: Asynchronous command

Manual operation: See "[Reference levels](#)" on page 313

MEASurement<m>:DISPlay:RESults <DisplayResult>

If enabled, the intermediate result lines are displayed in the measurement diagram.

Result lines mark the samples in the waveform that are used to obtain the measurement result. These are, for example, maximum and minimum values, mean, cycle start and cycle end, and others.

Suffix:

<m> 1..10
See "[Selection of the measurement group: MEASurement<m>](#)" on page 1583.

Parameters:

<DisplayResult> ON | OFF
*RST: OFF

Usage: Asynchronous command

Manual operation: See "[Result lines](#)" on page 313

MEASurement<m>:DISPlay:STYLe <DisplayStyle>

Selects the style in which the measurement waveform is displayed.

Suffix:

<m> 1..10
See "[Selection of the measurement group: MEASurement<m>](#)" on page 1583.

Parameters:

<DisplayStyle> LINE | MARKer

LINE

The individual data points are connected by a line.

MARKer

Only the individual data points are displayed as markers.

*RST: LINE

Usage: Asynchronous command

MEASurement<m>:DISPlay:HISTogram <DispHistg>

Displays a histogram for the source of the selected measurement.

Suffix:

<m> 1..10
See "[Selection of the measurement group: MEASurement<m>](#)" on page 1583.

Parameters:

<DispHistg> ON | OFF

*RST: OFF

Usage: Asynchronous command

27.12.10 Statistics and long-term measurements

See also: [Chapter 27.16.7, "Long term measurement results and measurement histogram export to file"](#), on page 1777.

MEASurement<m>:STATistics[:ENABLE]	1653
MEASurement<m>:CLEar	1653
MEASurement<m>:MULTiple	1653
MEASurement<m>:MNOMeas	1654
MEASurement<m>:STATistics:HISTogram	1654
MEASurement<m>:STATistics:HBINs	1654
MEASurement<m>:STATistics:MODE	1655
MEASurement<m>:STATistics:RCOunt	1655
MEASurement<m>:STATistics:RMEascount	1656
MEASurement<m>:STATistics:RTIME	1656
MEASurement<m>:STATistics:RESet	1656
MEASurement<m>:VERTical:CONT	1657

MEASurement<m>:VERTical:AUTO.....	1657
MEASurement<m>:VERTical:OFFSet.....	1657
MEASurement<m>:VERTical:SCALe.....	1658
MEASurement<m>:LTMeas[:STATe].....	1658
MEASurement<m>:LTMeas:COUNT.....	1658
MEASurement<m>:LTMeas:TIME.....	1659

MEASurement<m>:STATistics[:ENABle] <StatisticsState>

Enables statistics calculation for the measurement.

For details on the statistics results, see [Chapter 8.2.11.1, "Statistics"](#), on page 362.

Suffix:

<m> See ["Selection of the measurement group: MEASurement<m>"](#) on page 1583.

Parameters:

<StatisticsState> ON | OFF
*RST: OFF

Usage: Asynchronous command

Manual operation: See ["Statistics"](#) on page 310

MEASurement<m>:CLEar

Deletes the statistic results of the indicated measurement.

Suffix:

<m> 1..10
See ["Selection of the measurement group: MEASurement<m>"](#) on page 1583.

Usage: Event
Asynchronous command

MEASurement<m>:MULTiple <MultiMeas>

The measurement is performed repeatedly if the measured parameter occurs several times inside the acquisition or defined gate.

Suffix:

<m> 1..10
See ["Selection of the measurement group: MEASurement<m>"](#) on page 1583.

Parameters:

<MultiMeas> ON | OFF
*RST: OFF

Usage: Asynchronous command

Manual operation: See ["Measure all events in each acquisition"](#) on page 368

MEASurement<m>:MNOMeas <MaxMeasPerAcq>

Sets the maximum number of measurements per acquisition if repeated measurement is enabled (`MEASurement<m>:MULTiple` is ON).

Suffix:

<m> 1..10
See "[Selection of the measurement group: MEASurement<m>](#)" on page 1583.

Parameters:

<MaxMeasPerAcq> Range: 2 to 1000000
Increment: 1
*RST: 1000

Usage: Asynchronous command

Manual operation: See "[Measure all events in each acquisition](#)" on page 368

MEASurement<m>:STATistics:HISTogram <ShowHistogram>

Displays a histogram of the statistical results. Enabling the histogram enables also the calculation and display of statistics for the measurement results if statistics were disabled. the histogram shows the cumulative occurrence distribution of mean measurement results in a graphic.

Suffix:

<m> 1..10
See "[Selection of the measurement group: MEASurement<m>](#)" on page 1583.

Parameters:

<ShowHistogram> ON | OFF
*RST: OFF

Usage: Asynchronous command

Manual operation: See "[Enable \(Histogram\)](#)" on page 366

MEASurement<m>:STATistics:HBINs <HistogramBins>

Sets the number of bins - the number of vertical bars that build the histogram.

If `MEASurement<m>:VERTical:CONT` is ON, the instrument determines the number of bins automatically based on the time base, the current measurements, and other settings.

Suffix:

<m> 1..10
See "[Selection of the measurement group: MEASurement<m>](#)" on page 1583.

Parameters:

<HistogramBins> Range: 2 to 1000
 Increment: 10
 *RST: 1000

Usage: Asynchronous command

Manual operation: See "[Number of bins](#)" on page 367

MEASurement<m>:STATistics:MODE <ResetMode>

Defines when the statistics for long term measurements are reset.

Suffix:

<m> 1..10
 See "[Selection of the measurement group: MEASurement<m>](#)"
 on page 1583.

Parameters:

<ResetMode> TIME | WFMS | MEAS

TIME

Sets one long term measurement point after the time defined using [MEASurement<m>:STATistics:RTIME](#).

WFMS - Waveforms

Sets one long term measurement point after a number of acquired waveforms defined using [MEASurement<m>:STATistics:RCOUNT](#).

MEAS

Sets one long term measurement point after a number of measurement results.

*RST: TIME

Usage: Asynchronous command

Manual operation: See "[Scale mode](#)" on page 368

MEASurement<m>:STATistics:RCOUNT <RstWfmCnt>

Defines the number of measured waveforms from which one point of the long term measurement is created (reset of statistics).

Suffix:

<m> 1..10
 See "[Selection of the measurement group: MEASurement<m>](#)"
 on page 1583.

Parameters:

<RstWfmCnt> Range: 1 to 65535
 Increment: 10
 *RST: 1000

Usage: Asynchronous command

Manual operation: See ["Wfms / point"](#) on page 369

MEASurement<m>:STATistics:RMEascount <RstMeasCnt>

Defines the number of measurement results from which one point of the long term measurement is created.

This setting is only available if `MEASurement<m>:STATistics:MODE` is set to MEAS.

Suffix:

<m> 1..10
See ["Selection of the measurement group: MEASurement<m>"](#) on page 1583.

Parameters:

<RstMeasCnt> Range: 1 to 65535
Increment: 10
*RST: 1000

Usage: Asynchronous command

Manual operation: See ["Measurements / point"](#) on page 369

MEASurement<m>:STATistics:RTIME <ResetTime>

Defines the time or period after which the statistics are reset.

Suffix:

<m> 1..10
See ["Selection of the measurement group: MEASurement<m>"](#) on page 1583.

Parameters:

<ResetTime> Range: 0.1 to 2.14748E+9
Increment: 1E-3
*RST: 0.2
Default unit: s

Usage: Asynchronous command

Manual operation: See ["Time / point"](#) on page 369

MEASurement<m>:STATistics:RESet

Resets the histogram, the long term measurement and the statistics.

Suffix:

<m> 1..10
See ["Selection of the measurement group: MEASurement<m>"](#) on page 1583.

Usage: Event
Asynchronous command

Manual operation: See ["Reset"](#) on page 367

MEASurement<m>:VERTical:CONT <ContAutoScl>

If enabled, automatic vertical scaling is performed whenever the waveform does not fit in the diagram during the long term measurement period.

Suffix:

<m> 1..10
See ["Selection of the measurement group: MEASurement<m>"](#) on page 1583.

Parameters:

<ContAutoScl> ON | OFF
*RST: ON

Usage: Asynchronous command

Manual operation: See ["Analysis scale"](#) on page 367

MEASurement<m>:VERTical:AUTO

Performs an automatic scaling once so that the scaling is adapted to the current measurement results. Available only for long term measurement.

Suffix:

<m> 1..10
See ["Selection of the measurement group: MEASurement<m>"](#) on page 1583.

Usage: Event
Asynchronous command

Manual operation: See ["Analysis scale"](#) on page 367

MEASurement<m>:VERTical:OFFSet <VerticalOffset>

Defines a vertical offset for the long term measurement.

Suffix:

<m> 1..10
See ["Selection of the measurement group: MEASurement<m>"](#) on page 1583.

Parameters:

<VerticalOffset> Range: -100E+12 to 100E+12
Increment: 1E-6
*RST: 0
Default unit: div

Usage: Asynchronous command

Manual operation: See ["Analysis scale"](#) on page 367

MEASurement<m>:VERTical:SCALe <VerticalScale>

Defines the vertical scaling per division, so that the scaling can be adapted automatically during the long term measurement period.

Suffix:

<m> 1..10
See "[Selection of the measurement group: MEASurement<m>](#)" on page 1583.

Parameters:

<VerticalScale> Range: 1E-12 to 100E+12
Increment: 10E-6
*RST: 0.5
Default unit: V/div

Usage: Asynchronous command

Manual operation: See "[Analysis scale](#)" on page 367

MEASurement<m>:LTMeas[:STATe] <ShowDiagram>

Enables long term measurement for a defined number of measurement points (see [MEASurement<m>:LTMeas:COUNT](#) on page 1658) or a specified time (see [MEASurement<m>:LTMeas:TIME](#) on page 1659).

Suffix:

<m> 1..10
See "[Selection of the measurement group: MEASurement<m>](#)" on page 1583.

Parameters:

<ShowDiagram> ON | OFF
*RST: OFF

Usage: Asynchronous command

Manual operation: See "[Enable \(Long term\)](#)" on page 366

MEASurement<m>:LTMeas:COUNT <MeasCnt>

Defines the total number of points to be measured during the long term measurement.

Suffix:

<m> 1..10
See "[Selection of the measurement group: MEASurement<m>](#)" on page 1583.

Parameters:

<MeasCnt> Range: 1000 to 200000
Increment: 10
*RST: 1000

Usage: Asynchronous command

Manual operation: See "Number of points" on page 368

MEASurement<m>:LTMeas:TIME <MeasurementTime>

Defines the total duration of the long term measurement.

This setting is only available if `MEASurement<m>:STATistics:MODE` is set to "Time".

Suffix:

<m>

1..10

See "Selection of the measurement group: MEASurement<m>" on page 1583.

Parameters:

<MeasurementTime> Range: 0.01 to 2.14748E+9
 Increment: 1
 *RST: 200
 Default unit: s

Usage: Asynchronous command

Manual operation: See "Measurement time" on page 369

27.12.11 Protocol

Before starting the protocol measurement, a bus type has to be selected (`BUS<m>:TYPE`) and the bus has to be activated (`BUS<m>[:STATe]`).

The following table lists the <MeasType> parameter values with a short description.

Table 27-11: Protocol measurements

<MeasType> parameter value (remote control)	Measurement (manual operation)	Description/Result
AUDio	Audio	
FLDValue	Field value	Value of a field over time
F2F	Frame to frame	The distance between two frame types
	Trigger to frame	
GAP	Gap	Measures a gap, periods at which the bus is idle. The distance of a gap can only be measured between two identified frames.
MBITrate	Main bit rate	Bit rate of the protocol
SBITrate	2nd bit rate	Additional bit rate, protocol dependent.
BIDLe	Bus idle	Calculates the bus idle time
FCNT	Frame count	Number of all frames within the acquisition window
FEC	Frame error count	Sum of all frames with errors within the acquisition window

<MeasType> parameter value (remote control)	Measurement (manual operation)	Description/Result
FER	Frame error rate	Sum of all frames with errors divided by all frames within the acquisition window
CFER	Consecutive frame error rate	Measures the frame error rate

MEASurement<m>:PROTocol:F2FRame:FLDFrom.....	1660
MEASurement<m>:PROTocol:F2FRame:FLDTo.....	1660
MEASurement<m>:PROTocol:F2FRame:FRMFrom.....	1661
MEASurement<m>:PROTocol:F2FRame:FRMTo.....	1661
MEASurement<m>:PROTocol:F2FRame:VALFrom.....	1661
MEASurement<m>:PROTocol:F2FRame:VALTo.....	1661
MEASurement<m>:PROTocol:FLDValue:FLD.....	1662
MEASurement<m>:PROTocol:FLDValue:FRM.....	1662
MEASurement<m>:PROTocol:FLDValue:TRCK.....	1662
MEASurement<m>:PROTocol:FLDValue:VAL.....	1663
MEASurement<m>:PROTocol:MBITrate:FLD.....	1663
MEASurement<m>:PROTocol:MBITrate:FRM.....	1663
MEASurement<m>:PROTocol:MBITrate:VAL.....	1663
MEASurement<m>:PROTocol:SBITrate:FLD.....	1664
MEASurement<m>:PROTocol:SBITrate:FRM.....	1664
MEASurement<m>:PROTocol:SBITrate:VAL.....	1664
MEASurement<m>:PROTocol:T2FRame:DIRection.....	1664
MEASurement<m>:PROTocol:T2FRame:FLD.....	1665
MEASurement<m>:PROTocol:T2FRame:FRM.....	1665
MEASurement<m>:PROTocol:T2FRame:VALue.....	1665

MEASurement<m>:PROTocol:F2FRame:FLDFrom <FieldName>

Sets the type of field for the start frame of the frame to frame protocol measurement.

Suffix:

<m> 1..10

See "[Selection of the measurement group: MEASurement<m>](#)" on page 1583.

Parameters:

<FieldName>

Manual operation: See "[Frame to frame](#)" on page 357

MEASurement<m>:PROTocol:F2FRame:FLDTo <FieldName>

Sets the type of field for the end frame of the frame to frame protocol measurement.

Suffix:

<m> 1..10

See "[Selection of the measurement group: MEASurement<m>](#)" on page 1583.

Parameters:

<FieldName>

Manual operation: See ["Frame to frame"](#) on page 357**MEASurement<m>:PROTOcol:F2FRame:FRMFrom <FrameName>**

Sets the type of start frame for the frame to frame protocol measurement.

Suffix:

<m> 1..10

See ["Selection of the measurement group: MEASurement<m>"](#) on page 1583.**Parameters:**

<FrameName>

Manual operation: See ["Frame to frame"](#) on page 357**MEASurement<m>:PROTOcol:F2FRame:FRMTo <FrameName>**

Sets the type of end frame for the frame to frame protocol measurement.

Suffix:

<m> 1..10

See ["Selection of the measurement group: MEASurement<m>"](#) on page 1583.**Parameters:**

<FrameName>

Manual operation: See ["Frame to frame"](#) on page 357**MEASurement<m>:PROTOcol:F2FRame:VALFrom <FrmFrmFromVal>**

Sets the field value of the start frame for the frame to frame protocol measurement.

Suffix:

<m> 1..10

See ["Selection of the measurement group: MEASurement<m>"](#) on page 1583.**Parameters:**

<FrmFrmFromVal>

Usage: Asynchronous command**Manual operation:** See ["Frame to frame"](#) on page 357**MEASurement<m>:PROTOcol:F2FRame:VALTo <FrmFrmVal>**

Sets the field value of the end frame for the frame to frame protocol measurement.

Suffix:

<m>

1..10

See "[Selection of the measurement group: MEASurement<m>](#)" on page 1583.**Parameters:**

<FrmFrmVal>

Usage:

Asynchronous command

Manual operation: See "[Frame to frame](#)" on page 357**MEASurement<m>:PROTOcol:FLDValue:FLD <FieldName>**

Sets the type of field for the frame of the field value protocol measurement.

Suffix:

<m>

1..10

See "[Selection of the measurement group: MEASurement<m>](#)" on page 1583.**Parameters:**

<FieldName>

Manual operation: See "[Field value](#)" on page 360**MEASurement<m>:PROTOcol:FLDValue:FRM <FrameName>**

Sets the type frame for the field value protocol measurement.

Suffix:

<m>

1..10

See "[Selection of the measurement group: MEASurement<m>](#)" on page 1583.**Parameters:**

<FrameName>

Manual operation: See "[Field value](#)" on page 360**MEASurement<m>:PROTOcol:FLDValue:TRCK <FieldName>**

Sets the field to be tracked value of the frame for the field value protocol measurement.

Suffix:

<m>

1..10

See "[Selection of the measurement group: MEASurement<m>](#)" on page 1583.**Parameters:**

<FieldName>

Manual operation: See "[Field value](#)" on page 360

MEASurement<m>:PROTOCOL:FLDValue:VAL <FieldValIdVal>

Sets the field value of the frame for the field value protocol measurement.

Suffix:

<m> 1..10

See "[Selection of the measurement group: MEASurement<m>](#)" on page 1583.

Parameters:

<FieldValIdVal>

Usage:

Asynchronous command

Manual operation: See "[Field value](#)" on page 360

MEASurement<m>:PROTOCOL:MBITrate:FLD <FieldName>

Sets the type of field for the frame of the main bit rate protocol measurement.

Suffix:

<m> 1..10

See "[Selection of the measurement group: MEASurement<m>](#)" on page 1583.

Parameters:

<FieldName>

Manual operation: See "[Main bit rate / 2nd bit rate](#)" on page 361

MEASurement<m>:PROTOCOL:MBITrate:FRM <FrameName>

Sets the type frame for the main bit rate protocol measurement.

Suffix:

<m> 1..10

See "[Selection of the measurement group: MEASurement<m>](#)" on page 1583.

Parameters:

<FrameName>

Manual operation: See "[Main bit rate / 2nd bit rate](#)" on page 361

MEASurement<m>:PROTOCOL:MBITrate:VAL <MainBtRateIdVal>

Sets the field value of the frame for the main bit rate protocol measurement.

Suffix:

<m> 1..10

See "[Selection of the measurement group: MEASurement<m>](#)" on page 1583.

Parameters:

<MainBtRateIdVal>

Usage: Asynchronous command
Manual operation: See ["Main bit rate / 2nd bit rate"](#) on page 361

MEASurement<m>:PROTOcol:SBITrate:FLD <FieldName>

Sets the type of field for the frame of the secondary bit rate protocol measurement.

Suffix:
 <m> 1..10
 See ["Selection of the measurement group: MEASurement<m>"](#) on page 1583.

Parameters:
 <FieldName>

Manual operation: See ["Main bit rate / 2nd bit rate"](#) on page 361

MEASurement<m>:PROTOcol:SBITrate:FRM <FrameName>

Sets the type frame for the secondary bit rate protocol measurement.

Suffix:
 <m> 1..10
 See ["Selection of the measurement group: MEASurement<m>"](#) on page 1583.

Parameters:
 <FrameName>

Manual operation: See ["Main bit rate / 2nd bit rate"](#) on page 361

MEASurement<m>:PROTOcol:SBITrate:VAL <SecondaryBtRateIdVal>

Sets the field value of the frame for the secondary bit rate protocol measurement.

Suffix:
 <m> 1..10
 See ["Selection of the measurement group: MEASurement<m>"](#) on page 1583.

Parameters:
 <SecondaryBtRateIdVal>

Usage: Asynchronous command

Manual operation: See ["Main bit rate / 2nd bit rate"](#) on page 361

MEASurement<m>:PROTOcol:T2FRame:DIRection <TrigFrmDirct>

Sets the direction of the field for trigger to frame protocol measurement.

Suffix:
 <m> 1..10

Parameters:

<TrigFrmDirct> T2F | F2T
 T2F: trigger to frame
 F2T: frame to trigger
 *RST: T2F

Usage: Asynchronous command

Manual operation: See ["Trigger to frame"](#) on page 360

MEASurement<m>:PROTOcol:T2FRame:FLD <FieldName>

Sets the type of the field for trigger to frame protocol measurement.

Suffix:

<m> 1..10

Parameters:

<FieldName>

Manual operation: See ["Trigger to frame"](#) on page 360

MEASurement<m>:PROTOcol:T2FRame:FRM <FrameName>

Sets the value of the frame for trigger to frame protocol measurement.

Suffix:

<m> 1..10

Parameters:

<FrameName>

Manual operation: See ["Trigger to frame"](#) on page 360

MEASurement<m>:PROTOcol:T2FRame:VALue <TrigFrmVal>

Sets the value of the field for trigger to frame protocol measurement.

Suffix:

<m> 1..10

Parameters:

<TrigFrmVal>

Usage: Asynchronous command

Manual operation: See ["Trigger to frame"](#) on page 360

27.12.12 Track

MEASurement<m>:TRACk[:STATe].....	1666
MEASurement<m>:TRACk:DATA:HEADer?	1666
MEASurement<m>:TRACk:DATA:STYPe?	1666
MEASurement<m>:TRACk:DATA[:VALues]?	1666

MEASurement<m>:TRACk[:STATe] <State>

Enables the track functionality and displays the track.

The track functionality requires at least one option, see "[Enable \(Track\)](#)" on page 367.

Suffix:

<m> 1..10
See "[Selection of the measurement group: MEASurement<m>](#)" on page 1583.

Parameters:

<State> ON | OFF
*RST: OFF

Usage: Asynchronous command

Manual operation: See "[Enable \(Track\)](#)" on page 367

MEASurement<m>:TRACk:DATA:HEADer?

Returns the header of the track.

Suffix:

<m> 1..10
See "[Selection of the measurement group: MEASurement<m>](#)" on page 1583.

Usage: Query only

MEASurement<m>:TRACk:DATA:STYPe?

Returns the data type: TRK (track).

Suffix:

<m> 1..10
See "[Selection of the measurement group: MEASurement<m>](#)" on page 1583.

Usage: Query only

MEASurement<m>:TRACk:DATA[:VALues]?

Returns the data of track points for transmission from the instrument to the controlling computer. The data can be used in MATLAB, for example.

To set the export format, use `FORMat [: DATA]`.

Suffix:

<m> 1..10
See "[Selection of the measurement group: MEASurement<m>](#)" on page 1583.

Usage: Query only

27.12.13 Gating

MEASurement<m>:GATE[:STATe]	1667
MEASurement<m>:GATE:MODE	1667
MEASurement<m>:GATE:ABSolute:START	1668
MEASurement<m>:GATE:ABSolute:STOP	1668
MEASurement<m>:GATE:RELative:START	1668
MEASurement<m>:GATE:RELative:STOP	1668
MEASurement<m>:GATE:CURSor	1668
MEASurement<m>:GATE:CCOupling	1669
MEASurement<m>:GATE:ZCOupling	1669
MEASurement<m>:GATE:ZDIagram	1670
MEASurement<m>:GATE:GCOupling	1670

MEASurement<m>:GATE[:STATe] <State>

Considers the gating settings of the source waveform for the measurement.

Suffix:

<m> 1..10
See "[Selection of the measurement group: MEASurement<m>](#)" on page 1583.

Parameters:

<State> ON | OFF
*RST: OFF

Usage: Asynchronous command

Manual operation: See "[Use gate](#)" on page 314

MEASurement<m>:GATE:MODE <Mode>

Defines whether the gate settings are configured using absolute or relative values.

Suffix:

<m> 1..10
See "[Selection of the measurement group: MEASurement<m>](#)" on page 1583.

Parameters:

<Mode> ABS | REL
*RST: ABS

Usage: Asynchronous command

Manual operation: See "[Gate description](#)" on page 314

MEASurement<m>:GATE:ABSolute:START <Start>

MEASurement<m>:GATE:ABSolute:STOP <Stop>

Define the absolute start and end values for the gate.

Suffix:

<m> 1..10

See "[Selection of the measurement group: MEASurement<m>](#)" on page 1583.

Parameters:

<Stop> Range: -100E+24 to 100E+24

Increment: 0.01

*RST: 0.01

Usage: Asynchronous command

Manual operation: See "[\(Relative\) Stop](#)" on page 315

MEASurement<m>:GATE:RELative:START <RelativeStart>

MEASurement<m>:GATE:RELative:STOP <RelativeStop>

Define the relative start and end values for the gate, respectively.

Suffix:

<m> 1..10

See "[Selection of the measurement group: MEASurement<m>](#)" on page 1583.

Parameters:

<RelativeStop> Range: 0 to 100

Increment: 0.1

*RST: 100

Default unit: %

Usage: Asynchronous command

Manual operation: See "[\(Relative\) Stop](#)" on page 315

MEASurement<m>:GATE:CURSor <Cursorset>

Selects the cursor set to be used for measurement gating. The gate area is defined by the cursor lines.

Suffix:

<m> 1..10

See "[Selection of the measurement group: MEASurement<m>](#)" on page 1583.

Parameters:

<Cursorset> CURSOR1 | CURSor1 | CURSOR2 | CURSor2 | CURSOR3 |
 CURSor3 | CURSOR4 | CURSor4
 CURSOR1 = CURSor1, CURSOR2 = CURSor2, CURSOR3 =
 CURSor3, CURSOR4 = CURSor4
 *RST: CURSOR1

Usage: Asynchronous command

Manual operation: See "[Cursor](#)" on page 315

MEASurement<m>:GATE:CCoupling <CursorCoupling>

Enables the cursor coupling for automatic measurements.

Select the cursor set to be used with [MEASurement<m>:GATE:CURSor](#).

Suffix:

<m> 1..10
 See "[Selection of the measurement group: MEASurement<m>](#)"
 on page 1583.

Parameters:

<CursorCoupling> ON | OFF
 *RST: OFF

Usage: Asynchronous command

Manual operation: See "[Cursor](#)" on page 315

MEASurement<m>:GATE:ZCOupling <ZoomCoupling>

If enabled, the gate area is defined identically to the zoom area for the zoom diagram.

If enabled, define the zoom area to be used as gate with [MEASurement<m>:GATE:ZDiagram](#).

Suffix:

<m> 1..10
 See "[Selection of the measurement group: MEASurement<m>](#)"
 on page 1583.

Parameters:

<ZoomCoupling> ON | OFF
 *RST: OFF

Usage: Asynchronous command

Manual operation: See "[Zoom](#)" on page 315

MEASurement<m>:GATE:ZDiagram <DiagramName>, <ZoomName>

If [MEASurement<m>:GATE:ZCoupling](#) is enabled, the gate area is defined identically to the zoom area for the selected zoom diagram.

Suffix:

<m> 1..10
See ["Selection of the measurement group: MEASurement<m>"](#) on page 1583.

Parameters:

<ZoomDiagram> String with the name of the diagram on which the zoom is based

Example:

Prerequisite: Zoom 1 is available
MEASurement:GATE:ZCoupling ON
MEASurement:GATE:ZDiagram "Diagram1", "Zoom1"

Usage:

Asynchronous command

Manual operation: See ["Zoom"](#) on page 315

MEASurement<m>:GATE:GCoupling <GateCoupling>

If you enable the gate coupling, the gate settings of the selected measurement are copied to all other measurements. If zoom or cursor coupling is active in a measurement, the zoom size and cursor positions are adjusted.

Suffix:

<m> 1..10
See ["Selection of the measurement group: MEASurement<m>"](#) on page 1583.

Parameters:

<GateCoupling> ON | OFF
*RST: OFF

Usage:

Asynchronous command

Manual operation: See ["Apply to all meas"](#) on page 314

27.12.14 Limit check and event actions

MEASurement<m>:LCHeck	1670
MEASurement<m>:ONViolation:BEEP	1671
MEASurement<m>:ONViolation:ACQStop	1671
MEASurement<m>:ONViolation:WFMSave	1672
MEASurement<m>:ONViolation:REPort	1672
MEASurement<m>:ONViolation:TRIGgerout	1672
MEASurement<m>:ONViolation:RUNexec	1673

MEASurement<m>:LCHeck <LimitCheckState>

Defines the type of the limit check that can run together with the measurement.

Suffix:
 <m> 1..10
 See "[Selection of the measurement group: MEASurement<m>](#)" on page 1583.

Parameters:
 <LimitCheckState> OFF | LIMit | LMARgin
OFF
 No limit check.
LIMit
 Only limits are checked.
LMARgin
 Limits and margins are checked.
 *RST: OFF

Usage: Asynchronous command

MEASurement<m>:ONViolation:BEEP <Beep>

Generates a beep sound for the specified event.

Suffix:
 <m> 1..10
 See "[Selection of the measurement group: MEASurement<m>](#)" on page 1583.

Parameters:
 <Beep> NOAction | SUCCess | VIOLation
 See [Chapter 27.4.5, "Event parameter"](#), on page 1373
 *RST: NOAction

Usage: Asynchronous command

Manual operation: See "[Beep](#)" on page 373

MEASurement<m>:ONViolation:ACQStop <StopAcq>

Stops data acquisition for the specified event.

Suffix:
 <m> 1..10
 See "[Selection of the measurement group: MEASurement<m>](#)" on page 1583.

Parameters:
 <StopAcq> NOAction | SUCCess | VIOLation
 See [Chapter 27.4.5, "Event parameter"](#), on page 1373
 *RST: NOAction

Usage: Asynchronous command

Manual operation: See "[Stop acq](#)" on page 373

MEASurement<m>:ONViolation:WFMSave <SaveWfm>

Saves the waveform data using the default RefCurve filename.

Suffix:

<m> 1..10
See ["Selection of the measurement group: MEASurement<m>"](#) on page 1583.

Parameters:

<SaveWfm> NOAction | SUCCess | VIOLation
See [Chapter 27.4.5, "Event parameter"](#), on page 1373
*RST: NOAction

Usage: Asynchronous command

Manual operation: See ["Save Wfm"](#) on page 373

MEASurement<m>:ONViolation:REPort <Report>

Creates and saves a report of the current settings and results.

Suffix:

<m> 1..10
See ["Selection of the measurement group: MEASurement<m>"](#) on page 1583.

Parameters:

<Report> NOAction | SUCCess | VIOLation
See [Chapter 27.4.5, "Event parameter"](#), on page 1373
*RST: NOAction

Usage: Asynchronous command

Manual operation: See ["Report"](#) on page 373

MEASurement<m>:ONViolation:TRIGgerout <TriggerOutPulse>

Creates a trigger out pulse on limit or margin violation or on successful completion of the measurement.

Suffix:

<m> 1..10

Parameters:

<TriggerOutPulse> NOAction | SUCCess | VIOLation
*RST: NOAction

Usage: Asynchronous command

Manual operation: See ["Trigger Out Pulse"](#) on page 373

MEASurement<m>:ONViolation:RUNexec <RunExecutable>

Starts an external application if the command is set to `VIOLation` or `SUCCESS`.

Use the following commands to set up the application:

- `EXECutable:NAME` on page 1787
- `EXECutable:PARAMeter` on page 1787
- `EXECutable:WDIRECTory` on page 1788

Suffix:

`<m>` 1..10
See "[Selection of the measurement group: MEASurement<m>](#)" on page 1583.

Parameters:

`<RunExecutable>` NOAction | SUCCESS | VIOLation
See [Chapter 27.4.5, "Event parameter"](#), on page 1373
*RST: NOAction

Usage: Asynchronous command

Manual operation: See "[Start Executable](#)" on page 373

27.13 Spectrum analysis

Some of the commands in the following chapter are asynchronous. An overlapping or asynchronous command does not automatically finish executing before the next command starts executing. If overlapping commands must be executed in a defined order, e.g. to avoid wrong measurement results, they must be serviced sequentially.

To prevent an overlapping execution of commands, one of the commands `*OPC`, `*OPC?` or `*WAI` can be used after the command or a command set.

For more information, see:

- www.rohde-schwarz.com/rc-via-sdpi, chapter "Command sequence and synchronization"
- [Chapter 27.3, "Programming examples"](#), on page 1345

27.13.1 Basic FFT

<code>CALCulate:MATH<m>:FFT:LOGScale</code>	1674
<code>CALCulate:MATH<m>:FFT:START</code>	1674
<code>CALCulate:MATH<m>:FFT:STOP</code>	1675
<code>CALCulate:MATH<m>:FFT:CFRequency</code>	1675
<code>CALCulate:MATH<m>:FFT:FULLspan</code>	1676
<code>CALCulate:MATH<m>:FFT:SPAN</code>	1676
<code>CALCulate:MATH<m>:FFT:TYPE</code>	1676
<code>CALCulate:MATH<m>:FFT:BANDwidth[:RESolution]:ADJusted?</code>	1676

CALCulate:MATH<m>:FFT:BANDwidth[:RESolution]:AUTO.....	1677
CALCulate:MATH<m>:FFT:BANDwidth[:RESolution]:RATio.....	1677
CALCulate:MATH<m>:FFT:BANDwidth[:RESolution][:VALue].....	1677
CALCulate:MATH<m>:FFT:WINDow:TYPE.....	1678
CALCulate:MATH<m>:FFT:FRAMe:ARITHmetics.....	1679
CALCulate:MATH<m>:FFT:FRAMe:COVerge?.....	1679
CALCulate:MATH<m>:FFT:FRAMe:MAXCount.....	1680
CALCulate:MATH<m>:FFT:FRAMe:OFACtor.....	1680
CALCulate:MATH<m>:FFT:GATE:COUPling.....	1681
TIMEbase:RACTime?.....	1681
CALCulate:MATH<m>:FFT:GATE:ABSolute:START.....	1681
CALCulate:MATH<m>:FFT:GATE:ABSolute:STOP.....	1682
CALCulate:MATH<m>:FFT:GATE:MODE.....	1682
CALCulate:MATH<m>:FFT:GATE:RELative:START.....	1682
CALCulate:MATH<m>:FFT:GATE:RELative:STOP.....	1683
CALCulate:MATH<m>:FFT:GATE:ZCOUpling.....	1683
CALCulate:MATH<m>:FFT:GATE[:STATe].....	1683
CALCulate:MATH<m>:FFT:MAGNitude:LEVel.....	1684
CALCulate:MATH<m>:FFT:MAGNitude:RANGe.....	1684
CALCulate:MATH<m>:FFT:MAGNitude:SCALE.....	1684
CALCulate:MATH<m>:FFT:PHASe:SCALE.....	1686
CALCulate:MATH<m>:FFT:PHASe:SUPPression.....	1686
CALCulate:MATH<m>:FFT:PHASe:THReshold.....	1686
CALCulate:MATH<m>:FFT:PHASe:UNWRap.....	1687
CALCulate:MATH<m>:FFT:COUPled:WITH<1..8>.....	1687

CALCulate:MATH<m>:FFT:LOGScale <XAxisMode>

Defines the scaling method for the frequency (x-)axis of the spectrogram.

Suffix:

<m> 1..8

Parameters:

<XAxisMode> LIN | LOG
LOG
 Logarithmic scaling
LIN
 Linear scaling
 *RST: LIN

Usage: Asynchronous command

Manual operation: See "Frequency axis" on page 385

CALCulate:MATH<m>:FFT:STARt <StartFreq>

Defines the start frequency of the displayed frequency span.

Suffix:

<m> 1..8
math waveform

Parameters:

<StartFreq> start frequency
Range: 0 to 5E+9
Increment: 1
*RST: 2E+9
Default unit: Hz

Usage: Asynchronous command

Manual operation: See "[Start frequency](#)" on page 386

CALCulate:MATH<m>:FFT:STOP <StopFreq>

Defines the stop frequency of the displayed frequency span.

Suffix:

<m> 1..8
math waveform

Parameters:

<StopFreq> stop frequency
Range: 0 to 5E+9
Increment: 1
*RST: 2E+9
Default unit: Hz

Usage: Asynchronous command

Manual operation: See "[Stop frequency](#)" on page 386

CALCulate:MATH<m>:FFT:CFrequency <CenterFreq>

Defines the position of the displayed frequency range, which is (Center - Span/2) to (Center + Span/2). The width of the range is defined using the [CALCulate:MATH<m>:FFT:SPAN](#) command.

Suffix:

<m> 1..8
math waveform

Parameters:

<CenterFreq> center frequency
Range: 0 to 2E+12
Increment: 1
*RST: 2.5E+9
Default unit: Hz

Usage: Asynchronous command

Manual operation: See "[Center frequency](#)" on page 386

CALCulate:MATH<m>:FFT:FULLspan

Performs FFT calculation for the full frequency span.

Suffix:

<m> 1..8
math waveform

Usage:

Event
Asynchronous command

Manual operation: See "[Full span](#)" on page 386

CALCulate:MATH<m>:FFT:SPAN <FreqSpan>

The span is specified in Hertz and defines the width of the displayed frequency range, which is (Center - Span/2) to (Center + Span/2). The position of the span is defined using the [CALCulate:MATH<m>:FFT:CFrequency](#) command.

Suffix:

<m> 1..8
Math waveform

Parameters:

<FreqSpan> Frequency span
Range: 1 to 10E+9
Increment: 1
*RST: Bandwidth of the instrument model, bandwidth extension options are not considered
Default unit: Hz

Usage:

Asynchronous command

Manual operation: See "[Frequency span](#)" on page 386

CALCulate:MATH<m>:FFT:TYPE <Type>

Selects between the magnitude and phase spectrum type.

Suffix:

<m> 1..8

Parameters:

<Type> MAGNitude | PHASe
*RST: MAGNitude

Usage:

Asynchronous command

Manual operation: See "[Type](#)" on page 385

CALCulate:MATH<m>:FFT:BANDwidth[:RESolution]:ADJusted?

Queries the effective resolution bandwidth.

Suffix:

<m> 1..8
Math waveform

Return values:

<AdjResBW> effective resolution bandwidth
Range: 0.01 to 20E+12
*RST: 0
Default unit: Hz

Usage: Query only

Manual operation: See "[Resolution BW](#)" on page 387

CALCulate:MATH<m>:FFT:BANDwidth[:RESolution]:AUTO <State>

Couples the frequency span to the RBW.

Suffix:

<m> 1..8
math waveform

Parameters:

<State> ON | OFF
*RST: ON

Usage: Asynchronous command

Manual operation: See "[Span/RBW Coupling](#)" on page 386

CALCulate:MATH<m>:FFT:BANDwidth[:RESolution]:RATio <SpanRBWRatio>

This command defines the ratio of span (Hz) / resolution bandwidth (Hz).

Suffix:

<m> 1..8
math waveform

Parameters:

<SpanRBWRatio> ratio span / resolution bandwidth
Range: 1 to 1000
Increment: 1
*RST: 100

Usage: Asynchronous command

Manual operation: See "[Span/RBW Ratio](#)" on page 387

CALCulate:MATH<m>:FFT:BANDwidth[:RESolution][:VALue] <ResolutionBW>

This command defines the resolution bandwidth.

Suffix:

<m> 1..8
math waveform

Parameters:

<ResolutionBW> resolution bandwidth
Range: 0.01 to 160E+6
Increment: 0.01
*RST: 2E+6
Default unit: Hz

Usage: Asynchronous command

Manual operation: See "[Resolution BW](#)" on page 387

CALCulate:MATH<m>:FFT:WINDow:TYPE <WindowType>

Windowing helps minimize the discontinuities at the end of the measured signal interval and thus reduces the effect of spectral leakage, increasing the frequency resolution.

Various different window functions are provided in the R&S RTO6 to suit different input signals. Each of the window functions has specific characteristics, including some advantages and some trade-offs. These characteristics need to be considered carefully to find the optimum solution for the measurement task.

Suffix:

<m> 1..8
math waveform

Parameters:

<WindowType> RECTangular | HAMMING | HANN | BLACKharris | GAUSSian | FLATTOP2 | FLATtop2 | KAISerbessel

RECTangular

The rectangular window has the best frequency resolution, but a poor amplitude accuracy and is recommended for separating two tones with almost equal amplitudes and a small frequency distance.

HAMMING

The Hamming window is bell shaped and has a good frequency resolution and fair amplitude accuracy. It is recommended for frequency response measurements as well as sine waves, periodic signals and narrow-band noise

HANN

The Hann window is bell shaped and has a slightly worse frequency resolution but smaller sidelobe level than the Hamming window. The applications are the same.

BLACKharris

The Blackman window is bell shaped and has a poor frequency resolution, but very good amplitude accuracy. It is recommended mainly for signals with single frequencies to detect harmonics.

GAUSSian

Good frequency resolution and best magnitude resolution, recommended for weak signals and short duration

FLATTOP2 = FLATtop2

The flattop window has a poor frequency resolution, but the best amplitude accuracy and the sharpest side lobe. It is recommended for accurate single-tone amplitude measurements.

KAISerbessel

The Kaiser-Bessel window has a fair frequency resolution and good amplitude accuracy, and a very high sidelobe level. It is recommended for separating two tones with differing amplitudes and a small frequency distance.

*RST: BLACKharris

- Usage:** Asynchronous command
- Firmware/software:** Version 3.35 and higher: Use FLATTOP2 or FLATtop2 instead of FLAT2
- Manual operation:** See "[Window type](#)" on page 387

CALCulate:MATH<m>:FFT:FRAME:ARITHmetics <Arithmetics>

The arithmetic mode defines how the final FFT result is calculated from the individual frame results.

Suffix:

<m> 1..8
Selects the math waveform.

Parameters:

<Arithmetics> OFF | ENVELOpe | AVERAge | RMS | MINHold | MAXHold
See "[Segment arithmetic](#)" on page 389
*RST: OFF

Usage: Asynchronous command

Manual operation: See "[Segment arithmetic](#)" on page 389

CALCulate:MATH<m>:FFT:FRAME:COVERage?

Due to the restriction of the number of frames (see [CALCulate:MATH<m>:FFT:FRAME:MAXCount](#) on page 1680), the waveform may only be analyzed partially. This command queries the percentage of the trace that was analyzed, i.e. which part of the trace was included in the frame calculation.

Suffix:

<m> 1..8
math waveform

Return values:

<FrameCoverage> Range: 0 to 100
 *RST: 100
 Default unit: %

Usage:

Query only
 Asynchronous command

Manual operation: See "[Max FFTs per acquisition](#)" on page 388

CALCulate:MATH<m>:FFT:FRAME:MAXCount <MaxFrameCount>

Restricts the maximum number of frames to be calculated. Due to the other parameter settings, the required number of frames may become very high, thus slowing performance. By restricting the number of frames, you can avoid performance loss without changing the other parameters.

Suffix:

<m> 1..8
 math waveform

Parameters:

<MaxFrameCount> Range: 1 to 10000
 Increment: 10
 *RST: 1000

Usage:

Asynchronous command

Manual operation: See "[Max FFTs per acquisition](#)" on page 388

CALCulate:MATH<m>:FFT:FRAME:OFACtor <OverlapFactor>

Defines the minimum factor by which two neighboring frames overlap. If the required number of frames to cover the input values allows for more overlap, the factor is increased.

The higher the overlap factor, the more frames are used. This leads to more individual results and improves detection of transient signal effects. However, it also extends the duration of the calculation.

Suffix:

<m> 1..8
 math waveform

Parameters:

<OverlapFactor> Range: 0 to 90
 Increment: 1
 *RST: 50
 Default unit: %

Usage:

Asynchronous command

Manual operation: See "[Overlap Factor](#)" on page 389

CALCulate:MATH<m>:FFT:GATE:COUPLing <GateRBWCoupling>

Defines the behaviour of the record length or RBW value in dependency to the other FFT parameters.

See also:

- ["Record Length/RBW Coupling"](#) on page 392
- [Chapter 9.1.1, "Fundamentals of FFT analysis"](#), on page 376

Suffix:

<m> 1..8
 math waveform

Parameters:

<GateRBWCoupling> LENGth | RBW

LENGth

The record length remains constant. If not enough samples are available for the selected RBW, the RBW will be decreased.

RBW

The RBW is not adapted, i.e. remains as defined by the user. The required acquisition time for this RBW is indicated. If necessary and possible, the record length is extended to acquire the required number of samples.

*RST: RBW

Usage: Asynchronous command

Manual operation: See ["Record Length/RBW Coupling"](#) on page 392

TIMEbase:RACTime?

Queries the required acquisition time. If FFT gating is used and the resolution BW is set to constant, record length can be extended to acquire the required number of samples. In this case, the required acquisition time differs from the adjusted acquisition time ([TIMEbase:RANGe](#)).

Return values:

<RqrdAcqTime> Required acquisition time for FFT
 Range: 125E-12 to 100E+3
 *RST: 0.5
 Default unit: s

Usage: Query only
 Asynchronous command

Manual operation: See ["Required acquisition time"](#) on page 392

CALCulate:MATH<m>:FFT:GATE:ABSolute:STARt <Start>

Defines the starting value for the gate.

Suffix:

<m> 1..8
math waveform

Parameters:

<Start> Range: -100E+24 to 100E+24
Increment: 0.01
*RST: 0

Usage: Asynchronous command

Manual operation: See "[\(Relative\) Start](#)" on page 315

CALCulate:MATH<m>:FFT:GATE:ABSolute:STOP <Stop>

Defines the end value for the gate.

Suffix:

<m> 1..8
math waveform

Parameters:

<Stop> Range: -100E+24 to 100E+24
Increment: 0.01
*RST: 0.01

Usage: Asynchronous command

Manual operation: See "[\(Relative\) Stop](#)" on page 315

CALCulate:MATH<m>:FFT:GATE:MODE <Mode>

Defines whether the gate settings are configured using absolute or relative values.

Suffix:

<m> 1..8
math waveform

Parameters:

<Mode> ABS | REL
*RST: ABS

Usage: Asynchronous command

Manual operation: See "[Gate description](#)" on page 314

CALCulate:MATH<m>:FFT:GATE:RELative:START <RelativeStart>

Defines the starting value for the gate in percent.

Suffix:

<m> 1..8
math waveform

Parameters:

<RelativeStart> Range: 0 to 100
 Increment: 0.1
 *RST: 0
 Default unit: %

Usage: Asynchronous command

Manual operation: See "(Relative) Start" on page 315

CALCulate:MATH<m>:FFT:GATE:RELative:STOP <RelativeStop>

Defines the end value for the gate in percent.

Suffix:

<m> 1..8
 math waveform

Parameters:

<RelativeStop> Range: 0 to 100
 Increment: 0.1
 *RST: 100
 Default unit: %

Usage: Asynchronous command

Manual operation: See "(Relative) Stop" on page 315

CALCulate:MATH<m>:FFT:GATE:ZCOupling <ZoomCoupling>

If enabled, the gate area is defined identically to the zoom area for the zoom diagram.

Suffix:

<m> 1..8
 math waveform

Parameters:

<ZoomCoupling> ON | OFF
 *RST: OFF

Usage: Asynchronous command

Manual operation: See "Zoom" on page 315

CALCulate:MATH<m>:FFT:GATE[:STATe] <State>

Enables FFT gating.

Suffix:

<m> 1..8
 math waveform

Parameters:

<State> ON | OFF
 *RST: OFF

Usage: Asynchronous command

CALCulate:MATH<m>:FFT:MAGNitude:LEVel <VerticalMax>

Defines the reference level for dB scaling.

Suffix:

<m> 1..8
 Math waveform

Parameters:

<VerticalMax> Range: -1E+15 to 1E+15
 Increment: 0.01
 *RST: 0
 Default unit: div

Usage: Asynchronous command

Manual operation: See ["Reference level"](#) on page 395

CALCulate:MATH<m>:FFT:MAGNitude:RANGe <Range>

Defines the vertical value range in spectrum mode.

Suffix:

<m> 1..8
 math waveform

Parameters:

<Range> Range: 1 to 500
 Increment: 1
 *RST: 100
 Default unit: dB

Usage: Asynchronous command

CALCulate:MATH<m>:FFT:MAGNitude:SCALe <MagnitudeScale>

Defines the scaling of the y-axis for magnitude spectrums. The display values are valid for 50Ω termination impedance.

Select the unit according to the vertical unit of the source waveform.

Suffix:

<m> 1..8
math waveform

Parameters:

<MagnitudeScale> LINear | DBM | DB | DBUV | DBMV | DBV | DBPS | DBNS |
DBUS | DBMS | DBS | DBHZ | DBKHZ | DBKHz | DBMHZ |
DBMHz | DBGHZ | DBGHz | DBA | DBMA | DBUA

LINear

Linear scaling; displays the RMS value.

DBM | DB | DBUV | DBMV | DBV

Basic FFT

**DBPS | DBNS | DBUS | DBMS | DBS | DBHZ | DBKHZ |
DBKHz | DBMHZ | DBMHz | DBGHZ | DBGHz**

FFT on tracks of time or frequency measurements

DBA | DBMA | DBUA

FFT on current waveforms

*RST: DBM

Usage:

Asynchronous command

Manual operation: See "Unit" on page 395

Table 27-12: Logarithmic scaling values

DBM	dBm
DB	dB (related to reference level) Set the reference level with <code>CALCulate:MATH<m>:FFT:MAGNitude:LEVel</code> .
DBUV	dB μ V
DBMV	dBmV
DBV	dBV
DBPS	dBps
DBNS	dBns
DBUS	dB μ s
DBMS	dBms
DBS	dBs
DBHZ	dBHz
DBKHZ = DBKHz	dBkHz
DBMHZ = DBMHz	dBMHz
DBGHZ = DBGHz	dBGHz
DBA	dBa
DBMA	dBmA
DBUA	dB μ A

CALCulate:MATH<m>:FFT:PHASe:SCALE <PhaseScale>

Defines the scaling unit for phase display.

Suffix:

<m> 1..8
math waveform

Parameters:

<PhaseScale> DEGRees | RADians
*RST: DEGRees

Usage: Asynchronous command

Manual operation: See "[Unit](#)" on page 395

CALCulate:MATH<m>:FFT:PHASe:SUPPression <Suppression>

Enables noise suppression. Phase calculation is restricted to frequencies with a minimum magnitude, the threshold value (see [CALCulate:MATH<m>:FFT:PHASe:THReshold](#) on page 1686).

Suffix:

<m> 1..8
math waveform

Parameters:

<Suppression> ON | OFF
*RST: OFF

Usage: Asynchronous command

Manual operation: See "[Suppression](#)" on page 395

CALCulate:MATH<m>:FFT:PHASe:THReshold <SupprThres>

Defines the minimum frequency magnitude for which phases are calculated. This setting is only available if [CALCulate:MATH<m>:FFT:PHASe:SUPPression](#) is set to "ON".

Suffix:

<m> 1..8
math waveform

Parameters:

<SupprThres> Range: -180 to 180
Increment: 0.1
*RST: 0
Default unit: dBm

Usage: Asynchronous command

Manual operation: See "[Threshold](#)" on page 395

CALCulate:MATH<m>:FFT:PHASe:UNWRap <Unwrap>

If enabled, phase shifts due to a limitation of the value range are eliminated.

Suffix:

<m> 1..8
math waveform

Parameters:

<Unwrap> ON | OFF
*RST: OFF

Usage: Asynchronous command

Manual operation: See "Unwrap" on page 395

CALCulate:MATH<m>:FFT:COUPlEd:WITH<1..8> <MathIndex>

Copies the current FFT settings of the selected math waveform (m) to the other selected math waveform (m2), and couples the two waveforms. This can be repeated for all math waveforms.

If any FFT setting for any of the coupled spectrums is changed, it is changed for all coupled spectrums.

Suffix:

<m> 1..8
FFT waveforms to be coupled. <m>, <m2> must be active and distinct.

Parameters:

<MathIndex> ON | OFF
*RST: OFF

Example: Prerequisite: FFt waveforms M1 and M2 are active.
CALC:MATH1:FFT:COUP:WITH2 ON
Couples the math waveforms M1 and M2.

Usage: Asynchronous command

Manual operation: See "Coupled to M1...M8" on page 393

27.13.2 Waveform data

CALCulate:MATH<m>:DATA:STYPe?	1687
CALCulate:MATH<m>:DATA:HEADer?	1688
CALCulate:MATH<m>:DATA[:VALues]?	1688

CALCulate:MATH<m>:DATA:STYPe?

Returns the signal type of the source of the math waveform.

Suffix:

<m> 1..8
Selects the math waveform.

Return values:

<SignalType> SOUR | SPEC | CORR | MEAS | NONE
 SOURce = normal signal
 SPECTrum = FFT spectrum, specific math signal
 CORRelation = correlated signal, specific math signal
 MEAsurement = result of a measurement
 NONE = undefined

Usage:

Query only
Asynchronous command

CALCulate:MATH<m>:DATA:HEADer?

Returns the header of math waveform data. The header contains attributes of the waveform.

Table 27-13: Header data

Position	Meaning	Example
1	XStart in s	-9.477E-008 = - 94,77 ns
2	XStop in s	9.477E-008 = 94,77 ns
3	Record length of the waveform in Samples	200000
4	Number of values per sample interval. For most waveforms the result is 1, for peak detect and envelope waveforms it is 2. If the number is 2, the number of returned values is twice the number of samples (record length).	1

Suffix:

<m> 1..8
Selects the math waveform.

Example:

```
CALC:MATH1:DATA:HEAD?
-9.477E-008,9.477E-008,200000,1
```

Usage:

Query only

CALCulate:MATH<m>:DATA[:VALues]?

Returns the data of the math waveform points for transmission from the instrument to the controlling computer. The data can be used in MATLAB, for example.

To set the export format, use [FORMat \[:DATA\]](#).

You can retrieve only Y-values, or X- and Y-values. Use [EXPort:WAVeform:INCXvalues](#) to define this.

Suffix:	
<m>	1..8 Selects the math waveform.
Return values:	
<Data>	List of values according to the format and content settings.
Usage:	Query only

27.13.3 Spectrum analysis (option R&S RTO6-K37)

In all `CALC:MATH<m>:FFT` commands, the suffix <m> selects the math waveform.

In all `CALC:MATH<m>:FFT:SPEC:TIM` commands, the suffix <m> selects the timeline.

<code>CALCulate:MATH<m>:FFT:SPECTrogram:CMODE</code>	1689
<code>CALCulate:MATH<m>:FFT:USEColtab</code>	1689
<code>CALCulate:MATH<m>:FFT:SPECTrogram:STAtE</code>	1690
<code>CALCulate:MATH<m>:FFT:SPECTrogram:TIMeline<n>:POSition</code>	1690
<code>CALCulate:MATH<m>:FFT:SPECTrogram:TIMeline<n>:STAtE</code>	1691

`CALCulate:MATH<m>:FFT:SPECTrogram:CMODE` <ColorTableMode>

Selects the color table mode for the frequency analysis display.

Suffix:	
<m>	1..8
Parameters:	
<ColorTableMode>	INCI AMPL
	INCI ("Incidence") The display color is set depending on the frequency of occurrence of a value.
	AMPL ("Amplitude") In the spectrogram and the frequency analysis display, the color is used to indicate the magnitude of the FFT signal. The higher the amplitude the higher the color in the assigned color table.
	*RST: INCI
Usage:	Asynchronous command

`CALCulate:MATH<m>:FFT:USEColtab` <UseColorTable>

If enabled, the selected waveform is displayed according to its assigned color table. For information on the available color tables, see [Chapter 4.3.2, "Color tables"](#), on page 76.

If this option is disabled, the preset color of the selected channel source is displayed, and the intensity of the specific signal color varies according to the cumulative occurrence of the values.

Suffix:

<m> 1..8

Parameters:

<UseColorTable> ON | OFF
 *RST: OFF

Usage: Asynchronous command**Manual operation:** See ["Use color table"](#) on page 387**CALCulate:MATH<m>:FFT:SPECTrogram:STATe <State>**

Enables the spectrogram display for a math waveform.

Suffix:

<m> 1..8

Parameters:

<State> ON | OFF
 *RST: OFF

Usage: Asynchronous command**Manual operation:** See ["Display"](#) on page 399**CALCulate:MATH<m>:FFT:SPECTrogram:TIMeline<n>:POSition <Position>**

Defines the position of one of the two possible time lines in a spectrogram. The time line must be enabled first, using the [CALCulate:MATH<m>:FFT:SPECTrogram:TIMeline<n>:STATe](#) command.

Suffix:

<m> 1..8

<n> 1..2

Parameters:

<Position> The position of the time line is defined by the index of the data acquisition in the history. How many acquisitions are available depends on the history settings.
 Range: 0 to 4294967295
 Increment: 1
 *RST: 0

Usage: Asynchronous command**Manual operation:** See ["Time line 1/2"](#) on page 399

CALCulate:MATH<m>:FFT:SPECTrogram:TIMeline<n>:STATe <State>

Enables one of two possible time lines in a spectrogram diagram. A time line marks a single waveform in the spectrogram, that is: the power vs frequency results for the data acquired at a specific time. After enabling a time line, the results for that time are displayed in the spectrum diagram.

The position of the time line is defined using the `CALCulate:MATH<m>:FFT:SPECTrogram:TIMeline<n>:POSition` command.

Suffix:

<m> 1..8

<n> 1..2

Parameters:

<State> ON | OFF

*RST: OFF

Usage: Asynchronous command

Manual operation: See "Time line 1/2" on page 399

27.14 Mask testing

Some of the commands in the following chapter are asynchronous. An overlapping or asynchronous command does not automatically finish executing before the next command starts executing. If overlapping commands must be executed in a defined order, e.g. to avoid wrong measurement results, they must be serviced sequentially.

To prevent an overlapping execution of commands, one of the commands `*OPC`, `*OPC?` or `*WAI` can be used after the command or a command set.

For more information, see:

- www.rohde-schwarz.com/rc-via-scp, chapter "Command sequence and synchronization"
- [Chapter 27.3, "Programming examples"](#), on page 1345
- [Mask test definition](#)..... 1691
- [Mask definition: user mask](#)..... 1696
- [Mask definition: waveform mask](#)..... 1703
- [Event actions](#)..... 1705
- [Results](#)..... 1708
- [Eye mask testing](#)..... 1710

27.14.1 Mask test definition

MTEST:ADD	1692
MTEST:REMOve	1692
MTEST[:STATe]	1692

MTESt:SHOW	1693
MTESt:RST	1693
MTESt:SOURce	1693
MTESt:CONDition	1694
MTESt:TOLerance	1694
MTESt:CTYPe	1694
MTESt:FILE:NAME	1695
MTESt:FILE:SAVE	1695
MTESt:FILE:OPEN	1695
MTESt:FILE:DELeTe	1696
MTESt:PAMOrder?	1696

MTESt:ADD <MaskTestName>

Creates a new mask test definition with the specified name.

Setting parameters:

<MaskTestName> String with the name of the mask test

Example: See [Chapter 27.3.3.1, "Creating a user mask"](#), on page 1351

Usage: Setting only
Asynchronous command

MTESt:REMOve <MaskTestName>

Deletes the mask test definition with the specified name.

Setting parameters:

<MaskTestName> String with the name of the mask test

Usage: Setting only
Asynchronous command

MTESt[:STATe] <MaskTestName>,<State>

MTESt[:STATe]? <MaskTestName>

Activates and deactivates the mask test. If the acquisition is running, the test starts immediately. Otherwise, the test starts when acquisition is started.

The testing is stopped when acquisition is stopped, also due to the [MTESt:ONViolation:STOP](#) command, or if [MASK\[:STATe\]](#) is set to "OFF".

The command needs *OPC command synchronisation.

Parameters:

<State> ON | OFF
*RST: OFF

Parameters for setting and query:

<MaskTestName> String with the name of the mask test

Example: `MTESt:STAT 'MyMask', ON; *OPC?`
See [Chapter 27.3.3.1, "Creating a user mask"](#), on page 1351

Usage: Asynchronous command
Manual operation: See ["Enable"](#) on page 403

MTEST:SHOW <State>

Switches the display of all mask segments on or off.

Parameters:

<State> ON | OFF
 *RST: ON

Usage: Asynchronous command
Manual operation: See ["Show mask"](#) on page 413

MTEST:RST

Clears all totals and results in all "Mask Test" result boxes.

Usage: Event
 Asynchronous command

Manual operation: See ["Mask results > Reset all"](#) on page 414

MTEST:SOURce <MaskTestName>,<Source>

MTEST:SOURce? <MaskTestName>

Selects the waveform to be tested against the mask.

Parameters:

<Source> C1W1 | C1W2 | C1W3 | C2W1 | C2W2 | C2W3 | C3W1 | C3W2 |
 C3W3 | C4W1 | C4W2 | C4W3 | M1 | M2 | M3 | M4 | M5 | M6 |
 M7 | M8 | R1 | R2 | R3 | R4 | XY1 | XY2 | XY3 | XY4 | SG1TL1 |
 SG1TL2 | SG2TL1 | SG2TL2 | SG3TL1 | SG3TL2 | SG4TL1 |
 SG4TL2 | SG5TL1 | SG5TL2 | SG6TL1 | SG6TL2 | SG7TL1 |
 SG7TL2 | SG8TL1 | SG8TL2 | Z1V1 | Z1V2 | Z1V3 | Z1V4 |
 Z1I1 | Z1I2 | Z1I3 | Z1I4 | Z2V1 | Z2V2 | Z2V3 | Z2V4 | Z2I1 |
 Z2I2 | Z2I3 | Z2I4 | DIFF1 | DIFF2 | COMMON1 | COMMON2
 Waveform to be tested, see [Chapter 27.4.2, "Waveform parameter"](#), on page 1371
 *RST: C1W1

Parameters for setting and query:

<MaskTestName> String containing the name of the mask test

Usage: Asynchronous command

Manual operation: See ["Target"](#) on page 403

MTESt:CONDition <MaskTestName>,<PassFailMode>

MTESt:CONDition? <MaskTestName>

Sets the first criteria for a failed test, the kind of hits to be considered for test evaluation. A test has failed if the number of sample hits or acquisition hits exceeds the limit defined by [MTESt:TOLerance](#).

Parameters:

<PassFailMode> SAMPlEs | ACQuisitions

SAMPlEs

Considers the number of samples that hit the mask.

ACQuisitions

Considers the number of acquisitions that contain at least one sample hit. How many samples hit the mask in that acquisition is not relevant.

*RST: SAMPlEs

Parameters for setting and query:

<MaskTestName> String with the name of the mask test

Usage: Asynchronous command

Manual operation: See "[Fail condition, Violation tolerance](#)" on page 411

MTESt:TOLerance <MaskTestName>,<ToViolCnt>

MTESt:TOLerance? <MaskTestName>

Sets the second criteria for a failed test, the number of tolerable sample hits or acquisition hits. Use [MTESt:CONDition](#) to define which hits are considered for test evaluation.

Parameters:

<ToViolCnt> Range: 0 to 4000000000

Increment: 1

*RST: 0

Parameters for setting and query:

<MaskTestName> String with the name of the mask test

Usage: Asynchronous command

Manual operation: See "[Fail condition, Violation tolerance](#)" on page 411

MTESt:CTYPe <MaskTestName>,<DefinitionType>

MTESt:CTYPe? <MaskTestName>

Sets the method of mask definition.

Parameters:

<DefinitionType> USER | WFML | EYEMask | PROTOcol

USER

The mask segments are created by entering the numerical x- and y-values of the mask points.

See: [Chapter 27.14.2, "Mask definition: user mask"](#), on page 1696

WFML

The mask is created from the envelope of an existing waveform.

See: [Chapter 27.14.3, "Mask definition: waveform mask"](#), on page 1703

EYEMask

Mask for eye diagram testing. See: [Chapter 27.23.6, "Eye mask testing"](#), on page 2732.

Requires jitter option R&S RTO6-K12

*RST: USER

Parameters for setting and query:

<MaskTestName> String with the name of the mask test

Usage: Asynchronous command

Manual operation: See ["Mask Type"](#) on page 403

MTEST:FILE:NAME <MaskTestName>, <Path>

MTEST:FILE:NAME? <MaskTestName>

Specifies a file to save the mask test.

Parameters:

<Path> String containing path and file name, format .xml

Parameters for setting and query:

<MaskTestName> String with the name of the mask test

Manual operation: See ["Save / load mask"](#) on page 403

MTEST:FILE:SAVE <MaskTestName>

Saves the specified mask test. It contains the mask definition, defined actions and fail conditions.

Setting parameters:

<MaskTestName> String with the name of the mask test

Usage: Setting only
Asynchronous command

Manual operation: See ["Save / load mask"](#) on page 403

MTEST:FILE:OPEN <MaskTestName>

Loads the specified mask test to the instrument.

Setting parameters:

<MaskTestName> String with the name of the mask test

Usage:

Setting only
Asynchronous command

Manual operation: See "[Save / load mask](#)" on page 403

MTESt:FILE:DELeTe <MaskTestName>

Deletes the specified mask test.

Setting parameters:

<MaskTestName> String with the name of the mask test

Usage:

Setting only
Asynchronous command

Manual operation: See "[Save / load mask](#)" on page 403

MTESt:PAMOrder? <MaskTestName>

Retruns the PAM order of the signal for the selected mask source.

Query parameters:

<MaskTestName>

Return values:

<PAMOrder> PAM2 | PAM3 | PAM4 | PAM5 | PAM6 | PAM7 | PAM8
*RST: PAM2

Usage:

Query only
Asynchronous command

27.14.2 Mask definition: user mask

The chapter contains commands required for the definition of user masks - [MTESt:CTYPe](#) is set to `USER`.

**Segment and point indices**

In remote control, the numbering of segments and points starts from 0. But in manual operation, the numbering starts from 1.

MTESt:SEGMENT:STATE	1697
MTESt:SEGMENT:ADD	1697
MTESt:SEGMENT:COUNT?	1697
MTESt:SEGMENT:INSert	1698
MTESt:SEGMENT:REMOve	1698
MTESt:SEGMENT:CLear	1698
MTESt:SEGMENT:REGion	1698
MTESt:SEGMENT:POINt:ADD	1699

MTESt:SEGMent:POINt:INSert.....	1699
MTESt:SEGMent:POINt:REMove.....	1699
MTESt:SEGMent:POINt:COUnT?.....	1700
MTESt:SEGMent:POINt:X.....	1700
MTESt:SEGMent:POINt:Y.....	1700
MTESt:SEGMent:RESCale:RECalculate.....	1701
MTESt:SEGMent:RESCale:XFACTOR.....	1701
MTESt:SEGMent:RESCale:YFACTOR.....	1701
MTESt:SEGMent:RESCale:XOFFset.....	1702
MTESt:SEGMent:RESCale:YOFFset.....	1702

MTESt:SEGMent:STATe <MaskTestName>, <MaskSegIdx>, <State>

MTESt:SEGMent:STATe? <MaskTestName>, <MaskSegIdx>

Enables and disables the mask segment. Disabled segments are not considered by running tests.

Parameters:

<State> ON | OFF
 *RST: ON

Parameters for setting and query:

<MaskTestName> String with the name of the mask test
 <MaskSegIdx> Number of the segment. Counting starts from 0.

Usage: Asynchronous command

Manual operation: See "[Mask segments](#)" on page 405

MTESt:SEGMent:ADD <MaskTestName>

Creates a new segment in the mask definition.

Setting parameters:

<MaskTestName> String with the name of the mask test

Example: See [Chapter 27.3.3.1, "Creating a user mask"](#), on page 1351

Usage: Setting only
 Asynchronous command

Manual operation: See "[Mask segments](#)" on page 405

MTESt:SEGMent:COUnT? <MaskTestName>

Returns the number of segments in the mask definition

Query parameters:

<MaskTestName> String with the name of the mask test

Return values:

<Count> Number of segments

Usage: Query only

Manual operation: See "[Mask segments](#)" on page 405

MTESt:SEGMENT:INSert <MaskTestName>, <MaskSegIdx>

Inserts a new segment before the specified index in the mask definition.

Setting parameters:

<MaskTestName> String with the name of the mask test

<MaskSegIdx> Number of the segment. Counting starts from 0.

Usage: Setting only
Asynchronous command

Manual operation: See "[Mask segments](#)" on page 405

MTESt:SEGMENT:REMOve <MaskTestName>, <MaskSegIdx>

Removes the specified segment from the mask definition.

Setting parameters:

<MaskTestName> String with the name of the mask test

<MaskSegIdx> Number of the segment. Counting starts from 0.

Usage: Setting only
Asynchronous command

Manual operation: See "[Mask segments](#)" on page 405

MTESt:SEGMENT:CLEar <MaskTestName>

Deletes all mask segments of the indicated mask test.

Setting parameters:

<MaskTestName> String with the name of the mask test

Usage: Setting only
Asynchronous command

MTESt:SEGMENT:REGion <MaskTestName>, <MaskSegIdx>, <Region>

MTESt:SEGMENT:REGion? <MaskTestName>, <MaskSegIdx>

Defines the region of the segment that builds the mask.

Parameters:

<Region> UPPER | LOWER | INNER

UPPER

the segment points are connected to a line, the display area above this line is the mask segment

LOWER

the segment points are connected to a line, the display area below this line is the mask segment

INNER

the segment points form a closed geometrical shape, which is the mask segment

*RST: INNER

Parameters for setting and query:

<MaskTestName> String with the name of the mask test

<MaskSegIdx> Number of the segment. Counting starts from 0.

Example: See [Chapter 27.3.3.1, "Creating a user mask"](#), on page 1351

Usage: Asynchronous command

Manual operation: See ["Mask segments"](#) on page 405

MTESt:SEGMENT:POINT:ADD <MaskTestName>, <MaskSegIdx>

Adds a new point to the segment definition.

Setting parameters:

<MaskTestName> String with the name of the mask test

<MaskSegIdx> Number of the segment. Counting starts from 0.

Example: See [Chapter 27.3.3.1, "Creating a user mask"](#), on page 1351

Usage: Setting only
Asynchronous command

Manual operation: See ["Definition of segment"](#) on page 406

MTESt:SEGMENT:POINT:INSert <MaskTestName>, <MaskSegIdx>,
<MaskSegPtIdx>

Inserts a new point before the specified mask segment point.

Setting parameters:

<MaskTestName> String with the name of the mask test

<MaskSegIdx> Number of the segment. Counting starts from 0.

<MaskSegPtIdx> Number of the point. Counting starts from 0.

Usage: Setting only
Asynchronous command

Manual operation: See ["Definition of segment"](#) on page 406

MTESt:SEGMENT:POINT:REMOve <MaskTestName>, <MaskSegIdx>,
<MaskSegPtIdx>

Removes the specified point from the mask segment.

Setting parameters:

<MaskTestName> String with the name of the mask test

<MaskSegIdx> Number of the segment. Counting starts from 0.

<MaskSegmPtIdx> Number of the point. Counting starts from 0.

Usage: Setting only
Asynchronous command

Manual operation: See ["Definition of segment"](#) on page 406

MTES:SEGMENT:POINT:COUNT? <MaskTestName>, <MaskSegIdx>

Returns the number of defined points for the specified mask segment.

Query parameters:

<MaskTestName> String with the name of the mask test

<MaskSegIdx> Number of the segment. Counting starts from 0.

Usage: Query only

Manual operation: See ["Definition of segment"](#) on page 406

MTES:SEGMENT:POINT:X <MaskTestName>, <MaskSegIdx>,
<MaskSegmPtIdx>,<X>

MTES:SEGMENT:POINT:X? <MaskTestName>, <MaskSegIdx>, <MaskSegmPtIdx>

Defines the x-value of the mask segment point.

Parameters:

<X> Range: -100E+24 to 100E+24
Increment: 1E-6
*RST: 0
Default unit: s

Parameters for setting and query:

<MaskTestName> String with the name of the mask test

<MaskSegIdx> Number of the segment. Counting starts from 0.

<MaskSegmPtIdx> Number of the point. Counting starts from 0.

Example: See [Chapter 27.3.3.1, "Creating a user mask"](#), on page 1351

Usage: Asynchronous command

Manual operation: See ["Definition of segment"](#) on page 406

MTES:SEGMENT:POINT:Y <MaskTestName>, <MaskSegIdx>,
<MaskSegmPtIdx>,<Y>

MTES:SEGMENT:POINT:Y? <MaskTestName>, <MaskSegIdx>, <MaskSegmPtIdx>

Defines the y-value of the mask segment point.

Parameters:

<Y> Range: -100E+24 to 100E+24
 Increment: 1E-6
 *RST: 0
 Default unit: V

Parameters for setting and query:

<MaskTestName> String with the name of the mask test
 <MaskSegIdx> Number of the segment. Counting starts from 0.
 <MaskSegmPtIdx> Number of the point. Counting starts from 0.

Example: See [Chapter 27.3.3.1, "Creating a user mask"](#), on page 1351

Usage: Asynchronous command

Manual operation: See ["Definition of segment"](#) on page 406

MTESt:SEGMENT:RESCale:RECalculate <MaskTestName>, <MaskSegIdx>

Multiplies and adds the given x- and y-factors and offsets to the coordinates of all points of the selected mask segment.

Setting parameters:

<MaskTestName> String with the name of the mask test
 <MaskSegIdx> Number of the segment. Counting starts from 0.

Usage: Setting only
 Asynchronous command

Manual operation: See ["Apply"](#) on page 407

MTESt:SEGMENT:RESCale:XFACTOR <MaskTestName>,
 <MaskSegIdx>,<ExpansFactX>**MTESt:SEGMENT:RESCale:XFACTOR?** <MaskTestName>, <MaskSegIdx>**MTESt:SEGMENT:RESCale:YFACTOR** <MaskTestName>,
 <MaskSegIdx>,<ExpansFactY>**MTESt:SEGMENT:RESCale:YFACTOR?** <MaskTestName>, <MaskSegIdx>

Stretches or compresses the selected mask segment in horizontal (XFACTOR) or vertical direction (YFACTOR). The x- or y-values of all points of the selected mask segment are multiplied with this factor. Factors >1 stretch the mask segment, while factors between 0 and 1 compress it. Negative values are possible and change the algebraic sign.

Only takes effect after the [MTESt:SEGMENT:RESCale:RECalculate](#) command.

Parameters:

<ExpansFactY> Range: -100 to 100
 Increment: 1
 *RST: 1

Parameters for setting and query:

<MaskTestName> String with the name of the mask test

<MaskSegIdx> Number of the segment. Counting starts from 0.

Usage: Asynchronous command

Manual operation: See "[Factor Y](#)" on page 407

MTESt:SEGMENT:RESCale:XOFFset <MaskTestName>, <MaskSegIdx>,<OffsetX>

MTESt:SEGMENT:RESCale:XOFFset? <MaskTestName>, <MaskSegIdx>

Moves the mask segment horizontally. The specified offset is added to the x-values of all points of the selected mask segment.

Only takes effect after the [MTESt:SEGMENT:RESCale:RECalculate](#) command.

Parameters:

<OffsetX> Range: -50 to 50
 Increment: 1E-9
 *RST: 0
 Default unit: s

Parameters for setting and query:

<MaskTestName> String with the name of the mask test

<MaskSegIdx> Number of the segment. Counting starts from 0.

Usage: Asynchronous command

Manual operation: See "[Offset X](#)" on page 407

MTESt:SEGMENT:RESCale:YOFFset <MaskTestName>, <MaskSegIdx>,<OffsetY>

MTESt:SEGMENT:RESCale:YOFFset? <MaskTestName>, <MaskSegIdx>

Moves the mask segment vertically. The specified offset is added to the y-values of all points of the selected mask segment.

Only takes effect after the [MTESt:SEGMENT:RESCale:RECalculate](#) command.

Parameters:

<OffsetY> Range: -1000 to 1000
 Increment: 1E-6
 *RST: 0
 Default unit: V

Parameters for setting and query:

<MaskTestName> String with the name of the mask test

<MaskSegIdx> Number of the segment. Counting starts from 0.

Usage: Asynchronous command

Manual operation: See "[Offset Y](#)" on page 407

27.14.3 Mask definition: waveform mask

The chapter contains commands required for the definition of waveform masks -
MTEST:CTYPE is set to **WFML**.

MTEST:REFWfm	1703
MTEST:WFMLupdate	1703
MTEST:WFMRscale:XWIDth	1703
MTEST:WFMRscale:YWIDth	1704
MTEST:WFMRscale:YPOSition	1704
MTEST:WFMRscale:YSTRetch	1705

MTEST:REFWfm <MaskTestName>,<Source>

MTEST:REFWfm? <MaskTestName>

Sets the reference waveform from which the mask is created.

The reference waveform can be created before, or loaded from a file with **REFCurve** commands, see [Chapter 27.10.2, "Reference waveforms"](#), on page 1545.

Parameters:

<Source> REF1 | REFerence1 | REF2 | REFerence2 | REF3 |
 REFerence3 | REF4 | REFerence4
 REF1 = REFerence1, REF2 = REFerence2, REF3 = REFer-
 ence3, REF4 = REFerence4: reference waveforms
 *RST: REF1

Parameters for setting and query:

<MaskTestName> String containing the name of the mask test

Usage: Asynchronous command

MTEST:WFMLupdate <MaskTestName>

Creates the upper and lower mask limit from the envelope of the selected reference waveform. If the reference waveform was not defined before, it is created automatically from the mask test source waveform which is set with **MTEST:SOURce**.

Setting parameters:

<MaskTestName> String containing the name of the mask test

Usage: Setting only
 Asynchronous command

MTEST:WFMRscale:XWIDth <MaskTestName>,<HorizontalWidth>

MTEST:WFMRscale:XWIDth? <MaskTestName>

Sets the width of the mask in horizontal direction. The specified factor in divisions is added to the positive x-values and subtracted from the negative x-values of the mask limits in relation to the source waveform of the mask.

Parameters:

<HorizontalWidth> Range: 0 to 1000
 Increment: 0.01
 *RST: 0
 Default unit: div

Parameters for setting and query:

<MaskTestName> String containing the name of the mask test

Usage: Asynchronous command

Manual operation: See "[Horizontal width](#)" on page 409

MTESt:WFMRescale:YWIDTH <MaskTestName>,<VerticalWidth>

MTESt:WFMRescale:YWIDTH? <MaskTestName>

Sets the width of the waveform mask in vertical direction. The specified factor in divisions is added to the y-values of the upper mask limit and subtracted from the y-values of the lower mask limit. Thus, the upper half of the mask is pulled upwards, the lower half is pulled down.

Parameters:

<VerticalWidth> Vertical mask width in divisions
 Range: 0 to 1000
 Increment: 0.01
 *RST: 0
 Default unit: div

Parameters for setting and query:

<MaskTestName> String containing the name of the mask test

Usage: Asynchronous command

Manual operation: See "[Vertical width](#)" on page 409

MTESt:WFMRescale:YPOSITION <MaskTestName>,<VertPosi>

MTESt:WFMRescale:YPOSITION? <MaskTestName>

Moves the mask vertically within the display.

Parameters:

<VertPosi> Range: -1000 to 1000
 Increment: 0.01
 *RST: 0
 Default unit: div

Parameters for setting and query:

<MaskTestName> String containing the name of the mask test

Usage: Asynchronous command

Manual operation: See "[Vertical position](#)" on page 410

MTESt:WFMRescale:YSTRetch <MaskTestName>,<VerticalStretch>
MTESt:WFMRescale:YSTRetch? <MaskTestName>

Sets the vertical scaling to stretch the mask in y-direction. The scaling axis is the horizontal line through the lowest value of the lower mask limit.

Parameters:

<VerticalStretch> Scale factor in %
 Range: 10 to 1000
 Increment: 1
 *RST: 100
 Default unit: %

Parameters for setting and query:

<MaskTestName> String containing the name of the mask test

Usage: Asynchronous command

Manual operation: See "[Vertical stretch](#)" on page 410

27.14.4 Event actions

MTESt:ONViolation:BEEP	1705
MTESt:ONViolation:STOP	1705
MTESt:ONViolation:PRINt	1706
MTESt:ONViolation:SAVewaveform	1706
MTESt:ONViolation:REPort	1706
MTESt:ONViolation:TRIGgerout	1707
MTESt:ONViolation:RUNexec	1707

MTESt:ONViolation:BEEP <MaskTestName>,<Beep>

MTESt:ONViolation:BEEP? <MaskTestName>

Generates a beep sound for the specified event.

Parameters:

<Beep> NOAction | SUCCess | VIOLation
 See [Chapter 27.4.5, "Event parameter"](#), on page 1373
 *RST: NOAction

Parameters for setting and query:

<MaskTestName> String with the name of the mask test

Usage: Asynchronous command

Manual operation: See "[Beep](#)" on page 412

MTESt:ONViolation:STOP <MaskTestName>,<StopAcq>

MTESt:ONViolation:STOP? <MaskTestName>

Stops data acquisition for the specified event.

Parameters:

<StopAcq> NOAction | SUCCESS | VIOLation
 See [Chapter 27.4.5, "Event parameter"](#), on page 1373
 *RST: NOAction

Parameters for setting and query:

<MaskTestName> String with the name of the mask test

Usage: Asynchronous command

Manual operation: See ["Stop acq."](#) on page 412

MTESt:ONViolation:PRINt <MaskTestName>,<Print>

MTESt:ONViolation:PRINt? <MaskTestName>

Saves a screenshot including the measurement results for the specified event.

Parameters:

<Print> NOAction | SUCCESS | VIOLation
 See [Event parameter](#)
 *RST: NOAction

Parameters for setting and query:

<MaskTestName> String with the name of the mask test

Usage: Asynchronous command

Manual operation: See ["Save screenshot"](#) on page 412

MTESt:ONViolation:SAVewaveform <MaskTestName>,<SaveWfm>

MTESt:ONViolation:SAVewaveform? <MaskTestName>

Saves the waveform data.

Parameters:

<SaveWfm> NOAction | SUCCESS | VIOLation
 See [Chapter 27.4.5, "Event parameter"](#), on page 1373
 *RST: NOAction

Parameters for setting and query:

<MaskTestName> String with the name of the mask test

Usage: Asynchronous command

Manual operation: See ["Save waveform"](#) on page 413

MTESt:ONViolation:REPort <MaskTestName>,<Report>

MTESt:ONViolation:REPort? <MaskTestName>

Creates and saves a report of the current settings and results.

Parameters:

<Report> NOAction | SUCCess | VIOLation
 See [Chapter 27.4.5, "Event parameter"](#), on page 1373
 *RST: NOAction

Parameters for setting and query:

<MaskTestName> String with the name of the mask test

Usage: Asynchronous command

Manual operation: See ["Report"](#) on page 413

MTESt:ONViolation:TRIGgerout <MaskTestName>,<TriggerOutPulse>

MTESt:ONViolation:TRIGgerout? <MaskTestName>

Creates a trigger out pulse on mask violation or successful completion of the test cycle.

Parameters:

<TriggerOutPulse> NOAction | SUCCess | VIOLation
 *RST: NOAction

Parameters for setting and query:

<MaskTestName> String with the name of the mask test

Usage: Asynchronous command

Manual operation: See ["Trigger out pulse"](#) on page 413

MTESt:ONViolation:RUNexec <MaskTestName>,<RunExecutable>

MTESt:ONViolation:RUNexec? <MaskTestName>

Starts an external application if the command is set to VIOLation or SUCCess.

Use the following commands to set up the application:

- [EXECutable:NAME](#) on page 1787
- [EXECutable:PARAMeter](#) on page 1787
- [EXECutable:WDIRECTory](#) on page 1788

Parameters:

<RunExecutable> NOAction | SUCCess | VIOLation
 See [Chapter 27.4.5, "Event parameter"](#), on page 1373
 *RST: NOAction

Parameters for setting and query:

<MaskTestName> String with the name of the mask test

Usage: Asynchronous command

Manual operation: See ["Start Executable"](#) on page 413

27.14.5 Results

MTESt:RESult:STATe?	1708
MTESt:RESult[:RESult]?	1708
MTESt:RESult:COUNT:WAVeforms?	1708
MTESt:RESult:COUNT:REMAining?	1709
MTESt:RESult:COUNT:FWAVeforms?	1709
MTESt:RESult:COUNT:FAILures?	1709
MTESt:RESult:FRATe?	1710

MTESt:RESult:STATe? <MaskTestName>

Shows if the test is running or has finished. The state is set to "Finished" if no acquisitions remain (see [MTESt:RESult:COUNT:REMAining?](#) on page 1709).

Query parameters:

<MaskTestName>

Return values:

<State> RUNNING | FINISHED
*RST: RUNNING

Usage: Query only
 Asynchronous command

Manual operation: See "[State](#)" on page 401

MTESt:RESult[:RESult]? <MaskTestName>

Returns the test result.

A test has failed if the number of sample hits or acquisition hits exceeds the limit of "Violation tolerance" hits (see [MTESt:TOLerance](#) on page 1694, [MTESt:RESult:COUNT:FAILures?](#) on page 1709 and [MTESt:RESult:COUNT:FWAVeforms?](#) on page 1709).

Query parameters:

<MaskTestName>

Return values:

<TestResult> PASS | FAIL
*RST: PASS

Usage: Query only
 Asynchronous command

Manual operation: See "[Test result](#)" on page 402

MTESt:RESult:COUNT:WAVeforms? <MaskTestName>

Returns the number of tested acquisitions.

Query parameters:

<MaskTestName>

Return values:

<AcqsCompleted> Range: 0 to 100E+24

*RST: 0

Usage:

Query only

Asynchronous command

Manual operation: See ["Acq. completed"](#) on page 401**MTESt:RESult:COUNt:REMAining? <MaskTestName>**

Remaining acquisitions until "Average count / Nx Single count" is reached.

The value is useful if you test a specified number of acquisitions with action "Stop acquisition" on violation, or if the acquisition has been stopped manually.

Query parameters:

<MaskTestName>

Return values:

<AcqsRemaining> Range: 0 to 100E+24

*RST: 0

Usage:

Query only

Asynchronous command

Manual operation: See ["Acq. remaining"](#) on page 401**MTESt:RESult:COUNt:FWAVEforms? <MaskTestName>**

Returns the number of acquisitions that contained at least one sample hit.

Query parameters:

<MaskTestName>

Return values:

<AcquisitionHits> Range: 0 to 100E+24

*RST: 0

Usage:

Query only

Asynchronous command

Manual operation: See ["Acquisition hits"](#) on page 401**MTESt:RESult:COUNt:FAILures? <MaskTestName>**

Returns the number of sample hits that violated the mask.

Query parameters:

<MaskTestName>

Return values:

<SampleHits> Range: 0 to 100E+24
 *RST: 0

Usage:

Query only
 Asynchronous command

Manual operation: See "Sample hits" on page 401

MTES:RESult:FRATe? <MaskTestName>

Ratio of acquisition hits to the number of tested acquisitions.

Query parameters:

<MaskTestName>

Return values:

<FailRate> Range: -100E+24 to 100E+24
 *RST: 0
 Default unit: %

Usage:

Query only
 Asynchronous command

Manual operation: See "Fail rate" on page 401

27.14.6 Eye mask testing

27.14.6.1 Definition of eye masks

To perform mask testing on eye diagrams, the option R&S RTO6-K12 adds a special mask definition type to the common mask definitions: the definition type "Eye".

MTES:CEMask.....	1711
MTES:EYEMask:TYPE.....	1711
MTES:EYEMask:HEIGHt<m>[:VALue].....	1711
MTES:EYEMask:WIDTh<m>[:VALue].....	1711
MTES:EYEMask:MSKRight.....	1712
MTES:EYEMask:MSKLeft.....	1712
MTES:EYEMask:HPERiod.....	1712
MTES:EYEMask:MSKTop.....	1713
MTES:EYEMask:MSKBottom.....	1713
MTES:EYEMask:TOFFset.....	1713
MTES:EYEMask:BOFFset.....	1713
MTES:EYEMask:TBSYmmetric.....	1713
MTES:EYEMask:TBWidth.....	1714
MTES:EYEMask:HPOSition.....	1714
MTES:EYEMask:VPOSition.....	1714
MTES:EYEMask:PAMNeye.....	1715
MTES:EYEMask:REFDelta.....	1715

MTESt:CEMask <MaskTestName>

Converts the test and mask definitions of the current mask test to a new mask test of type "User".

Setting parameters:

<MaskTestName> String with the name of the mask test

Usage: Setting only
Asynchronous command

Manual operation: See "[Convert to user mask](#)" on page 417

MTESt:EYEMask:TYPE <MaskTestName>,<Type>**MTESt:EYEMask:TYPE?** <MaskTestName>

Defines the outline of the eye mask.

Parameters:

<Type> SQUARE | DIAMOND | HEXAGON | OCTAGON
*RST: DIAMOND

Parameters for setting and query:

<MaskTestName> String with the name of the mask test

Usage: Asynchronous command

Manual operation: See "[Shape](#)" on page 415

MTESt:EYEMask:HEIGHT<m>[:VALUE] <MaskTestName>, <value>

Defines the main height of all eye mask shapes and the minor height for octagon mask shapes.

Suffix:

<m> 1..2
1 - main width
2 - minor width

Parameters:

<value> Default unit: s

Setting parameters:

<MaskTestName> String with the name of the mask test

Usage: Asynchronous command

Manual operation: See "[Main height \(H1\), Minor height \(H2\)](#)" on page 416

MTESt:EYEMask:WIDTH<m>[:VALUE] <MaskTestName>, <value>

Defines the main width of all eye mask shapes and the minor width for hexagon and octagon mask shapes.

Suffix:

<m> 1..2
 1 - main width
 2 - minor width

Parameters:

<value> Default unit: s

Setting parameters:

<MaskTestName> String with the name of the mask test

Usage: Asynchronous command

Manual operation: See "[Main width \(W1\), Minor width \(W2\)](#)" on page 416

MTESt:EYEMask:MSKRight <MaskTestName>,<Copy>

MTESt:EYEMask:MSKRight? <MaskTestName>

MTESt:EYEMask:MSKLeft <MaskTestName>,<Copy>

MTESt:EYEMask:MSKLeft? <MaskTestName>

Copies the eye shape to the right and left, respectively.

The distance of the copy is defined using [MTESt:EYEMask:HPERiod](#).

Parameters:

<Copy> ON | OFF
 *RST: OFF

Parameters for setting and query:

<MaskTestName> String with the name of the mask test

Usage: Asynchronous command

Manual operation: See "[Segments](#)" on page 417

MTESt:EYEMask:HPERiod <MaskTestName>,<InterpattLength>

MTESt:EYEMask:HPERiod? <MaskTestName>

Defines the time distance between the shape centers if [MTESt:EYEMask:MSKLeft](#) and/or [MTESt:EYEMask:MSKRight](#) are ON.

Parameters:

<InterpattLength> Range: 0 to 100
 Increment: 0.01
 *RST: 0.5
 Default unit: s

Parameters for setting and query:

<MaskTestName> String with the name of the mask test

Usage: Asynchronous command

Manual operation: See "[Periodicity](#)" on page 416

MTEST:EYEMask:MSKTop <MaskTestName>,<Add>
MTEST:EYEMask:MSKTop? <MaskTestName>
MTEST:EYEMask:MSKBottom <MaskTestName>,<Add>
MTEST:EYEMask:MSKBottom? <MaskTestName>

Enable the upper (top) and lower (bottom) mask region, respectively.

Parameters:

<Add> ON | OFF
 *RST: OFF

Parameters for setting and query:

<MaskTestName> String with the name of the mask test

Usage: Asynchronous command

Manual operation: See "[Segments](#)" on page 417

MTEST:EYEMask:TOFFset <MaskTestName>,<RectDistTop>
MTEST:EYEMask:TOFFset? <MaskTestName>
MTEST:EYEMask:BOFFset <MaskTestName>,<RectDistBtom>
MTEST:EYEMask:BOFFset? <MaskTestName>

Voltage distance from the eye shape center that limit the upper (TOFFset) and lower (BOFFset) regions.

Parameters:

<RectDistBtom> Range: 0 to 100
 Increment: 0.01
 *RST: 0.5
 Default unit: V

Parameters for setting and query:

<MaskTestName> String with the name of the mask test

Usage: Asynchronous command

Manual operation: See "[Offset top, Offset bottom](#)" on page 417

MTEST:EYEMask:TBSymmetric <MaskTestName>,<TopBtomSymetrie>
MTEST:EYEMask:TBSymmetric? <MaskTestName>

Sets bottom and top offsets to the same value so that the outer regions are symmetric to the eye shape.

Parameters:

<TopBtomSymetrie> ON | OFF
 *RST: ON

Parameters for setting and query:

<MaskTestName> String with the name of the mask test

Usage: Asynchronous command

Manual operation: See "[Symmetric](#)" on page 416

MTESt:EYEMask:TBWidth <MaskTestName>,<RectangleLength>
MTESt:EYEMask:TBWidth? <MaskTestName>

Sets the time width of the outer regions, symmetric to the eye shape center.

Parameters:

<RectangleLength> Range: 0 to 100
 Increment: 0.01
 *RST: 0.5
 Default unit: s

Parameters for setting and query:

<MaskTestName> String with the name of the mask test

Usage: Asynchronous command

Manual operation: See "[Width](#)" on page 416

MTESt:EYEMask:HPOsition <MaskTestName>,<PatOffsetX>
MTESt:EYEMask:HPOsition? <MaskTestName>

Sets the horizontal (time) value of the eye shape enter and thus defines the horizontal position of the eye shape on the display.

Parameters:

<PatOffsetX> Range: -100 to 100
 Increment: 0.01
 *RST: 0
 Default unit: s

Parameters for setting and query:

<MaskTestName> String with the name of the mask test

Usage: Asynchronous command

Manual operation: See "[Horizontal center/Vertical center](#)" on page 415

MTESt:EYEMask:VPOsition <MaskTestName>,<PatOffsetY>
MTESt:EYEMask:VPOsition? <MaskTestName>

Sets the vertical (voltage) value of the eye shape enter and thus defines the vertical position of the eye shape on the display.

Parameters:

<PatOffsetY> Range: -100 to 100
 Increment: 0.01
 *RST: 0
 Default unit: V

Parameters for setting and query:

<MaskTestName> String with the name of the mask test

Usage: Asynchronous command

Manual operation: See "[Horizontal center/Vertical center](#)" on page 415

MTESt:EYEMask:PAMNeye <MaskTestName>,<PAMEye>
MTESt:EYEMask:PAMNeye? <MaskTestName>

Enable if a PAM-N signal is used for the mask.

Parameters:

<PAMEye> ON | OFF
 *RST: OFF

Parameters for setting and query:

<MaskTestName>

Usage: Asynchronous command

Manual operation: See "[PAM eye](#)" on page 415

MTESt:EYEMask:REFDelta <MaskTestName>,<DeltaYToRefLev>
MTESt:EYEMask:REFDelta? <MaskTestName>

Sets the vertical delta to the reference level for a PAM-N signal eye.

Available, if [MTESt:EYEMask:PAMNeye](#) is set to ON.

Parameters:

<DeltaYToRefLev> Range: -100 to 100
 Increment: 0.01
 *RST: 0
 Default unit: V

Parameters for setting and query:

<MaskTestName>

Usage: Asynchronous command

Manual operation: See "[Vertical data to ref. level](#)" on page 415

27.15 Search

Some of the commands in the following chapter are asynchronous. An overlapping or asynchronous command does not automatically finish executing before the next command starts executing. If overlapping commands must be executed in a defined order, e.g. to avoid wrong measurement results, they must be serviced sequentially.

To prevent an overlapping execution of commands, one of the commands *OPC, *OPC? or *WAI can be used after the command or a command set.

For more information, see:

- www.rohde-schwarz.com/rc-via-scp, chapter "Command sequence and synchronization"
- [Chapter 27.3, "Programming examples"](#), on page 1345

• General search settings.....	1716
• Basic trigger search conditions.....	1718
• Edge search conditions.....	1720
• Glitch search conditions.....	1721
• Interval search conditions.....	1722
• Runt search conditions.....	1724
• Slew rate search conditions.....	1726
• Timeout search conditions.....	1729
• Width search conditions.....	1729
• Window search conditions.....	1732
• Data2clock search conditions.....	1734
• Pattern search conditions.....	1737
• State search conditions.....	1741
• Search on spectrum.....	1744
• Search gate settings.....	1745
• Noise rejection.....	1748
• Search results.....	1750

27.15.1 General search settings

SEARch:ADD.....	1716
SEARch:CLear.....	1716
SEARch:REMove.....	1717
SEARch:SOURce.....	1717
SEARch:ONLine.....	1717
SEARch:ALL.....	1718

SEARch:ADD <SearchName>

Creates a new search definition with the specified name.

Setting parameters:

<SearchName> String with the name of the search

Example: See [Chapter 27.3.4.1, "Searching for a pulse of a specified width"](#), on page 1352

Usage: Setting only
Asynchronous command

SEARch:CLear <SearchName>

Clears the search results once to start a new search.

Setting parameters:

<SearchName> Search definition

Usage: Setting only
Asynchronous command

Manual operation: See ["Clear results"](#) on page 445

SEARCh:REMOve <Key>

Deletes the specified search definition.

Setting parameters:

<Key> String with the name of the search

Usage: Setting only
Asynchronous command

SEARCh:SOURce <SearchName>,<Source>**SEARCh:SOURce?** <SearchName>

Defines the source on which the search conditions are applied. The source can be any analog or digital channel, math or reference waveform as well as a serial bus configured for a supported protocol.

Parameters:

<Source> C1W1 | C1W2 | C1W3 | C2W1 | C2W2 | C2W3 | C3W1 | C3W2 |
C3W3 | C4W1 | C4W2 | C4W3 | M1 | M2 | M3 | M4 | M5 | M6 |
M7 | M8 | R1 | R2 | R3 | R4 | D0 | D1 | D2 | D3 | D4 | D5 | D6 |
D7 | D8 | D9 | D10 | D11 | D12 | D13 | D14 | D15 | SBUS1 |
SBUS2 | SBUS3 | SBUS4 | LANE1 | LANE2 | LANE3 | LANE4

Source of the search, see [Chapter 27.4.2, "Waveform parameter"](#), on page 1371

*RST: C1W1

Parameters for setting and query:

<SearchName> String with the name of the search

Example: See [Chapter 27.3.4.1, "Searching for a pulse of a specified width"](#), on page 1352

Usage: Asynchronous command

Manual operation: See ["Source"](#) on page 427

SEARCh:ONLine <SearchName>,<OnlineState>**SEARCh:ONLine?** <SearchName>

If enabled, a search is performed repeatedly for each new data acquisition.

Parameters:

<OnlineState> ON | OFF

*RST: OFF

Parameters for setting and query:

<SearchName> Search definition

Usage: Asynchronous command

Manual operation: See ["Enable"](#) on page 427

SEARCh:ALL <SearchName>

Performs a search for all results on the existing data from the selected source.

Setting parameters:

<SearchName> Search definition

Example: See [Chapter 27.3.4.1, "Searching for a pulse of a specified width"](#), on page 1352

Usage: Setting only
Asynchronous command

Manual operation: See ["Enable"](#) on page 427

27.15.2 Basic trigger search conditions

SEARCh:TRIGger:EDGE[:STATe]	1718
SEARCh:TRIGger:GLITCh[:STATe]	1718
SEARCh:TRIGger:INTerval[:STATe]	1718
SEARCh:TRIGger:PATtern[:STATe]	1718
SEARCh:TRIGger:RUNT[:STATe]	1719
SEARCh:TRIGger:SETHold[:STATe]	1719
SEARCh:TRIGger:SLEWrate[:STATe]	1719
SEARCh:TRIGger:STATe[:STATe]	1719
SEARCh:TRIGger:TIMeout[:STATe]	1719
SEARCh:TRIGger:WIDTh[:STATe]	1719
SEARCh:TRIGger:WINDow[:STATe]	1719
SEARCh:TRIGger:LEVel[:VALue]	1719
SEARCh:TRIGger:EDGE:ACOPy	1720
SEARCh:TRIGger:GLITCh:ACOPy	1720
SEARCh:TRIGger:INTerval:ACOPy	1720
SEARCh:TRIGger:PATtern:ACOPy	1720
SEARCh:TRIGger:RUNT:ACOPy	1720
SEARCh:TRIGger:SETHold:ACOPy	1720
SEARCh:TRIGger:SLEWrate:ACOPy	1720
SEARCh:TRIGger:STATe:ACOPy	1720
SEARCh:TRIGger:TIMeout:ACOPy	1720
SEARCh:TRIGger:WIDTh:ACOPy	1720
SEARCh:TRIGger:WINDow:ACOPy	1720
SEARCh:TRIGger:EDGE:BCOPy	1720

SEARCh:TRIGger:EDGE[:STATe] <SearchName>,<State>

SEARCh:TRIGger:EDGE[:STATe]? <SearchName>

SEARCh:TRIGger:GLITCh[:STATe] <SearchName>,<State>

SEARCh:TRIGger:GLITCh[:STATe]? <SearchName>

SEARCh:TRIGger:INTerval[:STATe] <SearchName>,<State>

SEARCh:TRIGger:INTerval[:STATe]? <SearchName>

SEARCh:TRIGger:PATtern[:STATe] <SearchName>,<State>

SEARCh:TRIGger:PATtern[:STATe]? <SearchName>

SEARCH:TRIGger:RUNT[:STATe] <SearchName>,<State>
SEARCH:TRIGger:RUNT[:STATe]? <SearchName>
SEARCH:TRIGger:SETHold[:STATe] <SearchName>,<State>
SEARCH:TRIGger:SETHold[:STATe]? <SearchName>
SEARCH:TRIGger:SLEWrate[:STATe] <SearchName>,<State>
SEARCH:TRIGger:SLEWrate[:STATe]? <SearchName>
SEARCH:TRIGger:STATe[:STATe] <SearchName>,<State>
SEARCH:TRIGger:STATe[:STATe]? <SearchName>
SEARCH:TRIGger:TIMEout[:STATe] <SearchName>,<State>
SEARCH:TRIGger:TIMEout[:STATe]? <SearchName>
SEARCH:TRIGger:WIDTH[:STATe] <SearchName>,<State>
SEARCH:TRIGger:WIDTH[:STATe]? <SearchName>
SEARCH:TRIGger:WINDow[:STATe] <SearchName>,<State>
SEARCH:TRIGger:WINDow[:STATe]? <SearchName>

Includes the search conditions for the selected trigger event type in the next search.

Parameters:

<State> ON | OFF
 *RST: OFF

Parameters for setting and query:

<SearchName> Search definition

Usage: Asynchronous command

Manual operation: See ["Edge, Glitch, Width, Runt, Window, Timeout, Interval, Slew rate, Setup & Hold, State, Pattern"](#) on page 428

SEARCH:TRIGger:LEVel[:VALue] <SearchName>, <SignalSource>, <Value>
SEARCH:TRIGger:LEVel[:VALue]? <Key>, <SignalSource>

Sets the voltage of the trigger level that is used to determine other parameters.

Parameters:

<Value> Voltage value

Parameters for setting and query:

<SearchName> String with the name of the search

<SignalSource> C1W1 | C1W2 | C1W3 | C2W1 | C2W2 | C2W3 | C3W1 | C3W2 |
 C3W3 | C4W1 | C4W2 | C4W3 | M1 | M2 | M3 | M4 | M5 | M6 |
 M7 | M8 | R1 | R2 | R3 | R4 | D0 | D1 | D2 | D3 | D4 | D5 | D6 |
 D7 | D8 | D9 | D10 | D11 | D12 | D13 | D14 | D15 | TRK1 | TRK2 |
 TRK3 | TRK4 | TRK5 | TRK6 | TRK7 | TRK8 | Z1V1 | Z1V2 |
 Z1V3 | Z1V4 | Z1I1 | Z1I2 | Z1I3 | Z1I4 | Z2V1 | Z2V2 | Z2V3 |
 Z2V4 | Z2I1 | Z2I2 | Z2I3 | Z2I4

Source of the search, see [Chapter 27.4.2, "Waveform parameter"](#), on page 1371

Usage: Asynchronous command

Manual operation: See ["Level"](#) on page 429

SEARCh:TRIGger:EDGE:ACOPy <SearchName>
SEARCh:TRIGger:GLITCh:ACOPy <SearchName>
SEARCh:TRIGger:INTerval:ACOPy <SearchName>
SEARCh:TRIGger:PATTern:ACOPy <SearchName>
SEARCh:TRIGger:RUNT:ACOPy <SearchName>
SEARCh:TRIGger:SETHold:ACOPy <SearchName>
SEARCh:TRIGger:SLEWrate:ACOPy <SearchName>
SEARCh:TRIGger:STATe:ACOPy <SearchName>
SEARCh:TRIGger:TIMeout:ACOPy <SearchName>
SEARCh:TRIGger:WIDTh:ACOPy <SearchName>
SEARCh:TRIGger:WINDow:ACOPy <SearchName>

Copies the trigger event configuration from Trigger A for the selected channel source to the search condition settings.

See [Chapter 6.3, "Trigger types"](#), on page 197.

Setting parameters:

<SearchName> Search definition

Usage: Setting only
Asynchronous command

Manual operation: See ["Copy from trigger A"](#) on page 428

SEARCh:TRIGger:EDGE:BCOPy <SearchName>

Copies the trigger event configuration from trigger B for the selected channel source to the search condition settings.

Setting parameters:

<SearchName> String with name of the search

Usage: Setting only
Asynchronous command

27.15.3 Edge search conditions

Trigger level setting: [SEARCh:TRIGger:LEVel\[:VALue\]](#) on page 1719

[SEARCh:TRIGger:EDGE:SLOPe](#)..... 1720

SEARCh:TRIGger:EDGE:SLOPe <SearchName>,<Slope>

SEARCh:TRIGger:EDGE:SLOPe? <SearchName>

Selects the edge type.

Parameters:

<Slope> POSitive | NEGative | EITHer

See [Chapter 27.4.3, "Slope parameter"](#), on page 1373.

*RST: POSitive

Parameters for setting and query:`<SearchName>` Search definition**Usage:** Asynchronous command**Manual operation:** See "[Slope](#)" on page 429

27.15.4 Glitch search conditions

Trigger level setting: [SEARCH:TRIGger:LEVel\[:VALue\]](#) on page 1719

SEARCH:TRIGger:GLITch:POLarity	1721
SEARCH:TRIGger:GLITch:RANGe	1721
SEARCH:TRIGger:GLITch:WIDTh	1722

SEARCH:TRIGger:GLITch:POLarity `<SearchName>`,`<Polarity>`**SEARCH:TRIGger:GLITch:POLarity?** `<SearchName>`

Indicates the polarity of a pulse, that is the direction of the first pulse slope.

Parameters:`<Polarity>` POSitive | NEGative | EITHerSee [Chapter 27.4.4, "Polarity parameter"](#), on page 1373.`*RST:` POSitive**Parameters for setting and query:**`<SearchName>` Search definition**Usage:** Asynchronous command**Manual operation:** See "[Polarity, Range, Width](#)" on page 430**SEARCH:TRIGger:GLITch:RANGe** `<SearchName>`,`<RangeMode>`**SEARCH:TRIGger:GLITch:RANGe?** `<SearchName>`Selects which glitches are identified: shorter or longer than the specified width (see [SEARCH:TRIGger:GLITch:WIDTh](#) on page 1722).**Parameters:**`<RangeMode>` SHORter | LONGer`*RST:` SHORter**Parameters for setting and query:**`<SearchName>` Search definition**Usage:** Asynchronous command**Manual operation:** See "[Polarity, Range, Width](#)" on page 430

SEARCh:TRIGger:GLITch:WIDTh <SearchName>,<Width>
SEARCh:TRIGger:GLITch:WIDTh? <SearchName>

Sets the length of a glitch. The instrument triggers on pulses shorter or longer than this value (see also [SEARCh:TRIGger:GLITch:RANGe](#) on page 1721).

You need to know the expected pulse widths of the circuit to set the glitch width correctly.

Parameters:

<Width> Range: 100E-12 to 1E-3
 Increment: 100E-6
 *RST: 1E-9
 Default unit: s

Parameters for setting and query:

<SearchName> Search definition

Usage: Asynchronous command

Manual operation: See "[Polarity, Range, Width](#)" on page 430

27.15.5 Interval search conditions

Trigger level setting: [SEARCh:TRIGger:LEVel\[:VALue\]](#) on page 1719

SEARCh:TRIGger:INTerval:SLOPe	1722
SEARCh:TRIGger:INTerval:DELTA	1722
SEARCh:TRIGger:INTerval:RANGe	1723
SEARCh:TRIGger:INTerval:WIDTh	1723

SEARCh:TRIGger:INTerval:SLOPe <SearchName>,<Slope>
SEARCh:TRIGger:INTerval:SLOPe? <SearchName>

Sets the edge for the search.

Parameters:

<Slope> POSitive | NEGative | EITHer
 See [Chapter 27.4.3, "Slope parameter"](#), on page 1373.
 *RST: POSitive

Parameters for setting and query:

<SearchName> String parameter, name of the search definition

Usage: Asynchronous command

Manual operation: See "[Slope, Range, Interv. width, ±Delta](#)" on page 435

SEARCh:TRIGger:INTerval:DELTA <SearchName>,<WidthDelta>
SEARCh:TRIGger:INTerval:DELTA? <SearchName>

Defines a range around the "Interval width" value (see [SEARCh:TRIGger:INTerval:WIDTh](#) on page 1723).

Parameters:

<WidthDelta> Range: 0 to 10
 Increment: 100E-9
 *RST: 0
 Default unit: s

Parameters for setting and query:

<SearchName> Search definition

Usage: Asynchronous command

Manual operation: See "[Slope, Range, Interv. width, ±Delta](#)" on page 435

SEARCH:TRIGger:INTERval:RANGE <SearchName>,<RangeMode>

SEARCH:TRIGger:INTERval:RANGE? <SearchName>

Selects how the range of an interval is defined based on the interval width and delta (see [SEARCH:TRIGger:INTERval:WIDTH](#) on page 1723 and [SEARCH:TRIGger:INTERval:DELTA](#) on page 1722).

Parameters:

<RangeMode> WITHin | OUTSide | SHORter | LONGer

WITHin

Triggers on pulse intervals inside a given range. The range is defined by "Interv. width" and "±Delta".

OUTSide

Triggers on intervals outside a given range. The range definition is the same as for "Within" range.

SHORter

Triggers on intervals shorter than the given "Interv. width".

LONGer

Triggers on intervals longer than the given "Interv. width".

*RST: OUTSide

Parameters for setting and query:

<SearchName> Search definition

Usage: Asynchronous command

Manual operation: See "[Slope, Range, Interv. width, ±Delta](#)" on page 435

SEARCH:TRIGger:INTERval:WIDTH <SearchName>,<Width>

SEARCH:TRIGger:INTERval:WIDTH? <SearchName>

Defines the time between two pulses.

Parameters:

<Width> Range: 100E-12 to 864
 Increment: 100E-9
 *RST: 5E-9
 Default unit: s

Parameters for setting and query:

<SearchName> Search definition

Usage: Asynchronous command

Manual operation: See "[Slope, Range, Interv. width, ±Delta](#)" on page 435

27.15.6 Runt search conditions

SEARCh:TRIGger:RUNT:DELTA	1724
SEARCh:TRIGger:RUNT:POLarity	1724
SEARCh:TRIGger:RUNT:RANGe	1725
SEARCh:TRIGger:RUNT:WIDTh	1725
SEARCh:TRIGger:LEVel:RUNT:LOWer	1726
SEARCh:TRIGger:LEVel:RUNT:UPPer	1726

SEARCh:TRIGger:RUNT:DELTA <SearchName>,<WidthDelta>

SEARCh:TRIGger:RUNT:DELTA? <SearchName>

Defines a range around the given runt width.

Parameters:

<WidthDelta> Range: 100E-12 to 864
 Increment: 100E-9
 *RST: 100E-12
 Default unit: s

Parameters for setting and query:

<SearchName> Search definition

Usage: Asynchronous command

Manual operation: See "[Polarity, Range, Runt width, ±Delta](#)" on page 432

SEARCh:TRIGger:RUNT:POLarity <SearchName>,<Polarity>

SEARCh:TRIGger:RUNT:POLarity? <SearchName>

Indicates the polarity of a pulse, that is the direction of the first pulse slope.

Parameters:

<Polarity> POSitive | NEGative | EITHer
 See [Chapter 27.4.4, "Polarity parameter"](#), on page 1373.
 *RST: POSitive

Parameters for setting and query:

<SearchName> Search definition

Usage: Asynchronous command

Manual operation: See "[Polarity, Range, Runt width, ±Delta](#)" on page 432

SEARCH:TRIGger:RUNT:RANGe <SearchName>,<Mode>

SEARCH:TRIGger:RUNT:RANGe? <SearchName>

Selects how the time limit of the runt pulse is defined based on the runt width and delta (see [SEARCH:TRIGger:RUNT:WIDTh](#) on page 1725 and [SEARCH:TRIGger:RUNT:DELTA](#) on page 1724).

Parameters:

<Mode> ANY | LONGer | SHORter | WITHin | OUTSide

ANY

Triggers on all runts fulfilling the level condition, without time limitation.

LONGer

Triggers on runts longer than the given "Runt width".

SHORter

Triggers on runts shorter than the given "Runt width".

WITHin

Triggers if the runt length is inside a given time range. The range is defined by "Runt width" and "±Delta".

OUTSide

Triggers if the runt length is outside a given time range. The range definition is the same as for "Within" range.

*RST: ANY

Parameters for setting and query:

<SearchName> Search definition

Usage: Asynchronous command

Manual operation: See "[Polarity, Range, Runt width, ±Delta](#)" on page 432

SEARCH:TRIGger:RUNT:WIDTh <SearchName>,<Width>

SEARCH:TRIGger:RUNT:WIDTh? <SearchName>

For the ranges "Shorter" and "Longer", the runt width defines the maximum and minimum pulse width, respectively.

For the ranges "Within" and "Outside", the runt width defines the center of a range which is defined by "±Delta".

The range is defined using [SEARCH:TRIGger:RUNT:RANGe](#) on page 1725.

Parameters:

<Width> Range: 100E-12 to 864

Increment: 100E-9

*RST: 5E-9

Default unit: s

Parameters for setting and query:

<SearchName> Search definition

Usage: Asynchronous command

Manual operation: See ["Polarity, Range, Runt width, ±Delta"](#) on page 432

SEARCH:TRIGger:LEVel:RUNT:LOWer <SearchName>, <SignalSource>, <Value>

SEARCH:TRIGger:LEVel:RUNT:LOWer? <Key>, <SignalSource>

SEARCH:TRIGger:LEVel:RUNT:UPPer <SearchName>, <SignalSource>, <Value>

SEARCH:TRIGger:LEVel:RUNT:UPPer? <Key>, <SignalSource>

Set the lower and upper voltage threshold, respectively.

Parameters:

<Value> Voltage value

Parameters for setting and query:

<SearchName> String with the name of the search

<SignalSource> C1W1 | C1W2 | C1W3 | C2W1 | C2W2 | C2W3 | C3W1 | C3W2 | C3W3 | C4W1 | C4W2 | C4W3 | M1 | M2 | M3 | M4 | M5 | M6 | M7 | M8 | R1 | R2 | R3 | R4 | D0 | D1 | D2 | D3 | D4 | D5 | D6 | D7 | D8 | D9 | D10 | D11 | D12 | D13 | D14 | D15 | TRK1 | TRK2 | TRK3 | TRK4 | TRK5 | TRK6 | TRK7 | TRK8 | Z1V1 | Z1V2 | Z1V3 | Z1V4 | Z1I1 | Z1I2 | Z1I3 | Z1I4 | Z2V1 | Z2V2 | Z2V3 | Z2V4 | Z2I1 | Z2I2 | Z2I3 | Z2I4 | LANE1 | LANE2 | LANE3 | LANE4

Source of the search, see [Chapter 27.4.2, "Waveform parameter"](#), on page 1371

Usage: Asynchronous command

Manual operation: See ["Upper level, Lower level"](#) on page 432

27.15.7 Slew rate search conditions

[SEARCH:TRIGger:SLEWrate:DELTA](#)..... 1726

[SEARCH:TRIGger:SLEWrate:RANGe](#)..... 1727

[SEARCH:TRIGger:SLEWrate:SLOPe](#)..... 1727

[SEARCH:TRIGger:SLEWrate:TIME](#)..... 1728

[SEARCH:TRIGger:LEVel:TRANsition:LOWer](#)..... 1728

[SEARCH:TRIGger:LEVel:TRANsition:UPPer](#)..... 1728

SEARCH:TRIGger:SLEWrate:DELTA <SearchName>,<TimeDelta>

SEARCH:TRIGger:SLEWrate:DELTA? <SearchName>

Defines a time range around the given slew rate.

Parameters:

<TimeDelta> Range: 0 to 10
Increment: 100E-9
*RST: 0
Default unit: s

Parameters for setting and query:

<SearchName> String with the name of the search

Usage: Asynchronous command

Manual operation: See "[Polarity, Range, Slew rate, \$\pm\$ Delta](#)" on page 436

SEARCH:TRIGger:SLEWrate:RANGe <SearchName>,<RangeMode>

SEARCH:TRIGger:SLEWrate:RANGe? <SearchName>

Selects how the time limit for the slew rate is defined. The time measurement starts when the signal crosses the first trigger level - the upper or lower level depending on the selected slope - and stops when the signal crosses the second level.

Parameters:

<RangeMode> INSRange | OUTRange | LTHan | GTHan

INSRange

Triggers on slew rates inside a given time range. The range is defined by "Slew rate" and " \pm Delta".

OUTRange

Triggers on slew rates outside a given time range. The range definition is the same as for "Within" range.

LTHan

Triggers on slew rates shorter than the given "Slew rate" limit.

GTHan

Triggers on slew rates longer than the given "Slew rate" limit.

*RST: GTHan

Parameters for setting and query:

<SearchName> String with the name of the search

Usage: Asynchronous command

Manual operation: See "[Polarity, Range, Slew rate, \$\pm\$ Delta](#)" on page 436

SEARCH:TRIGger:SLEWrate:SLOPe <SearchName>,<Slope>

SEARCH:TRIGger:SLEWrate:SLOPe? <SearchName>

Selects the edge type.

Parameters:

<Slope> POSitive | NEGative | EITHer

See [Chapter 27.4.3, "Slope parameter"](#), on page 1373.

*RST: POSitive

Parameters for setting and query:

<SearchName> String with the name of the search

Usage: Asynchronous command

Manual operation: See "[Polarity, Range, Slew rate, \$\pm\$ Delta](#)" on page 436

SEARCh:TRIGger:SLEWrate:TIME <SearchName>,<Time>
SEARCh:TRIGger:SLEWrate:TIME? <SearchName>

For the ranges "Within" and "Outside", the slew rate defines the center of a range which is defined by the limits " $\pm\Delta$ ".

For the ranges "Shorter" and "Longer", the slew rate defines the maximum and minimum slew rate limits, respectively.

The range is defined using [SEARCh:TRIGger:SLEWrate:RANGe](#).

Parameters:

<Time> Range: 100E-12 to 864
 Increment: 100E-9
 *RST: 100E-12
 Default unit: s

Parameters for setting and query:

<SearchName> String with the name of the search

Usage: Asynchronous command

Manual operation: See "[Polarity, Range, Slew rate, \$\pm\Delta\$](#) " on page 436

SEARCh:TRIGger:LEVel:TRANsition:LOWer <SearchName>, <SignalSource>,
 <Value>

SEARCh:TRIGger:LEVel:TRANsition:LOWer? <Key>, <SignalSource>

SEARCh:TRIGger:LEVel:TRANsition:UPPer <SearchName>, <SignalSource>,
 <Value>

SEARCh:TRIGger:LEVel:TRANsition:UPPer? <Key>, <SignalSource>

Set the lower and upper voltage thresholds, respectively. When the signal crosses this level, the slew rate measurement starts or stops depending on the selected slope.

Parameters:

<Value> Voltage value

Parameters for setting and query:

<SearchName> String with the name of the search

<SignalSource> C1W1 | C1W2 | C1W3 | C2W1 | C2W2 | C2W3 | C3W1 | C3W2 |
 C3W3 | C4W1 | C4W2 | C4W3 | M1 | M2 | M3 | M4 | M5 | M6 |
 M7 | M8 | R1 | R2 | R3 | R4 | D0 | D1 | D2 | D3 | D4 | D5 | D6 |
 D7 | D8 | D9 | D10 | D11 | D12 | D13 | D14 | D15 | TRK1 | TRK2 |
 TRK3 | TRK4 | TRK5 | TRK6 | TRK7 | TRK8 | Z1V1 | Z1V2 |
 Z1V3 | Z1V4 | Z1I1 | Z1I2 | Z1I3 | Z1I4 | Z2V1 | Z2V2 | Z2V3 |
 Z2V4 | Z2I1 | Z2I2 | Z2I3 | Z2I4 | LANE1 | LANE2 | LANE3 |
 LANE4

Source of the search, see [Chapter 27.4.2, "Waveform parameter"](#), on page 1371

Usage: Asynchronous command

Manual operation: See "[Upper level, Lower level](#)" on page 436

27.15.8 Timeout search conditions

Trigger level setting: [SEARCh:TRIGger:LEVel\[:VALue\]](#) on page 1719

SEARCh:TRIGger:TIMEout:RANGe	1729
SEARCh:TRIGger:TIMEout:TIME	1729

SEARCh:TRIGger:TIMEout:RANGe <SearchName>,<TimeoutMode>
SEARCh:TRIGger:TIMEout:RANGe? <SearchName>

Selects the relation of the signal level to the trigger level:

Parameters:

<TimeoutMode> HIGH | LOW | EITHer

HIGH

The signal level stays above the trigger level.

LOW

The signal level stays below the trigger level.

EITHer

The signal level stays above or below the trigger level.

*RST: HIGH

Parameters for setting and query:

<SearchName> Search definition

Usage: Asynchronous command

Manual operation: See "[Range, Time](#)" on page 434

SEARCh:TRIGger:TIMEout:TIME <SearchName>,<Time>
SEARCh:TRIGger:TIMEout:TIME? <SearchName>

Defines the time limit for the timeout at which the instrument triggers.

Parameters:

<Time> Range: 100E-12 to 864
 Increment: 100E-9
 *RST: 100E-9
 Default unit: s

Parameters for setting and query:

<SearchName> Search definition

Usage: Asynchronous command

Manual operation: See "[Range, Time](#)" on page 434

27.15.9 Width search conditions

Trigger level setting: [SEARCh:TRIGger:LEVel\[:VALue\]](#) on page 1719

SEARCh:TRIGger:WIDTh:DELTA	1730
SEARCh:TRIGger:WIDTh:POLarity	1730
SEARCh:TRIGger:WIDTh:RANGe	1730
SEARCh:TRIGger:WIDTh:WIDTh	1731

SEARCh:TRIGger:WIDTh:DELTA <SearchName>,<WidthDelta>

SEARCh:TRIGger:WIDTh:DELTA? <SearchName>

Defines a range around the given width value (see also [SEARCh:TRIGger:WIDTh:WIDTh](#) on page 1731).

Parameters:

<WidthDelta> Range: 0 to 432
 Increment: 500E-12
 *RST: 0
 Default unit: s

Parameters for setting and query:

<SearchName> Search definition

Example: See [Chapter 27.3.4.1, "Searching for a pulse of a specified width"](#), on page 1352

Usage: Asynchronous command

Manual operation: See "[Polarity, Range, Width, ±Delta](#)" on page 431

SEARCh:TRIGger:WIDTh:POLarity <SearchName>,<Polarity>

SEARCh:TRIGger:WIDTh:POLarity? <SearchName>

Indicates the polarity of a pulse, that is the direction of the first pulse slope.

Parameters:

<Polarity> POSitive | NEGative | EITHer
 See [Chapter 27.4.4, "Polarity parameter"](#), on page 1373.
 *RST: POSitive

Parameters for setting and query:

<SearchName> Search definition

Usage: Asynchronous command

Manual operation: See "[Polarity, Range, Width, ±Delta](#)" on page 431

SEARCh:TRIGger:WIDTh:RANGe <SearchName>,<RangeMode>

SEARCh:TRIGger:WIDTh:RANGe? <SearchName>

Selects how the range of a pulse width is defined in relation to the width and delta (see [SEARCh:TRIGger:WIDTh:WIDTh](#) on page 1731 and [SEARCh:TRIGger:WIDTh:DELTA](#) on page 1730).

Parameters:

<RangeMode> WITHin | OUTSide | SHORter | LONGer

WITHin

Triggers on pulses inside a given range. The range of the pulse width is defined by "Width" and "±Delta".

OUTSide

Triggers on pulses outside a given range. The range definition is the same as for "Within" range.

SHORter

Triggers on pulses shorter than the given "Width".

LONGer

Triggers on pulses longer than the given "Width".

*RST: WITHin

Parameters for setting and query:

<SearchName> Search definition

Example: See [Chapter 27.3.4.1, "Searching for a pulse of a specified width"](#), on page 1352

Usage: Asynchronous command

Manual operation: See "[Polarity, Range, Width, ±Delta](#)" on page 431

SEARch:TRIGger:WIDTh:WIDTh <SearchName>,<Width>

SEARch:TRIGger:WIDTh:WIDTh? <SearchName>

For the ranges "Within" and "Outside", the width defines the center of a range which is defined by the limits "±Delta".

For the ranges "Shorter" and "Longer", the width defines the maximum and minimum pulse width, respectively.

The range is defined using [SEARch:TRIGger:WIDTh:RANGe](#).

Parameters:

<Width> Range: 100E-12 to 864
 Increment: 100E-9
 *RST: 5E-9
 Default unit: s

Parameters for setting and query:

<SearchName> Search definition

Example: See [Chapter 27.3.4.1, "Searching for a pulse of a specified width"](#), on page 1352

Usage: Asynchronous command

Manual operation: See "[Polarity, Range, Width, ±Delta](#)" on page 431

27.15.10 Window search conditions

SEARCh:TRIGger:WINDow:DELTA.....	1732
SEARCh:TRIGger:WINDow:RANGe.....	1732
SEARCh:TRIGger:WINDow:TIMerange.....	1733
SEARCh:TRIGger:WINDow:WIDTh.....	1733
SEARCh:TRIGger:LEVel:WINDow:LOWer.....	1734
SEARCh:TRIGger:LEVel:WINDow:UPPer.....	1734

SEARCh:TRIGger:WINDow:DELTA <SearchName>,<WidthDelta>

SEARCh:TRIGger:WINDow:DELTA? <SearchName>

Defines a range around the "Width" value (see [SEARCh:TRIGger:WINDow:WIDTh](#) on page 1733).

Parameters:

<WidthDelta> Range: 0 to 432
 Increment: 500E-12
 *RST: 0
 Default unit: s

Parameters for setting and query:

<SearchName> Search definition

Usage: Asynchronous command

Manual operation: See "[Time condition, Width, ±Delta](#)" on page 433

SEARCh:TRIGger:WINDow:RANGe <SearchName>,<RangeMode>

SEARCh:TRIGger:WINDow:RANGe? <SearchName>

Selects how the signal run is compared with the window.

Parameters:

<RangeMode> ENTEr | EXIT | WITHIn | OUTSide

ENTEr

Triggers when the signal crosses the upper or lower level and thus enters the window made up of these two levels.

EXIT

Triggers when the signal leaves the window.

WITHIn

Triggers if the signal stays between the upper and lower level for a specified time. The time is defined in various ways by the [SEARCh:TRIGger:WINDow:TIMerange](#) command.

OUTSide

Triggers if the signal stays above the upper level or below the lower level for a specified time. The time is also defined by the [SEARCh:TRIGger:WINDow:TIMerange](#) command.

*RST: ENTEr

Parameters for setting and query:

<SearchName> Search definition

Usage: Asynchronous command

Manual operation: See "[Vertical condition](#)" on page 433

SEARch:TRIGger:WINDow:TIMerange <SearchName>,<TimeRangeMode>

SEARch:TRIGger:WINDow:TIMerange? <SearchName>

Selects how the time limit of the window is defined. Time conditioning is available for the vertical conditions "WITHin" and "OUTSide" (see [SEARch:TRIGger:WINDow:RANGe](#) on page 1732).

Parameters:

<TimeRangeMode> WITHin | OUTSide | SHORter | LONGer

WITHin

Triggers if the signal stays inside or outside the vertical window limits at least for the time *Width - Delta* and for *Width + Delta* at the most.

OUTSide

"Outside" is the opposite definition of "Within". The instrument triggers if the signal stays inside or outside the vertical window limits for a time shorter than *Width - Delta* or longer than *Width + Delta*.

SHORter

Triggers if the signal crosses vertical limits before the specified "Width" time is reached.

LONGer

Triggers if the signal crosses vertical limits before the specified "Width" time is reached.

*RST: WITHin

Parameters for setting and query:

<SearchName> Search definition

Usage: Asynchronous command

Manual operation: See "[Time condition, Width, ±Delta](#)" on page 433

SEARch:TRIGger:WINDow:WIDTh <SearchName>,<Width>

SEARch:TRIGger:WINDow:WIDTh? <SearchName>

For the ranges "Within" and "Outside", the width defines the center of a time range which is defined by the limits "±Delta".

For the ranges "Shorter" and "Longer", it defines the maximum and minimum time lapse, respectively.

The range is defined using [SEARch:TRIGger:WINDow:RANGe](#).

Parameters:

<Width> Range: 100E-12 to 864
 Increment: 100E-9
 *RST: 5E-9
 Default unit: s

Parameters for setting and query:

<SearchName> Search definition

Usage: Asynchronous command

Manual operation: See "[Time condition, Width, ±Delta](#)" on page 433

SEARCh:TRIGger:LEVel:WINDow:LOWer <SearchName>, <SignalSource>, <Value>

SEARCh:TRIGger:LEVel:WINDow:LOWer? <Key>, <SignalSource>

SEARCh:TRIGger:LEVel:WINDow:UPPer <SearchName>, <SignalSource>, <Value>

SEARCh:TRIGger:LEVel:WINDow:UPPer? <Key>, <SignalSource>

Set the lower and upper voltage limits for the window.

Parameters:

<Value> Voltage value

Parameters for setting and query:

<SearchName> String with the name of the search

<SignalSource> C1W1 | C1W2 | C1W3 | C2W1 | C2W2 | C2W3 | C3W1 | C3W2 |
 C3W3 | C4W1 | C4W2 | C4W3 | M1 | M2 | M3 | M4 | M5 | M6 |
 M7 | M8 | R1 | R2 | R3 | R4 | D0 | D1 | D2 | D3 | D4 | D5 | D6 |
 D7 | D8 | D9 | D10 | D11 | D12 | D13 | D14 | D15 | TRK1 | TRK2 |
 TRK3 | TRK4 | TRK5 | TRK6 | TRK7 | TRK8 | Z1V1 | Z1V2 |
 Z1V3 | Z1V4 | Z1I1 | Z1I2 | Z1I3 | Z1I4 | Z2V1 | Z2V2 | Z2V3 |
 Z2V4 | Z2I1 | Z2I2 | Z2I3 | Z2I4 | LANE1 | LANE2 | LANE3 |
 LANE4

Source of the search, see [Chapter 27.4.2, "Waveform parameter"](#), on page 1371

Usage: Asynchronous command

Manual operation: See "[Upper level, Lower level](#)" on page 433

27.15.11 Data2clock search conditions

Data level setting: [SEARCh:TRIGger:LEVel\[:VALue\]](#) on page 1719

SEARCh:TRIGger:SETHold:CEdGe	1735
SEARCh:TRIGger:SETHold:CLEVel	1735
SEARCh:TRIGger:SETHold:CSOurce	1735
SEARCh:TRIGger:SETHold:HTIME	1736
SEARCh:TRIGger:SETHold:STIME	1736

SEARCh:TRIGger:SETHold:CEdGe <SearchName>,<ClockEdge>
SEARCh:TRIGger:SETHold:CEdGe? <SearchName>

Sets the edge of the clock signal to define the time reference point for the setup and hold time.

Parameters:

<ClockEdge> POSitive | NEGative | EITHer
 See [Chapter 27.4.3, "Slope parameter"](#), on page 1373.
 *RST: POSitive

Parameters for setting and query:

<SearchName>

Usage: Asynchronous command

Manual operation: See "[Clock source](#), [Clock edge](#), [Clock level](#)" on page 437

SEARCh:TRIGger:SETHold:CLEVel <SearchName>,<ClockLevel>
SEARCh:TRIGger:SETHold:CLEVel? <SearchName>

Sets the voltage level for the clock signal. Both this command and [SEARCh:TRIGger:SETHold:CEdGe](#) define the starting point for calculation of the setup and hold time.

Parameters:

<ClockLevel> Range: -10 to 10
 Increment: 1E-3
 *RST: 0
 Default unit: V

Parameters for setting and query:

<SearchName> Search definition

Usage: Asynchronous command

Manual operation: See "[Clock source](#), [Clock edge](#), [Clock level](#)" on page 437

SEARCh:TRIGger:SETHold:CSource <SearchName>,<ClockSource>
SEARCh:TRIGger:SETHold:CSource? <SearchName>

Selects the waveform used for the clock signal.

Parameters:

<ClockSource> C1W1 | C1W2 | C1W3 | C2W1 | C2W2 | C2W3 | C3W1 | C3W2 |
 C3W3 | C4W1 | C4W2 | C4W3 | M1 | M2 | M3 | M4 | M5 | M6 |
 M7 | M8 | R1 | R2 | R3 | R4
 Source of the clock signal, see [Chapter 27.4.2, "Waveform parameter"](#), on page 1371
 *RST: C1W1

Parameters for setting and query:

<SearchName> Search definition name

Usage: Asynchronous command

Manual operation: See "[Clock source, Clock edge, Clock level](#)" on page 437

SEARCh:TRIGger:SETHold:HTIME <SearchName>,<HoldTime>

SEARCh:TRIGger:SETHold:HTIME? <SearchName>

Sets the minimum time **after** the clock edge while the data signal must stay steady above or below the data level.

The hold time can be negative. In this case, the setup time is always positive. The setup/hold interval starts before the clock edge (setup time) and ends before the clock edge (hold time). If you change the negative hold time, the setup time is adjusted by the instrument.

Parameters:

<HoldTime> Range: -99.999E-9 to 0.1
 Increment: 1E-9
 *RST: 0
 Default unit: s

Parameters for setting and query:

<SearchName> Search definition

Usage: Asynchronous command

Manual operation: See "[Setup time, Hold time](#)" on page 437

SEARCh:TRIGger:SETHold:STIME <SearchName>,<SetupTime>

SEARCh:TRIGger:SETHold:STIME? <SearchName>

Sets the minimum time **before** the clock edge while the data signal must stay steady above or below the data level.

The setup time can be negative. In this case, the hold time is always positive. The setup/hold interval starts after the clock edge (setup time) and ends after the clock edge (hold time). If you change the negative setup time, the hold time is adjusted by the instrument.

Parameters:

<SetupTime> Range: -99.999E-9 to 0.1
 Increment: 1E-9
 *RST: 0
 Default unit: s

Parameters for setting and query:

<SearchName> Search definition

Usage: Asynchronous command

Manual operation: See "[Setup time, Hold time](#)" on page 437

27.15.12 Pattern search conditions

SEARch:TRIGger:PATtern:A[:ENABle].....	1737
SEARch:TRIGger:PATtern:B[:ENABle].....	1737
SEARch:TRIGger:PATtern:C[:ENABle].....	1737
SEARch:TRIGger:PATtern:D[:ENABle].....	1737
SEARch:TRIGger:PATtern:A:LOGic.....	1737
SEARch:TRIGger:PATtern:B:LOGic.....	1737
SEARch:TRIGger:PATtern:C:LOGic.....	1738
SEARch:TRIGger:PATtern:D:LOGic.....	1738
SEARch:TRIGger:PATtern:AB:LOGic.....	1738
SEARch:TRIGger:PATtern:CD:LOGic.....	1738
SEARch:TRIGger:PATtern:ABCD:LOGic.....	1738
SEARch:TRIGger:PATtern:MODE.....	1739
SEARch:TRIGger:PATtern:TIMEout:MODE.....	1739
SEARch:TRIGger:PATtern:TIMEout[:TIME].....	1740
SEARch:TRIGger:PATtern:WIDTh:RANGe.....	1740
SEARch:TRIGger:PATtern:WIDTh[:WIDTh].....	1740
SEARch:TRIGger:PATtern:WIDTh:DELTA.....	1741

SEARch:TRIGger:PATtern:A[:ENABle] <Searchname>, <State>

SEARch:TRIGger:PATtern:A[:ENABle]? <Searchname>

SEARch:TRIGger:PATtern:B[:ENABle] <Searchname>, <State>

SEARch:TRIGger:PATtern:B[:ENABle]? <Searchname>

SEARch:TRIGger:PATtern:C[:ENABle] <Searchname>, <State>

SEARch:TRIGger:PATtern:C[:ENABle]? <Searchname>

SEARch:TRIGger:PATtern:D[:ENABle] <Searchname>, <State>

SEARch:TRIGger:PATtern:D[:ENABle]? <Searchname>

Enables the channel to be considered in the pattern search. The trigger source channel is selected by default.

- A[:ENABle]: CH1
- B[:ENABle]: CH2
- C[:ENABle]: CH3
- D[:ENABle]: CH4

Digital channels are not available.

Parameters:

<State> ON | OFF

Parameters for setting and query:

<Searchname> String with name of the search

Usage: Asynchronous command

SEARch:TRIGger:PATtern:A:LOGic <Searchname>, <Operator>

SEARch:TRIGger:PATtern:A:LOGic? <Searchname>

SEARch:TRIGger:PATtern:B:LOGic <Searchname>, <Operator>

SEARch:TRIGger:PATtern:B:LOGic? <Searchname>

SEARCH:TRIGger:PATtern:C:LOGic <Searchname>, <Operator>

SEARCH:TRIGger:PATtern:C:LOGic? <Searchname>

SEARCH:TRIGger:PATtern:D:LOGic <Searchname>, <Operator>

SEARCH:TRIGger:PATtern:D:LOGic? <Searchname>

Defines the logic for the indicated channel:

- A: CH1
- B: CH2
- C: CH3
- D: CH4

Parameters:

<Operator> DIReCt | HIGH | NOT | LOW

DIReCt

Input value remains unchanged

NOT

Input value is inverted

Parameters for setting and query:

<Searchname> String with the name of the search

Usage: Asynchronous command

SEARCH:TRIGger:PATtern:AB:LOGic <Searchname>, <Operator>

SEARCH:TRIGger:PATtern:AB:LOGic? <Searchname>

SEARCH:TRIGger:PATtern:CD:LOGic <Searchname>, <Operator>

SEARCH:TRIGger:PATtern:CD:LOGic? <Searchname>

SEARCH:TRIGger:PATtern:ABCD:LOGic <Searchname>, <Operator>

SEARCH:TRIGger:PATtern:ABCD:LOGic? <Searchname>

Defines the logical combination of the indicated channels after evaluating the previous logical operations:

- AB: CH1 and CH2
- CD: CH3 and CH4
- ABCD: result of AB and CD

Parameters:

<Operator> AND | NAND | OR | NOR

AND: logical AND, conjunctive combination

NAND: logical NOT AND

OR: logical OR, disjunctive combination

NOR: logical NOT OR

Parameters for setting and query:

<Searchname> String with the name of the search

Usage: Asynchronous command

Manual operation: See "[Pattern](#)" on page 439

SEARCh:TRIGger:PATtern:MODE <SearchName>,<Mode>
SEARCh:TRIGger:PATtern:MODE? <SearchName>

Adds additional time limitation to the pattern definition.

Parameters:

<Mode> OFF | TIMEout | WIDTH

OFF

No time limitation. The event is found if the pattern condition is fulfilled.

TIMEout

Defines how long the result of the pattern condition stays high or low. The duration of the timeout is defined using [SEARCh:TRIGger:PATtern:TIMEout\[:TIME\]](#) The result state is defined using [SEARCh:TRIGger:PATtern:TIMEout:MODE](#).

WIDTH

Defines a time range for keeping up the true result of the pattern condition. The range is defined using [SEARCh:TRIGger:PATtern:WIDTH:RANGE](#).

*RST: OFF

Parameters for setting and query:

<SearchName> String with the name of the search

Usage: Asynchronous command

Manual operation: See "[Timing condition: Mode, Range, Time, Width, ±Delta](#)" on page 439

SEARCh:TRIGger:PATtern:TIMEout:MODE <SearchName>,<TimeoutMode>
SEARCh:TRIGger:PATtern:TIMEout:MODE? <SearchName>

Defines the condition for the timeout.

Parameters:

<TimeoutMode> HIGH | LOW | EITHer

EITHer

High or low, the pattern remains unchanged for the given time.

*RST: HIGH

Parameters for setting and query:

<SearchName> String with the name of the search

Usage: Asynchronous command

Manual operation: See "[Timing condition: Mode, Range, Time, Width, ±Delta](#)" on page 439

SEARCh:TRIGger:PATtern:TIMEout[:TIME] <SearchName>,<Time>
SEARCh:TRIGger:PATtern:TIMEout[:TIME]? <SearchName>

Defines how long the result of the pattern condition must keep the given state.

Parameters:

<Time> Range: 100E-12 to 864
 Increment: 100E-9
 *RST: 100E-9
 Default unit: s

Parameters for setting and query:

<SearchName> String with the name of the search

Usage: Asynchronous command

Manual operation: See "[Timing condition: Mode, Range, Time, Width, ±Delta](#)"
 on page 439

SEARCh:TRIGger:PATtern:WIDTH:RANGe <SearchName>,<WidthRangeMode>
SEARCh:TRIGger:PATtern:WIDTH:RANGe? <SearchName>

Defines the time range of a pulse width for keeping up the true result of the pattern condition. The width and delta are specified using [SEARCh:TRIGger:PATtern:WIDTH\[:WIDTH\]](#) and [SEARCh:TRIGger:PATtern:WIDTH:DELTA](#).

Parameters:

<WidthRangeMode> WITHin | OUTSide | SHORter | LONGer

WITHin | OUTSide

Triggers on pulses inside or outside a given range. The range is defined by the width ±delta.

SHORter | LONGer

Triggers on pulses shorter or longer than the given width.

*RST: WITHin

Parameters for setting and query:

<SearchName> String with the name of the search

Usage: Asynchronous command

Manual operation: See "[Timing condition: Mode, Range, Time, Width, ±Delta](#)"
 on page 439

SEARCh:TRIGger:PATtern:WIDTH[:WIDTH] <SearchName>,<Width>
SEARCh:TRIGger:PATtern:WIDTH[:WIDTH]? <SearchName>

For the ranges WITHin and OUTSide, the width defines the center of a range that is defined by the limits ±delta.

For the ranges SHORter and LONGer, the width defines the maximum and minimum pulse width, respectively.

To set the range mode, use `SEARCH:TRIGger:PATtern:WIDTH:RANGE`. To set the delta value, use `SEARCH:TRIGger:PATtern:WIDTH:DELTA`.

Parameters:

<Width> Range: 100E-12 to 864
 Increment: 100E-9
 *RST: 5E-9
 Default unit: s

Parameters for setting and query:

<SearchName> String with the name of the search

Usage: Asynchronous command

Manual operation: See "Timing condition: Mode, Range, Time, Width, ±Delta" on page 439

SEARCH:TRIGger:PATtern:WIDTH:DELTA <SearchName>,<WidthDelta>

SEARCH:TRIGger:PATtern:WIDTH:DELTA? <SearchName>

Defines a range around the width value specified using `SEARCH:TRIGger:PATtern:WIDTH[:WIDTH]`.

Parameters:

<WidthDelta> Range: 0 to 432
 Increment: 500E-12
 *RST: 0
 Default unit: s

Parameters for setting and query:

<SearchName> String with the name of the search

Usage: Asynchronous command

Manual operation: See "Timing condition: Mode, Range, Time, Width, ±Delta" on page 439

27.15.13 State search conditions

<code>SEARCH:TRIGger:STATe:CSOurce</code>	1742
<code>SEARCH:TRIGger:STATe:CEdGe</code>	1742
<code>SEARCH:TRIGger:STATe:CLeVel</code>	1742
<code>SEARCH:TRIGger:STATe:A[:ENABle]</code>	1743
<code>SEARCH:TRIGger:STATe:B[:ENABle]</code>	1743
<code>SEARCH:TRIGger:STATe:C[:ENABle]</code>	1743
<code>SEARCH:TRIGger:STATe:D[:ENABle]</code>	1743
<code>SEARCH:TRIGger:STATe:A:LOGic</code>	1743
<code>SEARCH:TRIGger:STATe:B:LOGic</code>	1743
<code>SEARCH:TRIGger:STATe:C:LOGic</code>	1743
<code>SEARCH:TRIGger:STATe:D:LOGic</code>	1743

SEARCh:TRIGger:STATe:AB:LOGic.....	1744
SEARCh:TRIGger:STATe:CD:LOGic.....	1744
SEARCh:TRIGger:STATe:ABCD:LOGic.....	1744

SEARCh:TRIGger:STATe:CSource <SearchName>,<Source>
SEARCh:TRIGger:STATe:CSource? <SearchName>

Sets the source of the clock signal.

Parameters:

<Source> C1W1 | C2W1 | C3W1 | C4W1 | M1 | M2 | M3 | M4 | M5 | M6 |
M7 | M8 | R1 | R2 | R3 | R4 | D0 | D1 | D2 | D3 | D4 | D5 | D6 |
D7 | D8 | D9 | D10 | D11 | D12 | D13 | D14 | D15

Parameters for setting and query:

<SearchName> String with the name of the search

Usage: Asynchronous command

Manual operation: See "[Clock source, Clock edge](#)" on page 438

SEARCh:TRIGger:STATe:CEdGe <SearchName>,<ClockEdge>
SEARCh:TRIGger:STATe:CEdGe? <SearchName>

Sets the trigger edge of the clock signal.

Parameters:

<ClockEdge> POSitive | NEGative | EITHer
*RST: POSitive

Parameters for setting and query:

<SearchName> String with the name of the search

Usage: Asynchronous command

Manual operation: See "[Clock source, Clock edge](#)" on page 438

SEARCh:TRIGger:STATe:CLeVel <SearchName>,<ClockLevel>
SEARCh:TRIGger:STATe:CLeVel? <SearchName>

Sets the trigger level of the clock signal.

The command has the same effect as with [SEARCh:TRIGger:LEVel\[:VALue\]](#).

Parameters:

<ClockLevel> Range: -10 to 10
Increment: 1E-3
*RST: 0
Default unit: V

Parameters for setting and query:

<SearchName> String with the name of the search

Usage: Asynchronous command

Manual operation: See "[Clock source, Clock edge](#)" on page 438

```

SEARCH:TRIGger:STATe:A:ENABle] <Searchname>, <State>
SEARCH:TRIGger:STATe:A:ENABle]? <Searchname>
SEARCH:TRIGger:STATe:B:ENABle] <Searchname>, <State>
SEARCH:TRIGger:STATe:B:ENABle]? <Searchname>
SEARCH:TRIGger:STATe:C:ENABle] <Searchname>, <State>
SEARCH:TRIGger:STATe:C:ENABle]? <Searchname>
SEARCH:TRIGger:STATe:D:ENABle] <Searchname>, <State>
SEARCH:TRIGger:STATe:D:ENABle]? <Searchname>

```

Enables the channel to be considered in the state search. You can enable all channel signals except for the trigger source.

- A[:ENABle]: CH1
- B[:ENABle]: CH2
- C[:ENABle]: CH3
- D[:ENABle]: CH4

Digital channels are not available.

Parameters:

<State> ON | OFF

Parameters for setting and query:

<Searchname> String with the name of the search

Usage: Asynchronous command

```

SEARCH:TRIGger:STATe:A:LOGic <Searchname>, <Operator>
SEARCH:TRIGger:STATe:A:LOGic? <Searchname>
SEARCH:TRIGger:STATe:B:LOGic <Searchname>, <Operator>
SEARCH:TRIGger:STATe:B:LOGic? <Searchname>
SEARCH:TRIGger:STATe:C:LOGic <Searchname>, <Operator>
SEARCH:TRIGger:STATe:C:LOGic? <Searchname>
SEARCH:TRIGger:STATe:D:LOGic <Searchname>, <Operator>
SEARCH:TRIGger:STATe:D:LOGic? <Searchname>

```

Defines the logic for the indicated channel:

- A: CH1
- B: CH2
- C: CH3
- D: CH4

Parameters:

<Operator> DIRect | HIGH | NOT | LOW

DIRect

Input value remains unchanged

NOT

Input value is inverted

Parameters for setting and query:

<Searchname> String with the name of the search

Usage: Asynchronous command

SEARCh:TRIGger:STATe:AB:LOGic <Searchname>, <Operator>

SEARCh:TRIGger:STATe:AB:LOGic? <Searchname>

SEARCh:TRIGger:STATe:CD:LOGic <Searchname>, <Operator>

SEARCh:TRIGger:STATe:CD:LOGic? <Searchname>

SEARCh:TRIGger:STATe:ABCD:LOGic <Searchname>, <Operator>

SEARCh:TRIGger:STATe:ABCD:LOGic? <Searchname>

Defines the logical combination of the indicated channels after evaluating the previous logical operations:

- AB: CH1 and CH2
- CD: CH3 and CH4
- ABCD: result of AB and CD

Parameters:

<Operator> AND | NAND | OR | NOR

AND: logical AND, conjunctive combination

NAND: logical NOT AND

OR: logical OR, disjunctive combination

NOR: logical NOT OR

Parameters for setting and query:

<Searchname> String with the name of the search

Usage: Asynchronous command

Manual operation: See "[State pattern](#)" on page 438

27.15.14 Search on spectrum

CURSor<m>:PEXCursion <Value>

Defines the minimum level by which the waveform must rise or fall so that it will be identified as a maximum or a minimum by the search functions.

Suffix:

<m> The suffix is irrelevant

Parameters:

<Value> Range: 0 to 100

Increment: 1

*RST: 5

Default unit: dB

Usage: Asynchronous command

Manual operation: See "[Peak excursion](#)" on page 304

CURSor<m>:THReshold <Value>

Defines an absolute threshold as an additional condition for the peak search. Only peaks that exceed the threshold are detected.

Suffix:

<m> The suffix is irrelevant.

Parameters:

<Value> Threshold in dBm

Usage: Asynchronous command

Firmware/software: Version 2.70

Manual operation: See "[Threshold](#)" on page 303

27.15.15 Search gate settings

SEARCh:GATE[:STATe]	1745
SEARCh:GATE:MODE	1745
SEARCh:GATE:SHOW	1746
SEARCh:GATE:ABSolute:START	1746
SEARCh:GATE:ABSolute:STOP	1746
SEARCh:GATE:RELative:START	1747
SEARCh:GATE:RELative:STOP	1747
SEARCh:GATE:ZCOupling	1747
SEARCh:GATE:ZDIagram	1748

SEARCh:GATE[:STATe] <SearchName>,<State>**SEARCh:GATE[:STATe]?** <SearchName>

Performs the search only on the defined gate area of the source waveform.

Parameters:

<State> ON | OFF
 *RST: OFF

Parameters for setting and query:

<SearchName> Search definition

Usage: Asynchronous command

Manual operation: See "[Use gate](#)" on page 442

SEARCh:GATE:MODE <SearchName>,<Mode>**SEARCh:GATE:MODE?** <SearchName>

Defines whether the gate settings are configured using absolute or relative values.

Parameters:

<Mode> ABS | REL
 *RST: ABS

Parameters for setting and query:

<SearchName> Search definition

Usage: Asynchronous command

Manual operation: See "[Gate description](#)" on page 314

SEARCH:GATE:SHOW <SearchName>,<DisplayState>

SEARCH:GATE:SHOW? <SearchName>

If enabled, the gate area is indicated in the source diagram.

Parameters:

<DisplayState> ON | OFF

*RST: OFF

Parameters for setting and query:

<SearchName> Search definition

Usage: Asynchronous command

Manual operation: See "[Display state](#)" on page 442

SEARCH:GATE:ABSolute:START <SearchName>,<Start>

SEARCH:GATE:ABSolute:START? <SearchName>

Defines the starting value for the gate.

Parameters:

<Start> Range: -100E+24 to 100E+24

Increment: 0.01

*RST: 0

Parameters for setting and query:

<SearchName> Search definition

Usage: Asynchronous command

Manual operation: See "[\(Relative\) Start](#)" on page 315

SEARCH:GATE:ABSolute:STOP <SearchName>,<Stop>

SEARCH:GATE:ABSolute:STOP? <SearchName>

Defines the end value for the gate.

Parameters:

<Stop> Range: -100E+24 to 100E+24

Increment: 0.01

*RST: 0.01

Parameters for setting and query:

<SearchName> Search definition

Usage: Asynchronous command

Manual operation: See "[\(Relative\) Stop](#)" on page 315

SEARCH:GATE:RELative:START <SearchName>,<RelativeStart>

SEARCH:GATE:RELative:START? <SearchName>

Defines the starting value for the gate.

Parameters:

<RelativeStart> Range: 0 to 100
 Increment: 0.1
 *RST: 0
 Default unit: %

Parameters for setting and query:

<SearchName> Search definition

Usage: Asynchronous command

Manual operation: See "[\(Relative\) Start](#)" on page 315

SEARCH:GATE:RELative:STOP <SearchName>,<RelativeStop>

SEARCH:GATE:RELative:STOP? <SearchName>

Defines the end value for the gate.

Parameters:

<RelativeStop> Range: 0 to 100
 Increment: 0.1
 *RST: 100
 Default unit: %

Parameters for setting and query:

<SearchName> Search definition

Usage: Asynchronous command

Manual operation: See "[\(Relative\) Stop](#)" on page 315

SEARCH:GATE:ZCOupling <SearchName>,<ZoomCoupling>

SEARCH:GATE:ZCOupling? <SearchName>

If enabled, the gate area is set to the limits of a zoom area.

The zoom diagramm is selected using [SEARCH:GATE:ZDIagram](#).

Parameters:

<ZoomCoupling> ON | OFF
 *RST: OFF

Parameters for setting and query:

<SearchName> String with the name of the search

Usage: Asynchronous command

Manual operation: See "[Zoom](#)" on page 315

SEARCh:GATE:ZDiagram <SearchName>, <DiagramName>, <ZoomName>
SEARCh:GATE:ZDiagram? <SearchName>

Selects the zoom to which the gate area is set if [SEARCh:GATE:ZCOupling](#) is set to "ON".

Parameters:

<ZoomDiagram> String with the name of the diagram, where the zoom is defined

Parameters for setting and query:

<SearchName> String with the name of the search

Example:

Prerequisite: Search1 and Zoom2 are available.

```
SEARCh:GATE:ZCOupling 'Search1',ON
SEARCh:GATE:ZDIagram 'Search1','Diagram1','Zoom2'
SEARCh:GATE:ZDIagram? 'Search1'
<-- Diagram1;Zoom2
SEARCh:GATE:STAtE 'Search1', ON
SEARCh:GATE:SHOw 'Search2', ON
```

Enables the zoom coupling to define the gate, and selects Zoom2 as gate area. Zoom2 is based on Diagram1. Then the gate is activated and displayed.

Usage: Asynchronous command

Manual operation: See "[Zoom](#)" on page 315

27.15.16 Noise rejection

SEARCh:TRIGger:LEVel:NOISe:ABSolute	1748
SEARCh:TRIGger:LEVel:NOISe:MODE	1749
SEARCh:TRIGger:LEVel:NOISe:RELative	1749
SEARCh:TRIGger:LEVel:NOISe[:STATe]	1750

SEARCh:TRIGger:LEVel:NOISe:ABSolute <SearchName>, <SignalSource>, <Value>

Defines the trigger hysteresis, a range in absolute values around the trigger level. If the signal jitters inside this range and crosses the trigger level, no trigger event is detected.

Parameters:

<Value> Hysteresis value

Setting parameters:

<SearchName> String with the name of the search

<SignalSource> C1W1 | C1W2 | C1W3 | C2W1 | C2W2 | C2W3 | C3W1 | C3W2 | C3W3 | C4W1 | C4W2 | C4W3 | M1 | M2 | M3 | M4 | M5 | M6 | M7 | M8 | R1 | R2 | R3 | R4 | D0 | D1 | D2 | D3 | D4 | D5 | D6 | D7 | D8 | D9 | D10 | D11 | D12 | D13 | D14 | D15 | TRK1 | TRK2 | TRK3 | TRK4 | TRK5 | TRK6 | TRK7 | TRK8 | Z1V1 | Z1V2 | Z1V3 | Z1V4 | Z1I1 | Z1I2 | Z1I3 | Z1I4 | Z2V1 | Z2V2 | Z2V3 | Z2V4 | Z2I1 | Z2I2 | Z2I3 | Z2I4

Source of the search, see [Chapter 27.4.2, "Waveform parameter"](#), on page 1371

Usage: Asynchronous command

SEARch:TRIGger:LEVel:NOISe:MODE <SearchName>, <SignalSource>, <Mode>

SEARch:TRIGger:LEVel:NOISe:MODE? <Key>, <SignalSource>

Defines whether absolute values or relative values to the vertical scaling are used as a hysteresis for noise rejection.

Parameters:

<Mode> ABS | REL

Parameters for setting and query:

<SearchName> String with the name of the search

<SignalSource> C1W1 | C1W2 | C1W3 | C2W1 | C2W2 | C2W3 | C3W1 | C3W2 | C3W3 | C4W1 | C4W2 | C4W3 | M1 | M2 | M3 | M4 | M5 | M6 | M7 | M8 | R1 | R2 | R3 | R4 | D0 | D1 | D2 | D3 | D4 | D5 | D6 | D7 | D8 | D9 | D10 | D11 | D12 | D13 | D14 | D15 | TRK1 | TRK2 | TRK3 | TRK4 | TRK5 | TRK6 | TRK7 | TRK8 | Z1V1 | Z1V2 | Z1V3 | Z1V4 | Z1I1 | Z1I2 | Z1I3 | Z1I4 | Z2V1 | Z2V2 | Z2V3 | Z2V4 | Z2I1 | Z2I2 | Z2I3 | Z2I4

Source of the trigger waveform, see [Chapter 27.4.2, "Waveform parameter"](#), on page 1371

Usage: Asynchronous command

SEARch:TRIGger:LEVel:NOISe:RELative <SearchName>, <SignalSource>, <Value>

Defines a range around the trigger level in relative values. If the signal jitters inside this range and crosses the trigger level, no trigger event is detected.

Parameters:

<Value> Hysteresis value in %

Setting parameters:

<SearchName> String with the name of the search

<SignalSource> C1W1 | C1W2 | C1W3 | C2W1 | C2W2 | C2W3 | C3W1 | C3W2 | C3W3 | C4W1 | C4W2 | C4W3 | M1 | M2 | M3 | M4 | M5 | M6 | M7 | M8 | R1 | R2 | R3 | R4 | D0 | D1 | D2 | D3 | D4 | D5 | D6 | D7 | D8 | D9 | D10 | D11 | D12 | D13 | D14 | D15 | TRK1 | TRK2 | TRK3 | TRK4 | TRK5 | TRK6 | TRK7 | TRK8 | Z1V1 | Z1V2 | Z1V3 | Z1V4 | Z1I1 | Z1I2 | Z1I3 | Z1I4 | Z2V1 | Z2V2 | Z2V3 | Z2V4 | Z2I1 | Z2I2 | Z2I3 | Z2I4

Source of the search, see [Chapter 27.4.2, "Waveform parameter"](#), on page 1371

Usage: Asynchronous command

SEARCh:TRIGger:LEVel:NOISe[:STATe] <SearchName>, <SignalSource>, <State>
SEARCh:TRIGger:LEVel:NOISe[:STATe]? <Key>, <SignalSource>

If enabled, the noise reject settings for the waveform are considered for the search.

Parameters:

<State> ON | OFF

Parameters for setting and query:

<SearchName> String with the name of the search

<SignalSource> C1W1 | C1W2 | C1W3 | C2W1 | C2W2 | C2W3 | C3W1 | C3W2 | C3W3 | C4W1 | C4W2 | C4W3 | M1 | M2 | M3 | M4 | M5 | M6 | M7 | M8 | R1 | R2 | R3 | R4 | D0 | D1 | D2 | D3 | D4 | D5 | D6 | D7 | D8 | D9 | D10 | D11 | D12 | D13 | D14 | D15 | TRK1 | TRK2 | TRK3 | TRK4 | TRK5 | TRK6 | TRK7 | TRK8 | Z1V1 | Z1V2 | Z1V3 | Z1V4 | Z1I1 | Z1I2 | Z1I3 | Z1I4 | Z2V1 | Z2V2 | Z2V3 | Z2V4 | Z2I1 | Z2I2 | Z2I3 | Z2I4

Source of the search, see [Chapter 27.4.2, "Waveform parameter"](#), on page 1371

Usage: Asynchronous command

27.15.17 Search results

SEARCh:RESDiagram:HORIZ:ABSolute:POSition	1751
SEARCh:RESDiagram:HORIZ:ABSolute:SPAN	1751
SEARCh:RESDiagram:HORIZ:MODE	1751
SEARCh:RESDiagram:HORIZ:RELative:POSition	1752
SEARCh:RESDiagram:HORIZ:RELative:SPAN	1752
SEARCh:RESDiagram:SHOW	1752
SEARCh:RESDiagram:VERT:ABSolute:POSition	1753
SEARCh:RESDiagram:VERT:ABSolute:SPAN	1753
SEARCh:RESDiagram:VERT:MODE	1753
SEARCh:RESDiagram:VERT:RELative:POSition	1753
SEARCh:RESDiagram:VERT:RELative:SPAN	1754
SEARCh:RESult:LIMit	1754
SEARCh:RESult:SHOW	1755

SEARCH:RESult:SORT:ASCending.....	1755
SEARCH:RESult:SORT[:MODE].....	1755
SEARCH:RESult[:ALL]?.....	1756

SEARCH:RESDiagram:HORIZ:ABSolute:POStion <SearchName>,<Position>
SEARCH:RESDiagram:HORIZ:ABSolute:POStion? <SearchName>

Defines the x-value of the centerpoint of the zoom area.

Parameters:

<Position> Range: -100E+24 to 100E+24
 Increment: 0.01
 *RST: 0.01

Parameters for setting and query:

<SearchName> Search definition

Usage: Asynchronous command

Manual operation: See "[X position](#)" on page 247

SEARCH:RESDiagram:HORIZ:ABSolute:SPAN <SearchName>,
SEARCH:RESDiagram:HORIZ:ABSolute:SPAN? <SearchName>

Defines the width of the zoom area.

Parameters:

 Range: 0 to 100E+24
 Increment: 0.01
 *RST: 0.01

Parameters for setting and query:

<SearchName> Search definition

Usage: Asynchronous command

Manual operation: See "[X range](#)" on page 248

SEARCH:RESDiagram:HORIZ:MODE <SearchName>,<Mode>
SEARCH:RESDiagram:HORIZ:MODE? <SearchName>

Defines whether absolute or relative values are used to specify the x-axis values.

Parameters:

<Mode> ABS | REL
 *RST: ABS

Parameters for setting and query:

<SearchName> Search definition

Usage: Asynchronous command

Manual operation: See "[X mode](#)" on page 248

SEARCh:RESDiagram:HORZ:RELative:POSition <SearchName>,<RelPosi>
SEARCh:RESDiagram:HORZ:RELative:POSition? <SearchName>

Defines the x-value of the centerpoint of the zoom area.

Parameters:

<RelPosi> Range: 0 to 100
 Increment: 0.1
 *RST: 100
 Default unit: %

Parameters for setting and query:

<SearchName> Search definition

Usage: Asynchronous command

Manual operation: See "[X position](#)" on page 247

SEARCh:RESDiagram:HORZ:RELative:SPAN <SearchName>,<RelativeSpan>
SEARCh:RESDiagram:HORZ:RELative:SPAN? <SearchName>

Defines the width of the zoom area.

Parameters:

<RelativeSpan> Range: 1E-15 to 100
 Increment: 0.1
 *RST: 1
 Default unit: %

Parameters for setting and query:

<SearchName> Search definition

Usage: Asynchronous command

Manual operation: See "[X range](#)" on page 248

SEARCh:RESDiagram:SHOW <SearchName>,<ShwSearchWind>
SEARCh:RESDiagram:SHOW? <SearchName>

If enabled, a zoom window is displayed for the currently selected search result. The zoom area is indicated in the diagram that displays the source waveform of the search.

Parameters:

<ShwSearchWind> ON | OFF
 *RST: OFF

Parameters for setting and query:

<SearchName> Search definition

Usage: Asynchronous command

Manual operation: See "[Show result zoom](#)" on page 445

SEARCh:RESDiagram:VERT:ABSolute:POStion <SearchName>,<Position>
SEARCh:RESDiagram:VERT:ABSolute:POStion? <SearchName>

Defines the y-value of the centerpoint of the zoom area.

Parameters:

<Position>	Range:	-100E+24 to 100E+24
	Increment:	0.01
	*RST:	0.01

Parameters for setting and query:

<SearchName>	Search definition
--------------	-------------------

Usage: Asynchronous command

Manual operation: See "[Y position](#)" on page 248

SEARCh:RESDiagram:VERT:ABSolute:SPAN <SearchName>,
SEARCh:RESDiagram:VERT:ABSolute:SPAN? <SearchName>

Defines the height of the zoom area.

Parameters:

	Range:	0 to 100E+24
	Increment:	0.01
	*RST:	0.01

Parameters for setting and query:

<SearchName>	Search definition
--------------	-------------------

Usage: Asynchronous command

Manual operation: See "[Y range](#)" on page 248

SEARCh:RESDiagram:VERT:MODE <SearchName>,<Mode>
SEARCh:RESDiagram:VERT:MODE? <SearchName>

Defines whether absolute or relative values are used to specify the y-axis values.

Parameters:

<Mode>	ABS REL
	*RST: ABS

Parameters for setting and query:

<SearchName>	Search definition
--------------	-------------------

Usage: Asynchronous command

Manual operation: See "[Y mode](#)" on page 248

SEARCh:RESDiagram:VERT:RELative:POStion <SearchName>,<RelPosi>
SEARCh:RESDiagram:VERT:RELative:POStion? <SearchName>

Defines the y-value of the centerpoint of the zoom area.

Parameters:

<RelPosi> Range: 0 to 100
 Increment: 0.1
 *RST: 100
 Default unit: %

Parameters for setting and query:

<SearchName> Search definition

Usage: Asynchronous command

Manual operation: See "[Y position](#)" on page 248

SEARCH:RESDiagram:VERT:RELative:SPAN <SearchName>,<RelativeSpan>
SEARCH:RESDiagram:VERT:RELative:SPAN? <SearchName>

Defines the height of the zoom area.

Parameters:

<RelativeSpan> Range: 1E-15 to 100
 Increment: 0.1
 *RST: 1
 Default unit: %

Parameters for setting and query:

<SearchName> Search definition

Usage: Asynchronous command

Manual operation: See "[Y range](#)" on page 248

SEARCH:RESult:LIMit <SearchName>,<ResultListLimit>
SEARCH:RESult:LIMit? <SearchName>

Defines the maximum number of entries in the search result table.

Parameters:

<ResultListLimit> Range: 1 to 1000
 Increment: 1
 *RST: 100

Parameters for setting and query:

<SearchName> Search definition

Example: See [Chapter 27.3.4.1](#), "[Searching for a pulse of a specified width](#)", on page 1352

Usage: Asynchronous command

Manual operation: See "[Max result count](#)" on page 445

SEARCh:RESult:SHOW <SearchName>,<ShowResultTable>
SEARCh:RESult:SHOW? <SearchName>

Displays or hides the search result table.

Parameters:

<ShowResultTable> ON | OFF
 *RST: OFF

Parameters for setting and query:

<SearchName> Search definition

Usage: Asynchronous command

Manual operation: See "[Show result table](#)" on page 445

SEARCh:RESult:SORT:ASCending <SearchName>,<SortAscending>
SEARCh:RESult:SORT:ASCending? <SearchName>

If enabled, the results are listed in ascending order, i.e. the smallest value at the top.

Parameters:

<SortAscending> ON | OFF
 *RST: OFF

Parameters for setting and query:

<SearchName> Search definition

Usage: Asynchronous command

Manual operation: See "[Sort ascending](#)" on page 445

SEARCh:RESult:SORT[:MODE] <SearchName>,<SortMode>
SEARCh:RESult:SORT[:MODE]? <SearchName>

Sorts the search result table by x-value position or value of the result.

Parameters:

<SortMode> POSition | VALue

POSition

Sorts the search result table by the x-value position.

VALue

Sorts the search result table by the value of the result.

*RST: POSition

Parameters for setting and query:

<SearchName> Search definition

Usage: Asynchronous command

Manual operation: See "[Sort by](#)" on page 445

SEARch:RESult[:ALL]? <SearchName>

Returns all search results.

Query parameters:

<SearchName> Search definition

Return values:

<Data> List of search results, separated by commas. For each result, six values are returned:

1. Acquisition index, currently always 0.
2. X-position of the search result
3. Y-position of the search result, currently not relevant
4. Type of the search result (Edge, Glitch, ...)
5. Slope or polarity of the search result
6. For runt, glitch, width, and window searches, the value contains the width. For timeout and interval searches, it contains the timeout. For transition searches, it contains the slew rate. For all other searches, the value is not relevant. If a value is not relevant, 9.91E+37 is returned.

Example:

```
SEAR:RES? 'Search1'
0,1.5375e-007,-84,Edge,Positive,9.91E+37,
0,5.3e-008,-84,Edge,Positive,9.91E+37
```

The query returns two search results for edge search on rising edges at X-position 153,75 ns and 53 ns.

Usage:

Query only
Asynchronous command

27.16 Data management

Some of the commands in the following chapter are asynchronous. An overlapping or asynchronous command does not automatically finish executing before the next command starts executing. If overlapping commands must be executed in a defined order, e.g. to avoid wrong measurement results, they must be serviced sequentially.

To prevent an overlapping execution of commands, one of the commands *OPC, *OPC? or *WAI can be used after the command or a command set.

For more information, see:

- www.rohde-schwarz.com/rc-via-scpj, chapter "Command sequence and synchronization"
- [Chapter 27.3, "Programming examples"](#), on page 1345
- [Instrument settings](#)..... 1757
- [Savesets and one file](#)..... 1764
- [Waveform data transmission](#)..... 1765
- [Waveform data export to file](#)..... 1766
- [Waveform histogram export to file](#)..... 1774
- [Eye](#)..... 1775

• Long term measurement results and measurement histogram export to file.....	1777
• Screenshots.....	1779
• Reports.....	1783
• Autonaming.....	1785
• CSV export.....	1786
• External application.....	1787

27.16.1 Instrument settings

The Mass MEMory subsystem provides commands to access the storage media and to save and reload instrument settings.

File and directory names

The <file_name> and <directory_name> parameters are strings. Some commands use a fixed directory; for others the <file_name> can contain the complete path including the drive name and all subdirectories. If no complete path is specified, the file location is relative to the current directory, queried with `MMEMemory:CDIRectory?`. The filename itself may contain the period as a separator for extensions.

Example: 'C:\TEMP\TRASH\test.txt' for the file named test.txt in the TEMP\TRASH subdirectory of the internal hard disk drive C:\.

File and directory names can be chosen according to Windows™ conventions; the restrictions placed on filenames known from DOS systems do not apply. All letters and numbers are allowed, as well as the special characters "_", "^", "\$", "~", "!", "#", "%", "&", "-", "{", "}", "(", ")", "@", and "'". Reserved filenames are CON, AUX, COM1, ..., COM4, LPT1, ..., LPT3, NUL and PRN.

The use of wildcards ? and * is not allowed.

MMEMemory:DRIVes?	1758
MMEMemory:MSIS	1758
MMEMemory:DCATalog?	1758
MMEMemory:DCATalog:LENGth?	1758
MMEMemory:CDIRectory	1759
MMEMemory:MDIRectory	1759
MMEMemory:RDIRectory	1759
MMEMemory:CATalog?	1759
MMEMemory:CATalog:LENGth?	1760
MMEMemory:COPIY	1760
MMEMemory:MOVE	1761
MMEMemory:DELeTe	1761
MMEMemory:DATA	1762
MMEMemory:ATTRibute	1762
MMEMemory:SAV	1763
MMEMemory:RCL	1763
MMEMemory:STORe:STATe	1763
MMEMemory:LOAD:STATe	1764

MMEMory:DRIVes?

Returns a list of the logical drives of the instrument as configured in the operating system.

Return values:

<Drive> List of strings, for example, "C:\", "E:\", "H:\"

Usage: Query only

MMEMory:MSIS [<msus>]

Changes the default storage device to the indicated drive or network server.

Parameters:

<msus> String parameter. Drives are indicated with their drive letter, network servers require the UNC format.

Example: `MMEM:MSIS 'C:'`

Example: `MMEM:MSIS '\\server1\share1'`

MMEMory:DCATalog? [<PathName>]

Returns the subdirectories of the current or of a specified directory.

Query parameters:

<PathName> String parameter to specify the directory. If the directory is omitted, the command queries the contents of the current directory, to be set and queried with [MMEMory:CDIRectory](#).

Return values:

<FileEntry> Names of the subdirectories separated by colons. The first two strings are related to the parent directory.

Example: `MMEM:DCAT?`
`".","..","Documents and Settings","Program Files","temp"`

Usage: Query only

MMEMory:DCATalog:LENGth? [<PathName>]

Returns the number of subdirectories of the current or of a specified directory. The number includes the parent directory strings "." and ".." and corresponds to the number of strings returned by the [MMEMory:DCATalog?](#) command.

Query parameters:

<PathName> String parameter to specify the directory. If the directory is omitted, the command queries the contents of the current directory, to be set and queried with [MMEMory:CDIRectory](#).

Return values:

<FileEntryCount> Number of parent directories and subdirectories.

Example: MMEM:DCAT:LENG?
5

Usage: Query only

MMEMory:CDIRectory [<DirectoryName>]

Changes the default directory for file access.

Parameters:

<DirectoryName> String parameter to specify the directory. If the string also contains a drive letter or network server name, the command [MMEMory:MSIS](#) is executed implicitly.

*RST: "\

Example: MMEM:CDIR 'C:\USER\DATA'

Usage: SCPI confirmed

MMEMory:MDIRectory <DirectoryName>

Creates a new directory with the specified name.

Setting parameters:

<DirectoryName> String parameter to specify the new directory. If the path consists of several subdirectories, the complete tree is created if necessary. If no drive letter or server name is indicated, the directory is created on the default storage device specified with [MMEMory:MSIS](#).

Example: MMEM:MDIR 'C:\USER\DATA'

Usage: Setting only

MMEMory:RDIRectory <DirectoryName>

Deletes the specified directory.

Setting parameters:

<DirectoryName> String parameter to specify the directory to be deleted. This directory must be empty, otherwise it is not deleted.

Example: MMEM:RDIR 'C:\USER\TEST'

Usage: Setting only

MMEMory:CATalog? [<PathName>],[<Format>]

Returns a list of files contained in the specified directory. The result corresponds to the number of files returned by the [MMEMory:CATalog:LENGth](#) command.

Query parameters:

<PathName>	String parameter to specify the directory. If the directory is omitted, the command queries directory specified with MMEMemory:CDIRectory .
<Format>	ALL WTIME ALL: Extended result including file, date, time and attributes WTIME: Extended result including file, date, time

Return values:

<UsedMemory>	Total amount of storage currently used in the directory, in bytes.
<FreeMemory>	Total amount of storage available in the directory, in bytes.
<FileEntry>	All files and subdirectories of the directory are listed with their filename, format and size in bytes. The first two strings are related to the parent directory.

Example:

```
MMEM:CAT? 'C:\USER\DATA'
529479,1831777894400,".,DIR,0","..,DIR,0",
"Backup,DIR,0","CSS,DIR,0","DATEN,DIR,0",
"Commands.jar,BIN,529479","FAVORITES,DIR,0",
"LOG,DIR,0","DATA,DIR,0","test,DIR,0",
"TotalCMD,DIR,0"
```

Usage:

Query only
SCPI confirmed

MMEMemory:CATalog:LENGth? [<PathName>]

Returns the number of files and subdirectories of the current or specified directory. The number includes the parent directory strings "." and ".." and it corresponds to the number of <FileEntry> strings returned by the [MMEMemory:CATalog?](#) command.

Query parameters:

<PathName>	String parameter, directory to be queried. If the directory is omitted, the current directory is queried, specified with MMEMemory:CDIRectory .
------------	---

Return values:

<Count>	Number of files and subdirectories including parent directory entries.
---------	--

Example:

```
MMEM:CDIR 'C:\USER\DATA'
MMEM:CAT:LENG?
11
```

Usage:

Query only

MMEMemory:COPIY <FileSource>[, <FileDestination>]

Copies an existing file to a new file.

Setting parameters:

- <FileSource> String parameter. Contains name and path of the file to be copied. Wildcards (* and ?) are allowed.
- <FileDestination> String parameter. Contains name and path of the new file. If the file already exists, it is overwritten without notice. If no file destination is specified, the source file is written to the current directory specified with [MMEMory:CDIRectory](#).

Example:

```
MMEM: COPY 'C:\Users\Public\Documents
\Rohde-Schwarz\RTx\RefWaveforms
\RefCurve_2011-03-16*.bin', 'E:'
```

Copies all reference waveforms saved on March 16, 2011 to an external storage medium, mapped to drive E:\.

Usage:

Setting only
SCPI confirmed

MMEMory:MOVE <FileSource>, <FileDestination>

Moves the specified file to a new location on the same drive and renames it.

Setting parameters:

- <FileSource> String parameter, contains name and path of the file to be copied. Wildcards (* and ?) are allowed. Therefore, specify a directory for <FileDestination>. Renaming is not possible.
- <FileDestination> String parameter. Contains name and path of the new file. If no path is specified, the <FileSource> directory is used - the file is renamed.

Example:

```
MMEM: MOVE 'C:\USER\DATA\SETUP.CFG', 'C:\STORE'
```

Moves the file "Setup.cfg" from the directory C:\USER\DATA to C:\STORE.

Usage:

Setting only
SCPI confirmed

MMEMory:DELeTe <FileName>

Removes the specified file/files. To delete directories, use [MMEMory:RDIRectory](#).

Setting parameters:

- <FileName> String parameter to specify the name and directory of the file to be removed. Wildcards (* and ?) are allowed. If no path is defined, the current directory is used, specified with [MMEMory:CDIRectory](#).

Example:

```
MMEM: DEL '* .CFG'
```

Deletes all CFG files from the current directory.

Usage:

Setting only
SCPI confirmed

Manual operation: See "Save to file" on page 486

MMEemory:DATA <FileName>, <Data>

MMEemory:DATA? <FileName>

Stores data in the specified file to the storage location specified using [MMEemory:CDIRectory](#).

Parameters:

<Data> <block>

488.2 block data format. The delimiter EOI must be selected to achieve correct data transfer.

The block begins with character '#'. The next digit is the length of the length information, followed by this given number of digits providing the number of bytes in the following binary data.

Parameters for setting and query:

<FileName> String parameter, the name of the file the data is stored to.

Example: MMEM:DATA 'abc.txt', #216This is the file
#2: the length information has two digits.
16: the binary data has 16 bytes.

Example: MMEM:DATA? 'abc.txt'
Returns the data from file abc.txt.

MMEemory:ATTRibute <FileName>, <Attributes>

MMEemory:ATTRibute? <FileName>

Sets file attributes for the specified file/files. The command can be used for files only.

Setting parameters:

<Attributes> String with attributes and setting information.
'+' before the attribute: sets the attribute
'-' before the attribute: deletes the attribute
'R': read only
'A': archive file
'S': system file
'H': hidden file

Parameters for setting and query:

<FileName> String parameter, contains name and path of the file. Wildcards (* and ?) are allowed.

Return values:

<FileEntry> String containing: "<file_name>,<file_attributes>"

Example: MMEM:ATTR 'C:\USER\DATA*.LOG', '-R -A'
Deletes the read-only and archive attributes from all log files in the directory C:\USER\DATA*.LOG.

Example: `M MEM:ATTR? 'C:\USER\DATA*.*'
 "Datei1.LOG,A", "Datei2.LOG,A",
 "Datei3.LOG,ASH", "Datei4.DLL,RSH",
 "Datei5.INI,SH"`

M MEMory:SAV <FileDestination>

Stores the current instrument settings to the specified file.

This command has the same effect as the combination of *SAV and M MEMory:STORe:STATe.

Parameters:

<FileDestination> String parameter specifying path and filename of the target file. Wildcards are not allowed.

Example: `M MEM:SAV 'C:\mysavefile.dfl'`
 Saves the current instrument settings to the file `mysavefile.dfl` located in the directory `C:\`.

Usage: Event

Manual operation: See "[Save to file](#)" on page 452

M MEMory:RCL <FileSource>

Restores the instrument settings from the specified file.

This command has the same effect as the combination of M MEMory:LOAD:STATe and *RCL.

Parameters:

<FileSource> String parameter specifying the path and filename of the source file. Wildcards are not allowed.

Example: `M MEM:RCL 'C:\mysavefile.dfl'`
 Loads and activates the instrument settings from the file `mysavefile.dfl` located in the directory `C:\`.

Usage: Event

Manual operation: See "[Load from file](#)" on page 452

M MEMory:STORe:STATe <MemoryNumber>, <FileName>

Stores the instrument settings from the specified internal memory to the specified file. To store the current instrument settings to the internal memory, use *SAV first.

Setting parameters:

<MemoryNumber> Number of the internal memory
 Range: 1 to 99

<FileName> String parameter specifying the complete path and filename of the source file.

Example: *SAV 4
 MMEM:STORe:STATe 4, 'C:
 \Settings\Settings_1051.dfl'
 Saves current instrument settings to the internal memory number 4. Then stores the settings from the internal memory number 4 to the file C:\Settings\Settings_1051.dfl.

Usage: Setting only

MMEMory:LOAD:STATe <MemoryNumber>, <FileName>

Loads the instrument settings from the specified file to the specified internal memory. After the file has been loaded, the settings must be activated using a *RCL command.

Setting parameters:

<MemoryNumber> Number of the internal memory
 Range: 1 to 99

<FileName> String parameter specifying the complete path and filename of the source file.

Example: MMEM:LOAD:STATe 4, 'C:
 \Settings\Settings_1051.dfl'
 *RCL 4
 Loads instrument settings from the file C:\Settings\Settings_1051.dfl to the internal memory number 4, and then activates the settings in internal memory number 4.

Usage: Setting only

27.16.2 Savesets and one file

SAVeset:CONFig:PREView.....	1764
SAVeset:ONEFile:NAME.....	1765
SAVeset:ONEFile:SAVE.....	1765
SAVeset:ONEFile:OPEN.....	1765
SAVeset:ONEFile:USERpref.....	1765

SAVeset:CONFig:PREView <Include>

If set to OFF, the saveset is stored without the preview image to reduce the file size.

Use the command each time before you save a saveset.

Parameters:

<Include> ON | OFF
 *RST: ON

Usage: Asynchronous command

SAVeset:ONEFile:NAME <Name>

Sets the path and the file name of the One File. The file format is ZIP.

Parameters:

<Name> String parameter

Usage: Asynchronous command

Manual operation: See ["Save to file"](#) on page 453

SAVeset:ONEFile:SAVE

Usage: Event

Manual operation: See ["Save to file"](#) on page 453

Saves the One File data to the file that is specified with `SAVeset:ONEFile:NAME`.

SAVeset:ONEFile:OPEN

Loads the One File that is specified with `SAVeset:ONEFile:NAME`.

Usage: Event

Manual operation: See ["Load from file"](#) on page 454

SAVeset:ONEFile:USERpref <Include>

If ON, the user preferences settings are also restored together with the saveset and reference waveform. User preferences settings include the user-specific display settings like diagram layout, toolbar, intensity and transparency settings.

Parameters:

<Include> ON | OFF

*RST: OFF

Usage: Asynchronous command

Manual operation: See ["Include user preferences"](#) on page 454

27.16.3 Waveform data transmission

The R&S RTO6 provides specific data export commands for the various waveform types. The commands transmit the data of the waveform points from the instrument to the controlling computer. The data can be used in MATLAB, for example.

The commands are described in the relevant chapters:

- Analog waveforms: [Chapter 27.8.6, "Waveform data"](#), on page 1432
- Reference waveforms: [Chapter 27.10.2.3, "Waveform data export"](#), on page 1553
- Math waveforms: [Chapter 27.10.3, "Mathematics"](#), on page 1558
- Spectrum waveforms: [Chapter 27.13.2, "Waveform data"](#), on page 1687

- Logic channels: [Chapter 27.19.5, "MSO data"](#), on page 2629
- I/Q data: [Chapter 27.22.2, "I/Q data output"](#), on page 2668

27.16.4 Waveform data export to file

The resulting files of waveforms exports are described in [Chapter 12.2.1, "Waveform export files"](#), on page 459.

EXPort:WAVeform:SOURce	1766
EXPort:WAVeform:MULTichannel	1767
CHANnel<m>:EXPortstate	1768
EXPort:WAVeform:NAME	1768
EXPort:WAVeform:SAVE	1769
EXPort:WAVeform:SCOPE	1769
EXPort:WAVeform:START	1769
EXPort:WAVeform:STOP	1770
EXPort:WAVeform:ZOOM	1770
EXPort:WAVeform:CURSorset	1770
EXPort:WAVeform:MEAS	1771
EXPort:WAVeform:DLOGging	1771
EXPort:WAVeform:TIMestamps	1772
EXPort:WAVeform:INCXvalues	1772
EXPort:WAVeform:RAW	1773
EXPort:WAVeform:DISPlayoff	1773
EXPort:WAVeform:FASTexport	1773
EXPort:WAVeform:ICDR	1774

EXPort:WAVeform:SOURce <Source>

Selects the waveform to be exported to file.

The commands takes effect if [EXPort:WAVeform:MULTichannel](#) is OFF.

Parameters:

<Source> | C1W1 | C1W2 | C1W3 | C2W1 | C2W2 | C2W3 | C3W1 | C3W2 | C3W3 | C4W1 | C4W2 | C4W3 | M1 | M2 | M3 | M4 | M5 | M6 | M7 | M8 | R1 | R2 | R3 | R4 | D0 | D1 | D2 | D3 | D4 | D5 | D6 | D7 | D8 | D9 | D10 | D11 | D12 | D13 | D14 | D15 | MSOB1 | MSOB2 | MSOB3 | MSOB4 | TRK1 | TRK2 | TRK3 | TRK4 | TRK5 | TRK6 | TRK7 | TRK8 | Z1V1 | Z1V2 | Z1V3 | Z1V4 | Z1I1 | Z1I2 | Z1I3 | Z1I4 | Z2V1 | Z2V2 | Z2V3 | Z2V4 | Z2I1 | Z2I2 | Z2I3 | Z2I4 | DIFF1 | DIFF2 | COMMON1 | COMMON2 | BATHtub1 | BMEas1 | SRESponse1 | SRHist1 | SDHist1 | TJHist1 | DJHist1 | DDJHist1 | PJHist1 | RJOHist1 | SRTRack1 | SDTRack1 | TJTRack1 | DJTRack1 | DDJTrack1 | PJTrack1 | RJOTrack1 | TJSpectrum1 | DDJSpectrum1 | PJSpectrum1 | RJOspectrum1 | SEYE1 | BATHtub2 | BMEas2 | SRESponse2 | SRHist2 | SDHist2 | TJHist2 | DJHist2 | DDJHist2 | PJHist2 | RJOHist2 | SRTRack2 | SDTRack2 | TJTRack2 | DJTRack2 | DDJTrack2 | PJTrack2 | RJOTrack2 | TJSpectrum2 | DDJSpectrum2 | PJSpectrum2 | RJOspectrum2 | SEYE2 | NBATHtub1 | NBMeas1 | TNHist1 | DNHist1 | DDNHist1 | PNHist1 | RNOHist1 | TNTRack1 | DNTRack1 | DDNTrack1 | PNTRack1 | RNORack1 | TNSpectrum1 | DDNSpectrum1 | PNSpectrum1 | RNOSpectrum1 | NBATHtub2 | NBMeas2 | TNHist2 | DNHist2 | DDNHist2 | PNHist2 | RNOHist2 | TNTRack2 | DNTRack2 | DDNTrack2 | PNTRack2 | RNORack2 | TNSpectrum2 | DDNSpectrum2 | PNSpectrum2 | RNOSpectrum2 | PJDHist1 | BUJHist1 | RJHist1 | PJDTrack1 | PJDspectrum1 | PJDHist2 | BUJHist2 | RJHist2 | PJDTrack2 | PJDspectrum2 | PNDHist1 | BUNHist1 | RNHist1 | PNDTrack1 | PNDspectrum1 | PNDHist2 | BUNHist2 | RNHist2 | PNDTrack2 | PNDspectrum2 | LANE1 | LANE2 | LANE3 | LANE4

*RST: C1W1

Example: See [Chapter 27.3.5.2, "Exporting waveform data to file"](#), on page 1353

Usage: Asynchronous command

Manual operation: See ["Source"](#) on page 468

EXPort:WAVeform:MULTichannel <MltChXpt>

Enables or disables the multichannel export.

If you enable the multichannel export, all active channels are included to the export data. You can change the export state using the [CHANnel<m>:EXPortstate](#) command.

If multichannel export is disabled, select the waveform to be exported using the [EXPort:WAVeform:SOURce](#) command.

Note that [CHANnel<m>\[:WAVeform<n>\]:DATA\[:VALues\]?](#) returns the data of all channels that are selected for export, no matter of the channel suffix.

Parameters:

<MltChXpt> ON | OFF
 *RST: OFF

Usage: Asynchronous command

Manual operation: See "[Multi channel](#)" on page 467

CHANnel<m>:EXPortstate <ExportState>

Includes or excludes the indicated channel in waveform export. The data of channel waveform 1 is exported.

The commands takes effect if `EXPort:WAVeform:MULTichannel` is ON.

Suffix:

<m> 1..4
 Selects the input channel.

Parameters:

<ExportState> ON | OFF
 If you enable the multichannel export, the export state of all active channels is automatically set ON.
 *RST: OFF

Usage: Asynchronous command

Manual operation: See "[Selected sources](#)" on page 468

EXPort:WAVeform:NAME <FileName>

Sets the file name, file format and path to save the waveform to.

See also: [Chapter 12.2.1, "Waveform export files"](#), on page 459

Parameters:

<FileName> String with path and file name with extension .xml, .bin, or .csv

Example: `EXPort:WAVeform:NAME 'C:\temp\Export_Ch1.xml'`
`EXPort:WAVeform:SAVE`
 Saves the waveform data in XML format to
 C:\temp\Export_Ch1.xml.

Example: `EXPort:WAVeform:NAME 'C:\temp\Export_Ch2.bin'`
`EXPort:WAVeform:SAVE`
 Saves the waveform data in binary format to
 C:\temp\Export_Ch2.bin.

Usage: Asynchronous command

Manual operation: See "[Save to file](#)" on page 470

EXPort:WAVeform:SAVE

Saves the waveform(s) to the file specified with `EXPort:WAVeform:NAME`. The file format is also set using the `...NAME` command.

Example: See [Chapter 27.3.5.2, "Exporting waveform data to file"](#), on page 1353

Usage: Event

Manual operation: See ["Save to file"](#) on page 470

EXPort:WAVeform:SCOPE <Scope>

Defines the part of the waveform record that has to be stored.

Parameters:

<Scope>

WFM | ZOOM | CURSor | GATE | MANual

WFM

Complete waveform

ZOOM

Data included in the zoom area if a zoom is defined for the source waveform.

CURSor

Data between the cursor lines if a cursor measurement is defined for the source waveform.

GATE

data included in the measurement gate if a gated measurement is defined for the source waveform.

MANual

Saves the data between user-defined start and stop values to be set with `EXPort:WAVeform:START` and `EXPort:WAVeform:STOP`.

*RST: WFM

Example: See [Chapter 27.3.5.2, "Exporting waveform data to file"](#), on page 1353

Usage: Asynchronous command

Manual operation: See ["Scope"](#) on page 468

EXPort:WAVeform:START <Start>

Sets the start value of the waveform section for export, if `EXPort:WAVeform:SCOPE` is set to `MANual`.

Parameters:

<Start> Range: -100E+24 to 100E+24
 Increment: 0.01
 *RST: 0.01
 Default unit: s

Usage: Asynchronous command

Manual operation: See "[Scope](#)" on page 468

EXPort:WAVeform:STOP <Stop>

Sets the end value of the waveform section for export, if `EXPort:WAVeform:SCOPE` is set to `Manual`.

Parameters:

<Stop> Range: -100E+24 to 100E+24
 Increment: 0.01
 *RST: 0.01
 Default unit: s

Usage: Asynchronous command

Manual operation: See "[Scope](#)" on page 468

EXPort:WAVeform:ZOOM <ZoomDiagram>

Sets the zoom area to be used for limited data export if `EXPort:WAVeform:SCOPE` is set to `ZOOM`.

Parameters:

<ZoomDiagram> Name of the diagram on which the zoom area is based.

Example: See "[Exporting interleaved x/y data of a zoom to CSV file](#)" on page 1355

Usage: Asynchronous command

Manual operation: See "[Scope](#)" on page 468

EXPort:WAVeform:CURSorset <Cursorset>

Sets the cursor set to be used for limited data export if `EXPort:WAVeform:SCOPE` is set to `CURSor`.

Parameters:

<Cursorset> CURSOR1 | CURSor1 | CURSOR2 | CURSor2 | CURSOR3 |
 CURSor3 | CURSOR4 | CURSor4
 CURSOR1 = CURSor1, CURSOR2 = CURSor2, CURSOR3 =
 CURSor3, CURSOR4 = CURSor4

Usage: Asynchronous command

Manual operation: See "[Scope](#)" on page 468

EXPort:WAVeform:MEAS <MeasGate>

Sets the gate to be used for limited data export if `EXPort:WAVeform:SCOPE` is set to GATE.

Parameters:

<MeasGate> MEAS1 | MEAS2 | MEAS3 | MEAS4 | MEAS5 | MEAS6 |
MEAS7 | MEAS8
Measurement for which the gate is defined.

Example: See ["Exporting raw data of a measurement gate to a BIN file"](#) on page 1354

Usage: Asynchronous command

Manual operation: See ["Scope"](#) on page 468

EXPort:WAVeform:DLOGging <DataLogging>

The command enables the export of subsequent acquisitions of the selected waveforms. The waveforms are taken from a running Nx Single acquisition (data logging, history is disabled), or from the history (multiple waveforms, history is enabled).

If the history is disabled (`CHANnel<m>[:WAVeform<n>]:HISTory[:STATe]`) and data logging is enabled, a specified number of waveforms is transferred to file directly during RUN Nx SINGLE acquisition. Enabling data logging stops a running acquisition. Set the number of acquisitions to be acquired and stored with `ACQuire:COUNT` and start export using `RUNSingle`.

If the history is enabled, the subsequent waveforms are taken from the history. Specify the range with `CHANnel<m>[:WAVeform<n>]:HISTory:START` and `CHANnel<m>[:WAVeform<n>]:HISTory:STOP`. Then play the history with `CHANnel<m>[:WAVeform<n>]:HISTory:PLAY`.

The commands `EXPort:WAVeform:SAVE`, `CHANnel<m>[:WAVeform<n>]:DATA[:VALues]?` and `CHANnel<m>[:WAVeform<n>]:DATA:HEADer?` are not available if data logging is enabled. The `RUNContinuous` command disables data logging.

If data logging is off, and the history is enabled, one waveform out of the history is written to file. Specify the waveform using `CHANnel<m>[:WAVeform<n>]:HISTory:CURRENT` and save it using `EXPort:WAVeform:SAVE`.

Parameters:

<DataLogging> ON | OFF
*RST: OFF

Example: See:
["Exporting multiple running acquisitions of a single waveform to an XML file"](#) on page 1356
["Exporting multiple acquisitions of the history to an XML file"](#) on page 1357
["Exporting a single acquisition of the history to a BIN file"](#) on page 1356

Usage: Asynchronous command
Manual operation: See ["Enable"](#) on page 472

EXPort:WAVeform:TIMestamps <UseTimestamps>

Exports the relative timestamps of all history waveforms to the waveform data file. The time is written at the beginning of each waveform record.

Parameters:

<UseTimestamps> ON | OFF
 *RST: OFF

Usage: Asynchronous command
Manual operation: See ["Time stamps"](#) on page 471

EXPort:WAVeform:INCXvalues <IncHorValues>

Includes horizontal values in the retrieved data (time or frequency values, depending on the waveform). X and Y-values are written alternately to the file. If disabled, only Y-values - mostly voltage values - are written. The X-values are always returned in 64 bit real format, regardless of the defined data format.

The setting is not available for the export of raw data.

The command affects the content of export files as well as data retrieved with:

- [CHANnel<m>\[:WAVeform<n>\]:DATA\[:VALues\]?](#)
- [CALCulate:MATH<m>:DATA\[:VALues\]?](#)
- [REFCurve<m>:DATA\[:VALues\]?](#)
- [DIGital<m>:DATA\[:VALues\]?](#)
- [BUS<m>:PARallel:DATA\[:VALues\]?](#)
- [ZVC:Z<m>:I<n>:DATA\[:VALues\]?](#)
- [ZVC:Z<m>:V<n>:DATA\[:VALues\]?](#)

Parameters:

<IncHorValues> ON | OFF
 *RST: OFF

Example: See:
["Exporting interleaved x/y data of a single waveform to a CSV file"](#) on page 1355
["Exporting interleaved x/y data of a zoom to CSV file"](#) on page 1355

Usage: Asynchronous command
Manual operation: See ["Interleaved x/y"](#) on page 470

EXPort:WAVeform:RAW <RawValues>

Enables the export of raw sample data, and sets the data format to integer 8 bit. In high definition acquisition mode, the data format is integer 16 bit. For INT16, you can set the byte order using the [FORMat:BOrDer](#) command.

The raw format reduces the file size but changes also the precision of the values.

Currently, the setting is not available for the export of digital channel data and data of R&S RT-ZVC channels.

The raw export of interleaved X/Y values is not supported.

Parameters:

<RawValues> ON | OFF
*RST: OFF

Example:

See:
["Exporting raw data of a single waveform to a BIN file"](#)
on page 1354
["Exporting raw data of a measurement gate to a BIN file"](#)
on page 1354

Usage: Asynchronous command

Manual operation: See ["Raw \(ADC direct\)"](#) on page 469

EXPort:WAVeform:DISPlayoff <FastExport>

Enables or disables the display update during an Nx Single acquisition.

Parameters:

<FastExport> ON | OFF
ON: Disables the display update for maximum export speed.
OFF: Enables the display update. The export is slower.
*RST: OFF

Usage: Asynchronous command

EXPort:WAVeform:FASTexport <Enable>

To improve the performance of data export to file, the measurements are performed slower while the data export speeds up.

Setting parameters:

<Enable> ON | OFF

Example: See [Chapter 27.3.5.2, "Exporting waveform data to file"](#),
on page 1353

Usage: Setting only
Asynchronous command

EXPort:WAVeform:ICDR <IncludeCDRInformation>

Includes the CDR information in the waveform file.

Parameters:

<IncludeCDRInformation> | OFF

*RST: OFF

Usage: Asynchronous command

Manual operation: See ["Include CDR info"](#) on page 467

27.16.5 Waveform histogram export to file

[EXPort:HISTogram:SElect](#).....1774

[EXPort:HISTogram:INCidence](#).....1774

[EXPort:HISTogram:NAME](#).....1774

[EXPort:HISTogram:SAVE](#).....1775

[EXPort:HISTogram:DATA?](#).....1775

EXPort:HISTogram:SElect <Name>

Selects the histogram to be exported.

Parameters:

<Name> String with the histogram name.

Example: See ["Exporting histogram data to file"](#) on page 1350

Usage: Asynchronous command

Manual operation: See ["Select"](#) on page 474

EXPort:HISTogram:INCidence <Incidence>

Sets the mode of exported data: relative or absolute frequency of amplitude values.

Parameters:

<Incidence> ABS | REL

*RST: REL

Example: See ["Exporting histogram data to file"](#) on page 1350

Usage: Asynchronous command

Manual operation: See ["Incidence"](#) on page 474

EXPort:HISTogram:NAME <Path>

Sets the file name and path to save the histogram to.

Parameters:

<Path> String with path and file name. The file extension defines the file format: XML, CSV, or BIN.

Example: See "Exporting histogram data to file" on page 1350

Usage: Asynchronous command

Manual operation: See "Save to file" on page 474

EXPort:HISTogram:SAVE

Saves the histogram to the file specified with `EXPort:HISTogram:NAME`.

Example: See "Exporting histogram data to file" on page 1350

Usage: Event
Asynchronous command

Manual operation: See "Save to file" on page 474

EXPort:HISTogram:DATA?

Transfers the histogram data to the controlling computer. The data can be used in MATLAB, for example.

To set the export data format, use `FORMat[:DATA]`.

Return values:

<Data> List of values according to the format settings and `EXPort:HISTogram:INCidence`.

Example: See "Transferring histogram data" on page 1350.

Usage: Query only

Manual operation: See "Save to file" on page 474

27.16.6 Eye

<code>EXPort:EYE:DATA?</code>	1775
<code>EXPort:EYE:NAME</code>	1776
<code>EXPort:EYE:SAVE</code>	1776
<code>EXPort:EYE:SElect</code>	1776
<code>EXPort:EYE:SOURce?</code>	1776

EXPort:EYE:DATA?

Transfers the eye data to the controlling computer. The data can be used in MATLAB, for example.

To set the export data format, use `FORMat[:DATA]`.

Usage: Query only

Manual operation: See "Save to file" on page 480

EXPort:EYE:NAME <Path>

Sets the path, the file name, and the file format for the eye file. Available file formats are *csv and *bin.

Parameters:

<Path>

Usage: Asynchronous command

Manual operation: See ["Save to file"](#) on page 480

EXPort:EYE:SAVE

Saves the selected eye to the file that is specified with `EXPort:EYE:NAME`.

Usage: Event

Manual operation: See ["Save to file"](#) on page 480

EXPort:EYE:SElect <SelectableEye>

Selects the eye that you want to save to a file.

Parameters:

<SelectableEye> EYE1 | EYE2 | EYE3 | EYE4
*RST: EYE1

Usage: Asynchronous command

Manual operation: See ["Select/ Source"](#) on page 480

EXPort:EYE:SOURce?

Returns the source of the eye measurement, selected with `EXPort:EYE:SElect`.

Return values:

<Source> C1W1 | C1W2 | C1W3 | C1W4 | C2W1 | C2W2 | C2W3 | C2W4 |
C3W1 | C3W2 | C3W3 | C3W4 | C4W1 | C4W2 | C4W3 | C4W4
*RST: NONE

Usage: Query only
Asynchronous command

Manual operation: See ["Select/ Source"](#) on page 480

27.16.7 Long term measurement results and measurement histogram export to file

EXPort:MEASurement:SElect.....	1777
EXPort:MEASurement:TYPE.....	1777
EXPort:MEASurement:NAME.....	1777
EXPort:MEASurement:SAVE.....	1778
EXPort:MEASurement:DATA?.....	1778

EXPort:MEASurement:SElect <SelcMeas>

Selects the measurement for export of long term or measurement histogram data.

Parameters:

<SelcMeas> MEAS1 | MEAS2 | MEAS3 | MEAS4 | MEAS5 | MEAS6 |
MEAS7 | MEAS8
*RST: MEAS1

Example: See "[Exporting long-term measurement data to file](#)"
on page 1350

Usage: Asynchronous command

Manual operation: See "[Measurement](#)" on page 478

EXPort:MEASurement:TYPE <ExportType>

You can export the result data of the long term measurement, or the measurement histogram, or the track data.

To export the measurement histogram, it must be enabled using [MEASurement<m>:STATistics:HISTogram](#).

To export the long term results, the long term measurement must be enabled using [MEASurement<m>:LTMeas\[:STATe\]](#).

To export a track, the track must be enabled before. Track measurements require an option, see "[Enable \(Track\)](#)" on page 367.

Parameters:

<ExportType> LONGterm | HISTogram | TRACK
LONGTERM = LONGterm, HISTOGRAM = HISTogram
*RST: HISTogram

Example: See "[Exporting long-term measurement data to file](#)"
on page 1350

Usage: Asynchronous command

Manual operation: See "[Export type](#)" on page 478

EXPort:MEASurement:NAME <Path>

Sets the file name and path to save the long term or measurement histogram data to.

Parameters:

<Path> String with path and file name. The file extension defines the file format: XML, CSV, or BIN.

Example: See ["Exporting long-term measurement data to file"](#) on page 1350

Usage: Asynchronous command

EXPort:MEASurement:SAVE

Saves the long term or measurement histogram results to the file specified using `EXPort:MEASurement:NAME`.

The measurement data can be exported as absolute or relative values, which is defined using `EXPort:HISTogram:INCidence`.

Example: See ["Exporting long-term measurement data to file"](#) on page 1350

Usage: Event

Manual operation: See ["Save to file"](#) on page 479

EXPort:MEASurement:DATA?

Transfers the long term measurement data to the controlling computer. The data can be used in MATLAB, for example. The transferred data are the same as the data written to files.

To set the export data format, use `FORMat [:DATA]`.

Return values:

<Data> List of values according to the format settings
 Long term data:
 If statistics are disabled, the current value of each long term point is returned.
 If statistics are enabled (`MEASurement<m>:STATistics[:ENABLE]`), seven values for each long term point are returned: upper peak, lower peak, RMS, standard deviation, average, number of measured results per long term point, number of waveforms per long term point.
 For measurement histograms, absolute values are returned.
 See also: [Chapter 12.2.5, "Result plots analysis"](#), on page 476.

Example: See ["Transferring long-term measurement data"](#) on page 1351

Usage: Query only

Manual operation: See ["Save to file"](#) on page 479

27.16.8 Screenshots

The HCOPy subsystem and some other commands control the output of display information for documentation purposes. The instrument allows two independent output configurations which can be set separately with the suffix.

Note that the remote mode is intended for maximum performance. Therefore, the display does not follow the remote commands consistently. To get a correct screenshot, turn the display on using `SYST:DISP:UPD ON`.

<code>HCOPy:DESTination<1..2></code>	1779
<code>MMEMy:NAME</code>	1779
<code>HCOPy:DEVice<m>:LANGUage</code>	1780
<code>HCOPy:DEVice<m>:INVerse</code>	1780
<code>HCOPy:WBKG</code>	1781
<code>HCOPy:CMAP<m>:DEFault</code>	1781
<code>HCOPy:SSD</code>	1781
<code>HCOPy:ISBA</code>	1782
<code>HCOPy:IMMediate<m>[:DUM]</code>	1782
<code>HCOPy:IMMediate<m>:NEXT</code>	1782
<code>HCOPy:STABs</code>	1783

`HCOPy:DESTination<1..2>` <Medium>

Selects the output medium: file, printer or clipboard.

Suffix:

1..2 Selects the output configuration.

Parameters:

<Medium> MMEM | SYST:COMM:CLIP
String parameter

MMEM

Directs the display image to a file. The `MMEMy:NAME` command defines the file name. The file format is defined with `HCOPy:DEVice<m>:LANGUage`.

SYST:COMM:CLIP

Directs the hardcopy to the clipboard.

*RST: SYST:COMM:CLIP

Example:

`HCOP:DEST 'MMEM'`

See also [Chapter 27.3.5.1, "Saving a screenshot to file"](#), on page 1353

Usage:

Asynchronous command

Manual operation: See ["Save to file"](#) on page 486

`MMEMy:NAME` <FileName>

Defines the file name when an image of the display is stored to a file.

Setting parameters:

<FileName> String parameter specifying path and file name of the screenshot.

Example: See [Chapter 27.3.5.1, "Saving a screenshot to file"](#), on page 1353

Usage: Setting only
SCPI confirmed
Asynchronous command

Manual operation: See ["Save to file"](#) on page 486

HCOPY:DEvice<m>:LANGuage <FileFormat>

Defines the file format for output of the display image to file.

To set the output to file, use `HCOPY:DESTination<1..2>` with parameter 'MMEM'.

Suffix:

<m> 1..2
Selects the output configuration.

Parameters:

<FileFormat> PNG | JPG | BMP | TIFF | PDF
*RST: PNG

Example: See [Chapter 27.3.5.1, "Saving a screenshot to file"](#), on page 1353

Usage: Asynchronous command

Manual operation: See ["Save to file"](#) on page 486

HCOPY:DEvice<m>:INVerse <InverseColor>

Inverts the colors of the output, i.e. a dark waveform is printed on a white background. Screenshots are inverted per default when you save using remote commands. Turn inversion off if you want the screen display in the screenshot.

See also:

- [HCOPY:WBKG](#) on page 1781
- ["White background"](#) on page 485

Suffix:

<m> 1..2
Selects the output configuration.

Parameters:

<InverseColor> ON | OFF
*RST: ON

Usage: Asynchronous command

Manual operation: See ["Inverse color"](#) on page 486

HCOPY:WBKG <WhiteBackground>

Inverts the background color. So you can print waveforms with normal waveform colors on white background.

If both `HCOPY:WBKG` and `HCOPY:DEVICE<m>:INVERSE` are ON, the instrument inverts the background twice, and it appears black.

See also: "[White background](#)" on page 485.

Parameters:

<WhiteBackground> ON | OFF
*RST: OFF

Usage: Asynchronous command

Manual operation: See "[White background](#)" on page 485

HCOPY:CMAP<m>:DEFAULT <PrintColorSet>

Defines the default color set for printing of the display image.

To set the output to printer, use `HCOPY:DESTINATION<1..2>` with parameter 'SYST:COMM:PRIN'.

Suffix:

<m> 1..2
Selects the output configuration.

Parameters:

<PrintColorSet> DEF1 | DEF4
DEF1
Current screen colors with white background and black grid.
DEF4
Current screen colors without any changes (black background).
*RST: DEF1

Usage: Asynchronous command

HCOPY:SSD <ShowSetupDialog>

Enables or disables the display of open dialog boxes in screenshots. Use this command if you want to document settings in screenshots.

Parameters:

<ShowSetupDialog> ON | OFF
*RST: OFF

Usage: Asynchronous command

Firmware/software: FW 3.20

Manual operation: See "[Show setup dialog](#)" on page 486

HCOPY:ISBA IncludeSignalBar

If the value is set to `OFF`, the screenshot shows only the diagram area, without the signal bar.

Parameters:

IncludeSignalBar `ON | OFF`
 *`RST:` `OFF`

Usage: Asynchronous command

Manual operation: See "[Show only grid](#)" on page 486

HCOPY:IMMEDIATE<m>[:DUM]

Starts the immediate output of the display image, depending on the `HCOPY:DESTINATION<1..2>` destination setting.

By default, screenshots are inverted when saving them with remote commands. If you want the screen display in the screenshot, turn inversion off (`HCOPY:DEVICE<m>:INVERSE`).

To get a correct screenshot of the diagrams, results, and dialog boxes, turn on the display using `SYST:DISP:UPD ON`.

Suffix:

<m> `1..2`
 Selects the output configuration.

Example:

```
SYST:DISP:UPD ON
HCOP:DEST 'MMEM'
MMEM:NAME 'C:\Temp\Print.bmp'
HCOP:IMMEDIATE; *OPC?
```

Example: See [Chapter 27.3.5.1, "Saving a screenshot to file"](#), on page 1353

Usage: Event
 Asynchronous command

Manual operation: See "[Save to file](#)" on page 486

HCOPY:IMMEDIATE<m>:NEXT

Starts the output of the next display image, depending on the `HCOPY:DESTINATION<1..2>` destination setting.

If the screenshot is saved to a file, the file name used in the last saving process is automatically counted up to the next unused name.

Suffix:

<m> `1..2`
 Selects the output configuration.

- Example:** See [Chapter 27.3.5.1, "Saving a screenshot to file"](#), on page 1353
- Usage:** Event
Asynchronous command
- Manual operation:** See ["Save to file"](#) on page 486

HCOPY:STABs

Saves screenshots of all tabs in the diagrams. The instrument creates one screenshot for each tab.

- Usage:** Event
Asynchronous command
- Manual operation:** See ["Screenshot of tabs"](#) on page 486

27.16.9 Reports

The following commands configure and save report files. To configure the screenshot that is included in the report, use the commands explained in [Chapter 27.16.8, "Screenshots"](#), on page 1779.

REPort:LANGUage	1783
REPort:PAPersize	1783
REPort:LOGType	1784
REPort:LOGO	1784
REPort:USER	1784
REPort:COMMeNt	1784
REPort:FILE:NAME	1785
REPort:FILE:SAVE	1785

REPort:LANGUage <Language>

Sets the language to be used in the report. Available languages are listed in the specifications document.

Parameters:

<Language> String with the english language name, upper case.

Example: `REPort:LANGUage 'Spanish'`

Manual operation: See ["Language"](#) on page 488

REPort:PAPersize <PaperSize>

Selects the paper size: A4 or US Letter.

Parameters:

<PaperSize> A4 | USL
*RST: A4

Usage: Asynchronous command

Manual operation: See "[Paper size](#)" on page 489

REPort:LOGType <Logo>

By default, the Rohde & Schwarz logo is shown in the header of the report pages. You can switch the logo off, or select your logo to be shown.

Parameters:

<Logo> RS | CUST | NONE

CUST

Select the logo file using `REPort:LOGO`.

*RST: RS

Usage: Asynchronous command

Manual operation: See "[Logo](#)" on page 489

REPort:LOGO <LogoFile>

Defines the logo file that is used on the report if `REPort:LOGType` is set to `CUSTom`.

Parameters:

<LogoFile> String with the path and filename of the logo image.

Example: `REPort:LOGO 'C:\Company files\logo.jpg'`

Usage: Asynchronous command

Manual operation: See "[Logo](#)" on page 489

REPort:USER <User>

Enter the user name that appears in the general information section at the beginning of the report.

Parameters:

<User> String parameter

Usage: Asynchronous command

Manual operation: See "[User name / Comment](#)" on page 489

REPort:COMMent <Comment>

Enter a comment that appears in the general information section at the beginning of the report.

Parameters:

<Comment> String parameter

Usage: Asynchronous command

Manual operation: See ["User name / Comment"](#) on page 489

REPort:FILE:NAME <ReportFile>

Sets the file name and path to save the report to.

Parameters:

<ReportFile> String with path and file name. The file extension defines the file format: PDF, HTML, or DOC.

Usage: Asynchronous command

Manual operation: See ["Save to file"](#) on page 489

REPort:FILE:SAVE

Saves the report to the specified file.

Usage: Event
Asynchronous command

Manual operation: See ["Save to file"](#) on page 489

27.16.10 Autonoming

MMEMory:AUTonoming:PREFix	1785
MMEMory:AUTonoming:USERtext	1785
MMEMory:AUTonoming:DATE	1785
MMEMory:AUTonoming:INDEX	1785
MMEMory:AUTonoming:TIME	1785
MMEMory:AUTonoming:TEXT	1786
MMEMory:AUTonoming:DEFaultpath	1786
MMEMory:AUTonoming:RESPath	1786
MMEMory:AUTonoming:RESall	1786

MMEMory:AUTonoming:PREFix <State>

MMEMory:AUTonoming:USERtext <State>

MMEMory:AUTonoming:DATE <State>

MMEMory:AUTonoming:INDEX <State>

MMEMory:AUTonoming:TIME <State>

Includes or excludes the name part in the file name pattern for automatic file name generation. This name is used as the default file name.

The prefix indicates the type of data that is saved, for example, Histogram, RefCurve, Settings.

To define a user text, use [MMEMory:AUTonoming:TEXT](#).

Parameters:

<State> ON | OFF
*RST: ON

Usage: Asynchronous command

Manual operation: See ["Time"](#) on page 106

MMEMory:AUTonaming:TEXT <NameString>

Defines a text, that can be included in the autonaming pattern.

Parameters:

<NameString> String parameter

Usage: Asynchronous command

Manual operation: See ["Text input"](#) on page 105

MMEMory:AUTonaming:DEFaultpath <Path>

Sets the path where data and settings files will be stored. The factory default path is:

- "C:\Users\Public\Documents\Rohde-Schwarz\RTx" if no USB flash drive is connected
- Drive letter of the USB flash drive, for example, "E:\ " or "F:\ " if a USB flash drive is connected.

Parameters:

<Path> String parameter

Usage: Asynchronous command

Manual operation: See ["Default path for all file operations"](#) on page 106

MMEMory:AUTonaming:RESPath

Resets the path for file operations to the factory default path.

Usage: Event
Asynchronous command

Manual operation: See ["Reset"](#) on page 106

MMEMory:AUTonaming:RESall

Resets all autonaming settings to the default value, including the path.

Usage: Event
Asynchronous command

Manual operation: See ["Reset"](#) on page 106

27.16.11 CSV export

EXPort:RESult:DECSymbol	1787
EXPort:RESult:DELimiter	1787

EXPort:RESult:DECSymbol <DecimalSymbol>

Sets if point or comma is used as a decimal symbol.

Parameters:

<DecimalSymbol> POINT | COMMa
*RST: POINT

Usage: Asynchronous command

Manual operation: See "[Decimal symbol](#)" on page 107

EXPort:RESult:DELimiter <CsvDelimiter>

Selects the list separator symbol from a list.

Parameters:

<CsvDelimiter> SEMICOLON | COMMA | SPACE | TAB | COLON
*RST: COMMA

Usage: Asynchronous command

Manual operation: See "[Csv delimiter](#)" on page 107

27.16.12 External application

The commands configure an external application that can be started at various events, for example, trigger event, or mask test violation.

EXECutable:NAME	1787
EXECutable:PARAmeter	1787
EXECutable:WDIRectory	1788

EXECutable:NAME <ApplicationPath>

Sets the path to the application executable.

Parameters:

<ApplicationPath> String parameter containing path, filename, and file extension

Example:

```
EXECutable:NAME 'C:\Program
Files\Wireshark\Wireshark.exe'
TRIGger:EVENT:RUNexec TRIGger
```

Usage: Asynchronous command

EXECutable:PARAmeter <AppParameters>

Sets optional parameters for the external executable.

Parameters:

<AppParameters> String parameter

Usage: Asynchronous command

EXECutable:WDIRECTory <WorkDirectory>

Sets the working directory for the executable.

Parameters:

<WorkDirectory> String parameter

Usage: Asynchronous command

27.17 Signal configuration

- [General setup](#).....1788
- [Signal anad reference levels for NRZ signals](#).....1791
- [Signal anad reference levels for PAM-N signals](#).....1805

27.17.1 General setup

SIGNAlconfig:SETup:ADD	1788
SIGNAlconfig:SETup:COUNT?	1789
SIGNAlconfig:SETup:REMOve	1789
SIGNAlconfig:SETup:SETTing<m>:PAMorder	1789
SIGNAlconfig:SETup:SETTing<m>:SERStandard	1789
SIGNAlconfig:SETup:SETTing<m>:SOURce	1790
SIGNAlconfig:SETup:SETTing<m>:SYMBOLrate	1790
SIGNAlconfig:SETup:SOURce	1791
SIGNAlconfig:SETup:SREStimation	1791

SIGNAlconfig:SETup:ADD [<Source>], [<Serial standard>]

Adds a new signal to be configured. You can define up to 8 signals.

Setting parameters:

<Source> NONE | C1W1 | C1W2 | C1W3 | C2W1 | C2W2 | C2W3 | C3W1 | C3W2 | C3W3 | C4W1 | C4W2 | C4W3 | C1W4 | C2W4 | C3W4 | C4W4 | M1 | M2 | M3 | M4 | M5 | M6 | M7 | M8 | R1 | R2 | R3 | R4 | DIFF1 | DIFF2 | COMMON1 | COMMON2

<Serial standard> CUSTOM | USB20 | USB31GEN1 | USB31GEN2 | USB32GEN1 | USB32GEN2 | USB40 | DISPPORT11 | DISPPORT12 | DISPPORT13 | DISPPORT14 | FIBCHAN1 | FIBCHAN2 | FIBCHAN4 | FIBCHAN8 | FIBCHAN16 | HDMI12 | HDMI14 | HDMI20 | PCIGEN1 | PCIGEN2 | PCIGEN3 | PCIGEN4 | PCIGEN5 | SATAGEN1500 | SATAGEN11667 | SATAGEN1 | SATAGEN2500 | SATAGEN21667 | SATAGEN2 | SATAGEN3500 | SATAGEN31667 | SATAGEN3 | SASGEN1 | SASGEN2 | SASGEN3 | TB10G | XAUI | HBT | TBT | HBTO | TBTO | TPFGBTO | FGBTO | TGBTO | FTBR | HGBR | THGBR | FHGBR

Usage: Setting only
Asynchronous command

Manual operation: See ["Add"](#) on page 494

SIGNALconfig:SETup:COUNT?

Returns the number of lines defined in the signal configuration dialog.

Usage: Query only
Asynchronous command

Manual operation: See ["Add"](#) on page 494

SIGNALconfig:SETup:REMove <Index>

Removes the signal with the corresponding index.

Setting parameters:
<Index>

Usage: Setting only
Asynchronous command

Manual operation: See ["Remove"](#) on page 494

SIGNALconfig:SETup:SETTING<m>:PAMorder <PAMOrder>

Requires option R&S RTO6-K135.

Selects the PAM order. You can select a value up to 8.

Suffix:
<m> 1..20
Selects the index of the configured source.

Parameters:
<PAMOrder> PAM2 | PAM3 | PAM4 | PAM5 | PAM6 | PAM7 | PAM8
*RST: PAM2

Usage: Asynchronous command

Manual operation: See ["PAM order"](#) on page 493

SIGNALconfig:SETup:SETTING<m>:SERStandard <SerialStandard>

Sets the serial standard. Set `CUSTOM` to adjust the symbol rate manually.

Suffix:
<m> 1..20
Selects the index of the configured source.

Parameters:

<SerialStandard> CUSTOM | USB20 | USB31GEN1 | USB31GEN2 |
 USB32GEN1 | USB32GEN2 | USB40 | DISPPORT11 |
 DISPPORT12 | DISPPORT13 | DISPPORT14 | FIBCHAN1 |
 FIBCHAN2 | FIBCHAN4 | FIBCHAN8 | FIBCHAN16 | HDMI12 |
 HDMI14 | HDMI20 | PCIGEN1 | PCIGEN2 | PCIGEN3 |
 PCIGEN4 | PCIGEN5 | SATAGEN1500 | SATAGEN11667 |
 SATAGEN1 | SATAGEN2500 | SATAGEN21667 | SATAGEN2 |
 SATAGEN3500 | SATAGEN31667 | SATAGEN3 | SASGEN1 |
 SASGEN2 | SASGEN3 | TB10G | XAUI | HBT | TBT | HBTO |
 TBTO | TPFGBTO | FGBTO | TGBTO | FTBR | HGBR |
 THGBR | FHGBR | CUSTOM | USB20 | USB31GEN1 |
 DISPPORT11 | DISPPORT12 | FIBCHAN1 | FIBCHAN2 |
 FIBCHAN4 | HDMI12 | HDMI14 | HDMI20 | PCIGEN1 |
 PCIGEN2 | SATAGEN1500 | SATAGEN11667 | SATAGEN1 |
 SATAGEN2500 | SATAGEN21667 | SATAGEN2 |
 SATAGEN3500 | SATAGEN31667 | SATAGEN3 | SASGEN1 |
 SASGEN2 | XAUI

Usage: Asynchronous command

Manual operation: See "[Technology, Serial standard](#)" on page 492

SIGNalconfig:SETup:SETTING<m>:SOURce <Source>

Selects the source for the signal configuration for the selected index.

Suffix:

<m> 1..20
 Selects the index of the configured source.

Parameters:

<Source> NONE | C1W1 | C1W2 | C1W3 | C2W1 | C2W2 | C2W3 | C3W1 |
 C3W2 | C3W3 | C4W1 | C4W2 | C4W3 | C1W4 | C2W4 | C3W4 |
 C4W4 | M1 | M2 | M3 | M4 | M5 | M6 | M7 | M8 | R1 | R2 | R3 |
 R4 | DIFF1 | DIFF2 | COMMON1 | COMMON2
 *RST: NONE

Usage: Asynchronous command

SIGNalconfig:SETup:SETTING<m>:SYMBolrate <SymbolRate>

Sets/ displays the symbol rate. Most standards have a pre-defined symbol rate, see [Technology and serial standard properties](#).

Suffix:

<m> 1..20
 Selects the index of the configured source.

Parameters:

<SymbolRate> Range: 100 to 40E+9
 Increment: 10
 *RST: 1E+9
 Default unit: Baud

Usage: Asynchronous command

Manual operation: See "[Symbol rate](#)" on page 494

SIGNAconfig:SETup:SOURce <Source>

Selects the source that is used for the symbol rate estimation. You can only select sources that has been enabled

You can start the estimation of the symbol rate with [SIGNAconfig:SETup:SREStimation](#) on page 1791

Parameters:

<Source> NONE | C1W1 | C1W2 | C1W3 | C2W1 | C2W2 | C2W3 | C3W1 |
 C3W2 | C3W3 | C4W1 | C4W2 | C4W3 | C1W4 | C2W4 | C3W4 |
 C4W4 | M1 | M2 | M3 | M4 | M5 | M6 | M7 | M8 | R1 | R2 | R3 |
 R4 | DIFF1 | DIFF2 | COMMON1 | COMMON2
 *RST: NONE

Usage: Asynchronous command

Manual operation: See "[Source](#)" on page 492

SIGNAconfig:SETup:SREStimation

Starts a software algorithm for the automatic determination of the symbol rate for the source selected with [SIGNAconfig:SETup:SOURce](#).

Example: `SIGNAconfig:SETup:SOURce C1W1`
 `// selects C1W1 as a source`
 `SIGNAconfig:SETup:SREStimation`
 `// starts a symbol rate estimation for C1W1`

Usage: Event
 Asynchronous command

Manual operation: See "[Symbol rate estimation](#)" on page 494

27.17.2 Signal and reference levels for NRZ signals

- [General reference level settings](#)..... 1792
- [Automatic configuration](#)..... 1794
- [Manual configuration](#)..... 1796
- [Hysteresis](#)..... 1801
- [Tube](#)..... 1801
- [Results](#)..... 1803

27.17.2.1 General reference level settings

REFLevel<m>:LDEtection.....	1792
REFLevel<m>:LMODe.....	1792
REFLevel<m>:RELative:MODE.....	1793
REFLevel<m>:USRLevel.....	1793

REFLevel<m>:LDEtection <Mode>

Defines whether the reference level is configured manually or automatically.

For automatic configuration, select the signal level to be used (see [REFLevel<m>:AUTO:MODE](#) on page 1794).

Suffix:

<m> Valid suffix numbers: 2 to 21, 61 to 68, 108 to 118, 151 to 157, 173 to 179
Source waveform of the measurement, see [Chapter 27.4.1, "Waveform suffix"](#), on page 1366.

Parameters:

<Mode> AUTO | MANual

Example:

REFLevel2:LDEtection MANual

Sets manual level configuration for C1W1. C1W1 corresponds to suffix number 2.

Example:

See: [Chapter 27.3.2.2, "Setting reference levels"](#), on page 1348

Usage:

Asynchronous command

Manual operation: See ["Mode"](#) on page 499

REFLevel<m>:LMODe <Mode>

Defines whether the reference is configured using absolute or relative values.

Suffix:

<m> Valid suffix numbers: 2 to 21, 61 to 68, 108 to 118, 151 to 157, 173 to 179
Source waveform of the measurement, see [Chapter 27.4.1, "Waveform suffix"](#), on page 1366.

Parameters:

<Mode> ABS | REL

Example:

REFLevel2:LMODe ABS

Sets definition of reference levels to absolute values for C1W1. C1W1 corresponds to suffix number 2.

Example:

See: ["Manual reference level definition using relative values"](#) on page 1348

Usage:

Asynchronous command

Manual operation: See ["Level mode"](#) on page 502

REFLevel<m>:RELative:MODE <Mode>

The lower, middle and upper reference levels, defined as percentages of the high signal level.

Suffix:

<m> Valid suffix numbers: 2 to 21, 61 to 68, 108 to 118, 151 to 157, 173 to 179
Source waveform of the measurement, see [Chapter 27.4.1, "Waveform suffix"](#), on page 1366.

Parameters:

<Mode> FIVE | TEN | TWENTy | USER

FIVE

5/50/95

TEN

10/50/90

TWENTy

20/50/80

USER

Set the reference levels to individual values with [REFLevel<m>:RELative:LOWer](#), [REFLevel<m>:RELative:MIDDLE](#), and [REFLevel<m>:RELative:UPPer](#).

Example:

REFL2:REL:MODE FIVE

Reference levels for C1W1: Lower reference level = 5% of high signal level, middle reference level = 50% of high signal level, upper reference level = 95% of high signal level

Example:

See: ["Manual reference level definition using relative values"](#) on page 1348

Usage:

Asynchronous command

Manual operation: See ["Relative levels"](#) on page 503

REFLevel<m>:USRLevel <Mode>

Defines whether the user-defined signal levels or user-defined reference levels are used for the measurements.

Suffix:

<m> Valid suffix numbers: 2 to 21, 61 to 68, 108 to 118, 151 to 157, 173 to 179
Source waveform of the measurement, see [Chapter 27.4.1, "Waveform suffix"](#), on page 1366.

Parameters:

<Mode> USIGnal | UREF

USIGnal

The high and low signal levels are defined by the user.

UREF

The reference levels are defined by the user.

- Example:** `REFLevel12:USRLevel UREF`
Sets user-defined reference levels to be used for C1W1. C1W1 corresponds to suffix number 2.
- Example:** See: "[Manual reference level definition using absolute values](#)" on page 1348
- Usage:** Asynchronous command
- Manual operation:** See "[User level](#)" on page 503

27.17.2.2 Automatic configuration

REFLevel<m>:AUTO:MODE	1794
REFLevel<m>:AUTO[:STATe]	1795
REFLevel<m>:AUTO:COUNT	1795

REFLevel<m>:AUTO:MODE <Mode>

Defines the high and low signal levels from which the reference levels are derived.

This setting is only available for automatic reference level mode (see [REFLevel<m>:LDEtection](#) on page 1792).

Suffix:

<m> Valid suffix numbers: 2 to 21, 61 to 68, 108 to 118, 151 to 157, 173 to 179
Source waveform of the measurement, see [Chapter 27.4.1, "Waveform suffix"](#), on page 1366.

Parameters:

<Mode> AUTO | PPRobability | MPRobability | ABSolutepeak | UPLM | UMLP | UALM | UMLA

AUTO

Auto select absolute probability: most suitable signal levels for the selected measurement

PPRobability

Peak probability: signal levels with the highest probability value

MPRobability

Mean probability: signal levels with mean probability

ABSolutepeak

Absolute peak: absolute peak signal levels

UPLM

Upper absolute peak, lower mean probability: high signal level is the upper absolute peak, low signal level is the level with the mean probability in the lower half of the histogram.

UMLP

Upper mean probability, lower absolute peak: high signal level is the level with mean probability in the upper half of the histogram, low signal level is the lower absolute peak.

UALM

Upper absolute peak, lower manual value: high signal level is the maximum result value of the amplitude measurement; low signal level is manually set using `REFLevel<m>:RELative:LOWer`.

UMLA

Upper manual, lower absolute peak: The upper signal level is set manually using `REFLevel<m>:RELative:UPPer`. The lower level is the minimum result value of the amplitude measurement.

Example:

```
REFLevel15:AUTO:MODE PPRobability
```

Sets the automatic reference level mode for C2W1 to "Peak probability". C2W1 corresponds to suffix number 5.

Example:

See: "[Automatic level detection, peak probability](#)" on page 1349

Usage:

Asynchronous command

Manual operation:

See "[Signal level](#)" on page 500

REFLevel<m>:AUTO[:STATe] <Value>

Enables averaging over several histograms to determine the reference levels. The number of histograms to consider is defined using `REFLevel<m>:AUTO:COUNT`.

This function is only available in automatic reference level mode (see `REFLevel<m>:LDEtECTION` on page 1792).

Suffix:

<m> Valid suffix numbers: 2 to 21, 61 to 68, 108 to 118, 151 to 157, 173 to 179
Source waveform of the measurement, see [Chapter 27.4.1, "Waveform suffix"](#), on page 1366.

Parameters:

<Value> ON | OFF

Usage:

Asynchronous command

Manual operation:

See "[Histogram averaging](#)" on page 501

REFLevel<m>:AUTO:COUNT <Value>

Defines the number of histograms from which the average is calculated.

Prerequisites:

- `REFLevel<m>:AUTO[:STATe]` is set to ON

- `REFLevel<m>:LDEtection` on page 1792 is set to `AUTO`

Suffix:

`<m>` Valid suffix numbers: 2 to 21, 61 to 68, 108 to 118, 151 to 157, 173 to 179
 Source waveform of the measurement, see [Chapter 27.4.1, "Waveform suffix"](#), on page 1366.

Parameters:

`<Value>`

Usage: Asynchronous command

Manual operation: See ["Average Count"](#) on page 501

27.17.2.3 Manual configuration

<code>REFLevel<m>:ABSolute:HIGH</code>	1796
<code>REFLevel<m>:ABSolute:LOW</code>	1796
<code>REFLevel<m>:ABSolute:TDIStance</code>	1797
<code>REFLevel<m>:ABSolute:BDIStance</code>	1797
<code>REFLevel<m>:ABSolute:MLeVel</code>	1798
<code>REFLevel<m>:ABSolute:ULeVel</code>	1798
<code>REFLevel<m>:ABSolute:LLeVel</code>	1799
<code>REFLevel<m>:RELative:UPPer</code>	1799
<code>REFLevel<m>:RELative:MIDdle</code>	1800
<code>REFLevel<m>:RELative:LOWer</code>	1800

REFLevel<m>:ABSolute:HIGH <Value>

The signal value that represents a high level.

Suffix:

`<m>` Valid suffix numbers: 2 to 21, 61 to 68, 108 to 118, 151 to 157, 173 to 179
 Source waveform of the measurement, see [Chapter 27.4.1, "Waveform suffix"](#), on page 1366.

Parameters:

`<Value>`

Example:

`REFLevel2:ABSolute:HIGH 0.015`
 Sets the high signal level for C1W1 to 15 mV. C1W1 corresponds to suffix number 2.

Usage: Asynchronous command

Manual operation: See ["High"](#) on page 500

REFLevel<m>:ABSolute:LOW <Value>

The signal value that represents a low level.

Suffix:

<m> Valid suffix numbers: 2 to 21, 61 to 68, 108 to 118, 151 to 157, 173 to 179
 Source waveform of the measurement, see [Chapter 27.4.1, "Waveform suffix"](#), on page 1366.

Parameters:

<Value>

Example:

REFLevel2:ABSolute:Low 0.0015

Sets the low signal level for C1W1 to 1.5 mV. C1W1 corresponds to suffix number 2.

Usage:

Asynchronous command

Manual operation: See "[Low](#)" on page 500

REFLevel<m>:ABSolute:TDistance <Value>

The distance between the high signal level and the upper reference level.

Suffix:

<m> Valid suffix numbers: 2 to 21, 61 to 68, 108 to 118, 151 to 157, 173 to 179
 Source waveform of the measurement, see [Chapter 27.4.1, "Waveform suffix"](#), on page 1366.

Parameters:

<Value>

Example:

REFLevel2:ABSolute:TDistance 0.0002

Sets the top distance for C1W1 to 0.2 mV. C1W1 corresponds to suffix number 2.

Example:

See: "[Manual reference level definition using absolute values](#)" on page 1348

Usage:

Asynchronous command

Manual operation: See "[Top distance](#)" on page 504

REFLevel<m>:ABSolute:BDistance <Value>

The distance between the lower reference level and the low signal value.

Suffix:

<m> Valid suffix numbers: 2 to 21, 61 to 68, 108 to 118, 151 to 157, 173 to 179
 Source waveform of the measurement, see [Chapter 27.4.1, "Waveform suffix"](#), on page 1366.

Parameters:

<Value>

- Example:** REFLevel2:ABSolute:BDistance 0.0002
Sets the bottom distance for C1W1 to 0.2 mV. C1W1 corresponds to suffix number 2.
- Example:** See: "[Manual reference level definition using absolute values](#)" on page 1348
- Usage:** Asynchronous command
- Manual operation:** See "[Bottom distance](#)" on page 503

REFLevel<m>:ABSolute:MLEVel <Value>

For user signal level selection, the level is the middle level between high and low signal level. The value is adjusted automatically if you change the high or low signal levels. Vice versa, if you change the middle level, the high and low signal levels are adjusted.

For user reference level selection, the level is the middle level between upper and lower reference level. The value is adjusted automatically if you change the upper or lower reference levels. Vice versa, if you change the middle level, the upper and lower reference levels are adjusted.

Suffix:

<m> Valid suffix numbers: 2 to 21, 61 to 68, 108 to 118, 151 to 157, 173 to 179
Source waveform of the measurement, see [Chapter 27.4.1, "Waveform suffix"](#), on page 1366.

Parameters:

<Value>

Example: REFLevel2:ABSolute:MLEVel 0.05
Sets the middle signal level for C1W1 to 50 mV. C1W1 corresponds to suffix number 2.

Example: See: "[Manual reference level definition using absolute values](#)" on page 1348

Usage: Asynchronous command

Manual operation: See "[Middle](#)" on page 504

REFLevel<m>:ABSolute:ULEVel <Value>

The upper reference level, required e.g. to determine a rise.

Suffix:

<m> Valid suffix numbers: 2 to 21, 61 to 68, 108 to 118, 151 to 157, 173 to 179
Source waveform of the measurement, see [Chapter 27.4.1, "Waveform suffix"](#), on page 1366.

Parameters:

<Value>

- Example:** `REFLevel2:ABSolute:ULEVel 0.01`
Sets the upper reference level for C1W1 to 10 mV. C1W1 corresponds to suffix number 2.
- Example:** See: ["Manual reference level definition using absolute values"](#) on page 1348
- Usage:** Asynchronous command
- Manual operation:** See ["Upper level"](#) on page 503

REFLevel<m>:ABSolute:LLEVel <Value>

The lower reference level, required e.g. to determine a fall.

Suffix:

<m> Valid suffix numbers: 2 to 21, 61 to 68, 108 to 118, 151 to 157, 173 to 179
Source waveform of the measurement, see [Chapter 27.4.1, "Waveform suffix"](#), on page 1366.

Parameters:

<Value>

- Example:** `REFLevel2:ABSolute:LLEVel 0.001`
Sets the lower reference level for C1W1 to 1 mV. C1W1 corresponds to suffix number 2.
- Example:** See: ["Manual reference level definition using absolute values"](#) on page 1348
- Usage:** Asynchronous command
- Manual operation:** See ["Lower level"](#) on page 503

REFLevel<m>:RELative:UPPer <Value>

Sets the upper relative reference level if `REFLevel<m>:RELative:MODE` is set to USER.

Suffix:

<m> Valid suffix numbers: 2 to 21, 61 to 68, 108 to 118, 151 to 157, 173 to 179
Source waveform of the measurement, see [Chapter 27.4.1, "Waveform suffix"](#), on page 1366.

Parameters:

<Value> Percentage of the high signal level.

- Example:** `REFLevel8:RELative:LOWer 85`
Sets the upper reference level for C3W1 to 85 %. C3W1 corresponds to suffix number 8.
- Example:** See: ["Manual reference level definition using relative values"](#) on page 1348

Usage: Asynchronous command

Manual operation: See ["Upper ref level, Middle ref level, Lower ref level"](#) on page 503

REFLevel<m>:RELative:MIDDLE <Value>

Sets the middle relative reference level if `REFLevel<m>:RELative:MODE` is set to `USER`.

Suffix:

<m> Valid suffix numbers: 2 to 21, 61 to 68, 108 to 118, 151 to 157, 173 to 179
Source waveform of the measurement, see [Chapter 27.4.1, "Waveform suffix"](#), on page 1366.

Parameters:

<Value> Percentage of the high signal level.

Example:

`REFLevel8:RELative:MIDDLE 50`

Sets the middle reference level for C3W1 to 50 %. C3W1 corresponds to suffix number 8.

Example:

See: ["Manual reference level definition using relative values"](#) on page 1348

Usage:

Asynchronous command

Manual operation:

See ["Upper ref level, Middle ref level, Lower ref level"](#) on page 503

REFLevel<m>:RELative:LOWer <Value>

Sets the lower relative reference level if `REFLevel<m>:RELative:MODE` is set to `USER`.

Suffix:

<m> Valid suffix numbers: 2 to 21, 61 to 68, 108 to 118, 151 to 157, 173 to 179
Source waveform of the measurement, see [Chapter 27.4.1, "Waveform suffix"](#), on page 1366.

Parameters:

<Value> Percentage of the high signal level.

Example:

`REFLevel8:RELative:LOWer 15`

Sets the lower reference level for C3W1 to 15 %. C3W1 corresponds to suffix number 8.

Example:

See: ["Manual reference level definition using relative values"](#) on page 1348

Usage:

Asynchronous command

Manual operation: See ["Upper ref level, Middle ref level, Lower ref level"](#) on page 503

27.17.2.4 Hysteresis

REFLevel<m>:RELative:HYSTeresis <Value>

Defines a hysteresis for the middle reference level. A rise or fall from the middle reference value that does not exceed the hysteresis is rejected as noise.

Suffix:

<m> Valid suffix numbers: 2 to 21, 61 to 68, 108 to 118, 151 to 157, 173 to 179
 Source waveform of the measurement, see [Chapter 27.4.1, "Waveform suffix"](#), on page 1366.

Parameters:

<Value>

Usage: Asynchronous command

Manual operation: See ["Hysteresis"](#) on page 504

27.17.2.5 Tube

REFLevel<m>:RELative:OTUBe.....	1801
REFLevel<m>:RELative:ITUBe.....	1802
REFLevel<m>:ABSolute:TOTube.....	1802
REFLevel<m>:ABSolute:TITube.....	1802
REFLevel<m>:ABSolute:BITube.....	1803
REFLevel<m>:ABSolute:BOTube.....	1803

REFLevel<m>:RELative:OTUBe <Value>

Defines a percentage of the signal level by which the absolute signal level may be larger than the high signal level or lower than the low signal level to be considered high or low, respectively.

Suffix:

<m> Valid suffix numbers: 2 to 21, 61 to 68, 108 to 118, 151 to 157, 173 to 179
 Source waveform of the measurement, see [Chapter 27.4.1, "Waveform suffix"](#), on page 1366.

Parameters:

<Value>

Usage: Asynchronous command

Manual operation: See ["Relative outer"](#) on page 505

REFLevel<m>:RELative:ITuBe <Value>

Defines a percentage of the signal level by which the absolute signal level may be higher than the low signal level or lower than the high signal level to be considered low or high, respectively.

Suffix:

<m> Valid suffix numbers: 2 to 21, 61 to 68, 108 to 118, 151 to 157, 173 to 179
Source waveform of the measurement, see [Chapter 27.4.1, "Waveform suffix"](#), on page 1366.

Parameters:

<Value>

Usage: Asynchronous command

Manual operation: See ["Relative inner"](#) on page 505

REFLevel<m>:ABSolute:TOTube <Value>

Defines an area above the high signal level which is still considered to be high level.

Suffix:

<m> Valid suffix numbers: 2 to 21, 61 to 68, 108 to 118, 151 to 157, 173 to 179
Source waveform of the measurement, see [Chapter 27.4.1, "Waveform suffix"](#), on page 1366.

Parameters:

<Value>

Usage: Asynchronous command

Manual operation: See ["Top outer"](#) on page 505

REFLevel<m>:ABSolute:TITube <Value>

Defines an area beneath the high signal level which is still considered to be high level.

Suffix:

<m> Valid suffix numbers: 2 to 21, 61 to 68, 108 to 118, 151 to 157, 173 to 179
Source waveform of the measurement, see [Chapter 27.4.1, "Waveform suffix"](#), on page 1366.

Parameters:

<Value>

Usage: Asynchronous command

Manual operation: See ["Top inner"](#) on page 505

REFLevel<m>:ABSolute:BITube <Value>

Defines an area above the low signal level which is still considered to be low level.

Suffix:

<m> Valid suffix numbers: 2 to 21, 61 to 68, 108 to 118, 151 to 157, 173 to 179
Source waveform of the measurement, see [Chapter 27.4.1, "Waveform suffix"](#), on page 1366.

Parameters:

<Value>

Usage: Asynchronous command

Manual operation: See ["Bottom inner"](#) on page 505

REFLevel<m>:ABSolute:BOTube <Value>

Defines an area beneath the low signal level which is still considered to be low level.

Suffix:

<m> Valid suffix numbers: 2 to 21, 61 to 68, 108 to 118, 151 to 157, 173 to 179
Source waveform of the measurement, see [Chapter 27.4.1, "Waveform suffix"](#), on page 1366.

Parameters:

<Value>

Usage: Asynchronous command

Manual operation: See ["Bottom outer"](#) on page 505

27.17.2.6 Results

MEASurement<m>:REFLevel:RESult:LOWer?	1803
MEASurement<m>:REFLevel:RESult:MIDDLE?	1803
MEASurement<m>:REFLevel:RESult:UPPer?	1803
MEASurement<m>:REFLevel:RESult:SIGLow?	1804
MEASurement<m>:REFLevel:RESult:SIGHigh?	1804
MEASurement<m>:REFLevel:RESult:BINNer?	1804
MEASurement<m>:REFLevel:RESult:BOUter?	1804
MEASurement<m>:REFLevel:RESult:TINNer?	1805
MEASurement<m>:REFLevel:RESult:TOUTer?	1805

MEASurement<m>:REFLevel:RESult:LOWer?**MEASurement<m>:REFLevel:RESult:MIDDLE?****MEASurement<m>:REFLevel:RESult:UPPer?**

Return the lower, middle, and upper reference level, respectively.

Suffix:

<m> 1..10

See "[Selection of the measurement group: MEASurement<m>](#)" on page 1583.**Return values:**<Upper> Range: -100E+24 to 100E+24
*RST: 0**Usage:**Query only
Asynchronous command**MEASurement<m>:REFLevel:RESult:SIGLow?****MEASurement<m>:REFLevel:RESult:SIGHigh?**

Return the signal value that represents a low or high level, respectively.

Suffix:

<m> 1..10

See "[Selection of the measurement group: MEASurement<m>](#)" on page 1583.**Return values:**<SignalHigh> Range: -100E+24 to 100E+24
*RST: 0**Usage:**Query only
Asynchronous command**MEASurement<m>:REFLevel:RESult:BINNer?**

Returns the area above the low signal level which is still considered to be low level.

Suffix:

<m> 1..10

See "[Selection of the measurement group: MEASurement<m>](#)" on page 1583.**Return values:**<BottomInner> Range: -100E+24 to 100E+24
*RST: 0**Usage:**Query only
Asynchronous command**Manual operation:** See "[Bottom inner](#)" on page 505**MEASurement<m>:REFLevel:RESult:BOUter?**

Returns the area beneath the low signal level which is still considered to be low level.

Suffix:

<m>

1..10

See "[Selection of the measurement group: MEASurement<m>](#)" on page 1583.**Return values:**

<BottomOuter>

Range: -100E+24 to 100E+24

*RST: 0

Usage:

Query only

Asynchronous command

Manual operation: See "[Bottom outer](#)" on page 505**MEASurement<m>:REFLevel:RESult:TINner?**

Returns the area beneath the high signal level which is still considered to be high level.

Suffix:

<m>

1..10

See "[Selection of the measurement group: MEASurement<m>](#)" on page 1583.**Return values:**

<TopInner>

Range: -100E+24 to 100E+24

*RST: 0

Usage:

Query only

Asynchronous command

Manual operation: See "[Top inner](#)" on page 505**MEASurement<m>:REFLevel:RESult:TOUTer?**

Returns the area above the high signal level which is still considered to be high level.

Suffix:

<m>

1..10

See "[Selection of the measurement group: MEASurement<m>](#)" on page 1583.**Return values:**

<TopOuter>

Range: -100E+24 to 100E+24

*RST: 0

Usage:

Query only

Asynchronous command

Manual operation: See "[Top outer](#)" on page 505

27.17.3 Signal and reference levels for PAM-N signals

Requires option R&S RTO6-K135.

REFLevel<m>:PAMReference:LOWer.....	1806
REFLevel<m>:PAMReference:LVLDef.....	1806
REFLevel<m>:PAMReference:LVLJumphgt<n>:THReshold<o>:ABSLower.....	1807
REFLevel<m>:PAMReference:LVLJumphgt<n>:THReshold<o>:ABSMiddle.....	1807
REFLevel<m>:PAMReference:LVLJumphgt<n>:THReshold<o>:ABSUpper.....	1807
REFLevel<m>:PAMReference:LVLJumphgt<n>:THReshold<o>:RELLower.....	1808
REFLevel<m>:PAMReference:LVLJumphgt<n>:THReshold<o>:RELMiddle.....	1808
REFLevel<m>:PAMReference:LVLJumphgt<n>:THReshold<o>:RELUpper.....	1809
REFLevel<m>:PAMReference:MIDDLE.....	1809
REFLevel<m>:PAMReference:PRESet.....	1810
REFLevel<m>:PAMReference:RELLevel.....	1810
REFLevel<m>:PAMReference:UPPer.....	1810
REFLevel<m>:PAMSignal:ESTimate.....	1811
REFLevel<m>:PAMSignal:LEVel<0..7>.....	1811
REFLevel<m>:PAMSignal:LVLalgorithm.....	1812

REFLevel<m>:PAMReference:LOWer <DefaultLowRefLev>

Sets the lower relative reference level if [REFLevel<m>:PAMReference:RELLevel](#) is set to `USER`.

Suffix:

<m> Valid suffix numbers: 2 to 21, 61 to 68, 108 to 118, 151 to 157, 173 to 179
 Source waveform of the measurement, see [Chapter 27.4.1, "Waveform suffix"](#), on page 1366.

Parameters:

<DefaultLowRefLev> Range: 0 to 100
 Increment: 1
 *RST: 10
 Default unit: %

Manual operation: See ["Upper ref level, Middle ref level, Lower ref level"](#) on page 508

REFLevel<m>:PAMReference:LVLDef <RefLevMd>

Defines whether the reference is configured using absolute or relative values.

Suffix:

<m> Valid suffix numbers: 2 to 21, 61 to 68, 108 to 118, 151 to 157, 173 to 179
 Source waveform of the measurement, see [Chapter 27.4.1, "Waveform suffix"](#), on page 1366.

Parameters:

<RefLevMd> ABS | REL
 *RST: REL

Manual operation: See ["Referenc level mode"](#) on page 508

REFLevel<m>:PAMReference:LVLJumphgt<n>:THReshold<o>:ABSLower
 <AbsLowRefLev>

Sets the lower absolute reference level if [REFLevel<m>:PAMReference:LVLDef](#) is set to ABS.

Suffix:

<m> Valid suffix numbers: 2 to 21, 61 to 68, 108 to 118, 151 to 157, 173 to 179

Source waveform of the measurement, see [Chapter 27.4.1, "Waveform suffix"](#), on page 1366.

<n> 1..7

Selects the level jump height

<o> *

Selects the threshold

Parameters:

<AbsLowRefLev>

Manual operation: See ["Level jump height dependent reference levels"](#) on page 508

REFLevel<m>:PAMReference:LVLJumphgt<n>:THReshold<o>:ABSMiddle
 <AbsMidRefLev>

Sets the middle absolute reference level if [REFLevel<m>:PAMReference:LVLDef](#) is set to ABS.

Suffix:

<m> Valid suffix numbers: 2 to 21, 61 to 68, 108 to 118, 151 to 157, 173 to 179

Source waveform of the measurement, see [Chapter 27.4.1, "Waveform suffix"](#), on page 1366.

<n> 1..7

Selects the level jump height

<o> *

Selects the threshold

Parameters:

<AbsMidRefLev>

Manual operation: See ["Level jump height dependent reference levels"](#) on page 508

REFLevel<m>:PAMReference:LVLJumphgt<n>:THReshold<o>:ABSUpper
 <AbsUppRefLev>

Sets the upper absolute reference level if [REFLevel<m>:PAMReference:LVLDef](#) is set to ABS.

Suffix:

<m>	Valid suffix numbers: 2 to 21, 61 to 68, 108 to 118, 151 to 157, 173 to 179 Source waveform of the measurement, see Chapter 27.4.1, "Waveform suffix" , on page 1366.
<n>	1..7 Selects the level jump height
<o>	* Selects the threshold

Parameters:

<AbsUppRefLev>

Manual operation: See "[Level jump height dependent reference levels](#)" on page 508

REFLevel<m>:PAMReference:LVLJumphgt<n>:THReshold<o>:RELLower
<RelLowRefLev>

Sets the lower relative reference level if [REFLevel<m>:PAMReference:LVLDef](#) is set to REL.

Suffix:

<m>	Valid suffix numbers: 2 to 21, 61 to 68, 108 to 118, 151 to 157, 173 to 179 Source waveform of the measurement, see Chapter 27.4.1, "Waveform suffix" , on page 1366.
<n>	1..7 Selects the level jump height
<o>	* Selects the threshold

Parameters:

<RelLowRefLev>

Manual operation: See "[Level jump height dependent reference levels](#)" on page 508

REFLevel<m>:PAMReference:LVLJumphgt<n>:THReshold<o>:RELMiddle
<RelMidRefLev>

Sets the middle relative reference level if [REFLevel<m>:PAMReference:LVLDef](#) is set to REL.

Suffix:

<m>	Valid suffix numbers: 2 to 21, 61 to 68, 108 to 118, 151 to 157, 173 to 179 Source waveform of the measurement, see Chapter 27.4.1, "Waveform suffix" , on page 1366.
-----	--

<n>	1..7 Selects the level jump height
<o>	* Selects the threshold

Parameters:

<RelMidRefLev>

Manual operation: See ["Level jump height dependent reference levels"](#) on page 508

**REFLevel<m>:PAMReference:LVLJumpght<n>:THReshold<o>:RELupper
<RelUpRefLev>**

Sets the upper relative reference level if `REFLevel<m>:PAMReference:LVLDef` is set to `REL`.

Suffix:

<m> Valid suffix numbers: 2 to 21, 61 to 68, 108 to 118, 151 to 157, 173 to 179
Source waveform of the measurement, see [Chapter 27.4.1, "Waveform suffix"](#), on page 1366.

<n>	1..7 Selects the level jump height
<o>	* Selects the threshold

Parameters:

<RelUpRefLev>

Manual operation: See ["Level jump height dependent reference levels"](#) on page 508

REFLevel<m>:PAMReference:MIDDLE <DefaultMidRefLev>

Sets the middle relative reference level if `REFLevel<m>:PAMReference:RELLevel` is set to `USER`.

Suffix:

<m> Valid suffix numbers: 2 to 21, 61 to 68, 108 to 118, 151 to 157, 173 to 179
Source waveform of the measurement, see [Chapter 27.4.1, "Waveform suffix"](#), on page 1366.

Parameters:

<DefaultMidRefLev> Range: 0 to 100
Increment: 1
*RST: 50
Default unit: %

Manual operation: See ["Upper ref level, Middle ref level, Lower ref level"](#) on page 508

REFLevel<m>:PAMReference:PRESet

Presets the the level jump height dependent reference levels according to the value of the selected [REFLevel<m>:PAMReference:RELLLevel](#).

Suffix:

<m> Valid suffix numbers: 2 to 21, 61 to 68, 108 to 118, 151 to 157, 173 to 179
Source waveform of the measurement, see [Chapter 27.4.1, "Waveform suffix"](#), on page 1366.

Usage: Event

Manual operation: See ["Preset"](#) on page 508

REFLevel<m>:PAMReference:RELLLevel <DefaultRelLevs>

The lower, middle and upper reference levels, defined as percentages of the high signal level.

Suffix:

<m> Valid suffix numbers: 2 to 21, 61 to 68, 108 to 118, 151 to 157, 173 to 179
Source waveform of the measurement, see [Chapter 27.4.1, "Waveform suffix"](#), on page 1366.

Parameters:

<DefaultRelLevs> FIVE | TEN | TWENTy | USER

FIVE
5/50/95

TEN
10/50/90

TWENTy
20/50/80

USER
Set the reference levels to individual values with [REFLevel<m>:PAMReference:LOWer](#), [REFLevel<m>:PAMReference:MIDDLE](#), and [REFLevel<m>:PAMReference:UPPer](#).

*RST: TEN

Manual operation: See ["Preset levels"](#) on page 508

REFLevel<m>:PAMReference:UPPer <DefaultUppRefLev>

Sets the upper relative reference level if [REFLevel<m>:PAMReference:RELLLevel](#) is set to USER.

Suffix:

<m> Valid suffix numbers: 2 to 21, 61 to 68, 108 to 118, 151 to 157, 173 to 179
 Source waveform of the measurement, see [Chapter 27.4.1, "Waveform suffix"](#), on page 1366.

Parameters:

<DefaultUppRefLev> Range: 0 to 100
 Increment: 1
 *RST: 90
 Default unit: %

Manual operation: See ["Upper ref level, Middle ref level, Lower ref level"](#) on page 508

REFLevel<m>:PAMSignal:ESTimate

Starts a software algorithm for the automatic determination of the signal level.

Suffix:

<m> Valid suffix numbers: 2 to 21, 61 to 68, 108 to 118, 151 to 157, 173 to 179
 Source waveform of the measurement, see [Chapter 27.4.1, "Waveform suffix"](#), on page 1366.

Usage:

Event
 Asynchronous command

Manual operation: See ["Estimate signal levels"](#) on page 507

REFLevel<m>:PAMSignal:LEVel<0..7> <SignalLevel>

Sets the signal levels for the discrete amplitudes that the PAM signal can take based on the digital data being transmitted. The number of signal levels available ,0..7, depends on the PAM order of the signal.

Suffix:

<m> Valid suffix numbers: 2 to 21, 61 to 68, 108 to 118, 151 to 157, 173 to 179
 Source waveform of the measurement, see [Chapter 27.4.1, "Waveform suffix"](#), on page 1366.

Parameters:

<SignalLevel>

Example:

The following example sets the signal levels 0 to 3.

```
REFLevel1:PAMSignal:LEVel0 -0.124
REFLevel1:PAMSignal:LEVel1 -0.024
REFLevel1:PAMSignal:LEVel2 0.024
REFLevel1:PAMSignal:LEVel3 0.124
```

Manual operation: See ["Signal levels"](#) on page 507

REFLevel<m>:PAMSignal:LVLAlgorithm <LevDetectAlgorithm>

Selects the algorithm that defines how the signal levels are detected.

Suffix:

<m> Valid suffix numbers: 2 to 21, 61 to 68, 108 to 118, 151 to 157, 173 to 179
 Source waveform of the measurement, see [Chapter 27.4.1, "Waveform suffix"](#), on page 1366.

Parameters:

<LevDetectAlgorithm>KMEans
 *RST: KMEans

Manual operation: See "[Level detection algorithm](#)" on page 507

27.18 Protocols

• Configuration settings for all serial protocols	1813
• Trigger settings for all serial protocols	1817
• I²C (option R&S RTO6-K510)	1819
• SPI (option R&S RTO6-K510)	1853
• UART/RS-232/RS-422/RS-485 (option R&S RTO6-K510)	1873
• Audio signals (option R&S RTO6-K510)	1884
• Custom: manchester / NRZ (option R&S RTO6-K510)	1900
• CAN (option R&S RTO6-K520)	1944
• LIN (option R&S RTO6-K520)	1988
• Flexray (option R&S RTO6-K520)	2019
• SENT (option R&S RTO6-K520)	2055
• CXPI (option R&S RTO6-K520)	2087
• MIL-1553 (option R&S RTO6-K530)	2115
• ARINC 429 (option R&S RTO6-K530)	2143
• Space wire (option R&S RTO6-K530)	2160
• Ethernet 10BASE-T and 100BASE-TX (option R&S RTO6-K540)	2179
• MDIO (option R&S RTO6-K540)	2203
• RFFE (option R&S RTO6-K550)	2219
• Ethernet 100BASE-T1 (option R&S RTO6-K560)	2251
• Ethernet 1000BASE-T1 (option R&S RTO6-K560)	2282
• USB (option R&S RTO6-K570)	2315
• USB 3.1 (option R&S RTO6-K570)	2358
• USBPD (option R&S RTO6-K570)	2390
• D-PHY (option R&S RTO6-K580)	2415
• M-PHY (option R&S RTO6-K580)	2448
• 8B/10B (option R&S RTO6-K590)	2509
• PCIe (option R&S RTO6K72)	2525
• DDR (option R&S RTO6-K91)	2568

27.18.1 Configuration settings for all serial protocols

BUS<m>:TYPE.....	1813
BUS<m>[:STATe].....	1813
BUS<m>:SETReflevels.....	1814
BUS<m>:FAUToSet.....	1814
BUS<m>:RESult.....	1814
BUS<m>:THReshold.....	1815
BUS<m>:FORMat.....	1815
BUS<m>:NEWList.....	1815
BUS<m>:SYMBols.....	1815
BUS<m>:ZCOupling.....	1816
DISPlay:RESultboxes:DEPosition.....	1816
BUS<m>:EXPResult:DETail.....	1816
BUS<m>:EXPResult:SAVE.....	1817
BUS<m>:EXPResult:TIME.....	1817

BUS<m>:TYPE <Type>

Defines the bus or protocol type for analysis. The type of available buses depends on the installed options.

Suffix:

<m> 1..4
Selects the serial bus.

Parameters:

<Type> I2C | SPI | UART | CAN | CANFd | LIN | MILS1553 |
MILStd1553 | ARIN429 | ARINc429 | SWIRe | MDIO | HBTO |
USB | USBPD | ETHernet | CMSB | FLXRay | I2S | SENT | CXPI
| RFFE | DPHY | MPHY | EBTB | USB3 | PCIE | TBTO
MILS1553 = MILStd1553: specification MIL-STD-1553
ARIN429 = ARINc429: specification ARINC 429
HBTO: Ethernet 100BASE-T1
CMSB: custom decode serial bus
SWIRe: SpaceWire
*RST: I2C

Usage: Asynchronous command

Manual operation: See "[Protocol](#)" on page 512

BUS<m>[:STATe] <State>

Enables the decoding of the specified bus.

Suffix:

<m> 1..4
Selects the serial bus.

Parameters:

<State> ON | OFF
 *RST: OFF

Usage: Asynchronous command

Manual operation: See "[Decode](#)" on page 512

BUS<m>:SETReflevels

Executes the measurement of reference levels and sets the thresholds to the middle reference level of the measured amplitude.

Suffix:

<m> 1..4
 Selects the serial bus.

Usage: Event
 Asynchronous command

Manual operation: See "[Threshold](#)" on page 524

BUS<m>:FAUToset

Starts software algorithms for determining the signal threshold levels and bitrate.

Suffix:

<m> 1..4

Usage: Event
 Asynchronous command

Manual operation: See "[Threshold](#)" on page 524

BUS<m>:RESult <ShowResultTable>

Opens a table with decoded data of the serial signal. The function affects all protocol types and requires the option for the analyzed protocol.

Suffix:

<m> 1..4
 Selects the serial bus.

Parameters:

<ShowResultTable> ON | OFF
 *RST: ON

Usage: Asynchronous command

Manual operation: See "[Show table](#)" on page 514

BUS<m>:THReshold <ShwThresLines>

If ON, the threshold levels are displayed in the diagram.

Suffix:

<m> 1..4
Selects the serial bus.

Parameters:

<ShwThresLines> ON | OFF
*RST: OFF

Usage: Asynchronous command

Manual operation: See ["Show thresholds"](#) on page 524

BUS<m>:FORMat <DataFormat>

Sets the number format for decoded data values of the indicated serial bus. It defines the format in the decode table, and in the combs of the decoded signal on the screen.

Suffix:

<m> 1..4
Selects the serial bus.

Parameters:

<DataFormat> HEX | OCT | BIN | ASCII | ASCii | SIGN | USIG
ASCII = ASCii
USIG = unsigned
*RST: HEX

Manual operation: See ["Data format"](#) on page 515

BUS<m>:NEWList <FileName>

Loads a label list file.

Suffix:

<m> 1..4
Selects the serial bus.

Setting parameters:

<FileName> String parameter with path and file name.

Example:

```
BUS1:NEWList 'C:\Protocols\CAN.csv'  
BUS1:SYMBOLS ON
```

Usage: Setting only

Manual operation: See ["Load symbols"](#) on page 515

BUS<m>:SYMBOLS <UseTranslation>

Activates the label list to be used for decoding.

Suffix:

<m> 1..4
Selects the serial bus.

Parameters:

<UseTranslation> ON | OFF
*RST: OFF

Usage: Asynchronous command

Manual operation: See "[Show symbols](#)" on page 515

BUS<m>:ZCOupling <ZoomCoupling>

If enabled, the protocol decode zoom and result table are synchronized.

Suffix:

<m> 1..4

Parameters:

<ZoomCoupling> ON | OFF
*RST: OFF

Manual operation: See "[Zoom coupling](#)" on page 515

DISPlay:RESultboxes:DEPosition <DecodePosition>

Defines the position of the protocol decode result table on the screen.

Parameters:

<DecodePosition> PREV | FLOA | DOCK
PREV
Preview: result icon on the sidebar.
FLOA
Floating result box in front of the diagrams.
DOCK
Docked: fixed tab below the diagrams.
*RST: DOCK

Usage: Asynchronous command

Manual operation: See "[Table position](#)" on page 90

BUS<m>:EXPResult:DETail <XptResDetails>

Includes the detailed results for all frames for the exported protocol results.

Suffix:

<m> 1..4

Parameters:

<XptResDetails> ON | OFF
 *RST: ON

Manual operation: See "[Include details](#)" on page 518

BUS<m>:EXPResult:SAVE <FileName>

Saves the selected results to the indicated file.

Suffix:

<m> 1..4

Setting parameters:

<FileName>

Usage: Setting only

Manual operation: See "[Export to file](#)" on page 518

BUS<m>:EXPResult:TIME <XptResTim>

Includes the frame timing for the exported protocol results.

Suffix:

<m> 1..4

Parameters:

<XptResTim> ON | OFF
 *RST: ON

Manual operation: See "[Include frame timing](#)" on page 518

27.18.2 Trigger settings for all serial protocols

The following commands are available for all serial protocols that have a protocol trigger.

TRIGger<m>:SOURce[:SElect]	1817
TRIGger<m>:SOURce:SBSelect	1818
BUS<m>:TYPE	1819

TRIGger<m>:SOURce[:SElect] <SourceDetailed>

Selects the source of the trigger signal.

Suffix:

<m>

1..3

1 = A-trigger, 2 = B-trigger, 3 = R-trigger

Available values depend on the selected trigger source. For input channels CHAN1...4, a trigger sequence can be configured.

For all other trigger sources, only suffix 1 is allowed.

Parameters:

<SourceDetailed>

CHAN1 | CHANnel1 | CHAN2 | CHANnel2 | CHAN3 |
 CHANnel3 | CHAN4 | CHANnel4 | EXTeranalog | SBUS | D0 |
 D1 | D2 | D3 | D4 | D5 | D6 | D7 | D8 | D9 | D10 | D11 | D12 |
 D13 | D14 | D15 | LOGIC | MSOB1 | MSOB2 | MSOB3 |
 MSOB4 | Z1V1 | Z1V2 | Z1V3 | Z1V4 | Z1I1 | Z1I2 | Z1I3 | Z1I4 |
 Z2V1 | Z2V2 | Z2V3 | Z2V4 | Z2I1 | Z2I2 | Z2I3 | Z2I4 | DIFF1 |
 DIFF2 | COMMON1 | COMMON2

CHAN1 = CHANnel1, CHAN2 = CHANnel2, CHAN3 = CHANnel3, CHAN4 = CHANnel4

Input channels

EXTeranalog

External analog signal connected to the External Trigger Input. For this source, only the analog edge trigger is available.

SBUS

Serial bus

D0...D15

Digital channels (option R&S RTO6-B1)

See also: [Chapter 27.19.4, "Trigger settings for digital signals and parallel buses"](#), on page 2619

LOGic

Logic combination of digital channels, used as trigger source (option R&S RTO6-B1)

MSOB1 | MSOB2 | MSOB3 | MSOB4

Parallel bus (option R&S RTO6-B1)

**Z1V1 | Z1V2 | Z1V3 | Z1V4 | Z1I1 | Z1I2 | Z1I3 | Z1I4 | Z2V1 |
 Z2V2 | Z2V3 | Z2V4 | Z2I1 | Z2I2 | Z2I3 | Z2I4**

Input channels of R&S RT-ZVCmulti-channel power probe. Only available in the A-trigger with trigger type EDGE.

DIFF1 | DIFF2 | COMMON1 | COMMON2

Differential signals

*RST: CHAN1

Usage:

Asynchronous command

Manual operation: See "[Source]" on page 36

TRIGger<m>:SOURce:SBSelect <SerialBus>

Selects the serial bus to be triggered on.

Suffix:	
<m>	1..3 Event in a trigger sequence: 1 = A-event only
Parameters:	
<SerialBus>	SBUS1 SBUS2 SBUS3 SBUS4
Usage:	Asynchronous command
Firmware/software:	Version 2.70
Manual operation:	See " Serial bus " on page 526

BUS<m>:TYPE <Type>

Defines the bus or protocol type for analysis. The type of available buses depends on the installed options.

Suffix:	
<m>	1..4 Selects the serial bus.
Parameters:	
<Type>	I2C SPI UART CAN CANFd LIN MILS1553 MILStd1553 ARIN429 ARINc429 SWIRe MDIO HBTO USB USBPD ETHernet CMSB FLXRay I2S SENT CXPI RFFE DPHY MPHY EBTB USB3 PCIE TBTO MILS1553 = MILStd1553: specification MIL-STD-1553 ARIN429 = ARINc429: specification ARINC 429 HBTO: Ethernet 100BASE-T1 CMSB: custom decode serial bus SWIRe: SpaceWire *RST: I2C
Usage:	Asynchronous command
Manual operation:	See " Protocol " on page 512

27.18.3 I²C (option R&S RTO6-K510)

- [Configuration](#)..... 1819
- [Trigger](#)..... 1822
- [Decode results](#)..... 1828
- [I²C search settings](#)..... 1837
- [I²C search results](#)..... 1847

27.18.3.1 Configuration

BUS<m>:I2C:SCL:SOURce	1820
BUS<m>:I2C:SDA:SOURce	1820
BUS<m>:I2C:SCL:THReshold	1820

BUS<m>:I2C:SDA:THReshold.....	1821
BUS<m>:I2C:TECHnology.....	1821
BUS<m>:I2C:RWBit.....	1822

BUS<m>:I2C:SCL:SOURce <SCLSource>

Sets the waveform of the clock line.

Suffix:

<m> 1..4
Selects the serial bus.

Parameters:

<SCLSource> C1W1 | C2W1 | C3W1 | C4W1 | M1 | M2 | M3 | M4 | M5 | M6 |
M7 | M8 | R1 | R2 | R3 | R4 | D0 | D1 | D2 | D3 | D4 | D5 | D6 |
D7 | D8 | D9 | D10 | D11 | D12 | D13 | D14 | D15

Digital and analog channels cannot be used at the same time for data and clock lines.

See [Chapter 27.4.2, "Waveform parameter"](#), on page 1371

*RST: C2W1

Usage: Asynchronous command

Manual operation: See ["SDA, SCL"](#) on page 523

BUS<m>:I2C:SDA:SOURce <SDASource>

Sets the waveform of the data line.

Suffix:

<m> 1..4
Selects the serial bus.

Parameters:

<SDASource> C1W1 | C2W1 | C3W1 | C4W1 | M1 | M2 | M3 | M4 | M5 | M6 |
M7 | M8 | R1 | R2 | R3 | R4 | D0 | D1 | D2 | D3 | D4 | D5 | D6 |
D7 | D8 | D9 | D10 | D11 | D12 | D13 | D14 | D15

Digital and analog channels cannot be used at the same time for data and clock lines.

See [Chapter 27.4.2, "Waveform parameter"](#), on page 1371

*RST: C1W1

Usage: Asynchronous command

Manual operation: See ["SDA, SCL"](#) on page 523

BUS<m>:I2C:SCL:THReshold <SCLThreshold>

Sets a user-defined threshold value for the clock line.

Alternatively, you can set the threshold according to the signal technology with [BUS<m>:I2C:TECHnology](#).

Suffix:

<m> 1..4
Selects the serial bus.

Parameters:

<SCLThreshold> User-defined clock threshold
Range: -12 to 12
Increment: 0.1
*RST: 0
Default unit: V

Manual operation: See "[Threshold](#)" on page 524

BUS<m>:I2C:SDA:THReshold <SDAThreshold>

Sets a user-defined threshold value for the data line.

Alternatively, you can set the threshold according to the signal technology with [BUS<m>:I2C:TECHnology](#).

Suffix:

<m> 1..4
Selects the serial bus.

Parameters:

<SDAThreshold> User-defined data threshold
Range: -12 to 12
Increment: 0.1
*RST: 0
Default unit: V

Manual operation: See "[Threshold](#)" on page 524

BUS<m>:I2C:TECHnology <Technology>

Sets the threshold voltage clock and data lines as defined for various signal technologies.

Suffix:

<m> 1..4
Selects the serial bus.

Parameters:

<Technology> V15 | V25 | V165 | V125 | V09 | VM13 | V38 | V20 | V0 | MANual
V15 | V25 | V165 | V125 | V09 | V38 | V20 | V0
1.5 V, 2.5 V, 1.65 V ... respectively
VM13
-1.3 V (negative value)
MANual
Manual setting of user-defined values with [BUS<m>:I2C:SCL:THReshold](#) and [BUS<m>:I2C:SDA:THReshold](#).

*RST: V165

Manual operation: See "Threshold" on page 524

BUS<m>:I2C:RWBit <BusConfig>

Defines if the R/W bit of a 7-bit address is considered separately or as part of the address. 10-bit addresses are not affected. The setting defines which address lengths are available with TRIGger<m>:I2C:AMODe.

Suffix:

<m> 1..4
Selects the serial bus.

Parameters:

<BusConfig> SEParate | INADdress
SEParate
7-bit address and separate R/W bit.
INADdress
8-bit address with R/W bit included.
*RST: SEParate

Manual operation: See "R/W bit" on page 523

27.18.3.2 Trigger

The trigger suffix <m> is always 1 and can be omitted. It selects the trigger event: Only the A-trigger is available for triggering on serial buses.

To trigger on a serial bus, make sure that:

- TRIGger<m>:SOURce[:SElect] is set to SBUS.
- The sources of the serial bus are channel signals: use BUS<m>:...:SOURce commands.
- Decoding is enabled: BUS<m>[:STATe] is set to ON.

TRIGger<m>:I2C:TYPE.....	1823
TRIGger<m>:I2C:ACCess.....	1823
TRIGger<m>:I2C:ADNack.....	1824
TRIGger<m>:I2C:DWNack.....	1824
TRIGger<m>:I2C:DRNack.....	1824
TRIGger<m>:I2C:AMODe.....	1824
TRIGger<m>:I2C:ACONdition.....	1825
TRIGger<m>:I2C:ADDResS.....	1825
TRIGger<m>:I2C:ADDTo.....	1825
TRIGger<m>:I2C:ADOR<n>:ENABle.....	1825
TRIGger<m>:I2C:ADOR<n>:ADRTypE.....	1826
TRIGger<m>:I2C:ADOR<n>[:VALue].....	1826
TRIGger<m>:I2C:ADOR<n>:RWBit.....	1826
TRIGger<m>:I2C:DPOPerator.....	1827
TRIGger<m>:I2C:DPOSitioN.....	1827

TRIGger<m>:I2C:DPTO.....	1827
TRIGger<m>:I2C:DCONdition.....	1828
TRIGger<m>:I2C:DMIN.....	1828
TRIGger<m>:I2C:DMAX.....	1828

TRIGger<m>:I2C:TYPE <Type>

Selects the trigger type for I²C analysis.

Parameters:

<Type> START | REPStart | STOP | NACK | ADDRess | ADOR | ADAT

START

Start condition

REPStart

Repeated start - the start condition occurs without previous stop condition.

NACK

Missing acknowledge bit. To localize specific missing acknowledge bits, use [TRIGger<m>:I2C:ADNack](#), [TRIGger<m>:I2C:DWNack](#), and [TRIGger<m>:I2C:DRNack](#).

ADDRess

Triggers on one specific address

ADOR

Triggers on an OR combination with up to four address conditions.

ADAT

Triggers on a combination of address and data condition.

STOP

Stop condition, end of frame

*RST: START

Usage: Asynchronous command

Manual operation: See "[Trigger type](#)" on page 526

TRIGger<m>:I2C:ACCess <RWBitAddress>

Sets the trigger condition for the R/W bit - the transfer direction of the data.

Parameters:

<RWBitAddress> READ | WRITe | EITHer

EITHer

Transfer direction is not relevant.

*RST: EITHer

Usage: Asynchronous command

Manual operation: See "[R/W bit](#)" on page 529

TRIGger<m>:I2C:ADNack <AddressNack>

Triggers if the address acknowledge bit is missing - no slave recognizes the address.

Parameters:

<AddressNack> ON | OFF
*RST: ON

Usage: Asynchronous command

Manual operation: See "[No Ack conditions](#)" on page 528

TRIGger<m>:I2C:DWNack <DataWriteNack>

Triggers if a data acknowledge bit is missing - the addressed slave does not accept the data.

Parameters:

<DataWriteNack> ON | OFF
*RST: ON

Usage: Asynchronous command

Manual operation: See "[No Ack conditions](#)" on page 528

TRIGger<m>:I2C:DRNack <DataReadNack>

Triggers on the end of the read process when the master reads data from the slave. This Nack is sent according to the protocol definition, it is not an error.

Parameters:

<DataReadNack> ON | OFF
*RST: ON

Usage: Asynchronous command

Manual operation: See "[No Ack conditions](#)" on page 528

TRIGger<m>:I2C:AMODe <AddressType>

Sets the address length. The setting affects the address input with [TRIGger<m>:I2C:ADDRESS](#) and [TRIGger<m>:I2C:ADDTo](#).

Parameters:

<AddressType> BIT7 | BIT7_RW | BIT10 | ANY

BIT7

Enter the 7 address bits. Only available if [BUS<m>:I2C:RWBitSEParate](#) is set.

BIT7_RW

Enter 7 address bits and the R/W bit. Only available if [BUS<m>:I2C:RWBitINADdress](#) is set.

BIT10

10-bit address

ANY

Only available for trigger type "Address + data" (`TRIGger<m>:I2C:TYPE ADAT`). Used to trigger on data only, regardless of the address.

*RST: BIT7

Usage: Asynchronous command**Manual operation:** See "[Address Type](#)" on page 529**TRIGger<m>:I2C:ACONdition <AddressOperator>**

Sets the operator to set a specific address or an address range. The address values are set with `TRIGger<m>:I2C:ADDRess` and `TRIGger<m>:I2C:ADDTTo`.

Parameters:

<AddressOperator> EQUAL | NEQUAL | LTHan | LETHan | GTHan | GETHan | INRange | OORange

*RST: EQUAL

TRIGger<m>:I2C:ADDRess <Address>

Triggers on the specified slave address, or sets the the start value of an address range depending on the condition set with `TRIGger<m>:I2C:ACONdition`.

Parameters:

<Address> Numeric or string pattern, see [Chapter 27.4.6, "Bit pattern parameter"](#), on page 1373.

Manual operation: See "[Address](#)" on page 529**TRIGger<m>:I2C:ADDTTo <AddressTo>**

Sets the the end value of an address range if the condition is set to an address range with `TRIGger<m>:I2C:ACONdition`.

Parameters:

<AddressTo> Numeric or string pattern, see [Chapter 27.4.6, "Bit pattern parameter"](#), on page 1373.

Usage: Asynchronous command**Manual operation:** See "[Address](#)" on page 529**TRIGger<m>:I2C:ADOR<n>:ENABLE <UseAddress>**

Includes the indicated ADOR address in the "address OR" trigger condition.

Suffix:

<n> 1..4
Index of the address in an "address OR" condition (OR slot)

Parameters:

<UseAddress> ON | OFF
*RST: OFF

Manual operation: See "[OR x](#)" on page 530

TRIGger<m>:I2C:ADOR<n>:ADRTYPE <AddressType>

Sets the address type for the indicated ADOR address in the "address OR" trigger condition.

Suffix:

<n> 1..4
Index of the address in an "address OR" condition (OR slot)

Parameters:

<AddressType> BIT7 | BIT7_RW | BIT10
*RST: BIT7

Manual operation: See "[Address Type](#)" on page 529

TRIGger<m>:I2C:ADOR<n>[:VALue] <Address>

Defines the address pattern of the indicated ADOR address in the "address OR" trigger condition.

Suffix:

<n> 1..4
Index of the address in an "address OR" condition (OR slot)

Parameters:

<Address> Numeric or string pattern, see [Chapter 27.4.6, "Bit pattern parameter"](#), on page 1373.

Manual operation: See "[Address](#)" on page 529

TRIGger<m>:I2C:ADOR<n>:RWBit <RWBit>

Defines the R/W bit of the indicated ADOR address in the "address OR" trigger condition.

Suffix:

<n> 1..4
Index of the address in an "address OR" condition (OR slot)

Parameters:

<RWBit> UNDeFined | READ | WRITe | EITHer

UNDeFined

Return value only

*RST: EITHer

Manual operation: See "[R/W bit](#)" on page 529

TRIGger<m>:I2C:DPOPerator <DataPosOperator>

Sets the operator for the data position. You can defined an exact position, or a position range.

Parameters:

<DataPosOperator> ANY | OFF | EQUal | GETHan | INRange | RANGE

ANY = OFF

The position of the required pattern is not relevant.

EQUal | GETHan

Equal, Greater or equal than. These conditions require one data position to be set with [TRIGger<m>:I2C:DPOsition](#).

INRange = RANGE

In range: Set the minimum and maximum value of the range with [TRIGger<m>:I2C:DPOsition](#) and [TRIGger<m>:I2C:DPTO](#).

*RST: ANY

Manual operation: See "[Position](#)" on page 530

TRIGger<m>:I2C:DPOsition <DataPosition>

Sets the number of data bytes before the first byte of interest. These bytes are ignored.

Parameters:

<DataPosition> The index 0 is associated with the first data byte.

Range: 0 to 4095

Increment: 1

*RST: 0

Manual operation: See "[Position](#)" on page 530

TRIGger<m>:I2C:DPTO <DataPositionTo>

Defines the last byte of interest, if [TRIGger<m>:I2C:DPOPerator](#) is set to RANGE.

Parameters:

<DataPositionTo> Range: 0 to 4095

Increment: 1

*RST: 0

Manual operation: See "[Position](#)" on page 530

TRIGger<m>:I2C:DCONdition <DataOperator>

Sets the operator to set a specific data value or a data range.

Parameters:

<DataOperator> EQUal | NEQual | LTHan | LETHan | GTHan | GETHan |
 INRange | OORange
*RST: EQUal

Manual operation: See "[Data](#)" on page 530

TRIGger<m>:I2C:DMIN <Data>

Specifies the data bit pattern, or sets the the start value of a data pattern range.. Enter the bytes in msb first bit order. The maximum pattern length is 64 bit. Waveform data is compared with the pattern byte-by-byte.

Parameters:

<Data> Numeric or string pattern, see [Chapter 27.4.6, "Bit pattern parameter"](#), on page 1373. The string parameter accepts the bit value X (don't care).

Usage: Asynchronous command

Manual operation: See "[Data](#)" on page 530

TRIGger<m>:I2C:DMAX <DataTo>

Sets the the end value of an data range if [TRIGger<m>:I2C:DCONdition](#) is set to INRange or OORange.

Parameters:

<DataTo> Numeric or string pattern, see [Chapter 27.4.6, "Bit pattern parameter"](#), on page 1373. The string parameter accepts the bit value X (don't care).

Usage: Asynchronous command

Manual operation: See "[Data](#)" on page 530

27.18.3.3 Decode results

To load and activate a label list, use:

- [BUS<m>:NEWList](#) on page 1815
- [BUS<m>:SYMBOLs](#) on page 1815

BUS<m>:I2C:FRAMe<n>:DATA?	1829
BUS<m>:I2C:FCOunt?	1829
BUS<m>:I2C:FRAMe<n>:AACcess?	1830
BUS<m>:I2C:FRAMe<n>:ACcess?	1830
BUS<m>:I2C:FRAMe<n>:ACOMplete?	1830
BUS<m>:I2C:FRAMe<n>:ADBStart?	1830

BUS<m>:I2C:FRAMe<n>:ADDRess?.....	1831
BUS<m>:I2C:FRAMe<n>:ADEVice?.....	1831
BUS<m>:I2C:FRAMe<n>:AMODE?.....	1832
BUS<m>:I2C:FRAMe<n>:AStart?.....	1832
BUS<m>:I2C:FRAMe<n>:BITRate?.....	1832
BUS<m>:I2C:FRAMe<n>:RWBStart?.....	1833
BUS<m>:I2C:FRAMe<n>:STATus?.....	1833
BUS<m>:I2C:FRAMe<n>:START?.....	1834
BUS<m>:I2C:FRAMe<n>:STOP?.....	1834
BUS<m>:I2C:FRAMe<n>:SYMBol?.....	1834
BUS<m>:I2C:FRAMe<n>:BCOunt?.....	1835
BUS<m>:I2C:FRAMe<n>:BYTE<o>:ACCess?.....	1835
BUS<m>:I2C:FRAMe<n>:BYTE<o>:ACKStart?.....	1835
BUS<m>:I2C:FRAMe<n>:BYTE<o>:COMPLete?.....	1836
BUS<m>:I2C:FRAMe<n>:BYTE<o>:START?.....	1836
BUS<m>:I2C:FRAMe<n>:BYTE<o>:VALue?.....	1837

BUS<m>:I2C:FRAMe<n>:DATA?

Returns the data words of the specified frame.

Suffix:

<m>	1..4 Selects the serial bus.
<n>	* Selects the frame.

Return values:

<Data> Comma-separated list of integer values (N, D1, D2,..., DN). N is the number of bytes in the frame, and D1...DN are the values of the bytes.

Example: BUS:I2C:FRAMe4:DATA?
<-- 3,74,164,18

Usage: Query only

BUS<m>:I2C:FCOunt?

Returns the number of decoded frames.

Suffix:

<m>	1..4 Selects the serial bus.
-----	---------------------------------

Return values:

<Count> Total number of decoded frames.

Usage: Query only

BUS<m>:I2C:FRAMe<n>:AACcess?

Returns the address acknowledge bit value for the indicated frame.

Suffix:

<m>	1..4 Selects the serial bus.
<n>	* Selects the frame.

Return values:

<AddressAckBit>	INComplete ACK NACK EITHer
*RST:	INComplete

Usage: Query only

BUS<m>:I2C:FRAMe<n>:ACCess?

Returns the value of the R/W bit of the indicated frame.

Suffix:

<m>	1..4 Selects the serial bus.
<n>	* Selects the frame.

Return values:

<RWBit>	UNDefined READ WRITe EITHer
*RST:	UNDefined

Usage: Query only

BUS<m>:I2C:FRAMe<n>:ACOMplete?

Returns if the address is completely contained in the acquisition.

Suffix:

<m>	1..4 Selects the serial bus.
<n>	* Selects the frame.

Return values:

<AddressComplete>	ON OFF
*RST:	OFF

Usage: Query only

BUS<m>:I2C:FRAMe<n>:ADBStart?

Returns the start time of the address acknowledge bit.

Suffix:

<m> 1..4
Selects the serial bus.

<n> *
Selects the frame.

Return values:

<AddrAckBtStrt> Range: -100E+24 to 100E+24
*RST: 0
Default unit: s

Usage: Query only

BUS<m>:I2C:FRAMe<n>:ADDRESS?

Returns the device address value of the indicated frame, that is, the address value that is shown in the decoded cells and in the decode results table.

If the frame has a 7-bit address, the command considers the status of [BUS<m>:I2C:RWBit](#). If [BUS<m>:I2C:RWBit INAddress](#) is set, the returned address includes the R/W bit (8 bit). Otherwise, the pure address without the R/W bit is returned (7 bit, same result as returned with [BUS<m>:I2C:FRAMe<n>:ADEVICE?](#)).

Suffix:

<m> 1..4
Selects the serial bus.

<n> *
Selects the frame.

Return values:

<AddressValue> To set the value format, use [FORMat:BPATtern](#).
The values below – range, increment and default – are decimal values.

Range: 0 to 1023
*RST: 0

Usage: Query only

BUS<m>:I2C:FRAMe<n>:ADEVICE?

Returns the pure device address of the indicated frame *without* the R/W bit.

Suffix:

<m> 1..4
Selects the serial bus.

<n> *
Selects the frame.

Return values:

<DeviceAddress> To set the value format, use [FORMat:BPATtern](#).
The values below – range, increment and default – are decimal values.

Range: 0 to 1023
*RST: 0

Usage: Query only

BUS<m>:I2C:FRAMe<n>:AMODe?

Returns the address length.

Suffix:

<m> 1..4
Selects the serial bus.

<n> *
Selects the frame.

Return values:

<AddressType> BIT7 | BIT7_RW | BIT10 | AUTO | ANY
*RST: BIT7

Usage: Query only

BUS<m>:I2C:FRAMe<n>:AStart?

Returns the start time of the address for the indicated frame.

Suffix:

<m> 1..4
Selects the serial bus.

<n> *
Selects the frame.

Return values:

<AddressStart> Range: -100E+24 to 100E+24
*RST: 0
Default unit: s

Usage: Query only

BUS<m>:I2C:FRAMe<n>:BITRate?

Returns the primary bit rate.

Suffix:

<m> 1..4
Selects the serial bus.

<n> *
Selects the frame.

Return values:

<PrimaryBitRate> Range: 0 to 100000000000
Increment: 1
*RST: 0
Default unit: bps

Usage: Query only

BUS<m>:I2C:FRAMe<n>:RWBStart?

Returns the start time of the R/W bit

Suffix:

<m> 1..4
Selects the serial bus.

<n> *
Selects the frame.

Return values:

<RWBitStart> Range: -100E+24 to 100E+24
*RST: 0
Default unit: s

Usage: Query only

BUS<m>:I2C:FRAMe<n>:STATus?

Returns the overall state of the frame.

Suffix:

<m> 1..4
Selects the serial bus.

<n> *
Selects the frame.

Return values:

<FrameState> INComplete | OK | UNEXpstop | INSufficient | ADDifferent | UNKNown

INComplete

The stop bit is missing.

OK

The frame is valid.

UNEXpstop

A stop bit was detected but clock and data are continued.

INSufficient

The frame is not completely contained in the acquisition. The acquired part of the frame is valid.

ADDifferent

Error in 10 bit address. In case of a read access on a 10 bit address, the first address byte is sent twice, first as write, the second as read. The first seven bits of the byte must be identical. If they are not identical, the ADDifferent error is indicated.

*RST: OK

Usage: Query only

BUS<m>:I2C:FRAMe<n>:START?

Returns the start time of the specified frame.

Suffix:

<m> 1..4
Selects the serial bus.

<n> *
Selects the frame.

Return values:

<FrameStart> Range: -100E+24 to 100E+24
*RST: 0
Default unit: s

Usage: Query only

BUS<m>:I2C:FRAMe<n>:STOP?

Returns the end time of the specified frame.

Suffix:

<m> 1..4
Selects the serial bus.

<n> *
Selects the frame.

Return values:

<FrameStop> Range: -100E+24 to 100E+24
*RST: 0
Default unit: s

Usage: Query only

BUS<m>:I2C:FRAMe<n>:SYMBol?

Returns the symbolic label of the specified frame if the label list is enabled.

Suffix:

<m> 1..4
Selects the serial bus.

<n> *
Selects the number of the frame in the current acquisition, 1...n.

Return values:

<Translation> String with symbolic name of the address

Usage: Query only

BUS<m>:I2C:FRAMe<n>:BCOunt?

Returns the number of bytes in the specified frame.

Suffix:

<m> 1..4
Selects the serial bus.

<n> *
Selects the frame.

Return values:

<Count> Byte count

Usage: Query only

BUS<m>:I2C:FRAMe<n>:BYTE<o>:ACCess?

Returns the acknowledge bit value of the specified data byte.

Suffix:

<m> 1..4
Selects the serial bus.

<n> *
Selects the frame.

<o> *
Selects the byte number.

Return values:

<AckBit> INComplete | ACK | NACK | EITHer
*RST: INComplete

Usage: Query only

BUS<m>:I2C:FRAMe<n>:BYTE<o>:ACKStart?

Returns the start time of the acknowledge bit of the specified byte.

Suffix:

<m> 1..4
Selects the serial bus.

<n> *
Selects the frame.

<o> *
Selects the byte number.

Return values:

<AckBitStart> To set the value format, use [FORMat:BPATtern](#).
The values below – range, increment and reset – are decimal values.

Range: -100E+24 to 100E+24

*RST: 0

Default unit: s

Usage: Query only

BUS<m>:I2C:FRAMe<n>:BYTE<o>:COMPlete?

Returns if the indicated byte is completely contained in the acquisition.

Suffix:

<m> 1..4
Selects the serial bus.

<n> *
Selects the frame.

<o> *
Selects the byte number.

Return values:

<ValueComplete> ON | OFF
*RST: OFF

Usage: Query only

BUS<m>:I2C:FRAMe<n>:BYTE<o>:STARt?

Returns the start time of the specified data byte.

Suffix:

<m> 1..4
Selects the serial bus.

<n> *
Selects the frame.

<o> *
Selects the byte number.

Return values:

<Start> Range: -100E+24 to 100E+24
*RST: 0
Default unit: s

Usage: Query only

BUS<m>:I2C:FRAMe<n>:BYTE<o>:VALue?

Returns the data value of the specified byte.

Suffix:

<m>	1..4 Selects the serial bus.
<n>	* Selects the frame.
<o>	* Selects the byte number.

Return values:

<Value> To set the value format, use [FORMat:BPATtern](#).
The values below – range, increment and default – are decimal values.

Range: 0 to 255
*RST: 0

Usage: Query only

27.18.3.4 I²C search settings

In search setup commands, you have to specify the <SearchName> parameter. It is a string parameter that contains the search definition name. The commands are similar to I²C trigger commands.

SEARch:TRIGger:I2C:SCONdition	1838
SEARch:TRIGger:I2C:RCONdition	1838
SEARch:TRIGger:I2C:STCNDition	1838
SEARch:TRIGger:I2C:NACKnowledge	1838
SEARch:TRIGger:I2C:SADDRESS	1839
SEARch:TRIGger:I2C:ADOR	1839
SEARch:TRIGger:I2C:ADData	1840
SEARch:TRIGger:I2C:ACONdition	1840
SEARch:TRIGger:I2C:AMODE	1840
SEARch:TRIGger:I2C:ADDRESS	1841
SEARch:TRIGger:I2C:ADDTTo	1841
SEARch:TRIGger:I2C:ACCess	1842
SEARch:TRIGger:I2C:ADDO<m>:ENABLE	1842
SEARch:TRIGger:I2C:ADDO<m>:ADRTYPE	1842
SEARch:TRIGger:I2C:ADDO<m>[:VALue]	1843
SEARch:TRIGger:I2C:ADDO<m>:RWBit	1843
SEARch:TRIGger:I2C:DPOPerator	1844
SEARch:TRIGger:I2C:DPOSition	1844
SEARch:TRIGger:I2C:DPTO	1844
SEARch:TRIGger:I2C:DCONdition	1845
SEARch:TRIGger:I2C:DMIN	1845
SEARch:TRIGger:I2C:DMAX	1845

SEARCH:TRIGger:I2C:ADNack.....	1846
SEARCH:TRIGger:I2C:DRNack.....	1846
SEARCH:TRIGger:I2C:DWNack.....	1846

SEARCH:TRIGger:I2C:SCONdition <SearchName>,<Start>
SEARCH:TRIGger:I2C:SCONdition? <SearchName>

Enables the search for the start of the message.

Parameters:

<Start> ON | OFF
 *RST: OFF

Parameters for setting and query:

<SearchName>

Manual operation: See "[Select search types](#)" on page 533

SEARCH:TRIGger:I2C:RCONdition <SearchName>,<RepeatedStart>
SEARCH:TRIGger:I2C:RCONdition? <SearchName>

Enables the search for a start condition without previous stop condition.

Parameters:

<RepeatedStart> ON | OFF
 *RST: OFF

Parameters for setting and query:

<SearchName>

Manual operation: See "[Select search types](#)" on page 533

SEARCH:TRIGger:I2C:STCNdition <SearchName>,<Stop>
SEARCH:TRIGger:I2C:STCNdition? <SearchName>

Enables the search for the start of the message.

Parameters:

<Stop> ON | OFF
 *RST: OFF

Parameters for setting and query:

<SearchName>

Manual operation: See "[Select search types](#)" on page 533

SEARCH:TRIGger:I2C:NACKnowledge <SearchName>,<NoAcknowledge>
SEARCH:TRIGger:I2C:NACKnowledge? <SearchName>

Searches for missing address acknowledge bits.

Parameters:

<NoAcknowledge> ON | OFF
 *RST: OFF

Parameters for setting and query:

<SearchName>

Manual operation: See "[Select search types](#)" on page 533

SEARCH:TRIGger:I2C:SADDRESS <SearchName>,<Address>

SEARCH:TRIGger:I2C:SADDRESS? <SearchName>

Enables the search for one specific address condition or for a combination of address conditions.

To define the address condition, use the following commands:

- [SEARCH:TRIGger:I2C:ACONdition](#) on page 1840
- [SEARCH:TRIGger:I2C:ADDRes](#) on page 1841
- [SEARCH:TRIGger:I2C:ADDTo](#) on page 1841
- [SEARCH:TRIGger:I2C:AMODE](#) on page 1840
- [SEARCH:TRIGger:I2C:ACCess](#) on page 1842

Parameters:

<Address> ON | OFF
 *RST: OFF

Parameters for setting and query:

<SearchName>

Manual operation: See "[Select search types](#)" on page 533

SEARCH:TRIGger:I2C:ADOR <SearchName>,<AddressOr>

SEARCH:TRIGger:I2C:ADOR? <SearchName>

Enables the search for one to four address conditions.

- [SEARCH:TRIGger:I2C:ADDO<m>:ENABLE](#) on page 1842
- [SEARCH:TRIGger:I2C:ADDO<m>:ADRTYPE](#) on page 1842
- [SEARCH:TRIGger:I2C:ADDO<m>\[:VALUE\]](#) on page 1843
- [SEARCH:TRIGger:I2C:ADDO<m>:RWBIT](#) on page 1843

Parameters:

<AddressOr> ON | OFF
 *RST: OFF

Parameters for setting and query:

<SearchName>

Manual operation: See "[Select search types](#)" on page 533

SEARCh:TRIGger:I2C:ADDData <SearchName>,<AddressData>
SEARCh:TRIGger:I2C:ADDData? <SearchName>

Enables the search for a combination of address and data conditions.

Parameters:

<AddressData> ON | OFF
 *RST: OFF

Parameters for setting and query:

<SearchName>

Manual operation: See "[Select search types](#)" on page 533

SEARCh:TRIGger:I2C:ACONdition <SearchName>,<AddressOperator>
SEARCh:TRIGger:I2C:ACONdition? <SearchName>

Sets the operator to set a specific address or an address range.

Parameters:

<AddressOperator> EQUal | NEQual | LTHan | LETHan | GTHan | GETHan |
 INRange | OORange

EQUal | NEQual | LTHan | LETHan | GTHan | GETHan

Equal, Not equal, Less than, Less or equal than, Greater Than, Greater or equal than. These condition require one identifier pattern to be set with [SEARCh:TRIGger:I2C:ADDRess](#) on page 1841.

INRange | OORange

In range / Out of range: Set the minimum and maximum value of the range with [SEARCh:TRIGger:I2C:ADDRess](#) on page 1841 and [SEARCh:TRIGger:I2C:ADDTo](#) on page 1841.

*RST: EQUal

Parameters for setting and query:

<SearchName>

Manual operation: See "[Address setup: Condition, Type, Addr. min, Addr. max, R/W bit](#)" on page 534

SEARCh:TRIGger:I2C:AMODE <SearchName>,<AddressType>
SEARCh:TRIGger:I2C:AMODE? <SearchName>

Sets the address length.

Parameters:

<AddressType> BIT7 | BIT7_RW | BIT10 | ANY

BIT7 | BIT10

Enter only address bits in the address pattern.

BIT7_RW

Enter seven address bits and also the R/W bit in the address pattern.

ANY

Only available for search criteria "Address and data" ([SEARCH:TRIGger:I2C:ADDData](#) is set ON). Used to search for data only, regardless of the address.

*RST: BIT7

Parameters for setting and query:

<SearchName>

Usage: Asynchronous command

Manual operation: See "Address setup: Condition, Type, Addr. min, Addr. max, R/W bit" on page 534

SEARCH:TRIGger:I2C:ADDRESS <SearchName>,<Address>

SEARCH:TRIGger:I2C:ADDRESS? <SearchName>

Specifies an address pattern, or sets the the start value of an address range.

Parameters:

<Address> Numeric or string pattern, see [Chapter 27.4.6, "Bit pattern parameter"](#), on page 1373.
The pattern length is defined with [SEARCH:TRIGger:I2C:AMODE](#).

Parameters for setting and query:

<SearchName>

Manual operation: See "Address setup: Condition, Type, Addr. min, Addr. max, R/W bit" on page 534

SEARCH:TRIGger:I2C:ADDTo <SearchName>,<AddressTo>

SEARCH:TRIGger:I2C:ADDTo? <SearchName>

Sets the the end value of an address range if [SEARCH:TRIGger:I2C:ACONdition](#) is set to [INRange](#) or [OORange](#).

Parameters:

<AddressTo> Numeric or string pattern, see [Chapter 27.4.6, "Bit pattern parameter"](#), on page 1373.
The pattern length is defined with [SEARCH:TRIGger:I2C:AMODE](#).

Parameters for setting and query:

<SearchName>

Usage: Asynchronous command

Manual operation: See "Address setup: Condition, Type, Addr. min, Addr. max, R/W bit" on page 534

SEARCh:TRIGger:I2C:ACcEss <SearchName>,<RWBitAddress>
SEARCh:TRIGger:I2C:ACcEss? <SearchName>

Sets the transfer direction of the data.

Parameters:

<RWBitAddress> READ | WRITe | EITHer
 *RST: EITHer

Parameters for setting and query:

<SearchName>

Usage: Asynchronous command

Manual operation: See "Address setup: Condition, Type, Addr. min, Addr. max, R/W bit" on page 534

SEARCh:TRIGger:I2C:ADDO<m>:ENABle <SearchName>,<UseAddress>
SEARCh:TRIGger:I2C:ADDO<m>:ENABle? <SearchName>

Includes the indicated ADOR address in the "address OR" search condition.

Suffix:

<m> 1..4
 Index of the address in an "address OR" condition (OR slot)

Parameters:

<UseAddress> ON | OFF
 *RST: OFF

Parameters for setting and query:

<SearchName>

Manual operation: See "Address OR setup: , OR x Address type, Address, R/W bit" on page 534

SEARCh:TRIGger:I2C:ADDO<m>:ADRTyPe <SearchName>,<AddressType>
SEARCh:TRIGger:I2C:ADDO<m>:ADRTyPe? <SearchName>

Sets the address type for the indicated ADOR address in the "address OR" search condition.

Suffix:

<m> 1..4
 Index of the address in an "address OR" condition (OR slot)

Parameters:

<AddressType> BIT7 | BIT7_RW | BIT10
BIT7 | BIT10
 Enter only address bits in the address pattern.
BIT7_RW
 Enter seven address bits and also the R/W bit in the address pattern.

*RST: BIT7

Parameters for setting and query:

<SearchName>

Manual operation: See "Address OR setup: , OR x Address type, Address, R/W bit" on page 534

SEARCh:TRIGger:I2C:ADDO<m>[:VALue] <SearchName>,<Address>

SEARCh:TRIGger:I2C:ADDO<m>[:VALue]? <SearchName>

Defines the address pattern of the indicated ADOR address in the "address OR" search condition.

Suffix:

<m> 1..4
Index of the address in an "address OR" condition (OR slot)

Parameters:

<Address> Numeric or string pattern, see [Chapter 27.4.6, "Bit pattern parameter"](#), on page 1373.
The pattern length is defined with [SEARCh:TRIGger:I2C:ADDO<m>:ADRTYPE](#).

Parameters for setting and query:

<SearchName>

Manual operation: See "Address OR setup: , OR x Address type, Address, R/W bit" on page 534

SEARCh:TRIGger:I2C:ADDO<m>:RWBit <SearchName>,<RWBit>

SEARCh:TRIGger:I2C:ADDO<m>:RWBit? <SearchName>

Defines the R/W bit of the indicated ADOR address in the "address OR" search condition.

Suffix:

<m> 1..4
Index of the address in an "address OR" condition (OR slot)

Parameters:

<RWBit> UNDEFINED | READ | WRITE | EITHER

UNDEFINED

Only return value

*RST: EITHER

Parameters for setting and query:

<SearchName>

Manual operation: See "Address OR setup: , OR x Address type, Address, R/W bit" on page 534

SEARch:TRIGger:I2C:DPOperator <SearchName>,<DataPosOperator>
SEARch:TRIGger:I2C:DPOperator? <SearchName>

Sets the operator for the data position. You can defined an exact position, or a position range.

Parameters:

<DataPosOperator> ANY | OFF | EQUal | GETHan | INRange | RANGE

ANY = OFF

The position of the required pattern is not relevant.

EQUal | GETHan

Equal, Greater or equal than. These conditions require one data position to be set with [SEARch:TRIGger:I2C:DPOsition](#).

INRange = RANGE

In range: Set the minimum and maximum value of the range with [SEARch:TRIGger:I2C:DPOsition](#) and [SEARch:TRIGger:I2C:DPTO](#).

*RST: ANY

Parameters for setting and query:

<SearchName>

Manual operation: See "[Data setup: Condition, Position, Index min, Index max, Value min, Value max](#)" on page 534

SEARch:TRIGger:I2C:DPOsition <SearchName>,<DataPosition>
SEARch:TRIGger:I2C:DPOsition? <SearchName>

Defines the first byte of interest. All bytes before that byte are ignored.

Parameters:

<DataPosition> The index 0 is associated with the first data byte.

Range: 0 to 4095

Increment: 1

*RST: 0

Parameters for setting and query:

<SearchName>

Manual operation: See "[Data setup: Condition, Position, Index min, Index max, Value min, Value max](#)" on page 534

SEARch:TRIGger:I2C:DPTO <SearchName>,<DataPositionTo>
SEARch:TRIGger:I2C:DPTO? <SearchName>

Defines the last byte of interest, if [SEARch:TRIGger:I2C:DPOperator](#) defines a range.

Parameters:

<DataPositionTo> Range: 0 to 4095
 Increment: 1
 *RST: 0

Parameters for setting and query:

<SearchName>

Manual operation: See "[Data setup: Condition, Position, Index min, Index max, Value min, Value max](#)" on page 534

SEARCh:TRIGger:I2C:DCONDition <SearchName>,<DataOperator>

SEARCh:TRIGger:I2C:DCONDition? <SearchName>

Sets the operator to set a specific data value or a data range.

Parameters:

<DataOperator> EQUal | NEQual | LTHan | LETHan | GTHan | GETHan |
 INRange | OORange
 *RST: EQUal

Parameters for setting and query:

<SearchName>

Manual operation: See "[Data setup: Condition, Position, Index min, Index max, Value min, Value max](#)" on page 534

SEARCh:TRIGger:I2C:DMIN <SearchName>,<Data>

SEARCh:TRIGger:I2C:DMIN? <SearchName>

Specifies the data bit pattern, or sets the the start value of a data pattern range.. Enter the bytes in msb first bit order. The maximum pattern length is 64 bit. Waveform data is compared with the pattern byte-by-byte.

Parameters:

<Data> Numeric or string pattern, see [Chapter 27.4.6, "Bit pattern parameter"](#), on page 1373.

Parameters for setting and query:

<SearchName>

Usage: Asynchronous command

Manual operation: See "[Data setup: Condition, Position, Index min, Index max, Value min, Value max](#)" on page 534

SEARCh:TRIGger:I2C:DMAX <SearchName>,<DataTo>

SEARCh:TRIGger:I2C:DMAX? <SearchName>

Sets the the end value of an address range if [SEARCh:TRIGger:I2C:DCONDition](#) is set to INRange or OORange.

Parameters:

<DataTo> Numeric or string pattern, see [Chapter 27.4.6, "Bit pattern parameter"](#), on page 1373.

Parameters for setting and query:

<SearchName>

Usage: Asynchronous command

Manual operation: See "[Data setup: Condition, Position, Index min, Index max, Value min, Value max](#)" on page 534

SEARCH:TRIGger:I2C:ADNack <SearchName>,<AddressNack>

SEARCH:TRIGger:I2C:ADNack? <SearchName>

Parameters:

<AddressNack> ON | OFF
 *RST: ON

Parameters for setting and query:

<SearchName>

Usage: Asynchronous command

SEARCH:TRIGger:I2C:DRNack <SearchName>,<DataReadNack>

SEARCH:TRIGger:I2C:DRNack? <SearchName>

Searches for the end of the read process when the master reads data from the slave. This Nack is sent according to the protocol definition, it is not an error.

Parameters:

<DataReadNack> ON | OFF
 *RST: ON

Parameters for setting and query:

<SearchName>

Usage: Asynchronous command

Manual operation: See "[No ACK setup: Addr/W/R NACK](#)" on page 535

SEARCH:TRIGger:I2C:DWNack <SearchName>,<DataWriteNack>

SEARCH:TRIGger:I2C:DWNack? <SearchName>

Searches for missing data write acknowledge bits.

Parameters:

<DataWriteNack> ON | OFF
 *RST: ON

Parameters for setting and query:

<SearchName>

Usage: Asynchronous command

Manual operation: See "No ACK setup: Addr/W/R NACK" on page 535

27.18.3.5 I²C search results

The search on decoded CAN data returns the same results as the queries for decode results.

In search result commands, you have to specify the <SearchName> parameter. It is a string parameter that contains the search definition name.

For a description of the returned values, see the corresponding commands in [Chapter 27.18.3.3, "Decode results"](#), on page 1828.

SEARCh:RESult:I2C:FCOunt?.....	1847
SEARCh:RESult:I2C:FRAMe<m>:STATus?.....	1847
SEARCh:RESult:I2C:FRAMe<m>:START?.....	1848
SEARCh:RESult:I2C:FRAMe<m>:STOP?.....	1848
SEARCh:RESult:I2C:FRAMe<m>:AACcess?.....	1848
SEARCh:RESult:I2C:FRAMe<m>:ACCess?.....	1849
SEARCh:RESult:I2C:FRAMe<m>:ACOMplete?.....	1849
SEARCh:RESult:I2C:FRAMe<m>:ADBStart?.....	1849
SEARCh:RESult:I2C:FRAMe<m>:ADDReSS?.....	1849
SEARCh:RESult:I2C:FRAMe<m>:ADEVice?.....	1850
SEARCh:RESult:I2C:FRAMe<m>:AMODE?.....	1850
SEARCh:RESult:I2C:FRAMe<m>:AStart?.....	1850
SEARCh:RESult:I2C:FRAMe<m>:DATA?.....	1851
SEARCh:RESult:I2C:FRAMe<m>:RWBStart?.....	1851
SEARCh:RESult:I2C:FRAMe<m>:SYMBOL?.....	1851
SEARCh:RESult:I2C:FRAMe<m>:BCOunt?.....	1851
SEARCh:RESult:I2C:FRAMe<m>:BYTE<n>:ACCess?.....	1852
SEARCh:RESult:I2C:FRAMe<m>:BYTE<n>:ACKStart?.....	1852
SEARCh:RESult:I2C:FRAMe<m>:BYTE<n>:COMPLete?.....	1852
SEARCh:RESult:I2C:FRAMe<m>:BYTE<n>:START?.....	1853
SEARCh:RESult:I2C:FRAMe<m>:BYTE<n>:VALue?.....	1853

SEARCh:RESult:I2C:FCOunt? <SearchName>

Query parameters:

<SearchName>

Return values:

<Count>	Range:	0 to 100000
	Increment:	1
	*RST:	0

Usage: Query only

SEARCh:RESult:I2C:FRAMe<m>:STATus? <SearchName>

Suffix:

<m> *

Query parameters:

<SearchName>

Return values:

<State> INComplete | OK | UNEXpstop | INSufficient | ADDifferent | UNKNown
 *RST: OK

Usage: Query only**SEARCh:RESult:I2C:FRAMe<m>:STARt? <SearchName>****Suffix:**

<m> *

Query parameters:

<SearchName>

Return values:

<Start> Range: -100E+24 to 100E+24
 Increment: 100E-12
 *RST: 0
 Default unit: s

Usage: Query only**SEARCh:RESult:I2C:FRAMe<m>:STOP? <SearchName>****Suffix:**

<m> *

Query parameters:

<SearchName>

Return values:

<Stop> Range: -100E+24 to 100E+24
 Increment: 100E-12
 *RST: 0
 Default unit: s

Usage: Query only**SEARCh:RESult:I2C:FRAMe<m>:AACcess? <SearchName>****Suffix:**

<m> *

Query parameters:

<SearchName>

Return values:

<AddressAckBit> INComplete | ACK | NACK | EITHer
 *RST: INComplete

Usage: Query only

SEARCH:RESult:I2C:FRAMe<m>:ACCess? <SearchName>

Suffix:
<m> *

Query parameters:
<SearchName>

Return values:
<RWBit> UNDEFINED | READ | WRITe | EITHer
*RST: UNDEFINED

Usage: Query only

SEARCH:RESult:I2C:FRAMe<m>:ACOMplete? <SearchName>

Suffix:
<m> *

Query parameters:
<SearchName>

Return values:
<AddressComplete> ON | OFF
*RST: OFF

Usage: Query only

SEARCH:RESult:I2C:FRAMe<m>:ADBStart? <SearchName>

Returns the start time of the address acknowledge bit.

Suffix:
<m> *

Query parameters:
<SearchName>

Return values:
<AddrAckBtStrt> Range: -100E+24 to 100E+24
Increment: 100E-12
*RST: 0
Default unit: s

Usage: Query only

SEARCH:RESult:I2C:FRAMe<m>:ADDResS? <SearchName>

Suffix:
<m> *

Query parameters:

<SearchName>

Return values:

<AddressValue> Range: 0 to 2047
 Increment: 1
 *RST: 0

Usage: Query only**SEARCh:RESult:I2C:FRAMe<m>:ADEVICE? <SearchName>****Suffix:**

<m> *

Query parameters:

<SearchName>

Return values:

<DeviceAddress> Range: 0 to 1023
 Increment: 1
 *RST: 0

Usage: Query only**SEARCh:RESult:I2C:FRAMe<m>:AMODE? <SearchName>****Suffix:**

<m> *

Query parameters:

<SearchName>

Return values:

<AddressType> BIT7 | BIT7_RW | BIT10 | AUTO | ANY
 *RST: BIT7

Usage: Query only**SEARCh:RESult:I2C:FRAMe<m>:ASStart? <SearchName>****Suffix:**

<m> *

Query parameters:

<SearchName>

Return values:

<AddressStart> Range: -100E+24 to 100E+24
 Increment: 100E-12
 *RST: 0
 Default unit: s

Usage: Query only

SEARCh:RESult:I2C:FRAMe<m>:DATA? <SearchName>

Returns the data bytes of the indicated frame.

Suffix:

<m> *

Query parameters:

<SearchName>

Return values:

<Data>

Usage: Query only

SEARCh:RESult:I2C:FRAMe<m>:RWBStart? <SearchName>**Suffix:**

<m> *

Query parameters:

<SearchName>

Return values:

<RWBitStart> Range: -100E+24 to 100E+24
 Increment: 100E-12
 *RST: 0
 Default unit: s

Usage: Query only

SEARCh:RESult:I2C:FRAMe<m>:SYMBol? <SearchName>**Suffix:**

<m> *

Query parameters:

<SearchName>

Return values:

<Translation>

Usage: Query only

SEARCh:RESult:I2C:FRAMe<m>:BCOunt?**Suffix:**

<m> *

Return values:

<Count>

Usage: Query only

SEARCh:RESUlt:I2C:FRAMe<m>:BYTE<n>:ACCess? <SearchName>**Suffix:**

<m> *

<n> *

Query parameters:

<SearchName>

Return values:

<ByteAckBit> INComplete | ACK | NACK | EITHer

*RST: INComplete

Usage: Query only

SEARCh:RESUlt:I2C:FRAMe<m>:BYTE<n>:ACKStart? <SearchName>

Returns the start time of the acknowledge bit of the indicated data byte.

Suffix:

<m> *

<n> *

Query parameters:

<SearchName>

Return values:

<ByteAckBitStart> Range: -100E+24 to 100E+24

Increment: 100E-12

*RST: 0

Default unit: s

Usage: Query only

SEARCh:RESUlt:I2C:FRAMe<m>:BYTE<n>:COMPLete? <SearchName>**Suffix:**

<m> *

<n> *

Query parameters:

<SearchName>

Return values:

<ByteComplete> ON | OFF

*RST: OFF

Usage: Query only

SEARch:RESult:I2C:FRAMe<m>:BYTE<n>:STARt? <SearchName>

Suffix:

<m> *

<n> *

Query parameters:

<SearchName>

Return values:

<ByteStart> Range: -100E+24 to 100E+24
 Increment: 100E-12
 *RST: 0
 Default unit: s

Usage: Query only

SEARch:RESult:I2C:FRAMe<m>:BYTE<n>:VALue? <SearchName>

Suffix:

<m> *

<n> *

Query parameters:

<SearchName>

Return values:

<Value> Range: 0 to 255
 Increment: 1
 *RST: 0

Usage: Query only

27.18.4 SPI (option R&S RTO6-K510)

- [SPI bus configuration](#)..... 1853
- [SPI trigger](#)..... 1858
- [SPI decode results](#)..... 1861
- [SPI search settings](#)..... 1866
- [SPI search results](#)..... 1869

27.18.4.1 SPI bus configuration

BUS<m>:SPI:BORDER	1854
BUS<m>:SPI:WSIZE	1854
BUS<m>:SPI:SCLK:SOURce	1854
BUS<m>:SPI:SSElect:SOURce	1855
BUS<m>:SPI:SSElect:POLarity	1855
BUS<m>:SPI:MISO:SOURce	1856
BUS<m>:SPI:MISO:POLarity	1856

BUS<m>:SPI:MOSI:SOURce.....	1856
BUS<m>:SPI:MOSI:POLarity.....	1857
BUS<m>:SPI:SCLK:THReshold.....	1857
BUS<m>:SPI:MISO:THReshold.....	1857
BUS<m>:SPI:MOSI:THReshold.....	1857
BUS<m>:SPI:SSElect:THReshold.....	1857
BUS<m>:SPI:FRCondition.....	1857
BUS<m>:SPI:TIMEout.....	1858

BUS<m>:SPI:BORDER <BitOrder>

Defines if the data of the messages starts with msb (most significant bit) or lsb (least significant bit).

Suffix:

<m> 1..4
Selects the serial bus.

Parameters:

<BitOrder> LSBF | MSBF
*RST: MSBF

Usage: Asynchronous command

Manual operation: See "[Bit order](#)" on page 539

BUS<m>:SPI:WSIZE <WordLength>

Sets the number of bits in a message.

Suffix:

<m> 1..4
Selects the serial bus.

Parameters:

<WordLength> Number of bits
Range: 4 to 64
Increment: 1
*RST: 8

Usage: Asynchronous command

Manual operation: See "[Word length](#)" on page 539

BUS<m>:SPI:SCLK:SOURce <SCLKSource>

Sets the input channel of the clock line.

Suffix:

<m> 1..4
Selects the serial bus.

Parameters:

<SCLKSource> C1W1 | C2W1 | C3W1 | C4W1 | M1 | M2 | M3 | M4 | M5 | M6 | M7 | M8 | R1 | R2 | R3 | R4 | D0 | D1 | D2 | D3 | D4 | D5 | D6 | D7 | D8 | D9 | D10 | D11 | D12 | D13 | D14 | D15

Digital and analog channels cannot be used at the same time for data, clock and slave select lines.

See [Chapter 27.4.2, "Waveform parameter"](#), on page 1371

*RST: C2W1

Usage:

Asynchronous command

Manual operation: See "[SCLK source](#)" on page 537

BUS<m>:SPI:SSElect:SOURce <SlaveSelectSource>

Sets the input channel of the slave select line.

Suffix:

<m> 1..4
Selects the serial bus.

Parameters:

<SlaveSelectSource> NONE | C1W1 | C2W1 | C3W1 | C4W1 | M1 | M2 | M3 | M4 | M5 | M6 | M7 | M8 | R1 | R2 | R3 | R4 | D0 | D1 | D2 | D3 | D4 | D5 | D6 | D7 | D8 | D9 | D10 | D11 | D12 | D13 | D14 | D15

Digital and analog channels cannot be used at the same time for data, clock and slave select lines.

See [Chapter 27.4.2, "Waveform parameter"](#), on page 1371

*RST: None

Usage:

Asynchronous command

Manual operation: See "[Source](#)" on page 538

BUS<m>:SPI:SSElect:POLarity <SSPolarity>

Selects whether transmitted slave select signal is high active (high = 1) or low active (low = 1).

Suffix:

<m> 1..4
Selects the serial bus.

Parameters:

<SSPolarity> ACTLow | ACTHigh
*RST: ACTLow

Usage:

Asynchronous command

Manual operation: See "[Polarity](#)" on page 538

BUS<m>:SPI:MISO:SOURce <MISOSource>

Sets the input channel of the MISO line.

Suffix:

<m> 1..4
Selects the serial bus.

Parameters:

<MISOSource> NONE | C1W1 | C2W1 | C3W1 | C4W1 | M1 | M2 | M3 | M4 |
M5 | M6 | M7 | M8 | R1 | R2 | R3 | R4 | D0 | D1 | D2 | D3 | D4 |
D5 | D6 | D7 | D8 | D9 | D10 | D11 | D12 | D13 | D14 | D15
Digital and analog channels cannot be used at the same time for
data, clock and slave select lines.
See [Chapter 27.4.2, "Waveform parameter"](#), on page 1371
*RST: None

Usage: Asynchronous command

Manual operation: See "[Source](#)" on page 538

BUS<m>:SPI:MISO:POLarity <MISOPolarity>

Selects whether transmitted data is high active (high = 1) or low active (low = 1).

Suffix:

<m> 1..4
Selects the serial bus.

Parameters:

<MISOPolarity> ACTLow | ACTHigh
*RST: ACTHigh

Usage: Asynchronous command

Manual operation: See "[Polarity](#)" on page 538

BUS<m>:SPI:MOSI:SOURce <MOSISource>

Sets the input channel of the MOSI line.

Suffix:

<m> 1..4
Selects the serial bus.

Parameters:

<MOSISource> NONE | C1W1 | C2W1 | C3W1 | C4W1 | M1 | M2 | M3 | M4 |
M5 | M6 | M7 | M8 | R1 | R2 | R3 | R4 | D0 | D1 | D2 | D3 | D4 |
D5 | D6 | D7 | D8 | D9 | D10 | D11 | D12 | D13 | D14 | D15
Digital and analog channels cannot be used at the same time for
data, clock and slave select lines.
See [Chapter 27.4.2, "Waveform parameter"](#), on page 1371
*RST: C1W1

Usage: Asynchronous command
Manual operation: See "[Source](#)" on page 538

BUS<m>:SPI:MOSI:POLarity <MOSIPolarity>

Selects whether transmitted data is high active (high = 1) or low active (low = 1).

Suffix:
 <m> 1..4
 Selects the serial bus.

Parameters:
 <MOSIPolarity> ACTLow | ACTHigh
 *RST: ACTHigh

Usage: Asynchronous command
Manual operation: See "[Polarity](#)" on page 538

BUS<m>:SPI:SCLK:THReshold <SCLKThreshold>

BUS<m>:SPI:MISO:THReshold <MISOThreshold>

BUS<m>:SPI:MOSI:THReshold <MOSIThreshold>

BUS<m>:SPI:SSElect:THReshold <SSThreshold>

Set user-defined threshold values for the clock, MISO, MOSI and slave select lines.

Suffix:
 <m> 1..4
 Selects the serial bus.

Parameters:
 <SSThreshold> User-defined value
 Range: -12 to 12
 Increment: 0.1
 *RST: 0
 Default unit: V

Manual operation: See "[Set Thresholds](#)" on page 538

BUS<m>:SPI:FRCondition <FrameCondition>

Defines the start of a frame. A frame contains a number of successive words, at least one word.

Suffix:
 <m> 1..4
 Selects the serial bus.

Parameters:
 <FrameCondition> SS | CLKTimeout

SS

Start and end of the frame is defined by the active state of the slave select signal, see [BUS<m>:SPI:SSElect:POLarity](#).

CLKTimeout

Defines a timeout on the clock line SCLK as limiter between two frames. The timeout condition is used for SPI connections without an SS line.

*RST: SS

Manual operation: See "[Frame condition](#)" on page 540

BUS<m>:SPI:TIMEout <ClockTimeout>

Defines a timeout on the clock line SCLK as limiter between two frames. The timeout condition is used for SPI connections without an SS line.

Suffix:

<m> 1..4
Selects the serial bus.

Parameters:

<ClockTimeout> Range: 50E-9 to 10
Increment: 1E-6
*RST: 1E-3
Default unit: s

Manual operation: See "[Timeout](#)" on page 540

27.18.4.2 SPI trigger

The trigger suffix <m> is always 1 and can be omitted. It selects the trigger event: Only the A-trigger is available for triggering on serial buses.

To trigger on a serial bus, make sure that:

- [TRIGger<m>:SOURce\[:SElect\]](#) is set to SBUS.
- The sources of the serial bus are channel signals: use [BUS<m>:...:SOURce](#) commands.
- Decoding is enabled: [BUS<m>\[:STATe\]](#) is set to ON.

TRIGger<m>:SPI:TYPE	1859
TRIGger<m>:SPI:PALignment	1859
TRIGger<m>:SPI:DPOperator	1860
TRIGger<m>:SPI:DPOsition	1860
TRIGger<m>:SPI:DPTO	1860
TRIGger<m>:SPI:FCONdition	1860
TRIGger<m>:SPI:MISOpattern	1861
TRIGger<m>:SPI:MOSIpattern	1861

TRIGger<m>:SPI:TYPE <Type>

Selects the trigger type for SPI analysis.

Parameters:

<Type>

SSActive | TIMEout | MOSI | MISO | MOMI

SSActive

Start of the message: slave select signal SS changes to the active state.

TIMEout

Triggers on the next message start after the "Timeout" time.

MOSI

Triggers on a specified data pattern in that is expected on the MOSI line. Define the pattern with [TRIGger<m>:SPI:MOSipattern](#).

MISO

Triggers on a specified data pattern in that is expected on the MISO line. Define the pattern with [TRIGger<m>:SPI:MISOpattern](#)

MOMI

Triggers on a specified data patterns on the MISO and MISO lines.

*RST: SSActive

Usage: Asynchronous command

Manual operation: See "[Trigger type](#)" on page 541

TRIGger<m>:SPI:PALignment <DataAlignment>

Defines how the specified data pattern is searched.

Parameters:

<DataAlignment>

WORD | BIT

WORD

The pattern is matched only at word boundaries.

BIT

Bit-by bit: the pattern can be at any position in the data word.

*RST: WORD

Usage: Asynchronous command

Manual operation: See "[Search mode](#)" on page 543

TRIGger<m>:SPI:DPOperator <DataPosOperator>

Sets the operator for the data position. You can defined an exact position, or a position range.

Parameters:

<DataPosOperator> ANY | OFF | EQUal | GETHan | INRange | RANGE

ANY = OFF

The position of the required pattern is not relevant.

EQUal | GETHan

Equal, Greater or equal than. These conditions require one data position to be set with [TRIGger<m>:SPI:DPOsition](#).

INRange = RANGE

Set the minimum and maximum value of the range with [TRIGger<m>:SPI:DPOsition](#) and [TRIGger<m>:SPI:DPTO](#).

*RST: ANY

Manual operation: See "[Position](#)" on page 542

TRIGger<m>:SPI:DPOsition <DataPosition>

Sets the number of bits or words to be ignored before the first bit or word od interest. The effect is defined by [TRIGger<m>:SPI:PALignment](#).

Parameters:

<DataPosition> The index 0 is associated with the first data byte.

Range: 0 to 4095 for triggering on one line (MISO or MOSI), 2047 for triggering on both lines.

Increment: 1

*RST: 0

Manual operation: See "[Index min, Index max](#)" on page 543

TRIGger<m>:SPI:DPTO <DataPositionTo>

Defines the last bit or word of interest, if [TRIGger<m>:SPI:DPOperator](#) is set to INRange.

Parameters:

<DataPositionTo> Range: 1 to 4095 for triggering on one line (MISO or MOSI), 2047 for triggering on both lines.

Increment: 1

*RST: 1

Manual operation: See "[Index min, Index max](#)" on page 543

TRIGger<m>:SPI:FCONdition <DataOperator>

Selects the operator for the MISO and MOSI pattern.

Parameters:

<DataOperator> EQUal | NEQual
 *RST: EQUal

Manual operation: See "[Condition](#)" on page 542

TRIGger<m>:SPI:MISOpattern <MISOPattern>

Specifies the pattern to be triggered on the MISO line.

Parameters:

<MISOPattern> Numeric or string pattern, see [Chapter 27.4.6, "Bit pattern parameter"](#), on page 1373. The string parameter accepts the bit value X (don't care).

Usage: Asynchronous command

Manual operation: See "[MOSI pattern, MISO pattern](#)" on page 542

TRIGger<m>:SPI:MOSIpattern <MOSIPattern>

Specifies the pattern to be triggered on the MOSI line.

Parameters:

<MOSIPattern> Numeric or string pattern, see [Chapter 27.4.6, "Bit pattern parameter"](#), on page 1373. The string parameter accepts the bit value X (don't care).

Usage: Asynchronous command

Manual operation: See "[MOSI pattern, MISO pattern](#)" on page 542

27.18.4.3 SPI decode results

BUS<m>:SPI:FRAMe<n>:DATA?	1861
BUS<m>:SPI:FCOunt?	1862
BUS<m>:SPI:FRAMe<n>:COUnT?	1862
BUS<m>:SPI:FRAMe<n>:BITRate?	1862
BUS<m>:SPI:FRAMe<n>:STATus?	1863
BUS<m>:SPI:FRAMe<n>:START?	1863
BUS<m>:SPI:FRAMe<n>:STOP?	1863
BUS<m>:SPI:FRAMe<n>:WCOunt?	1864
BUS<m>:SPI:FRAMe<n>:WORD<o>:START?	1864
BUS<m>:SPI:FRAMe<n>:WORD<o>:STOP?	1864
BUS<m>:SPI:FRAMe<n>:WORD<o>:MISO?	1865
BUS<m>:SPI:FRAMe<n>:WORD<o>:FMISo?	1865
BUS<m>:SPI:FRAMe<n>:WORD<o>:MOSI?	1866
BUS<m>:SPI:FRAMe<n>:WORD<o>:FMOSi?	1866

BUS<m>:SPI:FRAMe<n>:DATA?

Returns the data words of the specified frame.

Suffix:

<m> 1..4
Selects the serial bus.

<n> *
Selects the frame.

Return values:

<FrameData> Comma-separated sequence of integer values (N, L1, R1, ..., LN, RN). N is the number of word pairs in the frame, and {L1,R1} ...{LN,RN} are the value pairs. The values Lx and Rx are associated with the MOSI and the MISO channel, respectively. If a channel is disabled, an empty value is returned.

Example:

```
BUS:SPI:FRAME3:DATA?
<-- 2,10,108,35,70 (MOSI+MISO)
2,10,,35, (MOSI only)
2,,108,,70 (MISO only)
```

Usage: Query only

BUS<m>:SPI:FCOUNT?**BUS<m>:SPI:FRAME<n>:COUNT?**

Returns the number of decoded frames.

Suffix:

<m> 1..4
Selects the serial bus.

<n> *

Return values:

<Count> Total number of decoded frames.

Usage: Query only

BUS<m>:SPI:FRAME<n>:BITRate?

Returns the primary bit rate.

Suffix:

<m> 1..4
Selects the serial bus.

<n> *
Selects the frame.

Return values:

<PrimaryBitRate> Range: 0 to 100000000000
Increment: 1
*RST: 0
Default unit: bps

Usage: Query only

BUS<m>:SPI:FRAME<n>:STATus?

Returns the overall state of the specified frame.

Suffix:

<m> 1..4
Selects the serial bus.

<n> *
Selects the frame.

Return values:

<FrameState> OK | VOID | INCFirst | INCLast | INSufficient
 OK: the frame is valid.
 VOID: the frame is empty.
 INCFirst: INComplete First word. The first word does not have the expected word length.
 INCLast: INComplete Last word. The last word does not have the expected word length.
 INSufficient: The frame is not completely contained in the acquisition. The acquired part of the frame is valid.
 *RST: OK

Usage: Query only

BUS<m>:SPI:FRAME<n>:START?

Returns the start time of the specified frame.

Suffix:

<m> 1..4
Selects the serial bus.

<n> *
Selects the frame.

Return values:

<FrameStart> Range: -100E+24 to 100E+24
 *RST: 0
 Default unit: s

Usage: Query only

BUS<m>:SPI:FRAME<n>:STOP?

Returns the end time of the specified frame.

Suffix:

<m> 1..4
Selects the serial bus.

<n> *
Selects the frame.

Return values:

<FrameStop> Range: -100E+24 to 100E+24
 *RST: 0
 Default unit: s

Usage: Query only

BUS<m>:SPI:FRAMe<n>:WCOunt?

Returns the number of words in the specified frame.

Suffix:

<m> 1..4
 Selects the serial bus.

<n> *
 Selects the frame.

Return values:

<WordCount> Range: 0 to 4096
 *RST: 0

Usage: Query only

BUS<m>:SPI:FRAMe<n>:WORD<o>:START?

Returns the start time of the specified data word.

Suffix:

<m> 1..4
 Selects the serial bus.

<n> *
 Selects the frame.

<o> *
 Selects the word number.

Return values:

<Start> Range: -100E+24 to 100E+24
 *RST: 0
 Default unit: s

Usage: Query only

BUS<m>:SPI:FRAMe<n>:WORD<o>:STOP?

Returns the end time of the specified data word.

Suffix:

<m> 1..4
 Selects the serial bus.

<n> *
Selects the frame.

<o> *
Selects the word number.

Return values:
<Stop> Range: -100E+24 to 100E+24
*RST: 0
Default unit: s

Usage: Query only

BUS<m>:SPI:FRAME<n>:WORD<o>:MISO?

Returns the data value of the specified word on the MISO line.

Suffix:
<m> 1..4
Selects the serial bus.

<n> *
Selects the frame.

<o> *
Selects the word number.

Return values:
<MISOValue> To set the value format, use [FORMat:BPATtern](#).
The values below – range, increment and reset – are decimal values.
Range: 0 to 4294967295
*RST: 0

Usage: Query only

BUS<m>:SPI:FRAME<n>:WORD<o>:FMISO?

Returns the formatted value of the specified word on the MISO line.

Suffix:
<m> 1..4
Selects the serial bus.

<n> *
Selects the frame.

<o> *
Selects the word number.

Return values:
<FormattedMISOVal>

Usage: Query only

BUS<m>:SPI:FRAME<n>:WORD<o>:MOSI?

Returns the data value of the specified word on the MOSI line.

Suffix:

<m>	1..4	Selects the serial bus.
<n>	*	Selects the frame.
<o>	*	Selects the word number.

Return values:

<MOSIValue> To set the value format, use [FORMat:BPATtern](#).
The values below – range, increment and reset – are decimal values.

Range: 0 to 4294967295
*RST: 0

Usage: Query only

BUS<m>:SPI:FRAME<n>:WORD<o>:FMOSI?

Returns the formatted value of the specified word on the MOSI line.

Suffix:

<m>	1..4	Selects the serial bus.
<n>	*	Selects the frame.
<o>	*	Selects the word number.

Return values:

<FormattedMOSIVal>

Usage: Query only

27.18.4.4 SPI search settings

In search setup commands, you must specify the <SearchName> parameter. It is a string parameter that contains the search definition name. All commands are similar to SPI trigger commands.

SEARCh:TRIGger:SPI:TYPE	1867
SEARCh:TRIGger:SPI:FCONdition	1867
SEARCh:TRIGger:SPI:MISopattern	1868
SEARCh:TRIGger:SPI:MOSipattern	1868
SEARCh:TRIGger:SPI:DPOPerator	1868

SEARCh:TRIGger:SPI:DPOsition.....	1868
SEARCh:TRIGger:SPI:DPTO.....	1869
SEARCh:TRIGger:SPI:PALignment.....	1869

SEARCh:TRIGger:SPI:TYPE <SearchName>,<Type>
SEARCh:TRIGger:SPI:TYPE? <SearchName>

Sets the event to be searched for.

Parameters:

<Type> SSActive | TIMEout | MOSI | MISO | MOMI

SSActive

Searches for the start of the frame when slave select signal SS changes to the active state. This type is available if the slave select line is configured in the bus setup, and [BUS<m>:SPI:FRCondition](#) is SS.

TIMEout

Searches for the start of the frame when the clock idle time exceeds the timeout. This type is available if the slave select line is configured in the bus setup, and [BUS<m>:SPI:FRCondition](#) is CLKTimeout.

MOSI | MISO

Searches for a specified data pattern expected on the MOSI line or on the MISO line, respectively.

MOMI

Searches in parallel for specified data patterns expected on the MOSI and MISO lines.

*RST: SSActive

Parameters for setting and query:

<SearchName>

Usage: Asynchronous command

Manual operation: See "[Type](#)" on page 545

SEARCh:TRIGger:SPI:FCONdition <SearchName>,<DataOperator>
SEARCh:TRIGger:SPI:FCONdition? <SearchName>

Selects the operator for the data pattern: equal or not equal.

Parameters:

<DataOperator> EQUal | NEQual

*RST: EQUal

Parameters for setting and query:

<SearchName>

Firmware/software: FW 3.30

Manual operation: See "[MOSI and MISO data search](#)" on page 545

SEARCh:TRIGger:SPI:MISOpattern <SearchName>,<MISOPattern>
SEARCh:TRIGger:SPI:MISOpattern? <SearchName>
SEARCh:TRIGger:SPI:MOSIpattern <SearchName>,<MOSIPattern>
SEARCh:TRIGger:SPI:MOSIpattern? <SearchName>

Specifies a data pattern for the MISO or MOSI line, respectively.

Parameters:

<MISOPattern> Numeric or string pattern, see [Chapter 27.4.6, "Bit pattern parameter"](#), on page 1373.
 <MOSIPattern>

Parameters for setting and query:

<SearchName>

Usage: Asynchronous command

Firmware/software: FW 3.30

Manual operation: See "[MOSI and MISO data search](#)" on page 545

SEARCh:TRIGger:SPI:DPOperator <SearchName>,<DataPosOperator>
SEARCh:TRIGger:SPI:DPOperator? <SearchName>

Operator for the data position. You can define an exact position, a position range, or let the position undefined (ANY).

Parameters:

<DataPosOperator> ANY | OFF | EQUal | GETHan | INRange | RANGE
 ANY = OFF, INRange = RANGE
 *RST: ANY

Parameters for setting and query:

<SearchName>

Firmware/software: FW 3.30

Manual operation: See "[MOSI and MISO data search](#)" on page 545

SEARCh:TRIGger:SPI:DPOsition <SearchName>,<DataPosition>
SEARCh:TRIGger:SPI:DPOsition? <SearchName>

Sets the number of bits or words before the first word of interest, see also [SEARCH:TRIGger:SPI:PALignment](#). These offset bits/words are skipped. The index 0 is associated with the first data bit or word.

If the position operator defines a range, also define the last bit/word of interest using [SEARCH:TRIGger:SPI:DPTO](#)

Parameters:

<DataPosition> Range: 0 to 32767
 Increment: 1
 *RST: 0

Parameters for setting and query:

<SearchName>

Firmware/software: FW 3.30**Manual operation:** See "[MOSI and MISO data search](#)" on page 545**SEARCh:TRIGger:SPI:DPTO** <SearchName>,<DataPositionTo>**SEARCh:TRIGger:SPI:DPTO?** <SearchName>

Sets the the end value of a data postion range.

Parameters:

<DataPositionTo>	Range:	1 to 32767
	Increment:	1
	*RST:	1

Parameters for setting and query:

<SearchName>

Firmware/software: FW 3.30**Manual operation:** See "[MOSI and MISO data search](#)" on page 545**SEARCh:TRIGger:SPI:PALignment** <SearchName>,<DataAlignment>**SEARCh:TRIGger:SPI:PALignment?** <SearchName>

Defines how the specified data pattern is searched.

Parameters:

<DataAlignment> WORD | BIT

WORD

The pattern is matched only at word boundaries.

BIT

Bit-by-bit: the pattern can start at any position in the message.

*RST: WORD

Parameters for setting and query:

<SearchName>

Usage: Asynchronous command**Firmware/software:** FW 3.30**Manual operation:** See "[MOSI and MISO data search](#)" on page 545**27.18.4.5 SPI search results**

The search on decoded SPI data returns the same results as the queries for decode results.

In search result commands, you must specify the <SearchName> parameter. It is a string parameter that contains the search definition name.

The suffix FRAME<m> indicates the frame index. The suffix WORD<n> indicates the word index inside a frame-

For a description of the returned values, see the corresponding commands in [Chapter 27.18.4.3, "SPI decode results"](#), on page 1861.

SEARCh:RESult:SPI:FCOunt?.....	1870
SEARCh:RESult:SPI:FRAME<m>:COUNT?.....	1870
SEARCh:RESult:SPI:FRAME<m>:DATA?.....	1870
SEARCh:RESult:SPI:FRAME<m>:START?.....	1871
SEARCh:RESult:SPI:FRAME<m>:STATus?.....	1871
SEARCh:RESult:SPI:FRAME<m>:STOP?.....	1871
SEARCh:RESult:SPI:FRAME<m>:WCOunt?.....	1872
SEARCh:RESult:SPI:FRAME<m>:WORD<n>:MISO?.....	1872
SEARCh:RESult:SPI:FRAME<m>:WORD<n>:MOSI?.....	1872
SEARCh:RESult:SPI:FRAME<m>:WORD<n>:START?.....	1872
SEARCh:RESult:SPI:FRAME<m>:WORD<n>:STOP?.....	1873

SEARCh:RESult:SPI:FCOunt? <SearchName>

Query parameters:

<SearchName>

Return values:

<Count> Range: 0 to 100000
 Increment: 1
 *RST: 0

Usage: Query only

SEARCh:RESult:SPI:FRAME<m>:COUNT?

Returns the number of frames that have matched the search criteria. In the search result table on the display, the number of rows is the number of frames that match the search criteria.

Suffix:

<m> *

Return values:

<Count>

Usage: Query only

SEARCh:RESult:SPI:FRAME<m>:DATA? <SearchName>

Suffix:

<m> *

Query parameters:

<SearchName>

Return values:

<FrameData>

Usage: Query only**SEARCH:RESult:SPI:FRAMe<m>:START? <SearchName>****Suffix:**

<m> *

Query parameters:

<SearchName>

Return values:

<FrameStart> Range: -100E+24 to 100E+24
 Increment: 100E-12
 *RST: 0
 Default unit: s

Usage: Query only**SEARCH:RESult:SPI:FRAMe<m>:STATus? <SearchName>****Suffix:**

<m> *

Query parameters:

<SearchName>

Return values:

<FrameState> OK | VOID | INCFirst | INCLast | INSufficient
 *RST: OK

Usage: Query only**SEARCH:RESult:SPI:FRAMe<m>:STOP? <SearchName>****Suffix:**

<m> *

Query parameters:

<SearchName>

Return values:

<FrameStop> Range: -100E+24 to 100E+24
 Increment: 100E-12
 *RST: 0
 Default unit: s

Usage: Query only

SEARCh:RESult:SPI:FRAMe<m>:WCOunt? <SearchName>**Suffix:**

<m> *

Query parameters:

<SearchName>

Return values:

<FrameWordCount> Range: 0 to 4096
 Increment: 1
 *RST: 0

Usage: Query only

SEARCh:RESult:SPI:FRAMe<m>:WORD<n>:MISO? <SearchName>**Suffix:**

<m> *

<n> *

Query parameters:

<SearchName>

Return values:

<WordMISOValue> Range: 0 to 4294967295
 Increment: 1
 *RST: 0

Usage: Query only

SEARCh:RESult:SPI:FRAMe<m>:WORD<n>:MOSI? <SearchName>**Suffix:**

<m> *

<n> *

Query parameters:

<SearchName>

Return values:

<WordMOSIValue> Range: 0 to 4294967295
 Increment: 1
 *RST: 0

Usage: Query only

SEARCh:RESult:SPI:FRAMe<m>:WORD<n>:START? <SearchName>**Suffix:**

<m> *

<n> *

Query parameters:

<SearchName>

Return values:

<FrameWordStart> Range: -100E+24 to 100E+24
 Increment: 100E-12
 *RST: 0
 Default unit: s

Usage: Query only

SEARCh:RESUlt:SPI:FRAMe<m>:WORD<n>:STOP? <SearchName>
Suffix:

<m> *

<n> *

Query parameters:

<SearchName>

Return values:

<FrameWordStop> Range: -100E+24 to 100E+24
 Increment: 100E-12
 *RST: 0
 Default unit: s

Usage: Query only**27.18.5 UART/RS-232/RS-422/RS-485 (option R&S RTO6-K510)**

- [Configuration](#)..... 1873
- [Trigger](#)..... 1879
- [Decode results](#)..... 1881

27.18.5.1 Configuration

BUS<m>:UART:RX:SOURce	1874
BUS<m>:UART:TX:SOURce	1874
BUS<m>:UART:RX:THReshold	1874
BUS<m>:UART:TX:THReshold	1875
BUS<m>:UART:TECHnology	1875
BUS<m>:UART:BITRate	1876
BUS<m>:UART:BAUDrate	1876
BUS<m>:UART:PARity	1876
BUS<m>:UART:POLarity	1877
BUS<m>:UART:SBIT	1877
BUS<m>:UART:SSIZe	1877
BUS<m>:UART:PACKets	1878
BUS<m>:UART:TOUT	1878
BUS<m>:UART:EWORd	1879

BUS<m>:UART:RX:SOURce <RxSource>

Selects the input channel for the receiver signal.

Suffix:

<m> 1..4
Selects the serial bus.

Parameters:

<RxSource> NONE | C1W1 | C2W1 | C3W1 | C4W1 | M1 | M2 | M3 | M4 | M5 | M6 | M7 | M8 | R1 | R2 | R3 | R4 | D0 | D1 | D2 | D3 | D4 | D5 | D6 | D7 | D8 | D9 | D10 | D11 | D12 | D13 | D14 | D15
Digital and analog channels cannot be used at the same time for RX and TX lines.
See [Chapter 27.4.2, "Waveform parameter"](#), on page 1371
*RST: None

Usage: Asynchronous command

Manual operation: See "[Source: Tx, Rx](#)" on page 548

BUS<m>:UART:TX:SOURce <TxSource>

Selects the input channel for the transmitter signal.

Suffix:

<m> 1..4
Selects the serial bus.

Parameters:

<TxSource> NONE | C1W1 | C2W1 | C3W1 | C4W1 | M1 | M2 | M3 | M4 | M5 | M6 | M7 | M8 | R1 | R2 | R3 | R4 | D0 | D1 | D2 | D3 | D4 | D5 | D6 | D7 | D8 | D9 | D10 | D11 | D12 | D13 | D14 | D15
Digital and analog channels cannot be used at the same time for RX and TX lines.
See [Chapter 27.4.2, "Waveform parameter"](#), on page 1371
*RST: C1W1

Usage: Asynchronous command

Manual operation: See "[Source: Tx, Rx](#)" on page 548

BUS<m>:UART:RX:THReshold <RxThreshold>

Sets a user-defined threshold value for the Rx line.

Alternatively, you can set the threshold according to the signal technology with [BUS<m>:UART:TECHnology](#).

Suffix:

<m> 1..4
Selects the serial bus.

Parameters:

<RxThreshold> User-defined clock threshold
 Range: -15 to 15
 Increment: 0.1
 *RST: 0
 Default unit: V

Manual operation: See "[Threshold](#)" on page 548

BUS<m>:UART:TX:THReshold <TxThreshold>

Sets a user-defined threshold value for the Tx line.

Alternatively, you can set the threshold according to the signal technology with [BUS<m>:UART:TECHnology](#).

Suffix:

<m> 1..4
 Selects the serial bus.

Parameters:

<TxThreshold> User-defined clock threshold
 Range: -15 to 15
 Increment: 0.1
 *RST: 0
 Default unit: V

Manual operation: See "[Threshold](#)" on page 548

BUS<m>:UART:TECHnology <Technology>

Sets the threshold voltage Tx and Rx lines as defined for various signal technologies.

Suffix:

<m> 1..4
 Selects the serial bus.

Parameters:

<Technology> V15 | V25 | V165 | V125 | V09 | VM13 | V38 | V20 | V0 | MANual
V15 | V25 | V165 | V125 | V09 | V38 | V20 | V0
 1.5 V, 2.5 V, 1.65 V ... respectively
VM13
 -1.3 V (negative value)
MANual
 Manual setting of user-defined values with [BUS<m>:UART:RX:THReshold](#) and [BUS<m>:UART:TX:THReshold](#).
 *RST: V165

Manual operation: See "[Threshold](#)" on page 548

BUS<m>:UART:BITRate <Bitrate>

Sets the number of transmitted bits per second.

Suffix:

<m> 1..4

Parameters:

<Bitrate> Range: 300 to 20000000
Increment: 1
*RST: 9600
Default unit: bps

Usage: Asynchronous command

Manual operation: See "[Bit rate](#)" on page 549

BUS<m>:UART:BAUDRate <Bitrate>

Same as [BUS<m>:UART:BITRate](#).

Suffix:

<m> 1..4

Parameters:

<Bitrate> Range: 300 to 20000000
Increment: 1
*RST: 9600
Default unit: bps

Usage: Asynchronous command

Manual operation: See "[Bit rate](#)" on page 549

BUS<m>:UART:PARity <Parity>

Defines the optional parity bit that is used for error detection.

See also: "[Parity](#)" on page 549.

Suffix:

<m> 1..4
Selects the serial bus.

Parameters:

<Parity> NONE | ODD | EVEN | MARK | SPC | DC
MARK
The parity bit is always a logic 1.
SPC
SPaCe: The parity bit is always a logic 0.
DC
Don't Care: the parity is ignored.
*RST: NONE

Usage: Asynchronous command

Manual operation: See "[Parity](#)" on page 549

BUS<m>:UART:POLarity <Polarity>

Defines the idle state of the bus. The idle state corresponds to a logic 1. The transmitted data on the bus is high (high = 1) or low (low = 1) active.

Suffix:

<m> 1..4
Selects the serial bus.

Parameters:

<Polarity> IDLLow | IDLHigh
*RST: IDLHigh

Usage: Asynchronous command

Manual operation: See "[Polarity](#)" on page 549

BUS<m>:UART:SBIT <StopBits>

Sets the number of stop bits: 1; 1.5 or 2 stop bits are possible.

Suffix:

<m> 1..4
Selects the serial bus.

Parameters:

<StopBits> B1 | B15 | B2
*RST: B1

Usage: Asynchronous command

Manual operation: See "[Stop bits](#)" on page 549

BUS<m>:UART:SSIZe <DataBits>

Sets the number of data bits in a message.

Suffix:

<m> 1..4
Selects the serial bus.

Parameters:

<DataBits> Number of data bits. 9 data bits are only possible with parity = none.
Range: 5 to 9
Increment: 1
*RST: 8

Usage: Asynchronous command

Manual operation: See ["Data bits"](#) on page 549

BUS<m>:UART:PACKets <Packets>

Defines the method of packet separation. A packet is a number of subsequent words in a data stream.

Suffix:

<m> 1..4
Selects the serial bus.

Parameters:

<Packets> NONE | EWORD | TOUT

NONE
Packets are not considered.

EWORd
End word, the end condition of a packet is a pattern. To define the end word, use [BUS<m>:UART:EWORd](#)

TOUT
Defines a timeout between the packets. To set the timeout, use [BUS<m>:UART:TOUT](#)

*RST: NONE

Firmware/software: FW 2.25

Manual operation: See ["Packets"](#) on page 550

BUS<m>:UART:TOUT <InterframeTime>

Sets the timeout between packets in a UART data stream. A new packet starts with the first start bit after the timeout.

The command is relevant if [BUS<m>:UART:PACKets](#) is set to TOUT.

Suffix:

<m> 1..4
Selects the serial bus.

Parameters:

<InterframeTime> Range: 1E-6 to 1
Increment: 1
*RST: 1E-3
Default unit: s

Usage: Asynchronous command

Firmware/software: FW 2.25

Manual operation: See ["Packets"](#) on page 550

BUS<m>:UART:EWORd <EndOfFrame>

Sets the end pattern of the packets. A new packet starts with the first start bit after the defined end pattern.

The command is relevant if `BUS<m>:UART:PACKets` is set to `EWORd`.

Suffix:

<m> 1..4
Selects the serial bus.

Parameters:

<EndOfFrame> End word value in decimal format (range 0 to 255) or hexadecimal format (prefix #H). The query always returns hexadecimal values.

Example:
`:BUS:UART:PACK EWOR`
`:BUS:UART:EWOR 10 // Decimal value`
`:BUS:UART:EWOR?`
`#H0A // Query returns hex`

Example:
`:BUS:UART:PACK EWOR`
`:BUS:UART:EWOR #Hff // Hexadecimal, prefix #H`
`:BUS:UART:EWOR?`
`#HFF`

Usage: Asynchronous command

Firmware/software: FW 2.25

Manual operation: See "Packets" on page 550

27.18.5.2 Trigger

The trigger suffix <m> is always 1 and can be omitted. It selects the trigger event: Only the A-trigger is available for triggering on serial buses.

To trigger on a serial bus, make sure that:

- `TRIGger<m>:SOURce[:SELEct]` is set to `SBUS`.
- The sources of the serial bus are channel signals: use `BUS<m>:...:SOURce` commands.
- Decoding is enabled: `BUS<m>[:STATe]` is set to `ON`.

<code>TRIGger<m>:UART:TYPE</code>	1880
<code>TRIGger<m>:UART:SOURce</code>	1880
<code>TRIGger<m>:UART:DPOPerator</code>	1880
<code>TRIGger<m>:UART:DPOSitioN</code>	1880
<code>TRIGger<m>:UART:DPTO</code>	1881
<code>TRIGger<m>:UART:FCONdition</code>	1881
<code>TRIGger<m>:UART:DATA</code>	1881

TRIGger<m>:UART:TYPE <Type>

Selects the trigger type for UART analysis.

See also: "[Type](#)" on page 552

Parameters:

<Type> STBT | PCKS | DATA | PRER | BRKC | STPerror
 STBT: Start bit
 PCKS: Packet start
 DATA: Serial pattern
 PRER: Parity error
 BRKC: Break condition
 STPerror: Stop error
 *RST: STBT

Usage: Asynchronous command

Manual operation: See "[Type](#)" on page 552

TRIGger<m>:UART:SOURce <Source>

Selects the transmitter or receiver line as trigger source.

Parameters:

<Source> TX | RX
 *RST: TX

Usage: Asynchronous command

Manual operation: See "[Trigger source](#)" on page 553

TRIGger<m>:UART:DPOperator <DataPosOperator>

Sets the operator for the data position. You can defined an exact position, or a position range.

Parameters:

<DataPosOperator> EQUal | GETHan | INRange | RANGE
 INRange = RANGE
 *RST: GETHan

Usage: Asynchronous command

Manual operation: See "[Position](#)" on page 554

TRIGger<m>:UART:DPOsition <DataPosition>

Sets the number of words before the first word of interest. These offset words are ignored.

Parameters:

<DataPosition> Number of words
 Range: 0 to 32767
 Increment: 1
 *RST: 0

Usage: Asynchronous command

Manual operation: See "[Index min](#), [Index max](#)" on page 554

TRIGger<m>:UART:DPTO <DataPositionTo>

Defines the last word of interest, if [TRIGger<m>:UART:DPOperator](#) defines a position range.

Parameters:

<DataPositionTo> Range: 0 to 32767
 Increment: 1
 *RST: 0

Usage: Asynchronous command

Manual operation: See "[Index min](#), [Index max](#)" on page 554

TRIGger<m>:UART:FCONdition <DataOperator>

Selects the operator for the data pattern ([TRIGger<m>:UART:DATA](#)).

Parameters:

<DataOperator> EQUal | NEQual
 *RST: EQUal

Manual operation: See "[Condition](#)" on page 553

TRIGger<m>:UART:DATA <Data>

Specifies the data pattern to be found on the specified trigger source, in binary or hex format. Enter the words in msb first bit order.

Parameters:

<Data> Numeric or string pattern, see [Chapter 27.4.6, "Bit pattern parameter"](#), on page 1373. The string parameter accepts the bit value X (don't care).

Usage: Asynchronous command

Manual operation: See "[Pattern](#)" on page 554

27.18.5.3 Decode results

[BUS<m>:UART:WORD<n>:RXValue?](#)..... 1882
[BUS<m>:UART:WORD<n>:TXValue?](#)..... 1882

BUS<m>:UART:WORD<n>:BITRate?	1882
BUS<m>:UART:WORD<n>:COUNT?	1882
BUS<m>:UART:WORD<n>:SOURCE?	1883
BUS<m>:UART:WORD<n>:START?	1883
BUS<m>:UART:WORD<n>:STATE?	1883

BUS<m>:UART:WORD<n>:RXValue?**BUS<m>:UART:WORD<n>:TXValue?**

Returns the value of the specified word on the Rx line or Tx line, respectively.

Suffix:

<m>	1..4 Selects the serial bus.
<n>	* Selects the word.

Return values:

<Value> To set the value format, use [FORMat:BPATtern](#).
The stated values for range, increment and reset are decimal values.

Range: 0 to 511
*RST: 0

Usage: Query only

BUS<m>:UART:WORD<n>:BITRate?

Returns the primary bit rate.

Suffix:

<m>	1..4 Selects the serial bus.
<n>	* The suffix is irrelevant.

Return values:

<PrimaryBitRate> Range: 0 to 100000000000
Increment: 1
*RST: 0
Default unit: bps

Usage: Query only

BUS<m>:UART:WORD<n>:COUNT?

Returns the number of words in the acquisition.

Suffix:

<m>	1..4 Selects the serial bus.
-----	---------------------------------

<n> *
The suffix is irrelevant.

Return values:

<Count> Number of words

Usage: Query only

BUS<m>:UART:WORD<n>:SOURce?

Returns the line on which the specified word was transferred.

Suffix:

<m> 1..4
Selects the serial bus.

<n> *
Selects the word.

Return values:

<WordSource> TX | RX
*RST: TX

Usage: Query only

BUS<m>:UART:WORD<n>:STARt?

Returns the start time of the specified word.

Suffix:

<m> 1..4
Selects the serial bus.

<n> *
Selects the word.

Return values:

<WordStart> Range: -100E+24 to 100E+24
*RST: 0
Default unit: s

Usage: Query only

BUS<m>:UART:WORD<n>:STATe?

Returns the status of the specified word.

Suffix:

<m> 1..4
Selects the serial bus.

<n>	*
	Selects the word.
Return values:	
<WordState>	OK FRStart FRENd FRME BREak STERror SPERror PRERror INSufficient
	OK: the frame is valid.
	BREak:stop bit error with 0x00 word
	STERror: StarT ERror, incorrect start bit
	SPERror: StoP ERror, incorrect stop bit
	PRERror:PaRity ERror, incorrect parity bit.
	INSufficient: The frame is not completely contained in the acquisition. The acquired part of the frame is valid.
	*RST: OK
Usage:	Query only

27.18.6 Audio signals (option R&S RTO6-K510)

- [Configuration](#)..... 1884
- [Trigger](#)..... 1891
- [Decode results](#)..... 1895
- [Track and trend](#)..... 1897

27.18.6.1 Configuration

BUS<m>:I2S:AVARiant	1884
BUS<m>:I2S:CLOCK:SOURce	1885
BUS<m>:I2S:CLOCK:POLarity	1885
BUS<m>:I2S:WSElect:SOURce	1886
BUS<m>:I2S:WSElect:POLarity	1886
BUS<m>:I2S:DATA:SOURce	1886
BUS<m>:I2S:DATA:POLarity	1887
BUS<m>:I2S:TCoupling	1887
BUS<m>:I2S:CLOCK:THReshold	1887
BUS<m>:I2S:WSElect:THReshold	1888
BUS<m>:I2S:DATA:THReshold	1888
BUS<m>:I2S:CHANnel:ORDer	1888
BUS<m>:I2S:WLENgth	1889
BUS<m>:I2S:BORDer	1889
BUS<m>:I2S:CHANnel:OFFSet	1889
BUS<m>:I2S:CHANnel:TDMCount	1890
BUS<m>:I2S:FOFFset	1890
BUS<m>:I2S:CHANnel:LENgth	1890

BUS<m>:I2S:AVARiant <AudioVariant>

Selects the audio signal type.

For details, see [Chapter 14.5.2.1, "Audio signal configuration"](#), on page 558.

Suffix:

<m> 1..4
Selects the serial bus.

Parameters:

<AudioVariant> I2S | LJ | RJ | TDM
I2S: Inter-IC Sound standard audio format.
LJ: left-justified data format
RJ: right-justified data format
TDM: Time Division Multiplexed audio format
*RST: I2S

Manual operation: See ["Audio Variant"](#) on page 559

BUS<m>:I2S:CLOCK:SOURce <ClockSource>

Selects the source of the clock line.

Suffix:

<m> 1..4
Selects the serial bus.

Parameters:

<ClockSource> C1W1 | C2W1 | C3W1 | C4W1 | M1 | M2 | M3 | M4 | M5 | M6 |
M7 | M8 | R1 | R2 | R3 | R4 | D0 | D1 | D2 | D3 | D4 | D5 | D6 |
D7 | D8 | D9 | D10 | D11 | D12 | D13 | D14 | D15
Digital channels require installation of R&S RTO6-B1. Digital
and analog channels cannot be used at the same time. For trig-
gering on a serial bus, analog or digital input channels are
required.
*RST: C1W1

Manual operation: See ["SCLK"](#) on page 560

BUS<m>:I2S:CLOCK:POLarity <BitClockEdge>

Sets the polarity of the clock signal, that is the edge at which the instrument samples the data on the data line.

Suffix:

<m> 1..4
Selects the serial bus.

Parameters:

<BitClockEdge> FALLing | RISing
*RST: RISing

Manual operation: See ["SCLK Polarity"](#) on page 560

BUS<m>:I2S:WSElect:SOURce <WSsource>

Selects the source of the word select line for I²S standard, left- und right-justified data formats, or the source of the frame synchronization pulse for TDM audio signals.

Suffix:

<m> 1..4
Selects the serial bus.

Parameters:

<WSsource> C1W1 | C2W1 | C3W1 | C4W1 | M1 | M2 | M3 | M4 | M5 | M6 | M7 | M8 | R1 | R2 | R3 | R4 | D0 | D1 | D2 | D3 | D4 | D5 | D6 | D7 | D8 | D9 | D10 | D11 | D12 | D13 | D14 | D15

Digital channels require installation of R&S RTO6-B1. Digital and analog channels cannot be used at the same time. For triggering on a serial bus, analog or digital input channels are required.

*RST: C2W1

Manual operation: See "[WS / FSYNC](#)" on page 560

BUS<m>:I2S:WSElect:POLarity <WSPolarity>

For a word select line, the polarity defines the signal values assigned to the left and right channels.

For an FSYNC line (TDM), the polarity defines the edge of the FSYNC pulse that identifies the beginning of a frame.

Suffix:

<m> 1..4
Selects the serial bus.

Parameters:

<WSPolarity> NORMal | INVert
NORMal: 0 = left, 1 = right channel; or rising edge for TDM
INVert: 1= left, 0 = right channel; or falling edge for TDM
*RST: NORMal

Manual operation: See "[WS / FSYNC Polarity](#)" on page 560

BUS<m>:I2S:DATA:SOURce <DataSource>

Selects the source of the audio data line.

Suffix:

<m> 1..4
Selects the serial bus.

Parameters:

<DataSource> C1W1 | C2W1 | C3W1 | C4W1 | M1 | M2 | M3 | M4 | M5 | M6 |
M7 | M8 | R1 | R2 | R3 | R4 | D0 | D1 | D2 | D3 | D4 | D5 | D6 |
D7 | D8 | D9 | D10 | D11 | D12 | D13 | D14 | D15

Digital channels require installation of R&S RTO6-B1. Digital and analog channels cannot be used at the same time. For triggering on a serial bus, analog or digital input channels are required.

*RST: C3W1

Manual operation: See "[SDATA](#)" on page 560

BUS<m>:I2S:DATA:POLarity <SDataPolarity>

Defines the interpretation of high and low signal states on the data line.

Suffix:

<m> 1..4
Selects the serial bus.

Parameters:

<SDataPolarity> ACTLow | ACTHigh
ACTHigh: HIGH = 1 and LOW = 0
ACTLow: HIGH = 0 and LOW = 1
*RST: ACTHigh

Manual operation: See "[SDATA Polarity](#)" on page 561

BUS<m>:I2S:TCOupling <Coupling>

Sets all thresholds to the value of the clock threshold [BUS<m>:I2S:CLOCK:THReshold](#).

Suffix:

<m> 1..4
Selects the serial bus.

Parameters:

<Coupling> ON | OFF
*RST: ON

Manual operation: See "[Threshold setup](#)" on page 561

BUS<m>:I2S:CLOCK:THReshold <SCLKThreshold>

Sets the threshold value for the clock line SCLK.

If [BUS<m>:I2S:TCOupling](#) is ON, the command sets the threshold for all lines.

Suffix:

<m> 1..4
Selects the serial bus.

Parameters:

<SCLKThreshold> Range: -10 to 10
 Increment: 1E-3
 *RST: 1.6
 Default unit: V

Manual operation: See "[Threshold setup](#)" on page 561

BUS<m>:I2S:WSElect:THReshold <WSThreshold>

Sets the threshold value for the word select and FSYNC lines.

Suffix:

<m> 1..4
 Selects the serial bus.

Parameters:

<WSThreshold> Range: -10 to 10
 Increment: 1E-3
 *RST: 1.6
 Default unit: V

Manual operation: See "[Threshold setup](#)" on page 561

BUS<m>:I2S:DATA:THReshold <SDATAThreshold>

Sets the threshold value for the data line.

Suffix:

<m> 1..4
 Selects the serial bus.

Parameters:

<SDATAThreshold> Range: -10 to 10
 Increment: 1E-3
 *RST: 1.6
 Default unit: V

Manual operation: See "[Threshold setup](#)" on page 561

BUS<m>:I2S:CHANnel:ORDer <ChannelOrder>

Defines if the left or the right channel is the first channel in the frame.

The setting is not available for TDM audio signals.

Suffix:

<m> 1..4
 Selects the serial bus.

Manual operation: See ["Channel offset"](#) on page 563

BUS<m>:I2S:CHANnel:TDMCount <ChannelsTDM>

Sets the number of channels transmitted on the TDM audio line.

Suffix:

<m> 1..4
Selects the serial bus.

Parameters:

<ChannelsTDM> Range: 1 to 8
Increment: 1
*RST: 1

Manual operation: See ["Number of channels"](#) on page 563

BUS<m>:I2S:FOFFset <FrameOffsetTDM>

Sets the number of bits between the frame start and the start of the first channel of a TDM audio line. Each FSYNC edge restarts the offset count.

Suffix:

<m> 1..4
Selects the serial bus.

Parameters:

<FrameOffsetTDM> Range: 0 to 256
Increment: 1
*RST: 0
Default unit: bit

Manual operation: See ["Frame offset"](#) on page 563

BUS<m>:I2S:CHANnel:LENGth <ChlGthTDM>

Sets the number of bits in a TDM channel block.

Suffix:

<m> 1..4
Selects the serial bus.

Parameters:

<ChlGthTDM> Range: 4 to 32
Increment: 4
*RST: 8
Default unit: bit

Manual operation: See ["Channel length"](#) on page 563

27.18.6.2 Trigger

The trigger suffix <m> is always 1 and can be omitted. It selects the trigger event: Only the A-trigger is available for triggering on serial buses.

To trigger on a serial bus, make sure that:

- `TRIGger<m>:SOURce[:SElect]` is set to `SBUS`.
- The sources of the serial bus are channel signals: use `BUS<m>:...:SOURce` commands.
- Decoding is enabled: `BUS<m>[:STATe]` is set to `ON`.

<code>TRIGger<m>:I2S:TYPE</code>	1891
<code>TRIGger<m>:I2S:TCONdition<n>:CHANnel</code>	1892
<code>TRIGger<m>:I2S:TCONdition<n>:CONDtion</code>	1893
<code>TRIGger<m>:I2S:TCONdition<n>:DMIN</code>	1893
<code>TRIGger<m>:I2S:TCONdition<n>:DMAX</code>	1894
<code>TRIGger<m>:I2S:SOWords</code>	1894
<code>TRIGger<m>:I2S:WSSLope</code>	1894

`TRIGger<m>:I2S:TYPE <Type>`

Selects the trigger type for audio signal analysis.

Parameters:

<Type>

DATA | WINDow | CONDition | WSElect | ECONdition

DATA

Triggers on a data word or data range on a specified channel or on any channel.

To set the channel, use `TRIGger<m>:I2S:TCONdition<n>:CHANnel`.

To set the data condition, use:

`TRIGger<m>:I2S:TCONdition<n>:CONDtion`,
`TRIGger<m>:I2S:TCONdition<n>:DMIN` and `TRIGger<m>:I2S:TCONdition<n>:DMAX`.

WINDow

Triggers if the decoded data values stay inside a "window" that is formed by a data range and a time specified by a number of subsequent words. It considers a selected channel or all channels.

To set up a window trigger, you define the channel and data condition in the same way as for DATA trigger type. Additionally, you set the time limit with `TRIGger<m>:I2S:SOWords`.

CONDition

The frame condition trigger sets the trigger on an AND combination of data conditions on different channels. The instrument triggers if all conditions are met inside one frame.

To set up a CONDition trigger, you define up to four channel and data conditions in the same way as for DATA trigger type.

WSElect

WordSElect: Triggers on the selected edge of the WS line (I²S standard, left- and right-justified). For TDM signals, it triggers on the selected edge of the FSYNC line. Set the edge with

[TRIGger<m>:I2S:WSSLoPe](#).

ECONdition

ErrorCONdition: Triggers on irregularities between the WS or FSYNC edges.

*RST: DATA

Usage: Asynchronous command

Manual operation: See "[Type](#)" on page 565

TRIGger<m>:I2S:TCONdition<n>:CHANnel <Channel>

Selects the audio channel on which the instrument looks for the specified data condition.

Suffix:

<n> 1..4
 1 if trigger type is DATA or WINDow
 Specifies the condition number if trigger type is CONdition:
 – 1 | 2 for I²S standard, left- und right-justified data formats
 – 1 | 2 | 3 | 4 for TDM signals

Parameters:

<Channel> ANY | TDMC1 | TDMCh1 | TDMC2 | TDMCh2 | TDMC3 | TDMCh3 | TDMC4 | TDMCh4 | TDMC5 | TDMCh5 | TDMC6 | TDMCh6 | TDMC7 | TDMCh7 | TDMC8 | TDMCh8 | LEFT | RIGHT | RIGHT

ANY

The instrument triggers on any channel on which the specified data is found.

LEFT | RIGHT = RIGHT

Available for I²S Standard, left- und right-justified data formats.

TDMCh1 | TDMCh2 | TDMCh3 | TDMCh4 | TDMCh5 | TDMCh6 | TDMCh7 | TDMCh8

Available for TDM audio signals

TDMC1 = TDMCh1, TDMC2 = TDMCh2, TDMC3 = TDMCh3, TDMC4 = TDMCh4, TDMC5 = TDMCh5, TDMC6 = TDMCh6, TDMC7 = TDMCh7, TDMC8 = TDMCh8. Query returns short form.

Note: Available audio channels depend on the configuration of the audio bus. The command [BUS<m>:I2S:CHANnel:TDMCount](#) specifies the number of channels in a TDM frame.

*RST: ANY

Manual operation: See "[Channel](#)" on page 566

TRIGger<m>:I2S:TCONdition<n>:CONDtion <DataCondition>

Sets the operator to set a specific data pattern or a data pattern range.

Suffix:

<n> 1..4
 1 if trigger type is DATA or WINDow
 Specifies the condition number if trigger type is CONDition:
 – 1 | 2 for I²S standard, left- und right-justified data formats
 – 1 | 2 | 3 | 4 for TDM signals

Parameters:

<DataCondition> OFF | ANY | EQUal | NEQual | LTHan | LETHan | GTHan |
 GETHan | INRange | OORange

OFF = ANY

No range is defined.

EQUal | NEQual | LTHan | LETHan | GTHan | GETHan

Equal, Not equal, Less than, Less or equal than, Greater Than, Greater or equal than. These conditions require one data pattern to be set with [TRIGger<m>:I2S:TCONdition<n>:DMIN](#).

INRange | OORange

In range, Out of range: Set the minimum and maximum value of the range with [TRIGger<m>:I2S:TCONdition<n>:DMIN](#) and [TRIGger<m>:I2S:TCONdition<n>:DMAX](#).

*RST: OFF

Manual operation: See "[Data condition](#)" on page 566

TRIGger<m>:I2S:TCONdition<n>:DMIN <DataMinPattern>

Specifies a data pattern, or sets the the start value of a data pattern range.

Suffix:

<n> 1..4
 1 if trigger type is DATA or WINDow
 Specifies the condition number if trigger type is CONDition:
 – 1 | 2 for I²S standard, left- und right-justified data formats
 – 1 | 2 | 3 | 4 for TDM signals

Parameters:

<DataMinPattern> Numeric pattern in 2's complement format. See also: [Chapter 27.4.6, "Bit pattern parameter"](#), on page 1373
 X bits are not allowed. If the bit string is shorter than the word length, the rightmost bit of the input bit string is aligned to the rightmost (LSB) bit of the word.

Manual operation: See "[Data condition](#)" on page 566

TRIGger<m>:I2S:TCONdition<n>:DMax <DataMaxPattern>

Sets the the end value of an data range if the operator [TRIGger<m>:I2S:TCONdition<n>:CONDtion](#) is set to [INRange](#) or [OORange](#).

Suffix:

<n> 1..4
 1 if trigger type is DATA or WINDow
 Specifies the condition number if trigger type is CONDition:
 – 1 | 2 for I²S standard, left- und right-justified data formats
 – 1 | 2 | 3 | 4 for TDM signals

Parameters:

<DataMaxPattern> Numeric pattern in 2's complement format. See also: [Chapter 27.4.6, "Bit pattern parameter"](#), on page 1373
 DMAX must be greater or equal than DMIN.
 X bits are not allowed. If the bit string is shorter than the word length, the rightmost bit of the input bit string is aligned to the rightmost (LSB) bit of the word.

Manual operation: See "[Data condition](#)" on page 566

TRIGger<m>:I2S:SOWords <SequenceOfWords>

Sets the number of words that is used as time limit for the "Window" trigger type. The instrument triggers if the data condition is fulfilled on the same channel for the given number of subsequent frames.

Parameters:

<SequenceOfWords> Range: 1 to 1000000
 Increment: 1
 *RST: 1
 Default unit: word

Usage: Asynchronous command

Manual operation: See "[Window length](#)" on page 567

TRIGger<m>:I2S:WSSlope <WSSlope>

Sets the edge of the WS or FSYNC signal as trigger condition. The instrument triggers on the first clock edge after the specified edge.

Parameters:

<WSSlope> POSitive | NEGative
 *RST: POSitive

Usage: Asynchronous command

Manual operation: See "[Word select: Slope](#)" on page 567

27.18.6.3 Decode results

BUS<m>:I2S:FCOunt?	1895
BUS<m>:I2S:FRAMe<n>:STATe?	1895
BUS<m>:I2S:FRAMe<n>:START?	1895
BUS<m>:I2S:FRAMe<n>:STOP?	1895
BUS<m>:I2S:FRAMe<n>:LEFT:VALue?	1896
BUS<m>:I2S:FRAMe<n>:RIGHT:VALue?	1896
BUS<m>:I2S:FRAMe<n>:LEFT:STATe?	1896
BUS<m>:I2S:FRAMe<n>:RIGHT:STATe?	1896
BUS<m>:I2S:FRAMe<n>:TDM<o>:STATe?	1897
BUS<m>:I2S:FRAMe<n>:TDM<o>:VALue?	1897

BUS<m>:I2S:FCOunt?

Returns the number of decoded frames.

Suffix:

<m> 1..4
Selects the serial bus.

Return values:

<Count> Number of decoded audio frames

Usage: Query only

BUS<m>:I2S:FRAMe<n>:STATe?

Returns the overall state of the selected frame.

Suffix:

<m> 1..4
Selects the serial bus.

<n> *
Selects the frame.

Return values:

<FrameState> ERRor | OK | INSufficient
OK: the frame is valid.
ERRor: an error occurred in the frame.
INSufficient: The frame is not completely contained in the acquisition. The acquired part of the frame is valid.

Usage: Query only

BUS<m>:I2S:FRAMe<n>:START?

BUS<m>:I2S:FRAMe<n>:STOP?

Return the start time and stop time of the selected frame.

Suffix:

<m> 1..4
Selects the serial bus.

<n> *
Selects the frame.

Return values:

<Start>, <Stop> Range: -100E+24 to 100E+24
*RST: 0

Usage: Query only

BUS<m>:I2S:FRAMe<n>:LEFT:VALue?**BUS<m>:I2S:FRAMe<n>:RIGHT:VALue?**

Return the data values of the left and right channel, respectively.

Suffix:

<m> 1..4
Selects the serial bus.

<n> *
Selects the frame.

Return values:

<Value> Comma-separated list of values. To set the value format, use [FORMat:BPATtern](#).

Range: 0 to 4294967295
*RST: 0

Usage: Query only

BUS<m>:I2S:FRAMe<n>:LEFT:STATe?**BUS<m>:I2S:FRAMe<n>:RIGHT:STATe?**

Return the status of the left and right channel of the selected frame.

Suffix:

<m> 1..4
Selects the serial bus.

<n> *
Selects the frame.

Return values:

<WordState> ERRor | OK | INSufficient
OK: the channel data is valid.
ERRor: an error occurred in the channel.
INSufficient: the channel is not completely contained in the acquisition.

Usage: Query only

BUS<m>:I2S:FRAMe<n>:TDM<o>:STATe?

Returns the state of the indicated channel of the selected frame.

Suffix:

<m>	1..4 Selects the serial bus.
<n>	* Selects the frame.
<o>	1..8 Selects the TDM channel.

Return values:

<State>	ERRor OK INSufficient OK: the channel data is valid. ERRor: an error occurred in the channel. INSufficient: the channel is not completely contained in the acquisition. *RST: UNDefined
---------	---

Usage: Query only

BUS<m>:I2S:FRAMe<n>:TDM<o>:VALue?

Returns the data value of the indicated TDM channel.

Suffix:

<m>	1..4 Selects the serial bus.
<n>	* Selects the frame.
<o>	1..8 Selects the TDM channel.

Return values:

<Value>	To set the value format, use FORMat:BPATtern on page 1381. The stated values for range, increment and reset are decimal values. Range: 0 to 4294967295 Increment: 1 *RST: 0
---------	---

Usage: Query only

27.18.6.4 Track and trend

BUS<m>:I2S:TRACk:LEFT	1898
BUS<m>:I2S:TRACk:RIGHT	1898
BUS<m>:I2S:TRACk:TD1Ch	1898

BUS<m>:I2S:TRACk:TD2Ch.....	1898
BUS<m>:I2S:TRACk:TD3Ch.....	1898
BUS<m>:I2S:TRACk:TD4Ch.....	1898
BUS<m>:I2S:TRACk:TD5Ch.....	1898
BUS<m>:I2S:TRACk:TD6Ch.....	1898
BUS<m>:I2S:TRACk:TD7Ch.....	1898
BUS<m>:I2S:TRACk:TD8Ch.....	1898
MEASurement<m>:TRACk[:STATe].....	1899
MEASurement<m>:TRACk:DATA:HEADer?.....	1899
MEASurement<m>:TRACk:DATA:STYPe?.....	1899
MEASurement<m>:TRACk:DATA[:VALues]?.....	1899

BUS<m>:I2S:TRACk:LEFT <Left>
BUS<m>:I2S:TRACk:RIGHT <Right>

Enables or disables the track of the indicated channel. The commands are relevant for I²S standard, left-justified and right-justified audio data formats.

Suffix:

<m> 1..4
 Selects the serial bus.

Parameters:

<Left>, <Right> ON | OFF
 *RST: OFF

Manual operation: See "[Show Track Waveform\(s\)](#)" on page 571

BUS<m>:I2S:TRACk:TD1Ch <TDMCh1>
BUS<m>:I2S:TRACk:TD2Ch <TDMCh2>
BUS<m>:I2S:TRACk:TD3Ch <TDMCh3>
BUS<m>:I2S:TRACk:TD4Ch <TDMCh4>
BUS<m>:I2S:TRACk:TD5Ch <TDMCh5>
BUS<m>:I2S:TRACk:TD6Ch <TDMCh6>
BUS<m>:I2S:TRACk:TD7Ch <TDMCh7>
BUS<m>:I2S:TRACk:TD8Ch <TDMCh8>

Enables or disables the track of the indicated channel. The commands are relevant for TDM audio data.

Suffix:

<m> 1..4
 Selects the serial bus.

Parameters:

<TDMChX> ON | OFF
 *RST: OFF

Manual operation: See "[Show Track Waveform\(s\)](#)" on page 571

MEASurement<m>:TRACk[:STATe] <State>

Enables the track functionality and displays the track.

The track functionality requires at least one option, see ["Enable \(Track\)"](#) on page 367.

Suffix:

<m> 1..10
See ["Selection of the measurement group: MEASurement<m>"](#) on page 1583.

Parameters:

<State> ON | OFF
*RST: OFF

Usage: Asynchronous command

Manual operation: See ["Enable \(Track\)"](#) on page 367

MEASurement<m>:TRACk:DATA:HEADer?

Returns the header of the track.

Suffix:

<m> 1..10
See ["Selection of the measurement group: MEASurement<m>"](#) on page 1583.

Usage: Query only

MEASurement<m>:TRACk:DATA:STYPe?

Returns the data type: TRK (track).

Suffix:

<m> 1..10
See ["Selection of the measurement group: MEASurement<m>"](#) on page 1583.

Usage: Query only

MEASurement<m>:TRACk:DATA[:VALues]?

Returns the data of track points for transmission from the instrument to the controlling computer. The data can be used in MATLAB, for example.

To set the export format, use [FORMat \[:DATA \]](#).

Suffix:

<m> 1..10
See ["Selection of the measurement group: MEASurement<m>"](#) on page 1583.

Usage: Query only

27.18.7 Custom: manchester / NRZ (option R&S RTO6-K510)

• Configuration.....	1900
• Trigger.....	1916
• Filter.....	1923
• Decode results.....	1927
• Search settings.....	1933
• Search results.....	1938

27.18.7.1 Configuration

In all `BUS<m>:CMSB` commands, the suffix `<m>` selects the serial bus.

In all `BUS<m>:CMSB:FRAMe<n>` commands, the suffix `<n>` selects a frame number, and the suffix `<o>` selects a cell number.

<code>BUS<m>:CMSB:CODing</code>	1901
<code>BUS<m>:CMSB:MANChester:DATA</code>	1901
<code>BUS<m>:CMSB:MANChester:POLarity</code>	1902
<code>BUS<m>:CMSB:MANChester:THReshold:HIGH</code>	1902
<code>BUS<m>:CMSB:MANChester:THReshold:LOW</code>	1902
<code>BUS<m>:CMSB:MANChester:THReshold:PRESet</code>	1903
<code>BUS<m>:CMSB:MANChester:THReshold:COUPling</code>	1903
<code>BUS<m>:CMSB:MANChester:CPHase</code>	1904
<code>BUS<m>:CMSB:NRZ:CLCK</code>	1904
<code>BUS<m>:CMSB:NRZ:DATA</code>	1904
<code>BUS<m>:CMSB:NRZ:IDLPolarity</code>	1905
<code>BUS<m>:CMSB:NRZ:CPOLarity</code>	1905
<code>BUS<m>:CMSB:NRZ:CPHase</code>	1906
<code>BUS<m>:CMSB:NRZ:ENBLE</code>	1906
<code>BUS<m>:CMSB:NRZ:ENAPolarity</code>	1907
<code>BUS<m>:CMSB:NRZ:POLarity</code>	1907
<code>BUS<m>:CMSB:NRZ:THReshold:CLCK</code>	1907
<code>BUS<m>:CMSB:NRZ:HYSTeresis:CLCK</code>	1907
<code>BUS<m>:CMSB:NRZ:THReshold:DATA</code>	1908
<code>BUS<m>:CMSB:NRZ:HYSTeresis:DATA</code>	1908
<code>BUS<m>:CMSB:NRZ:THReshold:ENBLE</code>	1908
<code>BUS<m>:CMSB:NRZ:HYSTeresis:ENBLE</code>	1909
<code>BUS<m>:CMSB:NRZ:THReshold:PRESet</code>	1909
<code>BUS<m>:CMSB:NRZ:THReshold:COUPling</code>	1909
<code>BUS<m>:CMSB:BITRate:ENABLE</code>	1910
<code>BUS<m>:CMSB:BITRate:VALue</code>	1910
<code>BUS<m>:CMSB:GAPTime:ENABLE</code>	1910
<code>BUS<m>:CMSB:GAPTime:VALue</code>	1911
<code>BUS<m>:CMSB:ADDFrame</code>	1911
<code>BUS<m>:CMSB:FCOunt?</code>	1911
<code>BUS<m>:CMSB:CLR</code>	1912
<code>BUS<m>:CMSB:FRAMe<n>:TYPE</code>	1912
<code>BUS<m>:CMSB:FRAMe<n>:APPend</code>	1912
<code>BUS<m>:CMSB:FRAMe<n>:CCOunt?</code>	1912

BUS<m>:CMSB:FRAMe<n>:CELL<o>:NAME.....	1913
BUS<m>:CMSB:FRAMe<n>:CELL<o>:BITCount.....	1913
BUS<m>:CMSB:FRAMe<n>:CELL<o>:CONDition.....	1913
BUS<m>:CMSB:FRAMe<n>:CELL<o>:FORMat.....	1914
BUS<m>:CMSB:FRAMe<n>:CELL<o>:BITOrder.....	1914
BUS<m>:CMSB:FRAMe<n>:CELL<o>:CRGB.....	1914
BUS<m>:CMSB:EXRBits.....	1915
BUS<m>:CMSB:FRAMe<n>:CELL<o>:CLMN.....	1915
BUS<m>:CMSB:LOAD.....	1916
BUS<m>:CMSB:SAVE.....	1916

BUS<m>:CMSB:CODing <CodingStandard>

Selects the custom serial bus coding standard.

Suffix:

<m> 1..4

Parameters:

<CodingStandard> MANC | MANT | NRZ | NRZU

MANC

Manchester (normal polarity)

MANT

Manchester II (inverted polarity).

Note that some additional subtle differences between MANC and MANT require separate protocols.

NRZ

NRZ (non-return-to-zero), clocked

NRZU

NRZ (non-return-to-zero), unclocked

*RST: MANC

Manual operation: See "[Coding Standard](#)" on page 576

BUS<m>:CMSB:MANChester:DATA <SourceMANData>

Selects the source channel for the data signal. For triggering on a serial bus, analog channels "C1"–"C4" are required. Otherwise, if no serial bus trigger has been selected, permitted source selections include the mathematical channels and the reference channels .

Suffix:

<m> 1..4

Parameters:

<SourceMANData> C1W1 | C2W1 | C3W1 | C4W1 | M1 | M2 | M3 | M4 | M5 | M6 | M7 | M8 | R1 | R2 | R3 | R4

*RST: C1W1

Manual operation: See "[Data Source](#)" on page 577

BUS<m>:CMSB:MANChester:POLarity <PolarityData>

Selects the polarity of the custom serial bus data signal in Manchester coding standards.

Suffix:

<m> 1..4

Parameters:

<PolarityData> NORMAl | INVert

NORMAl

Manchester or Manchester II polarity remains unchanged

INVert

Manchester polarity is inverted and becomes Manchester II polarity, Manchester II polarity is inverted and becomes Manchester polarity

*RST: NORMAl

Manual operation: See "[Data Polarity \(Manchester\)](#)" on page 578

BUS<m>:CMSB:MANChester:THReshold:HIGH <ThresholdUpper>

Sets the upper threshold for data signal digitization in Manchester coding standards.

Suffix:

<m> 1..4

Parameters:

<ThresholdUpper> Range: -25 to 25
Increment: 0.1
*RST: 5
Default unit: V

Manual operation: See "[Set Thresholds](#)" on page 580

BUS<m>:CMSB:MANChester:THReshold:LOW <ThresholdLower>

Sets the lower threshold for data signal digitization in Manchester coding standards.

Suffix:

<m> 1..4

Parameters:

<ThresholdLower> Range: -25 to 25
Increment: 0.1
*RST: -5
Default unit: V

Manual operation: See "[Set Thresholds](#)" on page 580

BUS<m>:CMSB:MANChester:THReshold:PRESet <PresetValue>

Sets the Manchester thresholds to predefined or individually definable voltage levels.

Suffix:

<m> 1..4

Parameters:

<PresetValue> V05 | V2 | V5 | V7 | MANual

V05

Sets the upper threshold to +0.5 V and the lower threshold to -0.5 V

V2

Sets the upper threshold to +2.0 V and the lower threshold to -2.0 V

V5

Sets the upper threshold to +5.0 V and the lower threshold to -5.0 V

V7

Sets the upper threshold to +7.0 V and the lower threshold to -7.0 V

MANual

Allows to set individual threshold voltage levels

*RST: V5

BUS<m>:CMSB:MANChester:THReshold:COUPling <ThresholdCoupling>

Couples the upper and lower threshold values for the Manchester and Manchester II coding standards. The values are coupled to voltages with the same magnitude but opposite sign (positive for the upper threshold and negative for the lower threshold). However, if the upper threshold is set to a negative voltage or the lower threshold is set to a positive voltage, coupling is disabled, and the other voltage (the one that was not actively set) is automatically adjusted, to avoid an upper threshold below the lower one, or a lower threshold above the upper one.

Suffix:

<m> 1..4

Parameters:

<ThresholdCoupling> ON | OFF

ON

Activates coupling of the upper and lower threshold values.

OFF

Disables coupling of the upper and lower threshold values.

*RST: ON

Manual operation: See "[Set Thresholds](#)" on page 580

BUS<m>:CMSB:MANChester:CPHase <ClockPhase>

Selects the phase of the custom serial bus clock signal for the "Manchester" coding standards. For details, see "[Clock Phase \(Manchester\)](#)" on page 578.

Suffix:

<m> 1..4

Parameters:

<ClockPhase> FEDGe | SEDGe

FEDGe

Sets the sampling edge to be on the first edge.

SEdGe

Sets the sampling edge to be on the second edge.

AUTO

Lets the decoder automatically select the method ("First Edge" or "Second Edge") for detecting the sampling edge.

*RST: SEDGe

Manual operation: See "[Clock Phase \(Manchester\)](#)" on page 578

BUS<m>:CMSB:NRZ:CLCK <SourceNRZClock>

Selects the source channel for the clock signal in the NRZ Clocked coding standard.

For triggering on the serial bus when the NRZ clocked coding standard is selected, analog or digital channel sources are required.

Otherwise, if no serial bus trigger has been selected, permitted source selections include the mathematical channels and the reference channels.

Suffix:

<m> 1..4

Parameters:

<SourceNRZClock> NONE | C1W1 | C2W1 | C3W1 | C4W1 | M1 | M2 | M3 | M4 | M5 | M6 | M7 | M8 | R1 | R2 | R3 | R4 | D0 | D1 | D2 | D3 | D4 | D5 | D6 | D7 | D8 | D9 | D10 | D11 | D12 | D13 | D14 | D15

*RST: C2W1

Manual operation: See "[Clock Source](#)" on page 577

BUS<m>:CMSB:NRZ:DATA <SourceNRZData>

Selects the source channel for the data signal in NRZ coding standards.

For triggering on the serial bus when the NRZ clocked coding standard is selected, analog or digital channel sources are required.

For triggering on the serial bus when the NRZ unclocked coding standard is selected, analog channel sources are required.

Otherwise, if no serial bus trigger has been selected, permitted source selections include the mathematical channels and the reference channels.

Suffix:

<m> 1..4

Parameters:

<SourceNRZData> C1W1 | C2W1 | C3W1 | C4W1 | M1 | M2 | M3 | M4 | M5 | M6 | M7 | M8 | R1 | R2 | R3 | R4 | D0 | D1 | D2 | D3 | D4 | D5 | D6 | D7 | D8 | D9 | D10 | D11 | D12 | D13 | D14 | D15
 *RST: C1W1

Manual operation: See ["Data Source"](#) on page 577

BUS<m>:CMSB:NRZ:IDLPolarity <PolarityIdle>

Selects the idle polarity of the custom serial bus data signal (only available for the coding standard "NRZ Unlocked").

Suffix:

<m> 1..4

Parameters:

<PolarityIdle> IDLLow | IDLHigh

IDLLow

Sets the base value of the data bus to be "0". After an idle period, the data signal starts with a low-to-high transition

IDLHigh

Sets the base value of the data bus to be "1". After an idle period, the data signal starts with a high-to-low transition

*RST: IDLLow

Manual operation: See ["Data Idle Polarity \(NRZ Unlocked\)"](#) on page 578

BUS<m>:CMSB:NRZ:CPOLarity <PolarityClock>

Selects the polarity of the clock signal for the coding standard NRZ Clocked.

Suffix:

<m> 1..4

Parameters:

<PolarityClock> IDLLow | IDLHigh

IDLLow

Sets the base value of the clock to be "0", the clock signal starts with a low-to-high transition

IDLHigh

Sets the base value of the clock to be "1", the clock signal starts with a high-to-low transition.

*RST: IDLLow

Manual operation: See ["Clock Polarity \(NRZ Clocked\)"](#) on page 578

BUS<m>:CMSB:NRZ:CPHase <ClockPhase>

Selects the phase of the custom serial bus clock signal for the coding standard "NRZ Clocked", depending on [BUS<m>:CMSB:NRZ:IDLPolarity](#) on page 1905.

Suffix:

<m> 1..4

Parameters:

<ClockPhase> FEDGe | SEDGe

FEDGe

Sets the clocking transaction to be on the first edge:

If Clock Polarity = "IDLLow", data are captured on the clock's rising edge (low-to-high transition) and propagated on a falling edge

If Clock Polarity = "IDLHigh", data are captured on the clock's falling edge (high-to-low transition) and propagated on a rising edge

SEDEGe

Sets the clocking transaction to be on the second edge:

If Clock Polarity = "IDLLow", data are captured on the clock's falling edge (high-to-low transition) and propagated on a rising edge

If Clock Polarity = "IDLHigh", data are captured on the clock's rising edge (low-to-high transition) and propagated on a falling edge

*RST: FEDGe

Manual operation: See "[Clock Phase \(NRZ Clocked\)](#)" on page 579

BUS<m>:CMSB:NRZ:ENBLE <SourceNRZEnable>

Selects the input source for the custom serial bus enable signal.

If an input is chosen, signals will be only decoded while this channel is in the enabled state. This allows you to mark a time when the signal on the selected source is active and when not.

For triggering on a serial bus, analog channels "C1"—"C4" are required. Otherwise, if no serial bus trigger has been selected, permitted source selections include the mathematical channels and the reference channels.

Suffix:

<m> 1..4

Parameters:

<SourceNRZEnable> C1W1 | C2W1 | C3W1 | C4W1 | M1 | M2 | M3 | M4 | M5 | M6 | M7 | M8 | R1 | R2 | R3 | R4 | D0 | D1 | D2 | D3 | D4 | D5 | D6 | D7 | D8 | D9 | D10 | D11 | D12 | D13 | D14 | D15

Manual operation: See "[Enable Source \(NRZ\)](#)" on page 579

BUS<m>:CMSB:NRZ:ENAPolarity <PolarityEnable>

Sets whether the transmitted enable signal is active when the voltage is below the threshold (`ENALow`) or higher than it (`ENAHigh`).

Suffix:

<m> 1..4

Parameters:

<PolarityEnable> `ENALow` | `ENAHigh`
*RST: `ENAHigh`

Manual operation: See "[Enable Polarity \(NRZ\)](#)" on page 579

BUS<m>:CMSB:NRZ:POLarity <PolarityData>

Selects the polarity of the custom serial bus data signal in NRZ coding standards.

Suffix:

<m> 1..4

Parameters:

<PolarityData> `ACTLow` | `ACTHigh`

ACTLow

Active low: the value "1" is represented by a voltage below the threshold

ACTHigh

Active high: the value "1" is represented by a voltage above the threshold

*RST: `ACTHigh`

Manual operation: See "[Data Polarity \(NRZ\)](#)" on page 578

BUS<m>:CMSB:NRZ:THReshold:CLCK <ThresholdClock>

Sets the threshold for the clock signal digitization in the NRZ Clocked coding standard.

Suffix:

<m> 1..4

Parameters:

<ThresholdClock> Range: `-25` to `25`
Increment: `0.1`
*RST: `2`
Default unit: `V`

Manual operation: See "[Set Thresholds](#)" on page 580

BUS<m>:CMSB:NRZ:HYSTeresis:CLCK <HystClock>

Sets the hysteresis size on the clock channel.

Suffix:

<m> 1..4

Parameters:

<HystClock> Range: -25 to 25
 Increment: 0.1
 *RST: 0.1
 Default unit: V

Manual operation: See "[Set Thresholds](#)" on page 580**BUS<m>:CMSB:NRZ:THReshold:DATA <ThresholdData>**

Sets the threshold for the data signal digitization in NRZ coding standards.

Suffix:

<m> 1..4

Parameters:

<ThresholdData> Range: -25 to 25
 Increment: 0.1
 *RST: 2
 Default unit: V

Manual operation: See "[Set Thresholds](#)" on page 580**BUS<m>:CMSB:NRZ:HYSTeresis:DATA <HystData>**

Sets the hysteresis size on the data line channel.

Suffix:

<m> 1..4

Parameters:

<HystData> Range: -25 to 25
 Increment: 0.1
 *RST: 0.1
 Default unit: V

Manual operation: See "[Set Thresholds](#)" on page 580**BUS<m>:CMSB:NRZ:THReshold:ENBLe <ThresholdEnable>**

Sets the threshold for the enable signal digitization in NRZ coding standards.

Suffix:

<m> 1..4

Parameters:

<ThresholdEnable> Range: -25 to 25
 Increment: 0.1
 *RST: 2
 Default unit: V

Manual operation: See ["Set Thresholds"](#) on page 580

BUS<m>:CMSB:NRZ:HYSTerisis:ENBLe <HystEnable>

Sets the hysteresis size on the enable line channel.

Suffix:

<m> 1..4

Parameters:

<HystEnable> Range: -25 to 25
 Increment: 0.1
 *RST: 0.1
 Default unit: V

Manual operation: See ["Set Thresholds"](#) on page 580

BUS<m>:CMSB:NRZ:THReshold:PRESet <PresetValue>

Sets the NRZ thresholds to predefined or individually definable voltage levels.

Suffix:

<m> 1..4

Parameters:

<PresetValue> V05 | V2 | V5 | V7 | MANual

V05

Sets the clock and data threshold to +0.5 V (in case of NRZ
 Unlocked: data threshold, only)

V2

Sets the clock and data threshold to +2.0 V (in case of NRZ
 Unlocked: data threshold, only)

V5

Sets the clock and data threshold to +5.0 V (in case of NRZ
 Unlocked: data threshold, only)

V7

Sets the clock and data threshold to +7.0 V (in case of NRZ
 Unlocked: data threshold, only)

MANual

Allows to set individual threshold voltage levels

*RST: V5

BUS<m>:CMSB:NRZ:THReshold:COUPling <ThresholdCoupling>

Couples the clock and data threshold values for the NRZ Clocked coding standard.
 The values are coupled to the same number.

Suffix:

<m> 1..4

Parameters:

<ThresholdCoupling> ON | OFF

ON

Activates coupling of the NRZ clock and data threshold values.

OFF

Disables coupling of the NRZ clock and data threshold values.

*RST: ON

Manual operation: See "[Set Thresholds](#)" on page 580**BUS<m>:CMSB:BITRate:ENABLE <BitrateEnable>**

Enables the bit rate settings (must always be enabled for the coding standard "NRZ Unclocked", and also for triggering on signals in any coding standard).

Suffix:

<m> 1..4

Parameters:

<BitrateEnable> ON | OFF

ON

Bit rate settings enabled

OFF

Bit rate settings disabled

*RST: OFF

Manual operation: See "[Check bit rate](#)" on page 582**BUS<m>:CMSB:BITRate:VALue <Bitrate>**

Sets the transmission speed setting for the custom serial bus data signal.

Suffix:

<m> 1..4

Parameters:

<Bitrate> Range: 300 to 2E9

Increment: 100E3

*RST: 10E6

Default unit: bps

Manual operation: See "[Bit Rate](#)" on page 582**BUS<m>:CMSB:GAPTime:ENABLE <GapTimeEnable>**

Enables the gap time settings (must always be enabled for the coding standard "NRZ Unclocked", and also for triggering on signals in any coding standard).

Suffix:

<m> 1..4

Parameters:

<GapTimeEnable> ON | OFF
ON
 Gap time settings enabled
OFF
 Gap time settings disabled
 *RST: OFF

Manual operation: See "[Check gap time](#)" on page 582**BUS<m>:CMSB:GAPTime:VALue <MinGapTime>**

Sets a minimum gap time for synchronization.

Suffix:

<m> 1..4

Parameters:

<MinGapTime> Range: 1E-9 to 1
 Increment: 1E-9
 *RST: 10E-6
 Default unit: s

Manual operation: See "[Min gap time](#)" on page 583**BUS<m>:CMSB:ADDFrame**

Creates an empty frame format description and adds it to the end of the frame description list.

Suffix:

<m> 1..4

Usage: Event**Manual operation:** See "[Frames](#)" on page 584**BUS<m>:CMSB:FCOut?**

Returns the number of frames.

Suffix:

<m> 1..4

Return values:

<Count>

Usage: Query only**Manual operation:** See "[Frames](#)" on page 584

BUS<m>:CMSB:CLR

Erases all cells and frames that have been created for a specific custom protocol.

Suffix:

<m> 1..4

Usage: Event

Manual operation: See "[Frames](#)" on page 584

BUS<m>:CMSB:FRAME<n>:TYPE <FrameType>

Enables the user to set a string to describe the frame type, typically according to the applicable protocol standard specifications. (For example, [MDIO \(option R&S RTO6-K540\)](#) defines the frames READ, WRITE, ADDRESS, etc.)

Suffix:

<m> 1..4

<n> *

Parameters:

<FrameType>

Manual operation: See "[Frames](#)" on page 584

BUS<m>:CMSB:FRAME<n>:APPend

Creates an empty cell description and adds it to the end of the active frame description.

Suffix:

<m> 1..4

<n> *

Usage: Event

Manual operation: See "[Field name](#)" on page 585

BUS<m>:CMSB:FRAME<n>:CCOunt?

Returns the number of cells in the specified frame.

Suffix:

<m> 1..4

<n> *

Return values:

<Count>

Usage: Query only

Manual operation: See "[Field name](#)" on page 585

BUS<m>:CMSB:FRAME<n>:CELL<o>:NAME <CellName>

Enables the user to set a cell name within a frame. Names do not have to be unique, they are just for user support.

Suffix:

<m>	1..4
<n>	*
<o>	*

Parameters:

<CellName>

Manual operation: See ["Field Name"](#) on page 585

BUS<m>:CMSB:FRAME<n>:CELL<o>:BITCount <BitCount>

Sets the bit count of a cell, hence its length. Based upon the lengths of the previous cells, this also defines the position of the cell start and end within a frame.

Suffix:

<m>	1..4
<n>	*
<o>	*

Parameters:

<BitCount> Range: 1 to 64
 Increment: 1
 *RST: 1

Manual operation: See ["Bits"](#) on page 586

BUS<m>:CMSB:FRAME<n>:CELL<o>:CONDition <Condition>

Sets various operators for a cell, to identify, e.g., mandatory values such as a CRC checksum or an ID, that help to identify a frame.

The implemented conditions and functionalities are the "equal" and "array" operators.

The numeric format of the condition needs to be set according to [BUS<m>:CMSB:FRAME<n>:CELL<o>:FORMat](#) on page 1914.

Suffix:

<m>	1..4
<n>	*
<o>	*

Parameters:

<Condition>

Manual operation: See ["Condition"](#) on page 586

BUS<m>:CMSB:FRAME<n>:CELL<o>:FORMat <CellFormat>

Selects the numeric data format for the command [BUS<m>:CMSB:FRAME<n>:CELL<o>:CONDition](#) on page 1913, as well as for the result and honeycomb display.

Suffix:

<m>	1..4
<n>	*
<o>	*

Parameters:

<CellFormat>	DEC HEX OCT BIN
	DEC
	Decimal
	HEX
	Hexadecimal
	OCT
	Octal
	BIN
	Binary
	*RST: BIN

Manual operation: See "[Format](#)" on page 589

BUS<m>:CMSB:FRAME<n>:CELL<o>:BITorder <BitOrder>

Selects in which order the bits of a cell are evaluated, as well as presented in the results table and honeycomb display.

Suffix:

<m>	1..4
<n>	*
<o>	*

Parameters:

<BitOrder>	LSBF MSBF
	LSBF
	Least significant bit first, evaluation starts at the LSB
	MSBF
	Most significant bit first, evaluation starts at the MSB
	*RST: MSBF

Manual operation: See "[Bit Order](#)" on page 590

BUS<m>:CMSB:FRAME<n>:CELL<o>:CRGB <Color>

Selects a cell's color representation in the honeycomb display.

Suffix:

<m> 1..4

<n> *

<o> *

Parameters:

<Color> ARGB value of the color to be used for the table entry.
 ARGB=<Opacity(alpha) value><red value><green value><blue value>, in hexadecimal or decimal format.

Range: 0 to 4294967295

Increment: 1

*RST: 0

Manual operation: See "[Color](#)" on page 590**BUS<m>:CMSB:EXRBits**

Exports the decoded frames as raw bits.

Suffix:

<m> 1..4

Usage: Event**BUS<m>:CMSB:FRAME<n>:CELL<o>:CLMN <Column>**

Selects which cell shall be displayed in which result column of the decode table.

The decode table supports three result columns, which have to be unique for each frame type. For different frame types, though, different result columns can be defined to display unrelated information.

Suffix:

<m> 1..4

<n> *

<o> *

Parameters:

<Column> NONE | COL1 | COL2 | COL3

NONE

The result is not displayed in the decode table.

COL1

The result is displayed in column 1 of the decode table.

COL2

The result is displayed in column 2 of the decode table.

COL3

The result is displayed in column 3 of the decode table.

*RST: NONE

Manual operation: See ["Result"](#) on page 590

BUS<m>:CMSB:LOAD <FileName>

Opens an existing frame description file in xml format. The default path is
 \\Public\Documents\Rohde-Schwarz\RTx\SaveXML

Suffix:

<m> 1..4

Setting parameters:

<FileName>

Usage: Setting only

Manual operation: See ["Open or Save XML File"](#) on page 590

BUS<m>:CMSB:SAVE <FileName>

Saves a created frame description into an xml file ("Save As..."). The default path is
 \\Public\Documents\Rohde-Schwarz\RTx\SaveXML

Suffix:

<m> 1..4

Setting parameters:

<FileName>

Usage: Setting only

Manual operation: See ["Open or Save XML File"](#) on page 590

27.18.7.2 Trigger

The trigger suffix <m> is always 1 and can be omitted. It selects the trigger event: Only the A-trigger is available for triggering on serial buses.

To trigger on a serial bus, make sure that:

- `TRIGger<m>:SOURce[:SElect]` is set to SBUS.
- The sources of the serial bus are channel signals: use `BUS<m>:...:SOURce` commands.
- Decoding is enabled: `BUS<m>[:STATe]` is set to ON.

<code>TRIGger<m>:CMSB:TYPE</code>	1917
<code>TRIGger<m>:CMSB:PATtern</code>	1917
<code>TRIGger<m>:CMSB:ICONdition</code>	1918
<code>TRIGger<m>:CMSB:IMIN</code>	1918
<code>TRIGger<m>:CMSB:IMAX</code>	1918
<code>TRIGger<m>:CMSB:NRZ:WRDLength</code>	1919
<code>TRIGger<m>:CMSB:ADVanced:FRAMe<n>:ENABLE</code>	1919
<code>TRIGger<m>:CMSB:ADVanced:FRENable</code>	1919
<code>TRIGger<m>:CMSB:ADVanced:FRAMe<n>:FLD<o>:ENABLE</code>	1919
<code>TRIGger<m>:CMSB:ADVanced:FIENable</code>	1919

TRIGger<m>:CMSB:ADVanced:FRAMe<n>:FLD<o>:BIT.....	1920
TRIGger<m>:CMSB:ADVanced:BIT.....	1920
TRIGger<m>:CMSB:ADVanced:FRAMe<n>:FLD<o>:DMAX.....	1920
TRIGger<m>:CMSB:ADVanced:DMAX.....	1920
TRIGger<m>:CMSB:ADVanced:FRAMe<n>:FLD<o>:DMIN.....	1920
TRIGger<m>:CMSB:ADVanced:DMIN.....	1920
TRIGger<m>:CMSB:ADVanced:FRAMe<n>:FLD<o>:DOPerator.....	1921
TRIGger<m>:CMSB:ADVanced:DOPerator.....	1921
TRIGger<m>:CMSB:ADVanced:ERRor<n>:ENABle.....	1921
TRIGger<m>:CMSB:ADVanced:ERENable.....	1921
TRIGger<m>:CMSB:ADVanced:FRAMe<n>:FLD<o>:IMAX.....	1922
TRIGger<m>:CMSB:ADVanced:IMAX.....	1922
TRIGger<m>:CMSB:ADVanced:FRAMe<n>:FLD<o>:IMIN.....	1922
TRIGger<m>:CMSB:ADVanced:IMIN.....	1922
TRIGger<m>:CMSB:ADVanced:FRAMe<n>:FLD<o>:IOPerator.....	1922
TRIGger<m>:CMSB:ADVanced:IOPerator.....	1922

TRIGger<m>:CMSB:TYPE <Type>

Selects the trigger type for custom serial bus analysis.

Suffix:

<m> 1..3

Parameters:

<Type> START | PATtern | ADVanced

START

Triggers on the frame start, which is the end of the gap time as specified in [BUS<m>:CMSB:GAPTime:VALue](#) on page 1911

ADVanced

Advanced trigger with `TRIGger:CMSB:ADVanced` commands. Only available if frames are defined.

PATtern

Triggers on a data pattern to be specified in [TRIGger<m>:CMSB:PATtern](#) on page 1917

*RST: START

Manual operation: See "[Type](#)" on page 595

TRIGger<m>:CMSB:PATtern <DataPattern>

Sets the pattern match conditions for a payload data check. The trigger is set to the first occurrence of a matching data bit pattern (which can be freely specified), starting after the minimum gap time ([BUS<m>:CMSB:GAPTime:VALue](#) on page 1911), and after the detected start of the data frame.

Suffix:

<m> 1..3

Parameters:

<DataPattern>

Manual operation: See ["Pattern"](#) on page 596

TRIGger<m>:CMSB:ICONdition <DataIdxOperator>

Sets the operator to set a specific bit index (data position).

Suffix:

<m> 1..3

Parameters:

<DataIdxOperator> EQUal | GETHan | INRange

EQUal

Equal

GETHan

Greater than or equal

INRange

In range

*RST: INRange

Manual operation: See ["Pattern"](#) on page 596

TRIGger<m>:CMSB:IMIN <DataPosition>

Sets the bit index (data position). If [TRIGger<m>:CMSB:ICONdition](#) on page 1918 is set to "INRange", "IMIN" sets the start value of the bit index range.

Suffix:

<m> 1..3

Parameters:

<DataPosition> Range: 0 to 65535

Increment: 1

*RST: 0

Manual operation: See ["Pattern"](#) on page 596

TRIGger<m>:CMSB:IMAX <DataPositionTo>

Sets the end value of the bit index range (data position range), if [TRIGger<m>:CMSB:ICONdition](#) on page 1918 is set to "INRange".

Suffix:

<m> 1..3

Parameters:

<DataPositionTo> Range: 0 to 65535

Increment: 1

*RST: 65535

Manual operation: See ["Pattern"](#) on page 596

TRIGger<m>:CMSB:NRZ:WRDLength <NRZWordLength>

Sets the number of bits in an NRZ Unlocked word.

Suffix:

<m> 1..3

Parameters:

<NRZWordLength> Range: 0 to 31
Increment: 1
*RST: 8

Manual operation: See "[Pattern](#)" on page 596

TRIGger<m>:CMSB:ADVanced:FRAME<n>:ENABLE <Enable>**TRIGger<m>:CMSB:ADVanced:FREnable <Frame>, <Enabler>**

Enables or disables the specific frame to be triggered on.

Suffix:

<m> 1..3
Only 1 = A-trigger, 2 | 3 = not available. Can be omitted.

Setting parameters:

<Frame>

<Enabler> ON | OFF

Example:

```
:TRIGger:CMSB:ADVanced:FREnable "Master" 1
Enables the Master frame.
:TRIGger:CMSB:ADVanced:FRAMe1:ENABLE 1
Enables the 1st frame that you have defined.
```

Usage: Setting only

TRIGger<m>:CMSB:ADVanced:FRAME<n>:FLD<o>:ENABLE <CondEnabler>**TRIGger<m>:CMSB:ADVanced:FIENable <Frame>, <Field>, <Enabler>**

Enables or disables the specific field within the defined frame to be triggered on.

Suffix:

<m> 1..3
Only 1 = A-trigger, 2 | 3 = not available. Can be omitted.

Setting parameters:

<Frame>

<Field>

<Enabler> ON | OFF

Example:

```
:TRIGger:CMSB:ADVanced:FIEN "Master", "CRC", 1
Enables the CRC field of the Master frame.
:TRIGger:CMSB:ADVanced:FRAMe1:FLD3:ENABLE 1
Enables the 3rd field of the 1st frame that you have defined.
```

Usage: Setting only

Manual operation: See "[Field name / Condition / Enable](#)" on page 598

TRIGger<m>:CMSB:ADVanced:FRAME<n>:FLD<o>:BIT <BitState>

TRIGger<m>:CMSB:ADVanced:BIT <Frame>, <Field>, <Bit>

Sets the bit state of a field to be triggered on that only consists of one bit.

Suffix:

<m> 1..3

Only 1 = A-trigger, 2 | 3 = not available. Can be omitted.

Setting parameters:

<Frame>

<Field>

<Bit> ONE | ZERO | DC

ONE

1

ZERO

0

DC

"Do not care" (DC) = X

Usage: Setting only

Manual operation: See "[BitState](#)" on page 599

TRIGger<m>:CMSB:ADVanced:FRAME<n>:FLD<o>:DMAX <DataMax>

TRIGger<m>:CMSB:ADVanced:DMAX <Frame>, <Field>, <Data>

Sets the end value of a data pattern range if [TRIGger<m>:CMSB:ADVanced:DOperator](#) is set to [INRange](#) or [OORange](#).

Suffix:

<m> 1..3

Only 1 = A-trigger, 2 | 3 = not available. Can be omitted.

Setting parameters:

<Frame>

<Field>

<Data>

Usage: Setting only

Manual operation: See "[Data](#)" on page 599

TRIGger<m>:CMSB:ADVanced:FRAME<n>:FLD<o>:DMIN <DataMin>

TRIGger<m>:CMSB:ADVanced:DMIN <Frame>, <Field>, <Data>

Specifies the data pattern, or sets the start value of a data pattern range.

Suffix:

<m> 1..3
Only 1 = A-trigger, 2 | 3 = not available. Can be omitted.

Setting parameters:

<Frame>

<Field>

<Data>

Usage: Setting only

Manual operation: See "[Data](#)" on page 599

TRIGger<m>:CMSB:ADVanced:FRAME<n>:FLD<o>:DOPerator <DataOperator>

TRIGger<m>:CMSB:ADVanced:DOPerator <Frame>, <Field>, <Operator>

Sets the operator for the data pattern.

Suffix:

<m> 1..3
Only 1 = A-trigger, 2 | 3 = not available. Can be omitted.

Setting parameters:

<Frame>

<Field>

<Operator> OFF | ANY | EQUal | NEQual | LTHan | LETHan | GTHan |
GETHan | INRange | OORange

ANY = OFF

The data of the required pattern is not relevant.

EQUal | NEQual | LTHan | LETHan | GTHan | GETHan

This condition requires one endpoint value to be set using

[TRIGger<m>:CMSB:ADVanced:DMIN](#).

INRange | RANGE

This condition requires a range of endpoint values to be set using [TRIGger<m>:CMSB:ADVanced:DMAX](#) and

[TRIGger<m>:CMSB:ADVanced:DMIN](#).

Usage: Setting only

Manual operation: See "[Data](#)" on page 599

TRIGger<m>:CMSB:ADVanced:ERRor<n>:ENABLE <Enable>

TRIGger<m>:CMSB:ADVanced:ERENable <ErrorName>, <Enabler>

Enables triggering on errors. You can search for all error types in parallel.

Suffix:

<m> 1..3

Setting parameters:

<ErrorName>

<Enabler> ON | OFF

Usage: Setting only

Manual operation: See "[Error types: Item name, Enable](#)" on page 598

TRIGger<m>:CMSB:ADVanced:FRAME<n>:FLD<o>:IMAX <IndexMax>

TRIGger<m>:CMSB:ADVanced:IMAX <Frame>, <Field>, <Data>

Sets the end value of an index range if **TRIGger<m>:CMSB:ADVanced:IMAX** is set to INRange or RANGE.

Suffix:

<m> 1..3

Only 1 = A-trigger, 2 | 3 = not available. Can be omitted.

Setting parameters:

<Frame>

<Field>

<Data>

Usage: Setting only

Manual operation: See "[Index](#)" on page 599

TRIGger<m>:CMSB:ADVanced:FRAME<n>:FLD<o>:IMIN <IndexMin>

TRIGger<m>:CMSB:ADVanced:IMIN <Frame>, <Field>, <Data>

Specifies the index, or sets the start value of an index range.

Suffix:

<m> 1..3

Only 1 = A-trigger, 2 | 3 = not available. Can be omitted.

Setting parameters:

<Frame>

<Field>

<Data>

Usage: Setting only

Manual operation: See "[Index](#)" on page 599

TRIGger<m>:CMSB:ADVanced:FRAME<n>:FLD<o>:IOperator <IndexOperator>

TRIGger<m>:CMSB:ADVanced:IOperator <Frame>, <Field>, <Operator>

Sets the operator for the index in the selected field of the selected frame.

Suffix:

<m> Only 1 = A-trigger, 2 | 3 = not available. Can be omitted.

Setting parameters:

<Frame>

<Field>

<Operator> ANY | OFF | EQUal | NEQual | LTHan | LETHan | GTHan |
GETHan | INRange | RANGE

ANY = OFF

The index of the required pattern is not relevant.

EQUal | NEQual | LTHan | LETHan | GTHan | GETHan

This condition requires one endpoint value to be set using
[TRIGger<m>:CMSB:ADVanced:IMIN](#).

INRange | RANGE

This condition requires a range of endpoint values to be set
using [TRIGger<m>:CMSB:ADVanced:IMAX](#) and
[TRIGger<m>:CMSB:ADVanced:IMIN](#).

Usage: Setting only

Manual operation: See "[Index](#)" on page 599

27.18.7.3 Filter

BUS<m>:CMSB:FILTer:ENABle <Enable>

Enables filtering for the custom serial bus.

Suffix:

<m> 1..4

Parameters:

<Enable> ON | OFF
*RST: OFF

Manual operation: See "[Apply Filter](#)" on page 593

BUS<m>:CMSB:FILTer:ERENable <ErrorName>, <Enabler>

Enables filtering on error.

Suffix:

<m> 1..4

Setting parameters:

<ErrorName>
<Enabler> ON | OFF

Usage: Setting only

BUS<m>:CMSB:FILTer:ERRor<n>:ENABle <Enable>

Enables filtering on error. You can filter all error types in parallel.

Suffix:

<m> 1..4

<n> *

Parameters:

<Enable> ON | OFF
*RST: ON

Manual operation: See "[Error types: Item name, Enable](#)" on page 602

BUS<m>:CMSB:FILTer:FRAMe<n>:ENABLE <Enable>

Enables or disables the specific frame to be filtered.

Suffix:

<m> 1..4

<n> *

Parameters:

<Enable> ON | OFF
*RST: OFF

Manual operation: See "[Frame type](#)" on page 601

BUS<m>:CMSB:FILTer:FRENable <Frame>, <Enabler>

Enables or disables the specific frame to be filtered.

Suffix:

<m> 1..4

Setting parameters:

<Frame>
<Enabler> ON | OFF

Usage: Setting only

BUS<m>:CMSB:FILTer:FIENable <Frame>, <Field>, <Enabler>

Enables or disables the specific field within the defined frame to be filtered.

Suffix:

<m> 1..4

Setting parameters:

<Frame>
<Field>
<Enabler> ON | OFF

Usage: Setting only

BUS<m>:CMSB:FILTER:FRAME<n>:FLD<o>:BIT <BitState>

Sets the bit state of a field to be filtered on that only consists of one bit.

Suffix:

<m>	1..4
<n>	*
<o>	*

Parameters:

<BitState>	ONE ZERO DC
*RST:	DC

Manual operation: See ["Bit State"](#) on page 602

BUS<m>:CMSB:FILTER:FRAME<n>:FLD<o>:DMAX <DataMax>

Sets the end value of a data pattern range if [BUS<m>:CMSB:FILTER:FRAME<n>:FLD<o>:DOPerator](#) is set to INRange or OORange.

Suffix:

<m>	1..4
<n>	*
<o>	*

Parameters:

<DataMax>

Manual operation: See ["Data"](#) on page 602

BUS<m>:CMSB:FILTER:FRAME<n>:FLD<o>:DMIN <DataMin>

Specifies the data pattern, or sets the start value of a data pattern range.

Suffix:

<m>	1..4
<n>	*
<o>	*

Parameters:

<DataMin>

Manual operation: See ["Data"](#) on page 602

BUS<m>:CMSB:FILTER:FRAME<n>:FLD<o>:DOPerator <DataOperator>

Sets the operator for the data pattern.

Suffix:

<m>	1..4
-----	------

<n> *

<o> *

Parameters:

<DataOperator> EQUal | NEQual | LTHan | LETHan | GTHan | GETHan |
INRange | OORange
*RST: EQUal

Manual operation: See "[Data](#)" on page 602

BUS<m>:CMSB:FILTer:FRAMe<n>:FLD<o>:ENABLE <CondEnabler>

Enables or disables the specific field within the defined frame to be filtered.

Suffix:

<m> 1..4

<n> *

<o> *

Parameters:

<CondEnabler> ON | OFF
*RST: OFF

Manual operation: See "[Field name / Condition / Enable](#)" on page 602

BUS<m>:CMSB:FILTer:FRAMe<n>:FLD<o>:IMAX <IndexMax>

Sets the end value of an index range if [BUS<m>:CMSB:FILTer:FRAMe<n>:FLD<o>:IOPerator](#) is set to INRange or RANGe.

Suffix:

<m> 1..4

<n> *

<o> *

Parameters:

<IndexMax> Range: 1 to 65534
Increment: 1
*RST: 65534

Manual operation: See "[Index](#)" on page 602

BUS<m>:CMSB:FILTer:FRAMe<n>:FLD<o>:IMIN <IndexMin>

Specifies the index, or sets the start value of an index range.

Suffix:

<m> 1..4

<n> *

<o> *

Parameters:

<IndexMin> Range: 1 to 65534
 Increment: 1
 *RST: 1

Manual operation: See "[Index](#)" on page 602

BUS<m>:CMSB:FILTER:FRAME<n>:FLD<o>:IOPERator <IndexOperator>

Sets the operator for the index in the selected field of the selected frame.

Suffix:

<m> 1..4

<n> *

<o> *

Parameters:

<IndexOperator> EQUal | INRange | RANGE
 *RST: INRange

Manual operation: See "[Index](#)" on page 602

27.18.7.4 Decode results

In all `BUS<m>:CSMB:RESult<n>` commands, the suffix `<m>` selects the serial bus, the suffix `<n>` selects the result number in the decode table, and the suffix `<o>` selects the cell number.

The following is an example for a set of query commands for bus 1 and result 1 is shown in the following, together with examples for outcomes of these queries:

- `:BUS1:CMSB:RCOunt? !5`
- `:BUS1:CMSB:RESult1:STATe? !OK`
- `:BUS1:CMSB:RESult1:START? !-0.0024964177`
- `:BUS1:CMSB:RESult1:STOP? !-0.0024030384`
- `:BUS1:CMSB:RESult1:TYPE? !ff`
- `:BUS1:CMSB:RESult1:CONe? !0b11111111`
- `:BUS1:CMSB:RESult1:CTWO? !0xAA`
- `:BUS1:CMSB:RESult1:CTHR? !0xF590`
- `:BUS1:CMSB:RESult1:CCOunt? !5`
- `:BUS1:CMSB:RESult1:CELL1:STAT? !OK`
- `:BUS1:CMSB:RESult1:CELL1:NAME? !Start Delim`
- `:BUS1:CMSB:RESult1:CELL1:VALue? !101010101HL10HL0`

- :BUS1:CMSB:RESult1:CELL2:STAT? !OK
- :BUS1:CMSB:RESult1:CELL2:NAME? !OP-FF
- :BUS1:CMSB:RESult1:CELL2:VALue? !0b11111111

- :BUS1:CMSB:RESult1:CELL3:STAT? !OK
- :BUS1:CMSB:RESult1:CELL3:NAME? !data
- :BUS1:CMSB:RESult1:CELL3:VALue? !0xAA

- :BUS1:CMSB:RESult1:CELL4:STAT? !OK
- :BUS1:CMSB:RESult1:CELL4:NAME? !CRC
- :BUS1:CMSB:RESult1:CELL4:VALue? !0xF590

- :BUS1:CMSB:RESult1:CELL5:STAT? !OK
- :BUS1:CMSB:RESult1:CELL5:NAME? !End Delim
- :BUS1:CMSB:RESult1:CELL5:VALue? !1HLHL101

To show the results on the screen, use the following commands:

- [BUS<m>:RESult](#) on page 1814

BUS<m>:CMSB:RCOunt?	1928
BUS<m>:CMSB:RESult<n>:STATe?	1929
BUS<m>:CMSB:RESult<n>:START?	1929
BUS<m>:CMSB:RESult<n>:STOP?	1930
BUS<m>:CMSB:RESult<n>:TYPE?	1930
BUS<m>:CMSB:RESult<n>:CONE?	1930
BUS<m>:CMSB:RESult<n>:CTWO?	1930
BUS<m>:CMSB:RESult<n>:CTHRee?	1931
BUS<m>:CMSB:RESult<n>:CCOunt?	1931
BUS<m>:CMSB:RESult<n>:CELL<o>:NAME?	1931
BUS<m>:CMSB:RESult<n>:CELL<o>:START?	1932
BUS<m>:CMSB:RESult<n>:CELL<o>:STOP?	1932
BUS<m>:CMSB:RESult<n>:CELL<o>:STATE?	1932
BUS<m>:CMSB:RESult<n>:CELL<o>:VALue?	1933

BUS<m>:CMSB:RCOunt?

Returns the count number of decoded result frames in a custom serial bus waveform. Basically, this is the maximum result index <n> when querying results by using `BUS<m>:CMSB:RESult<n>:XXX`.

Suffix:

<m> 1..4

Return values:

<Count>

Usage: Query only

BUS<m>:CMSB:RESult<n>:STATe?

Returns the overall state of the frame: either OK or the relevant error condition.
R&S RTO6-K510 marks each frame with a status that indicates whether the decode succeeded or not.

Suffix:

<m> 1..4
<n> *

Return values:

<State> OK | LENGth | UNKNown | INComplete | CRC | PARity

OK

The frame was decoded normally and conforms to the frame description.

LENGth

The length error indicates that the frame ended prematurely, or an array in the frame had too few elements. The amount of bits that the software expected (based upon the user's frame description) was not found before the frame was terminated. This might occur because a new frame synchronized, or a gap appeared between the bits.

UNKNown

Unknown error

INComplete

The frame ended prematurely because it extends past the end of the record.

CRC

Checksum error in cyclic redundancy check (error in data)

PARity

Parity bit error, indicating a transmission error (only available if a parity is configured)

*RST: OK

Usage: Query only

BUS<m>:CMSB:RESult<n>:START?

Returns the start time of the frame.

Suffix:

<m> 1..4
<n> *

Return values:

<Start> Range: -100E+24 to 100E+24
Increment: 100E-12
*RST: 0
Default unit: s

Usage: Query only

BUS<m>:CMSB:RESult<n>:STOP?

Returns the stop time of the frame.

Suffix:

<m> 1..4

<n> *

Return values:

<Stop> Range: -100E+24 to 100E+24
 Increment: 100E-12
 *RST: 0
 Default unit: s

Usage: Query only

BUS<m>:CMSB:RESult<n>:TYPE?

Returns the name of the selected frame (n) from the user defined frame format description, labeled according to [BUS<m>:CMSB:FRAMe<n>:TYPE](#) on page 1912.

Suffix:

<m> 1..4

<n> *

Return values:

<Type>

Usage: Query only

BUS<m>:CMSB:RESult<n>:CONE?

Returns the 1st cell content as specified in the "Result" column of the "Frame Format" specification table.

Suffix:

<m> 1..4

<n> *

Return values:

<Custom1>

Usage: Query only

BUS<m>:CMSB:RESult<n>:CTWO?

Returns the 2nd cell content as specified in the "Result" column of the "Frame Format" specification table.

Suffix:

<m> 1..4

<n> *

Return values:

<Custom2>

Usage: Query only**BUS<m>:CMSB:RESult<n>:CTHRee?**

Returns the 3rd cell content as specified in the "Result" column of the "Frame Format" specification table.

Suffix:

<m> 1..4

<n> *

Return values:

<Custom3>

Usage: Query only**BUS<m>:CMSB:RESult<n>:CCOunt?**

Returns the number of decoded cells in the specified result frame.

Suffix:

<m> 1..4

<n> *

Return values:

<NumWords> Range: 0 to 4294967295
 Increment: 1
 *RST: 0

Usage: Query only**BUS<m>:CMSB:RESult<n>:CELL<o>:NAME?**

Returns the name of the specified cell. Cell names are not necessarily unique.

Suffix:

<m> 1..4

<n> *

<o> *

Return values:

<Name>

Usage: Query only

BUS<m>:CMSB:RESult<n>:CELL<o>:START?

Returns the start time of the selected cell.

Suffix:

<m>	1..4	Selects the serial bus.
<n>	*	
<o>	*	Selects the cell.

Return values:

<Start>	Range: -100E+24 to 100E+24
	Increment: 100E-12
	*RST: 0
	Default unit: s

Usage: Query only

BUS<m>:CMSB:RESult<n>:CELL<o>:STOP?

Returns the end time of the selected cell.

Suffix:

<m>	1..4	Selects the serial bus.
<n>	*	
<o>	*	Selects the cell.

Return values:

<Stop>	Range: -100E+24 to 100E+24
	Increment: 100E-12
	*RST: 0
	Default unit: s

Usage: Query only

BUS<m>:CMSB:RESult<n>:CELL<o>:STATE?

Returns the state of the cell.

Suffix:

<m>	1..4	
<n>	*	
<o>	*	

Return values:

<State>	OK LENGth UNKNown INComplete CRC PARity
---------	---

OK

No error detected

LENGth

The length error indicates that the cell ended prematurely. The amount of bits that the software expected (based upon the user's frame description) was not found before the cell was terminated. This might occur because a new frame synchronized, or a gap appeared between the bits.

UNKNown

Unknown error

INComplete

The cell ended prematurely because it extends past the end of the record.

CRC

Checksum error in cyclic redundancy check (error in data)

PARity

Parity bit error, indicating a transmission error (only available if a parity is configured)

Usage: Query only

BUS<m>:CMSB:RESult<n>:CELL<o>:VALue?

Data content of the specified cell.

Suffix:

<m> 1..4

<n> *

<o> *

Return values:

<Value>

Usage: Query only

27.18.7.5 Search settings

SEARch:TRIGger:CMSB:ERENable.....	1934
SEARch:TRIGger:CMSB:ERRor<m>:ENABLE.....	1934
SEARch:TRIGger:CMSB:FIENable.....	1934
SEARch:TRIGger:CMSB:FRENable.....	1934
SEARch:TRIGger:CMSB:BIT.....	1935
SEARch:TRIGger:CMSB:FRAMe<m>:FLD<n>:BIT.....	1935
SEARch:TRIGger:CMSB:DMAX.....	1935
SEARch:TRIGger:CMSB:FRAMe<m>:FLD<n>:DMAX.....	1935
SEARch:TRIGger:CMSB:DMIN.....	1936
SEARch:TRIGger:CMSB:FRAMe<m>:FLD<n>:DMIN.....	1936
SEARch:TRIGger:CMSB:DOPerator.....	1936
SEARch:TRIGger:CMSB:FRAMe<m>:FLD<n>:DOPerator.....	1936

SEARCh:TRIGger:CMSB:FRAMe<m>:ENABle.....	1937
SEARCh:TRIGger:CMSB:FRAMe<m>:FLD<n>:ENABle.....	1937
SEARCh:TRIGger:CMSB:FRAMe<m>:FLD<n>:IMAX.....	1937
SEARCh:TRIGger:CMSB:IMAX.....	1937
SEARCh:TRIGger:CMSB:FRAMe<m>:FLD<n>:IMIN.....	1937
SEARCh:TRIGger:CMSB:IMIN.....	1937
SEARCh:TRIGger:CMSB:IOPerator.....	1938
SEARCh:TRIGger:CMSB:FRAMe<m>:FLD<n>:IOPerator.....	1938

SEARCh:TRIGger:CMSB:ERENable <SearchName>, <ErrorName>, <Enabler>

SEARCh:TRIGger:CMSB:ERRor<m>:ENABle <SearchName>, <Enable>

SEARCh:TRIGger:CMSB:ERRor<m>:ENABle? <SearchName>

Defines the error type to be searched for. You can search for all error types in parallel.

Suffix:

<m> *

Parameters:

<Enable> ON | OFF

*RST: ON

Parameters for setting and query:

<SearchName>

Manual operation: See "[Frame](#)" on page 604

SEARCh:TRIGger:CMSB:FIENable <SearchName>, <Frame>, <Field>, <Enabler>

Enables or disables the specific field within the defined frame to be searched for.

Setting parameters:

<SearchName>

<Frame>

<Field>

<Enabler> ON | OFF

Usage: Setting only

Manual operation: See "[Frame](#)" on page 604

SEARCh:TRIGger:CMSB:FRENable <SearchName>, <Frame>, <Enabler>

Enables or disables the specific frame to be searched for.

Setting parameters:

<SearchName>

<Frame>

<Enabler> ON | OFF

Usage: Setting only

Manual operation: See "Frame" on page 604

SEARCH:TRIGger:CMSB:BIT <SearchName>,<Frame>, <Field>, <Bit>
SEARCH:TRIGger:CMSB:FRAMe<m>:FLD<n>:BIT <SearchName>,<BitState>
SEARCH:TRIGger:CMSB:FRAMe<m>:FLD<n>:BIT? <SearchName>

Sets the bit state of a field to be searched that only consists of one bit.

Suffix:

<m> *

<n> *

Parameters:

<BitState> ONE | ZERO | DC
ONE
 1
ZERO
 0
DC
 "Do not care" (DC) = X
 *RST: DC

Parameters for setting and query:

<SearchName>

Manual operation: See "Frame" on page 604

SEARCH:TRIGger:CMSB:DMAX <SearchName>,<Frame>, <Field>, <Data>
SEARCH:TRIGger:CMSB:FRAMe<m>:FLD<n>:DMAX <SearchName>,<DataMax>
SEARCH:TRIGger:CMSB:FRAMe<m>:FLD<n>:DMAX? <SearchName>

Sets the end value of a data pattern range if [SEARCH:TRIGger:CMSB:FRAMe<m>:FLD<n>:DOperator](#) is set to INRange or OORange.

Suffix:

<m> *

<n> *

Parameters:

<DataMax> Specifies the name of the generic trigger setting frame.

Parameters for setting and query:

<SearchName>

Manual operation: See "Frame" on page 604

SEARCh:TRIGger:CMSB:DMIN <SearchName>,<Frame>, <Field>, <Data>
SEARCh:TRIGger:CMSB:FRAMe<m>:FLD<n>:DMIN <SearchName>,<DataMin>
SEARCh:TRIGger:CMSB:FRAMe<m>:FLD<n>:DMIN? <SearchName>

Specifies the data pattern to be searched, or sets the start value of a data pattern range to be searched.

Suffix:

<m> *

<n> *

Parameters:

<DataMin> Specifies the name of the generic trigger setting frame.

Parameters for setting and query:

<SearchName>

Manual operation: See "[Frame](#)" on page 604

SEARCh:TRIGger:CMSB:DOPerator <SearchName>,<Frame>, <Field>, <Operator>
SEARCh:TRIGger:CMSB:FRAMe<m>:FLD<n>:DOPerator
 <SearchName>,<DataOperator>

SEARCh:TRIGger:CMSB:FRAMe<m>:FLD<n>:DOPerator? <SearchName>

Sets the operator to set a specific data pattern to be searched in the selected field of the selected frame.

Suffix:

<m> *

<n> *

Parameters:

<DataOperator> EQUal | NEQual | LTHan | LETHan | GTHan | GETHan |
 INRange | OORange

EQUal | NEQual | LTHan | LETHan | GTHan | GETHan

Equal, Not equal, Less than, Less than or equal, Greater than, Greater than or equal. These conditions require one endpoint value to be set using [SEARCh:TRIGger:CMSB:FRAMe<m>:FLD<n>:DMIN](#).

INRange | OORange

In range, out of range. These conditions require a range of endpoint values to be set using [SEARCh:TRIGger:CMSB:FRAMe<m>:FLD<n>:DMIN](#) and [SEARCh:TRIGger:CMSB:FRAMe<m>:FLD<n>:DMAX](#).

*RST: EQUal

Parameters for setting and query:

<SearchName>

Manual operation: See "[Frame](#)" on page 604

SEARCH:TRIGger:CMSB:FRAME<m>:ENABLE <SearchName>,<Enable>

SEARCH:TRIGger:CMSB:FRAME<m>:ENABLE? <SearchName>

SEARCH:TRIGger:CMSB:FRAME<m>:FLD<n>:ENABLE

<SearchName>,<CondEnabler>

SEARCH:TRIGger:CMSB:FRAME<m>:FLD<n>:ENABLE? <SearchName>

Enables or disables the checking condition for searching a specific data pattern in the selected field of the selected frame.

Suffix:

<m> *

<n> *

Parameters:

<CondEnabler> ON | OFF

ON

Checking condition enabled

OFF

Checking condition disabled

*RST: OFF

Parameters for setting and query:

<SearchName>

SEARCH:TRIGger:CMSB:FRAME<m>:FLD<n>:IMAX <SearchName>,<IndexMax>

SEARCH:TRIGger:CMSB:FRAME<m>:FLD<n>:IMAX? <SearchName>

SEARCH:TRIGger:CMSB:IMAX <SearchName>,<Frame>,<Field>,<Data>

Sets the end value of the bit index range (data position range), if [SEARCH:TRIGger:CMSB:IOperator](#) is set to `INRange`.

Setting parameters:

<SearchName>

<Frame>

<Field>

<Data>

Usage: Setting only

Manual operation: See "[Frame](#)" on page 604

SEARCH:TRIGger:CMSB:FRAME<m>:FLD<n>:IMIN <SearchName>,<IndexMin>

SEARCH:TRIGger:CMSB:FRAME<m>:FLD<n>:IMIN? <SearchName>

SEARCH:TRIGger:CMSB:IMIN <SearchName>,<Frame>,<Field>,<Data>

Sets the bit index (data position).

Setting parameters:

<SearchName>

<Frame>

<Field>

<Data>

Usage: Setting only

Manual operation: See "Frame" on page 604

SEARch:TRIGger:CMSB:IOPerator <SearchName>,<Frame>, <Field>, <Operator>

SEARch:TRIGger:CMSB:FRAMe<m>:FLD<n>:IOPerator

<SearchName>,<IndexOperator>

SEARch:TRIGger:CMSB:FRAMe<m>:FLD<n>:IOPerator? <SearchName>

Sets the operator for the index for searching in the selected field of the selected frame.

Suffix:

<m> *

<n> *

Parameters:

<IndexOperator> EQUal | INRange | RANGe

EQUal

This condition requires one endpoint value to be set using
[SEARch:TRIGger:CMSB:FRAMe<m>:FLD<n>:IMIN](#).

INRange | RANGe

This condition requires a range of endpoint values to be set
using [SEARch:TRIGger:CMSB:FRAMe<m>:FLD<n>:IMIN](#) and
[SEARch:TRIGger:CMSB:FRAMe<m>:FLD<n>:IMAX](#).

*RST: INRange

Parameters for setting and query:

<SearchName>

Manual operation: See "Frame" on page 604

27.18.7.6 Search results

SEARch:RESult:CMSB<m>:FCOunt?	1939
SEARch:RESult:CMSB<m>:FRAMe<n>:CCOunt?	1939
SEARch:RESult:CMSB<m>:FRAMe<n>:CELL<o>:NAME?	1939
SEARch:RESult:CMSB<m>:FRAMe<n>:CELL<o>:START?	1940
SEARch:RESult:CMSB<m>:FRAMe<n>:CELL<o>:STATe?	1940
SEARch:RESult:CMSB<m>:FRAMe<n>:CELL<o>:STOP?	1941
SEARch:RESult:CMSB<m>:FRAMe<n>:CELL<o>:VALue?	1941
SEARch:RESult:CMSB<m>:FRAMe<n>:CONE?	1941
SEARch:RESult:CMSB<m>:FRAMe<n>:CTHRee?	1942
SEARch:RESult:CMSB<m>:FRAMe<n>:CTWO?	1942
SEARch:RESult:CMSB<m>:FRAMe<n>:START?	1942
SEARch:RESult:CMSB<m>:FRAMe<n>:STATe?	1943
SEARch:RESult:CMSB<m>:FRAMe<n>:STOP?	1943
SEARch:RESult:CMSB<m>:FRAMe<n>:TYPE?	1944

SEARCh:RESult:CMSB<m>:FCOunt? <SearchName>

Returns the count number of decoded result frames in a custom serial bus waveform. Basically, this is the maximum result index <n> when querying results by using SEARCh:RESult:CMSB<m>:FRAMe<n>:XXX.

Suffix:

<m> *

Query parameters:

<SearchName>

Return values:

<FrameCount> Range: 0 to 100000
 Increment: 1
 *RST: 0

Usage: Query only

SEARCh:RESult:CMSB<m>:FRAMe<n>:CCOunt? <SearchName>

Returns the count number of cell in the frames, within the search result, in a custom serial bus waveform.

Suffix:

<m> *

<n> *

Query parameters:

<SearchName>

Return values:

<NumWords> Range: 0 to 4294967295
 Increment: 1
 *RST: 0

Usage: Query only

SEARCh:RESult:CMSB<m>:FRAMe<n>:CELL<o>:NAME? <SearchName>

Returns the name of the specified cell within the search result. Cell names are not necessarily unique.

Suffix:

<m> *

<n> *

<o> *

Query parameters:

<SearchName>

Return values:

<Name>

Usage: Query only

SEARCh:RESult:CMSB<m>:FRAMe<n>:CELL<o>:STARt? <SearchName>

Returns the start time of the cell within the search result.

Suffix:

<m> *

<n> *

<o> *

Query parameters:

<SearchName>

Return values:

<Start> Range: -100E+24 to 100E+24
 Increment: 100E-12
 *RST: 0
 Default unit: s

Usage: Query only

SEARCh:RESult:CMSB<m>:FRAMe<n>:CELL<o>:STATe? <SearchName>

Returns the state of the cell within the search result.

Suffix:

<m> *

<n> *

<o> *

Query parameters:

<SearchName>

Return values:

<State> OK | LENGth | UNKNown | INComplete | CRC | PARity

OK

No error detected

LENGth

The length error indicates that the cell ended prematurely. The amount of bits that the software expected (based upon the user's frame description) was not found before the cell was terminated. This might occur because a new frame synchronized, or a gap appeared between the bits.

UNKNown

Unknown error

INComplete

The cell ended prematurely because it extends past the end of the record.

CRC

Checksum error in cyclic redundancy check (error in data)

PARity

Parity bit error, indicating a transmission error (only available if a parity is configured)

*RST: OK

Usage: Query only

SEARCh:RESult:CMSB<m>:FRAMe<n>:CELL<o>:STOP? <SearchName>

Returns the stop time of the cell within the search result.

Suffix:

<m> *

<n> *

<o> *

Query parameters:

<SearchName>

Return values:

<Stop> Range: -100E+24 to 100E+24

Increment: 100E-12

*RST: 0

Default unit: s

Usage: Query only

SEARCh:RESult:CMSB<m>:FRAMe<n>:CELL<o>:VALue? <SearchName>

Data content of the specified cell within the search result.

Suffix:

<m> *

<n> *

<o> *

Query parameters:

<SearchName>

Return values:

<Value>

Usage: Query only

SEARCh:RESult:CMSB<m>:FRAMe<n>:CONE? <SearchName>

Returns the 1st field content within the search result.

Suffix:

<m> *

<n> *

Query parameters:

<SearchName>

Return values:

<Custom1>

Usage: Query only**SEARCh:RESult:CMSB<m>:FRAMe<n>:CTHRee? <SearchName>**Returns the 3rd field content.**Suffix:**

<m> *

<n> *

Query parameters:

<SearchName>

Return values:

<Custom3>

Usage: Query only**SEARCh:RESult:CMSB<m>:FRAMe<n>:CTWO? <SearchName>**Returns the 2nd field content.**Suffix:**

<m> *

<n> *

Query parameters:

<SearchName>

Return values:

<Custom2>

Usage: Query only**SEARCh:RESult:CMSB<m>:FRAMe<n>:STARt? <SearchName>**

Returns the start time of the frame within the search result.

Suffix:

<m> *

<n> *

Query parameters:

<SearchName>

Return values:

<Start> Range: -100E+24 to 100E+24
 Increment: 100E-12
 *RST: 0
 Default unit: s

Usage: Query only**SEARch:RESult:CMSB<m>:FRAMe<n>:STATe? <SearchName>**

Returns the overall state of the frame within the search result: either OK or the relevant error condition. R&S RTO6-K510 marks each frame with a status that indicates whether the decode succeeded or not.

Suffix:

<m> *

<n> *

Query parameters:

<SearchName>

Return values:

<State> OK | LENGth | UNKNown | INComplete | CRC | PARity

OK

The frame was decoded normally and conforms to the frame description.

LENGth

The length error indicates that the frame ended prematurely, or an array in the frame had too few elements. The amount of bits that the software expected (based upon the user's frame description) was not found before the frame was terminated. This might occur because a new frame synchronized, or a gap appeared between the bits.

UNKNown

Unknown error

INComplete

The frame ended prematurely because it extends past the end of the record.

CRC

Checksum error in cyclic redundancy check (error in data)

*RST: OK

Usage: Query only**SEARch:RESult:CMSB<m>:FRAMe<n>:STOP? <SearchName>**

Returns the stop time of the frame within the search result.

Suffix:

<m> *

<n> *

Query parameters:

<SearchName>

Return values:

<Stop> Range: -100E+24 to 100E+24
 Increment: 100E-12
 *RST: 0
 Default unit: s

Usage: Query only**SEARch:RESult:CMSB<m>:FRAME<n>:TYPE? <SearchName>**

Returns the name of the selected frame (n) from the user defined frame format description, labeled according to [BUS<m>:CMSB:FRAME<n>:TYPE](#) on page 1912.

Suffix:

<m> *

<n> *

Query parameters:

<SearchName>

Return values:

<Type>

Usage: Query only**27.18.8 CAN (option R&S RTO6-K520)**

• Configuration	1944
• Trigger	1950
• Decode results	1958
• Search settings	1967
• Search results	1977
• Symbolic trigger, decode and search	1983

27.18.8.1 Configuration

BUS<m>:CAN:DATA:SOURce	1945
BUS<m>:CAN:TYPE	1945
BUS<m>:CAN:FDATa:PSTandard	1945
BUS<m>:CAN:DATA:THReshold	1946
BUS<m>:CAN:TECHnology	1946
BUS<m>:CAN:BITRate	1947
BUS<m>:CAN:FDATa:ENABLE	1947

BUS<m>:CAN:FDATa:DBITrate.....	1947
BUS<m>:CAN:FDATa:SAMPlEpoint.....	1948
BUS<m>:CAN:SAMPlEpoint.....	1948
BUS<m>:CAN:FDATa:T1Segment.....	1948
BUS<m>:CAN:T1Segment.....	1948
BUS<m>:CAN:FDATa:T2Segment.....	1949
BUS<m>:CAN:T2Segment.....	1949
BUS<m>:CAN:FDATa:JWIDth.....	1949
BUS<m>:CAN:JWIDth.....	1949

BUS<m>:CAN:DATA:SOURce <DataSource>

Sets the source of the data line that is selected with `BUS<m>:CAN:TYPE`.

Usually, the source is one of the analog channels. Reference and math waveforms are available as source if the trigger source is one of the analog channels but not the serial bus.

Suffix:

<m> 1..4
Selects the serial bus.

Parameters:

<DataSource> C1W1 | C2W1 | C3W1 | C4W1 | M1 | M2 | M3 | M4 | M5 | M6 |
M7 | M8 | R1 | R2 | R3 | R4 | D0 | D1 | D2 | D3 | D4 | D5 | D6 |
D7 | D8 | D9 | D10 | D11 | D12 | D13 | D14 | D15
*RST: C1W1

Usage: Asynchronous command

Manual operation: See "Data" on page 608

BUS<m>:CAN:TYPE <SignalType>

Selects the CAN-High or CAN-Low line. Both lines are required for differential signal transmission used by CAN.

Suffix:

<m> 1..4
Selects the serial bus.

Parameters:

<SignalType> CANH | CANL
*RST: CANL

Manual operation: See "Type" on page 609

BUS<m>:CAN:FDATa:PSTandard <ProtStd>

Only available for CAN FD buses. Selects whether the tested signal is an ISO CAN FD signal or not.

Suffix:

<m> 1..4

Parameters:

<ProtStd> ISO | NISO

ISO

Signals are decoded according to the the ISO CAN FD protocol. This protocol has an additional stuff count field before the CRC sequence.

NISO

Non-ISO. Signals are decoded according to the the Bosch CAN FD protocol.

*RST: ISO

Firmware/software: FW 3.35**Manual operation:** See "[Standard](#)" on page 609**BUS<m>:CAN:DATA:THReshold <Threshold>**

Sets a user-defined threshold value.

Alternatively, you can set the threshold according to the signal technology with [BUS<m>:CAN:TECHnology](#).

Suffix:<m> 1..4
Selects the serial bus.**Parameters:**

<Threshold> Range: -12 to 12
Increment: 0.1
*RST: 0
Default unit: V

Manual operation: See "[Threshold](#)" on page 609**BUS<m>:CAN:TECHnology <Technology>**

Sets the threshold voltage as defined for various signal technologies.

Suffix:<m> 1..4
Selects the serial bus.**Parameters:**

<Technology> V25 | V3 | V2 | V0 | MANual
V25
2.5 Volt (CMOS 5.0 V)
V3
3.0 Volt (CAN_H HS / CAN_L LS)

V2

2.0 Volt (CAN_L HS / CAN_H LS)

V0

Ground

MANualManual setting of user-defined values with `BUS<m>:CAN:DATA:THReshold`.

*RST: V25

Manual operation: See ["Threshold"](#) on page 609**BUS<m>:CAN:BITRate <Bitrate>**

For CAN buses, the "Bit rate" sets the number of transmitted bits per second.

For CAN FD buses, this parameter is called "Arbitration rate" and sets the bit rate of the arbitration phase.

The maximum bit rate for High Speed CAN is 1 Mbit/s. The bit rate is uniform and fixed for a given CAN or CAN FD bus.

Suffix:

<m>	1..4
	Selects the serial bus.

Parameters:

<Bitrate>	Range: 100 to 5E+6
	Increment: 1
	*RST: 100E+3
	Default unit: bps

Manual operation: See ["Bit rate \(CAN\) / Arbitration rate \(CAN FD\)"](#) on page 610**BUS<m>:CAN:FDATa:ENABLE <CANFDEnabled>**

Enables the CAN FD protocol configuration.

Suffix:

<m>	1..4
-----	------

Parameters:

<CANFDEnabled>	ON OFF
	*RST: ON

Manual operation: See ["CAN-FD"](#) on page 609**BUS<m>:CAN:FDATa:DBITrate <FlexDatBitrate>**

Sets the bit rate of the data phase. The data rate can be higher than the arbitration rate, but it is uniform and fixed for a given CAN FD bus.

Suffix:

<m> 1..4

Parameters:

<FlexDatBitrate> Range: 100 to 15E+6
 Increment: 1
 *RST: 1E+6
 Default unit: bps

Manual operation: See ["Data rate"](#) on page 610**BUS<m>:CAN:FDATa:SAMPlEpoint** <FlexDatSmpPt>**BUS<m>:CAN:SAMPlEpoint** <SamplePoint>

Sets the position of the sample point within the bit in percent of the nominal bit time.

Alternatively, you can set the sample point with [BUS<m>:CAN:T1Segment](#) and [BUS<m>:CAN:T2Segment](#).For CAN FD signals, [BUS<m>:CAN:SAMPlEpoint](#) defines the synchronization of the arbitration phase, and [BUS<m>:CAN:FDATa:SAMPlEpoint](#) defines the synchronization of the data phase.**Suffix:**<m> 1..4
Selects the serial bus.**Parameters:**

<FlexDatSmpPt> Range: 12 to 96 if number of segments is 24. The range
 <SamplePoint> reduces if the signal has fewer segments.
 Increment: 5
 *RST: 66
 Default unit: %

Manual operation: See ["Sample point"](#) on page 612**BUS<m>:CAN:FDATa:T1Segment** <FlexDatTimeSeg1>**BUS<m>:CAN:T1Segment** <TimeSeg1>

Sets the number of time quanta before the sample point (T1Segment). T1Segment comprises the segments Synch_seg, Prop_seg, and Phase_seg1 which are specified in the CAN standard.

Make sure to set also [BUS<m>:CAN:T2Segment](#) for correct definition of the sample point. Alternatively, you can use [BUS<m>:CAN:SAMPlEpoint](#).See also: [Chapter 14.7.2.2, "Advanced settings"](#), on page 610For CAN FD signals, [BUS<m>:CAN:T1Segment](#) defines the synchronization of the arbitration phase, and [BUS<m>:CAN:FDATa:T1Segment](#) defines the synchronization of the data phase.**Suffix:**

<m> 1..4

Parameters:

<FlexDatTimeSeg1> Time quanta
 <TimeSeg1> Range: 3 to 23
 Increment: 1
 *RST: 6.6

Manual operation: See "[Time segment1](#), [Time segment2](#)" on page 612

BUS<m>:CAN:FDATa:T2Segment <FlexDatTimeSeg2>

BUS<m>:CAN:T2Segment <TimeSeg2>

Sets the number of time quanta after the sample point (T2Segment). T2Segment matches Phase_seg2 specified in the CAN standard.

Make sure to set also [BUS<m>:CAN:T1Segment](#) on page 1948 for correct definition of the sample point. Alternatively, you can use [BUS<m>:CAN:SAMPlepoint](#).

See also: [Chapter 14.7.2.2, "Advanced settings"](#), on page 610

For CAN FD signals, [BUS<m>:CAN:T2Segment](#) defines the synchronization of the arbitration phase, and [BUS<m>:CAN:FDATa:T2Segment](#) defines the synchronization of the data phase.

Suffix:

<m> 1..4
 Selects the serial bus.

Parameters:

<FlexDatTimeSeg2> Time quanta
 <TimeSeg2> Range: 1 to 21
 Increment: 1
 *RST: 3.4

Manual operation: See "[Time segment1](#), [Time segment2](#)" on page 612

BUS<m>:CAN:FDATa:JWIDth <FlexDatJumpWdt>

BUS<m>:CAN:JWIDth <JumpWidth>

Defines the maximum number of time quanta for phase correction. Time segment1 may be lengthened or Time segment2 may be shortened due to resynchronization. Resynchronization corrects the phase error of an edge caused by the drift of the oscillators.

For CAN FD signals, this setting defines the synchronization of the arbitration phase.

Suffix:

<m> 1..4
 Selects the serial bus.

Parameters:

<JumpWidth>	Time quanta
Range:	1 to 4, available maximum depends on the number of segments and the sample point
Increment:	1
*RST:	1

Manual operation: See "[Jump width](#)" on page 612

27.18.8.2 Trigger

The trigger suffix <m> is always 1 and can be omitted. It selects the trigger event: Only the A-trigger is available for triggering on serial buses.

To trigger on a serial bus, make sure that:

- `TRIGger<m>:SOURce[:SELEct]` is set to `SBUS`.
- The sources of the serial bus are channel signals: use `BUS<m>:...:SOURce` commands.
- Decoding is enabled: `BUS<m>[:STATe]` is set to `ON`.

<code>TRIGger<m>:CAN:TYPE</code>	1950
<code>TRIGger<m>:CAN:FDATa:STANdard</code>	1951
<code>TRIGger<m>:CAN:FTYPE</code>	1952
<code>TRIGger<m>:CAN:ITYPe</code>	1952
<code>TRIGger<m>:CAN:ICONdition</code>	1952
<code>TRIGger<m>:CAN:IMIN</code>	1953
<code>TRIGger<m>:CAN:IMAX</code>	1953
<code>TRIGger<m>:CAN:FDATa:FDF</code>	1953
<code>TRIGger<m>:CAN:FDATa:BRS</code>	1954
<code>TRIGger<m>:CAN:FDATa:ESI</code>	1954
<code>TRIGger<m>:CAN:DCONdition</code>	1954
<code>TRIGger<m>:CAN:DMIN</code>	1954
<code>TRIGger<m>:CAN:DMAX</code>	1955
<code>TRIGger<m>:CAN:BORDer</code>	1955
<code>TRIGger<m>:CAN:DLCCONdition</code>	1955
<code>TRIGger<m>:CAN:DLC</code>	1956
<code>TRIGger<m>:CAN:NDBYtes?</code>	1956
<code>TRIGger<m>:CAN:FDATa:DPOPerator</code>	1956
<code>TRIGger<m>:CAN:FDATa:DPOSitioN</code>	1957
<code>TRIGger<m>:CAN:FDATa:DPTO</code>	1957
<code>TRIGger<m>:CAN:ACKerror</code>	1957
<code>TRIGger<m>:CAN:BITSterror</code>	1957
<code>TRIGger<m>:CAN:CRCError</code>	1958
<code>TRIGger<m>:CAN:FORMerror</code>	1958
<code>TRIGger<m>:CAN:FDATa:SCERror</code>	1958

TRIGger<m>:CAN:TYPE <Type>

Selects the trigger type for CAN analysis.

See: "[Trigger type](#)" on page 615.

Parameters:

<Type>

STOF | FTYP | ID | IDDT | ERRC

STOF

STart Of Frame: triggers on the first edge of the dominant SOF bit (synchronization bit).

FTYP

Frame TYPE: triggers on a specified frame type (data, remote, error, or overload) and on the identifier format.

To set the frame type, use `TRIGger<m>:CAN:FTYPE`. Set the identifier format with `TRIGger<m>:CAN:ITYPE`

ID

Identifier: Sets the trigger to one specific identifier or an identifier range. To set the identifier, use `TRIGger<m>:CAN:ICONdition`, `TRIGger<m>:CAN:IMIN`, and `TRIGger<m>:CAN:IMAX`.

IDDT

Identifier and DaTa: Combination of identifier and data conditions To set the identifier condition, use `TRIGger<m>:CAN:ICONdition`, `TRIGger<m>:CAN:IMIN`, and `TRIGger<m>:CAN:IMAX`.

To set the data condition, use `TRIGger<m>:CAN:DCONDITION`, `TRIGger<m>:CAN:DMIN`, and `TRIGger<m>:CAN:DMAX`.

ERRC

ERRor Condition: Define the error types with

`TRIGger<m>:CAN:ACKerror`,

`TRIGger<m>:CAN:BITSterror`,

`TRIGger<m>:CAN:CRCErrror`,

`TRIGger<m>:CAN:FORMerror`,

`TRIGger<m>:CAN:FDATA:SCERror` on page 1958.

*RST: STOF

Manual operation: See "[Trigger type](#)" on page 615

TRIGger<m>:CAN:FDATA:STANDARD <Standard>

Selects the CAN standard. Use ANY if the standard of the signal is unknown.

Parameters:

<Standard>

ANY | CAN | CANFd

*RST: CAN

Manual operation: See "[Standard](#)" on page 617

TRIGger<m>:CAN:FTYPe <FrameType>

Selects the CAN frame type if **TRIGger<m>:CAN:TYPE** is set to FTYP (frame type) or ID (identifier).

For data and remote frames, the identifier format has to be set with **TRIGger<m>:CAN:ITYPe**.

See also: "[Frame type](#)" on page 617

Parameters:

<FrameType>

ANY | DATA | REMote | ERRor | OVERload

Available values depend on the CAN standard and on the **TRIGger<m>:CAN:TYPE** setting:

Remote frames are not available in the CAN FD protocol.

If the trigger type is set to FTYP (frame type), you can set the values DATA | REMote | ERRor | OVERload.

If the trigger type is set to ID (identifier), you can set the values ANY | DATA | REMote.

*RST: ANY

Manual operation: See "[Frame type](#)" on page 617

TRIGger<m>:CAN:ITYPe <IdentifierType>

Selects the format of data and remote frames.

Remote frames are not available in the CAN FD protocol.

Parameters:

<IdentifierType>

ANY | B11 | B29

B11

11 bit identifier (standard format). The instrument triggers on the sample point of the IDE bit.

B29

29 bit identifier (extended format). The instrument triggers on the sample point of the RTR bit.

ANY

The ID type and ID pattern are not relevant for the trigger condition.

*RST: ANY

Manual operation: See "[ID type](#)" on page 617

TRIGger<m>:CAN:ICONdition <IdOperator>

Sets the operator to set a specific identifier or an identifier range.

Parameters:

<IdOperator>

EQUal | NEQUal | LTHan | LETHan | GTHan | GETHan | INRange | OORange

EQUal | NEQUal | LTHan | LETHan | GTHan | GETHan

Equal, Not equal, Less than, Less or equal than, Greater Than, Greater or equal than. These condition require one identifier pattern to be set with `TRIGger<m>:CAN:IMIN`.

INRange | OORange

In range / Out of range: Set the minimum and maximum value of the range with `TRIGger<m>:CAN:IMIN` and `TRIGger<m>:CAN:IMAX` on page 1953.

*RST: EQUal

Manual operation: See "[Identifier setup: Condition, Identifier min, Identifier max](#)" on page 618

TRIGger<m>:CAN:IMIN <IdPattern>

Specifies a message identifier pattern, or sets the the start value of an identifier range.

Parameters:

<IdPattern> Numeric or string pattern, see [Chapter 27.4.6, "Bit pattern parameter"](#), on page 1373.

Manual operation: See "[Identifier setup: Condition, Identifier min, Identifier max](#)" on page 618

TRIGger<m>:CAN:IMAX <IdPatternTo>

Sets the the end value of an identifier range if `TRIGger<m>:CAN:ICONdition` is set to `INRange` or `OORange`.

Parameters:

<IdPatternTo> Numeric or string pattern, see [Chapter 27.4.6, "Bit pattern parameter"](#), on page 1373.

Manual operation: See "[Identifier setup: Condition, Identifier min, Identifier max](#)" on page 618

TRIGger<m>:CAN:FDATa:FDf <FDfBit>

Specifies the CAN FD frame format. It corresponds to the EDL bit (extended data length), which only exists in CAN FD format.

Parameters:

<FDfBit> ONE | ZERO | DC
 ONE: CAN FD.
 ZERO: CAN.
 DC: don't care, the format is not relevant.

*RST: DC

Manual operation: See "[FD bits](#)" on page 618

TRIGger<m>:CAN:FDATa:BRS <BRSBit>

Sets the bit rate switch bit.

Parameters:

<BRSBit> ONE | ZERO | DC

ONE: the bit rate switches from the bit rate of the arbitration phase to the faster data rate.

*RST: ONE

Manual operation: See "[FD bits](#)" on page 618

TRIGger<m>:CAN:FDATa:ESI <ESIBit>

Sets the error state indicator bit.

Parameters:

<ESIBit> ONE | ZERO | DC

DC: don't care, bit is not relevant

*RST: DC

Manual operation: See "[FD bits](#)" on page 618

TRIGger<m>:CAN:DCONDition <DataOperator>

Sets the operator to set a specific data pattern or a data pattern range.

Parameters:

<DataOperator> EQUal | NEQual | LTHan | LETHan | GTHan | GETHan | INRange | OORange

EQUal | NEQual | LTHan | LETHan | GTHan | GETHan

Equal, Not equal, Less than, Less or equal than, Greater Than, Greater or equal than. These conditions require one data pattern to be set with [TRIGger<m>:CAN:DMIN](#).

INRange | OORange

In range / Out of range: Set the minimum and maximum value of the range with [TRIGger<m>:CAN:DMIN](#) and [TRIGger<m>:CAN:DMAX](#).

*RST: EQUal

Manual operation: See "[Data setup: DLC, NDB, Transfer, Condition, Data min, Data max](#)" on page 618

TRIGger<m>:CAN:DMIN <DataPattern>

Specifies a data pattern, or sets the the start value of a data pattern range.

Parameters:

<DataPattern> Numeric or string pattern, see [Chapter 27.4.6, "Bit pattern parameter"](#), on page 1373. The string parameter accepts the bit value X (don't care).

Manual operation: See ["Data setup: DLC, NDB, Transfer, Condition, Data min, Data max"](#) on page 618

TRIGger<m>:CAN:DMAX <DataPatternTo>

Sets the the end value of an data range if [TRIGger<m>:CAN:DCONdition](#) is set to [INRange](#) or [OORange](#).

Parameters:

<DataPatternTo> Numeric or string pattern, see [Chapter 27.4.6, "Bit pattern parameter"](#), on page 1373. The string parameter accepts the bit value X (don't care).

Manual operation: See ["Data setup: DLC, NDB, Transfer, Condition, Data min, Data max"](#) on page 618

TRIGger<m>:CAN:BORDER <Endianness>

Sets the byte order (endianness) of the data transfer. Only for CAN protocol.

Parameters:

<Endianness> BENDian | LENDian

BENDian

Big endian, data is analyzed and evaluated in the order of reception.

LENDian

Little endian, the instrument reads the complete data, reverses the byte order of the data, and compares it with the specified data word.

*RST: BENDian

Manual operation: See ["Data setup: DLC, NDB, Transfer, Condition, Data min, Data max"](#) on page 618

TRIGger<m>:CAN:DLCCONdition <DLCOperator>

Operator to set the data length code for triggering on CAN and CAN FD data.

For details, see ["Data setup: DLC, NDB, Transfer, Condition, Data min, Data max"](#) on page 618.

The number of data bytes to be found is set with [TRIGger<m>:CAN:DLC](#).

See also: [TRIGger<m>:CAN:BORDER](#).

Parameters:

<DLCOperator> EQUal | GETHan
 For little endian transfer direction, EQUal must be set.
 *RST: GETHan

Manual operation: See "[Data setup: DLC, NDB, Transfer, Condition, Data min, Data max](#)" on page 618

TRIGger<m>:CAN:DLC <WordCount>

Sets the Data Length Code, the number of data bytes to be found. For complete definition, set also the operator with [TRIGger<m>:CAN:DLCCondition](#) on page 1955.

Parameters:

<WordCount> Range: CAN: 1 to 8, CAN FD: 1 to 15 (64 bytes)
 Increment: 1
 *RST: 1

Manual operation: See "[Data setup: DLC, NDB, Transfer, Condition, Data min, Data max](#)" on page 618

TRIGger<m>:CAN:NDBYtes?

Returns the number of data bytes defined by DLC. DLC and NDB are different in CAN FD for DLCs > 8.

See also: "[Data setup: DLC, NDB, Transfer, Condition, Data min, Data max](#)" on page 618.

Return values:

<NDBytes> Range: 1 to 64
 Increment: 1
 *RST: 1

Usage: Query only

Manual operation: See "[Data setup: DLC, NDB, Transfer, Condition, Data min, Data max](#)" on page 618

TRIGger<m>:CAN:FDATa:DPOPerator <DataPosOperator>

Sets the operator to define an exact position or a data range where the instrument looks for the specified data pattern.

The position can be defined if the data field of the frame is longer than 8 bytes - if [TRIGger<m>:CAN:DLC](#)≥9.

Parameters:

<DataPosOperator> ANY | OFF | EQUal | GETHan | INRange | RANGE

ANY = OFF

The data position is not relevant for the trigger condition.

EQUal | GETHan

Equal, Greater or equal than. These conditions require one data position to be set with `TRIGger<m>:CAN:FDATa:DPOStion`.

INRange = RANGE

In range: Set the minimum and maximum value of the range with `TRIGger<m>:CAN:FDATa:DPOStion` and `TRIGger<m>:CAN:FDATa:DPTO`.

*RST: ANY

Manual operation: See "[Data position](#)" on page 619

TRIGger<m>:CAN:FDATa:DPOStion <DataPosition>

Defines the number of the first data byte at which the data pattern may start.

Parameters:

<DataPosition> Range: 1 to 57
 Increment: 1
 *RST: 1

Manual operation: See "[Data position](#)" on page 619

TRIGger<m>:CAN:FDATa:DPTO <DataPositionTo>

Sets the number of the last byte at which the required data pattern may start.

Parameters:

<DataPositionTo> Range: 8 to 64
 Increment: 1
 *RST: 8

Manual operation: See "[Data position](#)" on page 619

TRIGger<m>:CAN:ACKerror <AckError>

Triggers when the transmitter does not receive an acknowledgment - a dominant bit during the Ack Slot.

The trigger type has to be set before: `TRIGger<m>:CAN:TYPE` to `ERRC`.

Parameters:

<AckError> ON | OFF
 *RST: ON

Manual operation: See "[Error conditions](#)" on page 620

TRIGger<m>:CAN:BITSterror <BitStuffError>

Triggers if a stuff error occurs - when the 6th consecutive equal bit level in the mentioned fields is detected.

The trigger type has to be set before: `TRIGger<m>:CAN:TYPE` to `ERRC`.

Parameters:

<BitStuffError> ON | OFF
 *RST: ON

Manual operation: See "[Error conditions](#)" on page 620

TRIGger<m>:CAN:CRCError <ChecksumError>

Triggers on CRC errors. A CRC error occurs when the CRC calculated by the receiver differs from the received value in the CRC sequence.

The trigger type has to be set before: `TRIGger<m>:CAN:TYPE` to `ERRC`.

Parameters:

<ChecksumError> ON | OFF
 *RST: ON

Manual operation: See "[Error conditions](#)" on page 620

TRIGger<m>:CAN:FORMError <FormError>

Triggers when a fixed-form bit field contains one or more illegal bits.

The trigger type has to be set before: `TRIGger<m>:CAN:TYPE` to `ERRC`.

Parameters:

<FormError> ON | OFF
 *RST: ON

Manual operation: See "[Error conditions](#)" on page 620

TRIGger<m>:CAN:FDATa:SCERror <StuffCountError>

Triggers on stuff count errors. A stuff count error occurs if the received stuff count value does not match the value calculated from the own stuff bit count.

The trigger type `TRIGger<m>:CAN:TYPE` must be set to `ERRC`.

Only relevant for CAN FD signals in ISO standard.

Parameters:

<StuffCountError> ON | OFF
 *RST: ON

Manual operation: See "[Error conditions](#)" on page 620

27.18.8.3 Decode results

To load and activate a label list, use:

- `BUS<m>:NEWLlist` on page 1815

- [BUS<m>:SYMBOLs](#) on page 1815

BUS<m>:CAN:FCOunt?	1959
BUS<m>:CAN:FDATa:FRAMe<n>:STANdard?	1959
BUS<m>:CAN:FRAMe<n>:STATus?	1960
BUS<m>:CAN:FRAMe<n>:NDBYtes?	1961
BUS<m>:CAN:FRAMe<n>:STARt?	1961
BUS<m>:CAN:FRAMe<n>:STOP?	1961
BUS<m>:CAN:FRAMe<n>:SYMBol?	1961
BUS<m>:CAN:FRAMe<n>:TYPE?	1962
BUS<m>:CAN:FRAMe<n>:DATA?	1962
BUS<m>:CAN:FRAMe<n>:ACKState?	1962
BUS<m>:CAN:FRAMe<n>:CSState?	1962
BUS<m>:CAN:FRAMe<n>:DLCState?	1962
BUS<m>:CAN:FRAMe<n>:IDState?	1962
BUS<m>:CAN:FRAMe<n>:ACKValue?	1963
BUS<m>:CAN:FRAMe<n>:BITRate?	1963
BUS<m>:CAN:FRAMe<n>:CSValue?	1964
BUS<m>:CAN:FRAMe<n>:DLCValue?	1964
BUS<m>:CAN:FRAMe<n>:IDType?	1964
BUS<m>:CAN:FRAMe<n>:IDValue?	1965
BUS<m>:CAN:FRAMe<n>:BSEPosition?	1965
BUS<m>:CAN:FRAMe<n>:FERCause?	1965
BUS<m>:CAN:FRAMe<n>:SDExport?	1966
BUS<m>:CAN:FDATa:FRAMe<n>:SCValue?	1966
BUS<m>:CAN:FRAMe<n>:BYTE<o>:STATe?	1966
BUS<m>:CAN:FRAMe<n>:BYTE<o>:VALue?	1967

BUS<m>:CAN:FCOunt?

Returns the number of decoded frames of the acquisition.

Suffix:

<m> 1..4
Selects the serial bus.

Return values:

<Count> Total number of decoded frames.
Range: 0 to 100000
Increment: 1
*RST: 0

Usage: Query only

BUS<m>:CAN:FDATa:FRAMe<n>:STANdard?

Returns the CAN standard.

Suffix:

<m> 1..4
Selects the serial bus.

<n> The frame suffix is irrelevant.

Return values:

<Standard> CAN | CANFd
*RST: CAN

Usage: Query only

Manual operation: See "[CAN-FD](#)" on page 609

BUS<m>:CAN:FRAME<n>:STATus?

Returns the overall state of the selected frame.

Suffix:

<m> 1..4
Selects the serial bus.

<n> *
Selects the frame.

Return values:

<FrameState> OK | FORM | BTST | CRC | CRCD | NOACK | ACKD | EOFD | CAERror | FCERror | INSufficient | SERRror | SFERror | SCERror | SAERror | SCAE | SCFE
OK: the frame is valid.
FORM: Fixed-bit form error
BTST: Bit stuffing error occurred.
CRC: Cyclic redundancy check failed.
CRCD: Wrong CRC delimiter occurred.
NOACK: Acknowledge is missing.
ACKD: Wrong ACK delimiter occurred.
EOFD: Wrong end of frame.
CAERror: CRC error followed by an acknowledgement error (missing acknowledge)
FCERror: CRC error followed by a form error (wrong CRC delimiter or wrong ACK delimiter)
INSufficient: The frame is not completely contained in the acquisition. The acquired part of the frame is valid.
SERRror: Stuff count error (CAN-FD ISO only)
SFER: Stuff count error and FORM error (CAN-FD ISO only)
SCER: Stuff count error and CRC error (CAN-FD ISO only)
SAER: Stuff count error and ACK error (CAN-FD ISO only)
SCAE: Stuff count error and CRC error and ACK error (CAN-FD ISO only)
SCFE: Stuff count error and CRC error and FORM error (CAN-FD ISO only)
*RST: OK

Usage: Query only

BUS<m>:CAN:FRAME<n>:NDBYtes?

REturns the number of data bytes.

Suffix:

<m> 1..4
 <n> *

Return values:

<NDBytes> Range: 1 to 64
 Increment: 1
 *RST: 1

Usage: Query only

Firmware/software: FW 3.35

BUS<m>:CAN:FRAME<n>:START?**BUS<m>:CAN:FRAME<n>:STOP?**

Return the start time and stop time of the selected frame.

Suffix:

<m> 1..4
 Selects the serial bus.
 <n> *
 Selects the frame.

Return values:

<Start>, <Stop> Time
 Range: -100E+24 to 100E+24
 *RST: 0
 Default unit: s

Usage: Query only

BUS<m>:CAN:FRAME<n>:SYMBOL?

Returns the symbolic label of the specified frame if the label list is enabled.

Suffix:

<m> 1..4
 Selects the serial bus.
 <n> *
 Selects the number of the frame in the current acquisition, 1...n.

Return values:

<Label> String with symbolic label of the identifier

Example: BUS:CAN:FRAME:SYMBOL?

Response: Temperature

Usage: Query only

BUS<m>:CAN:FRAMe<n>:TYPE?

Returns the frame type of the selected frame.

Suffix:

<m>	1..4 Selects the serial bus.
<n>	* Selects the frame.

Return values:

<FrameType>	DATA REMote ERR OVLD Data, remote, error or overload frame.
*RST:	DATA

Usage: Query only

BUS<m>:CAN:FRAMe<n>:DATA?

Returns the data of the specified frame.

Suffix:

<m>	1..4 Selects the serial bus.
<n>	* Selects the frame.

Return values:

<Data> Comma-separated list of values. The first value is the number of bytes, followed by the values of the data bytes.

Example:

```
BUS1:CAN:FRAMe2:DATA?
```

```
--> 3,208,231,32
```

Returns the data of the second frame: the number of bytes is 3 data (first value).

Usage: Query only

BUS<m>:CAN:FRAMe<n>:ACKState?**BUS<m>:CAN:FRAMe<n>:CSSTate?****BUS<m>:CAN:FRAMe<n>:DLCState?****BUS<m>:CAN:FRAMe<n>:IDSTate?**

Return the states of following parts of a message

- ACKState: state of acknowledgement field
- CSSTate: state of checksum field (CRC)
- DLCState: state of data length code
- IDSTate: identifier state

Suffix:

<m> 1..4
Selects the serial bus.

<n> *
Selects the frame.

Return values:

<State> OK | ERRor | UNDF
UNDF: Undefined
*RST: OK

Usage: Query only

BUS<m>:CAN:FRAME<n>:ACKValue?

Returns the value of the acknowledge slot for the selected frame.

Suffix:

<m> 1..4
Selects the serial bus.

<n> *
Selects the frame.

Return values:

<AckValue> To set the value format, use [FORMat:BPATtern](#).
The values below – range, increment and reset – are decimal values.

Range: 0 to 1
*RST: 0

Usage: Query only

BUS<m>:CAN:FRAME<n>:BITRate?

Returns the primary bit rate.

Suffix:

<m> 1..4
Selects the serial bus.

<n> *
Selects the frame.

Return values:

<PrimaryBitRate> Range: 0 to 100000000000
Increment: 1
*RST: 0
Default unit: bps

Usage: Query only

BUS<m>:CAN:FRAME<n>:CSValue?

Returns the CRC sequence value of the selected frame.

Suffix:

<m> 1..4
Selects the serial bus.

<n> *
Selects the frame.

Return values:

<ChecksumValue> To set the value format, use [FORMat:BPATtern](#).
The values below – range, increment and reset – are decimal values.

Range: 0 to 2097151
*RST: 0

Usage: Query only

BUS<m>:CAN:FRAME<n>:DLCValue?

Returns the data length code of the selected frame - the number of data bytes in the frame.

Suffix:

<m> 1..4
Selects the serial bus.

<n> *
Selects the frame.

Return values:

<FrameDLCValue> Number of data bytes in decimal values.

Range: 0 to 15
*RST: 0

Usage: Query only

BUS<m>:CAN:FRAME<n>:IDType?

Returns the identifier type of the selected frame, the identifier format of data and remote frames.

Suffix:

<m> 1..4
Selects the serial bus.

<n> *
Selects the frame.

Return values:

<IdentifierType> ANY | B11 | B29
 B11: standard format, 11 bit
 B29: extended format, 29 bit
 *RST: B11

Usage: Query only

BUS<m>:CAN:FRAME<n>:IDValue?

Returns the identifier value of the selected frame.

Suffix:

<m> 1..4
 Selects the serial bus.

<n> *
 Selects the frame.

Return values:

<IdentifierValue> To set the value format, use [FORMat:BPATtern](#).
 The values below – range, increment and reset – are decimal values.
 Range: 0 to 536870911
 *RST: 0

Usage: Query only

BUS<m>:CAN:FRAME<n>:BSEPosition?

Returns the location of a bit stuffing error.

Suffix:

<m> 1..4
 Selects the serial bus.

<n> *
 Selects the frame.

Return values:

<BitStuffErrorPos> Time when the error occurred
 Range: 0 to 5000
 *RST: 0

Usage: Query only

BUS<m>:CAN:FRAME<n>:FERCause?

Returns information on a form error, if the frame status query returned a FORM error.

See also: [BUS<m>:CAN:FRAME<n>:STATus?](#) on page 1960

Suffix:

<m> 1..4

<n> *

Return values:

<FormErrorCause> NONE | CRCDError | ACKDError | FSBE | RESError

CRCDError = CRC delimiter error

ACKDError = ACK delimiter error

FSBE = Fixed stuff bit error (CAN-FD ISO only)

RESError = Reserved bit error

*RST: NONE

Usage: Query only**BUS<m>:CAN:FRAME<n>:SDEExport?**

Returns the symbolic data of the frame in export format.

Suffix:<m> 1..4
Selects the serial bus.<n> *
Selects the frame.**Return values:**

<SymbolicData>

Usage: Query only**BUS<m>:CAN:FDATA:FRAME<n>:SCValue?**

Returns the stuff bit count modulo 8 value.

Suffix:

<m> 1..4

<n> *

Return values:

<StuffCount> Range: 0 to 7

Increment: 1

*RST: 0

Usage: Query only**BUS<m>:CAN:FRAME<n>:BYTE<o>:STATE?**

Returns the state of the specified byte.

Suffix:<m> 1..4
Selects the serial bus.

<n> *
Selects the frame.

<o> *
Selects the byte number.

Return values:

<State> OK | ERRor | UNDF
UNDF: Undefined
*RST: OK

Usage: Query only

BUS<m>:CAN:FRAME<n>:BYTE<o>:VALue?

Returns the value of the specified byte.

Suffix:

<m> 1..4
Selects the serial bus.

<n> *
Selects the frame.

<o> *
Selects the byte number.

Return values:

<Value> To set the value format, use [FORMat:BPATtern](#).
The values below – range, increment and reset – are decimal values.

Range: 0 to 255
*RST: 0

Usage: Query only

27.18.8.4 Search settings

SEARch:TRIGger:CAN[:SSOFrame]	1968
SEARch:TRIGger:CAN:SFTYpe	1968
SEARch:TRIGger:CAN:SFIDentifier	1968
SEARch:TRIGger:CAN:SIDData	1969
SEARch:TRIGger:CAN:SERRor	1969
SEARch:TRIGger:CAN:FDATa:STANdard	1969
SEARch:TRIGger:CAN:FTYpe	1970
SEARch:TRIGger:CAN:ITYpe	1970
SEARch:TRIGger:CAN:ICONdition	1970
SEARch:TRIGger:CAN:IMAX	1971
SEARch:TRIGger:CAN:IMIN	1971
SEARch:TRIGger:CAN:DCONdition	1971
SEARch:TRIGger:CAN:DMIN	1972
SEARch:TRIGger:CAN:DMAX	1972

SEARCh:TRIGger:CAN:DLCCCondition.....	1972
SEARCh:TRIGger:CAN:DLC.....	1973
SEARCh:RESult:CAN:FRAMe<m>:NDBYtes?.....	1973
SEARCh:TRIGger:CAN:FDATa:DPOPerator.....	1973
SEARCh:TRIGger:CAN:FDATa:DPOStion.....	1974
SEARCh:TRIGger:CAN:FDATa:DPTO.....	1974
SEARCh:TRIGger:CAN:ACKerror.....	1974
SEARCh:TRIGger:CAN:BITSterror.....	1975
SEARCh:TRIGger:CAN:CRCError.....	1975
SEARCh:TRIGger:CAN:FORMerror.....	1975
SEARCh:TRIGger:CAN:FDATa:SCERror.....	1976
SEARCh:TRIGger:CAN:FDATa[:FDF].....	1976
SEARCh:TRIGger:CAN:FDATa:BRS.....	1976
SEARCh:TRIGger:CAN:FDATa:ESl.....	1977

SEARCh:TRIGger:CAN[:SSOFrame] <SearchName>,<FrameStart>
SEARCh:TRIGger:CAN[:SSOFrame]? <SearchName>

Enables the search for a start of frame.

Parameters:

<FrameStart> ON | OFF
 *RST: OFF

Parameters for setting and query:

<SearchName>

Manual operation: See "[Search Criteria](#)" on page 623

SEARCh:TRIGger:CAN:SFTYpe <SearchName>,<FrameType>
SEARCh:TRIGger:CAN:SFTYpe? <SearchName>

Enables the search for a specified frame type.

Parameters:

<FrameType> ON | OFF
 *RST: OFF

Parameters for setting and query:

<SearchName>

Manual operation: See "[Search Criteria](#)" on page 623

SEARCh:TRIGger:CAN:SFIDentifier <SearchName>,<Identifier>
SEARCh:TRIGger:CAN:SFIDentifier? <SearchName>

Enables the search for frame identifier.

Parameters:

<Identifier> ON | OFF
 *RST: OFF

Parameters for setting and query:

<SearchName>

Manual operation: See "[Search Criteria](#)" on page 623**SEARCh:TRIGger:CAN:SIDData** <SearchName>,<IdentifierData>**SEARCh:TRIGger:CAN:SIDData?** <SearchName>

Enables the search for identifier and data.

Parameters:

<IdentifierData> ON | OFF

*RST: OFF

Parameters for setting and query:

<SearchName>

Manual operation: See "[Search Criteria](#)" on page 623**SEARCh:TRIGger:CAN:SERRor** <SearchName>,<ErrorCondition>**SEARCh:TRIGger:CAN:SERRor?** <SearchName>

Enables the search for a specified error.

Parameters:

<ErrorCondition> ON | OFF

*RST: OFF

Parameters for setting and query:

<SearchName>

Manual operation: See "[Search Criteria](#)" on page 623**SEARCh:TRIGger:CAN:FDATa:STANdard** <SearchName>,<Standard>**SEARCh:TRIGger:CAN:FDATa:STANdard?** <SearchName>

Selects the CAN standard: CAN, CAN FD, or Any.

Use "Any" to search on either CAN or CAN-FD frame. In this case, the search configuration provides all possible settings, for CAN as well as for CAN FD.

Parameters:

<Standard> ANY | CAN | CANFd

*RST: CAN

Parameters for setting and query:

<SearchName> String with the search name

Manual operation: See "[Standard](#)" on page 625

SEARCh:TRIGger:CAN:FTYPE <SearchName>,<FrameType>
SEARCh:TRIGger:CAN:FTYPE? <SearchName>

Selects the CAN frame type to be searched for.

For data and remote frames, the identifier format has to be set with [SEARCh:TRIGger:CAN:ITYPE](#) on page 1970.

Parameters:

<FrameType> ANY | DATA | REMote | ERRor | OVERload
 *RST: ANY

Parameters for setting and query:

<SearchName>

Manual operation: See "[Frame type](#)" on page 625

SEARCh:TRIGger:CAN:ITYPE <SearchName>,<IdentifierType>
SEARCh:TRIGger:CAN:ITYPE? <SearchName>

Selects the format of data and remote frames: 11 bit for CAN base frames, or 29 bits for CAN extended frames.

Parameters:

<IdentifierType> ANY | B11 | B29
 *RST: ANY

Parameters for setting and query:

<SearchName>

Manual operation: See "[ID type](#)" on page 625

SEARCh:TRIGger:CAN:ICONdition <SearchName>,<IdOperator>
SEARCh:TRIGger:CAN:ICONdition? <SearchName>

Sets the operator to set a specific identifier or an identifier range.

Parameters:

<IdOperator> EQUal | NEQual | LTHan | LETHan | GTHan | GETHan |
 INRange | OORange

EQUal | NEQual | LTHan | LETHan | GTHan | GETHan

Equal, Not equal, Less than, Less or equal than, Greater Than, Greater or equal than. These condition require one identifier pattern to be set with [SEARCh:TRIGger:CAN:IMIN](#).

INRange | OORange

In range / Out of range: Set the minimum and maximum value of the range with [SEARCh:TRIGger:CAN:IMIN](#) and [SEARCh:TRIGger:CAN:IMAX](#).

*RST: EQUal

Parameters for setting and query:

<SearchName>

Manual operation: See "Identifier setup: Condition, Identifier min, Identifier max" on page 625

SEARCH:TRIGger:CAN:IMAX <SearchName>,<IdPatternTo>
SEARCH:TRIGger:CAN:IMAX? <SearchName>

Sets the the end value of an identifier range if **SEARCH:TRIGger:CAN:ICONdition** is set to **INRange** or **ORange**.

Parameters:

<IdPatternTo> Numeric or string pattern, see [Chapter 27.4.6, "Bit pattern parameter"](#), on page 1373.

Parameters for setting and query:

<SearchName>

Manual operation: See "Identifier setup: Condition, Identifier min, Identifier max" on page 625

SEARCH:TRIGger:CAN:IMIN <SearchName>,<IdPattern>
SEARCH:TRIGger:CAN:IMIN? <SearchName>

Specifies a message identifier pattern, or sets the the start value of an identifier range.

Parameters:

<IdPattern> Numeric or string pattern, see [Chapter 27.4.6, "Bit pattern parameter"](#), on page 1373.

Parameters for setting and query:

<SearchName>

Manual operation: See "Identifier setup: Condition, Identifier min, Identifier max" on page 625

SEARCH:TRIGger:CAN:DCondition <SearchName>,<DataOperator>
SEARCH:TRIGger:CAN:DCondition? <SearchName>

Sets the operator to set a specific data pattern or a data pattern range.

Parameters:

<DataOperator> **EQUAL** | **NEQUAL** | **LTHan** | **LETHan** | **GTHan** | **GETHan** | **INRange** | **ORange**

EQUAL | **NEQUAL** | **LTHan** | **LETHan** | **GTHan** | **GETHan**

Equal, Not equal, Less than, Less or equal than, Greater Than, Greater or equal than. These conditions require one data pattern to be set with **SEARCH:TRIGger:CAN:DMIN**.

INRange | **ORange**

In range / Out of range: Set the minimum and maximum value of the range with **SEARCH:TRIGger:CAN:DMIN** and **SEARCH:TRIGger:CAN:DMAX**.

*RST: **EQUAL**

Parameters for setting and query:

<SearchName>

Manual operation: See "[Data setup: DLC, NDB, Condition, Data min, Data max](#)" on page 626**SEARCh:TRIGger:CAN:DMIN** <SearchName>,<DataPattern>**SEARCh:TRIGger:CAN:DMIN?** <SearchName>

Specifies a data pattern, or sets the the start value of a data pattern range.

Parameters:<DataPattern> Numeric or string pattern, see [Chapter 27.4.6, "Bit pattern parameter"](#), on page 1373. The string parameter accepts the bit value X (don't care).**Parameters for setting and query:**

<SearchName>

Manual operation: See "[Data setup: DLC, NDB, Condition, Data min, Data max](#)" on page 626**SEARCh:TRIGger:CAN:DMAX** <SearchName>,<DataPatternTo>**SEARCh:TRIGger:CAN:DMAX?** <SearchName>Sets the the end value of an data range if [SEARCh:TRIGger:CAN:DCONdition](#) is set to INRange or OORange.**Parameters:**<DataPatternTo> Numeric or string pattern, see [Chapter 27.4.6, "Bit pattern parameter"](#), on page 1373. The string parameter accepts the bit value X (don't care).**Parameters for setting and query:**

<SearchName>

Manual operation: See "[Data setup: DLC, NDB, Condition, Data min, Data max](#)" on page 626**SEARCh:TRIGger:CAN:DLCCCondition** <SearchName>,<DLCCOperator>**SEARCh:TRIGger:CAN:DLCCCondition?** <SearchName>

Operator to set the data length code for search.

Parameters:<DLCCOperator> EQUal | GETHan
*RST: GETHan**Parameters for setting and query:**

<SearchName>

Manual operation: See "[Data setup: DLC, NDB, Condition, Data min, Data max](#)" on page 626

SEARCh:TRIGger:CAN:DLC <SearchName>,<WordCount>
SEARCh:TRIGger:CAN:DLC? <SearchName>

Sets the Data Length Code, the number of data bytes to be found. For complete definition, set also the operator with [SEARCh:TRIGger:CAN:DLCCondition](#).

Parameters:

<WordCount> Range: 1 to 8
 Increment: 1
 *RST: 1

Parameters for setting and query:

<SearchName>

Manual operation: See "[Data setup: DLC, NDB, Condition, Data min, Data max](#)"
on page 626

SEARCh:RESult:CAN:FRAMe<m>:NDBYtes? <SearchName>

Returns the number of data bytes defined by DLC. DLC and NDB are different in CAN FD for DLCs > 8.

See also: "[Data setup: DLC, NDB, Transfer, Condition, Data min, Data max](#)"
on page 618.

Suffix:

<m> *

Query parameters:

<SearchName>

Return values:

<NDBytes> Range: 1 to 64
 Increment: 1
 *RST: 1

Usage: Query only

Manual operation: See "[Data setup: DLC, NDB, Condition, Data min, Data max](#)"
on page 626

SEARCh:TRIGger:CAN:FDATa:DPOPerator <SearchName>,<DataPosOperator>
SEARCh:TRIGger:CAN:FDATa:DPOPerator? <SearchName>

Sets the operator for the data position if DLC ≥ 9. You can define an exact position, or a position range.

Parameters:

<DataPosOperator> ANY | OFF | EQUal | GETHan | INRange | RANGE
ANY = OFF
The data position is not relevant for the search.

EQUal | GETHan

Equal, Greater or equal than. These conditions require one data position to be set with `SEARCH:TRIGger:CAN:FDATa:DPOStion`.

INRange = RANGE

In range: Set the minimum and maximum value of the range with `SEARCH:TRIGger:CAN:FDATa:DPOStion` and `SEARCH:TRIGger:CAN:FDATa:DPTO`.

*RST: ANY

Parameters for setting and query:

<SearchName> String with the search name

Manual operation: See "[Data position](#)" on page 626

SEARCH:TRIGger:CAN:FDATa:DPOStion <SearchName>,<DataPosition>

SEARCH:TRIGger:CAN:FDATa:DPOStion? <SearchName>

Defines the first possible start position of the data pattern.

Parameters:

<DataPosition> Range: 1 to 57
Increment: 1
*RST: 1

Parameters for setting and query:

<SearchName> String with the search name

Manual operation: See "[Data position](#)" on page 626

SEARCH:TRIGger:CAN:FDATa:DPTO <SearchName>,<DataPositionTo>

SEARCH:TRIGger:CAN:FDATa:DPTO? <SearchName>

Defines the last possible start position of the data pattern if the position operator `SEARCH:TRIGger:CAN:FDATa:DPOPerator` defines a range.

Parameters:

<DataPositionTo> Range: 8 to 64
Increment: 1
*RST: 8

Parameters for setting and query:

<SearchName> String with the search name

Manual operation: See "[Data position](#)" on page 626

SEARCH:TRIGger:CAN:ACKError <SearchName>,<AckError>

SEARCH:TRIGger:CAN:ACKError? <SearchName>

Searches for acknowledgement errors. An acknowledgement error occurs when the transmitter does not receive an acknowledgment - a dominant bit during the Ack Slot.

Parameters:

<AckError> ON | OFF
*RST: ON

Parameters for setting and query:

<SearchName>

Manual operation: See ["Error Condition"](#) on page 626

SEARCh:TRIGger:CAN:BITSterror <SearchName>,<BitStuffError>

SEARCh:TRIGger:CAN:BITSterror? <SearchName>

Searches for bit stuffing errors.

Parameters:

<BitStuffError> ON | OFF
*RST: ON

Parameters for setting and query:

<SearchName>

Manual operation: See ["Error Condition"](#) on page 626

SEARCh:TRIGger:CAN:CRCErrror <SearchName>,<ChecksumError>

SEARCh:TRIGger:CAN:CRCErrror? <SearchName>

Searches for errors in the Cyclic Redundancy Check.

Parameters:

<ChecksumError> ON | OFF
*RST: ON

Parameters for setting and query:

<SearchName>

Manual operation: See ["Error Condition"](#) on page 626

SEARCh:TRIGger:CAN:FORMerror <SearchName>,<FormError>

SEARCh:TRIGger:CAN:FORMerror? <SearchName>

Searches for form errors. A form error occurs when a fixed-form bit field contains one or more illegal bits.

Parameters:

<FormError> ON | OFF
*RST: ON

Parameters for setting and query:

<SearchName>

Manual operation: See ["Error Condition"](#) on page 626

SEARCh:TRIGger:CAN:FDATa:SCERror <SearchName>,<StuffCountError>
SEARCh:TRIGger:CAN:FDATa:SCERror? <SearchName>

Triggers on stuff count errors. A stuff count error occurs if the received stuff count value does not match the value calculated from the own stuff bit count.

Only relevant for CAN FD signals in ISO standard.

Parameters:

<StuffCountError> ON | OFF
 *RST: ON

Parameters for setting and query:

<SearchName>

Manual operation: See "[Error Condition](#)" on page 626

SEARCh:TRIGger:CAN:FDATa[:FDF] <SearchName>,<FDFBit>
SEARCh:TRIGger:CAN:FDATa[:FDF]? <SearchName>

Sets the EDL bit (extended data length), which determines whether a frame is CAN or CAN-FD.

Parameters:

<FDFBit> ONE | ZERO | DC
 ONE: CAN FD.
 ZERO: CAN.
 DC: don't care, the format is not relevant.
 *RST: DC

Parameters for setting and query:

<SearchName> String with the search name

Manual operation: See "[FD bits](#)" on page 626

SEARCh:TRIGger:CAN:FDATa:BRS <SearchName>,<BRSBit>
SEARCh:TRIGger:CAN:FDATa:BRS? <SearchName>

Sets the bit rate switching bit for identifier and identifier + data searches.

Parameters:

<BRSBit> ONE | ZERO | DC
 DC: Don't care
 *RST: ONE

Parameters for setting and query:

<SearchName> String with the search name

Manual operation: See "[FD bits](#)" on page 626

SEARCh:TRIGger:CAN:FDATa:ESI <SearchName>,<ESIBit>
SEARCh:TRIGger:CAN:FDATa:ESI? <SearchName>

Sets the error state indicator bit for identifier and identifier + data searches.

Parameters:

<ESIBit> ONE | ZERO | DC
 *RST: DC

Parameters for setting and query:

<SearchName> String with the search name

Manual operation: See "FD bits" on page 626

27.18.8.5 Search results

The search on decoded CAN data returns the same results as the queries for decode results.

In search result commands, you have to specify the <SearchName> parameter. It is a string parameter that contains the search definition name.

For a description of the returned values, see the corresponding commands in [Chapter 27.18.8.3, "Decode results"](#), on page 1958.

SEARCh:RESult:CAN:FCOunt?.....	1977
SEARCh:RESult:CAN:FRAMe<m>:ACKValue?.....	1978
SEARCh:RESult:CAN:FRAMe<m>:BSEPosition?.....	1978
SEARCh:RESult:CAN:FRAMe<m>:BYTE<n>:STATe?.....	1978
SEARCh:RESult:CAN:FRAMe<m>:BYTE<n>:VALue?.....	1979
SEARCh:RESult:CAN:FRAMe<m>:ACKState?.....	1979
SEARCh:RESult:CAN:FRAMe<m>:CSState?.....	1979
SEARCh:RESult:CAN:FRAMe<m>:DLCState?.....	1979
SEARCh:RESult:CAN:FRAMe<m>:IDState?.....	1979
SEARCh:RESult:CAN:FRAMe<m>:CSValue?.....	1979
SEARCh:RESult:CAN:FRAMe<m>:DATA?.....	1979
SEARCh:RESult:CAN:FRAMe<m>:DLCValue?.....	1980
SEARCh:RESult:CAN:FRAMe<m>:FERCause?.....	1980
SEARCh:RESult:CAN:FRAMe<m>:IDTYpe?.....	1980
SEARCh:RESult:CAN:FRAMe<m>:IDValue?.....	1981
SEARCh:RESult:CAN:FDATa:FRAMe<m>:SCValue?.....	1981
SEARCh:RESult:CAN:FDATa:FRAMe<m>:STANdard?.....	1981
SEARCh:RESult:CAN:FRAMe<m>:STARt?.....	1982
SEARCh:RESult:CAN:FRAMe<m>:STATus?.....	1982
SEARCh:RESult:CAN:FRAMe<m>:STOP?.....	1982
SEARCh:RESult:CAN:FRAMe<m>:SYMBol?.....	1982
SEARCh:RESult:CAN:FRAMe<m>:TYPE?.....	1983

SEARCh:RESult:CAN:FCOunt? <SearchName>

Query parameters:

<SearchName>

Return values:

<Count> Range: 0 to 100000
 Increment: 1
 *RST: 0

Usage: Query only

SEARCH:RESult:CAN:FRAME<m>:ACKValue? <SearchName>**Suffix:**

<m> *

Query parameters:

<SearchName>

Return values:

<AckValue> Range: 0 to 1
 Increment: 1
 *RST: 0

Usage: Query only

SEARCH:RESult:CAN:FRAME<m>:BSEPosition? <SearchName>**Suffix:**

<m> *

Query parameters:

<SearchName>

Return values:

<BitStuffErrorPos> Range: 0 to 5000
 Increment: 1
 *RST: 0

Usage: Query only

SEARCH:RESult:CAN:FRAME<m>:BYTE<n>:STATe? <SearchName>**Suffix:**

<m> *

<n> *

Query parameters:

<SearchName>

Return values:

<State> OK | ERRor | UNDF
 *RST: OK

Usage: Query only

SEARCh:RESult:CAN:FRAMe<m>:BYTE<n>:VALue? <SearchName>

Suffix:

<m> *

<n> *

Query parameters:

<SearchName>

Return values:

<Value> Range: 0 to 255
 Increment: 1
 *RST: 0

Usage: Query only

SEARCh:RESult:CAN:FRAMe<m>:ACKState? <SearchName>

SEARCh:RESult:CAN:FRAMe<m>:CSState? <SearchName>

SEARCh:RESult:CAN:FRAMe<m>:DLCState? <SearchName>

SEARCh:RESult:CAN:FRAMe<m>:IDState? <SearchName>

Suffix:

<m> *

Query parameters:

<SearchName>

Return values:

<IdentifierState> OK | ERRor | UNDF
 *RST: OK

Usage: Query only

SEARCh:RESult:CAN:FRAMe<m>:CSValue? <SearchName>

Suffix:

<m> *

Query parameters:

<SearchName>

Return values:

<ChecksumValue> Range: 0 to 2097151
 Increment: 1
 *RST: 0

Usage: Query only

SEARCh:RESult:CAN:FRAMe<m>:DATA? <SearchName>

Suffix:

<m> *

Query parameters:

<SearchName>

Return values:

<Data>

Usage: Query only**SEARCh:RESult:CAN:FRAMe<m>:DLCValue? <SearchName>****Suffix:**

<m> *

Query parameters:

<SearchName>

Return values:

<FrameDLCValue> Range: 0 to 15
 Increment: 1
 *RST: 0

Usage: Query only**SEARCh:RESult:CAN:FRAMe<m>:FERCause? <SearchName>**

Returns information on a form error, if the frame status query returned a FORM error.

See also: [SEARCh:RESult:CAN:FRAMe<m>:STATus?](#) on page 1982.**Suffix:**

<m> *

Query parameters:

<SearchName>

Return values:

<FormErrorCause> NONE | CRCDerror | ACKDerror | FSBE | RESerror
 See [BUS<m>:CAN:FRAMe<n>:FERCause?](#) on page 1965.
 *RST: NONE

Usage: Query only**SEARCh:RESult:CAN:FRAMe<m>:IDTYpe? <SearchName>****Suffix:**

<m> *

Query parameters:

<SearchName>

Return values:

<IdentifierType> ANY | B11 | B29
 *RST: B11

Usage: Query only

SEARCh:RESult:CAN:FRAMe<m>:IDValue? <SearchName>

Suffix:
<m> *

Query parameters:
<SearchName>

Return values:
<IdentifierValue> Range: 0 to 536870911
Increment: 1
*RST: 0

Usage: Query only

SEARCh:RESult:CAN:FDATa:FRAMe<m>:SCValue? <SearchName>

Returns the stuff bit count modulo 8.

Suffix:
<m> *

Query parameters:
<SearchName>

Return values:
<StuffCount> Range: 0 to 7
Increment: 1
*RST: 0

Usage: Query only

SEARCh:RESult:CAN:FDATa:FRAMe<m>:STANdard? <SearchName>

Returns the CAN protocol standard: CAN or CAN FD.

Suffix:
<m> *

Query parameters:
<SearchName>

Return values:
<Standard> CAN | CANFd
*RST: CAN

Usage: Query only

SEARCh:RESult:CAN:FRAMe<m>:STARt? <SearchName>**Suffix:**

<m> *

Query parameters:

<SearchName>

Return values:

<FrameStart> Range: -100E+24 to 100E+24
 Increment: 100E-12
 *RST: 0
 Default unit: s

Usage: Query only

SEARCh:RESult:CAN:FRAMe<m>:STATus? <SearchName>**Suffix:**

<m> *

Query parameters:

<SearchName>

Return values:

<FrameState> OK | FORM | BTST | CRC | CRCD | NOAck | ACKD | EOFD |
 CAERror | FCERror | INSufficient | SERRror | SFERror |
 SCERror | SAERror | SCAE | SCFE
 See [BUS<m>:CAN:FRAMe<n>:STATus?](#) on page 1960.
 *RST: OK

Usage: Query only

SEARCh:RESult:CAN:FRAMe<m>:STOP? <SearchName>**Suffix:**

<m> *

Query parameters:

<SearchName>

Return values:

<FrameStop> Range: -100E+24 to 100E+24
 Increment: 100E-12
 *RST: 0
 Default unit: s

Usage: Query only

SEARCh:RESult:CAN:FRAMe<m>:SYMBol? <SearchName>

Returns the symbolic label of the specified frame if the label list is enabled.

Suffix:
 <m> *
 Selects the number of the frame in the current acquisition, 1...n.

Query parameters:
 <SearchName> String parameter that contains the search definition name

Return values:
 <Label> Symbolic label (string)

Usage: Query only

SEARCh:RESUlt:CAN:FRAMe<m>:TYPE? <SearchName>

Suffix:
 <m> *

Query parameters:
 <SearchName>

Return values:
 <FrameType> DATA | REMote | ERR | OVLD
 *RST: DATA

Usage: Query only

27.18.8.6 Symbolic trigger, decode and search

- [Symbolic trigger](#)..... 1983
- [Symbolic decode results](#)..... 1985
- [Symbolic search](#)..... 1985

Symbolic trigger

TRIGger<m>:CAN:SYMBolic:MSGValue	1983
TRIGger<m>:CAN:SYMBolic:TSIGnals	1984
TRIGger<m>:CAN:SYMBolic:SIGValue	1984
TRIGger<m>:CAN:SYMBolic:DMAX	1984
TRIGger<m>:CAN:SYMBolic:DMIN	1984
TRIGger<m>:CAN:SYMBolic:SGEValue	1985

TRIGger<m>:CAN:SYMBolic:MSGValue <MessageName>

Sets the message to be triggered or searched for.

The setting is used by symbolic trigger and symbolic search. Thus, you always trigger on and search for the same message if symbolic trigger and symbolic search is used at the same time.

See also: [SEARCh:TRIGger:CAN:SYMBolic:MSGValue](#) on page 1986

Parameters:
 <MessageName> String with the symbolic message name

Manual operation: See ["Message"](#) on page 628

TRIGger<m>:CAN:SYMBOLic:TSIGnals <TriggerOnSignal>

Enables the trigger on a specific signal value that is part of the selected message.

Parameters:

<TriggerOnSignal> ON | OFF
 *RST: OFF

Manual operation: See ["Signal trigger"](#) on page 629

TRIGger<m>:CAN:SYMBOLic:SIGValue <SignalName>

Sets the signal name to be triggered or searched for.

The setting is used by symbolic trigger and symbolic search. Thus, you always trigger on and search for the same signal if symbolic trigger and symbolic search is used at the same time.

See also: [SEARCH:TRIGger:CAN:SYMBOLic:SIGValue](#) on page 1987

Parameters:

<SignalName> String with the signal name as defined in the DBC file.

Manual operation: See ["Signal"](#) on page 629

TRIGger<m>:CAN:SYMBOLic:DMAX <DataPatternTo>

Defines the maximum data value of the signal.

This value is required to specify a range if condition `INRange` | `OORange` is set with [TRIGger<m>:CAN:DCONDITION](#).

Parameters:

<DataPatternTo> Decimal representation of the data pattern
 Range: -100E+24 to 100E+24
 Increment: 1
 *RST: 1

Manual operation: See ["Value max"](#) on page 629

TRIGger<m>:CAN:SYMBOLic:DMIN <DataPattern>

Defines the minimum data value of the signal.

To set the condition, use [TRIGger<m>:CAN:DCONDITION](#).

Parameters:

<DataPattern> Decimal representation of the data pattern
 Range: -100E+24 to 100E+24
 Increment: 1
 *RST: 0

Manual operation: See "Value, Value min" on page 629

TRIGger<m>:CAN:SYMBOLic:SGEValue <SignalEnumValue>

Sets a symbolic data value for signals with enumerated values.

Parameters:

<SignalEnumValue> Numeric value according to the value definition in the DBC file

Example:

Definition line in DBC file:

```
VAL_ 2175091489 Gear 0 "Idle" 1 "Gear_1" 2 "Gear_2" 3 "Gear_3"
4 "Gear_4" 5 "Gear_5" ;
```

Search for "Gear_4"

```
TRIGger:CAN:SYMBOLic:SGEValue 4
```

Manual operation: See "Value, Value min" on page 629

Symbolic decode results

BUS<m>:CAN:FRAME<n>:SDATa?

Returns the complete symbolic data of the selected frame.

Suffix:

<m> 1..4
Selects the serial bus.

<n> *
Selects the frame.

Return values:

<SymbolicData> String with comma-separated list of symbolic data

Example:

```
BUS:CAN:FRAME9:SDATa?
```

```
<-- [sym] 325 kW, 0x0A, 423 N, 174 l, Running, 90 degC, 0x06, 437 rpm
```

Returns the symbolic results of the 9th frame.

Usage: Query only

Symbolic search

SEARch:RESult:CAN:FRAME<m>:SDATa?	1986
SEARch:TRIGger:CAN:SSYMBOLic	1986
SEARch:TRIGger:CAN:SYMBOLic:MSGValue	1986
SEARch:TRIGger:CAN:SYMBOLic:SSIGNals	1987
SEARch:TRIGger:CAN:SYMBOLic:SIGValue	1987
SEARch:TRIGger:CAN:SYMBOLic:DMIN	1987
SEARch:TRIGger:CAN:SYMBOLic:DMAX	1988
SEARch:TRIGger:CAN:SYMBOLic:SGEValue	1988

SEARCh:RESult:CAN:FRAMe<m>:SDATa? <SearchName>

Returns the symbolic data of the selected result frame.

Suffix:

<m> *
Sets the index of the search result frame.

Query parameters:

<SearchName> String that contains the search definition name

Return values:

<SymbolicData> String with comma-separated list of symbolic data

Example:

```
SEARCh:RESult:CAN:FRAMe:SDATa? 'Search1'  
<-- [sym] 325 kW, 0x0A, 423 N, 174 l, Running, 90 degC, 0x06, 437 rpm
```

Returns the symbolic results of the first search result.

Usage: Query only

SEARCh:TRIGGer:CAN:SSYMBOLic <SearchName>,<CheckSymbolic>**SEARCh:TRIGGer:CAN:SSYMBOLic? <SearchName>**

Enables the symbolic search and disables all other search criteria.

Parameters:

<CheckSymbolic> ON | OFF
*RST: OFF

Parameters for setting and query:

<SearchName> String that contains the search definition name

Manual operation: See "[Search Criteria](#)" on page 623

SEARCh:TRIGGer:CAN:SYMBOLic:MSGValue <SearchName>,<MessageName>**SEARCh:TRIGGer:CAN:SYMBOLic:MSGValue? <SearchName>**

Sets the message to be triggered or searched for.

The setting is used by symbolic trigger and symbolic search. Thus, you always trigger on and search for the same message if symbolic trigger and symbolic search is used at the same time.

See also: [TRIGGer<m>:CAN:SYMBOLic:MSGValue](#) on page 1983

Parameters:

<MessageName> String that contains the symbolic message name

Parameters for setting and query:

<SearchName> String that contains the search definition name

Example:

```
SEARCh:TRIGGer:CAN:SYMBOLic:MSGValue "Search1","EngineData"
```

Manual operation: See "[Message](#)" on page 631

SEARCh:TRIGger:CAN:SYMBOLic:SSIGNALs <SearchName>,<SymbolicSearch>
SEARCh:TRIGger:CAN:SYMBOLic:SSIGNALs? <SearchName>

Enables the search for symbolic values if DBC label list file is loaded and applied.
 Symbolic search disables all other search criteria.

Parameters:

<SymbolicSearch> ON | OFF
 *RST: OFF

Parameters for setting and query:

<SearchName> String that contains the search definition name

Manual operation: See "[Search signals](#)" on page 631

SEARCh:TRIGger:CAN:SYMBOLic:SIGValue <SearchName>, <SignalName>
SEARCh:TRIGger:CAN:SYMBOLic:SIGValue? <SearchName>

Sets the signal name to be triggered or searched for.

The setting is used by symbolic trigger and symbolic search. Thus, you always trigger on and search for the same signal if symbolic trigger and symbolic search is used at the same time.

See also: [TRIGger<m>:CAN:SYMBOLic:SIGValue](#) on page 1984

Parameters:

<SignalName> String that contains the symbolic signal name

Parameters for setting and query:

<SearchName> String that contains the search definition name

Example: SEARCh:TRIGger:CAN:SYMBOLic:SIGValue "Search1","EngForce"

Manual operation: See "[Signal](#)" on page 631

SEARCh:TRIGger:CAN:SYMBOLic:DMIN <SearchName>,<DataPattern>
SEARCh:TRIGger:CAN:SYMBOLic:DMIN? <SearchName>

Defines the minimum data pattern in a symbolic search.

To set the condition, use [SEARCh:TRIGger:CAN:DCondition](#).

Parameters:

<DataPattern> Range: -100E+24 to 100E+24
 Increment: 1
 *RST: 0

Parameters for setting and query:

<SearchName> String that contains the search definition name

Manual operation: See "[Value, Value \(min\)](#)" on page 631

SEARCh:TRIGger:CAN:SYMBolic:DMAX <SearchName>,<DataPatternTo>
SEARCh:TRIGger:CAN:SYMBolic:DMAX? <SearchName>

Defines the maximum data pattern of the signal in a symbolic search.

This value is required to specify a range if condition `INRange` | `OORange` is set with [SEARCh:TRIGger:CAN:DCONdition](#) on page 1971.

Parameters:

<DataPatternTo> Range: -100E+24 to 100E+24
 Increment: 1
 *RST: 1

Parameters for setting and query:

<SearchName> String that contains the search definition name

Manual operation: See "[Value \(max\)](#)" on page 631

SEARCh:TRIGger:CAN:SYMBolic:SGEValue <SearchName>, <SignalEnumValue>
SEARCh:TRIGger:CAN:SYMBolic:SGEValue? <SearchName>

Sets a symbolic data value for signals with enumerated values.

Parameters:

<SignalEnumValue> Numeric value according to the value definition in the DBC file

Parameters for setting and query:

<SearchName> String that contains the search definition name

Example:

Definition line in DBC file:

```
VAL_ 2175091489 Gear 0 "Idle" 1 "Gear_1" 2 "Gear_2"
3 "Gear_3" 4 "Gear_4" 5 "Gear_5" ;
```

Search for "Gear_3"

```
SEARCh:TRIGger:CAN:SYMBolic:SGEValue "Search1",3
```

Manual operation: See "[Value, Value \(min\)](#)" on page 631

27.18.9 LIN (option R&S RTO6-K520)

- [Configuration](#)..... 1988
- [Trigger](#)..... 1991
- [Decode results](#)..... 1998
- [LIN search settings](#)..... 2005
- [LIN search results](#)..... 2013

27.18.9.1 Configuration

[BUS<m>:LIN:DATA:SOURce](#)..... 1989
[BUS<m>:LIN:DATA:THReshold](#)..... 1989
[BUS<m>:LIN:TECHnology](#)..... 1989

BUS<m>:LIN:BITRate	1990
BUS<m>:LIN:POLarity	1990
BUS<m>:LIN:STANdard	1990

BUS<m>:LIN:DATA:SOURce <DataSource>

Sets the waveform of the data line.

Suffix:

<m> 1..4
Selects the serial bus.

Parameters:

<DataSource> C1W1 | C2W1 | C3W1 | C4W1 | M1 | M2 | M3 | M4 | M5 | M6 |
M7 | M8 | R1 | R2 | R3 | R4 | D0 | D1 | D2 | D3 | D4 | D5 | D6 |
D7 | D8 | D9 | D10 | D11 | D12 | D13 | D14 | D15

See [Chapter 27.4.2, "Waveform parameter"](#), on page 1371

*RST: C1W1

Usage: Asynchronous command

Manual operation: See ["Data"](#) on page 634

BUS<m>:LIN:DATA:THReshold <Threshold>

Sets a user-defined threshold value.

Alternatively, you can set the threshold according to the signal technology with [BUS<m>:LIN:TECHnology](#).

Suffix:

<m> 1..4
Selects the serial bus.

Parameters:

<Threshold> Range: -12 to 12
Increment: 0.1
*RST: 0
Default unit: V

Manual operation: See ["Threshold"](#) on page 635

BUS<m>:LIN:TECHnology <Technology>

Sets the threshold voltage as defined for various signal technologies.

Suffix:

<m> 1..4
Selects the serial bus.

Parameters:

<Technology> V15 | V25 | V35 | V6 | V9 | MANual

V15

1.5 Volt (TTL)

V25

2.5 Volt (CMOS 5.0 V)

V35 | V6 | V9

3.5 V (7 V supply), 6.0 V (12 V supply), 9.0 V (18 V supply) respectively

MANualManual setting of user-defined values with [BUS<m>:LIN:DATA:THReshold](#).

*RST: V35

Manual operation: See "[Threshold](#)" on page 635**BUS<m>:LIN:BITRate <Bitrate>**

Sets the number of transmitted bits per second.

Suffix:

<m>	1..4
-----	------

 Selects the serial bus.
Parameters:

<Bitrate>	Range:	1000 to 20000
	Increment:	1
	*RST:	9600
	Default unit:	bps

Manual operation: See "[Bit rate](#)" on page 635**BUS<m>:LIN:POLarity <Polarity>**

Defines the idle state of the bus. The idle state is the rezessive state and corresponds to a logic 1.

Suffix:

<m>	1..4
-----	------

 Selects the serial bus.
Parameters:

<Polarity>	IDLLow IDLHigh
	*RST: IDLHigh

Manual operation: See "[Polarity](#)" on page 635**BUS<m>:LIN:STANdard <Standard>**

Selects the version of the LIN standard.

See also: "[LIN standard](#)" on page 634

Suffix:

<m> 1..4
Selects the serial bus.

Parameters:

<Standard> V1X | V2X | J2602 | AUTO
*RST: AUTO

Manual operation: See "[LIN standard](#)" on page 634

27.18.9.2 Trigger

The trigger suffix <m> is always 1 and can be omitted. It selects the trigger event: Only the A-trigger is available for triggering on serial buses.

To trigger on a serial bus, make sure that:

- `TRIGger<m>:SOURce[:SElect]` is set to `SBUS`.
- The sources of the serial bus are channel signals: use `BUS<m>:...:SOURce` commands.
- Decoding is enabled: `BUS<m>[:STATe]` is set to `ON`.

<code>TRIGger<m>:LIN:TYPE</code>	1991
<code>TRIGger<m>:LIN:ICONdition</code>	1992
<code>TRIGger<m>:LIN:IMIN</code>	1993
<code>TRIGger<m>:LIN:IMAX</code>	1993
<code>TRIGger<m>:LIN:DCondition</code>	1993
<code>TRIGger<m>:LIN:DMIN</code>	1993
<code>TRIGger<m>:LIN:DMAX</code>	1994
<code>TRIGger<m>:LIN:BORDER</code>	1994
<code>TRIGger<m>:LIN:DLECondition</code>	1994
<code>TRIGger<m>:LIN:DLENgth</code>	1995
<code>TRIGger<m>:LIN:IDOR<n>:ENABLE</code>	1995
<code>TRIGger<m>:LIN:IDOR<n>[:VALue]</code>	1995
<code>TRIGger<m>:LIN:SYERror</code>	1996
<code>TRIGger<m>:LIN:IPERror</code>	1996
<code>TRIGger<m>:LIN:CHKSError</code>	1996
<code>TRIGger<m>:LIN:ERRPattern</code>	1996
<code>TRIGger<m>:LIN:CRCDatalen</code>	1997
<code>TRIGger<m>:LIN:STANdard</code>	1997

TRIGger<m>:LIN:TYPE <Type>

Selects the trigger type for LIN analysis.

See: "[Trigger type](#)" on page 639.

Parameters:

<Type> SYNC | ID | IDOR | IDDT | WKFR | ERRC

SYNC

Start of the frame, triggers on the stop bit of the sync field.

ID

Sets the trigger to one specific identifier or an identifier range. To set the identifier, use `TRIGger<m>:LIN:ICONdition`, `TRIGger<m>:LIN:IMIN` on page 1993, and `TRIGger<m>:LIN:IMAX` on page 1993.

IDOR

Triggers on an OR combination with up to four identifier conditions. For each identifier condition, enable it with `TRIGger<m>:LIN:IDOR<n>:ENABLE` and set the value with `TRIGger<m>:LIN:IDOR<n>[:VALue]`

IDDT

Combination of identifier and data conditions

To set the identifier condition, use `TRIGger<m>:LIN:ICONdition`, `TRIGger<m>:LIN:IMIN`, and `TRIGger<m>:LIN:IMAX`.

To set the data condition, use `TRIGger<m>:LIN:DCONdition`, `TRIGger<m>:LIN:DMIN`, and `TRIGger<m>:LIN:DMAX`.

WKFR

Wakeup frame

ERRC

Error condition. Define the error types with `TRIGger<m>:LIN:CHKSError` on page 1996, `TRIGger<m>:LIN:IPERror`, and `TRIGger<m>:LIN:SYERror`

*RST: SYNC

Manual operation: See "Trigger type" on page 639

TRIGger<m>:LIN:ICONdition <IdOperator>

Sets the operator to set a specific identifier or an identifier range.

Parameters:

<IdOperator>

EQUal | NEQUal | LTHan | LETHan | GTHan | GETHan | INRange | OORange

EQUal | NEQUal | LTHan | LETHan | GTHan | GETHan

Equal, Not equal, Less than, Less or equal than, Greater Than, Greater or equal than. These condition require one identifier pattern to be set with `TRIGger<m>:LIN:IMIN`

INRange | OORange

In range / Out of range: Set the minimum and maximum value of the range with `TRIGger<m>:LIN:IMIN` and `TRIGger<m>:LIN:IMAX`

*RST: EQUal

Manual operation: See "Identifier setup: Condition, Frame ID min, Frame ID max" on page 640

TRIGger<m>:LIN:IMIN <IdPattern>

Specifies a slave identifier pattern, or sets the the start value of an identifier range.

Parameters:

<IdPattern> Numeric or string pattern, see [Chapter 27.4.6, "Bit pattern parameter"](#), on page 1373.

Manual operation: See "[Identifier setup: Condition, Frame ID min, Frame ID max](#)" on page 640

TRIGger<m>:LIN:IMAX <IdPatternTo>

Sets the the end value of an identifier range if [TRIGger<m>:LIN:ICONdition](#) is set to [INRange](#) or [OORange](#).

Parameters:

<IdPatternTo> Numeric or string pattern, see [Chapter 27.4.6, "Bit pattern parameter"](#), on page 1373.

Manual operation: See "[Identifier setup: Condition, Frame ID min, Frame ID max](#)" on page 640

TRIGger<m>:LIN:DCONDITION <DataOperator>

Sets the operator to set a specific data pattern or a data pattern range.

Parameters:

<DataOperator> [EQUal](#) | [NEQual](#) | [LTHan](#) | [LETHan](#) | [GTHan](#) | [GETHan](#) | [INRange](#) | [OORange](#)

[EQUal](#) | [NEQual](#) | [LTHan](#) | [LETHan](#) | [GTHan](#) | [GETHan](#)

Equal, Not equal, Less than, Less or equal than, Greater Than, Greater or equal than. These conditions require one data pattern to be set with [TRIGger<m>:LIN:DMIN](#).

[INRange](#) | [OORange](#)

In range / Out of range: Set the minimum and maximum value of the range with [TRIGger<m>:LIN:DMIN](#) and [TRIGger<m>:LIN:DMAX](#)

*RST: [EQUal](#)

Manual operation: See "[Data setup: Data length, Transfer, Condition, Data min, Data max](#)" on page 641

TRIGger<m>:LIN:DMIN <DataPattern>

Specifies a data pattern, or sets the the start value of a data pattern range.

Parameters:

<DataPattern> Numeric or string pattern, see [Chapter 27.4.6, "Bit pattern parameter"](#), on page 1373. The string parameter accepts the bit value X (don't care).

Manual operation: See "Data setup: Data length, Transfer, Condition, Data min, Data max" on page 641

TRIGger<m>:LIN:DMAX <DataPatternTo>

Sets the the end value of an data range if TRIGger<m>:LIN:DCONdition is set to INRange or OORange.

Parameters:

<DataPatternTo> Numeric or string pattern, see Chapter 27.4.6, "Bit pattern parameter", on page 1373. The string parameter accepts the bit value X (don't care).

Manual operation: See "Data setup: Data length, Transfer, Condition, Data min, Data max" on page 641

TRIGger<m>:LIN:BORDER <Endianness>

Sets the byte order (endianness) of the data transfer.

According to the standard, LIN data is transmitted in little endian transfer order.

Parameters:

<Endianness> BENDian | LENDian

BENDian

Big endian, data is analyzed and evaluated in the order of reception.

LENDian

Little endian, the instrument reads the complete data, reverses the byte order of the data, and compares it with the specified data word.

*RST: BENDian

Manual operation: See "Data setup: Data length, Transfer, Condition, Data min, Data max" on page 641

TRIGger<m>:LIN:DLECondition <DLCOperator>

Operator to set the data length for triggering on LIN data.

For Big Endian transfer direction, you can trigger on a number of bytes less than the data length of the frame, that means, on the first bytes that are transmitted. For Little Endian transfer direction, the exact number of data bytes in the frame must be set.

Example: The data word to be sent is 12 34 56, and it is sent little endian by the LIN node. With Data length ≥ 2 and Transfer = Big endian, you trigger on the data of the first two bytes, that is 56 34. With Data length = 3 and Transfer = Little endian, you trigger on the required data word 12 34 56.

The number of data bytes to be found is set with TRIGger<m>:LIN:DLEnGth on page 1995.

See also: [TRIGger<m>:LIN:BORDER](#) on page 1994 .

Parameters:

<DLCOperator> EQUal | GETHan
 For little endian transfer direction, EQUal must be set.
 *RST: GETHan

Manual operation: See "[Data setup: Data length, Transfer, Condition, Data min, Data max](#)" on page 641

TRIGger<m>:LIN:DLEnGth <WordCount>

Sets the length of the bit pattern to be found, in bytes. For "Big Endian" transfer direction, you can trigger on a number of bytes less than the data length of the frame, that means, on the beginning of the data pattern. For "Little Endian" transfer direction, the exact number of data bytes in the frame must be set.

For complete definition, set also the operator with [TRIGger<m>:LIN:DLECondition](#) on page 1994.

Parameters:

<WordCount> Range: 1 to 8
 Increment: 1
 *RST: 1

Manual operation: See "[Data setup: Data length, Transfer, Condition, Data min, Data max](#)" on page 641

TRIGger<m>:LIN:IDOR<n>:ENABle <UseIdentifier>

Includes the indicated IDOR address in the "identifier OR" trigger condition.

Suffix:

<n> 1..4
 Index of the identifier in an "identifier OR" condition

Parameters:

<UseIdentifier> ON | OFF
 *RST: OFF

Manual operation: See "[Identifier OR setup: Monitor, Frame ID](#)" on page 641

TRIGger<m>:LIN:IDOR<n>[:VALue] <IdPattern>

Defines the pattern of the indicated IDOR identifier in the "identifier OR" trigger condition.

Suffix:

<n> 1..4
 Index of the identifier in an "identifier OR" condition

Parameters:

<IdPattern> Numeric or string pattern, see [Chapter 27.4.6, "Bit pattern parameter"](#), on page 1373. The parameter accepts the bit value X (don't care).

Manual operation: See ["Identifier OR setup: Monitor, Frame ID"](#) on page 641

TRIGger<m>:LIN:SYError <SyncError>

Triggers if a synchronization error occurs.

The trigger type has to be set before: [TRIGger<m>:LIN:TYPE](#) to `ERRC`.

Parameters:

<SyncError> ON | OFF
*RST: ON

Manual operation: See ["Error conditions"](#) on page 642

TRIGger<m>:LIN:IPERror <IdParityError>

Triggers if an error occurs in the identifier parity bits. These are the bits 6 and 7 of the identifier.

The trigger type has to be set before: [TRIGger<m>:LIN:TYPE](#) to `ERRC`.

Parameters:

<IdParityError> ON | OFF
*RST: ON

Manual operation: See ["Error conditions"](#) on page 642

TRIGger<m>:LIN:CHKSError <ChecksumError>

Triggers on checksum errors according to the LIN standard set with [BUS<m>:LIN:STANdard](#).

The trigger type has to be set before: [TRIGger<m>:LIN:TYPE](#) to `ERRC`.

The frame identifier must be set with [TRIGger<m>:LIN:ERRPattern](#) on page 1996 and the data length with [TRIGger<m>:LIN:CRCDatalen](#) on page 1997.

Parameters:

<ChecksumError> ON | OFF
*RST: ON

Manual operation: See ["Error conditions"](#) on page 642

TRIGger<m>:LIN:ERRPattern <ErrorPattern>

Sets the frame identifier to trigger on a checksum error with [TRIGger<m>:LIN:CHKSError](#) on page 1996.

Parameters:

<ErrorPattern> Numeric or string pattern, see [Chapter 27.4.6, "Bit pattern parameter"](#), on page 1373.
Possible values depend on [TRIGger<m>:LIN:CRCDatalen](#).
Defining don't care bits 'X' in the ERRP bit string resets CRCDatalen to 0. When CRCDatalen is different than 0, then all the bits in ERRP must be 1 or 0, and X bits are set to 0.

Example:

```
FORM:BPAT STRG
TRIG1:LIN:ERRP '1X0'
TRIG1:LIN:ERRP?
<-- 1X0XXX
TRIGger:LIN:CRCDatalen?
<-- 0
TRIGger:LIN:CRCDatalen 4
TRIG1:LIN:ERRP?
<-- 100000
TRIG1:LIN:ERRP '00x11'
TRIG1:LIN:ERRP?
<-- 00X11X
TRIGger:LIN:CRCDatalen?
<-- 0
```

Manual operation: See ["Error conditions"](#) on page 642

TRIGger<m>:LIN:CRCDatalen <CRCDataLength>

Sets the number of data bytes to trigger on CRC errors ([TRIGger<m>:LIN:TYPE](#) is set to ERRC and [TRIGger<m>:LIN:CHKSError](#) is set ON.)

Parameters:

<CRCDataLength> Values ≠0 restrict allowed bit values in [TRIGger<m>:LIN:ERRPattern](#) to 0 and 1.
Range: 0 to 8
Increment: 1
*RST: 0

Manual operation: See ["Error conditions"](#) on page 642

TRIGger<m>:LIN:STANdard <LINStandard>

Sets the LIN standard to trigger on CRC errors ([TRIGger<m>:LIN:TYPE](#) is set to ERRC and [TRIGger<m>:LIN:CHKSError](#) is set ON.)

See also: ["LIN standard"](#) on page 634.

Parameters:

<LINStandard> V1X | V2X | J2602 | AUTO
*RST: AUTO

Manual operation: See ["Error conditions"](#) on page 642

27.18.9.3 Decode results

To load and activate a label list, use:

- `BUS<m>:NEWList` on page 1815
- `BUS<m>:SYMBOLs` on page 1815

<code>BUS<m>:LIN:FCOunt?</code>	1998
<code>BUS<m>:LIN:FRAMe<n>:STATUs?</code>	1998
<code>BUS<m>:LIN:FRAMe<n>:STARt?</code>	1999
<code>BUS<m>:LIN:FRAMe<n>:STOP?</code>	1999
<code>BUS<m>:LIN:FRAMe<n>:SDATa?</code>	1999
<code>BUS<m>:LIN:FRAMe<n>:SDEXport?</code>	2000
<code>BUS<m>:LIN:FRAMe<n>:SYMBol?</code>	2000
<code>BUS<m>:LIN:FRAMe<n>:VERSIon?</code>	2000
<code>BUS<m>:LIN:FRAMe<n>:DATA?</code>	2001
<code>BUS<m>:LIN:FRAMe<n>:IDStAtE?</code>	2001
<code>BUS<m>:LIN:FRAMe<n>:IDVAlue?</code>	2001
<code>BUS<m>:LIN:FRAMe<n>:IDPValue?</code>	2002
<code>BUS<m>:LIN:FRAMe<n>:SYStAtE?</code>	2002
<code>BUS<m>:LIN:FRAMe<n>:CSStAtE?</code>	2003
<code>BUS<m>:LIN:FRAMe<n>:CSVAlue?</code>	2003
<code>BUS<m>:LIN:FRAMe<n>:BITRate?</code>	2003
<code>BUS<m>:LIN:FRAMe<n>:BYTE<o>:STATe?</code>	2004
<code>BUS<m>:LIN:FRAMe<n>:BYTE<o>:VALue?</code>	2004

`BUS<m>:LIN:FCOunt?`

Returns the number of decoded frames.

Suffix:

`<m>` 1..4
Selects the serial bus.

Return values:

`<Count>` Total number of decoded frames.

Usage: Query only

`BUS<m>:LIN:FRAMe<n>:STATUs?`

Returns the overall state of the selected frame.

Suffix:

`<m>` 1..4
Selects the serial bus.

`<n>` *
Selects the frame.

Return values:

`<FrameState>` OK | UART | CHCKsum | VERS | LENer | SPERror | PRERror | SYERror | WAKeup | CPERror | INSufficient | INComplete

UART: at least one UART error occurred. LIN uses UART words without parity bit.

CHCKsum: checksum error

VERS: the version of the LIN standard is not valid

LENER: unexpected length

SPERror: stop error

PRERror: parity error in identifier

SYERror: synchronization error

WAKEup: the frame is a wakeup frame

CPError: parity error and checksum error

INSufficient: the frame is not completely contained in the acquisition. The decoded part of the frame is valid.

INComplete: the frame is missing some parts

*RST: OK

Usage: Query only

BUS<m>:LIN:FRAME<n>:START?

BUS<m>:LIN:FRAME<n>:STOP?

Returns the start time and stop time of the selected frame, respectively.

Suffix:

<m> 1..4
Selects the serial bus.

<n> *
Selects the frame.

Return values:

<Start>, <Stop> Range: -100E+24 to 100E+24
*RST: 0
Default unit: s

Usage: Query only

BUS<m>:LIN:FRAME<n>:SDATA?

Returns the complete symbolic data of the frame.

Suffix:

<m> 1..4
Selects the serial bus.

<n> *
Selects the frame.

Return values:

<SymbolicData>

Usage: Query only

BUS<m>:LIN:FRAMe<n>:SDEXport?

Returns the symbolic data of the frame in export format.

Suffix:

<m> 1..4
Selects the serial bus.

<n> *
Selects the frame.

Return values:

<SymbolicData>

Usage: Query only

BUS<m>:LIN:FRAMe<n>:SYMBol?

Returns the symbolic label of the specified frame if the label list is enabled.

Suffix:

<m> 1..4
Selects the serial bus.

<n> *
Selects the number of the frame in the current acquisition, 1...n.

Return values:

<Label> String with symbolic name of the identifier

Example:

BUS:LIN:FRAMe2:SYMBol?
Response: Temperature

Usage: Query only

BUS<m>:LIN:FRAMe<n>:VERSion?

Returns the version of the LIN standard for the specified frame.

Suffix:

<m> 1..4
Selects the serial bus.

<n> *
Selects the frame.

Return values:

<FrameVersion> V1X | V2X | UNK
UNK: Unknown
*RST: UNK

Usage: Query only

BUS<m>:LIN:FRAMe<n>:DATA?

Returns the data bytes of the specified frame.

Suffix:

<m>	1..4 Selects the serial bus.
<n>	* Selects the frame.

Return values:

<Data>	Comma-separated list of integer values (N, D1, D2,..., DN). N is the number of bytes in the frame, and D1...DN are the values of the bytes.
--------	---

Example: BUS:LIN:FRAMe4:DATA?
 <-- 4,118,39,71,123

Usage: Query only

BUS<m>:LIN:FRAMe<n>:IDStAtE?

Returns the identifier state of the selected frame.

Suffix:

<m>	1..4 Selects the serial bus.
<n>	* Selects the frame.

Return values:

<IdentifierState>	OK STERror SPERror PRERror UVAL NOEXists INSufficient STERror: start error SPERror: stop error PRERror: parity error UVAL: unexpected value NOEXists: byte does not exist INSufficient: the frame is not completely contained in the acquisition. The decoded part of the frame is valid. *RST: OK
-------------------	---

Usage: Query only

BUS<m>:LIN:FRAMe<n>:IDValue?

Returns the identifier value of the selected frame.

Suffix:

<m>	1..4 Selects the serial bus.
-----	---------------------------------

<n> *
Selects the frame.

Return values:

<IdentifierValue> To set the value format, use [FORMat:BPATtern](#).
The values below – range, increment and reset – are decimal values.

Range: 0 to 63

*RST: 0

Usage: Query only

BUS<m>:LIN:FRAMe<n>:IDPValue?

Returns the value of the identifier parity bits of the selected frame.

Suffix:

<m> 1..4
Selects the serial bus.

<n> *
Selects the frame.

Return values:

<IdtfParityValue> To set the value format, use [FORMat:BPATtern](#).
The values below – range, increment and reset – are decimal values.

Range: 0 to 3

*RST: 0

Usage: Query only

BUS<m>:LIN:FRAMe<n>:SYSTate?

Returns the state of the sync field for the specified frame.

Suffix:

<m> 1..4
Selects the serial bus.

<n> *
Selects the frame.

Return values:

<SyncState> OK | STERror | SPERror | UVAL | NOEXists | INSufficient
STERror: start error
SPERror: stop error
UVAL: unexpected value
NOEXists: byte does not exist
INSufficient: the frame is not completely contained in the acquisition. The decoded part of the frame is valid.

*RST: OK

Usage: Query only

BUS<m>:LIN:FRAME<n>:CSState?

Returns the checksum state of the specified frame.

Suffix:

<m> 1..4
Selects the serial bus.

<n> *
Selects the frame.

Return values:

<ChecksumState> OK | STERror | SPERror | UVAL | NOEXists | INSufficient
 STERror: start error
 SPERror: stop error
 UVAL: unexpected value
 NOEXists: byte does not exist
 INSufficient: the frame is not completely contained in the acquisition. The decoded part of the frame is valid.
 *RST: OK

Usage: Query only

BUS<m>:LIN:FRAME<n>:CSValue?

Returns the checksum value of the specified frame.

Suffix:

<m> 1..4
Selects the serial bus.

<n> *
Selects the frame.

Return values:

<ChecksumValue> To set the value format, use [FORMat:BPATtern](#).
 The values below – range, increment and reset – are decimal values.
 Range: 0 to 255
 *RST: 0

Usage: Query only

BUS<m>:LIN:FRAME<n>:BITRate?

Returns the primary bit rate.

Suffix:

<m> 1..4
Selects the serial bus.

<n> *
Selects the frame.

Return values:

<PrimaryBitRate> Range: 0 to 100000000000
Increment: 1
*RST: 0
Default unit: bps

Usage: Query only

BUS<m>:LIN:FRAME<n>:BYTE<o>:STATE?

Returns the state of the specified byte.

Suffix:

<m> 1..4
Selects the serial bus.

<n> *
Selects the frame.

<o> *
Selects the byte number.

Return values:

<ByteState> OK | STERror | SPERror | UVAL | NOEXists | INSufficient
STERror: start error
SPERror: stop error
UVAL: unexpected value
NOEXists: byte does not exist
INSufficient: the frame is not completely contained in the acquisition. The decoded part of the frame is valid.
*RST: OK

Usage: Query only

BUS<m>:LIN:FRAME<n>:BYTE<o>:VALue?

Returns the value of the specified byte.

Suffix:

<m> 1..4
Selects the serial bus.

<n> *
Selects the frame.

<o> *
Selects the byte.

Return values:

<ByteValue>

To set the value format, use `FORMat:BPATtern`.

The values below – range, increment and reset – are decimal values.

Range: 0 to 255

*RST: 0

Usage:

Query only

27.18.9.4 LIN search settings

In search setup commands, you have to specify the <SearchName> parameter. It is a string parameter that contains the search definition name. The commands are similar to LIN trigger commands.

<code>SEARch:TRIGger:LIN:SSOFrame</code>	2005
<code>SEARch:TRIGger:LIN:SFIDentifier</code>	2006
<code>SEARch:TRIGger:LIN:IDENtifieror</code>	2006
<code>SEARch:TRIGger:LIN:SIDData</code>	2006
<code>SEARch:TRIGger:LIN:SERRor</code>	2006
<code>SEARch:TRIGger:LIN:WUFRame</code>	2007
<code>SEARch:TRIGger:LIN:ICONdition</code>	2007
<code>SEARch:TRIGger:LIN:IMIN</code>	2007
<code>SEARch:TRIGger:LIN:IMAX</code>	2008
<code>SEARch:TRIGger:LIN:IDOR<m>:ENABLE</code>	2008
<code>SEARch:TRIGger:LIN:IDOR<m>[:VALue]</code>	2008
<code>SEARch:TRIGger:LIN:DCONdition</code>	2009
<code>SEARch:TRIGger:LIN:DMIN</code>	2009
<code>SEARch:TRIGger:LIN:DMAX</code>	2009
<code>SEARch:TRIGger:LIN:BORDER</code>	2010
<code>SEARch:TRIGger:LIN:DLECondition</code>	2010
<code>SEARch:TRIGger:LIN:DLENgth</code>	2011
<code>SEARch:TRIGger:LIN:IPERRor</code>	2011
<code>SEARch:TRIGger:LIN:SYERRor</code>	2011
<code>SEARch:TRIGger:LIN:CHKSerror</code>	2012
<code>SEARch:TRIGger:LIN:ERRPattern</code>	2012
<code>SEARch:TRIGger:LIN:CRCDatalen</code>	2012
<code>SEARch:TRIGger:LIN:STANdard</code>	2013

SEARch:TRIGger:LIN:SSOFrame <SearchName>,<FrameStart>

SEARch:TRIGger:LIN:SSOFrame? <SearchName>

Enables the search for the stop bit of the sync field, which marks the frame start.

Parameters:

<FrameStart> ON | OFF

*RST: OFF

Parameters for setting and query:

<SearchName>

Manual operation: See ["Search types"](#) on page 644

SEARCH:TRIGger:LIN:SFIDentifier <SearchName>,<Identifier>
SEARCH:TRIGger:LIN:SFIDentifier? <SearchName>

Enables the search for one specific identifier or an identifier range.

Parameters:

<Identifier> ON | OFF
 *RST: OFF

Parameters for setting and query:

<SearchName>

Manual operation: See ["Search types"](#) on page 644

SEARCH:TRIGger:LIN:IDENTifieror <SearchName>,<IdentifierOr>
SEARCH:TRIGger:LIN:IDENTifieror? <SearchName>

Enables the search for one to four address conditions.

Parameters:

<IdentifierOr> ON | OFF
 *RST: OFF

Parameters for setting and query:

<SearchName>

Manual operation: See ["Search types"](#) on page 644

SEARCH:TRIGger:LIN:SIDData <SearchName>,<IdentifierData>
SEARCH:TRIGger:LIN:SIDData? <SearchName>

Enables the search for a combination of identifier and data conditions.

Parameters:

<IdentifierData> ON | OFF
 *RST: OFF

Parameters for setting and query:

<SearchName>

Manual operation: See ["Search types"](#) on page 644

SEARCH:TRIGger:LIN:SERRor <SearchName>,<ErrorCondition>
SEARCH:TRIGger:LIN:SERRor? <SearchName>

Enables the search for various errors in the frame.

Parameters:

<ErrorCondition> ON | OFF
 *RST: OFF

Parameters for setting and query:

<SearchName>

Manual operation: See ["Search types"](#) on page 644**SEARch:TRIGger:LIN:WUFRame** <SearchName>,<WakeUpFrame>**SEARch:TRIGger:LIN:WUFRame?** <SearchName>

Enables the search for wakeup frames.

Parameters:

<WakeUpFrame> ON | OFF

*RST: OFF

Parameters for setting and query:

<SearchName>

Manual operation: See ["Search types"](#) on page 644**SEARch:TRIGger:LIN:ICONdition** <SearchName>,<IdOperator>**SEARch:TRIGger:LIN:ICONdition?** <SearchName>

Sets the operator to define a specific identifier or an identifier range.

Parameters:

<IdOperator> EQUal | NEQual | LTHan | LETHan | GTHan | GETHan | INRange | OORange

EQUal | NEQual | LTHan | LETHan | GTHan | GETHanEqual, Not equal, Less than, Less or equal than, Greater Than, Greater or equal than. These operators require one identifier pattern to be set with [SEARch:TRIGger:LIN:IMIN](#)**INRange | OORange**In range / Out of range: Set the minimum and maximum value of the range with [SEARch:TRIGger:LIN:IMIN](#) and [SEARch:TRIGger:LIN:IMAX](#).

*RST: EQUal

Parameters for setting and query:

<SearchName>

Manual operation: See ["Identifier setup: Condition, Frame ID min, Frame ID max"](#) on page 645**SEARch:TRIGger:LIN:IMIN** <SearchName>,<IdPattern>**SEARch:TRIGger:LIN:IMIN?** <SearchName>

Specifies a slave identifier pattern, or sets the the start value of an identifier range.

Parameters:<IdPattern> Numeric or string pattern, see [Chapter 27.4.6, "Bit pattern parameter"](#), on page 1373.

Parameters for setting and query:

<SearchName>

Manual operation: See "Identifier setup: Condition, Frame ID min, Frame ID max" on page 645**SEARCh:TRIGger:LIN:IMAX** <SearchName>,<IdPatternTo>**SEARCh:TRIGger:LIN:IMAX?** <SearchName>Sets the the end value of an identifier range if **SEARCh:TRIGger:LIN:ICONdition** is set to **INRange** or **ORange**.**Parameters:**<IdPatternTo> Numeric or string pattern, see [Chapter 27.4.6, "Bit pattern parameter"](#), on page 1373.**Parameters for setting and query:**

<SearchName>

Manual operation: See "Identifier setup: Condition, Frame ID min, Frame ID max" on page 645**SEARCh:TRIGger:LIN:IDOR<m>:ENABLE** <SearchName>,<UseIdentifier>**SEARCh:TRIGger:LIN:IDOR<m>:ENABLE?** <SearchName>

Includes the indicated IDOR address in the "identifier OR" search.

Suffix:<m> 1..4
Index of the identifier in an "identifier OR" condition**Parameters:**<UseIdentifier> ON | OFF
*RST: OFF**Parameters for setting and query:**

<SearchName>

Manual operation: See "Identifier OR setup: Monitor, Frame ID" on page 645**SEARCh:TRIGger:LIN:IDOR<m>[:VALue]** <SearchName>,<IdPattern>**SEARCh:TRIGger:LIN:IDOR<m>[:VALue]?** <SearchName>

Defines the pattern of the indicated IDOR identifier in the "identifier OR" trigger condition.

Suffix:<m> 1..4
Index of the identifier in an "identifier OR" condition**Parameters:**<IdPattern> Numeric or string pattern, see [Chapter 27.4.6, "Bit pattern parameter"](#), on page 1373.

Parameters for setting and query:

<SearchName>

Manual operation: See ["Identifier OR setup: Monitor, Frame ID"](#) on page 645**SEARCh:TRIGger:LIN:DCONdition** <SearchName>,<DataOperator>**SEARCh:TRIGger:LIN:DCONdition?** <SearchName>

Sets the operator to set a specific data pattern or a data pattern range.

Parameters:<DataOperator> EQUal | NEQual | LTHan | LETHan | GTHan | GETHan |
INRange | OORange**EQUal | NEQual | LTHan | LETHan | GTHan | GETHan**Equal, Not equal, Less than, Less or equal than, Greater Than, Greater or equal than. These conditions require one data pattern to be set with [SEARCh:TRIGger:LIN:DMIN](#).**INRange | OORange**In range / Out of range: Set the minimum and maximum value of the range with [SEARCh:TRIGger:LIN:DMIN](#) and [SEARCh:TRIGger:LIN:DMAX](#).

*RST: EQUal

Parameters for setting and query:

<SearchName>

Manual operation: See ["Data setup: Condition, Data min, Data max, Data length, Transfer"](#) on page 645**SEARCh:TRIGger:LIN:DMIN** <SearchName>,<DataPattern>**SEARCh:TRIGger:LIN:DMIN?** <SearchName>

Specifies a data pattern, or sets the the start value of a data pattern range.

Parameters:<DataPattern> Numeric or string pattern, see [Chapter 27.4.6, "Bit pattern parameter"](#), on page 1373.**Parameters for setting and query:**

<SearchName>

Manual operation: See ["Data setup: Condition, Data min, Data max, Data length, Transfer"](#) on page 645**SEARCh:TRIGger:LIN:DMAX** <SearchName>,<DataPatternTo>**SEARCh:TRIGger:LIN:DMAX?** <SearchName>Sets the the end value of an identifier range if [SEARCh:TRIGger:LIN:DCONdition](#) is set to [INRange](#) or [OORange](#).

Parameters:

<DataPatternTo> Numeric or string pattern, see [Chapter 27.4.6, "Bit pattern parameter"](#), on page 1373.

Parameters for setting and query:

<SearchName>

Manual operation: See "[Data setup: Condition, Data min, Data max, Data length, Transfer](#)" on page 645

SEARch:TRIGger:LIN:BORDER <SearchName>,<Endianness>

SEARch:TRIGger:LIN:BORDER? <SearchName>

Sets the byte order (endianness) of the data transfer.

Parameters:

<Endianness> BENDian | LENDian

BENDian

Big endian, data is analyzed and evaluated in the order of reception.

LENDian

Little endian, the instrument reads the complete data, reverses the byte order of the data, and compares it with the specified data word.

*RST: BENDian

Parameters for setting and query:

<SearchName>

Manual operation: See "[Data setup: Condition, Data min, Data max, Data length, Transfer](#)" on page 645

SEARch:TRIGger:LIN:DLECondition <SearchName>,<DLCOperator>

SEARch:TRIGger:LIN:DLECondition? <SearchName>

Operator to set the data length for search on LIN data.

For Big Endian transfer direction, you can trigger on a number of bytes less than the data length of the frame, that means, on the first bytes that are transmitted. For Little Endian transfer direction, the exact number of data bytes in the frame must be set.

Example: The data word to be sent is *12 34 56*, and it is sent little endian by the LIN node. With Data length ≥ 2 and Transfer = Big endian, you trigger on the data of the first two bytes, that is *56 34*. With Data length = 3 and Transfer = Little endian, you trigger on the required data word *12 34 56*.

The number of data bytes to be found is set with [SEARch:TRIGger:LIN:DLENgth](#).

See also: [SEARch:TRIGger:LIN:BORDER](#) on page 2010.

Parameters:

<DLCOperator> EQUal | GETHan
 For little endian transfer direction, EQUal must be set.
 *RST: GETHan

Parameters for setting and query:

<SearchName>

Manual operation: See "[Data setup: Condition, Data min, Data max, Data length, Transfer](#)" on page 645

SEARCh:TRIGger:LIN:DLENgth <SearchName>,<WordCount>

SEARCh:TRIGger:LIN:DLENgth? <SearchName>

Sets the length of the bit pattern to be found, in bytes.

For complete definition, set the operator using [SEARCh:TRIGger:LIN:DLECondition](#), and the transfer direction with [SEARCh:TRIGger:LIN:BORDER](#).

Parameters:

<WordCount> Range: 1 to 8
 Increment: 1
 *RST: 1

Parameters for setting and query:

<SearchName>

Manual operation: See "[Data setup: Condition, Data min, Data max, Data length, Transfer](#)" on page 645

SEARCh:TRIGger:LIN:IPERror <SearchName>,<IdParityError>

SEARCh:TRIGger:LIN:IPERror? <SearchName>

Searches for errors in the identifier parity bits. These are the bits 6 and 7 of the identifier.

Parameters:

<IdParityError> ON | OFF
 *RST: ON

Parameters for setting and query:

<SearchName>

Manual operation: See "[Error Condition](#)" on page 646

SEARCh:TRIGger:LIN:SYERror <SearchName>,<SyncError>

SEARCh:TRIGger:LIN:SYERror? <SearchName>

Searches for synchronization errors.

Parameters:

<SyncError> ON | OFF
 *RST: ON

Parameters for setting and query:

<SearchName>

Manual operation: See "[Error Condition](#)" on page 646

SEARCH:TRIGger:LIN:CHKSError <SearchName>,<ChecksumError>

SEARCH:TRIGger:LIN:CHKSError? <SearchName>

Searches for checksum errors according to the LIN standard.

Use the following commands to configure the checksum error search:

- [SEARCH:TRIGger:LIN:ERRPattern](#) on page 2012
- [SEARCH:TRIGger:LIN:CRCDatalen](#) on page 2012
- [SEARCH:TRIGger:LIN:STANdard](#) on page 2013

Parameters:

<ChecksumError> ON | OFF
 *RST: ON

Parameters for setting and query:

<SearchName>

Manual operation: See "[Error Condition](#)" on page 646

SEARCH:TRIGger:LIN:ERRPattern <SearchName>,<ErrorPattern>

SEARCH:TRIGger:LIN:ERRPattern? <SearchName>

Sets the frame identifier to search for a checksum error.

Parameters:

<ErrorPattern> Numeric or string pattern, see [Chapter 27.4.6, "Bit pattern parameter"](#), on page 1373.

Parameters for setting and query:

<SearchName>

Manual operation: See "[Error Condition](#)" on page 646

SEARCH:TRIGger:LIN:CRCDatalen <SearchName>,<CRCDataLength>

SEARCH:TRIGger:LIN:CRCDatalen? <SearchName>

Sets the number of data bytes search for CRC errors.

Parameters:

<CRCDataLength> Range: 0 to 8
 Increment: 1
 *RST: 0

Parameters for setting and query:

<SearchName>

Manual operation: See ["Error Condition"](#) on page 646**SEARCh:TRIGger:LIN:STANdard** <SearchName>,<LINStandard>**SEARCh:TRIGger:LIN:STANdard?** <SearchName>

Sets the LIN standard to search for CRC errors.

Parameters:

<LINStandard> V1X | V2X | J2602 | AUTO

*RST: AUTO

Parameters for setting and query:

<SearchName>

Manual operation: See ["Error Condition"](#) on page 646**27.18.9.5 LIN search results**

The search on decoded LIN data returns the same results as the queries for decode results.

In search result commands, you have to specify the <SearchName> parameter. It is a string parameter that contains the search definition name.

For a description of the returned values, see the corresponding commands in [Chapter 27.18.9.3, "Decode results"](#), on page 1998.

SEARCh:RESult:LIN:FCOunt?	2013
SEARCh:RESult:LIN:FRAMe<m>:STATus?	2014
SEARCh:RESult:LIN:FRAMe<m>:START?	2014
SEARCh:RESult:LIN:FRAMe<m>:STOP?	2014
SEARCh:RESult:LIN:FRAMe<m>:DATA?	2015
SEARCh:RESult:LIN:FRAMe<m>:SDATa?	2015
SEARCh:RESult:LIN:FRAMe<m>:SDEXport?	2015
SEARCh:RESult:LIN:FRAMe<m>:CSSTate?	2015
SEARCh:RESult:LIN:FRAMe<m>:CSValue?	2016
SEARCh:RESult:LIN:FRAMe<m>:IDSTate?	2016
SEARCh:RESult:LIN:FRAMe<m>:IDValue?	2016
SEARCh:RESult:LIN:FRAMe<m>:IDPValue?	2017
SEARCh:RESult:LIN:FRAMe<m>:SYMBol?	2017
SEARCh:RESult:LIN:FRAMe<m>:SYSTate?	2017
SEARCh:RESult:LIN:FRAMe<m>:VERSion?	2018
SEARCh:RESult:LIN:FRAMe<m>:BYTE<n>:STATe?	2018
SEARCh:RESult:LIN:FRAMe<m>:BYTE<n>:VALue?	2018

SEARCh:RESult:LIN:FCOunt? <SearchName>**Query parameters:**

<SearchName>

Return values:

<Count> Range: 0 to 100000
 Increment: 1
 *RST: 0

Usage: Query only

SEARCh:RESult:LIN:FRAMe<m>:STATus? <SearchName>**Suffix:**

<m> *

Query parameters:

<SearchName>

Return values:

<State> OK | UART | CHCKsum | VERS | LENer | SPERror | PRERror |
 SYERror | WAKeup | CPERror | INSufficient | INComplete
 *RST: OK

Usage: Query only

SEARCh:RESult:LIN:FRAMe<m>:STARt? <SearchName>**Suffix:**

<m> *

Query parameters:

<SearchName>

Return values:

<Start> Range: -100E+24 to 100E+24
 Increment: 100E-12
 *RST: 0
 Default unit: s

Usage: Query only

SEARCh:RESult:LIN:FRAMe<m>:STOP? <SearchName>**Suffix:**

<m> *

Query parameters:

<SearchName>

Return values:

<Stop> Range: -100E+24 to 100E+24
 Increment: 100E-12
 *RST: 0
 Default unit: s

Usage: Query only

SEARCh:RESult:LIN:FRAMe<m>:DATA? <SearchName>**Suffix:**

<m> *

Query parameters:

<SearchName>

Return values:

<Data> Data bytes in the Frame

Usage: Query only

SEARCh:RESult:LIN:FRAMe<m>:SDATa? <SearchName>

Returns the symbolic data of the frame.

Suffix:

<m> *

Query parameters:

<SearchName>

Return values:

<SymbolicData>

Usage: Query only

SEARCh:RESult:LIN:FRAMe<m>:SDEXport? <SearchName>

Returns the symbolic data of the frame for the export format.

Suffix:

<m> *

Query parameters:

<SearchName>

Return values:

<SymbolicData>

Usage: Query only

SEARCh:RESult:LIN:FRAMe<m>:CSState? <SearchName>

Returns the status of the frame checksum.

Suffix:

<m> *

Query parameters:

<SearchName>

Return values:<ChecksumState> OK | STERror | SPERror | PRERror | UVAL | NOEXists |
INSufficient

STERror: StarT ERror, incorrect start bit
 SPERror: StoP ERror, incorrect stop bit
 PRERror:PaRity ERror, incorrect parity bit.
 UVAL: unexpected value
 NOEXists: byte does not exist
 *RST: OK

Usage: Query only

SEARCh:RESult:LIN:FRAMe<m>:CSValue? <SearchName>

Returns the checksum value.

Suffix:
 <m> *

Query parameters:
 <SearchName>

Return values:
 <ChecksumValue> Range: 0 to 255
 Increment: 1
 *RST: 0

Usage: Query only

SEARCh:RESult:LIN:FRAMe<m>:IDStAtE? <SearchName>

Returns the status of the identifier.

Suffix:
 <m> *

Query parameters:
 <SearchName>

Return values:
 <IdentifierState> OK | STERror | SPERror | PRERror | UVAL | NOEXists |
 INSufficient
 STERror: StarT ERror, incorrect start bit
 SPERror: StoP ERror, incorrect stop bit
 PRERror:PaRity ERror, incorrect parity bit.
 UVAL: unexpected value
 NOEXists: byte does not exist
 *RST: OK

Usage: Query only

SEARCh:RESult:LIN:FRAMe<m>:IDValue? <SearchName>

Returns the value of the identifier.

Suffix:

<m> *

Query parameters:

<SearchName>

Return values:

<IdentifierValue>	Range:	0 to 63
	Increment:	1
	*RST:	0

Usage: Query only**SEARCh:RESult:LIN:FRAMe<m>:IDPValue? <SearchName>**

Returns the value of the identifier parity bit.

Suffix:

<m> *

Query parameters:

<SearchName>

Return values:

<IdParityValue>	Range:	0 to 3
	Increment:	1
	*RST:	0

Usage: Query only**SEARCh:RESult:LIN:FRAMe<m>:SYMBol? <SearchName>****Suffix:**

<m> *

Query parameters:

<SearchName>

Return values:

<Label>

Usage: Query only**SEARCh:RESult:LIN:FRAMe<m>:SYSTate? <SearchName>****Suffix:**

<m> *

Query parameters:

<SearchName>

Return values:

<SyncState> OK | STERror | SPERror | PRERror | UVAL | NOEXists |
INSufficient
*RST: OK

Usage: Query only

SEARch:RESult:LIN:FRAMe<m>:VERSion? <SearchName>**Suffix:**

<m> *

Query parameters:

<SearchName>

Return values:

<Version> V1X | V2X | UNK
*RST: UNK

Usage: Query only

SEARch:RESult:LIN:FRAMe<m>:BYTE<n>:STATe? <SearchName>**Suffix:**

<m> *

<n> *

Query parameters:

<SearchName>

Return values:

<ByteState> OK | STERror | SPERror | PRERror | UVAL | NOEXists |
INSufficient
*RST: OK

Usage: Query only

SEARch:RESult:LIN:FRAMe<m>:BYTE<n>:VALue? <SearchName>**Suffix:**

<m> *

<n> *

Query parameters:

<SearchName>

Return values:

<ByteValue> Range: 0 to 255
Increment: 1
*RST: 0

Usage: Query only

27.18.10 Flexray (option R&S RTO6-K520)

• Configuration.....	2019
• Trigger.....	2024
• Decode results.....	2033
• Search settings.....	2039
• Search results.....	2050

27.18.10.1 Configuration

BUS<m>:FLXRay:SRCType.....	2019
BUS<m>:FLXRay:SOURce<n>.....	2020
BUS<m>:FLXRay:THReshold<n>.....	2020
BUS<m>:FLXRay:THENable.....	2021
BUS<m>:FLXRay:THData.....	2021
BUS<m>:FLXRay:PRSingle.....	2021
BUS<m>:FLXRay:PRDiff.....	2022
BUS<m>:FLXRay:PRLogic.....	2022
BUS<m>:FLXRay:POLarity.....	2022
BUS<m>:FLXRay:BITRate.....	2023
BUS<m>:FLXRay:CHTType.....	2023
BUS<m>:FLXRay:SEHB.....	2023

BUS<m>:FLXRay:SRCType <SourceType>

Sets the type of measurement.

Suffix:

<m> 1..4
Selects the serial bus.

Parameters:

<SourceType> SINGle | DIFFerential | LOGic

SINGle

Used for measurements with single-ended probes or single-ended voltage measurements with differential probes on the FlexRay bus. Two thresholds have to be defined as absolute voltage levels, see [BUS<m>:FLXRay:THReshold<n>](#) on page 2020.

DIFFerential

Used for differential measurements on the FlexRay bus. This is the most common measurement. Two thresholds have to be defined as differential voltages.

LOGic

Used for measurements of the logic signal inside the FlexRay node, between the communication controller and the bus driver. It is possible to measure simultaneously on a data line and on the "enable" line. Each line requires its own threshold.

*RST: SINGle

Manual operation: See "[Source type](#)" on page 647

BUS<m>:FLXRay:SOURce<n> <Sources>

Sets the input channel of the bus signal, or of the data and enable lines in case of a LOGic source type.

Suffix:

<m> 1..4
Selects the serial bus.

<n> 1 | 2
Selects the source: 1 = bus signal or data line, 2 = enable line

Parameters:

<Sources> NONE | C1W1 | C2W1 | C3W1 | C4W1 | M1 | M2 | M3 | M4 | M5 | M6 | M7 | M8 | R1 | R2 | R3 | R4 | D0 | D1 | D2 | D3 | D4 | D5 | D6 | D7 | D8 | D9 | D10 | D11 | D12 | D13 | D14 | D15

C1W1 | C2W1 | C3W1 | C4W1
Always available

NONE
Only available for SOURce2 (enable line)

M1 | M2 | M3 | M4 | R1 | R2 | R3 | R4
Only available if the trigger source is one of the input channels but not the serial bus.

D0 | D1 | D2 | D3 | D4 | D5 | D6 | D7 | D8 | D9 | D10 | D11 | D12 | D13 | D14 | D15
Only available if `BUS<m>:FLXRay:SOURce<n>` is set to LOGic.

*RST: SOURce1: C1W1, SOURce2: C2W1

Manual operation: See "[Data](#)" on page 647

BUS<m>:FLXRay:THReshold<n> <THResholds>

Sets the thresholds for the bus signal if the source type is SINGLE or DIFFerential.

For LOGic source type, use `BUS<m>:FLXRay:THData` on page 2021 and `BUS<m>:FLXRay:THENable` on page 2021.

Suffix:

<m> 1..4
Selects the serial bus.

<n> 1 | 2
1 = threshold high, 2 = threshold low

Parameters:

<THResholds> Differential or absolute voltage level, depending on the source type. See `BUS<m>:FLXRay:SRCType` on page 2019.

Manual operation: See "[Thresholds](#)" on page 648

BUS<m>:FLXRay:THENable <ThresholdEnable>

Sets the threshold for the enable line if the source type is LOGic.

Suffix:

<m> 1..4
Selects the serial bus.

Parameters:

<ThresholdEnable> Range: -12 to 12
Increment: 0.1
*RST: 2.65
Default unit: V

Manual operation: See "[Thresholds](#)" on page 648

BUS<m>:FLXRay:THData <ThresholdData>

Sets the threshold for the data line if the source type is LOGic.

Suffix:

<m> 1..4
Selects the serial bus.

Parameters:

<ThresholdData> Range: -12 to 12
Increment: 0.1
*RST: 2.35
Default unit: V

Manual operation: See "[Thresholds](#)" on page 648

BUS<m>:FLXRay:PRSingle <PresetSingleEnd>

Selects a default threshold voltage if [BUS<m>:FLXRay:SRCType](#) is set to SINGle.

Suffix:

<m> 1..4
Selects the serial bus.

Parameters:

<PresetSingleEnd> MV150 | MV200 | MV250 | MV300 | MANual
MV150 | MV200 | MV250 | MV300
2.5 ± 0.15 V; 2.5 ± 0.2 V; 2.5 ± 0.25 V; 2.5 ± 0.3 V, respectively
MANual
Manual setting of user-defined values with [BUS<m>:FLXRay:THReshold<n>](#) on page 2020.
*RST: MV150

Manual operation: See "[Thresholds](#)" on page 648

BUS<m>:FLXRay:PRDiff <PresetDiff>

Selects a default threshold voltage if [BUS<m>:FLXRay:SRCType](#) is set to DIFFerential.

Suffix:

<m> 1..4
Selects the serial bus.

Parameters:

<PresetDiff> MV150 | MV200 | MV250 | MV300 | MANual
MV150 | MV200 | MV250 | MV300
 ±150 mV, ±200 mV, ±250 mV, ±300 mV respectively
MANual
 Manual setting of user-defined values with [BUS<m>:FLXRay:THReshold<n>](#) on page 2020.
 *RST: MV150

Manual operation: See "[Thresholds](#)" on page 648

BUS<m>:FLXRay:PRLogic <PresetLogic>

Selects a default threshold voltage if [BUS<m>:FLXRay:SRCType](#) is set to LOGic.

Suffix:

<m> 1..4
Selects the serial bus.

Parameters:

<PresetLogic> V25 | V165 | V125 | V09 | V0 | MANual
V25 | V165 | V125 | V09 | V0
 2.5 V (CMOS 5.0 V); 1.65 V (CMOS 3.5V), 1.25 V (CMOS 2.5V),
 0.9 V (CMOS 1.8V), 0 V (ground)
MANual
 Manual setting of user-defined values with [BUS<m>:FLXRay:THReshold<n>](#) on page 2020.
 *RST: V25

Manual operation: See "[Thresholds](#)" on page 648

BUS<m>:FLXRay:POLarity <Polarity>

Selects the wire on which the bus signal is measured in case of SINGLE source type. The setting affects the digitization of the signal.

Suffix:

<m> 1..4
Selects the serial bus.

Parameters:

<Polarity> BPLus | BMINus
 *RST: BPLus

Manual operation: See "[Polarity](#)" on page 649

BUS<m>:FLXRay:BITRate <Bitrate>

Selects the number of transmitted bits per second.

Suffix:

<m> 1..4
 Selects the serial bus.

Parameters:

<Bitrate> M10 | M5 | M2_5
 10, 5, or 2.5 Mbit/s.
 The return value of 2.5 Mbit/s is M25.
 *RST: M10

Example:

```
BUS:FLXRay:BITRate M2_5
BUS:FLXRay:BITRate?
M25
```

Manual operation: See "[Bit rate](#)" on page 649

BUS<m>:FLXRay:CHType <Channel>

Selects the channel on which the signal is measured. The setting is considered in the calculation of the frame CRC.

Suffix:

<m> 1..4
 Selects the serial bus.

Parameters:

<Channel> CHA | CHB
 Channel A or channel B
 *RST: CHA

Manual operation: See "[Channel](#)" on page 649

BUS<m>:FLXRay:SEHB <SeparateHdrBts>

The command affects the decoding and its display. If ON, the leading five indicator bits of the header are decoded as five single bits. Otherwise, the indicator bits are shown as one word with word length five bit.

Suffix:

<m> 1..4
 Selects the serial bus.

Parameters:

<SeparateHdrBts> ON | OFF
 *RST: OFF

Manual operation: See "[Separate header bits](#)" on page 649

27.18.10.2 Trigger

The trigger suffix <m> is always 1 and can be omitted. It selects the trigger event: Only the A-trigger is available for triggering on serial buses.

To trigger on a serial bus, make sure that:

- `TRIGger<m>:SOURce[:SElect]` is set to SBUS.
- The sources of the serial bus are channel signals: use `BUS<m>:...:SOURce` commands.
- Decoding is enabled: `BUS<m>[:STATe]` is set to ON.

<code>TRIGger<m>:FLXRay:TYPE</code>	2025
<code>TRIGger<m>:FLXRay:PLPReamble</code>	2026
<code>TRIGger<m>:FLXRay:NUFRame</code>	2026
<code>TRIGger<m>:FLXRay:SYFRame</code>	2026
<code>TRIGger<m>:FLXRay:STFRame</code>	2026
<code>TRIGger<m>:FLXRay:FCONdition</code>	2027
<code>TRIGger<m>:FLXRay:FMIN</code>	2027
<code>TRIGger<m>:FLXRay:FMAX</code>	2027
<code>TRIGger<m>:FLXRay:PCONdition</code>	2028
<code>TRIGger<m>:FLXRay:PMIN</code>	2028
<code>TRIGger<m>:FLXRay:PMAX</code>	2028
<code>TRIGger<m>:FLXRay:CENable</code>	2029
<code>TRIGger<m>:FLXRay:CMIN</code>	2029
<code>TRIGger<m>:FLXRay:CMAX</code>	2029
<code>TRIGger<m>:FLXRay:CSTep</code>	2029
<code>TRIGger<m>:FLXRay:DPOPerator</code>	2030
<code>TRIGger<m>:FLXRay:DPOStition</code>	2030
<code>TRIGger<m>:FLXRay:DPTO</code>	2030
<code>TRIGger<m>:FLXRay:DCONdition</code>	2031
<code>TRIGger<m>:FLXRay:DMIN</code>	2031
<code>TRIGger<m>:FLXRay:DMAX</code>	2031
<code>TRIGger<m>:FLXRay:SYMBol</code>	2032
<code>TRIGger<m>:FLXRay:BSSerror</code>	2032
<code>TRIGger<m>:FLXRay:FESerror</code>	2032
<code>TRIGger<m>:FLXRay:FSSerror</code>	2032
<code>TRIGger<m>:FLXRay:HCRCError</code>	2033
<code>TRIGger<m>:FLXRay:PCRCerror</code>	2033

TRIGger<m>:FLXRay:TYPE <Type>

Selects the trigger type for FlexRay analysis.

Parameters:

<Type>

STOF | IDDT | SYMBol | ERRC

STOF

Start Of Frame: triggers on the first rising edge after the transmission start sequence (TSS).

IDDT

Identifier and DaTa: triggers on the decoded frame content, on header and payload data.

For all settings that are not needed for the trigger condition, make sure to set its condition to OFF.

Indicator bits: see [TRIGger<m>:FLXRay:NUFRame](#)

Frame identifier: sets the trigger to one specific frame ID or an identifier range. To set the identifier, use [TRIGger<m>:FLXRay:FCONdition](#), [TRIGger<m>:FLXRay:FMIN](#), and [TRIGger<m>:FLXRay:FMAX](#).

Payload length: trigger on the number of words in the payload segment. To set the payload length, use [TRIGger<m>:FLXRay:PCONdition](#), [TRIGger<m>:FLXRay:PMIN](#), and [TRIGger<m>:FLXRay:PMAX](#).

Cycle count: trigger on the number of the current FlexRay cycle. To set the cycle count, use [TRIGger<m>:FLXRay:CENable](#), [TRIGger<m>:FLXRay:CMIN](#), [TRIGger<m>:FLXRay:CMAX](#), and [TRIGger<m>:FLXRay:CSTep](#).

Data position: sets the position of the data bit pattern within the payload segment. To set the data position, use [TRIGger<m>:FLXRay:DPOperator](#), [TRIGger<m>:FLXRay:DPOSITION](#), and [TRIGger<m>:FLXRay:DPTO](#).

Data bit pattern: sets the data bit pattern to be found in the payload segment. The starting point of the pattern is defined by the data position. To set the bit pattern, use [TRIGger<m>:FLXRay:DCONdition](#), [TRIGger<m>:FLXRay:DMIN](#), and [TRIGger<m>:FLXRay:DMAX](#).

SYMBol

Triggers on a symbol or wakeup pattern. Set the required symbol with [TRIGger<m>:FLXRay:SYMBol](#)

ERRC

ERRor Condition: triggers on one or more errors that are detected in the decoded data. Use [TRIGger<m>:FLXRay:BSSerror](#), [TRIGger<m>:FLXRay:FESerror](#), [TRIGger<m>:FLXRay:FSSerror](#), and [TRIGger<m>:FLXRay:PCRerror](#).

*RST: STOF

Manual operation: See "[Trigger type](#)" on page 652

TRIGger<m>:FLXRay:PLPReamble <PayloadPreamble>

Triggers on the payload preamble indicator bit that indicates a Network Management Vector in the payload segment.

Parameters:

<PayloadPreamble> ONE | ZERO | DC
Bit value: 1, 0, or X (don't care)
*RST: DC

Manual operation: See "[Indicator bits](#)" on page 653

TRIGger<m>:FLXRay:NUFRame <NullFrame>

Triggers on the null frame indicator bit, a frame without usable data.

Parameters:

<NullFrame> ONE | ZERO | DC
Bit value: 1, 0, or X (don't care)
*RST: DC

Manual operation: See "[Indicator bits](#)" on page 653

TRIGger<m>:FLXRay:SYFRame <SyncFrame>

Triggers on the sync frame used for synchronization of the FlexRay system. Only sync nodes can send this frame type.

Parameters:

<SyncFrame> ONE | ZERO | DC
Bit value: 1, 0, or X (don't care)
*RST: DC

Manual operation: See "[Indicator bits](#)" on page 653

TRIGger<m>:FLXRay:STFRame <StartupFrame>

Triggers on startup frames used for startup of the network. Only specific start nodes can send this frame type.

Parameters:

<StartupFrame> ONE | ZERO | DC
Bit value: 1, 0, or X (don't care)
*RST: DC

Manual operation: See "[Indicator bits](#)" on page 653

TRIGger<m>:FLXRay:FCONdition <IdOperator>

Sets the operator to set a frame ID or a frame ID range.

Parameters:

<IdOperator> OFF | ANY | EQUal | NEQual | LTHan | LETHan | GTHan |
GETHan | INRange | OORange

OFF = ANY

The frame ID is not relevant for the trigger condition.

EQUal | NEQual | LTHan | LETHan | GTHan | GETHan

Equal, Not equal, Less than, Less or equal than, Greater Than, Greater or equal than. These conditions require one frame ID to be set with [TRIGger<m>:FLXRay:FMIN](#).

INRange | OORange

In range, Out of range: Set the minimum and maximum value of the range with [TRIGger<m>:FLXRay:FMIN](#) and [TRIGger<m>:FLXRay:FMAX](#).

*RST: EQUal

Manual operation: See "[Frame ID \(min/max\)](#)" on page 654

TRIGger<m>:FLXRay:FMIN <IdPattern>

Specifies a frame identifier pattern - the number of the slot - or sets the the start value of an identifier range.

Parameters:

IdPattern Numeric or string pattern, see [Chapter 27.4.6, "Bit pattern parameter"](#), on page 1373.

Manual operation: See "[Frame ID \(min/max\)](#)" on page 654

TRIGger<m>:FLXRay:FMAX <IdPatternTo>

Sets the the end value of an identifier range if the condition [TRIGger<m>:FLXRay:FCONdition](#) is set to [INRange](#) or [OORange](#).

Parameters:

IdPatternTo Numeric or string pattern, see [Chapter 27.4.6, "Bit pattern parameter"](#), on page 1373.
FMAX must be greater or equal than FMIN, and the position of the X bits are common to FMIN and FMAX.

Manual operation: See "[Frame ID \(min/max\)](#)" on page 654

TRIGger<m>:FLXRay:PCONdition <PayloadLengthOp>

Sets the operator for the payload length trigger setting. You can defined an exact value, or a range.

Parameters:

<PayloadLengthOp> OFF | ANY | EQUal | NEQual | LTHan | LETHan | GTHan | GETHan | INRange | OORange

OFF = ANY

The payload length is not relevant for the trigger condition.

EQUal | NEQual | LTHan | LETHan | GTHan | GETHan

Equal, Not equal, Less than, Less or equal than, Greater Than, Greater or equal than. These conditions require one payload length to be set with [TRIGger<m>:FLXRay:PMIN](#).

INRange | OORange

In range / Out of range: Set the minimum and maximum value of the range with [TRIGger<m>:FLXRay:PMIN](#) and [TRIGger<m>:FLXRay:PMAX](#).

*RST: OFF

Manual operation: See "[Payload length \(min/max\)](#)" on page 654

TRIGger<m>:FLXRay:PMIN <PayloadLength>

Specifies a payload length - the number of words in the payload segment - or sets the the start value of an payload length range. Information is transmitted in 2-byte words, so the number of data bytes in the payload segment is twice the payload length.

Parameters:

<PayloadLength> Range: 0 to 127
Increment: 1
*RST: 0

Manual operation: See "[Payload length \(min/max\)](#)" on page 654

TRIGger<m>:FLXRay:PMAX <PayloadLengthTo>

Sets the the end value of a payload length range if the condition [TRIGger<m>:FLXRay:PCONdition](#) is set to [INRange](#) or [OORange](#).

Parameters:

<PayloadLengthTo> Range: 0 to 127
Increment: 1
*RST: 0

Manual operation: See "[Payload length \(min/max\)](#)" on page 654

TRIGger<m>:FLXRay:CENable <CycleCount>

Sets the operator to define a cycle count or a cycle count range.

Parameters:

<CycleCount> OFF | EQUal | NEQual | LTHan | LETHan | GTHan | GETHan |
INRange | OORange

OFF

The cycle count is not relevant for the trigger condition.

EQUal | NEQual | LTHan | LETHan | GTHan | GETHan

Equal, Not equal, Less than, Less or equal than, Greater Than, Greater or equal than. These conditions require one cycle count number to be set with [TRIGger<m>:FLXRay:CMIN](#).

INRange | OORange

In range / Out of range: Set the minimum and maximum value of the range with [TRIGger<m>:FLXRay:CMIN](#) and [TRIGger<m>:FLXRay:CMAx](#).

*RST: OFF

Manual operation: See "[Cycle count \(min, max\), Step](#)" on page 654

TRIGger<m>:FLXRay:CMIN <CycleCountMin>

Specifies a cycle count - the number of the current FlexRay cycle - or sets the the start value of an cycle count range.

Parameters:

<CycleCountMin> Range: 0 to 63
Increment: 1
*RST: 0

Manual operation: See "[Cycle count \(min, max\), Step](#)" on page 654

TRIGger<m>:FLXRay:CMAx <CycleCountMax>

Sets the the end value of a cycle count range if the condition [TRIGger<m>:FLXRay:CENable](#) on page 2029 is set to [INRange](#) or [OORange](#).

Parameters:

<CycleCountMax> Range: 0 to 63
Increment: 1
*RST: 0

Manual operation: See "[Cycle count \(min, max\), Step](#)" on page 654

TRIGger<m>:FLXRay:CSTep <CycleCountStep>

Specifies a step to trigger on each n-th cycle inside the given range. This allows for specific triggering if slot multiplexing is used.

The condition `TRIGger<m>:FLXRay:CENable` on page 2029 must be set to `INRange` or `ORange`.

Parameters:

<CycleCountStep> Range: 1 to 63
Increment: 1
*RST: 1

Manual operation: See "[Cycle count \(min, max\), Step](#)" on page 654

TRIGger<m>:FLXRay:DPOperator <DataPosOperator>

Sets the operator for the data position. You can defined an exact position, or a position range.

Parameters:

<DataPosOperator> ANY | OFF | EQUAL | GETHan | INRange | RANGE

OFF = ANY

The data position is not relevant for the trigger condition.

EQUAL | GETHan

Equal, Greater or equal than. These conditions require one data position to be set with `TRIGger<m>:FLXRay:DPOsition`.

INRange = RANGE

In range: Set the minimum and maximum value of the range with `TRIGger<m>:FLXRay:DPOsition` and `TRIGger<m>:FLXRay:DPTO`.

*RST: EQUAL

Manual operation: See "[Position, Index \(min, max\) - Data setup](#)" on page 655

TRIGger<m>:FLXRay:DPOsition <DataPosition>

Sets the number of data bytes to be skipped after start of the payload segment

Parameters:

<DataPosition> Range: 0 to 255
Increment: 1
*RST: 0

Manual operation: See "[Position, Index \(min, max\) - Data setup](#)" on page 655

TRIGger<m>:FLXRay:DPTO <DataPositionTo>

Defines the last byte of interest, if the position operator `TRIGger<m>:FLXRay:DPOperator` defines a range.

Parameters:

<DataPositionTo> Range: 0 to 255
Increment: 1
*RST: 0

Manual operation: See ["Position, Index \(min, max\) - Data setup"](#) on page 655

TRIGger<m>:FLXRay:DCONdition <DataOperator>

Sets the operator to set a specific data pattern or a data pattern range.

Parameters:

<DataOperator> OFF | ANY | EQUal | NEQual | LTHan | LETHan | GTHan | GETHan | INRange | OORange

OFF = ANY

The data position is not relevant for the trigger condition.

EQUal | NEQual | LTHan | LETHan | GTHan | GETHan

Equal, Not equal, Less than, Less or equal than, Greater Than, Greater or equal than. These conditions require one data position to be set with [TRIGger<m>:FLXRay:DMIN](#).

INRange | OORange

In range, Out of range: Set the minimum and maximum value of the range with [TRIGger<m>:FLXRay:DMIN](#) and [TRIGger<m>:FLXRay:DMAX](#).

*RST: EQUal

Manual operation: See ["Condition, Data \(min, max\) - Data setup"](#) on page 655

TRIGger<m>:FLXRay:DMIN <DataPattern>

Specifies a data pattern, or sets the the start value of a data pattern range.

Parameters:

<DataPattern> Numeric or string pattern, see [Chapter 27.4.6, "Bit pattern parameter"](#), on page 1373. The string parameter accepts the bit value X (don't care).

Manual operation: See ["Condition, Data \(min, max\) - Data setup"](#) on page 655

TRIGger<m>:FLXRay:DMAX <DataPatternTo>

Sets the the end value of an data range if the operator [TRIGger<m>:FLXRay:DCondition](#) is set to [INRange](#) or [OORange](#).

Parameters:

<DataPatternTo> Numeric or string pattern, see [Chapter 27.4.6, "Bit pattern parameter"](#), on page 1373. The string parameter accepts the bit value X (don't care).

Manual operation: See ["Condition, Data \(min, max\) - Data setup"](#) on page 655

TRIGger<m>:FLXRay:SYMBOL <Symbol>

Triggers on a symbol or on a wakeup pattern.

Parameters:

<Symbol> CASMTs | WAKEup

CASMTs

Collision Avoidance Symbol / Media access Test Symbol. These symbols are identical and can be sent in the optional symbol window at the end of a communication cycle. They are used to avoid collisions during the system start.

WAKEup

The wakeup pattern is sent to activate the nodes of the system.

*RST: CASMTs

Manual operation: See "[Symbol](#)" on page 656

TRIGger<m>:FLXRay:BSSerror <BSSerror>

Triggers on error in SyteStart Sequence. The BSS is transmitted before each byte.

Parameters:

<BSSerror> ON | OFF

*RST: ON

Manual operation: See "[Error conditions](#)" on page 656

TRIGger<m>:FLXRay:FESerror <FESErrror>

Triggers on error in Frame End Sequence. FES indicates the end of each frame.

Parameters:

<FESErrror> ON | OFF

*RST: ON

Manual operation: See "[Error conditions](#)" on page 656

TRIGger<m>:FLXRay:FSSerror <FSSErrror>

Triggers on Error in a Frame Start Sequence. FSS follows the Transmission Start Sequence TSS at the beginning of each frame.

Parameters:

<FSSErrror> ON | OFF

*RST: ON

Manual operation: See "[Error conditions](#)" on page 656

TRIGger<m>:FLXRay:HRCError <CRCHeaderError>

Triggers on error in the Cyclic Redundancy Check of the header data (mainly frame ID and payload length).

Parameters:

<CRCHeaderError> ON | OFF
*RST: ON

Manual operation: See "[Error conditions](#)" on page 656

TRIGger<m>:FLXRay:PCRCError <CRCPayloadError>

Triggers on error in the Cyclic Redundancy Check of the payload data.

Parameters:

<CRCPayloadError> ON | OFF
*RST: ON

Manual operation: See "[Error conditions](#)" on page 656

27.18.10.3 Decode results

To load and activate a label list, use:

- [BUS<m>:NEWList](#) on page 1815
- [BUS<m>:SYMBOLs](#) on page 1815

To show the results on the screen, use the following commands:

- [BUS<m>:RESult](#) on page 1814

BUS<m>:FLXRay:FCOunt?	2033
BUS<m>:FLXRay:FRAME<n>:STATus?	2034
BUS<m>:FLXRay:FRAME<n>:START?	2034
BUS<m>:FLXRay:FRAME<n>:STOP?	2034
BUS<m>:FLXRay:FRAME<n>:SYMBOL?	2035
BUS<m>:FLXRay:FRAME<n>:TYPE?	2035
BUS<m>:FLXRay:FRAME<n>:DATA?	2035
BUS<m>:FLXRay:FRAME<n>:FLAGs?	2036
BUS<m>:FLXRay:FRAME<n>:ADID?	2036
BUS<m>:FLXRay:FRAME<n>:PAYLength?	2037
BUS<m>:FLXRay:FRAME<n>:CYCount?	2037
BUS<m>:FLXRay:FRAME<n>:CSState?	2037
BUS<m>:FLXRay:FRAME<n>:CSValue?	2038
BUS<m>:FLXRay:FRAME<n>:FCState?	2038
BUS<m>:FLXRay:FRAME<n>:FCValue?	2038

BUS<m>:FLXRay:FCOunt?

Returns the number of decoded frames.

Suffix:

<m> 1..4
Selects the serial bus.

Return values:

<Count> Returns the number of decoded frames.
Range: 0 to 100000
Increment: 1
*RST: 0

Usage: Query only

BUS<m>:FLXRay:FRAMe<n>:STATUs?

Returns the overall state of the selected frame.

Suffix:

<m> 1..4
Selects the serial bus.

<n> *
Selects the frame.

Return values:

<FrameState> OK | FSS | BSS | FES | INDicator | HCRCerror | CRCerr |
LENER | LENer | HCFCerror | INSufficient
OK: the frame is valid.
FSS: Frame Start Sequence after TSS is missing.
BSS: Byte Start Sequence is missing.
FES: error in the Frame End Sequence.
INDicator: Error in indicator bits.
HCRCerror: Header CRC is not valid.
CRCerr: Payload CRC is not valid.
LENER = LENer: Unexpected length of the frame.
HCFCerror: Header CRC error and frame CRC error
INSufficient: The frame is not completely contained in the acquisition. The acquired part of the frame is valid.
*RST: OK

Usage: Query only

BUS<m>:FLXRay:FRAMe<n>:START?**BUS<m>:FLXRay:FRAMe<n>:STOP?**

Return the start time and stop time of the selected frame.

Suffix:

<m> 1..4
Selects the serial bus.

<n> *
Selects the frame.

Return values:

<FrameStop> Time
 Range: -100E+24 to 100E+24
 *RST: 0
 Default unit: s

Usage: Query only

BUS<m>:FLXRay:FRAMe<n>:SYMBol?

Returns the symbolic label of the specified frame if the label list is enabled.

Suffix:

<m> 1..4
 Selects the serial bus.

<n> *
 Selects the number of the frame in the current acquisition, 1...n.

Return values:

<Label> String with symbolic name of the identifier

Example:

BUS:FLXRay:FRAMe2:SYMBol?
 Response: Temperature

Usage: Query only

BUS<m>:FLXRay:FRAMe<n>:TYPE?

Returns the frame type of the selected frame.

Suffix:

<m> 1..4
 Selects the serial bus.

<n> *
 Selects the frame.

Return values:

<FrameType> UNKNown | STATic | DYNamic | WAKE | SYMBol
 STATic: frame of the static segment
 DYNamic: frame of the dynamic segment
 WAKE: frame contains wakeup pattern
 SYMBol: frame contains a MTS or CAS symbol
 *RST: STATic

Usage: Query only

BUS<m>:FLXRay:FRAMe<n>:DATA?

Returns the data of the specified frame.

Suffix:

<m> 1..4
Selects the serial bus.

<n> *
Selects the frame.

Return values:

<Data> Comma-separated list of integer values (N, D1, D2,..., DN). N is the number of bytes in the frame, and D1...DN are the values of the bytes.

Example:

```
BUS:FLXRay:FRAME4:DATA?
<-- 4,17,85,170,85
```

Usage: Query only

BUS<m>:FLXRay:FRAME<n>:FLAGS?

Returns the value of the indicator bits at the beginning of the header segment. The five bits are read as one word.

Suffix:

<m> 1..4
Selects the serial bus.

<n> *
Selects the frame.

Return values:

<Flags> Range: 0 to 31
*RST: 0

Usage: Query only

BUS<m>:FLXRay:FRAME<n>:ADID?

Returns the frame identifier, the number of the slot in which the frame is transmitted.

Suffix:

<m> 1..4
Selects the serial bus.

<n> *
Selects the frame.

Return values:

<AddressID> To set the value format, use [FORMat:BPATtern](#) on page 1381. The values below – range, increment and default – are decimal values.

Range: 0 to 2047
*RST: 0

Usage: Query only

BUS<m>:FLXRay:FRAMe<n>:PAYLength?

Returns the payload length, the number of data words in the payload segment. Information is transmitted in 2-byte words, so the number of data bytes in the payload segment is twice the payload length.

Suffix:

<m> 1..4
Selects the serial bus.

<n> *
Selects the frame.

Return values:

<PayLen> Range: 0 to 127
*RST: 0

Usage: Query only

BUS<m>:FLXRay:FRAMe<n>:CYCount?

Returns the number of the current FlexRay cycle.

Suffix:

<m> 1..4
Selects the serial bus.

<n> *
Selects the frame.

Return values:

<CycleCount> Range: 0 to 63
*RST: 0

Usage: Query only

BUS<m>:FLXRay:FRAMe<n>:CSStAtE?

Returns the state of the cyclic redundancy check code of the header data.

Suffix:

<m> 1..4
Selects the serial bus.

<n> *
Selects the frame.

Return values:

<HdrCksumSt> OK | UVAL | INSufficient
OK: the CRC is valid.
UVAL: unexpected value
INSufficient: the frame is not completely contained in the acquisition. The decoded part of the frame is valid.
*RST: OK

Usage: Query only

BUS<m>:FLXRay:FRAMe<n>:CSValue?

Returns the checksum value of the header CRC.

Suffix:

<m> 1..4
Selects the serial bus.

<n> *
Selects the frame.

Return values:

<HdrCksumVal> To set the value format, use [FORMat:BPATtern](#) on page 1381. The values below – range, increment and default – are decimal values.

Range: 0 to 2047
*RST: 0

Usage: Query only

BUS<m>:FLXRay:FRAMe<n>:FCState?

Returns the state of the cyclic redundancy check code of the frame data.

Suffix:

<m> 1..4
Selects the serial bus.

<n> *
Selects the frame.

Return values:

<ChecksumState> OK | UVAL | INSufficient
OK: the CRC is valid.
UVAL: unexpected value
INSufficient: the frame is not completely contained in the acquisition. The decoded part of the frame is valid.

*RST: OK

Usage: Query only

BUS<m>:FLXRay:FRAMe<n>:FCValue?

Returns the cyclic redundancy check code of the frame CRC.

Suffix:

<m> 1..4
Selects the serial bus.

<n> *
Selects the frame.

Return values:

<ChecksumValue> To set the value format, use [FORMat:BPATtern](#) on page 1381. The values below – range, increment and default – are decimal values.

Range: 0 to 16777215
*RST: 0

Usage: Query only

27.18.10.4 Search settings

SEARch:TRIGger:FLXRay:SERRor.....	2039
SEARch:TRIGger:FLXRay:SIDData.....	2040
SEARch:TRIGger:FLXRay[:SSOFrame].....	2040
SEARch:TRIGger:FLXRay:SSYMBOL.....	2040
SEARch:TRIGger:FLXRay:CENable.....	2041
SEARch:TRIGger:FLXRay:CMAX.....	2041
SEARch:TRIGger:FLXRay:CMIN.....	2041
SEARch:TRIGger:FLXRay:CSTep.....	2042
SEARch:TRIGger:FLXRay:DCONdition.....	2042
SEARch:TRIGger:FLXRay:DMAX.....	2043
SEARch:TRIGger:FLXRay:DMIN.....	2043
SEARch:TRIGger:FLXRay:DPOperator.....	2043
SEARch:TRIGger:FLXRay:DPOsition.....	2044
SEARch:TRIGger:FLXRay:DPTO.....	2044
SEARch:TRIGger:FLXRay:FCONdition.....	2044
SEARch:TRIGger:FLXRay:FMAX.....	2045
SEARch:TRIGger:FLXRay:FMIN.....	2045
SEARch:TRIGger:FLXRay:NUFRame.....	2045
SEARch:TRIGger:FLXRay:PLPReamble.....	2046
SEARch:TRIGger:FLXRay:PCONdition.....	2046
SEARch:TRIGger:FLXRay:PMAX.....	2046
SEARch:TRIGger:FLXRay:PMIN.....	2047
SEARch:TRIGger:FLXRay:STFRame.....	2047
SEARch:TRIGger:FLXRay:SYFRame.....	2047
SEARch:TRIGger:FLXRay:SYMBOL.....	2048
SEARch:TRIGger:FLXRay:BSSerror.....	2048
SEARch:TRIGger:FLXRay:FESerror.....	2048
SEARch:TRIGger:FLXRay:FSSerror.....	2049
SEARch:TRIGger:FLXRay:HCRError.....	2049
SEARch:TRIGger:FLXRay:PCRError.....	2049

SEARch:TRIGger:FLXRay:SERRor <SearchName>,<ErrorCondition>

SEARch:TRIGger:FLXRay:SERRor? <SearchName>

Enables the search for specified error or error combination.

Parameters:

<ErrorCondition> ON | OFF
*RST: OFF

Parameters for setting and query:

<SearchName>

Manual operation: See ["Select Search Types"](#) on page 659**SEARCh:TRIGger:FLXRay:SIDData** <SearchName>,<IdentifierData>**SEARCh:TRIGger:FLXRay:SIDData?** <SearchName>

Enables the search for identifier and data.

Parameters:

<IdentifierData> ON | OFF

*RST: OFF

Parameters for setting and query:

<SearchName>

Manual operation: See ["Select Search Types"](#) on page 659**SEARCh:TRIGger:FLXRay[:SSOFrame]** <SearchName>,<FrameStart>**SEARCh:TRIGger:FLXRay[:SSOFrame]?** <SearchName>

Enables the search for a start of frame.

Parameters:

<FrameStart> ON | OFF

*RST: OFF

Parameters for setting and query:

<SearchName>

Manual operation: See ["Select Search Types"](#) on page 659**SEARCh:TRIGger:FLXRay:SSYMBOL** <SearchName>,<CheckSymbol>**SEARCh:TRIGger:FLXRay:SSYMBOL?** <SearchName>

Enables the search for specified symbol.

Parameters:

<CheckSymbol> ON | OFF

*RST: OFF

Parameters for setting and query:

<SearchName>

Manual operation: See ["Select Search Types"](#) on page 659

SEARch:TRIGger:FLXRay:CENable <SearchName>,<CycleCount>
SEARch:TRIGger:FLXRay:CENable? <SearchName>

Sets the operator to define a cycle count or a cycle count range.

Parameters:

<CycleCount> OFF | ANY | EQUal | NEQual | LTHan | LETHan | GTHan |
 GETHan | INRange | OORange

OFF = ANY

The cycle count is not relevant for the search condition.

EQUal | NEQual | LTHan | LETHan | GTHan | GETHan

Equal, Not equal, Less than, Less or equal than, Greater Than, Greater or equal than. These conditions require one cycle count number to be set with [SEARch:TRIGger:FLXRay:CMIN](#).

INRange | OORange

In range, Out of range: Set the minimum and maximum value of the range with [SEARch:TRIGger:FLXRay:CMIN](#) and [SEARch:TRIGger:FLXRay:CMAX](#).

*RST: OFF

Parameters for setting and query:

<SearchName>

Manual operation: See "[Cycle count \(min, max\), Step](#)" on page 660

SEARch:TRIGger:FLXRay:CMAX <SearchName>,<CycleCountMax>
SEARch:TRIGger:FLXRay:CMAX? <SearchName>

Sets the the end value of a cycle count range if the condition [SEARch:TRIGger:FLXRay:CENable](#) is set to [INRange](#) or [OORange](#).

Parameters:

<CycleCountMax> Range: 0 to 63
 Increment: 1
 *RST: 0

Parameters for setting and query:

<SearchName>

Manual operation: See "[Cycle count \(min, max\), Step](#)" on page 660

SEARch:TRIGger:FLXRay:CMIN <SearchName>,<CycleCountMin>
SEARch:TRIGger:FLXRay:CMIN? <SearchName>

Specifies a cycle count - the number of the current FlexRay cycle - or sets the the start value of an cycle count range.

Parameters:

<CycleCountMin> Range: 0 to 63
 Increment: 1
 *RST: 0

Parameters for setting and query:

<SearchName>

Manual operation: See "[Cycle count \(min, max\), Step](#)" on page 660**SEARch:TRIGger:FLXRay:CSTep** <SearchName>,<CycleCountStep>**SEARch:TRIGger:FLXRay:CSTep?** <SearchName>

Specifies a step to search for each n-th cycle inside the given range. This allows for a specific search if slot multiplexing is used.

The condition [SEARch:TRIGger:FLXRay:CENable](#) must be set to INRange or OORange.

Parameters:

<CycleCountStep> Range: 1 to 63
 Increment: 1
 *RST: 1

Parameters for setting and query:

<SearchName>

Manual operation: See "[Cycle count \(min, max\), Step](#)" on page 660**SEARch:TRIGger:FLXRay:DCondition** <SearchName>,<DataOperator>**SEARch:TRIGger:FLXRay:DCondition?** <SearchName>

Sets the operator to set a specific data pattern or a data pattern range.

Parameters:

<DataOperator> OFF | ANY | EQUal | NEQual | LTHan | LETHan | GTHan |
 GETHan | INRange | OORange

OFF = ANY

The data pattern is not relevant for the search condition.

EQUal | NEQual | LTHan | LETHan | GTHan | GETHan

Equal, Not equal, Less than, Less or equal than, Greater Than, Greater or equal than. These conditions require one data pattern to be set with [SEARch:TRIGger:FLXRay:DMIN](#).

INRange | OORange

In range, Out of range: Set the minimum and maximum value of the range with [SEARch:TRIGger:FLXRay:DMIN](#) and [SEARch:TRIGger:FLXRay:DMAX](#).

*RST: EQUal

Parameters for setting and query:

<SearchName>

Manual operation: See "[Condition, Data \(min, max\) - Data setup](#)" on page 661

SEARCh:TRIGger:FLXRay:DMAX <SearchName>,<DataPatternTo>
SEARCh:TRIGger:FLXRay:DMAX? <SearchName>

Sets the the end value of an data range if [SEARCh:TRIGger:FLXRay:DCONdition](#) is set to [INRange](#) or [OORange](#).

Parameters:

<DataPatternTo> Numeric or string pattern, see [Chapter 27.4.6, "Bit pattern parameter"](#), on page 1373. The string parameter accepts the bit value X (don't care).

Parameters for setting and query:

<SearchName>

Manual operation: See "[Condition, Data \(min, max\) - Data setup](#)" on page 661

SEARCh:TRIGger:FLXRay:DMIN <SearchName>,<DataPattern>
SEARCh:TRIGger:FLXRay:DMIN? <SearchName>

Specifies a data pattern, or sets the the start value of a data pattern range.

Parameters:

<DataPattern> Numeric or string pattern, see [Chapter 27.4.6, "Bit pattern parameter"](#), on page 1373. The string parameter accepts the bit value X (don't care).

Parameters for setting and query:

<SearchName>

Manual operation: See "[Condition, Data \(min, max\) - Data setup](#)" on page 661

SEARCh:TRIGger:FLXRay:DPOperator <SearchName>,<DataPosOperator>
SEARCh:TRIGger:FLXRay:DPOperator? <SearchName>

Sets the operator for the data position. You can defined an exact position, or a position range.

Parameters:

<DataPosOperator> ANY | OFF | EQUal | GETHan | INRange | RANGE

OFF = ANY

The data position is not relevant for the search condition.

EQUal | GETHan

Equal, Greater or equal than. These conditions require one data position to be set with [SEARCh:TRIGger:FLXRay:DPOsition](#)

INRange = RANGE

In range: Set the minimum and maximum value of the range with [SEARCh:TRIGger:FLXRay:DPOsition](#) and [SEARCh:TRIGger:FLXRay:DPTO](#).

*RST: EQUal

Parameters for setting and query:

<SearchName>

Manual operation: See "[Position, Index \(min, max\) - Data setup](#)" on page 661

SEARCH:TRIGger:FLXRay:DPOsition <SearchName>,<DataPosition>
SEARCH:TRIGger:FLXRay:DPOsition? <SearchName>

Sets the number of data bytes to be skipped after start of the payload segment.

Parameters:

<DataPosition> Range: 0 to 255
 Increment: 1
 *RST: 0

Parameters for setting and query:

<SearchName>

Manual operation: See "[Position, Index \(min, max\) - Data setup](#)" on page 661

SEARCH:TRIGger:FLXRay:DPTO <SearchName>,<DataPositionTo>
SEARCH:TRIGger:FLXRay:DPTO? <SearchName>

Defines the last byte of interest, if the position operator [SEARCH:TRIGger:FLXRay:DPOperator](#) defines a range.

Parameters:

<DataPositionTo> Range: 0 to 255
 Increment: 1
 *RST: 0

Parameters for setting and query:

<SearchName>

Manual operation: See "[Position, Index \(min, max\) - Data setup](#)" on page 661

SEARCH:TRIGger:FLXRay:FCONdition <SearchName>,<IdOperator>
SEARCH:TRIGger:FLXRay:FCONdition? <SearchName>

Sets the operator to set a frame ID or a frame ID range.

Parameters:

<IdOperator> OFF | ANY | EQUal | NEQual | LTHan | LETHan | GTHan |
 GETHan | INRange | OORange

OFF = ANY

The frame ID is not relevant for the search condition.

EQUal | NEQual | LTHan | LETHan | GTHan | GETHan

Equal, Not equal, Less than, Less or equal than, Greater Than, Greater or equal than. These conditions require one frame ID to be set with [SEARCH:TRIGger:FLXRay:FMIN](#).

INRange | OORange

In range, Out of range: Set the minimum and maximum value of the range with [SEARCH:TRIGger:FLXRay:FMIN](#) and [SEARCH:TRIGger:FLXRay:FMAX](#).

*RST: EQUAL

Parameters for setting and query:

<SearchName>

Manual operation: See "[Frame ID \(min/max\)](#)" on page 660

SEARCh:TRIGger:FLXRay:FMAX <SearchName>,<IdPatternTo>

SEARCh:TRIGger:FLXRay:FMAX? <SearchName>

Sets the the end value of an identifier range if the condition [SEARCh:TRIGger:FLXRay:FCONDition](#) is set to [INRange](#) or [OORange](#).

Parameters:

<IdPatternTo> Numeric or string pattern, see [Chapter 27.4.6, "Bit pattern parameter"](#), on page 1373.

Parameters for setting and query:

<SearchName>

Manual operation: See "[Frame ID \(min/max\)](#)" on page 660

SEARCh:TRIGger:FLXRay:FMIN <SearchName>,<IdPattern>

SEARCh:TRIGger:FLXRay:FMIN? <SearchName>

Specifies a frame identifier pattern - the number of the slot - or sets the the start value of an identifier range.

Parameters:

<IdPattern> Numeric or string pattern, see [Chapter 27.4.6, "Bit pattern parameter"](#), on page 1373.

Parameters for setting and query:

<SearchName>

Manual operation: See "[Frame ID \(min/max\)](#)" on page 660

SEARCh:TRIGger:FLXRay:NUFRame <SearchName>,<NullFrame>

SEARCh:TRIGger:FLXRay:NUFRame? <SearchName>

Searches for the null frame indicator bit, a frame without usable data.

Parameters:

<NullFrame> ONE | ZERO | DC
 Bit value: 1, 0, or X (don't care)
 *RST: DC

Parameters for setting and query:

<SearchName>

Manual operation: See "[Indicator bits](#)" on page 659

SEARch:TRIGger:FLXRay:PLPReamble <SearchName>,<PayloadPreamble>
SEARch:TRIGger:FLXRay:PLPReamble? <SearchName>

Searches for the payload preamble indicator bit that indicates a Network Management Vector in the payload segment.

Parameters:

<PayloadPreamble> ONE | ZERO | DC
 Bit value: 1, 0, or X (don't care)
 *RST: DC

Parameters for setting and query:

<SearchName>

Manual operation: See "[Indicator bits](#)" on page 659

SEARch:TRIGger:FLXRay:PCONdition <SearchName>,<PayloadLengthOp>
SEARch:TRIGger:FLXRay:PCONdition? <SearchName>

Sets the operator for the payload length search setting. You can defined an exact value, or a range.

Parameters:

<PayloadLengthOp> OFF | ANY | EQUal | NEQual | LTHan | LETHan | GTHan |
 GETHan | INRange | OORange

OFF = ANY

The payload length is not relevant for the search condition.

EQUal | NEQual | LTHan | LETHan | GTHan | GETHan

Equal, Not equal, Less than, Less or equal than, Greater Than, Greater or equal than. These conditions require one payload length to be set with [SEARch:TRIGger:FLXRay:PMIN](#).

INRange | OORange

In range, Out of range: Set the minimum and maximum value of the range with [SEARch:TRIGger:FLXRay:PMIN](#) and [SEARch:TRIGger:FLXRay:PMAX](#).

*RST: OFF

Parameters for setting and query:

<SearchName>

Manual operation: See "[Payload length \(min/max\)](#)" on page 660

SEARch:TRIGger:FLXRay:PMAX <SearchName>,<PayloadLengthTo>
SEARch:TRIGger:FLXRay:PMAX? <SearchName>

Sets the the end value of a payload length range if the condition [SEARch:TRIGger:FLXRay:PCONdition](#) is set to [INRange](#) or [OORange](#).

Parameters:

<PayloadLengthTo> Range: 0 to 127
 Increment: 1
 *RST: 0

Parameters for setting and query:

<SearchName>

Manual operation: See "[Payload length \(min/max\)](#)" on page 660

SEARCh:TRIGger:FLXRay:PMIN <SearchName>,<PayloadLength>

SEARCh:TRIGger:FLXRay:PMIN? <SearchName>

Specifies a payload length - the number of words in the payload segment - or sets the the start value of an payload length range. Information is transmitted in 2-byte words, so the number of data bytes in the payload segment is twice the payload length.

Parameters:

<PayloadLength> Range: 0 to 127
 Increment: 1
 *RST: 0

Parameters for setting and query:

<SearchName>

Manual operation: See "[Payload length \(min/max\)](#)" on page 660

SEARCh:TRIGger:FLXRay:STFrame <SearchName>,<StartupFrame>

SEARCh:TRIGger:FLXRay:STFrame? <SearchName>

Searches for startup frames used for startup of the network. Only specific start nodes can send this frame type.

Parameters:

<StartupFrame> ONE | ZERO | DC
 Bit value: 1, 0, or X (don't care)
 *RST: DC

Parameters for setting and query:

<SearchName>

Manual operation: See "[Indicator bits](#)" on page 659

SEARCh:TRIGger:FLXRay:SYFrame <SearchName>,<SyncFrame>

SEARCh:TRIGger:FLXRay:SYFrame? <SearchName>

Searches for the sync frame used for synchronization of the FlexRay system. Only sync nodes can send this frame type.

Parameters:

<SyncFrame> ONE | ZERO | DC
 Bit value: 1, 0, or X (don't care)
 *RST: DC

Parameters for setting and query:

<SearchName>

Manual operation: See "[Indicator bits](#)" on page 659

SEARCH:TRIGger:FLXRay:SYMBOL <SearchName>,<Symbol>

SEARCH:TRIGger:FLXRay:SYMBOL? <SearchName>

Searches for a symbol or for a wakeup pattern.

Parameters:

<Symbol> CASMTs | WAKEup

CASMTs

Collision Avoidance Symbol / Media access Test Symbol. These symbols are identical and can be sent in the optional symbol window at the end of a communication cycle. They are used to avoid collisions during the system start.

WAKEup

The wakeup pattern is sent to activate the nodes of the system.

*RST: CASMTs

Parameters for setting and query:

<SearchName>

Manual operation: See "[Symbol](#)" on page 661

SEARCH:TRIGger:FLXRay:BSSerror <SearchName>,<BSSError>

SEARCH:TRIGger:FLXRay:BSSerror? <SearchName>

Searches for error in SyteStart Sequence. The BSS is transmitted before each byte.

Parameters:

<BSSError> ON | OFF
 *RST: ON

Parameters for setting and query:

<SearchName>

Manual operation: See "[Error Condition](#)" on page 661

SEARCH:TRIGger:FLXRay:FESerror <SearchName>,<FESError>

SEARCH:TRIGger:FLXRay:FESerror? <SearchName>

Searches for error in Frame End Sequence. FES indicates the end of each frame.

Parameters:

<FSErrror> ON | OFF
 *RST: ON

Parameters for setting and query:

<SearchName>

Manual operation: See ["Error Condition"](#) on page 661

SEARCh:TRIGger:FLXRay:FSSerror <SearchName>,<FSSError>

SEARCh:TRIGger:FLXRay:FSSerror? <SearchName>

Searches for an error in a Frame Start Sequence(FSS). FSS follows the Transmission Start Sequence (TSS) at the beginning of each frame.

Parameters:

<FSSError> ON | OFF
 *RST: ON

Parameters for setting and query:

<SearchName>

Manual operation: See ["Error Condition"](#) on page 661

SEARCh:TRIGger:FLXRay:HCRCErrror <SearchName>,<CRCHeaderError>

SEARCh:TRIGger:FLXRay:HCRCErrror? <SearchName>

Searches for an error in the Cyclic Redundancy Check of the header data (mainly frame ID and payload length).

Parameters:

<CRCHeaderError> ON | OFF
 *RST: ON

Parameters for setting and query:

<SearchName>

Manual operation: See ["Error Condition"](#) on page 661

SEARCh:TRIGger:FLXRay:PCRCError <SearchName>,<CRCPayloadError>

SEARCh:TRIGger:FLXRay:PCRCError? <SearchName>

Searches for error in the Cyclic Redundancy Check of the payload data.

Parameters:

<CRCPayloadError> ON | OFF
 *RST: ON

Parameters for setting and query:

<SearchName>

Manual operation: See ["Error Condition"](#) on page 661

27.18.10.5 Search results

The search on decoded FlexRay data returns the same results as the queries for decode results.

In search result commands, you have to specify the <SearchName> parameter. It is a string parameter that contains the search definition name.

For a description of the returned values, see the corresponding commands in [Chapter 27.18.10.3, "Decode results"](#), on page 2033.

SEARCh:RESult:FLXRay:FCOunt?.....	2050
SEARCh:RESult:FLXRay:FRAMe<m>:ADID?.....	2050
SEARCh:RESult:FLXRay:FRAMe<m>:CSState?.....	2051
SEARCh:RESult:FLXRay:FRAMe<m>:CSValue?.....	2051
SEARCh:RESult:FLXRay:FRAMe<m>:CYCount?.....	2051
SEARCh:RESult:FLXRay:FRAMe<m>:DATA?.....	2052
SEARCh:RESult:FLXRay:FRAMe<m>:FCState?.....	2052
SEARCh:RESult:FLXRay:FRAMe<m>:FCValue?.....	2052
SEARCh:RESult:FLXRay:FRAMe<m>:FLAGs?.....	2052
SEARCh:RESult:FLXRay:FRAMe<m>:PAYLength?.....	2053
SEARCh:RESult:FLXRay:FRAMe<m>:STATus?.....	2053
SEARCh:RESult:FLXRay:FRAMe<m>:START?.....	2054
SEARCh:RESult:FLXRay:FRAMe<m>:STOP?.....	2054
SEARCh:RESult:FLXRay:FRAMe<m>:TYPE?.....	2054
SEARCh:RESult:FLXRay:FRAMe<m>:SYMBol?.....	2054

SEARCh:RESult:FLXRay:FCOunt? <SearchName>

Query parameters:

<SearchName>

Return values:

<Count>	Range:	0 to 100000
	Increment:	1
	*RST:	0

Usage: Query only

SEARCh:RESult:FLXRay:FRAMe<m>:ADID? <SearchName>

Suffix:

<m> *

Query parameters:

<SearchName>

Return values:

<AddressID>	Range:	0 to 2047
	Increment:	1
	*RST:	0

Usage: Query only

SEARCh:RESult:FLXRaY:FRAMe<m>:CSStAtE? <SearchName>

Returns the status of the header checksum.

Suffix:

<m> *

Query parameters:

<SearchName>

Return values:

<HeadCksumState> OK | STERror | SPERror | PRERror | UVAL | INSufficient

STERror: StarT ERror, incorrect start bit

SPERror: StoP ERror, incorrect stop bit

PRERror:PaRity ERror, incorrect parity bit.

UVAL: unexpected value

*RST: OK

Usage: Query only

SEARCh:RESult:FLXRaY:FRAMe<m>:CSValue? <SearchName>

Returns the value of the header checksum.

Suffix:

<m> *

Query parameters:

<SearchName>

Return values:

<HeadCksumValue> Range: 0 to 2047

Increment: 1

*RST: 0

Usage: Query only

SEARCh:RESult:FLXRaY:FRAMe<m>:CYCount? <SearchName>**Suffix:**

<m> *

Query parameters:

<SearchName>

Return values:

<CycleCount> Range: 0 to 65535

Increment: 1

*RST: 0

Usage: Query only

SEARCh:RESult:FLXRay:FRAMe<m>:DATA? <SearchName>**Suffix:**

<m> *

Query parameters:

<SearchName>

Return values:

<Data>

Usage: Query only

SEARCh:RESult:FLXRay:FRAMe<m>:FCStAtE? <SearchName>

Returns the status of the frame checksum.

Suffix:

<m> *

Query parameters:

<SearchName>

Return values:

<ChecksumState> OK | STERror | SPERror | PRERror | UVAL | INSufficient

STERror: StarT ERror, incorrect start bit

SPERror: StoP ERror, incorrect stop bit

PRERror:PaRity ERror, incorrect parity bit.

UVAL: unexpected value

*RST: OK

Usage: Query only

SEARCh:RESult:FLXRay:FRAMe<m>:FCVAlue? <SearchName>

Returns the value of the frame checksum.

Suffix:

<m> *

Query parameters:

<SearchName>

Return values:

<ChecksumValue> Range: 0 to 16777215

Increment: 1

*RST: 0

Usage: Query only

SEARCh:RESult:FLXRay:FRAMe<m>:FLAGs? <SearchName>**Suffix:**

<m> *

Query parameters:

<SearchName>

Return values:

<Flags> Range: 0 to 255
 Increment: 1
 *RST: 0

Usage: Query only**SEARCh:RESult:FLXRay:FRAMe<m>:PAYLength? <SearchName>****Suffix:**

<m> *

Query parameters:

<SearchName>

Return values:

<PayLen> Range: 0 to 127
 Increment: 1
 *RST: 0

Usage: Query only**SEARCh:RESult:FLXRay:FRAMe<m>:STATus? <SearchName>**

Returns the overall state of the selected frame.

Suffix:

<m> *

Query parameters:

<SearchName>

Return values:

<State> OK | FSS | BSS | FES | INDicator | HCRrError | CRCerr |
 LENER | LENer | HCFCerror | INSufficient
 OK: the frame is valid.
 FSS: Frame Start Sequence after TSS is missing.
 BSS: Byte Start Sequence is missing.
 FES: error in the Frame End Sequence.
 INDicator: Error in indicator bits.
 HCRrError: Header CRC is not valid.
 CRCerr: Payload CRC is not valid.
 LENER = LENer: Unexpected length of the frame.
 HCFCerror: Header CRC error and frame CRC error
 INSufficient: The frame is not completely contained in the acquisition. The acquired part of the frame is valid.
 *RST: OK

Usage: Query only

SEARCh:RESult:FLXRay:FRAMe<m>:STARt? <SearchName>**Suffix:**

<m> *

Query parameters:

<SearchName>

Return values:

<Start> Range: -100E+24 to 100E+24
 Increment: 100E-12
 *RST: 0
 Default unit: s

Usage: Query only

SEARCh:RESult:FLXRay:FRAMe<m>:STOP? <SearchName>**Suffix:**

<m> *

Query parameters:

<SearchName>

Return values:

<Stop> Range: -100E+24 to 100E+24
 Increment: 100E-12
 *RST: 0
 Default unit: s

Usage: Query only

SEARCh:RESult:FLXRay:FRAMe<m>:TYPE? <SearchName>**Suffix:**

<m> *

Query parameters:

<SearchName>

Return values:

<Type> UNKNown | STATic | DYNamic | WAKE | SYMBol
 *RST: STATic

Usage: Query only

SEARCh:RESult:FLXRay:FRAMe<m>:SYMBol? <SearchName>

Returns the symbolic label of the specified frame if the label list is enabled.

Suffix:

<m> *

Selects the number of the frame in the current acquisition, 1...n.

Query parameters:

<SearchName> String parameter that contains the search definition name

Return values:

<Translation> Symbolic label (string)

Usage: Query only

27.18.11 SENT (option R&S RTO6-K520)

- [Configuration](#).....2055
- [Trigger](#).....2059
- [Decode results](#).....2066
- [SENT search settings](#).....2073
- [SENT search results](#).....2081

27.18.11.1 Configuration

BUS<m>:SENT:DATA:SOURce	2055
BUS<m>:SENT:DATA:THReshold	2055
BUS<m>:SENT:TECHnology	2056
BUS<m>:SENT:CLKPeriod	2056
BUS<m>:SENT:CLKTolerance	2056
BUS<m>:SENT:DNIBbles	2057
BUS<m>:SENT:SFOFormat	2057
BUS<m>:SENT:CRCVersion	2057
BUS<m>:SENT:CRCMethod	2058
BUS<m>:SENT:PPULse	2058
BUS<m>:SENT:PPFLength	2059

BUS<m>:SENT:DATA:SOURce <DataSource>

Selects the source of the data line.

Suffix:

<m> 1..4
Selects the serial bus.

Parameters:

<DataSource> C1W1 | C2W1 | C3W1 | C4W1 | M1 | M2 | M3 | M4 | M5 | M6 |
M7 | M8 | R1 | R2 | R3 | R4
*RST: C1W1

Usage: Asynchronous command

Manual operation: See "[Data](#)" on page 668

BUS<m>:SENT:DATA:THReshold <Threshold>

Sets a user-defined threshold value. Alternatively, you can set the threshold according to the signal technology [BUS<m>:SENT:TECHnology](#).

Suffix:

<m> 1..4
Selects the serial bus.

Parameters:

<Threshold> Range: -12 to 12
Increment: 0.1
*RST: 1.65
Default unit: V

Manual operation: See ["Threshold"](#) on page 668

BUS<m>:SENT:TECHnology <Technology>

Selects the threshold voltage.

Suffix:

<m> 1..4
Selects the serial data bus.

Parameters:

<Technology> V25 | MANual

V25

The threshold value is 2.5 V, according to CMOS technology.

MANual

Sets the threshold to the value set with [BUS<m>:SENT:DATA:THReshold](#).

*RST: V25

Manual operation: See ["Threshold"](#) on page 668

BUS<m>:SENT:CLKPeriod <ClockPeriod>

Sets the nominal clock period (clock tick).

Suffix:

<m> 1..4
Selects the serial bus.

Parameters:

<ClockPeriod> Range: 1E-6 to 100E-6
Increment: 1E-6
*RST: 6E-6
Default unit: s

Manual operation: See ["Clock Period"](#) on page 668

BUS<m>:SENT:CLKTolerance <ClockTolerance>

Sets a tolerated deviation of the clock signal.

Suffix:

<m> 1..4
Selects the serial bus.

Parameters:

<ClockTolerance> Range: 0 to 25
Increment: 1
*RST: 20
Default unit: %

Manual operation: See "[Clock tolerance](#)" on page 668

BUS<m>:SENT:DNIBbles <DataNibbles>

Sets the number of data nibbles for a transmission sequence.

Suffix:

<m> 1..4
Selects the serial data bus.

Parameters:

<DataNibbles> Range: 1 to 6
Increment: 1
*RST: 6

Manual operation: See "[Data Nibbles](#)" on page 668

BUS<m>:SENT:SFORMAT <Format>

Selects the serial message format.

Suffix:

<m> 1..4

Parameters:

<Format> SHORT | ENHanced | NONE
Short serial message, Enhanced serial message, none = single transmission sequence.
*RST: NONE

Manual operation: See "[Serial protocol](#)" on page 668

BUS<m>:SENT:CRCVersion <CRCVersion>

Selects the calculation method for the cyclic redundancy check (CRC).

Suffix:

<m> 1..4
Selects the serial data bus.

Parameters:

<CRCVersion> LEGA | V2010

Legacy: method used up to 2010**V2010:** current method

*RST: V2010

Manual operation: See "[CRC version](#)" on page 669**BUS<m>:SENT:CRCCMethod <CRCCalculation>**

Selects the calculation method for the CRC checksum.

Suffix:<m> 1..4
Selects the serial bus.**Parameters:**

<CRCCalculation> SAEJ | TLE

SAEJ: according to the standard**TLE:** according to the computing method for TLE_4998X sensors.

*RST: SAEJ

Manual operation: See "[CRC calculation](#)" on page 669**BUS<m>:SENT:PPULSe <PausePulse>**

Determines if a pause pulse is part of the SENT transmission sequence.

Suffix:<m> 1..4
Selects the serial data bus.**Parameters:**

<PausePulse> NPP | PP | PPFL

NPP

Transmits the SENT message without pause pulse.

PP

Transmits the message with a fixed pulse length, automatically calculated.

PPFL

Transmits the pause pulse with a user-defined frame length to obtain a transmission sequence with constant length.

*RST: PPFL

Manual operation: See "[Pause pulse](#)" on page 669

BUS<m>:SENT:PPFLength <FrameLength>

Defines a constant transmission sequence length. To select the fixed sequence length, set `BUS:SENT:PPUL PPFL`.

Suffix:

<m> 1..4
Selects the serial bus.

Parameters:

<FrameLength> Range: 104 to 922
Increment: 1
*RST: 256

Manual operation: See "Frame length [clock ticks]" on page 669

27.18.11.2 Trigger

Event in a trigger sequence: 1 = A-event only

The trigger suffix <m> is always 1 and can be omitted. It selects the trigger event: Only the A-trigger is available for triggering on serial buses.

To trigger on a serial bus, make sure that:

- `TRIGger<m>:SOURce[:SElect]` is set to `SBUS`.
- The sources of the serial bus are channel signals: use `BUS<m>:...:SOURce` commands.
- Decoding is enabled: `BUS<m>[:STATe]` is set to `ON`.

<code>TRIGger<m>:SENT:TYPE</code>	2060
<code>TRIGger<m>:SENT:TYPe</code>	2060
<code>TRIGger<m>:SENT:STATus</code>	2061
<code>TRIGger<m>:SENT:TDCN</code>	2061
<code>TRIGger<m>:SENT:TDMN</code>	2061
<code>TRIGger<m>:SENT:TDMX</code>	2062
<code>TRIGger<m>:SENT:STYPe</code>	2062
<code>TRIGger<m>:SENT:SIDType</code>	2062
<code>TRIGger<m>:SENT:SICN</code>	2062
<code>TRIGger<m>:SENT:SIMN</code>	2063
<code>TRIGger<m>:SENT:SIMX</code>	2063
<code>TRIGger<m>:SENT:SDCN</code>	2063
<code>TRIGger<m>:SENT:SDMN</code>	2064
<code>TRIGger<m>:SENT:SDMX</code>	2064
<code>TRIGger<m>:SENT:FORMerror</code>	2064
<code>TRIGger<m>:SENT:PULSeerror</code>	2064
<code>TRIGger<m>:SENT:PPERioderror</code>	2065
<code>TRIGger<m>:SENT:CRCError</code>	2065
<code>TRIGger<m>:SENT:IRFLength</code>	2065

TRIGger<m>:SENT:TYPE <Type>

Selects the trigger event for the SENT transmission type.

Parameters:

<Type>

CALI | TSEQ | SMSG | ERRC

CALI

CALibration: triggers on the falling edge of the calibration/synchronization pulse.

TSEQ

Transmission SEQUENCE: triggers either on the falling edge of the status nibble, or on the last data nibble.

To set the transmission sequence conditions, use

[TRIGger<m>:SENT:TTYPe](#) and [TRIGger<m>:SENT:STATUS](#).

To set the data condition, use [TRIGger<m>:SENT:TDCN](#), [BUS<m>:SENT:DNIBbles](#), [TRIGger<m>:SENT:TDMN](#) and [TRIGger<m>:SENT:TDMX](#).

SMSG

Serial Message: combination of identifier and data conditions.

To select the sequence condition, use [TRIGger<m>:SENT:STYPe](#).

To select the message ID format for an enhanced serial message, use [TRIGger<m>:SENT:SIDType](#).

To set the identifier condition, use [TRIGger<m>:SENT:SICN](#), [TRIGger<m>:SENT:SIMN](#) and [TRIGger<m>:SENT:SIMX](#).

To set the data condition, use [TRIGger<m>:SENT:SDCN](#), [TRIGger<m>:SENT:SDMN](#) and [TRIGger<m>:SENT:SDMX](#).

ERRC

ERRor Condition: triggers on an error event.

Define the error types with [TRIGger<m>:SENT:PULSeerror](#), [TRIGger<m>:SENT:PPERioderror](#) or [TRIGger<m>:SENT:CRCError](#).

*RST: CALI

Manual operation: See "[Type](#)" on page 671

TRIGger<m>:SENT:TTYPe <TSFieldType>

Selects the trigger sequence type for [TRIGger<m>:SENT:TYPE TSEQ](#) (transmission sequence).

Parameters:

<TSFieldType>

STAT | STDA

STAT

Triggers on the status nibble.

STDA

Triggers at the end of the combination of status and data nibble(s).

Define the data conditions with `TRIGger<m>:SENT:STATus`, `TRIGger<m>:SENT:TDCN`, `BUS<m>:SENT:DNIBbles`, `TRIGger<m>:SENT:TDMN` and `TRIGger<m>:SENT:TDMX`

*RST: STAT

Manual operation: See "[Sequence](#)" on page 673

TRIGger<m>:SENT:STATUS <StatusBits>

Sets the status nibble data.

Parameters:

<StatusBits> Numeric or string pattern, [Chapter 27.4.6, "Bit pattern parameter"](#), on page 1373. The string parameter accepts the bit value X (don't care).

Manual operation: See "[Status](#)" on page 673

TRIGger<m>:SENT:TDCN <TSDDataOperator>

Sets the operator to set a specific data pattern or a data pattern range.

Parameters:

<TSDDataOperator> `EQUal` | `NEQUal` | `LTHan` | `LETHan` | `GTHan` | `GETHan` | `INRange` | `OORange`

`EQUal` | `NEQUal` | `LTHan` | `LETHan` | `GTHan` | `GETHan`

Equal, Not equal, Less than, Less or equal than, Greater than, Greater or equal than. These conditions require one data pattern to be set with `TRIGger<m>:SENT:TDMN`.

`INRange` | `OORange`

In range / Out of range. To define the range set the minimum and maximum values with `TRIGger<m>:SENT:TDMN` and `TRIGger<m>:SENT:TDMX`.

*RST: `EQUal`

Manual operation: See "[Condition](#)" on page 673

TRIGger<m>:SENT:TDMN <TSDDataPattern>

Specifies a data pattern, or sets the start value of a data pattern range.

Parameters:

<TSDDataPattern> Numeric or string pattern, [Chapter 27.4.6, "Bit pattern parameter"](#), on page 1373. The string parameter accepts the bit value X (don't care).

Manual operation: See "[Data min](#)" on page 674

TRIGger<m>:SENT:TDMX <TSDDataPatternTo>

Sets the end value of an identifier range for [TRIGger:SENT:TDCN INRange](#) or [OORange](#).

Parameters:

<TSDDataPatternTo> Numeric or string pattern, [Chapter 27.4.6, "Bit pattern parameter"](#), on page 1373. The string parameter accepts the bit value X (don't care).

Manual operation: See ["Data max"](#) on page 674

TRIGger<m>:SENT:STYPe <SMFieldType>

Selects the trigger sequence type for [TRIGger:SENT:TYPE SSMSg](#) or [ESMSg](#) (serial message).

Parameters:

<SMFieldType> ID | IDDT

ID

Triggers on the identifier.

To set the identifier condition for a serial message, use [TRIGger<m>:SENT:SICN](#), [TRIGger<m>:SENT:SIMN](#) and [TRIGger<m>:SENT:SIMX](#).

IDDT

Triggers at the end of the combination of identifier and data.

To set the identifier condition, use the commands shown above.

To set the data condition, use [TRIGger<m>:SENT:SDCN](#), [TRIGger<m>:SENT:SDMN](#) and [TRIGger<m>:SENT:SDMX](#).

*RST: ID

Manual operation: See ["Sequence"](#) on page 674

TRIGger<m>:SENT:SIDType <SMIDType>

Sets the message ID format (4 bit or 8 bit) of the enhanced serial message.

Parameters:

<SMIDType> B4 | B8

*RST: B4

Manual operation: See ["ID Type"](#) on page 674

TRIGger<m>:SENT:SICN <SMIDOperator>

Sets the operator to set a specific data pattern or a data pattern range.

Parameters:

<SMIDOperator> EQUal | NEQUal | LTHan | LETHan | GTHan | GETHan | INRange | OORange

EQUal | NEQUal | LTHan | LETHan | GTHan | GETHan

Equal, Not equal, Less than, Less or equal than, Greater than, Greater or equal than. These conditions require one data pattern to be set with `TRIGger<m>:SENT:SIMN`.

INRange | OORange

In range / Out of range. To define the range set the minimum and maximum values with `TRIGger<m>:SENT:SIMN` and `TRIGger<m>:SENT:SIMX`.

*RST: EQUal

Manual operation: See "[Identifier Condition](#)" on page 674

TRIGger<m>:SENT:SIMN <SMIDPattern>

Specifies a message identifier pattern, or sets the start value of an identifier range.

Parameters:

<SMIDPattern> Numeric or string pattern, [Chapter 27.4.6, "Bit pattern parameter"](#), on page 1373. The string parameter accepts the bit value X (don't care).

Manual operation: See "[Identifier min](#)" on page 675

TRIGger<m>:SENT:SIMX <SMIDPatternTo>

Sets the end value of an identifier range for `TRIGger<m>:SENT:SICN` [INRange](#) or [OORange](#).

Parameters:

<SMIDPatternTo> Numeric or string pattern, [Chapter 27.4.6, "Bit pattern parameter"](#), on page 1373. The string parameter accepts the bit value X (don't care).

Manual operation: See "[Identifier max](#)" on page 675

TRIGger<m>:SENT:SDCN <SMDDataOperator>

Sets the operator to set a specific data pattern or a data pattern range.

Parameters:

<SMDDataOperator> EQUal | NEQUal | LTHan | LETHan | GTHan | GETHan | INRange | OORange

EQUal | NEQUal | LTHan | LETHan | GTHan | GETHan

Equal, Not equal, Less than, Less or equal than, Greater than, Greater or equal than. These conditions require one data pattern to be set with `TRIGger<m>:SENT:SDMN`.

INRange | OORange

In range / Out of range. To define the range set the minimum and maximum values with `TRIGger<m>:SENT:SDMN` and `TRIGger<m>:SENT:SDMX`.

*RST: EQUAL

Manual operation: See "[Data Condition](#)" on page 675

TRIGger<m>:SENT:SDMN <SMDDataPattern>

Specifies a data pattern, or sets the start value of a data pattern range.

Parameters:

<SMDDataPattern> Numeric or string pattern, [Chapter 27.4.6, "Bit pattern parameter"](#), on page 1373. The string parameter accepts the bit value X (don't care).

Manual operation: See "[Data min](#)" on page 675

TRIGger<m>:SENT:SDMX <SMDDataPatternTo>

Sets the end value of an identifier range for [TRIGger<m>:SENT:SCONdition INRange](#) or [OORange](#).

Parameters:

<SMDDataPatternTo> Numeric or string pattern, [Chapter 27.4.6, "Bit pattern parameter"](#), on page 1373. The string parameter accepts the bit value X (don't care).

Manual operation: See "[Data max](#)" on page 675

TRIGger<m>:SENT:FORMerror <FormError>

Triggers on format errors in serial messages.

A form error occurs when at least one of the transmission sequences that form a serial message has an error.

To trigger on an error event, select the corresponding trigger type with [TRIGger<m>:SENT:TYPE ERRC](#).

Parameters:

<FormError> ON | OFF

*RST: OFF

Manual operation: See "[Error conditions setup](#)" on page 676

TRIGger<m>:SENT:PULSEerror <CalibPulseError>

Trigger son calibration pulse errors in transmission sequences.

An error occurs when

- the duration of the "Calibration/Sync" pulse (in ticks) is less than $56 \cdot (1 - \text{clock tolerance})$ or more than $56 \cdot (1 + \text{clock tolerance})$
- the "Calibration/Sync" pulse duration of frame (n-1) varies by more than 1.5625% from the "Calibration/Sync" pulse duration of frame (n)

To trigger on an error event, select the correspondig trigger type with `TRIGGER<m>:SENT:TYPE ERRC`.

Parameters:

<CalibPulseError> ON | OFF
*RST: OFF

Manual operation: See "[Error conditions setup](#)" on page 676

TRIGGER<m>:SENT:PPERioderror <PulsePeriodErr>

Triggers on pulse period errors.

An error occurs when a nibble has any of the following:

- number of ticks at low is less than 4 ticks.
- nibble value < 0 (less than 12 ticks) or > 15 (more than 27 ticks).

To trigger on an error event, select the correspondig trigger type with `TRIGGER<m>:SENT:TYPE ERRC`.

Parameters:

<PulsePeriodErr> ON | OFF
*RST: OFF

Manual operation: See "[Error conditions setup](#)" on page 676

TRIGGER<m>:SENT:CRCError <CRCError>

Triggers on CRC errors in both, the transmission sequences and serial messages.

A CRC error occurs when the CRC calculated by the receiver differs from the received value in the CRC sequence. The CRC length is 4 bits for transmission sequences and short serial messages, and 6 bit of enhanced serial messages.

To trigger on an error event, select the correspondig trigger type with `TRIGGER<m>:SENT:TYPE ERRC`.

Parameters:

<CRCError> ON | OFF
*RST: ON

Manual operation: See "[Error conditions setup](#)" on page 676

TRIGGER<m>:SENT:IRFLength <IrregularFrmLen>

Triggers on frame length errors in transmission sequences when pause pulse for constant frame length is set, see `BUS<m>:SENT:PPULse PPFL`.

An error occurs when the total length of the transmission sequence (including pause pulse) does not match the frame length setting, see `BUS<m>:SENT:PPFLength` on page 2059.

To trigger on an error event, select the correspondig trigger type with `TRIGger<m>:SENT:TYPE ERRc`.

Parameters:

<IrregularFrmLen> ON | OFF
*RST: OFF

Manual operation: See "Error conditions setup" on page 676

27.18.11.3 Decode results

To load and activate a label list, use:

- `BUS<m>:NEWList` on page 1815
- `BUS<m>:SYMBOLs` on page 1815

<code>BUS<m>:SENT:FCOunt?</code>	2066
<code>BUS<m>:SENT:FRAMe<n>:STATus?</code>	2067
<code>BUS<m>:SENT:FRAMe<n>:START?</code>	2067
<code>BUS<m>:SENT:FRAMe<n>:STOP?</code>	2067
<code>BUS<m>:SENT:FRAMe<n>:CSValue?</code>	2067
<code>BUS<m>:SENT:FRAMe<n>:DATA?</code>	2068
<code>BUS<m>:SENT:FRAMe<n>:IDTYpe?</code>	2068
<code>BUS<m>:SENT:FRAMe<n>:IDValue?</code>	2069
<code>BUS<m>:SENT:FRAMe<n>:NIBBle<o>:STATe?</code>	2069
<code>BUS<m>:SENT:FRAMe<n>:NIBBle<o>:VALue?</code>	2069
<code>BUS<m>:SENT:FRAMe<n>:PAPTicks?</code>	2070
<code>BUS<m>:SENT:FRAMe<n>:SCOM?</code>	2070
<code>BUS<m>:SENT:FRAMe<n>:SDATa?</code>	2070
<code>BUS<m>:SENT:FRAMe<n>:SDEXport?</code>	2071
<code>BUS<m>:SENT:FRAMe<n>:SYMBOL?</code>	2071
<code>BUS<m>:SENT:FRAMe<n>:SYNCduration?</code>	2071
<code>BUS<m>:SENT:FRAMe<n>:TYPE?</code>	2072
<code>BUS<m>:SENT:RDSL</code>	2072
<code>BUS<m>:SENT:FRAMe<n>:BITRate?</code>	2072

BUS<m>:SENT:FCOunt?

Returns the number of decoded frames of the acquisition.

Suffix:

<m> 1..4
Selects the serial data bus.

Return values:

<Count> Total number of decoded frames.
Range: 0 to 100000
Increment: 1
*RST: 0

Usage: Query only

BUS<m>:SENT:FRAME<n>:STATus?

Returns the overall state of the selected frame.

Suffix:

<m>	1..4 Selects the serial data bus.
<n>	* Selects the frame.

Return values:

<FrameState>	OK SYNC PULSe CRC IRFL FORM INSufficient OK: the frame is valid. SYNC: Synchronization error occurred. PULSe: Pulse error occurred. CRC: Cyclic redundancy check failed. IRFL: Irregular frame length error occurred. FORM: Format error occurred. INSufficient: The frame is not completely contained in the acquisition. The acquired part of the frame is valid. *RST: OK
--------------	--

Usage: Query only

BUS<m>:SENT:FRAME<n>:START?**BUS<m>:SENT:FRAME<n>:STOP?**

Returns the start time and stop time of the selected frame.

Suffix:

<m>	1..4 Selects the serial bus.
<n>	* Selects the frame.

Return values:

<Start>, <Stop>	Range: -100E+24 to 100E+24 Increment: 100E-12 *RST: 0 Default unit: s
-----------------	--

Usage: Query only

BUS<m>:SENT:FRAME<n>:CSValue?

Returns the CRC sequence value of the selected frame.

Suffix:

<m>	1..4 Selects the serial bus.
-----	---------------------------------

<n> *
Selects the frame.

Return values:

<ChecksumValue> To set the value format, use `FORMat:BPATtern`.
The values below – range, increment and reset – are decimal values.

Range: 0 to 63

Increment: 1

*RST: 0

Usage: Query only

BUS<m>:SENT:FRAME<n>:DATA?

Returns the data of the specified frame.

Suffix:

<m> 1..4
Selects the serial bus.

<n> *
Selects the frame.

Parameters:

<Data> Comma-separated sequence of integer values (N, D1, D2,..., DN). N is the number of nibbles in the frame, and D1...DN are the values of the nibbles.

Example: `BUS:SENT:FRAME4:DATA?`
`<-- 4,3,15,11,9`

Usage: Query only

BUS<m>:SENT:FRAME<n>:IDType?

Returns the identifier type of the selected frame.

Suffix:

<m> 1..4
Selects the serial bus.

<n> *
Selects the frame.

Return values:

<IdentifierType> B4 | B8
B4: standard format, 4 bit
B8: extended format, 8 bit
*RST: B4

Usage: Query only

BUS<m>:SENT:FRAME<n>:IDValue?

Returns the identifier value of the selected frame.

Suffix:

<m>	1..4 Selects the serial bus.
<n>	* Selects the frame.

Return values:

<IdentifierValue> To set the value format, use [FORMat:BPATtern](#).
The values below – range, increment and reset – are decimal values.

Range:	0 to 255
Increment:	1
*RST:	0

Usage: Query only

BUS<m>:SENT:FRAME<n>:NIBBLE<o>:STATE?

Returns the state of the specified nibble.

Suffix:

<m>	1..4 Selects the serial bus.
<n>	* Selects the frame.
<o>	* Selects the nibble number.

Return values:

<State> OK | UNDF
UNDF: Undefined
*RST: OK

Usage: Query only

BUS<m>:SENT:FRAME<n>:NIBBLE<o>:VALue?

Returns the value of the specified nibble.

Suffix:

<m>	1..4 Selects the serial bus.
<n>	* Selects the frame.

<0> *
Selects the nibble number.

Return values:

<Value> To set the value format, use [FORMat:BPATtern](#).
The values below – range, increment and reset – are decimal values.

Range: 0 to 15

Increment: 1

*RST: 0

Usage: Query only

BUS<m>:SENT:FRAME<n>:PAPTicks?

Returns the number of the pulse pause clock ticks.

Suffix:

<m> 1..4
Selects the serial bus.

<n> *
Selects the frame.

Return values:

<PausePulseTicks> Range: 12 to 768
Increment: 1
*RST: 12

Usage: Query only

BUS<m>:SENT:FRAME<n>:SCOM?

Returns the value of the status/communication pulse.

Suffix:

<m> 1..4
Selects the serial bus.

<n> *
Selects the frame.

Return values:

<StatusComm> Range: 0 to 15
Increment: 1
*RST: 0

Usage: Query only

BUS<m>:SENT:FRAME<n>:SDATa?

Returns the symbolic data of the frame.

Suffix:

<m> 1..4
Selects the serial bus.

<n> *
Selects the frame.

Return values:

<SymbolicData> Comma-separated list of values. The first value is the number of bytes, followed by the decoded data bytes.
To set the value format, use `FORMat:BPATtern`.

Usage: Query only

BUS<m>:SENT:FRAME<n>:SDEXport?

Returns the symbolic data of the frame in export format.

Suffix:

<m> 1..4
Selects the serial bus.

<n> *
Selects the frame.

Return values:

<SymbolicData>

Usage: Query only

BUS<m>:SENT:FRAME<n>:SYMBOL?

Returns the symbolic label of the specified frame if the label list is enabled.

Suffix:

<m> 1..4
Selects the serial bus.

<n> *
Selects the number of the frame in the current acquisition, 1...n.

Return values:

<Translation> String with symbolic label of the identifier.

Example:

`BUS:SENT:FRAME:SYMBOL?`
Response: Air Temperature

Usage: Query only

BUS<m>:SENT:FRAME<n>:SYNCDuration?

Returns the time of the synchronization pulse.

Suffix:

<m> 1..4
Selects the serial bus.

<n> *
Selects the frame.

Return values:

<SyncDuration> Range: -100E+24 to 100E+24
Increment: 100E-12
*RST: 0
Default unit: s

Usage: Query only

BUS<m>:SENT:FRAME<n>:TYPE?

Returns the type of SENT message.

Suffix:

<m> 1..4
Selects the serial bus.

<n> *
Selects the frame.

Return values:

<FrameType> TRSQ | SMSG | EMSG
Transmission sequence, short serial message or enhanced serial message.
*RST: TRSQ

Usage: Query only

BUS<m>:SENT:RDSL <RessDispSel>

Selects the results to be displayed.

Suffix:

<m> 1..4
Selects the serial bus.

Parameters:

<RessDispSel> TRSQ | SMSG | ALL
Transmission sequence, serial messages or all.
*RST: ALL

BUS<m>:SENT:FRAME<n>:BITRate?

Returns the bit rate of the selected frame.

Suffix:

<m> 1..4

<n> *

Return values:

<PrimaryBitRate> Range: 0 to 100000000000
 Increment: 1
 *RST: 0
 Default unit: bps

Usage: Query only**27.18.11.4 SENT search settings**

In search setup commands, you have to specify the <SearchName> parameter. It is a string parameter that contains the search definition name. The commands are similar to SENT trigger commands.

SEARch:TRIGger:SENT:CALibration.....	2073
SEARch:TRIGger:SENT:TRANsmission.....	2074
SEARch:TRIGger:SENT:SMSG.....	2074
SEARch:TRIGger:SENT:ERRor.....	2074
SEARch:TRIGger:SENT:TTPe.....	2075
SEARch:TRIGger:SENT:STATus.....	2075
SEARch:TRIGger:SENT:TDCN.....	2076
SEARch:TRIGger:SENT:TDMN.....	2076
SEARch:TRIGger:SENT:TDMX.....	2076
SEARch:TRIGger:SENT:STYPe.....	2077
SEARch:TRIGger:SENT:SIDType.....	2077
SEARch:TRIGger:SENT:SICN.....	2078
SEARch:TRIGger:SENT:SIMN.....	2078
SEARch:TRIGger:SENT:SIMX.....	2078
SEARch:TRIGger:SENT:SDCN.....	2079
SEARch:TRIGger:SENT:SDMN.....	2079
SEARch:TRIGger:SENT:SDMX.....	2079
SEARch:TRIGger:SENT:PULSeerror.....	2080
SEARch:TRIGger:SENT:PPERioderror.....	2080
SEARch:TRIGger:SENT:IRFLength.....	2080
SEARch:TRIGger:SENT:FORMerror.....	2081
SEARch:TRIGger:SENT:CRCerror.....	2081

SEARch:TRIGger:SENT:CALibration <SearchName>,<CalSyncPulse>

SEARch:TRIGger:SENT:CALibration? <SearchName>

Enables the search for the Calibration/Synchronization pulse.

Parameters:

<CalSyncPulse> ON | OFF

*RST: OFF

Parameters for setting and query:

<SearchName>

Manual operation: See ["Search types"](#) on page 689**SEARCH:TRIGger:SENT:TRANmission** <SearchName>,<TransmSequence>**SEARCH:TRIGger:SENT:TRANmission?** <SearchName>

Enables the search for a transmission sequence, which is combination of status and data conditions.

To set the transmission sequence conditions, use [SEARCH:TRIGger:SENT:TTYPe](#) and [SEARCH:TRIGger:SENT:STATus](#).

To set the data condition, use [SEARCH:TRIGger:SENT:TDCN](#), [TRIGger<m>:SENT:TDCN](#), [SEARCH:TRIGger:SENT:TDMN](#) and [SEARCH:TRIGger:SENT:TDMX](#).

Parameters:

<TransmSequence> ON | OFF

*RST: OFF

Parameters for setting and query:

<SearchName>

Manual operation: See ["Search types"](#) on page 689**SEARCH:TRIGger:SENT:SMSG** <SearchName>,<SerialMessage>**SEARCH:TRIGger:SENT:SMSG?** <SearchName>

Enables the search in a serial message, which is combination of identifier and data conditions.

To select the sequence condition, use [SEARCH:TRIGger:SENT:STYPe](#).

To set the identifier condition for the serial message, use [SEARCH:TRIGger:SENT:SICN](#), [SEARCH:TRIGger:SENT:SIMN](#) and [SEARCH:TRIGger:SENT:SIMX](#).

To set the data condition, use [SEARCH:TRIGger:SENT:SDCN](#), [SEARCH:TRIGger:SENT:SDMN](#) and [SEARCH:TRIGger:SENT:SDMX](#).

Parameters:

<SerialMessage> ON | OFF

*RST: OFF

Parameters for setting and query:

<SearchName>

Manual operation: See ["Search types"](#) on page 689**SEARCH:TRIGger:SENT:ERRor** <SearchName>,<ErrorCondition>**SEARCH:TRIGger:SENT:ERRor?** <SearchName>

Enables the search for specified errors.

Define the error types with `SEARCH:TRIGGER:SENT:PULSEerror`, `SEARCH:TRIGGER:SENT:PPERioderror`, `SEARCH:TRIGGER:SENT:FORMerror` on page 2081 and `SEARCH:TRIGGER:SENT:CRCerror`.

Parameters:

<ErrorCondition> ON | OFF
 *RST: OFF

Parameters for setting and query:

<SearchName>

Manual operation: See "[Search types](#)" on page 689

SEARCH:TRIGGER:SENT:TTYPE <SearchName>,<TSFieldType>

SEARCH:TRIGGER:SENT:TTYPE? <SearchName>

Selects the SENT transmission sequence to be searched for.

To enable the search for the transmission sequence, use `SEARCH:TRIGGER:SENT:TRANmission`.

Parameters:

<TSFieldType> STAT | STDA

STAT

Searches on the status nibble.

STDA

Searches for the end of the combination of status and data nibble(s).

Define the data conditions with `SEARCH:TRIGGER:SENT:STATUS`, `SEARCH:TRIGGER:SENT:TDCN`, `BUS<m>:SENT:DNIBbles`, `SEARCH:TRIGGER:SENT:TDMN` and `SEARCH:TRIGGER:SENT:TDMX`.

*RST: STAT

Parameters for setting and query:

<SearchName>

Manual operation: See "[Sequence](#)" on page 690

SEARCH:TRIGGER:SENT:STATUS <SearchName>,<StatusBits>

SEARCH:TRIGGER:SENT:STATUS? <SearchName>

Sets the status nibble data.

Parameters:

<StatusBits> Numeric or string pattern, [Chapter 27.4.6, "Bit pattern parameter"](#), on page 1373. The string parameter accepts the bit value X (don't care).

Parameters for setting and query:

<SearchName>

Manual operation: See ["Status"](#) on page 690

SEARCH:TRIGger:SENT:TDCN <SearchName>,<TSDDataOperator>
SEARCH:TRIGger:SENT:TDCN? <SearchName>

Sets the operator for a specific data pattern or a data pattern range.

Parameters:

<TSDDataOperator> EQUal | NEQual | LTHan | LETHan | GTHan | GETHan |
 INRange | OORange

EQUal | NEQual | LTHan | LETHan | GTHan | GETHan

Equal, Not equal, Less than, Less or equal than, Greater than,
 Greater or equal than. These conditions require one data pattern
 to be set with [SEARCH:TRIGger:SENT:TDMN](#).

INRange | OORange

In range / Out of range. To define the range set the minimum
 and maximum values with [SEARCH:TRIGger:SENT:TDMN](#) and
[SEARCH:TRIGger:SENT:TDMX](#).

*RST: EQUal

Parameters for setting and query:

<SearchName>

Manual operation: See ["Condition"](#) on page 690

SEARCH:TRIGger:SENT:TDMN <SearchName>,<TSDDataPattern>
SEARCH:TRIGger:SENT:TDMN? <SearchName>

Specifies a data pattern, or sets the start value of a data pattern range.

Parameters:

<TSDDataPattern> Numeric or string pattern, [Chapter 27.4.6, "Bit pattern parameter"](#), on page 1373. The string parameter accepts the bit value X
 (don't care).

Parameters for setting and query:

<SearchName>

Manual operation: See ["Data min"](#) on page 691

SEARCH:TRIGger:SENT:TDMX <SearchName>,<TSDDataPatternTo>
SEARCH:TRIGger:SENT:TDMX? <SearchName>

Sets the end value of an identifier range for [SEARCH:TRIGger:SENT:DCondition](#)
[INRange](#) or [OORange](#).

Parameters:

<TSDDataPatternTo> Numeric or string pattern, [Chapter 27.4.6, "Bit pattern parameter"](#), on page 1373. The string parameter accepts the bit value X
 (don't care).

Parameters for setting and query:

<SearchName>

Manual operation: See "Data max" on page 691**SEARCH:TRIGger:SENT:STYPe** <SearchName>,<SMFieldType>**SEARCH:TRIGger:SENT:STYPe?** <SearchName>

Selects the serial message sequence to be searched for.

To enable the search for one of the serial message types, use `BUS<m>:SENT:SFORmat` and enable with `SEARCH:TRIGger:SENT:SMSG`.**Parameters:**

<SMFieldType> ID | IDDT

ID

Searches for the identifier.

To set the identifier condition for the serial message, use

`SEARCH:TRIGger:SENT:SICN`, `SEARCH:TRIGger:SENT:SIMN` and `SEARCH:TRIGger:SENT:SIMX`.**IDDT**

Searches for the combination of identifier and data.

To set the identifier condition, use the commands shown above.

To set the data condition, use `SEARCH:TRIGger:SENT:SDCN`, `SEARCH:TRIGger:SENT:SDMN` and `SEARCH:TRIGger:SENT:SDMX`.***RST:** ID**Parameters for setting and query:**

<SearchName>

Manual operation: See "Sequence" on page 691**SEARCH:TRIGger:SENT:SIDType** <SearchName>,<SMIDType>**SEARCH:TRIGger:SENT:SIDType?** <SearchName>

Sets the message ID format (4 bit or 8 bit) of the enhanced serial message.

Parameters:

<SMIDType> B4 | B8

***RST:** B4**Parameters for setting and query:**

<SearchName>

Manual operation: See "ID Type" on page 691

SEARch:TRIGger:SENT:SICN <SearchName>,<SMIDOperator>

SEARch:TRIGger:SENT:SICN? <SearchName>

Sets the operator to set a specific data pattern or a data pattern range.

Parameters:

<SMIDOperator> EQUal | NEQual | LTHan | LETHan | GTHan | GETHan |
INRange | OORange

EQUal | NEQual | LTHan | LETHan | GTHan | GETHan

Equal, Not equal, Less than, Less or equal than, Greater than,
Greater or equal than. These conditions require one data pattern
to be set with [SEARch:TRIGger:SENT:SIMN](#).

INRange | OORange

In range / Out of range. To define the range set the minimum
and maximum values with [SEARch:TRIGger:SENT:SIMN](#) and
[SEARch:TRIGger:SENT:SIMX](#).

*RST: EQUal

Parameters for setting and query:

<SearchName>

Manual operation: See "[Identifier Condition](#)" on page 691

SEARch:TRIGger:SENT:SIMN <SearchName>,<SMIDPattern>

SEARch:TRIGger:SENT:SIMN? <SearchName>

Specifies a message identifier pattern, or sets the start value of an identifier range.

Parameters:

<SMIDPattern> Numeric or string pattern, [Chapter 27.4.6, "Bit pattern parameter"](#), on page 1373. The string parameter accepts the bit value X
(don't care).

Parameters for setting and query:

<SearchName>

Manual operation: See "[Identifier min](#)" on page 692

SEARch:TRIGger:SENT:SIMX <SearchName>,<SMIDPatternTo>

SEARch:TRIGger:SENT:SIMX? <SearchName>

Sets the end value of an identifier range for [SEARch:TRIGger:SENT:SICN](#)
[INRange](#) or [OORange](#).

Parameters:

<SMIDPatternTo> Numeric or string pattern, [Chapter 27.4.6, "Bit pattern parameter"](#), on page 1373. The string parameter accepts the bit value X
(don't care).

Parameters for setting and query:

<SearchName>

Manual operation: See "[Identifier max](#)" on page 692

SEARCH:TRIGger:SENT:SDCN <SearchName>,<SMDDataOperator>
SEARCH:TRIGger:SENT:SDCN? <SearchName>

Sets the operator to set a specific data pattern or a data pattern range.

Parameters:

<SMDDataOperator> **EQUal** | **NEQual** | **LTHan** | **LETHan** | **GTHan** | **GETHan** |
INRange | **OORange**

EQUal | **NEQual** | **LTHan** | **LETHan** | **GTHan** | **GETHan**

Equal, Not equal, Less than, Less or equal than, Greater than, Greater or equal than. These conditions require one data pattern to be set with [SEARCH:TRIGger:SENT:SDMN](#).

INRange | **OORange**

In range / Out of range. To define the range set the minimum and maximum values with [SEARCH:TRIGger:SENT:SDMN](#) and [SEARCH:TRIGger:SENT:SDMX](#).

*RST: **EQUal**

Parameters for setting and query:

<SearchName>

Manual operation: See "[SSM Data Condition](#)" on page 692

SEARCH:TRIGger:SENT:SDMN <SearchName>,<SMDDataPattern>
SEARCH:TRIGger:SENT:SDMN? <SearchName>

Specifies a data pattern, or sets the start value of a data pattern range.

Parameters:

<SMDDataPattern> Numeric or string pattern, [Chapter 27.4.6, "Bit pattern parameter"](#), on page 1373. The string parameter accepts the bit value X (don't care).

Parameters for setting and query:

<SearchName>

Manual operation: See "[Data min](#)" on page 692

SEARCH:TRIGger:SENT:SDMX <SearchName>,<SMDDataPatternTo>
SEARCH:TRIGger:SENT:SDMX? <SearchName>

Sets the end value of an identifier range for [SEARCH:TRIGger:SENT:SDCN](#) [INRange](#) or [OORange](#).

Parameters:

<SMDDataPatternTo> Numeric or string pattern, [Chapter 27.4.6, "Bit pattern parameter"](#), on page 1373. The string parameter accepts the bit value X (don't care).

Parameters for setting and query:

<SearchName>

Manual operation: See ["Data max"](#) on page 692**SEARCH:TRIGger:SENT:PULSEerror** <SearchName>,<CalibPulseError>**SEARCH:TRIGger:SENT:PULSEerror?** <SearchName>

Enables the search for calibration pulse errors.

To initially enable the search for an error event, set [SEARCH:TRIGger:SENT:ERRor](#) to ON.**Parameters:**

<CalibPulseError> ON | OFF

*RST: OFF

Parameters for setting and query:

<SearchName>

Manual operation: See ["Error conditions setup"](#) on page 692**SEARCH:TRIGger:SENT:PPERioderror** <SearchName>,<PulsePeriodErr>**SEARCH:TRIGger:SENT:PPERioderror?** <SearchName>

Enables the search for pulse period errors.

To initially enable the search for an error event, set [SEARCH:TRIGger:SENT:ERRor](#) to ON.**Parameters:**

<PulsePeriodErr> ON | OFF

*RST: OFF

Parameters for setting and query:

<SearchName>

Manual operation: See ["Error conditions setup"](#) on page 692**SEARCH:TRIGger:SENT:IRFLength** <SearchName>,<IrregularFrmLen>**SEARCH:TRIGger:SENT:IRFLength?** <SearchName>

Enables the search for irregular frame length errors in transmission sequences.

This error type is relevant if pause pulse mode is set to constant frame length.

To initially enable the search for an error event, set [SEARCH:TRIGger:SENT:ERRor](#) to ON.**Parameters:**

<IrregularFrmLen> ON | OFF

*RST: OFF

Parameters for setting and query:

<SearchName>

Manual operation: See ["Error conditions setup"](#) on page 692**SEARCH:TRIGger:SENT:FORMError** <SearchName>,<FormError>**SEARCH:TRIGger:SENT:FORMError?** <SearchName>

Enables the search for format errors in serial messages.

To initially enable the search for an error event, set [SEARCH:TRIGger:SENT:ERRor](#) to ON.**Parameters:**

<FormError> ON | OFF

*RST: OFF

Parameters for setting and query:

<SearchName>

Manual operation: See ["Error conditions setup"](#) on page 692**SEARCH:TRIGger:SENT:CRCError** <SearchName>,<CRCError>**SEARCH:TRIGger:SENT:CRCError?** <SearchName>

Enables the search for errors in the Cyclic Redundancy Check.

To initially enable the search for an error event, set [SEARCH:TRIGger:SENT:ERRor](#) to ON.**Parameters:**

<CRCError> ON | OFF

*RST: ON

Parameters for setting and query:

<SearchName>

Manual operation: See ["Error conditions setup"](#) on page 692**27.18.11.5 SENT search results**

The search on decoded SENT data returns the same results as the queries for decode results.

In search result commands, you have to specify the <SearchName> parameter. It is a string parameter that contains the search definition name.

For a description of the returned values, see the corresponding commands in [Chapter 27.18.11.3, "Decode results"](#), on page 2066.

SEARCH:RESult:SENT:FCOunt?	2082
SEARCH:RESult:SENT:FRAMe<m>:CSValue?	2082
SEARCH:RESult:SENT:FRAMe<m>:DATA?	2082
SEARCH:RESult:SENT:FRAMe<m>:IDTYpe?	2083

SEARCh:RESult:SENT:FRAMe<m>:IDValue?.....	2083
SEARCh:RESult:SENT:FRAMe<m>:NIBBle<n>:STATe?.....	2083
SEARCh:RESult:SENT:FRAMe<m>:NIBBle<n>:VALue?.....	2084
SEARCh:RESult:SENT:FRAMe<m>:PAPTicks?.....	2084
SEARCh:RESult:SENT:FRAMe<m>:SCOM?.....	2084
SEARCh:RESult:SENT:FRAMe<m>:SDATa?.....	2085
SEARCh:RESult:SENT:FRAMe<m>:START?.....	2085
SEARCh:RESult:SENT:FRAMe<m>:STATus?.....	2085
SEARCh:RESult:SENT:FRAMe<m>:STOP?.....	2085
SEARCh:RESult:SENT:FRAMe<m>:SYMBol?.....	2086
SEARCh:RESult:SENT:FRAMe<m>:SYNCduration?.....	2086
SEARCh:RESult:SENT:FRAMe<m>:TYPE?.....	2086

SEARCh:RESult:SENT:FCOunt? <SearchName>

Query parameters:

<SearchName>

Return values:

<Count>	Range:	0 to 100000
	Increment:	1
	*RST:	0

Usage: Query only

SEARCh:RESult:SENT:FRAMe<m>:CSValue? <SearchName>

Returns the checksum value.

Suffix:

<m> *

Query parameters:

<SearchName>

Return values:

<ChecksumValue>	Range:	0 to 63
	Increment:	1
	*RST:	0

Usage: Query only

SEARCh:RESult:SENT:FRAMe<m>:DATA? <SearchName>

Returns the data of the specified frame.

Suffix:

<m> *

Query parameters:

<SearchName>

Return values:

<Data>

Usage: Query only**SEARCh:RESult:SENT:FRAMe<m>:IDType? <SearchName>**

Returns the identifier type of the selected frame.

Suffix:

<m>	*
	Selects the frame.

Query parameters:

<SearchName>

Return values:

<IdentifierType>	B4 B8
	B4: standard format, 4 bit
	B8: extended format, 8 bit
*RST:	B4

Usage: Query only**SEARCh:RESult:SENT:FRAMe<m>:IDValue? <SearchName>**

Returns the identifier value of the selected frame.

Suffix:

<m>	*
	Selects the serial bus.

Query parameters:

<SearchName>

Return values:

<IdentifierValue>	Range: 0 to 255
	Increment: 1
*RST:	0

Usage: Query only**SEARCh:RESult:SENT:FRAMe<m>:NIBBlE<n>:STATe? <SearchName>****Suffix:**

<m>	*
<n>	*

Query parameters:

<SearchName>

Return values:

<State> OK | UNDF
 *RST: OK

Usage: Query only

SEARCh:RESult:SENT:FRAMe<m>:NIBBlE<n>:VALue? <SearchName>**Suffix:**

<m> *
 <n> *

Query parameters:

<SearchName>

Return values:

<Value> Range: 0 to 15
 Increment: 1
 *RST: 0

Usage: Query only

SEARCh:RESult:SENT:FRAMe<m>:PAPTicks? <SearchName>**Suffix:**

<m> *

Query parameters:

<SearchName>

Return values:

<PausePulseTicks> Range: 12 to 768
 Increment: 1
 *RST: 12

Usage: Query only

SEARCh:RESult:SENT:FRAMe<m>:SCOM? <SearchName>**Suffix:**

<m> *

Query parameters:

<SearchName>

Return values:

<StatusComm> Range: 0 to 15
 Increment: 1
 *RST: 0

Usage: Query only

SEARCh:RESult:SENT:FRAMe<m>:SDATa? <SearchName>

Returns the symbolic data of the specified frame.

Suffix:

<m> *

Query parameters:

<SearchName>

Return values:

<SymbolicData> String that contain the symbolic data.

Usage: Query only

SEARCh:RESult:SENT:FRAMe<m>:START? <SearchName>**Suffix:**

<m> *

Query parameters:

<SearchName>

Return values:

<FrameStart> Range: -100E+24 to 100E+24
Increment: 100E-12
*RST: 0
Default unit: s

Usage: Query only

SEARCh:RESult:SENT:FRAMe<m>:STATUs? <SearchName>**Suffix:**

<m> *

Query parameters:

<SearchName>

Return values:

<FrameState> OK | SYNC | PULSe | CRC | IRFL | FORM | INSufficient
*RST: OK

Usage: Query only

SEARCh:RESult:SENT:FRAMe<m>:STOP? <SearchName>**Suffix:**

<m> *

Query parameters:

<SearchName>

Return values:

<FrameStop> Range: -100E+24 to 100E+24
 Increment: 100E-12
 *RST: 0
 Default unit: s

Usage: Query only

SEARCh:RESUlt:SENT:FRAMe<m>:SYMBol? <SearchName>**Suffix:**

<m> *

Query parameters:

<SearchName>

Return values:

<Translation>

Usage: Query only

SEARCh:RESUlt:SENT:FRAMe<m>:SYNCduration? <SearchName>**Suffix:**

<m> *

Query parameters:

<SearchName>

Return values:

<SyncDuration> Range: -100E+24 to 100E+24
 Increment: 100E-12
 *RST: 0
 Default unit: s

Usage: Query only

SEARCh:RESUlt:SENT:FRAMe<m>:TYPE? <SearchName>**Suffix:**

<m> *

Query parameters:

<SearchName>

Return values:

<FrameType> TRSQ | SMSG | EMSG
 *RST: TRSQ

Usage: Query only

27.18.12 CXPI (option R&S RTO6-K520)

• Configuration.....	2087
• Trigger.....	2091
• Decode results.....	2099
• Search settings.....	2103
• Search result settings.....	2112

27.18.12.1 Configuration

BUS<m>:CXPI:BITRate:ENABle.....	2087
BUS<m>:CXPI:BITRate:VALue.....	2087
BUS<m>:CXPI:RESult:BITRate?.....	2088
BUS<m>:CXPI:DORD.....	2088
BUS<m>:CXPI:HYSteresis.....	2088
BUS<m>:CXPI:POLarity.....	2089
BUS<m>:CXPI:THReshold.....	2089
BUS<m>:CXPI:SDATa.....	2089
BUS<m>:CXPI:IBS:MAX.....	2090
BUS<m>:CXPI:IBS:MIN.....	2090
BUS<m>:CXPI:IFS:MAX.....	2090
BUS<m>:CXPI:IFS:MIN.....	2090

BUS<m>:CXPI:BITRate:ENABle <BitrateEnable>

Enables the manual setting of a bit rate. You can set the bitrate value with `BUS<m>:CXPI:BITRate:VALue`.

Suffix:

<m> 1..4

Parameters:

<BitrateEnable> ON | OFF
*RST: OFF

Manual operation: See "Enable bit rate/ Average bit rate" on page 698

BUS<m>:CXPI:BITRate:VALue <Bitrate>

Sets the number of transmitted bits per second. To set this value, you have to enable the bitrate first with `BUS<m>:CXPI:BITRate:ENABle`.

Suffix:

<m> 1..4

Parameters:

<Bitrate> Range: 1000 to 100000
Increment: 100
*RST: 19200
Default unit: bps

Manual operation: See ["Enable bit rate/ Average bit rate"](#) on page 698

BUS<m>:CXPI:RESult:BITRate?

Queries the measured average bit rate, which is calculated if `BUS<m>:CXPI:BITRate:ENABle` is set to `OFF`.

Suffix:

<m> 1..4

Return values:

<AverageBitrate> Range: 1000 to 100000
 Increment: 100
 *RST: 19200
 Default unit: bps

Usage: Query only

Manual operation: See ["Enable bit rate/ Average bit rate"](#) on page 698

BUS<m>:CXPI:DORD <DisplayOrder>

Selects the order in which the signal is displayed in the honeycomb.

If `TRANsmitted` is selected, the signal is displayed in the order it occurs. If `LOGical` is selected, the signal is displayed according to the definition of the standard (MSB bit order).

Suffix:

<m> 1..4

Parameters:

<DisplayOrder> TRANsmitted | LOGical
 *RST: TRANsmitted

Manual operation: See ["Display order"](#) on page 698

BUS<m>:CXPI:HYSTeresis <ThresHyst>

Sets a value for the hysteresis.

Suffix:

<m> 1..4

Parameters:

<ThresHyst> Range: -12 to 12
 Increment: 0.01
 *RST: 1
 Default unit: V

Manual operation: See ["Hysteresis"](#) on page 697

BUS<m>:CXPI:POLarity <Polarity>

Sets the polarity of the transmitted waveform to normal (high = 1) or inverted (low = 1).

Suffix:

<m> 1..4

Parameters:

<Polarity> NORMal | INVert
*RST: NORMal

Manual operation: See "[Polarity](#)" on page 696

BUS<m>:CXPI:THReshold <Threshold>

Sets the threshold value for the signal.

Suffix:

<m> 1..4

Parameters:

<Threshold> Range: -15 to 12
Increment: 0.01
*RST: 6
Default unit: V

Manual operation: See "[Threshold](#)" on page 697

BUS<m>:CXPI:SDATa <SourceData>

Selects the input channel for the signal.

Usually, the source is one of the analog channels. Reference and math waveforms are available as source if the trigger source is one of the analog channels but not the serial bus.

Alternatively, digital channels can be used if MSO option R&S RTO6-B1 is installed. Digital and analog channels cannot be used at the same time.

For triggering on a serial bus, analog or digital channel sources are required.

Suffix:

<m> 1..4

Parameters:

<SourceData> C1W1 | C2W1 | C3W1 | C4W1 | M1 | M2 | M3 | M4 | M5 | M6 |
M7 | M8 | R1 | R2 | R3 | R4 | D0 | D1 | D2 | D3 | D4 | D5 | D6 |
D7 | D8 | D9 | D10 | D11 | D12 | D13 | D14 | D15

For triggering on a serial bus, analog or digital channel sources are required.

*RST: C1W1

Manual operation: See "[Source](#)" on page 696

BUS<m>:CXPI:IBS:MAX <ExpectedIBSMax>

Sets the maximum for the inter-byte-space range.

Suffix:

<m> 1..4

Parameters:

<ExpectedIBSMax> Range: 0 to 15
Increment: 1
*RST: 10

Manual operation: See "[Expected IBS length](#)" on page 697

BUS<m>:CXPI:IBS:MIN <ExpectedIBSMin>

Sets the minimum for the inter-byte-space range.

Suffix:

<m> 1..4

Parameters:

<ExpectedIBSMin> Range: 0 to 15
Increment: 1
*RST: 0

Manual operation: See "[Expected IBS length](#)" on page 697

BUS<m>:CXPI:IFS:MAX <ExpectedIFSMax>

Sets the maximum for the inter-frame-space range.

Suffix:

<m> 1..4

Parameters:

<ExpectedIFSMax> Range: 16 to 100000
Increment: 1
*RST: 1000

Manual operation: See "[Expected IFS length](#)" on page 697

BUS<m>:CXPI:IFS:MIN <ExpectedIFSMin>

Sets the minimum for the inter-frame-space range.

Suffix:

<m> 1..4

Parameters:

<ExpectedIFSMin> Range: 16 to 1000
Increment: 1
*RST: 21

Manual operation: See "[Expected IFS length](#)" on page 697

27.18.12.2 Trigger

The trigger suffix <m> is always 1 and can be omitted. It selects the trigger event: Only the A-trigger is available for triggering on serial buses.

To trigger on a serial bus, make sure that:

- `TRIGger<m>:SOURce[:SElect]` is set to `SBUS`.
- The sources of the serial bus are channel signals: use `BUS<m>:...:SOURce` commands.
- Decoding is enabled: `BUS<m>[:STATe]` is set to `ON`.

<code>TRIGger<m>:CXPI:CT</code>	2091
<code>TRIGger<m>:CXPI:DATA:DCondition</code>	2092
<code>TRIGger<m>:CXPI:DATA:DMax</code>	2092
<code>TRIGger<m>:CXPI:DATA:DMin</code>	2092
<code>TRIGger<m>:CXPI:DATA:ICondition</code>	2093
<code>TRIGger<m>:CXPI:DATA:IMax</code>	2093
<code>TRIGger<m>:CXPI:DATA:IMin</code>	2093
<code>TRIGger<m>:CXPI:DEXTension:Condition</code>	2094
<code>TRIGger<m>:CXPI:DEXTension:Max</code>	2094
<code>TRIGger<m>:CXPI:DEXTension:Min</code>	2094
<code>TRIGger<m>:CXPI:DLC:Condition</code>	2094
<code>TRIGger<m>:CXPI:DLC:Max</code>	2095
<code>TRIGger<m>:CXPI:DLC:Min</code>	2095
<code>TRIGger<m>:CXPI:ERRor:CRc</code>	2095
<code>TRIGger<m>:CXPI:ERRor:DLC</code>	2096
<code>TRIGger<m>:CXPI:ERRor:IBS</code>	2096
<code>TRIGger<m>:CXPI:ERRor:IFS</code>	2096
<code>TRIGger<m>:CXPI:ERRor:LENGth</code>	2096
<code>TRIGger<m>:CXPI:ERRor:PARity</code>	2097
<code>TRIGger<m>:CXPI:ERRor:UART</code>	2097
<code>TRIGger<m>:CXPI:FID:Condition</code>	2097
<code>TRIGger<m>:CXPI:FID:Max</code>	2098
<code>TRIGger<m>:CXPI:FID:Min</code>	2098
<code>TRIGger<m>:CXPI:NM</code>	2098
<code>TRIGger<m>:CXPI:TYPE</code>	2098

`TRIGger<m>:CXPI:CT <CT>`

Sets the value of the counter (CT), 2 bits indicating the continuity of the frame.

Suffix:

<m> 1..3

Parameters:

<CT>

Manual operation: See "`CT`" on page 706

TRIGger<m>:CXPI:DATA:DCondition <DataOperator>

Sets the condition for the data pattern. You can define no value, an exact value or a value range.

Suffix:

<m> 1..3

Parameters:

<DataOperator> OFF | ANY | EQUal | NEQual | LTHan | LETHan | GTHan | GETHan | INRange | OORange

OFF = ANY

Any data pattern is considered

EQUal | NEQual | LTHan | LETHan | GTHan | GETHan

Equal, Not equal, Less than, Less or equal than, Greater Than, Greater or equal than. These conditions require one data pattern to be set with the corresponding **TRIGger<m>:CXPI:DATA:DMIN** command.

INRange | OORange

In range/Out of range: set the minimum and maximum value of the range with **TRIGger<m>:CXPI:DATA:DMIN** and **TRIGger<m>:CXPI:DATA:DMAX**.

*RST: OFF

Manual operation: See "[Data](#)" on page 705

TRIGger<m>:CXPI:DATA:DMAX <DataMax>

Sets the end value of a data type range if **TRIGger<m>:CXPI:DATA:DCondition** is set to **INRange** or **OORange**.

Suffix:

<m> 1..3

Parameters:

<DataMax>

Manual operation: See "[Data](#)" on page 705

TRIGger<m>:CXPI:DATA:DMIN <DataMin>

Specifies a data bit pattern, or sets the start value of a pattern range.

Suffix:

<m> 1..3

Parameters:

<DataMin>

Manual operation: See "[Data](#)" on page 705

TRIGger<m>:CXPI:DATA:ICONdition <DataIdxOperator>

Set the condition for the data index value. You can define an exact value or a value range.

Suffix:

<m> 1..3

Parameters:

<DataIdxOperator> EQUal | LTHan | LETHan | GTHan | GETHan | INRange | RANGE

EQUal | NEQUal | LTHan | LETHan | GTHan | GETHan

Equal, Not equal, Less than, Less or equal than, Greater Than, Greater or equal than. These conditions require one pattern to be set with the corresponding [TRIGger<m>:CXPI:DATA:IMIN](#) command.

INRange = RANGE

In range: Set the minimum and maximum value using [TRIGger<m>:CXPI:DATA:IMIN](#) and [TRIGger<m>:CXPI:DATA:IMAX](#).

*RST: INRange

Manual operation: See "[Index](#)" on page 706

TRIGger<m>:CXPI:DATA:IMAX <DataIndexMax>

Sets the end value of a data index range if [TRIGger<m>:CXPI:DATA:ICONdition](#) is set to INRange or RANGE.

Suffix:

<m> 1..3

Parameters:

<DataIndexMax> Range: 1 to 0
Increment: 1
*RST: 0

Manual operation: See "[Index](#)" on page 706

TRIGger<m>:CXPI:DATA:IMIN <DataIndexMin>

Specifies a data index bit pattern, or sets the start value of a pattern range.

Suffix:

<m> 1..3

Parameters:

<DataIndexMin> Range: 1 to 0
Increment: 1
*RST: 1

Manual operation: See "[Index](#)" on page 706

TRIGger<m>:CXPI:DEXTension:CONDition <DLCEXTOperator>

Set the condition for the DLC extend value. You can define an exact value or a value range.

Suffix:

<m> 1..3

Parameters:

<DLCEXTOperator> EQUal | NEQual | LTHan | LETHan | GTHan | GETHan | INRange | OORange

EQUal | NEQual | LTHan | LETHan | GTHan | GETHan

Equal, Not equal, Less than, Less or equal than, Greater Than, Greater or equal than. These conditions require one data pattern to be set with the corresponding [TRIGger<m>:CXPI:DEXTension:MIN](#) command.

INRange | OORange

In range/Out of range: set the minimum and maximum value of the range with [TRIGger<m>:CXPI:DEXTension:MIN](#) and [TRIGger<m>:CXPI:DEXTension:MAX](#).

*RST: EQUal

Manual operation: See "[DLC Extend](#)" on page 705

TRIGger<m>:CXPI:DEXTension:MAX <DLCEXTMax>

Sets the end value of a DLC extend range if [TRIGger<m>:CXPI:DEXTension:CONDition](#) is set to [INRange](#) or [OORange](#).

Suffix:

<m> 1..3

Parameters:

<DLCEXTMax>

Manual operation: See "[DLC Extend](#)" on page 705

TRIGger<m>:CXPI:DEXTension:MIN <DLCEXTMin>

Specifies a data extension bit pattern, or sets the start value of a pattern range.

Suffix:

<m> 1..3

Parameters:

<DLCEXTMin>

Manual operation: See "[DLC Extend](#)" on page 705

TRIGger<m>:CXPI:DLC:CONDition <DLCOperator>

Set the condition for the DLC. You can define an exact value or a value range.

Suffix:

<m> 1..3

Parameters:

<DLCOperator> EQUal | NEQual | LTHan | LETHan | GTHan | GETHan | INRange | OORange

EQUal | NEQual | LTHan | LETHan | GTHan | GETHan

Equal, Not equal, Less than, Less or equal than, Greater Than, Greater or equal than. These conditions require one DLC pattern to be set with the corresponding [TRIGger<m>:CXPI:DLC:MIN](#) command.

INRange | OORange

In range/Out of range: set the minimum and maximum value of the range with [TRIGger<m>:CXPI:DLC:MIN](#) and [TRIGger<m>:CXPI:DLC:MAX](#).

*RST: EQUal

Manual operation: See "[DLC](#)" on page 705**TRIGger<m>:CXPI:DLC:MAX <DLCMax>**

Sets the end value of a data type range if [TRIGger<m>:CXPI:DLC:CONDition](#) is set to [INRange](#) or [OORange](#).

Suffix:

<m> 1..3

Parameters:

<DLCMax>

Manual operation: See "[DLC](#)" on page 705**TRIGger<m>:CXPI:DLC:MIN <DLCMin>**

Specifies a DLC pattern, or sets the start value of a pattern range.

Suffix:

<m> 1..3

Parameters:

<DLCMin>

Manual operation: See "[DLC](#)" on page 705**TRIGger<m>:CXPI:ERRor:CRc <ErrorCRc>**

Triggers on a cyclic redundancy check error, if [TRIGger<m>:CXPI:TYPE](#) is set to [ERRor](#).

The transmitting node calculates the cyclic redundancy check (CRC) value of a frame and stores it into the CRC field of the frame. CRC error occurs when this CRC field value differs from the value calculated by the receiving node.

Suffix:

<m> 1..3

Parameters:<ErrorCRC> ON | OFF
*RST: ON**TRIGger<m>:CXPI:ERRor:DLC <ErrorDLC>**

Triggers on a data length code (DLC) error, if [TRIGger<m>:CXPI:TYPE](#) is set to `ERRor`.

DLC error occurs when the value of the DLC field is different from the data byte field value.

Suffix:

<m> 1..3

Parameters:<ErrorDLC> ON | OFF
*RST: ON**TRIGger<m>:CXPI:ERRor:IBS <ErrorIBS>**

Triggers on an inter-byte-space (IBS) error, if [TRIGger<m>:CXPI:TYPE](#) is set to `ERRor`.

Suffix:

<m> 1..3

Parameters:<ErrorIBS> ON | OFF
*RST: ON**TRIGger<m>:CXPI:ERRor:IFS <ErrorIFS>**

Triggers on an inter-frame-space (IFS) error, if [TRIGger<m>:CXPI:TYPE](#) is set to `ERRor`.

Suffix:

<m> 1..3

Parameters:<ErrorIFS> ON | OFF
*RST: ON**TRIGger<m>:CXPI:ERRor:LENGth <ErrorLength>**

Triggers on a length error, if [TRIGger<m>:CXPI:TYPE](#) is set to `ERRor`.

Suffix:

<m> 1..3

Parameters:<ErrorLength> ON | OFF
*RST: ON**TRIGger<m>:CXPI:ERRor:PARity <ErrorParity>**

Triggers on a parity error indicating a transmission error, if `TRIGger<m>:CXPI:TYPE` is set to `ERRor`.

Suffix:

<m> 1..3

Parameters:<ErrorParity> ON | OFF
*RST: ON**TRIGger<m>:CXPI:ERRor:UART <ErrorUart>**

Triggers on an UART error, if `TRIGger<m>:CXPI:TYPE` is set to `ERRor`.

Suffix:

<m> 1..3

Parameters:<ErrorUart> ON | OFF
*RST: ON**TRIGger<m>:CXPI:FID:CONDition <FrameIDOperator>**

Set the condition for the frame ID. You can define an exact value or a value range.

Suffix:

<m> 1..3

Parameters:

<FrameIDOperator> EQUal | NEQual | LTHan | LETHan | GTHan | GETHan | INRange | OORange

EQUal | NEQual | LTHan | LETHan | GTHan | GETHan

Equal, Not equal, Less than, Less or equal than, Greater Than, Greater or equal than. These conditions require one data pattern to be set with the corresponding `TRIGger<m>:CXPI:FID:MIN` command.

INRange | OORange

In range/Out of range: set the minimum and maximum value of the range with `TRIGger<m>:CXPI:FID:MIN` and `TRIGger<m>:CXPI:FID:MAX`.

*RST: EQUal

Manual operation: See "Frame ID" on page 704

TRIGger<m>:CXPI:FID:MAX <FrameIDMax>

Sets the end value of a frame ID range if **TRIGger<m>:CXPI:FID:CONDition** is set to **INRange** or **OORange**.

Suffix:

<m> 1..3

Parameters:

<FrameIDMax>

Manual operation: See "Frame ID" on page 704

TRIGger<m>:CXPI:FID:MIN <FrameIDMin>

Specifies a frame ID pattern, or sets the start value of a pattern range.

Suffix:

<m> 1..3

Parameters:

<FrameIDMin>

Manual operation: See "Frame ID" on page 704

TRIGger<m>:CXPI:NM <NM>

Sets the value of the network management (NM) field.

Suffix:

<m> 1..3

Parameters:

<NM>

Manual operation: See "NM" on page 709

TRIGger<m>:CXPI:TYPE <Type>

Selects the trigger type for the CXPI analysis.

Suffix:

<m> 1..3

Parameters:

<Type> START | NORMAl | NPOLI | SLEEP | LONG | LPOLI | PID | PTYPe | PTPD | ERRor

START

Triggers on the START of the frame.

NORMAL

Triggers on a NORMAL frame. Optionally you can define a frame ID condition, an NM, a CT, a DLC condition, a data pattern condition and an index condition.

NPOLI

Triggers on a Normal POLL frame. Optionally you can define a frame ID condition, an NM, a CT, a DLC condition, a data pattern condition and an index condition.

SLEEP

Triggers on a SLEEP frame. Optionally you can define an NM, a CT, a data pattern condition and an index condition.

LONG

Triggers on a Long frame. Optionally you can define a frame ID condition, an NM, a CT, a DLC extend condition, a data pattern condition and an index condition.

LPOLI

Triggers on a Long POLL frame.

PID

Triggers on a Protected ID field. Optionally, you can define the frame ID pattern.

PTYPE

Triggers on a Protected TYPE field.

PTPID

Triggers on a Protected Type field followed by a PID field. Optionally, you can define the frame ID pattern.

ERROR

Trigger on selected error types. Define the error types with:

`TRIGGER<m>:CXPI:ERROR:CRC`

`TRIGGER<m>:CXPI:ERROR:DLC`

`TRIGGER<m>:CXPI:ERROR:IBS`

`TRIGGER<m>:CXPI:ERROR:IFS`

`TRIGGER<m>:CXPI:ERROR:LENGTH`

`TRIGGER<m>:CXPI:ERROR:PARITY`

`TRIGGER<m>:CXPI:ERROR:UART`

`*RST: START`

Manual operation: See "[Trigger type](#)" on page 699

27.18.12.3 Decode results

To show the results on the screen, use the following commands:

- `BUS<m>:RESult` on page 1814

```
BUS<m>:CXPI:RESult:FCOunt?.....2100
BUS<m>:CXPI:RESult:FRAME<n>:DATA?.....2100
BUS<m>:CXPI:RESult:FRAME<n>:DLCV?.....2100
BUS<m>:CXPI:RESult:FRAME<n>:START?.....2100
```

BUS<m>:CXPI:RESult:FRAMe<n>:STATe?	2101
BUS<m>:CXPI:RESult:FRAMe<n>:STOP?	2101
BUS<m>:CXPI:RESult:FRAMe<n>:TYPE?	2101
BUS<m>:CXPI:RESult:FRAMe<n>:WORD<o>:STATus?	2102
BUS<m>:CXPI:RESult:FRAMe<n>:WORD<o>:TYPE?	2102
BUS<m>:CXPI:RESult:FRAMe<n>:WORD<o>:VALue?	2103

BUS<m>:CXPI:RESult:FCOut?

Returns the number of frames in the acquisition.

Suffix:

<m> 1..4

Return values:

<FrameCount> Range: 0 to 100000
 Increment: 1
 *RST: 0

Usage: Query only

BUS<m>:CXPI:RESult:FRAMe<n>:DATA?

Returns the data bytes of the specified frame.

Suffix:

<m> 1..4

<n> *

Return values:

<Data>

Usage: Query only

BUS<m>:CXPI:RESult:FRAMe<n>:DLCV?

Returns the data length code/ extension data length code field value.

Suffix:

<m> 1..4

<n> *

Return values:

<DLC> Range: 0 to 4294967295
 Increment: 1
 *RST: 0

Usage: Query only

BUS<m>:CXPI:RESult:FRAMe<n>:START?

Returns the start time of the specified frame.

Suffix:

<m> 1..4

<n> *

Return values:

<Start> Range: -100E+24 to 100E+24
 Increment: 100E-12
 *RST: 0
 Default unit: s

Usage: Query only**BUS<m>:CXPI:RESult:FRAMe<n>:STATe?**

Returns the state of the specified frame.

Suffix:

<m> 1..4

<n> *

Return values:

<State> OK | INComplete | ERR_IBS | ERR_IFS | ERR_LENGTH |
 ERR_CRC | ERR_PARITY | ERR_DLC | ERR_UART
 *RST: OK

Usage: Query only**BUS<m>:CXPI:RESult:FRAMe<n>:STOP?**

Returns the stop time of the specified frame.

Suffix:

<m> 1..4

<n> *

Return values:

<Stop> Range: -100E+24 to 100E+24
 Increment: 100E-12
 *RST: 0
 Default unit: s

Usage: Query only**BUS<m>:CXPI:RESult:FRAMe<n>:TYPE?**

Returns the type of the specified frame.

Suffix:

<m> 1..4

<n> *

Return values:
 <Type> NORMal | NPOLI | SLEEP | LONG | LPOLI | PID | PType | PTPID | UNKNown | IFS

NPOLI
 Normal POLI

LPOLI
 Long POLI

PID
 Protected ID

PTPID
 Protected Type + Protected ID

IFS
 Inter-Frame-Space

*RST: NORMal

Usage: Query only

BUS<m>:CXPI:RESult:FRAMe<n>:WORD<o>:STATus?

Returns the status of the specified field.

Suffix:
 <m> 1..4
 <n> *
 <o> *

Return values:
 <Status> OK | INComplete | ERR_IBS | ERR_IFS | ERR_LENGTH | ERR_CRC | ERR_PARITY | ERR_DLC | ERR_UART

*RST: OK

Usage: Query only

BUS<m>:CXPI:RESult:FRAMe<n>:WORD<o>:TYPE?

Returns the type (name) of the specified field.

Suffix:
 <m> 1..4
 <n> *
 <o> *

Return values:
 <WordType>

Usage: Query only

BUS<m>:CXPI:RESult:FRAMe<n>:WORD<o>:VALue?

Returns the numeric value of the specified field.

Suffix:

<m>	1..4
<n>	*
<o>	*

Return values:

<WordValue>	Range:	0 to 65535
	Increment:	1
	*RST:	0

Usage: Query only

27.18.12.4 Search settings

In search setup commands, you have to specify the <SearchName> parameter. It is a string parameter that contains the search definition name. The commands are similar to CXPI trigger commands.

SEARch:TRIGger:CXPI:CT.....	2104
SEARch:TRIGger:CXPI:DATA:DCONDition.....	2104
SEARch:TRIGger:CXPI:DATA:DMAX.....	2104
SEARch:TRIGger:CXPI:DATA:DMIN.....	2105
SEARch:TRIGger:CXPI:DATA:ICONDition.....	2105
SEARch:TRIGger:CXPI:DATA:IMAX.....	2105
SEARch:TRIGger:CXPI:DATA:IMIN.....	2106
SEARch:TRIGger:CXPI:DEXTension:CONDition.....	2106
SEARch:TRIGger:CXPI:DEXTension:MAX.....	2106
SEARch:TRIGger:CXPI:DEXTension:MIN.....	2107
SEARch:TRIGger:CXPI:DLC:CONDition.....	2107
SEARch:TRIGger:CXPI:DLC:MAX.....	2107
SEARch:TRIGger:CXPI:DLC:MIN.....	2108
SEARch:TRIGger:CXPI:ERRor:CRc.....	2108
SEARch:TRIGger:CXPI:ERRor:DLC.....	2108
SEARch:TRIGger:CXPI:ERRor:IBS.....	2108
SEARch:TRIGger:CXPI:ERRor:IFS.....	2109
SEARch:TRIGger:CXPI:ERRor:LENGth.....	2109
SEARch:TRIGger:CXPI:ERRor:PARity.....	2109
SEARch:TRIGger:CXPI:ERRor:UART.....	2109
SEARch:TRIGger:CXPI:FID:CONDition.....	2110
SEARch:TRIGger:CXPI:FID:MAX.....	2110
SEARch:TRIGger:CXPI:FID:MIN.....	2110
SEARch:TRIGger:CXPI:NM.....	2111
SEARch:TRIGger:CXPI:TYPE.....	2111

SEARCh:TRIGger:CXPI:CT <SearchName>,<CT>
SEARCh:TRIGger:CXPI:CT? <SearchName>

Sets the value of the counter (CT), 2 bits indicating the continuity of the frame.

Parameters:
 <CT>

Parameters for setting and query:
 <SearchName>

Manual operation: See "CT" on page 709

SEARCh:TRIGger:CXPI:DATA:DCondition <SearchName>,<DataOperator>
SEARCh:TRIGger:CXPI:DATA:DCondition? <SearchName>

Sets the condition for the data pattern. You can define no value, an exact value or a value range.

Parameters:
 <DataOperator> OFF | ANY | EQUal | NEQual | LTHan | LETHan | GTHan |
 GETHan | INRange | OORange

OFF = ANY

Any data pattern is considered

EQUal | NEQual | LTHan | LETHan | GTHan | GETHan

Equal, Not equal, Less than, Less or equal than, Greater Than, Greater or equal than. These conditions require one data pattern to be set with the corresponding [SEARCh:TRIGger:CXPI:DATA:DMIN](#) command.

INRange | OORange

In range/Out of range: set the minimum and maximum value of the range with [SEARCh:TRIGger:CXPI:DATA:DMIN](#) and [SEARCh:TRIGger:CXPI:DATA:DCondition](#).

*RST: OFF

Parameters for setting and query:
 <SearchName>

Manual operation: See "Data" on page 709

SEARCh:TRIGger:CXPI:DATA:DMAX <SearchName>,<DataMax>
SEARCh:TRIGger:CXPI:DATA:DMAX? <SearchName>

Sets the end value of a data type range if [SEARCh:TRIGger:CXPI:DATA:DCondition](#) is set to [INRange](#) or [OORange](#).

Parameters:
 <DataMax>

Parameters for setting and query:
 <SearchName>

Manual operation: See "Data" on page 709

SEARCH:TRIGger:CXPI:DATA:DMIN <SearchName>,<DataMin>
SEARCH:TRIGger:CXPI:DATA:DMIN? <SearchName>

Specifies a data bit pattern, or sets the start value of a pattern range.

Parameters:

<DataMin>

Parameters for setting and query:

<SearchName>

Manual operation: See "Data" on page 709

SEARCH:TRIGger:CXPI:DATA:ICONdition <SearchName>,<DataIdxOperator>
SEARCH:TRIGger:CXPI:DATA:ICONdition? <SearchName>

Set the condition for the data index value. You can define an exact value or a value range.

Parameters:

<DataIdxOperator> EQUal | LTHan | LETHan | GTHan | GETHan | INRange |
 RANGE

EQUal | NEQUal | LTHan | LETHan | GTHan | GETHan

Equal, Not equal, Less than, Less or equal than, Greater Than, Greater or equal than. These conditions require one pattern to be set with the corresponding [SEARCH:TRIGger:CXPI:DATA:IMIN](#) command.

INRange = RANGE

In range: Set the minimum and maximum value using [SEARCH:TRIGger:CXPI:DATA:IMIN](#) and [SEARCH:TRIGger:CXPI:DATA:IMAX](#).

*RST: INRange

Parameters for setting and query:

<SearchName>

Manual operation: See "Index" on page 709

SEARCH:TRIGger:CXPI:DATA:IMAX <SearchName>,<DataIndexMax>
SEARCH:TRIGger:CXPI:DATA:IMAX? <SearchName>

Sets the end value of a data index range if [SEARCH:TRIGger:CXPI:DATA:ICONdition](#) is set to INRange or RANGE.

Parameters:

<DataIndexMax> Range: 1 to 0
 Increment: 1
 *RST: 0

Parameters for setting and query:

<SearchName>

Manual operation: See "[Index](#)" on page 709**SEARCH:TRIGger:CXPI:DATA:IMIN** <SearchName>,<DataIndexMin>**SEARCH:TRIGger:CXPI:DATA:IMIN?** <SearchName>

Specifies a data index bit pattern, or sets the start value of a pattern range.

Parameters:

<DataIndexMin>	Range:	1 to 0
	Increment:	1
	*RST:	1

Parameters for setting and query:

<SearchName>

Manual operation: See "[Index](#)" on page 709**SEARCH:TRIGger:CXPI:DEXTension:CONDition**

<SearchName>,<DLCEXTOperator>

SEARCH:TRIGger:CXPI:DEXTension:CONDition? <SearchName>

Set the condition for the DLC extend value. You can define an exact value or a value range.

Parameters:

<DLCEXTOperator>	EQUal NEQUal LTHan LETHan GTHan GETHan INRange OORange
------------------	--

EQUal | NEQUal | LTHan | LETHan | GTHan | GETHanEqual, Not equal, Less than, Less or equal than, Greater Than, Greater or equal than. These conditions require one data pattern to be set with the corresponding [SEARCH:TRIGger:CXPI:DEXTension:MIN](#) command.**INRange | OORange**In range/Out of range: set the minimum and maximum value of the range with [SEARCH:TRIGger:CXPI:DEXTension:MIN](#) and [SEARCH:TRIGger:CXPI:DEXTension:MAX](#).

*RST: EQUal

Parameters for setting and query:

<SearchName>

Manual operation: See "[DLC Extend](#)" on page 709**SEARCH:TRIGger:CXPI:DEXTension:MAX** <SearchName>,<DLCEXTMax>**SEARCH:TRIGger:CXPI:DEXTension:MAX?** <SearchName>Sets the end value of a DLC extend range if [SEARCH:TRIGger:CXPI:DEXTension:CONDition](#) is set to [INRange](#) or [OORange](#).

Parameters:

<DLCEXTMax>

Parameters for setting and query:

<SearchName>

Manual operation: See "DLC Extend" on page 709**SEARCh:TRIGger:CXPI:DEXTension:MIN** <SearchName>,<DLCEXTMin>**SEARCh:TRIGger:CXPI:DEXTension:MIN?** <SearchName>

Specifies a data extension bit pattern, or sets the start value of a pattern range.

Parameters:

<DLCEXTMin>

Parameters for setting and query:

<SearchName>

Manual operation: See "DLC Extend" on page 709**SEARCh:TRIGger:CXPI:DLC:CONDition** <SearchName>,<DLCOperator>**SEARCh:TRIGger:CXPI:DLC:CONDition?** <SearchName>

Set the condition for the DLC. You can define an exact value or a value range.

Parameters:

<DLCOperator>

EQUAL | NEQUAL | LTHAN | LETHAN | GTHAN | GETHAN |
INRANGE | OORANGE**EQUAL | NEQUAL | LTHAN | LETHAN | GTHAN | GETHAN**Equal, Not equal, Less than, Less or equal than, Greater Than,
Greater or equal than. These conditions require one DLC pattern
to be set with the corresponding [SEARCh:TRIGger:CXPI:
DLC:MIN](#) command.**INRANGE | OORANGE**In range/Out of range: set the minimum and maximum value of
the range with [SEARCh:TRIGger:CXPI:DLC:MIN](#) and
[SEARCh:TRIGger:CXPI:DLC:MAX](#).

*RST: EQUAL

Parameters for setting and query:

<SearchName>

Manual operation: See "DLC" on page 708**SEARCh:TRIGger:CXPI:DLC:MAX** <SearchName>,<DLCMax>**SEARCh:TRIGger:CXPI:DLC:MAX?** <SearchName>Sets the end value of a data type range if [SEARCh:TRIGger:CXPI:DLC:CONDition](#)
is set to [INRANGE](#) or [OORANGE](#).

Parameters:

<DLCMax>

Parameters for setting and query:

<SearchName>

Manual operation: See "DLC" on page 708**SEARCH:TRIGger:CXPI:DLC:MIN** <SearchName>,<DLCMin>**SEARCH:TRIGger:CXPI:DLC:MIN?** <SearchName>

Specifies a DLC pattern, or sets the start value of a pattern range.

Parameters:

<DLCMin>

Parameters for setting and query:

<SearchName>

Manual operation: See "DLC" on page 708**SEARCH:TRIGger:CXPI:ERRor:CRC** <SearchName>,<ErrorCRC>**SEARCH:TRIGger:CXPI:ERRor:CRC?** <SearchName>Searches for a cyclic redundancy check error, if `SEARCH:TRIGger:CXPI:TYPE` is set to `ERRor`.**Parameters:**

<ErrorCRC>	ON OFF
*RST:	ON

Parameters for setting and query:

<SearchName>

SEARCH:TRIGger:CXPI:ERRor:DLC <SearchName>,<ErrorDLC>**SEARCH:TRIGger:CXPI:ERRor:DLC?** <SearchName>Searches for a data length code error, if `SEARCH:TRIGger:CXPI:TYPE` is set to `ERRor`.**Parameters:**

<ErrorDLC>	ON OFF
*RST:	ON

Parameters for setting and query:

<SearchName>

SEARCH:TRIGger:CXPI:ERRor:IBS <SearchName>,<ErrorIBS>**SEARCH:TRIGger:CXPI:ERRor:IBS?** <SearchName>Searches for an inter-byte-space error, if `SEARCH:TRIGger:CXPI:TYPE` is set to `ERRor`.

Parameters:

<ErrorIBS> ON | OFF
 *RST: ON

Parameters for setting and query:

<SearchName>

SEARCH:TRIGGER:CXPI:ERROR:IFS <SearchName>,<ErrorIFS>

SEARCH:TRIGGER:CXPI:ERROR:IFS? <SearchName>

Searches for an inter-frame-space error, if `SEARCH:TRIGGER:CXPI:TYPE` is set to `ERROR`.

Parameters:

<ErrorIFS> ON | OFF
 *RST: ON

Parameters for setting and query:

<SearchName>

SEARCH:TRIGGER:CXPI:ERROR:LENGTH <SearchName>,<ErrorLength>

SEARCH:TRIGGER:CXPI:ERROR:LENGTH? <SearchName>

Searches for a length error, if `SEARCH:TRIGGER:CXPI:TYPE` is set to `ERROR`.

Parameters:

<ErrorLength> ON | OFF
 *RST: ON

Parameters for setting and query:

<SearchName>

SEARCH:TRIGGER:CXPI:ERROR:PARITY <SearchName>,<ErrorParity>

SEARCH:TRIGGER:CXPI:ERROR:PARITY? <SearchName>

Searches for a parity error, if `SEARCH:TRIGGER:CXPI:TYPE` is set to `ERROR`.

Parameters:

<ErrorParity> ON | OFF
 *RST: ON

Parameters for setting and query:

<SearchName>

SEARCH:TRIGGER:CXPI:ERROR:UART <SearchName>,<ErrorUart>

SEARCH:TRIGGER:CXPI:ERROR:UART? <SearchName>

Searches for an UART error, if `SEARCH:TRIGGER:CXPI:TYPE` is set to `ERROR`.

Parameters:

<ErrorUart> ON | OFF
 *RST: ON

Parameters for setting and query:

<SearchName>

SEARCH:TRIGger: CXPI:FID:CONDition <SearchName>,<FrameIDOperator>

SEARCH:TRIGger: CXPI:FID:CONDition? <SearchName>

Set the condition for the frame ID. You can define an exact value or a value range.

Parameters:

<FrameIDOperator> EQUal | NEQual | LTHan | LETHan | GTHan | GETHan |
 INRange | OORange

EQUal | NEQual | LTHan | LETHan | GTHan | GETHan

Equal, Not equal, Less than, Less or equal than, Greater Than, Greater or equal than. These conditions require one data pattern to be set with the corresponding [SEARCH:TRIGger: CXPI: FID:MIN](#) command.

INRange | OORange

In range/Out of range: set the minimum and maximum value of the range with [SEARCH:TRIGger: CXPI: FID:MIN](#) and [SEARCH:TRIGger: CXPI: FID:MAX](#).

*RST: EQUal

Parameters for setting and query:

<SearchName>

Manual operation: See "[Frame ID](#)" on page 708

SEARCH:TRIGger: CXPI:FID:MAX <SearchName>,<FrameIDMax>

SEARCH:TRIGger: CXPI:FID:MAX? <SearchName>

Sets the end value of a frame ID range if [SEARCH:TRIGger: CXPI: FID:CONDition](#) is set to [INRange](#) or [OORange](#).

Parameters:

<FrameIDMax>

Parameters for setting and query:

<SearchName>

Manual operation: See "[Frame ID](#)" on page 708

SEARCH:TRIGger: CXPI:FID:MIN <SearchName>,<FrameIDMin>

SEARCH:TRIGger: CXPI:FID:MIN? <SearchName>

Specifies a frame ID pattern, or sets the start value of a pattern range.

Parameters:

<FrameIDMin>

Parameters for setting and query:

<SearchName>

Manual operation: See "Frame ID" on page 708**SEARCh:TRIGger:CXPI:NM** <SearchName>,<NM>**SEARCh:TRIGger:CXPI:NM?** <SearchName>

Sets the value of the network management (NM) field.

Parameters:

<NM>

Parameters for setting and query:

<SearchName>

Manual operation: See "NM" on page 706**SEARCh:TRIGger:CXPI:TYPE** <SearchName>,<Type>**SEARCh:TRIGger:CXPI:TYPE?** <SearchName>

Searches for the selected CXPI frame type.

Parameters:

<Type>

START | NORMAl | NPOLI | SLEEP | LONG | LPOLI | PID |
PTYPe | PTPD | ERRor**START**

Triggers on the START of the frame.

NORMAl

Triggers on a NORMAl frame. Optionally you can define a frame ID condition, a NM, a CT, a DLC condition, a data pattern condition and an index condition.

NPOLI

Triggers on a Normal POLL frame. Optionally you can define a frame ID condition, a NM, a CT, a DLC condition, a data pattern condition and an index condition.

SLEEP

Triggers on a SLEEP frame. Optionally you can define a NM, a CT, a data pattern condition and an index condition.

LONG

Triggers on a Long frame. Optionally you can define a frame ID condition, a NM, a CT, a DLC extend condition, a data pattern condition and an index condition.

LPOLI

Triggers on a Long POLL frame.

PID

Triggers on a Protected ID field. Optionally, you can define the frame ID pattern.

PTYPE

Triggers on a Protected TYPE field.

PTPID

Triggers on a PType field followed by a PID field. Optionally, you can define the frame ID pattern.

ERRor

Trigger on selected error types. Define the error types with:

[SEARch:TRIGger: CXPI:ERRor: CRC](#) on page 2108

[SEARch:TRIGger: CXPI:ERRor: CRC](#) on page 2108

[SEARch:TRIGger: CXPI:ERRor: DLC](#) on page 2108

[SEARch:TRIGger: CXPI:ERRor: IBS](#) on page 2108

[SEARch:TRIGger: CXPI:ERRor: IFS](#) on page 2109

[SEARch:TRIGger: CXPI:ERRor: LENGth](#) on page 2109

[SEARch:TRIGger: CXPI:ERRor: PARity](#) on page 2109

[SEARch:TRIGger: CXPI:ERRor: UARt](#) on page 2109

*RST: START

Parameters for setting and query:

<SearchName>

Manual operation: See "[Search type](#)" on page 707

27.18.12.5 Search result settings

The search on decoded CXPI data returns the same results as the queries for decode results.

In search result commands, you have to specify the <SearchName> parameter. It is a string parameter that contains the search definition name.

For a description of the returned values, see the corresponding commands in [Chapter 27.18.12.3, "Decode results"](#), on page 2099.

SEARch:RESult: CXPI:FCOut?	2113
SEARch:RESult: CXPI:FRAMe<m>:DATA?	2113
SEARch:RESult: CXPI:FRAMe<m>:DLCV?	2113
SEARch:RESult: CXPI:FRAMe<m>:START?	2113
SEARch:RESult: CXPI:FRAMe<m>:STATe?	2114
SEARch:RESult: CXPI:FRAMe<m>:STOP?	2114
SEARch:RESult: CXPI:FRAMe<m>:TYPE?	2114
SEARch:RESult: CXPI:FRAMe<m>:WORD<n>:STATus?	2114
SEARch:RESult: CXPI:FRAMe<m>:WORD<n>:TYPE?	2115
SEARch:RESult: CXPI:FRAMe<m>:WORD<n>:VALue?	2115

SEARCh:RESult:CXPI:FCOunt? <SearchName>

Query parameters:

<SearchName>

Return values:

<FrameCount> Range: 0 to 100000
 Increment: 1
 *RST: 0

Usage: Query only

SEARCh:RESult:CXPI:FRAMe<m>:DATA? <SearchName>

Suffix:

<m> *

Query parameters:

<SearchName>

Return values:

<Data>

Usage: Query only

SEARCh:RESult:CXPI:FRAMe<m>:DLCV? <SearchName>

Suffix:

<m> *

Query parameters:

<SearchName>

Return values:

<DLC> Range: 0 to 4294967295
 Increment: 1
 *RST: 0

Usage: Query only

SEARCh:RESult:CXPI:FRAMe<m>:STARt? <SearchName>

Suffix:

<m> *

Query parameters:

<SearchName>

Return values:

<Start> Range: -100E+24 to 100E+24
 Increment: 100E-12
 *RST: 0
 Default unit: s

Usage: Query only

SEARCh:RESult:CXPI:FRAMe<m>:STATe? <SearchName>

Suffix:
<m> *

Query parameters:
<SearchName>

Return values:
<State> OK | INComplete | ERR_IBS | ERR_IFS | ERR_LENGTH |
ERR_CRC | ERR_PARITY | ERR_DLC | ERR_UART
*RST: OK

Usage: Query only

SEARCh:RESult:CXPI:FRAMe<m>:STOP? <SearchName>

Suffix:
<m> *

Query parameters:
<SearchName>

Return values:
<Stop> Range: -100E+24 to 100E+24
Increment: 100E-12
*RST: 0
Default unit: s

Usage: Query only

SEARCh:RESult:CXPI:FRAMe<m>:TYPE? <SearchName>

Suffix:
<m> *

Query parameters:
<SearchName>

Return values:
<Type> NORMal | NPOLI | SLEEP | LONG | LPOLI | PID | PTYPE |
PTPID | UNKNown | IFS
*RST: NORMal

Usage: Query only

SEARCh:RESult:CXPI:FRAMe<m>:WORD<n>:STATUs? <SearchName>

Suffix:
<m> *

<n> *

Query parameters:

<SearchName>

Return values:

<Status> OK | INComplete | ERR_IBS | ERR_IFS | ERR_LENGTH |
ERR_CRC | ERR_PARITY | ERR_DLC | ERR_UART
*RST: OK

Usage: Query only

SEARCH:RESult:CXPI:FRAMe<m>:WORD<n>:TYPE? <SearchName>

Suffix:

<m> *

<n> *

Query parameters:

<SearchName>

Return values:

<WordType>

Usage: Query only

SEARCH:RESult:CXPI:FRAMe<m>:WORD<n>:VALue? <SearchName>

Suffix:

<m> *

<n> *

Query parameters:

<SearchName>

Return values:

<WordValue> Range: 0 to 65535
Increment: 1
*RST: 0

Usage: Query only

27.18.13 MIL-1553 (option R&S RTO6-K530)

- [Configuration](#).....2116
- [Trigger](#).....2118
- [Decode results](#).....2130
- [Search settings](#).....2133
- [Search results](#).....2140

27.18.13.1 Configuration

BUS<m>:MILStd:SOURce.....	2116
BUS<m>:MILStd:MAXResponse:BITS.....	2116
BUS<m>:MILStd:MAXResponse:SElect.....	2116
BUS<m>:MILStd:MINGap:SElect.....	2117
BUS<m>:MILStd:MINGap:BITS.....	2117
BUS<m>:MILStd:POLarity.....	2117
BUS<m>:MILStd:PRESet.....	2118
BUS<m>:MILStd:THReshold:HIGH.....	2118
BUS<m>:MILStd:THReshold:LOW.....	2118

BUS<m>:MILStd:SOURce <SourceData>

Sets the channel for the signal source.

Suffix:

<m> 1..4
Selects the serial bus.

Parameters:

<SourceData> C1W1 | C2W1 | C3W1 | C4W1 | M1 | M2 | M3 | M4 | M5 | M6 |
M7 | M8 | R1 | R2 | R3 | R4
*RST: C1W1

Manual operation: See "[Source](#)" on page 716

BUS<m>:MILStd:MAXResponse:BITS <MaxResponseTime>

Sets the value for the maximum response time.

See also: [BUS<m>:MILStd:MAXResponse:SElect](#).

Suffix:

<m> 1..4

Parameters:

<MaxResponseTime> Range: 2E-6 to 262E-6
Increment: 100E-9
*RST: 14E-6
Default unit: s

Manual operation: See "[Check max response](#)" on page 717

BUS<m>:MILStd:MAXResponse:SElect <MaxRespSel>

Enables the detection of the maximum response time between the last bit of a word and the following status word sync during decoding.

To specify the maximum response time, use [BUS<m>:MILStd:MAXResponse:BITS](#) on page 2116.

Suffix:

<m> 1..4

Parameters:

<MaxRespSelect> ON | OFF
 *RST: ON

Manual operation: See "[Check max response](#)" on page 717

BUS<m>:MILStd:MINGap:SElect <MinGapSelect>

Enables the detection of the minimum idle time between the last bit of a message and the following command word sync during decoding.

To specify the minimum gap, use [BUS<m>:MILStd:MINGap:BITS](#).

Suffix:

<m> 1..4

Parameters:

<MinGapSelect> ON | OFF
 *RST: ON

Manual operation: See "[Check min gap](#)" on page 717

BUS<m>:MILStd:MINGap:BITS <MinGapTime>

Sets a value for the minimum gap.

See also: [BUS<m>:MILStd:MINGap:SElect](#).

Suffix:

<m> 1..4

Parameters:

<MinGapTime> Range: 2E-6 to 262E-6
 Increment: 100E-9
 *RST: 4E-6
 Default unit: s

Manual operation: See "[Check min gap](#)" on page 717

BUS<m>:MILStd:POLarity <Polarity>

Selects the wire on which the bus signal is measured.

Suffix:

<m> 1..4

Parameters:

<Polarity> NORMal | INVerted
 *RST: NORMal

Manual operation: See "[Polarity](#)" on page 716

BUS<m>:MILStd:PRESet <Preset>

Sets the default threshold voltage.

Suffix:

<m> 1..4

Parameters:

<Preset> V05 | V2 | V5 | V7 | MANual
*RST: V5

Manual operation: See "[Thresholds](#)" on page 717

BUS<m>:MILStd:THReshold:HIGH <ThresholdHigh>

Sets the lower threshold level of the signal.

Suffix:

<m> 1..4

Parameters:

<ThresholdHigh> Range: 0 to 14
Increment: 0.1
*RST: 5
Default unit: V

Manual operation: See "[Thresholds](#)" on page 717

BUS<m>:MILStd:THReshold:LOW <ThresholdLow>

Sets the lower threshold level of the signal.

Suffix:

<m> 1..4

Parameters:

<ThresholdLow> Range: -14 to 0
Increment: 0.1
*RST: -5
Default unit: V

Manual operation: See "[Thresholds](#)" on page 717

27.18.13.2 Trigger

The trigger suffix <m> is always 1 and can be omitted. It selects the trigger event: Only the A-trigger is available for triggering on serial buses.

To trigger on a serial bus, make sure that:

- `TRIGger<m>:SOURce[:SElect]` is set to SBUS.
- The sources of the serial bus are channel signals: use `BUS<m>:...:SOURce` commands.

- Decoding is enabled: `BUS<m> [: STATe]` is set to ON.

<code>TRIGger<m>:MILStd:TYPE</code>	2119
<code>TRIGger<m>:MILStd:DATA:RCONdition</code>	2120
<code>TRIGger<m>:MILStd:CMD:RCONdition</code>	2120
<code>TRIGger<m>:MILStd:CDST:RCONdition</code>	2120
<code>TRIGger<m>:MILStd:DATA:RMIN</code>	2121
<code>TRIGger<m>:MILStd:CMD:RMIN</code>	2121
<code>TRIGger<m>:MILStd:CDST:RMIN</code>	2121
<code>TRIGger<m>:MILStd:DATA:RMAX</code>	2121
<code>TRIGger<m>:MILStd:CMD:RMAX</code>	2121
<code>TRIGger<m>:MILStd:CDST:RMAX</code>	2121
<code>TRIGger<m>:MILStd:CMD:CConDition</code>	2121
<code>TRIGger<m>:MILStd:CMD:CMAx</code>	2122
<code>TRIGger<m>:MILStd:CMD:CMIx</code>	2122
<code>TRIGger<m>:MILStd:CMD:SConDition</code>	2122
<code>TRIGger<m>:MILStd:CMD:SMAX</code>	2123
<code>TRIGger<m>:MILStd:CMD:SMIN</code>	2123
<code>TRIGger<m>:MILStd:CMD:TR</code>	2123
<code>TRIGger<m>:MILStd:CDST:ICONdition</code>	2123
<code>TRIGger<m>:MILStd:CDST:IMAX</code>	2124
<code>TRIGger<m>:MILStd:CDST:IMIN</code>	2124
<code>TRIGger<m>:MILStd:DATA:DConDition</code>	2124
<code>TRIGger<m>:MILStd:DATA:DMAx</code>	2125
<code>TRIGger<m>:MILStd:DATA:DMIx</code>	2125
<code>TRIGger<m>:MILStd:DATA:ICONdition</code>	2125
<code>TRIGger<m>:MILStd:DATA:IMAX</code>	2125
<code>TRIGger<m>:MILStd:DATA:IMIN</code>	2126
<code>TRIGger<m>:MILStd:ERRor:MANChester</code>	2126
<code>TRIGger<m>:MILStd:ERRor:PARity</code>	2126
<code>TRIGger<m>:MILStd:ERRor:SYNC</code>	2126
<code>TRIGger<m>:MILStd:MAXResponse:BITS</code>	2127
<code>TRIGger<m>:MILStd:MAXResponse:SElect</code>	2127
<code>TRIGger<m>:MILStd:MINGap:BITS</code>	2127
<code>TRIGger<m>:MILStd:MINGap:SElect</code>	2127
<code>TRIGger<m>:MILStd:STATus:BCReceivEd</code>	2128
<code>TRIGger<m>:MILStd:STATus:BUSY</code>	2128
<code>TRIGger<m>:MILStd:STATus:DBCaccept</code>	2128
<code>TRIGger<m>:MILStd:STATus:INSTRument</code>	2128
<code>TRIGger<m>:MILStd:STATus:MERRor</code>	2128
<code>TRIGger<m>:MILStd:STATus:SREQuest</code>	2129
<code>TRIGger<m>:MILStd:STATus:SUBSystem</code>	2129
<code>TRIGger<m>:MILStd:STATus:TERMIx</code>	2129
<code>TRIGger<m>:MILStd:TPSPecifier</code>	2129

TRIGger<m>:MILStd:TYPE <Type>

Sets the trigger type for MIL-1553 analysis.

Parameters:

<Type> STYPe | WTYPe | DATA | CDST | CMD | STATword | ERR

STYPe

SyncTYPe: triggers on a sync impulse.

WTYPe

WordTYPe: triggers on the selected word type.

DATA

Triggers on a data word that can be specified.

CDST

CommanDStatus word: triggers on a command word or on a status word that can be specified.

CMD

CoMmanD word: triggers on a command word or on a status word that can be specified.

STATword

STATus word: triggers on a status word that can be specified.

ERR

ERRor: triggers on any combination of protocol errors.

*RST: STYPe

Manual operation: See "[Trigger Type](#)" on page 719

TRIGger<m>:MILStd:DATA:RCONdition <RTAOperator>

TRIGger<m>:MILStd:CMD:RCONdition <RTAOperator>

TRIGger<m>:MILStd:CDST:RCONdition <RTAOperator>

Sets the operator to define a remote terminal address:

- DATA: for data words
- CMD: for command words
- CDST: for status words

Parameters:

<RTAOperator> EQUal | NEQual | LTHan | LETHan | GTHan | GETHan |
INRange | OORange

EQUal | NEQual | LTHan | LETHan | GTHan | GETHan

Equal, Not equal, Less than, Less or equal than, Greater Than, Greater or equal than. These conditions require one pattern to be set with [TRIGger<m>:MILStd:CDST:RMIN](#).

INRange | OORange

In range/Out of range: set the minimum and maximum value of the range with [TRIGger<m>:MILStd:CDST:RMIN](#) and [TRIGger<m>:MILStd:CDST:RMAX](#).

*RST: EQUal

Manual operation: See "[Remote Terminal Address](#)" on page 721

TRIGger<m>:MILStd:DATA:RMIN <RTAPatternMin>

TRIGger<m>:MILStd:CMD:RMIN <RTAPatternMin>

TRIGger<m>:MILStd:CDST:RMIN <RTAPatternMin>

Specify a remote terminal address or set the the start value of a remote terminal address range:

- DATA: for data words
- CMD: for command words
- CDST: for status words

Parameters:

<RTAPatternMin> Numeric or string pattern, see [Chapter 27.4.6, "Bit pattern parameter"](#), on page 1373. The string parameter accepts the bit value X (don't care).

Manual operation: See ["Remote Terminal Address"](#) on page 721

TRIGger<m>:MILStd:DATA:RMAX <RTAPatternMax>

TRIGger<m>:MILStd:CMD:RMAX <RTAPatternMax>

TRIGger<m>:MILStd:CDST:RMAX <RTAPatternMax>

Set the end value of a data range if [TRIGger<m>:MILStd:CDST:RCONdition](#) is set to [INRange](#) or [OORange](#):

- DATA: for data words
- CMD: for command words
- CDST: for status words

Parameters:

<RTAPatternMax> Numeric or string pattern, see [Chapter 27.4.6, "Bit pattern parameter"](#), on page 1373. The string parameter accepts the bit value X (don't care).

Manual operation: See ["Remote Terminal Address"](#) on page 721

TRIGger<m>:MILStd:CMD:CCondition <WordCntOperator>

Sets the operator to set a specific data word count or mode code pattern.

Parameters:

<WordCntOperator> **EQUal** | **NEQual** | **LTHan** | **LETHan** | **GTHan** | **GETHan** | **INRange** | **OORange**

EQUal | **NEQual** | **LTHan** | **LETHan** | **GTHan** | **GETHan**

Equal, Not equal, Less than, Less or equal than, Greater Than, Greater or equal than. These conditions require one pattern to be set with [TRIGger<m>:MILStd:CMD:CMIN](#).

INRange | **OORange**

In range/Out of range: Set the minimum and maximum value of the range with [TRIGger<m>:MILStd:CMD:CMIN](#) and [TRIGger<m>:MILStd:CMD:CMAX](#).

*RST: EQUal

Manual operation: See ["Data Word Count/Mode Code"](#) on page 723

TRIGger<m>:MILStd:CMD:CMAX <WordCntPattMax>

Sets the end value of a data word count/mode code pattern if [TRIGger<m>:MILStd:CMD:CCONdition](#) is set to [INRange](#) or [OORange](#).

Parameters:

<WordCntPattMax> Numeric or string pattern, see [Chapter 27.4.6, "Bit pattern parameter"](#), on page 1373. The string parameter accepts the bit value X (don't care).

Manual operation: See ["Data Word Count/Mode Code"](#) on page 723

TRIGger<m>:MILStd:CMD:CMIN <WordCntPattMin>

Specifies a data word count/mode code pattern or sets the the start value of a pattern range.

Parameters:

<WordCntPattMin> Numeric or string pattern, see [Chapter 27.4.6, "Bit pattern parameter"](#), on page 1373. The string parameter accepts the bit value X (don't care).

Manual operation: See ["Data Word Count/Mode Code"](#) on page 723

TRIGger<m>:MILStd:CMD:SCONdition <SubaddrOperator>

Sets the operator to set a specific subaddress/mode pattern.

Parameters:

<SubaddrOperator> EQUal | NEQual | LTHan | LETHan | GTHan | GETHan |
INRange | OORange

EQUal | NEQual | LTHan | LETHan | GTHan | GETHan

Equal, Not equal, Less than, Less or equal than, Greater Than, Greater or equal than. These conditions require one pattern to be set with [TRIGger<m>:MILStd:CMD:SMIN](#).

INRange | OORange

In range/Out of range: set the minimum and maximum value of the range with [TRIGger<m>:MILStd:CMD:SMIN](#) and [TRIGger<m>:MILStd:CMD:SMAX](#).

*RST: EQUal

Manual operation: See ["Subaddress/ Mode"](#) on page 723

TRIGger<m>:MILStd:CMD:SMAx <SubaddrPattMax>

Sets the end value of the subaddress range if **TRIGger<m>:MILStd:CMD:SCONdition** is set to **INRange** or **OORange**.

Parameters:

<SubaddrPattMax> Numeric or string pattern, see [Chapter 27.4.6, "Bit pattern parameter"](#), on page 1373. The string parameter accepts the bit value X (don't care).

Manual operation: See ["Subaddress/ Mode"](#) on page 723

TRIGger<m>:MILStd:CMD:SMIN <SubaddrPattMin>

Specifies a subaddress or sets the the start value of a subaddress range.

Parameters:

<SubaddrPattMin> Numeric or string pattern, see [Chapter 27.4.6, "Bit pattern parameter"](#), on page 1373. The string parameter accepts the bit value X (don't care).

Manual operation: See ["Subaddress/ Mode"](#) on page 723

TRIGger<m>:MILStd:CMD:TR <TRFlag>

Triggers on a transmission mode.

Parameters:

<TRFlag> ONE | ZERO | DC
ONE
 Transmit direction.
ZERO
 Receive direction.
DC
 Either directions.
 *RST: DC

Manual operation: See ["T/R \(Transmit/receive\)"](#) on page 724

TRIGger<m>:MILStd:CDST:ICONdition <InfoOperator>

Sets the operator to set a specific info for the 9th to 19th bit of a command or status word.

Parameters:

<InfoOperator> EQUal | NEQual | LTHan | LETHan | GTHan | GETHan | INRange | OORange
EQUal | NEQual | LTHan | LETHan | GTHan | GETHan
 Equal, Not equal, Less than, Less or equal than, Greater Than, Greater or equal than. These conditions require one pattern to be set with **TRIGger<m>:MILStd:CDST:IMIN**.

INRange | OORange

In range/Out of range: set the minimum and maximum value of the range with `TRIGger<m>:MILStd:CDST:IMIN` and `TRIGger<m>:MILStd:CDST:IMAX`.

*RST: EQUal

Manual operation: See "[11-Bit Information](#)" on page 723

TRIGger<m>:MILStd:CDST:IMAX <InfoPatternMax>

Sets the end value of the info range if `TRIGger<m>:MILStd:CDST:ICONdition` is set to `INRange`.

Parameters:

<InfoPatternMax> Numeric or string pattern, see [Chapter 27.4.6, "Bit pattern parameter"](#), on page 1373. The string parameter accepts the bit value X (don't care).

Manual operation: See "[11-Bit Information](#)" on page 723

TRIGger<m>:MILStd:CDST:IMIN <InfoPatternMin>

Specifies an info or sets the the start value of an info range.

Parameters:

<InfoPatternMin> Numeric or string pattern, see [Chapter 27.4.6, "Bit pattern parameter"](#), on page 1373. The string parameter accepts the bit value X (don't care).

Manual operation: See "[11-Bit Information](#)" on page 723

TRIGger<m>:MILStd:DATA:DCondition <DataOperator>

Sets the operator to set a specific data pattern.

Parameters:

<DataOperator> EQUal | NEQual | LTHan | LETHan | GTHan | GETHan |
INRange | OORange

EQUal | NEQual | LTHan | LETHan | GTHan | GETHan

Equal, Not equal, Less than, Less or equal than, Greater Than, Greater or equal than. These conditions require one pattern to be set with `TRIGger<m>:MILStd:DATA:DMIN`.

INRange | OORange

In range/Out of range: set the minimum and maximum value of the range with `TRIGger<m>:MILStd:DATA:DMIN` and `TRIGger<m>:MILStd:DATA:DMAX`.

*RST: EQUal

Manual operation: See "[Data Pattern](#)" on page 722

TRIGger<m>:MILStd:DATA:DMAX <DataPatternMax>

Sets the end value of a data pattern range if [TRIGger<m>:MILStd:DATA:DCONdition](#) is set to [INRange](#) or [OORange](#).

Parameters:

<DataPatternMax> Numeric or string pattern, see [Chapter 27.4.6, "Bit pattern parameter"](#), on page 1373. The string parameter accepts the bit value X (don't care).

Manual operation: See ["Data Pattern"](#) on page 722

TRIGger<m>:MILStd:DATA:DMIN <DataPatternMin>

Specifies a data pattern or sets the the start value of a data pattern range.

Parameters:

<DataPatternMin> Numeric or string pattern, see [Chapter 27.4.6, "Bit pattern parameter"](#), on page 1373. The string parameter accepts the bit value X (don't care).

Manual operation: See ["Data Pattern"](#) on page 722

TRIGger<m>:MILStd:DATA:ICONdition <DataIdxOperator>

Sets the operator to set a specific range within this series of the data words that is considered for the analysis.

Parameters:

<DataIdxOperator> [EQUal](#) | [LTHan](#) | [LETHan](#) | [GTHan](#) | [GETHan](#) | [INRange](#) | [RANGe](#)

[EQUal](#) | [LTHan](#) | [LETHan](#) | [GTHan](#) | [GETHan](#)

Equal, Less than, Less or equal than, Greater Than, Greater or equal than. These conditions require one pattern to be set with [TRIGger<m>:MILStd:DATA:IMIN](#).

[INRange](#) = [RANGe](#)

In range: set the minimum and maximum value of the range with [TRIGger<m>:MILStd:DATA:IMIN](#) and [TRIGger<m>:MILStd:DATA:IMAX](#).

*RST: [INRange](#)

Manual operation: See ["Data Index"](#) on page 722

TRIGger<m>:MILStd:DATA:IMAX <DataIndexMax>

Sets the end value of a data word series index range if [TRIGger<m>:MILStd:DATA:ICONdition](#) is set to [INRange](#).

Parameters:

<DataIndexMax> Range: 1 to 32
 Increment: 1
 *RST: 32

Manual operation: See "[Data Index](#)" on page 722

TRIGger<m>:MILStd:DATA:IMIN <DataIndexMin>

Specifies an index or sets the the start value of a data word series index range.

Parameters:

<DataIndexMin> Range: 1 to 32
 Increment: 1
 *RST: 1

Manual operation: See "[Data Index](#)" on page 722

TRIGger<m>:MILStd:ERRor:MANChester <ManCodingError>

Triggers on an error of the manchester coding if [TRIGger<m>:MILStd:TYPE](#) is set to `ERRor`.

Parameters:

<ManCodingError> ON | OFF
 *RST: ON

Manual operation: See "[Manchester Coding Error](#)" on page 724

TRIGger<m>:MILStd:ERRor:PARity <ParityError>

Triggers on even parity if [TRIGger<m>:MILStd:TYPE](#) is set to `ERRor`.

Parameters:

<ParityError> ON | OFF
 *RST: ON

Manual operation: See "[Parity Error](#)" on page 724

TRIGger<m>:MILStd:ERRor:SYNC <SyncError>

Triggers on an error of the synchronization if [TRIGger<m>:MILStd:TYPE](#) is set to `ERRor`.

Parameters:

<SyncError> ON | OFF
 *RST: ON

Manual operation: See "[Synchronization Error](#)" on page 724

TRIGger<m>:MILStd:MAXResponse:BITS <MaxResponseTime>

Sets the value for the maximum response time to be triggered on if **TRIGger<m>:MILStd:TYPE** is set to **ERRor**

Enable the error trigger on maximum response time with **TRIGger<m>:MILStd:MAXResponse:SElect**.

Parameters:

<MaxResponseTime> Range: 2E-6 to 262E-6
 Increment: 100E-9
 *RST: 14E-6
 Default unit: s

Manual operation: See "[Check max response](#)" on page 717

TRIGger<m>:MILStd:MAXResponse:SElect <MaxRespSel>

Enables the trigger on exceeding the maximum response time if **TRIGger<m>:MILStd:TYPE** is set to **ERRor**. You can set the maximum time with: **TRIGger<m>:MILStd:MAXResponse:BITS**.

Parameters:

<MaxRespSel> ON | OFF
 *RST: ON

Manual operation: See "[Check max response](#)" on page 717

TRIGger<m>:MILStd:MINGap:BITS <MinGapTime>

Sets the value for the minimum gap to be triggered on if **TRIGger<m>:MILStd:TYPE** is set to **ERRor**.

Parameters:

<MinGapTime> Range: 2E-6 to 262E-6
 Increment: 100E-9
 *RST: 4E-6
 Default unit: s

Manual operation: See "[Check min gap](#)" on page 717

TRIGger<m>:MILStd:MINGap:SElect <MinGapSelect>

Enables triggering when the minimum gap is out of range if **TRIGger<m>:MILStd:TYPE** is set to **ERRor**. You can set the minimum gap with: **TRIGger<m>:MILStd:MINGap:BITS**.

Parameters:

<MinGapSelect> ON | OFF
 *RST: ON

Manual operation: See "[Check min gap](#)" on page 717

TRIGger<m>:MILStd:STATus:BCReceived <BroadcastCmd>

Triggers on the state of the broadcast command received bit of the status word if [TRIGger<m>:MILStd:TYPE](#) is set to STATword.

Parameters:

<BroadcastCmd> ONE | ZERO | DC
*RST: DC

Manual operation: See "[Status Flags](#)" on page 724

TRIGger<m>:MILStd:STATus:BUSY <BusyFlag>

Triggers on the state of the busy bit of the status word if [TRIGger<m>:MILStd:TYPE](#) is set to STATword.

Parameters:

<BusyFlag> ONE | ZERO | DC
*RST: DC

Manual operation: See "[Status Flags](#)" on page 724

TRIGger<m>:MILStd:STATus:DBCaccept <DynBusControl>

Triggers on the state of the dynamic bus control accept bit of the status word if [TRIGger<m>:MILStd:TYPE](#) is set to STATword.

Parameters:

<DynBusControl> ONE | ZERO | DC
*RST: DC

Manual operation: See "[Status Flags](#)" on page 724

TRIGger<m>:MILStd:STATus:INSTrument <InstFlag>

Triggers on the state of the instrumentation bit of the status word if [TRIGger<m>:MILStd:TYPE](#) is set to STATword.

Parameters:

<InstFlag> ONE | ZERO | DC
*RST: ZERO

Manual operation: See "[Status Flags](#)" on page 724

TRIGger<m>:MILStd:STATus:MERRor <MessageError>

Triggers on the state of the message error bit of the status word if [TRIGger<m>:MILStd:TYPE](#) is set to STATword.

Parameters:

<MessageError> ONE | ZERO | DC
 *RST: DC

Manual operation: See ["Status Flags"](#) on page 724

TRIGger<m>:MILStd:STATus:SREQuest <ServiceRequest>

Triggers on the state of the the service request bit of the status word if [TRIGger<m>:MILStd:TYPE](#) is set to `STATword`.

Parameters:

<ServiceRequest> ONE | ZERO | DC
 *RST: DC

Manual operation: See ["Status Flags"](#) on page 724

TRIGger<m>:MILStd:STATus:SUBSystem <SubsystemFlag>

Triggers on the state of the subsystem flag bit of the status word if [TRIGger<m>:MILStd:TYPE](#) is set to `STATword`.

Parameters:

<SubsystemFlag> ONE | ZERO | DC
 *RST: DC

Manual operation: See ["Status Flags"](#) on page 724

TRIGger<m>:MILStd:STATus:TERMinal <TerminalFlag>

Triggers on the state of the terminal flag bit of the status word if [TRIGger<m>:MILStd:TYPE](#) is set to `STATword`.

Parameters:

<TerminalFlag> ONE | ZERO | DC
 *RST: DC

Manual operation: See ["Status Flags"](#) on page 724

TRIGger<m>:MILStd:TPSPecifier <TypeSpecifier>

Sets the sync impulse/ word type to be triggered on.

Parameters:

<TypeSpecifier> CStatus | DATA | ALL
 CStatus: command/status word
 *RST: ALL

Manual operation: See ["Sync Type / Word Type"](#) on page 721

27.18.13.3 Decode results

To load and activate a label list, use:

- `BUS<m>:NEWList` on page 1815
- `BUS<m>:SYMBOLs` on page 1815

<code>BUS<m>:MILStd:WCOunt?</code>	2130
<code>BUS<m>:MILStd:WORD<n>:DATA?</code>	2130
<code>BUS<m>:MILStd:WORD<n>:INFO?</code>	2130
<code>BUS<m>:MILStd:WORD<n>:RTADdress?</code>	2131
<code>BUS<m>:MILStd:WORD<n>:START?</code>	2131
<code>BUS<m>:MILStd:WORD<n>:STATus?</code>	2131
<code>BUS<m>:MILStd:WORD<n>:STOP?</code>	2132
<code>BUS<m>:MILStd:WORD<n>:SYMBOL?</code>	2132
<code>BUS<m>:MILStd:WORD<n>:TYPE?</code>	2133

BUS<m>:MILStd:WCOunt?

Returns the number of decoded words.

Suffix:

<m> 1..4

Return values:

<FrameCount> Range: 0 to 100000
 Increment: 1
 *RST: 0

Usage: Query only

BUS<m>:MILStd:WORD<n>:DATA?

Return the data bytes of the specified word.

Suffix:

<m> 1..4
 Selects the serial bus.

<n> *
 Selects the word.

Return values:

<Data> 16-bit data of the specified word as a 2-byte bit pattern (B1, B2).
 The first byte B1 is the most significant byte.

Example:

```
BUS:MILStd:WORD4:DATA?
<-- #H08,#H49
```

Usage: Query only

BUS<m>:MILStd:WORD<n>:INFO?

Returns the info value for the specified word.

Suffix:

<m> 1..4
Selects the serial bus.

<n> *
Selects the word.

Return values:

<FrameInfo> Range: 0 to 2047
Increment: 1
*RST: 0

Usage: Query only

BUS<m>:MILStd:WORD<n>:RTAddress?

Returns the RT address for the selected word.

Suffix:

<m> 1..4
Selects the serial bus.

<n> *
Selects the word.

Return values:

<FrameRta> Range: 0 to 31
Increment: 1
*RST: 0

Usage: Query only

BUS<m>:MILStd:WORD<n>:START?

Return the start time of the selected word.

Suffix:

<m> 1..4
Selects the serial bus.

<n> *
Selects the word.

Return values:

<FrameStart> Range: -100E+24 to 100E+24
Increment: 100E-12
*RST: 0
Default unit: s

Usage: Query only

BUS<m>:MILStd:WORD<n>:STATus?

Returns the overall state of the selected word.

Suffix:

<m> 1..4
Selects the serial bus.

<n> *
Selects the word.

Return values:

<FrameState> OK | SYNC | MANC | PAR | GAP | RT | INComplete | UNKNown
 OK: the word is valid.
 SYNC: synchronization error occurred.
 MANC: manchester coding error occurred.
 PAR: parity error occurred.
 GAP: timing gap error occurred.
 RT: remote terminal error occurred.
 INComplete: the sequence is not completely contained in the acquisition
 UNKNown: unknown frame type
 *RST: OK

Usage: Query only

BUS<m>:MILStd:WORD<n>:STOP?

Return the stop time of the selected word.

Suffix:

<m> 1..4
Selects the serial bus.

<n> *
Selects the word.

Return values:

<FrameStop> Range: -100E+24 to 100E+24
 Increment: 100E-12
 *RST: 0
 Default unit: s

Usage: Query only

BUS<m>:MILStd:WORD<n>:SYMBOL?

Returns the label name of the word ID.

Suffix:

<m> 1..4
Selects the serial bus.

<n> *
Selects the word.

Return values:

<Translation>

Usage: Query only**BUS<m>:MILStd:WORD<n>:TYPE?**

Returns the type of the specified word.

Suffix:<m> 1..4
Selects the serial bus.<n> *
Selects the word.**Return values:**<FrameType> UNKNown | DATA | CMD | STAT | CMST | IM
CMD: command word
CMST: command/status word
IM: inter message. Shows if there are gap errors or response timeout.
*RST: DATA**Usage:** Query only**27.18.13.4 Search settings**

The search remote commands are very similar to the trigger commands. Therefore, search coommands are described in short, for more details, see the corresponding trigger command in [Chapter 27.18.13.2, "Trigger"](#), on page 2118.

SEARch:TRIGger:MILStd:TYPE	2134
SEARch:TRIGger:MILStd:DATA:RCONdition	2134
SEARch:TRIGger:MILStd:CMD:RCONdition	2134
SEARch:TRIGger:MILStd:CDST:RCONdition	2134
SEARch:TRIGger:MILStd:DATA:RMIN	2135
SEARch:TRIGger:MILStd:CMD:RMIN	2135
SEARch:TRIGger:MILStd:CDST:RMIN	2135
SEARch:TRIGger:MILStd:DATA:RMAX	2136
SEARch:TRIGger:MILStd:CMD:RMAX	2136
SEARch:TRIGger:MILStd:CDST:RMAX	2136
SEARch:TRIGger:MILStd:CDST:ICONdition	2136
SEARch:TRIGger:MILStd:CMD:CCONdition	2136
SEARch:TRIGger:MILStd:CMD:SCONdition	2136
SEARch:TRIGger:MILStd:DATA:DCONdition	2136
SEARch:TRIGger:MILStd:CDST:IMIN	2137
SEARch:TRIGger:MILStd:CMD:CMIN	2137
SEARch:TRIGger:MILStd:CMD:SMIN	2137
SEARch:TRIGger:MILStd:DATA:DMIN	2137
SEARch:TRIGger:MILStd:CDST:IMAX	2137

SEARch:TRIGger:MILStd:CMD:CMAX.....	2137
SEARch:TRIGger:MILStd:CMD:SMAx.....	2137
SEARch:TRIGger:MILStd:DATA:DMAx.....	2137
SEARch:TRIGger:MILStd:DATA:ICONdition.....	2138
SEARch:TRIGger:MILStd:DATA:IMIN.....	2138
SEARch:TRIGger:MILStd:DATA:IMAX.....	2138
SEARch:TRIGger:MILStd:CMD:TR.....	2139
SEARch:TRIGger:MILStd:ERRor:MANChester.....	2139
SEARch:TRIGger:MILStd:ERRor:PARity.....	2139
SEARch:TRIGger:MILStd:ERRor:SYNC.....	2139
SEARch:TRIGger:MILStd:ERRor:TIMing.....	2139
SEARch:TRIGger:MILStd:STATus:BCReceivEd.....	2139
SEARch:TRIGger:MILStd:STATus:BUSY.....	2139
SEARch:TRIGger:MILStd:STATus:DBCaccept.....	2139
SEARch:TRIGger:MILStd:STATus:INSTrument.....	2139
SEARch:TRIGger:MILStd:STATus:MERRor.....	2139
SEARch:TRIGger:MILStd:STATus:SREQuest.....	2140
SEARch:TRIGger:MILStd:STATus:SUBSystem.....	2140
SEARch:TRIGger:MILStd:STATus:TERMinAl.....	2140
SEARch:TRIGger:MILStd:TSPecifier.....	2140

SEARch:TRIGger:MILStd:TYPE <SearchName>,<Type>

SEARch:TRIGger:MILStd:TYPE? <SearchName>

Sets the event to be searched for.

Parameters:

<Type> STYPe | WTYPe | DATA | CDST | CMD | STATword | ERR

See [TRIGger<m>:MILStd:TYPE](#) on page 2119

*RST: STYPe

Parameters for setting and query:

<SearchName>

Manual operation: See "[Type](#)" on page 727

SEARch:TRIGger:MILStd:DATA:RCONdition <SearchName>,<RTAOperator>

SEARch:TRIGger:MILStd:DATA:RCONdition? <SearchName>

SEARch:TRIGger:MILStd:CMD:RCONdition <SearchName>,<RTAOperator>

SEARch:TRIGger:MILStd:CMD:RCONdition? <SearchName>

SEARch:TRIGger:MILStd:CDST:RCONdition <SearchName>,<RTAOperator>

SEARch:TRIGger:MILStd:CDST:RCONdition? <SearchName>

Set the operator to define a remote terminal address:

- DATA: for data words
- CMD: for command words

- CDST: for status words

Parameters:

<RTAOperator> EQUal | NEQual | LTHan | LETHan | GTHan | GETHan |
INRange | OORange

EQUal | NEQual | LTHan | LETHan | GTHan | GETHan

Equal, Not equal, Less than, Less or equal than, Greater Than, Greater or equal than. These conditions require one pattern to be set with [SEARCh:TRIGger:MILStd:CDST:RMIN](#).

INRange | OORange

In range/Out of range: set the minimum and maximum value of the range with [SEARCh:TRIGger:MILStd:CDST:RMIN](#) and [SEARCh:TRIGger:MILStd:CDST:RMAX](#) on page 2136.

*RST: EQUal

Parameters for setting and query:

<SearchName> String parameter

Manual operation: See "[Remote terminal address setup: Condition, RTA](#)" on page 728

SEARCh:TRIGger:MILStd:DATA:RMIN <SearchName>,<RTAPatternMin>

SEARCh:TRIGger:MILStd:DATA:RMIN? <SearchName>

SEARCh:TRIGger:MILStd:CMD:RMIN <SearchName>,<RTAPatternMin>

SEARCh:TRIGger:MILStd:CMD:RMIN? <SearchName>

SEARCh:TRIGger:MILStd:CDST:RMIN <SearchName>,<RTAPatternMin>

SEARCh:TRIGger:MILStd:CDST:RMIN? <SearchName>

Specify a remote terminal address or set the the start value of a remote terminal address range:

- DATA: for data words
- CMD: for command words
- CDST: for status words

Parameters:

<RTAPatternMin> Numeric or string pattern, see [Chapter 27.4.6, "Bit pattern parameter"](#), on page 1373. The string parameter accepts the bit value X (don't care).

Parameters for setting and query:

<SearchName>

Manual operation: See "[Remote terminal address setup: Condition, RTA](#)" on page 728

SEARCh:TRIGger:MILStd:DATA:RMAX <SearchName>,<RTAPatternMax>
SEARCh:TRIGger:MILStd:DATA:RMAX? <SearchName>
SEARCh:TRIGger:MILStd:CMD:RMAX <SearchName>,<RTAPatternMax>
SEARCh:TRIGger:MILStd:CMD:RMAX? <SearchName>
SEARCh:TRIGger:MILStd:CDST:RMAX <SearchName>,<RTAPatternMax>
SEARCh:TRIGger:MILStd:CDST:RMAX? <SearchName>

Set the end value of a data range if [SEARCh:TRIGger:MILStd:CDST:RCONdition](#) is set to `INRange` or `OORange`:

- DATA: for data words
- CMD: for command words
- CDST: for status words

Parameters:

<RTAPatternMax> Numeric or string pattern, see [Chapter 27.4.6, "Bit pattern parameter"](#), on page 1373. The string parameter accepts the bit value X (don't care).

Parameters for setting and query:

<SearchName>

Manual operation: See ["Remote terminal address setup: Condition, RTA "](#) on page 728

SEARCh:TRIGger:MILStd:CDST:ICONdition <SearchName>,<InfoOperator>
SEARCh:TRIGger:MILStd:CDST:ICONdition? <SearchName>
SEARCh:TRIGger:MILStd:CMD:CCONDITION <SearchName>,<WordCntOperator>
SEARCh:TRIGger:MILStd:CMD:CCONDITION? <SearchName>
SEARCh:TRIGger:MILStd:CMD:SCONdition <SearchName>,<SubaddrOperator>
SEARCh:TRIGger:MILStd:CMD:SCONdition? <SearchName>
SEARCh:TRIGger:MILStd:DATA:DCONDITION <SearchName>,<DataOperator>
SEARCh:TRIGger:MILStd:DATA:DCONDITION? <SearchName>

Sets the operator for the corresponding search:

- CDST:ICON - specific info for the 9th to 19th bit of a command or status word.
- CMD:CCON - specific data word count or mode code pattern in a command word
- CMD:SCON - specific subaddress/mode pattern in a command word
- DATA:DCON - data pattern in a data word

Parameters:

<DataOperator> `EQUal` | `NEQUal` | `LTHan` | `LETHan` | `GTHan` | `GETHan` |
 `INRange` | `OORange`
 *RST: `EQUal`

Parameters for setting and query:

<SearchName>

Manual operation: See ["Data pattern setup: Condition, Data min, Data max"](#) on page 728

SEARCh:TRIGger:MILStd:CDST:IMIN <SearchName>,<InfoPatternMin>
SEARCh:TRIGger:MILStd:CDST:IMIN? <SearchName>
SEARCh:TRIGger:MILStd:CMD:CMIN <SearchName>,<WordCntPattMin>
SEARCh:TRIGger:MILStd:CMD:CMIN? <SearchName>
SEARCh:TRIGger:MILStd:CMD:SMIN <SearchName>,<SubaddrPattMin>
SEARCh:TRIGger:MILStd:CMD:SMIN? <SearchName>
SEARCh:TRIGger:MILStd:DATA:DMIN <SearchName>,<DataPatternMin>
SEARCh:TRIGger:MILStd:DATA:DMIN? <SearchName>

Sets the pattern or the start value of a pattern range for the corresponding search:

- CDST:IMIN - specific info for the 9th to 19th bit of a command or status word.
- CMD:CMIN - specific data word count or mode code pattern in a command word
- CMD:SMIN - specific subaddress/mode pattern in a command word
- DATA:DMIN - data pattern in a data word

Parameters:

<DataPatternMin>

Parameters for setting and query:

<SearchName>

Manual operation: See ["Data pattern setup: Condition, Data min, Data max"](#) on page 728

SEARCh:TRIGger:MILStd:CDST:IMAX <SearchName>,<InfoPatternMax>
SEARCh:TRIGger:MILStd:CDST:IMAX? <SearchName>
SEARCh:TRIGger:MILStd:CMD:CMAX <SearchName>,<WordCntPattMax>
SEARCh:TRIGger:MILStd:CMD:CMAX? <SearchName>
SEARCh:TRIGger:MILStd:CMD:SMAX <SearchName>,<SubaddrPattMax>
SEARCh:TRIGger:MILStd:CMD:SMAX? <SearchName>
SEARCh:TRIGger:MILStd:DATA:DMAX <SearchName>,<DataPatternMax>
SEARCh:TRIGger:MILStd:DATA:DMAX? <SearchName>

Sets the end value of a pattern range for the corresponding search:

- CDST:IMAX - specific info for the 9th to 19th bit of a command or status word.
- CMD:CMAX - specific data word count or mode code pattern in a command word
- CMD:SMAX - specific subaddress/mode pattern in a command word
- DATA:DMAX - data pattern in a data word

Parameters:

<DataPatternMax>

Parameters for setting and query:

<SearchName>

Manual operation: See ["Data pattern setup: Condition, Data min, Data max"](#) on page 728

SEARCh:TRIGger:MILStd:CMD:TR <SearchName>,<TRFlag>
SEARCh:TRIGger:MILStd:CMD:TR? <SearchName>

Searches for a transmission mode.

Parameters:

<TRFlag> ONE | ZERO | DC
 *RST: DC

Parameters for setting and query:

<SearchName>

Manual operation: See "[T/R \(Transmit/receive\)](#)" on page 729

SEARCh:TRIGger:MILStd:ERRor:MANChester <SearchName>,<ManCodingError>
SEARCh:TRIGger:MILStd:ERRor:MANChester? <SearchName>
SEARCh:TRIGger:MILStd:ERRor:PARity <SearchName>,<ParityError>
SEARCh:TRIGger:MILStd:ERRor:PARity? <SearchName>
SEARCh:TRIGger:MILStd:ERRor:SYNC <SearchName>,<SyncError>
SEARCh:TRIGger:MILStd:ERRor:SYNC? <SearchName>
SEARCh:TRIGger:MILStd:ERRor:TIMing <SearchName>,<MinGapSelect>
SEARCh:TRIGger:MILStd:ERRor:TIMing? <SearchName>

Enables search for errors if [SEARCh:TRIGger:MILStd:TYPE](#) is set to `ERRor`.

- MANChester: error of the manchester coding
- PARity: even parity (parity error)
- SYNC: error of the synchronization
- TIMing: Minimum gap is out of range

Parameters:

<SyncError>, ON | OFF
 <ParityError>, *RST: ON
 <ManCodingError>,
 <MinGapSelect>

Parameters for setting and query:

<SearchName>

Manual operation: See "[Error Condition](#)" on page 729

SEARCh:TRIGger:MILStd:STATus:BCReceivEd <SearchName>,<BroadcastCmd>
SEARCh:TRIGger:MILStd:STATus:BCReceivEd? <SearchName>
SEARCh:TRIGger:MILStd:STATus:BUSY <SearchName>,<BusyFlag>
SEARCh:TRIGger:MILStd:STATus:BUSY? <SearchName>
SEARCh:TRIGger:MILStd:STATus:DBCaccept <SearchName>,<DynBusControl>
SEARCh:TRIGger:MILStd:STATus:DBCaccept? <SearchName>
SEARCh:TRIGger:MILStd:STATus:INSTrument <SearchName>,<InstFlag>
SEARCh:TRIGger:MILStd:STATus:INSTrument? <SearchName>
SEARCh:TRIGger:MILStd:STATus:MERRor <SearchName>,<MessageError>
SEARCh:TRIGger:MILStd:STATus:MERRor? <SearchName>

SEARCH:TRIGger:MILStd:STATus:SREQuest <SearchName>,<ServiceRequest>
SEARCH:TRIGger:MILStd:STATus:SREQuest? <SearchName>
SEARCH:TRIGger:MILStd:STATus:SUBSystem <SearchName>,<SubsystemFlag>
SEARCH:TRIGger:MILStd:STATus:SUBSystem? <SearchName>
SEARCH:TRIGger:MILStd:STATus:TERMinal <SearchName>,<TerminalFlag>
SEARCH:TRIGger:MILStd:STATus:TERMinal? <SearchName>

Specifies the values (0, 1, X) of the status flags if **SEARCH:TRIGger:MILStd:TYPE** is set to **STATword**.

Parameters:

<TerminalFlag> ONE | ZERO | DC
 *RST: DC

Parameters for setting and query:

<SearchName>

Manual operation: See "[Status flags setup](#)" on page 729

SEARCH:TRIGger:MILStd:TPSPecifier <SearchName>,<TypeSpecifier>
SEARCH:TRIGger:MILStd:TPSPecifier? <SearchName>

Sets the sync impulse/ word type to be searched for.

Parameters:

<TypeSpecifier> CStatus | DATA | ALL
 CStatus: command/status word
 *RST: ALL

Parameters for setting and query:

<SearchName>

Manual operation: See "[Sync Type / Word Type](#)" on page 727

27.18.13.5 Search results

The search on decoded MIL-1553 data returns the same results as the queries for decode results.

In search result commands, you have to specify the <SearchName> parameter. It is a string parameter that contains the search definition name.

For a description of the returned values, see the corresponding commands in [Chapter 27.18.13.3, "Decode results"](#), on page 2130.

SEARCH:RESult:MILStd:WCOunt?	2141
SEARCH:RESult:MILStd:WORD<m>:TYPE?	2141
SEARCH:RESult:MILStd:WORD<m>:STATus?	2141
SEARCH:RESult:MILStd:WORD<m>:START?	2141
SEARCH:RESult:MILStd:WORD<m>:STOP?	2142
SEARCH:RESult:MILStd:WORD<m>:SYMBol?	2142

SEARCH:RESult:MILStd:WORD<m>:RTADdress?.....	2142
SEARCH:RESult:MILStd:WORD<m>:DATA?.....	2143
SEARCH:RESult:MILStd:WORD<m>:INFO?.....	2143

SEARCH:RESult:MILStd:WCOunt? <SearchName>
Query parameters:

<SearchName>

Return values:

<FrameCount> Range: 0 to 100000
 Increment: 1
 *RST: 0

Usage: Query only

SEARCH:RESult:MILStd:WORD<m>:TYPE? <SearchName>
Suffix:

<m> *

Query parameters:

<SearchName>

Return values:

<FrameType> UNKNown | DATA | CMD | STAT | CMST | IM
 *RST: DATA

Usage: Query only

SEARCH:RESult:MILStd:WORD<m>:STATus? <SearchName>
Suffix:

<m> *

Query parameters:

<SearchName>

Return values:

<FrameState> OK | SYNC | MANC | PAR | GAP | RT | INComplete | UNKNown
 *RST: OK

Usage: Query only

SEARCH:RESult:MILStd:WORD<m>:START? <SearchName>
Suffix:

<m> *

Query parameters:

<SearchName>

Return values:

<FrameStart> Range: -100E+24 to 100E+24
 Increment: 100E-12
 *RST: 0
 Default unit: s

Usage: Query only

SEARCh:RESUlt:MILStd:WORD<m>:STOP? <SearchName>**Suffix:**

<m> *

Query parameters:

<SearchName>

Return values:

<FrameStop> Range: -100E+24 to 100E+24
 Increment: 100E-12
 *RST: 0
 Default unit: s

Usage: Query only

SEARCh:RESUlt:MILStd:WORD<m>:SYMBol? <SearchName>**Suffix:**

<m> *

Query parameters:

<SearchName>

Return values:

<Translation>

Usage: Query only

SEARCh:RESUlt:MILStd:WORD<m>:RTADdress? <SearchName>**Suffix:**

<m> *

Query parameters:

<SearchName>

Return values:

<FrameRta> Range: 0 to 31
 Increment: 1
 *RST: 0

Usage: Query only

SEARCh:RESUlt:MILStd:WORD<m>:DATA? <SearchName>

Suffix:

<m> *

Query parameters:

<SearchName>

Return values:

<Data>

Usage: Query only

SEARCh:RESUlt:MILStd:WORD<m>:INFO? <SearchName>

Suffix:

<m> *

Query parameters:

<SearchName>

Return values:

<FrameInfo> Range: 0 to 2047
 Increment: 1
 *RST: 0

Usage: Query only

27.18.14 ARINC 429 (option R&S RTO6-K530)

• Configuration.....	2143
• Trigger.....	2147
• Decode results.....	2151
• Search settings.....	2154
• Search results.....	2157

27.18.14.1 Configuration

BUS<m>:ARINc:SOURce.....	2144
BUS<m>:ARINc:BRValue.....	2144
BUS<m>:ARINc:BRMode.....	2144
BUS<m>:ARINc:MAXGap:SElect.....	2144
BUS<m>:ARINc:MAXGap:BITS.....	2145
BUS<m>:ARINc:MINGap:SElect.....	2145
BUS<m>:ARINc:MINGap:BITS.....	2145
BUS<m>:ARINc:POLarity.....	2146
BUS<m>:ARINc:PRESet.....	2146
BUS<m>:ARINc:THReshold:HIGH.....	2146
BUS<m>:ARINc:THReshold:LOW.....	2146

BUS<m>:ARINc:SOURce <SourceData>

Sets the channel for the signal source.

Reference and math waveforms are only available if the trigger source is one of the input channels but not the serial bus.

Suffix:

<m> 1..4
Selects the serial bus.

Parameters:

<SourceData> C1W1 | C2W1 | C3W1 | C4W1 | M1 | M2 | M3 | M4 | M5 | M6 |
M7 | M8 | R1 | R2 | R3 | R4
*RST: C1W1

Manual operation: See "[Data](#)" on page 732

BUS<m>:ARINc:BRValue <BitRateValue>

Sets the number of transmitted bits per second.

Suffix:

<m> 1..4

Parameters:

<BitRateValue> Range: 10000 to 110000
Increment: 100
*RST: 100000
Default unit: bps

Manual operation: See "[Bit Rate](#)" on page 733

BUS<m>:ARINc:BRMode <BitRateMode>

Sets the bit rate mode to high or low speed.

Suffix:

<m> 1..4

Parameters:

<BitRateMode> HIGH | LOW
*RST: HIGH

Manual operation: See "[Bit Rate](#)" on page 733

BUS<m>:ARINc:MAXGap:SElect <MaxGapSelect>

Enables the detection of the maximum gap time during decoding.

To specify the minimum gap time [BUS<m>:ARINc:MINGap:BITS](#).

Suffix:

<m> 1..4

Parameters:

<MaxGapSelect> ON | OFF
 *RST: OFF

Manual operation: See "[Timing: Min gap, Max gap](#)" on page 733

BUS<m>:ARINc:MAXGap:BITS <MaxGapBits>

Sets the value for the maximum gap between two words.

See also: [BUS<m>:ARINc:MAXGap:SElect](#)

Suffix:

<m> 1..4

Parameters:

<MaxGapBits> Range: 0 to 1000
 Increment: 1
 *RST: 100
 Default unit: bit

Manual operation: See "[Timing: Min gap, Max gap](#)" on page 733

BUS<m>:ARINc:MINGap:SElect <MinGapSelect>

Enables the detection of the minimum idle time between two words during decoding.

To specify the minimum gap, use [BUS<m>:ARINc:MINGap:BITS](#).

Suffix:

<m> 1..4

Parameters:

<MinGapSelect> ON | OFF
 *RST: ON

Manual operation: See "[Timing: Min gap, Max gap](#)" on page 733

BUS<m>:ARINc:MINGap:BITS <MinGapBits>

Sets a value for the minimum timing gap between two words.

See also: [BUS<m>:ARINc:MINGap:SElect](#) on page 2145.

Suffix:

<m> 1..4

Parameters:

<MinGapBits> Range: 0 to 100
 Increment: 1
 *RST: 4
 Default unit: bit

Manual operation: See "[Timing: Min gap, Max gap](#)" on page 733

BUS<m>:ARINc:POLarity <Polarity>

Sets the wire on which the bus signal is measured.

Suffix:

<m> 1..4

Parameters:

<Polarity> ALEG | BLEG
*RST: ALEG

Manual operation: See "[Polarity](#)" on page 732

BUS<m>:ARINc:PRESet <Preset>

Sets the default threshold voltage.

Suffix:

<m> 1..4

Parameters:

<Preset> V25 | V5 | MANual
*RST: V5

Manual operation: See "[Thresholds](#)" on page 732

BUS<m>:ARINc:THReshold:HIGH <ThresholdHigh>

Sets the high threshold level of the signal.

Suffix:

<m> 1..4

Parameters:

<ThresholdHigh> Range: 0 to 12
Increment: 0.1
*RST: 5
Default unit: V

Manual operation: See "[Thresholds](#)" on page 732

BUS<m>:ARINc:THReshold:LOW <ThresholdLow>

Sets the low threshold level of the signal.

Suffix:

<m> 1..4

Parameters:

<ThresholdLow> Range: -12 to 0
Increment: 0.1
*RST: -5
Default unit: V

Manual operation: See ["Thresholds"](#) on page 732

27.18.14.2 Trigger

The trigger suffix <m> is always 1 and can be omitted. It selects the trigger event: Only the A-trigger is available for triggering on serial buses.

To trigger on a serial bus, make sure that:

- `TRIGger<m>:SOURce[:SElect]` is set to `SBUS`.
- The sources of the serial bus are channel signals: use `BUS<m>:...:SOURce` commands.
- Decoding is enabled: `BUS<m>[:STATe]` is set to `ON`.

<code>TRIGger<m>:ARINc:TYPE</code>	2147
<code>TRIGger<m>:ARINc:DATA:CONDition</code>	2147
<code>TRIGger<m>:ARINc:DATA:MIN</code>	2148
<code>TRIGger<m>:ARINc:DATA:MAX</code>	2148
<code>TRIGger<m>:ARINc:ERRor:CODing</code>	2148
<code>TRIGger<m>:ARINc:ERRor:PARity</code>	2148
<code>TRIGger<m>:ARINc:LAbel:CONDition</code>	2149
<code>TRIGger<m>:ARINc:LAbel:MIN</code>	2149
<code>TRIGger<m>:ARINc:LAbel:MAX</code>	2149
<code>TRIGger<m>:ARINc:MINGap:SElect</code>	2149
<code>TRIGger<m>:ARINc:MINGap:BITS</code>	2150
<code>TRIGger<m>:ARINc:MAXGap:SElect</code>	2150
<code>TRIGger<m>:ARINc:MAXGap:BITS</code>	2150
<code>TRIGger<m>:ARINc:SDI</code>	2150
<code>TRIGger<m>:ARINc:SSM</code>	2150

`TRIGger<m>:ARINc:TYPE` <Type>

Sets the trigger type for ARINC 429 analysis.

Parameters:

<Type> `START` | `STOP` | `LAbel` | `ERRor`
 *RST: `START`

Manual operation: See ["Trigger Type"](#) on page 735

`TRIGger<m>:ARINc:DATA:CONDition` <DataOperator>

Sets the condition for the data. You can define an exact data pattern or a data range.

Parameters:

<DataOperator> `EQUal` | `NEQUal` | `LTHan` | `LETHan` | `GTHan` | `GETHan` |
 `INRange` | `ORange`
 `EQUal` | `NEQUal` | `LTHan` | `LETHan` | `GTHan` | `GETHan`
 Equal, Not equal, Less than, Less or equal than, Greater Than,
 Greater or equal than. These conditions require one pattern to
 be set with `TRIGger<m>:ARINc:DATA:MIN`.

INRange | OORange

In range/Out of range: set the minimum and maximum value of the range with `TRIGger<m>:ARINc:DATA:MIN` and `TRIGger<m>:ARINc:DATA:MAX`.

*RST: EQUal

Manual operation: See "[Data setup: Condition, Data Min, Data Max](#)" on page 737

TRIGger<m>:ARINc:DATA:MIN <DataMin>

Defines the minimum bit pattern for the data.

Parameters:

<DataMin> Numeric or string pattern, see [Chapter 27.4.6, "Bit pattern parameter"](#), on page 1373. The string parameter accepts the bit value X (don't care).

Manual operation: See "[Data setup: Condition, Data Min, Data Max](#)" on page 737

TRIGger<m>:ARINc:DATA:MAX <DataMax>

Sets the end value of a data pattern if `TRIGger<m>:ARINc:DATA:CONDition` is set to `INRange` or `OORange`.

Parameters:

<DataMax>

Manual operation: See "[Data setup: Condition, Data Min, Data Max](#)" on page 737

TRIGger<m>:ARINc:ERRor:CODing <CodingError>

Enables triggering when a coding error occurs.

Parameters:

<CodingError> ON | OFF

*RST: ON

Manual operation: See "[Coding error](#)" on page 737

TRIGger<m>:ARINc:ERRor:PARity <ParityError>

Enables triggering when a parity error occurs.

Parameters:

<ParityError> ON | OFF

*RST: ON

Manual operation: See "[Parity Error](#)" on page 737

TRIGger<m>:ARINc:LABel:CONDition <LabelOperator>

Sets the condition for the label. You can define an exact label or a label range.

Parameters:

<LabelOperator> EQUal | NEQual | LTHan | LETHan | GTHan | GETHan |
INRange | OORange

EQUal | NEQual | LTHan | LETHan | GTHan | GETHan

Equal, Not equal, Less than, Less or equal than, Greater Than, Greater or equal than. These conditions require one data pattern to be set with [TRIGger<m>:ARINc:LABel:MIN](#).

INRange | OORange

In range/Out of range: set the minimum and maximum value of the range with [TRIGger<m>:ARINc:LABel:MIN](#) and [TRIGger<m>:ARINc:LABel:MAX](#).

*RST: EQUal

Manual operation: See "[Label setup: Condition, Label Min, Label Max](#)" on page 736

TRIGger<m>:ARINc:LABel:MIN <LabelMin>

Defines the minimum bit pattern for the label.

Parameters:

<LabelMin> Numeric or string pattern, see [Chapter 27.4.6, "Bit pattern parameter"](#), on page 1373. The string parameter accepts the bit value X (don't care).

Manual operation: See "[Label setup: Condition, Label Min, Label Max](#)" on page 736

TRIGger<m>:ARINc:LABel:MAX <LabelMax>

Sets the end value of a label pattern if [TRIGger<m>:ARINc:LABel:CONDition](#) is set to [INRange](#) or [OORange](#).

Parameters:

<LabelMax> Numeric or string pattern, see [TRIGger<m>:ARINc:LABel:MIN](#)

Manual operation: See "[Label setup: Condition, Label Min, Label Max](#)" on page 736

TRIGger<m>:ARINc:MINGap:SElect <MinGapSelect>

Enables triggering when the minimum gap is out of range. You can set the minimum gap with: [TRIGger<m>:ARINc:MINGap:BITS](#).

Parameters:

<MinGapSelect> ON | OFF
*RST: ON

Manual operation: See "[Timing: Min gap, Max gap](#)" on page 733

TRIGger<m>:ARINc:MINGap:BITS <MinGapBits>

Sets the value for the minimum gap to be triggered on.

Parameters:

<MinGapBits>	Range:	0 to 100
	Increment:	1
	*RST:	4
	Default unit:	bit

Manual operation: See "[Timing: Min gap, Max gap](#)" on page 733

TRIGger<m>:ARINc:MAXGap:SElect <MaxGapSelect>

Enables triggering when the maximum gap is out of range. You can set the maximum gap with: [TRIGger<m>:ARINc:MAXGap:BITS](#).

Parameters:

<MaxGapSelect>	ON OFF
	*RST: OFF

Manual operation: See "[Timing: Min gap, Max gap](#)" on page 733

TRIGger<m>:ARINc:MAXGap:BITS <MaxGapBits>

Sets the value for the maximum gap to be triggered on.

Parameters:

<MaxGapBits>	Range:	0 to 1000
	Increment:	1
	*RST:	100
	Default unit:	bit

Manual operation: See "[Timing: Min gap, Max gap](#)" on page 733

TRIGger<m>:ARINc:SDI <SDI>

Sets the source/destination identifier (SDI) bits.

Parameters:

<SDI>

Manual operation: See "[SDI / SSM](#)" on page 737

TRIGger<m>:ARINc:SSM <SSM>

Sets the sign/status matrix (SSM) bits.

Parameters:

<SSM>

Manual operation: See "[SDI / SSM](#)" on page 737

27.18.14.3 Decode results

To load and activate a label list, use:

- `BUS<m>:NEWList` on page 1815
- `BUS<m>:SYMBOLs` on page 1815

<code>BUS<m>:ARINc:WCOunt?</code>	2151
<code>BUS<m>:ARINc:WORD<n>:DATA?</code>	2151
<code>BUS<m>:ARINc:WORD<n>:LABel?</code>	2152
<code>BUS<m>:ARINc:WORD<n>:PATtern?</code>	2152
<code>BUS<m>:ARINc:WORD<n>:SDI?</code>	2152
<code>BUS<m>:ARINc:WORD<n>:SSM?</code>	2153
<code>BUS<m>:ARINc:WORD<n>:STARt?</code>	2153
<code>BUS<m>:ARINc:WORD<n>:STATe?</code>	2153
<code>BUS<m>:ARINc:WORD<n>:STOP?</code>	2154
<code>BUS<m>:ARINc:WORD<n>:SYMBOL?</code>	2154

BUS<m>:ARINc:WCOunt?

Returns the number of decoded words.

Suffix:

<m> 1..4

Return values:

<FrameCount> Range: 0 to 100000
Increment: 1
*RST: 0

Usage: Query only

BUS<m>:ARINc:WORD<n>:DATA?

Returns the data of the specified word.

Suffix:

<m> 1..4

<n> *

Return values:

<FrameData> 19-bit data field of the word as an integer
Range: 0 to 0
Increment: 1
*RST: 0

Example: `BUS:ARINc:WORD3:DATA?`
<-- 148035

Usage: Query only

BUS<m>:ARINc:WORD<n>:LABel?

Returns the label of the specified word.

Suffix:

<m>	1..4
<n>	*

Return values:

<FrameLabel>	Range:	0 to 255
	Increment:	1
	*RST:	0

Usage: Query only

BUS<m>:ARINc:WORD<n>:PATtern?

Returns all 32 bits of the specified word.

Suffix:

<m>	1..4	Selects the serial bus.
<n>	*	

Return values:

<Data> Comma-separated list of 4 bytes in big endian order. The format of each byte is defined by [FORMat:BPATtern](#).

Example:

```
BUS2:ARINc:WORD3:PATtern?
--> #H75, #H11, #H55, #H82
FORMat:BPATtern DEC
BUS2:ARINc:WORD3:PATtern?
--> 117,17,85,130
```

Usage: Query only

BUS<m>:ARINc:WORD<n>:SDI?

Returns the source/destination identifier (SDI) bits of the specified word.

Suffix:

<m>	1..4
<n>	*

Return values:

<SDI>	Range:	0 to 3
	Increment:	1
	*RST:	0

Usage: Query only

BUS<m>:ARINC:WORD<n>:SSM?

Returns the sign/status matrix(SSM) bits of the specified word.

Suffix:

<m> 1..4
<n> *

Return values:

<SSM> Range: 0 to 3
Increment: 1
*RST: 0

Usage: Query only

BUS<m>:ARINC:WORD<n>:START?

Returns the start time of the specified word.

Suffix:

<m> 1..4
<n> *

Return values:

<FrameStart> Range: -100E+24 to 100E+24
Increment: 100E-12
*RST: 0
Default unit: s

Usage: Query only

BUS<m>:ARINC:WORD<n>:STATE?

Returns the overall state of the specified word.

Suffix:

<m> 1..4
Selects the serial bus.
<n> *
Selects the word.

Return values:

<FrameState> OK | CODE | GAP | PAR | INComplete | UNKNown
CODE: coding error occurred.
GAP: timing gap error occurred.
PAR: parity error occurred.
INComplete: the sequence is not completely contained in the acquisition
UNKNown: unknown frame type
*RST: OK

Usage: Query only

BUS<m>:ARINc:WORD<n>:STOP?

Returns the end time of the specified word.

Suffix:

<m> 1..4

<n> *

Return values:

<FrameStop> Range: -100E+24 to 100E+24
 Increment: 100E-12
 *RST: 0
 Default unit: s

Usage: Query only

BUS<m>:ARINc:WORD<n>:SYMBol?

Returns the label name of the word ID.

Suffix:

<m> 1..4

<n> *

Return values:

<Translation>

Usage: Query only

27.18.14.4 Search settings

SEARch:TRIGger:ARINc:TYPE.....	2154
SEARch:TRIGger:ARINc:LABel:CONDition.....	2155
SEARch:TRIGger:ARINc:DATA:CONDition.....	2155
SEARch:TRIGger:ARINc:LABel:MIN.....	2155
SEARch:TRIGger:ARINc:DATA:MIN.....	2155
SEARch:TRIGger:ARINc:LABel:MAX.....	2156
SEARch:TRIGger:ARINc:DATA:MAX.....	2156
SEARch:TRIGger:ARINc:SDI.....	2156
SEARch:TRIGger:ARINc:SSM.....	2156
SEARch:TRIGger:ARINc:ERRor:CODing.....	2156
SEARch:TRIGger:ARINc:ERRor:PARity.....	2157
SEARch:TRIGger:ARINc:ERRor:TIMing.....	2157

SEARch:TRIGger:ARINc:TYPE <SearchName>,<Type>

SEARch:TRIGger:ARINc:TYPE? <SearchName>

Sets the search type.

Parameters:

<Type> START | STOP | LABEL | ERROR
 *RST: START

Parameters for setting and query:

<SearchName>

Manual operation: See ["Type"](#) on page 740

SEARCH:TRIGger:ARINc:LABel:CONDition <SearchName>,<LabelOperator>

SEARCH:TRIGger:ARINc:LABel:CONDition? <SearchName>

SEARCH:TRIGger:ARINc:DATA:CONDition <SearchName>,<DataOperator>

SEARCH:TRIGger:ARINc:DATA:CONDition? <SearchName>

Set the condition for the label or data, respectively. You can define an exact value or a value range

Parameters:

<DataOperator> EQUal | NEQUal | LTHan | LETHan | GTHan | GETHan |
 INRange | OORange

EQUal | NEQUal | LTHan | LETHan | GTHan | GETHan

Equal, Not equal, Less than, Less or equal than, Greater Than, Greater or equal than. These conditions require one data pattern to be set with the corresponding [SEARCH:TRIGger:ARINc: . . . :MIN](#) command.

INRange | OORange

In range/Out of range: set the minimum and maximum value of the range. with [TRIGger<m>:ARINc:LABel:MIN](#) and [TRIGger<m>:ARINc:LABel:MAX](#).

*RST: EQUal

Parameters for setting and query:

<SearchName>

Manual operation: See ["Data setup: Condition, Data min, Data max"](#) on page 740

SEARCH:TRIGger:ARINc:LABel:MIN <SearchName>,<LabelMin>

SEARCH:TRIGger:ARINc:LABel:MIN? <SearchName>

SEARCH:TRIGger:ARINc:DATA:MIN <SearchName>,<DataMin>

SEARCH:TRIGger:ARINc:DATA:MIN? <SearchName>

Specifies a label or data bit pattern, or sets the the start value of a pattern range.

Parameters:

<DataMin> Numeric or string pattern, see [Chapter 27.4.6, "Bit pattern parameter"](#), on page 1373. The string parameter accepts the bit value X (don't care).

Parameters for setting and query:

<SearchName> String parameter

Manual operation: See ["Data setup: Condition, Data min, Data max"](#) on page 740

SEARCH:TRIGger:ARINc:LABel:MAX <SearchName>,<LabelMax>
SEARCH:TRIGger:ARINc:LABel:MAX? <SearchName>
SEARCH:TRIGger:ARINc:DATA:MAX <SearchName>,<DataMax>
SEARCH:TRIGger:ARINc:DATA:MAX? <SearchName>

Set the end value of a label or data pattern if the condition is set to INRange or OORange.

Parameters:

<DataMax> Numeric or string pattern, see [SEARCH:TRIGger:ARINc:LABel:MIN](#)

Parameters for setting and query:

<SearchName>

Manual operation: See "[Data setup: Condition, Data min, Data max](#)" on page 740

SEARCH:TRIGger:ARINc:SDI <SearchName>,<SDI>
SEARCH:TRIGger:ARINc:SDI? <SearchName>

Sets the source/destination identifier (SDI) bits.

Parameters:

<SDI>

Parameters for setting and query:

<SearchName>

Manual operation: See "[SDI / SSM setup: SDI, SSM](#)" on page 741

SEARCH:TRIGger:ARINc:SSM <SearchName>,<SSM>
SEARCH:TRIGger:ARINc:SSM? <SearchName>

Sets the sign/status matrix (SSM) bits.

Parameters:

<SSM>

Parameters for setting and query:

<SearchName>

Manual operation: See "[SDI / SSM setup: SDI, SSM](#)" on page 741

SEARCH:TRIGger:ARINc:ERRor:CODing <SearchName>,<CodingError>
SEARCH:TRIGger:ARINc:ERRor:CODing? <SearchName>

Enables the search for coding errors.

Parameters:

<CodingError> ON | OFF
 *RST: ON

Parameters for setting and query:

<SearchName>

Manual operation: See ["Error Condition"](#) on page 741

SEARCH:TRIGger:ARINc:ERRor:PARity <SearchName>,<ParityError>
SEARCH:TRIGger:ARINc:ERRor:PARity? <SearchName>

Enables the search for parity errors.

Parameters:

<ParityError> ON | OFF
 *RST: ON

Parameters for setting and query:

<SearchName>

Manual operation: See ["Error Condition"](#) on page 741

SEARCH:TRIGger:ARINc:ERRor:TIMing <SearchName>,<MinGapSelect>
SEARCH:TRIGger:ARINc:ERRor:TIMing? <SearchName>

Enables the search for timing errors, when the minimum gap is out of range.

Parameters:

<MinGapSelect> ON | OFF
 *RST: ON

Parameters for setting and query:

<SearchName>

Manual operation: See ["Error Condition"](#) on page 741

27.18.14.5 Search results

The search on decoded ARINC 429 data returns the same results as the queries for decode results.

In search result commands, you have to specify the <SearchName> parameter. It is a string parameter that contains the search definition name.

For a description of the returned values, see the corresponding commands in [Chapter 27.18.14.3, "Decode results"](#), on page 2151.

SEARCH:RESult:ARINc:WORD<m>:LABel?	2158
SEARCH:RESult:ARINc:WORD<m>:PATtern?	2158
SEARCH:RESult:ARINc:WORD<m>:DATA?	2158
SEARCH:RESult:ARINc:WORD<m>:SSM?	2158
SEARCH:RESult:ARINc:WORD<m>:SYMBol?	2159
SEARCH:RESult:ARINc:WCOunt?	2159
SEARCH:RESult:ARINc:WORD<m>:STOP?	2159
SEARCH:RESult:ARINc:WORD<m>:SDI?	2159
SEARCH:RESult:ARINc:WORD<m>:STATe?	2160
SEARCH:RESult:ARINc:WORD<m>:STARt?	2160

SEARCh:RESult:ARINc:WORD<m>:LABel? <SearchName>**Suffix:**

<m> *

Query parameters:

<SearchName>

Return values:<Label> Range: 0 to 255
 Increment: 1
 *RST: 0**Usage:** Query only

SEARCh:RESult:ARINc:WORD<m>:PATTErn? <SearchName>**Suffix:**

<m> *

Query parameters:

<SearchName>

Return values:

<DataValues>

Usage: Query only

SEARCh:RESult:ARINc:WORD<m>:DATA? <SearchName>**Suffix:**

<m> *

Query parameters:

<SearchName>

Return values:<Data> Range: 0 to 0
 Increment: 1
 *RST: 0**Usage:** Query only

SEARCh:RESult:ARINc:WORD<m>:SSM? <SearchName>**Suffix:**

<m> *

Query parameters:

<SearchName>

Return values:

<SSM> Range: 0 to 3
 Increment: 1
 *RST: 0

Usage: Query only

SEARCh:RESult:ARINc:WORD<m>:SYMBol? <SearchName>**Suffix:**

<m> *

Query parameters:

<SearchName>

Return values:

<Translation>

Usage: Query only

SEARCh:RESult:ARINc:WCOunt? <SearchName>**Query parameters:**

<SearchName>

Return values:

<FrameCount> Range: 0 to 100000
 Increment: 1
 *RST: 0

Usage: Query only

SEARCh:RESult:ARINc:WORD<m>:STOP? <SearchName>**Suffix:**

<m> *

Query parameters:

<SearchName>

Return values:

<FrameStop> Range: -100E+24 to 100E+24
 Increment: 100E-12
 *RST: 0
 Default unit: s

Usage: Query only

SEARCh:RESult:ARINc:WORD<m>:SDI? <SearchName>**Suffix:**

<m> *

Query parameters:

<SearchName>

Return values:

<SDI> Range: 0 to 3
 Increment: 1
 *RST: 0

Usage: Query only**SEARCH:RESult:ARINc:WORD<m>:STATe?** <SearchName>**Suffix:**

<m> *

Query parameters:

<SearchName>

Return values:

<FrameState> OK | CODE | GAP | PAR | INComplete | UNKNown
 *RST: OK

Usage: Query only**SEARCH:RESult:ARINc:WORD<m>:START?** <SearchName>**Suffix:**

<m> *

Query parameters:

<SearchName>

Return values:

<FrameStart> Range: -100E+24 to 100E+24
 Increment: 100E-12
 *RST: 0
 Default unit: s

Usage: Query only**27.18.15 Space wire (option R&S RTO6-K530)**

- [Configuration](#).....2161
- [Trigger](#).....2164
- [Decode results](#).....2167
- [Search settings](#).....2172
- [Search results](#).....2176

27.18.15.1 Configuration

BUS<m>:SWIRe:BPOsition.....	2161
BUS<m>:SWIRe:DATA:HYSTeresis.....	2161
BUS<m>:SWIRe:DATA:SOURce.....	2161
BUS<m>:SWIRe:DATA:THReshold.....	2162
BUS<m>:SWIRe:MGAP.....	2162
BUS<m>:SWIRe:STRBe:HYSTeresis.....	2162
BUS<m>:SWIRe:STRBe:SOURce.....	2163
BUS<m>:SWIRe:STRBe:THReshold.....	2163
BUS<m>:SWIRe:SYSLect.....	2163
BUS<m>:SWIRe:COUPling.....	2163
BUS<m>:SWIRe:PRESet.....	2164

BUS<m>:SWIRe:BPOsition <SyncBitPos>

Sets the bit position, the align position for the manual synchronisation mode. This can be useful when parity errors exist in the signal, and parity check is the main indicator for the decoder to do packet alignment.

Suffix:

<m> 1..4

Parameters:

<SyncBitPos> Range: 0 to 10
Increment: 1
*RST: 0

Manual operation: See "[Bit Position](#)" on page 745

BUS<m>:SWIRe:DATA:HYSTeresis <HysteresisData>

Sets a value for the hysteresis of the data signal.

Suffix:

<m> 1..4

Parameters:

<HysteresisData> Range: 0 to 0.8
Increment: 0.01
*RST: 0.2
Default unit: V

Manual operation: See "[Hysteresis](#)" on page 745

BUS<m>:SWIRe:DATA:SOURce <SourceData>

Selects the source of the data signal.

Suffix:

<m> 1..4

Parameters:

<SourceData> C1W1 | C2W1 | C3W1 | C4W1 | M1 | M2 | M3 | M4 | M5 | M6 |
M7 | M8 | R1 | R2 | R3 | R4 | D0 | D1 | D2 | D3 | D4 | D5 | D6 |
D7 | D8 | D9 | D10 | D11 | D12 | D13 | D14 | D15
*RST: C1W1

Manual operation: See "[Data](#)" on page 744

BUS<m>:SWIRe:DATA:THReshold <ThresholdData>

Sets the threshold value for the digitization of the data signal.

Suffix:

<m> 1..4

Parameters:

<ThresholdData> Range: -10 to 10
Increment: 0.1
*RST: 1.25
Default unit: V

Manual operation: See "[Threshold setup](#)" on page 744

BUS<m>:SWIRe:MGAP <MinGapTime>

Sets the minimum duration of a gap. Any inactivity greater than this time will be interpreted as a gap and lead to a resynchronization to the signal.

Suffix:

<m> 1..4

Parameters:

<MinGapTime> Range: 1E-9 to 10E-6
Increment: 100E-9
*RST: 200E-9
Default unit: s

Firmware/software: FW 3.30. Replaces BUS<m>:SWIRe:MINGap.

Manual operation: See "[Min Gap](#)" on page 745

BUS<m>:SWIRe:STRBe:HYSTeresis <HystStrobe>

Sets a value for the hysteresis of the strobe signal.

Suffix:

<m> 1..4

Parameters:

<HystStrobe> Range: 0 to 0.8
Increment: 0.01
*RST: 0.2
Default unit: V

Manual operation: See ["Hysteresis"](#) on page 745

BUS<m>:SWIRe:STRBe:SOURce <SourceStrobe>

Selects the source of the strobe signal.

Suffix:

<m> 1..4

Parameters:

<SourceStrobe> C1W1 | C2W1 | C3W1 | C4W1 | M1 | M2 | M3 | M4 | M5 | M6 |
M7 | M8 | R1 | R2 | R3 | R4 | D0 | D1 | D2 | D3 | D4 | D5 | D6 |
D7 | D8 | D9 | D10 | D11 | D12 | D13 | D14 | D15
*RST: C2W1

Manual operation: See ["Strobe"](#) on page 744

BUS<m>:SWIRe:STRBe:THReshold <ThresholdStrobe>

Sets the threshold value for the digitization of the strobe signal.

Suffix:

<m> 1..4

Parameters:

<ThresholdStrobe> Range: -10 to 10
Increment: 0.1
*RST: 1.25
Default unit: V

Manual operation: See ["Threshold setup"](#) on page 744

BUS<m>:SWIRe:SYSLect <SyncSelector>

Selects the mode for the synchronisation settings, i.e. i.e. packet align.

Suffix:

<m> 1..4

Parameters:

<SyncSelector> AUTO | MANual
*RST: AUTO

Manual operation: See ["Sync Settings"](#) on page 745

BUS<m>:SWIRe:COUPling <ThresCpl>

Enables coupling, i.e. the same threshold and hysteresis value is used for the strob and the data signal.

Suffix:

<m> 1..4

Parameters:

<ThresCpl> ON | OFF
 *RST: ON

Manual operation: See "[Threshold setup](#)" on page 744

BUS<m>:SWIRe:PRESet <ThresholdPreset>

Prests the threshold and hysteresis value of the strobe and data signal.

Suffix:

<m> 1..4

Parameters:

<ThresholdPreset> V25 | V165 | V125 | V09 | V12 | V0 | MANual
 V25: 2.5 V (CMOS 5.0 V)
 V165: 1.65 V (CMOS 3.5 V)
 V125: 1.25 V (CMOS 1.5 V)
 V09: 2.5 V (CMOS 1.8V)
 V12: 1.2 V (LVDS single ended)
 V0: 0 V (LVDS differential)
 MANual: user-defined value
 *RST: V12

Manual operation: See "[Threshold setup](#)" on page 744

27.18.15.2 Trigger

TRIGger<m>:SWIRe:CTYPe.....	2164
TRIGger<m>:SWIRe:DATA:CONDition.....	2165
TRIGger<m>:SWIRe:DATA:MAX.....	2165
TRIGger<m>:SWIRe:DATA:MIN.....	2165
TRIGger<m>:SWIRe:ERRor:ESC.....	2166
TRIGger<m>:SWIRe:ERRor:PARity.....	2166
TRIGger<m>:SWIRe:TIME:CONDition.....	2166
TRIGger<m>:SWIRe:TIME:MAX.....	2167
TRIGger<m>:SWIRe:TIME:MIN.....	2167
TRIGger<m>:SWIRe:TYPE.....	2167

TRIGger<m>:SWIRe:CTYPe <ControlType>

Triggers on a specific control type character.

Suffix:

<m> 1..3

Parameters:

<ControlType> ANY | FCT | EOP | EEP
FCT
 Flow Control Token

EOP

Normal End of Packet

EEP

Error End of Packet

*RST: ANY

Manual operation: See "[Trigger Control Type](#)" on page 748**TRIGger<m>:SWIRe:DATA:CONDition <DataOperator>**

Set the condition for the data value. You can define an exact value or a value range.

Suffix:

<m> 1..3

Parameters:

<DataOperator> EQUal | NEQual | LTHan | LETHan | GTHan | GETHan | INRange | OORange

EQUal | NEQual | LTHan | LETHan | GTHan | GETHanEqual, Not equal, Less than, Less or equal than, Greater Than, Greater or equal than. These conditions require one data pattern to be set with the corresponding [TRIGger<m>:SWIRe:DATA:MIN](#) command.**INRange | OORange**In range/Out of range: set the minimum and maximum value of the range with [TRIGger<m>:SWIRe:DATA:MIN](#) and [TRIGger<m>:SWIRe:DATA:MAX](#).

*RST: EQUal

Manual operation: See "[Data \(Data Pattern\)](#)" on page 748**TRIGger<m>:SWIRe:DATA:MAX <DataPatternMax>**Sets the the end value of a data for the data pattern range if [TRIGger<m>:SWIRe:DATA:CONDition](#) is set to [INRange](#) or [OORange](#).**Suffix:**

<m> 1..3

Parameters:

<DataPatternMax>

Manual operation: See "[Data \(Data Pattern\)](#)" on page 748**TRIGger<m>:SWIRe:DATA:MIN <DataPatternMin>**

Specifies a data for the data pattern, or sets the the start value of a pattern range.

Suffix:

<m> 1..3

Parameters:

<DataPatternMin>

Manual operation: See ["Data \(Data Pattern\)"](#) on page 748**TRIGger<m>:SWIRe:ERRor:ESC <ErrorESC>**

Enables searching for an escape error.

Suffix:

<m> 1..3

Parameters:

<ErrorESC> ON | OFF
 *RST: ON

Manual operation: See ["ESC Error"](#) on page 749**TRIGger<m>:SWIRe:ERRor:PARity <ErrorParity>**

Enables triggering on a parity error (even parity).

Suffix:

<m> 1..3

Parameters:

<ErrorParity> ON | OFF
 *RST: ON

Manual operation: See ["Parity Error"](#) on page 749**TRIGger<m>:SWIRe:TIME:CONDition <TimeOperator>**

Set the condition for the data value for the time code. You can define an exact value or a value range.

Suffix:

<m> 1..3

Parameters:

<TimeOperator> EQUal | NEQual | LTHan | LETHan | GTHan | GETHan |
 INRange | OORange

EQUal | NEQual | LTHan | LETHan | GTHan | GETHan

Equal, Not equal, Less than, Less or equal than, Greater Than, Greater or equal than. These conditions require one data pattern to be set with the corresponding [TRIGger<m>:SWIRe:TIME:MIN](#) command.

INRange | OORange

In range/Out of range: set the minimum and maximum value of the range with [TRIGger<m>:SWIRe:TIME:MIN](#) and [TRIGger<m>:SWIRe:TIME:MAX](#).

*RST: EQUal

Manual operation: See ["Data \(Time Code\)"](#) on page 748

TRIGger<m>:SWIRe:TIME:MAX <TimePatternMax>

Sets the the end value of a data value for the time code range if [TRIGger<m>:SWIRe:TIME:CONDition](#) is set to [INRange](#) or [OORange](#).

Suffix:

<m> 1..3

Parameters:

<TimePatternMax>

Manual operation: See ["Data \(Time Code\)"](#) on page 748

TRIGger<m>:SWIRe:TIME:MIN <TimePatternMin>

Specifies a pattern for the data value for the time code, or sets the the start value of a pattern range.

Suffix:

<m> 1..3

Parameters:

<TimePatternMin>

Manual operation: See ["Data \(Time Code\)"](#) on page 748

TRIGger<m>:SWIRe:TYPE <Type>

Sets the trigger type for the SpaceWire analysis.

Suffix:

<m> 1..3

Parameters:

<Type> CTRL | DATA | NULL | TIME | ERRor

*RST: CTRL

Manual operation: See ["Type"](#) on page 747

27.18.15.3 Decode results

BUS<m>:SWIRe:RESults:FCOunt	2168
BUS<m>:SWIRe:RESults:FRAME<n>:DATA?	2168
BUS<m>:SWIRe:RESults:FRAME<n>:START?	2168
BUS<m>:SWIRe:RESults:FRAME<n>:STATe?	2169
BUS<m>:SWIRe:RESults:FRAME<n>:STOP?	2169
BUS<m>:SWIRe:RESults:FRAME<n>:TYPE?	2169
BUS<m>:SWIRe:RESults:FRAME<n>:FLD<o>:FVAL?	2170
BUS<m>:SWIRe:RESults:FRAME<n>:FLD<o>:START?	2170

BUS<m>:SWIRe:RESults:FRAMe<n>:FLD<o>:STATus?	2171
BUS<m>:SWIRe:RESults:FRAMe<n>:FLD<o>:STOP?	2171
BUS<m>:SWIRe:RESults:FRAMe<n>:FLD<o>:TYPE?	2172
BUS<m>:SWIRe:RESults:FRAMe<n>:FLD<o>:VAL?	2172

BUS<m>:SWIRe:RESults:FCOunt <Key>

Returns the number of decoded frames for the selected serial bus.

Suffix:

<m> 1..4

Setting parameters:

<Key>

Return values:

<Count>

BUS<m>:SWIRe:RESults:FRAMe<n>:DATA?

Returns the data value.

Suffix:

<m> 1..4
Selects the serial bus.

<n> *
Selects the frame.

Return values:

<Data> 8-bit data value

Example:

```
BUS:SWIRe:RESults:FRAMe2:DATA?
<-- #H12
```

Usage: Query only

BUS<m>:SWIRe:RESults:FRAMe<n>:START?

Returns the start time of the specified frame.

Suffix:

<m> 1..4
Selects the serial bus.

<n> *
Selects the frame.

Return values:

<Start> Range: -100E+24 to 100E+24
Increment: 100E-12
*RST: 0
Default unit: s

Usage: Query only

BUS<m>:SWIRe:RESuLts:FRAMe<n>:STATe?

Returns the overall state of the frame.

Suffix:

<m>	1..4 Selects the serial bus.
<n>	* Selects the serial bus.

Return values:

<State>	OK PAR ESC AMB INComplete
---------	-----------------------------------

OK
The frame is valid.

PARity
Parity error

ESC
Escape error

AMB
Ambiguous

INComplete
The frame is incomplete

*RST: OK

Usage: Query only

BUS<m>:SWIRe:RESuLts:FRAMe<n>:STOP?

Returns the end time of the specified frame.

Suffix:

<m>	1..4 Selects the serial bus.
<n>	* Selects the frame.

Return values:

<Stop>	Range: -100E+24 to 100E+24 Increment: 100E-12 *RST: 0 Default unit: s
--------	--

Usage: Query only

BUS<m>:SWIRe:RESuLts:FRAMe<n>:TYPE?

Returns the type of frame.

Suffix:

<m> 1..4
Selects the serial bus.

<n> *
Selects the frame.

Return values:

<Type> DATA | FCT | EOP | EEP | ESC | NULL | TCO

DATA

Data frame

FCT

Flow control token

EOP

End of packet

EEP

Error end of packet

ESC

Escape

NULL

Null symbol

TCOD

Time code

*RST: DATA

Usage: Query only

BUS<m>:SWIRe:RESults:FRAMe<n>:FLD<o>:FVAL?

Returns the formatted value of the field with the selected field number within the frame with the selected frame number.

Suffix:

<m> 1..4

<n> *
Selects the frame number.

<o> *
Selects the field number.

Return values:

<FrameByteValue>

Usage: Query only

BUS<m>:SWIRe:RESults:FRAMe<n>:FLD<o>:START?

Returns the start time of the field with the selected field number within the frame with the selected frame number.

Suffix:

<m>	1..4
<n>	*
	Selects the frame number.
<o>	*
	Selects the field number.

Return values:

<Start>	Range: -100E+24 to 100E+24
	Increment: 100E-12
	*RST: 0
	Default unit: s

Usage: Query only

BUS<m>:SWIRe:RESults:FRAMe<n>:FLD<o>:STATus?

Returns the status of the field with the selected field number within the frame with the selected frame number.

Suffix:

<m>	1..4
<n>	*
	Selects the frame number.
<o>	*
	Selects the field number.

Return values:

<State>	OK PAR ESC AMB INComplete
	PAR: parity error
	ESC: escape
	AMB: ambiguous
	*RST: OK

Usage: Query only

BUS<m>:SWIRe:RESults:FRAMe<n>:FLD<o>:STOP?

Returns the stop time of the field with the selected field number within the frame with the selected frame number.

Suffix:

<m>	1..4
<n>	*
	Selects the frame number.
<o>	*
	Selects the field number.

Return values:

<Stop> Range: -100E+24 to 100E+24
 Increment: 100E-12
 *RST: 0
 Default unit: s

Usage: Query only

BUS<m>:SWIRe:RESults:FRAMe<n>:FLD<o>:TYPE?

Returns the type of the field with the selected field number within the frame with the selected frame number.

Suffix:

<m> 1..4
 <n> *
 Selects the frame number.
 <o> *
 Selects the field number.

Return values:

<FrameByteValue>

Usage: Query only

BUS<m>:SWIRe:RESults:FRAMe<n>:FLD<o>:VAL?

Returns the value of the field with the selected field number within the frame with the selected frame number.

Suffix:

<m> 1..4
 <n> *
 Selects the frame number.
 <o> *
 Selects the field number.

Return values:

<FrameByteValue> Range: 0 to 65535
 Increment: 1
 *RST: 0

Usage: Query only

27.18.15.4 Search settings

SEARch:TRIGger:SWIRe:CTYPe.....	2173
SEARch:TRIGger:SWIRe:DATA:CONDition.....	2173
SEARch:TRIGger:SWIRe:DATA:MAX.....	2174
SEARch:TRIGger:SWIRe:DATA:MIN.....	2174

SEARCh:TRIGger:SWIRe:ERRor:ESC.....	2174
SEARCh:TRIGger:SWIRe:ERRor:PARity.....	2174
SEARCh:TRIGger:SWIRe:TIME:CONDition.....	2175
SEARCh:TRIGger:SWIRe:TIME:MAX.....	2175
SEARCh:TRIGger:SWIRe:TIME:MIN.....	2176
SEARCh:TRIGger:SWIRe:TYPE.....	2176

SEARCh:TRIGger:SWIRe:CTYPe <SearchName>,<ControlType>

SEARCh:TRIGger:SWIRe:CTYPe? <SearchName>

Searches for a specific control type character.

Parameters:

<ControlType> ANY | FCT | EOP | EEP

FCT

Flow Control Token

EOP

Normal End of Packet

EEP

Error End of Packet

*RST: ANY

Parameters for setting and query:

<SearchName>

Manual operation: See "[Trigger Control Type](#)" on page 751

SEARCh:TRIGger:SWIRe:DATA:CONDition <SearchName>,<DataOperator>

SEARCh:TRIGger:SWIRe:DATA:CONDition? <SearchName>

Set the condition for the data pattern data value. You can define an exact value or a value range.

Parameters:

<DataOperator> EQUal | NEQual | LTHan | LETHan | GTHan | GETHan |
INRange | OORange

EQUal | NEQual | LTHan | LETHan | GTHan | GETHan

Equal, Not equal, Less than, Less or equal than, Greater Than, Greater or equal than. These conditions require one data pattern to be set with the corresponding [SEARCh:TRIGger:SWIRe:DATA:MIN](#) command.

INRange | OORange

In range/Out of range: set the minimum and maximum value of the range with [SEARCh:TRIGger:SWIRe:DATA:MIN](#) and [SEARCh:TRIGger:SWIRe:DATA:MAX](#).

*RST: EQUal

Parameters for setting and query:

<SearchName>

Manual operation: See ["Data \(Data Pattern\)"](#) on page 752

SEARCH:TRIGger:SWIRe:DATA:MAX <SearchName>,<DataPatternMax>
SEARCH:TRIGger:SWIRe:DATA:MAX? <SearchName>

Sets the the end value of a data type range if [SEARCH:TRIGger:SWIRe:DATA:CONDition](#) is set to `INRange` or `OORange`.

Parameters:

<DataPatternMax> Numeric or string pattern, see [Chapter 27.4.6, "Bit pattern parameter"](#), on page 1373. The string parameter accepts the bit value X (don't care).

Parameters for setting and query:

<SearchName>

Manual operation: See ["Data \(Data Pattern\)"](#) on page 752

SEARCH:TRIGger:SWIRe:DATA:MIN <SearchName>,<DataPatternMin>
SEARCH:TRIGger:SWIRe:DATA:MIN? <SearchName>

Specifies a data bit pattern, or sets the the start value of a pattern range.

Parameters:

<DataPatternMin>

Parameters for setting and query:

<SearchName>

Manual operation: See ["Data \(Data Pattern\)"](#) on page 752

SEARCH:TRIGger:SWIRe:ERRor:ESC <SearchName>,<ErrorESC>
SEARCH:TRIGger:SWIRe:ERRor:ESC? <SearchName>

Enables triggering on an escape error.

Parameters:

<ErrorESC> ON | OFF
 *RST: ON

Parameters for setting and query:

<SearchName>

Manual operation: See ["ESC Error"](#) on page 753

SEARCH:TRIGger:SWIRe:ERRor:PARity <SearchName>,<ErrorParity>
SEARCH:TRIGger:SWIRe:ERRor:PARity? <SearchName>

Enables searching for a parity error (even parity).

Parameters:

<ErrorParity> ON | OFF
 *RST: ON

Parameters for setting and query:

<SearchName>

Manual operation: See "[Parity Error](#)" on page 752

SEARCH:TRIGger:SWIRe:TIME:CONDition <SearchName>,<TimeOperator>

SEARCH:TRIGger:SWIRe:TIME:CONDition? <SearchName>

Set the condition for the data value of the time code. You can define an exact value or a value range.

Parameters:

<TimeOperator> EQUal | NEQual | LTHan | LETHan | GTHan | GETHan |
 INRange | OORange

EQUal | NEQual | LTHan | LETHan | GTHan | GETHan

Equal, Not equal, Less than, Less or equal than, Greater Than, Greater or equal than. These conditions require one data pattern to be set with the corresponding [SEARCH:TRIGger:SWIRe:TIME:MIN](#) command.

INRange | OORange

In range/Out of range: set the minimum and maximum value of the range with [SEARCH:TRIGger:SWIRe:TIME:MIN](#) and [SEARCH:TRIGger:SWIRe:TIME:MAX](#).

*RST: EQUal

Parameters for setting and query:

<SearchName>

Manual operation: See "[Data \(Time Code\)](#)" on page 752

SEARCH:TRIGger:SWIRe:TIME:MAX <SearchName>,<TimePatternMax>

SEARCH:TRIGger:SWIRe:TIME:MAX? <SearchName>

Sets the the end value of a data type range for the time code if [SEARCH:TRIGger:SWIRe:TIME:CONDition](#) is set to INRange or OORange.

Parameters:

<TimePatternMax>

Parameters for setting and query:

<SearchName>

Manual operation: See "[Data \(Time Code\)](#)" on page 752

SEARCh:TRIGger:SWIRe:TIME:MIN <SearchName>,<TimePatternMin>
SEARCh:TRIGger:SWIRe:TIME:MIN? <SearchName>

Specifies a data bit pattern for the time code, or sets the the start value of a pattern range.

Parameters:
 <TimePatternMin>

Parameters for setting and query:
 <SearchName>

Manual operation: See "Data (Time Code)" on page 752

SEARCh:TRIGger:SWIRe:TYPE <SearchName>,<Type>
SEARCh:TRIGger:SWIRe:TYPE? <SearchName>

Sets the search type for the SpaceWire analysis.

Parameters:
 <Type> CTRL | DATA | NULL | TIME | ERRor
 *RST: CTRL

Parameters for setting and query:
 <SearchName>

Manual operation: See "Type" on page 751

27.18.15.5 Search results

In all **SEARCh:RESult:DPHY:FRAMe<m>** commands, the suffix <m> selects the frame number in the list of search results.

SEARCh:RESult:SWIRe:FCOut?	2176
SEARCh:RESult:SWIRe:FRAMe<m>:DATA?	2177
SEARCh:RESult:SWIRe:FRAMe<m>:STARt?	2177
SEARCh:RESult:SWIRe:FRAMe<m>:STATe?	2177
SEARCh:RESult:SWIRe:FRAMe<m>:STOP?	2178
SEARCh:RESult:SWIRe:FRAMe<m>:TYPE?	2178

SEARCh:RESult:SWIRe:FCOut? <SearchName>

Returns the number of frames within the search result for the selected serial bus.

Query parameters:
 <SearchName>

Return values:
 <FrameCount> Range: 0 to 100000
 Increment: 1
 *RST: 0

Usage: Query only

SEARCh:RESult:SWIRe:FRAMe<m>:DATA? <SearchName>

Returns the data value for the selected frame within the search result.

Suffix:

<m> *

Query parameters:

<SearchName>

Return values:

<Data>

Usage: Query only

SEARCh:RESult:SWIRe:FRAMe<m>:START? <SearchName>

Returns the start time of the specified frame within the search result.

Suffix:

<m> *

Query parameters:

<SearchName>

Return values:

<Start> Range: -100E+24 to 100E+24
Increment: 100E-12
*RST: 0
Default unit: s

Usage: Query only

SEARCh:RESult:SWIRe:FRAMe<m>:STATe? <SearchName>

Returns the overall state of the selected frame within the search result.

Suffix:

<m> *

Query parameters:

<SearchName>

Return values:

<State> OK | PAR | ESC | AMB | INComplete

OK

The frame is valid

PARity

Parity error

ESC

Escape Error

AMB

Ambiguous

INComplete

The frame is incomplete

*RST: OK

Usage: Query only**SEARCh:RESult:SWIRe:FRAMe<m>:STOP? <SearchName>**

Returns the end time for the selected frame within the search result.

Suffix:

<m> *

Query parameters:

<SearchName>

Return values:

<Stop> Range: -100E+24 to 100E+24
 Increment: 100E-12
 *RST: 0
 Default unit: s

Usage: Query only**SEARCh:RESult:SWIRe:FRAMe<m>:TYPE? <SearchName>**

Returns the type of frame for the selected frame within the search result.

Suffix:

<m> *

Query parameters:

<SearchName>

Return values:

<Type> DATA | FCT | EOP | EEP | ESC | NULL | TCOD

DATA

Data frame

FCT

Flow control token

EOP

End of packet

EEP

Error end of packet

ESC

Escape

NULL

Null symbol

TCOD

Time code

*RST: DATA

Usage: Query only

27.18.16 Ethernet 10BASE-T and 100BASE-TX (option R&S RTO6-K540)

- [Configuration](#).....2179
- [Trigger](#).....2182
- [Decode results](#).....2187
- [Search settings](#).....2193
- [Search results](#).....2198

27.18.16.1 Configuration

In all `BUS<m>:ETHernet` commands, the suffix `<m>` selects the serial bus.

BUS<m>:ETHernet:VARiant	2179
BUS<m>:ETHernet:SOURce	2179
BUS<m>:ETHernet:POLarity	2180
BUS<m>:ETHernet:THReshold:HIGH	2180
BUS<m>:ETHernet:THReshold:LOW	2180
BUS<m>:ETHernet:PRESet	2181
BUS<m>:ETHernet:BITRate	2181

BUS<m>:ETHernet:VARiant <Variant>

Selects the Ethernet protocol variant and transmission speed.

Suffix:

`<m>` 1..4

Parameters:

`<Variant>` B10T | B100TX | B100tx

B10T

Ethernet protocol variant 10BASE-T (10 Mbit/s)

B100TX = B100tx

Ethernet protocol variant 100BASE-TX (100 Mbit/s)

*RST: B10T

Manual operation: See "[Ethernet Variant](#)" on page 756

BUS<m>:ETHernet:SOURce <SourceData>

Selects the source channel for the data signal.

Usually, the source is one of the analog channels. Reference and math waveforms are available as source if the trigger source is one of the analog channels but not the serial bus.

Alternatively, digital channels can be used if MSO option R&S RTO6-B1 is installed. Digital and analog channels cannot be used at the same time.

For triggering on a serial bus, analog or digital channel sources are required.

Suffix:

<m> 1..4

Parameters:

<SourceData> C1W1 | C2W1 | C3W1 | C4W1 | M1 | M2 | M3 | M4 | M5 | M6 | M7 | M8 | R1 | R2 | R3 | R4

See [Chapter 27.4.2, "Waveform parameter"](#), on page 1371

*RST: C1W1

Manual operation: See ["Source"](#) on page 756**BUS<m>:ETHernet:POLarity <Polarity>**

Defines the polarity of the data signal. This setting is only available in 10BASE-T.

Suffix:

<m> 1..4

Parameters:

<Polarity> NORMal | INVert

NORMal

Normal (non-inverted) data signal polarity

INVert

Inverted data signal polarity

*RST: NORMal

Manual operation: See ["Polarity"](#) on page 756**BUS<m>:ETHernet:THReshold:HIGH <ThresholdUpper>**

Sets the upper threshold value for the signal digitization. If the signal value is higher than the this threshold, the signal state is considered high.

Suffix:

<m> 1..4

Parameters:

<ThresholdUpper> Range: 0 to 10

Increment: 0.01

*RST: 0.5

Default unit: V

Manual operation: See ["Thresholds"](#) on page 756**BUS<m>:ETHernet:THReshold:LOW <ThresholdLower>**

Sets the lower threshold value for the signal digitization. If the signal value is below this threshold, the signal state is considered low.

Suffix:

<m> 1..4

Parameters:

<ThresholdLower> Range: -10 to 0
 Increment: 0.01
 *RST: -0.5
 Default unit: V

Manual operation: See "[Thresholds](#)" on page 756

BUS<m>:ETHernet:PRESet <ThresholdPreset>

Sets the thresholds to predefined or individually definable voltage levels.

Suffix:

<m> 1..4

Parameters:

<ThresholdPreset> T0 | T100 | TX0 | TX100 | MANual

T0

Sets the thresholds to the default values for 10BASE-T (0 meters): upper threshold to 1.25 V, lower threshold to -1.25 V

T100

Sets the thresholds to the default values for 10BASE-T (100 meters): upper threshold to 0.75 V, lower threshold to -0.75 V

TX0

Sets the thresholds to the default values for 100BASE-TX (0 meters): upper threshold to 0.5 V, lower threshold to -0.5 V

TX100

Sets the thresholds to the default values for 100BASE-TX (100 meters): upper threshold to 0.35 V, lower threshold to -0.35 V

MANual

Allows to set individual threshold voltage levels

*RST: T0

Manual operation: See "[Thresholds](#)" on page 756

BUS<m>:ETHernet:BITRate <BitRateValue>

Sets the bit rate value that defines the transmission speed in bits per second.

Suffix:

<m> 1..4

Parameters:

<BitRateValue> Range: 10000 to 150000000
 Increment: 1000
 *RST: 10000000
 Default unit: bps

Manual operation: See "[Bit rate](#)" on page 757

27.18.16.2 Trigger

The trigger suffix <m> is always 1 and can be omitted. It selects the trigger event: Only the A-trigger is available for triggering on serial buses.

To trigger on a serial bus, make sure that:

- `TRIGger<m>:SOURce[:SElect]` is set to `SBUS`.
- The sources of the serial bus are channel signals: use `BUS<m>: . . . :SOURce` commands.
- Decoding is enabled: `BUS<m>[:STATe]` is set to `ON`.

<code>TRIGger<m>:ETHernet:TYPE</code>	2182
<code>TRIGger<m>:ETHernet:PATtern</code>	2183
<code>TRIGger<m>:ETHernet:ERRor:CRC</code>	2183
<code>TRIGger<m>:ETHernet:ERRor:LENGth</code>	2183
<code>TRIGger<m>:ETHernet:ERRor:PREamble</code>	2183
<code>TRIGger<m>:ETHernet:FRAMe:CCONdition</code>	2184
<code>TRIGger<m>:ETHernet:FRAMe:CMAx</code>	2184
<code>TRIGger<m>:ETHernet:FRAMe:CMIN</code>	2184
<code>TRIGger<m>:ETHernet:FRAMe:DConDition</code>	2185
<code>TRIGger<m>:ETHernet:FRAMe:DMAx</code>	2185
<code>TRIGger<m>:ETHernet:FRAMe:DMIN</code>	2185
<code>TRIGger<m>:ETHernet:FRAMe:SCONdition</code>	2185
<code>TRIGger<m>:ETHernet:FRAMe:SMAX</code>	2186
<code>TRIGger<m>:ETHernet:FRAMe:SMIN</code>	2186
<code>TRIGger<m>:ETHernet:FRAMe:TConDition</code>	2186
<code>TRIGger<m>:ETHernet:FRAMe:TMAx</code>	2187
<code>TRIGger<m>:ETHernet:FRAMe:TMIN</code>	2187

`TRIGger<m>:ETHernet:TYPE` <Type>

Selects the type of frame to be triggered on.

Suffix:

<m> 1..3

Parameters:

<Type> START | PATtern | ADVFrame | ADVCerror

START

Selects to trigger for the start of frame: search for the preamble and set the trigger instant thereafter.

PATtern

Selects to trigger for a bit pattern (data) to be specified in `TRIGger<m>:ETHernet:PATtern` on page 2183.

ADVFrame

Sets the trigger to the advanced frame. You can further define the values of the frame.

ADVCerror

Sets the trigger to advanced error. You can further enable the error conditions you want to trigger on.

*RST: START

Manual operation: See ["Type"](#) on page 760

TRIGger<m>:ETHernet:PAThern <DataPattern>

Specifies the bit pattern (or data) that is to be triggered.

Suffix:

<m> 1..3

Parameters:

<DataPattern>

Manual operation: See ["Data Pattern"](#) on page 762

TRIGger<m>:ETHernet:ERRor:CRc <ErrorCRC>

Enables the trigger on a mismatch of the cyclic redundancy check (CRC) value between the transmitting and receiving device.

Suffix:

<m> 1..3

Parameters:

<ErrorCRC> ON | OFF

*RST: ON

Manual operation: See ["Error"](#) on page 763

TRIGger<m>:ETHernet:ERRor:LENGth <ErrorLength>

Enables the trigger on an incorrect length of the sequence - when additional or missing bits are detected and the sequence of bits is not as expected.

Suffix:

<m> 1..3

Parameters:

<ErrorLength> ON | OFF

*RST: ON

Manual operation: See ["Error"](#) on page 763

TRIGger<m>:ETHernet:ERRor:PREamble <ErrorPreamble>

Enables the trigger on a frame with invalid preamble.

Suffix:

<m> 1..3

Parameters:

<ErrorPreamble> ON | OFF
 *RST: ON

Manual operation: See "Error" on page 763

TRIGger<m>:ETHernet:FRAMe:CCONDition <CRCCOperator>

Sets the operator to trigger on a specific frame check sequence value.

Suffix:

<m> 1..3

Parameters:

<CRCCOperator> EQUal | NEQual | LTHan | LETHan | GTHan | GETHan |
 INRange | OORange

EQUal | NEQual | LTHan | LETHan | GTHan | GETHan

Equal, Not equal, Less than, Less than or equal, Greater Than, Greater than or equal. These conditions require a destination address to be set with [TRIGger<m>:ETHernet:FRAMe:CMIN](#).

INRange | OORange

In range, Out of range. Set the minimum and maximum value of the range with [TRIGger<m>:ETHernet:FRAMe:CMIN](#) and [TRIGger<m>:ETHernet:FRAMe:CMAX](#).

*RST: EQUal

Manual operation: See "Frame check" on page 763

TRIGger<m>:ETHernet:FRAMe:CMAX <CRCPatternMax>

Sets the end value of the frame check sequence range, if [TRIGger<m>:ETHernet:FRAMe:CCONDition](#) is set to `INRange` or `OORange`.

Suffix:

<m> 1..3

Parameters:

<CRCPatternMax>

Manual operation: See "Frame check" on page 763

TRIGger<m>:ETHernet:FRAMe:CMIN <CRCPatternMin>

Specifies a CRC pattern, or sets the start value of a pattern range.

Suffix:

<m> 1..3

Parameters:

<CRCPatternMin>

Manual operation: See "Frame check" on page 763

TRIGger<m>:ETHernet:FRAMe:DCONdition <DestAddrOptor>

Sets the destination address operator to trigger on a specific pattern or a range.

Suffix:

<m> 1..3

Parameters:

<DestAddrOptor> EQUal | NEQUal | LTHan | LETHan | GTHan | GETHan | INRange | OORange

EQUal | NEQUal | LTHan | LETHan | GTHan | GETHan

Equal, Not equal, Less than, Less than or equal, Greater Than, Greater than or equal. These conditions require a destination address to be set with [TRIGger<m>:ETHernet:FRAMe:DMIN](#).

INRange | OORange

In range, Out of range. Set the minimum and maximum value of the range with [TRIGger<m>:ETHernet:FRAMe:DMIN](#) and [TRIGger<m>:ETHernet:FRAMe:DMAX](#).

*RST: EQUal

Manual operation: See "[Destination Address](#)" on page 762

TRIGger<m>:ETHernet:FRAMe:DMAX <DestAddrPattMax>

Sets the end value of a destination address range, if [TRIGger<m>:ETHernet:FRAMe:DMAX](#) is set to [INRange](#) or [OORange](#).

Suffix:

<m> 1..3

Parameters:

<DestAddrPattMax>

Manual operation: See "[Destination Address](#)" on page 762

TRIGger<m>:ETHernet:FRAMe:DMIN <DestAddrPattMin>

Specifies a destination address pattern, or sets the start value of a pattern range.

Suffix:

<m> 1..3

Parameters:

<DestAddrPattMin>

Manual operation: See "[Destination Address](#)" on page 762

TRIGger<m>:ETHernet:FRAMe:SCONdition <SrcAddrOperator>

Sets source address operator to trigger on a specific pattern or a range.

Suffix:

<m> 1..3

Parameters:

<SrcAddrOperator> EQUal | NEQual | LTHan | LETHan | GTHan | GETHan | INRange | OORange

EQUal | NEQual | LTHan | LETHan | GTHan | GETHanEqual, Not equal, Less than, Less than or equal, Greater Than, Greater than or equal. These conditions require a destination address to be set with [TRIGger<m>:ETHernet:FRAMe:SMIN](#).**INRange | OORange**In range, Out of range. Set the minimum and maximum value of the range with [TRIGger<m>:ETHernet:FRAMe:SMIN](#) and [TRIGger<m>:ETHernet:FRAMe:SMAX](#).

*RST: EQUal

Manual operation: See "[Source Address](#)" on page 762**TRIGger<m>:ETHernet:FRAMe:SMAX <SrcAddrPattMax>**Sets the end value of a range, if the data condition is set to `INRange` or `OORange`.**Suffix:**

<m> 1..3

Parameters:

<SrcAddrPattMax>

Manual operation: See "[Source Address](#)" on page 762**TRIGger<m>:ETHernet:FRAMe:SMIN <SrcAddrPattMin>**

Specifies a source address pattern, or sets the start value of a pattern range.

Suffix:

<m> 1..3

Parameters:

<SrcAddrPattMin>

Manual operation: See "[Source Address](#)" on page 762**TRIGger<m>:ETHernet:FRAMe:TCONdition <TypeOperator>**

Sets the type operator to trigger on a specific length/type value pattern or a range.

Suffix:

<m> 1..3

Parameters:

<TypeOperator> EQUal | NEQual | LTHan | LETHan | GTHan | GETHan | INRange | OORange

EQUal | NEQUal | LTHan | LETHan | GTHan | GETHan

Equal, Not equal, Less than, Less than or equal, Greater Than, Greater than or equal. These conditions require a destination address to be set with `TRIGger<m>:ETHernet:FRAMe:TMIN`.

INRange | OORange

In range, Out of range. Set the minimum and maximum value of the range with `TRIGger<m>:ETHernet:FRAMe:TMIN` and `TRIGger<m>:ETHernet:FRAMe:TMAX`.

*RST: EQUal

Manual operation: See "[Length/ Type](#)" on page 763

TRIGger<m>:ETHernet:FRAMe:TMAX <TypePatternMax>

Sets the end value of a length/type range, if `TRIGger<m>:ETHernet:FRAMe:TCONdition` is set to `INRange` or `OORange`.

Suffix:

<m> 1..3

Parameters:

<TypePatternMax>

Manual operation: See "[Length/ Type](#)" on page 763

TRIGger<m>:ETHernet:FRAMe:TMIN <TypePatternMin>

Specifies a length/type value, or sets the start value of a pattern range.

Suffix:

<m> 1..3

Parameters:

<TypePatternMin>

Manual operation: See "[Length/ Type](#)" on page 763

27.18.16.3 Decode results

In all `BUS<m>:ETHernet:WORD<n>` commands, the suffix <m> selects the serial bus and the suffix <n> selects the word number in the decode table.

As an example, a set of query commands for bus #1 and word #1 is shown in the following, together with examples for results of these queries:

- `BUS1:ETH:WCOunt? !2`
- `BUS1:ETH:WORD1:STATe? !OK`
- `BUS1:ETH:WORD1:STARt? !-0.000135`
- `BUS1:ETH:WORD1:STOP? !-6.62e-5`
- `BUS1:ETH:WORD1:DEST? !FF:FF:FF:FF:FF:FF`
- `BUS1:ETH:WORD1:SRC? !0F:0E:0D:0C:0B:0A`

- BUS1:ETH:WORD1:DATA? ![60]45003c3e6210...
- BUS1:ETH:WORD1:TYPE? !2048
- BUS1:ETH:WORD1:CRC? !-1821935433
- BUS1:ETH:WORD1:SSYM? !
- BUS1:ETH:WORD1:DSYM? !BroadCast
- BUS1:ETH:WORD1:BYTE1:VAL? !69
- BUS1:ETH:WORD1:BYTE2:VAL? !0

BUS<m>:ETHernet:WCOunt?.....	2188
BUS<m>:ETHernet:WORD<n>:FTYPE?.....	2188
BUS<m>:ETHernet:WORD<n>:STATE?.....	2189
BUS<m>:ETHernet:WORD<n>:START?.....	2189
BUS<m>:ETHernet:WORD<n>:STOP?.....	2189
BUS<m>:ETHernet:WORD<n>:DESTAddress?.....	2190
BUS<m>:ETHernet:WORD<n>:SRCAddress?.....	2190
BUS<m>:ETHernet:WORD<n>:TYPE?.....	2190
BUS<m>:ETHernet:WORD<n>:DATA?.....	2191
BUS<m>:ETHernet:WORD<n>:CRC?.....	2191
BUS<m>:ETHernet:WORD<n>:DSYMBOL?.....	2191
BUS<m>:ETHernet:WORD<n>:SSYMBOL?.....	2192
BUS<m>:ETHernet:WORD<n>:BITRate?.....	2192
BUS<m>:ETHernet:WORD<n>:BYTE<o>:VALue?.....	2192
BUS<m>:ETHernet:WORD<n>:NUMWords?.....	2193

BUS<m>:ETHernet:WCOunt?

Returns the frame count for the selected serial bus, i.e. the number of frames in the current acquisition. The result corresponds to the number of rows in the result table.

Suffix:

<m> 1..4

Return values:

<FrameCount> Range: 0 to 100000
Increment: 1
*RST: 0

Usage: Query only

BUS<m>:ETHernet:WORD<n>:FTYPE?

Returns the frame type of the selected word in the current acquisition.

Suffix:

<m> 1..4

<n> *

Return values:

<FrameType> MAC | IDLE | SLEEp | EOS | UNKNown
*RST: MAC

Usage: Query only

BUS<m>:ETHernet:WORD<n>:STATE?

Returns the frame state of the selected word in the current acquisition.

Suffix:

<m> 1..4

<n> *

Return values:

<State> OK | ERR_PREAMBLE | ERR_LENGTH | UNCorrelated | INComplete

OK

No error detected

ERR_PREAMBLE

Error in the preamble of the selected word

ERR_SFD

Error in the start frame delimiter (SFD). The value of a correct SFD byte is 171. The SFD is transmitted LSB first.

ERR_LENGTH

Error in the number of bits in the selected word

*RST: OK

Usage: Query only

BUS<m>:ETHernet:WORD<n>:START?

Returns the frame start time of the selected word in the current acquisition.

Suffix:

<m> 1..4

<n> *

Return values:

<Start> Range: -100E+24 to 100E+24
Increment: 100E-12
Default unit: s

Usage: Query only

BUS<m>:ETHernet:WORD<n>:STOP?

Returns the frame stop time of the selected word in the current acquisition.

Suffix:

<m> 1..4

<n> *

Return values:

<Stop> Range: -100E+24 to 100E+24
 Increment: 100E-12
 Default unit: s

Usage: Query only

BUS<m>:ETHernet:WORD<n>:DESTaddress?

Returns the destination address of the specified word.

Suffix:

<m> 1..4

<n> *

Return values:

<DestAddress> String parameter

Usage: Query only

BUS<m>:ETHernet:WORD<n>:SRCaddress?

Returns the source address of the specified word.

Suffix:

<m> 1..4

<n> *

Return values:

<SrcAddress> String parameter

Usage: Query only

BUS<m>:ETHernet:WORD<n>:TYPE?

The sub-protocol (e.g. HTML, video, etc.) determines what meaning this field has. Since the content of this data area is not decoded, the interpretation of the TYPE field is ambivalent.

Suffix:

<m> 1..4

<n> *

Return values:

<Type> Returns the word type (specific for the sub-protocol), or the length of the selected word.

Range: 0 to 65535

Increment: 1

*RST: 0

Usage: Query only

BUS<m>:ETHernet:WORD<n>:DATA?

Returns the number of word bytes in brackets [.] followed by the first six word bytes of data in hexadecimal format.

Use `BUS<m>:ETHernet:WORD<n>:BYTE<o>:VALue?` to access the word bytes.

Suffix:

<m> 1..4

<n> *

Return values:

<Data> String parameter

Example:

```
BUS:ETHernet:WORD3:DATA?
<-- '[60]FF00FFFF1234'
```

Usage: Query only

BUS<m>:ETHernet:WORD<n>:CRC?

Returns the Cyclic Redundancy Code (CRC, or frame check) checksum of the selected word.

Suffix:

<m> 1..4

<n> *

Return values:

<CRC> Range: 0 to 4294967295
Increment: 1
*RST: 0

Usage: Query only

BUS<m>:ETHernet:WORD<n>:DSYMBOL?

Returns the symbolic label (or translation) of the destination address of the specified word, if the label list is enabled.

Suffix:

<m> 1..4

<n> *

Return values:

<DestTranslation> String parameter

Usage: Query only

BUS<m>:ETHernet:WORD<n>:SSYMBOL?

Returns the symbolic label (or translation) of the source address of the specified word, if the label list is enabled.

Suffix:

<m> 1..4

<n> *

Return values:

<SrcTranslation> String parameter

Usage: Query only

BUS<m>:ETHernet:WORD<n>:BITRate?

Returns the primary bit rate.

Suffix:

<m> 1..4

<n> *

Return values:

<PrimaryBitRate> Range: 0 to 100000000000
 Increment: 1
 *RST: 0
 Default unit: bps

Usage: Query only

BUS<m>:ETHernet:WORD<n>:BYTE<o>:VALue?

BYTE returns all data of up to 1982 bytes (not just the first 5 or 6 bytes). This is also visible in the data table under "Show details".

Suffix:

<m> 1..4

<n> *

<o> *

Selects the byte number.

Return values:

<FrameByteValue> Range: 0 to 255
 Increment: 1
 *RST: 0

Usage: Query only

BUS<m>:ETHernet:WORD<n>:NUMWords?

Returns the number of words in the selected frame. The result corresponds to the "Number of Words" column in the results table.

Suffix:

<m>	1..4
<n>	*
	Frame index

Return values:

<NumWords>	Range:	0 to 4294967295
	Increment:	1
	*RST:	0

Usage: Query only

27.18.16.4 Search settings

SEARch:TRIGger:ETHernet:TYPE.....	2193
SEARch:TRIGger:ETHernet:FRAME:DCONdition.....	2194
SEARch:TRIGger:ETHernet:FRAME:DMIN.....	2194
SEARch:TRIGger:ETHernet:FRAME:DMAX.....	2194
SEARch:TRIGger:ETHernet:FRAME:SCONdition.....	2195
SEARch:TRIGger:ETHernet:FRAME:SMIN.....	2195
SEARch:TRIGger:ETHernet:FRAME:SMAX.....	2195
SEARch:TRIGger:ETHernet:FRAME:TCONdition.....	2196
SEARch:TRIGger:ETHernet:FRAME:TMIN.....	2196
SEARch:TRIGger:ETHernet:FRAME:TMAX.....	2197
SEARch:TRIGger:ETHernet:FRAME:CCONdition.....	2197
SEARch:TRIGger:ETHernet:FRAME:CMIN.....	2197
SEARch:TRIGger:ETHernet:FRAME:CMAX.....	2198
SEARch:TRIGger:ETHernet:ERRor:PREAmble.....	2198
SEARch:TRIGger:ETHernet:ERRor:LENGth.....	2198

SEARch:TRIGger:ETHernet:TYPE <SearchName>,<Type>

SEARch:TRIGger:ETHernet:TYPE? <SearchName>

Selects, if it searched on a MAC frame or on an error.

Parameters:

<Type>	FRAMe ERRor
*RST:	FRAMe

Parameters for setting and query:

<SearchName>

Manual operation: See "Type" on page 766

SEARCh:TRIGger:ETHernet:FRAMe:DCONdition <SearchName>,<DestAddrOptor>
SEARCh:TRIGger:ETHernet:FRAMe:DCONdition? <SearchName>

Defines the operator to search a specific destination address within a frame.

Parameters:

<DestAddrOptor> EQUal | NEQual | LTHan | LETHan | GTHan | GETHan |
 INRange | OORange

EQUal | NEQual | LTHan | LETHan | GTHan | GETHan

Equal, Not equal, Less than, Less than or equal, Greater Than, Greater than or equal. These conditions require a destination address to be set with [SEARCh:TRIGger:ETHernet:FRAMe:DMIN](#).

INRange | OORange

In range, Out of range. Set the minimum and maximum value of the range with [SEARCh:TRIGger:ETHernet:FRAMe:DMIN](#) and [SEARCh:TRIGger:ETHernet:FRAMe:DMAX](#).

*RST: EQUal

Parameters for setting and query:

<SearchName> String parameter

Manual operation: See "[Destination address](#)" on page 767

SEARCh:TRIGger:ETHernet:FRAMe:DMIN <SearchName>,<DestAddrPatt>
SEARCh:TRIGger:ETHernet:FRAMe:DMIN? <SearchName>

Defines a destination address, or sets the start value of a destination address range.

Parameters:

<DestAddrPatt> Numeric or string pattern, see [Chapter 27.4.6, "Bit pattern parameter"](#), on page 1373. The string parameter accepts the bit value X (don't care).

Parameters for setting and query:

<SearchName> String parameter

Manual operation: See "[Destination address](#)" on page 767

SEARCh:TRIGger:ETHernet:FRAMe:DMAX <SearchName>,<DestAddrPatt>
SEARCh:TRIGger:ETHernet:FRAMe:DMAX? <SearchName>

Sets the end value of a destination address range, if [SEARCh:TRIGger:ETHernet:FRAMe:DCONdition](#) is set to INRange or OORange.

Parameters:

<DestAddrPatt> Numeric or string pattern, see [Chapter 27.4.6, "Bit pattern parameter"](#), on page 1373. The string parameter accepts the bit value X (don't care).

Parameters for setting and query:

<SearchName> String parameter

Manual operation: See "[Destination address](#)" on page 767

SEARCH:TRIGger:ETHernet:FRAMe:SCONdition

<SearchName>, <SrcAddrOperator>

SEARCH:TRIGger:ETHernet:FRAMe:SCONdition? <SearchName>

Defines the operator to search a specific source address within a frame.

Parameters:

<SrcAddrOperator> EQUal | NEQual | LTHan | LETHan | GTHan | GETHan | INRange | OORange

EQUal | NEQual | LTHan | LETHan | GTHan | GETHan

Equal, Not equal, Less than, Less than or equal, Greater Than, Greater than or equal. These conditions require a destination address to be set with [SEARCH:TRIGger:ETHernet:FRAMe:SMIN](#).

INRange | OORange

In range, Out of range. Set the minimum and maximum value of the range with [SEARCH:TRIGger:ETHernet:FRAMe:SMIN](#) and [SEARCH:TRIGger:ETHernet:FRAMe:SMAX](#).

*RST: EQUal

Parameters for setting and query:

<SearchName> String parameter

Manual operation: See "[Source address](#)" on page 767

SEARCH:TRIGger:ETHernet:FRAMe:SMIN <SearchName>, <SrcAddrPatt>

SEARCH:TRIGger:ETHernet:FRAMe:SMIN? <SearchName>

Defines a source address, or sets the start value of a source address range.

Parameters:

<SrcAddrPatt> Numeric or string pattern, see [Chapter 27.4.6, "Bit pattern parameter"](#), on page 1373. The string parameter accepts the bit value X (don't care).

Parameters for setting and query:

<SearchName> String parameter

Manual operation: See "[Source address](#)" on page 767

SEARCH:TRIGger:ETHernet:FRAMe:SMAX <SearchName>, <SrcAddrPatt>

SEARCH:TRIGger:ETHernet:FRAMe:SMAX? <SearchName>

Sets the end value of a source address range, if [SEARCH:TRIGger:ETHernet:FRAMe:SCONdition](#) is set to INRange or OORange.

Parameters:

<SrcAddrPatt> Numeric or string pattern, see [Chapter 27.4.6, "Bit pattern parameter"](#), on page 1373. The string parameter accepts the bit value X (don't care).

Parameters for setting and query:

<SearchName> String parameter

Manual operation: See ["Source address"](#) on page 767

SEARch:TRIGger:ETHernet:FRAMe:TCONdition <SearchName>,<TypeOperator>
SEARch:TRIGger:ETHernet:FRAMe:TCONdition? <SearchName>

Defines the operator to search for a specific frame length or type.

Parameters:

<TypeOperator> EQUal | NEQual | LTHan | LETHan | GTHan | GETHan | INRange | OORange

EQUal | NEQual | LTHan | LETHan | GTHan | GETHan
 Equal, Not equal, Less than, Less than or equal, Greater Than, Greater than or equal. These conditions require a pattern to be set with [SEARch:TRIGger:ETHernet:FRAMe:TMIN](#).

INRange | OORange

In range, Out of range. Set the minimum and maximum value of the range with [SEARch:TRIGger:ETHernet:FRAMe:TMIN](#) and [SEARch:TRIGger:ETHernet:FRAMe:TMAX](#).

*RST: EQUal

Parameters for setting and query:

<SearchName> String parameter

Manual operation: See ["Length/Type"](#) on page 767

SEARch:TRIGger:ETHernet:FRAMe:TMIN <SearchName>,<TypePatternMin>
SEARch:TRIGger:ETHernet:FRAMe:TMIN? <SearchName>

Defines a frame length/type, or sets the start value for a range of frame lengths/types.

Parameters:

<TypePatternMin> Numeric or string pattern, see [Chapter 27.4.6, "Bit pattern parameter"](#), on page 1373. The string parameter accepts the bit value X (don't care).

Parameters for setting and query:

<SearchName> String parameter

Manual operation: See ["Length/Type"](#) on page 767

SEARCh:TRIGger:ETHernet:FRAMe:TMAX <SearchName>,<TypePatternMax>
SEARCh:TRIGger:ETHernet:FRAMe:TMAX? <SearchName>

Sets the end value of a range of frame lengths/types, if [SEARCh:TRIGger:ETHernet:FRAMe:TCONDition](#) is set to [INRange](#) or [OORange](#).

Parameters:

<TypePatternMax> Numeric or string pattern, see [Chapter 27.4.6, "Bit pattern parameter"](#), on page 1373. The string parameter accepts the bit value X (don't care).

Parameters for setting and query:

<SearchName> String parameter

Manual operation: See "[Length/Type](#)" on page 767

SEARCh:TRIGger:ETHernet:FRAMe:CCONDition <SearchName>,<CRCCOperator>
SEARCh:TRIGger:ETHernet:FRAMe:CCONDition? <SearchName>

Defines the operator to search for a Cyclic Redundancy Code (CRC, or frame check) error condition within a frame.

Parameters:

<CRCCOperator> [EQUAL](#) | [NEQUAL](#) | [LTHan](#) | [LETHan](#) | [GTHan](#) | [GETHan](#) | [INRange](#) | [OORange](#)

[EQUAL](#) | [NEQUAL](#) | [LTHan](#) | [LETHan](#) | [GTHan](#) | [GETHan](#)

Equal, Not equal, Less than, Less than or equal, Greater Than, Greater than or equal. These conditions require a CRC pattern to be set with [SEARCh:TRIGger:ETHernet:FRAMe:CMIN](#).

[INRange](#) | [OORange](#)

In range, Out of range. Set the minimum and maximum value of the range with [SEARCh:TRIGger:ETHernet:FRAMe:CMIN](#) and [SEARCh:TRIGger:ETHernet:FRAMe:CMAX](#).

*RST: [EQUAL](#)

Parameters for setting and query:

<SearchName> String parameter

Manual operation: See "[Frame check](#)" on page 767

SEARCh:TRIGger:ETHernet:FRAMe:CMIN <SearchName>,<CRCPatternMin>
SEARCh:TRIGger:ETHernet:FRAMe:CMIN? <SearchName>

Defines a CRC error condition pattern, or sets the start value of such a pattern.

Parameters:

<CRCPatternMin> Numeric or string pattern, see [Chapter 27.4.6, "Bit pattern parameter"](#), on page 1373. The string parameter accepts the bit value X (don't care).

Parameters for setting and query:

<SearchName> String parameter

Manual operation: See ["Frame check"](#) on page 767

SEARCH:TRIGger:ETHernet:FRAMe:CMAx <SearchName>,<CRCPatternMax>
SEARCH:TRIGger:ETHernet:FRAMe:CMAx? <SearchName>

Sets the end value of a CRC error condition pattern, if [SEARCH:TRIGger:ETHernet:FRAMe:CCONdition](#) is set to INRange or OORange.

Parameters:

<CRCPatternMax> Numeric or string pattern, see [Chapter 27.4.6, "Bit pattern parameter"](#), on page 1373. The string parameter accepts the bit value X (don't care).

Parameters for setting and query:

<SearchName> String parameter

Manual operation: See ["Frame check"](#) on page 767

SEARCH:TRIGger:ETHernet:ERRor:PREAmble <SearchName>,<ErrorPreamble>
SEARCH:TRIGger:ETHernet:ERRor:PREAmble? <SearchName>

Defines, whether a search for any preamble error shall be activated or not.

Parameters:

<ErrorPreamble> ON | OFF
 *RST: ON

Parameters for setting and query:

<SearchName> String parameter

Manual operation: See ["Preamble Error"](#) on page 768

SEARCH:TRIGger:ETHernet:ERRor:LENGth <SearchName>,<ErrorLength>
SEARCH:TRIGger:ETHernet:ERRor:LENGth? <SearchName>

Defines, whether a search for any word length error (too few or too many bits per word) shall be activated or not.

Parameters:

<ErrorLength> ON | OFF
 *RST: ON

Parameters for setting and query:

<SearchName> String parameter

Manual operation: See ["Length Error"](#) on page 768

27.18.16.5 Search results

To show the results on the screen, use the following commands:

- [BUS<m>:RESult](#) on page 1814

In all `SEARCH:RESult:ETHernet:WORD<m>` commands, the suffix `<m>` selects the word number in the list of search results.

<code>SEARCH:RESult:ETHernet:WCOunt?</code>	2199
<code>SEARCH:RESult:ETHernet:WORD<m>:STATe?</code>	2199
<code>SEARCH:RESult:ETHernet:WORD<m>:START?</code>	2200
<code>SEARCH:RESult:ETHernet:WORD<m>:STOP?</code>	2200
<code>SEARCH:RESult:ETHernet:WORD<m>:DESTAddress?</code>	2200
<code>SEARCH:RESult:ETHernet:WORD<m>:SRCAddress?</code>	2201
<code>SEARCH:RESult:ETHernet:WORD<m>:TYPE?</code>	2201
<code>SEARCH:RESult:ETHernet:WORD<m>:FTYPE?</code>	2201
<code>SEARCH:RESult:ETHernet:WORD<m>:DATA?</code>	2201
<code>SEARCH:RESult:ETHernet:WORD<m>:CRC?</code>	2202
<code>SEARCH:RESult:ETHernet:WORD<m>:DSYMBOL?</code>	2202
<code>SEARCH:RESult:ETHernet:WORD<m>:SSYMBOL?</code>	2202
<code>SEARCH:RESult:ETHernet:WORD<m>:BYTE<n>:VALue?</code>	2203

SEARCH:RESult:ETHernet:WCOunt? <SearchName>

Returns the number of decoded words within the search result.

Query parameters:

`<SearchName>` String parameter

Return values:

`<FrameCount>` Range: 0 to 100000
 Increment: 1
 *RST: 0

Usage: Query only

SEARCH:RESult:ETHernet:WORD<m>:STATe? <SearchName>

Returns the frame state of the selected word within the search result.

Suffix:

`<m>` *

Query parameters:

`<SearchName>` String parameter

Return values:

`<State>` OK | ERR_PREAMBLE | ERR_LENGTH

OK

No error detected

ERR_PREAMBLE

Error in the preamble of the selected word

ERR_SFD

Error in the start frame delimiter (SFD). The value of a correct SFD byte is 171. The SFD is transmitted LSB first.

ERR_LENGTH

Error in the number of bits in the selected word

*RST: OK

Usage: Query only

SEARCh:RESult:ETHernet:WORD<m>:START? <SearchName>

Returns the frame start time of the selected word within the search result.

Suffix:
<m> *

Query parameters:
<SearchName> String parameter

Return values:
<Start> Range: -100E+24 to 100E+24
Increment: 100E-12
*RST: 0
Default unit: s

Usage: Query only

SEARCh:RESult:ETHernet:WORD<m>:STOP? <SearchName>

Returns the frame stop time of the selected word within the search result.

Suffix:
<m> *

Query parameters:
<SearchName> String parameter

Return values:
<Stop> Range: -100E+24 to 100E+24
Increment: 100E-12
*RST: 0
Default unit: s

Usage: Query only

SEARCh:RESult:ETHernet:WORD<m>:DESTaddress? <SearchName>

Returns the destination address of the specified word within the search result.

Suffix:
<m> *

Query parameters:
<SearchName> String parameter

Return values:
<DestAddress> String parameter

Usage: Query only

SEARCh:RESult:ETHernet:WORD<m>:SRCaddress? <SearchName>

Returns the source address of the specified word within the search result.

Suffix:

<m> *

Query parameters:

<SearchName> String parameter

Return values:

<SourceAddress> String parameter

Usage: Query only

SEARCh:RESult:ETHernet:WORD<m>:TYPE? <SearchName>

The sub-protocol (e.g. HTML, video, etc.) determines what meaning this field has. Since the content of this data area is not decoded, the interpretation of the TYPE field is ambivalent. The query either returns the word type (specific for the sub-protocol), or the length of the selected word within the search result.

Suffix:

<m> *

Query parameters:

<SearchName> String parameter

Return values:

<Type> Range: 0 to 65535
Increment: 1
*RST: 0

Usage: Query only

SEARCh:RESult:ETHernet:WORD<m>:FTYPe? <SearchName>

Returns the frame type of the specified frame.

Suffix:

<m> *

Query parameters:

<SearchName>

Return values:

<FrameType> MAC | IDLE | SLEep | EOS | UNKNown
*RST: MAC

Usage: Query only

SEARCh:RESult:ETHernet:WORD<m>:DATA? <SearchName>

Returns the data bytes of the specified word within the search result.

Suffix:
<m> *

Query parameters:
<SearchName> String parameter

Return values:
<Data> String parameter

Usage: Query only

SEARCh:RESult:ETHernet:WORD<m>:CRC? <SearchName>

Returns the Cyclic Redundancy Code (CRC, or frame check) checksum of the selected word within the search result.

Suffix:
<m> *

Query parameters:
<SearchName> String parameter

Return values:
<CRC> Range: 0 to 4294967295
Increment: 1
*RST: 0

Usage: Query only

SEARCh:RESult:ETHernet:WORD<m>:DSYMBOL? <SearchName>

Returns the symbolic label (or translation) of the destination address of the specified word within the search result, if the label list is enabled.

Suffix:
<m> *

Query parameters:
<SearchName> String parameter

Return values:
<DestTranslation> String parameter

Usage: Query only

SEARCh:RESult:ETHernet:WORD<m>:SSYMBOL? <SearchName>

Returns the symbolic label (or translation) of the source address of the specified word within the search result, if the label list is enabled.

Suffix:
<m> *

Query parameters:
<SearchName> String parameter

Return values:

<SrcTranslation> String parameter

Usage: Query only**SEARch:RESult:ETHernet:WORD<m>:BYTE<n>:VALue? <SearchName>**

BYTE returns all data of up to 1982 bytes (not just the first 5 or 6 bytes). This is also visible in the data table under "Show details".

Suffix:

<m> *

<n> *

Selects the byte number.

Query parameters:

<SearchName> String parameter

Return values:

<FrameByteValue> Range: 0 to 255

Increment: 1

*RST: 0

Usage: Query only**27.18.17 MDIO (option R&S RTO6-K540)**

- [Configuration](#).....2203
- [Trigger](#).....2206
- [Decode results](#).....2208
- [Search settings](#).....2212
- [Search results](#).....2215

27.18.17.1 Configuration

In all `BUS<m>:MDIO` commands, the suffix `<m>` selects the serial bus.

[BUS<m>:MDIO:CLOCK:SOURce](#).....2203[BUS<m>:MDIO:DATA:SOURce](#).....2204[BUS<m>:MDIO:CLOCK:THReshold:HIGH](#).....2204[BUS<m>:MDIO:CLOCK:THReshold:LOW](#).....2205[BUS<m>:MDIO:DATA:THReshold:HIGH](#).....2205[BUS<m>:MDIO:DATA:THReshold:LOW](#).....2205[BUS<m>:MDIO:PRESet](#).....2205[BUS<m>:MDIO:COUPLing](#).....2206**BUS<m>:MDIO:CLOCK:SOURce <SourceClock>**

Selects the source for the clock line (management data clock, MDC). Permitted selections are the analog channels "C1"-"C4" and the digital channels "D0"-"D15".

Suffix:

<m> 1..4

Parameters:

<SourceClock> C1W1 | C2W1 | C3W1 | C4W1 | M1 | M2 | M3 | M4 | M5 | M6 | M7 | M8 | R1 | R2 | R3 | R4 | D0 | D1 | D2 | D3 | D4 | D5 | D6 | D7 | D8 | D9 | D10 | D11 | D12 | D13 | D14 | D15

Digital and analog channels cannot be used at the same time for data and clock lines. For triggering on a serial bus, analog or digital input channels are required.

See [Chapter 27.4.2, "Waveform parameter"](#), on page 1371

*RST: C2W1

Manual operation: See ["Source"](#) on page 772

BUS<m>:MDIO:DATA:SOURce <SourceData>

Selects the source for the data signal. Permitted selections are the analog channels "C1"–"C4" and the digital channels "D0"–"D15", but not the same as for "Clock".

Suffix:

<m> 1..4

Parameters:

<SourceData> C1W1 | C2W1 | C3W1 | C4W1 | M1 | M2 | M3 | M4 | M5 | M6 | M7 | M8 | R1 | R2 | R3 | R4 | D0 | D1 | D2 | D3 | D4 | D5 | D6 | D7 | D8 | D9 | D10 | D11 | D12 | D13 | D14 | D15

Digital and analog channels cannot be used at the same time for data and clock lines. For triggering on a serial bus, analog or digital input channels are required.

See [Chapter 27.4.2, "Waveform parameter"](#), on page 1371

*RST: C1W1

Manual operation: See ["Source"](#) on page 772

BUS<m>:MDIO:CLOCK:THReshold:HIGH <ThresClkHigh>

Defines the upper threshold level for the clock signal.

Suffix:

<m> 1..4

Parameters:

<ThresClkHigh> Range: -5 to 5
 Increment: 0.1
 *RST: 2
 Default unit: V

Manual operation: See ["Thresholds"](#) on page 772

BUS<m>:MDIO:CLOCK:THReshold:LOW <ThresClkLow>

Defines the lower threshold level for the clock signal.

Suffix:

<m> 1..4

Parameters:

<ThresClkLow> Range: -5 to 5
Increment: 0.1
*RST: 0.8
Default unit: V

Manual operation: See "[Thresholds](#)" on page 772

BUS<m>:MDIO:DATA:THReshold:HIGH <ThresDatHigh>

Defines the upper threshold level for the data signal.

Suffix:

<m> 1..4

Parameters:

<ThresDatHigh> Range: -5 to 5
Increment: 0.1
*RST: 2
Default unit: V

Manual operation: See "[Thresholds](#)" on page 772

BUS<m>:MDIO:DATA:THReshold:LOW <ThresDatLow>

Defines the lower threshold level for the data signal.

Suffix:

<m> 1..4

Parameters:

<ThresDatLow> Range: -5 to 5
Increment: 0.1
*RST: 0.8
Default unit: V

Manual operation: See "[Thresholds](#)" on page 772

BUS<m>:MDIO:PRESet <Preset>

Selects the default threshold settings according to the Ethernet standard: 2.0 V and 0.8 V.

Suffix:

<m> 1..4

Parameters:

<Preset> DEFault | MANual
 *RST: DEFault

Manual operation: See "[Thresholds](#)" on page 772

BUS<m>:MDIO:COUPling <ThresCpl>

Overwrites the data thresholds with the clock thresholds.

Suffix:

<m> 1..4

Parameters:

<ThresCpl> ON | OFF
 *RST: ON

Manual operation: See "[Thresholds](#)" on page 772

27.18.17.2 Trigger

The trigger suffix <m> is always 1 and can be omitted. It selects the trigger event: Only the A-trigger is available for triggering on serial buses.

To trigger on a serial bus, make sure that:

- `TRIGger<m>:SOURce[:SElect]` is set to SBUS.
- The sources of the serial bus are channel signals: use `BUS<m>:...:SOURce` commands.
- Decoding is enabled: `BUS<m>[:STATe]` is set to ON.

<code>TRIGger<m>:MDIO:TYPE</code>	2206
<code>TRIGger<m>:MDIO:ST</code>	2207
<code>TRIGger<m>:MDIO:FRAMetype</code>	2207
<code>TRIGger<m>:MDIO:PHYS</code>	2208
<code>TRIGger<m>:MDIO:REGl</code>	2208
<code>TRIGger<m>:MDIO:DATA</code>	2208

TRIGger<m>:MDIO:TYPE <Type>

Selects the trigger type for MDIO analysis.

Parameters:

<Type> START | STOP | DATA

START

Sets the trigger to the start of frame (SOF) field. The start of frame condition and the trigger instant is the end of the preamble. Trigger pattern: preamble (32 bits "1")

STOP

Sets the trigger to the end of frame (EOF) field. The trigger instant is after the last data bit. Trigger pattern: preamble (32 bits "1") + 32 bits "X"

DATA

Sets the trigger to the data field. For more information on the data condition, see MDIO in the Ethernet standard. The trigger instant is at the end of the frame after the last data bit, as indicated in the GUI. Trigger pattern: preamble (32 bits "1") + 2 bits "ST" (Start of Frame Code) + 2 bits "OP" (Frame Type Code, or "OpCode") + 5 bits "PHYAD/PRTAD" (Physical Layer Entity Address / Port Address) + 5 bits "REGAD/DEVAD" (Register Address / Device Address) + 2 bits "TA" (turnaround time, X bits) + 16 bits "DATA/ADDRESS"

*RST: START

Manual operation: See "[MDIO Trigger Type](#)" on page 776

TRIGger<m>:MDIO:ST <StartCode>

Selects the start of frame code of the frame pattern; available only in trigger type "Data".

Note that Clause 22 is coded by "01", while Clause 45 is coded by "00", thus the lower Clause number is represented by the higher parameter value.

Parameters:

<StartCode> ST00 | ST01 | ST0X

ST00

Clause 45

ST01

Clause 22

ST0X

Any permissible start pattern

*RST: ST0X

Manual operation: See "[ST](#)" on page 777

TRIGger<m>:MDIO:FRAMetype <FrameType>

Selects the Type of Frame code (or OP code, OpCode, operation code); available only in trigger type "Data".

Note that the same OpCode may have different meanings in Clause 22 and Clause 45.

Parameters:

<FrameType> OP00 | OP01 | OP10 | OP11 | OPXX

OP00

Address frame (in Clause 45, only)

OP01

Write frame (in Clause 22 or Clause 45)

OP10

Read frame (in Clause 22) or Post-Read increment address frame (in Clause 45)

OP11

Read frame (in Clause 45)

OPXX

Any frame type

*RST: OPXX

Note that the user interface shows interpretations of the numerical OpCode values corresponding to Clause 45. Clause 22 is not represented by this interpretation.

Manual operation: See "OP" on page 777

TRIGger<m>:MDIO:PHYS <PhyAddr>

Sets the physical address (in Clause 22) or port address (in Clause 45) of the frame pattern (5 bits); available only in trigger type "Data".

Parameters:

<PhyAddr>

Manual operation: See "PHYAD/PRTAD" on page 777

TRIGger<m>:MDIO:REGI <RegAddr>

Sets the register address (in Clause 22) or device address (in Clause 45) of the frame pattern (5 bits); available only in trigger type "Data".

Parameters:

<RegAddr>

Manual operation: See "REGAD/DEVAD" on page 778

TRIGger<m>:MDIO:DATA <Data>

Defines the 16-bit payload data pattern (both in Clause 22 or Clause 45) or the address pattern (in Clause 45, only) to trigger for; available only in trigger type "Data".

Parameters:

<Data>

Manual operation: See "DATA/ADDRESS" on page 778

27.18.17.3 Decode results

In all `BUS<m>:MDIO:WORD<n>` commands, the suffix `<m>` selects the serial bus and the suffix `<n>` selects the word number in the decode table.

BUS<m>:MDIO:WCOunt?.....	2209
BUS<m>:MDIO:WORD<n>:DATA?.....	2209
BUS<m>:MDIO:WORD<n>:PHYS?.....	2209
BUS<m>:MDIO:WORD<n>:REGI?.....	2210
BUS<m>:MDIO:WORD<n>:ST?.....	2210
BUS<m>:MDIO:WORD<n>:START?.....	2210
BUS<m>:MDIO:WORD<n>:STATe?.....	2211
BUS<m>:MDIO:WORD<n>:STOP?.....	2211
BUS<m>:MDIO:WORD<n>:SYMBol?.....	2212
BUS<m>:MDIO:WORD<n>:TYPE?.....	2212

BUS<m>:MDIO:WCOunt?

Returns the word count for the selected serial bus, i.e. the number of words in the present acquisition.

Suffix:

<m> 1..4

Return values:

<FrameCount> Range: 0 to 100000
Increment: 1
*RST: 0

Usage: Query only

BUS<m>:MDIO:WORD<n>:DATA?

Returns the 16-bit payload data field content (in Clause 22 or Clause 45), or the 16-bit address field content (in Clause 45, only) in the present acquisition of the selected word and the selected serial bus. The most significant bit (MSB) is transmitted first.

Suffix:

<m> 1..4

<n> *

Return values:

<Data>

Usage: Query only

BUS<m>:MDIO:WORD<n>:PHYS?

Returns the 5-bit address field content (PHYAD/PRTAD) in the present acquisition of the selected word and the selected serial bus.

Suffix:

<m> 1..4

<n> *

Return values:

<PhyAd> Range: 0 to 32
 Increment: 1
 *RST: 0

Usage: Query only

BUS<m>:MDIO:WORD<n>:REGI?

Returns the 5-bit register or device address field content (REGAD/DEVAD) in the present acquisition of the selected word and the selected serial bus.

Suffix:

<m> 1..4
 <n> *

Return values:

<RegAd> Range: 0 to 32
 Increment: 1
 *RST: 0

Usage: Query only

BUS<m>:MDIO:WORD<n>:ST?

Returns the Start Code (= start of frame code) in the present acquisition of the selected word and the selected serial bus.

Suffix:

<m> 1..4
 <n> *

Return values:

<StartCode> Range: 0 to 3
 Increment: 1
 *RST: 0

The parameter value "0" represents Clause 45, and "1" stands for Clause 22.

The values "2" and "3" do not correspond with any legal parameters according to the standard, but they can be searched for.

Usage: Query only

BUS<m>:MDIO:WORD<n>:START?

Returns the start time of the frame in the selected word of the selected serial bus.

Suffix:

<m> 1..4
 <n> *

Return values:

<Start> Range: -100E+24 to 100E+24
 Increment: 100E-12
 *RST: 0
 Default unit: s

Usage: Query only

BUS<m>:MDIO:WORD<n>:STATe?

Returns the state of the frame in the present acquisition of the selected serial bus.

Suffix:

<m> 1..4
 <n> *

Return values:

<State> OK | UNSYN | UNSYncronized | OPCO | TA_ERROR |
 INComplete | SHORT | SHORTt

OK

No error detected

UNSYN = UNSYncronized

UNSYncronized happens when bits are found, but they are not correlated with any synchronization sequence. We don't know what these bits are, but they are there. These bits receive a flag, but they are not decoded.

OPCO

OPcode Error

TA_ERROR

Tirnaround time error

INComplete

Incomplete Frame

SHORT = SHORTt

Length Error

*RST: OK

Usage: Query only

BUS<m>:MDIO:WORD<n>:STOP?

Returns the stop time of the frame from the selected word within the search result.

Suffix:

<m> 1..4
 <n> *

Return values:

<Stop> Range: -100E+24 to 100E+24
 Increment: 100E-12
 *RST: 0
 Default unit: s

Usage: Query only

BUS<m>:MDIO:WORD<n>:SYMBOL?

Returns a textual translation (called Register Name) of the PHY or port address label in the present acquisition of the selected word and the selected serial bus.

The translation is defined in the label list.

Suffix:

<m> 1..4
 <n> *

Return values:

<Translation>

Usage: Query only

BUS<m>:MDIO:WORD<n>:TYPE?

Returns the OpCode (= operation code or frame type) in the present acquisition of the selected word and the selected serial bus.

Suffix:

<m> 1..4
 <n> *

Return values:

<FrameType> Range: 0 to 3
 Increment: 1
 *RST: 0
 The parameter value "0" represents Clause 45, and "1" stands for Clause 22.
 The values "2" and "3" do not correspond with any legal parameters according to the standard, but they can be searched for.

Usage: Query only

27.18.17.4 Search settings

SEARCh:TRIGger:MDIO:DATA.....	2213
SEARCh:TRIGger:MDIO:FRAMetype.....	2213
SEARCh:TRIGger:MDIO:PHYS.....	2214

SEARCh:TRIGger:MDIO:REGI.....	2214
SEARCh:TRIGger:MDIO:ST.....	2214
SEARCh:TRIGger:MDIO:TYPE.....	2215

SEARCh:TRIGger:MDIO:DATA <SearchName>,<Data>
SEARCh:TRIGger:MDIO:DATA? <SearchName>

Allows to define the 16-bit payload data pattern (both in Clause 22 or Clause 45) or the address pattern (in Clause 45, only) to search for; available only in search criteria type "Data".

Parameters:

<Data>

Parameters for setting and query:

<SearchName>

Manual operation: See "DATA/ADDRESS" on page 781

SEARCh:TRIGger:MDIO:FRAMetype <SearchName>,<FrameType>
SEARCh:TRIGger:MDIO:FRAMetype? <SearchName>

Allows to select the Type of Frame code (or OP code, OpCode, operation code); available only in search criteria type "Data".

Note that the same OpCode may have different meanings in Clause 22 and Clause 45.

Parameters:

<FrameType> OP00 | OP01 | OP10 | OP11 | OPXX

OP00

Address frame (in Clause 45, only)

OP01

Write frame (in Clause 22 or Clause 45)

OP10

Read frame (in Clause 22) or Post-Read increment address frame (in Clause 45)

OP11

Read frame (in Clause 45)

OPXX

Any frame type

*RST: OPXX

Note that the user interface shows interpretations of the numerical OpCode values corresponding to Clause 45. Clause 22 is not represented by this interpretation.

Also, note that OPXX will never be a result of decoding, but it is still an option for triggering.

Parameters for setting and query:

<SearchName>

Manual operation: See "OP" on page 781

SEARCh:TRIGger:MDIO:PHYS <SearchName>,<PhyAddr>
SEARCh:TRIGger:MDIO:PHYS? <SearchName>

Allows to set the physical address (in Clause 22) or port address (in Clause 45) of the frame pattern (5 bits); available only in search criteria type "Data".

Parameters:
 <PhyAddr>

Parameters for setting and query:
 <SearchName>

Manual operation: See "[PHYAD/PRTAD](#)" on page 781

SEARCh:TRIGger:MDIO:REGI <SearchName>,<RegAddr>
SEARCh:TRIGger:MDIO:REGI? <SearchName>

Allows to set the register address (in Clause 22) or device address (in Clause 45) of the frame pattern (5 bits); available only in search criteria type "Data".

Parameters:
 <RegAddr>

Parameters for setting and query:
 <SearchName>

Manual operation: See "[REGAD/DEVAD](#)" on page 781

SEARCh:TRIGger:MDIO:ST <SearchName>,<StartCode>
SEARCh:TRIGger:MDIO:ST? <SearchName>

Allows to select the start of frame code of the frame pattern; available only in search criteria type "Data".

Parameters:
 <StartCode> ST00 | ST01 | ST0X
 ST00
 Clause 45
 ST01
 Clause 22
 ST0X
 Any permissible start pattern
 *RST: ST0X

Parameters for setting and query:
 <SearchName>

Manual operation: See "[ST](#)" on page 781

SEARCh:TRIGger:MDIO:TYPE <SearchName>,<Type>
SEARCh:TRIGger:MDIO:TYPE? <SearchName>

Selects the event type to search for.

Parameters:

<Type> START | STOP | DATA

START

Searches for the start of frame (SOF).

START

Searches for the end of frame (EOF).

DATA

Allows to specify a payload data pattern (both in Clause 22 or Clause 45) or an address pattern (in Clause 45, only) to search for.

*RST: START

Parameters for setting and query:

<SearchName>

Manual operation: See "[Search types](#)" on page 780

27.18.17.5 Search results

In all **SEARCh:RESult:MDIO:WORD<m>** commands, the suffix <m> selects the packet number in the list of search results.

SEARCh:RESult:MDIO:WORD<m>:DATA?	2215
SEARCh:RESult:MDIO:WORD<m>:PHYS?	2216
SEARCh:RESult:MDIO:WORD<m>:REGI?	2216
SEARCh:RESult:MDIO:WORD<m>:ST?	2216
SEARCh:RESult:MDIO:WORD<m>:START?	2217
SEARCh:RESult:MDIO:WORD<m>:STATE?	2217
SEARCh:RESult:MDIO:WORD<m>:STOP?	2218
SEARCh:RESult:MDIO:WORD<m>:SYMBol?	2218
SEARCh:RESult:MDIO:WORD<m>:TYPE?	2218
SEARCh:RESult:MDIO:WCOut?	2219

SEARCh:RESult:MDIO:WORD<m>:DATA? <SearchName>

Returns the 16-bit payload data field content (in Clause 22 or Clause 45), or the 16-bit address field content (in Clause 45, only) from the selected word within the search result.

Suffix:

<m> *

Query parameters:

<SearchName>

Return values:

<Data>

Usage: Query only

SEARCh:RESUlt:MDIO:WORD<m>:PHYS? <SearchName>

Returns the 5-bit address field content (PHYAD/PRTAD) from the selected word within the search result.

Suffix:
<m> *

Query parameters:
<SearchName>

Return values:
<PhyAd> Range: 0 to 32
 Increment: 1
 *RST: 0

Usage: Query only

SEARCh:RESUlt:MDIO:WORD<m>:REGI? <SearchName>

Returns the 5-bit register or device address field content (REGAD/DEVAD) from the selected word within the search result.

Suffix:
<m> *

Query parameters:
<SearchName>

Return values:
<RegAd> Range: 0 to 32
 Increment: 1
 *RST: 0

Usage: Query only

SEARCh:RESUlt:MDIO:WORD<m>:ST? <SearchName>

Returns the start of frame code from the selected word within the search result.

Suffix:
<m> *

Query parameters:
<SearchName>

Return values:
<StartCode> Range: 0 to 3
 Increment: 1
 *RST: 0

Usage: Query only

SEARCh:RESult:MDIO:WORD<m>:STARt? <SearchName>

Returns the start time of the frame from the selected word within the search result.

Suffix:

<m> *

Query parameters:

<SearchName>

Return values:

<Start> Range: -100E+24 to 100E+24
 Increment: 100E-12
 *RST: 0
 Default unit: s

Usage: Query only

SEARCh:RESult:MDIO:WORD<m>:STATe? <SearchName>

Returns the state of the frame from the selected word within the search result.

Suffix:

<m> *

Query parameters:

<SearchName>

Return values:

<State> OK | UNSYN | UNSYncronized | OPCO | TA_ERROR |
 INComplete | SHORT | SHORTt

OK

No error detected

UNSYN = UNSYncronized

UNSYncronized happens when bits are found, but they are not correlated with any synchronization sequence. We don't know what these bits are, but they are there. These bits receive a flag, but they are not decoded.

OPCO

OPcode error

TA_ERROR

turnaround time error

INComplete

Incomplete Frame

SHORT = SHORTt

Length Error

*RST: OK

Usage: Query only

SEARCh:RESult:MDIO:WORD<m>:STOP? <SearchName>

Returns the stop time of the frame from the selected word within the search result.

Suffix:

<m> *

Query parameters:

<SearchName>

Return values:

<Stop> Range: -100E+24 to 100E+24
 Increment: 100E-12
 *RST: 0
 Default unit: s

Usage: Query only

SEARCh:RESult:MDIO:WORD<m>:SYMBol? <SearchName>

Returns a textual translation (called Register Name) of the PHY or port address label from the selected word within the search result.

Suffix:

<m> *

Query parameters:

<SearchName>

Return values:

<Translation>

Usage: Query only

SEARCh:RESult:MDIO:WORD<m>:TYPE? <SearchName>

Returns the frame type (= operation code or OpCode) for the selected word within the search result.

Suffix:

<m> *

Query parameters:

<SearchName>

Return values:

<FrameType> Range: 0 to 3
 Increment: 1
 *RST: 0

Note that the user interface shows interpretations of the numerical OpCode values corresponding to Clause 45: "0" (= [bin]00) represents Address, "1" (= [bin]01) represents Write, "2" (= [bin]10) represents Post Read, "3" (= [bin]11) represents Read. Clause 22 is not represented by this interpretation.

Usage: Query only

SEARCh:RESult:MDIO:WCOunt? <SearchName>

Returns the word count within the search result.

Query parameters:

<SearchName>

Return values:

<FrameCount> Range: 0 to 100000
 Increment: 1
 *RST: 0

Usage: Query only

27.18.18 RFFE (option R&S RTO6-K550)

For programming examples, see [Chapter 27.3.7.1, "RFFE \(option R&S RTO6-K550\)"](#), on page 1360.

27.18.18.1 Configuration

In all BUS<m>:RFFE commands, the suffix <m> selects the serial bus.

For programming examples, see ["Configuring RFFE bus"](#) on page 1360.

BUS<m>:RFFE:CLOCK:SOURce.....	2219
BUS<m>:RFFE:DATA:SOURce.....	2220
BUS<m>:RFFE:PRESet.....	2220
BUS<m>:RFFE:COUPling.....	2220
BUS<m>:RFFE:DATA:THReshold:HIGH.....	2220
BUS<m>:RFFE:DATA:THReshold:LOW.....	2221
BUS<m>:RFFE:CLOCK:THReshold:HIGH.....	2221
BUS<m>:RFFE:CLOCK:THReshold:LOW.....	2221
BUS<m>:RFFE:GFILter.....	2222
BUS<m>:RFFE:GFWidth.....	2222
BUS<m>:RFFE:MINGap:SElect.....	2222
BUS<m>:RFFE:MINGap:TIME.....	2223
BUS<m>:RFFE:RDMD.....	2223
BUS<m>:RFFE:VERSiOn.....	2223

BUS<m>:RFFE:CLOCK:SOURce <SourceClock>

Sets the source of the RFFE clock line.

For triggering on a serial bus, analog or digital input channels are required.

Suffix:

<m> 1..4

Parameters:

<SourceClock> C1W1 | C2W1 | C3W1 | C4W1 | M1 | M2 | M3 | M4 | M5 | M6 |
M7 | M8 | R1 | R2 | R3 | R4 | D0 | D1 | D2 | D3 | D4 | D5 | D6 |
D7 | D8 | D9 | D10 | D11 | D12 | D13 | D14 | D15
*RST: C2W1

Manual operation: See "[SCLK Source](#)" on page 786

BUS<m>:RFFE:DATA:SOURce <SourceData>

Sets the source of the RFFE data line. For triggering on a serial bus, analog or digital input channels are required.

Suffix:

<m> 1..4

Parameters:

<SourceData> C1W1 | C2W1 | C3W1 | C4W1 | M1 | M2 | M3 | M4 | M5 | M6 |
M7 | M8 | R1 | R2 | R3 | R4 | D0 | D1 | D2 | D3 | D4 | D5 | D6 |
D7 | D8 | D9 | D10 | D11 | D12 | D13 | D14 | D15
*RST: C1W1

Manual operation: See "[SDATA Source](#)" on page 786

BUS<m>:RFFE:PRESet <ThresholdPreset>

Sets default threshold voltages for 1.2 V or 1.8 V bus. Set the value to MAN if you want to define individual thresholds.

Suffix:

<m> 1..4

Parameters:

<ThresholdPreset> V12 | V18 | MANual
*RST: V12

BUS<m>:RFFE:COUPling <ThresCpl>

If enabled, the SDATA thresholds are set to the SCLK threshold values.

Suffix:

<m> 1..4

Parameters:

<ThresCpl> ON | OFF
*RST: ON

BUS<m>:RFFE:DATA:THReshold:HIGH <ThresDatPos>

Set the positive going threshold (V_{TP}) for the data signal.

Note that the high and low thresholds and the hysteresis values are dependent, so it is sufficient to define two values for each line.

Suffix:

<m> 1..4

Parameters:

<ThresDatPos> Range: 0 to 2.5
 Increment: 0.1
 *RST: 0.72
 Default unit: V

Manual operation: See "[Thresholds](#)" on page 786

BUS<m>:RFFE:DATA:THReshold:LOW <ThresDatNeg>

Set the negative going threshold (V_{TN}) for the data signal.

Note that the high and low thresholds and the hysteresis values are dependent, so it is sufficient to define two values for each line.

Suffix:

<m> 1..4

Parameters:

<ThresDatNeg> Range: 0 to 2.5
 Increment: 0.1
 *RST: 0.48
 Default unit: V

Manual operation: See "[Thresholds](#)" on page 786

BUS<m>:RFFE:CLOCK:THReshold:HIGH <ThresClkPos>

Set the positive going threshold (V_{TP}) for the clock signal.

Note that the high and low thresholds and the hysteresis values are dependent, so it is sufficient to define two values for each line.

Suffix:

<m> 1..4

Parameters:

<ThresClkPos> Range: 0 to 2.5
 Increment: 0.1
 *RST: 0.72
 Default unit: V

Manual operation: See "[Thresholds](#)" on page 786

BUS<m>:RFFE:CLOCK:THReshold:LOW <ThresClkNeg>

Set the negative going threshold (V_{TN}) for the clock signal.

Note that the high and low thresholds and the hysteresis values are dependent, so it is sufficient to define two values for each line.

Suffix:

<m> 1..4

Parameters:

<ThresClkNeg> Range: 0 to 2.5
 Increment: 0.1
 *RST: 0.48
 Default unit: V

Manual operation: See "[Thresholds](#)" on page 786

BUS<m>:RFFE:GFILter <GlitchFilter>

Enables the glitch filter on the SCLK and SDATA lines to improve decode accuracy.

Suffix:

<m> 1..4
 Selects the serial bus.

Parameters:

<GlitchFilter> ON | OFF
 *RST: OFF

Manual operation: See "[Glitch filter](#)" on page 787

BUS<m>:RFFE:GFWidth <GlitchFilterWdt>

Sets the maximum glitch width to be ignored.

Suffix:

<m> 1..4

Parameters:

<GlitchFilterWdt> Range: 10E-12 to 10E-9
 Increment: 10E-12
 *RST: 1E-9
 Default unit: s

Manual operation: See "[Glitch filter](#)" on page 787

BUS<m>:RFFE:MINGap:SElect <MinGapSelect>

If the minimum gap is enabled, the instrument detects the specified gap.

Set the minimum gap time using `BUS<m>:RFFE:MINGap:TIME`.

Suffix:

<m> 1..4

Parameters:

<MinGapSelect> ON | OFF
 *RST: OFF

Manual operation: See "[Timing](#)" on page 787

BUS<m>:RFFE:MINGap:TIME <MinGapTime>

Sets the minimum idle time between the Bus Park Cycle (BP) and Sequence Start Condition (SSC).

The setting is only relevant if [BUS<m>:RFFE:MINGap:SElect](#) is enabled.

Suffix:

<m> 1..4

Parameters:

<MinGapTime> Range: 1E-9 to 10E-6
 Increment: 1E-9
 *RST: 10E-9
 Default unit: s

Manual operation: See "[Timing](#)" on page 787

BUS<m>:RFFE:RDMD <ReadMode>

Selects, if the standard or synchronous read ([SREAD](#)) mode is used.

Suffix:

<m> 1..4

Parameters:

<ReadMode> STRD | SREAD
 *RST: STRD

Manual operation: See "[Read mode](#)" on page 785

BUS<m>:RFFE:VERSion <Version>

Selects the RFFE version.

Suffix:

<m> 1..4

Parameters:

<Version> V1DX | V2D0 | V2D1 | V3D0
 V1DX: 1.x
 V2D0: 2.0
 V2D1: 2.1
 V3D0: 3.0 / 3.1
 *RST: V1DX

Manual operation: See "[Version](#)" on page 785

27.18.18.2 Trigger

The trigger suffix <m> is always 1 and can be omitted. It selects the trigger event: Only the A-trigger is available for triggering on serial buses.

To trigger on a serial bus, make sure that:

- `TRIGger<m>:SOURce[:SElect]` is set to `SBUS`.
- The sources of the serial bus are channel signals: use `BUS<m>:...:SOURce` commands.
- Decoding is enabled: `BUS<m>[:STATe]` is set to `ON`.

For programming examples, see "Triggering on RFFE bus" on page 1361.

<code>TRIGger<m>:RFFE:TYPE</code>	2224
<code>TRIGger<m>:RFFE:ADDRess:CONDition</code>	2227
<code>TRIGger<m>:RFFE:ADDRess:MIN</code>	2227
<code>TRIGger<m>:RFFE:ADDRess:MAX</code>	2227
<code>TRIGger<m>:RFFE:BCOunt:CONDition</code>	2228
<code>TRIGger<m>:RFFE:BCOunt:MIN</code>	2228
<code>TRIGger<m>:RFFE:BCOunt:MAX</code>	2228
<code>TRIGger<m>:RFFE:DATA:DCON</code>	2228
<code>TRIGger<m>:RFFE:DATA:DMIN</code>	2229
<code>TRIGger<m>:RFFE:DATA:DMAX</code>	2229
<code>TRIGger<m>:RFFE:DATA:ICONdition</code>	2229
<code>TRIGger<m>:RFFE:DATA:IMIN</code>	2230
<code>TRIGger<m>:RFFE:DATA:IMAX</code>	2230
<code>TRIGger<m>:RFFE:SADD:CONDition</code>	2230
<code>TRIGger<m>:RFFE:SADD:MIN</code>	2231
<code>TRIGger<m>:RFFE:SADD:MAX</code>	2231
<code>TRIGger<m>:RFFE:MASK:CONDition</code>	2231
<code>TRIGger<m>:RFFE:MASK:MAX</code>	2231
<code>TRIGger<m>:RFFE:MASK:MIN</code>	2232
<code>TRIGger<m>:RFFE:INTerrupt</code>	2232
<code>TRIGger<m>:RFFE:ERRor:BP</code>	2232
<code>TRIGger<m>:RFFE:ERRor:LENGth</code>	2232
<code>TRIGger<m>:RFFE:ERRor:NOResponse</code>	2232
<code>TRIGger<m>:RFFE:ERRor:PARity</code>	2233
<code>TRIGger<m>:RFFE:ERRor:SSC</code>	2233
<code>TRIGger<m>:RFFE:ERRor:USEQuence</code>	2233
<code>TRIGger<m>:RFFE:ERRor:GAP</code>	2233
<code>TRIGger<m>:RFFE:ERRor:VERSion</code>	2233
<code>TRIGger<m>:RFFE:INTerrupt</code>	2234

`TRIGger<m>:RFFE:TYPE <Type>`

Selects the trigger type for RFFE analysis.

Parameters:

<Type> START | STOP | RZWR | RWR | RRD | ERWR | ERRD | ERWL |
 ERRL | IRSUM | MSKW | MOHO | MASOHO | MWR | MASW |
 MRD | MASR | MCTW | MCTR | ERRor

START

Triggers on the beginning of a command sequence, exactly after the sub device address. Optionally, you can specify a sub device address condition.

STOP

Triggers on the end of a command sequence, exactly at the start of the bus park cycle. Optionally, you can specify a sub device address condition.

RZWR

Triggers on Register 0 Write command sequences. Optionally, you can specify a sub device address condition and a data pattern condition.

RWR

Triggers on Register Write command sequences. Optionally, you can specify a sub device address condition, a register address condition, and a data pattern condition.

RRD

Triggers on Register Read command sequences. Optionally, you can specify a sub device address condition, a register address condition, and a data pattern condition.

ERWR

Triggers on Extended Register Write command sequences. Optionally, you can specify a sub device address condition, a register address condition, a byte count condition, a data index condition, and a data pattern condition.

ERRD

Triggers on Extended Register Read command sequences. Optional trigger conditions are the same as for ERWR.

ERWL

Triggers on Extended Register Write Long command sequences. Optional trigger conditions are the same as for ERWR.

ERRL

Triggers on Extended Register Read Long command sequences. Optional trigger conditions are the same as for ERWR.

IRSUM

Triggers on Interrupt Summary and Notification command sequences. Optionally, you can specify a sub device address condition, bit count condition and a data pattern condition.

MSKW

Masked Write command sequence. Optionally, you can specify a sub device address condition, register address condition, mask condition and data pattern condition

MOHO | MASOHO

Triggers on Main Ownership Handover command sequences. Optionally, you can specify a MID condition.

MWR | MASW

Triggers on Main Device Write command sequences. Optionally, you can specify a MID condition, a register address condition, and a data pattern condition.

MRD | MASR

Triggers on Main Device Read command sequences. Optionally, you can specify a MID condition, a register address condition, and a data pattern condition.

MCTW

Main Device Context Transfer Write command sequence.
Optional: MID condition, register address condition, byte count condition, data index condition, and data pattern condition.

MCTR

Main Device Context Transfer Read command sequence.
Optional search conditions are the same as for MCTW.

ERRor

Triggers if one of the enabled errors occurs in a frame.
To enable the error types, use `TRIGger<m>:RFFE:ERRor:BP`, `TRIGger<m>:RFFE:ERRor:LENGth`, `TRIGger<m>:RFFE:ERRor:NOResponse`, `TRIGger<m>:RFFE:ERRor:PARity`, `TRIGger<m>:RFFE:ERRor:SSC`, and `TRIGger<m>:RFFE:ERRor:USEquence`.

*RST: START

Manual operation: See "[Type](#)" on page 789

To specify additional trigger conditions for command sequences, use the following commands:

Sub device address /MID	<code>TRIGger<m>:RFFE:SADD:CONDition</code> <code>TRIGger<m>:RFFE:SADD:MIN</code> <code>TRIGger<m>:RFFE:SADD:MAX</code>
Register address	<code>TRIGger<m>:RFFE:ADDRess:CONDition</code> <code>TRIGger<m>:RFFE:ADDRess:MIN</code> <code>TRIGger<m>:RFFE:ADDRess:MAX</code>
Data pattern	<code>TRIGger<m>:RFFE:DATA:DCON</code> <code>TRIGger<m>:RFFE:DATA:DMIN</code> <code>TRIGger<m>:RFFE:DATA:DMAX</code>
Mask address	<code>TRIGger<m>:RFFE:MASK:CONDition</code> <code>TRIGger<m>:RFFE:MASK:MAX</code> <code>TRIGger<m>:RFFE:MASK:MIN</code>

Byte count	TRIGger<m>:RFFE:BCOunt:CONDition TRIGger<m>:RFFE:BCOunt:MIN TRIGger<m>:RFFE:BCOunt:MAX
Data index	TRIGger<m>:RFFE:DATA:ICONdition TRIGger<m>:RFFE:DATA:IMIN TRIGger<m>:RFFE:DATA:IMAX

TRIGger<m>:RFFE:ADDRes:CONDition <AddressOperator>

Sets the operator to trigger on a specific address pattern or a range.

Parameters:

<AddressOperator> [EQUAL](#) | [NEQUAL](#) | [LTHan](#) | [LETHan](#) | [GTHan](#) | [GETHan](#) | [INRange](#) | [OORange](#)

[EQUAL](#) | [NEQUAL](#) | [LTHan](#) | [LETHan](#) | [GTHan](#) | [GETHan](#)

Equal, Not equal, Less than, Less or equal than, Greater than, Greater or equal than. These conditions require one pattern to be set with [TRIGger<m>:RFFE:ADDRes:MIN](#).

[INRange](#) | [OORange](#)

In range / Out of range: Set the minimum and maximum value of the range with [TRIGger<m>:RFFE:ADDRes:MIN](#) and [TRIGger<m>:RFFE:ADDRes:MAX](#).

*RST: [EQUAL](#)

Manual operation: See "[Address](#)" on page 793

TRIGger<m>:RFFE:ADDRes:MIN <AddressMin>

Specifies a pattern, or sets the start value of a pattern range.

Parameters:

<AddressMin> Numeric or string pattern, see [Chapter 27.4.6, "Bit pattern parameter"](#), on page 1373. The string parameter accepts the bit value X (do not care).

Manual operation: See "[Address](#)" on page 793

TRIGger<m>:RFFE:ADDRes:MAX <AddressMax>

Sets the end value of a range, if the data condition is set to [INRange](#) or [OORange](#). See [TRIGger<m>:RFFE:ADDRes:CONDition](#).

Parameters:

<AddressMax> Numeric or string pattern, see [Chapter 27.4.6, "Bit pattern parameter"](#), on page 1373. The string parameter accepts the bit value X (do not care).

Manual operation: See "[Address](#)" on page 793

TRIGger<m>:RFFE:BCOunt:CONDition <ByteCntOperator>

Sets the operator to trigger on a specific byte count or a byte count range.

Parameters:

<ByteCntOperator> EQUal | NEQual | LTHan | LETHan | GTHan | GETHan |
INRange | OORange

EQUal | NEQual | LTHan | LETHan | GTHan | GETHan

Equal, Not equal, Less than, Less or equal than, Greater than, Greater or equal than. These conditions require one pattern to be set with [TRIGger<m>:RFFE:BCOunt:MIN](#) command.

INRange | OORange

In range / Out of range: Set the minimum and maximum value using the corresponding [TRIGger<m>:RFFE:BCOunt:MIN](#) and [TRIGger<m>:RFFE:BCOunt:MAX](#)

*RST: EQUal

Manual operation: See "[Byte count](#)" on page 794

TRIGger<m>:RFFE:BCOunt:MIN <ByteCountMin>

Specifies a pattern, or sets the start value of a pattern range.

Parameters:

<ByteCountMin> Numeric or string pattern, see [Chapter 27.4.6, "Bit pattern parameter"](#), on page 1373. The string parameter accepts the bit value X (do not care).

Manual operation: See "[Byte count](#)" on page 794

TRIGger<m>:RFFE:BCOunt:MAX <ByteCountMax>

Sets the end value of a range, if the byte/bit count condition is set to [INRange](#) or [OORange](#). See [TRIGger<m>:RFFE:BCOunt:CONDition](#).

Parameters:

<ByteCountMax> Numeric or string pattern, see [Chapter 27.4.6, "Bit pattern parameter"](#), on page 1373. The string parameter accepts the bit value X (do not care).

Manual operation: See "[Byte count](#)" on page 794

TRIGger<m>:RFFE:DATA:DCON <DatPattOptor>

Sets the operator to trigger on a specific pattern or a range.

Parameters:

<DatPattOptor> EQUal | NEQual | LTHan | LETHan | GTHan | GETHan |
INRange | OORange

EQUal | NEQUal | LTHan | LETHan | GTHan | GETHan

Equal, Not equal, Less than, Less or equal than, Greater than, Greater or equal than. These conditions require one pattern to be set with [TRIGger<m>:RFFE:DATA:DMIN](#).

INRange | OORange

In range / Out of range: Set the minimum and maximum value of the range with [TRIGger<m>:RFFE:DATA:DMIN](#) and [TRIGger<m>:RFFE:DATA:DMAX](#)

*RST: EQUal

Example: See ["Triggering on RFFE bus"](#) on page 1361.

Manual operation: See ["Data"](#) on page 794

TRIGger<m>:RFFE:DATA:DMIN <DataPatternMin>

Specifies a pattern, or sets the start value of a pattern range.

Parameters:

<DataPatternMin> Numeric or string pattern, see [Chapter 27.4.6, "Bit pattern parameter"](#), on page 1373. The string parameter accepts the bit value X (do not care).

Example: See ["Triggering on RFFE bus"](#) on page 1361.

Manual operation: See ["Data"](#) on page 794

TRIGger<m>:RFFE:DATA:DMAX <DataPatternMax>

Sets the end value of a range, if the data condition is set to `INRange` or `OORange`. See [TRIGger<m>:RFFE:DATA:DCON](#).

Parameters:

<DataPatternMax> Numeric or string pattern, see [Chapter 27.4.6, "Bit pattern parameter"](#), on page 1373. The string parameter accepts the bit value X (do not care).

Example: See ["Triggering on RFFE bus"](#) on page 1361.

Manual operation: See ["Data"](#) on page 794

TRIGger<m>:RFFE:DATA:ICONdition <DataIdxOperator>

Sets the operator to define the data frames in which the data pattern is expected.

Parameters:

<DataIdxOperator> EQUal | LTHan | LETHan | GTHan | GETHan | INRange | RANGE

EQUal | LTHan | LETHan | GTHan | GETHan

Equal, Less than, Less or equal than, Greater Than, Greater or equal than. These conditions require one pattern to be set using [TRIGger<m>:RFFE:DATA:IMIN](#).

INRange = RANGE

In range: Set the minimum and maximum value using

[TRIGger<m>:RFFE:DATA:IMIN](#) and [TRIGger<m>:RFFE:DATA:IMAX](#).

*RST: INRange

Manual operation: See "[Index](#)" on page 794

TRIGger<m>:RFFE:DATA:IMIN <DataIndexMin>

Specifies a pattern, or sets the start value of the index range.

Parameters:

<DataIndexMin> Range: 1 to 32
 Increment: 1
 *RST: 1

Manual operation: See "[Index](#)" on page 794

TRIGger<m>:RFFE:DATA:IMAX <DataIndexMax>

Sets the end value of a range, if the index condition is set to `INRange` or `OORange`.

See [TRIGger<m>:RFFE:DATA:ICONdition](#).

Parameters:

<DataIndexMax> Range: 1 to 32
 Increment: 1
 *RST: 32

Manual operation: See "[Index](#)" on page 794

TRIGger<m>:RFFE:SADD:CONDition <SIDOperator>

Sets the operator to trigger on a specific sub device address/MID pattern or a range.

Parameters:

<SIDOperator> EQUal | NEQual | LTHan | LETHan | GTHan | GETHan |
 INRange | OORange

EQUal | NEQual | LTHan | LETHan | GTHan | GETHan

Equal, Not equal, Less than, Less or equal than, Greater than, Greater or equal than. These conditions require one pattern to be set with [TRIGger<m>:RFFE:SADD:MIN](#).

INRange | OORange

In range / Out of range: Set the minimum and maximum value of the range with [TRIGger<m>:RFFE:SADD:MIN](#) and [TRIGger<m>:RFFE:SADD:MAX](#) on page 2231.

*RST: EQUal

Manual operation: See "[Sub device addr. /MID](#) " on page 793

TRIGger<m>:RFFE:SADD:MIN <SIDMin>

Specifies a pattern, or sets the start value of a pattern range.

Parameters:

<SIDMin> Numeric or string pattern, see [Chapter 27.4.6, "Bit pattern parameter"](#), on page 1373. The string parameter accepts the bit value X (do not care).

Manual operation: See "[Sub device addr. /MID](#) " on page 793

TRIGger<m>:RFFE:SADD:MAX <SIDMax>

Sets the end value of a range, if the sub device address/MID condition is set to INRange or OORange. See [SEARCH:TRIGger:RFFE:SADD:CONDition](#).

Parameters:

<SIDMax> Numeric or string pattern, see [Chapter 27.4.6, "Bit pattern parameter"](#), on page 1373. The string parameter accepts the bit value X (do not care).

Manual operation: See "[Sub device addr. /MID](#) " on page 793

TRIGger<m>:RFFE:MASK:CONDition <MaskOperator>

Sets the operator to trigger on a mask pattern or a range.

Parameters:

<MaskOperator> EQUal | NEQual | LTHan | LETHan | GTHan | GETHan |
INRange | OORange

EQUal | NEQual | LTHan | LETHan | GTHan | GETHan

Equal, Not equal, Less than, Less or equal than, Greater than, Greater or equal than. These conditions require one pattern to be set with [TRIGger<m>:RFFE:MASK:MIN](#).

INRange | OORange

In range / Out of range: Set the minimum and maximum value of the range with [TRIGger<m>:RFFE:MASK:MIN](#) and [TRIGger<m>:RFFE:MASK:MAX](#).

*RST: EQUal

Manual operation: See "[Mask](#)" on page 795

TRIGger<m>:RFFE:MASK:MAX <MaskMax>

Sets the end value of a range, if the mask condition is set to INRange or OORange. See [TRIGger<m>:RFFE:MASK:CONDition](#).

Parameters:

<MaskMax> Numeric or string pattern, see [Chapter 27.4.6, "Bit pattern parameter"](#), on page 1373. The string parameter accepts the bit value X (do not care).

Manual operation: See "[Mask](#)" on page 795

TRIGger<m>:RFFE:MASK:MIN <MaskMin>

Specifies a mask pattern, or sets the start value of a mask pattern range.

Parameters:

<MaskMin>

Manual operation: See "[Mask](#)" on page 795

TRIGger<m>:RFFE:INTerrupt <Interrupt>

Sets the interrupt pattern for the interrupt summary and notification trigger type.

Parameters:

<Interrupt>

TRIGger<m>:RFFE:ERRor:BP <BusParkError>

Enables the trigger on a bus park error - when an incorrect bus park cycle has been found.

Parameters:

<BusParkError> ON | OFF
 *RST: ON

Manual operation: See "[Error conditions](#)" on page 792

TRIGger<m>:RFFE:ERRor:LENGth <LengthError>

Enables the trigger on a length error - when an incorrect length of the command sequence has been found.

Parameters:

<LengthError> ON | OFF
 *RST: ON

Manual operation: See "[Error conditions](#)" on page 792

TRIGger<m>:RFFE:ERRor:NOResponse <NoResponse>

Enables the trigger on any No Response Frame.

Parameters:

<NoResponse> ON | OFF
 *RST: ON

Manual operation: See "[Error conditions](#)" on page 792

TRIGger<m>:RFFE:ERRor:PARity <ParityError>

Enables the trigger on incorrect parity bits.

Parameters:

<ParityError> ON | OFF
*RST: ON

Manual operation: See ["Error conditions"](#) on page 792

TRIGger<m>:RFFE:ERRor:SSC <SSCError>

Enables the trigger on an SSC error - when no valid SSC sequence has been found after the idle time.

Parameters:

<SSCError> ON | OFF
*RST: ON

Manual operation: See ["Error conditions"](#) on page 792

TRIGger<m>:RFFE:ERRor:USEquence <UnknownSequence>

Enables the trigger on an unknown sequence - when the instrument cannot detect any supported command sequence.

Parameters:

<UnknownSequence> ON | OFF
*RST: ON

Manual operation: See ["Error conditions"](#) on page 792

TRIGger<m>:RFFE:ERRor:GAP <GapError>

Enables the trigger on a gap error.

Parameters:

<GapError> ON | OFF
*RST: ON

Manual operation: See ["Error conditions"](#) on page 792

TRIGger<m>:RFFE:ERRor:VERSion <VersionError>

Enables the trigger on RFFE version error.

Parameters:

<VersionError> ON | OFF
*RST: ON

Manual operation: See ["Error conditions"](#) on page 792

TRIGger<m>:RFFE:INTerrupt <Interrupt>

Sets the interrupt pattern for the interrupt summary and notification trigger type.

Parameters:

<Interrupt>

27.18.18.3 Decode results

In all BUS<m>:RFFE commands, the suffix <m> selects the serial bus. Suffix <n> selects index of the command sequence.

To load and activate a label list, use:

- [BUS<m>:NEWList](#) on page 1815
- [BUS<m>:SYMBOLs](#) on page 1815

BUS<m>:RFFE:FCOunt?	2234
BUS<m>:RFFE:SEquence<n>:STATe?	2235
BUS<m>:RFFE:SEquence<n>:STARt?	2235
BUS<m>:RFFE:SEquence<n>:STOP?	2235
BUS<m>:RFFE:SEquence<n>:TYPE?	2235
BUS<m>:RFFE:SEquence<n>:SADD?	2236
BUS<m>:RFFE:SEquence<n>:ADDRess?	2236
BUS<m>:RFFE:SEquence<n>:BCOunt?	2237
BUS<m>:RFFE:SEquence<n>:DATA?	2237
BUS<m>:RFFE:SEquence<n>:SYMBOL?	2237
BUS<m>:RFFE:SEquence<n>:PADone?	2238
BUS<m>:RFFE:SEquence<n>:PADZero?	2238
BUS<m>:RFFE:SEquence<n>:PCTRI?	2238
BUS<m>:RFFE:SEquence<n>:RBTRate?	2239
BUS<m>:RFFE:SEquence<n>:WBTRate?	2239
BUS<m>:RFFE:SEquence<n>:BYTE<o>:NAME?	2239
BUS<m>:RFFE:SEquence<n>:BYTE<o>:STATe?	2239
BUS<m>:RFFE:SEquence<n>:BYTE<o>:VALue?	2240

BUS<m>:RFFE:FCOunt?

Returns the number of command sequences in the current acquisition.

Suffix:

<m> 1..4

Return values:

<FrameCount> Range: 0 to 100000
Increment: 1
*RST: 0

Usage: Query only

BUS<m>:RFFE:SEQuence<n>:STATe?

Returns the overall state of the selected command sequence.

Suffix:

<m> 1..4
<n> *

Return values:

<FrameState> OK | SSC | VERSion | PARity | LENGth | BPERR | GAP |
NORESPONSE | INComplete

OK: the sequence is valid.

SSC: SSC error.

VERSion: RFFE version.

PARity: parity error.

LENGth: length error.

BPERR: bus park error.

NORESPONSE: No response.

INComplete: The sequence is not completely contained in the acquisition. The acquired part of the sequence is valid.

*RST: OK

Usage: Query only

BUS<m>:RFFE:SEQuence<n>:STARt?**BUS<m>:RFFE:SEQuence<n>:STOP?**

Return the start time (SSC) and stop time (BP) of the selected command sequence.

Suffix:

<m> 1..4
<n> *

Return values:

<Start>, <Stop> Time
Range: -100E+24 to 100E+24
Increment: 100E-12
*RST: 0
Default unit: s

Usage: Query only

BUS<m>:RFFE:SEQuence<n>:TYPE?

Returns the type of the selected command sequence.

Suffix:

<m> 1..4

<n> *

Return values:

<FrameType> UNDESC | RZWR | RWR | RRD | ERWR | ERRD | ERWL |
 ERRL | IRSUM | MSKW | MOHO | MWR | MRD | MCTW |
 MCTR | UNDEF | ERRor

RZWR: Register 0 Write
 RWR: Register Write
 RRD: Register Read
 ERWR: Extended Register Write
 ERRD: Extended Register Read
 ERWL: Extended Register Write Long
 ERRL: Extended Register Read Long
 MRD: Main Device Read, was MASR until FW 5.35
 MWR: Main Device Write, was MASW until FW 5.35
 MOHO: Main Device Ownership Handover, was MASOHO until
 FW 5.35
 IRSUM: Interrupt Summary and Notification
 MSKW: Masked Write
 MCTR: Main Device Context Transfer Read
 MCTW: Main Device Context Transfer Write
 ERRor: The bits defining the command sequence are not valid,
 no supported command sequence
 *RST: RZWR

Usage: Query only

BUS<m>:RFFE:SEquence<n>:SADD?

Returns the sub device address of the selected command sequence.

Suffix:

<m> 1..4

<n> *

Return values:

<FrameSID> Range: 0 to 15
 Increment: 1
 *RST: 0

Usage: Query only

BUS<m>:RFFE:SEquence<n>:ADDRess?

Returns the register address of the selected command sequence.

Suffix:

<m> 1..4

<n> *

Return values:

<FrameAddress> Range: Depends on the sequence type, address can have 0, 5, 8, or 16 bits
Increment: 1
*RST: 0

Usage: Query only

BUS<m>:RFFE:SEQuence<n>:BCOunt?

Returns the bit/ byte count of the selected command sequence.

Suffix:

<m> 1..4
<n> *

Return values:

<ByteCount> Decimal value
Range: 15
Increment: 1
*RST: 0

Usage: Query only

BUS<m>:RFFE:SEQuence<n>:DATA?

Returns the data bytes of the specified command sequence.

Use [BUS<m>:RFFE:SEQuence<n>:BYTE<o>:VALue?](#) to access the sequence bytes.

Suffix:

<m> 1..4
<n> *

Return values:

<Data> Bit pattern (B1, B2, B3, B4...) in variable length up to eight bytes.

Example:

```
BUS:RFFE:SEQuence3:DATA?  
<-- #H08, #H49, #H54, #H33, #HFF
```

Usage: Query only

BUS<m>:RFFE:SEQuence<n>:SYMBol?

Returns the symbolic label that belongs to the address of the selected command sequence.

Suffix:

<m> 1..4
<n> *

Return values:
 <Translation> String containing the label name

Usage: Query only

BUS<m>:RFFE:SEQuence<n>:PADone?

Returns the address-one parity for the selected command sequence.

Suffix:
 <m> 1..4
 <n> *

Return values:
 <ParityAddr1> OK | PARity
 PARity: PArity error
 *RST: OK

Usage: Query only

BUS<m>:RFFE:SEQuence<n>:PADZero?

Returns the address-zero parity for the selected command sequence.

Suffix:
 <m> 1..4
 <n> *

Return values:
 <ParityAddr0> OK | PARity
 PARity: PArity error
 *RST: OK

Usage: Query only

BUS<m>:RFFE:SEQuence<n>:PCTRI?

Returns the control parity for the selected command sequence.

Suffix:
 <m> 1..4
 <n> *

Return values:
 <ParityCtrl> OK | PARity
 PARity: PArity error
 *RST: OK

Usage: Query only

BUS<m>:RFFE:SEquence<n>:RBTRate?

Returns the read bit rate of the selected command sequence.

Suffix:

<m> 1..4
<n> *

Return values:

<ReadBitRate> Range: 0 to 100000000000
Increment: 1
*RST: 0
Default unit: bps

Usage: Query only

BUS<m>:RFFE:SEquence<n>:WBTRate?

Returns the write bit rate of the selected command sequence.

Suffix:

<m> 1..4
<n> *

Return values:

<WriteBitRate> Range: 0 to 100000000000
Increment: 1
*RST: 0
Default unit: bps

Usage: Query only

BUS<m>:RFFE:SEquence<n>:BYTE<o>:NAME?

Returns the name of the specified data byte.

Suffix:

<m> 1..4
<n> *
<o> *

Selects the number of the data byte (1...n).

Return values:

<FrameByteName>

Usage: Query only

BUS<m>:RFFE:SEquence<n>:BYTE<o>:STATE?

Returns the state of the specified data byte.

Suffix:

<m> 1..4

<n> *

<o> *

Selects the number of the data byte (1...n).

Return values:

<ByteState> OK | PARity

OK: the byte is valid.

PARity: parity error

*RST: OK

Usage: Query only**BUS<m>:RFFE:SEQUence<n>:BYTE<o>:VALue?**

Returns the value of the specified byte in the specified command sequence.

Suffix:

<m> 1..4

<n> *

<o> *

Selects the number of the data byte (1...n).

Return values:<ByteValue> To set the value format, use [FORMat:BPATtern](#).

The values below – range, increment and reset – are decimal values.

Range: 0 to 255

Increment: 1

*RST: 0

Usage: Query only**27.18.18.4 Search settings**For programming example, see "[Searching RFFE data](#)" on page 1361.

SEARch:TRIGger:RFFE:TYPE	2241
SEARch:TRIGger:RFFE:SADD:CONDition	2243
SEARch:TRIGger:RFFE:ADDRes:CONDition	2243
SEARch:TRIGger:RFFE:BCOunt:CONDition	2243
SEARch:TRIGger:RFFE:DATA:DCON	2243
SEARch:TRIGger:RFFE:DATA:ICONdition	2244
SEARch:TRIGger:RFFE:SADD:MIN	2244
SEARch:TRIGger:RFFE:ADDRes:MIN	2244
SEARch:TRIGger:RFFE:BCOunt:MIN	2244
SEARch:TRIGger:RFFE:DATA:IMIN	2244
SEARch:TRIGger:RFFE:DATA:DMIN	2244

SEARCh:TRIGger:RFFE:SADD:MAX.....	2245
SEARCh:TRIGger:RFFE:ADDResS:MAX.....	2245
SEARCh:TRIGger:RFFE:BCOunt:MAX.....	2245
SEARCh:TRIGger:RFFE:DATA:IMAX.....	2245
SEARCh:TRIGger:RFFE:DATA:DMAX.....	2245
SEARCh:TRIGger:RFFE:INTerrupt.....	2245
SEARCh:TRIGger:RFFE:ERRor:LENGth.....	2245
SEARCh:TRIGger:RFFE:ERRor:PARity.....	2246
SEARCh:TRIGger:RFFE:ERRor:SSC.....	2246
SEARCh:TRIGger:RFFE:ERRor:GAP.....	2246
SEARCh:TRIGger:RFFE:ERRor:VERsion.....	2246

SEARCh:TRIGger:RFFE:TYPE <SearchName>,<Type>
SEARCh:TRIGger:RFFE:TYPE? <SearchName>

Sets the event to be searched for.

See also: "Type" on page 798

Parameters:

<Type>

START | STOP | RZWR | RWR | RRD | ERWR | ERRD | ERWL |
 ERRL | IRSUM | MSKW | MOHO | MASOHO | MWR | MASW |
 MRD | MASR | MCTW | MCTR | ERRor

START

Start of a command sequence (SSC). Optional: sub device address.

STOP

End of a command sequence (start of the bus park cycle).
 Optional: sub device address condition.

RZWR

Register 0 Write command sequence. Optional: sub device address condition and data pattern condition.

RWR

Register Write command sequence. Optional: sub device address condition, register address condition, and data pattern condition.

RRD

Register Read command sequence. Optional: sub device address condition, register address condition, and data pattern condition.

ERWR

Extended Register Write command sequences. Optional: sub device address condition, register address condition, byte count condition, data index condition, and data pattern condition.

ERRD

Extended Register Read command sequence. Optional search conditions are the same as for ERWR.

ERWL

Extended Register Write Long command sequence. Optional search conditions are the same as for ERWR.

ERRL

Extended Register Read Long command sequence. Optional search conditions are the same as for ERWR.

MRD | MASR

Main Device Read command sequence. Optional: sub device address condition, register address condition, and data pattern condition.

MWR | MASW

Main Device Write command sequence. Optional: sub device address condition, register address condition, and data pattern condition.

MOHO | MASOHO

Main Device Ownership Handover command sequence. Optional: sub device address condition, and data pattern condition.

MSKW

Masked Write command sequence. Optional: sub device address condition, register address condition, mask condition and data pattern condition.

MCTW

Main Device Context Transfer Write command sequence. Optional: MID condition, register address condition, byte count condition, data index condition, and data pattern condition.

MCTR

Main Device Context Transfer Read command sequence. Optional search conditions are the same as for MCTW

IRSUM

Interrupt Summary and Notification. Optional: sub device address condition, byte count condition, and data pattern condition.

ERRor

Searches for enabled errors. To enable the error types, use:

`SEARCH:TRIGger:RFFE:ERRor:LENGth`

`SEARCH:TRIGger:RFFE:ERRor:PARity`

`SEARCH:TRIGger:RFFE:ERRor:SSC`

*RST: START

Parameters for setting and query:

<SearchName> String parameter

Example: See "[Searching RFFE data](#)" on page 1361

Manual operation: See "[Type](#)" on page 798

To specify additional search conditions for command sequences, use the following commands:

Sub device address	<pre>SEARCh:TRIGGger:RFFE:SADD:CONDition SEARCh:TRIGGger:RFFE:SADD:MIN SEARCh:TRIGGger:RFFE:SADD:MAX</pre>
Register address	<pre>SEARCh:TRIGGger:RFFE:ADDRess:CONDition SEARCh:TRIGGger:RFFE:ADDRess:MIN SEARCh:TRIGGger:RFFE:ADDRess:MAX</pre>
Data pattern	<pre>SEARCh:TRIGGger:RFFE:DATA:DCON SEARCh:TRIGGger:RFFE:DATA:DMIN SEARCh:TRIGGger:RFFE:DATA:DMAX</pre>
Byte count	<pre>SEARCh:TRIGGger:RFFE:BCOunt:CONDition SEARCh:TRIGGger:RFFE:BCOunt:MIN SEARCh:TRIGGger:RFFE:BCOunt:MAX</pre>
Data index	<pre>SEARCh:TRIGGger:RFFE:DATA:ICONDition SEARCh:TRIGGger:RFFE:DATA:IMIN SEARCh:TRIGGger:RFFE:DATA:IMAX</pre>

```
SEARCh:TRIGGger:RFFE:SADD:CONDition <SearchName>,<SIDOperator>
SEARCh:TRIGGger:RFFE:SADD:CONDition? <SearchName>
SEARCh:TRIGGger:RFFE:ADDRess:CONDition <SearchName>,<AddressOperator>
SEARCh:TRIGGger:RFFE:ADDRess:CONDition? <SearchName>
SEARCh:TRIGGger:RFFE:BCOunt:CONDition <SearchName>,<ByteCntOperator>
SEARCh:TRIGGger:RFFE:BCOunt:CONDition? <SearchName>
SEARCh:TRIGGger:RFFE:DATA:DCON <SearchName>,<DatPattOptor>
SEARCh:TRIGGger:RFFE:DATA:DCON? <SearchName>
```

Sets the operator to search for a specific pattern or a range

Parameters:

<DatPattOptor> **EQUal** | **NEQual** | **LTHan** | **LETHan** | **GTHan** | **GETHan** |
INRange | **OORange**

EQUal | **NEQual** | **LTHan** | **LETHan** | **GTHan** | **GETHan**

Equal, Not equal, Less than, Less or equal than, Greater Than, Greater or equal than. These conditions require one pattern to be set using the corresponding [SEARCh:TRIGger:RFFE:...:MIN](#) command.

INRange | **OORange**

In range / Out of range: Set the minimum and maximum value using the corresponding [SEARCh:TRIGger:RFFE:...:MIN](#) and [SEARCh:TRIGger:RFFE:...:MAX](#)

*RST: **EQUal**

Parameters for setting and query:

<SearchName> String parameter

Example: See "[Searching RFFE data](#)" on page 1361

Manual operation: See ["Data"](#) on page 801

SEARCH:TRIGger:RFFE:DATA:ICONdition <SearchName>,<DataIdxOperator>
SEARCH:TRIGger:RFFE:DATA:ICONdition? <SearchName>

Sets the operator to define the data frames in which the data pattern is searched

Parameters:

<DataIdxOperator> EQUal | LTHan | LETHan | GTHan | GETHan | INRange | RANGE

EQUal | LTHan | LETHan | GTHan | GETHan

Equal, Less than, Less or equal than, Greater Than, Greater or equal than. These conditions require one pattern to be set using [SEARCH:TRIGger:RFFE:DATA:IMIN](#).

INRange = RANGE

In range: Set the minimum and maximum value using [SEARCH:TRIGger:RFFE:DATA:IMIN](#) and [SEARCH:TRIGger:RFFE:DATA:IMAX](#).

*RST: INRange

Parameters for setting and query:

<SearchName> String parameter

Manual operation: See ["Index"](#) on page 801

SEARCH:TRIGger:RFFE:SADD:MIN <SearchName>,<SIDMin>
SEARCH:TRIGger:RFFE:SADD:MIN? <SearchName>
SEARCH:TRIGger:RFFE:ADDRESS:MIN <SearchName>,<AddressMin>
SEARCH:TRIGger:RFFE:ADDRESS:MIN? <SearchName>
SEARCH:TRIGger:RFFE:BCOunt:MIN <SearchName>,<ByteCountMin>
SEARCH:TRIGger:RFFE:BCOunt:MIN? <SearchName>
SEARCH:TRIGger:RFFE:DATA:IMIN <SearchName>,<DataIndexMin>
SEARCH:TRIGger:RFFE:DATA:IMIN? <SearchName>
SEARCH:TRIGger:RFFE:DATA:DMIN <SearchName>,<DataPatternMin>
SEARCH:TRIGger:RFFE:DATA:DMIN? <SearchName>

Specifies a pattern, or sets the the start value of a pattern range.

Parameters:

<DataPatternMin> Numeric or string pattern, see [Chapter 27.4.6, "Bit pattern parameter"](#), on page 1373. The string parameter accepts the bit value X (don't care).

Parameters for setting and query:

<SearchName> String parameter

Example: See ["Searching RFFE data"](#) on page 1361

Manual operation: See ["Data"](#) on page 801

```

SEARCh:TRIGger:RFFE:SADD:MAX <SearchName>,<SIDMax>
SEARCh:TRIGger:RFFE:SADD:MAX? <SearchName>
SEARCh:TRIGger:RFFE:ADDRess:MAX <SearchName>,<AddressMax>
SEARCh:TRIGger:RFFE:ADDRess:MAX? <SearchName>
SEARCh:TRIGger:RFFE:BCOunt:MAX <SearchName>,<ByteCountMax>
SEARCh:TRIGger:RFFE:BCOunt:MAX? <SearchName>
SEARCh:TRIGger:RFFE:DATA:IMAX <SearchName>,<DataIndexMax>
SEARCh:TRIGger:RFFE:DATA:IMAX? <SearchName>
SEARCh:TRIGger:RFFE:DATA:DMAX <SearchName>,<DataPatternMax>
SEARCh:TRIGger:RFFE:DATA:DMAX? <SearchName>

```

Sets the the end value of an range if the corresponding condition is set to `INRange` or `ORRange`. See [SEARCh:TRIGger:RFFE: . . . :CON](#)

Parameters:

<DataPatternMax> Numeric or string pattern, see [Chapter 27.4.6, "Bit pattern parameter"](#), on page 1373. The string parameter accepts the bit value X (don't care).

Parameters for setting and query:

<SearchName> String parameter

Manual operation: See ["Data"](#) on page 801

```

SEARCh:TRIGger:RFFE:INTerrupt <SearchName>,<Interrupt>
SEARCh:TRIGger:RFFE:INTerrupt? <SearchName>

```

Defines the pattern of the interrupt identification sequence, which consists of interrupt slots 15 to 0.

Parameters:

<Interrupt> Numeric or string pattern, see [Chapter 27.4.6, "Bit pattern parameter"](#), on page 1373. The string parameter accepts the bit value X (don't care).

Parameters for setting and query:

<SearchName> String parameter

Firmware/software: FW 3.30

Manual operation: See ["Data"](#) on page 801

```

SEARCh:TRIGger:RFFE:ERRor:LENGth <SearchName>,<LengthError>
SEARCh:TRIGger:RFFE:ERRor:LENGth? <SearchName>

```

Enables the search for length errors - when an incorrect length of the command sequence has been found.

Parameters:

<LengthError> ON | OFF
 *RST: ON

Parameters for setting and query:

<SearchName> String parameter

Manual operation: See "[Error conditions](#)" on page 801

SEARCh:TRIGger:RFFE:ERRor:PARity <SearchName>,<ParityError>

SEARCh:TRIGger:RFFE:ERRor:PARity? <SearchName>

Enables the search for incorrect parity bits.

Parameters:

<ParityError> ON | OFF

*RST: ON

Parameters for setting and query:

<SearchName> String parameter

Manual operation: See "[Error conditions](#)" on page 801

SEARCh:TRIGger:RFFE:ERRor:SSC <SearchName>,<SSCError>

SEARCh:TRIGger:RFFE:ERRor:SSC? <SearchName>

Enables the search for SSC errors - when no valid SSC sequence has been found after the idle time.

Parameters:

<SSCError> ON | OFF

*RST: ON

Parameters for setting and query:

<SearchName> String parameter

Manual operation: See "[Error conditions](#)" on page 801

SEARCh:TRIGger:RFFE:ERRor:GAP <SearchName>,<GapError>

SEARCh:TRIGger:RFFE:ERRor:GAP? <SearchName>

Enables the search for RFFE gap time error.

Parameters:

<GapError> ON | OFF

*RST: ON

Parameters for setting and query:

<SearchName>

Manual operation: See "[Error conditions](#)" on page 801

SEARCh:TRIGger:RFFE:ERRor:VERSion <SearchName>,<VersionError>

SEARCh:TRIGger:RFFE:ERRor:VERSion? <SearchName>

Enables the search for RFFE vresion error.

Parameters:

<VersionError> ON | OFF
 *RST: ON

Parameters for setting and query:

<SearchName>

Manual operation: See ["Error conditions"](#) on page 801

27.18.18.5 Search results

The search on decoded RFFE data returns the same results as the queries for decode results.

In all SEARch:RESult:RFFE commands, the suffix <m> selects the command sequence. Suffix <n> selects index of byte inside a command sequence.

In search result commands, you have to specify the <SearchName> parameter. It is a string parameter that contains the search definition name.

For a description of the returned values, see the corresponding commands in [Chapter 27.18.18.3, "Decode results"](#), on page 2234.

For programming example, see ["Searching RFFE data"](#) on page 1361.

SEARch:RESult:RFFE:FCOunt?.....	2247
SEARch:RESult:RFFE:SEQuence<m>:TYPE?.....	2247
SEARch:RESult:RFFE:SEQuence<m>:STATe?.....	2248
SEARch:RESult:RFFE:SEQuence<m>:START?.....	2248
SEARch:RESult:RFFE:SEQuence<m>:SADD?.....	2248
SEARch:RESult:RFFE:SEQuence<m>:STOP?.....	2249
SEARch:RESult:RFFE:SEQuence<m>:ADDReSS?.....	2249
SEARch:RESult:RFFE:SEQuence<m>:BCOunt?.....	2249
SEARch:RESult:RFFE:SEQuence<m>:DATA?.....	2250
SEARch:RESult:RFFE:SEQuence<m>:SYMBol?.....	2250
SEARch:RESult:RFFE:SEQuence<m>:BYTE<n>:STATe?.....	2250
SEARch:RESult:RFFE:SEQuence<m>:BYTE<n>:VALue?.....	2250

SEARch:RESult:RFFE:FCOunt? <SearchName>**Query parameters:**

<SearchName>

Return values:

<FrameCount> Range: 0 to 100000
 Increment: 1
 *RST: 0

Usage: Query only

SEARch:RESult:RFFE:SEQuence<m>:TYPE? <SearchName>

Returns the type of the specified command sequence.

Suffix:

<m> *

Query parameters:

<SearchName>

Return values:<FrameType> UNDESC | RZWR | RWR | RRD | ERWR | ERRD | ERWL |
ERRL | IRSUM | MSKW | MOHO | MWR | MRD | MCTW |
MCTR | UNDEF | ERRorSee [SEARCh:TRIGger:RFFE:TYPE](#).

*RST: RZWR

Usage:

Query only

SEARCh:RESult:RFFE:SEQuence<m>:STATe? <SearchName>**Suffix:**

<m> *

Query parameters:

<SearchName>

Return values:<FrameState> OK | SSC | VERSion | PARity | LENGth | BPERR | GAP |
NORESPONSE | INComplete

*RST: OK

Usage:

Query only

SEARCh:RESult:RFFE:SEQuence<m>:START? <SearchName>**Suffix:**

<m> *

Query parameters:

<SearchName>

Return values:<FrameStart> Range: -100E+24 to 100E+24
Increment: 100E-12
*RST: 0
Default unit: s**Usage:**

Query only

SEARCh:RESult:RFFE:SEQuence<m>:SADD? <SearchName>**Suffix:**

<m> *

Query parameters:

<SearchName>

Return values:

<FrameSID> Range: 0 to 15
 Increment: 1
 *RST: 0

Usage: Query only

SEARCh:RESult:RFFE:SEQuence<m>:STOP? <SearchName>**Suffix:**

<m> *

Query parameters:

<SearchName>

Return values:

<FrameStop> Range: -100E+24 to 100E+24
 Increment: 100E-12
 *RST: 0
 Default unit: s

Usage: Query only

SEARCh:RESult:RFFE:SEQuence<m>:ADDRess? <SearchName>**Suffix:**

<m> *

Query parameters:

<SearchName>

Return values:

<FrameAddress> Range: 0 to 65535
 Increment: 1
 *RST: 0

Usage: Query only

SEARCh:RESult:RFFE:SEQuence<m>:BCOunt? <SearchName>**Suffix:**

<m> *

Query parameters:

<SearchName>

Return values:

<ByteCount> Range: 0 to 256
 Increment: 1
 *RST: 0

Usage: Query only

SEARCh:RESult:RFFE:SEQuence<m>:DATA? <SearchName>

Suffix:

<m> *

Query parameters:

<SearchName>

Return values:

<Data>

Usage: Query only

SEARCh:RESult:RFFE:SEQuence<m>:SYMBol? <SearchName>

Suffix:

<m> *

Query parameters:

<SearchName>

Return values:

<Translation>

Usage: Query only

SEARCh:RESult:RFFE:SEQuence<m>:BYTE<n>:STATe? <SearchName>

Suffix:

<m> *

<n> *

Query parameters:

<SearchName>

Return values:

<ByteState> OK | PARity
 OK: the byte is valid.
 PARity: parity error
 *RST: OK

Usage: Query only

SEARCh:RESult:RFFE:SEQuence<m>:BYTE<n>:VALue? <SearchName>

Suffix:

<m> *

<n> *

Query parameters:

<SearchName>

Return values:

<ByteValue> Range: 0 to 255
 Increment: 1
 *RST: 0

Usage: Query only

27.18.19 Ethernet 100BASE-T1 (option R&S RTO6-K560)

• Configuration	2251
• Trigger	2255
• Decode results	2263
• Search settings	2269
• Search results	2277

27.18.19.1 Configuration

In all `BUS<m>:HBTO` commands, the suffix `<m>` selects the serial bus.

BUS<m>:HBTO:ATTN	2251
BUS<m>:HBTO:FDAM	2252
BUS<m>:HBTO:FDAP	2252
BUS<m>:HBTO:FDIF	2252
BUS<m>:HBTO:FTYP	2252
BUS<m>:HBTO:RDAM	2253
BUS<m>:HBTO:RDAP	2253
BUS<m>:HBTO:RDIF	2253
BUS<m>:HBTO:RTYP	2253
BUS<m>:HBTO:THReshold	2254
BUS<m>:HBTO:POLarity	2254
BUS<m>:HBTO:MODE	2254
BUS<m>:HBTO:SYMRate	2254

BUS<m>:HBTO:ATTN <Attenuation>

Sets the attenuation factor. It is used to de-amplify the reverse signal before subtracting it from the forward signal.

Suffix:

<m> 1..4

Parameters:

<Attenuation> Range: -100 to 0
 Increment: 0.1
 *RST: -26
 Default unit: dB

Manual operation: See "[Reverse attenuation](#)" on page 806

BUS<m>:HBTO:FDAM <SourceDAminus>

Selects the DA- source of the provided forward single ended signal, if **BUS<m>:HBTO:FTYP** is set to **SINGLE**.

Suffix:

<m> 1..4

Parameters:

<SourceDAminus> C1W1 | C2W1 | C3W1 | C4W1 | M1 | M2 | M3 | M4 | M5 | M6 |
M7 | M8 | R1 | R2 | R3 | R4
*RST: C2W1

Manual operation: See "[Forward](#)" on page 805

BUS<m>:HBTO:FDAP <SourceDAplus>

Selects the DA+ source of the provided forward single ended signal, if **BUS<m>:HBTO:FTYP** is set to **SINGLE**.

Suffix:

<m> 1..4

Parameters:

<SourceDAplus> C1W1 | C2W1 | C3W1 | C4W1 | M1 | M2 | M3 | M4 | M5 | M6 |
M7 | M8 | R1 | R2 | R3 | R4
*RST: C1W1

Manual operation: See "[Forward](#)" on page 805

BUS<m>:HBTO:FDIF <SrcDiff>

Sets the source of the provided forward differential signal, if **BUS<m>:HBTO:FTYP** is set to **DIFFERENTIAL**.

Suffix:

<m> 1..4

Parameters:

<SrcDiff> C1W1 | C2W1 | C3W1 | C4W1 | M1 | M2 | M3 | M4 | M5 | M6 |
M7 | M8 | R1 | R2 | R3 | R4
*RST: C1W1

Manual operation: See "[Forward](#)" on page 805

BUS<m>:HBTO:FTYP <SignalType>

Sets the type of forward signal measurement.

Suffix:

<m> 1..4

Parameters:

<SignalType> DIFFerential | SINGLE
 *RST: DIFFerential

Manual operation: See ["Forward"](#) on page 805

BUS<m>:HBTO:RDAM <SrcRevDAminus>

Selects the DA- source of the provided reversed single ended signal, if [BUS<m>:HBTO:RTYP](#) is set to SINGLE.

Suffix:

<m> 1..4

Parameters:

<SrcRevDAminus> C1W1 | C2W1 | C3W1 | C4W1 | M1 | M2 | M3 | M4 | M5 | M6 | M7 | M8 | R1 | R2 | R3 | R4

Manual operation: See ["Reverse"](#) on page 805

BUS<m>:HBTO:RDAP <SourceRevDAplus>

Selects the DA+ source of the provided reversed single ended signal, if [BUS<m>:HBTO:RTYP](#) is set to SINGLE.

Suffix:

<m> 1..4

Parameters:

<SourceRevDAplus> C1W1 | C2W1 | C3W1 | C4W1 | M1 | M2 | M3 | M4 | M5 | M6 | M7 | M8 | R1 | R2 | R3 | R4

Manual operation: See ["Reverse"](#) on page 805

BUS<m>:HBTO:RDIF <SrcRevDiff>

Sets the source of the provided reversed differential signal, if [BUS<m>:HBTO:RTYP](#) is set to DIFFerential.

Suffix:

<m> 1..4

Parameters:

<SrcRevDiff> C1W1 | C2W1 | C3W1 | C4W1 | M1 | M2 | M3 | M4 | M5 | M6 | M7 | M8 | R1 | R2 | R3 | R4

Manual operation: See ["Reverse"](#) on page 805

BUS<m>:HBTO:RTYP <SignalRevType>

Sets the type of reverse signal measurement.

Suffix:

<m> 1..4

Parameters:

<SignalRevType> DISabled | DIFFerential | SINGle
 *RST: DISabled

Manual operation: See "[Reverse](#)" on page 805**BUS<m>:HBTO:THReshold <TriggerLevel>**

Sets an user-defined threshold value.

Suffix:

<m> 1..4

Parameters:

<TriggerLevel> Range: 0 to 1
 Increment: 1E-3
 *RST: 0.03
 Default unit: V

Manual operation: See "[Thresholds](#)" on page 806**BUS<m>:HBTO:POLarity <Polarity>**

Selects the polarity of the data signal.

Suffix:

<m> 1..4

Parameters:

<Polarity> NORMal | INVert
 *RST: NORMal

Manual operation: See "[Polarity](#)" on page 806**BUS<m>:HBTO:MODE <Mode>**

Selects the direction of the full-duplex signal you want to look at.

Suffix:

<m> 1..4

Parameters:

<Mode> MASTer | SLAVe | AUTO
 *RST: AUTO

Manual operation: See "[Operation mode](#)" on page 806**BUS<m>:HBTO:SYMRate <SymbolRate>**

Defines the rate of ternary symbols.

Suffix:

<m> 1..4

Parameters:

<SymbolRate> Range: 10 to 150
 Increment: 1E-3
 *RST: 66.6667
 Default unit: MSymb/s

Manual operation: See "[Symbol rate](#)" on page 807

27.18.19.2 Trigger

The trigger suffix <m> is always 1 and can be omitted. It selects the trigger event: Only the A-trigger is available for triggering on serial buses.

To trigger on a serial bus, make sure that:

- `TRIGger<m>:SOURce[:SElect]` is set to SBUS.
- The sources of the serial bus are channel signals: use `BUS<m>:...:SOURce` commands.
- Decoding is enabled: `BUS<m>[:STATe]` is set to ON.

<code>TRIGger<m>:HBTO:TYPE</code>	2255
<code>TRIGger<m>:HBTO:DADDrESS:CONDition</code>	2256
<code>TRIGger<m>:HBTO:DADDrESS:MIN</code>	2256
<code>TRIGger<m>:HBTO:DADDrESS:MAX</code>	2257
<code>TRIGger<m>:HBTO:SADDrESS:CONDition</code>	2257
<code>TRIGger<m>:HBTO:SADDrESS:MIN</code>	2257
<code>TRIGger<m>:HBTO:SADDrESS:MAX</code>	2258
<code>TRIGger<m>:HBTO:LENGth:CONDition</code>	2258
<code>TRIGger<m>:HBTO:LENGth:MIN</code>	2258
<code>TRIGger<m>:HBTO:LENGth:MAX</code>	2259
<code>TRIGger<m>:HBTO:CRC:CONDition</code>	2259
<code>TRIGger<m>:HBTO:CRC:MIN</code>	2259
<code>TRIGger<m>:HBTO:CRC:MAX</code>	2260
<code>TRIGger<m>:HBTO:DATA:DCONDition</code>	2260
<code>TRIGger<m>:HBTO:DATA:DMIN</code>	2260
<code>TRIGger<m>:HBTO:DATA:DMAX</code>	2261
<code>TRIGger<m>:HBTO:DATA:ICONDition</code>	2261
<code>TRIGger<m>:HBTO:DATA:IMIN</code>	2261
<code>TRIGger<m>:HBTO:DATA:IMAX</code>	2262
<code>TRIGger<m>:HBTO:ERRor:PREAmble</code>	2262
<code>TRIGger<m>:HBTO:ERRor:CRC</code>	2262
<code>TRIGger<m>:HBTO:ERRor:SFD</code>	2263

TRIGger<m>:HBTO:TYPE <Type>

Selects the type of frame to be triggered on.

Suffix:

<m> 1..3

Parameters:

<Type> START | MAC | IDLE | ERRor

START

Start of frame.

MAC

MAC frame. This frame contains information that define how to go about transmitting and receiving frames.

IDLE

IDLE frame. This frame is used for clock synchronization.

ERRor

Error frame. Thi frame contains erroneous bits.

*RST: START

Manual operation: See "[Type](#)" on page 809**TRIGger<m>:HBTO:DADDRESS:CONDition** <DestAddrOptor>

Sets the condition for the destination address. You can define an exact value or a value range.

Suffix:

<m> 1..3

Parameters:

<DestAddrOptor> EQUal | NEQual | LTHan | LETHan | GTHan | GETHan | INRange | OORange

EQUal | NEQual | LTHan | LETHan | GTHan | GETHanEqual, Not equal, Less than, Less or equal than, Greater Than, Greater or equal than. These conditions require one data pattern to be set with the corresponding [TRIGger<m>:HBTO:DADDRESS:MIN](#) command.**INRange | OORange**In range/Out of range: set the minimum and maximum value of the range with [TRIGger<m>:HBTO:DADDRESS:MIN](#) and [TRIGger<m>:HBTO:DADDRESS:MAX](#).

*RST: EQUal

Manual operation: See "[Destination address](#)" on page 811**TRIGger<m>:HBTO:DADDRESS:MIN** <DestAddrPattMin>

Specifies the destination address bit pattern, or sets the start value of a pattern range.

Suffix:

<m> 1..3

Parameters:

<DestAddrPattMin> Numeric or string pattern, see [Chapter 27.4.6, "Bit pattern parameter"](#), on page 1373. The string parameter accepts the bit value X (don't care).

Manual operation: See ["Destination address"](#) on page 811

TRIGger<m>:HBTO:DADDRESS:MAX <DestAddrPattMax>

Sets the end value of the destination address range if [TRIGger<m>:HBTO:DADDRESS:CONDition](#) is set to [INRange](#) or [OORange](#).

Suffix:

<m> 1..3

Parameters:

<DestAddrPattMax> Numeric or string pattern, see [Chapter 27.4.6, "Bit pattern parameter"](#), on page 1373. The string parameter accepts the bit value X (don't care).

Manual operation: See ["Destination address"](#) on page 811

TRIGger<m>:HBTO:SADDRESS:CONDition <SrcAddrOperator>

Sets the condition for the source address. You can define an exact value or a value range.

Suffix:

<m> 1..3

Parameters:

<SrcAddrOperator> [EQUAL](#) | [NEQUAL](#) | [LTHan](#) | [LETHan](#) | [GTHan](#) | [GETHan](#) | [INRange](#) | [OORange](#)

[EQUAL](#) | [NEQUAL](#) | [LTHan](#) | [LETHan](#) | [GTHan](#) | [GETHan](#)

Equal, Not equal, Less than, Less or equal than, Greater Than, Greater or equal than. These conditions require one data pattern to be set with the corresponding [TRIGger<m>:HBTO:SADDRESS:MIN](#) command.

[INRange](#) | [OORange](#)

In range/Out of range: set the minimum and maximum value of the range with [TRIGger<m>:HBTO:SADDRESS:MIN](#) and [TRIGger<m>:HBTO:SADDRESS:MAX](#).

*RST: [EQUAL](#)

Manual operation: See ["Source address"](#) on page 811

TRIGger<m>:HBTO:SADDRESS:MIN <SrcAddrPattMin>

Specifies the source address bit pattern, or sets the start value of a pattern range.

Suffix:

<m> 1..3

Parameters:

<SrcAddrPattMin> Numeric or string pattern, see [Chapter 27.4.6, "Bit pattern parameter"](#), on page 1373. The string parameter accepts the bit value X (don't care).

Manual operation: See ["Source address"](#) on page 811

TRIGger<m>:HBTO:SADdRESS:MAX <SrcAddrPattMax>

Sets the end value of the source address range if [TRIGger<m>:HBTO:SADdRESS:CONDition](#) is set to [INRange](#) or [OORange](#).

Suffix:

<m> 1..3

Parameters:

<SrcAddrPattMax> Numeric or string pattern, see [Chapter 27.4.6, "Bit pattern parameter"](#), on page 1373. The string parameter accepts the bit value X (don't care).

Manual operation: See ["Source address"](#) on page 811

TRIGger<m>:HBTO:LENGth:CONDition <TypeOperator>

Sets the condition for the length / type. You can define an exact value or a value range.

Suffix:

<m> 1..3

Parameters:

<TypeOperator> [EQUal](#) | [NEQUal](#) | [LTHan](#) | [LETHan](#) | [GTHan](#) | [GETHan](#) | [INRange](#) | [OORange](#)

[EQUal](#) | [NEQUal](#) | [LTHan](#) | [LETHan](#) | [GTHan](#) | [GETHan](#)

Equal, Not equal, Less than, Less or equal than, Greater Than, Greater or equal than. These conditions require one data pattern to be set with the corresponding [TRIGger<m>:HBTO:LENGth:MIN](#) command.

[INRange](#) | [OORange](#)

In range/Out of range: set the minimum and maximum value of the range with [TRIGger<m>:HBTO:LENGth:MIN](#) and [TRIGger<m>:HBTO:LENGth:MAX](#).

*RST: [EQUal](#)

Manual operation: See ["Length/Type"](#) on page 812

TRIGger<m>:HBTO:LENGth:MIN <TypePatternMin>

Specifies the length / type bit pattern, or sets the start value of a pattern range.

Suffix:

<m> 1..3

Parameters:

<TypePatternMin> Numeric or string pattern, see [Chapter 27.4.6, "Bit pattern parameter"](#), on page 1373. The string parameter accepts the bit value X (don't care).

Manual operation: See "[Length/Type](#)" on page 812

TRIGger<m>:HBTO:LENGth:MAX <TypePatternMax>

Sets the end value of the length / type range if `TRIGger<m>:HBTO:LENGth:CONDition` is set to `INRange` or `OORange`.

Suffix:

<m> 1..3

Parameters:

<TypePatternMax> Numeric or string pattern, see [Chapter 27.4.6, "Bit pattern parameter"](#), on page 1373. The string parameter accepts the bit value X (don't care).

Manual operation: See "[Length/Type](#)" on page 812

TRIGger<m>:HBTO:CRC:CONDition <CRCOperator>

Sets the condition for the frame check. You can define an exact value or a value range.

Suffix:

<m> 1..3

Parameters:

<CRCOperator> `EQUal` | `NEQUal` | `LTHan` | `LETHan` | `GTHan` | `GETHan` | `INRange` | `OORange`

`EQUal` | `NEQUal` | `LTHan` | `LETHan` | `GTHan` | `GETHan`

Equal, Not equal, Less than, Less or equal than, Greater Than, Greater or equal than. These conditions require one data pattern to be set with the corresponding `TRIGger<m>:HBTO:CRC:MIN` command.

`INRange` | `OORange`

In range/Out of range: set the minimum and maximum value of the range with `TRIGger<m>:HBTO:CRC:MIN` and `TRIGger<m>:HBTO:CRC:MAX`.

*RST: `EQUal`

Manual operation: See "[Frame check](#)" on page 812

TRIGger<m>:HBTO:CRC:MIN <CRCPatternMin>

Specifies the frame check bit pattern, or sets the start value of a pattern range.

Suffix:

<m> 1..3

Parameters:

<CRCPatternMin> Numeric or string pattern, see [Chapter 27.4.6, "Bit pattern parameter"](#), on page 1373. The string parameter accepts the bit value X (don't care).

Manual operation: See ["Frame check"](#) on page 812

TRIGger<m>:HBTO:CRC:MAX <CRCPatternMax>

Sets the end value of the frame check range if [TRIGger<m>:HBTO:CRC:CONDition](#) is set to [INRange](#) or [OORange](#).

Suffix:

<m> 1..3

Parameters:

<CRCPatternMax> Numeric or string pattern, see [Chapter 27.4.6, "Bit pattern parameter"](#), on page 1373. The string parameter accepts the bit value X (don't care).

Manual operation: See ["Frame check"](#) on page 812

TRIGger<m>:HBTO:DATA:DCONDition <DataOperator>

Sets the condition for the data. You can define an exact value or a value range.

Suffix:

<m> 1..3

Parameters:

<DataOperator> [EQUAL](#) | [NEQUAL](#) | [LTHan](#) | [LETHan](#) | [GTHan](#) | [GETHan](#) | [INRange](#) | [OORange](#)

[EQUAL](#) | [NEQUAL](#) | [LTHan](#) | [LETHan](#) | [GTHan](#) | [GETHan](#)

Equal, Not equal, Less than, Less or equal than, Greater Than, Greater or equal than. These conditions require one data pattern to be set with the corresponding [TRIGger<m>:HBTO:DATA:DMIN](#) command.

[INRange](#) | [OORange](#)

In range/Out of range: set the minimum and maximum value of the range with [TRIGger<m>:HBTO:DATA:DMIN](#) and [TRIGger<m>:HBTO:DATA:DMAX](#).

*RST: [EQUAL](#)

Manual operation: See ["Data"](#) on page 813

TRIGger<m>:HBTO:DATA:DMIN <DataMin>

Specifies the data bit pattern, or sets the start value of a pattern range.

Suffix:

<m> 1..3

Parameters:

<DataMin> Numeric or string pattern, see [Chapter 27.4.6, "Bit pattern parameter"](#), on page 1373. The string parameter accepts the bit value X (don't care).

Manual operation: See ["Data"](#) on page 813

TRIGger<m>:HBTO:DATA:DMAX <DataMax>

Sets the end value of the data range if [TRIGger<m>:HBTO:DATA:DCondition](#) is set to [INRange](#) or [OORange](#).

Suffix:

<m> 1..3

Parameters:

<DataMax> Numeric or string pattern, see [Chapter 27.4.6, "Bit pattern parameter"](#), on page 1373. The string parameter accepts the bit value X (don't care).

Manual operation: See ["Data"](#) on page 813

TRIGger<m>:HBTO:DATA:ICONdition <DataIdxOperator>

Sets the condition for the index. You can define an exact value or a value range.

Suffix:

<m> 1..3

Parameters:

<DataIdxOperator> [EQUal](#) | [LTHan](#) | [LETHan](#) | [GTHan](#) | [GETHan](#) | [INRange](#) | [RANGe](#)

[EQUal](#) | [NEQUal](#) | [LTHan](#) | [LETHan](#) | [GTHan](#) | [GETHan](#)

Equal, Not equal, Less than, Less or equal than, Greater Than, Greater or equal than. These conditions require one data pattern to be set with the corresponding [TRIGger<m>:HBTO:DATA:IMIN](#) command.

[INRange](#) | [OORange](#)

In range/Out of range: set the minimum and maximum value of the range with [TRIGger<m>:HBTO:DATA:IMIN](#) and [TRIGger<m>:HBTO:DATA:IMAX](#).

*RST: [INRange](#)

Manual operation: See ["Index"](#) on page 813

TRIGger<m>:HBTO:DATA:IMIN <DataIndexMin>

Specifies the index bit pattern, or sets the start value of a pattern range.

Suffix:

<m> 1..3

Parameters:

<DataIndexMin>	Range:	1 to 65535
	Increment:	1
	*RST:	1

Manual operation: See "[Index](#)" on page 813**TRIGger<m>:HBTO:DATA:IMAX <DataIndexMax>**

Sets the end value of the index range if [TRIGger<m>:HBTO:DATA:ICONdition](#) is set to [INRange](#) or [OORange](#).

Suffix:

<m> 1..3

Parameters:

<DataIndexMax>	Range:	1 to 65535
	Increment:	1
	*RST:	0

Manual operation: See "[Index](#)" on page 813**TRIGger<m>:HBTO:ERRor:PREamble <ErrorPreamble>**

Enables / disables trigger on preamble error.

Suffix:

<m> 1..3

Parameters:

<ErrorPreamble>	ON OFF
	*RST: ON

Manual operation: See "[Preamble Error](#)" on page 813**TRIGger<m>:HBTO:ERRor:CRC <ErrorCRC>**

Enables / disables trigger on Cyclic Redundancy Check (CRC) error.

Suffix:

<m> 1..3

Parameters:

<ErrorCRC>	ON OFF
	*RST: ON

Manual operation: See "[CRC Error](#)" on page 814

TRIGger<m>:HBTO:ERRor:SFD <ErrorSFD>

Enables / disables trigger on start frame delimiter (SFD) error.

Suffix:

<m> 1..3

Parameters:

<ErrorSFD> ON | OFF
*RST: ON

Manual operation: See "SFD Error" on page 814

27.18.19.3 Decode results

To show the results on the screen, use the following commands:

- [BUS<m>:RESult](#) on page 1814

In all `BUS<m>:HBTO:RESult:FRAMe<n>:WORD<o>` commands, the suffix `<m>` selects the serial bus, suffix `<n>` selects the frame in the decode table and suffix `<o>` selects the word in the selected frame.

BUS<m>:HBTO:RESult:FCOunt?	2263
BUS<m>:HBTO:RESult:FRAMe<n>:FTYPe?	2264
BUS<m>:HBTO:RESult:FRAMe<n>:STATe?	2264
BUS<m>:HBTO:RESult:FRAMe<n>:STARt?	2265
BUS<m>:HBTO:RESult:FRAMe<n>:STOP?	2265
BUS<m>:HBTO:RESult:FRAMe<n>:DESTAddress?	2265
BUS<m>:HBTO:RESult:FRAMe<n>:SRCAddress?	2265
BUS<m>:HBTO:RESult:FRAMe<n>:TYPE?	2266
BUS<m>:HBTO:RESult:FRAMe<n>:DATA?	2266
BUS<m>:HBTO:RESult:FRAMe<n>:CRC?	2266
BUS<m>:HBTO:RESult:FRAMe<n>:NUMWords?	2267
BUS<m>:HBTO:RESult:FRAMe<n>:DSYMBOL?	2267
BUS<m>:HBTO:RESult:FRAMe<n>:SSYMBOL?	2267
BUS<m>:HBTO:RESult:FRAMe<n>:BITRate?	2267
BUS<m>:HBTO:RESult:FRAMe<n>:WORD<o>:TYPE?	2268
BUS<m>:HBTO:RESult:FRAMe<n>:WORD<o>:VALue?	2268
BUS<m>:HBTO:RESult:FRAMe<n>:WORD<o>:VSTR?	2268

BUS<m>:HBTO:RESult:FCOunt?

Returns the number of decoded frames.

Suffix:

<m> 1..4

Return values:

<FrameCount> Range: 0 to 100000
Increment: 1
*RST: 0

Usage: Query only

BUS<m>:HBTO:RESult:FRAMe<n>:FTYPe?

Returns the type of frame for the selected frame.

Suffix:

<m> 1..4
<n> *

Return values:

<FrameType> IDLE | MAC | FILLer | UNKNown

IDLE

IDLE frame. This frame is used for clock synchronization.

MAC

MAC frame. This frame contains information that define how to go about transmitting and receiving frames.

FILLer

Filler frame. The frame is used to maintain transmission activity.

UNKNown

No meaningful frame can be determined.

*RST: MAC

Usage: Query only

BUS<m>:HBTO:RESult:FRAMe<n>:STATe?

Returns the state of the frame.

Suffix:

<m> 1..4
<n> *

Return values:

<State> OK | ERR_PREAMBLE | ERR_SFD | ERR_LENGTH |
ERR_CRC | UNCorrelated | INComplete

OK

Valid frame.

ERR_PREAMBLE

Erroneous frame due to preamble error.

ERR_SFD

Erroneous frame due to SFD error.

ERR_LENGTH

Erroneous frame due to length / type error.

ERR_CRC

Erroneous frame due to CRC error.

*RST: OK

Usage: Query only

BUS<m>:HBTO:RESult:FRAMe<n>:STARt?

Returns the start time of the selected frame.

Suffix:

<m> 1..4

<n> *

Return values:

<Start> Range: -100E+24 to 100E+24
Increment: 100E-12
*RST: 0
Default unit: s

Usage: Query only

BUS<m>:HBTO:RESult:FRAMe<n>:STOP?

Returns the end time of the selected frame.

Suffix:

<m> 1..4

<n> *

Return values:

<Stop> Range: -100E+24 to 100E+24
Increment: 100E-12
*RST: 0
Default unit: s

Usage: Query only

BUS<m>:HBTO:RESult:FRAMe<n>:DESTaddress?

Returns the destination address of the selected frame.

Suffix:

<m> 1..4

<n> *

Return values:

<DestAddress>

Usage: Query only

BUS<m>:HBTO:RESult:FRAMe<n>:SRCaddress?

Returns the source address of the selected frame.

Suffix:

<m> 1..4

<n> *

Return values:

<SrcAddress>

Usage: Query only

BUS<m>:HBTO:RESult:FRAMe<n>:TYPE?

Returns the value of length / type field of the selected frame.

Suffix:

<m> 1..4

<n> *

Return values:<TypeLen> Range: 0 to 65535
Increment: 1
*RST: 0**Usage:** Query only

BUS<m>:HBTO:RESult:FRAMe<n>:DATA?

Returns the data for the selected frame, corresponds to the Data column in the decode results table.

Suffix:

<m> 1..4

<n> *

Return values:

<Data>

Usage: Query only

BUS<m>:HBTO:RESult:FRAMe<n>:CRC?

Returns the CRC (frame check) checksum of the selected frame.

Suffix:

<m> 1..4

<n> *

Return values:<CRC> Range: 0 to 4294967295
Increment: 1
*RST: 0**Usage:** Query only

BUS<m>:HBTO:RESult:FRAMe<n>:NUMWords?

Returns the number of decoded words for the selected frame.

Suffix:

<m> 1..4

<n> *

Return values:

<NumWords> Range: 0 to 4294967295
Increment: 1
*RST: 0

Usage: Query only

BUS<m>:HBTO:RESult:FRAMe<n>:DSYMBOL?

Returns the destination symbols of the selected frame.

Suffix:

<m> 1..4

<n> *

Return values:

<DestTranslation>

Usage: Query only

BUS<m>:HBTO:RESult:FRAMe<n>:SSYMBOL?

Returns the source symbols of the selected frame.

Suffix:

<m> 1..4

<n> *

Return values:

<SrcTranslation>

Usage: Query only

BUS<m>:HBTO:RESult:FRAMe<n>:BITRate?

Returns the primary bit rate.

Suffix:

<m> 1..4

<n> *

Return values:

<PrimaryBitRate> Range: 0 to 100000000000
 Increment: 1
 *RST: 0
 Default unit: bps

Usage: Query only

BUS<m>:HBTO:RESult:FRAMe<n>:WORD<o>:TYPE?

Returns the data type for the selected word.

Suffix:

<m> 1..4
 <n> *
 <o> *

Return values:

<WordType>

Usage: Query only

BUS<m>:HBTO:RESult:FRAMe<n>:WORD<o>:VALue?

Returns the data value for the selected word.

Suffix:

<m> 1..4
 <n> *
 <o> *

Return values:

<WordValue> Range: 0 to 65535
 Increment: 1
 *RST: 0

Usage: Query only

BUS<m>:HBTO:RESult:FRAMe<n>:WORD<o>:VSTR?

Returns the string equivalent of data value for the selected cell.

Suffix:

<m> 1..4
 <n> *
 <o> *

Return values:

<WordValueString> String parameter

Usage: Query only

27.18.19.4 Search settings

SEARch:TRIGger:HBTO:TYPE.....	2269
SEARch:TRIGger:HBTO:DADdress:CONDition.....	2270
SEARch:TRIGger:HBTO:DADdress:MIN.....	2270
SEARch:TRIGger:HBTO:DADdress:MAX.....	2270
SEARch:TRIGger:HBTO:SADdress:CONDition.....	2271
SEARch:TRIGger:HBTO:SADdress:MIN.....	2271
SEARch:TRIGger:HBTO:SADdress:MAX.....	2271
SEARch:TRIGger:HBTO:LENGth:CONDition.....	2272
SEARch:TRIGger:HBTO:LENGth:MIN.....	2272
SEARch:TRIGger:HBTO:LENGth:MAX.....	2273
SEARch:TRIGger:HBTO:CRC:CONDition.....	2273
SEARch:TRIGger:HBTO:CRC:MIN.....	2273
SEARch:TRIGger:HBTO:CRC:MAX.....	2274
SEARch:TRIGger:HBTO:DATA:DCONDition.....	2274
SEARch:TRIGger:HBTO:DATA:DMIN.....	2274
SEARch:TRIGger:HBTO:DATA:DMAX.....	2275
SEARch:TRIGger:HBTO:DATA:ICONDition.....	2275
SEARch:TRIGger:HBTO:DATA:IMIN.....	2275
SEARch:TRIGger:HBTO:DATA:IMAX.....	2276
SEARch:TRIGger:HBTO:ERRor:PREAmble.....	2276
SEARch:TRIGger:HBTO:ERRor:CRC.....	2276
SEARch:TRIGger:HBTO:ERRor:SFD.....	2277

SEARch:TRIGger:HBTO:TYPE <SearchName>,<Type>

SEARch:TRIGger:HBTO:TYPE? <SearchName>

Selects the type of frame to be searched for.

Parameters:

<Type> START | MAC | IDLE | ERRor

START

Start of frame.

MAC

MAC frame. This frame contains information that define how to go about transmitting and receiving frames.

IDLE

IDLE frame. This frame is used for clock synchronization.

ERRor

Error frame. Thi frame contains erroneous bits.

*RST: START

Parameters for setting and query:

<SearchName>

Manual operation: See "Type" on page 816

SEARCh:TRIGger:HBTO:DADDrESS:CONDition <SearchName>,<DestAddrOptor>
SEARCh:TRIGger:HBTO:DADDrESS:CONDition? <SearchName>

Sets the condition for the destination address. You can define an exact value or a value range.

Parameters:

<DestAddrOptor> EQUal | NEQual | LTHan | LETHan | GTHan | GETHan |
 INRange | OORange

EQUal | NEQual | LTHan | LETHan | GTHan | GETHan

Equal, Not equal, Less than, Less or equal than, Greater Than, Greater or equal than. These conditions require one data pattern to be set with the corresponding [SEARCh:TRIGger:HBTO:DADDrESS:MIN](#) command.

INRange | OORange

In range/Out of range: set the minimum and maximum value of the range with [SEARCh:TRIGger:HBTO:DADDrESS:MIN](#) and [SEARCh:TRIGger:HBTO:DADDrESS:MAX](#).

*RST: EQUal

Parameters for setting and query:

<SearchName>

Manual operation: See "[Destination address](#)" on page 817

SEARCh:TRIGger:HBTO:DADDrESS:MIN <SearchName>,<DestAddrPattMin>
SEARCh:TRIGger:HBTO:DADDrESS:MIN? <SearchName>

Specifies the destination address bit pattern, or sets the start value of a pattern range.

Parameters:

<DestAddrPattMin> Numeric or string pattern, see [Chapter 27.4.6, "Bit pattern parameter"](#), on page 1373. The string parameter accepts the bit value X (don't care).

Parameters for setting and query:

<SearchName>

Manual operation: See "[Destination address](#)" on page 817

SEARCh:TRIGger:HBTO:DADDrESS:MAX <SearchName>,<DestAddrPattMax>
SEARCh:TRIGger:HBTO:DADDrESS:MAX? <SearchName>

Sets the end value of the destination address range if [SEARCh:TRIGger:HBTO:DADDrESS:CONDition](#) is set to [INRange](#) or [OORange](#).

Parameters:

<DestAddrPattMax> Numeric or string pattern, see [Chapter 27.4.6, "Bit pattern parameter"](#), on page 1373. The string parameter accepts the bit value X (don't care).

Parameters for setting and query:

<SearchName>

Manual operation: See "[Destination address](#)" on page 817**SEARCh:TRIGger:HBTO:SADdress:CONDition** <SearchName>,<SrcAddrOperator>**SEARCh:TRIGger:HBTO:SADdress:CONDition?** <SearchName>

Sets the condition for the source address. You can define an exact value or a value range.

Parameters:

<SrcAddrOperator> EQUal | NEQual | LTHan | LETHan | GTHan | GETHan |
 INRange | OORange

EQUal | NEQual | LTHan | LETHan | GTHan | GETHan

Equal, Not equal, Less than, Less or equal than, Greater Than, Greater or equal than. These conditions require one data pattern to be set with the corresponding [SEARCh:TRIGger:HBTO:SADdress:MIN](#) command.

INRange | OORange

In range/Out of range: set the minimum and maximum value of the range with [SEARCh:TRIGger:HBTO:SADdress:MIN](#) and [SEARCh:TRIGger:HBTO:SADdress:MAX](#).

*RST: EQUal

Parameters for setting and query:

<SearchName>

Manual operation: See "[Source address](#)" on page 817**SEARCh:TRIGger:HBTO:SADdress:MIN** <SearchName>,<SrcAddrPattMin>**SEARCh:TRIGger:HBTO:SADdress:MIN?** <SearchName>

Specifies the source address bit pattern, or sets the start value of a pattern range.

Parameters:

<SrcAddrPattMin> Numeric or string pattern, see [Chapter 27.4.6, "Bit pattern parameter"](#), on page 1373. The string parameter accepts the bit value X (don't care).

Parameters for setting and query:

<SearchName>

Manual operation: See "[Source address](#)" on page 817**SEARCh:TRIGger:HBTO:SADdress:MAX** <SearchName>,<SrcAddrPattMax>**SEARCh:TRIGger:HBTO:SADdress:MAX?** <SearchName>

Sets the end value of the source address range if [SEARCh:TRIGger:HBTO:SADdress:CONDition](#) is set to `INRange` or `OORange`.

Parameters:

<SrcAddrPattMax> Numeric or string pattern, see [Chapter 27.4.6, "Bit pattern parameter"](#), on page 1373. The string parameter accepts the bit value X (don't care).

Parameters for setting and query:

<SearchName>

Manual operation: See ["Source address"](#) on page 817

SEARCh:TRIGger:HBTO:LENGth:CONDition <SearchName>,<TypeOperator>

SEARCh:TRIGger:HBTO:LENGth:CONDition? <SearchName>

Sets the condition for the length / type. You can define an exact value or a value range.

Parameters:

<TypeOperator> EQUAL | NEQUAL | LTHan | LETHan | GTHan | GETHan |
INRange | OORange

EQUAL | NEQUAL | LTHan | LETHan | GTHan | GETHan

Equal, Not equal, Less than, Less or equal than, Greater Than, Greater or equal than. These conditions require one data pattern to be set with the corresponding [SEARCh:TRIGger:HBTO:LENGth:MIN](#) command.

INRange | OORange

In range/Out of range: set the minimum and maximum value of the range with [SEARCh:TRIGger:HBTO:LENGth:MIN](#) and [SEARCh:TRIGger:HBTO:LENGth:MAX](#).

*RST: EQUAL

Parameters for setting and query:

<SearchName>

Manual operation: See ["Length/Type"](#) on page 818

SEARCh:TRIGger:HBTO:LENGth:MIN <SearchName>,<TypePatternMin>

SEARCh:TRIGger:HBTO:LENGth:MIN? <SearchName>

Specifies the length / type bit pattern, or sets the start value of a pattern range.

Parameters:

<TypePatternMin> Numeric or string pattern, see [Chapter 27.4.6, "Bit pattern parameter"](#), on page 1373. The string parameter accepts the bit value X (don't care).

Parameters for setting and query:

<SearchName>

Manual operation: See ["Length/Type"](#) on page 818

SEARCh:TRIGger:HBTO:LENGth:MAX <SearchName>,<TypePatternMax>
SEARCh:TRIGger:HBTO:LENGth:MAX? <SearchName>

Sets the end value of the length / type range if [SEARCh:TRIGger:HBTO:LENGth:CONDition](#) is set to [INRange](#) or [OORange](#).

Parameters:

<TypePatternMax> Numeric or string pattern, see [Chapter 27.4.6, "Bit pattern parameter"](#), on page 1373. The string parameter accepts the bit value X (don't care).

Parameters for setting and query:

<SearchName>

Manual operation: See "[Length/Type](#)" on page 818

SEARCh:TRIGger:HBTO:CRc:CONDition <SearchName>,<CRcOperator>
SEARCh:TRIGger:HBTO:CRc:CONDition? <SearchName>

Sets the condition for the frame check. You can define an exact value or a value range.

Parameters:

<CRcOperator> [EQUal](#) | [NEQUal](#) | [LTHan](#) | [LETHan](#) | [GTHan](#) | [GETHan](#) | [INRange](#) | [OORange](#)

[EQUal](#) | [NEQUal](#) | [LTHan](#) | [LETHan](#) | [GTHan](#) | [GETHan](#)

Equal, Not equal, Less than, Less or equal than, Greater Than, Greater or equal than. These conditions require one data pattern to be set with the corresponding [SEARCh:TRIGger:HBTO:CRc:MIN](#) command.

[INRange](#) | [OORange](#)

In range/Out of range: set the minimum and maximum value of the range with [SEARCh:TRIGger:HBTO:CRc:MIN](#) and [SEARCh:TRIGger:HBTO:CRc:MAX](#).

*RST: [EQUal](#)

Parameters for setting and query:

<SearchName>

Manual operation: See "[Frame check](#)" on page 818

SEARCh:TRIGger:HBTO:CRc:MIN <SearchName>,<CRcPatternMin>
SEARCh:TRIGger:HBTO:CRc:MIN? <SearchName>

Specifies the frame check bit pattern, or sets the start value of a pattern range.

Parameters:

<CRcPatternMin> Numeric or string pattern, see [Chapter 27.4.6, "Bit pattern parameter"](#), on page 1373. The string parameter accepts the bit value X (don't care).

Parameters for setting and query:

<SearchName>

Manual operation: See "Frame check" on page 818

SEARCH:TRIGger:HBTO:CRC:MAX <SearchName>,<CRCPatternMax>
SEARCH:TRIGger:HBTO:CRC:MAX? <SearchName>

Sets the end value of the frame check range if [SEARCH:TRIGger:HBTO:CRC:CONDition](#) is set to [INRange](#) or [OORange](#).

Parameters:

<CRCPatternMax> Numeric or string pattern, see [Chapter 27.4.6, "Bit pattern parameter"](#), on page 1373. The string parameter accepts the bit value X (don't care).

Parameters for setting and query:

<SearchName>

Manual operation: See "Frame check" on page 818

SEARCH:TRIGger:HBTO:DATA:DCONDition <SearchName>,<DataOperator>
SEARCH:TRIGger:HBTO:DATA:DCONDition? <SearchName>

Sets the condition for the data. You can define an exact value or a value range.

Parameters:

<DataOperator> [EQUAL](#) | [NEQUAL](#) | [LTHan](#) | [LETHan](#) | [GTHan](#) | [GETHan](#) | [INRange](#) | [OORange](#)

EQUAL | **NEQUAL** | **LTHan** | **LETHan** | **GTHan** | **GETHan**

Equal, Not equal, Less than, Less or equal than, Greater Than, Greater or equal than. These conditions require one data pattern to be set with the corresponding [SEARCH:TRIGger:HBTO:DATA:DMIN](#) command.

INRange | **OORange**

In range/Out of range: set the minimum and maximum value of the range with [SEARCH:TRIGger:HBTO:DATA:DMIN](#) and [SEARCH:TRIGger:HBTO:DATA:DMAX](#).

*RST: [EQUAL](#)

Parameters for setting and query:

<SearchName>

Manual operation: See "Data" on page 819

SEARCH:TRIGger:HBTO:DATA:DMIN <SearchName>,<DataMin>
SEARCH:TRIGger:HBTO:DATA:DMIN? <SearchName>

Specifies the data bit pattern, or sets the start value of a pattern range.

Parameters:

<DataMin> Numeric or string pattern, see [Chapter 27.4.6, "Bit pattern parameter"](#), on page 1373. The string parameter accepts the bit value X (don't care).

Parameters for setting and query:

<SearchName>

Manual operation: See "Data" on page 819**SEARCH:TRIGger:HBTO:DATA:DMAX** <SearchName>,<DataMax>**SEARCH:TRIGger:HBTO:DATA:DMAX?** <SearchName>Sets the end value of the data range if `SEARCH:TRIGger:HBTO:DATA:DCONdition` is set to `INRange` or `ORange`.**Parameters:**<DataMax> Numeric or string pattern, see [Chapter 27.4.6, "Bit pattern parameter"](#), on page 1373. The string parameter accepts the bit value X (don't care).**Parameters for setting and query:**

<SearchName>

Manual operation: See "Data" on page 819**SEARCH:TRIGger:HBTO:DATA:ICONdition** <SearchName>,<DataIdxOperator>**SEARCH:TRIGger:HBTO:DATA:ICONdition?** <SearchName>

Sets the condition for the index. You can define an exact value or a value range.

Parameters:<DataIdxOperator> `EQUal` | `LTHan` | `LETHan` | `GTHan` | `GETHan` | `INRange` | `RANGe`**`EQUal` | `NEQual` | `LTHan` | `LETHan` | `GTHan` | `GETHan`**Equal, Not equal, Less than, Less or equal than, Greater Than, Greater or equal than. These conditions require one data pattern to be set with the corresponding `SEARCH:TRIGger:HBTO:DATA:IMIN` command.**`INRange` | `ORange`**In range/Out of range: set the minimum and maximum value of the range with `SEARCH:TRIGger:HBTO:DATA:IMIN` and `SEARCH:TRIGger:HBTO:DATA:IMAX`.***RST: `INRange`****Parameters for setting and query:**

<SearchName>

Manual operation: See "Index" on page 819**SEARCH:TRIGger:HBTO:DATA:IMIN** <SearchName>,<DataIndexMin>**SEARCH:TRIGger:HBTO:DATA:IMIN?** <SearchName>

Specifies the index bit pattern, or sets the start value of a pattern range.

Parameters:

<DataIndexMin> Range: 1 to 0
 Increment: 1
 *RST: 1

Parameters for setting and query:

<SearchName>

Manual operation: See "[Index](#)" on page 819

SEARCH:TRIGger:HBTO:DATA:IMAX <SearchName>,<DataIndexMax>

SEARCH:TRIGger:HBTO:DATA:IMAX? <SearchName>

Sets the end value of the index range if [SEARCH:TRIGger:HBTO:DATA:ICONdition](#) is set to [INRange](#) or [OORange](#).

Parameters:

<DataIndexMax> Range: 1 to 0
 Increment: 1
 *RST: 0

Parameters for setting and query:

<SearchName>

Manual operation: See "[Index](#)" on page 819

SEARCH:TRIGger:HBTO:ERRor:PREAmble <SearchName>,<ErrorPreamble>

SEARCH:TRIGger:HBTO:ERRor:PREAmble? <SearchName>

Enables / disables search for preamble error.

Parameters:

<ErrorPreamble> ON | OFF
 *RST: ON

Parameters for setting and query:

<SearchName>

Manual operation: See "[Preamble Error](#)" on page 819

SEARCH:TRIGger:HBTO:ERRor:CRC <SearchName>,<ErrorCRC>

SEARCH:TRIGger:HBTO:ERRor:CRC? <SearchName>

Enables / disables trigger on Cyclic Redundancy Check (CRC) error.

Parameters:

<ErrorCRC> ON | OFF
 *RST: ON

Parameters for setting and query:

<SearchName>

Manual operation: See "[CRC Error](#)" on page 819

SEARCh:TRIGger:HBTO:ERRor:SFD <SearchName>,<ErrorSFD>
SEARCh:TRIGger:HBTO:ERRor:SFD? <SearchName>

Enables / disables search for start frame delimiter (SFD) error.

Parameters:

<ErrorSFD> ON | OFF
 *RST: ON

Parameters for setting and query:

<SearchName>

Manual operation: See "[SFD Error](#)" on page 820

27.18.19.5 Search results

In all **SEARCh:RESult:HBTO:FRAMe<m>** commands, the suffix <m> selects the frame number in the list of search results.

SEARCh:RESult:HBTO:FCOunt?	2277
SEARCh:RESult:HBTO:FRAMe<m>:TYPE?	2277
SEARCh:RESult:HBTO:FRAMe<m>:STATe?	2278
SEARCh:RESult:HBTO:FRAMe<m>:STARt?	2278
SEARCh:RESult:HBTO:FRAMe<m>:STOP?	2279
SEARCh:RESult:HBTO:FRAMe<m>:DESTAddress?	2279
SEARCh:RESult:HBTO:FRAMe<m>:SRCAddress?	2279
SEARCh:RESult:HBTO:FRAMe<m>:DATA?	2280
SEARCh:RESult:HBTO:FRAMe<m>:CRC?	2280
SEARCh:RESult:HBTO:FRAMe<m>:NUMWords?	2280
SEARCh:RESult:HBTO:FRAMe<m>:FTYPe?	2280
SEARCh:RESult:HBTO:FRAMe<m>:DSYMBOL?	2281
SEARCh:RESult:HBTO:FRAMe<m>:SSYMBOL?	2281
SEARCh:RESult:HBTO:FRAMe<m>:WORD<n>:TYPE?	2282
SEARCh:RESult:HBTO:FRAMe<m>:WORD<n>:VALue?	2282

SEARCh:RESult:HBTO:FCOunt? <SearchName>

Returns the number of decoded frames within the search result.

Query parameters:

<SearchName>

Return values:

<FrameCount> Range: 0 to 100000
 Increment: 1
 *RST: 0

Usage: Query only

SEARCh:RESult:HBTO:FRAMe<m>:TYPE? <SearchName>

Returns the value of length / type field of the selected frame within the search result.

Suffix:

<m> *

Query parameters:

<SearchName>

Return values:

<TypeLen> Range: 0 to 65535
 Increment: 1
 *RST: 0

Usage: Query only**SEARCh:RESult:HBTO:FRAMe<m>:STATe? <SearchName>**

Returns the state of the frame within the search result.

Suffix:

<m> *

Query parameters:

<SearchName>

Return values:

<State> OK | ERR_PREAMBLE | ERR_SFD | ERR_LENGTH |
 ERR_CRC | UNCorrelated | INComplete

OK

Valid frame.

ERR_PREAMBLE

Erroneous frame due to preamble error.

ERR_SFD

Erroneous frame due to SFD error.

ERR_LENGTH

Erroneous frame due to length / type error.

ERR_CRC

Erroneous frame due to CRC error.

*RST: OK

Usage: Query only**SEARCh:RESult:HBTO:FRAMe<m>:STARt? <SearchName>**

Returns the start time of the selected frame within the search result.

Suffix:

<m> *

Query parameters:

<SearchName>

Return values:

<Start> Range: -100E+24 to 100E+24
 Increment: 100E-12
 *RST: 0
 Default unit: s

Usage: Query only

SEARch:RESult:HBTO:FRAMe<m>:STOP? <SearchName>

Returns the end time of the selected frame within the search result.

Suffix:

<m> *

Query parameters:

<SearchName>

Return values:

<Stop> Range: -100E+24 to 100E+24
 Increment: 100E-12
 *RST: 0
 Default unit: s

Usage: Query only

SEARch:RESult:HBTO:FRAMe<m>:DESTaddress? <SearchName>

Returns the destination address of the selected frame within the search result.

Suffix:

<m> *

Query parameters:

<SearchName>

Return values:

<DestAddress>

Usage: Query only

SEARch:RESult:HBTO:FRAMe<m>:SRCaddress? <SearchName>

Returns the source address of the selected frame within the search result.

Suffix:

<m> *

Query parameters:

<SearchName>

Return values:

<SourceAddress>

Usage: Query only

SEARCh:RESult:HBTO:FRAMe<m>:DATA? <SearchName>

Returns the data for the selected frame, corresponds to the Data column in the decode results table.

Suffix:
<m> *

Query parameters:
<SearchName>

Return values:
<Data>

Usage: Query only

SEARCh:RESult:HBTO:FRAMe<m>:CRC? <SearchName>

Returns the CRC checksum of the selected frame within the search result.

Suffix:
<m> *

Query parameters:
<SearchName>

Return values:
<CRC> Range: 0 to 4294967295
 Increment: 1
 *RST: 0

Usage: Query only

SEARCh:RESult:HBTO:FRAMe<m>:NUMWords? <SearchName>

Returns the number of decoded words for the selected frame within the search result.

Suffix:
<m> *

Query parameters:
<SearchName>

Return values:
<NumWords> Range: 0 to 4294967295
 Increment: 1
 *RST: 0

Usage: Query only

SEARCh:RESult:HBTO:FRAMe<m>:FTYPe? <SearchName>

Returns the type of frame for the selected frame within the search result.

Suffix:

<m> *

Query parameters:

<SearchName>

Return values:

<FrameType> IDLE | MAC | FILLer | UNKNown

IDLE

IDLE frame. This frame is used for clock synchronization.

MAC

MAC frame. This frame contains information that define how to go about transmitting and receiving frames.

FILLer

Filler frame. The frame is used to maintain transmission activity.

UNKNown

No meaningful frame can be determined.

*RST: MAC

Usage: Query only**SEARCh:RESult:HBTO:FRAMe<m>:DSYMBOL? <SearchName>**

Returns the destination symbols of the selected frame within the search result.

Suffix:

<m> *

Query parameters:

<SearchName>

Return values:

<DestTranslation>

Usage: Query only**SEARCh:RESult:HBTO:FRAMe<m>:SSYMBOL? <SearchName>**

Returns the source symbols of the selected frame within the search result.

Suffix:

<m> *

Query parameters:

<SearchName>

Return values:

<SrcTranslation>

Usage: Query only

SEARCh:RESult:HBTO:FRAMe<m>:WORD<n>:TYPE? <SearchName>

Returns the data type of the selected word within the search result.

Suffix:

<m> *

<n> *

Query parameters:

<SearchName>

Return values:

<WordType> String parameter

Usage: Query only

SEARCh:RESult:HBTO:FRAMe<m>:WORD<n>:VALue? <SearchName>

Returns the data value of the selected word within the search result.

Suffix:

<m> *

<n> *

Query parameters:

<SearchName>

Return values:

<WordValue> Range: 0 to 65535
 Increment: 1
 *RST: 0

Usage: Query only

27.18.20 Ethernet 1000BASE-T1 (option R&S RTO6-K560)

- [Configuration](#).....2282
- [Decode results](#).....2286
- [Trigger](#).....2292
- [Search settings](#).....2301
- [Search results](#).....2309

27.18.20.1 Configuration

In all **BUS<m>:TBTO** commands, the suffix <m> selects the serial bus.

BUS<m>:TBTO:ATTN <Attenuation>

Sets the attenuation factor. It is used to de-amplify the reverse signal before subtracting it from the forward signal.

Suffix:

<m> 1..4

Parameters:

<Attenuation> Range: -100 to 0
 Increment: 0.1
 *RST: -26
 Default unit: dB

Manual operation: See ["Reverse attenuation"](#) on page 823**BUS<m>:TBTO:FDAM <SourceDAminus>**

Selects the DA- source of the provided forward single ended signal, if [BUS<m>:TBTO:FTYP](#) is set to `SINGLE`.

Suffix:

<m> 1..4

Parameters:

<SourceDAminus> C1W1 | C2W1 | C3W1 | C4W1 | M1 | M2 | M3 | M4 | M5 | M6 |
 M7 | M8 | R1 | R2 | R3 | R4

Manual operation: See ["Forward"](#) on page 822**BUS<m>:TBTO:FDAP <SourceDAplus>**

Selects the DA+ source of the provided forward single ended signal, if [BUS<m>:TBTO:FTYP](#) is set to `SINGLE`.

Suffix:

<m> 1..4

Parameters:

<SourceDAplus> C1W1 | C2W1 | C3W1 | C4W1 | M1 | M2 | M3 | M4 | M5 | M6 |
 M7 | M8 | R1 | R2 | R3 | R4

Manual operation: See ["Forward"](#) on page 822**BUS<m>:TBTO:FDIF <SrcDiff>**

Sets the source of the provided forward differential signal, if [BUS<m>:TBTO:FTYP](#) is set to `DIFFERENTIAL`.

Suffix:

<m> 1..4

Parameters:

<SrcDiff> C1W1 | C2W1 | C3W1 | C4W1 | M1 | M2 | M3 | M4 | M5 | M6 |
 M7 | M8 | R1 | R2 | R3 | R4

Manual operation: See ["Forward"](#) on page 822

BUS<m>:TBTO:FTYP <SignalType>

Sets the type of forward signal measurement.

Suffix:

<m> 1..4

Parameters:

<SignalType> DIFFerential | SINGle
*RST: DIFFerential

Manual operation: See "[Forward](#)" on page 822

BUS<m>:TBTO:RDAM <SrcRevDAminus>

Selects the DA- source of the provided reversed single ended signal, if [BUS<m>:TBTO:RTYP](#) is set to SINGle.

Suffix:

<m> 1..4

Parameters:

<SrcRevDAminus> C1W1 | C2W1 | C3W1 | C4W1 | M1 | M2 | M3 | M4 | M5 | M6 | M7 | M8 | R1 | R2 | R3 | R4

Manual operation: See "[Reverse](#)" on page 823

BUS<m>:TBTO:RDAP <SourceRevDAplus>

Selects the DA+ source of the provided reversed single ended signal, if [BUS<m>:TBTO:RTYP](#) is set to SINGle.

Suffix:

<m> 1..4

Parameters:

<SourceRevDAplus> C1W1 | C2W1 | C3W1 | C4W1 | M1 | M2 | M3 | M4 | M5 | M6 | M7 | M8 | R1 | R2 | R3 | R4

Manual operation: See "[Reverse](#)" on page 823

BUS<m>:TBTO:RDIF <SrcRevDiff>

Sets the source of the provided reversed differential signal, if [BUS<m>:TBTO:RTYP](#) is set to DIFFerential.

Suffix:

<m> 1..4

Parameters:

<SrcRevDiff> C1W1 | C2W1 | C3W1 | C4W1 | M1 | M2 | M3 | M4 | M5 | M6 | M7 | M8 | R1 | R2 | R3 | R4

Manual operation: See "[Reverse](#)" on page 823

BUS<m>:TBTO:RTYP <SignalRevType>

Sets the type of reverse signal measurement.

Suffix:

<m> 1..4

Parameters:

<SignalRevType> DISabled | DIFFerential | SINGle
*RST: DISabled

Manual operation: See "[Reverse](#)" on page 823

BUS<m>:TBTO:MODE <Mode>

Selects the direction of the full-duplex signal you want to look at.

Suffix:

<m> 1..4

Parameters:

<Mode> MASTer | SLAVe | AUTO
*RST: AUTO

Manual operation: See "[Operation mode](#)" on page 823

BUS<m>:TBTO:POLarity <Polarity>

Selects the polarity of the data signal.

Suffix:

<m> 1..4

Parameters:

<Polarity> NORMal | INVert
*RST: NORMal

Manual operation: See "[Polarity](#)" on page 823

BUS<m>:TBTO:SYMRate <SymbolRate>

Defines the rate of ternary symbols.

Suffix:

<m> 1..4

Parameters:

<SymbolRate> Range: 10 to 1500
Increment: 1E-3
*RST: 750
Default unit: MSymb/s

27.18.20.2 Decode results

To show the results on the screen, use the following commands:

- `BUS<m>:RESult` on page 1814

<code>BUS<m>:TBTO:RESult:FCOunt?</code>	2286
<code>BUS<m>:TBTO:RESult:FRAMe<n>:BITRate?</code>	2286
<code>BUS<m>:TBTO:RESult:FRAMe<n>:CRC?</code>	2287
<code>BUS<m>:TBTO:RESult:FRAMe<n>:DATA?</code>	2287
<code>BUS<m>:TBTO:RESult:FRAMe<n>:DESTAddress?</code>	2287
<code>BUS<m>:TBTO:RESult:FRAMe<n>:DSYMBOL?</code>	2288
<code>BUS<m>:TBTO:RESult:FRAMe<n>:FTYPE?</code>	2288
<code>BUS<m>:TBTO:RESult:FRAMe<n>:NUMWords?</code>	2288
<code>BUS<m>:TBTO:RESult:FRAMe<n>:SRCAddress?</code>	2289
<code>BUS<m>:TBTO:RESult:FRAMe<n>:SSYMBOL?</code>	2289
<code>BUS<m>:TBTO:RESult:FRAMe<n>:START?</code>	2289
<code>BUS<m>:TBTO:RESult:FRAMe<n>:STATE?</code>	2290
<code>BUS<m>:TBTO:RESult:FRAMe<n>:STOP?</code>	2290
<code>BUS<m>:TBTO:RESult:FRAMe<n>:TYPE?</code>	2291
<code>BUS<m>:TBTO:RESult:FRAMe<n>:WORD<o>:TYPE?</code>	2291
<code>BUS<m>:TBTO:RESult:FRAMe<n>:WORD<o>:VALue?</code>	2291

`BUS<m>:TBTO:RESult:FCOunt?`

Returns the number of decoded frames.

Suffix:

`<m>` 1..4
Selects the serial bus.

Return values:

`<FrameCount>` Range: 0 to 100000
 Increment: 1
 *RST: 0

Usage: Query only

`BUS<m>:TBTO:RESult:FRAMe<n>:BITRate?`

Returns the primary bit rate.

Suffix:

`<m>` 1..4
Selects the serial bus.

`<n>` *
Selects the frame.

Return values:

`<PrimaryBitRate>` Range: 0 to 100000000000
 Increment: 1
 *RST: 0
 Default unit: bps

Usage: Query only

BUS<m>:TBTO:RESult:FRAMe<n>:CRC?

Returns the CRC (frame check) checksum of the selected frame.

Suffix:

<m> 1..4
Selects the serial bus.

<n> *
Selects the frame.

Return values:

<CRC> Range: 0 to 4294967295
Increment: 1
*RST: 0

Usage: Query only

BUS<m>:TBTO:RESult:FRAMe<n>:DATA?

Returns the data for the selected frame.

Suffix:

<m> 1..4
Selects the serial bus.

<n> *
Selects the frame.

Return values:

<Data>

Usage: Query only

BUS<m>:TBTO:RESult:FRAMe<n>:DESTaddress?

Returns the destination address of the selected frame.

Suffix:

<m> 1..4
Selects the serial bus.

<n> *
Selects the frame.

Return values:

<DestAddress>

Usage: Query only

BUS<m>:TBTO:RESult:FRAMe<n>:DSYMBOL?

Returns the destination symbols of the selected frame.

Suffix:

<m>	1..4 Selects the serial bus.
<n>	* Selects the frame.

Return values:

<DestTranslation>

Usage: Query only

BUS<m>:TBTO:RESult:FRAMe<n>:FTYPE?

Returns the type of the selected frame.

Suffix:

<m>	1..4 Selects the serial bus.
<n>	* Selects the frame.

Return values:

<FrameType> IDLE | MAC | OAM | RSFEC | ZEROTSYM | UNKNown

IDLE
IDLE frame. This frame is used for clock synchronization.

MAC
MAC frame. This frame contains information that define how to go about transmitting and receiving frames.

OAM
Operations, administration, and maintenance frame.

RSFEC
Reed Solomon forward error correction check frame.

ZEROTSYM
Zero ternary symbol.

UNKNown
No meaningful frame can be determined.

*RST: MAC

Usage: Query only

BUS<m>:TBTO:RESult:FRAMe<n>:NUMWords?

Returns the number of decoded words for the selected frame.

Suffix:

<m> 1..4
Selects the serial bus.

<n> *
Selects the frame.

Return values:

<NumWords> Range: 0 to 4294967295
Increment: 1
*RST: 0

Usage: Query only

BUS<m>:TBTO:RESult:FRAMe<n>:SRCaddress?

Returns the source address of the selected frame.

Suffix:

<m> 1..4
Selects the serial bus.

<n> *
Selects the frame.

Return values:

<SrcAddress>

Usage: Query only

BUS<m>:TBTO:RESult:FRAMe<n>:SSYMBOL?

Returns the source symbols of the selected frame.

Suffix:

<m> 1..4
Selects the serial bus.

<n> *
Selects the frame.

Return values:

<SrcTranslation>

Usage: Query only

BUS<m>:TBTO:RESult:FRAMe<n>:START?

Returns the start time of the selected frame.

Suffix:

<m> 1..4
Selects the serial bus.

<n> *
Selects the frame.

Return values:

<Start> Range: -100E+24 to 100E+24
Increment: 100E-12
*RST: 0
Default unit: s

Usage: Query only

BUS<m>:TBTO:RESult:FRAMe<n>:STATe?

Returns the state of the frame.

Suffix:

<m> 1..4
Selects the serial bus.

<n> *
Selects the frame.

Return values:

<State> OK | ERRFEC | ERRZERO | ERROOR | ERRCRC | INComplete

OK

Valid frame.

ERRFEC

Reed-Solomon forward error correction.

ERRZERO

Zero ternary symbol pair error.

ERROOR

Values are out of range error.

ERR_CRC

Erroneous frame due to CRC error.

INComplete

Incomplete frame.

*RST: OK

Usage: Query only

BUS<m>:TBTO:RESult:FRAMe<n>:STOP?

Returns the end time of the selected frame.

Suffix:

<m> 1..4
Selects the serial bus.

<n> *
Selects the frame.

Return values:

<Stop> Range: -100E+24 to 100E+24
 Increment: 100E-12
 *RST: 0
 Default unit: s

Usage: Query only

BUS<m>:TBTO:RESult:FRAMe<n>:TYPE?

Returns the value of length / type field of the selected frame.

Suffix:

<m> 1..4
 Selects the serial bus.

<n> *
 Selects the frame.

Return values:

<TypeLen> Range: 0 to 65535
 Increment: 1
 *RST: 0

Usage: Query only

BUS<m>:TBTO:RESult:FRAMe<n>:WORD<o>:TYPE?

Returns the data type for the selected word.

Suffix:

<m> 1..4
 Selects the serial bus.

<n> *
 Selects the frame.

<o> *
 Selects the word.

Return values:

<WordType>

Usage: Query only

BUS<m>:TBTO:RESult:FRAMe<n>:WORD<o>:VALue?

Returns the data value for the selected word.

Suffix:

<m> 1..4
 Selects the serial bus.

<n>	*	Selects the frame.
<o>	*	Selects the word.

Return values:

<WordValue>	Range:	0 to 65535
	Increment:	1
	*RST:	0

Usage: Query only

27.18.20.3 Trigger

The trigger suffix <m> is always 1 and can be omitted. It selects the trigger event: Only the A-trigger is available for triggering on serial buses.

To trigger on a serial bus, make sure that:

- `TRIGger<m>:SOURce[:SELEct]` is set to `SBUS`.
- The sources of the serial bus are channel signals: use `BUS<m>:...:SOURce` commands.
- Decoding is enabled: `BUS<m>[:STATe]` is set to `ON`.

<code>TRIGger<m>:TBTO:TRGLevel</code>	2293
<code>TRIGger<m>:TBTO:TYPE</code>	2293
<code>TRIGger<m>:TBTO:CRC:CONDition</code>	2293
<code>TRIGger<m>:TBTO:CRC:MAX</code>	2294
<code>TRIGger<m>:TBTO:CRC:MIN</code>	2294
<code>TRIGger<m>:TBTO:DADDrESS:CONDition</code>	2294
<code>TRIGger<m>:TBTO:DADDrESS:MAX</code>	2295
<code>TRIGger<m>:TBTO:DADDrESS:MIN</code>	2295
<code>TRIGger<m>:TBTO:DATA:DCONDition</code>	2295
<code>TRIGger<m>:TBTO:DATA:DMAX</code>	2296
<code>TRIGger<m>:TBTO:DATA:DMIN</code>	2296
<code>TRIGger<m>:TBTO:DATA:ICONDition</code>	2296
<code>TRIGger<m>:TBTO:DATA:IMAX</code>	2297
<code>TRIGger<m>:TBTO:DATA:IMIN</code>	2297
<code>TRIGger<m>:TBTO:ERRor:CRC</code>	2297
<code>TRIGger<m>:TBTO:ERRor:FEC</code>	2298
<code>TRIGger<m>:TBTO:ERRor:OOR</code>	2298
<code>TRIGger<m>:TBTO:ERRor:ZERO</code>	2298
<code>TRIGger<m>:TBTO:LENGth:CONDition</code>	2298
<code>TRIGger<m>:TBTO:LENGth:MAX</code>	2299
<code>TRIGger<m>:TBTO:LENGth:MIN</code>	2299
<code>TRIGger<m>:TBTO:SADDrESS:CONDition</code>	2300
<code>TRIGger<m>:TBTO:SADDrESS:MAX</code>	2300
<code>TRIGger<m>:TBTO:SADDrESS:MIN</code>	2300

TRIGger<m>:TBTO:TRGLevel <TriggerLevel>

Sets the trigger level.

Suffix:

<m> 1..3

Parameters:

<TriggerLevel> Range: -0.5 to 0.5
Increment: 1E-3
*RST: 0.01
Default unit: V

Manual operation: See "[Trigger level](#)" on page 827

TRIGger<m>:TBTO:TYPE <Type>

Selects the type of frame to be triggered on.

Suffix:

<m> 1..3

Parameters:

<Type> START | MAC | IDLE | ERRor

START

Start of frame.

MAC

MAC frame. This frame contains information that define how to go about transmitting and receiving frames.

IDLE

IDLE frame. This frame is used for clock synchronization.

ERRor

Error frame. You can enable the error to be triggered on:

[TRIGger<m>:TBTO:ERRor:CRC](#)

[TRIGger<m>:TBTO:ERRor:FEC](#)

[TRIGger<m>:TBTO:ERRor:OOR](#)

[TRIGger<m>:TBTO:ERRor:ZERO](#)

*RST: START

Manual operation: See "[Type](#)" on page 826

TRIGger<m>:TBTO:CRC:CONDition <CRCOperator>

Sets the condition for the frame check. You can define an exact value or a value range.

Suffix:

<m> 1..3

Parameters:

<CRCOperator> EQUal | NEQUal | LTHan | LETHan | GTHan | GETHan |
INRange | OORange

EQUal | NEQUal | LTHan | LETHan | GTHan | GETHan

Equal, Not equal, Less than, Less or equal than, Greater Than, Greater or equal than. These conditions require one data pattern to be set with the corresponding `TRIGger<m>:TBTO:CRC:MIN` command.

INRange | OORange

In range/Out of range: set the minimum and maximum value of the range with `TRIGger<m>:TBTO:CRC:MIN` and `TRIGger<m>:TBTO:CRC:MAX`.

*RST: EQUal

Manual operation: See "[Frame check](#)" on page 829

TRIGger<m>:TBTO:CRC:MAX <CRCPatternMax>

Sets the end value of the frame check range if `TRIGger<m>:TBTO:CRC:CONDition` is set to `INRange` or `OORange`.

Suffix:

<m> 1..3

Parameters:

<CRCPatternMax> Numeric or string pattern, see [Chapter 27.4.6, "Bit pattern parameter"](#), on page 1373. The string parameter accepts the bit value X (do not care).

Manual operation: See "[Frame check](#)" on page 829

TRIGger<m>:TBTO:CRC:MIN <CRCPatternMin>

Specifies the frame check bit pattern, or sets the start value of a pattern range.

Suffix:

<m> 1..3

Parameters:

<CRCPatternMin> Numeric or string pattern, see [Chapter 27.4.6, "Bit pattern parameter"](#), on page 1373. The string parameter accepts the bit value X (do not care).

Manual operation: See "[Frame check](#)" on page 829

TRIGger<m>:TBTO:DADDRESS:CONDition <DestAddrOptor>

Sets the condition for the destination address. You can define an exact value or a value range.

Suffix:

<m> 1..3

Parameters:

<DestAddrOptor> EQUal | NEQual | LTHan | LETHan | GTHan | GETHan | INRange | OORange

EQUal | NEQual | LTHan | LETHan | GTHan | GETHanEqual, Not equal, Less than, Less or equal than, Greater Than, Greater or equal than. These conditions require one data pattern to be set with the corresponding [TRIGger<m>:TBTO:](#)[DADDRESS:MIN](#) command.**INRange | OORange**In range/Out of range: set the minimum and maximum value of the range with [TRIGger<m>:TBTO:DADDRESS:MIN](#) and [TRIGger<m>:TBTO:DADDRESS:MAX](#).

*RST: EQUal

Manual operation: See "[Destination address](#)" on page 827**TRIGger<m>:TBTO:DADDRESS:MAX <DestAddrPattMax>**Sets the end value of the destination address range if [TRIGger<m>:TBTO:DADDRESS:CONDition](#) is set to `INRange` or `OORange`.**Suffix:**

<m> 1..3

Parameters:<DestAddrPattMax> Numeric or string pattern, see [Chapter 27.4.6, "Bit pattern parameter"](#), on page 1373. The string parameter accepts the bit value X (do not care).**Manual operation:** See "[Destination address](#)" on page 827**TRIGger<m>:TBTO:DADDRESS:MIN <DestAddrPattMin>**

Specifies the destination address bit pattern, or sets the start value of a pattern range.

Suffix:

<m> 1..3

Parameters:<DestAddrPattMin> Numeric or string pattern, see [Chapter 27.4.6, "Bit pattern parameter"](#), on page 1373. The string parameter accepts the bit value X (do not care).**Manual operation:** See "[Destination address](#)" on page 827**TRIGger<m>:TBTO:DATA:DCONDition <DataOperator>**

Sets the condition for the data. You can define an exact value or a value range.

Suffix:
 <m> 1..3

Parameters:
 <DataOperator> EQUal | NEQual | LTHan | LETHan | GTHan | GETHan | INRange | OORange

EQUal | NEQual | LTHan | LETHan | GTHan | GETHan
 Equal, Not equal, Less than, Less or equal than, Greater Than, Greater or equal than. These conditions require one data pattern to be set with the corresponding [TRIGger<m>:TBTO:DATA:DMIN](#) command.

INRange | OORange
 In range/Out of range: set the minimum and maximum value of the range with [TRIGger<m>:TBTO:DATA:DMIN](#) and [TRIGger<m>:TBTO:DATA:DMAX](#).

*RST: EQUal

Manual operation: See "[Data](#)" on page 829

TRIGger<m>:TBTO:DATA:DMAX <DataMax>

Sets the end value of the data range if [TRIGger<m>:TBTO:DATA:DCONdition](#) is set to [INRange](#) or [OORange](#).

Suffix:
 <m> 1..3

Parameters:
 <DataMax> Numeric or string pattern, see [Chapter 27.4.6, "Bit pattern parameter"](#), on page 1373. The string parameter accepts the bit value X (do not care).

Manual operation: See "[Data](#)" on page 829

TRIGger<m>:TBTO:DATA:DMIN <DataMin>

Specifies the data bit pattern, or sets the start value of a pattern range.

Suffix:
 <m> 1..3

Parameters:
 <DataMin> Numeric or string pattern, see [Chapter 27.4.6, "Bit pattern parameter"](#), on page 1373. The string parameter accepts the bit value X (do not care).

Manual operation: See "[Data](#)" on page 829

TRIGger<m>:TBTO:DATA:ICONdition <DataIdxOperator>

Sets the condition for the index. You can define an exact value or a value range.

Suffix:

<m> 1..3

Parameters:

<DataIdxOperator> EQUal | LTHan | LETHan | GTHan | GETHan | INRange | RANGE

EQUal | NEQUal | LTHan | LETHan | GTHan | GETHan

Equal, Not equal, Less than, Less or equal than, Greater Than, Greater or equal than. These conditions require one data pattern to be set with the corresponding [TRIGger<m>:TBTO:DATA:IMIN](#) command.

INRange | OORange

In range/Out of range: set the minimum and maximum value of the range with [TRIGger<m>:TBTO:DATA:IMIN](#) and [TRIGger<m>:TBTO:DATA:IMAX](#).

*RST: INRange

Manual operation: See "[Index](#)" on page 829**TRIGger<m>:TBTO:DATA:IMAX** <DataIndexMax>

Sets the end value of the index range if [TRIGger<m>:TBTO:DATA:ICONdition](#) is set to [INRange](#) or [OORange](#).

Suffix:

<m> 1..3

Parameters:

<DataIndexMax> Range: 1 to 0
Increment: 1
*RST: 0

Manual operation: See "[Index](#)" on page 829**TRIGger<m>:TBTO:DATA:IMIN** <DataIndexMin>

Specifies the index bit pattern, or sets the start value of a pattern range.

Suffix:

<m> 1..3

Parameters:

<DataIndexMin> Range: 1 to 0
Increment: 1
*RST: 1

Manual operation: See "[Index](#)" on page 829**TRIGger<m>:TBTO:ERRor:CRc** <ErrorCRC>

Enables triggering on cyclic redundancy check (CRC) error.

Suffix:

<m> 1..3

Parameters:

<ErrorCRC> ON | OFF
 *RST: ON

Manual operation: See "[CRC error](#)" on page 830**TRIGger<m>:TBTO:ERRor:FEC <ErrorFEC>**

Enables triggering, if more than 22 RS-FEC errors are detected.

Suffix:

<m> 1..3

Parameters:

<ErrorFEC> ON | OFF
 *RST: ON

Manual operation: See "[RS-FEC error](#)" on page 830**TRIGger<m>:TBTO:ERRor:OOR <ErrorOOR>**

Enables triggering if values are out of range (OOR). For example, a preamble error, or invalid symbols in control blocks.

Suffix:

<m> 1..3

Parameters:

<ErrorOOR> ON | OFF
 *RST: ON

Manual operation: See "[Out of range error](#)" on page 830**TRIGger<m>:TBTO:ERRor:ZERO <ErrorZERO>**

Enables triggering, if a zero ternary symbol pair (0-0) is detected.

Suffix:

<m> 1..3

Parameters:

<ErrorZERO> ON | OFF
 *RST: ON

Manual operation: See "[Zero ternary symbol](#)" on page 830**TRIGger<m>:TBTO:LENGth:CONDition <TypeOperator>**

Sets the condition for the length / type. You can define an exact value or a value range.

Suffix:

<m> 1..3

Parameters:

<TypeOperator> EQUal | NEQual | LTHan | LETHan | GTHan | GETHan | INRange | OORange

EQUal | NEQual | LTHan | LETHan | GTHan | GETHan

Equal, Not equal, Less than, Less or equal than, Greater Than, Greater or equal than. These conditions require one data pattern to be set with the corresponding `TRIGger<m>:TBTO:LENGth:MIN` command.

INRange | OORange

In range/Out of range: set the minimum and maximum value of the range with `TRIGger<m>:TBTO:LENGth:MIN` and `TRIGger<m>:TBTO:LENGth:MAX`.

*RST: EQUal

Manual operation: See "[Length/Type](#)" on page 828**TRIGger<m>:TBTO:LENGth:MAX <TypePatternMax>**

Sets the end value of the length / type range if `TRIGger<m>:TBTO:LENGth:CONDition` is set to `INRange` or `OORange`.

Suffix:

<m> 1..3

Parameters:<TypePatternMax> Numeric or string pattern, see [Chapter 27.4.6, "Bit pattern parameter"](#), on page 1373. The string parameter accepts the bit value X (do not care).**Manual operation:** See "[Length/Type](#)" on page 828**TRIGger<m>:TBTO:LENGth:MIN <TypePatternMin>**

Specifies the length / type bit pattern, or sets the start value of a pattern range.

Suffix:

<m> 1..3

Parameters:<TypePatternMin> Numeric or string pattern, see [Chapter 27.4.6, "Bit pattern parameter"](#), on page 1373. The string parameter accepts the bit value X (do not care).**Manual operation:** See "[Length/Type](#)" on page 828

TRIGger<m>:TBTO:SADdress:CONDition <SrcAddrOperator>

Sets the condition for the source address. You can define an exact value or a value range.

Suffix:

<m> 1..3

Parameters:

<SrcAddrOperator> EQUal | NEQual | LTHan | LETHan | GTHan | GETHan | INRange | OORange

EQUal | NEQual | LTHan | LETHan | GTHan | GETHan

Equal, Not equal, Less than, Less or equal than, Greater Than, Greater or equal than. These conditions require one data pattern to be set with the corresponding [TRIGger<m>:TBTO:SADdress:MIN](#) command.

INRange | OORange

In range/Out of range: set the minimum and maximum value of the range with [TRIGger<m>:TBTO:SADdress:MIN](#) and [TRIGger<m>:TBTO:SADdress:MAX](#).

*RST: EQUal

Manual operation: See "[Source address](#)" on page 828

TRIGger<m>:TBTO:SADdress:MAX <SrcAddrPattMax>

Sets the end value of the source address range, if [TRIGger<m>:TBTO:SADdress:CONDition](#) is set to [INRange](#) or [OORange](#).

Suffix:

<m> 1..3

Parameters:

<SrcAddrPattMax> Numeric or string pattern, see [Chapter 27.4.6, "Bit pattern parameter"](#), on page 1373. The string parameter accepts the bit value X (do not care).

Manual operation: See "[Source address](#)" on page 828

TRIGger<m>:TBTO:SADdress:MIN <SrcAddrPattMin>

Specifies the source address bit pattern, or sets the start value of a pattern range.

Suffix:

<m> 1..3

Parameters:

<SrcAddrPattMin> Numeric or string pattern, see [Chapter 27.4.6, "Bit pattern parameter"](#), on page 1373. The string parameter accepts the bit value X (do not care).

Manual operation: See "[Source address](#)" on page 828

27.18.20.4 Search settings

SEARch:TRIGger:TBTO:CRC:CONDition.....	2301
SEARch:TRIGger:TBTO:CRC:MAX.....	2302
SEARch:TRIGger:TBTO:CRC:MIN.....	2302
SEARch:TRIGger:TBTO:DADDDress:CONDition.....	2302
SEARch:TRIGger:TBTO:DADDDress:MAX.....	2303
SEARch:TRIGger:TBTO:DADDDress:MIN.....	2303
SEARch:TRIGger:TBTO:DATA:DCONDition.....	2303
SEARch:TRIGger:TBTO:DATA:DMAX.....	2304
SEARch:TRIGger:TBTO:DATA:DMIN.....	2304
SEARch:TRIGger:TBTO:DATA:ICONDition.....	2304
SEARch:TRIGger:TBTO:DATA:IMAX.....	2305
SEARch:TRIGger:TBTO:DATA:IMIN.....	2305
SEARch:TRIGger:TBTO:ERRor:CRC.....	2305
SEARch:TRIGger:TBTO:ERRor:FEC.....	2306
SEARch:TRIGger:TBTO:ERRor:OOR.....	2306
SEARch:TRIGger:TBTO:ERRor:ZERO.....	2306
SEARch:TRIGger:TBTO:LENGth:CONDition.....	2307
SEARch:TRIGger:TBTO:LENGth:MAX.....	2307
SEARch:TRIGger:TBTO:LENGth:MIN.....	2307
SEARch:TRIGger:TBTO:SADDDress:CONDition.....	2308
SEARch:TRIGger:TBTO:SADDDress:MAX.....	2308
SEARch:TRIGger:TBTO:SADDDress:MIN.....	2308
SEARch:TRIGger:TBTO:TYPE.....	2309

SEARch:TRIGger:TBTO:CRC:CONDition <SearchName>,<CRCCOperator>

SEARch:TRIGger:TBTO:CRC:CONDition? <SearchName>

Sets the condition for the frame check. You can define an exact value or a value range.

Parameters:

<CRCCOperator>

EQUal | NEQUal | LTHan | LETHan | GTHan | GETHan |
INRange | OORange

EQUal | NEQUal | LTHan | LETHan | GTHan | GETHan

Equal, Not equal, Less than, Less or equal than, Greater Than,
Greater or equal than. These conditions require one data pattern
to be set with the corresponding **SEARch:TRIGger:TBTO:
CRC:MIN** command.

INRange | OORange

In range/Out of range: set the minimum and maximum value of
the range with **SEARch:TRIGger:TBTO:CRC:MIN** and
SEARch:TRIGger:TBTO:CRC:MAX.

*RST: EQUal

Parameters for setting and query:

<SearchName>

Manual operation: See "Frame check" on page 836

SEARCh:TRIGger:TBTO:CRC:MAX <SearchName>,<CRCPatternMax>
SEARCh:TRIGger:TBTO:CRC:MAX? <SearchName>

Sets the end value of the frame check range if [SEARCh:TRIGger:TBTO:CRC:CONDition](#) is set to [INRange](#) or [OORange](#).

Parameters:

<CRCPatternMax> Numeric or string pattern, see [Chapter 27.4.6, "Bit pattern parameter"](#), on page 1373. The string parameter accepts the bit value X (do not care).

Parameters for setting and query:

<SearchName>

Manual operation: See ["Frame check"](#) on page 836

SEARCh:TRIGger:TBTO:CRC:MIN <SearchName>,<CRCPatternMin>
SEARCh:TRIGger:TBTO:CRC:MIN? <SearchName>

Specifies the frame check bit pattern, or sets the start value of a pattern range.

Parameters:

<CRCPatternMin> Numeric or string pattern, see [Chapter 27.4.6, "Bit pattern parameter"](#), on page 1373. The string parameter accepts the bit value X (do not care).

Parameters for setting and query:

<SearchName>

Manual operation: See ["Frame check"](#) on page 836

SEARCh:TRIGger:TBTO:DADDRESS:CONDition <SearchName>,<DestAddrOptor>
SEARCh:TRIGger:TBTO:DADDRESS:CONDition? <SearchName>

Sets the condition for the destination address. You can define an exact value or a value range.

Parameters:

<DestAddrOptor> [EQUal](#) | [NEQUal](#) | [LTHan](#) | [LETHan](#) | [GTHan](#) | [GETHan](#) | [INRange](#) | [OORange](#)

[EQUal](#) | [NEQUal](#) | [LTHan](#) | [LETHan](#) | [GTHan](#) | [GETHan](#)

Equal, Not equal, Less than, Less or equal than, Greater Than, Greater or equal than. These conditions require one data pattern to be set with the corresponding [SEARCh:TRIGger:TBTO:DADDRESS:MIN](#) command.

[INRange](#) | [OORange](#)

In range/Out of range: set the minimum and maximum value of the range with [SEARCh:TRIGger:TBTO:DADDRESS:MIN](#) and [SEARCh:TRIGger:TBTO:DADDRESS:MAX](#).

*RST: [EQUal](#)

Parameters for setting and query:

<SearchName>

Manual operation: See "[Destination address](#)" on page 835**SEARCh:TRIGger:TBTO:DADdress:MAX** <SearchName>,<DestAddrPattMax>**SEARCh:TRIGger:TBTO:DADdress:MAX?** <SearchName>Sets the end value of the destination address range if [SEARCh:TRIGger:TBTO:DADdress:CONDition](#) is set to [INRange](#) or [OORange](#).**Parameters:**<DestAddrPattMax> Numeric or string pattern, see [Chapter 27.4.6, "Bit pattern parameter"](#), on page 1373. The string parameter accepts the bit value X (do not care).**Parameters for setting and query:**

<SearchName>

Manual operation: See "[Destination address](#)" on page 835**SEARCh:TRIGger:TBTO:DADdress:MIN** <SearchName>,<DestAddrPattMin>**SEARCh:TRIGger:TBTO:DADdress:MIN?** <SearchName>

Specifies the destination address bit pattern, or sets the start value of a pattern range.

Parameters:<DestAddrPattMin> Numeric or string pattern, see [Chapter 27.4.6, "Bit pattern parameter"](#), on page 1373. The string parameter accepts the bit value X (do not care).**Parameters for setting and query:**

<SearchName>

Manual operation: See "[Destination address](#)" on page 835**SEARCh:TRIGger:TBTO:DATA:DCONDition** <SearchName>,<DataOperator>**SEARCh:TRIGger:TBTO:DATA:DCONDition?** <SearchName>

Sets the condition for the data. You can define an exact value or a value range.

Parameters:<DataOperator> [EQUal](#) | [NEQual](#) | [LTHan](#) | [LETHan](#) | [GTHan](#) | [GETHan](#) | [INRange](#) | [OORange](#)**[EQUal](#) | [NEQual](#) | [LTHan](#) | [LETHan](#) | [GTHan](#) | [GETHan](#)**Equal, Not equal, Less than, Less or equal than, Greater Than, Greater or equal than. These conditions require one data pattern to be set with the corresponding [SEARCh:TRIGger:TBTO:DATA:DMIN](#) command.

INRange | OORange

In range/Out of range: set the minimum and maximum value of the range with [SEARCh:TRIGger:TBTO:DATA:DMIN](#) and [SEARCh:TRIGger:TBTO:DATA:DMAX](#).

*RST: EQUal

Parameters for setting and query:

<SearchName>

Manual operation: See ["Data"](#) on page 836

SEARCh:TRIGger:TBTO:DATA:DMAX <SearchName>,<DataMax>

SEARCh:TRIGger:TBTO:DATA:DMAX? <SearchName>

Sets the end value of the data range if [SEARCh:TRIGger:TBTO:DATA:DCONdition](#) is set to [INRange](#) or [OORange](#).

Parameters:

<DataMax> Numeric or string pattern, see [Chapter 27.4.6, "Bit pattern parameter"](#), on page 1373. The string parameter accepts the bit value X (do not care).

Parameters for setting and query:

<SearchName>

Manual operation: See ["Data"](#) on page 836

SEARCh:TRIGger:TBTO:DATA:DMIN <SearchName>,<DataMin>

SEARCh:TRIGger:TBTO:DATA:DMIN? <SearchName>

Specifies the data bit pattern, or sets the start value of a pattern range.

Parameters:

<DataMin> Numeric or string pattern, see [Chapter 27.4.6, "Bit pattern parameter"](#), on page 1373. The string parameter accepts the bit value X (do not care).

Parameters for setting and query:

<SearchName>

Manual operation: See ["Data"](#) on page 836

SEARCh:TRIGger:TBTO:DATA:ICONdition <SearchName>,<DataIdxOperator>

SEARCh:TRIGger:TBTO:DATA:ICONdition? <SearchName>

Sets the search condition for the index. You can define an exact value or a value range.

Parameters:

<DataIdxOperator> EQUal | LTHan | LETHan | GTHan | GETHan | INRange | RANGE

EQUal | NEQUal | LTHan | LETHan | GTHan | GETHan

Equal, Not equal, Less than, Less or equal than, Greater Than, Greater or equal than. These conditions require one data pattern to be set with the corresponding `SEARCH:TRIGGER:TBTO:DATA:IMIN` command.

INRange | OORange

In range/Out of range: set the minimum and maximum value of the range with `SEARCH:TRIGGER:TBTO:DATA:IMIN` and `SEARCH:TRIGGER:TBTO:DATA:IMAX`.

*RST: INRange

Parameters for setting and query:

<SearchName>

Manual operation: See "[Index](#)" on page 837

SEARCH:TRIGGER:TBTO:DATA:IMAX <SearchName>,<DataIndexMax>

SEARCH:TRIGGER:TBTO:DATA:IMAX? <SearchName>

Sets the end value of the index range to be searched for, if `SEARCH:TRIGGER:TBTO:DATA:IMAX` is set to `INRange` or `OORange`.

Parameters:

<DataIndexMax> Range: 1 to 0
 Increment: 1
 *RST: 0

Parameters for setting and query:

<SearchName>

Manual operation: See "[Index](#)" on page 837

SEARCH:TRIGGER:TBTO:DATA:IMIN <SearchName>,<DataIndexMin>

SEARCH:TRIGGER:TBTO:DATA:IMIN? <SearchName>

Specifies the index bit pattern, or sets the start value of a pattern range.

Parameters:

<DataIndexMin> Range: 1 to 0
 Increment: 1
 *RST: 1

Parameters for setting and query:

<SearchName>

Manual operation: See "[Index](#)" on page 837

SEARCH:TRIGGER:TBTO:ERROR:CRC <SearchName>,<ErrorCRC>

SEARCH:TRIGGER:TBTO:ERROR:CRC? <SearchName>

Enables search for cyclic redundancy check (CRC) error.

Parameters:

<ErrorCRC> ON | OFF
 *RST: ON

Parameters for setting and query:

<SearchName>

Manual operation: See "[CRC error](#)" on page 838

SEARCH:TRIGger:TBTO:ERRor:FEC <SearchName>,<ErrorFEC>

SEARCH:TRIGger:TBTO:ERRor:FEC? <SearchName>

Enables search for RS-FEC errors.

Parameters:

<ErrorFEC> ON | OFF
 *RST: ON

Parameters for setting and query:

<SearchName>

Manual operation: See "[RS-FEC error](#)" on page 837

SEARCH:TRIGger:TBTO:ERRor:OOR <SearchName>,<ErrorOOR>

SEARCH:TRIGger:TBTO:ERRor:OOR? <SearchName>

Enables search for values that are out of range.

Parameters:

<ErrorOOR> ON | OFF
 *RST: ON

Parameters for setting and query:

<SearchName>

Manual operation: See "[Out of range error](#)" on page 838

SEARCH:TRIGger:TBTO:ERRor:ZERO <SearchName>,<ErrorZERO>

SEARCH:TRIGger:TBTO:ERRor:ZERO? <SearchName>

Enables search for zero ternary symbol pairs error.

Parameters:

<ErrorZERO> ON | OFF
 *RST: ON

Parameters for setting and query:

<SearchName>

Manual operation: See "[Zero ternary symbol](#)" on page 838

SEARCh:TRIGger:TBTO:LENGth:CONDition <SearchName>,<TypeOperator>
SEARCh:TRIGger:TBTO:LENGth:CONDition? <SearchName>

Sets the condition for the length/ type. You can define an exact value or a value range.

Parameters:

<TypeOperator> EQUal | NEQual | LTHan | LETHan | GTHan | GETHan |
 INRange | OORange

EQUal | NEQual | LTHan | LETHan | GTHan | GETHan

Equal, not equal, less than, less or equal than, greater than, greater or equal than. These conditions require one data pattern to be set with the corresponding [SEARCh:TRIGger:TBTO:LENGth:MIN](#) command.

INRange | OORange

In range/Out of range: set the minimum and maximum value of the range with [SEARCh:TRIGger:TBTO:LENGth:MIN](#) and [SEARCh:TRIGger:TBTO:LENGth:MAX](#).

*RST: EQUal

Parameters for setting and query:

<SearchName>

Manual operation: See "[Length/Type](#)" on page 835

SEARCh:TRIGger:TBTO:LENGth:MAX <SearchName>,<TypePatternMax>
SEARCh:TRIGger:TBTO:LENGth:MAX? <SearchName>

Sets the end value of the length / type range if [SEARCh:TRIGger:TBTO:LENGth:CONDition](#) is set to [INRange](#) or [OORange](#).

Parameters:

<TypePatternMax>

Parameters for setting and query:

<SearchName> Numeric or string pattern, see [Chapter 27.4.6, "Bit pattern parameter"](#), on page 1373. The string parameter accepts the bit value X (do not care).

Manual operation: See "[Length/Type](#)" on page 835

SEARCh:TRIGger:TBTO:LENGth:MIN <SearchName>,<TypePatternMin>
SEARCh:TRIGger:TBTO:LENGth:MIN? <SearchName>

Specifies the length/ type bit pattern, or sets the start value of a pattern range.

Parameters:

<TypePatternMin> Numeric or string pattern, see [Chapter 27.4.6, "Bit pattern parameter"](#), on page 1373. The string parameter accepts the bit value X (do not care).

Parameters for setting and query:

<SearchName>

Manual operation: See "[Length/Type](#)" on page 835

SEARCH:TRIGger:TBTO:SADdress:CONDition <SearchName>,<SrcAddrOperator>
SEARCH:TRIGger:TBTO:SADdress:CONDition? <SearchName>

Sets the condition for the source address. You can define an exact value or a value range.

Parameters:

<SrcAddrOperator> EQUal | NEQual | LTHan | LETHan | GTHan | GETHan |
 INRange | OORange

EQUal | NEQual | LTHan | LETHan | GTHan | GETHan

Equal, not equal, less than, less or equal than, greater than, greater or equal than. These conditions require one data pattern to be set with the corresponding [SEARCH:TRIGger:TBTO:SADdress:MIN](#) command.

INRange | OORange

In range/Out of range: set the minimum and maximum value of the range with [SEARCH:TRIGger:TBTO:SADdress:MIN](#) and [SEARCH:TRIGger:TBTO:SADdress:MAX](#).

*RST: EQUal

Parameters for setting and query:

<SearchName>

Manual operation: See "[Source address](#)" on page 835

SEARCH:TRIGger:TBTO:SADdress:MAX <SearchName>,<SrcAddrPattMax>
SEARCH:TRIGger:TBTO:SADdress:MAX? <SearchName>

Sets the end value of the source address range if [SEARCH:TRIGger:TBTO:SADdress:CONDition](#) is set to [INRange](#) or [OORange](#).

Parameters:

<SrcAddrPattMax> Numeric or string pattern, see [Chapter 27.4.6, "Bit pattern parameter"](#), on page 1373. The string parameter accepts the bit value X (do not care).

Parameters for setting and query:

<SearchName>

Manual operation: See "[Source address](#)" on page 835

SEARCH:TRIGger:TBTO:SADdress:MIN <SearchName>,<SrcAddrPattMin>
SEARCH:TRIGger:TBTO:SADdress:MIN? <SearchName>

Specifies the source address bit pattern, or sets the start value of a pattern range.

Parameters:

<SrcAddrPattMin> Numeric or string pattern, see [Chapter 27.4.6, "Bit pattern parameter"](#), on page 1373. The string parameter accepts the bit value X (do not care).

Parameters for setting and query:

<SearchName>

Manual operation: See ["Source address"](#) on page 835

SEARCH:TRIGger:TBTO:TYPE <SearchName>,<Type>

SEARCH:TRIGger:TBTO:TYPE? <SearchName>

Selects the type of frame to be searched for.

Parameters:

<Type> START | MAC | IDLE | ERRor

START

Start of frame.

MAC

MAC frame. This frame contains information that define how to go about transmitting and receiving frames.

IDLE

IDLE frame. This frame is used for clock synchronization.

ERRor

Error frame. This frame contains erroneous bits.

*RST: START

Parameters for setting and query:

<SearchName>

Manual operation: See ["Type"](#) on page 834

27.18.20.5 Search results

SEARCH:RESult:TBTO:FCOunt?	2310
SEARCH:RESult:TBTO:FRAME<m>:CRC?	2310
SEARCH:RESult:TBTO:FRAME<m>:DATA?	2310
SEARCH:RESult:TBTO:FRAME<m>:DESTaddress?	2310
SEARCH:RESult:TBTO:FRAME<m>:DSYMBOL?	2311
SEARCH:RESult:TBTO:FRAME<m>:FTYPE?	2311
SEARCH:RESult:TBTO:FRAME<m>:NUMWords?	2312
SEARCH:RESult:TBTO:FRAME<m>:SRCaddress?	2312
SEARCH:RESult:TBTO:FRAME<m>:SSYMBOL?	2312
SEARCH:RESult:TBTO:FRAME<m>:START?	2313
SEARCH:RESult:TBTO:FRAME<m>:STATE?	2313
SEARCH:RESult:TBTO:FRAME<m>:STOP?	2313
SEARCH:RESult:TBTO:FRAME<m>:TYPE?	2314

SEARCh:RESult:TBTO:FRAMe<m>:WORD<n>:TYPE?	2314
SEARCh:RESult:TBTO:FRAMe<m>:WORD<n>:VALue?	2314
SEARCh:RESult:TBTO:FRAMe<m>:WORD<n>:VSTR?	2315

SEARCh:RESult:TBTO:FCOunt? <SearchName>

Returns the number of decoded frames within the search result.

Query parameters:

<SearchName>

Return values:

<FrameCount>	Range:	0 to 100000
	Increment:	1
	*RST:	0

Usage: Query only

SEARCh:RESult:TBTO:FRAMe<m>:CRC? <SearchName>

Returns the CRC checksum of the selected frame within the search result.

Suffix:

<m> *

Query parameters:

<SearchName>

Return values:

<CRC>	Range:	0 to 4294967295
	Increment:	1
	*RST:	0

Usage: Query only

SEARCh:RESult:TBTO:FRAMe<m>:DATA? <SearchName>

Returns the data for the selected frame.

Suffix:

<m> *

Query parameters:

<SearchName>

Return values:

<Data>

Usage: Query only

SEARCh:RESult:TBTO:FRAMe<m>:DESTAddress? <SearchName>

Returns the destination address of the selected frame within the search result.

Suffix:
<m> *

Query parameters:
<SearchName>

Return values:
<DestAddrstr>

Usage: Query only

SEARCh:RESult:TBTO:FRAMe<m>:DSYMBOL? <SearchName>

Returns the destination symbols of the selected frame within the search result.

Suffix:
<m> *

Query parameters:
<SearchName>

Return values:
<DestTranslation>

Usage: Query only

SEARCh:RESult:TBTO:FRAMe<m>:FTYPE? <SearchName>

Returns the type of frame for the selected frame within the search result.

Suffix:
<m> *

Query parameters:
<SearchName>

Return values:
<FrameType>

IDLE | MAC | OAM | RSFEC | BH | CTLADDR | CTLCODE | ZEROTSYM | UNKNOWN

IDLE

IDLE frame. This frame is used for clock synchronization.

MAC

MAC frame. This frame contains information that define how to go about transmitting and receiving frames.

OAM

Operations, administration and maintenance (OAM) frame.

RSFEC

Reed Solomon forward error correction check frame.

BH

BASE-H frame.

CTLADDR

Control address frame.

CTLCODE

Control code frame.

ZEROTSYM

Zero ternary symbol frame.

UNKNown

No meaningful frame can be determined.

*RST: MAC

Usage: Query only**SEARch:RESult:TBTO:FRAMe<m>:NUMWords? <SearchName>**

Returns the number of decoded words for the selected frame within the search result.

Suffix:

<m> *

Query parameters:

<SearchName>

Return values:

<NumWords>	Range:	0 to 4294967295
	Increment:	1
	*RST:	0

Usage: Query only**SEARch:RESult:TBTO:FRAMe<m>:SRCaddress? <SearchName>**

Returns the source address of the selected frame within the search result.

Suffix:

<m> *

Query parameters:

<SearchName>

Return values:

<SrcAddrstr>

Usage: Query only**SEARch:RESult:TBTO:FRAMe<m>:SSYMBOL? <SearchName>**

Returns the source symbols of the selected frame within the search result.

Suffix:

<m> *

Query parameters:

<SearchName>

Return values:

<SrcTranslation>

Usage: Query only

SEARCh:RESult:TBTO:FRAMe<m>:START? <SearchName>

Returns the start time of the selected frame within the search result.

Suffix:
<m> *

Query parameters:
<SearchName>

Return values:
<Start> Range: -100E+24 to 100E+24
 Increment: 100E-12
 *RST: 0
 Default unit: s

Usage: Query only

SEARCh:RESult:TBTO:FRAMe<m>:STATe? <SearchName>

Returns the state of the frame within the search result.

Suffix:
<m> *

Query parameters:
<SearchName>

Return values:
<State> OK | ERRFEC | ERRZERO | ERROOR | ERRCRC | INComplete
OK
Valid frame.
ERRFEC
Reed-Solomon forward error correction.
ERRZERO
Zero ternary symbol pair error.
ERROOR
Values are out of range error.
ERR_CRC
Erroneous frame due to CRC error.
INComplete
Incomplete frame.
*RST: OK

Usage: Query only

SEARCh:RESult:TBTO:FRAMe<m>:STOP? <SearchName>

Returns the end time of the selected frame within the search result.

Suffix:

<m> *

Query parameters:

<SearchName>

Return values:

<Stop> Range: -100E+24 to 100E+24
 Increment: 100E-12
 *RST: 0
 Default unit: s

Usage: Query only**SEARCh:RESult:TBTO:FRAMe<m>:TYPE? <SearchName>**

Returns the value of length / type field of the selected frame within the search result.

Suffix:

<m> *

Query parameters:

<SearchName>

Return values:

<TypeLen> Range: 0 to 65535
 Increment: 1
 *RST: 0

Usage: Query only**SEARCh:RESult:TBTO:FRAMe<m>:WORD<n>:TYPE? <SearchName>**

Returns the data type of the selected word within the search result.

Suffix:<m> *
Selects the frame.<n> *
Selects the word.**Query parameters:**

<SearchName>

Return values:

<WordType>

Usage: Query only**SEARCh:RESult:TBTO:FRAMe<m>:WORD<n>:VALue? <SearchName>**

Returns the data value of the selected word within the search result.

Suffix:

<m> *
Selects the frame.

<n> *
Selects the word.

Query parameters:

<SearchName>

Return values:

<WordValue> Range: 0 to 65535
Increment: 1
*RST: 0

Usage: Query only

SEARch:RESult:TBTO:FRAMe<m>:WORD<n>:VSTR? <SearchName>

Returns the string equivalent of data value for the selected cell.

Suffix:

<m> *

<n> *

Query parameters:

<SearchName>

Return values:

<WordValueString>

Usage: Query only

27.18.21 USB (option R&S RTO6-K570)

- [Configuration](#).....2315
- [Trigger](#).....2319
- [Decode results](#).....2332
- [Search settings](#).....2337
- [Search results](#).....2353

27.18.21.1 Configuration

In all `BUS<m>:USB` commands, the suffix <m> selects the serial bus.

BUS<m>:USB:TECHnology	2316
BUS<m>:USB:DPLus:SOURce	2316
BUS<m>:USB:DMINus:SOURce	2316
BUS<m>:USB:DIFFerential:SOURce	2317
BUS<m>:USB:DATA:SOURce	2317
BUS<m>:USB:STRobe:SOURce	2317
BUS<m>:USB:DPLus:THReshold	2318

BUS<m>:USB:DMINus:THReshold.....	2318
BUS<m>:USB:DIFFerential:THReshold.....	2318
BUS<m>:USB:DATA:THReshold.....	2318
BUS<m>:USB:STRobe:THReshold.....	2319

BUS<m>:USB:TECHnology <ProtocolType>

Defines the USB protocol technology and transmission speed.

Suffix:

<m> 1..4

Parameters:

<ProtocolType> LOW | FULL | HIGH | | HSIC

LOW

USB low speed protocol (1.5 Mbit/s)

FULL

USB full speed protocol (12 Mbit/s)

HIGH

USB high speed protocol (480 Mbit/s)

HSIC

USB high speed inter-chip (HSIC) protocol (480 Mbit/s)

*RST: LOW

Manual operation: See "[Protocol type](#)" on page 846

BUS<m>:USB:DPLus:SOURce <SourceDplus>

Selects the source for the D+ data signal (in USB low speed and USB full speed protocol, only).

Suffix:

<m> 1..4

Parameters:

<SourceDplus> C1W1 | C2W1 | C3W1 | C4W1 | M1 | M2 | M3 | M4 | M5 | M6 | M7 | M8 | R1 | R2 | R3 | R4

*RST: C1W1

Usage: Asynchronous command

Manual operation: See "[D+, D-](#)" on page 849

BUS<m>:USB:DMINus:SOURce <SourceDminus>

Selects the source for the D- data signal (in USB low speed and USB full speed protocol, only).

Suffix:

<m> 1..4

Parameters:

<SourceDminus> C1W1 | C2W1 | C3W1 | C4W1 | M1 | M2 | M3 | M4 | M5 | M6 |
M7 | M8 | R1 | R2 | R3 | R4
*RST: C2W1

Usage: Asynchronous command

Manual operation: See "[D+, D-](#)" on page 849

BUS<m>:USB:DIFFerential:SOURce <SrcDiff>

Selects the source for the differential signal in the USB high speed protocol.

Suffix:

<m> 1..4

Parameters:

<SrcDiff> C1W1 | C2W1 | C3W1 | C4W1 | M1 | M2 | M3 | M4 | M5 | M6 |
M7 | M8 | R1 | R2 | R3 | R4
*RST: C1W1

Usage: Asynchronous command

Manual operation: See "[Differential](#)" on page 849

BUS<m>:USB:DATA:SOURce <SourceData>

Selects the source for the data signal in the USB HSIC protocol.

Suffix:

<m> 1..4

Parameters:

<SourceData> C1W1 | C2W1 | C3W1 | C4W1 | M1 | M2 | M3 | M4 | M5 | M6 |
M7 | M8 | R1 | R2 | R3 | R4
*RST: C1W1

Usage: Asynchronous command

Manual operation: See "[Data, Strobe](#)" on page 850

BUS<m>:USB:STRobe:SOURce <SourceStrobe>

Selects the source for the strobe signal in the USB HSIC protocol.

Suffix:

<m> 1..4

Parameters:

<SourceStrobe> C1W1 | C2W1 | C3W1 | C4W1 | M1 | M2 | M3 | M4 | M5 | M6 |
M7 | M8 | R1 | R2 | R3 | R4
*RST: C2W1

Usage: Asynchronous command

Manual operation: See ["Data, Strobe"](#) on page 850

BUS<m>:USB:DPLus:THReshold <ThresholdDplus>

Defines the threshold level for the D+ data signal (in USB low speed and USB full speed protocol, only).

Suffix:

<m> 1..4

Parameters:

<ThresholdDplus> Range: -5 to 5
 Increment: 0.01
 *RST: 1.55
 Default unit: V

Manual operation: See ["Thresholds"](#) on page 850

BUS<m>:USB:DMINus:THReshold <ThresholdDminus>

Defines the threshold level for the D- data signal (in USB low speed and USB full speed protocol, only).

Suffix:

<m> 1..4

Parameters:

<ThresholdDminus> Range: -5 to 5
 Increment: 0.01
 *RST: 1.55
 Default unit: V

Manual operation: See ["Thresholds"](#) on page 850

BUS<m>:USB:DIFFerential:THReshold <ThresDiff>

Defines the threshold level for the differential signal in the USB high speed protocol.

Suffix:

<m> 1..4

Parameters:

<ThresDiff> Range: -2 to 2
 Increment: 0.01
 *RST: 0
 Default unit: V

Manual operation: See ["Thresholds"](#) on page 850

BUS<m>:USB:DATA:THReshold <ThresholdData>

Defines the threshold level for the data signal in the USB HSIC protocol.

Suffix:

<m> 1..4

Parameters:

<ThresholdData> Range: -2 to 2
 Increment: 0.01
 *RST: 0.65
 Default unit: V

Manual operation: See "[Thresholds](#)" on page 850**BUS<m>:USB:STRobe:THReshold <ThresholdStrobe>**

Defines the threshold level for the strobe signal in the USB HSIC protocol.

Suffix:

<m> 1..4

Parameters:

<ThresholdStrobe> Range: -2 to 2
 Increment: 0.01
 *RST: 0.65
 Default unit: V

Manual operation: See "[Thresholds](#)" on page 850**27.18.21.2 Trigger**

The trigger suffix <m> is always 1 and can be omitted. It selects the trigger event: Only the A-trigger is available for triggering on serial buses.

To trigger on a serial bus, make sure that:

- `TRIGger<m>:SOURce[:SElect]` is set to `SBUS`.
- The sources of the serial bus are channel signals: use `BUS<m>:...:SOURce` commands.
- Decoding is enabled: `BUS<m>[:STATe]` is set to `ON`.

<code>TRIGger<m>:USB:TYPE</code>	2320
<code>TRIGger<m>:USB:ACONdition</code>	2321
<code>TRIGger<m>:USB:AMIN</code>	2322
<code>TRIGger<m>:USB:AMAX</code>	2322
<code>TRIGger<m>:USB:DATA</code>	2322
<code>TRIGger<m>:USB:DCONDITION</code>	2322
<code>TRIGger<m>:USB:DPOPerator</code>	2323
<code>TRIGger<m>:USB:DPOSITION</code>	2323
<code>TRIGger<m>:USB:ECONDITION</code>	2323
<code>TRIGger<m>:USB:EMIN</code>	2324
<code>TRIGger<m>:USB:EMAX</code>	2324
<code>TRIGger<m>:USB:ERRC</code>	2324
<code>TRIGger<m>:USB:FCONDITION</code>	2325
<code>TRIGger<m>:USB:FMIN</code>	2325
<code>TRIGger<m>:USB:FMAX</code>	2325

TRIGger<m>:USB:HAND.....	2326
TRIGger<m>:USB:PATT.....	2326
TRIGger<m>:USB:PCONdition.....	2326
TRIGger<m>:USB:PMIN.....	2327
TRIGger<m>:USB:PMAX.....	2327
TRIGger<m>:USB:SCONdition.....	2327
TRIGger<m>:USB:SMIN.....	2327
TRIGger<m>:USB:SMAX.....	2328
TRIGger<m>:USB:SPEC.....	2328
TRIGger<m>:USB:STCO.....	2328
TRIGger<m>:USB:TCONdition.....	2329
TRIGger<m>:USB:TMIN.....	2329
TRIGger<m>:USB:TMAX.....	2329
TRIGger<m>:USB:TOKen.....	2329
TRIGger<m>:USB:WADD.....	2330
TRIGger<m>:USB:WEND.....	2330
TRIGger<m>:USB:WETCheck.....	2330
TRIGger<m>:USB:WFRN.....	2330
TRIGger<m>:USB:WPAY.....	2331
TRIGger<m>:USB:WPID.....	2331
TRIGger<m>:USB:WPOR.....	2331
TRIGger<m>:USB:WSEU.....	2331
TRIGger<m>:USB:WSTC.....	2331

TRIGger<m>:USB:TYPE <Type>

Selects the trigger type for USB analysis. The available trigger types depend on the activated USB protocol type.

Parameters:

<Type> SOP | EOP | RST | SUSPend | RESume | TOKen | DATA | HANDshake | SPECial | ERRCond

SOP

Sets the trigger to the SOP (start of packet) field. The start of packet condition is the end of the SYNC field. The trigger instant is the end of the SOP field.

EOP

Sets the trigger to the EOP (end of packet) field. Not available for USB High Speed and USB HSIC protocol types. The trigger instant is the beginning of the EOP field.

RST

Sets the trigger to the Reset field. Not available for USB High Speed and USB HSIC protocol types. For more information on the reset condition, see the USB standard. The trigger instant is the end of the 10 ms period after the SE0 field.

SUSPend

Sets the trigger to the Suspend field. Not available for USB High Speed and USB HSIC protocol types. For more information on the suspend condition, see the USB standard. The trigger instant will be declared after the defined 3 ms timeout.

RESume

Sets the trigger to the Resume field. Not available for USB High Speed and USB HSIC protocol types. For more information on the resume condition, see the USB standard. The trigger instant will be declared after the defined 20 ms timeout.

TOKen

Sets the trigger to one out of four different token trigger types: OUT, IN, SOF, or SETUP.

DATA

Sets the trigger to one out of four different data trigger types: DATA0, DATA1, DATA2, or MDATA.

HANDshake

Sets the trigger to one out of four different handshake trigger types: ACK, NAK, STALL, or NYET.

SPECial

Sets the trigger to one out of four different Special PID trigger types: PREamble, ERR, SPLIT, or PING.

ERRCond

Sets the trigger to one out of seven different error condition trigger types: PID error, CRC5 error, CRC16 error, Bitstuffing error, Unexpected PID error, SE1 error, or Glitching error.

*RST: SOP

Manual operation: See "[Trigger type USB](#)" on page 851

TRIGger<m>:USB:ACONdition <OperatorAddress>

Sets the operator to set a specific address or an address range. The address values are set with [TRIGger<m>:USB:AMIN](#) and [TRIGger<m>:USB:AMAX](#).

Parameters:

<OperatorAddress> OFF | ANY | EQUal | NEQual | LTHan | LETHan | GTHan | GETHan | INRange | OORange

EQUal | NEQual | LTHan | LETHan | GTHan | GETHan

Equal, Not equal, Less than, Less than or equal, Greater than, Greater than or equal. These conditions require one address value to be set using [TRIGger<m>:USB:AMIN](#).

INRange | OORange

In range, out of range. These conditions require an address range to be set using [TRIGger<m>:USB:AMIN](#) and [TRIGger<m>:USB:AMAX](#).

*RST: OFF

Manual operation: See ["Address"](#) on page 856

TRIGger<m>:USB:AMIN <Address>

Specifies the address, or sets the the start value of an address range. The string parameter does not accept the bit value X (don't care).

Parameters:

<Address>

Manual operation: See ["Address"](#) on page 856

TRIGger<m>:USB:AMAX <AddressTo>

Sets the the end value of an address range if [TRIGger<m>:USB:ACONdition](#) is set to [INRange](#) or [OORange](#). The string parameter does not accept the bit value X (don't care).

Parameters:

<AddressTo>

Manual operation: See ["Address"](#) on page 856

TRIGger<m>:USB:DATA <USBDataType>

Sets the trigger to one out of four different payload data types: DATA0, DATA1, DATA2, or MDATA.

Parameters:

<USBDataType> D0 | D1 | D2 | MD

D0

Sets the trigger to the DATA0 field (even PID).

D1

Sets the trigger to the DATA1 field (odd PID).

D2

Sets the trigger to the DATA2 field (data packet PID for high-speed, high bandwidth isochronous transaction in a microframe).

MD

Sets the trigger to the MDATA field (high-speed data packet PID for split and high bandwidth isochronous transactions).

*RST: D0

Manual operation: See ["Data"](#) on page 853

TRIGger<m>:USB:DCONdition <OperatorData>

Sets the operator (equal or unequal) to set a specific payload data pattern.

Parameters:

<OperatorData> OFF | ANY | EQUal | NEQual
 *RST: EQUal

Manual operation: See "Payload" on page 856

TRIGger<m>:USB:DPOperator <DataPosOperator>

Sets the operator (any or equal) for the payload data index position.

Parameters:

<DataPosOperator> ANY | OFF | EQUal

ANY = OFF

The position of the bit pattern within the payload data is not relevant.

EQUal

Sets the operator for specifying a special start position for the bit pattern within the payload data.

*RST: ANY

Manual operation: See "Payload" on page 856

TRIGger<m>:USB:DPOsition <DataPosition>

Specifies the position within a payload data packet, in which a special data pattern is to be searched.

Parameters:

<DataPosition> Range: 0 to 1024
 Increment: 1
 *RST: 0

Manual operation: See "Payload" on page 856

TRIGger<m>:USB:ECONdition <EndpointOptor>

Sets the operator to set a specific endpoint or an endpoint range. The endpoint values are set with [TRIGger<m>:USB:EMIN](#) and [TRIGger<m>:USB:EMAX](#).

Parameters:

<EndpointOptor> OFF | ANY | EQUal | NEQual | LTHan | LETHan | GTHan |
 GETHan | INRange | OORange

EQUal | NEQual | LTHan | LETHan | GTHan | GETHan

Equal, Not equal, Less than, Less than or equal, Greater than, Greater than or equal. These conditions require one endpoint value to be set using [TRIGger<m>:USB:EMIN](#).

INRange | OORange

In range, out of range. These conditions require a range of endpoint values to be set using [TRIGger<m>:USB:EMIN](#) and [TRIGger<m>:USB:EMAX](#).

*RST: OFF

Manual operation: See ["End Point"](#) on page 856

TRIGger<m>:USB:EMIN <Endp>

Specifies the endpoint, or sets the the start value of an endpoint range.

Parameters:

<Endp>

Manual operation: See ["End Point"](#) on page 856

TRIGger<m>:USB:EMAX <EndpTo>

Sets the the end value of an endpoint range if [TRIGger<m>:USB:ECONdition](#) is set to [INRange](#) or [OORange](#).

Parameters:

<EndpTo>

Manual operation: See ["End Point"](#) on page 856

TRIGger<m>:USB:ERRC <ErrorType>

Sets the trigger to an error condition type.

Parameters:

<ErrorType> ANY | PIDerror | CRC5error | CRC16error | BTST | UNEXpid | SE1error | GLITCherr

ANY

Triggers on any of the errors listed below.

PIDerror

Triggers on any packet identifier error.

CRC5error

Triggers on any CRC5 error event.

CRC16error

Triggers on any CRC16 error event.

BTST

Triggers on any bitstuffing error event (erroneous or missing bit stuffing sequence, see USB standard).

UNEXpid

Triggers on any unexpected PID error (illegal PID, that is not allowed in USB low speed and USB full speed protocols, especially PID's announcing packets such as SPLIT, DATA2, MDATA, or other noncompliant packets).

SE1error

Triggers on the illegal bus state Single Ended 1 (SE1 = both lines high).

GLITCherr

Triggers on any glitching error (illegal bit period, see USB standard for the definition of glitching).

*RST: ANY

Manual operation: See "[Error condition](#)" on page 855

TRIGger<m>:USB:FCONdition <FrameNoOperator>

Sets the operator to set a specific frame number or a frame number range. The frame number values are set with [TRIGger<m>:USB:FMIN](#) and [TRIGger<m>:USB:FMAX](#).

Parameters:

<FrameNoOperator> OFF | ANY | EQUal | NEQual | LTHan | LETHan | GTHan | GETHan | INRange | OORange

EQUal | NEQual | LTHan | LETHan | GTHan | GETHan

Equal, Not equal, Less than, Less than or equal, Greater than, Greater than or equal. These conditions require one frame number value to be set using [TRIGger<m>:USB:FMIN](#).

INRange | OORange

In range, out of range. These conditions require a range of frame number values to be set using [TRIGger<m>:USB:FMIN](#) and [TRIGger<m>:USB:FMAX](#).

*RST: OFF

Manual operation: See "[Frame number](#)" on page 857

TRIGger<m>:USB:FMIN <FrameNumber>

Specifies the frame number, or sets the the start value of a frame number range.

Parameters:

<FrameNumber>

Manual operation: See "[Frame number](#)" on page 857

TRIGger<m>:USB:FMAX <FrameNumberTo>

Sets the the end value of a frame number range if [TRIGger<m>:USB:FCONdition](#) is set to [INRange](#) or [OORange](#).

Parameters:

<FrameNumberTo>

Manual operation: See "[Frame number](#)" on page 857

TRIGger<m>:USB:HAND <HandshakeType>

Sets the trigger to one out of four different handshake types: ACK, NAK, STALI, or NYET.

Parameters:

<HandshakeType> ACK | NAK | STALI | NYET

ACK

Sets the trigger to the ACK field (acknowledgment of error-free data packet).

NAK

Sets the trigger to the NAK field (non-acknowledgment, no successful data transmission).

STALI

Sets the trigger to the STALL field (endpoint is halted or a control pipe request is not supported).

NYET

Sets the trigger to the NYET field (no response yet from receiver).

*RST: ACK

Manual operation: See "[Handshake](#)" on page 854

TRIGger<m>:USB:PATT <PayloadMuster>

Specifies the payload data pattern that is to be searched.

Parameters:

<PayloadMuster>

Manual operation: See "[Payload](#)" on page 856

TRIGger<m>:USB:PCONdition <OperatorPort>

Sets the operator to set a specific port number or a port number range. The port number values are set with [TRIGger<m>:USB:PMIN](#) and [TRIGger<m>:USB:PMAX](#).

Parameters:

<OperatorPort> OFF | ANY | EQUal | NEQual | LTHan | LETHan | GTHan | GETHan | INRange | OORange

EQUal | NEQual | LTHan | LETHan | GTHan | GETHan

Equal, Not equal, Less than, Less than or equal, Greater than, Greater than or equal. These conditions require one port number to be set using [TRIGger<m>:USB:PMIN](#).

INRange | OORange

In range, out of range. These conditions require a port number range to be set using [TRIGger<m>:USB:PMIN](#) and [TRIGger<m>:USB:PMAX](#).

*RST: OFF

Manual operation: See "Port" on page 857

TRIGger<m>:USB:PMIN <Port>

Specifies the port number, or sets the the start value of a port number range.

Parameters:

<Port>

Manual operation: See "Port" on page 857

TRIGger<m>:USB:PMAX <PortTo>

Sets the the end value of a port number range if `TRIGger<m>:USB:PCONdition` is set to `INRange` or `OORange`.

Parameters:

<PortTo>

Manual operation: See "Port" on page 857

TRIGger<m>:USB:SCONdition <OperatorSEU>

Sets the operator to set a specific SEU or an SEU range. The SEU values are set with `TRIGger<m>:USB:SMIN` and `TRIGger<m>:USB:SMAX`.

For SEU, see "SEU" on page 858.

Parameters:

<OperatorSEU>

OFF | ANY | EQUal | NEQual | LTHan | LETHan | GTHan | GETHan | INRange | OORange

EQUal | NEQual | LTHan | LETHan | GTHan | GETHan

Equal, Not equal, Less than, Less than or equal, Greater than, Greater than or equal. These conditions require one SEU value to be set using `TRIGger<m>:USB:SMIN`.

INRange | OORange

In range, out of range. These conditions require a range of SEU values to be set using `TRIGger<m>:USB:SMIN` and `TRIGger<m>:USB:SMAX`.

*RST: OFF

Manual operation: See "SEU" on page 858

TRIGger<m>:USB:SMIN <SEU>

Specifies the SEU, or sets the the start value of an SEU range.

Parameters:

<SEU>

Manual operation: See "SEU" on page 858

TRIGger<m>:USB:SMAx <SEUto>

Sets the the end value of an SEU range if **TRIGger<m>:USB:SCONdition** is set to **INRange** or **ORange**.

Parameters:

<SEUto>

Manual operation: See "SEU" on page 858

TRIGger<m>:USB:SPEC <USBSpecialType>

Sets the trigger to one out of four different Special PID types: **PREamble**, **ERR**, **SPLit**, or **PING**.

Parameters:

<USBSpecialType> **PREamble** | **ERR** | **SPLit** | **PING**

PREamble

Sets the trigger to the **PREamble** PID

ERR

Sets the trigger to the **ERRor** PID

SPLit

Sets the trigger to the **SPLIT** PID (in USB high speed transactions)

PING

Sets the trigger to the **PING** PID (in USB high speed transactions, flow control probe for a bulk/control endpoint)

*RST: **PREamble**

Manual operation: See "Special PID" on page 854

TRIGger<m>:USB:STCO <SC>

Sets the trigger to a specific start-split or complete-split transaction endpoint.

Parameters:

<SC> **ONE** | **ZERO** | **DC**

ONE

SC = 1 represents a complete-split (**CSPLIT**) transaction.

ZERO

SC = 0 represents a start-split (**SSPLIT**) transaction.

DC

SC = X represents "don't care" (**DC**)

*RST: **DC**

Manual operation: See "SC" on page 857

TRIGger<m>:USB:TCONdition <OperatorET>

Sets the operator to set a specific endpoint type (ET) or an ET range. The ET values are set with [TRIGger<m>:USB:TMIN](#) and [TRIGger<m>:USB:TMAX](#).

Parameters:

<OperatorET> OFF | ANY | EQUal | NEQual | LTHan | LETHan | GTHan |
GETHan | INRange | OORange

OFF = ANY

The position of the endpoint type is not relevant.

EQUal | NEQual | LTHan | LETHan | GTHan | GETHan

Equal, Not equal, Less than, Less than or equal, Greater than, Greater than or equal. These conditions require one ET value to be set using [TRIGger<m>:USB:TMIN](#).

INRange | OORange

In range, out of range. These conditions require a range of ET values to be set using [TRIGger<m>:USB:SMIN](#) and [TRIGger<m>:USB:SMAX](#).

*RST: OFF

Manual operation: See "[ET](#)" on page 858

TRIGger<m>:USB:TMIN <ET>

Specifies the endpoint type, or sets the the start value of an endpoint type range.

Parameters:

<ET>

Manual operation: See "[ET](#)" on page 858

TRIGger<m>:USB:TMAX <ETTo>

Sets the the end value of an endpoint type range if [TRIGger<m>:USB:TCONdition](#) is set to [INRange](#) or [OORange](#).

Parameters:

<ETTo>

Manual operation: See "[ET](#)" on page 858

TRIGger<m>:USB:TOKen <USBTokenType>

Sets the trigger to one out of four different token types: OUT, IN, SOF, or SETup.

Parameters:

<USBTokenType> OUT | IN | SOF | SETup

OUT

Sets the trigger to the OUT token (OUT packet from host to device).

IN

Sets the trigger to the IN token (IN packet from device to host).

SOF

Sets the trigger to the SOF token (start of frame marker and frame number).

SETup

Sets the trigger to the SETUP token (address and endpoint number in OUT transaction for setup to a control pipe).

*RST: OUT

Manual operation: See ["Token"](#) on page 853

TRIGger<m>:USB:WADD <AddressCheck>

Defines, whether the address check shall be activated or not.

Parameters:

<AddressCheck> ON | OFF

*RST: OFF

Manual operation: See ["Address"](#) on page 856

TRIGger<m>:USB:WEND <EndpointCheck>

Defines, whether the endpoint check shall be activated or not.

Parameters:

<EndpointCheck> ON | OFF

*RST: OFF

Manual operation: See ["End Point"](#) on page 856

TRIGger<m>:USB:WETCheck <WithETCheck>

Defines, whether the Endpoint Type (ET) check shall be activated or not.

Parameters:

<WithETCheck> ON | OFF

*RST: OFF

Manual operation: See ["ET"](#) on page 858

TRIGger<m>:USB:WFRN <FrameNoChk>

Defines, whether the frame number check shall be activated or not.

Parameters:

<FrameNoChk> ON | OFF

*RST: OFF

Manual operation: See ["Frame number"](#) on page 857

TRIGger<m>:USB:WPAY <PayloadCheck>

Defines, whether the payload data check shall be activated or not.

Parameters:

<PayloadCheck> ON | OFF
*RST: OFF

Manual operation: See "[Payload](#)" on page 856

TRIGger<m>:USB:WPID <WithPIDCheck>

Defines, whether the packet ID error check shall be activated or not.

Parameters:

<WithPIDCheck> ON | OFF
*RST: OFF

Manual operation: See "[PID error](#)" on page 856

TRIGger<m>:USB:WPOR <WithPortCheck>

Defines, whether the port check shall be activated or not.

Parameters:

<WithPortCheck> ON | OFF
*RST: OFF

Manual operation: See "[Port](#)" on page 857

TRIGger<m>:USB:WSEU <WithSEUCheck>

Defines, whether the SEU check shall be activated or not.

For SEU, see "[SEU](#)" on page 858.

Parameters:

<WithSEUCheck> ON | OFF
*RST: OFF

Manual operation: See "[SEU](#)" on page 858

TRIGger<m>:USB:WSTC <WithSCCheck>

Defines, whether the Start / Complete (SC) check shall be activated or not.

Parameters:

<WithSCCheck> ON | OFF
*RST: OFF

Manual operation: See "[SC](#)" on page 857

27.18.21.3 Decode results

In all `BUS<m>:USB:PACKet<n>` commands, the suffix `<m>` selects the serial bus and the suffix `<n>` selects the packet number in the decode table.

- ▶ Query the status of packet #19: `BUS:USB:PACKet19:STAT?`

The result of this remote command query should be "OK".

<code>BUS<m>:USB:PACKet<n>:PID?</code>	2332
<code>BUS<m>:USB:PACKet<n>:ADDRess?</code>	2333
<code>BUS<m>:USB:PACKet<n>:CRC?</code>	2334
<code>BUS<m>:USB:PACKet<n>:DATA?</code>	2334
<code>BUS<m>:USB:PACKet<n>:ENDPoint?</code>	2334
<code>BUS<m>:USB:PACKet<n>:ET?</code>	2335
<code>BUS<m>:USB:PACKet<n>:FRAMe?</code>	2335
<code>BUS<m>:USB:PACKet<n>:PORT?</code>	2335
<code>BUS<m>:USB:PACKet<n>:SC?</code>	2335
<code>BUS<m>:USB:PACKet<n>:SEU?</code>	2336
<code>BUS<m>:USB:PACKet<n>:START?</code>	2336
<code>BUS<m>:USB:PACKet<n>:STATus?</code>	2336
<code>BUS<m>:USB:PACKet<n>:STOP?</code>	2337
<code>BUS<m>:USB:PCOunt?</code>	2337

`BUS<m>:USB:PACKet<n>:PID?`

Returns the packet PID for the selected serial bus and packet number.

Suffix:

<code><m></code>	1..4
<code><n></code>	*

Return values:

<code><PID></code>	RES OUT ACK DATA0 DATA0 PING SOF NYET DATA2 DATA2 SPLIT SPLit IN NAK DATA1 DATA1 PRE SETUP SETUp STALL STALI MDATA MDATA UNK
	RES
	RES = Reserved
	OUT
	OUT Token PID
	IN
	IN Token PID
	SOF
	Start Of Frame PID
	SETUP = SETUp
	SETUP PID
	DATA0 = DATA0
	DATA0 PID, even PID

DATA1 = DATA1

DATA1 PID, odd PID

DATA2 = DATA2

DATA2 PID (only valid in USB high speed and USB HSIC protocols)

MDATA = MDATA

MDATA PID (only valid in USB high speed and USB HSIC protocols)

ACK

ACKnowledgment PID

NAK

Non-AcKnowledgegment PID

STALL = STALL

STALL PID

NYET

Not ready YET (only valid in USB high speed and USB HSIC protocols)

PRE

PREamble PID (only valid in USB high speed and USB HSIC protocols)

SPLIT = SPLIT

SPLIT PID (only valid in USB high speed and USB HSIC protocols)

PING

PING PID (only valid in USB high speed and USB HSIC protocols)

UNK

UNK = Unknown PID

*RST: RES

Usage: Query only

BUS<m>:USB:PACKet<n>:ADDRess?

Returns the packet address for the selected serial bus and packet number.

Suffix:

<m> 1..4

<n> *

Return values:

<Addr> Range: 0 to 127

Increment: 1

*RST: 0

Usage: Query only

BUS<m>:USB:PACKet<n>:CRC?

Returns the packet CRC (Cyclic Redundancy Code) for the selected serial bus and packet number.

Suffix:

<m> 1..4

<n> *

Return values:

<CRC> Range: 0 to 65535
Increment: 1
*RST: 0

Usage: Query only

BUS<m>:USB:PACKet<n>:DATA?

Returns the payload data from the packet with the selected packet number (for the selected serial bus).

Suffix:

<m> 1..4

<n> *

Parameters:

<Data> Comma-separated sequence of integer values (N, D1, D2, ..., DN). N is the number of bytes in the packet. and D1...DN are the values of the bytes.

Example:

```
BUS:USB:PACKet4:DATA?
<-- 6,18,52,86,120,154,188
```

Usage: Query only

BUS<m>:USB:PACKet<n>:ENDPoint?

Returns the endpoint for the selected serial bus and packet number.

Suffix:

<m> 1..4

<n> *

Return values:

<Endp> Range: 0 to 15
Increment: 1
*RST: 0

Usage: Query only

BUS<m>:USB:PACKet<n>:ET?

Returns the endpoint type (ET) for the selected serial bus and packet number.

Suffix:

<m> 1..4

<n> *

Return values:

<ET> Range: 0 to 3
Increment: 1
*RST: 0

Usage: Query only

BUS<m>:USB:PACKet<n>:FRAME?

Returns the frame number for the selected serial bus and packet number.

Suffix:

<m> 1..4

<n> *

Return values:

<FrameNo> Range: 0 to 2047
Increment: 1
*RST: 0

Usage: Query only

BUS<m>:USB:PACKet<n>:PORT?

Returns the port number for the selected serial bus and packet number.

Suffix:

<m> 1..4

<n> *

Return values:

<Port> Range: 0 to 127
Increment: 1
*RST: 0

Usage: Query only

BUS<m>:USB:PACKet<n>:SC?

Returns the Start- / Complete-split transaction (SSPLIT / CSPLIT) flag bits for the selected serial bus and packet number.

Suffix:

<m> 1..4

<n> *

Return values:

<SC>

Usage: Query only

BUS<m>:USB:PACKet<n>:SEU?

Returns the SEU values for the selected serial bus and packet number.

For SEU, see "SEU" on page 858.

Suffix:

<m> 1..4

<n> *

Return values:

<SEU> Range: 0 to 3
Increment: 1
*RST: 0

Usage: Query only

BUS<m>:USB:PACKet<n>:START?

Returns the start position of the packet with the selected packet number (for the selected serial bus).

Suffix:

<m> 1..4

<n> *

Return values:

<Start> Range: -100E+24 to 100E+24
Increment: 100E-12
*RST: 0
Default unit: s

Usage: Query only

BUS<m>:USB:PACKet<n>:STATus?

Returns the status of the packet with the selected packet number (for the selected serial bus).

Suffix:

<m> 1..4

<n> *

Return values:

<State> OK | PID | CRC | BTST | GLITCH | GLITCh | BYTE
 *RST: OK

Usage: Query only

BUS<m>:USB:PACKet<n>:STOP?

Returns the stop time of the packet with the selected packet number (for the selected serial bus).

Suffix:

<m> 1..4
 <n> *

Return values:

<Stop> Range: -100E+24 to 100E+24
 Increment: 100E-12
 *RST: 0
 Default unit: s

Usage: Query only

BUS<m>:USB:PCOunt?

Returns the packet count for the selected serial bus, i.e. the number of packets in the present acquisition.

Suffix:

<m> 1..4

Return values:

<Count> Range: 0 to 100000
 Increment: 1
 *RST: 0

Usage: Query only

27.18.21.4 Search settings

SEARCh:TRIGger:USB:ACONdition.....	2338
SEARCh:TRIGger:USB:AMIN.....	2339
SEARCh:TRIGger:USB:AMAX.....	2339
SEARCh:TRIGger:USB:BITSterror.....	2339
SEARCh:TRIGger:USB:CRC16error.....	2340
SEARCh:TRIGger:USB:CRC5error.....	2340
SEARCh:TRIGger:USB:DATA.....	2340
SEARCh:TRIGger:USB:DCONdition.....	2341
SEARCh:TRIGger:USB:DPOPerator.....	2341
SEARCh:TRIGger:USB:DPOSition.....	2341
SEARCh:TRIGger:USB:ECONdition.....	2342

SEARch:TRIGger:USB:EMIN.....	2342
SEARch:TRIGger:USB:EMAX.....	2342
SEARch:TRIGger:USB:FCONdition.....	2343
SEARch:TRIGger:USB:FMIN.....	2343
SEARch:TRIGger:USB:FMAX.....	2343
SEARch:TRIGger:USB:GLITCherror.....	2344
SEARch:TRIGger:USB:HAND.....	2344
SEARch:TRIGger:USB:PATT.....	2344
SEARch:TRIGger:USB:PCONdition.....	2344
SEARch:TRIGger:USB:PMIN.....	2345
SEARch:TRIGger:USB:PMAX.....	2345
SEARch:TRIGger:USB:PIDerror.....	2345
SEARch:TRIGger:USB:SCONdition.....	2346
SEARch:TRIGger:USB:SMIN.....	2346
SEARch:TRIGger:USB:SMAX.....	2346
SEARch:TRIGger:USB:SDATa.....	2347
SEARch:TRIGger:USB:SERRor.....	2347
SEARch:TRIGger:USB:SHANdshake.....	2347
SEARch:TRIGger:USB:SSOP.....	2347
SEARch:TRIGger:USB:SSPE.....	2348
SEARch:TRIGger:USB:SPEC.....	2348
SEARch:TRIGger:USB:STCO.....	2349
SEARch:TRIGger:USB:STOKen.....	2349
SEARch:TRIGger:USB:TCONdition.....	2349
SEARch:TRIGger:USB:TMIN.....	2350
SEARch:TRIGger:USB:TMAX.....	2350
SEARch:TRIGger:USB:TOKen.....	2350
SEARch:TRIGger:USB:WADD.....	2351
SEARch:TRIGger:USB:WEND.....	2351
SEARch:TRIGger:USB:WETCheck.....	2351
SEARch:TRIGger:USB:WFRN.....	2352
SEARch:TRIGger:USB:WPAY.....	2352
SEARch:TRIGger:USB:WPID.....	2352
SEARch:TRIGger:USB:WPOR.....	2352
SEARch:TRIGger:USB:WSEU.....	2353
SEARch:TRIGger:USB:WSTC.....	2353

SEARch:TRIGger:USB:ACONdition <SearchName>,<OperatorAddress>
SEARch:TRIGger:USB:ACONdition? <SearchName>

Sets the operator to set a specific address or an address range.

Parameters:

<OperatorAddress> OFF | ANY | EQUal | NEQual | LTHan | LETHan | GTHan |
 GETHan | INRange | OORange

EQUal | NEQual | LTHan | LETHan | GTHan | GETHan

Equal, Not equal, Less than, Less than or equal, Greater than,
 Greater than or equal. These conditions require one address
 value to be set using [SEARch:TRIGger:USB:AMIN](#).

INRange | OORange

In range, out of range. These conditions require an address range to be set using [SEARCH:TRIGGER:USB:AMIN](#) and [SEARCH:TRIGGER:USB:AMAX](#).

*RST: OFF

Parameters for setting and query:

<SearchName>

Manual operation: See ["Address check"](#) on page 863

SEARCH:TRIGGER:USB:AMIN <SearchName>,<Address>

SEARCH:TRIGGER:USB:AMIN? <SearchName>

Specifies an address, or sets the start value of an address range. The string parameter does not accept the bit value X (don't care).

Parameters:

<Address>

Parameters for setting and query:

<SearchName>

Manual operation: See ["Address check"](#) on page 863

SEARCH:TRIGGER:USB:AMAX <SearchName>,<AddressTo>

SEARCH:TRIGGER:USB:AMAX? <SearchName>

Sets the the end value of an address range if [TRIGGER<m>:USB:ACONdition](#) is set to [INRange](#) or [OORange](#). The string parameter does not accept the bit value X (don't care).

Parameters:

<AddressTo>

Parameters for setting and query:

<SearchName>

Manual operation: See ["Address check"](#) on page 863

SEARCH:TRIGGER:USB:BITSterror <SearchName>,<BitstuffError>

SEARCH:TRIGGER:USB:BITSterror? <SearchName>

Defines, whether a search for any bitstuffing error shall be activated or not.

Parameters:

<BitstuffError> ON | OFF

*RST: OFF

Parameters for setting and query:

<SearchName>

Manual operation: See ["Error condition"](#) on page 863

SEARCh:TRIGger:USB:CRC16error <SearchName>,<CRC16Error>
SEARCh:TRIGger:USB:CRC16error? <SearchName>

Defines, whether a search for any CRC16 error shall be activated or not.

Parameters:

<CRC16Error> ON | OFF
 *RST: OFF

Parameters for setting and query:

<SearchName>

Manual operation: See "[Error condition](#)" on page 863

SEARCh:TRIGger:USB:CRC5error <SearchName>,<CRC5Error>
SEARCh:TRIGger:USB:CRC5error? <SearchName>

Defines, whether a search for any CRC5 error shall be activated or not.

Parameters:

<CRC5Error> ON | OFF
 *RST: OFF

Parameters for setting and query:

<SearchName>

Manual operation: See "[Error condition](#)" on page 863

SEARCh:TRIGger:USB:DATA <SearchName>,<USBDataType>
SEARCh:TRIGger:USB:DATA? <SearchName>

Defines, which data packet type is searched for: "DATA0", "DATA1", "DATA2", or "MDATA", as well as "Any" data packet.

Parameters:

<USBDataType> ANY | D0 | D1 | D2 | MD

ANY

Searches for any of the data packet types listed below

D0

Searches for a DATA0 packet (even PID)

D1

Searches for a DATA1 packet (odd PID)

D2

Searches for a DATA2 packet (high-speed data packet for high bandwidth isochronous transaction in a microframe)

MD

Searches for an MDATA packet (high-speed data packet for split and high bandwidth isochronous transactions)

*RST: D0

Parameters for setting and query:

<SearchName>

Manual operation: See ["Data"](#) on page 862**SEARCh:TRIGger:USB:DCONdition** <SearchName>,<OperatorData>**SEARCh:TRIGger:USB:DCONdition?** <SearchName>

Sets the operator (equal or unequal) to set a specific payload data pattern.

Parameters:

<OperatorData> OFF | ANY | EQUal | NEQual

*RST: EQUal

Parameters for setting and query:

<SearchName>

Manual operation: See ["Payload check"](#) on page 864**SEARCh:TRIGger:USB:DPOPerator** <SearchName>,<DataPosOperator>**SEARCh:TRIGger:USB:DPOPerator?** <SearchName>

Sets the operator (any or equal) for the payload data index position.

Parameters:

<DataPosOperator> ANY | OFF | EQUal

ANY = OFF

The position of payload data is not relevant for the search condition.

*RST: ANY

Parameters for setting and query:

<SearchName>

Manual operation: See ["Payload check"](#) on page 864**SEARCh:TRIGger:USB:DPOStition** <SearchName>,<DataPosition>**SEARCh:TRIGger:USB:DPOStition?** <SearchName>

Specifies the position within a payload data packet, in which a special data pattern is to be searched.

Parameters:

<DataPosition> Range: 0 to 1024

Increment: 1

*RST: 0

Parameters for setting and query:

<SearchName>

Manual operation: See ["Payload check"](#) on page 864

SEARCh:TRIGger:USB:ECONdition <SearchName>,<EndpointOptor>
SEARCh:TRIGger:USB:ECONdition? <SearchName>

Sets the operator to set a specific endpoint or an endpoint range. The endpoint values are set with [SEARCh:TRIGger:USB:EMIN](#) and [SEARCh:TRIGger:USB:EMAX](#).

Parameters:

<EndpointOptor> OFF | ANY | EQUal | NEQual | LTHan | LETHan | GTHan |
 GETHan | INRange | OORange

EQUal | NEQual | LTHan | LETHan | GTHan | GETHan

Equal, Not equal, Less than, Less than or equal, Greater than, Greater than or equal. These conditions require one endpoint value to be set using [SEARCh:TRIGger:USB:EMIN](#).

INRange | OORange

In range, out of range. These conditions require a range of endpoint values to be set using [SEARCh:TRIGger:USB:EMIN](#) and [SEARCh:TRIGger:USB:EMAX](#).

*RST: OFF

Parameters for setting and query:

<SearchName>

Manual operation: See "[End Point check](#)" on page 863

SEARCh:TRIGger:USB:EMIN <SearchName>,<Endp>
SEARCh:TRIGger:USB:EMIN? <SearchName>

Specifies an endpoint, or sets the start value of an endpoint range.

Parameters:

<Endp>

Parameters for setting and query:

<SearchName>

Manual operation: See "[End Point check](#)" on page 863

SEARCh:TRIGger:USB:EMAX <SearchName>,<EndpTo>
SEARCh:TRIGger:USB:EMAX? <SearchName>

Sets the the end value of an endpoint range if [TRIGger<m>:USB:ECONdition](#) is set to [INRange](#) or [OORange](#).

Parameters:

<EndpTo>

Parameters for setting and query:

<SearchName>

Manual operation: See "[End Point check](#)" on page 863

SEARCh:TRIGger:USB:FCONdition <SearchName>,<FrameNoOperator>
SEARCh:TRIGger:USB:FCONdition? <SearchName>

Sets the operator to set a specific frame number or a frame number range. The frame number values are set with [SEARCh:TRIGger:USB:FMIN](#) and [SEARCh:TRIGger:USB:FMAX](#).

Parameters:

<FrameNoOperator> OFF | ANY | EQUal | NEQual | LTHan | LETHan | GTHan | GETHan | INRange | OORange

EQUal | NEQual | LTHan | LETHan | GTHan | GETHan

Equal, Not equal, Less than, Less than or equal, Greater than, Greater than or equal. These conditions require one frame number value to be set using [SEARCh:TRIGger:USB:FMIN](#).

INRange | OORange

In range, out of range. These conditions require a range of frame number values to be set using [SEARCh:TRIGger:USB:FMIN](#) and [SEARCh:TRIGger:USB:FMAX](#).

*RST: OFF

Parameters for setting and query:

<SearchName>

Manual operation: See "[Frame number check](#)" on page 864

SEARCh:TRIGger:USB:FMIN <SearchName>,<FrameNumber>
SEARCh:TRIGger:USB:FMIN? <SearchName>

Specifies a frame number, or sets the start value of a frame number range.

Parameters:

<FrameNumber>

Parameters for setting and query:

<SearchName>

Manual operation: See "[Frame number check](#)" on page 864

SEARCh:TRIGger:USB:FMAX <SearchName>,<FrameNumberTo>
SEARCh:TRIGger:USB:FMAX? <SearchName>

Sets the the end value of a frame number range if [TRIGger<m>:USB:FCONdition](#) is set to [INRange](#) or [OORange](#).

Parameters:

<FrameNumberTo>

Parameters for setting and query:

<SearchName>

Manual operation: See "[Frame number check](#)" on page 864

SEARCh:TRIGger:USB:GLITCherror <SearchName>,<GlitchError>
SEARCh:TRIGger:USB:GLITCherror? <SearchName>

Defines, whether a search for any glitch error shall be activated or not.

Parameters:

<GlitchError> ON | OFF
 *RST: OFF

Parameters for setting and query:

<SearchName>

Manual operation: See "[Error condition](#)" on page 863

SEARCh:TRIGger:USB:HAND <SearchName>,<HandshakeType>
SEARCh:TRIGger:USB:HAND? <SearchName>

Defines, which handshake type is searched for.

Parameters:

<HandshakeType> ANY | ACK | NAK | STALI | NYET
 *RST: ACK

Parameters for setting and query:

<SearchName>

Manual operation: See "[Handshake](#)" on page 862

SEARCh:TRIGger:USB:PATT <SearchName>,<PayloadMuster>
SEARCh:TRIGger:USB:PATT? <SearchName>

Defines the payload data pattern to search for.

Parameters:

<PayloadMuster>

Parameters for setting and query:

<SearchName>

Manual operation: See "[Payload check](#)" on page 864

SEARCh:TRIGger:USB:PCONdition <SearchName>,<OperatorPort>
SEARCh:TRIGger:USB:PCONdition? <SearchName>

Sets the operator to set a specific port number or a port number range. The port number values are set with [SEARCh:TRIGger:USB:PMIN](#) and [SEARCh:TRIGger:USB:PMAX](#).

Parameters:

<OperatorPort> OFF | ANY | EQUal | NEQual | LTHan | LETHan | GTHan |
 GETHan | INRange | OORange

EQUal | NEQual | LTHan | LETHan | GTHan | GETHan

Equal, Not equal, Less than, Less than or equal, Greater than, Greater than or equal. These conditions require one port number to be set using [SEARCh:TRIGger:USB:PMIN](#).

INRange | OORange

In range, out of range. These conditions require a port number range to be set using [SEARCh:TRIGger:USB:PMIN](#) and [SEARCh:TRIGger:USB:PMAX](#).

*RST: OFF

Parameters for setting and query:

<SearchName>

Manual operation: See ["Port check"](#) on page 865

SEARCh:TRIGger:USB:PMIN <SearchName>,<Port>

SEARCh:TRIGger:USB:PMIN? <SearchName>

Specifies a port number, or sets the start value of a port number range.

Parameters:

<Port>

Parameters for setting and query:

<SearchName>

Manual operation: See ["Port check"](#) on page 865

SEARCh:TRIGger:USB:PMAX <SearchName>,<PortTo>

SEARCh:TRIGger:USB:PMAX? <SearchName>

Sets the the end value of a port number range if [TRIGger<m>:USB:PCONdition](#) is set to [INRange](#) or [OORange](#).

Parameters:

<PortTo>

Parameters for setting and query:

<SearchName>

Manual operation: See ["Port check"](#) on page 865

SEARCh:TRIGger:USB:PIDerror <SearchName>,<PIDError>

SEARCh:TRIGger:USB:PIDerror? <SearchName>

Defines, whether a search for any PID error shall be activated or not.

Parameters:

<PIDError> ON | OFF

*RST: OFF

Parameters for setting and query:

<SearchName>

Manual operation: See "Error condition" on page 863**SEARCH:TRIGGER:USB:SCONdition** <SearchName>,<OperatorSEU>**SEARCH:TRIGGER:USB:SCONdition?** <SearchName>

Sets the operator to set a specific SEU or an SEU range. The SEU values are set with [SEARCH:TRIGGER:USB:SMIN](#) and [SEARCH:TRIGGER:USB:SMAX](#).

For SEU, see "SEU" on page 858.

Parameters:

<OperatorSEU> OFF | ANY | EQUAL | NEQUAL | LTHan | LETHan | GTHan |
GETHan | INRange | OORange

EQUAL | NEQUAL | LTHan | LETHan | GTHan | GETHan

Equal, Not equal, Less than, Less than or equal, Greater than, Greater than or equal. These conditions require one SEU value to be set using [SEARCH:TRIGGER:USB:SMIN](#).

INRange | OORange

In range, out of range. These conditions require a range of SEU values to be set using [SEARCH:TRIGGER:USB:SMIN](#) and [SEARCH:TRIGGER:USB:SMAX](#).

*RST: OFF

Parameters for setting and query:

<SearchName>

Manual operation: See "SEU check" on page 865**SEARCH:TRIGGER:USB:SMIN** <SearchName>,<SEU>**SEARCH:TRIGGER:USB:SMIN?** <SearchName>

Specifies an SEU, or sets the start value of an SEU range.

Parameters:

<SEU>

Parameters for setting and query:

<SearchName>

Manual operation: See "SEU check" on page 865**SEARCH:TRIGGER:USB:SMAX** <SearchName>,<SEUto>**SEARCH:TRIGGER:USB:SMAX?** <SearchName>

Sets the the end value of an SEU range if [TRIGGER<m>:USB:SCONdition](#) is set to [INRange](#) or [OORange](#).

Parameters:

<SEUto>

Parameters for setting and query:

<SearchName>

Manual operation: See ["SEU check"](#) on page 865**SEARCh:TRIGger:USB:SDATa** <SearchName>,<DataPacket>**SEARCh:TRIGger:USB:SDATa?** <SearchName>

Enables the search for any data packet.

Parameters:

<DataPacket> ON | OFF

*RST: OFF

Parameters for setting and query:

<SearchName>

Manual operation: See ["Search types"](#) on page 861**SEARCh:TRIGger:USB:SERRor** <SearchName>,<ErrorCondition>**SEARCh:TRIGger:USB:SERRor?** <SearchName>

Enables the search for various errors.

Parameters:

<ErrorCondition> ON | OFF

*RST: OFF

Parameters for setting and query:

<SearchName>

Manual operation: See ["Search types"](#) on page 861**SEARCh:TRIGger:USB:SHANdshake** <SearchName>,<HandshakePacket>**SEARCh:TRIGger:USB:SHANdshake?** <SearchName>

Defines, whether the search for any handshake packet shall be activated or not.

Parameters:

<HandshakePacket> ON | OFF

*RST: OFF

Parameters for setting and query:

<SearchName>

Manual operation: See ["Search types"](#) on page 861**SEARCh:TRIGger:USB:SSOP** <SearchName>,<StartofPacket>**SEARCh:TRIGger:USB:SSOP?** <SearchName>

Defines, whether a start of packet (SOP) search shall be activated or not.

Parameters:

<StartofPacket> ON | OFF
 *RST: OFF

Parameters for setting and query:

<SearchName>

Manual operation: See ["Search types"](#) on page 861

SEARch:TRIGger:USB:SSPE <SearchName>,<SpecialPacket>

SEARch:TRIGger:USB:SSPE? <SearchName>

Defines, whether the search for any special PID packet shall be activated or not.

Parameters:

<SpecialPacket> ON | OFF
 *RST: OFF

Parameters for setting and query:

<SearchName>

Manual operation: See ["Search types"](#) on page 861

SEARch:TRIGger:USB:SPEC <SearchName>,<USBSpecialType>

SEARch:TRIGger:USB:SPEC? <SearchName>

Defines, which special PID packet type is searched for: "PREamble", "ERR", "SPLit", "PING", or "Any" special PID packet.

Parameters:

<USBSpecialType> ANY | PREamble | ERR | SPLit | PING

ANY

Searches for any of the special PID packet types listed below

PREamble

Searches for any host-issued preamble token (enables downstream bus traffic to low speed USB devices)

ERR

Searches for any SPLIT transaction error handshake token (reuses PRE value)

SPLit

Searches for any high speed SPLIT transaction token

PING

Searches for any high speed flow control probe for a bulk/control endpoint

*RST: PREamble

Parameters for setting and query:

<SearchName>

Manual operation: See ["Special PID"](#) on page 862

SEARCh:TRIGger:USB:STCO <SearchName>,<SC>
SEARCh:TRIGger:USB:STCO? <SearchName>

Defines, which Start- / Complete- (SC) split transaction type is searched for: SSPLIT or CSPLIT.

Parameters:

<SC> ONE | ZERO | DC

ONE
 SC = 1 represents a complete-split (CSPLIT) transaction

ZERO
 SC = 0 represents a start-split (SSPLIT) transaction

DC
 SC = X represents "don't care" (DC)

*RST: DC

Parameters for setting and query:

<SearchName>

Manual operation: See "[SC check](#)" on page 865

SEARCh:TRIGger:USB:STOKen <SearchName>,<TokenPacket>
SEARCh:TRIGger:USB:STOKen? <SearchName>

Defines, whether a search for any token packet shall be activated or not.

Parameters:

<TokenPacket> ON | OFF

*RST: OFF

Parameters for setting and query:

<SearchName>

Manual operation: See "[Search types](#)" on page 861

SEARCh:TRIGger:USB:TCONDition <SearchName>,<OperatorET>
SEARCh:TRIGger:USB:TCONDition? <SearchName>

Sets the operator to set a specific endpoint type (ET) or an ET range. The ET values are set with [SEARCh:TRIGger:USB:TMIN](#) and [SEARCh:TRIGger:USB:TMAX](#).

Parameters:

<OperatorET> OFF | ANY | EQUal | NEQual | LTHan | LETHan | GTHan | GETHan | INRange | OORange

OFF = ANY
 The endpoint type is not relevant for the search condition.

EQUal | NEQual | LTHan | LETHan | GTHan | GETHan
 Equal, Not equal, Less than, Less than or equal, Greater than, Greater than or equal. These conditions require one ET value to be set using [SEARCh:TRIGger:USB:TMIN](#).

INRange | OORange

In range, out of range. These conditions require a range of ET values to be set using [SEARCH:TRIGger:USB:TMIN](#) and [SEARCH:TRIGger:USB:TMAX](#).

*RST: OFF

Parameters for setting and query:

<SearchName>

Manual operation: See ["ET check"](#) on page 865

SEARCH:TRIGger:USB:TMIN <SearchName>,<ET>

SEARCH:TRIGger:USB:TMIN? <SearchName>

Specifies an endpoint type (ET), or sets the start value of an ET range.

Parameters:

<ET>

Parameters for setting and query:

<SearchName>

Manual operation: See ["ET check"](#) on page 865

SEARCH:TRIGger:USB:TMAX <SearchName>,<ETTo>

SEARCH:TRIGger:USB:TMAX? <SearchName>

Sets the the end value of an endpoint type (ET) range if [TRIGger<m>:USB:TCONdition](#) is set to [INRange](#) or [OORange](#).

Parameters:

<ETTo>

Parameters for setting and query:

<SearchName>

Manual operation: See ["ET check"](#) on page 865

SEARCH:TRIGger:USB:TOKEN <SearchName>,<USBTokenType>

SEARCH:TRIGger:USB:TOKEN? <SearchName>

Defines, which token packet type is searched for: "OUT", "IN", "SOF", "SETUP", or "Any" token packet.

Parameters:

<USBTokenType> ANY | OUT | IN | SOF | SETUp

ANY

Searches for any of the token packet types listed below.

OUT

Searches for an OUT token.

IN

Searches for an IN token.

SOF

Searches for a start of frame (SOF) token.

SETup

Searches for a SETup token.

*RST: OUT

Parameters for setting and query:

<SearchName>

Manual operation: See "[Token](#)" on page 862

SEARCH:TRIGger:USB:WADD <SearchName>,<AddressCheck>

SEARCH:TRIGger:USB:WADD? <SearchName>

Defines, whether a search for any address field shall be activated or not.

Parameters:

<AddressCheck> ON | OFF

*RST: OFF

Parameters for setting and query:

<SearchName>

Manual operation: See "[Address check](#)" on page 863

SEARCH:TRIGger:USB:WEND <SearchName>,<EndpointCheck>

SEARCH:TRIGger:USB:WEND? <SearchName>

Defines, whether a search for any endpoint shall be activated or not.

Parameters:

<EndpointCheck> ON | OFF

*RST: OFF

Parameters for setting and query:

<SearchName>

Manual operation: See "[End Point check](#)" on page 863

SEARCH:TRIGger:USB:WETCheck <SearchName>,<WithETCheck>

SEARCH:TRIGger:USB:WETCheck? <SearchName>

Defines, whether a search for any Endpoint Type (ET) shall be activated or not.

Parameters:

<WithETCheck> ON | OFF

*RST: OFF

Parameters for setting and query:

<SearchName>

Manual operation: See "[ET check](#)" on page 865

SEARCh:TRIGger:USB:WFRN <SearchName>,<FrameNoCheck>
SEARCh:TRIGger:USB:WFRN? <SearchName>

Defines, whether a search for any frame number shall be activated or not.

Parameters:

<FrameNoCheck> ON | OFF
*RST: OFF

Parameters for setting and query:

<SearchName>

Manual operation: See "[Frame number check](#)" on page 864

SEARCh:TRIGger:USB:WPAY <SearchName>,<PayloadCheck>
SEARCh:TRIGger:USB:WPAY? <SearchName>

Defines, whether a search for any payload data shall be activated or not.

Parameters:

<PayloadCheck> ON | OFF
*RST: OFF

Parameters for setting and query:

<SearchName>

Manual operation: See "[Payload check](#)" on page 864

SEARCh:TRIGger:USB:WPID <SearchName>,<WithPIDCheck>
SEARCh:TRIGger:USB:WPID? <SearchName>

Defines, whether a search for any packet ID error shall be activated or not.

Parameters:

<WithPIDCheck> ON | OFF
*RST: OFF

Parameters for setting and query:

<SearchName>

SEARCh:TRIGger:USB:WPOR <SearchName>,<WithPortCheck>
SEARCh:TRIGger:USB:WPOR? <SearchName>

Defines, whether a search for any port shall be activated or not.

Parameters:

<WithPortCheck> ON | OFF
*RST: OFF

Parameters for setting and query:

<SearchName>

Manual operation: See "[Port check](#)" on page 865

SEARCh:TRIGger:USB:WSEU <SearchName>,<WithSEUCheck>
SEARCh:TRIGger:USB:WSEU? <SearchName>

Defines, whether a search for any SEU shall be activated or not.

For SEU, see "SEU" on page 858.

Parameters:

<WithSEUCheck> ON | OFF
 *RST: OFF

Parameters for setting and query:

<SearchName>

Manual operation: See "SEU check" on page 865

SEARCh:TRIGger:USB:WSTC <SearchName>,<WithSCCheck>
SEARCh:TRIGger:USB:WSTC? <SearchName>

Defines, whether a search for any Start / Complete (SC) shall be activated or not.

Parameters:

<WithSCCheck> ON | OFF
 *RST: OFF

Parameters for setting and query:

<SearchName>

Manual operation: See "SC check" on page 865

27.18.21.5 Search results

In all **SEARCh:RESult:USB:PACKet**<m> commands, the suffix <m> selects the packet number in the list of search results.

SEARCh:RESult:USB:PACKet <m>:ADDRess?	2354
SEARCh:RESult:USB:PACKet <m>:CRC?	2354
SEARCh:RESult:USB:PACKet <m>:DATA?	2354
SEARCh:RESult:USB:PACKet <m>:ENDPoint?	2354
SEARCh:RESult:USB:PACKet <m>:ET?	2355
SEARCh:RESult:USB:PACKet <m>:FRAME?	2355
SEARCh:RESult:USB:PACKet <m>:PID?	2355
SEARCh:RESult:USB:PACKet <m>:PORT?	2356
SEARCh:RESult:USB:PACKet <m>:SC?	2356
SEARCh:RESult:USB:PACKet <m>:SEU?	2356
SEARCh:RESult:USB:PACKet <m>:START?	2357
SEARCh:RESult:USB:PACKet <m>:STATus?	2357
SEARCh:RESult:USB:PACKet <m>:STOP?	2357
SEARCh:RESult:USB:PCount?	2358

SEARCh:RESult:USB:PACKet<m>:ADDRess? <SearchName>

Returns the packet address for the selected packet number within the search result.

Suffix:

<m> *

Query parameters:

<SearchName>

Return values:

<Addr> Range: 0 to 127
 Increment: 1
 *RST: 0

Usage: Query only

SEARCh:RESult:USB:PACKet<m>:CRC? <SearchName>

Returns the packet CRC (Cyclic Redundancy Code) for the selected packet number within the search result.

Suffix:

<m> *

Query parameters:

<SearchName>

Return values:

<CRC> Range: 0 to 65535
 Increment: 1
 *RST: 0

Usage: Query only

SEARCh:RESult:USB:PACKet<m>:DATA? <SearchName>

Returns the payload data from the packet with the selected packet number within the search result.

Suffix:

<m> *

Query parameters:

<SearchName>

Return values:

<Data>

Usage: Query only

SEARCh:RESult:USB:PACKet<m>:ENDPoint? <SearchName>

Returns the endpoint for the selected packet number within the search result.

Suffix:

<m> *

Query parameters:

<SearchName>

Return values:

<Endp> Range: 0 to 15
 Increment: 1
 *RST: 0

Usage: Query only

SEARCh:RESult:USB:PACKet<m>:ET? <SearchName>

Returns the endpoint type (ET) for the selected packet number within the search result.

Suffix:

<m> *

Query parameters:

<SearchName>

Return values:

<ET> Range: 0 to 3
 Increment: 1
 *RST: 0

Usage: Query only

SEARCh:RESult:USB:PACKet<m>:FRAME? <SearchName>

Returns the frame number for the selected packet number within the search result.

Suffix:

<m> *

Query parameters:

<SearchName>

Return values:

<FrameNo> Range: 0 to 2047
 Increment: 1
 *RST: 0

Usage: Query only

SEARCh:RESult:USB:PACKet<m>:PID? <SearchName>

Returns the packet PID for the selected packet number within the search result.

Suffix:

<m> *

Query parameters:

<SearchName>

Return values:

<PID>

RES | OUT | ACK | DATA0 | DATA0 | PING | SOF | NYET |
 DATA2 | DATA2 | SPLIT | SPLit | IN | NAK | DATA1 | DATA1 |
 PRE | SETUP | SETup | STALL | STALI | MDATA | MDATA | UNK

For a description of the return values, see [BUS<m>:USB:PACKet<n>:PID?](#) on page 2332.

*RST: RES

Usage:

Query only

SEARCh:RESult:USB:PACKet<m>:PORT? <SearchName>

Returns the port number for the selected packet number within the search result.

Suffix:

<m> *

Query parameters:

<SearchName>

Return values:

<Port>

Range: 0 to 127

Increment: 1

*RST: 0

Usage:

Query only

SEARCh:RESult:USB:PACKet<m>:SC? <SearchName>

Returns the Start- / Complete-split transaction (SSPLIT / CSPLIT) flag bits for the selected packet number within the search result.

Suffix:

<m> *

Query parameters:

<SearchName>

Return values:

<SC>

Usage:

Query only

SEARCh:RESult:USB:PACKet<m>:SEU? <SearchName>

Returns the SEU values for the selected packet number within the search result.

For SEU, see ["SEU"](#) on page 858.

Suffix:

<m> *

Query parameters:

<SearchName>

Return values:

<SEU> Range: 0 to 3
 Increment: 1
 *RST: 0

Usage: Query only**SEARCh:RESUlt:USB:PACKet<m>:STARt? <SearchName>**

Returns the start time of the packet with the selected packet number within the search result.

Suffix:

<m> *

Query parameters:

<SearchName>

Return values:

<Start> Range: -100E+24 to 100E+24
 Increment: 100E-12
 *RST: 0
 Default unit: s

Usage: Query only**SEARCh:RESUlt:USB:PACKet<m>:STATUs? <SearchName>**

Returns the status of the packet with the selected packet number within the search result.

Suffix:

<m> *

Query parameters:

<SearchName>

Return values:

<State> OK | PID | CRC | BTST | GLITCH | GLITCh | BYTE
 *RST: OK

Usage: Query only**SEARCh:RESUlt:USB:PACKet<m>:STOP? <SearchName>**

Returns the stop time of the packet with the selected packet number within the search result.

Suffix:

<m> *

Query parameters:

<SearchName>

Return values:

<Stop> Range: -100E+24 to 100E+24
 Increment: 100E-12
 *RST: 0
 Default unit: s

Usage: Query only**SEARch:RESult:USB:PCOunt? <SearchName>**

Returns the search result's packet count, i.e. the number of packets found in the search result.

Query parameters:

<SearchName>

Return values:

<Count> Range: 0 to 100000
 Increment: 1
 *RST: 0

Usage: Query only**27.18.22 USB 3.1 (option R&S RTO6-K570)**

- [Configuration](#).....2358
- [Digital signal processing \(DSP\)](#).....2360
- [Trigger](#).....2364
- [Decode results](#).....2375
- [Search settings](#).....2379
- [Search results](#).....2385

27.18.22.1 Configuration

In all `BUS<m>:USBT` commands, the suffix `<m>` selects the serial bus.

- [BUS<m>:USBThree:SOURce](#).....2358
- [BUS<m>:USBThree:POLarity](#).....2359
- [BUS<m>:USBThree:THRHigh](#).....2359
- [BUS<m>:USBThree:THRLow](#).....2359
- [BUS<m>:USBThree:SCRMode](#).....2360
- [BUS<m>:USBThree:TYPE](#).....2360

BUS<m>:USBThree:SOURce <SourceData>

Selects the source for the data signal in the USB 3.1 protocol.

Suffix:

<m> 1..4

Parameters:

<SourceData> C1W1 | C2W1 | C3W1 | C4W1 | M1 | M2 | M3 | M4 | M5 | M6 |
M7 | M8 | R1 | R2 | R3 | R4
*RST: C1W1

Usage:

Asynchronous command

Manual operation: See "[Source](#)" on page 876**BUS<m>:USBThree:POLarity <Polarity>**

Defines the polarity of the data signal for the active (U0) state of the port.

Suffix:

<m> 1..4

Parameters:

<Polarity> NORMal | INVert
NORMal
Normal (non-inverted) data signal polarity
INVert
Inverted data signal polarity
*RST: NORMal

Manual operation: See "[Polarity](#)" on page 877**BUS<m>:USBThree:THRHigh <ThresholdUpper>**

Defines the upper threshold level for digitization of the data signal in the USB 3.1 protocol.

Suffix:

<m> 1..4

Parameters:

<ThresholdUpper> Range: -2 to 2
Increment: 0.01
*RST: 0.05
Default unit: V

Manual operation: See "[Thresholds](#)" on page 877**BUS<m>:USBThree:THRLow <ThresholdLower>**

Defines the lower threshold level for digitization of the data signal in the USB 3.1 protocol.

Suffix:

<m> 1..4

Parameters:

<ThresholdLower> Range: -2 to 2
 Increment: 0.01
 *RST: -0.05
 Default unit: V

Manual operation: See "[Thresholds](#)" on page 877

BUS<m>:USBThree:SCRMode <ScrambleMode>

Selects if the data pattern is scrambled or unscrambled.

Suffix:

<m> 1..4

Parameters:

<ScrambleMode> SCRM | NSCR

SCRM

Scrambling is enabled as specified in the standard, to minimize EMI emissions.

NSCR

No scrambling: To simplify testing and debugging, scrambling is disabled.

*RST: SCRM

Manual operation: See "[Scramble Mode](#)" on page 877

BUS<m>:USBThree:TYPE <Protocol>

Selects the USB 3.1 protocol type.

Suffix:

<m> 1..4

Parameters:

<Protocol> SS
 *RST: SS

Usage: Asynchronous command

Manual operation: See "[Protocol type](#)" on page 876

27.18.22.2 Digital signal processing (DSP)

BUS<m>:CTLE:DCGain.....	2361
BUS<m>:CTLE:ENBLE.....	2361
BUS<m>:CTLE:P1FReq.....	2361
BUS<m>:CTLE:P2FReq.....	2361
BUS<m>:CTLE:Z1FReq.....	2362
BUS<m>:USBThree:BITR.....	2362
BUS<m>:USBThree:DFE:COEFFicient.....	2362

BUS<m>:USBThree:DFE:ENBLE.....	2363
BUS<m>:USBThree:DFE:ESTCoeff.....	2363
BUS<m>:USBThree:DFE:TCONt.....	2363
BUS<m>:USBThree:PROTocol.....	2363

BUS<m>:CTLE:DCGain <DCGain>

Sets the adjustable DC gain. This value can be chosen according to the channel loss characteristics. For low-loss channels, you can set a value close to 0 dB.

Suffix:

<m> 1..4

Parameters:

<DCGain> Range: -100 to 100
 Increment: 0.01
 *RST: 0
 Default unit: dB

Manual operation: See "[DC Gain \(\$A_{DC}\$ \)](#)" on page 878

BUS<m>:CTLE:ENBLE <EnableCTLE>

Enables the continuous time linear equalization (CTLE) equalization.

Suffix:

<m> 1..4

Parameters:

<EnableCTLE> ON | OFF
 *RST: OFF

Manual operation: See "[Enable](#)" on page 878

BUS<m>:CTLE:P1FReq <PoleOneFreq>

Sets the pole 1 frequency for the transfer function of the CTLE algorithm.

Suffix:

<m> 1..4

Parameters:

<PoleOneFreq> Range: 1 to 40E+9
 Increment: 1
 *RST: 0
 Default unit: Hz

Manual operation: See "[Pole frequency \(\$wp1\$ \)/\(\$wp2\$ \)](#)" on page 878

BUS<m>:CTLE:P2FReq <PoleTwoFreq>

Sets the pole 2 frequency for the transfer function of the CTLE algorithm.

Suffix:

<m> 1..4

Parameters:

<PoleTwoFreq> Range: 1 to 40E+9
 Increment: 1
 *RST: 0
 Default unit: Hz

Manual operation: See "[Pole frequency \(wp1\)/\(wp2\)](#)" on page 878

BUS<m>:CTLE:Z1FReq <ZroOneFreq>

Sets the zero frequency for the transfer function of the CTLE algorithm.

Suffix:

<m> 1..4

Parameters:

<ZroOneFreq> Range: 1 to 40E+9
 Increment: 1
 *RST: 0
 Default unit: Hz

Manual operation: See "[Zero frequency \(fz\)](#)" on page 878

BUS<m>:USBThree:BITR <HighSpdBitrate>

Sets the bit rate.

Suffix:

<m> 1..4

Parameters:

<HighSpdBitrate> Range: 1000 to 3E+9
 Increment: 1000
 *RST: 3E+9
 Default unit: bps

BUS<m>:USBThree:DFE:COEFFicient <DFEcoeff>

Sets the value of the coefficient for the DFE .

Suffix:

<m> 1..4

Parameters:

<DFEcoeff> Range: -1 to 1
 Increment: 1E-3
 *RST: 0
 Default unit: V

Manual operation: See "[Coefficient](#)" on page 879

BUS<m>:USBThree:DFE:ENBLe <EnableDFE>

Enables the use of the decision feedback equalization for USB 3.1.

Suffix:

<m> 1..4

Parameters:

<EnableDFE> ON | OFF
*RST: ON

Manual operation: See "[Enable](#)" on page 879

BUS<m>:USBThree:DFE:ESTCoeff <AutoChEstimate>

Enables the use of estimate coefficients for the decision feedback equalization.

Suffix:

<m> 1..4

Parameters:

<AutoChEstimate> ON | OFF
*RST: ON

Manual operation: See "[Estimate coefficients](#)" on page 879

BUS<m>:USBThree:DFE:TCONt <CIRLength>

Sets a number of taps for the decision feedback filter.

Suffix:

<m> 1..4

Parameters:

<CIRLength> Range: 1 to 20
Increment: 1
*RST: 5

Manual operation: See "[Number of Taps](#)" on page 879

BUS<m>:USBThree:PROTocol <ProtHSSPTSt>

Selects the USB Super Speed channel length.

Suffix:

<m> 1..4

Parameters:

<ProtHSSPTSt> OFF | LOWFLTR | HIGHFLTR
*RST: LOWFLTR

Manual operation: See "[Channel Length](#)" on page 879

27.18.22.3 Trigger

The trigger suffix <m> is always 1 and can be omitted. It selects the trigger event: Only the A-trigger is available for triggering on serial buses.

To trigger on a serial bus, make sure that:

- `TRIGger<m>:SOURce[:SElect]` is set to `SBUS`.
- The sources of the serial bus are channel signals: use `BUS<m>: . . . :SOURce` commands.
- Decoding is enabled: `BUS<m>[:STATe]` is set to `ON`.

There are two commands for each parameter, that you can use for defining the USB 3.1 settings.

For example, to set the *Frame type =ACK > Field =Route String >Data* value you can use one of the following commands:

- `TRIGger:USBThree:FRAME13:FLD1:DMIN 01100`
Defines the parameter by using the index <m> for the frame number and <n> for the field number.
- `TRIGger:USBThree:DMIN "ACK", "Route String", 01100`
Defines the parameter by using the frame and field name.

Table 27-14: Overview of frame and field numbers for USB 3.1, Protocol Type > Super Speed

Frame number	Frame name	Field number	Field name
1	TSEQ	1	Symbol
2	TS1	1	Train
		2	Loop
		3	Scramble
		4	LL
		5	Retimer
3	TS1A	-	-
4	TS1B	-	-
5	TS2	1	Train
		2	Loop
		3	Scramble
		4	LL
		5	Retimer
6	Set Link Function	1	SLF
		2	HDr #
		3	Hub #
		4	DLY
		5	DFR

Frame number	Frame name	Field number	Field name
7	U2 Inactivity Timeout	1	U2 IT
		2	HDr #
		3	Hub #
		4	DLY
		5	DFR
8	Vendor Device Test	1	VDT
		2	Vendor Def
		3	HDr #
		4	Hub #
		5	DLY
		6	DFR
9	Port Capability	1	Link Speed
		2	Num HP Buf
		3	Dir
		4	OTG
		5	Tiebreake
		6	HDr #
		7	Hub #
		8	DLY
		9	DFR
10	Port Config	1	Link Speed
		2	HDr #
		3	Hub #
		4	DLY
		5	DFR
11	Port Config Rsp	1	Response Code
		2	HDr #
		3	Hub #
		4	DLY
		5	DFR
12	Link Delay Meas	1	LDM Type
		2	LDMS
		3	Response Delay

Frame number	Frame name	Field number	Field name
		4	HDr #
		5	Hub #
		6	DLY
		7	DFR
13	ACK	1	Route String
		2	Device Address
		3	rty
		4	D
		5	EPTNum
		6	TT
		7	HE
		8	NumP
		9	SeqNum
		10	TPF
		11	StreamId
		12	SSI
		13	WPA
		14	DBI
		15	PP
		16	NBI
		17	HDr #
		18	Hub #
		19	DLY
		20	DFR
14	NRDY	1	Device Address
		2	D
		3	EPTNum
		4	StreamId
		5	HDr #
		6	Hub #
		7	DLY
		8	DFR
15	ERDY	1	Device Address

Frame number	Frame name	Field number	Field name
		2	D
		3	EPTNum
		4	NumP
		5	StreamId
		6	HDr #
		7	Hub #
		8	DLY
		9	DFR
		16	Status
2	Device Address		
3	D		
4	EPTNum		
5	PP		
6	HDr #		
7	Hub #		
8	DLY		
9	DFR		
17	Stall	1	Device Address
		2	D
		3	EPTNum
		4	HDr #
		5	Hub #
		6	DLY
		7	DFR
18	Function Wake	1	Device Address
		2	Interface
		3	HDr #
		4	Hub #
		5	DLY
		6	DFR
19	Latency Tolerance	1	Device Address
		2	BELT
		3	HDr #

Frame number	Frame name	Field number	Field name
		4	Hub #
		5	DLY
		6	DFR
20	Bus Interval Adjust	1	Device Address
		2	BusIntAdj
		3	HDr #
		4	Hub #
		5	DLY
		6	DFR
21	Host Role Req	1	Device Address
		2	RSP
		3	HDr #
		4	Hub #
		5	DLY
		6	DFR
22	Sublink Speed	1	Device Address
		2	TPF
		3	LSE
		4	ST
		5	Lanes
		6	LP
		7	LSM
		8	HDr #
		9	Hub #
		10	DLY
		11	DFR
23	Ping	1	Route String
		2	Device Address
		3	D
		4	EPTNum
		5	HDr #
		6	Hub #
		7	DLY

Frame number	Frame name	Field number	Field name
		8	DFR
24	Ping Rsp	1	Device Address
		2	D
		3	EPTNum
		4	HDr #
		5	Hub #
		6	DLY
		7	DFR
25	Data Packet Header	1	Route String
		2	Device Address
		3	SeqNum
		4	EOB
		5	D
		6	EPTNum
		7	TT
		8	S
		9	Length
		10	StreamId
		11	SSI
		12	WPA
		13	DBI
		14	PP
		15	NBI
		16	HDr #
		17	Hub #
		18	DLY
		19	DFR
26	Data Packet Payload	1	Data
27	DPP Aborted	1	Data
28	ITP	1	Counter
		2	Delta
		3	Adj Ctrl
		4	Corr

Frame number	Frame name	Field number	Field name
		5	HDr #
		6	Hub #
		7	DLY
		8	DFR
29	Link Command	1	Sub-type
30	Skip	-	-
31	BRST	-	-
32	BDAT	-	-
33	BERC	-	-
34	BCNT	1	EC
35	Idle	-	-

TRIGger<m>:USBThree:ERENable.....	2370
TRIGger<m>:USBThree:ERRor<n>:ENABLE.....	2370
TRIGger<m>:USBThree:FRENable.....	2371
TRIGger<m>:USBThree:FRAMe<n>:ENABLE.....	2371
TRIGger<m>:USBThree:FIENable.....	2371
TRIGger<m>:USBThree:FRAMe<n>:FLD<o>:ENABLE.....	2371
TRIGger<m>:USBThree:DOPerator.....	2372
TRIGger<m>:USBThree:FRAMe<n>:FLD<o>:DOPerator.....	2372
TRIGger<m>:USBThree:DMIN.....	2372
TRIGger<m>:USBThree:FRAMe<n>:FLD<o>:DMIN.....	2372
TRIGger<m>:USBThree:DMAX.....	2373
TRIGger<m>:USBThree:FRAMe<n>:FLD<o>:DMAX.....	2373
TRIGger<m>:USBThree:BIT.....	2373
TRIGger<m>:USBThree:FRAMe<n>:FLD<o>:BIT.....	2373
TRIGger<m>:USBThree:IOPerator.....	2374
TRIGger<m>:USBThree:FRAMe<n>:FLD<o>:IOPerator.....	2374
TRIGger<m>:USBThree:IMIN.....	2374
TRIGger<m>:USBThree:FRAMe<n>:FLD<o>:IMIN.....	2374
TRIGger<m>:USBThree:IMAX.....	2374
TRIGger<m>:USBThree:FRAMe<n>:FLD<o>:IMAX.....	2374

TRIGger<m>:USBThree:ERENable <ErrorName>, <Enabler>

TRIGger<m>:USBThree:ERRor<n>:ENABLE <Enable>

Defines the error type to be triggered on. You can trigger on all error types in parallel.

Suffix:

<m> 1..3
Only 1 = A-trigger, 2 | 3 = not available. Can be omitted.

<n> *
Specifies the error number.

Parameters:

<Enable> ON | OFF
 *RST: ON

Example:

Trigger on CRC and length errors:
 TRIGger:USBThree:ERRor1:ENABle ON
 Enables CRC Error.
 TRIGger:USBThree:ERENable "Length Error",ON
 Enables Length Error.

Manual operation: See "[Error types: Item name, Enable](#)" on page 881

TRIGger<m>:USBThree:FRENable <Frame>, <Enabler>

TRIGger<m>:USBThree:FRAME<n>:ENABle <Enable>

Enables or disables the checking condition for the selected frame.

Suffix:

<m> 1..3
 Only 1 = A-trigger, 2 | 3 = not available. Can be omitted.

<n> *
 Specifies the frame number.

Parameters:

<Enable> ON | OFF
 *RST: OFF

Example:

TRIGger:USBThree:FRAME1:ENABle ON
 Enables the checking condition for the TSEQ frame.
 TRIGger:USBThree:FRENable "TS1" ON
 Enables the checking condition for the TS1 frame.

Manual operation: See "[Frame type](#)" on page 881

TRIGger<m>:USBThree:FIENable <Frame>, <Field>, <Enabler>

TRIGger<m>:USBThree:FRAME<n>:FLD<o>:ENABle <CondEnabler>

Enables or disables the checking condition for the selected field of the selected frame.

Suffix:

<m> 1..3
 Only 1 = A-trigger, 2 | 3 = not available. Can be omitted.

<n> *
 Specifies the frame number.

<o> *
 Specifies the field number within the frame.

Parameters:

<CondEnabler> ON | OFF
ON
 Checking condition enabled

OFF

Checking condition disabled

*RST: OFF

Example:

TRIGger:USBThree:FRAME1:FLD1:ENABle ON

Enables the checking condition for the Symbol field of the TSEQ frame.

TRIGger:USBThree:FRENable "TS1", "Loop" ON

Enables the checking condition for the Loop field of the TS1 frame.

Manual operation: See ["Field name / Condition Summary / Enable"](#) on page 882**TRIGger<m>:USBThree:DOPerator** <Frame>, <Field>, <Operator>**TRIGger<m>:USBThree:FRAME<n>:FLD<o>:DOPerator** <DataOperator>

Sets the operator for the data pattern in the selected field of the selected frame.

Suffix:<m> 1..3
Only 1 = A-trigger, 2 | 3 = not available. Can be omitted.<n> *
Specifies the field number within the frame.

<o> *

Parameters:

<DataOperator> EQUal | NEQual | LTHan | LETHan | GTHan | GETHan | INRange | OORange

EQUal | NEQual | LTHan | LETHan | GTHan | GETHanEqual, Not equal, Less than, Less than or equal, Greater than, Greater than or equal. These conditions require one endpoint value to be set using [TRIGger<m>:USBThree:FRAME<n>:FLD<o>:DMIN](#).**INRange | OORange**In range, out of range. These conditions require a range of endpoint values to be set using [TRIGger<m>:USBThree:FRAME<n>:FLD<o>:DMIN](#) and [TRIGger<m>:USBThree:FRAME<n>:FLD<o>:DMAX](#).

*RST: EQUal

Manual operation: See ["Data"](#) on page 882**TRIGger<m>:USBThree:DMIN** <Frame>, <Field>, <Data>**TRIGger<m>:USBThree:FRAME<n>:FLD<o>:DMIN** <DataMin>

Specifies the data pattern, or sets the start value of a data pattern range.

Suffix:<m> 1..3
Only 1 = A-trigger, 2 | 3 = not available. Can be omitted.

<n> *
Specifies the field number within the frame.

<o> *

Parameters:

<DataMin>

Manual operation: See "Data" on page 882

TRIGger<m>:USBThree:DMAX <Frame>, <Field>, <Data>

TRIGger<m>:USBThree:FRAME<n>:FLD<o>:DMAX <DataMax>

Sets the end value of a data pattern range if **TRIGger<m>:USBThree:FRAME<n>:FLD<o>:DOPerator** is set to **INRange** or **OORange**.

Suffix:

<m> 1..3
Only 1 = A-trigger, 2 | 3 = not available. Can be omitted.

<n> *
Specifies the field number within the frame.

<o> *

Parameters:

<DataMax>

Manual operation: See "Data" on page 882

TRIGger<m>:USBThree:BIT <Frame>, <Field>, <Bit>

TRIGger<m>:USBThree:FRAME<n>:FLD<o>:BIT <BitState>

Sets the bit state of a field that only consists of one bit.

Suffix:

<m> 1..3
Only 1 = A-trigger, 2 | 3 = not available. Can be omitted.

<n> *
Specifies the field number within the frame.

<o> *

Parameters:

<BitState> ONE | ZERO | DC
ONE
1
ZERO
0
DC
"Don't care" (DC) = X
*RST: DC

Manual operation: See "Data BitState" on page 883

TRIGger<m>:USBThree:IOperator <Frame>, <Field>, <Operator>
TRIGger<m>:USBThree:FRAME<n>:FLD<o>:IOperator <IndexOperator>

Sets the operator for the index in the selected field of the selected frame.

Suffix:

<m> 1..3
 Only 1 = A-trigger, 2 | 3 = not available. Can be omitted.

<n> *
 Specifies the field number within the frame.

<o> *

Parameters:

<IndexOperator> EQUal | INRange | RANGE

EQUal

This condition requires one endpoint value to be set using
[TRIGger<m>:USBThree:FRAME<n>:FLD<o>:IMIN](#).

INRange | RANGE

This condition requires a range of endpoint values to be set
 using [TRIGger<m>:USBThree:FRAME<n>:FLD<o>:IMIN](#) and
[TRIGger<m>:USBThree:FRAME<n>:FLD<o>:IMAX](#).

*RST: INRange

Manual operation: See "[Index](#)" on page 883

TRIGger<m>:USBThree:IMIN <Frame>, <Field>, <Data>
TRIGger<m>:USBThree:FRAME<n>:FLD<o>:IMIN <IndexMin>

Specifies the index, or sets the start value of an index range.

Suffix:

<m> 1..3

<n> *
 Specifies the field number within the frame.

<o> *

Parameters:

<IndexMin> Specifies the index value or index start value within the field.
 The index range, increment and *RST values depend on the
 field type.

Manual operation: See "[Index](#)" on page 883

TRIGger<m>:USBThree:IMAX <Frame>, <Field>, <Data>
TRIGger<m>:USBThree:FRAME<n>:FLD<o>:IMAX <IndexMax>

Sets the end value of an index range if [TRIGger<m>:USBThree:FRAME<n>:FLD<o>:IOperator](#) is set to INRange or RANGE.

Suffix:

<m> 1..3
Only 1 = A-trigger, 2 | 3 = not available. Can be omitted.

<n> *
Specifies the field number within the frame.

<o> *

Parameters:

<IndexMax> Specifies the end value for the index range within the field.
The index range, increment and *RST values depend on the field type.

Manual operation: See "[Index](#)" on page 883

27.18.22.4 Decode results

In all `BUS<m>:USBThree:RESult:FRAMe<n>` commands, the suffix <m> selects the serial bus and the suffix <n> selects the frame number in the decode table.

<code>BUS<m>:USBThree:RESult:FCOut?</code>	2375
<code>BUS<m>:USBThree:RESult:FRAMe<n>:INFO?</code>	2375
<code>BUS<m>:USBThree:RESult:FRAMe<n>:TYPE?</code>	2376
<code>BUS<m>:USBThree:RESult:FRAMe<n>:STATe?</code>	2376
<code>BUS<m>:USBThree:RESult:FRAMe<n>:START?</code>	2377
<code>BUS<m>:USBThree:RESult:FRAMe<n>:STOP?</code>	2377
<code>BUS<m>:USBThree:RESult:FRAMe<n>:FLD<o>:TYPE?</code>	2377
<code>BUS<m>:USBThree:RESult:FRAMe<n>:FLD<o>:STATus?</code>	2378
<code>BUS<m>:USBThree:RESult:FRAMe<n>:FLD<o>:START?</code>	2378
<code>BUS<m>:USBThree:RESult:FRAMe<n>:FLD<o>:STOP?</code>	2378
<code>BUS<m>:USBThree:RESult:FRAMe<n>:FLD<o>:VAL?</code>	2379
<code>BUS<m>:USBThree:RESult:FRAMe<n>:FLD<o>:FVAL?</code>	2379

BUS<m>:USBThree:RESult:FCOut?

Returns the number of decoded frames in the selected serial bus.

Suffix:

<m> 1..4

Return values:

<FrameCount> Range: 0 to 100000
Increment: 1

Usage: Query only

BUS<m>:USBThree:RESult:FRAMe<n>:INFO?

Returns specific frame information details of the selected frame. This information is also shown in the "Info" column of the decode results table.

Suffix:

<m> 1..4

<n> *

Specifies the frame number.

Return values:

<Info>

Usage: Query only**BUS<m>:USBThree:RESult:FRAMe<n>:TYPE?**

Returns the frame type for the selected serial bus and frame number.

Suffix:

<m> 1..4

<n> *

Selects the frame number.

Return values:

<FrameType>

TSEQ | TS1 | TS1A | TS1B | TS2 | SLF | U2IT | VDT | PCAP | PCNF | PCNR | LDM | ACK | NRDY | ERDY | STATus | STALI | FWAKe | LTM | BIAM | HRR | SSPD | PING | PNGR | DPH | DPHN | DPP | DPPA | ITP | LC | SKIP | BRST | BDAT | BERC | BCNT | IDLE | CP0 | CP1 | CP2 | CP3 | CP5or6 | UHP | ULMP | UTP | UDVN | UDEF | ERRor | CTLB | DATB | SYNC | SDS

For a description of the frame types, see "[Frame types](#)" on page 869.

*RST: UDEF

Usage: Query only**BUS<m>:USBThree:RESult:FRAMe<n>:STATe?**

Returns the status of the frame with the selected frame number (for the selected serial bus).

Suffix:

<m> 1..4

<n> *

Selects the frame number.

Return values:

<State>

OK | INComplete | UNCorrelated | UNKNown | AMB | CRC | LENGth | VOOR | SYMB

VOOR

Value out of range

Usage: Query only

BUS<m>:USBThree:RESult:FRAMe<n>:START?

Returns the start time of the frame with the selected frame number (for the selected serial bus).

Suffix:

<m> 1..4

<n> *

Selects the frame number.

Return values:

<Start> Range: -100E+24 to 100E+24
Increment: 100E-12
Default unit: s

Usage: Query only

BUS<m>:USBThree:RESult:FRAMe<n>:STOP?

Returns the stop time of the frame with the selected frame number (for the selected serial bus).

Suffix:

<m> 1..4

<n> *

Selects the frame number.

Return values:

<Stop> Range: -100E+24 to 100E+24
Increment: 100E-12
Default unit: s

Usage: Query only

BUS<m>:USBThree:RESult:FRAMe<n>:FLD<o>:TYPE?

Returns the type of the field with the selected field number within the frame with the selected frame number (for the selected serial bus).

Suffix:

<m> 1..4

<n> *

Selects the frame number.

<o> *

Selects the field number.

Return values:

<FieldType>

Usage: Query only

BUS<m>:USBThree:RESult:FRAMe<n>:FLD<o>:STATus?

Returns the status of the field with the selected field number within the frame with the selected frame number (for the selected serial bus).

Suffix:

<m>	1..4
<n>	*
	Selects the frame number.
<o>	*
	Selects the field number.

Return values:

<FieldState> OK | INComplete | UNCorrelated | UNKNown | AMB | CRC | LENGth | VOOR | SYMB

VOOR

Value out of range

Usage: Query only

BUS<m>:USBThree:RESult:FRAMe<n>:FLD<o>:STARt?

Returns the start time of the field with the selected field number within the frame with the selected frame number (for the selected serial bus).

Suffix:

<m>	1..4
<n>	*
<o>	*

Return values:

<Start> Range: -100E+24 to 100E+24
Increment: 100E-12
*RST: 0
Default unit: s

Usage: Query only

BUS<m>:USBThree:RESult:FRAMe<n>:FLD<o>:STOP?

Returns the stop time of the field with the selected field number within the frame with the selected frame number (for the selected serial bus).

Suffix:

<m>	1..4
<n>	*
<o>	*

Return values:

<Stop> Range: -100E+24 to 100E+24
 Increment: 100E-12
 *RST: 0
 Default unit: s

Usage: Query only

BUS<m>:USBThree:RESult:FRAMe<n>:FLD<o>:VAL?

Returns the value of the field with the selected field number within the frame with the selected frame number (for the selected serial bus).

Suffix:

<m> 1..4
 <n> *
 Selects the frame number.
 <o> *
 Selects the field number.

Return values:

<FieldValue>

Usage: Query only

BUS<m>:USBThree:RESult:FRAMe<n>:FLD<o>:FVAL?

Returns the formatted value of the field with the selected field number within the frame with the selected frame number (for the selected serial bus).

Suffix:

<m> 1..4
 <n> *
 Selects the frame number.
 <o> *
 Selects the field number.

Return values:

<ValueFormatted>

Usage: Query only

27.18.22.5 Search settings

There are two commands for each parameter, that you can use for defining the SSIC search settings.

For example, to set the *Frame type =ACK > Field =Route String >Data* value you can use one of the following commands:

- SEARCH:TRIGger:USBThree:FRAMe13:FLD1:DMIN 01100

Defines the parameter by using the index <m> for the frame number and <n> for the field number. For an overview, see [Table 27-14](#).

- SEARCH:TRIGger:USBThree:DMIN "ACK", "Route String", 01100
Defines the parameter by using the frame and field name.

SEARCH:TRIGger:USBThree:ERENable.....	2380
SEARCH:TRIGger:USBThree:ERRor<m>:ENABLE.....	2380
SEARCH:TRIGger:USBThree:FRENable.....	2381
SEARCH:TRIGger:USBThree:FRAMe<m>:ENABLE.....	2381
SEARCH:TRIGger:USBThree:FIENable.....	2381
SEARCH:TRIGger:USBThree:FRAMe<m>:FLD<n>:ENABLE.....	2381
SEARCH:TRIGger:USBThree:DOPerator.....	2382
SEARCH:TRIGger:USBThree:FRAMe<m>:FLD<n>:DOPerator.....	2382
SEARCH:TRIGger:USBThree:DMIN.....	2382
SEARCH:TRIGger:USBThree:FRAMe<m>:FLD<n>:DMIN.....	2382
SEARCH:TRIGger:USBThree:DMAX.....	2383
SEARCH:TRIGger:USBThree:FRAMe<m>:FLD<n>:DMAX.....	2383
SEARCH:TRIGger:USBThree:BIT.....	2383
SEARCH:TRIGger:USBThree:FRAMe<m>:FLD<n>:BIT.....	2383
SEARCH:TRIGger:USBThree:IOPerator.....	2384
SEARCH:TRIGger:USBThree:FRAMe<m>:FLD<n>:IOPerator.....	2384
SEARCH:TRIGger:USBThree:IMIN.....	2384
SEARCH:TRIGger:USBThree:FRAMe<m>:FLD<n>:IMIN.....	2384
SEARCH:TRIGger:USBThree:IMAX.....	2385
SEARCH:TRIGger:USBThree:FRAMe<m>:FLD<n>:IMAX.....	2385

SEARCH:TRIGger:USBThree:ERENable <SearchName>,<ErrorName>, <Enabler>

SEARCH:TRIGger:USBThree:ERRor<m>:ENABLE <SearchName>,<Enable>

SEARCH:TRIGger:USBThree:ERRor<m>:ENABLE? <SearchName>

Enables the search for errors. You can search for all error types in parallel.

Suffix:

<m> *
Specifies the error.

Parameters:

<Enable> ON | OFF
*RST: ON

Parameters for setting and query:

<SearchName> String with the name of the search.

Example:

Searches for CRC and length errors:

```
SEARCH:TRIGger:USBThree:ERRor1:ENABLE ON
```

Enables searching for CRC Error.

```
SEARCH:TRIGger:USBThree:ERENable "Length  
Error",ON
```

Enables searching for Length Error.

Manual operation: See "[Search criteria](#)" on page 886

SEARCh:TRIGger:USBThree:FRENable <SearchName>,<Frame>, <Enabler>

SEARCh:TRIGger:USBThree:FRAME<m>:ENABLE <SearchName>,<Enable>

SEARCh:TRIGger:USBThree:FRAME<m>:ENABLE? <SearchName>

Defines the frame type to be searched for.

Suffix:

<m> *

Parameters:

<Enable> ON | OFF

*RST: OFF

Parameters for setting and query:

<SearchName>

Example:

SEARCh:TRIGger:USBThree:FRAME1:ENABLE ON

Enables searching for the TSEQ frame.

SEARCh:TRIGger:USBThree:FRENable "TS1" ON

Enables searching for the TS1 frame.

Manual operation: See "[Search criteria](#)" on page 886

SEARCh:TRIGger:USBThree:FIENable <SearchName>,<Frame>, <Field>,
<Enabler>

SEARCh:TRIGger:USBThree:FRAME<m>:FLD<n>:ENABLE

<SearchName>,<CondEnabler>

SEARCh:TRIGger:USBThree:FRAME<m>:FLD<n>:ENABLE? <SearchName>

Enables or disables the checking condition for searching a specific field of the selected frame.

Suffix:

<m> *
Specifies the frame.

<n> *
Specifies the field number within the frame.

Parameters:

<CondEnabler> ON | OFF

ON

Checking condition enabled

OFF

Checking condition disabled

*RST: OFF

Parameters for setting and query:

<SearchName> String with the name of the search.

Example: SEARCH:TRIGger:USBThree:FRAME1:FLD1:ENABLE ON
 Enables searching for the Symbol field of the TSEQ frame.
 SEARCH:TRIGger:USBThree:FRENable "TS1", "Loop"
 ON
 Enables searching for the Loop field of the TS1 frame.

Manual operation: See "[Search criteria](#)" on page 886

SEARCH:TRIGger:USBThree:DOPerator <SearchName>,<Frame>, <Field>,
 <Operator>

SEARCH:TRIGger:USBThree:FRAME<m>:FLD<n>:DOPerator
 <SearchName>,<DataOperator>

SEARCH:TRIGger:USBThree:FRAME<m>:FLD<n>:DOPerator? <SearchName>

Sets the operator to set a specific data pattern to be searched in the selected field of the selected frame.

Suffix:

<m> *
 Specifies the field number within the frame.

<n> *

Parameters:

<DataOperator> EQUal | NEQUal | LTHan | LETHan | GTHan | GETHan |
 INRange | OORange

EQUal | NEQUal | LTHan | LETHan | GTHan | GETHan

Equal, Not equal, Less than, Less than or equal, Greater than, Greater than or equal. These conditions require one endpoint value to be set using [SEARCH:TRIGger:USBThree:FRAME<m>:FLD<n>:IMIN](#).

INRange | OORange

In range, out of range. These conditions require a range of endpoint values to be set using [SEARCH:TRIGger:USBThree:FRAME<m>:FLD<n>:IMIN](#) and [SEARCH:TRIGger:USBThree:FRAME<m>:FLD<n>:IMAX](#) on page 2385.

*RST: EQUal

Parameters for setting and query:

<SearchName> String with the name of the search.

Manual operation: See "[Search criteria](#)" on page 886

SEARCH:TRIGger:USBThree:DMIN <SearchName>,<Frame>, <Field>, <Data>

SEARCH:TRIGger:USBThree:FRAME<m>:FLD<n>:DMIN
 <SearchName>,<DataMin>

SEARCH:TRIGger:USBThree:FRAME<m>:FLD<n>:DMIN? <SearchName>

Specifies the data pattern to be searched, or sets the start value of a data pattern range to be searched.

Suffix:

<m> *
Specifies the field number within the frame.

<n> *

Parameters:

<DataMin> Specifies the name of the generic trigger setting frame, see [SEARCH:RESult:USBThree:FRAME<m>:TYPE?](#) on page 2386.

Parameters for setting and query:

<SearchName> String with the name of the search.

Manual operation: See "[Search criteria](#)" on page 886

SEARCH:TRIGger:USBThree:DMAX <SearchName>,<Frame>, <Field>, <Data>

SEARCH:TRIGger:USBThree:FRAME<m>:FLD<n>:DMAX

<SearchName>,<DataMax>

SEARCH:TRIGger:USBThree:FRAME<m>:FLD<n>:DMAX? <SearchName>

Sets the end value of a data pattern range if [SEARCH:TRIGger:USBThree:FRAME<m>:FLD<n>:DOPerator](#) is set to INRange or OORange.

Suffix:

<m> *
Specifies the field number within the frame.

<n> *

Parameters:

<DataMax> Specifies the name of the generic trigger setting frame, see [SEARCH:RESult:USBThree:FRAME<m>:TYPE?](#) on page 2386.

Parameters for setting and query:

<SearchName> String with the name of the search.

Manual operation: See "[Search criteria](#)" on page 886

SEARCH:TRIGger:USBThree:BIT <SearchName>,<Frame>, <Field>, <Bit>

SEARCH:TRIGger:USBThree:FRAME<m>:FLD<n>:BIT <SearchName>,<BitState>

SEARCH:TRIGger:USBThree:FRAME<m>:FLD<n>:BIT? <SearchName>

Sets the bit state of a field to be searched that only consists of one bit.

Suffix:

<m> *
Specifies the frame.

<n> *
Specifies the field number within the frame.

Parameters:

<BitState> ONE | ZERO | DC

ONE

1

ZERO

0

DC

"Don't care" (DC) = X

*RST: DC

Parameters for setting and query:

<SearchName> String with the name of the search.

Manual operation: See "Search criteria" on page 886**SEARCh:TRIGger:USBThree:IOperator** <SearchName>, <Frame>, <Field>, <Operator>**SEARCh:TRIGger:USBThree:FRAME<m>:FLD<n>:IOperator** <SearchName>, <IndexOperator>**SEARCh:TRIGger:USBThree:FRAME<m>:FLD<n>:IOperator?** <SearchName>

Sets the operator for the index for searching in the selected field of the selected frame.

Suffix:<m> *
Specifies the field number within the frame.

<n> *

Parameters:

<IndexOperator> EQUal | INRange | RANGE

EQUalThis condition requires one endpoint value to be set using [SEARCh:TRIGger:USBThree:FRAME<m>:FLD<n>:IMIN](#).**INRange | RANGE**This condition requires a range of endpoint values to be set using [SEARCh:TRIGger:USBThree:FRAME<m>:FLD<n>:IMIN](#) and [SEARCh:TRIGger:USBThree:FRAME<m>:FLD<n>:IMAX](#).

*RST: INRange

Parameters for setting and query:

<SearchName> String with the name of the search.

Manual operation: See "Search criteria" on page 886**SEARCh:TRIGger:USBThree:IMIN** <SearchName>, <Frame>, <Field>, <Data>**SEARCh:TRIGger:USBThree:FRAME<m>:FLD<n>:IMIN** <SearchName>, <IndexMin>**SEARCh:TRIGger:USBThree:FRAME<m>:FLD<n>:IMIN?** <SearchName>

Specifies the index at which the data is to be searched, or sets the start value of an index range in which the data is to be searched.

Suffix:

<m> *
Specifies the field number within the frame.

<n> *

Parameters:

<IndexMin> Specifies the index value or the start value of an index range within the field.
The index range, increment and *RST values depend on the field type.

Parameters for setting and query:

<SearchName> String with the name of the search.

Manual operation: See "[Search criteria](#)" on page 886

SEARCh:TRIGger:USBThree:IMAX <SearchName>,<Frame>, <Field>, <Data>

SEARCh:TRIGger:USBThree:FRAME<m>:FLD<n>:IMAX

<SearchName>,<IndexMax>

SEARCh:TRIGger:USBThree:FRAME<m>:FLD<n>:IMAX? <SearchName>

Sets the end value of an index range if [SEARCh:TRIGger:USBThree:FRAME<m>:FLD<n>:IOPerator](#) is set to INRange or RANGE.

Suffix:

<m> *
Specifies the field number within the frame.

<n> *

Parameters:

<IndexMax> Specifies the end value for the index range within the field.
The index range, increment and *RST values depend on the field type.

Parameters for setting and query:

<SearchName> String with the name of the search.

Manual operation: See "[Search criteria](#)" on page 886

27.18.22.6 Search results

In all [SEARCh:RESult:USBThree:FRAME<m>](#) commands, the suffix <m> selects the frame number in the list of search results.

SEARCh:RESult:USBThree:FRAME<m>:TYPE?	2386
SEARCh:RESult:USBThree:FRAME<m>:INFO?	2386
SEARCh:RESult:USBThree:FCOunt?	2386
SEARCh:RESult:USBThree:FRAME<m>:STATe?	2387
SEARCh:RESult:USBThree:FRAME<m>:START?	2387
SEARCh:RESult:USBThree:FRAME<m>:STOP?	2387
SEARCh:RESult:USBThree:FRAME<m>:FLD<n>:TYPE?	2388
SEARCh:RESult:USBThree:FRAME<m>:FLD<n>:STATus?	2388

SEARCh:RESult:USBThree:FRAMe<m>:FLD<n>:STARt?	2388
SEARCh:RESult:USBThree:FRAMe<m>:FLD<n>:STOP?	2389
SEARCh:RESult:USBThree:FRAMe<m>:FLD<n>:VAL?	2389
SEARCh:RESult:USBThree:FRAMe<m>:FLD<n>:FVAL?	2389

SEARCh:RESult:USBThree:FRAMe<m>:TYPE? <SearchName>

Returns the frame type for the selected frame number within the search result.

Suffix:

<m> *

Query parameters:

<SearchName>

Return values:

<FrameType> TSEQ | TS1T | TS2T | SLF | U2IT | VDT | PCAP | PCNF |
PCNR | LDM | ACK | NRDY | ERDY | STATus | STALI | FWAKe |
LTM | BIAM | HRR | SSPD | PING | PNGR | DPH | DPP | DPPA |
ITP | LC | SKIP | BRST | BDAT | BERc | BCNT | IDLE | UHP |
ULMP | UTP | UDVN | UDEF | ERRor

For a description of the frame types, see "[Frame types](#)"
on page 869.

Usage: Query only

SEARCh:RESult:USBThree:FRAMe<m>:INFO? <SearchName>

Returns specific frame information details of the selected frame in the search result.
This information is also shown in the "Info" column of the decode results table.

Suffix:

<m> *
Specifies the frame number.

Query parameters:

<SearchName>

Return values:

<Info>

Usage: Query only

SEARCh:RESult:USBThree:FCOunt? <SearchName>

Returns the number of decoded frames in the search result.

Query parameters:

<SearchName>

Return values:

<FrameCount>

Usage: Query only

SEARCh:RESult:USBThree:FRAMe<m>:STATe? <SearchName>

Returns the status of the frame with the selected frame number within the search result.

Suffix:
<m> *

Query parameters:
<SearchName>

Return values:
<State> OK | INComplete | UNCorrelated | UNKNown | AMB | CRC |
LENGth | VOOR | SYMB

VOOR
Value out of range

Usage: Query only

SEARCh:RESult:USBThree:FRAMe<m>:STARt? <SearchName>

Returns the start time of the frame with the selected frame number within the search result.

Suffix:
<m> *

Query parameters:
<SearchName>

Return values:
<Start> Range: -100E+24 to 100E+24
Increment: 100E-12
Default unit: s

Usage: Query only

SEARCh:RESult:USBThree:FRAMe<m>:STOP? <SearchName>

Returns the stop time of the frame with the selected frame number within the search result.

Suffix:
<m> *

Query parameters:
<SearchName>

Return values:
<Stop> Range: -100E+24 to 100E+24
Increment: 100E-12
Default unit: s

Usage: Query only

SEARCh:RESult:USBThree:FRAME<m>:FLD<n>:TYPE? <SearchName>

Returns the field name of the field with the selected field number within the frame with the selected frame number within the search result.

Suffix:

<m> *

<n> *

Selects the field number.

Query parameters:

<SearchName>

Return values:

<FieldType>

Usage: Query only

SEARCh:RESult:USBThree:FRAME<m>:FLD<n>:STATus? <SearchName>

Returns the field status of the field with the selected field number within the frame with the selected frame number within the search result.

Suffix:

<m> *

<n> *

Selects the field number.

Query parameters:

<SearchName>

Return values:

<FieldState> OK | INComplete | UNCorrelated | UNKNown | AMB | CRC |
LENGth | VOOR | SYMB

VOOR

Value out of range

Usage: Query only

SEARCh:RESult:USBThree:FRAME<m>:FLD<n>:STARt? <SearchName>

Returns the start time of the field with the selected field number within the frame with the selected frame number within the search result.

Suffix:

<m> *

<n> *

Query parameters:

<SearchName>

Return values:

<Start> Range: -100E+24 to 100E+24
 Increment: 100E-12
 *RST: 0
 Default unit: s

Usage: Query only

SEARCh:RESult:USBThree:FRAMe<m>:FLD<n>:STOP? <SearchName>

Returns the stop time of the field with the selected field number within the frame with the selected frame number within the search result.

Suffix:

<m> *
 <n> *

Query parameters:

<SearchName>

Return values:

<Stop> Range: -100E+24 to 100E+24
 Increment: 100E-12
 *RST: 0
 Default unit: s

Usage: Query only

SEARCh:RESult:USBThree:FRAMe<m>:FLD<n>:VAL? <SearchName>

Returns the value of the field with the selected field number within the frame with the selected frame number within the search result.

Suffix:

<m> *
 <n> *

Selects the field number.

Query parameters:

<SearchName>

Return values:

<ByteValue>

Usage: Query only

SEARCh:RESult:USBThree:FRAMe<m>:FLD<n>:FVAL? <SearchName>

Returns the formatted value of the field with the selected field number within the frame with the selected frame number within the search result.

Suffix:

<m> *

<n> *

Selects the field number.

Query parameters:

<SearchName>

Return values:

<\ValueFormatted>

Usage: Query only**27.18.23 USBPD (option R&S RTO6-K570)**

- [Configuration](#).....2390
- [Trigger](#).....2392
- [Decode results](#).....2399
- [Search settings](#).....2404
- [Search results](#).....2410

27.18.23.1 Configuration

In all `BUS<m>:USBPd` commands, the suffix `<m>` selects the serial bus.

BUS<m>:USBPd:DETail	2390
BUS<m>:USBPd:HYSTeresis	2390
BUS<m>:USBPd:SOURce	2391
BUS<m>:USBPd:THReshold	2391
BUS<m>:USBPd:THRBottom	2391
BUS<m>:USBPd:THRMid	2392
BUS<m>:USBPd:THRTop	2392

BUS<m>:USBPd:DETail <Detail>

If enabled, the data words are broken down into subframes. If not enabled the data words are displayed as 32-bit data words.

Suffix:

<m> 1..4

Parameters:

<Detail> ON | OFF

*RST: OFF

Manual operation: See "[Show decode detail](#)" on page 892**BUS<m>:USBPd:HYSTeresis <Hysteresis>**

Sets a value for the hysteresis of the data.

Suffix:

<m> 1..4

Parameters:

<Hysteresis> Range: -10 to 10
 Increment: 0.01
 *RST: 0.05
 Default unit: V

Manual operation: See "[Hysteresis](#)" on page 891**BUS<m>:USBPd:SOURce <SourceData>**

Selects the source for the data signal in the USBPD protocol.

For triggering on a serial bus, analog input channels are required.

Suffix:

<m> 1..4

Parameters:

<SourceData> C1W1 | C2W1 | C3W1 | C4W1 | M1 | M2 | M3 | M4 | M5 | M6 |
 M7 | M8 | R1 | R2 | R3 | R4
 *RST: C1W1

Usage: Asynchronous command**Manual operation:** See "[Data](#)" on page 891**BUS<m>:USBPd:THReshold <Threshold>**

Sets the threshold value of the data.

Suffix:

<m> 1..4

Parameters:

<Threshold> Range: -10 to 10
 Increment: 0.01
 *RST: 0.6
 Default unit: V

Manual operation: See "[vData](#)" on page 891**BUS<m>:USBPd:THRBottom <ThresholdBot>**

Sets the bottom threshold (for the low current) for the current advertisement mode.

Suffix:

<m> 1..4

Parameters:

<ThresholdBot> Range: -10 to 10
 Increment: 0.01
 *RST: 0.2
 Default unit: V

Manual operation: See "[Current advertisement thresholds](#)" on page 891

BUS<m>:USBPd:THRMid <ThresholdMid>

Sets the middle threshold (at default USB Type-C current) for the current advertisement mode.

Suffix:

<m> 1..4

Parameters:

<ThresholdMid> Range: -10 to 10
 Increment: 0.01
 *RST: 0.66
 Default unit: V

Manual operation: See "[Current advertisement thresholds](#)" on page 891

BUS<m>:USBPd:THRTop <ThresholdTop>

Sets the top threshold (at USB Type-C current of 1.5 A) for the current advertisement mode.

Suffix:

<m> 1..4

Parameters:

<ThresholdTop> Range: -10 to 10
 Increment: 0.01
 *RST: 1.23
 Default unit: V

Manual operation: See "[Current advertisement thresholds](#)" on page 891

27.18.23.2 Trigger

The trigger suffix <m> is always 1 and can be omitted. It selects the trigger event: Only the A-trigger is available for triggering on serial buses.

To trigger on a serial bus, make sure that:

- `TRIGger<m>:SOURce[:SElect]` is set to SBUS.
- The sources of the serial bus are channel signals: use `BUS<m>:...:SOURce` commands.
- Decoding is enabled: `BUS<m>[:STATe]` is set to ON.

There are two commands for each parameter, that you can use for defining the USBPD settings.

For example, to set the *Frame type =Control Frame > Field =MsgID >Data* value you can use one of the following commands:

- `TRIGger:USBPD:FRAME3:FLD3:DMIN 01100`
Defines the parameter by using the index <m> for the frame number and <n> for the field number. For an overview, see [Overview of frame and field numbers for USBPD](#).
- `TRIGger:USBPD:DMIN "Control", "MsgID", 01100`
Defines the parameter by using the frame and field name.

[Table 27-15](#) gives an overview of the available frame and field numbers. Those numbers follow the GUI numbers.

Table 27-15: Overview of frame and field numbers for USBPD

Frame number	Frame name	Field number	Field name
1	Test Frame	-	-
2	Reset	-	-
3	Control frame	1	Extended
		2	NumDataObjs
		3	MsgID
		4	PwrRole/Plug
		5	Rev
		6	DataRole
		7	MsgType
4	Data Frame	1	Extended
		2	NumDataObjs
		3	MsgID
		4	PwrRole/Plug
		5	Rev
		6	DataRole
		7	MsgType
		8	DATA
5	Extended	1	Extended
		2	NumDataObjs
		3	MsgID
		4	PwrRole/Plug
		5	Rev

Frame number	Frame name	Field number	Field name
		6	DataRole
		7	MsgType
		8	Chunked
		9	Chunk Num
		10	Req Chunk
		11	Data Size
		12	DATA

TRIGger<m>:USBPd:ERENable.....	2394
TRIGger<m>:USBPd:ERRor<n>:ENABle.....	2394
TRIGger<m>:USBPd:FRENable.....	2395
TRIGger<m>:USBPd:FRAMe<n>:ENABle.....	2395
TRIGger<m>:USBPd:FIENable.....	2395
TRIGger<m>:USBPd:FRAMe<n>:FLD<o>:ENABle.....	2395
TRIGger<m>:USBPd:BIT.....	2396
TRIGger<m>:USBPd:FRAMe<n>:FLD<o>:BIT.....	2396
TRIGger<m>:USBPd:DMAX.....	2396
TRIGger<m>:USBPd:FRAMe<n>:FLD<o>:DMAX.....	2396
TRIGger<m>:USBPd:DMIN.....	2397
TRIGger<m>:USBPd:FRAMe<n>:FLD<o>:DMIN.....	2397
TRIGger<m>:USBPd:DOPerator.....	2397
TRIGger<m>:USBPd:FRAMe<n>:FLD<o>:DOPerator.....	2397
TRIGger<m>:USBPd:IMAX.....	2397
TRIGger<m>:USBPd:FRAMe<n>:FLD<o>:IMAX.....	2397
TRIGger<m>:USBPd:IMIN.....	2398
TRIGger<m>:USBPd:FRAMe<n>:FLD<o>:IMIN.....	2398
TRIGger<m>:USBPd:IOPerator.....	2398
TRIGger<m>:USBPd:FRAMe<n>:FLD<o>:IOPerator.....	2398

TRIGger<m>:USBPd:ERENable <ErrorName>, <Enabler>

TRIGger<m>:USBPd:ERRor<n>:ENABle <Enable>

Enables or disables the checking condition for a specific error in the selected field of the selected frame.

Suffix:

<m> 1..3
Only 1 = A-trigger, 2 | 3 = not available. Can be omitted.

<n> *
Specifies the error number.

Parameters:

<Enable> ON | OFF
*RST: ON

Example: TRIGger:USBPd:ERRor1:ENABle ON
Enables CRC Error.
TRIGger:USBPd:ERENable "Length Error",ON
Enables Length Error.

Manual operation: See "[Error > Enable /Item](#)" on page 895

TRIGger<m>:USBPd:FRENable <Frame>, <Enabler>

TRIGger<m>:USBPd:FRAME<n>:ENABle <Enable>

Enables or disables the checking condition for the selected frame.

Suffix:

<m> 1..3
Only 1 = A-trigger, 2 | 3 = not available. Can be omitted.

<n> *
Specifies the frame number.

Parameters:

<Enable> ON | OFF
*RST: OFF

Example: TRIGger:USBPd:FRAME1:ENABle ON
Enables searching for for the Test frame.
TRIGger:USBPd:FRENable "Control Frame" ON
Enables searching for the Control frame.

Manual operation: See "[Frame Type](#)" on page 894

TRIGger<m>:USBPd:FIENable <Frame>, <Field>, <Enabler>

TRIGger<m>:USBPd:FRAME<n>:FLD<o>:ENABle <CondEnabler>

Enables or disables the checking condition for a specific data pattern in the selected field of the selected frame.

Suffix:

<m> 1..3
Only 1 = A-trigger, 2 | 3 = not available. Can be omitted.

<n> *
Specifies the frame.

<o> *
Specifies the field number within the frame.

Parameters:

<CondEnabler> ON | OFF
ON
Checking condition enabled
OFF
Checking condition disabled
*RST: OFF

Example: TRIGger:USBPd:FRAMe3:FLD1:ENABle ON
 Enables the checking condition for the Extended field of the Control frame.
 TRIGger:USBPd:FRENable "Data Frame", "Data Role" ON
 Enables the checking condition for the Data Role field of the Data frame.

Manual operation: See "[Enable/ Field name/ Condition](#)" on page 895

TRIGger<m>:USBPd:BIT <Frame>, <Field>, <Bit>
TRIGger<m>:USBPd:FRAMe<n>:FLD<o>:BIT <BitState>

Sets the bit state of a field that only consists of one bit.

Suffix:

<m>	1..3
<n>	*
<o>	*

Specifies the field number within the frame.

Parameters:

<BitState>	ONE ZERO DC
------------	-----------------

ONE
1

ZERO
0

DC
"Don't care" (DC) = X
*RST: DC

Manual operation: See "[Data BitState](#)" on page 896

TRIGger<m>:USBPd:DMAX <Frame>, <Field>, <Data>
TRIGger<m>:USBPd:FRAMe<n>:FLD<o>:DMAX <DataMax>

Sets the end value of a data pattern range if [TRIGger<m>:USBPd:FRAMe<n>:FLD<o>:DMAX](#) is set to INRange or OORange.

Suffix:

<m>	1..3
<n>	*

Specifies the field number within the frame.

<o>	*
-----	---

Parameters:

<DataMax>	Specifies the name of the generic trigger setting frame, see BUS<m>:USBPd:RESult:FRAMe<n>:TYPE? on page 2403.
-----------	---

Manual operation: See "[Data](#)" on page 895

TRIGger<m>:USBPd:DMIN <Frame>, <Field>, <Data>

TRIGger<m>:USBPd:FRAME<n>:FLD<o>:DMIN <DataMin>

Specifies the data pattern, or sets the start value of a data pattern range.

Suffix:

<m> 1..3

<n> *

Specifies the field number within the frame.

<o> *

Parameters:

<DataMin>

Manual operation: See "Data" on page 895

TRIGger<m>:USBPd:DOPerator <Frame>, <Field>, <Operator>

TRIGger<m>:USBPd:FRAME<n>:FLD<o>:DOPerator <DataOperator>

Sets the operator for the data pattern in the selected field of the selected frame.

Suffix:

<m> 1..3

<n> *

Specifies the field number within the frame.

<o> *

Parameters:

<DataOperator> EQUal | NEQual | LTHan | LETHan | GTHan | GETHan | INRange | OORange

EQUal | NEQual | LTHan | LETHan | GTHan | GETHan

Equal, Not equal, Less than, Less than or equal, Greater than, Greater than or equal. These conditions require one endpoint value to be set using [TRIGger<m>:USBPd:FRAME<n>:FLD<o>:DMIN](#).

INRange | OORange

In range, out of range. These conditions require a range of endpoint values to be set using [TRIGger<m>:USBPd:FRAME<n>:FLD<o>:DMIN](#) and [TRIGger<m>:USBPd:FRAME<n>:FLD<o>:DMAX](#).

*RST: EQUal

Manual operation: See "Data" on page 895

TRIGger<m>:USBPd:IMAX <Frame>, <Field>, <Data>

TRIGger<m>:USBPd:FRAME<n>:FLD<o>:IMAX <IndexMax>

Sets the end value of an index range if [TRIGger<m>:USBPd:FRAME<n>:FLD<o>:IOperator](#) on page 2398 is set to INRange or RANGE.

Suffix:

<m>	1..3
<n>	*
	Specifies the field number within the frame.
<o>	*

Parameters:

<IndexMax>	Specifies the end value for the index range within the field. The index range, increment and *RST values depend on the field type.
------------	---

Manual operation: See "[Index](#)" on page 896

TRIGger<m>:USBPd:IMIN <Frame>, <Field>, <Data>

TRIGger<m>:USBPd:FRAME<n>:FLD<o>:IMIN <IndexMin>

Specifies the index, or sets the start value of an index range.

Suffix:

<m>	1..3
<n>	*
	Specifies the field number within the frame.
<o>	*

Parameters:

<IndexMin>	Specifies the index value or index start value within the field. The index range, increment and *RST values depend on the field type.
------------	--

Manual operation: See "[Index](#)" on page 896

TRIGger<m>:USBPd:IOperator <Frame>, <Field>, <Operator>

TRIGger<m>:USBPd:FRAME<n>:FLD<o>:IOperator <IndexOperator>

Sets the operator for the index in the selected field of the selected frame.

Suffix:

<m>	1..3
<n>	*
<o>	*

Parameters:

<IndexOperator>	EQUal INRange RANGE
-----------------	-------------------------

EQUal

This condition requires one endpoint value to be set using [TRIGger<m>:USBPd:FRAME<n>:FLD<o>:IMIN](#).

INRange | RANGE

This condition requires a range of endpoint values to be set using `TRIGger<m>:USBPd:FRAMe<n>:FLD<o>:IMIN` and `TRIGger<m>:USBPd:FRAMe<n>:FLD<o>:IMAX`.

*RST: INRange

Manual operation: See "Index" on page 896

27.18.23.3 Decode results

In all `BUS<m>:USBPd:RESult:FRAMe<n>` commands, the suffix `<m>` selects the serial bus and the suffix `<n>` selects the frame number in the decode table.

<code>BUS<m>:USBPd:RESult:FCOut?</code>	2399
<code>BUS<m>:USBPd:RESult:FRAMe<n>:DATA?</code>	2399
<code>BUS<m>:USBPd:RESult:FRAMe<n>:FLD<o>:FVAL?</code>	2400
<code>BUS<m>:USBPd:RESult:FRAMe<n>:FLD<o>:STATus?</code>	2400
<code>BUS<m>:USBPd:RESult:FRAMe<n>:FLD<o>:START?</code>	2401
<code>BUS<m>:USBPd:RESult:FRAMe<n>:FLD<o>:STOP?</code>	2401
<code>BUS<m>:USBPd:RESult:FRAMe<n>:FLD<o>:TYPE?</code>	2401
<code>BUS<m>:USBPd:RESult:FRAMe<n>:FLD<o>:VAL?</code>	2402
<code>BUS<m>:USBPd:RESult:FRAMe<n>:INFO?</code>	2402
<code>BUS<m>:USBPd:RESult:FRAMe<n>:START?</code>	2402
<code>BUS<m>:USBPd:RESult:FRAMe<n>:STATe?</code>	2403
<code>BUS<m>:USBPd:RESult:FRAMe<n>:STOP?</code>	2403
<code>BUS<m>:USBPd:RESult:FRAMe<n>:TYPE?</code>	2403

BUS<m>:USBPd:RESult:FCOut?

Returns the number of decoded frames in the selected serial bus.

Suffix:

<m> 1..4

Return values:

<FrameCount> Range: 0 to 100000
Increment: 1

Usage: Query only

BUS<m>:USBPd:RESult:FRAMe<n>:DATA?

Returns the data from the frame with the selected frame number (for the selected serial bus). This is the hex value of the first four bytes of data fields, prefixed by the total number of data fields (in square brackets), e.g. [5]FF008041.

Suffix:

<m> 1..4

<n> *

Return values:

<Data>

Usage: Query only**BUS<m>:USBPd:RESult:FRAMe<n>:FLD<o>:FVAL?**

Returns the formatted value of the field with the selected field number within the frame with the selected frame number (for the selected serial bus).

Suffix:

<m> 1..4

<n> *

Selects the frame number.

<o> *

Selects the field number.

Return values:

<FrameByteValue>

Usage: Query only**BUS<m>:USBPd:RESult:FRAMe<n>:FLD<o>:STATus?**

Returns the status of the field with the selected field number within the frame with the selected frame number (for the selected serial bus).

Suffix:

<m> 1..4

<n> *

Selects the frame number.

<o> *

Selects the field number.

Return values:

<FieldState> OK | UNKNown | INComplete | PREamble | SOP | CRC | LENGth | FBFB

SOP

Start of packet warning

CRC

Cyclic redundancy check error

FBFB

4b5b error

*RST: OK

Usage: Query only

BUS<m>:USBPd:RESult:FRAMe<n>:FLD<o>:START?

Returns the start time of the field with the selected field number within the frame with the selected frame number (for the selected serial bus).

Suffix:

<m> 1..4

<n> *

<o> *

Return values:

<Start> Range: -100E+24 to 100E+24
Increment: 100E-12
*RST: 0
Default unit: s

Usage: Query only

BUS<m>:USBPd:RESult:FRAMe<n>:FLD<o>:STOP?

Returns the stop time of the field with the selected field number within the frame with the selected frame number (for the selected serial bus).

Suffix:

<m> 1..4

<n> *

<o> *

Return values:

<Stop> Range: -100E+24 to 100E+24
Increment: 100E-12
*RST: 0
Default unit: s

Usage: Query only

BUS<m>:USBPd:RESult:FRAMe<n>:FLD<o>:TYPE?

Returns the type of the field with the selected field number within the frame with the selected frame number (for the selected serial bus).

Suffix:

<m> 1..4

<n> *
Selects the frame number.

<o> *
Selects the field number.

Return values:

<FieldType>

Usage: Query only

BUS<m>:USBPd:RESult:FRAMe<n>:FLD<o>:VAL?

Returns the value of the field with the selected field number within the frame with the selected frame number (for the selected serial bus).

Suffix:

<m>	1..4
<n>	*
	Selects the frame number.
<o>	*
	Selects the field number.

Return values:

<FrameByteValue>

Usage: Query only

BUS<m>:USBPd:RESult:FRAMe<n>:INFO?

Returns information on the frame with the selected frame number (for the selected serial bus).

Suffix:

<m>	1..4
<n>	*

Return values:

<Info>

Usage: Query only

BUS<m>:USBPd:RESult:FRAMe<n>:START?

Returns the start time of the frame with the selected frame number (for the selected serial bus).

Suffix:

<m>	1..4
<n>	*

Return values:

<Start>	Range: -100E+24 to 100E+24
	Increment: 100E-12
	*RST: 0
	Default unit: s

Usage: Query only

BUS<m>:USBPd:RESUlt:FRAMe<n>:STATe?

Returns the status of the frame with the selected frame number (for the selected serial bus).

Suffix:

<m> 1..4

<n> *

Return values:

<State> OK | UNKNown | INComplete | PREamble | SOP | CRC | LENGth | FBFB

SOP

Start of packet warning

CRC

Cyclic redundancy check error

FBFB

4b5b error

*RST: OK

Usage: Query only

BUS<m>:USBPd:RESUlt:FRAMe<n>:STOP?

Returns the stop time of the frame with the selected frame number (for the selected serial bus).

Suffix:

<m> 1..4

<n> *

Return values:

<Stop> Range: -100E+24 to 100E+24

Increment: 100E-12

*RST: 0

Default unit: s

Usage: Query only

BUS<m>:USBPd:RESUlt:FRAMe<n>:TYPE?

Returns the frame type for the selected serial bus and frame number.

Suffix:

<m> 1..4

<n> *

Return values:

<FrameType> START | RESet | CTRL | DATA | BIST | RQST | SINK | SRC |
 VEND | BATT | ALRT | XMSG | XSRC | XSTA | XGBC | XGBS |
 XBAC | XGMI | XMFI | XSRQ | XSRS | XFRQ | XFRS | TEST |
 LOWP | UNKNown

For a description of the frame types, see "[Frame packet types](#)"
 on page 889.

*RST: UNKNown

Usage: Query only

27.18.23.4 Search settings

The trigger suffix <m> is always 1 and can be omitted. It selects the trigger event: Only the A-trigger is available for triggering on serial buses.

To trigger on a serial bus, make sure that:

- `TRIGger<m>:SOURce[:SElect]` is set to SBUS.
- The sources of the serial bus are channel signals: use `BUS<m>:...:SOURce` commands.
- Decoding is enabled: `BUS<m>[:STATe]` is set to ON.

There are two commands for each parameter, that you can use for defining the USBPD settings.

For example, to set the *Frame type =Control Frame > Field =MsgID >Data* value you can use one of the following commands:

- `SEARch:TRIGger:USBPD:FRAME3:FLD3:DMIN 01100`
 Defines the parameter by using the index <m> for the frame number and <n> for the field number. For an overview, see [Table 27-15](#).
- `SEARch:TRIGger:USBPD:DMIN "Control", "MsgID", 01100`
 Defines the parameter by using the frame and field name.

<code>SEARch:TRIGger:USBpd:ERENable</code>	2405
<code>SEARch:TRIGger:USBpd:ERRor<m>:ENABLE</code>	2405
<code>SEARch:TRIGger:USBpd:FRENable</code>	2405
<code>SEARch:TRIGger:USBpd:FRAME<m>:ENABLE</code>	2405
<code>SEARch:TRIGger:USBpd:FIENable</code>	2406
<code>SEARch:TRIGger:USBpd:FRAME<m>:FLD<n>:ENABLE</code>	2406
<code>SEARch:TRIGger:USBpd:BIT</code>	2406
<code>SEARch:TRIGger:USBpd:FRAME<m>:FLD<n>:BIT</code>	2406
<code>SEARch:TRIGger:USBpd:DMAX</code>	2407
<code>SEARch:TRIGger:USBpd:FRAME<m>:FLD<n>:DMAX</code>	2407
<code>SEARch:TRIGger:USBpd:DMIN</code>	2407
<code>SEARch:TRIGger:USBpd:FRAME<m>:FLD<n>:DMIN</code>	2407
<code>SEARch:TRIGger:USBpd:DOPerator</code>	2408
<code>SEARch:TRIGger:USBpd:FRAME<m>:FLD<n>:DOPerator</code>	2408
<code>SEARch:TRIGger:USBpd:IMAX</code>	2408
<code>SEARch:TRIGger:USBpd:FRAME<m>:FLD<n>:IMAX</code>	2408
<code>SEARch:TRIGger:USBpd:IMIN</code>	2409

SEARCH:TRIGger:USBPd:FRAMe<m>:FLD<n>:IMIN.....	2409
SEARCH:TRIGger:USBPd:IOPerator.....	2409
SEARCH:TRIGger:USBPd:FRAMe<m>:FLD<n>:IOPerator.....	2409

SEARCH:TRIGger:USBPd:ERENable <SearchName>,<ErrorName>,<Enabler>

SEARCH:TRIGger:USBPd:ERRor<m>:ENABle <SearchName>,<Enable>

SEARCH:TRIGger:USBPd:ERRor<m>:ENABle? <SearchName>

Enables or disables the checking condition for searching a specific error in the selected field of the selected frame.

Suffix:

<m> *
Specifies the error number.

Parameters:

<Enable> ON | OFF
*RST: ON

Parameters for setting and query:

<SearchName>

Example:

```
SEARCH:TRIGger:USBPd:ERRor1:ENABle ON
Enables searching for CRC Error.
SEARCH:TRIGger:USBPd:ERENable "Length Error",ON
Enables searching for Length Error.
```

Manual operation: See ["Search"](#) on page 899

SEARCH:TRIGger:USBPd:FRENable <SearchName>,<Frame>,<Enabler>

SEARCH:TRIGger:USBPd:FRAMe<m>:ENABle <SearchName>,<Enable>

SEARCH:TRIGger:USBPd:FRAMe<m>:ENABle? <SearchName>

Suffix:

<m> *
Specifies the frame number.

Parameters:

<Enable> ON | OFF
*RST: OFF

Parameters for setting and query:

<SearchName>

Example:

```
SEARCH:TRIGger:USBPd:FRAMe1:ENABle ON
Enables the checking condition for the Test frame.
SEARCH:TRIGger:USBPd:FRENable "Control Frame"
ON
Enables the checking condition for the Control frame.
```

SEARCh:TRIGger:USBPd:FIENable <SearchName>,<Frame>, <Field>, <Enabler>

SEARCh:TRIGger:USBPd:FRAMe<m>:FLD<n>:ENABLe

<SearchName>,<CondEnabler>

SEARCh:TRIGger:USBPd:FRAMe<m>:FLD<n>:ENABLe? <SearchName>

Enables or disables the checking condition for searching a specific data pattern in the selected field of the selected frame.

Suffix:

<m> *
Specifies the frame.

<n> *
Specifies the field number within the frame.

Parameters:

<CondEnabler> ON | OFF
ON
Checking condition enabled
OFF
Checking condition disabled
*RST: OFF

Parameters for setting and query:

<SearchName> String with the name of the search.

Example:

```
SEARCh:TRIGger:USBPd:FRAMe3:FLD1:ENABLe ON
Enables searching for the Extended field of the Control frame.
SEARCh:TRIGger:USBPd:FRAMe3:FLD1:ENABLe "Data Frame",
"Data Role" ON
Enables searching for the Data Role field of the Data frame.
```

SEARCh:TRIGger:USBPd:BIT <SearchName>,<Frame>, <Field>, <Bit>

SEARCh:TRIGger:USBPd:FRAMe<m>:FLD<n>:BIT <SearchName>,<BitState>

SEARCh:TRIGger:USBPd:FRAMe<m>:FLD<n>:BIT? <SearchName>

Sets the bit state of a field to be searched that only consists of one bit.

Suffix:

<m> *
Specifies the frame.

<n> *
Specifies the field number within the frame.

Parameters:

<BitState> ONE | ZERO | DC
ONE
1
ZERO
0

DC

"Don't care" = X

*RST: DC

Parameters for setting and query:

<SearchName> String with the name of the search.

Manual operation: See "Search" on page 899**SEARCh:TRIGger:USBPd:DMAX** <SearchName>, <Frame>, <Field>, <Data>**SEARCh:TRIGger:USBPd:FRAME<m>:FLD<n>:DMAX** <SearchName>, <DataMax>**SEARCh:TRIGger:USBPd:FRAME<m>:FLD<n>:DMAX?** <SearchName>Sets the end value of a data pattern range if [SEARCh:TRIGger:USBPd:FRAME<m>:FLD<n>:DOPerator](#) is set to INRange or OORange.**Suffix:**<m> *
Specifies the frame.<n> *
Specifies the field number within the frame.**Parameters:**<DataMax> Specifies the name of the generic trigger setting frame, see [SEARCh:RESult:USBPd:FRAME<m>:TYPE?](#) on page 2414.**Parameters for setting and query:**

<SearchName> String with the name of the search.

Manual operation: See "Search" on page 899**SEARCh:TRIGger:USBPd:DMIN** <SearchName>, <Frame>, <Field>, <Data>**SEARCh:TRIGger:USBPd:FRAME<m>:FLD<n>:DMIN** <SearchName>, <DataMin>**SEARCh:TRIGger:USBPd:FRAME<m>:FLD<n>:DMIN?** <SearchName>

Specifies the data pattern to be searched, or sets the start value of a data pattern range to be searched.

Suffix:<m> *
Specifies the frame.<n> *
Specifies the field number within the frame.**Parameters:**<DataMin> Specifies the name of the generic trigger setting frame, see [SEARCh:RESult:USBPd:FRAME<m>:TYPE?](#) on page 2414.**Parameters for setting and query:**

<SearchName> String with the name of the search.

Manual operation: See "Search" on page 899

SEARCh:TRIGger:USBPd:DOPerator <SearchName>,<Frame>, <Field>, <Operator>
SEARCh:TRIGger:USBPd:FRAME<m>:FLD<n>:DOPerator

<SearchName>,<DataOperator>

SEARCh:TRIGger:USBPd:FRAME<m>:FLD<n>:DOPerator? <SearchName>

Sets the operator to set a specific data pattern to be searched in the selected field of the selected frame.

Suffix:

<m> *
 Specifies the frame.

<n> *
 Specifies the field number within the frame.

Parameters:

<DataOperator> EQUal | NEQual | LTHan | LETHan | GTHan | GETHan | INRange | OORange

EQUal | NEQual | LTHan | LETHan | GTHan | GETHan

Equal, Not equal, Less than, Less than or equal, Greater than, Greater than or equal. These conditions require one endpoint value to be set using [SEARCh:TRIGger:USBPd:FRAME<m>:FLD<n>:DMIN](#).

INRange | OORange

In range, out of range. These conditions require a range of endpoint values to be set using [SEARCh:TRIGger:USBPd:FRAME<m>:FLD<n>:DMIN](#) and [SEARCh:TRIGger:USBPd:FRAME<m>:FLD<n>:DMAX](#).

*RST: EQUal

Parameters for setting and query:

<SearchName> String with the name of the search.

Manual operation: See "[Search](#)" on page 899

SEARCh:TRIGger:USBPd:IMAX <SearchName>,<Frame>, <Field>, <Data>

SEARCh:TRIGger:USBPd:FRAME<m>:FLD<n>:IMAX <SearchName>,<IndexMax>

SEARCh:TRIGger:USBPd:FRAME<m>:FLD<n>:IMAX? <SearchName>

Sets the end value of an index range if [SEARCh:TRIGger:USBPd:FRAME<m>:FLD<n>:IOperator](#) is set to INRange or RANGE.

Suffix:

<m> *
 Specifies the frame.

<n> *
 Specifies the field number within the frame.

Parameters:

<IndexMax> Specifies the end value for the index range within the field. The index range, increment and *RST values depend on the field type.

Parameters for setting and query:

<SearchName> String with the name of the search.

Manual operation: See "[Search](#)" on page 899

SEARch:TRIGger:USBPd:IMIN <SearchName>,<Frame>, <Field>, <Data>
SEARch:TRIGger:USBPd:FRAMe<m>:FLD<n>:IMIN <SearchName>,<IndexMin>
SEARch:TRIGger:USBPd:FRAMe<m>:FLD<n>:IMIN? <SearchName>

Specifies the index at which the data is to be searched, or sets the start value of an index range in which the data is to be searched.

Suffix:

<m> *
 Specifies the frame.

<n> *
 Specifies the field number within the frame.

Parameters:

<IndexMin> Specifies the index value or the start value of an index range within the field.
 The index range, increment and *RST values depend on the field type.

Parameters for setting and query:

<SearchName> String with the name of the search.

Manual operation: See "[Search](#)" on page 899

SEARch:TRIGger:USBPd:IOPerator <SearchName>,<Frame>, <Field>, <Operator>
SEARch:TRIGger:USBPd:FRAMe<m>:FLD<n>:IOPerator
 <SearchName>,<IndexOperator>
SEARch:TRIGger:USBPd:FRAMe<m>:FLD<n>:IOPerator? <SearchName>

Sets the operator for the index for searching in the selected field of the selected frame.

Suffix:

<m> *
 Specifies the frame.

<n> *
 Specifies the field number within the frame.

Parameters:

<IndexOperator> EQUal | INRange | RANGE

EQUal

This condition requires one endpoint value to be set using [SEARch:TRIGger:USBPd:FRAMe<m>:FLD<n>:IMIN](#).

INRange | RANGE

This condition requires a range of endpoint values to be set using [SEARch:TRIGger:USBPd:FRAMe<m>:FLD<n>:IMIN](#) and [SEARch:TRIGger:USBPd:FRAMe<m>:FLD<n>:IMAX](#).

*RST: INRange

Parameters for setting and query:

<SearchName> String with the name of the search.

Manual operation: See "Search" on page 899

27.18.23.5 Search results

In all `SEARch:RESult:USBPd:FRAMe<m>` commands, the suffix <m> selects the frame number in the list of search results.

<code>SEARch:RESult:USBPd:FCOunt?</code>	2410
<code>SEARch:RESult:USBPd:FRAMe<m>:DATA?</code>	2410
<code>SEARch:RESult:USBPd:FRAMe<m>:FLD<n>:FVAL?</code>	2411
<code>SEARch:RESult:USBPd:FRAMe<m>:FLD<n>:STATus?</code>	2411
<code>SEARch:RESult:USBPd:FRAMe<m>:FLD<n>:START?</code>	2412
<code>SEARch:RESult:USBPd:FRAMe<m>:FLD<n>:STOP?</code>	2412
<code>SEARch:RESult:USBPd:FRAMe<m>:FLD<n>:TYPE?</code>	2412
<code>SEARch:RESult:USBPd:FRAMe<m>:FLD<n>:VAL?</code>	2413
<code>SEARch:RESult:USBPd:FRAMe<m>:INFO?</code>	2413
<code>SEARch:RESult:USBPd:FRAMe<m>:START?</code>	2413
<code>SEARch:RESult:USBPd:FRAMe<m>:STATe?</code>	2414
<code>SEARch:RESult:USBPd:FRAMe<m>:STOP?</code>	2414
<code>SEARch:RESult:USBPd:FRAMe<m>:TYPE?</code>	2414

`SEARch:RESult:USBPd:FCOunt?` <SearchName>

Returns the number of decoded frames in the search result.

Query parameters:

<SearchName>

Return values:

<FrameCount> Range: 0 to 100000
 Increment: 1
 *RST: 0

Usage: Query only

`SEARch:RESult:USBPd:FRAMe<m>:DATA?` <SearchName>

Searches for data from the frame with the selected frame number (for the selected serial bus). This is the hex value of the first four bytes of data fields, prefixed by the total number of data fields (in square brackets), e.g. [5] FF008041.

Suffix:

<m> *

Query parameters:

<SearchName>

Return values:

<Data>

Usage: Query only

SEARCh:RESult:USBPd:FRAMe<m>:FLD<n>:FVAL? <SearchName>

Returns the formatted value of the field with the selected field number within the frame with the selected frame number within the search result.

Suffix:

<m> *

<n> *

Selects the field number.

Query parameters:

<SearchName>

Return values:

<ValueFormatted>

Usage: Query only

SEARCh:RESult:USBPd:FRAMe<m>:FLD<n>:STATus? <SearchName>

Returns the field status of the field with the selected field number within the frame with the selected frame number within the search result.

Suffix:

<m> *

<n> *

Selects the field number.

Query parameters:

<SearchName>

Return values:

<FieldState> OK | UNKNown | INComplete | PREamble | SOP | CRC | LENGth | FBFB

SOP

Start of packet warning

CRC

Cyclic redundancy check error

FBFB

4b5b error

*RST: OK

Usage: Query only

SEARCh:RESult:USBPd:FRAMe<m>:FLD<n>:STARt? <SearchName>

Returns the start time of the field with the selected field number within the frame with the selected frame number within the search result.

Suffix:

<m> *

<n> *

Query parameters:

<SearchName>

Return values:

<Start> Range: -100E+24 to 100E+24
 Increment: 100E-12
 *RST: 0
 Default unit: s

Usage: Query only

SEARCh:RESult:USBPd:FRAMe<m>:FLD<n>:STOP? <SearchName>

Returns the stop time of the field with the selected field number within the frame with the selected frame number within the search result.

Suffix:

<m> *

<n> *

Query parameters:

<SearchName>

Return values:

<Stop> Range: -100E+24 to 100E+24
 Increment: 100E-12
 *RST: 0
 Default unit: s

Usage: Query only

SEARCh:RESult:USBPd:FRAMe<m>:FLD<n>:TYPE? <SearchName>

Returns the field name of the field with the selected field number within the frame with the selected frame number within the search result.

Suffix:

<m> *

<n> *

Selects the field number.

Query parameters:

<SearchName>

Return values:

<FieldType>

Usage: Query only**SEARCh:RESult:USBPd:FRAMe<m>:FLD<n>:VAL? <SearchName>**

Returns the value of the field with the selected field number within the frame with the selected frame number within the search result.

Suffix:

<m> *

<n> *

Selects the field number.

Query parameters:

<SearchName>

Return values:

<ByteValue>

Usage: Query only**SEARCh:RESult:USBPd:FRAMe<m>:INFO? <SearchName>**

Returns specific frame information details of the selected frame in the search result. This information is also shown in the "Info" column of the decode results table.

Suffix:

<m> *

Query parameters:

<SearchName>

Return values:

<Info>

Usage: Query only**SEARCh:RESult:USBPd:FRAMe<m>:START? <SearchName>**

Returns the start time of the frame with the selected frame number within the search result.

Suffix:

<m> *

Query parameters:

<SearchName>

Return values:

<Start> Range: -100E+24 to 100E+24
 Increment: 100E-12
 Default unit: s

Usage: Query only

SEARCh:RESUlt:USBPd:FRAMe<m>:STATe? <SearchName>

Returns the status of the frame with the selected frame number within the search result.

Suffix:
<m> *

Query parameters:
<SearchName>

Return values:
<State> OK | UNKNown | INComplete | PREAmble | SOP | CRC | LENGth | FBFB

SOP

Start of packet warning

CRC

Cyclic redundancy check error

FBFB

4b5b error

*RST: OK

Usage: Query only

SEARCh:RESUlt:USBPd:FRAMe<m>:STOP? <SearchName>

Returns the stop time of the frame with the selected frame number within the search result.

Suffix:
<m> *

Query parameters:
<SearchName>

Return values:
<Stop> Range: -100E+24 to 100E+24
Increment: 100E-12
Default unit: s

Usage: Query only

SEARCh:RESUlt:USBPd:FRAMe<m>:TYPE? <SearchName>

Returns the frame type for the selected frame number within the search result.

Suffix:
<m> *

Query parameters:

<SearchName>

Return values:

<FrameType> START | RESet | CTRL | DATA | BIST | RQST | SINK | SRC |
 VEND | BATT | ALRT | XMSG | XSRC | XSTA | XGBC | XGBS |
 XBAC | XGMI | XMFI | XSRQ | XSRS | XFRQ | XFRS | TEST |
 LOWP | UNKNown

For a description of the frame types, see "[Frame packet types](#)"
 on page 889.

*RST: UNKNown

Usage: Query only

27.18.24 D-PHY (option R&S RTO6-K580)

- [D-PHY configuration](#)..... 2415
- [D-PHY trigger](#).....2421
- [D-PHY decode results](#).....2428
- [D-PHY search settings](#).....2434
- [D-PHY search results](#).....2443

27.18.24.1 D-PHY configuration

BUS<m>:DPHY:CONFig	2416
BUS<m>:DPHY:CP:PROBe	2416
BUS<m>:DPHY:CP:SOURce	2416
BUS<m>:DPHY:DRATe	2417
BUS<m>:DPHY:DSPData	2417
BUS<m>:DPHY:THCoupling	2417
BUS<m>:DPHY:THPReset	2418
BUS<m>:DPHY:VARiant	2418
BUS<m>:DPHY:DNZero:LPOWer:THUPper	2418
BUS<m>:DPHY:DPZero:LPOWer:THUPper	2418
BUS<m>:DPHY:DNZero:LPOWer:THLower	2419
BUS<m>:DPHY:DPZero:LPOWer:THLower	2419
BUS<m>:DPHY:DPZero:SOURce	2419
BUS<m>:DPHY:DNZero:SOURce	2419
BUS<m>:DPHY:DPONe:SOURce	2419
BUS<m>:DPHY:DPTWo:SOURce	2419
BUS<m>:DPHY:DPTHree:SOURce	2419
BUS<m>:DPHY:DNZero:PROBe	2419
BUS<m>:DPHY:DPZero:PROBe	2419
BUS<m>:DPHY:DPONe:PROBe	2420
BUS<m>:DPHY:DPTWo:PROBe	2420
BUS<m>:DPHY:DPTHree:PROBe	2420
BUS<m>:DPHY:CP:HSPeed:HYSteresis	2420
BUS<m>:DPHY:DPZero:HSPeed:HYSteresis	2420
BUS<m>:DPHY:DPONe:HSPeed:HYSteresis	2420

BUS<m>:DPHY:DPTWo:HSPeed:HYSTeresis.....	2420
BUS<m>:DPHY:DPTHree:HSPeed:HYSTeresis.....	2420
BUS<m>:DPHY:CP:HSPeed:THReshold.....	2420
BUS<m>:DPHY:DPZero:HSPeed:THReshold.....	2420
BUS<m>:DPHY:DPONe:HSPeed:THReshold.....	2420
BUS<m>:DPHY:DPTWo:HSPeed:THReshold.....	2420
BUS<m>:DPHY:DPTHree:HSPeed:THReshold.....	2420
BUS<m>:DPHY:SMLanes.....	2421

BUS<m>:DPHY:CONFig <Configuration>

Sets the number of data lanes and if the clock lane and low power are available.

Suffix:

<m> 1..4

Parameters:

<Configuration> D1CN | D1CL | D2CN | D2CL | D3CN | D3NL | D4NN

D1CN: 1 data lane, clock lane

D1CL: 1 data lane, clock lane, low power

D2CN: 2 data lanes, clock lane

D2CL: 2 data lanes, clock lane, low power

D3CN: 3 data lanes, clock lane

D3CL: 3 data lanes, clock lane, low power

D4NN: 4 data lanes and no clock

*RST: D4NN

Manual operation: See "[Physical configuration](#)" on page 903

BUS<m>:DPHY:CP:PROBe <ProbeCP>

Selects the type of probe used for the clock lane.

Suffix:

<m> 1..4
Selects the serial bus.

Parameters:

<ProbeCP> DIFFerential | SINGLE

*RST: SINGLE

Manual operation: See "[Probe](#)" on page 904

BUS<m>:DPHY:CP:SOURce <ClockSource>

Selects the source of the clock lane.

Usually, the source is one of the analog channels. Reference and math waveforms are available as source if the trigger source is one of the analog channels but not the serial bus.

Alternatively, digital channels can be used if MSO option R&S RTO6-B1 is installed. Digital and analog channels cannot be used at the same time.

For triggering on a serial bus, analog or digital channel sources are required.

Suffix:

<m> 1..4
Selects the serial bus.

Parameters:

<ClockSource> NONE | C1W1 | C2W1 | C3W1 | C4W1 | M1 | M2 | M3 | M4 |
M5 | M6 | M7 | M8 | R1 | R2 | R3 | R4
*RST: NONE

Manual operation: See "[CP](#)" on page 903

BUS<m>:DPHY:DRATe <DataRate>

Sets a data rate.

Suffix:

<m> 1..4
Selects the serial bus.

Parameters:

<DataRate> Range: 1000000 to 2500000000
Increment: 1000000
*RST: 800000000
Default unit: bps

Manual operation: See "[Data Rate](#)" on page 904

BUS<m>:DPHY:DSPData <DispDatVect>

Enables the display of the data vector, which means that the whole frame will be decoded.

When the display vector is disabled only the packet header will be decoded and not the actual data payload of the frame. This will speed up the decoding.

Suffix:

<m> 1..4
Selects the serial bus.

Parameters:

<DispDatVect> ON | OFF
*RST: OFF

Manual operation: See "[Data Rate](#)" on page 904

BUS<m>:DPHY:THCoupling <ThresCpl>

Enables coupling, i.e. the same threshold and hysteresis value is used for all lanes.

Suffix:

<m> 1..4
Selects the serial bus.

Parameters:

<ThresCpl> ON | OFF
*RST: ON

Manual operation: See "[Couple thresholds](#)" on page 905

BUS<m>:DPHY:THPReset <ThresholdPreset>

Prests the threshold and hysteresis values of the high speed data lanes. A preset sets the low power threshold to 1.20V and high speed threshold to 200 mV.

Suffix:

<m> 1..4
Selects the serial bus.

Parameters:

<ThresholdPreset> LPHS | MANual
*RST: LPHS

BUS<m>:DPHY:VARiant <ProtSel>

Selects the protocol running on the interface.

Suffix:

<m> 1..4
Selects the serial bus.

Parameters:

<ProtSel> DSI | CSI2
*RST: CSI2

Manual operation: See "[Variant](#)" on page 903

BUS<m>:DPHY:DNZero:LPOWer:THUPper <ThresLPDN0High>**BUS<m>:DPHY:DPZero:LPOWer:THUPper <ThresLPDP0High>**

Sets the upper threshold value for the respective lane used for the low power mode.

Suffix:

<m> 1..4
Selects the serial bus.

Parameters:

<ThresLPDP0High> Range: -1.5 to 1.5
Increment: 0.01
*RST: 0.88
Default unit: V

Manual operation: See "[DP0 High / DN0 High](#)" on page 905

BUS<m>:DPHY:DNZero:LPOWer:THLower <ThresLPDN0Low>

BUS<m>:DPHY:DPZero:LPOWer:THLower <ThresLPDP0Low>

Sets the lower threshold value for the respective lane used for the low power mode.

Suffix:

<m> 1..4
Selects the serial bus.

Parameters:

<ThresLPDP0Low> Range: -1.5 to 1.5
Increment: 0.01
*RST: 0.55
Default unit: V

Manual operation: See "[DP0 Low / DN0 Low](#)" on page 905

BUS<m>:DPHY:DPZero:SOURce <DataSource>

Selects the source of the DP0 data line.

Suffix:

<m> 1..4

Parameters:

<DataSource> C1W1 | C2W1 | C3W1 | C4W1 | M1 | M2 | M3 | M4 | M5 | M6 |
M7 | M8 | R1 | R2 | R3 | R4
*RST: C1W1

Manual operation: See "[DP0/DN0](#)" on page 904

BUS<m>:DPHY:DNZero:SOURce <DataSource>

BUS<m>:DPHY:DPONe:SOURce <DataSource>

BUS<m>:DPHY:DPTWo:SOURce <DataSource>

BUS<m>:DPHY:DPTHree:SOURce <DataSource>

Selects the source of the corresponding data line.

Suffix:

<m> 1..4
Selects the serial bus.

Parameters:

<DataSource> NONE | C1W1 | C2W1 | C3W1 | C4W1 | M1 | M2 | M3 | M4 |
M5 | M6 | M7 | M8 | R1 | R2 | R3 | R4
*RST: DNZero: NONE, DPONe: C2W1, DPTWo: C3W1,
DPTHree: C4W1

Manual operation: See "[DP1/DP2/DP3](#)" on page 904

BUS<m>:DPHY:DNZero:PROBe <ProbeDN0>

BUS<m>:DPHY:DPZero:PROBe <ProbeDP0>

BUS<m>:DPHY:DPONe:PROBe <ProbeDP1>
BUS<m>:DPHY:DPTWo:PROBe <ProbeDP2>
BUS<m>:DPHY:DPTHree:PROBe <ProbeDP3>

Selects the type of probe used for the corresponding data lane.

Suffix:

<m> 1..4
 Selects the serial bus.

Parameters:

<ProbeDP3> DIFFerential | SINGLE
 *RST: SINGLE

Manual operation: See "[Probe](#)" on page 904

BUS<m>:DPHY:CP:HSPeEd:HYSTerEsis <HysteresisHSCP>
BUS<m>:DPHY:DPZero:HSPeEd:HYSTerEsis <HysteresisHSDP0>
BUS<m>:DPHY:DPONe:HSPeEd:HYSTerEsis <HysteresisHSDP1>
BUS<m>:DPHY:DPTWo:HSPeEd:HYSTerEsis <HysteresisHSDP2>
BUS<m>:DPHY:DPTHree:HSPeEd:HYSTerEsis <HysteresisHSDP3>

Sets a value for the hysteresis of the respective lane.

Suffix:

<m> 1..4
 Selects the serial bus.

Parameters:

<HysteresisHSDP3> Range: 0 to 0.5
 Increment: 0.01
 *RST: 0.2
 Default unit: V

Manual operation: See "[HS Hysteresis](#)" on page 904

BUS<m>:DPHY:CP:HSPeEd:THReshold <ThresholdHSCP>
BUS<m>:DPHY:DPZero:HSPeEd:THReshold <ThresholdHSDP0>
BUS<m>:DPHY:DPONe:HSPeEd:THReshold <ThresholdHSDP1>
BUS<m>:DPHY:DPTWo:HSPeEd:THReshold <ThresholdHSDP2>
BUS<m>:DPHY:DPTHree:HSPeEd:THReshold <ThresholdHSDP3>

Sets the threshold value for the digitization of the respective high speed data line.

Suffix:

<m> 1..4
 Selects the serial bus.

Parameters:

<ThresholdHSDP3> Range: -1 to 1
 Increment: 0.01
 *RST: 0.2
 Default unit: V

Manual operation: See "HS Threshold" on page 904

BUS<m>:DPHY:SMLanes <Active>

Enables the display of the results in multiple lanes.

Suffix:

<m> 1..4

Parameters:

<Active> ON | OFF

*RST: ON

Manual operation: See "Show multiple lanes" on page 906

27.18.24.2 D-PHY trigger

The trigger suffix <m> is always 1 and can be omitted. It selects the trigger event: Only the A-trigger is available for triggering on serial buses.

To trigger on a serial bus, make sure that:

- `TRIGger<m>:SOURce[:SElect]` is set to `SBUS`.
- The sources of the serial bus are channel signals: use `BUS<m>:...:SOURce` commands.
- Decoding is enabled: `BUS<m>[:STATe]` is set to `ON`.

<code>TRIGger<m>:DPHY:TYPE</code>	2422
<code>TRIGger<m>:DPHY:DATA:CONDition</code>	2422
<code>TRIGger<m>:DPHY:DATA:MAX</code>	2423
<code>TRIGger<m>:DPHY:DATA:MIN</code>	2423
<code>TRIGger<m>:DPHY:DIDX:CONDition</code>	2423
<code>TRIGger<m>:DPHY:DIDX:MAX</code>	2423
<code>TRIGger<m>:DPHY:DIDX:MIN</code>	2424
<code>TRIGger<m>:DPHY:DTYPE:CONDition</code>	2424
<code>TRIGger<m>:DPHY:DTYPE:MAX</code>	2424
<code>TRIGger<m>:DPHY:DTYPE:MIN</code>	2425
<code>TRIGger<m>:DPHY:ESCMODE:CONDition</code>	2425
<code>TRIGger<m>:DPHY:ESCMODE:MAX</code>	2425
<code>TRIGger<m>:DPHY:ESCMODE:MIN</code>	2425
<code>TRIGger<m>:DPHY:ESDTa:CONDition</code>	2426
<code>TRIGger<m>:DPHY:ESDTa:MAX</code>	2426
<code>TRIGger<m>:DPHY:ESDTa:MIN</code>	2426
<code>TRIGger<m>:DPHY:ESINDEX:CONDition</code>	2427
<code>TRIGger<m>:DPHY:ESINDEX:MAX</code>	2427
<code>TRIGger<m>:DPHY:ESINDEX:MIN</code>	2427
<code>TRIGger<m>:DPHY:HSVC</code>	2427
<code>TRIGger<m>:DPHY:WCOunt:CONDition</code>	2428
<code>TRIGger<m>:DPHY:WCOunt:MAX</code>	2428
<code>TRIGger<m>:DPHY:WCOunt:MIN</code>	2428

TRIGger<m>:DPHY:TYPE <Type>

Sets the type of frame to be triggered on.

Parameters:

<Type> HS_SOP | HS_EOP | HS_PH | HS_DATA | LP_ESC |
LP_TURN | LP_HSRQ

HS_SOP

High speed start of packet

HS_EOP

High speed end of packet

HS_PH

High speed packet header

HS_DATA

High speed data

LP_ESC

Low power escape mode frame

LP_TURN

Low power lane turnaround

LP_HSRQ

Low power high speed request

*RST: HS_SOP

Manual operation: See "[Type](#)" on page 907

TRIGger<m>:DPHY:DATA:CONDition <Format>

Set the condition for the data value. You can define an exact value or a value range.

Parameters:

<Format> EQUal | NEQual | LTHan | LETHan | GTHan | GETHan |
INRange | OORange

EQUal | NEQual | LTHan | LETHan | GTHan | GETHan

Equal, Not equal, Less than, Less or equal than, Greater Than, Greater or equal than. These conditions require one data pattern to be set with the corresponding [TRIGger<m>:DPHY:DATA:MIN](#) command.

INRange | OORange

In range/Out of range: set the minimum and maximum value of the range with [TRIGger<m>:DPHY:DATA:MIN](#) and [TRIGger<m>:DPHY:DATA:MAX](#).

*RST: EQUal

Manual operation: See "[Data Value](#)" on page 910

TRIGger<m>:DPHY:DATA:MAX <DataMax>

Sets the the end value of a data type range if `TRIGger<m>:DPHY:DATA:CONDition` is set to `INRange` or `ORange`.

Parameters:

<DataMax> Numeric or string pattern, see [Chapter 27.4.6, "Bit pattern parameter"](#), on page 1373. The string parameter accepts the bit value X (don't care).

Manual operation: See ["Data Value"](#) on page 910

TRIGger<m>:DPHY:DATA:MIN <DataMin>

Specifies a data bit pattern, or sets the the start value of a pattern range.

Parameters:

<DataMin> Numeric or string pattern, see [Chapter 27.4.6, "Bit pattern parameter"](#), on page 1373. The string parameter accepts the bit value X (don't care).

Manual operation: See ["Data Value"](#) on page 910

TRIGger<m>:DPHY:DIDX:CONDition <Format>

Sets the condition for the data index. You can define an exact value or a value range.

Parameters:

<Format> `EQUal` | `LTHan` | `LETHan` | `GTHan` | `GETHan` | `INRange` | `RANGe`

EQUal | NEQUal | LTHan | LETHan | GTHan | GETHan

Equal, Not equal, Less than, Less or equal than, Greater Than, Greater or equal than. These conditions require one pattern to be set with the corresponding `TRIGger<m>:DPHY:DIDX:MIN` command.

INRange = RANGe

In range: Set the minimum and maximum value using `TRIGger<m>:DPHY:DIDX:MIN` and `TRIGger<m>:DPHY:DIDX:MAX`.

*RST: `INRange`

Manual operation: See ["Data Index"](#) on page 911

TRIGger<m>:DPHY:DIDX:MAX <DXSymbol>

Sets the the end value of a data index range if `TRIGger<m>:DPHY:DIDX:CONDition` is set to `INRange` or `RANGe`.

Parameters:

<DXSymbol> Range: 0 to 65535
 Increment: 1
 *RST: 0

Manual operation: See ["Data Index"](#) on page 911

TRIGger<m>:DPHY:DIDX:MIN <SymbolType>

Specifies a data index minimum, or sets the the start value of a range.

Parameters:

<SymbolType> Range: 0 to 65535
 Increment: 1
 *RST: 0

Manual operation: See ["Data Index"](#) on page 911

TRIGger<m>:DPHY:DTYPe:CONDition <Format>

Set the condition for the data type. You can define an exact value or a value range

Parameters:

<Format> EQUal | NEQual | LTHan | LETHan | GTHan | GETHan |
 INRange | OORange
EQUal | NEQual | LTHan | LETHan | GTHan | GETHan
 Equal, Not equal, Less than, Less or equal than, Greater Than,
 Greater or equal than. These conditions require one pattern to
 be set with the corresponding [TRIGger<m>:DPHY:DTYPe:MIN](#)
 command.
INRange | OORange
 In range/Out of range: set the minimum and maximum value of
 the range with [TRIGger<m>:DPHY:DTYPe:MIN](#) and
[TRIGger<m>:DPHY:DTYPe:MAX](#).
 *RST: EQUal

Manual operation: See ["Data Type"](#) on page 910

TRIGger<m>:DPHY:DTYPe:MAX <HSDataTpeMax>

Sets the the end value of a data type range if [TRIGger<m>:DPHY:DTYPe:CONDition](#) is set to [INRange](#) or [OORange](#).

Parameters:

<HSDataTpeMax> Numeric or string pattern, see [Chapter 27.4.6, "Bit pattern parameter"](#), on page 1373. The string parameter accepts the bit value X (don't care).

Manual operation: See ["Data Type"](#) on page 910

TRIGger<m>:DPHY:DTYPe:MIN <HSDataTypeMin>

Specifies a data type pattern, or sets the the start value of a pattern range.

Parameters:

<HSDataTypeMin> Numeric or string pattern, see [Chapter 27.4.6, "Bit pattern parameter"](#), on page 1373. The string parameter accepts the bit value X (don't care).

Manual operation: See ["Data Type"](#) on page 910

TRIGger<m>:DPHY:ESCMoDe:CONDition <Format>

Set the condition for the escape mode. You can define an exact value or a value range

Parameters:

<Format> EQUal | NEQUal | LTHan | LETHan | GTHan | GETHan |
INRange | OORange

EQUal | NEQUal | LTHan | LETHan | GTHan | GETHan

Equal, Not equal, Less than, Less or equal than, Greater Than, Greater or equal than. These conditions require one pattern to be set with the corresponding [TRIGger<m>:DPHY:ESCMoDe:MIN](#) command.

INRange | OORange

In range/Out of range: set the minimum and maximum value of the range with [TRIGger<m>:DPHY:ESCMoDe:MIN](#) and [TRIGger<m>:DPHY:ESCMoDe:MAX](#).

*RST: EQUal

Manual operation: See ["Escape mode"](#) on page 911

TRIGger<m>:DPHY:ESCMoDe:MAX <LPEscapeModeMax>

Sets the the end value of an escape mode range if [TRIGger<m>:DPHY:ESCMoDe:CONDition](#) is set to [INRange](#) or [OORange](#).

Parameters:

<LPEscapeModeMax> Numeric or string pattern, see [Chapter 27.4.6, "Bit pattern parameter"](#), on page 1373. The string parameter accepts the bit value X (don't care).

Manual operation: See ["Escape mode"](#) on page 911

TRIGger<m>:DPHY:ESCMoDe:MIN <LPEscapeModeMin>

Specifies a escape mode bit pattern, or sets the the start value of a pattern range.

Parameters:

<LPEscapeModeMin> Numeric or string pattern, see [Chapter 27.4.6, "Bit pattern parameter"](#), on page 1373. The string parameter accepts the bit value X (don't care).

Manual operation: See "Escape mode" on page 911

TRIGger<m>:DPHY:ESDTa:CONDition <Format>

Set the condition for the escape mode data value. You can define an exact value or a value range.

Parameters:

<Format>

OFF | ANY | EQUAL | NEQUAL | LTHan | LETHan | GTHan |
GETHan | INRange | OORange

EQUAL | NEQUAL | LTHan | LETHan | GTHan | GETHan

Equal, Not equal, Less than, Less or equal than, Greater Than, Greater or equal than. These conditions require one data pattern to be set with the corresponding `TRIGger<m>:DPHY:ESDTa:MIN` command.

INRange | OORange

In range/Out of range: set the minimum and maximum value of the range with `TRIGger<m>:DPHY:ESDTa:MIN` and `TRIGger<m>:DPHY:ESDTa:MAX`.

OFF | ANY

Any pattern is detected.

*RST: EQUAL

Manual operation: See "Data Value" on page 910

TRIGger<m>:DPHY:ESDTa:MAX <LPEscapeDataMax>

Sets the the end value of a escape mode data type range if `TRIGger<m>:DPHY:ESDTa:CONDition` is set to `INRange` or `OORange`.

Parameters:

<LPEscapeDataMax>

Manual operation: See "Data Value" on page 910

TRIGger<m>:DPHY:ESDTa:MIN <LPEscapeDataMin>

Specifies an escape mode data bit pattern, or sets the the start value of a pattern range.

Parameters:

<LPEscpMdDatMin>

Manual operation: See "Data Value" on page 910

TRIGger<m>:DPHY:ESINdex:CONDition <Format>

Sets the condition for the escape mode data index. You can define an exact value or a value range.

Parameters:

<Format> EQUal | LTHan | LETHan | GTHan | GETHan | INRange | RANGE

EQUal | NEQUal | LTHan | LETHan | GTHan | GETHan

Equal, Not equal, Less than, Less or equal than, Greater Than, Greater or equal than. These conditions require one pattern to be set with the corresponding [TRIGger<m>:DPHY:ESINdex:MIN](#) command.

INRange = RANGE

In range: Set the minimum and maximum value using [TRIGger<m>:DPHY:ESINdex:MIN](#) and [TRIGger<m>:DPHY:ESINdex:MAX](#).

*RST: INRange

Manual operation: See "[Data Index](#)" on page 911

TRIGger<m>:DPHY:ESINdex:MAX <DXSymbol>

Sets the the end value of a data index range if [TRIGger<m>:DPHY:ESINdex:CONDition](#) is set to [INRange](#) or [RANGE](#).

Parameters:

<DXSymbol> Range: 0 to 255
 Increment: 1
 *RST: 0

Manual operation: See "[Data Index](#)" on page 911

TRIGger<m>:DPHY:ESINdex:MIN <SymbolType>

Specifies an escape mode data index minimum, or sets the the start value of a range.

Parameters:

<SymbolType> Range: 0 to 255
 Increment: 1
 *RST: 0

Manual operation: See "[Data Index](#)" on page 911

TRIGger<m>:DPHY:HSVC <HSVC>

Sets the virtual channel to be triggered on.

Parameters:

<HSVC>

Manual operation: See ["Virtual Channel"](#) on page 910

TRIGger<m>:DPHY:WCOunt:CONDition <Format>

Set the condition for the word count. You can define an exact value or a value range.

Parameters:

<Format>

EQUal | NEQUal | LTHan | LETHan | GTHan | GETHan |
INRange | OORange

EQUal | NEQUal | LTHan | LETHan | GTHan | GETHan

Equal, Not equal, Less than, Less or equal than, Greater Than, Greater or equal than. These conditions require one pattern to be set with the corresponding [TRIGger<m>:DPHY:WCOunt:MIN](#) command.

INRange | OORange

In range/Out of range: set the minimum and maximum value of the range with [TRIGger<m>:DPHY:WCOunt:MIN](#) and [TRIGger<m>:DPHY:WCOunt:MAX](#).

*RST: EQUal

Manual operation: See ["Word Count"](#) on page 910

TRIGger<m>:DPHY:WCOunt:MAX <HSWordCountMax>

Sets the the end value of a data type range if [TRIGger<m>:DPHY:WCOunt:CONDition](#) is set to [INRange](#) or [OORange](#).

Parameters:

<HSWordCountMax> Numeric or string pattern, see [Chapter 27.4.6, "Bit pattern parameter"](#), on page 1373. The string parameter accepts the bit value X (don't care).

Manual operation: See ["Word Count"](#) on page 910

TRIGger<m>:DPHY:WCOunt:MIN <HSWordCountMin>

Specifies a word bit pattern, or sets the the start value of a pattern range.

Parameters:

<HSWordCountMin> Numeric or string pattern, see [Chapter 27.4.6, "Bit pattern parameter"](#), on page 1373. The string parameter accepts the bit value X (don't care).

Manual operation: See ["Word Count"](#) on page 910

27.18.24.3 D-PHY decode results

To show the results on the screen, use the following commands:

- [BUS<m>:RESult](#) on page 1814

BUS<m>:DPHY:RESult:FCOunt?.....	2429
BUS<m>:DPHY:RESult:FRAMe<n>:CS?.....	2429
BUS<m>:DPHY:RESult:FRAMe<n>:DATA?.....	2429
BUS<m>:DPHY:RESult:FRAMe<n>:DTName?.....	2430
BUS<m>:DPHY:RESult:FRAMe<n>:DTYPe?.....	2430
BUS<m>:DPHY:RESult:FRAMe<n>:ECC?.....	2431
BUS<m>:DPHY:RESult:FRAMe<n>:PACKet<o>:IDX?.....	2431
BUS<m>:DPHY:RESult:FRAMe<n>:PACKet<o>:VALue?.....	2431
BUS<m>:DPHY:RESult:FRAMe<n>:STARt?.....	2432
BUS<m>:DPHY:RESult:FRAMe<n>:STATe?.....	2432
BUS<m>:DPHY:RESult:FRAMe<n>:STOP?.....	2433
BUS<m>:DPHY:RESult:FRAMe<n>:TYPE?.....	2433
BUS<m>:DPHY:RESult:FRAMe<n>:NUMPackets?.....	2434
BUS<m>:DPHY:RESult:FRAMe<n>:VCHannel?.....	2434

BUS<m>:DPHY:RESult:FCOunt?

Returns the number of decoded frames for the selected serial bus.

Suffix:

<m> 1..4

Return values:

<Count> Range: 0 to 100000
 Increment: 1
 *RST: 0

Usage: Query only

BUS<m>:DPHY:RESult:FRAMe<n>:CS?

Returns the checksum of the specified frame.

Suffix:

<m> 1..4
 Selects the serial bus.

<n> *
 Selects the frame.

Return values:

<CS> Range: 0 to 65535
 Increment: 1
 *RST: 0

Usage: Query only

BUS<m>:DPHY:RESult:FRAMe<n>:DATA?

Returns the data or word count value.

Suffix:

<m> 1..4
Selects the serial bus.

<n> *
Selects the frame.

Return values:

<WordCountOrData> 16 bit integer value
Range: 0 to 65535
Increment: 1
*RST: 0

Example: BUS:DPHY:RESult:FRAMe2:DATA?
<-- 13245

Usage: Query only

BUS<m>:DPHY:RESult:FRAMe<n>:DTName?

Returns the data type name for the specified frame.

Suffix:

<m> 1..4
Selects the serial bus.

<n> *
Selects the frame.

Return values:

<DataTypeName>

Usage: Query only

BUS<m>:DPHY:RESult:FRAMe<n>:DTYPe?

Returns the data type for the specified frame.

Suffix:

<m> 1..4
Selects the serial bus.

<n> *
Selects the frame.

Return values:

<DataType> Range: 0 to 255
Increment: 1
*RST: 0

Usage: Query only

BUS<m>:DPHY:RESult:FRAMe<n>:ECC?

Returns the error correction code (ECC) of the specified frame.

Suffix:

<m> 1..4
Selects the serial bus.

<n> *
Selects the frame.

Return values:

<ECC> Range: 0 to 255
Increment: 1
*RST: 0

Usage: Query only

BUS<m>:DPHY:RESult:FRAMe<n>:PACKet<o>:IDX?

Returns the index of the data payload.

Suffix:

<m> 1..4
Selects the serial bus.

<n> *
Selects the frame.

<o> *
Selects the packet number.

Return values:

<PacketIndex> Range: 0 to 4294967295
Increment: 1
*RST: 0

Usage: Query only

BUS<m>:DPHY:RESult:FRAMe<n>:PACKet<o>:VALue?

Returns the byte value of the data payload.

Suffix:

<m> 1..4
Selects the serial bus.

<n> *
Selects the frame.

<o> *
Selects the packet number.

Return values:

<PacketValue> Range: 0 to 9223372036854775808
 Increment: 1
 *RST: 0

Usage: Query only

BUS<m>:DPHY:RESult:FRAMe<n>:STARt?

Returns the start time of the specified frame.

Suffix:

<m> 1..4
 Selects the serial bus.

<n> *
 Selects the frame.

Return values:

<Start> Range: -100E+24 to 100E+24
 Increment: 100E-12
 *RST: 0
 Default unit: s

Usage: Query only

BUS<m>:DPHY:RESult:FRAMe<n>:STATe?

Returns the overall state of the frame.

Suffix:

<m> 1..4
 Selects the serial bus.

<n> *
 Selects the frame.

Return values:

<State> OK | CS | ECC | ECCWarning | LENGth | FORMat |
 UNKNOWN_FRAME | INComplete

OK
 The frame is valid.

LENGth
 Length error.

UNKNOWN_FRAME
 Unknown frame type

INComplete
 The sequence is not completely contained in the acquisition

*RST: OK

Usage: Query only

BUS<m>:DPHY:RESult:FRAMe<n>:STOP?

Returns the end time of the specified frame.

Suffix:

<m> 1..4
Selects the serial bus.

<n> *
Selects the frame.

Return values:

<Stop> Range: -100E+24 to 100E+24
Increment: 100E-12
*RST: 0
Default unit: s

Usage: Query only

BUS<m>:DPHY:RESult:FRAMe<n>:TYPE?

Returns the type of frame.

Suffix:

<m> 1..4
Selects the serial bus.

<n> *
Selects the frame.

Return values:

<FrameType> HS_SP | HS_LP | HS_INCOMPLETE | LP_HSREQ | LP_TA |
LP_ESC

HS_SP

High speed short packet frame

HS_LP

High speed long packet frame

HS_INCOMPLETE

Incomplete high speed frame

LP_HSREQ

High speed request frame

LP_TA

Low power lane turnaround frame

LP_ESC

Low power escape mode frame

*RST: HS_SP

Usage: Query only

BUS<m>:DPHY:RESult:FRAMe<n>:NUMPackets?

Returns the number of packets in the indicated frame.

Suffix:

<m>	1..4	Selects the serial bus.
<n>	*	Selects the frame.

Return values:

<NumPackets>	Range:	0 to 4294967295
	Increment:	1
	*RST:	0

Usage: Query only

BUS<m>:DPHY:RESult:FRAMe<n>:VCHannel?

Returns the number of virtual channels.

Suffix:

<m>	1..4	Selects the serial bus.
<n>	*	Selects the frame.

Return values:

<VirtualChannel>	Range:	0 to 3
	Increment:	1
	*RST:	0

Usage: Query only

27.18.24.4 D-PHY search settings

SEARch:TRIGger:DPHY:TYPE.....	2435
SEARch:TRIGger:DPHY:DATA:CONDition.....	2435
SEARch:TRIGger:DPHY:DATA:MAX.....	2436
SEARch:TRIGger:DPHY:DATA:MIN.....	2436
SEARch:TRIGger:DPHY:DIDX:CONDition.....	2437
SEARch:TRIGger:DPHY:DIDX:MAX.....	2437
SEARch:TRIGger:DPHY:DIDX:MIN.....	2437
SEARch:TRIGger:DPHY:DTYPE:CONDition.....	2438
SEARch:TRIGger:DPHY:DTYPE:MAX.....	2438
SEARch:TRIGger:DPHY:DTYPE:MIN.....	2438
SEARch:TRIGger:DPHY:ESCMode:CONDition.....	2439
SEARch:TRIGger:DPHY:ESCMode:MAX.....	2439
SEARch:TRIGger:DPHY:ESCMode:MIN.....	2439
SEARch:TRIGger:DPHY:ESDTa:CONDition.....	2440
SEARch:TRIGger:DPHY:ESDTa:MAX.....	2440

SEARCh:TRIGger:DPHY:ESDTa:MIN.....	2441
SEARCh:TRIGger:DPHY:ESINdex:CONDition.....	2441
SEARCh:TRIGger:DPHY:ESINdex:MAX.....	2441
SEARCh:TRIGger:DPHY:ESINdex:MIN.....	2442
SEARCh:TRIGger:DPHY:HSVC.....	2442
SEARCh:TRIGger:DPHY:WCOunt:CONDition.....	2442
SEARCh:TRIGger:DPHY:WCOunt:MAX.....	2443
SEARCh:TRIGger:DPHY:WCOunt:MIN.....	2443

SEARCh:TRIGger:DPHY:TYPE <SearchName>,<Type>

SEARCh:TRIGger:DPHY:TYPE? <SearchName>

Sets the type of frame to be searched for.

Parameters:

<Type> HS_SOP | HS_EOP | HS_PH | HS_DATA | LP_ESC |
LP_TURN | LP_HSRQ

HS_SOP

High speed start of packet

HS_EOP

High speed end of packet

HS_PH

High speed packet header

HS_DATA

High speed data

LP_ESC

Low power escape mode frame

LP_TURN

Low power lane turnaround

LP_HSRQ

Low power high speed request

*RST: HS_SOP

Parameters for setting and query:

<SearchName>

Manual operation: See "[Type](#)" on page 914

SEARCh:TRIGger:DPHY:DATA:CONDition <SearchName>,<Format>

SEARCh:TRIGger:DPHY:DATA:CONDition? <SearchName>

Set the condition for the data value. You can define an exact value or a value range.

Parameters:

<Format> EQUal | NEQUal | LTHan | LETHan | GTHan | GETHan |
INRange | OORange

EQUal | NEQal | LTHan | LETHan | GTHan | GETHan

Equal, Not equal, Less than, Less or equal than, Greater Than, Greater or equal than. These conditions require one data pattern to be set with the corresponding [SEARCh:TRIGGer:DPHY:DATA:MIN](#) command.

INRange | OORange

In range/Out of range: set the minimum and maximum value of the range with [SEARCh:TRIGGer:DPHY:DATA:MIN](#) and [SEARCh:TRIGGer:DPHY:DATA:MAX](#).

*RST: EQUal

Parameters for setting and query:

<SearchName>

Manual operation: See "[Data Value](#)" on page 915

SEARCh:TRIGGer:DPHY:DATA:MAX <SearchName>,<DataMax>

SEARCh:TRIGGer:DPHY:DATA:MAX? <SearchName>

Sets the the end value of a data type range if [SEARCh:TRIGGer:DPHY:DATA:CONDition](#) is set to [INRange](#) or [OORange](#).

Parameters:

<DataMax> Numeric or string pattern, see [Chapter 27.4.6, "Bit pattern parameter"](#), on page 1373. The string parameter accepts the bit value X (don't care).

Parameters for setting and query:

<SearchName>

Manual operation: See "[Data Value](#)" on page 915

SEARCh:TRIGGer:DPHY:DATA:MIN <SearchName>,<DataMin>

SEARCh:TRIGGer:DPHY:DATA:MIN? <SearchName>

Specifies a data bit pattern, or sets the the start value of a pattern range.

Parameters:

<DataMin> Numeric or string pattern, see [Chapter 27.4.6, "Bit pattern parameter"](#), on page 1373. The string parameter accepts the bit value X (don't care).

Parameters for setting and query:

<SearchName>

Manual operation: See "[Data Value](#)" on page 915

SEARCh:TRIGger:DPHY:DIDX:CONDition <SearchName>,<Format>
SEARCh:TRIGger:DPHY:DIDX:CONDition? <SearchName>

Sets the condition for the data index. You can define an exact value or a value range.

Parameters:

<Format> EQUal | LTHan | LETHan | GTHan | GETHan | INRange | RANGE

EQUal | NEQUal | LTHan | LETHan | GTHan | GETHan

Equal, Not equal, Less than, Less or equal than, Greater Than, Greater or equal than. These conditions require one pattern to be set with the corresponding [SEARCh:TRIGger:DPHY:DIDX:MIN](#) command.

INRange = RANGE

In range: Set the minimum and maximum value using [SEARCh:TRIGger:DPHY:DIDX:MIN](#) and [SEARCh:TRIGger:DPHY:DIDX:MAX](#).

*RST: INRange

Parameters for setting and query:

<SearchName>

Manual operation: See "[Data Index](#)" on page 916

SEARCh:TRIGger:DPHY:DIDX:MAX <SearchName>,<DXSymbol>
SEARCh:TRIGger:DPHY:DIDX:MAX? <SearchName>

Sets the the end value of a data index range if [SEARCh:TRIGger:DPHY:DIDX:CONDition](#) is set to INRange or RANGE.

Parameters:

<DXSymbol> Range: 0 to 65535
 Increment: 1
 *RST: 0

Parameters for setting and query:

<SearchName>

Manual operation: See "[Data Index](#)" on page 916

SEARCh:TRIGger:DPHY:DIDX:MIN <SearchName>,<SymbolType>
SEARCh:TRIGger:DPHY:DIDX:MIN? <SearchName>

Specifies a data index minimum, or sets the the start value of a range.

Parameters:

<SymbolType> Range: 0 to 65535
 Increment: 1
 *RST: 0

Parameters for setting and query:

<SearchName>

Manual operation: See ["Data Index"](#) on page 916

SEARCH:TRIGger:DPHY:DTYPE:CONDition <SearchName>,<Format>
SEARCH:TRIGger:DPHY:DTYPE:CONDition? <SearchName>

Set the condition for the data type. You can define an exact value or a value range

Parameters:

<Format>

EQUal | NEQUal | LTHan | LETHan | GTHan | GETHan |
 INRange | OORange

EQUal | NEQUal | LTHan | LETHan | GTHan | GETHan

Equal, Not equal, Less than, Less or equal than, Greater Than, Greater or equal than. These conditions require one pattern to be set with the corresponding [SEARCH:TRIGger:DPHY:DTYPE:MIN](#) command.

INRange | OORange

In range/Out of range: set the minimum and maximum value of the range with [SEARCH:TRIGger:DPHY:DATA:MIN](#) and [SEARCH:TRIGger:DPHY:DATA:MAX](#).

*RST: EQUal

Parameters for setting and query:

<SearchName>

Manual operation: See ["Data Type"](#) on page 915

SEARCH:TRIGger:DPHY:DTYPE:MAX <SearchName>,<HSDataTypeMax>
SEARCH:TRIGger:DPHY:DTYPE:MAX? <SearchName>

Sets the the end value of a data type range if [SEARCH:TRIGger:DPHY:DTYPE:CONDition](#) is set to [INRange](#) or [OORange](#).

Parameters:

<HSDataTypeMax>

Numeric or string pattern, see [Chapter 27.4.6, "Bit pattern parameter"](#), on page 1373. The string parameter accepts the bit value X (don't care).

Parameters for setting and query:

<SearchName>

Manual operation: See ["Data Type"](#) on page 915

SEARCH:TRIGger:DPHY:DTYPE:MIN <SearchName>,<HSDataTypeMin>
SEARCH:TRIGger:DPHY:DTYPE:MIN? <SearchName>

Specifies a data type pattern, or sets the the start value of a pattern range.

Parameters:

<HSDataTypeMin>

Numeric or string pattern, see [Chapter 27.4.6, "Bit pattern parameter"](#), on page 1373. The string parameter accepts the bit value X (don't care).

Parameters for setting and query:

<SearchName>

Manual operation: See ["Data Type"](#) on page 915**SEARCH:TRIGger:DPHY:ESCMODE:CONDition** <SearchName>,<Format>**SEARCH:TRIGger:DPHY:ESCMODE:CONDition?** <SearchName>

Set the condition for the escape mode. You can define an exact value or a value range

Parameters:<Format> EQUal | NEQual | LTHan | LETHan | GTHan | GETHan |
INRange | OORange**EQUal | NEQual | LTHan | LETHan | GTHan | GETHan**Equal, Not equal, Less than, Less or equal than, Greater Than, Greater or equal than. These conditions require one pattern to be set with the corresponding [SEARCH:TRIGger:DPHY:ESCMODE:MIN](#) command.**INRange | OORange**In range/Out of range: set the minimum and maximum value of the range with [SEARCH:TRIGger:DPHY:ESCMODE:MIN](#) and [SEARCH:TRIGger:DPHY:ESCMODE:MAX](#).

*RST: EQUal

Parameters for setting and query:

<SearchName>

Manual operation: See ["Escape mode"](#) on page 916**SEARCH:TRIGger:DPHY:ESCMODE:MAX** <SearchName>,<LPEscapeModeMax>**SEARCH:TRIGger:DPHY:ESCMODE:MAX?** <SearchName>Sets the the end value of an escape mode range if [SEARCH:TRIGger:DPHY:ESCMODE:CONDition](#) is set to [INRange](#) or [OORange](#).**Parameters:**<LPEscapeModeMax>Numeric or string pattern, see [Chapter 27.4.6, "Bit pattern parameter"](#), on page 1373. The string parameter accepts the bit value X (don't care).**Parameters for setting and query:**

<SearchName>

Manual operation: See ["Escape mode"](#) on page 916**SEARCH:TRIGger:DPHY:ESCMODE:MIN** <SearchName>,<LPEscapeModeMin>**SEARCH:TRIGger:DPHY:ESCMODE:MIN?** <SearchName>

Specifies a escape mode bit pattern, or sets the the start value of a pattern range.

Parameters:

<LPEscapeModeMin> Numeric or string pattern, see [Chapter 27.4.6, "Bit pattern parameter"](#), on page 1373. The string parameter accepts the bit value X (don't care).

Parameters for setting and query:

<SearchName>

Manual operation: See ["Escape mode"](#) on page 916

SEARCH:TRIGger:DPHY:ESDTa:CONDition <SearchName>,<Format>

SEARCH:TRIGger:DPHY:ESDTa:CONDition? <SearchName>

Set the condition for the escape mode data value. You can define an exact value or a value range.

Parameters:

<Format>

OFF | ANY | EQUAL | NEQUAL | LTHan | LETHan | GTHan | GETHan | INRange | OORange

EQUAL | NEQUAL | LTHan | LETHan | GTHan | GETHan

Equal, Not equal, Less than, Less or equal than, Greater Than, Greater or equal than. These conditions require one data pattern to be set with the corresponding [SEARCH:TRIGger:DPHY:ESDTa:MIN](#) command.

INRange | OORange

In range/Out of range: set the minimum and maximum value of the range with [SEARCH:TRIGger:DPHY:ESDTa:MIN](#) and [SEARCH:TRIGger:DPHY:ESDTa:MAX](#).

OFF | ANY

Any pattern is detected.

*RST: EQUAL

Parameters for setting and query:

<SearchName>

Manual operation: See ["Data Value"](#) on page 915

SEARCH:TRIGger:DPHY:ESDTa:MAX <SearchName>,<LPEscapeDataMax>

SEARCH:TRIGger:DPHY:ESDTa:MAX? <SearchName>

Sets the the end value of a escape mode data type range if [SEARCH:TRIGger:DPHY:ESDTa:CONDition](#) is set to [INRange](#) or [OORange](#).

Parameters:

<LPEscapeDataMax>

Parameters for setting and query:

<SearchName>

Manual operation: See ["Data Value"](#) on page 915

SEARCh:TRIGger:DPHY:ESDTa:MIN <SearchName>,<LPEscapeDataMin>
SEARCh:TRIGger:DPHY:ESDTa:MIN? <SearchName>

Specifies an escape mode data bit pattern, or sets the the start value of a pattern range.

Parameters:

<LPEscapeDataMin>

Parameters for setting and query:

<SearchName>

Manual operation: See "Data Value" on page 915

SEARCh:TRIGger:DPHY:ESINdex:CONDition <SearchName>,<Format>
SEARCh:TRIGger:DPHY:ESINdex:CONDition? <SearchName>

Sets the condition for the escape mode data index. You can define an exact value or a value range.

Parameters:

<Format>

EQUal | LTHan | LETHan | GTHan | GETHan | INRange | RANGE

EQUal | NEQUal | LTHan | LETHan | GTHan | GETHan

Equal, Not equal, Less than, Less or equal than, Greater Than, Greater or equal than. These conditions require one pattern to be set with the corresponding [SEARCh:TRIGger:DPHY:ESINdex:MIN](#) command.

INRange = RANGE

In range: Set the minimum and maximum value using [SEARCh:TRIGger:DPHY:ESINdex:MIN](#) and [SEARCh:TRIGger:DPHY:ESINdex:MAX](#).

*RST: INRange

Parameters for setting and query:

<SearchName>

Manual operation: See "Data Index" on page 916

SEARCh:TRIGger:DPHY:ESINdex:MAX <SearchName>,<DXSymbol>
SEARCh:TRIGger:DPHY:ESINdex:MAX? <SearchName>

Sets the the end value of a data index range if [SEARCh:TRIGger:DPHY:ESINdex:CONDition](#) is set to INRange or RANGE.

Parameters:

<DXSymbol>

Range: 0 to 255

Increment: 1

*RST: 0

Parameters for setting and query:

<SearchName>

Manual operation: See "[Data Index](#)" on page 916

SEARch:TRIGger:DPHY:ESINdex:MIN <SearchName>,<SymbolType>
SEARch:TRIGger:DPHY:ESINdex:MIN? <SearchName>

Specifies an escape mode data index minimum, or sets the the start value of a range.

Parameters:

<SymbolType> Range: 0 to 255
 Increment: 1
 *RST: 0

Parameters for setting and query:

<SearchName>

Manual operation: See "[Data Index](#)" on page 916

SEARch:TRIGger:DPHY:HSVC <SearchName>,<HSVC>
SEARch:TRIGger:DPHY:HSVC? <SearchName>

Sets the virtual channel to be searched for.

Parameters:

<HSVC>

Parameters for setting and query:

<SearchName>

Manual operation: See "[Virtual Channel](#)" on page 914

SEARch:TRIGger:DPHY:WCOunt:CONDition <SearchName>,<Format>
SEARch:TRIGger:DPHY:WCOunt:CONDition? <SearchName>

Set the condition for the word count. You can define an exact value or a value range.

Parameters:

<Format> EQUal | NEQual | LTHan | LETHan | GTHan | GETHan |
 INRange | OORange

EQUal | NEQual | LTHan | LETHan | GTHan | GETHan

Equal, Not equal, Less than, Less or equal than, Greater Than, Greater or equal than. These conditions require one pattern to be set with the corresponding [SEARch:TRIGger:DPHY:WCOunt:MIN](#) command.

INRange | OORange

In range/Out of range: set the minimum and maximum value of the range with [SEARch:TRIGger:DPHY:WCOunt:MIN](#) and [SEARch:TRIGger:DPHY:WCOunt:MAX](#).

*RST: EQUal

Parameters for setting and query:

<SearchName>

Manual operation: See ["Word Count/ Data"](#) on page 915

SEARCH:TRIGger:DPHY:WCOunt:MAX <SearchName>,<HSWordCountMax>
SEARCH:TRIGger:DPHY:WCOunt:MAX? <SearchName>

Sets the the end value of a data type range if [SEARCH:TRIGger:DPHY:WCOunt:CONDition](#) is set to [INRange](#) or [OORange](#).

Parameters:

<HSWordCountMax> Numeric or string pattern, see [Chapter 27.4.6, "Bit pattern parameter"](#), on page 1373. The string parameter accepts the bit value X (don't care).

Parameters for setting and query:

<SearchName>

Manual operation: See ["Word Count/ Data"](#) on page 915

SEARCH:TRIGger:DPHY:WCOunt:MIN <SearchName>,<HSWordCountMin>
SEARCH:TRIGger:DPHY:WCOunt:MIN? <SearchName>

Specifies a word bit pattern, or sets the the start value of a pattern range.

Parameters:

<HSWordCountMin> Numeric or string pattern, see [Chapter 27.4.6, "Bit pattern parameter"](#), on page 1373. The string parameter accepts the bit value X (don't care).

Parameters for setting and query:

<SearchName>

Manual operation: See ["Word Count/ Data"](#) on page 915

27.18.24.5 D-PHY search results

In all [SEARCH:RESult:DPHY:FRAMe<m>](#) commands, the suffix <m> selects the frame number in the list of search results.

SEARCH:RESult:DPHY:FCOunt?	2444
SEARCH:RESult:DPHY:FRAMe<m>:CS?	2444
SEARCH:RESult:DPHY:FRAMe<m>:DATA?	2444
SEARCH:RESult:DPHY:FRAMe<m>:DTName?	2444
SEARCH:RESult:DPHY:FRAMe<m>:DTYPe?	2445
SEARCH:RESult:DPHY:FRAMe<m>:ECC?	2445
SEARCH:RESult:DPHY:FRAMe<m>:PACKet<n>:IDX?	2445
SEARCH:RESult:DPHY:FRAMe<m>:PACKet<n>:VALue?	2446
SEARCH:RESult:DPHY:FRAMe<m>:START?	2446
SEARCH:RESult:DPHY:FRAMe<m>:STATe?	2446
SEARCH:RESult:DPHY:FRAMe<m>:STOP?	2447
SEARCH:RESult:DPHY:FRAMe<m>:TYPE?	2447
SEARCH:RESult:DPHY:FRAMe<m>:VChannel?	2448

SEARCh:RESult:DPHY:FCOunt? <SearchName>

Returns the number of frames within the search result for the selected serial bus.

Query parameters:

<SearchName>

Return values:

<FrameCount> Range: 0 to 100000
 Increment: 1
 *RST: 0

Usage: Query only

SEARCh:RESult:DPHY:FRAMe<m>:CS? <SearchName>

Returns the checksum for the selected frame within the search result.

Suffix:

<m> *

Query parameters:

<SearchName>

Return values:

<CS> Range: 0 to 65535
 Increment: 1
 *RST: 0

Usage: Query only

SEARCh:RESult:DPHY:FRAMe<m>:DATA? <SearchName>

Returns the data or word count value for the selected frame within the search result.

Suffix:

<m> *

Query parameters:

<SearchName>

Return values:

<WordCountOrData> Range: 0 to 65535
 Increment: 1
 *RST: 0

Usage: Query only

SEARCh:RESult:DPHY:FRAMe<m>:DTName? <SearchName>

Returns the data type name for the specified frame within the search result.

Suffix:

<m> *

Query parameters:

<SearchName>

Return values:

<DataTypeName>

Usage: Query only**SEARCh:RESult:DPHY:FRAMe<m>:DTYPe? <SearchName>**

Returns the data type for the specified frame within the search result.

Suffix:

<m> *

Query parameters:

<SearchName>

Return values:

<DataType>	Range:	0 to 255
	Increment:	1
	*RST:	0

Usage: Query only**SEARCh:RESult:DPHY:FRAMe<m>:ECC? <SearchName>**

Returns the error correction code (ECC) of the specified frame within the search result.

Suffix:

<m> *

Query parameters:

<SearchName>

Return values:

<ECC>	Range:	0 to 255
	Increment:	1
	*RST:	0

Usage: Query only**SEARCh:RESult:DPHY:FRAMe<m>:PACKet<n>:IDX? <SearchName>**

Returns the index of the data payload for the selected frame within the search result.

Suffix:

<m> *

<n> *

Query parameters:

<SearchName>

Return values:

<PacketIndex> Range: 0 to 4294967295
 Increment: 1
 *RST: 0

Usage: Query only

SEARch:RESult:DPHY:FRAMe<m>:PACKet<n>:VALue? <SearchName>

Returns the byte value of the data payload for the selected frame within the search result.

Suffix:

<m> *
 <n> *

Query parameters:

<SearchName>

Return values:

<PacketValue> Range: 0 to 9223372036854775808
 Increment: 1
 *RST: 0

Usage: Query only

SEARch:RESult:DPHY:FRAMe<m>:STARt? <SearchName>

Returns the start time of the specified frame within the search result.

Suffix:

<m> *

Query parameters:

<SearchName>

Return values:

<Start> Range: -100E+24 to 100E+24
 Increment: 100E-12
 *RST: 0
 Default unit: s

Usage: Query only

SEARch:RESult:DPHY:FRAMe<m>:STATe? <SearchName>

Returns the overall state of the selected frame within the search result.

Suffix:

<m> *

Query parameters:

<SearchName>

Return values:

<State> OK | CS | ECC | ECCWarning | LENGth | FORMat | UNKNOWN_FRAME | INComplete

OK

The frame is valid.

LENGth

Length error.

UNKNOWN_FRAME

Unknown frame type

*RST: OK

Usage: Query only**SEARCh:RESult:DPHY:FRAMe<m>:STOP? <SearchName>**

Returns the end time for the selected frame within the search result.

Suffix:

<m> *

Query parameters:

<SearchName>

Return values:<Stop> Range: -100E+24 to 100E+24
Increment: 100E-12
*RST: 0
Default unit: s**Usage:** Query only**SEARCh:RESult:DPHY:FRAMe<m>:TYPE? <SearchName>**

Returns the type of frame for the selected frame within the search result.

Suffix:

<m> *

Query parameters:

<SearchName>

Return values:

<FrameType> HS_SP | HS_LP | HS_INCOMPLETE | LP_HSREQ | LP_TA | LP_ESC

HS_SP

High speed short packet frame

HS_LP

High speed long packet frame

HS_INCOMPLETE

Incomplete high speed frame

LP_HSREQ

High speed request frame

LP_TA

Low power lane turnaround frame

LP_ESC

Low power escape mode frame

*RST: HS_SP

Usage: Query only**SEARCh:RESult:DPHY:FRAMe<m>:VCHannel? <SearchName>**

Returns the number of virtual channels for the selected frame within the search result.

Suffix:

<m> *

Query parameters:

<SearchName>

Return values:

<VirtualChannel>	Range:	0 to 3
	Increment:	1
	*RST:	0

Usage: Query only**27.18.25 M-PHY (option R&S RTO6-K580)**

- [Configuration](#).....2448
- [Trigger M-PHY](#)..... 2451
- [Decode results M-PHY](#).....2468
- [Search settings M-PHY](#).....2475
- [Search results M-PHY](#).....2492
- [Trigger USB SSIC \(Option R&S RTO6-K570\)](#).....2497
- [Search settings USB SSIC \(Option R&S RTO6-K570\)](#).....2502

27.18.25.1 Configuration

BUS<m>:MPHY:VARiant	2449
BUS<m>:MPHY:DLANes	2449
BUS<m>:MPHY:DZERo:SOURce	2449
BUS<m>:MPHY:DONE:SOURce	2450
BUS<m>:MPHY:DTWO:SOURce	2450
BUS<m>:MPHY:DTHRee:SOURce	2450
BUS<m>:MPHY:DZERo:THReshold	2450
BUS<m>:MPHY:DONE:THReshold	2450

BUS<m>:MPHY:DTWO:THReshold.....	2450
BUS<m>:MPHY:DTHRee:THReshold.....	2450
BUS<m>:MPHY:THCoupling.....	2450
BUS<m>:MPHY:THPReset.....	2451
BUS<m>:MPHY:SCRMode.....	2451
BUS<m>:MPHY:SMLanes.....	2451

BUS<m>:MPHY:VARiant <Protocol>

Selects the protocol running on the interface.

Suffix:

<m> 1..4
Selects the serial bus.

Parameters:

<Protocol> MPHY | UNIPRO | SSIC
*RST: MPHY

Manual operation: See "[Variant](#)" on page 920

BUS<m>:MPHY:DLANes <DataLaneCount>

Sets the number of data lanes.

Suffix:

<m> 1..4
Selects the serial bus.

Parameters:

<DataLaneCount> Range: 1 to 4
Increment: 1
*RST: 4

Manual operation: See "[Lanes](#)" on page 921

BUS<m>:MPHY:DZERo:SOURce <DataSource>

Sets the source for the lane.

Suffix:

<m> 1..4

Parameters:

<DataSource> C1W1 | C2W1 | C3W1 | C4W1 | M1 | M2 | M3 | M4 | M5 | M6 |
M7 | M8 | R1 | R2 | R3 | R4
*RST: C1W1

Manual operation: See "[Lane 0 / Lane 1 / Lane 2 / Lane 3: Channel](#)" on page 921

BUS<m>:MPHY:DONE:SOURce <DataSource>
BUS<m>:MPHY:DTWO:SOURce <DataSource>
BUS<m>:MPHY:DTHRee:SOURce <DataSource>

Selects the source of the corresponding data lane.

Suffix:

<m> 1..4
 Selects the serial bus.

Parameters:

<DataSource> C1W1 | C2W1 | C3W1 | C4W1 | M1 | M2 | M3 | M4 | M5 | M6 |
 M7 | M8 | R1 | R2 | R3 | R4 | NONE
 *RST: DONE: C2W1, DTWo: C3W1, DTHree: C4W1

Manual operation: See "[Lane 0 / Lane 1 / Lane 2 / Lane 3: Channel](#)" on page 921

BUS<m>:MPHY:DZERO:THReshold <ThresholdD0>
BUS<m>:MPHY:DONE:THReshold <ThresholdD1>
BUS<m>:MPHY:DTWO:THReshold <ThresholdD2>
BUS<m>:MPHY:DTHRee:THReshold <ThresholdD3>

Sets the threshold value for the respective lane.

Suffix:

<m> 1..4
 Selects the serial bus.

Parameters:

<ThresholdD1> Range: 0 to 1
 <ThresholdD2> Increment: 0.01
 <ThresholdD3> *RST: 0.1
 Default unit: V

Manual operation: See "[Threshold setup](#)" on page 921

BUS<m>:MPHY:THCoupling <Coupling>

Enables the same threshold value to be used for all lanes.

When the threshold coupling is disabled, changes to the threshold value only affect the respective lane.

Suffix:

<m> 1..4
 Selects the serial bus.

Parameters:

<Coupling> ON | OFF
 *RST: ON

Manual operation: See "[Threshold setup](#)" on page 921

BUS<m>:MPHY:THPReset <ThresholdPreset>

Selects the predefined value to preset the threshold value of the data lanes.

Suffix:

<m> 1..4
Selects the serial bus.

Parameters:

<ThresholdPreset> THRES_60MV | THRES_120MV | THRES_240MV | MANual
THRES_60MV | THRES_120MV | THRES_240MV
Sets the threshold value of the data lane to the selected predefined value.
MANual
Automatically switches to this option if you edit the threshold text box manually.
*RST: MANual

BUS<m>:MPHY:SCRMode <SSICScrambleMd>

Sets if the SSIC data is scrambled or unscrambled.

Suffix:

<m> 1..4

Parameters:

<SSICScrambleMd> SCRM | NSCR
SCRM: scrambled
NSCR: unscrambled
*RST: SCRM

Manual operation: See "[Scrambled Mode](#)" on page 922

BUS<m>:MPHY:SMLanes <Active>

Enables the display of the results in multiple lanes.

Suffix:

<m> 1..4

Parameters:

<Active> ON | OFF
*RST: ON

Manual operation: See "[Show multiple lanes](#)" on page 922

27.18.25.2 Trigger M-PHY

The trigger suffix <m> is always 1 and can be omitted. It selects the trigger event: Only the A-trigger is available for triggering on serial buses.

To trigger on a serial bus, make sure that:

- `TRIGger<m>:SOURce[:SElect]` is set to SBUS.
- The sources of the serial bus are channel signals: use `BUS<m>:...:SOURce` commands.
- Decoding is enabled: `BUS<m>[:STATe]` is set to ON.

<code>TRIGger<m>:MPHY:TYPE</code>	2453
<code>TRIGger<m>:MPHY:LCCType</code>	2453
<code>TRIGger<m>:MPHY:LWONe:CONDition</code>	2454
<code>TRIGger<m>:MPHY:LWONe:MIN</code>	2455
<code>TRIGger<m>:MPHY:LWONe:MAX</code>	2455
<code>TRIGger<m>:MPHY:LWTWo:CONDition</code>	2455
<code>TRIGger<m>:MPHY:LWTWo:MIN</code>	2456
<code>TRIGger<m>:MPHY:LWTWo:MAX</code>	2456
<code>TRIGger<m>:MPHY:LWTHree:CONDition</code>	2456
<code>TRIGger<m>:MPHY:LWTHree:MIN</code>	2457
<code>TRIGger<m>:MPHY:LWTHree:MAX</code>	2457
<code>TRIGger<m>:MPHY:LWFour:CONDition</code>	2457
<code>TRIGger<m>:MPHY:LWFour:MIN</code>	2458
<code>TRIGger<m>:MPHY:LWFour:MAX</code>	2458
<code>TRIGger<m>:MPHY:TC</code>	2458
<code>TRIGger<m>:MPHY:DATA:DCON</code>	2459
<code>TRIGger<m>:MPHY:DATA:DMIN</code>	2459
<code>TRIGger<m>:MPHY:DATA:DMAX</code>	2459
<code>TRIGger<m>:MPHY:DATA:ICONdition</code>	2460
<code>TRIGger<m>:MPHY:DATA:IMIN</code>	2460
<code>TRIGger<m>:MPHY:DATA:IMAX</code>	2460
<code>TRIGger<m>:MPHY:FSNumber:CONDition</code>	2461
<code>TRIGger<m>:MPHY:FSNumber:MIN</code>	2461
<code>TRIGger<m>:MPHY:FSNumber:MAX</code>	2461
<code>TRIGger<m>:MPHY:CRC:CONDition</code>	2462
<code>TRIGger<m>:MPHY:CRC:MIN</code>	2462
<code>TRIGger<m>:MPHY:CRC:MAX</code>	2462
<code>TRIGger<m>:MPHY:CREQ</code>	2463
<code>TRIGger<m>:MPHY:RREQ</code>	2463
<code>TRIGger<m>:MPHY:CREDit:CONDition</code>	2463
<code>TRIGger<m>:MPHY:CREDit:MIN</code>	2464
<code>TRIGger<m>:MPHY:CREDit:MAX</code>	2464
<code>TRIGger<m>:MPHY:PBEGin:CONDition</code>	2464
<code>TRIGger<m>:MPHY:PBEGin:MIN</code>	2465
<code>TRIGger<m>:MPHY:PBEGin:MAX</code>	2465
<code>TRIGger<m>:MPHY:PFID:CONDition</code>	2465
<code>TRIGger<m>:MPHY:PFID:MIN</code>	2466
<code>TRIGger<m>:MPHY:PFID:MAX</code>	2466
<code>TRIGger<m>:MPHY:PRPLength</code>	2466
<code>TRIGger<m>:MPHY:ERRor:LCMD</code>	2467
<code>TRIGger<m>:MPHY:ERRor:LENGth</code>	2467
<code>TRIGger<m>:MPHY:ERRor:REServed</code>	2467
<code>TRIGger<m>:MPHY:ERRor:SYMBol</code>	2467
<code>TRIGger<m>:MPHY:ERRor:UNKNown</code>	2468

TRIGger<m>:MPHY:TYPE <Type>

Selects the type of frame to be triggered on.

Suffix:

<m> 1..3

Parameters:

<Type> START | BURST | ADAPT | LCC | DLPDUSOF | DLPDUCOF | DLPDUEOF | DLPDUNAC | DLPDUAFC | PACP | TRIGUPR0 | TRIGUPR1 | TRIGUPR2 | ERRor

START

M-PHY or UniPro start of frame.

BURST

M-PHY burst frame.

ADAPT

M-PHY Adapt frame. This control frame is used for clock/bit synchronization.

LCC

M-PHY LCC frame. This control frame is used for line configuration depending on the [LCC Type](#).

DLPDUSOF | DLPDUCOF | DLPDUEOF | DLPDUNAC | DLPDUAFC

UniPro DL PDU frame.

PACP

UniPro PACP frame. This control frame is used mainly for power mode change and L1.5 link management.

TRIGUPR0 | TRIGUPR1 | TRIGUPR2

UniPro Trigger Upper frame. This control frame is used for link startup sequence.

ERRor

M-PHY or UniPro error frame.

*RST: START

Manual operation: See "[Type](#)" on page 923

TRIGger<m>:MPHY:LCCType <LCCType>

Selects the type of LCC frame to be triggered on.

Suffix:

<m> 1..3

Parameters:

<LCCType> ANY | SLEEP | STALL | READCAP | READMFG | READVEND | WRITEATTR | PWMG0 | PWMG1 | PWMG2 | PWMG3 | PWMG4 | PWMG5 | PWMG6 | PWMG7 | HSG1A | HSG2A | HSG3A | HSG4A | HSG1B | HSG2B | HSG3B | HSG4B | RESERVED

ANY

All the available LCC commands.

SLEEP

Switches the power-saving state to ultra-low power. In this state, up to 90% power saving is achieved.

STALL

Switches the power-saving state to ultra-low power. In this state, up to 75% power saving is achieved.

READCAP

Recovers data about the OMC's capabilities.

READMFG

Retrieves manufacturing ID and vendor-specific information.

READVEND

Retrieves the additional four delimited bytes containing vendor-specific information.

WRITEATTR

Sets the configuration parameters required for lane operation.

PWMG0 | PWMG1 | PWMG2 | PWMG3 | PWMG4 | PWMG5 | PWMG6 | PWMG7

Switches the transmission mode to the selected low-power gear.

HSG1A | HSG2A | HSG3A | HSG4A | HSG1B | HSG2B | HSG3B | HSG4B

Switches the transmission mode to the selected high-speed gear.

RESERVED

Reserved bit command. These bits are reserved for future use.

*RST: ANY

Manual operation: See "[LCC Type](#)" on page 929

TRIGger<m>:MPHY:LWONe:CONDition <CondOperator>

Sets the condition for WORD 1. You can define an exact value or a value range.

Suffix:

<m> 1..3

Parameters:

<CondOperator> EQUal | NEQual | LTHan | LETHan | GTHan | GETHan | INRange | OORange

EQUal | NEQual | LTHan | LETHan | GTHan | GETHan

Equal, Not equal, Less than, Less or equal than, Greater Than, Greater or equal than. These conditions require one pattern to be set with the corresponding [TRIGger<m>:MPHY:LWONe:MIN](#) command.

INRange | OORange

In range/Out of range: set the minimum and maximum value of the range with `TRIGger<m>:MPHY:LWONe:MIN` and `TRIGger<m>:MPHY:LWONe:MAX`.

*RST: EQUal

Manual operation: See "[WORD 1/WORD 2/WORD 3/WORD 4](#)" on page 930

TRIGger<m>:MPHY:LWONe:MIN <LCCWORD1Min>

Specifies the WORD 1 pattern, or sets the start value of a pattern range.

Suffix:

<m> 1..3

Parameters:

<LCCWORD1Min> Numeric or string pattern, see [Chapter 27.4.6, "Bit pattern parameter"](#), on page 1373. The string parameter accepts the bit value X (don't care).

Manual operation: See "[WORD 1/WORD 2/WORD 3/WORD 4](#)" on page 930

TRIGger<m>:MPHY:LWONe:MAX <LCCWORD1Max>

Sets the end value of the WORD 1 range if `TRIGger<m>:MPHY:LWONe:CONDition` is set to `INRange` or `OORange`.

Suffix:

<m> 1..3

Parameters:

<LCCWORD1Max> Numeric or string pattern, see [Chapter 27.4.6, "Bit pattern parameter"](#), on page 1373. The string parameter accepts the bit value X (don't care).

Manual operation: See "[WORD 1/WORD 2/WORD 3/WORD 4](#)" on page 930

TRIGger<m>:MPHY:LWTWo:CONDition <CondOperator>

Sets the condition for WORD 2. You can define an exact value or a value range.

Suffix:

<m> 1..3

Parameters:

<CondOperator> EQUal | NEQual | LTHan | LETHan | GTHan | GETHan | INRange | OORange

EQUal | NEQual | LTHan | LETHan | GTHan | GETHan

Equal, Not equal, Less than, Less or equal than, Greater Than, Greater or equal than. These conditions require one pattern to be set with the corresponding `TRIGger<m>:MPHY:LWTWo:MIN` command.

INRange | OORange

In range/Out of range: set the minimum and maximum value of the range with `TRIGger<m>:MPHY:LWTWo:MIN` and `TRIGger<m>:MPHY:LWTWo:MAX`.

*RST: EQUal

Manual operation: See "[WORD 1/WORD 2/WORD 3/WORD 4](#)" on page 930

TRIGger<m>:MPHY:LWTWo:MIN <LCCWORD2Min>

Specifies the WORD 2 pattern, or sets the start value of a pattern range.

Suffix:

<m> 1..3

Parameters:

<LCCWORD2Min> Numeric or string pattern, see [Chapter 27.4.6, "Bit pattern parameter"](#), on page 1373. The string parameter accepts the bit value X (don't care).

Manual operation: See "[WORD 1/WORD 2/WORD 3/WORD 4](#)" on page 930

TRIGger<m>:MPHY:LWTWo:MAX <LCCWORD2Max>

Sets the end value of the WORD 2 range if `TRIGger<m>:MPHY:LWTWo:CONDition` is set to `INRange` or `OORange`.

Suffix:

<m> 1..3

Parameters:

<LCCWORD2Max> Numeric or string pattern, see [Chapter 27.4.6, "Bit pattern parameter"](#), on page 1373. The string parameter accepts the bit value X (don't care).

Manual operation: See "[WORD 1/WORD 2/WORD 3/WORD 4](#)" on page 930

TRIGger<m>:MPHY:LWTHree:CONDition <CondOperator>

Sets the condition for WORD 3. You can define an exact value or a value range.

Suffix:

<m> 1..3

Parameters:

<CondOperator> EQUal | NEQual | LTHan | LETHan | GTHan | GETHan | INRange | OORange

EQUal | NEQual | LTHan | LETHan | GTHan | GETHan

Equal, Not equal, Less than, Less or equal than, Greater Than, Greater or equal than. These conditions require one pattern to be set with the corresponding `TRIGger<m>:MPHY:LWTHree:MIN` command.

INRange | OORange

In range/Out of range: set the minimum and maximum value of the range with `TRIGger<m>:MPHY:LWTHree:MIN` and `TRIGger<m>:MPHY:LWTHree:MAX`.

*RST: EQUal

Manual operation: See "[WORD 1/WORD 2/WORD 3/WORD 4](#)" on page 930

TRIGger<m>:MPHY:LWTHree:MIN <LCCWORD3Min>

Specifies the WORD 3 pattern, or sets the start value of a pattern range.

Suffix:

<m> 1..3

Parameters:

<LCCWORD3Min> Numeric or string pattern, see [Chapter 27.4.6, "Bit pattern parameter"](#), on page 1373. The string parameter accepts the bit value X (don't care).

Manual operation: See "[WORD 1/WORD 2/WORD 3/WORD 4](#)" on page 930

TRIGger<m>:MPHY:LWTHree:MAX <LCCWORD3Max>

Sets the end value of the WORD 3 range if `TRIGger<m>:MPHY:LWTHree:CONDition` is set to `INRange` or `OORange`.

Suffix:

<m> 1..3

Parameters:

<LCCWORD3Max> Numeric or string pattern, see [Chapter 27.4.6, "Bit pattern parameter"](#), on page 1373. The string parameter accepts the bit value X (don't care).

Manual operation: See "[WORD 1/WORD 2/WORD 3/WORD 4](#)" on page 930

TRIGger<m>:MPHY:LWFour:CONDition <CondOperator>

Sets the condition for WORD 4. You can define an exact value or a value range.

Suffix:

<m> 1..3

Parameters:

<CondOperator> EQUal | NEQual | LTHan | LETHan | GTHan | GETHan | INRange | OORange

EQUal | NEQual | LTHan | LETHan | GTHan | GETHan

Equal, Not equal, Less than, Less or equal than, Greater Than, Greater or equal than. These conditions require one pattern to be set with the corresponding `TRIGger<m>:MPHY:LWFour:MIN` command.

INRange | OORange

In range/Out of range: set the minimum and maximum value of the range with `TRIGger<m>:MPHY:LWFour:MIN` and `TRIGger<m>:MPHY:LWFour:MAX`.

*RST: EQUal

Manual operation: See "[WORD 1/WORD 2/WORD 3/WORD 4](#)" on page 930

TRIGger<m>:MPHY:LWFour:MIN <LCCWORD4Min>

Specifies the WORD 4 pattern, or sets the start value of a pattern range.

Suffix:

<m> 1..3

Parameters:

<LCCWORD4Min> Numeric or string pattern, see [Chapter 27.4.6, "Bit pattern parameter"](#), on page 1373. The string parameter accepts the bit value X (don't care).

Manual operation: See "[WORD 1/WORD 2/WORD 3/WORD 4](#)" on page 930

TRIGger<m>:MPHY:LWFour:MAX <LCCWORD4Max>

Sets the end value of the WORD 4 range if `TRIGger<m>:MPHY:LWFour:CONDition` is set to `INRange` or `OORange`.

Suffix:

<m> 1..3

Parameters:

<LCCWORD4Max> Numeric or string pattern, see [Chapter 27.4.6, "Bit pattern parameter"](#), on page 1373. The string parameter accepts the bit value X (don't care).

Manual operation: See "[WORD 1/WORD 2/WORD 3/WORD 4](#)" on page 930

TRIGger<m>:MPHY:TC <TC>

Specifies the TC bit pattern.

Suffix:

<m> 1..3

Parameters:

<TC> Numeric or string pattern, see [Chapter 27.4.6, "Bit pattern parameter"](#), on page 1373. The string parameter accepts the bit value X (don't care).

Manual operation: See "[TC](#)" on page 930

TRIGger<m>:MPHY:DATA:DCON <DataOperator>

Sets the condition for the data. You can define an exact value or a value range.

Suffix:

<m> 1..3

Parameters:

<DataOperator> EQUal | NEQUal | LTHan | LETHan | GTHan | GETHan | INRange | OORange

EQUal | NEQUal | LTHan | LETHan | GTHan | GETHan

Equal, Not equal, Less than, Less or equal than, Greater Than, Greater or equal than. These conditions require one data pattern to be set with the corresponding [TRIGger<m>:MPHY:DATA:DMIN](#) command.

INRange | OORange

In range/Out of range: set the minimum and maximum value of the range with [TRIGger<m>:MPHY:DATA:DMIN](#) and [TRIGger<m>:MPHY:DATA:DMAX](#).

*RST: EQUal

Manual operation: See "[Data](#)" on page 931

TRIGger<m>:MPHY:DATA:DMIN <DataMin>

Specifies the data bit pattern, or sets the start value of a pattern range.

Suffix:

<m> 1..3

Parameters:

<DataMin> Numeric or string pattern, see [Chapter 27.4.6, "Bit pattern parameter"](#), on page 1373. The string parameter accepts the bit value X (don't care).

Manual operation: See "[Data](#)" on page 931

TRIGger<m>:MPHY:DATA:DMAX <DataMax>

Sets the end value of the data range if [TRIGger<m>:MPHY:DATA:DCON](#) is set to INRange or OORange.

Suffix:

<m> 1..3

Parameters:

<DataMax> Numeric or string pattern, see [Chapter 27.4.6, "Bit pattern parameter"](#), on page 1373. The string parameter accepts the bit value X (don't care).

Manual operation: See "[Data](#)" on page 931

TRIGger<m>:MPHY:DATA:ICONdition <DataIdxOperator>

Sets the condition for the index. You can define an exact value or a value range.

Suffix:

<m> 1..3

Parameters:

<DataIdxOperator> EQUal | LTHan | LETHan | GTHan | GETHan | INRange | RANGE

EQUal | LTHan | LETHan | GTHan | GETHan

Equal, Less than, Less or equal than, Greater Than, Greater or equal than. These conditions require one pattern to be set with the corresponding [TRIGger<m>:MPHY:DATA:IMIN](#) command.

INRange = RANGE

In range: Set the minimum and maximum value using [TRIGger<m>:MPHY:DATA:IMIN](#) and [TRIGger<m>:MPHY:DATA:IMAX](#).

*RST: INRange

Manual operation: See "[Index](#)" on page 931

TRIGger<m>:MPHY:DATA:IMIN <DataIndexMin>

Specifies the index minimum, or sets the start value of a range.

Suffix:

<m> 1..3

Parameters:

<DataIndexMin> Range: 1 to 0
Increment: 1
*RST: 1

Manual operation: See "[Index](#)" on page 931

TRIGger<m>:MPHY:DATA:IMAX <DataIndexMax>

Sets the end value of the index range if [TRIGger<m>:MPHY:DATA:ICONdition](#) is set to INRange or RANGE.

Suffix:

<m> 1..3

Parameters:

<DataIndexMax> Range: 1 to 0
Increment: 1
*RST: 0

Manual operation: See "[Index](#)" on page 931

TRIGger<m>:MPHY:FSNumber:CONDition <FSNOperator>

Sets the condition for FSN. You can define an exact value or a value range.

Suffix:

<m> 1..3

Parameters:

<FSNOperator> EQUal | NEQual | LTHan | LETHan | GTHan | GETHan | INRange | OORange

EQUal | NEQual | LTHan | LETHan | GTHan | GETHan

Equal, Not equal, Less than, Less or equal than, Greater Than, Greater or equal than. These conditions require one data pattern to be set with the corresponding [TRIGger<m>:MPHY:FSNumber:MIN](#) command.

INRange | OORange

In range/Out of range: set the minimum and maximum value of the range with [TRIGger<m>:MPHY:FSNumber:MIN](#) and [TRIGger<m>:MPHY:FSNumber:MAX](#).

*RST: EQUal

Manual operation: See "[FSN](#)" on page 931

TRIGger<m>:MPHY:FSNumber:MIN <FSNMin>

Specifies the FSN bit pattern, or sets the start value of a pattern range.

Suffix:

<m> 1..3

Parameters:

<FSNMin> Numeric or string pattern, see [Chapter 27.4.6, "Bit pattern parameter"](#), on page 1373. The string parameter accepts the bit value X (don't care).

Manual operation: See "[FSN](#)" on page 931

TRIGger<m>:MPHY:FSNumber:MAX <FSNMax>

Sets the end value of the FSN range if [TRIGger<m>:MPHY:FSNumber:CONDition](#) is set to [INRange](#) or [OORange](#).

Suffix:

<m> 1..3

Parameters:

<FSNMax> Numeric or string pattern, see [Chapter 27.4.6, "Bit pattern parameter"](#), on page 1373. The string parameter accepts the bit value X (don't care).

Manual operation: See "[FSN](#)" on page 931

TRIGger<m>:MPHY:CRC:CONDition <CRCOperator>

Sets the condition for CRC. You can define an exact value or a value range.

Suffix:

<m> 1..3

Parameters:

<CRCOperator> EQUal | NEQual | LTHan | LETHan | GTHan | GETHan | INRange | OORange

EQUal | NEQual | LTHan | LETHan | GTHan | GETHan

Equal, Not equal, Less than, Less or equal than, Greater Than, Greater or equal than. These conditions require one data pattern to be set with the corresponding [TRIGger<m>:MPHY:CRC:MIN](#) command.

INRange | OORange

In range/Out of range: set the minimum and maximum value of the range with [TRIGger<m>:MPHY:CRC:MIN](#) and [TRIGger<m>:MPHY:CRC:MAX](#).

*RST: EQUal

Manual operation: See "[CRC](#)" on page 932

TRIGger<m>:MPHY:CRC:MIN <CRCMin>

Specifies the CRC bit pattern, or sets the start value of a pattern range.

Suffix:

<m> 1..3

Parameters:

<CRCMin> Numeric or string pattern, see [Chapter 27.4.6, "Bit pattern parameter"](#), on page 1373. The string parameter accepts the bit value X (don't care).

Manual operation: See "[CRC](#)" on page 932

TRIGger<m>:MPHY:CRC:MAX <CRCMax>

Sets the end value of the CRC range if [TRIGger<m>:MPHY:CRC:CONDition](#) is set to [INRange](#) or [OORange](#).

Suffix:

<m> 1..3

Parameters:

<CRCMax> Numeric or string pattern, see [Chapter 27.4.6, "Bit pattern parameter"](#), on page 1373. The string parameter accepts the bit value X (don't care).

Manual operation: See "[CRC](#)" on page 932

TRIGger<m>:MPHY:CREQ <REQ>

Specifies the CREQ bit pattern.

Suffix:

<m> 1..3

Parameters:

<REQ> ONE | ZERO | DC

ONE

Sets the trigger condition to binary 1.

ZERO

Sets the trigger condition to binary 0.

DC

Sets the trigger condition to any CREQ value (don't care).

*RST: DC

Manual operation: See "[Req](#)" on page 932

TRIGger<m>:MPHY:RREQ <REQ>

Specifies the RREQ bit pattern.

Suffix:

<m> 1..3

Parameters:

<REQ> ONE | ZERO | DC

ONE

Sets the trigger condition to binary 1.

ZERO

Sets the trigger condition to binary 0.

DC

Sets the trigger condition to any RREQ value (don't care).

*RST: DC

Manual operation: See "[Req](#)" on page 932

TRIGger<m>:MPHY:CREdit:CONDition <CreditOperator>

Sets the condition for Credit. You can define an exact value or a value range.

Suffix:

<m> 1..3

Parameters:

<CreditOperator> EQUal | NEQUal | LTHan | LETHan | GTHan | GETHan |
INRange | OORange

EQUal | NEQUal | LTHan | LETHan | GTHan | GETHan

Equal, Not equal, Less than, Less or equal than, Greater Than, Greater or equal than. These conditions require one data pattern to be set with the corresponding `TRIGger<m>:MPHY:CREDit:MIN` command.

INRange | OORange

In range/Out of range: set the minimum and maximum value of the range with `TRIGger<m>:MPHY:CREDit:MIN` and `TRIGger<m>:MPHY:CREDit:MAX`.

*RST: EQUal

Manual operation: See "Credit" on page 932

TRIGger<m>:MPHY:CREDit:MIN <CreditMin>

Specifies the Credit bit pattern, or sets the start value of a pattern range.

Suffix:

<m> 1..3

Parameters:

<CreditMin> Numeric or string pattern, see [Chapter 27.4.6, "Bit pattern parameter"](#), on page 1373. The string parameter accepts the bit value X (don't care).

Manual operation: See "Credit" on page 932

TRIGger<m>:MPHY:CREDit:MAX <CreditMax>

Sets the end value of the Credit range if `TRIGger<m>:MPHY:CREDit:CONDition` is set to `INRange` or `OORange`.

Suffix:

<m> 1..3

Parameters:

<CreditMax> Numeric or string pattern, see [Chapter 27.4.6, "Bit pattern parameter"](#), on page 1373. The string parameter accepts the bit value X (don't care).

Manual operation: See "Credit" on page 932

TRIGger<m>:MPHY:PBEGin:CONDition <CondPACPBegin>

Sets the condition for PACP Begin. You can define an exact value or a value range.

Suffix:

<m> 1..3

Parameters:

<CondPACPBegin> EQUal | NEQUal | LTHan | LETHan | GTHan | GETHan | INRange | OORange

EQUal | NEQUal | LTHan | LETHan | GTHan | GETHan

Equal, Not equal, Less than, Less or equal than, Greater Than, Greater or equal than. These conditions require one data pattern to be set with the corresponding `TRIGger<m>:MPHY:PBEGin:MIN` command.

INRange | OORange

In range/Out of range: set the minimum and maximum value of the range with `TRIGger<m>:MPHY:PBEGin:MIN` and `TRIGger<m>:MPHY:PBEGin:MAX`.

*RST: EQUal

Manual operation: See "PACP Begin" on page 933

TRIGger<m>:MPHY:PBEGin:MIN <PACPBEGINMin>

Specifies the PACP Begin bit pattern, or sets the start value of a pattern range.

Suffix:

<m> 1..3

Parameters:

<PACPBEGINMin> Numeric or string pattern, see [Chapter 27.4.6, "Bit pattern parameter"](#), on page 1373. The string parameter accepts the bit value X (don't care).

Manual operation: See "PACP Begin" on page 933

TRIGger<m>:MPHY:PBEGin:MAX <PACPBEGINMax>

Sets the end value of the PACP Begin range if `TRIGger<m>:MPHY:PBEGin:CONDition` is set to `INRange` or `OORange`.

Suffix:

<m> 1..3

Parameters:

<PACPBEGINMax> Numeric or string pattern, see [Chapter 27.4.6, "Bit pattern parameter"](#), on page 1373. The string parameter accepts the bit value X (don't care).

Manual operation: See "PACP Begin" on page 933

TRIGger<m>:MPHY:PFID:CONDition <CondPACPFunc>

Sets the condition for PACP Function ID. You can define an exact value or a value range.

Suffix:

<m> 1..3

Parameters:

<CondPACPFunc> EQUal | NEQual | LTHan | LETHan | GTHan | GETHan | INRange | OORange

EQUal | NEQual | LTHan | LETHan | GTHan | GETHan

Equal, Not equal, Less than, Less or equal than, Greater Than, Greater or equal than. These conditions require one data pattern to be set with the corresponding [TRIGger<m>:MPHY:PFID:MIN](#) command.

INRange | OORange

In range/Out of range: set the minimum and maximum value of the range with [TRIGger<m>:MPHY:PFID:MIN](#) and [TRIGger<m>:MPHY:PFID:MAX](#).

*RST: EQUal

Manual operation: See "[PACP Function ID](#)" on page 933

TRIGger<m>:MPHY:PFID:MIN <PACPFunIDMin>

Specifies the PACP Function ID bit pattern, or sets the start value of a pattern range.

Suffix:

<m> 1..3

Parameters:

<PACPFunIDMin> Numeric or string pattern, see [Chapter 27.4.6, "Bit pattern parameter"](#), on page 1373. The string parameter accepts the bit value X (don't care).

Manual operation: See "[PACP Function ID](#)" on page 933

TRIGger<m>:MPHY:PFID:MAX <PACPFunIDMax>

Sets the end value of the PACP Function ID range if [TRIGger<m>:MPHY:PFID:CONDition](#) is set to [INRange](#) or [OORange](#).

Suffix:

<m> 1..3

Parameters:

<PACPFunIDMax> Numeric or string pattern, see [Chapter 27.4.6, "Bit pattern parameter"](#), on page 1373. The string parameter accepts the bit value X (don't care).

Manual operation: See "[PACP Function ID](#)" on page 933

TRIGger<m>:MPHY:PRPLength <Width>

Sets the width for the width trigger based upon the data rate.

Suffix:

<m> 1..3

Parameters:

<Width> Range: 100E-12 to 10000
 Increment: 100E-9
 *RST: 5E-9
 Default unit: s

TRIGger<m>:MPHY:ERRor:LCMD <LCCError>

Enables/disables trigger on LCC error.

Suffix:

<m> 1..3

Parameters:

<LCCError> ON | OFF
 *RST: ON

Manual operation: See "[LCC Command Error](#)" on page 934**TRIGger<m>:MPHY:ERRor:LENGth <ErrorLength>**

Enables/disables trigger on length error.

Suffix:

<m> 1..3

Parameters:

<ErrorLength> ON | OFF
 *RST: ON

Manual operation: See "[Length Error](#)" on page 934**TRIGger<m>:MPHY:ERRor:REServed <ErrorReserved>**

Enables/disables trigger on reserved bit error.

Suffix:

<m> 1..3

Parameters:

<ErrorReserved> ON | OFF
 *RST: ON

Manual operation: See "[Reserved Bit Error](#)" on page 934**TRIGger<m>:MPHY:ERRor:SYMBol <ErrorSymbol>**

Enables/disables trigger on 8b10b symbol error.

Suffix:

<m> 1..3

Parameters:

<ErrorSymbol> ON | OFF
 *RST: ON

Manual operation: See "[8b10b Symbol Error](#)" on page 934

TRIGger<m>:MPHY:ERRor:UNKNown <ErrorUnknown>

Enables/disables trigger on unidentified UniPro frame error.

Suffix:

<m> 1..3

Parameters:

<ErrorUnknown> ON | OFF
 *RST: ON

Manual operation: See "[Unknown Unipro Frame](#)" on page 934

27.18.25.3 Decode results M-PHY

To show the results on the screen, use the following commands:

- [BUS<m>:RESult](#) on page 1814

BUS<m>:MPHY:RESult:FRAMe<n>:FTYPE?	2468
BUS<m>:MPHY:RESult:FRAMe<n>:STATe?	2469
BUS<m>:MPHY:RESult:FCOunt?	2470
BUS<m>:MPHY:RESult:FRAMe<n>:CCOunt?	2470
BUS<m>:MPHY:RESult:FRAMe<n>:CELL<o>:DATA?	2471
BUS<m>:MPHY:RESult:FRAMe<n>:CELL<o>:START?	2471
BUS<m>:MPHY:RESult:FRAMe<n>:CELL<o>:STOP?	2472
BUS<m>:MPHY:RESult:FRAMe<n>:CELL<o>:STATe?	2472
BUS<m>:MPHY:RESult:FRAMe<n>:CELL<o>:TYPE?	2472
BUS<m>:MPHY:RESult:FRAMe<n>:DATA?	2473
BUS<m>:MPHY:RESult:FRAMe<n>:INFO?	2473
BUS<m>:MPHY:RESult:FRAMe<n>:SSFT?	2473
BUS<m>:MPHY:RESult:FRAMe<n>:START?	2474
BUS<m>:MPHY:RESult:FRAMe<n>:STOP?	2474

BUS<m>:MPHY:RESult:FRAMe<n>:FTYPE?

Returns the type of frame for the selected frame.

Suffix:

<m> 1..4
 Selects the serial bus.

<n>	* Selects the frame.
Return values: <FrameType>	<p>BURST ADAPT LCC DLPDUSOF DLPDUCOF DLPDUEOF DLPDUNAC DLPDUAFC PACP TRIGUPR0 TRIGUPR1 TRIGUPR2 SKIP FILLER SPACER UNKNOWN</p> <p>BURST M-PHY burst frame.</p> <p>ADAPT M-PHY Adapt frame. This control frame is used for clock/bit synchronization.</p> <p>LCC M-PHY LCC frame. This control frame is used for line configuration depending on the LCC Type.</p> <p>DLPDUSOF DLPDUCOF DLPDUEOF DLPDUNAC DLPDUAFC UniPro DL PDU frame.</p> <p>PACP UniPro frame. This control frame is used mainly for power mode change and L1.5 link management.</p> <p>TRIGUPR0 TRIGUPR1 TRIGUPR2 UniPro frame. This control frame is used for link startup sequence.</p> <p>SKIP UniPro frame with Skip symbols for reducing protocol payload bandwidth.</p> <p>FILLER M-PHY or UniPro frame with filler words to maintain transmission activity.</p> <p>SPACER Scrambled UniPro frame with filler words.</p> <p>UNKNOWN No meaningful frame can be determined.</p> <p>*RST: UNKNOWN</p>
Usage:	Query only

BUS<m>:MPHY:RESult:FRAMe<n>:STATe?

Returns the state of the frame.

Suffix:

<m>	1..4 Selects the serial bus.
-----	---------------------------------

<n>	*	Selects the frame.
Return values:		
<State>		OK RSVDError CMDERROR SYMBOLERROR UNKNOWNERROR INVALID INCOMPLETE UNCorrelated CRCERROR VOOR LENGTHERROR
		OK Valid frame.
		RSVDERROR Erroneous frame due to reserved bit error.
		CMDERROR Erroneous frame due to LCC error.
		SYMBOLERROR Erroneous frame due to 8b10b symbol error.
		UNKNOWNERROR Erroneous frame due to unidentified UniPro frame error.
		INVALID Invalid frame.
		INCOMPLETE The frame is not complete.
		LENGTHERROR Erroneous frame due to length error.
		*RST: OK
Usage:		Query only

BUS<m>:MPHY:RESult:FCOut?

Returns the number of decoded frames.

Suffix:

<m>	1..4	Selects the serial bus.
-----	------	-------------------------

Return values:

<Count>	Range: 0 to 100000
	Increment: 1
	*RST: 0

Usage: Query only

BUS<m>:MPHY:RESult:FRAMe<n>:CCOut?

Returns the number of decoded cells for the selected frame.

Suffix:

<m>	1..4	Selects the serial bus.
-----	------	-------------------------

<n> *
Selects the frame.

Return values:

<NumWords> Range: 0 to 4294967295
Increment: 1
*RST: 0

Usage: Query only

BUS<m>:MPHY:RESult:FRAMe<n>:CELL<o>:DATA?

Returns the data value for the selected cell.

Suffix:

<m> 1..4
Selects the serial bus.

<n> *
Selects the frame.

<o> *
Selects the cell.

Return values:

<WordValue> Range: 0 to 4294967295
Increment: 1
*RST: 0

Usage: Query only

BUS<m>:MPHY:RESult:FRAMe<n>:CELL<o>:START?

Returns the start time for the selected cell.

Suffix:

<m> 1..4
Selects the serial bus.

<n> *
Selects the frame.

<o> *
Selects the cell.

Return values:

<Start> Range: -100E+24 to 100E+24
Increment: 100E-12
*RST: 0
Default unit: s

Usage: Query only

BUS<m>:MPHY:RESult:FRAMe<n>:CELL<o>:STOP?

Returns the stop time for the selected cell.

Suffix:

<m>	1..4 Selects the serial bus.
<n>	* Selects the frame.
<o>	* Selects the cell.

Return values:

<Stop>	Range: -100E+24 to 100E+24 Increment: 100E-12 *RST: 0 Default unit: s
--------	--

Usage: Query only

BUS<m>:MPHY:RESult:FRAMe<n>:CELL<o>:STATe?

Returns the state for the selected cell.

Suffix:

<m>	1..4 Selects the serial bus.
<n>	* Selects the frame.
<o>	* Selects the cell.

Return values:

<State>	OK RSVDError CMDERROR SYMBOLERROR UNKNOWNERROR INVALID INCOMPLETE UNCorrelated CRCERROR VOOR LENGTHERROR *RST: OK
---------	--

Usage: Query only

BUS<m>:MPHY:RESult:FRAMe<n>:CELL<o>:TYPE?

Returns the data type for the selected cell.

Suffix:

<m>	1..4 Selects the serial bus.
<n>	* Selects the frame.

<0> *
Selects the cell.

Return values:
<WordType>

Usage: Query only

BUS<m>:MPHY:RESult:FRAMe<n>:DATA?

Returns the data for the selected frame, corresponds to the Data column in the decode results table.

Suffix:
<m> 1..4
Selects the serial bus.

<n> *
Selects the frame.

Return values:
<Data>

Usage: Query only

BUS<m>:MPHY:RESult:FRAMe<n>:INFO?

Returns the selected frame label. This label is on top of the frame as seen in the honeycomb display, also corresponds to the Info column in the decode results table.

Suffix:
<m> 1..4
Selects the serial bus.

<n> *
Selects the frame.

Return values:
<Info>

Usage: Query only

BUS<m>:MPHY:RESult:FRAMe<n>:SSFT?

Returns the type of frame for the selected SSIC frame.

Suffix:
<m> 1..4
Selects the serial bus.

<n> *
Selects the frame.

Return values:

<SSICFrameType> TSEQ | TS1 | TS1A | TS1B | TS2 | SLF | U2IT | VDT | PCAP | PCNF | PCNR | LDM | ACK | NRDY | ERDY | STATus | STALI | FWAKe | LTM | BIAM | HRR | SSPD | PING | PNGR | DPH | DPHN | DPP | DPPA | ITP | LC | SKIP | BRST | BDAT | BERC | BCNT | IDLE | CP0 | CP1 | CP2 | CP3 | CP5or6 | UHP | ULMP | UTP | UDVN | UDEF | ERRor | CTLB | DATB | SYNC | SDS
 *RST: UDEF

Usage: Query only

BUS<m>:MPHY:RESult:FRAMe<n>:START?

Returns the start time of the selected frame.

Suffix:

<m> 1..4
 Selects the serial bus.

<n> *
 Selects the frame.

Return values:

<Start> Range: -100E+24 to 100E+24
 Increment: 100E-12
 *RST: 0
 Default unit: s

Usage: Query only

BUS<m>:MPHY:RESult:FRAMe<n>:STOP?

Returns the end time of the selected frame.

Suffix:

<m> 1..4
 Selects the serial bus.

<n> *
 Selects the frame.

Return values:

<Stop> Range: -100E+24 to 100E+24
 Increment: 100E-12
 *RST: 0
 Default unit: s

Usage: Query only

27.18.25.4 Search settings M-PHY

SEARch:TRIGger:MPHY:TYPE.....	2476
SEARch:TRIGger:MPHY:LCCType.....	2476
SEARch:TRIGger:MPHY:LWONe:CONDition.....	2477
SEARch:TRIGger:MPHY:LWONe:MIN.....	2478
SEARch:TRIGger:MPHY:LWONe:MAX.....	2478
SEARch:TRIGger:MPHY:LWTWo:CONDition.....	2478
SEARch:TRIGger:MPHY:LWTWo:MIN.....	2479
SEARch:TRIGger:MPHY:LWTWo:MAX.....	2479
SEARch:TRIGger:MPHY:LWTHree:CONDition.....	2480
SEARch:TRIGger:MPHY:LWTHree:MIN.....	2480
SEARch:TRIGger:MPHY:LWTHree:MAX.....	2480
SEARch:TRIGger:MPHY:LWFour:CONDition.....	2481
SEARch:TRIGger:MPHY:LWFour:MIN.....	2481
SEARch:TRIGger:MPHY:LWFour:MAX.....	2481
SEARch:TRIGger:MPHY:TC.....	2482
SEARch:TRIGger:MPHY:DATA:DCONDition.....	2482
SEARch:TRIGger:MPHY:DATA:DMIN.....	2482
SEARch:TRIGger:MPHY:DATA:DMAX.....	2483
SEARch:TRIGger:MPHY:DATA:ICONDition.....	2483
SEARch:TRIGger:MPHY:DATA:IMIN.....	2484
SEARch:TRIGger:MPHY:DATA:IMAX.....	2484
SEARch:TRIGger:MPHY:FSNumber:CONDition.....	2484
SEARch:TRIGger:MPHY:FSNumber:MIN.....	2485
SEARch:TRIGger:MPHY:FSNumber:MAX.....	2485
SEARch:TRIGger:MPHY:CRC:CONDition.....	2485
SEARch:TRIGger:MPHY:CRC:MIN.....	2486
SEARch:TRIGger:MPHY:CRC:MAX.....	2486
SEARch:TRIGger:MPHY:CREQ.....	2486
SEARch:TRIGger:MPHY:RREQ.....	2487
SEARch:TRIGger:MPHY:CREDit:CONDition.....	2487
SEARch:TRIGger:MPHY:CREDit:MIN.....	2488
SEARch:TRIGger:MPHY:CREDit:MAX.....	2488
SEARch:TRIGger:MPHY:PBEGin:CONDition.....	2488
SEARch:TRIGger:MPHY:PBEGin:MIN.....	2489
SEARch:TRIGger:MPHY:PBEGin:MAX.....	2489
SEARch:TRIGger:MPHY:PFID:CONDition.....	2489
SEARch:TRIGger:MPHY:PFID:MIN.....	2490
SEARch:TRIGger:MPHY:PFID:MAX.....	2490
SEARch:TRIGger:MPHY:ERRor:REServed.....	2490
SEARch:TRIGger:MPHY:ERRor:LCMD.....	2491
SEARch:TRIGger:MPHY:ERRor:SYMBOL.....	2491
SEARch:TRIGger:MPHY:ERRor:UNKNown.....	2491
SEARch:TRIGger:MPHY:ERRor:LENGth.....	2491

SEARCh:TRIGger:MPHY:TYPE <SearchName>,<Type>
SEARCh:TRIGger:MPHY:TYPE? <SearchName>

Selects the type of frame to be searched for.

Parameters:

<Type>

START | BURST | ADAPT | LCC | DLPDUSOF | DLPDUCOF |
 DLPDUEOF | DLPDUNAC | DLPDUAFC | PACP | TRIGUPR0 |
 TRIGUPR1 | TRIGUPR2 | ERRor

START

M-PHY or UniPro start of frame.

BURST

M-PHY burst frame.

ADAPT

M-PHY Adapt frame. This control frame is used for clock/bit synchronization.

LCC

M-PHY LCC frame. This control frame is used for line configuration depending on the [LCCType](#).

**DLPDUSOF | DLPDUCOF | DLPDUEOF | DLPDUNAC |
 DLPDUAFC**

UniPro DL PDU frame.

PACP

UniPro PACP frame. This control frame is used mainly for power mode change and L1.5 link management.

TRIGUPR0 | TRIGUPR1 | TRIGUPR2

UniPro Trigger Upper frame. This control frame is used for link startup sequence.

ERRor

M-PHY or UniPro error frame.

*RST: START

Parameters for setting and query:

<SearchName>

Manual operation: See "[Type](#)" on page 939

SEARCh:TRIGger:MPHY:LCCType <SearchName>,<LCCType>
SEARCh:TRIGger:MPHY:LCCType? <SearchName>

Selects the type of LCC frame to be searched for.

Parameters:

<LCCType>

ANY | SLEEP | STALL | READCAP | READMFG | READVEND |
 WRITEATTR | PWMG0 | PWMG1 | PWMG2 | PWMG3 |
 PWMG4 | PWMG5 | PWMG6 | PWMG7 | HSG1A | HSG2A |
 HSG3A | HSG4A | HSG1B | HSG2B | HSG3B | HSG4B |
 RESERVED

ANY

All the available LCC commands.

SLEEP

Switches the power-saving state to ultra-low power. In this state, up to 90% power saving is achieved.

STALL

Switches the power-saving state to ultra-low power. In this state, up to 75% power saving is achieved.

READCAP

Recovers data about the OMC's capabilities.

READMFG

Retrieves manufacturing ID and vendor-specific information.

READVEND

Retrieves the additional four delimited bytes containing vendor-specific information.

WRITEATTR

Sets the configuration parameters required for lane operation.

PWMG0 | PWMG1 | PWMG2 | PWMG3 | PWMG4 | PWMG5 | PWMG6 | PWMG7

Switches the transmission mode to the selected low-power gear.

HSG1A | HSG2A | HSG3A | HSG4A | HSG1B | HSG2B | HSG3B | HSG4B

Switches the transmission mode to the selected high-speed gear.

RESERVED

Reserved bit command. These bits are reserved for future use.

*RST: ANY

Parameters for setting and query:

<SearchName>

Manual operation: See "LCC Type" on page 941

SEARCh:TRIGger:MPHY:LWONe:CONDition <SearchName>,<CondOperator>

SEARCh:TRIGger:MPHY:LWONe:CONDition? <SearchName>

Sets the condition for WORD 1. You can define an exact value or a value range.

Parameters:

<CondOperator> EQUal | NEQual | LTHan | LETHan | GTHan | GETHan | INRange | OORange

EQUal | NEQual | LTHan | LETHan | GTHan | GETHan

Equal, Not equal, Less than, Less or equal than, Greater Than, Greater or equal than. These conditions require one pattern to be set with the corresponding [SEARCh:TRIGger:MPHY:LWONe:MIN](#) command.

INRange | OORange

In range/Out of range: set the minimum and maximum value of the range with `SEARch:TRIGger:MPHY:LWONe:MIN` and `SEARch:TRIGger:MPHY:LWONe:MAX`.

*RST: EQUal

Parameters for setting and query:

<SearchName>

Manual operation: See "[WORD 1/WORD 2/WORD 3/WORD 4](#)" on page 941

SEARch:TRIGger:MPHY:LWONe:MIN <SearchName>,<LCCWORD1Min>

SEARch:TRIGger:MPHY:LWONe:MIN? <SearchName>

Specifies the WORD 1 pattern, or sets the the start value of a pattern range.

Parameters:

<LCCWORD1Min> Numeric or string pattern, see [Chapter 27.4.6, "Bit pattern parameter"](#), on page 1373. The string parameter accepts the bit value X (don't care).

Parameters for setting and query:

<SearchName>

Manual operation: See "[WORD 1/WORD 2/WORD 3/WORD 4](#)" on page 941

SEARch:TRIGger:MPHY:LWONe:MAX <SearchName>,<LCCWORD1Max>

SEARch:TRIGger:MPHY:LWONe:MAX? <SearchName>

Sets the end value of the WORD 1 range if `SEARch:TRIGger:MPHY:LWONe:CONDition` is set to `INRange` or `OORange`.

Parameters:

<LCCWORD1Max> Numeric or string pattern, see [Chapter 27.4.6, "Bit pattern parameter"](#), on page 1373. The string parameter accepts the bit value X (don't care).

Parameters for setting and query:

<SearchName>

Manual operation: See "[WORD 1/WORD 2/WORD 3/WORD 4](#)" on page 941

SEARch:TRIGger:MPHY:LWTWo:CONDition <SearchName>,<CondOperator>

SEARch:TRIGger:MPHY:LWTWo:CONDition? <SearchName>

Sets the condition for WORD 2. You can define an exact value or a value range.

Parameters:

<CondOperator> EQUal | NEQUal | LTHan | LETHan | GTHan | GETHan |
INRange | OORange

EQUal | NEQual | LTHan | LETHan | GTHan | GETHan

Equal, Not equal, Less than, Less or equal than, Greater Than, Greater or equal than. These conditions require one pattern to be set with the corresponding `SEARCh:TRIGger:MPHY:LWTWo:MIN` command.

INRange | OORange

In range/Out of range: set the minimum and maximum value of the range with `SEARCh:TRIGger:MPHY:LWTWo:MIN` and `SEARCh:TRIGger:MPHY:LWTWo:MAX`.

*RST: EQUal

Parameters for setting and query:

<SearchName>

Manual operation: See "[WORD 1/WORD 2/WORD 3/WORD 4](#)" on page 941

SEARCh:TRIGger:MPHY:LWTWo:MIN <SearchName>,<LCCWORD2Min>

SEARCh:TRIGger:MPHY:LWTWo:MIN? <SearchName>

Specifies the WORD 2 pattern, or sets the the start value of a pattern range.

Parameters:

<LCCWORD2Min> Numeric or string pattern, see [Chapter 27.4.6, "Bit pattern parameter"](#), on page 1373. The string parameter accepts the bit value X (don't care).

Parameters for setting and query:

<SearchName>

Manual operation: See "[WORD 1/WORD 2/WORD 3/WORD 4](#)" on page 941

SEARCh:TRIGger:MPHY:LWTWo:MAX <SearchName>,<LCCWORD2Max>

SEARCh:TRIGger:MPHY:LWTWo:MAX? <SearchName>

Sets the end value of the WORD 2 range if `SEARCh:TRIGger:MPHY:LWTWo:CONDition` is set to `INRange` or `OORange`.

Parameters:

<LCCWORD2Max> Numeric or string pattern, see [Chapter 27.4.6, "Bit pattern parameter"](#), on page 1373. The string parameter accepts the bit value X (don't care).

Parameters for setting and query:

<SearchName>

Manual operation: See "[WORD 1/WORD 2/WORD 3/WORD 4](#)" on page 941

SEARCh:TRIGger:MPHY:LWTHree:CONDition <SearchName>,<CondOperator>
SEARCh:TRIGger:MPHY:LWTHree:CONDition? <SearchName>

Sets the condition for WORD 3. You can define an exact value or a value range.

Parameters:

<CondOperator> EQUal | NEQual | LTHan | LETHan | GTHan | GETHan |
 INRange | OORange

EQUal | NEQual | LTHan | LETHan | GTHan | GETHan

Equal, Not equal, Less than, Less or equal than, Greater Than, Greater or equal than. These conditions require one pattern to be set with the corresponding [SEARCh:TRIGger:MPHY:LWTHree:MIN](#) command.

INRange | OORange

In range/Out of range: set the minimum and maximum value of the range with [SEARCh:TRIGger:MPHY:LWTHree:MIN](#) and [SEARCh:TRIGger:MPHY:LWTHree:MAX](#).

*RST: EQUal

Parameters for setting and query:

<SearchName>

Manual operation: See "[WORD 1/WORD 2/WORD 3/WORD 4](#)" on page 941

SEARCh:TRIGger:MPHY:LWTHree:MIN <SearchName>,<LCCWORD3Min>
SEARCh:TRIGger:MPHY:LWTHree:MIN? <SearchName>

Specifies the WORD 3 pattern, or sets the the start value of a pattern range.

Parameters:

<LCCWORD3Min> Numeric or string pattern, see [Chapter 27.4.6, "Bit pattern parameter"](#), on page 1373. The string parameter accepts the bit value X (don't care).

Parameters for setting and query:

<SearchName>

Manual operation: See "[WORD 1/WORD 2/WORD 3/WORD 4](#)" on page 941

SEARCh:TRIGger:MPHY:LWTHree:MAX <SearchName>,<LCCWORD3Max>
SEARCh:TRIGger:MPHY:LWTHree:MAX? <SearchName>

Sets the end value of the WORD 3 range if [SEARCh:TRIGger:MPHY:LWTHree:CONDition](#) is set to INRange or OORange.

Parameters:

<LCCWORD3Max> Numeric or string pattern, see [Chapter 27.4.6, "Bit pattern parameter"](#), on page 1373. The string parameter accepts the bit value X (don't care).

Parameters for setting and query:

<SearchName>

Manual operation: See "[WORD 1/WORD 2/WORD 3/WORD 4](#)" on page 941

SEARCh:TRIGger:MPHY:LWFour:CONDition <SearchName>,<CondOperator>
SEARCh:TRIGger:MPHY:LWFour:CONDition? <SearchName>

Sets the condition for WORD 4. You can define an exact value or a value range.

Parameters:

<CondOperator> EQUal | NEQual | LTHan | LETHan | GTHan | GETHan |
 INRange | OORange

EQUal | NEQual | LTHan | LETHan | GTHan | GETHan

Equal, Not equal, Less than, Less or equal than, Greater Than, Greater or equal than. These conditions require one pattern to be set with the corresponding [SEARCh:TRIGger:MPHY:LWFour:MIN](#) command.

INRange | OORange

In range/Out of range: set the minimum and maximum value of the range with [SEARCh:TRIGger:MPHY:LWFour:MIN](#) and [SEARCh:TRIGger:MPHY:LWFour:MAX](#).

*RST: EQUal

Parameters for setting and query:

<SearchName>

Manual operation: See "[WORD 1/WORD 2/WORD 3/WORD 4](#)" on page 941

SEARCh:TRIGger:MPHY:LWFour:MIN <SearchName>,<LCCWORD4Min>
SEARCh:TRIGger:MPHY:LWFour:MIN? <SearchName>

Specifies the WORD 4 pattern, or sets the the start value of a pattern range.

Parameters:

<LCCWORD4Min> Numeric or string pattern, see [Chapter 27.4.6, "Bit pattern parameter"](#), on page 1373. The string parameter accepts the bit value X (don't care).

Parameters for setting and query:

<SearchName>

Manual operation: See "[WORD 1/WORD 2/WORD 3/WORD 4](#)" on page 941

SEARCh:TRIGger:MPHY:LWFour:MAX <SearchName>,<LCCWORD4Max>
SEARCh:TRIGger:MPHY:LWFour:MAX? <SearchName>

Sets the end value of the WORD 4 range if [SEARCh:TRIGger:MPHY:LWFour:CONDition](#) is set to [INRange](#) or [OORange](#).

Parameters:

<LCCWORD4Max> Numeric or string pattern, see [Chapter 27.4.6, "Bit pattern parameter"](#), on page 1373. The string parameter accepts the bit value X (don't care).

Parameters for setting and query:

<SearchName>

Manual operation: See "[WORD 1/WORD 2/WORD 3/WORD 4](#)" on page 941**SEARCh:TRIGger:MPHY:TC** <SearchName>,<TC>**SEARCh:TRIGger:MPHY:TC?** <SearchName>

Specifies the TC bit pattern.

Parameters:<TC> Numeric or string pattern, see [Chapter 27.4.6, "Bit pattern parameter"](#), on page 1373. The string parameter accepts the bit value X (don't care).**Parameters for setting and query:**

<SearchName>

Manual operation: See "[TC](#)" on page 942**SEARCh:TRIGger:MPHY:DATA:DCONDition** <SearchName>,<DataOperator>**SEARCh:TRIGger:MPHY:DATA:DCONDition?** <SearchName>

Sets the condition for the data. You can define an exact value or a value range.

Parameters:<DataOperator> EQUal | NEQual | LTHan | LETHan | GTHan | GETHan |
INRange | OORange**EQUal | NEQual | LTHan | LETHan | GTHan | GETHan**Equal, Not equal, Less than, Less or equal than, Greater Than, Greater or equal than. These conditions require one data pattern to be set with the corresponding [SEARCh:TRIGger:MPHY:DATA:DMIN](#) command.**INRange | OORange**In range/Out of range: set the minimum and maximum value of the range with [SEARCh:TRIGger:MPHY:DATA:DMIN](#) and [SEARCh:TRIGger:MPHY:DATA:DMAX](#).***RST:** EQUal**Parameters for setting and query:**

<SearchName>

Manual operation: See "[Data](#)" on page 942**SEARCh:TRIGger:MPHY:DATA:DMIN** <SearchName>,<DataMin>**SEARCh:TRIGger:MPHY:DATA:DMIN?** <SearchName>

Specifies the data bit pattern, or sets the the start value of a pattern range.

Parameters:

<DataMin> Numeric or string pattern, see [Chapter 27.4.6, "Bit pattern parameter"](#), on page 1373. The string parameter accepts the bit value X (don't care).

Parameters for setting and query:

<SearchName>

Manual operation: See ["Data"](#) on page 942

SEARCH:TRIGger:MPHY:DATA:DMAX <SearchName>,<DataMax>

SEARCH:TRIGger:MPHY:DATA:DMAX? <SearchName>

Sets the end value of the data range if [SEARCH:TRIGger:MPHY:DATA:DCondition](#) is set to [INRange](#) or [OORange](#).

Parameters:

<DataMax> Numeric or string pattern, see [Chapter 27.4.6, "Bit pattern parameter"](#), on page 1373. The string parameter accepts the bit value X (don't care).

Parameters for setting and query:

<SearchName>

Manual operation: See ["Data"](#) on page 942

SEARCH:TRIGger:MPHY:DATA:ICONdition <SearchName>,<DataIdxOperator>

SEARCH:TRIGger:MPHY:DATA:ICONdition? <SearchName>

Sets the condition for the index. You can define an exact value or a value range.

Parameters:

<DataIdxOperator> [EQUal](#) | [LTHan](#) | [LETHan](#) | [GTHan](#) | [GETHan](#) | [INRange](#) | [RANGe](#)

[EQUal](#) | [LTHan](#) | [LETHan](#) | [GTHan](#) | [GETHan](#)

Equal, Less than, Less or equal than, Greater Than, Greater or equal than. These conditions require one pattern to be set with the corresponding [SEARCH:TRIGger:MPHY:DATA:IMIN](#) command.

[INRange](#) = [RANGe](#)

In range: Set the minimum and maximum value using [SEARCH:TRIGger:MPHY:DATA:IMIN](#) and [SEARCH:TRIGger:MPHY:DATA:IMAX](#).

*RST: [INRange](#)

Parameters for setting and query:

<SearchName>

Manual operation: See ["Index"](#) on page 943

SEARCh:TRIGger:MPHY:DATA:IMIN <SearchName>,<DataIndexMin>
SEARCh:TRIGger:MPHY:DATA:IMIN? <SearchName>

Specifies the index minimum, or sets the start value of a range.

Parameters:

<DataIndexMin> Range: 1 to 0
 Increment: 1
 *RST: 1

Parameters for setting and query:

<SearchName>

Manual operation: See "[Index](#)" on page 943

SEARCh:TRIGger:MPHY:DATA:IMAX <SearchName>,<DataIndexMax>
SEARCh:TRIGger:MPHY:DATA:IMAX? <SearchName>

Sets the end value of the index range if [SEARCh:TRIGger:MPHY:DATA:ICONdition](#) is set to [INRange](#) or [RANge](#).

Parameters:

<DataIndexMax> Range: 1 to 0
 Increment: 1
 *RST: 0

Parameters for setting and query:

<SearchName>

Manual operation: See "[Index](#)" on page 943

SEARCh:TRIGger:MPHY:FSNumber:CONDition <SearchName>,<FSNOperator>
SEARCh:TRIGger:MPHY:FSNumber:CONDition? <SearchName>

Sets the condition for FSN. You can define an exact value or a value range.

Parameters:

<FSNOperator> [EQUal](#) | [NEQUal](#) | [LTHan](#) | [LETHan](#) | [GTHan](#) | [GETHan](#) |
 [INRange](#) | [OORange](#)

[EQUal](#) | [NEQUal](#) | [LTHan](#) | [LETHan](#) | [GTHan](#) | [GETHan](#)

Equal, Not equal, Less than, Less or equal than, Greater Than, Greater or equal than. These conditions require one data pattern to be set with the corresponding [SEARCh:TRIGger:MPHY:FSNumber:MIN](#) command.

[INRange](#) | [OORange](#)

In range/Out of range: set the minimum and maximum value of the range with [SEARCh:TRIGger:MPHY:FSNumber:MIN](#) and [SEARCh:TRIGger:MPHY:FSNumber:MAX](#).

*RST: [EQUal](#)

Parameters for setting and query:

<SearchName>

Manual operation: See "FSN" on page 943

SEARCH:TRIGger:MPHY:FSNumber:MIN <SearchName>,<FSNMin>
SEARCH:TRIGger:MPHY:FSNumber:MIN? <SearchName>

Specifies the FSN bit pattern, or sets the start value of a pattern range.

Parameters:

<FSNMin> Numeric or string pattern, see [Chapter 27.4.6, "Bit pattern parameter"](#), on page 1373. The string parameter accepts the bit value X (don't care).

Parameters for setting and query:

<SearchName>

Manual operation: See "FSN" on page 943

SEARCH:TRIGger:MPHY:FSNumber:MAX <SearchName>,<FSNMax>
SEARCH:TRIGger:MPHY:FSNumber:MAX? <SearchName>

Sets the end value of the FSN range if [SEARCH:TRIGger:MPHY:FSNumber:CONDition](#) is set to `INRange` or `ORange`.

Parameters:

<FSNMax> Numeric or string pattern, see [Chapter 27.4.6, "Bit pattern parameter"](#), on page 1373. The string parameter accepts the bit value X (don't care).

Parameters for setting and query:

<SearchName>

Manual operation: See "FSN" on page 943

SEARCH:TRIGger:MPHY:CRC:CONDition <SearchName>,<CRCCOperator>
SEARCH:TRIGger:MPHY:CRC:CONDition? <SearchName>

Sets the condition for CRC. You can define an exact value or a value range.

Parameters:

<CRCCOperator> `EQUal` | `NEQUal` | `LTHan` | `LETHan` | `GTHan` | `GETHan` | `INRange` | `ORange`

`EQUal` | `NEQUal` | `LTHan` | `LETHan` | `GTHan` | `GETHan`

Equal, Not equal, Less than, Less or equal than, Greater Than, Greater or equal than. These conditions require one data pattern to be set with the corresponding [SEARCH:TRIGger:MPHY:CRC:MIN](#) command.

`INRange` | `ORange`

In range/Out of range: set the minimum and maximum value of the range with [SEARCH:TRIGger:MPHY:CRC:MIN](#) and [SEARCH:TRIGger:MPHY:CRC:MAX](#).

*RST: `EQUal`

Parameters for setting and query:

<SearchName>

Manual operation: See "CRC" on page 943**SEARCh:TRIGger:MPHY:CRc:MIN** <SearchName>,<CRCMin>**SEARCh:TRIGger:MPHY:CRc:MIN?** <SearchName>

Specifies the CRC bit pattern, or sets the start value of a pattern range.

Parameters:

<CRCMin> Numeric or string pattern, see [Chapter 27.4.6, "Bit pattern parameter"](#), on page 1373. The string parameter accepts the bit value X (don't care).

Parameters for setting and query:

<SearchName>

Manual operation: See "CRC" on page 943**SEARCh:TRIGger:MPHY:CRc:MAX** <SearchName>,<CRCMax>**SEARCh:TRIGger:MPHY:CRc:MAX?** <SearchName>Sets the end value of the CRC range if [SEARCh:TRIGger:MPHY:CRc:CONDition](#) is set to INRange or OORange.**Parameters:**

<CRCMax> Numeric or string pattern, see [Chapter 27.4.6, "Bit pattern parameter"](#), on page 1373. The string parameter accepts the bit value X (don't care).

Parameters for setting and query:

<SearchName>

Manual operation: See "CRC" on page 943**SEARCh:TRIGger:MPHY:CREQ** <SearchName>,<REQ>**SEARCh:TRIGger:MPHY:CREQ?** <SearchName>

Specifies the CREQ bit pattern.

Parameters:

<REQ> ONE | ZERO | DC

ONE

Sets the trigger condition to binary 1.

ZERO

Sets the trigger condition to binary 0.

DC

Sets the trigger condition to any CREQ value (don't care).

*RST: DC

Parameters for setting and query:

<SearchName>

Manual operation: See "Req" on page 944**SEARCh:TRIGger:MPHY:RREQ** <SearchName>,<REQ>**SEARCh:TRIGger:MPHY:RREQ?** <SearchName>

Specifies the RREQ bit pattern.

Parameters:

<REQ> ONE | ZERO | DC

ONE

Sets the trigger condition to binary 1.

ZERO

Sets the trigger condition to binary 0.

DC

Sets the trigger condition to any RREQ value (don't care).

*RST: DC

Parameters for setting and query:

<SearchName>

Manual operation: See "Req" on page 944**SEARCh:TRIGger:MPHY:CREDit:CONDition** <SearchName>,<CreditOperator>**SEARCh:TRIGger:MPHY:CREDit:CONDition?** <SearchName>

Sets the condition for Credit. You can define an exact value or a value range.

Parameters:

<CreditOperator> EQUal | NEQual | LTHan | LETHan | GTHan | GETHan | INRange | OORange

EQUal | NEQual | LTHan | LETHan | GTHan | GETHanEqual, Not equal, Less than, Less or equal than, Greater Than, Greater or equal than. These conditions require one data pattern to be set with the corresponding [SEARCh:TRIGger:MPHY:CREDit:MIN](#) command.**INRange | OORange**In range/Out of range: set the minimum and maximum value of the range with [SEARCh:TRIGger:MPHY:CREDit:MIN](#) and [SEARCh:TRIGger:MPHY:CREDit:MAX](#).

*RST: EQUal

Parameters for setting and query:

<SearchName>

Manual operation: See "Credit" on page 944

SEARCh:TRIGger:MPHY:CREDit:MIN <SearchName>,<CreditMin>
SEARCh:TRIGger:MPHY:CREDit:MIN? <SearchName>

Specifies the Credit bit pattern, or sets the start value of a pattern range.

Parameters:

<CreditMin> Numeric or string pattern, see [Chapter 27.4.6, "Bit pattern parameter"](#), on page 1373. The string parameter accepts the bit value X (don't care).

Parameters for setting and query:

<SearchName>

Manual operation: See "[Credit](#)" on page 944

SEARCh:TRIGger:MPHY:CREDit:MAX <SearchName>,<CreditMax>
SEARCh:TRIGger:MPHY:CREDit:MAX? <SearchName>

Sets the end value of the Credit range if [SEARCh:TRIGger:MPHY:CREDit:CONDition](#) is set to [INRange](#) or [OORange](#).

Parameters:

<CreditMax> Numeric or string pattern, see [Chapter 27.4.6, "Bit pattern parameter"](#), on page 1373. The string parameter accepts the bit value X (don't care).

Parameters for setting and query:

<SearchName>

Manual operation: See "[Credit](#)" on page 944

SEARCh:TRIGger:MPHY:PBEGin:CONDition <SearchName>,<CondPACPBegin>
SEARCh:TRIGger:MPHY:PBEGin:CONDition? <SearchName>

Sets the condition for PACP Begin. You can define an exact value or a value range.

Parameters:

<CondPACPBegin> EQUal | NEQual | LTHan | LETHan | GTHan | GETHan |
 INRange | OORange

EQUal | NEQual | LTHan | LETHan | GTHan | GETHan

Equal, Not equal, Less than, Less or equal than, Greater Than, Greater or equal than. These conditions require one data pattern to be set with the corresponding [SEARCh:TRIGger:MPHY:PBEGin:MIN](#) command.

INRange | OORange

In range/Out of range: set the minimum and maximum value of the range with [SEARCh:TRIGger:MPHY:PBEGin:MIN](#) and [SEARCh:TRIGger:MPHY:PBEGin:MAX](#).

*RST: EQUal

Parameters for setting and query:

<SearchName>

Manual operation: See "PACP Begin" on page 945

SEARCH:TRIGger:MPHY:PBEGIN:MIN <SearchName>,<PACPBEGINMin>
SEARCH:TRIGger:MPHY:PBEGIN:MIN? <SearchName>

Specifies the PACP Begin bit pattern, or sets the start value of a pattern range.

Parameters:

<PACPBEGINMin> Numeric or string pattern, see [Chapter 27.4.6, "Bit pattern parameter"](#), on page 1373. The string parameter accepts the bit value X (don't care).

Parameters for setting and query:

<SearchName>

Manual operation: See "PACP Begin" on page 945

SEARCH:TRIGger:MPHY:PBEGIN:MAX <SearchName>,<PACPBEGINMax>
SEARCH:TRIGger:MPHY:PBEGIN:MAX? <SearchName>

Sets the end value of the PACP Begin range if [SEARCH:TRIGger:MPHY:PBEGIN:CONDition](#) is set to `INRange` or `ORange`.

Parameters:

<PACPBEGINMax> Numeric or string pattern, see [Chapter 27.4.6, "Bit pattern parameter"](#), on page 1373. The string parameter accepts the bit value X (don't care).

Parameters for setting and query:

<SearchName>

Manual operation: See "PACP Begin" on page 945

SEARCH:TRIGger:MPHY:PFID:CONDition <SearchName>,<CondPACPFunc>
SEARCH:TRIGger:MPHY:PFID:CONDition? <SearchName>

Sets the condition for PACP Function ID. You can define an exact value or a value range.

Parameters:

<CondPACPFunc> `EQUAL` | `NEQUAL` | `LTHan` | `LETHan` | `GTHan` | `GETHan` | `INRange` | `ORange`

EQUAL | **NEQUAL** | **LTHan** | **LETHan** | **GTHan** | **GETHan**

Equal, Not equal, Less than, Less or equal than, Greater Than, Greater or equal than. These conditions require one data pattern to be set with the corresponding [SEARCH:TRIGger:MPHY:PFID:MIN](#) command.

INRange | **ORange**

In range/Out of range: set the minimum and maximum value of the range with [SEARCH:TRIGger:MPHY:PFID:MIN](#) and [SEARCH:TRIGger:MPHY:PFID:MAX](#).

*RST: EQUAL

Parameters for setting and query:

<SearchName>

Manual operation: See "PACP Function ID" on page 945

SEARCh:TRIGger:MPHY:PFID:MIN <SearchName>,<PACPFunIDMin>

SEARCh:TRIGger:MPHY:PFID:MIN? <SearchName>

Specifies the PACP Function ID bit pattern, or sets the start value of a pattern range.

Parameters:

<PACPFunIDMin> Numeric or string pattern, see [Chapter 27.4.6, "Bit pattern parameter"](#), on page 1373. The string parameter accepts the bit value X (don't care).

Parameters for setting and query:

<SearchName>

Manual operation: See "PACP Function ID" on page 945

SEARCh:TRIGger:MPHY:PFID:MAX <SearchName>,<PACPFunIDMax>

SEARCh:TRIGger:MPHY:PFID:MAX? <SearchName>

Sets the end value of the PACP Function ID range if [SEARCh:TRIGger:MPHY:PFID:CONDition](#) is set to `INRange` or `ORRange`.

Parameters:

<PACPFunIDMax> Numeric or string pattern, see [Chapter 27.4.6, "Bit pattern parameter"](#), on page 1373. The string parameter accepts the bit value X (don't care).

Parameters for setting and query:

<SearchName>

Manual operation: See "PACP Function ID" on page 945

SEARCh:TRIGger:MPHY:ERRor:REServed <SearchName>,<ErrorReserved>

SEARCh:TRIGger:MPHY:ERRor:REServed? <SearchName>

Enables/disables search for reserved bit error.

Parameters:

<ErrorReserved> ON | OFF

*RST: ON

Parameters for setting and query:

<SearchName>

Manual operation: See "Reserved Bit Error" on page 945

SEARCh:TRIGger:MPHY:ERRor:LCMD <SearchName>,<LCCError>
SEARCh:TRIGger:MPHY:ERRor:LCMD? <SearchName>

Enables/disables search for LCC error.

Parameters:

<LCCError> ON | OFF
 *RST: ON

Parameters for setting and query:

<SearchName>

Manual operation: See "[LCC Command Error](#)" on page 946

SEARCh:TRIGger:MPHY:ERRor:SYMBol <SearchName>,<ErrorSymbol>
SEARCh:TRIGger:MPHY:ERRor:SYMBol? <SearchName>

Enables/disables search for 8b10b symbol error.

Parameters:

<ErrorSymbol> ON | OFF
 *RST: ON

Parameters for setting and query:

<SearchName>

Manual operation: See "[8b10b Symbol Error](#)" on page 946

SEARCh:TRIGger:MPHY:ERRor:UNKNown <SearchName>,<ErrorUnknown>
SEARCh:TRIGger:MPHY:ERRor:UNKNown? <SearchName>

Enables/disables search for unidentified UniPro frame error.

Parameters:

<ErrorUnknown> ON | OFF
 *RST: ON

Parameters for setting and query:

<SearchName>

Manual operation: See "[Unknown Unipro Frame](#)" on page 946

SEARCh:TRIGger:MPHY:ERRor:LENGth <SearchName>,<ErrorLength>
SEARCh:TRIGger:MPHY:ERRor:LENGth? <SearchName>

Enables/disables search for length error.

Parameters:

<ErrorLength> ON | OFF
 *RST: ON

Parameters for setting and query:

<SearchName>

Manual operation: See "Length Error" on page 946

27.18.25.5 Search results M-PHY

In all `SEARCH:RESULT:MPHY:FRAME<m>` commands, the suffix `<m>` selects the frame number and suffix `<n>` selects the cell number in the list of search results.

<code>SEARCH:RESULT:MPHY:FCOUNT?</code>	2492
<code>SEARCH:RESULT:MPHY:FRAME<m>:CCOUNT?</code>	2492
<code>SEARCH:RESULT:MPHY:FRAME<m>:CELL<n>:DATA?</code>	2493
<code>SEARCH:RESULT:MPHY:FRAME<m>:CELL<n>:TYPE?</code>	2493
<code>SEARCH:RESULT:MPHY:FRAME<m>:CELL<n>:START?</code>	2493
<code>SEARCH:RESULT:MPHY:FRAME<m>:CELL<n>:STOP?</code>	2494
<code>SEARCH:RESULT:MPHY:FRAME<m>:CELL<n>:STATE?</code>	2494
<code>SEARCH:RESULT:MPHY:FRAME<m>:DATA?</code>	2494
<code>SEARCH:RESULT:MPHY:FRAME<m>:FTYPE?</code>	2495
<code>SEARCH:RESULT:MPHY:FRAME<m>:STATE?</code>	2495
<code>SEARCH:RESULT:MPHY:FRAME<m>:START?</code>	2496
<code>SEARCH:RESULT:MPHY:FRAME<m>:STOP?</code>	2497

`SEARCH:RESULT:MPHY:FCOUNT? <SearchName>`

Returns the number of frames within the search result.

Query parameters:

`<SearchName>`

Return values:

<code><Count></code>	Range:	0 to 100000
	Increment:	1
	*RST:	0

Usage: Query only

`SEARCH:RESULT:MPHY:FRAME<m>:CCOUNT? <SearchName>`

Returns the number of cells within the search result for the selected frame.

Suffix:

`<m>` *

Query parameters:

`<SearchName>`

Return values:

<code><NumWords></code>	Range:	0 to 4294967295
	Increment:	1
	*RST:	0

Usage: Query only

SEARCh:RESult:MPHY:FRAMe<m>:CELL<n>:DATA? <SearchName>

Returns the data value within the search result for the selected cell.

Suffix:

<m> *

<n> *

Query parameters:

<SearchName>

Return values:

<WordValue> Range: 0 to 4294967295
 Increment: 1
 *RST: 0

Usage: Query only

SEARCh:RESult:MPHY:FRAMe<m>:CELL<n>:TYPE? <SearchName>

Returns the data type within the search result for the selected cell.

Suffix:

<m> *

<n> *

Query parameters:

<SearchName>

Return values:

<WordType>

Usage: Query only

SEARCh:RESult:MPHY:FRAMe<m>:CELL<n>:START? <SearchName>

Returns the start time of the cell with the selected field number within the frame with the selected frame number within the search result.

Suffix:

<m> *

<n> *

Query parameters:

<SearchName>

Return values:

<Start> Range: -100E+24 to 100E+24
 Increment: 100E-12
 *RST: 0
 Default unit: s

Usage: Query only

SEARCh:RESult:MPHY:FRAMe<m>:CELL<n>:STOP? <SearchName>

Returns the stop time of the cell with the selected field number within the frame with the selected frame number within the search result.

Suffix:

<m> *

<n> *

Query parameters:

<SearchName>

Return values:

<Stop> Range: -100E+24 to 100E+24
 Increment: 100E-12
 *RST: 0
 Default unit: s

Usage: Query only

SEARCh:RESult:MPHY:FRAMe<m>:CELL<n>:STATe? <SearchName>

Returns the state type within the search result for the selected cell.

Suffix:

<m> *

<n> *

Query parameters:

<SearchName>

Return values:

<State> OK | RSVDError | CMDERROR | SYMBOLERROR |
 UNKNOWNERROR | INVALID | INCOMPLETE | UNCorrelated |
 CRCERROR | VOOR | LENGTHERROR
 *RST: OK

Usage: Query only

SEARCh:RESult:MPHY:FRAMe<m>:DATA? <SearchName>

Returns the data for the selected frame within the search result, corresponds to the Data column in the search results table.

Suffix:

<m> *

Query parameters:

<SearchName>

Return values:

<Data>

Usage: Query only

SEARCh:RESult:MPHY:FRAMe<m>:FTYPe? <SearchName>

Returns the type of frame for the selected frame within the search result.

Suffix:

<m> *

Query parameters:

<SearchName>

Return values:

<FrameType> BURST | ADAPT | LCC | DLPDUSOF | DLPDUCOF | DLPDUEOF | DLPDUNAC | DLPDUAFC | PACP | TRIGUPR0 | TRIGUPR1 | TRIGUPR2 | SKIP | FILLER | SPACER | UNKNOWN

BURST

M-PHY burst frame.

ADAPT

M-PHY Adapt frame. This control frame is used for clock/bit synchronization.

LCC

M-PHY LCC frame. This control frame is used for line configuration depending on the [LCC Type](#).

DLPDUSOF | DLPDUCOF | DLPDUEOF | DLPDUNAC | DLPDUAFC

UniPro DL PDU frame.

PACP

UniPro frame. This control frame is used mainly for power mode change and L1.5 link management.

TRIGUPR0 | TRIGUPR1 | TRIGUPR2

UniPro frame. This control frame is used for link startup sequence.

SKIP

UniPro frame with Skip symbols for reducing protocol payload bandwidth.

FILLER

M-PHY or UniPro frame with filler words to maintain transmission activity.

SPACER

Scrambled UniPro frame with filler words.

UNKNOWN

No meaningful frame can be determined.

*RST: UNKNOWN

Usage: Query only

SEARCh:RESult:MPHY:FRAMe<m>:STATe? <SearchName>

Returns the state of the selected frame within the search result.

Suffix:
<m> *

Query parameters:
<SearchName>

Return values:
<State> OK | RSVDError | CMDERROR | SYMBOLERROR | UNKNOWNERROR | INVALID | INCOMPLETE | UNCorrelated | CRCERROR | VOOR | LENGTHERROR

OK
Valid frame.

RSVDERROR
Erroneous frame due to reserved bit error.

CMDERROR
Erroneous frame due to LCC error.

LENGTHERROR
Erroneous frame due to length error.

SYMBOLERROR
Erroneous frame due to 8b10b symbol error.

UNKNOWNERROR
Erroneous frame due to unidentified UniPro frame error.

INVALID
Invalid frame.

INCOMPLETE
The frame is not complete.

*RST: OK

Usage: Query only

SEARCh:RESult:MPHY:FRAMe<m>:STARt? <SearchName>

Returns the start time of the selected frame within the search result.

Suffix:
<m> *

Query parameters:
<SearchName>

Return values:
<Start> Range: -100E+24 to 100E+24
Increment: 100E-12
*RST: 0
Default unit: s

Usage: Query only

SEARCh:RESult:MPHY:FRAMe<m>:STOP? <SearchName>

Returns the end time for the selected frame within the search result.

Suffix:

<m> *

Query parameters:

<SearchName>

Return values:

<Stop> Range: -100E+24 to 100E+24
 Increment: 100E-12
 *RST: 0
 Default unit: s

Usage: Query only

27.18.25.6 Trigger USB SSIC (Option R&S RTO6-K570)

The trigger suffix <m> is always 1 and can be omitted. It selects the trigger event: Only the A-trigger is available for triggering on serial buses.

To trigger on a serial bus, make sure that:

- `TRIGger<m>:SOURce[:SElect]` is set to `SBUS`.
- The sources of the serial bus are channel signals: use `BUS<m>:...:SOURce` commands.
- Decoding is enabled: `BUS<m>[:STATe]` is set to `ON`.

There are two commands for each parameter, that you can use for defining the SSIC trigger settings.

For example, to set the *Frame type =ACK > Field =Route String >Data* value you can use one of the following commands:

- `TRIGger:MPHY:SSIC:FRAMe13:FLD1:DMIN 01100`
 Defines the parameter by using the index <m> for the frame number and <n> for the field number.
- `TRIGger:MPHY:SSIC:DMIN "ACK", "Route String", 01100`
 Defines the parameter by using the frame and field name.

<code>TRIGger<m>:MPHY:SSIC:ERENable</code>	2498
<code>TRIGger<m>:MPHY:SSIC:ERRor<n>:ENABLE</code>	2498
<code>TRIGger<m>:MPHY:SSIC:FRENable</code>	2498
<code>TRIGger<m>:MPHY:SSIC:FRAMe<n>:ENABLE</code>	2498
<code>TRIGger<m>:MPHY:SSIC:FIENable</code>	2499
<code>TRIGger<m>:MPHY:SSIC:FRAMe<n>:FLD<o>:ENABLE</code>	2499
<code>TRIGger<m>:MPHY:SSIC:BIT</code>	2499
<code>TRIGger<m>:MPHY:SSIC:FRAMe<n>:FLD<o>:BIT</code>	2499
<code>TRIGger<m>:MPHY:SSIC:DMAX</code>	2499
<code>TRIGger<m>:MPHY:SSIC:FRAMe<n>:FLD<o>:DMAX</code>	2499
<code>TRIGger<m>:MPHY:SSIC:DMIN</code>	2500
<code>TRIGger<m>:MPHY:SSIC:FRAMe<n>:FLD<o>:DMIN</code>	2500

TRIGger<m>:MPHY:SSIC:DOPerator.....	2500
TRIGger<m>:MPHY:SSIC:FRAMe<n>:FLD<o>:DOPerator.....	2500
TRIGger<m>:MPHY:SSIC:IMAX.....	2501
TRIGger<m>:MPHY:SSIC:FRAMe<n>:FLD<o>:IMAX.....	2501
TRIGger<m>:MPHY:SSIC:IMIN.....	2501
TRIGger<m>:MPHY:SSIC:FRAMe<n>:FLD<o>:IMIN.....	2501
TRIGger<m>:MPHY:SSIC:IOPerator.....	2502
TRIGger<m>:MPHY:SSIC:FRAMe<n>:FLD<o>:IOPerator.....	2502

TRIGger<m>:MPHY:SSIC:ERENable <ErrorName>, <Enabler>

TRIGger<m>:MPHY:SSIC:ERRor<n>:ENABle <Enable>

Enables or disables the trigger on an error condition.

Suffix:

<m> 1..3

<n> *

Parameters:

<Enable> ON | OFF

*RST: ON

Example:

Trigger on CRC and length errors:

```
TRIGger:MPHY:SSIC:ERRor1:ENABle ON
```

Enables CRC Error.

```
TRIGger:MPHY:SSIC:ERENable "Length Error",ON
```

Enables Length Error.

Manual operation: See "[Error types, Enable](#)" on page 935

TRIGger<m>:MPHY:SSIC:FRENable <Frame>, <Enabler>

TRIGger<m>:MPHY:SSIC:FRAMe<n>:ENABle <Enable>

Enables or disables the checking condition for the selected frame.

Suffix:

<m> 1..3

Only 1 = A-trigger, 2 | 3 = not available. Can be omitted.

<n> *

Specifies the field number within the frame.

Parameters:

<Enable> ON | OFF

*RST: OFF

Example:

```
TRIGger:MPHY:SSIC:FRAMe1:ENABle ON
```

Enables the checking condition for the TSEQ frame.

```
TRIGger:MPHY:SSIC:FRENable "TS1" ON
```

Enables the checking condition for the TS1 frame.

TRIGger<m>:MPHY:SSIC:FIENable <Frame>, <Field>, <Enabler>

TRIGger<m>:MPHY:SSIC:FRAMe<n>:FLD<o>:ENABle <CondEnabler>

Enables or disables the checking condition for the selected field of the selected frame.

Suffix:

<m> 1..3
Only 1 = A-trigger, 2 | 3 = not available. Can be omitted.

<n> *
Specifies the field number within the frame.

<o> *
Specifies the field number within the frame.

Parameters:

<CondEnabler> ON | OFF
*RST: OFF

Example:

TRIGger:MPHY:SSIC:FRAMe1:FLD1:ENABle ON
Enables the checking condition for the Symbol field of the TSEQ frame.

TRIGger:MPHY:SSIC:FRENable "TS1", "Loop" ON
Enables the checking condition for the Loop field of the TS1 frame.

Manual operation: See ["AND / Field name / Condition"](#) on page 936

TRIGger<m>:MPHY:SSIC:BIT <Frame>, <Field>, <Bit>

TRIGger<m>:MPHY:SSIC:FRAMe<n>:FLD<o>:BIT <BitState>

Sets the bit state of a field that only consists of one bit.

Suffix:

<m> 1..3
Only 1 = A-trigger, 2 | 3 = not available. Can be omitted.

<n> *
Specifies the frame number.

<o> *
Specifies the field number within the frame.

Parameters:

<BitState> ONE | ZERO | DC
*RST: DC

Manual operation: See ["BitState"](#) on page 937

TRIGger<m>:MPHY:SSIC:DMAX <Frame>, <Field>, <Data>

TRIGger<m>:MPHY:SSIC:FRAMe<n>:FLD<o>:DMAX <DataMax>

Sets the end value of a data pattern range if [TRIGger<m>:MPHY:SSIC:FRAMe<n>:FLD<o>:DOPerator](#) is set to [INRange](#) or [OORange](#).

Suffix:

<m>	1..3 Only 1 = A-trigger, 2 3 = not available. Can be omitted.
<n>	* Specifies the frame number.
<o>	* Specifies the field number within the frame.

Parameters:

<DataMax>

Manual operation: See "Data" on page 936**TRIGger<m>:MPHY:SSIC:DMIN** <Frame>, <Field>, <Data>**TRIGger<m>:MPHY:SSIC:FRAMe<n>:FLD<o>:DMIN** <DataMin>

Specifies the data pattern, or sets the start value of a data pattern range.

Suffix:

<m>	1..3 Only 1 = A-trigger, 2 3 = not available. Can be omitted.
<n>	* Specifies the frame number.
<o>	* Specifies the field number within the frame.

Parameters:

<DataMin>

Manual operation: See "Data" on page 936**TRIGger<m>:MPHY:SSIC:DOPerator** <Frame>, <Field>, <Operator>**TRIGger<m>:MPHY:SSIC:FRAMe<n>:FLD<o>:DOPerator** <DataOperator>

Sets the operator for the data pattern in the selected field of the selected frame.

Suffix:

<m>	1..3 Only 1 = A-trigger, 2 3 = not available. Can be omitted.
<n>	* Specifies the field number within the frame.
<o>	*

Parameters:

<DataOperator> EQUal | NEQual | LTHan | LETHan | GTHan | GETHan | INRange | OORange

EQUal | NEQUal | LTHan | LETHan | GTHan | GETHan

Equal, Not equal, Less than, Less than or equal, Greater than, Greater than or equal. These conditions require one endpoint value to be set using `TRIGger<m>:MPHY:SSIC:FRAMe<n>:FLD<o>:DMIN`.

INRange | OORange

In range, out of range. These conditions require a range of endpoint values to be set using `TRIGger<m>:MPHY:SSIC:FRAMe<n>:FLD<o>:DMIN` and `TRIGger<m>:MPHY:SSIC:FRAMe<n>:FLD<o>:DMAX`.

*RST: EQUal

Manual operation: See "[Data](#)" on page 936

TRIGger<m>:MPHY:SSIC:IMAX <Frame>, <Field>, <Data>

TRIGger<m>:MPHY:SSIC:FRAMe<n>:FLD<o>:IMAX <IndexMax>

Sets the end value of an index range if `TRIGger<m>:MPHY:SSIC:FRAMe<n>:FLD<o>:IOPerator` is set to `INRange` or `RANGE`.

Suffix:

<m> 1..3
Only 1 = A-trigger, 2 | 3 = not available. Can be omitted.

<n> *
Specifies the field number within the frame.

<o> *

Parameters:

<IndexMax> Specifies the end value for the index range within the field. The index range, increment and *RST values depend on the field type.

Manual operation: See "[Index](#)" on page 937

TRIGger<m>:MPHY:SSIC:IMIN <Frame>, <Field>, <Data>

TRIGger<m>:MPHY:SSIC:FRAMe<n>:FLD<o>:IMIN <IndexMin>

Specifies the index, or sets the start value of an index range.

Suffix:

<m> 1..3

<n> *
Specifies the field number within the frame.

<o> *

Parameters:

<IndexMin> Specifies the index value or index start value within the field. The index range, increment and *RST values depend on the field type.

Range: 1 to 65534

Increment: 1

*RST: 1

Manual operation: See "[Index](#)" on page 937

TRIGger<m>:MPHY:SSIC:IOPerator <Frame>, <Field>, <Operator>

TRIGger<m>:MPHY:SSIC:FRAMe<n>:FLD<o>:IOPerator <IndexOperator>

Sets the operator for the index in the selected field of the selected frame.

Suffix:

<m> 1..3

Only 1 = A-trigger, 2 | 3 = not available. Can be omitted.

<n> *

Specifies the field number within the frame.

<o> *

Parameters:

<IndexOperator> EQUal | INRange | RANGe

EQUal

This condition requires one endpoint value to be set using [TRIGger<m>:MPHY:SSIC:FRAMe<n>:FLD<o>:IMIN](#).

INRange | RANGe

This condition requires a range of endpoint values to be set using [TRIGger<m>:MPHY:SSIC:FRAMe<n>:FLD<o>:IMIN](#) and [TRIGger<m>:MPHY:SSIC:FRAMe<n>:FLD<o>:IMAX](#).

*RST: INRange

Manual operation: See "[Index](#)" on page 937

27.18.25.7 Search settings USB SSIC (Option R&S RTO6-K570)

There are two commands for each parameter, that you can use for defining the SSIC search settings.

For example, to set the *Frame type =ACK > Field =Route String >Data* value you can use one of the following commands:

- `SEARCH:TRIGger:MPHY:SSIC:FRAMe13:FLD1:DMIN 01100`
Defines the parameter by using the index <m> for the frame number and <n> for the field number.
- `SEARCH:TRIGger:MPHY:SSIC:DMIN "ACK", "Route String", 01100`
Defines the parameter by using the frame and field name.

SEARCh:TRIGger:MPHY:SSIC:ERENable <SearchName>,<ErrorName>, <Enabler>
SEARCh:TRIGger:MPHY:SSIC:ERRor<m>:ENABle <SearchName>,<Enable>
SEARCh:TRIGger:MPHY:SSIC:ERRor<m>:ENABle? <SearchName>

Enables or disables the searching for an error condition.

Suffix:

<m> *

Parameters:

<Enable> ON | OFF
 *RST: ON

Parameters for setting and query:

<SearchName>

Example:

Searches for CRC and length errors:

SEARCh:TRIGger:MPHY:SSIC:ERRor1:ENABle ON

Enables searching for CRC Error.

SEARCh:TRIGger:MPHY:SSIC:ERENable "Length
 Error",ON

Enables searching for Length Error.

Manual operation: See "[Search criteria](#)" on page 947

SEARCh:TRIGger:MPHY:SSIC:FRENable <SearchName>,<Frame>, <Enabler>
SEARCh:TRIGger:MPHY:SSIC:FRAMe<m>:ENABle <SearchName>,<Enable>
SEARCh:TRIGger:MPHY:SSIC:FRAMe<m>:ENABle? <SearchName>

Defines the frame type to be searched for.

Suffix:

<m> *
 Specifies the frame number.

Parameters:

<Enable> ON | OFF
 *RST: OFF

Parameters for setting and query:

<SearchName> String with the name of the search.

Example:

SEARCh:TRIGger:MPHY:SSIC:FRAMe1:ENABle ON

Enables searching for the TSEQ frame.

SEARCh:TRIGger:MPHY:SSIC:FRENable "TS1" ON

Enables searching for the TS1 frame.

Manual operation: See "[Search criteria](#)" on page 947

SEARCh:TRIGger:MPHY:SSIC:FIENable <SearchName>,<Frame>, <Field>,
<Enabler>

SEARCh:TRIGger:MPHY:SSIC:FRAMe<m>:FLD<n>:ENABLE
<SearchName>,<CondEnabler>

SEARCh:TRIGger:MPHY:SSIC:FRAMe<m>:FLD<n>:ENABLE? <SearchName>

Enables or disables the checking condition for searching a specific data pattern in the selected field of the selected frame.

Suffix:

<m> *
Specifies the frame number.

<n> *
Specifies the field number within the frame.

Parameters:

<CondEnabler> ON | OFF
ON
Checking condition enabled
OFF
Checking condition disabled
*RST: OFF

Parameters for setting and query:

<SearchName>

Example:

SEARCh:TRIGger:MPHY:SSIC:FRAMe1:FLD1:ENABLE ON
Enables searching for the Symbol field of the TSEQ frame.
SEARCh:TRIGger:MPHY:SSIC:FRENable "TS1", "Loop"
ON
Enables searching for the Loop field of the TS1 frame.

Manual operation: See "[Search criteria](#)" on page 947

SEARCh:TRIGger:MPHY:SSIC:FRAMe<m>:FLD<n>:ENABLE
<SearchName>,<CondEnabler>

SEARCh:TRIGger:MPHY:SSIC:FRAMe<m>:FLD<n>:ENABLE? <SearchName>

Enables or disables the checking condition for searching a specific data pattern in the selected field of the selected frame.

Suffix:

<m> *
Specifies the frame number.

<n> *
Specifies the field number within the frame.

Parameters:

<CondEnabler> ON | OFF
ON
Checking condition enabled

OFF

Checking condition disabled

*RST: OFF

Parameters for setting and query:

<SearchName>

Example:

```
SEARCH:TRIGger:MPHY:SSIC:FRAME1:FLD1:ENABLE ON
```

Enables searching for the Symbol field of the TSEQ frame.

```
SEARCH:TRIGger:MPHY:SSIC:FREnable "TS1", "Loop" ON
```

Enables searching for the Loop field of the TS1 frame.

Manual operation: See "[Search criteria](#)" on page 947

```
SEARCH:TRIGger:MPHY:SSIC:BIT <SearchName>,<Frame>, <Field>, <Bit>
```

```
SEARCH:TRIGger:MPHY:SSIC:FRAME<m>:FLD<n>:BIT <SearchName>,<BitState>
```

```
SEARCH:TRIGger:MPHY:SSIC:FRAME<m>:FLD<n>:BIT? <SearchName>
```

Sets the bit state of a field to be searched that only consists of one bit.

Suffix:

<m> *

Specifies the frame number.

<n> *

Specifies the field number within the frame.

Parameters:

<BitState> ONE | ZERO | DC

ONE

1

ZERO

0

DC

"Don't care" (DC) = X

*RST: DC

Parameters for setting and query:

<SearchName> String with the name of the search.

Manual operation: See "[Search criteria](#)" on page 947

```
SEARCH:TRIGger:MPHY:SSIC:DMAX <SearchName>,<Frame>, <Field>, <Data>
```

```
SEARCH:TRIGger:MPHY:SSIC:FRAME<m>:FLD<n>:DMAX
```

```
<SearchName>,<DataMax>
```

```
SEARCH:TRIGger:MPHY:SSIC:FRAME<m>:FLD<n>:DMAX? <SearchName>
```

Sets the end value of a data pattern range if [SEARCH:TRIGger:MPHY:SSIC:FRAME<m>:FLD<n>:DOPerator](#) is set to INRange or OORange.

Suffix:

<m> *
Specifies the frame number.

<n> *
Specifies the field number within the frame.

Parameters:

<DataMax> Specifies the name of the generic trigger setting frame.

Parameters for setting and query:

<SearchName> String with the name of the search.

Manual operation: See "[Search criteria](#)" on page 947

SEARCh:TRIGger:MPHY:SSIC:DMIN <SearchName>,<Frame>, <Field>, <Data>

SEARCh:TRIGger:MPHY:SSIC:FRAME<m>:FLD<n>:DMIN

<SearchName>,<DataMin>

SEARCh:TRIGger:MPHY:SSIC:FRAME<m>:FLD<n>:DMIN? <SearchName>

Specifies the data pattern to be searched, or sets the start value of a data pattern range to be searched.

Suffix:

<m> *
Specifies the frame number.

<n> *
Specifies the field number within the frame.

Parameters:

<DataMin> Specifies the name of the generic trigger setting frame.

Parameters for setting and query:

<SearchName>

Manual operation: See "[Search criteria](#)" on page 947

SEARCh:TRIGger:MPHY:SSIC:DOPerator <SearchName>,<Frame>, <Field>,
<Operator>

SEARCh:TRIGger:MPHY:SSIC:FRAME<m>:FLD<n>:DOPerator

<SearchName>,<DataOperator>

SEARCh:TRIGger:MPHY:SSIC:FRAME<m>:FLD<n>:DOPerator? <SearchName>

Sets the operator to set a specific data pattern to be searched in the selected field of the selected frame.

Suffix:

<m> *
Specifies the frame number.

<n> *
Specifies the field number within the frame.

Parameters:

<DataOperator> EQUal | NEQual | LTHan | LETHan | GTHan | GETHan | INRange | OORange
EQUal | NEQual | LTHan | LETHan | GTHan | GETHan
Equal, Not equal, Less than, Less than or equal, Greater than, Greater than or equal. These conditions require one endpoint value to be set using `SEARCH:TRIGger:MPHY:SSIC:FRAME<m>:FLD<n>:DMIN`.

INRange | OORange
In range, out of range. These conditions require a range of endpoint values to be set using `SEARCH:TRIGger:MPHY:SSIC:FRAME<m>:FLD<n>:DMIN` and `SEARCH:TRIGger:MPHY:SSIC:FRAME<m>:FLD<n>:DMAX`.

*RST: EQUal

Parameters for setting and query:

<SearchName>

Manual operation: See "[Search criteria](#)" on page 947**SEARCH:TRIGger:MPHY:SSIC:FRENable** <SearchName>,<Frame>, <Enabler>**Setting parameters:**

<SearchName>

<Frame>

<Enabler> ON | OFF

Usage: Setting only**Manual operation:** See "[Search criteria](#)" on page 947**SEARCH:TRIGger:MPHY:SSIC:IMAX** <SearchName>,<Frame>, <Field>, <Data>**SEARCH:TRIGger:MPHY:SSIC:FRAME<m>:FLD<n>:IMAX**

<SearchName>,<IndexMax>

SEARCH:TRIGger:MPHY:SSIC:FRAME<m>:FLD<n>:IMAX? <SearchName>Sets the end value of an index range if `SEARCH:TRIGger:MPHY:SSIC:FRAME<m>:FLD<n>:IOperator` is set to `INRange` or `RANGE`.**Suffix:**<m> *
Specifies the frame number.<n> *
Specifies the field number within the frame.

Parameters:

<IndexMax> Specifies the end value for the index range within the field.
The index range, increment and *RST values depend on the field type.

Parameters for setting and query:

<SearchName>

Manual operation: See "[Search criteria](#)" on page 947

SEARCh:TRIGger:MPHY:SSIC:IMIN <SearchName>,<Frame>, <Field>, <Data>

SEARCh:TRIGger:MPHY:SSIC:FRAMe<m>:FLD<n>:IMIN

<SearchName>,<IndexMin>

SEARCh:TRIGger:MPHY:SSIC:FRAMe<m>:FLD<n>:IMIN? <SearchName>

Specifies the index at which the data is to be searched, or sets the start value of an index range in which the data is to be searched.

Suffix:

<m> *
Specifies the field number within the frame.

<n> *

Parameters:

<IndexMin> Specifies the index value or the start value of an index range within the field.
The index range, increment and *RST values depend on the field type.

Parameters for setting and query:

<SearchName> String with the name of the search.

Manual operation: See "[Search criteria](#)" on page 947

SEARCh:TRIGger:MPHY:SSIC:IOPerator <SearchName>,<Frame>, <Field>,
<Operator>

SEARCh:TRIGger:MPHY:SSIC:FRAMe<m>:FLD<n>:IOPerator

<SearchName>,<IndexOperator>

SEARCh:TRIGger:MPHY:SSIC:FRAMe<m>:FLD<n>:IOPerator? <SearchName>

Sets the operator for the index for searching in the selected field of the selected frame.

Suffix:

<m> *
Specifies the field number within the frame.

<n> *

Parameters:

<IndexOperator> EQUal | INRange | RANGe

EQUal

This condition requires one endpoint value to be set using
[SEARCh:TRIGger:MPHY:SSIC:FRAMe<m>:FLD<n>:IMIN](#).

INRange | RANGE

This condition requires a range of endpoint values to be set using `SEARCH:TRIGGER:MPHY:SSIC:FRAME<m>:FLD<n>:IMIN` and `SEARCH:TRIGGER:MPHY:SSIC:FRAME<m>:FLD<n>:IMAX`.

*RST: INRange

Parameters for setting and query:

<SearchName>

Manual operation: See "[Search criteria](#)" on page 947

27.18.26 8B/10B (option R&S RTO6-K590)**27.18.26.1 Configuration**

In all `BUS<m>:EBTB` commands, the suffix <m> selects the serial bus.

<code>BUS<m>:EBTB:BITRate</code>	2509
<code>BUS<m>:EBTB:EBTRate?</code>	2510
<code>BUS<m>:EBTB:DIFFerential:SOURce</code>	2510
<code>BUS<m>:EBTB:DIFFerential:THRHigh</code>	2510
<code>BUS<m>:EBTB:DIFFerential:THRLow</code>	2511
<code>BUS<m>:EBTB:DISF</code>	2511
<code>BUS<m>:EBTB:DMINus:SOURce</code>	2511
<code>BUS<m>:EBTB:DMINus:THReshold</code>	2511
<code>BUS<m>:EBTB:DPLus:SOURce</code>	2512
<code>BUS<m>:EBTB:DPLus:THReshold</code>	2512
<code>BUS<m>:EBTB:FCSY</code>	2512
<code>BUS<m>:EBTB:SCOut?</code>	2513
<code>BUS<m>:EBTB:SCSY</code>	2513
<code>BUS<m>:EBTB:SYNC</code>	2513
<code>BUS<m>:EBTB:TYPE</code>	2513
<code>BUS<m>:EBTB:USCS</code>	2514
<code>BUS<m>:EBTB:BITDetermi</code>	2514
<code>BUS<m>:EBTB:FAUToscale</code>	2514

BUS<m>:EBTB:BITRate <Bitrate>

Sets the number of transmitted bits per second.

Suffix:

<m> 1..4

Parameters:

<Bitrate> Range: 100 to 200E+9
 Increment: 10
 *RST: 1.25E+9
 Default unit: bps

Manual operation: See ["Bitrate"](#) on page 951

BUS<m>:EBTB:EBTRate?

Queries the estimated bitrate value.

Suffix:

<m> 1..4

Return values:

<EstimatedBitrate> Range: 100 to 100E+9
 Increment: 10
 *RST: 1.25E+9
 Default unit: bps

Usage: Query only

Manual operation: See ["Estimate Bitrate"](#) on page 951

BUS<m>:EBTB:DIFFerential:SOURce <SrcDiff>

Selects the source of the provided differential signal, if `BUS<m>:EBTB:TYPE DIFFerential` is set.

Suffix:

<m> 1..4

Parameters:

<SrcDiff> C1W1 | C2W1 | C3W1 | C4W1 | M1 | M2 | M3 | M4 | M5 | M6 |
 M7 | M8 | R1 | R2 | R3 | R4
 *RST: C1W1

Usage: Asynchronous command

Manual operation: See ["Source"](#) on page 950

BUS<m>:EBTB:DIFFerential:THRHigh <ThresholdHigh>

Sets the high threshold of the signal, if `BUS<m>:EBTB:TYPE DIFFerential`.

Suffix:

<m> 1..4

Parameters:

<ThresholdHigh> Range: -10 to 10
 Increment: 1E-3
 *RST: 0.15
 Default unit: V

Manual operation: See ["Threshold High"](#) on page 951

BUS<m>:EBTB:DIFFerential:THRLow <ThresholdLow>

Sets the low threshold of the signal, if `BUS<m>:EBTB:TYPE DIFFerential`.

Suffix:

<m> 1..4

Parameters:

<ThresholdLow> Range: -10 to 10
Increment: 1E-3
*RST: -0.15
Default unit: V

Manual operation: See "[Threshold Low](#)" on page 951

BUS<m>:EBTB:DISF <DisplayFormat>

Selects the display format for the results in the decode table and for the results of `BUS<m>:EBTB:SYMBOL<n>:DATA?`.

Suffix:

<m> 1..4

Parameters:

<DisplayFormat> KD | EB | TB
KD: K/D codes
EB: 8-bit pattern
TB: 10-bit pattern
*RST: KD

Manual operation: See "[Display Format](#)" on page 953

BUS<m>:EBTB:DMINus:SOURce <SourceDminus>

Selects the D- source of the provided single ended signal, if `BUS<m>:EBTB:TYPE SINGLE` is set.

Suffix:

<m> 1..4

Parameters:

<SourceDminus> NONE | C1W1 | C2W1 | C3W1 | C4W1 | M1 | M2 | M3 | M4 |
M5 | M6 | M7 | M8 | R1 | R2 | R3 | R4

Usage: Asynchronous command

Manual operation: See "[Source D-](#)" on page 950

BUS<m>:EBTB:DMINus:THReshold <ThresholdDminus>

Sets the low threshold (D-) of the signal, if `BUS<m>:EBTB:TYPE SINGLE`.

Suffix:

<m> 1..4

Parameters:

<ThresholdDminus> Range: -10 to 10
 Increment: 1E-3
 *RST: 0
 Default unit: V

Manual operation: See ["Threshold D-"](#) on page 951**BUS<m>:EBTB:DPLus:SOURce <SourceDplus>**

Selects the D+ source of the provided single-ended signal, if BUS<m>:EBTB:TYPE SINGLE is set.

Suffix:

<m> 1..4

Parameters:

<SourceDplus> NONE | C1W1 | C2W1 | C3W1 | C4W1 | M1 | M2 | M3 | M4 |
 M5 | M6 | M7 | M8 | R1 | R2 | R3 | R4
 *RST: C1W1

Usage: Asynchronous command**Manual operation:** See ["Source D+"](#) on page 950**BUS<m>:EBTB:DPLus:THReshold <ThresholdDplus>**

Sets the high threshold (D +) of the signal, if BUS<m>:EBTB:TYPE SINGLE.

Suffix:

<m> 1..4

Parameters:

<ThresholdDplus> Range: -10 to 10
 Increment: 1E-3
 *RST: 0
 Default unit: V

Manual operation: See ["Threshold D+"](#) on page 951**BUS<m>:EBTB:FCSY <CustSync>**

Sets a pattern value, if BUS<m>:EBTB:SYNC CUS.

Suffix:

<m> 1..4

Parameters:

<CustSync>

Manual operation: See ["Pattern"](#) on page 952

BUS<m>:EBTB:SCOUNT?

Returns the symbol count for the selected serial bus, i.e. the number of symbols in the present acquisition.

Suffix:

<m> 1..4

Return values:

<Count> Range: 0 to 100000
Increment: 1
*RST: 0

Usage: Query only

BUS<m>:EBTB:SCSY <CustSync2>

Sets the value for the second pattern, if `BUS<m>:EBTB:SYNC CUS` and `BUS<m>:EBTB:USCS ON`.

Suffix:

<m> 1..4

Parameters:

<CustSync2>

Manual operation: See "[Pattern 2](#)" on page 952

BUS<m>:EBTB:SYNC <CommaSymbol>

Sets the sync symbol, a control symbol used for low level control functions.

Suffix:

<m> 1..4

Parameters:

<CommaSymbol> K285 | K281 | K287 | CUS
*RST: K285

Manual operation: See "[Sync symbol](#)" on page 952

BUS<m>:EBTB:TYPE <SignalType>

Selects the signal type that is used for the decoding. You can choose between a differential and single-ended signal.

Suffix:

<m> 1..4

Parameters:

<SignalType> DIFFerential | SINGLE
*RST: DIFFerential

Manual operation: See "[Signal type](#)" on page 950

BUS<m>:EBTB:USCS <IsSecondSync>

Selects whether the second pattern is enabled, if `BUS<m>:EBTB:SYNC CUS`.

Suffix:

<m> 1..4

Parameters:

<IsSecondSync> ON | OFF
*RST: OFF

Manual operation: See "Pattern 2" on page 952

BUS<m>:EBTB:BITDetermi

Starts a software algorithm for the automatic determination of the bitrate.

Suffix:

<m> 1..4

Usage:

Event
Asynchronous command

Manual operation: See "Estimate Bitrate" on page 951

BUS<m>:EBTB:FAUToscale

Starts software algorithms for determining the signal threshold levels and bitrate.

Suffix:

<m> 1..4

Usage:

Event
Asynchronous command

27.18.26.2 Trigger settings

The trigger suffix <m> is always 1 and can be omitted. It selects the trigger event: Only the A-trigger is available for triggering on serial buses.

To trigger on a serial bus, make sure that:

- `TRIGger<m>:SOURce[:SELEct]` is set to `SBUS`.
- The sources of the serial bus are channel signals: use `BUS<m>:...:SOURce` commands.
- Decoding is enabled: `BUS<m>[:STATE]` is set to `ON`.

<code>TRIGger<m>:EBTB:DISParityerr</code>	2515
<code>TRIGger<m>:EBTB:DX</code>	2515
<code>TRIGger<m>:EBTB:DY</code>	2515
<code>TRIGger<m>:EBTB:EBPA</code>	2515
<code>TRIGger<m>:EBTB:GLITCherror</code>	2516
<code>TRIGger<m>:EBTB:SSType</code>	2516

TRIGger<m>:EBTB:SYME.....	2516
TRIGger<m>:EBTB:SYMType.....	2516
TRIGger<m>:EBTB:TBPA.....	2516
TRIGger<m>:EBTB:STYPe.....	2517
TRIGger<m>:EBTB:UNK.....	2517

TRIGger<m>:EBTB:DISParityerr <DispError>

Defines, if a trigger on a disparity error is activated or not.

Parameters:

<DispError> ON | OFF
 *RST: OFF

Manual operation: See "[Disparity error](#)" on page 956

TRIGger<m>:EBTB:DX <DXSymbol>

Sets the value of the data character Dx.y to be triggered on, if [TRIGger<m>:EBTB:SYMType](#) is set to Dx.y.

Parameters:

<DXSymbol> Range: 0 to 31
 Increment: 1
 *RST: 0

Manual operation: See "[x value](#)" on page 955

TRIGger<m>:EBTB:DY <DYSymbol>

Sets the y value of the data character Dx.y to be triggered on, if [TRIGger<m>:EBTB:SYMType](#) is set to Dx.y.

Parameters:

<DYSymbol> Range: 0 to 7
 Increment: 1
 *RST: 0

Manual operation: See "[y value](#)" on page 955

TRIGger<m>:EBTB:EBPA <EBPattern>

Sets the 8-bit pattern to be triggered on, if [TRIGger<m>:EBTB:STYPe](#) is set to EB.

Parameters:

<EBPattern>

Manual operation: See "[8 bit pattern](#)" on page 955

TRIGger<m>:EBTB:GLITCherror <GlitchError>

Defines, if a trigger on a glitch error is activated or not.

Parameters:

<GlitchError> ON | OFF
 *RST: OFF

Manual operation: See "[Glitching error](#)" on page 956

TRIGger<m>:EBTB:SSType <SymbolType>

Selects the symbol type to be triggered on. You can select a single symbol or an expression (defined series of symbols).

Parameters:

<SymbolType> SYMBol | EXPReSSion
 *RST: SYMBol

TRIGger<m>:EBTB:SYME <Expression>

Selects the format of the symbol to be triggered on, if [TRIGger<m>:EBTB:SSType](#) is set to `EXPReSSion`.

Parameters:

<Expression>

Manual operation: See "[Expression](#)" on page 955

TRIGger<m>:EBTB:SYMType <SymbolType>

Selects the data character (Dx.y) or control character to be triggered on. You can specify the value of the data character to be triggered on with [TRIGger<m>:EBTB:DX](#) and [TRIGger<m>:EBTB:DY](#).

Parameters:

<SymbolType> DXY | K280 | K281 | K282 | K283 | K284 | K285 | K286 | K287 |
 K237 | K277 | K297 | K307
 *RST: K285

Manual operation: See "[K/D Codes Symbol](#)" on page 955

TRIGger<m>:EBTB:TBPA <TBPattern>

Sets the 10-bit pattern to be triggered on, if [TRIGger<m>:EBTB:SType](#) is set to `TB`.

Parameters:

<TBPattern>

Manual operation: See "[10 bit pattern](#)" on page 955

TRIGger<m>:EBTB:STYPe <Type>

Selects the type of condition to be triggered on for 8b10b.

Parameters:

<Type> KD | EB | TB | EXPReSSion | ERRor
 KD: K/D symbol
 EB: 8-bit pattern
 TB: 10-bit pattern
 *RST: KD

Manual operation: See "[Type 8b/10b](#)" on page 954

TRIGger<m>:EBTB:UNK <UnkError>

Defines, if a trigger on a unknown symbol error is activated or not.

Parameters:

<UnkError> ON | OFF
 *RST: OFF

Manual operation: See "[Unknown symbol error](#)" on page 956

27.18.26.3 Decode results

In all `BUS<m>:EBTB:SYMBOL<n>` commands, the suffix `<m>` selects the serial bus and the suffix `<n>` selects the symbol in the decode table.

<code>BUS<m>:EBTB:SYMBOL<n>:DATA?</code>	2517
<code>BUS<m>:EBTB:SYMBOL<n>:START?</code>	2518
<code>BUS<m>:EBTB:SYMBOL<n>:STATUS?</code>	2518
<code>BUS<m>:EBTB:SYMBOL<n>:STOP?</code>	2519
<code>BUS<m>:EBTB:SYMBOL<n>:BYTE?</code>	2519
<code>BUS<m>:EBTB:SYMBOL<n>:KDCODE?</code>	2519
<code>BUS<m>:EBTB:SYMBOL<n>:TENBIT?</code>	2519

BUS<m>:EBTB:SYMBOL<n>:DATA?

Returns the data of the specified symbol.

The format is determined by the remote command `BUS<m>:EBTB:DISF`.

Suffix:

<m> 1..4
 <n> *

Return values:

<Data>

Example:

```
BUS<m>:EBTB:DISF EB
BUS:EBTB:SYMBOL15:DATA?
<-- BC+
```

Example: BUS<m>:EBTB:DISF KD
 BUS:EBTB:SYMBOL5:DATA?
 <-- K28.5+

Example: BUS<m>:EBTB:DISF TB
 BUS:EBTB:SYMBOL5:DATA?
 <-- 305

Usage: Query only

BUS<m>:EBTB:SYMBOL<n>:START?

Returns the start time of the specified symbol.

Suffix:

<m> 1..4

<n> *

Return values:

<Start> Range: -100E+24 to 100E+24
 Increment: 100E-12
 *RST: 0
 Default unit: s

Usage: Query only

BUS<m>:EBTB:SYMBOL<n>:STATUS?

Returns the status of the specified symbol. It can show what kind of error was detected or no error.

Suffix:

<m> 1..4

<n> *

Return values:

<State> OK | UNK | DISPARITY | DISParity | GLITCH | GLITCh
OK
 There are no errors in the state of the specified symbol.
UNK
 An unknown error was detected for the specified symbol.
DISPARITY = DISParity
 A disparity error was detected for the specified symbol.
GLITCH = GLITCh
 A glitch error was detected for the specified symbol.
 *RST: OK

Usage: Query only

BUS<m>:EBTB:SYMBOL<n>:STOP?

Returns the stop time of the specified symbol.

Suffix:

<m>	1..4
<n>	*

Return values:

<Stop>	Range: -100E+24 to 100E+24
	Increment: 100E-12
	*RST: 0
	Default unit: s

Usage: Query only

BUS<m>:EBTB:SYMBOL<n>:BYTE?

Returns the symbol byte value.

Suffix:

<m>	1..4
<n>	*

Return values:

<Byte>	Range: 0 to 0
	Increment: 1
	*RST: 0

Usage: Query only

BUS<m>:EBTB:SYMBOL<n>:KDCODE?

Returns the K/D code.

Suffix:

<m>	1..4
<n>	*

Return values:

<KDCODE>

Usage: Query only

BUS<m>:EBTB:SYMBOL<n>:TENBIT?

Returns the 10-bit symbol.

Suffix:

<m>	1..4
<n>	*

Return values:

<TenBit>

Usage: Query only**27.18.26.4 Search settings**

SEARch:TRIGger:EBTB:DISParityerr.....	2520
SEARch:TRIGger:EBTB:DX.....	2520
SEARch:TRIGger:EBTB:DY.....	2521
SEARch:TRIGger:EBTB:EBPA.....	2521
SEARch:TRIGger:EBTB:GLITCherror.....	2521
SEARch:TRIGger:EBTB:STYPe.....	2521
SEARch:TRIGger:EBTB:SYME.....	2522
SEARch:TRIGger:EBTB:SYMType.....	2522
SEARch:TRIGger:EBTB:TBPA.....	2522
SEARch:TRIGger:EBTB:UNK.....	2523

SEARch:TRIGger:EBTB:DISParityerr <SearchName>,<DispError>**SEARch:TRIGger:EBTB:DISParityerr?** <SearchName>

Defines, if a search for any disparity error is activated or not.

Parameters:

<DispError> ON | OFF
 *RST: OFF

Parameters for setting and query:

<SearchName>

Manual operation: See "[Disparity error](#)" on page 960**SEARch:TRIGger:EBTB:DX** <SearchName>,<DXSymbol>**SEARch:TRIGger:EBTB:DX?** <SearchName>Sets the x value of the data character Dx.y to be searched for, if [SEARch:TRIGger:EBTB:SYMType](#) is set to Dxy.**Parameters:**

<DXSymbol> Range: 0 to 31
 Increment: 1
 *RST: 0

Parameters for setting and query:

<SearchName>

Manual operation: See "[x value](#)" on page 959

SEARCh:TRIGger:EBTB:DY <SearchName>,<DYSymbol>
SEARCh:TRIGger:EBTB:DY? <SearchName>

Sets the y value of the data character Dx.y to be searched for, if **SEARCh:TRIGger:EBTB:SYMType** is set to Dxy.

Parameters:

<DYSymbol> Range: 0 to 7
 Increment: 1
 *RST: 0

Parameters for setting and query:

<SearchName>

Manual operation: See "[y value](#)" on page 959

SEARCh:TRIGger:EBTB:EBPA <SearchName>,<EBPattern>
SEARCh:TRIGger:EBTB:EBPA? <SearchName>

Sets the 8-bit pattern to be searched for.

Parameters:

<EBPattern>

Parameters for setting and query:

<SearchName>

Manual operation: See "[8b Pattern](#)" on page 960

SEARCh:TRIGger:EBTB:GLITCherror <SearchName>,<GlitchError>
SEARCh:TRIGger:EBTB:GLITCherror? <SearchName>

Defines, if a search for any glitch error is activated or not.

Parameters:

<GlitchError> ON | OFF
 *RST: OFF

Parameters for setting and query:

<SearchName>

Manual operation: See "[Glitching error](#)" on page 960

SEARCh:TRIGger:EBTB:STYPe <SearchName>,<Type>
SEARCh:TRIGger:EBTB:STYPe? <SearchName>

Selects the search type.

Parameters:

<Type> KD | EB | TB | EXPReSSion | ERRor
 KD: K/D symbol
 EB: 8-bit pattern
 TB: 10-bit pattern
 *RST: KD

Parameters for setting and query:

<SearchName>

SEARCh:TRIGger:EBTB:SYME <SearchName>,<Expression>

SEARCh:TRIGger:EBTB:SYME? <SearchName>

Selects the format of the symbol to be searched for, if **SEARCh:TRIGger:EBTB:STYPe** is set to **EXPReSSion**.

Parameters:

<Expression>

Parameters for setting and query:

<SearchName>

Manual operation: See "[Expression](#)" on page 960

SEARCh:TRIGger:EBTB:SYMType <SearchName>,<SymbolType>

SEARCh:TRIGger:EBTB:SYMType? <SearchName>

Selects the data character (Dx.y) or control character to be searched for. You can specify the value of the data character to be searched for with **SEARCh:TRIGger:EBTB:DX** and **SEARCh:TRIGger:EBTB:DY**.

Parameters:

<SymbolType> DXY | K280 | K281 | K282 | K283 | K284 | K285 | K286 | K287 |
 K237 | K277 | K297 | K307
 *RST: K285

Parameters for setting and query:

<SearchName>

Manual operation: See "[K/D Codes Symbol](#)" on page 959

SEARCh:TRIGger:EBTB:TBPA <SearchName>,<TBPattern>

SEARCh:TRIGger:EBTB:TBPA? <SearchName>

Sets the 10-bit pattern to be searched for, if **SEARCh:TRIGger:EBTB:STYPe** is set to **TB**.

Parameters:

<TBPattern>

Parameters for setting and query:

<SearchName>

Manual operation: See "[10b Pattern](#)" on page 960

SEARCH:TRIGger:EBTB:UNK <SearchName>,<UnkError>
SEARCH:TRIGger:EBTB:UNK? <SearchName>

Defines, if a search for any unknown symbol error is activated or not.

Parameters:

<UnkError> ON | OFF
 *RST: OFF

Parameters for setting and query:

<SearchName>

Manual operation: See "[Unknown symbol error](#)" on page 960

27.18.26.5 Search results

In all **SEARCH:RESult:EBTB:SYMBol<m>** commands, the suffix <m> selects the frame number in the list of search results.

SEARCH:RESult:EBTB:SCOut?	2523
SEARCH:RESult:EBTB:SYMBol<m>:DATA?	2523
SEARCH:RESult:EBTB:SYMBol<m>:START?	2524
SEARCH:RESult:EBTB:SYMBol<m>:STATus?	2524
SEARCH:RESult:EBTB:SYMBol<m>:STOP?	2524

SEARCH:RESult:EBTB:SCOut? <SearchName>

Returns the symbol count, i.e. the number of symbols found in the specified search result.

Query parameters:

<SearchName>

Return values:

<Count> Range: 0 to 100000
 Increment: 1
 *RST: 0

Usage: Query only

SEARCH:RESult:EBTB:SYMBol<m>:DATA? <SearchName>

Returns the data of the specified symbol.

Suffix:

<m> *

Query parameters:

<SearchName>

Return values:

<Data>

Usage: Query only**SEARCh:RESult:EBTB:SYMBol<m>:START? <SearchName>**

Returns the start time of the specified symbol within the search result.

Suffix:

<m> *

Query parameters:

<SearchName>

Return values:

<Start> Range: -100E+24 to 100E+24
 Increment: 100E-12
 *RST: 0
 Default unit: s

Usage: Query only**SEARCh:RESult:EBTB:SYMBol<m>:STATus? <SearchName>**

Returns the status of the specified symbol within the search result. It can show what kind of error was detected or no error.

Suffix:

<m> *

Query parameters:

<SearchName>

Return values:

<State> OK | UNK | DISPARITY | DISParity | GLITCH | GLITCh

OK
There are no errors in the state of the specified symbol.

UNK
An unknown error was detected for the specified symbol.

DISPARITY = DISParity
A disparity error was detected for the specified symbol.

GLITCH = GLITCh
A glitch error was detected for the specified symbol.

*RST: OK

Usage: Query only**SEARCh:RESult:EBTB:SYMBol<m>:STOP? <SearchName>**

Returns the stop time of the specified symbol within the search result.

Suffix:

<m> *

Query parameters:

<SearchName>

Return values:

<Stop> Range: -100E+24 to 100E+24
 Increment: 100E-12
 *RST: 0
 Default unit: s

Usage: Query only**27.18.27 PCIe (option R&S RTO6K72)**

- [Configuration](#).....2525
- [Clock data recovery](#)..... 2528
- [Trigger](#).....2530
- [Decode results](#).....2540
- [Search settings](#).....2548
- [Search results](#).....2561

27.18.27.1 Configuration

In all `BUS<m>:PCIE` commands, the suffix `<m>` selects the serial bus.

BUS<m>:PCIE:DSCRambling	2525
BUS<m>:PCIE:FIDLe	2526
BUS<m>:PCIE:GEN	2526
BUS<m>:PCIE:LNKW	2526
BUS<m>:PCIE:LZER:SOURce	2527
BUS<m>:PCIE:LONE:SOURce	2527
BUS<m>:PCIE:LTWO:SOURce	2527
BUS<m>:PCIE:LTHRee:SOURce	2527
BUS<m>:PCIE:LZER:THRHigh	2527
BUS<m>:PCIE:LONE:THRHigh	2527
BUS<m>:PCIE:LTWO:THRHigh	2527
BUS<m>:PCIE:LTHRee:THRHigh	2527
BUS<m>:PCIE:LZER:THRLow	2527
BUS<m>:PCIE:LONE:THRLow	2527
BUS<m>:PCIE:LTWO:THRLow	2527
BUS<m>:PCIE:LTHRee:THRLow	2528
BUS<m>:PCIE:SMLanes	2528

BUS<m>:PCIE:DSCRambling <Active>

Enables descrambling of the data.

Suffix:

<m> 1..4

Parameters:

<Active> ON | OFF
 *RST: ON

Manual operation: See "[Descrambling](#)" on page 965

BUS<m>:PCIE:FIDLe <Active>

Enables the filtering of idle packets.

Suffix:

<m> 1..4

Parameters:

<Active> ON | OFF
 *RST: ON

Manual operation: See "[Filter Idle](#)" on page 967

BUS<m>:PCIE:GEN <Generation>

Sets the generation of the PCIe technology.

Suffix:

<m> 1..4

Parameters:

<Generation> V1 | V2 | V3
V1
 PCIe Gen1 (2.5 Gbit/s)
V2
 PCIe Gen2 (5 Gbit/s)
 *RST: V1

Manual operation: See "[Generation](#)" on page 964

BUS<m>:PCIE:LNKW <LinkWidth>

Sets the link width, the number of lanes that are used for the transmission of the data.

Suffix:

<m> 1..4

Parameters:

<LinkWidth> X1 | X2 | X4
 *RST: X1

Manual operation: See "[Link](#)" on page 965

BUS<m>:PCIE:LZER:SOURce <SourceL0>

Sets the signal sources for Lane 0.

Suffix:

<m> 1..4

Parameters:

<SourceL0> C1W1 | C2W1 | C3W1 | C4W1 | M1 | M2 | M3 | M4 | M5 | M6 | M7 | M8 | R1 | R2 | R3 | R4

*RST: C1W1

Manual operation: See "[Lane 0/1/2/3](#)" on page 965

BUS<m>:PCIE:LONE:SOURce <SourceL1>

BUS<m>:PCIE:LTWO:SOURce <SourceL2>

BUS<m>:PCIE:LTHRee:SOURce <SourceL3>

Sets the signal sources for the corresponding logical lane.

Suffix:

<m> 1..4

Parameters:

<SourceL3> C1W1 | C2W1 | C3W1 | C4W1 | M1 | M2 | M3 | M4 | M5 | M6 | M7 | M8 | R1 | R2 | R3 | R4 | NONE

*RST: LONe: C2W1, LTW0: C3W1, LTHree: C4W1

Manual operation: See "[Lane 0/1/2/3](#)" on page 965

BUS<m>:PCIE:LZER:THRHigh <ThresholdL0High>

BUS<m>:PCIE:LONE:THRHigh <ThresholdL1High>

BUS<m>:PCIE:LTWO:THRHigh <ThresholdL2High>

BUS<m>:PCIE:LTHRee:THRHigh <ThresholdL3High>

Sets the high threshold value for the respective lane.

Suffix:

<m> 1..4

Parameters:

<ThresholdL3High> Range: -5 to 5

Increment: 1E-3

*RST: 0.02

Default unit: V

Manual operation: See "[High threshold](#)" on page 966

BUS<m>:PCIE:LZER:THRLow <ThresholdL0Low>

BUS<m>:PCIE:LONE:THRLow <ThresholdL1Low>

BUS<m>:PCIE:LTWO:THRLow <ThresholdL2Low>

BUS<m>:PCIE:LTHRee:THRLow <ThresholdL3Low>

BUS<m>:PCIE:SMLanes <Active>

Enables the display of the result in multiple lanes.

Suffix:

<m> 1..4

Parameters:

<Active> ON | OFF

*RST: ON

Manual operation: See "[Show multiple lanes](#)" on page 967

27.18.27.2 Clock data recovery

BUS<m>:CDR:BITRate.....	2528
BUS<m>:CDR:PLL:BWIDth.....	2528
BUS<m>:CDR:PLL:DAMPing.....	2529
BUS<m>:CDR:PLL:ORDer.....	2529
BUS<m>:CDR:PLL:RELBwidth.....	2529
BUS<m>:CDR:RESults.....	2530
BUS<m>:CDR:SYNC.....	2530

BUS<m>:CDR:BITRate <Bitrate>

For NRZ signals, you can set a "Nominal bit rate".

For signals with a "PAM order" > 2, you can do a "Nominal symbol rate".

Sets the quiescent frequency of the PLL. It corresponds to the data rate of the data stream from which the clock is to be recovered.

Suffix:

<m> 1..4

Parameters:

<Bitrate> Range: 100 to 5E+9

Increment: 10

*RST: 1E+9

Default unit: bps

Manual operation: See "[Nominal bit rate](#)" on page 968

BUS<m>:CDR:PLL:BWIDth <PLLBandwidth>

Sets the PLL bandwidth. It defines the part of the spectrum that the PLL can follow during synchronization. The PLL bandwidth is usually defined by the transmission standard.

Suffix:

<m> 1..4

Parameters:

<PLLBandwidth> Range: 20E+3 to 10E+6
 Increment: 10
 *RST: 599.88E+3
 Default unit: Hz

Manual operation: See "[PLL settings](#)" on page 968

BUS<m>:CDR:PLL:DAMPing <DampingFactor>

Sets the damping factor, which is only relevant for second order PLL.

Suffix:

<m> 1..4

Parameters:

<DampingFactor> Range: 0.5 to 2
 Increment: 0.01
 *RST: 0.7

Manual operation: See "[PLL settings](#)" on page 968

BUS<m>:CDR:PLL:ORDer <PLLOrder>

Sets the order of the PLL: first or second order. PLL of higher order can compensate for more complex jitter behavior.

Suffix:

<m> 1..4

Parameters:

<PLLOrder> FIRSt | SEConD
 *RST: SEConD

Manual operation: See "[PLL settings](#)" on page 968

BUS<m>:CDR:PLL:RELBwidth <PLLRelBw>

Sets the relative bandwidth, that is the ratio of the nominal bit rate to the PLL bandwidth.

Suffix:

<m> 1..4

Parameters:

<PLLRelBw> Range: 10 to 5000
 Increment: 1
 *RST: 1667

Manual operation: See "[PLL settings](#)" on page 968

BUS<m>:CDR:RESults <Results>

The PLL requires some time to synchronize to the phase of the data stream. You can select when the CDR algorithm returns clock edges.

Suffix:

<m> 1..4

Parameters:

<Results> ALL | AISYnc
*RST: ALL

Manual operation: See "[Selected results](#)" on page 969

BUS<m>:CDR:SYNC <InitialSync>

Defines the phase reference for the first clock edge.

Suffix:

<m> 1..4

Parameters:

<InitialSync> SAMPlE | DATaedge

SAMPlE

The first clock edge matches the first sample of the waveform at the left border of the display.

DATaedge

The first clock edge matches the first edge of the data signal.

*RST: DATaedge

Manual operation: See "[Initial phase sync](#)." on page 969

27.18.27.3 Trigger

The trigger suffix <m> is always 1 and can be omitted. It selects the trigger event: Only the A-trigger is available for triggering on serial buses.

To trigger on a serial bus, make sure that:

- `TRIGger<m>:SOURce[:SElect]` is set to `SBUS`.
- The sources of the serial bus are channel signals: use `BUS<m>:...:SOURce` commands.
- Decoding is enabled: `BUS<m>[:STATe]` is set to `ON`.

<code>TRIGger<m>:PCIE:DLLP:FCTL:CRET</code>	2531
<code>TRIGger<m>:PCIE:DLLP:FCTL:VCID</code>	2531
<code>TRIGger<m>:PCIE:DLLP:MULT:AUTH</code>	2532
<code>TRIGger<m>:PCIE:DLLP:MULT:CRET</code>	2532
<code>TRIGger<m>:PCIE:DLLP:MULT:DVPT</code>	2532
<code>TRIGger<m>:PCIE:DLLP:MULT:HABS</code>	2532
<code>TRIGger<m>:PCIE:DLLP:MULT:MIXT</code>	2532
<code>TRIGger<m>:PCIE:DLLP:MULT:PHAS</code>	2533

TRIGger<m>:PCIE:DLLP:MULT:RESA.....	2533
TRIGger<m>:PCIE:DLLP:MULT:TLPT.....	2533
TRIGger<m>:PCIE:DLLP:MULT:TYPE.....	2533
TRIGger<m>:PCIE:DLLP:MULT:VHFC.....	2534
TRIGger<m>:PCIE:DLLP:MULT:VHGR.....	2534
TRIGger<m>:PCIE:DLLP:MULT:VLNR.....	2534
TRIGger<m>:PCIE:DLLP:POWM.....	2534
TRIGger<m>:PCIE:DLLP:SEQ.....	2534
TRIGger<m>:PCIE:DLLP:TYPE.....	2535
TRIGger<m>:PCIE:DLLP:VPAT.....	2535
TRIGger<m>:PCIE:ERRC:CRC.....	2535
TRIGger<m>:PCIE:ERRC:DISP.....	2535
TRIGger<m>:PCIE:ERRC:ECRC.....	2535
TRIGger<m>:PCIE:ERRC:INVP.....	2536
TRIGger<m>:PCIE:ERRC:LCRC.....	2536
TRIGger<m>:PCIE:OSET:TYPE.....	2536
TRIGger<m>:PCIE:TLP:ADRT.....	2537
TRIGger<m>:PCIE:TLP:CFGT.....	2537
TRIGger<m>:PCIE:TLP:CPID.....	2537
TRIGger<m>:PCIE:TLP:CPLS.....	2537
TRIGger<m>:PCIE:TLP:DEID.....	2537
TRIGger<m>:PCIE:TLP:MERW.....	2538
TRIGger<m>:PCIE:TLP:MSGC.....	2538
TRIGger<m>:PCIE:TLP:MSGR.....	2538
TRIGger<m>:PCIE:TLP:ORDE.....	2538
TRIGger<m>:PCIE:TLP:REID.....	2538
TRIGger<m>:PCIE:TLP:SNOO.....	2539
TRIGger<m>:PCIE:TLP:SNUM.....	2539
TRIGger<m>:PCIE:TLP:TCHN.....	2539
TRIGger<m>:PCIE:TLP:TYPE.....	2539
TRIGger<m>:PCIE:TYPE.....	2539

TRIGger<m>:PCIE:DLLP:FCTL:CRET <CreditType>

Sets credit type value to be triggered on for the data link layer trigger.

Parameters:

<CreditType> ANY | P | NP | CPL
 *RST: ANY

Manual operation: See "[Credit Type](#)" on page 976

TRIGger<m>:PCIE:DLLP:FCTL:VCID <VirtualChnID>

Sets the virtual channel ID to be triggered on for the data link layer trigger.

Parameters:

<VirtualChnID> ANY | ZERO | ONE | TWO | THREE | FOUR | FIVE | SIX |
 SEVEN
 *RST: ANY

Manual operation: See ["VC ID"](#) on page 976

TRIGger<m>:PCIE:DLLP:MULT:AUTH <Authorized>

Sets the authorized presence state to be triggered on for the data link layer trigger.

Parameters:

<Authorized> ANY | YES | NO
*RST: ANY

Manual operation: See ["Authorized"](#) on page 974

TRIGger<m>:PCIE:DLLP:MULT:CRET <CreditType>

Sets the credit type to be triggered on for the multi-root data link layer trigger.

Parameters:

<CreditType> ANY | DATA | HEADER
*RST: ANY

Manual operation: See ["Credit Type"](#) on page 975

TRIGger<m>:PCIE:DLLP:MULT:DVPT <DevicePortType>

Sets the device/port type to be triggered on for the data link layer trigger.

Parameters:

<DevicePortType> ANY | ZERO | ONE | TWO | THREE | FOUR | FIVE | SIX | SEVEN | EIGHT | NINE | TEN | ELEVEN | TWELVE | THIRTEEN | FOURTEEN | FIFTEEN
*RST: ANY

Manual operation: See ["Device/Port Type"](#) on page 974

TRIGger<m>:PCIE:DLLP:MULT:HABS <VHAbsent>

Sets the state of the absent virtual hierarchies (VH) to be triggered on for the data link layer trigger.

Parameters:

<VHAbsent> ANY | YES | NO
*RST: ANY

Manual operation: See ["VH Absent"](#) on page 975

TRIGger<m>:PCIE:DLLP:MULT:MIXT <MixedType>

Sets the mixed type presence state to be triggered on for the data link layer trigger.

Parameters:

<MixedType> ANY | YES | NO
 *RST: ANY

Manual operation: See "[Mixed Type](#)" on page 974

TRIGger<m>:PCIE:DLLP:MULT:PHAS <Phase>

Sets the phase state to be triggered on for the data link layer trigger.

Parameters:

<Phase> ANY | YES | NO
 *RST: ANY

Manual operation: See "[Phase](#)" on page 974

TRIGger<m>:PCIE:DLLP:MULT:RESA <ResetA>

Sets the on the value of the A bit to be triggered on for the data link layer trigger.

Parameters:

<ResetA> ANY | ACK | REQUEST
 *RST: ANY

Manual operation: See "[A](#)" on page 976

TRIGger<m>:PCIE:DLLP:MULT:TLPT <TLPTType>

Sets the multi-root type to be triggered on for the data link layer trigger.

Parameters:

<TLPTType> ANY | P | NP | CPL
P
 Posted credit.
NP
 Non posted credit.
CL
 Completion credit.
 *RST: ANY

Manual operation: See "[TLP Type](#)" on page 975

TRIGger<m>:PCIE:DLLP:MULT:TYPE <Type>

Sets the multi-root type for the data link layer to be triggered on.

Parameters:

<Type> MRINIT | MRRESET | MRUPDATEFC | MRINITFC1 |
 MRINITFC2
 *RST: MRINIT

Manual operation: See ["MR DLLP"](#) on page 973

TRIGger<m>:PCIE:DLLP:MULT:VHFC <InitVHFC>

Sets the virtual hierarchies flow control presence state to be triggered on for the data link layer trigger.

Parameters:

<InitVHFC> ANY | YES | NO
*RST: ANY

Manual operation: See ["VH FC"](#) on page 974

TRIGger<m>:PCIE:DLLP:MULT:VHGR <ResetVHGroup>

Sets the virtual hierarchies group to be triggered on for the data link layer trigger.

Parameters:

<ResetVHGroup> ANY | ZERO | ONE | TWO | THREE | FOUR | FIVE | SIX | SEVEN | EIGHT | NINE | TEN | ELEVEN | TWELVE | THIRTEEN | FOURTEEN | FIFTEEN
*RST: ANY

Manual operation: See ["VH Group"](#) on page 976

TRIGger<m>:PCIE:DLLP:MULT:VLNR <VirtualLink>

Sets the virtual link (VL) number to be triggered on for the data link layer trigger.

Parameters:

<VirtualLink> ANY | ZERO | ONE | TWO | THREE | FOUR | FIVE | SIX | SEVEN
*RST: ANY

Manual operation: See ["VL Number"](#) on page 975

TRIGger<m>:PCIE:DLLP:POWM <PowerMngtType>

Sets the power management type to be triggered on for the data link layer trigger.

Parameters:

<PowerMngtType> ANY | ENTERL1 | ENTERL23 | ACTREQ1 | REQUESTACK
*RST: ANY

Manual operation: See ["PM Type"](#) on page 977

TRIGger<m>:PCIE:DLLP:SEQ <ACKNAKSequence>

Sets the sequence field, indicating what TLPs are affected by the ACK/NAK, to be triggered on for the data link layer trigger.

Parameters:

<ACKNAKSequence>

Manual operation: See ["Sequence"](#) on page 976**TRIGger<m>:PCIE:DLLP:TYPE <Type>**

Sets the DLLP t type to be triggered on for the data link layer trigger.

Parameters:

<Type> ANY | MRDLLP | ACK | NAK | INITFC1 | INITFC2 | UPDATEFC |
PM | VENDOR
*RST: ANY

Manual operation: See ["DLLP Type"](#) on page 973**TRIGger<m>:PCIE:DLLP:VPAT <VendorBtPatt>**

Sets the vendor pattern to be triggered on for the data link layer trigger.

Parameters:

<VendorBtPatt> 24-bit pattern, see [Chapter 27.4.6, "Bit pattern parameter"](#),
on page 1373. The string parameter accepts the bit value X
(don't care).

Manual operation: See ["Vendor Pattern"](#) on page 977**TRIGger<m>:PCIE:ERRC:CRC <CRC16>**

Enables triggering on 16-bit cyclic redundancy check (CRC) errors.

Parameters:

<CRC16> ON | OFF
*RST: OFF

Manual operation: See ["Error Condition PCIe Gen 1/2"](#) on page 977**TRIGger<m>:PCIE:ERRC:DISP <Disparity>**

Enables triggering on disparity errors.

Parameters:

<Disparity> ON | OFF
*RST: OFF

Manual operation: See ["Error Condition PCIe Gen 1/2"](#) on page 977**TRIGger<m>:PCIE:ERRC:ECRC <ECRC>**

Enables triggering on end-to-end cyclic redundancy checksum (ECRC) errors.

Parameters:

<ECRC> ON | OFF
 *RST: OFF

Manual operation: See ["Error Condition PCIe Gen 1/2"](#) on page 977

TRIGger<m>:PCIE:ERRC:INVP <InvalidSymbol>

Enables triggering on invalid symbol errors.

Parameters:

<InvalidSymbol> ON | OFF
 *RST: OFF

Manual operation: See ["Error Condition PCIe Gen 1/2"](#) on page 977

TRIGger<m>:PCIE:ERRC:LCRC <LCRC>

Enables triggering on link cyclic redundancy check (LCRC) errors.

Parameters:

<LCRC> ON | OFF
 *RST: OFF

Manual operation: See ["Error Condition PCIe Gen 1/2"](#) on page 977

TRIGger<m>:PCIE:OSET:TYPE <Type>

Sets the ordered set to be triggered on.

Parameters:

<Type> SKP | TS1 | TS2 | FTS | EIOS | EIEOS | COMP
SKP
 SKP ordered sets
TS1
 Training sequence 1
TS2
 Training sequence 2
FTS
 Fast training sequence
EIOS
 Electrical idle ordered set
EIEOS
 Electrical idle exit ordered set
COMP
 Compliance pattern
 *RST: SKP

Manual operation: See ["Ordered set condition"](#) on page 977

TRIGger<m>:PCIE:TLP:ADRT <AddressType>

Sets the address type to be triggered on for the transaction layer type trigger.

Parameters:

<AddressType> ANY | X32 | X64
*RST: ANY

Manual operation: See "[Address Type](#)" on page 972

TRIGger<m>:PCIE:TLP:CFGT <ConfigType>

Sets the configuration type to be triggered on for the transaction layer type trigger.

Parameters:

<ConfigType> ANY | TYPE0 | TYPE1
*RST: ANY

Manual operation: See "[Type](#)" on page 972

TRIGger<m>:PCIE:TLP:CPID <TLPCompleterID>

Sets the completer ID to be triggered on for the transaction layer type trigger.

Parameters:

<TLPCompleterID> 16-bit pattern, see [Chapter 27.4.6, "Bit pattern parameter"](#), on page 1373. The string parameter accepts the bit value X (don't care).

Manual operation: See "[Completer ID](#)" on page 973

TRIGger<m>:PCIE:TLP:CPLS <CplStatus>

Sets the completion status to be triggered on for the transaction layer type trigger.

Parameters:

<CplStatus> ANY | SUCCESS | UNSUPPORTED | RETRY | ABORT
*RST: ANY

Manual operation: See "[Status](#)" on page 972

TRIGger<m>:PCIE:TLP:DEID <TLPDeviceID>

Sets the device ID to be triggered on for the transaction layer type trigger.

Parameters:

<TLPDeviceID> 16-bit pattern, see [Chapter 27.4.6, "Bit pattern parameter"](#), on page 1373. The string parameter accepts the bit value X (don't care).

Manual operation: See "[Device ID](#)" on page 972

TRIGger<m>:PCIE:TLP:MERW <MemRW>

Sets the read/ write type to be triggered on for the transaction layer type trigger.

Parameters:

<MemRW> ANY | READ | WRITE
*RST: ANY

Manual operation: See ["Read/Write"](#) on page 972

TRIGger<m>:PCIE:TLP:MSGC <TLPMMessageCode>

Sets the message code to be triggered on for the transaction layer type trigger.

Parameters:

<TLPMMessageCode> 8-bit pattern, see [Chapter 27.4.6, "Bit pattern parameter"](#), on page 1373. The string parameter accepts the bit value X (don't care).

Manual operation: See ["Message Code"](#) on page 972

TRIGger<m>:PCIE:TLP:MSGR <MsgRouting>

Sets the message routing type to be triggered on for the transaction layer type trigger.

Parameters:

<MsgRouting> ANY | ROOTCOMPLEX | ADDRESS | DEVICEID | DEViceid | BROADCAST | LOCAL | GATHERED
DEVICEID = DEViceid
*RST: ANY

Manual operation: See ["Routing"](#) on page 972

TRIGger<m>:PCIE:TLP:ORDE <Ordering>

Sets the ordering type to be triggered on for the transaction layer type trigger.

Parameters:

<Ordering> ANY | STRONG | RELAX
*RST: ANY

Manual operation: See ["Ordering"](#) on page 971

TRIGger<m>:PCIE:TLP:REID <TLPRequesterID>

Sets the requester ID to be triggered on for the transaction layer type trigger.

Parameters:

<TLPRequesterID> 16-bit pattern, see [Chapter 27.4.6, "Bit pattern parameter"](#), on page 1373. The string parameter accepts the bit value X (don't care).

Manual operation: See ["Requester ID"](#) on page 972

TRIGger<m>:PCIE:TLP:SNOO <Snoop>

Sets the snoop state to be triggered on for the transaction layer type trigger.

Parameters:

<Snoop> ANY | YES | NO
 *RST: ANY

Manual operation: See ["Snoop"](#) on page 971

TRIGger<m>:PCIE:TLP:SNUM <TLPSeqNo>

Sets the sequence number to be triggered on for the transaction layer type trigger.

Parameters:

<TLPSeqNo> 12-bit pattern, see [Chapter 27.4.6, "Bit pattern parameter"](#), on page 1373. The string parameter accepts the bit value X (don't care).

Manual operation: See ["Sequence Number"](#) on page 971

TRIGger<m>:PCIE:TLP:TCHN <TrafficClass>

Sets the traffic class to be triggered on for the transaction layer type trigger.

Parameters:

<TrafficClass> ANY | ZERO | ONE | TWO | THREE | FOUR | FIVE | SIX | SEVEN
 *RST: ANY

Manual operation: See ["TC"](#) on page 971

TRIGger<m>:PCIE:TLP:TYPE <Type>

Sets the transaction type to be triggered on for the transaction layer type trigger.

Parameters:

<Type> ANY | MEM | IO | CFG | MSG | CPL | FETCH | SWAP | CAS
 *RST: ANY

Manual operation: See ["TLP"](#) on page 970

TRIGger<m>:PCIE:TYPE <Type>

Sets the trigger type for the PCI express analysis..

Parameters:

<Type> TLP | DLLP | ORD | ERR
 *RST: TLP

Manual operation: See "Trigger type PCI express" on page 970

27.18.27.4 Decode results

In all `BUS<m>:PCIE:RESult:PACKet<n>` commands, the suffix `<m>` selects the serial bus and the suffix `<n>` selects the frame number in the decode table.

<code>BUS<m>:PCIE:RESult:PACKet<n>:ADDR?</code>	2540
<code>BUS<m>:PCIE:RESult:PACKet<n>:CPID?</code>	2540
<code>BUS<m>:PCIE:RESult:PACKet<n>:CPS?</code>	2541
<code>BUS<m>:PCIE:RESult:PACKet<n>:DATA?</code>	2541
<code>BUS<m>:PCIE:RESult:PACKet<n>:DFC?</code>	2541
<code>BUS<m>:PCIE:RESult:PACKet<n>:FCOunt?</code>	2542
<code>BUS<m>:PCIE:RESult:PACKet<n>:FLD<o>:FVAL?</code>	2542
<code>BUS<m>:PCIE:RESult:PACKet<n>:FLD<o>:STATus?</code>	2542
<code>BUS<m>:PCIE:RESult:PACKet<n>:FLD<o>:TYPE?</code>	2543
<code>BUS<m>:PCIE:RESult:PACKet<n>:FLD<o>:VAL?</code>	2543
<code>BUS<m>:PCIE:RESult:PACKet<n>:HFC?</code>	2544
<code>BUS<m>:PCIE:RESult:PACKet<n>:LEN?</code>	2544
<code>BUS<m>:PCIE:RESult:PACKet<n>:RQID?</code>	2544
<code>BUS<m>:PCIE:RESult:PACKet<n>:SEQN?</code>	2545
<code>BUS<m>:PCIE:RESult:PACKet<n>:STARt?</code>	2545
<code>BUS<m>:PCIE:RESult:PACKet<n>:STATe?</code>	2545
<code>BUS<m>:PCIE:RESult:PACKet<n>:STOP?</code>	2546
<code>BUS<m>:PCIE:RESult:PACKet<n>:TAG?</code>	2546
<code>BUS<m>:PCIE:RESult:PACKet<n>:TYPE?</code>	2547
<code>BUS<m>:PCIE:RESult:PCOunt?</code>	2547
<code>BUS<m>:PCIE:RESult:PACKet<n>:BITRate?</code>	2547

`BUS<m>:PCIE:RESult:PACKet<n>:ADDR?`

Returns the packet address for the specified packet.

Suffix:

<code><m></code>	1..4
<code><n></code>	*

Return values:

<code><Address></code>	Range: 0 to 0
	Increment: 1
	*RST: 0

Usage: Query only

`BUS<m>:PCIE:RESult:PACKet<n>:CPID?`

Returns the completer ID of the specified packet.

Suffix:

<code><m></code>	1..4
------------------------	------

<n> *

Return values:

<CompleterID> Range: 0 to 65535
Increment: 1
*RST: 0

Usage: Query only

BUS<m>:PCIE:RESult:PACKet<n>:CPS?

Returns the completion status field value of the specified packet.

Suffix:

<m> 1..4

<n> *

Return values:

<CplStatus> RESERVED | SC | UR | CRS | CA

RESERVED

Others

SC

Successful Completion

UR

Unsupported Request

CRS

Configuration Request Retry Status

CA

Completer Abort

*RST: RESERVED

Usage: Query only

BUS<m>:PCIE:RESult:PACKet<n>:DATA?

Returns the data value of the specified packet.

Suffix:

<m> 1..4

<n> *

Return values:

<Data>

Usage: Query only

BUS<m>:PCIE:RESult:PACKet<n>:DFC?

Returns the credit value of the payload data of the specified packet.

Suffix:

<m> 1..4

<n> *

Return values:

<DataFC> Range: 0 to 4095

Increment: 1

*RST: 0

Usage: Query only**BUS<m>:PCIE:RESult:PACKet<n>:FCOunt?**

Returns the number of decoded fields in the selected packet.

Suffix:

<m> 1..4

<n> *

Return values:

<FieldCount> Range: 0 to 65535

Increment: 1

*RST: 0

Usage: Query only**BUS<m>:PCIE:RESult:PACKet<n>:FLD<o>:FVAL?**

Returns the formatted value of the field with the selected field number within the frame with the selected packet number (for the selected serial bus).

Suffix:

<m> 1..4

<n> *

<o> *

Selects the field number.

Return values:

<ValueFormatted> String parameter

Usage: Query only**BUS<m>:PCIE:RESult:PACKet<n>:FLD<o>:STATus?**

Returns the status of the frame with the selected field number within the packet with the selected packet number (for the selected serial bus).

Suffix:

<m> 1..4

<n> *

<o>	*
	Selects the field number.
Return values:	
<State>	OK MALF CRC16 ECRC LCRC LEN POE MEE UNCorrelated FCRC FPERror UNKNown OUTRange INComplete SYNCerror
	MALF Malformed packet
	CRC16 CRC16 error
	ECRC ECRC error
	LCRC Link CRC error
	LEN Length error
	POE TLP prefix error
	MEE Max end-end TLP prefix error
	*RST: OK
Usage:	Query only

BUS<m>:PCIE:RESult:PACKet<n>:FLD<o>:TYPE?

Returns the type of the field with the selected field number within the frame with the selected packet number (for the selected serial bus).

Suffix:

<m>	1..4
<n>	*
<o>	*
	Selects the field number.

Return values:

<Type>

Usage: Query only

BUS<m>:PCIE:RESult:PACKet<n>:FLD<o>:VAL?

Returns the value of the field with the selected field number within the packet with the selected packet number (for the selected serial bus).

Suffix:

<m>	1..4
-----	------

<n> *

<o> *

Selects the field number.

Return values:

<FieldValue> Range: 0 to 0
 Increment: 1
 *RST: 0

Usage: Query only

BUS<m>:PCIE:RESult:PACKet<n>:HFC?

Returns the credit value of the header of the specified packet.

Suffix:

<m> 1..4

<n> *

Return values:

<HeaderFC> Range: 0 to 255
 Increment: 1
 *RST: 0

Usage: Query only

BUS<m>:PCIE:RESult:PACKet<n>:LEN?

Returns the length of the specified packet.

Suffix:

<m> 1..4

<n> *

Return values:

<Length> Range: 0 to 1023
 Increment: 1
 *RST: 0

Usage: Query only

BUS<m>:PCIE:RESult:PACKet<n>:RQID?

Returns the requester ID of the specified packet.

Suffix:

<m> 1..4

<n> *

Return values:

<RequesterID> Range: 0 to 65535
 Increment: 1
 *RST: 0

Usage: Query only

BUS<m>:PCIE:RESult:PACKet<n>:SEQN?

Returns the sequence number of the specified packet.

Suffix:

<m> 1..4
 <n> *

Return values:

<SequenceNumber> Range: 0 to 4095
 Increment: 1
 *RST: 0

Usage: Query only

BUS<m>:PCIE:RESult:PACKet<n>:START?

Returns the start time of the specified packet.

Suffix:

<m> 1..4
 <n> *

Return values:

<Start> Range: -100E+24 to 100E+24
 Increment: 100E-12
 *RST: 0
 Default unit: s

Usage: Query only

BUS<m>:PCIE:RESult:PACKet<n>:STATe?

Returns the state of the specified packet.

Suffix:

<m> 1..4
 <n> *

Return values:

<State> OK | MALF | CRC16 | ECRC | LCRC | LEN | POE | MEE |
 UNCorrelated | FCRC | FPERror | UNKNown | OUTRange |
 INComplete | SYNCerror

MALF

Mal formatted packet

CRC16

CRC16 error

ECRC

ECRC error

LCRC

LCRC error

LEN

Length error

POE

TLP prefix error

MEE

Max end-end TLP prefix error

*RST: OK

Usage: Query only**BUS<m>:PCIE:RESult:PACKet<n>:STOP?**

Returns the stop time of the specified packet.

Suffix:

<m> 1..4

<n> *

Return values:

<Stop> Range: -100E+24 to 100E+24

Increment: 100E-12

*RST: 0

Default unit: s

Usage: Query only**BUS<m>:PCIE:RESult:PACKet<n>:TAG?**

Returns the tag of the specified packet.

Suffix:

<m> 1..4

<n> *

Return values:

<Tag> Range: 0 to 255

Increment: 1

*RST: 0

Usage: Query only

BUS<m>:PCIE:RESult:PACKet<n>:TYPE?

Returns the type of the specified packet. For a description of the packet types, see [Chapter 14.26.1, "The PCIe protocol"](#), on page 962.

Suffix:

<m> 1..4

<n> *

Return values:

<Type> MRD32 | MRD64 | MRDLK32 | MRDLK64 | MWR32 | MWR64 | IORD | IOWR | CFGRD0 | CFGWR0 | CFGRD1 | CFGWR1 | MSG | MSGD | CPL | CPLD | CPLLK | CPLDLK | FA32 | FA64 | SWP32 | SWP64 | CAS32 | CAS64 | LPRFX | EPRFX | ACK | NAK | PMEL1 | PMEL23 | PMASRL1 | PMRA | VENDS | IFC1P | IFC1NP | IFC1CPL | IFC2P | IFC2NP | IFC2CPL | UPDFCP | UPDFCNP | UPDFCCPL | MRUPDFC | MRIFC1 | MRIFC2 | MRINIT | MRRESET | UNK | SKPOS | EIOS | FTSOS | TS1OS | TS2OS | EIEOS | COMPL | MCOMPL | DCOMPL | UDEF | IDLE | SDS | EDB | EDS | SDAT | SCTR | PMUX | UNKTlp | UNKDIlp | SINV
*RST: UNK

Usage: Query only

BUS<m>:PCIE:RESult:PCOunt?

Returns the packet count for the selected serial bus, i.e. the number of packets in the present acquisition.

Suffix:

<m> 1..4

Return values:

<FrameCount> Range: 0 to 100000
Increment: 1
*RST: 0

Usage: Query only

BUS<m>:PCIE:RESult:PACKet<n>:BITRate?

Returns the bit rate of the selected packet.

Suffix:

<m> 1..4

<n> *

Return values:

<PrimaryBitRate> Range: 0 to 100000000000
 Increment: 1
 *RST: 0
 Default unit: bps

Usage: Query only

27.18.27.5 Search settings

SEARch:TRIGger:PCIE:DLLP:FCTL:CRET.....	2549
SEARch:TRIGger:PCIE:DLLP:FCTL:VCID.....	2549
SEARch:TRIGger:PCIE:DLLP:MULT:AUTH.....	2549
SEARch:TRIGger:PCIE:DLLP:MULT:CRET.....	2550
SEARch:TRIGger:PCIE:DLLP:MULT:DVPT.....	2550
SEARch:TRIGger:PCIE:DLLP:MULT:HABS.....	2550
SEARch:TRIGger:PCIE:DLLP:MULT:MIXT.....	2550
SEARch:TRIGger:PCIE:DLLP:MULT:PHAS.....	2551
SEARch:TRIGger:PCIE:DLLP:MULT:RESA.....	2551
SEARch:TRIGger:PCIE:DLLP:MULT:TLPT.....	2551
SEARch:TRIGger:PCIE:DLLP:MULT:TYPE.....	2552
SEARch:TRIGger:PCIE:DLLP:MULT:VHFC.....	2552
SEARch:TRIGger:PCIE:DLLP:MULT:VHGR.....	2552
SEARch:TRIGger:PCIE:DLLP:MULT:VLNR.....	2552
SEARch:TRIGger:PCIE:DLLP:POWM.....	2553
SEARch:TRIGger:PCIE:DLLP:SEQ.....	2553
SEARch:TRIGger:PCIE:DLLP:TYPE.....	2553
SEARch:TRIGger:PCIE:DLLP:VPAT.....	2554
SEARch:TRIGger:PCIE:ERRC:CRC.....	2554
SEARch:TRIGger:PCIE:ERRC:DISP.....	2554
SEARch:TRIGger:PCIE:ERRC:ECRC.....	2554
SEARch:TRIGger:PCIE:ERRC:INVP.....	2555
SEARch:TRIGger:PCIE:ERRC:LCRC.....	2555
SEARch:TRIGger:PCIE:OSET:COMP.....	2555
SEARch:TRIGger:PCIE:OSET:EIDE.....	2555
SEARch:TRIGger:PCIE:OSET:EIDL.....	2556
SEARch:TRIGger:PCIE:OSET:FTS.....	2556
SEARch:TRIGger:PCIE:OSET:SKIP.....	2556
SEARch:TRIGger:PCIE:OSET:TSONe.....	2557
SEARch:TRIGger:PCIE:OSET:TSTWo.....	2557
SEARch:TRIGger:PCIE:TLP:ADRT.....	2557
SEARch:TRIGger:PCIE:TLP:CFGT.....	2557
SEARch:TRIGger:PCIE:TLP:CPID.....	2558
SEARch:TRIGger:PCIE:TLP:CPLS.....	2558
SEARch:TRIGger:PCIE:TLP:DEID.....	2558
SEARch:TRIGger:PCIE:TLP:MERW.....	2558
SEARch:TRIGger:PCIE:TLP:MSGC.....	2559
SEARch:TRIGger:PCIE:TLP:MSGR.....	2559
SEARch:TRIGger:PCIE:TLP:ORDE.....	2559
SEARch:TRIGger:PCIE:TLP:REID.....	2560

SEARCh:TRIGger:PCIE:TLP:SNOO.....	2560
SEARCh:TRIGger:PCIE:TLP:SNUM.....	2560
SEARCh:TRIGger:PCIE:TLP:TCHN.....	2560
SEARCh:TRIGger:PCIE:TLP:TYPE.....	2561
SEARCh:TRIGger:PCIE:TYPE.....	2561

SEARCh:TRIGger:PCIE:DLLP:FCTL:CRET <SearchName>,<CreditType>
SEARCh:TRIGger:PCIE:DLLP:FCTL:CRET? <SearchName>

Sets credit type value to be searched for, for the data link layer.

Parameters:

<CreditType> ANY | P | NP | CPL
 *RST: ANY

Parameters for setting and query:

<SearchName>

Manual operation: See "[Credit Type](#)" on page 986

SEARCh:TRIGger:PCIE:DLLP:FCTL:VCID <SearchName>,<VirtualChnID>
SEARCh:TRIGger:PCIE:DLLP:FCTL:VCID? <SearchName>

Sets the virtual channel ID to be searched for, for the data link layer.

Parameters:

<VirtualChnID> ANY | ZERO | ONE | TWO | THREE | FOUR | FIVE | SIX |
 SEVEN
 *RST: ANY

Parameters for setting and query:

<SearchName>

Manual operation: See "[VC ID](#)" on page 987

SEARCh:TRIGger:PCIE:DLLP:MULT:AUTH <SearchName>,<Authorized>
SEARCh:TRIGger:PCIE:DLLP:MULT:AUTH? <SearchName>

Sets the authorized presence state to be searched for, for the data link layer.

Parameters:

<Authorized> ANY | YES | NO
 *RST: ANY

Parameters for setting and query:

<SearchName>

Manual operation: See "[Authorized](#)" on page 985

SEARCh:TRIGger:PCIE:DLLP:MULT:CRET <SearchName>,<CreditType>
SEARCh:TRIGger:PCIE:DLLP:MULT:CRET? <SearchName>

Sets the credit type to be searched for, for the data link layer.

Parameters:

<CreditType> ANY | DATA | HEADER
 *RST: ANY

Parameters for setting and query:

<SearchName>

SEARCh:TRIGger:PCIE:DLLP:MULT:DVPT <SearchName>,<DevicePortType>
SEARCh:TRIGger:PCIE:DLLP:MULT:DVPT? <SearchName>

Sets the device/port type to be searched for, for the data link layer.

Parameters:

<DevicePortType> ANY | ZERO | ONE | TWO | THREE | FOUR | FIVE | SIX |
 SEVEN | EIGHT | NINE | TEN | ELEVEN | TWELVE |
 THIRTEEN | FOURTEEN | FIFTEEN
 *RST: ANY

Parameters for setting and query:

<SearchName>

Manual operation: See "[Device/Port Type](#)" on page 985

SEARCh:TRIGger:PCIE:DLLP:MULT:HABS <SearchName>,<VHAbsent>
SEARCh:TRIGger:PCIE:DLLP:MULT:HABS? <SearchName>

Sets the state of the absent virtual hierarchies (VH) to be searched for, for the data link layer.

Parameters:

<VHAbsent> ANY | YES | NO
 *RST: ANY

Parameters for setting and query:

<SearchName>

Manual operation: See "[VH Absent](#)" on page 986

SEARCh:TRIGger:PCIE:DLLP:MULT:MIXT <SearchName>,<MixedType>
SEARCh:TRIGger:PCIE:DLLP:MULT:MIXT? <SearchName>

Sets the mixed type presence state to be searched for, for the data link layer.

Parameters:

<MixedType> ANY | YES | NO
 *RST: ANY

Parameters for setting and query:

<SearchName>

Manual operation: See ["Mixed Type"](#) on page 985**SEARCH:TRIGGER:PCIE:DLLP:MULT:PHAS** <SearchName>,<Phase>**SEARCH:TRIGGER:PCIE:DLLP:MULT:PHAS?** <SearchName>

Sets the phase state to be searched for, for the data link layer.

Parameters:

<Phase> ANY | YES | NO
 *RST: ANY

Parameters for setting and query:

<SearchName>

Manual operation: See ["Phase"](#) on page 985**SEARCH:TRIGGER:PCIE:DLLP:MULT:RESA** <SearchName>,<ResetA>**SEARCH:TRIGGER:PCIE:DLLP:MULT:RESA?** <SearchName>

Sets the on the value of the A bit to be searched for, for the data link layer.

Parameters:

<ResetA> ANY | ACK | REQUEST
 *RST: ANY

Parameters for setting and query:

<SearchName>

Manual operation: See ["A"](#) on page 987**SEARCH:TRIGGER:PCIE:DLLP:MULT:TLPT** <SearchName>,<Type>**SEARCH:TRIGGER:PCIE:DLLP:MULT:TLPT?** <SearchName>

Sets the multi-root type to be searched for, for the data link layer.

Parameters:

<Type> ANY | P | NP | CPL
P
 Posted credit.
NP
 Non posted credit.
CL
 Completion credit.
 *RST: ANY

Parameters for setting and query:

<SearchName>

Manual operation: See ["TLP Type"](#) on page 986

SEARCh:TRIGger:PCIE:DLLP:MULT:TYPE <SearchName>,<MRType>
SEARCh:TRIGger:PCIE:DLLP:MULT:TYPE? <SearchName>

Sets the multi-root type to be searched for, for the data link layer.

Parameters:

<MRType> MRINIT | MRRESET | MRUPDATEFC | MRINITFC1 |
 MRINITFC2
 *RST: MRINIT

Parameters for setting and query:

<SearchName>

Manual operation: See "[MR DLLP](#)" on page 984

SEARCh:TRIGger:PCIE:DLLP:MULT:VHFC <SearchName>,<InitVHFC>
SEARCh:TRIGger:PCIE:DLLP:MULT:VHFC? <SearchName>

Sets the virtual hierarchies flow control presence state to be searched for, for the data link layer.

Parameters:

<InitVHFC> ANY | YES | NO
 *RST: ANY

Parameters for setting and query:

<SearchName>

Manual operation: See "[VH FC](#)" on page 985

SEARCh:TRIGger:PCIE:DLLP:MULT:VHGR <SearchName>,<ResetVHGroup>
SEARCh:TRIGger:PCIE:DLLP:MULT:VHGR? <SearchName>

Sets the virtual hierarchies group to be searched for, for the data link layer.

Parameters:

<ResetVHGroup> ANY | ZERO | ONE | TWO | THREE | FOUR | FIVE | SIX |
 SEVEN | EIGHT | NINE | TEN | ELEVEN | TWELVE |
 THIRTEEN | FOURTEEN | FIFTEEN
 *RST: ANY

Parameters for setting and query:

<SearchName>

Manual operation: See "[VH Group](#)" on page 987

SEARCh:TRIGger:PCIE:DLLP:MULT:VLNR <SearchName>,<VirtualLink>
SEARCh:TRIGger:PCIE:DLLP:MULT:VLNR? <SearchName>

Sets the virtual link (VL) number to be searched for, for the data link layer.

Parameters:

<VirtualLink> ANY | ZERO | ONE | TWO | THREE | FOUR | FIVE | SIX | SEVEN
 *RST: ANY

Parameters for setting and query:

<SearchName>

Manual operation: See "[VL Number](#)" on page 986

SEARCh:TRIGger:PCIE:DLLP:POWM <SearchName>,<PowerMngtType>

SEARCh:TRIGger:PCIE:DLLP:POWM? <SearchName>

Sets the power management type to be searched for, for the data link layer.

Parameters:

<PowerMngtType> ANY | ENTERL1 | ENTERL23 | ACTREQL1 | REQUESTACK
 *RST: ANY

Parameters for setting and query:

<SearchName>

Manual operation: See "[PM Type](#)" on page 988

SEARCh:TRIGger:PCIE:DLLP:SEQ <SearchName>,<ACKNAKSequence>

SEARCh:TRIGger:PCIE:DLLP:SEQ? <SearchName>

Sets the sequence field, indicating what TLPs are affected by the ACK/NAK, to be searched for, for the data link layer.

Parameters:

<ACKNAKSequence>

Parameters for setting and query:

<SearchName>

Manual operation: See "[Sequence](#)" on page 987

SEARCh:TRIGger:PCIE:DLLP:TYPE <SearchName>,<Type>

SEARCh:TRIGger:PCIE:DLLP:TYPE? <SearchName>

Sets the DLLP t type to be searched for, for the data link layer.

Parameters:

<Type> ANY | MRDLLP | ACK | NAK | INITFC1 | INITFC2 | UPDATEFC | PM | VENDOR
 *RST: ANY

Parameters for setting and query:

<SearchName>

Manual operation: See "[DLLP Type](#)" on page 984

SEARCh:TRIGger:PCIE:DLLP:VPAT <SearchName>,<VendorBtPatt>
SEARCh:TRIGger:PCIE:DLLP:VPAT? <SearchName>

Sets the vendor pattern to be searched for, for the data link layer.

Parameters:

<VendorBtPatt> 24-bit pattern, see [Chapter 27.4.6, "Bit pattern parameter"](#),
on page 1373. The string parameter accepts the bit value X
(don't care).

Parameters for setting and query:

<SearchName>

Manual operation: See "[Vendor Pattern](#)" on page 988

SEARCh:TRIGger:PCIE:ERRC:CRC <SearchName>,<CRC16>
SEARCh:TRIGger:PCIE:ERRC:CRC? <SearchName>

Enables searching for 16-bit cyclic redundancy check (CRC) errors.

Parameters:

<CRC16> ON | OFF
*RST: OFF

Parameters for setting and query:

<SearchName>

Manual operation: See "[Error Condition](#)" on page 988

SEARCh:TRIGger:PCIE:ERRC:DISP <SearchName>,<Disparity>
SEARCh:TRIGger:PCIE:ERRC:DISP? <SearchName>

Enables searching for disparity errors.

Parameters:

<Disparity> ON | OFF
*RST: OFF

Parameters for setting and query:

<SearchName>

Manual operation: See "[Error Condition](#)" on page 988

SEARCh:TRIGger:PCIE:ERRC:ECRC <SearchName>,<ECRC>
SEARCh:TRIGger:PCIE:ERRC:ECRC? <SearchName>

Enables searching for end-to-end cyclic redundancy checksum (ECRC) errors.

Parameters:

<ECRC> ON | OFF
*RST: OFF

Parameters for setting and query:

<SearchName>

Manual operation: See ["Error Condition"](#) on page 988**SEARCH:TRIGger:PCIE:ERRC:INVP** <SearchName>,<InvalidSymbol>**SEARCH:TRIGger:PCIE:ERRC:INVP?** <SearchName>

Enables searching for invalid symbol errors.

Parameters:

<InvalidSymbol> ON | OFF

*RST: OFF

Parameters for setting and query:

<SearchName>

Manual operation: See ["Error Condition"](#) on page 988**SEARCH:TRIGger:PCIE:ERRC:LCRC** <SearchName>,<LCRC>**SEARCH:TRIGger:PCIE:ERRC:LCRC?** <SearchName>

Enables searching for link cyclic redundancy check (LCRC) errors.

Parameters:

<LCRC> ON | OFF

*RST: OFF

Parameters for setting and query:

<SearchName>

Manual operation: See ["Error Condition"](#) on page 988**SEARCH:TRIGger:PCIE:OSET:COMP** <SearchName>,<Format>**SEARCH:TRIGger:PCIE:OSET:COMP?** <SearchName>

Enables searching for compliance pattern ordered sets.

Parameters:

<Format> ON | OFF

*RST: OFF

Parameters for setting and query:

<SearchName>

Manual operation: See ["Ordered set condition"](#) on page 988**SEARCH:TRIGger:PCIE:OSET:EIDE** <SearchName>,<Format>**SEARCH:TRIGger:PCIE:OSET:EIDE?** <SearchName>

Enables searching for electrical idle exit ordered sets.

Parameters:

<Format> ON | OFF
 *RST: OFF

Parameters for setting and query:

<SearchName>

Manual operation: See "[Ordered set condition](#)" on page 988

SEARCH:TRIGger:PCIE:OSET:EIDL <SearchName>,<Format>
SEARCH:TRIGger:PCIE:OSET:EIDL? <SearchName>

Enables searching for electrical idle ordered sets.

Parameters:

<Format> ON | OFF
 *RST: OFF

Parameters for setting and query:

<SearchName>

Manual operation: See "[Ordered set condition](#)" on page 988

SEARCH:TRIGger:PCIE:OSET:FTS <SearchName>,<Format>
SEARCH:TRIGger:PCIE:OSET:FTS? <SearchName>

Enables searching for fast training sequence ordered sets.

Parameters:

<Format> ON | OFF
 *RST: OFF

Parameters for setting and query:

<SearchName>

Manual operation: See "[Ordered set condition](#)" on page 988

SEARCH:TRIGger:PCIE:OSET:SKIP <SearchName>,<Format>
SEARCH:TRIGger:PCIE:OSET:SKIP? <SearchName>

Enables searching for SKP ordered sets.

Parameters:

<Format> ON | OFF
 *RST: OFF

Parameters for setting and query:

<SearchName>

Manual operation: See "[Ordered set condition](#)" on page 988

SEARCh:TRIGger:PCIE:OSET:TSONe <SearchName>,<Format>
SEARCh:TRIGger:PCIE:OSET:TSONe? <SearchName>

Enables searching for training sequence 1 ordered sets.

Parameters:

<Format> ON | OFF
 *RST: OFF

Parameters for setting and query:

<SearchName>

Manual operation: See "[Ordered set condition](#)" on page 988

SEARCh:TRIGger:PCIE:OSET:TSTWo <SearchName>,<Format>
SEARCh:TRIGger:PCIE:OSET:TSTWo? <SearchName>

Enables searching for training sequence 2 ordered sets.

Parameters:

<Format> ON | OFF
 *RST: OFF

Parameters for setting and query:

<SearchName>

Manual operation: See "[Ordered set condition](#)" on page 988

SEARCh:TRIGger:PCIE:TLP:ADRT <SearchName>,<AddressType>
SEARCh:TRIGger:PCIE:TLP:ADRT? <SearchName>

Sets the address type to be searched for in the transaction layer type.

Parameters:

<AddressType> ANY | X32 | X64
 *RST: ANY

Parameters for setting and query:

<SearchName>

Manual operation: See "[Address Type](#)" on page 983

SEARCh:TRIGger:PCIE:TLP:CFGT <SearchName>,<CfgType>
SEARCh:TRIGger:PCIE:TLP:CFGT? <SearchName>

Sets the configuration type to be searched for in the transaction layer type.

Parameters:

<CfgType> ANY | TYPE0 | TYPE1
 *RST: ANY

Parameters for setting and query:

<SearchName>

Manual operation: See ["Type"](#) on page 983

SEARCH:TRIGger:PCIE:TLP:CPID <SearchName>,<TLPCompleterID>
SEARCH:TRIGger:PCIE:TLP:CPID? <SearchName>

Sets the completer ID to be searched for in the transaction layer type.

Parameters:

<TLPCompleterID> 16-bit pattern, see [Chapter 27.4.6, "Bit pattern parameter"](#), on page 1373. The string parameter accepts the bit value X (don't care).

Parameters for setting and query:

<SearchName>

Manual operation: See ["Completer ID"](#) on page 984

SEARCH:TRIGger:PCIE:TLP:CPLS <SearchName>,<CplStatus>
SEARCH:TRIGger:PCIE:TLP:CPLS? <SearchName>

Sets the completion status to be searched for in the transaction layer type.

Parameters:

<CplStatus> ANY | SUCCESS | UNSUPPORTED | RETRY | ABORT
 *RST: ANY

Parameters for setting and query:

<SearchName>

Manual operation: See ["Status"](#) on page 983

SEARCH:TRIGger:PCIE:TLP:DEID <SearchName>,<TLPDeviceID>
SEARCH:TRIGger:PCIE:TLP:DEID? <SearchName>

Sets the device ID to be searched for in the transaction layer type.

Parameters:

<TLPDeviceID> 16-bit pattern, see [Chapter 27.4.6, "Bit pattern parameter"](#), on page 1373. The string parameter accepts the bit value X (don't care).

Parameters for setting and query:

<SearchName>

Manual operation: See ["Device ID"](#) on page 983

SEARCH:TRIGger:PCIE:TLP:MERW <SearchName>,<MemRW>
SEARCH:TRIGger:PCIE:TLP:MERW? <SearchName>

Sets the read/ write type to be searched for in the transaction layer type.

Parameters:

<MemRW> ANY | READ | WRITE
 *RST: ANY

Parameters for setting and query:

<SearchName>

Manual operation: See ["Read/Write"](#) on page 983

SEARCh:TRIGger:PCIE:TLP:MSGC <SearchName>,<TLPMMessageCode>

SEARCh:TRIGger:PCIE:TLP:MSGC? <SearchName>

Sets the message code to be searched for in the transaction layer type.

Parameters:

<TLPMMessageCode> 8-bit pattern, see [Chapter 27.4.6, "Bit pattern parameter"](#), on page 1373. The string parameter accepts the bit value X (don't care).

Parameters for setting and query:

<SearchName>

Manual operation: See ["Message Code"](#) on page 983

SEARCh:TRIGger:PCIE:TLP:MSGR <SearchName>,<MsgRouting>

SEARCh:TRIGger:PCIE:TLP:MSGR? <SearchName>

Sets the message routing type to be searched for in the transaction layer type.

Parameters:

<MsgRouting> ANY | ROOTCOMPLEX | ADDRESS | DEVICEID | DEViceid |
 BROADCAST | LOCAL | GATHERED
 DEVICEID = DEViceid
 *RST: ANY

Parameters for setting and query:

<SearchName>

Manual operation: See ["Routing"](#) on page 983

SEARCh:TRIGger:PCIE:TLP:ORDE <SearchName>,<Ordering>

SEARCh:TRIGger:PCIE:TLP:ORDE? <SearchName>

Sets the ordering type to be searched for in the transaction layer type.

Parameters:

<Ordering> ANY | STRONG | RELAX
 *RST: ANY

Parameters for setting and query:

<SearchName>

Manual operation: See ["Ordering"](#) on page 982

SEARCh:TRIGger:PCIE:TLP:REID <SearchName>,<TLPRequesterID>
SEARCh:TRIGger:PCIE:TLP:REID? <SearchName>

Sets the requester ID to be searched for in the transaction layer type.

Parameters:

<TLPRequesterID> 16-bit pattern, see [Chapter 27.4.6, "Bit pattern parameter"](#), on page 1373. The string parameter accepts the bit value X (don't care).

Parameters for setting and query:

<SearchName>

Manual operation: See "[Requester ID](#)" on page 983

SEARCh:TRIGger:PCIE:TLP:SNOO <SearchName>,<Snoop>
SEARCh:TRIGger:PCIE:TLP:SNOO? <SearchName>

Sets the snoop state to be searched for in the transaction layer type.

Parameters:

<Snoop> ANY | YES | NO
 *RST: ANY

Parameters for setting and query:

<SearchName>

Manual operation: See "[Snoop](#)" on page 982

SEARCh:TRIGger:PCIE:TLP:SNUM <SearchName>,<TLPSeqNo>
SEARCh:TRIGger:PCIE:TLP:SNUM? <SearchName>

Sets the sequence numbe to be searched for in the transaction layer type.

Parameters:

<TLPSeqNo> 12-bit pattern, see [Chapter 27.4.6, "Bit pattern parameter"](#), on page 1373. The string parameter accepts the bit value X (don't care).

Parameters for setting and query:

<SearchName>

Manual operation: See "[Sequence Number](#)" on page 982

SEARCh:TRIGger:PCIE:TLP:TCHN <SearchName>,<TrafficClass>
SEARCh:TRIGger:PCIE:TLP:TCHN? <SearchName>

Sets the traffic class to be searched for in the transaction layer type.

Parameters:

<TrafficClass> ANY | ZERO | ONE | TWO | THREE | FOUR | FIVE | SIX | SEVEN
 *RST: ANY

Parameters for setting and query:

<SearchName>

Manual operation: See ["TC"](#) on page 982**SEARCh:TRIGger:PCIE:TLP:TYPE** <SearchName>,<Type>**SEARCh:TRIGger:PCIE:TLP:TYPE?** <SearchName>

Sets the transaction type to be searched for in the transaction layer type.

Parameters:

<Type> ANY | MEM | IO | CFG | MSG | CPL | FETCH | SWAP | CAS
 *RST: ANY

Parameters for setting and query:

<SearchName>

Manual operation: See ["TLP"](#) on page 981**SEARCh:TRIGger:PCIE:TYPE** <SearchName>,<Type>**SEARCh:TRIGger:PCIE:TYPE?** <SearchName>**Parameters:**

<Type> TLP | DLLP | ORD | ERR
 *RST: TLP

Parameters for setting and query:

<SearchName>

Manual operation: See ["Searches for PCI express"](#) on page 981**27.18.27.6 Search results**

In all **SEARCh:RESult:PCIE:PACKet<m>** commands, the suffix <m> selects the frame number in the list of search results.

In search result commands, you have to specify the <SearchName> parameter. It is a string parameter that contains the search definition name.

For a description of the returned values, see the corresponding commands in [Chapter 27.18.27.4, "Decode results"](#), on page 2540.

SEARCh:RESult:PCIE:PACKet<m>:ADDR?	2562
SEARCh:RESult:PCIE:PACKet<m>:CPID?	2562
SEARCh:RESult:PCIE:PACKet<m>:CPS?	2562
SEARCh:RESult:PCIE:PACKet<m>:DATA?	2563
SEARCh:RESult:PCIE:PACKet<m>:DFC?	2563
SEARCh:RESult:PCIE:PACKet<m>:FCOunt?	2563
SEARCh:RESult:PCIE:PACKet<m>:FLD<n>:FVAL?	2563
SEARCh:RESult:PCIE:PACKet<m>:FLD<n>:STAtus?	2564
SEARCh:RESult:PCIE:PACKet<m>:FLD<n>:TYPE?	2564
SEARCh:RESult:PCIE:PACKet<m>:FLD<n>:VAL?	2564

SEARCh:RESult:PCIE:PACKet<m>:HFC?	2565
SEARCh:RESult:PCIE:PACKet<m>:LEN?	2565
SEARCh:RESult:PCIE:PACKet<m>:RQID?	2565
SEARCh:RESult:PCIE:PACKet<m>:SEQN?	2565
SEARCh:RESult:PCIE:PACKet<m>:START?	2566
SEARCh:RESult:PCIE:PACKet<m>:STATE?	2566
SEARCh:RESult:PCIE:PACKet<m>:STOP?	2566
SEARCh:RESult:PCIE:PACKet<m>:TAG?	2567
SEARCh:RESult:PCIE:PACKet<m>:TYPE?	2567
SEARCh:RESult:PCIE:PCOunt?	2567

SEARCh:RESult:PCIE:PACKet<m>:ADDR? <SearchName>

Suffix:

<m> *

Query parameters:

<SearchName>

Return values:

<Address>

Usage: Query only

SEARCh:RESult:PCIE:PACKet<m>:CPID? <SearchName>

Suffix:

<m> *

Query parameters:

<SearchName>

Return values:

<CompleterID>	Range:	0 to 65535
	Increment:	1
	*RST:	0

Usage: Query only

SEARCh:RESult:PCIE:PACKet<m>:CPS? <SearchName>

Suffix:

<m> *

Query parameters:

<SearchName>

Return values:

<CompleteState>	RESERVED SC UR CRS CA
	*RST: RESERVED

Usage: Query only

SEARCh:RESult:PCIE:PACKet<m>:DATA? <SearchName>**Suffix:**

<m> *

Query parameters:

<SearchName>

Return values:

<Data>

Usage: Query only

SEARCh:RESult:PCIE:PACKet<m>:DFC? <SearchName>**Suffix:**

<m> *

Query parameters:

<SearchName>

Return values:<DataFC> Range: 0 to 4095
Increment: 1
*RST: 0**Usage:** Query only

SEARCh:RESult:PCIE:PACKet<m>:FCOunt? <SearchName>**Suffix:**

<m> *

Query parameters:

<SearchName>

Return values:<FieldCount> Range: 0 to 65535
Increment: 1
*RST: 0**Usage:** Query only

SEARCh:RESult:PCIE:PACKet<m>:FLD<n>:FVAL? <SearchName>**Suffix:**

<m> *

<n> *

Query parameters:

<SearchName> String parameter

Return values:

<ValueFormatted> String parameter

Usage: Query only

SEARCH:RESult:PCIE:PACKet<m>:FLD<n>:STATus? <SearchName>

Suffix:

<m> *

<n> *

Query parameters:

<SearchName>

Return values:

<State> OK | MALF | CRC16 | ECRC | LCRC | LEN | POE | MEE |
UNCorrelated | FCRC | FPERror | UNKNown | OUTRange |
INComplete | SYNCerror
*RST: OK

Usage: Query only

SEARCH:RESult:PCIE:PACKet<m>:FLD<n>:TYPE? <SearchName>

Suffix:

<m> *

<n> *

Query parameters:

<SearchName>

Return values:

<Type>

Usage: Query only

SEARCH:RESult:PCIE:PACKet<m>:FLD<n>:VAL? <SearchName>

Suffix:

<m> *

<n> *

Query parameters:

<SearchName>

Return values:

<FieldValue> Range: 0 to 0
Increment: 1
*RST: 0

Usage: Query only

SEARCh:RESult:PCIE:PACKet<m>:HFC? <SearchName>**Suffix:**

<m> *

Query parameters:

<SearchName>

Return values:

<HeaderFC>	Range:	0 to 255
	Increment:	1
	*RST:	0

Usage: Query only

SEARCh:RESult:PCIE:PACKet<m>:LEN? <SearchName>**Suffix:**

<m> *

Query parameters:

<SearchName>

Return values:

<Length>	Range:	0 to 1023
	Increment:	1
	*RST:	0

Usage: Query only

SEARCh:RESult:PCIE:PACKet<m>:RQID? <SearchName>**Suffix:**

<m> *

Query parameters:

<SearchName>

Return values:

<RequesterID>	Range:	0 to 65535
	Increment:	1
	*RST:	0

Usage: Query only

SEARCh:RESult:PCIE:PACKet<m>:SEQN? <SearchName>**Suffix:**

<m> *

Query parameters:

<SearchName>

Return values:

<SequenceNumber> Range: 0 to 4095
 Increment: 1
 *RST: 0

Usage: Query only

SEARCh:RESult:PCIE:PACKet<m>:START? <SearchName>**Suffix:**

<m> *

Query parameters:

<SearchName>

Return values:

<Start> Range: -100E+24 to 100E+24
 Increment: 100E-12
 *RST: 0
 Default unit: s

Usage: Query only

SEARCh:RESult:PCIE:PACKet<m>:STATe? <SearchName>**Suffix:**

<m> *

Query parameters:

<SearchName>

Return values:

<State> OK | MALF | CRC16 | ECRC | LCRC | LEN | POE | MEE |
 UNCorrelated | FCRC | FPERror | UNKNown | OUTRange |
 INComplete | SYNCerror
 *RST: OK

Usage: Query only

SEARCh:RESult:PCIE:PACKet<m>:STOP? <SearchName>**Suffix:**

<m> *

Query parameters:

<SearchName>

Return values:

<Stop> Range: -100E+24 to 100E+24
 Increment: 100E-12
 *RST: 0
 Default unit: s

Usage: Query only

SEARCh:RESult:PCIE:PACKet<m>:TAG? <SearchName>

Suffix:
<m> *

Query parameters:
<SearchName>

Return values:
<Tag> Range: 0 to 255
Increment: 1
*RST: 0

Usage: Query only

SEARCh:RESult:PCIE:PACKet<m>:TYPE? <SearchName>

Suffix:
<m> *

Query parameters:
<SearchName>

Return values:
<Type> MRD32 | MRD64 | MRDLK32 | MRDLK64 | MWR32 | MWR64 |
IORD | IOWR | CFGRD0 | CFGWR0 | CFGRD1 | CFGWR1 |
MSG | MSGD | CPL | CPLD | CPLLK | CPLDLK | FA32 | FA64 |
SWP32 | SWP64 | CAS32 | CAS64 | LPRFX | EPRFX | ACK |
NAK | PMEL1 | PMEL23 | PMASRL1 | PMRA | VENDS | IFC1P |
IFC1NP | IFC1CPL | IFC2P | IFC2NP | IFC2CPL | UPDFCP |
UPDFCNP | UPDFCCPL | MRUPDFC | MRIFC1 | MRIFC2 |
MRINIT | MRRESET | UNK | SKPOS | EIOS | FTSOS | TS1OS |
TS2OS | EIEOS | COMPL | MCOMPL | DCOMPL | UDEF |
IDLE | SDS | EDB | EDS | SDAT | SCTR | PMUX | UNKTIp |
UNKDIIp | SINV
*RST: UNK

Usage: Query only

SEARCh:RESult:PCIE:PCOunt? <SearchName>

Query parameters:
<SearchName>

Return values:
<FrameCount> Range: 0 to 100000
Increment: 1
*RST: 0

Usage: Query only

27.18.28 DDR (option R&S RTO6-K91)

• Configuration.....	2568
• Decode results.....	2570
• Search settings.....	2574
• Search results.....	2579
• Eye diagram analysis.....	2583

27.18.28.1 Configuration

In all `BUS<m>:DDR` commands, the suffix `<m>` selects the serial bus.

<code>BUS<m>:DDR:STANdard</code>	2568
<code>BUS<m>:DDR:DATA:HYSteresis</code>	2568
<code>BUS<m>:DDR:DATA:SOURce</code>	2569
<code>BUS<m>:DDR:DATA:THReshold</code>	2569
<code>BUS<m>:DDR:STRBe:HYSteresis</code>	2569
<code>BUS<m>:DDR:STRBe:SOURce</code>	2569
<code>BUS<m>:DDR:STRBe:THReshold</code>	2570
<code>BUS<m>:DDR:BITRate</code>	2570

BUS<m>:DDR:STANdard <Standard>

Selects the DDR standard.

Suffix:

`<m>` 1..4

Parameters:

`<Standard>` DDR3

DDR3: requires option R&S RTO6-K91.

*RST: DDR3

Usage: Asynchronous command

Manual operation: See "[Variant](#)" on page 992

BUS<m>:DDR:DATA:HYSteresis <DataHysteresis>

Sets a value for the hysteresis of the data.

Suffix:

`<m>` 1..4

Parameters:

`<DataHysteresis>` Range: 0 to 10

Increment: 0.01

*RST: 0.15

Default unit: V

Usage: Asynchronous command

Manual operation: See "[Hysteresis](#)" on page 993

BUS<m>:DDR:DATA:SOURce <DataSource>

Selects the source for the data output signal.

Suffix:

<m> 1..4

Parameters:

<DataSource> C1W1 | C2W1 | C3W1 | C4W1 | M1 | M2 | M3 | M4 | M5 | M6 |
M7 | M8 | R1 | R2 | R3 | R4 | D0 | D1 | D2 | D3 | D4 | D5 | D6 |
D7 | D8 | D9 | D10 | D11 | D12 | D13 | D14 | D15
*RST: C1W1

Usage: Asynchronous command

Manual operation: See "[DQ](#)" on page 992

BUS<m>:DDR:DATA:THReshold <DataThreshold>

Sets the threshold value for the digitization of the data line.

Suffix:

<m> 1..4

Parameters:

<DataThreshold> Range: -10 to 10
Increment: 0.01
*RST: 0.75
Default unit: V

Usage: Asynchronous command

Manual operation: See "[Threshold](#)" on page 993

BUS<m>:DDR:STRBe:HYSTeresis <StrobeHyst>

Sets a value for the hysteresis of the strobe.

Suffix:

<m> 1..4

Parameters:

<StrobeHyst> Range: 0 to 10
Increment: 0.01
*RST: 0.35
Default unit: V

Usage: Asynchronous command

Manual operation: See "[Hysteresis](#)" on page 993

BUS<m>:DDR:STRBe:SOURce <StrobeSource>

Selects the source for the strobe signal.

Suffix:

<m> 1..4

Parameters:

<StrobeSource> C1W1 | C2W1 | C3W1 | C4W1 | M1 | M2 | M3 | M4 | M5 | M6 |
 M7 | M8 | R1 | R2 | R3 | R4 | D0 | D1 | D2 | D3 | D4 | D5 | D6 |
 D7 | D8 | D9 | D10 | D11 | D12 | D13 | D14 | D15
 *RST: C2W1

Usage: Asynchronous command**Manual operation:** See "[DQS](#)" on page 992**BUS<m>:DDR:STRBe:THReshold <StrobeThreshold>**

Sets the threshold value for the digitization of the strobe line.

Suffix:

<m> 1..4

Parameters:

<StrobeThreshold> Range: -10 to 10
 Increment: 0.01
 *RST: 0
 Default unit: V

Usage: Asynchronous command**Manual operation:** See "[Threshold](#)" on page 993**BUS<m>:DDR:BITRate <Bitrate>**

Declares the nominal bit rate of the data signal for the DDR eye diagram analysis.

Suffix:

<m> 1..4

Parameters:

<Bitrate> Range: 1000 to 10E+9
 Increment: 100E+3
 *RST: 800E+6
 Default unit: bps

Usage: Asynchronous command**Manual operation:** See "[Bit rate \(for eye diagram\)](#)" on page 993**27.18.28.2 Decode results**

In all `BUS<m>:DDR:REsult:FRAMe<n>` commands, the suffix <m> selects the serial bus and the suffix <n> selects the frame number in the decode table.

BUS<m>:DDR:RESult:FCOunt?.....	2571
BUS<m>:DDR:RESult:FRAMe<n>:FLD<o>:FVAL?.....	2571
BUS<m>:DDR:RESult:FRAMe<n>:FLD<o>:START?.....	2571
BUS<m>:DDR:RESult:FRAMe<n>:FLD<o>:STATus?.....	2572
BUS<m>:DDR:RESult:FRAMe<n>:FLD<o>:STOP?.....	2572
BUS<m>:DDR:RESult:FRAMe<n>:FLD<o>:VAL?.....	2573
BUS<m>:DDR:RESult:FRAMe<n>:NWRDs?.....	2573
BUS<m>:DDR:RESult:FRAMe<n>:START?.....	2573
BUS<m>:DDR:RESult:FRAMe<n>:STATe?.....	2574
BUS<m>:DDR:RESult:FRAMe<n>:STOP?.....	2574
BUS<m>:DDR:RESult:FRAMe<n>:TYPE?.....	2574

BUS<m>:DDR:RESult:FCOunt?

Returns the number of decoded frames in the selected serial bus.

Suffix:

<m> 1..4

Return values:

<FrameCount> Range: 0 to 100000
 Increment: 1
 *RST: 0

Usage: Query only

BUS<m>:DDR:RESult:FRAMe<n>:FLD<o>:FVAL?

Returns the formatted value of the field with the selected field number within the frame with the selected frame number (for the selected serial bus).

Suffix:

<m> 1..4

<n> *
 Selects the frame number.

<o> *
 Selects the field number.

Return values:

<FrameByteValue>

Usage: Query only

BUS<m>:DDR:RESult:FRAMe<n>:FLD<o>:START?

Returns the start time of the field with the selected field number within the frame with the selected frame number (for the selected serial bus).

Suffix:

<m> 1..4

<n> *
Selects the frame number.

<o> *
Selects the field number.

Return values:

<Start> Range: -100E+24 to 100E+24
Increment: 100E-12
*RST: 0
Default unit: s

Usage: Query only

BUS<m>:DDR:RESult:FRAMe<n>:FLD<o>:STATus?

Returns the status of the field with the selected field number within the frame with the selected frame number (for the selected serial bus).

Suffix:

<m> 1..4

<n> *
Selects the frame number.

<o> *
Selects the field number.

Return values:

<State> OK | UNKNown | INComplete | LENGth
*RST: OK

Usage: Query only

BUS<m>:DDR:RESult:FRAMe<n>:FLD<o>:STOP?

Returns the stop time of the field with the selected field number within the frame with the selected frame number (for the selected serial bus).

Suffix:

<m> 1..4

<n> *
Selects the frame number.

<o> *
Selects the field number.

Return values:

<Stop> Range: -100E+24 to 100E+24
Increment: 100E-12
*RST: 0
Default unit: s

Usage: Query only

BUS<m>:DDR:RESult:FRAMe<n>:FLD<o>:VAL?

Returns the value of the field with the selected field number within the frame with the selected frame number (for the selected serial bus).

Suffix:

<m>	1..4
<n>	*
	Selects the frame number.
<o>	*
	Selects the field number.

Return values:

<FrameByteValue>	Range:	0 to 0
	Increment:	1
	*RST:	0

Usage: Query only

BUS<m>:DDR:RESult:FRAMe<n>:NWRDs?

Returns the number of words for the selected serial bus and frame number.

Suffix:

<m>	1..4
<n>	*

Return values:

<NumWords>	Range:	0 to 4294967295
	Increment:	1
	*RST:	0

Usage: Query only

BUS<m>:DDR:RESult:FRAMe<n>:STARt?

Returns the start time of the frame with the selected frame number (for the selected serial bus).

Suffix:

<m>	1..4
<n>	*

Return values:

<Start>	Range:	-100E+24 to 100E+24
	Increment:	100E-12
	*RST:	0
	Default unit:	s

Usage: Query only

BUS<m>:DDR:RESult:FRAMe<n>:STATe?

Returns the status of the frame with the selected frame number (for the selected serial bus).

Suffix:

<m> 1..4

<n> *

Return values:

<State> OK | UNKNown | INComplete | LENGth

*RST: OK

Usage: Query only

BUS<m>:DDR:RESult:FRAMe<n>:STOP?

Returns the stop time of the frame with the selected frame number (for the selected serial bus).

Suffix:

<m> 1..4

<n> *

Return values:

<Stop> Range: -100E+24 to 100E+24

Increment: 100E-12

*RST: 0

Default unit: s

Usage: Query only

BUS<m>:DDR:RESult:FRAMe<n>:TYPE?

Returns the frame type for the selected serial bus and frame number.

Suffix:

<m> 1..4

<n> *

Usage: Query only

27.18.28.3 Search settings

There are two commands for each parameter, that you can use for defining the DDR search settings.

For example, to set the *Frame type =Read > Field =Data >Data* value you can use one of the following commands:

- SEARCH:TRIGger:DDR:FRAMe1:ENABle:DMIN 01100

Defines the parameter by using the index <m> for the frame number and <n> for the field number.

- `SEARCH:TRIGger:DDR:DMIN "Read", "Data", 01100`
Defines the parameter by using the frame and field name.

<code>SEARCH:TRIGger:DDR:ERENable</code>	2575
<code>SEARCH:TRIGger:DDR:ERRor<m>:ENABLE</code>	2575
<code>SEARCH:TRIGger:DDR:FIENable</code>	2576
<code>SEARCH:TRIGger:DDR:FRENable</code>	2576
<code>SEARCH:TRIGger:DDR:DMAX</code>	2576
<code>SEARCH:TRIGger:DDR:FRAMe<m>:FLD<n>:DMAX</code>	2576
<code>SEARCH:TRIGger:DDR:DMIN</code>	2576
<code>SEARCH:TRIGger:DDR:FRAMe<m>:FLD<n>:DMIN</code>	2576
<code>SEARCH:TRIGger:DDR:DOPerator</code>	2577
<code>SEARCH:TRIGger:DDR:FRAMe<m>:FLD<n>:DOPerator</code>	2577
<code>SEARCH:TRIGger:DDR:FRENable</code>	2577
<code>SEARCH:TRIGger:DDR:FRAMe<m>:ENABLE</code>	2577
<code>SEARCH:TRIGger:DDR:IMAX</code>	2578
<code>SEARCH:TRIGger:DDR:FRAMe<m>:FLD<n>:IMAX</code>	2578
<code>SEARCH:TRIGger:DDR:IMIN</code>	2578
<code>SEARCH:TRIGger:DDR:FRAMe<m>:FLD<n>:IMIN</code>	2578
<code>SEARCH:TRIGger:DDR:IOPerator</code>	2579
<code>SEARCH:TRIGger:DDR:FRAMe<m>:FLD<n>:IOPerator</code>	2579

SEARCH:TRIGger:DDR:ERENable <SearchName>,<ErrorName>, <Enabler>
SEARCH:TRIGger:DDR:ERRor<m>:ENABLE <SearchName>,<Enable>
SEARCH:TRIGger:DDR:ERRor<m>:ENABLE? <SearchName>

Defines the error type to be searched for. You can search for all error types in parallel.

Suffix:

<m> *
Specifies the error.

Parameters:

<Enable> ON | OFF
*RST: ON

Parameters for setting and query:

<SearchName> The following errors are available:
Frame Incomplete
Length Error

Example:

`SEARCH:TRIGger:DDR:ERRor1:ENABLE ON`
Enables searching for Frame Incomplete error.
`SEARCH:TRIGger:DDR:ERENable "Length Error",ON`
Enables searching for Length Error.

Manual operation: See "Error type" on page 996

SEARCh:TRIGger:DDR:FIENable <SearchName>,<Frame>, <Field>, <Enabler>

Setting parameters:

<SearchName>

<Frame>

<Field>

<Enabler> ON | OFF

Usage: Setting only

Manual operation: See "[Set details](#)" on page 996

SEARCh:TRIGger:DDR:FRENable <SearchName>,<Frame>, <Enabler>

Setting parameters:

<SearchName>

<Frame>

<Enabler> ON | OFF

Usage: Setting only

Manual operation: See "[DDR search](#)" on page 995

SEARCh:TRIGger:DDR:DMAX <SearchName>,<Frame>, <Field>, <Data>

SEARCh:TRIGger:DDR:FRAME<m>:FLD<n>:DMAX <SearchName>,<DataMax>

SEARCh:TRIGger:DDR:FRAME<m>:FLD<n>:DMAX? <SearchName>

Sets the end value of a data pattern range if [SEARCh:TRIGger:DDR:FRAME<m>:FLD<n>:DOPerator](#) is set to [INRange](#) or [OORange](#).

Suffix:

<m> *

<n> *

Parameters:

<DataMax>

Parameters for setting and query:

<SearchName>

Manual operation: See "[Value](#)" on page 996

SEARCh:TRIGger:DDR:DMIN <SearchName>,<Frame>, <Field>, <Data>

SEARCh:TRIGger:DDR:FRAME<m>:FLD<n>:DMIN <SearchName>,<DataMin>

SEARCh:TRIGger:DDR:FRAME<m>:FLD<n>:DMIN? <SearchName>

Specifies the data pattern to be searched, or sets the start value of a data pattern range to be searched.

Suffix:

<m> *

<n> *

Parameters:

<DataMin> Specifies the name of the generic trigger setting frame.

Parameters for setting and query:

<SearchName>

Manual operation: See "Value" on page 996**SEARCh:TRIGger:DDR:DOPerator** <SearchName>,<Frame>, <Field>, <Operator>**SEARCh:TRIGger:DDR:FRAMe<m>:FLD<n>:DOPerator**

<SearchName>,<DataOperator>

SEARCh:TRIGger:DDR:FRAMe<m>:FLD<n>:DOPerator? <SearchName>

Sets the operator to set a specific data pattern to be searched in the selected field of the selected frame.

Suffix:

<m> *

<n> *

Parameters:

<DataOperator> EQUal | NEQUal | LTHan | LETHan | GTHan | GETHan | INRange | OORange

EQUal | NEQUal | LTHan | LETHan | GTHan | GETHanEqual, Not equal, Less than, Less than or equal, Greater than, Greater than or equal. These conditions require one endpoint value to be set using [SEARCh:TRIGger:DDR:FRAMe<m>:FLD<n>:DMIN](#).**INRange | OORange**In range, out of range. These conditions require a range of endpoint values to be set using [SEARCh:TRIGger:DDR:FRAMe<m>:FLD<n>:DMIN](#) and [SEARCh:TRIGger:DDR:FRAMe<m>:FLD<n>:DMAX](#).

*RST: EQUal

Parameters for setting and query:

<SearchName>

Manual operation: See "Value" on page 996**SEARCh:TRIGger:DDR:FRENable** <SearchName>,<Frame>, <Enabler>**SEARCh:TRIGger:DDR:FRAMe<m>:ENABLe** <SearchName>,<Enable>**SEARCh:TRIGger:DDR:FRAMe<m>:ENABLe?** <SearchName>

Enables or disables the specific frame to be searched for.

Suffix:

<m> *

Parameters:

<Enable> ON | OFF
*RST: OFF

Parameters for setting and query:

<SearchName> The following frames are available:
Read
Write
Read NC
Write NC

Manual operation: See "[DDR search](#)" on page 995

SEARch:TRIGger:DDR:IMAX <SearchName>,<Frame>, <Field>, <Data>

SEARch:TRIGger:DDR:FRAMe<m>:FLD<n>:IMAX <SearchName>,<IndexMax>

SEARch:TRIGger:DDR:FRAMe<m>:FLD<n>:IMAX? <SearchName>

Sets the end value of the bit index range (data position range), if [SEARch:TRIGger:DDR:FRAMe<m>:FLD<n>:IOPerator](#) is set to INRange or RANGe.

Suffix:

<m> *

<n> *

Parameters:

<IndexMax> Range: 1 to 65534
Increment: 1
*RST: 65534

Parameters for setting and query:

<SearchName>

Manual operation: See "[Index](#)" on page 997

SEARch:TRIGger:DDR:IMIN <SearchName>,<Frame>, <Field>, <Data>

SEARch:TRIGger:DDR:FRAMe<m>:FLD<n>:IMIN <SearchName>,<IndexMin>

SEARch:TRIGger:DDR:FRAMe<m>:FLD<n>:IMIN? <SearchName>

Sets the index at which the data is to be searched, or sets the start value of an index range in which the data is to be searched.

Suffix:

<m> *

<n> *

Parameters:

<IndexMin> Specifies the index value or the start value of an index range within the field.
The index range, increment and *RST values depend on the field type.

Range: 1 to 65534
Increment: 1
*RST: 1

Parameters for setting and query:

<SearchName>

Manual operation: See "Index" on page 997

SEARCH:TRIGger:DDR:IOperator <SearchName>, <Frame>, <Field>, <Operator>

SEARCH:TRIGger:DDR:FRAMe<m>:FLD<n>:IOperator

<SearchName>, <IndexOperator>

SEARCH:TRIGger:DDR:FRAMe<m>:FLD<n>:IOperator? <SearchName>

Sets the operator for the index for searching in the selected field of the selected frame.

Suffix:

<m> *

<n> *

Parameters:

<IndexOperator> EQUal | INRange | RANGE

EQUal

This condition requires one endpoint value to be set using [SEARCH:TRIGger:DDR:FRAMe<m>:FLD<n>:IMIN](#).

INRange | RANGE

This condition requires a range of endpoint values to be set using [SEARCH:TRIGger:DDR:FRAMe<m>:FLD<n>:IMIN](#) and [SEARCH:TRIGger:DDR:FRAMe<m>:FLD<n>:IMAX](#).

*RST: INRange

Parameters for setting and query:

<SearchName>

Manual operation: See "Index" on page 997

27.18.28.4 Search results

In all [SEARCH:RESult:DDR:FRAMe<m>](#) commands, the suffix <m> selects the frame number in the list of search results.

SEARCH:RESult:DDR:FCOut?	2580
SEARCH:RESult:DDR:FRAMe<m>:FLD<n>:FVAL?	2580
SEARCH:RESult:DDR:FRAMe<m>:FLD<n>:START?	2580
SEARCH:RESult:DDR:FRAMe<m>:FLD<n>:STATus?	2581
SEARCH:RESult:DDR:FRAMe<m>:FLD<n>:STOP?	2581

SEARCh:RESult:DDR:FRAMe<m>:FLD<n>:VAL?.....	2581
SEARCh:RESult:DDR:FRAMe<m>:NWRDs?.....	2582
SEARCh:RESult:DDR:FRAMe<m>:START?.....	2582
SEARCh:RESult:DDR:FRAMe<m>:STATe?.....	2583
SEARCh:RESult:DDR:FRAMe<m>:STOP?.....	2583
SEARCh:RESult:DDR:FRAMe<m>:TYPE?.....	2583

SEARCh:RESult:DDR:FCOunt? <SearchName>

Returns the number of decoded frames in the search result.

Query parameters:

<SearchName>

Return values:

<FrameCount>	Range:	0 to 100000
	Increment:	1
	*RST:	0

Usage: Query only

SEARCh:RESult:DDR:FRAMe<m>:FLD<n>:FVAL? <SearchName>

Returns the formatted value of the field with the selected field number within the frame with the selected frame number within the search result.

Suffix:

<m> *

<n> *

Selects the field number.

Query parameters:

<SearchName>

Return values:

<BteFormattedVal>

Usage: Query only

SEARCh:RESult:DDR:FRAMe<m>:FLD<n>:START? <SearchName>

Returns the start time of the selected field number within the frame with the selected frame number within the search result.

Suffix:

<m> *

<n> *

Selects the field number.

Query parameters:

<SearchName>

Return values:

<Start> Range: -100E+24 to 100E+24
 Increment: 100E-12
 *RST: 0
 Default unit: s

Usage: Query only

SEARCh:RESult:DDR:FRAMe<m>:FLD<n>:STATus? <SearchName>

Returns the field status of the field with the selected field number within the frame with the selected frame number within the search result.

Suffix:

<m> *
 <n> *

Query parameters:

<SearchName>

Return values:

<State> OK | UNKNown | INComplete | LENGth
 *RST: OK

Usage: Query only

SEARCh:RESult:DDR:FRAMe<m>:FLD<n>:STOP? <SearchName>

Returns the stop time of the field with the selected field number within the frame with the selected frame number within the search result.

Suffix:

<m> *
 <n> *
 Selects the field number.

Query parameters:

<SearchName>

Return values:

<Stop> Range: -100E+24 to 100E+24
 Increment: 100E-12
 *RST: 0
 Default unit: s

Usage: Query only

SEARCh:RESult:DDR:FRAMe<m>:FLD<n>:VAL? <SearchName>

Returns the value of the field with the selected field number within the frame with the selected frame number within the search result.

Suffix:

<m> *

<n> *

Selects the field number.

Query parameters:

<SearchName>

Return values:

<ByteValue> Range: 0 to 0
 Increment: 1
 *RST: 0

Usage: Query only**SEARCh:RESult:DDR:FRAMe<m>:NWRDs? <SearchName>**

Returns the number of words of the selected frame in the search result.

Suffix:

<m> *

Query parameters:

<SearchName>

Return values:

<NumWords> Range: 0 to 4294967295
 Increment: 1
 *RST: 0

Usage: Query only**SEARCh:RESult:DDR:FRAMe<m>:START? <SearchName>**

Returns the start time of the frame with the selected frame number within the search result.

Suffix:

<m> *

Query parameters:

<SearchName>

Return values:

<Start> Range: -100E+24 to 100E+24
 Increment: 100E-12
 *RST: 0
 Default unit: s

Usage: Query only

SEARCh:RESUlt:DDR:FRAMe<m>:STATe? <SearchName>

Returns the status of the frame with the selected frame number within the search result.

Suffix:
<m> *

Query parameters:
<SearchName>

Return values:
<State> OK | UNKNown | INComplete | LENGth
*RST: OK

Usage: Query only

SEARCh:RESUlt:DDR:FRAMe<m>:STOP? <SearchName>

Returns the stop time of the frame with the selected frame number within the search result.

Suffix:
<m> *

Query parameters:
<SearchName>

Return values:
<Stop> Range: -100E+24 to 100E+24
Increment: 100E-12
*RST: 0
Default unit: s

Usage: Query only

SEARCh:RESUlt:DDR:FRAMe<m>:TYPE? <SearchName>

Returns the frame type for the selected frame number within the search result.

Suffix:
<m> *

Query parameters:
<SearchName>

Usage: Query only

27.18.28.5 Eye diagram analysis

The suffix EYE<m> selects the eye diagram to which the command applies. You can configure and analyze up to four eye diagrams in parallel.

There are two ways to generate eye diagrams on the R&S RTO6:

- Standard eye diagrams, which are a superposition of repetitively sampled digital data.
- To use advanced eye diagrams, option R&S RTO6-K136 or R&S RTO6-K91 is required.

Basic setup

EYE<m>[:STATe].....	2584
EYE<m>:SOURce.....	2585
EYE<m>:HORizontal[:UNIT].....	2585
EYE<m>:HORizontal:ABSolute:RANGe.....	2585
EYE<m>:HORizontal:ABSolute:POSition.....	2586
EYE<m>:HORizontal:UINterval:RANGe.....	2586
EYE<m>:HORizontal:UINterval:POSition.....	2586
EYE<m>:TIMReference:CLOCK:EDGE.....	2587
EYE<m>:TIMReference:CLOCK:FACTor.....	2587
EYE<m>:TIMReference:CLOCK:FREQuency.....	2587
EYE<m>:TIMReference:CLOCK:FREStimation.....	2587
EYE<m>:TIMReference:CLOCK:LEVel.....	2588
EYE<m>:TIMReference:CLOCK:OFEStimation.....	2588
EYE<m>:TIMReference:CLOCK:OFFSet.....	2588
EYE<m>:TIMReference:CLOCK:SOURce.....	2589
EYE<m>:TIMReference:PROTocol:SElect.....	2589
EYE<m>:TIMReference[:SOURce].....	2589
EYE<m>:TIMReference:CDR:SOFTware.....	2589
EYE<m>:TIMReference:CDR[:SElect].....	2590
EYE<m>:MEASurement:MAXPrecision.....	2590
EYE<m>:VERTical:OFFSet.....	2590
EYE<m>:VERTical:POSition.....	2591
EYE<m>:VERTical:SCALE.....	2591
EYE<m>:TIMReference:CDR:SOFTware:SAMTime.....	2591
EYE<m>:PAMorder?.....	2592
EYE<m>:SYMBOLrate?.....	2592
EYE<m>:BITRate?.....	2592

EYE<m>[:STATe] <State>

Activates or deactivates the eye diagram.

Suffix:

<m> 1..4

Parameters:

<State> ON | OFF
*RST: OFF

Usage: Asynchronous command

Manual operation: See "State" on page 1147

EYE<m>:SOURce <MainSource>

Selects the waveform from which the eye diagram is generated (data source). For analog channels, peak detect, envelope, and average waveforms are not supported.

Suffix:

<m> 1..4

Parameters:

<MainSource> C1W1 | C2W1 | C3W1 | C4W1 | M1 | M2 | M3 | M4 | M5 | M6 | M7 | M8 | R1 | R2 | R3 | R4

Usage: Asynchronous command

Manual operation: See "[Source](#)" on page 1147

EYE<m>:HORizontal[:UNIT] <TimeUnits>

Sets the method to define the horizontal scale of the eye diagram.

Suffix:

<m> 1..4

Parameters:

<TimeUnits> ATIME | UINterval

ATIME

Absolute time

UINterval

Unit intervals. You can use unit interval, if the nominal frequency of the clock signal is known.

*RST: ATIME

Usage: Asynchronous command

Manual operation: See "[Time units](#)" on page 1152

EYE<m>:HORizontal:ABSolute:RANGe <HorizontalRange>

Sets the time range that is covered by the eye diagram.

Suffix:

<m> 1..4

Parameters:

<HorizontalRange> Range: 100E-12 to 100
Increment: 1E-9
*RST: 2E-9
Default unit: s

Usage: Asynchronous command

Manual operation: See "[Range, Position](#)" on page 1152

EYE<m>:HORizontal:ABSolute:POSition <HorizPosition>

Sets the place of the zero point in the diagram, in seconds. The zero point is the alignment point on which the slice timestamps are superimposed.

Suffix:

<m> 1..4

Parameters:

<HorizPosition> Range: -100 to 100
Increment: 1E-9
*RST: 0
Default unit: s

Usage: Asynchronous command

Manual operation: See "[Range, Position](#)" on page 1152

EYE<m>:HORizontal:UINterval:RANGe <RangeUI>

Sets the number of unit intervals that are visible in the eye diagram.

Suffix:

<m> 1..4

Parameters:

<RangeUI> Range: 100E-12 to 100E+9
Increment: 0.01
*RST: 2
Default unit: UI

Usage: Asynchronous command

Manual operation: See "[Range UI, Position UI](#)" on page 1153

EYE<m>:HORizontal:UINterval:POSition <PositionUI>

Sets the zero point in the diagram, in unit intervals. The zero point is the alignment point on which the segment timestamps are superimposed.

Suffix:

<m> 1..4

Parameters:

<PositionUI> Range: -100E+9 to 100E+9
Increment: 0.01
*RST: 0
Default unit: UI

Usage: Asynchronous command

Manual operation: See "[Range UI, Position UI](#)" on page 1153

EYE<m>:TIMReference:CLOCK:EDGE <EdgeType>

The clock edge sets the point in time when the state of the data signal is checked.

Suffix:

<m> 1..4

Parameters:

<EdgeType> POSitive | NEGative | EITHer
*RST: EITHer

Usage: Asynchronous command

Manual operation: See "[Clock edge](#)" on page 1150

EYE<m>:TIMReference:CLOCK:FACTor <Factor>

Sets a clock multiplier factor.

Available if [EYE<m>:TIMReference\[:SOURce\]](#) is set to CLOCK.

Suffix:

<m> 1..4

Parameters:

<Factor> Range: 1 to 100
Increment: 1
*RST: 1

Usage: Asynchronous command

Manual operation: See "[Clock multiplier](#)" on page 1150

EYE<m>:TIMReference:CLOCK:FREQuency <Frequency>

Sets the clock frequency for the explicit clock signal.

Available if [EYE<m>:TIMReference\[:SOURce\]](#) is set to CLOCK.

Suffix:

<m> 1..4

Parameters:

<Frequency> Range: 1000 to 10E+9
Increment: 10
*RST: 500E+6
Default unit: Hz

Usage: Asynchronous command

Manual operation: See "[Clock frequency](#)" on page 1150

EYE<m>:TIMReference:CLOCK:FREStimation

Executes an estimation of the signal for the clock frequency.

Available if `EYE<m>:TIMReference[:SOURCE]` is set to `CLOCK`.

Suffix:

<m> 1..4

Usage: Event

Manual operation: See "[Estimate clock frequency](#)" on page 1150

EYE<m>:TIMReference:CLOCK:LEVel <Level>

Sets the vertical reference level of the timing reference source.

Available if `EYE<m>:TIMReference[:SOURCE]` is set to `CLOCK`.

Suffix:

<m> 1..4

Parameters:

<Level> UPPer | MIDDle | LOWer

*RST: MIDDle

Usage: Asynchronous command

Manual operation: See "[Vertical reference level](#)" on page 1150

EYE<m>:TIMReference:CLOCK:OFEstimation

Executes an estimation of the signal for the clock offset.

Available if `EYE<m>:TIMReference[:SOURCE]` is set to `CLOCK`.

Suffix:

<m> 1..4

Usage: Event

Manual operation: See "[Estimate clock offset](#)" on page 1151

EYE<m>:TIMReference:CLOCK:OFFSet <Offset>

Sets a clock offset for the explicit clock signal.

Available if `EYE<m>:TIMReference[:SOURCE]` is set to `CLOCK`.

Suffix:

<m> 1..4

Parameters:

<Offset> Range: -1000 to 1000

Increment: 0.01

*RST: 0

Default unit: UI

Usage: Asynchronous command

Manual operation: See ["Clock offset"](#) on page 1151

EYE<m>:TIMReference:CLOCK:SOURce <SourceType>

Selects the source of the clock channel, if [EYE<m>:TIMReference\[:SOURce\]](#) is set to `CLOCK`.

Suffix:

<m> 1..4

Parameters:

<SourceType> C1W1 | C2W1 | C3W1 | C4W1 | M1 | M2 | M3 | M4 | M5 | M6 | M7 | M8 | R1 | R2 | R3 | R4 | D0 | D1 | D2 | D3 | D4 | D5 | D6 | D7 | D8 | D9 | D10 | D11 | D12 | D13 | D14 | D15

Usage: Asynchronous command

Manual operation: See ["Clock"](#) on page 1148

EYE<m>:TIMReference:PROTocol:SElect <SerialBusIndex>

Selects the active bus for the eye analysis, if [EYE<m>:TIMReference\[:SOURce\]](#) is set to `PROTocol`.

Suffix:

<m> 1..4

Parameters:

<SerialBusIndex> SBUS1 | SBUS2 | SBUS3 | SBUS4
*RST: SBUS1

Usage: Asynchronous command

Manual operation: See ["Protocol"](#) on page 1149

EYE<m>:TIMReference[:SOURce] <ReferenceSource>

Selects the source of the reference signal used for the eye diagram.

Suffix:

<m> 1..4

Parameters:

<ReferenceSource> CLOCK | CDR | PROTocol
*RST: CDR

Usage: Asynchronous command

Manual operation: See ["Clock / CDR / Protocol"](#) on page 1147

EYE<m>:TIMReference:CDR:SOFTware <SoftwareCDRIIdx>

Selects the software CDR used for the reference signal of the the eye diagram.

Suffix:

<m> 1..4

Parameters:

<SoftwareCDRIIdx> SW1 | SW2 | SW3 | SW4
 *RST: SW1

Usage: Asynchronous command**Manual operation:** See "[CDR](#)" on page 1148**EYE<m>:TIMReference:CDR[:SElect] <CDRType>**

Selects hardware or software clock data recovery.

Available, if [EYE<m>:TIMReference\[:SOURCE\]](#) is set to CDR.**Suffix:**

<m> 1..4

Parameters:

<CDRType> SW | HW
 *RST: SW

Usage: Asynchronous command**Manual operation:** See "[CDR](#)" on page 1148**EYE<m>:MEASurement:MAXPrecision <EnabClassifier>**

If this function is enabled, the rising and falling transitions for the eye measurments "Eye rise time", "Eye fall time" and "Duty cycle distortion" are separated.

Suffix:

<m> 1..4

Parameters:

<EnabClassifier> ON | OFF
 *RST: OFF

Usage: Asynchronous command**Manual operation:** See "[Maximum precision](#)" on page 1168**EYE<m>:VERTical:OFFSet <VerticalOffset>**

The offset voltage is subtracted to correct an offset-affected signal.

Suffix:

<m> 1..4

Parameters:

<VerticalOffset> Range: -100E+24 to 100E+24
 Increment: 0.01
 *RST: 0
 Default unit: V

Usage: Asynchronous command

Manual operation: See "[Offset](#)" on page 1153

EYE<m>:VERTical:POSition <VertPosi>

Sets the vertical position of the indicated eye as a graphical value.

Suffix:

<m> 1..4

Parameters:

<VertPosi> Range: -100E+24 to 100E+24
 Increment: 0.1
 *RST: 0
 Default unit: div

Usage: Asynchronous command

Manual operation: See "[Position](#)" on page 1153

EYE<m>:VERTical:SCALe <VerticalScale>

Sets the vertical scale for the indicated eye.

Suffix:

<m> 1..4

Parameters:

<VerticalScale> Range: 1E-12 to 100
 Increment: 1E-3
 *RST: 0.05
 Default unit: V/div

Usage: Asynchronous command

Manual operation: See "[Scale](#)" on page 1153

EYE<m>:TIMReference:CDR:SOFTware:SAMTime <SamplingTime>

Sets the sampling time for the software CDR.

Available, if [EYE<m>:TIMReference\[:SOURCE\]](#) is set to CDR and [EYE<m>:TIMReference:CDR\[:SElect\]](#) is set to SW.

Suffix:

<m> 1..4

Parameters:

<SamplingTime> Range: 0 to 1
 Increment: 0.01
 *RST: 0.5
 Default unit: UI

Usage: Asynchronous command

Manual operation: See "[CDR](#)" on page 1148

EYE<m>:PAMorder?

Queries the PAM order of the selected eye source.

Suffix:

<m> 1..4

Return values:

<PAMOrder> PAM2 | PAM3 | PAM4 | PAM5 | PAM6 | PAM7 | PAM8
 *RST: PAM2

Usage: Query only
 Asynchronous command

EYE<m>:SYMBOLrate?

Queries the symbol rate of the selected eye source.

Suffix:

<m> 1..4

Return values:

<Bitrate> Range: 1000 to 16E+9
 Increment: 1
 *RST: 2E+9
 Default unit: bps

Usage: Query only
 Asynchronous command

EYE<m>:BITRate?

Queries the bit rate of the selected eye source.

Suffix:

<m> 1..4

Return values:

<Bitrate> Range: 1000 to 16E+9
 Increment: 1
 *RST: 2E+9
 Default unit: bps

Usage: Query only
Asynchronous command

Display

EYE<m>:MSLices <MaxSliceCount>

Sets the number of waveform slices for a single acquisition.

Suffix:
<m> 1..4

Parameters:
<MaxSliceCount> Range: 1 to 2500000
Increment: 1
*RST: 2000

Usage: Asynchronous command

Manual operation: See "[Slices per acquisition \(Upper limit\)](#)" on page 1151

EYE<m>:DISPlay:MODE <EyestripeMode>

Defines when the eye stripe is shown: always, never, or during mask tests.

Suffix:
<m> 1..4

Parameters:
<EyestripeMode> ALWays | MTONly | NEVer
MTONly: Mask test only
*RST: MTONly

Usage: Asynchronous command

Manual operation: See "[Display mode](#)" on page 1155

EYE<m>:DISPlay:PERsistence:INFinite <State>

If persistence is enabled ([EYE<m>:DISPlay:PERsistence:STATe](#)), each new data point in the diagram area remains on the screen infinitely until this command is set to OFF.

Suffix:
<m> 1..4

Parameters:
<State> ON | OFF
*RST: OFF

Usage: Asynchronous command

Manual operation: See "[Infinite persistence](#)" on page 1155

EYE<m>:DISPlay:PERsistence:RESet

Resets the display, removing persistent values.

Suffix:

<m> 1..4

Usage:

Event
Asynchronous command

Manual operation: See ["Reset"](#) on page 1155

EYE<m>:DISPlay:PERsistence:STATe <State>

If enabled, each new data point in the diagram area remains on the screen for the duration defined using [EYE<m>:DISPlay:PERsistence:TIME](#), or as long as [EYE<m>:DISPlay:PERsistence:INFinite](#) is enabled.

If disabled, the signal value is only displayed as long as it actually occurs.

Suffix:

<m> 1..4

Parameters:

<State> ON | OFF
*RST: ON

Usage:

Asynchronous command

Manual operation: See ["Enable"](#) on page 1155

EYE<m>:DISPlay:PERsistence:TIME <Time>

If persistence is enabled ([EYE<m>:DISPlay:PERsistence:STATe](#)), each new data point in the diagram area remains on the screen for the duration defined here.

Suffix:

<m> 1..4

Parameters:

<Time> Range: 0.05 to 50
Increment: 0.05
*RST: 0.05
Default unit: s

Usage:

Asynchronous command

Manual operation: See ["Time"](#) on page 1155

Qualify: gate settings

EYE<m>:QUALify:GATE[:STATe]	2595
EYE<m>:QUALify:GATE:COUPLing	2595
EYE<m>:QUALify:GATE:MODE	2595
EYE<m>:QUALify:GATE:ABSolute:START	2596

EYE<m>:QUALify:GATE:ABSolute:STOP.....	2596
EYE<m>:QUALify:GATE:RELative:START.....	2596
EYE<m>:QUALify:GATE:RELative:STOP.....	2596
EYE<m>:QUALify:GATE:CURSor.....	2596
EYE<m>:QUALify:GATE:ZDIagram.....	2597

EYE<m>:QUALify:GATE[:STATE] <State>

Enables the gate.

Suffix:

<m> 1..4

Parameters:

<State> ON | OFF
*RST: OFF

Usage: Asynchronous command

Manual operation: See "Gate" on page 1156

EYE<m>:QUALify:GATE:COUPling <CouplingMode>

Sets the gate coupling. To use cursor lines or zoom areas as gate limits, the cursor or zoom must be defined before.

Suffix:

<m> 1..4

Parameters:

<CouplingMode> NONE | CURSor | ZOOM
*RST: NONE

Usage: Asynchronous command

Manual operation: See "Gate" on page 1156

EYE<m>:QUALify:GATE:MODE <Mode>

Defines whether the gate limit is defined in absolute or relative values when no gate coupling is set.

Suffix:

<m> 1..4

Parameters:

<Mode> ABS | REL
*RST: ABS

Usage: Asynchronous command

Manual operation: See "Gate" on page 1156

EYE<m>:QUALify:GATE:ABSolute:START <Start>

EYE<m>:QUALify:GATE:ABSolute:STOP <Stop>

Set the absolute time values for gate start and gate end.

Suffix:

<m> 1..4

Parameters:

<Start>, <Stop> Range: -100E+24 to 100E+24
 Increment: 0.01
 *RST: 0.01

Example:

Gate definition for eye diagram 2 in absolute time values:

```
EYE2:QUALify:GATE:COUPling NONE
EYE2:QUALify:GATE:MODE ABS
EYE2:QUALify:GATE:ABSolute:START -0.0002
EYE2:QUALify:GATE:ABSolute:STOP 0.0002
```

Usage:

Asynchronous command

Manual operation: See "[Gate](#)" on page 1156

EYE<m>:QUALify:GATE:RELative:START <RelativeStart>

EYE<m>:QUALify:GATE:RELative:STOP <RelativeStop>

Set the relative values for gate start and gate end.

Suffix:

<m> 1..4

Parameters:

<RelativeStart>, <RelativeStop> Range: 0 to 100
 Increment: 0.1
 *RST: 100
 Default unit: %

Example:

Gate definition for eye diagram 2 in relative values:

```
EYE2:QUALify:GATE:COUPling NONE
EYE2:QUALify:GATE:MODE REL
EYE2:QUALify:GATE:RELative:START 10
EYE2:QUALify:GATE:RELative:STOP 90
```

Usage:

Asynchronous command

Manual operation: See "[Gate](#)" on page 1156

EYE<m>:QUALify:GATE:CURSOr <Cursorset>

Selects the cursor set to be used for eye gating. The gate area is defined by the cursor lines.

Suffix:

<m> 1..4

Parameters:	
<Cursorset>	CURSOR1 CURSor1 CURSOR2 CURSor2 CURSOR3 CURSor3 CURSOR4 CURSor4 CURSOR1 = CURSor1, CURSOR2 = CURSor2, CURSOR3 = CURSor3, CURSOR4 = CURSor4 *RST: CURSOR1
Example:	Gate definition for eye diagram 2 with cursor coupling: EYE2:QUALify:GATE:COUPling CURSor EYE2:QUALify:GATE:CURSor CURSor1
Usage:	Asynchronous command
Manual operation:	See "Gate" on page 1156

EYE<m>:QUALify:GATE:ZDiagram <ZoomDiagram>

Selects the zoom diagram to be used for eye gating. The zoom area is used as gate.

Suffix:

<m> 1..4

Parameters:

<ZoomDiagram> String with the name of the zoom diagram

Example:

Gate definition for eye diagram 2 with zoom coupling:
EYE2:QUALify:GATE:COUPling ZOOM
EYE2:QUALify:GATE:ZDiagram "Zoom1"

Usage:

Asynchronous command

Manual operation: See "Gate" on page 1156

Qualify: signal settings

EYE<m>:QUALify:SIGNal[:STATe].....	2597
EYE<m>:QUALify:SIGNal:SOURce.....	2598
EYE<m>:QUALify:SIGNal:CONDition.....	2598
EYE<m>:QUALify:SIGNal:LSElect.....	2598

EYE<m>:QUALify:SIGNal[:STATe] <State>

Enables the waveform-based qualification for the eye generation.

Suffix:

<m> 1..4

Parameters:

<State> ON | OFF
*RST: OFF

Usage:

Asynchronous command

Manual operation: See "State" on page 1157

EYE<m>:QUALify:SIGNal:SOURce <Source>

Selects the waveform to be compared.

Suffix:

<m> 1..4

Parameters:

<Source> C1W1 | C2W1 | C3W1 | C4W1 | M1 | M2 | M3 | M4 | M5 | M6 | M7 | M8 | R1 | R2 | R3 | R4

Usage: Asynchronous command

Manual operation: See "[Source](#)" on page 1157

EYE<m>:QUALify:SIGNal:CONDition <Condition>

Selects the comparison condition for the the waveform level.

Suffix:

<m> 1..4

Parameters:

<Condition> LTHan | GTHan | INRange | OORange
*RST: GTHan

Usage: Asynchronous command

Manual operation: See "[Condition](#)" on page 1157

EYE<m>:QUALify:SIGNal:LSElect <LevelSelection>

Selects the threshold. You can use the lower, middle, or upper reference level. These levels are the reference levels that are defined for measurements.

Suffix:

<m> 1..4

Parameters:

<LevelSelection> UPPer | MIDDle | LOWer
*RST: MIDDle

Example: The slices of the channel 1 signal only contribute to the eye generation if the voltage level of the signal on channel 2 is higher than the upper reference level.

```
EYE:SOURce C1W1
EYE:QUALify:SIGNal:SOURce C2W1
EYE:QUALify:SIGNal:CONDition GTHan
EYE:QUALify:SIGNal:LSElect UPPer
EYE:QUALify:SIGNal ON
```

Usage: Asynchronous command

Manual operation: See "[Vertical reference level](#)" on page 1157

Filter

EYE<m>:FILTer:STATe.....	2599
EYE<m>:FILTer:BPATtern:MODE.....	2599
EYE<m>:FILTer:BPATtern:PREFix<1..8>.....	2600
EYE<m>:FILTer:BPATtern:CENTer.....	2600
EYE<m>:FILTer:BPATtern:SUFFix<1..5>.....	2600
EYE<m>:FILTer:BPATtern:SLEFt.....	2600
EYE<m>:FILTer:BPATtern:SRIght.....	2600
EYE<m>:FILTer:BPATtern:RESet.....	2600
EYE<m>:FILTer:DDR:FtYPe.....	2601
EYE<m>:FILTer:DDR:LEnError.....	2601
EYE<m>:FILTer:PAMN:BLEVel.....	2601
EYE<m>:FILTer:PAMN:EMODe.....	2602
EYE<m>:FILTer:PAMN:SEYE.....	2602
EYE<m>:FILTer:PAMN:TLEVel.....	2602

EYE<m>:FILTer:STATe <State>

Applies the filter settings to the data signal.

Suffix:

<m> 1..4

Parameters:

<State> ON | OFF
*RST: OFF

Usage: Asynchronous command

Manual operation: See "Enable" on page 1158

EYE<m>:FILTer:BPATtern:MODE <Mode>

Selects which bits contribute to the eye generation.

Suffix:

<m> 1..4

Parameters:

<Mode> ABITs | LTRansition | CLEVel | BPATtern

ABITs

All bits contribute to the eye diagram, same as EYE<m> :
FILTer:STATe is OFF.

LTRansition

Level transition, only bits after a signal transition contribute (0 to 1, or 1 to 0).

CLEVel

Constant level, only bits without a preceding signal transition contribute (0 to 0, or 1 to 1).

BPATtern

Only bits contribute that match the defined pattern before and after the center eye.

*RST: ABITs

Usage: Asynchronous command

Manual operation: See "[Mode](#)" on page 1158

EYE<m>:FILTer:BPATtern:PREFix<1..8> <Bit>

EYE<m>:FILTer:BPATtern:CENTer <BitValue>

EYE<m>:FILTer:BPATtern:SUFFix<1..5> <Bit>

Set the values of the indicated prefix, center, and suffix bits.

Suffix:

<m> 1..4

Parameters:

<Bit> ONE | ZERO | DC

DC: don't care

Manual operation: See "[Pattern](#)" on page 1159

EYE<m>:FILTer:BPATtern:SLEFt

Shifts the pattern one bit to the left.

Suffix:

<m> 1..4

Usage: Event
Asynchronous command

Manual operation: See "[Pattern control](#)" on page 1159

EYE<m>:FILTer:BPATtern:SRIGht

Shifts the pattern one bit to the right.

Suffix:

<m> 1..4

Usage: Event
Asynchronous command

Manual operation: See "[Pattern control](#)" on page 1159

EYE<m>:FILTer:BPATtern:RESEt

Resets the bit sequence filter to the default (DC for all bits).

Suffix:

<m> 1..4

Usage: Event
Asynchronous command

Manual operation: See "[Pattern control](#)" on page 1159

EYE<m>:FILTer:DDR:FTYPE <CommTyp>

Sets which frame types contribute to the eye diagram.

Suffix:
<m> 1..4

Parameters:
<CommTyp> ANY | ANYC | READ | WRITe | RDNC | WRNC
ANYC: any consecutive
RDNC: read non-consecutive
WRNC: write non-consecutive
*RST: ANY

Usage: Asynchronous command

Manual operation: See "[Frame Type](#)" on page 1160

EYE<m>:FILTer:DDR:LEnError <CommTyp>

If enabled, the length errors contribute to the eye diagram.

Suffix:
<m> 1..4

Parameters:
<CommTyp> ON | OFF
*RST: OFF

Usage: Asynchronous command

Manual operation: See "[Length Error](#)" on page 1160

EYE<m>:FILTer:PAMN:BLEVel <PAMNSelcEyeBaseLev>

Selects the base level for the PAM-N signal eye, if [EYE<m>:FILTer:PAMN:EMODE](#) is set to SELEcted.

Suffix:
<m> 1..4

Parameters:
<PAMNSelcEyeBaseLev> LEVEL0 | LEVEL1 | LEVEL2 | LEVEL3 | LEVEL4 | LEVEL5 |
LEVEL6
*RST: LEVEL0

Usage: Asynchronous command

Manual operation: See "[PAM-N diagram filter mode](#)" on page 1161

EYE<m>:FILTer:PAMN:EMODe <PAMNEyeSel>

Selects the filter mode for PAM-N signals. It defines which part of the signal is used to build the eye.

Suffix:

<m> 1..4

Parameters:

<PAMNEyeSel> WHOLe | SPECific | SELEcted

WHOLe

Displays all level transitions of the selected source.

SPECific

Displays an explicit eye opening (e.g. for level transition 1-2) with all involved level transitions. You can select the eye with [EYE<m>:FILTer:PAMN:SEYE](#).

SELEcted

Displays an explicit eye opening (e.g. for level transition 1-2) with only its own level transitions. You can select the base level ([EYE<m>:FILTer:PAMN:BLEVel](#)) and target level ([EYE<m>:FILTer:PAMN:TLEVel](#)).

*RST: WHOLe

Usage: Asynchronous command

Manual operation: See "[PAM-N diagram filter mode](#)" on page 1161

EYE<m>:FILTer:PAMN:SEYE <PAMNSpecificEye>

Selects the specific eye for the PAM-N signal eye, if [EYE<m>:FILTer:PAMN:EMODe](#) is set to `SPECific`.

Suffix:

<m> 1..4

Parameters:

<PAMNSpecificEye> EYE1 | EYE2 | EYE3 | EYE4 | EYE5 | EYE6 | EYE7

*RST: EYE1

Usage: Asynchronous command

Manual operation: See "[PAM-N diagram filter mode](#)" on page 1161

EYE<m>:FILTer:PAMN:TLEVel <PAMNSelcEyeTargetLev>

Selects the target level for the PAM-N signal eye, if [EYE<m>:FILTer:PAMN:EMODe](#) is set to `SELEcted`.

Suffix:

<m> 1..4

Parameters:

<PAMNSelcEyeTargetLevel> LEVEL1 | LEVEL2 | LEVEL3 | LEVEL4 | LEVEL5 | LEVEL6 |
LEVEL7
*RST: LEVEL1

Usage: Asynchronous command

Manual operation: See "[PAM-N diagram filter mode](#)" on page 1161

Results of eye

EYE<m>:RESult:SLICe<n>:COUNT?	2603
EYE<m>:RESult:SLICe<n>:LPOSition?	2603
EYE<m>:RESult:SLICe<n>[:POSition]?	2603
EYE<m>:RESult:TACQs?	2604
EYE<m>:RESult:TSLices?	2604

EYE<m>:RESult:SLICe<n>:COUNT?

Returns the number of filtered bits.

Suffix:

<m>	1..4
<n>	*
	Not relevant

Return values:

<Count>

Usage: Query only

EYE<m>:RESult:SLICe<n>:LPOSition?

Returns the position of the last slice in the acquisition.

Suffix:

<m>	1..4
<n>	*

Return values:

<LastPosition>

Usage: Query only

EYE<m>:RESult:SLICe<n>[:POSition]?

Returns the position of the filtered bit in the acquisition.

Suffix:

<m>	1..4
<n>	*

Return values:

<Position> Range: -100 to 100
 Increment: 1E-3
 *RST: 0
 Default unit: s

Usage:

Query only
 Asynchronous command

EYE<m>:RESult:TACQs?

Returns the total number of acquisitions accumulated into the eye.

Suffix:

<m> 1..4

Return values:

<Acquisitions> Range: 0 to 1000000000
 Increment: 1
 *RST: 0

Usage:

Query only
 Asynchronous command

EYE<m>:RESult:TSLices?

Returns the total number of slices accumulated into the eye.

Suffix:

<m> 1..4

Return values:

<Slices> Range: 0 to 1000000000
 Increment: 1
 *RST: 0

Usage:

Query only
 Asynchronous command

Results of mask tests on eye diagrams

MTESt:RESult:COUNT:SLICES?	2605
MTESt:RESult:COUNT:FSLICES?	2605
MTESt:RESult:VIOLation<m>:COUNT?	2605
MTESt:RESult:VIOLation<m>[:SLICEj]?	2605
MTESt:RESult:VIOLation<m>:START?	2606
MTESt:RESult:VIOLation<m>:STOP?	2606
EYE<m>:ZCOupling	2606
EYE<m>:ZDIagram	2606

MTESt:RESult:COUNt:SLICes? <MaskTestName>

Returns the number of slices that contributed to the eye diagram.

Query parameters:

<MaskTestName> String parameter

Return values:

<SlicesCompleted> Range: 0 to 100E+24
Increment: 1
*RST: 0

Usage: Query only
Asynchronous command

MTESt:RESult:COUNt:FSLices? <MaskTestName>

Returns the number of slices that violated the mask.

Query parameters:

<MaskTestName> String parameter

Return values:

<SliceHits> Range: 0 to 100E+24
Increment: 1
*RST: 0

Usage: Query only
Asynchronous command

MTESt:RESult:VIOLation<m>:COUNt? <MaskTestName>**Suffix:**

<m> *
Violation index, corresponds to the number in the "Violation" column of mask test result.

Query parameters:

<MaskTestName>

Return values:

<Count>

Usage: Query only

MTESt:RESult:VIOLation<m>[:SLICe]? <MaskTestName>**Suffix:**

<m> *
Violation index, corresponds to the number in the "Violation" column of mask test result.

Query parameters:

<MaskTestName>

Return values:

<Slice> Range: 0 to 4294967295
 Increment: 1
 *RST: 0

Usage:

Query only
 Asynchronous command

MTESt:RESult:VIOLation<m>:START? <MaskTestName>

MTESt:RESult:VIOLation<m>:STOP? <MaskTestName>

Return the start and stop time of the slice with the indicated violation.

Suffix:

<m> *
 Violation index, corresponds to the number in the "Violation" column of mask test result.

Query parameters:

<MaskTestName>

Return values:

<Time> Range: -100 to 100
 Increment: 1E-3
 *RST: 0
 Default unit: s

Usage:

Query only
 Asynchronous command

EYE<m>:ZCOupling <ZoomCoupling>

If enabled, the mask eye area is set to the limits of a zoom area.

The zoom diagram is selected using [EYE<m>:ZDIagram](#).

Suffix:

<m> 1..4

Parameters:

<ZoomCoupling> ON | OFF
 *RST: OFF

Usage:

Asynchronous command

EYE<m>:ZDIagram <ZoomDiagram>

Selects the zoom to which the eye mask area is set if [EYE<m>:ZCOupling](#) is enabled.

Suffix:

<m> 1..4

Parameters:

<ZoomDiagram> String with the name of the diagram on which the zoom is based

Usage: Asynchronous command

27.19 Mixed signal option (MSO, R&S RTO6-B1)

This chapter describes the remote commands of MSO option R&S RTO6-B1.

Some of the commands in the following chapter are asynchronous. An overlapping or asynchronous command does not automatically finish executing before the next command starts executing. If overlapping commands must be executed in a defined order, e.g. to avoid wrong measurement results, they must be serviced sequentially.

To prevent an overlapping execution of commands, one of the commands `*OPC`, `*OPC?` or `*WAI` can be used after the command or a command set.

For more information, see:

- www.rohde-schwarz.com/rc-via-scp, chapter "Command sequence and synchronization"
- Chapter 27.3, "Programming examples", on page 1345
- [Digital channels](#).....2607
- [Parallel bus configuration](#).....2610
- [Digital resolution](#).....2618
- [Trigger settings for digital signals and parallel buses](#)..... 2619
- [MSO data](#).....2629

27.19.1 Digital channels

All `DIGital`: commands affect only the settings of the first MSO bus (Bus1). The settings of all other parallel buses (Bus 2, 3,4) remain unchanged.

DIGital<m>:DISPlay	2607
DIGital<m>:TECHnology	2608
DIGital<m>:THReshold	2608
DIGital<m>:THCoupling	2609
DIGital<m>:HYSTeresis	2609
DIGital<m>:LABel	2609
DIGital<m>:DESKew	2610

DIGital<m>:DISPlay <Display>

Enables or disables the indicated digital channel, displays it, and enables the parallel Bus1 if the bus was disabled. That is, `BUS<m>:PARAllel:DISPlay:SHDI` and `BUS<m>:PARAllel:STATe` are set to ON automatically.

If another active bus already uses the selected digital channel, the instrument disables the other bus to avoid conflicts.

For Bus1, the `DIG:DISP` command has the same effect as `BUS<m>:PARAllel:BIT<n>[:STATe]`. To enable digital channels for buses 2, 3 and 4, use the `BUS:PAR:BIT[:STAT]` command.

Suffix:

<m> 0..15
Number of the digital channel

Parameters:

<Display> ON | OFF

DIGital<m>:TECHnology <Technology>

Selects the threshold voltage for various types of integrated circuits and applies it to all digital channels.

The setting affects only the settings of the first MSO bus (Bus1). You can set the technology value for all buses with `BUS<m>:PARAllel:TECHnology`.

Suffix:

<m> 0..15
The suffix is irrelevant.

Parameters:

<Technology> V15 | V25 | V165 | V125 | V09 | VM13 | V38 | V20 | V0 | MANual
See `BUS<m>:PARAllel:TECHnology`

Manual operation: See "[Technology, Threshold](#)" on page 1002

DIGital<m>:THReshold <Value>

Sets the logical threshold for the channel group to which the indicated digital channel belongs. The setting affects only the settings of the first MSO bus (Bus1).

The setting affects only the settings of the first MSO bus (Bus1). You can set the threshold for all buses with `BUS<m>:PARAllel:TECHnology` or `BUS<m>:PARAllel:THReshold<n>`.

See also: `DIGital<m>:THCoupling`

Suffix:

<m> 0..15
Number of the digital channel.
Channel groups: 0..3; 4..7; 8..11; 12..15

Parameters:

<Value> Range: -8.0 to 8.0
Increment: 200.0e-12
*RST: 0
Default unit: V

Manual operation: See "[Technology, Threshold](#)" on page 1002

DIGital<m>:THCOupling <State>

Sets the threshold and the hysteresis for all digital channels of parallel bus 1 to the same value.

The command `BUS<m>:PARAllel:THCOupling` is used to set all buses.

Suffix:

<m> 0..15
The suffix is irrelevant.

Parameters:

<State> ON | OFF

Manual operation: See "[Couple thresholds](#)" on page 1003

DIGital<m>:HYSTEResis <Hysteresis>

Defines the size of the hysteresis to avoid the change of signal states due to noise for the channel group to which the indicated digital channel belongs.

The setting affects only the settings of the first MSO bus (Bus1). You can set the hysteresis for all buses with `BUS<m>:PARAllel:HYSTEResis<n>`.

See also: [DIGital<m>:THCOupling](#)

Suffix:

<m> 0..15
Number of the digital channel
Channel groups: 0..3; 4..7; 8..11; 12..15

Parameters:

<Hysteresis> MAXIMUM | MAXimum | ROBUST | ROBust | NORMAL | NORMAl

MAXIMUM = MAXimum

Maximum value that is possible and useful for the signal and its settings

ROBUST = ROBust

Different hysteresis values for falling and rising edges to avoid an undefined state of the trigger system.

NORMAL = NORMAl

The instrument sets a value suitable for the signal and its settings.

Manual operation: See "[Hysteresis](#)" on page 1004

DIGital<m>:LABel <Label>

Sets a name for the indicated digital channel. The name is displayed in the diagram.

The setting affects only the settings of the first MSO bus (Bus1). You can set the label for all buses with `BUS<m>:PARAllel:BIT<n>:LABel`.

Suffix:

<m> 0..15
Number of the digital channel

Parameters:

<Label> String containing the channel name

DIGital<m>:DESKew <Deskew>

Sets an individual delay for each digital channel to time-align it with other digital channels. The deskew value compensates delays that are known from the circuit specifics or caused by the different length of cables.

The setting affects only the settings of the first MSO bus (Bus1). You can set the deskew for all buses with `BUS<m>:PARAllel:BIT<n>:DESKew`.

Suffix:

<m> 0..15
Number of the digital channel

Parameters:

<Deskew> Range: -200.0E-09 to 200.0E-09
Increment: 200.0E-12
*RST: 0
Default unit: s

Manual operation: See "Skew" on page 1007

27.19.2 Parallel bus configuration

The following commands configure the four parallel buses of R&S RTO6-B1.

<code>BUS<m>:PARAllel:STATe</code>	2611
<code>BUS<m>:PARAllel:BIT<n>[:STATe]</code>	2611
<code>BUS<m>:PARAllel:THReshold<n></code>	2611
<code>BUS<m>:PARAllel:TECHnology</code>	2612
<code>BUS<m>:PARAllel:THCoupling</code>	2613
<code>BUS<m>:PARAllel:HYSTeresis<n></code>	2613
<code>BUS<m>:PARAllel:BIT<n>:DESKew</code>	2614
<code>BUS<m>:PARAllel:DESoffset</code>	2614
<code>BUS<m>:PARAllel:BIT<n>:LABel</code>	2614
<code>BUS<m>:PARAllel:DATA:FORMat</code>	2615
<code>BUS<m>:PARAllel:DISPlay:SHDI</code>	2615
<code>BUS<m>:PARAllel:DISPlay:SHBU</code>	2615
<code>BUS<m>:PARAllel:DISPlay:BTYP</code>	2616
<code>BUS<m>:PARAllel:CLON</code>	2616
<code>BUS<m>:PARAllel:CLOCK</code>	2616
<code>BUS<m>:PARAllel:CLSLope</code>	2617
<code>BUS<m>:PARAllel:CLEar</code>	2617

BUS<m>:PARAllel:DECTable<n>:SHOW.....	2617
BUS<m>:PARAllel:DECTable<n>:COUNT?.....	2617
BUS<m>:PARAllel:DECTable<n>:DATA?.....	2618

BUS<m>:PARAllel:STATe <Enable>

Enables or disables the indicated parallel bus. The threshold settings of the bus take effect for all *active* parallel buses.

Dependencies: At least one digital channel must be enabled for the selected bus, otherwise the command does not work. The bus is enabled automatically if the first digital channel is enabled with `BUS<m>:PARAllel:BIT<n>[:STATe]` or `DIGital<m>:DISPlay`.

Suffix:

<m> 1..4
Selects the parallel bus.

Parameters:

<Enable> ON | OFF
*RST: OFF

Manual operation: See "Enable bus" on page 1002

BUS<m>:PARAllel:BIT<n>[:STATe] <Assigned>

Assigns the selected digital channel to the indicated bus, displays it, and enables the bus if the bus was disabled. That is, `BUS<m>:PARAllel:DISPlay:SHDI` and `BUS<m>:PARAllel:STATe` are set to ON automatically.

If another active bus already uses the selected digital channel, the instrument disables the other bus to avoid conflicts.

For parallel bus 1, the `BUS:PAR:BIT[:STATe]` command has the same effect as `DIGital<m>:DISPlay`.

Suffix:

<m> 1..4
Selects the parallel bus.

<n> 0..15
Selects the bit of the bus word. Each bit corresponds to a digital channel.

Parameters:

<Assigned> ON | OFF
*RST: OFF

BUS<m>:PARAllel:THReshold<n> <Threshold>

Sets the logical threshold for the indicated channel group.

Alternatively, you can set the threshold with `BUS<m>:PARAllel:TECHnology`. For the parallel bus 1, you can also use `DIGital<m>:THReshold`.

See also: `DIGital<m>:THCoupling`

Suffix:

`<m>` 1..4
Selects the parallel bus.

`<n>` 1..4
Selects the channel group:
1 = dig. channels 0..3;
2 = dig. channels 4..7
3 = dig. channels 8..11
4 = dig. channels 12..15

Parameters:

`<Threshold>` Range: -8.0 to 8.0
Increment: 200.0e-12
*RST: 0
Default unit: V

Manual operation: See "[Technology, Threshold](#)" on page 1002

BUS<m>:PARAllel:TECHnology <Technology>

Selects the threshold voltage for various types of integrated circuits and applies it to all digital channels.

Suffix:

`<m>` 1..4
Selects the parallel bus.

Parameters:

`<Technology>` V15 | V25 | V165 | V125 | V09 | VM13 | V38 | V20 | V0 | MANual
V15: TTL
V25: CMOS 5.0 V
V165: CMOS 3.3 V
V125: CMOS 2.5 V
V09: CMOS 1.85 V
VM13: ECL, -1.3 V
V38: PECL
V20: LVPECL
V0: Ground
MANual: Set a user-defined threshold value with `DIGital<m>:THReshold`
*RST: V165

Manual operation: See "[Technology, Threshold](#)" on page 1002

BUS<m>:PARAllel:THCOupling <LevelCoupling>

Sets the threshold for all digital channels of the selected bus to the same value. Also the hysteresis value is applied to all digital channels.

Tor parallel bus 1, the command `DIGital<m>:THCOupling` has the same effect.

Suffix:

<m> 1..4
The suffix is irrelevant.

Parameters:

<LevelCoupling> ON | OFF
*RST: ON

Manual operation: See "[Couple thresholds](#)" on page 1003

BUS<m>:PARAllel:HYSTEResis<n> <Hysteresis>

Defines the size of the hysteresis for the channel group to avoid the change of signal states due to noise.

For the parallel bus 1, you can also use `DIGital<m>:HYSTEResis`.

Suffix:

<m> 1..4
Selects the parallel bus.

<n> 1..4
Selects the channel group:
1 = dig. channels 0..3;
2 = dig. channels 4..7
3 = dig. channels 8..11
4 = dig. channels 12..15

Parameters:

<Hysteresis> MAXIMUM | MAXimum | ROBUST | ROBust | NORMAL | NORMAl

MAXIMUM = MAXimum

Maximum value that is possible and useful for the signal and its settings

ROBUST = ROBust

Different hysteresis values for falling and rising edges to avoid an undefined state of the trigger system.

NORMAL = NORMAl

The instrument sets a value suitable for the signal and its settings.

Manual operation: See "[Hysteresis](#)" on page 1004

BUS<m>:PARAllel:BIT<n>:DESKew <Deskew>

Sets an individual delay for each digital channel to time-align it with other digital channels. The deskew value compensates delays that are known from the circuit specifics or caused by the different length of cables.

For the parallel bus 1, you can also use [DIGital<m>:DESKew](#).

Suffix:

<m> 1..4
Selects the parallel bus.

<n> 0..15
Selects the bit of the bus word. Each bit corresponds to a digital channel.

Parameters:

<Deskew> Range: -200E-9 to 200E-9
Increment: 200E-12
*RST: 0
Default unit: s

Manual operation: See "[Skew](#)" on page 1007

BUS<m>:PARAllel:DESOffset <DeskewOffset>

Sets a general delay for all digital channels. The resulting deskew of a digital channel is the sum of this general value and the individual value set with [BUS<m>:PARAllel:BIT<n>:DESKew](#).

Suffix:

<m> 1..4
Selects the parallel bus.

Parameters:

<DeskewOffset> Range: -200E-9 to 200E-9
Increment: 200E-12
*RST: 0
Default unit: s

Manual operation: See "[Global skew](#)" on page 1007

BUS<m>:PARAllel:BIT<n>:LABel <Label>

Sets a name for the indicated digital channel. The name is displayed in the diagram.

For the parallel bus 1, you can also use [DIGital<m>:LABel](#).

Suffix:

<m> 1..4
Selects the parallel bus.

<n> 0..15
Selects the bit of the bus word. Each bit corresponds to a digital channel.

Parameters:

<Label> String containing the channel name

BUS<m>:PARAllel:DATA:FORMat <DataFormat>

Sets the number format for decoded data values on the display for the indicated parallel bus.

It sets also the number representation for remote data transfer with [BUS<m>:PARAllel:DATA\[:VALues\]?](#).

Suffix:

<m> 1..4

Parameters:

<DataFormat> HEX | OCT | BIN | ASCII | ASCii | SIGN | USIG
*RST: HEX

Manual operation: See "[Data format](#)" on page 1005

BUS<m>:PARAllel:DISPlay:SHDI <ShwDigSigns>

If enabled, the selected digital signals are shown in the diagram. Each channel is displayed as a logic signal.

See also: [DIGital<m>:DISPlay](#)

Suffix:

<m> 1..4
Selects the parallel bus.

Parameters:

<ShwDigSigns> ON | OFF
*RST: OFF

Manual operation: See "[Show channels](#)" on page 1002

BUS<m>:PARAllel:DISPlay:SHBU <ShowBus>

Shows or hides the indicated parallel bus. If enabled, the resulting bus signal and bus values are displayed in the diagram.

Suffix:

<m> 1..4
Selects the parallel bus.

Parameters:

<ShowBus> ON | OFF
*RST: OFF

Manual operation: See ["Show bus"](#) on page 1005

BUS<m>:PARAllel:DISPlay:BTYP <BusRepres>

Selects the display type of the indicated parallel bus.

Suffix:

<m> 1..4
Selects the parallel bus.

Parameters:

<BusRepres> COMB | ANALog
COMB
Displays the decoded bus signal with bus values.
ANALog
Displays the bus value as amplitude, similar to an analog waveform.
*RST: COMB

Manual operation: See ["Bus display"](#) on page 1005

BUS<m>:PARAllel:CLON <Clocked>

Defines if the bus is a clocked bus - one of the digital channels serves as clock of the bus.

Suffix:

<m> 1 | 2
Selects the parallel bus. The clocked bus is available on parallel buses 1 and 2.

Parameters:

<Clocked> ON | OFF
*RST: OFF

Manual operation: See ["Enable"](#) on page 1005

BUS<m>:PARAllel:CLOCK <ClockSource>

Selects the digital channel used as clock of the indicated parallel bus.

Suffix:

<m> 1 | 2
Selects the parallel bus. The clocked bus is available on parallel buses 1 and 2.

Parameters:

<ClockSource> D0 | D1 | D2 | D3 | D4 | D5 | D6 | D7 | D8 | D9 | D10 | D11 | D12 | D13 | D14 | D15
Clock channel
*RST: D1

Manual operation: See ["Clock source"](#) on page 1006

BUS<m>:PARAllel:CLSLope <ClockSlope>

Selects the slope of the clock signal at which all digital channels of the bus are analyzed.

Suffix:

<m> 1 | 2

Selects the parallel bus. The clocked bus is available on parallel buses 1 and 2.

Parameters:

<ClockSlope> POSitive | NEGative | EITHER

*RST: POSitive

Manual operation: See ["Clock slope"](#) on page 1006

BUS<m>:PARAllel:CLEar

Removes all assigned digital channels from the bus

Suffix:

<m> 1..4

Selects the parallel bus.

Usage: Event

BUS<m>:PARAllel:DECTable<n>:SHOW <ShowDecodeTable>

Available only if `BUS<m>:PARAllel:CLON` is set to ON.

If enabled, a results box opens with decoded values of the bus signal and its time. You can query the number of values (`BUS<m>:PARAllel:DECTable<n>:COUNT?`) and their data value (`BUS<m>:PARAllel:DECTable<n>:DATA?`).

Suffix:

<m> 1..4

<n> 1..5

Parameters:

<ShowDecodeTable> ON | OFF

*RST: OFF

Manual operation: See ["Show table"](#) on page 1005

BUS<m>:PARAllel:DECTable<n>:COUNT?

Returns the number of clock edges in the decode table.

Suffix:

<m> 1..4

<n> 1..5
Usage: Query only
Manual operation: See "[Show table](#)" on page 1005

BUS<m>:PARAllel:DECTable<n>:DATA?

Returns the data of the decoded values of the bus signal and its time.

Suffix:
 <m> 1..4
 <n> 1..5
Usage: Query only
Manual operation: See "[Show table](#)" on page 1005

27.19.3 Digital resolution

[ACQUIRE:DRESolution?](#).....2618
[ACQUIRE:POINts:DVALue?](#).....2618

ACQUIRE:DRESolution?

Returns the current digital resolution of the digital channels.

Return values:
 <DigRes> Default unit: s
Usage: Query only
 Asynchronous command
Manual operation: See "[Dig. resolution](#)" on page 1008

ACQUIRE:POINts:DVALue?

Returns the current digital record length used by each digital channel.

Return values:
 <DigReclgth> Range: 1000 to 200E6
 Increment: 2
 *RST: 1000
 Default unit: pts
Usage: Query only
 Asynchronous command

27.19.4 Trigger settings for digital signals and parallel buses

In all TRIGger<m>:PARAllel commands, the trigger suffix <m> is always 1 and can be omitted. It selects the trigger event: Only the A-trigger is available for triggering on digital signals and parallel buses.

• General commands.....	2619
• Edge trigger.....	2621
• Width trigger.....	2622
• Timeout trigger.....	2623
• Setup & Hold trigger.....	2624
• State trigger.....	2625
• Pattern trigger.....	2626
• Serial pattern trigger.....	2628

27.19.4.1 General commands

TRIGger<m>:SOURce[:SElect].....	2619
TRIGger<m>:PARAllel:TYPE.....	2620
TRIGger<m>:PARAllel:SETHold:CSOURce[:VALue].....	2621
TRIGger<m>:PARAllel:STATe:CSOURce:VALue.....	2621
TRIGger<m>:PARAllel:SPATtern:CSOURce[:VALue].....	2621
TRIGger<m>:PARAllel:EDGE:EXPRession[:DEFine].....	2621
TRIGger<m>:PARAllel:WIDTh:EXPRession[:DEFine].....	2621
TRIGger<m>:PARAllel:TIMeout:EXPRession[:DEFine].....	2621
TRIGger<m>:PARAllel:STATe:EXPRession[:DEFine].....	2621
TRIGger<m>:PARAllel:PATtern:EXPRession[:DEFine].....	2621
TRIGger<m>:PARAllel:SPATtern:EXPRession[:DEFine].....	2621

TRIGger<m>:SOURce[:SElect] <SourceDetailed>

Selects the source of the trigger signal.

Suffix:

<m> 1..3
 1 = A-trigger, 2 = B-trigger, 3 = R-trigger
 Available values depend on the selected trigger source. For input channels CHAN1...4, a trigger sequence can be configured.
 For all other trigger sources, only suffix 1 is allowed.

Parameters:

<SourceDetailed> CHAN1 | CHANnel1 | CHAN2 | CHANnel2 | CHAN3 |
 CHANnel3 | CHAN4 | CHANnel4 | EXTErnanalog | SBUS | D0 |
 D1 | D2 | D3 | D4 | D5 | D6 | D7 | D8 | D9 | D10 | D11 | D12 |
 D13 | D14 | D15 | LOGIC | MSOB1 | MSOB2 | MSOB3 |
 MSOB4 | Z1V1 | Z1V2 | Z1V3 | Z1V4 | Z1I1 | Z1I2 | Z1I3 | Z1I4 |
 Z2V1 | Z2V2 | Z2V3 | Z2V4 | Z2I1 | Z2I2 | Z2I3 | Z2I4 | DIFF1 |
 DIFF2 | COMMON1 | COMMON2

CHAN1 = CHANnel1, CHAN2 = CHANnel2, CHAN3 = CHANnel3, CHAN4 = CHANnel4

Input channels

EXTeranalog

External analog signal connected to the External Trigger Input. For this source, only the analog edge trigger is available.

SBUS

Serial bus

D0...D15

Digital channels (option R&S RTO6-B1)

See also: [Chapter 27.19.4, "Trigger settings for digital signals and parallel buses"](#), on page 2619

LOGic

Logic combination of digital channels, used as trigger source (option R&S RTO6-B1)

MSOB1 | MSOB2 | MSOB3 | MSOB4

Parallel bus (option R&S RTO6-B1)

Z1V1 | Z1V2 | Z1V3 | Z1V4 | Z1I1 | Z1I2 | Z1I3 | Z1I4 | Z2V1 | Z2V2 | Z2V3 | Z2V4 | Z2I1 | Z2I2 | Z2I3 | Z2I4

Input channels of R&S RT-ZVCmulti-channel power probe. Only available in the A-trigger with trigger type EDGE.

DIFF1 | DIFF2 | COMMON1 | COMMON2

Differential signals

*RST: CHAN1

Usage: Asynchronous command

Manual operation: See "[\[Source\]](#)" on page 36

TRIGger<m>:PARAllel:TYPE <Type>

Selects the trigger type to trigger on digital channels and parallel buses.

To trigger on analog channels or the external trigger input, use [TRIGger<m>:TYPE](#).

Parameters:

<Type> EDGE | WIDTH | TIMEout | SETHold | STATe | PATTeRn | SERPattern |

SERPattern = serial pattern trigger

*RST: EDGE

Usage: Asynchronous command

Manual operation: See "[Type](#)" on page 1014

TRIGger<m>:PARAllel:SETHold:CSOUrce[:VALue] <ClockSource>
TRIGger<m>:PARAllel:STATe:CSOUrce:VALue <ClockSource>
TRIGger<m>:PARAllel:SPATtern:CSOUrce[:VALue] <ClockSource>

Selects the digital channel of the clock signal.

Parameters:

<ClockSource> D0 | D1 | D2 | D3 | D4 | D5 | D6 | D7 | D8 | D9 | D10 | D11 | D12 |
D13 | D14 | D15
*RST: D0

Usage: Asynchronous command

Manual operation: See "[Clock source](#)" on page 1019

TRIGger<m>:PARAllel:EDGE:EXPRession[:DEFine] <LogicalExpr>
TRIGger<m>:PARAllel:WIDTh:EXPRession[:DEFine] <LogicalExpr>
TRIGger<m>:PARAllel:TIMEout:EXPRession[:DEFine] <LogicalExpr>
TRIGger<m>:PARAllel:STATe:EXPRession[:DEFine] <LogicalExpr>
TRIGger<m>:PARAllel:PATtern:EXPRession[:DEFine] <LogicalExpr>
TRIGger<m>:PARAllel:SPATtern:EXPRession[:DEFine] <LogicalExpr>

Defines a logical combination of several digital channels as trigger condition if
[TRIGger<m>:SOUrce\[:SElect\]](#) is set to LOGIC.

Parameters:

<LogicalExpr> String with logical expression

Example: `TRIGger:PARAllel:EDGE:EXPRession 'D1 and D2'`

Usage: Asynchronous command

Manual operation: See "[Logical expression](#)" on page 1018

27.19.4.2 Edge trigger

See also:

- [TRIGger<m>:PARAllel:EDGE:EXPRession\[:DEFine\]](#) on page 2621

[TRIGger<m>:PARAllel:EDGE:SLOPe](#).....2621

TRIGger<m>:PARAllel:EDGE:SLOPe <Slope>

Defines the edge - the state transition - of the signal to trigger on a single digital channel (a logic bit), or a logical combination of digital channels.

Parameters:

<Slope> POSitive | NEGative | EITHer
*RST: POSitive

Usage: Asynchronous command

Manual operation: See "[Slope](#)" on page 1015

27.19.4.3 Width trigger

See also:

- [TRIGger<m>:PARAllel:WIDTh:EXPRession\[:DEFine\]](#) on page 2621

TRIGger<m>:PARAllel:WIDTh:POLarity	2622
TRIGger<m>:PARAllel:WIDTh:RANGe	2622
TRIGger<m>:PARAllel:WIDTh:WIDTh	2622
TRIGger<m>:PARAllel:WIDTh:DELTA	2623

TRIGger<m>:PARAllel:WIDTh:POLarity <Polarity>

Sets the polarity of a pulse. When triggering on a positive pulse, the trigger event occurs on the high to low transition of the pulse if the timing condition is true. When triggering on a negative pulse, the trigger event occurs on the low to high transition of the pulse if the timing condition is true.

Parameters:

<Polarity> POSitive | NEGative | EITHer
 *RST: POSitive

Usage: Asynchronous command

Manual operation: See "[Polarity](#)" on page 1016

TRIGger<m>:PARAllel:WIDTh:RANGe <RangeMode>

Selects how the range of a pulse width is defined:

Parameters:

<RangeMode> WITHin | OUTSide | SHORter | LONGer

WITHin | OUTSide

Pulses inside or outside a given time range. The time range *Width ± Delta* is defined by [TRIGger<m>:PARAllel:WIDTh:WIDTh](#) and [TRIGger<m>:PARAllel:WIDTh:DELTA](#).

SHORter | LONGer

Pulses shorter or longer than a given width defined by [TRIGger<m>:PARAllel:WIDTh:WIDTh](#)

*RST: WITHin

Usage: Asynchronous command

Manual operation: See "[Range](#)" on page 1016

TRIGger<m>:PARAllel:WIDTh:WIDTh <Width>

Sets the limit for the pulse width.

The effect depends on [TRIGger<m>:PARAllel:WIDTh:RANGe](#).

- For the ranges SHORter and LONGer, the width defines the maximum and minimum pulse width, respectively.

- For the ranges WITHin and OUTSide, the width defines the center of a range which is defined by the limits `TRIGger<m>:PARAllel:WIDTh:DELTA`.

Parameters:

<Width> Range: 200E-12 to 10000
 Increment: 200E-9
 *RST: 5E-9
 Default unit: s

Usage: Asynchronous command

Manual operation: See "[Width](#)" on page 1017

TRIGger<m>:PARAllel:WIDTh:DELTA <WidthDelta>

Defines a range around the given width value. the setting is relevant if `TRIGger<m>:PARAllel:WIDTh:RANGe` is set to WITHin or OUTSide. The width is set with `TRIGger<m>:PARAllel:WIDTh:WIDTh`.

Parameters:

<WidthDelta> Range: 0 to 432
 Increment: 600E-12
 *RST: 0
 Default unit: s

Usage: Asynchronous command

Manual operation: See "[±Delta](#)" on page 1017

27.19.4.4 Timeout trigger

See also:

- `TRIGger<m>:PARAllel:TIMEout:EXPRession[:DEFine]` on page 2621

`TRIGger<m>:PARAllel:TIMEout:RANGe`..... 2623

`TRIGger<m>:PARAllel:TIMEout:TIME`.....2624

TRIGger<m>:PARAllel:TIMEout:RANGe <TimeoutMode>

Sets the state condition.

Parameters:

<TimeoutMode> HIGH | LOW | EITHER

HIGH

The level of a digital channel stays above the threshold, or the logical expression for LOGic trigger source is true.

LOW

The level of a digital channel stays below the threshold, or the logical expression for LOGic trigger source is false.

EITHER

The signal state remains unchanged.

*RST: HIGH

Usage: Asynchronous command

Manual operation: See "[Range](#)" on page 1017

TRIGger<m>:PARAllel:TIMEout:TIME <Time>

Defines the time limit for the timeout at which the instrument triggers.

Parameters:

<Time> Range: 100E-12 to 10000
 Increment: 100E-9
 *RST: 100E-9
 Default unit: s

Usage: Asynchronous command

Manual operation: See "[Time](#)" on page 1018

27.19.4.5 Setup & Hold trigger

See also:

- [TRIGger<m>:PARAllel:SETHold:CSource\[:VALue\]](#) on page 2621

TRIGger<m>:PARAllel:SETHold:CSource:EDGE	2624
TRIGger<m>:PARAllel:SETHold:HTIME	2624
TRIGger<m>:PARAllel:SETHold:STIME	2625

TRIGger<m>:PARAllel:SETHold:CSource:EDGE <ClockEdge>

Sets the edge of the clock signal. The crossing of the clock edge and the logical threshold defines the time reference point for the setup and hold time measurement.

Parameters:

<ClockEdge> POSitive | NEGative | EITHER
 *RST: POSitive

Usage: Asynchronous command

Manual operation: See "[Clock edge](#)" on page 1019

TRIGger<m>:PARAllel:SETHold:HTIME <HoldTime>

Sets the minimum time *after* the clock edge while data should be stable and not change its state.

See also: "[Hold time](#)" on page 1019

Parameters:

<HoldTime> Range: -99.8E-9 to 100E-9
 Increment: 1E-9
 *RST: 0
 Default unit: s

Usage: Asynchronous command

Manual operation: See "[Hold time](#)" on page 1019

TRIGger<m>:PARAllel:SETHold:STIME <SetupTime>

Sets the minimum time *before* the clock edge while data should be stable and not change its state.

See also: "[Setup time](#)" on page 1019

Parameters:

<SetupTime> Range: -99.8E-9 to 100E-9
 Increment: 1E-9
 *RST: 0
 Default unit: s

Usage: Asynchronous command

Manual operation: See "[Setup time](#)" on page 1019

27.19.4.6 State trigger

See also:

- [TRIGger<m>:PARAllel:STATe:CSOurce:VALue](#) on page 2621
- [TRIGger<m>:PARAllel:STATe:EXPRession\[:DEFine\]](#) on page 2621

[TRIGger<m>:PARAllel:STATe:CSOurce:EDGE](#).....2625
[TRIGger<m>:PARAllel:STATe:BIT<0..15>](#).....2625

TRIGger<m>:PARAllel:STATe:CSOurce:EDGE <Slope>

Sets the edge of the clock signal. The crossing of the clock edge and the logical threshold defines the time at which the logical states and the bus value are analyzed.

Parameters:

<Slope> POSitive | NEGative | EITHer
 *RST: POSitive

Usage: Asynchronous command

Manual operation: See "[Clock edge](#)" on page 1020

TRIGger<m>:PARAllel:STATe:BIT<0..15> <Bit>

Sets the required state for each digital channel that is used in the bus.

Parameters:

<Bit> HIGH | LOW | DONTCARE | DONTcare
 Bit value: 1 (HIGH), 0 (LOW), or X (DONTCARE = DONTcare)

Usage: Asynchronous command

Manual operation: See "[Channel states](#)" on page 1020

27.19.4.7 Pattern trigger

TRIGger<m>:PARAllel:PATtern:BIT<0..15> <Bit>

Sets the required state for each digital channel that is used in the bus.

Parameters:

<Bit> HIGH | LOW | DONTCARE | DONTcare
 Bit value: 1 (HIGH), 0 (LOW), or X (DONTCARE = DONTcare)

Usage: Asynchronous command

Manual operation: See "[Channel states](#)" on page 1021

TRIGger<m>:PARAllel:PATtern:MODE <Mode>

Sets the mode of the timing condition.

Parameters:

<Mode> OFF | TIMEout | WIDTH

OFF

No timing condition, only the logical pattern condition is relevant.

TIMEout

Defines a minimum time qualification to avoid triggering on unstable or transitional conditions. Use [TRIGger<m>:PARAllel:PATtern:TIMEout:MODE](#) and [TRIGger<m>:PARAllel:PATtern:TIMEout\[:TIME\]](#) to specify the timeout.

WIDTH

Sets a pulse width as timing condition. The pulse starts when the pattern comes true, and the trigger event occurs when the pattern comes false during the specified time limit. Use [TRIGger<m>:PARAllel:PATtern:WIDTH:RANGE](#), [TRIGger<m>:PARAllel:PATtern:WIDTH\[:WIDTH\]](#), and [TRIGger<m>:PARAllel:PATtern:WIDTH:DELTA](#) to specify the width.

*RST: OFF

Usage: Asynchronous command

Manual operation: See "[Mode: Off, Timeout, Width](#)" on page 1022

TRIGger<m>:PARAllel:PATtern:TIMEout:MODE <TimeoutMode>

Sets the state condition for the timeout qualification if `TRIGger<m>:PARAllel:PATtern:MODE` is set to `TIMEout`. To set the time limit, use `TRIGger<m>:PARAllel:PATtern:TIMEout[:TIME]`.

Parameters:

<TimeoutMode> HIGH | LOW | EITHER
 HIGH: The pattern stays true for the specified time.
 LOW: The pattern stays false for the specified time.
 EITHER: The pattern remains unchanged for the specified time.

*RST: HIGH

Usage: Asynchronous command

Manual operation: See "Range" on page 1022

TRIGger<m>:PARAllel:PATtern:TIMEout[:TIME] <Time>

Defines the time limit for the timeout at which the instrument triggers.

Parameters:

<Time> Range: 100E-12 to 10000
 Increment: 100E-9
 *RST: 100E-9
 Default unit: s

Usage: Asynchronous command

Manual operation: See "Time" on page 1022

TRIGger<m>:PARAllel:PATtern:WIDTH:RANGE <WidthRangeMode>

Selects how the range of a pulse width is defined if `TRIGger<m>:PARAllel:PATtern:MODE` is set to `WIDTH`.

Parameters:

<WidthRangeMode> WITHin | OUTSide | SHORter | LONGer

WITHin

Triggers when the pattern comes false inside a given time range. The time limit is defined by `TRIGger<m>:PARAllel:PATtern:WIDTH[:WIDTH]` and `TRIGger<m>:PARAllel:PATtern:WIDTH:DELTA` (*Width ± Delta*).

OUTSide

Triggers when the pattern comes false before or after the given time range. The time limit definition is the same as for `WITHin` range.

SHORter | LONGer

Triggers when the pattern comes false before or after the given width has expired. Width is set with `TRIGger<m>:PARAllel:PATtern:WIDTH[:WIDTH]`.

*RST: WITHin

Usage: Asynchronous command

Manual operation: See "[Range](#)" on page 1023

TRIGger<m>:PARAllel:PATtern:WIDTh[:WIDTh] <Width>

The effect depend on the setting of the [TRIGger<m>:PARAllel:PATtern:WIDTh:RANGe](#) command.

For the ranges SHORter and LONGer, the width defines the maximum and minimum time limit, respectively.

For the ranges WITHin and OUTSide, the width defines the center of a range which is defined by the limits " $\pm\Delta$ ".

Parameters:

<Width> Range: 100E-12 to 10000
 Increment: 100E-9
 *RST: 5E-9
 Default unit: s

Usage: Asynchronous command

Manual operation: See "[Width](#)" on page 1023

TRIGger<m>:PARAllel:PATtern:WIDTh:DELTA <WidthDelta>

Defines a range around the width value set with [TRIGger<m>:PARAllel:PATtern:WIDTh\[:WIDTh\]](#).

Parameters:

<WidthDelta> Range: 0 to 432
 Increment: 500E-12
 *RST: 0
 Default unit: s

Usage: Asynchronous command

Manual operation: See "[±Delta](#)" on page 1023

27.19.4.8 Serial pattern trigger

See also:

- [TRIGger<m>:PARAllel:SPATtern:CSource\[:VALue\]](#) on page 2621
- [TRIGger<m>:PARAllel:SPATtern:EXPRession\[:DEFine\]](#) on page 2621

TRIGger<m>:PARAllel:SPATtern:CSource:EDGE <ClockEdge>

Sets the edge of the clock signal. The bit value is determined at the crossing of the clock edge and the logical threshold.

Parameters:

<ClockEdge> POSitive | NEGative | EITHer
 *RST: POSitive

Usage: Asynchronous command

Manual operation: See "Clock edge" on page 1024

TRIGger<m>:PARAllel:SPATtern:PATtern <Pattern>

Defines the serial bit string on which to trigger.

Parameters:

<Pattern> Numeric or string pattern, see [Chapter 27.4.6, "Bit pattern parameter"](#), on page 1373. The bit value X (don't care) is not allowed.

Usage: Asynchronous command

Manual operation: See "Pattern" on page 1024

27.19.5 MSO data

To export data of digital channels and parallel buses to file, use the following commands:

- [EXPort:WAVeform:SOURce](#) on page 1766
- [EXPort:WAVeform:NAME](#) on page 1768
- [EXPort:WAVeform:SAVE](#) on page 1769

The remote data transfer from the instrument to the controlling computer is performed using the following commands:

DIGital<m>:DATA:HEADer?	2629
DIGital<m>:DATA[:VALues]?	2630
BUS<m>:PARAllel:DATA:FORMat	2630
BUS<m>:PARAllel:DATA:HEADer?	2630
BUS<m>:PARAllel:DATA[:VALues]?	2630

DIGital<m>:DATA:HEADer?

Returns the header of digital channel data

Table 27-16: Header data

Position	Meaning	Example
1	XStart, acquisition time before trigger, in s	-5E-008 = - 50 ns
2	XStop, acquisition time after trigger, in s	5E-008 = 50 ns
3	Record length of the waveform in Samples	1000
4	Number of values per sample interval. For digital data the result is 1.	1

Suffix:
 <m> 0..15
 Number of the digital channel

Usage: Query only

DIGital<m>:DATA[:VALues]?

Returns the data of the indicated digital channel for transmission from the instrument to the controlling computer. The data can be used in MATLAB, for example.

Suffix:
 <m> 0..15
 Selects the digital channel.

Return values:
 <Data> List of data (0 and 1)

Usage: Query only

BUS<m>:PARAllel:DATA:FORMat <DataFormat>

Sets the number format for decoded data values on the display for the indicated parallel bus.

It sets also the number representation for remote data transfer with [BUS<m>:PARAllel:DATA\[:VALues\]?](#).

Suffix:
 <m> 1..4

Parameters:
 <DataFormat> HEX | OCT | BIN | ASCII | ASCii | SIGN | USIG
 *RST: HEX

Manual operation: See "[Data format](#)" on page 1005

BUS<m>:PARAllel:DATA:HEADer?

Returns the header data of the indicated bus.

For a detailed description, see [DIGital<m>:DATA:HEADer?](#).

Suffix:
 <m> 1..4
 Selects the parallel bus.

Usage: Query only

Firmware/software: V 2.40

BUS<m>:PARAllel:DATA[:VALues]?

Returns the data of the indicated parallel bus.

Requirements:

- `BUS<m>:PARAllel:STATe` is set to ON.
- `BUS<m>:PARAllel:DISPlay:SHBU` is set to ON.
- Number format is set with `BUS<m>:PARAllel:DATA:FORMat`.

Suffix:

`<m>` 1..4
Selects the parallel bus.

Return values:

`<Data>` List of values according to the format setting.

Example:

```
BUS:PAR:STAT ON
BUS:PAR:DISP:SHBU ON
BUS:PAR:DISP:BTYP COMB
BUS:PAR:DATA:FORMat HEX
BUS:PAR:DATA:VAL?
```

Usage: Query only

27.20 Waveform generator (option R&S RTO6-B6)

27.20.1 Waveform generator setup

27.20.1.1 General

<code>WGENerator<m>:ACOPy</code>	2631
<code>WGENerator<m>[:ENABle]</code>	2631
<code>WGENerator<m>:SOURce</code>	2632
<code>WGENerator<m>:PRESet</code>	2632

`WGENerator<m>:ACOPy`

Copies all settings from Gen1/Gen2 and applies them to Gen2/Gen1.

Suffix:

`<m>` 1..2

Usage: Event

Manual operation: See "[Copy settings from Gen1/Gen2](#)" on page 1031

`WGENerator<m>[:ENABle] <State>`

Enables the waveform generator and outputs the waveform.

Suffix:

<m> 1..2

Parameters:

<State> ON | OFF

Manual operation: See "Enable" on page 1030**WGENerator<m>:SOURce <OperationMode>**

Sets the operation mode for the the waveform generator.

Suffix:

<m> 1..2

Parameters:

<OperationMode> FUNCgen | MODulation | SWEep | ARBGenerator

*RST: FUNCgen

Manual operation: See "Operation mode" on page 1030**WGENerator<m>:PRESet**

Sets the parameters of the waveform generator to their default values.

Suffix:

<m> 1..2

Usage:

Event

Manual operation: See "Preset Gen1/Gen2/Patt Gen" on page 1031**27.20.1.2 Function generator**

WGENerator<m>:FUNCtion[:SElect].....	2632
WGENerator<m>:FREQuency.....	2633
WGENerator<m>:PERiod.....	2633
WGENerator<m>:FUNCtion:PULSe[:WIDTh].....	2633
WGENerator<m>:FUNCtion:RAMP[:SYMMetry].....	2633
WGENerator<m>:FUNCtion:SQUare:DCYCLE.....	2634

WGENerator<m>:FUNCtion[:SElect] <FunctionType>

Sets the type of waveform to be generated for the function generator.

Suffix:

<m> 1..2

Parameters:

<FunctionType> SINusoid | SQUare | RAMP | DC | PULSe | SINC | CARDiac | GAUSs | LORNtz | EXPRise | EXPFall

SINC: Cardial sine

*RST: SINusoid

Manual operation: See ["Function type"](#) on page 1031

WGENerator<m>:FREQuency <Frequency>

Sets the frequency of the waveform. The available frequency range depends on the selected function type, see [Table 16-1](#).

Suffix:

<m> 1..2

Parameters:

<Frequency> Range: 1E-3 to 100E+6
 Increment: 1
 *RST: 1E+6
 Default unit: Hz

Manual operation: See ["Frequency"](#) on page 1035

WGENerator<m>:PERiod <Period>

Sets the period of the waveform. The available period range depends on the selected function type.

Suffix:

<m> 1..2

Parameters:

<Period> Range: 8E-9 to 1000
 Increment: 1
 *RST: 1E-6
 Default unit: s

Manual operation: See ["Period"](#) on page 1036

WGENerator<m>:FUNction:PULSe[:WIDTH] <PulseWidth>

Sets the pulse duration for a pulse waveform.

Suffix:

<m> 1..2

Parameters:

<PulseWidth> Range: 16.5E-9 to 1000, actual range depends on the
 selected frequency
 Increment: 1
 *RST: 500E-9
 Default unit: s

Manual operation: See ["Pulse width"](#) on page 1036

WGENerator<m>:FUNction:RAMP[:SYMMetry] <RampSymmetry>

Sets the symmetry for a ramp waveform.

Suffix:

<m> 1..2

Parameters:

<RampSymmetry> Range: 0 to 100
 Increment: 1
 *RST: 50
 Default unit: %

Manual operation: See "[Symmetry](#)" on page 1036**WGENerator<m>:FUNction:SQUare:DCYCLE <SquareDutyCycle>**

Sets the duty cycle for the generated square waveform.

Suffix:

<m> 1..2

Parameters:

<SquareDutyCycle> Range: 0.01 to 99.99 at minimum frequency, actual range depends on the selected frequency
 Increment: 1
 *RST: 50
 Default unit: %

Manual operation: See "[Duty cycle](#)" on page 1036**27.20.1.3 Modulation**

WGENerator<m>:MODulation:TYPE.....	2635
WGENerator<m>:MODulation:AM:DCYCLE.....	2635
WGENerator<m>:MODulation:AM:DEPTH.....	2635
WGENerator<m>:MODulation:AM:FREQUENCY.....	2635
WGENerator<m>:MODulation:AM:SYMMetry.....	2636
WGENerator<m>:MODulation:CARRier:FREQUENCY.....	2636
WGENerator<m>:MODulation:CARRier:PERiod.....	2636
WGENerator<m>:MODulation:AM[:FUNction].....	2637
WGENerator<m>:MODulation:FM:DCYCLE.....	2637
WGENerator<m>:MODulation:FM:DEViation.....	2637
WGENerator<m>:MODulation:FM:FREQUENCY.....	2637
WGENerator<m>:MODulation:FM:SYMMetry.....	2638
WGENerator<m>:MODulation:FM[:FUNction].....	2638
WGENerator<m>:MODulation:FSK:FONE.....	2638
WGENerator<m>:MODulation:FSK:FTWO.....	2639
WGENerator<m>:MODulation:FSK[:RATE].....	2639
WGENerator<m>:MODulation:PWM:DCYCLE.....	2639
WGENerator<m>:MODulation:PWM:DEPTH.....	2639
WGENerator<m>:MODulation:PWM:FREQUENCY.....	2640
WGENerator<m>:MODulation:PWM:SYMMetry.....	2640
WGENerator<m>:MODulation:PWM[:FUNction].....	2640

WGENerator<m>:MODulation:TYPE <ModulationType>

Sets the modulation type.

Suffix:

<m> 1..2

Parameters:

<ModulationType> AM | FM | PWM | FSK
*RST: AM

Manual operation: See "[Modulation type](#)" on page 1037

WGENerator<m>:MODulation:AM:DCYCLE <SquareDutyCycle>

Sets the duty cycle of a square waveform for amplitude modulation, if [WGENerator<m>:MODulation:TYPE](#) is set to AM.

Suffix:

<m> 1..2

Parameters:

<SquareDutyCycle> Range: 10 to 90
Increment: 1
*RST: 50
Default unit: %

Manual operation: See "[Duty cycle](#)" on page 1039

WGENerator<m>:MODulation:AM:DEPTH <Depth>

Sets the amplitude modulation depth.

Suffix:

<m> 1..2

Parameters:

<Depth> Range: 0 to 100
Increment: 1
*RST: 50
Default unit: %

Manual operation: See "[Modulation depth](#)" on page 1038

WGENerator<m>:MODulation:AM:FREQUENCY <Frequency>

Sets the frequency of the modulation waveform for amplitude modulation, if [WGENerator<m>:MODulation:TYPE](#) is set to AM.

Suffix:

<m> 1..2

Parameters:

<Frequency> Range: 1E-3 to 1E+6
 Increment: 1
 *RST: 1000
 Default unit: Hz

Manual operation: See "[Modulation freq](#)" on page 1038

WGENerator<m>:MODulation:AM:SYMMetry <RampSymmetry>

Sets the symmetry, the percentage of time the ramp modulation waveform is rising, for amplitude modulation, if [WGENerator<m>:MODulation:TYPE](#) is set to AM.

Suffix:

<m> 1..2

Parameters:

<RampSymmetry> Range: 0 to 100
 Increment: 1
 *RST: 50
 Default unit: %

Manual operation: See "[Symmetry](#)" on page 1039

WGENerator<m>:MODulation:CARRier:FREQUENCY <CarrierFreq>

Sets the frequency of the carrier signal for a modulation waveform.

Suffix:

<m> 1..2

Parameters:

<CarrierFreq> Range: 1E-3 to 100E+6
 Increment: 10
 *RST: 1E+6
 Default unit: Hz

Manual operation: See "[Carrier frequency](#)" on page 1037

WGENerator<m>:MODulation:CARRier:PERiod <CarrierPeriod>

Sets the period of the carrier signal for a modulation waveform.

Suffix:

<m> 1..2

Parameters:

<CarrierPeriod> Range: 8E-9 to 1000
 Increment: 10
 *RST: 1E-6
 Default unit: s

Manual operation: See "[Carrier period](#)" on page 1038

WGENerator<m>:MODulation:AM[:FUNCTION] <SignalType>

Sets the type of the modulation signal for the amplitude modulation, if [WGENerator<m>:MODulation:TYPE](#) is set to AM.

Suffix:

<m> 1..2

Parameters:

<SignalType> SINusoid | SQUare | RAMP
*RST: SINusoid

Manual operation: See "[Modulation signal](#)" on page 1038

WGENerator<m>:MODulation:FM:DCYCLE <SquareDutyCycle>

Sets the duty cycle of a square waveform for frequency modulation, if [WGENerator<m>:MODulation:TYPE](#) is set to FM.

Suffix:

<m> 1..2

Parameters:

<SquareDutyCycle> Range: 10 to 90
Increment: 1
*RST: 50
Default unit: %

Manual operation: See "[Duty cycle](#)" on page 1042

WGENerator<m>:MODulation:FM:DEVIation <Deviation>

Sets the frequency modulation deviation.

Suffix:

<m> 1..2

Parameters:

<Deviation> Range: 1E-3 to 10E+6
Increment: 1
*RST: 1000
Default unit: Hz

Manual operation: See "[Freq deviation](#)" on page 1041

WGENerator<m>:MODulation:FM:FREQUency <Frequency>

Sets the frequency of the modulation waveform for frequency modulation, if [WGENerator<m>:MODulation:TYPE](#) is set to FM.

Suffix:

<m> 1..2

Parameters:

<Frequency> Range: 1E-3 to 1E+6
 Increment: 1
 *RST: 1000
 Default unit: Hz

Manual operation: See "[Modulation freq](#)" on page 1041

WGENerator<m>:MODulation:FM:SYMMetry <RampSymmetry>

Sets the symmetry, the percentage of time the ramp modulation waveform is rising, for frequency modulation, if [WGENerator<m>:MODulation:TYPE](#) is set to FM.

Suffix:

<m> 1..2

Parameters:

<RampSymmetry> Range: 0 to 100
 Increment: 1
 *RST: 50
 Default unit: %

Manual operation: See "[Symmetry](#)" on page 1041

WGENerator<m>:MODulation:FM[:FUNCTION] <SignalType>

Sets the type of the modulation signal for the frequency modulation, if [WGENerator<m>:MODulation:TYPE](#) is set to FM.

Suffix:

<m> 1..2

Parameters:

<SignalType> SINusoid | SQUare | RAMP
 *RST: SINusoid

Manual operation: See "[Modulation signal](#)" on page 1041

WGENerator<m>:MODulation:FSK:FONE <Frequency1>

Sets the frequency of the carrier waveform, if [WGENerator<m>:MODulation:TYPE](#) is set to FSK.

Suffix:

<m> 1..2

Parameters:

<Frequency1> Range: 1E-3 to 100E+6
 Increment: 1
 *RST: 1E+6
 Default unit: Hz

Manual operation: See "[Frequency 1](#)" on page 1042

WGENerator<m>:MODulation:FSK:FTWO <Frequency2>

Sets the frequency of the modulated waveform, if `WGENerator<m>:MODulation:TYPE` is set to `FSK`.

Suffix:

<m> 1..2

Parameters:

<Frequency2> Range: 1E-3 to 100E+6
Increment: 1
*RST: 1000
Default unit: Hz

Manual operation: See "[Frequency 2](#)" on page 1042

WGENerator<m>:MODulation:FSK[:RATE] <Rate>

Sets the hop rate, the time before a switch from the carrier frequency set with `WGENerator<m>:MODulation:FSK:FONE` and the modulation frequency set with `WGENerator<m>:MODulation:FSK:FTWO`.

Suffix:

<m> 1..2

Parameters:

<Rate> Range: 1E-3 to 1E+6
Increment: 1
*RST: 1000
Default unit: Hz

Manual operation: See "[Hop rate](#)" on page 1042

WGENerator<m>:MODulation:PWM:DCYCLE <SquareDutyCycle>

Sets the duty cycle of a square waveform for pulse width modulation, if `WGENerator<m>:MODulation:TYPE` is set to `PWM`.

Suffix:

<m> 1..2

Parameters:

<SquareDutyCycle> Range: 10 to 90
Increment: 1
*RST: 50
Default unit: %

Manual operation: See "[Duty cycle](#)" on page 1040

WGENerator<m>:MODulation:PWM:DEPTH <Depth>

Sets the modulation depth for pulse width modulation.

Suffix:

<m> 1..2

Parameters:

<Depth> Range: 0 to 100
 Increment: 1
 *RST: 50
 Default unit: %

Manual operation: See "[Modulation depth](#)" on page 1040**WGENerator<m>:MODulation:PWM:FREQUency** <Frequency>

Sets the frequency of the modulation waveform for pulse width modulation, if [WGENerator<m>:MODulation:TYPE](#) is set to PWM.

Suffix:

<m> 1..2

Parameters:

<Frequency> Range: 1E-3 to 1E+6
 Increment: 1
 *RST: 1000
 Default unit: Hz

Manual operation: See "[Modulation freq](#)" on page 1040**WGENerator<m>:MODulation:PWM:SYMMetry** <RampSymmetry>

Sets the symmetry, the percentage of time the ramp modulation waveform is rising, for pulse width modulation, if [WGENerator<m>:MODulation:TYPE](#) is set to PWM.

Suffix:

<m> 1..2

Parameters:

<RampSymmetry> Range: 0 to 100
 Increment: 1
 *RST: 50
 Default unit: %

Manual operation: See "[Symmetry](#)" on page 1040**WGENerator<m>:MODulation:PWM[:FUNCTion]** <SignalType>

Sets the type of the modulation signal for the pulse width modulation, if [WGENerator<m>:MODulation:TYPE](#) is set to PWM.

Suffix:

<m> 1..2

Parameters:

<SignalType> SINusoid | SQUare | RAMP
 *RST: SINusoid

Manual operation: See "[Modulation signal](#)" on page 1039

27.20.1.4 Sweep

WGENerator<m>:SWEep:FSTart	2641
WGENerator<m>:SWEep:TIME	2641
WGENerator<m>:SWEep[:FEND]	2641

WGENerator<m>:SWEep:FSTart <StartFrequency>

Sets the start frequency of the sweep range.

Suffix:

<m> 1..2

Parameters:

<StartFrequency> Range: 1E-3 to 100E+6
 Increment: 1
 *RST: 1000
 Default unit: Hz

Manual operation: See "[Start frequency](#)" on page 1043

WGENerator<m>:SWEep:TIME <Time>

Sets the duration of the sweep.

Suffix:

<m> 1..2

Parameters:

<Time> Range: 1E-3 to 500
 Increment: 1
 *RST: 1E-3
 Default unit: s

Manual operation: See "[Sweep time](#)" on page 1043

WGENerator<m>:SWEep[:FEND] <StopFrequency>

Sets the stop frequency of the sweep range.

Suffix:

<m> 1..2

Parameters:

<StopFrequency> Range: 1E-3 to 100E+6
 Increment: 1
 *RST: 1E+6
 Default unit: Hz

Manual operation: See "Stop frequency" on page 1043

27.20.1.5 ARB

WGENerator<m>:ARBGen:COPY.....	2642
WGENerator<m>:ARBGen:MULTichannel:IMPort.....	2642
WGENerator<m>:ARBGen:MULTichannel:NAME.....	2643
WGENerator<m>:ARBGen:MULTichannel:OPEN.....	2643
WGENerator<m>:ARBGen:NAME.....	2643
WGENerator<m>:ARBGen:OPEN.....	2644
WGENerator<m>:ARBGen:RUNMode.....	2644
WGENerator<m>:ARBGen:SAMPles?.....	2644
WGENerator<m>:ARBGen:SElect.....	2644
WGENerator<m>:ARBGen:SRATe.....	2645
WGENerator<m>:ARBGen[:SOURce].....	2645
WGENerator<m>:ARBGen:RUNSingle.....	2645

WGENerator<m>:ARBGen:COPY

Loads the waveform from the selected signal source (`WGENerator<m>:ARBGen:SElect`).

Suffix:

<m> 1..2

Usage: Event

Manual operation: See "Load" on page 1048

WGENerator<m>:ARBGen:MULTichannel:IMPort <SavedWfmSrc>

Assigns a waveform from the multichannel file to the arbitrary waveform generator.

Suffix:

<m> 1..2

Parameters:

<SavedWfmSrc> WFM1 | WFM2 | WFM3 | WFM4
 *RST: WFM1

Example:

```
WGENerator1:ARBGen:MULTichannel:NAME
ArbMultichannelCurve_2017-02-16_01.bin
WGENerator1:ARBGen:MULTichannel:IMPort WF1
WGENerator1:ARBGen:MULTichannel:OPEN
```

Manual operation: See "Select waveform" on page 1047

WGENerator<m>:ARBGen:MULTichannel:NAME <FilePath>

Defines the path and the multichannel arbitrary waveform file to be imported. If not path is given, the default path

C:\Users\Public\Public Documents\Rohde-Schwarz\RTx\RefWaveforms is used.

Suffix:

<m> 1..2

Parameters:

<FilePath>

Example: See [WGENerator<m>:ARBGen:MULTichannel:IMPort](#) on page 2642.

Manual operation: See "[Select waveform](#)" on page 1047

WGENerator<m>:ARBGen:MULTichannel:OPEN

Loads the arbitrary waveform.

Suffix:

<m> 1..2

Example: See [WGENerator<m>:ARBGen:MULTichannel:IMPort](#) on page 2642.

Usage: Event

Manual operation: See "[Select waveform](#)" on page 1047

WGENerator<m>:ARBGen:NAME <FilePath>

Sets the file path and the file for an arbitrary waveform, if [WGENerator<m>:ARBGen\[:SOURce\]](#) on page 2645 is set to ARBitrary.

If not path is given, the default path

C:\Users\Public\Public Documents\Rohde-Schwarz\RTx\RefWaveforms is used.

This command is only relevant for files with one waveform defined. For multichannel arbitrary waveform files, see [WGENerator<m>:ARBGen:MULTichannel:OPEN](#).

Suffix:

<m> 1..2

Parameters:

<FilePath>

Manual operation: See "[Load arbitrary waveform](#)" on page 1046

WGENerator<m>:ARBGen:OPEN

Loads the arbitrary waveform, that is selected with the [WGENerator<m>:ARBGen:NAME](#) command.

This command is only relevant for files with one waveform defined. For multichannel arbitrary waveform files, see [WGENerator<m>:ARBGen:MULTichannel:OPEN](#).

Suffix:

<m> 1..2

Usage: Event

Manual operation: See "[Load arbitrary waveform](#)" on page 1046

WGENerator<m>:ARBGen:RUNMode <RunMode>

Sets the duration for which the signal of the arbitrary generator will be output after the trigger event.

Suffix:

<m> 1..2

Parameters:

<RunMode> SINGLE | CONTInuous
*RST: CONTInuous

Manual operation: See "[Run mode](#)" on page 1045

WGENerator<m>:ARBGen:SAMPles?

Displays the number of samples for the arbitrary waveform.

Suffix:

<m> 1..2

Return values:

<NumSamples> Range: 0 to 128000000
Increment: 10
*RST: 0
Default unit: pts

Usage: Query only

Manual operation: See "[Samples](#)" on page 1046

WGENerator<m>:ARBGen:SElect <ScopeSignSrc>

Selects the oscilloscope source, from which the arbitrary signal is loaded, if [WGENerator<m>:ARBGen\[:SOURce\]](#) is set to SCOPE.

Suffix:

<m> 1..2

Parameters:

<ScopeSignSrc> NONE | C1W1 | C1W2 | C1W3 | C2W1 | C2W2 | C2W3 | C3W1 | C3W2 | C3W3 | C4W1 | C4W2 | C4W3 | R1 | R2 | R3 | R4 | DIFF1 | DIFF2 | COMMON1 | COMMON2
 *RST: NONE

Manual operation: See ["Signal source"](#) on page 1047

WGENerator<m>:ARBGen:SRATE <SampleRate>

Sets the sample rate for the arbitrary waveform.

Suffix:

<m> 1..2

Parameters:

<SampleRate> Range: 1 to 250E+6
 Increment: 10
 *RST: 1E+6
 Default unit: Sa/s

Manual operation: See ["Sample rate"](#) on page 1046

WGENerator<m>:ARBGen[:SOURce] <WaveformSource>

Sets the arbitrary waveform source.

Suffix:

<m> 1..2

Parameters:

<WaveformSource> ARbitrary | SCOPe
ARbitrary
 Enables you to load an existing arbitrary file.
SCOPe
 Enables you to load a scope waveform.
 *RST: ARbitrary

Manual operation: See ["Waveform source"](#) on page 1045

WGENerator<m>:ARBGen:RUNSingle

Executes a single period of the arbitrary signal generator, for [WGENerator<m>:ARBGen:RUNModeSINGle](#).

Suffix:

<m> 1..2

Usage: Event

Manual operation: See ["Run single"](#) on page 1046

27.20.2 Pattern generator setup

PGENERator:BITRate.....	2646
PGENERator:ENABLE.....	2646
PGENERator:FILE:OPEN.....	2646
PGENERator:FILE[:NAME].....	2646
PGENERator:HLEVel.....	2646
PGENERator:PRESet.....	2647
PGENERator:RUNMode.....	2647
PGENERator:RUNSingle.....	2647

PGENERator:BITRate <BitRate>

Sets the number of transmitted bits per second for the pattern generator.

Parameters:

<BitRate>	Range: 1 to 40E+6
	Increment: 10
	*RST: 1E+6
	Default unit: bps

Manual operation: See "[Bit rate](#)" on page 1050

PGENERator:ENABLE <State>

Enables the pattern generator and outputs the waveform.

Parameters:

<State>	ON OFF
---------	----------

Manual operation: See "[Enable](#)" on page 1030

PGENERator:FILE:OPEN

Loads the specified pattern file to the instrument.

Usage: Event

Manual operation: See "[Load pattern file](#)" on page 1050

PGENERator:FILE[:NAME] <FilePath>

Specifies a file path to open a pattern generator file.

Parameters:

<FilePath>	String with the name of the file.
------------	-----------------------------------

Manual operation: See "[Load pattern file](#)" on page 1050

PGENERator:HLEVel <HighLevel>

Sets the high level of the pattern generator signal.

Parameters:

<HighLevel> Range: 1.2 to 5
 Increment: 0.1
 *RST: 1.2
 Default unit: V

PGENERator:PRESet

Sets the default pattern generator settings.

Usage: Event

Manual operation: See "[Preset Gen1/Gen2/Patt Gen](#)" on page 1031

PGENERator:RUNMode <RunMode>

Sets the duration for which the signal of the pattern generator will be output after the trigger event.

Parameters:

<RunMode> SINGle | CONTInuous
 *RST: CONTInuous

Manual operation: See "[Run mode](#)" on page 1050

PGENERator:RUNSingle

Executes a single period of the pattern generator, for [PGENERator:RUNModeSINGle](#).

Usage: Event

Manual operation: See "[Run single](#)" on page 1050

27.20.3 Output setup

WGENERator<m>:OUTPut[:LOAD]	2647
WGENERator<m>:VOLTage[:VPP]	2648
WGENERator<m>:VOLTage:DCLevel	2648
WGENERator<m>:VOLTage:HIGH	2648
WGENERator<m>:VOLTage:INVersion	2649
WGENERator<m>:VOLTage:LOW	2649
WGENERator<m>:VOLTage:OFFSet	2649

WGENERator<m>:OUTPut[:LOAD] <Load>

Sets the load of the DUT at its connection.

Suffix:

<m> 1..2

Parameters:

<Load> FIFTy | HIZ
 HIZ: high input impedance
 *RST: HIZ

Manual operation: See "[User Load](#)" on page 1052

WGENerator<m>:VOLTage[:VPP] <Amplitude>

Sets the amplitude, peak to peak voltage, of the output waveform. This is defined as the voltage difference between the maximum ([WGENerator<m>:VOLTage:HIGH](#)) and the minimum ([WGENerator<m>:VOLTage:LOW](#)) voltage levels.

The value is set for the currently selected load ([WGENerator<m>:OUTPut\[:LOAD\]](#)). If the load is changed, the value of the amplitude is adapted to this new setting.

Suffix:

<m> 1..2

Parameters:

<Amplitude> Range: 0.01 to 12
 Increment: 0.1
 *RST: 1
 Default unit: V

Manual operation: See "[Amplitude](#)" on page 1052

WGENerator<m>:VOLTage:DCLevel <DCLevel>

Sets the DC level of the generated DC signal.

Suffix:

<m> 1..2

Parameters:

<DCLevel> Range: -5.995 to 5.995
 Increment: 0.1
 *RST: 0
 Default unit: V

Manual operation: See "[DC Level](#)" on page 1052

WGENerator<m>:VOLTage:HIGH <High>

Sets the high signal level of the output waveform.

Suffix:

<m> 1..2

Parameters:

<High> Range: -5.99 to 6
 Increment: 0.1
 *RST: 0.5
 Default unit: V

Manual operation: See "[High](#)" on page 1052

WGENerator<m>:VOLTage:INVersion <Inversion>

Enables inversion, which swaps the two poles of the waveform.

Suffix:

<m> 1..2

Parameters:

<Inversion> ON | OFF
 *RST: OFF

Manual operation: See "[Invert](#)" on page 1052

WGENerator<m>:VOLTage:LOW <Low>

Sets the low signal level of the output waveform.

Suffix:

<m> 1..2

Parameters:

<Low> Range: -6 to 5.99
 Increment: 0.1
 *RST: -0.5
 Default unit: V

Manual operation: See "[Low](#)" on page 1052

WGENerator<m>:VOLTage:OFFSet <Offset>

Sets a voltage offset.

Suffix:

<m> 1..2

Parameters:

<Offset> Range: -5.995 to 5.995
 Increment: 0.1
 *RST: 0
 Default unit: V

Manual operation: See "[Offset](#)" on page 1052

27.20.4 Noise setup

WGENerator<m>:MODulation:NDCLevel.....	2650
WGENerator<m>:MODulation:NLABbsolute?.....	2650
WGENerator<m>:MODulation:NLPCent.....	2650
WGENerator<m>:MODulation:NOISe.....	2651

WGENerator<m>:MODulation:NDCLevel <LevelDC>

Sets the DC noise level.

Suffix:

<m> 1..2

Parameters:

<LevelDC> Range: 0 to 12
 Increment: 0.1
 *RST: 0.01
 Default unit: V

Manual operation: See "[Absolute level](#)" on page 1053

WGENerator<m>:MODulation:NLABbsolute?

Queries the level of the noise in volts.

Suffix:

<m> 1..2

Return values:

<LevelAbs> Range: 0 to 12
 Increment: 0.1
 *RST: 0
 Default unit: V

Usage: Query only

Manual operation: See "[Absolute level](#)" on page 1053

WGENerator<m>:MODulation:NLPCent <LevelPct>

Sets the noise level in percentage of the amplitude.

Suffix:

<m> 1..2

Parameters:

<LevelPct> Range: 0 to 100
 Increment: 1
 *RST: 0
 Default unit: %

Manual operation: See "[Relative level](#)" on page 1053

WGENerator<m>:MODulation:NOISe <State>

Enables the adding of noise to the waveform.

Suffix:

<m> 1..2

Parameters:

<State> ON | OFF
*RST: OFF

Manual operation: See "Enable" on page 1053

27.20.5 DC offset alignment

GENerator:ALIGNment:DC:ABORt.....	2651
GENerator:ALIGNment:DC:RESult:DATE?.....	2651
GENerator:ALIGNment:DC:RESult:TIME?.....	2651
GENerator:ALIGNment:DC:RESult[:STATe]?.....	2651
GENerator:ALIGNment:DC[:STARt].....	2652

GENerator:ALIGNment:DC:ABORt

Aborts a DC offset alignment.

Usage: Event

GENerator:ALIGNment:DC:RESult:DATE?

Queries the date of the last performed DC offset alignment.

Return values:

<Date>

Usage: Query only

Manual operation: See "Date" on page 1054

GENerator:ALIGNment:DC:RESult:TIME?

Queries the time of the last performed DC offset alignment.

Return values:

<Time>

Usage: Query only

Manual operation: See "Time" on page 1054

GENerator:ALIGNment:DC:RESult[:STATe]?

Queries the result of a DC offset alignment.

Return values:

<State> PASSEd | FAILed | NOALigndata
 *RST: NOALigndata

Usage: Query only

Manual operation: See ["Overall alignment state"](#) on page 1054

GENerator:ALIGNment:DC[:START]

Starts a DC offset alignment.

Usage: Event

Manual operation: See ["Start Alignement"](#) on page 1053

27.20.6 Coupling & sync

WGENerator<m>:COUPling:STATe.....	2652
WGENerator<m>:COUPling:AMPLitude.....	2652
WGENerator<m>:COUPling:PHASeshift.....	2653
WGENerator<m>:COUPling:FREQuency].....	2653
WGENerator<m>:COUPling:NOISe.....	2653
WGENerator<m>:COUPling:AWForm.....	2653
GENerator:SYNC[:COMBination].....	2654

WGENerator<m>:COUPling:STATe <CplEnabSt>

Enables the coupling of the generators, with the selected set of parameters: amplitude, frequency and noise.

Suffix:

<m> 1..2

Parameters:

<CplEnabSt> ON | OFF
 *RST: OFF

Manual operation: See ["Generator enable"](#) on page 1054

WGENerator<m>:COUPling:AMPLitude <CoupleAmplitude>

Enables the coupling of all amplitude parameters of the generators.

Suffix:

<m> 1..2
 Specifies the master generator.

Parameters:

<CoupleAmplitude> ON | OFF
 *RST: OFF

Manual operation: See ["Frequency parameters"](#) on page 1055

WGENerator<m>:COUPling:PHASeshift <PhaseShift>

Sets the phase shift between the waveform of Gen1 and Gen2 when the frequency parameters of the two waveforms are coupled.

Suffix:

<m> 1..2
Specifies the master generator.

Parameters:

<PhaseShift> Range: -180 to 180
Increment: 1
*RST: 0
Default unit: °

Manual operation: See ["Phase shift"](#) on page 1055

WGENerator<m>:COUPling[:FREQUency] <CoupleFrequency>

Enables the coupling of all frequency parameters of the generators.

Suffix:

<m> 1..2
Specifies the master generator.

Parameters:

<CoupleFrequency> ON | OFF
*RST: OFF

Manual operation: See ["Amplitude parameters"](#) on page 1055

WGENerator<m>:COUPling:NOISe <CoupleNoise>

Couples all noise parameters of the generators.

Suffix:

<m> 1..2

Parameters:

<CoupleNoise> ON | OFF
*RST: OFF

Manual operation: See ["Noise parameters"](#) on page 1055

WGENerator<m>:COUPling:AWForm <CplArbitraryWfm>

Enables the coupling of the arbitrary waveform of the generators.

Suffix:

<m> 1..2

Pulse Source and TDR/TDT Analysis (options R&S RTO6-B7/K130)

Parameters:

<CplArbitraryWfm> ON | OFF
 *RST: OFF

GENERator:SYNC[:COMBination] <Combination>

Sets which signals generated from the waveform generator are synchronized.

Parameters:

<Combination> NONE | GEN12 | G1PG | G2PG | G12PG
 GEN12: Gen1 and Gen 2
 GEN1PG/GEN2PG: Gen1/Gen 2 and Patt Gen
 GEN12PG: Gen1,Gen 2 and Patt Gen
 *RST: NONE

Manual operation: See "[Sync start](#)" on page 1056

27.21 Pulse Source and TDR/TDT Analysis (options R&S RTO6-B7/K130)

27.21.1 Pulse source (option R&S RTO6-B7)

Some of the commands in the following chapter are asynchronous. An overlapping or asynchronous command does not automatically finish executing before the next command starts executing. If overlapping commands must be executed in a defined order, e.g. to avoid wrong measurement results, they must be serviced sequentially.

To prevent an overlapping execution of commands, one of the commands *OPC, *OPC? or *WAI can be used after the command or a command set.

For more information, see:

- www.rohde-schwarz.com/rc-via-scpj, chapter "Command sequence and synchronization"
- [Chapter 27.3, "Programming examples"](#), on page 1345

PSRC[:STATe]	2654
PSRC:OUTPutlow	2655
PSRC:REPRate	2655
PSRC:DUTYcycle	2655
PSRC:CLOCKmode	2656
PSRC:RST	2656

PSRC[:STATe] <State>

Switches the pulse output on and off.

Parameters:

<State> ON | OFF
 *RST: OFF

Usage: Asynchronous command

Manual operation: See ["Enable"](#) on page 1061

PSRC:OUTPutlow <OutputLowLevel>

Sets the low level of the output pulse.

Parameters:

<OutputLowLevel> Range: -0.2 to -0.05
 Increment: 0.01
 *RST: -0.05
 Default unit: V

Usage: Asynchronous command

Manual operation: See ["Output level"](#) on page 1061

PSRC:REPRate <RepetitionRate>

Sets the pulse frequency, the repetition rate of the pulse.

Parameters:

<RepetitionRate> Available values depend on the selected clock mode:
 Locked: 5/10/20/50/100/200/500 Hz, 1/5/10/25/50/100/250 MHz
 Free running: 5/10/20/50/100/200/500 Hz, 1/5/10/25/50 MHz
 *RST: 1E+6
 Default unit: Hz

Usage: Asynchronous command

Manual operation: See ["Repetition rate"](#) on page 1061

PSRC:DUTYcycle <DutyCycle>

Sets the duty cycle of the pulse, which is the ratio of the positive pulse width to the period of the signal.

Parameters:

<DutyCycle> For repetition rates > 5 MHz, the value is fixed at 50 %.
 Range: 10 to 90
 Increment: 10
 *RST: 50
 Default unit: %

Usage: Asynchronous command

Manual operation: See ["Duty cycle"](#) on page 1061

PSRC:CLOCKmode <ClockMode>

Sets the dependency of the pulse clock on the instrument's reference clock.

Parameters:

<ClockMode> LOCKed | FREerunning

LOCKed

The pulse source is locked to the reference clock of the instrument.

FREerunning

The clock of the pulse source is independent. Deviations of the system do not affect the pulse clock, and deterministic conditions are avoided.

*RST: FREerunning

Usage: Asynchronous command

Manual operation: See "[Clock mode](#)" on page 1062

PSRC:RST

Resets the pulse source to the default state.

Usage: Event
Asynchronous command

Manual operation: See "[Preset](#)" on page 1062

27.21.2 TDR/TDT analysis

Some of the commands in the following chapter are asynchronous. An overlapping or asynchronous command does not automatically finish executing before the next command starts executing. If overlapping commands must be executed in a defined order, e.g. to avoid wrong measurement results, they must be serviced sequentially.

To prevent an overlapping execution of commands, one of the commands *OPC, *OPC? or *WAI can be used after the command or a command set.

For more information, see:

- www.rohde-schwarz.com/rc-via-sdpi, chapter "Command sequence and synchronization"
- [Chapter 27.3, "Programming examples"](#), on page 1345

27.21.2.1 Calibration

TDRT:DEFault.....	2657
TDRT:CALibration:OPEN:NAME.....	2657
TDRT:CALibration:OPEN[:EXECute].....	2657
TDRT:TYPE.....	2657
TDRT:PULSe:OUT.....	2658

Pulse Source and TDR/TDT Analysis (options R&S RTO6-B7/K130)

TDRT:PULSe:REFerence.....	2658
TDRT:SLENgth.....	2658
TDRT:CALibration:SAVE:NAME.....	2658
TDRT:CALibration:SAVE[:EXECute].....	2659

TDRT:DEFault

Starts the measurement with default correction values instead of calibrating the setup. Default values are rough values without time reference.

Usage: Event
Asynchronous command

Manual operation: See "[Measure with default values](#)" on page 1067

TDRT:CALibration:OPEN:NAME <Path>

Sets the file name, file format and path of the TDR/TDT calibration file to be opened. The file format is always `.xml`.

Parameters:

<Path> String with path and file name with extension `.xml`

Usage: Asynchronous command

Manual operation: See "[Open](#)" on page 1067

TDRT:CALibration:OPEN[:EXECute]

Opens and loads the TDR/TDT calibration from the file specified with [TDRT:CALibration:OPEN:NAME](#).

Usage: Event
Asynchronous command

Manual operation: See "[Open](#)" on page 1067

TDRT:TYPE <Type>

Selects the analysis type: TDR (time domain reflectometry), TDT (time domain transmission), or TDR/TDT (both TDR and TDT).

Parameters:

<Type> TDR | TDRTdt | TDT
*RST: TDR

Usage: Asynchronous command

Manual operation: See "[Measurement type](#)" on page 1066

TDRT:PULSe:OUT <Channel>

Sets the channel to which the "Out" connector of the pulse source is connected via calibration standard or DUT.

Parameters:

<Channel> C1W1 | C2W1 | C3W1 | C4W1
*RST: C2W1

Usage: Asynchronous command

Manual operation: See "[Channel](#)" on page 1067

TDRT:PULSe:REFerence <Channel>

Sets the channel to which the "Ref" connector of the pulse source is connected.

Parameters:

<Channel> C1W1 | C2W1 | C3W1 | C4W1
*RST: C1W1

Usage: Asynchronous command

Manual operation: See "[Channel](#)" on page 1067

TDRT:SLENGth <ShortLength>

Sets the electrical length of a user-defined short.

The reset value is the electrical length of the short hat is delivered with the pulse source R&S RTO6-B7.

Parameters:

<ShortLength> Range: 0 to 2E-9
Increment: 1E-12
*RST: 26.5E-12
Default unit: s

Usage: Asynchronous command

Manual operation: See "[Short type](#)" on page 1068

TDRT:CALibration:SAVE:NAME <Path>

Sets the file name, file format and path of the TDR/TDT calibration file to be saved. The file format is always `.xml`.

Parameters:

<Path> String with path and file name with extension `.xml`

Usage: Asynchronous command

Manual operation: See "[Save calibration](#)" on page 1070

TDRT:CALibration:SAVE[:EXECute]

Saves the TDR/TDT calibration results to the file that is specified with [TDRT:CALibration:SAVE:NAME](#).

Usage: Event
Asynchronous command

Manual operation: See "[Save calibration](#)" on page 1070

27.21.2.2 Measurements

TDRT:STATE	2659
TDRT:CALibration:USECaldata	2659
TDRT:BW	2660
TDRT:DOMain	2660
TDRT:PERMittivity	2660
TDRT:SIGNal<m>:STATe	2660
TDRT:SIGNal<m>:SCALe	2661
TDRT:SIGNal<m>:OFFSet	2661
TDRT:SIGNal<m>:POSition	2661
TDRT:SIGNal<m>:DATA:HEADer?	2662
TDRT:SIGNal<m>:DATA:VALues?	2662

TDRT:STATe <State>

Activates or deactivates the TDR/TDT measurements.

Parameters:

<State> ON | OFF
*RST: OFF

Usage: Asynchronous command

Manual operation: See "[Enable](#)" on page 1071

TDRT:CALibration:USECaldata <UseCalibrationDat>

Disables or enables the frequency response calibration. Without calibration, the measured signals are only rescaled, and you can see the impact of the frequency response calibration on the time domain waveform.

The command is not relevant when measuring with default values.

Parameters:

<UseCalibrationDat> ON | OFF
*RST: ON

Usage: Asynchronous command

Manual operation: See "[Use frequency response calibration](#)" on page 1071

TDRT:BW <Bandwidth>

Sets the bandwidth of the DUT.

Parameters:

<Bandwidth>	Range:	2E+9 to 16E+9
	Increment:	10
	*RST:	4E+9
	Default unit:	Hz

Usage: Asynchronous command

Manual operation: See "[Bandwidth](#)" on page 1071

TDRT:DOMain <OutputDomain>

Sets the domain of the x-axis: time or distance (in m or inch). If you select distance, enter also the permittivity with [TDRT:PERMittivity](#).

Parameters:

<OutputDomain>	TIME MDIStance INDistance
	MDIStance = distance in m
	INDistance = distance in inch
	*RST: TIME

Usage: Asynchronous command

Manual operation: See "[Domain, \$\epsilon_r\$](#) " on page 1072

TDRT:PERMittivity <Permittivity>

Sets the permittivity " ϵ_r " of the used DUT.

Parameters:

<Permittivity>	Range:	1 to 100
	Increment:	0.1
	*RST:	3.3

Usage: Asynchronous command

Manual operation: See "[Domain, \$\epsilon_r\$](#) " on page 1072

TDRT:SIGNal<m>STATe <State>

Enables the indicated TDR/TDT signal.

Suffix:

<m>	1..3
	1 = impedance Z (result of TDR measurement)
	2 = step response H (result of TDT measurement)
	3 = reflection coefficient ρ (result of TDR measurement)

Pulse Source and TDR/TDT Analysis (options R&S RTO6-B7/K130)

Parameters:

<State> ON | OFF
 *RST: OFF

Usage: Asynchronous command

Manual operation: See "State" on page 1072

TDRT:SIGNal<m>:SCALE <VerticalScale>

Set the vertical scale of the indicated TDR/TDT signal.

Suffix:

<m> 1..3
 See [TDRT:SIGNal<m>:STATe](#) on page 2660.

Parameters:

<VerticalScale> Range: 1E-12 to 100E+12
 Increment: 1E-3
 *RST: 0.05
 Default unit: /div

Usage: Asynchronous command

Manual operation: See "Vertical scale" on page 1072

TDRT:SIGNal<m>:OFFSet <Offset>

Set the offset of the indicated TDR/TDT signal.

Suffix:

<m> 1..3
 See [TDRT:SIGNal<m>:STATe](#) on page 2660.

Parameters:

<Offset> Range: 1E-12 to 100E+12
 Increment: 0.01
 *RST: 0

Usage: Asynchronous command

Manual operation: See "Offset" on page 1072

TDRT:SIGNal<m>:POSition <Position>

Set the vertical position of the indicated TDR/TDT signal.

Suffix:

<m> 1..3
 See [TDRT:SIGNal<m>:STATe](#) on page 2660.

Pulse Source and TDR/TDT Analysis (options R&S RTO6-B7/K130)

Parameters:

<Position> Range: 1E-12 to 100E+12
 Increment: 0.02
 *RST: 0
 Default unit: div

Usage: Asynchronous command

Manual operation: See "Offset" on page 1072

TDRT:SIGNal<m>:DATA:HEADer?

Returns the header of channel waveform data.

Table 27-17: Header data

Position	Meaning	Example
1	XStart in s	-9.477E-008 = - 94,77 ns
2	XStop in s	9.477E-008 = 94,77 ns
3	Record length of one waveform	200000
4	Number of values per sample interval, is 1	1

Suffix:

<m> 1..3
 See [TDRT:SIGNal<m>:STATe](#) on page 2660.

Usage: Query only

TDRT:SIGNal<m>:DATA:VALues? [<Offset>], [<Length>]

Returns the data of the waveform points for transmission from the instrument to the controlling computer. The data can be used in MATLAB, for example.

Without parameters, the complete waveform is retrieved. Using the offset and length parameters, data can be retrieved in smaller portions, which makes the command faster.

To set the export format, use [FORMat \[:DATA \]](#).

Suffix:

<m> 1..3
 See [TDRT:SIGNal<m>:STATe](#) on page 2660.

Query parameters:

[<Offset>] Number of offset waveform points.
 Range: 0 to m. Limit: n + m >= record length

Return values:

[<Length>] Number of waveform points to be retrieved.
 Range: 1 to n. Limit: n + m >= record length

Usage: Query only

27.22 I/Q software interface (option R&S RTO6-K11)

Some of the commands in the following chapter are asynchronous. An overlapping or asynchronous command does not automatically finish executing before the next command starts executing. If overlapping commands must be executed in a defined order, e.g. to avoid wrong measurement results, they must be serviced sequentially.

To prevent an overlapping execution of commands, one of the commands `*OPC`, `*OPC?` or `*WAI` can be used after the command or a command set.

For more information, see:

- www.rohde-schwarz.com/rc-via-scp, chapter "Command sequence and synchronization"
- Chapter 27.3, "Programming examples", on page 1345
- I/Q sampling settings.....2663
- I/Q data output.....2668
- NFC trigger.....2669

27.22.1 I/Q sampling settings

To switch on the input channels, use `CHANnel<m>:STATe`.

Some of the commands in the following chapter are asynchronous. An overlapping or asynchronous command does not automatically finish executing before the next command starts executing. If overlapping commands must be executed in a defined order, e.g. to avoid wrong measurement results, they must be serviced sequentially.

To prevent an overlapping execution of commands, one of the commands `*OPC`, `*OPC?` or `*WAI` can be used after the command or a command set.

For more information, see:

- www.rohde-schwarz.com/rc-via-scp, chapter "Command sequence and synchronization"
- Chapter 27.3, "Programming examples", on page 1345

<code>IQ:STATe</code>	2664
<code>IQ:INSRate</code>	2664
<code>CHANnel<m>:IQ:INPType</code>	2664
<code>CHANnel<m>:IQ:INPMode</code>	2664
<code>IQ:RBWidth</code>	2665
<code>IQ:BWIDth?</code>	2665
<code>IQ:SRATe</code>	2665
<code>IQ:RLENgth</code>	2666
<code>CHANnel<m>:IQ:CFRequency</code>	2666
<code>CHANnel<m>:IQ:SBRF</code>	2666
<code>CHANnel<m>:IQ:SBIF</code>	2667
<code>CHANnel<m>:IQ:WARNIing[:STATe]?</code>	2667
<code>CHANnel<m>:IQ:WARNIing:MESSAge?</code>	2668

IQ:STATE <IQMode>

Activates the I/Q mode of the instrument.

Parameters:

<IQMode> ON | OFF
 ON: I/Q mode
 OFF: normal oscilloscope mode
*RST: OFF

Usage: Asynchronous command

Manual operation: See ["Enable"](#) on page 1076

IQ:INSRate <InputSampleRate>

Shows the sample rate of capturing the input data in I/Q mode: 10 Gsample/s.

Return values:

<InputSampleRate> SR10G

Usage: Asynchronous command

Manual operation: See ["Input sample rate"](#) on page 1076

CHANnel<m>:IQ:INPType <IQInputType>

Sets the type of the input signal.

Suffix:

<m> 1..4

Parameters:

<IQInputType> REAL | COMPlEx

REAL

Real RF signal. One real RF signal requires one input channel, thus up to four real signals can be recorded in parallel.

COMPlEx

Complex I/Q signal in baseband or low IF range. One complex input signal requires two input channels. The In-Phase component must be connected to channel 1 or 3, and the Quadrature component must be connected to channel 2 or 4. Thus up to two complex input signals can be recorded in parallel.

*RST: REAL

Usage: Asynchronous command

Manual operation: See ["Input type, Input mode"](#) on page 1076

CHANnel<m>:IQ:INPMode <IQInputMode>

Selects the frequency band of a complex input signal.

Suffix:

<m> 1..4
Selects the input channel.

Parameters:

<IQInputMode> BASEband | RFIF
Baseband or intermediate frequency (RFIF)
*RST: BASEband

Usage: Asynchronous command

Manual operation: See "[Input type, Input mode](#)" on page 1076

IQ:RBWidth <RelBw>

Sets the bandwidth factor to define the filter bandwidth.

*Filter BW = Relative BW * Sample rate*

Parameters:

<RelBw> Range: 0.04 to 0.8
Increment: 0.01
*RST: 0.8

Usage: Asynchronous command

Manual operation: See "[Rel. BW, Filter BW](#)" on page 1077

IQ:BWIDth?

Returns the filter bandwidth.

See also: [IQ:RBWidth](#) on page 2665

Return values:

<AbsBw> Range: 40 to 8E+9
*RST: 4E+9
Default unit: Hz

Usage: Query only
Asynchronous command

Manual operation: See "[Rel. BW, Filter BW](#)" on page 1077

IQ:SRATe <SampleRate>

Sets the required sample rate of the output I/Q data.

Parameters:

<SampleRate> Range: 1000 to 10E+9
Increment: 1
*RST: 10E+9
Default unit: Sa/s

Usage: Asynchronous command

Manual operation: See ["Sample rate"](#) on page 1078

IQ:RLEn^gth <RecordLength>

Sets the required record length of the output I/Q data. The resulting acquisition time of the I/Q data is:

$$\text{Acquisition time} = \text{Record length} / \text{Sample rate}$$

Parameters:

<RecordLength> Range: 1 to 10E+6
 Increment: 2
 *RST: 100000
 Default unit: pts

Usage: Asynchronous command

Manual operation: See ["Record length"](#) on page 1078

CHANnel<m>:IQ:CFRequency <IQCarrierFreqInput>

Sets the carrier frequency of the modulated RF signal or of the complex signal in IF range.

Prerequisites:

- [CHANnel<m>:IQ:INPType](#) on page 2664 is set to REAL
or:
- [CHANnel<m>:IQ:INPType](#) on page 2664 is set to COMPl^ex and [CHANnel<m>:IQ:INPMode](#) on page 2664 is set to RFIF

Suffix:

<m> 1..4
 Selects the input channel.

Parameters:

<IQCarrierFreqInput> Range: 10E-3 to 10E+9
 Increment: 100
 *RST: 1E+6
 Default unit: Hz

Usage: Asynchronous command

Manual operation: See ["Carrier frequency"](#) on page 1078

CHANnel<m>:IQ:SBRF <IQSidebandRF>

Defines the frequency position of the RF spectrum in the input signal: normal or inverse. The position is important for correct down-conversion and filtering.

Prerequisite: [CHANnel<m>:IQ:INPType](#) on page 2664 is set to REAL

For details, see ["Sideband \(real input\)"](#) on page 1078

Suffix:

<m> 1..4
Selects the input channel.

Parameters:

<IQSidebandRF> INVerse | NORMal
*RST: NORMal

Usage: Asynchronous command

Manual operation: See "[Sideband \(real input\)](#)" on page 1078

CHANnel<m>:IQ:SBIF <IQSidebandIF>

Defines the sideband and the frequency position of complex modulated input signal in IF range.

Prerequisites: [CHANnel<m>:IQ:INPType](#) on page 2664 is set to COMPlEx and [CHANnel<m>:IQ:INPMode](#) on page 2664 is set to RFIF

For details, see "[Sideband \(complex IF input\)](#)" on page 1079

Suffix:

<m> 1..4
Selects the input channel.

Parameters:

<IQSidebandIF> NUPPer | NLOWer | IUPPer | ILOWer
NUPPer: Upper sideband in normal position
NLOWer: Lower sideband in normal position
IUPPer: Upper sideband in inverse position
ILOWer: Lower sideband in inverse position
*RST: NUPPer

Usage: Asynchronous command

Manual operation: See "[Sideband \(complex IF input\)](#)" on page 1079

CHANnel<m>:IQ:WARning[:STATe]?

Returns ON if the sampling setup results in an unfavorable combination.

To get the message, use [CHANnel<m>:IQ:WARning:MESSAge?](#).

Suffix:

<m> 1..4

Return values:

<WarningState> ON | OFF
*RST: OFF

Usage: Query only

CHANnel<m>:IQ:WARNing:MESSage?

Returns the message string if `CHANnel<m>:IQ:WARNing[:STATe]?` is true.

Suffix:

<m> 1..4

Return values:

<WarningMessage> The string is:
 "Undersampling" if the carrier frequency is too fast.
 "CF + BW/2 > DevBW" if bandwidth settings do not fit. CF is the carrier frequency, BW is the filter bandwidth, and DevBW is the maximum instrument bandwidth.

Usage: Query only

27.22.2 I/Q data output

`CHANnel<m>:IQ:DATA[:VALues]?`..... 2668
`CHANnel<m>:IQ:DATA:HEADer?`..... 2669

CHANnel<m>:IQ:DATA[:VALues]?

Returns the recorded I/Q data.

Suffix:

<m> 1..4
 Selects the input channel.
 In case of a complex input signal that requires two input channels, the results of sources Ch1 and Ch2 are identical, as well as the results of Ch3 and Ch4.

Return values:

<Data> In-phase and and Quadrature floating values in interleaved order.

Example:

```
CHAN1:IQ:DATA?
-9.6296054835E-005, -1.5046258568E-006,
0.0001013283545, 1.5832555391E-006,
-0.00014297277085, -2.233616442E-006,
0.000192677413, 3.0105845781E-006,
-0.00020517286612, -3.2058260331E-006,
-0.002648930531, -4.1546467401E-005,
-0.0028401580639, -4.4135249482E-005,
-0.0028636774514, -4.4877564505E-005, ...
```

Usage: Query only

Manual operation: See "[Save IQ data to file](#)" on page 1080

CHANnel<m>:IQ:DATA:HEADer?

Returns the header of I/Q data.

Table 27-18: Header data

Position	Meaning	Example
1	XStart, acquisition time before trigger, in s	-5E-008 = - 50 ns
2	XStop, acquisition time after trigger, in s	5E-008 = 50 ns
3	Record length of the waveform in Samples	1000
4	Number of values per sample interval.	2 (if I and Q values in the data)

Suffix:

<m> 1..4
Selects the input channel.

Example: CHAN1:IQ:DATA:HEAD?
-5E-008,5E-008,1000,1

Usage: Query only

Manual operation: See ["Save IQ data to file"](#) on page 1080

27.22.3 NFC trigger

TRIGger<m>:NFC:TECHnology.....	2669
TRIGger<m>:NFC:BITRate.....	2669
TRIGger<m>:NFC:EVENT.....	2670

TRIGger<m>:NFC:TECHnology <Technology>

Selects the NFC technology, the communication protocol used by the input signal.

Suffix:

<m> 1..3
Event in a trigger sequence: 1 = A-event only

Parameters:

<Technology> NFCA | NFCB | NFCF
*RST: NFCA

Usage: Asynchronous command

Manual operation: See ["Technology"](#) on page 1081

TRIGger<m>:NFC:BITRate <Bitrate>

Sets the bit rate of the signal. For NFC-A and NFC-B, the bit rate is always 106 kBit per second. For NFC-F, the bit rate can be either 212 or 424 kBit per second.

Suffix:	
<m>	1..3 Event in a trigger sequence: 1 = A-event only
Parameters:	
<Bitrate>	KBPS106 KBPS212 KBPS424 *RST: KBPS106
Usage:	Asynchronous command
Manual operation:	See " Bit rate " on page 1081

TRIGger<m>:NFC:EVENT <Event>

Sets the event to be triggered on.

Suffix:	
<m>	1..3 Event in a trigger sequence: 1 = A-event only
Parameters:	
<Event>	ALL SEN ALLB SENB SOS48 SOS96 ALL SEN ALL_REQ and SENS_REQ commands (polling requests), only with NFC-A technology ALLB SENB ALLB_REQ and SENSB_REQ commands, only with NFC-B technology SOS48 SOS96 Start of sequence, 48 bit 96 bit land length, only with NFC-F technology *RST: SEN
Usage:	Asynchronous command
Manual operation:	See " Event " on page 1082

27.23 Jitter analysis and clock data recovery

This chapter describes the remote commands of jitter option R&S RTO6-K12/K133 and CDR option R&S RTO6-K13.

Some of the commands in the following chapter are asynchronous. An overlapping or asynchronous command does not automatically finish executing before the next command starts executing. If overlapping commands must be executed in a defined order, e.g. to avoid wrong measurement results, they must be serviced sequentially.

To prevent an overlapping execution of commands, one of the commands *OPC, *OPC? or *WAI can be used after the command or a command set.

For more information, see:

- www.rohde-schwarz.com/rc-via-scpj, chapter "Command sequence and synchronization"
- [Chapter 27.3, "Programming examples"](#), on page 1345
- [Jitter measurements \(option R&S RTO6-K12\)](#).....2671
- [Advanced jitter and noise \(option R&S RTO6-K133/K134\)](#).....2676
- [Clock data recovery \(software-based, option R&S RTO6-K12\)](#).....2722
- [Clock data recovery \(hardware-based, option R&S RTO6-K13\)](#).....2728
- [Serial pattern trigger using CDR](#).....2731
- [Eye mask testing](#).....2732

27.23.1 Jitter measurements (option R&S RTO6-K12)

The following table lists the measurement suffixes and the <MeasType> parameter value with a short description.

For a detailed description, see [Chapter 19.1.1, "Jitter measurements"](#), on page 1084.

Table 27-19: Jitter measurements

Meas. suffix	<MeasType> parameter value	Meas. type	Description/Result
37	CCJitter	Cycle-cycle jitter	Difference between the periods of two adjacent cycles. The measurement is based on the period measurement.
38	NCJitter	N-cycle jitter	Difference between the time of two adjacent groups of N cycles (periods) each.
39	CCWidth	Cycle-cycle width	Difference between the pulse width of two adjacent cycles. The measurement is based on the pulse width measurement.
40	CCDutycycle	Cycle-cycle duty cycle	Difference between the duty cycle of two adjacent cycles. The measurement is based on the duty cycle measurement.
41	TIE	Time interval error	Time difference between the slope of the input signal and the slope of a reference signal. The reference signal can be a captured clock waveform, or a clock generated by clock data recovery (CDR, software algorithm or hardware generation).
42	UINterval	Unit interval	Period of the clock signal. If no clock signal is available, it is recovered by CDR. The period is calculated as the time difference between two consecutive clock edges of the same polarity.
43	DRATe	Data rate	Frequency of the clock signal. If no clock signal is available, it is recovered by CDR. The measurement is based on the unit interval measurement.
44	SKWDelay	Skew delay	Delay between the edges of two interdependent waveforms.
45	SKWPhase	Skew phase	Phase difference between the edges of two waveforms.
1 to 36; 46	Used for amplitude/time measurements (limit checks). The jitter category uses the same limit checks as amplitude/time. See Chapter 27.12.3, "Amplitude/time measurements" , on page 1594.		

MEASurement<m>:JITTer:CCSLope.....	2672
MEASurement<m>:JITTer:PULSe.....	2672
MEASurement<m>:JITTer:NCYCles.....	2673
MEASurement<m>:JITTer:CDRMode.....	2673
MEASurement<m>:JITTer:SOURce<n>:TIESlope.....	2674
MEASurement<m>:JITTer:DRUNit.....	2675
MEASurement<m>:JITTer:SKWSlope.....	2675
MEASurement<m>:JITTer:SKWRelation.....	2675

MEASurement<m>:JITTer:CCSLope <JitterCCSlope>

Selects the slope at which the periods and thus the jitter is measured.

The command is available for the following measurements: cycle-cycle jitter, N-cycle jitter, and cycle-cycle duty cycle ([MEASurement<m>:MAIN](#) and/or [MEASurement<m>:ADDITIONal](#) are set to measurements CCJitter | NCJitter | CCDutycycle).

Suffix:

<m> 1..10
See "[Selection of the measurement group: MEASurement<m>](#)" on page 1583.

Parameters:

<JitterCCSlope> FIRSt | POSitive | NEGative | EITHer

FIRSt

Measures the period from the first edge that is found, no matter of its direction.

POSitive

Measures the period at positive going edges.

NEGative

Measures the period at negative going edges.

EITHer

Measures the period at both positive and negative going edges. This option is useful, for example, to check the clock stability of a double data rate clock.

*RST: FIRSt

Usage: Asynchronous command

Manual operation: See "[Cycle begin](#)" on page 1088

MEASurement<m>:JITTer:PULSe <JittPlsPola>

Sets the polarity of pulses for which the pulse width is measured to obtain the cycle-cycle width and the cycle-cycle duty cycle.

The command is available for the following measurements: cycle-cycle width and cycle-cycle duty cycle ([MEASurement<m>:MAIN](#) and/or [MEASurement<m>:ADDITIONal](#) are set to measurements CCWidth | CCDutycycle).

Suffix:	
<m>	1..10 See " Selection of the measurement group: MEASurement<m> " on page 1583.
Parameters:	
<JittPlsPola>	POSitive NEGative Pulse width of positive or negative pulses is measured, respectively. *RST: POSitive
Usage:	Asynchronous command
Manual operation:	See " Pulse polarity " on page 1088

MEASurement<m>:JITTer:NCYCles <JitterNofCycles>

Sets the number of periods (cycles) that are accumulated to measure the N-cycle jitter.

See also: [Table 19-1](#)

Suffix:	
<m>	1..10 See " Selection of the measurement group: MEASurement<m> " on page 1583.
Parameters:	
<JitterNofCycles>	Range: 1 to 2147483647 Increment: 1 *RST: 2
Usage:	Asynchronous command
Firmware/software:	FW 2.60. The algorithm of N-cycle measurement has been changed and MEASurement:JITTer:COFFset has been removed.
Manual operation:	See " Number of cycles " on page 1088

MEASurement<m>:JITTer:CDRMode <JitterCDRMode>

Defines the origin of the clock signal - whether a real clock signal or a clock generated using one of the CDR methods.

The command is available for the following measurements: time-interval error, unit interval and data rate ([MEASurement<m>:MAIN](#) and/or [MEASurement<m>:ADDITIONal](#) are set to measurements TIE | UINterval | DRATe).

Suffix:

<m>

1..10

See "[Selection of the measurement group: MEASurement<m>](#)" on page 1583.

Parameters:

<JitterCDRMode>

SIGNal | SW1 | SW2 | SW3 | SW4 | | HW

SIGNal

The clock is a real clock signal.

SW1 | SW2 | SW3 | SW4

The clock is generated by a software algorithm. You can define two software algorithms for CDR. To configure the CDR, use the CDR:SOFTware commands.

HW

The clock is generated from the source signal by the integrated CDR circuitry. The HW CDR must be active to acquire the jitter data (trigger type = CDR or serial pattern with CDR)

*RST: SW1

Usage:

Asynchronous command

Manual operation:See "[Clock](#)" on page 1090**MEASurement<m>:JITTer:SOURce<n>:TIESlope <JitterTIESlope>**

Sets the clock and data edges that are used for measurements. Clock or data is defined by the SOURce suffix <n>.

The command is available for the following measurements: time-interval error, unit interval and data rate ([MEASurement<m>:MAIN](#) and/or [MEASurement<m>:ADDITIONal](#) are set to measurements TIE | UINterval | DRATe).

Suffix:

<m>

1..10

See "[Selection of the measurement group: MEASurement<m>](#)" on page 1583.

<n>

1..2

1 = data slope (only relevant for time interval error measurements with explicit clock signal)
2 = clock slope

Parameters:

<JitterTIESlope>

POSitive | NEGative | EITHER

POSitive

The positive clock slope can be used, for example, for single data rate (SDR) signals with bit start at the positive clock edge.

NEGative

The negative clock slope can be used, for example, for SDR signals with bit start at the negative clock edge.

EITHer

For clock edges, this option can be used for double data rate (DDR) signals.

For data edges, it is the most common setting.

*RST: EITHer

Usage: Asynchronous command

Manual operation: See "[Slope](#)" on page 1090

MEASurement<m>:JITTer:DRUNit <JittDatRateUnt>

Sets the unit for data rate measurements.

Suffix:

<m> 1..10

See "[Selection of the measurement group: MEASurement<m>](#)" on page 1583.

Parameters:

<JittDatRateUnt> BIT_S | Hz

*RST: BIT_S

Usage: Asynchronous command

Manual operation: See "[Unit](#)" on page 1091

MEASurement<m>:JITTer:SKWSlope <JitterSkewSlope>

Sets the edge of the first waveform from which the skew delay or phase is measured: positive, negative or both.

The command is available for the following measurement: skew delay and skew phase ([MEASurement<m>:MAIN](#) and/or [MEASurement<m>:ADDITIONAL](#) are set to measurements SKWDelay | SKWPhase).

Suffix:

<m> 1..10

See "[Selection of the measurement group: MEASurement<m>](#)" on page 1583.

Parameters:

<JitterSkewSlope> POSitive | NEGative | EITHer

*RST: POSitive

Usage: Asynchronous command

Manual operation: See "[Edge polarity](#)" on page 1092

MEASurement<m>:JITTer:SKWRelation <JittskwRelt>

Sets the edge of the second waveform relative to the first waveform.

The command is available for the following measurements: skew delay and skew phase ([MEASurement<m>:MAIN](#) and/or [MEASurement<m>:ADDITIONal](#) are set to measurements SKWDelay | SKWPhase).

Suffix:

<m> 1..10
See "[Selection of the measurement group: MEASurement<m>](#)" on page 1583.

Parameters:

<JittskwRelt> MATChing | INVerse
MATChing
Measures from positive to positive edge or from negative to negative edge.
INVerse
Measures from positive to negative edge or from negative to positive edge.
*RST: MATChing

Usage: Asynchronous command

Manual operation: See "[Relative polarity](#)" on page 1092

27.23.2 Advanced jitter and noise (option R&S RTO6-K133/K134)

This chapter contains all remote commands to set up the advanced jitter and advanced noise analysis.

Selection of the advanced jitter measurement: ADVJitter<m>

With R&S RTO6, you can configure up to two simultaneous advanced jitter measurements. In manual operation, they are represented by subtabs "JA1" and "JA2" in the "Advanced Jitter" dialog box. For remote operation, they are indicated by the suffix [ADVJitter<m>](#).

Remote control: ADVJitter suffix <m>	Manual operation: "JA" subtab
1 to 2 correspond to	"JA1" to "JA2"

- [Signal](#)..... 2676
- [Results](#)..... 2683
- [Advanced settings](#)..... 2719

27.23.2.1 Signal

ADVJitter<m>:SIGNal:TYPE	2677
ADVJitter<m>:SIGNal:SOURce	2677
ADVJitter<m>:SIGNal:QUICkmeas	2677
ADVJitter<m>:SIGNal:BITRate	2678
ADVJitter<m>:SIGNal:SYMBolrate?	2678

ADVJitter<m>:SIGNal:CDRMode.....	2678
ADVJitter<m>:SIGNal:REFSource.....	2679
ADVJitter<m>:SIGNal:CLKSource.....	2679
ADVJitter<m>:SIGNal:EDGE.....	2679
ADVJitter<m>:SIGNal:CLFFactor.....	2679
ADVJitter<m>:SIGNal:CLFRequency.....	2680
ADVJitter<m>:SIGNal:CLOffset.....	2680
ADVJitter<m>:SIGNal:DATRate?.....	2680
ADVJitter<m>:SIGNal:GATE:COUPling.....	2680
ADVJitter<m>:SIGNal:GATE:CURSor.....	2681
ADVJitter<m>:SIGNal:GATE:RANGe:ABSolute:START.....	2681
ADVJitter<m>:SIGNal:GATE:RANGe:ABSolute:STOP.....	2681
ADVJitter<m>:SIGNal:GATE:RANGe:MODE.....	2682
ADVJitter<m>:SIGNal:GATE:RANGe:RELative:START.....	2682
ADVJitter<m>:SIGNal:GATE:RANGe:RELative:STOP.....	2682
ADVJitter<m>:SIGNal:GATE:ZDIagram.....	2682
ADVJitter<m>:SIGNal:GATE:STATe.....	2683
ADVJitter<m>:SIGNal:FREStimation.....	2683
ADVJitter<m>:SIGNal:OFEstimation.....	2683

ADVJitter<m>:SIGNal:TYPE <SignalType>

Select, if the analyzed signal is a data or clock signal.

Suffix:

<m> 1..2

Parameters:

<SignalType> CLOCk | DATNrZ
*RST: DATNrZ

Manual operation: See "[Signal Type](#)" on page 1097

ADVJitter<m>:SIGNal:SOURce <SourceType>

Selects the source for the advanced jitter analysis.

Suffix:

<m> 1..2

Parameters:

<SourceType> C1W1 | C1W2 | C1W3 | C2W1 | C2W2 | C2W3 | C3W1 | C3W2 |
C3W3 | C4W1 | C4W2 | C4W3 | M1 | M2 | M3 | M4 | M5 | M6 |
M7 | M8 | R1 | R2 | R3 | R4 | DIFF1 | DIFF2 | COMMON1 |
COMMON2

Manual operation: See "[Analyzed source](#)" on page 1097

ADVJitter<m>:SIGNal:QUICKmeas

Starts a quick advanced jitter analysis.

Suffix:

<m> 1..2

Usage:

Event

Manual operation: See ["Quick start analysis"](#) on page 1097**ADVJitter<m>:SIGNal:BITRate <NominalBitRate>**

Sets the quiescent frequency of the PLL. It corresponds to the data rate of the data stream from which the clock is to be recovered.

Suffix:

<m> 1..2

Parameters:

<NominalBitRate> Range: 1000 to 10E+9
 Increment: 10
 *RST: 1E+9
 Default unit: bps

Manual operation: See ["Nominal bit rate / Nominal symbol rate"](#) on page 1099**ADVJitter<m>:SIGNal:SYMBOLrate?**

Sets/ displays the symbol rate.

Suffix:

<m> 1..2

Return values:

<SymbolrateValue> Range: 1000 to 10E+9
 Increment: 10
 *RST: 1E+9
 Default unit: bps

Usage: Query only**Manual operation:** See ["Nominal bit rate / Nominal symbol rate"](#) on page 1099**ADVJitter<m>:SIGNal:CDRMode <MethodType>**

Selects the reference source for the CDR signal, if [ADVJitter<m>:SIGNal:REFSource](#) is set to CDR.

Suffix:

<m> 1..2

Parameters:

<MethodType> SW1 | SW2 | SW3 | SW4
 *RST: SW1

Manual operation: See ["Software CDR"](#) on page 1099

ADVJitter<m>:SIGNal:REFSource <SourceType>

Selects if an explicit clock or a CDR signal is used as a reference signal.

Suffix:

<m> 1..2

Parameters:

<SourceType> CLOCK | CDR
*RST: CDR

Manual operation: See "[Clock / CDR](#)" on page 1099

ADVJitter<m>:SIGNal:CLKSource <SourceType>

Selects the reference source for the clock signal, if [ADVJitter<m>:SIGNal:REFSource](#) is set to `CLOCK`.

Suffix:

<m> 1..2

Parameters:

<SourceType> C1W1 | C1W2 | C1W3 | C2W1 | C2W2 | C2W3 | C3W1 | C3W2 | C3W3 | C4W1 | C4W2 | C4W3 | M1 | M2 | M3 | M4 | M5 | M6 | M7 | M8 | R1 | R2 | R3 | R4 | DIFF1 | DIFF2 | COMMON1 | COMMON2

Manual operation: See "[Reference source](#)" on page 1099

ADVJitter<m>:SIGNal:EDGE <EdgeType>

The clock edge sets the point in time when the state of the data signal is checked.

Suffix:

<m> 1..2

Parameters:

<EdgeType> POSitive | NEGative | EITHer
*RST: EITHer

Manual operation: See "[Clock edge](#)" on page 1100

ADVJitter<m>:SIGNal:CLFFactor <Factor>

Sets a clock multiplier factor.

Suffix:

<m> 1..2

Parameters:

<Factor> Range: 1 to 100
Increment: 1
*RST: 1

Manual operation: See ["Clock multiplier"](#) on page 1100

ADVJitter<m>:SIGNal:CLFRequency <Frequency>

Sets the clock frequency for the explicit clock signal.

Suffix:

<m> 1..2

Parameters:

<Frequency> Range: 1000 to 10E+9
 Increment: 10
 *RST: 1E+9
 Default unit: Hz

Manual operation: See ["Clock frequency"](#) on page 1100

ADVJitter<m>:SIGNal:CLOFfset <Offset>

Sets a clock offset for the explicit clock signal.

Suffix:

<m> 1..2

Parameters:

<Offset> Range: -1000 to 1000
 Increment: 0.01
 *RST: 0
 Default unit: UI

Manual operation: See ["Clock offset"](#) on page 1101

ADVJitter<m>:SIGNal:DATRate?

Displays the calculated data rate of the explicit clock signal.

Suffix:

<m> 1..2

Return values:

<DatarateValue> Range: 1000 to 10E+9
 Increment: 10
 *RST: 1E+9
 Default unit: bps

Usage: Query only

Manual operation: See ["Data rate"](#) on page 1101

ADVJitter<m>:SIGNal:GATE:COUPling <ModeType>

Sets if the gate is coupled to the zoom or cursor.

Suffix:

<m> 1..2

Parameters:

<ModeType> NONE | CURSor | ZOOM

*RST: NONE

Manual operation: See "[Coupling mode](#)" on page 1098**ADVJitter<m>:SIGNal:GATE:CURSor <CursorType>**Sets the cursor the gate is coupled to, if [ADVJitter<m>:SIGNal:GATE:COUPling](#) is set to CURSor.**Suffix:**

<m> 1..2

Parameters:

<CursorType> CURSOR1 | CURSor1 | CURSOR2 | CURSor2 | CURSOR3 | CURSor3 | CURSOR4 | CURSor4

*RST: CURSOR1

Manual operation: See "[Cursor / Zoom](#)" on page 1099**ADVJitter<m>:SIGNal:GATE:RANGe:ABSolute:STARt <StartValue>**Sets the start time of the gate area in percent, if [ADVJitter<m>:SIGNal:GATE:RANGe:MODE](#) is set to ABS.**Suffix:**

<m> 1..2

Parameters:

<StartValue> Range: -100E+24 to 100E+24

Increment: 0.01

*RST: 0

Manual operation: See "[Start / Stop](#)" on page 1099**ADVJitter<m>:SIGNal:GATE:RANGe:ABSolute:STOP <StopValue>**Sets the stop time of the gate area in percent, if [ADVJitter<m>:SIGNal:GATE:RANGe:MODE](#) is set to ABS.**Suffix:**

<m> 1..2

Parameters:

<StopValue> Range: -100E+24 to 100E+24

Increment: 0.01

*RST: 0.01

Manual operation: See "[Start / Stop](#)" on page 1099

ADVJitter<m>:SIGNal:GATE:RANGe:MODE <ModeType>

Selects if the gate area is defined in relative values (percent) or absolute.

Suffix:

<m> 1..2

Parameters:

<ModeType> ABS | REL
*RST: ABS

Manual operation: See "[Mode](#)" on page 1099

ADVJitter<m>:SIGNal:GATE:RANGe:RELative:START <StartValue>

Sets the relative start of the gate area in percent, if [ADVJitter<m>:SIGNal:GATE:RANGe:MODE](#) is set to REL.

Suffix:

<m> 1..2

Parameters:

<StartValue> Range: 0 to 100
Increment: 0.1
*RST: 0
Default unit: %

Manual operation: See "[Relative start / stop](#)" on page 1099

ADVJitter<m>:SIGNal:GATE:RANGe:RELative:STOP <StopValue>

Sets the relative stop of the gate area in percent, if [ADVJitter<m>:SIGNal:GATE:RANGe:MODE](#) is set to REL.

Suffix:

<m> 1..2

Parameters:

<StopValue> Range: 0 to 100
Increment: 0.1
*RST: 100
Default unit: %

Manual operation: See "[Relative start / stop](#)" on page 1099

ADVJitter<m>:SIGNal:GATE:ZDiagram <ZoomType>

Sets the zoom the gate is coupled to, if [ADVJitter<m>:SIGNal:GATE:COUPLing](#) is set to ZOOM.

Suffix:

<m> 1..2

Parameters:

<ZoomType>

Manual operation: See ["Cursor / Zoom"](#) on page 1099**ADVJitter<m>:SIGNal:GATE:STATe <State>**

Enables the gating setup for the advanced jitter analysis.

Suffix:

<m> 1..2

Parameters:

<State> ON | OFF

*RST: OFF

Manual operation: See ["Use gate"](#) on page 1098**ADVJitter<m>:SIGNal:FREStimation**

Executes an estimation of the signal frequency.

Suffix:

<m> 1..2

Usage:

Event

Asynchronous command

Manual operation: See ["Estimate clock frequency"](#) on page 1100**ADVJitter<m>:SIGNal:OFESTimation**

Executes an estimation of the clock offset frequency.

Suffix:

<m> 1..2

Usage:

Event

Asynchronous command

Manual operation: See ["Estimate clock offset"](#) on page 1101**27.23.2.2 Results**For remote operation, the component is indicated by the suffix `COMPONENTs<n>`.

Table 27-20: Advanced jitter components

Suffix <n>	Component	Description/Result
Basic components		
1	Symbol rate	Number of data symbols per second of the analyzed signal. It is equivalent to the baud rate. For binary signals, the signal rate is equal to the bit rate.
2	Symbol duration	The length of time to transfer one signal symbol. Equals the inverse value of the symbol rate.
3	Event Count	Number of analyzed data transitions.
Jitter components (option R&S RTO6-K133)		
4	TJ@BER	The eye closure at the user-defined target BER.
5	RJ+(O)BUJ	Consists of any influence that cannot be predicted with model parameters. Usually, this jitter component follows a Gaussian probability distribution. Other Bounded Uncorrelated Jitter (OBUJ) is included here. OBUJ refers to any jitter that is bounded, uncorrelated time interval error (TIE) distribution, for example from unobserved data signals.
6	DJ (δ - δ)	Industry standard approximation to the deterministic jitter measurement, calculated by fitting a model of two overlapping, equally large Gaussian distributions to the observed DJ histogram. The calculated value is the time difference between the two distributions center points.
7	TJ	Measures the total Time Interval Error (TIE) of the input signal. It is defined as the time between each transition of the input signal and its corresponding reference clock transition.
8	DJ	The reproducible portion of the overall TIE of the input signal. It consists of the Data Dependent Jitter (DDJ) and Periodic Jitter (PJ) components.
9	DDJ	Consists of Inter-symbol Interference (ISI) and Duty Cycle Distortion (DCD). It depends on the symbol sequence. ISI is an effect commonly caused by limited signal bandwidth in the transmitter and transmission line, which forces influence from past symbols onto future symbols. DCD is a mismatch between rising and falling signal transitions due to reference level mismatch or other imbalances between transitions.
10	DCD	Measure of imbalance between rising and falling data transitions. It is defined as the time difference between the average rising and average falling edge.
11	PJ	Caused by crosstalk from periodic signal sources to the transmitter or transmission line. It represents the harmonic portion of the overall time interval error (TIE).
12	ISI	The time between the earliest and the latest signal transition of a single transition type, i.e. rising and falling edges. The measurement result is the largest value across all transition types.
13	DDJ +PJ	Composite impact of all unknown but deterministic portions of the overall time interval error of the input signal. It consists of any disturbance that comes from a deterministic source but cannot be reproduced from the input signal. Often it is caused by crosstalk from other data signals.

Suffix <n>	Component	Description/Result
14	(O)BUJ	Composite impact of all unknown but deterministic portions of the overall time interval error of the input signal. It consists of any disturbance that comes from a deterministic source but cannot be reproduced from the input signal. Often it is caused by crosstalk from other data signals.
15	(O)BUJ (δ - δ)	Other bounded uncorrelated Dual-Dirac jitter (O)BUJ (δ - δ) is an industry standard approximation to the other bounded uncorrelated jitter measurement. It is calculated by fitting a model of two overlapping, equally large Gaussian distributions to the observed RJ+(O)BUJ histogram. The calculated value is the amplitude difference between the two distributions center points.
16	RJ	Consists of any influence that cannot be predicted with model parameters. Usually, this jitter component follows a Gaussian probability distribution. The algorithm computes the standard deviation and the peak-peak value of the TIE caused by RJ within the analyzed waveform.
Noise components (option R&S RTO6-K134)		
17	EH@BER	Returns the vertical eye opening at the user-defined BER.
18	RN+(O)BUN	Random noise plus (other) bounded uncorrelated noise or (other) bounded uncorrelated noise is the combined effect of both noise types. If periodic components are activated RN + OBUN are displayed, otherwise RN + BUN. RN + (O)BUN is typically used, if track or spectrum plots are desired. Both plots are not available for RN only or (O)BUN only components as the time dependencies of these noise types are unknown. RN + (O)BUN spectrum is a useful approximation of the RN spectrum for negligible small (O)BUN.
20	TN	Measures the total level error of the input signal. It is defined as the amplitude deviation between the amplitude of the input signal at the decision time point and its corresponding reference level.
21	DN	The reproducible portion of the overall level error of the input signal. It consists of the data-dependent noise, the periodic noise components and the other bounded uncorrelated jitter components.
22	DDN	Consists of inter-symbol interface noise and level distortion. It depends on the symbol sequence. ISIN is an effect whereby past symbols have an influence on future symbols. LD is a mismatch between rising and falling signal transitions due to reference level mismatch or other imbalances between transitions.
23	LD	A measure of imbalance between different symbol levels. It is defined as the difference between the average level errors of the symbols one and zero.
24	PN	Periodic noise is typically caused by crosstalk from periodic signal sources to the transmitter or transmission line. It represents the harmonic portion of the overall level error.
25	ISIN	The level difference between the highest and the lowest level error of a symbol, i.e. one or zero. The largest value across all symbols is the measurement result.

Suffix <n>	Component	Description/Result
26	DDN + PN	Data-dependent noise plus periodic noise is the combined effect of both jitter types. Note that DDN+PN equals deterministic noise minus other bounded uncorrelated noise. DDN+PN spectrum is a useful approximation of the deterministic noise spectrum for negligible small other bounded uncorrelated noise.
27	(O)BUN	Composite impact of all unknown but deterministic portions of the overall time interval error of the input signal. It consists of any disturbance that comes from a deterministic source but cannot be reproduced from the input signal. Often it is caused by crosstalk from other data signals.
28	(O)BUN (δ - δ)	Other bounded uncorrelated Dual-Dirac noise (O)BUN (δ - δ) is an industry standard approximation to the other bounded uncorrelated jitter measurement. It is calculated by fitting a model of two overlapping, equally large Gaussian distributions to the observed RN+(O)BUN histogram. The calculated value is the amplitude difference between the two distributions center points.
29	RN	Consists of any influence that cannot be predicted with model parameters. Usually, this noise component follows a Gaussian probability distribution. The algorithm computes the standard deviation and the peak-peak value of the level error (LE) caused by RN within the analyzed waveform.

General

ADVJitter<m>:RESult:ENABle.....	2686
ADVJitter<m>:DCOMposition:COMPOnents<n>:ENABle.....	2687
ADVJitter<m>:RESult:STATistics.....	2687
ADVJitter<m>:RESult:STEPresponse.....	2687
ADVJitter<m>:RESult:COMPOnents<n>:HISTogram.....	2687
ADVJitter<m>:RESult:COMPOnents<n>:SPECTrum.....	2688
ADVJitter<m>:RESult:COMPOnents<n>:TRACK.....	2688
ADVJitter<m>:RESult:UNIT.....	2688
ADVJitter<m>:RESult:COMPOnents<n>:STATistics:MAXPeakpeak?.....	2689
ADVJitter<m>:RESult:COMPOnents<n>:STATistics:MAXStddev?.....	2689
ADVJitter<m>:RESult:COMPOnents<n>:STATistics[:MINStddev]?.....	2689
ADVJitter<m>:RESult:COMPOnents<n>:STATistics:MINPeakpeak?.....	2689
ADVJitter<m>:RESult:COMPOnents<n>:STATistics:PEAKpeak?.....	2689
ADVJitter<m>:RESult:COMPOnents<n>:STATistics:WFMCOUNT?.....	2689
ADVJitter<m>:RESult:COMPOnents<n>:STATistics:STDDev?.....	2689
ADVJitter<m>:RESult:PERiodic<n>:COUNT?.....	2689
ADVJitter<m>:RESult:PERiodic<n>:DIRection?.....	2689
ADVJitter<m>:RESult:PERiodic<n>:VALue?.....	2690
ADVJitter<m>:RESult:PERiodic<n>[:FREQuency]?.....	2690

ADVJitter<m>:RESult:ENABle <State>

Enables the advanced jitter analysis. It displays all enabled diagrams and displays a table with the results for the component measurements.

Suffix:

<m> 1..2

Parameters:

<State> ON | OFF
 *RST: OFF

Manual operation: See ["Enable"](#) on page 1104

ADVJitter<m>:DCOMposition:COMPONENTs<n>:ENABLE <State>

Enables the measurement for the specified jitter component.

Suffix:

<m> 1..2
 <n> 1..29
 See [Table 27-20](#)

Parameters:

<State> ON | OFF
 *RST: OFF

Manual operation: See ["Basic components"](#) on page 1109

ADVJitter<m>:RESult:STATistics <State>

Enables statistics measurements for the advanced jitter analysis.

Suffix:

<m> 1..2

Parameters:

<State> ON | OFF
 *RST: OFF

Manual operation: See ["Statistics"](#) on page 1105

ADVJitter<m>:RESult:STEPresponse <State>

Enables a step response diagram for the advanced jitter measurements..

Suffix:

<m> 1..2

Parameters:

<State> ON | OFF
 *RST: OFF

Manual operation: See ["Step response"](#) on page 1105

ADVJitter<m>:RESult:COMPONENTs<n>:HISTogram <State>

Enables a histogram for the selected measurement component.

Suffix:

<m> 1..2
 <n> 1..29
 See [Table 27-20](#)

Parameters:

<State> ON | OFF
 *RST: OFF

Manual operation: See "[Component specific results](#)" on page 1106

ADVJitter<m>:RESult:COMPonents<n>:SPECtrum <State>

Enables a spectrum diagram for the selected measurement component.

Suffix:

<m> 1..2
 <n> 1..29
 See [Table 27-20](#)

Parameters:

<State> ON | OFF
 *RST: OFF

Manual operation: See "[Component specific results](#)" on page 1106

ADVJitter<m>:RESult:COMPonents<n>:TRACk <State>

Enables a track for the advanced jitter measurements.

Suffix:

<m> 1..2
 <n> 1..29
 See [Table 27-20](#)

Parameters:

<State> ON | OFF
 *RST: OFF

Manual operation: See "[Component specific results](#)" on page 1106

ADVJitter<m>:RESult:UNIT <UnitType>

Selects between the absolute and relative unit for the displayed results.

Suffix:

<m> 1..2

Parameters:

<UnitType> ABS | REL
 *RST: ABS

Manual operation: See "Unit" on page 1108

ADVJitter<m>:RESult:COMPONENTS<n>:STATistics:MAXPeakpeak? <PeakValue>
ADVJitter<m>:RESult:COMPONENTS<n>:STATistics:MAXStddev? <StdDevValue>
ADVJitter<m>:RESult:COMPONENTS<n>:STATistics[:MINStddev]? <StdDevValue>
ADVJitter<m>:RESult:COMPONENTS<n>:STATistics:MINPeakpeak? <PeakValue>
ADVJitter<m>:RESult:COMPONENTS<n>:STATistics:PEAKpeak?
ADVJitter<m>:RESult:COMPONENTS<n>:STATistics:WFMCOUNT? <CountValue>
ADVJitter<m>:RESult:COMPONENTS<n>:STATistics:STDDev?

Return the statistic results of the specified measurement.

- **MAXPeakpeak:** absolute maximum value of the component.
- **MAXStddev:** standard deviation of the maximum value.
- **MINPeakpeak:** absolute minimum value of the component.
- **MINStddev:** standard deviation of the minimum value.
- **PEAKpeak:** peak to peak value of the long-term measurement results.
- **WFMCOUNT:** number of waveforms (acquisitions) the measurement is based on.
- **STDDev:** standard deviation of the long-term measurement results.

Suffix:

<m> 1..2
 <n> 1..29
 See [Table 27-20](#)

Return values:

<StdDev> Range: -100E+24 to 100E+24
 Increment: 100E-12
 *RST: 0

Usage: Query only

ADVJitter<m>:RESult:PERiodic<n>:COUNT?

Returns the number of periodic components.

Suffix:

<m> 1..2
 <n> *
 Not relevant

Return values:

<Count>

Usage: Query only

ADVJitter<m>:RESult:PERiodic<n>:DIRection?

Returns the direction of the selected periodic component.

Suffix:

<m> 1..2
 <n> *
 Number of periodic components.

Return values:

<CompDirection> UNDEFINED | VERTICAL | HOEXtrinsic | HOINtrinsic
 HOEXtrinsic: horizontal extrinsic
 HOINtrinsic: horizontal intrinsic
 *RST: UNDEFINED

Usage: Query only

ADVJitter<m>:RESult:PERiodic<n>:VALue?

Returns the value of the selected periodic component.

Suffix:

<m> 1..2
 <n> *
 Number of periodic components.

Return values:

<CompValue> Range: -1000 to 1000
 Increment: 0
 *RST: 0

Usage: Query only

ADVJitter<m>:RESult:PERiodic<n>[:FREQuency]?

Returns the frequency of the selected periodic component.

Suffix:

<m> 1..2
 <n> *
 Number of periodic components.

Return values:

<FreqValue> Range: 0 to 1E+15
 Increment: 0
 *RST: 0
 Default unit: Hz

Usage: Query only

Measurements

[ADVJitter<m>:DCOMposition:CLEBasicmeas.....](#) 2691
[ADVJitter<m>:DCOMposition:SELBasicmeas.....](#) 2691
[ADVJitter<m>:DCOMposition:CLEJitcomp.....](#) 2691

ADVJitter<m>:DCOMposition:SELJitcomp.....	2691
ADVJitter<m>:DCOMposition:CLENoisecomp.....	2692
ADVJitter<m>:DCOMposition:SELNoisecomp.....	2692
ADVJitter<m>:RESult:TRANSitions.....	2692
ADVJitter<m>:RESult:LEVels.....	2692

ADVJitter<m>:DCOMposition:CLEBasicmeas

Clears all selected basic jitter components.

Suffix:

<m> 1..2

Usage:

Event
Asynchronous command

Manual operation: See "[Select all /Clear](#)" on page 1110

ADVJitter<m>:DCOMposition:SELBasicmeas

Selects all basic jitter components.

Suffix:

<m> 1..2

Usage:

Event
Asynchronous command

Manual operation: See "[Select all /Clear](#)" on page 1110

ADVJitter<m>:DCOMposition:CLEJitcomp

Clears all selected jitter components.

Suffix:

<m> 1..2

Usage:

Event
Asynchronous command

Manual operation: See "[Select all /Clear](#)" on page 1114

ADVJitter<m>:DCOMposition:SELJitcomp

Selects all jitter components.

Suffix:

<m> 1..2

Usage:

Event
Asynchronous command

Manual operation: See "[Select all /Clear](#)" on page 1114

ADVJitter<m>:DCOMposition:CLENoisecomp

Clears all selected noise components.

Suffix:

<m> 1..2

Usage:

Event
Asynchronous command

Manual operation: See ["Select all /Clear"](#) on page 1118

ADVJitter<m>:DCOMposition:SELNoisecomp

Selects all noise components.

Suffix:

<m> 1..2

Usage:

Event
Asynchronous command

Manual operation: See ["Select all /Clear"](#) on page 1118

ADVJitter<m>:RESult:TRANSitions <TransitionType>

Sets the measurements for which transitions are displayed in the diagram.

Suffix:

<m> 1..2

Parameters:

<TransitionType> RISING | FALLING | BOTH
*RST: BOTH

Manual operation: See ["Transitions"](#) on page 1114

ADVJitter<m>:RESult:LEVELs <LevelType>

Sets which levels are considered for the display of the diagrams, rising, falling or both. This setting is mostly relevant for histograms.

Suffix:

<m> 1..2

Parameters:

<LevelType> HIGH | LOW | BOTH
*RST: BOTH

Manual operation: See ["Levels"](#) on page 1119

Bathtub

ADVJitter<m>:DCOMposition:TARBer.....	2693
ADVJitter<m>:RESult:BATHtub.....	2693
ADVJitter<m>:RESult:TYPBathtub.....	2693
ADVJitter<m>:RESult:PJ.....	2694
ADVJitter<m>:RESult:OBUJ.....	2694
ADVJitter<m>:RESult:NBATHtub.....	2694
ADVJitter<m>:RESult:PN.....	2694
ADVJitter<m>:RESult:OBUN.....	2695

ADVJitter<m>:DCOMposition:TARBer <TargetBtErrRate>

Sets the target bit error rate for total jitter at BER components.

Suffix:

<m> 1..2

Parameters:

<TargetBtErrRate> Range: 1 to 32
Increment: 1
*RST: 12

Manual operation: See "[Target BER 10](#)" on page 1119

ADVJitter<m>:RESult:BATHtub <State>

Enables a bathtub plot for the advanced jitter measurements.

Suffix:

<m> 1..2

Parameters:

<State> ON | OFF
*RST: OFF

Manual operation: See "[DDJ bathtub](#)" on page 1119

ADVJitter<m>:RESult:TYPBathtub <BathtubType>

Selects if you want to display the bathtub results versus total jitter (TJ) or data-dependent jitter (DDJ) and random jitter (RJ) components.

Suffix:

<m> 1..2

Parameters:

<BathtubType> DDJ | DDJP | DDJB | DDJO | TJ | DDJRj
TJ: Total jitter
DDJRj: Data-dependent jitter and random jitter.
*RST: TJ

ADVJitter<m>:RESult:PJ <State>

If enabled, the periodic jitter components are considered for the jitter bathtub.

Suffix:

<m> 1..2

Parameters:

<State> ON | OFF
*RST: ON

Manual operation: See "[PJ / \(O\)BUJ components](#)" on page 1120

ADVJitter<m>:RESult:OBUJ <State>

If enabled, the other bounded uncorrelated jitter components are considered for the jitter bathtub.

Suffix:

<m> 1..2

Parameters:

<State> ON | OFF
*RST: ON

Manual operation: See "[PJ / \(O\)BUJ components](#)" on page 1120

ADVJitter<m>:RESult:NBATHtub <State>

Enables a noise bathtub plot, a graph of BER in a log scale versus data-dependent jitter (DDN).

Suffix:

<m> 1..2

Parameters:

<State> ON | OFF
*RST: OFF

Manual operation: See "[DDN bathtub](#)" on page 1120

ADVJitter<m>:RESult:PN <State>

If enabled, the periodic noise components are considered for the noise bathtub.

Suffix:

<m> 1..2

Parameters:

<State> ON | OFF
*RST: ON

Manual operation: See "[PN / \(O\)BUN components](#)" on page 1122

ADVJitter<m>:RESult:OBUN <State>

If enabled, the other bounded uncorrelated noise components are considered for the noise bathtub.

Suffix:

<m> 1..2

Parameters:

<State> ON | OFF
*RST: ON

Manual operation: See "[PN / \(O\)BUN components](#)" on page 1122

Eye

ADVJitter<m>:RESult:PHORizontal	2695
ADVJitter<m>:RESult:PVERtical	2695
ADVJitter<m>:RESult:SYNTheticeye	2695
ADVJitter<m>:RESult:TYPsynteye	2696

ADVJitter<m>:RESult:PHORizontal <State>

If enabled, adds horizontal periodic components to the data-dependent synthetic eye.

Suffix:

<m> 1..2

Parameters:

<State> ON | OFF
*RST: OFF

Manual operation: See "[Add periodic components to DD synthetic eye](#)" on page 1123

ADVJitter<m>:RESult:PVERtical <State>

If enabled, adds vertical periodic components to the data-dependent synthetic eye.

Suffix:

<m> 1..2

Parameters:

<State> ON | OFF
*RST: OFF

Manual operation: See "[Add periodic components to DD synthetic eye](#)" on page 1123

ADVJitter<m>:RESult:SYNTheticeye <State>

Selects if you want to display synthetic eye results only for the deterministic jitter (DJ) components or the data-dependent jitter (DDJ) components.

Suffix:

<m> 1..2

Parameters:

<State> ON | OFF
 *RST: OFF

Manual operation: See "[Synthetic eye](#)" on page 1122

ADVJitter<m>:RESult:TYPsynteye <SyntheticEyeTyp>

Selects if you want to display synthetic eye results only for the deterministic jitter (DDP) components or the data-dependent jitter (DD) components.

Suffix:

<m> 1..2

Parameters:

<SyntheticEyeTyp> DD | DDPH | DDPV | DDP
 *RST: DDP

Quality

[ADVJitter<m>:DCOMposition:ERRSignal](#)..... 2696

[ADVJitter<m>:DCOMposition:RECSignal](#)..... 2696

ADVJitter<m>:DCOMposition:ERRSignal <ShowErrorSignal>

If enabled, shows the error signal.

Suffix:

<m> 1..2

Parameters:

<ShowErrorSignal> ON | OFF
 *RST: OFF

Manual operation: See "[Error signal](#)" on page 1124

ADVJitter<m>:DCOMposition:RECSignal <ShwReconstructedSign>

If enabled, shows the reconstructed signal.

Suffix:

<m> 1..2

Parameters:

<ShwReconstructedSignal> ON | OFF
 *RST: OFF

Manual operation: See "[Reconstructed signal](#)" on page 1124

Diagram

ADVJitter<m>:RESult:VERTical:HBINs.....	2697
ADVJitter<m>:RESult:VERTical:CONTinuous.....	2697
ADVJitter<m>:RESult:VERTical:BMTYpe.....	2698
ADVJitter<m>:RESult:VERTical:BHContinuouS.....	2698
ADVJitter<m>:RESult:VERTical:JSContinuouS.....	2698
ADVJitter<m>:RESult:VERTical:NHContinuouS.....	2699
ADVJitter<m>:RESult:VERTical:NSContinuouS.....	2699
ADVJitter<m>:DCOMposition:SPJTable.....	2699
ADVJitter<m>:DCOMposition:SPJLabels.....	2700
ADVJitter<m>:DCOMposition:SPNLabels.....	2700
ADVJitter<m>:DCOMposition:JINTerleaved.....	2700
ADVJitter<m>:RESult:COMPOnentS<n>:HOFFset.....	2700
ADVJitter<m>:RESult:COMPOnentS<n>:HSCale.....	2701
ADVJitter<m>:RESult:COMPOnentS<n>:NOFFset.....	2701
ADVJitter<m>:RESult:COMPOnentS<n>:NSCale.....	2701
ADVJitter<m>:RESult:COMPOnentS<n>:NSPOffset.....	2702
ADVJitter<m>:RESult:COMPOnentS<n>:NSPScale.....	2702
ADVJitter<m>:RESult:COMPOnentS<n>:SDOFFset.....	2702
ADVJitter<m>:RESult:COMPOnentS<n>:SDSCale.....	2703
ADVJitter<m>:RESult:COMPOnentS<n>:SOFFset.....	2703
ADVJitter<m>:RESult:COMPOnentS<n>:SROFFset.....	2703
ADVJitter<m>:RESult:COMPOnentS<n>:SRSCale.....	2704
ADVJitter<m>:RESult:COMPOnentS<n>:SSCale.....	2704
ADVJitter<m>:RESult:COMPOnentS<n>:SPOFFset.....	2704
ADVJitter<m>:RESult:COMPOnentS<n>:SPSCale.....	2705

ADVJitter<m>:RESult:VERTical:HBINs <MaxBinNumber>

Sets the number of bins, the number of data intervals, of the histogram.

Suffix:

<m> 1..2

Parameters:

<MaxBinNumber> Range: 2 to 1000
 Increment: 10
 *RST: 200

Manual operation: See "[Max. numb of bins](#)" on page 1124

ADVJitter<m>:RESult:VERTical:CONTinuous <State>

If enabled, the measurement scale is set automatically.

If disabled you can manually set a scale and an offset.

Suffix:

<m> 1..2

Parameters:

<State> ON | OFF
 *RST: ON

Manual operation: See "[Continuous auto scale](#)" on page 1125

ADVJitter<m>:RESult:VERTical:BMTYpe <MeasType>

Selects the basic measurement type to apply the vertical scale to.

Suffix:

<m> 1..2

Parameters:

<MeasType> SBRate | SBDuration
 SBRate: Symbol rate
 SBDuration: Symbol duration
 *RST: SBRate

Manual operation: See "[Measurement type](#)" on page 1125

ADVJitter<m>:RESult:VERTical:BHContinuous <State>

If enabled, the measurement scale of the basic jitter measurement histogram and track is set automatically.

If disabled you can manually set a scale and an offset.

Suffix:

<m> 1..2

Parameters:

<State> ON | OFF
 *RST: ON

Manual operation: See "[Continuous auto scale](#)" on page 1125

ADVJitter<m>:RESult:VERTical:JSContinuous <State>

If enabled, the measurement scale of the jitter spectrum is set automatically.

If disabled you can manually set a scale ([ADVJitter<m>:RESult:COMPONENTs<n>:SScale](#)

) and an offset ([ADVJitter<m>:RESult:COMPONENTs<n>:SOFFset](#)

).

).

Suffix:

<m> 1..2

Parameters:

<State> ON | OFF
 *RST: ON

Manual operation: See "[Continuous auto scale](#)" on page 1125

ADVJitter<m>:RESult:VERTical:NHContinuous <State>

If enabled, the measurement scale of the noise histogram and track is set automatically.

If disabled you can manually set a scale ([ADVJitter<m>:RESult:COMPONENTS<n>:NScale](#)) and an offset ([ADVJitter<m>:RESult:COMPONENTS<n>:NOFFset](#)).

Suffix:

<m> 1..2

Parameters:

<State> ON | OFF
 *RST: ON

Manual operation: See "[Continuous auto scale](#)" on page 1125

ADVJitter<m>:RESult:VERTical:NSContinuous <State>

If enabled, the measurement scale for the noise spectrum is set automatically.

If disabled you can manually set a scale ([ADVJitter<m>:RESult:COMPONENTS<n>:NSPScale](#)) and an offset ([ADVJitter<m>:RESult:COMPONENTS<n>:NSPoffset](#)).

.

Suffix:

<m> 1..2

Parameters:

<State> ON | OFF
 *RST: ON

Manual operation: See "[Continuous auto scale](#)" on page 1125

ADVJitter<m>:DCOMposition:SPJTable <State>

Enables the display of the periodic jitter components table.

Suffix:

<m> 1..2

Parameters:

<State> ON | OFF
 *RST: ON

Manual operation: See "[PJ periodic component table](#)" on page 1126

ADVJitter<m>:DCOMposition:SPJLabels <State>

Enables the display of the periodic jitter components labels.

Suffix:

<m> 1..2

Parameters:

<State> ON | OFF
 *RST: OFF

Manual operation: See "[PJ periodic component labels](#)" on page 1126

ADVJitter<m>:DCOMposition:SPNLabels <State>

Enables the display of the periodic noise components labels.

Suffix:

<m> 1..2

Parameters:

<State> ON | OFF
 *RST: OFF

Manual operation: See "[PJ periodic component labels](#)" on page 1126

ADVJitter<m>:DCOMposition:JINTerleaved <State>

Displays interleaved histogram values.

Suffix:

<m> 1..2

Parameters:

<State> ON | OFF
 *RST: OFF

Manual operation: See "[Interleaved](#)" on page 1124

ADVJitter<m>:RESult:COMPONENTs<n>:HOFFset <Offset>

Sets the offset for the jitter track.

Suffix:

<m> 1..2

<n> 1..29

Parameters:

<Offset> Range: -1E+15 to 1E+15
 Increment: 1E-6
 *RST: 0
 Default unit: s

Manual operation: See "[Offset](#)" on page 1125

ADVJitter<m>:RESult:COMPonents<n>:HSCale <Scale>

Sets the vertical scaling per division for the jitter track.

Suffix:

<m> 1..2
 <n> 1..29

Parameters:

<Scale> Range: 1E-15 to 1E+15
 Increment: 10E-6
 *RST: 0.5
 Default unit: s/div

Manual operation: See "[Scale](#)" on page 1125

ADVJitter<m>:RESult:COMPonents<n>:NOFFset <Offset>

Sets the offset for the noise track.

Suffix:

<m> 1..2
 <n> 1..29

Parameters:

<Offset> Range: -1E+15 to 1E+15
 Increment: 1E-6
 *RST: 0
 Default unit: V

Manual operation: See "[Offset](#)" on page 1125

ADVJitter<m>:RESult:COMPonents<n>:NSCale <Scale>

Sets the vertical scaling per division for the noise track.

Suffix:

<m> 1..2
 <n> 1..29

Parameters:

<Scale> Range: 1E-15 to 1E+15
 Increment: 10E-6
 *RST: 0.5
 Default unit: V/div

Manual operation: See "[Scale](#)" on page 1125

ADVJitter<m>:RESult:COMPONENTs<n>:NSPoffset <Offset>

Sets the offset for the noise spectrum.

Suffix:

<m> 1..2
 <n> 1..29

Parameters:

<Offset> Range: -500 to 500
 Increment: 1
 *RST: 0
 Default unit: dBV

Manual operation: See "[Offset](#)" on page 1126

ADVJitter<m>:RESult:COMPONENTs<n>:NSPScale <Scale>

Sets the vertical scaling per division for the spectrum noise.

Suffix:

<m> 1..2
 <n> 1..29

Parameters:

<Scale> Range: 0.1 to 500
 Increment: 10E-6
 *RST: 100
 Default unit: dBV

Manual operation: See "[Scale](#)" on page 1126

ADVJitter<m>:RESult:COMPONENTs<n>:SDOffset <Offset>

Sets the offset for the symbol duration.

Suffix:

<m> 1..2
 <n> 1..29

Parameters:

<Offset> Range: -1E+15 to 1E+15
 Increment: 1E-6
 *RST: 0
 Default unit: s

Manual operation: See "[Offset](#)" on page 1125

ADVJitter<m>:RESult:COMPonents<n>:SDScale <Scale>

Sets the scale for the symbol duration.

Suffix:

<m> 1..2
 <n> 1..29

Parameters:

<Scale> Range: 1E-15 to 1E+15
 Increment: 10E-6
 *RST: 0.5
 Default unit: s/div

Manual operation: See "[Scale](#)" on page 1125

ADVJitter<m>:RESult:COMPonents<n>:SOFFset <Offset>

Sets the offset for the spectrum jitter.

Suffix:

<m> 1..2
 <n> 1..29

Parameters:

<Offset> Range: -500 to 500
 Increment: 1
 *RST: 0
 Default unit: dBs

Manual operation: See "[Offset](#)" on page 1126

ADVJitter<m>:RESult:COMPonents<n>:SROFFset <Offset>

Sets the offset for the symbol rate.

Suffix:

<m> 1..2
 <n> 1..29

Parameters:

<Offset> Range: -1E+15 to 1E+15
 Increment: 1E-6
 *RST: 0
 Default unit: Baud

Manual operation: See "[Offset](#)" on page 1125

ADVJitter<m>:RESult:COMPONENTs<n>:SRScale <Scale>

Sets the scale for the symbol rate.

Suffix:

<m> 1..2
 <n> 1

Parameters:

<Scale> Range: 1E-15 to 1E+15
 Increment: 10E-6
 *RST: 0.5
 Default unit: Baud

Manual operation: See "[Scale](#)" on page 1125

ADVJitter<m>:RESult:COMPONENTs<n>:SScale <Scale>

Sets the vertical scaling per division for the spectrum jitter.

Suffix:

<m> 1..2
 <n> 1..29

Parameters:

<Scale> Range: 0.1 to 500
 Increment: 10E-6
 *RST: 100
 Default unit: dBs

Manual operation: See "[Scale](#)" on page 1126

ADVJitter<m>:RESult:COMPONENTs<n>:SPOffset <Offset>

Sets the offset for the jitter spectrum.

Suffix:

<m> 1..2
 <n> 1..29

Parameters:

<Offset> Range: -500 to 500
 Increment: 1
 *RST: 0
 Default unit: dBs

ADVJitter<m>:RESult:COMPONENTs<n>:SPSCale <Scale>

Sets the vertical scaling per division for the spectrum.

Suffix:

<m> 1..2
 <n> 1..29

Parameters:

<Scale> Range: 0.1 to 500
 Increment: 10E-6
 *RST: 100
 Default unit: dBs

PAM-N Jitter

Requires option R&S RTO6-K135.

ADVJitter<m>:RESult:PAMJitter:CONFig:BASE.....	2706
ADVJitter<m>:RESult:PAMJitter:CONFig:CATegory<n>:ACTive?.....	2706
ADVJitter<m>:RESult:PAMJitter:CONFig:CATegory<n>:ADD.....	2706
ADVJitter<m>:RESult:PAMJitter:CONFig:CATegory<n>:MEASurement<o>:BASE.....	2707
ADVJitter<m>:RESult:PAMJitter:CONFig:CATegory<n>:MEASurement<o>:COLor.....	2707
ADVJitter<m>:RESult:PAMJitter:CONFig:CATegory<n>:MEASurement<o>:COMPONENT.....	2708
ADVJitter<m>:RESult:PAMJitter:CONFig:CATegory<n>:MEASurement<o>:TARGet.....	2708
ADVJitter<m>:RESult:PAMJitter:CONFig:CATegory<n>:MEASurement<o>:TRANsition.....	2709
ADVJitter<m>:RESult:PAMJitter:CONFig:CATegory<n>:REMOve.....	2709
ADVJitter<m>:RESult:PAMJitter:CONFig:COMPONENT.....	2709
ADVJitter<m>:RESult:PAMJitter:CONFig:ENABle.....	2710
ADVJitter<m>:RESult:PAMJitter:CONFig:EXPLicit.....	2710
ADVJitter<m>:RESult:PAMJitter:CONFig:LVLHeight.....	2710
ADVJitter<m>:RESult:PAMJitter:CONFig:MODE.....	2711
ADVJitter<m>:RESult:PAMJitter:CONFig:PRESet.....	2711
ADVJitter<m>:RESult:PAMJitter:CONFig:SELMode.....	2711
ADVJitter<m>:RESult:PAMJitter:CONFig:TARGet.....	2711
ADVJitter<m>:RESult:PAMJitter:RESult<n>:MEASurement<o>:MAXPeakpeak?.....	2712
ADVJitter<m>:RESult:PAMJitter:RESult<n>:MEASurement<o>:MAXStddev?.....	2712
ADVJitter<m>:RESult:PAMJitter:RESult<n>:MEASurement<o>:MINPeakpeak?.....	2712
ADVJitter<m>:RESult:PAMJitter:RESult<n>:MEASurement<o>:MINStddev?.....	2712
ADVJitter<m>:RESult:PAMJitter:RESult<n>:MEASurement<o>:PEAKpeak?.....	2712
ADVJitter<m>:RESult:PAMJitter:RESult<n>:MEASurement<o>:WFMCount?.....	2712
ADVJitter<m>:RESult:PAMJitter:RESult<n>:MEASurement<o>:STDDev?.....	2712

ADVJitter<m>:RESult:PAMJitter:CONFig:BASE <BaseLevel>

Selects the base level, the lowest amplitude level used in the modulation.

Suffix:

<m> 1..2

Parameters:

<BaseLevel> LEVEL0 | LEVEL1 | LEVEL2 | LEVEL3 | LEVEL4 | LEVEL5 | LEVEL6

*RST: LEVEL0

ADVJitter<m>:RESult:PAMJitter:CONFig:CATegory<n>:ACTive?

Returns a list the number of active components.

Suffix:

<m> 1..2

<n> 1..3

Selects the component category

1: Numeric results

2: Histogram

3: Track

Return values:

<ActComponents> Range: 0 to 20

Increment: 1

*RST: 0

Usage: Query only

ADVJitter<m>:RESult:PAMJitter:CONFig:CATegory<n>:ADD <Measurement>, <BaseLevel>, <TargetLevel>, [<Edge>], [<Color>]

Adds a new jitter result measurement.

Suffix:

<m> 1..2

<n> 1..3

Selects the component category

1: Numeric results

2: Histogram

3: Track

Setting parameters:

<Measurement> TJBER | RJOBuj | DJDD | TJ | DJ | DDJ | DCDJ | PJ | ISI | DDPJ | OBUJ | BUJDd | RJ | ALL

<BaseLevel>

<TargetLevel>

<Edge> RISing | FALLing | BOTH

<Color>

Example: ADVJitter:RESult:PAMJitter:CONFig:CATegory:ADD
TJBer,0,1,FALL,523454
Adds a TJ@BER measurement with a Base level=0, Target level=1, Falling edge and Color = Hex #523454

Usage: Setting only

Manual operation: See "Add" on page 1129

**ADVJitter<m>:RESult:PAMJitter:CONFig:CATegory<n>:MEASurement<o>:BASE
<BaseLevel>**

Selects the base level. This is the lowest amplitude level used in the modulation. It sets the reference point for the least amount of energy a pulse can carry in the system.

Suffix:

<m> 1..2

<n> 1..3
Selects the component category
1: Numeric results
2: Histogram
3: Track

<o> 1..13
Selects the index of the active component

Parameters:

<BaseLevel> LEVEL0 | LEVEL1 | LEVEL2 | LEVEL3 | LEVEL4 | LEVEL5 |
LEVEL6 | LEVEL7

Manual operation: See "Base" on page 1128

**ADVJitter<m>:RESult:PAMJitter:CONFig:CATegory<n>:MEASurement<o>:COLor
<Color>**

Selects the color of the active component.

Suffix:

<m> 1..2

<n> 1..3
Selects the component category
1: Numeric results
2: Histogram
3: Track

<o> 1..13
Selects the active component

Parameters:

<Color>

Manual operation: See "Color" on page 1129

**ADVJitter<m>:RESult:PAMJitter:CONFig:CATegory<n>:MEASurement<o>:
COMPONENT <Component>**

Selects the component type.

Suffix:

<m> 1..2

<n> 1..3

Selects the component category

1: Numeric results

2: Histogram

3: Track

<o> 1..13

Selects the index of the active component

Parameters:

<Component>

AMPLitude | RTIME | FTIME | SLERising | SLEFalling |
SIGNAllevel | ERATio | ERPercent | ERDB | EHEight | EWIDth |
ETOP | EBASe | CPOints | CPPercent | QFACTOR | SDNoise |
BER | PPNoise | RMSNoise | SNRatio | DCDistortion | ERTime |
EFTime | EBRate | EAMPLitude | EOFactor | EPWidth |
EDCYcle | ECRatio | PJITter | CJITter | TIERror | PPJitter |
STDJitter | RMSJitter | TJBER | RJOBuj | DJDD | TJ | DJ | DDJ |
DCDJ | PJ | ISI | DDPJ | OBUJ | BUJDD | RJ | EHBer | ROBN |
DNDD | TN | DN | DDN | LDN | PN | ISIN | DDPN | OBUN |
BUNDd | RN | ALL

Manual operation: See "Component" on page 1128

**ADVJitter<m>:RESult:PAMJitter:CONFig:CATegory<n>:MEASurement<o>:
TARGET <TargetLevel>**

Selects the target level.

Suffix:

<m> 1..2

<n> 1..3

Selects the component category

1: Numeric results

2: Histogram

3: Track

<o> 1..13

Selects the index of the active component

Parameters:

<TargetLevel>

LEVEL0 | LEVEL1 | LEVEL2 | LEVEL3 | LEVEL4 | LEVEL5 |
LEVEL6 | LEVEL7

Manual operation: See "[Target](#)" on page 1129

**ADVJitter<m>:RESult:PAMJitter:CONFig:CATegory<n>:MEASurement<o>:
TRANSition <Transition>**

Selects which transitions are considered for the display of the diagrams, rising or falling.

Suffix:

<m> 1..2

<n> 1..3

Selects the component category

1: Numeric results

2: Histogram

3: Track

<o> 1..13

Parameters:

<Transition> RISing | FALLing

Manual operation: See "[Transition](#)" on page 1129

ADVJitter<m>:RESult:PAMJitter:CONFig:CATegory<n>:REMOve

Removes the last component added to the category.

Suffix:

<m> 1..2

<n> 1..3

Selects the component category

1: Numeric results

2: Histogram

3: Track

Usage: Event

ADVJitter<m>:RESult:PAMJitter:CONFig:COMPonent <Component>

Selects the component type.

Suffix:

<m> 1..2

Parameters:

<Component> AMPLitude | RTIME | FTIME | SLERising | SLEFalling |
 SIGNAllevel | ERATio | ERPercent | ERDB | EHEight | EWIDth |
 ETOP | EBASe | CPOints | CPPercent | QFACTOR | SDNoise |
 BER | PPNoise | RMSNoise | SNRatio | DCDistortion | ERTime |
 EFTime | EBRate | EAMPLitude | EOFactor | EPWidth |
 EDCYcle | ECRatio | PJITter | CJITter | TIERror | PPJitter |
 STDJitter | RMSJitter | TJBer | RJOBuj | DJDD | TJ | DJ | DDJ |
 DCDJ | PJ | ISI | DDPJ | OBUJ | BUJDd | RJ | EHBer | ROBN |
 DNDD | TN | DN | DDN | LDN | PN | ISIN | DDPN | OBUN |
 BUNDd | RN | ALL

See [Table 27-20](#).

*RST: ALL

Manual operation: See "[Component](#)" on page 1128

ADVJitter<m>:RESult:PAMJitter:CONFig:ENABle <Enable>

Enables the jitter measurements for PAM-N signals.

Suffix:

<m> 1..2

Parameters:

<Enable> ON | OFF

*RST: OFF

Manual operation: See "[PAM-N results](#)" on page 1127

ADVJitter<m>:RESult:PAMJitter:CONFig:EXPLicit <ExplicitLevel>

Sets an explicit level to be set for all active jitter components.

Suffix:

<m> 1..2

Parameters:

<ExplicitLevel> LEVEL0 | LEVEL1 | LEVEL2 | LEVEL3 | LEVEL4 | LEVEL5 |
 LEVEL6 | LEVEL7

*RST: LEVEL1

Manual operation: See "[Selection mode](#)" on page 1128

ADVJitter<m>:RESult:PAMJitter:CONFig:LVLHeight <LevelHeight>

Sets a level height, level difference between the base and target level for all active components.

Suffix:

<m> 1..2

Parameters:

<LevelHeight> LEVEL1 | LEVEL2 | LEVEL3 | LEVEL4 | LEVEL5 | LEVEL6 | LEVEL7
 *RST: LEVEL1

Manual operation: See "[Selection mode](#)" on page 1128

ADVJitter<m>:RESult:PAMJitter:CONFig:MODE <Mode>

Selects if you want to add pre-defined user configurations to the active components or define your own user-defined settings.

Suffix:

<m> 1..2

Parameters:

<Mode> PREDefined | USERdefined
 *RST: PREDefined

Manual operation: See "[Mode](#)" on page 1128

ADVJitter<m>:RESult:PAMJitter:CONFig:PRESet

Adds a pre-defined preset configuration for the selected component to the active components.

Suffix:

<m> 1..2

Usage: Event

Manual operation: See "[Preset](#)" on page 1128

ADVJitter<m>:RESult:PAMJitter:CONFig:SELMode <SelectionMode>

Selects how the level difference between the base and target level of the PAM-N signal is defined.

Suffix:

<m> 1..2

Parameters:

<SelectionMode> HEIGHt | EXPLicit
 *RST: HEIGHt

Manual operation: See "[Selection mode](#)" on page 1128

ADVJitter<m>:RESult:PAMJitter:CONFig:TARGet <TargetLevel>

Selects the target level.

Suffix:

<m> 1..2

Parameters:

<TargetLevel> LEVEL1 | LEVEL2 | LEVEL3 | LEVEL4 | LEVEL5 | LEVEL6 | LEVEL7
 *RST: LEVEL1

ADVJitter<m>:RESult:PAMJitter:RESult<n>:MEASurement<o>:MAXPeakpeak?
 <MaxPeakValue>

ADVJitter<m>:RESult:PAMJitter:RESult<n>:MEASurement<o>:MAXStddev?
 <StdDevValue>

ADVJitter<m>:RESult:PAMJitter:RESult<n>:MEASurement<o>:MINPeakpeak?
 <MinPeakValue>

ADVJitter<m>:RESult:PAMJitter:RESult<n>:MEASurement<o>:MINStddev?
 <StdDevValue>

ADVJitter<m>:RESult:PAMJitter:RESult<n>:MEASurement<o>:PEAKpeak?

ADVJitter<m>:RESult:PAMJitter:RESult<n>:MEASurement<o>:WFMCOUNT?
 <CountValue>

ADVJitter<m>:RESult:PAMJitter:RESult<n>:MEASurement<o>:STDDev?

Return the statistic results of the specified jitter measurement for PAM-N signals.

- **MAXPeakpeak:** absolute maximum value of the component.
- **MAXStddev:** standard deviation of the maximum value.
- **MINPeakpeak:** absolute minimum value of the component.
- **MINStddev:** standard deviation of the minimum value.
- **PEAKpeak:** peak to peak value of the long-term measurement results.
- **WFMCOUNT:** number of waveforms (acquisitions) the measurement is based on.
- **STDDev:** standard deviation of the long-term measurement results.

Suffix:

<m> 1..2
 <n> 1
 <o> 1..13

Return values:

<StdDev> Range: -100E+24 to 100E+24
 Increment: 100E-12
 *RST: 0

Usage: Query only

PAM-N Noise

ADVJitter<m>:RESult:PAMNoise:CONFig:BASE..... 2713
 ADVJitter<m>:RESult:PAMNoise:CONFig:CATegory<n>:ACTive?..... 2713
 ADVJitter<m>:RESult:PAMNoise:CONFig:CATegory<n>:ADD..... 2714
 ADVJitter<m>:RESult:PAMNoise:CONFig:CATegory<n>:MEASurement<o>:BASE..... 2714
 ADVJitter<m>:RESult:PAMNoise:CONFig:CATegory<n>:MEASurement<o>:COLor..... 2715
 ADVJitter<m>:RESult:PAMNoise:CONFig:CATegory<n>:MEASurement<o>:COMPonent.... 2715

ADVJitter<m>:RESult:PAMNoise:CONFig:CATegory<n>:MEASurement<o>:DIAGram.....	2716
ADVJitter<m>:RESult:PAMNoise:CONFig:CATegory<n>:REMove.....	2716
ADVJitter<m>:RESult:PAMNoise:CONFig:COMPonent.....	2717
ADVJitter<m>:RESult:PAMNoise:CONFig:ENABle.....	2717
ADVJitter<m>:RESult:PAMNoise:CONFig:MODE.....	2717
ADVJitter<m>:RESult:PAMNoise:CONFig:PRESet.....	2718
ADVJitter<m>:RESult:PAMNoise:NUMerical<n>:MEASurement<o>:MAXPeakpeak?.....	2718
ADVJitter<m>:RESult:PAMNoise:NUMerical<n>:MEASurement<o>:MAXStddev?.....	2718
ADVJitter<m>:RESult:PAMNoise:NUMerical<n>:MEASurement<o>:MINPeakpeak?.....	2718
ADVJitter<m>:RESult:PAMNoise:NUMerical<n>:MEASurement<o>:MINStddev?.....	2718
ADVJitter<m>:RESult:PAMNoise:NUMerical<n>:MEASurement<o>:PEAKpeak?.....	2718
ADVJitter<m>:RESult:PAMNoise:NUMerical<n>:MEASurement<o>:WFMCount?.....	2718
ADVJitter<m>:RESult:PAMNoise:NUMerical<n>:MEASurement<o>:STDDev?.....	2718
ADVJitter<m>:RESult:PAMNoise:RESult<n>:MEASurement<o>:MAXPeakpeak?.....	2719
ADVJitter<m>:RESult:PAMNoise:RESult<n>:MEASurement<o>:MAXStddev?.....	2719
ADVJitter<m>:RESult:PAMNoise:RESult<n>:MEASurement<o>:MINPeakpeak?.....	2719
ADVJitter<m>:RESult:PAMNoise:RESult<n>:MEASurement<o>:MINStddev?.....	2719
ADVJitter<m>:RESult:PAMNoise:RESult<n>:MEASurement<o>:PEAKpeak?.....	2719
ADVJitter<m>:RESult:PAMNoise:RESult<n>:MEASurement<o>:WFMCount?.....	2719
ADVJitter<m>:RESult:PAMNoise:RESult<n>:MEASurement<o>:STDDev?.....	2719

ADVJitter<m>:RESult:PAMNoise:CONFig:BASE <BaseLevel>

Selects the base level. This is the lowest amplitude level used in the modulation.

Suffix:

<m> 1..2

Parameters:

<BaseLevel> LEVEL0 | LEVEL1 | LEVEL2 | LEVEL3 | LEVEL4 | LEVEL5 |
LEVEL6
*RST: LEVEL0

Manual operation: See "Level" on page 1130

ADVJitter<m>:RESult:PAMNoise:CONFig:CATegory<n>:ACTive?

Returns a list of the active components.

Suffix:

<m> 1..2

<n> 1..3

Selects the component category

1: Numeric results

2: Histogram

3: Track

Return values:

<ActComponents> Range: 0 to 20
Increment: 1
*RST: 0

Usage: Query only

Manual operation: See "[Active components](#)" on page 1131

ADVJitter<m>:RESult:PAMNoise:CONFig:CATegory<n>:ADD <Measurement>, <Level>, [<Color>]

Adds a new noise result measurement to the active components table of the selected category.

Suffix:

<m> 1..2

<n> 1..3

Selects the component category

1: Numeric results

2: Histogram

3: Track

Setting parameters:

<Measurement> EHBer | ROBN | DNDD | TN | DN | DDN | LDN | PN | ISIN | DDPN | OBUN | BUNDd | RN | ALL

<Level>

<Color>

Example:

```
:ADVJitter:RESult:PAMNoise:CONFig:CATegory:ADD
EHBer,1,523454
```

Adds a EH@BER measurement with a Level=1 and Color = Hex #523454

Usage: Setting only

Manual operation: See "[Add](#)" on page 1131

ADVJitter<m>:RESult:PAMNoise:CONFig:CATegory<n>:MEASurement<o>:BASE <BaseLevel>

Selects the base level. This is the lowest amplitude level used in the modulation. It sets the reference point for the least amount of energy a pulse can carry in the system.

Suffix:

<m> 1..2

<n> 1..3

Selects the component category

1: Numeric results

2: Histogram

3: Track

<o> 1..13

Selects the index of the active component

Parameters:

<BaseLevel> LEVEL0 | LEVEL1 | LEVEL2 | LEVEL3 | LEVEL4 | LEVEL5 |
LEVEL6 | LEVEL7

Manual operation: See "[Level](#)" on page 1131

**ADVJitter<m>:RESult:PAMNoise:CONFig:CATegory<n>:MEASurement<o>:
COLor <Color>**

Selects the color of the active component.

Suffix:

<m> 1..2
<n> 1..3
Selects the component category
1: Numeric results
2: Histogram
3: Track
<o> 1..13
Selects the active component

Parameters:

<Color>

Manual operation: See "[Color](#)" on page 1131

**ADVJitter<m>:RESult:PAMNoise:CONFig:CATegory<n>:MEASurement<o>:
COMPonent <Component>**

Selects the component type.

Suffix:

<m> 1..2
<n> 1..3
Selects the component category
1: Numeric results
2: Histogram
3: Track
<o> 1..13
Selects the index of the active component

Parameters:

<Component> AMPLitude | RTIME | FTIME | SLERising | SLEFalling |
 SIGNAllevel | ERATio | ERPercent | ERDB | EHEight | EWIDth |
 ETOP | EBASe | CPOints | CPPercent | QFACTOR | SDNoise |
 BER | PPNoise | RMSNoise | SNRatio | DCDistortion | ERTime |
 EFTime | EBRate | EAMPLitude | EOFactor | EPWidth |
 EDCYcle | ECRatio | PJITter | CJITter | TIERror | PPJitter |
 STDJitter | RMSJitter | TJBer | RJOBuj | DJDD | TJ | DJ | DDJ |
 DCDJ | PJ | ISI | DDPJ | OBUJ | BUJDd | RJ | EHBer | ROBN |
 DNDD | TN | DN | DDN | LDN | PN | ISIN | DDPN | OBUN |
 BUNDd | RN | ALL

Manual operation: See "[Component](#)" on page 1131

**ADVJitter<m>:RESult:PAMNoise:CONFig:CATegory<n>:MEASurement<o>:
 DIAGram <ShowDiagram>**

Enables the display of the dieagram for the selected measurement.

Suffix:

<m> 1..2
 <n> 1..3
 Selects the component category
 1: Numeric results
 2: Histogram
 3: Track
 <o> 1..13
 Selects the index of the active component

Parameters:

<ShowDiagram> ON | OFF
 *RST: OFF

ADVJitter<m>:RESult:PAMNoise:CONFig:CATegory<n>:REMove

Removes the last added line in the active components table of the selected category.

Suffix:

<m> 1..2
 <n> 1..3
 Selects the component category
 1: Numeric results
 2: Histogram
 3: Track

Example:

ADVJitter1:RESult:PAMNoise:CONFig:CATegory1:
 REMove

Usage:

Event

Manual operation: See "[Remove last](#)" on page 1129

ADVJitter<m>:RESult:PAMNoise:CONFig:COMPonent <Component>

Selects the component type.

Suffix:

<m> 1..2

Parameters:

<Component> AMPLitude | RTIME | FTIME | SLERising | SLEFalling |
 SIGNAllevel | ERATio | ERPercent | ERDB | EHEight | EWIDth |
 ETOP | EBASe | CPOints | CPPercent | QFACtor | SDNoise |
 BER | PPNoise | RMSNoise | SNRatio | DCDistortion | ERTime |
 EFTime | EBRate | EAMPLitude | EOFactor | EPWidth |
 EDCYcle | ECRatio | PJITter | CJITter | TIERror | PPJitter |
 STDJitter | RMSJitter | TJBER | RJOBuj | DJDD | TJ | DJ | DDJ |
 DCDJ | PJ | ISI | DDPJ | OBUJ | BUJDd | RJ | EHBer | ROBN |
 DNDD | TN | DN | DDN | LDN | PN | ISIN | DDPN | OBUN |
 BUNDd | RN | ALL

See [Table 27-20](#)

*RST: ALL

Manual operation: See "[Component](#)" on page 1130

ADVJitter<m>:RESult:PAMNoise:CONFig:ENABle <Enable>

Enables the noise measurements for PAM-N signals.

Suffix:

<m> 1..2

Parameters:

<Enable> ON | OFF

*RST: OFF

Manual operation: See "[PAM-N results](#)" on page 1130

ADVJitter<m>:RESult:PAMNoise:CONFig:MODE <Mode>

Selects if you want to add pre-defined user configurations to the active components or define your own user-defined settings.

Suffix:

<m> 1..2

Parameters:

<Mode> PREDefined | USERdefined

*RST: PREDefined

Manual operation: See "[Mode](#)" on page 1130

ADVJitter<m>:RESult:PAMNoise:CONFig:PRESet

Adds a pre-defined preset configuration for the selected component to the active components.

Suffix:

<m> 1..2

Usage: Event

Manual operation: See "Preset" on page 1130

**ADVJitter<m>:RESult:PAMNoise:NUMerical<n>:MEASurement<o>:
MAXPeakpeak? <MaxPeakValue>**

**ADVJitter<m>:RESult:PAMNoise:NUMerical<n>:MEASurement<o>:MAXStddev?
<StdDevValue>**

**ADVJitter<m>:RESult:PAMNoise:NUMerical<n>:MEASurement<o>:
MINPeakpeak? <MinPeakValue>**

**ADVJitter<m>:RESult:PAMNoise:NUMerical<n>:MEASurement<o>:MINStddev?
<StdDevValue>**

ADVJitter<m>:RESult:PAMNoise:NUMerical<n>:MEASurement<o>:PEAKpeak?

**ADVJitter<m>:RESult:PAMNoise:NUMerical<n>:MEASurement<o>:WFMCOUNT?
<CountValue>**

ADVJitter<m>:RESult:PAMNoise:NUMerical<n>:MEASurement<o>:STDDev?

Return the statistic results of the specified noise measurement for PAM-N signals.

- **MAXPeakpeak:** absolute maximum value of the component.
- **MAXStddev:** standard deviation of the maximum value.
- **MINPeakpeak:** absolute minimum value of the component.
- **MINStddev:** standard deviation of the minimum value.
- **PEAKpeak:** peak to peak value of the long-term measurement results.
- **WFMCOUNT:** number of waveforms (acquisitions) the measurement is based on.
- **STDDev:** standard deviation of the long-term measurement results.

Suffix:

<m> 1..2

<n> 1

<o> 1..13

Return values:

<StdDev> Range: -100E+24 to 100E+24
Increment: 100E-12
*RST: 0

Usage: Query only

ADVJitter<m>:RESult:PAMNoise:RESult<n>:MEASurement<o>:MAXPeakpeak?
<MaxPeakValue>

ADVJitter<m>:RESult:PAMNoise:RESult<n>:MEASurement<o>:MAXStddev?
<StdDevValue>

ADVJitter<m>:RESult:PAMNoise:RESult<n>:MEASurement<o>:MINPeakpeak?
<MinPeakValue>

ADVJitter<m>:RESult:PAMNoise:RESult<n>:MEASurement<o>:MINStddev?
<StdDevValue>

ADVJitter<m>:RESult:PAMNoise:RESult<n>:MEASurement<o>:PEAKpeak?

ADVJitter<m>:RESult:PAMNoise:RESult<n>:MEASurement<o>:WFMCCount?
<CountValue>

ADVJitter<m>:RESult:PAMNoise:RESult<n>:MEASurement<o>:STDDev?

Return the statistic results of the specified noise measurement for PAM-N signals.

- **MAXPeakpeak:** absolute maximum value of the component.
- **MAXStddev:** standard deviation of the maximum value.
- **MINPeakpeak:** absolute minimum value of the component.
- **MINStddev:** standard deviation of the minimum value.
- **PEAKpeak:** peak to peak value of the long-term measurement results.
- **WFMCCount:** number of waveforms (acquisitions) the measurement is based on.
- **STDDev:** standard deviation of the long-term measurement results.

Suffix:

<m> 1..2

<n> 1

<o> 1..13

Return values:

<StdDev> Range: -100E+24 to 100E+24
Increment: 100E-12
*RST: 0

Usage: Query only

27.23.2.3 Advanced settings

ADVJitter<m>:DCOMposition:MRESplength?	2720
ADVJitter<m>:DCOMposition:RLEStimate	2720
ADVJitter<m>:DCOMposition:POSStep	2720
ADVJitter<m>:DCOMposition:RESplength	2720
ADVJitter<m>:DCOMposition:ENP	2721
ADVJitter<m>:DCOMposition:NHORizontal	2721
ADVJitter<m>:DCOMposition:NVERTical	2721
ADVJitter<m>:DCOMposition:ENOBu	2722
ADVJitter<m>:DCOMposition:STEPresponse	2722

ADVJitter<m>:DCOMposition:MRESplength?

Queries the estimated maximum step length response.

Suffix:

<m> 1..2

Return values:

<MaxLength> Range: 1 to 200
Increment: 1
*RST: 20
Default unit: UI

Usage: Query only

Manual operation: See "[Length](#)" on page 1133

ADVJitter<m>:DCOMposition:RLEStimate

Runs an estimate of the step response for the advanced jitter analysis measurements.

Suffix:

<m> 1..2

Usage:

Event
Asynchronous command

Manual operation: See "[Length](#)" on page 1133

ADVJitter<m>:DCOMposition:POSStep <Position>

Sets the steps position.

Suffix:

<m> 1..2

Parameters:

<Position> Range: 0 to 100
Increment: 1
*RST: 50
Default unit: %

Manual operation: See "[Step position](#)" on page 1133

ADVJitter<m>:DCOMposition:RESPlength <Length>

Set the step response length in unit intervals.

Suffix:

<m> 1..2

Parameters:

<Length> Range: 1 to 200
 Increment: 1
 *RST: 20
 Default unit: UI

Manual operation: See "[Length](#)" on page 1133

ADVJitter<m>:DCOMposition:ENP <State>

Enables the display of the periodic jitter components table.

Suffix:

<m> 1..2

Parameters:

<State> ON | OFF
 *RST: ON

Manual operation: See "[Enable](#)" on page 1133

ADVJitter<m>:DCOMposition:NHORizontal <MaxNumber>

Sets the maximum number of periodic components in the horizontal direction that are considered for the measurement. If the actual number of periodic components is higher than the set value, they are considered for the random jitter component.

Suffix:

<m> 1..2

Parameters:

<MaxNumber> Range: 0 to 10
 Increment: 1
 *RST: 5

Manual operation: See "[Horizontal \(h\) direction](#)" on page 1133

ADVJitter<m>:DCOMposition:NVERTical <MaxNumber>

Sets the maximum number of periodic components in the vertical direction that are considered for the measurement. If the actual number of periodic components is higher than the set value, they are considered for the random jitter component.

Suffix:

<m> 1..2

Parameters:

<MaxNumber> Range: 0 to 10
 Increment: 1
 *RST: 5

Manual operation: See "[Vertical \(v\) direction](#)" on page 1134

ADVJitter<m>:DCOMposition:ENOBu <State>**Suffix:**

<m> 1..2

Parameters:

<State> ON | OFF

*RST: OFF

Manual operation: See "[\(Other\) bounded uncorrelated](#)" on page 1134

ADVJitter<m>:DCOMposition:STEPresponse <StepResponse>

Selects if separated edges or combined edges are used for the step response calculation.

Suffix:

<m> 1..2

Parameters:

<StepResponse> COMBined | SEPARated

*RST: COMBined

Manual operation: See "[Step response variant](#)" on page 1132

27.23.3 Clock data recovery (software-based, option R&S RTO6-K12)

CDR:SOFTware<m>:ALGorithm.....	2722
CDR:SOFTware<m>:ESBRate:SOURce.....	2723
CDR:SOFTware<m>:ESBRate:BREstimate.....	2723
CDR:SOFTware<m>:ESBRate:CONTInuous.....	2724
CDR:SOFTware<m>:ESSRate:SOURce.....	2724
CDR:SOFTware<m>:ESSRate:SREStimate.....	2724
CDR:SOFTware<m>:ESSRate:CONTInuous.....	2724
CDR:SOFTware<m>:BITRate.....	2725
CDR:SOFTware<m>:ESLope.....	2725
CDR:SOFTware<m>:SYNC.....	2726
CDR:SOFTware<m>:RESults.....	2726
CDR:SOFTware<m>:PLL:ORDer.....	2726
CDR:SOFTware<m>:PLL:BWIDth.....	2727
CDR:SOFTware<m>:PLL:RELBwidth.....	2727
CDR:SOFTware<m>:PLL:DAMPing.....	2727
CDR:SOFTware<m>:SYMRate.....	2728

CDR:SOFTware<m>:ALGorithm <Algorithm>

Sets the software algorithm that is used for clock data recovery.

Suffix:

<m> 1..4
Number of the software CDR setup

Parameters:

<Algorithm> CFRequency | PLL | FF | PLLStart | FFStart

CFRequency

Constant frequency. CDR uses the nominal bit rate to generate the clock signal. The method assumes that the frequency of the signal is constant during the complete acquisition.

PLL

Phase-locked loop control system. It can follow slow deviations in the frequency of the data stream.

FF

Feed forward algorithm, a mathematical optimization method. Feed forward is available if none of the listed serial standards is used (`SIGNalconfig:SETup:SETTing<m>:SERStandard` is set to `CUSTOM`). It is faster than PLL, i.e., the settling time is shorter. Feed forward is also more precise than PLL. To set up the algorithm, set the bandwidth and the relative bandwidth.

PLLStart

PLL is the phase-locked loop control system which is locked at the acquisition start.

FFStart

Feed forward algorithm locked at the acquisition start.

*RST: PLLStart

Usage: Asynchronous command

Manual operation: See "[Algorithm](#)" on page 1138

CDR:SOFTware<m>:ESBRate:SOURce <BitrateSource>

Selects the source of the data stream, which is analyzed to recover the clock.

Suffix:

<m> 1..4
Number of the software CDR setup

Parameters:

<BitrateSource> C1W1 | C2W1 | C3W1 | C4W1 | R1 | R2 | R3 | R4

Usage: Asynchronous command

Manual operation: See "[Source](#)" on page 1137

CDR:SOFTware<m>:ESBRate:BREstimate

Estimates the bit rate once, for the current acquisition.

Suffix:
 <m> 1..4
 Number of the software CDR setup

Usage: Event
 Asynchronous command

CDR:SOFTware<m>:ESBRate:CONTInuous <BitrateEstimation>

Enables ongoing correction of the bit rate.

Suffix:
 <m> 1..4
 Number of the software CDR setup

Parameters:
 <BitrateEstimation> ON | OFF
 *RST: OFF

Usage: Asynchronous command

CDR:SOFTware<m>:ESSRate:SOURce <BitrateSource>

Selects the source of the data stream, which is analyzed to recover the clock.

Suffix:
 <m> 1..4
 Number of the software CDR setup

Parameters:
 <BitrateSource> C1W1 | C2W1 | C3W1 | C4W1 | M1 | M2 | M3 | M4 | M5 | M6 |
 M7 | M8 | R1 | R2 | R3 | R4 | DIFF1 | DIFF2 | COMMON1 |
 COMMON2 | LPDFE1 | LPDFE2 | LPDFE3 | LPDFE4 | LANE1 |
 LANE2 | LANE3 | LANE4

Usage: Asynchronous command

CDR:SOFTware<m>:ESSRate:SREStimate

Estimates the nominal bit rate once, for the current acquisition.

Suffix:
 <m> 1..4
 Number of the software CDR setup

Usage: Event
 Asynchronous command

Manual operation: See "[Bit rate estimation/Symbol rate estimation](#)" on page 1138

CDR:SOFTware<m>:ESSRate:CONTInuous <ContBitrateestim>

Enables ongoing correction of the nominal bit rate.

Suffix:

<m> 1..4
Number of the software CDR setup

Parameters:

<ContBitrateestim> ON | OFF
*RST: OFF

Usage: Asynchronous command

Manual operation: See "[Bit rate estimation/Symbol rate estimation](#)" on page 1138

CDR:SOFTware<m>:BITRate <Bitrate>

Sets the quiescent frequency of the PLL. It corresponds to the data rate of the data stream from which the clock is to be recovered.

Suffix:

<m> 1..4
Number of the software CDR setup

Parameters:

<Bitrate> Range: 100 to max {5 Gbps, <available instrument bandwidth>
Increment: 10
*RST: 1E+9
Default unit: bps

Usage: Asynchronous command

Manual operation: See "[Nominal bit rate/ Nominal symbol rate](#)" on page 1138

CDR:SOFTware<m>:ESLope <Edge>

Selects the edges of the data stream that are used for the clock recovery.

- "Either": Both positive and negative edges are used
- "Positive / Negative": Only one edge direction is used. Use one of these settings if the other edge might deliver unreliable results.

Suffix:

<m> 1..4
Number of the software CDR setup

Parameters:

<Edge> POSitive | NEGative | EITHer
*RST: EITHer

Usage: Asynchronous command

Manual operation: See "[Data edges](#)" on page 1138

CDR:SOFTware<m>:SYNC <InitialSync>

Defines the phase reference for the first clock edge.

Suffix:

<m> 1..4
Number of the software CDR setup

Parameters:

<InitialSync> SAMPLE | DATAedge

SAMPLE

The first clock edge matches the first sample of the waveform at the left border of the display.

DATAedge

The first clock edge matches the first edge of the data signal.

*RST: DATAedge

Usage: Asynchronous command

Manual operation: See "[Initial phase](#)" on page 1139

CDR:SOFTware<m>:RESults <Results>

The PLL requires some time to synchronize to the phase of the data stream. You can select when the CDR algorithm returns clock edges.

Suffix:

<m> 1..4
Number of the software CDR setup

Parameters:

<Results> ALL | AISync

ALL

All clock edges are used.

AISync

The clock edges of the synchronization time are discarded; results are gathered after initial synchronization of the CDR. Thus, meaningful TIE measurement results can be obtained.

*RST: ALL

Usage: Asynchronous command

Manual operation: See "[Selected results](#)" on page 1139

CDR:SOFTware<m>:PLL:ORDer <PLLOrder>

Sets the order of the PLL: first or second order. PLL of higher order can compensate for more complex jitter behavior.

Suffix:

<m> 1..4
Number of the software CDR setup

Parameters:

<PLLOrder> FIRSt | SEConD
 *RST: SEConD

Usage: Asynchronous command

Manual operation: See "[Algorithm settings](#)" on page 1139

CDR:SOFTware<m>:PLL:BWIDth <PLLBandwidth>

Sets the PLL bandwidth. It defines the part of the spectrum that the PLL can follow during synchronization. The PLL bandwidth is usually defined by the transmission standard.

Suffix:

<m> 1..4
 Number of the software CDR setup

Parameters:

<PLLBandwidth> Range: Nominal BITRate * Range of RELBwidth (dependent range)
 Increment: 10
 *RST: 599.88E+3
 Default unit: Hz

Usage: Asynchronous command

Manual operation: See "[Algorithm settings](#)" on page 1139

CDR:SOFTware<m>:PLL:RELBwidth <PLLRelBw>

Sets the relative bandwidth, that is the ratio of the nominal bit rate to the PLL bandwidth.

Suffix:

<m> 1..4
 Number of the software CDR setup

Parameters:

<PLLRelBw> Range: 10 to 5000
 Increment: 1
 *RST: 1667

Usage: Asynchronous command

Manual operation: See "[Algorithm settings](#)" on page 1139

CDR:SOFTware<m>:PLL:DAMPing <DampingFactor>

Sets the damping factor, which is only relevant for second order PLL.

Suffix:

<m> 1..4
 Number of the software CDR setup

Parameters:

<DampingFactor> Range: 0.5 to 2
 Increment: 0.01
 *RST: 0.7

Usage: Asynchronous command

Manual operation: See "[Algorithm settings](#)" on page 1139

CDR:SOFTware<m>:SYMRate <Bitrate>

Sets the quiescent frequency of the PLL. It corresponds to the data rate of the data stream from which the clock is to be recovered.

Suffix:

<m> 1..4
 Number of the software CDR setup

Parameters:

<Bitrate> Range: 100 to 5E+9
 Increment: 10
 *RST: 1E+9
 Default unit: bps

Usage: Asynchronous command

Manual operation: See "[Nominal bit rate/ Nominal symbol rate](#)" on page 1138

27.23.4 Clock data recovery (hardware-based, option R&S RTO6-K13)

CDR:HARDware:SOURce	2728
CDR:HARDware:BREStimate	2729
CDR:HARDware:BITRate	2729
CDR:HARDware:ESLope	2729
CDR:HARDware:PLL:ORDer	2729
CDR:HARDware:PLL:BWIDth	2730
CDR:HARDware:PLL:RELBwidth	2730
CDR:HARDware:PLL:DAMPing	2730
TRIGger<m>:LEVel<n>[:VALue]	2730

CDR:HARDware:SOURce <AnalogSource>

Selects the channel signal that is used for clock recovery.

Parameters:

<AnalogSource> C1 | C2 | C3 | C4
 *RST: C1

Usage: Asynchronous command

Manual operation: See "[Source](#)" on page 1141

CDR:HARDware:BREstimate

Estimates the bite rate once, for the current acquisition.

Usage: Event
Asynchronous command

Manual operation: See "[Estimate](#)" on page 1142

CDR:HARDware:BITRate <Bitrate>**Parameters:**

<Bitrate> Range: 200E+3 to 2.5E+9 for 10 GSa/s; range depends on sample rate
Increment: 10
*RST: 1E+9
Default unit: bps

Usage: Asynchronous command

Manual operation: See "[Nominal bit rate](#)" on page 1142

CDR:HARDware:ESLope <Edge>

Selects the edges of the data stream that are used for the clock recovery.

- "Either": Both positive and negative edges are used
- "Positive / Negative": Only one edge direction is used. Use one of these settings if the other edge might deliver unreliable results.

Parameters:

<Edge> POSitive | NEGative | EITHer
*RST: EITHer

Usage: Asynchronous command

Manual operation: See "[Data edges](#)" on page 1141

CDR:HARDware:PLL:ORDer <PLLOrder>

Sets the order of the PLL: first or second order. PLL of higher order can compensate for more complex jitter behavior.

Parameters:

<PLLOrder> FIRSt | SEConD
*RST: FIRSt

Usage: Asynchronous command

Manual operation: See "[PLL settings](#)" on page 1142

CDR:HARDware:PLL:BWIDth <PLLBandwidth>

Sets the PLL bandwidth. It defines the part of the spectrum that the PLL can follow during synchronization. The PLL bandwidth is usually defined by the transmission standard.

Parameters:

<PLLBandwidth>	Range:	Nominal BITRate * Range of RELBwidth (dependent range)
	Increment:	10
	*RST:	599.88E+3
	Default unit:	Hz

Usage: Asynchronous command

Manual operation: See ["PLL settings"](#) on page 1142

CDR:HARDware:PLL:RELBwidth <PLLRelBw>

Sets the relative bandwidth, that is the ratio of the nominal bit rate to the PLL bandwidth.

Parameters:

<PLLRelBw>	Range:	500 to 3000
	Increment:	1
	*RST:	1667

Usage: Asynchronous command

Manual operation: See ["PLL settings"](#) on page 1142

CDR:HARDware:PLL:DAMPing <DampingFactor>

Sets the damping factor, which is only relevant for second order PLL.

Parameters:

<DampingFactor>	Range:	0.5 to 1
	Increment:	0.01
	*RST:	0.7

Usage: Asynchronous command

Manual operation: See ["PLL settings"](#) on page 1142

TRIGger<m>:LEVel<n>[:VALue] <Level>

Sets the trigger level for the specified event and source.

If the trigger source is serial bus, the trigger level is set by the thresholds in the protocol configuration.

Suffix:

<m>	1..3
	1 = A-trigger, 2 = B-trigger, 3 = R-trigger

<n>	1..31 Indicates the trigger source: 1...4 = channel 1 to 4 5 = external trigger input 6...11 = not available 12...27 = R&S RT-ZVC input channels 28...31 = differential signals Diff1, Diff2 and Common1, Common2
Parameters:	
<Level>	Voltage for the trigger level. Range: Depends on vertical scale, channel offset and other settings. The trigger level must be within the current display range. Increment: 1E-3 *RST: 0 Default unit: V
Example:	TRIG:LEV5 0.01 Sets the trigger level for the external trigger signal to 10 mV. TRIG2:LEV3 0.2 Sets the trigger level for the B-event and B-trigger source channel 3 to 200 mV.
Usage:	Asynchronous command
Manual operation:	See " Level " on page 200

27.23.5 Serial pattern trigger using CDR

TRIGger<m>:SPATtern:CDR.....	2731
CDR:HARDware:SAMTime.....	2732

TRIGger<m>:SPATtern:CDR <CdrInUse>

Disables the clock source and enables the recovered clock signal generated by hardware CDR.

Suffix:

<m> 1..3
Only 1 = A-trigger, 2 | 3 = not available. Can be omitted.

Parameters:

<CdrInUse> ON | OFF
*RST: OFF

Usage: Asynchronous command

CDR:HARDware:SAMTime <UntIntvlOffs>

Sets a sampling time for the clock signal, an offset for the clock edge in relation to the bit start. The clock edge sets the beginning of the unit interval. The sampling time is a number between 0 and 1. Value 0 sets the clock edge to the beginning of the bit period; value 0.5 sets the clock edge to the middle of the bit period.

Parameters:

<UntIntvlOffs>	Range:	0 to 1
	Increment:	0.01
	*RST:	0.5
	Default unit:	UI

Usage: Asynchronous command

27.23.6 Eye mask testing

The eye mask testing is available if the option R&S RTO6-K12 is activated on the instrument.

The commands for eye mask testing are described in [Chapter 27.14.6, "Eye mask testing"](#), on page 1710.

27.24 Eye diagram analysis

The suffix EYE<m> selects the eye diagram to which the command applies. You can configure and analyze up to four eye diagrams in parallel.

There are two ways to generate eye diagrams on the R&S RTO6:

- Standard eye diagrams, which are a superposition of repetitively sampled digital data.
- To use advanced eye diagrams, option R&S RTO6-K136 or R&S RTO6-K91 is required.

27.24.1 Basic setup

EYE<m>[:STATe].....	2733
EYE<m>:SOURce.....	2733
EYE<m>:HORizontal[:UNIT].....	2733
EYE<m>:HORizontal:ABSolute:RANGe.....	2734
EYE<m>:HORizontal:ABSolute:POSition.....	2734
EYE<m>:HORizontal:UINterval:RANGe.....	2735
EYE<m>:HORizontal:UINterval:POSition.....	2735
EYE<m>:TIMReference:CLOCK:EDGE.....	2735
EYE<m>:TIMReference:CLOCK:FACTor.....	2735
EYE<m>:TIMReference:CLOCK:FREQuency.....	2736
EYE<m>:TIMReference:CLOCK:FREStimation.....	2736

EYE<m>:TIMReference:CLOCK:LEVel.....	2736
EYE<m>:TIMReference:CLOCK:OFEstimation.....	2737
EYE<m>:TIMReference:CLOCK:OFFSet.....	2737
EYE<m>:TIMReference:CLOCK:SOURce.....	2737
EYE<m>:TIMReference:PROTocol:SElect.....	2738
EYE<m>:TIMReference[:SOURce].....	2738
EYE<m>:TIMReference:CDR:SOFTWare.....	2738
EYE<m>:TIMReference:CDR[:SElect].....	2738
EYE<m>:MEASurement:MAXPrecision.....	2739
EYE<m>:VERTical:OFFSet.....	2739
EYE<m>:VERTical:POSition.....	2739
EYE<m>:VERTical:SCALe.....	2740
EYE<m>:TIMReference:CDR:SOFTWare:SAMTime.....	2740
EYE<m>:PAMorder?.....	2740
EYE<m>:SYMBOLrate?.....	2741
EYE<m>:BITRate?.....	2741

EYE<m>[:STATE] <State>

Activates or deactivates the eye diagram.

Suffix:

<m> 1..4

Parameters:

<State> ON | OFF
*RST: OFF

Usage: Asynchronous command

Manual operation: See "State" on page 1147

EYE<m>:SOURce <MainSource>

Selects the waveform from which the eye diagram is generated (data source). For analog channels, peak detect, envelope, and average waveforms are not supported.

Suffix:

<m> 1..4

Parameters:

<MainSource> C1W1 | C2W1 | C3W1 | C4W1 | M1 | M2 | M3 | M4 | M5 | M6 |
M7 | M8 | R1 | R2 | R3 | R4

Usage: Asynchronous command

Manual operation: See "Source" on page 1147

EYE<m>:HORizontal[:UNIT] <TimeUnits>

Sets the method to define the horizontal scale of the eye diagram.

Suffix:

<m> 1..4

Parameters:

<TimeUnits> ATIME | UINterval

ATIME

Absolute time

UINterval

Unit intervals. You can use unit interval, if the nominal frequency of the clock signal is known.

*RST: ATIME

Usage:

Asynchronous command

Manual operation: See ["Time units"](#) on page 1152**EYE<m>:HORizontal:ABSolute:RANGe** <HorizontalRange>

Sets the time range that is covered by the eye diagram.

Suffix:

<m> 1..4

Parameters:

<HorizontalRange> Range: 100E-12 to 100

Increment: 1E-9

*RST: 2E-9

Default unit: s

Usage:

Asynchronous command

Manual operation: See ["Range, Position"](#) on page 1152**EYE<m>:HORizontal:ABSolute:POSition** <HorizPosition>

Sets the place of the zero point in the diagram, in seconds. The zero point is the alignment point on which the slice timestamps are superimposed.

Suffix:

<m> 1..4

Parameters:

<HorizPosition> Range: -100 to 100

Increment: 1E-9

*RST: 0

Default unit: s

Usage:

Asynchronous command

Manual operation: See ["Range, Position"](#) on page 1152

EYE<m>:HORizontal:UINterval:RANGe <RangeUI>

Sets the number of unit intervals that are visible in the eye diagram.

Suffix:

<m> 1..4

Parameters:

<RangeUI> Range: 100E-12 to 100E+9
Increment: 0.01
*RST: 2
Default unit: UI

Usage: Asynchronous command

Manual operation: See "[Range UI](#), [Position UI](#)" on page 1153

EYE<m>:HORizontal:UINterval:POSition <PositionUI>

Sets the zero point in the diagram, in unit intervals. The zero point is the alignment point on which the segment timestamps are superimposed.

Suffix:

<m> 1..4

Parameters:

<PositionUI> Range: -100E+9 to 100E+9
Increment: 0.01
*RST: 0
Default unit: UI

Usage: Asynchronous command

Manual operation: See "[Range UI](#), [Position UI](#)" on page 1153

EYE<m>:TIMReference:CLOCK:EDGE <EdgeType>

The clock edge sets the point in time when the state of the data signal is checked.

Suffix:

<m> 1..4

Parameters:

<EdgeType> POSitive | NEGative | EITHer
*RST: EITHer

Usage: Asynchronous command

Manual operation: See "[Clock edge](#)" on page 1150

EYE<m>:TIMReference:CLOCK:FACTor <Factor>

Sets a clock multiplier factor.

Available if `EYE<m>:TIMReference[:SOURce]` is set to `CLOCK`.

Suffix:

<m> 1..4

Parameters:

<Factor> Range: 1 to 100
 Increment: 1
 *RST: 1

Usage: Asynchronous command**Manual operation:** See "[Clock multiplier](#)" on page 1150**EYE<m>:TIMReference:CLOCK:FREQuency <Frequency>**

Sets the clock frequency for the explicit clock signal.

Available if [EYE<m>:TIMReference\[:SOURce\]](#) is set to CLOCK.**Suffix:**

<m> 1..4

Parameters:

<Frequency> Range: 1000 to 10E+9
 Increment: 10
 *RST: 500E+6
 Default unit: Hz

Usage: Asynchronous command**Manual operation:** See "[Clock frequency](#)" on page 1150**EYE<m>:TIMReference:CLOCK:FREStimation**

Executes an estimation of the signal for the clock frequency.

Available if [EYE<m>:TIMReference\[:SOURce\]](#) is set to CLOCK.**Suffix:**

<m> 1..4

Usage: Event**Manual operation:** See "[Estimate clock frequency](#)" on page 1150**EYE<m>:TIMReference:CLOCK:LEVEl <Level>**

Sets the vertical reference level of the timing reference source.

Available if [EYE<m>:TIMReference\[:SOURce\]](#) is set to CLOCK.**Suffix:**

<m> 1..4

Parameters:

<Level> UPPer | MIDDle | LOWer
 *RST: MIDDle

Usage: Asynchronous command
Manual operation: See "[Vertical reference level](#)" on page 1150

EYE<m>:TIMReference:CLOCK:OFEStimation

Executes an estimation of the signal for the clock offset.

Available if `EYE<m>:TIMReference[:SOURce]` is set to `CLOCK`.

Suffix:
 <m> 1..4

Usage: Event

Manual operation: See "[Estimate clock offset](#)" on page 1151

EYE<m>:TIMReference:CLOCK:OFFSet <Offset>

Sets a clock offset for the explicit clock signal.

Available if `EYE<m>:TIMReference[:SOURce]` is set to `CLOCK`.

Suffix:
 <m> 1..4

Parameters:
 <Offset> Range: -1000 to 1000
 Increment: 0.01
 *RST: 0
 Default unit: UI

Usage: Asynchronous command

Manual operation: See "[Clock offset](#)" on page 1151

EYE<m>:TIMReference:CLOCK:SOURce <SourceType>

Selects the source of the clock channel, if `EYE<m>:TIMReference[:SOURce]` is set to `CLOCK`.

Suffix:
 <m> 1..4

Parameters:
 <SourceType> C1W1 | C2W1 | C3W1 | C4W1 | M1 | M2 | M3 | M4 | M5 | M6 |
 M7 | M8 | R1 | R2 | R3 | R4 | D0 | D1 | D2 | D3 | D4 | D5 | D6 |
 D7 | D8 | D9 | D10 | D11 | D12 | D13 | D14 | D15

Usage: Asynchronous command

Manual operation: See "[Clock](#)" on page 1148

EYE<m>:TIMReference:PROTOCOL:SElect <SerialBusIndex>

Selects the active bus for the eye analysis, if [EYE<m>:TIMReference\[:SOURCE\]](#) is set to PROTOCOL.

Suffix:

<m> 1..4

Parameters:

<SerialBusIndex> SBUS1 | SBUS2 | SBUS3 | SBUS4
*RST: SBUS1

Usage: Asynchronous command

Manual operation: See "[Protocol](#)" on page 1149

EYE<m>:TIMReference[:SOURCE] <ReferenceSource>

Selects the source of the reference signal used for the eye diagram.

Suffix:

<m> 1..4

Parameters:

<ReferenceSource> CLOCK | CDR | PROTOCOL
*RST: CDR

Usage: Asynchronous command

Manual operation: See "[Clock / CDR / Protocol](#)" on page 1147

EYE<m>:TIMReference:CDR:SOFTWARE <SoftwareCDRIIdx>

Selects the software CDR used for the reference signal of the the eye diagram.

Suffix:

<m> 1..4

Parameters:

<SoftwareCDRIIdx> SW1 | SW2 | SW3 | SW4
*RST: SW1

Usage: Asynchronous command

Manual operation: See "[CDR](#)" on page 1148

EYE<m>:TIMReference:CDR[:SElect] <CDRType>

Selects hardware or software clock data recovery.

Available, if [EYE<m>:TIMReference\[:SOURCE\]](#) is set to CDR.

Suffix:

<m> 1..4

Parameters:

<CDRType> SW | HW
 *RST: SW

Usage: Asynchronous command

Manual operation: See "[CDR](#)" on page 1148

EYE<m>:MEASurement:MAXPrecision <EnabClassifier>

If this function is enabled, the rising and falling transitions for the eye measurements "Eye rise time", "Eye fall time" and "Duty cycle distortion" are separated.

Suffix:

<m> 1..4

Parameters:

<EnabClassifier> ON | OFF
 *RST: OFF

Usage: Asynchronous command

Manual operation: See "[Maximum precision](#)" on page 1168

EYE<m>:VERTical:OFFSet <VerticalOffset>

The offset voltage is subtracted to correct an offset-affected signal.

Suffix:

<m> 1..4

Parameters:

<VerticalOffset> Range: -100E+24 to 100E+24
 Increment: 0.01
 *RST: 0
 Default unit: V

Usage: Asynchronous command

Manual operation: See "[Offset](#)" on page 1153

EYE<m>:VERTical:POSition <VertPosi>

Sets the vertical position of the indicated eye as a graphical value.

Suffix:

<m> 1..4

Parameters:

<VertPosi> Range: -100E+24 to 100E+24
 Increment: 0.1
 *RST: 0
 Default unit: div

Usage: Asynchronous command

Manual operation: See "[Position](#)" on page 1153

EYE<m>:VERTical:SCALE <VerticalScale>

Sets the vertical scale for the indicated eye.

Suffix:

<m> 1..4

Parameters:

<VerticalScale> Range: 1E-12 to 100
 Increment: 1E-3
 *RST: 0.05
 Default unit: V/div

Usage: Asynchronous command

Manual operation: See "[Scale](#)" on page 1153

EYE<m>:TIMReference:CDR:SOFTware:SAMTime <SamplingTime>

Sets the sampling time for the software CDR.

Available, if [EYE<m>:TIMReference\[:SOURce\]](#) is set to CDR and [EYE<m>:TIMReference:CDR\[:SElect\]](#) is set to SW.

Suffix:

<m> 1..4

Parameters:

<SamplingTime> Range: 0 to 1
 Increment: 0.01
 *RST: 0.5
 Default unit: UI

Usage: Asynchronous command

Manual operation: See "[CDR](#)" on page 1148

EYE<m>:PAMorder?

Queries the PAM order of the selected eye source.

Suffix:

<m> 1..4

Return values:

<PAMOrder> PAM2 | PAM3 | PAM4 | PAM5 | PAM6 | PAM7 | PAM8
 *RST: PAM2

Usage: Query only
 Asynchronous command

EYE<m>:SYMBOLrate?

Queries the symbol rate of the selected eye source.

Suffix:

<m> 1..4

Return values:

<Bitrate> Range: 1000 to 16E+9
Increment: 1
*RST: 2E+9
Default unit: bps

Usage: Query only
Asynchronous command

EYE<m>:BITRate?

Queries the bit rate of the selected eye source.

Suffix:

<m> 1..4

Return values:

<Bitrate> Range: 1000 to 16E+9
Increment: 1
*RST: 2E+9
Default unit: bps

Usage: Query only
Asynchronous command

27.24.2 Display

EYE<m>:MSLices <MaxSliceCount>

Sets the number of waveform slices for a single acquisition.

Suffix:

<m> 1..4

Parameters:

<MaxSliceCount> Range: 1 to 2500000
Increment: 1
*RST: 2000

Usage: Asynchronous command

Manual operation: See "[Slices per acquisition \(Upper limit\)](#)" on page 1151

EYE<m>:DISPlay:MODE <EyestripeMode>

Defines when the eye stripe is shown: always, never, or during mask tests.

Suffix:

<m> 1..4

Parameters:

<EyestripeMode> ALWays | MTONly | NEVer
 MTONly: Mask test only
 *RST: MTONly

Usage: Asynchronous command**Manual operation:** See "[Display mode](#)" on page 1155**EYE<m>:DISPlay:PERSistence:INFinite <State>**

If persistence is enabled ([EYE<m>:DISPlay:PERSistence:STATe](#)), each new data point in the diagram area remains on the screen infinitely until this command is set to OFF.

Suffix:

<m> 1..4

Parameters:

<State> ON | OFF
 *RST: OFF

Usage: Asynchronous command**Manual operation:** See "[Infinite persistence](#)" on page 1155**EYE<m>:DISPlay:PERSistence:RESet**

Resets the display, removing persistent values.

Suffix:

<m> 1..4

Usage:

Event
 Asynchronous command

Manual operation: See "[Reset](#)" on page 1155**EYE<m>:DISPlay:PERSistence:STATe <State>**

If enabled, each new data point in the diagram area remains on the screen for the duration defined using [EYE<m>:DISPlay:PERSistence:TIME](#), or as long as [EYE<m>:DISPlay:PERSistence:INFinite](#) is enabled.

If disabled, the signal value is only displayed as long as it actually occurs.

Suffix:

<m> 1..4

Parameters:

<State> ON | OFF
 *RST: ON

Usage: Asynchronous command

Manual operation: See "Enable" on page 1155

EYE<m>:DISPlay:PERSistence:TIME <Time>

If persistence is enabled (**EYE<m>:DISPlay:PERSistence:STATe**), each new data point in the diagram area remains on the screen for the duration defined here.

Suffix:

<m> 1..4

Parameters:

<Time> Range: 0.05 to 50
 Increment: 0.05
 *RST: 0.05
 Default unit: s

Usage: Asynchronous command

Manual operation: See "Time" on page 1155

27.24.3 Qualify: gate settings

EYE<m>:QUALify:GATE[:STATe]	2743
EYE<m>:QUALify:GATE:COUPling	2744
EYE<m>:QUALify:GATE:MODE	2744
EYE<m>:QUALify:GATE:ABSolute:START	2744
EYE<m>:QUALify:GATE:ABSolute:STOP	2744
EYE<m>:QUALify:GATE:RELative:START	2745
EYE<m>:QUALify:GATE:RELative:STOP	2745
EYE<m>:QUALify:GATE:CURSor	2745
EYE<m>:QUALify:GATE:ZDIagram	2745

EYE<m>:QUALify:GATE[:STATe] <State>

Enables the gate.

Suffix:

<m> 1..4

Parameters:

<State> ON | OFF
 *RST: OFF

Usage: Asynchronous command

Manual operation: See "Gate" on page 1156

EYE<m>:QUALify:GATE:COUPling <CouplingMode>

Sets the gate coupling. To use cursor lines or zoom areas as gate limits, the cursor or zoom must be defined before.

Suffix:

<m> 1..4

Parameters:

<CouplingMode> NONE | CURSor | ZOOM
*RST: NONE

Usage: Asynchronous command

Manual operation: See "Gate" on page 1156

EYE<m>:QUALify:GATE:MODE <Mode>

Defines whether the gate limit is defined in absolute or relative values when no gate coupling is set.

Suffix:

<m> 1..4

Parameters:

<Mode> ABS | REL
*RST: ABS

Usage: Asynchronous command

Manual operation: See "Gate" on page 1156

EYE<m>:QUALify:GATE:ABSolute:START <Start>**EYE<m>:QUALify:GATE:ABSolute:STOP <Stop>**

Set the absolute time values for gate start and gate end.

Suffix:

<m> 1..4

Parameters:

<Start>, <Stop> Range: -100E+24 to 100E+24
Increment: 0.01
*RST: 0.01

Example:

Gate definition for eye diagram 2 in absolute time values:

```
EYE2:QUALify:GATE:COUPling NONE
EYE2:QUALify:GATE:MODE ABS
EYE2:QUALify:GATE:ABSolute:START -0.0002
EYE2:QUALify:GATE:ABSolute:STOP 0.0002
```

Usage: Asynchronous command

Manual operation: See "Gate" on page 1156

EYE<m>:QUALify:GATE:RELative:START <RelativeStart>

EYE<m>:QUALify:GATE:RELative:STOP <RelativeStop>

Set the relative values for gate start and gate end.

Suffix:

<m> 1..4

Parameters:

<RelativeStart>, Range: 0 to 100
 <RelativeStop> Increment: 0.1
 *RST: 100
 Default unit: %

Example:

Gate definition for eye diagram 2 in relative values:

```
EYE2:QUALify:GATE:COUPLing NONE
EYE2:QUALify:GATE:MODE REL
EYE2:QUALify:GATE:RELative:START 10
EYE2:QUALify:GATE:RELative:STOP 90
```

Usage: Asynchronous command

Manual operation: See "[Gate](#)" on page 1156

EYE<m>:QUALify:GATE:CURSor <Cursorset>

Selects the cursor set to be used for eye gating. The gate area is defined by the cursor lines.

Suffix:

<m> 1..4

Parameters:

<Cursorset> CURSOR1 | CURSor1 | CURSOR2 | CURSor2 | CURSOR3 |
 CURSor3 | CURSOR4 | CURSor4
 CURSOR1 = CURSor1, CURSOR2 = CURSor2, CURSOR3 =
 CURSor3, CURSOR4 = CURSor4
 *RST: CURSOR1

Example:

Gate definition for eye diagram 2 with cursor coupling:

```
EYE2:QUALify:GATE:COUPLing CURSor
EYE2:QUALify:GATE:CURSor CURSor1
```

Usage: Asynchronous command

Manual operation: See "[Gate](#)" on page 1156

EYE<m>:QUALify:GATE:ZDiagram <ZoomDiagram>

Selects the zoom diagram to be used for eye gating. The zoom area is used as gate.

Suffix:

<m> 1..4

Parameters:	
<ZoomDiagram>	String with the name of the zoom diagram
Example:	Gate definition for eye diagram 2 with zoom coupling: EYE2:QUALify:GATE:COUPling ZOOM EYE2:QUALify:GATE:ZDIagram "Zoom1"
Usage:	Asynchronous command
Manual operation:	See "Gate" on page 1156

27.24.4 Qualify: signal settings

EYE<m>:QUALify:SIGNal[:STATe].....	2746
EYE<m>:QUALify:SIGNal:SOURce.....	2746
EYE<m>:QUALify:SIGNal:CONDition.....	2746
EYE<m>:QUALify:SIGNal:LSElect.....	2747

EYE<m>:QUALify:SIGNal[:STATe] <State>

Enables the waveform-based qualification for the eye generation.

Suffix:

<m> 1..4

Parameters:

<State> ON | OFF
*RST: OFF

Usage: Asynchronous command

Manual operation: See ["State"](#) on page 1157

EYE<m>:QUALify:SIGNal:SOURce <Source>

Selects the waveform to be compared.

Suffix:

<m> 1..4

Parameters:

<Source> C1W1 | C2W1 | C3W1 | C4W1 | M1 | M2 | M3 | M4 | M5 | M6 |
M7 | M8 | R1 | R2 | R3 | R4

Usage: Asynchronous command

Manual operation: See ["Source"](#) on page 1157

EYE<m>:QUALify:SIGNal:CONDition <Condition>

Selects the comparison condition for the the waveform level.

Suffix:

<m> 1..4

Parameters:

<Condition> LTHan | GTHan | INRange | OORange
 *RST: GTHan

Usage:

Asynchronous command

Manual operation: See "[Condition](#)" on page 1157

EYE<m>:QUALify:SIGNal:LSElect <LevelSelection>

Selects the threshold. You can use the lower, middle, or upper reference level. These levels are the reference levels that are defined for measurements.

Suffix:

<m> 1..4

Parameters:

<LevelSelection> UPPer | MIDDle | LOWer
 *RST: MIDDle

Example:

The slices of the channel 1 signal only contribute to the eye generation if the voltage level of the signal on channel 2 is higher than the upper reference level.

```
EYE:SOURce C1W1
EYE:QUALify:SIGNal:SOURce C2W1
EYE:QUALify:SIGNal:CONDition GTHan
EYE:QUALify:SIGNal:LSElect UPPer
EYE:QUALify:SIGNal ON
```

Usage:

Asynchronous command

Manual operation: See "[Vertical reference level](#)" on page 1157

27.24.5 Filter

EYE<m>:FILTer:STATe.....	2748
EYE<m>:FILTer:BPATtern:MODE.....	2748
EYE<m>:FILTer:BPATtern:PREFix<1..8>.....	2748
EYE<m>:FILTer:BPATtern:CENTer.....	2748
EYE<m>:FILTer:BPATtern:SUFFix<1..5>.....	2748
EYE<m>:FILTer:BPATtern:SLEFt.....	2749
EYE<m>:FILTer:BPATtern:SRIGHt.....	2749
EYE<m>:FILTer:BPATtern:RESet.....	2749
EYE<m>:FILTer:DDR:FTYPe.....	2749
EYE<m>:FILTer:DDR:LENerror.....	2750
EYE<m>:FILTer:PAMN:BLEVel.....	2750
EYE<m>:FILTer:PAMN:EMODE.....	2750
EYE<m>:FILTer:PAMN:SEYE.....	2751
EYE<m>:FILTer:PAMN:TLEVel.....	2751

EYE<m>:FILTer:STATe <State>

Applies the filter settings to the data signal.

Suffix:

<m> 1..4

Parameters:

<State> ON | OFF
*RST: OFF

Usage: Asynchronous command

Manual operation: See "Enable" on page 1158

EYE<m>:FILTer:BPATtern:MODE <Mode>

Selects which bits contribute to the eye generation.

Suffix:

<m> 1..4

Parameters:

<Mode> ABITs | LTRansition | CLEVel | BPATtern

ABITs

All bits contribute to the eye diagram, same as [EYE<m>:FILTer:STATe](#) is OFF.

LTRansition

Level transition, only bits after a signal transition contribute (0 to 1, or 1 to 0).

CLEVel

Constant level, only bits without a preceding signal transition contribute (0 to 0, or 1 to 1).

BPATtern

Only bits contribute that match the defined pattern before and after the center eye.

*RST: ABITs

Usage: Asynchronous command

Manual operation: See "Mode" on page 1158

EYE<m>:FILTer:BPATtern:PREFix<1..8> <Bit>**EYE<m>:FILTer:BPATtern:CENTer <BitValue>****EYE<m>:FILTer:BPATtern:SUFFix<1..5> <Bit>**

Set the values of the indicated prefix, center, and suffix bits.

Suffix:

<m> 1..4

Parameters:

<Bit> ONE | ZERO | DC
DC: don't care

Manual operation: See ["Pattern"](#) on page 1159

EYE<m>:FILTer:BPATtern:SLEFt

Shifts the pattern one bit to the left.

Suffix:

<m> 1..4

Usage:

Event
Asynchronous command

Manual operation: See ["Pattern control"](#) on page 1159

EYE<m>:FILTer:BPATtern:SRIGHt

Shifts the pattern one bit to the right.

Suffix:

<m> 1..4

Usage:

Event
Asynchronous command

Manual operation: See ["Pattern control"](#) on page 1159

EYE<m>:FILTer:BPATtern:RESet

Resets the bit sequence filter to the default (DC for all bits).

Suffix:

<m> 1..4

Usage:

Event
Asynchronous command

Manual operation: See ["Pattern control"](#) on page 1159

EYE<m>:FILTer:DDR:FTYPE <CommTyp>

Sets which frame types contribute to the eye diagram.

Suffix:

<m> 1..4

Parameters:

<CommTyp> ANY | ANYC | READ | WRITe | RDNC | WRNC
 ANYC: any consecutive
 RDNC: read non-consecutive
 WRNC: write non-consecutive
 *RST: ANY

Usage: Asynchronous command

Manual operation: See "[Frame Type](#)" on page 1160

EYE<m>:FILTer:DDR:LEnError <CommTyp>

If enabled, the length errors contribute to the eye diagram.

Suffix:

<m> 1..4

Parameters:

<CommTyp> ON | OFF
 *RST: OFF

Usage: Asynchronous command

Manual operation: See "[Length Error](#)" on page 1160

EYE<m>:FILTer:PAMN:BLEVeI <PAMNSelcEyeBaseLev>

Selects the base level for the PAM-N signal eye, if [EYE<m>:FILTer:PAMN:EMODe](#) is set to `SElected`.

Suffix:

<m> 1..4

Parameters:

<PAMNSelcEyeBaseLev> LEVEL0 | LEVEL1 | LEVEL2 | LEVEL3 | LEVEL4 | LEVEL5 |
 LEVEL6
 *RST: LEVEL0

Usage: Asynchronous command

Manual operation: See "[PAM-N diagram filter mode](#)" on page 1161

EYE<m>:FILTer:PAMN:EMODe <PAMNEyeSel>

Selects the filter mode for PAM-N signals. It defines which part of the signal is used to build the eye.

Suffix:

<m> 1..4

Parameters:

<PAMNEyeSel> WHOLe | SPECific | SElected

WHOLe

Displays all level transitions of the selected source.

SPECific

Displays an explicit eye opening (e.g. for level transition 1-2) with all involved level transitions. You can select the eye with `EYE<m>:FILTer:PAMN:SEYE`.

SElected

Displays an explicit eye opening (e.g. for level transition 1-2) with only its own level transitions. You can select the base level (`EYE<m>:FILTer:PAMN:BLEVel`) and target level (`EYE<m>:FILTer:PAMN:TLEVel`).

*RST: WHOLe

Usage: Asynchronous command

Manual operation: See "PAM-N diagram filter mode" on page 1161

EYE<m>:FILTer:PAMN:SEYE <PAMNSpecificEye>

Selects the specific eye for the PAM-N signal eye, if `EYE<m>:FILTer:PAMN:EMODE` is set to `SPECific`.

Suffix:

<m> 1..4

Parameters:

<PAMNSpecificEye> EYE1 | EYE2 | EYE3 | EYE4 | EYE5 | EYE6 | EYE7
*RST: EYE1

Usage: Asynchronous command

Manual operation: See "PAM-N diagram filter mode" on page 1161

EYE<m>:FILTer:PAMN:TLEVel <PAMNSelcEyeTargetLev>

Selects the target level for the PAM-N signal eye, if `EYE<m>:FILTer:PAMN:EMODE` is set to `SElected`.

Suffix:

<m> 1..4

Parameters:

<PAMNSelcEyeTargetLev> LEVEL1 | LEVEL2 | LEVEL3 | LEVEL4 | LEVEL5 | LEVEL6 | LEVEL7
*RST: LEVEL1

Usage: Asynchronous command

Manual operation: See "PAM-N diagram filter mode" on page 1161

27.24.6 Results of eye

EYE<m>:RESult:SLICe<n>:COUNT?	2752
EYE<m>:RESult:SLICe<n>:LPOSition?	2752
EYE<m>:RESult:SLICe<n>[:POSition]?	2752
EYE<m>:RESult:TACQs?	2753
EYE<m>:RESult:TSLices?	2753

EYE<m>:RESult:SLICe<n>:COUNT?

Returns the number of filtered bits.

Suffix:

<m>	1..4
<n>	*
	Not relevant

Return values:

<Count>

Usage: Query only

EYE<m>:RESult:SLICe<n>:LPOSition?

Returns the position of the last slice in the acquisition.

Suffix:

<m>	1..4
<n>	*

Return values:

<LastPosition>

Usage: Query only

EYE<m>:RESult:SLICe<n>[:POSition]?

Returns the position of the filtered bit in the acquisition.

Suffix:

<m>	1..4
<n>	*

Return values:

<Position> Range: -100 to 100
 Increment: 1E-3
 *RST: 0
 Default unit: s

Usage: Query only
 Asynchronous command

EYE<m>:RESult:TACQs?

Returns the total number of acquisitions accumulated into the eye.

Suffix:

<m> 1..4

Return values:

<Acquisitions> Range: 0 to 1000000000
Increment: 1
*RST: 0

Usage:

Query only
Asynchronous command

EYE<m>:RESult:TSLices?

Returns the total number of slices accumulated into the eye.

Suffix:

<m> 1..4

Return values:

<Slices> Range: 0 to 1000000000
Increment: 1
*RST: 0

Usage:

Query only
Asynchronous command

27.24.7 Results of mask tests on eye diagrams

MTESt:RESult:COUNT:SLICes?	2753
MTESt:RESult:COUNT:FSLices?	2754
MTESt:RESult:VIOLation<m>:COUNT?	2754
MTESt:RESult:VIOLation<m>[:SLICe]?	2754
MTESt:RESult:VIOLation<m>:STARt?	2755
MTESt:RESult:VIOLation<m>:STOP?	2755
EYE<m>:ZCOupling	2755
EYE<m>:ZDIagram	2755

MTESt:RESult:COUNT:SLICes? <MaskTestName>

Returns the number of slices that contributed to the eye diagram.

Query parameters:

<MaskTestName> String parameter

Return values:

<SlicesCompleted> Range: 0 to 100E+24
Increment: 1
*RST: 0

Usage: Query only
Asynchronous command

MTESt:RESult:COUNT:FSLices? <MaskTestName>

Returns the number of slices that violated the mask.

Query parameters:

<MaskTestName> String parameter

Return values:

<SliceHits> Range: 0 to 100E+24
Increment: 1
*RST: 0

Usage: Query only
Asynchronous command

MTESt:RESult:VIOLation<m>:COUNT? <MaskTestName>

Suffix:

<m> *
Violation index, corresponds to the number in the "Violation" column of mask test result.

Query parameters:

<MaskTestName>

Return values:

<Count>

Usage: Query only

MTESt:RESult:VIOLation<m>[:SLICE]? <MaskTestName>

Suffix:

<m> *
Violation index, corresponds to the number in the "Violation" column of mask test result.

Query parameters:

<MaskTestName>

Return values:

<Slice> Range: 0 to 4294967295
Increment: 1
*RST: 0

Usage: Query only
Asynchronous command

MTESt:RESult:VIOLation<m>:START? <MaskTestName>

MTESt:RESult:VIOLation<m>:STOP? <MaskTestName>

Return the start and stop time of the slice with the indicated violation.

Suffix:

<m> *
Violation index, corresponds to the number in the "Violation" column of mask test result.

Query parameters:

<MaskTestName>

Return values:

<Time> Range: -100 to 100
Increment: 1E-3
*RST: 0
Default unit: s

Usage:

Query only
Asynchronous command

EYE<m>:ZCOupling <ZoomCoupling>

If enabled, the mask eye area is set to the limits of a zoom area.

The zoom diagram is selected using [EYE<m>:ZDIagram](#).

Suffix:

<m> 1..4

Parameters:

<ZoomCoupling> ON | OFF
*RST: OFF

Usage:

Asynchronous command

EYE<m>:ZDIagram <ZoomDiagram>

Selects the zoom to which the eye mask area is set if [EYE<m>:ZCOupling](#) is enabled.

Suffix:

<m> 1..4

Parameters:

<ZoomDiagram> String with the name of the diagram on which the zoom is based

Usage:

Asynchronous command

27.25 Power analysis (option R&S RTO6-K31)

• General.....	2756
• Deskew.....	2757
• Report.....	2758
• Power quality.....	2764
• Inrush current.....	2766
• Current harmonic.....	2768
• Modulation analysis.....	2771
• Dynamic ON resistance.....	2773
• Slew rate.....	2774
• S.O.A.....	2777
• Turn on/off.....	2780
• Switching loss.....	2782
• Power efficiency.....	2785
• Ripple.....	2786
• Transient response.....	2793
• Spectrum.....	2796

27.25.1 General

POWER:ENABLE.....	2756
POWER:SOURce:CURRent<1..2>.....	2756
POWER:SOURce:VOLTage<1..4>.....	2757

POWER:ENABLE

Activates the power mode and initializes the power measurements. If the power mode is disabled, the instrument does not accept any `POWER` command.

Use `POWER:ENABLE` after each `*RST`.

Example: See [Chapter 27.3.8.1, "Auto deskew"](#), on page 1363

Usage: Event
Asynchronous command

POWER:SOURce:CURRent<1..2> <CurrentSource>

Sets the channel for the current source.

Parameters:

<CurrentSource> CHAN1 | CHANnel1 | CHAN2 | CHANnel2 | CHAN3 |
 CHANnel3 | CHAN4 | CHANnel4

CHAN1 = CHANnel1, CHAN2 = CHANnel2, CHAN3 = CHAN-
nel3, CHAN4 = CHANnel4

*RST: CURRent1: CHAN2, CURRent2: CHAN4,

Usage: Asynchronous command

Manual operation: See ["Current Source"](#) on page 1183

POWER:SOURce:VOLTage<1..4> <VoltageSource>

Sets the channel for the voltage source input.

Parameters:

<VoltageSource> CHAN1 | CHANnel1 | CHAN2 | CHANnel2 | CHAN3 |
 CHANnel3 | CHAN4 | CHANnel4
 CHAN1 = CHANnel1, CHAN2 = CHANnel2, CHAN3 = CHAN-
 nel3, CHAN4 = CHANnel4
 *RST: VOLTage1: CHAN1, VOLTage2: CHAN3, VOLT-
 age3: CHAN3, VOLTage4: CHAN4

Usage: Asynchronous command

Manual operation: See ["Voltage Source"](#) on page 1184

27.25.2 Deskew

Programming example: [Chapter 27.3.8.1, "Auto deskew"](#), on page 1363

POWER:DESKew:CURRent	2757
POWER:DESKew:EXECute	2757
POWER:DESKew:RESet	2757
POWER:DESKew:TIME?	2758
POWER:DESKew:UDPReset	2758

POWER:DESKew:CURRent

Applies the result of the auto deskew to the "Skew offset" value.

Usage: Event

Manual operation: See ["Auto deskew result"](#) on page 1175

POWER:DESKew:EXECute

Starts the auto deskew.

Usage: Event

Manual operation: See ["Auto Deskew"](#) on page 1176

POWER:DESKew:RESet <OverwriteCurrSkew>

Overwrites the present skew setup.

Parameters:

<OverwriteCurrSkew>ON | OFF
 *RST: ON

Manual operation: See ["Overwrite present skew setup"](#) on page 1175

POWer:DESKew:TIME?

Queries the result of the auto deskew.

Return values:

<AutoDeskewOffs> Range: -100E-9 to 100E-9
 *RST: 0
 Default unit: s

Usage: Query only

Manual operation: See ["Auto deskew result"](#) on page 1175

POWer:DESKew:UDPReset <UsrDefinedPreset>

Activates or deactivates a user defined setup. If ON, the instrument setup including probe setup and the deskew values are written to a user defined preset file (saveset) that can be loaded using [MMEMory:RCL](#) on page 1763.

The default path is:

C:\Users\Public\Documents\Rohde-Schwarz\RTO6\SaveSets\

Parameters:

<UsrDefinedPreset> ON | OFF
 *RST: ON

Manual operation: See ["Activate user defined preset"](#) on page 1176

27.25.3 Report

POWer:REPort:CONTent:HSETup	2759
POWer:REPort:CONTent:MSETup	2759
POWer:REPort:CONTent:MSIGNAL	2759
POWer:REPort:CONTent:RESU	2759
POWer:REPort:CONTent:SETTings	2759
POWer:REPort:CONTent:TSETup	2759
POWer:REPort:CONTent:VSETup	2759
POWer:REPort:CONTent:TITLe	2759
POWer:REPort:DESCRiption	2759
POWer:REPort:DUT	2759
POWer:REPort:SITe	2759
POWer:REPort:TEMPerature	2759
POWer:REPort:USER	2759
POWer:REPort:FONT:COLO	2760
POWer:REPort:FONT:FAMI	2760
POWer:REPort:FONT:SIZE	2760
POWer:REPort:LOGO	2760
POWer:REPort:PAPerSize	2760

POWer:REPort:FILE:NAME.....	2761
POWer:REPort:FILE:DELeTe.....	2761
POWer:REPort:FILE:NEw.....	2761
POWer:REPort:FILE:SAVE.....	2761
POWer:REPort:TEST:ADD.....	2761
POWer:REPort:TEST:INSErt.....	2761
POWer:REPort:TEST:REMOve.....	2761
POWer:REPort:INVert.....	2762
POWer:REPort:TEST:DSEA.....	2762
POWer:REPort:TEST:ISE.....	2762
POWer:REPort:TEST:SEA.....	2762
POWer:REPort:TEST:RSE.....	2762
POWer:REPort:TEST:DIRectory.....	2763
POWer:REPort:TEST:COMMEnt.....	2763
POWer:REPort:TEST:COUNt.....	2764
POWer:REPort:TEST:LSEnd?.....	2764

POWer:REPort:CONTent:HSETup <ContentHorizSet>
POWer:REPort:CONTent:MSETup <ContentMeasSet>
POWer:REPort:CONTent:MSIGNAL <ContentMeasuredSigns>
POWer:REPort:CONTent:RESU <ContentResults>
POWer:REPort:CONTent:SETTings <ContentSettings>
POWer:REPort:CONTent:TSETup <ContentTrigSet>
POWer:REPort:CONTent:VSETup <ContentVertSet>

Sets how often the respective content is shown in the final report.

Parameters:

<ContentVertSet> ALWAYS | NEVER | ONCE
 *RST: ONCE

Manual operation: See "[Vertical Setup](#)" on page 1182

POWer:REPort:CONTent:TITLe <ContentTitle>

Includes the title page in the report.

Parameters:

<ContentTitle> ON | OFF
 *RST: ON

Manual operation: See "[Title Page](#)" on page 1182

POWer:REPort:DESCRiption <String>
POWer:REPort:DUT <String>
POWer:REPort:SITE <String>
POWer:REPort:TEMPERature <String>
POWer:REPort:USER <String>

The content of the strings is shown at the title page of a report if the title page is included in the report.

Parameters:

<String>

Manual operation: See ["User"](#) on page 1177

POWER:REPort:FONT:COLO <FontColor>

Sets the font color.

Parameters:

<FontColor>	Range:	0 to 4294967295
	Increment:	1
	*RST:	0

Manual operation: See ["Color"](#) on page 1181

POWER:REPort:FONT:FAMI <FontFamily>

Selects the font family. You can choose between Arial and Helvetica.

Parameters:

<FontFamily>	ARIAL HELV
	*RST: ARIAL

Manual operation: See ["Family"](#) on page 1180

POWER:REPort:FONT:SIZE <FontSize>

Sets the font size.

Parameters:

<FontSize>	Range:	10 to 30
	Increment:	1
	*RST:	12

Manual operation: See ["Size"](#) on page 1181

POWER:REPort:LOGO <LogoFile>

Selects a path to a logo picture file.

Parameters:

<LogoFile>

Manual operation: See ["Logo File"](#) on page 1181

POWER:REPort:PAPersize <PaperSize>

Set the layout of your report.

Parameters:

<PaperSize> A4 | USL
 *RST: A4

Manual operation: See "[Paper size](#)" on page 1180

POWer:REPort:FILE:NAME <Path>

Defines the path and file name of the report file that is to be created, saved, or deleted.

Parameters:

<Path> String containing path and file name

Manual operation: See "[Report Path](#)" on page 1179

POWer:REPort:FILE:DELeTe

Deletes the selected report file.

Usage: Event

Manual operation: See "[Report Path](#)" on page 1179

POWer:REPort:FILE:NEw

Creates a new report file.

Usage: Event

Manual operation: See "[Report Path](#)" on page 1179

POWer:REPort:FILE:SAVE

Saves the report file.

Usage: Event

Manual operation: See "[Report Path](#)" on page 1179

POWer:REPort:TEST:ADD <MeasType>

POWer:REPort:TEST:INSert <MeasType>, <Index>

POWer:REPort:TEST:REMOve <MeasType>, <Index>

Manage reports.

Setting parameters:

<MeasType> QUAL | RUSH | HARM | MODU | DONR | SLEW | SOA | TURN |
 SWIT | EFF | RIPP | TRANS | SPEC

QUAL

Power Quality

RUSH

Inrush Current

HARM

Current Harmonic

MODU

Modulation Analysis

DONR

Dynamic ON Resistance

SLEW

Slew Rate

SOA

Safe Operating Area (S.O.A.)

TURN

Turn On/Off

SWIT

Switching Loss

EFF

Power Efficiency

RIPP

Ripple

TRANS

Transient Response

SPEC

Spectrum

<Index>

Usage: Setting only**Manual operation:** See "[Report Table](#)" on page 1178**POWer:REPort:INVert** <InvertScreenshotClr>**POWer:REPort:TEST:DSEA** <MeasType>**POWer:REPort:TEST:ISE** <MeasType>**POWer:REPort:TEST:SEA** <MeasType>**POWer:REPort:TEST:RSE** <MeasType>

Manage the selection of reports.

Parameters:<MeasType> QUAL | RUSH | HARM | MODU | DONR | SLEW | SOA | TURN |
SWIT | EFF | RIPP | TRANS | SPEC**QUAL**

Power Quality

RUSH

Inrush Current

HARM

Current Harmonic

MODU

Modulation Analysis

DONR

Dynamic ON Resistance

SLEW

Slew Rate

SOA

Safe Operating Area (S.O.A.)

TURN

Turn On/Off

SWIT

Switching Loss

EFF

Power Efficiency

RIPP

Ripple

TRANS

Transient Response

SPEC

Spectrum

Manual operation: See ["Remove selected"](#) on page 1179**POWER:REPort:TEST:DIRectory** <MeasType>, <DirectoryPath>**POWER:REPort:TEST:DIRectory?** <MeasType>

Selects the directory, in which the reports are saved.

Setting parameters:

<DirectoryPath>

Parameters for setting and query:<MeasType> QUAL | RUSH | HARM | MODU | DONR | SLEW | SOA | TURN |
SWIT | EFF | RIPP | TRANS | SPEC**Manual operation:** See ["Directory"](#) on page 1179**POWER:REPort:TEST:COMMent** <MeasType>, <Comment>**POWER:REPort:TEST:COMMent?** <MeasType>

Sets a comment for the report.

Setting parameters:

<Comment>

Parameters for setting and query:<MeasType> QUAL | RUSH | HARM | MODU | DONR | SLEW | SOA | TURN |
SWIT | EFF | RIPP | TRANS | SPEC**Manual operation:** See ["Report Table"](#) on page 1178

POWER:REPort:TEST:COUNT <MeasType>**Parameters:**

<MeasType> QUAL | RUSH | HARM | MODU | DONR | SLEW | SOA | TURN |
SWIT | EFF | RIPP | TRANS | SPEC

Return values:

<Count>

Manual operation: See ["Report Table"](#) on page 1178

POWER:REPort:TEST:LSEnd? <MeasType>**Query parameters:**

<MeasType> QUAL | RUSH | HARM | MODU | DONR | SLEW | SOA | TURN |
SWIT | EFF | RIPP | TRANS | SPEC

Usage: Query only

Manual operation: See ["Report Table"](#) on page 1178

27.25.4 Power quality

POWER:QUALity:AUTO.....	2764
POWER:QUALity:EXECute.....	2765
POWER:QUALity:FREQ.....	2765
POWER:QUALity:FCUS.....	2765
POWER:QUALity:REPort:ADD.....	2765
POWER:QUALity:RESult:CURRent:CREStfactor?.....	2765
POWER:QUALity:RESult:CURRent:FREQuency?.....	2765
POWER:QUALity:RESult:CURRent:PEAK?.....	2765
POWER:QUALity:RESult:CURRent:RMS?.....	2765
POWER:QUALity:RESult:POWer:APParent?.....	2765
POWER:QUALity:RESult:POWer:PFACtor?.....	2765
POWER:QUALity:RESult:POWer:PHASe?.....	2765
POWER:QUALity:RESult:POWer:REACtive?.....	2765
POWER:QUALity:RESult:POWer:REALpower?.....	2766
POWER:QUALity:RESult:VOLTag:e:CREStfactor?.....	2766
POWER:QUALity:RESult:VOLTag:e:FREQuency?.....	2766
POWER:QUALity:RESult:VOLTag:e:PEAK?.....	2766
POWER:QUALity:RESult:VOLTag:e:RMS?.....	2766

POWER:QUALity:AUTO <Autoscale>

Selects the scaling for the display of the results.

Parameters:

<Autoscale> AUTO | MANUAL
*RST: MANUAL

Manual operation: See ["Optimize scaling"](#) on page 1191

POWER:QUALity:EXECute

Starts the power quality measurement.

Usage: Event

Manual operation: See "[Execute](#)" on page 1191

POWER:QUALity:FREQ <Frequency>

Sets the input frequency of the source signal in Hz.

Parameters:

<Frequency> F50 | F60 | F360 | F400 | F650 | F800 | NFF650 | WFF800 | FCUS
FCUS
NFF650: 360 to 650 Hz
WFF800: 360 to 800 Hz
FCUS: user-defined frequency to be set using [POWER:QUALity:FCUS](#).
*RST: F50

Manual operation: See "[Input frequency](#)" on page 1190

POWER:QUALity:FCUS <CustomFrequency>

Sets the user-defined frequency if [POWER:QUALity:FREQ](#) is set to FCUS.

Parameters:

<CustomFrequency> Range: 1 to 5000
Increment: 1
*RST: 16.666
Default unit: Hz

Firmware/software: Version 2.70

Manual operation: See "[Custom frequency](#)" on page 1191

POWER:QUALity:REPort:ADD

Adds the result to the report list.

Usage: Event

POWER:QUALity:RESult:CURRent:CREStfactor?

POWER:QUALity:RESult:CURRent:FREQuency?

POWER:QUALity:RESult:CURRent:PEAK?

POWER:QUALity:RESult:CURRent:RMS?

POWER:QUALity:RESult:POWer:APParent?

POWER:QUALity:RESult:POWer:PFACTOR?

POWER:QUALity:RESult:POWer:PHASe?

POWER:QUALity:RESult:POWer:REACTive?

Setting parameters:

<GateIndex>

Usage: Setting only**Manual operation:** See "[Gate Configuration](#)" on page 1194**POWER:INRush:COUNT?**

Queiries the number of inrush current gates.

Return values:

<Count>

Usage: Query only**Manual operation:** See "[Inrush current](#)" on page 1194**POWER:INRush:EXECute**

Starts the inrush current measurement.

Usage: Event**Manual operation:** See "[Execute](#)" on page 1195**POWER:INRush:GATE<m>:START** <StartTime>**POWER:INRush:GATE<m>:STOP** <StopTime>

Sets the measuring time for the selected gate.

Suffix:

<m> *

Parameters:

<StopTime>	Range:	0 to 10
	Increment:	0
	*RST:	100E-6
	Default unit:	s

Manual operation: See "[Stop time](#)" on page 1195**POWER:INRush:GATE<m>:VALue** <Value>

Returns the value of the inrush current.

Suffix:

<m> *

Parameters:

<Value>	Range:	-1000 to 1000
	Increment:	0
	*RST:	0
	Default unit:	A

POWER:INRush:MAXCurrent <MaxExpCurr>

Sets the maximum expected current for the vertical scale.

Parameters:

<MaxExpCurr> Range: -1000 to 1000
 Increment: 0
 *RST: 10
 Default unit: A

Manual operation: See "[Maximum current](#)" on page 1194

POWER:INRush:TRIGger <CurrentValue>

Sets the current value for the trigger.

Parameters:

<CurrentValue> Range: -1000 to 1000
 Increment: 0
 *RST: 1
 Default unit: A

Manual operation: See "[Trigger current value \(T\)](#)" on page 1194

POWER:INRush:REPort:ADD

Adds the result to the report list.

Usage: Event

27.25.6 Current harmonic

POWER:HARMonics:AUTO.....	2768
POWER:HARMonics:DOFR.....	2769
POWER:HARMonics:ENFR.....	2769
POWER:HARMonics:MIFR.....	2769
POWER:HARMonics:EVAL.....	2769
POWER:HARMonics:EXECute.....	2769
POWER:HARMonics:REPort:ADD.....	2770
POWER:HARMonics:RESult<m>:STDInuse?.....	2770
POWER:HARMonics:RESult<m>:FREQuency<n>:VALue?.....	2770
POWER:HARMonics:RESult<m>:MAXValue<n>:VALue?.....	2770
POWER:HARMonics:RESult<m>:STDValue<n>:VALue?.....	2770
POWER:HARMonics:RESult<m>:VALue<n>:VALue?.....	2770
POWER:HARMonics:STAN.....	2770
POWER:HARMonics:VOLT.....	2771

POWER:HARMonics:AUTO <Autoscale>

Selects the scaling for the display of the results.

Parameters:

<Autoscale> AUTO | MANUAL
*RST: MANUAL

Manual operation: See "[Optimize scaling](#)" on page 1199

POWER:HARMonics:DOFR <FrequencyDOA160>

Selects the frequency of the input signal.

Parameters:

<FrequencyDOA160> F360 | F400 | F650 | F800
*RST: F400

Manual operation: See "[Frequency](#)" on page 1199

POWER:HARMonics:ENFR <FreqEN61000>

Selects the frequency of the input signal.

Parameters:

<FreqEN61000> F50 | F60
*RST: F50

Manual operation: See "[Frequency](#)" on page 1199

POWER:HARMonics:MIFR <FreqMIL1399>

Selects the frequency of the input signal.

Parameters:

<FreqMIL1399> F400 | F60
*RST: F400

Manual operation: See "[Frequency](#)" on page 1199

POWER:HARMonics: EVAL <AnalysisRevised>

Sets the evaluation of the results for "Standard" > "RTCA DO-160".

Parameters:

<AnalysisRevised> REVISED | NOREVISED
*RST: NOREVISED

Manual operation: See "[Revised Current](#)" on page 1199

POWER:HARMonics:EXECute

Starts the current harmonic measurement.

Usage: Event

Manual operation: See ["Execute"](#) on page 1199

POWer:HARMonics:REPort:ADD

Adds the result to the report list.

Usage: Event

POWer:HARMonics:RESult<m>:STDInuse?

Returns the used standard.

Suffix:

<m> 1..2

Return values:

<StandardInUse> ENA | ENB | ENC | END | MIL | RTC
*RST: ENA

Usage: Query only

POWer:HARMonics:RESult<m>:FREQuency<n>:VALue?

POWer:HARMonics:RESult<m>:MAXValue<n>:VALue?

POWer:HARMonics:RESult<m>:STDValue<n>:VALue?

POWer:HARMonics:RESult<m>:VALue<n>:VALue?

Returns the value of the respective result.

Suffix:

<m> 1..2

<n> *

Return values:

<Value> Range: -1000 to 1000
*RST: 0
Default unit: A

Usage: Query only

POWer:HARMonics:STAN <StandardInUse>

Sets a standard for the current harmonic measurement.

Parameters:

<StandardInUse> ENA | ENB | ENC | END | MIL | RTC
*RST: ENA

Manual operation: See ["Standard in use"](#) on page 1198

POWer:HARMonics:VOLT <DOADisplayResult>

Selects if the voltage results are displayed or not for "Standard" > "RTCA DO-160" and enabled "Evaluation with voltage source and revised current law".

Parameters:

<DOADisplayResult> VOLTDISP | NOVOLTDISP
*RST: NOVOLTDISP

Example:

```
POW:HARM:STAN RTC
POW:HARM:EVAL REVISED
POW:HARM:VOLT NOVOLTDISP
```

Selects an evaluation with the revised current law and no voltage display.

Manual operation: See "[Revised Current](#)" on page 1199

27.25.7 Modulation analysis

This measurement is a single shot measurement. To start the measurement, use the **RUNS** command.

POWer:MODulation:AUTO	2771
POWer:MODulation:DHISTogram	2771
POWer:MODulation:EXECute	2772
POWer:MODulation:REPort:ADD	2772
POWer:MODulation:RESult:ACTual?	2772
POWer:MODulation:RESult:AVG?	2772
POWer:MODulation:RESult:EVTCount?	2772
POWer:MODulation:RESult:NPEak?	2772
POWer:MODulation:RESult:PPEak?	2772
POWer:MODulation:RESult:RMS?	2772
POWer:MODulation:RESult:STDDev?	2772
POWer:MODulation:RESult:WFMCOUNT?	2772
POWer:MODulation:SOURce	2772
POWer:MODulation:TYPE	2773

POWer:MODulation:AUTO <Autoscale>

Selects the scaling for the display of the results.

Parameters:

<Autoscale> AUTO | MANUAL
*RST: MANUAL

Manual operation: See "[Optimize scaling](#)" on page 1204

POWer:MODulation:DHISTogram <DispHistg>

Activates or deactivates the display of a histogram.

Parameters:

<DispHstg> ON | OFF
 *RST: ON

Manual operation: See "[Display Histogram](#)" on page 1204

POWER:MODulation:EXECute

Starts the modulation analysis measurement.

Usage: Event
 Asynchronous command

Manual operation: See "[Execute](#)" on page 1204

POWER:MODulation:REPort:ADD

Adds the result to the report list.

Usage: Event

POWER:MODulation:RESult:ACTual? <MeasType>
POWER:MODulation:RESult:AVG? <MeasType>
POWER:MODulation:RESult:EVTCount? <MeasType>
POWER:MODulation:RESult:NPEak? <MeasType>
POWER:MODulation:RESult:PPEak? <MeasType>
POWER:MODulation:RESult:RMS? <MeasType>
POWER:MODulation:RESult:STDDev? <MeasType>
POWER:MODulation:RESult:WFMCOUNT? <MeasType>

Return the specified statistic result of the specified measurement type.

- [:ACTual]: current measurement result
- AVG: average of the long-term measurement results
- EVTCount: number of measurement results in the long-term measurement
- NPEak: negative peak value of the long-term measurement results
- PPEak: positive peak value of the long-term measurement results
- RMS: RMS value of the long-term measurement results
- STDDev: standard deviation of the long-term measurement results

Query parameters:

<MeasType> FREQ | DUTY

Usage: Query only

POWER:MODulation:SOURce <Source>

Selects the source for the measurement.

Parameters:

<Source> CURRENT | VOLTAGE
 *RST: VOLTAGE

Manual operation: See "[Source](#)" on page 1203

POWer:MODulation:TYPE <AnalysisType>

Sets the type of measurement.

Parameters:

<AnalysisType> TURNON | CONT
 *RST: CONT

Manual operation: See "[Type](#)" on page 1203

27.25.8 Dynamic ON resistance

POWer:DONRes:AUTO	2773
POWer:DONRes:AVG	2773
POWer:DONRes:EXECute	2773
POWer:DONRes:GATE<m>:START	2774
POWer:DONRes:GATE<m>:STOP	2774
POWer:DONRes:REPort:ADD	2774
POWer:DONRes:RESult:RESistance?	2774

POWer:DONRes:AUTO <Autoscale>

Selects the scaling for the display of the results.

Parameters:

<Autoscale> AUTO | MANUAL
 *RST: MANUAL

Manual operation: See "[Optimize scaling](#)" on page 1208

POWer:DONRes:AVG <Average>

Enables/disables averaging.

Parameters:

<Average> ON | OFF
 *RST: ON

Manual operation: See "[Average](#)" on page 1207

POWer:DONRes:EXECute

Starts the dynamic on resistance measurement.

Usage: Event
Asynchronous command

Manual operation: See "Execute" on page 1208

POWER:DONRes:GATE<m>:START <Start>

POWER:DONRes:GATE<m>:STOP <Stop>

Sets the value for the cursor.

Suffix:

<m> 1..2

Parameters:

<Stop>

POWER:DONRes:REPort:ADD

Adds the result to the report list.

Usage: Event

POWER:DONRes:RESult:RESistance?

Returns the the dynamic on resistance value.

Return values:

<Resistance> Range: -100E+24 to 100E+24
*RST: 0
Default unit: Ω

Usage: Query only

27.25.9 Slew rate

POWER:SLEWrate:SOURce.....	2775
POWER:SLEWrate:AUTO.....	2775
POWER:SLEWrate:AVGDeriv.....	2775
POWER:SLEWrate:EXECute.....	2775
ACQUIRE:ARESet:MODE.....	2775
ACQUIRE:ARESet:TIME.....	2776
ACQUIRE:ARESet:COUNT.....	2776
POWER:SLEWrate:GATE:START.....	2776
POWER:SLEWrate:GATE:STOP.....	2776
POWER:SLEWrate:REPort:ADD.....	2776
POWER:SLEWrate:RESult:ACTual?.....	2777
POWER:SLEWrate:RESult:AVG?.....	2777
POWER:SLEWrate:RESult:EVTCount?.....	2777
POWER:SLEWrate:RESult:NPEak?.....	2777
POWER:SLEWrate:RESult:PPEak?.....	2777

[POWER:SLEWrate:RESult:RMS?](#)..... 2777
[POWER:SLEWrate:RESult:STDDev?](#)..... 2777
[POWER:SLEWrate:RESult:WFMCount?](#)..... 2777

POWER:SLEWrate:SOURce <Source>

Selects the source for the slew rate measurement.

Parameters:

<Source> CURRENT | VOLTAGE
 *RST: VOLTAGE

Manual operation: See "[Source](#)" on page 1211

POWER:SLEWrate:AUTO <Autoscale>

Selects the scaling for the display of the results.

Parameters:

<Autoscale> AUTO | MANUAL
 *RST: MANUAL

Manual operation: See "[Optimize scaling](#)" on page 1212

POWER:SLEWrate:AVGDeriv <AvgDerivative>

Activates or deactivates average.

Parameters:

<AvgDerivative> ON | OFF
 *RST: ON

Manual operation: See "[Average](#)" on page 1212

POWER:SLEWrate:EXECute

Starts the slew rate measurement.

Usage: Event

Manual operation: See "[Execute](#)" on page 1212

ACQUIRE:ARESet:MODE <ArtmRst>

Defines when the envelope and average evaluation restarts.

Parameters:

<ArtmRst> NONE | TIME | WFMS

TIME

Restarts the envelope and average calculation after the time defined with [ACQUIRE:ARESet:TIME](#).

WFMS

Restarts the envelope and average calculation after a number of acquired waveforms defined with `ACQUIRE:ARESet:COUNT` on page 1425.

*RST: NONE

Usage: Asynchronous command

Manual operation: See "[Arithmetic Reset > Mode](#)" on page 131

ACQUIRE:ARESet:TIME <EnvelopeTimeout>

Defines the time after which the envelope and average evaluation restarts.

The setting is relevant if `ACQUIRE:ARESet:MODE` is set to `TIME`.

Parameters:

<EnvelopeTimeout> Range: 0.1 to 10000
 Increment: 0.01
 *RST: 0.1
 Default unit: s

Usage: Asynchronous command

Manual operation: See "[Arithmetic Reset > Mode](#)" on page 131

ACQUIRE:ARESet:COUNT <NofWaveforms>

Defines the number of acquired waveforms after which the envelope and average evaluation restarts.

The setting is relevant if `ACQUIRE:ARESet:MODE` is set to `WFMS`.

Parameters:

<NofWaveforms> Range: 2 to 16777215
 Increment: 10
 *RST: 1000

Usage: Asynchronous command

Manual operation: See "[Arithmetic Reset > Mode](#)" on page 131

POWER:SLEWrate:GATE:START <T0>**POWER:SLEWrate:GATE:STOP** <T1>

Sets the value for the cursor.

Parameters:

<T1>

POWER:SLEWrate:REPort:ADD

Adds the result to the report list.

Usage: Event

POWer:SLEWrate:RESult:ACTual? <MeasType>
POWer:SLEWrate:RESult:AVG? <MeasType>
POWer:SLEWrate:RESult:EVTCount? <MeasType>
POWer:SLEWrate:RESult:NPEak? <MeasType>
POWer:SLEWrate:RESult:PPEak? <MeasType>
POWer:SLEWrate:RESult:RMS? <MeasType>
POWer:SLEWrate:RESult:STDDev? <MeasType>
POWer:SLEWrate:RESult:WFMCOUNT? <MeasType>

Return the specified statistic result of the specified measurement type.

- [:ACTual]: current measurement result
- AVG: average of the long-term measurement results
- EVTCount: number of measurement results in the long-term measurement
- NPEak: negative peak value of the long-term measurement results
- PPEak: positive peak value of the long-term measurement results
- RMS: RMS value of the long-term measurement results
- STDDev: standard deviation of the long-term measurement results

Query parameters:

<MeasType> MIN | MAX

Usage: Query only

27.25.10 S.O.A

POWer:SOA:EXECute	2777
POWer:SOA:LINear:ADD	2778
POWer:SOA:LOGarithmic:ADD	2778
POWer:SOA:LINear:COUNT?	2778
POWer:SOA:LOGarithmic:COUNT?	2778
POWer:SOA:LINear:REMOve	2778
POWer:SOA:LOGarithmic:REMOve	2778
POWer:SOA:LINear:INSert	2778
POWer:SOA:LOGarithmic:INSert	2778
POWer:SOA:LINear:POINt<m>:CURRent	2778
POWer:SOA:LOGarithmic:POINt<m>:CURRent	2778
POWer:SOA:LINear:POINt<m>:VOLTagE	2779
POWer:SOA:LOGarithmic:POINt<m>:VOLTagE	2779
POWer:SOA:MASK	2779
POWer:SOA:REPort:ADD	2779
POWer:SOA:SCALE	2779
POWer:SOA:SWITCh	2780

POWer:SOA:EXECute

Starts the safe operating area measurement.

Usage: Event

Manual operation: See ["Execute"](#) on page 1218

POWER:SOA:LINear:ADD
POWER:SOA:LOGarithmic:ADD

Adds a point.

Usage: Event

Manual operation: See ["SOA point definition"](#) on page 1217

POWER:SOA:LINear:COUNt?
POWER:SOA:LOGarithmic:COUNt?

Queries the number of points.

Return values:

<Count>

Usage: Query only

Manual operation: See ["SOA point definition"](#) on page 1217

POWER:SOA:LINear:REMOve <GateIndex>
POWER:SOA:LOGarithmic:REMOve <GateIndex>

Removes a point.

Setting parameters:

<GateIndex>

Usage: Setting only

Manual operation: See ["SOA point definition"](#) on page 1217

POWER:SOA:LINear:INSert <GateIndex>
POWER:SOA:LOGarithmic:INSert <GateIndex>

Inserts a point.

Setting parameters:

<GateIndex>

Usage: Setting only

Manual operation: See ["SOA point definition"](#) on page 1217

POWER:SOA:LINear:POINt<m>:CURRent <Amp>
POWER:SOA:LOGarithmic:POINt<m>:CURRent <Amp>

Sets the current value for the respective point.

Suffix:

<m> *

Parameters:

<Amp> Range: 0.01 to 1000
 Increment: 0
 *RST: 0.01
 Default unit: A

POWer:SOA:LINear:POINt<m>:VOLTage <Volt>**POWer:SOA:LOGarithmic:POINt<m>:VOLTage** <Volt>

Sets the voltage value for the respective point.

Suffix:

<m> *

Parameters:

<Volt> Range: 1E-3 to 1000
 Increment: 0
 *RST: 1E-3
 Default unit: V

POWer:SOA:MASK <EnableMaskTest>

Activates or deactivates a mask.

Parameters:

<EnableMaskTest> ON | OFF
 *RST: OFF

Manual operation: See "[Enable mask test](#)" on page 1217**POWer:SOA:REPort:ADD**

Adds the result to the report list.

Usage: Event**POWer:SOA:SCALe** <Scale>

Sets the scale for the measurement.

Parameters:

<Scale> LOG | LINEAR
 *RST: LOG

Manual operation: See "[Scale](#)" on page 1217

POWer:SOA:SWITCh <Switch>

Switches between linear and logarithmic scale.

Parameters:

<Switch> LOGLINEAR | LINEARLOG
 *RST: LOGLINEAR

27.25.11 Turn on/off

This measurement is a single shot measurement. To start the measurement, use the **RUNS** command.

POWer:ONOFF:ATOff.....	2780
POWer:ONOFF:ATON.....	2780
POWer:ONOFF:DTOFF.....	2780
POWer:ONOFF:DTON.....	2780
POWer:ONOFF:DSOOff.....	2780
POWer:ONOFF:DSON.....	2780
POWer:ONOFF:EXECute.....	2781
POWer:ONOFF:INPut.....	2781
POWer:ONOFF:REPort:ADD.....	2781
POWer:ONOFF:RESult:TOFF?.....	2781
POWer:ONOFF:RESult:TON?.....	2781
POWer:ONOFF:TIME.....	2781
POWer:ONOFF:TYPE.....	2782

POWer:ONOFF:ATOff <ACTrigLevOff>**POWer:ONOFF:ATON** <ACTrigLevOn>

Triggers the beginning of the measurements at the moment the AC input voltage reaches the set value.

Parameters:

<ACTrigLevOn> Range: -1E+6 to 1E+6
 Increment: 1E-3
 *RST: 10
 Default unit: V

Manual operation: See "[Trigger level on](#)" on page 1223

POWer:ONOFF:DTOFF <ACTrigLevOff>**POWer:ONOFF:DTON** <ACTrigLevOn>**POWer:ONOFF:DSOOff** <StateLevelOff>**POWer:ONOFF:DSON** <StateLevelOn>

Sets the percentage of the steady state level of the DC output that has to be reached.

Parameters:

<StateLevelOn> Range: 0 to 100
 Increment: 1
 *RST: 90
 Default unit: %

Manual operation: See "[Steady state level-Turn on](#)" on page 1222

POWER:ONOFF:EXECute

Starts the turn on/off measurement.

Usage: Event

Manual operation: See "[Execute](#)" on page 1223

POWER:ONOFF:INPut <InputType>

Sets the input type.

Parameters:

<InputType> AC | DC
 *RST: AC

Manual operation: See "[Input Type](#)" on page 1222

POWER:ONOFF:REPort:ADD

Adds the result to the report list.

Usage: Event

POWER:ONOFF:RESult:TOFF?**POWER:ONOFF:RESult:TON?**

Returns the result time.

Return values:

<TurnOnTime> Range: -100E+24 to 100E+24
 Increment: 100E-12
 *RST: 0
 Default unit: s

Usage: Query only

POWER:ONOFF:TIME <Time>

Sets the time, the start of the measurement of the turn off time is delay with, after the trigger point.

Parameters:

<Time> Range: 100E-12 to 10000
 Increment: 100E-9
 *RST: 0.1
 Default unit: s

Manual operation: See ["Time"](#) on page 1223

POWER:ONOFF:TYPE <MeasType>

Selects the measurement type.

Parameters:

<MeasType> TON | TOFF
 TON - "Turn on" measurement
 TOFF - "Turn off" measurement
 *RST: TON

Manual operation: See ["Measurement Type"](#) on page 1222

27.25.12 Switching loss

POWER:SWITChing:AUTO	2783
POWER:SWITChing:EXECute	2783
POWER:SWITChing:REPort:ADD	2783
POWER:SWITChing:SWIFrequency	2783
POWER:SWITChing:SWIT	2783
POWER:SWITChing:COND	2784
POWER:SWITChing:NCON	2784
POWER:SWITChing:TON	2784
POWER:SWITChing:TOFF	2784
POWER:SWITChing:TOTal	2784
POWER:SWITChing:GATE:COND:START	2784
POWER:SWITChing:GATE:COND:STOP	2784
POWER:SWITChing:GATE:NCON:START	2784
POWER:SWITChing:GATE:TOFF:START	2784
POWER:SWITChing:GATE:TOFF:STOP	2784
POWER:SWITChing:GATE:TON:START	2784
POWER:SWITChing:GATE:TON:STOP	2784
POWER:SWITChing:RESult:ENERgy:ACTual?	2784
POWER:SWITChing:RESult:ENERgy:AVG?	2784
POWER:SWITChing:RESult:ENERgy:EVTCount?	2784
POWER:SWITChing:RESult:ENERgy:NPEak?	2784
POWER:SWITChing:RESult:ENERgy:PPEak?	2784
POWER:SWITChing:RESult:ENERgy:RMS?	2784
POWER:SWITChing:RESult:ENERgy:STDDev?	2784
POWER:SWITChing:RESult:ENERgy:WFMCount?	2784
POWER:SWITChing:RESult:POWER:ACTual?	2785
POWER:SWITChing:RESult:POWER:AVG?	2785

POWER:SWITching:RESult:POWER:EVTCount?.....	2785
POWER:SWITching:RESult:POWER:NPEak?.....	2785
POWER:SWITching:RESult:POWER:PPEak?.....	2785
POWER:SWITching:RESult:POWER:RMS?.....	2785
POWER:SWITching:RESult:POWER:STDDev?.....	2785
POWER:SWITching:RESult:POWER:WFMCCount?.....	2785

POWER:SWITching:AUTO <Autoscale>

Selects the scaling for the display of the results.

Parameters:

<Autoscale> AUTO | MANUAL
 *RST: MANUAL

Manual operation: See "[Optimize scaling](#)" on page 1228

POWER:SWITching:EXECute

Starts the switching loss measurement.

Usage: Event
 Asynchronous command

Manual operation: See "[Execute](#)" on page 1228

POWER:SWITching:REPort:ADD

Adds the result to the report list.

Usage: Event

POWER:SWITching:SWIFrequency <SwitchingFreq>

Sets the switching frequency.

Parameters:

<SwitchingFreq> Range: 1 to 500E+9
 Increment: 1000
 *RST: 10E+6
 Default unit: Hz

Manual operation: See "[Switching frequency > Auto](#)" on page 1227

POWER:SWITching:SWIT <MeasSwitchingFreq>

Activates or deactivates the measurements of the switching frequency.

Parameters:

<MeasSwitchingFreq>ON | OFF
 *RST: ON

Manual operation: See "[Switching frequency > Auto](#)" on page 1227

POWER:SWITching:COND <MeasureConduction>
POWER:SWITching:NCON <MeasureNonConduction>
POWER:SWITching:TON <MeasureTurnOn>
POWER:SWITching:TOFF <MeasureTurnOff>
POWER:SWITching:TOTal <MeasureTotal>

Enables the measurement during the respective period.

Parameters:

<MeasureTotal> ON | OFF
 *RST: ON

Manual operation: See "[Total](#)" on page 1228

POWER:SWITching:GATE:COND:START <T1>
POWER:SWITching:GATE:COND:STOP <T2>
POWER:SWITching:GATE:NCON:START <T3>
POWER:SWITching:GATE:TOFF:START <T2>
POWER:SWITching:GATE:TOFF:STOP <T3>
POWER:SWITching:GATE:TON:START <T0>
POWER:SWITching:GATE:TON:STOP <T1>

Sets the value for the respective cursor.

Parameters:

<T1>

POWER:SWITching:RESult:ENERgy:ACTual? <MeasType>
POWER:SWITching:RESult:ENERgy:AVG? <MeasType>
POWER:SWITching:RESult:ENERgy:EVTCount? <MeasType>
POWER:SWITching:RESult:ENERgy:NPEak? <MeasType>
POWER:SWITching:RESult:ENERgy:PPEak? <MeasType>
POWER:SWITching:RESult:ENERgy:RMS? <MeasType>
POWER:SWITching:RESult:ENERgy:STDDev? <MeasType>
POWER:SWITching:RESult:ENERgy:WFMCCount? <MeasType>

Return the specified statistic result of the specified measurement type.

- [:ACTual]: current measurement result
- AVG: average of the long-term measurement results
- EVTCount: number of measurement results in the long-term measurement
- NPEak: negative peak value of the long-term measurement results
- PPEak: positive peak value of the long-term measurement results
- RMS: RMS value of the long-term measurement results
- STDDev: standard deviation of the long-term measurement results

Query parameters:

<MeasType> SWF | TON | TOF | CON | NCO | TOT

Usage: Query only

POWer:SWITching:RESult:POWer:ACTual? <MeasType>
POWer:SWITching:RESult:POWer:AVG? <MeasType>
POWer:SWITching:RESult:POWer:EVTCount? <MeasType>
POWer:SWITching:RESult:POWer:NPEak? <MeasType>
POWer:SWITching:RESult:POWer:PPEak? <MeasType>
POWer:SWITching:RESult:POWer:RMS? <MeasType>
POWer:SWITching:RESult:POWer:STDDev? <MeasType>
POWer:SWITching:RESult:POWer:WFMCount? <MeasType>

Return the specified statistic result of the specified measurement type.

- [:ACTual]: current measurement result
- AVG: average of the long-term measurement results
- EVTCount: number of measurement results in the long-term measurement
- NPEak: negative peak value of the long-term measurement results
- PPEak: positive peak value of the long-term measurement results
- RMS: RMS value of the long-term measurement results
- STDDev: standard deviation of the long-term measurement results

Query parameters:

<MeasType> SWF | TON | TOF | CON | NCO | TOT

Usage: Query only

27.25.13 Power efficiency

POWer:EFFiciency:AUTO	2785
POWer:EFFiciency:EXECute	2786
POWer:EFFiciency:REPort:ADD	2786
POWer:EFFiciency:RESult<m>:ACTual?	2786
POWer:EFFiciency:RESult<m>:AVG?	2786
POWer:EFFiciency:RESult<m>:EVTCount?	2786
POWer:EFFiciency:RESult<m>:NPEak?	2786
POWer:EFFiciency:RESult<m>:PPEak?	2786
POWer:EFFiciency:RESult<m>:RMS?	2786
POWer:EFFiciency:RESult<m>:STDDev?	2786
POWer:EFFiciency:RESult<m>:WFMCount?	2786

POWer:EFFiciency:AUTO <Autoscale>

Selects the scaling for the display of the results.

Parameters:

<Autoscale> AUTO | MANUAL
 *RST: MANUAL

Manual operation: See "[Optimize scaling](#)" on page 1231

POWer:EFFiciency:EXECute

Starts the power efficiency measurement.

Usage: Event

Manual operation: See "Execute" on page 1232

POWer:EFFiciency:REPort:ADD

Adds the result to the report list.

Usage: Event

POWer:EFFiciency:RESult<m>:ACTual?
POWer:EFFiciency:RESult<m>:AVG?
POWer:EFFiciency:RESult<m>:EVTCount?
POWer:EFFiciency:RESult<m>:NPEak?
POWer:EFFiciency:RESult<m>:PPEak?
POWer:EFFiciency:RESult<m>:RMS?
POWer:EFFiciency:RESult<m>:STDDev?
POWer:EFFiciency:RESult<m>:WFMCCount?

Return the specified statistic result of the specified measurement type.

- [:ACTual]: current measurement result
- AVG: average of the long-term measurement results
- EVTCount: number of measurement results in the long-term measurement
- NPEak: negative peak value of the long-term measurement results
- PPEak: positive peak value of the long-term measurement results
- RMS: RMS value of the long-term measurement results
- STDDev: standard deviation of the long-term measurement results

Suffix:

<m> 1..3

Return values:

<WaveformsCount> Range: 0 to 4E+9
 *RST: 0

Usage: Query only

27.25.14 Ripple

POWer:RIPPlE:AUToscale	2788
POWer:RIPPlE:CURRent	2788
POWer:RIPPlE:EXECute	2788
POWer:RIPPlE:FREQuency	2788
POWer:RIPPlE:REPort:ADD	2789
POWer:RIPPlE:RESult:FREQuency[:ACTual]?	2789

Power analysis (option R&S RTO6-K31)

POWer:RIPPlE:RESult:FREQuency:AVG?	2789
POWer:RIPPlE:RESult:FREQuency:EVTCount?	2789
POWer:RIPPlE:RESult:FREQuency:NPEak?	2789
POWer:RIPPlE:RESult:FREQuency:PPEak?	2789
POWer:RIPPlE:RESult:FREQuency:RMS?	2789
POWer:RIPPlE:RESult:FREQuency:STDDev?	2789
POWer:RIPPlE:RESult:FREQuency:WFMCCount?	2789
POWer:RIPPlE:RESult:MAXimum[:ACTual]?	2789
POWer:RIPPlE:RESult:MAXimum:AVG?	2789
POWer:RIPPlE:RESult:MAXimum:EVTCount?	2789
POWer:RIPPlE:RESult:MAXimum:NPEak?	2789
POWer:RIPPlE:RESult:MAXimum:PPEak?	2789
POWer:RIPPlE:RESult:MAXimum:RMS?	2789
POWer:RIPPlE:RESult:MAXimum:STDDev?	2789
POWer:RIPPlE:RESult:MAXimum:WFMCCount?	2789
POWer:RIPPlE:RESult:MINimum[:ACTual]?	2790
POWer:RIPPlE:RESult:MINimum:AVG?	2790
POWer:RIPPlE:RESult:MINimum:EVTCount?	2790
POWer:RIPPlE:RESult:MINimum:NPEak?	2790
POWer:RIPPlE:RESult:MINimum:PPEak?	2790
POWer:RIPPlE:RESult:MINimum:RMS?	2790
POWer:RIPPlE:RESult:MINimum:STDDev?	2790
POWer:RIPPlE:RESult:MINimum:WFMCCount?	2790
POWer:RIPPlE:RESult:NDCYcle[:ACTual]?	2790
POWer:RIPPlE:RESult:NDCYcle:AVG?	2790
POWer:RIPPlE:RESult:NDCYcle:EVTCount?	2790
POWer:RIPPlE:RESult:NDCYcle:NPEak?	2790
POWer:RIPPlE:RESult:NDCYcle:PPEak?	2790
POWer:RIPPlE:RESult:NDCYcle:RMS?	2790
POWer:RIPPlE:RESult:NDCYcle:STDDev?	2791
POWer:RIPPlE:RESult:NDCYcle:WFMCCount?	2791
POWer:RIPPlE:RESult:PDCYcle[:ACTual]?	2791
POWer:RIPPlE:RESult:PDCYcle:AVG?	2791
POWer:RIPPlE:RESult:PDCYcle:EVTCount?	2791
POWer:RIPPlE:RESult:PDCYcle:NPEak?	2791
POWer:RIPPlE:RESult:PDCYcle:PPEak?	2791
POWer:RIPPlE:RESult:PDCYcle:RMS?	2791
POWer:RIPPlE:RESult:PDCYcle:STDDev?	2791
POWer:RIPPlE:RESult:PDCYcle:WFMCCount?	2791
POWer:RIPPlE:RESult:PDEL[:ACTual]?	2792
POWer:RIPPlE:RESult:PDEL:AVG?	2792
POWer:RIPPlE:RESult:PDEL:EVTCount?	2792
POWer:RIPPlE:RESult:PDEL:NPEak?	2792
POWer:RIPPlE:RESult:PDEL:PPEak?	2792
POWer:RIPPlE:RESult:PDEL:RMS?	2792
POWer:RIPPlE:RESult:PDEL:STDDev?	2792
POWer:RIPPlE:RESult:PDEL:WFMCCount?	2792
POWer:RIPPlE:RESult:PERiod[:ACTual]?	2792
POWer:RIPPlE:RESult:PERiod:AVG?	2792
POWer:RIPPlE:RESult:PERiod:EVTCount?	2792

POWer:RIPPlE:RESult:PERiod:NPEak?.....	2792
POWer:RIPPlE:RESult:PERiod:PPEak?.....	2792
POWer:RIPPlE:RESult:PERiod:RMS?.....	2792
POWer:RIPPlE:RESult:PERiod:STDDev?.....	2792
POWer:RIPPlE:RESult:PERiod:WFMCCount?.....	2792
POWer:RIPPlE:RESult:STDDev[:ACTual]?.....	2793
POWer:RIPPlE:RESult:STDDev:AVG?.....	2793
POWer:RIPPlE:RESult:STDDev:EVTCount?.....	2793
POWer:RIPPlE:RESult:STDDev:NPEak?.....	2793
POWer:RIPPlE:RESult:STDDev:PPEak?.....	2793
POWer:RIPPlE:RESult:STDDev:RMS?.....	2793
POWer:RIPPlE:RESult:STDDev:STDDev?.....	2793
POWer:RIPPlE:RESult:STDDev:WFMCCount?.....	2793

POWer:RIPPlE:AUToscale <Autoscale>

Selects the scaling for the display of the results.

Parameters:

<Autoscale> AUTO | MANUAL
 *RST: MANUAL

Manual operation: See "[Optimize scaling](#)" on page 1238

POWer:RIPPlE:CURRent <TwoChMeas>

Activates or deactivates the input current.

Parameters:

<TwoChMeas> ON | OFF
 *RST: ON

POWer:RIPPlE:EXECute

Starts the ripple measurement.

Usage: Event

Manual operation: See "[Execute](#)" on page 1239

POWer:RIPPlE:FREQUency <SmPsFrequency>

Sets the SMPS switching frequency.

Parameters:

<SmPsFrequency> Range: 1 to 100E+9
 Increment: 1
 *RST: 1E+6
 Default unit: Hz

Manual operation: See "[Switching frequency](#)" on page 1238

POWer:RIPPlE:REPort:ADD

Adds the result to the report list.

Usage: Event

POWer:RIPPlE:RESult:FREQUency[:ACTual]? [<VoltageMeasType>]
POWer:RIPPlE:RESult:FREQUency:AVG? [<VoltageMeasType>]
POWer:RIPPlE:RESult:FREQUency:EVTCount? [<VoltageMeasType>]
POWer:RIPPlE:RESult:FREQUency:NPEak? [<VoltageMeasType>]
POWer:RIPPlE:RESult:FREQUency:PPEak? [<VoltageMeasType>]
POWer:RIPPlE:RESult:FREQUency:RMS? [<VoltageMeasType>]
POWer:RIPPlE:RESult:FREQUency:STDDev? [<VoltageMeasType>]
POWer:RIPPlE:RESult:FREQUency:WFMCount? [<VoltageMeasType>]

Return the specified statistic result of the frequency of the signal. The result is based on the period measurement.

- [:ACTual]: current measurement result
- AVG: average of the long-term measurement results
- EVTCount: number of measurement results in the long-term measurement
- NPEak: negative peak value of the long-term measurement results
- PPEak: positive peak value of the long-term measurement results
- RMS: RMS value of the long-term measurement results
- STDDev: standard deviation of the long-term measurement results

Query parameters:

<VoltageMeasType> VOLTage | CURRent
 *RST: VOLTage

Return values:

<Result> Statistic result of the frequency

Usage: Query only

POWer:RIPPlE:RESult:MAXimum[:ACTual]? [<VoltageMeasType>]
POWer:RIPPlE:RESult:MAXimum:AVG? [<VoltageMeasType>]
POWer:RIPPlE:RESult:MAXimum:EVTCount? [<VoltageMeasType>]
POWer:RIPPlE:RESult:MAXimum:NPEak? [<VoltageMeasType>]
POWer:RIPPlE:RESult:MAXimum:PPEak? [<VoltageMeasType>]
POWer:RIPPlE:RESult:MAXimum:RMS? [<VoltageMeasType>]
POWer:RIPPlE:RESult:MAXimum:STDDev? [<VoltageMeasType>]
POWer:RIPPlE:RESult:MAXimum:WFMCount? [<VoltageMeasType>]

Return the specified statistic result for the maximum value of the waveform.

- [:ACTual]: current measurement result
- AVG: average of the long-term measurement results
- EVTCount: number of measurement results in the long-term measurement
- NPEak: negative peak value of the long-term measurement results

- PPEak: positive peak value of the long-term measurement results
- RMS: RMS value of the long-term measurement results
- STDDev: standard deviation of the long-term measurement results

Query parameters:

<VoltageMeasType> VOLTage | CURRent
 *RST: VOLTage

Return values:

<Result> Statistic result

Usage: Query only

POWer:RIPPlE:RESult:MINimum[:ACTual]? [<VoltageMeasType>]
POWer:RIPPlE:RESult:MINimum:AVG? [<VoltageMeasType>]
POWer:RIPPlE:RESult:MINimum:EVTCount? [<VoltageMeasType>]
POWer:RIPPlE:RESult:MINimum:NPEak? [<VoltageMeasType>]
POWer:RIPPlE:RESult:MINimum:PPEak? [<VoltageMeasType>]
POWer:RIPPlE:RESult:MINimum:RMS? [<VoltageMeasType>]
POWer:RIPPlE:RESult:MINimum:STDDev? [<VoltageMeasType>]
POWer:RIPPlE:RESult:MINimum:WFMCOUNT? [<VoltageMeasType>]

Return the specified statistic result for the minimum value of the waveform.

- [:ACTual]: current measurement result
- AVG: average of the long-term measurement results
- EVTCount: number of measurement results in the long-term measurement
- NPEak: negative peak value of the long-term measurement results
- PPEak: positive peak value of the long-term measurement results
- RMS: RMS value of the long-term measurement results
- STDDev: standard deviation of the long-term measurement results

Query parameters:

<VoltageMeasType> VOLTage | CURRent
 *RST: VOLTage

Return values:

<Result> Statistic result

Usage: Query only

POWer:RIPPlE:RESult:NDCYcle[:ACTual]? [<VoltageMeasType>]
POWer:RIPPlE:RESult:NDCYcle:AVG? [<VoltageMeasType>]
POWer:RIPPlE:RESult:NDCYcle:EVTCount? [<VoltageMeasType>]
POWer:RIPPlE:RESult:NDCYcle:NPEak? [<VoltageMeasType>]
POWer:RIPPlE:RESult:NDCYcle:PPEak? [<VoltageMeasType>]
POWer:RIPPlE:RESult:NDCYcle:RMS? [<VoltageMeasType>]

POWER:RIPPLE:RESult:NDCYcle:STDDev? [<VoltageMeasType>]

POWER:RIPPLE:RESult:NDCYcle:WFMCount? [<VoltageMeasType>]

Return the specified statistic result for the negative duty cycle. The measurement requires at least one complete period of a triggered signal.

- [:ACTual]: current measurement result
- AVG: average of the long-term measurement results
- EVTCount: number of measurement results in the long-term measurement
- NPEak: negative peak value of the long-term measurement results
- PPEak: positive peak value of the long-term measurement results
- RMS: RMS value of the long-term measurement results
- STDDev: standard deviation of the long-term measurement results

Query parameters:

<VoltageMeasType> VOLTage | CURRent
 *RST: VOLTage

Return values:

<Result> Statistic result

Usage: Query only

POWER:RIPPLE:RESult:PDCYcle[:ACTual]? [<VoltageMeasType>]

POWER:RIPPLE:RESult:PDCYcle:AVG? [<VoltageMeasType>]

POWER:RIPPLE:RESult:PDCYcle:EVTCount? [<VoltageMeasType>]

POWER:RIPPLE:RESult:PDCYcle:NPEak? [<VoltageMeasType>]

POWER:RIPPLE:RESult:PDCYcle:PPEak? [<VoltageMeasType>]

POWER:RIPPLE:RESult:PDCYcle:RMS? [<VoltageMeasType>]

POWER:RIPPLE:RESult:PDCYcle:STDDev? [<VoltageMeasType>]

POWER:RIPPLE:RESult:PDCYcle:WFMCount? [<VoltageMeasType>]

Return the specified statistic result for the positive duty cycle. The measurement requires at least one complete period of a triggered signal.

- [:ACTual]: current measurement result
- AVG: average of the long-term measurement results
- EVTCount: number of measurement results in the long-term measurement
- NPEak: negative peak value of the long-term measurement results
- PPEak: positive peak value of the long-term measurement results
- RMS: RMS value of the long-term measurement results
- STDDev: standard deviation of the long-term measurement results

Query parameters:

<VoltageMeasType> VOLTage | CURRent
 *RST: VOLTage

Return values:

<Result> Statistic result

Usage: Query only

POWer:RIPPlE:RESult:PDEL[:ACTual]? [<VoltageMeasType>
POWer:RIPPlE:RESult:PDEL:AVG? [<VoltageMeasType>
POWer:RIPPlE:RESult:PDEL:EVTCount? [<VoltageMeasType>
POWer:RIPPlE:RESult:PDEL:NPEak? [<VoltageMeasType>
POWer:RIPPlE:RESult:PDEL:PPEak? [<VoltageMeasType>
POWer:RIPPlE:RESult:PDEL:RMS? [<VoltageMeasType>
POWer:RIPPlE:RESult:PDEL:STDDev? [<VoltageMeasType>
POWer:RIPPlE:RESult:PDEL:WFMCCount? [<VoltageMeasType>]

Return the specified statistic result for the peak to peak measurement.

- [:ACTual]: current measurement result
- AVG: average of the long-term measurement results
- EVTCount: number of measurement results in the long-term measurement
- NPEak: negative peak value of the long-term measurement results
- PPEak: positive peak value of the long-term measurement results
- RMS: RMS value of the long-term measurement results
- STDDev: standard deviation of the long-term measurement results

Query parameters:

<VoltageMeasType> VOLTage | CURRent
 *RST: VOLTage

Return values:

<Result> Statistic result

Usage: Query only

POWer:RIPPlE:RESult:PERiod[:ACTual]? [<VoltageMeasType>
POWer:RIPPlE:RESult:PERiod:AVG? [<VoltageMeasType>
POWer:RIPPlE:RESult:PERiod:EVTCount? [<VoltageMeasType>
POWer:RIPPlE:RESult:PERiod:NPEak? [<VoltageMeasType>
POWer:RIPPlE:RESult:PERiod:PPEak? [<VoltageMeasType>
POWer:RIPPlE:RESult:PERiod:RMS? [<VoltageMeasType>
POWer:RIPPlE:RESult:PERiod:STDDev? [<VoltageMeasType>
POWer:RIPPlE:RESult:PERiod:WFMCCount? [<VoltageMeasType>]

Return the specified statistic result for the period, the length of the left-most signal period of the waveform.

- [:ACTual]: current measurement result
- AVG: average of the long-term measurement results
- EVTCount: number of measurement results in the long-term measurement
- NPEak: negative peak value of the long-term measurement results
- PPEak: positive peak value of the long-term measurement results
- RMS: RMS value of the long-term measurement results
- STDDev: standard deviation of the long-term measurement results

Query parameters:

<VoltageMeasType> VOLTage | CURRent
 *RST: VOLTage

Return values:

<Result> Statistic result

Usage: Query only

POWER:RIPPlE:RESult:STDDev[:ACTual]? [<VoltageMeasType>]
POWER:RIPPlE:RESult:STDDev:AVG? [<VoltageMeasType>]
POWER:RIPPlE:RESult:STDDev:EVTCount? [<VoltageMeasType>]
POWER:RIPPlE:RESult:STDDev:NPEak? [<VoltageMeasType>]
POWER:RIPPlE:RESult:STDDev:PPEak? [<VoltageMeasType>]
POWER:RIPPlE:RESult:STDDev:RMS? [<VoltageMeasType>]
POWER:RIPPlE:RESult:STDDev:STDDev? [<VoltageMeasType>]
POWER:RIPPlE:RESult:STDDev:WFMCCount? [<VoltageMeasType>]

Return the specified statistic result for the standard deviation of the long-term measurement results.

- [:ACTual]: current measurement result
- AVG: average of the long-term measurement results
- EVTCount: number of measurement results in the long-term measurement
- NPEak: negative peak value of the long-term measurement results
- PPEak: positive peak value of the long-term measurement results
- RMS: RMS value of the long-term measurement results
- STDDev: standard deviation of the long-term measurement results

Query parameters:

<VoltageMeasType> VOLTage | CURRent
 *RST: VOLTage

Return values:

<Result> Statistic result

Usage: Query only

27.25.15 Transient response

This measurement is a single shot measurement. To start the measurement, use the `RUNS` command.

Programming example: [Chapter 27.3.8.2, "Transient response measurement"](#), on page 1365

POWER:TRANSient:AUToscale	2794
POWER:TRANSient:EXECute	2794
POWER:TRANSient:FREQuency	2794
POWER:TRANSient:HYSTeresis	2794
POWER:TRANSient:INPut	2795

POWer:TRANsient:REPort:ADD.....	2795
POWer:TRANsient:RESult[:ACTual]?	2795
POWer:TRANsient:SIGHigh.....	2795
POWer:TRANsient:SIGLow.....	2795
POWer:TRANsient:TRGChannel.....	2795
POWer:TRANsient:TRGLevel.....	2796
POWer:TRANsient:TRGSlope.....	2796

POWer:TRANsient:AUToscale <Autoscale>

Selects the scaling for the display of the results.

Parameters:

<Autoscale> AUTO | MANUAL
 *RST: MANUAL

Manual operation: See "[Optimize scaling](#)" on page 1243

POWer:TRANsient:EXECute

Starts the transient response measurement.

Usage: Event

Manual operation: See "[Execute](#)" on page 1243

POWer:TRANsient:FREQuency <SmpsFrequency>

Sets the SMPS switching frequency.

Parameters:

<SmpsFrequency> Range: 1 to 100E+6
 Increment: 1
 *RST: 1E+6
 Default unit: Hz

Manual operation: See "[Horizontal SMPS Frequency](#)" on page 1242

POWer:TRANsient:HYSTEResis <ToleranceTube>

Specifies a tolerated error band for the signal level.

Parameters:

<ToleranceTube> Range: 0 to 50
 Increment: 1
 *RST: 10
 Default unit: %

Manual operation: See "[Output tube tolerance](#)" on page 1243

POWer:TRANsient:INPut <ThreeChMeas>

Activates or deactivates the input voltage.

Parameters:

<ThreeChMeas> ON | OFF
*RST: OFF

POWer:TRANsient:REPort:ADD

Adds the result to the report list.

Usage: Event

POWer:TRANsient:RESult[:ACTual]? <MeasType>

Returns the results of the transient response measurement.

Query parameters:

<MeasType> OVERshoot | RTIME | DELay | PEAKtime | SETTling

Usage: Query only

POWer:TRANsient:SIGHigh <ExpHighOutputSignLev>

Sets the expected signal high voltage value.

Parameters:

<ExpHighOutputSignLev> Range: -1000 to 1000
 Increment: 1E-3
*RST: 1
 Default unit: V

Manual operation: See "[High](#)" on page 1243

POWer:TRANsient:SIGLow <ExpLowOutputSignLev>

Sets the expected signal low voltage value.

Parameters:

<ExpLowOutputSignLev> Range: -1000 to 1000
 Increment: 1E-3
*RST: 0
 Default unit: V

Manual operation: See "[Low](#)" on page 1243

POWer:TRANsient:TRGChannel <TriggerSource>

Sets the source channel of the trigger.

Parameters:

<TriggerSource> CHAN1 | CHANnel1 | CHAN2 | CHANnel2 | CHAN3 |
 CHANnel3 | CHAN4 | CHANnel4
 CHAN1 = CHANnel1, CHAN2 = CHANnel2, CHAN3 = CHAN-
 nel3, CHAN4 = CHANnel4
 Only the measurement source channels can be used as trigger
 source.
 *RST: CHAN1

Manual operation: See "[Source](#)" on page 1242

POWER:TRANSient:TRGLevel <TriggerLevel>**Parameters:**

<TriggerLevel> Range: -1000 to 1000
 Increment: 1E-3
 *RST: 0
 Default unit: V

Manual operation: See "[Level](#)" on page 1243

POWER:TRANSient:TRGSlope <TriggerSlope>

Sets the edge type for the trigger event.

Parameters:

<TriggerSlope> POSitive | NEGative | EITHer
 *RST: POSitive

Manual operation: See "[Slope](#)" on page 1242

27.25.16 Spectrum

POWER:SPECTrum:AUToscale	2796
POWER:SPECTrum:EXECute	2797
POWER:SPECTrum:FREQUency	2797
POWER:SPECTrum:REPort:ADD	2797
POWER:SPECTrum:RCOut?	2797
POWER:SPECTrum:RESult<m>:FREQUency?	2797
POWER:SPECTrum:RESult<m>:LEVel?	2797

POWER:SPECTrum:AUToscale <Autoscale>

Selects the scaling for the display of the results.

Parameters:

<Autoscale> AUTO | MANUAL
 *RST: MANUAL

Manual operation: See "[Optimize scaling](#)" on page 1247

POWER:SPECTrum:EXECute

Starts the spectrum measurement.

Usage: Event

Manual operation: See "[Execute](#)" on page 1247

POWER:SPECTrum:FREQuency <SmpsFrequency>

Sets the SMPS switching frequency.

Parameters:

<SmpsFrequency> Range: 1 to 100E+6
Increment: 1
*RST: 1E+6
Default unit: Hz

Manual operation: See "[Switching frequency](#)" on page 1246

POWER:SPECTrum:REPort:ADD

Adds the result to the report list.

Usage: Event

POWER:SPECTrum:RCOut?

Returns the total number of harmonics.

Return values:

<ResultCount>

Usage: Query only

POWER:SPECTrum:RESult<m>:FREQuency?

Returns the result frequency of the m-th result value.

Suffix:

<m> 1..*

Return values:

<Frequency>

Usage: Query only

POWER:SPECTrum:RESult<m>:LEVel?

Returns the result level of the m-th result value.

Suffix:

<m> 1..*

Return values:

<Level>

Usage:

Query only

27.26 Deembedding (option R&S RTO6-K121)

Some of the commands in the following chapter are asynchronous. An overlapping or asynchronous command does not automatically finish executing before the next command starts executing. If overlapping commands must be executed in a defined order, e.g. to avoid wrong measurement results, they must be serviced sequentially.

To prevent an overlapping execution of commands, one of the commands `*OPC`, `*OPC?` or `*WAI` can be used after the command or a command set.

For more information, see:

- www.rohde-schwarz.com/rc-via-scp, chapter "Command sequence and synchronization"
- Chapter 27.3, "Programming examples", on page 1345
- [Measurement setup](#)..... 2798
- [Save and load the deembedding setup](#)..... 2801
- [Components](#).....2802
- [Responses](#).....2809

27.26.1 Measurement setup

DEEMbedding<m>[:STATe]	2798
DEEMbedding<m>:ADD	2799
DEEMbedding<m>:REMove	2799
DEEMbedding<m>:CCOunt?	2799
DEEMbedding<m>:BANDwidth	2800
DEEMbedding<m>:CMPDelay	2800
DEEMbedding<m>:PRESet	2801

DEEMbedding<m>[:STATe] <State>

Activates the deembedding - the correction of parasitic effects of the measurement setup on the measured signal.

Suffix:

<m> 1..4
Selects the channel that is configured for deembedding.

Parameters:

<State> ON | OFF
*RST: OFF

Usage: Asynchronous command

Manual operation: See ["Enable"](#) on page 1250

DEEMbedding<m>:ADD <Index>, [<Type>]

Adds a component to the measurement setup.

Suffix:

<m> 1..4
Selects the channel that is configured for deembedding.

Setting parameters:

<Index> Defines the place of the component in the measurement path. The DUT is always the first component (index = 1), the probe or input is the last component.

<Type> PROBe | FIXTure | CABLe | DUT | ADAPter | INPut | OTHer | RTZA10 | RTZA16 | RTZA17 | RTZA50 | RTZA51 | PP | PC

RTZA10 | RTZA16 | RTZA17 | RTZA50 | RTZA51

SMA adapters and cable offered by Rohde & Schwarz

PP | PC

Proven probe, proven cable

Example: See [Chapter 27.3.6.1, "Adding cables to the measurement setup"](#), on page 1359.

Usage: Setting only
Asynchronous command

Manual operation: See ["Meas setup definition"](#) on page 1250

DEEMbedding<m>:REMove <Index>

Deletes the component with the indicated index from the measurement setup.

Suffix:

<m> 1..4
Selects the channel that is configured for deembedding.

Setting parameters:

<Index> Defines the place of the component in the measurement path. The DUT is always the first component (index = 1), the probe or input is the last component.

Usage: Setting only
Asynchronous command

Manual operation: See ["Meas setup definition"](#) on page 1250

DEEMbedding<m>:CCOunt?

Returns the total number of components in the measurement setup, including disabled components.

Suffix:
 <m> 1..4
 Selects the channel that is configured for deembedding.

Return values:
 <Value> Integer value, number of components

Usage: Query only

Manual operation: See "[Meas setup definition](#)" on page 1250

DEEMbedding<m>:BANDwidth <Bandwidth>

Sets the maximum bandwidth until which the signal is corrected. This maximum value is the minimum bandwidth value of probe, probe tip and oscilloscope bandwidth, and can not be higher than the highest frequency in a used S-parameter file.

Suffix:
 <m> 1..4
 Selects the channel that is configured for deembedding.

Parameters:
 <Bandwidth> Bandwidth limit for correction.
 Range: 1E+9 to 16E+9
 Increment: 10
 *RST: 4E+9
 Default unit: Hz

Usage: Asynchronous command

Manual operation: See "[Effective bandwidth](#)" on page 1250

DEEMbedding<m>:CMPDelay <DelayCompens>

Enables the compensation for the group delay of the complete measurement setup. If enabled, the calibration time reference point is the start point of the measurement setup. If disabled, the calibration time reference point is the oscilloscope's channel input.

Suffix:
 <m> 1..4
 Selects the channel that is configured for deembedding.

Parameters:
 <DelayCompens> ON | OFF
 *RST: ON

Usage: Asynchronous command

Manual operation: See "[Delay compensation](#)" on page 1250

DEEMbedding<m>:PRESet

Sets the complete deembedding configuration to the default values. Use this command always before setting up the deembedding, because *RST does not affect the deembedding settings.

Suffix:

<m> 1..4
Selects the channel that is configured for deembedding.

Example: See [Chapter 27.3.6.1, "Adding cables to the measurement setup"](#), on page 1359.

Usage: Event
Asynchronous command

Manual operation: See "[Preset Deembedding](#)" on page 1251

27.26.2 Save and load the deembedding setup

DEEMbedding<m>:NAME	2801
DEEMbedding<m>:SAVE	2801
DEEMbedding<m>:OPEN	2802
DEEMbedding<m>:DELete	2802

DEEMbedding<m>:NAME <Path>

Sets the file name, file format and path of the deembedding setup file. The file format is always `.xml`.

Suffix:

<m> 1..4
Selects the channel that is configured for deembedding.

Parameters:

<Path> String with path and file name with extension `.xml`

Usage: Asynchronous command

Manual operation: See "[Save / recall deembedding settings](#)" on page 1251

DEEMbedding<m>:SAVE

Saves the deembedding configuration to the file specified with [DEEMbedding<m>:NAME](#).

Suffix:

<m> 1..4
Selects the channel that is configured for deembedding.

Usage: Event

Manual operation: See "[Save / recall deembedding settings](#)" on page 1251

DEEMbedding<m>:OPEN

Opens and loads the deembedding configuration from the file specified with [DEEMbedding<m>:NAME](#).

Suffix:

<m> 1..4
Selects the channel that is configured for deembedding.

Usage: Event

Manual operation: See "[Save / recall deembedding settings](#)" on page 1251

DEEMbedding<m>:DELeTe

Deletes the deembedding configuration file specified with [DEEMbedding<m>:NAME](#).

Suffix:

<m> 1..4
Selects the channel that is configured for deembedding.

Usage: Event

Manual operation: See "[Save / recall deembedding settings](#)" on page 1251

27.26.3 Components

- [General settings](#).....2802
- [DUT settings](#).....2804
- [R&S RT-ZM probe settings](#).....2805
- [Cable, adapter, fixture and custom settings](#).....2807

27.26.3.1 General settings**DEEMbedding<m>:COMPONENT<n>[:STATe] <IsEnabled>**

Enables or disables the indicated component for deembedding.

The first and the last component are always enabled and cannot be disabled.

Suffix:

<m> 1..4
Selects the channel that is configured for deembedding.

<n> 2..n-1
Index of the component in the measurement setup. The DUT has index 1, the probe has index n.

Parameters:

<IsEnabled> ON | OFF
*RST: OFF

Usage: Asynchronous command

Manual operation: See ["Enable"](#) on page 1252

DEEMbedding<m>:COMPONENT<n>:TYPE <Type>

Sets the type of the indicated component. The first component is always DUT, the last component is PROBe or INPut.

Suffix:

<m> 1..4
Selects the channel that is configured for deembedding.

<n> 1..n
Index of the component in the measurement setup. The DUT has index 1, the probe has index n.

Parameters:

<Type> PROBe | FIXTure | CABLE | DUT | ADAPter | INPut | OTHer | RTZA10 | RTZA16 | RTZA17 | RTZA50 | RTZA51 | PP | PC
RTZA10 | RTZA16 | RTZA17 | RTZA50 | RTZA51
SMA adapters and cable offered by Rohde & Schwarz
PP | PC
Proven probe, proven cable
*RST: CABLE

Usage: Asynchronous command

Manual operation: See ["Component"](#) on page 1252

DEEMbedding<m>:COMPONENT<n>:NAME <Name>

Sets a name for the indicated component that helps you identifying it.

Suffix:

<m> 1..4
Selects the channel that is configured for deembedding.

<n> 1..n
Index of the component in the measurement setup. The DUT has index 1, the probe has index n.

Parameters:

<Name> String parameter, name of the component

Usage: Asynchronous command

Manual operation: See ["Name"](#) on page 1252

DEEMbedding<m>:COMPONENT<n>:PCOut?

Returns the number of all ports of the selected component (input ports and output ports).

The number of ports depends on the attached probe. If a modular probe R&S RT-ZM or differential probe R&S RT-ZD is used, the number of ports is 4. Otherwise, 2 ports are available.

Suffix:

<m> 1..4
Selects the channel that is configured for deembedding.

<n> 1..n
Index of the component in the measurement setup. The DUT has index 1, the probe has index n.

Return values:

<TotalPorts> ONE | TWO | THRee | FOUR
*RST: TWO

Usage: Query only
Asynchronous command

Manual operation: See "[Total ports](#)" on page 1252

27.26.3.2 DUT settings

DEEMbedding<m>:COMPONENT<n>:MODE	2804
DEEMbedding<m>:COMPONENT<n>:LOAD:REMPload	2805
DEEMbedding<m>:COMPONENT<n>:LOAD:IMPedance?	2805

DEEMbedding<m>:COMPONENT<n>:MODE <Mode>

Sets the probing mode.

Suffix:

<m> 1..4
Selects the channel that is configured for deembedding.

<n> 1, only for available DUT

Parameters:

<Mode> PROBing | TERMinating

PROBing

For measurements with a high-ohmic probe and measure on an existing line in parallel to the load.

TERMinating

For measurements if the measuring equipment is the load of the line.

*RST: PROBing

Usage: Asynchronous command

Manual operation: See "[Probing, Terminating](#)" on page 160

DEEMbedding<m>:COMPONENT<n>:LOAD:REMPobeload <Value>

Removes the loading of the probe if `DEEMbedding<m>:COMPONENT<n>:MODE` is set to `PROBing`.

If the probe loading is removed, you see the signal that would be at the measurement point if the probe's input impedance is ideal (infinite impedance).

Without removing the loading, you see the real signal at the measurement point, including the probe loading.

Suffix:

<m>	1..4 Selects the channel that is configured for deembedding.
<n>	1, only for available DUT

Parameters:

<Value> OFF | ON

Usage: Asynchronous command

Manual operation: See "[Remove probe load](#)" on page 160

DEEMbedding<m>:COMPONENT<n>:LOAD:IMPedance? <Value>

Shows the source impedance of the DUT. If an R&S RT-ZM probe is connected, the value depends on the selected probe mode: common mode, differential, or single-ended measurement.

Suffix:

<m>	1..4 Selects the channel that is configured for deembedding.
<n>	1, only for available DUT

Return values:

<Value> Numeric value

Usage: Query only
Asynchronous command

Manual operation: See "[Source impedance](#)" on page 160

27.26.3.3 R&S RT-ZM probe settings

This chapter lists the commands that correspond to the "Deembedding" > "RT-ZMxx" dialog box. More commands are provided in [Chapter 27.8.7.6, "Modular probes, deembedding"](#), on page 1449.

<code>PROBe<m>:DEEMbedding:TIPModule[:SElect]</code>	2806
<code>PROBe<m>:DEEMbedding:TIPModule:ZMA<n>:SUBModule</code>	2806
<code>PROBe<m>:DEEMbedding:BANDwidth</code>	2806

PROBe<m>:DEEMbedding:TIPModule[:SElect] <ProbeTipZMA>

Selects the tip module that is used for measurement.

Suffix:

<m> 1..4
Selects the channel to which the probe is connected.

Parameters:

<ProbeTipZMA> NONE | ZMA10 | ZMA12 | ZMA14 | ZMA15 | ZMA30 | ZMA40 | ZMA50
*RST: ZMA10

Usage: Asynchronous command

Manual operation: See "[Probe tip module, Pin spacing](#)" on page 159

PROBe<m>:DEEMbedding:TIPModule:ZMA<n>:SUBModule <Value>

Defines additional settings for some tip modules:

For the browser module R&S RT-ZMA30, measure the space between the pins, and select the appropriate value.

If R&S RT-ZMA40 is selected, choose the used submodule: semi-rigid cables or none.

Suffix:

<m> 1..4
Selects the channel to which the probe is connected.

<n> 30 (R&S RT-ZMA30) or 40 (R&S RT-ZMA40)

Parameters:

<Value> D16 | D25 | D45 | D75 | NONE | SRCS

For R&S RT-ZMA30:

D16 = 1.6 mm

D25 = 2.5 mm

D45 = 4.5 mm

D75 = 7.5 mm

For R&S RT-ZMA40:

NONE = no submodule

SRCS = semi-rigid cables

Usage: Asynchronous command

Manual operation: See "[Probe tip module, Pin spacing](#)" on page 159

PROBe<m>:DEEMbedding:BANDwidth <ProbeBandwidth>

Sets the maximum bandwidth until which the signal is corrected. This maximum value is the minimum bandwidth value of probe, probe tip and oscilloscope bandwidth, and can not be higher than the highest frequency in a used S-parameter file. Consider that most tip modules support the full bandwidth of the probe amplifier, but some tip modules have limited bandwidth.

Suffix:

<m> 1..4
Selects the channel to which the probe is connected.

Parameters:

<ProbeBandwidth> Range: 10000 to 16E+9
Increment: 10
*RST: 4E+9
Default unit: Hz

Usage: Asynchronous command

Manual operation: See "[Effective bandwidth](#)" on page 160

27.26.3.4 Cable, adapter, fixture and custom settings

DEEMbedding<m>:COMPONENT<n>:IDENTICAL	2807
DEEMbedding<m>:COMPONENT<n>:IPONE	2807
DEEMbedding<m>:COMPONENT<n>:IPTWo	2807
DEEMbedding<m>:COMPONENT<n>:OPONE	2808
DEEMbedding<m>:COMPONENT<n>:OPTWo	2808
DEEMbedding<m>:COMPONENT<n>:SPONE	2808
DEEMbedding<m>:COMPONENT<n>:SPTWo	2808

DEEMbedding<m>:COMPONENT<n>:IDENTICAL <MatchedPaths>

The setting is relevant if the measurement setup is a 4-port, and the component is a 2-port. Usually, these components are cables and adapters, which are described by *.s2p files. In case of a 4-port setup, 2 cables or 2 adapters are used. If they are identical, for example, when a matched-pair cable is used, they can be described by the same file. In this case, set the command to ON.

Suffix:

<m> 1..4
Selects the channel that is configured for deembedding.

<n> 1..*
Selects the component. The DUT has suffix 1.

Parameters:

<MatchedPaths> ON | OFF
*RST: OFF

Usage: Asynchronous command

Manual operation: See "[Identical Paths](#)" on page 1257

DEEMbedding<m>:COMPONENT<n>:IPONE <InputPort1>
DEEMbedding<m>:COMPONENT<n>:IPTWo <InputPort2>

DEEMbedding<m>:COMPONENT<n>:OPONe <OutputPort1>

DEEMbedding<m>:COMPONENT<n>:OPTWo <OutputPort2>

Assign the ports to the input and output of the component according to the data in the Touchstone file. This information is not directly written in the file. You need background information how the S-parameters were determined, i.e. which port was input and which port was output.

Suffix:

<m> 1..4
Selects the channel that is configured for deembedding.

<n> 1..*
Selects the component. The DUT has suffix 1.

Parameters:

<InputPort1> ONE | TWO | THRee | FOUR

<InputPort2> Port number that is assigned to the input or output.

<OutputPort1> *RST: ONE for input 1, TWO for output 1, THRee for
<OutputPort2> input 2, FOUR for output 4

Usage: Asynchronous command

Manual operation: See "[Input 1, Input 2, Output 1, Output 2](#)" on page 1257

DEEMbedding<m>:COMPONENT<n>:SPONe <SPParamFilePath>

DEEMbedding<m>:COMPONENT<n>:SPTWo <SPParamFilePath>

Set the file name, file format and path of the S-parameter file, and load the S-parameters.

See also: "[S-Parameters, Filetype](#)" on page 1257.

Suffix:

<m> 1..4
Selects the channel that is configured for deembedding.

<n> 1..*
Selects the component. The DUT has suffix 1.

Parameters:

<SPParamFilePath> String with path and file name with extension *s2p* (2-port component) or *s4p* (4-port component).

Example: See [Chapter 27.3.6.1, "Adding cables to the measurement setup"](#), on page 1359.

Usage: Asynchronous command

Manual operation: See "[S-Parameters, Filetype](#)" on page 1257

27.26.4 Responses

DEEMbedding<m>:CADC?

Maximum attenuation or gain of the measurement setup before deembedding at DC. This value is the expected basic attenuation or gain, which is corrected by deembedding.

Suffix:

<m> 1..4
Selects the channel that is configured for deembedding.

Return values:

ValueAtDC Range: -1E+9 to 1E+9
Increment: 0.01
*RST: 0
Default unit: dB

Usage: Query only

Manual operation: See "[Att_{DC}](#), [Gain_{DC}](#)" on page 1259

DEEMbedding<m>:MATTenuation?

Maximum attenuation of the measurement setup before deembedding, with reference to a frequency response normalized at DC to 0 dB. The deembedding filter must amplify the amplitude response by the "[Att_{max}](#)" value, and thus also increases the noise by this value. The value also helps to decide whether deembedding is useful for the defined effective bandwidth.

Suffix:

<m> 1..4
Selects the channel that is configured for deembedding.

Return values:

<MaxFilterAtt> Range: -1E+9 to 1E+9
Increment: 0.01
*RST: 0
Default unit: dB

Usage: Query only

Manual operation: See "[Att_{max}](#)" on page 1259

DEEMbedding<m>:MGAIN?

Maximum gain of the measurement setup before deembedding, with reference to a frequency response normalized at DC to 0 dB. The deembedding filter must attenuate the amplitude response by this value. The value helps also to avoid an overload of the ADC.

Suffix:

<m> 1..4
Selects the channel that is configured for deembedding.

Return values:

<MaxFilterGn> Range: -1E+9 to 1E+9
Increment: 0.01
*RST: 0
Default unit: dB

Usage: Query only

Manual operation: See "[Gain_{max}](#)" on page 1259

27.27 Embedding and equalization (option R&S RTO6-K126)

Some of the commands in the following chapter are asynchronous. An overlapping or asynchronous command does not automatically finish executing before the next command starts executing. If overlapping commands must be executed in a defined order, e.g. to avoid wrong measurement results, they must be serviced sequentially.

To prevent an overlapping execution of commands, one of the commands *OPC, *OPC? or *WAI can be used after the command or a command set.

For more information, see:

- www.rohde-schwarz.com/rc-via-scp, chapter "Command sequence and synchronization"
- [Chapter 27.3, "Programming examples"](#), on page 1345
- [Signal lanes](#).....2810
- [General](#)..... 2813
- [Vertical](#)..... 2816
- [TxFFE](#)..... 2817
- [Embedding](#).....2819
- [CTLE](#)..... 2827
- [FFE](#)..... 2831
- [DFE](#)..... 2835
- [Filter training](#)..... 2842

27.27.1 Signal lanes

LANE<m>:NAME	2811
LANE<m>:OPEN	2811
LANE<m>:PAMorder?	2811
LANE<m>:PRESet	2811
LANE<m>:SAVE	2812
LANE<m>:SOURce	2812
LANE<m>:STATe	2812
LANE<m>:SYMRate	2812

LANE<m>:NAME <SaveSetPath>

Sets the file name, file format and path of the lane setup file. The file format is always `.xml`.

Suffix:

<m> 1..4
Selects the lane that is configured.

Parameters:

<SaveSetPath>

Usage: Asynchronous command

Manual operation: See "[Save / recall settings](#)" on page 1269

LANE<m>:OPEN

Opens and loads the lane configuration from the file specified with [LANE<m> : SAVE](#).

Suffix:

<m> 1..4
Selects the lane that is configured.

Usage: Event
Asynchronous command

Manual operation: See "[Save / recall settings](#)" on page 1269

LANE<m>:PAMorder?

Selects the PAM order. You can select a value up to 8.

Suffix:

<m> 1..4
Selects the lane that is configured.

Return values:

<PAMOrder> PAM2 | PAM3 | PAM4 | PAM5 | PAM6 | PAM7 | PAM8
*RST: PAM2

Usage: Query only
Asynchronous command

LANE<m>:PRESet

Presets the equalization lane.

Suffix:

<m> 1..4
Selects the lane that is configured.

Usage: Event
Asynchronous command

Manual operation: See ["Preset"](#) on page 1269

LANE<m>:SAVE

Saves the embedding configuration to the file specified with [LANE<m> : NAME](#).

Suffix:

<m> 1..4
Selects the lane that is configured.

Usage: Event
Asynchronous command

Manual operation: See ["Save / recall settings"](#) on page 1269

LANE<m>:SOURCE <MainSource>

Selects the source of the lane.

Suffix:

<m> 1..4
Selects the lane.

Parameters:

<MainSource> C1W1 | C1W2 | C1W3 | C2W1 | C2W2 | C2W3 | C3W1 | C3W2 |
C3W3 | C4W1 | C4W2 | C4W3 | M1 | M2 | M3 | M4 | R1 | R2 |
R3 | R4 | DIFF1 | DIFF2 | COMMON1 | COMMON2 | M5 | M6 |
M7 | M8

Usage: Asynchronous command

Manual operation: See ["Source"](#) on page 1269

LANE<m>:STATE <State>

Activates the lane signal.

Suffix:

<m> 1..4
Selects the lane that is configured.

Parameters:

<State> ON | OFF
*RST: OFF

Usage: Asynchronous command

Manual operation: See ["Enable"](#) on page 1268

LANE<m>:SYMRate <SymbolRate>

Sets a nominal bit rate for the signal.

Suffix:

<m> 1..4
Selects the lane that is configured.

Parameters:

<SymbolRate> Range: 100 to 40E+9
Increment: 10
*RST: 1E+9
Default unit: Baud

Usage: Asynchronous command

Manual operation: See "[Nominal bit rate](#)" on page 1269

27.27.2 General

LANE<m>:CMPO	2813
LANE<m>:COMFilter:INCLude:DEEMbedding	2813
LANE<m>:COMFilter:INCLude:EMBedding	2814
LANE<m>:COMFilter:INCLude:TFFE	2814
LANE<m>:EQualization:NAME	2814
LANE<m>:EQualization:OPEN	2815
LANE<m>:EQualization:PRESet	2815
LANE<m>:EQualization:SAVE	2815
LANE<m>:EQualization:STATe	2815

LANE<m>:CMPO <OffsCompens>

Enables the DC offset compensation. If enabled, the application estimates the DC offset of the input signal and removes it prior to training and/or applying equalizers to it.

Suffix:

<m> 1..4
Selects the lane that is configured.

Parameters:

<OffsCompens> ON | OFF
*RST: ON

Usage: Asynchronous command

Manual operation: See "[DC offset compensation](#)" on page 1268

LANE<m>:COMFilter:INCLude:DEEMbedding <IncludeDeembedding>

Includes deembedding.

See also [Chapter 27.26, "Deembedding \(option R&S RTO6-K121\)"](#), on page 2798.

Suffix:

<m> 1..4
Selects the lane that is configured.

Parameters:

<IncludeDeembedding> ON | OFF

*RST: OFF

Usage:

Asynchronous command

Manual operation: See ["Deembedding"](#) on page 1270**LANE<m>:COMFilter:INCLude:EMBedding <IncludeEmbedding>**

Includes embedding.

See also [Chapter 27.27.5, "Embedding"](#), on page 2819.**Suffix:**

<m> 1..4

Selects the lane that is configured.

Parameters:

<IncludeEmbedding> ON | OFF

*RST: OFF

Usage:

Asynchronous command

Manual operation: See ["Embedding"](#) on page 1270**LANE<m>:COMFilter:INCLude:TFFE <IncludeTxFFE>**

Includes the transmitter feed forward equalization.

See also [Chapter 27.27.4, "TxFFE"](#), on page 2817.**Suffix:**

<m> 1..4

Selects the lane that is configured.

Parameters:

<IncludeTxFFE> ON | OFF

*RST: OFF

Usage:

Asynchronous command

Manual operation: See ["TxFFE"](#) on page 1270**LANE<m>:EQUalization:NAME <SaveSetPath>**Sets the file name, file format and path of the equalization setup file. The file format is always `.xml`.**Suffix:**

<m> 1..4

Selects the lane that is configured for equalization.

Parameters:

<SaveSetPath>

Usage: Asynchronous command
Manual operation: See ["Save / open equalization settings"](#) on page 1284

LANE<m>:EQUalization:OPEN

Opens and loads the equalization configuration from the file specified with [LANE<m> : EQUalization:SAVE](#).

Suffix:
 <m> 1..4
 Selects the lane that is configured for equalization.

Usage: Event
 Asynchronous command

Manual operation: See ["Save / open equalization settings"](#) on page 1284

LANE<m>:EQUalization:PRESet

Presets the equalization settings to their default values.

Suffix:
 <m> 1..4
Usage: Event
 Asynchronous command

Manual operation: See ["Preset"](#) on page 1284

LANE<m>:EQUalization:SAVE

Saves the equalization configuration to the file specified with [LANE<m> : EQUalization:SAVE](#).

Suffix:
 <m> 1..4
 Selects the lane that is configured for equalization.

Usage: Event
 Asynchronous command

Manual operation: See ["Save / open equalization settings"](#) on page 1284

LANE<m>:EQUalization:STATe <State>

Enables the equalization.

Suffix:
 <m> 1..4
 Selects the lane that is configured for equalization.

Parameters:

<State> ON | OFF
 *RST: OFF

Usage: Asynchronous command

Manual operation: See ["Enable"](#) on page 1283

27.27.3 Vertical

LANE<m>:VERTical:COUPlE.....	2816
LANE<m>:VERTical:OFFSet.....	2816
LANE<m>:VERTical:POSition.....	2817
LANE<m>:VERTical:SCALe.....	2817

LANE<m>:VERTical:COUPlE <VertCpl>

Determines how the vertical settings are defined.

If enabled, the vertical settings are coupled to the settings of the respective source. If disabled, the vertical settings for embedding and equalization are set in this dialog.

Suffix:

<m> 1..4
 Selects the lane that is configured.

Parameters:

<VertCpl> ON | OFF
 *RST: ON

Usage: Asynchronous command

Manual operation: See ["Couple settings to source"](#) on page 1272

LANE<m>:VERTical:OFFSet <VerticalOffset>

Sets the offset for embedding and equalization.

Suffix:

<m> 1..4
 Selects the lane that is configured.

Parameters:

<VerticalOffset> Range: -100E+24 to 100E+24
 Increment: 0.01
 *RST: 0
 Default unit: V

Usage: Asynchronous command

Manual operation: See ["Offset"](#) on page 1273

LANE<m>:VERTical:POSition <VertPosi>

Sets the vertical position for embedding and equalization.

Suffix:

<m> 1..4
Selects the lane that is configured.

Parameters:

<VertPosi> Range: -100E+24 to 100E+24
Increment: 0.1
*RST: 0
Default unit: div

Usage: Asynchronous command

Manual operation: See "[Position](#)" on page 1273

LANE<m>:VERTical:SCALe <VerticalScale>

Sets the vertical scale for embedding and equalization.

Suffix:

<m> Selects the lane that is configured.

Parameters:

<VerticalScale> Range: 1E-12 to 100
Increment: 1E-3
*RST: 0.05
Default unit: V/div

Usage: Asynchronous command

Manual operation: See "[Scale](#)" on page 1273

27.27.4 TxFFE

LANE<m>:TFFE:PSElection	2817
LANE<m>:TFFE:SCONfig:LIST?	2818
LANE<m>:TFFE:SCONfig[:SElect]	2818
LANE<m>:TFFE:STATe	2818
LANE<m>:TFFE:TAPS:COUNT	2819
LANE<m>:TFFE:TAPS:PRESet	2819
LANE<m>:TFFE:TAPS:TAP<*>	2819

LANE<m>:TFFE:PSElection <PlotSelection>

Selects the plots that is displayed for the selected TxFFE configuration.

Suffix:

<m> 1..4
Selects the lane that is configured.

Parameters:

<PlotSelection> MAGNitude | PHASe | GDElay | STEP | TAPS
 *RST: TAPS

Usage: Asynchronous command

Manual operation: See "[Plot](#)" on page 1270

LANE<m>:TFFE:SCONfig:LIST?

Returns the list of available presets for the selected standard.

Suffix:

<m> 1..4
 Selects the lane that is configured.

Usage: Query only
 Asynchronous command

Manual operation: See "[Standard configuration](#)" on page 1274

LANE<m>:TFFE:SCONfig[:SElect] <SubConfig>

Selects a preset standard according to the selected serial standard. You can set the serial standard with [SIGNalconfig:SETup:SETTing<m>:SERStandard](#).

Suffix:

<m> 1..4
 Selects the lane that is configured.

Parameters:

<SubConfig>

Usage: Asynchronous command

Manual operation: See "[Standard configuration](#)" on page 1274

LANE<m>:TFFE:STATe <State>

Enables the transmitter feed forward equalization.

Suffix:

<m> 1..4
 Selects the lane that is configured.

Parameters:

<State> ON | OFF
 *RST: OFF

Usage: Asynchronous command

Manual operation: See "[Enable](#)" on page 1274

LANE<m>:TFFE:TAPS:COUNT <NumItems>

Selects the number of taps for the TxFFE.

Suffix:

<m> 1..4
Selects the lane that is configured.

Parameters:

<NumItems> Range: 1 to 40
Increment: 1
*RST: 1

Usage: Asynchronous command

Manual operation: See "[Taps](#)" on page 1275

LANE<m>:TFFE:TAPS:PRESet

Presets the TFFE taps.

Suffix:

<m> 1..4
Selects the lane that is configured.

Usage: Event
Asynchronous command

LANE<m>:TFFE:TAPS:TAP<*> <Value>

Sets the value of the tap for the TxFFE.

Suffix:

<m> 1..4
Selects the lane that is configured.

Parameters:

<Value> Range: -40E+9 to 40E+9
Increment: 10
*RST: 1

Usage: Asynchronous command

Manual operation: See "[Taps](#)" on page 1275

27.27.5 Embedding

Some of the commands in the following chapter are asynchronous. An overlapping or asynchronous command does not automatically finish executing before the next command starts executing. If overlapping commands must be executed in a defined order, e.g. to avoid wrong measurement results, they must be serviced sequentially.

Embedding and equalization (option R&S RTO6-K126)

To prevent an overlapping execution of commands, one of the commands *OPC, *OPC? or *WAI can be used after the command or a command set.

For more information, see:

- www.rohde-schwarz.com/rc-via-scpj, chapter "Command sequence and synchronization"
- Chapter 27.3, "Programming examples", on page 1345

LANE<m>:EMBedding:STATe.....	2820
LANE<m>:EMBedding:ADD.....	2821
LANE<m>:EMBedding:BANDwidth.....	2821
LANE<m>:EMBedding:CASCade:PSElection.....	2821
LANE<m>:EMBedding:CCOunt?.....	2821
LANE<m>:EMBedding:CMPDelay.....	2822
LANE<m>:EMBedding:COMPOnent<n>:IDENtical.....	2822
LANE<m>:EMBedding:COMPOnent<n>:IPONe.....	2823
LANE<m>:EMBedding:COMPOnent<n>:IPTWo.....	2823
LANE<m>:EMBedding:COMPOnent<n>:OPONe.....	2823
LANE<m>:EMBedding:COMPOnent<n>:OPTWo.....	2823
LANE<m>:EMBedding:COMPOnent<n>:NAME.....	2823
LANE<m>:EMBedding:COMPOnent<n>:PCOunt?.....	2823
LANE<m>:EMBedding:COMPOnent<n>:PSONe.....	2824
LANE<m>:EMBedding:COMPOnent<n>:PSTWo.....	2824
LANE<m>:EMBedding:COMPOnent<n>:SPFSelection.....	2824
LANE<m>:EMBedding:COMPOnent<n>:SPFType.....	2825
LANE<m>:EMBedding:COMPOnent<n>:SPONe.....	2825
LANE<m>:EMBedding:COMPOnent<n>:SPTWo.....	2825
LANE<m>:EMBedding:COMPOnent<n>:TYPE.....	2825
LANE<m>:EMBedding:COMPOnent<n>[:STATe].....	2826
LANE<m>:EMBedding:NAME.....	2826
LANE<m>:EMBedding:OPEN.....	2826
LANE<m>:EMBedding:PRESet.....	2826
LANE<m>:EMBedding:REMOve.....	2827
LANE<m>:EMBedding:SAVE.....	2827

LANE<m>:EMBedding:STATe <State>

Activates the embedding.

Suffix:

<m> 1..4
Selects the lane that is configured for embedding.

Parameters:

<State> ON | OFF
*RST: OFF

Usage: Asynchronous command

Manual operation: See "Enable" on page 1278

LANE<m>:EMBedding:ADD <Index>, [<Type>]

Adds a component to the measurement setup.

Suffix:

<m> 1..4
Selects the channel that is configured for embedding.

Setting parameters:

<Index> Defines the place of the component in the measurement path.

<Type> FIXTure | CABLe | DUT | ADAPter | PC | OTHer

Usage: Setting only

Manual operation: See "[Meas setup definition](#)" on page 1279

LANE<m>:EMBedding:BANDwidth <Bandwidth>

Sets the maximum bandwidth until which the signal is corrected. This maximum value is the minimum bandwidth value of probe, probe tip and oscilloscope bandwidth, and can not be higher than the highest frequency in a used S-parameter file.

Suffix:

<m> 1..4
Selects the lane that is configured for embedding.

Parameters:

<Bandwidth> Range: 1E+9 to 16E+9
Increment: 10
*RST: 4E+9
Default unit: Hz

Usage: Asynchronous command

Manual operation: See "[Effective bandwidth](#)" on page 1278

LANE<m>:EMBedding:CASCade:PSELection <PlotSelection>**Suffix:**

<m> 1..4
Selects the lane that is configured for embedding.

Parameters:

<PlotSelection> S11 | S12 | S13 | S21 | S22 | S23 | S31 | S32 | S33
*RST: S21

Usage: Asynchronous command

LANE<m>:EMBedding:CCOunt?

Returns the total number of components in the measurement setup, including disabled components.

Embedding and equalization (option R&S RTO6-K126)

Suffix:
 <m> 1..4
 Selects the lane that is configured for embedding.

Return values:
 <Value>

Usage: Query only
 Asynchronous command

Manual operation: See "[Meas setup definition](#)" on page 1279

LANE<m>:EMBedding:CMPDelay <DlyCompens>

Enables the compensation for the group delay of the complete measurement setup. If enabled, the calibration time reference point is the start point of the measurement setup. If disabled, the calibration time reference point is the oscilloscope's channel input.

Suffix:
 <m> 1..4
 Selects the lane that is configured for embedding.

Parameters:
 <DlyCompens> ON | OFF
 *RST: ON

Usage: Asynchronous command

Manual operation: See "[Delay compensation](#)" on page 1278

LANE<m>:EMBedding:COMPonent<n>:IDENTical <MatchedPaths>

The setting is relevant if the measurement setup is a 4-port, and the component is a 2-port. Usually, these components are cables and adapters, which are described by *.s2p files. In case of a 4-port setup, 2 cables or 2 adapters are used. If they are identical, for example, when a matched-pair cable is used, they can be described by the same file. In this case, set the command to ON.

Suffix:
 <m> 1..4
 Selects the lane that is configured for embedding.

<n> 1..*
 Selects the component.

Parameters:
 <MatchedPaths> ON | OFF
 *RST: OFF

Usage: Asynchronous command

LANE<m>:EMBedding:COMPONENT<n>:IPONe <InputPort1>
LANE<m>:EMBedding:COMPONENT<n>:IPTWo <InputPort2>
LANE<m>:EMBedding:COMPONENT<n>:OPONe <OutputPort1>
LANE<m>:EMBedding:COMPONENT<n>:OPTWo <OutputPort2>

Assign the ports to the input and output of the component according to the data in the Touchstone file. This information is not directly written in the file. You need background information how the S-parameters were determined, i.e. which port was input and which port was output.

Suffix:

<m> 1..4
 Selects the lane that is configured for embedding.

<n> 1..*
 Selects the component.

Parameters:

<OutputPort2> ONE | TWO | THRee | FOUR
 *RST: ONE for input 1, TWO for output 1, THRee for input 2, FOUR for output 4

Usage: Asynchronous command

Manual operation: See "[Input 1, Input 2, Output 1, Output 2](#)" on page 1280

LANE<m>:EMBedding:COMPONENT<n>:NAME <Name>

Sets a name for the indicated component that helps you identifying it.

Suffix:

<m> 1..4
 Selects the lane that is configured for embedding.

<n> 1..n
 Index of the component in the measurement setup.

Parameters:

<Name> String parameter, name of the component

Usage: Asynchronous command

Manual operation: See "[Name](#)" on page 1280

LANE<m>:EMBedding:COMPONENT<n>:PCOunt?

Returns the number of all ports of the selected component (input ports and output ports).

Suffix:

<m> 1..4
 Selects the channel that is configured for deembedding.

<n> *
 Index of the component in the measurement setup.

Return values:

<TotalCompPorts> TWO | FOUR
 *RST: TWO

Usage:

Query only
 Asynchronous command

Manual operation: See "[Total ports](#)" on page 1280

LANE<m>:EMBedding:COMPONENT<n>:PSONE <PlotSelect1>

Selects the plot one.

Suffix:

<m> 1..4
 Selects the lane that is configured for embedding.

<n> *

Parameters:

<PlotSelect1> S11 | S12 | S13 | S14 | S21 | S22 | S23 | S24 | S31 | S32 | S33 |
 S34 | S41 | S42 | S43 | S44
 *RST: S21

Usage:

Asynchronous command

LANE<m>:EMBedding:COMPONENT<n>:PSTWo <PlotSelect2>**Suffix:**

<m> 1..4
 Selects the lane that is configured for embedding.

<n> *

Parameters:

<PlotSelect2> S11 | S12 | S21 | S22
 *RST: S12

Usage:

Asynchronous command

LANE<m>:EMBedding:COMPONENT<n>:SPFSelection <SPParamFileSel>**Suffix:**

<m> 1..4
 Selects the lane that is configured for embedding.

<n> *

Parameters:

<SPParamFileSel> SPF1 | SPF2
 *RST: SPF1

Usage:

Asynchronous command

LANE<m>:EMBedding:COMPonent<n>:SPFType <SPParamFile1Type>

Suffix:

<m> 1..4
Selects the lane that is configured for embedding.

<n> *

Parameters:

<SPParamFile1Type> S2P | S3P | S4P
*RST: S2P

Usage: Asynchronous command

LANE<m>:EMBedding:COMPonent<n>:SPONe <SPParamFilePath1>

LANE<m>:EMBedding:COMPonent<n>:SPTWo <SPParamFilePath2>

Set the file name, file format and path of the S-parameter file, and load the S-parameters.

Suffix:

<m> 1..4
Selects the lane that is configured for embedding.

<n> 1..*
Selects the component.

Parameters:

<SPParamFilePath2> String with path and file name with extension *s2p* (2-port component) or *s4p* (4-port component).

Usage: Asynchronous command

Manual operation: See "[S-Parameters, Filetype](#)" on page 1280

LANE<m>:EMBedding:COMPonent<n>:TYPE <Type>

Sets the type of the indicated component.

Suffix:

<m> 1..4
Selects the lane that is configured for embedding.

<n> *

Parameters:

<Type> FIXTure | CABLe | ADAPter | OTHer
*RST: CABLe

Usage: Asynchronous command

Manual operation: See "[Component](#)" on page 1280

LANE<m>:EMBedding:COMPonent<n>[:STATe] <IsEnabled>

Enables or disables the indicated component for embedding.

The first and the last component are always enabled and cannot be disabled.

Suffix:

<m> 1..4
Selects the lane that is configured for embedding.

<n> *
Index of the component in the measurement setup.

Parameters:

<IsEnabled> ON | OFF
*RST: OFF

Usage: Asynchronous command

Manual operation: See ["Enable"](#) on page 1280

LANE<m>:EMBedding:NAME <Path>

Sets the file name, file format and path of the embedding setup file. The file format is always `.xml`.

Suffix:

<m> 1..4
Selects the lane that is configured for embedding.

Parameters:

<Path> String with path and file name with extension `.xml`

Usage: Asynchronous command

Manual operation: See ["Save / recall embedding settings"](#) on page 1279

LANE<m>:EMBedding:OPEN

Opens and loads the embedding configuration from the file specified with [LANE<m>:EMBedding:NAME](#).

Suffix:

<m> 1..4
Selects the lane that is configured for embedding.

Usage: Event

Manual operation: See ["Save / recall embedding settings"](#) on page 1279

LANE<m>:EMBedding:PRESet

Sets the complete embedding configuration to the default values.

Embedding and equalization (option R&S RTO6-K126)

Suffix:
 <m> 1..4
 Selects the lane that is configured for embedding.

Usage: Event
 Asynchronous command

Manual operation: See "[Preset Embedding](#)" on page 1279

LANE<m>:EMBedding:REMove <Index>

Deletes the component with the indicated index from the measurement setup.

Suffix:
 <m> 1..4
 Selects the lane that is configured for embedding.

Setting parameters:
 <Index>

Usage: Setting only

Manual operation: See "[Meas setup definition](#)" on page 1279

LANE<m>:EMBedding:SAVE

Saves the embedding configuration to the file specified with [LANE<m>:EMBedding:NAME](#).

Suffix:
 <m> 1..4
 Selects the lane that is configured for embedding.

Usage: Event

Manual operation: See "[Save / recall embedding settings](#)" on page 1279

27.27.6 CTLE

LANE<m>:EQualization:CTLE:DCGain	2828
LANE<m>:EQualization:CTLE:NAME	2828
LANE<m>:EQualization:CTLE:OPEN	2828
LANE<m>:EQualization:CTLE:POLE:COUNT	2828
LANE<m>:EQualization:CTLE:POLE:FREQuency<*>	2829
LANE<m>:EQualization:CTLE:PSElection	2829
LANE<m>:EQualization:CTLE:SAVE	2829
LANE<m>:EQualization:CTLE:SCONfig:LIST?	2830
LANE<m>:EQualization:CTLE:SCONfig:SElect]	2830
LANE<m>:EQualization:CTLE:STATe	2830
LANE<m>:EQualization:CTLE:ZERO:COUNT	2830
LANE<m>:EQualization:CTLE:ZERO:FREQuency<*>	2831

LANE<m>:EQUalization:CTLE:DCGain <GainDC>

Sets a DC gain for the CTLE filter. The DC gain determines the level of signal amplification at the low frequency end, thus ensuring that low frequency components are amplified to an adequate level to maintain signal integrity.

Suffix:

<m> 1..4
Selects the lane that is configured for equalization.

Parameters:

<GainDC> Range: -40 to 40
Increment: 0.5
*RST: 0
Default unit: dB

Usage: Asynchronous command

Manual operation: See ["DC Gain"](#) on page 1285

LANE<m>:EQUalization:CTLE:NAME <SaveSetPath>

Sets the file name, file format and path of the CTLE equalization setup file. The file format is always `.xml`.

Suffix:

<m> 1..4
Selects the lane that is configured for equalization.

Parameters:

<SaveSetPath>

Usage: Asynchronous command

Manual operation: See ["Save / recall CTLE settings"](#) on page 1286

LANE<m>:EQUalization:CTLE:OPEN

Opens and loads the equalization CTLE configuration from the file specified with [LANE<m>:EQUalization:CTLE:NAME](#).

Suffix:

<m> 1..4
Selects the lane that is configured for equalization.

Usage:

Event
Asynchronous command

Manual operation: See ["Save / recall CTLE settings"](#) on page 1286

LANE<m>:EQUalization:CTLE:POLE:COUNT <NumItems>

Selects the number of pole frequencies for CTLE. You can set the individual value for each pole frequency with [LANE<m>:EQUalization:CTLE:POLE:FREquency<*>](#).

Suffix:

<m> 1..4
Selects the lane that is configured for equalization.

Parameters:

<NumItems> Range: 1 to 40
Increment: 1
*RST: 1

Usage: Asynchronous command

Manual operation: See "[Pole frequencies](#)" on page 1287

LANE<m>:EQualization:CTLE:POLE:FREQUency<*> <Value>

Set the value of the respective pole frequency.

Suffix:

<m> 1..4
Selects the lane that is configured for equalization.

Parameters:

<Value> Range: -40E+9 to 40E+9
Increment: 10
*RST: 1

Usage: Asynchronous command

Manual operation: See "[Pole frequencies](#)" on page 1287

LANE<m>:EQualization:CTLE:PSElection <PlotSelection>

Selects the plots that is displayed for the current CTLE configuration.

Suffix:

<m> 1..4
Selects the lane that is configured for equalization.

Parameters:

<PlotSelection> MAGNitude | PHASe | GDElay | STEP | TAPS
*RST: TAPS

Usage: Asynchronous command

Manual operation: See "[Plot selection](#)" on page 1287

LANE<m>:EQualization:CTLE:SAVE

Saves the CTLE configuration to the file specified with `LANE<m>:EQualization:CTLE:NAME`.

Suffix:

<m> 1..4
Selects the lane that is configured for equalization.

Usage: Event
Asynchronous command

Manual operation: See ["Save / recall CTLE settings"](#) on page 1286

LANE<m>:EQUalization:CTLE:SCONfig:LIST?

Returns the list of available presets for the selected standard.

Suffix:
<m> 1..4
Selects the lane that is configured for equalization.

Usage: Query only
Asynchronous command

Manual operation: See ["Standard configuration"](#) on page 1285

LANE<m>:EQUalization:CTLE:SCONfig[:SElect] <SubConfig>

Selects a preset standard according to the selected serial standard. You can set the serial standard with [SIGNalconfig:SETup:SETTing<m>:SERStandard](#).

Suffix:
<m> 1..4
Selects the lane that is configured for equalization.

Parameters:
<SubConfig>

Usage: Asynchronous command

Manual operation: See ["Standard configuration"](#) on page 1285

LANE<m>:EQUalization:CTLE:STATe <State>

Enables the continuous time linear equalizer (CTLE).

Suffix:
<m> 1..4
Selects the lane that is configured for equalization.

Parameters:
<State> ON | OFF
*RST: OFF

Usage: Asynchronous command

Manual operation: See ["Enable"](#) on page 1285

LANE<m>:EQUalization:CTLE:ZERO:COUNT <NumItems>

Selects the number of zero frequencies for CTLE. You can set the individual value for each zero frequency with [LANE<m>:EQUalization:CTLE:ZERO:FREQuency<*>](#).

Suffix:

<m> 1..4
Selects the lane that is configured for equalization.

Parameters:

<NumItems> Range: 1 to 40
Increment: 1
*RST: 1

Usage: Asynchronous command

Manual operation: See ["Zero frequencies"](#) on page 1287

LANE<m>:EQUalization:CTLE:ZERO:FREQuency<*> <Value>

Set the value of the respective zero frequency.

Suffix:

<m> 1..4
Selects the lane that is configured for equalization.

Parameters:

<Value> Range: -40E+9 to 40E+9
Increment: 10
*RST: 1

Usage: Asynchronous command

Manual operation: See ["Zero frequencies"](#) on page 1287

27.27.7 FFE

LANE<m>:EQUalization:FFE:NAME.....	2831
LANE<m>:EQUalization:FFE:OPEN.....	2832
LANE<m>:EQUalization:FFE:PSELection.....	2832
LANE<m>:EQUalization:FFE:SAVE.....	2832
LANE<m>:EQUalization:FFE:STATE.....	2832
LANE<m>:EQUalization:FFE:TAPS:COUnT.....	2833
LANE<m>:EQUalization:FFE:TAPS:NORMAlize.....	2833
LANE<m>:EQUalization:FFE:TAPS:PRESet.....	2833
LANE<m>:EQUalization:FFE:TAPS:SYMMode.....	2834
LANE<m>:EQUalization:FFE:TAPS:SYMValue.....	2834
LANE<m>:EQUalization:FFE:TAPS:TAP<*>.....	2834

LANE<m>:EQUalization:FFE:NAME <SaveSetPath>

Sets the file name, file format and path of the FFE equalization setup file. The file format is always `.xml`.

Suffix:

<m> 1..4
Selects the lane that is configured for equalization.

Parameters:

<SaveSetPath>

Usage: Asynchronous command**Manual operation:** See "[Save / recall FFE settings](#)" on page 1292**LANE<m>:EQUalization:FFE:OPEN**

Opens and loads the equalization FFE configuration from the file specified with [LANE<m>:EQUalization:FFE:SAVE](#).

Suffix:

<m> 1..4
Selects the lane that is configured for equalization.

Usage: Event
Asynchronous command

Manual operation: See "[Save / recall FFE settings](#)" on page 1292**LANE<m>:EQUalization:FFE:PSElection <PlotSelection>**

Selects the plots that is displayed for the selected FFE configuration.

Suffix:

<m> 1..4
Selects the lane that is configured for equalization.

Parameters:

<PlotSelection> MAGNitude | PHASe | GDElay | STEP | TAPS
*RST: TAPS

Usage: Asynchronous command**Manual operation:** See "[Plot selection](#)" on page 1291**LANE<m>:EQUalization:FFE:SAVE**

Saves the FFE configuration to the file specified with [LANE<m>:EQUalization:FFE:SAVE](#).

Suffix:

<m> 1..4
Selects the lane that is configured for equalization.

Usage: Event
Asynchronous command

Manual operation: See "[Save / recall FFE settings](#)" on page 1292**LANE<m>:EQUalization:FFE:STATe <State>**

Enables the feed-forward equalizer (FFE).

Suffix:
 <m> 1..4
 Selects the lane that is configured for equalization.

Parameters:
 <State> ON | OFF
 *RST: OFF

Usage: Asynchronous command

Manual operation: See "[Enable](#)" on page 1290

LANE<m>:EQUalization:FFE:TAPS:COUNT <NumItems>

Selects the number of taps for the FFE. You can set the individual value for each tap with [LANE<m>:EQUalization:FFE:TAPS:TAP<*>](#).

Suffix:
 <m> 1..4
 Selects the lane that is configured for equalization.

Parameters:
 <NumItems> Range: 1 to 40
 Increment: 1
 *RST: 1

Usage: Asynchronous command

Manual operation: See "[Taps](#)" on page 1291

LANE<m>:EQUalization:FFE:TAPS:NORMALize

Normalizes the taps so that their sum is 1.0.

Suffix:
 <m> 1..4
 Selects the lane that is configured for equalization.

Usage: Event
 Asynchronous command

Manual operation: See "[Normalize taps](#)" on page 1292

LANE<m>:EQUalization:FFE:TAPS:PRESet

Presets the FFE taps.

Suffix:
 <m> 1..4
 Selects the lane that is configured for equalization.

Usage: Event
 Asynchronous command

Manual operation: See "[Default taps](#)" on page 1292

LANE<m>:EQUalization:FFE:TAPS:SYMMode <TapsPerSymbolMd>

Selects how the taps per symbol are determined, if they track the data rate or manually.

Suffix:

<m> 1..4
Selects the lane that is configured for equalization.

Parameters:

<TapsPerSymbolMd> TDRA | AUTO | MANual
*RST: TDRA

Usage: Asynchronous command

Manual operation: See "[Taps per symbol](#)" on page 1292

LANE<m>:EQUalization:FFE:TAPS:SYMValue <TapsPerSymbolVal>

Available, if [LANE<m>:EQUalization:FFE:TAPS:SYMMode](#) is set to MANual.

Sets the number of taps per bit are used for the equalization.

Suffix:

<m> 1..4
Selects the lane that is configured for equalization.

Parameters:

<TapsPerSymbolVal> Range: 1 to 4
Increment: 1
*RST: 1

Usage: Asynchronous command

Manual operation: See "[Taps per symbol](#)" on page 1292

LANE<m>:EQUalization:FFE:TAPS:TAP<*> <Value>

Sets the value of the tap for the FFE.

Suffix:

<m> 1..4
Selects the lane that is configured for equalization.

Parameters:

<Value> Range: -40E+9 to 40E+9
Increment: 10
*RST: 1

Usage: Asynchronous command

Manual operation: See "[Taps](#)" on page 1291

27.27.8 DFE

LANE<m>:EQUalization:DFE:GAIN.....	2835
LANE<m>:EQUalization:DFE:NAME.....	2835
LANE<m>:EQUalization:DFE:OPEN.....	2836
LANE<m>:EQUalization:DFE:SAVE.....	2836
LANE<m>:EQUalization:DFE:STATe.....	2836
LANE<m>:EQUalization:DFE:TAPS:COUNT.....	2837
LANE<m>:EQUalization:DFE:TAPS:NORMalize.....	2837
LANE<m>:EQUalization:DFE:TAPS:PRESet.....	2837
LANE<m>:EQUalization:DFE:TAPS:TAP<*>.....	2837
LANE<m>:EQUalization:DFE:TIMReference:CDR[:SELEct].....	2838
LANE<m>:EQUalization:DFE:TIMReference:CDR:SOFTWare.....	2838
LANE<m>:EQUalization:DFE:TIMReference:CDR:SOFTWare:SAMTime.....	2838
LANE<m>:EQUalization:DFE:TIMReference:CLOCK:EDGE.....	2839
LANE<m>:EQUalization:DFE:TIMReference:CLOCK:FACTor.....	2839
LANE<m>:EQUalization:DFE:TIMReference:CLOCK:FREQuency.....	2839
LANE<m>:EQUalization:DFE:TIMReference:CLOCK:FREStimation.....	2840
LANE<m>:EQUalization:DFE:TIMReference:CLOCK:LEVel.....	2840
LANE<m>:EQUalization:DFE:TIMReference:CLOCK:OFEstimation.....	2840
LANE<m>:EQUalization:DFE:TIMReference:CLOCK:OFFSet.....	2841
LANE<m>:EQUalization:DFE:TIMReference:CLOCK:SAMTime.....	2841
LANE<m>:EQUalization:DFE:TIMReference:CLOCK:SOURce.....	2842
LANE<m>:EQUalization:DFE:TIMReference:SOURce.....	2842

LANE<m>:EQUalization:DFE:GAIN <Gain>

Sets the gain for the DFE filter.

Suffix:

<m> 1..4
Selects the lane that is configured for equalization.

Parameters:

<Gain> Range: 0.01 to 100
Increment: 2
*RST: 1

Usage: Asynchronous command

Manual operation: See "Gain" on page 1297

LANE<m>:EQUalization:DFE:NAME <SaveSetPath>

Sets the file name, file format and path of the DFE equalization setup file. The file format is always .xml.

Suffix:

<m> 1..4
Selects the lane that is configured for equalization.

Parameters:

<SaveSetPath>

Usage: Asynchronous command**Manual operation:** See "[Save / recall DFE settings](#)" on page 1297**LANE<m>:EQUalization:DFE:OPEN**

Opens and loads the equalization DFE configuration from the file specified with [LANE<m>:EQUalization:DFE:NAME](#).

Suffix:

<m> 1..4
Selects the lane that is configured for equalization.

Usage: Event
Asynchronous command

Manual operation: See "[Save / recall DFE settings](#)" on page 1297**LANE<m>:EQUalization:DFE:SAVE**

Saves the DFE configuration to the file specified with [LANE<m>:EQUalization:DFE:NAME](#).

Suffix:

<m> 1..4
Selects the lane that is configured for equalization.

Usage: Event
Asynchronous command

Manual operation: See "[Save / recall DFE settings](#)" on page 1297**LANE<m>:EQUalization:DFE:STATe <State>**

Enables the decision feedback equalization.

Suffix:

<m> 1..4
Selects the lane that is configured for equalization.

Parameters:

<State> ON | OFF
*RST: OFF

Usage: Asynchronous command**Manual operation:** See "[Enable](#)" on page 1293

LANE<m>:EQUalization:DFE:TAPS:COUNT <NumItems>

Selects the number of zero frequencies for DFE. You can set the individual value for each frequency with [LANE<m>:EQUalization:DFE:TAPS:TAP<*>](#).

Suffix:

<m> 1..4
Selects the lane that is configured for equalization.

Parameters:

<NumItems> Range: 1 to 40
Increment: 1
*RST: 1

Usage: Asynchronous command

Manual operation: See ["Taps"](#) on page 1296

LANE<m>:EQUalization:DFE:TAPS:NORMalize

Normalizes the DFE taps.

Suffix:

<m> 1..4
Selects the lane that is configured for equalization.

Usage: Event
Asynchronous command

Manual operation: See ["Normalize taps"](#) on page 1297

LANE<m>:EQUalization:DFE:TAPS:PRESet

Presets to default DFE taps value.

Suffix:

<m> 1..4
Selects the lane that is configured for equalization.

Usage: Event
Asynchronous command

Manual operation: See ["Default taps"](#) on page 1297

LANE<m>:EQUalization:DFE:TAPS:TAP<*> <Value>

Set the value of the respective tap.

Suffix:

<m> 1..4
Selects the lane that is configured for equalization.

Parameters:

<Value> Range: -40E+9 to 40E+9
 Increment: 10
 *RST: 1

Usage: Asynchronous command

Manual operation: See "[Taps](#)" on page 1296

LANE<m>:EQUalization:DFE:TIMReference:CDR[:SElect] <CDRType>

Selects hardware or software clock data recovery.

Available, if [LANE<m>:EQUalization:DFE:TIMReference:SOURce](#) is set to CDR.

Suffix:

<m> 1..4

Parameters:

<CDRType> SW | HW
 *RST: SW

Usage: Asynchronous command

Manual operation: See "[CDR](#)" on page 1294

LANE<m>:EQUalization:DFE:TIMReference:CDR:SOFTware <SoftwareCDRIIdx>

Selects the software CDR used for the reference signal for the DFE.

Suffix:

<m> 1..4
 Selects the lane that is configured for equalization.

Parameters:

<SoftwareCDRIIdx> SW1 | SW2 | SW3 | SW4
 *RST: SW1

Usage: Asynchronous command

Manual operation: See "[CDR](#)" on page 1294

**LANE<m>:EQUalization:DFE:TIMReference:CDR:SOFTware:SAMTime
 <SamplingTime>**

Sets a sampling time for the clock signal, an offset for the clock edge in relation to the bit start.

Available if [LANE<m>:EQUalization:DFE:TIMReference:SOURce](#) is set to CDR.

Suffix:

<m> 1..4
 Selects the lane that is configured for equalization.

Parameters:

<SamplingTime> Range: 0 to 1
 Increment: 0.01
 *RST: 0.5
 Default unit: UI

Usage: Asynchronous command

Manual operation: See "[CDR](#)" on page 1294

LANE<m>:EQUalization:DFE:TIMReference:CLOCK:EDGE <ClockEdge>

The clock edge sets the point in time when the state of the data signal is checked.

Suffix:

<m> 1..4
 Selects the lane that is configured for equalization.

Parameters:

<ClockEdge> POSitive | NEGative | EITHer
 *RST: EITHer

Usage: Asynchronous command

Manual operation: See "[Slope](#)" on page 1296

LANE<m>:EQUalization:DFE:TIMReference:CLOCK:FACTor <RefClkMultiplier>

Sets a clock multiplier factor.

Available if [LANE<m>:EQUalization:DFE:TIMReference:SOURce](#) is set to CLOCK.

Suffix:

<m> 1..4
 Selects the lane that is configured for equalization.

Parameters:

<RefClkMultiplier> Range: 1 to 100
 Increment: 1
 *RST: 1

Usage: Asynchronous command

Manual operation: See "[Multiplier](#)" on page 1295

LANE<m>:EQUalization:DFE:TIMReference:CLOCK:FREQuency <ClockFrequency>

Sets the clock frequency for the clock signal.

Available if [LANE<m>:EQUalization:DFE:TIMReference:SOURce](#) is set to CLOCK.

Suffix:

<m> 1..4
Selects the lane that is configured for equalization.

Parameters:

<ClockFrequency> Range: 1000 to 10E+9
Increment: 10
*RST: 500E+6
Default unit: Hz

Usage: Asynchronous command

Manual operation: See "[Frequency](#)" on page 1295

LANE<m>:EQUalization:DFE:TIMReference:CLOCK:FREStimation

Executes an estimation of the signal for the clock frequency.

Available if [LANE<m>:EQUalization:DFE:TIMReference:SOURce](#) is set to CLOCK.

Suffix:

<m> 1..4
Selects the lane that is configured for equalization.

Usage: Event
Asynchronous command

Manual operation: See "[Frequency](#)" on page 1295

LANE<m>:EQUalization:DFE:TIMReference:CLOCK:LEVEl <ClkRefLevSel>

Sets the vertical reference level of the timing reference source.

Available if [LANE<m>:EQUalization:DFE:TIMReference:SOURce](#) is set to CLOCK.

Suffix:

<m> 1..4
Selects the lane that is configured for equalization.

Parameters:

<ClkRefLevSel> UPPer | MIDDle | LOWer
*RST: MIDDle

Usage: Asynchronous command

Manual operation: See "[Vertical reference level](#)" on page 1295

LANE<m>:EQUalization:DFE:TIMReference:CLOCK:OFESTimation

Executes an estimation of the signal for the clock offset.

Available if `LANE<m>:EQUalization:DFE:TIMReference:SOURce` is set to `CLOCK`.

Suffix:

`<m>` 1..4
Selects the lane that is configured for equalization.

Usage:

Event
Asynchronous command

Manual operation: See "[Offset, Estimate offset](#)" on page 1296

LANE<m>:EQUalization:DFE:TIMReference:CLOCK:OFFSet <ClockOffset>

Sets a clock offset for the explicit clock signal.

Available if `LANE<m>:EQUalization:DFE:TIMReference:SOURce` is set to `CLOCK`.

Suffix:

`<m>` 1..4
Selects the lane that is configured for equalization.

Parameters:

`<ClockOffset>` Range: -1000 to 1000
Increment: 0.01
*RST: 0
Default unit: UI

Usage:

Asynchronous command

Manual operation: See "[Offset, Estimate offset](#)" on page 1296

LANE<m>:EQUalization:DFE:TIMReference:CLOCK:SAMTime <UIOffset>

Sets a sampling time for the clock signal, an offset for the clock edge in relation to the bit start. The clock edge sets the beginning of the unit interval. The sampling time is a number between 0 and 1. Value 0 sets the clock edge to the beginning of the bit period; value 0.5 sets the clock edge to the middle of the bit period.

Available if `LANE<m>:EQUalization:DFE:TIMReference:SOURce` is set to `CLOCK`.

Suffix:

`<m>` 1..4
Selects the lane that is configured for equalization.

Parameters:

`<UIOffset>` Range: 0 to 1
Increment: 0.01
*RST: 0.5
Default unit: UI

Usage:

Asynchronous command

LANE<m>:EQUalization:DFE:TIMReference:CLOCK:SOURce <ClockSource>

Selects the source of the clock channel, if `LANE<m>:EQUalization:DFE:TIMReference:SOURce` is set to `CLOCK`.

Suffix:

<m> 1..4
Selects the lane that is configured for equalization.

Parameters:

<ClockSource> C1W1 | C1W2 | C1W3 | C2W1 | C2W2 | C2W3 | C3W1 | C3W2 | C3W3 | C4W1 | C4W2 | C4W3 | M1 | M2 | M3 | M4 | R1 | R2 | R3 | R4 | DIFF1 | DIFF2 | COMMON1 | COMMON2 | M5 | M6 | M7 | M8

Usage: Asynchronous command

Manual operation: See "Source" on page 1295

LANE<m>:EQUalization:DFE:TIMReference:SOURce <ReferenceSource>

Selects the source of the clock channel, if `LANE<m>:EQUalization:DFE:TIMReference:SOURce` is set to `CLOCK`.

Suffix:

<m> 1..4
Selects the lane that is configured for equalization.

Parameters:

<ReferenceSource> CLOCK | CDR
*RST: CDR

Usage: Asynchronous command

Manual operation: See "Clock / CDR " on page 1293

27.27.9 Filter training

<code>LANE<m>:EQUalization:TRAIning:APPLY</code>	2843
<code>LANE<m>:EQUalization:TRAIning:DFE:LIMits:PRESet</code>	2843
<code>LANE<m>:EQUalization:TRAIning:DFE:LIMits:TAP<n>:LLIMit</code>	2843
<code>LANE<m>:EQUalization:TRAIning:DFE:LIMits:TAP<n>:ULIMit</code>	2844
<code>LANE<m>:EQUalization:TRAIning:DFE:TAPS:COUNT</code>	2844
<code>LANE<m>:EQUalization:TRAIning:DFE:TAPS:LLIMit<0></code>	2844
<code>LANE<m>:EQUalization:TRAIning:DFE:TAPS:UGLLimit</code>	2845
<code>LANE<m>:EQUalization:TRAIning:DFE:TAPS:ULIMit<0></code>	2845
<code>LANE<m>:EQUalization:TRAIning:FFE:TAPS:COUNT</code>	2845
<code>LANE<m>:EQUalization:TRAIning:FFE:TAPS:PRECursor</code>	2846
<code>LANE<m>:EQUalization:TRAIning:FFE:TAPS:SYMMode</code>	2846
<code>LANE<m>:EQUalization:TRAIning:FFE:TAPS:SYMValue</code>	2846
<code>LANE<m>:EQUalization:TRAIning:FSElection</code>	2847
<code>LANE<m>:EQUalization:TRAIning:MODE</code>	2847

LANE<m>:EQUalization:TRAIning:NORGain.....	2847
LANE<m>:EQUalization:TRAIning:REFWaveform.....	2848
LANE<m>:EQUalization:TRAIning:START.....	2848
LANE<m>:EQUalization:TRAIning:ERRor?.....	2848

LANE<m>:EQUalization:TRAIning:APPLY

Applies the tap values.

Suffix:

<m> 1..4
Selects the lane that is configured for equalization.

Usage: Event
Asynchronous command

Manual operation: See "[Apply tap values](#)" on page 1299

LANE<m>:EQUalization:TRAIning:DFE:LIMits:PRESet

Sets the DFE taps limits to their default values.

Suffix:

<m> 1..4
Selects the lane that is configured for equalization.

Usage: Event
Asynchronous command

Manual operation: See "[Preset limits](#)" on page 1301

LANE<m>:EQUalization:TRAIning:DFE:LIMits:TAP<n>:LLIMit <LowerLimit>

Sets the lower limit for the respective tap of the DFE filter. The trained/generated filter tap values are within these given limits.

Suffix:

<m> 1..4
Selects the lane that is configured for equalization.

<n> *
Selects the index of the tap.

Parameters:

<LowerLimit> Range: -1 to 1
Increment: 10
*RST: -0.2

Usage: Asynchronous command

Manual operation: See "[Lower limit, Upper limit](#)" on page 1301

LANE<m>:EQUalization:TRAIning:DFE:LIMits:TAP<n>:ULIMit <UpperLimit>

Sets the upper limit for the respective tap of the DFE filter. The trained/generated filter tap values are within these given limits.

Suffix:

<m> 1..4
Selects the lane that is configured for equalization.

<n> *
Selects the index of the tap.

Parameters:

<UpperLimit> Range: -1 to 1
Increment: 10
*RST: 0.2

Usage: Asynchronous command

Manual operation: See "[Lower limit, Upper limit](#)" on page 1301

LANE<m>:EQUalization:TRAIning:DFE:TAPS:COUNT <NumTapsDFE>

Sets the number of taps used for the training of the DFE.

Suffix:

<m> 1..4
Selects the lane that is configured for equalization.

Parameters:

<NumTapsDFE> Range: 1 to 5
Increment: 1
*RST: 1

Usage: Asynchronous command

Manual operation: See "[Taps](#)" on page 1301

LANE<m>:EQUalization:TRAIning:DFE:TAPS:LLIMit<0>

<EqualizationFilterTapsLimIdx>,<LowerLimit>

LANE<m>:EQUalization:TRAIning:DFE:TAPS:LLIMit<0>?

<EqualizationFilterTapsLimIdx>

Sets the lower global limit for the DFE filter. The trained/generated filter tap values are within these given limits.

Suffix:

<m> 1..4
Selects the lane that is configured for equalization.

Parameters:

<LowerLimit> Range: -1 to 1
Increment: 10
*RST: -0.2

Parameters for setting and query:

<EqualizationFilterTapsLimIdx>

Usage: Asynchronous command**Manual operation:** See "[Lower limit, Upper limit](#)" on page 1301**LANE<m>:EQUalization:TRAIning:DFE:TAPS:UGLLimit <UseGlobalLimsDFE>**

If enabled, you can define the same lower limit ([LANE<m>:EQUalization:TRAIning:DFE:TAPS:LLIMit<0>](#)) and upper limit ([LANE<m>:EQUalization:TRAIning:DFE:TAPS:ULIMit<0>](#)) for all taps. Else, you can define separate values for each tap.

Suffix:

<m> 1..4
Selects the lane that is configured for equalization.

Parameters:

<UseGlobalLimsDFE>ON | OFF
*RST: OFF

Usage: Asynchronous command**Manual operation:** See "[Global limits](#)" on page 1301**LANE<m>:EQUalization:TRAIning:DFE:TAPS:ULIMit<0>**

<EqualizationFilterTapsLimIdx>,<UpperLimit>

LANE<m>:EQUalization:TRAIning:DFE:TAPS:ULIMit<0>?

<EqualizationFilterTapsLimIdx>

Sets the upper global limit for the DFE filter. The trained/generated filter tap values are within these given limits.

Suffix:

<m> 1..4
Selects the lane that is configured for equalization.

Parameters:

<UpperLimit> Range: -1 to 1
Increment: 10
*RST: 0.2

Parameters for setting and query:

<EqualizationFilterTapsLimIdx>

Usage: Asynchronous command**Manual operation:** See "[Lower limit, Upper limit](#)" on page 1301**LANE<m>:EQUalization:TRAIning:FFE:TAPS:COUNT <NumTapsFFE>**

Sets the number of taps used for the training of the FFE. You can select up to 40 taps.

Suffix:

<m> 1..4
Selects the lane that is configured for equalization.

Parameters:

<NumTapsFFE> Range: 1 to 40
Increment: 1
*RST: 1

Usage: Asynchronous command

Manual operation: See "[Taps](#)" on page 1299

LANE<m>:EQualization:TRAIning:FFE:TAPS:PRECursor
<NumPrecursorSymbolsFFE>

Sets a value for the number of the precursor symbols that are used.

Suffix:

<m> 1..4
Selects the lane that is configured for equalization.

Parameters:

<NumPrecursorSymbolsFFE> Range: 0 to 39
Increment: 1
*RST: 0

Usage: Asynchronous command

Manual operation: See "[Precursor symbols](#)" on page 1300

LANE<m>:EQualization:TRAIning:FFE:TAPS:SYMMode <TapsPerSymbolMdFFE>

Selects how the taps per symbol for the FFE filter training are determined, if they track the data rate or manually.

Suffix:

<m> 1..4
Selects the lane that is configured for equalization.

Parameters:

<TapsPerSymbolMdFFE> TDRA | AUTO | MANual
*RST: TDRA

Usage: Asynchronous command

Manual operation: See "[Taps per symbol](#)" on page 1300

LANE<m>:EQualization:TRAIning:FFE:TAPS:SYMValue <TapsPerSymbolValFFE>

Available, if [LANE<m>:EQualization:TRAIning:FFE:TAPS:SYMMode](#) is set to MANual.

Sets the number of taps per bit are used for the FFE filter training.

Suffix:

<m> 1..4
Selects the lane that is configured for equalization.

Parameters:

<TapsPerSymbolValFFE> Range: 1 to 4
Increment: 1
*RST: 1

Usage: Asynchronous command

Manual operation: See "[Taps per symbol](#)" on page 1300

LANE<m>:EQualization:TRaining:FSElection <FilterSelection>

Selects the filter for the filter training. You can select between an FFE filter and a combination of FFE and DFE filter (BOTH).

Suffix:

<m> 1..4
Selects the lane that is configured for equalization.

Parameters:

<FilterSelection> FFE | BOTH
*RST: BOTH

Usage: Asynchronous command

Manual operation: See "[Filter selection](#)" on page 1298

LANE<m>:EQualization:TRaining:MODE <TrainingMode>

Selects the waveform to be trained. You can select a scope waveform (SCOPE) or load a reference waveform (REFERENCE).

Suffix:

<m> 1..4
Selects the lane that is configured for equalization.

Parameters:

<TrainingMode> REFERENCE | SCOPE
*RST: SCOPE

Usage: Asynchronous command

Manual operation: See "[Training mode](#)" on page 1298

LANE<m>:EQualization:TRaining:NORGain <NormalizeGain>

Sets the state of the normalize gain for FFE. The gain of a trained DFE is always 1.

If enabled, the gain of the FFE is normalized to 1, such that the signal has a similar amplitude at the input and output of the equalizer.

If disabled, the equalizer is trained such that the output PAM levels are separated by 1 V (e.g., +/- 0.5 V for NRZ).

Suffix:

<m> 1..4
Selects the lane that is configured for equalization.

Parameters:

<NormalizeGain> ON | OFF
*RST: ON

Usage: Asynchronous command

Manual operation: See ["Normalize gain"](#) on page 1298

LANE<m>:EQUalization:TRAIning:REFWaveform <RefWfm>

Selects the reference waveform to be used for the filter training, if [LANE<m>:EQUalization:TRAIning:MODE](#) is set to REFerence.

Suffix:

<m> 1..4
Selects the lane that is configured.

Parameters:

<RefWfm> NONE | R1 | R2 | R3 | R4

Usage: Asynchronous command

LANE<m>:EQUalization:TRAIning:STARt

Starts the filter training.

Suffix:

<m> 1..4
Selects the lane that is configured for equalization.

Usage: Event
Asynchronous command

Manual operation: See ["Start training"](#) on page 1299

LANE<m>:EQUalization:TRAIning:ERRor?**Suffix:**

<m> 1..4
Selects the lane that is configured for equalization.

Return values:

<ErrorValue> Range: -100E+24 to 100E+24
Increment: 1
*RST: 0

Usage: Query only
Asynchronous command

Manual operation: See "Error" on page 1299

27.28 Maintenance

Some of the commands in the following chapter are asynchronous. An overlapping or asynchronous command does not automatically finish executing before the next command starts executing. If overlapping commands must be executed in a defined order, e.g. to avoid wrong measurement results, they must be serviced sequentially.

To prevent an overlapping execution of commands, one of the commands *OPC, *OPC? or *WAI can be used after the command or a command set.

For more information, see:

- www.rohde-schwarz.com/rc-via-scp, chapter "Command sequence and synchronization"
- Chapter 27.3, "Programming examples", on page 1345

DIAGnostic:SERVice:WFAModel?	2849
DIAGnostic:SERVice:WFASeries?	2849
DIAGnostic:SERVice:WFAType?	2850
CALibration:DATE?	2850
CALibration:TIME?	2850
CALibration:RESult?	2850
DIAGnostic:SERVice:STST:EXECute	2851
DIAGnostic:SERVice:STST:STATe?	2851
DIAGnostic:SERVice:PWD	2851

DIAGnostic:SERVice:WFAModel?

Returns the model name of the oscilloscope.

Return values:

<WFAModel> Product type

Usage: Query only
Asynchronous command

DIAGnostic:SERVice:WFASeries?

Returns the model series of the oscilloscope.

Return values:

<WFASeries> RTO | RTE | RTP
*RST: RTO

Usage: Query only
Asynchronous command

DIAGnostic:SERVice:WFAType?

Returns the instrument family of the oscilloscope.

Return values:

<WFAType> RTO2000 | RTO6 | RTP | RTPFL
RTP: part numbers 1320.5007
RTPFI: part numbers 1803.7000
*RST: RTO2000

Usage: Query only
Asynchronous command

CALibration:DATE?

Returns the date of the last selfalignment.

Return values:

<Date>

Usage: Query only
Asynchronous command

Manual operation: See ["Date / Time / Overall alignment state"](#) on page 101

CALibration:TIME?

Returns the time of the last selfalignment.

Return values:

<Time>

Usage: Query only
Asynchronous command

Manual operation: See ["Date / Time / Overall alignment state"](#) on page 101

CALibration:RESult?

Returns the result of the last selfalignment and the current alignment status. In remote mode, *CAL? provides more detailed information.

Return values:

<ResultState> PASSEd | FAILed | NOALigndata
*RST: FAILed

Usage: Query only
Asynchronous command

Manual operation: See ["Date / Time / Overall alignment state"](#) on page 101

DIAGnostic:SERVice:STST:EXECute

Starts the selftest.

Usage: Event
Asynchronous command

DIAGnostic:SERVice:STST:STATe?

Returns the summary result of the selftest.

Return values:

<State> PSSD | FAILed | UNDEFINED
*RST: UNDEFINED

Usage: Query only
Asynchronous command

Manual operation: See ["State"](#) on page 103

DIAGnostic:SERVice:PWD <Password>

Sets the password to enter the service mode.

Setting parameters:

<Password> Password string

Usage: Setting only
Asynchronous command

27.29 Status reporting

This chapter describes the remote commands that are used to read the status registers.

For information on structure, hierarchy, and contents of the status registers, see [Chapter 25.5.4, "Remote control - status reporting system"](#), on page 1331.

- [STATus:OPERation register](#).....2851
- [STATus:QUESTionable registers](#)..... 2852

27.29.1 STATus:OPERation register

STATus:OPERation commands provide information on the activity of the instrument.

See also: ["STATus:OPERation register"](#) on page 1332

[STATus:OPERation:CONDition?](#).....2852
[STATus:OPERation\[:EVENT\]?](#).....2852
[STATus:OPERation:ENABLE](#).....2852

STATus:OPERation:CONDition?**STATus:OPERation[:EVENT]?**

The CONDition command returns information on actions the instrument is currently executing. The contents of the register is retained.

The EVENT command returns information on actions the instrument has executed since the last reading. Reading the EVENT register deletes its contents.

Bits:

- 0 = ALIGNment
- 2 = AUToset
- 3= WTRIGGER (wait for trigger)
- 4= MEASuring

Usage: Query only

STATus:OPERation:ENABLE <Enable>

Controls the ENABLE part of the STATus:OPERation register. The ENABLE defines which events in the EVENT part of the status register are forwarded to the OPERATION summary bit (bit 7) of the status byte. The status byte can be used to create a service request.

Parameters:

<Enable> Range: 1 to 65535
Increment: 1

Example:

STATus:OPERation:ENABLE 5

The ALIGNment event (bit 0) and AUToset event (bit 2) are forwarded to the OPERATION summary bit of the status byte.

27.29.2 STATus:QUEStionable registers

The commands of the STATus:QUEStionable subsystem control the status reporting structures of the STATus:QUEStionable registers.

See also: "[STATus:QUEStionable register](#)" on page 1333

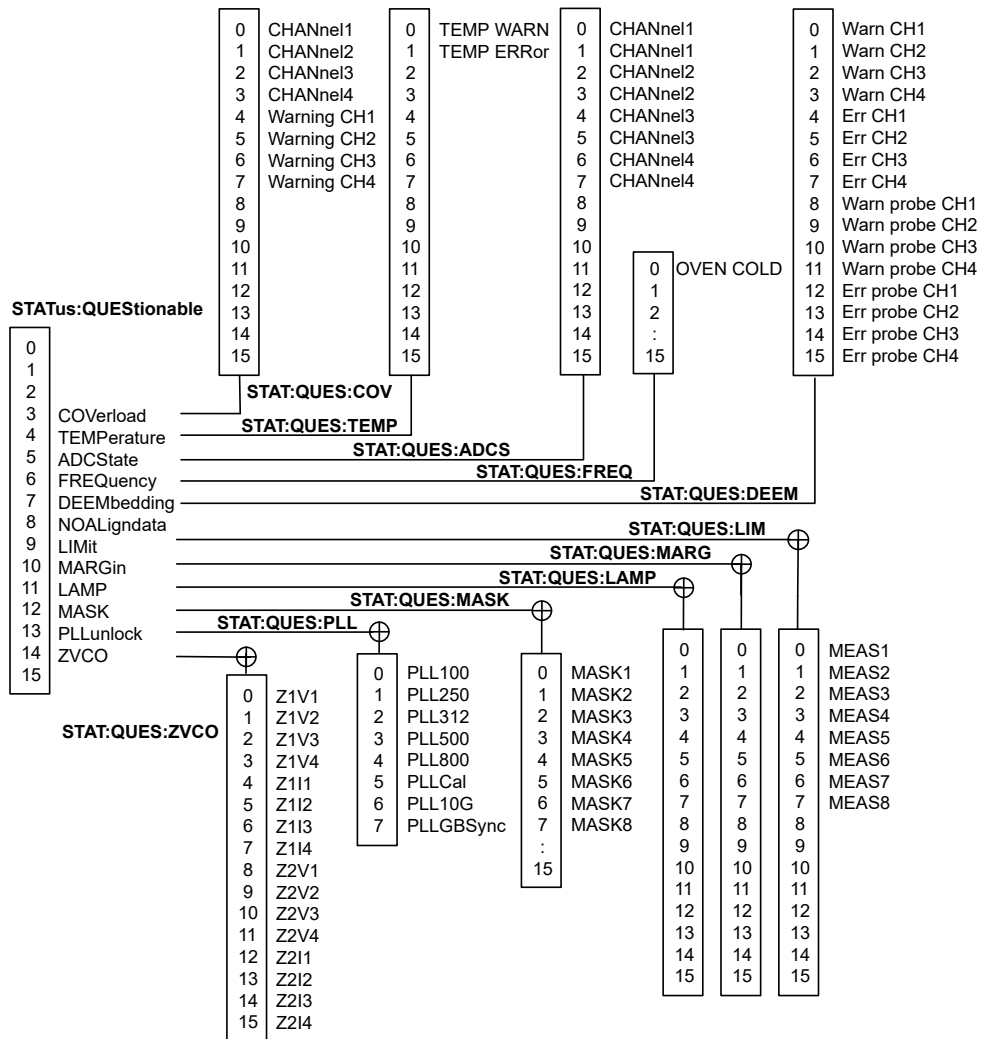

Figure 27-1: Overview of the STATUS:QUESTIONABLE register

The following commands are available:

STATUS:QUESTIONABLE:COVERload:CONDition?	2854
STATUS:QUESTIONABLE:TEMPerature:CONDition?	2854
STATUS:QUESTIONABLE:ADCState:CONDition?	2854
STATUS:QUESTIONABLE:LIMit:CONDition?	2854
STATUS:QUESTIONABLE:MARGin:CONDition?	2854
STATUS:QUESTIONABLE:FREQuency:CONDition?	2854
STATUS:QUESTIONABLE:PLL:CONDition?	2854
STATUS:QUESTIONABLE:DEEMbedding:CONDition?	2855
STATUS:QUESTIONABLE:LAMPliitude:CONDition?	2855
STATUS:QUESTIONABLE:ZVCoverload:CONDition?	2855
STATUS:QUESTIONABLE:MASK:CONDition?	2855
STATUS:QUESTIONABLE:COVERload:ENABLE	2855
STATUS:QUESTIONABLE:TEMPerature:ENABLE	2855
STATUS:QUESTIONABLE:ADCState:ENABLE	2855

STATus:QUEStionable:LIMit:ENABle.....	2855
STATus:QUEStionable:MARGin:ENABle.....	2855
STATus:QUEStionable:FREQuency:ENABle.....	2855
STATus:QUEStionable:PLL:ENABle.....	2855
STATus:QUEStionable:LAMPliitude:ENABle.....	2855
STATus:QUEStionable:ZVCoverload:ENABle.....	2855
STATus:QUEStionable:MASK:ENABle.....	2855
STATus:QUEStionable:COVerload[:EVENT]?	2855
STATus:QUEStionable:TEMPerature[:EVENT]?	2855
STATus:QUEStionable:ADCState[:EVENT]?	2855
STATus:QUEStionable:LIMit[:EVENT]?	2855
STATus:QUEStionable:MARGin[:EVENT]?	2855
STATus:QUEStionable:FREQuency:EVENT?	2855
STATus:QUEStionable:PLL[:EVENT]?	2855
STATus:QUEStionable:DEEMbedding[:EVENT]?	2855
STATus:QUEStionable:LAMPliitude[:EVENT]?	2855
STATus:QUEStionable:ZVCoverload[:EVENT]?	2855
STATus:QUEStionable:MASK[:EVENT]?	2855
STATus:QUEStionable:COVerload:NTRansition.....	2856
STATus:QUEStionable:TEMPerature:NTRansition.....	2856
STATus:QUEStionable:ADCState:NTRansition.....	2856
STATus:QUEStionable:LIMit:NTRansition.....	2856
STATus:QUEStionable:MARGin:NTRansition.....	2856
STATus:QUEStionable:FREQuency:NTRansition.....	2856
STATus:QUEStionable:PLL:NTRansition.....	2856
STATus:QUEStionable:DEEMbedding:NTRansition.....	2856
STATus:QUEStionable:LAMPliitude:NTRansition.....	2856
STATus:QUEStionable:ZVCoverload:NTRansition.....	2856
STATus:QUEStionable:MASK:NTRansition.....	2856
STATus:QUEStionable:COVerload:PTRansition.....	2856
STATus:QUEStionable:TEMPerature:PTRansition.....	2856
STATus:QUEStionable:ADCState:PTRansition.....	2856
STATus:QUEStionable:LIMit:PTRansition.....	2856
STATus:QUEStionable:MARGin:PTRansition.....	2856
STATus:QUEStionable:FREQuency:PTRansition.....	2856
STATus:QUEStionable:PLL:PTRansition.....	2856
STATus:QUEStionable:DEEMbedding:PTRansition.....	2856
STATus:QUEStionable:LAMPliitude:PTRansition.....	2856
STATus:QUEStionable:ZVCoverload:PTRansition.....	2856
STATus:QUEStionable:MASK:PTRansition.....	2856
MTESt:SBITnumber?.....	2856

STATus:QUEStionable:COVerload:CONDition?
STATus:QUEStionable:TEMPerature:CONDition?
STATus:QUEStionable:ADCState:CONDition?
STATus:QUEStionable:LIMit:CONDition?
STATus:QUEStionable:MARGin:CONDition?
STATus:QUEStionable:FREQuency:CONDition?
STATus:QUEStionable:PLL:CONDition?

STATus:QUESTionable:DEEMbedding:CONDition?
STATus:QUESTionable:LAMPliTude:CONDition?
STATus:QUESTionable:ZVCoverload:CONDition?
STATus:QUESTionable:MASK:CONDition?

Returns the contents of the CONDition part of the status register to check for questionable instrument or measurement states. Reading the CONDition registers does not delete the contents.

Usage: Query only

STATus:QUESTionable:COVerload:ENABle <Value>
STATus:QUESTionable:TEMPerature:ENABle <Value>
STATus:QUESTionable:ADCState:ENABle <Value>
STATus:QUESTionable:LIMit:ENABle <Value>
STATus:QUESTionable:MARGin:ENABle <Value>
STATus:QUESTionable:FREQuency:ENABle <Value>
STATus:QUESTionable:PLL:ENABle <Value>
STATus:QUESTionable:LAMPliTude:ENABle <Value>
STATus:QUESTionable:ZVCoverload:ENABle <Value>
STATus:QUESTionable:MASK:ENABle <Value>

Sets the ENABle part that allows true conditions in the EVENT part to be reported in the summary bit. If a bit is set to 1 in the enable part and its associated event bit transitions to true, a positive transition occurs in the summary bit and is reported to the next higher level.

Parameters:

<Value> Bit mask in decimal representation

Example:

STATus:QUESTionable:MASK:ENABle 24

Set bits no. 3 and 4 of the STATus:QUESTionable:MASK:ENABle register part: $24 = 8 + 16 = 2^3 + 2^4$

STATus:QUESTionable:COVerload[:EVENT]?
STATus:QUESTionable:TEMPerature[:EVENT]?
STATus:QUESTionable:ADCState[:EVENT]?
STATus:QUESTionable:LIMit[:EVENT]?
STATus:QUESTionable:MARGin[:EVENT]?
STATus:QUESTionable:FREQuency:EVENT?
STATus:QUESTionable:PLL[:EVENT]?
STATus:QUESTionable:DEEMbedding[:EVENT]?
STATus:QUESTionable:LAMPliTude[:EVENT]?
STATus:QUESTionable:ZVCoverload[:EVENT]?
STATus:QUESTionable:MASK[:EVENT]?

Returns the contents of the EVENT part of the status register to check whether an event has occurred since the last reading. Reading an EVENT register deletes its contents.

Usage: Query only

STATus:QUESTionable:COVerload:NTRansition <Value>
STATus:QUESTionable:TEMPerature:NTRansition <Value>
STATus:QUESTionable:ADCState:NTRansition <Value>
STATus:QUESTionable:LIMit:NTRansition <Value>
STATus:QUESTionable:MARGin:NTRansition <Value>
STATus:QUESTionable:FREQuency:NTRansition <Value>
STATus:QUESTionable:PLL:NTRansition <Value>
STATus:QUESTionable:DEEMbedding:NTRansition <Value>
STATus:QUESTionable:LAMPliitude:NTRansition <Value>
STATus:QUESTionable:ZVCoverload:NTRansition <Value>
STATus:QUESTionable:MASK:NTRansition <Value>

Sets the negative transition filter. If a bit is set, a 1 to 0 transition in the corresponding bit of the condition register causes a 1 to be written in the corresponding bit of the event register.

Parameters:

<Value> Bit mask in decimal representation

Example:

STATus:QUESTionable:MASK:NTRansition 24
 Set bits no. 3 and 4 of the **STATus:QUESTionable:MASK:NTRan-**
sition register part: $24 = 8 + 16 = 2^3 + 2^4$

STATus:QUESTionable:COVerload:PTRansition <Value>
STATus:QUESTionable:TEMPerature:PTRansition <Value>
STATus:QUESTionable:ADCState:PTRansition <Value>
STATus:QUESTionable:LIMit:PTRansition <Value>
STATus:QUESTionable:MARGin:PTRansition <Value>
STATus:QUESTionable:FREQuency:PTRansition <Value>
STATus:QUESTionable:PLL:PTRansition <Value>
STATus:QUESTionable:DEEMbedding:PTRansition <Value>
STATus:QUESTionable:LAMPliitude:PTRansition <Value>
STATus:QUESTionable:ZVCoverload:PTRansition <Value>
STATus:QUESTionable:MASK:PTRansition <Value>

Sets the positive transition filter. If a bit is set, a 0 to 1 transition in the corresponding bit of the condition register causes a 1 to be written in the corresponding bit of the event register.

Parameters:

<Value> Bit mask in decimal representation

Example:

STATus:QUESTionable:MASK:PTRansition 24
 Set bits no. 3 and 4 of the **STATus:QUESTionable:MASK:PTRan-**
sition register part: $24 = 8 + 16 = 2^3 + 2^4$

MTESt:SBITnumber? <MaskTestName>

Returns the number of the status bit that belongs to the indicated mask test in the **STATus:QUESTionable:MASK** register. The status bits are assigned in the order of mask creation.

Query parameters:

<MaskTestName> String with the name of the mask test

Return values:

<StatusBitNumber> Bit number, see "[STATus:QUEStionable:MASK register](#)" on page 1338.

Range: 0 to 7

Increment: 1

*RST: 0

Example:

```
:MTESt:SBITnumber? 'MT1'
<--0
:MTESt:SBITnumber? 'MT2'
<--1
:MTESt:SBITnumber? 'MT3'
<--2
```

Usage:

Query only

Asynchronous command

27.30 Remote trace

The commands in this section configure tracing of the remote control interface and of events. They also configure the display of the SCPI remote trace.

Before you start tracing, configure all settings as desired. Modifying settings while tracing is active may result in loss of already traced data. Useful exception: Selecting a new target file while tracing is allowed. For start mode `EXPLICIT` a restart of the instrument resets the settings to the documented default values.

If you want to start tracing already during startup of the instrument, configure all settings (including start mode `AUTO`). Then restart your instrument. Tracing will be started automatically during the restart, using the already configured settings.

If you use an XML file as trace file, ensure that tracing is stopped properly. If tracing is aborted instead of stopped, for example by shutting down the instrument for stop mode `EXPLICIT`, the XML file will be invalid, because some tags are not closed.

When the maximum file size is reached (except for stop mode `BUFFERFULL`) or if tracing is started with an already existing trace file, a backup of the trace file is created and the file itself is reset and overwritten. When the file is full for the second time or when tracing is started the next time, the first backup file is lost because it is overwritten by the next backup. In order to prevent loss of data, set a sufficient file size, select an appropriate stop mode and archive/copy completed trace files if you want to keep them.

27.30.1 Standard commands

TRACe:REMOte:MODE:FILE:NAME.....	2858
TRACe:REMOte:MODE:FILE:FORMat.....	2858
TRACe:REMOte:MODE:FILE:SIZE.....	2858
TRACe:REMOte:MODE:FILE:STARtmode.....	2858
TRACe:REMOte:MODE:FILE:STOPmode.....	2858
TRACe:REMOte:MODE:FILE:ENABle.....	2859
TRACe:REMOte:MODE:FILE:FILTer.....	2859

TRACe:REMOte:MODE:FILE:NAME <FilePath>

Sets the directory and file name where the remote trace file is stored.

Parameters:

<FilePath> String parameter

TRACe:REMOte:MODE:FILE:FORMat <Format>

Sets the file format of the remote trace file.

Parameters:

<Format> ASCII | XML

TRACe:REMOte:MODE:FILE:SIZE <FileSize>

Sets the maximum size of the remote trace file.

Parameters:

<FileSize> Integer value

TRACe:REMOte:MODE:FILE:STARtmode <StartMode>

Defines how the remote trace is started.

Parameters:

<StartMode> AUTO | EXPLicit

AUTO

Starts the remote trace immediately.

EXPLicit

Starts remote trace with TRACe:REMOte:MODE:FILE:ENABle
ON

TRACe:REMOte:MODE:FILE:STOPmode <StopMode>

Defines when the remote trace is stopped.

Parameters:

<StopMode> AUTO | EXPLicit | ERRor | BUFFerfull

AUTO

Ends the remote trace on device shutdown.

EXPLicit

Ends remote trace with `TRACe:REMOte:MODE:FILE:ENABLe`
`OFF`

ERRor

Ends remote trace when a SCPI error occurs.

BUFFerfull

Ends remote trace when the maximum file size is reached.

TRACe:REMOte:MODE:FILE:ENABLe <Enable>

Enables and disables the remote trace to file.

Parameters:

<Enable> ON | OFF

TRACe:REMOte:MODE:FILE:FILTER <Input>, <Output>, <Error>, <Trigger>, <DeviceClear>, <StatusRegister>, <Connection>, <RemoteLocalEvents>, <Locking>

Defines the content of the remote trace file.

Parameters:

<Input>	ON OFF	Input data
<Output>	ON OFF	Output data
<Error>	ON OFF	New SCPI error queue entries
<Trigger>	ON OFF	Trigger events
<DeviceClear>	ON OFF	Device clear events
<StatusRegister>	ON OFF	Status register conditions
<Connection>	ON OFF	Open/close connection events
<RemoteLocalEvents>	ON OFF	Local/remote transition events
<Locking>	ON OFF	Remote locking events

27.30.2 Diagnostic remote trace commands

TRACe:REMOte:MODE:FILE:DEXecution:DURation.....	2860
TRACe:REMOte:MODE:FILE:RPC.....	2860
TRACe:REMOte:MODE:FILE:PARSer.....	2860
TRACe:REMOte:MODE:FILE:FUNCTions.....	2860

TRACe:REMOte:MODE:FILE:DEXecution:DURation <Enable>

Traces the device execution time of a command

Parameters:

<Enable> ON | OFF

TRACe:REMOte:MODE:FILE:RPC <Enable>

Enables and disables output of rpc calls to remote trace.

Parameters:

<Enable> ON | OFF

TRACe:REMOte:MODE:FILE:PARSer <Enable>

Enables and disables output of parser transitions to remote trace.

Parameters:

<Enable> ON | OFF

TRACe:REMOte:MODE:FILE:FUNCTions <Enable>

Enables and disables output of function names to remote trace.

Parameters:

<Enable> ON | OFF

27.31 Deprecated commands

The following commands are provided for compatibility to previous oscilloscope versions only. For new remote control programs, use the specified alternative commands.

27.31.1 Base instrument

Legacy command	Replaced by	Comment
EXPort:RESult:SElect EXPort:RESult:NUMeric EXPort:RESult:NAME EXPort:RESult:SAVE		Functionality is not supported since FW 5.20
TRIGger<m>:OUT:STATe TRIGger<m>:OUT:ACTion	TRIGger<m>:EVENT:TRIGgerout on page 1531	Replaced since FW 5.00 Replaced since FW 5.35
TRIGger<m>:SEQUence:MODE	TRIGger<m>:SEQUence:TYPE on page 1525	Replaced since FW 5.10

27.31.2 Options

Legacy command	Replaced by	Comment
RFFE		
BUS<m>:RFFE:DATA:THReshold:HYStere- sis BUS<m>:RFFE:CLOCK:THReshold:HYSTe- resis	none	Functionality is no longer suppor- ted since FW 5.30.
I2C		
TRIGger<m>:I2C:MODE	TRIGger<m>:I2C:TYPE on page 1823	Replaced since FW 5.20
SPI		
TRIGger<m>:SPI:MODE SEARch:TRIGger:SPI:MODE	TRIGger<m>:SPI:TYPE on page 1859 SEARch:TRIGger:SPI:TYPE on page 1867	Replaced since FW 5.20
Ethernet		
SEARch:TRIGger:ETHernet:ERRor:SElect SEARch:TRIGger:ETHernet:FRAMe:SElect	SEARch:TRIGger:ETHernet:TYPE on page 2193	Replaced since FW 5.20

27.31.2.1 Advanced jitter analysis

Legacy command	Replaced by	Comment
ADVJitter<m>::RESult:TYPBathtub ADVJitter<m>::RESult:TYPsynteye		Functionality is not supported.
ADVJitter<m>:SIGNal:UIOffset		Functionality is not supported.
ADVJitter<m>:SIGNal:SERStandard	SIGNalconfig:SETup:SETTing<m>: SERStandard on page 1789	Replaced since FW 5.40
ADVJitter<m>:SIGNal:SAMTime		Functionality is not supported since FW 5.40.

Legacy command	Replaced by	Comment
ADVJitter<m>:RESult:COMPo- nents<n>:SCALE	ADVJitter<m>:RESult: COMPonents<n>:HSCale on page 2701 ADVJitter<m>:RESult: COMPonents<n>:NSCale on page 2701 ADVJitter<m>:RESult: COMPonents<n>:NSPScale on page 2702 ADVJitter<m>:RESult: COMPonents<n>:SDSCale on page 2703 ADVJitter<m>:RESult: COMPonents<n>:SRSCale on page 2704 ADVJitter<m>:RESult: COMPonents<n>:SSCale on page 2704	Replaced since FW 5.40
ADVJitter<m>:RESult:COMPo- nents<n>:OFFSet	ADVJitter<m>:RESult: COMPonents<n>:HOFFset on page 2700 ADVJitter<m>:RESult: COMPonents<n>:NOFFset on page 2701 ADVJitter<m>:RESult: COMPonents<n>:NSPoffset on page 2702 ADVJitter<m>:RESult: COMPonents<n>:SDOFFset on page 2702 ADVJitter<m>:RESult: COMPonents<n>:SOFFset on page 2703 ADVJitter<m>:RESult: COMPonents<n>:SROFFset on page 2703	Replaced since FW 5.40
ADVJitter<m>:SIGNal:CLEStimation	ADVJitter<m>:SIGNal:OFEstimation on page 2683	Replaced since FW 5.40
ADVJitter<m>:SIGNal:CFEstimation	ADVJitter<m>:SIGNal:FREStimation on page 2683	Replaced since FW 5.40
CDR:SOFTware<m>:SERStandard	SIGNalconfig:SETup:SETTing<m>: SERStandard on page 1789	Replaced since FW 5.40
TRIGger<m>:CDR:EYE:SERStandard	SIGNalconfig:SETup:SETTing<m>: SERStandard on page 1789	Replaced since FW 5.40
CDR:SOFTware<m>:ESBRate:SOURce	CDR:SOFTware<m>:ESSRate:SOURce on page 2724	Replaced since FW 5.40
CDR:SOFTware<m>:ESBRate:CONTInu- ous	CDR:SOFTware<m>:ESSRate: CONTInuous on page 2724	Replaced since FW 5.40
CDR:SOFTware<m>:ESBRate:BREsti- mate	CDR:SOFTware<m>:ESSRate: SREStimate on page 2724	Replaced since FW 5.40
CDR:SOFTware<m>:SAMTime		Functionality is not supported.

List of commands

*CAL?	1375
*CLS	1375
*ESE	1375
*ESR?	1376
*IDN?	1376
*IST?	1376
*OPC	1376
*OPT?	1376
*PCB	1377
*PRE	1377
*PSC	1377
*RCL	1377
*RST	1378
*SAV	1378
*SRE	1378
*STB?	1378
*TRG	1378
*TST?	1379
*WAI	1379
ACQUIRE:ARESet:COUNT	1425
ACQUIRE:ARESet:COUNT	2776
ACQUIRE:ARESet:IMMEDIATE	1424
ACQUIRE:ARESet:MODE	1425
ACQUIRE:ARESet:MODE	2775
ACQUIRE:ARESet:TIME	1425
ACQUIRE:ARESet:TIME	2776
ACQUIRE:AVAILABLE?	1563
ACQUIRE:CDTA	1422
ACQUIRE:COUNT	1424
ACQUIRE:CURRENT?	1535
ACQUIRE:DRESOLUTION?	2618
ACQUIRE:INTERPOLATE	1421
ACQUIRE:MUWAVEFORM	1422
ACQUIRE:POINTS:AADJUST	1418
ACQUIRE:POINTS:ARATE?	1419
ACQUIRE:POINTS:AUTO	1418
ACQUIRE:POINTS:DVALUE?	2618
ACQUIRE:POINTS:MAXIMUM	1418
ACQUIRE:POINTS:ZVALUE?	1472
ACQUIRE:POINTS[VALUE]	1420
ACQUIRE:RESOLUTION	1420
ACQUIRE:SEGMENTED:AUTOPLAY	1426
ACQUIRE:SEGMENTED:MAX	1426
ACQUIRE:SEGMENTED:STATE	1426
ACQUIRE:SRATE	1419
ACQUIRE:SRREAL	1419
ACQUIRE:ZRESOLUTION?	1473

ADVJitter<m>:DCOMposition:CLEBasicmeas.....	2691
ADVJitter<m>:DCOMposition:CLEJitcomp.....	2691
ADVJitter<m>:DCOMposition:CLENoisecomp.....	2692
ADVJitter<m>:DCOMposition:COMPOnents<n>:ENABle.....	2687
ADVJitter<m>:DCOMposition:ENOBu.....	2722
ADVJitter<m>:DCOMposition:ENP.....	2721
ADVJitter<m>:DCOMposition:ERRSignal.....	2696
ADVJitter<m>:DCOMposition:JINTerleaved.....	2700
ADVJitter<m>:DCOMposition:MRESplength?.....	2720
ADVJitter<m>:DCOMposition:NHORizontal.....	2721
ADVJitter<m>:DCOMposition:NVERTical.....	2721
ADVJitter<m>:DCOMposition:POSStep.....	2720
ADVJitter<m>:DCOMposition:RECSignal.....	2696
ADVJitter<m>:DCOMposition:RESPlength.....	2720
ADVJitter<m>:DCOMposition:RESEstimate.....	2720
ADVJitter<m>:DCOMposition:SELBasicmeas.....	2691
ADVJitter<m>:DCOMposition:SELJitcomp.....	2691
ADVJitter<m>:DCOMposition:SELNoisecomp.....	2692
ADVJitter<m>:DCOMposition:SPJLabels.....	2700
ADVJitter<m>:DCOMposition:SPJTable.....	2699
ADVJitter<m>:DCOMposition:SPNLabels.....	2700
ADVJitter<m>:DCOMposition:STEPresponse.....	2722
ADVJitter<m>:DCOMposition:TARBer.....	2693
ADVJitter<m>:RESult:BATHtub.....	2693
ADVJitter<m>:RESult:COMPOnents<n>:HISTogam.....	2687
ADVJitter<m>:RESult:COMPOnents<n>:HOFFset.....	2700
ADVJitter<m>:RESult:COMPOnents<n>:HSCale.....	2701
ADVJitter<m>:RESult:COMPOnents<n>:NOFFset.....	2701
ADVJitter<m>:RESult:COMPOnents<n>:NSCale.....	2701
ADVJitter<m>:RESult:COMPOnents<n>:NSPOffset.....	2702
ADVJitter<m>:RESult:COMPOnents<n>:NSPScale.....	2702
ADVJitter<m>:RESult:COMPOnents<n>:SDOFFset.....	2702
ADVJitter<m>:RESult:COMPOnents<n>:SDSCale.....	2703
ADVJitter<m>:RESult:COMPOnents<n>:SOFFset.....	2703
ADVJitter<m>:RESult:COMPOnents<n>:SPECTrum.....	2688
ADVJitter<m>:RESult:COMPOnents<n>:SPOFFset.....	2704
ADVJitter<m>:RESult:COMPOnents<n>:SPSCale.....	2705
ADVJitter<m>:RESult:COMPOnents<n>:SROFFset.....	2703
ADVJitter<m>:RESult:COMPOnents<n>:SRSCale.....	2704
ADVJitter<m>:RESult:COMPOnents<n>:SSCale.....	2704
ADVJitter<m>:RESult:COMPOnents<n>:STATistics:MAXPeakpeak?.....	2689
ADVJitter<m>:RESult:COMPOnents<n>:STATistics:MAXStddev?.....	2689
ADVJitter<m>:RESult:COMPOnents<n>:STATistics:MINPeakpeak?.....	2689
ADVJitter<m>:RESult:COMPOnents<n>:STATistics:PEAKpeak?.....	2689
ADVJitter<m>:RESult:COMPOnents<n>:STATistics:STDDev?.....	2689
ADVJitter<m>:RESult:COMPOnents<n>:STATistics:WFMCOUNT?.....	2689
ADVJitter<m>:RESult:COMPOnents<n>:STATistics[.MINStddev]?.....	2689
ADVJitter<m>:RESult:COMPOnents<n>:TRACK.....	2688
ADVJitter<m>:RESult:ENABle.....	2686
ADVJitter<m>:RESult:LEVels.....	2692

ADVJitter<m>:RESult:NBAThtub.....	2694
ADVJitter<m>:RESult:OBUJ.....	2694
ADVJitter<m>:RESult:OBUN.....	2695
ADVJitter<m>:RESult:PAMJitter:CONFig:BASE.....	2706
ADVJitter<m>:RESult:PAMJitter:CONFig:CATegory<n>:ACTive?.....	2706
ADVJitter<m>:RESult:PAMJitter:CONFig:CATegory<n>:ADD.....	2706
ADVJitter<m>:RESult:PAMJitter:CONFig:CATegory<n>:MEASurement<o>:BASE.....	2707
ADVJitter<m>:RESult:PAMJitter:CONFig:CATegory<n>:MEASurement<o>:COLor.....	2707
ADVJitter<m>:RESult:PAMJitter:CONFig:CATegory<n>:MEASurement<o>:COMPonent.....	2708
ADVJitter<m>:RESult:PAMJitter:CONFig:CATegory<n>:MEASurement<o>:TARGet.....	2708
ADVJitter<m>:RESult:PAMJitter:CONFig:CATegory<n>:MEASurement<o>:TRANSition.....	2709
ADVJitter<m>:RESult:PAMJitter:CONFig:CATegory<n>:REMOve.....	2709
ADVJitter<m>:RESult:PAMJitter:CONFig:COMPonent.....	2709
ADVJitter<m>:RESult:PAMJitter:CONFig:ENABle.....	2710
ADVJitter<m>:RESult:PAMJitter:CONFig:EXPLicit.....	2710
ADVJitter<m>:RESult:PAMJitter:CONFig:LVLHeight.....	2710
ADVJitter<m>:RESult:PAMJitter:CONFig:MODE.....	2711
ADVJitter<m>:RESult:PAMJitter:CONFig:PRESet.....	2711
ADVJitter<m>:RESult:PAMJitter:CONFig:SELMode.....	2711
ADVJitter<m>:RESult:PAMJitter:CONFig:TARGet.....	2711
ADVJitter<m>:RESult:PAMJitter:RESult<n>:MEASurement<o>:MAXPeakpeak?.....	2712
ADVJitter<m>:RESult:PAMJitter:RESult<n>:MEASurement<o>:MAXStddev?.....	2712
ADVJitter<m>:RESult:PAMJitter:RESult<n>:MEASurement<o>:MINPeakpeak?.....	2712
ADVJitter<m>:RESult:PAMJitter:RESult<n>:MEASurement<o>:MINStddev?.....	2712
ADVJitter<m>:RESult:PAMJitter:RESult<n>:MEASurement<o>:PEAKpeak?.....	2712
ADVJitter<m>:RESult:PAMJitter:RESult<n>:MEASurement<o>:STDDev?.....	2712
ADVJitter<m>:RESult:PAMJitter:RESult<n>:MEASurement<o>:WFMCount?.....	2712
ADVJitter<m>:RESult:PAMNoise:CONFig:BASE.....	2713
ADVJitter<m>:RESult:PAMNoise:CONFig:CATegory<n>:ACTive?.....	2713
ADVJitter<m>:RESult:PAMNoise:CONFig:CATegory<n>:ADD.....	2714
ADVJitter<m>:RESult:PAMNoise:CONFig:CATegory<n>:MEASurement<o>:BASE.....	2714
ADVJitter<m>:RESult:PAMNoise:CONFig:CATegory<n>:MEASurement<o>:COLor.....	2715
ADVJitter<m>:RESult:PAMNoise:CONFig:CATegory<n>:MEASurement<o>:COMPonent.....	2715
ADVJitter<m>:RESult:PAMNoise:CONFig:CATegory<n>:MEASurement<o>:DIAGram.....	2716
ADVJitter<m>:RESult:PAMNoise:CONFig:CATegory<n>:REMOve.....	2716
ADVJitter<m>:RESult:PAMNoise:CONFig:COMPonent.....	2717
ADVJitter<m>:RESult:PAMNoise:CONFig:ENABle.....	2717
ADVJitter<m>:RESult:PAMNoise:CONFig:MODE.....	2717
ADVJitter<m>:RESult:PAMNoise:CONFig:PRESet.....	2718
ADVJitter<m>:RESult:PAMNoise:NUMerical<n>:MEASurement<o>:MAXPeakpeak?.....	2718
ADVJitter<m>:RESult:PAMNoise:NUMerical<n>:MEASurement<o>:MAXStddev?.....	2718
ADVJitter<m>:RESult:PAMNoise:NUMerical<n>:MEASurement<o>:MINPeakpeak?.....	2718
ADVJitter<m>:RESult:PAMNoise:NUMerical<n>:MEASurement<o>:MINStddev?.....	2718
ADVJitter<m>:RESult:PAMNoise:NUMerical<n>:MEASurement<o>:PEAKpeak?.....	2718
ADVJitter<m>:RESult:PAMNoise:NUMerical<n>:MEASurement<o>:STDDev?.....	2718
ADVJitter<m>:RESult:PAMNoise:NUMerical<n>:MEASurement<o>:WFMCount?.....	2718
ADVJitter<m>:RESult:PAMNoise:RESult<n>:MEASurement<o>:MAXPeakpeak?.....	2719
ADVJitter<m>:RESult:PAMNoise:RESult<n>:MEASurement<o>:MAXStddev?.....	2719
ADVJitter<m>:RESult:PAMNoise:RESult<n>:MEASurement<o>:MINPeakpeak?.....	2719
ADVJitter<m>:RESult:PAMNoise:RESult<n>:MEASurement<o>:MINStddev?.....	2719

ADVJitter<m>:RESult:PAMNoise:RESult<n>:MEASurement<o>:PEAKpeak?	2719
ADVJitter<m>:RESult:PAMNoise:RESult<n>:MEASurement<o>:STDDev?	2719
ADVJitter<m>:RESult:PAMNoise:RESult<n>:MEASurement<o>:WFMCOUNT?	2719
ADVJitter<m>:RESult:PERiodic<n>:COUNT?	2689
ADVJitter<m>:RESult:PERiodic<n>:DIRection?	2689
ADVJitter<m>:RESult:PERiodic<n>:VALue?	2690
ADVJitter<m>:RESult:PERiodic<n>[:FREQuency]?	2690
ADVJitter<m>:RESult:PHORizontal	2695
ADVJitter<m>:RESult:PJ	2694
ADVJitter<m>:RESult:PN	2694
ADVJitter<m>:RESult:PVERTical	2695
ADVJitter<m>:RESult:STATistics	2687
ADVJitter<m>:RESult:STEPresponse	2687
ADVJitter<m>:RESult:SYNTheticeye	2695
ADVJitter<m>:RESult:TRANSitions	2692
ADVJitter<m>:RESult:TYPBathtub	2693
ADVJitter<m>:RESult:TYPsynteye	2696
ADVJitter<m>:RESult:UNIT	2688
ADVJitter<m>:RESult:VERTical:BHContinuous	2698
ADVJitter<m>:RESult:VERTical:BMTYpe	2698
ADVJitter<m>:RESult:VERTical:CONTinuous	2697
ADVJitter<m>:RESult:VERTical:HBINs	2697
ADVJitter<m>:RESult:VERTical:JSContinuous	2698
ADVJitter<m>:RESult:VERTical:NHContinuous	2699
ADVJitter<m>:RESult:VERTical:NSContinuous	2699
ADVJitter<m>:SIGNal:BITRate	2678
ADVJitter<m>:SIGNal:CDRMode	2678
ADVJitter<m>:SIGNal:CLFfactor	2679
ADVJitter<m>:SIGNal:CLFRequency	2680
ADVJitter<m>:SIGNal:CLKSource	2679
ADVJitter<m>:SIGNal:CLOffset	2680
ADVJitter<m>:SIGNal:DATRate?	2680
ADVJitter<m>:SIGNal:EDGE	2679
ADVJitter<m>:SIGNal:FREStimation	2683
ADVJitter<m>:SIGNal:GATE:COUPling	2680
ADVJitter<m>:SIGNal:GATE:CURSor	2681
ADVJitter<m>:SIGNal:GATE:RANGe:ABSolute:START	2681
ADVJitter<m>:SIGNal:GATE:RANGe:ABSolute:STOP	2681
ADVJitter<m>:SIGNal:GATE:RANGe:MODE	2682
ADVJitter<m>:SIGNal:GATE:RANGe:RELative:START	2682
ADVJitter<m>:SIGNal:GATE:RANGe:RELative:STOP	2682
ADVJitter<m>:SIGNal:GATE:STATe	2683
ADVJitter<m>:SIGNal:GATE:ZDIagram	2682
ADVJitter<m>:SIGNal:OFESTimation	2683
ADVJitter<m>:SIGNal:QUICKmeas	2677
ADVJitter<m>:SIGNal:REFSource	2679
ADVJitter<m>:SIGNal:SOURce	2677
ADVJitter<m>:SIGNal:SYMBOLrate?	2678
ADVJitter<m>:SIGNal:TYPE	2677
AUToscale	1417

BUS<m>:ARINc:BRMode.....	2144
BUS<m>:ARINc:BRValue.....	2144
BUS<m>:ARINc:MAXGap:BITS.....	2145
BUS<m>:ARINc:MAXGap:SElect.....	2144
BUS<m>:ARINc:MINGap:BITS.....	2145
BUS<m>:ARINc:MINGap:SElect.....	2145
BUS<m>:ARINc:POLarity.....	2146
BUS<m>:ARINc:PRESet.....	2146
BUS<m>:ARINc:SOURce.....	2144
BUS<m>:ARINc:THReshold:HIGH.....	2146
BUS<m>:ARINc:THReshold:LOW.....	2146
BUS<m>:ARINc:WCOut?... ..	2151
BUS<m>:ARINc:WORD<n>:DATA?.....	2151
BUS<m>:ARINc:WORD<n>:LABel?.....	2152
BUS<m>:ARINc:WORD<n>:PATtern?.....	2152
BUS<m>:ARINc:WORD<n>:SDI?.....	2152
BUS<m>:ARINc:WORD<n>:SSM?.....	2153
BUS<m>:ARINc:WORD<n>:STARt?.....	2153
BUS<m>:ARINc:WORD<n>:STATe?.....	2153
BUS<m>:ARINc:WORD<n>:STOP?.....	2154
BUS<m>:ARINc:WORD<n>:SYMBol?.....	2154
BUS<m>:CAN:BITRate.....	1947
BUS<m>:CAN:DATA:SOURce.....	1945
BUS<m>:CAN:DATA:THReshold.....	1946
BUS<m>:CAN:FCOut?... ..	1959
BUS<m>:CAN:FDATa:DBITrate.....	1947
BUS<m>:CAN:FDATa:ENABle.....	1947
BUS<m>:CAN:FDATa:FRAMe<n>:SCValue?.....	1966
BUS<m>:CAN:FDATa:FRAMe<n>:STANdard?.....	1959
BUS<m>:CAN:FDATa:JWIDth.....	1949
BUS<m>:CAN:FDATa:PSTandard.....	1945
BUS<m>:CAN:FDATa:SAMPlepoint.....	1948
BUS<m>:CAN:FDATa:T1Segment.....	1948
BUS<m>:CAN:FDATa:T2Segment.....	1949
BUS<m>:CAN:FRAMe<n>:ACKState?.....	1962
BUS<m>:CAN:FRAMe<n>:ACKValue?.....	1963
BUS<m>:CAN:FRAMe<n>:BITRate?.....	1963
BUS<m>:CAN:FRAMe<n>:BSEPosition?.....	1965
BUS<m>:CAN:FRAMe<n>:BYTE<o>:STATe?.....	1966
BUS<m>:CAN:FRAMe<n>:BYTE<o>:VALue?.....	1967
BUS<m>:CAN:FRAMe<n>:CSSTate?.....	1962
BUS<m>:CAN:FRAMe<n>:CSValue?.....	1964
BUS<m>:CAN:FRAMe<n>:DATA?.....	1962
BUS<m>:CAN:FRAMe<n>:DLCState?.....	1962
BUS<m>:CAN:FRAMe<n>:DLCValue?.....	1964
BUS<m>:CAN:FRAMe<n>:FERCause?.....	1965
BUS<m>:CAN:FRAMe<n>:IDSTate?.....	1962
BUS<m>:CAN:FRAMe<n>:IDTYpe?.....	1964
BUS<m>:CAN:FRAMe<n>:IDValue?.....	1965
BUS<m>:CAN:FRAMe<n>:NDBYtes?.....	1961

BUS<m>:CAN:FRAMe<n>:SDATa?	1985
BUS<m>:CAN:FRAMe<n>:SDEXport?	1966
BUS<m>:CAN:FRAMe<n>:START?	1961
BUS<m>:CAN:FRAMe<n>:STATUs?	1960
BUS<m>:CAN:FRAMe<n>:STOP?	1961
BUS<m>:CAN:FRAMe<n>:SYMBol?	1961
BUS<m>:CAN:FRAMe<n>:TYPE?	1962
BUS<m>:CAN:JWIDth	1949
BUS<m>:CAN:SAMPlEpoint	1948
BUS<m>:CAN:T1Segment	1948
BUS<m>:CAN:T2Segment	1949
BUS<m>:CAN:TECHnology	1946
BUS<m>:CAN:TYPE	1945
BUS<m>:CDR:BITRate	2528
BUS<m>:CDR:PLL:BWIDth	2528
BUS<m>:CDR:PLL:DAMPing	2529
BUS<m>:CDR:PLL:ORDer	2529
BUS<m>:CDR:PLL:RELBwidth	2529
BUS<m>:CDR:RESUltS	2530
BUS<m>:CDR:SYNC	2530
BUS<m>:CMSB:ADDFrame	1911
BUS<m>:CMSB:BITRate:ENABle	1910
BUS<m>:CMSB:BITRate:VALue	1910
BUS<m>:CMSB:CLR	1912
BUS<m>:CMSB:CODing	1901
BUS<m>:CMSB:EXRBits	1915
BUS<m>:CMSB:FCOunt?	1911
BUS<m>:CMSB:FILTer:ENABle	1923
BUS<m>:CMSB:FILTer:ERENable	1923
BUS<m>:CMSB:FILTer:ERRor<n>:ENABle	1923
BUS<m>:CMSB:FILTer:FIENable	1924
BUS<m>:CMSB:FILTer:FRAMe<n>:ENABle	1924
BUS<m>:CMSB:FILTer:FRAMe<n>:FLD<o>:BIT	1925
BUS<m>:CMSB:FILTer:FRAMe<n>:FLD<o>:DMAX	1925
BUS<m>:CMSB:FILTer:FRAMe<n>:FLD<o>:DMIN	1925
BUS<m>:CMSB:FILTer:FRAMe<n>:FLD<o>:DOPerator	1925
BUS<m>:CMSB:FILTer:FRAMe<n>:FLD<o>:ENABle	1926
BUS<m>:CMSB:FILTer:FRAMe<n>:FLD<o>:IMAX	1926
BUS<m>:CMSB:FILTer:FRAMe<n>:FLD<o>:IMIN	1926
BUS<m>:CMSB:FILTer:FRAMe<n>:FLD<o>:IOPerator	1927
BUS<m>:CMSB:FILTer:FRENable	1924
BUS<m>:CMSB:FRAMe<n>:APPend	1912
BUS<m>:CMSB:FRAMe<n>:CCOunt?	1912
BUS<m>:CMSB:FRAMe<n>:CELL<o>:BITCount	1913
BUS<m>:CMSB:FRAMe<n>:CELL<o>:BITOrder	1914
BUS<m>:CMSB:FRAMe<n>:CELL<o>:CLMN	1915
BUS<m>:CMSB:FRAMe<n>:CELL<o>:CONDition	1913
BUS<m>:CMSB:FRAMe<n>:CELL<o>:CRGB	1914
BUS<m>:CMSB:FRAMe<n>:CELL<o>:FORMat	1914
BUS<m>:CMSB:FRAMe<n>:CELL<o>:NAME	1913

BUS<m>:CMSB:FRAME<n>:TYPE.....	1912
BUS<m>:CMSB:GAPTime:ENABLE.....	1910
BUS<m>:CMSB:GAPTime:VALue.....	1911
BUS<m>:CMSB:LOAD.....	1916
BUS<m>:CMSB:MANChester:CPHase.....	1904
BUS<m>:CMSB:MANChester:DATA.....	1901
BUS<m>:CMSB:MANChester:POLarity.....	1902
BUS<m>:CMSB:MANChester:THReshold:COUPling.....	1903
BUS<m>:CMSB:MANChester:THReshold:HIGH.....	1902
BUS<m>:CMSB:MANChester:THReshold:LOW.....	1902
BUS<m>:CMSB:MANChester:THReshold:PRESet.....	1903
BUS<m>:CMSB:NRZ:CLCK.....	1904
BUS<m>:CMSB:NRZ:CPHase.....	1906
BUS<m>:CMSB:NRZ:CPOLarity.....	1905
BUS<m>:CMSB:NRZ:DATA.....	1904
BUS<m>:CMSB:NRZ:ENAPolarity.....	1907
BUS<m>:CMSB:NRZ:ENBLe.....	1906
BUS<m>:CMSB:NRZ:HYSTeresis:CLCK.....	1907
BUS<m>:CMSB:NRZ:HYSTeresis:DATA.....	1908
BUS<m>:CMSB:NRZ:HYSTeresis:ENBLe.....	1909
BUS<m>:CMSB:NRZ:IDLParity.....	1905
BUS<m>:CMSB:NRZ:POLarity.....	1907
BUS<m>:CMSB:NRZ:THReshold:CLCK.....	1907
BUS<m>:CMSB:NRZ:THReshold:COUPling.....	1909
BUS<m>:CMSB:NRZ:THReshold:DATA.....	1908
BUS<m>:CMSB:NRZ:THReshold:ENBLe.....	1908
BUS<m>:CMSB:NRZ:THReshold:PRESet.....	1909
BUS<m>:CMSB:RCOunt?.....	1928
BUS<m>:CMSB:RESult<n>:CCOunt?.....	1931
BUS<m>:CMSB:RESult<n>:CELL<o>:NAME?.....	1931
BUS<m>:CMSB:RESult<n>:CELL<o>:START?.....	1932
BUS<m>:CMSB:RESult<n>:CELL<o>:STATe?.....	1932
BUS<m>:CMSB:RESult<n>:CELL<o>:STOP?.....	1932
BUS<m>:CMSB:RESult<n>:CELL<o>:VALue?.....	1933
BUS<m>:CMSB:RESult<n>:CONE?.....	1930
BUS<m>:CMSB:RESult<n>:CTHRee?.....	1931
BUS<m>:CMSB:RESult<n>:CTWO?.....	1930
BUS<m>:CMSB:RESult<n>:START?.....	1929
BUS<m>:CMSB:RESult<n>:STATe?.....	1929
BUS<m>:CMSB:RESult<n>:STOP?.....	1930
BUS<m>:CMSB:RESult<n>:TYPE?.....	1930
BUS<m>:CMSB:SAVE.....	1916
BUS<m>:CTLE:DCGain.....	2361
BUS<m>:CTLE:ENBLe.....	2361
BUS<m>:CTLE:P1FReq.....	2361
BUS<m>:CTLE:P2FReq.....	2361
BUS<m>:CTLE:Z1FReq.....	2362
BUS<m>:CXPI:BITRate:ENABLE.....	2087
BUS<m>:CXPI:BITRate:VALue.....	2087
BUS<m>:CXPI:DORD.....	2088

BUS<m>:CXPI:HYSteresis.....	2088
BUS<m>:CXPI:IBS:MAX.....	2090
BUS<m>:CXPI:IBS:MIN.....	2090
BUS<m>:CXPI:IFS:MAX.....	2090
BUS<m>:CXPI:IFS:MIN.....	2090
BUS<m>:CXPI:POLarity.....	2089
BUS<m>:CXPI:RESult:BITRate?.....	2088
BUS<m>:CXPI:RESult:FCOut?.....	2100
BUS<m>:CXPI:RESult:FRAMe<n>:DATA?.....	2100
BUS<m>:CXPI:RESult:FRAMe<n>:DLCV?.....	2100
BUS<m>:CXPI:RESult:FRAMe<n>:START?.....	2100
BUS<m>:CXPI:RESult:FRAMe<n>:STATe?.....	2101
BUS<m>:CXPI:RESult:FRAMe<n>:STOP?.....	2101
BUS<m>:CXPI:RESult:FRAMe<n>:TYPE?.....	2101
BUS<m>:CXPI:RESult:FRAMe<n>:WORD<o>:STATus?.....	2102
BUS<m>:CXPI:RESult:FRAMe<n>:WORD<o>:TYPE?.....	2102
BUS<m>:CXPI:RESult:FRAMe<n>:WORD<o>:VALue?.....	2103
BUS<m>:CXPI:SDATa.....	2089
BUS<m>:CXPI:THReshold.....	2089
BUS<m>:DDR:BITRate.....	2570
BUS<m>:DDR:DATA:HYSteresis.....	2568
BUS<m>:DDR:DATA:SOURce.....	2569
BUS<m>:DDR:DATA:THReshold.....	2569
BUS<m>:DDR:RESult:FCOut?.....	2571
BUS<m>:DDR:RESult:FRAMe<n>:FLD<o>:FVAL?.....	2571
BUS<m>:DDR:RESult:FRAMe<n>:FLD<o>:START?.....	2571
BUS<m>:DDR:RESult:FRAMe<n>:FLD<o>:STATus?.....	2572
BUS<m>:DDR:RESult:FRAMe<n>:FLD<o>:STOP?.....	2572
BUS<m>:DDR:RESult:FRAMe<n>:FLD<o>:VAL?.....	2573
BUS<m>:DDR:RESult:FRAMe<n>:NWRDs?.....	2573
BUS<m>:DDR:RESult:FRAMe<n>:START?.....	2573
BUS<m>:DDR:RESult:FRAMe<n>:STATe?.....	2574
BUS<m>:DDR:RESult:FRAMe<n>:STOP?.....	2574
BUS<m>:DDR:RESult:FRAMe<n>:TYPE?.....	2574
BUS<m>:DDR:STANdard.....	2568
BUS<m>:DDR:STRBe:HYSteresis.....	2569
BUS<m>:DDR:STRBe:SOURce.....	2569
BUS<m>:DDR:STRBe:THReshold.....	2570
BUS<m>:DPHY:CONFig.....	2416
BUS<m>:DPHY:CP:HSPeed:HYSteresis.....	2420
BUS<m>:DPHY:CP:HSPeed:THReshold.....	2420
BUS<m>:DPHY:CP:PROBe.....	2416
BUS<m>:DPHY:CP:SOURce.....	2416
BUS<m>:DPHY:DNZero:LPOWer:THLower.....	2419
BUS<m>:DPHY:DNZero:LPOWer:THUPper.....	2418
BUS<m>:DPHY:DNZero:PROBe.....	2419
BUS<m>:DPHY:DNZero:SOURce.....	2419
BUS<m>:DPHY:DPONe:HSPeed:HYSteresis.....	2420
BUS<m>:DPHY:DPONe:HSPeed:THReshold.....	2420
BUS<m>:DPHY:DPONe:PROBe.....	2420

BUS<m>:DPHY:DPONe:SOURce.....	2419
BUS<m>:DPHY:DPTHree:HSPeEd:HYSTerEsis.....	2420
BUS<m>:DPHY:DPTHree:HSPeEd:THReshold.....	2420
BUS<m>:DPHY:DPTHree:PROBe.....	2420
BUS<m>:DPHY:DPTHree:SOURce.....	2419
BUS<m>:DPHY:DPTWo:HSPeEd:HYSTerEsis.....	2420
BUS<m>:DPHY:DPTWo:HSPeEd:THReshold.....	2420
BUS<m>:DPHY:DPTWo:PROBe.....	2420
BUS<m>:DPHY:DPTWo:SOURce.....	2419
BUS<m>:DPHY:DPZero:HSPeEd:HYSTerEsis.....	2420
BUS<m>:DPHY:DPZero:HSPeEd:THReshold.....	2420
BUS<m>:DPHY:DPZero:LPOWer:THLower.....	2419
BUS<m>:DPHY:DPZero:LPOWer:THUPper.....	2418
BUS<m>:DPHY:DPZero:PROBe.....	2419
BUS<m>:DPHY:DPZero:SOURce.....	2419
BUS<m>:DPHY:DRATe.....	2417
BUS<m>:DPHY:DSPData.....	2417
BUS<m>:DPHY:RESult:FCOut?.....	2429
BUS<m>:DPHY:RESult:FRAMe<n>:CS?.....	2429
BUS<m>:DPHY:RESult:FRAMe<n>:DATA?.....	2429
BUS<m>:DPHY:RESult:FRAMe<n>:DTName?.....	2430
BUS<m>:DPHY:RESult:FRAMe<n>:DTYPe?.....	2430
BUS<m>:DPHY:RESult:FRAMe<n>:ECC?.....	2431
BUS<m>:DPHY:RESult:FRAMe<n>:NUMPackets?.....	2434
BUS<m>:DPHY:RESult:FRAMe<n>:PACKet<o>:IDX?.....	2431
BUS<m>:DPHY:RESult:FRAMe<n>:PACKet<o>:VALue?.....	2431
BUS<m>:DPHY:RESult:FRAMe<n>:STARt?.....	2432
BUS<m>:DPHY:RESult:FRAMe<n>:STATe?.....	2432
BUS<m>:DPHY:RESult:FRAMe<n>:STOP?.....	2433
BUS<m>:DPHY:RESult:FRAMe<n>:TYPe?.....	2433
BUS<m>:DPHY:RESult:FRAMe<n>:VChAnnel?.....	2434
BUS<m>:DPHY:SMLanes.....	2421
BUS<m>:DPHY:THCoupling.....	2417
BUS<m>:DPHY:THPReset.....	2418
BUS<m>:DPHY:VARiant.....	2418
BUS<m>:EBTB:BITDetermi.....	2514
BUS<m>:EBTB:BITRate.....	2509
BUS<m>:EBTB:DIFFerential:SOURce.....	2510
BUS<m>:EBTB:DIFFerential:THRHigh.....	2510
BUS<m>:EBTB:DIFFerential:THRLow.....	2511
BUS<m>:EBTB:DISF.....	2511
BUS<m>:EBTB:DMINus:SOURce.....	2511
BUS<m>:EBTB:DMINus:THReshold.....	2511
BUS<m>:EBTB:DPLus:SOURce.....	2512
BUS<m>:EBTB:DPLus:THReshold.....	2512
BUS<m>:EBTB:EBTRate?.....	2510
BUS<m>:EBTB:FAUToscale.....	2514
BUS<m>:EBTB:FCSY.....	2512
BUS<m>:EBTB:SCOut?.....	2513
BUS<m>:EBTB:SCSY.....	2513

BUS<m>:EBTB:SYMBOL<n>:BYTE?	2519
BUS<m>:EBTB:SYMBOL<n>:DATA?	2517
BUS<m>:EBTB:SYMBOL<n>:KDCODE?	2519
BUS<m>:EBTB:SYMBOL<n>:START?	2518
BUS<m>:EBTB:SYMBOL<n>:STATUS?	2518
BUS<m>:EBTB:SYMBOL<n>:STOP?	2519
BUS<m>:EBTB:SYMBOL<n>:TENBIT?	2519
BUS<m>:EBTB:SYNC	2513
BUS<m>:EBTB:TYPE	2513
BUS<m>:EBTB:USCS	2514
BUS<m>:ETHERNET:BITRATE	2181
BUS<m>:ETHERNET:POLARITY	2180
BUS<m>:ETHERNET:PRESET	2181
BUS<m>:ETHERNET:SOURCE	2179
BUS<m>:ETHERNET:THRESHOLD:HIGH	2180
BUS<m>:ETHERNET:THRESHOLD:LOW	2180
BUS<m>:ETHERNET:VARIANT	2179
BUS<m>:ETHERNET:WCOUNT?	2188
BUS<m>:ETHERNET:WORD<n>:BITRATE?	2192
BUS<m>:ETHERNET:WORD<n>:BYTE<o>:VALUE?	2192
BUS<m>:ETHERNET:WORD<n>:CRC?	2191
BUS<m>:ETHERNET:WORD<n>:DATA?	2191
BUS<m>:ETHERNET:WORD<n>:DESTADDRESS?	2190
BUS<m>:ETHERNET:WORD<n>:DSYMBOL?	2191
BUS<m>:ETHERNET:WORD<n>:FTYPE?	2188
BUS<m>:ETHERNET:WORD<n>:NUMWORDS?	2193
BUS<m>:ETHERNET:WORD<n>:SRCADDRESS?	2190
BUS<m>:ETHERNET:WORD<n>:SSYMBOL?	2192
BUS<m>:ETHERNET:WORD<n>:START?	2189
BUS<m>:ETHERNET:WORD<n>:STATE?	2189
BUS<m>:ETHERNET:WORD<n>:STOP?	2189
BUS<m>:ETHERNET:WORD<n>:TYPE?	2190
BUS<m>:EXPRESET:DETAIL	1816
BUS<m>:EXPRESET:SAVE	1817
BUS<m>:EXPRESET:TIME	1817
BUS<m>:FAUTOSET	1814
BUS<m>:FLXRAY:BITRATE	2023
BUS<m>:FLXRAY:CHTYPE	2023
BUS<m>:FLXRAY:FCOUNT?	2033
BUS<m>:FLXRAY:FRAME<n>:ADID?	2036
BUS<m>:FLXRAY:FRAME<n>:CSSSTATE?	2037
BUS<m>:FLXRAY:FRAME<n>:CSVALUE?	2038
BUS<m>:FLXRAY:FRAME<n>:CYCOUNT?	2037
BUS<m>:FLXRAY:FRAME<n>:DATA?	2035
BUS<m>:FLXRAY:FRAME<n>:FCSTATE?	2038
BUS<m>:FLXRAY:FRAME<n>:FCVALUE?	2038
BUS<m>:FLXRAY:FRAME<n>:FLAG?	2036
BUS<m>:FLXRAY:FRAME<n>:PAYLENGTH?	2037
BUS<m>:FLXRAY:FRAME<n>:START?	2034
BUS<m>:FLXRAY:FRAME<n>:STATUS?	2034

BUS<m>:FLXRay:FRAMe<n>:STOP?.....	2034
BUS<m>:FLXRay:FRAMe<n>:SYMBol?.....	2035
BUS<m>:FLXRay:FRAMe<n>:TYPE?.....	2035
BUS<m>:FLXRay:POLarity.....	2022
BUS<m>:FLXRay:PRDiff.....	2022
BUS<m>:FLXRay:PRLogic.....	2022
BUS<m>:FLXRay:PRSingle.....	2021
BUS<m>:FLXRay:SEHB.....	2023
BUS<m>:FLXRay:SOURce<n>.....	2020
BUS<m>:FLXRay:SRCType.....	2019
BUS<m>:FLXRay:THData.....	2021
BUS<m>:FLXRay:THENable.....	2021
BUS<m>:FLXRay:THReshold<n>.....	2020
BUS<m>:FORMat.....	1815
BUS<m>:HBTO:ATTN.....	2251
BUS<m>:HBTO:FDAM.....	2252
BUS<m>:HBTO:FDAP.....	2252
BUS<m>:HBTO:FDIF.....	2252
BUS<m>:HBTO:FTYP.....	2252
BUS<m>:HBTO:MODE.....	2254
BUS<m>:HBTO:POLarity.....	2254
BUS<m>:HBTO:RDAM.....	2253
BUS<m>:HBTO:RDAP.....	2253
BUS<m>:HBTO:RDIF.....	2253
BUS<m>:HBTO:RESult:FCOunt?.....	2263
BUS<m>:HBTO:RESult:FRAMe<n>:BITRate?.....	2267
BUS<m>:HBTO:RESult:FRAMe<n>:CRC?.....	2266
BUS<m>:HBTO:RESult:FRAMe<n>:DATA?.....	2266
BUS<m>:HBTO:RESult:FRAMe<n>:DESTAddress?.....	2265
BUS<m>:HBTO:RESult:FRAMe<n>:DSYMBOL?.....	2267
BUS<m>:HBTO:RESult:FRAMe<n>:FTYPE?.....	2264
BUS<m>:HBTO:RESult:FRAMe<n>:NUMWords?.....	2267
BUS<m>:HBTO:RESult:FRAMe<n>:SRCAddress?.....	2265
BUS<m>:HBTO:RESult:FRAMe<n>:SSYMBOL?.....	2267
BUS<m>:HBTO:RESult:FRAMe<n>:START?.....	2265
BUS<m>:HBTO:RESult:FRAMe<n>:STATe?.....	2264
BUS<m>:HBTO:RESult:FRAMe<n>:STOP?.....	2265
BUS<m>:HBTO:RESult:FRAMe<n>:TYPE?.....	2266
BUS<m>:HBTO:RESult:FRAMe<n>:WORD<o>:TYPE?.....	2268
BUS<m>:HBTO:RESult:FRAMe<n>:WORD<o>:VALue?.....	2268
BUS<m>:HBTO:RESult:FRAMe<n>:WORD<o>:VSTR?.....	2268
BUS<m>:HBTO:RTYP.....	2253
BUS<m>:HBTO:SYMRate.....	2254
BUS<m>:HBTO:THReshold.....	2254
BUS<m>:I2C:FCOunt?.....	1829
BUS<m>:I2C:FRAMe<n>:AACCess?.....	1830
BUS<m>:I2C:FRAMe<n>:ACCess?.....	1830
BUS<m>:I2C:FRAMe<n>:ACOMplete?.....	1830
BUS<m>:I2C:FRAMe<n>:ADBStart?.....	1830
BUS<m>:I2C:FRAMe<n>:ADDRes?.....	1831

BUS<m>:I2C:FRAME<n>:ADEvice?.....	1831
BUS<m>:I2C:FRAME<n>:AMODE?.....	1832
BUS<m>:I2C:FRAME<n>:AStart?.....	1832
BUS<m>:I2C:FRAME<n>:BCount?.....	1835
BUS<m>:I2C:FRAME<n>:BITRate?.....	1832
BUS<m>:I2C:FRAME<n>:BYTE<o>:ACcEss?.....	1835
BUS<m>:I2C:FRAME<n>:BYTE<o>:ACKStart?.....	1835
BUS<m>:I2C:FRAME<n>:BYTE<o>:COMPLete?.....	1836
BUS<m>:I2C:FRAME<n>:BYTE<o>:STARt?.....	1836
BUS<m>:I2C:FRAME<n>:BYTE<o>:VALue?.....	1837
BUS<m>:I2C:FRAME<n>:DATA?.....	1829
BUS<m>:I2C:FRAME<n>:RWBStart?.....	1833
BUS<m>:I2C:FRAME<n>:STARt?.....	1834
BUS<m>:I2C:FRAME<n>:STATus?.....	1833
BUS<m>:I2C:FRAME<n>:STOP?.....	1834
BUS<m>:I2C:FRAME<n>:SYMBol?.....	1834
BUS<m>:I2C:RWBit.....	1822
BUS<m>:I2C:SCL:SOURce.....	1820
BUS<m>:I2C:SCL:THReshold.....	1820
BUS<m>:I2C:SDA:SOURce.....	1820
BUS<m>:I2C:SDA:THReshold.....	1821
BUS<m>:I2C:TECHnology.....	1821
BUS<m>:I2S:AVARiant.....	1884
BUS<m>:I2S:BORDer.....	1889
BUS<m>:I2S:CHANnel:LENGth.....	1890
BUS<m>:I2S:CHANnel:OFFSet.....	1889
BUS<m>:I2S:CHANnel:ORDer.....	1888
BUS<m>:I2S:CHANnel:TDMCount.....	1890
BUS<m>:I2S:CLOCK:POLarity.....	1885
BUS<m>:I2S:CLOCK:SOURce.....	1885
BUS<m>:I2S:CLOCK:THReshold.....	1887
BUS<m>:I2S:DATA:POLarity.....	1887
BUS<m>:I2S:DATA:SOURce.....	1886
BUS<m>:I2S:DATA:THReshold.....	1888
BUS<m>:I2S:FCOunt?.....	1895
BUS<m>:I2S:FOFFset.....	1890
BUS<m>:I2S:FRAME<n>:LEFT:STATe?.....	1896
BUS<m>:I2S:FRAME<n>:LEFT:VALue?.....	1896
BUS<m>:I2S:FRAME<n>:RIGHT:STATe?.....	1896
BUS<m>:I2S:FRAME<n>:RIGHT:VALue?.....	1896
BUS<m>:I2S:FRAME<n>:STARt?.....	1895
BUS<m>:I2S:FRAME<n>:STATe?.....	1895
BUS<m>:I2S:FRAME<n>:STOP?.....	1895
BUS<m>:I2S:FRAME<n>:TDM<o>:STATe?.....	1897
BUS<m>:I2S:FRAME<n>:TDM<o>:VALue?.....	1897
BUS<m>:I2S:TCOupling.....	1887
BUS<m>:I2S:TRACK:LEFT.....	1898
BUS<m>:I2S:TRACK:RIGHT.....	1898
BUS<m>:I2S:TRACK:TD1Ch.....	1898
BUS<m>:I2S:TRACK:TD2Ch.....	1898

BUS<m>:I2S:TRACK:TD3Ch.....	1898
BUS<m>:I2S:TRACK:TD4Ch.....	1898
BUS<m>:I2S:TRACK:TD5Ch.....	1898
BUS<m>:I2S:TRACK:TD6Ch.....	1898
BUS<m>:I2S:TRACK:TD7Ch.....	1898
BUS<m>:I2S:TRACK:TD8Ch.....	1898
BUS<m>:I2S:WLENgth.....	1889
BUS<m>:I2S:WSElect:POLarity.....	1886
BUS<m>:I2S:WSElect:SOURce.....	1886
BUS<m>:I2S:WSElect:THReshold.....	1888
BUS<m>:LIN:BITRate.....	1990
BUS<m>:LIN:DATA:SOURce.....	1989
BUS<m>:LIN:DATA:THReshold.....	1989
BUS<m>:LIN:FCOunt?.....	1998
BUS<m>:LIN:FRAME<n>:BITRate?.....	2003
BUS<m>:LIN:FRAME<n>:BYTE<o>:STATe?.....	2004
BUS<m>:LIN:FRAME<n>:BYTE<o>:VALue?.....	2004
BUS<m>:LIN:FRAME<n>:CSSTATe?.....	2003
BUS<m>:LIN:FRAME<n>:CSValue?.....	2003
BUS<m>:LIN:FRAME<n>:DATA?.....	2001
BUS<m>:LIN:FRAME<n>:IDPValue?.....	2002
BUS<m>:LIN:FRAME<n>:IDSTATe?.....	2001
BUS<m>:LIN:FRAME<n>:IDValue?.....	2001
BUS<m>:LIN:FRAME<n>:SDATa?.....	1999
BUS<m>:LIN:FRAME<n>:SDEXport?.....	2000
BUS<m>:LIN:FRAME<n>:START?.....	1999
BUS<m>:LIN:FRAME<n>:STATus?.....	1998
BUS<m>:LIN:FRAME<n>:STOP?.....	1999
BUS<m>:LIN:FRAME<n>:SYMBol?.....	2000
BUS<m>:LIN:FRAME<n>:SYSTATe?.....	2002
BUS<m>:LIN:FRAME<n>:VERSion?.....	2000
BUS<m>:LIN:POLarity.....	1990
BUS<m>:LIN:STANdard.....	1990
BUS<m>:LIN:TECHnology.....	1989
BUS<m>:MDIO:CLOCK:SOURce.....	2203
BUS<m>:MDIO:CLOCK:THReshold:HIGH.....	2204
BUS<m>:MDIO:CLOCK:THReshold:LOW.....	2205
BUS<m>:MDIO:COUPLing.....	2206
BUS<m>:MDIO:DATA:SOURce.....	2204
BUS<m>:MDIO:DATA:THReshold:HIGH.....	2205
BUS<m>:MDIO:DATA:THReshold:LOW.....	2205
BUS<m>:MDIO:PRESet.....	2205
BUS<m>:MDIO:WCOunt?.....	2209
BUS<m>:MDIO:WORD<n>:DATA?.....	2209
BUS<m>:MDIO:WORD<n>:PHYS?.....	2209
BUS<m>:MDIO:WORD<n>:REGI?.....	2210
BUS<m>:MDIO:WORD<n>:ST?.....	2210
BUS<m>:MDIO:WORD<n>:START?.....	2210
BUS<m>:MDIO:WORD<n>:STATe?.....	2211
BUS<m>:MDIO:WORD<n>:STOP?.....	2211

BUS<m>:MDIO:WORD<n>:SYMBOL?	2212
BUS<m>:MDIO:WORD<n>:TYPE?	2212
BUS<m>:MILStd:MAXResponse:BITS	2116
BUS<m>:MILStd:MAXResponse:SElect	2116
BUS<m>:MILStd:MINGap:BITS	2117
BUS<m>:MILStd:MINGap:SElect	2117
BUS<m>:MILStd:POLarity	2117
BUS<m>:MILStd:PRESet	2118
BUS<m>:MILStd:SOURce	2116
BUS<m>:MILStd:THReshold:HIGH	2118
BUS<m>:MILStd:THReshold:LOW	2118
BUS<m>:MILStd:WCOunt?	2130
BUS<m>:MILStd:WORD<n>:DATA?	2130
BUS<m>:MILStd:WORD<n>:INFO?	2130
BUS<m>:MILStd:WORD<n>:RTADdress?	2131
BUS<m>:MILStd:WORD<n>:STARt?	2131
BUS<m>:MILStd:WORD<n>:STATus?	2131
BUS<m>:MILStd:WORD<n>:STOP?	2132
BUS<m>:MILStd:WORD<n>:SYMBOL?	2132
BUS<m>:MILStd:WORD<n>:TYPE?	2133
BUS<m>:MPHY:DLANes	2449
BUS<m>:MPHY:DONE:SOURce	2450
BUS<m>:MPHY:DONE:THReshold	2450
BUS<m>:MPHY:DTHRee:SOURce	2450
BUS<m>:MPHY:DTHRee:THReshold	2450
BUS<m>:MPHY:DTWO:SOURce	2450
BUS<m>:MPHY:DTWO:THReshold	2450
BUS<m>:MPHY:DZERo:SOURce	2449
BUS<m>:MPHY:DZERo:THReshold	2450
BUS<m>:MPHY:RESult:FCOunt?	2470
BUS<m>:MPHY:RESult:FRAMe<n>:CCOunt?	2470
BUS<m>:MPHY:RESult:FRAMe<n>:CELL<o>:DATA?	2471
BUS<m>:MPHY:RESult:FRAMe<n>:CELL<o>:STARt?	2471
BUS<m>:MPHY:RESult:FRAMe<n>:CELL<o>:STATe?	2472
BUS<m>:MPHY:RESult:FRAMe<n>:CELL<o>:STOP?	2472
BUS<m>:MPHY:RESult:FRAMe<n>:CELL<o>:TYPE?	2472
BUS<m>:MPHY:RESult:FRAMe<n>:DATA?	2473
BUS<m>:MPHY:RESult:FRAMe<n>:FTYPE?	2468
BUS<m>:MPHY:RESult:FRAMe<n>:INFO?	2473
BUS<m>:MPHY:RESult:FRAMe<n>:SSFT?	2473
BUS<m>:MPHY:RESult:FRAMe<n>:STARt?	2474
BUS<m>:MPHY:RESult:FRAMe<n>:STATe?	2469
BUS<m>:MPHY:RESult:FRAMe<n>:STOP?	2474
BUS<m>:MPHY:SCRMode	2451
BUS<m>:MPHY:SMLanes	2451
BUS<m>:MPHY:THCOupling	2450
BUS<m>:MPHY:THPReset	2451
BUS<m>:MPHY:VARiant	2449
BUS<m>:NEWList	1815
BUS<m>:PARAllel:BIT<n>:DESKew	2614

BUS<m>:PARAllel:BIT<n>:LABel.....	2614
BUS<m>:PARAllel:BIT<n>[:STATe].....	2611
BUS<m>:PARAllel:CLEAr.....	2617
BUS<m>:PARAllel:CLOCK.....	2616
BUS<m>:PARAllel:CLON.....	2616
BUS<m>:PARAllel:CLSLope.....	2617
BUS<m>:PARAllel:DATA:FORMat.....	2615
BUS<m>:PARAllel:DATA:FORMat.....	2630
BUS<m>:PARAllel:DATA:HEADer?.....	2630
BUS<m>:PARAllel:DATA[:VALues]?.....	2630
BUS<m>:PARAllel:DECTable<n>:COUNT?.....	2617
BUS<m>:PARAllel:DECTable<n>:DATA?.....	2618
BUS<m>:PARAllel:DECTable<n>:SHOW.....	2617
BUS<m>:PARAllel:DESoffset.....	2614
BUS<m>:PARAllel:DISPlay:BTYP.....	2616
BUS<m>:PARAllel:DISPlay:SHBU.....	2615
BUS<m>:PARAllel:DISPlay:SHDI.....	2615
BUS<m>:PARAllel:HYSTeresis<n>.....	2613
BUS<m>:PARAllel:STATe.....	2611
BUS<m>:PARAllel:TECHnology.....	2612
BUS<m>:PARAllel:THCOupling.....	2613
BUS<m>:PARAllel:THReshold<n>.....	2611
BUS<m>:PCIE:DSCRambling.....	2525
BUS<m>:PCIE:FIDLe.....	2526
BUS<m>:PCIE:GEN.....	2526
BUS<m>:PCIE:LNKW.....	2526
BUS<m>:PCIE:LONE:SOURce.....	2527
BUS<m>:PCIE:LONE:THRHigh.....	2527
BUS<m>:PCIE:LONE:THRLow.....	2527
BUS<m>:PCIE:LTHRee:SOURce.....	2527
BUS<m>:PCIE:LTHRee:THRHigh.....	2527
BUS<m>:PCIE:LTHRee:THRLow.....	2528
BUS<m>:PCIE:LTWO:SOURce.....	2527
BUS<m>:PCIE:LTWO:THRHigh.....	2527
BUS<m>:PCIE:LTWO:THRLow.....	2527
BUS<m>:PCIE:LZER:SOURce.....	2527
BUS<m>:PCIE:LZER:THRHigh.....	2527
BUS<m>:PCIE:LZER:THRLow.....	2527
BUS<m>:PCIE:RESult:PACKet<n>:ADDR?.....	2540
BUS<m>:PCIE:RESult:PACKet<n>:BITRate?.....	2547
BUS<m>:PCIE:RESult:PACKet<n>:CPID?.....	2540
BUS<m>:PCIE:RESult:PACKet<n>:CPS?.....	2541
BUS<m>:PCIE:RESult:PACKet<n>:DATA?.....	2541
BUS<m>:PCIE:RESult:PACKet<n>:DFC?.....	2541
BUS<m>:PCIE:RESult:PACKet<n>:FCOunt?.....	2542
BUS<m>:PCIE:RESult:PACKet<n>:FLD<o>:FVAL?.....	2542
BUS<m>:PCIE:RESult:PACKet<n>:FLD<o>:STATus?.....	2542
BUS<m>:PCIE:RESult:PACKet<n>:FLD<o>:TYPE?.....	2543
BUS<m>:PCIE:RESult:PACKet<n>:FLD<o>:VAL?.....	2543
BUS<m>:PCIE:RESult:PACKet<n>:HFC?.....	2544

BUS<m>:PCIE:RESult:PACKet<n>:LEN?	2544
BUS<m>:PCIE:RESult:PACKet<n>:RQID?	2544
BUS<m>:PCIE:RESult:PACKet<n>:SEQN?	2545
BUS<m>:PCIE:RESult:PACKet<n>:START?	2545
BUS<m>:PCIE:RESult:PACKet<n>:STATe?	2545
BUS<m>:PCIE:RESult:PACKet<n>:STOP?	2546
BUS<m>:PCIE:RESult:PACKet<n>:TAG?	2546
BUS<m>:PCIE:RESult:PACKet<n>:TYPE?	2547
BUS<m>:PCIE:RESult:PCOunt?	2547
BUS<m>:PCIE:SMLanes	2528
BUS<m>:RESult	1814
BUS<m>:RFFE:CLOCK:SOURce	2219
BUS<m>:RFFE:CLOCK:THReshold:HIGH	2221
BUS<m>:RFFE:CLOCK:THReshold:LOW	2221
BUS<m>:RFFE:COUPling	2220
BUS<m>:RFFE:DATA:SOURce	2220
BUS<m>:RFFE:DATA:THReshold:HIGH	2220
BUS<m>:RFFE:DATA:THReshold:LOW	2221
BUS<m>:RFFE:FCOunt?	2234
BUS<m>:RFFE:GFILter	2222
BUS<m>:RFFE:GFWidth	2222
BUS<m>:RFFE:MINGap:SElect	2222
BUS<m>:RFFE:MINGap:TIME	2223
BUS<m>:RFFE:PRESet	2220
BUS<m>:RFFE:RDMD	2223
BUS<m>:RFFE:SEQuence<n>:ADDRes?	2236
BUS<m>:RFFE:SEQuence<n>:BCOunt?	2237
BUS<m>:RFFE:SEQuence<n>:BYTE<o>:NAME?	2239
BUS<m>:RFFE:SEQuence<n>:BYTE<o>:STATe?	2239
BUS<m>:RFFE:SEQuence<n>:BYTE<o>:VALue?	2240
BUS<m>:RFFE:SEQuence<n>:DATA?	2237
BUS<m>:RFFE:SEQuence<n>:PADone?	2238
BUS<m>:RFFE:SEQuence<n>:PADZero?	2238
BUS<m>:RFFE:SEQuence<n>:PCTRI?	2238
BUS<m>:RFFE:SEQuence<n>:RBTRate?	2239
BUS<m>:RFFE:SEQuence<n>:SADD?	2236
BUS<m>:RFFE:SEQuence<n>:START?	2235
BUS<m>:RFFE:SEQuence<n>:STATe?	2235
BUS<m>:RFFE:SEQuence<n>:STOP?	2235
BUS<m>:RFFE:SEQuence<n>:SYMBol?	2237
BUS<m>:RFFE:SEQuence<n>:TYPE?	2235
BUS<m>:RFFE:SEQuence<n>:WBTRate?	2239
BUS<m>:RFFE:VERSion	2223
BUS<m>:SENT:CLKPeriod	2056
BUS<m>:SENT:CLKTolerance	2056
BUS<m>:SENT:CRCMethoD	2058
BUS<m>:SENT:CRCVersion	2057
BUS<m>:SENT:DATA:SOURce	2055
BUS<m>:SENT:DATA:THReshold	2055
BUS<m>:SENT:DNIBbles	2057

BUS<m>:SENT:FCOut?.....	2066
BUS<m>:SENT:FRAMe<n>:BITRate?.....	2072
BUS<m>:SENT:FRAMe<n>:CSValue?.....	2067
BUS<m>:SENT:FRAMe<n>:DATA?.....	2068
BUS<m>:SENT:FRAMe<n>:IDTYpe?.....	2068
BUS<m>:SENT:FRAMe<n>:IDValue?.....	2069
BUS<m>:SENT:FRAMe<n>:NIBBle<o>:STATe?.....	2069
BUS<m>:SENT:FRAMe<n>:NIBBle<o>:VALue?.....	2069
BUS<m>:SENT:FRAMe<n>:PAPTicks?.....	2070
BUS<m>:SENT:FRAMe<n>:SCOM?.....	2070
BUS<m>:SENT:FRAMe<n>:SDATa?.....	2070
BUS<m>:SENT:FRAMe<n>:SDEXport?.....	2071
BUS<m>:SENT:FRAMe<n>:START?.....	2067
BUS<m>:SENT:FRAMe<n>:STATus?.....	2067
BUS<m>:SENT:FRAMe<n>:STOP?.....	2067
BUS<m>:SENT:FRAMe<n>:SYMBol?.....	2071
BUS<m>:SENT:FRAMe<n>:SYNCduration?.....	2071
BUS<m>:SENT:FRAMe<n>:TYPE?.....	2072
BUS<m>:SENT:PPFLength.....	2059
BUS<m>:SENT:PPULse.....	2058
BUS<m>:SENT:RDSL.....	2072
BUS<m>:SENT:SFORMat.....	2057
BUS<m>:SENT:TECHnology.....	2056
BUS<m>:SETRefllevels.....	1814
BUS<m>:SPI:BORDer.....	1854
BUS<m>:SPI:FCOut?.....	1862
BUS<m>:SPI:FRAMe<n>:BITRate?.....	1862
BUS<m>:SPI:FRAMe<n>:COUNT?.....	1862
BUS<m>:SPI:FRAMe<n>:DATA?.....	1861
BUS<m>:SPI:FRAMe<n>:START?.....	1863
BUS<m>:SPI:FRAMe<n>:STATus?.....	1863
BUS<m>:SPI:FRAMe<n>:STOP?.....	1863
BUS<m>:SPI:FRAMe<n>:WCOut?.....	1864
BUS<m>:SPI:FRAMe<n>:WORD<o>:FMISo?.....	1865
BUS<m>:SPI:FRAMe<n>:WORD<o>:FMOSi?.....	1866
BUS<m>:SPI:FRAMe<n>:WORD<o>:MISO?.....	1865
BUS<m>:SPI:FRAMe<n>:WORD<o>:MOSI?.....	1866
BUS<m>:SPI:FRAMe<n>:WORD<o>:START?.....	1864
BUS<m>:SPI:FRAMe<n>:WORD<o>:STOP?.....	1864
BUS<m>:SPI:FRCondition.....	1857
BUS<m>:SPI:MISO:POLarity.....	1856
BUS<m>:SPI:MISO:SOURce.....	1856
BUS<m>:SPI:MISO:THReshold.....	1857
BUS<m>:SPI:MOSI:POLarity.....	1857
BUS<m>:SPI:MOSI:SOURce.....	1856
BUS<m>:SPI:MOSI:THReshold.....	1857
BUS<m>:SPI:SCLK:SOURce.....	1854
BUS<m>:SPI:SCLK:THReshold.....	1857
BUS<m>:SPI:SSElect:POLarity.....	1855
BUS<m>:SPI:SSElect:SOURce.....	1855

BUS<m>:SPI:SSElect:THReshold.....	1857
BUS<m>:SPI:TIMEout.....	1858
BUS<m>:SPI:WSIZE.....	1854
BUS<m>:SWIRe:BPOStion.....	2161
BUS<m>:SWIRe:COUPling.....	2163
BUS<m>:SWIRe:DATA:HYSteresis.....	2161
BUS<m>:SWIRe:DATA:SOURce.....	2161
BUS<m>:SWIRe:DATA:THReshold.....	2162
BUS<m>:SWIRe:MGAP.....	2162
BUS<m>:SWIRe:PRESet.....	2164
BUS<m>:SWIRe:RESults:FCOunt.....	2168
BUS<m>:SWIRe:RESults:FRAMe<n>:DATA?.....	2168
BUS<m>:SWIRe:RESults:FRAMe<n>:FLD<o>:FVAL?.....	2170
BUS<m>:SWIRe:RESults:FRAMe<n>:FLD<o>:START?.....	2170
BUS<m>:SWIRe:RESults:FRAMe<n>:FLD<o>:STATus?.....	2171
BUS<m>:SWIRe:RESults:FRAMe<n>:FLD<o>:STOP?.....	2171
BUS<m>:SWIRe:RESults:FRAMe<n>:FLD<o>:TYPE?.....	2172
BUS<m>:SWIRe:RESults:FRAMe<n>:FLD<o>:VAL?.....	2172
BUS<m>:SWIRe:RESults:FRAMe<n>:STARt?.....	2168
BUS<m>:SWIRe:RESults:FRAMe<n>:STATe?.....	2169
BUS<m>:SWIRe:RESults:FRAMe<n>:STOP?.....	2169
BUS<m>:SWIRe:RESults:FRAMe<n>:TYPE?.....	2169
BUS<m>:SWIRe:STRBe:HYSteresis.....	2162
BUS<m>:SWIRe:STRBe:SOURce.....	2163
BUS<m>:SWIRe:STRBe:THReshold.....	2163
BUS<m>:SWIRe:SYSlect.....	2163
BUS<m>:SYMBols.....	1815
BUS<m>:TBTO:ATTN.....	2282
BUS<m>:TBTO:FDAM.....	2283
BUS<m>:TBTO:FDAP.....	2283
BUS<m>:TBTO:FDIF.....	2283
BUS<m>:TBTO:FTYP.....	2284
BUS<m>:TBTO:MODE.....	2285
BUS<m>:TBTO:POLarity.....	2285
BUS<m>:TBTO:RDAM.....	2284
BUS<m>:TBTO:RDAP.....	2284
BUS<m>:TBTO:RDIF.....	2284
BUS<m>:TBTO:RESult:FCOunt?.....	2286
BUS<m>:TBTO:RESult:FRAMe<n>:BITRate?.....	2286
BUS<m>:TBTO:RESult:FRAMe<n>:CRC?.....	2287
BUS<m>:TBTO:RESult:FRAMe<n>:DATA?.....	2287
BUS<m>:TBTO:RESult:FRAMe<n>:DEStAddress?.....	2287
BUS<m>:TBTO:RESult:FRAMe<n>:DSYMBOL?.....	2288
BUS<m>:TBTO:RESult:FRAMe<n>:FTYPe?.....	2288
BUS<m>:TBTO:RESult:FRAMe<n>:NUMWOrdS?.....	2288
BUS<m>:TBTO:RESult:FRAMe<n>:SRCAddress?.....	2289
BUS<m>:TBTO:RESult:FRAMe<n>:SSYMBOL?.....	2289
BUS<m>:TBTO:RESult:FRAMe<n>:STARt?.....	2289
BUS<m>:TBTO:RESult:FRAMe<n>:STATe?.....	2290
BUS<m>:TBTO:RESult:FRAMe<n>:STOP?.....	2290

BUS<m>:TBTO:RESult:FRAMe<n>:TYPE?	2291
BUS<m>:TBTO:RESult:FRAMe<n>:WORD<o>:TYPE?	2291
BUS<m>:TBTO:RESult:FRAMe<n>:WORD<o>:VALue?	2291
BUS<m>:TBTO:RTYP	2285
BUS<m>:TBTO:SYMRate	2285
BUS<m>:THReshold	1815
BUS<m>:TYPE	1813
BUS<m>:TYPE	1819
BUS<m>:UART:BAUDrate	1876
BUS<m>:UART:BITRate	1876
BUS<m>:UART:EWORd	1879
BUS<m>:UART:PACKets	1878
BUS<m>:UART:PARity	1876
BUS<m>:UART:POLarity	1877
BUS<m>:UART:RX:SOURce	1874
BUS<m>:UART:RX:THReshold	1874
BUS<m>:UART:SBIT	1877
BUS<m>:UART:SSIZe	1877
BUS<m>:UART:TECHnology	1875
BUS<m>:UART:TOUT	1878
BUS<m>:UART:TX:SOURce	1874
BUS<m>:UART:TX:THReshold	1875
BUS<m>:UART:WORD<n>:BITRate?	1882
BUS<m>:UART:WORD<n>:COUNT?	1882
BUS<m>:UART:WORD<n>:RXValue?	1882
BUS<m>:UART:WORD<n>:SOURce?	1883
BUS<m>:UART:WORD<n>:START?	1883
BUS<m>:UART:WORD<n>:STATe?	1883
BUS<m>:UART:WORD<n>:TXValue?	1882
BUS<m>:USB:DATA:SOURce	2317
BUS<m>:USB:DATA:THReshold	2318
BUS<m>:USB:DIFFerential:SOURce	2317
BUS<m>:USB:DIFFerential:THReshold	2318
BUS<m>:USB:DMINus:SOURce	2316
BUS<m>:USB:DMINus:THReshold	2318
BUS<m>:USB:DPLus:SOURce	2316
BUS<m>:USB:DPLus:THReshold	2318
BUS<m>:USB:PACKet<n>:ADDRes?	2333
BUS<m>:USB:PACKet<n>:CRC?	2334
BUS<m>:USB:PACKet<n>:DATA?	2334
BUS<m>:USB:PACKet<n>:ENDPoint?	2334
BUS<m>:USB:PACKet<n>:ET?	2335
BUS<m>:USB:PACKet<n>:FRAMe?	2335
BUS<m>:USB:PACKet<n>:PID?	2332
BUS<m>:USB:PACKet<n>:PORT?	2335
BUS<m>:USB:PACKet<n>:SC?	2335
BUS<m>:USB:PACKet<n>:SEU?	2336
BUS<m>:USB:PACKet<n>:START?	2336
BUS<m>:USB:PACKet<n>:STATus?	2336
BUS<m>:USB:PACKet<n>:STOP?	2337

BUS<m>:USB:PCOunt?.....	2337
BUS<m>:USB:STRobe:SOURce.....	2317
BUS<m>:USB:STRobe:THReshold.....	2319
BUS<m>:USB:TECHnology.....	2316
BUS<m>:USBPd:DETail.....	2390
BUS<m>:USBPd:HYSTeresis.....	2390
BUS<m>:USBPd:RESult:FCOunt?.....	2399
BUS<m>:USBPd:RESult:FRAMe<n>:DATA?.....	2399
BUS<m>:USBPd:RESult:FRAMe<n>:FLD<o>:FVAL?.....	2400
BUS<m>:USBPd:RESult:FRAMe<n>:FLD<o>:START?.....	2401
BUS<m>:USBPd:RESult:FRAMe<n>:FLD<o>:STATus?.....	2400
BUS<m>:USBPd:RESult:FRAMe<n>:FLD<o>:STOP?.....	2401
BUS<m>:USBPd:RESult:FRAMe<n>:FLD<o>:TYPE?.....	2401
BUS<m>:USBPd:RESult:FRAMe<n>:FLD<o>:VAL?.....	2402
BUS<m>:USBPd:RESult:FRAMe<n>:INFO?.....	2402
BUS<m>:USBPd:RESult:FRAMe<n>:START?.....	2402
BUS<m>:USBPd:RESult:FRAMe<n>:STATe?.....	2403
BUS<m>:USBPd:RESult:FRAMe<n>:STOP?.....	2403
BUS<m>:USBPd:RESult:FRAMe<n>:TYPE?.....	2403
BUS<m>:USBPd:SOURce.....	2391
BUS<m>:USBPd:THRBottom.....	2391
BUS<m>:USBPd:THReshold.....	2391
BUS<m>:USBPd:THRMid.....	2392
BUS<m>:USBPd:THRTop.....	2392
BUS<m>:USBThree:BITR.....	2362
BUS<m>:USBThree:DFE:COEFFicient.....	2362
BUS<m>:USBThree:DFE:ENBLE.....	2363
BUS<m>:USBThree:DFE:ESTCoeff.....	2363
BUS<m>:USBThree:DFE:TCONT.....	2363
BUS<m>:USBThree:POLarity.....	2359
BUS<m>:USBThree:PROToCol.....	2363
BUS<m>:USBThree:RESult:FCOunt?.....	2375
BUS<m>:USBThree:RESult:FRAMe<n>:FLD<o>:FVAL?.....	2379
BUS<m>:USBThree:RESult:FRAMe<n>:FLD<o>:START?.....	2378
BUS<m>:USBThree:RESult:FRAMe<n>:FLD<o>:STATus?.....	2378
BUS<m>:USBThree:RESult:FRAMe<n>:FLD<o>:STOP?.....	2378
BUS<m>:USBThree:RESult:FRAMe<n>:FLD<o>:TYPE?.....	2377
BUS<m>:USBThree:RESult:FRAMe<n>:FLD<o>:VAL?.....	2379
BUS<m>:USBThree:RESult:FRAMe<n>:INFO?.....	2375
BUS<m>:USBThree:RESult:FRAMe<n>:START?.....	2377
BUS<m>:USBThree:RESult:FRAMe<n>:STATe?.....	2376
BUS<m>:USBThree:RESult:FRAMe<n>:STOP?.....	2377
BUS<m>:USBThree:RESult:FRAMe<n>:TYPE?.....	2376
BUS<m>:USBThree:SCRMode.....	2360
BUS<m>:USBThree:SOURce.....	2358
BUS<m>:USBThree:THRHigh.....	2359
BUS<m>:USBThree:THRLow.....	2359
BUS<m>:USBThree:TYPE.....	2360
BUS<m>:ZCOupling.....	1816
BUS<m>[:STATe].....	1813

CALCulate:MATH<m>:ARITHmatics.....	1559
CALCulate:MATH<m>:DATA:HEADer?.....	1562
CALCulate:MATH<m>:DATA:HEADer?.....	1688
CALCulate:MATH<m>:DATA:STYPe?.....	1561
CALCulate:MATH<m>:DATA:STYPe?.....	1687
CALCulate:MATH<m>:DATA[:VALues]?.....	1562
CALCulate:MATH<m>:DATA[:VALues]?.....	1688
CALCulate:MATH<m>:ENVSelection.....	1559
CALCulate:MATH<m>:FFT:BANDwidth[:RESolution]:ADJusted?.....	1676
CALCulate:MATH<m>:FFT:BANDwidth[:RESolution]:AUTO.....	1677
CALCulate:MATH<m>:FFT:BANDwidth[:RESolution]:RATio.....	1677
CALCulate:MATH<m>:FFT:BANDwidth[:RESolution][:VALue].....	1677
CALCulate:MATH<m>:FFT:CFRequency.....	1675
CALCulate:MATH<m>:FFT:COUPled:WITH<1..8>.....	1687
CALCulate:MATH<m>:FFT:FRAMe:ARITHmatics.....	1679
CALCulate:MATH<m>:FFT:FRAMe:COVerge?.....	1679
CALCulate:MATH<m>:FFT:FRAMe:MAXCount.....	1680
CALCulate:MATH<m>:FFT:FRAMe:OFACtor.....	1680
CALCulate:MATH<m>:FFT:FULLspan.....	1676
CALCulate:MATH<m>:FFT:GATE:ABSolute:START.....	1681
CALCulate:MATH<m>:FFT:GATE:ABSolute:STOP.....	1682
CALCulate:MATH<m>:FFT:GATE:COUPling.....	1681
CALCulate:MATH<m>:FFT:GATE:MODE.....	1682
CALCulate:MATH<m>:FFT:GATE:RELative:START.....	1682
CALCulate:MATH<m>:FFT:GATE:RELative:STOP.....	1683
CALCulate:MATH<m>:FFT:GATE:ZCOUpling.....	1683
CALCulate:MATH<m>:FFT:GATE[:STATe].....	1683
CALCulate:MATH<m>:FFT:LOGScale.....	1674
CALCulate:MATH<m>:FFT:MAGNitude:LEVel.....	1684
CALCulate:MATH<m>:FFT:MAGNitude:RANGe.....	1684
CALCulate:MATH<m>:FFT:MAGNitude:SCALE.....	1684
CALCulate:MATH<m>:FFT:PHASe:SCALE.....	1686
CALCulate:MATH<m>:FFT:PHASe:SUPPression.....	1686
CALCulate:MATH<m>:FFT:PHASe:THReshold.....	1686
CALCulate:MATH<m>:FFT:PHASe:UNWRap.....	1687
CALCulate:MATH<m>:FFT:SPAN.....	1676
CALCulate:MATH<m>:FFT:SPECTrogram:CMODE.....	1689
CALCulate:MATH<m>:FFT:SPECTrogram:STATe.....	1690
CALCulate:MATH<m>:FFT:SPECTrogram:TIMeline<n>:POSition.....	1690
CALCulate:MATH<m>:FFT:SPECTrogram:TIMeline<n>:STATe.....	1691
CALCulate:MATH<m>:FFT:START.....	1674
CALCulate:MATH<m>:FFT:STOP.....	1675
CALCulate:MATH<m>:FFT:TYPE.....	1676
CALCulate:MATH<m>:FFT:USEColtab.....	1689
CALCulate:MATH<m>:FFT:WINDow:TYPE.....	1678
CALCulate:MATH<m>:STATe.....	1558
CALCulate:MATH<m>:VERTical:MAXimum.....	1561
CALCulate:MATH<m>:VERTical:OFFSet.....	1560
CALCulate:MATH<m>:VERTical:RANGe.....	1560
CALCulate:MATH<m>:VERTical:SCALE.....	1561

CALCulate:MATH<m>[:EXPRession][:DEFine].....	1558
CALibration:DATE?.....	1411
CALibration:DATE?.....	2850
CALibration:RESult?.....	1412
CALibration:RESult?.....	2850
CALibration:SOURce:FREQuency.....	1481
CALibration:SOURce:STATe.....	1481
CALibration:TIME?.....	1411
CALibration:TIME?.....	2850
CDR:HARDware:BITRate.....	2729
CDR:HARDware:BRestimate.....	2729
CDR:HARDware:ESLope.....	2729
CDR:HARDware:PLL:BWIDth.....	2730
CDR:HARDware:PLL:DAMPing.....	2730
CDR:HARDware:PLL:ORDer.....	2729
CDR:HARDware:PLL:RELBwidth.....	2730
CDR:HARDware:SAMTime.....	2732
CDR:HARDware:SOURce.....	2728
CDR:SOFTware<m>:ALGorithm.....	2722
CDR:SOFTware<m>:BITRate.....	2725
CDR:SOFTware<m>:ESBRate:BRestimate.....	2723
CDR:SOFTware<m>:ESBRate:CONTinuous.....	2724
CDR:SOFTware<m>:ESBRate:SOURce.....	2723
CDR:SOFTware<m>:ESLope.....	2725
CDR:SOFTware<m>:ESSRate:CONTinuous.....	2724
CDR:SOFTware<m>:ESSRate:SOURce.....	2724
CDR:SOFTware<m>:ESSRate:SREstimate.....	2724
CDR:SOFTware<m>:PLL:BWIDth.....	2727
CDR:SOFTware<m>:PLL:DAMPing.....	2727
CDR:SOFTware<m>:PLL:ORDer.....	2726
CDR:SOFTware<m>:PLL:RELBwidth.....	2727
CDR:SOFTware<m>:RESults.....	2726
CDR:SOFTware<m>:SYMRate.....	2728
CDR:SOFTware<m>:SYNC.....	2726
CHANnel<m>:BANDwidth.....	1430
CHANnel<m>:COUPLing.....	1427
CHANnel<m>:CPLing.....	1430
CHANnel<m>:DIGFilter:CUToff.....	1478
CHANnel<m>:DIGFilter:STATe.....	1478
CHANnel<m>:EATScale.....	1436
CHANnel<m>:EATTenuation.....	1437
CHANnel<m>:EXPortstate.....	1768
CHANnel<m>:FILDesign.....	1431
CHANnel<m>:GND.....	1428
CHANnel<m>:IMPedance.....	1431
CHANnel<m>:INVert.....	1429
CHANnel<m>:IQ:CFREquency.....	2666
CHANnel<m>:IQ:DATA:HEADer?.....	2669
CHANnel<m>:IQ:DATA[:VALues]?.....	2668
CHANnel<m>:IQ:INPMode.....	2664

CHANnel<m>:IQ:INPTType.....	2664
CHANnel<m>:IQ:SBIF.....	2667
CHANnel<m>:IQ:SBRF.....	2666
CHANnel<m>:IQ:WARning:MESSage?.....	2668
CHANnel<m>:IQ:WARning[:STATe]?.....	2667
CHANnel<m>:OFFSet.....	1429
CHANnel<m>:OVERload.....	1431
CHANnel<m>:POSition.....	1429
CHANnel<m>:RANGe.....	1428
CHANnel<m>:SCALe.....	1428
CHANnel<m>:SKEW:EXTended.....	1480
CHANnel<m>:SKEW:MANual.....	1479
CHANnel<m>:SKEW:TIME.....	1480
CHANnel<m>:STATe.....	1427
CHANnel<m>[:WAVeform<n>]:ARITHmetics.....	1423
CHANnel<m>[:WAVeform<n>]:DATA:HEADer?.....	1432
CHANnel<m>[:WAVeform<n>]:DATA[:VALues]?.....	1433
CHANnel<m>[:WAVeform<n>]:HISTory:CURRent.....	1564
CHANnel<m>[:WAVeform<n>]:HISTory:PLAY.....	1565
CHANnel<m>[:WAVeform<n>]:HISTory:REPLay.....	1566
CHANnel<m>[:WAVeform<n>]:HISTory:STARt.....	1564
CHANnel<m>[:WAVeform<n>]:HISTory:STOP.....	1565
CHANnel<m>[:WAVeform<n>]:HISTory:TPACq.....	1565
CHANnel<m>[:WAVeform<n>]:HISTory:TSABbsolute?.....	1566
CHANnel<m>[:WAVeform<n>]:HISTory:TSDate?.....	1566
CHANnel<m>[:WAVeform<n>]:HISTory:TSRRelative?.....	1567
CHANnel<m>[:WAVeform<n>]:HISTory:TSRReference?.....	1567
CHANnel<m>[:WAVeform<n>]:HISTory[:STATe].....	1563
CHANnel<m>[:WAVeform<n>]:TYPE.....	1423
CHANnel<m>[:WAVeform<n>][:STATe].....	1422
CURSor<m>:AOFF.....	1572
CURSor<m>:FFT:SETCenter.....	1581
CURSor<m>:FFT:TOCenter.....	1581
CURSor<m>:FUNCTion.....	1572
CURSor<m>:LABel:X<1..2>.....	1579
CURSor<m>:LABel:Y<1..2>.....	1579
CURSor<m>:LABel[:LABel].....	1578
CURSor<m>:MAXimum:LEFT.....	1582
CURSor<m>:MAXimum:NEXT.....	1582
CURSor<m>:MAXimum:RIGHT.....	1582
CURSor<m>:MAXimum[:PEAK].....	1582
CURSor<m>:PEXCursion.....	1744
CURSor<m>:SIAD.....	1579
CURSor<m>:SOURce.....	1572
CURSor<m>:SSOURce.....	1573
CURSor<m>:STATe.....	1571
CURSor<m>:STYLE.....	1402
CURSor<m>:THReshold.....	1745
CURSor<m>:TRACKing[:STATe].....	1575
CURSor<m>:USSource.....	1574

CURSor<m>:X1ENvelope.....	1577
CURSor<m>:X1Position.....	1575
CURSor<m>:X2ENvelope.....	1578
CURSor<m>:X2Position.....	1575
CURSor<m>:XCoupling.....	1576
CURSor<m>:XDELta:INVerse?.....	1580
CURSor<m>:XDELta[:VALue]?.....	1580
CURSor<m>:Y1Position.....	1576
CURSor<m>:Y2Position.....	1577
CURSor<m>:YCOupling.....	1577
CURSor<m>:YDELta:SLOPe.....	1581
CURSor<m>:YDELta[:VALue]?.....	1580
DEEMbedding<m>:ADD.....	2799
DEEMbedding<m>:BANDwidth.....	2800
DEEMbedding<m>:CADC?.....	2809
DEEMbedding<m>:CCOut?.....	2799
DEEMbedding<m>:CMPDelay.....	2800
DEEMbedding<m>:COMPonent<n>:IDENTical.....	2807
DEEMbedding<m>:COMPonent<n>:IPONe.....	2807
DEEMbedding<m>:COMPonent<n>:IPTWo.....	2807
DEEMbedding<m>:COMPonent<n>:LOAD:IMPedance?.....	2805
DEEMbedding<m>:COMPonent<n>:LOAD:REMProbeload.....	2805
DEEMbedding<m>:COMPonent<n>:MODE.....	2804
DEEMbedding<m>:COMPonent<n>:NAME.....	2803
DEEMbedding<m>:COMPonent<n>:OPONe.....	2808
DEEMbedding<m>:COMPonent<n>:OPTWo.....	2808
DEEMbedding<m>:COMPonent<n>:PCOut?.....	2803
DEEMbedding<m>:COMPonent<n>:SPONe.....	2808
DEEMbedding<m>:COMPonent<n>:SPTWo.....	2808
DEEMbedding<m>:COMPonent<n>:TYPE.....	2803
DEEMbedding<m>:COMPonent<n>[:STATe].....	2802
DEEMbedding<m>:DELete.....	2802
DEEMbedding<m>:MATTenuation?.....	2809
DEEMbedding<m>:MGAin?.....	2809
DEEMbedding<m>:NAME.....	2801
DEEMbedding<m>:OPEN.....	2802
DEEMbedding<m>:PRESet.....	2801
DEEMbedding<m>:REMove.....	2799
DEEMbedding<m>:SAVE.....	2801
DEEMbedding<m>[:STATe].....	2798
DIAGnostic:SERVice:CHANnelcount?.....	1413
DIAGnostic:SERVice:COMPutername.....	1385
DIAGnostic:SERVice:FWVersion?.....	1413
DIAGnostic:SERVice:PARTnumber.....	1413
DIAGnostic:SERVice:PWD.....	2851
DIAGnostic:SERVice:SERialnumber?.....	1413
DIAGnostic:SERVice:STST:EXECute.....	2851
DIAGnostic:SERVice:STST:STATe?.....	1412
DIAGnostic:SERVice:STST:STATe?.....	2851
DIAGnostic:SERVice:WFAModel?.....	2849

DIAGnostic:SERVice:WFASeries?	2849
DIAGnostic:SERVice:WFAType?	2850
DIFFerential<m>:AOUTput	1475
DIFFerential<m>:BOUTput	1475
DIFFerential<m>:COMMOn:OFFSet	1477
DIFFerential<m>:COMMOn:POSition	1477
DIFFerential<m>:COMMOn:SCALe	1476
DIFFerential<m>:COMMOn:STATe	1476
DIFFerential<m>:COUPling	1476
DIFFerential<m>:DIFFerential:OFFSet	1477
DIFFerential<m>:DIFFerential:POSition	1477
DIFFerential<m>:DIFFerential:SCALe	1476
DIFFerential<m>:DIFFerential:STATe	1476
DIFFerential<m>:NSIGnal:STATe	1476
DIFFerential<m>:NSIGnal[:SELEct]	1475
DIFFerential<m>:PSIGnal:STATe	1476
DIFFerential<m>:PSIGnal[:SELEct]	1475
DIFFerential<m>:STATe	1475
DIGital<m>:DATA:HEADer?	2629
DIGital<m>:DATA[:VALues]?	2630
DIGital<m>:DESKew	2610
DIGital<m>:DISPlay	2607
DIGital<m>:HYSTEResis	2609
DIGital<m>:LABel	2609
DIGital<m>:TECHnology	2608
DIGital<m>:THCOupling	2609
DIGital<m>:THReshold	2608
DISPlay:CLR	1410
DISPlay:COLor:PALette:ADD	1387
DISPlay:COLor:PALette:COUNT?	1387
DISPlay:COLor:PALette:POINT:ADD	1387
DISPlay:COLor:PALette:POINT:COUNT?	1388
DISPlay:COLor:PALette:POINT:INSert	1387
DISPlay:COLor:PALette:POINT:REMOve	1387
DISPlay:COLor:PALette:POINT[:VALue]	1388
DISPlay:COLor:PALette:REMOve	1387
DISPlay:COLor:SIGnal<m>:ASSign	1386
DISPlay:COLor:SIGnal<m>:COLor	1386
DISPlay:COLor:SIGnal<m>:USE	1386
DISPlay:DIAGram:CROSShair	1389
DISPlay:DIAGram:FINegrid	1389
DISPlay:DIAGram:GRID	1389
DISPlay:DIAGram:LABels	1389
DISPlay:DIAGram:STYLe	1409
DISPlay:DIAGram:TITLe	1394
DISPlay:DIAGram:XFIXed	1390
DISPlay:DIAGram:YFIXed	1389
DISPlay:EXTended:PORDialogs	1401
DISPlay:EXTended:POSDialogs	1402
DISPlay:GATE:TRANSparency	1394

DISPlay:INTensity.....	1409
DISPlay:PERsistence:INFinite.....	1408
DISPlay:PERsistence:RESet.....	1409
DISPlay:PERsistence:TIME.....	1409
DISPlay:PERsistence[:STATe].....	1408
DISPlay:RESultboxes:CUPosition.....	1402
DISPlay:RESultboxes:DEPosition.....	1816
DISPlay:RESultboxes:MEPosition.....	1403
DISPlay:SIGBar[:STATe].....	1394
DISPlay:SIGNal:LABel:ADD.....	1396
DISPlay:SIGNal:LABel:FONTsize.....	1396
DISPlay:SIGNal:LABel:HORIZontal:ABSolute:POSition.....	1400
DISPlay:SIGNal:LABel:HORIZontal:RELative:POSition.....	1401
DISPlay:SIGNal:LABel:IDSList.....	1398
DISPlay:SIGNal:LABel:POSMode.....	1396
DISPlay:SIGNal:LABel:REMove.....	1398
DISPlay:SIGNal:LABel:SHOW.....	1399
DISPlay:SIGNal:LABel:STATe.....	1400
DISPlay:SIGNal:LABel:TEXT.....	1400
DISPlay:SIGNal:LABel:VERTical:ABSolute:POSition.....	1400
DISPlay:SIGNal:LABel:VERTical:RELative:POSition.....	1401
DISPlay:TRIGger:LINes.....	1488
EXECutable:NAME.....	1787
EXECutable:PARAmeter.....	1787
EXECutable:WDIRectory.....	1788
EXPort:EYE:DATA?.....	1775
EXPort:EYE:NAME.....	1776
EXPort:EYE:SAVE.....	1776
EXPort:EYE:SElect.....	1776
EXPort:EYE:SOURce?.....	1776
EXPort:HISTogram:DATA?.....	1775
EXPort:HISTogram:INCidence.....	1774
EXPort:HISTogram:NAME.....	1774
EXPort:HISTogram:SAVE.....	1775
EXPort:HISTogram:SElect.....	1774
EXPort:MEASurement:DATA?.....	1778
EXPort:MEASurement:NAME.....	1777
EXPort:MEASurement:SAVE.....	1778
EXPort:MEASurement:SElect.....	1777
EXPort:MEASurement:TYPE.....	1777
EXPort:RESult:DECSymbol.....	1787
EXPort:RESult:DELimiter.....	1787
EXPort:WAVEform:CURSorset.....	1770
EXPort:WAVEform:DISPlayoff.....	1773
EXPort:WAVEform:DLOGging.....	1771
EXPort:WAVEform:FASTexport.....	1773
EXPort:WAVEform:ICDR.....	1774
EXPort:WAVEform:INCXvalues.....	1772
EXPort:WAVEform:MEAS.....	1771
EXPort:WAVEform:MULTichannel.....	1767

EXPort:WAVeform:NAME.....	1768
EXPort:WAVeform:RAW.....	1773
EXPort:WAVeform:SAVE.....	1769
EXPort:WAVeform:SCOPE.....	1769
EXPort:WAVeform:SOURce.....	1766
EXPort:WAVeform:STARt.....	1769
EXPort:WAVeform:STOP.....	1770
EXPort:WAVeform:TIMestamps.....	1772
EXPort:WAVeform:ZOOM.....	1770
EYE<m>:BITRate?.....	2592
EYE<m>:BITRate?.....	2741
EYE<m>:DISPlay:MODE.....	2593
EYE<m>:DISPlay:MODE.....	2741
EYE<m>:DISPlay:PERsistence:INFinite.....	2593
EYE<m>:DISPlay:PERsistence:INFinite.....	2742
EYE<m>:DISPlay:PERsistence:RESet.....	2594
EYE<m>:DISPlay:PERsistence:RESet.....	2742
EYE<m>:DISPlay:PERsistence:STATe.....	2594
EYE<m>:DISPlay:PERsistence:STATe.....	2742
EYE<m>:DISPlay:PERsistence:TIME.....	2594
EYE<m>:DISPlay:PERsistence:TIME.....	2743
EYE<m>:FILTer:BPATtern:CENTer.....	2600
EYE<m>:FILTer:BPATtern:CENTer.....	2748
EYE<m>:FILTer:BPATtern:MODE.....	2599
EYE<m>:FILTer:BPATtern:MODE.....	2748
EYE<m>:FILTer:BPATtern:PREFix<1..8>.....	2600
EYE<m>:FILTer:BPATtern:PREFix<1..8>.....	2748
EYE<m>:FILTer:BPATtern:RESet.....	2600
EYE<m>:FILTer:BPATtern:RESet.....	2749
EYE<m>:FILTer:BPATtern:SLEFt.....	2600
EYE<m>:FILTer:BPATtern:SLEFt.....	2749
EYE<m>:FILTer:BPATtern:SRIGHt.....	2600
EYE<m>:FILTer:BPATtern:SRIGHt.....	2749
EYE<m>:FILTer:BPATtern:SUFFix<1..5>.....	2600
EYE<m>:FILTer:BPATtern:SUFFix<1..5>.....	2748
EYE<m>:FILTer:DDR:FTYPE.....	2601
EYE<m>:FILTer:DDR:FTYPE.....	2749
EYE<m>:FILTer:DDR:LENerror.....	2601
EYE<m>:FILTer:DDR:LENerror.....	2750
EYE<m>:FILTer:PAMN:BLEVel.....	2601
EYE<m>:FILTer:PAMN:BLEVel.....	2750
EYE<m>:FILTer:PAMN:EMODE.....	2602
EYE<m>:FILTer:PAMN:EMODE.....	2750
EYE<m>:FILTer:PAMN:SEYE.....	2602
EYE<m>:FILTer:PAMN:SEYE.....	2751
EYE<m>:FILTer:PAMN:TLEVel.....	2602
EYE<m>:FILTer:PAMN:TLEVel.....	2751
EYE<m>:FILTer:STATe.....	2599
EYE<m>:FILTer:STATe.....	2748
EYE<m>:HORizontal:ABSolute:POSition.....	2586

EYE<m>:HORizontal:ABSolute:POSition.....	2734
EYE<m>:HORizontal:ABSolute:RANGe.....	2585
EYE<m>:HORizontal:ABSolute:RANGe.....	2734
EYE<m>:HORizontal:UINterval:POSition.....	2586
EYE<m>:HORizontal:UINterval:POSition.....	2735
EYE<m>:HORizontal:UINterval:RANGe.....	2586
EYE<m>:HORizontal:UINterval:RANGe.....	2735
EYE<m>:HORizontal[:UNIT].....	2585
EYE<m>:HORizontal[:UNIT].....	2733
EYE<m>:MEASurement:MAXPrecision.....	2590
EYE<m>:MEASurement:MAXPrecision.....	2739
EYE<m>:MSLices.....	2593
EYE<m>:MSLices.....	2741
EYE<m>:PAMorder?.....	2592
EYE<m>:PAMorder?.....	2740
EYE<m>:QUALify:GATE:ABSolute:START.....	2596
EYE<m>:QUALify:GATE:ABSolute:START.....	2744
EYE<m>:QUALify:GATE:ABSolute:STOP.....	2596
EYE<m>:QUALify:GATE:ABSolute:STOP.....	2744
EYE<m>:QUALify:GATE:COUPling.....	2595
EYE<m>:QUALify:GATE:COUPling.....	2744
EYE<m>:QUALify:GATE:CURSor.....	2596
EYE<m>:QUALify:GATE:CURSor.....	2745
EYE<m>:QUALify:GATE:MODE.....	2595
EYE<m>:QUALify:GATE:MODE.....	2744
EYE<m>:QUALify:GATE:RELative:START.....	2596
EYE<m>:QUALify:GATE:RELative:START.....	2745
EYE<m>:QUALify:GATE:RELative:STOP.....	2596
EYE<m>:QUALify:GATE:RELative:STOP.....	2745
EYE<m>:QUALify:GATE:ZDIagram.....	2597
EYE<m>:QUALify:GATE:ZDIagram.....	2745
EYE<m>:QUALify:GATE[:STATe].....	2595
EYE<m>:QUALify:GATE[:STATe].....	2743
EYE<m>:QUALify:SIGNal:CONDition.....	2598
EYE<m>:QUALify:SIGNal:CONDition.....	2746
EYE<m>:QUALify:SIGNal:LSElect.....	2598
EYE<m>:QUALify:SIGNal:LSElect.....	2747
EYE<m>:QUALify:SIGNal:SOURce.....	2598
EYE<m>:QUALify:SIGNal:SOURce.....	2746
EYE<m>:QUALify:SIGNal[:STATe].....	2597
EYE<m>:QUALify:SIGNal[:STATe].....	2746
EYE<m>:RESult:SLICe<n>:COUNT?.....	2603
EYE<m>:RESult:SLICe<n>:COUNT?.....	2752
EYE<m>:RESult:SLICe<n>:LPOSition?.....	2603
EYE<m>:RESult:SLICe<n>:LPOSition?.....	2752
EYE<m>:RESult:SLICe<n>[:POSition]?.....	2603
EYE<m>:RESult:SLICe<n>[:POSition]?.....	2752
EYE<m>:RESult:TACQs?.....	2604
EYE<m>:RESult:TACQs?.....	2753
EYE<m>:RESult:TSLices?.....	2604

EYE<m>:RESult:TSlices?.....	2753
EYE<m>:SOURce.....	2585
EYE<m>:SOURce.....	2733
EYE<m>:SYMBolrate?.....	2592
EYE<m>:SYMBolrate?.....	2741
EYE<m>:TIMReference:CDR:SOFTware.....	2589
EYE<m>:TIMReference:CDR:SOFTware.....	2738
EYE<m>:TIMReference:CDR:SOFTware:SAMTime.....	2591
EYE<m>:TIMReference:CDR:SOFTware:SAMTime.....	2740
EYE<m>:TIMReference:CDR[:SELEct].....	2590
EYE<m>:TIMReference:CDR[:SELEct].....	2738
EYE<m>:TIMReference:CLOCK:EDGE.....	2587
EYE<m>:TIMReference:CLOCK:EDGE.....	2735
EYE<m>:TIMReference:CLOCK:FACTor.....	2587
EYE<m>:TIMReference:CLOCK:FACTor.....	2735
EYE<m>:TIMReference:CLOCK:FREQUency.....	2587
EYE<m>:TIMReference:CLOCK:FREQUency.....	2736
EYE<m>:TIMReference:CLOCK:FREStimation.....	2587
EYE<m>:TIMReference:CLOCK:FREStimation.....	2736
EYE<m>:TIMReference:CLOCK:LEVel.....	2588
EYE<m>:TIMReference:CLOCK:LEVel.....	2736
EYE<m>:TIMReference:CLOCK:OFEStimation.....	2588
EYE<m>:TIMReference:CLOCK:OFEStimation.....	2737
EYE<m>:TIMReference:CLOCK:OFFSet.....	2588
EYE<m>:TIMReference:CLOCK:OFFSet.....	2737
EYE<m>:TIMReference:CLOCK:SOURce.....	2589
EYE<m>:TIMReference:CLOCK:SOURce.....	2737
EYE<m>:TIMReference:PROTocol:SELEct.....	2589
EYE<m>:TIMReference:PROTocol:SELEct.....	2738
EYE<m>:TIMReference[:SOURce].....	2589
EYE<m>:TIMReference[:SOURce].....	2738
EYE<m>:VERTical:OFFSet.....	2590
EYE<m>:VERTical:OFFSet.....	2739
EYE<m>:VERTical:POSition.....	2591
EYE<m>:VERTical:POSition.....	2739
EYE<m>:VERTical:SCALe.....	2591
EYE<m>:VERTical:SCALe.....	2740
EYE<m>:ZCOupling.....	2606
EYE<m>:ZCOupling.....	2755
EYE<m>:ZDIagram.....	2606
EYE<m>:ZDIagram.....	2755
EYE<m>[:STATe].....	2584
EYE<m>[:STATe].....	2733
FORMat:BORDER.....	1381
FORMat:BORDER.....	1483
FORMat:BPATtern.....	1381
FORMat[:DATA].....	1380
GENerator:ALIGnment:DC:ABORt.....	2651
GENerator:ALIGnment:DC:RESult:DATE?.....	2651
GENerator:ALIGnment:DC:RESult:TIME?.....	2651

GENerator:ALIGnment:DC:RESult[:STATe]?	2651
GENerator:ALIGnment:DC[:START]	2652
GENerator:SYNC[:COMBination]	2654
GPIB:ADDRess	1382
GPIB:TERMinator	1382
HCOPy:CMAP<m>:DEFault	1781
HCOPy:DESTination<1..2>	1779
HCOPy:DEVice<m>:INVerse	1780
HCOPy:DEVice<m>:LANGuage	1780
HCOPy:IMMEDIATE<m>:NEXT	1782
HCOPy:IMMEDIATE<m>[:DUM]	1782
HCOPy:ISBA	1782
HCOPy:SSD	1781
HCOPy:STABs	1783
HCOPy:WBKG	1781
HDEFinition:BWIDth	1482
HDEFinition:RESolution?	1482
HDEFinition:STATe	1482
IQ:BWIDth?	2665
IQ:INSRate	2664
IQ:RBWIDth	2665
IQ:RENGth	2666
IQ:SRATE	2665
IQ:STATe	2664
LANE<m>:CMPO	2813
LANE<m>:COMFilter:INCLude:DEEMbedding	2813
LANE<m>:COMFilter:INCLude:EMBedding	2814
LANE<m>:COMFilter:INCLude:TFFE	2814
LANE<m>:EMBedding:ADD	2821
LANE<m>:EMBedding:BANDwidth	2821
LANE<m>:EMBedding:CASCade:PSElection	2821
LANE<m>:EMBedding:CCOunt?	2821
LANE<m>:EMBedding:CMPDelay	2822
LANE<m>:EMBedding:COMPonent<n>:IDENTical	2822
LANE<m>:EMBedding:COMPonent<n>:IPONe	2823
LANE<m>:EMBedding:COMPonent<n>:IPTWo	2823
LANE<m>:EMBedding:COMPonent<n>:NAME	2823
LANE<m>:EMBedding:COMPonent<n>:OPONe	2823
LANE<m>:EMBedding:COMPonent<n>:OPTWo	2823
LANE<m>:EMBedding:COMPonent<n>:PCOunt?	2823
LANE<m>:EMBedding:COMPonent<n>:PSONe	2824
LANE<m>:EMBedding:COMPonent<n>:PSTWo	2824
LANE<m>:EMBedding:COMPonent<n>:SPFSelection	2824
LANE<m>:EMBedding:COMPonent<n>:SPFType	2825
LANE<m>:EMBedding:COMPonent<n>:SPONe	2825
LANE<m>:EMBedding:COMPonent<n>:SPTWo	2825
LANE<m>:EMBedding:COMPonent<n>:TYPE	2825
LANE<m>:EMBedding:COMPonent<n>[:STATe]	2826
LANE<m>:EMBedding:NAME	2826
LANE<m>:EMBedding:OPEN	2826

LANE<m>:EMBedding:PRESet.....	2826
LANE<m>:EMBedding:REMove.....	2827
LANE<m>:EMBedding:SAVE.....	2827
LANE<m>:EMBedding:STATe.....	2820
LANE<m>:EQUalization:CTLE:DCGain.....	2828
LANE<m>:EQUalization:CTLE:NAME.....	2828
LANE<m>:EQUalization:CTLE:OPEN.....	2828
LANE<m>:EQUalization:CTLE:POLE:COUNT.....	2828
LANE<m>:EQUalization:CTLE:POLE:FREQuency<*>.....	2829
LANE<m>:EQUalization:CTLE:PSELection.....	2829
LANE<m>:EQUalization:CTLE:SAVE.....	2829
LANE<m>:EQUalization:CTLE:SCONfig:LIST?.....	2830
LANE<m>:EQUalization:CTLE:SCONfig[SELect].....	2830
LANE<m>:EQUalization:CTLE:STATe.....	2830
LANE<m>:EQUalization:CTLE:ZERO:COUNT.....	2830
LANE<m>:EQUalization:CTLE:ZERO:FREQuency<*>.....	2831
LANE<m>:EQUalization:DFE:GAIN.....	2835
LANE<m>:EQUalization:DFE:NAME.....	2835
LANE<m>:EQUalization:DFE:OPEN.....	2836
LANE<m>:EQUalization:DFE:SAVE.....	2836
LANE<m>:EQUalization:DFE:STATe.....	2836
LANE<m>:EQUalization:DFE:TAPS:COUNT.....	2837
LANE<m>:EQUalization:DFE:TAPS:NORMAlize.....	2837
LANE<m>:EQUalization:DFE:TAPS:PRESet.....	2837
LANE<m>:EQUalization:DFE:TAPS:TAP<*>.....	2837
LANE<m>:EQUalization:DFE:TIMReference:CDR:SOFTware.....	2838
LANE<m>:EQUalization:DFE:TIMReference:CDR:SOFTware:SAMTime.....	2838
LANE<m>:EQUalization:DFE:TIMReference:CDR[SELect].....	2838
LANE<m>:EQUalization:DFE:TIMReference:CLOCK:EDGE.....	2839
LANE<m>:EQUalization:DFE:TIMReference:CLOCK:FACTor.....	2839
LANE<m>:EQUalization:DFE:TIMReference:CLOCK:FREQuency.....	2839
LANE<m>:EQUalization:DFE:TIMReference:CLOCK:FREStimation.....	2840
LANE<m>:EQUalization:DFE:TIMReference:CLOCK:LEVel.....	2840
LANE<m>:EQUalization:DFE:TIMReference:CLOCK:OFEstimation.....	2840
LANE<m>:EQUalization:DFE:TIMReference:CLOCK:OFFSet.....	2841
LANE<m>:EQUalization:DFE:TIMReference:CLOCK:SAMTime.....	2841
LANE<m>:EQUalization:DFE:TIMReference:CLOCK:SOURce.....	2842
LANE<m>:EQUalization:DFE:TIMReference:SOURce.....	2842
LANE<m>:EQUalization:FFE:NAME.....	2831
LANE<m>:EQUalization:FFE:OPEN.....	2832
LANE<m>:EQUalization:FFE:PSELection.....	2832
LANE<m>:EQUalization:FFE:SAVE.....	2832
LANE<m>:EQUalization:FFE:STATe.....	2832
LANE<m>:EQUalization:FFE:TAPS:COUNT.....	2833
LANE<m>:EQUalization:FFE:TAPS:NORMAlize.....	2833
LANE<m>:EQUalization:FFE:TAPS:PRESet.....	2833
LANE<m>:EQUalization:FFE:TAPS:SYMMode.....	2834
LANE<m>:EQUalization:FFE:TAPS:SYMValue.....	2834
LANE<m>:EQUalization:FFE:TAPS:TAP<*>.....	2834
LANE<m>:EQUalization:NAME.....	2814

LANE<m>:EQUalization:OPEN.....	2815
LANE<m>:EQUalization:PRESet.....	2815
LANE<m>:EQUalization:SAVE.....	2815
LANE<m>:EQUalization:STATe.....	2815
LANE<m>:EQUalization:TRAIning:APPLY.....	2843
LANE<m>:EQUalization:TRAIning:DFE:LIMits:PRESet.....	2843
LANE<m>:EQUalization:TRAIning:DFE:LIMits:TAP<n>:LLIMit.....	2843
LANE<m>:EQUalization:TRAIning:DFE:LIMits:TAP<n>:ULIMit.....	2844
LANE<m>:EQUalization:TRAIning:DFE:TAPS:COUNT.....	2844
LANE<m>:EQUalization:TRAIning:DFE:TAPS:LLIMit<0>.....	2844
LANE<m>:EQUalization:TRAIning:DFE:TAPS:UGLLimit.....	2845
LANE<m>:EQUalization:TRAIning:DFE:TAPS:ULIMit<0>.....	2845
LANE<m>:EQUalization:TRAIning:ERRor?.....	2848
LANE<m>:EQUalization:TRAIning:FFE:TAPS:COUNT.....	2845
LANE<m>:EQUalization:TRAIning:FFE:TAPS:PRECursor.....	2846
LANE<m>:EQUalization:TRAIning:FFE:TAPS:SYMMode.....	2846
LANE<m>:EQUalization:TRAIning:FFE:TAPS:SYMValue.....	2846
LANE<m>:EQUalization:TRAIning:FSElection.....	2847
LANE<m>:EQUalization:TRAIning:MODE.....	2847
LANE<m>:EQUalization:TRAIning:NORGain.....	2847
LANE<m>:EQUalization:TRAIning:REFWaveform.....	2848
LANE<m>:EQUalization:TRAIning:STARt.....	2848
LANE<m>:NAME.....	2811
LANE<m>:OPEN.....	2811
LANE<m>:PAMorder?.....	2811
LANE<m>:PRESet.....	2811
LANE<m>:SAVE.....	2812
LANE<m>:SOURce.....	2812
LANE<m>:STATe.....	2812
LANE<m>:SYMRate.....	2812
LANE<m>:TFFE:PSElection.....	2817
LANE<m>:TFFE:SCONfig:LIST?.....	2818
LANE<m>:TFFE:SCONfig[:SElect].....	2818
LANE<m>:TFFE:STATe.....	2818
LANE<m>:TFFE:TAPS:COUNT.....	2819
LANE<m>:TFFE:TAPS:PRESet.....	2819
LANE<m>:TFFE:TAPS:TAP<*>.....	2819
LANE<m>:VERTical:COUple.....	2816
LANE<m>:VERTical:OFFSet.....	2816
LANE<m>:VERTical:POSition.....	2817
LANE<m>:VERTical:SCALe.....	2817
LAYout:ADD.....	1390
LAYout:HISTogram:ADD.....	1640
LAYout:HISTogram:ENABLE.....	1641
LAYout:HISTogram:HORIZ:ABSolute:STARt.....	1643
LAYout:HISTogram:HORIZ:ABSolute:STOP.....	1643
LAYout:HISTogram:HORIZ:MODE.....	1643
LAYout:HISTogram:HORIZ:RELative:STARt.....	1644
LAYout:HISTogram:HORIZ:RELative:STOP.....	1644
LAYout:HISTogram:MODE.....	1642

LAYout:HISTogram:REMove.....	1646
LAYout:HISTogram:RESet.....	1646
LAYout:HISTogram:SOURce.....	1642
LAYout:HISTogram:VERTical:ABSolute:START.....	1645
LAYout:HISTogram:VERTical:ABSolute:STOP.....	1645
LAYout:HISTogram:VERTical:MODE.....	1644
LAYout:HISTogram:VERTical:RELative:START.....	1645
LAYout:HISTogram:VERTical:RELative:STOP.....	1646
LAYout:REMove.....	1392
LAYout:SHOW.....	1392
LAYout:SIGNal:ASSign.....	1392
LAYout:SIGNal:AXIS.....	1569
LAYout:SIGNal:UNASsign.....	1394
LAYout:ZOOM:ADD.....	1537
LAYout:ZOOM:ADDCoupled.....	1537
LAYout:ZOOM:HORZ:ABSolute:POSition.....	1538
LAYout:ZOOM:HORZ:ABSolute:SPAN.....	1539
LAYout:ZOOM:HORZ:ABSolute:START.....	1539
LAYout:ZOOM:HORZ:ABSolute:STOP.....	1539
LAYout:ZOOM:HORZ:MODE.....	1538
LAYout:ZOOM:HORZ:RELative:POSition.....	1540
LAYout:ZOOM:HORZ:RELative:SPAN.....	1540
LAYout:ZOOM:HORZ:RELative:START.....	1541
LAYout:ZOOM:HORZ:RELative:STOP.....	1541
LAYout:ZOOM:ONEDiagram.....	1395
LAYout:ZOOM:POSCoupling.....	1538
LAYout:ZOOM:REMove.....	1545
LAYout:ZOOM:VERTical:ABSolute:POSition.....	1542
LAYout:ZOOM:VERTical:ABSolute:SPAN.....	1542
LAYout:ZOOM:VERTical:ABSolute:START.....	1543
LAYout:ZOOM:VERTical:ABSolute:STOP.....	1543
LAYout:ZOOM:VERTical:MODE.....	1541
LAYout:ZOOM:VERTical:RELative:POSition.....	1543
LAYout:ZOOM:VERTical:RELative:SPAN.....	1544
LAYout:ZOOM:VERTical:RELative:START.....	1544
LAYout:ZOOM:VERTical:RELative:STOP.....	1545
MEASurement<m>:ADDITIONal.....	1588
MEASurement<m>:AMPTime:ALEVel.....	1597
MEASurement<m>:AMPTime:ARITHmetic:CONStant.....	1608
MEASurement<m>:AMPTime:ARITHmetic:COUNIt.....	1608
MEASurement<m>:AMPTime:ARITHmetic:CUNState.....	1609
MEASurement<m>:AMPTime:ARITHmetic:CUUNIt.....	1609
MEASurement<m>:AMPTime:ARITHmetic:CUUState.....	1610
MEASurement<m>:AMPTime:ARITHmetic:OPERator.....	1610
MEASurement<m>:AMPTime:ARITHmetic:PARAmeter<n>:AMPTime.....	1610
MEASurement<m>:AMPTime:ARITHmetic:PARAmeter<n>:GROUp.....	1611
MEASurement<m>:AMPTime:ARITHmetic:PARAmeter<n>:SPECtrum.....	1611
MEASurement<m>:AMPTime:ARITHmetic:PARAmeter<n>:TYPE.....	1612
MEASurement<m>:AMPTime:CLCK<n>:LSElect.....	1602
MEASurement<m>:AMPTime:CSLoPe.....	1601

MEASurement<m>:AMPTime:DATA<n>:LSElect.....	1602
MEASurement<m>:AMPTime:DElay<n>:DIRection.....	1599
MEASurement<m>:AMPTime:DElay<n>:ECOUNT.....	1599
MEASurement<m>:AMPTime:DElay<n>:LSElect.....	1600
MEASurement<m>:AMPTime:DElay<n>:SLOPe.....	1600
MEASurement<m>:AMPTime:DTOTrigger<n>:LSElect.....	1603
MEASurement<m>:AMPTime:DTOTrigger<n>:SLOPe.....	1603
MEASurement<m>:AMPTime:EINCrement.....	1606
MEASurement<m>:AMPTime:ESLOPe.....	1601
MEASurement<m>:AMPTime:LCHeck<n>:LOWer:LIMit.....	1604
MEASurement<m>:AMPTime:LCHeck<n>:LOWer:MARGIn.....	1604
MEASurement<m>:AMPTime:LCHeck<n>:UPPer:LIMit.....	1604
MEASurement<m>:AMPTime:LCHeck<n>:UPPer:MARGIn.....	1604
MEASurement<m>:AMPTime:LCHeck<n>:VALid.....	1603
MEASurement<m>:AMPTime:NPERiod.....	1605
MEASurement<m>:AMPTime:PFSLope.....	1598
MEASurement<m>:AMPTime:PLHYsteresis.....	1607
MEASurement<m>:AMPTime:PRLevel.....	1606
MEASurement<m>:AMPTime:PRLMode.....	1606
MEASurement<m>:AMPTime:PSLOPe.....	1598
MEASurement<m>:AMPTime:PTCount.....	1601
MEASurement<m>:AMPTime:VCHYsteresis.....	1605
MEASurement<m>:AMPTime:VCMLLevel.....	1607
MEASurement<m>:AOFF.....	1589
MEASurement<m>:AON.....	1589
MEASurement<m>:ARES?.....	1590
MEASurement<m>:ARNames.....	1591
MEASurement<m>:CATegory.....	1586
MEASurement<m>:CLEar.....	1653
MEASurement<m>:DETTreshold.....	1597
MEASurement<m>:DISPlay:GROuping.....	1403
MEASurement<m>:DISPlay:HISTogram.....	1652
MEASurement<m>:DISPlay:LEVels.....	1651
MEASurement<m>:DISPlay:RESults.....	1651
MEASurement<m>:DISPlay:STYLe.....	1652
MEASurement<m>:ENVSelect.....	1597
MEASurement<m>:EYEJitter:AUToscale.....	1618
MEASurement<m>:EYEJitter:DCDistortion:RELative:LEVel.....	1622
MEASurement<m>:EYEJitter:EYEHeight:ABSolute:START.....	1627
MEASurement<m>:EYEJitter:EYEHeight:ABSolute:STOP.....	1627
MEASurement<m>:EYEJitter:EYEHeight:ALGorithm.....	1625
MEASurement<m>:EYEJitter:EYEHeight:MODE.....	1627
MEASurement<m>:EYEJitter:EYEHeight:RELative:START.....	1626
MEASurement<m>:EYEJitter:EYEHeight:RELative:STOP.....	1626
MEASurement<m>:EYEJitter:EYEWIdth:ABSolute:START.....	1624
MEASurement<m>:EYEJitter:EYEWIdth:ABSolute:STOP.....	1625
MEASurement<m>:EYEJitter:EYEWIdth:ALGorithm.....	1622
MEASurement<m>:EYEJitter:EYEWIdth:MEASwindow.....	1623
MEASurement<m>:EYEJitter:EYEWIdth:MODE.....	1625
MEASurement<m>:EYEJitter:EYEWIdth:RELative:START.....	1623

MEASurement<m>:EYEJitter:EYEWidth:RELative:STOP.....	1624
MEASurement<m>:EYEJitter:GENSettings:ABSolute:START.....	1621
MEASurement<m>:EYEJitter:GENSettings:ABSolute:STOP.....	1622
MEASurement<m>:EYEJitter:GENSettings:MLEHistogram:ALGorithm.....	1620
MEASurement<m>:EYEJitter:GENSettings:MLEHistogram:THReshold.....	1620
MEASurement<m>:EYEJitter:GENSettings:RELative:START.....	1621
MEASurement<m>:EYEJitter:GENSettings:RELative:STOP.....	1621
MEASurement<m>:EYEJitter:JITTer:MEASlevel.....	1628
MEASurement<m>:EYEJitter:JITTer:RELative:LEVel.....	1628
MEASurement<m>:EYEJitter:LCHeck<n>:LOWer:LIMit.....	1619
MEASurement<m>:EYEJitter:LCHeck<n>:LOWer:MARGin.....	1619
MEASurement<m>:EYEJitter:LCHeck<n>:UPPer:LIMit.....	1619
MEASurement<m>:EYEJitter:LCHeck<n>:UPPer:MARGin.....	1619
MEASurement<m>:EYEJitter:LCHeck<n>:VALid.....	1618
MEASurement<m>:EYEJitter:RTFTime:RELative:START.....	1629
MEASurement<m>:EYEJitter:RTFTime:RELative:STOP.....	1629
MEASurement<m>:FSRC.....	1586
MEASurement<m>:GATE:ABSolute:START.....	1668
MEASurement<m>:GATE:ABSolute:STOP.....	1668
MEASurement<m>:GATE:CCOupling.....	1669
MEASurement<m>:GATE:CURSor.....	1668
MEASurement<m>:GATE:GCOupling.....	1670
MEASurement<m>:GATE:MODE.....	1667
MEASurement<m>:GATE:RELative:START.....	1668
MEASurement<m>:GATE:RELative:STOP.....	1668
MEASurement<m>:GATE:ZCOupling.....	1669
MEASurement<m>:GATE:ZDIagram.....	1670
MEASurement<m>:GATE[:STATe].....	1667
MEASurement<m>:HISTogram:LCHeck<n>:LOWer:LIMit.....	1650
MEASurement<m>:HISTogram:LCHeck<n>:LOWer:MARGin.....	1650
MEASurement<m>:HISTogram:LCHeck<n>:UPPer:LIMit.....	1650
MEASurement<m>:HISTogram:LCHeck<n>:UPPer:MARGin.....	1650
MEASurement<m>:HISTogram:LCHeck<n>:VALid.....	1649
MEASurement<m>:HISTogram:PROBability:LIMit.....	1649
MEASurement<m>:HISTogram:PROBability:TYPE.....	1648
MEASurement<m>:HISTogram:SElect.....	1648
MEASurement<m>:JITTer:CCSLope.....	2672
MEASurement<m>:JITTer:CDRMode.....	2673
MEASurement<m>:JITTer:DRUNit.....	2675
MEASurement<m>:JITTer:NCYCles.....	2673
MEASurement<m>:JITTer:PULSe.....	2672
MEASurement<m>:JITTer:SKWRelation.....	2675
MEASurement<m>:JITTer:SKWSlope.....	2675
MEASurement<m>:JITTer:SOURce<n>:TIESlope.....	2674
MEASurement<m>:LCHeck.....	1670
MEASurement<m>:LTMeas:COUNT.....	1658
MEASurement<m>:LTMeas:TIME.....	1659
MEASurement<m>:LTMeas[:STATe].....	1658
MEASurement<m>:MAIN.....	1587
MEASurement<m>:MNOMeas.....	1654

MEASurement<m>:MULTiple.....	1653
MEASurement<m>:ONViolation:ACQStop.....	1671
MEASurement<m>:ONViolation:BEEP.....	1671
MEASurement<m>:ONViolation:REPort.....	1672
MEASurement<m>:ONViolation:RUNExec.....	1673
MEASurement<m>:ONViolation:TRIGgerout.....	1672
MEASurement<m>:ONViolation:WFMSave.....	1672
MEASurement<m>:OPTical:LCHeck<n>:LOWer:LIMit.....	1639
MEASurement<m>:OPTical:LCHeck<n>:LOWer:MARGin.....	1639
MEASurement<m>:OPTical:LCHeck<n>:UPPer:LIMit.....	1639
MEASurement<m>:OPTical:LCHeck<n>:UPPer:MARGin.....	1639
MEASurement<m>:OPTical:LCHeck<n>:VALid.....	1639
MEASurement<m>:OPTical:OMAMplitude:RELative:START.....	1637
MEASurement<m>:OPTical:OMAMplitude:RELative:STOP.....	1638
MEASurement<m>:OPTical:UNIT.....	1638
MEASurement<m>:PROTocol:F2FRame:FLDFrom.....	1660
MEASurement<m>:PROTocol:F2FRame:FLDTo.....	1660
MEASurement<m>:PROTocol:F2FRame:FRMFrom.....	1661
MEASurement<m>:PROTocol:F2FRame:FRMTo.....	1661
MEASurement<m>:PROTocol:F2FRame:VALFrom.....	1661
MEASurement<m>:PROTocol:F2FRame:VALTo.....	1661
MEASurement<m>:PROTocol:FLDValue:FLD.....	1662
MEASurement<m>:PROTocol:FLDValue:FRM.....	1662
MEASurement<m>:PROTocol:FLDValue:TRCK.....	1662
MEASurement<m>:PROTocol:FLDValue:VAL.....	1663
MEASurement<m>:PROTocol:MBITrate:FLD.....	1663
MEASurement<m>:PROTocol:MBITrate:FRM.....	1663
MEASurement<m>:PROTocol:MBITrate:VAL.....	1663
MEASurement<m>:PROTocol:SBITrate:FLD.....	1664
MEASurement<m>:PROTocol:SBITrate:FRM.....	1664
MEASurement<m>:PROTocol:SBITrate:VAL.....	1664
MEASurement<m>:PROTocol:T2FRame:DIRection.....	1664
MEASurement<m>:PROTocol:T2FRame:FLD.....	1665
MEASurement<m>:PROTocol:T2FRame:FRM.....	1665
MEASurement<m>:PROTocol:T2FRame:VALue.....	1665
MEASurement<m>:REFLevel:RESult:BINNer?.....	1804
MEASurement<m>:REFLevel:RESult:BOUter?.....	1804
MEASurement<m>:REFLevel:RESult:LOWer?.....	1803
MEASurement<m>:REFLevel:RESult:MIDDLE?.....	1803
MEASurement<m>:REFLevel:RESult:SIGHigh?.....	1804
MEASurement<m>:REFLevel:RESult:SIGLow?.....	1804
MEASurement<m>:REFLevel:RESult:TINNer?.....	1805
MEASurement<m>:REFLevel:RESult:TOUTer?.....	1805
MEASurement<m>:REFLevel:RESult:UPPer?.....	1803
MEASurement<m>:RESult:AVG?.....	1591
MEASurement<m>:RESult:COUNT?.....	1593
MEASurement<m>:RESult:EVTCount?.....	1591
MEASurement<m>:RESult:INVerse.....	1404
MEASurement<m>:RESult:LABorder.....	1404
MEASurement<m>:RESult:MAXCount.....	1634

MEASurement<m>:RESult:NPEak?	1591
MEASurement<m>:RESult:PPEak?	1591
MEASurement<m>:RESult:RELIability?	1591
MEASurement<m>:RESult:RMS?	1591
MEASurement<m>:RESult:SHFRequency	1634
MEASurement<m>:RESult:SHLabels	1635
MEASurement<m>:RESult:START?	1593
MEASurement<m>:RESult:STDDev?	1591
MEASurement<m>:RESult:STOP?	1593
MEASurement<m>:RESult:WFMCount?	1591
MEASurement<m>:RESult[:ACTual]?	1591
MEASurement<m>:SOURce	1584
MEASurement<m>:SPECtrum:ARITHmetic:CONStant	1612
MEASurement<m>:SPECtrum:ARITHmetic:COUNit	1613
MEASurement<m>:SPECtrum:ARITHmetic:CUNState	1613
MEASurement<m>:SPECtrum:ARITHmetic:CUUNit	1614
MEASurement<m>:SPECtrum:ARITHmetic:CUUState	1614
MEASurement<m>:SPECtrum:ARITHmetic:OPERator	1614
MEASurement<m>:SPECtrum:ARITHmetic:PARAmeter<n>:AMPTime	1614
MEASurement<m>:SPECtrum:ARITHmetic:PARAmeter<n>:GROup	1615
MEASurement<m>:SPECtrum:ARITHmetic:PARAmeter<n>:SPECtrum	1615
MEASurement<m>:SPECtrum:ARITHmetic:PARAmeter<n>:TYPE	1616
MEASurement<m>:SPECtrum:ATHReshold	1632
MEASurement<m>:SPECtrum:CPOWer:BANDwidth	1631
MEASurement<m>:SPECtrum:CPOWer:CFRequency	1631
MEASurement<m>:SPECtrum:LCHeck<n>:LOWer:LIMit	1636
MEASurement<m>:SPECtrum:LCHeck<n>:LOWer:MARGin	1636
MEASurement<m>:SPECtrum:LCHeck<n>:UPPer:LIMit	1636
MEASurement<m>:SPECtrum:LCHeck<n>:UPPer:MARGin	1636
MEASurement<m>:SPECtrum:LCHeck<n>:VALid	1635
MEASurement<m>:SPECtrum:NDBDown	1632
MEASurement<m>:SPECtrum:OBANDwidth	1631
MEASurement<m>:SPECtrum:PEXCursion	1632
MEASurement<m>:SPECtrum:RESult<n>:COUNT	1633
MEASurement<m>:SPECtrum:RESult<n>:MODE	1633
MEASurement<m>:SSRC	1586
MEASurement<m>:STATistics:HBINs	1654
MEASurement<m>:STATistics:HISTogram	1654
MEASurement<m>:STATistics:MODE	1655
MEASurement<m>:STATistics:RCOunt	1655
MEASurement<m>:STATistics:RESet	1656
MEASurement<m>:STATistics:RMEascount	1656
MEASurement<m>:STATistics:RTIME	1656
MEASurement<m>:STATistics[:ENABle]	1653
MEASurement<m>:TRACk:DATA:HEADer?	1666
MEASurement<m>:TRACk:DATA:HEADer?	1899
MEASurement<m>:TRACk:DATA:STYPe?	1666
MEASurement<m>:TRACk:DATA:STYPe?	1899
MEASurement<m>:TRACk:DATA[:VALues]?	1666
MEASurement<m>:TRACk:DATA[:VALues]?	1899

MEASurement<m>:TRACk[:STATe].....	1666
MEASurement<m>:TRACk[:STATe].....	1899
MEASurement<m>:VERTical:AUTO.....	1657
MEASurement<m>:VERTical:CONT.....	1657
MEASurement<m>:VERTical:OFFSet.....	1657
MEASurement<m>:VERTical:SCALE.....	1658
MEASurement<m>[:ENABLE].....	1584
MMEMory:ATTRibute.....	1762
MMEMory:AUTonaming:DATE.....	1785
MMEMory:AUTonaming:DEFaultpath.....	1786
MMEMory:AUTonaming:INDEX.....	1785
MMEMory:AUTonaming:PREFix.....	1785
MMEMory:AUTonaming:RESall.....	1786
MMEMory:AUTonaming:RESPath.....	1786
MMEMory:AUTonaming:TEXT.....	1786
MMEMory:AUTonaming:TIME.....	1785
MMEMory:AUTonaming:USERtext.....	1785
MMEMory:CATalog:LENGth?.....	1760
MMEMory:CATalog?.....	1759
MMEMory:CDIRectory.....	1759
MMEMory:COPI.....	1760
MMEMory:DATA.....	1762
MMEMory:DCATalog:LENGth?.....	1758
MMEMory:DCATalog?.....	1758
MMEMory:DELeTe.....	1761
MMEMory:DRIVes?.....	1758
MMEMory:LOAD:STATe.....	1764
MMEMory:MDIRectory.....	1759
MMEMory:MOVE.....	1761
MMEMory:MSIS.....	1758
MMEMory:NAME.....	1779
MMEMory:RCL.....	1763
MMEMory:RDIRectory.....	1759
MMEMory:SAV.....	1763
MMEMory:STORe:STATe.....	1763
MTESt:ADD.....	1692
MTESt:CEMask.....	1711
MTESt:COLor:BORDer.....	1407
MTESt:COLor:INTerior.....	1407
MTESt:COLor:MATCh.....	1407
MTESt:COLor:UNMatch.....	1406
MTESt:CONDition.....	1694
MTESt:CTYPE.....	1694
MTESt:EYEMask:BOFFset.....	1713
MTESt:EYEMask:HEIGHt<m>[:VALue].....	1711
MTESt:EYEMask:HPERiod.....	1712
MTESt:EYEMask:HPOStion.....	1714
MTESt:EYEMask:MSKBottom.....	1713
MTESt:EYEMask:MSKLeft.....	1712
MTESt:EYEMask:MSKRight.....	1712

MTESt:EYEMask:MSKTop.....	1713
MTESt:EYEMask:PAMNeye.....	1715
MTESt:EYEMask:REFDelta.....	1715
MTESt:EYEMask:TBSymmetric.....	1713
MTESt:EYEMask:TBWidth.....	1714
MTESt:EYEMask:TOFFset.....	1713
MTESt:EYEMask:TYPE.....	1711
MTESt:EYEMask:VPOsition.....	1714
MTESt:EYEMask:WIDTh<m>[:VALue].....	1711
MTESt:FILE:DELeTe.....	1696
MTESt:FILE:NAME.....	1695
MTESt:FILE:OPEN.....	1695
MTESt:FILE:SAVE.....	1695
MTESt:HIGHlight:INFinite.....	1405
MTESt:HIGHlight:STATe.....	1406
MTESt:HIGHlight:TIME.....	1406
MTESt:LABel.....	1405
MTESt:ONViolation:BEeP.....	1705
MTESt:ONViolation:PRINt.....	1706
MTESt:ONViolation:REPort.....	1706
MTESt:ONViolation:RUNeXec.....	1707
MTESt:ONViolation:SAVewaveform.....	1706
MTESt:ONViolation:STOP.....	1705
MTESt:ONViolation:TRIGgerout.....	1707
MTESt:PAMOrder?.....	1696
MTESt:REFWfm.....	1703
MTESt:REMove.....	1692
MTESt:REName.....	1405
MTESt:RESult:COUNT:FAILures?.....	1709
MTESt:RESult:COUNT:FSLices?.....	2605
MTESt:RESult:COUNT:FSLices?.....	2754
MTESt:RESult:COUNT:FWAVEforms?.....	1709
MTESt:RESult:COUNT:REMAining?.....	1709
MTESt:RESult:COUNT:SLICes?.....	2605
MTESt:RESult:COUNT:SLICes?.....	2753
MTESt:RESult:COUNT:WAVEforms?.....	1708
MTESt:RESult:FRATe?.....	1710
MTESt:RESult:STATe?.....	1708
MTESt:RESult:VIOLation<m>:COUNT?.....	2605
MTESt:RESult:VIOLation<m>:COUNT?.....	2754
MTESt:RESult:VIOLation<m>:START?.....	2606
MTESt:RESult:VIOLation<m>:START?.....	2755
MTESt:RESult:VIOLation<m>:STOP?.....	2606
MTESt:RESult:VIOLation<m>:STOP?.....	2755
MTESt:RESult:VIOLation<m>[:SLICe]?.....	2605
MTESt:RESult:VIOLation<m>[:SLICe]?.....	2754
MTESt:RESult[:RESult]?.....	1708
MTESt:RST.....	1693
MTESt:SBITnumber?.....	2856
MTESt:SEGMENT:ADD.....	1697

MTESt:SEGMent:CLear.....	1698
MTESt:SEGMent:COUNT?.....	1697
MTESt:SEGMent:INSert.....	1698
MTESt:SEGMent:POINT:ADD.....	1699
MTESt:SEGMent:POINT:COUNT?.....	1700
MTESt:SEGMent:POINT:INSert.....	1699
MTESt:SEGMent:POINT:REMove.....	1699
MTESt:SEGMent:POINT:X.....	1700
MTESt:SEGMent:POINT:Y.....	1700
MTESt:SEGMent:REGion.....	1698
MTESt:SEGMent:REMove.....	1698
MTESt:SEGMent:RESCale:RECalculate.....	1701
MTESt:SEGMent:RESCale:XFACTOR.....	1701
MTESt:SEGMent:RESCale:XOFFset.....	1702
MTESt:SEGMent:RESCale:YFACTOR.....	1701
MTESt:SEGMent:RESCale:YOFFset.....	1702
MTESt:SEGMent:STATe.....	1697
MTESt:SHOW.....	1693
MTESt:SOURce.....	1693
MTESt:TOLerance.....	1694
MTESt:WFMLupdate.....	1703
MTESt:WFMRescale:XWIDth.....	1703
MTESt:WFMRescale:YPOSITION.....	1704
MTESt:WFMRescale:YSTRetch.....	1705
MTESt:WFMRescale:YWIDth.....	1704
MTESt[:STATe].....	1692
PGENerator:BITRate.....	2646
PGENerator:ENABLE.....	2646
PGENerator:FILE:OPEN.....	2646
PGENerator:FILE[:NAME].....	2646
PGENerator:HLEVel.....	2646
PGENerator:PRESet.....	2647
PGENerator:RUNMode.....	2647
PGENerator:RUNSingle.....	2647
POWer:DESKew:CURRent.....	2757
POWer:DESKew:EXECute.....	2757
POWer:DESKew:RESet.....	2757
POWer:DESKew:TIME?.....	2758
POWer:DESKew:UDPReset.....	2758
POWer:DONRes:AUTO.....	2773
POWer:DONRes:AVG.....	2773
POWer:DONRes:EXECute.....	2773
POWer:DONRes:GATE<m>:START.....	2774
POWer:DONRes:GATE<m>:STOP.....	2774
POWer:DONRes:REPort:ADD.....	2774
POWer:DONRes:RESult:RESistance?.....	2774
POWer:EFFiciency:AUTO.....	2785
POWer:EFFiciency:EXECute.....	2786
POWer:EFFiciency:REPort:ADD.....	2786
POWer:EFFiciency:RESult<m>:ACTual?.....	2786

POWer:EFFiciency:RESult<m>:AVG?	2786
POWer:EFFiciency:RESult<m>:EVTCount?	2786
POWer:EFFiciency:RESult<m>:NPEak?	2786
POWer:EFFiciency:RESult<m>:PPEak?	2786
POWer:EFFiciency:RESult<m>:RMS?	2786
POWer:EFFiciency:RESult<m>:STDDev?	2786
POWer:EFFiciency:RESult<m>:WFMCOUNT?	2786
POWer:ENABle	2756
POWer:HARMonics:AUTO	2768
POWer:HARMonics:DOFR	2769
POWer:HARMonics:ENFR	2769
POWer:HARMonics:EVAL	2769
POWer:HARMonics:EXECute	2769
POWer:HARMonics:MIFR	2769
POWer:HARMonics:REPort:ADD	2770
POWer:HARMonics:RESult<m>:FREQuency<n>:VALue?	2770
POWer:HARMonics:RESult<m>:MAXValue<n>:VALue?	2770
POWer:HARMonics:RESult<m>:STDinuse?	2770
POWer:HARMonics:RESult<m>:STDValue<n>:VALue?	2770
POWer:HARMonics:RESult<m>:VALue<n>:VALue?	2770
POWer:HARMonics:STAN	2770
POWer:HARMonics:VOLT	2771
POWer:INRush:ADD	2766
POWer:INRush:COUNT?	2767
POWer:INRush:EXECute	2767
POWer:INRush:GATE<m>:START	2767
POWer:INRush:GATE<m>:STOP	2767
POWer:INRush:GATE<m>:VALue	2767
POWer:INRush:INSert	2766
POWer:INRush:MAXCurrent	2768
POWer:INRush:REMove	2766
POWer:INRush:REPort:ADD	2768
POWer:INRush:TRIGger	2768
POWer:MODulation:AUTO	2771
POWer:MODulation:DHIStoqram	2771
POWer:MODulation:EXECute	2772
POWer:MODulation:REPort:ADD	2772
POWer:MODulation:RESult:ACTual?	2772
POWer:MODulation:RESult:AVG?	2772
POWer:MODulation:RESult:EVTCount?	2772
POWer:MODulation:RESult:NPEak?	2772
POWer:MODulation:RESult:PPEak?	2772
POWer:MODulation:RESult:RMS?	2772
POWer:MODulation:RESult:STDDev?	2772
POWer:MODulation:RESult:WFMCOUNT?	2772
POWer:MODulation:SOURce	2772
POWer:MODulation:TYPE	2773
POWer:ONOff:ATOff	2780
POWer:ONOff:ATON	2780
POWer:ONOff:DSOff	2780

POWer:ONOfF:DSOn.....	2780
POWer:ONOfF:DTOfF.....	2780
POWer:ONOfF:DTOn.....	2780
POWer:ONOfF:EXECute.....	2781
POWer:ONOfF:INPut.....	2781
POWer:ONOfF:REPort:ADD.....	2781
POWer:ONOfF:RESult:TOFF?.....	2781
POWer:ONOfF:RESult:TON?.....	2781
POWer:ONOfF:TIME.....	2781
POWer:ONOfF:TYPE.....	2782
POWer:QUALity:AUTO.....	2764
POWer:QUALity:EXECute.....	2765
POWer:QUALity:FCUS.....	2765
POWer:QUALity:FREQ.....	2765
POWer:QUALity:REPort:ADD.....	2765
POWer:QUALity:RESult:CURRent:CREStfactor?.....	2765
POWer:QUALity:RESult:CURRent:FREQuency?.....	2765
POWer:QUALity:RESult:CURRent:PEAK?.....	2765
POWer:QUALity:RESult:CURRent:RMS?.....	2765
POWer:QUALity:RESult:POWer:APParent?.....	2765
POWer:QUALity:RESult:POWer:PFACtor?.....	2765
POWer:QUALity:RESult:POWer:PHASe?.....	2765
POWer:QUALity:RESult:POWer:REACtive?.....	2765
POWer:QUALity:RESult:POWer:REALpower?.....	2766
POWer:QUALity:RESult:VOLTagE:CREStfactor?.....	2766
POWer:QUALity:RESult:VOLTagE:FREQuency?.....	2766
POWer:QUALity:RESult:VOLTagE:PEAK?.....	2766
POWer:QUALity:RESult:VOLTagE:RMS?.....	2766
POWer:REPort:CONtent:HSETup.....	2759
POWer:REPort:CONtent:MSETup.....	2759
POWer:REPort:CONtent:MSIGNAL.....	2759
POWer:REPort:CONtent:RESU.....	2759
POWer:REPort:CONtent:SETTings.....	2759
POWer:REPort:CONtent:TITLe.....	2759
POWer:REPort:CONtent:TSETup.....	2759
POWer:REPort:CONtent:VSETup.....	2759
POWer:REPort:DESCription.....	2759
POWer:REPort:DUT.....	2759
POWer:REPort:FILE:DELeTe.....	2761
POWer:REPort:FILE:NAME.....	2761
POWer:REPort:FILE:NEW.....	2761
POWer:REPort:FILE:SAVE.....	2761
POWer:REPort:FONT:COLO.....	2760
POWer:REPort:FONT:FAMI.....	2760
POWer:REPort:FONT:SIZE.....	2760
POWer:REPort:INVert.....	2762
POWer:REPort:LOGO.....	2760
POWer:REPort:PAPerSize.....	2760
POWer:REPort:SITe.....	2759
POWer:REPort:TEMPerature.....	2759

POWer:REPort:TEST:ADD.....	2761
POWer:REPort:TEST:COMMENT.....	2763
POWer:REPort:TEST:COUNT.....	2764
POWer:REPort:TEST:DIRectory.....	2763
POWer:REPort:TEST:DSEA.....	2762
POWer:REPort:TEST:INSert.....	2761
POWer:REPort:TEST:ISE.....	2762
POWer:REPort:TEST:LSEnd?.....	2764
POWer:REPort:TEST:REMove.....	2761
POWer:REPort:TEST:RSE.....	2762
POWer:REPort:TEST:SEA.....	2762
POWer:REPort:USER.....	2759
POWer:RIPple:AUToscale.....	2788
POWer:RIPple:CURRent.....	2788
POWer:RIPple:EXECute.....	2788
POWer:RIPple:FREQuency.....	2788
POWer:RIPple:REPort:ADD.....	2789
POWer:RIPple:RESult:FREQuency:AVG?.....	2789
POWer:RIPple:RESult:FREQuency:EVTCount?.....	2789
POWer:RIPple:RESult:FREQuency:NPEak?.....	2789
POWer:RIPple:RESult:FREQuency:PPEak?.....	2789
POWer:RIPple:RESult:FREQuency:RMS?.....	2789
POWer:RIPple:RESult:FREQuency:STDDev?.....	2789
POWer:RIPple:RESult:FREQuency:WFMCount?.....	2789
POWer:RIPple:RESult:FREQuency[:ACTual]?.....	2789
POWer:RIPple:RESult:MAXimum:AVG?.....	2789
POWer:RIPple:RESult:MAXimum:EVTCount?.....	2789
POWer:RIPple:RESult:MAXimum:NPEak?.....	2789
POWer:RIPple:RESult:MAXimum:PPEak?.....	2789
POWer:RIPple:RESult:MAXimum:RMS?.....	2789
POWer:RIPple:RESult:MAXimum:STDDev?.....	2789
POWer:RIPple:RESult:MAXimum:WFMCount?.....	2789
POWer:RIPple:RESult:MAXimum[:ACTual]?.....	2789
POWer:RIPple:RESult:MINimum:AVG?.....	2790
POWer:RIPple:RESult:MINimum:EVTCount?.....	2790
POWer:RIPple:RESult:MINimum:NPEak?.....	2790
POWer:RIPple:RESult:MINimum:PPEak?.....	2790
POWer:RIPple:RESult:MINimum:RMS?.....	2790
POWer:RIPple:RESult:MINimum:STDDev?.....	2790
POWer:RIPple:RESult:MINimum:WFMCount?.....	2790
POWer:RIPple:RESult:MINimum[:ACTual]?.....	2790
POWer:RIPple:RESult:NDCYcle:AVG?.....	2790
POWer:RIPple:RESult:NDCYcle:EVTCount?.....	2790
POWer:RIPple:RESult:NDCYcle:NPEak?.....	2790
POWer:RIPple:RESult:NDCYcle:PPEak?.....	2790
POWer:RIPple:RESult:NDCYcle:RMS?.....	2790
POWer:RIPple:RESult:NDCYcle:STDDev?.....	2791
POWer:RIPple:RESult:NDCYcle:WFMCount?.....	2791
POWer:RIPple:RESult:NDCYcle[:ACTual]?.....	2790
POWer:RIPple:RESult:PDCYcle:AVG?.....	2791

POWer:RIPPlE:RESult:PDCYcle:EVTCount?.....	2791
POWer:RIPPlE:RESult:PDCYcle:NPEak?.....	2791
POWer:RIPPlE:RESult:PDCYcle:PPEak?.....	2791
POWer:RIPPlE:RESult:PDCYcle:RMS?.....	2791
POWer:RIPPlE:RESult:PDCYcle:STDDev?.....	2791
POWer:RIPPlE:RESult:PDCYcle:WFMCCount?.....	2791
POWer:RIPPlE:RESult:PDCYcle[:ACTual]?.....	2791
POWer:RIPPlE:RESult:PDEL:AVG?.....	2792
POWer:RIPPlE:RESult:PDEL:EVTCount?.....	2792
POWer:RIPPlE:RESult:PDEL:NPEak?.....	2792
POWer:RIPPlE:RESult:PDEL:PPEak?.....	2792
POWer:RIPPlE:RESult:PDEL:RMS?.....	2792
POWer:RIPPlE:RESult:PDEL:STDDev?.....	2792
POWer:RIPPlE:RESult:PDEL:WFMCCount?.....	2792
POWer:RIPPlE:RESult:PDEL[:ACTual]?.....	2792
POWer:RIPPlE:RESult:PERiod:AVG?.....	2792
POWer:RIPPlE:RESult:PERiod:EVTCount?.....	2792
POWer:RIPPlE:RESult:PERiod:NPEak?.....	2792
POWer:RIPPlE:RESult:PERiod:PPEak?.....	2792
POWer:RIPPlE:RESult:PERiod:RMS?.....	2792
POWer:RIPPlE:RESult:PERiod:STDDev?.....	2792
POWer:RIPPlE:RESult:PERiod:WFMCCount?.....	2792
POWer:RIPPlE:RESult:PERiod[:ACTual]?.....	2792
POWer:RIPPlE:RESult:STDDev:AVG?.....	2793
POWer:RIPPlE:RESult:STDDev:EVTCount?.....	2793
POWer:RIPPlE:RESult:STDDev:NPEak?.....	2793
POWer:RIPPlE:RESult:STDDev:PPEak?.....	2793
POWer:RIPPlE:RESult:STDDev:RMS?.....	2793
POWer:RIPPlE:RESult:STDDev:STDDev?.....	2793
POWer:RIPPlE:RESult:STDDev:WFMCCount?.....	2793
POWer:RIPPlE:RESult:STDDev[:ACTual]?.....	2793
POWer:SLEWrate:AUTO.....	2775
POWer:SLEWrate:AVGDeriv.....	2775
POWer:SLEWrate:EXECute.....	2775
POWer:SLEWrate:GATE:START.....	2776
POWer:SLEWrate:GATE:STOP.....	2776
POWer:SLEWrate:REPort:ADD.....	2776
POWer:SLEWrate:RESult:ACTual?.....	2777
POWer:SLEWrate:RESult:AVG?.....	2777
POWer:SLEWrate:RESult:EVTCount?.....	2777
POWer:SLEWrate:RESult:NPEak?.....	2777
POWer:SLEWrate:RESult:PPEak?.....	2777
POWer:SLEWrate:RESult:RMS?.....	2777
POWer:SLEWrate:RESult:STDDev?.....	2777
POWer:SLEWrate:RESult:WFMCCount?.....	2777
POWer:SLEWrate:SOURce.....	2775
POWer:SOA:EXECute.....	2777
POWer:SOA:LINear:ADD.....	2778
POWer:SOA:LINear:COUNt?.....	2778
POWer:SOA:LINear:INSert.....	2778

POWer:SOA:LINear:POINt<m>:CURRent.....	2778
POWer:SOA:LINear:POINt<m>:VOLTagE.....	2779
POWer:SOA:LINear:REMove.....	2778
POWer:SOA:LOGarithmic:ADD.....	2778
POWer:SOA:LOGarithmic:COUNt?.....	2778
POWer:SOA:LOGarithmic:INSert.....	2778
POWer:SOA:LOGarithmic:POINt<m>:CURRent.....	2778
POWer:SOA:LOGarithmic:POINt<m>:VOLTagE.....	2779
POWer:SOA:LOGarithmic:REMove.....	2778
POWer:SOA:MASK.....	2779
POWer:SOA:REPort:ADD.....	2779
POWer:SOA:SCALE.....	2779
POWer:SOA:SWITCh.....	2780
POWer:SOURce:CURRent<1..2>.....	2756
POWer:SOURce:VOLTagE<1..4>.....	2757
POWer:SPECtrum:AUToscale.....	2796
POWer:SPECtrum:EXECute.....	2797
POWer:SPECtrum:FREQuency.....	2797
POWer:SPECtrum:RCounT?.....	2797
POWer:SPECtrum:REPort:ADD.....	2797
POWer:SPECtrum:RESult<m>:FREQuency?.....	2797
POWer:SPECtrum:RESult<m>:LEVel?.....	2797
POWer:SWITChing:AUTO.....	2783
POWer:SWITChing:COND.....	2784
POWer:SWITChing:EXECute.....	2783
POWer:SWITChing:GATE:COND:START.....	2784
POWer:SWITChing:GATE:COND:STOP.....	2784
POWer:SWITChing:GATE:NCON:START.....	2784
POWer:SWITChing:GATE:TOFF:START.....	2784
POWer:SWITChing:GATE:TOFF:STOP.....	2784
POWer:SWITChing:GATE:TON:START.....	2784
POWer:SWITChing:GATE:TON:STOP.....	2784
POWer:SWITChing:NCON.....	2784
POWer:SWITChing:REPort:ADD.....	2783
POWer:SWITChing:RESult:ENERgy:ACTual?.....	2784
POWer:SWITChing:RESult:ENERgy:AVG?.....	2784
POWer:SWITChing:RESult:ENERgy:EVTCount?.....	2784
POWer:SWITChing:RESult:ENERgy:NPEak?.....	2784
POWer:SWITChing:RESult:ENERgy:PPEak?.....	2784
POWer:SWITChing:RESult:ENERgy:RMS?.....	2784
POWer:SWITChing:RESult:ENERgy:STDDev?.....	2784
POWer:SWITChing:RESult:ENERgy:WFMCounT?.....	2784
POWer:SWITChing:RESult:POWer:ACTual?.....	2785
POWer:SWITChing:RESult:POWer:AVG?.....	2785
POWer:SWITChing:RESult:POWer:EVTCount?.....	2785
POWer:SWITChing:RESult:POWer:NPEak?.....	2785
POWer:SWITChing:RESult:POWer:PPEak?.....	2785
POWer:SWITChing:RESult:POWer:RMS?.....	2785
POWer:SWITChing:RESult:POWer:STDDev?.....	2785
POWer:SWITChing:RESult:POWer:WFMCounT?.....	2785

POWer:SWITching:SWIFrequency.....	2783
POWer:SWITching:SWIT.....	2783
POWer:SWITching:TOFF.....	2784
POWer:SWITching:TON.....	2784
POWer:SWITching:TOTal.....	2784
POWer:TRANSient:AUToscale.....	2794
POWer:TRANSient:EXECute.....	2794
POWer:TRANSient:FREQUency.....	2794
POWer:TRANSient:HYSteresis.....	2794
POWer:TRANSient:INPut.....	2795
POWer:TRANSient:REPort:ADD.....	2795
POWer:TRANSient:RESult[ACTual]?	2795
POWer:TRANSient:SIGHigh.....	2795
POWer:TRANSient:SIGLow.....	2795
POWer:TRANSient:TRGChannel.....	2795
POWer:TRANSient:TRGLevel.....	2796
POWer:TRANSient:TRGSlope.....	2796
PROBe<m>:DEEMbedding:BANDwidth.....	1451
PROBe<m>:DEEMbedding:BANDwidth.....	2806
PROBe<m>:DEEMbedding:LOAD:IMPedance.....	1452
PROBe<m>:DEEMbedding:MODE.....	1451
PROBe<m>:DEEMbedding:PMODE.....	1450
PROBe<m>:DEEMbedding:REMPobeload.....	1452
PROBe<m>:DEEMbedding:TIPModule:ZMA<n>:SUBModule.....	1450
PROBe<m>:DEEMbedding:TIPModule:ZMA<n>:SUBModule.....	2806
PROBe<m>:DEEMbedding:TIPModule[SElect].....	1450
PROBe<m>:DEEMbedding:TIPModule[SElect].....	2806
PROBe<m>:ID:PARTnumber?.....	1458
PROBe<m>:ID:PRDate?.....	1457
PROBe<m>:ID:SRNumber?.....	1458
PROBe<m>:ID:SWVersion?.....	1457
PROBe<m>:PMETer:RESults:COMMOn?.....	1440
PROBe<m>:PMETer:RESults:DIFFerential?.....	1440
PROBe<m>:PMETer:RESults:NEGative?.....	1441
PROBe<m>:PMETer:RESults:POSitive?.....	1441
PROBe<m>:PMETer:RESults:SINGle?.....	1439
PROBe<m>:PMETer:VISibility.....	1439
PROBe<m>:SETup:ACCoupling.....	1444
PROBe<m>:SETup:ADAPter?.....	1459
PROBe<m>:SETup:ADVanced:AUDioverload.....	1445
PROBe<m>:SETup:ADVanced:FILTer.....	1445
PROBe<m>:SETup:ADVanced:PMTOffset.....	1444
PROBe<m>:SETup:ADVanced:RANGe.....	1444
PROBe<m>:SETup:ALIGnment:GAIN:EXECute.....	1456
PROBe<m>:SETup:ALIGnment:STATe?.....	1457
PROBe<m>:SETup:ALIGnment:WRITe.....	1457
PROBe<m>:SETup:ALIGnment:ZERO:EXECute.....	1456
PROBe<m>:SETup:ATTenuation:DEFProbe.....	1453
PROBe<m>:SETup:ATTenuation:MANual.....	1442
PROBe<m>:SETup:ATTenuation:MODE.....	1442

PROBe<m>:SETup:ATTenuation:TDEFprobe.....	1459
PROBe<m>:SETup:ATTenuation:UNIT.....	1442
PROBe<m>:SETup:ATTenuation[:AUTO]?.....	1435
PROBe<m>:SETup:BANDwidth?.....	1435
PROBe<m>:SETup:CAPacitance?.....	1458
PROBe<m>:SETup:CMOFFset.....	1443
PROBe<m>:SETup:CMOFFset.....	1447
PROBe<m>:SETup:DEGauss.....	1454
PROBe<m>:SETup:DISPlaydiff.....	1439
PROBe<m>:SETup:DMOFFset.....	1446
PROBe<m>:SETup:GAIN:MANual.....	1443
PROBe<m>:SETup:IMPedance?.....	1459
PROBe<m>:SETup:LAOPerhours?.....	1455
PROBe<m>:SETup:LASTate?.....	1455
PROBe<m>:SETup:MODE.....	1437
PROBe<m>:SETup:NAME?.....	1435
PROBe<m>:SETup:NOFFset.....	1447
PROBe<m>:SETup:OFFSet:AZERo.....	1436
PROBe<m>:SETup:OFFSet:STPRobe.....	1454
PROBe<m>:SETup:OFFSet:TOMean.....	1453
PROBe<m>:SETup:OFFSet:USEautozero.....	1436
PROBe<m>:SETup:OFFSet:ZADJust.....	1454
PROBe<m>:SETup:POFFset.....	1448
PROBe<m>:SETup:PRMode.....	1446
PROBe<m>:SETup:STATE?.....	1434
PROBe<m>:SETup:TERM:ADJust.....	1449
PROBe<m>:SETup:TERM:MEASure?.....	1449
PROBe<m>:SETup:TERM:MODE.....	1448
PROBe<m>:SETup:TERM:STATE.....	1448
PROBe<m>:SETup:TYPE?.....	1434
PROBe<m>:SETup:UNIT.....	1456
PROBe<m>:SETup:ZAXV.....	1443
PROBe<m>:SKEState.....	1480
PSRC:CLOCKmode.....	2656
PSRC:DUTYcycle.....	2655
PSRC:OUTPutlow.....	2655
PSRC:REPRate.....	2655
PSRC:RST.....	2656
PSRC[:STATE].....	2654
REFCurve<m>:CDR:ALGorithm?.....	1555
REFCurve<m>:CDR:BITRate?.....	1556
REFCurve<m>:CDR:BWIDth?.....	1556
REFCurve<m>:CDR:RELBwidth?.....	1557
REFCurve<m>:CDR:SAMTime?.....	1557
REFCurve<m>:CDR:SOURce?.....	1557
REFCurve<m>:CLEar.....	1548
REFCurve<m>:DATA:HEADer?.....	1553
REFCurve<m>:DATA:STYPe?.....	1553
REFCurve<m>:DATA[:VALues]?.....	1554
REFCurve<m>:DELeTe.....	1547

REFCurve<m>:HMODE.....	1551
REFCurve<m>:MULTichannel:IMPort.....	1554
REFCurve<m>:MULTichannel:NAME.....	1554
REFCurve<m>:MULTichannel:OPEN.....	1555
REFCurve<m>:NAME.....	1546
REFCurve<m>:OPEN.....	1547
REFCurve<m>:POSition.....	1549
REFCurve<m>:RESCale:HORizontal:FACTor.....	1552
REFCurve<m>:RESCale:HORizontal:OFFSet.....	1552
REFCurve<m>:RESCale:HORizontal:POSition.....	1552
REFCurve<m>:RESCale:HORizontal:STATe.....	1551
REFCurve<m>:RESCale:VERTical:FACTor.....	1550
REFCurve<m>:RESCale:VERTical:OFFSet.....	1550
REFCurve<m>:RESCale:VERTical:STATe.....	1550
REFCurve<m>:RESTore.....	1548
REFCurve<m>:SAVE.....	1547
REFCurve<m>:SCALe.....	1549
REFCurve<m>:SOURce.....	1546
REFCurve<m>:STATe.....	1546
REFCurve<m>:TOORignal.....	1550
REFCurve<m>:UPDate.....	1547
REFCurve<m>:VMODE.....	1548
REFLevel<m>:ABSolute:BDIStance.....	1797
REFLevel<m>:ABSolute:BITube.....	1803
REFLevel<m>:ABSolute:BOTube.....	1803
REFLevel<m>:ABSolute:HIGH.....	1796
REFLevel<m>:ABSolute:LLEVel.....	1799
REFLevel<m>:ABSolute:LOW.....	1796
REFLevel<m>:ABSolute:MLEVel.....	1798
REFLevel<m>:ABSolute:TDIStance.....	1797
REFLevel<m>:ABSolute:TITube.....	1802
REFLevel<m>:ABSolute:TOTube.....	1802
REFLevel<m>:ABSolute:ULEVel.....	1798
REFLevel<m>:AUTO:COUNT.....	1795
REFLevel<m>:AUTO:MODE.....	1794
REFLevel<m>:AUTO[:STATe].....	1795
REFLevel<m>:LDETection.....	1792
REFLevel<m>:LMODE.....	1792
REFLevel<m>:PAMReference:LOWer.....	1806
REFLevel<m>:PAMReference:LVLDef.....	1806
REFLevel<m>:PAMReference:LVLJumphgt<n>:THReshold<o>:ABSLower.....	1807
REFLevel<m>:PAMReference:LVLJumphgt<n>:THReshold<o>:ABSMiddle.....	1807
REFLevel<m>:PAMReference:LVLJumphgt<n>:THReshold<o>:ABSupper.....	1807
REFLevel<m>:PAMReference:LVLJumphgt<n>:THReshold<o>:RELLower.....	1808
REFLevel<m>:PAMReference:LVLJumphgt<n>:THReshold<o>:RELMiddle.....	1808
REFLevel<m>:PAMReference:LVLJumphgt<n>:THReshold<o>:RELupper.....	1809
REFLevel<m>:PAMReference:MIDDLE.....	1809
REFLevel<m>:PAMReference:PRESet.....	1810
REFLevel<m>:PAMReference:RELevel.....	1810
REFLevel<m>:PAMReference:UPPer.....	1810

REFLevel<m>:PAMSignal:ESTimate.....	1811
REFLevel<m>:PAMSignal:LEVel<0..7>.....	1811
REFLevel<m>:PAMSignal:LVLalgorithm.....	1812
REFLevel<m>:RELative:HYSteresis.....	1801
REFLevel<m>:RELative:ITUBe.....	1802
REFLevel<m>:RELative:LOWer.....	1800
REFLevel<m>:RELative:MIDDLE.....	1800
REFLevel<m>:RELative:MODE.....	1793
REFLevel<m>:RELative:OTUBe.....	1801
REFLevel<m>:RELative:UPPer.....	1799
REFLevel<m>:USRLevel.....	1793
REPort:COMMeNt.....	1784
REPort:FILE:NAME.....	1785
REPort:FILE:SAVE.....	1785
REPort:LANGUage.....	1783
REPort:LOGO.....	1784
REPort:LOGType.....	1784
REPort:PAPerSize.....	1783
REPort:USER.....	1784
RUN.....	1414
RUNContinous.....	1414
RUNSingle.....	1415
SAVeset:CONFIg:PREView.....	1764
SAVeset:ONEFile:NAME.....	1765
SAVeset:ONEFile:OPEN.....	1765
SAVeset:ONEFile:SAVE.....	1765
SAVeset:ONEFile:USERpref.....	1765
SEARch:ADD.....	1716
SEARch:ALL.....	1718
SEARch:CLEar.....	1716
SEARch:GATE:ABSolute:STARt.....	1746
SEARch:GATE:ABSolute:STOP.....	1746
SEARch:GATE:MODE.....	1745
SEARch:GATE:RELative:STARt.....	1747
SEARch:GATE:RELative:STOP.....	1747
SEARch:GATE:SHOW.....	1746
SEARch:GATE:ZCOupling.....	1747
SEARch:GATE:ZDIagram.....	1748
SEARch:GATE[:STATe].....	1745
SEARch:ONLine.....	1717
SEARch:REMOve.....	1717
SEARch:RESDiagram:HORIZ:ABSolute:POSition.....	1751
SEARch:RESDiagram:HORIZ:ABSolute:SPAN.....	1751
SEARch:RESDiagram:HORIZ:MODE.....	1751
SEARch:RESDiagram:HORIZ:RELative:POSition.....	1752
SEARch:RESDiagram:HORIZ:RELative:SPAN.....	1752
SEARch:RESDiagram:SHOW.....	1752
SEARch:RESDiagram:VERT:ABSolute:POSition.....	1753
SEARch:RESDiagram:VERT:ABSolute:SPAN.....	1753
SEARch:RESDiagram:VERT:MODE.....	1753

SEARch:RESDiagram:VERT:RELative:POSition.....	1753
SEARch:RESDiagram:VERT:RELative:SPAN.....	1754
SEARch:RESult:ARINc:WCOunt?.....	2159
SEARch:RESult:ARINc:WORD<m>:DATA?.....	2158
SEARch:RESult:ARINc:WORD<m>:LABel?.....	2158
SEARch:RESult:ARINc:WORD<m>:PATtern?.....	2158
SEARch:RESult:ARINc:WORD<m>:SDI?.....	2159
SEARch:RESult:ARINc:WORD<m>:SSM?.....	2158
SEARch:RESult:ARINc:WORD<m>:STARt?.....	2160
SEARch:RESult:ARINc:WORD<m>:STATe?.....	2160
SEARch:RESult:ARINc:WORD<m>:STOP?.....	2159
SEARch:RESult:ARINc:WORD<m>:SYMBol?.....	2159
SEARch:RESult:CAN:FCOunt?.....	1977
SEARch:RESult:CAN:FDATa:FRAMe<m>:SCVAlue?.....	1981
SEARch:RESult:CAN:FDATa:FRAMe<m>:STANdard?.....	1981
SEARch:RESult:CAN:FRAMe<m>:ACKStAte?.....	1979
SEARch:RESult:CAN:FRAMe<m>:ACKVAlue?.....	1978
SEARch:RESult:CAN:FRAMe<m>:BSEPosition?.....	1978
SEARch:RESult:CAN:FRAMe<m>:BYTE<n>:STATe?.....	1978
SEARch:RESult:CAN:FRAMe<m>:BYTE<n>:VALue?.....	1979
SEARch:RESult:CAN:FRAMe<m>:CSStAte?.....	1979
SEARch:RESult:CAN:FRAMe<m>:CSVAlue?.....	1979
SEARch:RESult:CAN:FRAMe<m>:DATA?.....	1979
SEARch:RESult:CAN:FRAMe<m>:DLcStAte?.....	1979
SEARch:RESult:CAN:FRAMe<m>:DLcVAlue?.....	1980
SEARch:RESult:CAN:FRAMe<m>:FERCAlue?.....	1980
SEARch:RESult:CAN:FRAMe<m>:IDStAte?.....	1979
SEARch:RESult:CAN:FRAMe<m>:IDTYpe?.....	1980
SEARch:RESult:CAN:FRAMe<m>:IDVAlue?.....	1981
SEARch:RESult:CAN:FRAMe<m>:NDBYtes?.....	1973
SEARch:RESult:CAN:FRAMe<m>:SDATa?.....	1986
SEARch:RESult:CAN:FRAMe<m>:STARt?.....	1982
SEARch:RESult:CAN:FRAMe<m>:STATus?.....	1982
SEARch:RESult:CAN:FRAMe<m>:STOP?.....	1982
SEARch:RESult:CAN:FRAMe<m>:SYMBol?.....	1982
SEARch:RESult:CAN:FRAMe<m>:TYPE?.....	1983
SEARch:RESult:CMSB<m>:FCOunt?.....	1939
SEARch:RESult:CMSB<m>:FRAMe<n>:CCOunt?.....	1939
SEARch:RESult:CMSB<m>:FRAMe<n>:CELL<o>:NAME?.....	1939
SEARch:RESult:CMSB<m>:FRAMe<n>:CELL<o>:STARt?.....	1940
SEARch:RESult:CMSB<m>:FRAMe<n>:CELL<o>:STATe?.....	1940
SEARch:RESult:CMSB<m>:FRAMe<n>:CELL<o>:STOP?.....	1941
SEARch:RESult:CMSB<m>:FRAMe<n>:CELL<o>:VALue?.....	1941
SEARch:RESult:CMSB<m>:FRAMe<n>:CONE?.....	1941
SEARch:RESult:CMSB<m>:FRAMe<n>:CTHRee?.....	1942
SEARch:RESult:CMSB<m>:FRAMe<n>:CTWO?.....	1942
SEARch:RESult:CMSB<m>:FRAMe<n>:STARt?.....	1942
SEARch:RESult:CMSB<m>:FRAMe<n>:STATe?.....	1943
SEARch:RESult:CMSB<m>:FRAMe<n>:STOP?.....	1943
SEARch:RESult:CMSB<m>:FRAMe<n>:TYPE?.....	1944

SEARch:RESult:CXPI:FCOunt?.....	2113
SEARch:RESult:CXPI:FRAMe<m>:DATA?.....	2113
SEARch:RESult:CXPI:FRAMe<m>:DLCV?.....	2113
SEARch:RESult:CXPI:FRAMe<m>:START?.....	2113
SEARch:RESult:CXPI:FRAMe<m>:STATe?.....	2114
SEARch:RESult:CXPI:FRAMe<m>:STOP?.....	2114
SEARch:RESult:CXPI:FRAMe<m>:TYPE?.....	2114
SEARch:RESult:CXPI:FRAMe<m>:WORD<n>:STATus?.....	2114
SEARch:RESult:CXPI:FRAMe<m>:WORD<n>:TYPE?.....	2115
SEARch:RESult:CXPI:FRAMe<m>:WORD<n>:VALue?.....	2115
SEARch:RESult:DDR:FCOunt?.....	2580
SEARch:RESult:DDR:FRAMe<m>:FLD<n>:FVAL?.....	2580
SEARch:RESult:DDR:FRAMe<m>:FLD<n>:START?.....	2580
SEARch:RESult:DDR:FRAMe<m>:FLD<n>:STATus?.....	2581
SEARch:RESult:DDR:FRAMe<m>:FLD<n>:STOP?.....	2581
SEARch:RESult:DDR:FRAMe<m>:FLD<n>:VAL?.....	2581
SEARch:RESult:DDR:FRAMe<m>:NWRDs?.....	2582
SEARch:RESult:DDR:FRAMe<m>:START?.....	2582
SEARch:RESult:DDR:FRAMe<m>:STATe?.....	2583
SEARch:RESult:DDR:FRAMe<m>:STOP?.....	2583
SEARch:RESult:DDR:FRAMe<m>:TYPE?.....	2583
SEARch:RESult:DPHY:FCOunt?.....	2444
SEARch:RESult:DPHY:FRAMe<m>:CS?.....	2444
SEARch:RESult:DPHY:FRAMe<m>:DATA?.....	2444
SEARch:RESult:DPHY:FRAMe<m>:DTName?.....	2444
SEARch:RESult:DPHY:FRAMe<m>:DTYPe?.....	2445
SEARch:RESult:DPHY:FRAMe<m>:ECC?.....	2445
SEARch:RESult:DPHY:FRAMe<m>:PACKet<n>:IDX?.....	2445
SEARch:RESult:DPHY:FRAMe<m>:PACKet<n>:VALue?.....	2446
SEARch:RESult:DPHY:FRAMe<m>:START?.....	2446
SEARch:RESult:DPHY:FRAMe<m>:STATe?.....	2446
SEARch:RESult:DPHY:FRAMe<m>:STOP?.....	2447
SEARch:RESult:DPHY:FRAMe<m>:TYPE?.....	2447
SEARch:RESult:DPHY:FRAMe<m>:VChannel?.....	2448
SEARch:RESult:EBTB:SCOunt?.....	2523
SEARch:RESult:EBTB:SYMBol<m>:DATA?.....	2523
SEARch:RESult:EBTB:SYMBol<m>:START?.....	2524
SEARch:RESult:EBTB:SYMBol<m>:STATus?.....	2524
SEARch:RESult:EBTB:SYMBol<m>:STOP?.....	2524
SEARch:RESult:ETHernet:WCOunt?.....	2199
SEARch:RESult:ETHernet:WORD<m>:BYTE<n>:VALue?.....	2203
SEARch:RESult:ETHernet:WORD<m>:CRC?.....	2202
SEARch:RESult:ETHernet:WORD<m>:DATA?.....	2201
SEARch:RESult:ETHernet:WORD<m>:DESTAddress?.....	2200
SEARch:RESult:ETHernet:WORD<m>:DSYMBol?.....	2202
SEARch:RESult:ETHernet:WORD<m>:FTYPe?.....	2201
SEARch:RESult:ETHernet:WORD<m>:SRCAddress?.....	2201
SEARch:RESult:ETHernet:WORD<m>:SSYMBol?.....	2202
SEARch:RESult:ETHernet:WORD<m>:START?.....	2200
SEARch:RESult:ETHernet:WORD<m>:STATe?.....	2199

SEARch:RESult:ETHernet:WORD<m>:STOP?.....	2200
SEARch:RESult:ETHernet:WORD<m>:TYPE?.....	2201
SEARch:RESult:FLXRay:FCOunt?.....	2050
SEARch:RESult:FLXRay:FRAMe<m>:ADID?.....	2050
SEARch:RESult:FLXRay:FRAMe<m>:CSState?.....	2051
SEARch:RESult:FLXRay:FRAMe<m>:CSVAlue?.....	2051
SEARch:RESult:FLXRay:FRAMe<m>:CYCOunt?.....	2051
SEARch:RESult:FLXRay:FRAMe<m>:DATA?.....	2052
SEARch:RESult:FLXRay:FRAMe<m>:FCState?.....	2052
SEARch:RESult:FLXRay:FRAMe<m>:FCVAlue?.....	2052
SEARch:RESult:FLXRay:FRAMe<m>:FLAGs?.....	2052
SEARch:RESult:FLXRay:FRAMe<m>:PAYLength?.....	2053
SEARch:RESult:FLXRay:FRAMe<m>:StARt?.....	2054
SEARch:RESult:FLXRay:FRAMe<m>:StAtus?.....	2053
SEARch:RESult:FLXRay:FRAMe<m>:StOP?.....	2054
SEARch:RESult:FLXRay:FRAMe<m>:SYMBol?.....	2054
SEARch:RESult:FLXRay:FRAMe<m>:TYPE?.....	2054
SEARch:RESult:HBTO:FCOunt?.....	2277
SEARch:RESult:HBTO:FRAMe<m>:CRC?.....	2280
SEARch:RESult:HBTO:FRAMe<m>:DATA?.....	2280
SEARch:RESult:HBTO:FRAMe<m>:DEStAddress?.....	2279
SEARch:RESult:HBTO:FRAMe<m>:DSYMBol?.....	2281
SEARch:RESult:HBTO:FRAMe<m>:FTYPE?.....	2280
SEARch:RESult:HBTO:FRAMe<m>:NUMWOrdS?.....	2280
SEARch:RESult:HBTO:FRAMe<m>:SRCAddress?.....	2279
SEARch:RESult:HBTO:FRAMe<m>:SSYMBol?.....	2281
SEARch:RESult:HBTO:FRAMe<m>:StARt?.....	2278
SEARch:RESult:HBTO:FRAMe<m>:StAtE?.....	2278
SEARch:RESult:HBTO:FRAMe<m>:StOP?.....	2279
SEARch:RESult:HBTO:FRAMe<m>:TYPE?.....	2277
SEARch:RESult:HBTO:FRAMe<m>:WORD<n>:TYPE?.....	2282
SEARch:RESult:HBTO:FRAMe<m>:WORD<n>:VALue?.....	2282
SEARch:RESult:I2C:FCOunt?.....	1847
SEARch:RESult:I2C:FRAMe<m>:AACcEss?.....	1848
SEARch:RESult:I2C:FRAMe<m>:ACcEss?.....	1849
SEARch:RESult:I2C:FRAMe<m>:ACOMplete?.....	1849
SEARch:RESult:I2C:FRAMe<m>:ADBStARt?.....	1849
SEARch:RESult:I2C:FRAMe<m>:ADDRess?.....	1849
SEARch:RESult:I2C:FRAMe<m>:ADEVice?.....	1850
SEARch:RESult:I2C:FRAMe<m>:AMODE?.....	1850
SEARch:RESult:I2C:FRAMe<m>:AStARt?.....	1850
SEARch:RESult:I2C:FRAMe<m>:BCOunt?.....	1851
SEARch:RESult:I2C:FRAMe<m>:BYTE<n>:ACcEss?.....	1852
SEARch:RESult:I2C:FRAMe<m>:BYTE<n>:ACKStARt?.....	1852
SEARch:RESult:I2C:FRAMe<m>:BYTE<n>:COMplete?.....	1852
SEARch:RESult:I2C:FRAMe<m>:BYTE<n>:StARt?.....	1853
SEARch:RESult:I2C:FRAMe<m>:BYTE<n>:VALue?.....	1853
SEARch:RESult:I2C:FRAMe<m>:DATA?.....	1851
SEARch:RESult:I2C:FRAMe<m>:RWBStARt?.....	1851
SEARch:RESult:I2C:FRAMe<m>:StARt?.....	1848

SEARch:RESult:I2C:FRAMe<m>:STATus?	1847
SEARch:RESult:I2C:FRAMe<m>:STOP?	1848
SEARch:RESult:I2C:FRAMe<m>:SYMBol?	1851
SEARch:RESult:LIMit	1754
SEARch:RESult:LIN:FCOunt?	2013
SEARch:RESult:LIN:FRAMe<m>:BYTE<n>:STATe?	2018
SEARch:RESult:LIN:FRAMe<m>:BYTE<n>:VALue?	2018
SEARch:RESult:LIN:FRAMe<m>:CSSTate?	2015
SEARch:RESult:LIN:FRAMe<m>:CSVAlue?	2016
SEARch:RESult:LIN:FRAMe<m>:DATA?	2015
SEARch:RESult:LIN:FRAMe<m>:IDPValue?	2017
SEARch:RESult:LIN:FRAMe<m>:IDSTate?	2016
SEARch:RESult:LIN:FRAMe<m>:IDVAlue?	2016
SEARch:RESult:LIN:FRAMe<m>:SDATa?	2015
SEARch:RESult:LIN:FRAMe<m>:SDEXport?	2015
SEARch:RESult:LIN:FRAMe<m>:START?	2014
SEARch:RESult:LIN:FRAMe<m>:STATus?	2014
SEARch:RESult:LIN:FRAMe<m>:STOP?	2014
SEARch:RESult:LIN:FRAMe<m>:SYMBol?	2017
SEARch:RESult:LIN:FRAMe<m>:SYSTate?	2017
SEARch:RESult:LIN:FRAMe<m>:VERSion?	2018
SEARch:RESult:MDIO:WCOunt?	2219
SEARch:RESult:MDIO:WORD<m>:DATA?	2215
SEARch:RESult:MDIO:WORD<m>:PHYS?	2216
SEARch:RESult:MDIO:WORD<m>:REGI?	2216
SEARch:RESult:MDIO:WORD<m>:ST?	2216
SEARch:RESult:MDIO:WORD<m>:START?	2217
SEARch:RESult:MDIO:WORD<m>:STATe?	2217
SEARch:RESult:MDIO:WORD<m>:STOP?	2218
SEARch:RESult:MDIO:WORD<m>:SYMBol?	2218
SEARch:RESult:MDIO:WORD<m>:TYPE?	2218
SEARch:RESult:MILStd:WCOunt?	2141
SEARch:RESult:MILStd:WORD<m>:DATA?	2143
SEARch:RESult:MILStd:WORD<m>:INFO?	2143
SEARch:RESult:MILStd:WORD<m>:RTADdress?	2142
SEARch:RESult:MILStd:WORD<m>:START?	2141
SEARch:RESult:MILStd:WORD<m>:STATus?	2141
SEARch:RESult:MILStd:WORD<m>:STOP?	2142
SEARch:RESult:MILStd:WORD<m>:SYMBol?	2142
SEARch:RESult:MILStd:WORD<m>:TYPE?	2141
SEARch:RESult:MPHY:FCOunt?	2492
SEARch:RESult:MPHY:FRAMe<m>:CCOunt?	2492
SEARch:RESult:MPHY:FRAMe<m>:CELL<n>:DATA?	2493
SEARch:RESult:MPHY:FRAMe<m>:CELL<n>:START?	2493
SEARch:RESult:MPHY:FRAMe<m>:CELL<n>:STATe?	2494
SEARch:RESult:MPHY:FRAMe<m>:CELL<n>:STOP?	2494
SEARch:RESult:MPHY:FRAMe<m>:CELL<n>:TYPE?	2493
SEARch:RESult:MPHY:FRAMe<m>:DATA?	2494
SEARch:RESult:MPHY:FRAMe<m>:FTYPE?	2495
SEARch:RESult:MPHY:FRAMe<m>:START?	2496

SEARch:RESult:MPHY:FRAMe<m>:STATe?	2495
SEARch:RESult:MPHY:FRAMe<m>:STOP?	2497
SEARch:RESult:PCIE:PACKet<m>:ADDR?	2562
SEARch:RESult:PCIE:PACKet<m>:CPID?	2562
SEARch:RESult:PCIE:PACKet<m>:CPS?	2562
SEARch:RESult:PCIE:PACKet<m>:DATA?	2563
SEARch:RESult:PCIE:PACKet<m>:DFC?	2563
SEARch:RESult:PCIE:PACKet<m>:FCOunt?	2563
SEARch:RESult:PCIE:PACKet<m>:FLD<n>:FVAL?	2563
SEARch:RESult:PCIE:PACKet<m>:FLD<n>:STATus?	2564
SEARch:RESult:PCIE:PACKet<m>:FLD<n>:TYPE?	2564
SEARch:RESult:PCIE:PACKet<m>:FLD<n>:VAL?	2564
SEARch:RESult:PCIE:PACKet<m>:HFC?	2565
SEARch:RESult:PCIE:PACKet<m>:LEN?	2565
SEARch:RESult:PCIE:PACKet<m>:RQID?	2565
SEARch:RESult:PCIE:PACKet<m>:SEQN?	2565
SEARch:RESult:PCIE:PACKet<m>:START?	2566
SEARch:RESult:PCIE:PACKet<m>:STATe?	2566
SEARch:RESult:PCIE:PACKet<m>:STOP?	2566
SEARch:RESult:PCIE:PACKet<m>:TAG?	2567
SEARch:RESult:PCIE:PACKet<m>:TYPE?	2567
SEARch:RESult:PCIE:PCOunt?	2567
SEARch:RESult:RFFE:FCOunt?	2247
SEARch:RESult:RFFE:SEQuence<m>:ADDRes?	2249
SEARch:RESult:RFFE:SEQuence<m>:BCOunt?	2249
SEARch:RESult:RFFE:SEQuence<m>:BYTE<n>:STATe?	2250
SEARch:RESult:RFFE:SEQuence<m>:BYTE<n>:VALue?	2250
SEARch:RESult:RFFE:SEQuence<m>:DATA?	2250
SEARch:RESult:RFFE:SEQuence<m>:SADD?	2248
SEARch:RESult:RFFE:SEQuence<m>:START?	2248
SEARch:RESult:RFFE:SEQuence<m>:STATe?	2248
SEARch:RESult:RFFE:SEQuence<m>:STOP?	2249
SEARch:RESult:RFFE:SEQuence<m>:SYMBol?	2250
SEARch:RESult:RFFE:SEQuence<m>:TYPE?	2247
SEARch:RESult:SENT:FCOunt?	2082
SEARch:RESult:SENT:FRAMe<m>:CSValue?	2082
SEARch:RESult:SENT:FRAMe<m>:DATA?	2082
SEARch:RESult:SENT:FRAMe<m>:IDTYpe?	2083
SEARch:RESult:SENT:FRAMe<m>:IDValue?	2083
SEARch:RESult:SENT:FRAMe<m>:NIBBle<n>:STATe?	2083
SEARch:RESult:SENT:FRAMe<m>:NIBBle<n>:VALue?	2084
SEARch:RESult:SENT:FRAMe<m>:PAPTicks?	2084
SEARch:RESult:SENT:FRAMe<m>:SCOM?	2084
SEARch:RESult:SENT:FRAMe<m>:SDATa?	2085
SEARch:RESult:SENT:FRAMe<m>:START?	2085
SEARch:RESult:SENT:FRAMe<m>:STATus?	2085
SEARch:RESult:SENT:FRAMe<m>:STOP?	2085
SEARch:RESult:SENT:FRAMe<m>:SYMBol?	2086
SEARch:RESult:SENT:FRAMe<m>:SYNCduration?	2086
SEARch:RESult:SENT:FRAMe<m>:TYPE?	2086

SEARch:RESult:SHOW.....	1755
SEARch:RESult:SORT:ASCending.....	1755
SEARch:RESult:SORT[:MODE].....	1755
SEARch:RESult:SPI:FCOut?.....	1870
SEARch:RESult:SPI:FRAMe<m>:COUNT?.....	1870
SEARch:RESult:SPI:FRAMe<m>:DATA?.....	1870
SEARch:RESult:SPI:FRAMe<m>:START?.....	1871
SEARch:RESult:SPI:FRAMe<m>:STATus?.....	1871
SEARch:RESult:SPI:FRAMe<m>:STOP?.....	1871
SEARch:RESult:SPI:FRAMe<m>:WCOut?.....	1872
SEARch:RESult:SPI:FRAMe<m>:WORD<n>:MISO?.....	1872
SEARch:RESult:SPI:FRAMe<m>:WORD<n>:MOSI?.....	1872
SEARch:RESult:SPI:FRAMe<m>:WORD<n>:START?.....	1872
SEARch:RESult:SPI:FRAMe<m>:WORD<n>:STOP?.....	1873
SEARch:RESult:SWIRe:FCOut?.....	2176
SEARch:RESult:SWIRe:FRAMe<m>:DATA?.....	2177
SEARch:RESult:SWIRe:FRAMe<m>:START?.....	2177
SEARch:RESult:SWIRe:FRAMe<m>:STATe?.....	2177
SEARch:RESult:SWIRe:FRAMe<m>:STOP?.....	2178
SEARch:RESult:SWIRe:FRAMe<m>:TYPE?.....	2178
SEARch:RESult:TBTO:FCOut?.....	2310
SEARch:RESult:TBTO:FRAMe<m>:CRC?.....	2310
SEARch:RESult:TBTO:FRAMe<m>:DATA?.....	2310
SEARch:RESult:TBTO:FRAMe<m>:DESTAddress?.....	2310
SEARch:RESult:TBTO:FRAMe<m>:DSYMBOL?.....	2311
SEARch:RESult:TBTO:FRAMe<m>:FTYPE?.....	2311
SEARch:RESult:TBTO:FRAMe<m>:NUMWords?.....	2312
SEARch:RESult:TBTO:FRAMe<m>:SRCAddress?.....	2312
SEARch:RESult:TBTO:FRAMe<m>:SSYMBOL?.....	2312
SEARch:RESult:TBTO:FRAMe<m>:START?.....	2313
SEARch:RESult:TBTO:FRAMe<m>:STATe?.....	2313
SEARch:RESult:TBTO:FRAMe<m>:STOP?.....	2313
SEARch:RESult:TBTO:FRAMe<m>:TYPE?.....	2314
SEARch:RESult:TBTO:FRAMe<m>:WORD<n>:TYPE?.....	2314
SEARch:RESult:TBTO:FRAMe<m>:WORD<n>:VALue?.....	2314
SEARch:RESult:TBTO:FRAMe<m>:WORD<n>:VSTR?.....	2315
SEARch:RESult:USB:PACKet<m>:ADDResS?.....	2354
SEARch:RESult:USB:PACKet<m>:CRC?.....	2354
SEARch:RESult:USB:PACKet<m>:DATA?.....	2354
SEARch:RESult:USB:PACKet<m>:ENDPoint?.....	2354
SEARch:RESult:USB:PACKet<m>:ET?.....	2355
SEARch:RESult:USB:PACKet<m>:FRAMe?.....	2355
SEARch:RESult:USB:PACKet<m>:PID?.....	2355
SEARch:RESult:USB:PACKet<m>:PORT?.....	2356
SEARch:RESult:USB:PACKet<m>:SC?.....	2356
SEARch:RESult:USB:PACKet<m>:SEU?.....	2356
SEARch:RESult:USB:PACKet<m>:START?.....	2357
SEARch:RESult:USB:PACKet<m>:STATus?.....	2357
SEARch:RESult:USB:PACKet<m>:STOP?.....	2357
SEARch:RESult:USB:PCOut?.....	2358

SEARch:RESult:USBPd:FCOunt?.....	2410
SEARch:RESult:USBPd:FRAMe<m>:DATA?.....	2410
SEARch:RESult:USBPd:FRAMe<m>:FLD<n>:FVAL?.....	2411
SEARch:RESult:USBPd:FRAMe<m>:FLD<n>:START?.....	2412
SEARch:RESult:USBPd:FRAMe<m>:FLD<n>:STATus?.....	2411
SEARch:RESult:USBPd:FRAMe<m>:FLD<n>:STOP?.....	2412
SEARch:RESult:USBPd:FRAMe<m>:FLD<n>:TYPE?.....	2412
SEARch:RESult:USBPd:FRAMe<m>:FLD<n>:VAL?.....	2413
SEARch:RESult:USBPd:FRAMe<m>:INFO?.....	2413
SEARch:RESult:USBPd:FRAMe<m>:START?.....	2413
SEARch:RESult:USBPd:FRAMe<m>:STATe?.....	2414
SEARch:RESult:USBPd:FRAMe<m>:STOP?.....	2414
SEARch:RESult:USBPd:FRAMe<m>:TYPE?.....	2414
SEARch:RESult:USBThree:FCOunt?.....	2386
SEARch:RESult:USBThree:FRAMe<m>:FLD<n>:FVAL?.....	2389
SEARch:RESult:USBThree:FRAMe<m>:FLD<n>:START?.....	2388
SEARch:RESult:USBThree:FRAMe<m>:FLD<n>:STATus?.....	2388
SEARch:RESult:USBThree:FRAMe<m>:FLD<n>:STOP?.....	2389
SEARch:RESult:USBThree:FRAMe<m>:FLD<n>:TYPE?.....	2388
SEARch:RESult:USBThree:FRAMe<m>:FLD<n>:VAL?.....	2389
SEARch:RESult:USBThree:FRAMe<m>:INFO?.....	2386
SEARch:RESult:USBThree:FRAMe<m>:START?.....	2387
SEARch:RESult:USBThree:FRAMe<m>:STATe?.....	2387
SEARch:RESult:USBThree:FRAMe<m>:STOP?.....	2387
SEARch:RESult:USBThree:FRAMe<m>:TYPE?.....	2386
SEARch:RESult[:ALL]?.....	1756
SEARch:SOURce.....	1717
SEARch:TRIGger:ARINc:DATA:CONDition.....	2155
SEARch:TRIGger:ARINc:DATA:MAX.....	2156
SEARch:TRIGger:ARINc:DATA:MIN.....	2155
SEARch:TRIGger:ARINc:ERRor:CODing.....	2156
SEARch:TRIGger:ARINc:ERRor:PARity.....	2157
SEARch:TRIGger:ARINc:ERRor:TIMing.....	2157
SEARch:TRIGger:ARINc:LAbel:CONDition.....	2155
SEARch:TRIGger:ARINc:LAbel:MAX.....	2156
SEARch:TRIGger:ARINc:LAbel:MIN.....	2155
SEARch:TRIGger:ARINc:SDI.....	2156
SEARch:TRIGger:ARINc:SSM.....	2156
SEARch:TRIGger:ARINc:TYPE.....	2154
SEARch:TRIGger:CAN:ACKerror.....	1974
SEARch:TRIGger:CAN:BITSterror.....	1975
SEARch:TRIGger:CAN:CRCError.....	1975
SEARch:TRIGger:CAN:DCONDition.....	1971
SEARch:TRIGger:CAN:DLC.....	1973
SEARch:TRIGger:CAN:DLCCondition.....	1972
SEARch:TRIGger:CAN:DMAX.....	1972
SEARch:TRIGger:CAN:DMIN.....	1972
SEARch:TRIGger:CAN:FDATa:BRS.....	1976
SEARch:TRIGger:CAN:FDATa:DPOperator.....	1973
SEARch:TRIGger:CAN:FDATa:DPOStition.....	1974

SEARch:TRIGger:CAN:FDATa:DPTO.....	1974
SEARch:TRIGger:CAN:FDATa:ESI.....	1977
SEARch:TRIGger:CAN:FDATa:SCERror.....	1976
SEARch:TRIGger:CAN:FDATa:STANdard.....	1969
SEARch:TRIGger:CAN:FDATa[:FDF].....	1976
SEARch:TRIGger:CAN:FORMerror.....	1975
SEARch:TRIGger:CAN:FTYPE.....	1970
SEARch:TRIGger:CAN:ICONdition.....	1970
SEARch:TRIGger:CAN:IMAX.....	1971
SEARch:TRIGger:CAN:IMIN.....	1971
SEARch:TRIGger:CAN:ITYPe.....	1970
SEARch:TRIGger:CAN:SERRor.....	1969
SEARch:TRIGger:CAN:SFIDentifier.....	1968
SEARch:TRIGger:CAN:SFTYPE.....	1968
SEARch:TRIGger:CAN:SIDData.....	1969
SEARch:TRIGger:CAN:SSYMBOLic.....	1986
SEARch:TRIGger:CAN:SYMBOLic:DMAX.....	1988
SEARch:TRIGger:CAN:SYMBOLic:DMIN.....	1987
SEARch:TRIGger:CAN:SYMBOLic:MSGValue.....	1986
SEARch:TRIGger:CAN:SYMBOLic:SGEValue.....	1988
SEARch:TRIGger:CAN:SYMBOLic:SIGValue.....	1987
SEARch:TRIGger:CAN:SYMBOLic:SSIGNals.....	1987
SEARch:TRIGger:CAN[:SSOFrame].....	1968
SEARch:TRIGger:CMSB:BIT.....	1935
SEARch:TRIGger:CMSB:DMAX.....	1935
SEARch:TRIGger:CMSB:DMIN.....	1936
SEARch:TRIGger:CMSB:DOPERator.....	1936
SEARch:TRIGger:CMSB:ERENable.....	1934
SEARch:TRIGger:CMSB:ERRor<m>:ENABLE.....	1934
SEARch:TRIGger:CMSB:FIENable.....	1934
SEARch:TRIGger:CMSB:FRAMe<m>:ENABLE.....	1937
SEARch:TRIGger:CMSB:FRAMe<m>:FLD<n>:BIT.....	1935
SEARch:TRIGger:CMSB:FRAMe<m>:FLD<n>:DMAX.....	1935
SEARch:TRIGger:CMSB:FRAMe<m>:FLD<n>:DMIN.....	1936
SEARch:TRIGger:CMSB:FRAMe<m>:FLD<n>:DOPERator.....	1936
SEARch:TRIGger:CMSB:FRAMe<m>:FLD<n>:ENABLE.....	1937
SEARch:TRIGger:CMSB:FRAMe<m>:FLD<n>:IMAX.....	1937
SEARch:TRIGger:CMSB:FRAMe<m>:FLD<n>:IMIN.....	1937
SEARch:TRIGger:CMSB:FRAMe<m>:FLD<n>:IOPERator.....	1938
SEARch:TRIGger:CMSB:FRENable.....	1934
SEARch:TRIGger:CMSB:IMAX.....	1937
SEARch:TRIGger:CMSB:IMIN.....	1937
SEARch:TRIGger:CMSB:IOPERator.....	1938
SEARch:TRIGger:CXPI:CT.....	2104
SEARch:TRIGger:CXPI:DATA:DCONdition.....	2104
SEARch:TRIGger:CXPI:DATA:DMAX.....	2104
SEARch:TRIGger:CXPI:DATA:DMIN.....	2105
SEARch:TRIGger:CXPI:DATA:ICONdition.....	2105
SEARch:TRIGger:CXPI:DATA:IMAX.....	2105
SEARch:TRIGger:CXPI:DATA:IMIN.....	2106

SEARch:TRIGger:CXPI:DEXTension:CONDition.....	2106
SEARch:TRIGger:CXPI:DEXTension:MAX.....	2106
SEARch:TRIGger:CXPI:DEXTension:MIN.....	2107
SEARch:TRIGger:CXPI:DLC:CONDition.....	2107
SEARch:TRIGger:CXPI:DLC:MAX.....	2107
SEARch:TRIGger:CXPI:DLC:MIN.....	2108
SEARch:TRIGger:CXPI:ERRor:CRC.....	2108
SEARch:TRIGger:CXPI:ERRor:DLC.....	2108
SEARch:TRIGger:CXPI:ERRor:IBS.....	2108
SEARch:TRIGger:CXPI:ERRor:IFS.....	2109
SEARch:TRIGger:CXPI:ERRor:LENGth.....	2109
SEARch:TRIGger:CXPI:ERRor:PARity.....	2109
SEARch:TRIGger:CXPI:ERRor:UART.....	2109
SEARch:TRIGger:CXPI:FID:CONDition.....	2110
SEARch:TRIGger:CXPI:FID:MAX.....	2110
SEARch:TRIGger:CXPI:FID:MIN.....	2110
SEARch:TRIGger:CXPI:NM.....	2111
SEARch:TRIGger:CXPI:TYPE.....	2111
SEARch:TRIGger:DDR:DMAX.....	2576
SEARch:TRIGger:DDR:DMIN.....	2576
SEARch:TRIGger:DDR:DOPerator.....	2577
SEARch:TRIGger:DDR:ERENable.....	2575
SEARch:TRIGger:DDR:ERRor<m>:ENABle.....	2575
SEARch:TRIGger:DDR:FIENable.....	2576
SEARch:TRIGger:DDR:FRAMe<m>:ENABle.....	2577
SEARch:TRIGger:DDR:FRAMe<m>:FLD<n>:DMAX.....	2576
SEARch:TRIGger:DDR:FRAMe<m>:FLD<n>:DMIN.....	2576
SEARch:TRIGger:DDR:FRAMe<m>:FLD<n>:DOPerator.....	2577
SEARch:TRIGger:DDR:FRAMe<m>:FLD<n>:IMAX.....	2578
SEARch:TRIGger:DDR:FRAMe<m>:FLD<n>:IMIN.....	2578
SEARch:TRIGger:DDR:FRAMe<m>:FLD<n>:IOPerator.....	2579
SEARch:TRIGger:DDR:FRENable.....	2576
SEARch:TRIGger:DDR:FRENable.....	2577
SEARch:TRIGger:DDR:IMAX.....	2578
SEARch:TRIGger:DDR:IMIN.....	2578
SEARch:TRIGger:DDR:IOPerator.....	2579
SEARch:TRIGger:DPHY:DATA:CONDition.....	2435
SEARch:TRIGger:DPHY:DATA:MAX.....	2436
SEARch:TRIGger:DPHY:DATA:MIN.....	2436
SEARch:TRIGger:DPHY:DIDX:CONDition.....	2437
SEARch:TRIGger:DPHY:DIDX:MAX.....	2437
SEARch:TRIGger:DPHY:DIDX:MIN.....	2437
SEARch:TRIGger:DPHY:DTYPE:CONDition.....	2438
SEARch:TRIGger:DPHY:DTYPE:MAX.....	2438
SEARch:TRIGger:DPHY:DTYPE:MIN.....	2438
SEARch:TRIGger:DPHY:ESCMoDe:CONDition.....	2439
SEARch:TRIGger:DPHY:ESCMoDe:MAX.....	2439
SEARch:TRIGger:DPHY:ESCMoDe:MIN.....	2439
SEARch:TRIGger:DPHY:ESDTa:CONDition.....	2440
SEARch:TRIGger:DPHY:ESDTa:MAX.....	2440

SEARch:TRIGger:DPHY:ESDTa:MIN.....	2441
SEARch:TRIGger:DPHY:ESINdex:CONDition.....	2441
SEARch:TRIGger:DPHY:ESINdex:MAX.....	2441
SEARch:TRIGger:DPHY:ESINdex:MIN.....	2442
SEARch:TRIGger:DPHY:HSVC.....	2442
SEARch:TRIGger:DPHY:TYPE.....	2435
SEARch:TRIGger:DPHY:WCOunt:CONDition.....	2442
SEARch:TRIGger:DPHY:WCOunt:MAX.....	2443
SEARch:TRIGger:DPHY:WCOunt:MIN.....	2443
SEARch:TRIGger:EBTB:DISParityerr.....	2520
SEARch:TRIGger:EBTB:DX.....	2520
SEARch:TRIGger:EBTB:DY.....	2521
SEARch:TRIGger:EBTB:EBPA.....	2521
SEARch:TRIGger:EBTB:GLITCherror.....	2521
SEARch:TRIGger:EBTB:STYPe.....	2521
SEARch:TRIGger:EBTB:SYME.....	2522
SEARch:TRIGger:EBTB:SYMType.....	2522
SEARch:TRIGger:EBTB:TBPA.....	2522
SEARch:TRIGger:EBTB:UNK.....	2523
SEARch:TRIGger:EDGE:ACOPy.....	1720
SEARch:TRIGger:EDGE:BCOPy.....	1720
SEARch:TRIGger:EDGE:SLOPe.....	1720
SEARch:TRIGger:EDGE[:STATe].....	1718
SEARch:TRIGger:ETHernet:ERRor:LENGth.....	2198
SEARch:TRIGger:ETHernet:ERRor:PREamble.....	2198
SEARch:TRIGger:ETHernet:FRAMe:CCONdition.....	2197
SEARch:TRIGger:ETHernet:FRAMe:CMAX.....	2198
SEARch:TRIGger:ETHernet:FRAMe:CMIN.....	2197
SEARch:TRIGger:ETHernet:FRAMe:DCCONdition.....	2194
SEARch:TRIGger:ETHernet:FRAMe:DMAX.....	2194
SEARch:TRIGger:ETHernet:FRAMe:DMIN.....	2194
SEARch:TRIGger:ETHernet:FRAMe:SCONdition.....	2195
SEARch:TRIGger:ETHernet:FRAMe:SMAX.....	2195
SEARch:TRIGger:ETHernet:FRAMe:SMIN.....	2195
SEARch:TRIGger:ETHernet:FRAMe:TCCONdition.....	2196
SEARch:TRIGger:ETHernet:FRAMe:TMAX.....	2197
SEARch:TRIGger:ETHernet:FRAMe:TMIN.....	2196
SEARch:TRIGger:ETHernet:TYPE.....	2193
SEARch:TRIGger:FLXRay:BSSerror.....	2048
SEARch:TRIGger:FLXRay:CENable.....	2041
SEARch:TRIGger:FLXRay:CMAX.....	2041
SEARch:TRIGger:FLXRay:CMIN.....	2041
SEARch:TRIGger:FLXRay:CSTep.....	2042
SEARch:TRIGger:FLXRay:DCCONdition.....	2042
SEARch:TRIGger:FLXRay:DMAX.....	2043
SEARch:TRIGger:FLXRay:DMIN.....	2043
SEARch:TRIGger:FLXRay:DPOPerator.....	2043
SEARch:TRIGger:FLXRay:DPOStion.....	2044
SEARch:TRIGger:FLXRay:DPTO.....	2044
SEARch:TRIGger:FLXRay:FCCONdition.....	2044

SEARch:TRIGger:FLXRay:FESerror.....	2048
SEARch:TRIGger:FLXRay:FMAX.....	2045
SEARch:TRIGger:FLXRay:FMIN.....	2045
SEARch:TRIGger:FLXRay:FSSerror.....	2049
SEARch:TRIGger:FLXRay:HRCerror.....	2049
SEARch:TRIGger:FLXRay:NUFframe.....	2045
SEARch:TRIGger:FLXRay:PCONdition.....	2046
SEARch:TRIGger:FLXRay:PCRCerror.....	2049
SEARch:TRIGger:FLXRay:PLPReamble.....	2046
SEARch:TRIGger:FLXRay:PMAX.....	2046
SEARch:TRIGger:FLXRay:PMIN.....	2047
SEARch:TRIGger:FLXRay:SERRor.....	2039
SEARch:TRIGger:FLXRay:SIDData.....	2040
SEARch:TRIGger:FLXRay:SSYMBOL.....	2040
SEARch:TRIGger:FLXRay:STFframe.....	2047
SEARch:TRIGger:FLXRay:SYFframe.....	2047
SEARch:TRIGger:FLXRay:SYMBOL.....	2048
SEARch:TRIGger:FLXRay[:SSOframe].....	2040
SEARch:TRIGger:GLITch:ACOPY.....	1720
SEARch:TRIGger:GLITch:POLarity.....	1721
SEARch:TRIGger:GLITch:RANGe.....	1721
SEARch:TRIGger:GLITch:WIDTh.....	1722
SEARch:TRIGger:GLITch[:STATe].....	1718
SEARch:TRIGger:HBTO:CRC:CONDItion.....	2273
SEARch:TRIGger:HBTO:CRC:MAX.....	2274
SEARch:TRIGger:HBTO:CRC:MIN.....	2273
SEARch:TRIGger:HBTO:DADDRESS:CONDItion.....	2270
SEARch:TRIGger:HBTO:DADDRESS:MAX.....	2270
SEARch:TRIGger:HBTO:DADDRESS:MIN.....	2270
SEARch:TRIGger:HBTO:DATA:DCONDItion.....	2274
SEARch:TRIGger:HBTO:DATA:DMAX.....	2275
SEARch:TRIGger:HBTO:DATA:DMIN.....	2274
SEARch:TRIGger:HBTO:DATA:ICONDItion.....	2275
SEARch:TRIGger:HBTO:DATA:IMAX.....	2276
SEARch:TRIGger:HBTO:DATA:IMIN.....	2275
SEARch:TRIGger:HBTO:ERRor:CRC.....	2276
SEARch:TRIGger:HBTO:ERRor:PREamble.....	2276
SEARch:TRIGger:HBTO:ERRor:SFD.....	2277
SEARch:TRIGger:HBTO:LENGth:CONDItion.....	2272
SEARch:TRIGger:HBTO:LENGth:MAX.....	2273
SEARch:TRIGger:HBTO:LENGth:MIN.....	2272
SEARch:TRIGger:HBTO:SADDRESS:CONDItion.....	2271
SEARch:TRIGger:HBTO:SADDRESS:MAX.....	2271
SEARch:TRIGger:HBTO:SADDRESS:MIN.....	2271
SEARch:TRIGger:HBTO:TYPE.....	2269
SEARch:TRIGger:I2C:ACCess.....	1842
SEARch:TRIGger:I2C:ACONDItion.....	1840
SEARch:TRIGger:I2C:ADData.....	1840
SEARch:TRIGger:I2C:ADDO<m>:ADRTYPE.....	1842
SEARch:TRIGger:I2C:ADDO<m>:ENABle.....	1842

SEARch:TRIGger:I2C:ADDO<m>:RWBit.....	1843
SEARch:TRIGger:I2C:ADDO<m>[:VALue].....	1843
SEARch:TRIGger:I2C:ADDRess.....	1841
SEARch:TRIGger:I2C:ADDTo.....	1841
SEARch:TRIGger:I2C:ADNack.....	1846
SEARch:TRIGger:I2C:ADOR.....	1839
SEARch:TRIGger:I2C:AMODE.....	1840
SEARch:TRIGger:I2C:DCONDition.....	1845
SEARch:TRIGger:I2C:DMAX.....	1845
SEARch:TRIGger:I2C:DMIN.....	1845
SEARch:TRIGger:I2C:DPOPerator.....	1844
SEARch:TRIGger:I2C:DPOStion.....	1844
SEARch:TRIGger:I2C:DPTO.....	1844
SEARch:TRIGger:I2C:DRNack.....	1846
SEARch:TRIGger:I2C:DWNack.....	1846
SEARch:TRIGger:I2C:NACKnowledge.....	1838
SEARch:TRIGger:I2C:RCONDition.....	1838
SEARch:TRIGger:I2C:SADDRess.....	1839
SEARch:TRIGger:I2C:SCONDition.....	1838
SEARch:TRIGger:I2C:STCNdition.....	1838
SEARch:TRIGger:INTerval:ACOPY.....	1720
SEARch:TRIGger:INTerval:DELTA.....	1722
SEARch:TRIGger:INTerval:RANGe.....	1723
SEARch:TRIGger:INTerval:SLOPe.....	1722
SEARch:TRIGger:INTerval:WIDTh.....	1723
SEARch:TRIGger:INTerval[:STATe].....	1718
SEARch:TRIGger:LEVel:NOISe:ABSolute.....	1748
SEARch:TRIGger:LEVel:NOISe:MODE.....	1749
SEARch:TRIGger:LEVel:NOISe:RELative.....	1749
SEARch:TRIGger:LEVel:NOISe[:STATe].....	1750
SEARch:TRIGger:LEVel:RUNT:LOWer.....	1726
SEARch:TRIGger:LEVel:RUNT:UPPer.....	1726
SEARch:TRIGger:LEVel:TRANSition:LOWer.....	1728
SEARch:TRIGger:LEVel:TRANSition:UPPer.....	1728
SEARch:TRIGger:LEVel:WINDow:LOWer.....	1734
SEARch:TRIGger:LEVel:WINDow:UPPer.....	1734
SEARch:TRIGger:LEVel[:VALue].....	1719
SEARch:TRIGger:LIN:BORDER.....	2010
SEARch:TRIGger:LIN:CHKSError.....	2012
SEARch:TRIGger:LIN:CRCDatalen.....	2012
SEARch:TRIGger:LIN:DCONDition.....	2009
SEARch:TRIGger:LIN:DLECondition.....	2010
SEARch:TRIGger:LIN:DLEngth.....	2011
SEARch:TRIGger:LIN:DMAX.....	2009
SEARch:TRIGger:LIN:DMIN.....	2009
SEARch:TRIGger:LIN:ERRPattern.....	2012
SEARch:TRIGger:LIN:ICONDition.....	2007
SEARch:TRIGger:LIN:IDENtifieror.....	2006
SEARch:TRIGger:LIN:IDOR<m>:ENABle.....	2008
SEARch:TRIGger:LIN:IDOR<m>[:VALue].....	2008

SEARch:TRIGger:LIN:IMAX.....	2008
SEARch:TRIGger:LIN:IMIN.....	2007
SEARch:TRIGger:LIN:IPERror.....	2011
SEARch:TRIGger:LIN:SERRor.....	2006
SEARch:TRIGger:LIN:SFIDentifier.....	2006
SEARch:TRIGger:LIN:SIDData.....	2006
SEARch:TRIGger:LIN:SSOFrAmE.....	2005
SEARch:TRIGger:LIN:STANdard.....	2013
SEARch:TRIGger:LIN:SYERror.....	2011
SEARch:TRIGger:LIN:WUFRAmE.....	2007
SEARch:TRIGger:MDIO:DATA.....	2213
SEARch:TRIGger:MDIO:FRAMetype.....	2213
SEARch:TRIGger:MDIO:PHYS.....	2214
SEARch:TRIGger:MDIO:REGI.....	2214
SEARch:TRIGger:MDIO:ST.....	2214
SEARch:TRIGger:MDIO:TYPE.....	2215
SEARch:TRIGger:MILStd:CDST:ICONdition.....	2136
SEARch:TRIGger:MILStd:CDST:IMAX.....	2137
SEARch:TRIGger:MILStd:CDST:IMIN.....	2137
SEARch:TRIGger:MILStd:CDST:RCONdition.....	2134
SEARch:TRIGger:MILStd:CDST:RMAX.....	2136
SEARch:TRIGger:MILStd:CDST:RMIN.....	2135
SEARch:TRIGger:MILStd:CMD:CCONdition.....	2136
SEARch:TRIGger:MILStd:CMD:CMAx.....	2137
SEARch:TRIGger:MILStd:CMD:CMIN.....	2137
SEARch:TRIGger:MILStd:CMD:RCONdition.....	2134
SEARch:TRIGger:MILStd:CMD:RMAX.....	2136
SEARch:TRIGger:MILStd:CMD:RMIN.....	2135
SEARch:TRIGger:MILStd:CMD:SCONdition.....	2136
SEARch:TRIGger:MILStd:CMD:SMAX.....	2137
SEARch:TRIGger:MILStd:CMD:SMIN.....	2137
SEARch:TRIGger:MILStd:CMD:TR.....	2139
SEARch:TRIGger:MILStd:DATA:DCONdition.....	2136
SEARch:TRIGger:MILStd:DATA:DMAx.....	2137
SEARch:TRIGger:MILStd:DATA:DMIN.....	2137
SEARch:TRIGger:MILStd:DATA:ICONdition.....	2138
SEARch:TRIGger:MILStd:DATA:IMAX.....	2138
SEARch:TRIGger:MILStd:DATA:IMIN.....	2138
SEARch:TRIGger:MILStd:DATA:RCONdition.....	2134
SEARch:TRIGger:MILStd:DATA:RMAX.....	2136
SEARch:TRIGger:MILStd:DATA:RMIN.....	2135
SEARch:TRIGger:MILStd:ERRor:MANChester.....	2139
SEARch:TRIGger:MILStd:ERRor:PARity.....	2139
SEARch:TRIGger:MILStd:ERRor:SYNC.....	2139
SEARch:TRIGger:MILStd:ERRor:TIMing.....	2139
SEARch:TRIGger:MILStd:STATus:BCReceivEd.....	2139
SEARch:TRIGger:MILStd:STATus:BUSY.....	2139
SEARch:TRIGger:MILStd:STATus:DBCaccept.....	2139
SEARch:TRIGger:MILStd:STATus:INSTrument.....	2139
SEARch:TRIGger:MILStd:STATus:MERRor.....	2139

SEARch:TRIGger:MILStd:STATus:SREQuest.....	2140
SEARch:TRIGger:MILStd:STATus:SUBSystem.....	2140
SEARch:TRIGger:MILStd:STATus:TERMinal.....	2140
SEARch:TRIGger:MILStd:TPSPecifier.....	2140
SEARch:TRIGger:MILStd:TYPE.....	2134
SEARch:TRIGger:MPHY:CRC:CONDition.....	2485
SEARch:TRIGger:MPHY:CRC:MAX.....	2486
SEARch:TRIGger:MPHY:CRC:MIN.....	2486
SEARch:TRIGger:MPHY:CREDit:CONDition.....	2487
SEARch:TRIGger:MPHY:CREDit:MAX.....	2488
SEARch:TRIGger:MPHY:CREDit:MIN.....	2488
SEARch:TRIGger:MPHY:CREQ.....	2486
SEARch:TRIGger:MPHY:DATA:DCONDition.....	2482
SEARch:TRIGger:MPHY:DATA:DMAX.....	2483
SEARch:TRIGger:MPHY:DATA:DMIN.....	2482
SEARch:TRIGger:MPHY:DATA:ICONDition.....	2483
SEARch:TRIGger:MPHY:DATA:IMAX.....	2484
SEARch:TRIGger:MPHY:DATA:IMIN.....	2484
SEARch:TRIGger:MPHY:ERRor:LCMD.....	2491
SEARch:TRIGger:MPHY:ERRor:LENGth.....	2491
SEARch:TRIGger:MPHY:ERRor:REServed.....	2490
SEARch:TRIGger:MPHY:ERRor:SYMBol.....	2491
SEARch:TRIGger:MPHY:ERRor:UNKNown.....	2491
SEARch:TRIGger:MPHY:FSNumber:CONDition.....	2484
SEARch:TRIGger:MPHY:FSNumber:MAX.....	2485
SEARch:TRIGger:MPHY:FSNumber:MIN.....	2485
SEARch:TRIGger:MPHY:LCCType.....	2476
SEARch:TRIGger:MPHY:LWFOur:CONDition.....	2481
SEARch:TRIGger:MPHY:LWFOur:MAX.....	2481
SEARch:TRIGger:MPHY:LWFOur:MIN.....	2481
SEARch:TRIGger:MPHY:LWONe:CONDition.....	2477
SEARch:TRIGger:MPHY:LWONe:MAX.....	2478
SEARch:TRIGger:MPHY:LWONe:MIN.....	2478
SEARch:TRIGger:MPHY:LWTHree:CONDition.....	2480
SEARch:TRIGger:MPHY:LWTHree:MAX.....	2480
SEARch:TRIGger:MPHY:LWTHree:MIN.....	2480
SEARch:TRIGger:MPHY:LWTWo:CONDition.....	2478
SEARch:TRIGger:MPHY:LWTWo:MAX.....	2479
SEARch:TRIGger:MPHY:LWTWo:MIN.....	2479
SEARch:TRIGger:MPHY:PBEGin:CONDition.....	2488
SEARch:TRIGger:MPHY:PBEGin:MAX.....	2489
SEARch:TRIGger:MPHY:PBEGin:MIN.....	2489
SEARch:TRIGger:MPHY:PFID:CONDition.....	2489
SEARch:TRIGger:MPHY:PFID:MAX.....	2490
SEARch:TRIGger:MPHY:PFID:MIN.....	2490
SEARch:TRIGger:MPHY:RREQ.....	2487
SEARch:TRIGger:MPHY:SSIC:BIT.....	2505
SEARch:TRIGger:MPHY:SSIC:DMAX.....	2505
SEARch:TRIGger:MPHY:SSIC:DMIN.....	2506
SEARch:TRIGger:MPHY:SSIC:DOPerator.....	2506

SEARch:TRIGger:MPHY:SSIC:ERENable.....	2503
SEARch:TRIGger:MPHY:SSIC:ERRor<m>:ENABle.....	2503
SEARch:TRIGger:MPHY:SSIC:FIENable.....	2504
SEARch:TRIGger:MPHY:SSIC:FRAMe<m>:ENABle.....	2503
SEARch:TRIGger:MPHY:SSIC:FRAMe<m>:FLD<n>:BIT.....	2505
SEARch:TRIGger:MPHY:SSIC:FRAMe<m>:FLD<n>:DMAX.....	2505
SEARch:TRIGger:MPHY:SSIC:FRAMe<m>:FLD<n>:DMIN.....	2506
SEARch:TRIGger:MPHY:SSIC:FRAMe<m>:FLD<n>:DOPerator.....	2506
SEARch:TRIGger:MPHY:SSIC:FRAMe<m>:FLD<n>:ENABle.....	2504
SEARch:TRIGger:MPHY:SSIC:FRAMe<m>:FLD<n>:ENABle.....	2504
SEARch:TRIGger:MPHY:SSIC:FRAMe<m>:FLD<n>:IMAX.....	2507
SEARch:TRIGger:MPHY:SSIC:FRAMe<m>:FLD<n>:IMIN.....	2508
SEARch:TRIGger:MPHY:SSIC:FRAMe<m>:FLD<n>:IOPerator.....	2508
SEARch:TRIGger:MPHY:SSIC:FRENable.....	2503
SEARch:TRIGger:MPHY:SSIC:FRENable.....	2507
SEARch:TRIGger:MPHY:SSIC:IMAX.....	2507
SEARch:TRIGger:MPHY:SSIC:IMIN.....	2508
SEARch:TRIGger:MPHY:SSIC:IOPerator.....	2508
SEARch:TRIGger:MPHY:TC.....	2482
SEARch:TRIGger:MPHY:TYPE.....	2476
SEARch:TRIGger:PATTer:n:A:LOGic.....	1737
SEARch:TRIGger:PATTer:n:A:[ENABle].....	1737
SEARch:TRIGger:PATTer:n:AB:LOGic.....	1738
SEARch:TRIGger:PATTer:n:ABCD:LOGic.....	1738
SEARch:TRIGger:PATTer:n:ACOPy.....	1720
SEARch:TRIGger:PATTer:n:B:LOGic.....	1737
SEARch:TRIGger:PATTer:n:B:[ENABle].....	1737
SEARch:TRIGger:PATTer:n:C:LOGic.....	1738
SEARch:TRIGger:PATTer:n:C:[ENABle].....	1737
SEARch:TRIGger:PATTer:n:CD:LOGic.....	1738
SEARch:TRIGger:PATTer:n:D:LOGic.....	1738
SEARch:TRIGger:PATTer:n:D:[ENABle].....	1737
SEARch:TRIGger:PATTer:n:MODE.....	1739
SEARch:TRIGger:PATTer:n:TIMEout:MODE.....	1739
SEARch:TRIGger:PATTer:n:TIMEout[:TIME].....	1740
SEARch:TRIGger:PATTer:n:WIDTh:DELTA.....	1741
SEARch:TRIGger:PATTer:n:WIDTh:RANGe.....	1740
SEARch:TRIGger:PATTer:n:WIDTh[:WIDTh].....	1740
SEARch:TRIGger:PATTer:n[:STATe].....	1718
SEARch:TRIGger:PCIE:DLLP:FCTL:CRET.....	2549
SEARch:TRIGger:PCIE:DLLP:FCTL:VCID.....	2549
SEARch:TRIGger:PCIE:DLLP:MULT:AUTH.....	2549
SEARch:TRIGger:PCIE:DLLP:MULT:CRET.....	2550
SEARch:TRIGger:PCIE:DLLP:MULT:DVPT.....	2550
SEARch:TRIGger:PCIE:DLLP:MULT:HABS.....	2550
SEARch:TRIGger:PCIE:DLLP:MULT:MIXT.....	2550
SEARch:TRIGger:PCIE:DLLP:MULT:PHAS.....	2551
SEARch:TRIGger:PCIE:DLLP:MULT:RESA.....	2551
SEARch:TRIGger:PCIE:DLLP:MULT:TLPT.....	2551
SEARch:TRIGger:PCIE:DLLP:MULT:TYPE.....	2552

SEARch:TRIGger:PCIE:DLLP:MULT:VHFC.....	2552
SEARch:TRIGger:PCIE:DLLP:MULT:VHGR.....	2552
SEARch:TRIGger:PCIE:DLLP:MULT:VLNR.....	2552
SEARch:TRIGger:PCIE:DLLP:POWM.....	2553
SEARch:TRIGger:PCIE:DLLP:SEQ.....	2553
SEARch:TRIGger:PCIE:DLLP:TYPE.....	2553
SEARch:TRIGger:PCIE:DLLP:VPAT.....	2554
SEARch:TRIGger:PCIE:ERRC:CRC.....	2554
SEARch:TRIGger:PCIE:ERRC:DISP.....	2554
SEARch:TRIGger:PCIE:ERRC:ECRC.....	2554
SEARch:TRIGger:PCIE:ERRC:INVP.....	2555
SEARch:TRIGger:PCIE:ERRC:LCRC.....	2555
SEARch:TRIGger:PCIE:OSET:COMP.....	2555
SEARch:TRIGger:PCIE:OSET:EIDE.....	2555
SEARch:TRIGger:PCIE:OSET:EIDL.....	2556
SEARch:TRIGger:PCIE:OSET:FTS.....	2556
SEARch:TRIGger:PCIE:OSET:SKIP.....	2556
SEARch:TRIGger:PCIE:OSET:TSONe.....	2557
SEARch:TRIGger:PCIE:OSET:TSTWo.....	2557
SEARch:TRIGger:PCIE:TLP:ADRT.....	2557
SEARch:TRIGger:PCIE:TLP:CFGT.....	2557
SEARch:TRIGger:PCIE:TLP:CPID.....	2558
SEARch:TRIGger:PCIE:TLP:CPLS.....	2558
SEARch:TRIGger:PCIE:TLP:DEID.....	2558
SEARch:TRIGger:PCIE:TLP:MERW.....	2558
SEARch:TRIGger:PCIE:TLP:MSGC.....	2559
SEARch:TRIGger:PCIE:TLP:MSGR.....	2559
SEARch:TRIGger:PCIE:TLP:ORDE.....	2559
SEARch:TRIGger:PCIE:TLP:REID.....	2560
SEARch:TRIGger:PCIE:TLP:SNOO.....	2560
SEARch:TRIGger:PCIE:TLP:SNUM.....	2560
SEARch:TRIGger:PCIE:TLP:TCHN.....	2560
SEARch:TRIGger:PCIE:TLP:TYPE.....	2561
SEARch:TRIGger:PCIE:TYPE.....	2561
SEARch:TRIGger:RFFE:ADDRes:CONDition.....	2243
SEARch:TRIGger:RFFE:ADDRes:MAX.....	2245
SEARch:TRIGger:RFFE:ADDRes:MIN.....	2244
SEARch:TRIGger:RFFE:BCOunt:CONDition.....	2243
SEARch:TRIGger:RFFE:BCOunt:MAX.....	2245
SEARch:TRIGger:RFFE:BCOunt:MIN.....	2244
SEARch:TRIGger:RFFE:DATA:DCON.....	2243
SEARch:TRIGger:RFFE:DATA:DMAX.....	2245
SEARch:TRIGger:RFFE:DATA:DMIN.....	2244
SEARch:TRIGger:RFFE:DATA:ICONdition.....	2244
SEARch:TRIGger:RFFE:DATA:IMAX.....	2245
SEARch:TRIGger:RFFE:DATA:IMIN.....	2244
SEARch:TRIGger:RFFE:ERRor:GAP.....	2246
SEARch:TRIGger:RFFE:ERRor:LENGth.....	2245
SEARch:TRIGger:RFFE:ERRor:PARity.....	2246
SEARch:TRIGger:RFFE:ERRor:SSC.....	2246

SEARch:TRIGger:RFFE:ERRor:VERsion.....	2246
SEARch:TRIGger:RFFE:INTerrupt.....	2245
SEARch:TRIGger:RFFE:SADD:CONDition.....	2243
SEARch:TRIGger:RFFE:SADD:MAX.....	2245
SEARch:TRIGger:RFFE:SADD:MIN.....	2244
SEARch:TRIGger:RFFE:TYPE.....	2241
SEARch:TRIGger:RUNT:ACOPy.....	1720
SEARch:TRIGger:RUNT:DELTA.....	1724
SEARch:TRIGger:RUNT:POLarity.....	1724
SEARch:TRIGger:RUNT:RANGe.....	1725
SEARch:TRIGger:RUNT:WIDTh.....	1725
SEARch:TRIGger:RUNT[:STATe].....	1719
SEARch:TRIGger:SENT:CALibration.....	2073
SEARch:TRIGger:SENT:CRCError.....	2081
SEARch:TRIGger:SENT:ERRor.....	2074
SEARch:TRIGger:SENT:FORMerror.....	2081
SEARch:TRIGger:SENT:IRFLength.....	2080
SEARch:TRIGger:SENT:PPERioderror.....	2080
SEARch:TRIGger:SENT:PULSeerror.....	2080
SEARch:TRIGger:SENT:SDCN.....	2079
SEARch:TRIGger:SENT:SDMN.....	2079
SEARch:TRIGger:SENT:SDMX.....	2079
SEARch:TRIGger:SENT:SICN.....	2078
SEARch:TRIGger:SENT:SIDType.....	2077
SEARch:TRIGger:SENT:SIMN.....	2078
SEARch:TRIGger:SENT:SIMX.....	2078
SEARch:TRIGger:SENT:SMSG.....	2074
SEARch:TRIGger:SENT:STATus.....	2075
SEARch:TRIGger:SENT:STYPe.....	2077
SEARch:TRIGger:SENT:TDCN.....	2076
SEARch:TRIGger:SENT:TDMN.....	2076
SEARch:TRIGger:SENT:TDMX.....	2076
SEARch:TRIGger:SENT:TRANsmission.....	2074
SEARch:TRIGger:SENT:TTPe.....	2075
SEARch:TRIGger:SETHold:ACOPy.....	1720
SEARch:TRIGger:SETHold:CEdGe.....	1735
SEARch:TRIGger:SETHold:CLEVel.....	1735
SEARch:TRIGger:SETHold:CSourCe.....	1735
SEARch:TRIGger:SETHold:HTIME.....	1736
SEARch:TRIGger:SETHold:STIME.....	1736
SEARch:TRIGger:SETHold[:STATe].....	1719
SEARch:TRIGger:SLEWrate:ACOPy.....	1720
SEARch:TRIGger:SLEWrate:DELTA.....	1726
SEARch:TRIGger:SLEWrate:RANGe.....	1727
SEARch:TRIGger:SLEWrate:SLOPe.....	1727
SEARch:TRIGger:SLEWrate:TIME.....	1728
SEARch:TRIGger:SLEWrate[:STATe].....	1719
SEARch:TRIGger:SPI:DPOPerator.....	1868
SEARch:TRIGger:SPI:DPOsition.....	1868
SEARch:TRIGger:SPI:DPTO.....	1869

SEARch:TRIGger:SPI:FCONdition.....	1867
SEARch:TRIGger:SPI:MISopattern.....	1868
SEARch:TRIGger:SPI:MOSipattern.....	1868
SEARch:TRIGger:SPI:PALignment.....	1869
SEARch:TRIGger:SPI:TYPE.....	1867
SEARch:TRIGger:STATe:A:LOGic.....	1743
SEARch:TRIGger:STATe:A[:ENABle].....	1743
SEARch:TRIGger:STATe:AB:LOGic.....	1744
SEARch:TRIGger:STATe:ABCD:LOGic.....	1744
SEARch:TRIGger:STATe:ACOPY.....	1720
SEARch:TRIGger:STATe:B:LOGic.....	1743
SEARch:TRIGger:STATe:B[:ENABle].....	1743
SEARch:TRIGger:STATe:C:LOGic.....	1743
SEARch:TRIGger:STATe:C[:ENABle].....	1743
SEARch:TRIGger:STATe:CD:LOGic.....	1744
SEARch:TRIGger:STATe:CEdGe.....	1742
SEARch:TRIGger:STATe:CLEVel.....	1742
SEARch:TRIGger:STATe:CSource.....	1742
SEARch:TRIGger:STATe:D:LOGic.....	1743
SEARch:TRIGger:STATe:D[:ENABle].....	1743
SEARch:TRIGger:STATe[:STATe].....	1719
SEARch:TRIGger:SWIRe:CTYPE.....	2173
SEARch:TRIGger:SWIRe:DATA:CONDition.....	2173
SEARch:TRIGger:SWIRe:DATA:MAX.....	2174
SEARch:TRIGger:SWIRe:DATA:MIN.....	2174
SEARch:TRIGger:SWIRe:ERRor:ESC.....	2174
SEARch:TRIGger:SWIRe:ERRor:PARity.....	2174
SEARch:TRIGger:SWIRe:TIME:CONDition.....	2175
SEARch:TRIGger:SWIRe:TIME:MAX.....	2175
SEARch:TRIGger:SWIRe:TIME:MIN.....	2176
SEARch:TRIGger:SWIRe:TYPE.....	2176
SEARch:TRIGger:TBTO:CRC:CONDition.....	2301
SEARch:TRIGger:TBTO:CRC:MAX.....	2302
SEARch:TRIGger:TBTO:CRC:MIN.....	2302
SEARch:TRIGger:TBTO:DADDress:CONDition.....	2302
SEARch:TRIGger:TBTO:DADDress:MAX.....	2303
SEARch:TRIGger:TBTO:DADDress:MIN.....	2303
SEARch:TRIGger:TBTO:DATA:DCONDition.....	2303
SEARch:TRIGger:TBTO:DATA:DMAX.....	2304
SEARch:TRIGger:TBTO:DATA:DMIN.....	2304
SEARch:TRIGger:TBTO:DATA:ICONDition.....	2304
SEARch:TRIGger:TBTO:DATA:IMAX.....	2305
SEARch:TRIGger:TBTO:DATA:IMIN.....	2305
SEARch:TRIGger:TBTO:ERRor:CRC.....	2305
SEARch:TRIGger:TBTO:ERRor:FEC.....	2306
SEARch:TRIGger:TBTO:ERRor:OOR.....	2306
SEARch:TRIGger:TBTO:ERRor:ZERO.....	2306
SEARch:TRIGger:TBTO:LENGth:CONDition.....	2307
SEARch:TRIGger:TBTO:LENGth:MAX.....	2307
SEARch:TRIGger:TBTO:LENGth:MIN.....	2307

SEARch:TRIGger:TBTO:SADdress:CONDition.....	2308
SEARch:TRIGger:TBTO:SADdress:MAX.....	2308
SEARch:TRIGger:TBTO:SADdress:MIN.....	2308
SEARch:TRIGger:TBTO:TYPE.....	2309
SEARch:TRIGger:TIMeout:ACOPY.....	1720
SEARch:TRIGger:TIMeout:RANGe.....	1729
SEARch:TRIGger:TIMeout:TIME.....	1729
SEARch:TRIGger:TIMeout[:STATe].....	1719
SEARch:TRIGger:USB:ACONdition.....	2338
SEARch:TRIGger:USB:AMAX.....	2339
SEARch:TRIGger:USB:AMIN.....	2339
SEARch:TRIGger:USB:BITSterror.....	2339
SEARch:TRIGger:USB:CRC5error.....	2340
SEARch:TRIGger:USB:CRC16error.....	2340
SEARch:TRIGger:USB:DATA.....	2340
SEARch:TRIGger:USB:DCONdition.....	2341
SEARch:TRIGger:USB:DPOperator.....	2341
SEARch:TRIGger:USB:DPOStition.....	2341
SEARch:TRIGger:USB:ECONdition.....	2342
SEARch:TRIGger:USB:EMAX.....	2342
SEARch:TRIGger:USB:EMIN.....	2342
SEARch:TRIGger:USB:FCONdition.....	2343
SEARch:TRIGger:USB:FMAX.....	2343
SEARch:TRIGger:USB:FMIN.....	2343
SEARch:TRIGger:USB:GLITCherror.....	2344
SEARch:TRIGger:USB:HAND.....	2344
SEARch:TRIGger:USB:PATT.....	2344
SEARch:TRIGger:USB:PCONdition.....	2344
SEARch:TRIGger:USB:PIDerror.....	2345
SEARch:TRIGger:USB:PMAX.....	2345
SEARch:TRIGger:USB:PMIN.....	2345
SEARch:TRIGger:USB:SCONdition.....	2346
SEARch:TRIGger:USB:SDATa.....	2347
SEARch:TRIGger:USB:SERRor.....	2347
SEARch:TRIGger:USB:SHANdshake.....	2347
SEARch:TRIGger:USB:SMAX.....	2346
SEARch:TRIGger:USB:SMIN.....	2346
SEARch:TRIGger:USB:SPEC.....	2348
SEARch:TRIGger:USB:SSOP.....	2347
SEARch:TRIGger:USB:SSPE.....	2348
SEARch:TRIGger:USB:STCO.....	2349
SEARch:TRIGger:USB:STOKen.....	2349
SEARch:TRIGger:USB:TCONdition.....	2349
SEARch:TRIGger:USB:TMAX.....	2350
SEARch:TRIGger:USB:TMIN.....	2350
SEARch:TRIGger:USB:TOKen.....	2350
SEARch:TRIGger:USB:WADD.....	2351
SEARch:TRIGger:USB:WEND.....	2351
SEARch:TRIGger:USB:WETCheck.....	2351
SEARch:TRIGger:USB:WFRN.....	2352

SEARch:TRIGger:USB:WPAY.....	2352
SEARch:TRIGger:USB:WPID.....	2352
SEARch:TRIGger:USB:WPOR.....	2352
SEARch:TRIGger:USB:WSEU.....	2353
SEARch:TRIGger:USB:WSTC.....	2353
SEARch:TRIGger:USBPd:BIT.....	2406
SEARch:TRIGger:USBPd:DMAX.....	2407
SEARch:TRIGger:USBPd:DMIN.....	2407
SEARch:TRIGger:USBPd:DOPerator.....	2408
SEARch:TRIGger:USBPd:ERENable.....	2405
SEARch:TRIGger:USBPd:ERRor<m>:ENable.....	2405
SEARch:TRIGger:USBPd:FIENable.....	2406
SEARch:TRIGger:USBPd:FRAMe<m>:ENABLE.....	2405
SEARch:TRIGger:USBPd:FRAMe<m>:FLD<n>:BIT.....	2406
SEARch:TRIGger:USBPd:FRAMe<m>:FLD<n>:DMAX.....	2407
SEARch:TRIGger:USBPd:FRAMe<m>:FLD<n>:DMIN.....	2407
SEARch:TRIGger:USBPd:FRAMe<m>:FLD<n>:DOPerator.....	2408
SEARch:TRIGger:USBPd:FRAMe<m>:FLD<n>:ENable.....	2406
SEARch:TRIGger:USBPd:FRAMe<m>:FLD<n>:IMAX.....	2408
SEARch:TRIGger:USBPd:FRAMe<m>:FLD<n>:IMIN.....	2409
SEARch:TRIGger:USBPd:FRAMe<m>:FLD<n>:IOPerator.....	2409
SEARch:TRIGger:USBPd:FRENable.....	2405
SEARch:TRIGger:USBPd:IMAX.....	2408
SEARch:TRIGger:USBPd:IMIN.....	2409
SEARch:TRIGger:USBPd:IOPerator.....	2409
SEARch:TRIGger:USBThree:BIT.....	2383
SEARch:TRIGger:USBThree:DMAX.....	2383
SEARch:TRIGger:USBThree:DMIN.....	2382
SEARch:TRIGger:USBThree:DOPerator.....	2382
SEARch:TRIGger:USBThree:ERENable.....	2380
SEARch:TRIGger:USBThree:ERRor<m>:ENable.....	2380
SEARch:TRIGger:USBThree:FIENable.....	2381
SEARch:TRIGger:USBThree:FRAMe<m>:ENABLE.....	2381
SEARch:TRIGger:USBThree:FRAMe<m>:FLD<n>:BIT.....	2383
SEARch:TRIGger:USBThree:FRAMe<m>:FLD<n>:DMAX.....	2383
SEARch:TRIGger:USBThree:FRAMe<m>:FLD<n>:DMIN.....	2382
SEARch:TRIGger:USBThree:FRAMe<m>:FLD<n>:DOPerator.....	2382
SEARch:TRIGger:USBThree:FRAMe<m>:FLD<n>:ENable.....	2381
SEARch:TRIGger:USBThree:FRAMe<m>:FLD<n>:IMAX.....	2385
SEARch:TRIGger:USBThree:FRAMe<m>:FLD<n>:IMIN.....	2384
SEARch:TRIGger:USBThree:FRAMe<m>:FLD<n>:IOPerator.....	2384
SEARch:TRIGger:USBThree:FRENable.....	2381
SEARch:TRIGger:USBThree:IMAX.....	2385
SEARch:TRIGger:USBThree:IMIN.....	2384
SEARch:TRIGger:USBThree:IOPerator.....	2384
SEARch:TRIGger:WIDTh:ACOPY.....	1720
SEARch:TRIGger:WIDTh:DELTA.....	1730
SEARch:TRIGger:WIDTh:POLarity.....	1730
SEARch:TRIGger:WIDTh:RANGe.....	1730
SEARch:TRIGger:WIDTh:WIDTh.....	1731

SEARch:TRIGger:WIDTh[:STATe].....	1719
SEARch:TRIGger:WINDow:ACOPy.....	1720
SEARch:TRIGger:WINDow:DELTA.....	1732
SEARch:TRIGger:WINDow:RANGe.....	1732
SEARch:TRIGger:WINDow:TIMerange.....	1733
SEARch:TRIGger:WINDow:WIDTh.....	1733
SEARch:TRIGger:WINDow[:STATe].....	1719
SENSe[:ROSCillator]:EXTernal:FREQuency.....	1484
SENSe[:ROSCillator]:SOURce.....	1483
SIGNalconfig:SETup:ADD.....	1788
SIGNalconfig:SETup:COUNT?.....	1789
SIGNalconfig:SETup:REMOve.....	1789
SIGNalconfig:SETup:SETTing<m>:PAMorder.....	1789
SIGNalconfig:SETup:SETTing<m>:SERStandard.....	1789
SIGNalconfig:SETup:SETTing<m>:SOURce.....	1790
SIGNalconfig:SETup:SETTing<m>:SYMBOLrate.....	1790
SIGNalconfig:SETup:SOURce.....	1791
SIGNalconfig:SETup:SREStimation.....	1791
SINGLE.....	1415
STATus:OPERation:CONDition?.....	2852
STATus:OPERation:ENABle.....	2852
STATus:OPERation[:EVENT]?.....	2852
STATus:QUEStionable:ADCState:CONDition?.....	2854
STATus:QUEStionable:ADCState:ENABle.....	2855
STATus:QUEStionable:ADCState:NTRansition.....	2856
STATus:QUEStionable:ADCState:PTRansition.....	2856
STATus:QUEStionable:ADCState[:EVENT]?.....	2855
STATus:QUEStionable:COVerload:CONDition?.....	2854
STATus:QUEStionable:COVerload:ENABle.....	2855
STATus:QUEStionable:COVerload:NTRansition.....	2856
STATus:QUEStionable:COVerload:PTRansition.....	2856
STATus:QUEStionable:COVerload[:EVENT]?.....	2855
STATus:QUEStionable:DEEMbedding:CONDition?.....	2855
STATus:QUEStionable:DEEMbedding:NTRansition.....	2856
STATus:QUEStionable:DEEMbedding:PTRansition.....	2856
STATus:QUEStionable:DEEMbedding[:EVENT]?.....	2855
STATus:QUEStionable:FREQuency:CONDition?.....	2854
STATus:QUEStionable:FREQuency:ENABle.....	2855
STATus:QUEStionable:FREQuency:EVENT?.....	2855
STATus:QUEStionable:FREQuency:NTRansition.....	2856
STATus:QUEStionable:FREQuency:PTRansition.....	2856
STATus:QUEStionable:LAMPliitude:CONDition?.....	2855
STATus:QUEStionable:LAMPliitude:ENABle.....	2855
STATus:QUEStionable:LAMPliitude:NTRansition.....	2856
STATus:QUEStionable:LAMPliitude:PTRansition.....	2856
STATus:QUEStionable:LAMPliitude[:EVENT]?.....	2855
STATus:QUEStionable:LIMit:CONDition?.....	2854
STATus:QUEStionable:LIMit:ENABle.....	2855
STATus:QUEStionable:LIMit:NTRansition.....	2856
STATus:QUEStionable:LIMit:PTRansition.....	2856

STATus:QUEStionable:LIMit[:EVENT]?.....	2855
STATus:QUEStionable:MARGin:CONDition?.....	2854
STATus:QUEStionable:MARGin:ENABle.....	2855
STATus:QUEStionable:MARGin:NTRansition.....	2856
STATus:QUEStionable:MARGin:PTRansition.....	2856
STATus:QUEStionable:MARGin[:EVENT]?.....	2855
STATus:QUEStionable:MASK:CONDition?.....	2855
STATus:QUEStionable:MASK:ENABle.....	2855
STATus:QUEStionable:MASK:NTRansition.....	2856
STATus:QUEStionable:MASK:PTRansition.....	2856
STATus:QUEStionable:MASK[:EVENT]?.....	2855
STATus:QUEStionable:PLL:CONDition?.....	2854
STATus:QUEStionable:PLL:ENABle.....	2855
STATus:QUEStionable:PLL:NTRansition.....	2856
STATus:QUEStionable:PLL:PTRansition.....	2856
STATus:QUEStionable:PLL[:EVENT]?.....	2855
STATus:QUEStionable:TEMPerature:CONDition?.....	2854
STATus:QUEStionable:TEMPerature:ENABle.....	2855
STATus:QUEStionable:TEMPerature:NTRansition.....	2856
STATus:QUEStionable:TEMPerature:PTRansition.....	2856
STATus:QUEStionable:TEMPerature[:EVENT]?.....	2855
STATus:QUEStionable:ZVCoverload:CONDition?.....	2855
STATus:QUEStionable:ZVCoverload:ENABle.....	2855
STATus:QUEStionable:ZVCoverload:NTRansition.....	2856
STATus:QUEStionable:ZVCoverload:PTRansition.....	2856
STATus:QUEStionable:ZVCoverload[:EVENT]?.....	2855
STOP.....	1415
SWTRigger:HISTory.....	1532
SYSTem:DATE.....	1384
SYSTem:DEvice:ID?.....	1385
SYSTem:DFPRint.....	1412
SYSTem:DISPlay:MESSage:STATe.....	1383
SYSTem:DISPlay:MESSage[:TEXT].....	1383
SYSTem:DISPlay:UPDate.....	1382
SYSTem:EXIT.....	1384
SYSTem:KLOCK.....	1382
SYSTem:LANGuage.....	1383
SYSTem:PRESet.....	1384
SYSTem:SHUTdown.....	1384
SYSTem:TIME?.....	1385
TDRT:BW.....	2660
TDRT:CALibration:OPEN:NAME.....	2657
TDRT:CALibration:OPEN[:EXECute].....	2657
TDRT:CALibration:SAVE:NAME.....	2658
TDRT:CALibration:SAVE[:EXECute].....	2659
TDRT:CALibration:USECaldata.....	2659
TDRT:DEFault.....	2657
TDRT:DOMain.....	2660
TDRT:PERMittivity.....	2660
TDRT:PULSe:OUT.....	2658

TDRT:PULSe:REFerence.....	2658
TDRT:SIGNal<m>:DATA:HEADer?.....	2662
TDRT:SIGNal<m>:DATA:VALues?.....	2662
TDRT:SIGNal<m>:OFFSet.....	2661
TDRT:SIGNal<m>:POSition.....	2661
TDRT:SIGNal<m>:SCALE.....	2661
TDRT:SIGNal<m>:STATe.....	2660
TDRT:SLENgth.....	2658
TDRT:STATe.....	2659
TDRT:TYPE.....	2657
TIMebase:DIVisions?.....	1416
TIMebase:HORIZontal:POSition.....	1416
TIMebase:RACTime?.....	1681
TIMebase:RANGe.....	1416
TIMebase:REFerence.....	1417
TIMebase:ROLL:ENABle.....	1420
TIMebase:ROLL:MTIME.....	1421
TIMebase:ROLL:STATe?.....	1420
TIMebase:SCALE.....	1415
TRACe:REMote:MODE:FILE:DEXecution:DURation.....	2860
TRACe:REMote:MODE:FILE:ENABle.....	2859
TRACe:REMote:MODE:FILE:FILTer.....	2859
TRACe:REMote:MODE:FILE:FORMat.....	2858
TRACe:REMote:MODE:FILE:FUNCTions.....	2860
TRACe:REMote:MODE:FILE:NAME.....	2858
TRACe:REMote:MODE:FILE:PARSer.....	2860
TRACe:REMote:MODE:FILE:RPC.....	2860
TRACe:REMote:MODE:FILE:SIZE.....	2858
TRACe:REMote:MODE:FILE:STARtmode.....	2858
TRACe:REMote:MODE:FILE:STOPmode.....	2858
TRIGger<m>:ANEDge:COUPLing.....	1532
TRIGger<m>:ANEDge:CUToff:HIGHPass.....	1533
TRIGger<m>:ANEDge:CUToff:LOWPass.....	1534
TRIGger<m>:ANEDge:FILTer.....	1533
TRIGger<m>:ANEDge:GND.....	1534
TRIGger<m>:ANEDge:SLOPe.....	1535
TRIGger<m>:ARINc:DATA:CONDition.....	2147
TRIGger<m>:ARINc:DATA:MAX.....	2148
TRIGger<m>:ARINc:DATA:MIN.....	2148
TRIGger<m>:ARINc:ERRor:CODing.....	2148
TRIGger<m>:ARINc:ERRor:PARity.....	2148
TRIGger<m>:ARINc:LAbel:CONDition.....	2149
TRIGger<m>:ARINc:LAbel:MAX.....	2149
TRIGger<m>:ARINc:LAbel:MIN.....	2149
TRIGger<m>:ARINc:MAXGap:BITS.....	2150
TRIGger<m>:ARINc:MAXGap:SElect.....	2150
TRIGger<m>:ARINc:MINGap:BITS.....	2150
TRIGger<m>:ARINc:MINGap:SElect.....	2149
TRIGger<m>:ARINc:SDI.....	2150
TRIGger<m>:ARINc:SSM.....	2150

TRIGger<m>:ARINc:TYPE.....	2147
TRIGger<m>:CAN:ACKerror.....	1957
TRIGger<m>:CAN:BITSterror.....	1957
TRIGger<m>:CAN:BORDER.....	1955
TRIGger<m>:CAN:CRCError.....	1958
TRIGger<m>:CAN:DcONdition.....	1954
TRIGger<m>:CAN:DLC.....	1956
TRIGger<m>:CAN:DLCCondition.....	1955
TRIGger<m>:CAN:DMAX.....	1955
TRIGger<m>:CAN:DMIN.....	1954
TRIGger<m>:CAN:FDATa:BRS.....	1954
TRIGger<m>:CAN:FDATa:DPOperator.....	1956
TRIGger<m>:CAN:FDATa:DPOsition.....	1957
TRIGger<m>:CAN:FDATa:DPTO.....	1957
TRIGger<m>:CAN:FDATa:ESL.....	1954
TRIGger<m>:CAN:FDATa:FDF.....	1953
TRIGger<m>:CAN:FDATa:SCERror.....	1958
TRIGger<m>:CAN:FDATa:STANdard.....	1951
TRIGger<m>:CAN:FORMerror.....	1958
TRIGger<m>:CAN:FTYPE.....	1952
TRIGger<m>:CAN:IcONdition.....	1952
TRIGger<m>:CAN:IMAX.....	1953
TRIGger<m>:CAN:IMIN.....	1953
TRIGger<m>:CAN:ITYPE.....	1952
TRIGger<m>:CAN:NDBYtes?.....	1956
TRIGger<m>:CAN:SYMBolic:DMAX.....	1984
TRIGger<m>:CAN:SYMBolic:DMIN.....	1984
TRIGger<m>:CAN:SYMBolic:MSGValue.....	1983
TRIGger<m>:CAN:SYMBolic:SGEValue.....	1985
TRIGger<m>:CAN:SYMBolic:SIGValue.....	1984
TRIGger<m>:CAN:SYMBolic:TSIGNals.....	1984
TRIGger<m>:CAN:TYPE.....	1950
TRIGger<m>:CMSB:ADVanced:BIT.....	1920
TRIGger<m>:CMSB:ADVanced:DMAX.....	1920
TRIGger<m>:CMSB:ADVanced:DMIN.....	1920
TRIGger<m>:CMSB:ADVanced:DOPerator.....	1921
TRIGger<m>:CMSB:ADVanced:ERENable.....	1921
TRIGger<m>:CMSB:ADVanced:ERRor<n>:ENABLE.....	1921
TRIGger<m>:CMSB:ADVanced:FIENable.....	1919
TRIGger<m>:CMSB:ADVanced:FRAMe<n>:ENABLE.....	1919
TRIGger<m>:CMSB:ADVanced:FRAMe<n>:FLD<o>:BIT.....	1920
TRIGger<m>:CMSB:ADVanced:FRAMe<n>:FLD<o>:DMAX.....	1920
TRIGger<m>:CMSB:ADVanced:FRAMe<n>:FLD<o>:DMIN.....	1920
TRIGger<m>:CMSB:ADVanced:FRAMe<n>:FLD<o>:DOPerator.....	1921
TRIGger<m>:CMSB:ADVanced:FRAMe<n>:FLD<o>:ENABLE.....	1919
TRIGger<m>:CMSB:ADVanced:FRAMe<n>:FLD<o>:IMAX.....	1922
TRIGger<m>:CMSB:ADVanced:FRAMe<n>:FLD<o>:IMIN.....	1922
TRIGger<m>:CMSB:ADVanced:FRAMe<n>:FLD<o>:IOPerator.....	1922
TRIGger<m>:CMSB:ADVanced:FRENable.....	1919
TRIGger<m>:CMSB:ADVanced:IMAX.....	1922

TRIGger<m>:CMSB:ADVanced:IMIN.....	1922
TRIGger<m>:CMSB:ADVanced:IOperator.....	1922
TRIGger<m>:CMSB:ICONdition.....	1918
TRIGger<m>:CMSB:IMAX.....	1918
TRIGger<m>:CMSB:IMIN.....	1918
TRIGger<m>:CMSB:NRZ:WRDLength.....	1919
TRIGger<m>:CMSB:PATtern.....	1917
TRIGger<m>:CMSB:TYPE.....	1917
TRIGger<m>:COUpling.....	1478
TRIGger<m>:CXPI:CT.....	2091
TRIGger<m>:CXPI:DATA:DCondition.....	2092
TRIGger<m>:CXPI:DATA:DMAX.....	2092
TRIGger<m>:CXPI:DATA:DMIN.....	2092
TRIGger<m>:CXPI:DATA:ICONdition.....	2093
TRIGger<m>:CXPI:DATA:IMAX.....	2093
TRIGger<m>:CXPI:DATA:IMIN.....	2093
TRIGger<m>:CXPI:DEXTension:CONdITION.....	2094
TRIGger<m>:CXPI:DEXTension:MAX.....	2094
TRIGger<m>:CXPI:DEXTension:MIN.....	2094
TRIGger<m>:CXPI:DLC:CONdITION.....	2094
TRIGger<m>:CXPI:DLC:MAX.....	2095
TRIGger<m>:CXPI:DLC:MIN.....	2095
TRIGger<m>:CXPI:ERRor:CRC.....	2095
TRIGger<m>:CXPI:ERRor:DLC.....	2096
TRIGger<m>:CXPI:ERRor:IBS.....	2096
TRIGger<m>:CXPI:ERRor:IFS.....	2096
TRIGger<m>:CXPI:ERRor:LENGth.....	2096
TRIGger<m>:CXPI:ERRor:PARity.....	2097
TRIGger<m>:CXPI:ERRor:UART.....	2097
TRIGger<m>:CXPI:FID:CONdITION.....	2097
TRIGger<m>:CXPI:FID:MAX.....	2098
TRIGger<m>:CXPI:FID:MIN.....	2098
TRIGger<m>:CXPI:NM.....	2098
TRIGger<m>:CXPI:TYPE.....	2098
TRIGger<m>:DPHY:DATA:CONdITION.....	2422
TRIGger<m>:DPHY:DATA:MAX.....	2423
TRIGger<m>:DPHY:DATA:MIN.....	2423
TRIGger<m>:DPHY:DIDX:CONdITION.....	2423
TRIGger<m>:DPHY:DIDX:MAX.....	2423
TRIGger<m>:DPHY:DIDX:MIN.....	2424
TRIGger<m>:DPHY:DTYPE:CONdITION.....	2424
TRIGger<m>:DPHY:DTYPE:MAX.....	2424
TRIGger<m>:DPHY:DTYPE:MIN.....	2425
TRIGger<m>:DPHY:ESCMode:CONdITION.....	2425
TRIGger<m>:DPHY:ESCMode:MAX.....	2425
TRIGger<m>:DPHY:ESCMode:MIN.....	2425
TRIGger<m>:DPHY:ESDTa:CONdITION.....	2426
TRIGger<m>:DPHY:ESDTa:MAX.....	2426
TRIGger<m>:DPHY:ESDTa:MIN.....	2426
TRIGger<m>:DPHY:ESINdex:CONdITION.....	2427

TRIGger<m>:DPHY:ESINdex:MAX.....	2427
TRIGger<m>:DPHY:ESINdex:MIN.....	2427
TRIGger<m>:DPHY:HSVC.....	2427
TRIGger<m>:DPHY:TYPE.....	2422
TRIGger<m>:DPHY:WCOunt:CONDition.....	2428
TRIGger<m>:DPHY:WCOunt:MAX.....	2428
TRIGger<m>:DPHY:WCOunt:MIN.....	2428
TRIGger<m>:EBTB:DISParityerr.....	2515
TRIGger<m>:EBTB:DX.....	2515
TRIGger<m>:EBTB:DY.....	2515
TRIGger<m>:EBTB:EBPA.....	2515
TRIGger<m>:EBTB:GLITCherror.....	2516
TRIGger<m>:EBTB:SSType.....	2516
TRIGger<m>:EBTB:STYPe.....	2517
TRIGger<m>:EBTB:SYME.....	2516
TRIGger<m>:EBTB:SYMType.....	2516
TRIGger<m>:EBTB:TBPA.....	2516
TRIGger<m>:EBTB:UNK.....	2517
TRIGger<m>:ECOupling.....	1525
TRIGger<m>:EDGE:SLOPe.....	1488
TRIGger<m>:ETHernet:ERRor:CRC.....	2183
TRIGger<m>:ETHernet:ERRor:LENGth.....	2183
TRIGger<m>:ETHernet:ERRor:PREAmble.....	2183
TRIGger<m>:ETHernet:FRAME:CCONDition.....	2184
TRIGger<m>:ETHernet:FRAME:CMAx.....	2184
TRIGger<m>:ETHernet:FRAME:CMIN.....	2184
TRIGger<m>:ETHernet:FRAME:DCONDition.....	2185
TRIGger<m>:ETHernet:FRAME:DMAx.....	2185
TRIGger<m>:ETHernet:FRAME:DMIN.....	2185
TRIGger<m>:ETHernet:FRAME:SCONdition.....	2185
TRIGger<m>:ETHernet:FRAME:SMAX.....	2186
TRIGger<m>:ETHernet:FRAME:SMIN.....	2186
TRIGger<m>:ETHernet:FRAME:TCONDition.....	2186
TRIGger<m>:ETHernet:FRAME:TMAx.....	2187
TRIGger<m>:ETHernet:FRAME:TMIN.....	2187
TRIGger<m>:ETHernet:PATtern.....	2183
TRIGger<m>:ETHernet:TYPE.....	2182
TRIGger<m>:EVENT:BEEP.....	1530
TRIGger<m>:EVENT:PRINt.....	1530
TRIGger<m>:EVENT:RUNexec.....	1530
TRIGger<m>:EVENT:TRIGgerout.....	1531
TRIGger<m>:EVENT:WFMSave.....	1531
TRIGger<m>:EVENT[:EVENT].....	1524
TRIGger<m>:EXtern:OVERload.....	1535
TRIGger<m>:FINDlevel.....	1488
TRIGger<m>:FLXRay:BSSerror.....	2032
TRIGger<m>:FLXRay:CENable.....	2029
TRIGger<m>:FLXRay:CMAx.....	2029
TRIGger<m>:FLXRay:CMIN.....	2029
TRIGger<m>:FLXRay:CSTep.....	2029

TRIGger<m>:FLXRay:DCONdition.....	2031
TRIGger<m>:FLXRay:DMAX.....	2031
TRIGger<m>:FLXRay:DMIN.....	2031
TRIGger<m>:FLXRay:DPOperator.....	2030
TRIGger<m>:FLXRay:DPOsition.....	2030
TRIGger<m>:FLXRay:DPTO.....	2030
TRIGger<m>:FLXRay:FCONdition.....	2027
TRIGger<m>:FLXRay:FESerror.....	2032
TRIGger<m>:FLXRay:FMAX.....	2027
TRIGger<m>:FLXRay:FMIN.....	2027
TRIGger<m>:FLXRay:FSSerror.....	2032
TRIGger<m>:FLXRay:HCRError.....	2033
TRIGger<m>:FLXRay:NUFRame.....	2026
TRIGger<m>:FLXRay:PCONdition.....	2028
TRIGger<m>:FLXRay:PCRCerror.....	2033
TRIGger<m>:FLXRay:PLPReamble.....	2026
TRIGger<m>:FLXRay:PMAX.....	2028
TRIGger<m>:FLXRay:PMIN.....	2028
TRIGger<m>:FLXRay:STFRame.....	2026
TRIGger<m>:FLXRay:SYFRame.....	2026
TRIGger<m>:FLXRay:SYMBol.....	2032
TRIGger<m>:FLXRay:TYPE.....	2025
TRIGger<m>:FORCe.....	1528
TRIGger<m>:GLITCh:POLarity.....	1489
TRIGger<m>:GLITCh:RANGe.....	1489
TRIGger<m>:GLITCh:WIDTh.....	1489
TRIGger<m>:HBTO:CRC:CONDItion.....	2259
TRIGger<m>:HBTO:CRC:MAX.....	2260
TRIGger<m>:HBTO:CRC:MIN.....	2259
TRIGger<m>:HBTO:DADDrESS:CONDItion.....	2256
TRIGger<m>:HBTO:DADDrESS:MAX.....	2257
TRIGger<m>:HBTO:DADDrESS:MIN.....	2256
TRIGger<m>:HBTO:DATA:DCONDItion.....	2260
TRIGger<m>:HBTO:DATA:DMAX.....	2261
TRIGger<m>:HBTO:DATA:DMIN.....	2260
TRIGger<m>:HBTO:DATA:ICONDItion.....	2261
TRIGger<m>:HBTO:DATA:IMAX.....	2262
TRIGger<m>:HBTO:DATA:IMIN.....	2261
TRIGger<m>:HBTO:ERRor:CRC.....	2262
TRIGger<m>:HBTO:ERRor:PREamble.....	2262
TRIGger<m>:HBTO:ERRor:SFD.....	2263
TRIGger<m>:HBTO:LENGth:CONDItion.....	2258
TRIGger<m>:HBTO:LENGth:MAX.....	2259
TRIGger<m>:HBTO:LENGth:MIN.....	2258
TRIGger<m>:HBTO:SADDrESS:CONDItion.....	2257
TRIGger<m>:HBTO:SADDrESS:MAX.....	2258
TRIGger<m>:HBTO:SADDrESS:MIN.....	2257
TRIGger<m>:HBTO:TYPE.....	2255
TRIGger<m>:HOLDoff:AUTotime?.....	1521
TRIGger<m>:HOLDoff:EVENTs.....	1519

TRIGger<m>:HOLDoff:MAX.....	1520
TRIGger<m>:HOLDoff:MIN.....	1520
TRIGger<m>:HOLDoff:MODE.....	1518
TRIGger<m>:HOLDoff:SCALing.....	1521
TRIGger<m>:HOLDoff:TIME.....	1519
TRIGger<m>:I2C:ACCess.....	1823
TRIGger<m>:I2C:ACONdition.....	1825
TRIGger<m>:I2C:ADDResS.....	1825
TRIGger<m>:I2C:ADDTo.....	1825
TRIGger<m>:I2C:ADNack.....	1824
TRIGger<m>:I2C:ADOR<n>:ADRTyPe.....	1826
TRIGger<m>:I2C:ADOR<n>:ENABle.....	1825
TRIGger<m>:I2C:ADOR<n>:RWBit.....	1826
TRIGger<m>:I2C:ADOR<n>[:VALue].....	1826
TRIGger<m>:I2C:AMODe.....	1824
TRIGger<m>:I2C:DCONdition.....	1828
TRIGger<m>:I2C:DMAX.....	1828
TRIGger<m>:I2C:DMIN.....	1828
TRIGger<m>:I2C:DPOPerator.....	1827
TRIGger<m>:I2C:DPOStion.....	1827
TRIGger<m>:I2C:DPTO.....	1827
TRIGger<m>:I2C:DRNack.....	1824
TRIGger<m>:I2C:DWNack.....	1824
TRIGger<m>:I2C:TYPE.....	1823
TRIGger<m>:I2S:SOWords.....	1894
TRIGger<m>:I2S:TCONdition<n>:CHANnel.....	1892
TRIGger<m>:I2S:TCONdition<n>:CONDtion.....	1893
TRIGger<m>:I2S:TCONdition<n>:DMAX.....	1894
TRIGger<m>:I2S:TCONdition<n>:DMIN.....	1893
TRIGger<m>:I2S:TYPE.....	1891
TRIGger<m>:I2S:WSSLOpe.....	1894
TRIGger<m>:INTErval:DELTA.....	1499
TRIGger<m>:INTErval:RANGe.....	1498
TRIGger<m>:INTErval:SLOPe.....	1498
TRIGger<m>:INTErval:WIDTh.....	1498
TRIGger<m>:LEVel<n>:NOISe:ABSolute.....	1523
TRIGger<m>:LEVel<n>:NOISe:MODE.....	1522
TRIGger<m>:LEVel<n>:NOISe:PERDivision.....	1523
TRIGger<m>:LEVel<n>:NOISe:RELative.....	1524
TRIGger<m>:LEVel<n>:NOISe[:STATe].....	1522
TRIGger<m>:LEVel<n>:RUNT:LOWer.....	1492
TRIGger<m>:LEVel<n>:RUNT:UPPer.....	1492
TRIGger<m>:LEVel<n>:SLEW:LOWer.....	1500
TRIGger<m>:LEVel<n>:SLEW:UPPer.....	1500
TRIGger<m>:LEVel<n>:WINDow:LOWer.....	1494
TRIGger<m>:LEVel<n>:WINDow:UPPer.....	1494
TRIGger<m>:LEVel<n>[:VALue].....	1487
TRIGger<m>:LEVel<n>[:VALue].....	2730
TRIGger<m>:LIN:BORDer.....	1994
TRIGger<m>:LIN:CHKSError.....	1996

TRIGger<m>:LIN:CRCDatalen.....	1997
TRIGger<m>:LIN:DCondition.....	1993
TRIGger<m>:LIN:DLECondition.....	1994
TRIGger<m>:LIN:DLEnGth.....	1995
TRIGger<m>:LIN:DMAX.....	1994
TRIGger<m>:LIN:DMIN.....	1993
TRIGger<m>:LIN:ERRPattern.....	1996
TRIGger<m>:LIN:ICONdition.....	1992
TRIGger<m>:LIN:IDOR<n>:ENABle.....	1995
TRIGger<m>:LIN:IDOR<n>[:VALue].....	1995
TRIGger<m>:LIN:IMAX.....	1993
TRIGger<m>:LIN:IMIN.....	1993
TRIGger<m>:LIN:IPERror.....	1996
TRIGger<m>:LIN:STANdard.....	1997
TRIGger<m>:LIN:SYERror.....	1996
TRIGger<m>:LIN:TYPE.....	1991
TRIGger<m>:MDIO:DATA.....	2208
TRIGger<m>:MDIO:FRAMetype.....	2207
TRIGger<m>:MDIO:PHYS.....	2208
TRIGger<m>:MDIO:REGI.....	2208
TRIGger<m>:MDIO:ST.....	2207
TRIGger<m>:MDIO:TYPE.....	2206
TRIGger<m>:MILStd:CDST:ICONdition.....	2123
TRIGger<m>:MILStd:CDST:IMAX.....	2124
TRIGger<m>:MILStd:CDST:IMIN.....	2124
TRIGger<m>:MILStd:CDST:RCONdition.....	2120
TRIGger<m>:MILStd:CDST:RMAX.....	2121
TRIGger<m>:MILStd:CDST:RMIN.....	2121
TRIGger<m>:MILStd:CMD:CConDition.....	2121
TRIGger<m>:MILStd:CMD:CMAx.....	2122
TRIGger<m>:MILStd:CMD:CMIN.....	2122
TRIGger<m>:MILStd:CMD:RCONdition.....	2120
TRIGger<m>:MILStd:CMD:RMAx.....	2121
TRIGger<m>:MILStd:CMD:RMIN.....	2121
TRIGger<m>:MILStd:CMD:SCONdition.....	2122
TRIGger<m>:MILStd:CMD:SMAX.....	2123
TRIGger<m>:MILStd:CMD:SMIN.....	2123
TRIGger<m>:MILStd:CMD:TR.....	2123
TRIGger<m>:MILStd:DATA:DCondition.....	2124
TRIGger<m>:MILStd:DATA:DMAx.....	2125
TRIGger<m>:MILStd:DATA:DMIN.....	2125
TRIGger<m>:MILStd:DATA:ICONdition.....	2125
TRIGger<m>:MILStd:DATA:IMAX.....	2125
TRIGger<m>:MILStd:DATA:IMIN.....	2126
TRIGger<m>:MILStd:DATA:RCONdition.....	2120
TRIGger<m>:MILStd:DATA:RMAx.....	2121
TRIGger<m>:MILStd:DATA:RMIN.....	2121
TRIGger<m>:MILStd:ERRor:MANChester.....	2126
TRIGger<m>:MILStd:ERRor:PARity.....	2126
TRIGger<m>:MILStd:ERRor:SYNC.....	2126

TRIGger<m>:MILStd:MAXResponse:BITS.....	2127
TRIGger<m>:MILStd:MAXResponse:SElect.....	2127
TRIGger<m>:MILStd:MINGap:BITS.....	2127
TRIGger<m>:MILStd:MINGap:SElect.....	2127
TRIGger<m>:MILStd:STATus:BCReceived.....	2128
TRIGger<m>:MILStd:STATus:BUSY.....	2128
TRIGger<m>:MILStd:STATus:DBCaccept.....	2128
TRIGger<m>:MILStd:STATus:INSTRument.....	2128
TRIGger<m>:MILStd:STATus:MERRor.....	2128
TRIGger<m>:MILStd:STATus:SREquest.....	2129
TRIGger<m>:MILStd:STATus:SUBSystem.....	2129
TRIGger<m>:MILStd:STATus:TERMinal.....	2129
TRIGger<m>:MILStd:TPSPecifier.....	2129
TRIGger<m>:MILStd:TYPE.....	2119
TRIGger<m>:MODE.....	1528
TRIGger<m>:MPHY:CRC:CONDition.....	2462
TRIGger<m>:MPHY:CRC:MAX.....	2462
TRIGger<m>:MPHY:CRC:MIN.....	2462
TRIGger<m>:MPHY:CREDit:CONDition.....	2463
TRIGger<m>:MPHY:CREDit:MAX.....	2464
TRIGger<m>:MPHY:CREDit:MIN.....	2464
TRIGger<m>:MPHY:CREQ.....	2463
TRIGger<m>:MPHY:DATA:DCON.....	2459
TRIGger<m>:MPHY:DATA:DMAX.....	2459
TRIGger<m>:MPHY:DATA:DMIN.....	2459
TRIGger<m>:MPHY:DATA:ICONDition.....	2460
TRIGger<m>:MPHY:DATA:IMAX.....	2460
TRIGger<m>:MPHY:DATA:IMIN.....	2460
TRIGger<m>:MPHY:ERRor:LCMD.....	2467
TRIGger<m>:MPHY:ERRor:LENGth.....	2467
TRIGger<m>:MPHY:ERRor:REServed.....	2467
TRIGger<m>:MPHY:ERRor:SYMBol.....	2467
TRIGger<m>:MPHY:ERRor:UNKNown.....	2468
TRIGger<m>:MPHY:FSNumber:CONDition.....	2461
TRIGger<m>:MPHY:FSNumber:MAX.....	2461
TRIGger<m>:MPHY:FSNumber:MIN.....	2461
TRIGger<m>:MPHY:LCCType.....	2453
TRIGger<m>:MPHY:LWFour:CONDition.....	2457
TRIGger<m>:MPHY:LWFour:MAX.....	2458
TRIGger<m>:MPHY:LWFour:MIN.....	2458
TRIGger<m>:MPHY:LWONe:CONDition.....	2454
TRIGger<m>:MPHY:LWONe:MAX.....	2455
TRIGger<m>:MPHY:LWONe:MIN.....	2455
TRIGger<m>:MPHY:LWTHree:CONDition.....	2456
TRIGger<m>:MPHY:LWTHree:MAX.....	2457
TRIGger<m>:MPHY:LWTHree:MIN.....	2457
TRIGger<m>:MPHY:LWTWo:CONDition.....	2455
TRIGger<m>:MPHY:LWTWo:MAX.....	2456
TRIGger<m>:MPHY:LWTWo:MIN.....	2456
TRIGger<m>:MPHY:PBEGin:CONDition.....	2464

TRIGger<m>:MPHY:PBEGin:MAX.....	2465
TRIGger<m>:MPHY:PBEGin:MIN.....	2465
TRIGger<m>:MPHY:PFID:CONDition.....	2465
TRIGger<m>:MPHY:PFID:MAX.....	2466
TRIGger<m>:MPHY:PFID:MIN.....	2466
TRIGger<m>:MPHY:PRPLength.....	2466
TRIGger<m>:MPHY:RREQ.....	2463
TRIGger<m>:MPHY:SSIC:BIT.....	2499
TRIGger<m>:MPHY:SSIC:DMAX.....	2499
TRIGger<m>:MPHY:SSIC:DMIN.....	2500
TRIGger<m>:MPHY:SSIC:DOPerator.....	2500
TRIGger<m>:MPHY:SSIC:ERENable.....	2498
TRIGger<m>:MPHY:SSIC:ERRor<n>:ENABle.....	2498
TRIGger<m>:MPHY:SSIC:FIENable.....	2499
TRIGger<m>:MPHY:SSIC:FRAMe<n>:ENABle.....	2498
TRIGger<m>:MPHY:SSIC:FRAMe<n>:FLD<o>:BIT.....	2499
TRIGger<m>:MPHY:SSIC:FRAMe<n>:FLD<o>:DMAX.....	2499
TRIGger<m>:MPHY:SSIC:FRAMe<n>:FLD<o>:DMIN.....	2500
TRIGger<m>:MPHY:SSIC:FRAMe<n>:FLD<o>:DOPerator.....	2500
TRIGger<m>:MPHY:SSIC:FRAMe<n>:FLD<o>:ENABle.....	2499
TRIGger<m>:MPHY:SSIC:FRAMe<n>:FLD<o>:IMAX.....	2501
TRIGger<m>:MPHY:SSIC:FRAMe<n>:FLD<o>:IMIN.....	2501
TRIGger<m>:MPHY:SSIC:FRAMe<n>:FLD<o>:IOPerator.....	2502
TRIGger<m>:MPHY:SSIC:FRENable.....	2498
TRIGger<m>:MPHY:SSIC:IMAX.....	2501
TRIGger<m>:MPHY:SSIC:IMIN.....	2501
TRIGger<m>:MPHY:SSIC:IOPerator.....	2502
TRIGger<m>:MPHY:TC.....	2458
TRIGger<m>:MPHY:TYPE.....	2453
TRIGger<m>:NFC:BITRate.....	2669
TRIGger<m>:NFC:EVENT.....	2670
TRIGger<m>:NFC:TECHnology.....	2669
TRIGger<m>:OFFSet:LIMited.....	1417
TRIGger<m>:OUT:DELay.....	1529
TRIGger<m>:OUT:PLENght.....	1529
TRIGger<m>:OUT:POLarity.....	1529
TRIGger<m>:PARallel:EDGE:EXPRession[:DEFine].....	2621
TRIGger<m>:PARallel:EDGE:SLOPe.....	2621
TRIGger<m>:PARallel:PATtern:BIT<0..15>.....	2626
TRIGger<m>:PARallel:PATtern:EXPRession[:DEFine].....	2621
TRIGger<m>:PARallel:PATtern:MODE.....	2626
TRIGger<m>:PARallel:PATtern:TIMEout:MODE.....	2627
TRIGger<m>:PARallel:PATtern:TIMEout[:TIME].....	2627
TRIGger<m>:PARallel:PATtern:WIDTh:DELTA.....	2628
TRIGger<m>:PARallel:PATtern:WIDTh:RANGe.....	2627
TRIGger<m>:PARallel:PATtern:WIDTh[:WIDTh].....	2628
TRIGger<m>:PARallel:SETHold:CSource:EDGE.....	2624
TRIGger<m>:PARallel:SETHold:CSource[:VALue].....	2621
TRIGger<m>:PARallel:SETHold:HTIME.....	2624
TRIGger<m>:PARallel:SETHold:STIME.....	2625

TRIGger<m>:PARAllel:SPATtern:CSourCe:EDGE.....	2628
TRIGger<m>:PARAllel:SPATtern:CSourCe[:VALue].....	2621
TRIGger<m>:PARAllel:SPATtern:EXPRession[:DEFine].....	2621
TRIGger<m>:PARAllel:SPATtern:PATtern.....	2629
TRIGger<m>:PARAllel:STATe:BIT<0..15>.....	2625
TRIGger<m>:PARAllel:STATe:CSourCe:EDGE.....	2625
TRIGger<m>:PARAllel:STATe:CSourCe:VALue.....	2621
TRIGger<m>:PARAllel:STATe:EXPRession[:DEFine].....	2621
TRIGger<m>:PARAllel:TIMeout:EXPRession[:DEFine].....	2621
TRIGger<m>:PARAllel:TIMeout:RANGe.....	2623
TRIGger<m>:PARAllel:TIMeout:TIME.....	2624
TRIGger<m>:PARAllel:TYPE.....	2620
TRIGger<m>:PARAllel:WIDTh:DELTA.....	2623
TRIGger<m>:PARAllel:WIDTh:EXPRession[:DEFine].....	2621
TRIGger<m>:PARAllel:WIDTh:POLarity.....	2622
TRIGger<m>:PARAllel:WIDTh:RANGe.....	2622
TRIGger<m>:PARAllel:WIDTh:WIDTh.....	2622
TRIGger<m>:PATtern:MODE.....	1505
TRIGger<m>:PATtern:TIMeout:MODE.....	1505
TRIGger<m>:PATtern:TIMeout[:TIME].....	1506
TRIGger<m>:PATtern:WIDTh:DELTA.....	1507
TRIGger<m>:PATtern:WIDTh:RANGe.....	1506
TRIGger<m>:PATtern:WIDTh[:WIDTh].....	1507
TRIGger<m>:PCIE:DLLP:FCTL:CRET.....	2531
TRIGger<m>:PCIE:DLLP:FCTL:VCID.....	2531
TRIGger<m>:PCIE:DLLP:MULT:AUTH.....	2532
TRIGger<m>:PCIE:DLLP:MULT:CRET.....	2532
TRIGger<m>:PCIE:DLLP:MULT:DVPT.....	2532
TRIGger<m>:PCIE:DLLP:MULT:HABS.....	2532
TRIGger<m>:PCIE:DLLP:MULT:MIXT.....	2532
TRIGger<m>:PCIE:DLLP:MULT:PHAS.....	2533
TRIGger<m>:PCIE:DLLP:MULT:RESA.....	2533
TRIGger<m>:PCIE:DLLP:MULT:TLPT.....	2533
TRIGger<m>:PCIE:DLLP:MULT:TYPE.....	2533
TRIGger<m>:PCIE:DLLP:MULT:VHFC.....	2534
TRIGger<m>:PCIE:DLLP:MULT:VHGR.....	2534
TRIGger<m>:PCIE:DLLP:MULT:VLNR.....	2534
TRIGger<m>:PCIE:DLLP:POWM.....	2534
TRIGger<m>:PCIE:DLLP:SEQ.....	2534
TRIGger<m>:PCIE:DLLP:TYPE.....	2535
TRIGger<m>:PCIE:DLLP:VPAT.....	2535
TRIGger<m>:PCIE:ERRC:CRC.....	2535
TRIGger<m>:PCIE:ERRC:DISP.....	2535
TRIGger<m>:PCIE:ERRC:ECRC.....	2535
TRIGger<m>:PCIE:ERRC:INVP.....	2536
TRIGger<m>:PCIE:ERRC:LCRC.....	2536
TRIGger<m>:PCIE:OSET:TYPE.....	2536
TRIGger<m>:PCIE:TLP:ADRT.....	2537
TRIGger<m>:PCIE:TLP:CFGT.....	2537
TRIGger<m>:PCIE:TLP:CPID.....	2537

TRIGger<m>:PCIE:TLP:CPLS.....	2537
TRIGger<m>:PCIE:TLP:DEID.....	2537
TRIGger<m>:PCIE:TLP:MERW.....	2538
TRIGger<m>:PCIE:TLP:MSGC.....	2538
TRIGger<m>:PCIE:TLP:MSGR.....	2538
TRIGger<m>:PCIE:TLP:ORDE.....	2538
TRIGger<m>:PCIE:TLP:REID.....	2538
TRIGger<m>:PCIE:TLP:SNOO.....	2539
TRIGger<m>:PCIE:TLP:SNUM.....	2539
TRIGger<m>:PCIE:TLP:TCHN.....	2539
TRIGger<m>:PCIE:TLP:TYPE.....	2539
TRIGger<m>:PCIE:TYPE.....	2539
TRIGger<m>:QUALify<n>:A:LOGic.....	1516
TRIGger<m>:QUALify<n>:A[:ENABLE].....	1516
TRIGger<m>:QUALify<n>:AB:LOGic.....	1517
TRIGger<m>:QUALify<n>:ABCD:LOGic.....	1517
TRIGger<m>:QUALify<n>:B:LOGic.....	1516
TRIGger<m>:QUALify<n>:B[:ENABLE].....	1516
TRIGger<m>:QUALify<n>:C:LOGic.....	1516
TRIGger<m>:QUALify<n>:C[:ENABLE].....	1516
TRIGger<m>:QUALify<n>:CD:LOGic.....	1517
TRIGger<m>:QUALify<n>:D:LOGic.....	1516
TRIGger<m>:QUALify<n>:D[:ENABLE].....	1516
TRIGger<m>:QUALify<n>:STATE.....	1515
TRIGger<m>:RFFE:ADDResS:CONDition.....	2227
TRIGger<m>:RFFE:ADDResS:MAX.....	2227
TRIGger<m>:RFFE:ADDResS:MIN.....	2227
TRIGger<m>:RFFE:BCOunt:CONDition.....	2228
TRIGger<m>:RFFE:BCOunt:MAX.....	2228
TRIGger<m>:RFFE:BCOunt:MIN.....	2228
TRIGger<m>:RFFE:DATA:DCON.....	2228
TRIGger<m>:RFFE:DATA:DMAX.....	2229
TRIGger<m>:RFFE:DATA:DMIN.....	2229
TRIGger<m>:RFFE:DATA:ICONDition.....	2229
TRIGger<m>:RFFE:DATA:IMAX.....	2230
TRIGger<m>:RFFE:DATA:IMIN.....	2230
TRIGger<m>:RFFE:ERRor:BP.....	2232
TRIGger<m>:RFFE:ERRor:GAP.....	2233
TRIGger<m>:RFFE:ERRor:LENGth.....	2232
TRIGger<m>:RFFE:ERRor:NOResponse.....	2232
TRIGger<m>:RFFE:ERRor:PARity.....	2233
TRIGger<m>:RFFE:ERRor:SSC.....	2233
TRIGger<m>:RFFE:ERRor:USEquence.....	2233
TRIGger<m>:RFFE:ERRor:VERSion.....	2233
TRIGger<m>:RFFE:INTerrupt.....	2232
TRIGger<m>:RFFE:INTerrupt.....	2234
TRIGger<m>:RFFE:MASK:CONDition.....	2231
TRIGger<m>:RFFE:MASK:MAX.....	2231
TRIGger<m>:RFFE:MASK:MIN.....	2232
TRIGger<m>:RFFE:SADD:CONDition.....	2230

TRIGger<m>:RFFE:SADD:MAX.....	2231
TRIGger<m>:RFFE:SADD:MIN.....	2231
TRIGger<m>:RFFE:TYPE.....	2224
TRIGger<m>:RFRReject.....	1479
TRIGger<m>:RUNT:DELTA.....	1494
TRIGger<m>:RUNT:POLarity.....	1492
TRIGger<m>:RUNT:RANGe.....	1493
TRIGger<m>:RUNT:WIDTh.....	1493
TRIGger<m>:SCOupling.....	1504
TRIGger<m>:SENT:CRCError.....	2065
TRIGger<m>:SENT:FORMError.....	2064
TRIGger<m>:SENT:IRFLength.....	2065
TRIGger<m>:SENT:PPERioderror.....	2065
TRIGger<m>:SENT:PULSeerror.....	2064
TRIGger<m>:SENT:SDCN.....	2063
TRIGger<m>:SENT:SDMN.....	2064
TRIGger<m>:SENT:SDMX.....	2064
TRIGger<m>:SENT:SICN.....	2062
TRIGger<m>:SENT:SIDType.....	2062
TRIGger<m>:SENT:SIMN.....	2063
TRIGger<m>:SENT:SIMX.....	2063
TRIGger<m>:SENT:STATus.....	2061
TRIGger<m>:SENT:STYPe.....	2062
TRIGger<m>:SENT:TDCN.....	2061
TRIGger<m>:SENT:TDMN.....	2061
TRIGger<m>:SENT:TDMX.....	2062
TRIGger<m>:SENT:TTPe.....	2060
TRIGger<m>:SENT:TYPE.....	2060
TRIGger<m>:SEQuence:COUNt.....	1526
TRIGger<m>:SEQuence:DELay.....	1526
TRIGger<m>:SEQuence:RESet:EVENT.....	1526
TRIGger<m>:SEQuence:RESet:TIMEout:TIME.....	1527
TRIGger<m>:SEQuence:RESet:TIMEout[:ENABLE].....	1527
TRIGger<m>:SEQuence:TYPE.....	1525
TRIGger<m>:SETHold:CSORce:EDGE.....	1502
TRIGger<m>:SETHold:CSORce:LEVel.....	1502
TRIGger<m>:SETHold:CSORce[:VALue].....	1502
TRIGger<m>:SETHold:HTIME.....	1503
TRIGger<m>:SETHold:STIME.....	1503
TRIGger<m>:SLEW:DELTA.....	1501
TRIGger<m>:SLEW:RANGe.....	1500
TRIGger<m>:SLEW:RATE.....	1501
TRIGger<m>:SLEW:SLOPe.....	1499
TRIGger<m>:SOURce:SBSelect.....	1818
TRIGger<m>:SOURce[:SElect].....	1485
TRIGger<m>:SOURce[:SElect].....	1817
TRIGger<m>:SOURce[:SElect].....	2619
TRIGger<m>:SPATtern:CDR.....	2731
TRIGger<m>:SPATtern:CSORce:EDGE.....	1508
TRIGger<m>:SPATtern:CSORce:LEVel.....	1508

TRIGger<m>:SPATtern:CSource[:VALue].....	1508
TRIGger<m>:SPATtern:PATtern.....	1509
TRIGger<m>:SPATtern:REFSource.....	1509
TRIGger<m>:SPI:DPOperator.....	1860
TRIGger<m>:SPI:DPOsition.....	1860
TRIGger<m>:SPI:DPTO.....	1860
TRIGger<m>:SPI:FCONdition.....	1860
TRIGger<m>:SPI:MIsoPattern.....	1861
TRIGger<m>:SPI:MOsIPattern.....	1861
TRIGger<m>:SPI:PALignment.....	1859
TRIGger<m>:SPI:TYPE.....	1859
TRIGger<m>:SWIRe:CTYPE.....	2164
TRIGger<m>:SWIRe:DATA:CONdition.....	2165
TRIGger<m>:SWIRe:DATA:MAX.....	2165
TRIGger<m>:SWIRe:DATA:MIN.....	2165
TRIGger<m>:SWIRe:ERRor:ESC.....	2166
TRIGger<m>:SWIRe:ERRor:PARity.....	2166
TRIGger<m>:SWIRe:TIME:CONdition.....	2166
TRIGger<m>:SWIRe:TIME:MAX.....	2167
TRIGger<m>:SWIRe:TIME:MIN.....	2167
TRIGger<m>:SWIRe:TYPE.....	2167
TRIGger<m>:TBTO:CRC:CONdition.....	2293
TRIGger<m>:TBTO:CRC:MAX.....	2294
TRIGger<m>:TBTO:CRC:MIN.....	2294
TRIGger<m>:TBTO:DADdress:CONdition.....	2294
TRIGger<m>:TBTO:DADdress:MAX.....	2295
TRIGger<m>:TBTO:DADdress:MIN.....	2295
TRIGger<m>:TBTO:DATA:DCONdition.....	2295
TRIGger<m>:TBTO:DATA:DMAX.....	2296
TRIGger<m>:TBTO:DATA:DMIN.....	2296
TRIGger<m>:TBTO:DATA:ICONdition.....	2296
TRIGger<m>:TBTO:DATA:IMAX.....	2297
TRIGger<m>:TBTO:DATA:IMIN.....	2297
TRIGger<m>:TBTO:ERRor:CRC.....	2297
TRIGger<m>:TBTO:ERRor:FEC.....	2298
TRIGger<m>:TBTO:ERRor:OOR.....	2298
TRIGger<m>:TBTO:ERRor:ZERO.....	2298
TRIGger<m>:TBTO:LENGth:CONdition.....	2298
TRIGger<m>:TBTO:LENGth:MAX.....	2299
TRIGger<m>:TBTO:LENGth:MIN.....	2299
TRIGger<m>:TBTO:SADdress:CONdition.....	2300
TRIGger<m>:TBTO:SADdress:MAX.....	2300
TRIGger<m>:TBTO:SADdress:MIN.....	2300
TRIGger<m>:TBTO:TRGLevel.....	2293
TRIGger<m>:TBTO:TYPE.....	2293
TRIGger<m>:TImeout:RANge.....	1497
TRIGger<m>:TImeout:TIME.....	1497
TRIGger<m>:TV:CUSTom:LDURation.....	1513
TRIGger<m>:TV:CUSTom:SCANmode.....	1513
TRIGger<m>:TV:CUSTom:SDURation.....	1514

TRIGger<m>:TV:CUSTom:STYPe.....	1513
TRIGger<m>:TV:LField.....	1512
TRIGger<m>:TV:LINE.....	1511
TRIGger<m>:TV:MODE.....	1510
TRIGger<m>:TV:POLarity.....	1511
TRIGger<m>:TV:STANdard.....	1510
TRIGger<m>:TYPE.....	1486
TRIGger<m>:UART:DATA.....	1881
TRIGger<m>:UART:DPOPerator.....	1880
TRIGger<m>:UART:DPOStion.....	1880
TRIGger<m>:UART:DPTO.....	1881
TRIGger<m>:UART:FCONdition.....	1881
TRIGger<m>:UART:SOURce.....	1880
TRIGger<m>:UART:TYPE.....	1880
TRIGger<m>:USB:ACONdition.....	2321
TRIGger<m>:USB:AMAX.....	2322
TRIGger<m>:USB:AMIN.....	2322
TRIGger<m>:USB:DATA.....	2322
TRIGger<m>:USB:DCONdition.....	2322
TRIGger<m>:USB:DPOPerator.....	2323
TRIGger<m>:USB:DPOStion.....	2323
TRIGger<m>:USB:ECONdition.....	2323
TRIGger<m>:USB:EMAX.....	2324
TRIGger<m>:USB:EMIN.....	2324
TRIGger<m>:USB:ERRC.....	2324
TRIGger<m>:USB:FCONdition.....	2325
TRIGger<m>:USB:FMAX.....	2325
TRIGger<m>:USB:FMIN.....	2325
TRIGger<m>:USB:HAND.....	2326
TRIGger<m>:USB:PATT.....	2326
TRIGger<m>:USB:PCONdition.....	2326
TRIGger<m>:USB:PMAX.....	2327
TRIGger<m>:USB:PMIN.....	2327
TRIGger<m>:USB:SCONdition.....	2327
TRIGger<m>:USB:SMAX.....	2328
TRIGger<m>:USB:SMIN.....	2327
TRIGger<m>:USB:SPEC.....	2328
TRIGger<m>:USB:STCO.....	2328
TRIGger<m>:USB:TCONdition.....	2329
TRIGger<m>:USB:TMAX.....	2329
TRIGger<m>:USB:TMIN.....	2329
TRIGger<m>:USB:TOKen.....	2329
TRIGger<m>:USB:TYPE.....	2320
TRIGger<m>:USB:WADD.....	2330
TRIGger<m>:USB:WEND.....	2330
TRIGger<m>:USB:WETCheck.....	2330
TRIGger<m>:USB:WFRN.....	2330
TRIGger<m>:USB:WPAY.....	2331
TRIGger<m>:USB:WPID.....	2331
TRIGger<m>:USB:WPOR.....	2331

TRIGger<m>:USB:WSEU.....	2331
TRIGger<m>:USB:WSTC.....	2331
TRIGger<m>:USBPd:BIT.....	2396
TRIGger<m>:USBPd:DMAX.....	2396
TRIGger<m>:USBPd:DMIN.....	2397
TRIGger<m>:USBPd:DOPerator.....	2397
TRIGger<m>:USBPd:ERENable.....	2394
TRIGger<m>:USBPd:ERRor<n>:ENABle.....	2394
TRIGger<m>:USBPd:FIENable.....	2395
TRIGger<m>:USBPd:FRAMe<n>:ENABle.....	2395
TRIGger<m>:USBPd:FRAMe<n>:FLD<o>:BIT.....	2396
TRIGger<m>:USBPd:FRAMe<n>:FLD<o>:DMAX.....	2396
TRIGger<m>:USBPd:FRAMe<n>:FLD<o>:DMIN.....	2397
TRIGger<m>:USBPd:FRAMe<n>:FLD<o>:DOPerator.....	2397
TRIGger<m>:USBPd:FRAMe<n>:FLD<o>:ENABle.....	2395
TRIGger<m>:USBPd:FRAMe<n>:FLD<o>:IMAX.....	2397
TRIGger<m>:USBPd:FRAMe<n>:FLD<o>:IMIN.....	2398
TRIGger<m>:USBPd:FRAMe<n>:FLD<o>:IOPerator.....	2398
TRIGger<m>:USBPd:FRENable.....	2395
TRIGger<m>:USBPd:IMAX.....	2397
TRIGger<m>:USBPd:IMIN.....	2398
TRIGger<m>:USBPd:IOPerator.....	2398
TRIGger<m>:USBThree:BIT.....	2373
TRIGger<m>:USBThree:DMAX.....	2373
TRIGger<m>:USBThree:DMIN.....	2372
TRIGger<m>:USBThree:DOPerator.....	2372
TRIGger<m>:USBThree:ERENable.....	2370
TRIGger<m>:USBThree:ERRor<n>:ENABle.....	2370
TRIGger<m>:USBThree:FIENable.....	2371
TRIGger<m>:USBThree:FRAMe<n>:ENABle.....	2371
TRIGger<m>:USBThree:FRAMe<n>:FLD<o>:BIT.....	2373
TRIGger<m>:USBThree:FRAMe<n>:FLD<o>:DMAX.....	2373
TRIGger<m>:USBThree:FRAMe<n>:FLD<o>:DMIN.....	2372
TRIGger<m>:USBThree:FRAMe<n>:FLD<o>:DOPerator.....	2372
TRIGger<m>:USBThree:FRAMe<n>:FLD<o>:ENABle.....	2371
TRIGger<m>:USBThree:FRAMe<n>:FLD<o>:IMAX.....	2374
TRIGger<m>:USBThree:FRAMe<n>:FLD<o>:IMIN.....	2374
TRIGger<m>:USBThree:FRAMe<n>:FLD<o>:IOPerator.....	2374
TRIGger<m>:USBThree:FRENable.....	2371
TRIGger<m>:USBThree:IMAX.....	2374
TRIGger<m>:USBThree:IMIN.....	2374
TRIGger<m>:USBThree:IOPerator.....	2374
TRIGger<m>:WIDTh:DELTA.....	1491
TRIGger<m>:WIDTh:POLarity.....	1490
TRIGger<m>:WIDTh:RANGe.....	1490
TRIGger<m>:WIDTh:WIDTh.....	1491
TRIGger<m>:WINDow:DELTA.....	1496
TRIGger<m>:WINDow:RANGe.....	1495
TRIGger<m>:WINDow:TIME.....	1495
TRIGger<m>:WINDow:WIDTh.....	1496

TRIGger<m>:ZONE:EXPRession[:DEFine].....	1531
USRDefined:RST:NAME.....	1410
USRDefined:RST:OPEN.....	1410
USRDefined:RST:SAVE.....	1410
USRDefined:RST[:ENABle].....	1411
WAVeform<m>:XYCurve:RATIo.....	1568
WAVeform<m>:XYCurve:STATe.....	1568
WAVeform<m>:XYCurve:SWAP.....	1569
WAVeform<m>:XYCurve:XSource.....	1569
WAVeform<m>:XYCurve:YSource.....	1570
WGENerator<m>:ACOPy.....	2631
WGENerator<m>:ARBGen:COPI.....	2642
WGENerator<m>:ARBGen:MULTichannel:IMPorT.....	2642
WGENerator<m>:ARBGen:MULTichannel:NAME.....	2643
WGENerator<m>:ARBGen:MULTichannel:OPEN.....	2643
WGENerator<m>:ARBGen:NAME.....	2643
WGENerator<m>:ARBGen:OPEN.....	2644
WGENerator<m>:ARBGen:RUNMode.....	2644
WGENerator<m>:ARBGen:RUNSingle.....	2645
WGENerator<m>:ARBGen:SAMPles?.....	2644
WGENerator<m>:ARBGen:SELect.....	2644
WGENerator<m>:ARBGen:SRATe.....	2645
WGENerator<m>:ARBGen[:SOURce].....	2645
WGENerator<m>:COUPling:AMPLitude.....	2652
WGENerator<m>:COUPling:AWForm.....	2653
WGENerator<m>:COUPling:NOISe.....	2653
WGENerator<m>:COUPling:PHASeshift.....	2653
WGENerator<m>:COUPling:STATe.....	2652
WGENerator<m>:COUPling[:FREQuency].....	2653
WGENerator<m>:FREQuency.....	2633
WGENerator<m>:FUNCTion:PULSe[:WIDTh].....	2633
WGENerator<m>:FUNCTion:RAMP[:SYMMetry].....	2633
WGENerator<m>:FUNCTion:SQUare:DCYClE.....	2634
WGENerator<m>:FUNCTion[:SELect].....	2632
WGENerator<m>:MODulation:AM:DCYClE.....	2635
WGENerator<m>:MODulation:AM:DEPTH.....	2635
WGENerator<m>:MODulation:AM:FREQuency.....	2635
WGENerator<m>:MODulation:AM:SYMMetry.....	2636
WGENerator<m>:MODulation:AM[:FUNCTion].....	2637
WGENerator<m>:MODulation:CARRier:FREQuency.....	2636
WGENerator<m>:MODulation:CARRier:PERiod.....	2636
WGENerator<m>:MODulation:FM:DCYClE.....	2637
WGENerator<m>:MODulation:FM:DEViation.....	2637
WGENerator<m>:MODulation:FM:FREQuency.....	2637
WGENerator<m>:MODulation:FM:SYMMetry.....	2638
WGENerator<m>:MODulation:FM[:FUNCTion].....	2638
WGENerator<m>:MODulation:FSK:FONE.....	2638
WGENerator<m>:MODulation:FSK:FTWO.....	2639
WGENerator<m>:MODulation:FSK[:RATE].....	2639
WGENerator<m>:MODulation:NDCLevel.....	2650

WGENerator<m>:MODulation:NLABsolute?.....	2650
WGENerator<m>:MODulation:NLPCent.....	2650
WGENerator<m>:MODulation:NOISe.....	2651
WGENerator<m>:MODulation:PWM:DCYCLE.....	2639
WGENerator<m>:MODulation:PWM:DEPTH.....	2639
WGENerator<m>:MODulation:PWM:FREQuency.....	2640
WGENerator<m>:MODulation:PWM:SYMMetry.....	2640
WGENerator<m>:MODulation:PWM[:FUNcTION].....	2640
WGENerator<m>:MODulation:TYPE.....	2635
WGENerator<m>:OUTPut[:LOAD].....	2647
WGENerator<m>:PERiod.....	2633
WGENerator<m>:PRESet.....	2632
WGENerator<m>:SOURce.....	2632
WGENerator<m>:SWEep:FSTart.....	2641
WGENerator<m>:SWEep:TIME.....	2641
WGENerator<m>:SWEep[:FEND].....	2641
WGENerator<m>:VOLTag:e:DCLevel.....	2648
WGENerator<m>:VOLTag:e:HIGH.....	2648
WGENerator<m>:VOLTag:e:INVersion.....	2649
WGENerator<m>:VOLTag:e:LOW.....	2649
WGENerator<m>:VOLTag:e:OFFSet.....	2649
WGENerator<m>:VOLTag:e[:VPP].....	2648
WGENerator<m>[:ENABle].....	2631
ZVC:BANdwidth.....	1461
ZVC:RESCOupled.....	1463
ZVC:TYPE.....	1461
ZVC:Z<m>:I<n>:BANdwidth?.....	1461
ZVC:Z<m>:I<n>:DATA:HEADer?.....	1473
ZVC:Z<m>:I<n>:DATA[:VALues]?.....	1473
ZVC:Z<m>:I<n>:IMPedance.....	1462
ZVC:Z<m>:I<n>:OFFSet.....	1462
ZVC:Z<m>:I<n>:OVERload:RSTO.....	1463
ZVC:Z<m>:I<n>:OVERload:VALue?.....	1464
ZVC:Z<m>:I<n>:POSition.....	1464
ZVC:Z<m>:I<n>:SCALE.....	1464
ZVC:Z<m>:I<n>:SHUNt:EVALue.....	1465
ZVC:Z<m>:I<n>:SHUNt:MAXCurrent.....	1465
ZVC:Z<m>:I<n>:SHUNt:MAXVoltage.....	1466
ZVC:Z<m>:I<n>:SHUNt:MODE.....	1465
ZVC:Z<m>:I<n>:SHUNt:MXCValue?.....	1466
ZVC:Z<m>:I<n>:SKEW.....	1467
ZVC:Z<m>:I<n>:ZERComp:DETECT.....	1471
ZVC:Z<m>:I<n>:ZERComp:STATe?.....	1472
ZVC:Z<m>:I<n>:ZERComp:USE.....	1471
ZVC:Z<m>:I<n>[:STATe].....	1467
ZVC:Z<m>:ID:NAME?.....	1470
ZVC:Z<m>:ID:PARTNumber?.....	1470
ZVC:Z<m>:ID:SRNumber?.....	1471
ZVC:Z<m>:ID:SWVersion?.....	1471
ZVC:Z<m>:V<n>:BANdwidth?.....	1467

ZVC:Z<m>:V<n>:DATA:HEADer?.....	1473
ZVC:Z<m>:V<n>:DATA[VALues]?.....	1473
ZVC:Z<m>:V<n>:IMPedance.....	1468
ZVC:Z<m>:V<n>:OFFSet.....	1468
ZVC:Z<m>:V<n>:OVERload:RSTO.....	1468
ZVC:Z<m>:V<n>:OVERload:VALue?.....	1469
ZVC:Z<m>:V<n>:POSition.....	1469
ZVC:Z<m>:V<n>:SCALe.....	1469
ZVC:Z<m>:V<n>:SKEW.....	1470
ZVC:Z<m>:V<n>[:STATe].....	1470

Index

Symbols

8b/10b	
Trigger settings	954
Triggering	957
100BASE-T1	
Configuration settings	804
Configuring	808
Trigger settings	809
Triggering	814
1000BASE-T1	
Configuration settings	822
Configuring	825
Trigger settings	825
Triggering	831

A

Acquisition	
Decimation	129
Modes	113
Single, multiple	37
Start and stop	36
Time	114
Acquisition modes	113
Acquisition time	114
Actions	
Mask test	411
Active probe	
Differential	118
Micro button	148
Offset compensation	164
Overview	117
ProbeMeter	149
Setup	152
Active waveform	50
Adapter for Tektronix probes	173
ADC overflow	1336
ADC sample rate	111
ADC samples	111
Aligning	
Input channels	102
Alignment	101
Amplitude measurement	317
Amplitude/time measurements	
Settings	321
Analog	
Parallel bus display	1005
Annotate	58
App Cockpit key	42
Appearance	
Color tables	76
Application, external	107
Area level	
Amplitude/time measurements	322
Area measurements	320
Arithmetic	130
Arranging waveforms	51
Audio	
Configuring	563
Track	569
Trend	572
Trigger settings	564

Auto clear	
Search results	445
Auto Norm	
Key (trigger)	36
Auto trigger mode	36
Auto-logout	1310
Auto, trigger mode	224
Autocorrelation	270
Automatic measurements	
Configuration settings	308
Display settings	312
Gate settings	314
Autonaming	104
Autoset	
for protocols	513
Key	41
AutoZero	146
Average	130
FFT	389
Mathematics	281
Average count	127, 131, 282
Average count (N-single count)	127, 131, 282

B

Bandwidth	141
Instrument	111
Probe	111
Spectrum measurement	341
Bench top operation	25
Biased correlation	270
Big endian	
CAN	618
LIN	641
Bit pattern editor	519
Bit string	
serial pattern, MSO	1023
Blackman Harris window (FFT)	387
Brochure	21
Bug report	1342
Burst width	318
Bus key	39

C

C<n> keys	38
Camera key	41
CAN	
Configuration settings	607
Data length	618
Data pattern	618
Endianness	618
Frame types	617
ID type	617
Identifier	618
Transfer order	618
Trigger settings	614
Trigger types	615
Center frequency	
Spectrum measurement	343
Channel	
Bandwidth measurement	343
C<n> keys	38

- Center frequency 343
 - Connector 31
 - Offset 139
 - Waveforms 49
 - Channel power
 - Spectrum measurement 341
 - Clear status
 - Remote 1375
 - Clipping 1336
 - Clock
 - Parallel bus 1005
 - Clock period
 - SENT configuration 668
 - Clock tolerance
 - SENT configuration 668
 - Color tables 76
 - Comb
 - Parallel bus display 1005
 - Command sequence
 - Remote 1379
 - Commands
 - Finding a command 1344
 - Compensation, passive probes 189
 - Computer name
 - Changing 1316
 - Configuration
 - hardware 103
 - SENT 667
 - Connectors
 - Probe compensation 32
 - Rear panel 32
 - USB 32
 - Coupled zoom 252
 - quick access 57, 245
 - Coupling 109
 - Channel 140
 - Trigger 241
 - Waveform generator settings 1054
 - CRC calculation
 - SENT configuration 669
 - CRC version
 - SENT configuration 669
 - Cross-correlation 270
 - CSV
 - Waveform export 464
 - CSV export 107
 - Cursor
 - Saving data 481
 - Settings for data export 466
 - Used for gating 314
 - Cursor key 41
 - Cursor measurements
 - Disabling 295
 - Enable 297
 - Envelope waveform 300
 - How to 294
 - Peak excursion 304, 344
 - Peak search 302
 - Results 293
 - Settings 297
 - Cursors 57
 - Configuring display 297
 - Configuring measurement 295
 - Coupling 301
 - Display 301
 - Position 299
 - Start measurement 295
 - Track waveform 295, 300
 - Type 299
 - Custom:
 - Filter settings 600
 - Custom: Manchester / NRZ
 - Configuration settings 576
 - Configuring 594
 - Decoding 603
 - Trigger settings 595
 - Triggering 600
 - Customer support 1341
 - CXPI
 - Configuration settings 695
 - Configuring 698
 - Trigger settings 699
 - Triggering 706
 - Cycle area measurement 320
 - Cycle measurements 317
- ## D
- D-PHY
 - Basics 902
 - Configuration settings 902
 - Configuring 906
 - Triggering 912
 - Data
 - SENT configuration 668
 - Data entry 62
 - Data length
 - LIN 641
 - Data Length Code
 - CAN 618
 - Data nibbles
 - SENT configuration 668, 691
 - Data pattern
 - CAN 618
 - LIN 641
 - Data security 1342
 - Data sheet 21
 - DDR
 - Configuration settings 991
 - Configuring 994
 - Decode results 998
 - Decimation 113, 129
 - Decode
 - Custom protocol, decode layer 593
 - CXPI, decode layer 698
 - D-PHY, decode layer 905
 - DDR, decode layer 993
 - Ethernet, decode layer 757, 807, 823
 - M-PHY, decode layer 922
 - MDIO, decode layer 773
 - SENT 687
 - SpaceWire, decode layer 746
 - USBPD, decode layer 892
 - Decode layer
 - Custom protocol 593
 - CXPI 698
 - D-PHY 905
 - DDR 993
 - Ethernet 757, 807, 823
 - M-PHY 922
 - MDIO 773
 - SpaceWire 746
 - USBPD 892

Decode table	
MSO	1011
Decoded bus	
Parallel bus display	1005
Default	
File names	106
Path for saving	106
Default values	
Remote	1378
Delay	318
Delay measurement	323
Delete	59
Demo	57
Device footprint	1342
DHCP	1315
DHCP server	
LAN configuration	1316
Diagrams	44
Dialog boxes	
Usage	61
Dialogs	47
Differential probe	118
Digital channels	1001
Configuration settings	1001
Configuring	1009
Decode table	1011
Export	1026
Search	1027
Triggering	1025
Digital filter	143
Digital resolution	1007
Digital signals	1001
Digital waveforms	49
Display	
Intensity	92
Overview	43
XY-diagram	289, 291
Zoom	245
Display elements	47
Diagram	43
Signal bar	43
DisplayPort	29, 34
DNS server	
LAN configuration	1316
Duty cycle	
Eye	334
Duty cycle measurement	318

E

Edge	
Search conditions	429
Trigger	200
Edge count	321
Edge trigger	
MSO	1014
Electric power (math. function)	271
Enable registers	
Remote	1377
Endianness	
CAN	618
LIN	641
Envelope	130
FFT	389
Mathematics	281
Measurements	309

Envelope waveform	
Cursor measurement	300
Error report	1342
ESR	1332
Ethernet	
Configuration settings	755
Configuring	759
Trigger settings	760
Triggering	764
Event actions	
Mask test	411
Event status enable register (ESE)	
Remote	1375
Event status register (ESR)	
Remote	1376
Export	
Data	466
Digital channels	1026
History	481
Include horizontal values	470
Integer format	469
Parallel buses	1026
Raw values	469
Waveform histograms	473
XML, CSV, BIN	459
Expressions	266
External application	107
External monitor	29, 34
External trigger input	34, 240
External trigger out	229
External trigger output	34
Extinction ratio	
Eye	334
Eye	
Amplitude	334
Base	334
Bit rate	334
Fall time	334
Height	334
Jitter	334
Measurement results	334
Rise time	334
Top	334
Width	334
Eye measurements	
Characteristics	332
Results	334
Settings	335

F

Fail condition, mask test	411
Fail criteria, mask test	400
Fall time	318
FFT	58, 376
Configuring	380
Fundamentals	376
Gating	389
Key	39
measurement speed	379
MSO	1027
Peak excursion	304, 344
Performance considerations	381
Search	425
Setup	384, 388
Window types	387

File formats
 Waveform export 459

File import
 Restrictions 459

File names
 Default 104, 106

Filter
 Custom 600

Find
 Remote control command 65

Find trigger level 57

FIR (math. function) 271

FIR filter 274

Firmware
 shutdown (remote) 1384

Flattop2 window (FFT) 387

FlexRay
 Configuration settings 646
 Trigger settings 651
 Triggering 656

Formula editor
 Reference 266
 Using 273

Formulas
 Advanced expressions 266
 Operator editor 264

Frame length
 SENT configuration 669

Frame types
 CAN 617

Frontend
 information 103

Frontpanel
 information 103

Function generator option 35

G

Gain, vertical 109

Gate
 Coupled to cursor 314
 Coupled to zoom 314
 Saving data 481
 Search 441
 Search, defining 443
 Settings 314
 Settings for data export 466

Gate area
 Configuring 313
 Coupling to zoom 315, 391, 443

Gating
 FFT 389

Gaussian window (FFT) 387

GBIP connector 35

Gen key 39

Getting started 19

Glitch
 Search conditions 430
 Trigger 201

GPIO
 Address 1328
 Remote control interface 1327

GPIO bus control
 Remote 1377

Grid 45

Grounding 27

H

Hamming window (FFT) 387

Hann window (FFT) 387

Hardware
 information 103

Hardware check 103

Hardware zoom 57, 245

HD key 41

HDMI 34

HDMI connector 34

Header files 459

Help 19, 56
 Open 65
 Search for topic 66
 Using 66

High definition 133

High res 129

High signal level measurement 317

Histogram
 Saving 458

Histogram measurements
 Settings 352

Histograms 58, 346
 Area 47
 averaging 501
 Characteristics 346
 Configuring 350
 Diagram 47
 Exporting waveform histograms 473
 Horizontal 346
 Jitter measurement 349
 Markers 353
 Measurement histograms 365
 Measurement results 346
 Saving waveform histograms 473
 Setup 351
 Toolbar icons 350
 Tubes 504
 Vertical 346

History
 Export 466, 481
 MSO 1010
 time stamp 287

History key 41

Hold time 324

Holdoff 225
 TV trigger 219
 Using 196

Horizontal
 Controls 37
 Label 46
 Position 37

Horizontal position 115

Hysteresis
 Reference level 497
 Trigger 226

I

I²C
 Basics 520
 Configuration settings 522
 Configuring 525, 650
 Decode results 531
 Trigger settings 525
 Triggering 530, 568

- Icons
 - Measurement status 311
- ID type
 - CAN 617
- Identification
 - Remote 1376
- Identifier
 - CAN 618
 - LIN 640
- Import waveforms
 - Restrictions 459
- Infinite persistence 91, 1155
- Input 31
- Instrument settings
 - Loading 451
 - Recall 1377
 - Save 1378
 - Saving 456
- Intensity 92
- Intensity key 40
- Intensity of display elements 40
- Interfaces
 - GPIB 1328
 - LAN 1327
- Interlaced scanning 223
- Interleaved sample rate 112
- Interleaved X/Y 470
- Interpolation 127
- Interval
 - Search conditions 434
 - Trigger 208
- IP address 1327
 - Changing 1315
 - Remote Desktop 1325
- IST 1332
- IST flag
 - Remote 1376
- J**
 - Jitter
 - Measurement via histogram 349
 - Jitter measurements
 - Settings 1086
- K**
 - Kaiser Bessel window (FFT) 387
 - Keep X-grid fixed 79
 - Keep Y-grid fixed 79
 - Keyboard
 - On-screen 62
 - Keyboard, connecting 29
 - Keypad 62
- L**
 - Label list
 - SENT 677
 - Labels
 - Waveform 83
 - LAN 1319
 - Configuration 1314, 1319
 - Connector 34
 - Environment 1314
 - Interface 1327
 - IP address 1327
 - LAN configuration 1320
 - Ping 1322
 - Remote control interface 1327
 - Resource string 1327
 - Level knob 36
 - Level measurements 317
 - Limit checks
 - Actions 372
 - Configuring 370
 - Enable 371
 - Performing 370
 - Violation settings 372
 - Limits
 - Range 371
 - LIN
 - Configuration settings 634
 - Configuring 638
 - Data length 641
 - Data pattern 641
 - Endianness 641
 - Identifier 640
 - Transfer order 641
 - Trigger settings 638
 - Trigger types 639
 - Triggering 642
 - Little endian
 - CAN 618
 - LIN 641
 - Load instrument settings 1377
 - Loading
 - User settings 451
 - Lock touchscreen 41
 - Logic analyzer 1000
 - Logic key 39
 - Logic probe connector 35
 - Logical operations on channels 215, 231
 - Logical thresholds
 - MSO, configuring 1010
 - MSO, settings 1002
 - Login 1310
 - Long-term measurements
 - Basics 363
 - Configuring 364
 - Horizontal scale 368
 - Number of points 368
 - Period of time per point 368
 - Saving 476
 - Scale mode 368
 - Settings 365
 - Low signal level measurement 317
- M**
 - M-PHY
 - Basics 919
 - Configuration settings 920
 - Configuring 922
 - Decode results 938
 - Trigger settings 923
 - Mainboard
 - information 103
 - Margins
 - Range 371
 - Marker limit
 - Histograms 353
 - Markers
 - Histograms 346, 353

- Mask definition
 - Settings 404
 - Type 403
- Mask setup 404
- Mask test 58, 400
 - Appearance settings 414
 - Display settings 413, 414
 - Display, configuring 422
 - Event actions, configuring 422
 - Event actions, settings 411
 - Fail condition 411
 - Fail criteria 400
 - Fail criteria, configuring 422
 - History, testing 424
 - Performing 423
 - Results 400
 - Setting up 422
 - Starting 423
 - State, mask test result 423
 - Test settings 402
 - Violation tolerance 411
- Mask test results
 - Acq. completed 401
 - Acq. remaining 401
 - Acquisition hits 401
 - Fail rate 401
 - Sample hits 401
 - State 401
 - Test result 402
- Mask testing 400
- Masks
 - Creating user mask 417
 - Definition 400, 404
 - Load settings 403
 - Loading 423
 - modifying user mask 419
 - Save settings 403
 - Saving 423
 - Segments, point settings 406
 - Segments, settings 405
 - User mask definition 404
 - Waveform mask definition 407
- Math key 39
- Math waveforms 39, 49
 - Arithmetic 281
 - Displaying 261
 - FFT 376
 - FFT Gating 389
 - FFT setup 384, 388
 - Formula editor 266
 - Operator editor 264
 - Operators 264, 266
 - Saving 261
 - Scale 280
 - Setup 262
- Max value measurement 317
- Maximum sample rate 112
- MDIO
 - Configuration settings 771
 - Configuring 774
 - Trigger settings 775
 - Triggering 778
- MDIO protocol
 - Basics 770
- Mean measurement 317
- Measure key 41, 306
- Measurement 58
 - Measurement histograms 365
 - Measurement types
 - Area 320
 - Arithmetic 321
 - Counting 321
 - Eye 334
 - Histograms 346
 - Protocol 356
 - Spectrum 341
 - Time 318
 - Measurements
 - Amplitude/time 316
 - Configuring 306
 - Delay 323
 - Icons in results table 311
 - Pulse train count 326
 - Results 310
 - Setup/Hold 324
 - Source for analysis 365
 - Starting 306
 - Statistics 362
 - Median
 - Histograms 346
 - Memory 283
 - Menu 47
 - Micro button 118, 148
 - Min value measurement 317
 - Mixed signal option 1000
 - Mixed Signal Option 35
 - Monitor 29, 34, 93
 - Mouse, connecting 29
 - MSO 35, 1000
 - FFT 1027
 - History 1010
 - Resolution 1007
 - Time qualification 1021
 - Trigger settings 1013
 - Zoom 1010
 - Multi channel export
 - Enable 467
 - Remote control 1432, 1766
 - Results in header file 462
 - Multiple measurements 368
- N**
 - N dB down
 - Spectrum 343
 - Network
 - Environment 1314
 - Noise
 - Eye 334
 - Hysteresis settings 226
 - Normal trigger mode 36
 - Normal, trigger mode 224
 - Notification 46
 - Numeric data entry 62
- O**
 - Occupied bandwidth
 - Spectrum measurement 341, 344
 - OCXO 124
 - Offset 39
 - Active probe 164
 - Channel 139
 - On/Off key 35

- One File 452
 - Open source acknowledgment 21
 - Operating system 1309
 - Access 1313
 - service packs 1311
 - Settings 1313
 - Operation
 - Concepts 42
 - Manual 42
 - Operation complete
 - Remote 1376
 - Operator
 - Type 264
 - Operators
 - Formula editor mathematics 266
 - Optical
 - Average power 354
 - Modulation amplitude 354
 - Options
 - Identification (remote) 1376
 - K510, I²S, Audio 556
 - K520, FlexRay 646
 - R&S RTO6-B1 (MSO) 35
 - R&S RTO6-B1E (for R&S RT-ZVC) 35
 - R&S RTO6-B6 (waveform and function generator) ... 35
 - R&S RTO6-B10 (GBIP) 35
 - Output buffer 1332
 - Overshoot measurement 317
- P**
- Parallel buses 1001
 - Clock setup 1005
 - Configuration settings 1001
 - Configuring 1009
 - Decode table 1011
 - Export 1026
 - Triggering 1025
 - Parallel poll register enable
 - Remote 1377
 - Passive probe
 - Overview 117
 - Settings 150
 - Password 1310
 - Remote Desktop 1325
 - Pattern
 - Qualification, state trigger 215, 231
 - Pattern generator
 - Setup 1048
 - Pattern search condition 214
 - Pattern trigger 214
 - MSO 1021
 - Pause pulse
 - SENT configuration 669
 - PCIe
 - Trigger settings 969
 - PCIe Gen 1/2
 - Search settings 980
 - Searching 990
 - Triggering 978
 - Peak detect 129
 - Peak excursion
 - Cursor measurement 304, 344
 - Search 304, 344
 - Spectrum measurement 304, 344
 - Peak search
 - Cursor measurement 294, 295
 - Spectrum measurement 294, 302
 - Peak to peak measurement 317
 - Performance 94
 - Considerations for FFT 381
 - FFT parameters 379
 - Performance test 125
 - Ping 1322
 - Position 39
 - Horizontal 37, 115
 - Vertical 39, 109
 - Position mode 82
 - Power
 - Connector 33
 - Key 35
 - On/Off 27
 - PPE 1332
 - Preset 98
 - Preset key 41
 - Printing
 - Settings 484
 - Probability markers
 - Histograms 353
 - ProbeMeter 118
 - Measurement 317
 - Setting 149
 - Probes
 - Active 117
 - AutoZero 146
 - Compensation 32
 - Differential 118
 - Passive 117
 - Passive, compensation 189
 - Setup 145
 - Tektronix 173
 - Progressive scanning 223
 - Projector 29
 - Protocol
 - SENT 663
 - Protocols
 - 8b/10b trigger settings 954
 - 100BASE-T1 configuration settings 804
 - 100BASE-T1 trigger settings 809
 - 1000BASE-T1 configuration settings 822
 - 1000BASE-T1 trigger settings 825
 - Audio trigger settings 564
 - CAN configuration settings 607
 - Custom: filter settings 600
 - Custom: Manchester / NRZ configuration settings ... 576
 - Custom: Manchester / NRZ trigger settings 595
 - CXPI configuration settings 695
 - CXPI trigger settings 699
 - D-PHY configuration settings 902
 - Data format 513
 - DDR configuration settings 991
 - DDR decode results 998
 - Display settings 513
 - Ethernet configuration settings 755
 - Ethernet trigger settings 760
 - FlexRay configuration settings 646
 - FlexRay trigger settings 651
 - I²C configuration settings 522
 - I²C decode results 531
 - I²C trigger settings 525
 - LIN configuration settings 634
 - LIN trigger settings 638

- M-PHY configuration settings 920
 - M-PHY decode results 938
 - M-PHY trigger settings 923
 - MDIO configuration settings 771
 - MDIO trigger settings 775
 - PCIe Gen 1/2 search settings 980
 - PCIe trigger settings 969
 - SENT 662
 - SENT configuration 667
 - SENT decode results 687
 - SENT label list 677
 - SENT protocol 663
 - SENT search 688
 - SENT trigger 671
 - SpaceWire configuration settings 743
 - SPI configuration settings 536
 - SPI decode results 543
 - SPI trigger settings 541
 - UART decode results 554
 - USB 2.0 configuration settings 845
 - USB 2.0 trigger settings 851
 - USB 3.1 configuration settings 876
 - USB 3.1 trigger settings 880
 - USBPD configuration settings 890
 - USBPD trigger settings 893
 - Pulse count 321
 - Pulse train count 326
- Q**
- Q-factor
 - Eye 334
 - Quick measurements 58
- R**
- R&S RT-ZVC
 - multi-channel power probe 175
 - R&S RT-Z2T 173
 - Rack mounting 26
 - Recall instrument settings 1377
 - Recall intermediate 1377
 - Record length 111, 114
 - Rectangular window (FFT) 387
 - Redo 56
 - Ref key 38
 - Reference levels
 - Basics 495
 - Configuring 496
 - Defining automatically 496
 - Defining manually 497
 - displaying 313
 - Displaying 498
 - Hysteresis 497
 - Level settings 498, 501
 - Settings 498, 501
 - Tubes 497
 - Reference point 37, 46, 115
 - Reference signal
 - 1 GHz, internal 125
 - External 124
 - OCXO 124
 - Reference waveforms 38, 49
 - Displaying 253
 - Loading 253
 - Saving 253
 - Registers 1332
 - Release notes 21
 - Remote commands
 - Finding a command 1344
 - Remote control 42
 - Find command using help 65
 - GPIO address 1328
 - Interfaces 1327
 - Protocols 1327
 - Starting 1330
 - Remote Desktop 42, 1324
 - Remote operation 42, 1322, 1324
 - Repetitive, trigger mode 224
 - Reset
 - Histogram, long-term meas., statistics 367
 - Reset values
 - Remote 1378
 - Resolution 109, 111, 114
 - 16 bit 133
 - Resolution enhancement 113
 - Resource string
 - LAN 1327
 - Restoring
 - Settings 99
 - Result boxes
 - Displaying 59
 - Result lines
 - Displaying 313
 - Result tables 47
 - Results
 - Clear 312
 - Configuring display 59
 - Lines in display 498
 - Mask test 400
 - Measurements 310
 - Reset long-term measurement 367
 - Saving 475
 - RFFE
 - Advanced 787
 - Trigger settings 788
 - Triggering 795
 - Rise time 318
 - RMS
 - Acquisition setting 129
 - RMS measurement 317
 - Roll mode 121
 - Start roll time 122
 - RS232 546
 - Basics 546
 - RTO6-B10 35
 - Run / Stop 56
 - Run Stop key 36
 - Runt
 - Search conditions 431
 - Trigger 203
- S**
- Safety instructions 20
 - Sample rate 111
 - Samples 111
 - History 283
 - Save instrument settings 1378
 - Save intermediate 1378
 - Save Reference 59
 - Save Waveform 59

- Save/Recall
 - Remote 1757
 - User preferences 454
 - User settings 451, 452
 - Waveforms 466
- Saveset 451, 456
- Saving
 - File name generation 104
 - History 466, 481
 - Instrument settings 451, 456
 - Long-term measurements 476
 - Preset 98
 - Results 475
 - Screenshots 487
 - User preferences 454
 - Waveform histograms 473
 - Waveform segments 466, 481
 - Waveforms 466, 481
- Scale
 - Horizontal, rotary knob 37
 - Math waveforms 280
 - Vertical 109, 139
 - Vertical, rotary knob 40
- Scaling
 - Horizontal 120
 - Long-term measurements 367
 - Long-term measurements, horizontal 368
 - Measurement histograms 367
- Scanning system (TV signals) 223
- SCPI
 - Finding a command 1344
- Screen resolution 29
- Screenshot
 - Saving 487
 - Web interface 1323
- Screenshots 484
 - Meta information 483
 - Print and save 483
- Search 57
 - Auto clear 445
 - Clearing results 445
 - Conditions 425
 - Control 425
 - Copy trigger settings 428
 - Definition 425
 - Edge 429
 - Enable 427
 - FFT 425
 - Gate 441
 - Glitch 430
 - Interval 434
 - On digital signals 1027
 - PCIe Gen 1/2 settings 980
 - Peak excursion 304, 344
 - Results 426
 - Runt 431
 - Scope 425
 - SENT 688
 - SENT error condition 692
 - SENT search criteria 689
 - SENT settings 688
 - SENT short serial message 691
 - SENT transmission sequence 690
 - Setup & Hold 436
 - Show results 445
 - Slew rate 435
 - Sorting results 445
 - Source 427
 - Timeout 433
 - Trigger level 429, 430, 431, 434, 435, 437
 - Trigger search 428
 - Width 430
 - Window 432
 - Zoom window, configuring 448
- Search conditions
 - Pattern 214
- Searching
 - In help 66
- Secured environment 1342
- Select
 - Waveform 51
- Selected waveform 50
- Self-alignment 101, 102, 1375
- Self-test
 - Remote 1379
- Selftest 103
- SENT
 - About 662
 - Configuration 667
 - Configuring 670
 - Decode results 687
 - Label list 677
 - Protocol 663
 - Search 688
 - Search criteria 689
 - Search error condition 692
 - Search settings 688
 - Search short serial message 691
 - Search transmission sequence 690
 - Trigger error condition 676
 - Trigger serial message setup 674
 - Trigger settings 671
 - Trigger transmission sequence 673
 - Trigger types 671
 - Triggering 677
- SENT configuration
 - Clock period 668
 - Clock tolerance 668
 - CRC calculation 669
 - CRC version 669
 - Data 668
 - Data nibbles 668, 691
 - Frame length 669
 - Pause pulse 669
 - Serial protocol 668
 - Threshold 668
- Sequence
 - Search 691
 - Trigger 674
- Serial message
 - Search sequence 691
 - Sequence 674, 691
 - Trigger sequence 674
- Serial pattern trigger
 - MSO 1023
- Serial Pattern trigger 217
- Serial protocol
 - SENT configuration 668
- Service manual 20
- Service packs 1311
- Service request enable register (SRE)
 - Remote 1378
- Settling time 318

Setup & Hold	
Search	436
Trigger	211
Trigger (MSO)	1018
Setup time	324
Setup/Hold measurement	324
Setup/Hold ratio	324
Show labels	82
Shutdown	
firmware (remote)	1384
Signal bar	46
Signal icons	46
Signal label	46
Signal levels	
Configuring	496
Signal preview	50
Signal threshold	
Amplitude/time measurements	322
Signal view	46
Signals	
Color settings	76
Single	56
Single key	37
Skew	123
Slew rate	
Trigger	209
Slew Rate	
Search conditions	435
Slope key	36
SmartGrid	51
Source key	36
SpaceWire	
Advanced	745
Basics	742
Configuration settings	743
Configuring	746
Spectrogram	59
Spectrum measurements	
Channel BW	343
Channel CF	343
Cursor measurement	294, 295
N dB down	343
Occupied bandwidth	344
Peak detection	295
Peak excursion	304, 344
Peak search	294
Results	341
Settings	342
SPI	
Configuration settings	536
Configuring	540
Decode results	543
Trigger settings	541
Triggering	543
SPI protocol	
Basics	535
SRE	1332
Standard	
TV trigger	220
Standard deviation	
Histograms	346
Standard deviation measurement	317
State trigger	213
MSO	1020
Statistics	
Enable	365
Measurement results	362
Status	
Measurements	311
Status byte	
Remote	1375, 1378
Status registers	
Overview	1331
STATus:OPERation	1332
Status reporting system	
Common commands	1374
Status reports	1331
STB	1332
Style (waveforms)	92
Switch off	
Waveform	51
Switch on	
Waveform	50
Switching of transitions	321
T	
Technical support	1342
Temperature	
Changes	102
Termination	109
Text entry	62
Threshold	
SENT configuration	668
Thresholds	
MSO, configuring	1010
MSO, settings	1002
Time base	37, 114
Time measurements	318
Time qualification	
MSO	1021
Time scale	37, 114, 120
Time stamp	287
Timebase	120
Timeout	
Search conditions	433
Trigger	207
Timeout trigger	
MSO	1017
Toolbar	53
Annotate	58
Coupled zoom	57, 245
Cursor	57
Delete	59
FFT	58
Find level	57
Hardware zoom	57, 245
Hide/show icons	54
Histogram	58
Histogram icons	350
Load saveset	56
Masks	58
Measure	58
Measurement	306
Overview	54
Quick measurement	58
Redo	56
Run / Stop	56
Save Reference	59
Save Waveform	59
Search	57
Show tooltips	56
Single	56
Undo	55

- Zone trigger 59
 - Zoom 57, 245
 - Tooltips 56
 - Show 65
 - Total harmonic distortion
 - Spectrum measurement 341
 - Touch Lock key 41
 - Touchscreen
 - Adjusting 97
 - Compared with mouse 42
 - Control elements 47
 - Lock, unlock 41
 - Usage 42
 - Track 569
 - Enable 365
 - Track waveform
 - Cursor measurement 295, 300
 - Transfer order
 - CAN 618
 - LIN 641
 - Transition switching count 321
 - Transition trigger
 - See Slew rate trigger 209
 - Transparency 40
 - Trend 572
 - Trigger
 - 8b/10b settings 954
 - 100BASE-T1 settings 809
 - 1000BASE-T1 settings 825
 - Audio settings 564
 - CAN settings 614
 - Controls 36
 - Custom: Manchester / NRZ settings 595
 - CXPI settings 699
 - Delay (Holdoff) 225
 - Edge 200
 - Edge (MSO) 1014
 - Ethernet settings 760
 - Event (definition) 194
 - Event (remote) 1378
 - External input 34, 240
 - External output 34
 - FlexRay settings 651
 - Force 225
 - Glitch 201
 - Holdoff 225
 - I²C settings 525
 - Information 195
 - Interval 208
 - Label 46
 - Level 36, 45
 - Level, search 429, 430, 431, 434, 435, 437
 - LIN settings 638
 - M-PHY settings 923
 - MDIO settings 775
 - Mode 36, 224
 - MSO settings 1013
 - Pattern 214
 - Pattern (MSO) 1021
 - PCIe settings 969
 - Position 45
 - Run 224
 - Runt 203
 - Search 428
 - SENT 671
 - SENT error condition 676
 - SENT serial message setup 674
 - SENT transmission sequence 673
 - SENT trigger type 671
 - Sequence (definition) 194
 - Serial Pattern 217
 - Serial pattern (MSO) 1023
 - Settings, copy to search 428
 - Setup & Hold 211
 - Setup & Hold (MSO) 1018
 - Slew rate 209
 - Slope 36
 - Source 36
 - Sources, MSO 1013
 - SPI settings 541
 - State 195, 213
 - State (MSO) 1020
 - Timeout 207
 - Timeout (MSO) 1017
 - TV (video) 219
 - USB 2.0 settings 851
 - USB 3.1 settings 880
 - USBPD settings 893
 - Width 202
 - Width (MSO) 1015
 - Window 205
 - Trigger level
 - Find 57
 - Trigger offset 115
 - Trigger out
 - Pulse on limit violation 373
 - Settings 229
 - Trigger sources
 - MSO 1013
 - Trigger types
 - CAN 615
 - Edge 200
 - Glitch 201
 - Interval 208
 - LIN 639
 - Pattern 214
 - Runt 203
 - Setup & Hold 211
 - Slew rate 209
 - Timeout 207
 - Width 202
 - Window 205
 - Trigger Types 199
 - NFC 223
 - Serial Pattern 217
 - State 213
 - TV/Video 219
 - Tubes
 - Configuring 504
 - Histograms 504
 - Reference level 497
 - TV trigger 219
 - Type
 - Trigger 199
- ## U
- UART 546
 - Basics 546
 - Configuring 551
 - Decode results 554
 - Triggering 554
 - Unbiased correlation 270
 - Undersampling 111

- Undo 55
- Unlock touchscreen 41
- USB
 - Configuring 850
 - Connecting devices 29
 - Connector 32
 - Device 34
 - Triggering 883
- USB 2.0
 - Configuration settings 845
 - Trigger settings 851
 - Triggering 858
- USB 3.1
 - Configuration settings 876
 - Configuring 879
 - Trigger settings 880
- USB 3.1 protocol
 - Basics 867
- USB protocol
 - Basics 840
- USBPD
 - Configuration settings 890
 - Configuring 893
 - Trigger settings 893
 - Triggering 896
- User ID
 - Remote Desktop 1325
- User manual 20
- User mask
 - Settings 404
- User name 1310
- User settings
 - Saving 451
- V**
- Vertical
 - Controls 38
 - Position 109
 - Resolution 109
 - Scale 109, 139
- Vertical system 109
- Video (TV) trigger 219
- Violation
 - Limit checks 372
- Violation of limits
 - Actions 372
- Violation tolerance, mask test 411
- Virus protection 1311
- VISA
 - Resource string 1327
- VNC 42, 1322
- W**
- Wait
 - Remote 1379
- Waveform
 - Arithmetic 113
 - Data query 1432
 - Loading 458
 - Saving 458
- Waveform arithmetic 130
- Waveform count
 - Histograms 346
- Waveform export
 - CSV 464
 - Data query 1432
 - Files and formats 459
 - Header files 459
 - Remote control 1766
 - Value files 464
 - XML 464
- Waveform generator
 - AM modulation 1038
 - Arbitrary 1043
 - Coupling 1054
 - DC offset alignment 1053
 - FM modulation 1040
 - FSK modulation 1042
 - Function generator 1031
 - Modulation 1036
 - Noise 1053
 - Output 1051, 1052
 - PWM modulation 1039
 - Settings 1029
 - Sweep 1042
- Waveform generator option 35
- Waveform mask
 - Settings 407
- Waveform samples 111
- Waveform Value files 464
- Waveforms 49
 - Arrange 51
 - Clipping 1336
 - Overview and usage 49
 - Preview 51
 - Saving 466, 481
 - Select 51
 - States 50
 - Style 92
 - Switch off 51
 - Switch on 50
 - Zooming 243
- Web browser 1319
- Web control 1322
- Web interface 42, 1319
 - Browser 1319
 - LAN configuration 1320
- Width
 - Search conditions 430
 - Trigger 202
- Width trigger
 - MSO 1015
- Window
 - Search conditions 432
 - Trigger 205
- Windows 1309
 - Access 1313
 - Settings 1313
- X**
- XML
 - Waveform export 464
- xx
 - Advanced 806
- XY-diagram
 - Displaying 291
 - settings 289
- XY-waveforms 49

Z

Zone key	37
Zone trigger	37, 59
Zoom	243
Area	46
Area, coupling	315, 391, 443
Coupled	252
Diagram	46
Key	38
Methods	243
MSO	1010
Multiple	251
On the touchscreen	249
Position/Range	251
Procedures	249
Quick access	57, 245
Saving data	481
Settings	245
Settings for data export	466
Start-stop values	250
Start/Stop settings	246
Used for gating	314
Waveforms	49