

R&S[®] RT-ZC30 Current Probe User Manual



1409787202

Version 04

ROHDE & SCHWARZ

Make ideas real



This manual describes the following R&S products:

- R&S®RT-ZC30, Current Probe (1409.7772.02)
- R&S®RT-ZA13, Probe Power Supply (1409.7789.02)

© 2023 Rohde & Schwarz GmbH & Co. KG
Muehldorfstr. 15, 81671 Muenchen, Germany
Phone: +49 89 41 29 - 0
Email: info@rohde-schwarz.com
Internet: www.rohde-schwarz.com

Subject to change – data without tolerance limits is not binding.

R&S® is a registered trademark of Rohde & Schwarz GmbH & Co. KG.

Trade names are trademarks of the owners.

1409.7872.02 | Version 04 | R&S®RT-ZC30

The following abbreviations are used in this manual: R&S®RT-ZC30 is abbreviated as R&S RT-ZC30.

Contents

1 Safety and regulatory information.....	5
1.1 Safety instructions.....	5
1.2 Labels on the product.....	7
1.3 Warning messages in the documentation.....	8
2 Product description.....	9
2.1 Product overview.....	9
2.2 Key features.....	9
2.3 Unpacking and checking.....	9
2.4 Description of the probe.....	10
2.4.1 Probe overview.....	10
2.4.2 Terminator.....	11
2.4.3 Sensor.....	12
2.4.4 Key and LEDs.....	13
3 Connecting the probe.....	15
3.1 Handling the probe.....	15
3.2 Connecting the probe to the power supply.....	16
3.3 Connecting the probe to the oscilloscope.....	17
3.4 Setting up and demagnetizing.....	18
3.5 Connecting the probe to the DUT.....	19
3.6 Disconnecting the probe from the DUT.....	21
3.7 Considerations for measurements.....	21
4 Troubleshooting.....	25
5 Maintenance and service.....	27
5.1 Cleaning.....	27

5.2 Contacting customer support.....27

5.3 Returning for servicing..... 28

5.4 Calibration interval..... 28

5.5 Storage and transport..... 29

5.6 Disposal..... 29

6 R&S RT-ZA13 probe power supply..... 31

1 Safety and regulatory information

The product documentation helps you to use the product safely and efficiently. Follow the instructions provided here and in the [Chapter 1.1, "Safety instructions"](#), on page 5.

Intended use

The product is intended for the development, production and verification of electronic components and devices in industrial, administrative, and laboratory environments. Use the product only for its designated purpose. Observe the operating conditions and performance limits stated in the data sheet.

Where do I find safety information?

Safety information is part of the product documentation. It warns you of potential dangers and gives instructions on how to prevent personal injury or damage caused by dangerous situations. Safety information is provided as follows:

- In [Chapter 1.1, "Safety instructions"](#), on page 5. The same information is provided in many languages as printed "Safety Instructions". The printed "Safety Instructions" are delivered with the product.
- Throughout the documentation, safety instructions are provided when you need to take care during setup or operation.

1.1 Safety instructions

Products from the Rohde & Schwarz group of companies are manufactured according to the highest technical standards. To use the products safely, follow the instructions provided here and in the product documentation. Keep the product documentation nearby and offer it to other users.

Use the product only for its intended use and within its performance limits. Intended use and limits are described in the product documentation such as the data sheet, manuals and the printed "Safety Instructions". If you are unsure about the appropriate use, contact Rohde & Schwarz customer service.

Using the product requires specialists or specially trained personnel. These users also need sound knowledge of at least one of the languages in which the user interfaces and the product documentation are available.

Reconfigure or adjust the product only as described in the product documentation or the data sheet. Any other modifications can affect safety and are not permitted.

Never open the casing of the product. Only service personnel authorized by Rohde & Schwarz are allowed to repair the product. If any part of the product is damaged or broken, stop using the product. Contact Rohde & Schwarz customer service at <https://www.rohde-schwarz.com/support>.

In these safety instructions, the term "product" covers instruments (oscilloscopes), probes and their accessories.

Choosing the operating site

Only use the product indoors. The product casing is not waterproof. Water that enters can electrically connect the casing with live parts, which can lead to electric shock, serious personal injury or death if you touch the casing. If Rohde & Schwarz provides accessories designed for outdoor use of your product, e.g. a protective cover, you can use the product outdoors.

Unless otherwise specified in the data sheet, you can operate the product up to an altitude of 2000 m above sea level.

The product is suitable for pollution degree 2 environments where nonconductive contamination can occur. For more information on environmental conditions such as ambient temperature and humidity, see the data sheet.

Performing measurements

Take the following measures for your safety:

- Observe all voltage and current ratings of the instrument, the probes, and the accessories. Exceeding the allowed limits can lead to an electric shock. Limits and ratings are marked on the products and listed in the data sheets. Consider that the rated values depend on the frequency. The limitation curves or values are provided in the data sheet.
- Never cause any short circuits when measuring sources with high output currents.
- When working with current probes, observe the additional operating conditions specified in these safety instructions.
- Prevent the probe from receiving mechanical shock. Avoid putting excessive strain on the probe cable or exposing it to sharp bends. Touching a broken cable during measurements can cause injuries.
- Set up all probe connections to the instrument before applying power.

Working with current probes

When working with current probes, you can measure high-frequency currents or currents that contain high-frequency components.

- Switch off the test circuit while connecting the probe.
- Do not attach the clamp to bare unisolated conductors. To avoid injury from a short circuit, measure at a location on an insulated wire where the insulation is sufficient for the circuit voltage.
- Connect the probe only to the secondary side of a breaker. With this measure, you avoid injury, if a short circuit occurs.
- The following effects can cause burns and fire or damage to the measurement site:
 - Eddy current loss can cause heating of the sensor head.
 - Dielectric heating can cause heating of cord insulation and other materials.
- When measuring current that includes a high-frequency component, consider the derating characteristics of the probe. Do not measure any current that exceeds the rated current.
- Using the probes with high frequencies or strong magnetic fields may cause the device to become abnormally hot, resulting in fire, equipment damage, or burns.

1.2 Labels on the product

Labels on the casing inform about:

- Personal safety
- Product and environment safety
- Identification of the product

Table 1-1: Meaning of safety labels



	<p>Potential hazard Read the product documentation to avoid personal injury or product damage.</p>
	<p>Hazardous contact voltages Do not use the probe at uninsulated live lines. Make sure to measure at sufficiently insulated conductors. This measure protects you against electric shock, electric burn, or arc flash.</p>

Table 1-2: Labels regarding product and environment safety

	Labeling in line with EN 50419 for disposal of electrical and electronic equipment after the product has come to the end of its service life.
---	---

1.3 Warning messages in the documentation

A warning message points out a risk or danger that you need to be aware of. The signal word indicates the severity of the safety hazard and how likely it will occur if you do not follow the safety precautions.

WARNING

Potentially hazardous situation. Could result in death or serious injury if not avoided.

CAUTION

Potentially hazardous situation. Could result in minor or moderate injury if not avoided.

NOTICE

Potential risks of damage. Could result in damage to the supported product or to other property.

2 Product description

2.1 Product overview

The R&S RT-ZC30 is an AC/DC current probe. It allows the user to make current measurements from DC to 120 MHz. By clamping on the conductor to be measured, the current waveform is captured easily without interrupting the electric circuit.

2.2 Key features

- The sensor head has a clamp design that makes it possible to easily observe current waveforms while current continues to flow through the conductor being measured.
- LED warnings indicate overload and unlocked sensor head.
- You can observe low-current waveforms at the high sensitivity of 1 V/A.
- Broadband frequency characteristics DC to 120 MHz.
- Demagnetization and automatic zero adjustment functions make it easy to get ready for measurement.

2.3 Unpacking and checking

1. Unpack the product carefully.
2. Retain the original packing material. Use it when transporting or shipping the product later.
3. Using the delivery notes, check the equipment for completeness.
4. Check the equipment for damage.

If the delivery is incomplete or equipment is damaged, contact Rohde & Schwarz.

Delivery notes

The delivery contains the following items:

- User manual
- Carrying case
- R&S RT-Zxx high-voltage and current probes data sheet
- Safety instructions for oscilloscopes and accessories (multilingual)
- Calibration certificate
- Documentation of calibrated values

2.4 Description of the probe

2.4.1 Probe overview

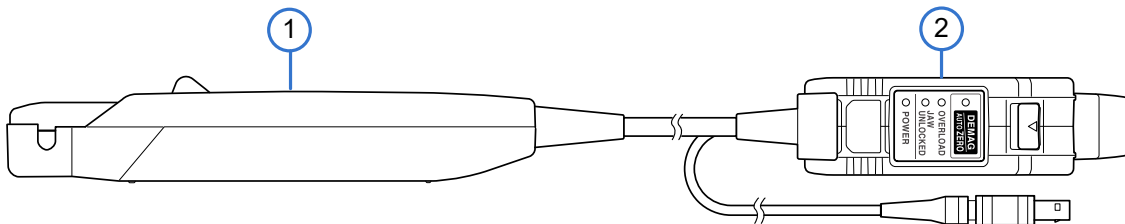

Figure 2-1: Probe overview

- 1 = Sensor
2 = Terminator

2.4.2 Terminator

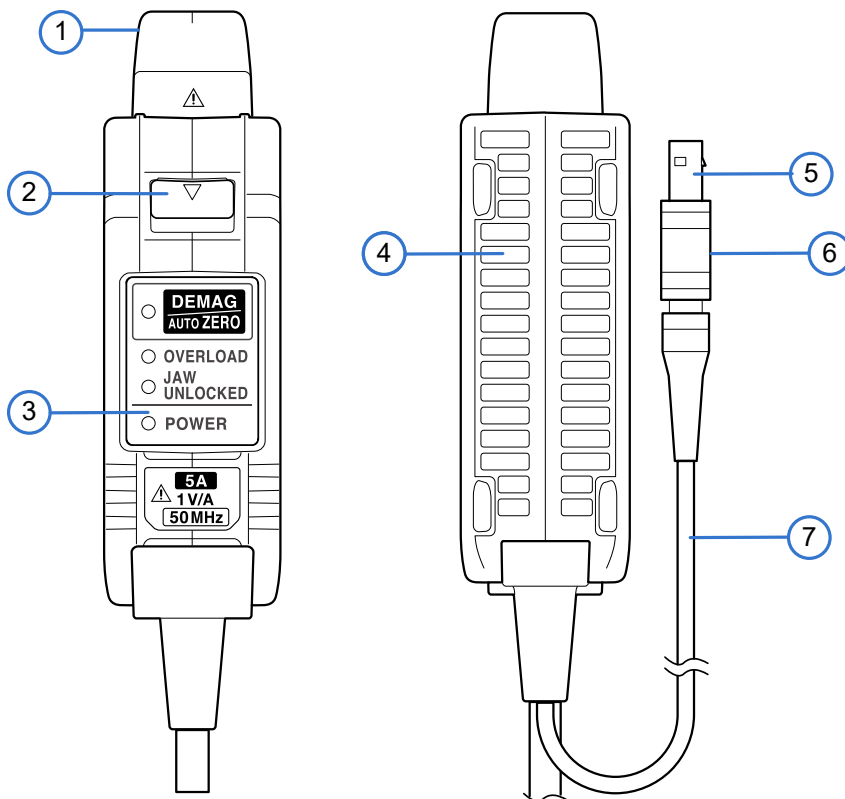

Figure 2-2: Terminator overview

- 1 = Output connector
- 2 = Unlock lever
- 3 = Key and LEDs
- 4 = Ventilation holes
- 5 = Power plug
- 6 = Shell
- 7 = Power supply cord

Output connector

Connect to the BNC input connector of the waveform measuring instrument.

The current waveform of the measured conductor is output at a constant rate (1 V/A).

The terminator's output connector can be connected when the locking pin on the waveform measurement instrument's BNC input connector is in either the horizontal or vertical orientation.

Unlock lever

The lock mechanism keeps the clamp closed.

Power plug

Connect the plug to the R&S RT-ZA13 probe power supply receptacle to supply power to the sensor.

2.4.3 Sensor

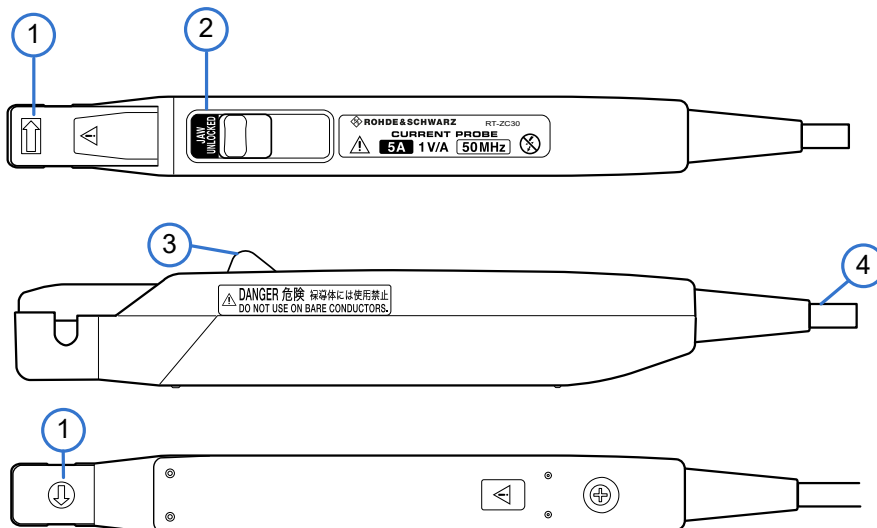

Figure 2-3: Sensor overview

- 1 = Current direction indication
- 2 = Jaw unlocked
- 3 = Opening lever
- 4 = Sensor cord

Current direction indication

Clamp the device to the conductor so that the direction in which the current being measured is flowing matches the arrow.

Opening lever

Operating lever for opening the sensor head. Always use this lever to open the sensor head.

JAW UNLOCKED indication

If the sensor head is unlocked, you can see this indication on the probe.

Sensor head

The sensor head clamps on the conductor being measured, and carries out the actual current measurement.

2.4.4 Key and LEDs

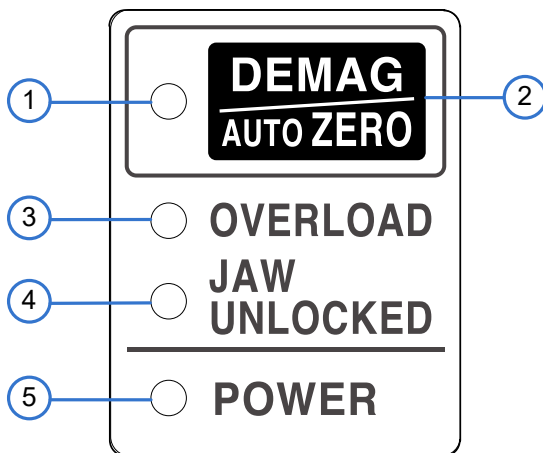

Figure 2-4: Key and LEDs

- 1 = DEMAG/AUTO ZERO LED
- 2 = DEMAG/AUTO ZERO Key
- 3 = OVERLOAD
- 4 = JAW UNLOCKED LED
- 5 = POWER LED

The key is used to perform demagnetization and zero adjustment, while the LEDs indicate the device status.

DEMAG/AUTO ZERO key

Performs demagnetization and zero adjustment.

Press this key long (approx. 1 sec.) for demagnetization and zero adjustment.

Press this key short (within 0.5 sec.) for a zero adjustment only.

Demagnetization and zero adjustment cannot be performed in the following circumstances:

- The sensor head is unlocked (JAW UNLOCKED LED is lit up)
- During an overload condition (the OVERLOAD LED is flashing)
- When a measured current is detected

DEMAG/AUTO ZERO LED

Shows the status of the demagnetization/zeroing process. The following states are defined:

Description of the probe

Color	State
Slow flashing orange	<ul style="list-style-type: none"> • Before demagnetization and zero adjustment (when either can be performed) • After an overload is detected • When demagnetization terminated abnormally
Orange	During demagnetization and zero adjustment process
Off	After demagnetization and zero adjustment is successfully completed

OVERLOAD LED

Shows the overload status of the system The following states are defined:

Color	State
Slow flashing red	Indicates that the maximum rated current is about to be reached. Exercise care so as not to exceed the rating.
Fast flashing red	Indicates that the maximum rated current is being exceeded. Remove the sensor from the measurement target immediately.

JAW UNLOCKED LED

The JAW UNLOCKED LED turns red (lighting up continuously) if the sensor head is not locked.

POWER LED

The POWER LED turns green (lighting up continuously) when the device is energized.

3 Connecting the probe

3.1 Handling the probe

The R&S RT-ZC30 can withstand a moderate amount of physical and electrical stress. To avoid damage, treat the probe with care:

- Prevent the probe from receiving mechanical shock.
- Avoid strain on the probe cable and route it carefully. Keep the cable away from heat sources, as bare conductors could be exposed if the insulation melts.
- Do not spill liquids on the probe.
- Do not obstruct the ventilation holes on the sides and bottom of the terminator, as it could overheat and be damaged, or cause a fire.
- Do not store or use the device near induction heating systems (such as high-frequency induction heating systems and IH cooking equipment)

Handling the sensor head

The sensor head is a precision assembly including a molded component, a ferrite core, and a Hall effect element. To avoid damage, treat it with care:

- Do not subject it to sudden changes in ambient temperature.
- If the mating surfaces are scratched, performance may be impaired. Prevent the mating surfaces of the sensor head from being scratched:
 - Keep the sensor head closed when not in use, to avoid accumulating dust or dirt.
 - Do not place foreign objects between the mating faces of the sensor head, insert foreign objects into the gaps of the sensor head, or touch the mating faces.
 - When the power is on, keep the core section of the sensor closed, except when clamping it onto the conductor to be measured. The mating surface of the core section can be scratched while it is open.

Electromagnetic compatibility

The electromagnetic compatibility (EMC) class indicates where you can operate the product. The product is rated in EMC class B, see also data sheet under "General data".

Class B equipment is suitable for use in:

- Residential environments
- Environments that are directly connected to a low-voltage supply network that supplies residential buildings

3.2 Connecting the probe to the power supply

1. Have the R&S RT-ZA13 probe power supply, and an oscilloscope or waveform measuring instrument ready.
2. **NOTICE!** Voltage check. When using a different power supply than the R&S RT-ZA13 probe power supply, before turning on the power, make sure that the voltage of the used power supply matches the supply voltage indicated in the data sheet "R&S RT-Zxx high voltage and current probes".
Turn off the power switch at the rear of the R&S RT-ZA13 probe power supply.
3. Connect the power cord.
4. Connect the power plug of the R&S RT-ZC30 to the power receptacle of the R&S RT-ZA13 probe power supply.

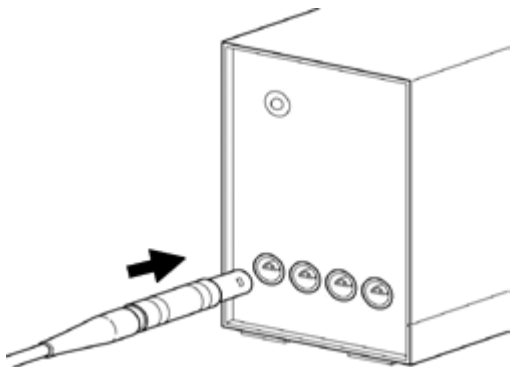

5. Check that the conductor being measured is not clamped when supplying power to the R&S RT-ZC30. When power is turned on, a demagnetizing waveform is initially applied to the output. This is intentional in the design, and not a fault.

Connecting the probe to the oscilloscope

- Turn on the power switch of R&S RT-ZA13 probe power supply. Ensure that the front panel power indicator lights.

The POWER LED lights up in green and the DEMAG/AUTO ZERO LED is slowly flashing in orange.

- Connect the R&S RT-ZC30 to the oscilloscope, as described in [Chapter 3.3, "Connecting the probe to the oscilloscope"](#), on page 17.

3.3 Connecting the probe to the oscilloscope

-  The output of this device is terminated internally. Use a high impedance input of the measuring instrument. With an input impedance of 50 Ω , accurate measurement is not possible.
- If using BNC-banana plug adapters or similar to connect to input terminals other than BNC connectors, make sure the polarity is correct.

To connect the probe:

- NOTICE!** Risk of instrument damage. To avoid damaging the terminator, keep it oriented in a straight line relative to the waveform measurement instrument when connecting and disconnecting it.

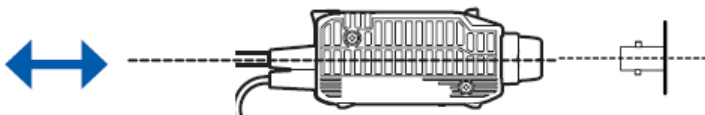

Insert the terminator of the R&S RT-ZC30 straight into one of the BNC input connectors of the oscilloscope until it clicks. Take care not to tilt it.

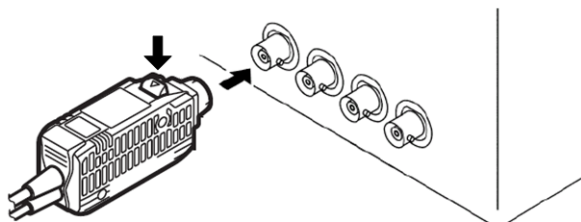

Figure 3-1: Connecting the probe to the Rohde & Schwarz oscilloscope

- Configure the probe connection at the oscilloscope.

Setting up and demagnetizing

The exact procedure depends on the used instrument and is described in the oscilloscope's user manual. Supported oscilloscopes are listed in the R&S RT-Zxx data sheet.

Make sure to set the following:

- Vertical unit = Ampere
- Coupling = DC
- Termination = 1 M Ω
- Manual Gain = 1 V/A

Alternatively, select "Predefined probe" = R&S RT-ZC30 if this selection is available on the instrument.

To disconnect the probe:

1. To avoid damaging the output connector of the terminator, or the BNC input terminal's locking mechanism on the oscilloscope, do not rotate when both terminals are connected.

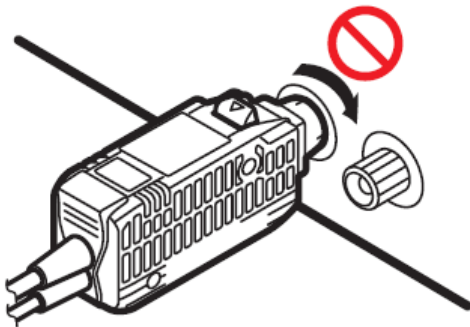

2. Pull the unlock lever toward you.
3. Pull the connector away from the oscilloscope.

3.4 Setting up and demagnetizing

1. With the waveform measuring instrument input at ground, adjust the waveform to the zero position.
2. Connect the R&S RT-ZC30 current probe to the power supply as described in [Chapter 3.2, "Connecting the probe to the power supply"](#), on page 16.
3. Connect the R&S RT-ZC30 current probe to the oscilloscope as described in [Chapter 3.3, "Connecting the probe to the oscilloscope"](#), on page 17.

Connecting the probe to the DUT

- NOTICE!** Risk of circuit damage. Demagnetizing causes current to flow into the conductor, which may damage parts in the circuit to be measured. Do not demagnetize while the R&S RT-ZC30 is clamping a conductor to be measured.

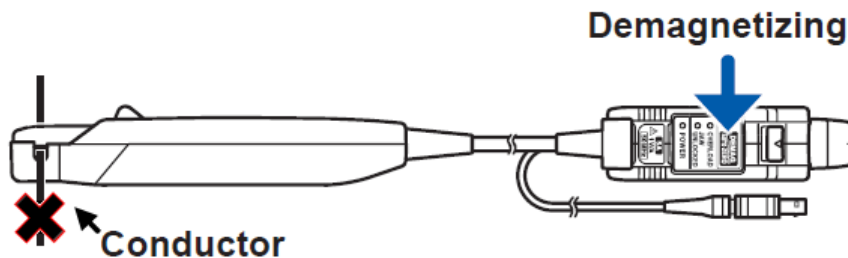

Make sure that there is no conductor in the sensor aperture.

- Press the opening lever until the JAW UNLOCK indication disappears. Ensure that the sensor head is properly closed.
- Press and hold the DEMAG/ AUTO ZERO key for about 1 second. Zero-adjustment is performed after demagnetization. The process takes about 20 seconds. During demagnetizing, a demagnetizing waveform is shown on the oscilloscope. The positive and negative components of this waveform may be asymmetrical.
Note: If the DEMAG/AUTO ZERO LED continues flashing instead of turning off when the DEMAG/AUTO ZERO key is pressed, demagnetization and zero adjustment did not complete normally.

3.5 Connecting the probe to the DUT

- Check that the system is safe, and that the preparations described in the preceding sections have been carried out.
- Pull the sensor opening lever, so that the sensor head opens.

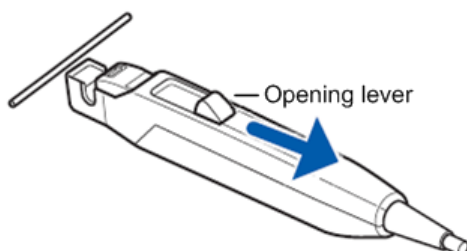

Connecting the probe to the DUT

3. Align the sensor so that the current direction indication matches the direction of current flow through the conductor that you measure. The conductor should be in the center of the clamp aperture because the measurement may be affected by the position within the clamp aperture of the conductor being measured.
4. Press the opening lever until the JAW UNLOCKED indication disappears. Check, if the sensors head is properly closed. The JAW UNLOCKED LED turns off.

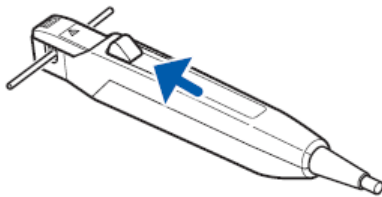

If the sensor head is not properly closed, accurate measurement is not possible.

i Measuring low currents

- To measure DC or low-frequency current, multiple windings may be used to increase relative sensitivity (10 windings multiplies the measured current by a factor of 10). However, in this case, the windings should be made radially, with a diameter of at least 20 cm.

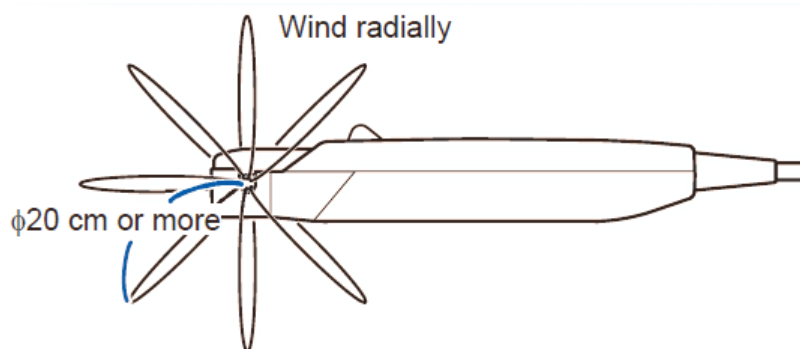

- Cord placement and the act of clamping the probe onto the conductor being measured may trigger load fluctuations, affecting the observed waveform.

3.6 Disconnecting the probe from the DUT

Once measurement has completed:

1. Pull the opening lever toward you. Remove the device from the conductor that you measure.
2. Disconnect the terminator from the waveform measurement instrument.
3. Turn the R&S RT-ZA13 probe power supply POWER switch off.
4. Remove the power plug of the device from the R&S RT-ZA13 probe power supply.
5. Unplug the R&S RT-ZA13 probe power supply power cord from the electrical outlet.

3.7 Considerations for measurements

Measurements of continuous input current

To avoid damage to the probe when doing measurements of continuous input current, consider the following:

- The maximum continuous input range is based on heat that is internally generated during measurement. It varies according to the frequency of the current being measured. Refer to the data sheet "R&S RT-Zxx high voltage and current probes".
- The device may sustain damage from self-heating even at current levels that are lower than the maximum rated current. The maximum rated current is a recommended value that assumes sine-wave input under standard conditions. Self-heating may happen if the ambient temperature increases or the measurement current waveform contains other frequency components.
- If the input current exceeds a certain level, generated heat activates a built-in safety function that blocks normal output. If this happens, remove the input immediately (remove the sensor from the conductor being measured, or reduce the input current to zero). Wait until the sensor has had sufficient time to cool before resuming operation.

Considerations for measurements

Continuous input of current exceeding the rated maximum or repeated activation of the safety function may result in damage to the device.

- Even if the input current does not exceed the rated continuous maximum current, continuous input for an extended period of time may result in activation of the safety circuit to prevent damage resulting from heating of the sensor. At high ambient temperatures, the built-in safety circuit may activate at current input levels below the rated continuous maximum current.
- Current measurement exceeding approx. 1 kHz may result in temperature rise on the sensor-head. This is attributed to excitation loss that cannot be prevented due to natural physical principles. Be careful to avoid injury, electric shock due to short-circuits, or damage to the device that may be caused by the increased temperature.
- Do not place any unclamped conductor with an electric current of a frequency of 10 kHz or more near the sensor head. Current flowing in the conductor nearby may heat up the sensor head and cause its temperature to rise, leading to damage to the sensor. For example, when one side of a go-and-return conductor is clamped and the other side is also placed near the sensor head as shown in the diagram, even if the electric current is lower than the consecutive maximum current, electric currents in both sides will heat up the sensor and raise the temperature, thereby causing damage to the sensor.

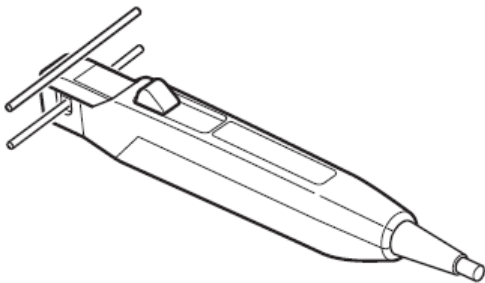
**Drift, oscillation, and sound**

- Immediately after powering on, the probe may be subject to an appreciable offset drift due to the effect of self-heating. Therefore, warm up the probe for about 30 minutes before carrying out measurements.
- When performing continuous measurements, be aware that the offset voltage drifts, depending on factors such as the ambient temperature.
- Under certain circumstances, oscillation may occur while the power supply is on. This does not indicate a malfunction. Oscillation can be stopped and operation restored to normal by opening and closing the sensor head.

Considerations for measurements

- Acoustic resonance can occur depending on the amplitude and frequency of the measured current. This sound may also occur during demagnetizing operation, but it is not a malfunction or probe failure.
If a foreign substance such as dust is present on the contact surfaces of the sensor head, a slight gap can occur between the upper and lower sensors, and a resonant sound may be emitted. Clean the sensors as described in this manual to ensure correct measurements.
 - An increasing volume of the resonant sound during use may indicate that the gap between the upper and lower sensors has increased. Since the sensor characteristics may change, it is recommended to calibrate the device.
- i** At high frequencies, common mode noise may affect measurements taken on the high-voltage side of circuits. If this occurs, reduce the frequency range of the waveform measuring instrument, or clamp onto the low-voltage side of the circuit, as appropriate.

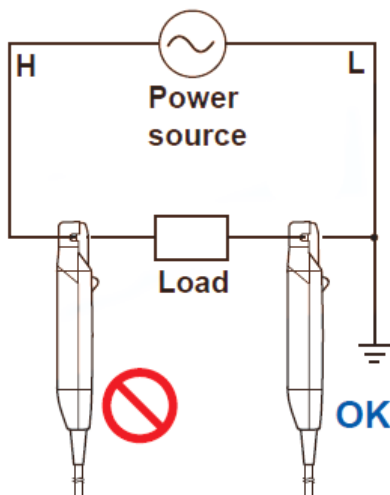

4 Troubleshooting

You can determine the nature of an error by observing the device's LED. The following table explains possible error indications and their cause.

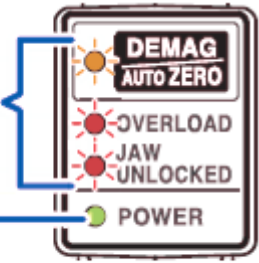
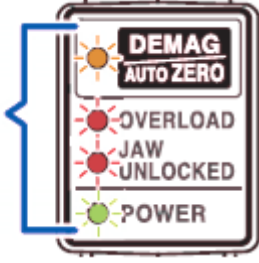
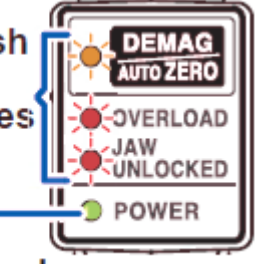
Error State	Meaning						
<p>LEDs continue to flash quickly.</p> <p>LED is lit up continuously.</p> 	<p>A temperature anomaly has been detected due to heating caused by an overload.</p> <p>Remove the device from the conductor being measured immediately. Allow the device to cool under conditions of no input and then press the DEMAG/AUTO ZERO key. The device returns to its state when it was turned on.</p> <p>Start measurement after performing demagnetization and zero adjustment again. It is recommended to calibrate the device since internal components may have been subject to stress.</p>						
<p>LEDs continue to flash quickly.</p> 	<p>An internal CPU malfunction (checksum error) has occurred. Send it to the service center for repair.</p>						
<p>LEDs flash quickly three times</p> <p>LED is lit up continuously.</p> 	<p>This issue occurs when the DEMAG/ AUTO ZERO key is pressed under the circumstances described in the table below.</p> <p>Demagnetization and automatic zero adjustment cannot be performed. Perform demagnetization and zero adjustment again after implementing the remedy described below.</p> <table border="1" data-bbox="722 1518 1425 1836"> <thead> <tr> <th data-bbox="722 1518 938 1608">Circumstances</th> <th data-bbox="946 1518 1425 1608">Remedy</th> </tr> </thead> <tbody> <tr> <td data-bbox="722 1619 938 1720">When the JAW UNLOCKED LED is lit up</td> <td data-bbox="946 1619 1425 1720">Lock the sensor head. (Press the opening lever until the JAW UNLOCKED indicator turns off.)</td> </tr> <tr> <td data-bbox="722 1731 938 1836">When the OVERLOAD LED is flashing</td> <td data-bbox="946 1731 1425 1836">Remove the device from the conductor being measured.</td> </tr> </tbody> </table>	Circumstances	Remedy	When the JAW UNLOCKED LED is lit up	Lock the sensor head. (Press the opening lever until the JAW UNLOCKED indicator turns off.)	When the OVERLOAD LED is flashing	Remove the device from the conductor being measured.
Circumstances	Remedy						
When the JAW UNLOCKED LED is lit up	Lock the sensor head. (Press the opening lever until the JAW UNLOCKED indicator turns off.)						
When the OVERLOAD LED is flashing	Remove the device from the conductor being measured.						

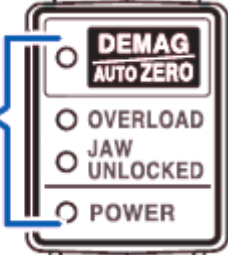
Error State	Meaning	
	<p>When a current of 0.5 A (RMS) or greater has been detected</p>	
<p>All LEDs off even though the device is receiving power</p> 	<p>The device has malfunctioned. Send it to the service center for repair.</p>	

5 Maintenance and service

If service or calibration is needed, contact your Rohde & Schwarz service center. Return a defective product to the Rohde & Schwarz service center for diagnosis and exchange.

5.1 Cleaning

1. Discharge any static electricity at your hands before cleaning the facing surfaces of the sensor head.

Thus, you ensure that no high voltage caused by static electricity is applied to the product. Application of a high voltage can damage the internal Hall elements or circuitry. You can attract static electricity to your hands by touching a nearby metal object.

2. Clean the outside of the product using a soft cloth moistened with either distilled water or isopropyl alcohol. Keep in mind that the casing is not waterproof.
Note: Do not use cleaning agents. Solvents (thinners, acetone), acids and bases can damage the labeling or plastic parts.
3. Dry the product completely before using it.

5.2 Contacting customer support

Technical support – where and when you need it

For quick, expert help with any Rohde & Schwarz product, contact our customer support center. A team of highly qualified engineers provides support and works with you to find a solution to your query on any aspect of the operation, programming or applications of Rohde & Schwarz products.

Contact information

Contact our customer support center at www.rohde-schwarz.com/support, or follow this QR code:



Figure 5-1: QR code to the Rohde & Schwarz support page

5.3 Returning for servicing

Use the original packaging to return your R&S RT-ZC30 to your Rohde & Schwarz service center. A list of all service centers is available on:

www.services.rohde-schwarz.com

If you cannot use the original packaging, consider the following:

1. Use a sufficiently sized box.
2. Protect the product from damage and moisture (e.g. with bubble wrap).
3. Use some kind of protective material (e.g. crumpled newspaper) to stabilize the product inside the box.
4. Seal the box with tape.
5. Address the package to your nearest Rohde & Schwarz service center.

5.4 Calibration interval

The recommended calibration interval for R&S RT-ZC30 current probe is one year. For servicing, send the probe to your nearest Rohde & Schwarz service center (see [Chapter 5.3, "Returning for servicing"](#), on page 28).

5.5 Storage and transport

Protect the product against dust. Ensure that the environmental conditions, e.g. temperature range and climatic load, meet the values specified in the data sheet.

Store the product in a shock-resistant case, e.g. in the shipping case.

Unless otherwise specified in the data sheet, the maximum transport altitude without pressure compensation is 4500 m above sea level.

5.6 Disposal

Rohde & Schwarz is committed to making careful, ecologically sound use of natural resources and minimizing the environmental footprint of our products. Help us by disposing of waste in a way that causes minimum environmental impact.

Disposing electrical and electronic equipment

A product that is labeled as follows cannot be disposed of in normal household waste after it has come to the end of its service life. Even disposal via the municipal collection points for waste electrical and electronic equipment is not permitted.



Figure 5-2: Labeling in line with EU directive WEEE

Rohde & Schwarz has developed a disposal concept for the eco-friendly disposal or recycling of waste material. As a manufacturer, Rohde & Schwarz completely fulfills its obligation to take back and dispose of electrical and electronic waste. Contact your local service representative to dispose of the product.

6 R&S RT-ZA13 probe power supply

This unit is a special-purpose power supply for the current probes.

You can connect up to four current probes to the power supply.

Front view

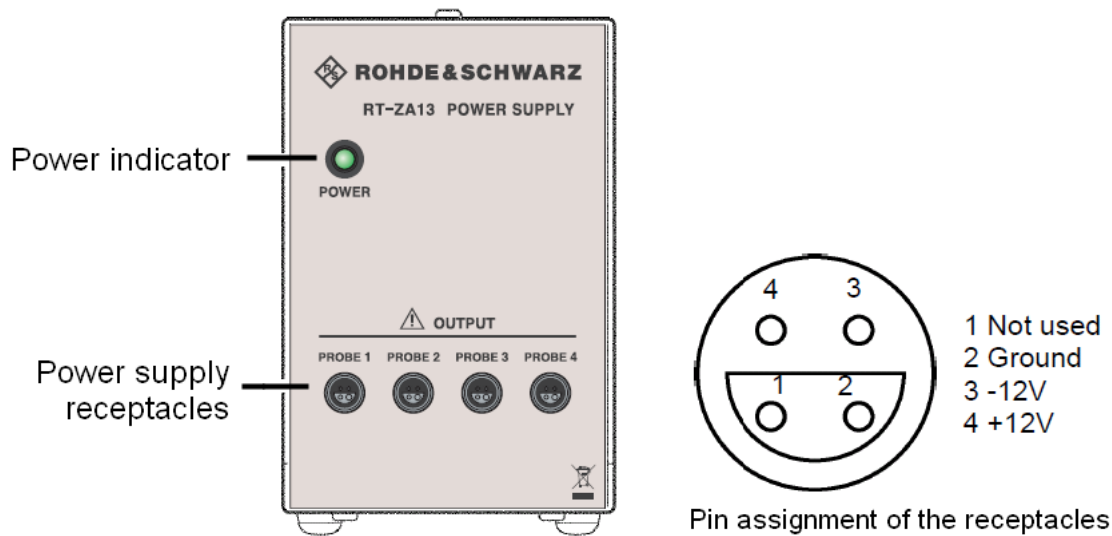

Rear view

