

R&S[®]SMM-K14x/-K17x

3GPP 5G NR Signal Generation

User Manual



1179322102
Version 09

ROHDE & SCHWARZ
Make ideas real



This document describes the following software options:

- R&S®SMM-K144 5G NR Release 15 (1441.1730.02)
- R&S®SMM-K148 5G NR Release 16 (1441.2166.02)
- R&S®SMM-K170 5G NR Sidelink (1441.1076.02)
- R&S®SMM-K171 5G NR Release 17/18 (1441.1018.02)

This manual describes firmware version FW 5.30.175.xx and later of the R&S®SMM100A.

© 2024 Rohde & Schwarz

Muehldorfstr. 15, 81671 Muenchen, Germany

Phone: +49 89 41 29 - 0

Email: info@rohde-schwarz.com

Internet: www.rohde-schwarz.com

Subject to change – data without tolerance limits is not binding.

R&S® is a registered trademark of Rohde & Schwarz GmbH & Co. KG.

Trade names are trademarks of the owners.

1179.3221.02 | Version 09 | R&S®SMM-K14x/-K17x

Throughout this manual, products from Rohde & Schwarz are indicated without the ® symbol , e.g. R&S®SMM100A is indicated as R&S SMM. Linux® is abbreviated as Linux.

Contents

1	Welcome to the 5G New Radio option.....	11
1.1	Accessing the 5G New Radio dialog.....	13
1.2	What's new.....	13
1.3	Documentation overview.....	13
1.3.1	Getting started manual.....	13
1.3.2	User manuals and help.....	13
1.3.3	Service manual.....	14
1.3.4	Instrument security procedures.....	14
1.3.5	Printed safety instructions.....	14
1.3.6	Specifications and product brochures.....	14
1.3.7	Calibration certificate.....	15
1.3.8	Release notes and open source acknowledgment.....	15
1.3.9	Application notes, application cards, white papers, etc.....	15
1.3.10	Videos.....	15
1.4	Scope.....	16
1.5	Notes on screenshots.....	16
2	About the 5G New Radio option.....	17
2.1	Required options.....	18
2.2	5G NR numerology.....	18
2.3	Multiple accesses schemes.....	19
2.4	Frame structure, slots and slot formats.....	19
2.5	Resource blocks and resource grid.....	20
2.6	Transmission bandwidths TxBW.....	21
2.7	Synchronization signals and SS/PBCH block.....	23
2.8	Carrier bandwidth part (BWP).....	25
2.9	Carrier aggregation.....	26
2.10	Antenna port mapping.....	27
2.11	5G NR channels and signals overview.....	28
2.12	Overlap handling.....	29
3	Find out the implemented 3GPP specification.....	31

4	5G NR quick settings.....	32
4.1	General settings.....	32
4.2	Frame format.....	37
5	5G New Radio configuration and settings.....	40
5.1	General settings.....	40
5.2	Node settings.....	49
5.2.1	Scheduling.....	49
5.2.2	Carriers settings.....	51
5.2.3	System information settings.....	57
5.2.4	Timing & Phase Settings.....	60
5.2.5	Transmission bandwidth (TxBW) settings.....	63
5.2.6	LTE-CRS coexistence settings.....	65
5.2.7	SS/PBCH settings.....	68
5.2.8	S-SS/PSBCH settings.....	75
5.2.9	PRS settings.....	78
5.2.10	Dummy REs settings.....	84
5.2.11	OCNG settings.....	86
5.2.12	PBCH settings.....	87
5.2.13	PSBCH settings.....	92
5.3	Users / BWPs settings.....	93
5.3.1	General settings.....	93
5.3.2	DL and UL user properties settings.....	95
5.3.3	SL user properties settings.....	105
5.3.4	DL/UL BWPs settings.....	107
5.3.5	SL BWPs settings.....	111
5.3.6	DL BWP configuration settings.....	113
5.3.7	UL BWP configuration settings.....	155
5.3.8	SL BWP configuration settings.....	192
5.4	Scheduling settings.....	198
5.5	PDSCH and PUSCH settings.....	212
5.5.1	General settings.....	213
5.5.2	TxScheme settings.....	219
5.5.3	DMRS settings.....	222

5.5.4	Channel coding settings.....	226
5.5.5	UCI settings.....	228
5.5.6	PTRS settings.....	230
5.5.7	PTRS settings with enabled transform precoding.....	233
5.5.8	Antenna ports.....	235
5.5.9	Info.....	236
5.6	CORESET settings.....	237
5.6.1	General settings.....	237
5.6.2	Payload settings.....	242
5.6.3	Info.....	268
5.7	CSI-RS settings (scheduling table).....	269
5.7.1	General CSI-RS settings.....	270
5.7.2	Antenna port configuration for CSI-RS.....	272
5.8	RIM-RS setting (scheduling table).....	272
5.9	PUCCH settings.....	273
5.9.1	General settings.....	274
5.9.2	Payload settings.....	278
5.9.3	Info.....	279
5.10	PRACH settings.....	280
5.11	SRS settings (scheduling table).....	282
5.11.1	General SRS settings.....	283
5.11.2	Antenna port settings for SRS.....	286
5.12	PSSCH and PSCCH settings.....	288
5.12.1	General PSSCH and PSCCH settings.....	288
5.12.2	SCI1A settings.....	290
5.12.3	SCI2A settings.....	292
5.12.4	SCI2B settings.....	293
5.12.5	TxScheme settings for PSSCH and PSCCH.....	294
5.12.6	DMRS settings for PSSCH.....	294
5.12.7	Channel coding settings.....	295
5.12.8	Antenna ports settings for PSSCH and PSCCH.....	297
5.12.9	Info layer for PSSCH and PSCCH.....	298
5.13	PSFCH settings.....	298

6	Signal control and signal characteristics.....	301
6.1	Trigger settings.....	301
6.2	Marker settings.....	307
6.3	TDD UL/DL marker mode.....	310
6.4	Clock settings.....	313
6.5	Local and global connectors settings.....	314
6.6	Output settings.....	314
6.7	Time domain windowing settings.....	318
6.8	Adjusting the signal power.....	320
6.8.1	Effects of the power mode.....	321
6.8.2	Power settings.....	326
6.9	Crest factor reduction settings.....	328
7	Observing current allocations on the time plan.....	331
8	Performing BS tests according to TS 38.141 specifications.....	334
8.1	Introduction to BS conformance testing.....	334
8.2	Required options.....	335
8.3	Supported test cases.....	335
8.3.1	Generic structure of the description of the implemented test cases.....	336
8.4	Exemplary test setups.....	336
8.4.1	Exemplary test setups for conducted tests (TS 38.141-1).....	337
8.4.2	Exemplary test setups for radiated (OTA) tests (TS 38.141-2).....	337
8.5	General considerations.....	338
8.5.1	General considerations for radiated (OTA) tests.....	339
8.6	User interface.....	341
8.6.1	General settings.....	342
8.6.2	Test case settings.....	343
8.6.3	OTA declaration.....	345
8.6.4	Instrument settings.....	346
8.6.5	Wanted signal settings.....	348
8.6.6	Frequency allocation settings.....	353
8.6.7	Interfering signal settings.....	354
8.6.8	Moving UE settings.....	357
8.6.9	Stationary UE settings.....	359

8.6.10	AWGN settings.....	360
8.6.11	Information.....	360
8.7	Conducted transmitter characteristics (TS 38.141-1, chapter 6).....	361
8.7.1	Prior considerations.....	361
8.7.2	General workflow for carrying out a transmitter test.....	362
8.7.3	Test case 6.7: transmitter intermodulation.....	363
8.8	Conducted receiver characteristics (TS 38.141-1, chapter 7).....	364
8.8.1	Prior considerations.....	365
8.8.2	General workflow for carrying out a receiver test.....	366
8.8.3	Test case 7.2: reference sensitivity level.....	367
8.8.4	Test case 7.3: dynamic range.....	368
8.9	Radiated transmitter characteristics (TS 38.141-2, chapter 6).....	369
8.9.1	Prior considerations.....	369
8.9.2	General workflow for carrying out a radiated transmitter test.....	369
8.9.3	Test case 6.8: OTA transmitter intermodulation.....	370
8.10	Radiated receiver characteristics (TS 38.141-2, chapter 7).....	372
8.10.1	Prior considerations.....	372
8.10.2	General workflow for carrying out a receiver test.....	375
8.10.3	Test case 7.2: OTA sensitivity.....	376
8.10.4	Test case 7.3: OTA reference sensitivity level.....	377
8.10.5	Test case 7.4: OTA dynamic range.....	378
8.10.6	Test case 7.6: OTA out-of-band blocking.....	379
9	Generating user plane data.....	381
9.1	Required options.....	381
9.2	File format and folder structure.....	381
10	Remote-control commands.....	383
10.1	Programming examples.....	384
10.2	General commands.....	414
10.3	FRC wizard commands.....	421
10.4	Quick settings command.....	426
10.5	Carrier commands.....	434
10.6	Copy carrier commands.....	440
10.7	System information commands.....	442

10.8	TxBW commands	446
10.9	LTE-CRS coexistence commands	448
10.10	SS/PBCH commands	450
10.11	S-SS/PSBCH configuration commands	462
10.12	PRS commands	464
10.13	Dummy resource elements commands	470
10.14	OCGN commands	473
10.15	DL and UL user properties commands	476
10.16	SL user properties commands	492
10.17	DL/UL BWP commands	494
10.18	SL BWP commands	501
10.19	BWP configuration commands	503
10.19.1	PDSCH commands.....	503
10.19.2	PTRS commands.....	523
10.19.3	RMC commands.....	527
10.19.4	PDCCH commands.....	530
10.19.5	DL control information commands.....	532
10.19.6	ZP and NZP CSI-RS commands.....	538
10.19.7	Rate match commands.....	546
10.19.8	PUCCH commands.....	549
10.19.9	FRC commands.....	551
10.19.10	PUSCH commands.....	557
10.19.11	PUSCH UCI commands.....	574
10.19.12	SRS commands.....	576
10.19.13	Bandwidth part configuration for sidelink commands.....	588
10.20	Scheduling commands	593
10.21	PDSCH and PUSCH scheduling commands	608
10.21.1	General PDSCH and PUSCH scheduling commands.....	609
10.21.2	PDSCH and PUSCH Tx scheme commands.....	616
10.21.3	PDSCH and PUSCH DMRS commands.....	622
10.21.4	PDSCH and PUSCH channel coding commands.....	628
10.21.5	PUSCH UCI commands.....	630
10.21.6	PDSCH and PUSCH PTRS commands.....	632

10.21.7	PDSCH and PUSCH antenna port configuration commands.....	638
10.22	CORESET scheduling commands.....	639
10.22.1	General CORESET scheduling commands.....	640
10.22.2	CORESET payload scheduling commands.....	644
10.22.3	DCI field configuration commands.....	652
10.23	CSI-RS scheduling commands.....	691
10.24	RIM-RS scheduling commands.....	694
10.25	PUCCH scheduling commands.....	695
10.25.1	General PUCCH scheduling commands.....	695
10.25.2	PUCCH payload scheduling commands.....	699
10.26	PRACH scheduling commands.....	701
10.27	SRS scheduling commands.....	704
10.28	PSSCH / PSCCH scheduling commands.....	710
10.28.1	PSSCH / PSCCH general configuration commands.....	710
10.28.2	SCI1A configuration commands.....	712
10.28.3	SCI2A configuration commands.....	716
10.28.4	SCI2B configuration commands.....	718
10.28.5	TxScheme configuration commands.....	719
10.28.6	DMRS configuration commands.....	720
10.28.7	PSxCH channel coding commands.....	720
10.29	PSFCH scheduling commands.....	723
10.30	Output commands.....	725
10.31	Trigger commands.....	735
10.32	Marker commands.....	740
10.33	Clock commands.....	747
10.34	Test case wizard remote-control commands.....	748
	Glossary: Abbreviations.....	769
	Glossary: 5G NR 3GPP specification references.....	771
	List of commands.....	772
	Index.....	803

1 Welcome to the 5G New Radio option

The R&S SMM-K144/-K148 are firmware applications that add functionality to generate signals in accordance with the 3GPP standard 5G New Radio.

Preamble

All supported features are in line with the official 3GPP specifications (releases 15, 16 and 17). You can check in the user interface to which version of the specification the firmware currently corresponds to (see [Chapter 3, "Find out the implemented 3GPP specification"](#), on page 31).

The R&S SMM-K144 key features

The R&S SMM-K144 provides 3GPP release 15 features.

The R&S SMM100A simulates signals at the physical channel level. The following list gives an overview of the functions provided for generating an 5G New Radio signal:

- Supports uplink and downlink
- Intuitive user interface with graphical display of time plan
- PSS/SSS, PBCH (incl. MIB), PDCCH (i.e. CORESET), PDSCH, CSI-RS, PDSCH PTRS, PUSCH, PUCCH, SRS, PRACH supported
PBCH, PDSCH, PDCCH and PUSCH incl. DMRS
- Support of downlink and uplink DCI content inside CORESET;
- Automatic PDSCH scheduling from DCI
- PDSCH time domain scheduling
- Support of two codewords for PDSCH
- Support of SRS codebook
- PUSCH/PUCCH spatial multiplexing
- Configurable multilayer transmissions for PDSCH and PUSCH, incl. USCH channel coding and antenna ports
- Support of FRCs and TMs
- All modulation schemes supported
- Carrier aggregation, including cross-carrier scheduling
- Test case wizard for 3GPP 38.141 test cases

The R&S SMM-K148 key features

The R&S SMM-K148 provides 3GPP release 16 features.

The R&S SMM-K148 requires an R&S SMM-K144.

Release 16 features include:

- PRS (positioning reference signals)
- Support of the DCI types and their corresponding RNTI types included in the release 16

- MIB system frame number (SFN) increments independently from the configured ARB sequence length
- Support of up-to 50 users

The R&S SMM-K170 key features

The R&S SMM100A simulates 5G NR sidelink signals at the physical channel level.

- Support for PSSCH and PSCCH
- Support of S-SS/PSBCH
- Support of sidelink bandwidth part configuration, including resource pool configuration
- Support of SSCH channel coding
- Support of sidelink control information (SCI)
- Support of sidelink carrier aggregation

The R&S SMM-K171 key features

The R&S SMM-K171 provides 3GPP release 17 and 18 features.

The R&S SMM-K171 requires an R&S SMM-K144 and R&S SMM-K148.

Release 17 and 18 features include:

- New deployment frequency range (FR2-2, up to 71 GHz).
- New channel bandwidths introduced with FR2-2 (800 MHz, 1600 MHz and 2000 MHz).
- New subcarrier spacings for various channels (user allocations, SS/PBCH, PRACH etc.) introduced with FR2-2.
- New channel bandwidths introduced with release 17 (3 MHz, 35 MHz and 45 MHz).
- Support of 1024QAM modulation in FR1.
- New operating bands, test models and FRCs introduced with release 17.

This user manual contains a description of the functionality that the application provides, including remote control operation.

All functions not discussed in this manual are the same as in the base unit and are described in the R&S SMM100A user manual. The latest version is available at:

www.rohde-schwarz.com/manual/SMM100A

Installation

You can find detailed installation instructions in the delivery of the option or in the R&S SMM100A service manual.

1.1 Accessing the 5G New Radio dialog

To open the dialog with 5G New Radio settings

- ▶ In the block diagram of the R&S SMM100A, select "Baseband > 5G NR".

A dialog box opens that displays the provided general settings.

The signal generation is not started immediately. To start signal generation with the default settings, select "State > On".

1.2 What's new

This manual describes firmware version FW 5.30.175.xx and later of the R&S®SMW200A.

For a detailed list of new features, refer to the release notes published with the corresponding firmware version.

- Support of 3 MHz channel bandwidth.
- Test models and FRCs: added various release 18 test models and FRCs.
- Downlink: support of [CORESET puncturing](#) for 5 MHz bandwidths and a 15 kHz subcarrier spacing.
- Sidelink: Support of [PSFCH](#).

1.3 Documentation overview

This section provides an overview of the R&S SMM100A user documentation. Unless specified otherwise, you find the documents at:

www.rohde-schwarz.com/manual/smm100a

1.3.1 Getting started manual

Introduces the R&S SMM100A and describes how to set up and start working with the product. Includes basic operations, typical measurement examples, and general information, e.g. safety instructions, etc. A printed version is delivered with the instrument.

1.3.2 User manuals and help

Separate manuals for the base unit and the software options are provided for download:

- Base unit manual

Contains the description of all instrument modes and functions. It also provides an introduction to remote control, a complete description of the remote control commands with programming examples, and information on maintenance, instrument interfaces and error messages. Includes the contents of the getting started manual.

- **Software option manual**
Contains the description of the specific functions of an option. Basic information on operating the R&S SMM100A is not included.

The contents of the user manuals are available as help in the R&S SMM100A. The help offers quick, context-sensitive access to the complete information for the base unit and the software options.

All user manuals are also available for download or for immediate display on the internet.

1.3.3 Service manual

Describes the performance test for checking compliance with rated specifications, firmware update, troubleshooting, adjustments, installing options and maintenance.

The service manual is available for registered users on the global Rohde & Schwarz information system (GLORIS):

<https://gloris.rohde-schwarz.com>

1.3.4 Instrument security procedures

Deals with security issues when working with the R&S SMM100A in secure areas. It is available for download on the internet.

1.3.5 Printed safety instructions

Provides safety information in many languages. The printed document is delivered with the product.

1.3.6 Specifications and product brochures

The specifications document, also known as the data sheet, contains the technical specifications of the R&S SMM100A. It also lists the firmware applications and their order numbers, and optional accessories.

The brochure provides an overview of the instrument and deals with the specific characteristics.

See www.rohde-schwarz.com/brochure-datasheet/smm100a

1.3.7 Calibration certificate

The document is available on <https://gloris.rohde-schwarz.com/calcert>. You need the device ID of your instrument, which you can find on a label on the rear panel.

1.3.8 Release notes and open source acknowledgment

The release notes list new features, improvements and known issues of the current software version, and describe the software installation.

The software uses several valuable open source software packages. An open source acknowledgment document provides verbatim license texts of the used open source software.

www.rohde-schwarz.com/firmware/smm100a

1.3.9 Application notes, application cards, white papers, etc.

These documents deal with special applications or background information on particular topics.

For some application sheets, see also:

www.rohde-schwarz.com/application/smm100a

1.3.10 Videos

Find various videos on Rohde & Schwarz products and test and measurement topics on YouTube: <https://www.youtube.com/@RohdeundSchwarz>



On the menu bar, search for your product to find related videos.

HOME VIDEOS SHORTS PLAYLISTS COMMUNITY CHANNELS ABOUT



Figure 1-1: Product search on YouTube

1.4 Scope



Tasks (in manual or remote operation) that are also performed in the base unit in the same way are not described here.

In particular, it includes:

- Managing settings and data lists, like saving and loading settings, creating and accessing data lists, or accessing files in a particular directory.
- Information on regular trigger, marker and clock signals and filter settings, if appropriate.
- General instrument configuration, such as checking the system configuration, configuring networks and remote operation
- Using the common status registers

For a description of such tasks, see the R&S SMM100A user manual.

1.5 Notes on screenshots

When describing the functions of the product, we use sample screenshots. These screenshots are meant to illustrate as many as possible of the provided functions and possible interdependencies between parameters. The shown values may not represent realistic usage scenarios.

The screenshots usually show a fully equipped product, that is: with all options installed. Thus, some functions shown in the screenshots may not be available in your particular product configuration.

2 About the 5G New Radio option

The implementation of the option 5G New Radio R&S SMM-K144 is based on the 3GPP Rel. 15 specification group TS 38.xxx. According to these specifications, the 3GPP defines a great flexibility of the signal on the air interface.

This section is a brief summary of the main air interface parameters, see [Table 2-1](#).



Availability of main air interface parameters

Several main air interface parameters have been upgraded with 3GPP release 16 and 3GPP release 17, in particular the extended frequency deployment ranges, certain channel bandwidths (for example 35 MHz and 35 MHz) or certain subcarrier spacings and are therefore only available with the corresponding option (R&S SMM-K148 and R&S SMM-K171).

If you do not have R&S SMM-K171 and the distinction between FR2-1 and FR2-2, you only see FR2. All settings that depend on the frequency deployment range are treated as if they were in FR2-1 in that case.

Table 2-1: Main air interface parameters

Parameter	Frequency range FR1*	Frequency range FR2*
Frequency bands**	410 MHz to 7.125 GHz 7.125 GHz to 24.250 GHz	FR 2-1: 24.250 GHz to 52.60 GHz FR 2-2: 52.60 GHz to 71.00 GHz
Carrier aggregation	≤ 16 carriers Initially 1	≤ 16 carriers
Channel bandwidth	3, 5, 10, 15, 20, 25, 30, 35, 40, 45, 50, 60, 70, 80, 90 MHz and 100 MHz	FR 2-1: 50, 100, 200, 400 FR 2-2: 400, 800, 1600, 2000 MHz
Subcarrier spacing (SCS)	15, 30, 60 kHz	FR 2-1: 60, 120 kHz FR 2-2: 120, 480, 960 kHz (depending on channel bandwidth)
Modulation schemes	Up to 1024QAM	Up to 1024QAM
MIMO schemes	<ul style="list-style-type: none"> DL: 2x2 and 4x4 MIMO (≤ 8 layers) UL: SISO and 2x2 MIMO (≤ 4 layers) 	≤ 2 layers: <ul style="list-style-type: none"> DL: 2x2 MIMO UL: SISO and 2x2 MIMO
Multiple access schemes	<ul style="list-style-type: none"> DL: CP-OFDMA UL: CP-OFDMA and optionally DFT-s-OFDM 	<ul style="list-style-type: none"> DL: CP-OFDMA UL: CP-OFDMA and optionally DFT-s-OFDM

*) Throughout this description, the designations are used interchangeably.

**) Frequency bands as defined by the 3GPP specification group TS 38.104 (currently release 17). You can however select also any other frequency within the frequency range your R&S SMM100A supports (see [Chapter 2.1, "Required options"](#), on page 18).

2.1 Required options

The basic equipment layout for generating 5G New Radio signals includes the options:

- Base unit
- Baseband generator (R&S SMM-B9)
- Baseband real-time extension (R&S SMM-B520)
- Option 5G New Radio (R&S SMM-K144)
- Optional, option 5G NR Release 16 (R&S SMM-K148). Requires R&S SMM-K144.
- Optional, option 5G NR Sidelink (R&S SMM-K170).
- Optional, option 5G NR Release 17 (R&S SMM-K171). Requires R&S SMM-K144 and R&S SMM-K148.

You can generate signals via playback of waveform files at the signal generator. To create the waveform file with R&S WinIQSIM2, you do not need a specific option.

To play back the waveform file at the signal generator, you have two options:

- Install the R&S WinIQSIM2 option of the digital standard, for example, R&S SMM-K255 for playing LTE waveforms.
- If supported, install the real-time option of the digital standard, for example, R&S SMM-K55 for playing LTE waveforms.

For more information, see data sheet.

2.2 5G NR numerology

5G NR signals can be transmitted in several frequency ranges. For each of the frequency range, the 3GPP specifies the allowed subcarrier spacing (SCS) and the supported cyclic prefix (CP), see [Table 2-2](#).

However, not all combinations of frequency range, SCS and CP are allowed. Moreover, the 3GPP specification defines the allowed combinations indirectly, as the so called numerology. A numerology is thus the combination of the SCS and the CP, where the SCS is defined as follows:

$$\Delta f = 15 \text{ kHz} * 2^\mu, \text{ with } \mu = 0 \text{ to } 4.$$

Table 2-2: Supported combinations of SCS and CP per frequency range

μ	SCS, kHz (Δf)	Max. channel bandwidth, MHz	$N_{\text{sym-slot}}$	$N_{\text{slot}}^{\text{frames}}$	$N_{\text{frame-slot}}^{\text{sub}}$	Symbol duration μs	Normal cyclic prefix (NCP)	Extended cyclic prefix (ECP)	Supported for data	Supported for synchronization	FR1	FR2-1	FR2-2
0	15	50	14	10	1	66.67	x	-	x	x	x	-	-
1	30	100	14	20	2	33.33	x	-	x	x	x	-	-

μ	SCS, kHz (Δf)	Max. channel bandwidth, MHz	$N_{\text{sym-slot}}$	$N_{\text{slot frames}}$	$N_{\text{sub-frame slot}}$	Symbol duration μs	Normal cyclic prefix (NCP)	Extended cyclic prefix (ECP)	Supported for data	Supported for synchronization	FR1	FR2-1	FR2-2
2	60	100 (FR1) 200 (FR2-1)	14 (NCP) 12 (ECP)	40	4	16.67	x	x	x	-	x	x	-
3	120	400 100 (FR2-2)	14	80	8	8.33	x	-	x	x	-	x	x
4	240	-	14	160	16	4.17	x	-	-	x	-	x	-
5	480	1600	14	320	32	2.08	x	-	x	x	-	-	x
6	960	2000	14	640	64	1.04	x	-	x	x	-	-	x

2.3 Multiple accesses schemes

5G NR supports two channel access methods for uplink signals, CP-OFDM and DFT-s-OFDM (see [Table 2-1](#)). Depending on the use case, one or the other has advantages over the other. For DFT-s-OFDM, an additional signal processing stage, transform precoding, is applied. Transform precoding is the term for the digital Fourier transformation (DFT) used in the 5G NR standard.

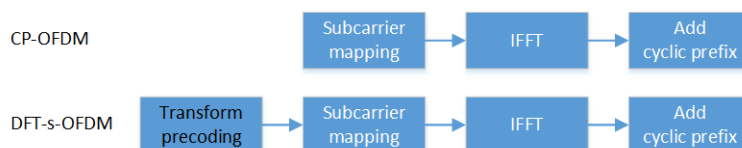

Figure 2-1: Signal processing depending on multiple access schemes

In this implementation, you can define per PUSCh which of the two access schemes is used.

2.4 Frame structure, slots and slot formats

Frame structure

As it is in LTE, the 5G NR **frame** is 10 ms long; a half-frame lasts 5 ms. Frames consist of 10 subframes, each of them with a length of 1 ms.

Subframes contain a *variable number of slots*, depending on the subcarrier spacing (SCS). Moreover, subframes can use different SCS in different bandwidth parts (BWP), see [Figure 2-4](#).

Because the frame (subframe) lengths are constant but the number of slots and their lengths varies, the common time boundaries between the different numerologies are the frames (or the subframes).

Slots and slots formats

The basic transmission unit in 5G NR is the **slot**. Slots can have different formats; slots comprise of 14 or 12 OFDM symbols, depending on the used cyclic prefix (CP). Hence, depending on the used CP, there are different numbers of slots per frame (and sub-frame) and the CP itself depends on the used numerology, see [Table 2-2](#).

Slots can have different formats, defined by the slot format index (SFI). The SFI is signaled by group common PDCCHs. The slot formats differ in the number of symbols that can be used for DL (D) and UL (U) transmission. Most of the symbols are usually used for transmission of user data (payload). Slots can also contain flexible symbols (x), that can be used for dynamic DL/UL transmission or as a gap for the DL to UL and vice versa switching.

The slot formats are defined in [TS 38.211](#), table 4.3.2-3.

2.5 Resource blocks and resource grid

Resource grid

The basic granularity in 5G NR resource grid is the **resource element** (RE), which consists of one OFDM symbol over one subcarrier and is the same as in LTE. Another granularity unit is a resource block (RB), which spans 12 subcarriers in frequency domain.

Resource blocks

The 5G NR specification defines different types of resource blocks:

- Common resource blocks (CRB)
The term CRB is typically used when referring to the whole carrier. A CRB grid is defined for each numerology.
The center of subcarrier #0 of the CRB#0 is referred as **Reference point A**; it is signaled relative to SS/PBCH or ARFCN.
See [Figure 2-2](#) and [Figure 2-3](#).
- Usable resource blocks (URBs)
The term URB is used to specify the subset of the CRBs of a specific numerology where transmission is allowed; that is, these RBs are not in the guard bands. The URBs define the so called transmission bandwidth (TxBW) for the respective numerology, see [Chapter 2.6, "Transmission bandwidths TxBWs"](#), on page 21.
- Physical resource blocks (PRB)

The term PRB describes the RBs inside the bandwidth parts (BWP). PRBs are numbered relative to the beginning of the bandwidth part.

See [Carrier bandwidth part \(BWP\)](#) and [Figure 5-4](#).

2.6 Transmission bandwidths TxBWs

As listed in [Table 2-2](#), there are different numerologies (that is different combinations of subcarrier spacing SCS and cyclic prefix CP) supported for each deployment and channel bandwidth combination. The different SCSs results in transmission bandwidths TxBWs, which span different frequency ranges and according to [TS 38.104](#) use different number of resource blocks N_{RB} . The start of the TxBW is signaled relative to the Reference point A and is numerology-specific.

To achieve a common alignment between the different TxBWs within a carrier, the 3GPP specification defines the following rules:

- Alignment is achieved, if the center of the first subcarrier (SC#0) of an RB is aligned to the center of the SC#0 of the RBs of all numerologies with a smaller μ .
- The TxBWs are centered on the carrier center, that is around the center of the "Channel Bandwidth" for the corresponding carrier.
- If not applicable, the TxBWs can be shifted with ± 6 subcarriers relative to the carrier center, where for each TxBWs the corresponding SCS applies.

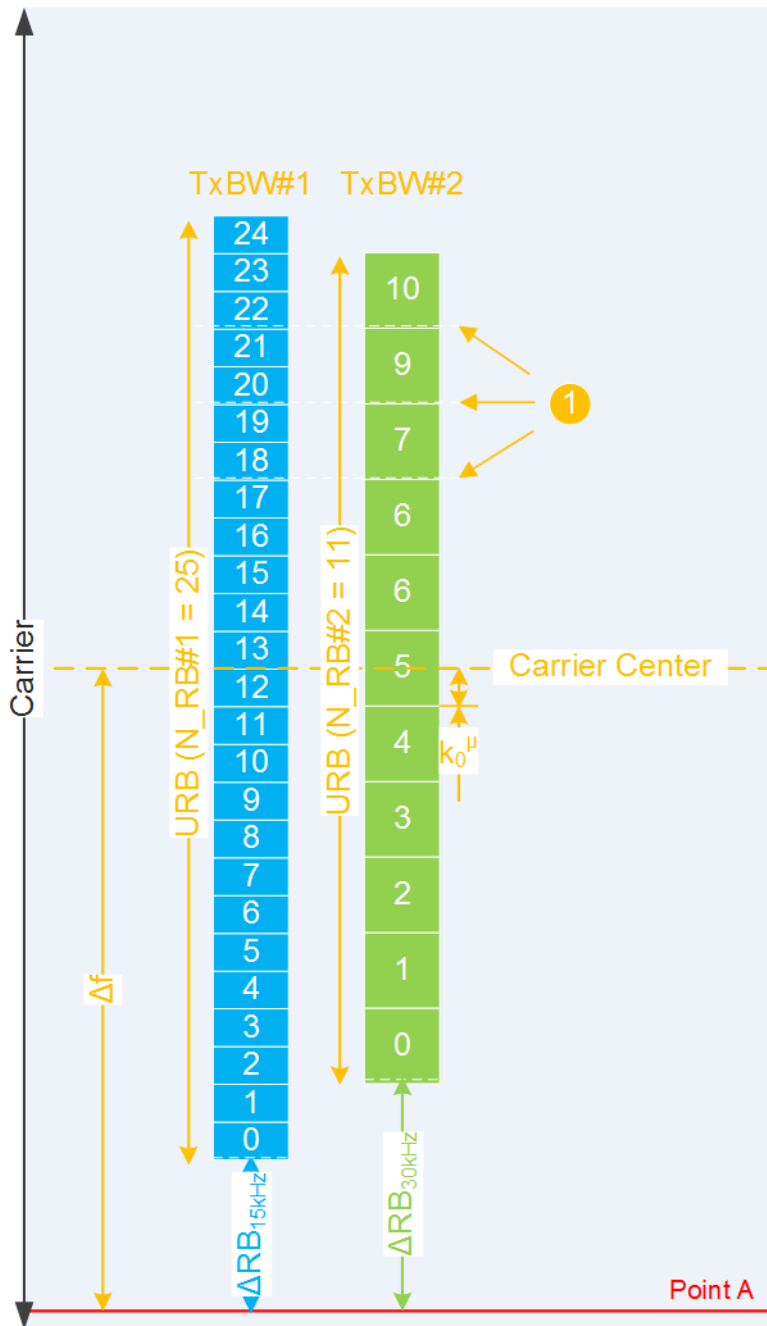

Figure 2-2: Transmission bandwidth (example)

- Carrier = Channel bandwidth = 5 MHz
- RB = Resource blocks
- SCS = Subcarrier spacing
- TxBWs = Transmission bandwidth
- TxBWs#1 = SCS 15 kHz, usable resource blocks USB = " $N_{RB} = 25$ "; TxBWs is not centered on the carrier center, a frequency shift with $k_0^\mu = -6$ subcarriers is applied
- TxBWs#2 = SCS 30 kHz, usable resource blocks USB = " $N_{RB} = 11$ "; TxBWs is centered on the carrier center (" $k_0^\mu = 0$ ")
- k_0^μ = Number of subcarriers the TxBW is shifted related to the carrier center, see k_0^μ
- ΔRB = Usable RB to common RBs, see [TxBW Offset](#)

1	= Aligned centers of the first subcarrier (SC#0) of resource blocks
Point A	= Common reference point for all numerologies and TxBW; does not have to be within the carrier bandwidth. Point A is the center of subcarrier #0 of the CRB#0
Carrier center	= Center frequency of the carrier
Δf	= Offset between the baseband center frequency and the reference point A, see Point A to Baseband Center .

From all possible TxBW for a specific channel bandwidth, the base station decides which TxBW to use. The base station/network signals the position of the used TxBW to the users as function of the following:

- The position of the Reference point A, that is common to all numerologies.
- The frequency offset ΔRB between the usable resource blocks of the TxBW and the Reference point A, see [TxBW Offset](#).
- The used frequency shift $k_0^\mu = \{-6, 0, 6\}$, see [k0 \$\mu\$](#) .

2.7 Synchronization signals and SS/PBCH block

The 3GPP specifies two synchronization signals (SS), the primary synchronization signal (PSS) and the secondary synchronization signal (SSS). Together with the physical broadcast channel (PBCH), they are bundled in a synchronization signal block (SS/PBCH block). PSS/SSS are used for radio frame synchronization and detection of the physical layer cell ID. The location of the synchronization signal is variable.

The PBCH carries general system information. It is polar-coded and QPSK modulated. The PBCH symbols carry its own DMRS, which position depends on the physical layer cell ID.

An SS/PBCH block is transmitted on a fixed schedule. Each half-frame contains of either 4, 8 or 64 SS/PBCH blocks, depending on the subcarrier spacing (SCS). The SS/PBCH block is transmitted twice in a slot, if that slot carries the synchronization signal.

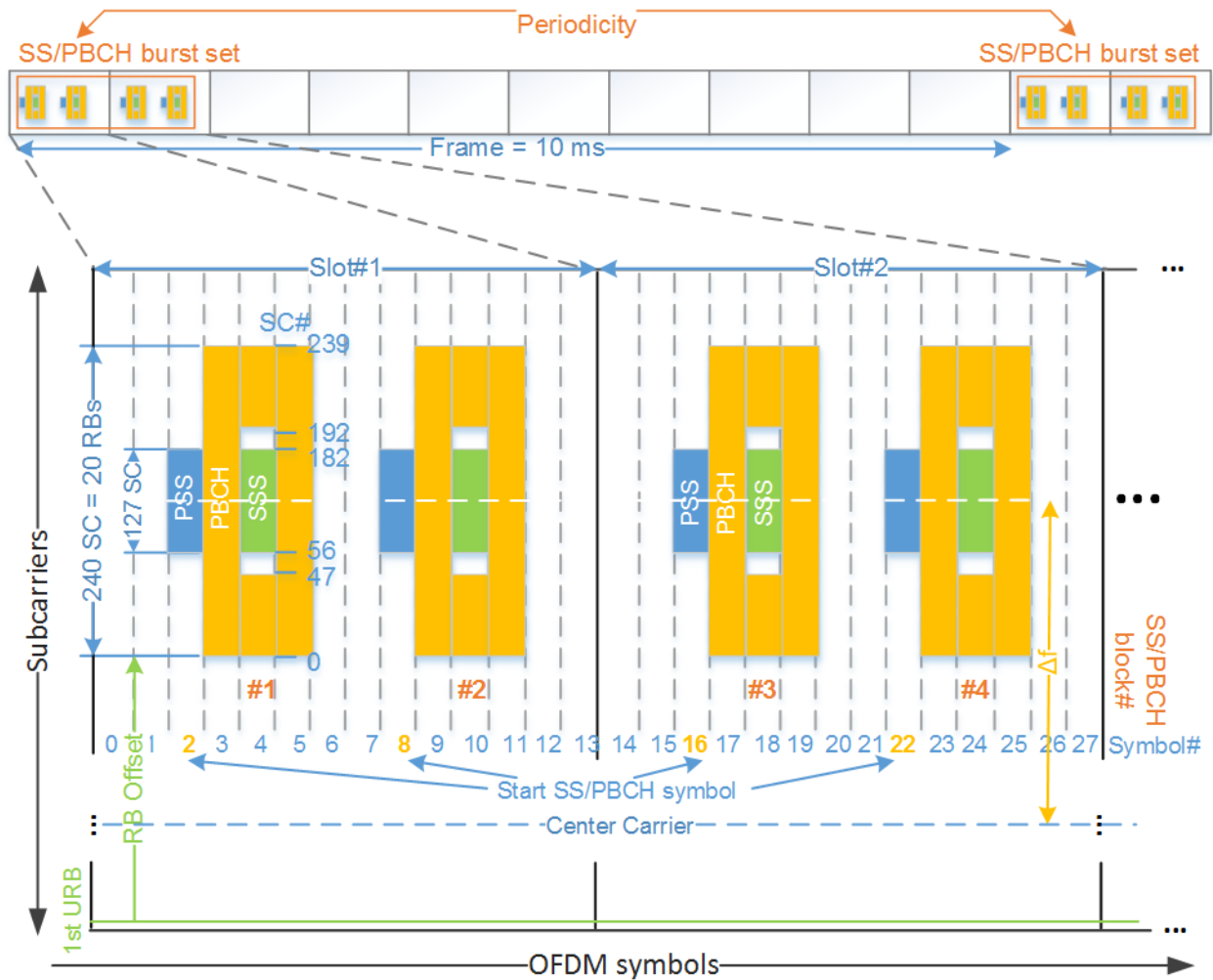

Figure 2-3: Location of synchronization signals in a succession of several slots (Case A - 15 kHz SCS, $f < 3$ GHz)

- PSS/SSS = Primary/secondary synchronization signals
- PBCH = Physical broadcast channel
- SS/PBCH block = SS and PBCH are always transmitted together in a block
- SS/PBCH burst set = A group of 4, 8 or 64 SS/PBCH blocks, depending on the SCS (in this example, burst set = 4 blocks)
- Frame = 10 ms = 10 slots
- 1 slot = 1 subframe = 1 ms
- SC = Subcarrier
- Start SS/PBCH symbol = $\{2, 8\} + 14n$, where $n = 0, 1$; Start symbols = 2, 8, 16 and 22
- RB offset = Defines the SS/PBCH allocation position in the frequency (see [RB Offset/RB Offset \(15 kHz SCS\)/RB Offset \(60 kHz SCS\)](#)); within an RB, the allocation can be further shifted (see [SC Offset/SC Offset \(15 kHz SCS\)/SC Offset \(60 kHz SCS\)](#))
- Periodicity = Defines how often the burst set is repeated (in this example, periodicity = 10 ms; the SS/PBCH burst set is repeated every frame), see [Burst Set Periodicity](#)
- 1st URB = First usable resource block (URB), that is the first RB within the TxBW, see [Figure 2-2](#)
- Carrier center = Center frequency of the cell
- Δf = Offset between the center frequency of SS/PBCH block and the carrier center frequency

The SSs are allocated on predefined symbols but the allocated resource blocks and subcarriers are user-defined. The TS 38.213 specifies the number of and the start of the symbols depending on the used SCS and frequency range, see Figure 2-3. In 3GPP, these different start positions of the SS/PBCH blocks are referred as case A to case E.

2.8 Carrier bandwidth part (BWP)

In 5G NR, the bandwidth used for the communication with a specific user (UE) is typically smaller than the channel bandwidth. These user-specific bandwidths are managed by the different-sized, so called (carrier) bandwidth parts (BWP). Each of BWP uses its own numerology and thus can use different SCS, symbol duration and CP length (see Table 2-2).

Using BWPs with different bandwidths allows flexible resource allocation, for example, for support of UE with reduced bandwidth capabilities or supporting non-contiguous spectrum. Bandwidth parts can overlap, in which case UEs share the resource elements.

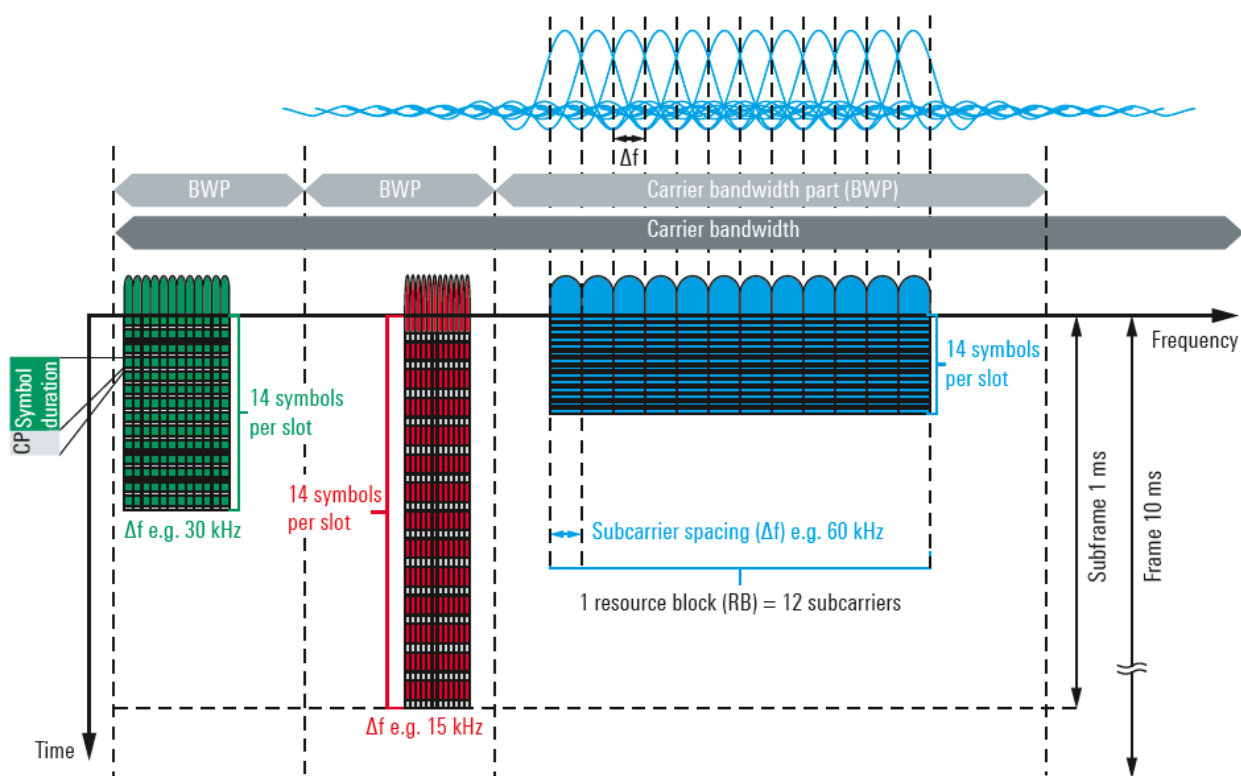

Figure 2-4: 5G NR numerology and BWP [1]

A BWP is a contiguous set of physical resource blocks that has the same subcarrier spacing and thus numerology. UEs can be configured with up to 4 BWPs in DL and UL, but only one can be active at a time. UEs are not expected to receive and transmit outside its active BWP.

2.9 Carrier aggregation

The 5G NR specification defines the aggregation of multiple 5G carriers. Two up to 16 component carriers (CC, in 5G phase 1) can be grouped to provide wider transmission bandwidths. Up to 1 GHz of spectrum can be aggregated. A UE could simultaneously receive or transmit on one or multiple CCs depending on its capabilities.

Spectrum deployment can be either contiguous with adjacent component carriers, or non-contiguous with non-adjacent component carriers. The individual component carriers can belong to the same frequency band (intra-band) or to different frequency bands (inter-band). Component carriers transmitted by the same base station provide the same cell coverage.

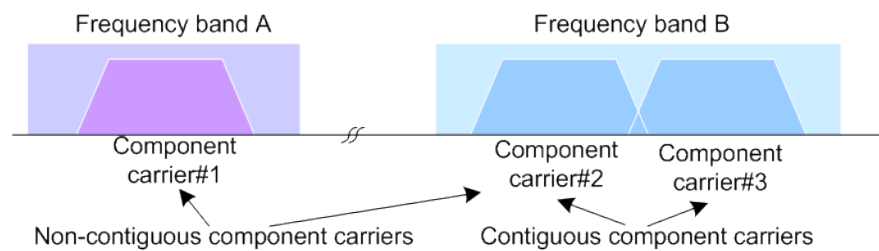

Figure 2-5: Carrier aggregation

The 5G NR specification defines two different approaches about informing the UE about the scheduling for each band: a separate PDCCH for each carrier or a common PDCCH for multiple carriers (cross-carrier scheduling).

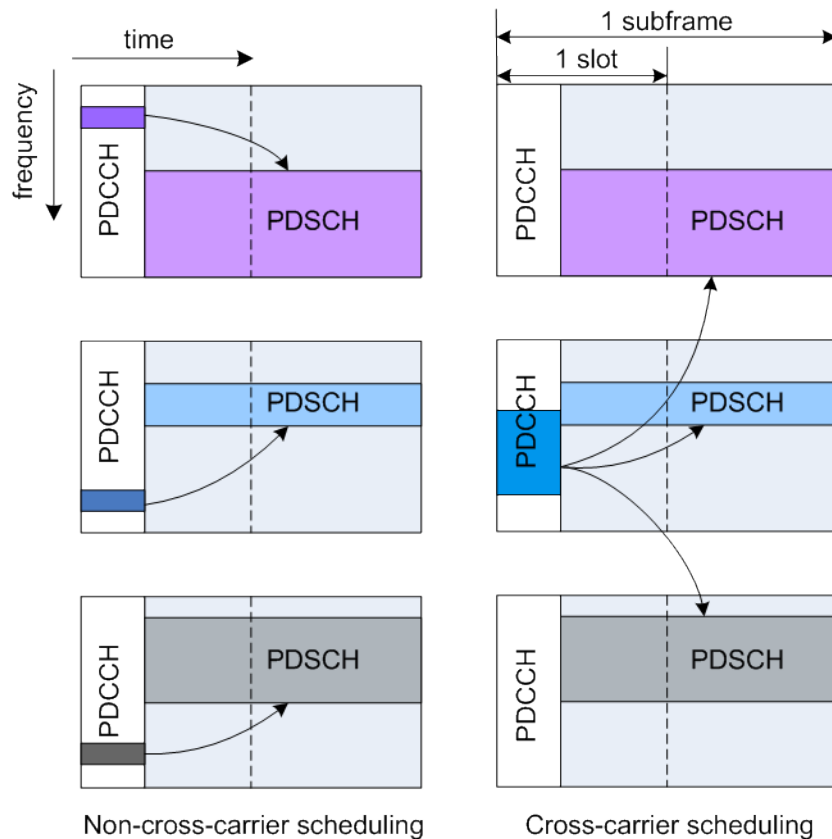

Figure 2-6: 5G NR scheduling approaches

In the dedicated/non-cross-carrier approach, the PDCCH on a component carrier assigns PDSCH resources on the same component carrier.

In the cross-carrier approach, the PDCCH on a component carrier assigns resources on one of multiple component carriers. The component carriers are identified by the DCI field CIF (carrier indicator field).

Related settings

See:

- Enable fading on the SMW.
Set "System Config > System Configuration > Fading/Baseband Config > Mode" to "Advanced".
- [Chapter 5.2.2, "Carriers settings"](#), on page 51
Set at least 2 carrier.

2.10 Antenna port mapping

Antenna ports are not physical antennas, but rather are a logical concept. Each antenna port carries certain signal components (= physical channels) that have to be transmitted under the same conditions. Physical channels can be transmitted on a sin-

gle antenna port, or on several antenna ports. Each antenna port in turn can be mapped to one of the physical antennas. Typically, one physical antenna combines several antenna ports. However, one specific antenna port can also be transmitted on more than one physical antenna.

In this implementation, you can map the antenna ports used by the various physical channels defined by 3GPP to one or two layer configurations in the dedicated "Antenna Ports" dialogs.

These dialogs display the antenna port-mapping settings in a table form, as an antenna port-mapping table.

The mapping table is a matrix with number of rows equal to the number of physical Tx antennas (basebands) and number of columns equal of the number of antenna ports (AP). The available antenna ports depend on the current configuration. The yellow matrix elements in the mapping table indicate the default antenna port to physical antenna (TX antenna/baseband) mapping.

Signal/Channel	Antenna port
<ul style="list-style-type: none"> • PSS / SSS • PBCH • S-PSS / S-SSS • PSBCH 	The synchronization signals are assumed to be transmitted on antenna port 4000.
PDSCH	The PDSCH can be transmitted on multiple antenna ports (1000 to 1011). By default, the PDSCH is transmitted on antenna port 1000 (for physical antenna 1) and antenna port 1001 (for physical antenna 2).
PSSCH	The PSSCH can be transmitted on antenna ports 1000 to 1001.
PUSCH	The PUSCH can be transmitted on multiple antenna ports (0 to 11). By default, the PUSCH is transmitted on antenna port 0 (for physical antenna 1) and antenna port 1 (for physical antenna 2).
<ul style="list-style-type: none"> • PDCCH • PUCCH • PSCCH 	The PDCCH/PUCCH are assumed to be transmitted on antenna port 2000.

Related settings:

- "Users/BWPs > UL BWPs > NZP CSI-RS" > [Resource-Settings > Antenna Port Mapping](#)
- "Users/BWPs > UL BWPs > SRS > SRS Resource Set Settings" > [Antenna Ports > Config](#)
- "Scheduling > PDSCH/PUSCH" > [Antenna ports](#)

2.11 5G NR channels and signals overview

Channels:

- DL: PBCH, PDCCH (CORESET), PDSCH
- UL: PRACH, PUCCH, PUSCH

Signals:

- DL: PSS/SSS, CSI-RS, PRS, DMRS (for PBCH, PDCCH, PDSCH), TRS, PTRS
- UL: DMRS (for PUCCH, PUSCH), PTRS, SRS

The following channels and signals are supported in the current firmware version:

- PSS/SSS, PBCH, PDCCH (CORESET), PDSCH, PUSCH, PUCCH; PBCH incl. MIB, PDSCH, PDCCH and PUSCH incl. DMRS, PTRS, SRS, CSI-RS, PRS

Related settings:

- [Chapter 5.2.12, "PBCH settings"](#), on page 87
- [Chapter 5.3.6.6, "ZP CSI-RS settings"](#), on page 144 and [Chapter 5.3.6.7, "NZP CSI-RS settings"](#), on page 147
- ["PTRS Config ..."](#) on page 128 and [Chapter 5.5.6, "PTRS settings"](#), on page 230
- [Chapter 5.3.6.2, "PDSCH settings"](#), on page 115
- [Chapter 5.3.7.4, "PUSCH settings"](#), on page 163 and [Chapter 5.3.7.5, "PUSCH UCI settings"](#), on page 181
- [Chapter 5.3.7.6, "SRS settings"](#), on page 183
- [Chapter 5.5, "PDSCH and PUSCH settings"](#), on page 212
- [Chapter 5.6, "CORESET settings"](#), on page 237
- [Chapter 5.3.7.2, "PUCCH settings"](#), on page 157 and [Chapter 5.9, "PUCCH settings"](#), on page 273
- [Chapter 5.10, "PRACH settings"](#), on page 280

2.12 Overlap handling

The [TS 38.211](#) defines channels and signals that share the available resources in the time-frequency domain.

Flexible scheduling is one of the main functions in 5G new radio. But this flexibility in scheduling can lead to allocations of the same or different type that overlap fully or partly in the time-frequency domain. Because the specification does not define all possible combinations of channels and signals, a proprietary internal mechanism decides what bits are mapped to the affected subcarriers.

The handling of overlapping resources depends on the priority of the affected channels, see [Table 2-3](#).

Table 2-3: Priority

Priority	Channel or signal
High	CORESET, PBCH, PDSCH, PRACH, PUCCH All signals
Middle	PDSCH PUSCH
Low	Dummy allocations

Overlap handling rules:

- Overlapping of signals and/or channels with different priorities
The channel with the higher priority is transmitted completely. The overlap is not indicated, not in the "Scheduling" dialog or in the "Time Plan".
- Overlapping of allocations with the same priority
If channels with the same priority are scheduled to share resources, the signals of the channels are added.
Both the "Scheduling" dialog and the "Time Plan" indicate the overlapping resources.

Example: Unresolved conflict

Figure 2-7 shows the scheduling table and the time plan of overlapping allocations (PDSCH) with the same priorities.

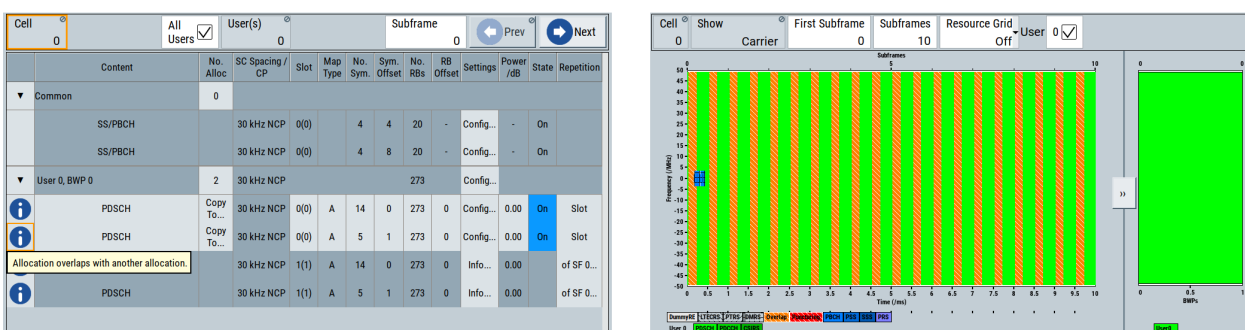

Figure 2-7: Overlapping allocations

3 Find out the implemented 3GPP specification

The "Info" dialog displays the currently supported version of the 3GPP standard and the installed version of the 5G New Radio application.

Access:

- ▶ Select "5G New Radio > Info".

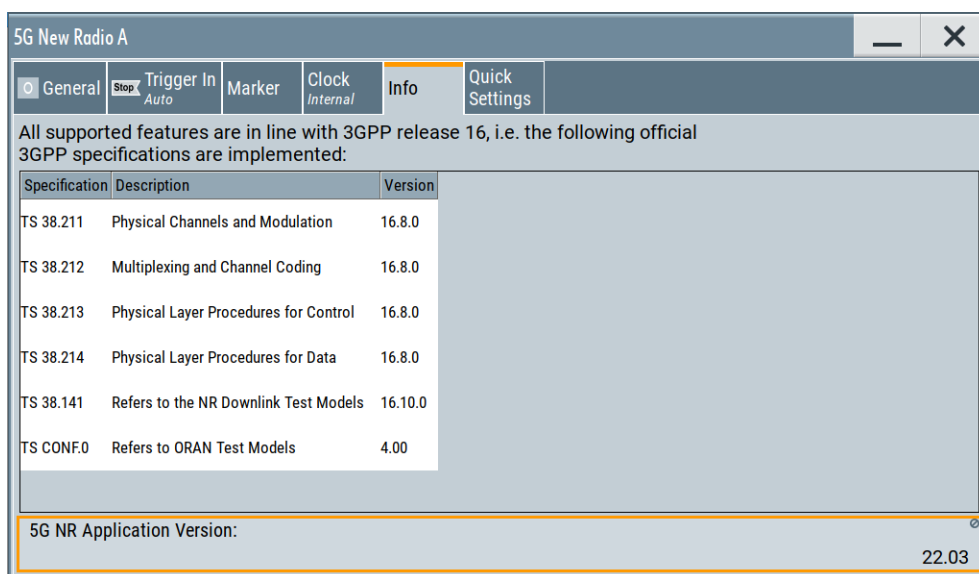

Settings:

3GPP Specification Table	31
5G NR Application Version	31

3GPP Specification Table

Displays the 3GPP specifications and versions implemented in the R&S SMM features.

Remote command:

`[:SOURCE] :BB:NR5G:VERSION?` on page 420

5G NR Application Version

Displays the installed version of the 5G New Radio application.

Remote command:

`[:SOURCE] :BB:NR5G:PLVersion?` on page 415

4 5G NR quick settings

Access:

1. Select "Baseband > 5G NR".
2. Select "Quick Settings".

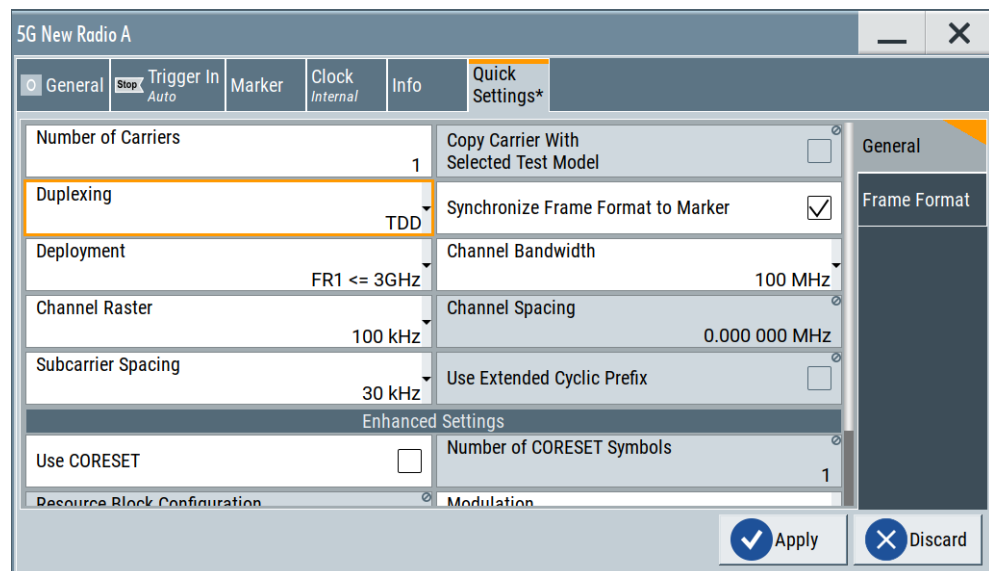

With the provided settings, you can quickly configure a 5G new radio signal. Configured is signal with the selected settings and one BWP, one user, one frame and if TDD is used, the power mode active subframe is selected automatically. If enabled, CORESET is configured, too (see "Use CORESET" on page 35).

The remote commands required to define these settings are described in [Chapter 10, "Remote-control commands"](#), on page 383.



Applying quick settings automatically adjusts the corresponding marker settings.

Settings:

4.1 General settings

Access:

1. Select "Baseband > 5G NR".
2. Select "Quick Settings > General".

Settings:

Number of Carriers.....	33
Copy Carrier With Selected Test Model.....	33
Duplexing.....	33
Synchronize Frame Format to Marker.....	33
Deployment.....	34
Channel Bandwidth.....	34
Channel Raster.....	34
Channel Spacing.....	35
Subcarrier Spacing.....	35
Use Extended Cyclic Prefix.....	35
Use CORESET.....	35
Number of CORESET Symbols.....	35
Use Transform Precoding.....	36
Resource Block Configuration.....	36
Modulation.....	36
Number of Resource Blocks.....	36
Resource Block Offset.....	36
Apply.....	36
Discard.....	36

Number of Carriers

Selects the number of carriers. Needed for carrier aggregation.

Note: Value can be configured if "System Config > Fading & BB Config > BB Sources" is set to "Separate". If it is set to "Coupled", the value is read-only.

Remote command:

`[:SOURce<hw>] :BB:NR5G:QCKSet:GENeral:NCARier` on page 429

Copy Carrier With Selected Test Model

Creates a copy of a component carrier based on a test model configuration.

To copy carriers like this, proceed as follows.

- Select a test model for the first carrier.
- Increase the number of carrier in the "Quick Settings".
- Copy the carrier with the test model with "Copy Carrier with Selected Test Model".
- "Apply" the changes.

After confirmation ("Apply"), the copied carriers are displayed in the [carrier settings](#) dialog.

Remote command:

`[:SOURce<hw>] :BB:NR5G:QCKSet:GENeral:CCTModel` on page 427

Duplexing

Selects the duplexing mode.

Remote command:

`[:SOURce<hw>] :BB:NR5G:QCKSet:GENeral:DUPLexing` on page 429

Synchronize Frame Format to Marker

Turns synchronization of the frame format and markers on and off.

If on, the application automatically places the markers according to the selected duplexing pattern.

Remote command:

`[:SOURCE<hw>] :BB:NR5G:QCKSet:GENeral:SFFM:STATe` on page 431

Deployment

Selects one of the frequency ranges, specified for 5G NR transmission, see [Table 2-1](#).

Remote command:

`[:SOURCE<hw>] :BB:NR5G:QCKSet:GENeral:CARDepl` on page 427

Channel Bandwidth

Selects the bandwidth of the node carrier from a list with predefined values, see [Table 2-1](#).

Remote command:

`[:SOURCE<hw>] :BB:NR5G:QCKSet:GENeral:CBW` on page 427

Channel Raster

Sets the "Channel Raster" based on the set "Deployment".

Shows the distance between the RF reference frequencies in the selected operating band. The distance between frequencies depends on the channel raster the operating band belongs to (channel raster are defined by 3GPP).

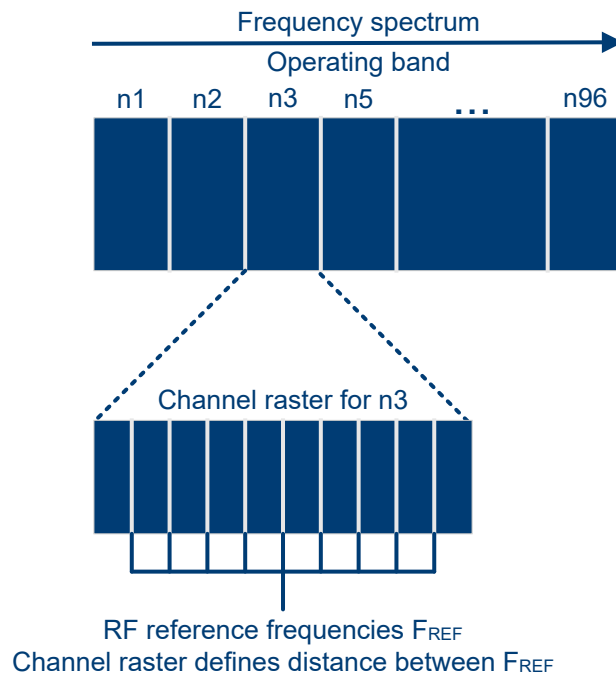

For most operating bands, the channel raster is a fix value of 15 kHz, 60 kHz or 100 kHz.

A few selected operating bands support multiple channel raster.

The channel raster is the basis for the calculation of the channel spacing (distance between component carriers) for intra-band contiguous carrier aggregation.

For details about the channel raster and its effects, see 3GPP 38.104, chapter 5.4.2.

Available channel raster values depend on the selected frequency range.

- FR1: channel raster can be 15 kHz or 100 kHz.
- FR2-1: channel raster is 60 kHz.
- FR2-2: channel raster is 100 kHz.

"Channel Raster" is not displayed when the "Number of Carriers" is shown inactive.

Remote command:

[\[:SOURCE<hw>\]:BB:NR5G:QCKSet:GENeral:CHRaster](#) on page 427

Channel Spacing

Displays the value for the "Channel Spacing". It is by default automatically calculated by the set "Channel Raster" and the set "Channel Bandwidth".

The value can be adjusted manually, but is recalculated if the "Channel Raster" or the "Channel Bandwidth" is adjusted.

"Channel Spacing" is not displayed when the "Number of Carriers" is shown inactive. In this case, it is used like "Carrier Spacing" equals 0.

Remote command:

[\[:SOURCE<hw>\]:BB:NR5G:QCKSet:GENeral:CHSPacing](#) on page 428

Subcarrier Spacing

Selects a combination of the subcarrier spacing (SCS) and the cyclic prefix (CP), where the available values depend on the "Deployment".

See [Table 2-2](#).

Remote command:

[\[:SOURCE<hw>\]:BB:NR5G:QCKSet:GENeral:SCSPacing](#) on page 428

Use Extended Cyclic Prefix

Show if the extended cyclic prefix is enabled or disabled.

Remote command:

[\[:SOURCE<hw>\]:BB:NR5G:QCKSet:GENeral:ECPState](#) on page 428

Use CORESET

If enabled, a CORESET is scheduled with the number of symbols, set with the parameter [Number of CORESET Symbols](#).

All other configurations are performed automatically. The CORESET is scheduled at the beginning of the slot. PDSCH is shortened or reallocated automatically.

CORESET is fully allocated; dummy REs are used.

Remote command:

[\[:SOURCE<hw>\]:BB:NR5G:QCKSet:GENeral:ES:CS:STATE](#) on page 429

Number of CORESET Symbols

Sets the number of symbols in the CORESET.

Remote command:

[\[:SOURCE<hw>\]:BB:NR5G:QCKSet:GENeral:ES:CSLength](#) on page 430

Use Transform Precoding

Turns [transform precoding](#) on and off.

Remote command:

[\[:SOURCE<hw>\]:BB:NR5G:QCKSet:GENeral:ES:TP:STATe](#) on page 431

Resource Block Configuration

Sets the configuration mode for the resource block configuration.

This value is according to TS 38.521 table 6.1-1 and 6.1-2.

Resource block configuration is available for uplink signals. Availability of resource block configurations also depends on the selected channel bandwidth.

Remote command:

[\[:SOURCE<hw>\]:BB:NR5G:QCKSet:GENeral:ES:RBConfig](#) on page 430

Modulation

Sets the modulation scheme.

3GPP release 17 introduces 1024QAM modulation on the downlink. Release 17 features require R&S SMM-K171. 1024QAM modulation on the uplink is also available with that option.

Remote command:

[\[:SOURCE<hw>\]:BB:NR5G:QCKSet:GENeral:ES:MOD](#) on page 429

Number of Resource Blocks

Sets the number of resource blocks.

Remote command:

[\[:SOURCE<hw>\]:BB:NR5G:QCKSet:GENeral:ES:RBNumber](#) on page 430

Resource Block Offset

Sets the resource block offset.

Remote command:

[\[:SOURCE<hw>\]:BB:NR5G:QCKSet:GENeral:ES:RBOffset](#) on page 430

Apply

Select to apply the configuration.

Note: Settings which are not configured by the "Quick Settings" are set to their default values by using the "Apply" button.

Remote command:

[\[:SOURCE<hw>\]:BB:NR5G:QCKSet:APPLY](#) on page 434

Discard

Ignores the configuration, i.e. the configuration in the "Quick Settings" dialog is not applied; configurations made in this dialog are lost.

Remote command:

[\[:SOURCE<hw>\]:BB:NR5G:QCKSet:DISCard](#) on page 434

4.2 Frame format

Access:

1. Select "Baseband > 5G NR".
2. Select "Quick Settings > General".
3. Select "Duplexing > TDD".
4. Select "Frame Format".

You can configure the number of slots in the frame, the slot format and the special slot configuration. The resulting configuration is graphically represented.

5G New Radio A

General Trigger In Auto Marker Clock Internal Info Quick Settings*

Slot Period: 10 Slots Use IAB Format

Number of DL Slots: 4 Number of Special Slots: 1 Number of UL Slots: 5

Slot Format: D D D D S U U U U U

Special Slot Configuration

Use Special Format Index Slot Format Index: 7

Number of DL Symbols: 9 Number of Guarded Symbols: 5 Number of UL Symbols: 0

Slot Format: D D D D D D D D D G G G G G

Apply Discard

Settings:

Slot Period.....	37
Use IAB Format.....	38
Number of DL Slots.....	38
Number of Special Slots.....	38
Number of UL Slots.....	38
Use Special Format Index.....	38
Slot Format Index.....	38
Number of DL Symbols.....	38
Number of Guarded Symbols.....	39
Number of UL Symbols.....	39

Slot Period

Sets the duration of the frame in slots.

Remote command:

[:SOURce<hw>] :BB:NR5G:QCKSet:FRMFormat:SLINT on page 431

Use IAB Format

Option: R&S SMM-K148

Turns usage of the frame formats for integrated access backhaul (IAB) applications on and off. Using the IAB format changes the order of uplink, downlink and the special slot within the frame.

Remote command:

`[:SOURce<hw>] :BB:NR5G:QCKSet:FRMFormat:IAB:STAtE` on page 431

Number of DL Slots

If "Link Direction > Downlink", sets the number of DL slots in the frame.

In uplink duration, the value is calculated as follows:

"Number of DL Slots" = "Slot Period" - "Number of UL Slots" - "Special Slots".

Remote command:

`[:SOURce<hw>] :BB:NR5G:QCKSet:FRMFormat:NDLSlots` on page 431

Number of Special Slots

Indicates that there is 1 special slot in the frame.

Remote command:

`[:SOURce<hw>] :BB:NR5G:QCKSet:FRMFormat:NSSLots?` on page 432

Number of UL Slots

If "Link Direction > Uplink", sets the number of UL slots in the frame.

In downlink duration, the value is calculated as follows:

"Number of UL Slots" = "Slot Period" - "Number of DL Slots" - "Special Slots".

Remote command:

`[:SOURce<hw>] :BB:NR5G:QCKSet:FRMFormat:NULSlots` on page 432

Use Special Format Index

Turns usage of the special format index on and off.

If on, you can select one of the [slot formats](#) defined by 3GPP.

If off, you can configure a custom slot format by entering the required number of [downlink symbols](#) or [uplink symbols](#).

Entering the number of downlink symbols is possible when you are in downlink mode.

Entering the number of uplink symbols is possible when you are in uplink mode.

Remote command:

`[:SOURce<hw>] :BB:NR5G:QCKSet:FRMFormat:SSC:SFI:STAtE` on page 434

Slot Format Index

Sets the special slot format index according to [TS 38.213](#) and thus defines the slot structure.

Remote command:

`[:SOURce<hw>] :BB:NR5G:QCKSet:FRMFormat:SSC:SLFMT` on page 432

Number of DL Symbols

Indicates the number of DL symbols, depending on the selected slot format index.

In downlink mode, defining the number of downlink symbols is possible when you turn off usage of a [special format index](#).

Remote command:

`[:SOURce<hw>] :BB:NR5G:QCKSet:FRMFormat:SSC:NDSLsymbols` on page 432

Number of Guarded Symbols

Indicates the number of guard symbols, depending on the selected slot format index.

Remote command:

`[:SOURce<hw>] :BB:NR5G:QCKSet:FRMFormat:SSC:NGSYmbols?` on page 433

Number of UL Symbols

Indicates the number of UL symbols, depending on the selected slot format index.

In uplink mode, defining the number of uplink symbols is possible when you turn off usage of a [special format index](#).

Remote command:

`[:SOURce<hw>] :BB:NR5G:QCKSet:FRMFormat:SSC:NULSymbols` on page 433

5 5G New Radio configuration and settings

Access:

- ▶ Select "Baseband > 5G NR".

The remote commands required to define these settings are described in [Chapter 10, "Remote-control commands"](#), on page 383.

Settings:

• General settings	40
• Node settings	49
• Users / BWPs settings	93
• Scheduling settings	198
• PDSCH and PUSCH settings	212
• CORESET settings	237
• CSI-RS settings (scheduling table)	269
• RIM-RS setting (scheduling table)	272
• PUCCH settings	273
• PRACH settings	280
• SRS settings (scheduling table)	282
• PSSCH and PSCCH settings	288
• PSFCH settings	298

5.1 General settings

Access:

- ▶ Select "Baseband > 5G NR".

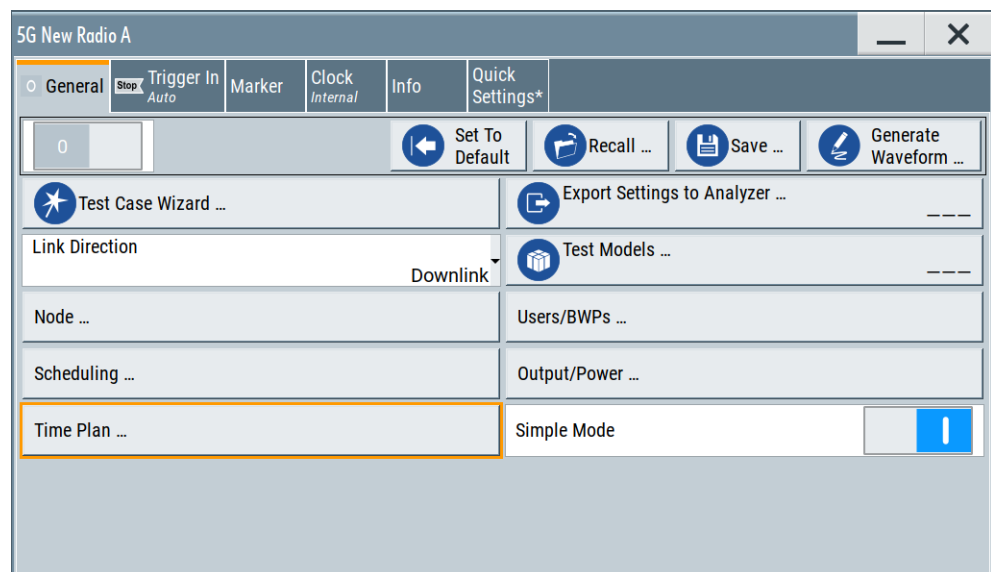

This dialog comprises the standard general settings, the default and the "Save/Recall" settings, and access to dialogs with further settings.

Settings:

State.....	41
Set to Default.....	42
Save/Recall.....	42
Generate Waveform File.....	42
Test Case Wizard.....	42
FRC Wizard.....	43
L User.....	43
L Carrier.....	43
L BWP.....	43
L FRC.....	43
L Deployment.....	43
L Modulation.....	43
L SC Spacing.....	43
L Payload Size.....	44
L RB Offset.....	44
L Mapping Type.....	44
L PTRS.....	44
Export Settings to Analyzer.....	44
Link Direction.....	44
Test Models	45
L User Files.....	45
L Filter Test Models.....	46
L Standard.....	46
L Test Models.....	47
L Test Case.....	47
L Frequency Range.....	47
L Duplexing.....	47
L Bandwidth.....	47
L Subcarrier Spacing.....	47
L Select.....	47
Node.....	47
Users/BWPs.....	48
Scheduling.....	48
Output/Power.....	48
Simple Mode.....	48
U-Plane Generation.....	48

State

Activates the standard and deactivates all the other digital standards and digital modulation modes in the same path.

Remote command:

[:SOURce<hw>] :BB:NR5G:STATe on page 420

Set to Default

Calls the default settings. The values of the main parameters are listed in the following table.

Parameter	Values
"State"	Not affected by "Set to Default"
"Link direction"	Downlink
"Channel bandwidth"	100 MHz
"Dummy REs > State"	On
"Dummy REs > SC Spacing/CP"	30 kHz NCP

Remote command:

[:SOURce<hw>] :BB:NR5G:PRESet on page 416

Save/Recall

Accesses the "Save/Recall" dialog, that is the standard instrument function for storing and recalling the complete dialog-related (or in coupled sources entity-related) settings in a file. The provided navigation possibilities in the dialog are self-explanatory.

The filename and the directory, in which the settings are stored, are user-definable; the file extension is predefined.

On recall, the instrument checks if the saved configuration is compatible with the software and hardware options installed on the current instrument. For example, the number of block outputs (see [Output settings](#)) and the number of internal entities (i.e. the currently selected system configuration) have to be the same.

See also, chapter "File and Data Management" in the R&S SMM100A user manual.

Remote command:

[:SOURce<hw>] :BB:NR5G:SETTing:CATaLog? on page 416

[:SOURce<hw>] :BB:NR5G:SETTing:LOAD on page 416

[:SOURce<hw>] :BB:NR5G:SETTing:STORe on page 417

[:SOURce<hw>] :BB:NR5G:SETTing:DEL on page 416

Generate Waveform File

With enabled signal generation, triggers the instrument to save the current settings of an arbitrary waveform signal in a waveform file with predefined extension *.wv. You can define the filename and the directory, in that you want to save the file.

Using the ARB modulation source, you can play back waveform files and/or process the file to generate multi-carrier or multi-segment signals.

Remote command:

[:SOURce<hw>] :BB:NR5G:WAVeform:CREate on page 421

Test Case Wizard

Accesses the "Test Case Wizard" dialog, see [Chapter 8, "Performing BS tests according to TS 38.141 specifications"](#), on page 334.

FRC Wizard

Opens a dialog for easy fixed frequency channel (FRC) configuration for base station testing.

The functionality of the FRC wizard is similar to the FRC configuration in the [user and bandwidth part](#) settings.

User: ← FRC Wizard

Selects the user to be configured.

Available if the [number of users](#) is greater than 1.

Remote command:

via suffix at `USER<ch>`

Carrier ← FRC Wizard

Displays the automatically assigned carrier names.

Remote command:

via suffix at `CELL<ch>`

BWP ← FRC Wizard

Select the bandwidth parts (BWP) whose settings are displayed for configuration.

There are one or more BWPs, as set with the parameter "User/BWP Settings > UL BWPs" > [Number of DL/UL BWPs](#).

Remote command:

via suffix at `BWP<dir0>`

FRC ← FRC Wizard

Selects one of the [FRCs](#) defined in 3GPP 38.141, 38.176 and 38.181.

Remote command:

`[:SOURce<hw>] :BB:NR5G:UBWP:USER<us>:CELL<cc>:UL:BWP<bwp>:FRC:WTYP` on page 423

Deployment ← FRC Wizard

Selects the [frequency deployment](#) for the selected FRC.

Note that availability of frequency deployments depends on the selected FRC.

Remote command:

`[:SOURce<hw>] :BB:NR5G:UBWP:USER<us>:CELL<cc>:UL:BWP<bwp>:FRC:WDEployment` on page 421

Modulation ← FRC Wizard

Shows the [modulation](#) of the PUSCH defined for the selected FRC.

Remote command:

`[:SOURce<hw>] :BB:NR5G:UBWP:USER<us>:CELL<cc>:UL:BWP<bwp>:FRC:WMODulation?` on page 422

SC Spacing ← FRC Wizard

Shows the subcarrier spacing defined for the selected FRC.

Remote command:

[:SOURce<hw>] :BB:NR5G:UBWP:USER<us>:CELL<cc>:UL:BWP<bwp>:FRC:WSCSpacing? on page 423

Payload Size ← FRC Wizard

Indicates the payload size of the selected FRC.

Remote command:

[:SOURce<hw>] :BB:NR5G:UBWP:USER<us>:CELL<cc>:UL:BWP<bwp>:FRC:WPASize? on page 422

RB Offset ← FRC Wizard

Sets the RB offset for the selected FRC.

Remote command:

[:SOURce<hw>] :BB:NR5G:UBWP:USER<us>:CELL<cc>:UL:BWP<bwp>:FRC:WROffset on page 423

Mapping Type ← FRC Wizard

Sets the PUSCH mapping type for the selected FRC.

Note that you can select the mapping type for certain FRCs only. For others, the mapping type is already defined and read-only.

Remote command:

[:SOURce<hw>] :BB:NR5G:UBWP:USER<us>:CELL<cc>:UL:BWP<bwp>:FRC:WMAType on page 422

PTRS ← FRC Wizard

Turns the PTRS for the FRC on and off.

Available for selected FRCs only.

Remote command:

[:SOURce<hw>] :BB:NR5G:UBWP:USER<us>:CELL<cc>:UL:BWP<bwp>:FRC:WPTRs:STATE on page 422

Export Settings to Analyzer

Exports the current NR 5G signal description to an `.allocation` file that you can transfer to a Rohde & Schwarz signal analyzer.

Note that the settings transfer includes only settings that are supported by the analyzer.

There are two ways to transfer settings:

- Save the settings in an `.allocation` file on the generator with "Export Settings to Analyzer" and import that `.allocation` file on an analyzer.
- Download the generator settings with the functionality available on the analyzer. For details, refer to the user manual of the NR 5G application of the analyzer.

Remote command:

[:SOURce<hw>] :BB:NR5G:ANALyzer:CONTent on page 415

Link Direction

Selects the transmission direction.

"Downlink"	The transmission direction selected is base station to user equipment. The signal corresponds to that of a base station.
"Uplink"	The transmission direction selected is user equipment to base station. The signal corresponds to that of a user equipment.
"Sidelink"	The transmission direction selected is user equipment to user equipment (V2X communication).

Remote command:

[:SOURce<hw>] :BB:NR5G:LINK on page 415

Test Models ...

Accesses a dialog for selecting of files with predefined 5G NR configurations.

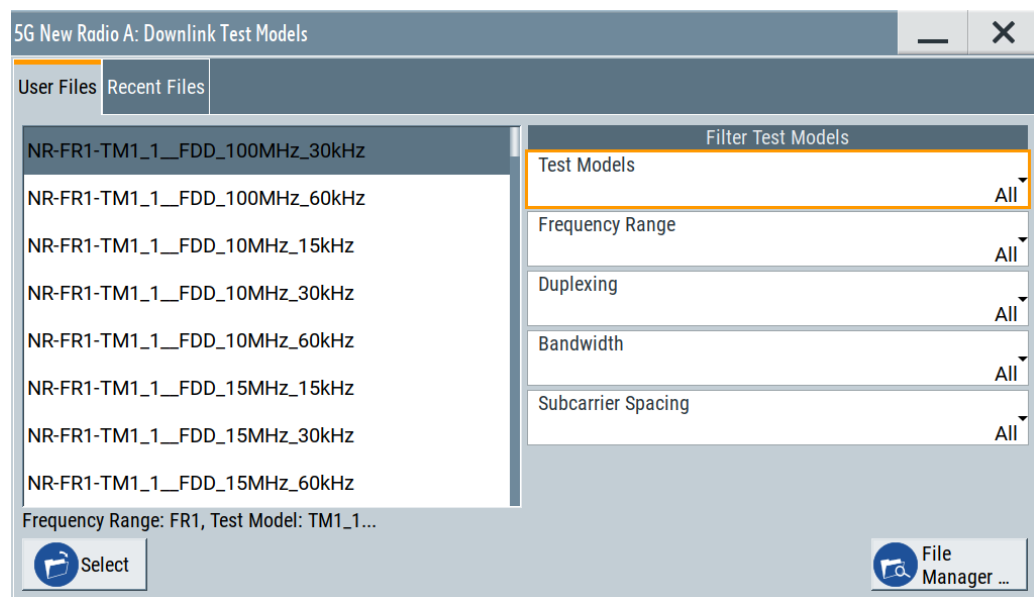

User Files ← Test Models ...

Shows the 5G NR test models (NR TM) defined in [TS 38.141-1/TS 38.141-2](#) and [TS 38.104](#).

The NR FR1/FR2 test models are predefined configurations of 5G NR settings. The 3GPP specifications define three main groups of test models, the NR-RF-TM1, NR-FR-TM2 and NR-FR-TM3. Each TM is defined for a subset of different channel bandwidths and subcarrier spacings.

The test model uses common physical channel parameters for PDSCH and PUCCH, and specific physical channels parameters per test model.

The following naming convention is used:

NR-<FR>-TM<TestModel>__<Duplexing>_<ChBW>MHz_<SCS>kHz, where:

- <FR> designates 5G NR test modules for the frequency range **FR1** and **FR2**
- <TestModel> is the TM designation according to [TS 38.141-1/TS 38.141-2](#)
- <Duplexing> indicates if FDD or TDD duplexing is used
- <ChBW> is one of the defined base station [channel bandwidths](#)
- <SCS> indicates the [subcarrier spacing](#).

Test models for bandwidths introduced with 3GPP release 17 require Option: R&S SMM-K171.

When you have installed R&S SMM-K175 and have selected **standard** = "ORAN", the list shows available ORAN test cases.

"NR FR1/FR2 Test Models"

The test models are defined for the following test purpose:

5G NR Test Model	Defined for tests on
NR-FR1-TM1.1 NR-FR2-TM1.1	<ul style="list-style-type: none"> • BS output power • TAE • Unwanted emissions • Occupied bandwidth • ACLR • Transmitter intermodulation • Transmitter spurious emissions • Operating band unwanted emissions
NR-FR1-TM1.2	<ul style="list-style-type: none"> • ACLR • Unwanted emissions • Operating band unwanted emissions
NR-FR1-TM2/2a/2b* NR-FR2-TM2	<ul style="list-style-type: none"> • Total power dynamic range (lower OFDM symbol power limit at min power) • EVM of single 64QAM/256QAM/1024QAM* PRB allocation (at min power) • Frequency error (at min power)
NR-FR1-TM3.1/3.1a/3.1b* NR-FR2-TM3.1	<ul style="list-style-type: none"> • Output power dynamics • Transmitted signal quality (Frequency error and EVM for 64QAM/256QAM* modulation, at max power) • Transmitted signal quality • Frequency error • EVM for 64QAM/256QAM/1024QAM* modulation (at max power)
NR-FR1-TM3.2	<ul style="list-style-type: none"> • Transmitted signal quality • Frequency error • EVM for 16QAM modulation
NR-FR1-TM3.3	<ul style="list-style-type: none"> • Transmitted signal quality • Frequency error • EVM for QPSK modulation

Remote command:

`[:SOURCE<hw>] :BB:NR5G:SETTING:TMODEL:UL:CATALOG?` on page 417

`[:SOURCE<hw>] :BB:NR5G:SETTING:TMODEL:DL:CATALOG?` on page 417

Filter Test Models ← Test Models ...

Applies the selected filter to the files shown in [User Files](#).

Remote command:

`[:SOURCE<hw>] :BB:NR5G:SETTING:TMODEL:FILTER:CATALOG` on page 418

Standard ← Filter Test Models ← Test Models ...

Available with Option: R&S SMM-K175.

Applies a standard filter to the files listed in [User Files](#). Supported standards are "ORAN" and "NR" (3GPP).

If you filter by "ORAN", the [user files list](#) contains only the ORAN test cases. The naming conventions are similar to the 3GPP test models:

ORAN-<FR>-TC<TestCase>__<Duplexing>_<ChBW>MHz_<SCS>kHz

Remote command:

[\[:SOURCE<hw>\]:BB:NR5G:SETTING:TMODEL:FILTER:TMSTANDARD](#) on page 420

Test Models ← Filter Test Models ← Test Models ...

Available if [Standard](#) = NR

Applies a test model filter to the files listed in [User Files](#).

Remote command:

[\[:SOURCE<hw>\]:BB:NR5G:SETTING:TMODEL:FILTER:TMODEL](#) on page 419

Test Case ← Filter Test Models ← Test Models ...

Available if [Standard](#) = ORAN

Applies an ORAN test case filter to the files listed in [User Files](#).

Remote command:

[\[:SOURCE<hw>\]:BB:NR5G:SETTING:TMODEL:FILTER:TCASE](#) on page 419

Frequency Range ← Filter Test Models ← Test Models ...

Applies a frequency range filter to the files listed in [User Files](#).

Remote command:

[\[:SOURCE<hw>\]:BB:NR5G:SETTING:TMODEL:FILTER:FREQ](#) on page 418

Duplexing ← Filter Test Models ← Test Models ...

Applies a duplexing filter to the files listed in [User Files](#).

Remote command:

[\[:SOURCE<hw>\]:BB:NR5G:SETTING:TMODEL:FILTER:DUPLExing](#) on page 418

Bandwidth ← Filter Test Models ← Test Models ...

Applies a bandwidth filter to the files listed in [User Files](#).

Remote command:

[\[:SOURCE<hw>\]:BB:NR5G:SETTING:TMODEL:FILTER:BW](#) on page 417

Subcarrier Spacing ← Filter Test Models ← Test Models ...

Applies a subcarrier spacing filter to the files listed in [User Files](#).

Remote command:

[\[:SOURCE<hw>\]:BB:NR5G:SETTING:TMODEL:FILTER:SCS](#) on page 419

Select ← Test Models ...

Loads the settings defined in the selected test model.

Remote command:

[\[:SOURCE<hw>\]:BB:NR5G:SETTING:TMODEL:UL](#) on page 417

[\[:SOURCE<hw>\]:BB:NR5G:SETTING:TMODEL:DL](#) on page 417

Node

Accesses the "Node" dialog, see [Chapter 5.2, "Node settings"](#), on page 49.

Remote command:
n.a.

Users/BWPs

Accesses the "Users/BWPs" dialog, see [Chapter 5.3, "Users / BWPs settings"](#), on page 93.

Remote command:
n.a.

Scheduling

Accesses the "Scheduling" dialog, see [Chapter 5.4, "Scheduling settings"](#), on page 198.

Remote command:
n.a.

Output/Power

Accesses the "Output/Power" dialog for setting the signal output and power-related settings.

The symbol  in the "Output/Power" field indicates the presence of [Conflicts](#) in the [Output settings](#).

See:

- [Chapter 6.6, "Output settings"](#), on page 314
- [Chapter 6.7, "Time domain windowing settings"](#), on page 318.

Remote command:
n.a.

Simple Mode

Turns simple mode on and off. The simple mode removes all parameters related to control information (DCI) from the user interface.

DCI related parameters are in the following dialogs:

- [Chapter 5.2.3, "System information settings"](#), on page 57 (carrier configuration)
- [Chapter 5.6.2, "Payload settings"](#), on page 242 (CORESET configuration)
- [Chapter 5.3.6.5, "Control settings \(DCI\)"](#), on page 135 (DL BWP configuration)
- [Chapter 5.3.6.2, "PDSCH settings"](#), on page 115 (DL BWP configuration)
- [Chapter 5.3.6.4, "PDCCH settings"](#), on page 135 (DL BWP configuration)
- [Chapter 5.3.7.2, "PUCCH settings"](#), on page 157 (UL BWP configuration)
- [Chapter 5.3.7.4, "PUSCH settings"](#), on page 163 (UL BWP configuration)
- [Chapter 5.3.7.6, "SRS settings"](#), on page 183 (UL BWP configuration)
- [Chapter 5.3.2.2, "Control settings"](#), on page 100 (UL & DL BWP configuration)

Note that the SCPI commands for the DCI related parameters still work when you turn on the simple mode, but won't have an effect on the generated signal.

Remote command:
[\[:SOURce<hw>\]:BB:NR5G:SIMPlE](#) on page 420

U-Plane Generation

Opens a dialog to turn user plane data generation according to the O-RAN standard on and off.

For more information, see [Chapter 9, "Generating user plane data"](#), on page 381.

Remote command:

[:SOURce<hw>] :BB:NR5G:UPLane:STATe on page 420

5.2 Node settings

Access:

- ▶ Select "Baseband > 5G New Radio > Node".

The settings in this dialog describe the basic physical structure of the generated signal.

Settings:

• Scheduling	49
• Carriers settings	51
• System information settings	57
• Timing & Phase Settings	60
• Transmission bandwidth (TxBW) settings	63
• LTE-CRS coexistence settings	65
• SS/PBCH settings	68
• S-SS/PSBCH settings	75
• PRS settings	78
• Dummy REs settings	84
• OCNG settings	86
• PBCH settings	87
• PSBCH settings	92

5.2.1 Scheduling

Access:

1. Select "5G New Radio > Link > Downlink".
2. Select "5G New Radio > General > Node > Scheduling".

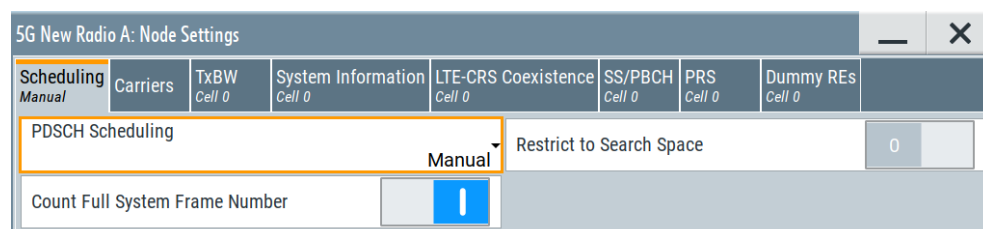

Settings:

PDSCH Scheduling	50
Restrict to Search Space	50
Count Full System Frame Number	50

PDSCH Scheduling

Defines whether the PDSCH scheduling is performed manually or according to the configuration made for the DCIs.

"Manual"	This mode is the default scheduling mode and the mode with full flexibility; you can configure any of the available settings. There is no cross-reference between the settings made for the CORESET DCIs and the PDSCHs settings. You are responsible for the content of the PDSCH allocations.
"Auto/DCI"	This mode assures a 3GPP compliant signal; the PDSCH allocations are configured automatically according to the configuration of the CORESET DCIs. The following settings are configured automatically: <ul style="list-style-type: none"> • "Users/BWPs > Properties" > DSCH Channel Coding = "On" • "Scheduling > CORESET > Custom DCI" > Channel Coding = "On" • For all DCI 1_1 and 1_0 in "Scheduling > CORESET > DCI Table", Create PDSCH = "On" • In the "Scheduling" dialog, you can configure only Content = "CORESET" (the PDSCH allocations are configured automatically).

Remote command:

[\[:SOURCE<hw>\]:BB:NR5G:SchEduling:MODE](#) on page 596

Restrict to Search Space

The term search space describes a set of CCEs that a UE monitors. The UE can decode only the control information on a PDCCH/CORESET that is transmitted over CCEs within the search space this UE monitors.

This parameter defines how the search space and the CCE indexes are defined. Together with other parameters it influences the way the search space is defined. For details, see "[Search Space](#)" on page 241.

"Off"	Define the search space by the CCE start index, see CCE Index .
"On"	The CCE start indexes are selected automatically so that they are within the search space. The "Scheduling > CORESET > Payload" > CCE Index indicates the selected CCE index where the value is defined by the combination of Aggregation Level and candidate number (Candidate).

Remote command:

[\[:SOURCE<hw>\]:BB:NR5G:SchEduling:RSSPace](#) on page 597

Count Full System Frame Number

Option: R&S SMM-K148.

Enables the full counting of the system frame number carried by the PBCH block from 0 to 1023, independent of the configured ARB [Sequence Length](#).

If [System Frame Number Offset](#) is set, the counting starts at the configured SFN offset value and restarts when the SFN offset value is reached again, as follows: offset, (offset+1), (offset+2), ..., 1023, 0, 1, 2, ..., (offset-1).

Remote command:

[:SOURce<hw>] :BB:NR5G:SCHeDuling:SFN:STATe on page 597

5.2.2 Carriers settings

Access:

1. Carriers settings for downlink:

- Select "5G New Radio > General > Link Direction > Downlink".
- Select "5G New Radio > General > Node > Carriers".

Number of Carriers		+ Copy Carriers ...										RF Phase Compensation		
1												Auto		
Carrier	Cell ID	CIF Pres.	Sched. By	CIF	Deployment	RF Ref.	Frequency (GHz)	Channel BW	Config	DMRS TypeA Position	Power (dB)	Δf to Output (MHz)	Cell Mapped	Shared Spectrum Access
Cell 0	0	<input type="checkbox"/>	Cell 0	0	FR1 <= 3GHz	RF A	1.000 000 0	100 MHz	Config...	2	0.00	0.000 000	On	Off

This dialog comprises the carrier settings for downlink.

2. Carriers settings for uplink:

- Select "5G New Radio > General > Link Direction > Uplink".
- Select "5G New Radio > General > Node > Carriers".

Number of Carriers		+ Copy Carriers ...										RF Phase Compensation		
1												Auto		
Carrier	Cell ID	CIF Pres.	Sched. By	CIF	Deployment	RF Ref.	Frequency (GHz)	Channel BW	Config	DMRS TypeA Position	Power (dB)	Δf to Output (MHz)	Cell Mapped	Shared Spectrum Access
Cell 0	0	<input type="checkbox"/>	Cell 0	0	FR1 <= 3GHz	RF A	1.000 000 0	100 MHz	Config...	2	0.00	0.000 000	On	Off

This dialog comprises the carrier settings for uplink.

Settings:

Number of Carriers.....	52
Copy Carriers.....	52
L Number of New Carriers.....	52
L Copy / Load From.....	52
L Recall File.....	53
L Load Carrier.....	53
L Carrier Info.....	53
L Copy To New Carrier.....	53
L Apply.....	53

RF Phase Compensation.....	53
Carrier table.....	54
L Carrier.....	54
L Cell Indicator.....	54
L Cell ID.....	54
L N1 ID/N2 ID.....	55
L CIF Present.....	55
L Scheduled By.....	55
L CIF.....	55
L Deployment.....	55
L RF Ref.....	56
L Frequency in GHz.....	56
L Channel Bandwidth.....	56
L Carrier Config.....	56
L DMRS Type A Position.....	57
L Delta f to Output/MHz.....	57
L Cell Mapped.....	57
L Shared Spectrum Access.....	57

Number of Carriers

Sets the number of simulated carriers. The carrier table displays one carrier per row.

According to the 3GPP specifications, carrier aggregation is user-specific and thus different users served by the same base station can use different carriers. Moreover, the different users can also have different primary cell (PCell). In this implementation, however, all users use the same carrier aggregation configuration, or with other words, the primary and secondary cells (SCells) are the same for all configured users. Hence, there are *16 carriers per node, not per user*.

Set the "Number of Carriers \geq 2" to enable carrier aggregation. The maximum value is 16 carriers.

Remote command:

`[:SOURCE<hw>] :BB:NR5G:NODE:NCARrier` on page 435

Copy Carriers

Opens a dialog to create an exact duplicate of an existing carrier. Copying a carrier creates a new carrier with the same configuration as the source carrier.

As the copy is an exact duplicate of an existing carrier, you have to adjust any settings that could or should be different in the copied carrier after you have copied (especially user settings).

Number of New Carriers ← Copy Carriers

Defines the number of additional carriers. The new carriers are added to the carrier table.

Remote command:

`[:SOURCE<hw>] :BB:NR5G:NODE:CC:NEWCarrriers` on page 442

Copy / Load From ← Copy Carriers

Selects the source of the new carrier configuration.

"Other Carrier" The source is one of the carrier listed in the [carrier table](#).

"5G NR Recall File" The source is a carrier configuration previously saved to a file. For more information about saving signal configurations, see "[Save/Recall](#)" on page 42.

Remote command:

[\[:SOURce<hw>\]:BB:NR5G:NODE:CC:CPYSe1](#) on page 441

Recall File ← Copy Carriers

Opens a dialog box to restore a previously saved signal configuration (.nr5g file extension).

Available if [Copy / Load From](#) = "5G NR Recall File".

When you load carriers from a file, the R&S SMM100A duplicates all settings except the user properties ("Users/BWPs" > "Properties"). After copying a carrier, check if these settings also apply to the new carrier.

Remote command:

[\[:SOURce<hw>\]:BB:NR5G:NODE:CC:LOAD](#) on page 441

Load Carrier ← Copy Carriers

Selects the carrier you want to duplicate.

If only one carrier exists in the table or in the file you have loaded, this is a read only field.

Remote command:

[\[:SOURce<hw>\]:BB:NR5G:NODE:CC:CPYFrom](#) on page 441

Carrier Info ← Copy Carriers

Shows basic information like deployment range, carrier bandwidth or subcarrier spacing about the carrier you want to duplicate. This information is only shown if you duplicate a carrier from a file.

Remote command:

[\[:SOURce<hw>\]:BB:NR5G:NODE:CC:CINFo?](#) on page 440

Copy To New Carrier ← Copy Carriers

Shows the index number of the carriers that are created. This is always the next available number. For example, if 2 carriers (carrier 0 and 1) already exist, the new carriers get numbers 2 and 3.

Remote command:

[\[:SOURce<hw>\]:BB:NR5G:NODE:CC:CPYTo?](#) on page 441

Apply ← Copy Carriers

Creates the new carriers.

Remote command:

[\[:SOURce<hw>\]:BB:NR5G:NODE:CC:ADD](#) on page 440

RF Phase Compensation

This parameter compensates the symbol phase difference caused by uplink/downlink processes, as specified in [TS 38.211](#).

It uses the parameter **Frequency in GHz** to set the carrier frequency to be compensated.

If you set the "RF Phase Compensation" to "Manual", the **Frequency in GHz** field activates for manual input of the carrier frequency value to be compensated.

If you set the "RF Phase Compensation" to "Auto", the system determines the phase compensation frequency value from one of the configured RF frequencies automatically. If an "RF Phase Compensation" is assigned automatically, the **Frequency in GHz** grays out and is not editable. If no "RF Phase Compensation" can be assigned automatically, the system assigns a default value of 1 GHz and activates the **Frequency in GHz** field so that you can edit the default value.

If you set the "RF Phase Compensation" to "Off", the phase compensation is disabled and the **Frequency in GHz** shows a "-" symbol.

This value is set to "Auto" by default.

Remote command:

`[:SOURce<hw>] :BB:NR5G:NODE:RFPHase:MODE` on page 435

Carrier table

Comprises the carrier settings. There is one table row per carrier.

Carrier ← Carrier table

Displays the automatically assigned carrier names.

Remote command:

via suffix at `CELL<ch>`

Cell Indicator ← Carrier table

Sets the cell indicator, to identify each of up to 16 carriers.

The cell indicator is unique and unambiguous index used to address the cell, for example for cross-carrier scheduling.

Remote command:

`[:SOURce<hw>] :BB:NR5G:NODE:CELL<cc>:CINDicator` on page 436

Cell ID ← Carrier table

Sets the cell identity of the selected cell.

The physical layer cell ID N_{ID}^{cell} is used for synchronization between network and user equipment. It identifies a specific radio cell in the 5G NR network.

For the uplink and downlink, the cell ID is a value between 0 and 1007, calculated as follows:

$$N_{ID}^{cell} = 3N_{ID}^{(1)} + N_{ID}^{(2)}$$

Unlike the **Cell Indicator**, cells can use the same "Cell ID".

For the sidelink, the cell ID is called SL SSID and can have a value between 0 and 671. It is calculated like this: $N_{ID}^{SL} = ID_{ID,1}^{SL} + 336ID_{ID,2}^{SL}$

Remote command:

`[:SOURce<hw>] :BB:NR5G:NODE:CELL<cc>:CELLid` on page 435

N1 ID/N2 ID ← Carrier table

Indicates the physical cell indicator group ($N_{ID}^{(1)}$) and the physical layer identity ($N_{ID}^{(2)}$), derived from the selected N_{ID}^{cell} (Cell ID).

(Sidelink: $N_{ID,1}^{SL} / N_{ID,2}^{SL}$)

Remote command:

[:SOURCE<hw>] :BB:NR5G:NODE:CELL<cc>:N1ID? on page 437

[:SOURCE<hw>] :BB:NR5G:NODE:CELL<cc>:N2ID? on page 437

CIF Present ← Carrier table

Defines whether the carrier indicator field (CIF) is included in the PDCCH DCI formats transmitted from the corresponding cell.

The CIF is present in each DCI format and identifies the component carrier that carries the PDSCH or PUSCH for the particular PDCCH in the cross-carrier approach.

According to the 5G NR specification, cross-carrier scheduling is enabled by higher-level signaling. To simulate a cross-carrier scheduling in this implementation, enable the "Node > Carriers > CIF Present" per each cell.

Remote command:

[:SOURCE<hw>] :BB:NR5G:NODE:CELL<cc>:CIFPresent on page 436

Scheduled By ← Carrier table

Displays in which cell coordinates the carrier aggregation, if there is intra-band CA.

Defines the component carrier/cell that signals the UL and DL grants for the selected cell. The signaling cell is determined by its cell index.

According to the 5G NR specification, cross-carrier scheduling has to be enabled per user and per component carrier.

To enable signaling for one particular cell on the primary cell, i.e. cross-carrier scheduling, set the "Scheduled By" to 0.

Remote command:

[:SOURCE<hw>] :BB:NR5G:NODE:CELL<cc>:SCHBy on page 439

CIF ← Carrier table

Displays the value of the carrier indicator field (CIF).

Remote command:

[:SOURCE<hw>] :BB:NR5G:NODE:CELL<cc>:CIF on page 436

Deployment ← Carrier table

Selects one of the frequency ranges, specified for 5G NR transmission, see [Table 2-1](#).

The selected frequency range (FR) determines the following parameters:

- [SC Spacing/CP](#)
- [Case](#) (i.e. the synchronization signal pattern).

3GPP release 17 introduces frequency deployment range FR2-2 which requires R&S SMM-K171.

Remote command:

[:SOURCE<hw>] :BB:NR5G:NODE:CELL<cc>:CARDeploy on page 437

RF Ref. ← Carrier table

Selects the reference frequency for [automatic RF phase compensation](#) for the corresponding carrier. Available for instruments with two baseband generators.

"None"	Allows you to configure the frequency manually .
"RF A"	Takes the frequency from baseband path A.
"RF B"	Takes the frequency from baseband path B.

Remote command:

`[:SOURCE<hw>] :BB:NR5G:NODE:CELL<cc>:RFPHase:REFerence` on page 439

Frequency in GHz ← Carrier table

Sets the carrier frequency at which the [RF Phase Compensation](#) is applied.

If [RF Phase Compensation](#) is set to "Manual", this field is enabled for manual input of the carrier frequency value at which the phase compensation is applied.

If [RF Phase Compensation](#) is set to "Auto", this field is grayed out and the carrier frequency value is set automatically.

Remote command:

`[:SOURCE<hw>] :BB:NR5G:NODE:CELL<cc>:PCFReq` on page 439

Channel Bandwidth ← Carrier table

Selects the bandwidth of the node carrier from a list with predefined values, see [Table 2-1](#).

The available values depend on the selected [Deployment](#). Together with the selected SCS ([SCS](#) or [SC Spacing/CP](#)), the channel bandwidth affects the number of available RBs ([N_RB](#) and [No. RBs](#)).

Signals, channels (e.g. SS/PBCH) and bandwidth parts (BWPs) can only be configured within the selected channel bandwidth. Thus, the value selected here sets the upper limit for the bandwidth-related settings.

You can select channel bandwidths that are larger than the baseband bandwidth available in the R&S SMM100A, because the used sample rate can be smaller than the channel bandwidth.

- The 70 MHz channel bandwidth in uplink requires the release 16 option (R&S SMM-K148).
- The 35 MHz and 45 MHz channel bandwidths require the release 17 option (R&S SMM-K171).
- The channel bandwidths > 400 MHz supported by FR2-2 frequency deployment require the release 17 option (R&S SMM-K171).
- The 3 MHz channel bandwidth requires the release 18 option (R&S SMM-K171). A 3 MHz bandwidth supports a 15 kHz subcarrier spacing and automatically applies puncturing in the SS/PBCH and CORESET.

Remote command:

`[:SOURCE<hw>] :BB:NR5G:NODE:CELL<cc>:CBW` on page 437

Carrier Config ← Carrier table

Opens a dialog to configure the system information of the carrier.

For details, see:

- [Chapter 5.2.3, "System information settings"](#), on page 57

- [Chapter 5.2.4, "Timing & Phase Settings"](#), on page 60

DMRS Type A Position ← **Carrier table**

Depending on the used mapping type (A or B), the demodulation reference signals (DMRS) are mapped to different symbols of the PDSCH/PUSCH allocation.

This parameter defines the position of the first DMRS symbol l_0 (`dmrs-TypeA-Position`) within the slot, if mapping type A is used.

Remote command:

`[:SOURce<hw>] :BB:NR5G:NODE:CELL<cc>:TAPos` on page 440

Delta f to Output/MHz ← **Carrier table**

Shifts the signal relative to the center output frequency.

Use different frequency offsets to separate the channels of the configured and enabled cells.

Remote command:

`[:SOURce<hw>] :BB:NR5G:NODE:CELL<cc>:DFReq` on page 438

Cell Mapped ← **Carrier table**

If enabled, the signal of the selected cell is mapped to the output.

Remote command:

`[:SOURce<hw>] :BB:NR5G:NODE:CELL<cc>:MAPPed` on page 438

Shared Spectrum Access ← **Carrier table**

Turns an increased number of available SS/PBCH blocks on and off.

The setting has an effect for FR1 deployments and [block patterns A and C](#).

Available with 3GPP release 16.

Remote command:

`[:SOURce<hw>] :BB:NR5G:NODE:CELL<cc>:SHSPec` on page 438

5.2.3 System information settings

Access:

1. Select "Simple Mode" = "Off".
2. Select "5G New Radio > General > Node > Carriers > Config".

System Information	
PDSCH HARQ ACK Codebook	semi-static
PDSCH HARQ ACK Codebook R16	not configured
SUL	Off
Indicator Size DCI0_2	0
Indicator Size DCI1_2	0

Settings:

PDSCH HARQ ACK Codebook.....	58
PDSCH HARQ ACK Codebook R16.....	59
SUL.....	59
Indicator Size DCI0_2.....	59
Indicator Size DCI1_2.....	59

PDSCH HARQ ACK Codebook

Defines the HARQ ACK reporting according to the PDSCH HARQ ACK codebook.

"Semi-static"	<p>Sets the HARQ ACK reporting according to the PDSCH HARQ ACK codebook to "semi-static".</p> <p>A UE reports HARQ ACK information for a corresponding PDSCH reception or SPS PDSCH release only in a HARQ ACK codebook that the UE transmits in a slot indicated by a value of a PDSCH-to-HARQ feedback timing indicator field in a corresponding DCI format 1_0 or DCI format 1_1.</p> <p>The UE reports NACK values for HARQ ACK information bits in an HARQ ACK codebook that the UE transmits in a slot not indicated by a value of a PDSCH-to-HARQ feedback timing indicator field in a corresponding DCI format 1_0 or DCI format 1_1.</p>
---------------	---

"Dynamic" Sets the HARQ ACK reporting according to the PDSCH HARQ ACK codebook to "dynamic".
For a serving cell, an active DL BWP, and an active UL BWP the UE determines a set of occasions for candidate PDSCH receptions for which the UE can transmit corresponding HARQ ACK information in a PUCCH in slot . If the serving cell is deactivated, the UE uses as the active DL BWP for determining the set of occasions for candidate PDSCH receptions a DL BWP provided by the first active downlink BWP identifier.

Remote command:

`[:SOURCE<hw>] :BB:NR5G:NODE:CELL<cc>:SYINFO:HACBOOK` on page 442

PDSCH HARQ ACK Codebook R16

Defines the state of the higher layer parameter `pdsch-HARQ-ACK-Codebook-r16` introduced with 3GPP release 16. The effects of this parameter are described in 3GPP 38.212.

"Not Configured" Does not use the release 16 codebook.

"Enhanced Dynamic" Uses the release 16 codebook and adjusts the bit lengths of various DCI fields according to 3GPP 38.212.

Remote command:

`[:SOURCE<hw>] :BB:NR5G:NODE:CELL<cc>:SYINFO:HACR` on page 443

SUL

Defines whether the carrier supports supplementary uplink (SUL).

The supplementary uplink (SUL) uses one of several dedicated NR bands under 2 GHz (band n80 to n86). By this supplementary uplink, the lower frequency helps to increase the cell coverage in UL direction and the UL performance at the cell edge.

Remote command:

`[:SOURCE<hw>] :BB:NR5G:NODE:CELL<cc>:SYINFO:SUL:STATE` on page 443

Indicator Size DCI0_2

Defines the bit length of the DCI field "Carrier Indicator" available in DCI formats 0_2.

Corresponds to higher layer parameter `carrierIndicatorSizeDCI-0-2` as defined in 3GPP 38.331.

Remote command:

`[:SOURCE<hw>] :BB:NR5G:NODE:CELL<cc>:SYINFO:IS02` on page 444

Indicator Size DCI1_2

Defines the bit length of the DCI field "Carrier Indicator" available in DCI formats 1_2.

Corresponds to higher layer parameter `carrierIndicatorSizeDCI-1-2` as defined in 3GPP 38.331.

Remote command:

`[:SOURCE<hw>] :BB:NR5G:NODE:CELL<cc>:SYINFO:INDSIZE` on page 444

5.2.4 Timing & Phase Settings

Access:

- ▶ Select "5G New Radio > General > Node > Carriers > Config".

Timing and Phase	
System Frame Number Offset	0
Sub Frame Offset	0
Custom Timing Advance Offset (Tc)	0
Phase Offset	0.00 deg
Ssb Time Offset R17	0 ms

The timing and phase section contains settings related to timing and phase characteristics of the selected carrier.

Settings:

System Frame Number Offset.....	60
Sub Frame Offset.....	61
Ssb Time Offset R17.....	61
Timing Advance Offset.....	61
Custom Timing Advance Offset (Tc).....	62
Phase Offset.....	62

System Frame Number Offset

Sets an offset value for the system frame number. The first generated frame starts with the given system frame number offset.

A system frame number offset changes, for example, the hopping patterns and has an effect on the following settings.

- ZP CSI-RS [Bitmap](#)
- NZP CSI-RS [Bitmap](#)
- SRS positions (see [SRS settings](#))
- [CCE Index](#) when [Restrict to Search Space](#) is enabled.
- SS/PBCH MIB [System Frame Number Start Offset](#)

Remote command:

[:SOURce<hw>] :BB:NR5G:NODE:CELL<cc>:TMPH:SYFNoffset on page 445

Sub Frame Offset

Defines a cyclic subframe shift within the selected carrier. The offset defines the number of subframes that are moved from the beginning of the signal to the end of the signal. The offset is in terms of subframes.

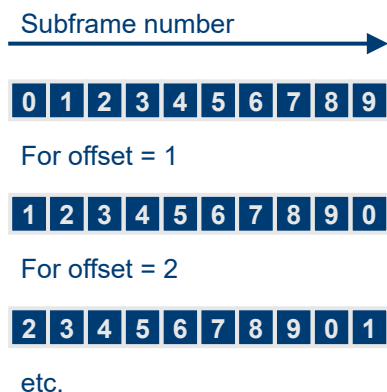

Figure 5-1: Example: Subframe shift in a frame

Remote command:

[:SOURce<hw>] :BB:NR5G:NODE:CELL<cc>:TMPH:SFOFfset on page 445

Ssb Time Offset R17

Defines a time offset for the SS/PBCH block. The SSB time offset corresponds to RRC parameter *Ssb-TimeOffset-r17* defined in 3GPP 38.331.

Note that the time offset only changes the position of the SS/PBCH block and moves it into the correct subframe, if necessary. Using a [subframe offset](#) or [system frame number offset](#) also changes the position of other signal parts in time.

Remote command:

[:SOURce<hw>] :BB:NR5G:NODE:CELL<cc>:TMPH:SSBToffset on page 445

Timing Advance Offset

Option: R&S SMM-K148

If [Link Direction](#) > "Uplink", sets an offset ($N_{TA\ offset}$) to the timing advance value for UL/DL switching synchronization as specified in [TS 38.211](#).

The timing advance offset is set to 0 by default. The available $N_{TA\ offset}$ values depend on the set [Deployment](#).

[TS 38.133](#) specifies the $N_{TA\ offset}$ value as shown in [Table 5-1](#).

Table 5-1: Value of $N_{TA\ offset}$ as specified in [TS 38.133](#)

Frequency range and band of cell used for uplink transmission	$N_{TA\ offset}$ (unit: T_C)
FR1 FDD or TDD band with neither E-UTRA-NR nor NB-IoT-NR coexistence case	25600 (see note below)
FR1 FDD band with E-UTRA-NR and/or NB-IoT-NR coexistence case	0 (see note below)
FR1 TDD band with E-UTRA-NR and/or NB-IoT-NR coexistence case	39936 (see note below)

Frequency range and band of cell used for uplink transmission	$N_{TA\ offset}$ (unit: T_c)
FR2-1	13792
FR2-2	13792 or 25600

Note:
The UE identifies $N_{TA\ offset}$ based on the information $n\text{-TimingAdvanceOffset}$ as specified in TS 38.331. If the UE is not provided with the information $n\text{-TimingAdvanceOffset}$, the default value of $N_{TA\ offset}$ is set as 25600 for FR1 band. In case of multiple UL carriers in the same timing advance group (TAG), the UE expects that the same value of $n\text{-TimingAdvanceOffset}$ is provided for all the UL carriers according to TS 38.213 and the value 39936 of $N_{TA\ offset}$ can also be provided for an FDD serving cell.

Remote command:

`[:SOURce<hw>] :BB:NR5G:NODE:CELL<cc> [:TMPH] :TAOffset` on page 445

Custom Timing Advance Offset (Tc)

Defines a cyclic signal offset for the selected component carrier in the time domain. The offset defines the part of a signal that is moved from the beginning of the signal to the end of the signal. The offset is measured in T_c as defined by 3GPP.

Available for number of carriers > 1.

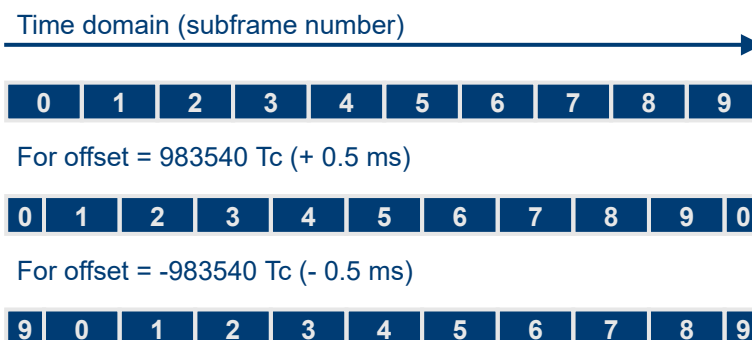

Figure 5-2: Example: Timing advance offset in a frame

Remote command:

`[:SOURce<hw>] :BB:NR5G:NODE:CELL<cc> :TMPH:CTOffset` on page 444

Phase Offset

Defines a phase offset for the selected component carrier relative to 0° . This phase offset allows you to generate component carriers with different phase characteristics, as required for beamforming, for example.

Available for number of carriers > 1.

Note that this phase offset refers to individual component carriers. When you define a phase offset for the complete signal in the block diagram, this basic phase offset is added to the phase offset of the component carriers.

For more information about the basic phase offset, refer to the R&S SMM100A user manual, chapter "Shifting and Boosting the Baseband Signal".

Remote command:

`[:SOURce<hw>] :BB:NR5G:NODE:CELL<cc> :TMPH:PHOffset` on page 444

5.2.5 Transmission bandwidth (TxBW) settings

Access:

1. Select "5G New Radio > General > Link Direction > Downlink".
2. Select "5G New Radio > General > Node > TxBW".

Scheduling <i>Manual</i>	Carriers	TxBW <i>Cell 0</i>	System Information <i>Cell 0</i>	LTE-CRS Coexistence <i>Cell 0</i>	SS/PBCH <i>Cell 0</i>	Dummy REs <i>Cell 0</i>
Carrier: Cell		0				
Point A to Carrier Center			-49.140 MHz	Channel Bandwidth		
				100 MHz		
Resolve Conflicts						
	Use	N_RB	TxBW Offset	k0μ		
30 kHz	<input checked="" type="checkbox"/>	273	0	0.0		
60 kHz	<input type="checkbox"/>	135	0	-		

This dialog comprises the settings, related to the transmission bandwidths (TxBW). These settings include: the frequency offset between the center carrier and the Point A, the transmission bandwidth width in number of RBs and the $k_0\mu$.

Settings:

Cell.....	63
Point A to Baseband Center.....	63
Channel Bandwidth.....	64
Resolve Conflicts.....	64
TxBW table.....	64
L SCS.....	64
L Use.....	65
L N_RB.....	65
L TxBW Offset.....	65
L k0μ.....	65

Cell

Selects/indicates to which carrier/cell the settings apply.

Remote command:

via suffix at CELL<ch>

Point A to Baseband Center

Sets the frequency offset between the reference Point A and the baseband center frequency.

The Point A is the reference point for the frequency-dependent parameters, for example **TxBW Offset** and **RB Offset/RB Offset (15 kHz SCS)/RB Offset (60 kHz SCS)**.

See [Chapter 2.6, "Transmission bandwidths Tx BWs"](#), on page 21.

Remote command:

[:SOURce<hw>] :BB:NR5G:NODE:CELL<cc>:TXBW:POINTa on page 446

Channel Bandwidth

Selects the bandwidth of the node carrier from a list with predefined values, see [Table 2-1](#).

The available values depend on the selected [Deployment](#). Together with the selected SCS ([SCS](#) or [SC Spacing/CP](#)), the channel bandwidth affects the number of available RBs ([N_RB](#) and [No. RBs](#)).

Signals, channels (e.g. SS/PBCH) and bandwidth parts (BWPs) can only be configured within the selected channel bandwidth. Thus, the value selected here sets the upper limit for the bandwidth-related settings.

You can select channel bandwidths that are larger than the baseband bandwidth available in the R&S SMM100A, because the used sample rate can be smaller than the channel bandwidth.

- The 70 MHz channel bandwidth in uplink requires the release 16 option (R&S SMM-K148).
- The 35 MHz and 45 MHz channel bandwidths require the release 17 option (R&S SMM-K171).
- The channel bandwidths > 400 MHz supported by FR2-2 frequency deployment require the release 17 option (R&S SMM-K171).
- The 3 MHz channel bandwidth requires the release 18 option (R&S SMM-K171). A 3 MHz bandwidth supports a 15 kHz subcarrier spacing and automatically applies puncturing in the SS/PBCH and CORESET.

Remote command:

[\[:SOURCE<hw>\]:BB:NR5G:NODE:CELL<cc>:CBW](#) on page 437

Resolve Conflicts

Recalculates the frequency-dependent settings and thus redefines the frequency position of the TxBW.

Conflicts arise if:

- [TxBW Offset](#) is not a multiple integer of RBs for the corresponding numerology
- $k0\mu \neq \{-6, 0, 6\}$.

Remote command:

[\[:SOURCE<hw>\]:BB:NR5G:NODE:CELL<cc>:TXBW:RESolve](#) on page 447

TxBW table

Comprises the frequency-related settings of the subcarrier spacings (SCS) supported for the selected [Deployment](#).

Displayed are all supported SCS combinations. To enable a specific SCS, set [Use](#) > "On".

See [Chapter 2.6, "Transmission bandwidths TxBWs"](#), on page 21.

SCS ← TxBW table

Indicates the SCS to that the settings apply.

Remote command:

via block `S<SCS>K`

Use ← TxBW table

From all possible TxBW for a specific channel bandwidth, the base station decides which TxBW to use. This parameter defines whether the SCS is supported in the particular cell and if it is used by the base station.

At least one SCS must be used.

Remote command:

[:SOURCE<hw>] :BB:NR5G:NODE:CELL<cc>:TXBW:S30K:USE on page 447
etc.

N_RB ← TxBW table

Indicates the number of available RBs N_{RB} within the TxBW for the selected SCS and Channel Bandwidth.

See Chapter 2.6, "Transmission bandwidths TxBW", on page 21.

Remote command:

[:SOURCE<hw>] :BB:NR5G:NODE:CELL<cc>:TXBW:S30K:NRB? on page 447
etc.

TxBW Offset ← TxBW table

Sets the usable RB to common RBs offset.

See Chapter 2.6, "Transmission bandwidths TxBW", on page 21.

Remote command:

[:SOURCE<hw>] :BB:NR5G:NODE:CELL<cc>:TXBW:S30K:OFFSet on page 448
etc.

 $k_0\mu$ ← TxBW table

Indicates the value of the parameter $k_0\mu$, that defines the number of subcarriers the transmission bandwidth is shifted related to the carrier center.

The value is calculated automatically, based on the selected SCS and "Channel Bandwidth".

According to the specification, $k_0\mu = \{-6, 0, 6\}$. If value different than these allowed values is displayed, a conflict is indicated. Use the [Resolve Conflicts](#) function to recalculate the values.

The value $k_0\mu = \text{"-"} indicates that the SCS is not used (Use > "Off").$

See Chapter 2.6, "Transmission bandwidths TxBW", on page 21.

Remote command:

[:SOURCE<hw>] :BB:NR5G:NODE:CELL<cc>:TXBW:S30K:KOMU? on page 448
etc.

5.2.6 LTE-CRS coexistence settings

Access:

1. Select "5G New Radio > General > Link Direction > Downlink".

2. Enable a carrier that **supports SCS of 15 kHz**, for example select "5G New Radio > General > Node > Carriers > Carrier x > Channel BW = 50 MHz".
3. Select "Node > TxBW > 15 kHz > Use = On".
4. Select "Resolve Conflicts".
5. Select "LTE-CRS Coexistence".

	Offset to Point A (15 kHz SCS)	LTE Bandwidth (RB)	vShift	LTE Antenna Ports
0	0	6	0	1
1	0	6	0	1

You can configure LTE CRS signals, if the carrier supports 15 kHz subcarrier spacing, because 15 kHz is the subcarrier spacing used in LTE.

In this dialog, you configure the allocation of the LTE-CRS as defined in [TS 38.214](#) in terms of:

- Frequency position as offset to Point A and bandwidth within the RS are spread.
- Number of RS and their configuration defined based on the number of used LTE antenna ports and position of the CRS patterns in the frequency domain (vShift).

The resources reserved for the transmission of the LTE CRS are omitted by 5G NR, which influences among others the PDSCH resource mapping. The LTE CRS allocation must be known by the UE and by the BS.

Observe the LTE CRS resources on the "Time Plan". In the "Scheduling" dialog, observe how enabled LTE CRS reduces the number of available physical resources for PDSCH.

Settings:

Cell.....	67
State.....	67
Number of LTE CRS Patterns.....	67
Offset to Point A (15 kHz SC Spacing).....	67
LTE Bandwidth (RB).....	67
vShift.....	67
LTE Antenna Ports.....	68

Cell

Selects/indicates to which carrier/cell the settings apply.

Remote command:

via suffix at `CELL<ch>`

State

Enable the LTE-CRS so that the configured resources are omitted by the 5G NR allocations.

This setting is useful if you simulate LTE and 5G NR coexistence scenarios, where the same frequency band is shared between LTE and 5G NR allocations.

Remote command:

`[:SOURCE<hw>] :BB:NR5G:NODE:CELL<cc>:LTE:STATE` on page 449

Number of LTE CRS Patterns

Option: R&S SMM-K148

Defines the number of LTE cell specific reference signals in the resource grid.

You can configure up to four CRS patterns in a table. Each row corresponds to one CRS pattern. The number of rows in the table changes, depending on the number of CRS patterns.

For each CRS pattern, you can define various characteristics.

- [Offset to point A](#)
- [vShift](#)
- [LTE bandwidth](#)
- [Number of antenna ports](#)

Remote command:

`[:SOURCE<hw>] :BB:NR5G:NODE:CELL<cc>:LTE:NPAT` on page 448

Offset to Point A (15 kHz SC Spacing)

Sets the LTE carrier center subcarrier location (`carrierFreqDL`) as offset from (reference) point A.

Remote command:

`[:SOURCE<hw>] :BB:NR5G:NODE:CELL<cc>:LTE:PATT<st0>:POINTa`
on page 450

LTE Bandwidth (RB)

Sets the LTE bandwidth (`carrierBandwidthDL`) as number of RBs and thus defines the bandwidth used for the LTE-CRS. The LTE-CRS always span the whole LTE bandwidth.

Remote command:

`[:SOURCE<hw>] :BB:NR5G:NODE:CELL<cc>:LTE:PATT<st0>:CBW` on page 449

vShift

Sets the parameter `v-Shift` required to configure the LTE-CRS allocation.

In LTE, `vShift` is defined as function of the cell ID. This parameter is used to shift the CRS patterns in LTE neighbor cells in the range of 0 to 5 subcarriers and thus prevent CRS pattern overlapping.

Remote command:

[:SOURce<hw>] :BB:NR5G:NOde:CELL<cc>:LTE:PATT<st0>:VShifT

on page 450

LTE Antenna Ports

Sets the parameter `nrofCRS-Ports` giving the number of antenna ports used for LTE-CRS.

The number of antenna ports defines the number and position of LTE CRS.

Remote command:

[:SOURce<hw>] :BB:NR5G:NOde:CELL<cc>:LTE:PATT<st0>:NAP on page 449

5.2.7 SS/PBCH settings

Access:

1. Select "5G New Radio > General > Link Direction > Downlink".
2. Select "5G New Radio > General > Node > SS/PBCH".

SC Spacing/CP	RB Offset	SC Offset	Δf to Carrier (Centers) /MHz	Case	L	Positions	Burst Set Period	Half Frame Idx.	PBCH	Power/Antenna Ports	State
0 30 kHz NCP	126	6	0.000 000	B	4	1100	10 ms	0	Settings...	Config...	On

This dialog comprises the settings of the broadcast channel (PBCH) and the synchronization signals (SS). The SS and the PBCH are cell-specific and are always transmitted in a block. For more information, see [Chapter 2.7, "Synchronization signals and SS/PBCH block"](#), on page 23.

Settings:

Cell.....	69
Number of SS/PBCH Patterns.....	69
Antenna Port.....	69
Offset Relative to.....	69
SS/PBCH patterns table.....	69
L SC Spacing/CP.....	70
L RB Offset/RB Offset (15 kHz SCS)/RB Offset (60 kHz SCS).....	70
L SC Offset/SC Offset (15 kHz SCS)/SC Offset (60 kHz SCS).....	71
L Δf to Carrier (Centers).....	71
L Case.....	71
L L.....	72
L Positions.....	72

L Burst Set Periodicity.....	72
L Half Frame Index.....	73
L PBCH Config.....	74
L Power/Antenna Ports Config.....	74
L PSS/SSS Power.....	74
L PBCH Power.....	74
L Position Index.....	75
L Mapping Coordinates.....	75
L Mapping table.....	75
L State.....	75

Cell

Selects/indicates to which carrier/cell the settings apply.

Remote command:

via suffix at CELL<ch>

Number of SS/PBCH Patterns

Defines how many patterns for the synchronization signals and the PBCH are configured. There is one table row per pattern.

See also [Chapter 2.7, "Synchronization signals and SS/PBCH block"](#), on page 23.

Remote command:

[:SOURce<hw>] :BB:NR5G:NODE:CELL<cc>:NSSPbch on page 452

Antenna Port

Indicates that antenna port 4000 is used.

Remote command:

[:SOURce<hw>] :BB:NR5G:NODE:CARMapping:AP4000 [:ROW<ch0>]
on page 452

Offset Relative to

Defines the reference point, relative to which the SS/PBCH is allocated in frequency domain.

"TxBW"	<p>The frequency position of the SS/PBCH is set relative to the usable RBs that apply for the current numerology, i.e. to the start of the TxBW.</p> <p>If this reference point is used, you can select the SC Spacing/CP for that the following applies:</p> <ul style="list-style-type: none"> • TxBW spans at least 20 RBs (i.e. N_RB > 20) • TxBW is enabled for this SCS (i.e. Use > "On").
"Point A"	<p>The frequency position of the SS/PBCH is set relative to the position of point A.</p>

Remote command:

[:SOURce<hw>] :BB:NR5G:NODE:CELL<cc>:OFFSet on page 451

SS/PBCH patterns table

Comprises the configuration of the SS/PBCH transmissions.

You can enable different SS/PBCH patterns and configure their individual settings in the SS/PBCH pattern table. There is one table row per pattern. Each row describes a periodically repeating burst set with definable timing and frequency position, defined as follows:

- Frequency: [SC Spacing/CP](#), [RB Offset/RB Offset \(15 kHz SCS\)/RB Offset \(60 kHz SCS\)](#), [SC Offset/SC Offset \(15 kHz SCS\)/SC Offset \(60 kHz SCS\)](#) and [Delta f to Carrier \(Centers\)](#)
- Timing: [Case](#), [Positions](#), [Burst Set Periodicity](#) and [Half Frame Index](#)

See also [Figure 2-3](#).

SC Spacing/CP ← SS/PBCH patterns table

Selects a combination of the subcarrier spacing (SCS) and the cyclic prefix (CP), where the available values depend on the "Deployment".

See [Table 2-2](#).

The available values also depend on the following:

- SCSs that span at least 20 RBs (i.e. $N_{RB} > 20$)
- For [Offset Relative to](#) = "TxBW", only SCSs that are enabled for the TxBW (i.e. [Use](#) > "On").
- For "SC Spacing / CP" = 240 kHz, the "Offset Relative to" must be set "Point A". Additional the "Node Settings" > "TxBW" > "Use" value and the "Node Settings" > "Carriers" > "Deployment" value has an impact on the possible "SC Spacing /CP" values.

Remote command:

```
[ :SOURCE<hw> ] :BB:NR5G:NODE:CELL<cc>:SSPBch<ssb>:SCSPacing
```

on page 452

RB Offset/RB Offset (15 kHz SCS)/RB Offset (60 kHz SCS) ← SS/PBCH patterns table

Sets the start resource block of the selected allocation and thus defines the allocation's position in the frequency domain.

The name of the parameter changes depending on the selected [Offset Relative to](#) as follows:

- "RB Offset": If [Offset Relative to](#) = "TxBW"
- "RB Offset (15 kHz SCS)": If [Offset Relative to](#) = "Point A" and [Deployment](#) = "f <= 3GHz" or "3GHz < f <= 6GHz"
- "RB Offset (60 kHz SCS)": If [Offset Relative to](#) = "Point A" and [Deployment](#) = "f > 6GHz"

For [Offset Relative to](#) = "TxBW", the value is set relative to the usable RBs that apply for the current numerology, i.e. to the start of the TxBWs ([SC Spacing/CP](#)), see [Figure 2-3](#).

Example:

- If "RB Offset = 0", the SS/PBCH block is allocated on the first subcarrier in the channel.
- If "RB Offset = 10", the SS/PBCH block is allocated on the $10 \cdot 12 = 120$ th subcarrier in the channel.

Remote command:

[:SOURCE<hw>] :BB:NR5G:NODE:CELL<cc>:SSPBch<ssb>:RBOffset
on page 453

SC Offset/SC Offset (15 kHz SCS)/SC Offset (60 kHz SCS) ← SS/PBCH patterns table

Sets the start subcarrier of the selected allocation within a resource block, where the latter is defined with the parameter [RB Offset/RB Offset \(15 kHz SCS\)/RB Offset \(60 kHz SCS\)](#).

Example:

- If "RB Offset = 0" and "SC Offset = 10", the SS/PBCH block is allocated on the 10th subcarrier in the channel.
- If "RB Offset = 10" and "SC Offset = 0", the SS/PBCH block is allocated on the $10 \cdot 12 = 120$ th subcarrier in the channel.

See also [Figure 2-3](#).

The name of the parameter changes depending on the selected [Offset Relative to](#) as follows:

- "SC Offset": If [Offset Relative to](#) = "TxBW"
- "SC Offset (15 kHz SCS)": If [Offset Relative to](#) = "Point A" and [Deployment](#) = "f <= 3GHz" or "3GHz < f <= 6GHz"
- "SC Offset (60 kHz SCS)": If [Offset Relative to](#) = "Point A" and [Deployment](#) = "f > 6GHz"

Remote command:

[:SOURCE<hw>] :BB:NR5G:NODE:CELL<cc>:SSPBch<ssb>:SCOffset
on page 453

Delta f to Carrier (Centers) ← SS/PBCH patterns table

Indicates the frequency offset between the center of the SS/PBCH block to the center of the carrier; thus indicates the allocation's position in the frequency domain.

The value is calculated automatically, based on the selected SCS, channel bandwidth, deployment method, RB and SC offsets.

Remote command:

[:SOURCE<hw>] :BB:NR5G:NODE:CELL<cc>:SSPBch<ssb>:DFReq? on page 453

Case ← SS/PBCH patterns table

Selects one of the SS/PBCH cases, as specified in [TS 38.213](#). The case defines which symbols in a slot carry the synchronization signals.

The SS/PBCH cases depend on the deployment and the used SCS.

SS/PBCH case	SCS	Frequency
Case A	15 kHz	< 6 GHz
Case B*	30 kHz	< 6 GHz
Case C*	30 kHz	< 6 GHz
Case D	120 kHz	> 6 GHz

SS/PBCH case	SCS	Frequency
Case E	240 kHz	> 6 GHz
Case F**	480 kHz	> 6 GHz
Case G**	960 kHz	> 6 GHz

*) The start symbol index in case B and case C is different.

***) Requires R&S SMM-K171

Remote command:

[:SOURce<hw>] :BB:NR5G:NODE:CELL<cc>:SSPBch<ssb>:CASE on page 454

L ← SS/PBCH patterns table

Sets the number of SS/PBCH blocks, transmitted per burst.

This value sets the pattern length, used to define the [Positions](#) of the transmitted SS/PBCH blocks.

The available values for "L" depend on the selected [Deployment](#) as follows:

- "Deployment" = "f ≤ 3 GHz": L = 4 or 8, where
L = 8 is supported for the unpaired spectrum below 3 GHz if [Case](#) = "C"
- "Deployment" = "3 GHz < f ≤ 6 GHz": L = 8
- "Deployment" = "f > 6 GHz": L = 64

If you turn on [shared spectrum access](#), L also depends on the SS/PBCH case.

- Case A = 15 kHz NCP: L = 10
- Case C = 30 kHz NCP: L = 20

Remote command:

[:SOURce<hw>] :BB:NR5G:NODE:CELL<cc>:SSPBch<ssb>:L on page 454

Positions ← SS/PBCH patterns table

A half-frame contains 4, 8 or 64 SS/PBCH blocks, depending on the selected subcarrier spacing and deployment and as set in the parameter [L](#). The group of 4, 8 or 64 blocks is referred to as burst set, see [Figure 2-3](#).

The "Positions" parameter defines which of these theoretically possible maximum numbers of SS/PBCH blocks are transmitted in each burst set. The definition is an internally generated sequence according to a bit pattern, where:

- Pattern length = 4, 8 or 64 and corresponds to the maximum number of SS/PBCH blocks
- Each bit applies to one SS/PBCH block
- 1: SS/PBCH block is present
- 0: SS/PBCH transmission is suppressed.

Use the "Pattern" box to define the bit pattern.

Remote command:

[:SOURce<hw>] :BB:NR5G:NODE:CELL<cc>:SSPBch<ssb>:POSition:PATtern on page 454

Burst Set Periodicity ← SS/PBCH patterns table

Defines how often a SS/PBCH burst set is transmitted.

The "Burst Set Periodicity = 10", for example, corresponds to a transmission in every frame.

See also [Figure 2-3](#).

When you select a burst set periodicity, make sure to adjust the signal length to the burst set periodicity. By default, for example, the signal out output has a length of 10 ms (10 subframes); when you define a burst set periodicity of, for example, 20 ms, the SSB is still output every 10 ms, because the signal output is not long enough.

IAB periodicities are available with R&S SMM-K148.

Remote command:

`[:SOURce<hw>] :BB:NR5G:NODe:CELL<cc>:SSPBch<ssb>:BSPeriodicity`
on page 455

Half Frame Index ← SS/PBCH patterns table

SS/PBCH time occasions are defined within a half-frame, i.e. 5 ms. This index defines in which half-frame of the time structure the first SS/PBCH block occasion is located.

This value depends on the configured [Burst Set Periodicity](#). It can be set to values from 0 to $\lceil \text{"Burst Set Periodicity"} / 5 - 1 \rceil$.

The default value is 0, it locates the first SS/PBCH occasion in the first half-frame. If you set the value to 1, the first SS/PBCH occasion is in the second half-frame (after 5 ms). A "Half Frame Index" of 2, sets the first SS/PBCH occasion in the third half-frame (after 10 ms), and so forth.

Example:

[Burst Set Periodicity](#) = 20

"Half Frame Idx." = 2

The first SS/PBCH block occasion is located in the third half-frame, i.e. after 10 ms, see [Figure 5-3](#).

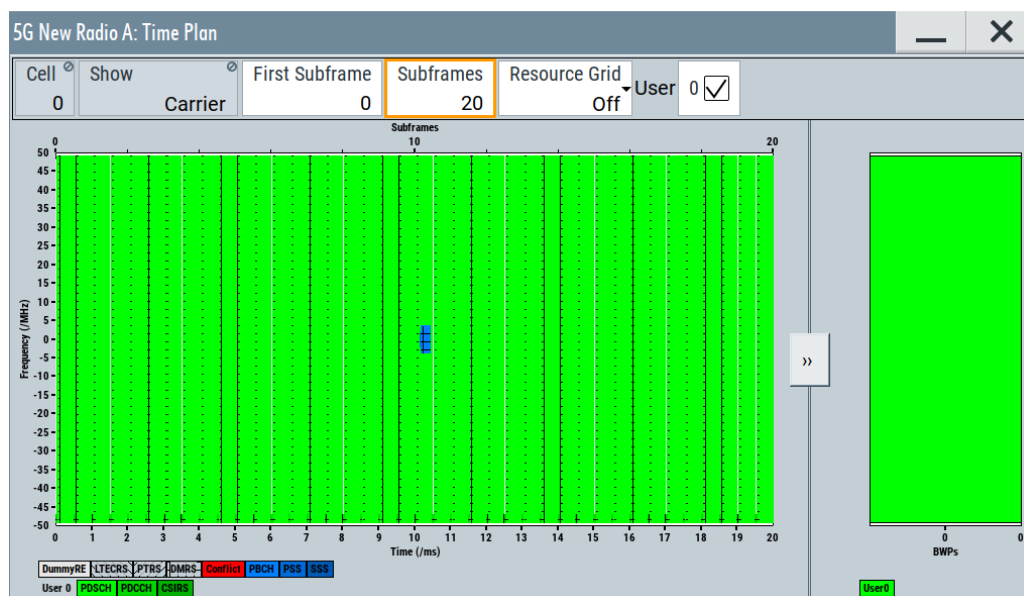

Figure 5-3: SS/PBCH in the Time Plan tab with a Half Frame Index = 2

Remote command:

[:SOURCE<hw>] :BB:NR5G:NOE:CELL<cc>:SSPBch<ssb>:HFRMidx
on page 455

PBCH Config ← SS/PBCH patterns table

Accesses the dialog with PBCH settings, see [Chapter 5.2.12, "PBCH settings"](#), on page 87.

Power/Antenna Ports Config ← SS/PBCH patterns table

Accesses a dialog with the power and antenna port-mapping settings for the SS/PBCH pattern.

5G New Radio A: SS/PBCH Power/AP Settings, Pattern 0		
Power Settings		
PSS Power	0.00 dB	SSS Power 0.00 dB
PBCH Power	0.00 dB	
Antenna Port Config		
Position Index	0	
Mapping		
Mapping Coordinates	Cartesian	
	AP 4000	
	Real	Imag
BB A	1.000+j0.000	

For details on the antenna port-mapping concept, see [Chapter 2.10, "Antenna port mapping"](#), on page 27.

PSS/SSS Power ← Power/Antenna Ports Config ← SS/PBCH patterns table

Sets the relative power of the allocations of the primary and the secondary synchronization signals (PSS and SSS).

The value is set relative to the power of the other resource elements.

Note that in the sidelink, the primary and secondary synchronization signals are called S-PSS and S-SSS.

Remote command:

[:SOURCE<hw>] :BB:NR5G:NOE:CELL<cc>:SSPBch<ssb>:PSSPow on page 455
[:SOURCE<hw>] :BB:NR5G:NOE:CELL<cc>:SSPBch<ssb>:SSSPow on page 455

PBCH Power ← Power/Antenna Ports Config ← SS/PBCH patterns table

Sets the relative power of the PBCH allocation.

The value is set relative to the power of the other resource elements.

Note that in sidelink, the channel is called PSBCH.

Remote command:

[:SOURCE<hw>] :BB:NR5G:NOE:CELL<cc>:SSPBch<ssb>:POWer on page 455

Position Index ← **Power/Antenna Ports Config** ← **SS/PBCH patterns table**

Defines the position of the SS/PBCH pattern to which the AP mapping configuration is applied.

The positions of a SS/PBCH pattern are defined in the [Positions](#) field.

You can configure the AP mapping independently for active positions, i.e. those with a value of 1. For example, if the [Positions](#) sequence is **1100**, you can set the "Position Index" to 0 or to 1, to configure the AP mapping of first and second position. The AP mapping settings for positions with a value of 0 are disabled.

Remote command:

via suffix at APMaP<dir0>

Mapping Coordinates ← **Power/Antenna Ports Config** ← **SS/PBCH patterns table**

Switches representation between the "Cartesian" (Real/Imag) and "Cylindrical" (Magn./Phase) coordinates.

Mapping table ← **Power/Antenna Ports Config** ← **SS/PBCH patterns table**

The mapping table is a matrix with number of rows equal to the number of physical Tx antennas (basebands). It contains one column for the antenna port 4000. For SS/PBCH, only the antenna port 4000 is active. The headers indicate the type of coordinates being used ("Real/Imag" for Cartesian or "Magn./Phase" for cylindrical). The yellow matrix elements highlight the none zero entries.

For details on the antenna port-mapping concept, see [Chapter 2.10, "Antenna port mapping"](#), on page 27.

Remote command:

"Mapping Coordinates = Cartesian":

```
[ :SOURce<hw> ] :BB:NR5G:NODE:CELL<cc>:SSPBch<ssb>:POSition:
APMaP<dir0>:COL<apc>:ROW<apr>:REAL on page 456
```

```
[ :SOURce<hw> ] :BB:NR5G:NODE:CELL<cc>:SSPBch<ssb>:POSition:
APMaP<dir0>:COL<apc>:ROW<apr>:IMAGinary on page 456
```

"Mapping Coordinates = Cylindrical":

```
[ :SOURce<hw> ] :BB:NR5G:NODE:CELL<cc>:SSPBch<ssb>:POSition:
APMaP<dir0>:COL<apc>:ROW<apr>:MAGNitude on page 457
```

```
[ :SOURce<hw> ] :BB:NR5G:NODE:CELL<cc>:SSPBch<ssb>:POSition:
APMaP<dir0>:COL<apc>:ROW<apr>:PHASe on page 457
```

State ← **SS/PBCH patterns table**

Disables the transmission of SS/PBCH.

Remote command:

```
[ :SOURce<hw> ] :BB:NR5G:NODE:CELL<cc>:SSPBch<ssb>:STATe on page 452
```

5.2.8 S-SS/PSBCH settings

Access:

1. Select "5G New Radio > General > Link Direction > Sidelink".

2. Select "5G New Radio > General > Node > S-SS/PSBCH".

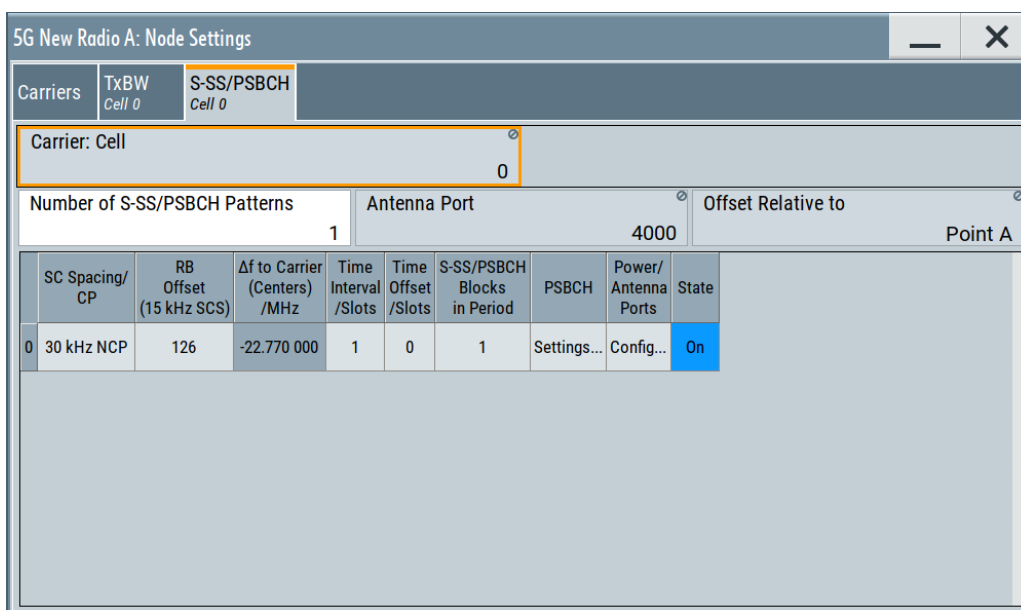

This dialog comprises the settings of the sidelink broadcast channel (PSBCH) and synchronization signals (S-SS). The S-SS and the PSBCH are cell-specific and are always transmitted in a block.

As in the downlink, the S-SS and PSBCH are bundled in a synchronization signal block which is transmitted on a fixed schedule. For more information about the synchronization block in the downlink, see [Chapter 2.7, "Synchronization signals and SS/PBCH block"](#), on page 23.

Most of the synchronization block settings in the sidelink are the same as in the downlink.

- Cell..... 76
- Number of S-SS/PSBCH Patterns..... 77
- Antenna Port..... 77
- Offset Relative to..... 77
- S-SS/PSBCH patterns table..... 77
 - SC Spacing/CP..... 77
 - RB Offset (15 kHz SCS)/RB Offset (60 kHz SCS)..... 77
 - Δf to Carrier (Centers)/MHz..... 78
 - Time Interval/Slots..... 78
 - Time Offset/Slots..... 78
 - S-SS/PSBCH Blocks in Period..... 78
 - PSBCH Config..... 78
 - Power/Antenna Ports Config..... 78
 - State..... 78

Cell

Selects/indicates to which carrier/cell the settings apply.

Remote command:
via suffix at `CELL<ch>`

Number of S-SS/PSBCH Patterns

Defines how many patterns for the synchronization signals and the PSBCH are configured. There is one table row per pattern.

In the sidelink, you can define up to 4 S-SS/PSBCH patterns.

Remote command:
`[:SOURCE<hw>] :BB:NR5G:NODE:CELL<cc>:NSSPbch` on page 452

Antenna Port

Shows the antenna port the synchronization block uses (always 4000).

Remote command:
`[:SOURCE<hw>] :BB:NR5G:NODE:CARMapping:AP4000 [:ROW<ch0>]`
on page 452

Offset Relative to

Defines the reference point, relative to which the S-SS/PSBCH is allocated in frequency domain. For the S-SS/PSBCH, the frequency position is always relative to reference point A.

Remote command:
`[:SOURCE<hw>] :BB:NR5G:NODE:CELL<cc>:OFFSet` on page 451

S-SS/PSBCH patterns table

Contains the settings to configure the S-SS/PSBCH transmissions.

The size of the table depends on the number of S-SS/PSBCH patterns you have defined. Each row corresponds to one pattern.

SC Spacing/CP ← S-SS/PSBCH patterns table

Selects a combination of the subcarrier spacing (SCS) and the cyclic prefix (CP), where the available values depend on the "Deployment".

See [Table 2-2](#).

The sidelink supports subcarrier spacings up to 120 kHz.

Remote command:
`[:SOURCE<hw>] :BB:NR5G:NODE:CELL<cc>:SSPBch<ssb>:SCSPacing`
on page 452

RB Offset (15 kHz SCS)/RB Offset (60 kHz SCS) ← S-SS/PSBCH patterns table

Sets the start resource block of the selected allocation and thus defines the allocation's position in the frequency domain.

The name of the parameter changes depending on the selected subcarrier spacing.

- "RB Offset (15 kHz SCS)": If `Deployment` = "f <= 3GHz" or "3GHz < f <= 6GHz"
- "RB Offset (60 kHz SCS)": If `Deployment` = "f > 6GHz"

Remote command:
`[:SOURCE<hw>] :BB:NR5G:NODE:CELL<cc>:SSPBch<ssb>:RBOffset`
on page 453

Δf to Carrier (Centers)/MHz ← S-SS/PSBCH patterns table

Indicates the frequency offset between the center of the S-SS/PSBCH block to the center of the carrier; thus indicates the allocation's position in the frequency domain.

The value is calculated automatically, based on the selected SCS, channel bandwidth, deployment method and RB offset.

Remote command:

`[:SOURCE<hw>] :BB:NR5G:NODE:CELL<cc>:SSPBch<ssb>:DFReq?` on page 453

Time Interval/Slots ← S-SS/PSBCH patterns table

Defines the number of slots between two consecutive S-SS/PSBCH blocks.

Remote command:

`[:SOURCE<hw>] :BB:NR5G:NODE:CELL<cc>:SSPBch<ssb>:SL:INTerval`
on page 463

Time Offset/Slots ← S-SS/PSBCH patterns table

Defines the offset between slot 0 and first S-SS/PSBCH block.

Remote command:

`[:SOURCE<hw>] :BB:NR5G:NODE:CELL<cc>:SSPBch<ssb>:SL:TOFFs`
on page 464

S-SS/PSBCH Blocks in Period ← S-SS/PSBCH patterns table

Defines the number of transmitted S-SS/PSBCH blocks.

The number of S-SS/PSBCH block depends on the selected [subcarrier spacing](#).

Remote command:

`[:SOURCE<hw>] :BB:NR5G:NODE:CELL<cc>:SSPBch<ssb>:SL:BINPeriod`
on page 462

PSBCH Config ← S-SS/PSBCH patterns table

Opens a dialog to configure the PSBCH.

For more information, see [Chapter 5.2.13, "PSBCH settings"](#), on page 92.

Power/Antenna Ports Config ← S-SS/PSBCH patterns table

Opens a dialog to configure the power and antenna port mapping of the S-SS/PSBCH pattern.

These settings are the same as for the SS/PBCH in the downlink. For more information, see ["Power/Antenna Ports Config"](#) on page 74.

State ← S-SS/PSBCH patterns table

Turns the transmission of S-SS/PSBCH on and off.

Remote command:

`[:SOURCE<hw>] :BB:NR5G:NODE:CELL<cc>:SSPBch<ssb>:STATE` on page 452

5.2.9 PRS settings

Option: R&S SMM-K148

Access:

► **PRS** settings for downlink:

- a) Select "5G New Radio > General > Link Direction > Downlink".
- b) Select "5G New Radio > General > Node > PRS".

Periodicity (T_per)	Slot Offset (T_offset)	Rep. Factor (T_rep)	Time Gap (T_gap)	No. RBs	Start RB (to PointA)	Comb Size (K_comb)	Resource
4 slots	0	1	1 slot	272	0	2	Config...

This dialog comprises the PRS (positioning reference signal) settings for downlink.

Settings:

Cell.....	79
State.....	80
SC Spacing / CP.....	80
Number of PRS Resource Sets.....	80
PRS Resource Sets Table.....	80
L Periodicity (T_per).....	80
L Slot Offset (T_offset).....	80
L Repetition Factor (T_rep).....	80
L Time Gap (T_gap).....	80
L No. RBs.....	81
L Start RB (to point A).....	81
L Comb Size (K_comb).....	81
L Resource Config.....	81
L Number of PRS Resources.....	81
L Resources Table.....	81
L RE Offset (k_off.).....	82
L Resource Slot Offset (k_off.,res).....	82
L No. Symbols (L_PRS).....	82
L Symbol Offset (l_start).....	82
L Sequence ID.....	82
L Power / dB.....	82
L Antenna Ports Config.....	83
L Mapping Coordinates.....	83
L Mapping table.....	83

Cell

Selects/indicates to which carrier/cell the settings apply.

Remote command:

via suffix at CELL<ch>

State

Enables/disables the DL PRS positioning frequency layer for the given carrier cell.

Remote command:

`[:SOURCE<hw>] :BB:NR5G:NODE:CELL<cc>:PRS:STATE` on page 470

SC Spacing / CP

Sets a combination of the subcarrier spacing (SCS) and the cyclic prefix (CP) for the DL PRS frequency layer.

The available values depend on the numerology of the set [Deployment](#).

Remote command:

`[:SOURCE<hw>] :BB:NR5G:NODE:CELL<cc>:PRS:SCSPacing` on page 470

Number of PRS Resource Sets

Sets the number of resource sets included in the DL PRS frequency layer.

Remote command:

`[:SOURCE<hw>] :BB:NR5G:NODE:CELL<cc>:PRS:NRSets` on page 465

PRS Resource Sets Table

Comprises the settings of the PRS resource sets. There is one table row per resource set.

Periodicity (T_per) ← PRS Resource Sets Table

Sets the periodicity of the DL PRS allocation in slots for the resource set.

Remote command:

`[:SOURCE<hw>] :BB:NR5G:NODE:CELL<cc>:PRS:RSET<st0>:PER` on page 466

Slot Offset (T_offset) ← PRS Resource Sets Table

Sets a slot offset for the resource set with respect to SFN0 slot 0.

The maximum value is defined by [Periodicity \(T_per\)](#) - 1.

Remote command:

`[:SOURCE<hw>] :BB:NR5G:NODE:CELL<cc>:PRS:RSET<st0>:SLOffset`
on page 469

Repetition Factor (T_rep) ← PRS Resource Sets Table

Sets the number of repetitions of each resource within the resource set.

The set value is applied to all resources in a resource set.

The default value "1" means no resource repetition.

Remote command:

`[:SOURCE<hw>] :BB:NR5G:NODE:CELL<cc>:PRS:RSET<st0>:REPFactor`
on page 466

Time Gap (T_gap) ← PRS Resource Sets Table

Sets an offset in slots between two resources with the same resource ID within a resource set.

The time gap should not exceed the [Periodicity \(T_per\)](#).

Remote command:

[:SOURce<hw>] :BB:NR5G:NOde:CELL<cc>:PRS:RSET<st0>:TGAP on page 470

No. RBs ← PRS Resource Sets Table

Sets the number of resource blocks (RBs) for all resources in the resource set in multiples of 4 RBs.

Remote command:

[:SOURce<hw>] :BB:NR5G:NOde:CELL<cc>:PRS:RSET<st0>:RBNumber
on page 466

Start RB (to point A) ← PRS Resource Sets Table

Sets the starting RB index of the resource set with respect to the reference point A.

The point A is defined as the absolute frequency of the reference resource block.

Remote command:

[:SOURce<hw>] :BB:NR5G:NOde:CELL<cc>:PRS:RSET<st0>:RBStart
on page 466

Comb Size (K_comb) ← PRS Resource Sets Table

Sets the resource element (RE) spacing in each symbol of a resource within a resource set.

Remote command:

[:SOURce<hw>] :BB:NR5G:NOde:CELL<cc>:PRS:RSET<st0>:CMBSize
on page 465

Resource Config ← PRS Resource Sets Table

Opens a dialog comprising the settings of the PRS resources. There is one table row per resource.

RE Offset (k_off.)	Resource Slot Offset (T_off.,res)	No. Symbols (L_PRS)	Symbol Offset (L_start)	Sequence ID	Power /dB	Antenna Ports
0	0	2	0	0	0.00	Config...

Number of PRS Resources ← Resource Config ← PRS Resource Sets Table

Sets the number of resources included in the resource set.

Remote command:

[:SOURce<hw>] :BB:NR5G:NOde:CELL<cc>:PRS:RSET<st0>:NRESources
on page 465

Resources Table ← Resource Config ← PRS Resource Sets Table

Comprises the settings of the PRS resources. There is one table row per resource.

RE Offset (k_{off}) ← Resources Table ← Resource Config ← PRS Resource Sets Table

Sets the resource element (RE) offset in the frequency domain for the first symbol in a resource.

The maximum value is defined by [Comb Size \(K_{comb}\)](#) - 1.

Remote command:

```
[ :SOURce<hw> ] :BB:NR5G:NODE:CELL<cc>:PRS:RSET<st0>:RES<dir0>:
REOffset on page 468
```

Resource Slot Offset (k_{off,res}) ← Resources Table ← Resource Config ← PRS Resource Sets Table

Set the starting slot of the resource with respect to the corresponding resource set [Slot Offset \(T_{offset}\)](#).

The maximum value is defined by [Periodicity \(T_{per}\)](#) - 1.

Remote command:

```
[ :SOURce<hw> ] :BB:NR5G:NODE:CELL<cc>:PRS:RSET<st0>:RES<dir0>:
SLOffset on page 468
```

No. Symbols (L_{PRS}) ← Resources Table ← Resource Config ← PRS Resource Sets Table

Sets the number of symbols of the resource within a slot.

Remote command:

```
[ :SOURce<hw> ] :BB:NR5G:NODE:CELL<cc>:PRS:RSET<st0>:RES<dir0>:
NSYMBOL on page 468
```

Symbol Offset (I_{start}) ← Resources Table ← Resource Config ← PRS Resource Sets Table

Sets the starting symbol of the resource within a slot.

Remote command:

```
[ :SOURce<hw> ] :BB:NR5G:NODE:CELL<cc>:PRS:RSET<st0>:RES<dir0>:
SYOffset on page 469
```

Sequence ID ← Resources Table ← Resource Config ← PRS Resource Sets Table

Sets the resource ID to initialize the c_{init} value for the generation of the DL PRS sequence.

Remote command:

```
[ :SOURce<hw> ] :BB:NR5G:NODE:CELL<cc>:PRS:RSET<st0>:RES<dir0>:SQID
on page 469
```

Power / dB ← Resources Table ← Resource Config ← PRS Resource Sets Table

Sets the resource average EPRE (energy per resource element) used for PRS transmission.

Remote command:

```
[ :SOURce<hw> ] :BB:NR5G:NODE:CELL<cc>:PRS:RSET<st0>:RES<dir0>:
POWER on page 468
```

Antenna Ports Config ← Resources Table ← Resource Config ← PRS Resource Sets Table

Opens a dialog comprising the resource antenna port settings.

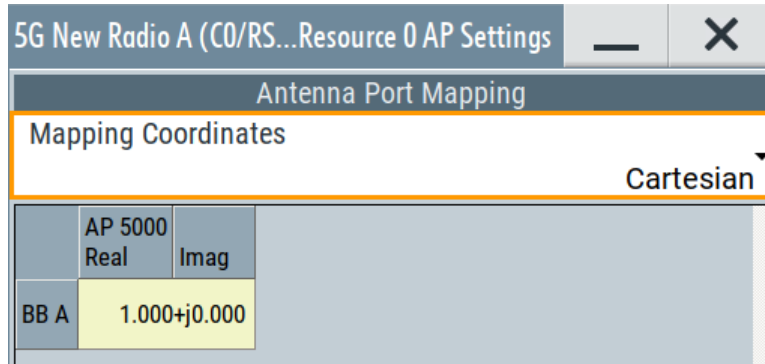

For details on the antenna port-mapping concept, see [Chapter 2.10, "Antenna port mapping"](#), on page 27.

Mapping Coordinates ← Antenna Ports Config ← Resources Table ← Resource Config ← PRS Resource Sets Table

Switches representation between the "Cartesian" (Real/Imag) and "Cylindrical" (Magn./Phase) coordinates.

Mapping table ← Antenna Ports Config ← Resources Table ← Resource Config ← PRS Resource Sets Table

The mapping table is a matrix with number of rows equal to the number of physical Tx antennas (basebands) and number of columns equal of the number of antenna ports (AP). The available antenna ports depend on the current configuration. The yellow matrix elements in the mapping table indicate the default antenna port to physical antenna (TX antenna/baseband) mapping.

For details on the antenna port-mapping concept, see [Chapter 2.10, "Antenna port mapping"](#), on page 27.

Remote command:

"Mapping Coordinates = Cartesian":

```
[ :SOURce<hw> ] :BB:NR5G:NODE:CELL<cc>:PRS:RSET<st0>:RES<dir0>:
APMap:COL<apc>:ROW<apr>:REAL on page 467
```

```
[ :SOURce<hw> ] :BB:NR5G:NODE:CELL<cc>:PRS:RSET<st0>:RES<dir0>:
APMap:COL<apc>:ROW<apr>:IMAGinary on page 467
```

"Mapping Coordinates = Cylindrical":

```
[ :SOURce<hw> ] :BB:NR5G:NODE:CELL<cc>:PRS:RSET<st0>:RES<dir0>:
APMap:COL<apc>:ROW<apr>:MAGNitude on page 467
```

```
[ :SOURce<hw> ] :BB:NR5G:NODE:CELL<cc>:PRS:RSET<st0>:RES<dir0>:
APMap:COL<apc>:ROW<apr>:PHASe on page 467
```

5.2.10 Dummy REs settings

Access:

- ▶ Select "5G New Radio > General > Node > Dummy REs/OCNG > General".

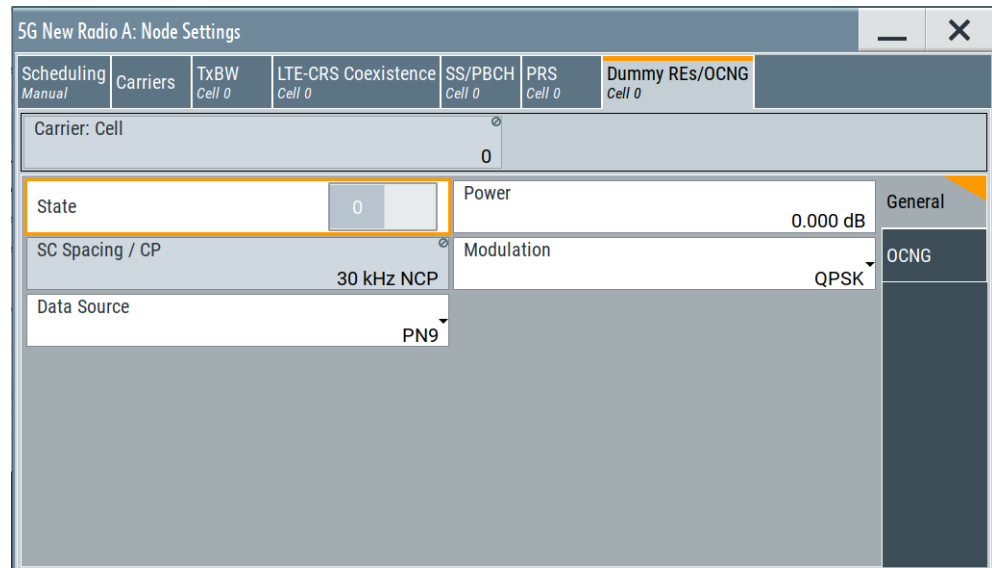

With the provided settings, you define if and what is transmitted in the resource elements that are not allocated.

The dummy REs are the allocations with the lowest priority. They do not include DMRS or PTRS.

Settings:

Cell.....	84
State.....	84
Power.....	85
SC Spacing/CP.....	85
Modulation.....	85
Transform Precoding.....	85
Data Source.....	85

Cell

Selects/indicates to which carrier/cell the settings apply.

Remote command:

via suffix at CELL<ch>

State

If enabled, the resource elements (RE) are filled in with dummy data, modulated and formatted as selected with the settings in the "Dummy REs" dialog.

Remote command:

[:SOURce<hw>] :BB:NR5G:NODE:CELL<cc>:DUMRes:STATe on page 471

Power

Sets the power of the resource elements filled in with dummy data. The value is set relative to the power of the other resource elements.

See also [Chapter 6.6, "Output settings"](#), on page 314.

Remote command:

[:SOURce<hw>] :BB:NR5G:NODE:CELL<cc>:DUMRes:POWer on page 471

SC Spacing/CP

Selects a combination of the subcarrier spacing (SCS) and the cyclic prefix (CP), where the available values depend on the "Deployment".

See [Table 2-2](#).

Remote command:

[:SOURce<hw>] :BB:NR5G:NODE:CELL<cc>:DUMRes:SCSPacing on page 471

Modulation

Sets the modulation scheme for the dummy REs.

Note: "60 kHz ECP" is supported by the existing parameters "Dummy REs", for "DL-BWPs" and for "UL-BWPs".

Interdependency: The preset value from I1 is from 11 to 10 for extended cyclic prefix. 3GPP release 17 introduces 1024QAM modulation which requires R&S SMM-K171.

Remote command:

[:SOURce<hw>] :BB:NR5G:NODE:CELL<cc>:DUMRes:MODulation on page 471

Transform Precoding

In uplink, enables using the optional DFT-S scheme.

If disabled, both DL and UL use the CP-OFDM.

Remote command:

[:SOURce<hw>] :BB:NR5G:NODE:CELL<cc>:DUMRes:TPState on page 472

Data Source

Selects the data source for the dummy REs.

The following standard data sources are available:

- "All 0"/"All 1"
An internally generated sequence containing 0 data or 1 data.
- "PNxx"
An internally generated pseudo-random noise sequence.
- "Pattern"
An internally generated sequence according to a bit pattern.
Use the "Pattern" box to set the bit pattern.
- "Data List"/"Select Data List"
Binary data from a list file, internally or externally generated.
Select "Select Data List" to open the standard "Select List" dialog. The dialog lists file with file extension *.dm_iqd if existing.
 - Navigate to the list file and tap "Select" to select the file.
 - Use the "New" and "Edit" functions to create a data list internally or to edit an existing one.

- Use the standard "File Manager" function to transfer external data lists to the instrument.

See also:

- Section "About data signals" in the R&S SMM100A user manual.
- Section "File and data management" in the R&S SMM100A user manual.
- Section "Data list editor" in the R&S SMM100A user manual.

Remote command:

[:SOURce<hw>] :BB:NR5G:NODe:CELL<cc>:DUMRes:DATA on page 472

[:SOURce<hw>] :BB:NR5G:NODe:CELL<cc>:DUMRes:DLISt on page 472

[:SOURce<hw>] :BB:NR5G:NODe:CELL<cc>:DUMRes:PATtern on page 473

5.2.11 OCNG settings

Access:

- ▶ Select "5G New Radio > General > Node > Dummy REs/OCNG > OCNG".

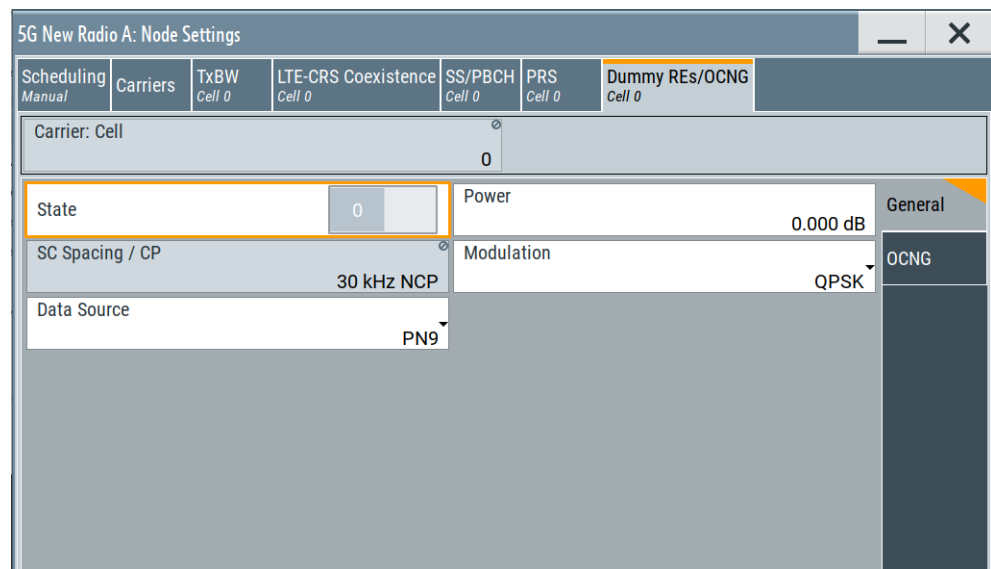

With the provided settings, you define the spatial multiplexing characteristics for a OCNG pattern for all unused resource elements. Using these settings, you can configure OCNG patterns according to 3GPP 38.521 A.5.

Settings:

Precoding.....	86
Number of Antenna Ports.....	87
Mapping Coordinates.....	87
Mapping Table.....	87

Precoding

Turns precoding for unused resource elements on and off.

The dimensions of the precoding matrix for OCNG depends on the system configuration and the number of the antenna ports.

Remote command:

[:SOURce<hw>] :BB:NR5G:NODe:CELL<cc>:DUMRes:PREC:STATe on page 476

Number of Antenna Ports

Selects the number of antenna ports the unused resource elements are mapped to. Depending on the number of antenna ports, the number of columns in the [mapping tabl](#)r changes (one column represents one antenna port).

Remote command:

[:SOURce<hw>] :BB:NR5G:NODe:CELL<cc>:DUMRes:NAPS on page 475

Mapping Coordinates

Selects the method to define mapping coordinates.

Switches representation between the "Cartesian" (Real/Imag) and Cylindrical" (Magn./Phase) coordinates.

Cartesian Coordinates defined by real and imaginary value pair.

Cylindrical Coordinates defined by magnitude and phase value pair.

Remote command:

n/a

Mapping Table

Defines the mapping of the antenna ports (AP) to the physical antennas.

Each row corresponds to a physical antenna. Each column corresponds to an [antenna port](#).

The type of values you can enter, depends on the [value type](#) you have selected.

Remote command:

Real value: [:SOURce<hw>] :BB:NR5G:NODe:CELL<cc>:DUMRes:APMap:COL<apc>:ROW<apr>:REAL on page 475

Imaginary value: [:SOURce<hw>] :BB:NR5G:NODe:CELL<cc>:DUMRes:APMap:COL<apc>:ROW<apr>:IMAGinary on page 473

Magnitude: [:SOURce<hw>] :BB:NR5G:NODe:CELL<cc>:DUMRes:APMap:COL<apc>:ROW<apr>:MAGNidute on page 474

Phase: [:SOURce<hw>] :BB:NR5G:NODe:CELL<cc>:DUMRes:APMap:COL<apc>:ROW<apr>:PHASe on page 474

5.2.12 PBCH settings

Access:

1. Select "5G New Radio > General > Link Direction > Downlink".
2. Select "5G New Radio > General > Node > SS/PBCH".

3. Select "Node > SS/PBCH > SS/PBCH Pattern Table > Pattern# > PBCH > Config".

MIB Content	
SCS Common	DMRS TypeA Position
15 or 60 kHz	2
Auto Subcarrier Offset	SSPBCH Subcarrier Offset
1	0
System Frame Number Start Offset	
0	
CORESET Zero	Search Space Zero
0	0
Cell Barred	Intra Freq Reselection
Barred	Allowed
Spare	<input type="checkbox"/>

This dialog comprises the settings of the broadcast channel (PBCH) channel coding settings.

Settings:

Dummy Content for MIB.....	88
Dummy Content Settings.....	89
L Channel Coding.....	89
L Transport Block Size.....	89
L Data Source.....	89
MIB Content.....	90
L SCS Common.....	90
L DMRS Type A Position.....	90
L Auto Subcarrier Offset.....	90
L SSPBCH Subcarrier Offset.....	91
L System Frame Number Start Offset.....	91
L CORESET Zero.....	91
L Search Space Zero.....	91
L Cell Barred.....	91
L Intra Freq Reselection.....	91
L Spare.....	92

Dummy Content for MIB

Defines how the MIB is defined:

"On"	Faster way to define the MIB. You can define if channel coding is used or not and select an arbitrary data source; further settings are not required. See "Dummy Content Settings" on page 89.
"Off"	Disable this parameter if you wish to configure the MIB content according to TS 38.331. See "MIB Content" on page 90.

Remote command:

[:SOURCE<hw>] :BB:NR5G:NOde:CELL<cc>:SSPBch<ssb>:MIB:STATe
on page 459

Dummy Content Settings

Available for "Dummy Content for MIB > On".

5G New Radio A: PBCH Settings, Pattern 0	
Dummy Content for MIB	0
MIB Content	
SCS Common	15 or 60 kHz
DMRS TypeA Position	2
Auto Subcarrier Offset	0
SSPBCH Subcarrier Offset	0
System Frame Number Start Offset	0
CORESET Zero	0
Search Space Zero	0
Cell Barred	Barred
Intra Freq Reselection	Allowed
Spare	<input type="checkbox"/>

Channel Coding ← Dummy Content Settings

Enables PBCH channel coding.

Remote command:

[:SOURCE<hw>] :BB:NR5G:NOde:CELL<cc>:SSPBch<ssb>:CCODing:STATe
on page 458

Transport Block Size ← Dummy Content Settings

Indicates the transport block size.

Data Source ← Dummy Content Settings

Selects the PBCH data source.

The following standard data sources are available:

- "All 0"/"All 1"
An internally generated sequence containing 0 data or 1 data.
- "PNxx"
An internally generated pseudo-random noise sequence.
- "Pattern"
An internally generated sequence according to a bit pattern.
Use the "Pattern" box to set the bit pattern.
- "Data List"/"Select Data List"
Binary data from a list file, internally or externally generated.
Select "Select Data List" to open the standard "Select List" dialog. The dialog lists file with file extension *.dm_iqd if existing.
 - Navigate to the list file and tap "Select" to select the file.
 - Use the "New" and "Edit" functions to create a data list internally or to edit an existing one.

- Use the standard "File Manager" function to transfer external data lists to the instrument.

See also:

- Section "About data signals" in the R&S SMM100A user manual.
- Section "File and data management" in the R&S SMM100A user manual.
- Section "Data list editor" in the R&S SMM100A user manual.

Remote command:

`[:SOURCE<hw>] :BB:NR5G:NODE:CELL<cc>:SSPBch<ssb>:CCODing:DATA`
on page 458

`[:SOURCE<hw>] :BB:NR5G:NODE:CELL<cc>:SSPBch<ssb>:CCODing:DLIST`
on page 458

`[:SOURCE<hw>] :BB:NR5G:NODE:CELL<cc>:SSPBch<ssb>:CCODing:PATtern`
on page 459

MIB Content

If "Dummy Content for MIB > Off", comprises the setting to configure the MIB as defined in the 3GPP specification.

MIB Content	
SCS Common	15 or 60 kHz
DMRS TypeA Position	2
SSPBCH Subcarrier Offset	0
System Frame Number Start Offset	0
CORESET Zero	0
Search Space Zero	0
Cell Barred	Barred
Intra Freq Reselection	Allowed
Spare	<input type="checkbox"/>

SCS Common ← MIB Content

Selects the common SCS (subcarrier spacing).

The selected SCS defines the default SSPBCH subcarrier offset.

Remote command:

`[:SOURCE<hw>] :BB:NR5G:NODE:CELL<cc>:SSPBch<ssb>:MIB:SCSC`
on page 459

DMRS Type A Position ← MIB Content

Indicates the first symbol that the DMRS uses, as set with the parameter "Node > Carriers" > [DMRS Type A Position](#).

Auto Subcarrier Offset ← MIB Content

Defines if the "SSPBCH Subcarrier Offset" value is derived from the selected [SCS Common](#) or set manually with [SSPBCH Subcarrier Offset](#).

Remote command:

[:SOURce<hw>] :BB:NR5G:NODe:CELL<cc>:SSPBch<ssb>:MIB:ASOF:STATe
on page 460

SSPBCH Subcarrier Offset ← MIB Content

Indicates or sets the SS/PBCH subcarrier offset:

- If **Auto Subcarrier Offset** = "On", the "SSPBCH Subcarrier Offset" is calculated automatically based on the selected "Node > SS/PBCH" > **SC Offset/SC Offset (15 kHz SCS)/SC Offset (60 kHz SCS)**.
- If **Auto Subcarrier Offset** = "Off", the SSPBCH subcarrier offset is user-definable.

Remote command:

[:SOURce<hw>] :BB:NR5G:NODe:CELL<cc>:SSPBch<ssb>:MIB:SCOFfset
on page 460

System Frame Number Start Offset ← MIB Content

By default, the counting of the SFN (system frame number) starts with 0. Use this parameter to set a different start SFN value.

Remote command:

[:SOURce<hw>] :BB:NR5G:NODe:CELL<cc>:SSPBch<ssb>:MIB:SFOFfset?
on page 460

CORESET Zero ← MIB Content

Sets the common control resource set (CORESET) of the initial downlink BWP `controlResourceSetZero` carried by the `PDCCH-ConfigSIB1` information element, as defined in [TS 38.331](#).

Remote command:

[:SOURce<hw>] :BB:NR5G:NODe:CELL<cc>:SSPBch<ssb>:MIB:CSZero
on page 460

Search Space Zero ← MIB Content

Sets the common search space of the initial downlink BWP `searchSpaceZero` carried by the `PDCCH-ConfigSIB1` information element, as defined in [TS 38.331](#).

Remote command:

[:SOURce<hw>] :BB:NR5G:NODe:CELL<cc>:SSPBch<ssb>:MIB:SSZero
on page 461

Cell Barred ← MIB Content

Cell barring (`cellBarred`) is system information that indicates if UEs can camp on the particular cell `notBarred` or not barred.

Remote command:

[:SOURce<hw>] :BB:NR5G:NODe:CELL<cc>:SSPBch<ssb>:MIB:CBARred
on page 461

Intra Freq Reselection ← MIB Content

Sets the value of the system information parameter `intraFreqReselection`.

Set "Intra Freq Reselection > Allowed" to allow UEs to perform cell reselection to intra-frequency cells.

Remote command:

[:SOURCE<hw>] :BB:NR5G:NODE:CELL<cc>:SSPBch<ssb>:MIB:IFRResel
on page 461

Spare ← MIB Content

Sets the system information bit spare, as defined in TS 38.331.

Remote command:

[:SOURCE<hw>] :BB:NR5G:NODE:CELL<cc>:SSPBch<ssb>:MIB:SPARE:STATE
on page 461

5.2.13 PSBCH settings

Access:

1. Select "5G New Radio > General > Link Direction > Sidelink".
2. Select "5G New Radio > General > Node > S-SS/PSBCH".
3. Select "Node > S-SS/PSBCH > S-SS/PSBCH Pattern Table > Pattern# > PSBCH > Config".

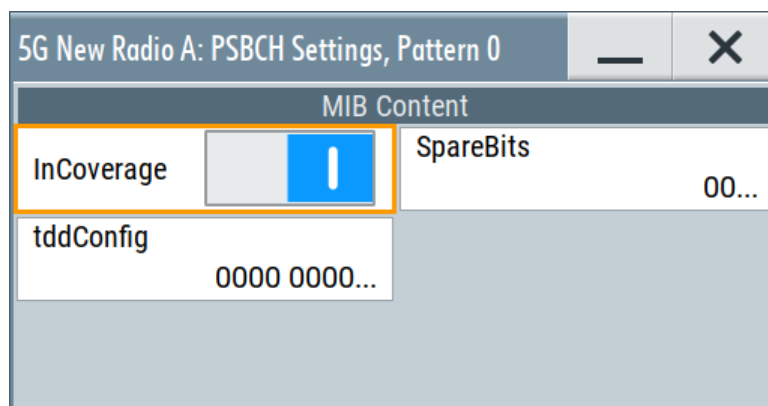

This dialog comprises the settings of the broadcast channel (PSBCH) channel coding settings. The settings correspond to `MasterInformationBlockSidelink` message definitions defined in 3GPP 38.331, chapter 6.6.2.

Settings:

InCoverage	92
SpareBits	93
tddConfig	93

InCoverage

Turns the higher layer parameter `InCoverage` on and off.

Remote command:

[:SOURCE<hw>] :BB:NR5G:NODE:CELL<cc>:SSPBch<ssb>:SL:INCoverage
on page 463

SpareBits

Defines the bit pattern for the higher layer parameter `reservedBits-r16`.

Remote command:

[:SOURce<hw>] :BB:NR5G:NODe:CELL<cc>:SSPBch<ssb>:SL:SBITs

on page 463

tddConfig

Defines the bit pattern for the higher layer parameter `sl-TDD-Config-r16`.

Remote command:

[:SOURce<hw>] :BB:NR5G:NODe:CELL<cc>:SSPBch<ssb>:SL:TDDConf

on page 464

5.3 Users / BWPs settings

Access:

- ▶ Select "Baseband > 5G NR > Users/BWPs".

Settings:

- [General settings](#)..... 93
- [DL and UL user properties settings](#)..... 95
- [SL user properties settings](#)..... 105
- [DL/UL BWPs settings](#)..... 107
- [SL BWPs settings](#)..... 111
- [DL BWP configuration settings](#)..... 113
- [UL BWP configuration settings](#)..... 155
- [SL BWP configuration settings](#)..... 192

5.3.1 General settings

Access:

- ▶ Select "5G New Radio > General > Users/BWPs > General".

5G New Radio A: Users/BWP Settings								
General	Properties	DL BWPs	DL BWP Config	UL BWPs	UL BWP Config	SL BWPs	SL BWP Config	
	User 0	User 0 / Cell 0	User 0 / Cell 0 / BWP 0	User 0 / Cell 0	User 0 / Cell 0 / BWP 0	User 0 / Cell 0	User 0 / Cell 0 / BWP 0	
Number of Users		1						
Restart Data and Control		After Each Slot						
Slot Interval		10				Slot Offset		0

In this tab, you define the number of users to be simulated.

Settings:

Number of Users.....	94
Restart Data and Control.....	94
Slot Interval - Data and Control.....	94
Slot Offset - Data and Control.....	94
Restart Slot Index.....	95
Slot Interval.....	95

Number of Users

Option: R&S SMM-K148 supports up to 200 users.

Sets the number of simulated users.

Remote command:

[:SOURce<hw>] :BB:NR5G:UBWP:NUSer on page 477

Restart Data and Control

Enables you to select an option for restarting the configured data sources in customized DCIs.

Off Disables the restart of data and control. Data sources are initialized only once at the start of the generated signal. This value is set by default.

After Each Codeword and Allocation

Enables the restart of data and control after each codeword and allocation. For example, the same payload is used for repeated allocations.

After Each Frame

Enables the restart of data and control after each frame. For example, the same payload is used for allocations which are repeated each frame.

After Each Slot Enables the restart of data and control after each slot. For example, the same payload is used for allocations which are repeated each slot.

Remote command:

[:SOURce<hw>] :BB:NR5G:UBWP:REStart on page 483

Slot Interval - Data and Control

Defines the number of slots after which the data source restarts (restart every <x> slots).

Available for:

- Single numerology setups
- **Restart Data and Control**= "After Each Slot"

Remote command:

[:SOURce<hw>] :BB:NR5G:UBWP:SINterval on page 478

Slot Offset - Data and Control

Defines an offset in terms of slots for the restart of the data source.

If you define a slot offset, the data source does not restart in the first <x> slots.

Available for:

- Single numerology setups
- [Restart data and control](#) = "After Each Slot"
- [Slot interval](#) > 1

Remote command:

[\[:SOURce<hw>\]:BB:NR5G:UBWP:SOFFset](#) on page 479

Restart Slot Index

Turns a restart of the slot index within a frame on and off.

"Off" No custom restart of the slot index within a frame.

"On" Slot index within a frame restarts in the defined interval.

Remote command:

[\[:SOURce<hw>\]:BB:NR5G:UBWP:REStart:SIDX:STATe](#) on page 478

Slot Interval

Defines the number of slots after which the slot index within a frame restarts (restart every <x> slots).

Remote command:

[\[:SOURce<hw>\]:BB:NR5G:UBWP:REStart:SIDX:INTerval](#) on page 478

5.3.2 DL and UL user properties settings

Access:

1. Select "5G New Radio > General > Link Direction > Uplink" or "Downlink".
2. Select "5G New Radio > General > Users/BWPs > Properties".

Settings:

- [General settings](#).....95
- [Control settings](#)..... 100

5.3.2.1 General settings

The general settings section of the user properties contain settings to configure general properties of the selected user.

General Settings	
UE ID (C-RNTI)	1
DSCH Channel Coding	<input checked="" type="checkbox"/>
DSCH Data Source	Pattern
Data Source Unique per Carrier	<input checked="" type="checkbox"/>
DSCH Scrambling	<input checked="" type="checkbox"/>
Pattern	0...

User.....	96
UE ID (C-RNTI).....	96
Use ORAN Data Source.....	96
ORAN Test Case.....	96
DSCH/USCH Channel Coding.....	97
DSCH/USCH Scrambling.....	97
(P)DSCH/(P)USCH Data Source.....	97
Initialization.....	98
Data Source Unique per Carrier.....	98
Unique Data Source for PUSCH UCI.....	98
PUSCH UCI Data Source.....	98
Initialization / Pattern / Data List.....	98
Unique Data Source for PUCCH Payload.....	99
PUCCH Payload Data Source.....	99
Initialization / Pattern / Data List.....	99

User:

Selects the user to be configured.

Available if the [number of users](#) is greater than 1.

Remote command:

via suffix at `USER<ch>`

UE ID (C-RNTI)

Sets the RNTI of the user. It is a unique UE identifier for the RRC connection and for scheduling.

Remote command:

`[:SOURCE<hw>] :BB:NR5G:UBWP:USER<us>:UEID` on page 487

Use ORAN Data Source

Requires Option: R&S SMM-K175

Turns usage of the PxSCH data source according to the ORAN standard on and off.

"Off" Select a data source as required.

"On" Automatically selects a data source that complies to the ORAN standard and adjusts the following settings according to the settings specified in the selected [ORAN test case](#).

- State of xSCH [scrambling](#)
- Type of [PxSCH data source](#)
- [Initialization value](#) specified in the ORAN standard

Remote command:

`[:SOURCE<hw>] :BB:NR5G:UBWP:USER<us>:ORAN:USDS` on page 480

ORAN Test Case

Requires Option: R&S SMM-K175

Selects the ORAN test case for ORAN data generation. Depending on the selected test case, the payload appears in different locations in the signal.

Remote command:

`[:SOURCE<hw>] :BB:NR5G:UBWP:USER<us>:ORAN:TC` on page 479

DSCH/USCH Channel Coding

Depending on the selected "Link Direction" direction, enables DSCH/USCH channel coding.

Configure the corresponding settings in "Scheduling > User x BWP x > Content > PDSCH/PUSCH > Settings > Config" > [Channel coding settings](#) dialog.

If [PDSCH Scheduling](#) = "Auto/DCI", the "DSCH Channel Coding" = "On".

Remote command:

`[:SOURCE<hw>] :BB:NR5G:UBWP:USER<us>:DSCH:CCODing:STATe` on page 488

`[:SOURCE<hw>] :BB:NR5G:UBWP:USER<us>:USCH:CCODing:STATe` on page 488

DSCH/USCH Scrambling

Depending on the selected "Link Direction" direction, turns PDSCH and PUSCH scrambling on and off.

Turn off scrambling to generate the raw bit pattern of the PDSCH or PUSCH. A pseudo random scrambling sequence is not applied, therefore the settings for the [PDSCH scrambling sequence](#) have no effect.

Remote command:

`[:SOURCE<hw>] :BB:NR5G:UBWP:USER<us>:DSCH:SCRambling:STATe`

on page 488

`[:SOURCE<hw>] :BB:NR5G:UBWP:USER<us>:USCH:SCRambling:STATe`

on page 488

(P)DSCH/(P)USCH Data Source

Depending on the selected "Link Direction", selects the PDSCH/PUSCH data source.

If channel coding is enabled, the parameter sets the DSCH/USCH data source.

The following standard data sources are available:

- "All 0"/"All 1"
An internally generated sequence containing 0 data or 1 data.
- "PNxx"
An internally generated pseudo-random noise sequence.
- "Pattern"
An internally generated sequence according to a bit pattern.
Use the "Pattern" box to set the bit pattern.
- "Data List"/"Select Data List"
Binary data from a list file, internally or externally generated.
Select "Select Data List" to open the standard "Select List" dialog. The dialog lists file with file extension *.dm_iqd if existing.
 - Navigate to the list file and tap "Select" to select the file.
 - Use the "New" and "Edit" functions to create a data list internally or to edit an existing one.
 - Use the standard "File Manager" function to transfer external data lists to the instrument.

See also:

- Section "About data signals" in the R&S SMM100A user manual.
- Section "File and data management" in the R&S SMM100A user manual.
- Section "Data list editor" in the R&S SMM100A user manual.

Remote command:

[:SOURce<hw>] :BB:NR5G:UBWP:USER<us>:DSCH:DATA on page 488
 [:SOURce<hw>] :BB:NR5G:UBWP:USER<us>:DSCH:DLISt on page 488
 [:SOURce<hw>] :BB:NR5G:UBWP:USER<us>:DSCH:PATTeRn on page 489
 [:SOURce<hw>] :BB:NR5G:UBWP:USER<us>:USCH:DATA on page 488
 [:SOURce<hw>] :BB:NR5G:UBWP:USER<us>:USCH:DLISt on page 488
 [:SOURce<hw>] :BB:NR5G:UBWP:USER<us>:USCH:PATTeRn on page 489

Initialization

Sets an initialization value for the second m-sequence in the selected PN sequence.

Enabled if "Data Source > PNxx".

Remote command:

[:SOURce<hw>] :BB:NR5G:UBWP:USER<us>:DSCH:INITpattErn on page 489
 [:SOURce<hw>] :BB:NR5G:UBWP:USER<us>:USCH:INITpattErn on page 489

Data Source Unique per Carrier

Turns usage of a unique data source for the P_xSCH in a multi-carrier scenario on and off.

"On" Uses a unique data source for each carrier.

"Off" Uses the the same data source for all carriers.

Remote command:

[:SOURce<hw>] :BB:NR5G:UBWP:USER<us>:DSPC:STATe on page 479

Unique Data Source for PUSCH UCI

Available in uplink only.

Turns selection of a unique data source of the PUSCH UCI on and off.

"On" Define the PUCCH payload manually for each scheduled allocation using the [UCI settings](#).

"Off" Select a single [data source](#) applied to all scheduled allocations.

Remote command:

[:SOURce<hw>] :BB:NR5G:UBWP:USER<us>:PUUCi:DSUNique on page 482

PUSCH UCI Data Source

Available in uplink only.

Selects the data source of the PUSCH UCI.

For an overview of available data sources, see "[\(P\)DSCH/\(P\)USCH Data Source](#)" on page 97. They are the same for the PUSCH UCI.

Remote command:

[:SOURce<hw>] :BB:NR5G:UBWP:USER<us>:PUUCi:DATA on page 481

Initialization / Pattern / Data List

Available in uplink only.

The contents of this field depends on the selected data source.

- "Initialization": For data source = "PN<x>"

Sets an initialization value for the second m-sequence in the selected PN sequence.

- "Pattern": For data source = "Pattern"
Defines the bit pattern the sequence is based on.
- "Data List": For data source = "Data List"
Opens a dialog to select a file that contains a data list (.dm_iqd file format).

Remote command:

Initialization: [:SOURce<hw>] :BB:NR5G:UBWP:USER<us>:PUUCi:INITpattern
on page 482

Bit pattern: [:SOURce<hw>] :BB:NR5G:UBWP:USER<us>:PUUCi:PATtern
on page 483

File: [:SOURce<hw>] :BB:NR5G:UBWP:USER<us>:PUUCi:DLIST on page 482

Unique Data Source for PUCCH Payload

Available in uplink only.

Turns selection of a unique data source of the PUCCH payload on and off.

"On" Define the PUCCH payload manually for each scheduled allocation using the [UCI settings](#).

"Off" Select a single [data source](#) applied to all scheduled allocations.

Remote command:

[:SOURce<hw>] :BB:NR5G:UBWP:USER<us>:PUPLoad:DSUNique on page 480

PUCCH Payload Data Source

Available in uplink only.

Selects the data source of the PUCCH payload.

For an overview of available data sources, see "[\(P\)DSCH/\(P\)USCH Data Source](#)" on page 97. They are the same for the PUCCH payload.

Remote command:

[:SOURce<hw>] :BB:NR5G:UBWP:USER<us>:PUPLoad:DATA on page 480

Initialization / Pattern / Data List

Available in uplink only.

The contents of this field depends on the selected data source.

- "Initialization": For data source = "PN<x>"
Sets an initialization value for the second m-sequence in the selected PN sequence.
- "Pattern": For data source = "Pattern"
Defines the bit pattern the sequence is based on.
- "Data List": For data source = "Data List"
Opens a dialog to select a file that contains a data list (.dm_iqd file format).

Remote command:

Initialization: [:SOURce<hw>] :BB:NR5G:UBWP:USER<us>:PUPLoad:
INITpattern on page 481

Bit pattern: [:SOURce<hw>] :BB:NR5G:UBWP:USER<us>:PUPLoad:PATtern
on page 481

File: [:SOURce<hw>] :BB:NR5G:UBWP:USER<us>:PUPLoad:DLISt on page 480

5.3.2.2 Control settings

The control settings section of the user properties contain settings related to DCI configuration.

Available when "Simple Mode" = "Off".

Control	
SCell Groups within Active Time 0	PDSCH Harq-Ack-One-Shot-Feedback-R16 <input type="checkbox"/>
Ack-Nack-Feedback-Mode Not Configured	NFI-TotalDAI-Included <input type="checkbox"/>
UL-TotalDAI-Included <input type="checkbox"/>	Downlink Assignment Index DCI0_2 <input type="checkbox"/>
Bits for Sidelink Assignment Index 0	PUCCH-sSCellDyn DCI1_1 <input type="checkbox"/>
HARQ-ACK Retransmission Indicator DCI1_1 <input type="checkbox"/>	Available RB Set Indicators in DCI2_0 0
Available RB Set Indicator Size DCI2_0 1	COT Duration Indicators in DCI2_0 0
COT Duration Indicator Size DCI2_0	Search Space Switching Flags in DCI2_0

SCell Groups Within Active Time.....	101
PDSCH Harq-Ack-One-Shot-Feedback-R16.....	101
Ack-Nack-Feedback-Mode.....	101
NFI-TotalDAI-Included.....	101
UL-TotalDai-Included.....	101
Downlink Assignment Index 0_2.....	101
Bits for Sidelink Assignment Index.....	102
PUCCH-sSCellDyn DCI1_1.....	102
HARQ-ACK Retransmission Indicator DCI1_1.....	102
Available RB Set Indicators DCI2_0.....	102
Available RB Set Indicator Size DCI2_0.....	102
COT Duration Indicators DCI2_0.....	102
COT Duration Indicator Size DCI2_0.....	102
Search Space Switching Flags DCI2_0.....	102
CS-RNTI.....	103
MCS-C-RNTI.....	103
SP-CSI-RNTI.....	103
SFI-RNTI.....	103
SFIs in DCI 2_0.....	103
RA-RNTI.....	103
TC-RNTI.....	103
MsgB-RNTI.....	104
SL-RNTI.....	104
SL-CS-RNTI.....	104
V-RNTI.....	104
PEI-RNTI.....	104
MCCH-RNTI.....	104
G-RNTI.....	105
G-CS-RNTI.....	105

SCell Groups Within Active Time

Defines the number of SCell group for dormancy within active time. This parameter represents the width of the "SCell Dormancy Indication" DCI field in DCI Format 1_1.

Remote command:

[:SOURce<hw>] :BB:NR5G:UBWP:USER<us>:DSCH:SCGW on page 489

PDSCH Harq-Ack-One-Shot-Feedback-R16

Turns the "One-Shot HARQ-ACK Request" DCI field in DCI format 1_1 on and off.

Corresponds to higher layer parameter `pdsch-HARQ-ACK-OneShotFeedback` as defined in 3GPP 38.331.

Remote command:

[:SOURce<hw>] :BB:NR5G:UBWP:USER<us>:DSCH:PH1F on page 490

Ack-Nack-Feedback-Mode

Configures the higher layer parameter `ackNackFeedbackMode` as defined in 3GPP 38.331.

This parameter has an effect on the DCI field "Downlink Assignment Index" in DCI format 1_1.

Remote command:

[:SOURce<hw>] :BB:NR5G:UBWP:USER<us>:DSCH:ANFMode on page 489

NFI-TotalDAI-Included

Option: R&S SMM-K148

Configures the higher layer parameter `nfi-TotalDAIIncluded` as defined in 3GPP 38.331.

This parameter has an effect on DCI fields "Downlink Assignment Index" and "New Feedback Indicator" in DCI Format 1_1 as defined in 3GPP 38.212.

Remote command:

[:SOURce<hw>] :BB:NR5G:UBWP:USER<us>:DSCH:DAIT on page 490

UL-TotalDai-Included

Option: R&S SMM-K148

Configures the higher layer parameter `ul-TotalDAI-Included` as defined in 3GPP 38.331.

This parameter has an effect on DCI fields "First Downlink Assignment Index" in DCI Format 0_1 as defined in 3GPP 38.212.

Remote command:

[:SOURce<hw>] :BB:NR5G:UBWP:USER<us>:DSCH:DAUL on page 490

Downlink Assignment Index 0_2

Option: R&S SMM-K148

Turns the 1st and 2nd "Downlink Assignment Index" fields in DCI format 0_2 on and off.

Corresponds to higher layer parameter `downlinkAssignmentIndexDCI-0-2`.

Remote command:

[:SOURce<hw>] :BB:NR5G:UBWP:USER<us>:DSCH:DA02 on page 490

Bits for Sidelink Assignment Index

Option: R&S SMM-K171

Turns the "Sidelink Assignment Index" field in DCI format 0_1 and 3_0 on and off and defines its size.

Remote command:

[:SOURce<hw>] :BB:NR5G:UBWP:USER<us>:USCH:NSAS on page 492

PUCCH-sSCellDyn DCI1_1

Option: R&S SMM-K171

Turns the "PUCCH Cell Indicator" field available in DCI format 1_1 on and off.

Remote command:

[:SOURce<hw>] :BB:NR5G:UBWP:USER<us>:DSCH:PSSCdyn on page 491

HARQ-ACK Retransmission Indicator DCI1_1

Option: R&S SMM-K171

Turns the "HARQ-ACK Retransmission Indicator" field available in DCI format 1_1 on and off.

Remote command:

[:SOURce<hw>] :BB:NR5G:UBWP:USER<us>:DSCH:HARTind on page 490

Available RB Set Indicators DCI2_0

Defines the number of the "Available RB Set Indicators" fields in DCI format 2_0.

Remote command:

[:SOURce<hw>] :BB:NR5G:UBWP:USER<us>:DSCH:NRBS on page 491

Available RB Set Indicator Size DCI2_0

Defines the size of the "Available RB Set Indicator" field in DCI format 2_0.

Remote command:

[:SOURce<hw>] :BB:NR5G:UBWP:USER<us>:DSCH:RBIS on page 491

COT Duration Indicators DCI2_0

Defines the number of the "COT Duration Indicators" fields in DCI format 2_0.

Remote command:

[:SOURce<hw>] :BB:NR5G:UBWP:USER<us>:DSCH:CDIN on page 491

COT Duration Indicator Size DCI2_0

Defines the size of the "COT Duration Indicator" field in DCI format 2_0.

Remote command:

[:SOURce<hw>] :BB:NR5G:UBWP:USER<us>:DSCH:CODS on page 492

Search Space Switching Flags DCI2_0

Defines the number of the "Search Space Switching Flags" fields in DCI format 2_0.

Remote command:

[:SOURce<hw>] :BB:NR5G:UBWP:USER<us>:DSCH:NSSF on page 492

CS-RNTI

Sets the CS-RNTI of the user. It is a unique UE identification used for semi-persistent scheduling in the downlink.

See also "Usage" on page 245.

Remote command:

[:SOURce<hw>] :BB:NR5G:UBWP:USER<us>:RNTI:CS on page 484

MCS-C-RNTI

Sets the MCS-C-RNTI of the user. It is a unique UE identification used for modulation coding scheme in the downlink.

See also "Usage" on page 245.

Remote command:

[:SOURce<hw>] :BB:NR5G:UBWP:USER<us>:RNTI:MCSC on page 485

SP-CSI-RNTI

Sets the SP-CSI-RNTI of the user. It is a unique UE identification used for semi-persistent CSI reporting on PUSCH.

See also "Usage" on page 245.

Remote command:

[:SOURce<hw>] :BB:NR5G:UBWP:USER<us>:RNTI:SPCSI on page 486

SFI-RNTI

Sets the SFI-RNTI of the user. It is used to identify the slot format.

See also "Usage" on page 245.

Remote command:

[:SOURce<hw>] :BB:NR5G:UBWP:USER<us>:RNTI:SFI on page 486

SFIs in DCI 2_0

Sets how many slot format indicator (SFI) fields are transmitted in the DCI format 2_0.

Remote command:

[:SOURce<hw>] :BB:NR5G:UBWP:USER<us>:NUMSfi on page 487

RA-RNTI

Sets the RA-RNTI of the user. It is an identifier for the random access response in the downlink during the random access procedure.

See also "Usage" on page 245.

Remote command:

[:SOURce<hw>] :BB:NR5G:UBWP:USER<us>:RNTI:RA on page 485

TC-RNTI

Sets the TC-RNTI of the user. It is a unique UE identifier for the RRC connection and for scheduling with a temporary cell.

See also "Usage" on page 245.

Remote command:

[:SOURce<hw>] :BB:NR5G:UBWP:USER<us>:RNTI:TC on page 486

MsgB-RNTI

Sets the MsgB-RNTI of the user. It is a unique UE identifier for the RRC connection and for scheduling with a temporary cell.

See also "Usage" on page 245.

Remote command:

[:SOURce<hw>] :BB:NR5G:UBWP:USER<us>:RNTI:MSGB on page 485

SL-RNTI

Sets the SL-RNTI of the user. It is an identifier for dynamically scheduled sidelink transmission.

See also "Usage" on page 245.

Remote command:

[:SOURce<hw>] :BB:NR5G:UBWP:USER<us>:RNTI:SL on page 486

SL-CS-RNTI

Sets the SL-RNTI of the user. It is an identifier for dynamically scheduled sidelink transmission.

See also "Usage" on page 245.

Remote command:

[:SOURce<hw>] :BB:NR5G:UBWP:USER<us>:RNTI:SLCS on page 487

V-RNTI

Sets the SL-RNTI of the user. It is an identifier for dynamically scheduled V2X transmission.

See also "Usage" on page 245.

Remote command:

[:SOURce<hw>] :BB:NR5G:UBWP:USER<us>:RNTI:V on page 487

PEI-RNTI

Sets the PEI-RNTI of the user. It is an identifier for paging early indication.

See also "Usage" on page 245.

Remote command:

[:SOURce<hw>] :BB:NR5G:UBWP:USER<us>:RNTI:PEI on page 485

MCCH-RNTI

Sets the MCCH-RNTI of the user. It is an identifier for dynamically scheduled MCCH signalling and MCCH change notification.

See also "Usage" on page 245.

Remote command:

[:SOURce<hw>] :BB:NR5G:UBWP:USER<us>:RNTI:MCCH on page 484

G-RNTI

Sets the G-RNTI of the user. It is an identifier for dynamically scheduled MBS PTM transmission.

See also "Usage" on page 245.

Remote command:

[:SOURce<hw>] :BB:NR5G:UBWP:USER<us>:RNTI:G on page 484

G-CS-RNTI

Sets the G-CS-RNTI of the user. It is an identifier for configured scheduled multicast transmission.

See also "Usage" on page 245.

Remote command:

[:SOURce<hw>] :BB:NR5G:UBWP:USER<us>:RNTI:GCS on page 484

5.3.3 SL user properties settings

Access:

1. Select "5G New Radio > General > Link Direction > Sidelink".
2. Select "5G New Radio > General > Users/BWPs > Properties".

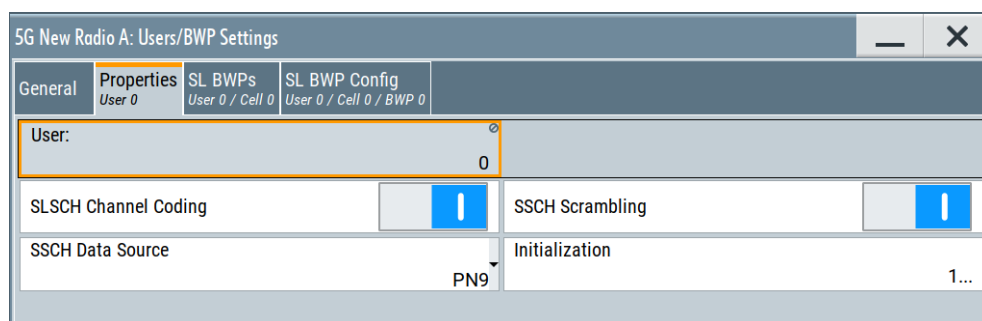

This dialog comprises the user-specific general settings.

Settings:

User.....	105
SSCH Channel Coding.....	106
SSCH Scrambling.....	106
SSCH Data Source.....	106
Initialization.....	106
Pattern.....	106
Data List.....	107
Data Source Unique per Carrier.....	107

User:

Selects the user to be configured.

Available if the [number of users](#) is greater than 1.

Remote command:
via suffix at USER<ch>

SSCH Channel Coding

Turns PSSCH channel coding on and off.

Configure the corresponding settings in "Scheduling > User x BWP x > Content > PSSCH/PSCCH > Settings > Config" > [Channel coding settings](#) dialog.

Remote command:

[\[:SOURCE<hw>\]:BB:NR5G:UBWP:USER<us>:SSCH:CCODing:STATe](#) on page 492

SSCH Scrambling

Turns PSSCH scrambling on and off.

Turn off scrambling to generate the raw bit pattern of the PSSCH. A pseudo random scrambling sequence is not applied in that case.

Remote command:

[\[:SOURCE<hw>\]:BB:NR5G:UBWP:USER<us>:SSCH:SCRambling:STATe](#) on page 494

SSCH Data Source

Selects the PSSCH data source.

If channel coding is enabled, the parameter sets the SSCH data source.

PSSCH data sources are the same as PDSCH data sources. For more information about the PSSCH data sources, see "[\(P\)DSCH/\(P\)USCH Data Source](#)" on page 97.

Remote command:

[\[:SOURCE<hw>\]:BB:NR5G:UBWP:USER<us>:SSCH:DATA](#) on page 493

Bit pattern definition:

Data list selection: [\[:SOURCE<hw>\]:BB:NR5G:UBWP:USER<us>:SSCH:DLIST](#) on page 493

Initialization

Sets an initialization value for the second m-sequence in the selected PN sequence.

Enabled if "Data Source > PNxx".

For more information about data sources, see "[\(P\)DSCH/\(P\)USCH Data Source](#)" on page 97.

Remote command:

[\[:SOURCE<hw>\]:BB:NR5G:UBWP:USER<us>:SSCH:INITpattErn](#) on page 493

Pattern

Opens an input field to define a bit pattern.

Enabled if "Data Source > Pattern".

For more information about data sources, see "[\(P\)DSCH/\(P\)USCH Data Source](#)" on page 97.

Remote command:

[\[:SOURCE<hw>\]:BB:NR5G:UBWP:USER<us>:SSCH:INITpattErn](#) on page 493

Data List

Opens a dialog box to select a file containing the data list ().

Enabled if "Data Source > Data List".

For more information about data sources, see "(P)DSCH/(P)USCH Data Source" on page 97.

Remote command:

[:SOURce<hw>] :BB:NR5G:UBWP:USER<us>:SSCH:INITpattern on page 493

Data Source Unique per Carrier

See "Data Source Unique per Carrier" on page 98 for details.

5.3.4 DL/UL BWPs settings

Access:

1. Select "5G New Radio > General > Link Direction > Downlink".
2. Select "General > Users/BWPs" > "DL BWPs".

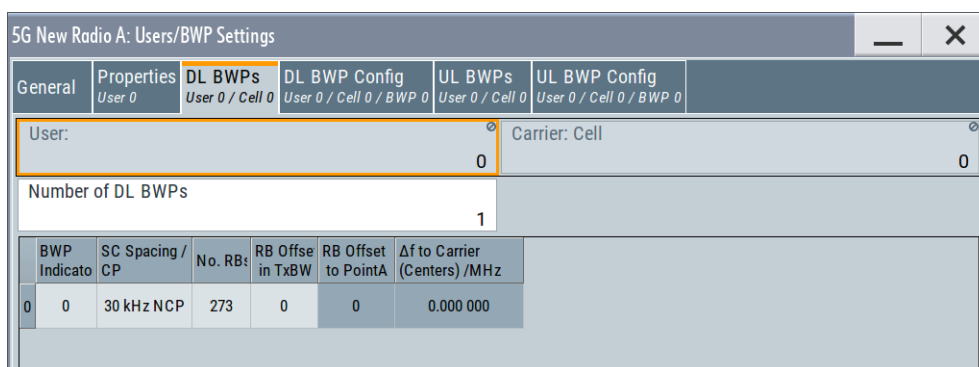

The dialog comprises the settings for the DL/UL bandwidth parts (BWP) configuration. The UL BWPs dialog is displayed for DL and UL direction, whereas the DL BWP - only for DL direction.

For each user and carrier combination, you can configure one or more BWPs. You can configure BWPs in the bandwidth part configuration table. This table consists of several rows, each of which corresponds to a BWP. The size of the table therefore depends on the number of BWPs you have selected.

Each BWP is indicated by a BWP indicator. The bandwidth of the BWP depends on the number of RBs it occupies. Its allocation in the frequency, on the selected RB offset. The resulting frequency offset between the BWP center and the center of the carrier is indicated, too.

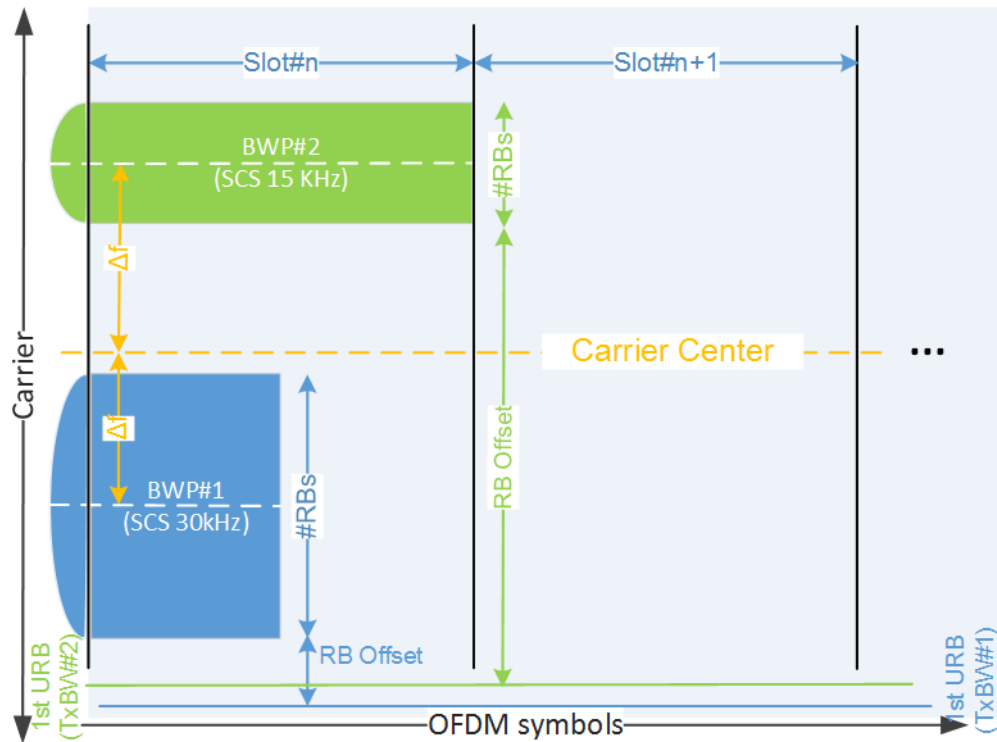

Figure 5-4: Bandwidth parts

- BWP# = Bandwidth part and indicator
- SCS = Subcarrier spacing
- Center carrier = Center frequency of the carrier (cell)
- #RB = Number of resource blocks or channel bandwidth per BWP
- RB offset = Frequency offset between the first usable resource block (URB) and the start of the BWP
- 1st URB = First usable resource block (URB), that is the first RB within the transmission bandwidth
TxBW, see Figure 2-2
- Δf = Frequency offset between the center frequency of the BWP and the center frequency of the carrier
- Carrier = Channel bandwidth of the carrier
- OFDM symbol = Represent the time domain

Settings:

- User..... 108
- Cell..... 109
- Number of DL/UL BWPs..... 109
- BWPs table..... 109
 - L BWP Indicator..... 109
 - L SC Spacing/CP..... 109
 - L No. RBs..... 110
 - L RB Offset in TxBW..... 110
 - L RB Offset to Point A..... 110
 - L Δf to Carrier (Centers) /MHz..... 110

User:

Selects the user to be configured.

Available if the [number of users](#) is greater than 1.

Remote command:

via suffix at `USER<ch>`

Cell

Selects/indicates to which carrier/cell the settings apply.

Remote command:

via suffix at `CELL<ch>`

Number of DL/UL BWPs

Sets the number of downlink bandwidth parts (BWP).

There is one table row per enabled DL/UL BWP.

See also:

- [Figure 5-4](#)
- [Chapter 7, "Observing current allocations on the time plan"](#), on page 331.

Remote command:

`[:SOURCE<hw>] :BB:NR5G:UBWP:USER<us>:CELL<cc>:DL:NBWParts`
on page 495

`[:SOURCE<hw>] :BB:NR5G:UBWP:USER<us>:CELL<cc>:UL:NBWParts`
on page 495

BWPs table

Comprises the BWPs settings.

There is one table row per enabled DL/UL BWP, see ["Number of DL/UL BWPs"](#) on page 109.

BWP Indicator ← BWPs table

Sets the unique indicator for the selected BWP, used to address the BWP within the DCI.

Remote command:

`[:SOURCE<hw>] :BB:NR5G:UBWP:USER<us>:CELL<cc>:DL:BWP<bwp>:`
`INDicator` on page 495

`[:SOURCE<hw>] :BB:NR5G:UBWP:USER<us>:CELL<cc>:UL:BWP<bwp>:`
`INDicator` on page 495

SC Spacing/CP ← BWPs table

Selects a combination of the subcarrier spacing (SCS) and the cyclic prefix (CP), where the available values depend on the "Deployment".

See [Table 2-2](#).

Note: The possible values for SC spacing depend on the selected "Node" > "TxBW" values.

Note: "60 kHz ECP" is supported by the existing parameters "Dummy REs", for "DL-BWPs" and for "UL-BWPs".

Interdependency: The preset value from I1 is changed from 11 to 10 for extended cyclic prefix.

Remote command:

[:SOURce<hw>] :BB:NR5G:UBWP:USER<us>:CELL<cc>:DL:BWP<bwp>:
SCSPacing on page 497

[:SOURce<hw>] :BB:NR5G:UBWP:USER<us>:CELL<cc>:UL:BWP<bwp>:
SCSPacing on page 497

No. RBs ← BWPs table

Defines the number of resource blocks (RB) the bandwidth part (BWP) occupies. This value defines the frequency width of the BWP.

The number of available RBs (N_{RB}) depends on the [SC Spacing/CP](#) and [Channel Bandwidth](#), where the latter depends on the selected deployment.

The number of available RBs is updated whenever the SCS or channel bandwidth is changed. The selected value is the maximum number of RB for the combination of SCS and channel bandwidth.

See also [Figure 5-4](#).

Remote command:

[:SOURce<hw>] :BB:NR5G:UBWP:USER<us>:CELL<cc>:DL:BWP<bwp>:
RBNumber on page 499

[:SOURce<hw>] :BB:NR5G:UBWP:USER<us>:CELL<cc>:UL:BWP<bwp>:
RBNumber on page 499

RB Offset in TxBW ← BWPs table

Defines the offset between the first resource block in the BWP relative to the first usable resource blocks (URB).

See also [Figure 5-4](#).

Remote command:

[:SOURce<hw>] :BB:NR5G:UBWP:USER<us>:CELL<cc>:DL:BWP<bwp>:
RBOffset on page 500

[:SOURce<hw>] :BB:NR5G:UBWP:USER<us>:CELL<cc>:UL:BWP<bwp>:
RBOffset on page 500

RB Offset to Point A ← BWPs table

Indicates the frequency starting position of the BWP relative to the point A, calculated as follows:

"RB Offset to Point A" = [RB Offset in TxBW](#) + [TxBW Offset](#)

See also [Figure 5-4](#).

Remote command:

[:SOURce<hw>] :BB:NR5G:UBWP:USER<us>:CELL<cc>:DL:BWP<bwp>:
PRBoffset? on page 500

[:SOURce<hw>] :BB:NR5G:UBWP:USER<us>:CELL<cc>:UL:BWP<bwp>:
PRBoffset? on page 500

Δf to Carrier (Centers) /MHz ← BWPs table

Indicates the frequency offset between the BWP center and the center frequency of the carrier; it thus defines the BWP position in the frequency domain.

The value is calculated automatically, based on the selected SCS, channel bandwidth, deployment method, number of RBs and RB offset.

See also [Figure 5-4](#).

Remote command:

[:SOURce<hw>] :BB:NR5G:UBWP:USER<us>:CELL<cc>:DL:BWP<bwp>:DFReq?
on page 500

[:SOURce<hw>] :BB:NR5G:UBWP:USER<us>:CELL<cc>:UL:BWP<bwp>:DFReq?
on page 500

5.3.5 SL BWPs settings

Access:

1. Select "5G New Radio > General > Link Direction > Sidelink".
2. Select "General > Users/BWPs" > "SL BWPs".

BWP Indicator	SC Spacing / CP	No. RBs	RB Offset in Tx BW	RB Offset to Point A	Δf to Carrier (Centers) /MHz
0	30 kHz NCP	273	0	0	0.000 000
1	30 kHz NCP	273	0	0	0.000 000

The dialog comprises the settings for the SL bandwidth parts (BWP) configuration. For more information about bandwidth parts in general, see [Chapter 5.3.4, "DL/UL BWPs settings"](#), on page 107.

Settings:

User:	112
Cell:	112
Number of SL BWPs:	112
BWPs table:	112
L BWP Indicator:	112
L SC Spacing/CP:	112
L No. RBs:	112
L RB Offset in Tx BW:	113
L RB Offset to Point A:	113
L Δf to Carrier (Centers) /MHz:	113

User:

Selects the user to be configured.

Available if the [number of users](#) is greater than 1.

Remote command:

via suffix at `USER<ch>`

Cell

Selects/indicates to which carrier/cell the settings apply.

Remote command:

via suffix at `CELL<ch>`

Number of SL BWPs

Sets the number of sidelink bandwidth parts (BWP).

There is one table row per enabled BWP.

See also:

- [Figure 5-4](#)
- [Chapter 7, "Observing current allocations on the time plan"](#), on page 331.

Remote command:

`[:SOURCE<hw>] :BB:NR5G:UBWP:USER<us>:CELL<cc>:SL:NBWParts`
on page 503

BWPs table

Contains the BWPs settings.

There is one table row per enabled SL BWP, see ["Number of SL BWPs"](#) on page 112.

BWP Indicator ← BWPs table

Sets the unique indicator for the selected BWP, used to address the BWP within the SCI.

Remote command:

`[:SOURCE<hw>] :BB:NR5G:UBWP:USER<us>:CELL<cc>:SL:BWP<bwp>:`
`INDicator` on page 501

SC Spacing/CP ← BWPs table

Selects a combination of the subcarrier spacing (SCS) and the cyclic prefix (CP), where the available values depend on the "Deployment".

See [Table 2-2](#).

Note: The possible values for SC spacing depend on the selected "Node" > "TxBW" values.

Remote command:

`[:SOURCE<hw>] :BB:NR5G:UBWP:USER<us>:CELL<cc>:SL:BWP<bwp>:`
`SCSPacing` on page 502

No. RBs ← BWPs table

Defines the number of resource blocks (RB) the bandwidth part (BWP) occupies. This value defines the frequency width of the BWP.

The number of available RBs (N_{RB}) depends on the [SC Spacing/CP](#) and [Channel Bandwidth](#), where the latter depends on the selected deployment.

The number of available RBs is updated whenever the SCS or channel bandwidth is changed. The selected value is the maximum number of RB for the combination of SCS and channel bandwidth.

See also [Figure 5-4](#).

Remote command:

```
[ :SOURCE<hw> ] :BB:NR5G:UBWP:USER<us>:CELL<cc>:SL:BWP<bwp>:
RBNumber on page 502
```

RB Offset in TxBW ← BWPs table

Defines the offset between the first resource block in the BWP relative to the first usable resource blocks (URB).

See also [Figure 5-4](#).

Remote command:

```
[ :SOURCE<hw> ] :BB:NR5G:UBWP:USER<us>:CELL<cc>:SL:BWP<bwp>:
RBOffset on page 502
```

RB Offset to Point A ← BWPs table

Indicates the frequency starting position of the BWP relative to the point A, calculated as follows:

"RB Offset to Point A" = [RB Offset in TxBW](#) + [TxBW Offset](#)

See also [Figure 5-4](#).

Remote command:

```
[ :SOURCE<hw> ] :BB:NR5G:UBWP:USER<us>:CELL<cc>:SL:BWP<bwp>:
PAOffset? on page 501
```

Δf to Carrier (Centers) /MHz ← BWPs table

Indicates the frequency offset between the BWP center and the center frequency of the carrier; it thus defines the BWP position in the frequency domain.

The value is calculated automatically, based on the selected SCS, channel bandwidth, deployment method, number of RBs and RB offset.

See also [Figure 5-4](#).

Remote command:

```
[ :SOURCE<hw> ] :BB:NR5G:UBWP:USER<us>:CELL<cc>:SL:BWP<bwp>:DFReq?
on page 501
```

5.3.6 DL BWP configuration settings

Access:

1. Select "5G New Radio > General > Link Direction > Downlink".

2. Select "General > Users/BWPs" > "DL BWP Config".

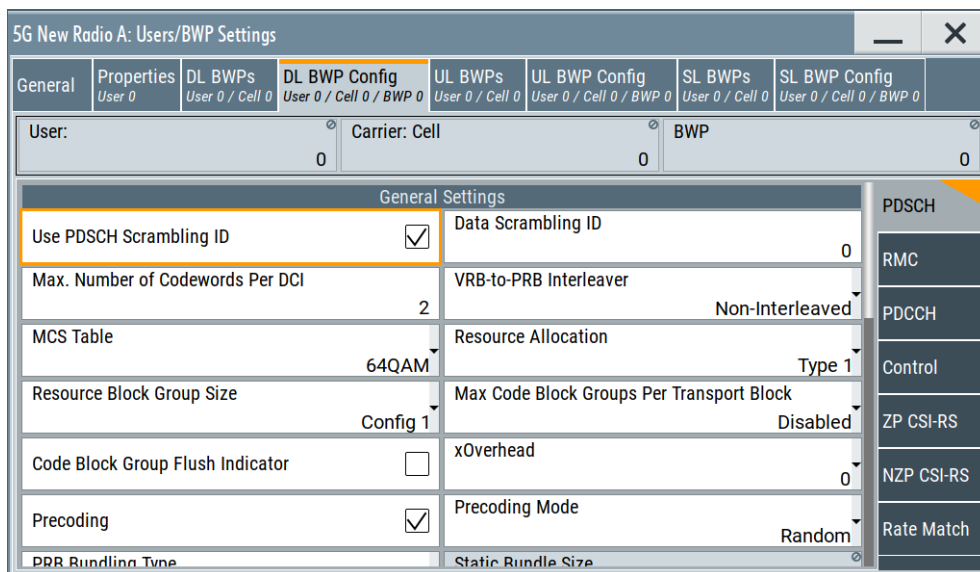

The dialog comprises the settings for the DL bandwidth parts (BWP) configuration.

Settings:

- [User, carrier, BWP settings](#)..... 114
- [PDSCH settings](#)..... 115
- [RMC settings](#)..... 133
- [PDCCH settings](#)..... 135
- [Control settings \(DCI\)](#)..... 135
- [ZP CSI-RS settings](#)..... 144
- [NZP CSI-RS settings](#)..... 147
- [Rate match settings](#)..... 153

5.3.6.1 User, carrier, BWP settings

- [User](#)..... 114
- [Cell](#)..... 114
- [BWP](#)..... 115

User:

Selects the user to be configured.
Available if the [number of users](#) is greater than 1.

Remote command:
via suffix at `USER<ch>`

Cell

Selects/indicates to which carrier/cell the settings apply.
Remote command:
via suffix at `CELL<ch>`

BWP

Select the bandwidth parts (BWP) whose settings are displayed for configuration.

There are one or more BWPs, as set with the parameter "User/BWP Settings > DL BWPs" > [Number of DL/UL BWPs](#).

Remote command:

via suffix at `BWP<dir0>`

5.3.6.2 PDSCH settings

Access:

- ▶ Select "User/BWP Settings > DL BWP Config > PDSCH".

The dialog comprises the DMRS and PTRS settings, divided per DMRS-mapping type A and B, as defined in [TS 38.211](#) and [TS 38.214](#).

For description of the remote-control commands, see [Chapter 10.19.1, "PDSCH commands"](#), on page 503.

About PDSCH and DMRS sequence generation

According to [TS 38.211](#), the **PDSCH** sequence is generated based among others on the value of the variable n_{ID} , that can be:

- $n_{ID} = N_{ID}^{cell}$ (i.e. equal to the physical cell identifier) or
- $n_{ID} = dataScramblingIdentityPDSCH$ (higher-layer parameter).

In this implementation, you set which of the two variants is used by the parameter [Use PDSCH Scrambling ID](#) and the n_{ID} value on both case by the parameters "Node > Carriers" > [Cell ID](#) and [Data Scrambling ID](#).

According to [TS 38.211](#), the **DMRS** sequence is generated based among others on the values of the variables N_{ID}^0, N_{ID}^1 and $N_{ID}^{n_SCID}$ or N_{ID}^0 and $N_{ID}^{n_SCID}$ with $n_SCID = \{0, 1\}$.

Which of these two combinations of variables is used depends on whether the PDSCH is scheduled by PDCCH using DCI format 1_1 or DCI format 1_0.

In this implementation, you define the values as follows:

- N_{ID}^0, N_{ID}^1 per DMRS type are set with "User/BWP > DL BWP > PDSCH" > [Scrambling ID 0/Scrambling ID 1](#).
- If N_{ID}^0 or N_{ID}^1 is used, is set with "Scheduling > PDSCH > DMRS" > [N_SCID](#).
- If $N_{ID}^{n_SCID} = N_{ID}^{cell}$ or $N_{ID}^{n_SCID} = N_{ID}^0$ or N_{ID}^1 is set with "Scheduling > PDSCH > DMRS" > [Sequence Generation](#).
- The [DCI Format 1_0](#) field "DMRS Sequence Initialization".

Settings:

- [General settings](#)..... 116
- [Control settings](#)..... 120
- [DMRS settings](#)..... 126
- [Time domain allocation](#)..... 130
- [Multi time domain allocation lists](#)..... 131

General settings

The general settings section of the PDSCH properties contain settings to configure general properties of the selected user.

General Settings	
Use PDSCH Scrambling ID <input type="checkbox"/>	Data Scrambling ID <input type="text" value="0"/>
Max. Number of Codewords Per DCI <input type="text" value="2"/>	VRB-to-PRB Interleaver <input type="text" value="Non-Interleaved"/>
MCS Table <input type="text" value="64QAM"/>	Resource Allocation <input type="text" value="Type 1"/>
Resource Block Group Size <input type="text" value="Config 1"/>	Max Code Block Groups Per Transport Block <input type="text" value="Disabled"/>
Code Block Group Flush Indicator <input type="checkbox"/>	xOverhead <input type="text" value="0"/>
Precoding <input type="checkbox"/>	Precoding Mode <input type="text" value="Random"/>
Harm-ProcessNumberSizeDCI 1	

Use PDSCH Scrambling ID	116
Data Scrambling ID	117
Max. Number of Codewords per DCI	117
VRB-to-PRB Interleaver	117
MCS Table	118
Resource Allocation	118
Resource Block Group Size	118
Max Code Block Groups Per Transport Block	119
Code Block Group Flush Indicator	119
xOverhead	119
Precoding	119
Precoding Mode	119

Use PDSCH Scrambling ID

Defines the value of the variable n_{ID} used for the initialization of the generator of the PDSCH scrambling sequence.

"Off" $n_{ID} = N_{ID}^{cell}$ (i.e. the physical layer cell identity)

"On" n_{ID} is the values set with the parameter "[Data Scrambling ID](#)" on page 117.

See also "[About PDSCH and DMRS sequence generation](#)" on page 115.

Remote command:

[:SOURCE<hw>] :BB:NR5G:UBWP:USER<us>:CELL<cc>:DL:BWP<bwp>:PDSCh:SCRambling:STAtE on page 516

Data Scrambling ID

If [Use PDSCH Scrambling ID](#) > "On", sets the identifier

dataScramblingIdentityPDSCH used to initialize data scrambling (c_init) for PDSCH.

The value of this parameter influences the PDSCH allocations.

See also "[About PDSCH and DMRS sequence generation](#)" on page 115.

Remote command:

[:SOURCE<hw>] :BB:NR5G:UBWP:USER<us>:CELL<cc>:DL:BWP<bwp>:PDSCh:DSID on page 516

Max. Number of Codewords per DCI

Sets if one or two codewords are transmitted.

Remote command:

[:SOURCE<hw>] :BB:NR5G:UBWP:USER<us>:CELL<cc>:DL:BWP<bwp>:PDSCh:MCWDci on page 516

VRB-to-PRB Interleaver

As defined in [TS 38.211](#), the virtual resource blocks (VRB) are mapped to the physical resource blocks (PRB) interleaved or non-interleaved.

With this parameter, you set whether the interleaved or non-interleaved mapping is used in general, *for all PDSCH allocations*.

"Non-interleaved"

Sets non-interleaved VRB-to-PRB mapping. The value applies for all PDSCH allocations, also for those allocations configured automatically from DCI format 1_0 or 1_1, if "Node > Scheduling > PDSCH Scheduling = Auto/DCI".

For all PDSCHs scheduled by DCI formats expect the 1_0 format, the VRB number n is mapped to PRB number n .

For all PDSCHs scheduled by DCI format 1_0 in common search space, the VRB number n is mapped to PRB number $n + N_{\text{start}}^{\text{CORE-SET}}$.

"2", "4"

Set one of these values to enable VRB-to-PRB interleaving in general and define the PRB bundle size, carried by the higher-level parameter `vrb-ToPRB-Interleaved`, defined in [TS 38.331](#).

You can change the *interleaving state per PDSCH* later:

- If "Node > Scheduling > PDSCH Scheduling = Manual", with this parameter.
- If "Node > Scheduling > PDSCH Scheduling = Auto/DCI", for PDSCH created automatically from DCI formats 1_0 and 1_1, with the DCI field [VRB-to-PRB Mapping](#).

Remote command:

[:SOURce<hw>] :BB:NR5G:UBWP:USER<us>:CELL<cc>:DL:BWP<bwp>:PDSCh:VPINter on page 519

MCS Table

Sets the MCS table and thus defines the used modulation scheme.

3GPP release 17 introduces the MCS table for 1024QAM modulation on the downlink. Release 17 features require R&S SMM-K171.

Remote command:

[:SOURce<hw>] :BB:NR5G:UBWP:USER<us>:CELL<cc>:DL:BWP<bwp>:PDSCh:MCSTable on page 517

Resource Allocation

Sets the PxSCH resource allocation scheme and defines the allocation in the frequency domain.

Type 0 and dynamic switch are not available when [transform precoding](#) is on.

"Type 0", "Type 1"

Selects the downlink resource allocation scheme, according to [TS 38.214](#).

"Dynamic Switch"

- If [PDSCH Scheduling](#) > "Auto/DCI":
UE uses downlink resource allocation type 0 or type 1, as defined by the DCI field "Frequency domain resource assignment".
- If [PDSCH Scheduling](#) > "Manual":
UE uses downlink resource allocation type 0 or type 1, as set with the parameter [Resource Allocation](#).

This parameter defines the **PDSCH** allocation in the frequency domain globally and if you configure the allocations manually.

To configure the PDSCH based on the DCI:

- Set "Node > Scheduling > PDSCH Scheduling = Auto/DCI"
- Enable a DCI format 1_1 ("Scheduling > CORESET > Payload > DCI Format = 1_1") with "Config > Frequency Domain Resource Assignment = 262 143"
Set "Create PDSCH > On"
- Observe the allocation information for PDSCH ("Scheduling > PDSCH > Info > Content > frequency domain allocation")

Remote command:

[:SOURce<hw>] :BB:NR5G:UBWP:USER<us>:CELL<cc>:DL:BWP<bwp>:PDSCh:RESalloc on page 517

[:SOURce<hw>] :BB:NR5G:UBWP:USER<us>:CELL<cc>:UL:BWP<bwp>:PUSCh:RESalloc on page 566

Resource Block Group Size

For [Resource Allocation](#) = "Type 0/Dynamic Switch", the resource block assignment is defined in terms of resource block groups (RBG). An RBG is a set of consecutive virtual resource blocks and its size (*rbg-Size*) is defined as function of the BWP size and one of two possible configurations.

This parameter sets which of the two configurations defined in [TS 38.214](#) is used.

Remote command:

[:SOURce<hw>] :BB:NR5G:UBWP:USER<us>:CELL<cc>:DL:BWP<bwp>:PDSCh:RBGSize on page 517

[:SOURce<hw>] :BB:NR5G:UBWP:USER<us>:CELL<cc>:DL:BWP<bwp>:PUSCh:RBGSize on page 566

Max Code Block Groups Per Transport Block

Enables limiting the number of code block groups per transport block.

The precoding matrices change according to the precoding granularity (defined per PDSCH allocation) following the PDSCH PRB bundling concept. The precoder chooses the matrices randomly.

Disabled Default value, which disabled the limitation of code block groups per transport block.

2, 4, 6, 8 Limits the number of code block groups per transport block to 2, 4, 6, or 8.

Remote command:

[:SOURce<hw>] :BB:NR5G:UBWP:USER<us>:CELL<cc>:DL:BWP<bwp>:PDSCh:MCBGroups on page 509

[:SOURce<hw>] :BB:NR5G:UBWP:USER<us>:CELL<cc>:UL:BWP<bwp>:PUSCh:MCBGroups on page 562

Code Block Group Flush Indicator

Indicates if the code block group buffer is empty.

Remote command:

[:SOURce<hw>] :BB:NR5G:UBWP:USER<us>:CELL<cc>:DL:BWP<bwp>:PDSCh:CBGF:STATe on page 506

xOverhead

Selects the size of the "xOverhead" parameter defined in 3GPP 38.214, chapter 5.1.3.2. The xOverhead parameter is used in RMCs for IAB-MT and determines the transport block size.

Remote command:

[:SOURce<hw>] :BB:NR5G:UBWP:USER<us>:CELL<cc>:DL:BWP<bwp>:PDSCh:XOVERhead on page 515

Precoding

Enabled or disables precoding.

The precoding matrices change according to the precoding granularity (defined per PDSCH allocation) following the PDSCH PRB bundling concept.

The applied matrices depends on the [precoding mode](#).

Remote command:

[:SOURce<hw>] :BB:NR5G:UBWP:USER<us>:CELL<cc>:DL:BWP<bwp>:PDSCh:PREC:STATe on page 515

Precoding Mode

Selects the precoding method.

- "Random" The precoder chooses the precoding matrix randomly.
- "Codebook" The precoder chooses the precoding matrix from a codebook.
The codebook precoding method automatically changes the [precoding granularity](#) to "Wideband".

Remote command:

[:SOURce<hw>] :BB:NR5G:UBWP:USER<us>:CELL<cc>:DL:BWP<bwp>:PDSCh:
PREC:MOD on page 516

Control settings

The control settings section of the PDSCH properties contain settings related to DCI configuration.

Available when "Simple Mode" = "Off".

Control	
PRB Bundling Type Dynamic	Static Bundle Size N4
Bundle Size Set 1 N4	Bundle Size Set 2 N4
Minimum Scheduling Offset Indicator K0 ... 0, 0	Priority Indicator DCI1_1 <input checked="" type="checkbox"/>
Bits for Redundancy Version DCI1_2 0	Bits for HARQ DCI1_2 0
Antenna Ports Present DCI1_2 <input type="checkbox"/>	DMRS Sequence Initialization DCI1_2 <input type="checkbox"/>
Priority Indicator DCI1_2 <input type="checkbox"/>	Type 1 Allocation Granularity DCI1_2 Not Configured

PRB Bundling Type	121
Static Bundle Size	121
Bundle Size Set 1.....	121
Bundle Size Set 2	122
Minimum Scheduling Offset Indicator K0.....	122
L Number of Entries.....	122
L Value for MinAppOffset.....	122
Priority Indicator DCI1_1.....	123
Bits For Redundancy Version DCI1_2.....	123
Bits For HARQ DCI1_2.....	123
Antenna Ports Present DCI1_2.....	123
DMRS Sequence Initialization DCI1_2.....	123
Priority Indicator DCI1_2.....	124
Type 1 Allocation Granularity DCI 1_2.....	124
TCI States Activation.....	124
L Number of Mapped TCI Codepoints.....	124
L TCI Codepoint Table.....	124
L Codepoint Value.....	124
L State ID 1.....	124
L Use State ID 2.....	125
L State ID 2.....	125

Harq-ProcessNumberSizeDCI1_1.....	125
Priority Indicator DCI4_2.....	125
PUCCH-sSCellDyn DCI1_2.....	125
HARQ-ACK Retransmission Indicator DCI1_2.....	125

PRB Bundling Type

Indicates the PRB bundle type and bundle sizes. If "dynamic" is chosen, the actual bundle size set to use is indicated via DCI.

Only available if "Precoding" is enabled.

The PRB bundling type supports the UE to reduce the computational effort to receive the information which PRBs use the same precoding. The UE only has to do channel estimation per PRB bundle not per PRB. Without this information, the UE has to decode all the information itself based on the DMRS.

PRB Bundling Type, Static Bundle Size, Bundle Size Set 1, and Bundle Size Set 2 are RRC parameters relevant only for the Node > Scheduling > PDSCH Scheduling > Auto/DCI mode. For the Manual mode, the precoding granularity for a PDSCH allocation can be set under "Scheduling > Config > Precoding Granularity".

"Not Configured"

PRB bundling is not configured.

"Static"

PRB bundling is set to static and can be adjusted by the "Static Bundle Size".

"Dynamic"

PRB bundling is set to dynamic and can be adjusted by the "Bundle Size Set 1" and "Bundle Size Set 2".

Remote command:

```
[ :SOURCE<hw> ] :BB:NR5G:UBWP:USER<us>:CELL<cc>:DL:BWP<bwp>:PDSCH:
PREC:BTYPe on page 512
```

Static Bundle Size

Configures the static PRB bundle type.

Only available if "Precoding" is enabled and "Static" is selected as "PRB Bundling Type".

PRB Bundling Type, Static Bundle Size, Bundle Size Set 1, and Bundle Size Set 2 are RRC parameters relevant only for the Auto/DCI mode. For the Manual mode, the precoding granularity for a PDSCH allocation can be set under "Scheduling > Config > Precoding Granularity".

"N4"

Static PRB bundle is set to N4.

"Wideband"

Static PRB bundle is set to wideband.

Remote command:

```
[ :SOURCE<hw> ] :BB:NR5G:UBWP:USER<us>:CELL<cc>:DL:BWP<bwp>:PDSCH:
PREC:BSIZE on page 511
```

Bundle Size Set 1

Configures the dynamic PRB bundle type.

Only available if "Precoding" is enabled and "Dynamic" is selected as "PRB Bundling Type".

PRB Bundling Type, Static Bundle Size, Bundle Size Set 1, and Bundle Size Set 2 are RRC parameters relevant only for the Auto/DCI mode. For the Manual mode, the precoding granularity for a PDSCH allocation can be set under "Scheduling > Config > Precoding Granularity".

- "N4" Dynamic PRB bundle size set 1 is set to N4.
- "Wideband" Dynamic PRB bundle size set 1 is set to wideband.
- "N2-Wideband" Dynamic PRB bundle size set 1 is set to N2-wideband.
- "N4-Wideband" Dynamic PRB bundle size set 1 is set to N4-wideband.

Remote command:

```
[ :SOURCE<hw> ] :BB:NR5G:UBWP:USER<us>:CELL<cc>:DL:BWP<bwp>:PDSCh:
PREC:BBSet1 on page 510
```

Bundle Size Set 2

Configures the dynamic PRB bundle type.

Only available if "Precoding" is enabled and "Dynamic" is selected as "PRB Bundling Type".

PRB Bundling Type, Static Bundle Size, Bundle Size Set 1, and Bundle Size Set 2 are RRC parameters relevant only for the Auto/DCI mode. For the Manual mode, the precoding granularity for a PDSCH allocation can be set under "Scheduling > Config > Precoding Granularity".

- "N4" Dynamic PRB bundle size set 2 is set to N4.
- "Wideband" Dynamic PRB bundle size set 2 is set to wideband.

Remote command:

```
[ :SOURCE<hw> ] :BB:NR5G:UBWP:USER<us>:CELL<cc>:DL:BWP<bwp>:PDSCh:
PREC:BSSet2 on page 510
```

Minimum Scheduling Offset Indicator K0

Option: R&S SMM-K148.

Opens a dialog box to configure the minimum applicable offset indicator for DCI format 1_1.

Corresponds to higher layer parameter `minimumSchedulingOffsetK0` as defined in 3GPP 38.331.

Number of Entries ← Minimum Scheduling Offset Indicator K0

Defines the number of K0 values you can configure for the minimum applicable offset indicator.

Remote command:

```
[ :SOURCE<hw> ] :BB:NR5G:UBWP:USER<us>:CELL<cc>:DL:BWP<bwp>:PDSCh:
MAOffset:NMOffset on page 511
```

Value for MinAppOffset ← Minimum Scheduling Offset Indicator K0

Defines the value of the corresponding minimum applicable offset indicator.

Remote command:

```
[ :SOURCE<hw> ] :BB:NR5G:UBWP:USER<us>:CELL<cc>:DL:BWP<bwp>:PDSCh:
MAOffset:VAL<gr0> on page 511
```

Priority Indicator DCI1_1

Turns the "Priority Indicator" DCI field in DCI formats 1_1 on and off.

Turn on this parameter if you want to define the bit length of the "Priority Indicator" DCI field.

Corresponds to higher layer parameter `priorityIndicatorDCI-1-1` as defined in 3GPP 38.331.

Remote command:

```
[ :SOURCE<hw> ] :BB:NR5G:UBWP:USER<us>:CELL<cc>:DL:BWP<bwp>:PDSCh:
PI11 on page 512
```

Bits For Redundancy Version DCI1_2

Defines the bit length of the DCI field "Redundancy Version" available in DCI format 1_2.

Corresponds to higher layer parameter `numberOfBitsForRV-DCI-1-2` as defined in 3GPP 38.331.

Remote command:

```
[ :SOURCE<hw> ] :BB:NR5G:UBWP:USER<us>:CELL<cc>:DL:BWP<bwp>:PDSCh:
RV12 on page 513
```

Bits For HARQ DCI1_2

Defines the bit length of the DCI field "HARQ Process Number" available in DCI formats 1_2.

Corresponds to higher layer parameter `harq-ProcessNumberSizeDCI-1-2` as defined in 3GPP 38.331.

Remote command:

```
[ :SOURCE<hw> ] :BB:NR5G:UBWP:USER<us>:CELL<cc>:DL:BWP<bwp>:PDSCh:
HA12 on page 513
```

Antenna Ports Present DCI1_2

Turns the "Antenna Ports" DCI field in DCI format 1_2 on and off.

Turn on this parameter if you want to define the bit length of the "Antenna Ports" DCI field.

Corresponds to higher layer parameter `antennaPortsFieldPresenceDCI-1-2` as defined in 3GPP 38.331.

Remote command:

```
[ :SOURCE<hw> ] :BB:NR5G:UBWP:USER<us>:CELL<cc>:DL:BWP<bwp>:PDSCh:
AP12 on page 513
```

DMRS Sequence Initialization DCI1_2

Turns the "DMRS Sequence Initialization" DCI field in DCI format 1_2 on and off.

Turn on this parameter if you want to define the bit length of the "DMRS Sequence Initialization" DCI field.

Corresponds to higher layer parameter `dmrs-SequenceInitializationDCI-1_2` as defined in 3GPP 38.331.

Remote command:

`[:SOURCE<hw>] :BB:NR5G:UBWP:USER<us>:CELL<cc>:DL:BWP<bwp>:PDSCh:DI12` on page 513

Priority Indicator DCI_2

Turns the "Priority Indicator" DCI field in DCI formats 1_2 on and off.

Turn on this parameter if you want to define the bit length of the "Priority Indicator" DCI field.

Corresponds to higher layer parameter `priorityIndicatorDCI-1-2` as defined in 3GPP 38.331.

Remote command:

`[:SOURCE<hw>] :BB:NR5G:UBWP:USER<us>:CELL<cc>:DL:BWP<bwp>:PDSCh:PI12` on page 512

Type 1 Allocation Granularity DCI 1_2

Option: R&S SMM-K148.

Configures the higher layer parameter `resourceAllocationType1GranularityDCI-1-2` as defined in 3GPP 38.331.

Remote command:

`[:SOURCE<hw>] :BB:NR5G:UBWP:USER<us>:CELL<cc>:DL:BWP<bwp>:PDSCh:AG12` on page 514

TCI States Activation

Opens a dialog to configure TCI's according to 3GPP 38.321, 6.1.3.24.

Number of Mapped TCI Codepoints ← TCI States Activation

Defines the number of mapped TCI codepoints.

The number of TCI codepoints adjusts the number of rows in the TCI codepoint table.

Remote command:

`[:SOURCE<hw>] :BB:NR5G:UBWP:USER<us>:CELL<cc>:DL:BWP<bwp>:PDSCh:TCI:NTCP` on page 514

TCI Codepoint Table ← TCI States Activation

The TCI codepoint table contains the following information for each TCI codepoint. Each row corresponds to a TCI codepoint.

Codepoint Value ← TCI States Activation

Index number of each codepoint beginning at 0.

Remote command:

not supported

State ID 1 ← TCI States Activation

Defines the value of the state ID 1 as defined in 3GPP 38.321.

Remote command:

```
[ :SOURce<hw> ] :BB:NR5G:UBWP:USER<us>:CELL<cc>:DL:BWP<bwp>:PDSCh:  
TCI:TCV<gr0>:ID1 on page 514
```

Use State ID 2 ← TCI States Activation

Turns usage of state ID 2 for the corresponding TCI codepoint on and off.

Remote command:

```
[ :SOURce<hw> ] :BB:NR5G:UBWP:USER<us>:CELL<cc>:DL:BWP<bwp>:PDSCh:  
TCI:TCV<gr0>:STATe on page 515
```

State ID 2 ← TCI States Activation

Defines the value of the state ID 2 as defined in 3GPP 38.321.

Remote command:

```
[ :SOURce<hw> ] :BB:NR5G:UBWP:USER<us>:CELL<cc>:DL:BWP<bwp>:PDSCh:  
TCI:TCV<gr0>:ID2 on page 514
```

Harq-ProcessNumberSizeDCI1_1

Option: R&S SMM-K171.

Selects the size of the "HARQ Process Number" DCI field in DCI format 1_1.

Remote command:

```
[ :SOURce<hw> ] :BB:NR5G:UBWP:USER<us>:CELL<cc>:DL:BWP<bwp>:PDSCh:  
HP5Bits on page 509
```

Priority Indicator DCI4_2

Option: R&S SMM-K171.

Turns the "Priority Indicator" field in DCI format 4_2 on and off.

Remote command:

```
[ :SOURce<hw> ] :BB:NR5G:UBWP:USER<us>:CELL<cc>:DL:BWP<bwp>:DCI:  
PRINDicator on page 506
```

PUCCH-sSCellIDyn DCI1_2

Turns the "PUCCH Cell Indicator" field available in DCI format 1_2 on and off.

Remote command:

```
[ :SOURce<hw> ] :BB:NR5G:UBWP:USER<us>:CELL<cc>:DL:BWP<bwp>:DCI:  
PSSCdyn on page 506
```

HARQ-ACK Retransmission Indicator DCI1_2

Option: R&S SMM-K171

Turns the "HARQ-ACK Retransmission Indicator" field available in DCI format 1_2 on and off.

Remote command:

```
[ :SOURce<hw> ] :BB:NR5G:UBWP:USER<us>:CELL<cc>:DL:BWP<bwp>:DCI:  
HARTind on page 505
```

DMRS settings

The DMRS settings section of the PDSCH properties contain settings related to DMRS.

DMRS for Mapping Type A and Type B	
Same Settings for Type A and Type B	<input checked="" type="checkbox"/>
Config Type	2
Max Length	2
Scrambling ID 0	0
Use R16 DMRS	<input type="checkbox"/>
Additional Position Index	0
Scrambling ID 1	0
PTRS Config ...	

Same Settings for Type A and Type B	126
Config Type	126
Additional Position Index	127
Max Length	127
Scrambling ID 0/Scrambling ID 1	127
Use R16 DMRS	127
PTRS Config ...	128
L State	128
L RE-offset	129
L EPRE Ratio	129
L I_MCS_1/I_MCS_2/I_MCS_3	129
L N_RB_1/N_RB_2	129

Same Settings for Type A and Type B

Per default, the same configuration applies for DMRS mapping type A and B. Disable "Same Settings for Type A and Type B" to modify the mapping type B settings.

Mapping type A and B define the DMRS position in the PDSCH, the starting symbol and length. The UE informs the BS about the mapping type supportability via the UE capability information message.

Remote command:

```
[ :SOURCE<hw> ] :BB:NR5G:UBWP:USER<us>:CELL<cc>:DL:BWP<bwp>:PDSCh:DMTA:BSAME on page 507
```

Config Type

Sets the configuration type (type 1 or type 2). It thus defines the mapping of the demodulation reference signal (DMRS) to the physical resource elements in the frequency domain, as defined in TS 38.211.

The configuration type is carried by the higher-layer parameter `dmrs-Type`.

Remote command:

[:SOURce<hw>] :BB:NR5G:UBWP:USER<us>:CELL<cc>:DL:BWP<bwp>:PDSCh:DMTA:CTYPE on page 507

[:SOURce<hw>] :BB:NR5G:UBWP:USER<us>:CELL<cc>:DL:BWP<bwp>:PDSCh:DMTB:CTYPE on page 507

Additional Position Index

Sets the parameter `dmrs-AdditionalPosition` that is required to select the positions of the DMRS symbols Γ , as defined in TS 38.211.

Remote command:

[:SOURce<hw>] :BB:NR5G:UBWP:USER<us>:CELL<cc>:DL:BWP<bwp>:PDSCh:DMTA:APINDEX on page 507

[:SOURce<hw>] :BB:NR5G:UBWP:USER<us>:CELL<cc>:DL:BWP<bwp>:PDSCh:DMTB:APINDEX on page 507

Max Length

Sets the parameter `maxLength` and defines whether single- or double-symbol DMRS is used.

If "Max Length = 1", only single-symbol DMRS is allowed.

Remote command:

[:SOURce<hw>] :BB:NR5G:UBWP:USER<us>:CELL<cc>:DL:BWP<bwp>:PDSCh:DMTA:MLENGTH on page 508

[:SOURce<hw>] :BB:NR5G:UBWP:USER<us>:CELL<cc>:DL:BWP<bwp>:PDSCh:DMTB:MLENGTH on page 508

Scrambling ID 0/Scrambling ID 1

Sets the higher-layer parameters `scramblingID0` and `scramblingID1` (N_{ID}^0, N_{ID}^1).

The values are used to calculate the initialization sequence of the pseudo-random sequence generator.

See also "[About PDSCH and DMRS sequence generation](#)" on page 115.

Remote command:

[:SOURce<hw>] :BB:NR5G:UBWP:USER<us>:CELL<cc>:DL:BWP<bwp>:PDSCh:DMTA:SID0 on page 508

[:SOURce<hw>] :BB:NR5G:UBWP:USER<us>:CELL<cc>:DL:BWP<bwp>:PDSCh:DMTA:SID1 on page 508

[:SOURce<hw>] :BB:NR5G:UBWP:USER<us>:CELL<cc>:DL:BWP<bwp>:PDSCh:DMTB:SID0 on page 508

[:SOURce<hw>] :BB:NR5G:UBWP:USER<us>:CELL<cc>:DL:BWP<bwp>:PDSCh:DMTB:SID1 on page 508

Use R16 DMRS

Option: R&S SMM-K148.

Turns the higher layer parameter "dmrs-downlink-r16" on and off.

This parameter reduces the peak-to-average power ratio (PAPR) of the PDSCH DMRS as defined 3GPP, release 16. Using the low PAPR also results in a different calculation of the DMRS sequence.

Remote command:

[:SOURce<hw>] :BB:NR5G:UBWP:USER<us>:CELL<cc>:DL:BWP<bwp>:PDSCh :
DMTA:UR16 on page 509

[:SOURce<hw>] :BB:NR5G:UBWP:USER<us>:CELL<cc>:DL:BWP<bwp>:PDSCh :
DMTB:UR16 on page 509

PTRS Config ...

Comprises the settings of the phase-tracking reference signals (PTRS) for P_xSCH, as defined in TS 38.214.

5G New Radio A: PTRS Settings - Mapping Type A (U0/C0/B0)	
State	0
RE-offset	00
EPRE Ratio	0
Threshold Time Density	
I_MCS_1	0
I_MCS_2	0
I_MCS_3	0
Threshold Frequency Density	
N_RB_0	1
N_RB_1	276

The phase tracking reference signal (PTRS) is a UE-specific reference signal that is used to compensate for the phase noise of the oscillator. Phase-tracking reference signals can be transmitted only in the resource blocks used for the P_xSCH and if the transmission is enabled.

If the PTRS "State" is on, you can define its "Power" relative to the P_xSCH and its location in the resource grid.

State ← PTRS Config ...

If [DSCH/USCH Channel Coding](#) > "On", enables the transmission of phase-tracking reference signals.

Remote command:

[:SOURce<hw>] :BB:NR5G:UBWP:USER<us>:CELL<cc>:DL:BWP<bwp>:PDSCh :
DMTA:PTRS:STATE on page 524

[:SOURce<hw>] :BB:NR5G:UBWP:USER<us>:CELL<cc>:DL:BWP<bwp>:PDSCh :
DMTB:PTRS:STATE on page 524

RE-offset ← PTRS Config ...

Sets the parameter `resourceElementOffset` k_{ref}^{RE} required to define the precoding and mapping to the physical resources.

Remote command:

[:SOURce<hw>] :BB:NR5G:UBWP:USER<us>:CELL<cc>:DL:BWP<bwp>:PDSCh :
DMTA:PTRS:REOF on page 525

[:SOURce<hw>] :BB:NR5G:UBWP:USER<us>:CELL<cc>:DL:BWP<bwp>:PDSCh :
DMTB:PTRS:REOF on page 525

EPRE Ratio ← PTRS Config ...

Sets the higher layer parameter `epre-Ratio` ratio, needed to define the ratio of PTRS EPRE to PDSCH EPRE per layer per RE for PTRS port.

The abbreviation EPRE stands for energy per resource element.

Remote command:

[:SOURce<hw>] :BB:NR5G:UBWP:USER<us>:CELL<cc>:DL:BWP<bwp>:PDSCh :
DMTA:PTRS:EPRE on page 525

[:SOURce<hw>] :BB:NR5G:UBWP:USER<us>:CELL<cc>:DL:BWP<bwp>:PDSCh :
DMTB:PTRS:EPRE on page 525

I_MCS_1/I_MCS_2/I_MCS_3 ← PTRS Config ...

Sets the threshold values `ptrs-MCSl` with $l = \{1, 2, 3\}$ transmitted by the higher-layer parameter `timeDensity` in `PTRS-DownlinkConfig` .

Remote command:

[:SOURce<hw>] :BB:NR5G:UBWP:USER<us>:CELL<cc>:DL:BWP<bwp>:PDSCh :
DMTA:PTRS:MCS1 on page 526

[:SOURce<hw>] :BB:NR5G:UBWP:USER<us>:CELL<cc>:DL:BWP<bwp>:PDSCh :
DMTA:PTRS:MCS2 on page 526

[:SOURce<hw>] :BB:NR5G:UBWP:USER<us>:CELL<cc>:DL:BWP<bwp>:PDSCh :
DMTA:PTRS:MCS3 on page 526

[:SOURce<hw>] :BB:NR5G:UBWP:USER<us>:CELL<cc>:DL:BWP<bwp>:PDSCh :
DMTB:PTRS:MCS1 on page 526

[:SOURce<hw>] :BB:NR5G:UBWP:USER<us>:CELL<cc>:DL:BWP<bwp>:PDSCh :
DMTB:PTRS:MCS2 on page 526

[:SOURce<hw>] :BB:NR5G:UBWP:USER<us>:CELL<cc>:DL:BWP<bwp>:PDSCh :
DMTB:PTRS:MCS3 on page 526

N_RB_1/N_RB_2 ← PTRS Config ...

Sets the threshold values `NRBl` with $l = \{0, 1\}$ transmitted by the higher-layer parameter `frequencyDensity` in `PTRS-DownlinkConfig` .

Remote command:

[:SOURce<hw>] :BB:NR5G:UBWP:USER<us>:CELL<cc>:DL:BWP<bwp>:PDSCh :
DMTA:PTRS:RB0 on page 527

[:SOURce<hw>] :BB:NR5G:UBWP:USER<us>:CELL<cc>:DL:BWP<bwp>:PDSCh :
DMTA:PTRS:RB1 on page 527

[:SOURce<hw>] :BB:NR5G:UBWP:USER<us>:CELL<cc>:DL:BWP<bwp>:PDSCh :
DMTB:PTRS:RB0 on page 527

[:SOURce<hw>] :BB:NR5G:UBWP:USER<us>:CELL<cc>:DL:BWP<bwp>:PDSCh :
DMTB:PTRS:RB1 on page 527

Time domain allocation

The time domain allocation list section of the PDSCH properties contain settings related to PDSCH time domain scheduling according to TS 38.214.

Available when "Simple Mode" = "Off".

Time Domain Allocation List					
Time Domain Allocations					
					1
K0	Mapping Type	No. Sym.	Sym. Offset	SLIV	
0	A	3	0	28	

Time Domain Allocations.....	130
K0.....	130
Mapping Type.....	130
Start.....	131
Length.....	131
SLIV.....	131

Time Domain Allocations

Sets the number of allocations.

There is one row per allocation in the time domain allocation table.

Remote command:

[:SOURce<hw>] :BB:NR5G:UBWP:USER<us>:CELL<cc>:DL:BWP<bwp>:PDSCh :
TDANum on page 518

K0

Sets the slot offset K_0 .

Remote command:

[:SOURce<hw>] :BB:NR5G:UBWP:USER<us>:CELL<cc>:DL:BWP<bwp>:PDSCh :
TD<grp0>:KNULL on page 518

Mapping Type

Sets the DMRS-mapping type A and B, as defined in TS 38.211

Remote command:

[:SOURce<hw>] :BB:NR5G:UBWP:USER<us>:CELL<cc>:DL:BWP<bwp>:PDSCh :
TD<grp0>:MAPPING on page 518

Start

Sets the start OFDM symbol (S) of the allocation, where the value range depends on the selected [SC Spacing/CP](#).

Remote command:

```
[ :SOURce<hw> ] :BB:NR5G:UBWP:USER<us>:CELL<cc>:DL:BWP<bwp>:PDSCh:TD<grp0>:START on page 518
```

Length

Sets the number of consecutive OFDM symbols (L) the allocation spans, where the value depends on the selected [SC Spacing/CP](#) and the following applies:

- $S + L \leq 14$, if normal cyclic prefix is used (NCP)
- $S + L \leq 12$, if extended cyclic prefix is used (ECP)

Remote command:

```
[ :SOURce<hw> ] :BB:NR5G:UBWP:USER<us>:CELL<cc>:DL:BWP<bwp>:PDSCh:TD<grp0>:LENGTh on page 519
```

SLIV

Indicates the resulting start and length indicator SLIV, selected automatically from the values of the parameters [K0](#), [Start](#) and [Length](#).

Remote command:

```
[ :SOURce<hw> ] :BB:NR5G:UBWP:USER<us>:CELL<cc>:DL:BWP<bwp>:PDSCh:TD<grp0>:SLIV? on page 519
```

Multi time domain allocation lists

Requires Option: R&S SMM-K171

The time domain allocation list for multi PDSCH is a feature introduced with 3GPP release 17 (TS 38.331). Using the time domain allocation lists for multi PDSCH, you can configure the PDSCH time domain scheduling according to TS 38.214.

Available when "Simple Mode" = "Off".

Multi Time Domain Allocation List					
Number of TD Allocation Lists			Current TD Allocation List		
6			1		
Multi Time Domain Allocations					2
	K0	Mapping Type	No. Sym.	Sym. Offset	SLIV
0	0	A	3	0	28
1	0	A	3	0	28

Number of TD Allocation Lists	132
Current TD Allocation List	132
Multi Time Domain Allocations	132
K0	132
Mapping Type	132

No. Sym.....	132
Sym. Offset.....	133
SLIV.....	133

Number of TD Allocation Lists

Defines the number of time domain allocation lists.

Remote command:

[:SOURce<hw>] :BB:NR5G:UBWP:USER<us>:CELL<cc>:DL:BWP<bwp>:PDSCh:
TDALists on page 520

Current TD Allocation List

Selects the allocation list you want to configure.

Remote command:

[:SOURce<hw>] :BB:NR5G:UBWP:USER<us>:CELL<cc>:DL:BWP<bwp>:PDSCh:
LSElected on page 520

Multi Time Domain Allocations

Defines the number of multi time domain allocations in the [selected time domain allocation list](#).

Remote command:

[:SOURce<hw>] :BB:NR5G:UBWP:USER<us>:CELL<cc>:DL:BWP<bwp>:PDSCh:
TDML<grp0>:TDANum on page 520

K0

Sets the slot offset K_0 for an allocation in a time domain allocation list.

Remote command:

[:SOURce<hw>] :BB:NR5G:UBWP:USER<us>:CELL<cc>:DL:BWP<bwp>:PDSCh:
TDML<grp0>:TD<user0>:KNULL on page 521

Mapping Type

Sets the DMRS-mapping type A and B for an allocation in a time domain allocation list, as defined in [TS 38.211](#)

Remote command:

[:SOURce<hw>] :BB:NR5G:UBWP:USER<us>:CELL<cc>:DL:BWP<bwp>:PDSCh:
TDML<grp0>:TD<user0>:MAPPING on page 521

No. Sym.

Sets the number of consecutive OFDM symbols (L) the allocation in a time domain allocation list spans, where the value depends on the selected [SC Spacing/CP](#) and the following applies:

- $S + L \leq 14$, if normal cyclic prefix is used (NCP)
- $S + L \leq 12$, if extended cyclic prefix is used (ECP)

Remote command:

[:SOURce<hw>] :BB:NR5G:UBWP:USER<us>:CELL<cc>:DL:BWP<bwp>:PDSCh:
TDML<grp0>:TD<user0>:LENGTH on page 522

Sym. Offset

Sets the start OFDM symbol (S) of the allocation, where the value range depends on the selected [SC Spacing/CP](#).

Remote command:

```
[ :SOURce<hw> ] :BB:NR5G:UBWP:USER<us>:CELL<cc>:DL:BWP<bwp>:PDSCh:TDML<grp0>:TD<user0>:START on page 522
```

SLIV

Indicates the resulting start and length indicator SLIV, selected automatically from the values of the parameters [K0](#), [No. Sym.](#) and [Sym. Offset](#).

Remote command:

```
[ :SOURce<hw> ] :BB:NR5G:UBWP:USER<us>:CELL<cc>:DL:BWP<bwp>:PDSCh:TDML<grp0>:TD<user0>:SLIV? on page 522
```

5.3.6.3 RMC settings

Access:

- ▶ Select "User/BWP Settings > DL BWP Config > RMC".

Reference measurement channels (RMC) have a specific configuration defined by 3GPP for conformance testing. The exact channel settings depend on the subcarrier spacing, the modulation and the duplexing method. For a comprehensive overview of the dependencies in FR1, see the tables in the annex of 3GPP 38.521-1.

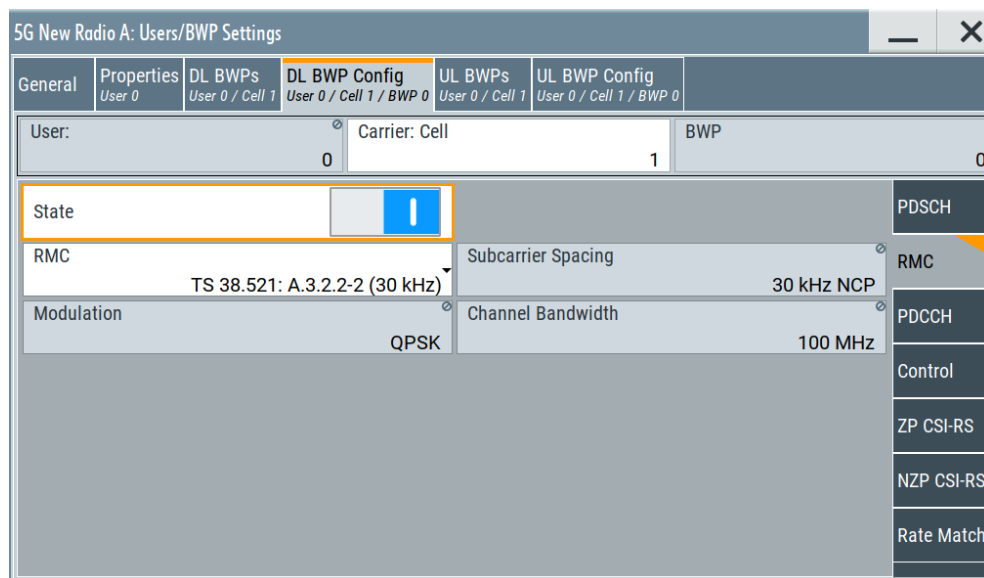

[State](#)..... 134

[RMC](#)..... 134

[CQI Index](#)..... 134

State

Turns the use and configuration of reference measurement channel (RMC) on and off. The corresponding settings are only displayed after you have turned on RMCs.

Remote command:

[:SOURce<hw>] :BB:NR5G:UBWP:USER<us>:CELL<cc>:DL:BWP<bwp>:RMC:STATE on page 529

RMC

Selects the RMC to be used.

The RMCs in the list are sorted by 3GPP specification (TS 38.521 / TS 38.176).

Sorting for TS 38.521 RMCs:

- Duplexing method
- Modulation scheme
- Subcarrier spacing

Note that you can only select the RMC that corresponds to the subcarrier spacing in the bandwidth part you are configuring. RMC are unavailable for subcarrier spacings with an extended cyclic prefix (for example 60 kHz ECP).

Sorting for TS 38.521 RMCs:

- Frequency range

The name of the RMC indicates several things:

- The 3GPP document the RMC is defined in (for example 38.521).
- For TS 38.176 RMCs: The frequency range of the RMC (for example M-FR1)
- The chapter in the annex of the 3GPP document (for example A.3.2.2-2).
- For TS 38.521 RMCs: The subcarrier spacing the RMC applies to (for example 60 kHz).

The other three fields in the RMC dialog are read only and indicate the **subcarrier spacing**, the **channel bandwidth** and **modulation** of the RMC. The modulation is automatically adjusted, depending on the RMC you select.

Remote command:

RMC selection: [:SOURce<hw>] :BB:NR5G:UBWP:USER<us>:CELL<cc>:DL:BWP<bwp>:RMC:ID on page 528

Modulation query: [:SOURce<hw>] :BB:NR5G:UBWP:USER<us>:CELL<cc>:DL:BWP<bwp>:RMC:MODulation? on page 529

SCS query: [:SOURce<hw>] :BB:NR5G:UBWP:USER<us>:CELL<cc>:DL:BWP<bwp>:RMC:SCS? on page 529

CQI Index

Selects the CQI index for the RMC. The CQI index controls certain characteristics of the RMC like the modulation.

The CQI index is available for certain RMCs only (for example the RMCs "TS 38.176: M-FR1-A3_5_1").

Remote command:

[:SOURce<hw>] :BB:NR5G:UBWP:USER<us>:CELL<cc>:DL:BWP<bwp>:RMC:CQI on page 528

5.3.6.4 PDCCH settings

Access:

1. Select "Simple Mode" = "Off".
2. Select "User/BWP Settings > DL BWP Config > PDCCH".

The dialog comprises the RNTI and DCI-related settings.

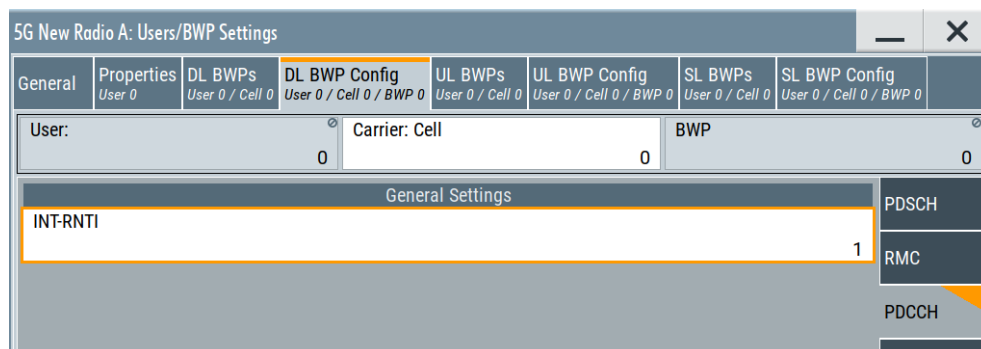

Settings:

INT-RNTI

Sets the RNTI of the user.

See also "[Usage](#)" on page 245.

Remote command:

`[:SOURce<hw>] :BB:NR5G:UBWP:USER<us>:CELL<cc>:DL:BWP<bwp>:RNTI :INT` on page 530

5.3.6.5 Control settings (DCI)

Access:

1. Select "Simple Mode" = "Off".
2. Select "User/BWP Settings > DL BWP Config > Control".

The dialog shows the uplink-related (control) settings that are transmitted in the downlink.

The contents of the dialog are dynamic and depend on the DCI format you have selected from the "DCI Settings" menu. The following lists contain the control settings that are available for each DCI format. The control settings themselves are listed and described below in the corresponding chapters.

For description of the remote-control commands, see [Chapter 10.19.5, "DL control information commands"](#), on page 532.

• Control information for DCI format 0_1.....	136
• Control information for DCI format 0_2.....	137
• Control information for DCI format 1_0.....	138
• Control information for DCI format 1_2.....	138
• Control information for DCI format 1_1.....	138
• Control information for DCI format 2_1.....	139
• Control information for DCI format 2_2.....	139
• Control information for DCI format 2_3.....	140
• Control information for DCI format 2_4.....	140
• Control information for DCI format 2_5.....	141
• Control information for DCI format 2_6.....	142
• Control information for DCI format 2_7.....	142
• Control information for DCI format 3_0.....	143
• Control information for DCI format 3_1.....	143
• Control information for DCI format 4_2.....	144

Control information for DCI format 0_1

Control settings for DCI format 0_1.

The following control settings are available with R&S SMM-K171:

- "Bits for PDCCH Monitoring Adaption Indication"
- "Bits for 2nd Precoding Information"
- "Bits for 2nd SRS Resource Indication"
- "Bits for 3rd Downlink Assignment Index"
- "Bits for SRS Offset Indicator"
- "Bits for SRS Resource Set Indication"
- "Max. Bits for 2nd Downlink Assignment Index"

Bits for PDCCH Monitoring Adaptation Indication.....	136
Bits for 2nd Precoding Information.....	136
Bits for 2nd SRS Resource Indication.....	137
Bits for 3rd Downlink Assignment Index.....	137
Bits for SRS Offset Indicator.....	137
Bits for SRS Resource Set Indication.....	137
Max. Bits for 2nd Downlink Assignment Index.....	137
Report Trigger Size.....	137

Bits for PDCCH Monitoring Adaptation Indication

Turns the DCI field "Monitoring Adaption Indication" on and off and defines its size.

Remote command:

[:SOURCE<hw>] :BB:NR5G:UBWP:USER<us>:CELL<cc>:DL:BWP<bwp>:PDCCh:
NMADaption on page 537

Bits for 2nd Precoding Information

Turns the "2nd Precoding Information and Number of Layer" field on and off and defines its size.

Remote command:

[:SOURce<hw>] :BB:NR5G:UBWP:USER<us>:CELL<cc>:DL:BWP<bwp>:DCI :
PRC2 on page 535

Bits for 2nd SRS Resource Indication

Turns the "2nd SRS Resource Indicator" field on and off and defines its size.

Remote command:

[:SOURce<hw>] :BB:NR5G:UBWP:USER<us>:CELL<cc>:DL:BWP<bwp>:DCI :
SRI2 on page 537

Bits for 3rd Downlink Assignment Index

Turns the "3rd Downlink Assignment Index" field on and off and defines its size.

Remote command:

[:SOURce<hw>] :BB:NR5G:UBWP:USER<us>:CELL<cc>:DL:BWP<bwp>:DCI :
DAI3 on page 534

Bits for SRS Offset Indicator

Turns the "SRS Offset Indicator" field on and off and defines its size.

Remote command:

[:SOURce<hw>] :BB:NR5G:UBWP:USER<us>:CELL<cc>:DL:BWP<bwp>:DCI :
SOIN on page 536

Bits for SRS Resource Set Indication

Turns the "SRS Resource Set Indicator" field on and off.

Remote command:

[:SOURce<hw>] :BB:NR5G:UBWP:USER<us>:CELL<cc>:DL:BWP<bwp>:DCI :
SRINd on page 537

Max. Bits for 2nd Downlink Assignment Index

Defines the bit length of the "2nd Downlink Assignment Index" field.

Remote command:

[:SOURce<hw>] :BB:NR5G:UBWP:USER<us>:CELL<cc>:DL:BWP<bwp>:DCI :
DAI2 on page 534

Report Trigger Size

Defines the trigger size of the CSI (channel state information) request field in DCI (bits).

Remote command:

[:SOURce<hw>] :BB:NR5G:UBWP:USER<us>:CELL<cc>:DL:BWP<bwp>:CSI :
RTSize on page 539

Control information for DCI format 0_2

Control settings for DCI format 0_2.

The control settings for DCI format 0_2 are the same as for [DCI format 0_1](#).

Control information for DCI format 1_0

Control settings for DCI format 1_0.

Bits for TRS Availability Indication	138
Large Response Window	138

Bits for TRS Availability Indication

Option: R&S SMM-K171

Selects the number of bits that you can use for the "TRS availability indication" DCI field. The parameter corresponds to higher layer parameter `TRS-ResourceSetConfig` as defined by 3GPP.

Availability depends on the [payload size](#) and the [PO number per PEI](#). The value range also depends on the payload size.

Remote command:

[\[:SOURCE<hw>\]:BB:NR5G:UBWP:USER<us>:CELL<cc>:DL:BWP<bwp>:DCI:TAINd](#) on page 537

Large Response Window

Turns the "LSBs of SFN" DCI field on and off. This field is available for MsgB-RNTI and RA-RNTI on and off.

Corresponds to higher layer parameter `msgB-responseWindow`, `ra-ResponseWindow` and `ra-ResponseWindow-v1610` as defined in 3GPP 38.212.

Remote command:

[\[:SOURCE<hw>\]:BB:NR5G:UBWP:USER<us>:CELL<cc>:DL:BWP<bwp>:CSI:LREsponse](#) on page 534

Control information for DCI format 1_2

Control settings for DCI format 1_2.

The control settings for DCI format 1_2 are the same as for [DCI format 1_1](#).

The following control settings are available with R&S SMM-K171:

- "Bits for Enhanced Type 3 Codebook Indicator"

Control information for DCI format 1_1

Control settings for DCI format 1_1.

Control settings for DCI format 1_1 described elsewhere:

- [Bits for PDCCH Monitoring Adaption Indication](#)
- [Bits for SRS Offset Indicator](#)

The following control settings are available with R&S SMM-K171:

- "Bits for Enhanced Type 3 Codebook Indicator"

Bits for Enhanced Type 3 Codebook Indicator	139
---	-----

Bits for Enhanced Type 3 Codebook Indicator

Turns the "Enhanced Type 3 Codebook Indicator" field on and off and defines its size.

Remote command:

[:SOURce<hw>] :BB:NR5G:UBWP:USER<us>:CELL<cc>:DL:BWP<bwp>:PDCCh:NT3C on page 538

Control information for DCI format 2_1

Control settings for DCI format 2_1.

Number of Pre-Emption Indications..... 139

Number of Pre-Emption Indications

Defines the number of "Pre-Emption Indicator" fields.

Remote command:

[:SOURce<hw>] :BB:NR5G:UBWP:USER<us>:CELL<cc>:DL:BWP<bwp>:PDCCh:NUMPreempt on page 530

Control information for DCI format 2_2

Control settings for DCI format 2_2.

Number of PUCCH Blocks..... 139
 Number of PUSCH Blocks..... 139
 TPC-PUCCH-RNTI..... 139
 TPC-PUSCH-RNTI..... 140
 TwoPUCCH-PC Adjustment..... 140
 TwoPUSCH-PC Adjustment..... 140

Number of PUCCH Blocks

Defines the number of "Closed Loop Indicator" and "TPC Command" fields (RNTI type: TPC-PUCCH-RNTI).

Remote command:

[:SOURce<hw>] :BB:NR5G:UBWP:USER<us>:CELL<cc>:DL:BWP<bwp>:PUCCh:BD22 on page 533

Number of PUSCH Blocks

Defines the number of "Closed Loop Indicator" and "TPC Command" fields (RNTI type: TPC-PUSCH-RNTI).

Remote command:

[:SOURce<hw>] :BB:NR5G:UBWP:USER<us>:CELL<cc>:DL:BWP<bwp>:PUSCh:BD22 on page 533

TPC-PUCCH-RNTI

Selects the RNTI of the user (RNTI type: TPC-PUCCH-RNTI). It is a unique UE ID to control the PUCCH power.

Remote command:

[:SOURce<hw>] :BB:NR5G:UBWP:USER<us>:CELL<cc>:DL:BWP<bwp>:RNTI:PUCCh on page 533

TPC-PUSCH-RNTI

Selects the **RNTI** of the user (RNTI type: TPC-PUSCH-RNTI). It is a unique UE ID to control the PUSCH power.

Remote command:

[:SOURce<hw>] :BB:NR5G:UBWP:USER<us>:CELL<cc>:DL:BWP<bwp>:RNTI : PUSCh on page 533

TwoPUCCH-PC Adjustment

Turns the "Closed Loop Indicator" field on and off (RNTI type: TPC-PUCCH-RNTI).

Remote command:

[:SOURce<hw>] :BB:NR5G:UBWP:USER<us>:CELL<cc>:DL:BWP<bwp>:PUCCh : TPAS on page 533

TwoPUSCH-PC Adjustment

Turns the "Closed Loop Indicator" field on and off (RNTI type: TPC-PUSCH-RNTI).

Remote command:

[:SOURce<hw>] :BB:NR5G:UBWP:USER<us>:CELL<cc>:DL:BWP<bwp>:PUSCh : TPAS on page 533

Control information for DCI format 2_3

Control settings for DCI format 2_3.

Number of Blocks.....	140
SRS-TPC-PDCCH-Group Type.....	140
TPC-SRS-RNTI.....	140

Number of Blocks

Defines the number of "SRS Request" and "TPC Command" fields.

Remote command:

[:SOURce<hw>] :BB:NR5G:UBWP:USER<us>:CELL<cc>:DL:BWP<bwp>:SRS : BD23 on page 498

SRS-TPC-PDCCH-Group Type

Selects the SRS-TPC-PDCCH-Group type.

Remote command:

[:SOURce<hw>] :BB:NR5G:UBWP:USER<us>:CELL<cc>:DL:BWP<bwp>:SRS : GTYPe on page 499

TPC-SRS-RNTI

Selects the **RNTI** of the user.

Remote command:

[:SOURce<hw>] :BB:NR5G:UBWP:USER<us>:CELL<cc>:DL:BWP<bwp>:RNTI : SRS on page 533

Control information for DCI format 2_4

Control settings for DCI format 2_4.

Requires: Option: R&S SMM-K148

Cancellation Indication Length.....	141
CI-RNTI.....	141
Number of Cancellation Indications.....	141

Cancellation Indication Length

Defines the bit length of the "Cancellation Indication" fields.

The "Cancellation Indication Length" in combination with the "Number of Cancellation Indications" defines the size of the [pattern](#).

Remote command:

```
[ :SOURce<hw> ] :BB:NR5G:UBWP:USER<us>:CELL<cc>:DL:BWP<bwp>:
CILength on page 496
```

CI-RNTI

Selects the [RNTI](#) of the user.

Remote command:

```
[ :SOURce<hw> ] :BB:NR5G:UBWP:USER<us>:CELL<cc>:DL:BWP<bwp>:RNTI:
CIRNti on page 496
```

Number of Cancellation Indications

Defines the number of "Cancellation Indication" fields.

The "Cancellation Indication Length" in combination with the "Number of Cancellation Indications" defines the size of the [pattern](#).

Remote command:

```
[ :SOURce<hw> ] :BB:NR5G:UBWP:USER<us>:CELL<cc>:DL:BWP<bwp>:NCINd
on page 496
```

Control information for DCI format 2_5

Control settings for DCI format 2_5.

Requires: Option: R&S SMM-K148

AI-RNTI.....	141
Number of Availability Indications.....	141

AI-RNTI

Selects the [RNTI](#) of the user.

Remote command:

```
[ :SOURce<hw> ] :BB:NR5G:UBWP:USER<us>:CELL<cc>:DL:BWP<bwp>:RNTI:
AIRNti on page 497
```

Number of Availability Indications

Defines the number of "Availability Indication" fields.

Remote command:

```
[ :SOURce<hw> ] :BB:NR5G:UBWP:USER<us>:CELL<cc>:DL:BWP<bwp>:NAINd
on page 497
```

Control information for DCI format 2_6

Control settings for DCI format 2_6.

Requires: Option: R&S SMM-K148

Number of Dormancy Indications.....	142
Number of SCell Groups Outside Active Time.....	142
PS-RNTI.....	142

Number of Dormancy Indications

Defines the number of "Wakeup Indication" and "SCell Dormancy Indication" fields.

Remote command:

[:SOURCE<hw>] :BB:NR5G:UBWP:USER<us>:CELL<cc>:DL:BWP<bwp>:SRS:
NB26 on page 498

Number of SCell Groups Outside Active Time

Defines the number of bits for the "SCell Dormancy Indication" pattern.

Remote command:

[:SOURCE<hw>] :BB:NR5G:UBWP:USER<us>:CELL<cc>:DL:BWP<bwp>:SRS:
NSCG on page 498

PS-RNTI

Selects the **RNTI** of the user.

Remote command:

[:SOURCE<hw>] :BB:NR5G:UBWP:USER<us>:CELL<cc>:DL:BWP<bwp>:RNTI:
PSRNTi on page 497

Control information for DCI format 2_7

Control settings for DCI format 2_7.

Requires: Option: R&S SMM-K148

Control settings for DCI format 2_7 described elsewhere:

- [Bits for TRS Availability Indication](#)

Number of Subgroups per PO.....	142
Payload Size.....	143
PO Number per PEI.....	143

Number of Subgroups per PO

Defines the higher layer parameter `subgroupConfig-r17` as defined in 3GPP 38.331. The parameter has an effect on the number of bits you can use for the "Early Indicator" DCI fields.

Availability depends on the [payload size](#) and the [PO number per PEI](#). The value range also depends on the payload size.

Remote command:

[:SOURCE<hw>] :BB:NR5G:UBWP:USER<us>:CELL<cc>:DL:BWP<bwp>:DCI:
SGPO on page 536

Payload Size

Defines the payload size of DCI format 2_7. The parameter corresponds to higher layer parameter `payloadSizeDCI-2-7-r17` as defined in 3GPP 38.331.

Remote command:

[:SOURCE<hw>] :BB:NR5G:UBWP:USER<us>:CELL<cc>:DL:BWP<bwp>:DCI:PS27 on page 536

PO Number per PEI

Defines the number of "Paging Early Indicator" fields. The parameter corresponds to higher layer parameter `po-NumPerPEI-r17` as defined by 3GPP.

Available number of PEI fields depends on the [payload size](#).

Remote command:

[:SOURCE<hw>] :BB:NR5G:UBWP:USER<us>:CELL<cc>:DL:BWP<bwp>:DCI:PNPPEI on page 535

Control information for DCI format 3_0

Control settings for DCI format 3_0.

Requires: Option: R&S SMM-K148

[Number of sl-PSFCH-ToPUCCH-Slots](#)..... 143

Number of sl-PSFCH-ToPUCCH-Slots

Defines the value of the `sl-PSFCH-ToPUCCH` parameter as defined in 3GPP 38.213, table 16.5-2.

The value has an effect on the values and bit pattern of the "PSFCH-to-HARQ Feedback" field in DCI format 3_0, which depends on the number of slots set by `sl-PSFCH-ToPUCCH`.

Remote command:

[:SOURCE<hw>] :BB:NR5G:UBWP:USER<us>:CELL<cc>:DL:BWP<bwp>:DCI:PTPSlots on page 536

Control information for DCI format 3_1

Control settings for DCI format 3_1.

Requires: Option: R&S SMM-K148

[Max LTE Subchannels](#)..... 143

Max LTE Subchannels

Sets the maximum number of LTE subchannels used in a V2X transmission.

The value has an effect on the values and bit pattern of the "First Subchannel" field.

Remote command:

[:SOURCE<hw>] :BB:NR5G:UBWP:USER<us>:CELL<cc>:DL:BWP<bwp>:DCI:LTEChan on page 535

Control information for DCI format 4_2

Control settings for DCI format 4_2.

Requires: Option: R&S SMM-K171

[HARQ-FeedbackEnabler](#)..... 144
[Minimum Size](#)..... 144

HARQ-FeedbackEnabler

Turns the DCI field "HARQ-FeedbackEnabler" on and off.

Remote command:

[:SOURce<hw>] :BB:NR5G:UBWP:USER<us>:CELL<cc>:DL:BWP<bwp>:DCI:HAENabler on page 535

Minimum Size

Defines the number of bits in the DCI format 4_2.

Remote command:

[:SOURce<hw>] :BB:NR5G:UBWP:USER<us>:CELL<cc>:DL:BWP<bwp>:DCI:DS42 on page 534

5.3.6.6 ZP CSI-RS settings

Access:

- ▶ Select "User/BWP Settings > DL BWP Config > ZP CSI-RS".

The dialog comprises the zero-power (ZP) CSI-RS settings, as defined in TS 38.211.

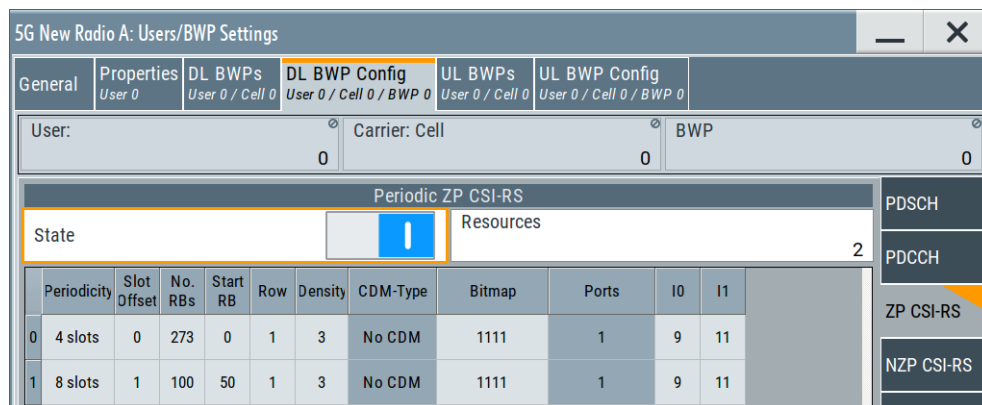

For description of the remote-control commands, see Chapter 10.19.6, "ZP and NZP CSI-RS commands", on page 538.

[State](#)..... 145
[Resources](#)..... 145
[Periodic ZP CSI-RS resource table](#)..... 145
 L [Periodicity](#)..... 145
 L [Slot Offset](#)..... 145

L No. RBs.....	146
L Start RB.....	146
L Row.....	146
L Density.....	146
L CDM-Type.....	146
L Bitmap.....	147
L Ports.....	147
L I0/I1.....	147

State

Enables the ZP CSI-RS transmission.

The CSI-RS can be used among others for time or frequency tracking or CSI calculation.

Remote command:

```
[ :SOURCE<hw> ] :BB:NR5G:UBWP:USER<us>:CELL<cc>:DL:BWP<bwp>:CSIRs:
ZP:STATE on page 540
```

Resources

Sets the number of periodicCSI-RS resources.

There is one table row per resource.

See "[Periodic ZP CSI-RS resource table](#)" on page 145.

Remote command:

```
[ :SOURCE<hw> ] :BB:NR5G:UBWP:USER<us>:CELL<cc>:DL:BWP<bwp>:CSIRs:
ZP:SET<gr0>:NRESources on page 540
```

Periodic ZP CSI-RS resource table

Each periodic ZP CSI-RS is configured individually; there is one table row per resource, where the number of rows is defined by the parameter [Resources](#).

Periodicity ← Periodic ZP CSI-RS resource table

For periodic ZP CSI-RS:

Sets the periodicity $T_{\text{CSI-RS}}$ (in slots) transmitted by the higher-layer parameter `CSI-ResourcePeriodicityAndOffset`.

Thus, this parameter defines how often the CSI-RS is transmitted.

Remote command:

```
[ :SOURCE<hw> ] :BB:NR5G:UBWP:USER<us>:CELL<cc>:DL:BWP<bwp>:CSIRs:
ZP:SET<gr0>:RES<user0>:PER on page 540
```

Slot Offset ← Periodic ZP CSI-RS resource table

For periodic ZP CSI-RS:

Sets the slot offset T_{offset} transmitted by the higher-layer parameter `CSI-ResourcePeriodicityAndOffset`.

Remote command:

```
[ :SOURCE<hw> ] :BB:NR5G:UBWP:USER<us>:CELL<cc>:DL:BWP<bwp>:CSIRs:
ZP:SET<gr0>:RES<user0>:OFFSet on page 541
```

No. RBs ← Periodic ZP CSI-RS resource table

Sets the periodicity $T_{\text{CSI-RS}}$ (in slots) transmitted by the higher-layer parameter `CSI-ResourcePeriodicityAndOffset`.

Thus, this parameter defines how often the CSI-RS is transmitted.

Remote command:

```
[ :SOURCE<hw> ] :BB:NR5G:UBWP:USER<us>:CELL<cc>:DL:BWP<bwp>:CSIRs :
ZP:SET<gr0>:RES<user0>:RBNumber on page 541
```

Start RB ← Periodic ZP CSI-RS resource table

If the number of RB the CSI-RS spans ("No. RBs") is smaller than the available number of RB (i.e. the whole width of the BWP), set the first RB (`startingRB`) the CSI-RS allocates.

The value is set relative to the common resource block #0 on the common RB grid.

Only multiples of 4 are allowed.

Remote command:

```
[ :SOURCE<hw> ] :BB:NR5G:UBWP:USER<us>:CELL<cc>:DL:BWP<bwp>:CSIRs :
ZP:SET<gr0>:RES<user0>:SRBNumber on page 541
```

Row ← Periodic ZP CSI-RS resource table

The CSI-RS location in a slot is defined according to [TS 38.211](#) as a function of the number of ports X , the "Density" and the "CDM-Type".

The possible combinations are listed in a table and the parameter "Row" indicates one of the combinations. It is not the consequent table row number in the CSI-RS resource table. The latter is defined with the suffix `RES<user0>` in the remote control command.

Remote command:

```
[ :SOURCE<hw> ] :BB:NR5G:UBWP:USER<us>:CELL<cc>:DL:BWP<bwp>:CSIRs :
ZP:SET<gr0>:RES<user0>:ROW on page 542
```

Density ← Periodic ZP CSI-RS resource table

Sets the value p that is the higher-layer parameter `density` in the `CSI-RS-ResourceMapping` or the `CSI-RS-CellMobility` messages.

Remote command:

```
[ :SOURCE<hw> ] :BB:NR5G:UBWP:USER<us>:CELL<cc>:DL:BWP<bwp>:CSIRs :
ZP:SET<gr0>:RES<user0>:DENSITY on page 542
```

CDM-Type ← Periodic ZP CSI-RS resource table

Indicates or sets value of the higher-layer parameter `cdm-Type` in the `CSI-RS-ResourceMapping`.

The value is selected automatically according to [TS 38.211](#) and depending on the selected "Row".

Remote command:

```
[ :SOURCE<hw> ] :BB:NR5G:UBWP:USER<us>:CELL<cc>:DL:BWP<bwp>:CSIRs :
ZP:SET<gr0>:RES<user0>:CDMType? on page 543
```

Bitmap ← Periodic ZP CSI-RS resource table

Sets the location of the CSI-RS in the frequency domain. The starting position and number of the resource blocks in which the CSI-RS is transmitted are defined by the higher-layer parameters `freqBand`.

This parameter is transmitted by the higher-layer parameters `frequencyDomainAllocation` as part of the CSI-RS-ResourceMapping or the CSI-RS-CellMobility messages.

Remote command:

```
[ :SOURce<hw> ] :BB:NR5G:UBWP:USER<us>:CELL<cc>:DL:BWP<bwp>:CSIRs :
ZP:SET<gr0>:RES<user0>:BITMap on page 543
```

Ports ← Periodic ZP CSI-RS resource table

Sets the number of ports x that is given by the higher-layer parameter `nrofPorts`.

Remote command:

```
[ :SOURce<hw> ] :BB:NR5G:UBWP:USER<us>:CELL<cc>:DL:BWP<bwp>:CSIRs :
ZP:SET<gr0>:RES<user0>:PORTs? on page 542
```

I0/I1 ← Periodic ZP CSI-RS resource table

Sets the parameters l_0 and l_1 and define the CSI-RS location relative to the start of a slot. Thus, the l_0 and l_1 give the location of the CSI-RS in time.

These parameters are transmitted by the higher-layer parameters `firstOFDMsymbolInTimeDomain` and `firstOFDMsymbolInTimeDomain2` as part of the CSI-RS-ResourceMapping or the CSI-RS-CellMobility messages.

Remote command:

```
[ :SOURce<hw> ] :BB:NR5G:UBWP:USER<us>:CELL<cc>:DL:BWP<bwp>:CSIRs :
ZP:SET<gr0>:RES<user0>:I0 on page 543
[ :SOURce<hw> ] :BB:NR5G:UBWP:USER<us>:CELL<cc>:DL:BWP<bwp>:CSIRs :
ZP:SET<gr0>:RES<user0>:I1 on page 543
```

5.3.6.7 NZP CSI-RS settings

Access:

- ▶ Select "User/BWP Settings > DL BWP Config > NZP CSI-RS".

The dialog comprises the non-zero-power (NZP) CSI-RS settings, as defined in TS 38.211.

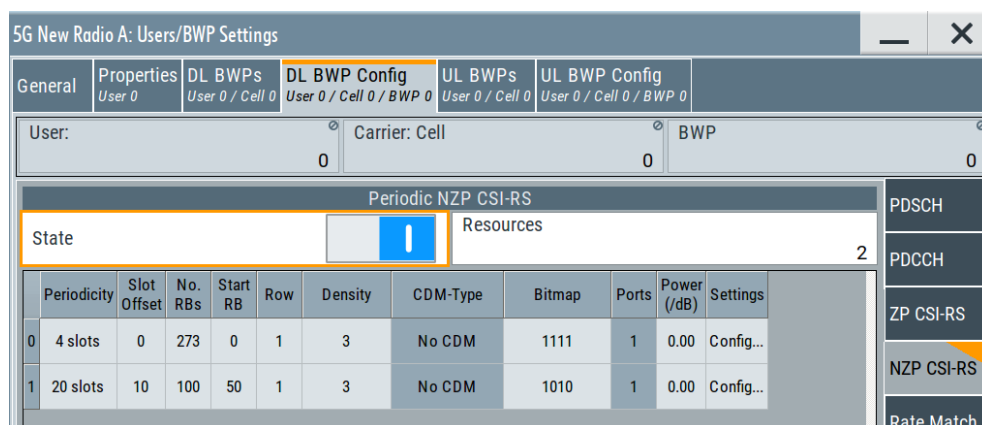

For description of the remote-control commands, see [Chapter 10.19.6, "ZP and NZP CSI-RS commands"](#), on page 538.

State.....	148
Resources.....	148
Periodic NZP CSI-RS resource table.....	149
L Periodicity.....	149
L Offset.....	149
L No. RBs.....	149
L Start RB.....	149
L Row.....	149
L Density.....	150
L CDM-Type.....	150
L Bitmap.....	150
L Ports.....	150
L Power.....	150
L Settings.....	151
L Resource-Settings > General.....	151
L Scrambling ID.....	151
L IO/I1.....	151
L Resource-Settings > Antenna Port Mapping.....	152
L Mapping Coordinates.....	152
L Mapping table.....	152

State

Enables the NZP CSI-RS transmission.

Remote command:

[: SOURCE<hw>] : BB:NR5G:UBWP:USER<us>:CELL<cc>:DL:BWP<bwp>:CSIRs : NZP:STATE on page 540

Resources

Sets the number of periodic CSI-RS resources.

There is one table row per resource.

See "[Periodic ZP CSI-RS resource table](#)" on page 145.

Remote command:

```
[ :SOURce<hw> ] :BB:NR5G:UBWP:USER<us>:CELL<cc>:DL:BWP<bwp>:CSI-Rs :
NZZP:SET<gr0>:NRESources on page 540
```

Periodic NZP CSI-RS resource table

Each periodic NZP CSI-RS is configured individually; there is one table row per resource, where the number of rows is defined by the parameter [Resources](#).

Periodicity ← Periodic NZP CSI-RS resource table

Sets the periodicity $T_{\text{CSI-RS}}$ (in slots) transmitted by the higher-layer parameter `CSI-ResourcePeriodicityAndOffset`.

Thus, this parameter defines how often the CSI-RS is transmitted.

Remote command:

```
[ :SOURce<hw> ] :BB:NR5G:UBWP:USER<us>:CELL<cc>:DL:BWP<bwp>:CSI-Rs :
NZZP:SET<gr0>:RES<user0>:PER on page 540
```

Offset ← Periodic NZP CSI-RS resource table

Sets the slot offset T_{offset} transmitted by the higher-layer parameter `CSI-ResourcePeriodicityAndOffset`.

Remote command:

```
[ :SOURce<hw> ] :BB:NR5G:UBWP:USER<us>:CELL<cc>:DL:BWP<bwp>:CSI-Rs :
NZZP:SET<gr0>:RES<user0>:OFFSet on page 541
```

No. RBs ← Periodic NZP CSI-RS resource table

Sets the periodicity $T_{\text{CSI-RS}}$ (in slots) transmitted by the higher-layer parameter `CSI-ResourcePeriodicityAndOffset`.

Thus, this parameter defines how often the CSI-RS is transmitted.

Remote command:

```
[ :SOURce<hw> ] :BB:NR5G:UBWP:USER<us>:CELL<cc>:DL:BWP<bwp>:CSI-Rs :
NZZP:SET<gr0>:RES<user0>:RBNumber on page 541
```

Start RB ← Periodic NZP CSI-RS resource table

If the number of RB the CSI-RS spans ("No. RBs") is smaller than the available number of RB (i.e. the whole width of the BWP), set the first RB (`startingRB`) the CSI-RS allocates.

The value is set relative to the common resource block #0 on the common RB grid.

Only multiples of 4 are allowed.

Remote command:

```
[ :SOURce<hw> ] :BB:NR5G:UBWP:USER<us>:CELL<cc>:DL:BWP<bwp>:CSI-Rs :
NZZP:SET<gr0>:RES<user0>:SRBNumber on page 541
```

Row ← Periodic NZP CSI-RS resource table

The CSI-RS location in a slot is defined according to [TS 38.211](#) as a function of the number of ports X , the "Density" and the "CDM-Type".

The possible combinations are listed in a table and the parameter "Row" indicates one of the combinations. It is not the consequent table row number in the CSI-RS resource table. The latter is defined with the suffix RES<user0> in the remote control command.

Remote command:

```
[ :SOURce<hw> ] :BB:NR5G:UBWP:USER<us>:CELL<cc>:DL:BWP<bwp>:CSIRs :
NZP:SET<gr0>:RES<user0>:ROW on page 542
```

Density ← Periodic NZP CSI-RS resource table

Sets the value ρ that is the higher-layer parameter `density` in the CSI-RS-ResourceMapping or the CSI-RS-CellMobility messages.

Remote command:

```
[ :SOURce<hw> ] :BB:NR5G:UBWP:USER<us>:CELL<cc>:DL:BWP<bwp>:CSIRs :
NZP:SET<gr0>:RES<user0>:DENSity on page 542
```

CDM-Type ← Periodic NZP CSI-RS resource table

Indicates or sets value of the higher-layer parameter `cdm-Type` in the CSI-RS-ResourceMapping.

The value is selected automatically according to TS 38.211 and depending on the selected "Row".

Remote command:

```
[ :SOURce<hw> ] :BB:NR5G:UBWP:USER<us>:CELL<cc>:DL:BWP<bwp>:CSIRs :
NZP:SET<gr0>:RES<user0>:CDMType? on page 543
```

Bitmap ← Periodic NZP CSI-RS resource table

Sets the location of the CSI-RS in the frequency domain. The starting position and number of the resource blocks in which the CSI-RS is transmitted are defined by the higher-layer parameters `freqBand`.

This parameter is transmitted by the higher-layer parameters `frequencyDomainAllocation` as part of the CSI-RS-ResourceMapping or the CSI-RS-CellMobility messages.

Remote command:

```
[ :SOURce<hw> ] :BB:NR5G:UBWP:USER<us>:CELL<cc>:DL:BWP<bwp>:CSIRs :
NZP:SET<gr0>:RES<user0>:BITMap on page 543
```

Ports ← Periodic NZP CSI-RS resource table

Sets the number of ports x that is given by the higher-layer parameter `nrofPorts`.

Remote command:

```
[ :SOURce<hw> ] :BB:NR5G:UBWP:USER<us>:CELL<cc>:DL:BWP<bwp>:CSIRs :
NZP:SET<gr0>:RES<user0>:PORTs? on page 542
```

Power ← Periodic NZP CSI-RS resource table

Sets the power of the NZP resource relative to the PDSCH power.

Remote command:

```
[ :SOURce<hw> ] :BB:NR5G:UBWP:USER<us>:CELL<cc>:DL:BWP<bwp>:CSIRs :
NZP:SET<gr0>:RES<user0>:PWR on page 544
```

Settings ← Periodic NZP CSI-RS resource table

Opens the "Resource-Settings" dialog where you configure:

- Scrambling and I0/I1 values, see "[Resource-Settings > General](#)" on page 151.
- The antenna port mapping for the selected resource, see "[Resource-Settings > Antenna Port Mapping](#)" on page 152.

Resource-Settings > General ← Periodic NZP CSI-RS resource table

Access: "General > Users/BWPs > DL BWP Config > NZP CSI-RS" > "Resources = 1" and select "Settings > Config > General".

General	Antenna Ports
Scrambling ID	0
I0	9
I1	11

Scrambling ID ← Resource-Settings > General ← Periodic NZP CSI-RS resource table

Sets the parameter n_{ID} that is defined by the higher-layer parameter `ScramblingID` and used for the generation of the pseudo-random reference-signal generator.

Remote command:

```
[ :SOURCE<hw> ] :BB:NR5G:UBWP:USER<us>:CELL<cc>:DL:BWP<bwp>:CSIRs : NZP:SET<gr0>:RES<user0>:SCID on page 544
```

I0/I1 ← Resource-Settings > General ← Periodic NZP CSI-RS resource table

Sets the parameters I_0 and I_1 and define the CSI-RS location relative to the start of a slot. Thus, the I_0 and I_1 give the location of the CSI-RS in time.

These parameters are transmitted by the higher-layer parameters

`firstOFDMSymbolInTimeDomain` and `firstOFDMSymbolInTimeDomain2` as part of the CSI-RS-ResourceMapping or the CSI-RS-CellMobility messages.

Remote command:

```
[ :SOURCE<hw> ] :BB:NR5G:UBWP:USER<us>:CELL<cc>:DL:BWP<bwp>:CSIRs : NZP:SET<gr0>:RES<user0>:I0 on page 543
```

```
[ :SOURCE<hw> ] :BB:NR5G:UBWP:USER<us>:CELL<cc>:DL:BWP<bwp>:CSIRs : NZP:SET<gr0>:RES<user0>:I1 on page 543
```

Resource-Settings > Antenna Port Mapping ← Periodic NZP CSI-RS resource table

Access: "General > Users/BWPs > DL BWP Config > NZP CSI-RS" > "Resources = 1" and select "Settings > Config > Antenna Ports".

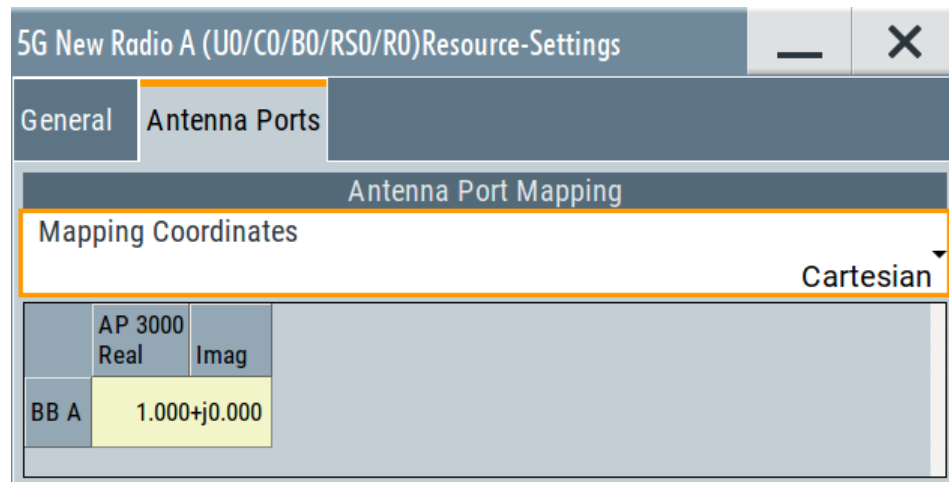

For details on the antenna port-mapping concept, see [Chapter 2.10, "Antenna port mapping"](#), on page 27.

Mapping Coordinates ← Resource-Settings > Antenna Port Mapping ← Periodic NZP CSI-RS resource table

Switches representation between the "Cartesian" (Real/Imag) and "Cylindrical" (Magn./Phase) coordinates.

Mapping table ← Resource-Settings > Antenna Port Mapping ← Periodic NZP CSI-RS resource table

The mapping table is a matrix with number of rows equal to the number of physical Tx antennas (basebands) and number of columns equal of the number of antenna ports (AP). The available antenna ports depend on the current configuration. The yellow matrix elements in the mapping table indicate the default antenna port to physical antenna (TX antenna/baseband) mapping.

For details on the antenna port-mapping concept, see [Chapter 2.10, "Antenna port mapping"](#), on page 27.

Remote command:

"Mapping Coordinates = Cartesian":

```
[ :SOURCE<hw> ] :BB:NR5G:UBWP:USER<us>:CELL<cc>:DL:BWP<bwp>:CSI-RS :
NZP:SET<gr0>:RES<user0>:APMap:AP<ap>:ROW<apr>:REAL on page 544
```

```
[ :SOURCE<hw> ] :BB:NR5G:UBWP:USER<us>:CELL<cc>:DL:BWP<bwp>:CSI-RS :
NZP:SET<gr0>:RES<user0>:APMap:AP<ap>:ROW<apr>:IMAGinary
```

on page 544

"Mapping Coordinates = Cylindrical":

[:SOURce<hw>] :BB:NR5G:UBWP:USER<us>:CELL<cc>:DL:BWP<bwp>:CSIRs: NZP:SET<gr0>:RES<user0>:APMap:AP<ap>:ROW<apr>:MAGNitude

on page 545

[:SOURce<hw>] :BB:NR5G:UBWP:USER<us>:CELL<cc>:DL:BWP<bwp>:CSIRs: NZP:SET<gr0>:RES<user0>:APMap:AP<ap>:ROW<apr>:PHASe on page 545

5.3.6.8 Rate match settings

Access:

- ▶ Select "User/BWP Settings > DL BWP Config > Rate Match".

The dialog comprises the PDSCH resources-mapping settings, required to configure the rate match patterns, as defined in [TS 38.214](#).

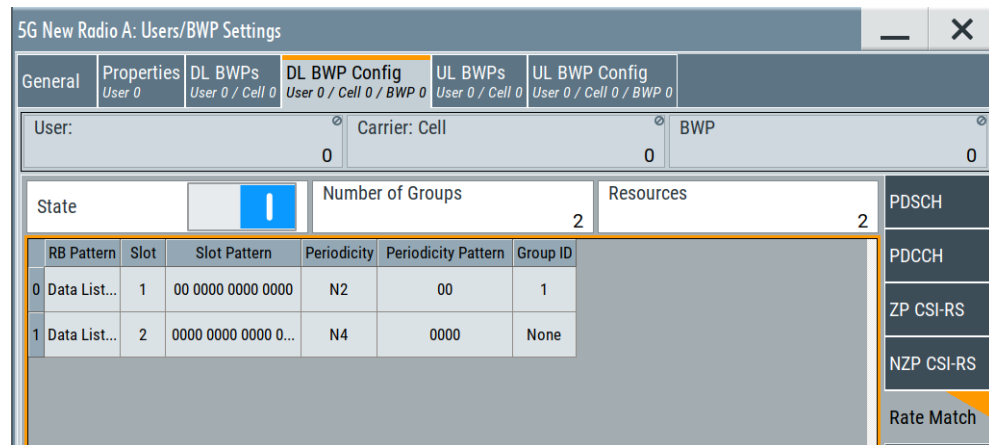

For description of the remote-control commands, see [Chapter 10.19.7, "Rate match commands"](#), on page 546.

State

Enables the configuration of rate match groups.

Remote command:

[:SOURce<hw>] :BB:NR5G:UBWP:USER<us>:CELL<cc>:DL:BWP<bwp>:RATM: STATE on page 546

Number of Groups

Sets the number of rate match pattern groups (`rateMatchPatternGroup`).

The value limits the available group ID, the groups that can be selected for PDSCH ("Scheduling > PDSCH > Config > General" > [Rate Match Pattern Group](#)) and the bit length of the DCI format 1_1 parameter "Rate Matching Indicator".

Each rate match pattern group contains a list of RB and slot indices that build a resource set of resources. These resources are not available for the PDSCH allocations, if one of the following is true:

- The "Rate Matching Indicator" field of the DCI format 1_1 used to schedule this PDSCH is set to value different than 0.
- A "Rate Match Group" is selected for a manually configured PDSCH.

Remote command:

[:SOURce<hw>] :BB:NR5G:UBWP:USER<us>:CELL<cc>:DL:BWP<bwp>:RATM:GRPNumber on page 547

Resources

Sets the number of rate match resources.

There is one table row per resource.

See "Rate match resource table" on page 154.

Remote command:

[:SOURce<hw>] :BB:NR5G:UBWP:USER<us>:CELL<cc>:DL:BWP<bwp>:RATM:NRESources on page 546

Rate match resource table

Each rate match resource is configured individually; there is one table row per resource, where the number of rows is defined by the parameter [Resources](#).

RB Pattern ← Rate match resource table

The resource block level bitmap is defined as a binary data from a data list, internally or externally generated.

The bitmap is 275 bits long. Longer patterns are truncated; shorter are zero-padded (i.e. the remaining bits are set to 0). If no data list is loaded, a pattern with all zeros is assumed.

A bit value of 1 in the RB level bitmaps indicates that the corresponding resource is not available for PDSCH.

To load a list:

- Select "Data List"
- In the standard "Select List" dialog, select the "Select Data List > navigate to the list file *.dm_iqd > Select" to select an existing data list.
- Use the "New" and "Edit" functions to create internally new data list or to edit an existing one.
- Use the standard "File Manager" function to transfer external data lists to the instrument.

Remote command:

[:SOURce<hw>] :BB:NR5G:UBWP:USER<us>:CELL<cc>:DL:BWP<bwp>:RATM:RS<gr0>:RBDList on page 547

[:SOURce<hw>] :BB:NR5G:UBWP:USER<us>:CELL<cc>:DL:BWP<bwp>:RATM:RS<gr0>:RBPatt on page 547

Slot ← Rate match resource table

Sets the number of slots and thus defines the "Slot Pattern" length.

Remote command:

[:SOURce<hw>] :BB:NR5G:UBWP:USER<us>:CELL<cc>:DL:BWP<bwp>:RATM:RS<gr0>:SLOT on page 548

Slot Pattern ← Rate match resource table

Set the slots to be used as a pattern.

The pattern length is the 14 or 28 depending on whether "Slot = 1 or 2".

A bit value of 1 in the symbol level bitmaps indicates that the corresponding resource is not available for PDSCH.

Remote command:

[:SOURce<hw>] :BB:NR5G:UBWP:USER<us>:CELL<cc>:DL:BWP<bwp>:RATM:RS<gr0>:SLTPatt on page 548

Periodicity ← Rate match resource table

Sets the time-domain pattern and defines the "Periodicity Pattern" length.

Remote command:

[:SOURce<hw>] :BB:NR5G:UBWP:USER<us>:CELL<cc>:DL:BWP<bwp>:RATM:RS<gr0>:PER on page 548

Periodicity Pattern ← Rate match resource table

Sets the periodicity in a pattern form, where the pattern length is set with the parameter "Periodicity".

Remote command:

[:SOURce<hw>] :BB:NR5G:UBWP:USER<us>:CELL<cc>:DL:BWP<bwp>:RATM:RS<gr0>:PERPatt on page 548

Group ID ← Rate match resource table

Sets the group identifier for the selected rate match pattern, where the available values depend on the selected [Number of GroupsIdPDbNr5gUserDIBwpRateMatchRsPeriodicity](#).

Up to four rate match patterns can use the same "Group ID".

Remote command:

[:SOURce<hw>] :BB:NR5G:UBWP:USER<us>:CELL<cc>:DL:BWP<bwp>:RATM:RS<gr0>:GRID on page 549

5.3.7 UL BWP configuration settings

Access:

1. Select "5G New Radio > General > Link Direction" > **"Uplink"**.
2. Select "General > Users/BWPs" > **"UL BWP Config"**.

3. Select "PUCCH".

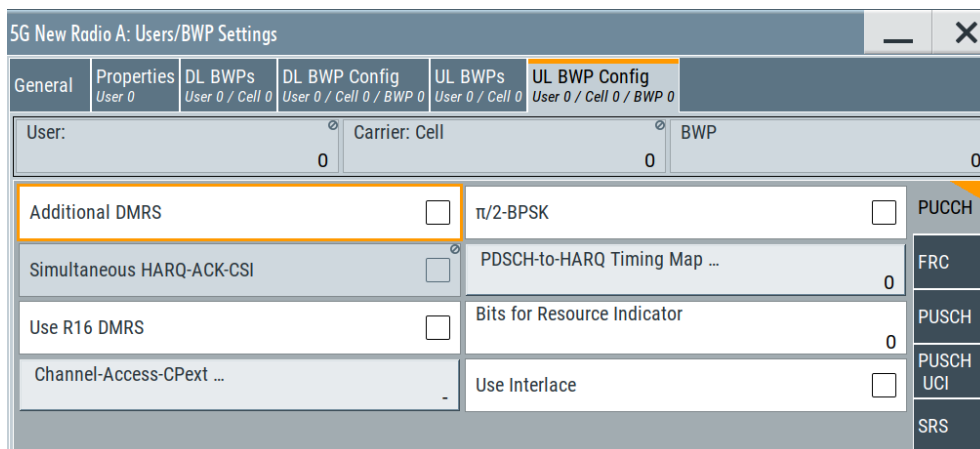

The dialog comprises the settings for the UL bandwidth parts (BWP) configuration.

Settings:

- [User, carrier, BWP settings](#)..... 156
- [PUCCH settings](#)..... 157
- [FRC settings](#)..... 160
- [PUSCH settings](#)..... 163
- [PUSCH UCI settings](#)..... 181
- [SRS settings](#)..... 183

5.3.7.1 User, carrier, BWP settings

- [User](#):.....156
- [Cell](#)..... 156
- [BWP](#)..... 156

User:

Selects the user to be configured.
Available if the [number of users](#) is greater than 1.

Remote command:
via suffix at `USER<ch>`

Cell

Selects/indicates to which carrier/cell the settings apply.

Remote command:
via suffix at `CELL<ch>`

BWP

Select the bandwidth parts (BWP) whose settings are displayed for configuration.
There are one or more BWPs, as set with the parameter "User/BWP Settings > UL BWPs" > [Number of DL/UL BWPs](#).

Remote command:
via suffix at BWP<dir0>

5.3.7.2 PUCCH settings

Access:

► Select "User/BWP Settings > UL BWP Config > PUCCH".

- [General settings](#)..... 157
- [Control settings](#)..... 158

General settings

The general settings section of the PUCCH properties contain settings to configure general properties of the selected user.

Additional DMRS	<input type="checkbox"/>	$\pi/2$ -BPSK	<input type="checkbox"/>
Use R16 DMRS	<input type="checkbox"/>	Use Interlace	<input type="checkbox"/>

Additional DMRS	157
$\pi/2$ - BPSK	157
Use R16 DMRS	157
Use Interlace	158

Additional DMRS

Global parameter that defines if additional DMRS is used for PUCCH format 3 and 4. According to [TS 38.211](#), the value is required to select the DMRS positions for the PUCCH format 3 and 4.

The value is ignored, if other PUCCH [Format](#) is configured.

Remote command:

[:SOURce<hw>] :BB:NR5G:UBWP:USER<us>:CELL<cc>:UL:BWP<bwp>:PUCCh:ADMRs:STATe on page 550

$\pi/2$ - BPSK

If enabled, the $\pi/2$ - BPSK modulation order is used for PUCCH, instead of the default QPSK.

Remote command:

[:SOURce<hw>] :BB:NR5G:UBWP:USER<us>:CELL<cc>:UL:BWP<bwp>:PUCCh:BPSK:STATe on page 550

Use R16 DMRS

Option: R&S SMM-K148.

Turns the higher layer parameter "dmrs-uplink-r16" on and off.

This parameter reduces the peak-to-average power ratio (PAPR) of the PUCCH DMRS as defined 3GPP, release 16. Using the low PAPR also results in a different calculation of the DMRS sequence.

Remote command:

[:SOURce<hw>] :BB:NR5G:UBWP:USER<us>:CELL<cc>:UL:BWP<bwp>:PUCCh:UR16 on page 530

Use Interlace

Option: R&S SMM-K148

Configures the higher layer parameter `useInterlacePUCCH-PUSCH` as defined in 3GPP 38.331.

In addition, this parameter unlocks the use of [interlaces](#).

Remote command:

[:SOURce<hw>] :BB:NR5G:UBWP:USER<us>:CELL<cc>:UL:BWP<bwp>:PUCCh:UITL on page 532

Control settings

The control settings section of the PUCCH properties contain settings related to DCI configuration.

Available when "Simple Mode" = "Off".

Control		
Simultaneous HARQ-ACK-CSI	<input type="checkbox"/>	PDSCH-to-HARQ Timing Map ... 0
Bits for Resource Indicator	0	Channel-Access-CPext ... -
Use 2nd TPC Command	<input type="checkbox"/>	ul-AccessConfigList DCI1_2 0

Simultaneous HARQ-ACK-CSI.....	158
PDSCH to HARQ Timing Map.....	159
L Number of Entries.....	159
L Value of Indicator x.....	159
Bits for Resource Indicator.....	159
Channel-Access-CPext.....	160
L Number of Entries.....	160
L Value <x>.....	160
Use 2nd TPC Command.....	160
ul-AccessConfigList DCI1_2.....	160

Simultaneous HARQ-ACK-CSI

Reserved for future use.

Remote command:

[:SOURce<hw>] :BB:NR5G:UBWP:USER<us>:CELL<cc>:UL:BWP<bwp>:PUCCh:HACK:STATE on page 550

PDSCH to HARQ Timing Map

Select the parameter name to access a dialog where you configure the PDSCH-to-HARQ-timing-indicator field values map, as defined in TS 38.213.

The PDSCH to HARQ timing map is transmitted by the higher-layer parameter `dl-DataToUL-ACK` and affects the DCI field "PDSCH-to-HARQ_feedback Timing Indicator" in DCI formats 1_1 and 1_2.. It is a sequence of up to 8 entries, every four bits long, where the number of entries is set with the parameter [Number of Entries](#).

The value of the individual timing indicators is defined by the parameter [Value of Indicator x](#). Observe the resulting sequence in the overview indication together with the parameter name "PDSCH to HARQ Timing Map".

Timing Map	
Number of Entries	3
Timing Values	
Value for Indicator 0	1
Value for Indicator 1	0
Value for Indicator 2	15

Number of Entries ← PDSCH to HARQ Timing Map

Sets the number of entries in the sequence of PDSCH to HARQ timing values.

Remote command:

```
[ :SOURCE<hw> ] :BB:NR5G:UBWP:USER<us>:CELL<cc>:UL:BWP<bwp>:PUCCh:
PDSHarq:NTMentry on page 550
```

Value of Indicator x ← PDSCH to HARQ Timing Map

Sets the individual timing values.

Remote command:

```
[ :SOURCE<hw> ] :BB:NR5G:UBWP:USER<us>:CELL<cc>:UL:BWP<bwp>:PUCCh:
PDSHarq:TMIValue<gr0> on page 551
```

Bits for Resource Indicator

Defines the bit length of the DCI field "PUCCH Resource Indicator" available in DCI format 1_2.

Corresponds to higher layer parameter `numberOfBitsForPUCCH-ResourceIndicatorDCI-1-2` as defined in 3GPP 38.331.

Remote command:

```
[ :SOURCE<hw> ] :BB:NR5G:UBWP:USER<us>:CELL<cc>:UL:BWP<bwp>:PUCCh:
BRIND on page 531
```

Channel-Access-CPext

Option: R&S SMM-K148.

Opens a dialog to configure the higher layer parameter `UL-AccessConfigListDCI` as defined in 3GPP 38.331.

This parameter has an effect on the "Channel-Access-Cpext" DCI field in DCI format 0_1. This field is available when you turn on [shared spectrum access](#).

Number of Entries ← Channel-Access-CPext

Defines the number of entries of the "Channel-Access-Cpext" DCI field.

Remote command:

`[:SOURCE<hw>] :BB:NR5G:UBWP:USER<us>:CELL<cc>:UL:BWP<bwp>:PUCCh:CPEXt:NCPXt` on page 531

Value <x> ← Channel-Access-CPext

Defines the value for each "Channel-Access-Cpext" DCI field.

Remote command:

`[:SOURCE<hw>] :BB:NR5G:UBWP:USER<us>:CELL<cc>:UL:BWP<bwp>:PUCCh:CPEXt:VAL<gr0>` on page 531

Use 2nd TPC Command

Turns the "2nd TPC Command for Scheduled PUCCH" DCI field on and off. This DCI field is supported by DCI formats 1_1 and 1_2.

Remote command:

`[:SOURCE<hw>] :BB:NR5G:UBWP:USER<us>:CELL<cc>:UL:BWP<bwp>:PUCCh:U2TPc` on page 551

ul-AccessConfigList DCI1_2

Option: R&S SMM-K171.

Configures the higher layer parameter `ul-AccessConfigListDCI1-2` as defined in 3GPP 38.331.

Remote command:

`[:SOURCE<hw>] :BB:NR5G:UBWP:USER<us>:CELL<cc>:UL:BWP<bwp>:PUCCh:A12List` on page 549

5.3.7.3 FRC settings

Access:

1. Select "User/BWP Settings > Properties" > **DSCH/USCH Channel Coding** > "On".

2. Select "User/BWP Settings > UL BWP Config > FRC".

General	Properties User 0	DL BWPs User 0 / Cell 0	DL BWP Config User 0 / Cell 0 / BWP 0	UL BWPs User 0 / Cell 0	UL BWP Config User 0 / Cell 0 / BWP 0
User:	0	Carrier: Cell	0	BWP	0
FRC State	<input checked="" type="checkbox"/>				PUCCH
FRC	TS 38.141: G-FR1-A1-2				FRC
Subcarrier Spacing	30 kHz				PUSCH
Allocated Resource Blocks	11				PUSCH UCI
Modulation	QPSK				SRS
Payload Size	984				
RB Offset	0				
Mapping Type	A				

The dialog allows you to select and enable fixed reference measurement channels (FRC), as defined in [TS 38.141](#).

The available FRCs depend on the selected BWP SCS ([SC Spacing/CP](#)) and selected number of RBs ([No. RBs](#)).

FRC State	161
FRC	161
Channel Bandwidth	162
Subcarrier Spacing	162
Allocated Resource Blocks	162
Modulation	162
Payload Size	163
RB Offset	163
Mapping Type	163
PTRS	163

FRC State

To enable the fixed reference measurement channels (FRC), set "User/BWP Settings > Properties" > [DSCH/USCH Channel Coding](#) > "On".

Remote command:

```
[ : SOURCE<hw> ] : BB:NR5G:UBWP:USER<us>:CELL<cc>:UL:BWP<bw>:FRC:
STATE on page 552
```

FRC

The available FRCs depend on the selected BWP subcarrier spacing [SC Spacing/CP](#)) and selected number of resource blocks ([No. RBs](#)).

For each particular combination, you can select from the FRCs that have the same subcarrier spacing (SCS) as the BWP and the number of RBs allocated in the FRC is less than or equal to the "No. RB" of current BWP.

The FRCs are configured as defined in [TS 38.141](#) (base station conformance testing) and [TS 38.176](#) (IAB conformance testing). For details, refer to [TS 38.141](#) and [TS 38.176](#).

"TS 38.141: G-FR1"

Subset of FRCs defined for the FR1 in the annex of TS 38.141.

"TS 38.141: G-FR2"

Subset of FRCs defined for the FR2 in the annex of TS 38.141.

"TS 38.176: D-FR1"

Subset of FRCs defined for the FR1 in the annex of TS 38.176.

"TS 38.176: D-FR2"

Subset of FRCs defined for the FR2 in the annex of TS 38.176.

"Not Available" Indicates that there is no FRC defined for the current combination of "SC Spacing/CP" and "No. RB".

If FRC is selected, the following parameters are set automatically:

- DMRS for Mapping Type A parameters [Config Type](#), [Additional Position Index](#) and [Max Length](#).
- PUSCH allocations
- All FRC parameters in the "FRC" dialog.

Release 16 FRCs require R&S SMM-K148.

Release 17 FRCs require R&S SMM-K171.

Remote command:

`[:SOURCE<hw>] :BB:NR5G:UBWP:USER<us>:CELL<cc>:UL:BWP<bwp>:FRC:TYPE` on page 552

Channel Bandwidth

Indicates the channel bandwidth of the selected FRC.

Remote command:

`[:SOURCE<hw>] :BB:NR5G:UBWP:USER<us>:CELL<cc>:UL:BWP<bwp>:FRC:BW?` on page 555

Subcarrier Spacing

Indicates the SCS of the selected FRC. It is the same as the SCS of the selected BWP.

Remote command:

`[:SOURCE<hw>] :BB:NR5G:UBWP:USER<us>:CELL<cc>:UL:BWP<bwp>:FRC:SCS?` on page 555

Allocated Resource Blocks

Indicates the number of used RBs of the selected FRC.

Remote command:

`[:SOURCE<hw>] :BB:NR5G:UBWP:USER<us>:CELL<cc>:UL:BWP<bwp>:FRC:ALRB?` on page 555

Modulation

Indicates the modulation scheme used by the selected FRC.

Remote command:

`[:SOURCE<hw>] :BB:NR5G:UBWP:USER<us>:CELL<cc>:UL:BWP<bwp>:FRC:MODulation?` on page 556

Payload Size

Indicates the payload size of the selected FRC.

Remote command:

[:SOURce<hw>] :BB:NR5G:UBWP:USER<us>:CELL<cc>:UL:BWP<bwp>:FRC: PAsize? on page 556

RB Offset

Sets the RB offset for the selected FRC.

Remote command:

[:SOURce<hw>] :BB:NR5G:UBWP:USER<us>:CELL<cc>:UL:BWP<bwp>:FRC: RBOffset on page 556

Mapping Type

Sets the PUSCH mapping type for the selected FRC.

Remote command:

[:SOURce<hw>] :BB:NR5G:UBWP:USER<us>:CELL<cc>:UL:BWP<bwp>:FRC: MAPType on page 557

PTRS

Enables PTRS for the selected FRC.

Remote command:

[:SOURce<hw>] :BB:NR5G:UBWP:USER<us>:CELL<cc>:UL:BWP<bwp>:FRC: PTRS:STate on page 557

5.3.7.4 PUSCH settings

Access:

- ▶ Select "User/BWP Settings > UL BWP Config > PUSCH".

If FRC is used ("UL BWP Config > FRC > State > On"), the settings of the "DMRS for Mapping Type A" are configured automatically and cannot be changed.

- [General settings](#)..... 163
- [Control settings](#)..... 169
- [DMRS settings](#)..... 172
- [Time domain allocation](#)..... 180

General settings

The general settings section of the PUSCH properties contain settings to configure general properties of the selected user.

General Settings	
Transform Precoding <input type="checkbox"/>	Max Rank 1
TxConfig Non-codebook	Codebook Subset Fully-and-partial-and-non-coherent
Use PUSCH Scrambling ID <input type="checkbox"/>	Data Scrambling ID 0
MCS Table 64QAM	MCS Table Transform Precoding 64QAM
Resource Allocation Type 1	Resource Block Group Size Config 1
Frequency Hopping Disabled	Max Code Block Groups Per Transport Block Disabled
xOverhead	Frequency Hopping Offsets

Transform Precoding.....	164
Max Rank.....	164
TxConfig.....	165
Codebook Subset.....	165
Use PUSCH Scrambling ID.....	165
Data Scrambling ID.....	165
MCS Table.....	165
MCS Table Transform Precoding.....	166
Resource Allocation.....	166
Resource Block Group Size.....	166
Frequency Hopping.....	167
Max Code Block Groups Per Transport Block.....	167
xOverhead.....	167
Frequency Hopping Offsets.....	167
L Number of Offsets.....	168
L Offset Values.....	168
Full Power Transmission.....	168
Use Interlace.....	169

Transform Precoding

Sets the higher layer parameter `transformPrecoder` that defines which access method is used, the optional DFT-s-OFDM or the CP-OFDM.

See also [Chapter 2.3, "Multiple accesses schemes"](#), on page 19.

"On" Enables the precoding operation and thus enables the DFT-s-OFDM. See ["PTRS Config \(Transform Precoding\) ..."](#) on page 178.

"Off" Disables the DFT-s-OFDM precoding operation.

Remote command:

[: SOURCE<hw>] : BB : NR5G : UBWP : USER<us> : CELL<cc> : UL : BWP<bwp> : PUSCh : TPState on page 564

Max Rank

Sets the higher layer parameter `maxRank` that defines the rank of the precoding matrix, as defined in [TS 38.212](#).

Remote command:

[:SOURce<hw>] :BB:NR5G:UBWP:USER<us>:CELL<cc>:UL:BWP<bwp>:PUSCh:MRANk on page 564

TxConfig

Sets the higher layer parameter `txConfig`. It defines if codebook-based or non-codebook-based transmission is used and thus defines how and which precoding matrix is used, as defined in TS 38.212.

Remote command:

[:SOURce<hw>] :BB:NR5G:UBWP:USER<us>:CELL<cc>:UL:BWP<bwp>:PUSCh:TXConfig on page 564

Codebook Subset

If codebook-based transmission ("TxConfig > Codebook") is used, this parameter sets the higher layer parameter `codebookSubset`, as defined in TS 38.212.

"Fully-and-partial-and-non-coherent"

`codebookSubset = fullyAndPartialAndNonCoherent`

"Partial-non-coherent"

`codebookSubset = partialAndNonCoherent`

"Non-coherent" `codebookSubset= nonCoherent`

Remote command:

[:SOURce<hw>] :BB:NR5G:UBWP:USER<us>:CELL<cc>:UL:BWP<bwp>:PUSCh:CBSubset on page 565

Use PUSCH Scrambling ID

Defines the value of the variable n_{ID} used for the initialization of the generator of the PUSCH scrambling sequence.

"Off" $n_{ID} = N_{ID}^{cell}$ (i.e. the physical layer cell identity)

"On" n_{ID} is the values set with the parameter [Data Scrambling ID](#).

Remote command:

[:SOURce<hw>] :BB:NR5G:UBWP:USER<us>:CELL<cc>:UL:BWP<bwp>:PUSCh:SCRambling:STAtE on page 566

Data Scrambling ID

If [Use PUSCH Scrambling ID](#) > "On", sets the identifier `dataScramblingIdentityPDSCH` used to initialize data scrambling (`c_init`) for PUSCH.

Remote command:

[:SOURce<hw>] :BB:NR5G:UBWP:USER<us>:CELL<cc>:UL:BWP<bwp>:PUSCh:DSID on page 566

MCS Table

Sets the MCS table and thus together with the parameter "[MCS Table Transform Pre-coding](#)" on page 166 defines the used modulation scheme.

Remote command:

[:SOURCE<hw>] :BB:NR5G:UBWP:USER<us>:CELL<cc>:UL:BWP<bwp>:PUSCh:MCSTable on page 565

MCS Table Transform Precoding

Together with the selected "MCS Table", this parameter defines the used modulation scheme.

Remote command:

[:SOURCE<hw>] :BB:NR5G:UBWP:USER<us>:CELL<cc>:UL:BWP<bwp>:PUSCh:MTTPrecoding on page 565

Resource Allocation

Sets the PDSCH resource allocation scheme and defines the allocation in the frequency domain.

Type 0 and dynamic switch are not available when [transform precoding](#) is on.

"Type 0", "Type 1"

Selects the downlink resource allocation scheme, according to [TS 38.214](#).

"Dynamic Switch"

- If [PDSCH Scheduling](#) > "Auto/DCI":
UE uses downlink resource allocation type 0 or type 1, as defined by the DCI field "Frequency domain resource assignment".
- If [PDSCH Scheduling](#) > "Manual":
UE uses downlink resource allocation type 0 or type 1, as set with the parameter [Resource Allocation](#).

This parameter defines the **PDSCH** allocation in the frequency domain globally and if you configure the allocations manually.

To configure the PDSCH based on the DCI:

- Set "Node > Scheduling > PDSCH Scheduling = Auto/DCI"
- Enable a DCI format 1_1 ("Scheduling > CORESET > Payload > DCI Format = 1_1") with "Config > Frequency Domain Resource Assignment = 262 143"
Set "Create PDSCH > On"
- Observe the allocation information for PDSCH ("Scheduling > PDSCH > Info > Content > frequency domain allocation")

Remote command:

[:SOURCE<hw>] :BB:NR5G:UBWP:USER<us>:CELL<cc>:DL:BWP<bwp>:PDSCh:RESalloc on page 517

[:SOURCE<hw>] :BB:NR5G:UBWP:USER<us>:CELL<cc>:UL:BWP<bwp>:PUSCh:RESalloc on page 566

Resource Block Group Size

For [Resource Allocation](#) = "Type 0/Dynamic Switch", the resource block assignment is defined in terms of resource block groups (RBG). An RBG is a set of consecutive virtual resource blocks and its size (*rbg-Size*) is defined as function of the BWP size and one of two possible configurations.

This parameter sets which of the two configurations defined in [TS 38.214](#) is used.

Remote command:

[:SOURce<hw>] :BB:NR5G:UBWP:USER<us>:CELL<cc>:DL:BWP<bwp>:PDSCh:RBGSize on page 517

[:SOURce<hw>] :BB:NR5G:UBWP:USER<us>:CELL<cc>:DL:BWP<bwp>:PUSCh:RBGSize on page 566

Frequency Hopping

"Frequency Hopping" disables or enables inter- or intra-slot frequency hopping.

"Disabled" Disable frequency hopping.

"Intra-Slot" Enable intra slot frequency hopping. Both intra- and inter-subframe hopping are performed. The PUSCH position in terms of used resource blocks is changed each slot and each subframe.

"Inter-Slot" Enable inter-slot frequency hopping. The PUSCH position in terms of used resource blocks is changed each subframe.

Remote command:

[:SOURce<hw>] :BB:NR5G:UBWP:USER<us>:CELL<cc>:UL:BWP<bwp>:PUSCh:FHOP on page 567

Max Code Block Groups Per Transport Block

Limits the number of code block groups per transport block.

In 5G NR a huge TB (transport block) is split into multiple code blocks (CB). Multiples CBs are grouped into one code block group (CBG). The number of code blocks grouped into the CBG can be limited by the "Max Code Block Groups Per Transport Block" setting.

Disabled Disabled the limitation of code block groups per transport block.

2, 4, 6, 8 Defines the max number of code block groups per TB.

Remote command:

[:SOURce<hw>] :BB:NR5G:UBWP:USER<us>:CELL<cc>:UL:BWP<bwp>:PUSCh:MCBGroups on page 562

xOverhead

Selects the size of the "xOverhead" parameter defined in 3GPP 38.214, chapter 5.1.3.2. The xOverhead parameter is used in RMCs for IAB-MT and determines the transport block size.

Remote command:

[:SOURce<hw>] :BB:NR5G:UBWP:USER<us>:CELL<cc>:UL:BWP<bwp>:PUSCh:XOVerhead on page 572

Frequency Hopping Offsets

Opens the "Frequency Hopping Offsets" dialog which displays the number of offsets and enables you to change the offset values.

Frequency Hopping Offsets	
Number of Offsets	4
Offset Values	
Offset 0	1
Offset 1	1
Offset 2	1
Offset 3	1

Number of Offsets ← Frequency Hopping Offsets

Displays the number of frequency hopping offsets.

The number of offsets is set automatically to 2 or 4 depending on the size of the active BWP, as follows:

- If the size of the active BWP is fewer than 50 PRBs, one of two higher layer configured offsets is indicated in the UL grant.
- If the size of the active BWP is equal to or greater than 50 PRBs, one of four higher layer configured offsets is indicated in the UL grant.

Remote command:

```
[ :SOURCE<hw> ] :BB:NR5G:UBWP:USER<us>:CELL<cc>:UL:BWP<bwp>:PUSCh:
FHOffsets:NOFFsets on page 567
```

Offset Values ← Frequency Hopping Offsets

Sets the value of the available offsets.

The number of offsets is set automatically to 2 or 4 depending on the size of the active BWP. See [Number of Offsets](#) for more information.

Remote command:

```
[ :SOURCE<hw> ] :BB:NR5G:UBWP:USER<us>:CELL<cc>:UL:BWP<bwp>:PUSCh:
FHOffsets:OFFSet<gr0> on page 567
```

Full Power Transmission

Option: R&S SMM-K148.

For downlink transmission, the parameter controls the bit length of DCI fields. It corresponds to the higher layer parameter `ul-FullPowerTransmission` as defined in 3GPP 38.331.

For uplink transmission that uses [codebook transmission](#), it defines the number of SRS resources and number of antenna ports used by the SRS resources. "Full power mode 2" allows to configure up to four SRS resources. Each SRS resource can use a different antenna ports. All other modes limit the SRS resources to two resources using the same antenna port.

Remote command:

[:SOURCE<hw>] :BB:NR5G:UBWP:USER<us>:CELL<cc>:UL:BWP<bwp>:PUSCh:FPTR on page 570

Use Interlace

Option: R&S SMM-K148.

Shows the state of the higher layer parameter `useInterlacePUCCH-PUSCH` as defined in 3GPP 38.331.

Remote command:

[:SOURCE<hw>] :BB:NR5G:UBWP:USER<us>:CELL<cc>:UL:BWP<bwp>:PUSCh:UITL? on page 570

Control settings

The control settings section of the PUSCH properties contain settings related to DCI configuration.

Available when "Simple Mode" = "Off".

Control	
Minimum Scheduling Offset K2	Harq-ProcessNumberSizeDCI0_1 0 4 Bits
Priority Indicator DCI0_1 <input type="checkbox"/>	Priority Indicator DCI0_2 <input type="checkbox"/>
Invalid Symbol Indicator <input type="checkbox"/>	olpc-ParameterSet Not Configured
p0-PUSCH-SetList	ul-AccessConfigList DCI0_1 0 0
ul-AccessConfigList DCI0_2	Bits for Redundancy Version DCI0_2 0 0
Bits for HARQ DCI 0_2	Antenna Ports Present DCI0_2 <input type="checkbox"/>
	Type 1 Allocation Granularity DCI0_2

Minimum Scheduling Offset K2.....	170
Harq-ProcessNumberSizeDCI0_1.....	170
Priority Indicator DCI0_1 / DCI0_2.....	170
Invalid Symbol Indicator.....	170
olpc-ParameterSet.....	170
p0-PUSCH-SetList.....	171
ul-AccessConfigList DCI0_1.....	171
ul-AccessConfigList DCI0_2.....	171
Bits For Redundancy Version DCI0_2.....	171
Bits For HARQ DCI 0_2.....	171
Antenna Ports Present DCI0_2.....	172

DMRS Sequence Initialization DCI0_2.....	172
Type 1 Allocation Granularity DCI 0_2.....	172
Use 2nd TPC Command.....	172

Minimum Scheduling Offset K2

Option: R&S SMM-K148.

Enables/disables the configuration of the minimum applicable scheduling offset indicator for the DCI format 0_1.

Remote command:

[:SOURce<hw>] :BB:NR5G:UBWP:USER<us>:CELL<cc>:UL:BWP<bwp>:PUSCh:OI01 on page 569

Harq-ProcessNumberSizeDCI0_1

Option: R&S SMM-K171.

Selects the size of the "HARQ Process Number" DCI field in DCI format 0_1.

Remote command:

[:SOURce<hw>] :BB:NR5G:UBWP:USER<us>:CELL<cc>:UL:BWP<bwp>:PUSCh:HP5Bits on page 564

Priority Indicator DCI0_1 / DCI0_2

Option: R&S SMM-K148.

Turns the "Priority Indicator" DCI field in DCI formats 0_1 and 0_2 on and off.

Turn on this parameter if you want to define the bit length of the "Priority Indicator" DCI field.

Corresponds to higher layer parameter `priorityIndicatorDCI-0-1 / priorityIndicatorDCI-0-2` as defined in 3GPP 38.331.

Remote command:

[:SOURce<hw>] :BB:NR5G:UBWP:USER<us>:CELL<cc>:UL:BWP<bwp>:PUSCh:PI01 on page 568

[:SOURce<hw>] :BB:NR5G:UBWP:USER<us>:CELL<cc>:UL:BWP<bwp>:PUSCh:PI02 on page 568

Invalid Symbol Indicator

Option: R&S SMM-K148.

Turns the "Invalid Symbol Pattern Indicator" DCI field in DCI formats 0_1 and 0_2 on and off.

Corresponds to higher layer parameter `invalidSymbolPatternIndicatorDCI-0-1` and `invalidSymbolPatternIndicatorDCI-0-2` as defined in 3GPP 38.331.

Remote command:

[:SOURce<hw>] :BB:NR5G:UBWP:USER<us>:CELL<cc>:UL:BWP<bwp>:PUSCh:ISIN on page 568

olpc-ParameterSet

Option: R&S SMM-K148.

Configures the open-loop power control parameter set indication as defined in 3GPP 38.212.

Corresponds to higher layer parameter `olpc-ParameterSetDCI-0-1` and `olpc-ParameterSetDCI-0-2` as defined in 3GPP 38.331.

Remote command:

```
[ :SOURCE<hw> ] :BB:NR5G:UBWP:USER<us>:CELL<cc>:UL:BWP<bwp>:PUSCh:  
OLPC on page 569
```

p0-PUSCH-SetList

Option: R&S SMM-K148.

Configures the higher layer parameter `p0-PUSCH-SetList` as defined in 3GPP 38.331.

Remote command:

```
[ :SOURCE<hw> ] :BB:NR5G:UBWP:USER<us>:CELL<cc>:UL:BWP<bwp>:PUSCh:  
PPSL on page 569
```

ul-AccessConfigList DCI0_1

Option: R&S SMM-K148.

Configures the higher layer parameter `ul-AccessConfigListDCI0-1` as defined in 3GPP 38.331.

Remote command:

```
[ :SOURCE<hw> ] :BB:NR5G:UBWP:USER<us>:CELL<cc>:UL:BWP<bwp>:PUSCh:  
ACCList on page 560
```

ul-AccessConfigList DCI0_2

Option: R&S SMM-K171.

Configures the higher layer parameter `ul-AccessConfigListDCI0-2` as defined in 3GPP 38.331.

Remote command:

```
[ :SOURCE<hw> ] :BB:NR5G:UBWP:USER<us>:CELL<cc>:UL:BWP<bwp>:PUSCh:  
A02List on page 559
```

Bits For Redundancy Version DCI0_2

Option: R&S SMM-K148.

Defines the bit length of the DCI field "Redundancy Version" available in DCI format 0_2.

Corresponds to higher layer parameter `numberOfBitsForRV-DCI-0-2` as defined in 3GPP 38.331.

Remote command:

```
[ :SOURCE<hw> ] :BB:NR5G:UBWP:USER<us>:CELL<cc>:UL:BWP<bwp>:PUSCh:  
BRV on page 560
```

Bits For HARQ DCI 0_2

Defines the bit length of the DCI field "HARQ Process Number" available in DCI formats 0_2.

Corresponds to higher layer parameter `harq-ProcessNumberSizeDCI-0-2` as defined in 3GPP 38.331.

Remote command:

`[:SOURCE<hw>] :BB:NR5G:UBWP:USER<us>:CELL<cc>:DL:BWP<bwp>:PDSCh:HA12` on page 513

Antenna Ports Present DCI0_2

Turns the "Antenna Ports" DCI field in DCI format 0_2 on and off.

Turn on this parameter if you want to define the bit length of the "Antenna Ports" DCI field.

Corresponds to higher layer parameter `antennaPortsFieldPresenceDCI-0-2` as defined in 3GPP 38.331.

Remote command:

`[:SOURCE<hw>] :BB:NR5G:UBWP:USER<us>:CELL<cc>:UL:BWP<bwp>:PUSCh:APPResent` on page 560

DMRS Sequence Initialization DCI0_2

Turns the "DMRS Sequence Initialization" DCI field in DCI format 0_2 on and off.

Turn on this parameter if you want to define the bit length of the "DMRS Sequence Initialization" DCI field.

Corresponds to higher layer parameter `dmrs-SequenceInitializationDCI-0_2` as defined in 3GPP 38.331.

Remote command:

`[:SOURCE<hw>] :BB:NR5G:UBWP:USER<us>:CELL<cc>:UL:BWP<bwp>:PUSCh:DSINit` on page 563

Type 1 Allocation Granularity DCI 0_2

Option: R&S SMM-K148.

Configures the higher layer parameter `resourceAllocationType1GranularityDCI-0-2` as defined in 3GPP 38.331.

Remote command:

`[:SOURCE<hw>] :BB:NR5G:UBWP:USER<us>:CELL<cc>:UL:BWP<bwp>:PUSCh:T1GRan` on page 569

Use 2nd TPC Command

Turns the "2nd TPC Command for Scheduled PUSCH" DCI field on and off. This DCI field is supported by DCI formats 0_1 and 0_2.

Remote command:

`[:SOURCE<hw>] :BB:NR5G:UBWP:USER<us>:CELL<cc>:UL:BWP<bwp>:PUSCh:U2TPc` on page 572

DMRS settings

The DMRS settings section of the PUSCH properties contain settings related to DMRS.

DMRS for Mapping Type A and Type B	
Same Settings for Type A and Type B	<input checked="" type="checkbox"/>
Config Type	1
Max Length	2
Scrambling ID 0	0
Use R16 DMRS	<input type="checkbox"/>
Additional Position Index	0
NPusch ID	0
Scrambling ID 1	0
PTRS Config ...	

Same Settings for Type A and Type B.....	173
Config Type.....	173
Additional Position Index.....	174
Max Length.....	174
NPusch ID.....	174
Scrambling ID 0/Scrambling ID 1.....	174
Use R16 DMRS.....	175
PTRS Config	175
L State.....	176
L RE-offset.....	176
L Power.....	177
L Max Number of Ports.....	177
L I_MCS_1/I_MCS_2/I_MCS_3.....	177
L N_RB_1/N_RB_2.....	177
PTRS Config (Transform Precoding)	178
L State.....	178
L Time Density.....	179
L Scrambling ID.....	179
L N_RB_x.....	179

Same Settings for Type A and Type B

Enables or disables the possibility to configure DMRS (demodulation reference signal) for mapping type A and B separately or identically. Per default, the same settings are applied for both DMRS mapping types.

Mapping type A and B define the DMRS position in the PUSCH, the starting symbol and length. The UE informs the BS about the mapping type supportability via the UE capability information message.

Remote command:

```
[ :SOURce<hw> ] :BB:NR5G:UBWP:USER<us>:CELL<cc>:UL:BWP<bwp>:PUSCh:DMTA:BSAMe on page 561
```

Config Type

Sets the configuration type (type 1 or type 2). It thus defines the mapping of the demodulation reference signal (DMRS) to the physical resource elements in the frequency domain, as defined in TS 38.211.

The configuration type is carried by the higher-layer parameter `dmrs-Type`.

Remote command:

[:SOURce<hw>] :BB:NR5G:UBWP:USER<us>:CELL<cc>:UL:BWP<bwp>:PUSCh:DMTA:CTYPe on page 561

[:SOURce<hw>] :BB:NR5G:UBWP:USER<us>:CELL<cc>:UL:BWP<bwp>:PUSCh:DMTB:CTYPe on page 561

Additional Position Index

Sets the parameter `dmrs-AdditionalPosition` that is required to select the positions of the DMRS symbols Γ , as defined in TS 38.211.

Remote command:

[:SOURce<hw>] :BB:NR5G:UBWP:USER<us>:CELL<cc>:UL:BWP<bwp>:PUSCh:DMTA:APINdex on page 562

[:SOURce<hw>] :BB:NR5G:UBWP:USER<us>:CELL<cc>:UL:BWP<bwp>:PUSCh:DMTB:APINdex on page 562

Max Length

Sets the parameter `maxLength` and defines whether single- or double-symbol DMRS is used.

If "Max Length = 1", only single-symbol DMRS is allowed.

Remote command:

[:SOURce<hw>] :BB:NR5G:UBWP:USER<us>:CELL<cc>:UL:BWP<bwp>:PUSCh:DMTA:MLENgtH on page 561

[:SOURce<hw>] :BB:NR5G:UBWP:USER<us>:CELL<cc>:UL:BWP<bwp>:PUSCh:DMTB:MLENgtH on page 561

NPusch ID

Sets the PUSCH ID value used for DMRS sequence generation.

Enabled if "Transform Precoding > On".

Remote command:

[:SOURce<hw>] :BB:NR5G:UBWP:USER<us>:CELL<cc>:UL:BWP<bwp>:PUSCh:DMTA:PUID on page 562

[:SOURce<hw>] :BB:NR5G:UBWP:USER<us>:CELL<cc>:UL:BWP<bwp>:PUSCh:DMTB:PUID on page 562

Scrambling ID 0/Scrambling ID 1

Sets the higher-layer parameters `scramblingID0` and `scramblingID1` (N_{ID}^0, N_{ID}^1).

The values are used to calculate the initialization sequence of the pseudo-random sequence generator.

Remote command:

[:SOURce<hw>] :BB:NR5G:UBWP:USER<us>:CELL<cc>:UL:BWP<bwp>:PUSCh:DMTA:SID0 on page 562

[:SOURce<hw>] :BB:NR5G:UBWP:USER<us>:CELL<cc>:UL:BWP<bwp>:PUSCh:DMTA:SID1 on page 562

[:SOURce<hw>] :BB:NR5G:UBWP:USER<us>:CELL<cc>:UL:BWP<bwp>:PUSCh :
DMTB:SID0 on page 562

[:SOURce<hw>] :BB:NR5G:UBWP:USER<us>:CELL<cc>:UL:BWP<bwp>:PUSCh :
DMTB:SID1 on page 562

Use R16 DMRS

Option: R&S SMM-K148.

Turns the higher layer parameter "dmrs-uplink-r16" on and off.

This parameter reduces the peak-to-average power ratio (PAPR) of the PUSCH DMRS as defined 3GPP, release 16. Using the low PAPR also results in a different calculation of the DMRS sequence.

Remote command:

[:SOURce<hw>] :BB:NR5G:UBWP:USER<us>:CELL<cc>:UL:BWP<bwp>:PUSCh :
DMTA:UR16 on page 563

[:SOURce<hw>] :BB:NR5G:UBWP:USER<us>:CELL<cc>:UL:BWP<bwp>:PUSCh :
DMTB:UR16 on page 563

PTRS Config ...

Enabled if [Transform Precoding](#).

Comprises the settings of the phase-tracking reference signals (PTRS) for PUSCH, as defined in TS 38.214.

5G New Radio A: PTRS Settings - Mapping Type A (U0/C0/B0)	
State	0
RE-offset	00
Power	00
Max Number of Ports	1
Threshold Time Density	
I_MCS_1	0
I_MCS_2	0
I_MCS_3	0
Threshold Frequency Density	
N_RB_0	1
N_RB_1	276

The phase tracking reference signal (PTRS) is a UE-specific reference signal that is used to compensate for the phase noise of the oscillator. Phase-tracking reference signals can be transmitted only in the resource blocks used for the P_xSCH and if the transmission is enabled.

If the PTRS "State" is on, you can define its "Power" relative to the P_xSCH and its location in the resource grid.

State ← PTRS Config ...

If [DSCH/USCH Channel Coding](#) > "On", enables the transmission of phase-tracking reference signals.

Remote command:

```
[ :SOURce<hw> ] :BB:NR5G:UBWP:USER<us>:CELL<cc>:UL:BWP<bwp>:PUSCh:DMTA:PTRS:STATe on page 524
```

```
[ :SOURce<hw> ] :BB:NR5G:UBWP:USER<us>:CELL<cc>:UL:BWP<bwp>:PUSCh:DMTB:PTRS:STATe on page 524
```

RE-offset ← PTRS Config ...

Sets the parameter `resourceElementOffset` $k_{\text{ref}}^{\text{RE}}$ required to define the precoding and mapping to the physical resources.

Remote command:

```
[ :SOURce<hw> ] :BB:NR5G:UBWP:USER<us>:CELL<cc>:UL:BWP<bwp>:PUSCh:
DMTA:PTRS:REOF on page 525
```

```
[ :SOURce<hw> ] :BB:NR5G:UBWP:USER<us>:CELL<cc>:UL:BWP<bwp>:PUSCh:
DMTB:PTRS:REOF on page 525
```

Power ← PTRS Config ...

Sets the parameter `ptrs-Power` and thus defines the PUSCH to PTRS power ratio per layer per resource element.

Remote command:

```
[ :SOURce<hw> ] :BB:NR5G:UBWP:USER<us>:CELL<cc>:UL:BWP<bwp>:PUSCh:
DMTA:PTRS:POWer on page 525
```

```
[ :SOURce<hw> ] :BB:NR5G:UBWP:USER<us>:CELL<cc>:UL:BWP<bwp>:PUSCh:
DMTB:PTRS:POWer on page 525
```

Max Number of Ports ← PTRS Config ...

Sets the maximum number of configured PTRS ports, given by the higher-level parameter `maxNrofPorts`.

Remote command:

```
[ :SOURce<hw> ] :BB:NR5G:UBWP:USER<us>:CELL<cc>:UL:BWP<bwp>:PUSCh:
DMTA:PTRS:PORT on page 526
```

```
[ :SOURce<hw> ] :BB:NR5G:UBWP:USER<us>:CELL<cc>:UL:BWP<bwp>:PUSCh:
DMTB:PTRS:PORT on page 526
```

I_MCS_1/I_MCS_2/I_MCS_3 ← PTRS Config ...

Sets the threshold values `ptrs-MCSl` with $l = \{1, 2, 3\}$ transmitted by the higher-layer parameter `timeDensity` in `PTRS-DownlinkConfig`.

Remote command:

```
[ :SOURce<hw> ] :BB:NR5G:UBWP:USER<us>:CELL<cc>:UL:BWP<bwp>:PUSCh:
DMTA:PTRS:MCS1 on page 526
```

```
[ :SOURce<hw> ] :BB:NR5G:UBWP:USER<us>:CELL<cc>:UL:BWP<bwp>:PUSCh:
DMTA:PTRS:MCS2 on page 526
```

```
[ :SOURce<hw> ] :BB:NR5G:UBWP:USER<us>:CELL<cc>:UL:BWP<bwp>:PUSCh:
DMTA:PTRS:MCS3 on page 526
```

```
[ :SOURce<hw> ] :BB:NR5G:UBWP:USER<us>:CELL<cc>:UL:BWP<bwp>:PUSCh:
DMTB:PTRS:MCS1 on page 526
```

```
[ :SOURce<hw> ] :BB:NR5G:UBWP:USER<us>:CELL<cc>:UL:BWP<bwp>:PUSCh:
DMTB:PTRS:MCS2 on page 526
```

```
[ :SOURce<hw> ] :BB:NR5G:UBWP:USER<us>:CELL<cc>:UL:BWP<bwp>:PUSCh:
DMTB:PTRS:MCS3 on page 526
```

N_RB_1/N_RB_2 ← PTRS Config ...

Sets the threshold values `NRBl` with $l = \{0, 1\}$ transmitted by the higher-layer parameter `frequencyDensity` in `PTRS-DownlinkConfig`.

Remote command:

[:SOURce<hw>] :BB:NR5G:UBWP:USER<us>:CELL<cc>:UL:BWP<bwp>:PUSCh:DMTA:PTRS:RB0 on page 527

[:SOURce<hw>] :BB:NR5G:UBWP:USER<us>:CELL<cc>:UL:BWP<bwp>:PUSCh:DMTA:PTRS:RB1 on page 527

[:SOURce<hw>] :BB:NR5G:UBWP:USER<us>:CELL<cc>:UL:BWP<bwp>:PUSCh:DMTB:PTRS:RB0 on page 527

[:SOURce<hw>] :BB:NR5G:UBWP:USER<us>:CELL<cc>:UL:BWP<bwp>:PUSCh:DMTB:PTRS:RB1 on page 527

PTRS Config (Transform Precoding) ...

Enabled if [Transform Precoding](#) > "On" and [Link Direction](#) > "Uplink".

Comprises the settings of the phase-tracking reference signals (PTRS) for PUSCH incl. transform precoding (TP), as defined in [TS 38.214](#).

Sample Density	
N_RB_0	1
N_RB_1	276
N_RB_2	276
N_RB_3	276
N_RB_4	276

State ← PTRS Config (Transform Precoding) ...

Simulates the transmission of the higher-layer parameter `transformPrecoderEnabled`.

Remote command:

[:SOURce<hw>] :BB:NR5G:UBWP:USER<us>:CELL<cc>:UL:BWP<bwp>:PUSCh :
DMTA:PTRS:TP:STATe on page 570

[:SOURce<hw>] :BB:NR5G:UBWP:USER<us>:CELL<cc>:UL:BWP<bwp>:PUSCh :
DMTB:PTRS:TP:STATe on page 570

Time Density ← PTRS Config (Transform Precoding) ...

Per default, an UE is configured with time density $L_{PTRS} = 1$.

Set the value of this parameter to 2 to simulated an UE configured by the higher-layer parameter `timeDensityTransformPrecoding`.

Remote command:

[:SOURce<hw>] :BB:NR5G:UBWP:USER<us>:CELL<cc>:UL:BWP<bwp>:PUSCh :
DMTA:PTRS:TP:TMDensity on page 571

[:SOURce<hw>] :BB:NR5G:UBWP:USER<us>:CELL<cc>:UL:BWP<bwp>:PUSCh :
DMTB:PTRS:TP:TMDensity on page 571

Scrambling ID ← PTRS Config (Transform Precoding) ...

Sets whether the PTRS Scrambling ID value used for PTRS sequence generation is configured by the **NPusch ID** (higher layer) or by the cell ID.

N_ID^Cell Sets the cell ID as the scrambling ID for PTRS sequence generation.

N_ID^PUSCH Sets the **NPusch ID** as the scrambling ID for PTRS sequence generation.

Remote command:

[:SOURce<hw>] :BB:NR5G:UBWP:USER<us>:CELL<cc>:UL:BWP<bwp>:PUSCh :
DMTA:PTRS:TP:SCID on page 571

[:SOURce<hw>] :BB:NR5G:UBWP:USER<us>:CELL<cc>:UL:BWP<bwp>:PUSCh :
DMTB:PTRS:TP:SCID on page 571

N_RB_x ← PTRS Config (Transform Precoding) ...

Sets the higher-layer parameter `sampleDensity` that indicates the sample density thresholds $N_{RB,i}$.

Remote command:

[:SOURce<hw>] :BB:NR5G:UBWP:USER<us>:CELL<cc>:UL:BWP<bwp>:PUSCh :
DMTA:PTRS:TP:RB0 on page 571

[:SOURce<hw>] :BB:NR5G:UBWP:USER<us>:CELL<cc>:UL:BWP<bwp>:PUSCh :
DMTA:PTRS:TP:RB1 on page 571

[:SOURce<hw>] :BB:NR5G:UBWP:USER<us>:CELL<cc>:UL:BWP<bwp>:PUSCh :
DMTA:PTRS:TP:RB2 on page 571

[:SOURce<hw>] :BB:NR5G:UBWP:USER<us>:CELL<cc>:UL:BWP<bwp>:PUSCh :
DMTA:PTRS:TP:RB3 on page 571

[:SOURce<hw>] :BB:NR5G:UBWP:USER<us>:CELL<cc>:UL:BWP<bwp>:PUSCh :
DMTA:PTRS:TP:RB4 on page 571

[:SOURce<hw>] :BB:NR5G:UBWP:USER<us>:CELL<cc>:UL:BWP<bwp>:PUSCh :
DMTB:PTRS:TP:RB0 on page 571

[:SOURce<hw>] :BB:NR5G:UBWP:USER<us>:CELL<cc>:UL:BWP<bwp>:PUSCh :
DMTB:PTRS:TP:RB1 on page 572

[:SOURce<hw>] :BB:NR5G:UBWP:USER<us>:CELL<cc>:UL:BWP<bwp>:PUSCh:DMTB:PTRS:TP:RB2 on page 572

[:SOURce<hw>] :BB:NR5G:UBWP:USER<us>:CELL<cc>:UL:BWP<bwp>:PUSCh:DMTB:PTRS:TP:RB3 on page 572

[:SOURce<hw>] :BB:NR5G:UBWP:USER<us>:CELL<cc>:UL:BWP<bwp>:PUSCh:DMTB:PTRS:TP:RB4 on page 572

Time domain allocation

The time domain allocation list section of the PUSCH properties contain settings related to PUSCH time domain scheduling.

Available when "Simple Mode" = "Off".

Time Domain Allocation List	
Time Domain Allocations DCI0_1	Time Domain Allocations DCI0_2
0	0
Time Domain Allocations Multi-PUSCH	Multi-PUSCH Length
0	1

Time Domain Allocations DCI0_1.....	180
Time Domain Allocations DCI0_2.....	180
Time Domain Allocations Multi-PUSCH.....	180
Multi-PUSCH Length.....	180

Time Domain Allocations DCI0_1

Sets the number of time domain allocations used to calculate the bitwidth of the "Time Domain Resource Assignment" for the UL DCI format 0_1 as specified in TS 38.214.

Remote command:

[:SOURce<hw>] :BB:NR5G:UBWP:USER<us>:CELL<cc>:UL:BWP<bwp>:PDSCh:TDANum on page 572

Time Domain Allocations DCI0_2

Sets the number of time domain allocations used to calculate the bitwidth of the "Time Domain Resource Assignment" for the UL DCI format 0_2 as specified in TS 38.214.

Remote command:

[:SOURce<hw>] :BB:NR5G:UBWP:USER<us>:CELL<cc>:UL:BWP<bwp>:PDSCh:DC02:TDANum on page 573

Time Domain Allocations Multi-PUSCH

Defines the number of entries in the higher layer parameter `pusch-TimeDomainAllocationListForMultiPUSCH` (number of schedulable PUSCH) as defined in 3GPP 38.212.

Remote command:

[:SOURce<hw>] :BB:NR5G:UBWP:USER<us>:CELL<cc>:UL:BWP<bwp>:PDSCh:MULTi:TDANum on page 573

Multi-PUSCH Length

Defines the maximum number of schedulable PUSCH among all entries in the higher layer parameter `pusch-TimeDomainAllocationListForMultiPUSCH`.

The multi-PUSCH length has effects on the length of various DCI fields.

Remote command:

[:SOURce<hw>] :BB:NR5G:UBWP:USER<us>:CELL<cc>:UL:BWP<bwp>:PDSCh:
MULTi:PLEN on page 573

5.3.7.5 PUSCH UCI settings

Access:

- ▶ Select "User/BWP Settings > UL BWP Config > PUSCH UCI".

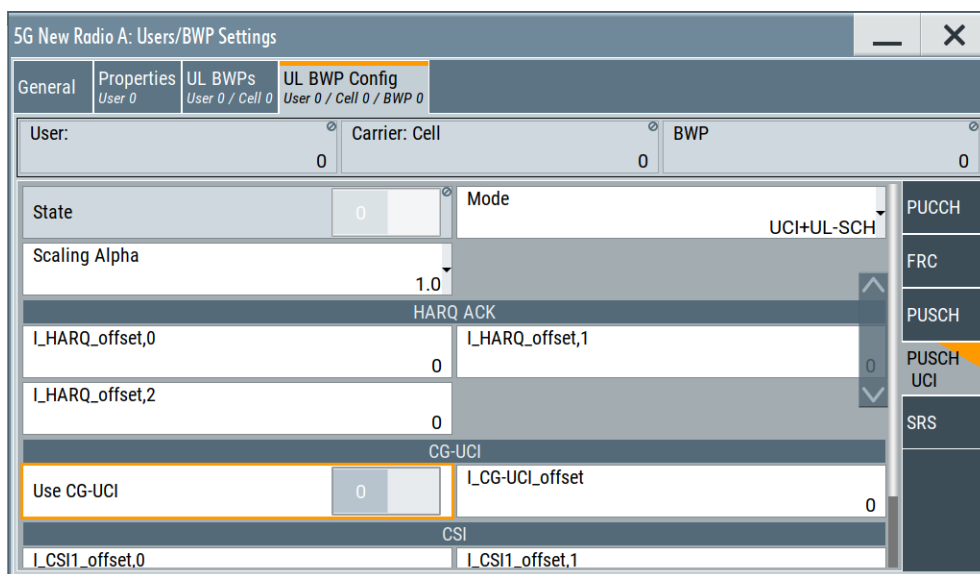

Here you can define the PUSCH uplink control information (UCI) parameters, such as the settings of the uplink shared channel (UL-SCH), HARQ control information, and the channel state information (CSI).

State.....	181
Mode.....	181
Scaling Alpha.....	182
I_HARQ_Offset,x.....	182
Use CG-UCI.....	182
I_CG-UCI_Offset.....	182
I_CSI1_Offset,x, I_CSI2_Offset,x.....	183

State

Enables the transmission and the configuration of the uplink control information (UCI).

Remote command:

[:SOURce<hw>] :BB:NR5G:UBWP:USER<us>:CELL<cc>:UL:BWP<bwp>:UCI:
STATe on page 574

Mode

Defines the information transmitted on the PUSCH.

"UCI+UL-SCH" Control information and data are multiplexed into the PUSCH.

"UCI only" Only uplink control information is transmitted on PUSCH.

Remote command:

[:SOURce<hw>] :BB:NR5G:UBWP:USER<us>:CELL<cc>:UL:BWP<bwp>:UCI:MODE on page 574

Scaling Alpha

Sets the higher-layer parameter `scaling`. It defines the value of the parameter α required for the calculation of the number of coded modulation symbols per layer for HARQ-ACK and CSI transmissions.

Remote command:

[:SOURce<hw>] :BB:NR5G:UBWP:USER<us>:CELL<cc>:UL:BWP<bwp>:UCI:ALPHa on page 575

I_HARQ_Offset,x

According to TS 38.213, the number of resources for multiplexing the HARQ-ACK information in a PUSCH is defined by the information offsets $\beta^{\text{HARQ-ACK}}_{\text{offset}}$.

The information offsets are defined by the indexes $I^{\text{HARQ-ACK}}_{\text{offset},x}$, where :

- $x = 0, 1, 2$ and
- $I^{\text{HARQ-ACK}}_{\text{offset},0}$ is used if up to 2 HARQ-ACK information bits are multiplexed
- $I^{\text{HARQ-ACK}}_{\text{offset},1}$ is used for multiplexing of 2 to 11 HARQ-ACK information bits
- $I^{\text{HARQ-ACK}}_{\text{offset},2}$ is used if more than 11 HARQ-ACK information bits are multiplexed

Remote command:

[:SOURce<hw>] :BB:NR5G:UBWP:USER<us>:CELL<cc>:UL:BWP<bwp>:UCI:HARQ:OFF0 on page 575

[:SOURce<hw>] :BB:NR5G:UBWP:USER<us>:CELL<cc>:UL:BWP<bwp>:UCI:HARQ:OFF1 on page 575

[:SOURce<hw>] :BB:NR5G:UBWP:USER<us>:CELL<cc>:UL:BWP<bwp>:UCI:HARQ:OFF2 on page 575

Use CG-UCI

Option: R&S SMM-K148.

Turns transmission of configured grant uplink control information (CG-UCI) in the PUSCH on and off. The CG-UCI is defined in 3GPP release 16.

Remote command:

[:SOURce<hw>] :BB:NR5G:UBWP:USER<us>:CELL<cc>:UL:BWP<bwp>:UCI:CGUCi:STATE on page 575

I_CG-UCI_Offset

Defines an offset for the CG-UCI according to 3GPP TS 38.213, table 9.1.3. The offset is a value in terms of resource elements within the resource elements used by PUSCH.

Remote command:

[:SOURce<hw>] :BB:NR5G:UBWP:USER<us>:CELL<cc>:UL:BWP<bwp>:UCI:CGUCi:OFFSet on page 575

I_CSI1_Offset,x, I_CSI2_Offset,x

According to [TS 38.213](#), the number of resources for multiplexing the CSI information in a PUSCH is defined by the CSI part 1 and CSI part 2 information offsets $\beta^{\text{CSI-1}}_{\text{offset}}$ and $\beta^{\text{CSI-2}}_{\text{offset}}$.

The information offsets are defined by the indexes $I^{\text{CSI-1}}_{\text{offset},x}$ and $I^{\text{CSI-2}}_{\text{offset},x}$, where :

- $x = 0, 1$ and
- $I^{\text{CSI-1}}_{\text{offset},0}$ and $I^{\text{CSI-2}}_{\text{offset},0}$ is used if up to 11 CSI bits are multiplexed
- $I^{\text{CSI-1}}_{\text{offset},1}$ and $I^{\text{CSI-2}}_{\text{offset},2}$ is used for more than 11 CSI bits

Remote command:

[\[:SOURCE<hw>\]:BB:NR5G:UBWP:USER<us>:CELL<cc>:UL:BWP<bwp>:UCI:CSI:OF10](#) on page 576

[\[:SOURCE<hw>\]:BB:NR5G:UBWP:USER<us>:CELL<cc>:UL:BWP<bwp>:UCI:CSI:OF11](#) on page 576

[\[:SOURCE<hw>\]:BB:NR5G:UBWP:USER<us>:CELL<cc>:UL:BWP<bwp>:UCI:CSI:OF20](#) on page 576

[\[:SOURCE<hw>\]:BB:NR5G:UBWP:USER<us>:CELL<cc>:UL:BWP<bwp>:UCI:CSI:OF21](#) on page 576

5.3.7.6 SRS settings

Access:

1. Select "User/BWP Settings > UL BWP Config > SRS".
2. Select "User/BWP Settings > UL BWP Config > SRS > Resource Set = 1".
3. Select "Resource > Config".
4. To observe the SRS allocations on the time plan, proceed as follows:
 - a) Select "5G NR > General > Link Direction > Uplink".
 - b) Select "Scheduling > PUSCH > State > Off".

c) Select "General > Time Plan".

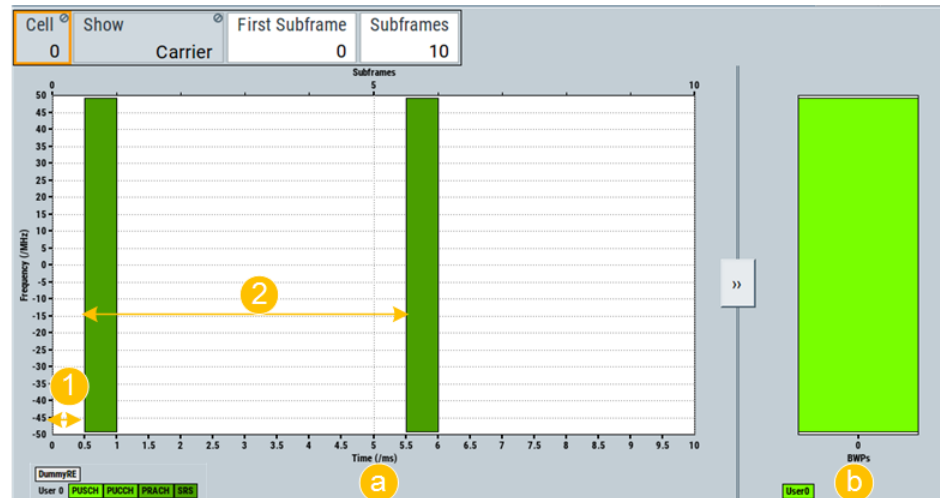

Figure 5-5: SRS representation on the Time Plan

a = SRS (PUSCH transmission is disabled)

b = Bandwidth part (273 RBs)

1 = Offset = 1 slot

2 = Periodicity = 10 slots

The sounding reference signal (SRS) is an UL reference signal transmitted by the UE. The BS uses the received SRS to estimate the UL channel quality for the particular user.

The SRS structure is defined in [TS 38.211](#), [TS 38.214](#) and [TS 38.331](#).

SRS structure

The SRS 5G NR structure is similar to the SRS structure used in LTE. In 5G NR, SRS is transmitted within the BWP, based on a flexible scheduling and using only portions of the overall channel bandwidth. Among other, the SRS supports the frequency hopping and transmission comb techniques known from LTE.

In the **time domain**, the SRS resource is defined as:

- 1, 2 or 4 consecutive OFDM symbols (**No. Sym.** $N_{\text{sym}}^{\text{SRS}}$)
- A starting position **Start Pos.** l_0 (i.e. the starting OFDM symbol), calculated as follows:

$$l_0 = N_{\text{sym}}^{\text{slot}} - 1 - l_{\text{offset}}$$

Where $l_{\text{offset}} = \{0 \text{ to } 5\}$ is an offset relative to the end of a slot.

In the **frequency domain**, its **starting position** is defined by the parameter k_0 and the density indication is given by the parameter **frequency shift**.

The SRS can be mapped to 1, 2 or 4 antenna ports (**No. Ports** $N_{\text{ap}}^{\text{SRS}}$) and its transmit **Power** is controlled, too.

Settings

- [General settings](#)..... 185
- [Control settings](#)..... 186
- [SRS configuration table](#)..... 186

General settings

The general settings section of the SRS properties contain settings to configure general properties of the selected user.

State	<input type="checkbox"/>	Configured By	SRS IE
Resource Sets	1		

- [State](#)..... 185
- [Configured By](#)..... 185
- [Resource Sets](#)..... 185

State

Enables the SRS transmission.

Use this function to suppress the SRS indication on the "Time Plan".

Remote command:

[:SOURce<hw>] :BB:NR5G:UBWP:USER<us>:CELL<cc>:UL:BWP<bwp>:SRS:STATE on page 577

Configured By

Option: R&S SMM-K148 and -K171

Selects the 3GPP release the SRS is based on.

As of 3GPP release 16, the SRS also can also be used for positioning purposes. Select "SRS Pos R16 IE" to generate signals in which the SRS carries positioning information.

Note that the value ranges for several SRS resources depend on which 3GPP release the SRS is based on.

Remote command:

[:SOURce<hw>] :BB:NR5G:UBWP:USER<us>:CELL<cc>:UL:BWP<bwp>:SRS:CONFIg on page 578

Resource Sets

Sets the number of SRS sets and thus defines the number of table rows in SRS resource set table.

Remote command:

[:SOURce<hw>] :BB:NR5G:UBWP:USER<us>:CELL<cc>:UL:BWP<bwp>:SRS:RS:NRSets on page 578

Control settings

The control settings section of the SRS properties contain settings related to DCI configuration.

Available when "Simple Mode" = "Off".

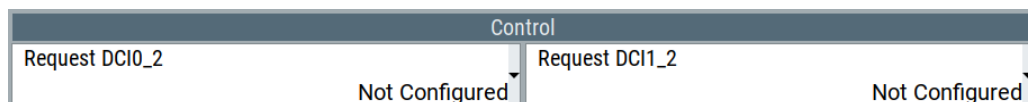

Request DCI0_2..... 186
 Request DCI1_2..... 186

Request DCI0_2

Configures the higher layer parameter `srs-RequestDCI0-2` available for DCI format 0_2 (number of bits of "SRS Request" DCI field).

Remote command:

```
[ :SOURCE<hw> ] :BB:NR5G:UBWP:USER<us>:CELL<cc>:UL:BWP<bwp>:SRS:RE02 on page 578
```

Request DCI1_2

Configures the higher layer parameter `srs-RequestDCI0-2` available for DCI format 1_2 (number of bits of "SRS Request" DCI field).

Remote command:

```
[ :SOURCE<hw> ] :BB:NR5G:UBWP:USER<us>:CELL<cc>:UL:BWP<bwp>:SRS:REQuest on page 579
```

SRS configuration table

The SRS table section of the SRS properties contain settings related to the SRS resource sets. The number of table rows depends on the number of resource sets.

	Resource Type	Usage	Resource
0	Periodic	Non-codebook	Config...

Resource Type..... 187
 Usage..... 187
 Resource > Config..... 187

- L Resources..... 187
- L Periodicity..... 188
- L Offset..... 188
- L Start Pos..... 188
- L No. Sym..... 188
- L Freq. Pos..... 188
- L Freq. Shift..... 188
- L B SRS..... 189
- L C SRS..... 189
- L B Hop..... 189
- L Rep. Factor..... 189

L Trans. Comb.....	189
L Comb Offset.....	189
L Sequence Settings > Config.....	189
L Cyclic Shift.....	190
L Sequence ID.....	190
L Group or Sequence Hopping.....	190
L Frequency Scaling Factor.....	190
L Start RB Index.....	190
L No. Ports.....	191
L PTRS Port Idx.....	191
L Power.....	191
L Antenna Ports > Config.....	191
L Mapping Coordinates.....	191
L Mapping table.....	192

Resource Type

Indicates that periodic SRS transmission is configured.

Periodic SRS means that the SRS occurs at regular time interval. "Aperiodic" and "Semi-Persistent" SRS will be supported in a future firmware version.

Remote command:

```
[ :SOURCE<hw> ] :BB:NR5G:UBWP:USER<us>:CELL<cc>:UL:BWP<bwp>:SRS:RS:SET<gr0>:RSType on page 580
```

Usage

Indicates whether a codebook based or a non-codebook based transmission is used.

The value is set automatically and resembles the transmission method selected for PUSCH, see "UL BWP Config > PUSCH" > [TxConfig](#).

Remote command:

```
[ :SOURCE<hw> ] :BB:NR5G:UBWP:USER<us>:CELL<cc>:UL:BWP<bwp>:SRS:RS:SET<gr0>:USAGe on page 580
```

Resource > Config

Opens a dialog where you configure the SRS resources for the selected SRS resource set.

Resources ← Resource > Config

Sets the number of SRS resources in the SRS resource set.

Each SRS resource is configured in an individual row in the SRS resource table.

The maximum number of SRS resources depends on whether [TxConfig](#) = "Codebook" or not.

Remote command:

```
[ :SOURCE<hw> ] :BB:NR5G:UBWP:USER<us>:CELL<cc>:UL:BWP<bwp>:SRS:RS:SET<gr0>:NRESources on page 580
```

Periodicity ← Resource > Config

If **Usage** = "Periodic", sets the SRS repetition factor T_{SRS} . The periodicity is a time interval defined as number of slots that indicates how often (i.e. after how many slots) the SRS is transmitted.

As smaller the periodicity value as frequent is the SRS transmission. To enable the SRS for example in each slot, set "Periodicity = 1 slot".

Remote command:

```
[ :SOURCE<hw> ] :BB:NR5G:UBWP:USER<us>:CELL<cc>:UL:BWP<bwp>:SRS:RS:SET<gr0>:RES<user0>:PER on page 581
```

Offset ← Resource > Config

If **Usage** = "Periodic" and **Periodicity** \geq "2 slots", sets time position of first SRS allocation within an SRS periodicity, given as an offset in number of slots (T_{offset}) from the start of the frame.

Logically, the maximum offset value is calculated as SRS **Periodicity** - 1.

Remote command:

```
[ :SOURCE<hw> ] :BB:NR5G:UBWP:USER<us>:CELL<cc>:UL:BWP<bwp>:SRS:RS:SET<gr0>:RES<user0>:OFFSet on page 581
```

Start Pos. ← Resource > Config

Sets the starting position of the SRS allocation l_0 within a slot. The value gives the OFDM symbol number counted backwards from the end of a slot, see "SRS structure" on page 184.

Remote command:

```
[ :SOURCE<hw> ] :BB:NR5G:UBWP:USER<us>:CELL<cc>:UL:BWP<bwp>:SRS:RS:SET<gr0>:RES<user0>:SPOS on page 581
```

No. Sym. ← Resource > Config

Sets the number of consecutive OFDM symbols ($N_{\text{symb}}^{\text{SRS}}$) the SRS resource spans.

Remote command:

```
[ :SOURCE<hw> ] :BB:NR5G:UBWP:USER<us>:CELL<cc>:UL:BWP<bwp>:SRS:RS:SET<gr0>:RES<user0>:SYMNumber on page 581
```

Freq. Pos. ← Resource > Config

Sets the parameter k_0 that defines the starting position of the SRS allocation in the frequency domain.

Remote command:

```
[ :SOURCE<hw> ] :BB:NR5G:UBWP:USER<us>:CELL<cc>:UL:BWP<bwp>:SRS:RS:SET<gr0>:RES<user0>:FPOS on page 582
```

Freq. Shift ← Resource > Config

The frequency shift n_{shift} influence the SRS transmission density in the frequency domain.

Remote command:

```
[ :SOURCE<hw> ] :BB:NR5G:UBWP:USER<us>:CELL<cc>:UL:BWP<bwp>:SRS:RS:SET<gr0>:RES<user0>:FQSHift on page 582
```

B SRS ← Resource > Config

Sets the filed b-SRS contained in the higher-layer parameter `freqHopping` and used to define the length of the SRS sequence, see TS 38.211, Table 6.4.1.4.3-1.

Remote command:

```
[ :SOURCE<hw> ] :BB:NR5G:UBWP:USER<us>:CELL<cc>:UL:BWP<bwp>:SRS:RS:SET<gr0>:RES<user0>:BSRS on page 582
```

C SRS ← Resource > Config

Sets the filed c-SRS contained in the higher-layer parameter `freqHopping` and used to define the length of the SRS sequence, see TS 38.211, Table 6.4.1.4.3-1.

Remote command:

```
[ :SOURCE<hw> ] :BB:NR5G:UBWP:USER<us>:CELL<cc>:UL:BWP<bwp>:SRS:RS:SET<gr0>:RES<user0>:CSRS on page 583
```

B Hop ← Resource > Config

Sets the parameter b_{Hop} that defines the frequency hopping of the SRS.

Set "B Hop" > "B SRS" to disable frequency hopping ("Rep. Factor" = 1).

Remote command:

```
[ :SOURCE<hw> ] :BB:NR5G:UBWP:USER<us>:CELL<cc>:UL:BWP<bwp>:SRS:RS:SET<gr0>:RES<user0>:BHOP on page 583
```

Rep. Factor ← Resource > Config

If **B Hop** < **B SRS**, defines how many times the SRS symbols are repeated.

Remote command:

```
[ :SOURCE<hw> ] :BB:NR5G:UBWP:USER<us>:CELL<cc>:UL:BWP<bwp>:SRS:RS:SET<gr0>:RES<user0>:REFactor on page 583
```

Trans. Comb ← Resource > Config

Transmission comb (k_{TC}) is a method for interleaving SRS symbols by using alternating subcarriers (only the even or odd subcarriers).

The value of k_{TC} defines the maximum number of cyclic shifts $n_{\text{SRS}}^{\text{CS}}$ (**Cyclic Shift**).

Remote command:

```
[ :SOURCE<hw> ] :BB:NR5G:UBWP:USER<us>:CELL<cc>:UL:BWP<bwp>:SRS:RS:SET<gr0>:RES<user0>:TRTCComb on page 583
```

Comb Offset ← Resource > Config

Sets the parameter transmission comb offset.

Remote command:

```
[ :SOURCE<hw> ] :BB:NR5G:UBWP:USER<us>:CELL<cc>:UL:BWP<bwp>:SRS:RS:SET<gr0>:RES<user0>:COFFset on page 584
```

Sequence Settings > Config ← Resource > Config

Access: "User/BWP Settings > UL BWP Config > SRS > Resource Set = 1", "Resource > Config" and select "Sequence > Config".

5G New Radio A (U0/C0/B0/RS0/R0) SRS Sequence Settings	
Cyclic Shift	1
Sequence ID	0
Group or Sequence Hopping	Neither

Cyclic Shift ← Sequence Settings > Config ← Resource > Config

Sets the number of cyclic shifts $n_{\text{SRS}}^{\text{CS}}$, required for the SRS sequence generation according to TS 38.211.

Remote command:

```
[ :SOURCE<hw> ] :BB:NR5G:UBWP:USER<us>:CELL<cc>:UL:BWP<bwp>:SRS:RS:SET<gr0>:RES<user0>:SEQ:CYCShift on page 584
```

Sequence ID ← Sequence Settings > Config ← Resource > Config

Sets the higher-layer parameter `sequenceId` ($n_{\text{ID}}^{\text{SRS}}$), required for the SRS sequence generation according to TS 38.211.

Remote command:

```
[ :SOURCE<hw> ] :BB:NR5G:UBWP:USER<us>:CELL<cc>:UL:BWP<bwp>:SRS:RS:SET<gr0>:RES<user0>:SEQ:ID on page 584
```

Group or Sequence Hopping ← Sequence Settings > Config ← Resource > Config

Sets the higher-layer parameter `groupOrSequenceHopping` that defines the sequence group, required for the SRS sequence generation according to TS 38.211.

Remote command:

```
[ :SOURCE<hw> ] :BB:NR5G:UBWP:USER<us>:CELL<cc>:UL:BWP<bwp>:SRS:RS:SET<gr0>:RES<user0>:SEQ:HOPping on page 585
```

Frequency Scaling Factor ← Sequence Settings > Config ← Resource > Config

Option: R&S SMM-K171

Selects the frequency scaling factor defined in 3GPP 38.211, chapter 6.4.1.4.3.

Remote command:

```
[ :SOURCE<hw> ] :BB:NR5G:UBWP:USER<us>:CELL<cc>:UL:BWP<bwp>:SRS:RS:SET<gr0>:RES<user0>:FS:FSFactor on page 579
```

Start RB Index ← Sequence Settings > Config ← Resource > Config

Option: R&S SMM-K171

Defines the start RB index defined in 3GPP 38.331. The parameter is defined through the RRC parameter `startRbIndexAndFreqScalingFactor`.

Values depend on the frequency scaling factor: possible values = scaling factor - 1.

Available if the frequency scaling factor > 1.

Remote command:

```
[ :SOURce<hw> ] :BB:NR5G:UBWP:USER<us>:CELL<cc>:UL:BWP<bwp>:SRS:RS:SET<gr0>:RES<user0>:FS:SRIDx on page 579
```

No. Ports ← Resource > Config

If **TxConfig** = "Codebook", sets how many antenna ports (AP) are used for every SRS transmission. The same number of antenna ports is used for all SRS resources.

If "Non-Codebook" transmission is used, the value of the parameter "No. Ports" is set automatically.

Remote command:

```
[ :SOURce<hw> ] :BB:NR5G:UBWP:USER<us>:CELL<cc>:UL:BWP<bwp>:SRS:RS:SET<gr0>:RES<user0>:NAPort on page 585
```

PTRS Port Idx ← Resource > Config

Sets the PTRS antenna port index. The maximum number of configured PTRS ports is set with the parameter **Max Number of Ports**.

Remote command:

```
[ :SOURce<hw> ] :BB:NR5G:UBWP:USER<us>:CELL<cc>:UL:BWP<bwp>:SRS:RS:SET<gr0>:RES<user0>:PTRS on page 586
```

Power ← Resource > Config

Sets the SRS power.

The value is set relative to the PUSCH power.

Remote command:

```
[ :SOURce<hw> ] :BB:NR5G:UBWP:USER<us>:CELL<cc>:UL:BWP<bwp>:SRS:RS:SET<gr0>:RES<user0>:POWer on page 585
```

Antenna Ports > Config ← Resource > Config

Access: "User/BWP Settings > UL BWP Config > SRS > Resource Set = 1", "Resource > Config" and select "Antenna Ports > Config".

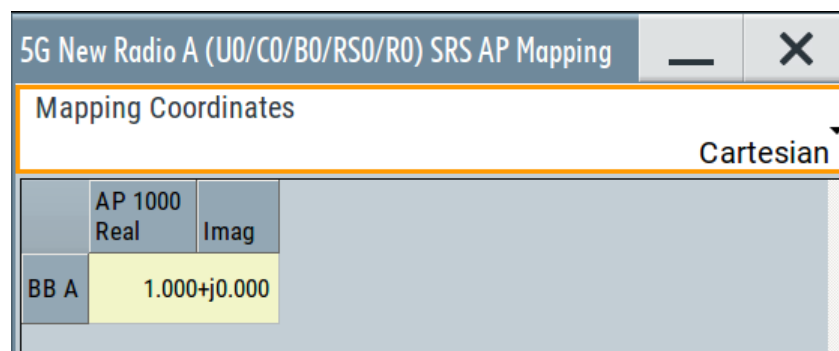

For details on the antenna ports-mapping concept, see [Chapter 2.10, "Antenna port mapping"](#), on page 27.

Mapping Coordinates ← Antenna Ports > Config ← Resource > Config

Switches representation between the "Cartesian" (Real/Imag) and "Cylindrical" (Magn./Phase) coordinates.

Mapping table ← Antenna Ports > Config ← Resource > Config

Defines the mapping of the antenna ports (AP) to the physical antennas.

Set the number of antenna ports (AP) with the parameter **No. Ports**.

For details on the antenna ports-mapping concept, see [Chapter 2.10, "Antenna port mapping"](#), on page 27.

Remote command:

"Mapping Coordinates = Cartesian":

[:SOURce<hw>] :BB:NR5G:UBWP:USER<us>:CELL<cc>:UL:BWP<bwp>:SRS:RS:SET<gr0>:RES<user0>:APMap:AP<ap>:ROW<apr>:REAL on page 586

[:SOURce<hw>] :BB:NR5G:UBWP:USER<us>:CELL<cc>:UL:BWP<bwp>:SRS:RS:SET<gr0>:RES<user0>:APMap:AP<ap>:ROW<apr>:IMAGinary on page 586

"Mapping Coordinates = Cylindrical":

[:SOURce<hw>] :BB:NR5G:UBWP:USER<us>:CELL<cc>:UL:BWP<bwp>:SRS:RS:SET<gr0>:RES<user0>:APMap:AP<ap>:ROW<apr>:MAGNitude on page 587

[:SOURce<hw>] :BB:NR5G:UBWP:USER<us>:CELL<cc>:UL:BWP<bwp>:SRS:RS:SET<gr0>:RES<user0>:APMap:AP<ap>:ROW<apr>:PHASe on page 587

5.3.8 SL BWP configuration settings

Access:

1. Select "5G New Radio > General > Link Direction > Sidelink".
2. Select "General > Users/BWPs" > "SL BWP Config".

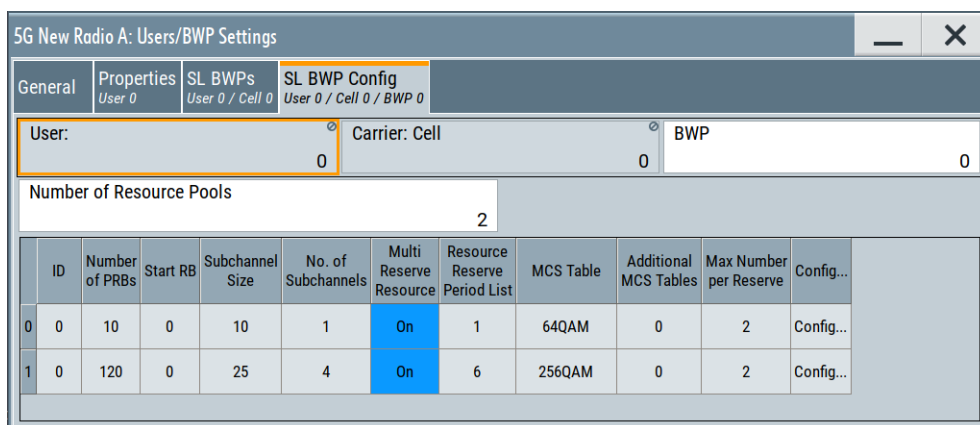

The dialog includes settings to configure sidelink resource pools.

- [Basic resource pool management](#).....193
- [Resource pool configuration table](#).....193
- [Enhanced resource pool configuration](#).....196

5.3.8.1 Basic resource pool management

Basic resource pool management settings allow you to select which signal part you want to configure.

User.....	193
Cell.....	193
BWP.....	193
Number of Resource Pools.....	193

User:

Selects the user to be configured.

Available if the [number of users](#) is greater than 1.

Remote command:

via suffix at `USER<ch>`

Cell

Selects/indicates to which carrier/cell the settings apply.

Remote command:

via suffix at `CELL<ch>`

BWP

Select the bandwidth parts (BWP) whose settings are displayed for configuration.

There are one or more BWPs, as set with the parameter "User/BWP Settings > DL BWPs" > [Number of SL BWPs](#).

Remote command:

via suffix at `BWP<dir0>`

Number of Resource Pools

Defines the number of resource pools used for sidelink transmissions.

A resource pool is a set of resource blocks that can span multiple subcarriers (sub-channels) in the frequency domain and subframes in the time domain. Within a sub-frame, each slot is automatically assigned to certain channels (PSSCH, PSCCH or S-SS/PSBCH).

Remote command:

`[:SOURCE<hw>] :BB:NR5G:UBWP:USER<us>:CELL<cc>:SL:BWP<bwp>:RESPool:NRESpool` on page 589

5.3.8.2 Resource pool configuration table

The resource pool configuration table contains settings to configure each resource pool. Each row in the table represents on resource pool. The number of rows therefore depends on the number of [resource pools](#) you have defined.

ID.....	194
Number of PRBs.....	194
Start RB.....	194
Subchannel Size.....	194

Number of Subchannels.....	194
Multi Reserve Resource.....	195
Reserve Resource Period List.....	195
MCS Table.....	195
Additional MCS Table.....	195
Max Number per Reserve.....	195
Config.....	196

ID

Shows the unique identifier for the resource pool in the range from 0 to 639.

Remote command:

```
[ :SOURce<hw> ] :BB:NR5G:UBWP:USER<us>:CELL<cc>:SL:BWP<bwp>:
RESPool:RES<gr0>:INDicator on page 590
```

Number of PRBs

Defines the number of contiguous physical resource blocks (PRB) the resource pool uses and therefore its overall size in the resource grid.

The number of physical resource blocks has an effect on the available [subchannel sizes](#) and the supported [number of subchannels](#).

Remote command:

```
[ :SOURce<hw> ] :BB:NR5G:UBWP:USER<us>:CELL<cc>:SL:BWP<bwp>:
RESPool:RES<gr0>:NPRB on page 591
```

Start RB

Defines the first resource block in the bandwidth part that the resource pool uses.

The value range depends on the [number of physical resource blocks](#) that the resource pool occupies.

Remote command:

```
[ :SOURce<hw> ] :BB:NR5G:UBWP:USER<us>:CELL<cc>:SL:BWP<bwp>:
RESPool:RES<gr0>:STRB on page 593
```

Subchannel Size

Defines the size of a resource pool subchannel in terms of physical resource blocks. In the frequency domain, a resource pool can consist of one or more subchannels.

Subchannel sizes are a set of predefined values whose availability depends on the [number of physical resource blocks](#) that the resource pool occupies.

For example, if you assign 50 PRBs to the resource pool, you can define a subchannel size up to 50 resource blocks. In that case, the subchannel would occupy all PRBs.

Remote command:

```
[ :SOURce<hw> ] :BB:NR5G:UBWP:USER<us>:CELL<cc>:SL:BWP<bwp>:
RESPool:RES<gr0>:SCHSize on page 593
```

Number of Subchannels

Selects the number of subchannels of the resource pool.

The number of subchannels you can define depends on the [number of physical resource blocks](#) that the resource pool occupies and the [size](#) of the subchannel.

For example, if you assign 50 PRBs to the resource pool and define a subchannel size of 25 resource blocks, you can create up to two subchannels.

Remote command:

```
[ :SOURce<hw> ] :BB:NR5G:UBWP:USER<us>:CELL<cc>:SL:BWP<bwp>:
RESPool:RES<gr0>:NSUBchannels on page 591
```

Multi Reserve Resource

Turns reservation of a sidelink resource for an initial transmission of a TB by an SCI associated with a different TB, based on sensing and resource selection procedure on and off.

Remote command:

```
[ :SOURce<hw> ] :BB:NR5G:UBWP:USER<us>:CELL<cc>:SL:BWP<bwp>:
RESPool:RES<gr0>:MREServe on page 590
```

Reserve Resource Period List

Defines the possible resource reservation period allowed in the resource pool in the unit of ms.

This value corresponds to higher layer parameter `sl-ResourceReservePeriodList` defined in 3GPP 38.331.

Remote command:

```
[ :SOURce<hw> ] :BB:NR5G:UBWP:USER<us>:CELL<cc>:SL:BWP<bwp>:
RESPool:RES<gr0>:REPList on page 592
```

MCS Table

Selects the modulation scheme of the resource pool.

Sidelink resource pools can have a 64QAM, 256QAM or 64QAMLowSE modulation.

Remote command:

```
[ :SOURce<hw> ] :BB:NR5G:UBWP:USER<us>:CELL<cc>:SL:BWP<bwp>:
RESPool:RES<gr0>:MSCTable on page 590
```

Additional MCS Table

Selects the MCS table additionally used by the resource pool.

This value corresponds to higher layer parameter `sl-Additional-MCS-Table` defined in 3GPP 38.331.

Remote command:

```
[ :SOURce<hw> ] :BB:NR5G:UBWP:USER<us>:CELL<cc>:SL:BWP<bwp>:
RESPool:RES<gr0>:AMCS on page 589
```

Max Number per Reserve

Defines the maximum number of reserved PSCCH/PSSCH resources that can be indicated by an SCI.

This value corresponds to higher layer parameter `sl-MaxNumPerReserve` defined in 3GPP 38.331.

Remote command:

```
[ :SOURce<hw> ] :BB:NR5G:UBWP:USER<us>:CELL<cc>:SL:BWP<bwp>:
RESPool:RES<gr0>:MNPRes on page 590
```

Config

Opens a dialog with [enhanced settings](#) for the resource pool.

5.3.8.3 Enhanced resource pool configuration

Contains settings to configure PSSCH and PSCCH properties in the corresponding resource pool.

PSSCH	
DMRS Pattern 2	<input type="checkbox"/> <input checked="" type="checkbox"/>
DMRS Pattern 3	<input type="checkbox"/> <input checked="" type="checkbox"/>
DMRS Pattern 4	<input type="checkbox"/> <input checked="" type="checkbox"/>
Scaling Factor	f0p5
betaOffset1	0
betaOffset2	0
betaOffset3	0
betaOffset4	0
PSCCH	
Reserved Bits	2

DMRS Pattern 2 ... 4.....	196
Scaling Factor.....	196
betaOffset1 ... 4.....	197
Reserved Bits.....	197

DMRS Pattern 2 ... 4

Turns DMRS time domain patterns in the first stage SCI (SCI1A) on and off.

The number of DMRS pattern in SCI1A depends on the number of active DMRS patterns.

These values corresponds to higher layer parameter `s1-PSSCH-DMRS-TimePatternList` defined in 3GPP 38.331.

Remote command:

DMRS pattern 2: [:SOURCE<hw>]:BB:NR5G:UBWP:USER<us>:CELL<cc>:SL:BWP<bwp>:RESPool:RES<gr0>:PAT2 on page 591

DMRS pattern 3: [:SOURCE<hw>]:BB:NR5G:UBWP:USER<us>:CELL<cc>:SL:BWP<bwp>:RESPool:RES<gr0>:PAT3 on page 591

DMRS pattern 4: [:SOURCE<hw>]:BB:NR5G:UBWP:USER<us>:CELL<cc>:SL:BWP<bwp>:RESPool:RES<gr0>:PAT4 on page 591

Scaling Factor

Selects a scaling factor to limit the number of resource elements assigned to the second stage SCI on PSSCH.

This value corresponds to higher layer parameter `s1-Scaling` defined in 3GPP 38.331.

Remote command:

```
[ :SOURCE<hw> ] :BB:NR5G:UBWP:USER<us>:CELL<cc>:SL:BWP<bwp>:  
RESPool:RES<gr0>:SCALing on page 592
```

betaOffset1 ... 4

Defines beta-offset values to determine the number of coded modulation symbols for second stage SCI (SCI2).

These values corresponds to higher layer parameter `s1-BetaOffsets2ndSCI` defined in 3GPP 38.331.

Remote command:

```
betaOffset1: [ :SOURCE<hw> ] :BB:NR5G:UBWP:USER<us>:CELL<cc>:SL:  
BWP<bwp>:RESPool:RES<gr0>:BOF1 on page 589
```

```
betaOffset2: [ :SOURCE<hw> ] :BB:NR5G:UBWP:USER<us>:CELL<cc>:SL:  
BWP<bwp>:RESPool:RES<gr0>:BOF2 on page 589
```

```
betaOffset3: [ :SOURCE<hw> ] :BB:NR5G:UBWP:USER<us>:CELL<cc>:SL:  
BWP<bwp>:RESPool:RES<gr0>:BOF3 on page 589
```

```
betaOffset4: [ :SOURCE<hw> ] :BB:NR5G:UBWP:USER<us>:CELL<cc>:SL:  
BWP<bwp>:RESPool:RES<gr0>:BOF4 on page 589
```

Reserved Bits

Defines the number of reserved bits in the first stage SCI pattern (SCI1A).

This value corresponds to higher layer parameter `s1-NumReservedBits` defined in 3GPP 38.331.

Remote command:

```
[ :SOURCE<hw> ] :BB:NR5G:UBWP:USER<us>:CELL<cc>:SL:BWP<bwp>:  
RESPool:RES<gr0>:RESBits on page 592
```

5.4 Scheduling settings

Access:

- ▶ Select "Baseband > 5G NR > Scheduling".

	Content	No. Alloc	SC Spacing / CP	Slot	Map Type	No. Sym.	Sym. Offset	No. RBs	RB Offset	Settings	Power /dB	State	Repetition
▼ Common													
	SS/PBCH		30 kHz NCP	0(0)		4	4	20	-	Config...	-	On	
	SS/PBCH		30 kHz NCP	0(0)		4	8	20	-	Config...	-	On	
▼ User 0, BWP 0													
	CORESET	Copy To...	30 kHz NCP	0(0)		1	0	270	0	Config...	0.00	On	Slot
	PDSCH	Copy To...	30 kHz NCP	0(0)	A	13	1	273	0	Config...	0.00	On	Slot
	CORESET		30 kHz NCP	1(1)		1	0	270	0	Info...	0.00		of SF 0...
	PDSCH		30 kHz NCP	1(1)	A	13	1	273	0	Info...	0.00		of SF 0...

This dialog displays an overview of distribution of the configured allocations in the time domain.

Because the slot is the basis time unit in 5G NR and the basis granularity in the numerologies, the **5G NR scheduling is performed on a per slot basis**. In comparison, the LTE scheduling is subframe-based. However, the scheduling dialog still shows the configuration of a complete subframe, as the subframe (besides the frame) is the common time boundary between the different numerologies.

Scheduling table: Understanding the displayed information

The allocation table lists the characteristics of all used allocations over all bandwidth parts and users for the corresponding link direction.

The table has two sections that distinguish the allocations between common and user-specific allocations.

- "Common" allocations:
All allocations that are independent of a specific user. These allocations include SS/PBCH allocations (downlink only), puncturing allocations, dummy RE allocations or positioning reference signal allocations (downlink only). Most of these allocations are configured elsewhere in the user interface and are therefore read-only, with the exception of puncturing allocations.
- "User x BWP x" allocations:
All allocations that are specific to a certain user. The table contains a group of allocations for each user throughout all bandwidth parts. The number of groups therefore depends on the number of users you have defined in each bandwidth part you have defined. User allocations include PDSCH and CORESET allocations (down-

link), PUSCH, PRACH and PUCCH allocations (uplink), LTE-CRS allocations or CSI-RS allocations.

You can collapse or expand each allocation group by selecting the arrow in the leftmost column of the table.

There are two types of allocations: configurable allocations and read-only allocations.

- *Configurable allocations*
You can configure these allocations in the first 256 subframes. The configurable allocations are always the first allocations in each allocation group.
To append or remove allocations of this type, set the number of allocations ([No. of Allocations](#)) for the corresponding group.
Once configured, these allocations are repeated as defined in the [Repetition/Repetition Type](#) field.
- *Read-only allocations*
These allocations are configured automatically, based on: scheduling mode, DCI, repetition of an allocation configured in previous/same subframe, ongoing allocations, aggregated PDSCH, or because they are configured elsewhere, like for example SS/PBCH, SRS, CSI-RS, dummy RE.
You can observe the allocations in all available subframes, where the number of subframes depends on the ARB sequence length.

The icon  at the beginning of a table row, indicates that this allocation is set as [Burst Mode Ref Alloc Identifier](#) for the "Burst" power mode.

To offer a better overview of the 5G NR frame structure in configurations including several slots, i.e. complicated TDD settings, the [Slot](#) column displays the slot number in the frame in parentheses next to the slot number in the subframe.

Allocating channels in the time and frequency domains

The following settings define the allocation position:

- [SC Spacing/CP](#) (defines the available resources)
- Time domain: [Slot](#), [No. Sym.](#) and [Sym. Offset](#)
- Frequency domain: [No. RB](#) and [RB Offset](#)
- [Repetition/Repetition Type](#)

The allocation table shows information on the selected channel or signal. Additionally, for each "User x BWP x" summary information is also displayed, if this information affects the channel allocation within the BWP, e.g. [SC Spacing/CP](#) or [No. RB](#).

If allocations are overlapping, a conflict is indicated in the most left column of the allocation table.

Settings:

Cell	200
All Users	200
User(s)	201
Subframe	201
Next/Prev	201
Expand/Collapse	201

Conflict.....	201
Content.....	201
No. of Allocations.....	203
Copy To.....	204
Subframe.....	204
Slot.....	204
Apply.....	204
SC Spacing/CP.....	204
Slot.....	205
Mapping Type.....	205
Format.....	206
Map Type / Format / Seq. Len.....	206
No. Sym.....	206
Sym. Offset.....	207
No. RB.....	207
RB Offset.....	208
Transform Precoding.....	208
Settings.....	208
L Config.....	208
L Info.....	208
Power.....	209
State.....	209
Repetition/Repetition Type.....	210
Repetition Settings.....	210
L Repetition Type.....	210
L Period.....	211
L Duration.....	211

Cell

Selects/indicates to which carrier/cell the settings apply.

Remote command:

via suffix at CELL<ch>

All Users

Selects the **number of users** shown in the scheduling table.

If on, the scheduling table shows all configurable users at the same time. Each row in the table corresponds to one user. The "Content" column shows the user ("User 0", "User 1" etc.).

If off, the scheduling table contains only one user (one row). You can select the displayed user in the "User(s)" field.

The table can display a maximum of 10 users. If you set up more than 10 configurable users, the table shows only one user at a time ("All Users" field is unavailable). Instead of displaying several users, the table only contains the currently **selected user**.

Remote command:

n/a

User(s)

Selects the user you can configure in the scheduling table. The selected user is represented as a single row in the scheduling table. The range of users depends on the [number of users](#) you have defined.

Available if [all users](#) is off.

Remote command:

n/a

Subframe

Sets the subframe to be configured.

The maximum number of available subframes N_{SF} is calculated as follows:

$$N_{SF} = 10 * \text{"ARB Sequence Length"} - 1$$

Remote command:

via suffix at `SUBF<st0>`

Next/Prev

Navigates through the subframes.

Remote command:

n.a.

Expand/Collapse

Shows/hides the group of settings.

Remote command:

n.a.

Conflict

Shows the status of the allocation.

- An empty field indicates that there is nothing special about the allocation.
- An exclamation mark indicates an overlapping conflict with another allocation.
- A burst icon indicates that the allocation is used as [reference](#) for the burst power mode.

Observe also the [Time Plan](#).

Remote command:

`[:SOURCE<hw>] :BB:NR5G:SCHed:CELL<cc>:SUBF<sf>:USER<us>:
BWPart<bwp>:ALLoc<al>:FACTs? on page 597`

Content

Selects the allocation type. The allocation type is the allocated channel or signal.

The allocation type also defines which cells / columns are available and editable in the scheduling table.

Common allocations:

- Dummy RE allocations
Dummy RE information is read only and the number of used allocations depends its configuration. For more information about configuring dummy REs, see [Chapter 5.2.10, "Dummy REs settings"](#), on page 84.
- Puncturing allocations

The number of used puncturing allocations is variable. You can configure these allocations directly in the scheduling table.

Puncturing allocations are necessary for NB-IoT in-band testing according to 3GPP 38.141-1, chapter 4.9.2.2.9. Puncturing allocations always have zero power.

- SS/PBCH (downlink only)
SS/PBCH information is read only and the number of used allocations depends its configuration. For more information about configuring the SS/PBCH, see [Chapter 5.2.7, "SS/PBCH settings"](#), on page 68.
- PRS (downlink only)
PRS information is read only and the number of used allocations depends its configuration. For more information about configuring the PRS, see [Chapter 5.2.9, "PRS settings"](#), on page 78.
If "Node > PRS" > **State** = "On", PRS allocations are configured automatically.
- S-SS/PSBCH (sidelink only)
S-SS/PSBCH information is read only and the number of used allocations depends its configuration. For more information about configuring the S-SS/PSBCH, see [Chapter 5.2.8, "S-SS/PSBCH settings"](#), on page 75.
Requires Option: R&S SMM-K170

User allocations:

- PDSCH and CORESET (downlink only)
The number of used PDSCH and CORESET allocations is variable. You can configure the these allocations directly in the scheduling table. For additional information about enhanced PDSCH and CORESET settings, see [Chapter 5.5, "PDSCH and PUSCH settings"](#), on page 212 and [Chapter 5.6, "CORESET settings"](#), on page 237.
If **PDSCH Scheduling** = "Auto/DCI", the "Content" = "CORESET".
(PDSCH allocations are configured automatically)
- LTE-CRS (downlink only)
LTE-CRS information is read only and the number of used allocations depends its configuration. For more information about configuring the LTE-CRS, see [Chapter 5.2.6, "LTE-CRS coexistence settings"](#), on page 65.
- CSI-RS (downlink only)
Configuring CSI-RS allocations is possible in two ways that are independent from each other.
 - Directly via the "Scheduling" dialog.
To configure CSI-RS allocations like this, select "Content" = "CSI-RS" for the corresponding allocation. This method allows you to edit various characteristics in the corresponding row of the scheduling table. More advanced settings become available when you select "Config" for the corresponding allocation. For more information, see [Chapter 5.7, "CSI-RS settings \(scheduling table\)"](#), on page 269.
 - Via the user / bandwidth part settings dialog.
To configure CSI-RS allocations like this, select "Users/BWPs" > "DL BWP Config" > "ZP / NZP CSI-RS". This method adds read-only allocations to the scheduling table. The number of rows depends on the number of resource sets you have defined for the CSI-RS. For more information about configuring the CSI-RS, see [Chapter 5.3.6.6, "ZP CSI-RS settings"](#), on page 144 and [Chapter 5.3.6.7, "NZP CSI-RS settings"](#), on page 147.
- RIM-RS

The number of used RIM-RS allocations is variable. You can configure the these allocations directly in the scheduling table. For more information about the RIM-RS settings, see [Chapter 5.8, "RIM-RS setting \(scheduling table\)"](#), on page 272.

- PUSCH and PUCCH (uplink only)

The number of used PUSCH and PUCCH allocations is variable. You can configure the these allocations directly in the scheduling table. For additional information about enhanced PUSCH and PUCCH settings, see [Chapter 5.5, "PDSCH and PUSCH settings"](#), on page 212 and [Chapter 5.9, "PUCCH settings"](#), on page 273.
- PRACH (uplink only)

The number of used PRACH allocations is variable. You can configure the these allocations directly in the scheduling table. For additional information about enhanced PRACH settings, see [Chapter 5.10, "PRACH settings"](#), on page 280.
- SRS (uplink only)

Configuring SRS allocations is possible in two ways that are independent from each other.

 - Directly via the "Scheduling" dialog.

To configure SRS allocations like this, select "Content" = "SRS" for the corresponding allocation. This method allows you to edit various characteristics in the corresponding row of the scheduling table. More advanced settings become available when you select "Config" for the corresponding allocation. For more information, see [Chapter 5.11, "SRS settings \(scheduling table\)"](#), on page 282.
 - Via the user / bandwidth part settings dialog.

To configure SRS allocations like this, select "Users/BWPs" > "UL BWP Config" > "SRS". This method adds read-only allocations to the scheduling table. The number of rows depends on the number of resource sets you have defined for the SRS. For more information about configuring the SRS, see [Chapter 5.3.7.6, "SRS settings"](#), on page 183.
- PSSCH and PSCCH (sidelink only)

The number of used PSSCH and PSCCH allocations is variable. You can configure the these allocations directly in the scheduling table. For additional information about enhanced PSSCH and PSCCH settings, see [Chapter 5.12, "PSSCH and PSCCH settings"](#), on page 288.
- PSFCH

The number of used PSFCH allocations is variable. You can configure the these allocations directly in the scheduling table. For additional information about enhanced PSFCH settings, see [Chapter 5.13, "PSFCH settings"](#), on page 298.

Remote command:

```
[ :SOURCE<hw> ] :BB:NR5G:SCHed:CELL<cc>:SUBF<sf>:USER<us>:
BWPart<bwp>:ALLoc<al>:CONTent on page 598
```

No. of Allocations

Defines the number of configurable allocations.

- For "Common" allocations, you can define the number of puncturing allocations.
- For each "User x BWP x" group, you can define the number of user allocations.

Remote command:

Common allocations: [:SOURce<hw>] :BB:NR5G:SCHed:CELL<cc>:SUBF<sf>:
NALLoc on page 607

User allocations: [:SOURce<hw>] :BB:NR5G:SCHed:CELL<cc>:SUBF<sf>:
USER<us>:BWPart<bwp>:NALLoc on page 607

Copy To...

Opens the "Copy To" dialog which enables you to copy the settings to another sub-frame and slot.

Copy To	
Subframe	2
Slot	1
<input checked="" type="checkbox"/> Apply	

Remote command:

n.a.

Subframe

Sets the target subframe to copy the settings to.

Remote command:

[:SOURce<hw>] :BB:NR5G:SCHed:CELL<cc>:SUBF<sf>:USER<us>:
BWPart<bwp>:ALLoc<al>:COPYto:SUBF on page 599

Slot

Sets the target slot to copy the settings to.

Remote command:

Copy To Slot: [:SOURce<hw>] :BB:NR5G:SCHed:CELL<cc>:SUBF<sf>:
USER<us>:BWPart<bwp>:ALLoc<al>:COPYto:SLOT on page 599

Apply

Starts the copying process.

Remote command:

Copy To Apply: [:SOURce<hw>] :BB:NR5G:SCHed:CELL<cc>:SUBF<sf>:
USER<us>:BWPart<bwp>:ALLoc<al>:COPYto:APPLY on page 598

SC Spacing/CP

Selects a combination of the subcarrier spacing (SCS) and the cyclic prefix (CP), where the available values depend on the "Deployment".

See [Table 2-2](#).

The provided values depend on the channel type.

The SCS of the selected BWP is also displayed, because the channel allocation in the frequency domain depends on this value.

Note that for most channel types, the subcarrier spacing in the scheduling table is read-only.

Remote command:

PRACH: [:SOURCE<hw>]:BB:NR5G:SCHed:CELL<cc>:SUBF<sf>:USER<us>:
BWPart<bwp>:RESulting:ALLoc<al>:PRACH:SCSPacing? on page 604

RIM-RS: [:SOURCE<hw>]:BB:NR5G:SCHed:CELL<cc>:SUBF<sf>:COMMON:
ALLoc<al>:RIMRs:SCSPacing on page 604

Slot

Sets the start slot in the subframe for the selected allocation. The available slots depend on the channel-specific [SC Spacing/CP](#) as follows:

Slot	SCS / CP (as selected for the specific channel)
0	15 kHz NCP
0 to 1	30 kHz NCP
0 to 3	60 kHz NCP 60 kHz ECP
0 to 7	120 kHz NCP
0 to 15	240 kHz NCP

Remote command:

[:SOURCE<hw>]:BB:NR5G:SCHed:CELL<cc>:SUBF<sf>:USER<us>:
BWPart<bwp>:ALLoc<al>:SLOT on page 605

Mapping Type

Defines to which symbols of the PDSCH/PUSCH allocation the demodulation reference signals (DMRS) are mapped.

Selection of the PDSCH-mapping type depends on the "Additional Position Index" dialog. If the "Additional Position Index" ≤ 1 a selection of the mapping type B is possible.

The PUSCH-mapping type is in case of "FRC" read-only. Otherwise a selection between mapping type "A" and "B" is always allowed.

Release 16 increases the number and length of the symbols the DMRS can use for mapping type B (downlink only).

Unavailable in the sidelink application.

"A" Location relative to the start of the slot.

"B" Location relative to the start of the PDSCH resources.

Remote command:

[:SOURCE<hw>]:BB:NR5G:SCHed:CELL<cc>:SUBF<sf>:USER<us>:
BWPart<bwp>:ALLoc<al>:MAPType on page 601

Format

In uplink, selects the PUCCH format.

3GPP defines several PUCCH formats. The PUCCH format affects several PUCCH characteristics, like the mapping to physical resource blocks.

You can select a different PUCCH format for each PUCCH allocation. Depending on the format, you can access different enhanced settings for the PUCCH.

For FR2-2 deployment frequency range, you can allocate up to 16 [resource blocks](#) to a PUCCH allocation, depending on the selected PUCCH format.

Remote command:

```
[ :SOURce<hw> ] :BB:NR5G:SCHed:CELL<cc>:SUBF<sf>:USER<us>:
BWPart<bwp>:ALLoc<al>:FMT on page 600
```

Map Type / Format / Seq. Len.

Option: R&S SMM-K148.

Defines the PRACH sequence length for unlicensed spectrum.

The sequence length depends on the PRACH subcarrier spacing. Additional sequence lengths become available when you turn on [shared spectrum access](#).

Remote command:

```
[ :SOURce<hw> ] :BB:NR5G:SCHed:CELL<cc>:SUBF<sf>:USER<us>:
BWPart<bwp>:ALLoc<al>:SEQLength on page 605
```

No. Sym.

Indicates the time duration of the allocation inside the slot.

Notes on the available number of symbols.

- The number of symbols depend on the cyclic prefix (CP) and the [Mapping Type](#). For details, see [Table 5-2](#).
- The parameters "No. Sym." and "Sym. Offset" are interdependent; their sum must not exceed the maximum of 14 or 12 symbols, for normal and extended CP respectively.
- For SRS allocations, the value is set with "Users/BWP > UL BWP Config > SRS > SRS Resource Table > Resource > Config" > [No. Sym.](#).
- For PUSCH allocations, the number of symbols is limited If intra slot frequency hopping is enabled:
 - Mapping type A: minimum 8
 - Mapping type B: minimum 2
- On the sidelink, an allocation has a size between 7 and 14 symbols, because there is no extended cyclic prefix and no mapping type.

Table 5-2: No. Sym. (L)

Mapping Type	Normal cyclic prefix	Extended cyclic prefix
Mapping type A	3, 14	3, 12
Mapping type B	2, 4, 7	2, 4, 6

Remote command:

```
[ :SOURce<hw> ] :BB:NR5G:SCHed:CELL<cc>:SUBF<sf>:USER<us>:
BWPart<bwp>:ALLoc<al>:SYMNumber on page 606
```

Sym. Offset

Sets the allocation's start (OFDM symbol) within the slot.

Notes on the symbol offset.

- The available values depend on the channel-specific [SC Spacing/CP](#) and the [Mapping Type](#), see [Table 5-3](#).
- For SRS allocations, the value is set with "Users/BWP > UL BWP Config > SRS > SRS Resource Table > Resource > Config" > [Offset](#).
- For sidelink allocations, the mapping type is unavailable and therefore has no effects on the symbol offset.

Table 5-3: Sym. Offset

Mapping Type	Normal cyclic prefix	Extended cyclic prefix
Mapping type A	0, 1, 2, 3	0, 1, 2, 3
Mapping type B	0, 12	0, 10

If the value "Sym. Offset" is read-only or not, depends on:

- Number of symbols
- Content type (PDSCH / PUSCH / PRACH / ...)
- Mapping type
- DMRS Type A position
- Cyclic prefix / numerology

Remote command:

```
[ :SOURCE<hw> ] :BB:NR5G:SCHed:CELL<cc>:SUBF<sf>:USER<us>:
BWPart<bwp>:ALLoc<al>:SYMoffset on page 606
```

No. RB

Sets the bandwidth (frequency size) of selected allocation in terms of resource blocks (RB).

The number of resource blocks generally depends on the SCS of the corresponding BWP, set with the parameter "Users/BWP > DL/UL BWPs" > [SC Spacing/CP](#). Observe the number of *total* available RBs in the selected "User x, BWP x".

The number of *RB per channel* also depends on the channel type as follows:

- CORESET allocations always span a multiple of 6 resource blocks. Thus, only values that are multiple of 6 are allowed for these allocations.
- The number of resource blocks that are available for PUSCH depends on whether the transform precoding is enabled or not (that is if DFT-s-OFDM is applied), see ["Transform Precoding"](#) on page 208.
- The number of resource blocks of the PRACH allocation are set automatically, depending on the selected [SC Spacing/CP](#).
- The number of resource blocks of the PUCCH allocation is limited when [Transform Precoding](#) is enabled. In this case setting the "No. of RB" to 7, 11 or 13 is prohibited.

For PUCCH formats F0, F1 and F4 in FR2-2, you can use up to 16 resource blocks for each PUCCH allocation. This feature requires R&S SMM-K171.

Symbol "-" indicates that the CORESET or P_xSCH allocations are defined as bitmaps:

- "Scheduling > CORESET > Config > General" > [Frequency Domain Resources](#)
- "Scheduling > P_xSCH > Config > General" > [Resource Allocation](#) = "Type 0"

Remote command:

[:SOURce<hw>] :BB:NR5G:SCHed:CELL<cc>:SUBF<sf>:USER<us>:
BWPart<bwp>:ALLoc<al>:RBNumber on page 603

[:SOURce<hw>] :BB:NR5G:SCHed:CELL<cc>:SUBF<sf>:USER<us>:
BWPart<bwp>:ALLoc<al>:PRACH:RBNumber? on page 703

RB Offset

Adds a frequency offset and sets the start resource block of the selected allocation.

The value range depends on the selected channel type and the parameters [SC Spacing/CP](#) and [No. RB](#).

Remote command:

[:SOURce<hw>] :BB:NR5G:SCHed:CELL<cc>:SUBF<sf>:USER<us>:
BWPart<bwp>:ALLoc<al>:RBOffset on page 603

Transform Precoding

In UL, you can define which access method is used, the optional DFT-s-OFDM or the CP-OFDM.

See also [Chapter 2.3, "Multiple accesses schemes"](#), on page 19.

"On" Enables the precoding operation and thus enables the DFT-s-OFDM.

"Off" Disables the precoding operation and thus enables the CP-OFDM.

Remote command:

[:SOURce<hw>] :BB:NR5G:SCHed:CELL<cc>:SUBF<sf>:USER<us>:
BWPart<bwp>:ALLoc<al>:TPState on page 607

Settings

Opens dialogs with additional setting or information.

Config ← Settings

Opens the dialogs for configuration of the corresponding settings.

See:

- [Chapter 5.2.7, "SS/PBCH settings"](#), on page 68
- [Chapter 5.2.10, "Dummy REs settings"](#), on page 84
- [Chapter 5.3.4, "DL/UL BWPs settings"](#), on page 107
- [Chapter 5.5, "PDSCH and PUSCH settings"](#), on page 212
- [Chapter 5.6, "CORESET settings"](#), on page 237
- [Chapter 5.9, "PUCCH settings"](#), on page 273
- [Chapter 5.12, "PSSCH and PSCCH settings"](#), on page 288

Info ← Settings

Opens the "Resulting Allocation Info" dialog with details on the automatically allocated and repeated resources, like, for example, PDSCH created from DCIs or repeated PDSCH or CORESET.

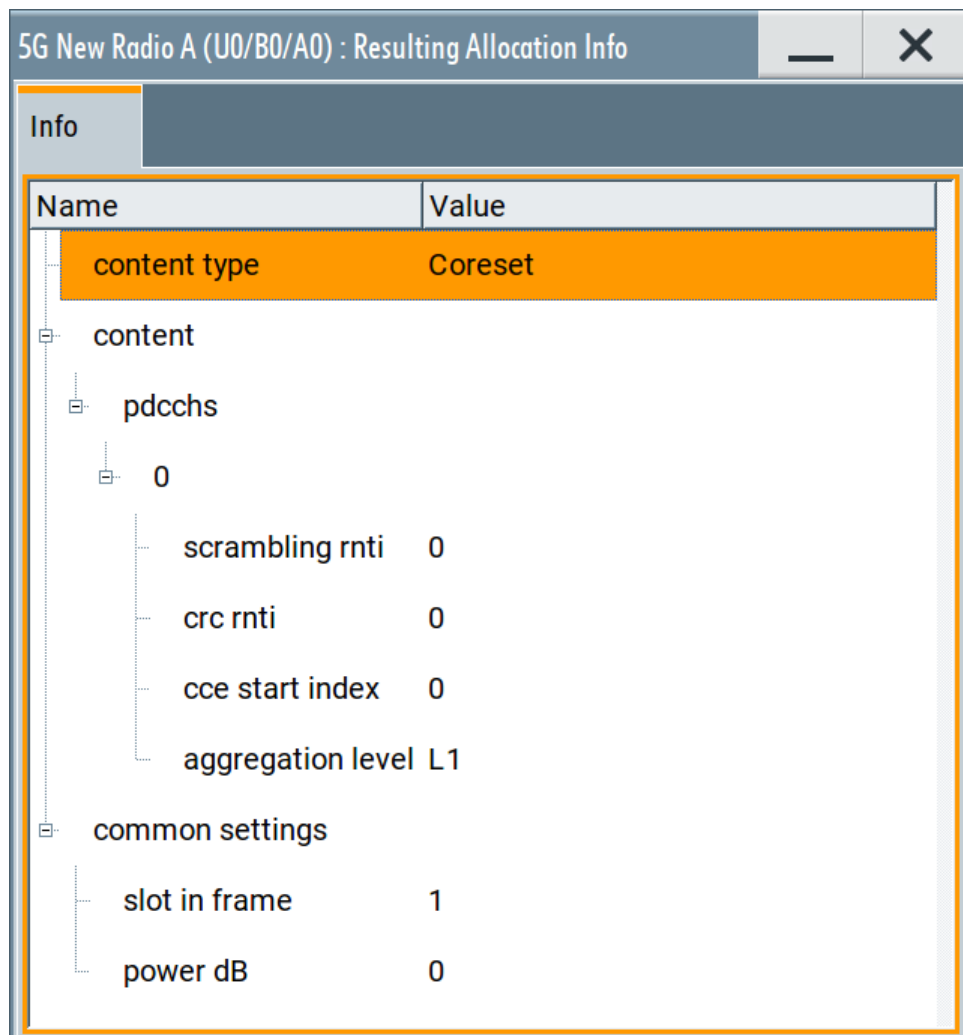

Name	Value
content type	Coreset
content	
pdcchs	
0	
scrambling rnti	0
crc rnti	0
cce start index	0
aggregation level L1	
common settings	
slot in frame	1
power dB	0

Remote command:

```
[ :SOURce<hw> ] :BB:NR5G:SCHed:CELL<cc>:SUBF<sf>:USER<us>:
BWPart<bwp>:ALLoc<al>:INFO? on page 600
```

Power

Sets the power for the selected allocation relative to the power of the other allocations.

Allocations with "Power = 0 dB" use the same power level.

Unavailable for puncturing allocations.

Remote command:

```
[ :SOURce<hw> ] :BB:NR5G:SCHed:CELL<cc>:SUBF<sf>:USER<us>:
BWPart<bwp>:ALLoc<al>:POWer on page 602
```

State

Sets the allocation to active or inactive state.

Remote command:

```
[ :SOURce<hw> ] :BB:NR5G:SCHed:CELL<cc>:SUBF<sf>:USER<us>:
BWPart<bwp>:ALLoc<al>:STATe on page 606
```

Repetition/Repetition Type

- Configurable allocations
Displays if and how often the allocation is repeated.
Select the field to open the [Repetition Settings](#) dialog where you can reconfigure the repetition.
- Read-only allocations
Indicates the read-only reason, e.g. ongoing allocation, from SF#, etc.
Select this indication to access the setting that causes the configuration.

Remote command:

```
[ :SOURce<hw> ] :BB:NR5G:SCHed:CELL<cc>:SUBF<sf>:USER<us>:
BWPart<bwp>:ALLoc<al>:REPetitions on page 603
```

Repetition Settings

Access: "Baseband > 5G NR > Scheduling > Repetition".

Repetition		X
Repetition Type		Custom
Period		10 Slots
Duration		1 Slots

Repetition Type ← Repetition Settings

Sets if and how the allocation is repeated, e.g. per slot, per subframe, on a per frame basis or at a user-defined period.

"Off" The allocation is transmitted once.

"Slot", "Subframe", "Frame"

Available for "Content = PDSCH/PUSCH/PUCCH/CORESET".

The allocation is transmitted every slot, subframe, or frame.

"Custom" User-defined repetition pattern, set as [Duration](#) and [Period](#).
Use the "Time Plan" to observe the current scheduling.

Example:



Figure 5-6: Repetition Type = Custom: Representation on the Time Plan

1 = [Duration](#) = "2 Slots"

2 = [Period](#) = "5 Slots"

If "Quick Setting" configuration with "Duplexing = TDD" is applied, the values set here resemble the slot configuration set in the "Quick Setting" > [Frame format](#) dialog.

Remote command:

```
[ :SOURCE<hw> ] :BB:NR5G:SCHed:CELL<cc>:SUBF<sf>:USER<us>:
BWPart<bwp>:ALLoc<al>:REPetitions on page 603
```

Period ← Repetition Settings

Sets after how many slots the group of configurable allocation and its repetitions is repeated, see [User-defined repetition](#).

The maximum repartition period is calculated as follows:

$\text{RepPeriod}_{\text{max}} = \# \text{SlotsPerFrame} * \text{"SequenceLength"}$, where

- [#SlotsPerFrame](#): is the number of available slots within a frame and depends on the used subcarrier spacing
- ["SequenceLength"](#): is the ARB sequence length as set with the parameter "Output/Power > Output" > [Sequence Length](#).

Remote command:

```
[ :SOURCE<hw> ] :BB:NR5G:SCHed:CELL<cc>:SUBF<sf>:USER<us>:
BWPart<bwp>:ALLoc<al>:PERiod on page 602
```

Duration ← Repetition Settings

Sets in how many consecutive slots within a frame the allocation is repeated.

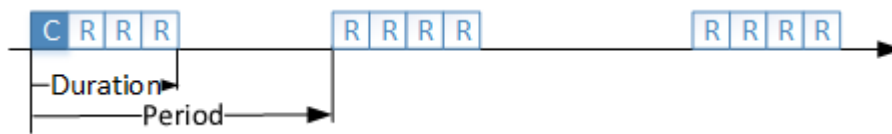

Figure 5-7: User-defined repetition

C = Configurable allocation

R = Repetition

Duration = Number of consecutive slots in that the allocation is transmitted

Period = Sets after how many slots the group of configurable allocation and its repetitions is repeated

Remote command:

[:SOURce<hw>] :BB:NR5G:SCHeD:CELL<cc>:SUBF<sf>:USER<us>:
BWPart<bwp>:ALLoc<al>:DURation on page 599

5.5 PDSCH and PUSCH settings

Access:

1. PDSCH settings:

- Select "5G New Radio > General > Link Direction > Downlink".
- Select "5G New Radio > Scheduling".
- Select "User x BWP x > Content > PDSCH".
- Select "PDSCH > Settings > Config".

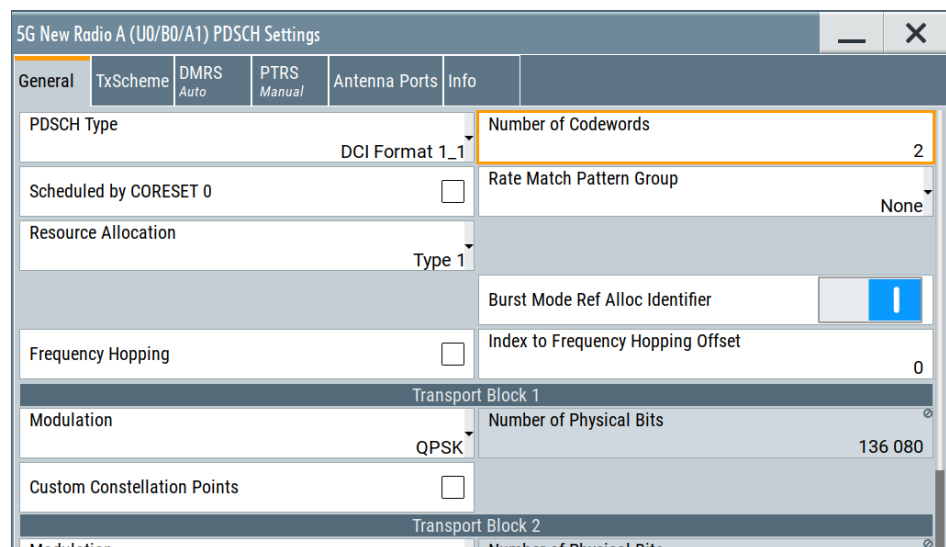

2. PUSCH settings:

- Select "5G New Radio > General > Link Direction > Uplink".
- Select "5G New Radio > Scheduling".
- Select "User x BWP x > Content > PUSCH".

d) Select "PUSCH > Settings > Config".

General	TxScheme	DMRS <i>Auto</i>	Channel Coding	PTRS <i>Auto</i>	Antenna Ports	Info
PUSCH Type						
DCI Format 0_1						
Resource Allocation						
Type 1						
Frequency Hopping						
<input type="checkbox"/>						
Index to Frequency Hopping Offset						
0						
Cyclic Prefix Extension						
0.000 µs						
Time Offset						
0.00 µs						
Number of Slots TBoMS						
2						
Modulation						
QPSK						
Number of Physical Bits						
88 452						
Custom Constellation Points						
<input type="checkbox"/>						

This dialog comprises the settings of the physical downlink shared channel (PDSCH) or the physical uplink shared channel (PUSCH).

The PDSCH carries the general user data and is therefore the most prominent channel in a radio frame; it occupies the most resources.

Settings:

• General settings	213
• TxScheme settings	219
• DMRS settings	222
• Channel coding settings	226
• UCI settings	228
• PTRS settings	230
• PTRS settings with enabled transform precoding	233
• Antenna ports	235
• Info	236

5.5.1 General settings

Access:

1. Select "Scheduling > User x BWP x > Content > PDSCH/PUSCH > Settings > Config".
2. Select "General".

Settings:

PDSCH Type/PUSCH Type	214
Number of Codewords	214
Scheduled by CORESET 0	214

Rate Match Pattern Group.....	215
Resource Allocation.....	215
Burst Mode Ref Alloc Identifier.....	215
Interlaces.....	215
L Number of Interlaces.....	216
L Value.....	216
Precoding Granularity.....	216
Frequency Hopping.....	216
Index to Frequency Hopping Offset.....	216
Cyclic Prefix Extension.....	217
Time Offset.....	217
Number of Slots TBoMS.....	217
Resource Block Group Bitmap.....	218
Modulation.....	218
Phys. Bits.....	219
HARQ Process Number.....	219

PDSCH Type/PUSCH Type

Defines the PDSCH/PUSCH type by selecting the DCI format by that the PDSCH/PUSCH content is defined.

The available settings depend on the current configuration. To select, for example, "PDSCH Type = DCI Format 1_0", select "Users/BWP > DL BWP Config > PDSCH > Additional Position Index = 2" and "Scheduling > PDSCH > Map Type = A".

For release 16 types: Option: R&S SMM-K148 is required.

Remote command:

```
[ :SOURce<hw> ] :BB:NR5G:SCHed:CELL<cc>:SUBF<sf>:USER<us>:
BWPart<bwp>:ALLoc<al>:PDSCh|PUSCh:TYPE on page 613
```

Number of Codewords

For PDSCH, sets if one or two codewords are used.

The combination of number of codewords and [Number of Layers](#) determines the layer mapping for the selected precoding scheme.

Remote command:

```
[ :SOURce<hw> ] :BB:NR5G:SCHed:CELL<cc>:SUBF<sf>:USER<us>:
BWPart<bwp>:ALLoc<al>:PDSCh:NCW on page 610
```

Scheduled by CORESET 0

For PDSCH allocations, defines if the PDSCH settings are scheduled by CORESET 0 or not.

You can enable several PDSCH allocations, also a combination of PDSCH scheduled by CORESET 0 and such that are not. To enable the CORESET 0 itself, set the parameter [CORESET ID](#) = "0".

Remote command:

```
[ :SOURce<hw> ] :BB:NR5G:SCHed:CELL<cc>:SUBF<sf>:USER<us>:
BWPart<bwp>:ALLoc<al>:PDSCh:SBCZero:STATe on page 612
```

Rate Match Pattern Group

For PDSCH allocations, selects one of the rate match pattern groups, configured in the "Users/BWP Settings > DL BWP Config > Rate Match" dialog.

Remote command:

```
[ :SOURCE<hw> ] :BB:NR5G:SCHed:CELL<cc>:SUBF<sf>:USER<us>:
BWPart<bwp>:ALLoc<al>:PDSCh:PATGrp on page 611
```

Resource Allocation

If "Users/BWPs > DL BWP Config > PDSCH > Resource Allocation = Dynamic Switch", sets the resource allocation type 0 or type 1.

This parameter allows you to schedule PUSCH type 0 allocation if manual scheduling is used ([PDSCH Scheduling](#) > "Manual").

For PDSCH, the resource allocation for type 0 allocation is set with the parameter [Resource Block Group Bitmap](#).

Remote command:

```
[ :SOURCE<hw> ] :BB:NR5G:SCHed:CELL<cc>:SUBF<sf>:USER<us>:
BWPart<bwp>:ALLoc<al>:PDSCh|PUSCh:RESAlloc on page 612
```

Burst Mode Ref Alloc Identifier

If [Power Mode](#) > "Burst", sets whether the bandwidth of the current allocation is used as reference for the "Burst" power mode.

The icon  in the [Scheduling settings](#) table indicates which allocation is set as burst reference.

Remote command:

```
[ :SOURCE<hw> ] :BB:NR5G:SCHed:CELL<cc>:SUBF<sf>:USER<us>:
BWPart<bwp>:ALLoc<al>:PDSCh|PUSCh:BMAid on page 612
```

Interlaces...

Option: R&S SMM-K148

Opens a dialog box to configure interlaces.

Interlacing is a method to achieve a power spectral density of at least 80 % of the bandwidth in a shared spectrum (according to 3GPP).

Interlaces are bundles of allocated resource elements that are distributed over the complete bandwidth. In between those allocated resource elements are unused resource elements. For example, you can configure an interlace to only use every 5th allocation, or two interlaces that use every 1st and 3rd allocation.

This principle makes sure that the used allocations use a certain amount of the bandwidth to fulfill the 3GPP specifications for shared spectrum.

The interlace location is always relative to reference point A. For example, an interlace with a value = 4 would start 4 subcarriers above the reference point A.

The maximum number of supported interlaces depends on the subcarrier spacing.

Interlaces are supported under the following conditions:

- ["Use Interlace"](#) = On
- [Resource Allocation](#) = Type 2, which in turn is available for DCI format 0_0 and 0_1.

Number of Interlaces ← Interlaces...

Defines the number of interlaces. The maximum number depends on the current sub-carrier spacing.

Remote command:

```
[ :SOURce<hw> ] :BB:NR5G:SCHed:CELL<cc>:SUBF<sf>:USER<us>:
BWPart<bwp>:ALLoc<al>:PUSCh:NINT on page 614
```

Value ← Interlaces...

Defines the distance between used resource elements. A value of 5, for example, would use every 5th resource element for the corresponding interlace.

Note that each interlace must have a different value. Otherwise interlaces would share the same allocation.

Remote command:

```
[ :SOURce<hw> ] :BB:NR5G:SCHed:CELL<cc>:SUBF<sf>:USER<us>:
BWPart<bwp>:ALLoc<al>:PUSCh:INT<il>:INTL on page 614
```

Precoding Granularity

For PDSCH allocations, the precoding granularity can be adjusted. Sets the precoding granularity if "User/BWP Settings > DL BWP Config > PDSCH > General Settings > Precoding" is enabled.

"N2" Precoding granularity is set to N2.

"N4" Precoding granularity is set to N4.

This setting is not available if following values are set at "Users/BWPs > DL BWP Config > PDSCH > General Settings":

- "VRB-to-PRB Interleaver" equals 2 or
- "Resource Block Group Size" equals Config1 and BWP size ≤ 36 RBs

"Wideband" Precoding granularity is set to wideband.

Remote command:

```
[ :SOURce<hw> ] :BB:NR5G:SCHed:CELL<cc>:SUBF<sf>:USER<us>:
BWPart<bwp>:ALLoc<al>:PDSCh:PRECg on page 611
```

Frequency Hopping

For PUSCH allocations, enable or disable the frequency hopping, configured in the "Users/BWP Settings > UL BWP Config > Frequency Hopping" dialog.

Remote command:

```
[ :SOURce<hw> ] :BB:NR5G:SCHed:CELL<cc>:SUBF<sf>:USER<us>:
BWPart<bwp>:ALLoc<al>:PUSCh:FHOP:STATe on page 613
```

Index to Frequency Hopping Offset

For PUSCH allocations, selects one of the frequency hopping offset index according to the entries, configured in the "Users/BWP Settings > UL BWP Config > Frequency Hopping Offsets" dialog.

"0, 1" If there are only 2 frequency hopping offsets configured.

"0, 1, 2, 3" If there are only 4 frequency hopping offsets configured.

Remote command:

```
[ :SOURce<hw> ] :BB:NR5G:SCHed:CELL<cc>:SUBF<sf>:USER<us>:
BWPart<bwp>:ALLoc<al>:PUSCh:FHOI on page 613
```

Cyclic Prefix Extension

Option: R&S SMM-K148

Defines the length of a cyclic prefix extension, which is added in front of the first PUSCH allocation in a slot. The other cyclic prefixes of the PUSCH allocations in the slot are not affected.

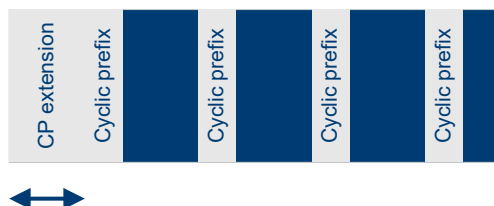

Remote command:

```
[ :SOURce<hw> ] :BB:NR5G:SCHed:CELL<cc>:SUBF<sf>:USER<us>:
BWPart<bwp>:ALLoc<al>:CPEXt on page 609
```

Time Offset

Defines an offset for PUSCH allocations in the time domain.

Useful, for example, for 2-step RACH applications.

Remote command:

```
[ :SOURce<hw> ] :BB:NR5G:SCHed:CELL<cc>:SUBF<sf>:USER<us>:
BWPart<bwp>:ALLoc<al>:TOFFset on page 616
```

Number of Slots TBoMS

Option: R&S SMM-K171

Selects the number of slots the PUSCH transport block is transmitted on.

Instead of transmitting the complete transport block in multiple slots, you can spread it over multiple slots. Spreading the PUSCH transport block over several slots increases the spectral power density, because fewer resource blocks are required.

Depending on your selection, the scheduling table is adjusted accordingly.

By default, the transmission of a transport block occurs on consecutive slots. However, TDD transmission also allows the transmission of a transport block on non-consecutive slots. In such scenarios, you can define the slots that carry the transport block in the table below the "Number of Slots TBoMS" parameter. The logic is as follows.

- The table only appears if "Number of Slots TBoMS" > 1.
- The number of columns depends on the number of slots the transport block uses. For example, if you spread the transport block over four slots, the table has three columns (the last slot the transmission uses is determined automatically).
- In each column, you can define a slot offset that the transport block transmission uses.

If all entries in the table are "1", the transmission occurs on consecutive slots.

To use non-consecutive slots, you can enter different values and thus skip specific slots.

Example:

The transport block over multiple slots table looks like this:

2	3	1
---	---	---

With this configuration, transport block transmission uses slots 0 - 3 - 7 - 9 (the first PUSCH slot is always configured in slot 0).

Spreading the PUSCH transport block over several slots is possible with the following settings.

- [Restart Data and Control](#) = "After Each Codeword and Allocation"
- [Channel coding](#) = on
- [UCI mode](#) = "UCI+UL-SCH"

Note that if you are transmitting transport blocks over multiple slots, HARQ feedback is always applied at the beginning of a transport block.

Remote command:

```
[ :SOURce<hw> ] :BB:NR5G:SCHed:CELL<cc>:SUBF<sf>:USER<us>:
BWPart<bwp>:ALLoc<al>:TBOMs on page 615
[ :SOURce<hw> ] :BB:NR5G:SCHed:CELL<cc>:SUBF<sf>:USER<us>:
BWPart<bwp>:ALLoc<al>:TBM<tbm>:SLOTs on page 615
```

Resource Block Group Bitmap

For [Resource Allocation](#) > "Type 0", sets the PxsCH resource block groups allocation as bit pattern.

The bitmap is a 19-bits long pattern where value of 1 indicates that the resource element group is used for PxsCH.

Remote command:

```
[ :SOURce<hw> ] :BB:NR5G:SCHed:CELL<cc>:SUBF<sf>:USER<us>:
BWPart<bwp>:ALLoc<al>:PDSCh|PUSCh:RESalloc:PATtern on page 613
```

Modulation

Selects the modulation scheme.

- PDSCH: QPSK, 16QAM, 64QAM, 256QAM
3GPP release 17 introduces 1024QAM modulation on the downlink. Release 17 features require R&S SMM-K171.
- PUSCH: QPSK, 16QAM, 64QAM, 256QAM, and if [Transform Precoding](#) > "Off" also pi/2-BPSK.
1024QAM modulation on the uplink requires R&S SMM-K171.

Note:

Preconditions for 256QAM:

- "Users/BWP" > "DL/UL BWP Config" > "PDSCH" > "MCS Table" equals "256QAM"
- "Users/BWP" > "DL/UL BWP Config" > "PUSCH" > "MCS Table" equals "256QAM"

Preconditions for 1024QAM (downlink only):

- "Users/BWP" > "DL/UL BWP Config" > "PDSCH" > "MCS Table" equals "1024QAM"

Preconditions for BPSK :

- BPSK is not available for PxSCH
- $\pi/2$ -BPSK:

Preconditions for $\pi/2$ -BPSK:

- $\pi/2$ -BPSK: "Users/BWP" > "DL/UL BWP Config" > "PUSCH" > "Transform Precoding" equals "Enabled"

See also [Table 2-1](#).

Remote command:

```
[ :SOURCE<hw> ] :BB:NR5G:SCHed:CELL<cc>:SUBF<sf>:USER<us>:
BWPart<bwp>:ALLoc<al> [ :CW<cw> ] :MOD on page 610
```

Phys. Bits

Indicates the size of the selected allocation in bits.

Remote command:

```
[ :SOURCE<hw> ] :BB:NR5G:SCHed:CELL<cc>:SUBF<sf>:USER<us>:
BWPart<bwp>:ALLoc<al> [ :CW<cw> ] :PHYSbits? on page 610
```

HARQ Process Number

Sets the HARQ process number for the relevant DCI.

The value can be set between 0 and 31.

Note: Only visible when the "HPN Mode" is enabled in the "Node Settings > Feedback" dialog.

Remote command:

```
[ :SOURCE<hw> ] :BB:NR5G:SCHed:CELL<cc>:SUBF<sf>:USER<us>:
BWPart<bwp>:ALLoc<al>:PUSCh:HPRNumber on page 614
```

5.5.2 TxScheme settings

Access:

1. Select "5G New Radio > General > Link Direction" > **"Downlink"**.
2. Select "Scheduling > User x BWP x > Content > PDSCH > Settings > Config".
3. Select "TxScheme".

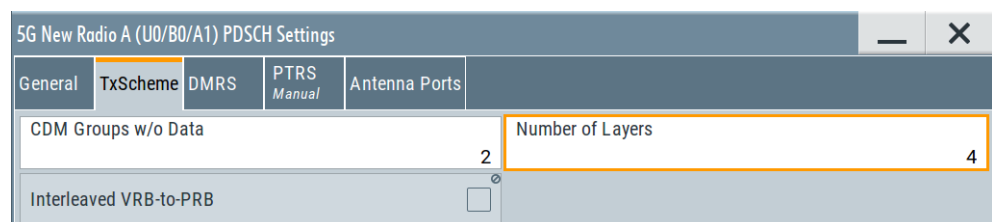

4. Select "5G New Radio > General > Link Direction" > **"Uplink"**.
5. Select "Scheduling > User x BWP x > Content > PUSCH > Settings > Config".
6. Select "General > PUSCH Type = DCI Format 0_1".

7. Select "TxScheme".

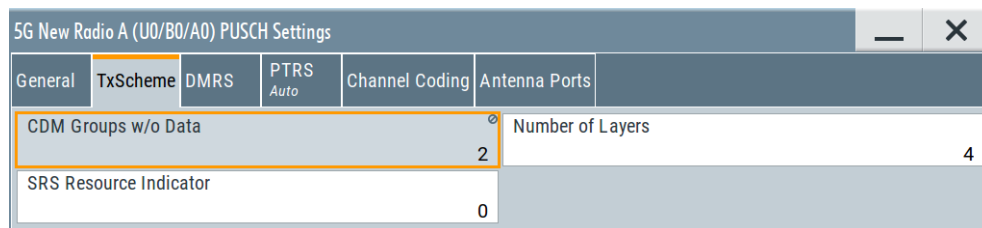
**Settings:**

CDM Groups w/o Data.....	220
Number of Layers.....	220
TPMI.....	220
SRS Resource Indicator.....	221
Interleaved VRB-to-PRB.....	221
Number of CSI-RS Antenna Ports.....	221
Codebook Type.....	221
Precoding configuration.....	222

CDM Groups w/o Data

Selects the number of CDM groups that are reserved and contain no data. They are therefore not used by the PDSCH/PUSCH for data transmission. In the resource grid, the resource elements for CDM (between PDSCH/PUSCH DMRS resource elements) remain empty.

The value is required to select the number of DMRS ports and hence the number of antenna ports. For details, see [TS 38.212](#).

If "User/BWPs > UL BWP Config > PUSCH" > [Transform Precoding](#) = "On", this parameter is set automatically.

Remote command:

```
[ :SOURce<hw> ] :BB:NR5G:SCHed:CELL<cc>:SUBF<sf>:USER<us>:
BWPart<bwp>:ALLoc<al>:PDSCh|PUSCh:TXScheme:CDMData on page 618
```

Number of Layers

Sets the number of precoding layers.

The combination of number of codewords and number of layers determines the layer mapping. Each layer is transmitted on a separate antenna port. The minimum number of layers corresponds to the selected [Number of Codewords](#).

If "User/BWPs > UL BWP Config > PUSCH" > [TxConfig](#) = "Codebook", this parameter is set automatically; a number of layers > 1 is possible if the [number of antenna ports](#) for an SRS resource is > 1.

Remote command:

```
[ :SOURce<hw> ] :BB:NR5G:SCHed:CELL<cc>:SUBF<sf>:USER<us>:
BWPart<bwp>:ALLoc<al>:PDSCh|PUSCh|PSSCh:TXScheme:NLAYers
on page 719
```

TPMI

Access: "User/BWPs > UL BWP Config > PUSCH" > [TxConfig](#) = "Codebook".

Sets the TPMI index, required to select the precoding matrix, as defined in TS 38.211.

Remote command:

```
[ :SOURce<hw> ] :BB:NR5G:SCHed:CELL<cc>:SUBF<sf>:USER<us>:
BWPart<bwp>:ALLoc<al>:PUSCh:TXSCHEME:TPMidx on page 622
```

SRS Resource Indicator

Access: "User/BWPs > UL BWP Config > SRS > Resource > Config" > [Resources](#) ≥ 1.

Selects the SRS resource to be used. SRS resources are defined in the SRS resource table and the resource indicator refers to a table row number.

See "[Resource > Config](#)" on page 187.

If only one SRS resource is defined, the "SRS Resource Indicator = 0".

Remote command:

```
[ :SOURce<hw> ] :BB:NR5G:SCHed:CELL<cc>:SUBF<sf>:USER<us>:
BWPart<bwp>:ALLoc<al>:PUSCh:TXSCHEME:SRI on page 621
```

Interleaved VRB-to-PRB

If "User/BWP Settings > DL BWP Config > PDSCH" > [VRB-to-PRB Interleaver](#) = "2 or 4", the VRB-to-PRB interleaving is enabled for all PDSCH allocation.

With this parameter, you can disable the VRB-to-PRB interleaving for the particular PDSCH.

Remote command:

```
[ :SOURce<hw> ] :BB:NR5G:SCHed:CELL<cc>:SUBF<sf>:USER<us>:
BWPart<bwp>:ALLoc<al>:PDSCh:TXSCHEME:INTervp on page 618
```

Number of CSI-RS Antenna Ports

Selects the number of antenna ports the CSI-RS is transmitted on.

The setting becomes available when you select the precoding based on a 3GPP codebook. The number of selected antenna ports in turn has an effect on the availability on the codebook parameters that define the precoding matrix.

Note that increasing the [number of layers](#) automatically adjusts the number of antenna ports.

Currently, the R&S SMM100A supports up to four antenna ports.

Remote command:

```
[ :SOURce<hw> ] :BB:NR5G:SCHed:CELL<cc>:SUBF<sf>:USER<us>:
BWPart<bwp>:ALLoc<al>:PDSCh:TXSCHEME:APCSirs on page 617
```

Codebook Type

Shows the codebook type (higher layer parameter `codebookType`).

Currently, the R&S SMM100A supports type I single panel codebook.

Remote command:

```
[ :SOURce<hw> ] :BB:NR5G:SCHed:CELL<cc>:SUBF<sf>:USER<us>:
BWPart<bwp>:ALLoc<al>:PDSCh:TXSCHEME:CBType? on page 618
```

Precoding configuration

The precoding configuration parameters define which precoding matrix from the codebook is applied.

The following precoding parameters are available:

- "N1"
- "N2"
- "Codebook Mode"
- "Codebook Index 1_1" ($i_{1,1}$)
- "Codebook Index 1_2" ($i_{1,2}$)
- "Codebook Index 1_3" ($i_{1,3}$)
- "Codebook Index 2" (i_2)

Depending on the antenna port and layer configuration, some precoding parameters are automatically set and read only.

The number and type of precoding parameters depend on the [number of antenna ports](#) and the [number of layers](#) you have selected.

The effects on precoding matrix selection, dependencies and ranges of the precoding parameters are described by the tables in 38.214, chapter 5.2.2.2.

Remote command:

N1: [:SOURCE<hw>]:BB:NR5G:SCHEd:CELL<cc>:SUBF<sf>:USER<us>:
BWPart<bwp>:ALLoc<al>:PDSCh:TXSCHEME:PCN1 on page 619

N2: [:SOURCE<hw>]:BB:NR5G:SCHEd:CELL<cc>:SUBF<sf>:USER<us>:
BWPart<bwp>:ALLoc<al>:PDSCh:TXSCHEME:PCN2? on page 619

Codebook Index 1_1: [:SOURCE<hw>]:BB:NR5G:SCHEd:CELL<cc>:SUBF<sf>:
USER<us>:BWPart<bwp>:ALLoc<al>:PDSCh:TXSCHEME:SPCB<s2us0>:I11
on page 620

Codebook Index 1_2: [:SOURCE<hw>]:BB:NR5G:SCHEd:CELL<cc>:SUBF<sf>:
USER<us>:BWPart<bwp>:ALLoc<al>:PDSCh:TXSCHEME:SPCB<s2us0>:I12
on page 620

Codebook Index 1_3: [:SOURCE<hw>]:BB:NR5G:SCHEd:CELL<cc>:SUBF<sf>:
USER<us>:BWPart<bwp>:ALLoc<al>:PDSCh:TXSCHEME:SPCB<s2us0>:I13
on page 621

Codebook Index 2: [:SOURCE<hw>]:BB:NR5G:SCHEd:CELL<cc>:SUBF<sf>:
USER<us>:BWPart<bwp>:ALLoc<al>:PDSCh:TXSCHEME:SPCB<s2us0>:I2
on page 621

Codebook Mode: [:SOURCE<hw>]:BB:NR5G:SCHEd:CELL<cc>:SUBF<sf>:
USER<us>:BWPart<bwp>:ALLoc<al>:PDSCh:TXSCHEME:CBMD on page 617

5.5.3 DMRS settings

Access:

1. Select "Scheduling > User x BWP x > Content > PDSCH/PUSCH > Settings > Config".
2. Select "DMRS".

General	TxScheme	DMRS Auto	PTRS Manual	Antenna Ports	Info
Mode					
Auto					
Sequence Generation			N_ID^Cell		N_SCID
					0
N_ID^RS			N_ID^Cell		Group or Sequence Hopping
					Neither
Length					Slot Symbols
					2
Power					
					3.00 dB
DMRS Antenna Port Mapping					
DMRS Antenna Ports ...					0

Settings:

Mode.....	223
Sequence Generation.....	223
N_SCID.....	224
N_ID^RS.....	224
Group or Sequence Hopping.....	224
TypeA Position.....	224
Config Type.....	225
Additional Position Index.....	225
Length.....	225
Slot Symbols.....	225
Power.....	225
DMRS Antenna Ports	225

Mode

Selects the configuration mode for the DMRS.

"Auto" Apply the same settings to all allocations.

"Manual" Define DMRS settings for each allocation separately.

Remote command:

```
[ :SOURce<hw> ] :BB:NR5G:SCHed:CELL<cc>:SUBF<sf>:USER<us>:
BWPart<bwp>:ALLoc<al>:PDSCh|PUSCh:DMRS:MODE on page 625
```

Sequence Generation

The initialization sequence of the pseudo-random sequence generator is generated based among others depending on a parameter called scrambling ID ($N_{ID}^{n_SCID}$).

This parameter defines how the scrambling ID is derived:

"N_ID^Cell" Scrambling ID (i.e. $N_{ID}^{n_SCID}$) = cell ID (i.e. N_{ID}^{Cell})

"N_ID^DMRS" Scrambling ID (i.e. $N_{ID}^{n_SCID}$) = DMRS scrambling ID (i.e. N_{ID}^{DMRS})

See also ["About PDSCH and DMRS sequence generation"](#) on page 115.

Remote command:

```
[ :SOURCE<hw> ] :BB:NR5G:SCHed:CELL<cc>:SUBF<sf>:USER<us>:
BWPart<bwp>:ALLoc<al>:PDSCh|PUSCh:DMRS:SEQGen on page 626
```

N_SCID

Sets which variable, N_{ID}^0 or N_{ID}^1 , is used by the generation of the initialization sequence of the pseudo-random sequence generator. The value of the parameters N_{ID}^0 or N_{ID}^1 is set per DMRS type with the parameters "User/BWP > DL BWP > PDSCH" > [127](#).

See also ["About PDSCH and DMRS sequence generation"](#) on page 115.

Remote command:

```
[ :SOURCE<hw> ] :BB:NR5G:SCHed:CELL<cc>:SUBF<sf>:USER<us>:
BWPart<bwp>:ALLoc<al>:PDSCh|PUSCh:DMRS:NSID on page 625
```

N_ID^RS

Sets whether the variable n_{ID}^{CELL} or n_{ID}^{PUSCH} is used by the generation of the DMRS sequence.

Enabled if "User/BWP > PUSCH Config > PUSCH > Transform Precoding > On".

Remote command:

```
[ :SOURCE<hw> ] :BB:NR5G:SCHed:CELL<cc>:SUBF<sf>:USER<us>:
BWPart<bwp>:ALLoc<al>:PUSCh:DMR:NIDSel on page 624
```

Group or Sequence Hopping

Sets the higher-layer parameter `groupOrSequenceHopping` that defines the sequence group for the DMRS sequence generation according to [TS 38.211](#).

Enabled if "User/BWP > PUSCH Config > PUSCH > Transform Precoding > On".

Neither Disables the group and sequence hopping for the DMRS sequence generation.

Group Hopping Enables the group hopping for the DMRS sequence generation.

Sequence Hopping Enables the sequence hopping for the DMRS sequence generation.

Remote command:

```
[ :SOURCE<hw> ] :BB:NR5G:SCHed:CELL<cc>:SUBF<sf>:USER<us>:
BWPart<bwp>:ALLoc<al>:PDSCh|PUSCh:DMRS:SEQHopping on page 626
```

TypeA Position

Defines the position of the DMRS.

For details see ["DMRS Type A Position"](#) on page 57.

Unavailable for individual allocations if configuration `mode` = "Auto".

Remote command:

```
[ :SOURCE<hw> ] :BB:NR5G:SCHed:CELL<cc>:SUBF<sf>:USER<us>:
BWPart<bwp>:ALLoc<al>:PDSCh|PUSCh:DMRS:TAPos on page 627
```

Config Type

Selects the DMRS configuration type.

For details see ["Config Type"](#) on page 126.

Unavailable for individual allocations if configuration `mode` = "Auto".

Remote command:

```
[ :SOURce<hw> ] :BB:NR5G:SCHed:CELL<cc>:SUBF<sf>:USER<us>:
BWPart<bwp>:ALLoc<al>:PDSCh|PUSCh:DMRS:CTYPe on page 623
```

Additional Position Index

Defines the position of the DMRS.

For details, see ["Additional Position Index"](#) on page 127.

Unavailable for individual allocations if configuration `mode` = "Auto".

Remote command:

```
[ :SOURce<hw> ] :BB:NR5G:SCHed:CELL<cc>:SUBF<sf>:USER<us>:
BWPart<bwp>:ALLoc<al>:PDSCh|PUSCh:DMRS:APINdex on page 623
```

Length

Defines whether single- or double-symbol DMRS is used.

Remote command:

```
[ :SOURce<hw> ] :BB:NR5G:SCHed:CELL<cc>:SUBF<sf>:USER<us>:
BWPart<bwp>:ALLoc<al>:PDSCh|PUSCh:DMRS:LENGth on page 624
```

Slot Symbols

Indicates the number of DMRS slot symbols. The value is set automatically, depending on the selected "Length".

Unavailable if configuration `mode` = "Manual".

Remote command:

```
[ :SOURce<hw> ] :BB:NR5G:SCHed:CELL<cc>:SUBF<sf>:USER<us>:
BWPart<bwp>:ALLoc<al>:PDSCh|PUSCh:DMRS:SLTSymbols? on page 626
```

Power

Sets the power of the PDSCH/PUSCH, relative to the power of the other channels.

Remote command:

```
[ :SOURce<hw> ] :BB:NR5G:SCHed:CELL<cc>:SUBF<sf>:USER<us>:
BWPart<bwp>:ALLoc<al>:PDSCh|PUSCh:DMRS:POWer on page 625
```

DMRS Antenna Ports ...

Sets the antenna ports.

The number of allocated antenna ports must be equal to the number of layers and must not be equal to the number of mapped antenna ports.

Note: When the codebook is used, the antenna ports in "Antenna Port" tab are numbered consecutively from 1000 to 1000 + number of mapped antenna ports. When the codebook is not used, the antenna ports configured for DMRS + 1000 are used.

Remote command:

```
[ :SOURce<hw> ] :BB:NR5G:SCHed:CELL<cc>:SUBF<sf>:USER<us>:
BWPart<bwp>:ALLoc<al>:PDSCh [ :DMRS ] :APSelect<s2us0> on page 506
[ :SOURce<hw> ] :BB:NR5G:SCHed:CELL<cc>:SUBF<sf>:USER<us>:
BWPart<bwp>:ALLoc<al>:PUSCh [ :DMRS ] :APSelect<s2us0> on page 627
```

5.5.4 Channel coding settings

Access:

1. Select "5G New Radio > General > Users/BWPs > Properties > DSCH/USCH Channel Coding > On".
2. Select "Scheduling > User x BWP x > Content > PDSCH/PUSCH > Settings > Config".
3. Select "Channel Coding".

The dialog comprises the settings for the LDPC channel coding for PDSCH and PUSCH.

5G New Radio A (U0/B0/A1) PDSCH Settings							
General	TxScheme	DMRS	Channel Coding	PTRS Manual	Antenna Ports	Info	
Manually defined Code Rate	0	Target Code Rate	0.117				
I _{MCS}	0	Number of Physical Bits	77 868				
Transport Block Size	9 480	Resulting MCS Table	MCS 1				
Redundancy Version Index	0						

Channel coding parameters determine the code rate of the PDSCH/PUSCH, which is the ratio between transmitted bits and maximum bits in a subframe (or 1 ms transport block). Because the number of bits in a subframe is variable, the target code rate has to be derived from the modulation order in combination with an index I_{MCS} .

You can select the modulation order for the PDSCH/PUSCH (one of several tables, one for each modulation type) by setting the corresponding index value "I_{MCS}". The target code rates for modulation order and index are defined in [TS 38.214](#).

In addition to the modulation order and I_{MCS} , the number of transmitted bits depends on the "Redundancy Version Index". Depending on the redundancy version index, the PDSCH/PUSCH contains a different number of parity bits for error detection: Index 0 adds 1 sequence of parity bits, index 1 adds two sequences of parity bits etc.

Settings:

Manually Defined Coderate.....	227
I_MCS.....	227
Target Code Rate.....	227
Phys. Bits.....	227
Transport Block Size.....	228
Resulting MCS Table.....	228
Redundancy Version Index.....	228
TBS Scaling Factor.....	228

Manually Defined Coderate

Turns custom coderate definition on and off.

Effects of automatic coderate definition:

- The target code rate, number of physical bits, transport block size and MCS table are automatically calculated based on the modulation and I_MCS.

Effects of manual coderate definition:

- You can define a custom target code rate.
- The number of physical bits and transport block size are calculated based on the modulation and target code rate.
- Selecting an I_MCS and calculation of MCS table becomes unavailable.

Remote command:

```
[ :SOURce<hw> ] :BB:NR5G:SCHed:CELL<cc>:SUBF<sf>:USER<us>:
BWPart<bwp>:ALLoc<al> [ :CW<cw> ] :PDSCh|PUSCh:CCODing:FRCR
on page 628
```

I_MCS

Sets the modulation and coding scheme index.

The available values depend on the selected [Modulation](#).

Remote command:

```
[ :SOURce<hw> ] :BB:NR5G:SCHed:CELL<cc>:SUBF<sf>:USER<us>:
BWPart<bwp>:ALLoc<al> [ :CW<cw> ] :PDSCh|PUSCh:CCODing:IMCS
on page 628
```

Target Code Rate

Shows or defines the target code rate.

- For automatic code rate selection, the target code rate is automatically calculated depending on the [modulation and coding scheme](#) ("I_MCS").
- For [manual code rate definition](#), you can define a custom target code rate. Selecting an I_MCS is not possible in that case.

Remote command:

```
[ :SOURce<hw> ] :BB:NR5G:SCHed:CELL<cc>:SUBF<sf>:USER<us>:
BWPart<bwp>:ALLoc<al> [ :CW<cw> ] :PDSCh|PUSCh:CCODing:TCRate
on page 629
```

Phys. Bits

Indicates the size of the selected allocation in bits.

Remote command:

```
[ :SOURCE<hw> ] :BB:NR5G:SCHed:CELL<cc>:SUBF<sf>:USER<us>:
BWPart<bwp>:ALLoc<al> [ :CW<cw> ] :PHYSbits? on page 610
```

Transport Block Size

Indicates the resulting transport block size (TBS), calculated for the selected modulation and coding scheme ("I_MSC").

Remote command:

```
[ :SOURCE<hw> ] :BB:NR5G:SCHed:CELL<cc>:SUBF<sf>:USER<us>:
BWPart<bwp>:ALLoc<al> [ :CW<cw> ] :PDSCh|PUSCh:CCODing:TBSize?
on page 629
```

Resulting MCS Table

Shows the MCS table the configuration corresponds to. The MCS tables are defined in 3GPP 38.214.

Automatic calculation of the MCS table is possible when [manual coderate definition](#) is off.

Remote command:

```
[ :SOURCE<hw> ] :BB:NR5G:SCHed:CELL<cc>:SUBF<sf>:USER<us>:
BWPart<bwp>:ALLoc<al> [ :CW<cw> ] :RMCStable? on page 630
```

Redundancy Version Index

Sets the redundancy version index.

Depending on the redundancy version index, the PDSCH/PUSCH contains a different number of parity bits for error detection: Index 0 adds 1 sequence of parity bits, index 1 adds two sequences of parity bits etc.

Remote command:

```
[ :SOURCE<hw> ] :BB:NR5G:SCHed:CELL<cc>:SUBF<sf>:USER<us>:
BWPart<bwp>:ALLoc<al> [ :CW<cw> ] :PDSCh|PUSCh:CCODing:RVIndex
on page 629
```

TBS Scaling Factor

Selects the size of the TB scaling factor S. The TB scaling factor S has an effect on the size of a transport block (TB), which in turn affects the code rate.

Remote command:

```
[ :SOURCE<hw> ] :BB:NR5G:SCHed:CELL<cc>:SUBF<sf>:USER<us>:
BWPart<bwp>:ALLoc<al> [ :CW<cw> ] :PDSCh|PUSCh:CCODing:TBSFactor
on page 629
```

5.5.5 UCI settings

Access:

1. Select "Users/BWPs > Properties > USCH Channel Coding > On".
2. Select "Users/BWPs > UL BWP Config > PUSCH UCI > State > On".

3. Select "Scheduling > User x BWP x > Content > PUSCH > Settings > Config".
4. Select "UCI".

5G New Radio A (U0/B0/A0)PUSCH Settings		—	×		
General	TxScheme	DMRS	Channel Coding	UCI	Antenna Ports
Number of ACK Bits	1	ACK Pattern	0...		
Number of CSI 1 Bits	1	CSI 1 Pattern	0...		
Number of CSI 2 Bits	1	CSI 2 Pattern	0...		

Settings:

Number of ACK Bits.....	229
ACK Pattern.....	229
Number of CG-UCI Bits.....	229
CG-UCI Pattern.....	230
Number of CSI x Bits.....	230
CSI x Pattern.....	230

Number of ACK Bits

Sets the number of ACK bits and defines the length of the "ACK Pattern" field.

Remote command:

```
[ :SOURce<hw> ] :BB:NR5G:SCHed:CELL<cc>:SUBF<sf>:USER<us>:
BWPart<bwp>:ALLoc<al>:PUSCh:UCI:ACK:BITS on page 631
```

ACK Pattern

Sets the ACK bits in pattern form, where the pattern length is set with the parameter "Number of ACK Bits".

A "1" indicates an ACK, a "0" - a NACK.

The pattern is read out once.

Remote command:

```
[ :SOURce<hw> ] :BB:NR5G:SCHed:CELL<cc>:SUBF<sf>:USER<us>:
BWPart<bwp>:ALLoc<al>:PUSCh:UCI:ACK:PATtern on page 631
```

Number of CG-UCI Bits

Sets the number of CG-UCI bits and defines the length of the "CG-UCI Pattern" field.

Remote command:

```
[ :SOURce<hw> ] :BB:NR5G:SCHed:CELL<cc>:SUBF<sf>:USER<us>:
BWPart<bwp>:ALLoc<al>:PUSCh:UCI:CGUCi:BITS on page 632
```

CG-UCI Pattern

Sets the ACK bits in pattern form, where the pattern length is set with the parameter "Number of CG-UCI Bits".

A "1" indicates an ACK, a "0" - a NACK.

The pattern is read out once.

Remote command:

```
[ :SOURce<hw> ] :BB:NR5G:SCHed:CELL<cc>:SUBF<sf>:USER<us>:
BWPart<bwp>:ALLoc<al>:PUSCh:UCI:CGUCi:PATtern on page 632
```

Number of CSI x Bits

Sets the number of CSI 1/CSI 2 bits and defines the length of the "CSI Pattern" fields.

Remote command:

```
[ :SOURce<hw> ] :BB:NR5G:SCHed:CELL<cc>:SUBF<sf>:USER<us>:
BWPart<bwp>:ALLoc<al>:PUSCh:UCI:CSI1:BITS on page 631
[ :SOURce<hw> ] :BB:NR5G:SCHed:CELL<cc>:SUBF<sf>:USER<us>:
BWPart<bwp>:ALLoc<al>:PUSCh:UCI:CSI2:BITS on page 631
```

CSI x Pattern

Sets the CSI bits in pattern form, where the pattern length is set with the parameter "Number of CSI x Bits".

A "1" indicates an ACK, a "0" - a NACK.

The pattern is read out once.

Remote command:

```
[ :SOURce<hw> ] :BB:NR5G:SCHed:CELL<cc>:SUBF<sf>:USER<us>:
BWPart<bwp>:ALLoc<al>:PUSCh:UCI:CSI1:PATtern on page 631
[ :SOURce<hw> ] :BB:NR5G:SCHed:CELL<cc>:SUBF<sf>:USER<us>:
BWPart<bwp>:ALLoc<al>:PUSCh:UCI:CSI2:PATtern on page 631
```

5.5.6 PTRS settings

Access:

1. Select "Scheduling > User x BWP x > Content > PDSCH/PUSCH > Settings > Config".

2. Select "PTRS".

The dialog comprises the settings of the phase-tracking reference signal (PTRS). The phase tracking reference signal (PTRS) is a UE-specific reference signal that is used to compensate for the phase noise of the oscillator. Phase-tracking reference signals can be transmitted only in the resource blocks used for the P_xSCH and if the transmission is enabled.

If the PTRS "State" is on, you can define its "Power" relative to the P_xSCH and its location in the resource grid.



The power of the PTRS is only defined for up to 6 layers (3GPP 38.214, table 4.1-2). Therefore, you can no longer define the characteristics of the PTRS when you select more than 6 **layers**.

Settings:

Mode.....	231
PTRS-DMRS Association	232
State.....	232
Time Density (L_PTRS).....	232
Frequency Density (K_PTRS).....	232
RE-offset.....	232
EPRE Ratio.....	232
Power.....	233
Max Number of Ports.....	233

Mode

Sets how the PTRS configuration is defined:

"Auto" If **DSCH/USCH Channel Coding** > "On" and "PTRS" > **State** > "On", the PTRS configuration is derived from the current PDSCH DMRS settings.

"Manual" You configure PTRS manually, with the settings provided in the "P_xSCH Settings > PTRS" dialog.

Remote command:

```
[ : SOURce<hw> ] : BB : NR5G : SCHed : CELL<cc> : SUBF<sf> : USER<us> :  
BWPart<bwp> : ALLoc<al> : PDSCh | PUSCh : PTRS : MODE on page 634
```

PTRS-DMRS Association

If "Scheduling > User x BWP x > Content = PUSCH", indicates the PTRS-DMRS association.

The association between UL PTRS ports and DMRS ports is signaled by PTRS-DMRS association field in DCI format 0_1.

Remote command:

```
[ :SOURCE<hw> ] :BB:NR5G:SCHed:CELL<cc>:SUBF<sf>:USER<us>:
BWPart<bwp>:ALLoc<al>:PUSCh:PTRS:PTDMrs on page 635
```

State

Enables the transmission of phase-tracking reference signals.

Remote command:

```
[ :SOURCE<hw> ] :BB:NR5G:SCHed:CELL<cc>:SUBF<sf>:USER<us>:
BWPart<bwp>:ALLoc<al>:PDSCh|PUSCh:PTRS:STATe on page 634
```

Time Density (L_PTRS)

Sets the higher-layer parameter `timeDensity`.

The "L_PTRS" defines distance between the PTRS in terms of OFDM symbols (transmission every 1, 2 or 4 OFDM symbols). If the subcarrier used by the PTRS also contains a DMRS, the distance can be larger.

Remote command:

```
[ :SOURCE<hw> ] :BB:NR5G:SCHed:CELL<cc>:SUBF<sf>:USER<us>:
BWPart<bwp>:ALLoc<al>:PDSCh|PUSCh:PTRS:TMDen on page 635
```

Frequency Density (K_PTRS)

Sets the higher-layer parameter `frequencyDensity`.

The "K_PTRS" and "RE-offset" define the location of the PTRS in the frequency domain. K_{PTRS} defines the distances between the PTRS in terms of subcarrier. You can also define an additional frequency offset for the PTRS relative to the first subcarrier.

Remote command:

```
[ :SOURCE<hw> ] :BB:NR5G:SCHed:CELL<cc>:SUBF<sf>:USER<us>:
BWPart<bwp>:ALLoc<al>:PDSCh|PUSCh:PTRS:FRQDen on page 633
```

RE-offset

Sets the parameter `resourceElementOffset` $k_{\text{ref}}^{\text{RE}}$ required to define the precoding and mapping to the physical resources.

Remote command:

```
[ :SOURCE<hw> ] :BB:NR5G:SCHed:CELL<cc>:SUBF<sf>:USER<us>:
BWPart<bwp>:ALLoc<al>:PDSCh|PUSCh:PTRS:REOF on page 634
```

EPRE Ratio

If "Scheduling > User x BWP x > Content = PDSCH", sets the higher layer parameter `epre-Ratio`. It is needed to define the ratio of PTRS EPRE to PDSCH EPRE per layer per RE for PTRS port.

The abbreviation EPRE stands for energy per resource element.

Remote command:

```
[ :SOURce<hw> ] :BB:NR5G:SCHed:CELL<cc>:SUBF<sf>:USER<us>:
BWPart<bwp>:ALLOc<al>:PDSCh:PTRS:EPRE on page 633
```

Power

If "Scheduling > User x BWP x > Content = PUSCH", sets the parameter `ptrs-Power` and thus defines the PUSCH to PTRS power ratio per layer per resource element.

Remote command:

```
[ :SOURce<hw> ] :BB:NR5G:SCHed:CELL<cc>:SUBF<sf>:USER<us>:
BWPart<bwp>:ALLOc<al>:PUSCh:PTRS:POWer on page 635
```

Max Number of Ports

If "Scheduling > User x BWP x > Content = PUSCH", sets the maximum number of configured PTRS ports, given by the higher-level parameter `maxNrofPorts`.

Remote command:

```
[ :SOURce<hw> ] :BB:NR5G:SCHed:CELL<cc>:SUBF<sf>:USER<us>:
BWPart<bwp>:ALLOc<al>:PUSCh:PTRS:PORT on page 635
```

5.5.7 PTRS settings with enabled transform precoding

Access:

1. Select "Users/BWPs > Properties > USCH Channel Coding > On".
2. Select "General > Users/BWPs > UL BWP Config > PUSCH > Transform Precoding > On"
3. Select "Scheduling > User x BWP x > Content > PUSCH > Settings > Config".
4. Select "PTRS".

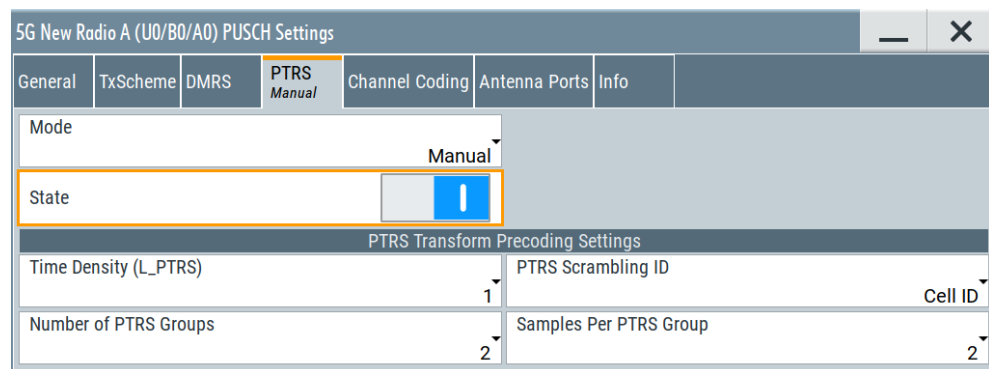

The dialog comprises the settings of the phase-tracking reference signal (PTRS) if transform precoding is enabled.

Settings:

Mode.....	234
State.....	234
Time Density (L_PTRS).....	234
Number of PTRS Groups.....	234
PTRS Scrambling ID.....	234
Samples Per PTRS Group.....	235

Mode

Sets how the PTRS configuration is defined:

- "Auto" If **DSCH/USCH Channel Coding** > "On" and "PTRS (Transform Pre-coding)" > **State** > "On", the PTRS configuration is derived from the current PUSCH DMRS settings.
- "Manual" You configure PTRS manually, with the settings provided in the "PUSCH Settings > PTRS" dialog.

Remote command:

```
[ :SOURce<hw> ] :BB:NR5G:SCHed:CELL<cc>:SUBF<sf>:USER<us>:
BWPart<bwp>:ALLoc<al>:PUSCh:PTRS:TP:MODE on page 636
```

State

Enables the transmission of phase-tracking reference signals.

Remote command:

```
[ :SOURce<hw> ] :BB:NR5G:SCHed:CELL<cc>:SUBF<sf>:USER<us>:
BWPart<bwp>:ALLoc<al>:PUSCh:PTRS:TP:STATe on page 637
```

Time Density (L_PTRS)

Sets the higher-layer parameter `timeDensity`.

Remote command:

```
[ :SOURce<hw> ] :BB:NR5G:SCHed:CELL<cc>:SUBF<sf>:USER<us>:
BWPart<bwp>:ALLoc<al>:PUSCh:PTRS:TP:TMDensity on page 637
```

Number of PTRS Groups

Sets the number of PTRS groups according to **TS 38.214**, required to define the PTRS group pattern.

Remote command:

```
[ :SOURce<hw> ] :BB:NR5G:SCHed:CELL<cc>:SUBF<sf>:USER<us>:
BWPart<bwp>:ALLoc<al>:PUSCh:PTRS:TP:NGRPs on page 636
```

PTRS Scrambling ID

Sets whether the PTRS Scrambling ID value used for PTRS sequence generation is configured by the **NPusch ID** (higher layer) or by the cell ID.

- Cell ID Sets the cell ID as the scrambling ID for PTRS sequence generation. This is the value by default.
- N_ID^PUSCH Sets the **NPusch ID** as the scrambling ID for PTRS sequence generation.

Remote command:

```
[ :SOURce<hw> ] :BB:NR5G:SCHed:CELL<cc>:SUBF<sf>:USER<us>:
BWPart<bwp>:ALLoc<al>:PUSCh:PTRS:TP:SCID on page 636
```

Samples Per PTRS Group

Sets the number of samples per PTRS group according to TS 38.214, required to define the PTRS group pattern.

Remote command:

```
[ :SOURce<hw> ] :BB:NR5G:SCHed:CELL<cc>:SUBF<sf>:USER<us>:
BWPart<bwp>:ALLoc<al>:PUSCh:PTRS:TP:SPPG on page 637
```

5.5.8 Antenna ports

Access:

1. Select "Scheduling > User x BWP x > Content > PDSCH/PUSCH > Settings > Config".
2. Select "Antenna Ports".

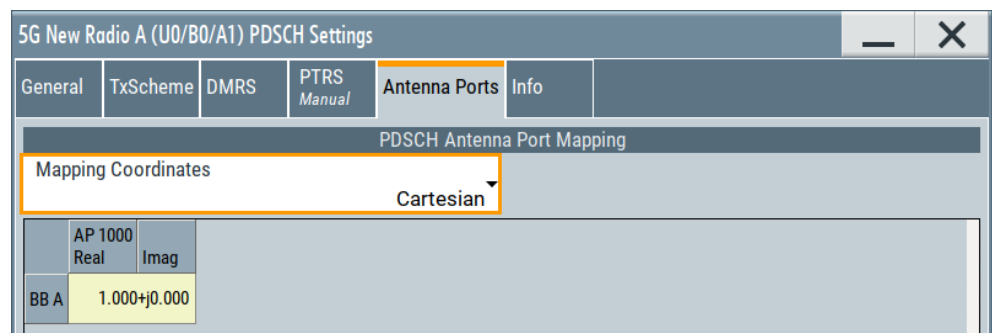

With the provided settings, you can map the antenna ports arbitrarily to the base-band outputs. The available antenna ports depend on the current configuration. For details on the antenna port-mapping concept, see [Chapter 2.10, "Antenna port mapping"](#), on page 27.

Settings:

Mapping Coordinates	235
Mapping Table	235

Mapping Coordinates

Switches representation between the "Cartesian" (Real/Imag) and "Cylindrical" (Magn./Phase) coordinates.

Mapping Table

Defines the mapping of the antenna ports (AP) to the physical antennas.

The available antenna ports depend on the current configuration. For details on the antenna port-mapping concept, see [Chapter 2.10, "Antenna port mapping"](#), on page 27.

Remote command:

"Mapping Coordinates = Cartesian":

```
[ :SOURce<hw> ] :BB:NR5G:SCHed:CELL<cc>:SUBF<sf>:USER<us>:
BWPart<bwp>:ALLoc<al>:APMap:COL<apc>:ROW<apr>:REAL on page 639
```

```
[ :SOURce<hw> ] :BB:NR5G:SCHed:CELL<cc>:SUBF<sf>:USER<us>:
BWPart<bwp>:ALLoc<al>:APMap:COL<apc>:ROW<apr>:IMAGinary
on page 639
```

"Mapping Coordinates = Cylindrical":

```
[ :SOURce<hw> ] :BB:NR5G:SCHed:CELL<cc>:SUBF<sf>:USER<us>:
BWPart<bwp>:ALLoc<al>:APMap:COL<apc>:ROW<apr>:MAGNitude
on page 638
```

```
[ :SOURce<hw> ] :BB:NR5G:SCHed:CELL<cc>:SUBF<sf>:USER<us>:
BWPart<bwp>:ALLoc<al>:APMap:COL<apc>:ROW<apr>:PHASe on page 638
```

5.5.9 Info

Access:

1. Select "Scheduling > User x BWP x > Content > PDSCH/PUSCH > Settings > Config".
2. Select "Info".

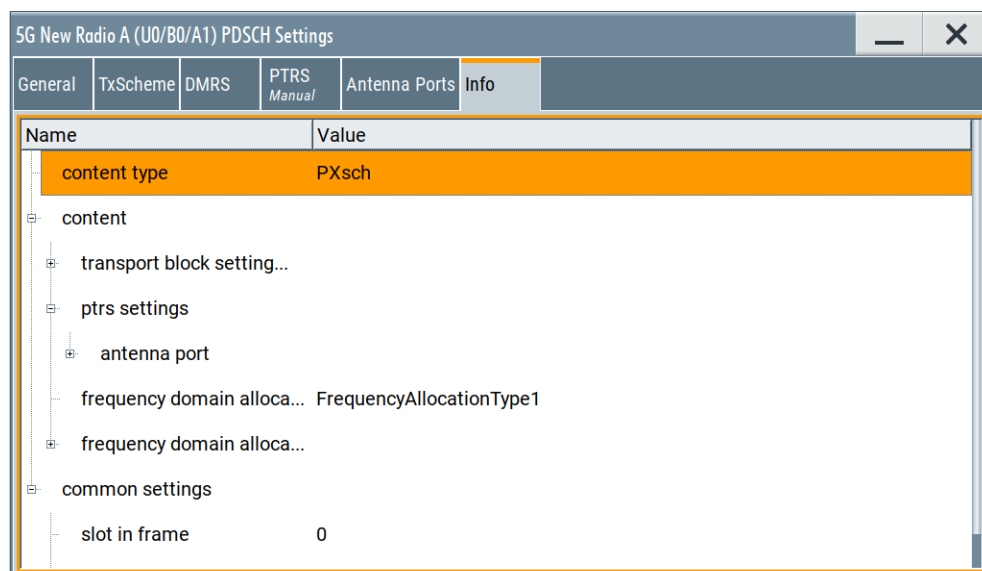

The dialog displays details on the PDSCH/PUSCH configuration.

Info

The dialog displays details on the configuration.

There are two information lists:

- "Stable": Naming and structure of the information in this list are stable in future firmware releases.
- "Mutable": Naming and structure of the information in this list can change in future firmware releases.

Remote command:

[:SOURce<hw>] :BB:NR5G:SCHed:CELL<cc>:SUBF<sf>:USER<us>:
BWPart<bwp>:ALLoc<al>:INFO? on page 600

5.6 CORESET settings

Access:

1. Select "5G New Radio > General > Link Direction > Downlink".
2. Select "5G New Radio > Scheduling".
3. Select "User x BWP x > Content > CORESET".
4. Select "CORESET > Settings > Config".

CORESET

The CORESET settings are defined per user and per BWP. The CORESET size in the frequency domain is given by number of resource blocks $N_{RB}^{CORESET}$ spans; in the time - it can occupy 1, 2 or 3 symbols.

A CCE consists of 6 resource-element groups (REGs). The mapping between the CEE and the REGs is unique per CORESET. It can be interleaved or non-interleaved and is described by the so called REG bundles with different sizes (L).

- [General settings](#).....237
- [Payload settings](#).....242
- [Info](#)..... 268

5.6.1 General settings

Access:

1. Select "5G New Radio > General > Link Direction > Downlink".
2. Select "5G New Radio > Scheduling".
3. Select "User x BWP x > Content > CORESET".

4. Select "CORESET > Settings > Config" > "General".

5G New Radio A (U0/B0/A0) CORESET Settings		
General	Payload	Info
Precoder Granularity	REG Bundle	CORESET ID 1
Use DMRS scrambling ID	<input checked="" type="checkbox"/>	ID 0
Use Bitmap for Resources in Frequency Domain	<input checked="" type="checkbox"/>	Frequency Domain Resources 1 1111 1111 1111 1111 1111 1111 1111 1111 ...
DMRS Reference Point	Point A	Puncturing <input checked="" type="checkbox"/>
Interleaving		
State	<input type="checkbox"/>	Bundle Size 2
Shift Index	0	Size 3
Search Space		
Aggregation Level	Max. Candidates	
0	1	1

This dialog comprises the settings of the Control Resource Set (CORESET). Each CORESET is assigned to a specific user and comprises of a set of one or more PDCCH channels.

The PDCCH channel carries the downlink control information.

Precoder Granularity.....	238
CORESET ID.....	239
Use DMRS Scrambling ID.....	239
ID.....	239
Use Bitmap for Resources in Frequency Domain.....	239
Frequency Domain Resources.....	239
DMRS Reference Point.....	240
Puncturing.....	240
Interleaving State.....	240
Bundle Size.....	240
Shift Index.....	240
Size.....	241
Search Space.....	241
└ Aggregation Level.....	241
└ Max Candidates.....	242

Precoder Granularity

Sets the value of the higher-layer parameter `precoderGranularity`, as defined in TS 38.211.

"REG Bundle" The same precoding is used within a REG bundle; corresponds to `precoderGranularity = sameAsREG-bundle`.

"All Contiguous RBs"

The same precoding is used across all REG within the set of contiguous resource blocks in the CORESET; corresponds to `precoderGranularity = allContiguousRBs`.

Remote command:

```
[ :SOURce<hw> ] :BB:NR5G:SCHed:CELL<cc>:SUBF<sf>:USER<us>:
BWPart<bwp>:ALLoc<al>:CS:PREGran on page 643
```

CORESET ID

Sets the CORESET ID.

Set "CORESET ID = 0" to simulate CORESET 0 (`controlResourceSetZero`). If CORESET 0 is used, the reference point changes and is according to [TS 38.211](#) the subcarrier 0 of the lowest-numbered resource block in the CORESET.

For "CORESET ID ≥ 1", the reference point is subcarrier 0 in common resource block 0.

Remote command:

```
[ :SOURce<hw> ] :BB:NR5G:SCHed:CELL<cc>:SUBF<sf>:USER<us>:
BWPart<bwp>:ALLoc<al>:CS:ID on page 642
```

Use DMRS Scrambling ID

Defines the parameter used to calculate the PUCCH scrambling sequence:

- If disabled, the [Cell ID](#) is used.
- If enabled, the demodulation reference signal [DMRS ID](#) is used.

Remote command:

```
[ :SOURce<hw> ] :BB:NR5G:SCHed:CELL<cc>:SUBF<sf>:USER<us>:
BWPart<bwp>:ALLoc<al>:CS:DMRS:SCRam:STATe on page 640
```

ID

For [Use DMRS Scrambling ID](#) > "On", sets the value of the higher-level parameter `PDCCH-DMRS-Scrambling-ID`, according to [TS 38.211](#).

This DMRS scrambling ID is used to calculate the PDCCH scrambling sequence instead of [Cell ID](#).

Remote command:

```
[ :SOURce<hw> ] :BB:NR5G:SCHed:CELL<cc>:SUBF<sf>:USER<us>:
BWPart<bwp>:ALLoc<al>:CS:DMRS:SCRam:ID on page 640
```

Use Bitmap for Resources in Frequency Domain

If enabled, the CORESET frequency allocation is set as a bitmap, defined with the parameter [Frequency Domain Resources](#).

Remote command:

```
[ :SOURce<hw> ] :BB:NR5G:SCHed:CELL<cc>:SUBF<sf>:USER<us>:
BWPart<bwp>:ALLoc<al>:CS:RESalloc:STATe on page 644
```

Frequency Domain Resources

Sets the value of the higher-level parameter `frequencyDomainResources` according to [TS 38.331](#) and thus defines the CORESET frequency allocation.

The frequency domain resources is a 45 bits long pattern, where value of 1 indicates a resource element group that is used for the CORESET.

Remote command:

```
[ :SOURce<hw> ] :BB:NR5G:SCHed:CELL<cc>:SUBF<sf>:USER<us>:
BWPart<bwp>:ALLoc<al>:CS:RESalloc:BITMap on page 644
```

DMRS Reference Point

Selects the reference point for the DMRS.

"Point A" Reference point is the reference point A.

"CORESET Start" Reference point ist the first resource used by the CORESET.

Remote command:

```
[ :SOURce<hw> ] :BB:NR5G:SCHed:CELL<cc>:SUBF<sf>:USER<us>:
BWPart<bwp>:ALLoc<al>:CS:REFDmrs on page 641
```

Puncturing

Turns puncturing in the CORESET allocation on and off.

Available for a 5 MHz channel bandwidth with 15 kHz subcarrier spacing.

Remote command:

```
[ :SOURce<hw> ] :BB:NR5G:SCHed:CELL<cc>:SUBF<sf>:USER<us>:
BWPart<bwp>:ALLoc<al>:CS:PUNcturing on page 643
```

Interleaving State

If enabled, the CCE-to-REG mapping is interleaved.

This parameter corresponds to the higher-level parameter CORESET-CCE-REG-mapping-type (TS 38.211).

See "CORESET" on page 237.

Remote command:

```
[ :SOURce<hw> ] :BB:NR5G:SCHed:CELL<cc>:SUBF<sf>:USER<us>:
BWPart<bwp>:ALLoc<al>:CS:IL:STATE on page 643
```

Bundle Size

For [Interleaving State](#) > "On", sets the higher-level parameter bundle size L (CORESET-REG-bundle-size).

The value is used to calculate the CCE-to-REG mapping, according to TS 38.211.

See also "CORESET" on page 237.

Remote command:

```
[ :SOURce<hw> ] :BB:NR5G:SCHed:CELL<cc>:SUBF<sf>:USER<us>:
BWPart<bwp>:ALLoc<al>:CS:IL:BUNSize on page 642
```

Shift Index

For [Interleaving State](#) > "On", sets the higher-level parameter shift index n_{shift} (CORESET-shift-index).

The value is used to calculate the CCE-to-REG mapping, according to TS 38.211.

See also "CORESET" on page 237.

Remote command:

```
[ :SOURce<hw> ] :BB:NR5G:SCHed:CELL<cc>:SUBF<sf>:USER<us>:
BWPart<bwp>:ALLoc<al>:CS:IL:SHIDx on page 642
```

Size

For **Interleaving State** > "On", sets higher-level parameter interleaver size R (CORESET-interleaver-size).

The value is used to calculate the CCE-to-REG mapping, according to TS 38.211.

See also "CORESET" on page 237.

Remote command:

```
[ :SOURce<hw> ] :BB:NR5G:SCHed:CELL<cc>:SUBF<sf>:USER<us>:
BWPart<bwp>:ALLoc<al>:CS:IL:SIZE on page 642
```

Search Space

The term search space describes a set of CCEs that a UE monitors. The UE can decode only the control information on a PDCCH/CORESET that is transmitted over CCEs within the search space this UE monitors.

A physical downlink control channel PDCCH consists of one or more control-channel elements (CCEs), where their number is defined by the "Aggregation level".

The following parameters influence the way the search space is defined:

- If **Restrict to Search Space** > "On", you define the search space by selecting the **aggregation level** and the **number of a particular candidate**. The available candidates are defined as a combination aggregation level and maximum number of candidates per aggregation level.

See:

- "Scheduling > CORESET > Payload" > [Aggregation Level](#)
- "Scheduling > CORESET > Payload" > [Candidate](#)
- "Scheduling > CORESET > General" > [Aggregation Level](#) and [Max Candidates](#)

The **CCE start index** [CCE Index](#) is selected automatically so that the CCE is within the search space.

- If **Restrict to Search Space** > "Off", you define the search space manually, by setting the CCE start index, see [CCE Index](#).

Example:

Select:

- [Restrict to Search Space](#) > "On".
- For "Scheduling > CORESET > General" > [Aggregation Level](#) = "1", select [Max Candidates](#) = "2".
- Select "Scheduling > CORESET > Payload" > [Aggregation Level](#) = "1" and [Candidate](#) = "1"

Observe the CCE index ("Scheduling > CORESET > Payload" > [CCE Index](#)). The value is set automatically.

Aggregation Level ← Search Space

Displays the possible aggregation levels, as defined in TS 38.213.

For each aggregation level, you can set the maximum number of candidates that are monitored, see [Max Candidates](#).

"Aggregation level"	Number of CCEs
1	1
2	2
4	4
8	8
16	16

For more information, see ["Search Space"](#) on page 241.

Remote command:

```
[ :SOURce<hw> ] :BB:NR5G:SCHed:CELL<cc>:SUBF<sf>:USER<us>:
BWPart<bwp>:ALLoc<al>:CS:DMRS:SPACe<s2us0>:AGGLLevel? on page 641
```

Max Candidates ← Search Space

Sets the maximum number of candidates allowed for the selected aggregation level, as specified in [TS 38.213](#).

For more information, see ["Search Space"](#) on page 241.

Remote command:

```
[ :SOURce<hw> ] :BB:NR5G:SCHed:CELL<cc>:SUBF<sf>:USER<us>:
BWPart<bwp>:ALLoc<al>:CS:DMRS:SPACe<s2us0>:MAXCandidate
on page 641
```

5.6.2 Payload settings

Access:

1. Select "5G New Radio > General > Link Direction > Downlink".
2. Select "5G New Radio > Scheduling".
3. Select "User x BWP x > Content > CORESET".
4. Select "CORESET > Settings > Config" > "Payload".

General	Payload	Info												
Unused CCEs		Dummy CCEs	Active UL BWP		0									
Data Source		Pattern	Pattern		0...									
TCI Present in DCI		<input type="checkbox"/>	TCI Size in DCI1_2		Not Configured									
Number of DCIs		1												
Usage	RNTI	DCI Format	Search Space	Aggregation Level	CCE Index	Content	Multiplexing Table	Create PDSCH	PDSCH DMRS Symbols	PDSCH Power (dB)				
0	C-RNTI	0	0_0	USS	1	0	Config...	-	<input type="checkbox"/>	-	0.00			

Unused CCEs.....	243
Dummy CCEs Data Source.....	244
Active UL BWP.....	244
TCI Present In DCI.....	245
TCI Size in DCI1_2.....	245
Number of DCIs.....	245
DCI Table.....	245
L Usage.....	245
L RNTI.....	245
L DCI Format.....	246
L Search Space.....	247
L Aggregation Level.....	248
L Candidate.....	248
L CCE Index.....	249
L Content.....	249
L Multiplexing Table.....	249
L Create PDSCH.....	249
L PDSCH DMRS Symbols.....	249
L PDSCH Power /dB.....	250
DCI content configuration.....	250
L Bit Data > Pattern.....	250
L DCI Format 0_0.....	250
L DCI Format 0_1.....	251
L DCI Format 0_2.....	253
L DCI Format 1_0.....	254
L DCI Format 1_1.....	256
L DCI Format 1_2.....	257
L DCI Format 2_0.....	259
L DCI Format 2_1.....	259
L DCI Format 2_2.....	260
L DCI Format 2_3.....	260
L DCI Format 2_4.....	261
L DCI Format 2_5.....	261
L DCI Format 2_6.....	262
L DCI Format 2_7.....	262
L DCI Format 3_0.....	263
L DCI Format 3_1.....	264
L DCI Format 4_0.....	264
L DCI Format 4_1.....	265
L DCI Format 4_2.....	266
L Custom.....	267
L Channel Coding.....	267
L Data Source.....	267
L Initialization.....	268
L Pattern Length.....	268

Unused CCEs

Defines if unused CORESET resources (CCEs) are used for data transmission or not.

"No Data" No data is transmitted in the unused CCEs.

"Dummy CCEs" Unused CCEs are filled in with dummy data.

"Allow PDSCH" PDSCH transmission is allowed in the unused CCEs.

Remote command:

```
[ :SOURce<hw> ] :BB:NR5G:SCHed:CELL<cc>:SUBF<sf>:USER<us>:
BWPart<bwp>:ALLoc<al>:CS:DCCes:STATe on page 646
```

Dummy CCEs Data Source

Selects the data source for the dummy CCEs.

The following standard data sources are available:

- "All 0"/"All 1"
An internally generated sequence containing 0 data or 1 data.
- "PNxx"
An internally generated pseudo-random noise sequence.
- "Pattern"
An internally generated sequence according to a bit pattern.
Use the "Pattern" box to set the bit pattern.
- "Data List"/"Select Data List"
Binary data from a list file, internally or externally generated.
Select "Select Data List" to open the standard "Select List" dialog. The dialog lists file with file extension *.dm_iqd if existing.
 - Navigate to the list file and tap "Select" to select the file.
 - Use the "New" and "Edit" functions to create a data list internally or to edit an existing one.
 - Use the standard "File Manager" function to transfer external data lists to the instrument.

See also:

- Section "About data signals" in the R&S SMM100A user manual.
- Section "File and data management" in the R&S SMM100A user manual.
- Section "Data list editor" in the R&S SMM100A user manual.

Remote command:

```
[ :SOURce<hw> ] :BB:NR5G:SCHed:CELL<cc>:SUBF<sf>:USER<us>:
BWPart<bwp>:ALLoc<al>:CS:DCCes:DATA on page 646
```

```
[ :SOURce<hw> ] :BB:NR5G:SCHed:CELL<cc>:SUBF<sf>:USER<us>:
BWPart<bwp>:ALLoc<al>:CS:DCCes:DLISt on page 646
```

```
[ :SOURce<hw> ] :BB:NR5G:SCHed:CELL<cc>:SUBF<sf>:USER<us>:
BWPart<bwp>:ALLoc<al>:CS:DCCes:PATtern on page 646
```

Active UL BWP

If more than one UL BWPs are configured ("Users/BWP Settings > UL BWPs" > [Number of UL BWPs](#) ≥ 2), this parameter sets the index of the UL BWP to be used by the calculation of the bit size of the DCI formats.

Remote command:

```
[ :SOURce<hw> ] :BB:NR5G:SCHed:CELL<cc>:SUBF<sf>:USER<us>:
BWPart<bwp>:ALLoc<al>:CS:AULBwp on page 645
```

TCI Present In DCI

Sets the higher-layer parameter `tci-PresentInDCI` according to [TS 38.212](#).

Available when `simple mode` = off.

"On" `Transmission configuration indication` (TCI) field in DCI format 1_1 is 3 bits long.

"Off" `Transmission configuration indication` field in DCI format 1_1 is not transmitted; field is disabled in the DCI format 1_1.

Remote command:

```
[ :SOURce<hw> ] :BB:NR5G:SCHed:CELL<cc>:SUBF<sf>:USER<us>:
BWPart<bwp>:ALLoc<al>:CS:TCI on page 650
```

TCI Size in DCI1_2

Defines the bit length of the DCI field "Transmission Configuration Indication" available in DCI format 1_2.

Corresponds to higher layer parameter `tci-PresentDCI-1-2` as defined in 3GPP 38.212.

Available when `simple mode` = off.

Remote command:

```
[ :SOURce<hw> ] :BB:NR5G:SCHed:CELL<cc>:SUBF<sf>:USER<us>:
BWPart<bwp>:ALLoc<al>:CS:TS12 on page 652
```

Number of DCIs

Sets the number of DCIs and thus defines the number of rows in the DCI table.

Remote command:

```
[ :SOURce<hw> ] :BB:NR5G:SCHed:CELL<cc>:SUBF<sf>:USER<us>:
BWPart<bwp>:ALLoc<al>:CS:NDCI on page 651
```

DCI Table

Comprises the DCI settings. There is one row per DCI. The number of rows depends on the selected [Number of DCIs](#).

Usage ← DCI Table

Sets the RNTI type to scramble the CRC, see [Table 5-5](#).

In addition to the RNTIs defined by 3GPP, you can select a "Custom RNTI" for which you can define custom DCIs. When you select a custom RNTI, the only available DCI format is the custom DCI format.

Remote command:

```
[ :SOURce<hw> ] :BB:NR5G:SCHed:CELL<cc>:SUBF<sf>:USER<us>:
BWPart<bwp>:ALLoc<al>:CS:DCI<dci>:USAGe on page 650
```

RNTI ← DCI Table

Displays the current applicable RNTI of the associated user.

When `simple mode` = on, you can only select a custom RNTI.

Remote command:

```
[ :SOURce<hw> ] :BB:NR5G:SCHed:CELL<cc>:SUBF<sf>:USER<us>:
BWPart<bwp>:ALLoc<al>:CS:DCI<dci>:RNTI on page 650
```

DCI Format ← DCI Table

Sets the DCI format.

The downlink control information (DCI) is a message used to control the physical layer resource allocations. It carries scheduling information and power control commands.

The DCI formats available in a particular situation depend on the selected [Usage](#) and [Search Space](#). For an overview of the available DCI formats, see [Table 5-4](#). Additionally, the "Custom" format with user-defined content is available.

Note that when you select a [custom RNTI](#), the only available DCI format is the custom DCI format.

When [simple mode](#) = on, you can only configure a custom DCI format.

To configure the parameters per DCI format, select "Content > Config".

Table 5-4: DCI formats overview [TS 38.212]

DCI format	Usage
0_0	Scheduling of PUSCH in one UL cell See " DCI Format 0_0 " on page 250.
0_1	Scheduling of one or multiple PUSCH in one cell, or indicating downlink feedback information for configured grant PUSCH (CG-DFI). See " DCI Format 0_1 " on page 251.
0_2	Option: R&S SMM-K148. Scheduling of PUSCH in one cell. See " DCI Format 0_2 " on page 253.
1_0	Scheduling of PDSCH in one DL cell (allocation type 1) See " DCI Format 1_0 " on page 254.
1_1	Scheduling of PDSCH in one DL cell See " DCI Format 1_1 " on page 256.
1_2	Option: R&S SMM-K148. Scheduling of PDSCH in one cell. See " DCI Format 1_2 " on page 257.
2_0	Notifying a group of UEs of the slot format See " DCI Format 2_0 " on page 259.
2_1	Notifying a group of UEs of the PRBs and OFDM symbols where UE can assume that no transmission is intended for the UE See " DCI Format 2_1 " on page 259.
2_2	Transmission of TPC commands for PUCCH and PUSCH See " DCI Format 2_2 " on page 260.
2_3	Transmission of a group of TPC commands for SRS transmissions by one or more UEs See " DCI Format 2_3 " on page 260.

DCI format	Usage
2_4	Option: R&S SMM-K148. Notifying a group of UEs of the PRB(s) and OFDM symbol(s) where UE cancels the corresponding UL transmission from the UE. See "DCI Format 2_4" on page 261.
2_5	Option: R&S SMM-K148. Notifying the availability of soft resources. See "DCI Format 2_5" on page 261.
2_6	Option: R&S SMM-K148. Notifying the power saving information outside DRX Active Time for one or more UEs. See "DCI Format 2_6" on page 262.
2_7	Option: R&S SMM-K171. Notifying paging early indication and TRS availability indication for one or more UEs. See "DCI Format 2_7" on page 262.
3_0	Option: R&S SMM-K148. Scheduling of NR PSCCH and NR PSSCH in one cell. See "DCI Format 3_0" on page 263.
3_1	Option: R&S SMM-K148. Scheduling of LTE PSCCH and LTE PSSCH in one cell. See "DCI Format 3_1" on page 264.
4_0	Option: R&S SMM-K171. Scheduling of PDSCH with CRC scrambled by MCCH-RNTI or G-RNTI for broadcast. See "DCI Format 4_0" on page 264.
4_1	Option: R&S SMM-K171. Scheduling of PDSCH with CRC scrambled by G-RNTI or G-CS-RNTI for multi-cast. See "DCI Format 4_1" on page 265.
4_2	Option: R&S SMM-K171. Scheduling of PDSCH with CRC scrambled by G-RNTI or G-CS-RNTI for multi-cast. See "DCI Format 4_2" on page 266.

Remote command:

```
[ :SOURCE<hw> ] :BB:NR5G:SCHed:CELL<cc>:SUBF<sf>:USER<us>:
BWPart<bwp>:ALLoc<al>:CS:DCI<dci>:FMT on page 648
```

Search Space ← DCI Table

Defines the search space for the selected DCI.

The search space defines the set of PDCCH candidates that a UE has to monitor. Search spaces can be common search space (CSS) and UE-specific search space (USS), where the non-common DCIs are mapped to the USS. The UE can decode only the control information that is transmitted within one or more search spaces this UE monitors.

TS 38.213 defines the search spaces listed in "[Search Space](#)" on page 247.

Table 5-5: Search space sets

Search space	Designation	Parameter	CRC scrambled with
CSS (Common search space)	Type0-PDCCH	"Type0 CSS"	SI-RNTI
	Type0A-PDCCH		RA-RNTI, TC-RNTI
	Type1-PDCCH	"Type1 CSS"	P-RNTI
	Type2-PDCCH	"Type2 CSS"	C-RNTI, CS-RNTI, P-RNTI, MCS-C-RNTI, SP-CSI-RNTI, INT-RNTI, TPC-PUSCH-RNTI, TPC-PUCCH-RNTI, RPC-SRS-RNTI
	Type3-PDCCH	"Type3 CSS"	INT-RNTI, SFI-RNTI, TPC-PUSCH/PUCCH/SRS-RNTI, C-RNTI, CS-RNTI, MCS-C-RNTI, P-RNTI, RA-RNTI, TC-RNTI, SP-CSI-RNTI, SI-RNTI, CI-RNTI, PS-RNTI
UE-specific search space	USS	"USS"	C-RNTI, CS-RNTI, MCS-C-RNTI, SP-CSI-RNTI

The available search spaces depend on the selected [Usage](#).

Inside the user BWPs, the common search space types Type0A, Type1 and Type2 are supported.

Remote command:

```
[ :SOURce<hw> ] :BB:NR5G:SCHed:CELL<cc>:SUBF<sf>:USER<us>:
BWPart<bwp>:ALLoc<al>:CS:DCI<dci>:SSP on page 650
```

Aggregation Level ← DCI Table

Sets the aggregation level for the selected DCI.

A physical downlink control channel PDCCH consists of one or more control-channel elements (CCEs), where their number is defined by the "Aggregation level".

This and several other parameters influence the way the search space is defined. For details, see "[Search Space](#)" on page 241.

Remote command:

```
[ :SOURce<hw> ] :BB:NR5G:SCHed:CELL<cc>:SUBF<sf>:USER<us>:
BWPart<bwp>:ALLoc<al>:CS:DCI<dci>:AGGLevel on page 647
```

Candidate ← DCI Table

Selects one of the candidates configured for the selected [Aggregation Level](#), where the number of candidates per aggregation level is set by the parameter "CORESET > General" > [Max Candidates](#).

This and several other parameters influence the way the search space is defined. For details, see "[Search Space](#)" on page 241.

Remote command:

```
[ :SOURce<hw> ] :BB:NR5G:SCHed:CELL<cc>:SUBF<sf>:USER<us>:
BWPart<bwp>:ALLoc<al>:CS:DCI<dci>:CANDidate on page 647
```

CCE Index ← DCI Table

Sets or displays the CCE start index and thus the position of the first CCE of the PDCCH.

This and several other parameters influence the way the search space is defined. For details, see "[Search Space](#)" on page 241.

Remote command:

```
[ :SOURce<hw> ] :BB:NR5G:SCHed:CELL<cc>:SUBF<sf>:USER<us>:
BWPart<bwp>:ALLoc<al>:CS:DCI<dci>:INDeX on page 649
```

Content ← DCI Table

Access a dialog for configuring the parameters per DCI format, see "[DCI content configuration](#)" on page 250.

Multiplexing Table ← DCI Table

Selects the time domain resource allocation table for the PDSCH.

Selecting one of the tables is possible for [DCI formats 1_0](#) and [1_1](#). The tables you can select depend on the selected [RNTI](#) and [search space](#) as defined in 3GPP 38.214, chapter 5.1.2.1.1.

Remote command:

```
[ :SOURce<hw> ] :BB:NR5G:SCHed:CELL<cc>:SUBF<sf>:USER<us>:
BWPart<bwp>:ALLoc<al>:CS:DCI<dci>:MULTable on page 649
```

Create PDSCH ← DCI Table

If enabled, the content and scheduling of the PDSCH is created automatically, as configured with the DCI format [1_0](#), [1_1](#) and [1_2](#) parameters.

If [PDSCH Scheduling](#) = "Auto/DCI", the "Create PDSCH" = "On".

Remote command:

```
[ :SOURce<hw> ] :BB:NR5G:SCHed:CELL<cc>:SUBF<sf>:USER<us>:
BWPart<bwp>:ALLoc<al>:CS:DCI<dci>:CPDSch on page 647
```

PDSCH DMRS Symbols ← DCI Table

Shows the PDSCH DMRS symbols that the corresponding DCI uses.

This information is displayed if the PDSCH content was [created automatically](#). Otherwise the cell remains empty.

If the DMRS symbols could not be created for any reason, a warning sign appears instead of the symbol numbers. Check the [time domain allocations](#).

This information is read only.

Remote command:

```
[ :SOURce<hw> ] :BB:NR5G:SCHed:CELL<cc>:SUBF<sf>:USER<us>:
BWPart<bwp>:ALLoc<al>:CS:DCI<dci>:DMSS? on page 648
```

PDSCH Power /dB ← DCI Table

Defines the power of PDSCH allocations according to the CORESET DCI.

Available for PDSCH scheduling DCI formats (for example 1_0, 1_1 and 1_2) and if the [PDSCH scheduling mode](#) is "Auto / DCI".

Remote command:

```
[ :SOURce<hw> ] :BB:NR5G:SCHed:CELL<cc>:SUBF<sf>:USER<us>:
BWPart<bwp>:ALLoc<al>:CS:DCI<dci>:POWer on page 649
```

DCI content configuration

Comprises the parameters of the selected DCI format.

The fields defined in the DCI format are mapped to the information bits according to [TS 38.212](#). The resulting [Bit Data > Pattern](#) is displayed.

The following parameters have an impact on the DCI bit data length and the DCI fields:

- Number of RB [No. RBs](#) of the first UL BWP
- Number of RB of the DL BWP, in that the DCI is configured
- [SUL](#) indicator of the selected cell
- DCI [Search Space](#)

Bit Data > Pattern ← DCI content configuration

Displays the resulting bit data as selected with the DCI format parameters.

Mapping of the information bits is according to [TS 38.212](#).

Padding bits are added in certain cases, that is zeros are append to the DCI format until the payload size is equal to a specified size.

Remote command:

```
[ :SOURce<hw> ] :BB:NR5G:SCHed:CELL<cc>:SUBF<sf>:USER<us>:
BWPart<bwp>:ALLoc<al>:CS:DCI<dci>:HBTS? on page 648
```

DCI Format 0_0 ← DCI content configuration

The DCI format 0_0 is used for scheduling of PUSCH in one UL cell.

DCI format 0_0 is available for:

- C-RNTI
- CS-RNTI

5G New Radio A: DCI Settings (DCI 0)	
Bit Data	
Pattern	0000 0000 0000 0000 0000 0000 0000 0000 0000 0000
DCI Fields	
Frequency Domain Resource Assignment	0
Frequency Hopping Flag	<input type="checkbox"/>
New Data Indicator (TB1)	<input type="checkbox"/>
HARQ Process Number	0
Time Domain Resource Assignment	0
Modulation and Coding Scheme (TB1)	0
Redundancy Version (TB1)	0
TPC Command for Scheduled PUSCH	0

For a list of remote commands required to configure the DCI fields, see [Chapter 10.22.3.1, "DCI format 0_0"](#), on page 653.

The following DCI fields are available for DCI format 0_0.

- "Frequency domain resource assignment"
- "Time domain resource assignment"
- "Frequency hopping flag"
Requires: [resource allocation](#) = type 1 and [PUSCH frequency hopping](#) = intra-slot
- "Modulation and coding scheme (TB1)"
"Modulation and coding scheme (TB2)"
- "New data indicator (TB1)"
"New data indicator (TB2)"
- "Redundancy version (TB1)"
"Redundancy version (TB2)"
- "HARQ process number"
- "TPC command for scheduling PUSCH"
- "Channel Access Cpevt"
Requires: [shared spectrum access](#) = on
- "UL/SUL Indicator"
Requires: [SUL](#) = on

DCI Format 0_1 ← DCI content configuration

The DCI format 0_1 is used for scheduling one or more PUSCH in one UL cell or for indicating downlink feedback information for configured grant PUSCH (CG-DFI).

DCI format 0_1 is available for:

- C-RNTI
- CS-RNTI
- MCS-C-RNTI
- SP-CSI-RNTI

5G New Radio A: DCI Settings (DCI 0)	
Bit Data	
Pattern	000 0000 0000 0000 0000 0000 0000 0000 0000 0000
DCI Fields	
Frequency Domain Resource Assignment	0
Time Domain Resource Assignment	0
Modulation and Coding Scheme (TB1)	0
New Data Indicator (TB1)	0
Redundancy Version (TB1)	0
HARQ Process Number	0
(1st) Downlink Assignment Index	0
2nd Downlink Assignment Index	0
TPC Command for Scheduled PUSCH	0
SRS Resource Indicator	0
Antenna Ports	0
SRS Request	0
CSI Request	0
CBG Transmission Information (CBGTI)	0

For a list of remote commands required to configure the DCI fields, see [Chapter 10.22.3.2, "DCI format 0_1"](#), on page 656.

The following DCI fields are available for DCI format 0_1.

- "Downlink Feedback Information"
Requires: CS-RNTI and [shared spectrum access](#) = on

- "UL/SUL Indicator"
Requires: [SUL](#) = on
- "Carrier indicator"
Requires: [CIF](#) = on
- "Bandwidth part indicator"
Requires: [number of bandwidth parts](#) > 1
- "Frequency domain resource assignment"
- "Time domain resource assignment"
- "Frequency hopping flag"
Requires: [resource allocation](#) = type 1 and [PUSCH frequency hopping](#) = intra-slot
- "Modulation and coding scheme (TB1)"
- "New data indicator (TB1)"
- "Redundancy version (TB1)"
- "HARQ process number"
- "(1st) downlink assignment index"
"2nd downlink assignment index"
Depends on: [PDSCH HARQ ACK codebook](#)
- "3rd downlink assignment index" (requires release 17 option)
Requires: [Bits for 3rd downlink assignment index](#) > 0
- "TPC command for scheduling PUSCH"
"2nd TPC command for scheduling PUSCH" (requires release 17 option)
Requires: [Use 2nd TPC command](#) = on
- "SRS resource set indicator" (requires release 17 option)
Requires: [Bits for SRS resource set indication](#) = on
- "SRS resource indicator"
"2nd SRS resource indicator" (requires release 17 option)
Requires: [Bits for 2nd SRS resource indication](#) > 0
- "Precoding information and number of layers"
Requires: "[TxConfig](#)" on page 165 = codebook, [SRS resource sets](#) = 1, [SRS no. of ports](#) = 4
"2nd Precoding information and number of layers" (requires release 17 option)
Requires: [Bits for 2nd precoding information](#) > 0
- "Antenna ports"
- "SRS request"
- "SRS Offset Indicator" (requires release 17 option)
Requires: [Bits for SRS offset indicator](#) > 0
- "CSI request"
- "CBG transmission information (CBGTI)"
- "PTRS-DMRS association"
Requires: [Max rank](#) ≥ 2
- "Beta_offset indicator"
- "DMRS sequence initialization"
- "SCell dormancy indication 1" (requires release 16 option)
Requires: [Number of SCell Groups Outside Active Time](#) > 0
- "UL-SCH indicator" (requires release 16 option)
Requires: [Shared spectrum access](#) = on
- "Channel Access Cpext" (requires release 16 option)
Requires: [Shared spectrum access](#) = on
- "Open-loop power control parameter indication" (requires release 16 option)
- "Priority indicator" (requires release 16 option)

- Requires: [Priority Indicator](#) = on
- "Invalid symbol pattern indicator" (requires release 16 option)
Requires: [Invalid symbol indicator](#) = on
- "Minimum applicable scheduling offset indicator" (requires release 16 option)
Requires: [Minimum scheduling offset](#) = on
- "PDCCH Monitoring Adaption Indication" (requires release 16 option)
Requires: [Bits for monitoring adaption indication](#) > 0

DCI Format 0_2 ← DCI content configuration

Option: R&S SMM-K148.

The DCI format 0_2 is used for scheduling of PUSCH in one UL cell.

DCI format 0_1 is available for:

- C-RNTI
- CS-RNTI
- MCS-C-RNTI
- SP-CSI-RNTI

5G New Radio A: DCI Settings (DCI 0)		
Bit Data		
Pattern	00 0000 0000 0000 0000 0000 0000 0000 0000 0000 0000 0000	
DCI Fields		
Carrier Indicator (CIF)	<input checked="" type="checkbox"/>	Frequency Domain Resource Assignment
Time Domain Resource Assignment	<input type="checkbox"/>	Modulation and Coding Scheme (TB1)
New Data Indicator (TB1)	<input type="checkbox"/>	Redundancy Version (TB1)
HARQ Process Number	<input type="checkbox"/>	(1st) Downlink Assignment Index
2nd Downlink Assignment Index	<input checked="" type="checkbox"/>	TPC Command for Scheduled PUSCH
Antenna Ports	<input type="checkbox"/>	SRS Request
CSI Request	<input checked="" type="checkbox"/>	PTRS-DMRS Association

For a list of remote commands required to configure the DCI fields, see [Chapter 10.22.3.3, "DCI format 0_2"](#), on page 663.

The following DCI fields are available for DCI format 0_2.

- "UL/SUL Indicator"
Requires: [SUL](#) = on
- "Bandwidth part indicator"
Requires: [number of bandwidth parts](#) > 1
- "Carrier indicator"
Requires: [CIF](#) = on
- "Frequency domain resource assignment"
- "Time domain resource assignment"
- "Frequency hopping flag"
Requires: [resource allocation](#) = type 1 and [PUSCH frequency hopping](#) = intra-slot
- "Modulation and coding scheme (TB1)"

- "New data indicator (TB1)"
- "Redundancy version (TB1)"
- "HARQ process number"
- "(1st) downlink assignment index"
"2nd downlink assignment index"
Requires: [Downlink assignment index](#) for DCI 0_2 = on
Depends on: [PDSCH HARQ ACK codebook](#)
- "3rd downlink assignment index" (requires release 17 option)
Requires: [Bits for 3rd downlink assignment index](#) > 0
- "TPC command for scheduling PUSCH"
"2nd TPC command for scheduling PUSCH" (requires release 17 option)
Requires: [Use 2nd TPC command](#) = on
- "SRS resource set indicator" (requires release 17 option)
Requires: [Bits for SRS resource set indication](#) = on
- "SRS resource indicator"
"2nd SRS resource indicator" (requires release 17 option)
Requires: [Bits for 2nd SRS resource indication](#) > 0
- "Precoding information and number of layers"
Requires: "TxConfig" on page 165 = codebook, [SRS resource sets](#) = 1, [SRS no. of ports](#) = 4
"2nd Precoding information and number of layers" (requires release 17 option)
Requires: [Bits for 2nd precoding information](#) > 0
- "Antenna ports"
- "SRS request"
- "SRS Offset Indicator" (requires release 17 option)
Requires: [Bits for SRS offset indicator](#) > 0
- "CSI request"
- "PTRS-DMRS association"
Requires: [Max rank](#) ≥ 2
- "Beta_offset indicator"
- "DMRS sequence initialization"
- "UL-SCH indicator"
Requires: [Shared spectrum access](#) = on
- "Open-loop power control parameter indication"
- "Priority indicator"
Requires: [Priority Indicator](#) = on
- "Invalid symbol pattern indicator"
Requires: [Invalid symbol indicator](#) = on
- "Monitoring Adaption Indication" (requires release 17 option)
Requires: [Bits for monitoring adaption indication](#) > 0

DCI Format 1_0 ← DCI content configuration

The DCI format 1_0 is used for scheduling of PDSCH in one DL cell and / or triggering one shot HARQ-ACK codebook feedback.

DCI format 1_0 is available for:

- C-RNTI
- P-RNTI
- CS-RNTI
- RA-RNTI
- SI-RNTI

- MsgB-RNTI

5G New Radio A: DCI Settings (DCI 2)	
Bit Data	
Pattern	1000 0000 0000 0000 0000 0000 0000 0000 0000 0000
DCI Fields	
Frequency Domain Resource Assignment	0
Time Domain Resource Assignment	0
VRB-to-PRB Mapping	<input type="checkbox"/>
Modulation and Coding Scheme (TB1)	0
New Data Indicator (TB1)	<input type="checkbox"/>
Redundancy Version (TB1)	0
HARQ Process Number	0
(1st) Downlink Assignment Index	0
TPC command for Scheduled PUCCH	0
PUCCH Resource Indicator	0
PDSCH-to-HARQ Feedback Timing Indicator	0

For a list of remote commands required to configure the DCI fields, see [Chapter 10.22.3.4, "DCI format 1_0"](#), on page 665.

The following DCI fields are available for DCI format 1_0.

- "Frequency domain resource assignment"
- "Time domain resource assignment"
- "VRB-to-PRB mapping"
- "Modulation and coding scheme (TB1)"
- "New data indicator (TB1)"
- "Redundancy version (TB1)"
- "HARQ process number"
- "(1st) downlink assignment index"
Depends on: [PDSCH HARQ ACK codebook](#)
- "TPC command for scheduling PUSCH"
- "PUCCH resource indicator"
Requires: C-RNTI or CS-RNTI
- "PDSCH-to-HARQ feedback timing indicator"
Requires: C-RNTI
- "Short message indicator"
Requires: P-RNTI
- "Short messages"
Requires: P-RNTI
- "System information indicator"
Requires: SI-RNTI
- "TB scaling"
- "TRS Availability Indication" (requires release 17 option)
Requires: [Bits for TSR Availability Indication](#) > 0 and [usage type](#) = P-RNTI
- "Padding bits, reserved bits"
Requires: SI-RNTI
- "Channel access CPext" (requires release 16 option)
Requires: [Shared spectrum access](#) = on
- "LSBs of SFN"
Requires: RA-RNTI

DCI Format 1_1 ← DCI content configuration

The DCI format 1_1 is used for scheduling of PDSCH in one DL cell.

The DCI resource allocator for DCI1_1 C-RNTI - CA is needed for cross-carrier scheduling.

DCI format 1_1 is available for:

- C-RNTI
- CS-RNTI
- MCS-C-RNTI

5G New Radio A: DCI Settings (DCI 3)		DCI Fields	
BWP Indicator	0	Frequency Domain Resource Assignment	0
Time Domain Resource Assignment	0	VRB-to-PRB Mapping	<input type="checkbox"/>
PRB Bundling Size Indicator	<input type="checkbox"/>	Rate Matching Indicator	0
ZP CSI-RS Trigger	0	Modulation and Coding Scheme (TB1)	0
New Data Indicator (TB1)	<input type="checkbox"/>	Redundancy Version (TB1)	0
Modulation and Coding Scheme (TB2)	0	New Data Indicator (TB2)	<input type="checkbox"/>
Redundancy Version (TB2)	0	HARQ Process Number	0
(1st) Downlink Assignment Index	0	TPC command for Scheduled PUCCH	0
PUCCH Resource Indicator	0	PDSCH-to-HARQ Feedback Timing Indicator	0
Antenna Ports	0	Transmission Configuration Indication	0
SRS Request	0	CBG Transmission Information (CBGTI)	0
CBG Flushing out Information (CBGFI)	<input type="checkbox"/>	DMRS Sequence Initialization	<input type="checkbox"/>

For a list of remote commands required to configure the DCI fields, see [Chapter 10.22.3.5, "DCI format 1_1"](#), on page 668.

The following DCI fields are available for DCI format 1_1.

- "Carrier indicator"
Requires: **CIF** = on
- "Bandwidth part indicator"
Requires: **number of bandwidth parts** > 1
- "Frequency domain resource assignment"
- "Time domain resource assignment"
- "VRB-to-PRB mapping"
- "PRB bundling size indicator"
- "Rate matching indicator"
- "ZP CSI-RS trigger"
- "Modulation and coding scheme (TB1)"
"Modulation and coding scheme (TB2)"
- "New data indicator (TB1)"
"New data indicator (TB2)"

- "Redundancy version (TB1)"
"Redundancy version (TB2)"
- "HARQ process number"
- "(1st) downlink assignment index"
Depends on: [PDSCH HARQ ACK codebook](#)
- "TPC command for scheduling PUCCH"
"2nd TPC command for scheduling PUCCH" (requires release 17 option)
Requires: [Use 2nd TPC command](#) = on
- "PUCCH resource indicator"
- "PDSCH-to-HARQ feedback timing indicator"
- "HARQ-ACK Retransmission Indicator" (requires release 17 option)
Requires: [HARQ-ACK retransmission indicator](#) = on
- "Enhanced Type 3 Codebook Indicator" (requires release 17 option)
Requires: [Bits for enhanced type 3 indicator](#) > 0
- "Antenna ports"
- "Transmission configuration indication"
Requires: [TCI present in DCI](#) = on
- "SRS request"
- "CBG transmission information (CBGTI)"
- "CBG flushing out information (CBGFI)"
- "DMRS sequence initialization"
- "SCell dormancy indication 1" (requires release 16 option)
Requires: [Number of SCell Groups Outside Active Time](#) > 0
- "Minimum applicable scheduling offset indicator" (requires release 16 option)
Requires: [Minimum scheduling offset indicator](#) = on
- "One-shot HARQ-ACK request" (requires release 16 option)
- "PDSCH group index" (requires release 16 option)
- "New feedback indicator" (requires release 16 option)
- "Number of requested PDSCH groups" (requires release 16 option)
- "Priority indicator" (requires release 16 option)
Requires: [Priority Indicator](#) = on
- "Channel Access Cpevt" (requires release 16 option)
Requires: [Shared spectrum access](#) = on
- "Monitoring Adaption Indication" (requires release 17 option)
Requires: [Bits for monitoring adaption indication](#) > 0
- "PUCCH Cell Indicator" (requires release 17 option)
Requires: [PUCCH-sCellDyn DCI1_1](#) = on

DCI Format 1_2 ← DCI content configuration

Option: R&S SMM-K148.

The DCI format 1_2 is used for scheduling of PDSCH in one DL cell.

DCI format 1_2 is available for:

- C-RNTI
- CS-RNTI
- MCS-C-RNTI

5G New Radio A: DCI Settings (DCI 0)	
Bit Data	
Pattern	1 0000 0000 0000 0000 0000 0000 0000
DCI Fields	
BWP Indicator	Frequency Domain Resource Assignment 0
Time Domain Resource Assignment	VRB-to-PRB Mapping <input type="checkbox"/>
PRB Bundling Size Indicator	Rate Matching Indicator 0
ZP CSI-RS Trigger	Modulation and Coding Scheme (TB1) 0
New Data Indicator (TB1)	Redundancy Version (TB1) 0
HARQ Process Number	(1st) Downlink Assignment Index 0
TPC command for Scheduled PUCCH	PUCCH Resource Indicator 0

For a list of remote commands required to configure the DCI fields, see [Chapter 10.22.3.6, "DCI format 1_2"](#), on page 673.

The following DCI fields are available for DCI format 1_1.

- "Carrier indicator"
Requires: [CIF](#) = on
- "Bandwidth part indicator"
Requires: [number of bandwidth parts](#) > 1
- "Frequency domain resource assignment"
- "Time domain resource assignment"
- "VRB-to-PRB mapping"
- "PRB bundling size indicator"
- "Rate matching indicator"
- "ZP CSI-RS trigger"
- "Modulation and coding scheme (TB1)"
- "New data indicator (TB1)"
- "Redundancy version (TB1)"
- "HARQ process number"
- "(1st) downlink assignment index"
Depends on: [PDSCH HARQ ACK codebook](#)
- "TPC command for scheduling PUCCH"
"2nd TPC command for scheduling PUCCH" (requires release 17 option)
Requires: [Use 2nd TPC command](#) = on
- "PUCCH resource indicator"
- "PDSCH-to-HARQ feedback timing indicator"
- "HARQ-ACK Retransmission Indicator" (requires release 17 option)
Requires: [HARQ-ACK retransmission indicator](#) = on
- "Enhanced Type 3 Codebook Indicator" (requires release 17 option)
Requires: [Bits for enhanced type 3 indicator](#) > 0
- "Antenna ports"
- "Transmission configuration indication"
Requires: [TCI present in DCI](#) = on

- "SRS request"
- "DMRS sequence initialization"
- "Priority indicator"
Requires: [Priority Indicator](#) = on
Option: R&S SMM-K148
- "Monitoring Adaption Indication" (requires release 17 option)
Requires: [Bits for monitoring adaption indication](#) > 0
- "PUCCH Cell Indicator" (requires release 17 option)
Requires: [PUCCH-sSCellDyn DCI1_1](#) = on

DCI Format 2_0 ← DCI content configuration

The DCI format 2_0 is used for notifying a group of UEs of the slot format.

DCI format 2_0 is available for:

- SFI-RNTI

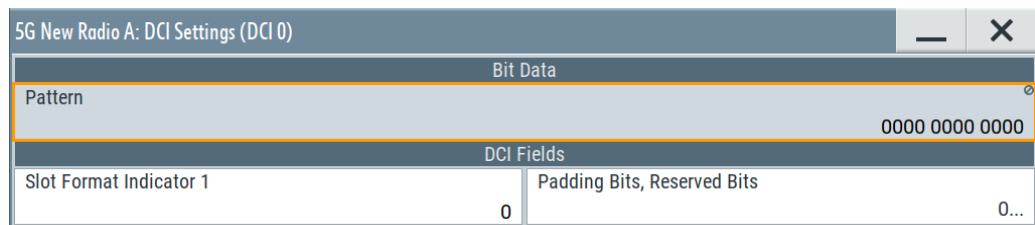

For a list of remote commands required to configure the DCI fields, see [Chapter 10.22.3.7, "DCI format 2_0"](#), on page 674.

The following DCI fields are available for DCI format 2_0.

- "Slot format indicator 1 ... 16"
Depends on the [number of SFIs in DCI2_0](#).
- "Available RB set indicator 1 ... 16"
Depends on the [number of available RB set indicators](#).
- "COT duration indicator 1 ... 16"
Depends on the [number of available COT duration indicators](#).
- "Search space set group switching flag 1 ... 4"
Depends on the [number of search space set group switching flags](#).
- "Padding bits, reserved bits"

DCI Format 2_1 ← DCI content configuration

The DCI format 2_1 is used for notifying a group of UEs of the PRBs and OFDM symbols where UE can assume that no transmission is intended for the UE.

DCI format 2_1 is available for:

- INT-RNTI

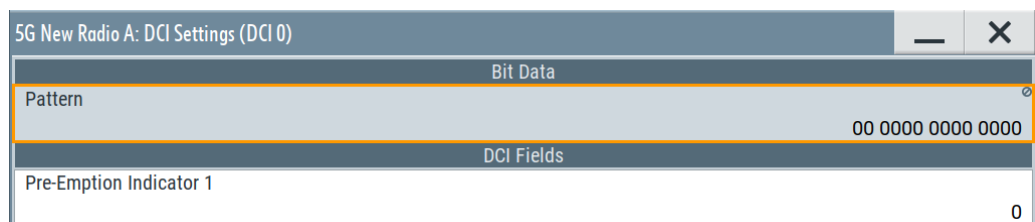

For a list of remote commands required to configure the DCI fields, see [Chapter 10.22.3.7, "DCI format 2_0"](#), on page 674.

The following DCI fields are available for DCI format 2_1.

- "Pre-emption indication 1 ... 9"
Depends on the [number of pre-emption indicators in DCI2_1](#).

DCI Format 2_2 ← DCI content configuration

The DCI format 2_2 is used for transmission of TPC commands for PUCCH and PUSCH.

DCI format 2_2 is available for:

- TPC-PUSCH-RNTI
- TPC-PUCCH-RNTI

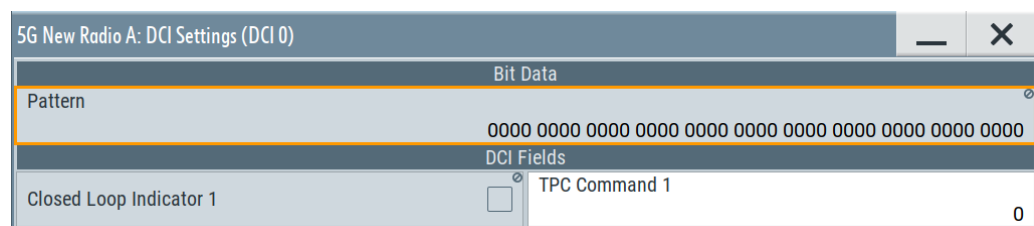

For a list of remote commands required to configure the DCI fields, see [Chapter 10.22.3.9, "DCI format 2_2"](#), on page 677.

The following DCI fields are available for DCI format 2_2.

- "Closed loop indicator 1 ... 14"
- "TPC command 1 ... 14"

The fields become available if [TPC-PUCCH-RNTI](#) (TPC-PUSCH-RNTI) or [TPC-PUCCH-RNTI](#) (TPC-PUCCH-RNTI) = on.

The number of fields depend on [Number of PUSCH Blocks](#) and [Number of PUCCH Blocks](#).

DCI Format 2_3 ← DCI content configuration

The DCI format 2_3 is used for transmission of a group of TPC commands for SRS transmissions by one or more UEs.

DCI format 2_3 is available for:

- TPC-SRS-RNTI

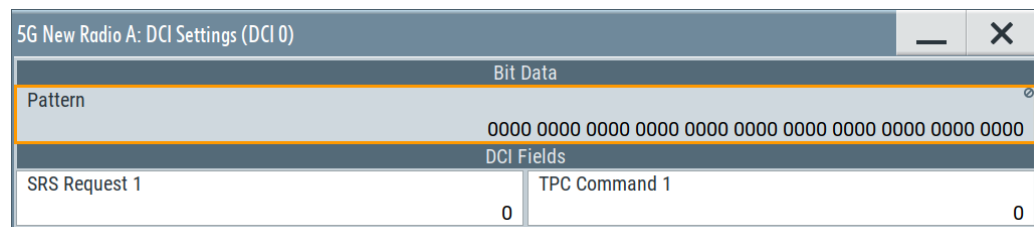

For a list of remote commands required to configure the DCI fields, see [Chapter 10.22.3.10, "DCI format 2_3"](#), on page 679.

The following DCI fields are available for DCI format 2_3.

- "SRS request 1 ... 22"
- "TPC command 1 ... 22"

The number of fields depend on the [number of blocks](#).

DCI Format 2_4 ← DCI content configuration

Option: R&S SMM-K148.

The DCI format 2_4 is used for notifying the PRB(s) and OFDM symbol(s) where UE cancels the corresponding UL transmission from the UE.

DCI format 2_4 is available for:

- CI-RNTI

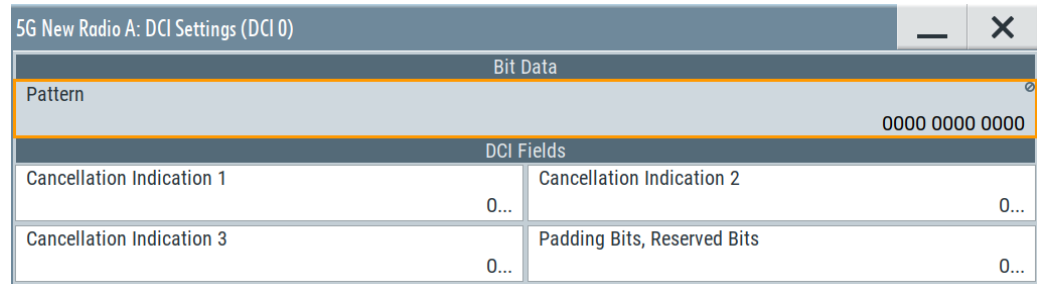

5G New Radio A: DCI Settings (DCI 0)	
Bit Data	
Pattern	0000 0000 0000
DCI Fields	
Cancellation Indication 1	0...
Cancellation Indication 2	0...
Cancellation Indication 3	0...
Padding Bits, Reserved Bits	0...

For a list of remote commands required to configure the DCI fields, see [Chapter 10.22.3.11, "DCI format 2_4"](#), on page 679.

The following DCI fields are available for DCI format 2_4.

- "Cancellation indication 1 ... 16"
- "Padding bits, reserved bits"

The number of fields depend on the [number of cancellation indications](#).

DCI Format 2_5 ← DCI content configuration

Option: R&S SMM-K148.

The DCI format 2_5 is used for notifying the availability of soft resources.

DCI format 2_5 is available for:

- AI-RNTI

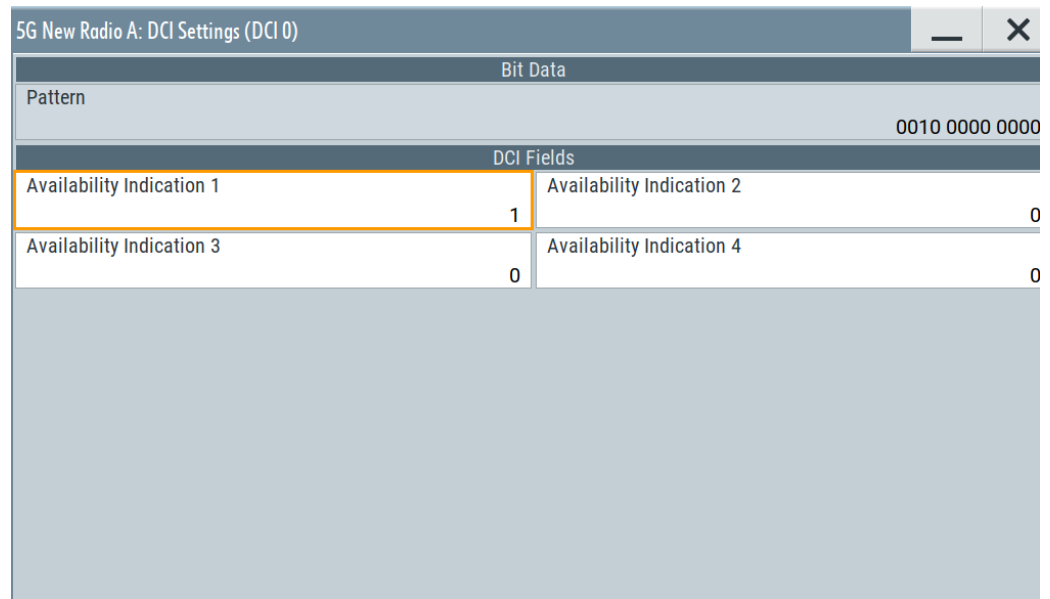

5G New Radio A: DCI Settings (DCI 0)	
Bit Data	
Pattern	0010 0000 0000
DCI Fields	
Availability Indication 1	1
Availability Indication 2	0
Availability Indication 3	0
Availability Indication 4	0

For a list of remote commands required to configure the DCI fields, see [Chapter 10.22.3.12, "DCI format 2_5"](#), on page 680.

The following DCI fields are available for DCI format 2_5.

- "Availability indication 1 ... 10"
- "Padding bits, reserved bits"

The number of fields depend on the [number of availability indications](#).

DCI Format 2_6 ← DCI content configuration

Option: R&S SMM-K148.

The DCI format 2_6 is used for notifying the power saving information outside DRX Active Time for one or more UEs.

DCI format 2_6 is available for:

- PS-RNTI

5G New Radio A: DCI Settings (DCI 0)		—	×
Bit Data			
Pattern			1001 0011 0111
DCI Fields			
Wakeup Indication 1	<input checked="" type="checkbox"/>	SCell Dormancy Indication 1	4
Wakeup Indication 2	<input checked="" type="checkbox"/>	SCell Dormancy Indication 2	0
Wakeup Indication 3	<input checked="" type="checkbox"/>	SCell Dormancy Indication 3	2
Padding Bits, Reserved Bits			1111...

For a list of remote commands required to configure the DCI fields, see [Chapter 10.22.3.13, "DCI format 2_6"](#), on page 681.

The following DCI fields are available for DCI format 2_6.

- "Wakeup indication 1 ... 10"
The number of fields depend on the [number of dormancy indications](#).
- "SCell dormancy indication 1 ... 10"
The number of fields depend on the [number of SCell groups](#).
- "Padding bits, reserved bits"

DCI Format 2_7 ← DCI content configuration

Option: R&S SMM-K171.

The DCI format 2_7 is used for notifying the paging early indication and TRS availability indication for one or more UEs.

DCI format 2_7 is available for:

- PEI-RNTI

5G New Radio A: DCI Settings (DCI 0)	
Bit Data	
Pattern	000 0000 0000 0000 0000 0000 0000 0000 0000 0000
DCI Fields	
Paging Early Indicator 1	0
Paging Early Indicator 2	0
TRS Availability Indication	0

For a list of remote commands required to configure the DCI fields, see [Chapter 10.22.3.14, "DCI format 2_7"](#), on page 682.

The following DCI fields are available for DCI format 2_7.

- "Paging early indicator 1...8"
The number of fields depend on the [PO number per PEI](#).
- "TRS availability indication"
Available when the [bits for TRS availability indication](#) > 1.

DCI Format 3_0 ← DCI content configuration

Option: R&S SMM-K148.

The DCI format 3_0 is used for scheduling of NR PSCCH and NR PSSCH in one cell.

DCI format 3_0 is available for:

- SL-RNTI
- SL-CS-RNTI

5G New Radio A: DCI Settings (DCI 3_0)	
Bit Data	
Pattern	00 0000 0000 0000 0000 0000 0000 0000
DCI Fields	
Resource Pool Index	0
Time Gap	0
HARQ Process Number	0
New Data Indicator (TB1)	0
First Subchannel	0
Frequency Domain Resource Assignment	0
Time Domain Resource Assignment	0
PSFCH-to-HARQ Feedback	0
PUCCH Resource Indicator	0
Configuration Index	0
Counter Sidelink Assignment Index	0

For a list of remote commands required to configure the DCI fields, see [Chapter 10.22.3.15, "DCI format 3_0"](#), on page 683.

The following DCI fields are available for DCI format 3_0.

- "Resource pool index"
Requires: [number of resource pools](#) > 1
- "Time gap"
- "HARQ process number"
- "New data indicator (TB1)"
"New data indicator (TB2)"
- "First subchannel"
Requires: [number of subchannels](#) > 1

- "Frequency domain resource assignment"
- "Time domain resource assignment"
- "PSFCH-to-HARQ feedback"
- "PUCCH resource indicator"
- "Configuration index"
Requires: SL-CS-RNTI
- "Counter sidelink assignment index"
- "Sidelink Assignment Index"
Requires: [Bits for sidelink assignment index](#) > 0

DCI Format 3_1 ← DCI content configuration

Option: R&S SMM-K148.

The DCI format 3_0 is used for scheduling of LTE PSCCH and LTE PSSCH in one cell.

DCI format 3_1 is available for:

- V-RNTI

Bit Data	
Pattern	000 0000 0000 0000 0000 0000 0000
DCI Fields	
Timing Offset	Carrier Indicator (CIF) 0
First Subchannel	Frequency Resource Location 0
Time Gap	SL Index 0
SL SPS Configuration Index	Activation/Release Indication <input type="checkbox"/>

For a list of remote commands required to configure the DCI fields, see [Chapter 10.22.3.16, "DCI format 3_1"](#), on page 685.

The following DCI fields are available for DCI format 3_1.

- "Timing offset"
- "Carrier indicator (CIF)"
- "First subchannel"
Requires: [number of subchannels](#) > 1
- "Frequency resource allocation"
- "Time gap"
- "SL index"
- "SL SPS configuration index"
- "Activation / release indication"

DCI Format 4_0 ← DCI content configuration

Option: R&S SMM-K171.

The DCI format 4_0 is used for scheduling of PDSCH with CRC scrambled by MCCH-RNTI or G-RNTI for broadcast.

DCI format 4_0 is available for:

- MCCH-RNTI
- G-RNTI

5G New Radio A: DCI Settings (DCI 0)	
Bit Data	
Pattern	0000 0000 0000 0000 0000 0000 0000 0000 0000 0000 0000
DCI Fields	
Frequency Domain Resource Assignment	0
Time Domain Resource Assignment	0
VRB-to-PRB Mapping	<input type="checkbox"/>
Modulation and Coding Scheme (TB1)	0
Redundancy Version (TB1)	0
MCCH Change Notifications	0

For a list of remote commands required to configure the DCI fields, see [Chapter 10.22.3.17, "DCI format 4_0"](#), on page 687.

The following DCI fields are available for DCI format 4_0.

- "Frequency domain resource assignment"
- "Time domain resource assignment"
- "VRB-to-PRB mapping"
- "Modulation and coding scheme (TB1)"
- "Redundancy version (TB1)"
- "MCCH change notifications"

DCI Format 4_1 ← DCI content configuration

Option: R&S SMM-K171.

The DCI format 4_1 is used for scheduling of PDSCH with CRC scrambled by G-RNTI or G-CS-RNTI for broadcast.

DCI format 4_1 is available for:

- G-RNTI
- G-CS-RNTI

5G New Radio A: DCI Settings (DCI 0)	
Bit Data	
Pattern	0000 0000 0000 0000 0000 0000 0000 0000 0000 0000 0000
DCI Fields	
Frequency Domain Resource Assignment	0
Time Domain Resource Assignment	0
VRB-to-PRB Mapping	<input type="checkbox"/>
Modulation and Coding Scheme (TB1)	0
New Data Indicator (TB1)	0
Redundancy Version (TB1)	0
HARQ Process Number	(1st) Downlink Assignment Index
PUCCH Resource Indicator	0
PDSCH-to-HARQ Feedback Timing Indicator	0
Padding Bits, Reserved Bits	0...

For a list of remote commands required to configure the DCI fields, see [Chapter 10.22.3.18, "DCI format 4_1"](#), on page 687.

The following DCI fields are available for DCI format 4_1.

- "Frequency domain resource assignment"
- "Time domain resource assignment"
- "VRB-to-PRB mapping"
- "Modulation and coding scheme (TB1)"
- "New data indicator (TB1)"
- "Redundancy version (TB1)"
- "HARQ process number"
- "(1st) downlink assignment index"
- "PUCCH resource indicator"
- "PDSCH-to-HARQ feedback timing indicator"
- "Padding bits, reserved bits"

DCI Format 4_2 ← DCI content configuration

Option: R&S SMM-K171.

The DCI format 4_2 is used for scheduling of PDSCH with CRC scrambled by G-RNTI or G-CS-RNTI for broadcast.

DCI format 4_2 is available for:

- G-RNTI
- G-CS-RNTI

5G New Radio A: DCI Settings (DCI 0)	
Bit Data	
Pattern	0 0000 0000 0000 0000 0000 0000 0000 0000
DCI Fields	
Frequency Domain Resource Assignment	0
VRB-to-PRB Mapping	<input type="checkbox"/>
Rate Matching Indicator	0
Modulation and Coding Scheme (TB1)	0
Redundancy Version (TB1)	0
New Data Indicator (TB2)	<input type="checkbox"/>
HARQ Process Number	0
PUCCH Resource Indicator	
Time Domain Resource Assignment	0
PRB Bundling Size Indicator	<input type="checkbox"/>
ZP CSI-RS Trigger	0
New Data Indicator (TB1)	0
Modulation and Coding Scheme (TB2)	0
Redundancy Version (TB2)	0
(1st) Downlink Assignment Index	0
PDSCH-to-HARQ Feedback Timing Indicator	

For a list of remote commands required to configure the DCI fields, see [Chapter 10.22.3.19, "DCI format 4_2"](#), on page 688.

The following DCI fields are available for DCI format 4_2.

- "Frequency domain resource assignment"
- "Time domain resource assignment"
- "VRB-to-PRB mapping"
- "PRB bundling size indicator"
- "Rate matching indicator"
- "ZP CSI-RS trigger"
- "Modulation and coding scheme (TB1)"

- "Modulation and coding scheme (TB2)"
- "New data indicator (TB1)"
- "New data indicator (TB2)"
- "Redundancy version (TB1)"
- "Redundancy version (TB2)"
- "HARQ process number"
- "(1st) downlink assignment index"
- "PUCCH resource indicator"
- "PDSCH-to-HARQ feedback timing indicator"
- "Antenna ports"
- "Transmission configuration indication"
- "DMRS sequence initialization"
- "Enabling HARQ-ACK feedback indication"
Requires: [HARQ_ACK feedback indication](#) = on.
- "Padding bits, reserved bits"
Requires: [Minimum size](#) > 34.

Custom ← DCI content configuration

This setting is a DCI without predefined DCI fields. The DCI content is user-definable.

5G New Radio A: DCI Settings (DCI 0)	
Channel Coding	<input checked="" type="checkbox"/>
Bit Data	
Data Source	PN9
Pattern Length	84
Initialization	1...

Channel Coding ← Custom ← DCI content configuration

Enables channel coding.

If [PDSCH Scheduling](#) = "Auto/DCI", the "Channel Coding" = "On".

Remote command:

```
[ :SOURce<hw> ] :BB:NR5G:SCHed:CELL<cc>:SUBF<sf>:USER<us>:
BWPart<bwp>:ALLoc<al>:CS:DCI<dci>:STATe on page 691
```

Data Source ← Custom ← DCI content configuration

Selects the data source for the custom DCI.

The following standard data sources are available:

- "All 0"/"All 1"
An internally generated sequence containing 0 data or 1 data.
- "PNxx"
An internally generated pseudo-random noise sequence.
- "Pattern"
An internally generated sequence according to a bit pattern.
Use the "Pattern" box to set the bit pattern.
- "Data List"/"Select Data List"
Binary data from a list file, internally or externally generated.

Select "Select Data List" to open the standard "Select List" dialog. The dialog lists file with file extension *.dm_iqd if existing.

- Navigate to the list file and tap "Select" to select the file.
- Use the "New" and "Edit" functions to create a data list internally or to edit an existing one.
- Use the standard "File Manager" function to transfer external data lists to the instrument.

See also:

- Section "About data signals" in the R&S SMM100A user manual.
- Section "File and data management" in the R&S SMM100A user manual.
- Section "Data list editor" in the R&S SMM100A user manual.

Remote command:

```
[ :SOURce<hw> ] :BB:NR5G:SCHed:CELL<cc>:SUBF<sf>:USER<us>:
BWPart<bwp>:ALLoc<al>:CS:DCI<dci>:DATA on page 690
[ :SOURce<hw> ] :BB:NR5G:SCHed:CELL<cc>:SUBF<sf>:USER<us>:
BWPart<bwp>:ALLoc<al>:CS:DCI<dci>:DLISt on page 690
[ :SOURce<hw> ] :BB:NR5G:SCHed:CELL<cc>:SUBF<sf>:USER<us>:
BWPart<bwp>:ALLoc<al>:CS:DCI<dci>:PATTern on page 691
```

Initialization ← Custom ← DCI content configuration

Sets an initialization value for the second m-sequence in the PN sequence of the custom DCI.

Enabled if "Data Source > PNxx".

Remote command:

```
[ :SOURce<hw> ] :BB:NR5G:SCHed:CELL<cc>:SUBF<sf>:USER<us>:
BWPart<bwp>:ALLoc<al>:CS:DCI<dci>:INITpattern on page 690
```

Pattern Length ← Custom ← DCI content configuration

If **Channel Coding** > "On", sets the number of DCI bits, i.e. the number of bits in the "Pattern" field.

If **Channel Coding** > "Off", the number of DCI bits is calculated based on the selected **Aggregation Level** for the corresponding DCI.

Remote command:

```
[ :SOURce<hw> ] :BB:NR5G:SCHed:CELL<cc>:SUBF<sf>:USER<us>:
BWPart<bwp>:ALLoc<al>:CS:DCI<dci>:BITLength on page 690
```

5.6.3 Info

Access:

1. Select "Scheduling > User x BWP x > Content > CORESET > Settings > Config".

2. Select "Info".

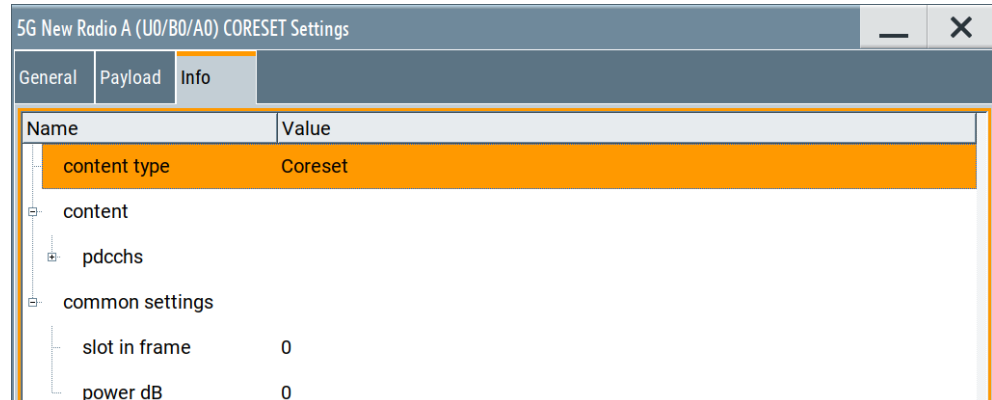

The dialog displays details on the CORESET configuration.

Info

The dialog displays details on the configuration.

There are two information lists:

- "Stable": Naming and structure of the information in this list are stable in future firmware releases.
- "Mutable": Naming and structure of the information in this list can change in future firmware releases.

Remote command:

```
[ :SOURce<hw> ] :BB:NR5G:SCHed:CELL<cc>:SUBF<sf>:USER<us>:
BWPart<bwp>:ALLoc<al>:INFO? on page 600
```

5.7 CSI-RS settings (scheduling table)

Access:

1. Select "5G New Radio > General > Link Direction > Downlink".
2. Select "5G New Radio > Scheduling".
3. For any configurable allocation, select "Content" = "CSI-RS".
4. For any CSI-RS allocation, select "Config" to configure the corresponding CSI-RS allocation.

This dialog comprises the settings of the CSI reference signal.



Note that the settings available in this dialog are a subset of the settings available for the CSI-RS in the "DL BWP Config" dialog. However, when you change a setting for the CSI-RS in one place, it has no effect on the other - both ways to configure a CSI-RS allocation are independent of each other.

- [General CSI-RS settings](#).....270
- [Antenna port configuration for CSI-RS](#).....272

5.7.1 General CSI-RS settings

Access:

1. Select "5G New Radio > General > Link Direction > Downlink".
2. Select "5G New Radio > Scheduling".
3. For any configurable allocation, select "Content" = "CSI-RS".
4. For any CSI-RS allocation, select "Config" to configure the corresponding CSI-RS allocation.
5. Select "General".

This dialog comprises general settings for the CSI reference signal (CSI-RS).

Settings:

Zero Power	270
Row	270
Density	271
Bitmap	271
Scrambling ID	271
I0/I1	271

Zero Power

Turns zero power transmission for the CSI-RS on and off (ZP CSI-RS or NZP CSI-RS).

If you turn on zero power transmission, the resource elements are allocated to the CSI-RS as if it were there, but it is not actually transmitted.

Remote command:

```
[ :SOURce<hw> ] :BB:NR5G:SCHed:CELL<cc>:SUBF<sf>:USER<us>:
BWPart<bwp>:ALLoc<al>:ISZPower on page 693
```

Row

The CSI-RS location in a slot is defined according to [TS 38.211](#) as a function of the number of ports X , the "Density" and the "CDM-Type".

The possible combinations are listed in a table and the parameter "Row" indicates one of the combinations. It is not the consequent table row number in the CSI-RS resource table. The latter is defined with the suffix `RES<user0>` in the remote control command.

Remote command:

```
[ :SOURce<hw> ] :BB:NR5G:SCHed:CELL<cc>:SUBF<sf>:USER<us>:
BWPart<bwp>:ALLoc<al>:ROW on page 693
```

Density

Sets the value p that is the higher-layer parameter `density` in the CSI-RS-ResourceMapping or the CSI-RS-CellMobility messages.

Remote command:

```
[ :SOURce<hw> ] :BB:NR5G:SCHed:CELL<cc>:SUBF<sf>:USER<us>:
BWPart<bwp>:ALLoc<al>:DENSity on page 692
```

Bitmap

Sets the location of the CSI-RS in the frequency domain. The starting position and number of the resource blocks in which the CSI-RS is transmitted are defined by the higher-layer parameters `freqBand`.

This parameter is transmitted by the higher-layer parameters `frequencyDomainAllocation` as part of the CSI-RS-ResourceMapping or the CSI-RS-CellMobility messages.

Remote command:

```
[ :SOURce<hw> ] :BB:NR5G:SCHed:CELL<cc>:SUBF<sf>:USER<us>:
BWPart<bwp>:ALLoc<al>:BITMap on page 692
```

Scrambling ID

Sets the parameter n_{ID} that is defined by the higher-layer parameter `ScramblingID` and used for the generation of the pseudo-random reference-signal generator.

Remote command:

```
[ :SOURce<hw> ] :BB:NR5G:SCHed:CELL<cc>:SUBF<sf>:USER<us>:
BWPart<bwp>:ALLoc<al>:SCID on page 693
```

I0/I1

Sets the parameters l_0 and l_1 and define the CSI-RS location relative to the start of as slot. Thus, the l_0 and l_1 give the location of the CSI-RS in time.

These parameters are transmitted by the higher-layer parameters `firstOFDMSymbolInTimeDomain` and `firstOFDMSymbolInTimeDomain2` as part of the CSI-RS-ResourceMapping or the CSI-RS-CellMobility messages.

Remote command:

```
 $l_0$ : [ :SOURce<hw> ] :BB:NR5G:SCHed:CELL<cc>:SUBF<sf>:USER<us>:
BWPart<bwp>:ALLoc<al>:I0 on page 692
 $l_1$ : [ :SOURce<hw> ] :BB:NR5G:SCHed:CELL<cc>:SUBF<sf>:USER<us>:
BWPart<bwp>:ALLoc<al>:I1 on page 693
```

5.7.2 Antenna port configuration for CSI-RS

Access:

1. Select "5G New Radio > General > Link Direction > Downlink".
2. Select "5G New Radio > Scheduling".
3. For any configurable allocation, select "Content" = "CSI-RS".
4. For any CSI-RS allocation, select "Config" to configure the corresponding CSI-RS allocation.
5. Select "Antenna Ports".

This dialog comprises antenna port settings for the CSI reference signal.

Settings:

Mapping Coordinates.....	272
Mapping table.....	272

Mapping Coordinates

Switches representation between the "Cartesian" (Real/Imag) and "Cylindrical" (Magn./Phase) coordinates.

Mapping table

Defines the mapping of the antenna ports (AP) to the physical antennas.

For details on the antenna ports-mapping concept, see [Chapter 2.10, "Antenna port mapping"](#), on page 27.

Remote command:

"Mapping Coordinates = Cartesian":

```
[ :SOURce<hw> ] :BB:NR5G:UBWP:USER<us>:CELL<cc>:UL:BWP<bwp>:SRS:RS:SET<gr0>:RES<user0>:APMap:AP<ap>:ROW<apr>:REAL on page 586
```

```
[ :SOURce<hw> ] :BB:NR5G:UBWP:USER<us>:CELL<cc>:UL:BWP<bwp>:SRS:RS:SET<gr0>:RES<user0>:APMap:AP<ap>:ROW<apr>:IMAGinary on page 586
```

"Mapping Coordinates = Cylindrical":

```
[ :SOURce<hw> ] :BB:NR5G:UBWP:USER<us>:CELL<cc>:UL:BWP<bwp>:SRS:RS:SET<gr0>:RES<user0>:APMap:AP<ap>:ROW<apr>:MAGNitude on page 587
```

```
[ :SOURce<hw> ] :BB:NR5G:UBWP:USER<us>:CELL<cc>:UL:BWP<bwp>:SRS:RS:SET<gr0>:RES<user0>:APMap:AP<ap>:ROW<apr>:PHASe on page 587
```

5.8 RIM-RS setting (scheduling table)

The remote interference management reference signal (RIM-RS) is used by a base station to measure remote interference and provide that information to other base stations. Remote interference can occur under certain atmospheric conditions and cause downlink transmissions to interfere with uplink transmissions.

You can define various parameters that define the sequence generation of each RIM-RS you add to the scheduling table.

NScid

Defines the scrambling ID for the RIM reference signal sequence generation.

Remote command:

```
[ :SOURCE<hw> ] :BB:NR5G:SCHed:CELL<cc>:SUBF<sf>:USER<us>:
BWPart<bwp>:RESulting:ALLoc<al>:RIMRs:SCID on page 695
```

NTRim

Defines the number of RIM-RS transmission periods since a certain reference time as defined in 3GPP 38.211, chapter 7.4.1.6.2.

Remote command:

```
[ :SOURCE<hw> ] :BB:NR5G:SCHed:CELL<cc>:SUBF<sf>:USER<us>:
BWPart<bwp>:RESulting:ALLoc<al>:RIMRs:NTRim on page 694
```

Gamma

Defines the multiplier factor γ as defined in 3GPP 38.211, chapter 7.4.1.6.2 that has an effect on the sequence generation of the RIM-RS.

Remote command:

```
[ :SOURCE<hw> ] :BB:NR5G:SCHed:CELL<cc>:SUBF<sf>:USER<us>:
BWPart<bwp>:RESulting:ALLoc<al>:RIMRs:GAMMa on page 694
```

Delta

Defines the offset δ as defined in 3GPP 38.211, chapter 7.4.1.6.2 that has an effect on the sequence generation of the RIM-RS.

Remote command:

```
[ :SOURCE<hw> ] :BB:NR5G:SCHed:CELL<cc>:SUBF<sf>:USER<us>:
BWPart<bwp>:RESulting:ALLoc<al>:RIMRs:DELTA on page 694
```

5.9 PUCCH settings

Access:

1. Select "5G New Radio > General > Link Direction > Uplink".
2. Select "5G New Radio > Scheduling".
3. Select "User x BWP x > Content > PUCCH".
4. For the PUCCH allocation, select "User x BWP x > Format = e.g. F0".
5. Select "PUCCH > Settings > Config".

This dialog comprises the settings of the physical uplink common channel (PUCCH).

PUCCH and PUCCH formats

The PUCCH supports 5 different formats (F0 to F4), each of them spanning different number of OFDM symbols. PUCCH can be transmitted on a constant frequency or optionally use frequency hopping, where the latter is signaled by a higher-level parameter. If frequency hopping is enabled, the PUCCH in formats F1, F3 and F4 spans the half of the OFDM symbols available in the constant frequency case.

Settings:

• General settings	274
• Payload settings	278
• Info	279

5.9.1 General settings

Access:

1. Select "Scheduling > User x BWP x > Content > PUCCH > Settings > Config".
2. Select "General".

5G New Radio A (U0/B0/A0) PUCCH Settings		
General	Payload	Info
Burst Mode Ref Alloc Identifier	<input checked="" type="checkbox"/>	
Group Hopping	Neither	
Hopping ID	0	
Intra Slot Frequency Hopping	<input type="checkbox"/>	
Second Hop PRB	0	
Format Specific		
Initial Cyclic Shift	0	

Settings:

Burst Mode Ref Alloc Identifier	275
Group Hopping	275
Hopping ID	275
Intra Slot Frequency Hopping	275

Second Hop PRB.....	276
Number of Interlaces.....	276
Interlace <x>.....	276
Initial Cyclic Shift.....	276
Cyclic Prefix Extension.....	276
Time Domain OCC Index.....	277
OCC Length.....	277
OCC Index.....	277

Burst Mode Ref Alloc Identifier

If **Power Mode** > "Burst", sets whether the bandwidth of the current allocation is used as reference for the "Burst" power mode.

The icon  in the **Scheduling settings** table indicates which allocation is set as burst reference.

Remote command:

```
[ :SOURce<hw> ] :BB:NR5G:SCHed:CELL<cc>:SUBF<sf>:USER<us>:
BWPart<bwp>:ALLoc<al>:PDSCh|PUSCh:BMAid on page 612
```

Group Hopping

Available for PUCCH formats 0 and 1.

Sets the higher-layer parameter `pucch-GroupHopping`, as defined in [TS 38.211](#).

You turn group and sequence hopping for the PUCCH demodulation reference signal on and off as follows:

"Neither"	Disables group and sequence hopping
"Enable"	Enables group hopping
"Disable"	Enables sequence hopping

Remote command:

```
[ :SOURce<hw> ] :BB:NR5G:SCHed:CELL<cc>:SUBF<sf>:USER<us>:
BWPart<bwp>:ALLoc<al>:PUCCh:GRPHopping on page 697
```

Hopping ID

Sets the parameter hopping ID (n_{ID}) used to select the frequency hopping sequence number and to initialize the pseudo-random sequence generator. In the practice, the value is transmitted by the higher-layer parameter `hoppingId` [[TS 38.211](#)].

Remote command:

```
[ :SOURce<hw> ] :BB:NR5G:SCHed:CELL<cc>:SUBF<sf>:USER<us>:
BWPart<bwp>:ALLoc<al>:PUCCh:HOPid on page 698
```

Intra Slot Frequency Hopping

Enables PUCCH demodulation reference signal hopping within a slot.

If intra-slot hopping is enabled, you can define the physical resource block offset for the second hop ("Second Hop PRB").

Remote command:

```
[ :SOURce<hw> ] :BB:NR5G:SCHed:CELL<cc>:SUBF<sf>:USER<us>:
BWPart<bwp>:ALLoc<al>:PUCCh:ISFHopping on page 698
```

Second Hop PRB

Sets the physical resource block (PRB) of the second hop.

Remote command:

```
[ :SOURce<hw> ] :BB:NR5G:SCHed:CELL<cc>:SUBF<sf>:USER<us>:
BWPart<bwp>:ALLoc<al>:PUCCh:SHOPping on page 699
```

Number of Interlaces

Option: R&S SMM-K148

Defines the number of [interlaces](#). The maximum number depends on the current sub-carrier spacing.

For PUCCH interlaces, the following conditions apply:

- PUCCH format 0 and 1: Only support one interlace whose [interlace value](#) (distance between interlaces) is defined by the [resource block offset](#).
- PUCCH format 2 and 3: Support up to two interlaces whose position in the resource grid depends on the interlace value you have entered, the resource block offset and the [spreading parameters](#).
- PUCCH format 4: No support of interlacing.
- Frequency hopping and interlacing at the same time is not possible.

Remote command:

```
[ :SOURce<hw> ] :BB:NR5G:SCHed:CELL<cc>:SUBF<sf>:USER<us>:
BWPart<bwp>:ALLoc<al>:PUCCh:NINT on page 698
```

Interlace <x>

Option: R&S SMM-K148

Defines the distance between resource elements used for [interlacing](#). A value of 4, for example, would use every 4th resource element for the corresponding interlace.

Note that each interlace must have a different value. Otherwise interlaces would share the same allocation.

Remote command:

```
[ :SOURce<hw> ] :BB:NR5G:SCHed:CELL<cc>:SUBF<sf>:USER<us>:
BWPart<bwp>:ALLoc<al>:PUCCh:INT<il>:INTL on page 698
```

Initial Cyclic Shift

For PUCCH formats F0 and F1, sets the initial cyclic shift (m0).

As defined in [TS 38.211](#), the value is required to calculate the cyclic shift for the hopping sequence.

Remote command:

```
[ :SOURce<hw> ] :BB:NR5G:SCHed:CELL<cc>:SUBF<sf>:USER<us>:
BWPart<bwp>:ALLoc<al>:PUCCh:FS:CYCShift on page 696
```

Cyclic Prefix Extension

Option: R&S SMM-K148

Defines the length of a cyclic prefix extension, which is added in front of the first PUCCH allocation in a slot. The other cyclic prefixes of the PUCCH allocations in the slot are not affected.



Remote command:

```
[ :SOURce<hw> ] :BB:NR5G:SCHed:CELL<cc>:SUBF<sf>:USER<us>:
BWPart<bwp>:ALLoc<al>:CPEXt on page 609
```

Time Domain OCC Index

For PUCCH format F1, sets the orthogonal sequence index \mathbb{I} ($\mathbb{I} = 0$ to 6). As defined in [TS 38.211](#), the value is required to select the orthogonal sequence, used for the block-wise spreading.

Remote command:

```
[ :SOURce<hw> ] :BB:NR5G:SCHed:CELL<cc>:SUBF<sf>:USER<us>:
BWPart<bwp>:ALLoc<al>:PUCCh:FS:TDOCC on page 697
```

OCC Length

For PUCCH format F4, sets the value of the parameter N_{SF}^{PUCCH} and thus defines which of the orthogonal sequences $w_n(m)$ defined in [TS 38.211](#) is used.

OCC lengths for PUCCH formats F2 and F3 are available with R&S SMM-K148.

Remote command:

```
F2: [ :SOURce<hw> ] :BB:NR5G:SCHed:CELL<cc>:SUBF<sf>:USER<us>:
BWPart<bwp>:ALLoc<al>:PUCCh:FS:FMT2:OCCLength on page 697
```

```
F3: [ :SOURce<hw> ] :BB:NR5G:SCHed:CELL<cc>:SUBF<sf>:USER<us>:
BWPart<bwp>:ALLoc<al>:PUCCh:FS:FMT3:OCCLength on page 697
```

```
F4: [ :SOURce<hw> ] :BB:NR5G:SCHed:CELL<cc>:SUBF<sf>:USER<us>:
BWPart<bwp>:ALLoc<al>:PUCCh:FS:OCCLength on page 696
```

OCC Index

For PUCCH format F4, sets the orthogonal sequence index n ($n = 0$ to 4). As defined in [TS 38.211](#), the value is required to select the orthogonal sequence, used for the block-wise spreading.

Display of the OCC index for PUCCH formats F2 and F3 are available with R&S SMM-K148.

Remote command:

```
[ :SOURce<hw> ] :BB:NR5G:SCHed:CELL<cc>:SUBF<sf>:USER<us>:
BWPart<bwp>:ALLoc<al>:PUCCh:FS:OCCindex on page 696
```

5.9.2 Payload settings

Access:

1. Select "Scheduling > User x BWP x > Content > PUCCH > Settings > Config".
2. Select "Payload".

5G New Radio A (U0/B0/A0) PUCCH Settings		
General	Payload	Info
Manual UCI Pattern	<input type="checkbox"/>	Number of UCI Part 1 Bits
Positive SR Count	1	SR Pattern
Number of ACK Bits	0	ACK Pattern
Number of CSI Part 1 Bits	3	CSI Part 1 Pattern
Number of CSI Part 2 Bits	3	CSI Part 2 Pattern
Max Code Rate	0.80	

Settings:

Positive SR Count.....	278
Number of ACK Bits.....	278
ACK Pattern.....	279
Number of UCI Bits.....	279
UCI Pattern.....	279

Positive SR Count

Sets the number of positive scheduling requests (SR). The value is used to define the mapping of the HARQ-ACK and CSI bits. For details, see [TS 38.213](#).

Remote command:

```
[ :SOURce<hw> ] :BB:NR5G:SCHed:CELL<cc>:SUBF<sf>:USER<us>:
BWPart<bwp>:ALLoc<al>:PUCCh:PL:SRCount on page 700
```

Number of ACK Bits

Sets the number of ACK bits and defines the length of the "ACK Pattern" field.

Remote command:

```
[ :SOURce<hw> ] :BB:NR5G:SCHed:CELL<cc>:SUBF<sf>:USER<us>:
BWPart<bwp>:ALLoc<al>:PUCCh:PL:ACK:BITS on page 699
```

ACK Pattern

Sets the ACK bits in pattern form, where the pattern length is set with the parameter "Number of ACK Bits".

A "1" indicates an ACK, a "0" - a NACK.

The pattern is read out once.

Remote command:

```
[ :SOURce<hw> ] :BB:NR5G:SCHed:CELL<cc>:SUBF<sf>:USER<us>:
BWPart<bwp>:ALLoc<al>:PUCCh:PL:ACK:PATtern on page 700
```

Number of UCI Bits

Sets the number of UCI bits and defines the length of the "UCI Pattern" field.

Remote command:

```
[ :SOURce<hw> ] :BB:NR5G:SCHed:CELL<cc>:SUBF<sf>:USER<us>:
BWPart<bwp>:ALLoc<al>:PUCCh:PL:UCI:BITS on page 700
```

UCI Pattern

Sets the UCI bit sequence according to [TS 38.212](#). The sequence is set in pattern form, where the pattern length is set with the parameter "Number of UCI Bits".

A "1" indicates an ACK, a "0" - a NACK.

The pattern is read out once.

Remote command:

```
[ :SOURce<hw> ] :BB:NR5G:SCHed:CELL<cc>:SUBF<sf>:USER<us>:
BWPart<bwp>:ALLoc<al>:PUCCh:PL:UCI:PATtern on page 701
```

5.9.3 Info

Access:

1. Select "Scheduling > User x BWP x > Content > PUCCH > Settings > Config".
2. Select "Info".

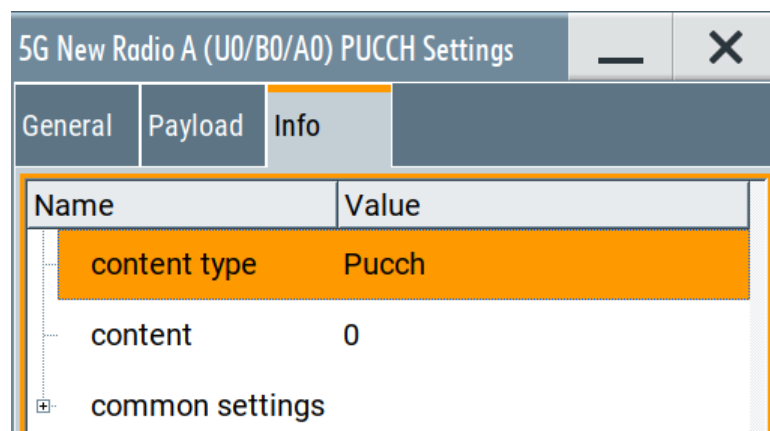

The dialog displays details on the PUCCH configuration.

Info

The dialog displays details on the configuration.

There are two information lists:

- "Stable": Naming and structure of the information in this list are stable in future firmware releases.
- "Mutable": Naming and structure of the information in this list can change in future firmware releases.

Remote command:

[:SOURce<hw>] :BB:NR5G:SCHed:CELL<cc>:SUBF<sf>:USER<us>:
BWPart<bwp>:ALLoc<al>:INFO? on page 600

5.10 PRACH settings

Access:

1. Select "5G New Radio > General > Link Direction > Uplink".
2. Select "5G New Radio > Scheduling".
3. Select "User x BWP x > Content > PRACH".
4. Select "PRACH > Settings > Config".

5G New Radio A (U0/B0/A0) PRACH Settings	
Format	Restricted Set
A1	Unrestricted
Logical Root Sequence	Zero Correlation Zone
0	0
Preamble Index	Time Offset
0	0.00 μs
Burst Mode Ref Alloc Identifier	

This dialog comprises the settings of the physical random access channel (PRACH).

According to TS 38.211, the 64 preambles ([Preamble Index](#)) defined in each time-frequency PRACH occasion are numbered starting from the first cyclic shift of a logical root sequence. Then following the logical root sequence index, starting with the index set by the parameter [Logical Root Sequence](#).

Settings:

Format	281
Restricted Set	281
Logical Root Sequence	281
Zero Correlation Zone	281
Preamble Index	281

Time Offset.....	282
Burst Mode Ref Alloc Identifier.....	282
Info.....	282

Format

Selects the PRACH format.

The available formats depend on the [SC Spacing/CP](#) as follows:

- SCS = {1.25 kHz; 5 KHz}: "Format" = 0, 1, 2, 3
- SCS = {15 kHz; 30 kHz; 60 kHz; 120 kHz; 480 kHz; 960 kHz}: "Format" = A1, A2, A3, B1, B2, B3, B4, C0, C2

Remote command:

```
[ :SOURce<hw> ] :BB:NR5G:SCHed:CELL<cc>:SUBF<sf>:USER<us>:
BWPart<bwp>:ALLoc<al>:PRACH:FORMat on page 702
```

Restricted Set

Sets the higher-layer parameter `restrictedSetConfig` that defines the type of restricted sets (unrestricted, restricted type A, restricted type B).

Supported restricted sets depend on the PRACH [Format](#) as follows:

- "Format" = 0, 1, 2, 3: "Restricted Type A, Restricted Type B"
- "Format" = A1, A2, A3, B1, B2, B3, B4, C0, C2: "Unrestricted"

Remote command:

```
[ :SOURce<hw> ] :BB:NR5G:SCHed:CELL<cc>:SUBF<sf>:USER<us>:
BWPart<bwp>:ALLoc<al>:PRACH:RSET on page 702
```

Logical Root Sequence

Sets the higher-layer parameter `prach-RootSequenceIndex` that defines the starting logical root sequence index and thus the 64 PRACH preambles.

Remote command:

```
[ :SOURce<hw> ] :BB:NR5G:SCHed:CELL<cc>:SUBF<sf>:USER<us>:
BWPart<bwp>:ALLoc<al>:PRACH:RSEquence on page 703
```

Zero Correlation Zone

Sets the parameter `zeroCorrelationZoneConfig` required to select the N_{cs} value that in turn is used for the calculation of the cyclic shift ([TS 38.211](#)).

Remote command:

```
[ :SOURce<hw> ] :BB:NR5G:SCHed:CELL<cc>:SUBF<sf>:USER<us>:
BWPart<bwp>:ALLoc<al>:PRACH:ZCZone on page 703
```

Preamble Index

Sets the PRACH preamble index and thus defines which one of the 64 PRACH preambles is used.

Remote command:

```
[ :SOURce<hw> ] :BB:NR5G:SCHed:CELL<cc>:SUBF<sf>:USER<us>:
BWPart<bwp>:ALLoc<al>:PRACH:PRINdex on page 703
```

Time Offset

Sets the timing offset base value for PRACH, required for the PRACH performance requirement tests according to TS 38.141-1.

The supported value range allows you to test PRACH detection also with in case of delay or misalignment greater than the values defined in the specification.

Remote command:

```
[ :SOURCE<hw> ] :BB:NR5G:SCHed:CELL<cc>:SUBF<sf>:USER<us>:
BWPart<bwp>:ALLoc<al>:PRACH:TOFFset on page 704
```

Burst Mode Ref Alloc Identifier

If **Power Mode** > "Burst", sets whether the bandwidth of the current allocation is used as reference for the "Burst" power mode.

The icon  in the **Scheduling settings** table indicates which allocation is set as burst reference.

Remote command:

```
[ :SOURCE<hw> ] :BB:NR5G:SCHed:CELL<cc>:SUBF<sf>:USER<us>:
BWPart<bwp>:ALLoc<al>:PRACH:BMAid on page 702
```

Info

The dialog displays details on the configuration.

There are two information lists:

- "Stable": Naming and structure of the information in this list are stable in future firmware releases.
- "Mutable": Naming and structure of the information in this list can change in future firmware releases.

Remote command:

```
[ :SOURCE<hw> ] :BB:NR5G:SCHed:CELL<cc>:SUBF<sf>:USER<us>:
BWPart<bwp>:ALLoc<al>:INFO? on page 600
```

5.11 SRS settings (scheduling table)

Access:

1. Select "5G New Radio > General > Link Direction > Uplink".
2. Select "5G New Radio > Scheduling".
3. For any configurable allocation, select "Content" = "SRS".
4. For any SRS allocation, select "Config" to configure the corresponding SRS allocation.

This dialog comprises the settings of the sounding reference signal (SRS). For more information about the SRS, see [Chapter 5.3.7.6, "SRS settings"](#), on page 183.



Note that the settings available in this dialog are a subset of the settings available for the SRS in the "UL BWP Config" dialog. However, when you change a setting for the SRS in one place, it has no effect on the other - both ways to configure a SRS allocation are independent of each other.

- [General SRS settings](#).....283
- [Antenna port settings for SRS](#).....286

5.11.1 General SRS settings

Access:

1. Select "5G New Radio > General > Link Direction > Uplink".
2. Select "5G New Radio > Scheduling".
3. For any configurable allocation, select "Content" = "SRS".
4. For any SRS allocation, select "Config" to configure the corresponding SRS allocation.
5. Select "General".

This dialog comprises general settings for the sounding reference signal (SRS).

Settings:

Config	283
Resource Type	284
Periodicity	284
Offset	284
Frequency Position	284
Frequency Shift	284
B SRS	285
C SRS	285
B Hop	285
Repetition Factor	285
Transmission Comb	285
Comb Offset	285
Sequence Cyclic Shift	286
Sequence ID	286
Group or Sequence Hopping	286
Frequency Scaling Factor	286
Start RB Index	286

Config

Option: R&S SMM-K148 and -K171

Selects the 3GPP release the SRS is based on.

As of 3GPP release 16, the SRS also can also be used for positioning purposes. Select "SRS Pos R16 IE" to generate signals in which the SRS carries positioning information.

Note that the value ranges for several SRS resources depend on which 3GPP release the SRS is based on.

Remote command:

```
[ :SOURCE<hw> ] :BB:NR5G:SCHed:CELL<cc>:SUBF<sf>:USER<us>:
BWPart<bwp>:ALLoc<al>:CONFig on page 706
```

Resource Type

Selects the slots in which the sounding reference signal appears.

"Aperiodic" Aperiodic transmission transmits the SRS in arbitrary slots.

Remote command:

```
[ :SOURCE<hw> ] :BB:NR5G:SCHed:CELL<cc>:SUBF<sf>:USER<us>:
BWPart<bwp>:ALLoc<al>:RSType on page 708
```

Periodicity

Sets the SRS repetition factor T_{SRS} . The periodicity is a time interval defined as number of slots that indicates how often (i.e. after how many slots) the SRS is transmitted.

As smaller the periodicity value as frequent is the SRS transmission. To enable the SRS for example in each slot, set "Periodicity = 1 slot".

Available for [periodic](#) SRS transmission.

Remote command:

```
[ :SOURCE<hw> ] :BB:NR5G:UBWP:USER<us>:CELL<cc>:UL:BWP<bwp>:SRS:RS:
SET<gr0>:RES<user0>:PER on page 581
```

Offset

Sets time position of first SRS allocation within an SRS periodicity, given as an offset in number of slots (T_{offset}) from the start of the frame.

Available for [periodic](#) SRS transmission and if [periodicity](#) > 1 slot.

Remote command:

```
[ :SOURCE<hw> ] :BB:NR5G:SCHed:CELL<cc>:SUBF<sf>:USER<us>:
BWPart<bwp>:ALLoc<al>:OFFSet on page 707
```

Frequency Position

Sets the parameter k_0 that defines the starting position of the SRS allocation in the frequency domain.

Remote command:

```
[ :SOURCE<hw> ] :BB:NR5G:SCHed:CELL<cc>:SUBF<sf>:USER<us>:
BWPart<bwp>:ALLoc<al>:FPOS on page 706
```

Frequency Shift

The frequency shift n_{shift} influence the SRS transmission density in the frequency domain.

Remote command:

```
[ :SOURce<hw> ] :BB:NR5G:SCHed:CELL<cc>:SUBF<sf>:USER<us>:
BWPart<bwp>:ALLoc<al>:FQSHift on page 706
```

B SRS

Sets the filed b-SRS contained in the higher-layer parameter `freqHopping` and used to define the length of the SRS sequence, see TS 38.211, Table 6.4.1.4.3-1.

Remote command:

```
[ :SOURce<hw> ] :BB:NR5G:SCHed:CELL<cc>:SUBF<sf>:USER<us>:
BWPart<bwp>:ALLoc<al>:BSRS on page 705
```

C SRS

Sets the filed c-SRS contained in the higher-layer parameter `freqHopping` and used to define the length of the SRS sequence, see TS 38.211, Table 6.4.1.4.3-1.

Remote command:

```
[ :SOURce<hw> ] :BB:NR5G:SCHed:CELL<cc>:SUBF<sf>:USER<us>:
BWPart<bwp>:ALLoc<al>:CSRS on page 706
```

B Hop

Sets the parameter b_{Hop} that defines the frequency hopping of the SRS.

Set "B Hop" > "B SRS" to disable frequency hopping ("Rep. Factor" = 1).

Remote command:

```
[ :SOURce<hw> ] :BB:NR5G:SCHed:CELL<cc>:SUBF<sf>:USER<us>:
BWPart<bwp>:ALLoc<al>:BHOP on page 705
```

Repetition Factor

Defines how many times the SRS symbols are repeated.

Available if B Hop < B SRS.

Remote command:

```
[ :SOURce<hw> ] :BB:NR5G:SCHed:CELL<cc>:SUBF<sf>:USER<us>:
BWPart<bwp>:ALLoc<al>:REFactor on page 708
```

Transmission Comb

Transmission comb (k_{TC}) is a method for interleaving SRS symbols by using alternating subcarriers (only the even or odd subcarriers).

The value of k_{TC} defines the maximum number of cyclic shifts $n_{\text{SRS}}^{\text{CS}}$.

Remote command:

```
[ :SOURce<hw> ] :BB:NR5G:SCHed:CELL<cc>:SUBF<sf>:USER<us>:
BWPart<bwp>:ALLoc<al>:TRTCComb on page 709
```

Comb Offset

Sets the parameter transmission comb offset.

Remote command:

```
[ :SOURce<hw> ] :BB:NR5G:SCHed:CELL<cc>:SUBF<sf>:USER<us>:
BWPart<bwp>:ALLoc<al>:COFFset on page 705
```

Sequence Cyclic Shift

Sets the number of cyclic shifts $n_{\text{SRS}}^{\text{CS}}$, required for the SRS sequence generation according to TS 38.211.

Remote command:

```
[ :SOURce<hw> ] :BB:NR5G:SCHed:CELL<cc>:SUBF<sf>:USER<us>:
BWPart<bwp>:ALLoc<al>:SEQ:CYCShift on page 708
```

Sequence ID

Sets the higher-layer parameter `sequenceId` ($n_{\text{ID}}^{\text{SRS}}$), required for the SRS sequence generation according to TS 38.211.

Remote command:

```
[ :SOURce<hw> ] :BB:NR5G:SCHed:CELL<cc>:SUBF<sf>:USER<us>:
BWPart<bwp>:ALLoc<al>:SEQ:ID on page 709
```

Group or Sequence Hopping

Sets the higher-layer parameter `groupOrSequenceHopping` that defines the sequence group, required for the SRS sequence generation according to TS 38.211.

Remote command:

```
[ :SOURce<hw> ] :BB:NR5G:SCHed:CELL<cc>:SUBF<sf>:USER<us>:
BWPart<bwp>:ALLoc<al>:SEQ:HOPPing on page 709
```

Frequency Scaling Factor

Option: R&S SMM-K171

Selects the frequency scaling factor defined in 3GPP 38.211, chapter 6.4.1.4.3.

Remote command:

```
[ :SOURce<hw> ] :BB:NR5G:SCHed:CELL<cc>:SUBF<sf>:USER<us>:
BWPart<bwp>:ALLoc<al>:FSFactor on page 707
```

Start RB Index

Option: R&S SMM-K171

Defines the start RB index defined in 3GPP 38.331. The parameter is defined through the RRC parameter `startRbIndexAndFreqScalingFactor`.

Values depend on the frequency scaling factor: possible values = scaling factor - 1.

Available if the frequency scaling factor > 1.

Remote command:

```
[ :SOURce<hw> ] :BB:NR5G:SCHed:CELL<cc>:SUBF<sf>:USER<us>:
BWPart<bwp>:ALLoc<al>:SRIDx on page 709
```

5.11.2 Antenna port settings for SRS

Access:

1. Select "5G New Radio > General > Link Direction > Uplink".
2. Select "5G New Radio > Scheduling".

3. For any configurable allocation, select "Content" = "SRS".
4. For any SRS allocation, select "Config" to configure the corresponding SRS allocation.
5. Select "Antenna Ports".

This dialog comprises antenna port settings for the sounding reference signal (SRS).

Settings:

Mapping Coordinates.....	287
Ports.....	287
Mapping table.....	287

Mapping Coordinates

Switches representation between the "Cartesian" (Real/Imag) and "Cylindrical" (Magn./Phase) coordinates.

Ports

Defines the number of antenna ports used by the SRS.

Remote command:

```
[ :SOURce<hw> ] :BB:NR5G:SCHed:CELL<cc>:SUBF<sf>:USER<us>:
BWPart<bwp>:ALLoc<al>:PORTs on page 708
```

Mapping table

Defines the mapping of the antenna ports (AP) to the physical antennas.

Set the number of antenna ports (AP) with the parameter "Ports" on page 287.

For details on the antenna ports-mapping concept, see [Chapter 2.10, "Antenna port mapping"](#), on page 27.

Remote command:

"Mapping Coordinates = Cartesian":

```
[ :SOURce<hw> ] :BB:NR5G:UBWP:USER<us>:CELL<cc>:UL:BWP<bwp>:SRS:RS:
SET<gr0>:RES<user0>:APMap:AP<ap>:ROW<apr>:REAL on page 586
```

```
[ :SOURce<hw> ] :BB:NR5G:UBWP:USER<us>:CELL<cc>:UL:BWP<bwp>:SRS:RS:
SET<gr0>:RES<user0>:APMap:AP<ap>:ROW<apr>:IMAGinary on page 586
```

"Mapping Coordinates = Cylindrical":

```
[ :SOURce<hw> ] :BB:NR5G:UBWP:USER<us>:CELL<cc>:UL:BWP<bwp>:SRS:RS:
SET<gr0>:RES<user0>:APMap:AP<ap>:ROW<apr>:MAGNitude on page 587
```

```
[ :SOURce<hw> ] :BB:NR5G:UBWP:USER<us>:CELL<cc>:UL:BWP<bwp>:SRS:RS:
SET<gr0>:RES<user0>:APMap:AP<ap>:ROW<apr>:PHASe on page 587
```

5.12 PSSCH and PSCCH settings

Access:

1. Select "5G New Radio > General > Link Direction > Sidelink".
2. Select "5G New Radio > Scheduling".
3. Select "User x BWP x > Content > PSSCH/PSCCH".
4. Select "PDSCH > Settings > Config".

This dialog comprises the settings of the physical sidelink shared channel (PSSCH) or the physical sidelink control channel (PSCCH).

The PDSCH carries the general user data and is therefore the most prominent channel in a radio frame; it occupies the most resources. The PSCCH carries control information.

● General PSSCH and PSCCH settings	288
● SCI1A settings	290
● SCI2A settings	292
● SCI2B settings	293
● TxScheme settings for PSSCH and PSCCH	294
● DMRS settings for PSSCH	294
● Channel coding settings	295
● Antenna ports settings for PSSCH and PSCCH	297
● Info layer for PSSCH and PSCCH	298

5.12.1 General PSSCH and PSCCH settings

Access:

1. Select "Scheduling > User x BWP x > Content > PSSCH/PSCCH > Settings > Config".
2. Select "General".

5G New Radio A (U0/B0/A0) PSSCH/PSCCH Settings						
General	SCI1A	SCI2	TxScheme	DMRS	Antenna Ports	InfoLayer
Resource Pool		0				
PSSCH						
Number of DMRS		2				
Number of Subchannels		1				
Modulation		QPSK				
PSCCH						
DMRS Scramble ID		0				
Bandwidth (PRBs)		10				
Symbol Length		2				

Settings:

Resource Pool.....	289
Number of DMRS.....	289
Number of Subchannels.....	289
Modulation.....	290
DMRS Scramble ID.....	290
Bandwidth (PRBs).....	290
Symbol Length.....	290

Resource Pool

Selects the resource pool the PSxCH settings apply to.

The number of available resource pools depends on the bandwidth part configuration for the sidelink ([number of resource pools](#)).

If you have defined only one resource pool, the field is read only.

Remote command:

```
[ :SOURce<hw> ] :BB:NR5G:SCHed:CELL<cc>:SUBF<sf>:USER<us>:
BWPart<bwp>:ALLoc<al>:PSSCh:POOL on page 712
```

Number of DMRS

Defines the number of PSSCH DMRS.

Remote command:

```
[ :SOURce<hw> ] :BB:NR5G:SCHed:CELL<cc>:SUBF<sf>:USER<us>:
BWPart<bwp>:ALLoc<al>:PSSCh:NDMRs on page 711
```

Number of Subchannels

Defines the number of subchannels the PSSCH uses.

The number of available subchannels depends on the bandwidth part configuration for the sidelink ([number of subchannels](#)).

Remote command:

```
[ :SOURce<hw> ] :BB:NR5G:SCHed:CELL<cc>:SUBF<sf>:USER<us>:
BWPart<bwp>:ALLoc<al>:PSSCh:NSUBchan on page 711
```

Modulation

Selects the modulation scheme for the PSSCH.

The available modulations depend on the selected [MCS table](#).

Remote command:

```
[ :SOURce<hw> ] :BB:NR5G:SCHed:CELL<cc>:SUBF<sf>:USER<us>:
BWPart<bwp>:ALLoc<al>:PSSCh:MOD on page 711
```

DMRS Scramble ID

Defines the pseudo-random seed value with which the PSCCH DMRS sequence is generated.

Remote command:

```
[ :SOURce<hw> ] :BB:NR5G:SCHed:CELL<cc>:SUBF<sf>:USER<us>:
BWPart<bwp>:ALLoc<al>:PSCCh:SCRid on page 710
```

Bandwidth (PRBs)

Selects the size of the PSCCH in physical resource blocks.

The available values depend on the [subchannel size](#).

When you change the bandwidth of the PSCCH here, the value in the scheduling table is automatically updated.

Remote command:

```
[ :SOURce<hw> ] :BB:NR5G:SCHed:CELL<cc>:SUBF<sf>:USER<us>:
BWPart<bwp>:ALLoc<al>:PSCCh:BDWidth on page 710
```

Symbol Length

Selects the number of symbols the PSCCH occupies. A PSCCH can use 2 or 3 symbols.

When you change the number of symbols here, the value in the scheduling table is automatically updated. Note that the symbol length here refers to the PSCCH without the AGC part, while the symbol length in the scheduling table also includes the AGC part (= one additional symbol).

Remote command:

```
[ :SOURce<hw> ] :BB:NR5G:SCHed:CELL<cc>:SUBF<sf>:USER<us>:
BWPart<bwp>:ALLoc<al>:PSCCh:SYMLength on page 711
```

5.12.2 SCI1A settings

Access:

1. Select "Scheduling > User x BWP x > Content > PSSCH/PSCCH > Settings > Config".
2. Select "SCI1A".

5G New Radio A (U0/B0/A0) PSSCH/PSCCH Settings						
General	SCI1A	SCI2	TxScheme	DMRS	Antenna Ports	InfoLayer
Bit Data						
Pattern						00 0000 0000 0000 0000 0000
SCI Fields						
Priority	0	Frequency Domain Resource Assignment	0			
Time Domain Resource Assignment	0	Beta Offset Indicator	0			
Resource Reservation Period	0	DMRS Patterns	0			
DMRS Ports	0	Modulation and Coding Scheme	0			
Additional MCS Indicator	0	2nd Stage SCI Format	0			
Reserved Bits	0...					

The "SCI1A" dialog contains all settings to configure the first stage SCI (sidelink control information). SCI1A carries scheduling information of the PSCCH.

The fields defined in the SCI are mapped to the information bits according to [TS 38.212](#). The resulting bit pattern is displayed in the "Pattern" field. Padding bits are added in certain cases, that is zeros are appended to the DCI format until the payload size is equal to a specified size.

For a list of remote commands required to configure the SCI1A fields, see [Chapter 10.28.2, "SCI1A configuration commands"](#), on page 712.

The following fields are available for the first stage SCI.

- "Priority"
- "Frequency domain resource assignment"
- "Time domain resource assignment"
- "Beta Offset Indicator"
Value range depends on [betaOffset 1...4](#).
- "Resource Reservation Period"
Editable if [resource reserve period list](#) > 1.
- "DMRS Patterns"
Value range depends on number of active [DMRS patterns](#).
- "DMRS Ports"
This value is read only and depends on the [number of layers](#) you have selected.
- "Modulation and Coding Scheme"
- "Additional MCS Indicator"
- "2nd Stage SCI Indicator"
This value corresponds to the selected SCI2 format. If you change the format, the value is updated automatically and vice versa.
- "Reserved Bits"

5.12.3 SCI2A settings

Access:

1. Select "Scheduling > User x BWP x > Content > PSSCH/PSCCH > Settings > Config".
2. Select "SCI2" > "Format" = "SCI2A".

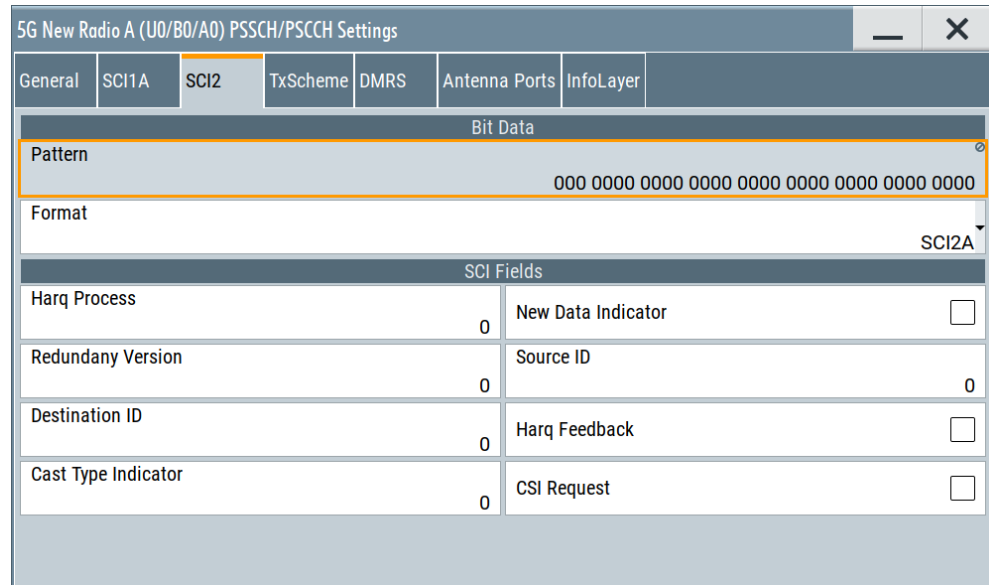

Bit Data	
Pattern	000 0000 0000 0000 0000 0000 0000 0000
Format	SCI2A
SCI Fields	
Harq Process	0
Redundancy Version	0
Destination ID	0
Cast Type Indicator	0
New Data Indicator	<input type="checkbox"/>
Source ID	0
Harq Feedback	<input type="checkbox"/>
CSI Request	<input type="checkbox"/>

The "SCI2" dialog contains all settings to configure the second stage SCI (sidelink control information). SCI2 carries scheduling information of the PSSCH. 3GPP defines two formats for second stage SCI: "SCI2A" and "SCI2B".

Format "SCI2A" is for decoding of PSSCH with HARQ operation when HARQ-ACK information includes ACK or NACK, when HARQ-ACK information includes only NACK, or when there is no feedback of HARQ-ACK information.

The fields defined in the SCI are mapped to the information bits according to [TS 38.212](#). The resulting bit pattern is displayed in the "Pattern" field. Padding bits are added in certain cases, that is zeros are appended to the DCI format until the payload size is equal to a specified size.

For a list of remote commands required to configure the SCI2A fields, see [Chapter 10.28.3, "SCI2A configuration commands"](#), on page 716.

The following SCI fields are available for SCI2A.

- "Harq Process"
- "New Data Indicator"
- "Redundancy Version"
- "Source ID"
- "Destination ID"
- "Harq Feedback"

- "Cast Type Indicator"
- "CSI Request"

5.12.4 SCI2B settings

Access:

1. Select "Scheduling > User x BWP x > Content > PSSCH/PSCCH > Settings > Config".
2. Select "SCI2" > "Format" = "SCI2B".

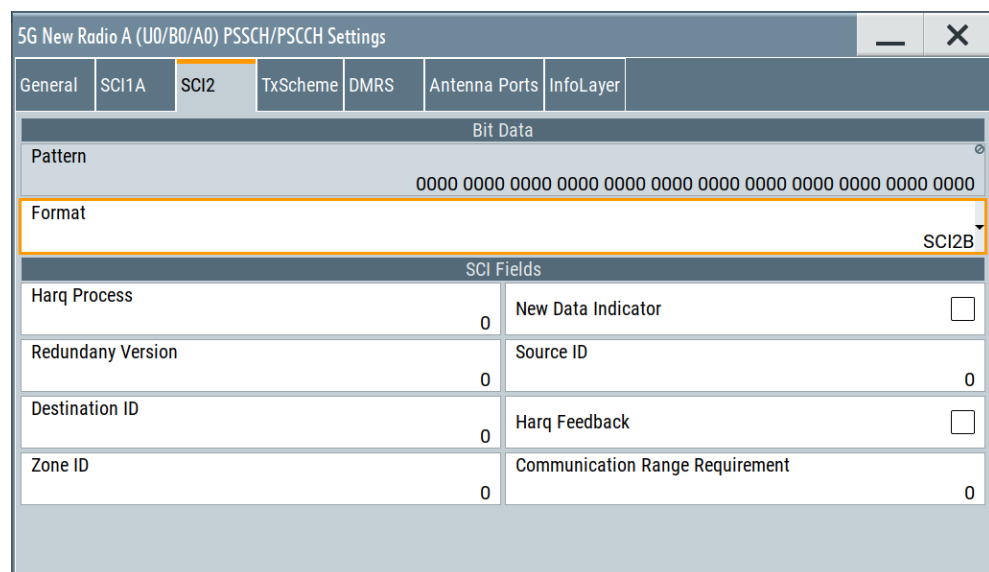

5G New Radio A (U0/B0/A0) PSSCH/PSCCH Settings						
General	SCI1A	SCI2	TxScheme	DMRS	Antenna Ports	InfoLayer
Bit Data						
Pattern 0000 0000 0000 0000 0000 0000 0000 0000 0000 0000 0000 0000						
Format SCI2B						
SCI Fields						
Harq Process	0	New Data Indicator	<input type="checkbox"/>			
Redundancy Version	0	Source ID	0			
Destination ID	0	Harq Feedback	<input type="checkbox"/>			
Zone ID	0	Communication Range Requirement	0			

The "SCI2" dialog contains all settings to configure the second stage SCI (sidelink control information). SCI2 carries scheduling information of the PSSCH. 3GPP defines two format for second stage SCI: "SCI2A" and "SCI2B".

Format "SCI2B" is for decoding of PSSCH, with HARQ operation when HARQ-ACK information includes only NACK, or when there is no feedback of HARQ-ACK information.

The fields defined in the SCI are mapped to the information bits according to [TS 38.212](#). The resulting bit pattern is displayed in the "Pattern" field. Padding bits are added in certain cases, that is zeros are append to the DCI format until the payload size is equal to a specified size.

For a list of remote commands required to configure the SCI2B fields, see [Chapter 10.28.4, "SCI2B configuration commands"](#), on page 718.

The following fields are available for SCI2B.

- "Harq Process"
- "New Data Indicator"
- "Redundancy Version"

- "Source ID"
- "Destination ID"
- "Harq Feedback"
- "Zone ID"
- "Communication Range Requirement"

5.12.5 TxScheme settings for PSSCH and PSCCH

Access:

1. Select "Scheduling > User x BWP x > Content > PSSCH/PSCCH > Settings > Config".
2. Select "TxScheme".

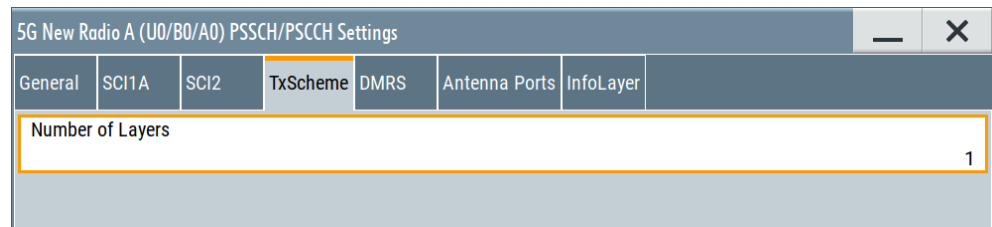

Settings:

[Number of Layers](#).....294

Number of Layers

Selects the number of precoding layers for the PSSCH transmission.

If you increase the number of layers, you can map the PSSCH to different [antenna ports](#).

Remote command:

```
[ :SOURce<hw> ] :BB:NR5G:SCHed:CELL<cc>:SUBF<sf>:USER<us>:
BWPart<bwp>:ALLoc<al>:PDSch|PUSCh|PSSCh:TXScheme:NLAYers
```

on page 719

5.12.6 DMRS settings for PSSCH

Access:

1. Select "Scheduling > User x BWP x > Content > PSSCH/PSCCH > Settings > Config".
2. Select "DMRS".

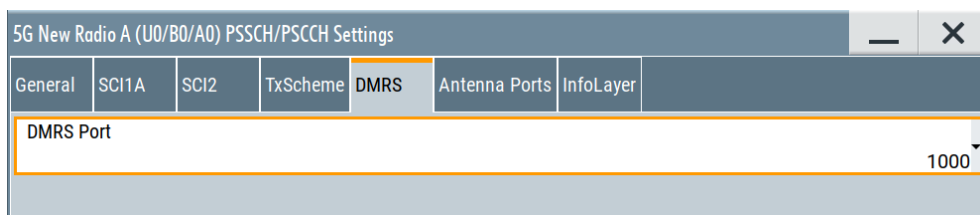

Settings:

[DMRS Port](#)..... 295

DMRS Port

Selects the antenna port the PSSCH DMRS is transmitted on (AP 1000 or AP1001).

Selection of the antenna port is possible if the [number of layers](#) for PSSCH transmission = 1. If the number of layers = 2, the DMRS is transmitted on both antenna ports.

Remote command:

```
[ :SOURce<hw> ] :BB:NR5G:SCHed:CELL<cc>:SUBF<sf>:USER<us>:
BWPart<bwp>:ALLoc<al>:PSSCh:DMRS:APSel on page 720
```

5.12.7 Channel coding settings

Access:

1. Select "Users/BWP > Properties > SLSCH Channel Coding" = "On"
2. Select "Scheduling > User x BWP x > Content > PSSCH/PSCCH > Settings > Config".
3. Select "Channel Coding".

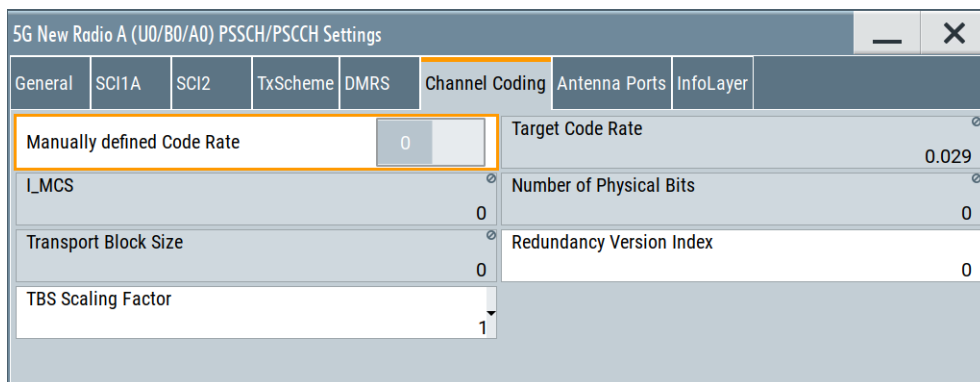

The channel coding settings available for the PSSCH are the same as those for the PDSCH and PUSCH. For a comprehensive description about channel coding and its settings, see [Chapter 5.5.4, "Channel coding settings"](#), on page 226.

Settings:

Manually Defined Code Rate.....	296
Target Code Rate.....	296
I_MCS.....	296
Number of Physical Bits.....	296
Transport Block Size.....	296
Redundancy Version Index.....	297
TBS Scaling Factor.....	297

Manually Defined Code Rate

Turns manual definition of the code rate on and off.

For details, see "[Manually Defined Coderate](#)" on page 227.

Remote command:

```
[ :SOURce<hw> ] :BB:NR5G:SCHed:CELL<cc>:SUBF<sf>:USER<us>:
BWPart<bwp>:ALLoc<al>[:CW<cw>]:PSSCh:CCODing:FRCR on page 721
```

Target Code Rate

Shows or defines the target code rate.

- For automatic code rate selection, the target code rate is automatically calculated depending on the [modulation and coding scheme](#) ("I_MCS").
- For [manual code rate definition](#), you can define a custom target code rate. Selecting an I_MCS is not possible in that case.

Remote command:

```
[ :SOURce<hw> ] :BB:NR5G:SCHed:CELL<cc>:SUBF<sf>:USER<us>:
BWPart<bwp>:ALLoc<al>[:CW<cw>]:PSSCh:CCODing:TCRate on page 723
```

I_MCS

Shows the currently applied modulation and coding scheme. The I_MCS depends on the selected [modulation and coding scheme](#) (SCI1A field).

Remote command:

```
[ :SOURce<hw> ] :BB:NR5G:SCHed:CELL<cc>:SUBF<sf>:USER<us>:
BWPart<bwp>:ALLoc<al>:SCI:MCS on page 714
```

Number of Physical Bits

Shows the size of the selected allocation in bits.

The number of physical bits is calculated automatically based on the selected [modulation and coding scheme](#) for SC1A.

Remote command:

```
[ :SOURce<hw> ] :BB:NR5G:SCHed:CELL<cc>:SUBF<sf>:USER<us>:
BWPart<bwp>:ALLoc<al>:SL:PHYSbits? on page 721
```

Transport Block Size

Shows the transport block size (TBS). The transport block size is calculated automatically based on the [modulation and coding scheme](#).

Remote command:

```
[ :SOURce<hw> ] :BB:NR5G:SCHed:CELL<cc>:SUBF<sf>:USER<us>:
BWPart<bwp>:ALLoc<al>[:CW<cw>]:PSSCh:CCODing:TBSize? on page 722
```

Redundancy Version Index

Defines the redundancy version index for the PSSCH.

For more information about its effects, see ["Redundancy Version Index"](#) on page 228.

Remote command:

```
[ :SOURce<hw> ] :BB:NR5G:SCHed:CELL<cc>:SUBF<sf>:USER<us>:
BWPart<bwp>:ALLoc<al>[:CW<cw>]:PSSCh:CCODing:RVINdex on page 722
```

TBS Scaling Factor

Selects the transport block scaling factor S for the PSSCH.

For more information about its effects, see ["TBS Scaling Factor"](#) on page 228.

Remote command:

```
[ :SOURce<hw> ] :BB:NR5G:SCHed:CELL<cc>:SUBF<sf>:USER<us>:
BWPart<bwp>:ALLoc<al>[:CW<cw>]:PSSCh:CCODing:TBSFactor on page 722
```

5.12.8 Antenna ports settings for PSSCH and PSCCH

Access:

1. Select "Scheduling > User x BWP x > Content > PSSCH/PSCCH > Settings > Config".
2. Select "Antenna Ports".

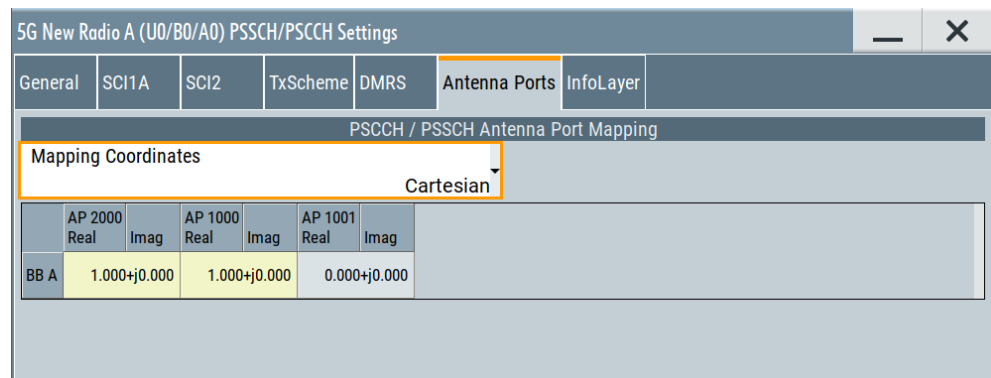

The antenna port configuration is the same as in the downlink and uplink. For more information, see [Chapter 5.5.8, "Antenna ports"](#), on page 235.

For an overview of the antenna port mapping, see [Chapter 2.10, "Antenna port mapping"](#), on page 27.

5.12.9 Info layer for PSSCH and PSCCH

Access:

1. Select "Scheduling > User x BWP x > Content > PSSCH/PSCCH > Settings > Config".
2. Select "InfoLayer".

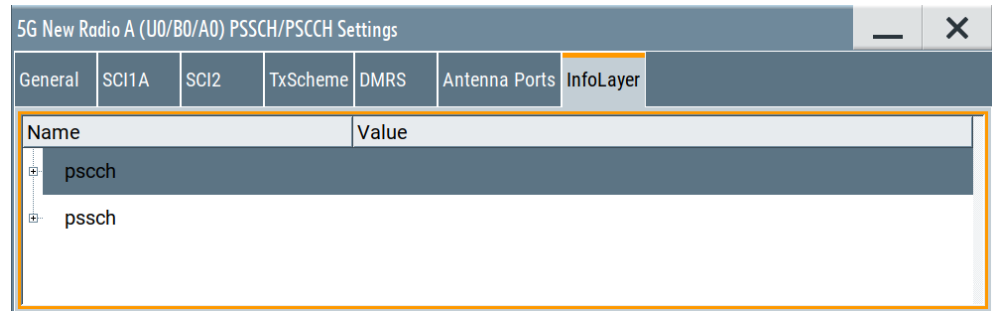

The dialog displays details on the PSSCH/PSCCH configuration.

Info..... 298

Info

The dialog displays details on the configuration.

There are two information lists:

- "Stable": Naming and structure of the information in this list are stable in future firmware releases.
- "Mutable": Naming and structure of the information in this list can change in future firmware releases.

Remote command:

```
[ :SOURce<hw> ] :BB:NR5G:SCHed:CELL<cc>:SUBF<sf>:USER<us>:
BWPart<bwp>:ALLoc<al>:INFO? on page 600
```

5.13 PSFCH settings

Access:

1. Select "5G New Radio > General > Link Direction > Sidelink".
2. Select "5G New Radio > Scheduling".
3. Select "User x BWP x > Content > PSFCH".
4. Select "PSFCH > Settings > Config".

This dialog comprises the settings of the physical sidelink feedback channel (PSFCH).

The PSFCH (physical sidelink feedback channel) contains information about the reception status of the sidelink signal.

5G New Radio A (U0/B0/A0) PSFCH Settings	
General	
Hopping ID	0
Initial Cyclic Shift	0
PSFCH Type	ACK/NACK
Harq ACK	ACK
Transmission Structure	Common Interlace

Settings:

Hopping ID.....	299
Initial Cyclic Shift.....	299
PSFCH Type.....	299
Harq ACK.....	299
Transmission Structure.....	300

Hopping ID

Defines the hopping ID which selects the frequency hopping sequence number for the PSFCH and initializes the pseudo-random sequence generator.

Remote command:

```
[ :SOURce<hw> ] :BB:NR5G:SCHed:CELL<cc>:SUBF<sf>:USER<us>:
BWPart<bwp>:ALLoc<al>:PSFCh:HOPid on page 724
```

Initial Cyclic Shift

Defines a value to calculate the cyclic shift for the PSFCH hopping sequence.

Remote command:

```
[ :SOURce<hw> ] :BB:NR5G:SCHed:CELL<cc>:SUBF<sf>:USER<us>:
BWPart<bwp>:ALLoc<al>:PSFCh:CYCShift on page 723
```

PSFCH Type

Selects the PSFCH type that defines which information the PSFCH contains.

"ACK / NACK" PSFCH transmits ACK or NACK information.

"NACK Only" PSFCH transmits NACK information only.

"Conflict" PSFCH transmits conflict information.

Remote command:

```
[ :SOURce<hw> ] :BB:NR5G:SCHed:CELL<cc>:SUBF<sf>:USER<us>:
BWPart<bwp>:ALLoc<al>:PSFCh:TYPE on page 725
```

Harq ACK

Selects the type of acknowledgment that the PSFCH carries.

Available if **PSFCH Type** = "ACK / NACK".

"ACK" PSFCH transmits ACK information.

"NACK" PSFCH transmits NACK information.

Remote command:

```
[ :SOURCE<hw> ] :BB:NR5G:SCHed:CELL<cc>:SUBF<sf>:USER<us>:  
BWPart<bwp>:ALLoc<al>:PSFCh:HARQ on page 724
```

Transmission Structure

Selects the transmission structure for PSFCH as defined in 3GPP 38.213, chapter 16.3.

"Common Interlace" Uses the common interlace (higher layer parameter `s1-PSFCH-Type2-CommonInterlace`).

"Dedicated Interlace" Uses the dedicated interlace (higher layer parameter `s1-PSFCH-Type2-DedicatedPRB`).

Remote command:

```
[ :SOURCE<hw> ] :BB:NR5G:SCHed:CELL<cc>:SUBF<sf>:USER<us>:  
BWPart<bwp>:ALLoc<al>:PSFCh:TRAN on page 724
```

6 Signal control and signal characteristics

This section lists settings provided for improving the signal and spectrum characteristics of the generated signal, defining the signal power and the signal generation start.

It covers the following topics:

- [Trigger settings](#)..... 301
- [Marker settings](#).....307
- [TDD UL/DL marker mode](#)..... 310
- [Clock settings](#).....313
- [Local and global connectors settings](#)..... 314
- [Output settings](#)..... 314
- [Time domain windowing settings](#)..... 318
- [Adjusting the signal power](#)..... 320
- [Crest factor reduction settings](#)..... 328

6.1 Trigger settings

Access:

- ▶ Select "5G New Radio > Trigger In".

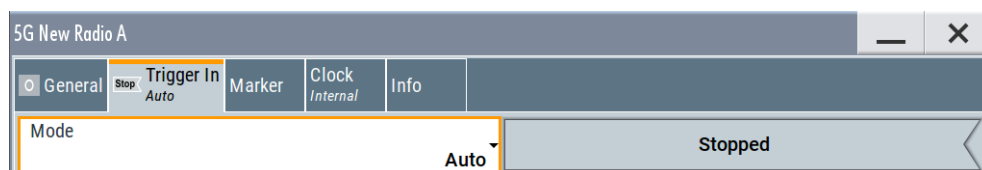

This tab provides settings to select and configure the trigger, like trigger source and mode, and to arm or trigger an internal trigger manually.

The header of the tab displays the status of the trigger signal and trigger mode. As in the tabs "Marker" and "Clock", this tab provides also access to the settings of the related connectors.

Routing and activating a trigger signal

1. Define the effect of a trigger event and the trigger signal source.
 - a) Select "Trigger In" > "Mode".
 - b) Select "Trigger In" > "Source".
2. For external trigger signals, define the connector for signal input. See [Chapter 6.5, "Local and global connectors settings"](#), on page 314.
 You can map trigger signals to one or more User x or T/M connectors.
 Local and global connectors settings allow you to configure the signal mapping, the polarity, the trigger threshold and the input impedance of the input connectors.
3. Activate baseband signal generation. In the block diagram, set "Baseband" > "On".

The R&S SMM100A starts baseband signal generation after the configured trigger event.

About baseband trigger signals

This section focuses on the available settings.

For detailed information on baseband trigger signals, see section "About trigger signals" in the R&S SMM100A user manual.

Settings:

Mode.....	302
Time Based Trigger.....	303
Trigger Time.....	303
Signal Duration Unit.....	303
Signal Duration.....	303
Running/Stopped.....	303
Arm.....	304
Execute Trigger.....	304
Source.....	304
Sync. Output to External Trigger/Sync. Output to Trigger.....	304
External Inhibit/Trigger Inhibit.....	305
(External) Delay Unit.....	305
(Specified) External Delay/(Specified) Trigger Delay.....	306
Actual Trigger Delay/Actual External Delay.....	306

Mode

Selects the trigger mode. The mode determines the effect of a trigger event on the signal generation.

For more information, see chapter "About trigger signals" in the R&S SMM100A user manual.

- "Auto"
The signal is generated continuously.
- "Retrigger"
The signal is generated continuously. A trigger event (internal or external) causes a restart.
- "Armed Auto"
The signal is generated only when a trigger event occurs. Then the signal is generated continuously.
An "Arm" stops the signal generation. A subsequent trigger event (internal or external) causes a restart.
- "Armed Retrigger"
The signal is generated only when a trigger event occurs. Then the signal is generated continuously. Every subsequent trigger event causes a restart.
An "Arm" stops signal generation. A subsequent trigger event (internal or external) causes a restart.
- "Single"
The signal is generated only when a trigger event occurs. Then the signal is generated once to the length specified at "Signal Duration".

Every subsequent trigger event (internal or external) causes a restart.

Remote command:

[\[:SOURce<hw>\]:BB:NR5G\[:TRIGger\]:SEQuence](#) on page 735

Time Based Trigger

Requires trigger "Mode" > "Armed Auto"/"Single".

Activates time-based triggering with a fixed time reference.

The R&S SMM100A triggers signal generation when its operating system time ("Current Time") matches a specified time trigger ("Trigger Time"). As trigger source, you can use an internal trigger or an external global trigger.

How to: Chapter "Time-based triggering" in the R&S SMM100A user manual.

Remote command:

[\[:SOURce<hw>\]:BB:NR5G:TRIGger:TIME\[:STATe\]](#) on page 740

Trigger Time

Requires trigger "Mode" > "Armed Auto"/"Single".

Sets date and time for a time-based trigger signal.

Set a trigger time that is later than the "Current Time". The current time is the operating system time of the R&S SMM100A. If you set an earlier trigger time than the current time, time-based triggering is not possible.

How to: Chapter "Time-based triggering" in the R&S SMM100A user manual.

Remote command:

Date: [\[:SOURce<hw>\]:BB:NR5G:TRIGger:TIME:DATE](#) on page 739

Time: [\[:SOURce<hw>\]:BB:NR5G:TRIGger:TIME:TIME](#) on page 740

Signal Duration Unit

Defines the unit for describing the length of the signal sequence to be output in the "Single" trigger mode.

Remote command:

[\[:SOURce<hw>\]:BB:NR5G:TRIGger:SLUNit](#) on page 739

Signal Duration

Requires trigger "Mode" > "Single".

Enters the length of the trigger signal sequence.

Use this parameter, for example, for the following applications:

- To output the trigger signal partly.
- To output a predefined sequence of the trigger signal.

Remote command:

[\[:SOURce<hw>\]:BB:NR5G:TRIGger:SLENgth](#) on page 739

Running/Stopped

With enabled modulation, displays the status of signal generation for all trigger modes.

- "Running"
The signal is generated; a trigger was (internally or externally) initiated in triggered mode.

- "Stopped"
The signal is not generated and the instrument waits for a trigger event.

Remote command:

[\[:SOURce<hw>\]:BB:NR5G:TRIGger:RMODe?](#) on page 738

Arm

Stops the signal generation until subsequent trigger event occurs.

Remote command:

[\[:SOURce<hw>\]:BB:NR5G:TRIGger:ARM:EXECute](#) on page 738

Execute Trigger

For internal trigger source, executes trigger manually.

Remote command:

[\[:SOURce<hw>\]:BB:NR5G:TRIGger:EXECute](#) on page 738

Source

The following sources of the trigger signal are available:

- "Internal"
The trigger event is internal. Tap "Execute Trigger" to trigger signal generation manually.
- "External Global Trigger"
The trigger event is the active edge of an external trigger signal provided and configured at the User x connectors.
- "Baseband Sync In"
Requires "Multi Instrument Trigger" > "Secondary" for primary-secondary instrument mode.
Triggers signal generation at the secondary instrument by the active edge of the baseband synchronization signal of the primary instrument.

Remote command:

[\[:SOURce<hw>\]:BB:NR5G:TRIGger:SOURce](#) on page 736

Sync. Output to External Trigger/Sync. Output to Trigger

Enables signal output synchronous to the trigger event.

- "On"
Corresponds to the default state of this parameter.
The signal calculation starts simultaneously with the trigger event. Because of the processing time of the instrument, the first samples are cut off and no signal is output. After elapsing of the internal processing time, the output signal is synchronous to the trigger event.

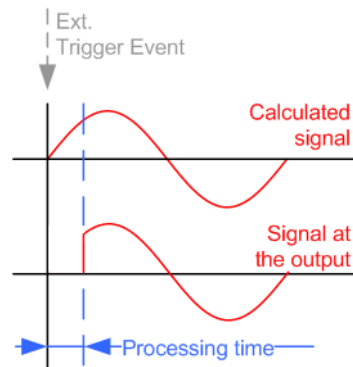

- "Off"

The signal output begins after elapsing of the processing time. Signal output starts with sample 0. The complete signal is output.

This mode is recommended for triggering of short signal sequences. Short sequences are sequences with signal duration comparable with the processing time of the instrument.

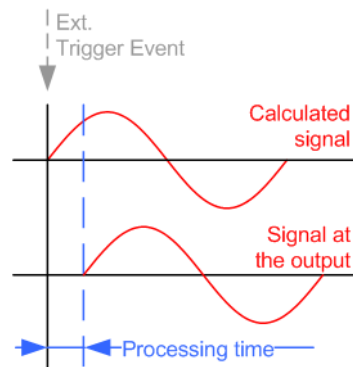

Remote command:

`[:SOURce<hw>] :BB:NR5G:TRIGger:EXTernal:SYNChronize:OUTPut`

on page 736

External Inhibit/Trigger Inhibit

Applies for an external trigger signal.

Sets the duration with that any following trigger event is suppressed. In "Retrigger" mode, for example, a new trigger event does not cause a restart of the signal generation until the specified inhibit duration does not expire.

For more information, see chapter "Basics on signals, modulation formats and filters" in the user manual.

Remote command:

`[:SOURce<hw>] :BB:NR5G:TRIGger [:EXTernal] :INHibit` on page 737

(External) Delay Unit

Determine whatever the trigger delay is expressed in samples or directly defined as a time period (seconds).

To specify the delay, use the parameter [\(Specified\) External Delay/\(Specified\) Trigger Delay](#).

The parameter **Actual Trigger Delay/Actual External Delay** displays the delay converted in time.

Remote command:

`[:SOURce<hw>] :BB:NR5G:TRIGger:DElay:UNIT` on page 736

(Specified) External Delay/(Specified) Trigger Delay

The name of the parameter and the units the delay is expressed in, changes depending on the parameter **(External) Delay Unit**.

Delays the trigger event of the signal from:

- The external trigger source

Use this setting to:

- Synchronize the instrument with the device under test (DUT) or other external devices

For more information, see chapter "Basics on ..." in the R&S SMM100A user manual.

For "(External) Delay Unit = Samples", the delay is relative to the sample rate of the first output of the respective baseband block.

The parameter displays the delay converted in time.

Remote command:

`[:SOURce<hw>] :BB:NR5G:TRIGger [:EXternal] :DElay` on page 737

`[:SOURce<hw>] :BB:NR5G:TRIGger:EXternal:TDElay` on page 737

Actual Trigger Delay/Actual External Delay

Indicates the resulting trigger delay in "Time" unit.

Remote command:

`[:SOURce<hw>] :BB:NR5G:TRIGger:EXternal:RDElay?` on page 737

6.2 Marker settings

Access:

- ▶ Select "5G New Radio > Marker".

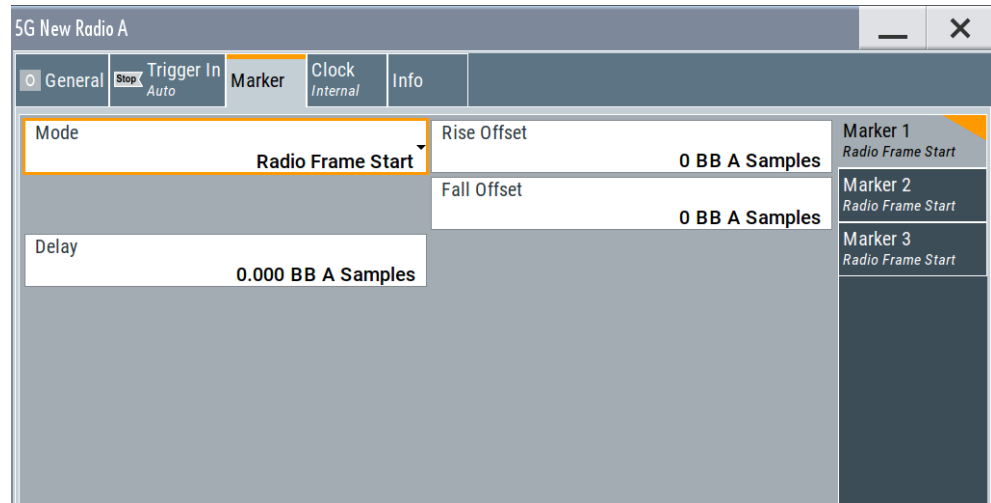

This tab provides access to the settings necessary to select and configure the marker output signal, like the marker mode or marker delay settings.



This section focuses on the available settings.

For detailed information on baseband trigger signals, see section "About trigger signals" in the R&S SMM100A user manual.



Routing and enabling a marker

The provided marker signals are not dedicated to a particular connector. They can be mapped to one or more User x or T/M connectors.

To route and enable a marker signal, perform the following *general steps*:

- Define the shape of the generated marker, i.e. select the "Marker > Mode".
- Define the connector where the selected signal is provided.
Use the [Local and global connectors settings](#).

Settings:

Marker Mode	307
Rise/Fall Offset	308
Invert	309
Marker x Delay	309
Delay (Time)	309

Marker Mode

Sets the marker mode that defines the shape and periodicity of the marker signals.

You can configure marker modes for up to 3 markers. The marker configuration changes with the selected marker mode.

- "Subframe" A marker signal is generated at the start of each subframe.
- "Radio Frame Start" A marker signal is generated at the start of each radio frame.
- "Restart (ARB)" A marker signal is generated at the start of each ARB sequence.
- "User Period" A marker signal is generated at the beginning of every user-defined period, as set with the parameter "Period."
Remote command:
`[:SOURce<hw>] :BB:NR5G:TRIGger:OUTPut<ch>:PERiod`
on page 742
- "On/Off Period" A regular marker signal that is defined by an on/off ratio. A period lasts one on and off cycle.

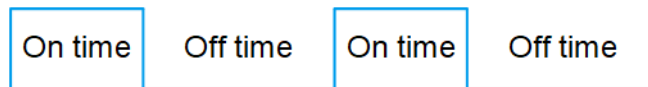

Remote command:

`[:SOURce<hw>] :BB:NR5G:TRIGger:OUTPut<ch>:ONTime`
on page 742

`[:SOURce<hw>] :BB:NR5G:TRIGger:OUTPut<ch>:OFFTime`
on page 742

- "System Frame Number (SFN) Restart" A marker signal is generated at the start of every SFN period.
- "TDD UL/DL" A marker signal is generated at the start of every UL/DL pattern.
Remote command:
`[:SOURce<hw>] :BB:NR5G:TRIGger:OUTPut<ch>:MODE` on page 741

Rise/Fall Offset

Sets the value for the rise/fall offset.

The ramps of the marker signal are shifted by the specified number of samples. Positive values delay the rising ramp; negative values - shift it back.

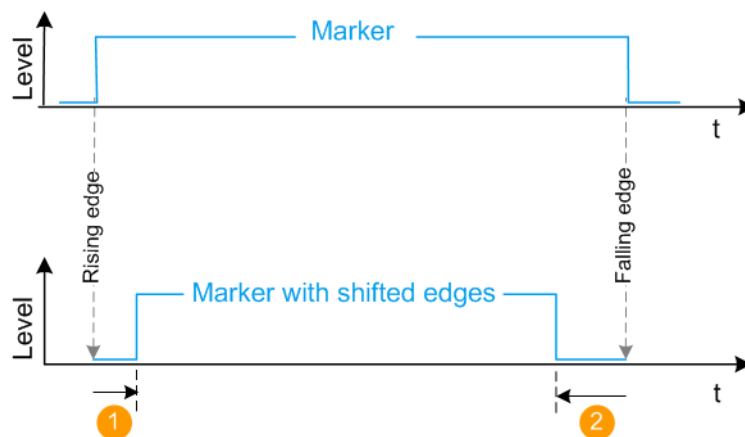

1 = Positive rise offset
2 = Positive fall offset

Remote command:

`[:SOURce<hw>] :BB:NR5G:TRIGger:OUTPut<ch>:ROFFset` on page 742

`[:SOURce<hw>] :BB:NR5G:TRIGger:OUTPut<ch>:FOFFset` on page 742

Invert

Selects the method the marker signal is applied.

"Active High" Marker is placed on a rising edge of the signal.

"Active Low" Marker is placed on a falling edge of the signal.

Remote command:

`[:SOURce<hw>] :BB:NR5G:TRIGger:OUTPut<ch>:INVert` on page 743

Marker x Delay

Delays the marker signal at the marker output relative to the signal generation start.

Variation of the parameter "Marker x" > "Delay" causes signal recalculation.

Remote command:

`[:SOURce<hw>] :BB:NR5G:TRIGger:OUTPut<ch>:DELay` on page 741

Delay (Time)

Shows the **marker delay** time in microseconds, milliseconds or seconds depending on the set marker delay.

Remote command:

`[:SOURce<hw>] :BB:NR5G:TRIGger:OUTPut<ch>:DINSec?` on page 742

6.3 TDD UL/DL marker mode

Access:

- ▶ Select "5G New Radio > Marker > TDD UL/DL".

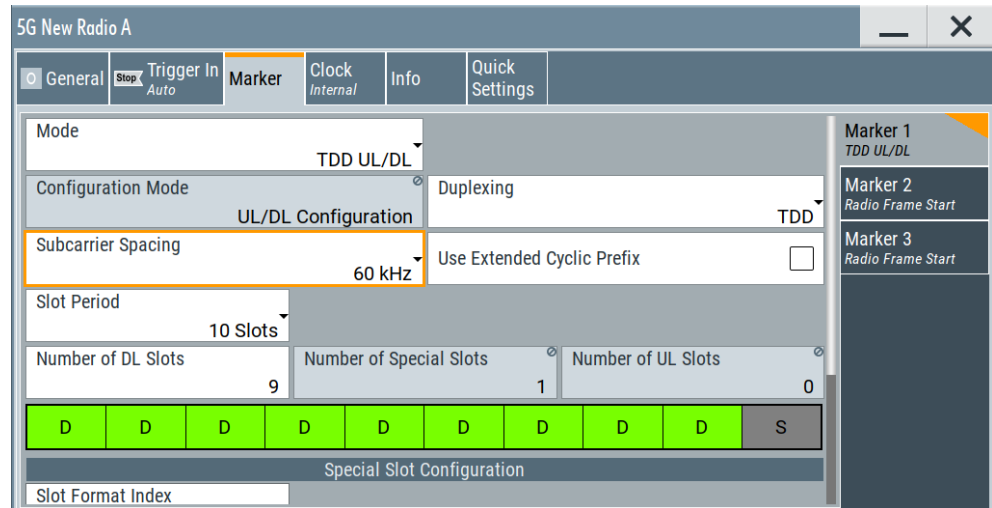

This dialog comprises the settings for the TDD UL/DL pattern in which you want to set a marker.



Marker settings are automatically adjusted when you apply the corresponding quick settings.

Settings:

Configuration Mode.....	310
Duplexing.....	311
Subcarrier Spacing.....	311
Use Extended Cyclic Prefix.....	311
Slot Period.....	311
Use IAB Format.....	311
Number of DL Slots.....	311
Number of Special Slots.....	312
Number of UL Slots.....	312
Use Special Format Index.....	312
Slot Format Index.....	312
Number of DL Symbols.....	312
Number of Guarded Symbols.....	313
Number of UL Symbols.....	313

Configuration Mode

Displays the marker mode being configured. In this case, "UL/DL Configuration". This field is disabled and you cannot change the configuration mode.

Remote command:

[:SOURce<hw>] :BB:NR5G:TRIGger:OUTPut<ch>:MMODE on page 744

Duplexing

Defines the duplexing mode for a UL/DL pattern containing a marker.

"TDD" Sets TDD (time division duplex) as the duplexing mode for the UL/DL pattern.

"FDD" Sets FDD (frequency division duplex) as the duplexing mode for the UL/DL pattern.
FDD is set by default.

Remote command:

[:SOURce<hw>] :BB:NR5G:TRIGger:OUTPut<ch>:DUPLexing on page 743

Subcarrier Spacing

Defines the subcarrier spacing (SCS) value for a UL/DL pattern containing a marker.

The available values depend on the set [Deployment](#) value. See [Table 2-2](#).

Remote command:

[:SOURce<hw>] :BB:NR5G:TRIGger:OUTPut<ch>:SCSPacing on page 745

Use Extended Cyclic Prefix

Enables/disables the extended cyclic prefix (ECP) for a UL/DL pattern containing a marker.

See [Chapter 2.2, "5G NR numerology"](#), on page 18 for more information.

Remote command:

[:SOURce<hw>] :BB:NR5G:TRIGger:OUTPut<ch>:ECPState on page 743

Slot Period

Sets the duration of a UL/DL pattern containing a marker.

Remote command:

[:SOURce<hw>] :BB:NR5G:TRIGger:OUTPut<ch>:SLINT on page 745

Use IAB Format

Option: R&S SMM-K148

Turns usage of the frame formats for integrated access backhaul (IAB) applications on and off. Using the IAB format changes the order of uplink, downlink and the special slot within the frame.

Supported for marker mode = TDD DL/UL

Remote command:

[:SOURce<hw>] :BB:NR5G:TRIGger:OUTPut<ch>:IAB:STATE on page 745

Number of DL Slots

Sets the number of DL slots in a UL/DL pattern containing a marker.

Enabled if "Link Direction > Downlink" and "Duplexing > TDD".

The value is calculated as follows:

"Number of DL Slots" = "Slot Period" - "Number of UL Slots" - "Special Slots".

Remote command:

`[:SOURce<hw>] :BB:NR5G:TRIGger:OUTPut<ch>:NDLSlots` on page 744

Number of Special Slots

Displays the number of special slots in a UL/DL pattern containing a marker.

Remote command:

`[:SOURce<hw>] :BB:NR5G:TRIGger:OUTPut<ch>:NSSLots?` on page 744

Number of UL Slots

Sets the number of UL slots in a UL/DL pattern containing a marker.

Enabled if "Link Direction > Uplink".

The value is calculated as follows:

"Number of UL Slots" = "Slot Period" - "Number of DL Slots" - "Special Slots".

Remote command:

`[:SOURce<hw>] :BB:NR5G:TRIGger:OUTPut<ch>:NULSlots` on page 745

Use Special Format Index

Turns usage of the special format index on and off.

If on, you can select one of the [slot formats](#) defined by 3GPP.

If off, you can configure a custom slot format by entering the required number of [downlink symbols](#) or [uplink symbols](#).

Entering the number of downlink symbols is possible when you are in downlink mode.

Entering the number of uplink symbols is possible when you are in uplink mode.

Remote command:

`[:SOURce<hw>] :BB:NR5G:TRIGger:OUTPut<ch>:SSC:SFI:STATE` on page 747

Slot Format Index

Sets the special slot format index of the special slot included in a UL/DL pattern containing a marker according to [TS 38.213](#) and thus defines the slot structure.

See [Chapter 2.4, "Frame structure, slots and slot formats"](#), on page 19 for more information about the slot format index.

Remote command:

`[:SOURce<hw>] :BB:NR5G:TRIGger:OUTPut<ch>:SSC:SLFMT` on page 747

Number of DL Symbols

Indicates the number of DL symbols in the special slot, depending on the selected slot format index.

In downlink mode, defining the number of downlink symbols is possible when you turn off usage of a [special format index](#).

Remote command:

`[:SOURce<hw>] :BB:NR5G:TRIGger:OUTPut<ch>:SSC:NDLSymbols`
on page 746

Number of Guarded Symbols

Indicates the number of guarded symbols in the special slot, depending on the selected slot format index.

Remote command:

`[:SOURce<hw>] :BB:NR5G:TRIGger:OUTPut<ch>:SSC:NGSYmbols?`
on page 746

Number of UL Symbols

Indicates the number of UL symbols in the special slot, depending on the selected slot format index.

In uplink mode, defining the number of uplink symbols is possible when you turn off usage of a [special format index](#).

Remote command:

`[:SOURce<hw>] :BB:NR5G:TRIGger:OUTPut<ch>:SSC:NULSYmbols`
on page 746

6.4 Clock settings

Access:

- ▶ Select "5G New Radio > Clock".

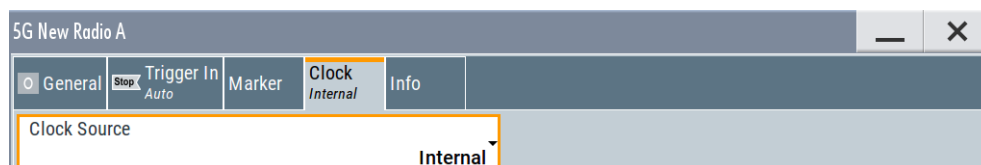

This tab provides access to the settings necessary to select and configure the clock signal, like the clock source and clock mode.



This section focuses on the available settings.

For detailed information on baseband trigger signals, see section "About trigger signals" in the R&S SMM100A user manual.

**Defining the clock**

The provided clock signals are not dedicated to a particular connector. They can be mapped to one or more User x and T/M/C connectors.

Use the [Local and global connectors settings](#) to configure the signal mapping, the polarity, the trigger threshold, and the input impedance of the input connectors.

To route and enable a trigger signal, perform the following *general steps*:

- Define the signal source, that is select the "Clock > Source".
- Define the connector where the selected signal is provided.
Use the [Local and global connectors settings](#).

Settings:

[Clock Source](#).....314

Clock Source

Selects the clock source.

- "Internal"
The instrument uses its internal clock reference.

Remote command:

[:SOURce<hw>] :BB:NR5G:CLOCK:SOURce on page 748

6.5 Local and global connectors settings

Opens a dialog to configure local connectors or global connectors.

The button is available in the following dialogs or tabs:

- "Trigger / Marker / Clock" dialog that is accessible via the "TMC" block in the block diagram.
- "Trigger In", "Marker" and "Clock" tabs of baseband signal configuration dialogs that you can open via the "Baseband" block in the block diagram. These tabs are available, for example, for "ARB" baseband signals.



See also chapter "Local and global connectors settings" in the user manual.

6.6 Output settings

Access:

- ▶ Select "5G New Radio" > "Output/Power" > "Output".

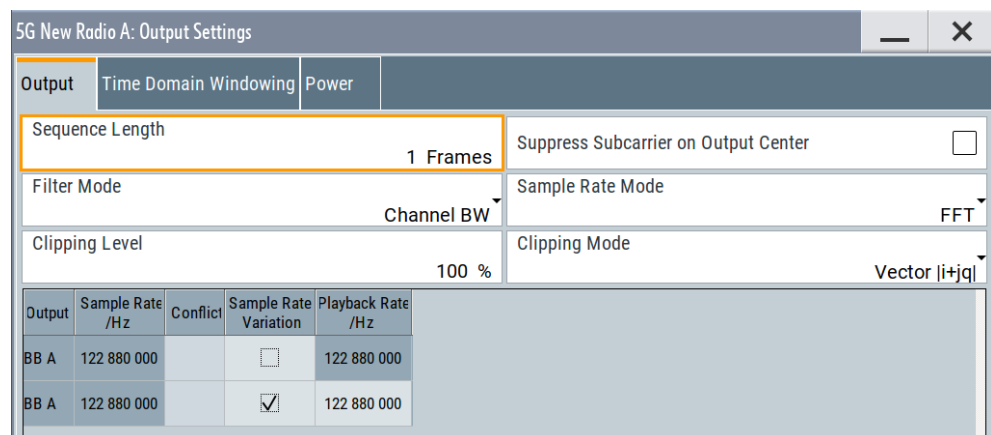

This dialog comprises the settings required for configuring the output power.

Settings:

Sequence Length.....	315
Suppress Subcarrier on Output Center.....	315
Filter Mode.....	315
Load User Filter.....	316
Clipping Level.....	317
Clipping Mode.....	317
Sample Rate Mode.....	317
Output.....	317
Sample Rate.....	317
Conflict.....	318
Sample Rate Variation.....	318
Playback Rate.....	318

Sequence Length

Sets the sequence length of the signal in terms of subframes. The signal is calculated in advance and output in the arbitrary waveform generator.

Remote command:

[:SOURce<hw>] :BB:NR5G:OUTPut:SUSLen on page 726

Suppress Subcarrier on Output Center

If enabled, the subcarriers that use the same frequency as the center frequency of the baseband output are not transmitted.

The suppressed subcarrier is not necessarily the center of a carrier (channel bandwidth), as it is if "Node > Carriers" > [Delta f to Output/MHz](#) ≠ 0 MHz is used to shift the center carrier relative to the output center. Not considered are center carrier shifts caused by baseband offsets applied by parameters like offsets in the "I/Q Stream Mapper" or "Baseband Offsets".

Remote command:

[:SOURce<hw>] :BB:NR5G:OUTPut:SSOC:STATe on page 726

Filter Mode

Enables filtering and sets how the filter is applied:

"Channel BW"	Applies a filter on the whole channel bandwidth.
"Per BWP"	Filters the individual BWPs separately.
"Off"	Disables filtering.
"Fast"	Applies fast filtering with reduced number of filter taps. Non-average power modes are supported. Supported in the following configuration: <ul style="list-style-type: none"> "Node > Carriers > Number of Carriers = 1" and "Node > Carriers > Δf to Output = 0".
"User"	You can load your custom filter, see " Load User Filter " on page 316.

"Optimize EVM" Applies a filter to optimize the EVM of the signal.

Each of these filters is designed for different application field and optimized for a particular performance.

Depending on the filter implementation, these filters require different calculation time:

- "Channel BW" and "Per BWP": high-quality filters, providing good EVM and ACP but requiring long calculation time
- "Fast": short calculation time combined with real-time processing, good EVM performance while ignoring the effects on ACP

Remote command:

[:SOURce<hw>] :BB:NR5G:OUTPut:FMODE on page 727

Load User Filter

For **Filter Mode** > "User", it opens the standard dialog "Select List File User Filter" for loading a user-defined filter file.

User filters are used as offline filters. The following types are supported:

- Files with predefined file format and extensions *.vaf
For information, refer to the description "Introduction to "filtwiz" Filter Editor" on the Rohde & Schwarz web page.
- ASCII files with simple format and file extension *.dat
These files describe filters as a sequence of normalized filter coefficients. Each coefficient is defined as a pair of I and Q samples. The I and Q components alternate at each file line. The I and Q values vary between - 1 and + 1.
A user filter can contain up to 2560 coefficients.
The user filter must be real-valued. For both I and Q components of the coefficients, only real coefficients different than 0 are allowed.

Example: Script that generates user filter file

This MATLAB® script creates a user filter file for a 5G NR carrier with 10 MHz bandwidth. The sampling rate is 30.72 MHz.

```
subcarriersubspacing = 15e3;
f_s = 2*1024*subcarriersubspacing;
used_bw = 52*12*subcarriersubspacing; %52RBs*12 subcarriers per RB
trans_region = 0.02 * f_s/2; %controls steepness of filter slopes

%cutoff frequencies
f = [used_bw/2 used_bw/2+trans_region];
%ripples in dB
rp = 0.01; %passband
rs = 80; %stopband
dev = [(10^(rp/20)-1)/(10^(rp/20)+1) 10^(-rs/20)];
%estimate filter order
[n,fo,ao,w] = firpmord(f,[1 0],dev,f_s);
%generate filter coefficients
b = firpm(n,fo,ao,w);
fvtool(b); %displays filter response
%write filter out into .dat filter coefficient file
```

```

coeffs_out = zeros(2*length(b),1);
coeffs_out(1:2:end) = real(b);
coeffs_out(2:2:end) = imag(b);
dlmwrite(['smw_nr_user_filter_', num2str(n), 'coeffs_', 'bw', num2str(used_bw),
        'Hz_fs_', num2str(f_s), 'Hz.dat'], coeffs_out);

```

Remote command:

[\[:SOURce<hw>\]:BB:NR5G:FM0De:USRFile](#) on page 727

Clipping Level

Sets the limit for clipping.

This value indicates at what point the signal is clipped. It is specified as a percentage, relative to the highest level. 100% indicates that clipping does not take place.

Remote command:

[\[:SOURce<hw>\]:BB:NR5G:OUTPut:CLEVel](#) on page 729

Clipping Mode

Selects the clipping method. The dialog displays a graphical illustration on how this two methods work.

- "Vector $|i + jq|$ "
The limit is related to the amplitude $|i + q|$. The I and Q components are mapped together, the angle is retained.
- "Scalar $|i|, |q|$ "
The limit is related to the absolute maximum of all the I and Q values $|i| + |q|$. The I and Q components are mapped separately, the angle changes.

Remote command:

[\[:SOURce<hw>\]:BB:NR5G:OUTPut:CMODE](#) on page 729

Sample Rate Mode

Sets how the sample rate is defined.

- | | |
|-----------|---|
| "FFT" | Sample rate is derived from the used FFT. |
| "Minimum" | Available if "Filter Mode"≠"Fast".
Sample rate is set to the minimum possible value.
This mode is set automatically in the following cases: <ul style="list-style-type: none"> • If more than two carriers are enabled |

Remote command:

[\[:SOURce<hw>\]:BB:NR5G:OUTPut:SAMRmode](#) on page 727

Output

Indicates the baseband (BB) output.

Sample Rate

Indicates the sample rate value, calculated according to the selected [Sample Rate Mode](#), configured signal contents and several other settings, such as the "Channel Bandwidth" or "Deployment".

Remote command:

[\[:SOURce<hw>\]:BB:NR5G:OUTPut:BBConf:ROW<apr>:SRATE?](#) on page 728

Conflict

Indicates an existing conflict between the **Playback Rate** and **Sample Rate** values with the symbol ⚠.

Available if **Sample Rate Variation** is turned off.

Conflicts are caused by mismatch between the nominal sample rate, playback rate and sample rate values.

The playback rate is limited by the instrument capabilities. A conflict is indicated if the playback rate of the instrument is not enough for processing NR signals.

For example, if you configure a 400 MHz BW channel on an instrument which does not support this bandwidth value and you do not modify other parameters, e.g. the BWP value, the required playback rate for this configuration is > 490 MSps, which is higher than the value supported by the instrument, then a conflict is indicated.

An existing conflict is also indicated with the symbol ⚠ in the **Output/Power** field in the "General Settings" dialog.

Remote command:

`[:SOURce<hw>] :BB:NR5G:OUTPut:BBConf:ROW<apr>:CONFLict` on page 728

`[:SOURce<hw>] :BB:NR5G:OUTPut:BBConf:CONFLict?` on page 728

Sample Rate Variation

Activates sample rate variation and allows you to change the **Playback Rate** manually.

Enabling "Sample Rate Variation" is useful for chipset testing, where the chipset runs with a modified clock rate for test reasons.

Remote command:

`[:SOURce<hw>] :BB:NR5G:OUTPut:BBConf:ROW<apr>:VARiation` on page 729

Playback Rate

Indicates the playback **speed**.

By default, the "Playback Rate = Sample Rate" but the "Playback Rate" value is also limited by the instrument capabilities (installed options).

If there is a mismatch between the sample rate and playback rate values, a conflict is indicated.

Changing the "Playback Rate" does not do resampling. If you need a resampled signal, generate a waveform and resample it, for example, with software like R&S®ARB Tool-box.

Remote command:

`[:SOURce<hw>] :BB:NR5G:OUTPut:BBConf:ROW<apr>:PBRate` on page 728

6.7 Time domain windowing settings

Access:

- ▶ Select "5G New Radio" > "Output/Power" > "Time Domain Windowing".



This dialog comprises the settings required for configuring the time domain windowing. You can set different transition time for each of the specified numerologies.

Settings:

Time Domain Windowing (WOLA).....	319
SC Spacing/CP.....	319
Transition Time.....	319
Transition BB A Samples.....	320

Time Domain Windowing (WOLA)

Activates/deactivates the time domain windowing.

Time domain windowing is a method that influences the spectral characteristics of the signal. The method removes the spikes caused by the OFDM; it does not replace oversampling and subsequent signal filtering.

The abbreviation WOLA stands for weighted-overlay-and-add.

Remote command:

`[:SOURce<hw>] :BB:NR5G:TDWind:STATe` on page 730

SC Spacing/CP

Indicates all allowed combinations of the subcarrier spacing (SSC) and the cyclic prefix (CP), see [Table 2-2](#).

Transition Time

Sets the transition time when time domain windowing is active.

The transition time defines the overlap range of two OFDM symbols. You can define different transition times for each of the numerologies ([SC Spacing/CP](#)).

Remote command:

`[:SOURce<hw>] :BB:NR5G:OUTPut:TDWind:S240K:TRTime` on page 730

etc.

Transition BB A Samples

Indicates the number of samples during the [Transition Time](#).

Remote command:

[:SOURce<hw>] :BB:NR5G:OUTPut:TDWind:S240K:TRTSamples? on page 730 etc.

6.8 Adjusting the signal power

In the R&S SMM100A, you can adjust the power level of the generated signal in different ways.

This section explains the different power calculation modes and outlines the signal settings influencing the relations between the power levels of the channels and signals in the signal itself.

Overview of the power-related settings

The following settings influence the power level of the generated signal:

- Output level (P_{out}) of the instrument
To adjust the value, select "Status bar > Level".
- Selected power calculation method
To define it, select "General > Output/Power > Power > Power Mode"
- Selected relative signal and channel power values
 - "5G New Radio > General > Node > SS/PBCH" > [PSS/SSS Power](#)
 - "5G New Radio > General > Node > SS/PBCH" > [PBCH Power](#)
 - "5G New Radio > General > Node > Dummy REs" > "[Power](#)" on page 85
 - "Scheduling > User x BWP x > Content > PDSCH/PUSCH > Settings > Config" > "[Power](#)" on page 225

General principles

By selecting the power calculation method ("Power Mode"), you define the **power level at the first instrument's output**. The signal power level of the other outputs is calculated automatically according to the current power relations of all channels and signals.

Relative vs absolute power

All the relative channel and signal power values are set **relative** to each other.

Example:

If "PSS Power = 2 dB" and "SSS Power = -3 dB", then the power level of the SSS subcarriers is with 5 dB higher than the power level of the PSS subcarriers.

The **absolute power level** of one resource element depends on the selected "Power Mode" and on the configuration during the remaining subframes.

6.8.1 Effects of the power mode

The power mode selects the method that is used to calculate the signal power at the first instrument output. The signal power at the other outputs is calculated according to the current power relations of all channels and signals.

The value displayed in the "Status bar > Level" is the current RMS level at the output. The RMS and PEP values are calculated differently, depending on the selected power mode.

Average power mode

The power level set with the parameter "Status Bar > Level" is the average **RMS power of the complete signal**.

The absolute power of a subframe depends on the configuration of the remaining signal. In fully allocated frames, the average RMS value applies for all subframes. If the frames are partly allocated, the absolute RMS power within an allocated subframe is greater than the displayed RMS value ("Status Bar > Level").

The following example is based on the following two signals.

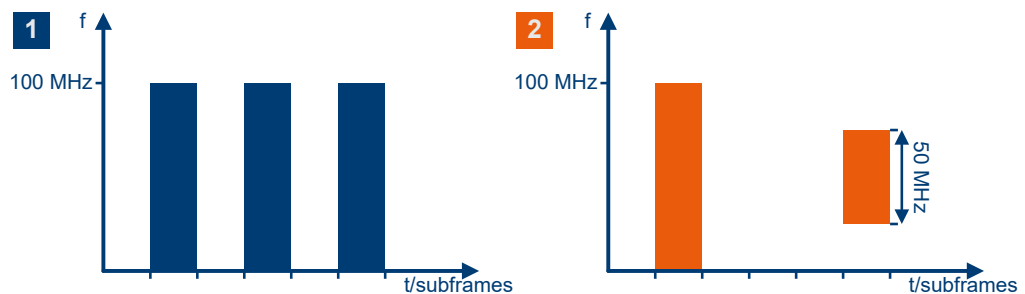

Figure 6-1: Time plan of signals to illustrate the effect of the power mode

Signal characteristics of signal 1

- All allocated subframes have a channel bandwidth = 100 MHz
- Every second subframe is allocated

Signal characteristics of signal 2

- Two subframes are allocated
- The first subframe has a channel bandwidth = 100 MHz
- The second subframe has a channel bandwidth = 50 MHz

The average power mode has the following effects on the power level of the two signals.

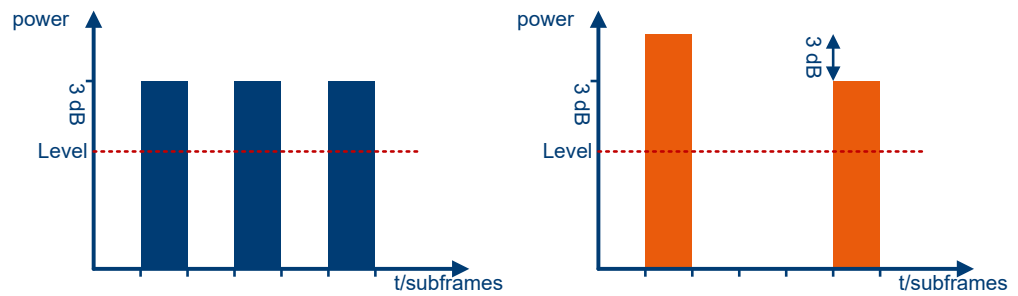

Figure 6-2: Signal power level for Power Mode = Average

Level = "Status Bar > Level"

If "Status Bar > Level" = -10 dBm, the RMS power measured with a power sensor in both cases is:

- $RMS_1 = RMS_2 = -10 \text{ dBm}$

Average active subframes power mode

The power level set with the parameter "Status Bar > Level" is the **average power in all allocated subframes**.

Thus, the absolute power of the allocated subframe depends only on the configuration of the remaining allocated signal. This mode is useful if a specific SNR is required for a particular channel but this channel is not transmitted in every subframe.

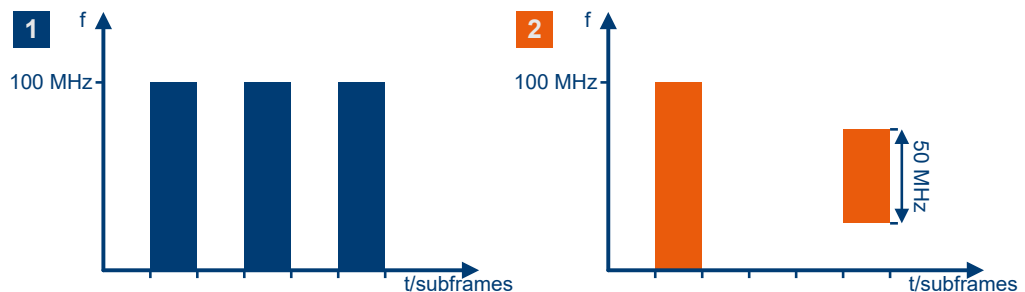

Figure 6-3: Time plan of signals to illustrate the effect of the power mode

Signal characteristics of signal 1

- All allocated subframes have a channel bandwidth = 100 MHz
- Every second subframe is allocated

Signal characteristics of signal 2

- Two subframes are allocated
- The first subframe has a channel bandwidth = 100 MHz
- The second subframe has a channel bandwidth = 50 MHz

The average active subframes power mode has the following effects on the two signals.

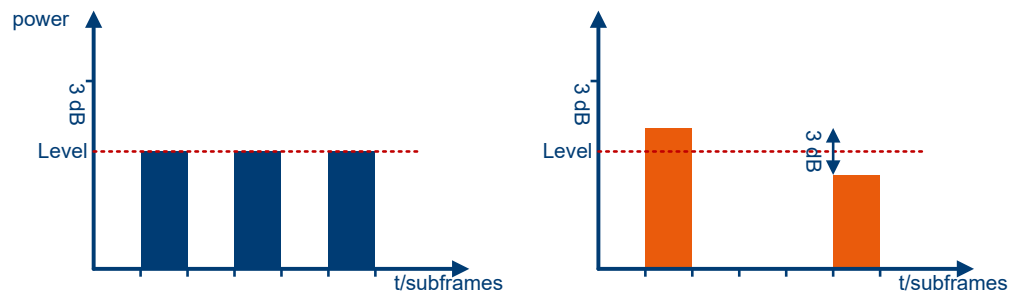

Figure 6-4: Signal power level for Power Mode = Average Active Subframes

Level = "Status Bar > Level"

If "Status Bar > Level" = -10 dBm, the RMS power measured with a power sensor in both cases is:

- $RMS_1 = -13$ dBm
- $RMS_2 = -14.5$ dBm

Average active signal power mode

The power level set with the parameter "Status Bar > Level" is the **average power of all active samples**. Active samples are samples that contain signal information.

The following example is based on the power level of the two signals.

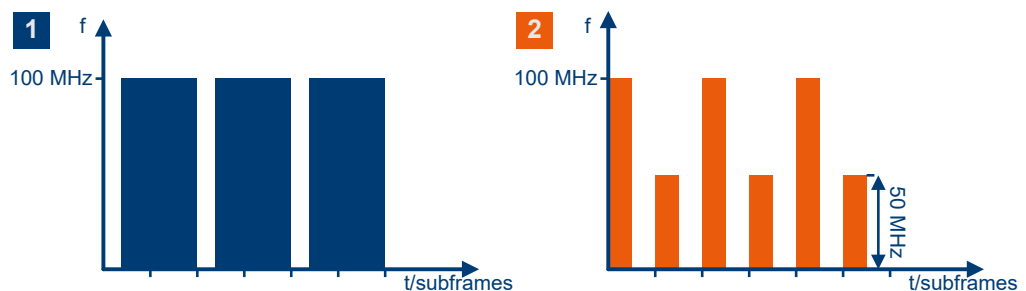

Figure 6-5: Time plan of signals to illustrate the effect of the power mode

1 = Every second subframe is allocated; for all subframes, channel bandwidth BW = 100 MHz

2 = 2 allocated subframes; channel bandwidth of the first allocation = 100 MHz, channel bandwidth of the second allocation = 50 MHz

Signal characteristics of signal 1

- All allocated subframe have a channel bandwidth = 100 MHz
- Subframes with an even index: first half = empty, second half = allocated
- Subframes with an odd index: fully allocated in the time domain

Signal characteristics of signal 2

- All allocated subframes: first half = allocated, second half = empty
- Subframes with an even index have a channel bandwidth = 100 MHz
- Subframes with an odd index have a channel bandwidth = 50 MHz

The average active signal power mode has the following effects on power levels of the signals:

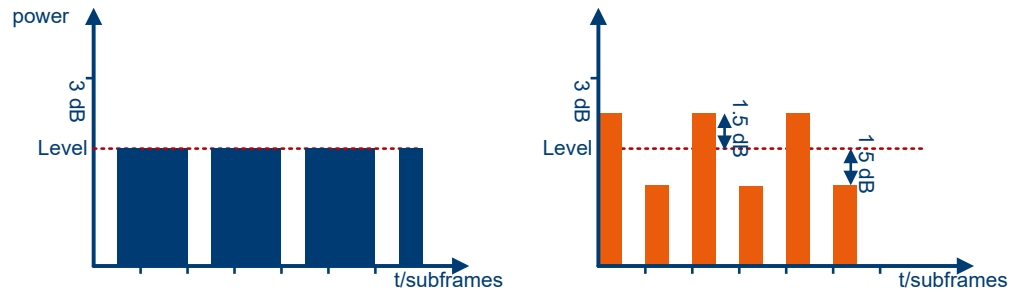

Figure 6-6: Signal power level for Power Mode = Average Active Signal

Level = "Status Bar > Level"

If "Status Bar > Level" = -10 dBm, the RMS power measured with a power sensor is:

- $RMS_1 = -11.24 \text{ dBm}$
- $RMS_2 = -13 \text{ dBm}$

Constant PSD power mode

The power level set with the parameter "Status Bar > Level" is the **power of a fully allocated, fictitious signal with a specific bandwidth** (Reference System Bandwidth). The power spectral density (PSD) of this fictitious signal is equal to the PSD of the current signal.

In this mode, you configure a specific power spectral density per resource element rather than the RMS of the complete signal. The absolute power of a particular allocation is then calculated by multiplying the configured PSD with the bandwidth of the allocation.

Thus, for a given "Reference System Bandwidth", the PSD and the signal power for a particular bandwidth ($SignalPower_{BW}$) are calculated as follows:

- $PSD = \text{"Status Bar > Level"} / \text{"Reference System Bandwidth"}$
- $SignalPower_{BW} = PSD * BW$, where BW is the channel bandwidth.

This mode is useful if you need to configure an absolute SNR. To achieve an absolute SNR, set the "AWGN > System Bandwidth" value to be equal to the "5G New Radio > Output/Power > Power > Reference System Bandwidth".

The following example is based on the power level of the two signals.

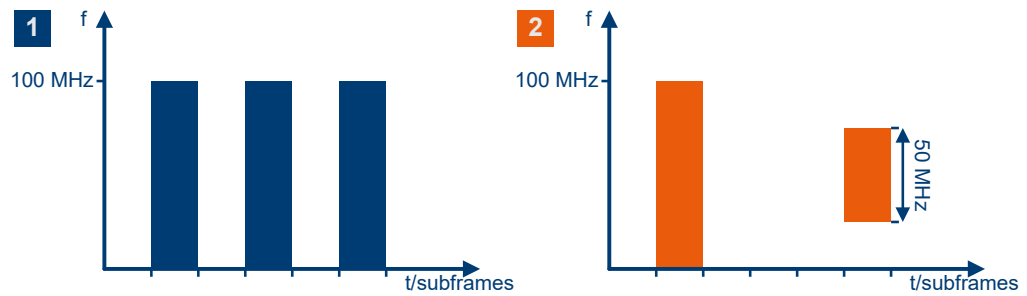

Figure 6-7: Time plan of signals to illustrate the effect of the power mode

Signal characteristics of signal 1

- All allocated subframes have a channel bandwidth = 100 MHz
- Every second subframe is allocated

Signal characteristics of signal 2

- Two subframes are allocated
- The first subframe has a channel bandwidth = 100 MHz
- The second subframe has a channel bandwidth = 50 MHz

The constant PSD power mode has the following effects on power levels of the signals.

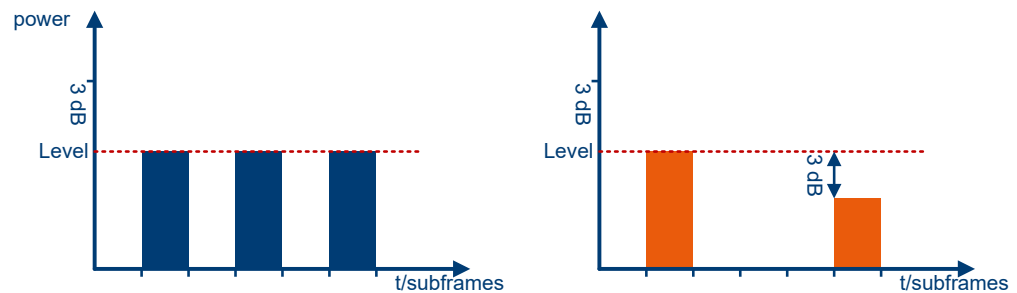

Figure 6-8: Signal power level for Power Mode = Constant PSD

Level = "Status Bar > Level"

For "Reference System Bandwidth" = 100 MHz, the signal power of a signal with 100 MHz bandwidth (BW = 100 MHz) is:

$$\text{SignalPower}_{100 \text{ MHz}} = (\text{"Status Bar > Level"} / 100 \text{ MHz}) * 100 \text{ MHz} = \text{"Status Bar > Level"}$$

The signal power of a signal with 50 MHz bandwidth (BW = 50 MHz) is then:

$$\text{SignalPower}_{50 \text{ MHz}} = (\text{"Status Bar > Level"} / 100 \text{ MHz}) * 50 \text{ MHz} = \text{"Status Bar > Level"} / 2$$

or

$$\text{SignalPower}_{50 \text{ MHz}} = \text{"Status Bar > Level"} - 3 \text{ dB}$$

If "Status Bar > Level" = -10 dBm, the RMS power measured with a power sensor in both cases is:

- $\text{RMS}_1 = -13 \text{ dBm}$

- $RMS_2 = -16 \text{ dBm}$

Burst power mode

For users configured on the baseband output, a reference allocation from the scheduling table has to be chosen. The software **computes the signal PSD bandwidth**, such that the **absolute power of the reference allocation** is equal to the "Level" value in the "Status Bar".

For the case of multiple users configured on the same baseband output, each user signal has the same PSD level computed using the reference allocation. If AWGN is turned on, both UEs have the same SNR.

The "Burst" mode is a special case of the "Constant PSD" mode in the sense that it computes automatically a reference bandwidth based on the chosen allocation.

Thus, for a given "Reference System Bandwidth", the PSD and the signal power for a particular bandwidth ($SignalPower_{BW}$) are calculated as follows:

- $PSD = \text{"Status Bar > Level"} / \text{"Reference System Bandwidth"}$
- $SignalPower_{BW} = PSD * BW$, where BW is the channel bandwidth.

6.8.2 Power settings

Access:

- ▶ Select "5G New Radio" > "Output/Power" > "Power".

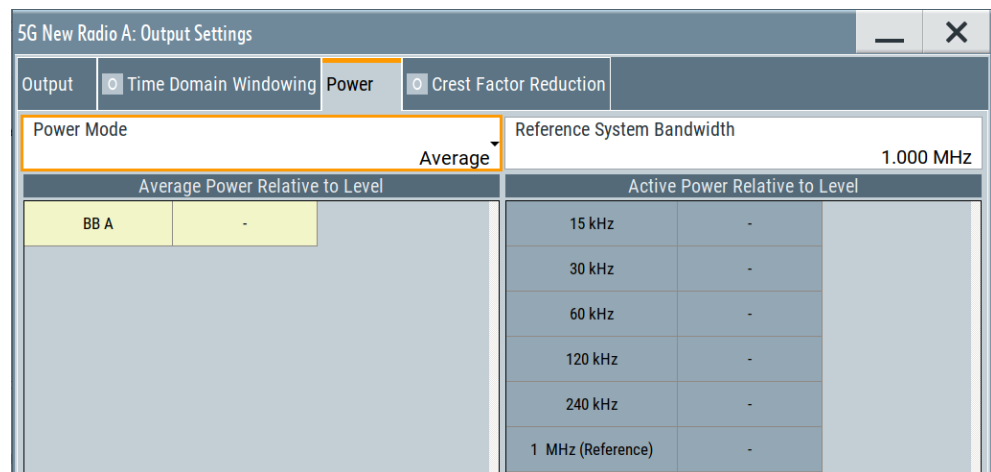

This dialog comprises the settings required for configuring the output power.

Settings:

Power Mode.....	327
Reference System Bandwidth.....	327
Carrier/Subframe/User/Bwp/Alloc.....	327
Average Power Relative To Level (per Baseband).....	327
L BB x.....	327

L Average Power.....	327
Active Power Relative To Level (per Bandwidth).....	328
L Numerology.....	328
L Active Power.....	328

Power Mode

Selects the power mode used to calculate the power level at the signal output.

For background and effects of the power modes, see [Chapter 6.8.1, "Effects of the power mode"](#), on page 321.

"Average" Selects [average](#) power mode.

"Average Active Subframes"
 Selects [average active subframes](#) power mode.

"Constant PSD"
 Selects [constant PSD](#) power mode.

"Burst"
 Selects [burst](#) power mode.

"Average
Active Signal" Selects [average active signal](#) power mode.

Remote command:

[\[:SOURce<hw>\]:BB:NR5G:OUTPut:POWer:MODE](#) on page 731

Reference System Bandwidth

In "Power Mode > Constant PSD", sets the system bandwidth used as reference for the calculation of the output power.

Remote command:

[\[:SOURce<hw>\]:BB:NR5G:OUTPut:POWer:RSBW](#) on page 732

Carrier/Subframe/User/Bwp/Alloc

If [Power Mode](#) > "Burst", displays the identifier of the allocation set as burst reference.

If you select "Carrier/Subframe/User/Bwp/Alloc", the [Scheduling settings](#) open. The allocation showing the icon  is used as burst reference.

The system sets by default the bandwidth of the first allocation in the "Scheduling Settings" as the burst reference.

The power value of the burst reference allocation is displayed in the last row of the [Active Power Relative To Level \(per Bandwidth\)](#) table.

Average Power Relative To Level (per Baseband)

The table displays the average power relative to the level of all baseband outputs associated to the current block.

BB x ← Average Power Relative To Level (per Baseband)

Displays the baseband (BB) output.

Average Power ← Average Power Relative To Level (per Baseband)

Displays the average power relative to the level of the corresponding baseband output associated to the current block.

Remote command:

[:SOURce<hw>] :BB:NR5G:OUTPut:POWer:BBConf:ROW<apr>:AVRL?
on page 731

Active Power Relative To Level (per Bandwidth)

The table displays the power of an active signal of a certain bandwidth relative to the level.

Numerology ← Active Power Relative To Level (per Bandwidth)

Displays the bandwidth value according to the numerology associated to the current block.

Active Power ← Active Power Relative To Level (per Bandwidth)

Displays the power of an active signal of a certain bandwidth relative to the level.

If **Power Mode** > "Burst" or "Constant PSD", the power value of the reference bandwidth set by **Burst Mode Ref Alloc Identifier** or **Reference System Bandwidth** is shown in the last row.

Remote command:

[:SOURce<hw>] :BB:NR5G:OUTPut:POWer:BWRef:ACRL? on page 732

6.9 Crest factor reduction settings

Access:

- ▶ Select the "Baseband > 5GNR > Output/Power...".

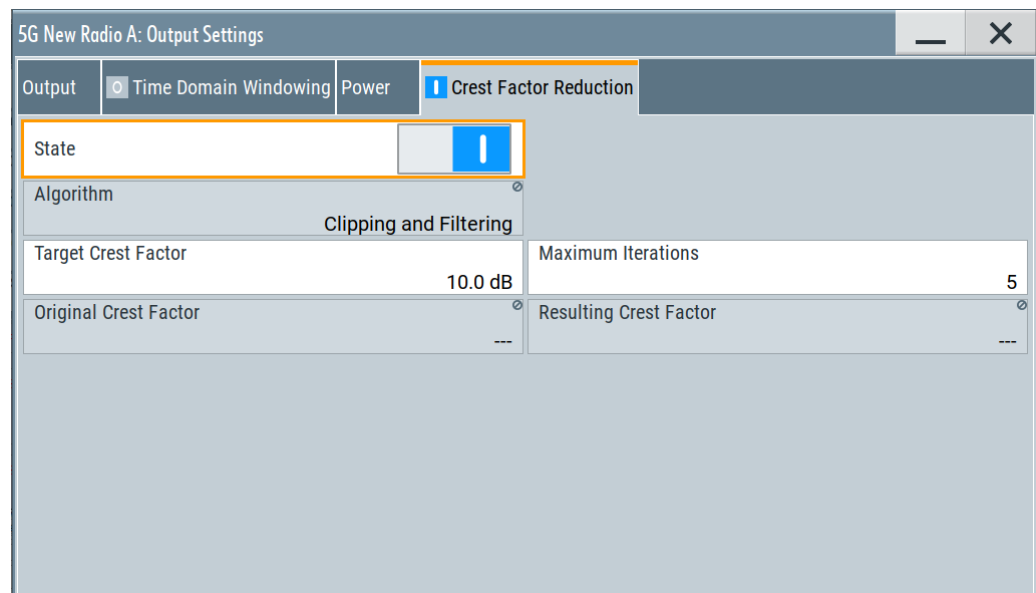

The remote commands required to define these settings are described in [Chapter 10, "Remote-control commands"](#), on page 383.

Settings:

State.....	329
Algorithm.....	329
Target Crest Factor.....	329
Max Iterations.....	329
Original Crest Factor.....	329
Resulting Crest Factor.....	330
Cancellation Pulse Bandwidth.....	330
Transition Bandwidth.....	330

State

Enables the crest factor reduction calculation.

Remote command:

`[:SOURce<hw>] :BB:NR5G:OUTPut:CFReduction:STATe` on page 734

Algorithm

Defines the algorithm for crest factor reduction.

"Clipping and Filtering"

This algorithm performs a hard clipping. It is followed by a low pass filtering of the result in an iterative manner until the target crest factor is reached. You can define the settings of the filter that is used for the calculation.

"Peak Cancelation"

This algorithm subtracts Blackman windowed sinc pulses from the signal wherever the amplitude is above a defined threshold.

Remote command:

`[:SOURce<hw>] :BB:NR5G:OUTPut:CFReduction:ALGorithm` on page 732

Target Crest Factor

Sets the desired crest factor value.

Remote command:

`[:SOURce<hw>] :BB:NR5G:OUTPut:CFReduction:TCRFactor` on page 735

Max Iterations

Sets the number of iterations that are used for calculating the resulting crest factor. The iteration process is stopped when the desired crest factor is achieved by 0.1 dB.

Remote command:

`[:SOURce<hw>] :BB:NR5G:OUTPut:CFReduction:ITERations` on page 733

Original Crest Factor

Displays the original crest factor of the waveform after the calculation of the resulting crest factor is completed. The original crest factor is calculated as an average over the whole waveform, including any idle periods that might be present in TDD waveforms.

Remote command:

`[:SOURce<hw>] :BB:NR5G:OUTPut:CFReduction:OCFactor?` on page 734

Resulting Crest Factor

Displays the resulting crest factor of the waveform after the calculations are completed. The resulting crest factor is calculated as an average over the whole waveform, including any idle periods that might be present in TDD waveforms.

Remote command:

`[:SOURce<hw>] :BB:NR5G:OUTPut:CFReduction:RCFactor?` on page 734

Cancellation Pulse Bandwidth

Sets the bandwidth of the cancellation pulse.

Available for the peak cancellation [algorithm](#).

Remote command:

`[:SOURce<hw>] :BB:NR5G:OUTPut:CFReduction:CPBWidth` on page 733

Transition Bandwidth

Sets the transition bandwidth of the cancellation pulse.

Available for the peak cancellation [algorithm](#).

Remote command:

`[:SOURce<hw>] :BB:NR5G:OUTPut:CFReduction:TRBWidth` on page 733

7 Observing current allocations on the time plan

You can observe the current allocations on the time plan.

The time plan shows active channels and signals, the allocations of the active and selected UEs and indicates the cell it applies for. The time plan shows also an overview of the configured BWPs. It indicates overlapping allocations, too.

Per default, the time plan shows the allocation per used channel bandwidth and one frame but you can change the displayed time region to up to 20 subframes. You can also scroll over all available subframes.

Zooming into the time plan is possible using a mouse or the touch screen.

With the mouse, click and hold the left mouse button and drag a rectangle on the area to be zoomed. Double-click the time plan to zoom out.

With the touch screen, tap and drag a rectangle on the area to be zoomed. Double-tap the time plan to zoom out.

Once the zoom is active, you can scroll through the time plan and view to areas in the zoomed display that are currently not displayed.

In the time plan the DMRS symbols are shown (shaded with the color of the associated allocation type).

Access:

- In the "General" dialog, select "Time Plan".

Allocations are calculated as configured in the "Scheduling" dialog and depend on the "Link Direction" and configured BWPs.

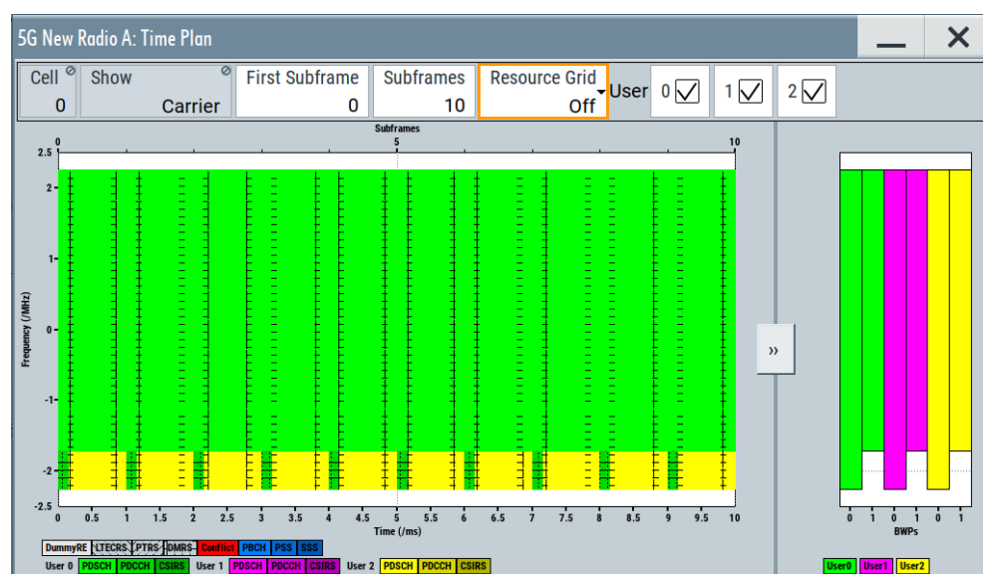

Figure 7-1: Time Plan: understanding the displayed information

- 1 = User 0, BWP 1
- 2 = User 2 , BWP 1
- 3 = User 0 , BWP 1
- 4 = User 0 , BWP 2
- 3 = User 1 , BWP 1
- 3 = User 1 , BWP 2
- 3 = User 2 , BWP 1
- 3 = User 2 , BWP 2
- a = "No. RBs"
- b = "RB Offset in TxBW" - illustrated as principle (because the time plan shows the entire channel bandwidth and the different Tx BWs use different SCSs, the RB offset in TxBW is not given as an offset relative to the lower edge of the channel bandwidth)

Settings:

Cell.....	332
Show.....	332
First Subframe.....	332
Subframe.....	332
Ressource Grid.....	332
User.....	333

Cell

Selects/indicates to which carrier/cell the settings apply.

Remote command:

via suffix at `CELL<ch>`

Show

Defines which portion of the carrier bandwidth is displayed:

"Carrier" Displayed is the entire carrier bandwidth.

Remote command:

n.a.

First Subframe

Selects the first subframe to be displayed.

Remote command:

n.a.

Subframe

Selects the number of subframes to be displayed.

Change the value to zoom in and out in the time plan. The maximum number of subframes that you can display, depends on the [sequence length](#). For each radio frame, you can display up to 10 subframes.

Remote command:

n.a.

Ressource Grid

Displays a grid in the time plan. The size of the grid can be changed between coarse and fine.

The scale of the x- and y-axes depend on your selection.

- "Off"
- X-axis: Time in ms
 - Y-axis: Frequency in MHz
- "Coarse"
- X-axis: Slots
 - Y-axis: Resource blocks
- "Fine"
- X-axis: Symbols
 - Y-axis: Resource elements

Remote command:

n.a.

User

Enable a User to display its allocations on the time plan.

Remote command:

n.a.

8 Performing BS tests according to TS 38.141 specifications

The "Test Case Wizard" supports tests on base stations according to the 3GPP [TS 38.141](#) specifications.

The [TS 38.141](#) specifications are divided in two parts depending on the required test methodology:

- [TS 38.141-1](#): Part 1: Conducted conformance testing
- [TS 38.141-2](#): Part 2: Radiated conformance testing

The "Test Case Wizard" offers a selection of predefined settings according to test cases in 3GPP [TS 38.141-1](#) and [TS 38.141-2](#). For an overview of the test cases covered by the test case wizard, refer to [Chapter 8.3, "Supported test cases"](#), on page 335.

With the "Test Case Wizard", it is possible to create highly complex test scenarios with just a few keystrokes.

The "Test Case Wizard" has effect on frequency and level settings, link direction, filter, trigger, baseband clock source, marker settings and base station configuration.

The "Test Case Wizard" also affects:

- AWGN
- Co-located modulation signals
- CW interferers



The "Test Case Wizard" presets the instrument for tests according to 3GPP [TS 38.141-1](#) and [TS 38.141-2](#) specifications. If it is required, you can change the predefined settings by varying the corresponding parameter in the 5GNR dialogs.

8.1 Introduction to BS conformance testing

The main purpose of the conformance testing is to ensure that the base station (BS) is fulfilling a defined level of minimum performance.

3GPP defines several requirements for the 5G new radio BS:

- **TS 38.104**: NR; Base Station (BS) radio transmission and reception
- **TS 38.113**: NR; Base Station (BS) ElectroMagnetic Compatibility (EMC)
- **TS 38.141**: NR; Base Station (BS) conformance testing
- **TS 38.817-02**: General aspects for Base Station (BS) Radio Frequency (RF) for NR

BS RF conformance test specifications

- The BS RF conformance tests are based on the core specification [TS 38.104](#) and are defined in the [TS 38.141](#) specifications.
- [TS 38.141-1](#): NR; Base Station (BS) conformance testing Part 1: Conducted conformance testing
- [TS 38.141-2](#): NR; Base Station (BS) conformance testing Part 2: Radiated conformance testing

A BS type 1-C only has conducted requirements so it requires compliance to [TS 38.141-1](#) only.

A BS type 1-H has both conducted and radiated requirements so it requires compliance to the applicable requirements of [TS 38.141-1](#) and [TS 38.141-2](#).

BS type 1-O and BS type 2-O have only radiated requirements so they require compliance to [TS 38.141-2](#) only.

The supported BS RF conformance tests [TS 38.141-1](#) and [TS 38.141-2](#) are described in [Chapter 8.3, "Supported test cases"](#), on page 335.

8.2 Required options

The basic equipment layout for performing test with the aid of "Test Case Wizard" is the same as for the 5G NR signal generation. It includes the options:

- Base unit
- Digital standard 5G new radio (NR) (R&S SMM-K144)
- Frequency option (e.g. R&S SMM-B1006)

Some of the tests require further options. You find a list of the required option at the beginning of each section that describes a group of test cases.



Test cases where the signal generator hardware and/or software equipment is not sufficient are grayed out and not selectable.

RF power and frequency limitations of the hardware equipment restrict the setting ranges.

8.3 Supported test cases

The BS RF conformance tests defined in the [TS 38.141-1](#) and [TS 38.141-2](#) specifications are divided into the following three main groups:

- [Transmitter characteristics tests](#)
- [Receiver characteristics tests](#)
- Performance requirements tests

The "Test Case Wizard" supports the test cases listed in the tables below.



Only the test cases that require a signal generator are implemented in the "Test Case Wizard".

Table 8-1: Transmitter characteristics tests

Chapter	Test case	Section in this document with further information
Conducted tests. Specification TS 38.141-1		
6.7	Reference sensitivity level	chap. 8.7.3, on page 363
Radiated tests. Specification TS 38.141-2		
6.8	OTA transmitter intermodulation	chap. 8.9.3, on page 370

Table 8-2: Receiver characteristics tests

Chapter	Test case	Section in this document with further information
Conducted tests. Specification TS 38.141-1		
7.2	Reference sensitivity level	chap. 8.8.3, on page 367
7.3	Dynamic range	chap. 8.8.4, on page 368
Radiated tests. Specification TS 38.141-2		
7.2	OTA sensitivity	chap. 8.10.3, on page 376
7.3	OTA reference sensitivity level	chap. 8.10.4, on page 377
7.4	OTA dynamic range	chap. 8.10.5, on page 378
7.6	OTA out-of-band blocking	chap. 8.10.6, on page 379

8.3.1 Generic structure of the description of the implemented test cases

The description of the test cases in this document follows a common structure.

- Test case number and test case name
- Short description and test purpose
Some of the definitions are directly taken from the 3GPP test specification.
- Prerequisites and required hardware and software options
- Test setup
- Description of test case-specific parameters

8.4 Exemplary test setups

The tests can be performed using the standard test setup according to [TS 38.141-1](#) and [TS 38.141-2](#). Test setups beside the standard test setups described below are specified at the individual description of the corresponding test case.

8.4.1 Exemplary test setups for conducted tests (TS 38.141-1)

8.4.1.1 Exemplary test setup - one path

The RF port outputs the wanted signal (with or without interference) and is connected to the Rx port of the base station. The signal generator starts signal generation at the first received gNB frame trigger.

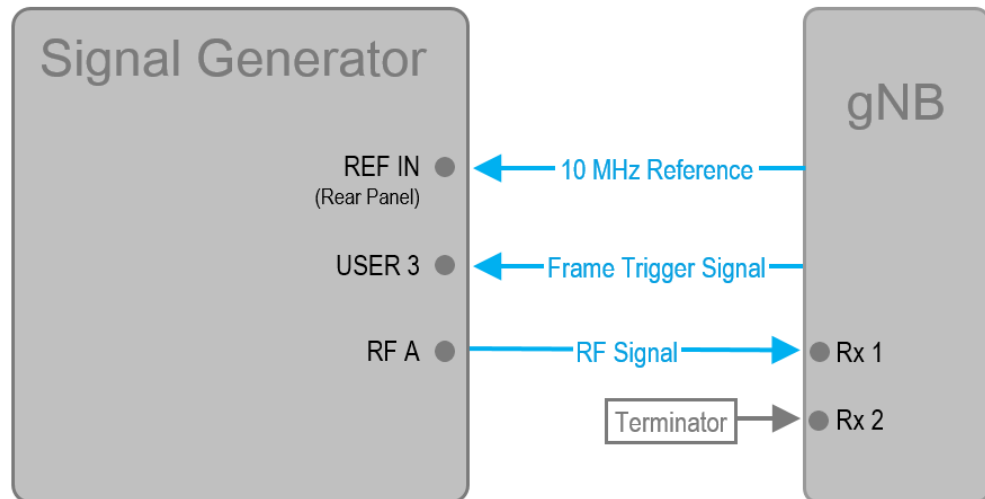

Figure 8-1: One path test setup (example of R&S SMM100A simulating the test case 7.3 "Dynamic range")

8.4.2 Exemplary test setups for radiated (OTA) tests (TS 38.141-2)

8.4.2.1 Exemplary test setup - one path

The RF port outputs the wanted signal (with or without interference) and is connected to the test antenna port of the OTA chamber. The signal generator starts signal generation at the first received gNB frame trigger.

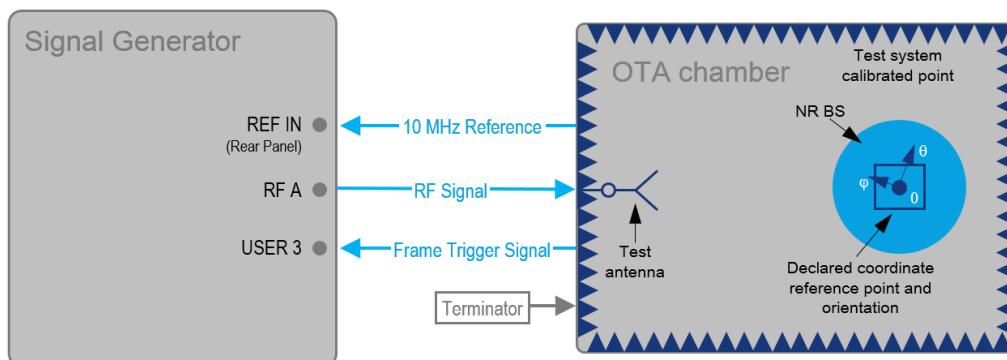

Figure 8-2: One path test setup (example of R&S SMM100A simulating the test case 7.4 "OTA dynamic range")

8.5 General considerations

This section lists some common topics for all BS RF conformance tests. Considerations specific to one conformance test part, are described at the corresponding section.

Test frequencies

5G NR is designed to operate in the operating bands defined in TS 38.104, tables 5.2-1 and 5.2-2.

The measurements have to be performed using appropriate frequencies in the bottom, middle and top of the operating frequency band of the base station (BS). These frequencies are denoted as RF channels bottom, middle and top (B, M and T).

Reference frequency

When building up the measurement setups according to TS 38.141-1 and TS 38.141-2, it can be useful that all the instruments share a common reference frequency. Fed in the external reference frequency at the Ref In connector and enable "RF > Reference Frequency > Source = External".

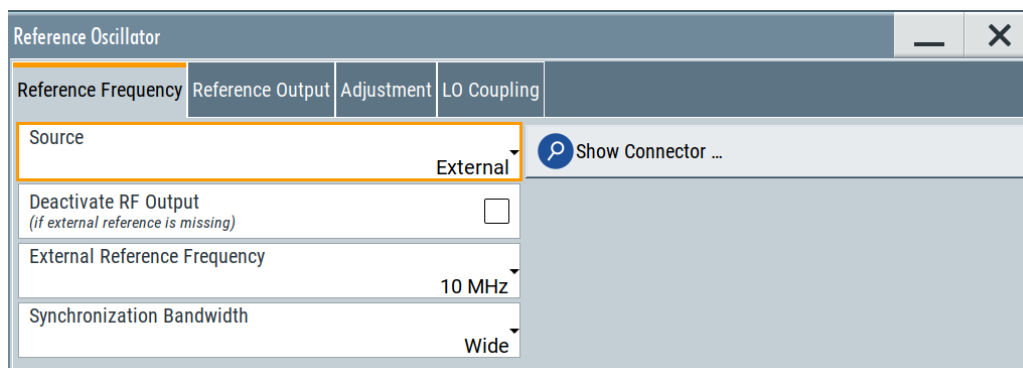

In the external reference mode, an external signal with selectable frequency and defined level must be input at the Ref In connector. This signal is output at the Ref Out

connector. The reference frequency setting is effective for both paths. For achieving good reference sources of high spectral purity, a wideband setting is provided.

Baseband clock

The clock source is automatically switched to internal when the test case settings are activated.

Resource block offset

In this implementation, the RBs are allocated by default at the left edge of the spectrum. However, some test cases do not require allocation of the entire bandwidth or RB allocation at a specific part of the bandwidth. Adjust the additional parameter "RB Offset" to define the position of the RBs.



Use also the [Observing current allocations on the time plan](#) to visualize the RB allocation for the wanted signal (path A) and the interfering signal (path B).

8.5.1 General considerations for radiated (OTA) tests

Base stations and reference points

In [TS 38.141-2](#) and [TS 38.104](#) two different base station types are defined for frequency range one (FR1) and two (FR2). Radiated requirements are also referred to as OTA requirements.

BS type 1-O and 2-O (FR1, FR2, radiated)

For base station types 1-O and 2-O the radiated characteristics are defined over-the-air (OTA) where the OTA interface is referred to as radiated interface boundary (RIB). Co-location requirements are specified at the conducted interface of the co-location reference antenna.

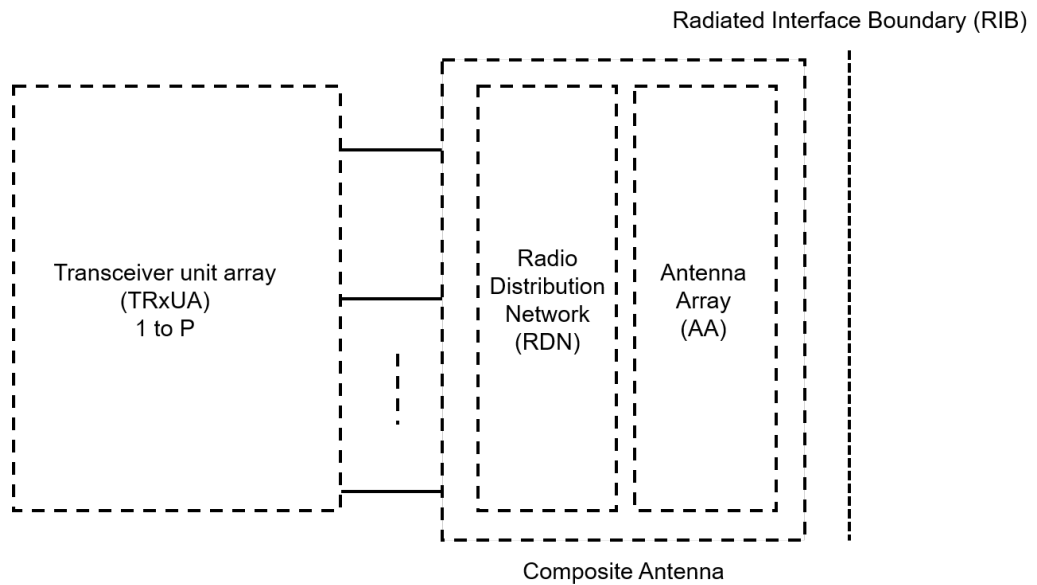

Figure 8-3: Radiated reference points for BS type 1-O and BS type 2-O as defined in TS 38.141-2

BS type 1-H (hybrid, radiated)

This base station type has two reference points fulfilling both radiated and conducted requirements.

Radiated characteristics are defined OTA and to be measured at the radiated interface boundary (RIB). The specific requirements and test cases are defined in TS 38.141-2.

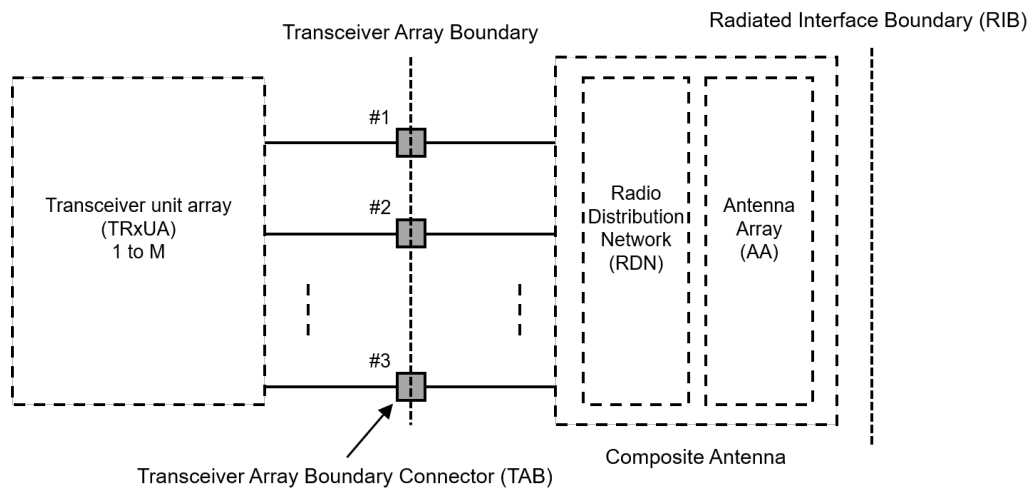

Figure 8-4: Radiated and conducted reference points for BS type 1-H as defined in TS 38.141-2

Base station classes

The specification TS 38.104 distinguishes base station classes by BS type 1-O and 2-O (Table 8-3) and BS type 1-H (Table 8-4).

Table 8-3: Base station classes for BS types 1-O and 2-O

BS type	BS class	Cell size	Minimum distance along the ground (m)
Type 1-O and type 2-O	Wide area	Macro cell	35
	Medium area	Micro cell	5
	Local area	Pico cell	2

Table 8-4: Base station classes for BS type 1-H

BS type	BS class	Cell size	Minimum coupling loss (dB)
Type 1-H	Wide area	Macro cell	70
	Medium area	Micro cell	53
	Local area	Pico cell	45

Reference coordinate system

For radiated test setups a reference coordinate system is required. The reference coordinate system should be associated to an identifiable physical feature on the base station enclosure.

The reference coordinate system is created of a Cartesian coordinate system with rectangular axis x, y, z and spherical angles θ, φ as shown in [Figure 8-5](#).

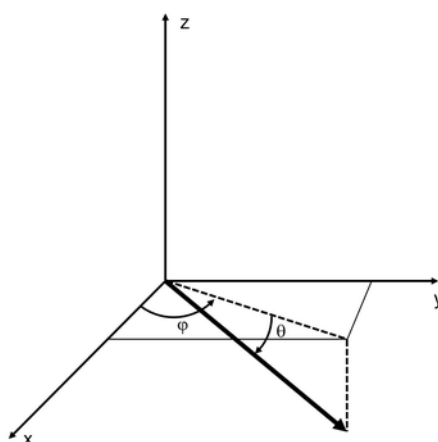
**Figure 8-5: Reference coordinate system**

8.6 User interface

Access:

- ▶ Select "Baseband Block > 5G NR > General > Test Case Wizard".

The "Test Case Wizard" graphically shows the actual test case configuration in a diagram in the upper part of the dialog.

The corresponding settings are displayed in tabs in the lower part of the dialog.

The number of displayed tabs depends on the selected test case. Use the fields in the different tabs to modify the default setting values as needed.

The "Test Case Wizard" dialog contains the tabs:

• General settings.....	342
• Test case settings.....	343
• OTA declaration.....	345
• Instrument settings.....	346
• Wanted signal settings.....	348
• Frequency allocation settings.....	353
• Interfering signal settings.....	354
• Moving UE settings.....	357
• Stationary UE settings.....	359
• AWGN settings.....	360
• Information.....	360

8.6.1 General settings

Access:

- Select "Baseband Block > 5G NR > General > Test Case Wizard".

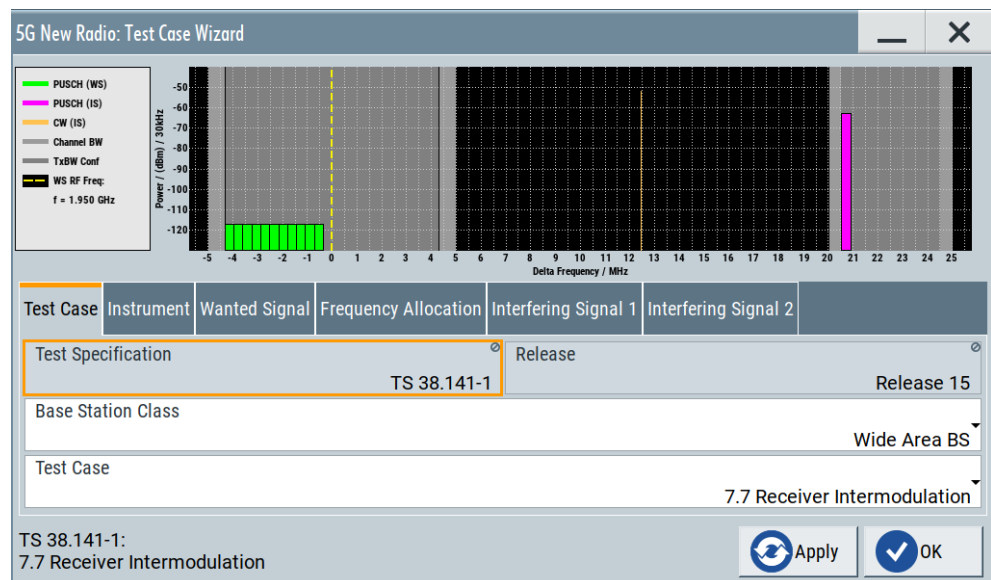

Diagram.....	343
Apply, OK.....	343

Diagram

In the upper part, the dialog displays a graph with the interference scenario defined by power level and frequency offset of the currently selected test case.

Apply,OK

Activates the current settings of the test case wizard.

The "Apply" triggers a selective preset of the signal generator before the presetting according to the selected test case. Further modification of the generator settings is still possible. Signal generation starts with the first trigger event.

Use "Ok" to apply the settings and close the dialog.

Note: The settings of the selected test case become active only after selecting "Apply" or "OK" button.

Before triggering the signal generator, you can still change these other settings. This configuration is particularly useful when compensating for cable loss or adjusting the RF power level offset of also inserted attenuators.

Signal generation is started at the first trigger received by the generator. The RF output is not activated /deactivated by the test case wizard. Activate the "RF > State > On" at the beginning of the measurement.

Note: The settings in the dialogs "5G NR > Trigger/Marker/Clock" and in the "Global/Local Connector Settings" are not affected by the selective preset, if the parameter "Trigger/Marker Configuration" is set to "Unchanged".

Remote command:

[:SOURce<hw>] :BB:NR5G:TCW:APPLY on page 749

8.6.2 Test case settings

Access:

1. Select "Baseband Block > 5G NR > General > Test Case Wizard".
2. Select "Test Case".

Test Case	Instrument	Wanted Signal	Frequency Allocation	Interfering Signal 1	Interfering Signal 2
Test Specification			TS 38.141-1	Release	Release 15
Base Station Class					Wide Area BS
Test Case					7.7 Receiver Intermodulation

This dialog comprises the settings for selecting the test case, the 3GPP test specification, release, and BS class.



When your signal generator misses an option required to perform the selected test case, it shows a message that lists all required options and a list of missing options.

Test Case	Instrument	Antenna	Wanted Signal	Feedback	AWGN	Info
Test Specification	TS 38.141-1				Release	Release 15
Base Station Class						Wide Area BS
Test Case	8.2.1 PUSCH Transform Precoding Disabled					
Required Options: 1*Baseband, 2*Fading, 2*RF, 1*K144, 1*K145, 2*K62						
Missing Options: 1*K62						

Test Specification.....	344
Release.....	344
Base Station Class.....	344
Test Case.....	344

Test Specification

Displays the 3GPP test specification used as a guide line for the test cases.

Remote command:

[:SOURce<hw>] :BB:NR5G:TCW:SPEC on page 756

Release

Displays the 3GPP test specification release version used as a guide line for the test cases.

Remote command:

[:SOURce<hw>] :BB:NR5G:TCW:RELease on page 756

Base Station Class

Determines whether the test is to be performed for an NR local area, NR medium area or an NR wide area base station. The different base station classes are specified for different output power (see also "[Power Level](#)" on page 351).

Remote command:

[:SOURce<hw>] :BB:NR5G:TCW:BSCLass on page 751

Test Case

Selects the test case.

See [Chapter 8.3, "Supported test cases"](#), on page 335 for an overview of the available test cases.

Remote command:

[:SOURce<hw>] :BB:NR5G:TCW:TC on page 756

8.6.3 OTA declaration

Access:

1. Select "Baseband Block > 5G NR > General > Test Case Wizard".
2. Select "OTA Declaration".

Test Case	OTA Declaration	Instrument	Antenna	Wanted Signal	Feedback	AWGN
Base Station Type				Declared Direction		
1-O				OTA REFSENS Reference Direction		
Minimum EIS				EIS 50M		
-101.0 dBm				-101.0 dBm		
BeW(θ REFSENS)				BeW(φ REFSENS)		
300.0 deg				300.0 deg		

This dialog comprises the settings for the OTA sensitivity directions declaration (OSDD).

Base Station Type.....	345
Declared Direction.....	345
Minimum EIS.....	346
EIS 50M.....	346
BeW(θ REFSENS).....	346
BeW(φ REFSENS).....	346

Base Station Type

Sets the base station type used for the OSDD.

"1-H"

Sets the BS type 1-H (FR1, hybrid) for the OTA settings.

This base station type has two reference points fulfilling both radiated and conducted requirements. Radiated characteristics are defined over-the air (OTA) and to be measured at the radiated interface boundary (RIB) as specified in [TS 38.141-2](#).

"1-O"

Sets the BS type 1-O (FR1) for the OTA settings.

"2-O"

Sets the BS type 2-O (FR2) for the OTA settings.

Remote command:

[\[:SOURce<hw>\]:BB:NR5G:TCW:BSType](#) on page 751

Declared Direction

Sets the reference for the OSDD.

"OTA minSENS Reference Direction"

Sets the OTA minimum sensitivity (minSENS) value as the reference for the OSDD.

"OTA REFSENS Reference Direction"

Sets the OTA reference sensitivity (REFSENS) value as the reference for the OSDD.

"Other Direction"

Sets a value different than the minSENS and REFSENS as the reference for the OSDD.

Remote command:

`[:SOURce<hw>] :BB:NR5G:TCW:DCLDirection` on page 751

Minimum EIS

Sets the lowest equivalent isotropic sensitivity value ($EIS_{\min SENS}$) for the OSDD.

Remote command:

`[:SOURce<hw>] :BB:NR5G:TCW:MEIS` on page 755

EIS 50M

Sets the $EIS_{REFSENS_50M}$ level value applicable in the OTA REFSENS RoAoA.

The $EIS_{REFSENS_50M}$ value is the declared OTA reference sensitivity basis level for FR2 based on a reference measurement channel with 50MHz BS channel bandwidth.

Remote command:

`[:SOURce<hw>] :BB:NR5G:TCW:E50` on page 752

BeW(θ REFSENS)

Sets the angle of the beamwidth for to the OTA REFSENS RoAoA in the θ -axis ($BeW_{\theta, REFSENS}$), applicable for FR1 only.

Remote command:

`[:SOURce<hw>] :BB:NR5G:TCW:BEWThet` on page 750

BeW(φ REFSENS)

Sets the angle of the beamwidth for to the OTA REFSENS RoAoA in the φ -axis ($BeW_{\varphi, REFSENS}$), applicable for FR1 only.

Remote command:

`[:SOURce<hw>] :BB:NR5G:TCW:BEWPhi` on page 750

8.6.4 Instrument settings

Access:

1. Select "Baseband Block > 5G NR > General > Test Case Wizard".
2. Select "Instrument".

The "Instrument" dialog comprises instrument-related settings, like trigger and marker settings or routing related settings.

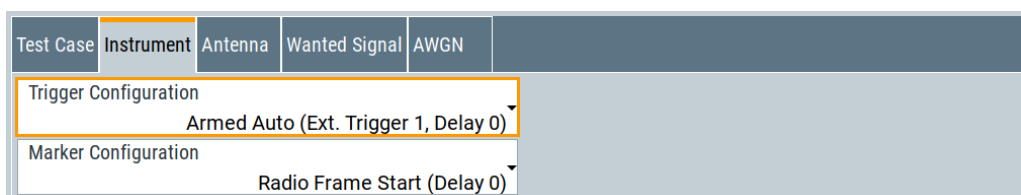

Trigger Configuration.....	347
Marker Configuration.....	347
Generated Signal.....	348

Trigger Configuration

Selects the trigger configuration. The trigger is used to synchronize the signal generator to the other equipment.

"Armed Auto (Ext. Trigger 1, Delay 0)"

The trigger settings are customized for the selected test case. The following settings apply:

- "Trigger Mode > Armed Auto"
- "Trigger Source > External Global Trigger 1"
- "Trigger Delay = 0"

Thus, the base station frame timing is able to synchronize the signal generator by a periodic trigger.

"Unchanged" The current trigger settings of the signal generator are retained unchanged.

Remote command:

[\[:SOURCE<hw>\]:BB:NR5G:TCW:TRIGGERconfig](#) on page 757

Marker Configuration

Selects the marker configuration. The marker can be used to synchronize the measuring equipment to the signal generator.

"Radio Frame Start (Delay 0)"

The marker settings are customized for the selected test case. The following settings apply:

- "Marker Mode 1/2/3 > Radio Frame Start"
 - "Global Connector Settings > User 1/2 > Direction > Output" and "User 1/2 > Signal > Baseband A Marker 1/2"
 - "Local Connector Settings > T/M 2/3 > Direction > Output" and "T/M 2/3 > Signal > Marker A 1/2"
- Marker signals "Marker 1" and "Marker 2" are output at the local T/M 2/3 and global USER1/2 connectors
- "Marker Delay = 0"

"Unchanged" The current marker settings of the signal generator are retained unchanged.

Remote command:

[\[:SOURCE<hw>\]:BB:NR5G:TCW:MARKERconfig](#) on page 755

Generated Signal

Selects the signals that are generated for test cases that require the generation of a wanted and a interferer signal.

- "All Signals" Generates both the wanted signal and the interferer signal. This option requires a generator with two baseband generators.
- "Wanted Signal" Generates only the wanted signal. You can use this option if your generator has only one baseband generator. This option requires a second signal generator to generate the interferer signal.
- "Interferer Signal" Generates only the interferer signal. You can use this option if your generator has only one baseband generator. This option requires a second signal generator to generate the wanted signal.

Remote command:

[:SOURce<hw>] :BB:NR5G:TCW:GENSignal on page 752

8.6.5 Wanted signal settings

The following settings are available for almost all transmitter and receiver characteristics and performance requirements tests. Specific parameters are listed together with the description of the corresponding test case.

Test Case	Instrument	Wanted Signal	Frequency Allocation	Interfering Signal	Wanted Signal
RF Frequency			1.950 000 000 GHz	Channel Bandwidth	10 MHz
Sub Carrier Spacing			30 kHz NCP	Cell ID	0
UE ID			0	DMRS TypeA Position	2
FRC			G-FR1-A1-2	RB Offset	1
Power Level			-97.4 dBm		

Additional DMRS.....	349
Cell ID.....	349
CSI Part.....	349
CSI 1 Pattern.....	349
CSI 2 Pattern.....	349
Channel Bandwidth.....	349
DMRS Type A Position.....	350
Duplexing.....	350
Fraction of Max. Throughput.....	350
FRC.....	350
Frequency Offset.....	350
Mapping Type.....	350
Mode.....	351
Number of OFDM Symbols.....	351
Preamble Format.....	351
Power Level.....	351

Propagation Conditions.....	351
RB Offset.....	351
Restricted Set.....	352
RF Frequency.....	352
Sub Carrier Spacing / Sub Carrier Spacing (BWP).....	352
Sub Carrier Spacing (PRACH).....	352
Test Requirement.....	352
Test Setup.....	352
Timing Offset Base Value.....	353
UCI Bits.....	353
CG-UCI Pattern.....	353
UE ID.....	353
Virtual Downlink RF Frequency.....	353

Additional DMRS

Enables or disabled the additional DMRS.

Additional DMRS signals increase the probability that the UE receives the demodulation reference symbols. It leads to a support of lower SNR conditions.

Remote command:

`[:SOURce<hw>] :BB:NR5G:TCW:WS:ADMRS:STATE` on page 758

Cell ID

Sets the cell ID.

Remote command:

`[:SOURce<hw>] :BB:NR5G:TCW:WS:CELLid` on page 758

CSI Part

Defines the CSI part selected for the test case.

The PUCCH-based CSI and the PUSCH-based CSI reporting, always padding the CSI report to the worst-case UCI payload size would result in too large overhead. For these cases, the CSI content is instead divided into two CSI parts.

Remote command:

`[:SOURce<hw>] :BB:NR5G:TCW:WS:UCI:CSIPart` on page 767

CSI 1 Pattern

Defines the frequency and time domain of the CSI part 1 subcarrier location.

Remote command:

`[:SOURce<hw>] :BB:NR5G:TCW:WS:UCI:CSI1:PATTern` on page 767

CSI 2 Pattern

Defines the frequency and time domain of the CSI part 2 subcarrier location.

Remote command:

`[:SOURce<hw>] :BB:NR5G:TCW:WS:UCI:CSI2:PATTern` on page 767

Channel Bandwidth

Selects the channel bandwidth (see also [Chapter 2.2, "5G NR numerology"](#), on page 18).

Remote command:

[:SOURce<hw>] :BB:NR5G:TCW:WS:CBW on page 758

DMRS Type A Position

Sets l_0 , i.e. the position of first DM-RS symbol for PUSCH (and PDSCH) mapping type A (dmrs-TypeA-Position).

Remote command:

[:SOURce<hw>] :BB:NR5G:TCW:WS:TAPos on page 766

Duplexing

The duplexing mechanism used can be switched between FDD and TDD.

TDD Time division duplex is used. In TDD mode, both uplink and downlink use the same spectrum frequencies but at different times.

FDD Frequency division duplex is used. In FDD mode, both uplink and downlink can transmit at the same time at different spectrum frequencies.

Remote command:

[:SOURce<hw>] :BB:NR5G:TCW:WS:DUPLex on page 759

Fraction of Max. Throughput

The required throughput is expressed as a fraction of maximum throughput for the FRC. The performance requirements assume HARQ retransmissions.

The throughput shall be equal to or larger than the fraction of maximum throughput for the FRCs at the given SNR.

Remote command:

[:SOURce<hw>] :BB:NR5G:TCW:WS:FMTHroughput on page 759

FRC

Displays the fixed reference channel used. An overview of the FRCs and the cross-reference between the selected [Channel Bandwidth](#) and [Sub Carrier Spacing / Sub Carrier Spacing \(BWP\)](#) is given in the individual description of the test cases.

See also 3GPP TS 138 141-1, annex A (normative): Reference measurement channels.

Remote command:

[:SOURce<hw>] :BB:NR5G:TCW:WS:FRC:TYPE on page 759

Frequency Offset

Sets the frequency offset used for the PRACH.

Remote command:

[:SOURce<hw>] :BB:NR5G:TCW:WS:FROffset on page 762

Mapping Type

Sets the mapping type A or B for the PUSCH.

Remote command:

[:SOURce<hw>] :BB:NR5G:TCW:WS:MAPType on page 762

Mode

Switches between the detection rate (Pd) and the false detection rate (Pfa).

Detection rate (Pd) Pd is defined as the probability of detection of preamble.

False detection rate (Pfa) Pfa is defined as the total probability of false detection of the preamble.

Remote command:

[:SOURce<hw>] :BB:NR5G:TCW:WS:MODE on page 762

Number of OFDM Symbols

Sets the number of used OFDM symbols.

The starting symbol index is 13 for 1 OFDM symbol and 12 for 2 OFDM symbols.

Remote command:

[:SOURce<hw>] :BB:NR5G:TCW:WS:SYMNumber on page 765

Preamble Format

Sets the designated PRACH preamble format.

The preamble is used to obtain the UL synchronization. In 5G NR, there are 64 preambles defined in each time-frequency PRACH occasion. The preamble consists of two parts cyclic prefix (CP) and preamble sequence.

In 5G NR, there are 13 types of preamble format supported known as format 0, format 1, format 2, format 3, format A1, format A2, format A3, format B1, format B2, format B3, format B4, format C0, format C1.

Remote command:

[:SOURce<hw>] :BB:NR5G:TCW:WS:PRACH:FORMat on page 763

Power Level

Displays the power level, depending on the selected test case.

Remote command:

[:SOURce<hw>] :BB:NR5G:TCW:WS:PLEVe1 on page 763

Propagation Conditions

The propagation conditions define the multipath fading environment.

They indicated as a combination of channel model name and maximum Doppler frequency, i.e. TDLA<DS>-<Doppler> where <DS> indicates the desired delay spread and <Doppler> indicates the maximum Doppler frequency.

Remote command:

[:SOURce<hw>] :BB:NR5G:TCW:WS:PROCondition on page 764

RB Offset

Sets the shift of the allocated wanted signal in No. of RBs (see also "[Resource block offset](#)" on page 339).

Remote command:

[:SOURce<hw>] :BB:NR5G:TCW:WS:RBOFFset on page 764

Restricted Set

Selects the **restricted set** type for the PRACH used in the test case.

Remote command:

[:SOURCE<hw>] :BB:NR5G:TCW:WS:RSET on page 764

RF Frequency

Sets the RF frequency of the wanted signal.

Remote command:

[:SOURCE<hw>] :BB:NR5G:TCW:WS:RFFrequency on page 764

Sub Carrier Spacing / Sub Carrier Spacing (BWP)

Sets the subcarrier spacing using normal cyclic prefix (NCP) or extended cyclic prefix (ECP). See also [Chapter 2.2, "5G NR numerology"](#), on page 18.

Remote command:

[:SOURCE<hw>] :BB:NR5G:TCW:WS:SCSPacing on page 765

Sub Carrier Spacing (PRACH)

Sets the subcarrier spacing for PRACH.

Remote command:

[:SOURCE<hw>] :BB:NR5G:TCW:WS:PRACH:SCSPacing on page 763

Test Requirement

Selects the test environment.

"Normal" Requirement for normal conditions.

"High Speed Train" Requirement for high speed train conditions.

Remote command:

[:SOURCE<hw>] :BB:NR5G:TCW:WS:TREquire on page 768

Test Setup

With the test setup selector, the signal definitions can be switched.

Parameter	Test Setup 1	Test Setup 2
Modulation	QPSK	
First PRB prior to frequency hopping	0	
Intra-slot frequency hopping	enabled	
First PRB after frequency hopping	The largest PRB index (number of PRBs -1)	
Group and sequence hopping	neither	
Hopping ID	0	
Number of PRBs	1	3
Number of symbols	14	4

Parameter	Test Setup 1	Test Setup 2
Number of UCI information bits	16	
First symbol	0	

Remote command:

`[:SOURce<hw>] :BB:NR5G:TCW:WS:TSETup` on page 766

Timing Offset Base Value

Displays the timing offset base value.

Remote command:

`[:SOURce<hw>] :BB:NR5G:TCW:WS:TIOBase?` on page 766

UCI Bits

Set the number of UCI bits used.

Defines the size of the uplink control information bits carried in the PUCCH channel. They consist of the HARQ feedback, CSI and SR.

Remote command:

`[:SOURce<hw>] :BB:NR5G:TCW:WS:UCI:BITS` on page 766

CG-UCI Pattern

Sets the ACK bits in pattern form.

A "1" indicates an ACK, a "0" a NACK.

Remote command:

`[:SOURce<hw>] :BB:NR5G:TCW:WS:UCI:CGUCi:PATtern` on page 767

UE ID

Sets the UE ID.

Remote command:

`[:SOURce<hw>] :BB:NR5G:TCW:WS:UEID` on page 767

Virtual Downlink RF Frequency

Sets the virtual downlink RF frequency.

Remote command:

`[:SOURce<hw>] :BB:NR5G:TCW:WS:VDRF` on page 768

8.6.6 Frequency allocation settings

Determines the frequency position of the wanted and the interfering signal.

Test Case	Instrument	Wanted Signal	Frequency Allocation	Interfering Signal
				Interfering Signal At Higher Frequencies

Frequency Allocation of the Interfering signal

Determines the frequency position of the wanted and the interfering signal.

Example: Wanted and interfering signal within the same channel

"Test Case" = "7.8 In-channel selectivity"

"Channel Bandwidth" = 15 MHz

The parameter "Frequency Allocation" determines the position of the allocated RBs within the channel. Allocation in the lower or higher frequencies is possible.

"Frequency Allocation of the Interfering signal"
= At higher resource blocks

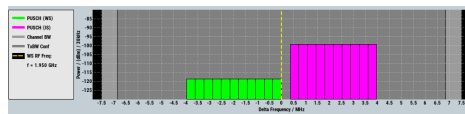

"Frequency Allocation of the Interfering signal"
= At lower resource blocks

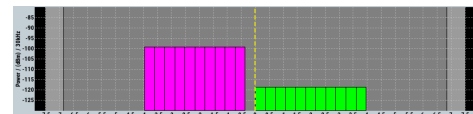

Example: Interfering signal in the adjacent channel

"Test Case" = "7.4.1 Adjacent channel selectivity"

"Channel Bandwidth (WS)" = 10 MHz

"Channel Bandwidth (IS)" = 5 MHz

The parameter "Frequency Allocation" determines the position of the wanted signal compared to the interfering signal. Allocation in the lower or higher frequencies is possible, i.e. the position of the allocated bandwidth of the wanted and the interfering signal can be mirrored.

"Frequency Allocation of the Interfering signal"
= At higher frequencies

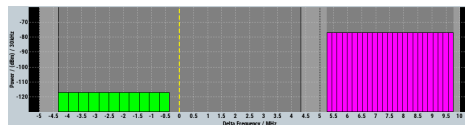

"Frequency Allocation of the Interfering signal"
= At lower frequencies

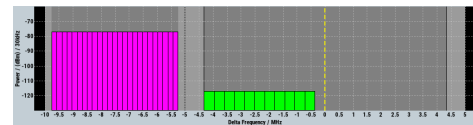

Remote command:

`[:SOURce<hw>] :BB:NR5G:TCW:FA:FRAllocation` on page 752

8.6.7 Interfering signal settings

Almost all receiver tests require an interfering signal (IS).

Test Case	Instrument	Wanted Signal	Frequency Allocation	Interfering Signal	
RF Frequency			1.957 507 500 GHz	Channel Bandwidth	5 MHz
Sub Carrier Spacing			15 kHz NCP	Cell ID	0
UE ID			0	Number of Resource Blocks	1
RB Offset			0	Power Level	-49.0 dBm
Frequency Shift m			0	Interfering RB Center Frequency	1.955 355 000 GHz

Figure 8-6: Interfering signal for in-band narrowband blocking (7.4.2B)

Band.....	355
n.....	355
Duplexing.....	355
Test Model.....	355
RF Frequency.....	356
Channel Bandwidth.....	356
Power Level.....	357

Band

Set the frequency band (n1 to n86) for the interfering signal.

Remote command:

[:SOURce<hw>] :BB:NR5G:TCW:IS:BAND on page 753

n

Set the offset factor for the interfering signal.

Remote command:

[:SOURce<hw>] :BB:NR5G:TCW:IS:OFN on page 753

Duplexing

The duplexing mechanism used for the interfering signal can be switched between FDD and TDD.

TDD Time division duplex is used. In TDD mode, both uplink and downlink use the same spectrum frequencies but at different times.

FDD Frequency division duplex is used. In FDD mode, both uplink and downlink can transmit at the same time at different spectrum frequencies.

Remote command:

[:SOURce<hw>] :BB:NR5G:TCW:IS:DUPLex on page 753

Test Model

Shows the test model set for the test case. The NR-TMs for FR1 are defined in TS 38.141-1 section 4.9.2.

Remote command:

[:SOURce<hw>] :BB:NR5G:TCW:IS:TMODe1? on page 754

RF Frequency

Display the center frequency of the interfering signal.

The center frequency is calculated as follows:

- For "Frequency Allocation > Interfering Signal > At Higher Frequencies"
"RF Frequency_{interfering signal}" = "RF Frequency_{wanted signal}" + Delta
- For "Frequency Allocation > Interfering Signal > At Lower Frequencies"
"RF Frequency_{interfering signal}" = "RF Frequency_{wanted signal}" - Delta

Where for both cases Delta is calculated as follows:

$$\text{Delta} = \text{"Channel Bandwidth}_{\text{wanted signal}}"/2 + \text{Offset}_{\text{interfering signal}}$$

Example:

$$\text{"Channel Bandwidth}_{\text{wanted signal}} = 5 \text{ MHz}$$

$$\text{"RF Frequency}_{\text{wanted signal}} = 1\,950 \text{ MHz}$$

$$\text{Offset}_{\text{interfering signal}} = 2.5025 \text{ MHz.}$$

$$\text{Delta} = 5/2 + 2.5025 = 5.0025 \text{ MHz}$$

For "Frequency Allocation > Interfering Signal > At Higher Frequencies": "RF Frequency_{interfering signal}" = 1 950 + 5.0025 = 1 955.0025 MHz

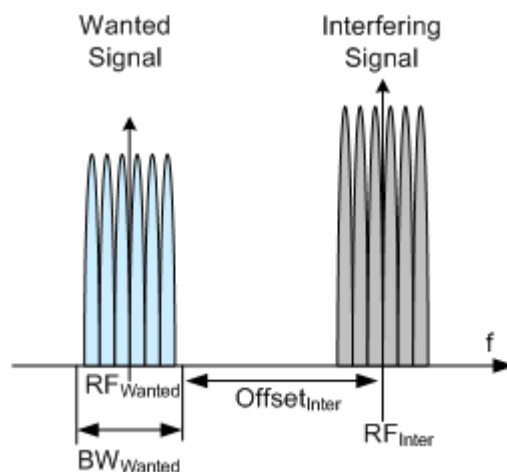

Figure 8-7: Example: adjacent channel selectivity (ACS)

Remote command:

[:SOURce<hw>] :BB:NR5G:TCW:IS:RFFrequency on page 754

[:SOURce<hw>] :BB:NR5G:TCW:IS2:RFFrequency? on page 754

Channel Bandwidth

Displays the channel bandwidth of the interfering signal. The bandwidth of the interfering signal is specified by 3GPP for a particular test case. Refer to [Chapter 8.8, "Conducted receiver characteristics \(TS 38.141-1, chapter 7\)"](#), on page 364.

Remote command:

[:SOURce<hw>] :BB:NR5G:TCW:IS:CHBW? on page 753

Power Level

The power level of the interfering 5G NR signal is set automatically depending on the selected channel bandwidth.

Remote command:

[:SOURce<hw>] :BB:NR5G:TCW:IS:PLEVel? on page 754

[:SOURce<hw>] :BB:NR5G:TCW:IS2:PLEVel? on page 754

8.6.8 Moving UE settings

Access:

1. Select "Baseband Block > 5G NR > General > Test Case Wizard".
2. Select "Moving UE".

The "Moving UE" dialog comprises settings for moving UE's according to the test specifications.

Test Case	Instrument	Antenna	Moving UE	Stationary UE	Feedback	AWGN	Antenna	
RF Frequency				1.950 000 000 GHz		Duplexing		FDD
Channel Bandwidth				10 MHz		Sub Carrier Spacing		30 kHz NCP
Cell ID				0		UE ID		0
Test Requirement				High Speed Train		Propagation Conditions		Scenario Y
Mapping Type				A		FRC		G-FR1-A4-32A
Transmit SRS				<input type="checkbox"/>		Power Level		-78.0 dBm

RF Frequency..... 357

Duplexing..... 358

Channel Bandwidth..... 358

Sub Carrier Spacing..... 358

Cell ID..... 358

UE ID..... 358

Test requirement..... 358

Propagation Conditions..... 358

Mapping Type..... 358

FRC..... 358

Transmit SRS..... 358

Power Level..... 359

RF Frequency

Selects the RF frequency that the signal generator uses for the test.

Remote command:

[:SOURce<hw>] :BB:NR5G:TCW:WS:RFFrequency on page 764

Duplexing

Selects the [duplexing method](#) used for the test.

Remote command:

[:SOURce<hw>] :BB:NR5G:TCW:WS:DUPLex on page 759

Channel Bandwidth

Selects the [channel bandwidth](#) used for the test.

Remote command:

[:SOURce<hw>] :BB:NR5G:TCW:WS:CBW on page 758

Sub Carrier Spacing

Selects the [subcarrier spacing](#) used for the test.

Remote command:

[:SOURce<hw>] :BB:NR5G:TCW:WS:SCSPacing on page 765

Cell ID

Selects the [cell ID](#) used for the test.

Remote command:

[:SOURce<hw>] :BB:NR5G:TCW:WS:CELLid on page 758

UE ID

Selects the [UE ID](#) of the DUT.

Remote command:

[:SOURce<hw>] :BB:NR5G:TCW:WS:UEID on page 767

Test requirement

Selects the [test environment](#).

Remote command:

[:SOURce<hw>] :BB:NR5G:TCW:WS:TREquire on page 768

Propagation Conditions

Selects the [propagation conditions](#) used for the test.

Remote command:

[:SOURce<hw>] :BB:NR5G:TCW:WS:PROCondition on page 764

Mapping Type

Selects the [mapping type](#) used for the test.

Remote command:

[:SOURce<hw>] :BB:NR5G:TCW:WS:MAPType on page 762

FRC

Displays the **"FRC"** on page 161 used for the test.

Remote command:

[:SOURce<hw>] :BB:NR5G:TCW:WS:FRC:TYPE on page 759

Transmit SRS

Turns transmission of the [SRS](#) for the test on and off.

Remote command:

[:SOURce<hw>] :BB:NR5G:TCW:MUE:TSRS on page 755

Power Level

Displays the power level used in the test.

Remote command:

[:SOURce<hw>] :BB:NR5G:TCW:WS:PLEVe1 on page 763

8.6.9 Stationary UE settings

Access:

1. Select "Baseband Block > 5G NR > General > Test Case Wizard".
2. Select "Stationary UE".

The "Stationary UE" dialog comprises settings for moving UE's according to the test specifications.

Test Case	Instrument	Antenna	Moving UE	Stationary UE	Feedback	AWGN
UE ID				0	Transmit SRS <input type="checkbox"/>	
Power Level				-78.0 dBm		

UE ID.....	359
Transmit SRS.....	359
Power Level.....	359

UE ID

Selects the **UE ID** of the DUT.

Remote command:

[:SOURce<hw>] :BB:NR5G:TCW:IS:UEID on page 754

Transmit SRS

Turns transmission of the **SRS** for the test on and off.

Remote command:

[:SOURce<hw>] :BB:NR5G:TCW:SUE:TSRS on page 768

Power Level

Displays the power level used in the test.

Remote command:

[:SOURce<hw>] :BB:NR5G:TCW:IS:PLEVe1? on page 754

8.6.10 AWGN settings

Comprises the settings of the interfering signal (only for test case 7.3 Dynamic Range).

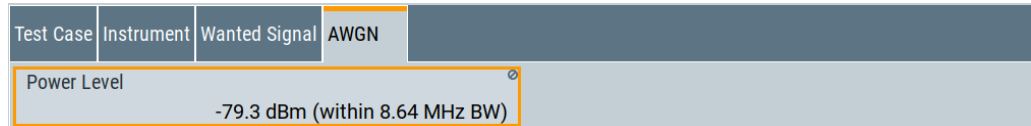

Power Level

Displays the power level of the AWGN signal. The value is set automatically.

Remote command:

`[:SOURce<hw>] :BB:NR5G:TCW:AWGN:PLEVel?` on page 750

8.6.11 Information

Using the test case wizard automatically adjusts the signal and other generator settings for the selected test case in the background. It can be hard to understand which settings the application adjusts and which values it applies for each setting. In the "Info", you can keep track of the settings that have been changed.

1. Select a test case.
2. "Apply" the test case.
3. Select the "Info" tab.
The "Info" tab contains a list of all SCPI commands that have been used to configure the selected test case, including the selected parameters.

```

:SOURce1:BB:NR5G:TRIGger:SEquence AAUT
:SOURce1:BB:NR5G:TRIGger:SOURce EGT1
:SOURce1:INPut:USER3:DIRection INP
:SOURce1:INPut:USER3:SIGNal TRIG1
:SOURce1:BB:NR5G:LINK UP
:SOURce1:BB:NR5G:NODE:CELL0:CELLid 0
:SOURce1:BB:NR5G:NODE:CELL0:TAPos 2
:SOURce1:BB:NR5G:NODE:CELL0:CARDePLY FR1LT3
:SOURce1:BB:NR5G:NODE:REPRece:MODE MAN

```

In addition, you can copy the list of SCPI commands and use them elsewhere.

4. Touch and hold the panel containing the SCPI commands to open the context menu.
5. From the context menu select the text you want to copy. Selected text is highlighted in orange.
6. Touch and hold the panel again to open the context menu.
7. Select "Copy Text To Clipboard" to copy the SCPI commands.

8.7 Conducted transmitter characteristics (TS 38.141-1, chapter 6)

The wizard supports 3GPP tests [TS 38.141-1](#), chapter 6: Conducted transmitter characteristics.

The 3GPP TS 38.141-1 contains several test cases in chapter 6, but only one transmitter test needs a signal generator. Therefore only one test case is listed in this document.

The transmitter requirements are divided into the following main categories, intended to:

- Prove the transmitters ability to transmit the wanted signal:
 - Output power dynamics (6.3)
 - Transmit ON/OFF power (6.4)
- Prove how susceptible the transmitter is to different types of interfering signals:
 - Transmitter signal quality (6.5)
 - Unwanted emissions (6.6)
- Prove the transmitter intermodulation:
 - [Chapter 8.7.3, "Test case 6.7: transmitter intermodulation"](#), on page 363

The tests cover a wide range of scenarios with different impairments on the wanted signal, that occur depending on the frequency offset between the wanted and the interfering signal.

8.7.1 Prior considerations

BS type 1-C

General test conditions for conducted transmitter tests are given in [TS 38.141-1](#). These test conditions include interpretation of measurement results and configurations for testing. Base station configurations are also given in [TS 38.141-1](#).

If some single-band connectors or multi-band connectors have been declared equivalent, only a representative one is necessary to be tested to demonstrate conformance.

BS type 1-H

General test conditions for conducted transmitter tests are given in [TS 38.141-1](#). Test conditions include interpretation of measurement results and configurations for testing. Base stations configurations are also given in [TS 38.141-1](#).

If some single-band connectors or multi-band connectors have been declared equivalent, only a representative one is necessary to be tested to demonstrate conformance.

The manufacturer of the base stations has to declare the minimum number of supported geographical cells (i.e. geographical areas). This number relates to the base station setting with the minimum amount of cell splitting supported with transmission on all TAB connectors supporting the operating band. The manufacturer also declares the

TAB connector Tx min cell groups. Every TAB connector supporting transmission in an operating band map to one TAB connector Tx min cell group supporting the same operating band. The mapping of TAB connectors to cells is implementation-dependent.

Test purpose

The minimum requirement applies per single-band connector, or per multi-band connector supporting transmission in the operating band.

Test requirements

The test purpose is to verify the accuracy of the maximum carrier output power across the frequency range and under normal and extreme conditions.

8.7.2 General workflow for carrying out a transmitter test

The following instruction lists the general steps for performing a BS conformance test with the help of "Test Case Wizard". Specific requirements are described together with the individual test case.



For detailed description about the configuration of the base station, refer to the corresponding description.

1. Connect the instrument and the base station according to the corresponding test case setup.
See also [Chapter 8.4, "Exemplary test setups"](#), on page 336.
2. Set the base station to the basic state:
 - a) Initialize the base station.
 - b) Set the frequency.
 - c) Set the base station to transmit the downlink signal (for most transmitter test cases).
 - d) Adjust ATT attenuator so that level of the interfering signal is as defined in clause 6.7.5 of 3GPP [TS 38.141-1](#).
3. Preset the signal generator to ensure a defined instrument state.
4. Configure the test case wizard.
 - a) Select "Baseband Block > 5G NR > General > Test Case Wizard".
 - b) Select a test case, e.g. [TS 38.141-1: "6.7 Transmitter Intermodulation"](#).
 - c) Enter additional required parameters, e.g. base station class.
 - d) Enter the test frequency of the wanted signal.
The setting must match with the base station configuration.
 - e) Select "Apply Settings" to activate the settings.
The signal generator is now ready.
5. Switch on RF output.

6. If necessary, make additional settings (e.g. in the "I/Q Mod" or "RF" block) or change test case settings.
See also [Chapter 8.5, "General considerations"](#), on page 338.
7. Start the measurement.
 - a) Send a start trigger impulse from the base station to the signal generator.
The signal generator starts signal generation.
8. Calculate the results.

8.7.3 Test case 6.7: transmitter intermodulation

Test purpose

From 3GPP 38.141-1: The test purpose is to verify the ability of the transmitter units associated with the single-band connectors or multi-band connector under test to restrict the generation of intermodulation products in its nonlinear elements. The nonlinear elements are caused by presence of the wanted signal and an interfering signal reaching the transmitter via the antenna to below specified levels.

For a detailed description on how to conduct this test case, see 3GPP 38.141-1, chapter 6.7.

Test setup

See also [Chapter 8.4, "Exemplary test setups"](#), on page 336.

Short description

From 3GPP 38.141-1: The transmitter intermodulation requirement reflects the capability of the transmitter unit to inhibit the generation of signals in its non-linear elements caused by presence of the wanted signal and an interfering signal reaching the transmitter unit. The requirement applies during the transmitter ON period and the transmitter transient period.

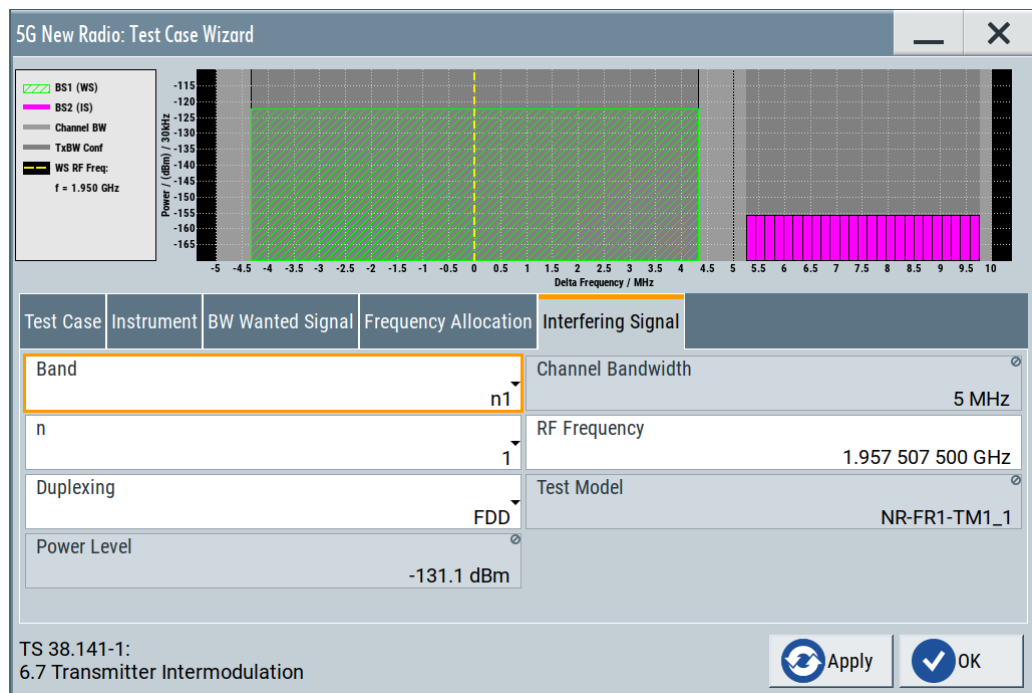

For a description of available settings, refer to:

- [Chapter 8.6.2, "Test case settings"](#), on page 343
- [Chapter 8.6.4, "Instrument settings"](#), on page 346
- [Chapter 8.6.5, "Wanted signal settings"](#), on page 348
- [Chapter 8.6.6, "Frequency allocation settings"](#), on page 353
- [Chapter 8.6.7, "Interfering signal settings"](#), on page 354

8.8 Conducted receiver characteristics (TS 38.141-1, chapter 7)

The wizard supports 3GPP tests TS 38.141-1, chapter 7: Conducted receiver characteristics.

Most of the receiver tests can be performed with the signal generator only, i.e. without additional measurement equipment.

The receiver requirements are divided into the following main categories, intended to:

- Prove the receiver's ability to receive the wanted signal:
 - [Chapter 8.8.3, "Test case 7.2: reference sensitivity level"](#), on page 367
 - [Chapter 8.8.4, "Test case 7.3: dynamic range"](#), on page 368

8.8.1 Prior considerations

Fixed reference channels (FRC)

The receiver tests use fixed reference channels (FRC) as defined in [TS 38.141-1](#), annex A "Reference measurement channels".

The following FRCs are defined for the receiver tests.

Table 8-5: Supported FRC

FRC	Description
G-FR1-A1-1 to G-FR1-A1-9	FRC for FR1 reference sensitivity level, ACS, in-band blocking, out-of-band blocking, receiver intermodulation and in-channel selectivity (QPSK, R=1/3)
G-FR1-A2-1 to G-FR1-A2-6	FRC for FR1 dynamic range (16QAM, R=2/3)

Channels

According to the [TS 38.141-1](#), the channels to test are located in the bottom (B), middle (M) and the top (T) of the supported frequency range of the base station. See [Chapter 8.5, "General considerations"](#), on page 338 for an overview of the supported frequency operating bands.

Channel bandwidth of the 5G NR interfering signal

For all test cases using an interfering 5G NR signal, the bandwidth of the interfering signal must be the same as the wanted signal.

Reference sensitivity power level P_{REFSENS}

The reference sensitivity power level P_{REFSENS} is the minimum mean power received at the BS connector.

P_{REFSENS} depends on the channel bandwidth and subcarrier spacing. Minimum requirements are specified in [TS 38.104](#), tables 7.2.2-x (see [Table 8-6](#)).

Table 8-6: Reference sensitivity levels

Channel bandwidth in MHz	Subcarrier spacing in kHz	FRC	Reference sensitivity power level, P_{REFSENS} in dBm
5, 10, 15	15	G-FR1-A1-2	-101.7
10, 15	30	G-FR1-A1-3	-101.8
10, 15	60	G-FR1-A1-4	-98.9
20, 25, 30, 40, 50	15	G-FR1-A1-5	-95.3
20, 25, 30, 40, 50, 60, 70, 80, 90, 100	30	G-FR1-A1-6	-95.6
20, 25, 30, 40, 50, 60, 70, 80, 90, 100	60	G-FR1-A1-2	-95.7

Filter settings

The 3GPP 5G NR specifications do not define a standardized transmit filter for the UE or for the base station. Therefore, when a test case for the UL direction is activated, a filter type 5G NR with "Per BWP" is automatically selected

8.8.2 General workflow for carrying out a receiver test

The following instruction lists the general steps for performing a BS conformance test with the help of "Test Case Wizard". Specific requirements are described together with the individual test case.



For detailed description about the configuration of the base station, refer to the corresponding description.

1. Connect the instrument and the DUT according to the corresponding test case setup.
See also [Chapter 8.4, "Exemplary test setups"](#), on page 336.
2. Set the base station to the basic state:
 - a) Initialize the base station.
 - b) Set the frequency.
 - c) Set the base station to receive the fixed reference channel (for most receiver test cases).
3. Preset the signal generator to ensure a defined instrument state.
4. Configure the test case wizard.
 - a) Select "Baseband Block > 5G NR > General > Test Case Wizard".
 - b) Select a test case, e.g. [TS 38.141-1: "7.3 Dynamic Range"](#).
 - c) Enter additional required parameters, e.g. base station class.
 - d) Enter the test frequency of the wanted signal, e.g. M.
The setting must match with the base station configuration.
 - e) Select "Apply Settings" to activate the settings.
The signal generator is now ready to start signal generation.
5. Switch on RF output.
6. If necessary, make additional settings (e.g. in the "I/Q Mod" or "RF" block) or change test case settings.
See also [Chapter 8.5, "General considerations"](#), on page 338.
7. Start the measurement.
 - a) Send a start trigger impulse from the base station to the signal generator.
The signal generator starts signal generation.
8. Calculate the results.

The base station internally calculates the BER, BLER, or the probability of detection of preamble (Pd), depending on the test case. This value is compared to the required value.

8.8.3 Test case 7.2: reference sensitivity level

Test purpose

From 3GPP 38.141-1: To verify that for the BS type 1-C receiver and each BS type 1-H TAB connector at the reference sensitivity level the throughput requirement shall be met for a specified reference measurement channel.

For a detailed description on how to conduct this test case, see 3GPP 38.141-1, chapter 7.2.

Test setup

See [Chapter 8.4, "Exemplary test setups"](#), on page 336.

Short description

From 3GPP 38.141-1: The reference sensitivity power level P_{REFSENS} is the minimum mean power received at the antenna connector for BS type 1-C or TAB connector for BS type 1-H at which a throughput requirement shall be met for a specified reference measurement channel.

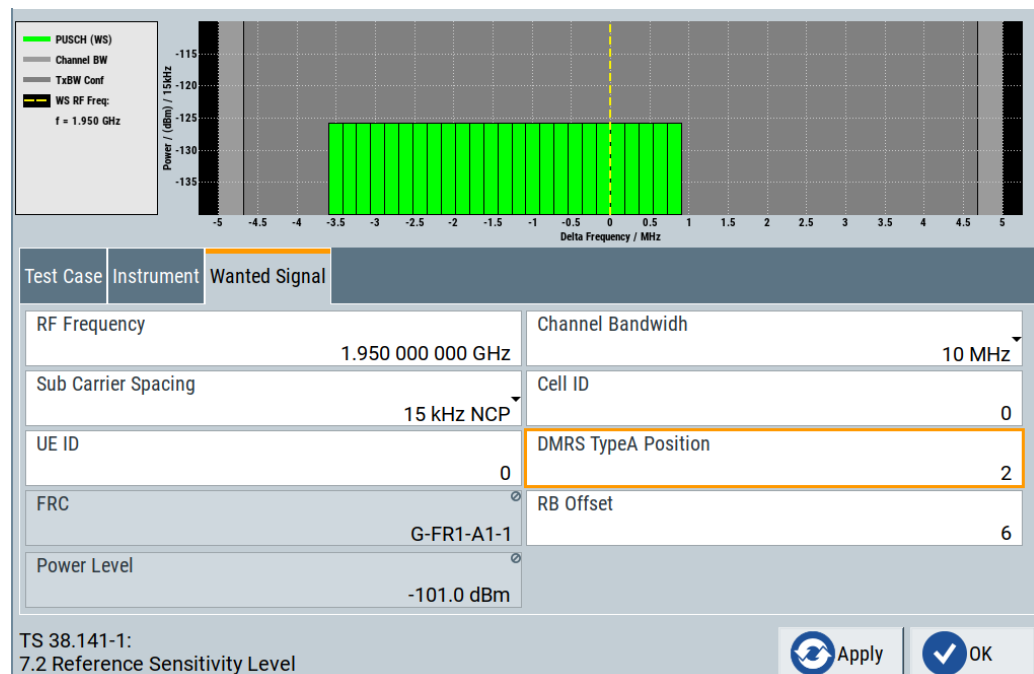

For a description of available settings, refer to:

- [Chapter 8.6.2, "Test case settings"](#), on page 343

- [Chapter 8.6.4, "Instrument settings"](#), on page 346
- [Chapter 8.6.5, "Wanted signal settings"](#), on page 348

8.8.4 Test case 7.3: dynamic range

From 3GPP 38.141-1: To verify that the BS type 1-C receiver and each BS type 1-H TAB connector receiver dynamic range, the relative throughput shall fulfil the specified limit.

For a detailed description on how to conduct this test case, see 3GPP 38.141-1, chapter 7.3.

Test setup

See [Chapter 8.4, "Exemplary test setups"](#), on page 336.

Short description

From 3GPP 38.141-1: The dynamic range is specified as a measure of the capability of the receiver to receive a wanted signal in the presence of an interfering signal at the antenna connector for BS type 1-C or TAB connector for BS type 1-H inside the received BS channel bandwidth. In this condition, a throughput requirement shall be met for a specified reference measurement channel. The interfering signal for the dynamic range requirement is an AWGN signal.

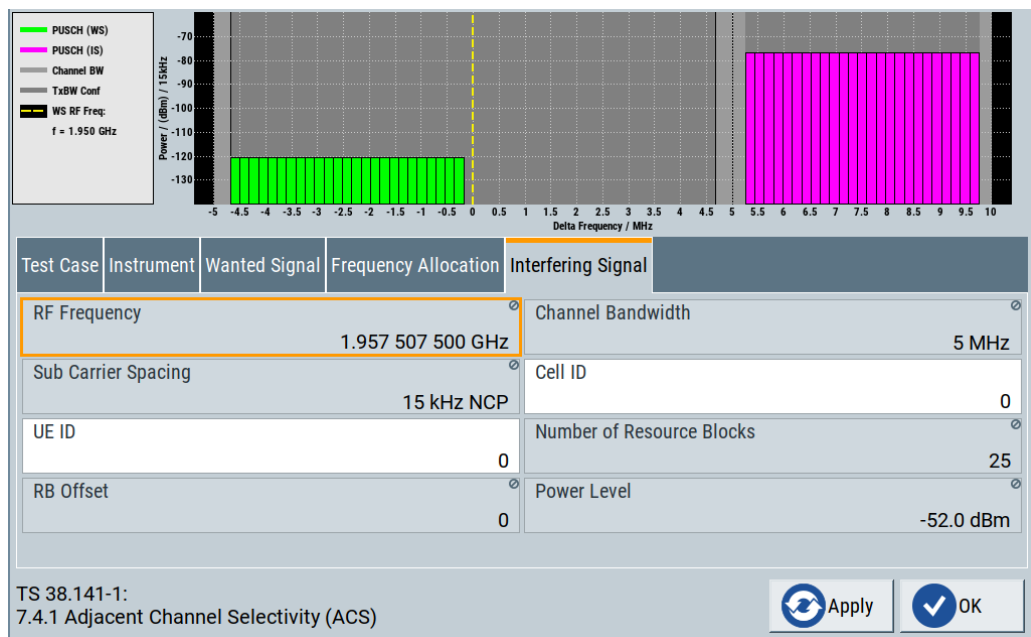

For a description of available settings, refer to:

- [Chapter 8.6.2, "Test case settings"](#), on page 343
- [Chapter 8.6.4, "Instrument settings"](#), on page 346
- [Chapter 8.6.5, "Wanted signal settings"](#), on page 348

- [Chapter 8.6.10, "AWGN settings"](#), on page 360

8.9 Radiated transmitter characteristics (TS 38.141-2, chapter 6)

The wizard supports 3GPP tests [TS 38.141-2](#), chapter 6: Radiated transmitter characteristics.

The 3GPP [TS 38.141-2](#) contains several test cases in chapter 6, but only one transmitter test requires a signal generator. Therefore only one test case is listed in this document.

The radiated transmitter requirements are divided into the following main categories, intended to:

- Prove the transmitters ability to transmit the wanted signal:
 - Test case 6.4: OTA output power dynamics
 - Test case 6.5: OTA transmit ON/OFF power
- Prove how susceptible the transmitter is to different types of interfering signals:
 - Test case 6.6: OTA transmitted signal quality
 - Test case 6.7: OTA unwanted emissions
- Prove the transmitter intermodulation:
 - [Test case 6.8: OTA transmitter intermodulation](#)

The tests cover a wide range of scenarios with different impairments on the wanted signal, that occur depending on the frequency offset between the wanted and the interfering signal.

8.9.1 Prior considerations

General test conditions for radiated transmitter tests are given in [TS 38.141-2](#). Test conditions include interpretation of measurement results and configurations for testing. Base stations configurations are also given in [TS 38.141-2](#).

Radiated transmitter characteristics requirements apply on the BS type 1-H, BS type 1-O or BS type 2-O including all its functional components active and for all foreseen modes of operation of the BS unless otherwise stated.

8.9.2 General workflow for carrying out a radiated transmitter test

The following instruction lists the general steps for performing a transmitter conformance test with the help of "Test Case Wizard". Specific requirements are described together with the individual test case.



For detailed description about the configuration of the OTA chamber, refer to its user manual.

1. Select an antenna test system (OTA chamber) that covers the radiated transmitter requirements for the test that you want to perform.

Note: Several antennas can be required to cover both the NR BS and the whole emission frequency range.

2. Connect the instrument to the selected antenna ports in the OTA chamber as specified for the corresponding test case setup.
See also [Chapter 8.4, "Exemplary test setups"](#), on page 336.
3. Set the OTA chamber to the basic state:
 - a) Initialize the OTA chamber.
 - b) Set the frequency.
 - c) Set the base station to transmit the downlink signal (for most transmitter test cases).
4. Preset the signal generator to ensure a defined instrument state.
5. Configure the test case wizard.
 - a) Select "Baseband Block > 5G NR > General > Test Case Wizard".
 - b) Select a test case, e.g. [TS 38.141-2: "6.8 OTA Transmitter Intermodulation"](#).
 - c) Enter additional required parameters, e.g. base station class.
 - d) Enter the test frequency of the wanted signal.
The setting must match with the base station configuration.
 - e) Select "Apply Settings" to activate the settings.
The signal generator is now ready.
6. Switch on RF output.
7. If necessary, make additional settings (e.g. in the "I/Q Mod" or "RF" block) or change test case settings.
See also [Chapter 8.5, "General considerations"](#), on page 338.
8. Start the measurement.
 - a) Send a start trigger impulse from the base station to the signal generator.
The signal generator starts signal generation.
9. Calculate the results.

8.9.3 Test case 6.8: OTA transmitter intermodulation

Test purpose

From 3GPP 38.141-2: The test purpose is to verify the ability of the transmitter units associated with the RIB under test to restrict the generation of intermodulation products in its nonlinear elements caused by presence of the wanted signal and an interfer-

ing signal reaching the transmitter unit via the RDN and antenna array from a co-located base station to below specified levels.

For a detailed description on how to conduct this test case, see 3GPP 38.141-2, chapter 6.8.

Test setup

See [Chapter 8.4.2, "Exemplary test setups for radiated \(OTA\) tests \(TS 38.141-2\)"](#), on page 337.

Short description

From 3GPP 38.141-2: The OTA transmitter intermodulation requirement applies during the transmitter ON period and the transmitter transient period. The transmitter intermodulation level is the total radiated power of the intermodulation products when an interfering signal is injected into the collocation test antenna (CLTA).

For BS type 1-O, the transmitter intermodulation requirement is captured by the collocation transmitter intermodulation scenario case, in which the interfering signal is injected into the CLTA.

This requirement is not applicable for BS type 2-O.

Test Case	Instrument	BS Wanted Signal	Frequency Allocation	Interfering Signal	Test Model
Band		n1	1	FDD	NR-FR1-TM1_1
Power Level			-52.0 dBm		
Channel Bandwidth				5 MHz	
RF Frequency				1.957 507 500 GHz	

TS 38.141-2:
6.8 OTA Transmitter Intermodulation

For a description of available settings, refer to:

- [Chapter 8.6.2, "Test case settings"](#), on page 343
- [Chapter 8.6.4, "Instrument settings"](#), on page 346
- [Chapter 8.6.5, "Wanted signal settings"](#), on page 348
- [Chapter 8.6.6, "Frequency allocation settings"](#), on page 353
- [Chapter 8.6.7, "Interfering signal settings"](#), on page 354

8.10 Radiated receiver characteristics (TS 38.141-2, chapter 7)

The wizard supports 3GPP tests TS 38.141-2, chapter 7: Radiated receiver characteristics.

The receiver requirements are divided into the following main categories, intended to:

- Prove the receiver's ability to receive the wanted signal:
 - Test case 7.2: OTA sensitivity
 - Test case 7.3: OTA reference sensitivity level
 - Test case 7.4: OTA dynamic range
- Prove how susceptible the receiver is to different types of interfering signals:
 - Test case 7.6: OTA out-of-band blocking

8.10.1 Prior considerations

Unless otherwise stated, the following arrangements apply for radiated receiver characteristics requirements according to TS 38.141-2:

- Requirements apply during the base station receive period
- Requirements must be met for any transmitter setting
- For FDD operation the requirements must be met with the transmitter units ON
- Throughput requirements defined for the radiated receiver characteristics do not assume HARQ retransmissions
- For ACS, blocking and intermodulation characteristics, the negative offsets of the interfering signal apply relative to the lower base station RF bandwidth edge or subblock edge inside a subblock gap, and the positive offsets of the interfering signal apply relative to the upper base station RF bandwidth edge or subblock edge inside a subblock gap

For FR1 requirements which are to be met over the OTA REFSENS RoAoA absolute requirement values are offset by the following terms:

- $\Delta_{\text{OTAREFSENS}} = 44.1 - 10 \cdot \log_{10}(\text{BeW}_{\theta, \text{REFSENS}} \cdot \text{BeW}_{\phi, \text{REFSENS}})$ (dB), for the reference direction.
- $\Delta_{\text{OTAREFSENS}} = 41.1 - 10 \cdot \log_{10}(\text{BeW}_{\theta, \text{REFSENS}} \cdot \text{BeW}_{\phi, \text{REFSENS}})$ (dB), for all other directions.

For requirements which are to be met over the minSENS RoAoA absolute requirement values are offset by the following term:

- $\Delta_{\text{minSENS}} = P_{\text{REFSENS}} - \text{EIS}_{\text{minSENS}}$

For FR2 requirements which are to be met over the OTA REFSENS RoAoA absolute requirement values are offset by the following terms:

- $\Delta_{\text{FR2_REFSENS}} = -3$ dB (for the reference direction)
- $\Delta_{\text{FR2_REFSENS}} = 0$ dB (for all other directions)

Fixed reference channels (FRC)

The receiver tests use fixed reference channels (FRC) as defined in TS 38.141-2, annex A "Reference measurement channels".

Table 8-7 shows the supported FRCs for receiver tests.

Table 8-7: Supported FRC

FRC	Description
G-FR1-A1-1 to G-FR1-A1-9	FRC for FR1 OTA sensitivity, OTA reference sensitivity level, OTA ACS, OTA in-band blocking, OTA out-of-band blocking, OTA receiver intermodulation and OTA in-channel selectivity (QPSK, R=1/3)
G-FR2-A1-1 to G-FR2-A1-5	FRC for FR2 OTA sensitivity, OTA reference sensitivity level, OTA ACS, OTA in-band blocking, OTA out-of-band blocking, OTA receiver intermodulation and OTA in-channel selectivity (QPSK, R=1/3)
G-FR1-A2-1 to G-FR1-A2-6	FRC for FR1 OTA dynamic range (16QAM, R=2/3)

Channels

According to the TS 38.141-2, the channels to test are located in the bottom (B), middle (M) and the top (T) of the supported frequency range of the base station in a normal test environment. The RF channels to be tested in each requirement are shown in Table 8-8.

Table 8-8: RF channels to test radiated receiver as specified in 38.141-2

Test	RF channel
7.2 OTA sensitivity	M
7.3 OTA reference sensitivity level	B, M, T
7.4 OTA dynamic range	M
7.5.1 OTA adjacent channel selectivity (ACS)	M
7.5.2A OTA in-band general blocking	M
7.5.2B OTA in-band narrowband blocking	M
7.6 OTA out-of-band blocking	M
7.7 OTA receiver spurious emissions ¹⁾	B/T
7.8 OTA receiver intermodulation	M
7.9 OTA in-channel sensitivity	M

¹⁾ No signal generator required

Base station type

The test applicability for each base station type is shown in Table 8-9 as specified in TS 38.141-2.

Table 8-9: Requirement set applicability

Test	Requirement set		
	BS type 1-H	BS type 1-O	BS type 2-O
7.2 OTA sensitivity	✓	✓	x
7.3 OTA reference sensitivity level	x	✓	✓
7.4 OTA dynamic range	x	✓	x
7.5.1 OTA adjacent channel selectivity (ACS)	x	✓	✓
7.5.2A OTA in-band general blocking	x	✓	✓
7.5.2B OTA in-band narrowband blocking	x	✓	✓
7.6 OTA out-of-band blocking	x	✓	✓
7.7 OTA receiver spurious emissions ¹⁾	x	✓	✓
7.8 OTA receiver intermodulation	x	✓	✓
7.9 OTA in-channel sensitivity	x	✓	✓

¹⁾ No signal generator required

✓ Applicable

x Not applicable

Channel bandwidth of the 5G NR interfering signal

For all test cases using an interfering 5G NR signal, the bandwidth of the interfering signal must be the same as the wanted signal.

Equivalent isotropic sensitivity (EIS)

The EIS describes the sensitivity for an isotropic directivity device equivalent to the sensitivity of the DUT exposed to an incoming wave from a defined angle of arrival.

In general, the EIS can be expressed as:

$$\text{EIS}(\theta, \phi) = P_s / G_{x, \text{DUT}}(\theta, \phi)$$

Where:

P_s is the radiated sensitivity of the DUT receiver

$G_{x, \text{DUT}}(\theta, \phi)$ is the relative isotropic gain (in polarization x) of the DUT antenna.

The radiated sensitivity corresponds to the minimum signal power at the radio receiver's input (antenna's output) required to meet the airlink's minimum performance criterion (typically expressed in terms of bit, block or frame error rate).

OTA reference sensitivity (EIS_{REFSENS})

The OTA reference sensitivity power level (EIS_{REFSENS}) is the minimum mean power received at the radiated interface (RIB) at which a reference performance requirement must be met for a specified reference measurement channel. The test purpose is to verify that the BS can meet the minimum throughput requirement for a specified measurement channel at the EIS_{REFSENS} level.

Effective isotropic radiated power (EIRP)

The EIRP denotes the absolute output power in a given direction. If no direction is defined, the direction of maximum radiation intensity is implied. The EIRP is the power an ideal isotropic radiator requires as input power to achieve the same power density in the given direction. EIRP is the power accepted by the antenna (P_{in}) multiplied by the antenna gain (G), or radiated power multiplied by the directivity and can be expressed as:

$$EIRP = P_{in}G$$

$$EIRPdBm = P_{in,dBm} + G_{dBi}$$

Total radiated power (TRP)

The TRP or the radiated power is simply the total power radiated by a base station. It is defined as the radiation intensity at each angle in watts per Steradian $I(\theta, \phi)$ integrated over the whole sphere around the antenna.

The power radiated by the antenna P_{rad} is also called the total radiated power (P_{TRP}). It is defined as the radiant intensity $I(\theta, \phi)$ integrated over the whole sphere around the antenna:

8.10.2 General workflow for carrying out a receiver test

The following instruction lists the general steps for performing a BS radiated conformance test with the help of "Test Case Wizard". Specific requirements are described together with the individual test case.



For detailed description about the configuration of the OTA chamber, refer to the corresponding description.

1. Select an antenna test system (OTA chamber) that covers the radiated transmitter requirements for the test that you want to perform.
Note: Several antennas can be required to cover both the NR BS and the whole emission frequency range.
2. Connect the instrument to the selected antenna ports in the OTA chamber as specified for the corresponding test case setup.
See also [Chapter 8.4, "Exemplary test setups"](#), on page 336.
3. Place the base station at the positioner. Align the coordinate system.

4. Align the base station with the test antenna in the declared direction to be tested.
5. Configure beam peak direction according to the declared reference beam direction pair.
6. Set the BS to transmit beams of the same operational band as the OTA REFSENS RoAoA or OSDD being tested.
7. Configure the test case wizard.
 - a) Select "Baseband Block > 5G NR > General > Test Case Wizard".
 - b) Select a test case, e.g. [TS 38.141-2: "7.4 OTA Dynamic Range"](#).
 - c) Enter additional required parameters, e.g. base station class, OTA declarations, etc.
 - d) Enter the test frequency of the wanted/interfering signal.
The setting must match with the base station configuration.
 - e) Select "Apply Settings" to activate the settings.The signal generator is now ready to start signal generation.
8. Switch on RF output.
9. If necessary, make additional settings (e.g. in the "I/Q Mod" or "RF" block) or change test case settings.
See also [Chapter 8.5, "General considerations"](#), on page 338.
10. Start the measurement for each supported polarization.
 - a) Send a start trigger impulse from the base station to the signal generator.
The signal generator starts signal generation.
11. Calculate the results.
12. Repeat the measurement for all OSDDs declared for the BS and supported polarizations.

8.10.3 Test case 7.2: OTA sensitivity

Test purpose

From 3GPP 38.141-2: To verify that the BS can meet the throughput requirement for a specified measurement channel at the EIS level and the range of angles of arrival declared in the OSDD.

For a detailed description on how to conduct this test case, see 3GPP 38.141-2, chapter 7.2.

Test setup

See [Chapter 8.4.2, "Exemplary test setups for radiated \(OTA\) tests \(TS 38.141-2\)"](#), on page 337.

Short description

From 3GPP 38.141-2: The OTA sensitivity requirement is based upon the declaration of one or more OTA sensitivity direction declarations (OSDD), related to a BS type 1-H and BS type 1-O receiver.

Test Case	OTA Declaration	Instrument	Wanted Signal
RF Frequency	1.950 000 000 GHz	Channel Bandwidth	10 MHz
Sub Carrier Spacing	30 kHz NCP	Cell ID	0
UE ID	0	DMRS TypeA Position	2
FRC	G-FR1-A1-2	RB Offset	0
Power Level			

TS 38.141-2:
7.2 OTA Sensitivity

For a description of available settings, refer to:

- [Chapter 8.6.2, "Test case settings"](#), on page 343
- [Chapter 8.6.3, "OTA declaration"](#), on page 345
- [Chapter 8.6.4, "Instrument settings"](#), on page 346
- [Chapter 8.6.5, "Wanted signal settings"](#), on page 348

8.10.4 Test case 7.3: OTA reference sensitivity level

Test purpose

From 3GPP 38.141-2: To verify that the BS can meet the throughput requirement for a specified measurement channel at the EISREFSENS level and the range of angles of arrival within the OTA REFSSENS RoAoA.

For a detailed description on how to conduct this test case, see 3GPP 38.141-2, chapter 7.3.

Test setup

See [Chapter 8.4.2, "Exemplary test setups for radiated \(OTA\) tests \(TS 38.141-2\)"](#), on page 337.

Short description

From 3GPP 38.141-2: The OTA REFSENS requirement is a directional requirement and is intended to ensure the minimum OTA reference sensitivity level for a declared OTA REFSENS RoAoA. The OTA reference sensitivity power level EISREFSENS is the minimum mean power received at the RIB at which a reference performance requirement shall be met for a specified reference measurement channel.

Test Case	OTA Declaration	Instrument	Wanted Signal
RF Frequency	1.950 000 000 GHz	Channel Bandwidth	10 MHz
Sub Carrier Spacing	30 kHz NCP	Cell ID	0
UE ID	0	DMRS TypeA Position	2
FRC	G-FR1-A1-2	RB Offset	0
Power Level			

TS 38.141-2:
7.3 OTA Reference Sensitivity Level

Apply OK

For a description of available settings, refer to:

- [Chapter 8.6.2, "Test case settings"](#), on page 343
- [Chapter 8.6.3, "OTA declaration"](#), on page 345
- [Chapter 8.6.4, "Instrument settings"](#), on page 346
- [Chapter 8.6.5, "Wanted signal settings"](#), on page 348

8.10.5 Test case 7.4: OTA dynamic range

Test purpose

From 3GPP 38.141-2: To verify that at the BS receiver dynamic range, the relative throughput shall fulfil the specified limit.

For a detailed description on how to conduct this test case, see 3GPP 38.141-2, chapter 7.4.

Test setup

See [Chapter 8.4.2, "Exemplary test setups for radiated \(OTA\) tests \(TS 38.141-2\)"](#), on page 337.

Short description

From 3GPP 38.141-2: The OTA dynamic range is a measure of the capability of the receiver unit to receive a wanted signal in the presence of an interfering signal inside the received BS channel bandwidth.

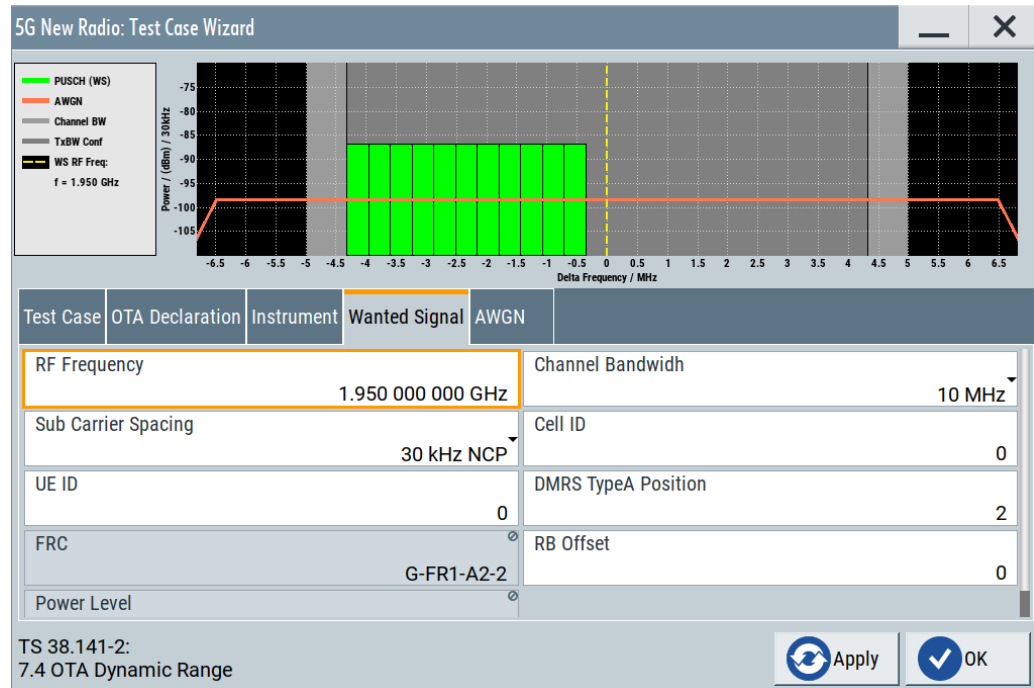

For a description of available settings, refer to:

- [Chapter 8.6.2, "Test case settings"](#), on page 343
- [Chapter 8.6.3, "OTA declaration"](#), on page 345
- [Chapter 8.6.4, "Instrument settings"](#), on page 346
- [Chapter 8.6.5, "Wanted signal settings"](#), on page 348
- [Chapter 8.6.10, "AWGN settings"](#), on page 360

8.10.6 Test case 7.6: OTA out-of-band blocking

Test purpose

From 3GPP 38.141-2: The test stresses the ability of the receiver unit associated with the RIB under test to withstand high-level interference from unwanted signals at specified frequency bands, without undue degradation of its sensitivity.

For a detailed description on how to conduct this test case, see 3GPP 38.141-2, chapter 7.6.

Test setup

See [Chapter 8.4.2, "Exemplary test setups for radiated \(OTA\) tests \(TS 38.141-2\)"](#), on page 337.

For tests with CW with frequency greater than 6 GHz a second signal generator is necessary, like R&S SMF for instance.

Short description

The OTA out-of-band blocking characteristics are a measure of the receiver unit ability to receive a wanted signal at the RIB at its assigned channel in the presence of an unwanted interferer.

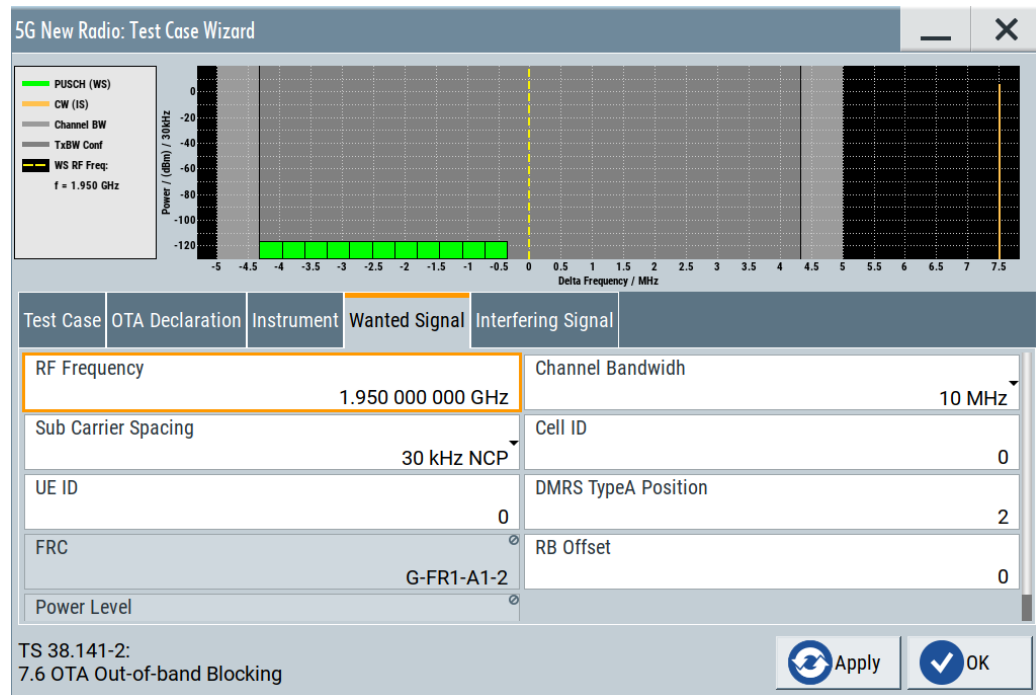

For a description of available settings, refer to:

- [Chapter 8.6.2, "Test case settings"](#), on page 343
- [Chapter 8.6.3, "OTA declaration"](#), on page 345
- [Chapter 8.6.4, "Instrument settings"](#), on page 346
- [Chapter 8.6.5, "Wanted signal settings"](#), on page 348
- [Chapter 8.6.7, "Interfering signal settings"](#), on page 354

9 Generating user plane data

If equipped with the option R&S SMM-K175, your R&S SMM100A can generate and export user plane (U-Plane) data based on the O-RAN specifications.

The O-RAN alliance defines a standardized data format for 3GPP signals. Data is exported into a set of `.json` files. The `.json` contain the raw frequency domain I/Q data, which you can convert into the desired format. This method allows you to use the data for various applications and on different types of measurement equipment based on the O-RAN standard.

For detailed information about the specifications, refer to the documents of the O-RAN alliance.

Access to U-Plane data generation

You can activate U-Plane data generation in the "General Settings" dialog. For details see [Chapter 5.1, "General settings"](#), on page 40.

Note that U-Plane data generation slows down the calculation speed of the instrument. Therefore, turn on U-Plane data generation only if required.

9.1 Required options

The generation of U-Plane data requires:

- Standard or wideband baseband generator (R&S SMM-B10/-B9)
- Baseband main module (R&S SMM-B13) or wideband baseband main module (R&S SMM-B13XT)
- Option 5G New Radio (R&S SMM-K144) (per signal path)
- Option log files generation (R&S SMM-K175)

9.2 File format and folder structure

When exporting the user plane, the R&S SMM100A stores the data in the `\user\u_plane` directory on its harddisk. A U-Plane dataset itself consists of a set of subdirectories.

```
\Output_0
  \Carrier_0
    \Num_0  \15 kHz
    \Num_1  \30 kHz
    \Num_2  \60 kHz NCP
    \Num_3  \60 kHz ECP
    \Num_4  \120 kHz
    \Num_5  \240 kHz
```

```

\Carrier_1
  \Num_0
  \Num_1
  \Num_2
  \Num_3
  \Num_4
  \Num_5
\Carrier_N
\Output_1
...
\Output_N

```

The Num_x folders contain the data files, one file for each subframe. Thus, every folder contains a set of .json files (SF_<xx>.json). The number of files depends on the number of frames and is therefore $10 * \text{no_of_rf_frames}$. The number of values in the file depends on the number of symbols. This number is variable, depending on the numerology. It also depends on the number of FFT samples:

number of I/Q values = number of symbols * FFT samples

- I/Q values within a symbol are separated by a comma
- The end of a symbol is indicated by a new line character (\n)

Example for 15 kHz subcarrier spacing:

```

0+0j,0+0j,0+0j,0+0j,0+0j,0+0j,0+0j,0+0j,0+0j,0+0j,0+0j,0+0j,0+0j,
0+0j,0+0j\n

```

Note that the R&S SMM100A always generates a complete set of data, even for symbols that are not allocated and numerologies that you do not use. Those I/Q data have the value 0 ("0+0j"), while the I/Q data for symbols that are allocated have the actual real and imaginary values (e.g. "-0.707106781+0.707106781j").

10 Remote-control commands

The following commands are required to perform signal generation with the option R&S SMM-K144 in a remote environment. We assume that the R&S SMM100A has already been set up for remote operation in a network as described in the R&S SMM100A documentation. A knowledge about the remote control operation and the SCPI command syntax is assumed.



Conventions used in SCPI command descriptions

For a description of the conventions used in the remote command descriptions, see section "Remote Control Commands" in the R&S SMM100A user manual.

Common suffixes

The following common suffixes are used in the remote commands:

Suffix	Value range	Description
SOURce<hw>	1	Available baseband signals
OUTPut<ch>	1 to 3	Available markers
CELL<cc>	0 to 15	Selects the carrier.
SSPBch<ssb>	0 to 3	Selects the SS/PBCH pattern.
SUBF<sf>	0 to 255	Selects the subframe.
USER<us>	0 to 200	Selects the user.
ALLoc<al>	0 to 64	Selects the allocation of a user.
BWPart<bwp>	0 to 4	Selects the bandwidth part.
DCI<dci>	0 to 32	Selects the DCI.
CW<s2us0>	0 to 1	Selects the codeword.
SET<gr0>	0 to 15	SRS resource sets
RES<user0>	0 to 63	SRS resources within a resource set
RES<gr0>	0 to 8	Sidelink resource pool in a bandwidth part
RSET<st0>	0 to 7	PRS resource sets
RES<dir0>	0 to 63	PRS resources within a resource set
TD<gr>	0 to 64	PDSCH time domain allocations

The following commands specific to the R&S SMM100A-K144 option are described here:

- [Programming examples](#)..... 384
- [General commands](#)..... 414
- [FRC wizard commands](#)..... 421
- [Quick settings command](#)..... 426

• Carrier commands.....	434
• Copy carrier commands.....	440
• System information commands.....	442
• TxBW commands.....	446
• LTE-CRS coexistence commands.....	448
• SS/PBCH commands.....	450
• S-SS/PSBCH configuration commands.....	462
• PRS commands.....	464
• Dummy resource elements commands.....	470
• OCGN commands.....	473
• DL and UL user properties commands.....	476
• SL user properties commands.....	492
• DL/UL BWP commands.....	494
• SL BWP commands.....	501
• BWP configuration commands.....	503
• Scheduling commands.....	593
• PDSCH and PUSCH scheduling commands.....	608
• CORESET scheduling commands.....	639
• CSI-RS scheduling commands.....	691
• RIM-RS scheduling commands.....	694
• PUCCH scheduling commands.....	695
• PRACH scheduling commands.....	701
• SRS scheduling commands.....	704
• PSSCH / PSCCH scheduling commands.....	710
• PSFCH scheduling commands.....	723
• Output commands.....	725
• Trigger commands.....	735
• Marker commands.....	740
• Clock commands.....	747
• Test case wizard remote-control commands.....	748

10.1 Programming examples

This description provides simple programming examples. The purpose of the examples is to present **all** commands for a given task. In real applications, one would rather reduce the examples to an appropriate subset of commands.

The programming examples have been tested with a software tool which provides an environment for the development and execution of remote tests. To keep the example as simple as possible, only the "clean" SCPI syntax elements are reported. Non-executable command lines (e.g. comments) start with two // characters.

At the beginning of the most remote control program, an instrument (p) reset is recommended to set the instrument to a definite state. The commands `*RST` and `SYSTem:PRESet` are equivalent for this purpose. `*CLS` also resets the status registers and clears the output buffer.

Example: Storing current configuration

```

SOURCE1:BB:NR5G:SETTING:STORE "/var/user/my_nr"
*RST
SOURCE1:BB:NR5G:SETTING:CATALOG?
// my_nr, 5gnr
SOURCE1:BB:NR5G:SETTING:LOAD "/var/user/5gnr"
SOURCE1:BB:NR5G:STATE 1
SOURCE1:BB:NR5G:NODE:NCARRIER?
// 1
SOURCE1:BB:NR5G:SETTING:DEL "my_nr"

SOURCE1:BB:NR5G:WAVEFORM:CREATE "/var/user/my_nr_wv"

```

Example: Loading predefined test signals

```

SOURCE1:BB:NR5G:LINK DOWN
SOURCE1:BB:NR5G:SETTING:TMODEL:DL:CATALOG?
// NR-FR1-TM1_1__FDD_100MHz_30kHz,
// NR-FR1-TM1_1__FDD_100MHz_60kHz,
// NR-FR1-TM1_1__FDD_10MHz_15kHz,
// ...
SOURCE1:BB:NR5G:SETTING:TMODEL:DL "NR-FR1-TM1_1__FDD_100MHz_30kHz"

SOURCE1:BB:NR5G:STATE 1
SOURCE1:BB:NR5G:PRESET

```

Example: Filtering and loading predefined test signals

```

SOURCE1:BB:NR5G:LINK DOWN
SOURCE1:BB:NR5G:SETTING:TMODEL:FILTER:TMODEL TM1_1
SOURCE1:BB:NR5G:SETTING:TMODEL:FILTER:DUPLExing FDD
SOURCE1:BB:NR5G:SETTING:TMODEL:FILTER:FREQ FR1
SOURCE1:BB:NR5G:SETTING:TMODEL:FILTER:BW F100
SOURCE1:BB:NR5G:SETTING:TMODEL:FILTER:SCS 30
SOURCE1:BB:NR5G:SETTING:TMODEL:FILTER:CATALOG?
// NR-FR1-TM1_1__FDD_100MHz_30kHz
SOURCE1:BB:NR5G:SETTING:TMODEL:DL "NR-FR1-TM1_1__FDD_100MHz_30kHz"

SOURCE1:BB:NR5G:STATE 1
SOURCE1:BB:NR5G:PRESET

```

Example: Using the quick settings

```

SOURCE1:BB:NR5G:QCKSet:GENeral:CARDeplY LT3
SOURCE1:BB:NR5G:QCKSet:GENeral:DUPLexing TDD
SOURCE1:BB:NR5G:QCKSet:GENeral:CBW BW100
SOURCE1:BB:NR5G:QCKSet:GENeral:CHRaster R15
SOURCE1:BB:NR5G:QCKSet:GENeral:CHSPacing 49980000
SOURCE1:BB:NR5G:QCKSet:GENeral:SCSPacing N30
SOURCE1:BB:NR5G:QCKSet:GENeral:ES:MOD QAM16
SOURCE1:BB:NR5G:QCKSet:GENeral:ES:CS:STATe 1
SOURCE1:BB:NR5G:QCKSet:GENeral:ES:CSLength 2
SOURCE1:BB:NR5G:QCKSet:FRMFormat:IAB:STATe 0
SOURCE1:BB:NR5G:QCKSet:FRMFormat:SLINT 10
SOURCE1:BB:NR5G:QCKSet:FRMFormat:NDLSlots 8
SOURCE1:BB:NR5G:QCKSet:FRMFormat:NSSLots?
// 1
SOURCE1:BB:NR5G:QCKSet:FRMFormat:NULSlots?
// 1

//Use special slot format
SOURCE1:BB:NR5G:QCKSet:FRMFormat:SSC:SFI:STATe 1
SOURCE1:BB:NR5G:QCKSet:FRMFormat:SSC:SLFMT 1
SOURCE1:BB:NR5G:QCKSet:FRMFormat:SSC:NDLSymbols?
// 0
SOURCE1:BB:NR5G:QCKSet:FRMFormat:SSC:NGSYmbols?
// 0
SOURCE1:BB:NR5G:QCKSet:FRMFormat:SSC:NULSymbols?
// 14

//Do not use special slot format
SOURCE1:BB:NR5G:QCKSet:FRMFormat:SSC:SFI:STATe 0
SOURCE1:BB:NR5G:QCKSet:FRMFormat:SSC:NDLSymbols 4
SOURCE1:BB:NR5G:QCKSet:FRMFormat:SSC:NGSYmbols?
// 10
SOURCE1:BB:NR5G:QCKSet:FRMFormat:SSC:NULSymbols?
// 0

SOURCE1:BB:NR5G:QCKSet:GENeral:NCARier 1
SOURCE1:BB:NR5G:QCKSet:GENeral:ES:TP:STATe?
// 1
SOURCE1:BB:NR5G:QCKSet:GENeral:ES:RBOffset?
// 0
SOURCE1:BB:NR5G:QCKSet:GENeral:ES:RBNumber 273
SOURCE1:BB:NR5G:QCKSet:GENeral:ES:RBConfig MAN
SOURCE1:BB:NR5G:QCKSet:GENeral:ECPState?
// 0
SOURCE1:BB:NR5G:QCKSet:APPLy

```

Example: Configuring the carrier

```
SOURcel:BB:NR5G:NODE:NCARrier 1
SOURcel:BB:NR5G:NODE:RFPHase:MODE AUTO
SOURcel:BB:NR5G:NODE:CELL0:CINDicator 1
SOURcel:BB:NR5G:NODE:CELL0:CELLid 1
SOURcel:BB:NR5G:NODE:CELL0:CIF 1
SOURcel:BB:NR5G:NODE:CELL0:SCHBy?
// 0
SOURcel:BB:NR5G:NODE:CELL0:CIFPresent?
// 0
SOURcel:BB:NR5G:NODE:CELL0:N1ID?
// 0
SOURcel:BB:NR5G:NODE:CELL0:N2ID?
// 1
SOURcel:BB:NR5G:NODE:CELL0:CARDeply FR1LT3
SOURcel:BB:NR5G:NODE:CELL0:CBW BW50
SOURcel:BB:NR5G:NODE:CELL0:TAPos 2
SOURcel:BB:NR5G:NODE:CELL0:PCFReq 1000000000
SOURcel:BB:NR5G:NODE:CELL0:TAPos 2
SOURcel:BB:NR5G:NODE:CELL0:RPOW?
// 0
SOURcel:BB:NR5G:NODE:CELL0:DFReq 0

// Defining timing and phase characteristics of the carrier
SOURcel:BB:NR5G:NODE:NCARrier 2
SOURcel:BB:NR5G:NODE:CELL0:TMPH:SYFNoffset 2
SOURcel:BB:NR5G:NODE:CELL0:TMPH:SFOFset 3
SOURcel:BB:NR5G:NODE:CELL0:TMPH:PHOffset 30
SOURcel:BB:NR5G:NODE:CELL0:TMPH:CTOffset 983540

//Defining system information
SOURcel:BB:NR5G:NODE:CELL0:SYINFo:HACBook DYN
SOURcel:BB:NR5G:NODE:CELL0:SYINFo:SUL:STATe ON
```

Example: Configuring the TxBWs

```
// enable 15 kHz SCS
SOURCE1:BB:NR5G:NODE:CELL0:TXBW:S15K:USE 1
SOURCE1:BB:NR5G:NODE:CELL0:TXBW:S15K:NRB?
// 270
SOURCE1:BB:NR5G:NODE:CELL0:TXBW:S15K:OFFSet 0
SOURCE1:BB:NR5G:NODE:CELL0:TXBW:S15K:KOMU?
// -1700

// enable 30 kHz SCS
SOURCE1:BB:NR5G:NODE:CELL0:TXBW:S30K:USE 1
SOURCE1:BB:NR5G:NODE:CELL0:TXBW:S30K:NRB?
// 133
SOURCE1:BB:NR5G:NODE:CELL0:TXBW:S30K:OFFSet?
// 0
SOURCE1:BB:NR5G:NODE:CELL0:TXBW:S30K:KOMU?
// -840
SOURCE1:BB:NR5G:NODE:CELL0:TXBW:POINTa?
// -49140000
// both k_0_u values are not allowed values

SOURCE1:BB:NR5G:NODE:CELL0:TXBW:CONFLICT?
// 1
// execute resolve conflicts to obtain valid values
SOURCE1:BB:NR5G:NODE:CELL0:TXBW:RESolve
SOURCE1:BB:NR5G:NODE:CELL0:TXBW:S30K:OFFSet?
// 1
SOURCE1:BB:NR5G:NODE:CELL0:TXBW:S30K:KOMU?
// 0
SOURCE1:BB:NR5G:NODE:CELL0:TXBW:POINTa?
// -24300000
```

Example: System Information

```
SOURCE1:BB:NR5G:NODE:CELL1:TMPH:SYFNoffset 1
SOURCE1:BB:NR5G:NODE:CELL1:SYINfo:HACBook DYN
SOURCE1:BB:NR5G:NODE:CELL1:SYINfo:SUL:STATe 1
```

Example: LTE-CRS Coexistence

```
SOURCE1:BB:NR5G:NODE:CELL0:CBW BW50
SOURCE1:BB:NR5G:NODE:CELL0:TXBW:S15K:USE 1
SOURCE1:BB:NR5G:NODE:CELL0:TXBW:RESolve

SOURCE1:BB:NR5G:NODE:CELL0:LTE:STATe 1
SOURCE1:BB:NR5G:NODE:CELL0:LTE:NPATT 2
//Configure pattern 2
SOURCE1:BB:NR5G:NODE:CELL0:LTE:PATT2:POINTa 100
SOURCE1:BB:NR5G:NODE:CELL0:LTE:PATT2:CBW N25
SOURCE1:BB:NR5G:NODE:CELL0:LTE:PATT2:VShift 2
SOURCE1:BB:NR5G:NODE:CELL0:LTE:PATT2:NAP AP2
```

Example: Configuring the SS/PBCH

```

SOURCE1:BB:NR5G:NODE:CELL0:NSSPBch 1
SOURCE1:BB:NR5G:NODE:CELL0:OFFSet TXBW
SOURCE1:BB:NR5G:NODE:CELL0:SSPBch0:STATe 1

SOURCE1:BB:NR5G:NODE:CELL0:SSPBch0:SCSPacing N15
SOURCE1:BB:NR5G:NODE:CELL0:SSPBch0:RBOffset 125
SOURCE1:BB:NR5G:NODE:CELL0:SSPBch0:SCOffset 0
SOURCE1:BB:NR5G:NODE:CELL0:SSPBch0:DFReq?
// -540000
SOURCE1:BB:NR5G:NODE:CELL0:SSPBch0:CASE A
SOURCE1:BB:NR5G:NODE:CELL0:SSPBch0:L L4
SOURCE1:BB:NR5G:NODE:CELL0:SSPBch0:POSITION:PATtern #HF,4
SOURCE1:BB:NR5G:NODE:CELL0:SSPBch0:BSPeriodicty BS10
SOURCE1:BB:NR5G:NODE:CELL0:SSPBch0:HFRMidx 1
SOURCE1:BB:NR5G:NODE:CELL0:SSPBch0:PSSPow 0
SOURCE1:BB:NR5G:NODE:CELL0:SSPBch0:SSSPow 0

// PBCH configuration
SOURCE1:BB:NR5G:NODE:CELL0:SSPBch0:POWer 0
SOURCE1:BB:NR5G:NODE:CELL0:SSPBch0:MIB:STATe 1
SOURCE1:BB:NR5G:NODE:CELL0:SSPBch0:CCODing:STATe 1
SOURCE1:BB:NR5G:NODE:CELL0:SSPBch0:CCODing:DATA PN9

SOURCE1:BB:NR5G:NODE:CELL0:SSPBch0:MIB:STATe 0
SOURCE1:BB:NR5G:NODE:CELL0:SSPBch0:MIB:SCSC N15_60
SOURCE1:BB:NR5G:NODE:CELL0:SSPBch0:MIB:ASOF:STATe 1
SOURCE1:BB:NR5G:NODE:CELL0:SSPBch0:MIB:SCOffset?
// 0
SOURCE1:BB:NR5G:NODE:CELL0:SSPBch0:MIB:SFOffset 0
SOURCE1:BB:NR5G:NODE:CELL0:SSPBch0:MIB:CSZero 1
SOURCE1:BB:NR5G:NODE:CELL0:SSPBch0:MIB:SSZero 1
SOURCE1:BB:NR5G:NODE:CELL0:SSPBch0:MIB:CBARred NBAR
SOURCE1:BB:NR5G:NODE:CELL0:SSPBch0:MIB:IFRResel ALWD
SOURCE1:BB:NR5G:NODE:CELL0:SSPBch0:MIB:SPARe:STATe 1
SOURCE1:BB:NR5G:NODE:CELL0:TAPos?
// 2
SOURCE1:BB:NR5G:NODE:CELL0:SSPBch0:MIB:SCOffset?
// 0

// AP configuration
SOURCE1:BB:NR5G:NODE:CELL0:SSPBch0:POSITION:APMap0:COL0:ROW0:REAL 1
SOURCE1:BB:NR5G:NODE:CELL0:SSPBch0:POSITION:APMap0:COL0:ROW0:IMAGinary 0.7
// SOURCE1:BB:NR5G:NODE:CELL0:SSPBch0:POSITION:APMap0:COL0:ROW0:MAGNitude 0.7
// SOURCE1:BB:NR5G:NODE:CELL0:SSPBch0:POSITION:APMap0:COL0:ROW0:PHASe 270

// Setting full SFN counting
SOURCE1:BB:NR5G:SCHeduling:SFN:STATe 1

```

Example: Configuring PRS resources

```

SOURCE1:BB:NR5G:NODE:CELL0:PRS:STATe 1
SOURCE1:BB:NR5G:NODE:CELL0:PRS:SCSPacing N30
SOURCE1:BB:NR5G:NODE:CELL0:PRS:NRSetS 1
SOURCE1:BB:NR5G:NODE:CELL0:PRS:RSET0:PER SL4
SOURCE1:BB:NR5G:NODE:CELL0:PRS:RSET0:SLOffset 0
SOURCE1:BB:NR5G:NODE:CELL0:PRS:RSET0:REPFactor REP1
SOURCE1:BB:NR5G:NODE:CELL0:PRS:RSET0:RBNumber 132
SOURCE1:BB:NR5G:NODE:CELL0:PRS:RSET0:CMBSize C2
SOURCE1:BB:NR5G:NODE:CELL0:PRS:RSET0:NRESources 1
SOURCE1:BB:NR5G:NODE:CELL0:PRS:RSET0:RES0:REOffset 0
SOURCE1:BB:NR5G:NODE:CELL0:PRS:RSET0:RES0:SLOffset 0
SOURCE1:BB:NR5G:NODE:CELL0:PRS:RSET0:RES0:NSYMBOL S4
SOURCE1:BB:NR5G:NODE:CELL0:PRS:RSET0:RES0:SYOffset 0
SOURCE1:BB:NR5G:NODE:CELL0:PRS:RSET0:RES0:SQID 0
SOURCE1:BB:NR5G:NODE:CELL0:PRS:RSET0:RES0:POWER -10
SOURCE1:BB:NR5G:NODE:CELL0:PRS:RSET0:RES0:APMap:COL0:ROW0:REAL 1
SOURCE1:BB:NR5G:NODE:CELL0:PRS:RSET0:RES0:APMap:COL0:ROW0:IMAGinary 0

```

Example: Filling in the frame with dummy REs

```

SOURCE1:BB:NR5G:NODE:CELL0:DUMRes:STATe 1
SOURCE1:BB:NR5G:NODE:CELL0:DUMRes:POWER 0
SOURCE1:BB:NR5G:NODE:CELL0:DUMRes:MODulation QPSK
SOURCE1:BB:NR5G:NODE:CELL0:DUMRes:SCSPacing N15

// load a data list from the default directory; the file must exist
SOURCE1:BB:NR5G:NODE:CELL0:DUMRes:DATA DLIS
SOURCE1:BB:NR5G:NODE:CELL0:DUMRes:DSElect "/var/user/dummyRE"

//Configure OCNG for cartesian coordinates
SOURCE1:BB:NR5G:NODE:CELL0:DUMRes:PREC:STATe ON
SOURCE1:BB:NR5G:NODE:CELL0:DUMRes:NAPS 2
SOURCE1:BB:NR5G:NODE:CELL0:DUMRes:APMap:COL0:ROW0:REAL 1
SOURCE1:BB:NR5G:NODE:CELL0:DUMRes:APMap:COL0:ROW0:IMAG 1
SOURCE1:BB:NR5G:NODE:CELL0:DUMRes:APMap:COL1:ROW0:REAL 0
SOURCE1:BB:NR5G:NODE:CELL0:DUMRes:APMap:COL0:ROW0:IMAG 0

//Configure OCNG for cylindrical coordinates
SOURCE1:BB:NR5G:NODE:CELL0:DUMRes:PREC:STATe ON
SOURCE1:BB:NR5G:NODE:CELL0:DUMRes:NAPS 2
SOURCE1:BB:NR5G:NODE:CELL0:DUMRes:APMap:COL0:ROW0:MAGNitude 1
SOURCE1:BB:NR5G:NODE:CELL0:DUMRes:APMap:COL0:ROW0:PHASe 0
SOURCE1:BB:NR5G:NODE:CELL0:DUMRes:APMap:COL1:ROW0:MAGNitude 0
SOURCE1:BB:NR5G:NODE:CELL0:DUMRes:APMap:COL0:ROW0:PHASe 0

```

Example: Configuring the users and the BWPs

```

// enable 2 users
SOURCE1:BB:NR5G:UBWP:NUSeR 2
SOURCE1:BB:NR5G:UBWP:REStArT COAL
SOURCE1:BB:NR5G:UBWP:USER0:UEID 10
SOURCE1:BB:NR5G:UBWP:USER0:RNTI:CS 1
SOURCE1:BB:NR5G:UBWP:USER0:RNTI:MCSC 1
SOURCE1:BB:NR5G:UBWP:USER0:RNTI:SPCSI 1
SOURCE1:BB:NR5G:UBWP:USER0:RNTI:RA 1
SOURCE1:BB:NR5G:UBWP:USER0:RNTI:SFI 1
SOURCE1:BB:NR5G:UBWP:USER0:NUMSfi 1
SOURCE1:BB:NR5G:UBWP:USER0:RNTI:TC 1
SOURCE1:BB:NR5G:UBWP:USER0:DSCH:CCODing:STATe 0
SOURCE1:BB:NR5G:UBWP:USER0:DSCH:DATA PN9
SOURCE1:BB:NR5G:UBWP:USER0:DSCH:INITpatterN 10
// SOURCE1:BB:NR5G:UBWP:USER0:DSCH:DATA PATT
// SOURCE1:BB:NR5G:UBWP:USER0:DSCH:PATTern #H1E15,14
SOURCE1:BB:NR5G:UBWP:USER1:UEID 20
SOURCE1:BB:NR5G:UBWP:USER1:DSCH:DATA DLIS
SOURCE1:BB:NR5G:UBWP:USER1:DSCH:DLISt "/var/user/user"
SOURCE1:BB:NR5G:UBWP:USER0:CELL0:DL:BWP0:SRS:GTYPe A
SOURCE1:BB:NR5G:UBWP:USER0:CELL0:DL:BWP0:SRS:BD23 4

// configure the BWPs per user
SOURCE1:BB:NR5G:UBWP:USER0:CELL0:DL:NBWParts 1
SOURCE1:BB:NR5G:UBWP:USER0:CELL0:DL:BWP0:INDicator 1
SOURCE1:BB:NR5G:UBWP:USER0:CELL0:DL:BWP0:SCSPacing N30
SOURCE1:BB:NR5G:UBWP:USER0:CELL0:DL:BWP0:RBNumber 100
SOURCE1:BB:NR5G:UBWP:USER0:CELL0:DL:BWP0:RBOffset 10
SOURCE1:BB:NR5G:UBWP:USER0:CELL0:DL:BWP0:PRBOffset?
// 10
SOURCE1:BB:NR5G:UBWP:USER0:CELL0:DL:BWP0:DFReq?
// -2340000
SOURCE1:BB:NR5G:UBWP:USER0:CELL0:UL:NBWParts 1
SOURCE1:BB:NR5G:UBWP:USER0:CELL0:UL:BWP0:INDicator 0
SOURCE1:BB:NR5G:UBWP:USER0:CELL0:UL:BWP0:SCSPacing N30
SOURCE1:BB:NR5G:UBWP:USER0:CELL0:UL:BWP0:RBNumber 11
SOURCE1:BB:NR5G:UBWP:USER0:CELL0:UL:BWP0:RBOffset 11
SOURCE1:BB:NR5G:UBWP:USER0:CELL0:UL:BWP0:DFReq?
// -18000000

SOURCE1:BB:NR5G:UBWP:USER1:CELL0:DL:NBWParts 2
SOURCE1:BB:NR5G:UBWP:USER1:CELL0:DL:BWP0:INDicator 1
SOURCE1:BB:NR5G:UBWP:USER1:CELL0:DL:BWP0:RBNumber 110
SOURCE1:BB:NR5G:UBWP:USER1:CELL0:DL:BWP0:RBOffset 20
SOURCE1:BB:NR5G:UBWP:USER1:CELL0:DL:BWP0:DFReq?
// 3060000
SOURCE1:BB:NR5G:UBWP:USER1:CELL0:DL:BWP1:INDicator 2
SOURCE1:BB:NR5G:UBWP:USER1:CELL0:DL:BWP1:RBNumber 120
SOURCE1:BB:NR5G:UBWP:USER1:CELL0:DL:BWP1:RBOffset 10

```

```
SOURce1:BB:NR5G:UBWP:USER1:CELL0:DL:BWP1:DFReq?
// 1260000
```

Example: Fixed reference channels

```
SOURce1:BB:NR5G:LINK UP
SOURce1:BB:NR5G:UBWP:USER0:USCH:CCODing:STATe 1
SOURce1:BB:NR5G:UBWP:USER0:CELL0:UL:BWP0:FRC:STATe 1
SOURce1:BB:NR5G:UBWP:USER0:CELL0:UL:BWP0:FRC:TYPE FR1A15
SOURce1:BB:NR5G:UBWP:USER0:CELL0:UL:BWP0:FRC:SCS?
// N30
SOURce1:BB:NR5G:UBWP:USER0:CELL0:UL:BWP0:FRC:ALRB?
// 51
SOURce1:BB:NR5G:UBWP:USER0:CELL0:UL:BWP0:FRC:MODulation?
// QPSK
SOURce1:BB:NR5G:UBWP:USER0:CELL0:UL:BWP0:FRC:PASize?
// 4352
SOURce1:BB:NR5G:UBWP:USER0:CELL0:UL:BWP0:FRC:RBOffset 10

SOURce1:BB:NR5G:NODE:CELL0:CARDePLY GT6
SOURce1:BB:NR5G:UBWP:USER0:USCH:CCODing:STATe 1
SOURce1:BB:NR5G:UBWP:USER0:CELL0:UL:BWP0:FRC:STATe 1
SOURce1:BB:NR5G:UBWP:USER0:CELL0:UL:BWP0:FRC:TYPE FR2A58
SOURce1:BB:NR5G:UBWP:USER0:CELL0:UL:BWP0:FRC:PTRS:STATe?
// 0
SOURce1:BB:NR5G:UBWP:USER0:CELL0:UL:BWP0:MAPTYPE?
// B
```

Example: Configuring the configurable allocations in the users and BWPs groups

```
SOURce1:BB:NR5G:LINK DOWN
SOURce1:BB:NR5G:SCHeDuling:MODE MANual

SOURce1:BB:NR5G:SCHeD:CELL0:SUBF0:USER1:BWPart0:NALLoc 1
SOURce1:BB:NR5G:SCHeD:CELL0:SUBF0:USER1:BWPart0:ALLoc0:CONTent PDSCh
SOURce1:BB:NR5G:SCHeD:CELL0:SUBF0:USER1:BWPart0:ALLoc0:SLOT 1

SOURce1:BB:NR5G:SCHeD:CELL0:SUBF0:USER1:BWPart0:ALLoc0:SYMNumber 14
SOURce1:BB:NR5G:SCHeD:CELL0:SUBF0:USER1:BWPart0:ALLoc0:SYMoffset 0
SOURce1:BB:NR5G:SCHeD:CELL0:SUBF0:USER1:BWPart0:ALLoc0:RBNumber 20
SOURce1:BB:NR5G:SCHeD:CELL0:SUBF0:USER1:BWPart0:ALLoc0:RBOffset 100
SOURce1:BB:NR5G:SCHeD:CELL0:SUBF0:USER1:BWPart0:ALLoc0:POWer 0
SOURce1:BB:NR5G:SCHeD:CELL0:SUBF0:USER1:BWPart0:ALLoc0:STATe 1
SOURce1:BB:NR5G:SCHeD:CELL0:SUBF0:USER1:BWPart0:ALLoc0:REPetitions SUBF

SOURce1:BB:NR5G:SCHeD:CELL0:SUBF0:USER1:BWPart1:NALLoc 1
SOURce1:BB:NR5G:SCHeD:CELL0:SUBF0:USER1:BWPart1:ALLoc0:CONTent COR
SOURce1:BB:NR5G:SCHeD:CELL0:SUBF0:USER1:BWPart1:ALLoc0:RBNumber 30
SOURce1:BB:NR5G:SCHeD:CELL0:SUBF0:USER1:BWPart1:ALLoc0:RBOffset 100
```



```
SOURcel:BB:NR5G:SCHEd:CELL0:SUBF0:USER1:BWPart1:ALLoc0:REPetitions FRAM
```

```
SOURcel:BB:NR5G:SCHEd:CELL0:SUBF0:USER1:BWPart1:ALLoc0:COpyto:SLOT 2
SOURcel:BB:NR5G:SCHEd:CELL0:SUBF0:USER1:BWPart1:ALLoc0:COpyto:SUBF 1
SOURcel:BB:NR5G:SCHEd:CELL0:SUBF0:USER1:BWPart1:ALLoc0:COpyto:APPLY
```

Example: Configuring the PDSCH incl. PTRS and Precoding settings

```
SOURcel:BB:NR5G:UBWP:USER0:CELL0:DL:BWP0:PDSCh:DMTA:CTYPE T1
SOURcel:BB:NR5G:UBWP:USER0:CELL0:DL:BWP0:PDSCh:DMTA:APINDEX 0
SOURcel:BB:NR5G:UBWP:USER0:CELL0:DL:BWP0:PDSCh:DMTA:MLENgtH 2
SOURcel:BB:NR5G:UBWP:USER0:CELL0:DL:BWP0:PDSCh:DMTA:SID0 10
SOURcel:BB:NR5G:UBWP:USER0:CELL0:DL:BWP0:PDSCh:DMTA:SID1 20
SOURcel:BB:NR5G:UBWP:USER0:CELL0:DL:BWP0:PDSCh:DMTB:CTYPE T2
SOURcel:BB:NR5G:UBWP:USER0:CELL0:DL:BWP0:PDSCh:DMTB:APINDEX 1
SOURcel:BB:NR5G:UBWP:USER0:CELL0:DL:BWP0:PDSCh:DMTB:MLENgtH 1
SOURcel:BB:NR5G:UBWP:USER0:CELL0:DL:BWP0:PDSCh:DMTB:SID0 100
SOURcel:BB:NR5G:UBWP:USER0:CELL0:DL:BWP0:PDSCh:DMTB:SID1 200

SOURcel:BB:NR5G:UBWP:USER0:CELL0:DL:BWP0:PDSCh:SCRambling:STATe 1
SOURcel:BB:NR5G:UBWP:USER0:CELL0:DL:BWP0:PDSCh:DSID 100
SOURcel:BB:NR5G:UBWP:USER0:CELL0:DL:BWP0:PDSCh:MCWDci 2
SOURcel:BB:NR5G:UBWP:USER0:CELL0:DL:BWP0:PDSCh:MCSTable QAM256
SOURcel:BB:NR5G:UBWP:USER0:CELL0:DL:BWP0:PDSCh:RESalloc?
// T1
SOURcel:BB:NR5G:UBWP:USER0:CELL0:DL:BWP0:PDSCh:VPINter?
// VPN
SOURcel:BB:NR5G:UBWP:USER0:CELL0:DL:BWP0:PDSCh:RESalloc T0
SOURcel:BB:NR5G:UBWP:USER0:CELL0:DL:BWP0:PDSCh:RBGSize C1
SOURcel:BB:NR5G:UBWP:USER0:CELL0:DL:BWP0:PDSCh:MCBGroups DIS
SOURcel:BB:NR5G:UBWP:USER0:CELL0:DL:BWP0:PDSCh:CBGF:STATe 0
SOURcel:BB:NR5G:UBWP:USER0:CELL0:DL:BWP0:PDSCh:XOVerhead N16

SOURcel:BB:NR5G:UBWP:USER0:CELL0:DL:BWP0:PDSCh:OI11 1

SOURcel:BB:NR5G:UBWP:USER0:CELL0:DL:BWP0:PDSCh:DMTA:BSAME 0
SOURcel:BB:NR5G:UBWP:USER0:CELL0:DL:BWP0:PDSCh:DMTA:PTRS:STATe 1
SOURcel:BB:NR5G:UBWP:USER0:CELL0:DL:BWP0:PDSCh:DMTA:PTRS:REOF RE01
SOURcel:BB:NR5G:UBWP:USER0:CELL0:DL:BWP0:PDSCh:DMTA:PTRS:EPRE RAT1
SOURcel:BB:NR5G:UBWP:USER0:CELL0:DL:BWP0:PDSCh:DMTA:PTRS:MCS1 1
SOURcel:BB:NR5G:UBWP:USER0:CELL0:DL:BWP0:PDSCh:DMTA:PTRS:MCS2 2
SOURcel:BB:NR5G:UBWP:USER0:CELL0:DL:BWP0:PDSCh:DMTA:PTRS:MCS3 3
SOURcel:BB:NR5G:UBWP:USER0:CELL0:DL:BWP0:PDSCh:DMTA:PTRS:RB0 10
SOURcel:BB:NR5G:UBWP:USER0:CELL0:DL:BWP0:PDSCh:DMTA:PTRS:RB1 100
SOURcel:BB:NR5G:UBWP:USER0:CELL0:DL:BWP0:PDSCh:DMTB:PTRS:STATe 0

//Configure precoding with codebook
SOURcel:BB:NR5G:UBWP:USER0:CELL0:DL:BWP0:PDSCh:PREC:STATe 1
SOURcel:BB:NR5G:UBWP:USER0:CELL0:DL:BWP0:PDSCh:PREC:MOD CB
SOURcel:BB:NR5G:SCHEd:CELL0:SUBF0:USER0:BWPart0:ALLoc1:PDSCh:TXScheme:APCSirs N4
SOURcel:BB:NR5G:SCHEd:CELL0:SUBF0:USER0:BWPart0:ALLoc1:PDSCh:TXScheme:CBType?
//T1SP
```

```

SOURCE1:BB:NR5G:SCHed:CELL0:SUBF0:USER0:BWPart0:ALLoc1:PDSch:TXScheme:PCN1?
//N2
SOURCE1:BB:NR5G:SCHed:CELL0:SUBF0:USER0:BWPart0:ALLoc1:PDSch:TXScheme:PCN2?
//N1
SOURCE1:BB:NR5G:SCHed:CELL0:SUBF0:USER0:BWPart0:ALLoc1:PDSch:TXScheme:CBMD N1
SOURCE1:BB:NR5G:SCHed:CELL0:SUBF0:USER0:BWPart0:ALLoc1:PDSch:TXScheme:SPCB0:I11 0
SOURCE1:BB:NR5G:SCHed:CELL0:SUBF0:USER0:BWPart0:ALLoc1:PDSch:TXScheme:SPCB0:I12?
//0
SOURCE1:BB:NR5G:SCHed:CELL0:SUBF0:USER0:BWPart0:ALLoc1:PDSch:TXScheme:SPCB0:I13?
//0
SOURCE1:BB:NR5G:SCHed:CELL0:SUBF0:USER0:BWPart0:ALLoc1:PDSch:TXScheme:SPCB0:I2 0

SOURCE1:BB:NR5G:SCHed:CELL0:SUBF0:USER0:BWPart0:ALLoc1:CONTent PDS
SOURCE1:BB:NR5G:SCHed:CELL0:SUBF0:USER0:BWPart0:ALLoc1:SLOT 0
SOURCE1:BB:NR5G:SCHed:CELL0:SUBF0:USER0:BWPart0:ALLoc1:MAPType A
SOURCE1:BB:NR5G:SCHed:CELL0:SUBF0:USER0:BWPart0:ALLoc1:SYMNumber 7
SOURCE1:BB:NR5G:SCHed:CELL0:SUBF0:USER0:BWPart0:ALLoc1:SYMoffset 1
SOURCE1:BB:NR5G:SCHed:CELL0:SUBF0:USER0:BWPart0:ALLoc1:RBNumber 273
SOURCE1:BB:NR5G:SCHed:CELL0:SUBF0:USER0:BWPart0:ALLoc1:REPetitions SLOT

SOURCE1:BB:NR5G:SCHed:CELL0:SUBF0:USER0:BWPart0:ALLoc1:PDSch:TYPE?
// F11
SOURCE1:BB:NR5G:SCHed:CELL0:SUBF0:USER0:BWPart0:ALLoc1:PDSch:NCW?
// 1
SOURCE1:BB:NR5G:SCHed:CELL0:SUBF0:USER0:BWPart0:ALLoc1:PDSch:PATGrp N
SOURCE1:BB:NR5G:SCHed:CELL0:SUBF0:USER0:BWPart0:ALLoc1:CW0:MOD QAM16
SOURCE1:BB:NR5G:SCHed:CELL0:SUBF0:USER0:BWPart0:ALLoc1:CW0:PHYSbits?
// 61488
SOURCE1:BB:NR5G:SCHed:CELL0:SUBF0:USER0:BWPart0:ALLoc1:PDSch:DMRS:SEQGen CELL
SOURCE1:BB:NR5G:SCHed:CELL0:SUBF0:USER0:BWPart0:ALLoc1:PDSch:DMRS:NSID 0
SOURCE1:BB:NR5G:SCHed:CELL0:SUBF0:USER0:BWPart0:ALLoc1:PDSch:DMRS:APSelect AP1000

SOURCE1:BB:NR5G:SCHed:CELL0:SUBF0:USER0:BWPart0:ALLoc1:PDSch:DMRS:LENGth 2
SOURCE1:BB:NR5G:SCHed:CELL0:SUBF0:USER0:BWPart0:ALLoc1:PDSch:DMRS:SLTSymbols?
// "2,3"
SOURCE1:BB:NR5G:SCHed:CELL0:SUBF0:USER0:BWPart0:ALLoc1:PDSch:DMRS:POWER 0
SOURCE1:BB:NR5G:SCHed:CELL0:SUBF0:USER0:BWPart0:ALLoc1:PDSch:TXScheme:NLAYer?
// 1
SOURCE1:BB:NR5G:SCHed:CELL0:SUBF0:USER0:BWPart0:ALLoc1:PDSch:TXScheme:CDMData 2
SOURCE1:BB:NR5G:SCHed:CELL0:SUBF0:USER0:BWPart0:ALLoc1:PDSch:TXScheme:INTervp?
// 0

SOURCE1:BB:NR5G:SCHed:CELL0:SUBF0:USER0:BWPart0:ALLoc1:PDSch:APSelect0?
// AP1000
SOURCE1:BB:NR5G:SCHed:CELL0:SUBF0:USER0:BWPart0:ALLoc1:APMap:AP0:ROW0:REAL 0.7
SOURCE1:BB:NR5G:SCHed:CELL0:SUBF0:USER0:BWPart0:ALLoc1:APMap:AP0:ROW0:IMAGinary 0.7

SOURCE1:BB:NR5G:UBWP:USER0:USCH:CCODing:STATe 1
SOURCE1:BB:NR5G:SCHed:CELL0:SUBF0:USER0:BWPart0:ALLoc1:CW0:PDSch:CCODing:IMCS 5
SOURCE1:BB:NR5G:SCHed:CELL0:SUBF0:USER0:BWPart0:ALLoc1:CW0:PDSch:CCODing:TCRate?

```

```
// 0.369140625
SOURCE1:BB:NR5G:SCHed:CELL0:SUBF0:USER0:BWPart0:ALLoc1:CW0:PDSch:CCODing:TBSize?
// 22536
SOURCE1:BB:NR5G:SCHed:CELL0:SUBF0:USER0:BWPart0:ALLoc1:CW0:PDSch:CCODing:RVIndex 1
SOURCE1:BB:NR5G:SCHed:CELL0:SUBF0:USER0:BWPart0:ALLoc1:CW0:PDSch:CCODing:TBSFactor S1

SOURCE1:BB:NR5G:SCHed:CELL0:SUBF0:USER0:BWPart0:ALLoc1:PDSch:PTRs:MODE MAN
SOURCE1:BB:NR5G:SCHed:CELL0:SUBF0:USER0:BWPart0:ALLoc1:PDSch:PTRs:STATe 1
SOURCE1:BB:NR5G:SCHed:CELL0:SUBF0:USER0:BWPart0:ALLoc1:PDSch:PTRs:TMDen TD1
SOURCE1:BB:NR5G:SCHed:CELL0:SUBF0:USER0:BWPart0:ALLoc1:PDSch:PTRs:REOF RE01
SOURCE1:BB:NR5G:SCHed:CELL0:SUBF0:USER0:BWPart0:ALLoc1:PDSch:PTRs:FRQDen FD2
SOURCE1:BB:NR5G:SCHed:CELL0:SUBF0:USER0:BWPart0:ALLoc1:PDSch:PTRs:EPRE RAT1

SOURCE1:BB:NR5G:SCHed:CELL0:SUBF0:USER0:BWPart0:ALLoc1:PDSch:PREC:STATe 1
SOURCE1:BB:NR5G:SCHed:CELL0:SUBF0:USER0:BWPart0:ALLoc1:PDSch:PREC:BTYPe DYN
SOURCE1:BB:NR5G:UBWP:USER0:CELL0:DL:BWP0:PDSch:PREC:BBSet1 N4
SOURCE1:BB:NR5G:UBWP:USER0:CELL0:DL:BWP0:PDSch:PREC:BBSet2 N4
SOURCE1:BB:NR5G:SCHed:CELL0:SUBF0:USER0:BWPart0:ALLoc1:PDSch:PREC:BTYPe STAT
SOURCE1:BB:NR5G:UBWP:USER0:CELL0:DL:BWP0:PDSch:PREC:BSZIE N4

SOURCE1:BB:NR5G:SCHed:CELL0:SUBF0:USER0:BWPart0:ALLoc1:PDSch:PREC:STATe 1
SOURCE1:BB:NR5G:SCHed:CELL0:SUBF0:USER0:BWPart0:ALLoc1:PDSch:PREC N2
SOURCE1:BB:NR5G:SCHed:CELL0:SUBF0:USER0:BWPart0:ALLoc1:PDSch:BMAid 1
SOURCE1:BB:NR5G:UBWP:USER0:CELL0:DL:BWP0:CSI:RTSize 0
```

Example: Configuring PDSCH time domain scheduling with PDSCH time domain allocation list

```
SOURCE1:BB:NR5G:UBWP:USER0:CELL0:DL:BWP0:PDSch:TDANum 2
SOURCE1:BB:NR5G:UBWP:USER0:CELL0:DL:BWP0:PDSch:TD0:KNULl 0
SOURCE1:BB:NR5G:UBWP:USER0:CELL0:DL:BWP0:PDSch:TD0:MAPPing A
SOURCE1:BB:NR5G:UBWP:USER0:CELL0:DL:BWP0:PDSch:TD0:STARt 0
SOURCE1:BB:NR5G:UBWP:USER0:CELL0:DL:BWP0:PDSch:TD0:LENGth 3
SOURCE1:BB:NR5G:UBWP:USER0:CELL0:DL:BWP0:PDSch:TD0:SLIV?
// 28
SOURCE1:BB:NR5G:UBWP:USER0:CELL0:DL:BWP0:PDSch:TD1:KNULl 10
SOURCE1:BB:NR5G:UBWP:USER0:CELL0:DL:BWP0:PDSch:TD1:MAPPing B
SOURCE1:BB:NR5G:UBWP:USER0:CELL0:DL:BWP0:PDSch:TD1:STARt 0
SOURCE1:BB:NR5G:UBWP:USER0:CELL0:DL:BWP0:PDSch:TD1:LENGth 2
SOURCE1:BB:NR5G:UBWP:USER0:CELL0:DL:BWP0:PDSch:TD1:SLIV?
// 14
```

Example: Scheduling PxsCH type 0 allocation

```
// PDSCH
SOURCE1:BB:NR5G:LINK DOWN
SOURCE1:BB:NR5G:SCHeduling:MODE MAN

SOURCE1:BB:NR5G:UBWP:USER0:CELL0:DL:BWP0:PDSch:RESalloc DS
SOURCE1:BB:NR5G:SCHed:CELL0:SUBF0:USER0:BWPart0:ALLoc1:PDSch:RESalloc T0
SOURCE1:BB:NR5G:SCHed:CELL0:SUBF0:USER0:BWPart0:ALLoc1:PDSch:RESalloc:PATtern #H3FFFF,18
```

```
// PUSCH
SOURCE1:BB:NR5G:LINK UP

SOURCE1:BB:NR5G:UBWP:USER0:CELL0:UL:BWP0:PUSCh:RESalloc DS
SOURCE1:BB:NR5G:UBWP:USER0:CELL0:UL:BWP0:PUSCh:RBGSize C1
SOURCE1:BB:NR5G:SCHed:CELL0:SUBF0:USER0:BWPart0:ALLoc1:PUSCh:RESalloc T0
SOURCE1:BB:NR5G:SCHed:CELL0:SUBF0:USER0:BWPart0:ALLoc1:PUSCh:RESalloc:PATtern #H3FFFF,18
```

Example: Configuring the CSI-RS settings

```
// periodic ZP CSI-RS
SOURCE1:BB:NR5G:UBWP:USER0:CELL0:DL:BWP0:CSIRs:ZP:STATe 1
SOURCE1:BB:NR5G:UBWP:USER0:CELL0:DL:BWP0:CSIRs:ZP:SET0:NRESources 1
SOURCE1:BB:NR5G:UBWP:USER0:CELL0:DL:BWP0:CSIRs:ZP:SET0:RES0:PER 10
SOURCE1:BB:NR5G:UBWP:USER0:CELL0:DL:BWP0:CSIRs:ZP:SET0:RES0:OFFSet 1
SOURCE1:BB:NR5G:UBWP:USER0:CELL0:DL:BWP0:CSIRs:ZP:SET0:RES0:RBNumber 273
SOURCE1:BB:NR5G:UBWP:USER0:CELL0:DL:BWP0:CSIRs:ZP:SET0:RES0:SRBNumber 0
SOURCE1:BB:NR5G:UBWP:USER0:CELL0:DL:BWP0:CSIRs:ZP:SET0:RES0:ROW 2
SOURCE1:BB:NR5G:UBWP:USER0:CELL0:DL:BWP0:CSIRs:ZP:SET0:RES0:BITMap #HAFA,12
SOURCE1:BB:NR5G:UBWP:USER0:CELL0:DL:BWP0:CSIRs:ZP:SET0:RES0:IO 1
SOURCE1:BB:NR5G:UBWP:USER0:CELL0:DL:BWP0:CSIRs:ZP:SET0:RES0:II 2

// periodic NZP CSI-RS
SOURCE1:BB:NR5G:UBWP:USER0:CELL0:DL:BWP0:CSIRs:NZP:STATe 1
SOURCE1:BB:NR5G:UBWP:USER0:CELL0:DL:BWP0:CSIRs:NZP:SET0:NRESources 1
SOURCE1:BB:NR5G:UBWP:USER0:CELL0:DL:BWP0:CSIRs:NZP:SET0:RES0:PER 4
SOURCE1:BB:NR5G:UBWP:USER0:CELL0:DL:BWP0:CSIRs:NZP:SET0:RES0:OFFSet 0
SOURCE1:BB:NR5G:UBWP:USER0:CELL0:DL:BWP0:CSIRs:NZP:SET0:RES0:RBNumber 100
SOURCE1:BB:NR5G:UBWP:USER0:CELL0:DL:BWP0:CSIRs:NZP:SET0:RES0:SRBNumber 50
SOURCE1:BB:NR5G:UBWP:USER0:CELL0:DL:BWP0:CSIRs:NZP:SET0:RES0:ROW 1
SOURCE1:BB:NR5G:UBWP:USER0:CELL0:DL:BWP0:CSIRs:NZP:SET0:RES0:BITMap #HF,4
SOURCE1:BB:NR5G:UBWP:USER0:CELL0:DL:BWP0:CSIRs:NZP:SET0:RES0:IO 0
SOURCE1:BB:NR5G:UBWP:USER0:CELL0:DL:BWP0:CSIRs:NZP:SET0:RES0:II 2
SOURCE1:BB:NR5G:UBWP:USER0:CELL0:DL:BWP0:CSIRs:NZP:SET0:RES0:SCID 10
SOURCE1:BB:NR5G:UBWP:USER0:CELL0:DL:BWP0:CSIRs:NZP:SET0:RES0:PWR 3

SOURCE1:BB:NR5G:UBWP:USER0:CELL0:DL:BWP0:CSIRs:NZP:SET0:RES0:APMap:AP3000:ROW0:REAL 1
SOURCE1:BB:NR5G:UBWP:USER0:CELL0:DL:BWP0:CSIRs:NZP:SET0:RES0:APMap:AP3000:ROW0:IMAGinary 0.7
```

Example: Antenna port settings

```
SOURCE1:BB:NR5G:LINK DOWN
SOURCE1:BB:NR5G:SCHed:CELL0:SUBF0:USER0:BWPart0:ALLoc1:APMap:COL0:ROW0:REAL 1
SOURCE1:BB:NR5G:SCHed:CELL0:SUBF0:USER0:BWPart0:ALLoc1:APMap:COL0:ROW0:IMAGinary?
// 0

SOURCE1:BB:NR5G:SCHed:CELL0:SUBF0:USER0:BWPart0:ALLoc1:APMap:COL0:ROW0:MAGNitude 1
SOURCE1:BB:NR5G:SCHed:CELL0:SUBF0:USER0:BWPart0:ALLoc1:APMap:COL0:ROW0:PHASe 360
```

Example: Configuring one SRS resource set

```

SOURCE1:BB:NR5G:UBWP:USER0:CELL0:UL:BWP0:SRS:RS:NRSets 1
SOURCE1:BB:NR5G:UBWP:USER0:CELL0:UL:BWP0:SRS:RS:SET0:RSType PER
SOURCE1:BB:NR5G:UBWP:USER0:CELL0:UL:BWP0:PUSCh:TXConfig NCB
SOURCE1:BB:NR5G:UBWP:USER0:CELL0:UL:BWP0:SRS:RS:SET0:USAGe?
// NCB

SOURCE1:BB:NR5G:UBWP:USER0:CELL0:UL:BWP0:SRS:RS:SET0:NRESources 1
SOURCE1:BB:NR5G:UBWP:USER0:CELL0:UL:BWP0:SRS:RS:SET0:RES0:PER SL10
SOURCE1:BB:NR5G:UBWP:USER0:CELL0:UL:BWP0:SRS:RS:SET0:RES0:OFFSet 1
SOURCE1:BB:NR5G:UBWP:USER0:CELL0:UL:BWP0:SRS:RS:SET0:RES0:SPOS 3
SOURCE1:BB:NR5G:UBWP:USER0:CELL0:UL:BWP0:SRS:RS:SET0:RES0:SYMNumber SYM2
SOURCE1:BB:NR5G:UBWP:USER0:CELL0:UL:BWP0:SRS:RS:SET0:RES0:FPOS 10
SOURCE1:BB:NR5G:UBWP:USER0:CELL0:UL:BWP0:SRS:RS:SET0:RES0:FQShift 20
SOURCE1:BB:NR5G:UBWP:USER0:CELL0:UL:BWP0:SRS:RS:SET0:RES0:BSRS 1
SOURCE1:BB:NR5G:UBWP:USER0:CELL0:UL:BWP0:SRS:RS:SET0:RES0:CSRS 1
SOURCE1:BB:NR5G:UBWP:USER0:CELL0:UL:BWP0:SRS:RS:SET0:RES0:BHOP 1
SOURCE1:BB:NR5G:UBWP:USER0:CELL0:UL:BWP0:SRS:RS:SET0:RES0:REFactor?
// REPl

SOURCE1:BB:NR5G:UBWP:USER0:CELL0:UL:BWP0:SRS:RS:SET0:RES0:TRTComb TC4
SOURCE1:BB:NR5G:UBWP:USER0:CELL0:UL:BWP0:SRS:RS:SET0:RES0:COFFset 1
SOURCE1:BB:NR5G:UBWP:USER0:CELL0:UL:BWP0:SRS:RS:SET0:RES0:SEQ:CYCShift 10
SOURCE1:BB:NR5G:UBWP:USER0:CELL0:UL:BWP0:SRS:RS:SET0:RES0:SEQ:ID 10
SOURCE1:BB:NR5G:UBWP:USER0:CELL0:UL:BWP0:SRS:RS:SET0:RES0:POWer 3
SOURCE1:BB:NR5G:UBWP:USER0:CELL0:UL:BWP0:SRS:RS:SET0:RES0:NAPort AP1
SOURCE1:BB:NR5G:UBWP:USER0:CELL0:UL:BWP0:SRS:RS:SET0:RES0:PTRS P0
SOURCE1:BB:NR5G:UBWP:USER0:CELL0:UL:BWP0:SRS:RS:SET0:RES0:APMap:AP1000:ROW0:MAGNitude 1
SOURCE1:BB:NR5G:UBWP:USER0:CELL0:UL:BWP0:SRS:RS:SET0:RES0:APMap:AP1000:ROW0:PHASe 0
// SOURCE1:BB:NR5G:UBWP:USER0:CELL0:UL:BWP0:SRS:RS:SET0:RES0:APMap:AP1000:ROW0:REAL?
// SOURCE1:BB:NR5G:UBWP:USER0:CELL0:UL:BWP0:SRS:RS:SET0:RES0:APMap:AP1000:ROW0:IMAGinary?

SOURCE1:BB:NR5G:LINK UP
SOURCE1:BB:NR5G:SCHed:CELL0:SUBF0:USER0:BWP0:ALLoc0:STATe 0
// open the timeplan and observe the SRS allocations

```

Example: Configuring the DL BWP rate match settings

```

SOURCE1:BB:NR5G:LINK DOWN

SOURCE1:BB:NR5G:UBWP:USER0:CELL0:DL:BWP0:RATM:STATe 1
SOURCE1:BB:NR5G:UBWP:USER0:CELL0:DL:BWP0:RATM:GRPNumber 2
SOURCE1:BB:NR5G:UBWP:USER0:CELL0:DL:BWP0:RATM:NRESources 2
SOURCE1:BB:NR5G:UBWP:USER0:CELL0:DL:BWP0:RATM:RS0:GRID G1
SOURCE1:BB:NR5G:UBWP:USER0:CELL0:DL:BWP0:RATM:RS0:SLTPatt #H1001,14
SOURCE1:BB:NR5G:UBWP:USER0:CELL0:DL:BWP0:RATM:RS0:PER 2
SOURCE1:BB:NR5G:UBWP:USER0:CELL0:DL:BWP0:RATM:RS0:PERPatt #H2,2
SOURCE1:BB:NR5G:UBWP:USER0:CELL0:DL:BWP0:RATM:RS0:RBDList "/var/user/dl"
SOURCE1:BB:NR5G:UBWP:USER0:CELL0:DL:BWP0:RATM:RS0:RBPatt?

SOURCE1:BB:NR5G:UBWP:USER0:CELL0:DL:BWP0:RATM:RS1:SLOT 2

```

```

SOURcel:BB:NR5G:UBWP:USER0:CELL0:DL:BWP0:RATM:RS1:PER 4
SOURcel:BB:NR5G:UBWP:USER0:CELL0:DL:BWP0:RATM:RS1:PER Patt #H5,4
SOURcel:BB:NR5G:UBWP:USER0:CELL0:DL:BWP0:RATM:RS1:SLTPatt #H8888888,28
SOURcel:BB:NR5G:SCHeD:CELL0:SUB0:USER0:BWPart0:ALLoc1:PDSCH:PATGrp G1

```

Example: Search space configuration

For example on how the CORESET is configured, see [Example"Configuring the CORESET settings"](#) on page 398.

```

SOURcel:BB:NR5G:SCHeDuling:MODE MAN
SOURcel:BB:NR5G:SCHeDuling:RSSPace 1

SOURcel:BB:NR5G:SCHeD:CELL0:SUBF0:USER0:BWPart0:ALLoc0:CS:DMRS:SPACe0:AGGLLevel?
// AL1
SOURcel:BB:NR5G:SCHeD:CELL0:SUBF0:USER0:BWPart0:ALLoc0:CS:DMRS:SPACe0:MAXCandidate 2
SOURcel:BB:NR5G:SCHeD:CELL0:SUBF0:USER0:BWPart0:ALLoc0:CS:DMRS:SPACe1:AGGLLevel?
// AL2
SOURcel:BB:NR5G:SCHeD:CELL0:SUBF0:USER0:BWPart0:ALLoc0:CS:DMRS:SPACe1:MAXCandidate 2
SOURcel:BB:NR5G:SCHeD:CELL0:SUBF0:USER0:BWPart0:ALLoc0:CS:DMRS:SPACe2:AGGLLevel?
// AL4
SOURcel:BB:NR5G:SCHeD:CELL0:SUBF0:USER0:BWPart0:ALLoc0:CS:DMRS:SPACe2:MAXCandidate 4
SOURcel:BB:NR5G:SCHeD:CELL0:SUBF0:USER0:BWPart0:ALLoc0:CS:DMRS:SPACe3:AGGLLevel?
// AL8
SOURcel:BB:NR5G:SCHeD:CELL0:SUBF0:USER0:BWPart0:ALLoc0:CS:DMRS:SPACe3:MAXCandidate 6
SOURcel:BB:NR5G:SCHeD:CELL0:SUBF0:USER0:BWPart0:ALLoc0:CS:DMRS:SPACe4:AGGLLevel?
// AL16
SOURcel:BB:NR5G:SCHeD:CELL0:SUBF0:USER0:BWPart0:ALLoc0:CS:DMRS:SPACe4:MAXCandidate 8

SOURcel:BB:NR5G:SCHeD:CELL0:SUBF0:USER0:BWPart0:ALLoc0:CS:DCI0:AGGLLevel AL1
SOURcel:BB:NR5G:SCHeD:CELL0:SUBF0:USER0:BWPart0:ALLoc0:CS:DCI0:CANDidate 1
SOURcel:BB:NR5G:SCHeD:CELL0:SUBF0:USER1:BWPart1:ALLoc0:CS:DCI0:INDex?
// 22

```

Example: Configuring the CORESET settings

For example of how the search space is configured, see [Example"Search space configuration"](#) on page 398.

```

SOURcel:BB:NR5G:SCHeD:CELL0:SUBF0:USER0:BWPart0:ALLoc0:CONTent COR

SOURcel:BB:NR5G:SCHeD:CELL0:SUBF0:USER0:BWPart0:ALLoc0:CS:PREGran REG
SOURcel:BB:NR5G:SCHeD:CELL0:SUBF0:USER0:BWPart0:ALLoc0:CS:ID 0
SOURcel:BB:NR5G:SCHeD:CELL0:SUBF0:USER0:BWPart0:ALLoc0:CS:DMRS:SCRam:STATe 1
SOURcel:BB:NR5G:SCHeD:CELL0:SUBF0:USER0:BWPart0:ALLoc0:CS:DMRS:SCRam:ID 0

SOURcel:BB:NR5G:SCHeD:CELL0:SUBF0:USER1:BWPart1:ALLoc0:CS:IL:STATe 1
SOURcel:BB:NR5G:SCHeD:CELL0:SUBF0:USER1:BWPart1:ALLoc0:CS:IL:BUNSize 6
SOURcel:BB:NR5G:SCHeD:CELL0:SUBF0:USER1:BWPart1:ALLoc0:CS:IL:SHIDx 1
SOURcel:BB:NR5G:SCHeD:CELL0:SUBF0:USER1:BWPart1:ALLoc0:CS:IL:SIZE IS6

```

```

SOURCE1:BB:NR5G:SCHed:CELL0:SUBF0:USER0:BWPart0:ALLoc0:CS:DCCes:STATe 1
SOURCE1:BB:NR5G:SCHed:CELL0:SUBF0:USER0:BWPart0:ALLoc0:CS:DCCes:DATA DLIS
SOURCE1:BB:NR5G:SCHed:CELL0:SUBF0:USER0:BWPart0:ALLoc0:CS:DCCes:DLISt "/var/user/dl"
// SOURCE1:BB:NR5G:SCHed:CELL0:SUBF0:USER0:BWPart0:ALLoc0:CS:DCCes:DATA PATtern
// SOURCE1:BB:NR5G:SCHed:CELL0:SUBF0:USER0:BWPart0:ALLoc0:CS:DCCes:PATtern #H9,4

SOURCE1:BB:NR5G:SCHed:CELL0:SUBF0:USER1:BWPart1:ALLoc0:CS:DMRS:SCRam:STATe 1
SOURCE1:BB:NR5G:SCHed:CELL0:SUBF0:USER1:BWPart1:ALLoc0:CS:DMRS:SCRam:ID 10
SOURCE1:BB:NR5G:SCHed:CELL0:SUBF0:USER0:BWPart0:ALLoc0:CS:AULBwp?

SOURCE1:BB:NR5G:SCHed:CELL0:SUBF0:USER1:BWPart1:ALLoc0:CS:NDCI 5

SOURCE1:BB:NR5G:SCHed:CELL0:SUBF0:USER0:BWPart0:ALLoc0:CS:DCI0:USAGe?
// C
SOURCE1:BB:NR5G:SCHed:CELL0:SUBF0:USER0:BWPart0:ALLoc0:CS:DCI0:RNTI?
// 0
SOURCE1:BB:NR5G:SCHed:CELL0:SUBF0:USER0:BWPart0:ALLoc0:CS:DCI0:FMT F00
SOURCE1:BB:NR5G:SCHed:CELL0:SUBF0:USER0:BWPart0:ALLoc0:CS:DCI0:SSP USS
SOURCE1:BB:NR5G:SCHed:CELL0:SUBF0:USER0:BWPart0:ALLoc0:CS:DCI0:AGGLevel AL1
SOURCE1:BB:NR5G:SCHed:CELL0:SUBF0:USER0:BWPart0:ALLoc0:CS:DCI0:CANDidate 1
SOURCE1:BB:NR5G:SCHed:CELL0:SUBF0:USER1:BWPart1:ALLoc0:CS:DCI0:INDex?
SOURCE1:BB:NR5G:SCHed:CELL0:SUBF0:USER0:BWPart0:ALLoc0:CS:DCI0:FRDRes 0
SOURCE1:BB:NR5G:SCHed:CELL0:SUBF0:USER0:BWPart0:ALLoc0:CS:DCI0:FRHFlag 1
SOURCE1:BB:NR5G:SCHed:CELL0:SUBF0:USER0:BWPart0:ALLoc0:CS:DCI0:TB1:MCS 1
SOURCE1:BB:NR5G:SCHed:CELL0:SUBF0:USER0:BWPart0:ALLoc0:CS:DCI0:TB1:NDI 1
SOURCE1:BB:NR5G:SCHed:CELL0:SUBF0:USER0:BWPart0:ALLoc0:CS:DCI0:TB1:RV 1
SOURCE1:BB:NR5G:SCHed:CELL0:SUBF0:USER0:BWPart0:ALLoc0:CS:DCI0:HAProc 1
SOURCE1:BB:NR5G:SCHed:CELL0:SUBF0:USER0:BWPart0:ALLoc0:CS:DCI0:TPUSch 2
// 1
SOURCE1:BB:NR5G:SCHed:CELL0:SUBF0:USER0:BWPart0:ALLoc0:CS:DCI0:USINd 0
SOURCE1:BB:NR5G:SCHed:CELL0:SUBF0:USER0:BWPart0:ALLoc0:CS:DCI0:HBTS?
// #H00000434600,44
SOURCE1:BB:NR5G:SCHed:CELL0:SUBF0:USER0:BWPart0:ALLoc0:CS:DCI0:SRSResind 4
SOURCE1:BB:NR5G:SCHed:CELL0:SUBF0:USER0:BWPart0:ALLoc0:CS:DCI0:PRECIInfo 0
SOURCE1:BB:NR5G:SCHed:CELL0:SUBF0:USER0:BWPart0:ALLoc0:CS:DCI0:CSIRequest 0
SOURCE1:BB:NR5G:SCHed:CELL0:SUBF0:USER0:BWPart0:ALLoc0:CS:DCI0:BOINd 0

SOURCE1:BB:NR5G:SCHed:CELL0:SUBF0:USER0:BWPart0:ALLoc0:CS:DCI0:MOFFs 1

SOURCE1:BB:NR5G:SCHed:CELL0:SUBF0:USER0:BWPart0:ALLoc0:CS:DCI1:USAGe?
// C
SOURCE1:BB:NR5G:SCHed:CELL0:SUBF0:USER0:BWPart0:ALLoc0:CS:DCI1:RNTI?
// 0
SOURCE1:BB:NR5G:SCHed:CELL0:SUBF0:USER1:BWPart1:ALLoc0:CS:DCI1:AGGLevel AL2
SOURCE1:BB:NR5G:SCHed:CELL0:SUBF0:USER1:BWPart1:ALLoc0:CS:DCI1:INDex 0
SOURCE1:BB:NR5G:SCHed:CELL0:SUBF0:USER0:BWPart0:ALLoc0:CS:DCI1:FMT F10
SOURCE1:BB:NR5G:SCHed:CELL0:SUBF0:USER0:BWPart0:ALLoc0:CS:DCI1:SSP CSS3
SOURCE1:BB:NR5G:SCHed:CELL0:SUBF0:USER0:BWPart0:ALLoc0:CS:DCI1:FRDRes 1
SOURCE1:BB:NR5G:SCHed:CELL0:SUBF0:USER0:BWPart0:ALLoc0:CS:DCI1:TIDRes 1
SOURCE1:BB:NR5G:SCHed:CELL0:SUBF0:USER0:BWPart0:ALLoc0:CS:DCI1:VTPRb?
// 0

```

```

SOURcel:BB:NR5G:SCHed:CELL0:SUBF0:USER0:BWPart0:ALLoc0:CS:DCI1:TB1:MCS 1
SOURcel:BB:NR5G:SCHed:CELL0:SUBF0:USER0:BWPart0:ALLoc0:CS:DCI1:TB1:NDI 1
SOURcel:BB:NR5G:SCHed:CELL0:SUBF0:USER0:BWPart0:ALLoc0:CS:DCI1:TB1:RV 1
SOURcel:BB:NR5G:SCHed:CELL0:SUBF0:USER0:BWPart0:ALLoc0:CS:DCI1:HAProc 1
SOURcel:BB:NR5G:SCHed:CELL0:SUBF0:USER0:BWPart0:ALLoc0:CS:DCI1:DAI1 1
SOURcel:BB:NR5G:SCHed:CELL0:SUBF0:USER0:BWPart0:ALLoc0:CS:DCI1:TPUCch 1
SOURcel:BB:NR5G:SCHed:CELL0:SUBF0:USER0:BWPart0:ALLoc0:CS:DCI1:PUCResind 1
SOURcel:BB:NR5G:SCHed:CELL0:SUBF0:USER0:BWPart0:ALLoc0:CS:DCI1:PDSHarq 1
SOURcel:BB:NR5G:SCHed:CELL0:SUBF0:USER0:BWPart0:ALLoc0:CS:DCI1:HBTS?
SOURcel:BB:NR5G:SCHed:CELL0:SUBF0:USER0:BWPart0:ALLoc0:CS:DCI1:CPDSch 1

SOURcel:BB:NR5G:SCHed:CELL0:SUBF0:USER0:BWPart0:ALLoc0:CS:DCI2:USAGE?
// C
SOURcel:BB:NR5G:SCHed:CELL0:SUBF0:USER0:BWPart0:ALLoc0:CS:DCI2:FMT F01
SOURcel:BB:NR5G:SCHed:CELL0:SUBF0:USER0:BWPart0:ALLoc0:CS:DCI2:ANTPorts 15
SOURcel:BB:NR5G:SCHed:CELL0:SUBF0:USER0:BWPart0:ALLoc0:CS:DCI2:SRSRequest 1
SOURcel:BB:NR5G:UBWP:USER0:CELL0:UL:BWP0:PUSCh:TPState 0
SOURcel:BB:NR5G:SCHed:CELL0:SUBF0:USER0:BWPart0:ALLoc0:CS:DCI2:DMSQinit 1
SOURcel:BB:NR5G:UBWP:USER0:CELL0:UL:BWP0:PUSCh:MRANK 2
SOURcel:BB:NR5G:SCHed:CELL0:SUBF0:USER0:BWPart0:ALLoc0:CS:DCI2:PTDMrs 1
...

SOURcel:BB:NR5G:SCHed:CELL0:SUBF0:USER0:BWPart0:ALLoc0:CS:DCI3:USAGE SI
SOURcel:BB:NR5G:SCHed:CELL0:SUBF0:USER0:BWPart0:ALLoc0:CS:DCI3:RNTI?
// 0
SOURcel:BB:NR5G:SCHed:CELL0:SUBF0:USER0:BWPart0:ALLoc0:CS:DCI3:FMT F10
SOURcel:BB:NR5G:SCHed:CELL0:SUBF0:USER0:BWPart0:ALLoc0:CS:DCI3:SSP CSS0
SOURcel:BB:NR5G:SCHed:CELL0:SUBF0:USER0:BWPart0:ALLoc0:CS:DCI3:AGGLevel AL1
SOURcel:BB:NR5G:SCHed:CELL0:SUBF0:USER0:BWPart0:ALLoc0:CS:DCI3:CANDidate 1
SOURcel:BB:NR5G:SCHed:CELL0:SUBF0:USER1:BWPart1:ALLoc0:CS:DCI3:INDex?
SOURcel:BB:NR5G:SCHed:CELL0:SUBF0:USER0:BWPart0:ALLoc0:CS:DCI3:FRDRes 0
SOURcel:BB:NR5G:SCHed:CELL0:SUBF0:USER0:BWPart0:ALLoc0:CS:DCI1:TIDRes 1
SOURcel:BB:NR5G:SCHed:CELL0:SUBF0:USER0:BWPart0:ALLoc0:CS:DCI1:VTPRb 1
SOURcel:BB:NR5G:SCHed:CELL0:SUBF0:USER0:BWPart0:ALLoc0:CS:DCI3:TB1:MCS 1
SOURcel:BB:NR5G:SCHed:CELL0:SUBF0:USER0:BWPart0:ALLoc0:CS:DCI3:TB1:RV 1
SOURcel:BB:NR5G:SCHed:CELL0:SUBF0:USER0:BWPart0:ALLoc0:CS:DCI3:SIInd 1
SOURcel:BB:NR5G:SCHed:CELL0:SUBF0:USER0:BWPart0:ALLoc0:CS:DCI3:RESVed?
SOURcel:BB:NR5G:SCHed:CELL0:SUBF0:USER0:BWPart0:ALLoc0:CS:DCI3:HBTS?
SOURcel:BB:NR5G:SCHed:CELL0:SUBF0:USER0:BWPart0:ALLoc0:CS:DCI3:CPDSch 1

SOURcel:BB:NR5G:SCHed:CELL0:SUBF0:USER0:BWPart0:ALLoc0:CS:DCI0:USAGE TSRS
SOURcel:BB:NR5G:SCHed:CELL0:SUBF0:USER0:BWPart0:ALLoc0:CS:DCI0:SR1 0
SOURcel:BB:NR5G:SCHed:CELL0:SUBF0:USER0:BWPart0:ALLoc0:CS:DCI0:TP1 0
SOURcel:BB:NR5G:SCHed:CELL0:SUBF0:USER0:BWPart0:ALLoc0:CS:DCI0:USAGE TPUC
SOURcel:BB:NR5G:SCHed:CELL0:SUBF0:USER0:BWPart0:ALLoc0:CS:DCI0:CL1?
// 0
SOURcel:BB:NR5G:SCHed:CELL0:SUBF0:USER0:BWPart0:ALLoc0:CS:DCI0:TP1 0
SOURcel:BB:NR5G:SCHed:CELL0:SUBF0:USER0:BWPart0:ALLoc0:CS:DCI0:USAGE INT
SOURcel:BB:NR5G:SCHed:CELL0:SUBF0:USER0:BWPart0:ALLoc0:CS:DCI0:PE1 0
SOURcel:BB:NR5G:SCHed:CELL0:SUBF0:USER0:BWPart0:ALLoc0:CS:DCI0:USAGE SFI
SOURcel:BB:NR5G:SCHed:CELL0:SUBF0:USER0:BWPart0:ALLoc0:CS:DCI0:SI1 0

```



```

SOURCE1:BB:NR5G:SCHed:CELL0:SUBF0:USER0:BWPart0:ALLoc0:CS:DCI0:TBScaLin 0
SOURCE1:BB:NR5G:SCHed:CELL0:SUBF0:USER0:BWPart0:ALLoc0:CS:DCI0:CAINd 0
SOURCE1:BB:NR5G:SCHed:CELL0:SUBF0:USER0:BWPart0:ALLoc0:CS:DCI0:SI16 0
SOURCE1:BB:NR5G:SCHed:CELL0:SUBF0:USER0:BWPart0:ALLoc0:CS:DCI0:SR1 0
SOURCE1:BB:NR5G:SCHed:CELL0:SUBF0:USER0:BWPart0:ALLoc0:CS:DCI0:CL22 0

```

Example: Custom DCI

```

SOURCE1:BB:NR5G:SCHed:CELL0:SUBF0:USER0:BWPart0:ALLoc0:CS:DCI0:FMT CUSTom
SOURCE1:BB:NR5G:SCHed:CELL0:SUBF0:USER0:BWPart0:ALLoc0:CS:DCI0:STATe 1
SOURCE1:BB:NR5G:SCHed:CELL0:SUBF0:USER0:BWPart0:ALLoc0:CS:DCI0:DATA PATTern
SOURCE1:BB:NR5G:SCHed:CELL0:SUBF0:USER0:BWPart0:ALLoc0:CS:DCI0:BITLength 12
SOURCE1:BB:NR5G:SCHed:CELL0:SUBF0:USER0:BWPart0:ALLoc0:CS:DCI0:PATTern #HCA3,12
// SOURCE1:BB:NR5G:SCHed:CELL0:SUBF0:USER0:BWPart0:ALLoc0:CS:DCI0:DATA DLISt
// SOURCE1:BB:NR5G:SCHed:CELL0:SUBF0:USER0:BWPart0:ALLoc0:CS:DCI0:DLISt "var/user/nr_dl"
// SOURCE1:BB:NR5G:SCHed:CELL0:SUBF0:USER0:BWPart0:ALLoc0:CS:DCI0:DATA PN9
// SOURCE1:BB:NR5G:SCHed:CELL0:SUBF0:USER0:BWPart0:ALLoc0:CS:DCI0:INITpattern 16

```

Example: DCI format 2_0, 2_1 and 2_2

Listed are only the related commands:

```

SOURCE1:BB:NR5G:UBWP:USER0:UEID 0

// DCI format 2_0
SOURCE1:BB:NR5G:UBWP:USER0:RNTI:SFI 1
SOURCE1:BB:NR5G:UBWP:USER0:NUMSfi 1
SOURCE1:BB:NR5G:SCHed:CELL0:SUBF0:USER0:BWPart0:ALLoc0:CS:DCI0:USAGe SFI
SOURCE1:BB:NR5G:SCHed:CELL0:SUBF0:USER0:BWPart0:ALLoc0:CS:DCI0:FMT F20
SOURCE1:BB:NR5G:SCHed:CELL0:SUBF0:USER0:BWPart0:ALLoc0:CS:DCI0:SI1 100

// DCI format 2_1
SOURCE1:BB:NR5G:UBWP:USER0:CELL0:DL:BWP0:RNTI:IN 10
SOURCE1:BB:NR5G:UBWP:USER0:CELL0:DL:BWP0:PDCCCh:NUMPreempt 1
SOURCE1:BB:NR5G:SCHed:CELL0:SUBF0:USER0:BWPart0:ALLoc0:CS:DCI1:USAGe INT
SOURCE1:BB:NR5G:SCHed:CELL0:SUBF0:USER0:BWPart0:ALLoc0:CS:DCI1:FMT F21
SOURCE1:BB:NR5G:SCHed:CELL0:SUBF0:USER0:BWPart0:ALLoc0:CS:DCI1:PE1 200

// DCI format 2_2
SOURCE1:BB:NR5G:UBWP:USER0:CELL0:DL:BWP0:RNTI:PUSCh 20
SOURCE1:BB:NR5G:UBWP:USER0:CELL0:DL:BWP0:RNTI:PUCCh 1
// SOURCE1:BB:NR5G:UBWP:USER0:CELL0:DL:BWP0:RNTI:SRS 100
SOURCE1:BB:NR5G:UBWP:USER0:CELL0:DL:BWP0:PUSCh:TPAS 1
SOURCE1:BB:NR5G:UBWP:USER0:CELL0:DL:BWP0:PUSCh:BD22 2
SOURCE1:BB:NR5G:UBWP:USER0:CELL0:DL:BWP0:PUCCh:TPAS 1
SOURCE1:BB:NR5G:UBWP:USER0:CELL0:DL:BWP0:PUCCh:BD22 1
SOURCE1:BB:NR5G:SCHed:CELL0:SUBF0:USER0:BWPart0:ALLoc0:CS:DCI2:USAGe TPUS
SOURCE1:BB:NR5G:SCHed:CELL0:SUBF0:USER0:BWPart0:ALLoc0:CS:DCI3:USAGe TPUC
SOURCE1:BB:NR5G:SCHed:CELL0:SUBF0:USER0:BWPart0:ALLoc0:CS:DCI2:FMT F22
SOURCE1:BB:NR5G:SCHed:CELL0:SUBF0:USER0:BWPart0:ALLoc0:CS:DCI3:FMT F22
SOURCE1:BB:NR5G:SCHed:CELL0:SUBF0:USER0:BWPart0:ALLoc0:CS:DCI2:CL1 1
SOURCE1:BB:NR5G:SCHed:CELL0:SUBF0:USER0:BWPart0:ALLoc0:CS:DCI2:TP1 0
SOURCE1:BB:NR5G:SCHed:CELL0:SUBF0:USER0:BWPart0:ALLoc0:CS:DCI2:TP2 1

```

```
SOURce1:BB:NR5G:SCHeD:CELL0:SUBF0:USER0:BWP0:ALLOc0:CS:DCI3:TP1 3
SOURce1:BB:NR5G:SCHeD:CELL0:SUBF0:USER0:BWP0:ALLOc0:CS:DCI3:CL1 1
```

Example: DCI format 2_4

R&S SMM-K148

Listed are only the related commands:

```
SOURce1:BB:NR5G:UBWP:USER0:UEID 0

SOURce1:BB:NR5G:UBWP:USER0:CELL0:DL:BWP0:RNTI:CIRNti 2
SOURce1:BB:NR5G:UBWP:USER0:CELL0:DL:BWP0:CILength 4
SOURce1:BB:NR5G:UBWP:USER0:CELL0:DL:BWP0:NCINd 2
SOURce1:BB:NR5G:SCHeD:CELL0:SUBF0:USER0:BWP0:ALLOc0:CS:DCI0:USAGe CI
SOURce1:BB:NR5G:SCHeD:CELL0:SUBF0:USER0:BWP0:ALLOc0:CS:DCI0:FMT F24
SOURce1:BB:NR5G:SCHeD:CELL0:SUBF0:USER0:BWP0:ALLOc0:CS:DCI0:CI1 #HE,4
SOURce1:BB:NR5G:SCHeD:CELL0:SUBF0:USER0:BWP0:ALLOc0:CS:DCI0:CI2 #H3,4
```

Example: DCI format 2_6

R&S SMM-K148

Listed are only the related commands:

```
SOURce1:BB:NR5G:UBWP:USER0:UEID 0

SOURce1:BB:NR5G:UBWP:USER0:CELL0:DL:BWP0:RNTI:PSRNti 1
SOURce1:BB:NR5G:UBWP:USER0:CELL0:DL:BWP0:SRS:NB26 1
SOURce1:BB:NR5G:UBWP:USER0:CELL0:DL:BWP0:SRS:NSCG 2
SOURce1:BB:NR5G:SCHeD:CELL0:SUBF0:USER0:BWP0:ALLOc0:CS:DCI0:USAGe PS
SOURce1:BB:NR5G:SCHeD:CELL0:SUBF0:USER0:BWP0:ALLOc0:CS:DCI0:WA1 1
SOURce1:BB:NR5G:SCHeD:CELL0:SUBF0:USER0:BWP0:ALLOc0:CS:DCI0:DI1 1
SOURce1:BB:NR5G:SCHeD:CELL0:SUBF0:USER0:BWP0:ALLOc0:CS:DCI0:RESVed #HF,4
```

Example: Configuring the PUSCH settings

```
SOURce1:BB:NR5G:LINK UP

SOURce1:BB:NR5G:UBWP:USER0:CELL0:UL:BWP0:PUSCh:DMTA:BSAME 0
SOURce1:BB:NR5G:UBWP:USER0:CELL0:UL:BWP0:PUSCh:DMTA:CTYPE T1
SOURce1:BB:NR5G:UBWP:USER0:CELL0:UL:BWP0:PUSCh:DMTA:APINdex 1
SOURce1:BB:NR5G:UBWP:USER0:CELL0:UL:BWP0:PUSCh:DMTA:MLENgtH 2
SOURce1:BB:NR5G:UBWP:USER0:CELL0:UL:BWP0:PUSCh:DMTA:PUID 1
SOURce1:BB:NR5G:UBWP:USER0:CELL0:UL:BWP0:PUSCh:DMTA:SID0 0
SOURce1:BB:NR5G:UBWP:USER0:CELL0:UL:BWP0:PUSCh:DMTA:SID1 0
SOURce1:BB:NR5G:UBWP:USER0:CELL0:UL:BWP0:PUSCh:DMTB:CTYPE T2
SOURce1:BB:NR5G:UBWP:USER0:CELL0:UL:BWP0:PUSCh:DMTB:APINdex 2
SOURce1:BB:NR5G:UBWP:USER0:CELL0:UL:BWP0:PUSCh:DMTB:MLENgtH 1
SOURce1:BB:NR5G:UBWP:USER0:CELL0:UL:BWP0:PUSCh:DMTB:PUID 2
SOURce1:BB:NR5G:UBWP:USER0:CELL0:UL:BWP0:PUSCh:DMTB:SID0 10
SOURce1:BB:NR5G:UBWP:USER0:CELL0:UL:BWP0:PUSCh:DMTB:SID1 10
SOURce1:BB:NR5G:UBWP:USER0:CELL0:UL:BWP0:PUSCh:TPStAtE 0
SOURce1:BB:NR5G:UBWP:USER0:CELL0:UL:BWP0:PUSCh:MRANK 2
SOURce1:BB:NR5G:UBWP:USER0:CELL0:UL:BWP0:PUSCh:TXConfig?
```

```

// CB
SOURCE1:BB:NR5G:UBWP:USER0:CELL0:UL:BWP0:PUSCh:MCSTable QAM256
SOURCE1:BB:NR5G:UBWP:USER0:CELL0:UL:BWP0:PUSCh:MTTPrecoding QAM256
SOURCE1:BB:NR5G:UBWP:USER0:CELL0:UL:BWP0:PUSCh:CBSUBset FPNC
SOURCE1:BB:NR5G:UBWP:USER0:CELL0:UL:BWP0:PUSCh:SCRambling:STATe 1
SOURCE1:BB:NR5G:UBWP:USER0:CELL0:UL:BWP0:PUSCh:DSID 100
SOURCE1:BB:NR5G:UBWP:USER0:CELL0:UL:BWP0:PUSCh:MCBGroups G0
SOURCE1:BB:NR5G:UBWP:USER0:CELL0:UL:BWP0:PUSCh:FHOP INTER
SOURCE1:BB:NR5G:UBWP:USER0:CELL0:UL:BWP0:PUSCh:FHOffsets:NOFFsets 4
SOURCE1:BB:NR5G:UBWP:USER0:CELL0:UL:BWP0:PUSCh:FHOffsets:OFFSet1 1
SOURCE1:BB:NR5G:UBWP:USER0:CELL0:UL:BWP0:PUSCh:FHOffsets:OFFSet1 2
SOURCE1:BB:NR5G:UBWP:USER0:CELL0:UL:BWP0:PUSCh:FHOffsets:OFFSet2 1
SOURCE1:BB:NR5G:UBWP:USER0:CELL0:UL:BWP0:PUSCh:FHOffsets:OFFSet3 2

SOURCE1:BB:NR5G:UBWP:USER0:CELL0:UL:BWP0:PUSCh:XOverhead N0
SOURCE1:BB:NR5G:UBWP:USER0:CELL0:UL:BWP0:PUSCh:FPTR FPM2
SOURCE1:BB:NR5G:UBWP:USER0:CELL0:UL:BWP0:PUSCh:OI01 1
SOURCE1:BB:NR5G:UBWP:USER0:CELL0:UL:BWP0:PUSCh:HPRNumber 4

SOURCE1:BB:NR5G:UBWP:USER0:CELL0:UL:BWP0:UCI:STATe 1
SOURCE1:BB:NR5G:UBWP:USER0:CELL0:UL:BWP0:UCI:MODE UCI
SOURCE1:BB:NR5G:UBWP:USER0:CELL0:UL:BWP0:UCI:MODE UCLS
SOURCE1:BB:NR5G:UBWP:USER0:CELL0:UL:BWP0:UCI:ALPHA A0_8
SOURCE1:BB:NR5G:UBWP:USER0:CELL0:UL:BWP0:UCI:ALPHA A1_0
SOURCE1:BB:NR5G:UBWP:USER0:CELL0:UL:BWP0:UCI:HARQ:OFF1 1
SOURCE1:BB:NR5G:UBWP:USER0:CELL0:UL:BWP0:UCI:HARQ:OFF2 5
SOURCE1:BB:NR5G:UBWP:USER0:CELL0:UL:BWP0:UCI:CGUCi:STATe 1
SOURCE1:BB:NR5G:UBWP:USER0:CELL0:UL:BWP0:UCI:CGUCi:OFFSet 2
SOURCE1:BB:NR5G:UBWP:USER0:CELL0:UL:BWP0:UCI:CSI:OF10 0
SOURCE1:BB:NR5G:UBWP:USER0:CELL0:UL:BWP0:UCI:CSI:OF11 5
SOURCE1:BB:NR5G:UBWP:USER0:CELL0:UL:BWP0:UCI:CSI:OF20 1
SOURCE1:BB:NR5G:UBWP:USER0:CELL0:UL:BWP0:UCI:CSI:OF21 10

SOURCE1:BB:NR5G:SCHed:CELL0:SUBF0:USER0:BWPpart0:ALLoc0:SLOT 0
SOURCE1:BB:NR5G:SCHed:CELL0:SUBF0:USER0:BWPpart0:ALLoc0:MAPType A
SOURCE1:BB:NR5G:SCHed:CELL0:SUBF0:USER0:BWPpart0:ALLoc0:SYMNumber 14
SOURCE1:BB:NR5G:SCHed:CELL0:SUBF0:USER0:BWPpart0:ALLoc0:RBNumber 273
SOURCE1:BB:NR5G:SCHed:CELL0:SUBF0:USER0:BWPpart0:ALLoc0:POWer 0
SOURCE1:BB:NR5G:SCHed:CELL0:SUBF0:USER0:BWPpart0:ALLoc0:REPetitions SLOT

SOURCE1:BB:NR5G:SCHed:CELL0:SUBF0:USER0:BWPpart0:ALLoc1:PUSCh:TYPE?
SOURCE1:BB:NR5G:SCHed:CELL0:SUBF0:USER0:BWPpart0:ALLoc0:MOD QAM64
SOURCE1:BB:NR5G:SCHed:CELL0:SUBF0:USER0:BWPpart0:ALLoc1:CW0:PHYSbits?
// 196560
SOURCE1:BB:NR5G:SCHed:CELL0:SUBF0:USER0:BWPpart0:ALLoc0:PUSCh:DMR:NIDSel CID
SOURCE1:BB:NR5G:SCHed:CELL0:SUBF0:USER0:BWPpart0:ALLoc0:PUSCh:DMR:SEQHopping GRP
SOURCE1:BB:NR5G:SCHed:CELL0:SUBF0:USER0:BWPpart0:ALLoc0:PUSCh:DMRS:LENGth 2
SOURCE1:BB:NR5G:SCHed:CELL0:SUBF0:USER0:BWPpart0:ALLoc0:PUSCh:DMRS:SLTSymbols?
// "2,3,10,11"
SOURCE1:BB:NR5G:SCHed:CELL0:SUBF0:USER0:BWPpart0:ALLoc0:PUSCh:DMRS:POWer -3
SOURCE1:BB:NR5G:SCHed:CELL0:SUBF0:USER0:BWPpart0:ALLoc1:PUSCh:TXScheme:NLAYer?
// 1

```

```

SOURCE1:BB:NR5G:SCHed:CELL0:SUBF0:USER0:BWPart0:ALLoc0:PUSCh:TXScheme:CDMData 2

SOURCE1:BB:NR5G:SCHed:CELL0:SUBF0:USER0:BWPart0:ALLoc0:PUSCh:TXScheme:TPMidx 1

// enable at least one SRS resource set with at least one SRS resource
// SOURCE1:BB:NR5G:UBWP:USER0:CELL0:UL:BWPart0:SRS:RS:NRSets 1
// SOURCE1:BB:NR5G:UBWP:USER0:CELL0:UL:BWPart0:SRS:RS:SET0:NRESources 1
// ... configure the SRS
// SOURCE1:BB:NR5G:SCHed:CELL0:SUBF0:USER0:BWPart0:ALLoc0:PUSCh:TXScheme:SRI 1

SOURCE1:BB:NR5G:UBWP:USER0:USCH:CCODing:STATe 1
SOURCE1:BB:NR5G:SCHed:CELL0:SUBF0:USER0:BWPart0:ALLoc0:PUSCh:CCODing:IMCS 11
SOURCE1:BB:NR5G:SCHed:CELL0:SUBF0:USER0:BWPart0:ALLoc0:CW0:PUSCh:CCODing:TCRate?
// 0.455078125
SOURCE1:BB:NR5G:SCHed:CELL0:SUBF0:USER0:BWPart0:ALLoc0:CW0:PUSCh:CCODing:TBSIZE?
// 90176
SOURCE1:BB:NR5G:SCHed:CELL0:SUBF0:USER0:BWPart0:ALLoc0:PUSCh:CCODing:RVINDEX 1

SOURCE1:BB:NR5G:SCHed:CELL0:SUBF0:USER0:BWPart0:ALLoc0:PUSCh:UCI:ACK:BITS 4
SOURCE1:BB:NR5G:SCHed:CELL0:SUBF0:USER0:BWPart0:ALLoc0:PUSCh:UCI:ACK:PATtern #HC,4
SOURCE1:BB:NR5G:SCHed:CELL0:SUBF0:USER0:BWPart0:ALLoc0:PUSCh:UCI:CSI1:BITS 5
SOURCE1:BB:NR5G:SCHed:CELL0:SUBF0:USER0:BWPart0:ALLoc0:PUSCh:UCI:CSI1:PATtern #H15,5
SOURCE1:BB:NR5G:SCHed:CELL0:SUBF0:USER0:BWPart0:ALLoc0:PUSCh:UCI:CSI2:PATtern #H0,1
SOURCE1:BB:NR5G:SCHed:CELL0:SUBF0:USER0:BWPart0:ALLoc0:PUSCh:UCI:CSI2:BITS 3
SOURCE1:BB:NR5G:SCHed:CELL0:SUBF0:USER0:BWPart0:ALLoc0:PUSCh:UCI:CSI2:PATtern #H2,3
SOURCE1:BB:NR5G:SCHed:CELL0:SUBF0:USER0:BWPart0:ALLoc0:PUSCh:UCI:CGUC:BITS 3
SOURCE1:BB:NR5G:SCHed:CELL0:SUBF0:USER0:BWPart0:ALLoc0:PUSCh:UCI:CGUC:PATtern #H2,3

SOURCE1:BB:NR5G:SCHed:CELL0:SUBF0:USER0:BWPart0:ALLoc0:PUSCh:FHOP:STATe 1
SOURCE1:BB:NR5G:SCHed:CELL0:SUBF0:USER0:BWPart0:ALLoc0:PUSCh:FHOI 0
SOURCE1:BB:NR5G:SCHed:CELL0:SUBF0:USER0:BWPart0:ALLoc0:PUSCh:DMRS:APSelect0 APO

//Configure PUSCH interlacing
SOURCE1:BB:NR5G:UBWP:USER0:CELL0:UL:BWPart0:PUCCh:UITL 1
SOURCE1:BB:NR5G:SCHed:CELL0:SUBF0:USER0:BWPart0:ALLoc1:PUSCh:NINT 2
SOURCE1:BB:NR5G:SCHed:CELL0:SUBF0:USER0:BWPart0:ALLoc1:PUSCh:INT0:INTL 0
SOURCE1:BB:NR5G:SCHed:CELL0:SUBF0:USER0:BWPart0:ALLoc1:PUSCh:INT1:INTL 2

```

Example: Configuring the PUSCH PTRS with enabled transform precoding

```

SOURCE1:BB:NR5G:LINK UP

SOURCE1:BB:NR5G:UBWP:USER0:USCH:CCODing:STATe 1
SOURCE1:BB:NR5G:UBWP:USER0:CELL0:UL:BWPart0:PUSCh:TPSTATe 1

SOURCE1:BB:NR5G:UBWP:USER0:CELL0:UL:BWPart0:PUSCh:DMTA:PTRS:TP:STATe 1
SOURCE1:BB:NR5G:UBWP:USER0:CELL0:UL:BWPart0:PUSCh:DMTA:PTRS:TP:TMDensity TD2
SOURCE1:BB:NR5G:UBWP:USER0:CELL0:UL:BWPart0:PUSCh:DMTA:PTRS:TP:SCID CID
SOURCE1:BB:NR5G:UBWP:USER0:CELL0:UL:BWPart0:PUSCh:DMTA:PTRS:TP:RB0 1
SOURCE1:BB:NR5G:UBWP:USER0:CELL0:UL:BWPart0:PUSCh:DMTA:PTRS:TP:RB1 270
SOURCE1:BB:NR5G:UBWP:USER0:CELL0:UL:BWPart0:PUSCh:DMTA:PTRS:TP:RB2 275
SOURCE1:BB:NR5G:UBWP:USER0:CELL0:UL:BWPart0:PUSCh:DMTA:PTRS:TP:RB3 276

```

```
SOURce1:BB:NR5G:UBWP:USER0:CELL0:UL:BWP0:PUSCh:DMTA:PTRS:TP:RB4?  
// 276  
  
SOURce1:BB:NR5G:SCHeD:CELL0:SUBF0:USER0:BWPart0:ALLoc0:CONTeNt PUSC  
SOURce1:BB:NR5G:SCHeD:CELL0:SUBF0:USER0:BWPart0:ALLoc0:PUSCh:PTRS:TP:MODE MAN  
SOURce1:BB:NR5G:SCHeD:CELL0:SUBF0:USER0:BWPart0:ALLoc0:PUSCh:PTRS:TP:STATe 1  
SOURce1:BB:NR5G:SCHeD:CELL0:SUBF0:USER0:BWPart0:ALLoc0:PUSCh:PTRS:TP:TMDensity TD2  
SOURce1:BB:NR5G:SCHeD:CELL0:SUBF0:USER0:BWPart0:ALLoc0:PUSCh:PTRS:TP:NGRPs G4  
SOURce1:BB:NR5G:SCHeD:CELL0:SUBF0:USER0:BWPart0:ALLoc0:PUSCh:PTRS:TP:SCID PUID  
SOURce1:BB:NR5G:SCHeD:CELL0:SUBF0:USER0:BWPart0:ALLoc0:PUSCh:PTRS:TP:SPPG S4
```

Example: Configuring the PUCCH settings

```

SOURCE1:BB:NR5G:LINK UP

SOURCE1:BB:NR5G:UBWP:USER0:CELL0:UL:BWP0:PUCCh:ADMRs:STATe 1
SOURCE1:BB:NR5G:UBWP:USER0:CELL0:UL:BWP0:PUCCh:BPSK:STATe 1
SOURCE1:BB:NR5G:UBWP:USER0:CELL0:UL:BWP0:PUCCh:HACK:STATe?
// 0

SOURCE1:BB:NR5G:UBWP:USER0:CELL0:UL:BWP0:PUCCh:UR16 0

SOURCE1:BB:NR5G:SCHeD:CELL0:SUBF0:USER0:BWPart0:NALLoc 2
SOURCE1:BB:NR5G:SCHeD:CELL0:SUBF0:USER0:BWPart0:ALLoc1:CONTEnt PUCc
SOURCE1:BB:NR5G:SCHeD:CELL0:SUBF0:USER0:BWPart0:ALLoc1:SLOT 0
SOURCE1:BB:NR5G:SCHeD:CELL0:SUBF0:USER0:BWPart0:ALLoc1:FMT F4
SOURCE1:BB:NR5G:SCHeD:CELL0:SUBF0:USER0:BWPart0:ALLoc1:SYMNumber 4
SOURCE1:BB:NR5G:SCHeD:CELL0:SUBF0:USER0:BWPart0:ALLoc1:SYMOffset 0
SOURCE1:BB:NR5G:SCHeD:CELL0:SUBF0:USER0:BWPart0:ALLoc1:RBNumber 10
SOURCE1:BB:NR5G:SCHeD:CELL0:SUBF0:USER0:BWPart0:ALLoc1:RBOFFset 0
SOURCE1:BB:NR5G:SCHeD:CELL0:SUBF0:USER0:BWPart0:ALLoc1:POWEr 0
SOURCE1:BB:NR5G:SCHeD:CELL0:SUBF0:USER0:BWPart0:ALLoc1:REPetitions SUBF

SOURCE1:BB:NR5G:SCHeD:CELL0:SUBF0:USER0:BWPart0:ALLoc1:PUCCh:GRPHopping ENA
SOURCE1:BB:NR5G:SCHeD:CELL0:SUBF0:USER0:BWPart0:ALLoc1:PUCCh:HOPid 100
SOURCE1:BB:NR5G:SCHeD:CELL0:SUBF0:USER0:BWPart0:ALLoc1:PUCCh:ISFHopping 0
SOURCE1:BB:NR5G:SCHeD:CELL0:SUBF0:USER0:BWPart0:ALLoc1:PUCCh:SHOPping 20
SOURCE1:BB:NR5G:SCHeD:CELL0:SUBF0:USER0:BWPart0:ALLoc1:PUCCh:TOFFset 0.000025
SOURCE1:BB:NR5G:SCHeD:CELL0:SUBF0:USER0:BWPart0:ALLoc1:CPEXt 25
SOURCE1:BB:NR5G:SCHeD:CELL0:SUBF0:USER0:BWPart0:ALLoc1:PUCCh:FS:OCCLength L4
SOURCE1:BB:NR5G:SCHeD:CELL0:SUBF0:USER0:BWPart0:ALLoc1:PUCCh:FS:OCcIndex 1
SOURCE1:BB:NR5G:SCHeD:CELL0:SUBF0:USER0:BWPart0:ALLoc1:PUCCh:PL:SRCount?
// 0
SOURCE1:BB:NR5G:SCHeD:CELL0:SUBF0:USER0:BWPart0:ALLoc1:PUCCh:PL:UCI:BITS 3
SOURCE1:BB:NR5G:SCHeD:CELL0:SUBF0:USER0:BWPart0:ALLoc1:PUCCh:PL:UCI:PATTErn #H5,3
SOURCE1:BB:NR5G:SCHeD:CELL0:SUBF0:USER0:BWPart0:ALLoc1:PUCCh:PL:ACK:BITS?
// 0
SOURCE1:BB:NR5G:SCHeD:CELL0:SUBF0:USER0:BWPart0:ALLoc1:PUCCh:PL:ACK:PATTErn?
// #H0,0

//Setting a PUCCH allocation as burst refence for the burst power mode
SOURCE1:BB:NR5G:SCHeD:CELL0:SUBF0:USER0:BWPart0:ALLoc1:PDSCh:BMAid 1

//Use PUCCH interlace
SOURCE1:BB:NR5G:SCHeD:CELL0:SUBF0:USER0:BWPart0:ALLoc1:FMT F2
SOURCE1:BB:NR5G:SCHeD:CELL0:SUBF0:USER0:BWPart0:ALLoc1:PUCCh:NINT 1
SOURCE1:BB:NR5G:SCHeD:CELL0:SUBF0:USER0:BWPart0:ALLoc1:PUCCh:INT0:INTL 2

```

Example: Configuring the PRACH settings

```

SOURCE1:BB:NR5G:LINK UP
SOURCE1:BB:NR5G:NODE:CELL0:CARDePLY GT6
SOURCE1:BB:NR5G:NODE:CELL0:TXBW:S120K:USE 1
SOURCE1:BB:NR5G:UBWP:USER0:CELL0:DL:BWP0:SCSPACING N120

SOURCE1:BB:NR5G:SCHED:CELL0:SUBF0:USER0:BWPART0:NALLOC 2
SOURCE1:BB:NR5G:SCHED:CELL0:SUBF0:USER0:BWPART0:ALLOCL:CONTENT PRACH
SOURCE1:BB:NR5G:SCHED:CELL0:SUBF0:USER0:BWPART0:ALLOCL:PRACH:SCSPACING N120
SOURCE1:BB:NR5G:SCHED:CELL0:SUBF0:USER0:BWPART0:ALLOCL:PRACH:FORMAT FA1
SOURCE1:BB:NR5G:SCHED:CELL0:SUBF0:USER0:BWPART0:ALLOCL:PRACH:RSET URES
SOURCE1:BB:NR5G:SCHED:CELL0:SUBF0:USER0:BWPART0:ALLOCL:PRACH:RSEQUENCE 1
SOURCE1:BB:NR5G:SCHED:CELL0:SUBF0:USER0:BWPART0:ALLOCL:PRACH:ZCZONE 1
SOURCE1:BB:NR5G:SCHED:CELL0:SUBF0:USER0:BWPART0:ALLOCL:PRACH:PRINDEX 1
SOURCE1:BB:NR5G:SCHED:CELL0:SUBF0:USER0:BWPART0:ALLOCL:PRACH:TOFFSET 0
SOURCE1:BB:NR5G:SCHED:CELL0:SUBF0:USER0:BWPART0:ALLOCL:PRACH:RBNUMBER?
// 12

//Setting a PRACH allocation as burst refence for the burst power mode
//SOURCE1:BB:NR5G:SCHED:CELL0:SUBF0:USER0:BWPART0:ALLOCL:PRACH:BMAID 1

```

Example: Time domain windowing

```

SOURCE1:BB:NR5G:TDWIND:STATE?
// 0
SOURCE1:BB:NR5G:OUTPUT:TDWIND:TRTIME:S15K:TRTIME 5
...
SOURCE1:BB:NR5G:OUTPUT:TDWIND:TRTIME:S240K:TRTIME 5
SOURCE1:BB:NR5G:OUTPUT:TDWIND:TRTIME:S240K:TRTSAMPLES?
// 11

```

Example: Output settings

```
SOURce1:BB:NR5G:OUTPut:SEQLen 10
SOURce1:BB:NR5G:OUTPut:SSOC:STATe 0
SOURce1:BB:NR5G:OUTPut:OUTPut:FMODE CBW
SOURce1:BB:NR5G:OUTPut:SAMRmode FFt
SOURce1:BB:NR5G:OUTPut:BBConf:ROW0:SRATe?
// 122880000
SOURce1:BB:NR5G:OUTPut:BBConf:ROW0:CONFLict?
// 0
SOURce1:BB:NR5G:OUTPut:BBConf:ROW0:PBRate?
// 122880000
SOURce1:BB:NR5G:OUTPut:BBConf:ROW0:VARiatiOn 0

SOURce1:BB:NR5G:OUTPut:CLEVel 80
SOURce1:BB:NR5G:OUTPut:CMODE VECT

SOURce1:BB:NR5G:OUTPut:CFReduction:STATe 1
SOURce1:BB:NR5G:OUTPut:CFReduction:ALGorithm?
// CLF
SOURce1:BB:NR5G:OUTPut:CFReduction:TCRFactor 10
SOURce1:BB:NR5G:OUTPut:CFReduction:ITERations 5
SOURce1:BB:NR5G:OUTPut:CFReduction:OCFactor?
// 0
SOURce1:BB:NR5G:OUTPut:CFReduction:RCFactor?
// 0

SOURce1:BB:NR5G:OUTPut:POWer:BBConf:ROW0:AVRL?
// 0
SOURce1:BB:NR5G:OUTPut:POWer:BWRef:ACRL?
// 0
SOURce1:BB:NR5G:OUTPut:POWer:S240K:ACRL?
// 0

SOURce1:BB:NR5G:OUTPut:BBConf:CONFLict?
// 0
```

Example: Configure and enable triggering

```
SOURce:BB:NR5G:TRIGger:SEQuence SINGle
SOURce:BB:NR5G:TRIGger:SLENgth 200

// the first 200 samples of the current waveform will be output after
// the next trigger event
// SOURce:BB:NR5G:TRIGger:SEQuence ARETrigger
// SOURce:BB:NR5G:TRIGger:SOURce EGT1
// external trigger signal must be provided at the User connector
// SOURce:BB:NR5G:TRIGger:EXTernal:SYNChronize:OUTPut ON
// SOURce:BB:NR5G:TRIGger:EXTernal:DELay 200
// SOURce:BB:NR5G:TRIGger:EXTernal:INHibit 100

SOURce:BB:NR5G:TRIGger:SEQuence AAUTO
SOURce:BB:NR5G:TRIGger:SOURce INTernal
SOURce:BB:NR5G:STAT ON
SOURce:BB:NR5G:TRIGger:EXEC
```

Example: Specifying delay and inhibit values in time units

```
SOURce1:BB:NR5G:CLOCk 1000000
SOURce1:BB:NR5G:TRIGger:SEQuence AAUT
SOURce1:BB:NR5G:TRIGger:SOURce EGT1
SOURce1:BB:NR5G:TRIGger:DELay:UNIT SAMP
SOURce1:BB:NR5G:TRIGger:EXTernal:DELay 100
SOURce1:BB:NR5G:TRIGger:EXTernal:RDELay?
// Response: 100

SOURce1:BB:NR5G:TRIGger:DELay:UNIT TIME
SOURce1:BB:NR5G:TRIGger:EXTernal:TDELay 0.00001
SOURce1:BB:NR5G:TRIGger:EXTernal:RDELay?
// Response: 0.00001

SOURce1:BB:NR5G:TRIGger:DELay:UNIT SAMP
SOURce1:BB:NR5G:TRIGger:EXTernal:DELay 10
```

Example: Configure and enable standard marker signals

```
SOURce:BB:NR5G:TRIGger:OUTPut1:MODE RAT
SOURce:BB:NR5G:TRIGger:OUTPut1:ONTime 10
SOURce:BB:NR5G:TRIGger:OUTPut1:OFFTime 20
SOURce:BB:NR5G:TRIGger:OUTPut1:INVert ON
```

```
SOURce:BB:NR5G:TRIGger:OUTPut2:MODE?
// REStart
SOURce:BB:NR5G:TRIGger:OUTPut2:FOFFset 10
SOURce:BB:NR5G:TRIGger:OUTPut2:ROFFset 20
```

```
SOURce:BB:NR5G:TRIGger:OUTPut2:DElay 16
```

```
SOURce:BB:NR5G:TRIGger:OUTPut3:MODE PER
SOURce:BB:NR5G:TRIGger:OUTPut3:PERiod 30
```

Example: Configure and enable an UL/DL marker

```
SOURcel:BB:NR5G:TRIGger:OUTPut1:MODE ULDL
SOURcel:BB:NR5G:TRIGger:OUTPut1:DUPLexing TDD
SOURcel:BB:NR5G:TRIGger:OUTPut1:SCSPacing SCS60
SOURcel:BB:NR5G:TRIGger:OUTPut1:ECPState 1
SOURcel:BB:NR5G:TRIGger:OUTPut1:SLINt 10
SOURcel:BB:NR5G:TRIGger:OUTPut1:NDLSlots 5
SOURcel:BB:NR5G:TRIGger:OUTPut1:NSSlots?
// 1
SOURcel:BB:NR5G:TRIGger:OUTPut1:NULSlots 4
SOURcel:BB:NR5G:TRIGger:OUTPut1:IAB:STATe 0
```

```
//Use special slot format
SOURcel:BB:NR5G:TRIGger:OUTPut1:SSC:SFI:STATe 1
SOURcel:BB:NR5G:TRIGger:OUTPut1:SSC:SLFMT 0
SOURcel:BB:NR5G:TRIGger:OUTPut1:SSC:NDLSymbols?
// 14
SOURcel:BB:NR5G:TRIGger:OUTPut1:SSC:NGSYmbols?
//0
SOURcel:BB:NR5G:TRIGger:OUTPut1:SSC:NULSYmbols?
// 0
```

```
//Do not use special slot format
SOURcel:BB:NR5G:TRIGger:OUTPut1:SSC:SFI:STATe 0
SOURcel:BB:NR5G:TRIGger:OUTPut1:SSC:NDLSymbols 8
SOURcel:BB:NR5G:TRIGger:OUTPut1:SSC:NGSYmbols?
// 6
SOURcel:BB:NR5G:TRIGger:OUTPut1:SSC:NULSYmbols?
// 0
```

Example: Clock settings

```
SOURce:BB:NR5G:CLOCK:SOURce INT
```

Example: Configuring the HARQ-ACK in DCI1_0 and 0_1 settings

```
SOURcel:BB:NR5G:NODE:NCARrier 2
SOURcel:BB:NR5G:SCHed:CELL0:SUBF0:USER0:BWPart0:ALLoc0:CS:NDCI 2
SOURcel:BB:NR5G:SCHed:CELL0:SUBF0:USER0:BWPart0:ALLoc0:CS:FMT F10
SOURcel:BB:NR5G:SCHed:CELL0:SUBF0:USER0:BWPart0:ALLoc0:CS:FMT F01
SOURcel:BB:NR5G:SCHed:CELL0:SUBF0:USER0:BWPart0:ALLoc0:CS:DAI1 1
SOURcel:BB:NR5G:SCHed:CELL0:SUBF0:USER0:BWPart0:ALLoc0:CS:HAProc 1
```

Example: Configuring a sidelink signal

```

SOURCE:BB:NR5G:LINK SIDE
//Carrier configuration
SOURCE:BB:NR5G:NODE:NCARrier 1
SOURCE:BB:NR5G:NODE:RFPhase:MODE AUTO
SOURCE:BB:NR5G:NODE:CELL0:CELLid 112
SOURCE:BB:NR5G:NODE:CELL0:CARDeploy FR1LT3
SOURCE:BB:NR5G:NODE:CELL0:CBW BW100
SOURCE:BB:NR5G:NODE:CELL0:DFReq 0
//Tx bandwidth configuration
SOURCE:BB:NR5G:NODE:CELL0:TXBW:S30K:USE 1
SOURCE:BB:NR5G:NODE:CELL0:TXBW:S30K:OFFSet 0
//S-SS/PSBCH configuration
SOURCE:BB:NR5G:NODE:CELL0:NSSPbch 1
SOURCE:BB:NR5G:NODE:CELL0:OFFSet?
//POIN
SOURCE:BB:NR5G:NODE:CELL0:SSPBch0:SCSPacing N30
SOURCE:BB:NR5G:NODE:CELL0:SSPBch0:RBOFFset 126
SOURCE:BB:NR5G:NODE:CELL0:SSPBch0:SL:INTerval 1
SOURCE:BB:NR5G:NODE:CELL0:SSPBch0:SL:TOFFs 0
SOURCE:BB:NR5G:NODE:CELL0:SSPBch0:SL:BINPeriod B1
SOURCE:BB:NR5G:NODE:CELL0:SSPBch0:SL:INCoverage 1
SOURCE:BB:NR5G:NODE:CELL0:SSPBch0:SL:SBITS #H0,2
SOURCE:BB:NR5G:NODE:CELL0:SSPBch0:SL:TDDConf #H000,12
SOURCE:BB:NR5G:NODE:CELL0:SSPBch0:PSSPow 0
SOURCE:BB:NR5G:NODE:CELL0:SSPBch0:SSSPow 0
SOURCE:BB:NR5G:NODE:CELL0:SSPBch0:POWer 0
SOURCE:BB:NR5G:NODE:CELL0:SSPBch0:STATe 1
//User and bandwidth part configuration
SOURCE:BB:NR5G:UBWP:NUSer 1
SOURCE:BB:NR5G:UBWP:REStart OFF
SOURCE:BB:NR5G:UBWP:USER0:SSCH:CCODing:STATe 1
SOURCE:BB:NR5G:UBWP:USER0:SSCH:SCRambling:STATe 1
SOURCE:BB:NR5G:UBWP:USER0:SSCH:DATA PN9
SOURCE:BB:NR5G:UBWP:USER0:SSCH:INITpattern 1
SOURCE:BB:NR5G:UBWP:USER0:CELL0:SL:NBWParts 1
SOURCE:BB:NR5G:UBWP:USER0:CELL0:SL:BWP0:INDicator 0
SOURCE:BB:NR5G:UBWP:USER0:CELL0:SL:BWP0:SCSPacing N30
SOURCE:BB:NR5G:UBWP:USER0:CELL0:SL:BWP0:RBNumber 273
SOURCE:BB:NR5G:UBWP:USER0:CELL0:SL:BWP0:RBOFFset 0
//Resource pool configuration
SOURCE:BB:NR5G:UBWP:USER0:CELL0:SL:BWP0:RESPool:NRESpool 1
SOURCE:BB:NR5G:UBWP:USER0:CELL0:SL:BWP0:RES0:NPRB 80
SOURCE:BB:NR5G:UBWP:USER0:CELL0:SL:BWP0:RES0:STRB 0
SOURCE:BB:NR5G:UBWP:USER0:CELL0:SL:BWP0:RES0:SCHSize R20
SOURCE:BB:NR5G:UBWP:USER0:CELL0:SL:BWP0:RES0:NSUBchannels 4
SOURCE:BB:NR5G:UBWP:USER0:CELL0:SL:BWP0:RES0:MREServe 1
SOURCE:BB:NR5G:UBWP:USER0:CELL0:SL:BWP0:RES0:REPList 1
SOURCE:BB:NR5G:UBWP:USER0:CELL0:SL:BWP0:RES0:MSCTable QAM64
SOURCE:BB:NR5G:UBWP:USER0:CELL0:SL:BWP0:RES0:AMCS 0

```

```

SOURCE:BB:NR5G:UBWP:USER0:CELL0:SL:BWP0:RES0:MNPRes 2
SOURCE:BB:NR5G:UBWP:USER0:CELL0:SL:BWP0:RES0:PAT2 1
SOURCE:BB:NR5G:UBWP:USER0:CELL0:SL:BWP0:RES0:PAT3 0
SOURCE:BB:NR5G:UBWP:USER0:CELL0:SL:BWP0:RES0:PAT4 0
SOURCE:BB:NR5G:UBWP:USER0:CELL0:SL:BWP0:RES0:SCALing FP5
SOURCE:BB:NR5G:UBWP:USER0:CELL0:SL:BWP0:RES0:BOF1 4
SOURCE:BB:NR5G:UBWP:USER0:CELL0:SL:BWP0:RES0:BOF2 4
SOURCE:BB:NR5G:UBWP:USER0:CELL0:SL:BWP0:RES0:BOF3 0
SOURCE:BB:NR5G:UBWP:USER0:CELL0:SL:BWP0:RES0:BOF4 0
SOURCE:BB:NR5G:UBWP:USER0:CELL0:SL:BWP0:RES0:RESBits 2
//PSSCH and PSCCH scheduling
SOURCE:BB:NR5G:SCHed:CELL0:SUBF0:USER0:BWPart0:NALLoc 1
SOURCE:BB:NR5G:SCHed:CELL0:SUBF0:USER0:BWPart0:ALLoc0:CONTEnt PSCS
SOURCE:BB:NR5G:SCHed:CELL0:SUBF0:USER0:BWPart0:ALLoc0:SLOT 0
SOURCE:BB:NR5G:SCHed:CELL0:SUBF0:USER0:BWPart0:ALLoc0:SYMNumber 10
SOURCE:BB:NR5G:SCHed:CELL0:SUBF0:USER0:BWPart0:ALLoc0:SYMoffset 1
SOURCE:BB:NR5G:SCHed:CELL0:SUBF0:USER0:BWPart0:ALLoc0:RBNumber 20
SOURCE:BB:NR5G:SCHed:CELL0:SUBF0:USER0:BWPart0:ALLoc0:RBOffset 0
SOURCE:BB:NR5G:SCHed:CELL0:SUBF0:USER0:BWPart0:ALLoc0:POWer 0
SOURCE:BB:NR5G:SCHed:CELL0:SUBF0:USER0:BWPart0:ALLoc0:STATe 1
SOURCE:BB:NR5G:SCHed:CELL0:SUBF0:USER0:BWPart0:ALLoc0:REPetitions SLOT
//PSSCH and PSCCH configuration
SOURCE:BB:NR5G:SCHed:CELL0:SUBF0:USER0:BWPart0:ALLoc0:PSSCh:NDMRs 2
SOURCE:BB:NR5G:SCHed:CELL0:SUBF0:USER0:BWPart0:ALLoc0:PSSCh:NSUBchan 1
SOURCE:BB:NR5G:SCHed:CELL0:SUBF0:USER0:BWPart0:ALLoc0:PSSCh:MOD QPSK
SOURCE:BB:NR5G:SCHed:CELL0:SUBF0:USER0:BWPart0:ALLoc0:PSSCh:TXScheme:NLAYers 1
SOURCE:BB:NR5G:SCHed:CELL0:SUBF0:USER0:BWPart0:ALLoc0:PSSCh:DMRS:APSel P1000
SOURCE:BB:NR5G:SCHed:CELL0:SUBF0:USER0:BWPart0:ALLoc0:PSCCh:SCRid 0
SOURCE:BB:NR5G:SCHed:CELL0:SUBF0:USER0:BWPart0:ALLoc0:PSCCh:BDWidth RB10
SOURCE:BB:NR5G:SCHed:CELL0:SUBF0:USER0:BWPart0:ALLoc0:PSCCh:SYMLength 2
//PSSCH and PSCCH antenna port configuration
SOURCE:BB:NR5G:SCHed:CELL0:SUBF0:USER0:BWPart0:ALLoc0:APMap:COL0:REAL 1
SOURCE:BB:NR5G:SCHed:CELL0:SUBF0:USER0:BWPart0:ALLoc0:APMap:COL0:ROW0:IMAGinary 0
SOURCE:BB:NR5G:SCHed:CELL0:SUBF0:USER0:BWPart0:ALLoc0:COL1:ROW0:REAL 1
SOURCE:BB:NR5G:SCHed:CELL0:SUBF0:USER0:BWPart0:ALLoc0:COL1:ROW0:IMAGinary 0
//SCI1A configuration
SOURCE:BB:NR5G:SCHed:CELL0:SUBF0:USER0:BWPart0:ALLoc0:SCI:PRTY 1
SOURCE:BB:NR5G:SCHed:CELL0:SUBF0:USER0:BWPart0:ALLoc0:SCI:FRDRes 1
SOURCE:BB:NR5G:SCHed:CELL0:SUBF0:USER0:BWPart0:ALLoc0:SCI:TIDRes 2
SOURCE:BB:NR5G:SCHed:CELL0:SUBF0:USER0:BWPart0:ALLoc0:SCI:BOInd 1
SOURCE:BB:NR5G:SCHed:CELL0:SUBF0:USER0:BWPart0:ALLoc0:SCI:DPATterns 1
SOURCE:BB:NR5G:SCHed:CELL0:SUBF0:USER0:BWPart0:ALLoc0:SCI:MCS 10
SOURCE:BB:NR5G:SCHed:CELL0:SUBF0:USER0:BWPart0:ALLoc0:SCI:AMCSind 0
SOURCE:BB:NR5G:SCHed:CELL0:SUBF0:USER0:BWPart0:ALLoc0:SCI:S2FMT 0
SOURCE:BB:NR5G:SCHed:CELL0:SUBF0:USER0:BWPart0:ALLoc0:SCI:RESVed #H3,2
SOURCE:BB:NR5G:SCHed:CELL0:SUBF0:USER0:BWPart0:ALLoc0:SCI:PAT1?
//SCI2A configuration
SOURCE:BB:NR5G:SCHed:CELL0:SUBF0:USER0:BWPart0:ALLoc0:SCI:S2FMT 0
SOURCE:BB:NR5G:SCHed:CELL0:SUBF0:USER0:BWPart0:ALLoc0:SCI:HARProc 5
SOURCE:BB:NR5G:SCHed:CELL0:SUBF0:USER0:BWPart0:ALLoc0:SCI:NDI 1

```

```

SOURCE:BB:NR5G:SCHed:CELL0:SUBF0:USER0:BWPart0:ALLoc0:SCI:REDundancy 1
SOURCE:BB:NR5G:SCHed:CELL0:SUBF0:USER0:BWPart0:ALLoc0:SCI:SOURid 124
SOURCE:BB:NR5G:SCHed:CELL0:SUBF0:USER0:BWPart0:ALLoc0:SCI:DESTid 1285
SOURCE:BB:NR5G:SCHed:CELL0:SUBF0:USER0:BWPart0:ALLoc0:SCI:HARFb 0
SOURCE:BB:NR5G:SCHed:CELL0:SUBF0:USER0:BWPart0:ALLoc0:SCI:CTINd 1
SOURCE:BB:NR5G:SCHed:CELL0:SUBF0:USER0:BWPart0:ALLoc0:SCI:CSIReq 1
SOURCE:BB:NR5G:SCHed:CELL0:SUBF0:USER0:BWPart0:ALLoc0:SCI2:PATtern?
//SCI2B configuration
SOURCE:BB:NR5G:SCHed:CELL0:SUBF0:USER0:BWPart0:ALLoc0:SCI:S2FmT 1
SOURCE:BB:NR5G:SCHed:CELL0:SUBF0:USER0:BWPart0:ALLoc0:SCI:HARProc 5
SOURCE:BB:NR5G:SCHed:CELL0:SUBF0:USER0:BWPart0:ALLoc0:SCI:NDI 1
SOURCE:BB:NR5G:SCHed:CELL0:SUBF0:USER0:BWPart0:ALLoc0:SCI:REDundancy 1
SOURCE:BB:NR5G:SCHed:CELL0:SUBF0:USER0:BWPart0:ALLoc0:SCI:SOURid 124
SOURCE:BB:NR5G:SCHed:CELL0:SUBF0:USER0:BWPart0:ALLoc0:SCI:DESTid 1285
SOURCE:BB:NR5G:SCHed:CELL0:SUBF0:USER0:BWPart0:ALLoc0:SCI:HARFb 0
SOURCE:BB:NR5G:SCHed:CELL0:SUBF0:USER0:BWPart0:ALLoc0:SCI:ZONEid 0
SOURCE:BB:NR5G:SCHed:CELL0:SUBF0:USER0:BWPart0:ALLoc0:SCI:CORReq 0
SOURCE:BB:NR5G:SCHed:CELL0:SUBF0:USER0:BWPart0:ALLoc0:SCI2:PATtern?
//Channel cosing configuration
SOURCE:BB:NR5G:SCHed:CELL0:SUBF0:USER0:BWPart0:ALLoc0:CW2U0:PSSCh:CCODing:FRCR 1
SOURCE:BB:NR5G:SCHed:CELL0:SUBF0:USER0:BWPart0:ALLoc0:CW2U0:PSSCh:CCODing:TCRate 0.1171875
SOURCE:BB:NR5G:SCHed:CELL0:SUBF0:USER0:BWPart0:ALLoc0:SL:PHYSbits?
//2676
SOURCE:BB:NR5G:SCHed:CELL0:SUBF0:USER0:BWPart0:ALLoc0:CW2U0:PSSCh:CCODing:TBSize?
//2664
SOURCE:BB:NR5G:SCHed:CELL0:SUBF0:USER0:BWPart0:ALLoc0:CW2U0:PSSCh:CCODing:RVINdex 0
SOURCE:BB:NR5G:SCHed:CELL0:SUBF0:USER0:BWPart0:ALLoc0:CW2U0:PSSCh:CCODing:TBSFactor S1

```

10.2 General commands

[SOURCE<hw>]:BB:NR5G:ANALyzer:CONTent.....	415
[SOURCE<hw>]:BB:NR5G:LINK.....	415
[SOURCE]:BB:NR5G:PLVersion?.....	415
[SOURCE<hw>]:BB:NR5G:PRESet.....	416
[SOURCE<hw>]:BB:NR5G:SETTing:CATalog?.....	416
[SOURCE<hw>]:BB:NR5G:SETTing:DEL.....	416
[SOURCE<hw>]:BB:NR5G:SETTing:LOAD.....	416
[SOURCE<hw>]:BB:NR5G:SETTing:STORe.....	417
[SOURCE<hw>]:BB:NR5G:SETTing:TMODeL:UL.....	417
[SOURCE<hw>]:BB:NR5G:SETTing:TMODeL:DL.....	417
[SOURCE<hw>]:BB:NR5G:SETTing:TMODeL:UL:CATalog?.....	417
[SOURCE<hw>]:BB:NR5G:SETTing:TMODeL:DL:CATalog?.....	417
[SOURCE<hw>]:BB:NR5G:SETTing:TMODeL:FILTer:BW.....	417
[SOURCE<hw>]:BB:NR5G:SETTing:TMODeL:FILTer:CATalog.....	418
[SOURCE<hw>]:BB:NR5G:SETTing:TMODeL:FILTer:DUPLexing.....	418
[SOURCE<hw>]:BB:NR5G:SETTing:TMODeL:FILTer:FREQ.....	418
[SOURCE<hw>]:BB:NR5G:SETTing:TMODeL:FILTer:SCS.....	419
[SOURCE<hw>]:BB:NR5G:SETTing:TMODeL:FILTer:TCASe.....	419

<code>[SOURce<hw>]:BB:NR5G:SETting:TMODEl:FiLTer:TMODEl</code>	419
<code>[SOURce<hw>]:BB:NR5G:SETting:TMODEl:FiLTer:TMSTandard</code>	420
<code>[SOURce<hw>]:BB:NR5G:SiMPle</code>	420
<code>[SOURce<hw>]:BB:NR5G:STATe</code>	420
<code>[SOURce<hw>]:BB:NR5G:UPLane:STATe</code>	420
<code>[SOURce]:BB:NR5G:VERSiOn?</code>	420
<code>[SOURce<hw>]:BB:NR5G:WAVeform:CREate</code>	421

`[SOURce<hw>]:BB:NR5G:ANALyzer:CONTent <FileName>`

Exports the signal configuration to an `.allocation` file that you can import into the NR 5G application on a signal and spectrum analyzer.

Parameters:

`<FileName>` string
String containing the name and path to the configuration file.

Manual operation: See ["Export Settings to Analyzer"](#) on page 44

`[SOURce<hw>]:BB:NR5G:LiNK <LinkDir>`

Selects the transmission direction.

Parameters:

`<LinkDir>` DOWN | SIDE | UP

DOWN
Selects downlink direction.

SIDE
Selects sidelink direction.
Requires Option: R&S SMM-K170

UP
Selects downlink direction.

*RST: DOWN

Example: See ["Example>Loading predefined test signals"](#) on page 385.

Manual operation: See ["Link Direction"](#) on page 44

`[SOURce]:BB:NR5G:PLVersion?`

Queries the installed version of the 5G New Radio application.

Return values:

`<PluginVersion>` string

Example: `SOURce1:BB:NR5G:PLVersion?`

Usage: Query only

Manual operation: See ["5G NR Application Version"](#) on page 31

[:SOURce<hw>]:BB:NR5G:PRESet

Sets the parameters of the digital standard to their default values (*RST values specified for the commands).

Not affected is the state set with the command `SOURce<hw>:BB:NR5G:STATe`.

Example: See [Example "Storing current configuration"](#) on page 385.

Usage: Event

Manual operation: See ["Set to Default"](#) on page 42

[:SOURce<hw>]:BB:NR5G:SETTing:CATalog?

Queries the files with settings in the default directory. Listed are files with the file extension *.nr5g.

Return values:

<FileNames> <filename1>,<filename2>,...

Returns a string of filenames separated by commas.

Example: See [Example "Storing current configuration"](#) on page 385.

Usage: Query only

Manual operation: See ["Save/Recall"](#) on page 42

[:SOURce<hw>]:BB:NR5G:SETTing:DEL <Filename>

Deletes the selected file from the default or the specified directory. Deleted are files with extension *.nr5g.

Parameters:

<Filename> "<filename>"

Filename or complete file path; file extension can be omitted

Example: See [Example "Storing current configuration"](#) on page 385.

Manual operation: See ["Save/Recall"](#) on page 42

[:SOURce<hw>]:BB:NR5G:SETTing:LOAD <Filename>

Loads the selected file from the default or the specified directory. Loaded are files with extension *.nr5g.

Parameters:

<Filename> "<filename>"

Filename or complete file path; file extension can be omitted

Example: See [Example "Storing current configuration"](#) on page 385.

Manual operation: See ["Save/Recall"](#) on page 42

```
[ :SOURce<hw>]:BB:NR5G:SETTing:STORe <Filename>
```

Saves the current settings into the selected file; the file extension (*.nr5g) is assigned automatically.

Parameters:

<Filename> "<filename>"
 Filename or complete file path

Example: See [Example "Storing current configuration"](#) on page 385.

Manual operation: See ["Save/Recall"](#) on page 42

```
[ :SOURce<hw>]:BB:NR5G:SETTing:TMODeI:UL <TmodUp>
```

```
[ :SOURce<hw>]:BB:NR5G:SETTing:TMODeI:DL <TmodDn>
```

Loads a test model file with predefined settings.

Parameters:

<TmodDn> "<filename>"
 Filename as queried with one of the following commands:
 [:SOURce<hw>]:BB:NR5G:SETTing:TMODeI:UL:
 CATalog?
 [:SOURce<hw>]:BB:NR5G:SETTing:TMODeI:DL:
 CATalog?
 [:SOURce<hw>]:BB:NR5G:SETTing:TMODeI:FILTer:
 CATalog

Example: See [Example "Loading predefined test signals"](#) on page 385.

Manual operation: See ["Select"](#) on page 47

```
[ :SOURce<hw>]:BB:NR5G:SETTing:TMODeI:UL:CATalog?
```

```
[ :SOURce<hw>]:BB:NR5G:SETTing:TMODeI:DL:CATalog?
```

Queries the filenames of predefined files with test signals in the default directory.

Return values:

<FileNames> <filename1>,<filename2>,...
 Returns a string of filenames separated by commas.

Example: See [Example "Loading predefined test signals"](#) on page 385.

Usage: Query only

Manual operation: See ["User Files"](#) on page 45

```
[ :SOURce<hw>]:BB:NR5G:SETTing:TMODeI:FILTer:BW <FilterBandwidth>
```

Applies a bandwidth filter to narrow down the files returned by the query [:
 SOURce<hw>]:BB:NR5G:SETTing:TMODeI:FILTer:CATalog.

Parameters:

<FilterBandwidth> ALL | F5 | F10 | F15 | F20 | F25 | F30 | F40 | F50 | F60 | F70 | F80 | F90 | F100 | F200 | F400 | F35 | F45 | F800 | F1600 | F2000
 *RST: ALL

Example:

See [Example"Filtering and loading predefined test signals"](#) on page 385.

Manual operation: See ["Bandwidth"](#) on page 47

[:SOURce<hw>]:BB:NR5G:SETTing:TMODeI:FiLTeR:CATalog

Queries the filenames of predefined test signal files in the default directory after applying a filter.

Return values:

<FileNames> <filename1>,<filename2>,...
 Returns a string of filenames separated by commas.

Example:

See [Example"Filtering and loading predefined test signals"](#) on page 385.

Manual operation: See ["Filter Test Models"](#) on page 46

[:SOURce<hw>]:BB:NR5G:SETTing:TMODeI:FiLTeR:DUPLexing <FilterDuplexing>

Applies a duplexing filter to narrow down the files returned by the query [:SOURce<hw>]:BB:NR5G:SETTing:TMODeI:FiLTeR:CATalog.

Parameters:

<FilterDuplexing> ALL | FDD | TDD
 *RST: ALL

Example:

See [Example"Filtering and loading predefined test signals"](#) on page 385.

Manual operation: See ["Duplexing"](#) on page 47

[:SOURce<hw>]:BB:NR5G:SETTing:TMODeI:FiLTeR:FREQ <FilterFreqRange>

Applies a frequency range filter to narrow down the files returned by the query [:SOURce<hw>]:BB:NR5G:SETTing:TMODeI:FiLTeR:CATalog.

Parameters:

<FilterFreqRange> ALL | FR1 | FR2
 *RST: ALL

Example:

See [Example"Filtering and loading predefined test signals"](#) on page 385.

Manual operation: See ["Frequency Range"](#) on page 47

[:SOURce<hw>]:BB:NR5G:SETTing:TMODeL:FiLTer:SCS <FilterScs>

Applies a subcarrier spacing filter to narrow down the files returned by the query [:SOURce<hw>]:BB:NR5G:SETTing:TMODeL:FiLTer:CATalog.

Parameters:

<FilterScs> ALL | F15 | F30 | F60 | F120 | F480 | F960
*RST: ALL

Example: See [Example "Filtering and loading predefined test signals"](#) on page 385.

Manual operation: See ["Subcarrier Spacing"](#) on page 47

[:SOURce<hw>]:BB:NR5G:SETTing:TMODeL:FiLTer:TCASe <FilterTestCase>

Applies a ORAN test case filter to narrow down the files returned by the query [:SOURce<hw>]:BB:NR5G:SETTing:TMODeL:FiLTer:CATalog.

Parameters:

<FilterTestCase> ALL | TC323110 | TC323112 | TC323114 | TC32311 | TC32312 | TC32314 | TC32316 | TC32318 | TC32511 | TC32512 | TC32513 | TC32514 | TC32515 | TC32516 | TC32517 | TC32518 | TC32611 | TC32612 | TC32613 | TC32614 | TC32615 | TC32313 | TC32315 | TC32317 | TC32319 | TC32381 | TC323111 | TC323113 | TC323115 | TC323117 | TC323121 | TC32332 | TC32532 | TC32333 | TC32334 | TC32335 | TC32336 | TC32337 | TC32338 | TC32339 | TC323310 | TC323311 | TC32533 | TC32534 | TC32535 | TC32536 | TC32537 | TC32538 | TC32539 | TC325310 | TC325311
*RST: n.a. (no preset. default: ALL)

Manual operation: See ["Test Case"](#) on page 47

[:SOURce<hw>]:BB:NR5G:SETTing:TMODeL:FiLTer:TMODeL <FilterTestModel>

Applies a test model filter to narrow down the files returned by the query [:SOURce<hw>]:BB:NR5G:SETTing:TMODeL:FiLTer:CATalog.

Parameters:

<FilterTestModel> ALL | TM1_1 | TM1_2 | TM2 | TM2a | TM3_1 | TM3_1A | TM3_2 | TM3_3 | TM2B | TM3_1B
*RST: ALL

Example: See [Example "Filtering and loading predefined test signals"](#) on page 385.

Manual operation: See ["Test Models"](#) on page 47

[:SOURce<hw>]:BB:NR5G:SETTing:TMODEl:FILTer:TMSTandard <FilterStandard>

Applies a standard filter to narrow down the files returned by the query [:
[SOURce<hw>\]:BB:NR5G:SETTing:TMODEl:FILTer:CATalog.](#)

Parameters:

<FilterStandard> **NR**
 3GPP test models.
ORAN
 ORAN test cases.
 *RST: n.a. (no preset. default: NR)

Manual operation: See "[Standard](#)" on page 46

[:SOURce<hw>]:BB:NR5G:SIMPIe <State>

Turns the simple mode of the user interface on and off.

Parameters:

<State> 1 | ON | 0 | OFF
 *RST: 0

Manual operation: See "[Simple Mode](#)" on page 48

[:SOURce<hw>]:BB:NR5G:STATe <State>

Activates the standard and deactivates all the other digital standards and digital modulation modes in the same path.

Parameters:

<State> 1 | ON | 0 | OFF
 *RST: 0

Example: See [Example "Storing current configuration"](#) on page 385.

Manual operation: See "[State](#)" on page 41

[:SOURce<hw>]:BB:NR5G:UPLane:STATe <UPlaneState>

Turns generation of user plane data according to O-RAN standard on and off.

Parameters:

<UPlaneState> 1 | ON | 0 | OFF
 *RST: 0

Manual operation: See "[U-Plane Generation](#)" on page 48

[:SOURce]:BB:NR5G:VERSion?

Queries the version of the 3GPP standard underlying the definitions.

Return values:

<Version> string

Example:

SOURce1:BB:NR5G:VERSion?

Usage:

Query only

Manual operation: See ["3GPP Specification Table"](#) on page 31

[:SOURce<hw>]:BB:NR5G:WAVeform:CREate <Filename>

Stores the current settings as an ARB signal in a waveform file (*.wv).

Parameters:

<Filename> string

Filename or complete file path; file extension is assigned automatically

Example:

See [Example"Storing current configuration"](#) on page 385.

Manual operation: See ["Generate Waveform File"](#) on page 42

10.3 FRC wizard commands

[:SOURce<hw>]:BB:NR5G:UBWP:USER<us>:CELL<cc>:UL:BWP<bwp>:FRC:WDEployment.....	421
[:SOURce<hw>]:BB:NR5G:UBWP:USER<us>:CELL<cc>:UL:BWP<bwp>:FRC:WMAType....	422
[:SOURce<hw>]:BB:NR5G:UBWP:USER<us>:CELL<cc>:UL:BWP<bwp>:FRC:WModulation?.....	422
[:SOURce<hw>]:BB:NR5G:UBWP:USER<us>:CELL<cc>:UL:BWP<bwp>:FRC:WPASize?...	422
[:SOURce<hw>]:BB:NR5G:UBWP:USER<us>:CELL<cc>:UL:BWP<bwp>:FRC:WPTRs:STATE.....	422
[:SOURce<hw>]:BB:NR5G:UBWP:USER<us>:CELL<cc>:UL:BWP<bwp>:FRC:WROffset...	423
[:SOURce<hw>]:BB:NR5G:UBWP:USER<us>:CELL<cc>:UL:BWP<bwp>:FRC:WSpacing?.....	423
[:SOURce<hw>]:BB:NR5G:UBWP:USER<us>:CELL<cc>:UL:BWP<bwp>:FRC:WTYP.....	423

[:SOURce<hw>]:BB:NR5G:UBWP:USER<us>:CELL<cc>:UL:BWP<bwp>:FRC:WDEployment <Deployment>

Selects the frequency deployment for the FRC wizard.

Parameters:

<Deployment> FR1LT3 | FR1GT3 | FR2_1 | FR2 | BT36 | GT6 | LT3 | BT37125 | GT7125 | FR2_2

*RST: FR1LT3

Example:

See [\[:SOURce<hw>\]:BB:NR5G:UBWP:USER<us>:CELL<cc>:UL:BWP<bwp>:FRC:WTYP](#) on page 423

Manual operation: See ["Deployment"](#) on page 43

[:SOURce<hw>]:BB:NR5G:UBWP:USER<us>:CELL<cc>:UL:BWP<bwp>:FRC:WMAType <MappingType>

Selects the PUSCH mapping type for the selected FRC.

Parameters:

<MappingType> A | B
 *RST: A

Manual operation: See "[Mapping Type](#)" on page 44

[:SOURce<hw>]:BB:NR5G:UBWP:USER<us>:CELL<cc>:UL:BWP<bwp>:FRC:WMOdulation?

Queries the modulation for the selected FRC in the FRC wizard.

Return values:

<Modulation> BPSK | BPSK2 | QPSK | QAM16 | QAM64 | QAM256 |
 QAM1024 | NSQAM2048 | NSQAM4096 | PSK8 |
 NSAPSK16_23 | NSAPSK16_34 | NSAPSK16_45 |
 NSAPSK16_56 | NSAPSK16_89 | NSAPSK16_910 |
 NSAPSK32_34 | NSAPSK32_45 | NSAPSK32_56 |
 NSAPSK32_89 | NSAPSK32_910
 *RST: QPSK

Example: See [:SOURce<hw>] :BB:NR5G:UBWP:USER<us> :
 CELL<cc> :UL:BWP<bwp> :FRC:WTYP on page 423

Usage: Query only

Manual operation: See "[Modulation](#)" on page 43

[:SOURce<hw>]:BB:NR5G:UBWP:USER<us>:CELL<cc>:UL:BWP<bwp>:FRC:WPASize?

Queries the payload size of the selected FRC.

Return values:

<PayloadSize> integer
 Range: 528 to 217128
 *RST: 984

Usage: Query only

Manual operation: See "[Payload Size](#)" on page 44

[:SOURce<hw>]:BB:NR5G:UBWP:USER<us>:CELL<cc>:UL:BWP<bwp>:FRC:WPTRs:STATe <State>

Turns the PTRS for an FRC on and off.

Available for selected FRCs only.

Parameters:

<State> 1 | ON | 0 | OFF
 *RST: 0

Example:

```
//Turn on PTRS
BB:NR5G:UBWP:USER:CELL:UL:BWP:FRC:WTYP FR2A41
BB:NR5G:UBWP:USER:CELL:UL:BWP:FRC:WPTRs:STATE 1
```

Manual operation: See "PTRS" on page 44

**[:SOURce<hw>]:BB:NR5G:UBWP:USER<us>:CELL<cc>:UL:BWP<bwp>:FRC:
 WROffset <RBOffset>**

Defines an RB offset for the selected FRC.

Parameters:

<RBOffset> integer
 Range: 0 to Nr5gMax_RbOffs
 *RST: 0

Manual operation: See "RB Offset" on page 44

**[:SOURce<hw>]:BB:NR5G:UBWP:USER<us>:CELL<cc>:UL:BWP<bwp>:FRC:
 WSCSpacing?**

Queries the subcarrier spacing for the selected FRC in the FRC wizard.

Return values:

<SCSpacing> N15 | N30 | N60 | X60 | N120 | N240 | N480 | N960
 *RST: N30

Example:

See `[:SOURce<hw>] :BB:NR5G:UBWP:USER<us> :
 CELL<cc> :UL:BWP<bwp> :FRC:WTYP` on page 423

Usage: Query only

Manual operation: See "SC Spacing" on page 43

**[:SOURce<hw>]:BB:NR5G:UBWP:USER<us>:CELL<cc>:UL:BWP<bwp>:FRC:
 WTYP <FrcWizardId>**

Selects an FRC for base station testing with the FRC wizard.

Parameters:

<FrcWizardId>

FR1A11 | FR1A12 | FR1A13 | FR1A14 | FR1A15 | FR1A16 |
FR1A17 | FR1A18 | FR1A19 | FR2A11 | FR2A12 | FR2A13 |
FR2A14 | FR2A15 | FR1A21 | FR1A22 | FR1A23 | FR1A24 |
FR1A25 | FR1A26 | NA | FR1A38 | FR1A39 | FR1A310 |
FR1A311 | FR1A312 | FR1A313 | FR1A314 | FR1A322 |
FR1A323 | FR1A324 | FR1A325 | FR1A326 | FR1A327 |
FR1A328 | FR1A48 | FR1A49 | FR1A410 | FR1A411 |
FR1A412 | FR1A413 | FR1A414 | FR1A422 | FR1A423 |
FR1A424 | FR1A425 | FR1A426 | FR1A427 | FR1A428 |
FR1A58 | FR1A59 | FR1A510 | FR1A511 | FR1A512 |
FR1A513 | FR1A514 | FR1A331 | FR1A332 | FR2A31 |
FR2A32 | FR2A33 | FR2A34 | FR2A35 | FR2A36 | FR2A37 |
FR2A38 | FR2A39 | FR2A310 | FR2A311 | FR2A312 | FR2A41 |
FR2A42 | FR2A43 | FR2A44 | FR2A45 | FR2A46 | FR2A47 |
FR2A48 | FR2A49 | FR2A410 | FR2A51 | FR2A52 | FR2A53 |
FR2A54 | FR2A55 | FR2A313 | FR2A314 | FR2A315 |
FR2A316 | FR2A317 | FR2A318 | FR2A319 | FR2A320 |
FR2A321 | FR2A322 | FR2A323 | FR2A324 | FR2A411 |
FR2A412 | FR2A413 | FR2A414 | FR2A415 | FR2A416 |
FR2A417 | FR2A418 | FR2A419 | FR2A420 | FR2A56 |
FR2A57 | FR2A58 | FR2A59 | FR2A510 | FR1A31 | FR1A32 |
FR1A33 | FR1A34 | FR1A35 | FR1A36 | FR1A37 | FR1A315 |
FR1A316 | FR1A317 | FR1A318 | FR1A319 | FR1A320 |
FR1A321 | FR1A329 | FR1A330 | FR1A41 | FR1A42 | FR1A43 |
FR1A44 | FR1A45 | FR1A46 | FR1A47 | FR1A415 | FR1A416 |
FR1A417 | FR1A418 | FR1A419 | FR1A420 | FR1A421 |
FR1A51 | FR1A52 | FR1A53 | FR1A54 | FR1A55 | FR1A56 |
FR1A57 | FR1A110 | FR1A111 | FR1A333 | FR1A333A |
FR1A334 | FR1A334A | FR2A71 | FR2A72 | FR2A73 | FR2A74 |
FR2A75 | FR2A76 | FR2A77 | FR2A78 | FR2A79 | FR2A710 |
FR1A429 | FR1A429A | FR1A430 | FR1A430A | FR1A431A |
FR1A431 | FR1A432A | FR1A432 | FR1A3A1 | FR1A3A2 |
FR1A3A3 | FR1A3A4 | FR1A3B1 | FR1A3B2 | FR1A3B3 |
FR1A3B4 | TS381411_FR1A71 | TS381411_FR1A72 |
TS381411_FR1A73 | TS381411_FR1A74 | TS381412_FR1A81 |
TS381412_FR1A82 | TS381412_FR1A83 |
TS381412_FR1A84 | FR2A325 | FR2A326 | FR2A3A1 |
FR2A3A2 | FR2A3A3 | FR2A3A4 | FR2A3A5 | FR2A3A6 |
FR2A3A7 | FR2A3A8 | TS38176_FR1A211 |
TS38176_FR1A212 | TS38176_FR1A213 |
TS38176_FR1A214 | TS38176_FR1A215 |
TS38176_FR1A216 | TS38176_FR1A217 |
TS38176_FR1A218 | TS38176_FR1A219 |
TS38176_FR1A2110 | TS38176_FR1A2111 |
TS38176_FR1A2112 | TS38176_FR1A2113 |
TS38176_FR1A2114 | TS38176_FR1A2115 |
TS38176_FR1A2116 | TS38176_FR1A231 |
TS38176_FR1A232 | TS38176_FR1A233 |
TS38176_FR1A234 | TS38176_FR1A235 |

TS38176_FR1A236 | TS38176_FR1A237 |
TS38176_FR1A238 | TS38176_FR1A239 |
TS38176_FR1A2310 | TS38176_FR1A2311 |
TS38176_FR1A2312 | TS38176_FR1A2313 |
TS38176_FR1A2314 | TS38176_FR1A241 |
TS38176_FR1A242 | TS38176_FR1A243 |
TS38176_FR1A244 | TS38176_FR1A245 |
TS38176_FR1A246 | TS38176_FR1A247 | TS38176_FR2A211 |
TS38176_FR2A212 | TS38176_FR2A213 |
TS38176_FR2A214 | TS38176_FR2A215 |
TS38176_FR2A216 | TS38176_FR2A217 |
TS38176_FR2A218 | TS38176_FR2A219 |
TS38176_FR2A2110 | TS38176_FR2A2111 |
TS38176_FR2A2112 | TS38176_FR2A2113 |
TS38176_FR2A2114 | TS38176_FR2A2115 |
TS38176_FR2A2116 | TS38176_FR2A2117 |
TS38176_FR2A2118 | TS38176_FR2A2119 |
TS38176_FR2A2120 | TS38176_FR2A2121 |
TS38176_FR2A2122 | TS38176_FR2A2123 |
TS38176_FR2A2124 | TS38176_FR2A221 |
TS38176_FR2A222 | TS38176_FR2A223 |
TS38176_FR2A224 | TS38176_FR2A225 |
TS38176_FR2A226 | TS38176_FR2A227 |
TS38176_FR2A228 | TS38176_FR2A229 |
TS38176_FR2A2210 | TS38176_FR2A231 |
TS38176_FR2A232 | TS38176_FR2A233 |
TS38176_FR2A234 | TS38176_FR2A235 |
TS38176_FR2A236 | TS38176_FR2A237 |
TS38176_FR2A238 | TS38176_FR2A239 |
TS38176_FR2A2310 | TS38176_FR2A2311 |
TS38176_FR2A2312 | TS38176_FR2A2313 |
TS38176_FR2A2314 | TS38176_FR2A2315 |
TS38176_FR2A2316 | TS38176_FR2A2317 |
TS38176_FR2A2318 | TS38176_FR2A2319 |
TS38176_FR2A2320 | TS38176_FR2A241 |
TS38176_FR2A242 | TS38176_FR2A243 |
TS38176_FR2A244 | TS38176_FR2A245 |
TS38176_FR2A246 | TS38176_FR2A247 |
TS38176_FR2A248 | TS38176_FR2A249 |
TS38176_FR2A2410 | FR1A112 | FR1A113 | FR1A114 |
FR1A115 | FR1A116 | FR1A117 | FR1A118 | FR1A119 |
FR1A27 | FR1A28 | FR1A29 | FR1A210 | FR1A211 | FR1A212 |
FR1A213 | FR1A214 | FR1A215 | FR1A216 |
TS381411_FR1A82 | TS381411_FR1A83 | TS381411_FR1A84 |
TS381411_FR1A81 | TS381411_FR1A85 | TS381412_FR1A91 |
TS381412_FR1A92 | TS381412_FR1A93 |
TS381412_FR1A94 | TS381412_FR1A95 | TS38181_FR1A11 |
TS38181_FR1A12 | TS38181_FR1A13 | TS38181_FR1A14 |
TS38181_FR1A15 | TS38181_FR1A16 | TS38181_FR1A17 |
TS38181_FR1A18 | TS38181_FR1A19 | TS38181_FR1A21 |

```

TS38181_FR1A22 | TS38181_FR1A23 | TS38181_FR1A24 |
TS38181_FR1A25 | TS38181_FR1A26 | TS38181_FR1A31 |
TS38181_FR1A32 | TS38181_FR1A33 | TS38181_FR1A34 |
TS38181_FR1A35 | TS38181_FR1A36 | TS38181_FR1A3A1 |
TS38181_FR1A3A3 | FR2A101 | FR2A102 | FR2A103 |
FR2A105 | FR2A104 | FR2A106 | FR2A107 | FR2A108 |
FR2A109 | FR2A1010 | FR2A1011 | FR2A1012 | FR1A335 |
FR1A337 | FR1A336 | FR1A338 | FR1A3B5 | FR1A3B6 |
FR1A3B7 | FR1A3B8 | FR2A327 | FR2A3B1 | FR2A3B2
*RST:      FR1A12

```

Example:

```

//Configure FRC wizard
BB:NR5G:UBWP:USER:CELL:UL:BWP:FRC:WTYP FR1A11
BB:NR5G:UBWP:USER:CELL:UL:BWP:FRC:WDEPLOYment FR1LT3
BB:NR5G:UBWP:USER:CELL:UL:BWP:FRC:WMOdulation?
BB:NR5G:UBWP:USER:CELL:UL:BWP:FRC:WSCSpacing?

```

Manual operation: See "FRC" on page 43

10.4 Quick settings command

[:SOURce<hw>]:BB:NR5G:QCKSet:GENeral:CARDePLY.....	427
[:SOURce<hw>]:BB:NR5G:QCKSet:GENeral:CBW.....	427
[:SOURce<hw>]:BB:NR5G:QCKSet:GENeral:CCTModel.....	427
[:SOURce<hw>]:BB:NR5G:QCKSet:GENeral:CHRaster.....	427
[:SOURce<hw>]:BB:NR5G:QCKSet:GENeral:CHSPacing.....	428
[:SOURce<hw>]:BB:NR5G:QCKSet:GENeral:SCSPacing.....	428
[:SOURce<hw>]:BB:NR5G:QCKSet:GENeral:ECPState.....	428
[:SOURce<hw>]:BB:NR5G:QCKSet:GENeral:DUPLexing.....	429
[:SOURce<hw>]:BB:NR5G:QCKSet:GENeral:NCARier.....	429
[:SOURce<hw>]:BB:NR5G:QCKSet:GENeral:ES:MOD.....	429
[:SOURce<hw>]:BB:NR5G:QCKSet:GENeral:ES:CS:STATe.....	429
[:SOURce<hw>]:BB:NR5G:QCKSet:GENeral:ES:CSLength.....	430
[:SOURce<hw>]:BB:NR5G:QCKSet:GENeral:ES:RBConfig.....	430
[:SOURce<hw>]:BB:NR5G:QCKSet:GENeral:ES:RBNumber.....	430
[:SOURce<hw>]:BB:NR5G:QCKSet:GENeral:ES:RBOffset.....	430
[:SOURce<hw>]:BB:NR5G:QCKSet:GENeral:ES:TP:STATe.....	431
[:SOURce<hw>]:BB:NR5G:QCKSet:FRMFormat:SLInt.....	431
[:SOURce<hw>]:BB:NR5G:QCKSet:FRMFormat:IAB:STATe.....	431
[:SOURce<hw>]:BB:NR5G:QCKSet:GENeral:SFFM:STATe.....	431
[:SOURce<hw>]:BB:NR5G:QCKSet:FRMFormat:NDLSlots.....	431
[:SOURce<hw>]:BB:NR5G:QCKSet:FRMFormat:NSSLots?.....	432
[:SOURce<hw>]:BB:NR5G:QCKSet:FRMFormat:NULSlots.....	432
[:SOURce<hw>]:BB:NR5G:QCKSet:FRMFormat:SSC:SLFMt.....	432
[:SOURce<hw>]:BB:NR5G:QCKSet:FRMFormat:SSC:NDLSymbols.....	432
[:SOURce<hw>]:BB:NR5G:QCKSet:FRMFormat:SSC:NGSYmbols?.....	433
[:SOURce<hw>]:BB:NR5G:QCKSet:FRMFormat:SSC:NULSymbols.....	433

[:SOURce<hw>]:BB:NR5G:QCKSet:FRMFormat:SSC:SFI:STATe.....	434
[:SOURce<hw>]:BB:NR5G:QCKSet:APPLY.....	434
[:SOURce<hw>]:BB:NR5G:QCKSet:DISCard.....	434

[:SOURce<hw>]:BB:NR5G:QCKSet:GENeral:CARDeplY <Deployment>

Selects one of the frequency ranges, specified for 5G NR transmission.

Parameters:

<Deployment> FR1LT3 | FR1GT3 | FR2_1 | FR2_2
*RST: FR1LT3

Example: See [Example"Using the quick settings"](#) on page 386.

Manual operation: See ["Deployment"](#) on page 34

[:SOURce<hw>]:BB:NR5G:QCKSet:GENeral:CBW <QckSetChannelBW>

Selects the bandwidth of the node carrier.

Parameters:

<QckSetChannelBW> BW5 | BW10 | BW15 | BW20 | BW25 | BW30 | BW35 | BW40 |
BW45 | BW50 | BW60 | BW70 | BW80 | BW90 | BW100 |
BW200 | BW400 | BW800 | BW1600 | BW2000
*RST: BW100

Example: See [Example"Using the quick settings"](#) on page 386.

Manual operation: See ["Channel Bandwidth"](#) on page 34

[:SOURce<hw>]:BB:NR5G:QCKSet:GENeral:CCTModel <State>

Creates a copy of a component carrier based on a test model configuration.

Prerequisites for this command

- Select a single carrier ([\[:SOURce<hw>\]:BB:NR5G:QCKSet:GENeral:NCARier](#)).
- Select a test model ([\[:SOURce<hw>\]:BB:NR5G:SETTing:TModel:DL](#) / [\[:SOURce<hw>\]:BB:NR5G:SETTing:TModel:UL](#)).

Parameters:

<State> 1 | ON | 0 | OFF
*RST: 0

Manual operation: See ["Copy Carrier With Selected Test Model"](#) on page 33

[:SOURce<hw>]:BB:NR5G:QCKSet:GENeral:CHRaster <ChannelRaster>

Sets the "Channel Raster" based on the set "Deployment".

If "Deployment" is set to "FR1 ≤ 3GHz" or "FR1 > 3GHz" the "Channel Raster" can be set to 15 kHz or 100 kHz.

If "Deployment" is set to "FR2-1" the "Channel Raster" is set to 60 kHz.

If "Deployment" is set to "FR2-2" the "Channel Raster" is set to 100 kHz.

"Channel Raster" is not displayed when the "Number of Carriers" is shown inactive.

Parameters:

<ChannelRaster> R15 | R60 | R100
*RST: R100

Example: See [Example"Using the quick settings"](#) on page 386

Manual operation: See ["Channel Raster"](#) on page 34

[:SOURce<hw>]:BB:NR5G:QCKSet:GENeral:CHSPacing <ChannelSpacing>

Queries or sets the value for the "Channel Spacing". It is by default automatically calculated by the set "Channel Raster" and the set "Channel Bandwidth".

The value can be manually adjusted, but is recalculated if the "Channel Raster" or the "Channel Bandwidth" is adjusted.

"Channel Spacing" is not displayed when the "Number of Carriers" is shown inactive. In this case, it is used like "Carrier Spacing" equals 0.

Parameters:

<ChannelSpacing> integer
Range: 0 to 800E6
*RST: 0

Example: See [Example"Using the quick settings"](#) on page 386

Manual operation: See ["Channel Spacing"](#) on page 35

[:SOURce<hw>]:BB:NR5G:QCKSet:GENeral:SCSPacing <SubcarrierSpacing>

Sets the subcarrier spacing.

Parameters:

<SubcarrierSpacing> SCS15 | SCS30 | SCS60 | SCS120 | SCS240 | SCS480 | SCS960
*RST: SCS30

Example: See [Example"Using the quick settings"](#) on page 386.

Options: SCS480 and SCS960 require R&S SMM-K171

Manual operation: See ["Subcarrier Spacing"](#) on page 35

[:SOURce<hw>]:BB:NR5G:QCKSet:GENeral:ECPState <QSScsEcpState>

Show if the extended cyclic prefix is enabled or disabled.

Parameters:

<QSScsEcpState> 1 | ON | 0 | OFF
 *RST: 0

Example: See [Example"Using the quick settings"](#) on page 386.

Manual operation: See ["Use Extended Cyclic Prefix"](#) on page 35

[:SOURce<hw>]:BB:NR5G:QCKSet:GENeral:DUPLexing <QckSetDuplexing>

Selects the duplexing mode.

Parameters:

<QckSetDuplexing> TDD | FDD
 *RST: FDD

Example: See [Example"Using the quick settings"](#) on page 386.

Manual operation: See ["Duplexing"](#) on page 33

[:SOURce<hw>]:BB:NR5G:QCKSet:GENeral:NCARier <QckSetNumCarrie>

Selects the number of carriers. Needed for carrier aggregation.

Parameters:

<QckSetNumCarrie> integer
 Range: 1 to 16
 *RST: 1

Example: See [Example"Using the quick settings"](#) on page 386.

Manual operation: See ["Number of Carriers"](#) on page 33

[:SOURce<hw>]:BB:NR5G:QCKSet:GENeral:ES:MOD <QckSetModType>

Sets the modulation scheme.

Parameters:

<QckSetModType> QPSK | QAM16 | QAM64 | QAM256 | BPSK2 | QAM1024
 *RST: QPSK

Example: See [Example"Using the quick settings"](#) on page 386.

Manual operation: See ["Modulation"](#) on page 36

[:SOURce<hw>]:BB:NR5G:QCKSet:GENeral:ES:CS:STATe <QckSetCSSState>

Activate to schedule a CORESET.

Parameters:

<QckSetCSSState> 1 | ON | 0 | OFF
 *RST: 0

Example: See [Example"Using the quick settings"](#) on page 386.

Manual operation: See ["Use CORESET"](#) on page 35

[:SOURce<hw>]:BB:NR5G:QCKSet:GENeral:ES:CSLength <QckSetCORSETLen>

Sets the number of symbols in the CORESET.

Parameters:

<QckSetCORSETLen> integer

Range: 1 to 3

*RST: 1

Example: See [Example"Using the quick settings"](#) on page 386.

Manual operation: See ["Number of CORESET Symbols"](#) on page 35

[:SOURce<hw>]:BB:NR5G:QCKSet:GENeral:ES:RBConfig <QckSetRbConfig>

Sets the configuration mode for the resource block configuration.

Parameters:

<QckSetRbConfig> MAN | EFL | EFR | ERL | ERR | OUTP | INNF | I1RL | I1RR |
OUTP | O1RL | O1RR | R1IF | R1IL | R1IR | R2IF | R2IL | R2IR

*RST: MAN

Example: See [Example"Using the quick settings"](#) on page 386.

Manual operation: See ["Resource Block Configuration"](#) on page 36

[:SOURce<hw>]:BB:NR5G:QCKSet:GENeral:ES:RBNumber <QckSetRBNum>

Sets the number of resource blocks.

Parameters:

<QckSetRBNum> integer

Range: 1 to 273

*RST: 273

Example: See [Example"Using the quick settings"](#) on page 386.

Manual operation: See ["Number of Resource Blocks"](#) on page 36

[:SOURce<hw>]:BB:NR5G:QCKSet:GENeral:ES:RBOffset <QckSetRBOffset>

Sets the resource block offset.

Parameters:

<QckSetRBOffset> integer

Range: 0 to 272

*RST: 0

Example: See [Example"Using the quick settings"](#) on page 386.

Manual operation: See ["Resource Block Offset"](#) on page 36

[:SOURce<hw>]:BB:NR5G:QCKSet:GENeral:ES:TP:STATe <State>

Turns transform precoding on and off.

Parameters:

<State> 1 | ON | 0 | OFF
*RST: 0

Example: See [Example"Using the quick settings"](#) on page 386.

Manual operation: See ["Use Transform Precoding"](#) on page 36

[:SOURce<hw>]:BB:NR5G:QCKSet:FRMFormat:SLINt <Slots>

Sets the duration of the frame in slots.

Parameters:

<Slots> integer
Range: 2 to 20
*RST: 10

Example: See [Example"Using the quick settings"](#) on page 386.

Manual operation: See ["Slot Period"](#) on page 37

[:SOURce<hw>]:BB:NR5G:QCKSet:FRMFormat:IAB:STATe <State>

Turns usage of the IAB frame format on and off.

Parameters:

<State> 1 | ON | 0 | OFF
*RST: 0

Example: See [Example"Using the quick settings"](#) on page 386.

Manual operation: See ["Use IAB Format"](#) on page 38

[:SOURce<hw>]:BB:NR5G:QCKSet:GENeral:SFFM:STATe <State>

Turns synchronization to the marker on and off.

Parameters:

<State> 1 | ON | 0 | OFF
*RST: 1

Manual operation: See ["Synchronize Frame Format to Marker"](#) on page 33

[:SOURce<hw>]:BB:NR5G:QCKSet:FRMFormat:NDLSlots <QckSetDLSlots>

Sets the number of DL slots in the frame.

Parameters:

<QckSetDLSlots> integer
 Range: 0 to 10
 *RST: 10

Example: See [Example"Using the quick settings"](#) on page 386.

Manual operation: See ["Number of DL Slots"](#) on page 38

[:SOURce<hw>]:BB:NR5G:QCKSet:FRMFormat:NSSLots?

Queries the number of special slots in the frame.

Return values:

<QckSetNoSplSlot> integer
 Range: 0 to 1
 *RST: n.a. (no preset. default: 0)

Example: See [Example"Using the quick settings"](#) on page 386.

Usage: Query only

Manual operation: See ["Number of Special Slots"](#) on page 38

[:SOURce<hw>]:BB:NR5G:QCKSet:FRMFormat:NULSlots <Slots>

Queries the number of UL slots in the frame.

Parameters:

<Slots> integer
 Range: 0 to 10
 *RST: 0

Example: See [Example"Using the quick settings"](#) on page 386.

Manual operation: See ["Number of UL Slots"](#) on page 38

[:SOURce<hw>]:BB:NR5G:QCKSet:FRMFormat:SSC:SLFMT <QckSetSlotFmt>

Sets the special slot format index.

Parameters:

<QckSetSlotFmt> integer
 Range: 0 to 45
 *RST: 0

Example: See [Example"Using the quick settings"](#) on page 386.

Manual operation: See ["Slot Format Index"](#) on page 38

[:SOURce<hw>]:BB:NR5G:QCKSet:FRMFormat:SSC:NDLSymbols <Symbols>

Defines the number of downlink symbols in a special slot.

Prerequisites to define the number of downlink symbols:

- Enter downlink mode (`[:SOURce<hw>] :BB:NR5G:LINK`).
- Turn off usage of special slot format (`[:SOURce<hw>] :BB:NR5G:QCKSet:FRMFormat:SSC:SFI:STATE`).

Otherwise, the command is a query only.

Parameters:

<Symbols> integer
 Range: 0 to 14
 *RST: 14

Example: See [Example"Using the quick settings"](#) on page 386.

Manual operation: See ["Number of DL Symbols"](#) on page 38

[:SOURce<hw>] :BB:NR5G:QCKSet:FRMFormat:SSC:NGSYmbols?

Queries the number of guard symbols.

Return values:

<QckSetSGuardSym>integer
 Range: 0 to 14
 *RST: 0

Example: See [Example"Using the quick settings"](#) on page 386.

Usage: Query only

Manual operation: See ["Number of Guarded Symbols"](#) on page 39

[:SOURce<hw>] :BB:NR5G:QCKSet:FRMFormat:SSC:NULSymbols <Symbols>

Defines the number of uplink symbols in a special slot.

Prerequisites to define the number of downlink symbols:

- Enter uplink mode (`[:SOURce<hw>] :BB:NR5G:LINK`).
- Turn off usage of special slot format (`[:SOURce<hw>] :BB:NR5G:QCKSet:FRMFormat:SSC:SFI:STATE`).

Otherwise, the command is a query only.

Parameters:

<Symbols> integer
 Range: 0 to 14
 *RST: 0

Example: See [Example"Using the quick settings"](#) on page 386.

Manual operation: See ["Number of UL Symbols"](#) on page 39

[:SOURce<hw>]:BB:NR5G:QCKSet:FRMFormat:SSC:STATe <State>

Turns usage of the special slot format on and off.

If on, select a special frame as defined by 3GPP with `[:SOURce<hw>] :BB:NR5G:QCKSet:FRMFormat:SSC:SLFMT`.

If off, select the number of symbols with

- Downlink: `[:SOURce<hw>] :BB:NR5G:QCKSet:FRMFormat:SSC:NDLSymbols`
- Uplink: `[:SOURce<hw>] :BB:NR5G:QCKSet:FRMFormat:SSC:NULSymbols`

Parameters:

<State> 1 | ON | 0 | OFF
 *RST: 1

Example: See [Example"Using the quick settings"](#) on page 386.

Manual operation: See ["Use Special Format Index"](#) on page 38

[:SOURce<hw>]:BB:NR5G:QCKSet:APPLY

Adopts the configuration.

Example: See [Example"Using the quick settings"](#) on page 386.

Usage: Event

Manual operation: See ["Apply"](#) on page 36

[:SOURce<hw>]:BB:NR5G:QCKSet:DISCard

Ignores the configuration.

Example: See [Example"Using the quick settings"](#) on page 386.

Usage: Event

Manual operation: See ["Discard"](#) on page 36

10.5 Carrier commands

<code>[:SOURce<hw>]:BB:NR5G:NODE:NCARrier</code>	435
<code>[:SOURce<hw>]:BB:NR5G:NODE:RFPHase:MODE</code>	435
<code>[:SOURce<hw>]:BB:NR5G:NODE:CELL<cc>:CELLid</code>	435
<code>[:SOURce<hw>]:BB:NR5G:NODE:CELL<cc>:CIF</code>	436
<code>[:SOURce<hw>]:BB:NR5G:NODE:CELL<cc>:CIFPresent</code>	436
<code>[:SOURce<hw>]:BB:NR5G:NODE:CELL<cc>:CINdicator</code>	436
<code>[:SOURce<hw>]:BB:NR5G:NODE:CELL<cc>:N1ID?</code>	437
<code>[:SOURce<hw>]:BB:NR5G:NODE:CELL<cc>:N2ID?</code>	437
<code>[:SOURce<hw>]:BB:NR5G:NODE:CELL<cc>:CARDepl</code>	437
<code>[:SOURce<hw>]:BB:NR5G:NODE:CELL<cc>:CBW</code>	437
<code>[:SOURce<hw>]:BB:NR5G:NODE:CELL<cc>:DFRReq</code>	438

<code>[:SOURce<hw>]:BB:NR5G:NODE:CELL<cc>:MAPPed</code>	438
<code>[:SOURce<hw>]:BB:NR5G:NODE:CELL<cc>:SHSPec</code>	438
<code>[:SOURce<hw>]:BB:NR5G:NODE:CELL<cc>:PCFReq</code>	439
<code>[:SOURce<hw>]:BB:NR5G:NODE:CELL<cc>:RFPHase:REFerence</code>	439
<code>[:SOURce<hw>]:BB:NR5G:NODE:CELL<cc>:SCHBy</code>	439
<code>[:SOURce<hw>]:BB:NR5G:NODE:CELL<cc>:TAPos</code>	440

`[:SOURce<hw>]:BB:NR5G:NODE:NCARrier <NumCarrier>`

Sets the number of simulated carriers.

When used in a previously configured system, reconfigures the number of simulated carriers.

Parameters:

`<NumCarrier>` integer
 Range: 1 to 16
 *RST: 1

Example: See [Example "Configuring the carrier"](#) on page 387.

Manual operation: See ["Number of Carriers"](#) on page 52

`[:SOURce<hw>]:BB:NR5G:NODE:RFPHase:MODE <RFPhaseComp>`

Enables the frequency-related phase compensation after each symbol, as specified in [TS 38.211](#).

It uses the parameter [Frequency in GHz](#) to set the carrier frequency to be compensated.

Parameters:

`<RFPhaseComp>` 0 | OFF | MANual | 1 | AUTO

0|OFF

Disables the frequency-related phase compensation.

MANual

Enables the [Frequency in GHz](#) field for manual input of the carrier frequency value to be compensated.

1|AUTO

Sets automatically the carrier [Frequency in GHz](#) value to be compensated.

*RST: AUTO

Example: See [Example "Configuring the carrier"](#) on page 387

Manual operation: See ["RF Phase Compensation"](#) on page 53

`[:SOURce<hw>]:BB:NR5G:NODE:CELL<cc>:CELLid <CellId>`

Sets the cell identity of the selected cell.

Parameters:

<CellId> integer
 For sidelink, the cell ID range is 0 to 671.
 Range: 0 to 1007
 *RST: 0

Example: See [Example "Configuring the carrier"](#) on page 387.

Manual operation: See ["Cell ID"](#) on page 54

[:SOURce<hw>]:BB:NR5G:NODE:CELL<cc>:CIF <Cif>

Queries the value of the carrier indicator field (CIF).

Parameters:

<Cif> 0 | 1 | 2 | 3 | 4 | 5 | 6 | 7
 *RST: 0

Example: See [Example "Configuring the carrier"](#) on page 387.

Manual operation: See ["CIF"](#) on page 55

[:SOURce<hw>]:BB:NR5G:NODE:CELL<cc>:CIFPresent <CifPresent>

Defines whether the carrier indicator field (CIF) is included in the PDCCH DCI formats transmitted from the corresponding cell.

The CIF is present in each DCI format and identifies the component carrier that carries the PDSCH or PUSCH for the particular PDCCH in the cross-carrier approach.

According to the 5G NR specification, cross-carrier scheduling is enabled by higher-level signaling. To simulate a cross-carrier scheduling in this implementation, enable the "Node > Carriers > CIF Present" per each cell.

Parameters:

<CifPresent> 1 | ON | 0 | OFF
 *RST: 0

Example: See [Example "Configuring the carrier"](#) on page 387.

Manual operation: See ["CIF Present"](#) on page 55

[:SOURce<hw>]:BB:NR5G:NODE:CELL<cc>:CINDicator <CellIndicator>

Sets the cell indicator.

Parameters:

<CellIndicator> integer
 Range: 0 to 15

Example: See [Example "Configuring the carrier"](#) on page 387.

Manual operation: See ["Cell Indicator"](#) on page 54

[:SOURce<hw>]:BB:NR5G:NODE:CELL<cc>:N1ID?

Queries the physical layer indicator group ($N_{ID}^{(1)}$).

(Sidelink: $N_{ID,1}^{SL}$)

Return values:

<ID> integer
Range: 0 to 335
*RST: 0

Example: See [Example"Configuring the carrier"](#) on page 387.

Usage: Query only

Manual operation: See ["N1 ID/N2 ID"](#) on page 55

[:SOURce<hw>]:BB:NR5G:NODE:CELL<cc>:N2ID?

Queries the physical layer indicator group ($N_{ID}^{(2)}$).

(Sidelink: $N_{ID,2}^{SL}$)

Return values:

<ID> integer
Range: 0 to 2
*RST: 0

Example: See [Example"Configuring the carrier"](#) on page 387.

Usage: Query only

Manual operation: See ["N1 ID/N2 ID"](#) on page 55

[:SOURce<hw>]:BB:NR5G:NODE:CELL<cc>:CARDeploy <Deployment>

Selects one of the frequency ranges, specified for 5G NR transmission.

Parameters:

<Deployment> FR1LT3 | FR1GT3 | FR2_1 | FR2_2
*RST: FR1LT3

Example: See [Example"Configuring the carrier"](#) on page 387.

Manual operation: See ["Deployment"](#) on page 55

[:SOURce<hw>]:BB:NR5G:NODE:CELL<cc>:CBW <ChanBandWidth>

Selects the bandwidth of the node carrier.

Some bandwidths are available with R&S SMM-K171.

Parameters:

<ChanBandWidth> BW5 | BW10 | BW15 | BW20 | BW25 | BW30 | BW35 | BW40 |
 BW45 | BW50 | BW60 | BW70 | BW80 | BW90 | BW100 |
 BW200 | BW400 | BW800 | BW1600 | BW2000
 *RST: BW100

Example: See [Example"Configuring the carrier"](#) on page 387.

Manual operation: See ["Channel Bandwidth"](#) on page 56

[:SOURce<hw>]:BB:NR5G:NODE:CELL<cc>:DFReq <DeltaFToDc>

Shifts the signal relative to the center output frequency.

Use different frequency offsets to separate the channels of the configured and enabled cells.

Parameters:

<DeltaFToDc> float
 Range: -40E6 to 40E6
 Increment: 1.0
 *RST: 0.0

Example: See [Example"Configuring the carrier"](#) on page 387.

Manual operation: See ["Delta f to Output/MHz"](#) on page 57

[:SOURce<hw>]:BB:NR5G:NODE:CELL<cc>:MAPPed <CellMapped>

If enabled, the signal of the selected cell is mapped to the output.

Parameters:

<CellMapped> 1 | ON | 0 | OFF
 *RST: 1

Example: See [Example"Configuring the carrier"](#) on page 387.

Manual operation: See ["Cell Mapped"](#) on page 57

[:SOURce<hw>]:BB:NR5G:NODE:CELL<cc>:SHSPec <State>

Turns shared spectrum access on and off.

Parameters:

<State> 1 | ON | 0 | OFF
 *RST: 0

Manual operation: See ["Shared Spectrum Access"](#) on page 57

[:SOURce<hw>]:BB:NR5G:NODE:CELL<cc>:PCFReq <CarrierFreq>

Sets the carrier frequency of the selected carrier at which the frequency phase compensation is applied.

Parameters:

<CarrierFreq> float
 Range: 0 to 999E9
 Increment: 1E2
 *RST: 1E9

Example: See [:SOURce<hw>] :BB:NR5G:NODE:RFPHase:MODE on page 435.

Manual operation: See "Frequency in GHz" on page 56

[:SOURce<hw>]:BB:NR5G:NODE:CELL<cc>:RFPHase:REFEreNce <RefFrequency>

Select the reference frequency for RF phase compensation.

Parameters:

<RefFrequency> RFA | RFB | NONE
NONE
 Define the frequency manually with [:SOURce<hw>] :BB:NR5G:NODE:CELL<cc>:PCFReq on page 439.
RFA | RFB
 Selects the frequency on path A or B as the reference frequency.
 *RST: RFA

Manual operation: See "RF Ref." on page 56

[:SOURce<hw>]:BB:NR5G:NODE:CELL<cc>:SCHBy <SchedBy>

Displays in which cell coordinates the carrier aggregation, if there is intra-band CA.

Queries the component carrier/cell that signals the UL and DL grants for the selected cell. The signaling cell is determined by its cell index.

According to the 5G NR specification, cross-carrier scheduling has to be enabled per user and per component carrier.

To enable signaling for one particular cell on the primary cell, i.e. cross-carrier scheduling, set the "Scheduled By" to 0.

Parameters:

<SchedBy> 0 | 1 | 2 | 3 | 4 | 5 | 6 | 7 | 8 | 9 | 10 | 11 | 12 | 13 | 14 | 15
 *RST: 0

Example: See Example "Configuring the carrier" on page 387.

Manual operation: See "Scheduled By" on page 55

[:SOURce<hw>]:BB:NR5G:NODE:CELL<cc>:TAPos <DmrsTypeAPos>

Sets the position of the first DMRS symbol within the slot, if mapping type A is used.

Parameters:

<DmrsTypeAPos> integer
 Range: 2 to 3
 *RST: 2

Example: See [Example"Configuring the carrier"](#) on page 387.

Manual operation: See ["DMRS Type A Position"](#) on page 57

10.6 Copy carrier commands

[:SOURce<hw>]:BB:NR5G:NODE:CC:ADD.....	440
[:SOURce<hw>]:BB:NR5G:NODE:CC:CINFo?.....	440
[:SOURce<hw>]:BB:NR5G:NODE:CC:CPYFrom.....	441
[:SOURce<hw>]:BB:NR5G:NODE:CC:CPYSel.....	441
[:SOURce<hw>]:BB:NR5G:NODE:CC:CPYTo?.....	441
[:SOURce<hw>]:BB:NR5G:NODE:CC:LOAD.....	441
[:SOURce<hw>]:BB:NR5G:NODE:CC:NEWCarriers.....	442

[:SOURce<hw>]:BB:NR5G:NODE:CC:ADD

Creates new carriers based on the configuration of an existing carrier.

Example:

```
//Duplicate carriers
BB:NR5G:NODE:CC:NEWCarriers 2
BB:NR5G:NODE:CC:CPYSel LOADfile
BB:NR5G:NODE:CC:LOAD "c:\configuration.nr5g"
BB:NR5G:NODE:CC:CPYFrom 1
BB:NR5G:NODE:CC:CINFo?
BB:NR5G:NODE:CC:CPYTo?
BB:NR5G:NODE:CC:ADD
```

Usage: Event

Manual operation: See ["Apply"](#) on page 53

[:SOURce<hw>]:BB:NR5G:NODE:CC:CINFo?

Queries basic information about the carrier you want to duplicate.

Prerequisites for this command

- Select a file as the source of the new carrier ([\[:SOURce<hw>\]:BB:NR5G:NODE:CC:CPYSel](#)).

Return values:

<Information> string
 String containing the information about the carrier.

Usage: Query only

Manual operation: See "[Carrier Info](#)" on page 53

[:SOURce<hw>]:BB:NR5G:NODE:CC:CPYFrom <Carrier>

Selects the carrier you want to duplicate.

Prerequisites for this command

- Selecting a carrier is only possible if there are more than one carrier in the table or in the configuration file.

Parameters:

<Carrier>	integer
	Range: 0 to 15
	*RST: 0

Manual operation: See "[Load Carrier](#)" on page 53

[:SOURce<hw>]:BB:NR5G:NODE:CC:CPYSel <Source>

Selects the source of a carrier that you want to create based on an existing carrier.

Parameters:

<Source>	CARRier Carrier from the current carrier table.
	LOADfile Carrier from a previously saved signal configuration (.nr5g file).
	*RST: CARRier

Manual operation: See "[Copy / Load From](#)" on page 52

[:SOURce<hw>]:BB:NR5G:NODE:CC:CPYTo?

Queries the index number the new carriers are created with.

Return values:

<Carrier>	string
	String containing the number of the new carriers.

Usage: Query only

Manual operation: See "[Copy To New Carrier](#)" on page 53

[:SOURce<hw>]:BB:NR5G:NODE:CC:LOAD <FileName>

Selects a file containing an existing carrier you want to duplicate.

Prerequisites for this command

- Select a file as the source of the new carrier ([\[:SOURce<hw>\]:BB:NR5G:NODE:CC:CPYSel](#)).

Parameters:

<FileName> string
String containing the file name.

Manual operation: See "Recall File" on page 53

[:SOURce<hw>]:BB:NR5G:NODE:CC:NEWCarrriers <Carriers>

Defines the number of carriers you want to create based on an existing carrier.

Parameters:

<Carriers> integer
Range: 0 to 15
*RST: 1

Manual operation: See "Number of New Carriers" on page 52

10.7 System information commands

[:SOURce<hw>]:BB:NR5G:NODE:CELL<cc>:SYINfo:HACBook	442
[:SOURce<hw>]:BB:NR5G:NODE:CELL<cc>:SYINfo:HACR	443
[:SOURce<hw>]:BB:NR5G:NODE:CELL<cc>:SYINfo:SUL:STATe	443
[:SOURce<hw>]:BB:NR5G:NODE:CELL<cc>:SYINfo:INDSize	444
[:SOURce<hw>]:BB:NR5G:NODE:CELL<cc>:SYINfo:IS02	444
[:SOURce<hw>]:BB:NR5G:NODE:CELL<cc>:TMPH:CTOOffset	444
[:SOURce<hw>]:BB:NR5G:NODE:CELL<cc>:TMPH:PHOOffset	444
[:SOURce<hw>]:BB:NR5G:NODE:CELL<cc>:TMPH:SFOOffset	445
[:SOURce<hw>]:BB:NR5G:NODE:CELL<cc>:TMPH:SSBTOffset	445
[:SOURce<hw>]:BB:NR5G:NODE:CELL<cc>:TMPH:SYFNOffset	445
[:SOURce<hw>]:BB:NR5G:NODE:CELL<cc>[:TMPH]:TAOOffset	445

[:SOURce<hw>]:BB:NR5G:NODE:CELL<cc>:SYINfo:HACBook
<HarqAckCodebook>

Defines the HARQ ACK reporting according to the PDSCH HARQ ACK codebook.

Parameters:

<HarqAckCodebook> SEMistatic | DYNamic

SEMistatic

Sets the HARQ ACK reporting according to the PDSCH HARQ ACK codebook to "Semi-static".

A UE reports HARQ ACK information for a corresponding PDSCH reception or SPS PDSCH release only in a HARQ ACK codebook that the UE transmits in a slot indicated by a value of a PDSCH-to- HARQ feedback timing indicator field in a corresponding DCI format 1_0 or DCI format 1_1.

The UE reports NACK values for HARQ-ACK information bits in an HARQ-ACK codebook that the UE transmits in a slot not indicated by a value of a PDSCH-to-HARQ feedback timing indicator field in a corresponding DCI format 1_0 or DCI format 1_1.

DYNAMIC

Sets the HARQ ACK reporting according to the PDSCH HARQ ACK codebook to "dynamic".

For a serving cell, an active DL BWP, and an active UL BWP, as described in clause 12, the UE determines a set of occasions for candidate PDSCH receptions for which the UE can transmit corresponding HARQ ACK information in a PUCCH in slot . If serving cell is deactivated, the UE uses as the active DL BWP for determining the set of occasions for candidate PDSCH receptions a DL BWP provided by firstActiveDownlinkBWP-ID.

*RST: SEMistatic

Example: See [Example"System Information"](#) on page 388

Manual operation: See ["PDSCH HARQ ACK Codebook"](#) on page 58

[:SOURCE<hw>]:BB:NR5G:NODE:CELL<cc>:SYINFO:HACR <CodebookR16>

Defines the state of the higher layer parameter `pdsch-HARQ-ACK-Codebook-r16`.

Parameters:

<CodebookR16> NCON | EDYN

NCON

Does not apply the release 16 codebook (not configured).

EDYN

Applies the release 16 codebook (enhanced dynamic).

*RST: NCON

Manual operation: See ["PDSCH HARQ ACK Codebook R16"](#) on page 59

**[:SOURCE<hw>]:BB:NR5G:NODE:CELL<cc>:SYINFO:SUL:STATE
<CarrierSULState>**

Defines if the carrier supports supplementary uplink (SUL) or not.

Parameters:

<CarrierSULState> 1 | ON | 0 | OFF

*RST: 0

Example: See [Example"System Information"](#) on page 388

Manual operation: See ["SUL"](#) on page 59

[:SOURce<hw>]:BB:NR5G:NODE:CELL<cc>:SYInfo:INDSize <BitLength>

Defines the bit length of the DCI field "Carrier Indicator" available in DCI formats 1_2.

Parameters:

<BitLength> integer
 Range: 0 to 3
 *RST: 0

Manual operation: See ["Indicator Size DCI1_2"](#) on page 59

[:SOURce<hw>]:BB:NR5G:NODE:CELL<cc>:SYInfo:IS02 <BitLength>

Defines the bit length of the DCI field "Carrier Indicator" available in DCI formats 0_2.

Parameters:

<BitLength> integer
 Range: 0 to 3
 *RST: 0

Manual operation: See ["Indicator Size DCI0_2"](#) on page 59

[:SOURce<hw>]:BB:NR5G:NODE:CELL<cc>:TMPH:CTOffset <Offset>

Defines a cell specific custom timing advance offset in terms of time (T_c).

Prerequisites for this command

- Select more than one carrier ([\[:SOURce<hw>\]:BB:NR5G:NODE:NCARrier](#)).

Parameters:

<Offset> integer
 Range: -2004572 to 1964636
 *RST: 0

Example: See: [Example"Configuring the carrier"](#) on page 387.

Manual operation: See ["Custom Timing Advance Offset \(\$T_c\$ \)"](#) on page 62

[:SOURce<hw>]:BB:NR5G:NODE:CELL<cc>:TMPH:PHOffset <Offset>

Defines a cell specific phase offset.

Parameters:

<Offset> float
 Range: 0 to 360
 Increment: 0.01
 *RST: 0

Example: See: [Example"Configuring the carrier"](#) on page 387.

Manual operation: See ["Phase Offset"](#) on page 62

[:SOURce<hw>]:BB:NR5G:NODE:CELL<cc>:TMPH:SFOffset <Offset>

Defines a cell specific cyclic subframe shift in terms of subframes.

Parameters:

<Offset> integer
 Range: 0 to 10
 *RST: 0

Example: See: [Example"Configuring the carrier"](#) on page 387.

Manual operation: See ["Sub Frame Offset"](#) on page 61

[:SOURce<hw>]:BB:NR5G:NODE:CELL<cc>:TMPH:SSBTOffset <Offset>

Defines a time offset for the SS/PBCH block.

Parameters:

<Offset> S0 | S5 | S10 | S15
 Time offset in milliseconds (0, 5, 10 and 15 ms).
 *RST: S0

Manual operation: See ["Ssb Time Offset R17"](#) on page 61

[:SOURce<hw>]:BB:NR5G:NODE:CELL<cc>:TMPH:SYFNOffset <SysFrmNumOff>

Sets an offset value for the system frame number. The first generated frame starts with the given system frame number offset.

Parameters:

<SysFrmNumOff> integer
 Range: 0 to 1023
 *RST: 0

Example: See [Example"System Information"](#) on page 388

Manual operation: See ["System Frame Number Offset"](#) on page 60

[:SOURce<hw>]:BB:NR5G:NODE:CELL<cc>[:TMPH]:TAOffset <TimingAdjOffset>

Sets an offset ($N_{TA\ offset}$) to the timing advance value for UL/DL switching synchronization as specified in [TS 38.211](#).

The $N_{TA\ offset}$ values can be set as specified in [TS 38.133](#).

Parameters:

<TimingAdjOffset> N0 | N13792 | N25600 | N39936
 *RST: N0

Example: See [Example"Configuring the carrier"](#) on page 387.

Options: R&S SMM-K148

Manual operation: See ["Timing Advance Offset"](#) on page 61

10.8 TxBW commands

[:SOURce<hw>]:BB:NR5G:NODE:CELL<cc>:TXBW:POINta.....	446
[:SOURce<hw>]:BB:NR5G:NODE:CELL<cc>:TXBW:CONFlIct?	446
[:SOURce<hw>]:BB:NR5G:NODE:CELL<cc>:TXBW:RESolve.....	447
[:SOURce<hw>]:BB:NR5G:NODE:CELL<cc>:TXBW:S960K:USE.....	447
[:SOURce<hw>]:BB:NR5G:NODE:CELL<cc>:TXBW:S480K:USE.....	447
[:SOURce<hw>]:BB:NR5G:NODE:CELL<cc>:TXBW:S240K:USE.....	447
[:SOURce<hw>]:BB:NR5G:NODE:CELL<cc>:TXBW:S120K:USE.....	447
[:SOURce<hw>]:BB:NR5G:NODE:CELL<cc>:TXBW:S15K:USE.....	447
[:SOURce<hw>]:BB:NR5G:NODE:CELL<cc>:TXBW:S60K:USE.....	447
[:SOURce<hw>]:BB:NR5G:NODE:CELL<cc>:TXBW:S30K:USE.....	447
[:SOURce<hw>]:BB:NR5G:NODE:CELL<cc>:TXBW:S120K:NRB?	447
[:SOURce<hw>]:BB:NR5G:NODE:CELL<cc>:TXBW:S15K:NRB?	447
[:SOURce<hw>]:BB:NR5G:NODE:CELL<cc>:TXBW:S60K:NRB?	447
[:SOURce<hw>]:BB:NR5G:NODE:CELL<cc>:TXBW:S30K:NRB?	447
[:SOURce<hw>]:BB:NR5G:NODE:CELL<cc>:TXBW:S120K:OFFSet.....	448
[:SOURce<hw>]:BB:NR5G:NODE:CELL<cc>:TXBW:S15K:OFFSet.....	448
[:SOURce<hw>]:BB:NR5G:NODE:CELL<cc>:TXBW:S60K:OFFSet.....	448
[:SOURce<hw>]:BB:NR5G:NODE:CELL<cc>:TXBW:S30K:OFFSet.....	448
[:SOURce<hw>]:BB:NR5G:NODE:CELL<cc>:TXBW:S120K:KOMU?	448
[:SOURce<hw>]:BB:NR5G:NODE:CELL<cc>:TXBW:S15K:KOMU?	448
[:SOURce<hw>]:BB:NR5G:NODE:CELL<cc>:TXBW:S60K:KOMU?	448
[:SOURce<hw>]:BB:NR5G:NODE:CELL<cc>:TXBW:S30K:KOMU?	448

[:SOURce<hw>]:BB:NR5G:NODE:CELL<cc>:TXBW:POINta <Frequency>

Sets the frequency offset between the reference Point A and the center carrier frequency.

Parameters:

<Frequency>	float
	Range: -50e6 to 0
	Increment: 0.015
	*RST: 49140000

Example: See [Example"Configuring the TxBWs"](#) on page 388.

Manual operation: See ["Point A to Baseband Center"](#) on page 63

[:SOURce<hw>]:BB:NR5G:NODE:CELL<cc>:TXBW:CONFlIct?

Queries whether there is a conflict.

Return values:

<Conflict> 1 | ON | 0 | OFF
 *RST: n.a. (no preset. default: 0)

Example: See [Example"Configuring the TxBW"](#) on page 388.

Usage: Query only

[:SOURce<hw>]:BB:NR5G:NODE:CELL<cc>:TXBW:RESolve

Recalculates the frequency-dependent settings and thus redefines the frequency position of the TxBW.

Example: See [Example"Configuring the TxBW"](#) on page 388.

Usage: Event

Manual operation: See ["Resolve Conflicts"](#) on page 64

```
[ :SOURce<hw>]:BB:NR5G:NODE:CELL<cc>:TXBW:S960K:USE <ScsUse>
[ :SOURce<hw>]:BB:NR5G:NODE:CELL<cc>:TXBW:S480K:USE <ScsUse>
[ :SOURce<hw>]:BB:NR5G:NODE:CELL<cc>:TXBW:S240K:USE <ScsUse>
[ :SOURce<hw>]:BB:NR5G:NODE:CELL<cc>:TXBW:S120K:USE <ScsUse>
[ :SOURce<hw>]:BB:NR5G:NODE:CELL<cc>:TXBW:S15K:USE <ScsUse>
[ :SOURce<hw>]:BB:NR5G:NODE:CELL<cc>:TXBW:S60K:USE <ScsUse>
[ :SOURce<hw>]:BB:NR5G:NODE:CELL<cc>:TXBW:S30K:USE <ScsUse>
```

Enables an SCS in the particular cell.

Parameters:

<ScsUse> 1 | ON | 0 | OFF

Example: See [Example"Configuring the TxBW"](#) on page 388.

Options: Subcarrier spacings 480 kHz and 960 kHz require R&S SMM-K171

Manual operation: See ["Use"](#) on page 65

```
[ :SOURce<hw>]:BB:NR5G:NODE:CELL<cc>:TXBW:S120K:NRB?
[ :SOURce<hw>]:BB:NR5G:NODE:CELL<cc>:TXBW:S15K:NRB?
[ :SOURce<hw>]:BB:NR5G:NODE:CELL<cc>:TXBW:S60K:NRB?
[ :SOURce<hw>]:BB:NR5G:NODE:CELL<cc>:TXBW:S30K:NRB?
```

Queries the number of available resource blocks (N_RB).

Return values:

<NRB> integer
 Range: 0 to 273
 *RST: 0

Example: See [Example"Configuring the TxBW"](#) on page 388.

Usage: Query only

Manual operation: See "N_RB" on page 65

```
[:SOURce<hw>]:BB:NR5G:NODE:CELL<cc>:TXBW:S120K:OFFSet <ScsOffset>
[:SOURce<hw>]:BB:NR5G:NODE:CELL<cc>:TXBW:S15K:OFFSet <ScsOffset>
[:SOURce<hw>]:BB:NR5G:NODE:CELL<cc>:TXBW:S60K:OFFSet <ScsOffset>
[:SOURce<hw>]:BB:NR5G:NODE:CELL<cc>:TXBW:S30K:OFFSet <ScsOffset>
```

Sets the offset between the usable RB and the common RBs.

Parameters:

<ScsOffset>	float
	Range: 0 to 9
	Increment: 1
	*RST: 0

Example: See [Example"Configuring the TxBW"](#) on page 388.

Manual operation: See "TxBW Offset" on page 65

```
[:SOURce<hw>]:BB:NR5G:NODE:CELL<cc>:TXBW:S120K:KOMU?
[:SOURce<hw>]:BB:NR5G:NODE:CELL<cc>:TXBW:S15K:KOMU?
[:SOURce<hw>]:BB:NR5G:NODE:CELL<cc>:TXBW:S60K:KOMU?
[:SOURce<hw>]:BB:NR5G:NODE:CELL<cc>:TXBW:S30K:KOMU?
```

Queries the value of the parameter k_0^{μ} .

Return values:

<KoMu>	integer
	Range: -6; 0; 6 further values indicate conflict
	*RST: 0

Example: See [Example"Configuring the TxBW"](#) on page 388.

Usage: Query only

Manual operation: See " k_0^{μ} " on page 65

10.9 LTE-CRS coexistence commands

[:SOURce<hw>]:BB:NR5G:NODE:CELL<cc>:LTE:NPAT	448
[:SOURce<hw>]:BB:NR5G:NODE:CELL<cc>:LTE:STATe	449
[:SOURce<hw>]:BB:NR5G:NODE:CELL<cc>:LTE:PATT<st0>:CBW	449
[:SOURce<hw>]:BB:NR5G:NODE:CELL<cc>:LTE:PATT<st0>:NAP	449
[:SOURce<hw>]:BB:NR5G:NODE:CELL<cc>:LTE:PATT<st0>:POINta	450
[:SOURce<hw>]:BB:NR5G:NODE:CELL<cc>:LTE:PATT<st0>:VSHift	450

```
[:SOURce<hw>]:BB:NR5G:NODE:CELL<cc>:LTE:NPAT <CRSPatterns>
```

Defines the number of LTE cell specific reference signals in the resource grid.

Parameters:

<CRSPatterns> integer
 Range: 1 to 4
 *RST: 1

Manual operation: See ["Number of LTE CRS Patterns"](#) on page 67

[:SOURCE<hw>]:BB:NR5G:NODE:CELL<cc>:LTE:STATE <LteCrsState>

Enable the LTE-CRS.

Parameters:

<LteCrsState> 1 | ON | 0 | OFF
 *RST: 0

Example: See [Example"LTE-CRS Coexistence"](#) on page 388.

Manual operation: See ["State"](#) on page 67

[:SOURCE<hw>]:BB:NR5G:NODE:CELL<cc>:LTE:PATT<st0>:CBW
 <ResourceBlocks>

Selects the channel bandwidth of an LTE carrier.

Prerequisites for this command

- Turn on LTE-CRS coexistence ([\[:SOURCE<hw>\]:BB:NR5G:NODE:CELL<cc>:LTE:STATE](#)).

Parameters:

<ResourceBlocks> N6 | N15 | N25 | N50 | N75 | N100
 *RST: N6

Example: See [Example"LTE-CRS Coexistence"](#) on page 388.

Manual operation: See ["LTE Bandwidth \(RB\)"](#) on page 67

[:SOURCE<hw>]:BB:NR5G:NODE:CELL<cc>:LTE:PATT<st0>:NAP <AntennaPorts>

Selects the number of antenna ports for an LTE signal.

Prerequisites for this command

- Turn on LTE-CRS coexistence ([\[:SOURCE<hw>\]:BB:NR5G:NODE:CELL<cc>:LTE:STATE](#)).

Parameters:

<AntennaPorts> AP1 | AP2 | AP4
 *RST: AP1

Example: See [Example"LTE-CRS Coexistence"](#) on page 388.

Manual operation: See ["LTE Antenna Ports"](#) on page 68

[:SOURce<hw>]:BB:NR5G:NODE:CELL<cc>:LTE:PATT<st0>:POINTa
 <ResourceBlocks>

Defines an LTE carrier offset relative to reference point A (in terms of resource blocks).

Prerequisites for this command

- Turn on LTE-CRS coexistence ([:SOURce<hw>] :BB:NR5G:NODE:CELL<cc> :
 LTE:STATE).

Parameters:

<ResourceBlocks> integer
 Range: 0 to 30300
 *RST: 0

Example: See [Example"LTE-CRS Coexistence"](#) on page 388.

Manual operation: See ["Offset to Point A \(15 kHz SC Spacing\)"](#) on page 67

[:SOURce<hw>]:BB:NR5G:NODE:CELL<cc>:LTE:PATT<st0>:VSHift <Value>

Selects the vShift parameter for an LTE signal.

Prerequisites for this command

- Turn on LTE-CRS coexistence ([:SOURce<hw>] :BB:NR5G:NODE:CELL<cc> :
 LTE:STATE).

Parameters:

<Value> integer
 Range: 0 to 5
 *RST: 0

Example: See [Example"LTE-CRS Coexistence"](#) on page 388.

Manual operation: See ["vShift"](#) on page 67

10.10 SS/PBCH commands

[:SOURce<hw>]:BB:NR5G:NODE:CELL<cc>:OFFSet.....	451
[:SOURce<hw>]:BB:NR5G:NODE:CELL<cc>:NSSPBch.....	452
[:SOURce<hw>]:BB:NR5G:NODE:CARMapping:AP4000[:ROW<ch0>].....	452
[:SOURce<hw>]:BB:NR5G:NODE:CELL<cc>:SSPBch<ssb>:STATE.....	452
[:SOURce<hw>]:BB:NR5G:NODE:CELL<cc>:SSPBch<ssb>:SCSPacing.....	452
[:SOURce<hw>]:BB:NR5G:NODE:CELL<cc>:SSPBch<ssb>:RBOFset.....	453
[:SOURce<hw>]:BB:NR5G:NODE:CELL<cc>:SSPBch<ssb>:SCOFset.....	453
[:SOURce<hw>]:BB:NR5G:NODE:CELL<cc>:SSPBch<ssb>:DFReq?.....	453
[:SOURce<hw>]:BB:NR5G:NODE:CELL<cc>:SSPBch<ssb>:CASE.....	454
[:SOURce<hw>]:BB:NR5G:NODE:CELL<cc>:SSPBch<ssb>:L.....	454
[:SOURce<hw>]:BB:NR5G:NODE:CELL<cc>:SSPBch<ssb>:POSition:PATtern.....	454
[:SOURce<hw>]:BB:NR5G:NODE:CELL<cc>:SSPBch<ssb>:BSPeriodicty.....	455
[:SOURce<hw>]:BB:NR5G:NODE:CELL<cc>:SSPBch<ssb>:HFRMidx.....	455

[:SOURce<hw>]:BB:NR5G:NODE:CELL<cc>:SSPBch<ssb>:POWer.....	455
[:SOURce<hw>]:BB:NR5G:NODE:CELL<cc>:SSPBch<ssb>:PSSPow.....	455
[:SOURce<hw>]:BB:NR5G:NODE:CELL<cc>:SSPBch<ssb>:SSSPow.....	455
[:SOURce<hw>]:BB:NR5G:NODE:CELL<cc>:SSPBch<ssb>:POSition:APMap<dir0>: COL<apc>:ROW<apr>:IMAGinary.....	456
[:SOURce<hw>]:BB:NR5G:NODE:CELL<cc>:SSPBch<ssb>:POSition:APMap<dir0>: COL<apc>:ROW<apr>:REAL.....	456
[:SOURce<hw>]:BB:NR5G:NODE:CELL<cc>:SSPBch<ssb>:POSition:APMap<dir0>: COL<apc>:ROW<apr>:MAGNitude.....	457
[:SOURce<hw>]:BB:NR5G:NODE:CELL<cc>:SSPBch<ssb>:POSition:APMap<dir0>: COL<apc>:ROW<apr>:PHASe.....	457
[:SOURce<hw>]:BB:NR5G:NODE:CELL<cc>:SSPBch<ssb>:CCODing:STATe.....	458
[:SOURce<hw>]:BB:NR5G:NODE:CELL<cc>:SSPBch<ssb>:CCODing:DATA.....	458
[:SOURce<hw>]:BB:NR5G:NODE:CELL<cc>:SSPBch<ssb>:CCODing:DLISt.....	458
[:SOURce<hw>]:BB:NR5G:NODE:CELL<cc>:SSPBch<ssb>:CCODing:PATTerN.....	459
[:SOURce<hw>]:BB:NR5G:NODE:CELL<cc>:SSPBch<ssb>:MIB:STATe.....	459
[:SOURce<hw>]:BB:NR5G:NODE:CELL<cc>:SSPBch<ssb>:MIB:SCSC.....	459
[:SOURce<hw>]:BB:NR5G:NODE:CELL<cc>:SSPBch<ssb>:MIB:ASOF:STATe.....	460
[:SOURce<hw>]:BB:NR5G:NODE:CELL<cc>:SSPBch<ssb>:MIB:SCOFset.....	460
[:SOURce<hw>]:BB:NR5G:NODE:CELL<cc>:SSPBch<ssb>:MIB:SFOFset?.....	460
[:SOURce<hw>]:BB:NR5G:NODE:CELL<cc>:SSPBch<ssb>:MIB:CSZero.....	460
[:SOURce<hw>]:BB:NR5G:NODE:CELL<cc>:SSPBch<ssb>:MIB:SSZero.....	461
[:SOURce<hw>]:BB:NR5G:NODE:CELL<cc>:SSPBch<ssb>:MIB:CBARred.....	461
[:SOURce<hw>]:BB:NR5G:NODE:CELL<cc>:SSPBch<ssb>:MIB:IFRResel.....	461
[:SOURce<hw>]:BB:NR5G:NODE:CELL<cc>:SSPBch<ssb>:MIB:SPARe:STATe.....	461

[:SOURce<hw>]:BB:NR5G:NODE:CELL<cc>:OFFSet <OffsetRelativeT>

Defines the reference point, relative to which the SS/PBCH is allocated in frequency domain.

For the sidelink application: the reference point of the S-SS/PSBCH is always the reference point A.

Parameters:

<OffsetRelativeT> TXBW | POINTa

TXBW

The frequency position of the SS/PBCH is set relative to the usable RBs that apply for the current numerology, i.e. to the start of the TxBW.

POINTa

The frequency position of the SS/PBCH is set relative to the position of point A.

*RST: TXBW

Example: See [Example "Configuring the SS/PBCH"](#) on page 389.

Manual operation: See ["Offset Relative to"](#) on page 69
See ["Offset Relative to"](#) on page 77

[[:SOURce<hw>]:BB:NR5G:NODE:CELL<cc>:NSSPBch <NuOfPbchPattern>

Sets the number of SS/PBCH patterns to be configured.

For the sidelink application: number of S-SS/PSBCH patterns.

Parameters:

<NuOfPbchPattern> integer
 Range: 0 to 4
 *RST: 1

Example: See [Example"Configuring the SS/PBCH"](#) on page 389.

Manual operation: See ["Number of SS/PBCH Patterns"](#) on page 69
 See ["Number of S-SS/PSBCH Patterns"](#) on page 77

[[:SOURce<hw>]:BB:NR5G:NODE:CARMapping:AP4000[:ROW<ch0>] <AP4000>

Sets if the SS/PBCHs are output at the selected output.

Parameters:

<AP4000> 0 | 1 | OFF | ON
 *RST: 1

Example: See [Example"Configuring the SS/PBCH"](#) on page 389.

Manual operation: See ["Antenna Port"](#) on page 69
 See ["Antenna Port"](#) on page 77

[[:SOURce<hw>]:BB:NR5G:NODE:CELL<cc>:SSPBch<ssb>:STATE <sspbchState>

Enables the transmission of SS/PBCH.

For the sidelink application: transmission state of the S-SS/PSBCH pattern.

Parameters:

<sspbchState> 1 | ON | 0 | OFF
 *RST: 1

Example: See [Example"Configuring the SS/PBCH"](#) on page 389.

Manual operation: See ["State"](#) on page 75
 See ["State"](#) on page 78

[[:SOURce<hw>]:BB:NR5G:NODE:CELL<cc>:SSPBch<ssb>:SCSPacing <SCSPacing>

Selects a combination of the subcarrier spacing (SCS) and the cyclic prefix (CP), where the available values depend on the "Deployment".

See [Table 2-2](#).

Parameters:

<SCSPacing> N15 | N30 | N60 | X60 | N120 | N240 | N480 | N960
 For the sidelink application, the maximum subcarrier spacing is 120 kHz.

*RST: N30

Example:

See [Example"Configuring the SS/PBCH"](#) on page 389.

Manual operation:

See ["SC Spacing/CP"](#) on page 70

See ["SC Spacing/CP"](#) on page 77

[:SOURCE<hw>]:BB:NR5G:NODE:CELL<cc>:SSPBch<ssb>:RBOffset <RBOffset>

Sets the start resource block of the selected allocation as offset to the start of usable RBs that apply for the current numerology.

Parameters:

<RBOffset> integer
 Range: 0 to 126
 *RST: 10

Example:

See [Example"Configuring the SS/PBCH"](#) on page 389.

Manual operation:

See ["RB Offset/RB Offset \(15 kHz SCS\)/RB Offset \(60 kHz SCS\)"](#) on page 70

See ["RB Offset \(15 kHz SCS\)/RB Offset \(60 kHz SCS\)"](#) on page 77

[:SOURCE<hw>]:BB:NR5G:NODE:CELL<cc>:SSPBch<ssb>:SCOffset <SCOffset>

Sets the start subcarrier of the selected allocation within the resource block.

Parameters:

<SCOffset> integer
 The value range depends on the selected RB offset ([:
[SOURCE<hw> \] : BB : NR5G : NODE : CELL<cc> : SSPBch<ssb> :
\[RBOffset\]\(#\) \).
 Range: 0 to 11
 *RST: 6](#)

Example:

See [Example"Configuring the SS/PBCH"](#) on page 389.

Manual operation:

See ["SC Offset/SC Offset \(15 kHz SCS\)/SC Offset \(60 kHz SCS\)"](#) on page 71

[:SOURCE<hw>]:BB:NR5G:NODE:CELL<cc>:SSPBch<ssb>:DFReq?

Queries the frequency offset between the center of the SS/PBCH block to the center of the carrier.

For the sidelink application: offset between S-SS/PSBCH block and center frequency of the carrier.

Return values:

<PbchDeltaF> float
 Range: -40E6 to 40E6
 Increment: 1.0
 *RST: 0.0

Example: See [Example"Configuring the SS/PBCH"](#) on page 389.

Usage: Query only

Manual operation: See "[Delta f to Carrier \(Centers\)](#)" on page 71
 See "[Δf to Carrier \(Centers\)/MHz](#)" on page 78

[:SOURce<hw>]:BB:NR5G:NODE:CELL<cc>:SSPBch<ssb>:CASE <PbschCase>

Selects one of the SS/PBCH cases, as specified in [TS 38.213](#).

Parameters:

<PbschCase> **A|B|C|D|E**
F|G
 Requires R&S SMM-K171.
 *RST: B

Example: See [Example"Configuring the SS/PBCH"](#) on page 389.

Manual operation: See "[Case](#)" on page 71

[:SOURce<hw>]:BB:NR5G:NODE:CELL<cc>:SSPBch<ssb>:L <PositionBitLen>

Sets the number of SS/PBCH blocks, transmitted per half-frame.

Parameters:

<PositionBitLen> L4 | L8 | L64 | L10 | L20
 *RST: L4

Example: See [Example"Configuring the SS/PBCH"](#) on page 389.

Manual operation: See "[L](#)" on page 72

**[:SOURce<hw>]:BB:NR5G:NODE:CELL<cc>:SSPBch<ssb>:POSition:PATtern
 <Pattern>, <BitCount>**

Sets a bit pattern as a data source.

Parameters:

<Pattern> 64 bits
 An internally generated sequence according to a bit pattern.
 Each bit applies to one SS/PBCH block.
 1: SS/PBCH block is present
 0: SS/PBCH transmission is suppressed.
 *RST: #HC

<BitCount> integer
 Range: 4 to 64
 *RST: 4

Example: See [Example"Configuring the SS/PBCH"](#) on page 389

Manual operation: See ["Positions"](#) on page 72

[:SOURce<hw>]:BB:NR5G:NODE:CELL<cc>:SSPBch<ssb>:BSPeriodicty
 <BurstSetPer>

Sets the burst set periodicity.

Parameters:

<BurstSetPer> BS5 | BS10 | BS20 | BS40 | BS80 | BS160 | BS320 | BS640
 *RST: BS10

Example: See [Example"Configuring the SS/PBCH"](#) on page 389.

Manual operation: See ["Burst Set Periodicity"](#) on page 72

[:SOURce<hw>]:BB:NR5G:NODE:CELL<cc>:SSPBch<ssb>:HFRMidx
 <HalfFrameIdx>

Defines in which half-frame of the time plan the first SS/PBCH burst occasion is located.

The "Half Frame Index" value depends on the configured "Burst Set Periodicity".

The default value is 0, it locates the first SS/PBCH occasion in the first half-frame. If you set the value to 1, the first SS/PBCH occasion is in the second half-frame and so forth.

Parameters:

<HalfFrameIdx> integer
 Range: 0 to 31
 *RST: 0

Example: See [Example"Configuring the SS/PBCH"](#) on page 389.

Manual operation: See ["Half Frame Index"](#) on page 73

[:SOURce<hw>]:BB:NR5G:NODE:CELL<cc>:SSPBch<ssb>:POWER <PbchPower>
[:SOURce<hw>]:BB:NR5G:NODE:CELL<cc>:SSPBch<ssb>:PSSPow <PssPower>
[:SOURce<hw>]:BB:NR5G:NODE:CELL<cc>:SSPBch<ssb>:SSSPow <SssPower>

Sets the power of the SSS/PSS/PBCH allocations relative to the power of the other resource elements.

For the sidelink application: power of S-PSS, S-SSS and PSBCH.

Parameters:

<SssPower> float
 Range: -80.0 to 10.0
 Increment: 0.01
 *RST: 0.0

Example: See [Example"Configuring the SS/PBCH"](#) on page 389.

Manual operation: See ["PSS/SSS Power"](#) on page 74

**[:SOURce<hw>]:BB:NR5G:NODE:CELL<cc>:SSPBch<ssb>:POSition:
 APMaP<dir0>:COL<apc>:ROW<apr>:IMAGinary <ImaginaryValue>
 [:SOURce<hw>]:BB:NR5G:NODE:CELL<cc>:SSPBch<ssb>:POSition:
 APMaP<dir0>:COL<apc>:ROW<apr>:REAL <RealValue>**

Define the mapping of the antenna ports to the physical antennas for the SS/PBCH pattern if Cartesian mapping coordinates are used.

Suffix:

<dir0> Depends on the number of positions defined in the SS/PBCH pattern
 Defines the position of the SS/PBCH pattern to which the AP-mapping configuration is applied

<apc> Depends on the selected number of layers
 Defines the antenna port (i.e. the column in the antenna port mapping table)

<apr> Depends on the number of basebands outputs currently mapped to a cell
 Available basebands (i.e. rows in the antenna port mapping table)

Parameters:

<RealValue> float
 The REAL (magnitude) and IMAGinary (phase) values are interdependent. Their value ranges change depending on each other and so that the resulting complex value is as follows:
 $|\text{REAL} + j \cdot \text{IMAGinary}| \leq 1$
 Otherwise, the values are normalized to magnitude = 1.
 Range: -1 to 1
 Increment: 0.001
 *RST: 1

Example: See [Example"Configuring the SS/PBCH"](#) on page 389

Manual operation: See ["Mapping table"](#) on page 75

**[:SOURce<hw>]:BB:NR5G:NODE:CELL<cc>:SSPBch<ssb>:POSition:
APMap<dir0>:COL<apc>:ROW<apr>:MAGNitude <Magnitude>**

Defines the mapping of the antenna ports to the physical antennas for the SS/PBCH pattern if cylindrical mapping coordinates are used.

Suffix:

<dir0>	Depends on the number of positions defined in the SS/PBCH pattern Defines the position of the SS/PBCH pattern to which the AP-mapping configuration is applied
<apc>	Depends on the selected number of layers Defines the antenna port (i.e. the column in the antenna port mapping table)
<apr>	Depends on the number of basebands outputs currently mapped to a cell Available basebands (i.e. rows in the antenna port mapping table)

Parameters:

<Magnitude>	float Range: 0 to 1 Increment: 0.001 *RST: 0
-------------	---

Example: [Example"Configuring the SS/PBCH"](#) on page 389

Manual operation: See "[Mapping table](#)" on page 75

**[:SOURce<hw>]:BB:NR5G:NODE:CELL<cc>:SSPBch<ssb>:POSition:
APMap<dir0>:COL<apc>:ROW<apr>:PHASe <Phase>**

Defines the mapping of the antenna ports to the physical antennas for the SS/PBCH pattern if cylindrical mapping coordinates are used.

Suffix:

<dir0>	Depends on the number of positions defined in the SS/PBCH pattern Defines the position of the SS/PBCH pattern to which the AP-mapping configuration is applied
<apc>	Depends on the selected number of layers Defines the antenna port (i.e. the column in the antenna port mapping table)
<apr>	Depends on the number of basebands outputs currently mapped to a cell Available basebands (i.e. rows in the antenna port mapping table)

Parameters:

<Phase> float
 Range: 0 to 360
 Increment: 0.1
 *RST: 0

Example: See [Example"Configuring the SS/PBCH"](#) on page 389

Manual operation: See ["Mapping table"](#) on page 75

[:SOURCE<hw>]:BB:NR5G:NODE:CELL<cc>:SSPBch<ssb>:CCODing:STATe
 <State>

Enables PBCH channel coding.

Parameters:

<State> 1 | ON | 0 | OFF
 *RST: 1

Example: See [Example"Configuring the SS/PBCH"](#) on page 389.

Manual operation: See ["Channel Coding"](#) on page 89

[:SOURCE<hw>]:BB:NR5G:NODE:CELL<cc>:SSPBch<ssb>:CCODing:DATA
 <PbchDataSource>

Selects the PBCH data source.

Parameters:

<PbchDataSource> PN9 | PN11 | PN15 | PN16 | PN20 | PN21 | PN23 | PATtern |
 DLISt | ZERO | ONE
 *RST: PN9

Example: See [Example"Configuring the SS/PBCH"](#) on page 389.

Manual operation: See ["Data Source"](#) on page 89

[:SOURCE<hw>]:BB:NR5G:NODE:CELL<cc>:SSPBch<ssb>:CCODing:DLISt
 <DataList>

Selects an existing data list file from the default directory or from the specific directory.

Parameters:

<DataList> string
 Filename incl. file extension or complete file path

Example: See [Example"Configuring the SS/PBCH"](#) on page 389.

Manual operation: See ["Data Source"](#) on page 89

[:SOURce<hw>]:BB:NR5G:NODE:CELL<cc>:SSPBch<ssb>:CCODing:PATtern
 <Pattern>, <BitCount>

Sets a bit pattern as a data source.

Parameters:

<Pattern> 64 bits
 *RST: #H0

<BitCount> integer
 Range: 1 to 64
 *RST: 1

Example: See [Example"Configuring the SS/PBCH"](#) on page 389.

Manual operation: See ["Data Source"](#) on page 89

[:SOURce<hw>]:BB:NR5G:NODE:CELL<cc>:SSPBch<ssb>:MIB:STATe
 <SSPbchMIBState>

Defines how the MIB is defined.

Parameters:

<SSPbchMIBState> 1 | ON | 0 | OFF
 1|ON

A faster way to define the MIB.

You can define if channel coding is used or not and select an arbitrary data source; further settings are not required.

0|OFF

Allows you to configure the MIB content according to [TS 38.331](#).

*RST: 1

Example: See [Example"Configuring the SS/PBCH"](#) on page 389.

Manual operation: See ["Dummy Content for MIB"](#) on page 88

[:SOURce<hw>]:BB:NR5G:NODE:CELL<cc>:SSPBch<ssb>:MIB:SCSC
 <SSPbchSCSCCommon>

Selects the common SCS (subcarrier spacing).

Parameters:

<SSPbchSCSCCommon> N15_60 | N30_120
 *RST: N15_60

Example: See [Example"Configuring the SS/PBCH"](#) on page 389.

Manual operation: See ["SCS Common"](#) on page 90

```
[ :SOURce<hw>]:BB:NR5G:NODE:CELL<cc>:SSPBch<ssb>:MIB:ASOF:STATE
<SSPbchASCOfStat>
```

If enabled, the SSPBCH subcarrier offset is set automatically, depending on the selected common subcarrier spacing.

Parameters:

```
<SSPbchASCOfStat> 1 | ON | 0 | OFF
```

Example: See [Example"Configuring the SS/PBCH"](#) on page 389.

Manual operation: See ["Auto Subcarrier Offset"](#) on page 90

```
[ :SOURce<hw>]:BB:NR5G:NODE:CELL<cc>:SSPBch<ssb>:MIB:SCOFset
<SSPbchCustomSsb>
```

Queries the SS/PBCH subcarrier offset.

Parameters:

```
<SSPbchCustomSsb>float
```

Range: 0 to 31

Example: See [Example"Configuring the SS/PBCH"](#) on page 389.

Manual operation: See ["SSPBCH Subcarrier Offset"](#) on page 91

```
[ :SOURce<hw>]:BB:NR5G:NODE:CELL<cc>:SSPBch<ssb>:MIB:SFOffset?
```

By default, the counting of the SFN (system frame number) starts with 0. Use this parameter to set a different start SFN value.

Return values:

```
<SSPbchSFStartOf> integer
```

Range: 0 to 1023

*RST: 0

Example: See [Example"Configuring the SS/PBCH"](#) on page 389.

Usage: Query only

Manual operation: See ["System Frame Number Start Offset"](#) on page 91

```
[ :SOURce<hw>]:BB:NR5G:NODE:CELL<cc>:SSPBch<ssb>:MIB:CSZero
<SSPbchCSZero>
```

Sets the common control resource set (CORESET) of the initial downlink BWP.

Parameters:

```
<SSPbchCSZero> integer
```

Range: 0 to 15

*RST: 0

Example: See [Example"Configuring the SS/PBCH"](#) on page 389.

Manual operation: See ["CORESET Zero"](#) on page 91

[:SOURce<hw>]:BB:NR5G:NODE:CELL<cc>:SSPBch<ssb>:MIB:SSZero
 <SSPbchSSZero>

Sets the common search space of the initial downlink BWP.

Parameters:

<SSPbchSSZero> integer
 Range: 0 to 15
 *RST: 0

Example: See [Example"Configuring the SS/PBCH"](#) on page 389.

Manual operation: See ["Search Space Zero"](#) on page 91

[:SOURce<hw>]:BB:NR5G:NODE:CELL<cc>:SSPBch<ssb>:MIB:CBARred
 <SSPbchCellBarre>

Cell barring is system information that indicates if UEs can camp on the particular cell NBAR or not BARR.

Parameters:

<SSPbchCellBarre> BARR | NBAR
 *RST: BARR

Example: See [Example"Configuring the SS/PBCH"](#) on page 389.

Manual operation: See ["Cell Barred"](#) on page 91

[:SOURce<hw>]:BB:NR5G:NODE:CELL<cc>:SSPBch<ssb>:MIB:IFRResel
 <SSPbchInFreqSel>

Sets the value of the system information parameter intraFreqReselection.

Parameters:

<SSPbchInFreqSel> ALWD | NALW
 *RST: ALWD

Example: See [Example"Configuring the SS/PBCH"](#) on page 389.

Manual operation: See ["Intra Freq Reselection"](#) on page 91

[:SOURce<hw>]:BB:NR5G:NODE:CELL<cc>:SSPBch<ssb>:MIB:SPARe:STATe
 <PbchSpareState>

Sets the system information bit spare, as defined in [TS 38.331](#).

Parameters:

<PbchSpareState> 1 | ON | 0 | OFF
 *RST: 0

Example: See [Example "Configuring the SS/PBCH"](#) on page 389.

Manual operation: See ["Spare"](#) on page 92

10.11 S-SS/PSBCH configuration commands

Commands to configure the S-SS/PSBCH described elsewhere.

- [:SOURCE<hw>]:BB:NR5G:NODE:CELL<cc>:NSSPBch
- [:SOURCE<hw>]:BB:NR5G:NODE:CELL<cc>:OFFSet
- [:SOURCE<hw>]:BB:NR5G:NODE:CELL<cc>:SSPBch<ssb>:SCSPacing
- [:SOURCE<hw>]:BB:NR5G:NODE:CELL<cc>:SSPBch<ssb>:RBOffset
- [:SOURCE<hw>]:BB:NR5G:NODE:CELL<cc>:SSPBch<ssb>:DFReq?

Commands to configure S-SS/PSBCH power described elsewhere.

- [:SOURCE<hw>]:BB:NR5G:NODE:CELL<cc>:SSPBch<ssb>:PSSPow
- [:SOURCE<hw>]:BB:NR5G:NODE:CELL<cc>:SSPBch<ssb>:SSSPow
- [:SOURCE<hw>]:BB:NR5G:NODE:CELL<cc>:SSPBch<ssb>:POWER

Commands to configure S-SS/PSBCH antenna port mapping described elsewhere.

- [:SOURCE<hw>]:BB:NR5G:NODE:CELL<cc>:SSPBch<ssb>:POSITION:APMap<dir0>:COL<apc>:ROW<apr>:IMAGinary
- [:SOURCE<hw>]:BB:NR5G:NODE:CELL<cc>:SSPBch<ssb>:POSITION:APMap<dir0>:COL<apc>:ROW<apr>:MAGNitude on page 457
- [:SOURCE<hw>]:BB:NR5G:NODE:CELL<cc>:SSPBch<ssb>:POSITION:APMap<dir0>:COL<apc>:ROW<apr>:PHASe on page 457
- [:SOURCE<hw>]:BB:NR5G:NODE:CELL<cc>:SSPBch<ssb>:POSITION:APMap<dir0>:COL<apc>:ROW<apr>:REAL on page 456

[:SOURCE<hw>]:BB:NR5G:NODE:CELL<cc>:SSPBch<ssb>:SL:BINPeriod.....	462
[:SOURCE<hw>]:BB:NR5G:NODE:CELL<cc>:SSPBch<ssb>:SL:INCoverage.....	463
[:SOURCE<hw>]:BB:NR5G:NODE:CELL<cc>:SSPBch<ssb>:SL:INTerval.....	463
[:SOURCE<hw>]:BB:NR5G:NODE:CELL<cc>:SSPBch<ssb>:SL:SBITs.....	463
[:SOURCE<hw>]:BB:NR5G:NODE:CELL<cc>:SSPBch<ssb>:SL:TDDConf.....	464
[:SOURCE<hw>]:BB:NR5G:NODE:CELL<cc>:SSPBch<ssb>:SL:TOFFs.....	464

**[:SOURCE<hw>]:BB:NR5G:NODE:CELL<cc>:SSPBch<ssb>:SL:BINPeriod
<SSBlocks>**

Defines the number of transmitted S-SS/PSBCH blocks.

Parameter values depend on:

- Selected subcarrier spacing ([:SOURCE<hw>]:BB:NR5G:NODE:CELL<cc>:SSPBch<ssb>:SCSPacing).

Parameters:

<SSBlocks> B1 | B2 | B4 | B8 | B16 | B32 | B64
 *RST: B1

Example: See [Example"Configuring a sidelink signal"](#) on page 412.

Manual operation: See ["S-SS/PSBCH Blocks in Period"](#) on page 78

[:SOURce<hw>]:BB:NR5G:NODE:CELL<cc>:SSPBch<ssb>:SL:INCoverage
 <State>

Turns the higher layer parameter `inCoverage` for the PSBCH on and off.

Parameters:

<State> 1 | ON | 0 | OFF
 *RST: 0

Example: See [Example"Configuring a sidelink signal"](#) on page 412.

Manual operation: See ["InCoverage"](#) on page 92

[:SOURce<hw>]:BB:NR5G:NODE:CELL<cc>:SSPBch<ssb>:SL:INTERval <Slots>

Defines the number of slots between two consecutive S-SS/PSBCH blocks.

Parameters:

<Slots> integer
 Range: 1 to 639
 *RST: 1

Example: See [Example"Configuring a sidelink signal"](#) on page 412.

Manual operation: See ["Time Interval/Slots"](#) on page 78

[:SOURce<hw>]:BB:NR5G:NODE:CELL<cc>:SSPBch<ssb>:SL:SBITs <Pattern>,
 <BitCount>

Defines the spare bits for the PSBCH.

Parameters:

<Pattern> 2 bits
 *RST: #H0
 <BitCount> integer
 Range: 2 to 2
 *RST: 2

Example: See [Example"Configuring a sidelink signal"](#) on page 412.

Manual operation: See ["SpareBits"](#) on page 93

```
[ :SOURce<hw>]:BB:NR5G:NODE:CELL<cc>:SSPBch<ssb>:SL:TDDConf
<Pattern>, <BitCount>
```

Defines the bit pattern for the PSBCH TDD configuration.

Parameters:

```
<Pattern>          12 bits
                   *RST:      #H0

<BitCount>        integer
                   Range:     12 to 12
                   *RST:     12
```

Example: See [Example "Configuring a sidelink signal"](#) on page 412.

Manual operation: See ["tddConfig"](#) on page 93

```
[ :SOURce<hw>]:BB:NR5G:NODE:CELL<cc>:SSPBch<ssb>:SL:TOFFs <Slots>
```

Defines the offset between slot 0 and first S-SS/PSBCH block.

Parameters:

```
<Slots>           integer
                   Range:     0 to 1279
                   *RST:     0
```

Example: See [Example "Configuring a sidelink signal"](#) on page 412.

Manual operation: See ["Time Offset/Slots"](#) on page 78

10.12 PRS commands

Option: R&S SMM-K148

[:SOURce<hw>]:BB:NR5G:NODE:CELL<cc>:PRS:NRSets.....	465
[:SOURce<hw>]:BB:NR5G:NODE:CELL<cc>:PRS:RSET<st0>:CMBSize.....	465
[:SOURce<hw>]:BB:NR5G:NODE:CELL<cc>:PRS:RSET<st0>:NRESources.....	465
[:SOURce<hw>]:BB:NR5G:NODE:CELL<cc>:PRS:RSET<st0>:PER.....	466
[:SOURce<hw>]:BB:NR5G:NODE:CELL<cc>:PRS:RSET<st0>:RBNumber.....	466
[:SOURce<hw>]:BB:NR5G:NODE:CELL<cc>:PRS:RSET<st0>:RBStart.....	466
[:SOURce<hw>]:BB:NR5G:NODE:CELL<cc>:PRS:RSET<st0>:REPFactor.....	466
[:SOURce<hw>]:BB:NR5G:NODE:CELL<cc>:PRS:RSET<st0>:RES<dir0>:APMap: COL<apc>:ROW<apr>:IMAGinary.....	467
[:SOURce<hw>]:BB:NR5G:NODE:CELL<cc>:PRS:RSET<st0>:RES<dir0>:APMap: COL<apc>:ROW<apr>:REAL.....	467
[:SOURce<hw>]:BB:NR5G:NODE:CELL<cc>:PRS:RSET<st0>:RES<dir0>:APMap: COL<apc>:ROW<apr>:MAGNitude.....	467
[:SOURce<hw>]:BB:NR5G:NODE:CELL<cc>:PRS:RSET<st0>:RES<dir0>:APMap: COL<apc>:ROW<apr>:PHASE.....	467
[:SOURce<hw>]:BB:NR5G:NODE:CELL<cc>:PRS:RSET<st0>:RES<dir0>:NSYMBOL.....	468
[:SOURce<hw>]:BB:NR5G:NODE:CELL<cc>:PRS:RSET<st0>:RES<dir0>:POWER.....	468

[:SOURce<hw>]:BB:NR5G:NODE:CELL<cc>:PRS:RSET<st0>:RES<dir0>:REOffset.....	468
[:SOURce<hw>]:BB:NR5G:NODE:CELL<cc>:PRS:RSET<st0>:RES<dir0>:SLOffset.....	468
[:SOURce<hw>]:BB:NR5G:NODE:CELL<cc>:PRS:RSET<st0>:RES<dir0>:SQID.....	469
[:SOURce<hw>]:BB:NR5G:NODE:CELL<cc>:PRS:RSET<st0>:RES<dir0>:SYOffset.....	469
[:SOURce<hw>]:BB:NR5G:NODE:CELL<cc>:PRS:RSET<st0>:SLOffset.....	469
[:SOURce<hw>]:BB:NR5G:NODE:CELL<cc>:PRS:RSET<st0>:TGAP.....	470
[:SOURce<hw>]:BB:NR5G:NODE:CELL<cc>:PRS:SCSPacing.....	470
[:SOURce<hw>]:BB:NR5G:NODE:CELL<cc>:PRS:STATe.....	470

[:SOURce<hw>]:BB:NR5G:NODE:CELL<cc>:PRS:NRSets <NumResSet>

Sets the number of resource sets of the DL PRS frequency layer.

Parameters:

<NumResSet>	integer
	Range: 1 to 8
	*RST: 1

Example: See [Example"Configuring PRS resources"](#) on page 390.

Manual operation: See ["Number of PRS Resource Sets"](#) on page 80

[:SOURce<hw>]:BB:NR5G:NODE:CELL<cc>:PRS:RSET<st0>:CMBSize <PrsRSCombSize>

Sets the resource element (RE) spacing in each symbol of a resource within a resource set.

Parameters:

<PrsRSCombSize>	C2 C4 C6 C12
	*RST: C2

Example: See [Example"Configuring PRS resources"](#) on page 390.

Manual operation: See ["Comb Size \(K_comb\)"](#) on page 81

[:SOURce<hw>]:BB:NR5G:NODE:CELL<cc>:PRS:RSET<st0>:NRESources <PrsNumRes>

Sets the number of resources included in the resource set.

Parameters:

<PrsNumRes>	integer
	Range: 1 to 64
	*RST: 1

Example: See [Example"Configuring PRS resources"](#) on page 390.

Manual operation: See ["Number of PRS Resources"](#) on page 81

```
[:SOURce<hw>]:BB:NR5G:NODE:CELL<cc>:PRS:RSET<st0>:PER <PrsRSPeriod>
```

Sets the periodicity of the DL PRS allocation in slots for the given resource set.

Parameters:

```
<PrsRSPeriod>    SL10240 | SL5120 | SL2560 | SL1280 | SL640 | SL320 | SL160 |
                  SL64 | SL64 | SL40 | SL32 | SL20 | SL16 | SL10 | SL8 | SL5 |
                  SL4
                  *RST:    SL4
```

Example: See [Example"Configuring PRS resources"](#) on page 390.

Manual operation: See ["Periodicity \(T_per\)"](#) on page 80

```
[:SOURce<hw>]:BB:NR5G:NODE:CELL<cc>:PRS:RSET<st0>:RBNumber
<PrsRSNumRB>
```

Sets the number of resource blocks (RBs) for all resources in the resource set in multiples of 4 RBs.

Parameters:

```
<PrsRSNumRB>    integer
                  Range:    24 to 272
                  *RST:    272
```

Example: See [Example"Configuring PRS resources"](#) on page 390.

Manual operation: See ["No. RBs"](#) on page 81

```
[:SOURce<hw>]:BB:NR5G:NODE:CELL<cc>:PRS:RSET<st0>:RBStart
<PrsRSRBStart>
```

Sets the starting RB index of the resource set with respect to the reference point A. The point A is defined as the absolute frequency of the reference resource block.

Parameters:

```
<PrsRSRBStart>  integer
                  Range:    0 to 2176
                  *RST:    0
```

Example: See [Example"Configuring PRS resources"](#) on page 390.

Manual operation: See ["Start RB \(to point A\)"](#) on page 81

```
[:SOURce<hw>]:BB:NR5G:NODE:CELL<cc>:PRS:RSET<st0>:REPFactor
<PrsRSRepFactor>
```

Sets the number of repetitions of each resource for a single instance of the resource set.

Parameters:

<PrsRSRepFactor> REP32 | REP16 | REP8 | REP4 | REP1 | REP2
 *RST: REP1

Example: See [Example"Configuring PRS resources"](#) on page 390.

Manual operation: See ["Repetition Factor \(T_rep\)"](#) on page 80

```
[ :SOURce<hw>]:BB:NR5G:NODE:CELL<cc>:PRS:RSET<st0>:RES<dir0>:APMap:
  COL<apc>:ROW<apr>:IMAGinary <PrsAPImag>
```

```
[ :SOURce<hw>]:BB:NR5G:NODE:CELL<cc>:PRS:RSET<st0>:RES<dir0>:APMap:
  COL<apc>:ROW<apr>:REAL <PrsAPReal>
```

Sets the mapping of the antenna ports (AP) for the PRS resource, if Cartesian coordinates are used.

Parameters:

<PrsAPReal> float
 The REAL (magnitude) and IMAGinary (phase) values are interdependent. Their value ranges change depending on each other and so that the resulting complex value is as follows:
 $|\text{REAL} + j \cdot \text{IMAGinary}| \leq 1$
 Otherwise, the values are normalized to Magnitude = 1.
 Range: -1 to 1
 Increment: 0.001
 *RST: 1

Example: See [Example"Configuring PRS resources"](#) on page 390.

Manual operation: See ["Mapping table"](#) on page 83

```
[ :SOURce<hw>]:BB:NR5G:NODE:CELL<cc>:PRS:RSET<st0>:RES<dir0>:APMap:
  COL<apc>:ROW<apr>:MAGNitude <PrsAPMagn>
```

```
[ :SOURce<hw>]:BB:NR5G:NODE:CELL<cc>:PRS:RSET<st0>:RES<dir0>:APMap:
  COL<apc>:ROW<apr>:PHASe <PrsAPPhase>
```

Sets the mapping of the antenna ports (AP) for the PRS resource, if cylindrical coordinates are used.

Parameters:

<PrsAPPhase> float
 Range: 0 to 360
 Increment: 0.1
 *RST: 0

Example: See [Example"Configuring PRS resources"](#) on page 390.

Manual operation: See ["Mapping table"](#) on page 83

```
[ :SOURce<hw>]:BB:NR5G:NODE:CELL<cc>:PRS:RSET<st0>:RES<dir0>:
  NSYMBOL <PrsResNSymb>
```

Sets the number of symbols of the resource within a slot.

Parameters:

```
<PrsResNSymb>  S12 | S6 | S4 | S2
                *RST:    S2
```

Example: See [Example "Configuring PRS resources"](#) on page 390.

Manual operation: See ["No. Symbols \(L_PRS\)"](#) on page 82

```
[ :SOURce<hw>]:BB:NR5G:NODE:CELL<cc>:PRS:RSET<st0>:RES<dir0>:POWER
  <PrsResPower>
```

Sets the average EPRE (energy per resource element) of the resource used for PRS transmission.

Parameters:

```
<PrsResPower>  float
                Range:    -80 to 10
                Increment: 0.01
                *RST:    0
```

Example: See [Example "Configuring PRS resources"](#) on page 390.

Manual operation: See ["Power / dB"](#) on page 82

```
[ :SOURce<hw>]:BB:NR5G:NODE:CELL<cc>:PRS:RSET<st0>:RES<dir0>:
  REOFFSET <PrsResREOff>
```

Sets the resource element (RE) offset in the frequency domain for the first symbol in a resource.

Parameters:

```
<PrsResREOff>  integer
                Range:    0 to 11
                *RST:    0
```

Example: See [Example "Configuring PRS resources"](#) on page 390.

Manual operation: See ["RE Offset \(k_off.\)"](#) on page 82

```
[ :SOURce<hw>]:BB:NR5G:NODE:CELL<cc>:PRS:RSET<st0>:RES<dir0>:
  SLOffset <PrsResSlotOff>
```

Set the starting slot of the resource with respect to the corresponding resource set [Slot Offset \(T_offset\)](#).

Parameters:

<PrsResSlotOff> integer
 Range: 0 to 10239
 *RST: 0

Example: See [Example"Configuring PRS resources"](#) on page 390.

Manual operation: See ["Resource Slot Offset \(k_off.,res\)"](#) on page 82

[:SOURce<hw>]:BB:NR5G:NODE:CELL<cc>:PRS:RSET<st0>:RES<dir0>:SQID
 <PrsResSeqID>

Sets the resource ID to initialize the c_{init} value for the generation of the DL PRS sequence.

Parameters:

<PrsResSeqID> integer
 Range: 0 to 4095
 *RST: 0

Example: See [Example"Configuring PRS resources"](#) on page 390.

Manual operation: See ["Sequence ID"](#) on page 82

[:SOURce<hw>]:BB:NR5G:NODE:CELL<cc>:PRS:RSET<st0>:RES<dir0>:SYOffset
 <PrsResSymbOff>

Sets the starting symbol of the resource within a slot.

Parameters:

<PrsResSymbOff> integer
 Range: 0 to 12
 *RST: 0

Example: See [Example"Configuring PRS resources"](#) on page 390.

Manual operation: See ["Symbol Offset \(l_start\)"](#) on page 82

[:SOURce<hw>]:BB:NR5G:NODE:CELL<cc>:PRS:RSET<st0>:SLOffset
 <PrsRSSlotOffset>

Sets a slot offset for the resource set with respect to the SFN0 slot 0.

Parameters:

<PrsRSSlotOffset> integer
 Range: 0 to 10239
 *RST: 0

Example: See [Example"Configuring PRS resources"](#) on page 390.

Manual operation: See ["Slot Offset \(T_offset\)"](#) on page 80

```
[ :SOURce<hw>]:BB:NR5G:NODE:CELL<cc>:PRS:RSET<st0>:TGAP
<PrsRSTimeGap>
```

Sets an offset in slots between two resources with the same resource ID within a resource set.

The time gap should not exceed the [Periodicity \(T_per\)](#).

Parameters:

```
<PrsRSTimeGap>  TG1 | TG2 | TG4 | TG8 | TG16 | TG32
*RST:           TG1
```

Example: See [Example"Configuring PRS resources"](#) on page 390.

Manual operation: See ["Time Gap \(T_gap\)"](#) on page 80

```
[ :SOURce<hw>]:BB:NR5G:NODE:CELL<cc>:PRS:SCSPacing <PrsNumerology>
```

Sets the combination of the subcarrier spacing (SCS) and the cyclic prefix (CP) for the DL PRS frequency layer.

Set the value according to the configured [Deployment](#).

Parameters:

```
<PrsNumerology>  N15 | N30 | N60 | N120 | X60 | N480 | N960
<N|X> <SCS>
N = Normal CP, X = Extended CP, SCS = SCS in kHz
*RST:           N30
```

Example: See [Example"Configuring PRS resources"](#) on page 390.

Manual operation: See ["SC Spacing / CP"](#) on page 80

```
[ :SOURce<hw>]:BB:NR5G:NODE:CELL<cc>:PRS:STATe <PrsState>
```

Enables the DL PRS positioning frequency layer for the given carrier cell.

Parameters:

```
<PrsState>       1 | ON | 0 | OFF
*RST:           0
```

Example: See [Example"Configuring PRS resources"](#) on page 390.

Manual operation: See ["State"](#) on page 80

10.13 Dummy resource elements commands

[:SOURce<hw>]:BB:NR5G:NODE:CELL<cc>:DUMRes:STATe	471
[:SOURce<hw>]:BB:NR5G:NODE:CELL<cc>:DUMRes:POWer	471
[:SOURce<hw>]:BB:NR5G:NODE:CELL<cc>:DUMRes:SCSPacing	471
[:SOURce<hw>]:BB:NR5G:NODE:CELL<cc>:DUMRes:MODulation	471
[:SOURce<hw>]:BB:NR5G:NODE:CELL<cc>:DUMRes:TPSTate	472

[:SOURce<hw>]:BB:NR5G:NODE:CELL<cc>:DUMRes:DATA.....	472
[:SOURce<hw>]:BB:NR5G:NODE:CELL<cc>:DUMRes:DLISt.....	472
[:SOURce<hw>]:BB:NR5G:NODE:CELL<cc>:DUMRes:PATtern.....	473

[:SOURce<hw>]:BB:NR5G:NODE:CELL<cc>:DUMRes:STATe <DummyResState>

Enables filling in unallocated resource elements (RE) with dummy data.

Parameters:

<DummyResState> 1 | ON | 0 | OFF
*RST: 0

Example: See [Example"Filling in the frame with dummy REs"](#) on page 390.

Manual operation: See ["State"](#) on page 84

[:SOURce<hw>]:BB:NR5G:NODE:CELL<cc>:DUMRes:POWer <Power>

Sets the power of the resource elements filled in with dummy data.

Parameters:

<Power> float
Range: -80 to 10
Increment: 0.001
*RST: 0

Example: See [Example"Filling in the frame with dummy REs"](#) on page 390.

Manual operation: See ["Power"](#) on page 85

[:SOURce<hw>]:BB:NR5G:NODE:CELL<cc>:DUMRes:SCSPacing <SCSPacing>

Selects a combination of the subcarrier spacing (SCS) and the cyclic prefix (CP), where the available values depend on the "Deployment".

See [Table 2-2](#).

Parameters:

<SCSPacing> N15 | N30 | N60 | X60 | N120 | N240 | N480 | N960
*RST: N30

Example: See [Example"Filling in the frame with dummy REs"](#) on page 390.

Manual operation: See ["SC Spacing/CP"](#) on page 85

[:SOURce<hw>]:BB:NR5G:NODE:CELL<cc>:DUMRes:MODulation <Modulation>

Sets the modulation scheme for the dummy REs.

Parameters:

<Modulation> BPSK | BPSK2 | QPSK | QAM16 | QAM64 | QAM256 | QAM1024
 *RST: QPSK

Example:

See [Example "Filling in the frame with dummy REs"](#) on page 390.

Manual operation: See ["Modulation"](#) on page 85

[:SOURce<hw>]:BB:NR5G:NODE:CELL<cc>:DUMRes:TPStAtE <TrPrecState>

In uplink, enables using the optional DFT-S scheme.

Parameters:

<TrPrecState> 1 | ON | 0 | OFF
 *RST: 0

Example:

```
SOURce1:BB:NR5G:LINK UP
SOURce1:BB:NR5G:NODE:CELL0:DUMRes:TPStAtE 1
```

Manual operation: See ["Transform Precoding"](#) on page 85

[:SOURce<hw>]:BB:NR5G:NODE:CELL<cc>:DUMRes:DATA <DataSource>

Sets the data source for the dummy REs.

Parameters:

<DataSource> PN9 | PN11 | PN15 | PN16 | PN20 | PN21 | PN23 | PATtern | DLISt | ZERO | ONE
 *RST: PN9

Example:

See [Example "Filling in the frame with dummy REs"](#) on page 390.

Manual operation: See ["Data Source"](#) on page 85

[:SOURce<hw>]:BB:NR5G:NODE:CELL<cc>:DUMRes:DLISt <DSelect>

Selects an existing data list file from the default directory or from the specific directory.

Parameters:

<DSelect> string
 Filename incl. file extension or complete file path

Example:

See [Example "Filling in the frame with dummy REs"](#) on page 390.

Manual operation: See ["Data Source"](#) on page 85

```
[ :SOURce<hw>]:BB:NR5G:NODE:CELL<cc>:DUMRes:PATtern <Pattern>,
  <BitCount>
```

Sets a bit pattern as a data source.

Parameters:

<Pattern>	64 bits
	*RST: #H0
<BitCount>	integer
	Range: 1 to 64
	*RST: 1

Example: See [Example "Filling in the frame with dummy REs"](#) on page 390.

Manual operation: See ["Data Source"](#) on page 85

10.14 OCGN commands

[:SOURce<hw>]:BB:NR5G:NODE:CELL<cc>:DUMRes:APMap:COL<apc>:ROW<apr>: IMAGinary.....	473
[:SOURce<hw>]:BB:NR5G:NODE:CELL<cc>:DUMRes:APMap:COL<apc>:ROW<apr>: MAGNidute.....	474
[:SOURce<hw>]:BB:NR5G:NODE:CELL<cc>:DUMRes:APMap:COL<apc>:ROW<apr>: PHASe.....	474
[:SOURce<hw>]:BB:NR5G:NODE:CELL<cc>:DUMRes:APMap:COL<apc>:ROW<apr>: REAL.....	475
[:SOURce<hw>]:BB:NR5G:NODE:CELL<cc>:DUMRes:NAPS.....	475
[:SOURce<hw>]:BB:NR5G:NODE:CELL<cc>:DUMRes:PREC:STATE.....	476

```
[ :SOURce<hw>]:BB:NR5G:NODE:CELL<cc>:DUMRes:APMap:COL<apc>:  
  ROW<apr>:IMAGinary <ImaginaryValue>
```

Define the mapping of the antenna ports to the physical antennas for unused (dummy) resource elements in cartesian mapping format (imaginary value).

Suffix:

<apc>	Depends on the selected number of layers Defines the antenna port (i.e. the column in the antenna port mapping table)
<apr>	Depends on the number of basebands outputs currently mapped to a cell Available basebands (i.e. rows in the antenna port mapping table)

Parameters:

<ImaginaryValue> float
 Range: -1 to 1
 Increment: 0.001
 *RST: 0

Example: See [Example "Filling in the frame with dummy REs"](#) on page 390.

Manual operation: See ["Mapping Table"](#) on page 87

**[:SOURce<hw>]:BB:NR5G:NODE:CELL<cc>:DUMRes:APMap:COL<apc>:
 ROW<apr>:MAGNidute <Magnitude>**

Define the mapping of the antenna ports to the physical antennas for unused (dummy) resource elements in cylindrical mapping format (magnitude value).

Suffix:

<apc> Depends on the selected number of layers
 Defines the antenna port (i.e. the column in the antenna port mapping table)

<apr> Depends on the number of basebands outputs currently mapped to a cell
 Available basebands (i.e. rows in the antenna port mapping table)

Parameters:

<Magnitude> float
 Range: 0 to 1
 Increment: 0.001
 *RST: 0

Example: See [Example "Filling in the frame with dummy REs"](#) on page 390.

Manual operation: See ["Mapping Table"](#) on page 87

**[:SOURce<hw>]:BB:NR5G:NODE:CELL<cc>:DUMRes:APMap:COL<apc>:
 ROW<apr>:PHASe <Phase>**

Define the mapping of the antenna ports to the physical antennas for unused (dummy) resource elements in cylindrical mapping format (phase value).

Suffix:

<apc> Depends on the selected number of layers
 Defines the antenna port (i.e. the column in the antenna port mapping table)

<apr> Depends on the number of basebands outputs currently mapped to a cell
 Available basebands (i.e. rows in the antenna port mapping table)

Parameters:

<Phase> float
 Range: 0 to 360
 Increment: 0.1
 *RST: 0

Example: See [Example "Filling in the frame with dummy REs"](#) on page 390.

Manual operation: See ["Mapping Table"](#) on page 87

**[:SOURce<hw>]:BB:NR5G:NODE:CELL<cc>:DUMRes:APMap:COL<apc>:
 ROW<apr>:REAL <RealValue>**

Define the mapping of the antenna ports to the physical antennas for unused (dummy) resource elements in cartesian mapping format (real value).

Suffix:

<apc> Depends on the selected number of layers
 Defines the antenna port (i.e. the column in the antenna port mapping table)

<apr> Depends on the number of basebands outputs currently mapped to a cell
 Available basebands (i.e. rows in the antenna port mapping table)

Parameters:

<RealValue> float
 The REAL (magnitude) and IMAGinary (phase) values are interdependent. Their value ranges change depending on each other and so that the resulting complex value is as follows:
 $|REAL+j*IMAGinary| \leq 1$
 Otherwise, the values are normalized to magnitude = 1.
 Range: -1 to 1
 Increment: 0.001
 *RST: 0

Example: See [Example "Filling in the frame with dummy REs"](#) on page 390.

Manual operation: See ["Mapping Table"](#) on page 87

[:SOURce<hw>]:BB:NR5G:NODE:CELL<cc>:DUMRes:NAPS <NumAPs>

Selects the number of antenna ports that unused resource elements (dummy REs) are mapped to.

Parameters:

<NumAPs> integer
 Range: 1 to 12
 *RST: 1

Example: See [Example"Filling in the frame with dummy REs"](#) on page 390.

Manual operation: See ["Number of Antenna Ports"](#) on page 87

[:SOURce<hw>]:BB:NR5G:NODE:CELL<cc>:DUMRes:PREC:STATe <State>

Turns precoding for unused resource elements (dummy REs) on and off.

Parameters:

<State> 1 | ON | 0 | OFF
*RST: 0

Example: See [Example"Filling in the frame with dummy REs"](#) on page 390.

Manual operation: See ["Precoding"](#) on page 86

10.15 DL and UL user properties commands

[:SOURce<hw>]:BB:NR5G:UBWP:NUSer.....	477
[:SOURce<hw>]:BB:NR5G:UBWP:REStart:SIDX:INterval.....	478
[:SOURce<hw>]:BB:NR5G:UBWP:REStart:SIDX:STATe.....	478
[:SOURce<hw>]:BB:NR5G:UBWP:SIINterval.....	478
[:SOURce<hw>]:BB:NR5G:UBWP:SOFFset.....	479
[:SOURce<hw>]:BB:NR5G:UBWP:USER<us>:DSPC:STATe.....	479
[:SOURce<hw>]:BB:NR5G:UBWP:USER<us>:ORAN:TC.....	479
[:SOURce<hw>]:BB:NR5G:UBWP:USER<us>:ORAN:USDS.....	480
[:SOURce<hw>]:BB:NR5G:UBWP:USER<us>:PUPLoad:DATA.....	480
[:SOURce<hw>]:BB:NR5G:UBWP:USER<us>:PUPLoad:DLISt.....	480
[:SOURce<hw>]:BB:NR5G:UBWP:USER<us>:PUPLoad:DSUNique.....	480
[:SOURce<hw>]:BB:NR5G:UBWP:USER<us>:PUPLoad:INITpattern.....	481
[:SOURce<hw>]:BB:NR5G:UBWP:USER<us>:PUPLoad:PATtern.....	481
[:SOURce<hw>]:BB:NR5G:UBWP:USER<us>:PUUCi:DATA.....	481
[:SOURce<hw>]:BB:NR5G:UBWP:USER<us>:PUUCi:DLISt.....	482
[:SOURce<hw>]:BB:NR5G:UBWP:USER<us>:PUUCi:DSUNique.....	482
[:SOURce<hw>]:BB:NR5G:UBWP:USER<us>:PUUCi:INITpattern.....	482
[:SOURce<hw>]:BB:NR5G:UBWP:USER<us>:PUUCi:PATtern.....	483
[:SOURce<hw>]:BB:NR5G:UBWP:REStart.....	483
[:SOURce<hw>]:BB:NR5G:UBWP:USER<us>:RNTI:CS.....	484
[:SOURce<hw>]:BB:NR5G:UBWP:USER<us>:RNTI:G.....	484
[:SOURce<hw>]:BB:NR5G:UBWP:USER<us>:RNTI:GCS.....	484
[:SOURce<hw>]:BB:NR5G:UBWP:USER<us>:RNTI:MCCH.....	484
[:SOURce<hw>]:BB:NR5G:UBWP:USER<us>:RNTI:MCSC.....	485
[:SOURce<hw>]:BB:NR5G:UBWP:USER<us>:RNTI:MSGb.....	485
[:SOURce<hw>]:BB:NR5G:UBWP:USER<us>:RNTI:PEI.....	485
[:SOURce<hw>]:BB:NR5G:UBWP:USER<us>:RNTI:RA.....	485
[:SOURce<hw>]:BB:NR5G:UBWP:USER<us>:RNTI:SFI.....	486
[:SOURce<hw>]:BB:NR5G:UBWP:USER<us>:RNTI:SPCSi.....	486

[SOURce<hw>]:BB:NR5G:UBWP:USER<us>:RNTI:TC.....	486
[SOURce<hw>]:BB:NR5G:UBWP:USER<us>:RNTI:SL.....	486
[SOURce<hw>]:BB:NR5G:UBWP:USER<us>:RNTI:SLCS.....	487
[SOURce<hw>]:BB:NR5G:UBWP:USER<us>:RNTI:V.....	487
[SOURce<hw>]:BB:NR5G:UBWP:USER<us>:UEID.....	487
[SOURce<hw>]:BB:NR5G:UBWP:USER<us>:NUMSfi.....	487
[SOURce<hw>]:BB:NR5G:UBWP:USER<us>:USCH:CCODing:STATe.....	488
[SOURce<hw>]:BB:NR5G:UBWP:USER<us>:DSCH:CCODing:STATe.....	488
[SOURce<hw>]:BB:NR5G:UBWP:USER<us>:DSCH:SCRambling:STATe.....	488
[SOURce<hw>]:BB:NR5G:UBWP:USER<us>:USCH:SCRambling:STATe.....	488
[SOURce<hw>]:BB:NR5G:UBWP:USER<us>:USCH:DATA.....	488
[SOURce<hw>]:BB:NR5G:UBWP:USER<us>:DSCH:DATA.....	488
[SOURce<hw>]:BB:NR5G:UBWP:USER<us>:USCH:DLISt.....	488
[SOURce<hw>]:BB:NR5G:UBWP:USER<us>:DSCH:DLISt.....	488
[SOURce<hw>]:BB:NR5G:UBWP:USER<us>:DSCH:INITpattern.....	489
[SOURce<hw>]:BB:NR5G:UBWP:USER<us>:USCH:INITpattern.....	489
[SOURce<hw>]:BB:NR5G:UBWP:USER<us>:USCH:PATtern.....	489
[SOURce<hw>]:BB:NR5G:UBWP:USER<us>:DSCH:PATtern.....	489
[SOURce<hw>]:BB:NR5G:UBWP:USER<us>:DSCH:SCGW.....	489
[SOURce<hw>]:BB:NR5G:UBWP:USER<us>:DSCH:ANFMode.....	489
[SOURce<hw>]:BB:NR5G:UBWP:USER<us>:DSCH:PH1F.....	490
[SOURce<hw>]:BB:NR5G:UBWP:USER<us>:DSCH:DAIT.....	490
[SOURce<hw>]:BB:NR5G:UBWP:USER<us>:DSCH:DAUL.....	490
[SOURce<hw>]:BB:NR5G:UBWP:USER<us>:DSCH:DA02.....	490
[SOURce<hw>]:BB:NR5G:UBWP:USER<us>:DSCH:HARTind.....	490
[SOURce<hw>]:BB:NR5G:UBWP:USER<us>:DSCH:NRBS.....	491
[SOURce<hw>]:BB:NR5G:UBWP:USER<us>:DSCH:PSSCdyn.....	491
[SOURce<hw>]:BB:NR5G:UBWP:USER<us>:DSCH:RBIS.....	491
[SOURce<hw>]:BB:NR5G:UBWP:USER<us>:DSCH:CDIN.....	491
[SOURce<hw>]:BB:NR5G:UBWP:USER<us>:DSCH:CODS.....	492
[SOURce<hw>]:BB:NR5G:UBWP:USER<us>:DSCH:NSSF.....	492
[SOURce<hw>]:BB:NR5G:UBWP:USER<us>:USCH:NSAS.....	492

[SOURce<hw>]:BB:NR5G:UBWP:NUSer <NumUsers>

Sets the number of simulated users.

Parameters:

<NumUsers>	integer
	Range: 1 to 50
	*RST: 1

Example: See [Example "Configuring the users and the BWPs"](#) on page 391.

Options: R&S SMM-K148 supports up to 50 users.

Manual operation: See ["Number of Users"](#) on page 94

[:SOURce<hw>]:BB:NR5G:UBWP:REStart:SIDX:INTerval <Slots>

Defines the number of slots after which the slot index within a frame restarts.

Prerequisites for this command

- Turn on custom slot index restart ([:SOURce<hw>]:BB:NR5G:UBWP:REStart:SIDX:STATE).

Parameters:

<Slots> integer
 Range: 0 to 640
 *RST: 10

Example: See [:SOURce<hw>]:BB:NR5G:UBWP:REStart:SIDX:STATE on page 478

Manual operation: See "Slot Interval" on page 95

[:SOURce<hw>]:BB:NR5G:UBWP:REStart:SIDX:STATE <State>

Turns a restart of the slot index within a frame on and off.

If on, define the restart interval with [:SOURce<hw>]:BB:NR5G:UBWP:REStart:SIDX:INTerval.

Parameters:

<State> 1 | ON | 0 | OFF
 *RST: 0

Example: //Use custom restart of the slot index
 [:SOURce]:BB:NR5G:UBWP:REStart:SIDX:STATE ON
 [:SOURce<hw>]:BB:NR5G:UBWP:REStart:SIDX:
 INTerval 80

Manual operation: See "Restart Slot Index" on page 95

[:SOURce<hw>]:BB:NR5G:UBWP:SINTerval <SlotInterval>

Defines the number of slots after which the data source restarts (restart every <x> slots).

Prerequisites for this command

- Single numerology setup
- [:SOURce<hw>]:BB:NR5G:UBWP:REStart = SLOT

Parameters:

<SlotInterval> integer
 Range: 1 to 20
 *RST: 10

Manual operation: See "Slot Interval - Data and Control" on page 94

[:SOURce<hw>]:BB:NR5G:UBWP:SOFFset <SlotOffset>

Defines an offset in terms of slots for the restart of the data source.

Prerequisites for this command

- Single numerology setup
- [:SOURce<hw>] :BB:NR5G:UBWP:REStart = SLOT
- [:SOURce<hw>] :BB:NR5G:UBWP:SInterval > 1

Parameters:

<SlotOffset> integer
 Maximum offset = slot interval - 1
 Range: 0 to 19
 *RST: 0

Manual operation: See "[Slot Offset - Data and Control](#)" on page 94

[:SOURce<hw>]:BB:NR5G:UBWP:USER<us>:DSPC:STATE <Source>

Turns usage of a unique data source for the PDSCH in a multi-carrier scenario on and off.

Parameters:

<Source> 1 | ON | 0 | OFF
 *RST: 1

Manual operation: See "[Data Source Unique per Carrier](#)" on page 98

[:SOURce<hw>]:BB:NR5G:UBWP:USER<us>:ORAN:TC <OranTc>

Selects the ORAN test case for ORAN data generation.

Prerequisites for this command

- Turn on ORAN compliant data source ([:SOURce<hw>] :BB:NR5G:UBWP:USER<us>:ORAN:USDS).

Parameters:

<OranTc> TC3231_1 | TC3231_2 | TC3231_3 | TC3231_4 | TC3231_5 |
 TC3231_6 | TC3231_7 | TC3231_8 | TC3231_9 | TC3231_10 |
 TC3231_11 | TC3231_12 | TC3231_13 | TC3231_14 |
 TC3231_15 | TC3231_16 | TC3231_17 | TC3251_1 |
 TC3251_2 | TC3251_3DL | TC3251_3UL | TC3251_5 |
 TC3251_7 | TC3251_8DL | TC3251_8UL | TC3251_4DL |
 TC3251_4UL | TC3261_1DL | TC3261_1UL | TC3261_3DL |
 TC3261_3UL | TC3261_5DL | TC3261_5UL | TC3261_6DL |
 TC3261_6UL
 *RST: TC3231_1

Manual operation: See "[ORAN Test Case](#)" on page 96

[:SOURce<hw>]:BB:NR5G:UBWP:USER<us>:ORAN:USDS <State>

Turns usage of the PxSCH data source according to the ORAN standard on and off.

Parameters:

<State> 1 | ON | 0 | OFF
 *RST: 0

Manual operation: See ["Use ORAN Data Source"](#) on page 96

[:SOURce<hw>]:BB:NR5G:UBWP:USER<us>:PUPLoad:DATA <DataSource>

Selects the data source for the PUSCH UCI.

Prerequisites for this command

- Allow selection of data source ([\[:SOURce<hw>\]:BB:NR5G:UBWP:USER<us>:PUPLoad:DSUNique](#)).

Parameters:

<DataSource> **ONE | ZERO**
 Data source is a sequence that contains only "0" or "1".
DLIST
 Data source is a sequence based on a binary data list.
PATTERN
 Data source is sequence based on a bit pattern.
PN9 | PN11 | PN15 | PN16 | PN20 | PN21 | PN23
 Data source is a pseudo-random sequence.
 *RST: PN9

Manual operation: See ["PUCCH Payload Data Source"](#) on page 99

[:SOURce<hw>]:BB:NR5G:UBWP:USER<us>:PUPLoad:DLIST <File>

Selects an existing data list file from the default directory or from the specific directory.

Prerequisites for this command

- Select a file as data source ([\[:SOURce<hw>\]:BB:NR5G:UBWP:USER<us>:PUPLoad:DATA](#)).

Parameters:

<File> string
 Filename incl. file extension or complete file path.

Manual operation: See ["Initialization / Pattern / Data List"](#) on page 99

[:SOURce<hw>]:BB:NR5G:UBWP:USER<us>:PUPLoad:DSUNique <State>

Turns selection of different data sources for the PUCCH payload on and off.

If off, you can select a data source with [\[:SOURce<hw>\]:BB:NR5G:UBWP:USER<us>:PUPLoad:DATA](#).

Parameters:

<State> 1 | ON | 0 | OFF
 *RST: 0

Manual operation: See ["Unique Data Source for PUCCH Payload"](#) on page 99

[:SOURce<hw>]:BB:NR5G:UBWP:USER<us>:PUPLoad:INITpattern <Pattern>

Sets an initialization value for the second m-sequence in the PN sequence.

Prerequisites for this command

- Select a PN sequence as data source ([\[:SOURce<hw> \] :BB:NR5G:UBWP:USER<us>:PUPLoad:DATA](#)).

Parameters:

<Pattern> integer
 Range: 1 to 0x7fffff
 *RST: 1

Manual operation: See ["Initialization / Pattern / Data List"](#) on page 99

[:SOURce<hw>]:BB:NR5G:UBWP:USER<us>:PUPLoad:PATtern <Pattern>, <BitCount>

Sets a bit pattern as a data source.

Prerequisites for this command

- Select a bit pattern as data source ([\[:SOURce<hw> \] :BB:NR5G:UBWP:USER<us>:PUPLoad:DATA](#)).

Parameters:

<Pattern> 64 bits
 *RST: #H0
 <BitCount> integer
 Range: 1 to 64
 *RST: 1

Manual operation: See ["Initialization / Pattern / Data List"](#) on page 99

[:SOURce<hw>]:BB:NR5G:UBWP:USER<us>:PUUCi:DATA <DataSource>

Selects the data source for the PUSCH UCI.

Prerequisites for this command

- Allow selection of data source ([\[:SOURce<hw> \] :BB:NR5G:UBWP:USER<us>:PUUCi:DSUNique](#)).

Parameters:

<DataSource> **ONE | ZERO**
 Data source is a sequence that contains only "0" or "1".

DLISt

Data source is a sequence based on a binary data list.

PATtern

Data source is sequence based on a bit pattern.

PN9 | PN11 | PN15 | PN16 | PN20 | PN21 | PN23

Data source is a pseudo-random sequence.

*RST: PN9

Manual operation: See "[PUSCH UCI Data Source](#)" on page 98

[:SOURce<hw>]:BB:NR5G:UBWP:USER<us>:PUUCi:DLISt <File>

Selects an existing data list file from the default directory or from the specific directory.

Prerequisites for this command

- Select a file as data source ([\[:SOURce<hw>\]:BB:NR5G:UBWP:USER<us>:PUUCi:DATA](#)).

Parameters:

<File> string

Manual operation: See "[Initialization / Pattern / Data List](#)" on page 98

[:SOURce<hw>]:BB:NR5G:UBWP:USER<us>:PUUCi:DSUNique <State>

Turns selection of different data sources for the PUSCH UCI on and off.

If off, you can select a data source with [\[:SOURce<hw>\]:BB:NR5G:UBWP:USER<us>:PUUCi:DATA](#).

Parameters:

<State> 1 | ON | 0 | OFF

*RST: 0

Manual operation: See "[Unique Data Source for PUSCH UCI](#)" on page 98

[:SOURce<hw>]:BB:NR5G:UBWP:USER<us>:PUUCi:INITpattern <Pattern>

Sets an initialization value for the second m-sequence in the PN sequence.

Prerequisites for this command

- Select a PN sequence as data source ([\[:SOURce<hw>\]:BB:NR5G:UBWP:USER<us>:PUUCi:DATA](#)).

Parameters:

<Pattern> float

Range: 1 to 0x7fffff

Increment: 1

*RST: 1

Manual operation: See "[Initialization / Pattern / Data List](#)" on page 98

```
[ :SOURce<hw>]:BB:NR5G:UBWP:USER<us>:PUUCi:PATtern <Pattern>,
<BitCount>
```

Sets a bit pattern as a data source.

Prerequisites for this command

- Select a bit pattern as data source (`[:SOURce<hw>]:BB:NR5G:UBWP:USER<us>:PUUCi:DATA`).

Parameters:

<Pattern>	64 bits
	*RST: #H0
<BitCount>	integer
	Range: 1 to 64
	*RST: 1

Manual operation: See "[Initialization / Pattern / Data List](#)" on page 98

```
[ :SOURce<hw>]:BB:NR5G:UBWP:REStart <RestartDataSel>
```

Sets the parameter for restarting the configured data sources in customized DCIs.

Parameters:

<RestartDataSel>	OFF COAL FRAME SLOT
------------------	---------------------------

OFF

Disables the restart of data and control. Data sources are initialized only once at the start of the generated signal.

COAL

Enables the restart of data and control after each codeword and allocation. For example, the same payload is used for repeated allocations.

FRAME

Enables the restart of data and control after each frame. For example, the same payload is used for allocations which are repeated each frame.

SLOT

Enables the restart of data and control after each slot. For example, the same payload is used for allocations which are repeated each slot.

*RST:	OFF
-------	-----

Example: See [Example"Configuring the users and the BWPs"](#) on page 391.

Manual operation: See "[Restart Data and Control](#)" on page 94

[:SOURCE<hw>]:BB:NR5G:UBWP:USER<us>:RNTI:CS <CsRnti>

Sets the CS-RNTI of the user. It is a unique UE identification used for semi-persistent scheduling in the downlink.

Parameters:

<CsRnti> integer
 Range: 1 to 65522
 *RST: 1

Example: See [Example "Configuring the users and the BWPs"](#) on page 391.

Manual operation: See ["CS-RNTI"](#) on page 103

[:SOURCE<hw>]:BB:NR5G:UBWP:USER<us>:RNTI:G <Value>

Sets the G-RNTI of the user.

Parameters:

<Value> integer
 Range: 1 to 65522
 *RST: 1

Manual operation: See ["G-RNTI"](#) on page 105

[:SOURCE<hw>]:BB:NR5G:UBWP:USER<us>:RNTI:GCS <Value>

Sets the G-CS-RNTI of the user.

Parameters:

<Value> integer
 Range: 1 to 65519
 *RST: 1

Manual operation: See ["G-CS-RNTI"](#) on page 105

[:SOURCE<hw>]:BB:NR5G:UBWP:USER<us>:RNTI:MCCH <Value>

Sets the MCCH-RNTI of the user.

Parameters:

<Value> integer
 For release 17, the MCCH-RNTI has a fix value of 65533.
 Range: 1 to 65533
 *RST: 1

Manual operation: See ["MCCH-RNTI"](#) on page 104

[:SOURCE<hw>]:BB:NR5G:UBWP:USER<us>:RNTI:MCSC <McsCRnti>

Sets the MCS-C-RNTI of the user. It is a unique UE identification used for modulation coding scheme in the downlink.

Parameters:

<McsCRnti> integer
 Range: 1 to 65522
 *RST: 1

Example: See [Example"Configuring the users and the BWPs"](#) on page 391.

Manual operation: See ["MCS-C-RNTI"](#) on page 103

[:SOURCE<hw>]:BB:NR5G:UBWP:USER<us>:RNTI:MSGB <MsgBRnti>

Sets the MsgB-RNTI of the user. It is a unique UE identification used as an identifier of the RRC connection and for scheduling with a temporary cell.

Parameters:

<MsgBRnti> integer
 Range: 1 to 65519
 *RST: 1

Manual operation: See ["MsgB-RNTI"](#) on page 104

[:SOURCE<hw>]:BB:NR5G:UBWP:USER<us>:RNTI:PEI <Value>

Sets the PEI-RNTI of the user.

Parameters:

<Value> integer
 For release 17, the MCCH-RNTI has a fix value of 65532.
 Range: 1 to 65532
 *RST: 1

Manual operation: See ["PEI-RNTI"](#) on page 104

[:SOURCE<hw>]:BB:NR5G:UBWP:USER<us>:RNTI:RA <RaRnti>

Sets the RA-RNTI of the user. It is used for an identification of the random access response in the downlink and is used during the random access procedure.

Parameters:

<RaRnti> integer
 Range: 1 to 65519
 *RST: 1

Example: See [Example"Configuring the users and the BWPs"](#) on page 391.

Manual operation: See ["RA-RNTI"](#) on page 103

[:SOURCE<hw>]:BB:NR5G:UBWP:USER<us>:RNTI:SFI <UserSfiRnti>

Parameters:

<UserSfiRnti> integer
 Range: 1 to 65519
 *RST: 1

Manual operation: See ["SFI-RNTI"](#) on page 103

[:SOURCE<hw>]:BB:NR5G:UBWP:USER<us>:RNTI:SPCSI <SpCsiRnti>

Sets the SP-CSI-RNTI of the user. It is a unique UE identification used for semi-persistent CSI reporting on PUSCH.

Parameters:

<SpCsiRnti> integer
 Range: 1 to 65519
 *RST: 1

Example: See [Example"Configuring the users and the BWPs"](#) on page 391.

Manual operation: See ["SP-CSI-RNTI"](#) on page 103

[:SOURCE<hw>]:BB:NR5G:UBWP:USER<us>:RNTI:TC <TcRnti>

Sets the TC-RNTI of the user. It is a unique UE identification used as an identifier of the RRC connection and for scheduling with a temporary cell.

Parameters:

<TcRnti> integer
 Range: 1 to 65519
 *RST: 1

Example: See [Example"Configuring the users and the BWPs"](#) on page 391.

Manual operation: See ["TC-RNTI"](#) on page 103

[:SOURCE<hw>]:BB:NR5G:UBWP:USER<us>:RNTI:SL <Value>

Sets the SL-RNTI of the user.

Parameters:

<Value> integer
 Range: 1 to 65519
 *RST: 1

Manual operation: See ["SL-RNTI"](#) on page 104

[[:SOURce<hw>]:BB:NR5G:UBWP:USER<us>:RNTI:SLCS <Value>

Sets the SL-CS-RNTI of the user.

Parameters:

<Value> integer
 Range: 1 to 65519
 *RST: 1

Manual operation: See "[SL-CS-RNTI](#)" on page 104

[[:SOURce<hw>]:BB:NR5G:UBWP:USER<us>:RNTI:V <Value>

Sets the V-RNTI of the user.

Parameters:

<Value> integer
 Range: 1 to 65519
 *RST: 1

Manual operation: See "[V-RNTI](#)" on page 104

[[:SOURce<hw>]:BB:NR5G:UBWP:USER<us>:UEID <UserId>

Sets the RNTI of the user.

Parameters:

<UserId> integer
 Range: 0 to 65535
 *RST: 0

Example: See [Example "Configuring the users and the BWPs"](#) on page 391.

Manual operation: See "[UE ID \(C-RNTI\)](#)" on page 96

[[:SOURce<hw>]:BB:NR5G:UBWP:USER<us>:NUMSfi <NumSfiInDci20>

Sets how many slot format indicator (SFI) fields are transmitted in the DCI format 2_0.

Parameters:

<NumSfiInDci20> integer
 Range: 1 to 16
 *RST: 1

Example: See [Example "Configuring the users and the BWPs"](#) on page 391.

Manual operation: See "[SFIs in DCI 2_0](#)" on page 103

```
[ :SOURce<hw>]:BB:NR5G:UBWP:USER<us>:USCH:CCODing:STATe
<UschChaCod>
```

```
[ :SOURce<hw>]:BB:NR5G:UBWP:USER<us>:DSCH:CCODing:STATe
<DschChaCod>
```

Enables DSCH/USCH channel coding.

Parameters:

```
<DschChaCod> 1 | ON | 0 | OFF
*RST: 0
```

Example: See [Example"Configuring the users and the BWPs"](#) on page 391.

Manual operation: See "[DSCH/USCH Channel Coding](#)" on page 97

```
[ :SOURce<hw>]:BB:NR5G:UBWP:USER<us>:DSCH:SCRambling:STATe <State>
[ :SOURce<hw>]:BB:NR5G:UBWP:USER<us>:USCH:SCRambling:STATe <State>
```

Turns PUSCH scrambling on and off.

Parameters:

```
<State> 1 | ON | 0 | OFF
*RST: 1
```

Manual operation: See "[DSCH/USCH Scrambling](#)" on page 97

```
[ :SOURce<hw>]:BB:NR5G:UBWP:USER<us>:USCH:DATA <UschDataSource>
[ :SOURce<hw>]:BB:NR5G:UBWP:USER<us>:DSCH:DATA <DschDataSource>
```

Sets the DSCH/USCH data source.

Parameters:

```
<DschDataSource> PN9 | PN11 | PN15 | PN16 | PN20 | PN21 | PN23 | PATTeRn |
DLISt | ZERO | ONE
*RST: PN9
```

Example: See [Example"Configuring the users and the BWPs"](#) on page 391.

Manual operation: See "[\(P\)DSCH/\(P\)USCH Data Source](#)" on page 97

```
[ :SOURce<hw>]:BB:NR5G:UBWP:USER<us>:USCH:DLISt <UschDataList>
[ :SOURce<hw>]:BB:NR5G:UBWP:USER<us>:DSCH:DLISt <DschDataList>
```

Selects an existing data list file from the default directory or from the specific directory.

Parameters:

```
<DschDataList> string
Filename incl. file extension or complete file path
```

Example: See [Example"Configuring the users and the BWPs"](#) on page 391.

Manual operation: See "(P)DSCH/(P)USCH Data Source" on page 97

```
[:SOURce<hw>]:BB:NR5G:UBWP:USER<us>:DSCH:INITpattern <Pattern>
[:SOURce<hw>]:BB:NR5G:UBWP:USER<us>:USCH:INITpattern <Pattern>
```

Sets an initialization value for the second m-sequence in the PN sequence.

Parameters:

<Pattern> float
 Range: 1 to 0x7ffff
 Increment: 1
 *RST: 1

Example: See [Example"Configuring the users and the BWPs"](#) on page 391.

Manual operation: See "[Initialization](#)" on page 98

```
[:SOURce<hw>]:BB:NR5G:UBWP:USER<us>:USCH:PATtern <Pattern>,
<BitCount>
[:SOURce<hw>]:BB:NR5G:UBWP:USER<us>:DSCH:PATtern <Pattern>,
<BitCount>
```

Sets a bit pattern as a data source.

Parameters:

<Pattern> 64 bits
 *RST: #H0
 <BitCount> integer
 Range: 1 to 64
 *RST: 1

Example: See [Example"Configuring the users and the BWPs"](#) on page 391.

Manual operation: See "(P)DSCH/(P)USCH Data Source" on page 97

```
[:SOURce<hw>]:BB:NR5G:UBWP:USER<us>:DSCH:SCGW <Value>
```

Sets the parameter "Number of SCell Groups Within Active Time".

Parameters:

<Value> integer
 Range: 0 to 5
 *RST: 0

Manual operation: See "[SCell Groups Within Active Time](#)" on page 101

```
[:SOURce<hw>]:BB:NR5G:UBWP:USER<us>:DSCH:ANFMode <Mode>
```

Selects the state of the parameter `ackNackFeedbackMode`.

Parameters:

<Mode> NCON | JOIN | SEP
 *RST: NCON

Manual operation: See "[Ack-Nack-Feedback-Mode](#)" on page 101

[:SOURce<hw>]:BB:NR5G:UBWP:USER<us>:DSCH:PH1F <State>

Turns the "One-Shot HARQ-ACK Request" DCI field in DCI format 1_1 on and off.

Parameters:

<State> 1 | ON | 0 | OFF
 *RST: 0

Manual operation: See "[PDSCH Harq-Ack-One-Shot-Feedback-R16](#)" on page 101

[:SOURce<hw>]:BB:NR5G:UBWP:USER<us>:DSCH:DAIT <State>

Configures the higher layer parameter `nfi-TotalDAIIncluded` as defined in 3GPP 38.331.

Parameters:

<State> 1 | ON | 0 | OFF
 *RST: 0

Manual operation: See "[NFI-TotalDAI-Included](#)" on page 101

[:SOURce<hw>]:BB:NR5G:UBWP:USER<us>:DSCH:DAUL <State>

Configures the higher layer parameter `ul-TotalDAI-Included` as defined in 3GPP 38.331.

Parameters:

<State> 1 | ON | 0 | OFF
 *RST: 0

Manual operation: See "[UL-TotalDai-Included](#)" on page 101

[:SOURce<hw>]:BB:NR5G:UBWP:USER<us>:DSCH:DA02 <DAIDci02>

Parameters:

<DAIDci02> 1 | ON | 0 | OFF
 *RST: 0

Manual operation: See "[Downlink Assignment Index 0_2](#)" on page 101

[:SOURce<hw>]:BB:NR5G:UBWP:USER<us>:DSCH:HARTind <State>

Turns the "HARQ-ACK Retransmission Indicator" field available in DCI format 1_1 on and off.

Parameters:

<State> 1 | ON | 0 | OFF
 *RST: 0

Manual operation: See ["HARQ-ACK Retransmission Indicator DCI1_1"](#) on page 102

[:SOURCE<hw>]:BB:NR5G:UBWP:USER<us>:DSCH:NRBS <Value>

Defines the number of the "Available RB Set Indicators" fields in DCI format 2_0.

Parameters:

<Value> integer
 Range: 0 to 16
 *RST: 0

Manual operation: See ["Available RB Set Indicators DCI2_0"](#) on page 102

[:SOURCE<hw>]:BB:NR5G:UBWP:USER<us>:DSCH:PSSCdyn <State>

Turns the "PUCCH Cell Indicator" field available in DCI format 1_1 on and off.

Parameters:

<State> 1 | ON | 0 | OFF
 *RST: 0

Manual operation: See ["PUCCH-sSCellDyn DCI1_1"](#) on page 102

[:SOURCE<hw>]:BB:NR5G:UBWP:USER<us>:DSCH:RBIS <IndicatorSize>

Defines the size of the "Available RB Set Indicator" field in DCI format 2_0.

Parameters:

<IndicatorSize> integer
 Range: 1 to 5
 *RST: 1

Manual operation: See ["Available RB Set Indicator Size DCI2_0"](#) on page 102

[:SOURCE<hw>]:BB:NR5G:UBWP:USER<us>:DSCH:CDIN <Value>

Defines the number of the "COT Duration Indicators" fields in DCI format 2_0.

Parameters:

<Value> integer
 Range: 0 to 16
 *RST: 0

Manual operation: See ["COT Duration Indicators DCI2_0"](#) on page 102

[[:SOURce<hw>]:BB:NR5G:UBWP:USER<us>:DSCH:CODS <CotDurationSize>

Defines the size of the "COT Duration Indicator" field in DCI format 2_0.

Parameters:

<CotDurationSize> integer
 Range: 1 to 6
 *RST: 1

Manual operation: See ["COT Duration Indicator Size DCI2_0"](#) on page 102

[[:SOURce<hw>]:BB:NR5G:UBWP:USER<us>:DSCH:NSSF <Value>

Defines the number of the "Search Space Switching Flags" fields in DCI format 2_0.

Parameters:

<Value> integer
 Range: 0 to 4
 *RST: 0

Manual operation: See ["Search Space Switching Flags DCI2_0"](#) on page 102

[[:SOURce<hw>]:BB:NR5G:UBWP:USER<us>:USCH:NSAS <Value>

Defines the size of the "Sidelink Assignment Index" in DCI format 3_0.

Parameters:

<Value> integer
 Range: 0 to 2
 *RST: 0

Manual operation: See ["Bits for Sidelink Assignment Index"](#) on page 102

10.16 SL user properties commands

[:SOURce<hw>]:BB:NR5G:UBWP:USER<us>:SSCH:CCODing:STAtE.....	492
[:SOURce<hw>]:BB:NR5G:UBWP:USER<us>:SSCH:DATA.....	493
[:SOURce<hw>]:BB:NR5G:UBWP:USER<us>:SSCH:DLISt.....	493
[:SOURce<hw>]:BB:NR5G:UBWP:USER<us>:SSCH:INITpattern.....	493
[:SOURce<hw>]:BB:NR5G:UBWP:USER<us>:SSCH:PATtern.....	494
[:SOURce<hw>]:BB:NR5G:UBWP:USER<us>:SSCH:SCRambling:STAtE.....	494

**[[:SOURce<hw>]:BB:NR5G:UBWP:USER<us>:SSCH:CCODing:STAtE
 <SschChaCoding>**

Turns channel coding for the PSSCH on and off.

Parameters:

<SschChaCoding> 1 | ON | 0 | OFF
 *RST: 0

Example: See [Example"Configuring a sidelink signal"](#) on page 412.

Manual operation: See ["SSCH Channel Coding"](#) on page 106

[:SOURce<hw>]:BB:NR5G:UBWP:USER<us>:SSCH:DATA <DataSource>

Selects the data source for the PSSCH.

Parameters:

<DataSource>

DLIST

Data source is binary data from a data list.

Select the data list with [\[:SOURce<hw>\]:BB:NR5G:UBWP:USER<us>:SSCH:DLIST](#).

PATtern

Data source is a equence according to a bit pattern.

Define the bit pattern with [\[:SOURce<hw>\]:BB:NR5G:UBWP:USER<us>:SSCH:PATtern](#).

PN9 | PN11 | PN15 | PN16 | PN20 | PN21 | PN23

Data source is a pseudo-random sequence.

Set the initial value with [\[:SOURce<hw>\]:BB:NR5G:UBWP:USER<us>:SSCH:INITpattern](#).

ZERO | ONE

Data source is a sequence containing all 0's or all 1's.

*RST: PN9

Example: See [Example"Configuring a sidelink signal"](#) on page 412.

Manual operation: See ["SSCH Data Source"](#) on page 106

[:SOURce<hw>]:BB:NR5G:UBWP:USER<us>:SSCH:DLIST <DataList>

Selects a data list as a PSSCH data source.

Prerequisites for this command

- Select a data list as data source ([\[:SOURce<hw>\]:BB:NR5G:UBWP:USER<us>:SSCH:DATA](#)).

Parameters:

<DataList>

string

String containing the path and file name of the data list.

Example: See [Example"Configuring a sidelink signal"](#) on page 412.

Manual operation: See ["SSCH Data Source"](#) on page 106

[:SOURce<hw>]:BB:NR5G:UBWP:USER<us>:SSCH:INITpattern <Pattern>

Defines the initial value when the PSSCH data source is a pseudo-random sequence.

Prerequisites for this command

- Select one of the pseudo-random sequences as data source (`[:SOURce<hw>] : BB:NR5G:UBWP:USER<us>:SSCH:DATA`).

Parameters:

<Pattern> integer
 Range: 1 to #H7ffff
 *RST: 1

Example: See [Example"Configuring a sidelink signal"](#) on page 412.

Manual operation: See ["Initialization"](#) on page 106
 See ["Pattern"](#) on page 106
 See ["Data List"](#) on page 107

`[:SOURce<hw>] : BB:NR5G:UBWP:USER<us> : SSCH:PATtern <Pattern> ,
 <BitCount>`

Defines a bit pattern as the PSSCH data source.

Prerequisites for this command

- Select bit pattern as data source (`[:SOURce<hw>] : BB:NR5G:UBWP:USER<us> : SSCH:DATA`).

Parameters:

<Pattern> 64 bits
 *RST: #H0

<BitCount> integer
 Range: 1 to 64
 *RST: 1

Example: See [Example"Configuring a sidelink signal"](#) on page 412.

`[:SOURce<hw>] : BB:NR5G:UBWP:USER<us> : SSCH:SCRambling:STATe <State>`

Turns PSSCH scrambling on and off.

Parameters:

<State> 1 | ON | 0 | OFF
 *RST: 1

Example: See [Example"Configuring a sidelink signal"](#) on page 412.

Manual operation: See ["SSCH Scrambling"](#) on page 106

10.17 DL/UL BWP commands

`[:SOURce<hw>] : BB:NR5G:UBWP:USER<us> : CELL<cc> : UL:NBWParts`..... 495
`[:SOURce<hw>] : BB:NR5G:UBWP:USER<us> : CELL<cc> : DL:NBWParts`..... 495

[SOURce<hw>]:BB:NR5G:UBWP:USER<us>:CELL<cc>:UL:BWP<bwp>:INDicator.....	495
[SOURce<hw>]:BB:NR5G:UBWP:USER<us>:CELL<cc>:DL:BWP<bwp>:INDicator.....	495
[SOURce<hw>]:BB:NR5G:UBWP:USER<us>:CELL<cc>:DL:BWP<bwp>:CILength.....	496
[SOURce<hw>]:BB:NR5G:UBWP:USER<us>:CELL<cc>:DL:BWP<bwp>:RNTI:CIRNti.....	496
[SOURce<hw>]:BB:NR5G:UBWP:USER<us>:CELL<cc>:DL:BWP<bwp>:NCINd.....	496
[SOURce<hw>]:BB:NR5G:UBWP:USER<us>:CELL<cc>:DL:BWP<bwp>:RNTI:AIRNti.....	497
[SOURce<hw>]:BB:NR5G:UBWP:USER<us>:CELL<cc>:DL:BWP<bwp>:NAINd.....	497
[SOURce<hw>]:BB:NR5G:UBWP:USER<us>:CELL<cc>:DL:BWP<bwp>:RNTI:PSRNti.....	497
[SOURce<hw>]:BB:NR5G:UBWP:USER<us>:CELL<cc>:UL:BWP<bwp>:SCSPacing.....	497
[SOURce<hw>]:BB:NR5G:UBWP:USER<us>:CELL<cc>:DL:BWP<bwp>:SCSPacing.....	497
[SOURce<hw>]:BB:NR5G:UBWP:USER<us>:CELL<cc>:DL:BWP<bwp>:SRS:NB26.....	498
[SOURce<hw>]:BB:NR5G:UBWP:USER<us>:CELL<cc>:DL:BWP<bwp>:SRS:NSCG.....	498
[SOURce<hw>]:BB:NR5G:UBWP:USER<us>:CELL<cc>:DL:BWP<bwp>:SRS:BD23.....	498
[SOURce<hw>]:BB:NR5G:UBWP:USER<us>:CELL<cc>:DL:BWP<bwp>:SRS:GTYPe.....	499
[SOURce<hw>]:BB:NR5G:UBWP:USER<us>:CELL<cc>:UL:BWP<bwp>:RBNumber.....	499
[SOURce<hw>]:BB:NR5G:UBWP:USER<us>:CELL<cc>:DL:BWP<bwp>:RBNumber.....	499
[SOURce<hw>]:BB:NR5G:UBWP:USER<us>:CELL<cc>:UL:BWP<bwp>:RBOffset.....	500
[SOURce<hw>]:BB:NR5G:UBWP:USER<us>:CELL<cc>:DL:BWP<bwp>:RBOffset.....	500
[SOURce<hw>]:BB:NR5G:UBWP:USER<us>:CELL<cc>:UL:BWP<bwp>:PRBoffset?.....	500
[SOURce<hw>]:BB:NR5G:UBWP:USER<us>:CELL<cc>:DL:BWP<bwp>:PRBoffset?.....	500
[SOURce<hw>]:BB:NR5G:UBWP:USER<us>:CELL<cc>:UL:BWP<bwp>:DFReq?.....	500
[SOURce<hw>]:BB:NR5G:UBWP:USER<us>:CELL<cc>:DL:BWP<bwp>:DFReq?.....	500

[SOURce<hw>]:BB:NR5G:UBWP:USER<us>:CELL<cc>:UL:NBWParts
<BandwidthParts>

[SOURce<hw>]:BB:NR5G:UBWP:USER<us>:CELL<cc>:DL:NBWParts
<BandwidthParts>

Sets the number of downlink bandwidth parts (BWP).

Parameters:

<BandwidthParts> integer
Range: 0 to 4
*RST: 1

Example: See [Example"Configuring the users and the BWPs"](#) on page 391.

Manual operation: See ["Number of DL/UL BWPs"](#) on page 109

[SOURce<hw>]:BB:NR5G:UBWP:USER<us>:CELL<cc>:UL:BWP<bwp>:
INDicator <ID>

[SOURce<hw>]:BB:NR5G:UBWP:USER<us>:CELL<cc>:DL:BWP<bwp>:
INDicator <ID>

Sets the indicator for the selected BWP.

Parameters:

<ID> integer
Range: 0 to 3
*RST: 0

Example: See [Example"Configuring the users and the BWPs"](#) on page 391.

Manual operation: See ["BWP Indicator"](#) on page 109

**[:SOURce<hw>]:BB:NR5G:UBWP:USER<us>:CELL<cc>:DL:BWP<bwp>:
CLength <CancelIndLength>**

Sets the length for each cancellation indication in the DCI format 2_4.

The "Cancellation Indication Length" and [Number of Cancellation Indications](#) set the size of the DCI format 2_4 [pattern](#).

Parameters:

<CancelIndLength> 1 | 2 | 4 | 7 | 8 | 14 | 16 | 32 | 56 | 112
*RST: 1

Example: See [Example"DCI format 2_4"](#) on page 402.

Options: R&S SMM-K148.

Manual operation: See ["Cancellation Indication Length"](#) on page 141

**[:SOURce<hw>]:BB:NR5G:UBWP:USER<us>:CELL<cc>:DL:BWP<bwp>:RNTI:
CiRnti <CiRnti>**

Sets the CI-RNTI of the user. This parameter is a unique UE identifier for the cancellation indication in the DCI format 2_4.

Parameters:

<CiRnti> integer
Range: 1 to 65519
*RST: 1

Example: See [Example"DCI format 2_4"](#) on page 402.

Options: R&S SMM-K148.

Manual operation: See ["CI-RNTI"](#) on page 141

**[:SOURce<hw>]:BB:NR5G:UBWP:USER<us>:CELL<cc>:DL:BWP<bwp>:NCINd
<NumCancelInd>**

Sets the number of cancellation indications in the DCI format 2_4.

The maximum number of cancellation indications depends on the [Cancellation Indication Length](#) value.

Parameters:

<NumCancelInd> integer
Range: 1 to 8
*RST: 1

Example: See [Example"DCI format 2_4"](#) on page 402.

Options: R&S SMM-K148.

Manual operation: See ["Number of Cancellation Indications"](#) on page 141

**[:SOURCE<hw>]:BB:NR5G:UBWP:USER<us>:CELL<cc>:DL:BWP<bwp>:RNTI:
AIRnti <AiRnti>**

Sets the AI-RNTI of the user. It is a unique UE identifier for the starting position block in the DCI format 2_5.

Parameters:

<AiRnti> integer
Range: 1 to 65519
*RST: 1

Manual operation: See ["AI-RNTI"](#) on page 141

**[:SOURCE<hw>]:BB:NR5G:UBWP:USER<us>:CELL<cc>:DL:BWP<bwp>:NAIND
<NumAvailInd>**

Sets the number of availability indications in the DCI format 2_5.

Parameters:

<NumAvailInd> integer
Range: 1 to 16
*RST: 1

Manual operation: See ["Number of Availability Indications"](#) on page 141

**[:SOURCE<hw>]:BB:NR5G:UBWP:USER<us>:CELL<cc>:DL:BWP<bwp>:RNTI:
PSRnti <PsRnti>**

Sets the PS-RNTI of the user. It is a unique UE identifier for the starting position block in the DCI format 2_6.

Parameters:

<PsRnti> integer
Range: 1 to 65519
*RST: 1

Example: See [Example"DCI format 2_6"](#) on page 402.

Options: R&S SMM-K148.

Manual operation: See ["PS-RNTI"](#) on page 142

**[:SOURCE<hw>]:BB:NR5G:UBWP:USER<us>:CELL<cc>:UL:BWP<bwp>:
SCSPacing <SCSPacing>
[:SOURCE<hw>]:BB:NR5G:UBWP:USER<us>:CELL<cc>:DL:BWP<bwp>:
SCSPacing <SCSpacing>**

Selects a combination of the subcarrier spacing (SCS) and the cyclic prefix (CP).

Parameters:

<SCSpacing> N15 | N30 | N60 | X60 | N120 | N240 | N480 | N960
 *RST: N30

Example:

See [Example"Configuring the users and the BWPs"](#) on page 391.

Options:

N480 and N960 require R&S SMM-K171

Manual operation:

See ["SC Spacing/CP"](#) on page 109

**[:SOURCE<hw>]:BB:NR5G:UBWP:USER<us>:CELL<cc>:DL:BWP<bwp>:SRS:
 NB26 <NumBlckInDci26>**

Sets the number of dormancy indications in the DCI format 2_6.

Parameters:

<NumBlckInDci26> integer
 Range: 1 to 10
 *RST: 1

Example:

See [Example"DCI format 2_6"](#) on page 402.

Options:

R&S SMM-K148.

Manual operation:

See ["Number of Dormancy Indications"](#) on page 142

**[:SOURCE<hw>]:BB:NR5G:UBWP:USER<us>:CELL<cc>:DL:BWP<bwp>:SRS:
 NSCG <NumCellGroups>**

Sets the number of bits for the "SCell Dormancy Indication" pattern in the DCI format 2_6.

Parameters:

<NumCellGroups> integer
 Range: 0 to 5
 *RST: 0

Example:

See [Example"DCI format 2_6"](#) on page 402.

Options:

R&S SMM-K148.

Manual operation:

See ["Number of SCell Groups Outside Active Time"](#) on page 142

**[:SOURCE<hw>]:BB:NR5G:UBWP:USER<us>:CELL<cc>:DL:BWP<bwp>:SRS:
 BD23 <NumBlocksInDci2>**

Sets the number of blocks (i.e. couples of closed loop indicators and TPC command fields) in the DCI format 2_3.

Parameters:

<NumBlocksInDci2> integer
 Range: 1 to 11
 *RST: 1

Example: See [Example"Configuring the users and the BWPs"](#) on page 391.

Manual operation: See ["Number of Blocks"](#) on page 140

[:SOURCE<hw>]:BB:NR5G:UBWP:USER<us>:CELL<cc>:DL:BWP<bwp>:SRS:GTYpe <GroupType>

Sets the SRS-TPC-PDCCH-Group type.

Parameters:

<GroupType> A | B
 *RST: A

Example: See [Example"Configuring the users and the BWPs"](#) on page 391.

Manual operation: See ["SRS-TPC-PDCCH-Group Type"](#) on page 140

[:SOURCE<hw>]:BB:NR5G:UBWP:USER<us>:CELL<cc>:UL:BWP<bwp>:RBNumber <UIBwpRBNumber>

[:SOURCE<hw>]:BB:NR5G:UBWP:USER<us>:CELL<cc>:DL:BWP<bwp>:RBNumber <DIBwpRBNum>

Sets the number of resource blocks (RB) the bandwidth part (BWP) occupies.

Parameters:

<DIBwpRBNum> integer
 The number of available RBs depends on the SCS and channel bandwidth.
 CORESET allocations span always a multiple of 6 resource blocks. Thus, for CORESET allocations the minimum value is 6 and the allowed values are multiple of 6.
 Range: 1 to 273
 *RST: 11

Example: See [Example"Configuring the users and the BWPs"](#) on page 391.

Manual operation: See ["No. RBs"](#) on page 110

```
[:SOURce<hw>]:BB:NR5G:UBWP:USER<us>:CELL<cc>:UL:BWP<bwp>:
  RBOffset <ResourceBlocks>
[:SOURce<hw>]:BB:NR5G:UBWP:USER<us>:CELL<cc>:DL:BWP<bwp>:
  RBOffset <ResourceBlocks>
```

Sets the offset between the first resource block in the BWP relative to the first usable resource blocks (URB).

Parameters:

<ResourceBlocks> integer
 Range: 0 to 255
 *RST: 0

Example: See [Example"Configuring the users and the BWPs"](#) on page 391.

Manual operation: See ["RB Offset in TxBW"](#) on page 110

```
[:SOURce<hw>]:BB:NR5G:UBWP:USER<us>:CELL<cc>:UL:BWP<bwp>:
  PRBoffset?
[:SOURce<hw>]:BB:NR5G:UBWP:USER<us>:CELL<cc>:DL:BWP<bwp>:
  PRBoffset?
```

Queries the frequency starting position of the BWP relative to the point A.

Return values:

<PointAOffset> integer
 Range: 0 to 500
 *RST: 0

Example: See [Example"Configuring the users and the BWPs"](#) on page 391.

Usage: Query only

Manual operation: See ["RB Offset to Point A"](#) on page 110

```
[:SOURce<hw>]:BB:NR5G:UBWP:USER<us>:CELL<cc>:UL:BWP<bwp>:DFReq?
[:SOURce<hw>]:BB:NR5G:UBWP:USER<us>:CELL<cc>:DL:BWP<bwp>:DFReq?
```

Queries the frequency offset between the BWP center and the center frequency of the carrier.

Return values:

<Frequency> float
 Range: -40E6 to 40E6
 Increment: 1.0
 *RST: 0.0

Example: See [Example"Configuring the users and the BWPs"](#) on page 391.

Usage: Query only

Manual operation: See "[Δf to Carrier \(Centers\) /MHz](#)" on page 110

10.18 SL BWP commands

[:SOURce<hw>]:BB:NR5G:UBWP:USER<us>:CELL<cc>:SL:BWP<bwp>:DFReq?	501
[:SOURce<hw>]:BB:NR5G:UBWP:USER<us>:CELL<cc>:SL:BWP<bwp>:INDicator	501
[:SOURce<hw>]:BB:NR5G:UBWP:USER<us>:CELL<cc>:SL:BWP<bwp>:PAOffset?	501
[:SOURce<hw>]:BB:NR5G:UBWP:USER<us>:CELL<cc>:SL:BWP<bwp>:RBNumber	502
[:SOURce<hw>]:BB:NR5G:UBWP:USER<us>:CELL<cc>:SL:BWP<bwp>:RBOffset	502
[:SOURce<hw>]:BB:NR5G:UBWP:USER<us>:CELL<cc>:SL:BWP<bwp>:SCSPacing	502
[:SOURce<hw>]:BB:NR5G:UBWP:USER<us>:CELL<cc>:SL:NBWParts	503

[\[:SOURce<hw>\]:BB:NR5G:UBWP:USER<us>:CELL<cc>:SL:BWP<bwp>:DFReq?](#)

Queries the frequency offset between the BWP center and the center frequency of the carrier.

Return values:

<Frequency> integer
 Range: -4E7 to 4E7
 *RST: 0

Example: See [Example"Configuring a sidelink signal"](#) on page 412.

Usage: Query only

Manual operation: See "[Δf to Carrier \(Centers\) /MHz](#)" on page 113

[\[:SOURce<hw>\]:BB:NR5G:UBWP:USER<us>:CELL<cc>:SL:BWP<bwp>:INDicator <ID>](#)

Defines the ID of a sidelink bandwidth part.

Parameters:

<ID> integer
 Range: 0 to 3
 *RST: 0

Example: See [Example"Configuring a sidelink signal"](#) on page 412.

Manual operation: See "[BWP Indicator](#)" on page 112

[\[:SOURce<hw>\]:BB:NR5G:UBWP:USER<us>:CELL<cc>:SL:BWP<bwp>:PAOffset?](#)

Queries the starting position of the sidelink bandwidth part in the frequency domain relative to point A.

Return values:

<ResourceBlocks> integer
 Range: 0 to 300
 *RST: 0

Example: See [Example"Configuring a sidelink signal"](#) on page 412.

Usage: Query only

Manual operation: See ["RB Offset to Point A"](#) on page 113

**[:SOURCE<hw>]:BB:NR5G:UBWP:USER<us>:CELL<cc>:SL:BWP<bwp>:
 RBNumber <ResourceBlocks>**

Defines the number of resource blocks for a sidelink bandwidth part.

Parameters:

<ResourceBlocks> integer
 Range: 1 to 273
 *RST: 273

Example: See [Example"Configuring a sidelink signal"](#) on page 412.

Manual operation: See ["No. RBs"](#) on page 112

**[:SOURCE<hw>]:BB:NR5G:UBWP:USER<us>:CELL<cc>:SL:BWP<bwp>:
 RBOffset <ResourceBlocks>**

Defines a resource block offset for a sidelink bandwidth part.

Parameters:

<ResourceBlocks> integer
 Range: 0 to 272
 *RST: 0

Example: See [Example"Configuring a sidelink signal"](#) on page 412.

Manual operation: See ["RB Offset in TxBW"](#) on page 113

**[:SOURCE<hw>]:BB:NR5G:UBWP:USER<us>:CELL<cc>:SL:BWP<bwp>:
 SCSPacing <Numerology>**

Defines the subcarrier spacing of a sidelink bandwidth part.

Parameters:

<Numerology> N15 | N30 | N60 | X60 | N120
 *RST: N30

Example: See [Example"Configuring a sidelink signal"](#) on page 412.

Manual operation: See ["SC Spacing/CP"](#) on page 112

[:SOURce<hw>]:BB:NR5G:UBWP:USER<us>:CELL<cc>:SL:NBWParts
 <BandwidthParts>

Defines the number of sidelink bandwidth parts.

Parameters:

<BandwidthParts> integer
 Range: 0 to 4
 *RST: 1

Example: See [Example "Configuring a sidelink signal"](#) on page 412.

Manual operation: See ["Number of SL BWPs"](#) on page 112

10.19 BWP configuration commands

• PDSCH commands	503
• PTRS commands	523
• RMC commands	527
• PDCCH commands	530
• DL control information commands	532
• ZP and NZP CSI-RS commands	538
• Rate match commands	546
• PUCCH commands	549
• FRC commands	551
• PUSCH commands	557
• PUSCH UCI commands	574
• SRS commands	576
• Bandwidth part configuration for sidelink commands	588

10.19.1 PDSCH commands

[:SOURce<hw>]:BB:NR5G:UBWP:USER<us>:CELL<cc>:DL:BWP<bwp>:DCI:HARTind	505
[:SOURce<hw>]:BB:NR5G:UBWP:USER<us>:CELL<cc>:DL:BWP<bwp>:DCI:PRINdicator ..	506
[:SOURce<hw>]:BB:NR5G:UBWP:USER<us>:CELL<cc>:DL:BWP<bwp>:DCI:PSSCdyn	506
[:SOURce<hw>]:BB:NR5G:UBWP:USER<us>:CELL<cc>:DL:BWP<bwp>:PDSCh: CBGF:STATe	506
[:SOURce<hw>]:BB:NR5G:SCHed:CELL<cc>:SUBF<sf>:USER<us>:BWPart<bwp>: ALLoc<al>:PDSCh[:DMRS]:APSelect<s2us0>	506
[:SOURce<hw>]:BB:NR5G:UBWP:USER<us>:CELL<cc>:DL:BWP<bwp>:PDSCh: DMTA:BSAMe	507
[:SOURce<hw>]:BB:NR5G:UBWP:USER<us>:CELL<cc>:DL:BWP<bwp>:PDSCh: DMTB:CTYPe	507
[:SOURce<hw>]:BB:NR5G:UBWP:USER<us>:CELL<cc>:DL:BWP<bwp>:PDSCh: DMTA:CTYPe	507
[:SOURce<hw>]:BB:NR5G:UBWP:USER<us>:CELL<cc>:DL:BWP<bwp>:PDSCh: DMTB:APINdex	507

BWP configuration commands

[:SOURce<hw>]:BB:NR5G:UBWP:USER<us>:CELL<cc>:DL:BWP<bwp>:PDSCh: DMTA:APINdex.....	507
[:SOURce<hw>]:BB:NR5G:UBWP:USER<us>:CELL<cc>:DL:BWP<bwp>:PDSCh: DMTB:MLENght.....	508
[:SOURce<hw>]:BB:NR5G:UBWP:USER<us>:CELL<cc>:DL:BWP<bwp>:PDSCh: DMTA:MLENght.....	508
[:SOURce<hw>]:BB:NR5G:UBWP:USER<us>:CELL<cc>:DL:BWP<bwp>:PDSCh: DMTA:SID0.....	508
[:SOURce<hw>]:BB:NR5G:UBWP:USER<us>:CELL<cc>:DL:BWP<bwp>:PDSCh: DMTA:SID1.....	508
[:SOURce<hw>]:BB:NR5G:UBWP:USER<us>:CELL<cc>:DL:BWP<bwp>:PDSCh: DMTB:SID0.....	508
[:SOURce<hw>]:BB:NR5G:UBWP:USER<us>:CELL<cc>:DL:BWP<bwp>:PDSCh: DMTB:SID1.....	508
[:SOURce<hw>]:BB:NR5G:UBWP:USER<us>:CELL<cc>:DL:BWP<bwp>:PDSCh: DMTB:UR16.....	509
[:SOURce<hw>]:BB:NR5G:UBWP:USER<us>:CELL<cc>:DL:BWP<bwp>:PDSCh: DMTA:UR16.....	509
[:SOURce<hw>]:BB:NR5G:UBWP:USER<us>:CELL<cc>:DL:BWP<bwp>:PDSCh:HP5Bits...	509
[:SOURce<hw>]:BB:NR5G:UBWP:USER<us>:CELL<cc>:DL:BWP<bwp>:PDSCh: MCBGroups.....	509
[:SOURce<hw>]:BB:NR5G:UBWP:USER<us>:CELL<cc>:DL:BWP<bwp>:PDSCh: PREC:BBSet1.....	510
[:SOURce<hw>]:BB:NR5G:UBWP:USER<us>:CELL<cc>:DL:BWP<bwp>:PDSCh: PREC:BSSet2.....	510
[:SOURce<hw>]:BB:NR5G:UBWP:USER<us>:CELL<cc>:DL:BWP<bwp>:PDSCh: PREC:BSIZe.....	511
[:SOURce<hw>]:BB:NR5G:UBWP:USER<us>:CELL<cc>:DL:BWP<bwp>:PDSCh: MAOffset:NMOFFset.....	511
[:SOURce<hw>]:BB:NR5G:UBWP:USER<us>:CELL<cc>:DL:BWP<bwp>:PDSCh: MAOffset:VAL<gr0>.....	511
[:SOURce<hw>]:BB:NR5G:UBWP:USER<us>:CELL<cc>:DL:BWP<bwp>:PDSCh: PREC:BTYPe.....	512
[:SOURce<hw>]:BB:NR5G:UBWP:USER<us>:CELL<cc>:DL:BWP<bwp>:PDSCh:PI11.....	512
[:SOURce<hw>]:BB:NR5G:UBWP:USER<us>:CELL<cc>:DL:BWP<bwp>:PDSCh:PI12.....	512
[:SOURce<hw>]:BB:NR5G:UBWP:USER<us>:CELL<cc>:DL:BWP<bwp>:PDSCh:RV12.....	513
[:SOURce<hw>]:BB:NR5G:UBWP:USER<us>:CELL<cc>:DL:BWP<bwp>:PDSCh:HA12.....	513
[:SOURce<hw>]:BB:NR5G:UBWP:USER<us>:CELL<cc>:DL:BWP<bwp>:PDSCh:AP12.....	513
[:SOURce<hw>]:BB:NR5G:UBWP:USER<us>:CELL<cc>:DL:BWP<bwp>:PDSCh:DI12.....	513
[:SOURce<hw>]:BB:NR5G:UBWP:USER<us>:CELL<cc>:DL:BWP<bwp>:PDSCh:AG12.....	514
[:SOURce<hw>]:BB:NR5G:UBWP:USER<us>:CELL<cc>:DL:BWP<bwp>:PDSCh:TCI: NTCP.....	514
[:SOURce<hw>]:BB:NR5G:UBWP:USER<us>:CELL<cc>:DL:BWP<bwp>:PDSCh:TCI: TCV<gr0>:ID1.....	514
[:SOURce<hw>]:BB:NR5G:UBWP:USER<us>:CELL<cc>:DL:BWP<bwp>:PDSCh:TCI: TCV<gr0>:ID2.....	514
[:SOURce<hw>]:BB:NR5G:UBWP:USER<us>:CELL<cc>:DL:BWP<bwp>:PDSCh:TCI: TCV<gr0>:STATe.....	515
[:SOURce<hw>]:BB:NR5G:UBWP:USER<us>:CELL<cc>:DL:BWP<bwp>:PDSCh: XOVerhead.....	515

BWP configuration commands

[:SOURce<hw>]:BB:NR5G:UBWP:USER<us>:CELL<cc>:DL:BWP<bwp>:PDSCh: PREC:STATe.....	515
[:SOURce<hw>]:BB:NR5G:UBWP:USER<us>:CELL<cc>:DL:BWP<bwp>:PDSCh: PREC:MOD.....	516
[:SOURce<hw>]:BB:NR5G:UBWP:USER<us>:CELL<cc>:DL:BWP<bwp>:PDSCh: SCRambling:STATe.....	516
[:SOURce<hw>]:BB:NR5G:UBWP:USER<us>:CELL<cc>:DL:BWP<bwp>:PDSCh:DSID.....	516
[:SOURce<hw>]:BB:NR5G:UBWP:USER<us>:CELL<cc>:DL:BWP<bwp>:PDSCh:MCWDci..	516
[:SOURce<hw>]:BB:NR5G:UBWP:USER<us>:CELL<cc>:DL:BWP<bwp>:PDSCh: MCSTable.....	517
[:SOURce<hw>]:BB:NR5G:UBWP:USER<us>:CELL<cc>:DL:BWP<bwp>:PDSCh: RESalloc.....	517
[:SOURce<hw>]:BB:NR5G:UBWP:USER<us>:CELL<cc>:DL:BWP<bwp>:PDSCh: RBGSize.....	517
[:SOURce<hw>]:BB:NR5G:UBWP:USER<us>:CELL<cc>:DL:BWP<bwp>:PDSCh: TDANum.....	518
[:SOURce<hw>]:BB:NR5G:UBWP:USER<us>:CELL<cc>:DL:BWP<bwp>:PDSCh: TD<grp0>:KNULI.....	518
[:SOURce<hw>]:BB:NR5G:UBWP:USER<us>:CELL<cc>:DL:BWP<bwp>:PDSCh: TD<grp0>:MAPPing.....	518
[:SOURce<hw>]:BB:NR5G:UBWP:USER<us>:CELL<cc>:DL:BWP<bwp>:PDSCh: TD<grp0>:START.....	518
[:SOURce<hw>]:BB:NR5G:UBWP:USER<us>:CELL<cc>:DL:BWP<bwp>:PDSCh: TD<grp0>:LENGth.....	519
[:SOURce<hw>]:BB:NR5G:UBWP:USER<us>:CELL<cc>:DL:BWP<bwp>:PDSCh: TD<grp0>:SLIV?.....	519
[:SOURce<hw>]:BB:NR5G:UBWP:USER<us>:CELL<cc>:DL:BWP<bwp>:PDSCh:VPINter...	519
[:SOURce<hw>]:BB:NR5G:UBWP:USER<us>:CELL<cc>:DL:BWP<bwp>:PDSCh: TDALists.....	520
[:SOURce<hw>]:BB:NR5G:UBWP:USER<us>:CELL<cc>:DL:BWP<bwp>:PDSCh: LSElected.....	520
[:SOURce<hw>]:BB:NR5G:UBWP:USER<us>:CELL<cc>:DL:BWP<bwp>:PDSCh: TDML<grp0>:TDANum.....	520
[:SOURce<hw>]:BB:NR5G:UBWP:USER<us>:CELL<cc>:DL:BWP<bwp>:PDSCh: TDML<grp0>:TD<user0>:KNULI.....	521
[:SOURce<hw>]:BB:NR5G:UBWP:USER<us>:CELL<cc>:DL:BWP<bwp>:PDSCh: TDML<grp0>:TD<user0>:MAPPing.....	521
[:SOURce<hw>]:BB:NR5G:UBWP:USER<us>:CELL<cc>:DL:BWP<bwp>:PDSCh: TDML<grp0>:TD<user0>:LENGth.....	522
[:SOURce<hw>]:BB:NR5G:UBWP:USER<us>:CELL<cc>:DL:BWP<bwp>:PDSCh: TDML<grp0>:TD<user0>:START.....	522
[:SOURce<hw>]:BB:NR5G:UBWP:USER<us>:CELL<cc>:DL:BWP<bwp>:PDSCh: TDML<grp0>:TD<user0>:SLIV?.....	522

**[:SOURce<hw>]:BB:NR5G:UBWP:USER<us>:CELL<cc>:DL:BWP<bwp>:DCI:
HARTind <State>**

Turns the "HARQ-ACK Retransmission Indicator" field available in DCI format 1_2 on and off.

Parameters:

<State> 1 | ON | 0 | OFF
 *RST: 0

Manual operation: See ["HARQ-ACK Retransmission Indicator DCI1_2"](#) on page 125

[:SOURce<hw>]:BB:NR5G:UBWP:USER<us>:CELL<cc>:DL:BWP<bwp>:DCI:PRINdicator <State>

Turns the "Priority Indicator" field in DCI format 4_2 on and off.

Parameters:

<State> 1 | ON | 0 | OFF
 *RST: 0

Manual operation: See ["Priority Indicator DCI4_2"](#) on page 125

[:SOURce<hw>]:BB:NR5G:UBWP:USER<us>:CELL<cc>:DL:BWP<bwp>:DCI:PSSCdyn <State>

Turns the "PUCCH Cell Indicator" field available in DCI format 1_2 on and off.

Parameters:

<State> 1 | ON | 0 | OFF
 *RST: 0

Manual operation: See ["PUCCH-sSCellDyn DCI1_2"](#) on page 125

[:SOURce<hw>]:BB:NR5G:UBWP:USER<us>:CELL<cc>:DL:BWP<bwp>:PDSCh:CBGF:STATe <CBGFlushIndicat>

Indicates if the code block group buffer is empty. Default is disabled.

Parameters:

<CBGFlushIndicat> 1 | ON | 0 | OFF
 *RST: 0

Example: See [Example"Configuring the PDSCH incl. PTRS and Precoding settings"](#) on page 393.

Manual operation: See ["Code Block Group Flush Indicator"](#) on page 119

[:SOURce<hw>]:BB:NR5G:SCHed:CELL<cc>:SUBF<sf>:USER<us>:BWPart<bwp>:ALLoc<al>:PDSCh[:DMRS]:APSelect<s2us0> <PdschAPSel>

Each layer of a PDSCH allocation is mapped to a certain antenna port. By the command the antenna ports are selected which are used for the transmission of the PDSCH allocation.

Parameters:

<PdschAPSel> AP1000 | AP1001 | AP1002 | AP1003 | AP1004 | AP1005 |
 AP1006 | AP1007 | AP1008 | AP1009 | AP1010 | AP1011
 *RST: AP1000

Example:

See [Example"Configuring the PDSCH incl. PTRS and Precoding settings"](#) on page 393.

Manual operation: See ["DMRS Antenna Ports ..."](#) on page 225

**[:SOURCE<hw>]:BB:NR5G:UBWP:USER<us>:CELL<cc>:DL:BWP<bwp>:PDSCH:
 DMTA:BSAMe <SameDmreSetting>**

Per default, the same configuration applies for DMRS mapping type A and B. Disable "Same Settings for Type A and Type B" to modify the mapping type B settings.

Mapping type A and B define the DMRS position in the PDSCH, the starting symbol and length. The UE informs the BS about the mapping type supportability via the UE capability information message.

Parameters:

<SameDmreSetting> 1 | ON | 0 | OFF
 *RST: 1

Example:

See [Example"Configuring the PDSCH incl. PTRS and Precoding settings"](#) on page 393.

Manual operation: See ["Same Settings for Type A and Type B"](#) on page 126

**[:SOURCE<hw>]:BB:NR5G:UBWP:USER<us>:CELL<cc>:DL:BWP<bwp>:PDSCH:
 DMTB:CTYPE <TypeBConfigType>**

**[:SOURCE<hw>]:BB:NR5G:UBWP:USER<us>:CELL<cc>:DL:BWP<bwp>:PDSCH:
 DMTA:CTYPE <TypeAConfigType>**

Sets the configuration type (type 1 or type 2) and defines the mapping of the DMRS to the physical resource elements.

Parameters:

<TypeAConfigType> T1 | T2
 *RST: T1

Example:

See [Example"Configuring the PDSCH incl. PTRS and Precoding settings"](#) on page 393.

Manual operation: See ["Config Type"](#) on page 126

**[:SOURCE<hw>]:BB:NR5G:UBWP:USER<us>:CELL<cc>:DL:BWP<bwp>:PDSCH:
 DMTB:APINDEX <TypeBAddPosIdx>**

**[:SOURCE<hw>]:BB:NR5G:UBWP:USER<us>:CELL<cc>:DL:BWP<bwp>:PDSCH:
 DMTA:APINDEX <TypeAAddPosIdx>**

Sets the parameter additional position index, required to select the positions of the DMRS symbols.

Parameters:

<TypeAAddPosIdx> integer
 Range: 0 to 3
 *RST: 0

Example: See [Example"Configuring the PDSCH incl. PTRS and Precoding settings"](#) on page 393.

Manual operation: See ["Additional Position Index"](#) on page 127

```
[:SOURce<hw>]:BB:NR5G:UBWP:USER<us>:CELL<cc>:DL:BWP<bwp>:PDSCh:
  DMTB:MLENgtH <TypeBMaxLength>
[:SOURce<hw>]:BB:NR5G:UBWP:USER<us>:CELL<cc>:DL:BWP<bwp>:PDSCh:
  DMTA:MLENgtH <DmrsMaxLength>
```

Sets if single- or double-symbol DMRS is used.

Parameters:

<DmrsMaxLength> integer
 Range: 1 to 2
 *RST: 2

Example: See [Example"Configuring the PDSCH incl. PTRS and Precoding settings"](#) on page 393.

Manual operation: See ["Max Length"](#) on page 127

```
[:SOURce<hw>]:BB:NR5G:UBWP:USER<us>:CELL<cc>:DL:BWP<bwp>:PDSCh:
  DMTA:SID0 <ScramID0>
[:SOURce<hw>]:BB:NR5G:UBWP:USER<us>:CELL<cc>:DL:BWP<bwp>:PDSCh:
  DMTA:SID1 <ScramID1>
[:SOURce<hw>]:BB:NR5G:UBWP:USER<us>:CELL<cc>:DL:BWP<bwp>:PDSCh:
  DMTB:SID0 <ScramID0>
[:SOURce<hw>]:BB:NR5G:UBWP:USER<us>:CELL<cc>:DL:BWP<bwp>:PDSCh:
  DMTB:SID1 <ScramID1>
```

Sets the scrambling ID.

Parameters:

<ScramID1> integer
 Range: 0 to 65535
 *RST: 0

Example: See [Example"Configuring the PDSCH incl. PTRS and Precoding settings"](#) on page 393.

Manual operation: See ["Scrambling ID 0/Scrambling ID 1"](#) on page 127

```
[:SOURce<hw>]:BB:NR5G:UBWP:USER<us>:CELL<cc>:DL:BWP<bwp>:PDSCh:
  DMTB:UR16 <State>
```

```
[:SOURce<hw>]:BB:NR5G:UBWP:USER<us>:CELL<cc>:DL:BWP<bwp>:PDSCh:
  DMTA:UR16 <State>
```

Turns the higher layer parameter "dmrs-downlink-r16" on and off.

Parameters:

```
<State>          1 | ON | 0 | OFF
                  *RST:      0
```

Manual operation: See ["Use R16 DMRS"](#) on page 127

```
[:SOURce<hw>]:BB:NR5G:UBWP:USER<us>:CELL<cc>:DL:BWP<bwp>:PDSCh:
  HP5Bits <BitLength>
```

Selects the size of the "HARQ Process Number" DCI field in DCI format 1_1.

Parameters:

```
<BitLength>      OFF | 0
                  4 bits
                  ON | 1
                  5 bits
                  *RST:      0
```

Manual operation: See ["Harq-ProcessNumberSizeDCI1_1"](#) on page 125

```
[:SOURce<hw>]:BB:NR5G:UBWP:USER<us>:CELL<cc>:DL:BWP<bwp>:PDSCh:
  MCBGroups <DIMaxCBGperTB>
```

Limits the number of code block groups per transport block.

In 5G NR a huge TB (transport block) is split into multiple code blocks (CB). Multiples CBs are grouped into one code block group (CBG). The number of code blocks grouped into the CBG can be limited by the "Max Code Block Groups Per Transport Block" setting.

Parameters:

```
<DIMaxCBGperTB> G2 | G4 | DISabled | G6 | G8
```

G2
Limits the number of code block groups per transport block to 2.

G4
Limits the number of code block groups per transport block to 4.

G6
Limits the number of code block groups per transport block to 6.

G8
Limits the number of code block groups per transport block to 8.

DISabled
Default value (also G0), which disabled the limitation of code block groups per transport block.

*RST: DISabled

Example: See: [Example"Configuring the PDSCH incl. PTRS and Precoding settings"](#) on page 393

Manual operation: See "[Max Code Block Groups Per Transport Block](#)" on page 119

**[:SOURCE<hw>]:BB:NR5G:UBWP:USER<us>:CELL<cc>:DL:BWP<bwp>:PDSCh:
PREC:BBSet1 <DIBwpBundleSet1>**

Configures the dynamic PRB bundle type. Only available if "Precoding" is enabled and "Dynamic" is selected as "PRB Bundling Type".

Parameters:

<DIBwpBundleSet1> N4 | WIDeband | N2WB | N4WB

N4

Default value. Dynamic PRB bundle size set 1 is set to N4.

WIDeband

Dynamic PRB bundle size set 1 is set to wideband.

N2WB

Dynamic PRB bundle size set 1 is set to N2-wideband.

N4WB

Dynamic PRB bundle size set 1 is set to N4-wideband.

*RST: N4

Example: See: [Example"Configuring the PDSCH incl. PTRS and Precoding settings"](#) on page 393

Manual operation: See "[Bundle Size Set 1](#)" on page 121

**[:SOURCE<hw>]:BB:NR5G:UBWP:USER<us>:CELL<cc>:DL:BWP<bwp>:PDSCh:
PREC:BSSet2 <DIBwpBundleSet2>**

Configures the dynamic PRB bundle type. Only available if "Precoding" is enabled and "Dynamic" is selected as "PRB Bundling Type".

Parameters:

<DIBwpBundleSet2> N4 | WIDeband

N4

Default value. Dynamic PRB bundle size set 2 is set to N4.

WIDeband

Dynamic PRB bundle size set 2 is set to wideband.

*RST: N4

Example: See: [Example"Configuring the PDSCH incl. PTRS and Precoding settings"](#) on page 393

Manual operation: See "[Bundle Size Set 2](#)" on page 122

**[:SOURce<hw>]:BB:NR5G:UBWP:USER<us>:CELL<cc>:DL:BWP<bwp>:PDSCh:
PREC:BSIZe <DIBwpStaticBSiz>**

Configures the static PRB bundle type. Only available if "Precoding" is enabled and "Static" is selected as "PRB Bundling Type".

Parameters:

<DIBwpStaticBSiz> N4 | WIDeband | N2WB | N4WB

N4

Default value. Static PRB bundle is set to N4.

WIDeband

Static PRB bundle is set to wideband.

N2WB

Static PRB bundle is set to N2 wideband.

N4WB

Static PRB bundle is set to N4 wideband.

*RST: N4

Example: See: [Example"Configuring the PDSCH incl. PTRS and Precoding settings"](#) on page 393

Manual operation: See ["Static Bundle Size "](#) on page 121

**[:SOURce<hw>]:BB:NR5G:UBWP:USER<us>:CELL<cc>:DL:BWP<bwp>:PDSCh:
MAOffset:NMOffset <Value>**

Turns the "Minimum Applicable Offset Indicator" field in DCI format 1_1 on and off and defines the number of K0 values you can configure.

Parameters:

<Value> integer

Range: 0 to 16

*RST: 0

Manual operation: See ["Number of Entries"](#) on page 122

**[:SOURce<hw>]:BB:NR5G:UBWP:USER<us>:CELL<cc>:DL:BWP<bwp>:PDSCh:
MAOffset:VAL<gr0> <MinAppOffset>**

Defines the value for the minimum applicable offset indicator.

Prerequisites for this command

- Define a number of K0 values > 0 ([\[:SOURce<hw>\]:BB:NR5G:UBWP:USER<us>:CELL<cc>:DL:BWP<bwp>:PDSCh:MAOffset:NMOffset](#)).

Suffix:

<gr0> depends on number of K0 values
Minimum applicable offset

Parameters:

<MinAppOffset> integer
 Range: 0 to 15
 *RST: 0

Manual operation: See ["Value for MinAppOffset"](#) on page 122

**[:SOURCE<hw>]:BB:NR5G:UBWP:USER<us>:CELL<cc>:DL:BWP<bwp>:PDSCh:
 PREC:BTYPe <DIBwpPRBbundlin>**

Indicates the PRB bundle type and bundle sizes.

If "dynamic" is chosen, the actual bundle size set to use is indicated via DCI.

Only available if "Precoding" is enabled.

The PRB bundling type supports the UE to reduce the computational effort to receive the information which PRBs use the same precoding. The UE only has to do channel estimation per PRB bundle not per PRB. Without this information, the UE has to decode all the information itself based on the DMRS.

Parameters:

<DIBwpPRBbundlin> NOTC | STATic | DYNamic

NOTC

Default value, PRB bundling is not configured.

STATIC

PRB bundling is set to static and can be adjusted by the "Static Bundle Size".

DYNAMIC

PRB bundling is set to dynamic and can be adjusted by the "Bundle Size Set 1" and "Bundle Size Set 2".

*RST: NOTC

Example: See: ["Example"Configuring the PDSCH incl. PTRS and Precoding settings"](#) on page 393

Manual operation: See ["PRB Bundling Type "](#) on page 121

**[:SOURCE<hw>]:BB:NR5G:UBWP:USER<us>:CELL<cc>:DL:BWP<bwp>:PDSCh:
 PI11 <PriIndicator>**

**[:SOURCE<hw>]:BB:NR5G:UBWP:USER<us>:CELL<cc>:DL:BWP<bwp>:PDSCh:
 PI12 <Dci12PriInd>**

Turns the "Priority Indicator" DCI field in DCI formats 1_2 on and off.

Parameters:

<Dci12PriInd> 1 | ON | 0 | OFF
 *RST: 0

Manual operation: See ["Priority Indicator DCI1_2"](#) on page 124

**[:SOURce<hw>]:BB:NR5G:UBWP:USER<us>:CELL<cc>:DL:BWP<bwp>:PDSCh:
RV12 <Value>**

Defines the bit length of the DCI field "Redundancy Version" available in DCI format 1_2.

Parameters:

<Value> integer
Range: 0 to 2
*RST: 0

Manual operation: See ["Bits For Redundancy Version DCI1_2"](#) on page 123

**[:SOURce<hw>]:BB:NR5G:UBWP:USER<us>:CELL<cc>:DL:BWP<bwp>:PDSCh:
HA12 <Value>**

Defines the bit length of the DCI field "HARQ Process Number" available in DCI formats 1_2.

Parameters:

<Value> integer
Range: 0 to 4
*RST: 0

Manual operation: See ["Bits For HARQ DCI1_2"](#) on page 123
See ["Bits For HARQ DCI 0_2"](#) on page 171

**[:SOURce<hw>]:BB:NR5G:UBWP:USER<us>:CELL<cc>:DL:BWP<bwp>:PDSCh:
AP12 <Dci12APPresent>**

Turns the "Antenna Ports" DCI field in DCI format 1_2 on and off.

Parameters:

<Dci12APPresent> 1 | ON | 0 | OFF
*RST: 0

Manual operation: See ["Antenna Ports Present DCI1_2"](#) on page 123

**[:SOURce<hw>]:BB:NR5G:UBWP:USER<us>:CELL<cc>:DL:BWP<bwp>:PDSCh:
DI12 <Dci12DmrsSeqIni>**

Turns the "DMRS Sequence Initialization" DCI field in DCI format 1_2 on and off.

Parameters:

<Dci12DmrsSeqIni> 1 | ON | 0 | OFF
*RST: 0

Manual operation: See ["DMRS Sequence Initialization DCI1_2"](#) on page 123

[:SOURce<hw>]:BB:NR5G:UBWP:USER<us>:CELL<cc>:DL:BWP<bwp>:PDsch:AG12 <State>

Configures the higher layer parameter

resourceAllocationType1GranularityDCI-1-2 as defined in 3GPP 38.331.

Parameters:

<State> NCON | N2 | N4 | N8 | N16

NCON
Not configured.

N2|N4|N8|N16
Granularity as defined by 3GPP.

*RST: NCON

Manual operation: See "[Type 1 Allocation Granularity DCI 1_2](#)" on page 124

[:SOURce<hw>]:BB:NR5G:UBWP:USER<us>:CELL<cc>:DL:BWP<bwp>:PDsch:TCI:NTCP <Codepoints>

Defines the number of mapped TCI codepoints.

Parameters:

<Codepoints> integer

Range: 0 to 8

*RST: 0

Manual operation: See "[Number of Mapped TCI Codepoints](#)" on page 124

[:SOURce<hw>]:BB:NR5G:UBWP:USER<us>:CELL<cc>:DL:BWP<bwp>:PDsch:TCI:TCV<gr0>:ID1 <ID>

Defines the value of the state ID 1 for a TCI codepoint.

Parameters:

<ID> integer

Range: 0 to 127

*RST: 0

Manual operation: See "[State ID 1](#)" on page 124

[:SOURce<hw>]:BB:NR5G:UBWP:USER<us>:CELL<cc>:DL:BWP<bwp>:PDsch:TCI:TCV<gr0>:ID2 <ID>

Defines the value of the state ID 1 for a TCI codepoint.

Prerequisites for this command

- Turn on usage of state ID 2 (`[:SOURce<hw>]:BB:NR5G:UBWP:USER<us>:CELL<cc>:DL:BWP<bwp>:PDsch:TCI:TCV<gr0>:STaTe`).

Suffix:

<gr0> 0...8
TCI codepoint

Parameters:

<ID> integer
Range: 0 to 127
*RST: 0

Manual operation: See ["State ID 2"](#) on page 125

**[:SOURce<hw>]:BB:NR5G:UBWP:USER<us>:CELL<cc>:DL:BWP<bwp>:PDSCh:
TCI:TCV<gr0>:STATe <State>**

Parameters:

<State> 1 | ON | 0 | OFF
*RST: 0

Manual operation: See ["Use State ID 2"](#) on page 125

**[:SOURce<hw>]:BB:NR5G:UBWP:USER<us>:CELL<cc>:DL:BWP<bwp>:PDSCh:
XOVerhead <XOverhead>**

Selects the value for the "xOverhead" parameter.

Parameters:

<XOverhead> N0 | N6 | N12 | N18
*RST: N0

Example: See [Example"Configuring the PDSCH incl. PTRS and Precoding settings"](#) on page 393.

Manual operation: See ["xOverhead"](#) on page 119

**[:SOURce<hw>]:BB:NR5G:UBWP:USER<us>:CELL<cc>:DL:BWP<bwp>:PDSCh:
PREC:STATe <State>**

Enabled or disables precoding.

Parameters:

<State> 1 | ON | 0 | OFF
*RST: 0

Example: See: [Example"Configuring the PDSCH incl. PTRS and Precoding settings"](#) on page 393

Manual operation: See ["Precoding "](#) on page 119

```
[ :SOURce<hw>]:BB:NR5G:UBWP:USER<us>:CELL<cc>:DL:BWP<bwp>:PDSCh:
  PREC:MOD <PrecMode>
```

Selects the precoding method.

Parameters:

```
<PrecMode>      CB
                  Precoding based on a codebook.

                  RDM
                  Precoding matrix chosen randomly.
                  *RST:      RDM
```

Example: See [Example"Configuring the PDSCH incl. PTRS and Precoding settings"](#) on page 393

Manual operation: See ["Precoding Mode"](#) on page 119

```
[ :SOURce<hw>]:BB:NR5G:UBWP:USER<us>:CELL<cc>:DL:BWP<bwp>:PDSCh:
  SCRambling:STAtE <PdschScrambling>
```

Sets if a data scrambling ID is used for the initialization of the generator of the PDSCH scrambling sequence.

Parameters:

```
<PdschScrambling> 1 | ON | 0 | OFF
                  *RST:      0
```

Example: See [Example"Configuring the PDSCH incl. PTRS and Precoding settings"](#) on page 393.

Manual operation: See ["Use PDSCH Scrambling ID"](#) on page 116

```
[ :SOURce<hw>]:BB:NR5G:UBWP:USER<us>:CELL<cc>:DL:BWP<bwp>:PDSCh:
  DSID <DataScrambleId>
```

If `[:SOURce<hw>]:BB:NR5G:UBWP:USER<us>:CELL<cc>:DL:BWP<bwp>:PDSCh:SCRambling:STAtE 1`, sets the data scrambling ID.

Parameters:

```
<DataScrambleId> integer
                  Range:      0 to 1023
                  *RST:      0
```

Example: See [Example"Configuring the PDSCH incl. PTRS and Precoding settings"](#) on page 393.

Manual operation: See ["Data Scrambling ID"](#) on page 117

```
[ :SOURce<hw>]:BB:NR5G:UBWP:USER<us>:CELL<cc>:DL:BWP<bwp>:PDSCh:
  MCWDci <MaxCodeWordsPer>
```

Sets the number of codewords.

Parameters:

<MaxCodeWordsPer>integer

Range: 1 to 2

*RST: 1

Example: See [Example"Configuring the PDSCH incl. PTRS and Precoding settings"](#) on page 393.**Manual operation:** See ["Max. Number of Codewords per DCI"](#) on page 117**[:SOURCE<hw>]:BB:NR5G:UBWP:USER<us>:CELL<cc>:DL:BWP<bwp>:PDSCH:MCSTable <Modulation>**

Sets the MCS table and defines the used modulation scheme.

Parameters:

<Modulation> QAM64 | QAM64LSE | QAM256 | QAM1024

*RST: QAM64

Example: See [Example"Configuring the PDSCH incl. PTRS and Precoding settings"](#) on page 393.**Manual operation:** See ["MCS Table"](#) on page 118**[:SOURCE<hw>]:BB:NR5G:UBWP:USER<us>:CELL<cc>:DL:BWP<bwp>:PDSCH:RESalloc <ResourceAlloc>**

Sets the used resource allocation type.

Parameters:

<ResourceAlloc> T0 | T1 | DS

*RST: T1

Example: See [Example"Configuring the PDSCH incl. PTRS and Precoding settings"](#) on page 393.**Manual operation:** See ["Resource Allocation"](#) on page 118**[:SOURCE<hw>]:BB:NR5G:UBWP:USER<us>:CELL<cc>:DL:BWP<bwp>:PDSCH:RBGSize <UrDIBpPdschRBGS>**

Sets the size of the resource block group.

Parameters:

<UrDIBpPdschRBGS>C1 | C2

*RST: C1

Example: See [Example"Configuring the PDSCH incl. PTRS and Precoding settings"](#) on page 393.**Manual operation:** See ["Resource Block Group Size"](#) on page 118

**[:SOURce<hw>]:BB:NR5G:UBWP:USER<us>:CELL<cc>:DL:BWP<bwp>:PDSCh:
TDANum <Allocations>**

Sets the number of PDSCH time domain allocations.

Parameters:

<Allocations> integer
 Range: 0 to 16
 *RST: 0

Example: See [Example"Configuring PDSCH time domain scheduling with PDSCH time domain allocation list"](#) on page 395.

Manual operation: See ["Time Domain Allocations"](#) on page 130

**[:SOURce<hw>]:BB:NR5G:UBWP:USER<us>:CELL<cc>:DL:BWP<bwp>:PDSCh:
TD<grp0>:KNULI <K0>**

Sets the slot offset K_0 .

Parameters:

<K0> integer
 Range: 0 to 32
 *RST: 0

Example: See [Example"Configuring PDSCH time domain scheduling with PDSCH time domain allocation list"](#) on page 395.

Manual operation: See ["K0"](#) on page 130

**[:SOURce<hw>]:BB:NR5G:UBWP:USER<us>:CELL<cc>:DL:BWP<bwp>:PDSCh:
TD<grp0>:MAPPING <MappingType>**

Sets the DMRS-mapping type A and B.

Parameters:

<MappingType> A | B
 *RST: A

Example: See [Example"Configuring PDSCH time domain scheduling with PDSCH time domain allocation list"](#) on page 395.

Manual operation: See ["Mapping Type"](#) on page 130

**[:SOURce<hw>]:BB:NR5G:UBWP:USER<us>:CELL<cc>:DL:BWP<bwp>:PDSCh:
TD<grp0>:START <Start>**

Sets the start OFDM symbol of the PDSCH allocation.

Parameters:

<Start> integer
 Range: 0 to 12
 *RST: 0

Example: See [Example"Configuring PDSCH time domain scheduling with PDSCH time domain allocation list"](#) on page 395.

Manual operation: See ["Start"](#) on page 131

**[:SOURCE<hw>]:BB:NR5G:UBWP:USER<us>:CELL<cc>:DL:BWP<bwp>:PDSCH:
 TD<grp0>:LENGTH <Length>**

Sets the PDSCH allocation length.

Parameters:

<Length> 2 | 3 | 4 | 5 | 6 | 7 | 8 | 9 | 10 | 11 | 12 | 13 | 14
 *RST: 2

Example: See [Example"Configuring PDSCH time domain scheduling with PDSCH time domain allocation list"](#) on page 395.

Manual operation: See ["Length"](#) on page 131

**[:SOURCE<hw>]:BB:NR5G:UBWP:USER<us>:CELL<cc>:DL:BWP<bwp>:PDSCH:
 TD<grp0>:SLIV?**

Queries the resulting start and length indicator SLIV.

Return values:

<SLIV> integer
 Range: 0 to 32
 *RST: 0

Example: See [Example"Configuring PDSCH time domain scheduling with PDSCH time domain allocation list"](#) on page 395.

Usage: Query only

Manual operation: See ["SLIV"](#) on page 131

**[:SOURCE<hw>]:BB:NR5G:UBWP:USER<us>:CELL<cc>:DL:BWP<bwp>:PDSCH:
 VPINter <VrbToPrbInterle>**

Queries the mapping method used for the mapping of the virtual resource blocks (VRB) to the physical resource blocks (PRB).

Parameters:

<VrbToPrbInterle> VPN | VP2 | VP4
VPN
 Non-interleaved

VP2|VP4

Interleaving is enabled. The value defines the interleaving unit size: VP2 = 2 and VP4 = 4.

*RST: VPN

Example: See [Example"Configuring the PDSCH incl. PTRS and Precoding settings"](#) on page 393.

Manual operation: See ["VRB-to-PRB Interleaver"](#) on page 117

[:SOURCE<hw>]:BB:NR5G:UBWP:USER<us>:CELL<cc>:DL:BWP<bwp>:PDSCh:TDALists <Lists>

Defines the number of time domain allocation lists.

Parameters:

<Lists> integer
 Range: 0 to 16
 *RST: 0

Manual operation: See ["Number of TD Allocation Lists"](#) on page 132

[:SOURCE<hw>]:BB:NR5G:UBWP:USER<us>:CELL<cc>:DL:BWP<bwp>:PDSCh:LSElected <List>

Selects the allocation list you want to configure.

Prerequisites for this command

- [\[:SOURCE<hw>\]:BB:NR5G:UBWP:USER<us>:CELL<cc>:DL:BWP<bwp>:PDSCh:TDALists > 1](#)

Parameters:

<List> integer
 Range: 0 to 15
 *RST: 0

Manual operation: See ["Current TD Allocation List"](#) on page 132

[:SOURCE<hw>]:BB:NR5G:UBWP:USER<us>:CELL<cc>:DL:BWP<bwp>:PDSCh:TDML<grp0>:TDANum <Allocations>

Defines the number of multi time domain allocations in the selected time domain allocation list.

Prerequisites for this command

- [\[:SOURCE<hw>\]:BB:NR5G:UBWP:USER<us>:CELL<cc>:DL:BWP<bwp>:PDSCh:TDALists > 1](#)

Suffix:

<grp0> 0...15
 Selects a time domain allocation list.

Parameters:

<Allocations> integer
 Range: 0 to 16
 *RST: 0

Manual operation: See "[Multi Time Domain Allocations](#)" on page 132

**[:SOURce<hw>]:BB:NR5G:UBWP:USER<us>:CELL<cc>:DL:BWP<bwp>:PDSCh:
 TDML<grp0>:TD<user0>:KNULI <K0>**

Sets the slot offset K_0 for an allocation in a time domain allocation list.

Prerequisites for this command

- `[:SOURce<hw>] :BB:NR5G:UBWP:USER<us>:CELL<cc>:DL:BWP<bwp>:
 PDSCh:TDALists > 1`

Suffix:

<grp0> 0...15
 Selects a time domain allocation list.

<user0> 1...8
 Selects an allocation.

Parameters:

<K0> integer
 Range: 0 to 32
 *RST: 0

Manual operation: See "[K0](#)" on page 132

**[:SOURce<hw>]:BB:NR5G:UBWP:USER<us>:CELL<cc>:DL:BWP<bwp>:PDSCh:
 TDML<grp0>:TD<user0>:MAPPING <MappingType>**

Sets the DMRS-mapping type for an allocation in a time domain allocation list.

Prerequisites for this command

- `[:SOURce<hw>] :BB:NR5G:UBWP:USER<us>:CELL<cc>:DL:BWP<bwp>:
 PDSCh:TDALists > 1`

Suffix:

<grp0> 0...15
 Selects a time domain allocation list.

<user0> 1...8
 Selects an allocation.

Parameters:

<MappingType> A | B
 *RST: A

Manual operation: See "[Mapping Type](#)" on page 132

[:SOURce<hw>]:BB:NR5G:UBWP:USER<us>:CELL<cc>:DL:BWP<bwp>:PDSCh:TDML<grp0>:TD<user0>:LENGth <Length>

Sets the number of consecutive OFDM symbols (L) the allocation in a time domain allocation list spans.

Prerequisites for this command

- [:SOURce<hw>] :BB:NR5G:UBWP:USER<us>:CELL<cc>:DL:BWP<bwp>:PDSCh:TDALists > 1

Suffix:

<grp0> 0...15
Selects a time domain allocation list.

<user0> 1...8
Selects an allocation.

Parameters:

<Length> 2 | 3 | 4 | 5 | 6 | 7 | 8 | 9 | 10 | 11 | 12 | 13 | 14
*RST: 3

Manual operation: See "No. Sym." on page 132

[:SOURce<hw>]:BB:NR5G:UBWP:USER<us>:CELL<cc>:DL:BWP<bwp>:PDSCh:TDML<grp0>:TD<user0>:STARt <Start>

Sets the start OFDM symbol (S) of an allocation in a time domain allocation list.

Prerequisites for this command

- [:SOURce<hw>] :BB:NR5G:UBWP:USER<us>:CELL<cc>:DL:BWP<bwp>:PDSCh:TDALists > 1

Suffix:

<grp0> 0...15
Selects a time domain allocation list.

<user0> 1...8
Selects an allocation.

Parameters:

<Start> integer
Range: 0 to 12
*RST: 0

Manual operation: See "Sym. Offset" on page 133

[:SOURce<hw>]:BB:NR5G:UBWP:USER<us>:CELL<cc>:DL:BWP<bwp>:PDSCh:TDML<grp0>:TD<user0>:SLIV?

Queries the resulting start and length indicator SLIV for an allocation in a time domain allocation list.

Suffix:	
<grp0>	0...15 Selects a time domain allocation list.
<user0>	1...8 Selects an allocation.
Return values:	
<SLIV>	integer Range: 0 to 32 *RST: 0
Usage:	Query only
Manual operation:	See "SLIV" on page 133

10.19.2 PTRS commands

[SOURce<hw>]:BB:NR5G:UBWP:USER<us>:CELL<cc>:UL:BWP<bwp>:PUSCh: DMTA:PTRS:STATe.....	524
[SOURce<hw>]:BB:NR5G:UBWP:USER<us>:CELL<cc>:UL:BWP<bwp>:PUSCh: DMTB:PTRS:STATe.....	524
[SOURce<hw>]:BB:NR5G:UBWP:USER<us>:CELL<cc>:DL:BWP<bwp>:PDSCh: DMTA:PTRS:STATe.....	524
[SOURce<hw>]:BB:NR5G:UBWP:USER<us>:CELL<cc>:DL:BWP<bwp>:PDSCh: DMTB:PTRS:STATe.....	524
[SOURce<hw>]:BB:NR5G:UBWP:USER<us>:CELL<cc>:UL:BWP<bwp>:PUSCh: DMTA:PTRS:REOF.....	525
[SOURce<hw>]:BB:NR5G:UBWP:USER<us>:CELL<cc>:UL:BWP<bwp>:PUSCh: DMTB:PTRS:REOF.....	525
[SOURce<hw>]:BB:NR5G:UBWP:USER<us>:CELL<cc>:DL:BWP<bwp>:PDSCh: DMTA:PTRS:REOF.....	525
[SOURce<hw>]:BB:NR5G:UBWP:USER<us>:CELL<cc>:DL:BWP<bwp>:PDSCh: DMTB:PTRS:REOF.....	525
[SOURce<hw>]:BB:NR5G:UBWP:USER<us>:CELL<cc>:DL:BWP<bwp>:PDSCh: DMTA:PTRS:EPRE.....	525
[SOURce<hw>]:BB:NR5G:UBWP:USER<us>:CELL<cc>:DL:BWP<bwp>:PDSCh: DMTB:PTRS:EPRE.....	525
[SOURce<hw>]:BB:NR5G:UBWP:USER<us>:CELL<cc>:UL:BWP<bwp>:PUSCh: DMTA:PTRS:POWer.....	525
[SOURce<hw>]:BB:NR5G:UBWP:USER<us>:CELL<cc>:UL:BWP<bwp>:PUSCh: DMTB:PTRS:POWer.....	525
[SOURce<hw>]:BB:NR5G:UBWP:USER<us>:CELL<cc>:UL:BWP<bwp>:PUSCh: DMTA:PTRS:PORT.....	526
[SOURce<hw>]:BB:NR5G:UBWP:USER<us>:CELL<cc>:UL:BWP<bwp>:PUSCh: DMTB:PTRS:PORT.....	526
[SOURce<hw>]:BB:NR5G:UBWP:USER<us>:CELL<cc>:UL:BWP<bwp>:PUSCh: DMTA:PTRS:MCS1.....	526
[SOURce<hw>]:BB:NR5G:UBWP:USER<us>:CELL<cc>:UL:BWP<bwp>:PUSCh: DMTA:PTRS:MCS2.....	526

BWP configuration commands

<code>[SOURce<hw>]:BB:NR5G:UBWP:USER<us>:CELL<cc>:UL:BWP<bwp>:PUSCh: DMTA:PTRS:MCS3</code>	526
<code>[SOURce<hw>]:BB:NR5G:UBWP:USER<us>:CELL<cc>:UL:BWP<bwp>:PUSCh: DMTB:PTRS:MCS1</code>	526
<code>[SOURce<hw>]:BB:NR5G:UBWP:USER<us>:CELL<cc>:UL:BWP<bwp>:PUSCh: DMTB:PTRS:MCS2</code>	526
<code>[SOURce<hw>]:BB:NR5G:UBWP:USER<us>:CELL<cc>:UL:BWP<bwp>:PUSCh: DMTB:PTRS:MCS3</code>	526
<code>[SOURce<hw>]:BB:NR5G:UBWP:USER<us>:CELL<cc>:DL:BWP<bwp>:PDSCh: DMTA:PTRS:MCS1</code>	526
<code>[SOURce<hw>]:BB:NR5G:UBWP:USER<us>:CELL<cc>:DL:BWP<bwp>:PDSCh: DMTA:PTRS:MCS2</code>	526
<code>[SOURce<hw>]:BB:NR5G:UBWP:USER<us>:CELL<cc>:DL:BWP<bwp>:PDSCh: DMTA:PTRS:MCS3</code>	526
<code>[SOURce<hw>]:BB:NR5G:UBWP:USER<us>:CELL<cc>:DL:BWP<bwp>:PDSCh: DMTB:PTRS:MCS1</code>	526
<code>[SOURce<hw>]:BB:NR5G:UBWP:USER<us>:CELL<cc>:DL:BWP<bwp>:PDSCh: DMTB:PTRS:MCS2</code>	526
<code>[SOURce<hw>]:BB:NR5G:UBWP:USER<us>:CELL<cc>:DL:BWP<bwp>:PDSCh: DMTB:PTRS:MCS3</code>	526
<code>[SOURce<hw>]:BB:NR5G:UBWP:USER<us>:CELL<cc>:UL:BWP<bwp>:PUSCh: DMTA:PTRS:RB0</code>	527
<code>[SOURce<hw>]:BB:NR5G:UBWP:USER<us>:CELL<cc>:UL:BWP<bwp>:PUSCh: DMTA:PTRS:RB1</code>	527
<code>[SOURce<hw>]:BB:NR5G:UBWP:USER<us>:CELL<cc>:UL:BWP<bwp>:PUSCh: DMTB:PTRS:RB0</code>	527
<code>[SOURce<hw>]:BB:NR5G:UBWP:USER<us>:CELL<cc>:UL:BWP<bwp>:PUSCh: DMTB:PTRS:RB1</code>	527
<code>[SOURce<hw>]:BB:NR5G:UBWP:USER<us>:CELL<cc>:DL:BWP<bwp>:PDSCh: DMTA:PTRS:RB0</code>	527
<code>[SOURce<hw>]:BB:NR5G:UBWP:USER<us>:CELL<cc>:DL:BWP<bwp>:PDSCh: DMTA:PTRS:RB1</code>	527
<code>[SOURce<hw>]:BB:NR5G:UBWP:USER<us>:CELL<cc>:DL:BWP<bwp>:PDSCh: DMTB:PTRS:RB0</code>	527
<code>[SOURce<hw>]:BB:NR5G:UBWP:USER<us>:CELL<cc>:DL:BWP<bwp>:PDSCh: DMTB:PTRS:RB1</code>	527

`[SOURce<hw>]:BB:NR5G:UBWP:USER<us>:CELL<cc>:UL:BWP<bwp>:PUSCh:
DMTA:PTRS:STATe <TypeAPtrsState>`

`[SOURce<hw>]:BB:NR5G:UBWP:USER<us>:CELL<cc>:UL:BWP<bwp>:PUSCh:
DMTB:PTRS:STATe <PtrsState>`

`[SOURce<hw>]:BB:NR5G:UBWP:USER<us>:CELL<cc>:DL:BWP<bwp>:PDSCh:
DMTA:PTRS:STATe <TypeAPtrsState>`

`[SOURce<hw>]:BB:NR5G:UBWP:USER<us>:CELL<cc>:DL:BWP<bwp>:PDSCh:
DMTB:PTRS:STATe <PtrsState>`

Enables the transmission of phase-tracking reference signals.

Parameters:

<PtrsState> 1 | ON | 0 | OFF
 *RST: 0

Example: See [Example"Configuring the PDSCH incl. PTRS and Precoding settings"](#) on page 393.

Manual operation: See ["State"](#) on page 128

**[:SOURCE<hw>]:BB:NR5G:UBWP:USER<us>:CELL<cc>:UL:BWP<bwp>:PUSCh:
 DMTA:PTRS:REOF <ResElemOffset>**

**[:SOURCE<hw>]:BB:NR5G:UBWP:USER<us>:CELL<cc>:UL:BWP<bwp>:PUSCh:
 DMTB:PTRS:REOF <ResElemOffset>**

**[:SOURCE<hw>]:BB:NR5G:UBWP:USER<us>:CELL<cc>:DL:BWP<bwp>:PDSCh:
 DMTA:PTRS:REOF <ResElemOffset>**

**[:SOURCE<hw>]:BB:NR5G:UBWP:USER<us>:CELL<cc>:DL:BWP<bwp>:PDSCh:
 DMTB:PTRS:REOF <ResElemOffset>**

Sets the parameter resource element offset.

Parameters:

<ResElemOffset> RE00 | RE01 | RE10 | RE11
 *RST: RE00

Example: See [Example"Configuring the PDSCH incl. PTRS and Precoding settings"](#) on page 393.

Manual operation: See ["RE-offset"](#) on page 129

**[:SOURCE<hw>]:BB:NR5G:UBWP:USER<us>:CELL<cc>:DL:BWP<bwp>:PDSCh:
 DMTA:PTRS:EPRE <EpreRatio>**

**[:SOURCE<hw>]:BB:NR5G:UBWP:USER<us>:CELL<cc>:DL:BWP<bwp>:PDSCh:
 DMTB:PTRS:EPRE <PtrsEpreRatio>**

Sets the parameter EPRE ratio.

Parameters:

<PtrsEpreRatio> RAT0 | RAT1
 *RST: RAT0

Example: See [Example"Configuring the PDSCH incl. PTRS and Precoding settings"](#) on page 393.

Manual operation: See ["EPRE Ratio"](#) on page 129

**[:SOURCE<hw>]:BB:NR5G:UBWP:USER<us>:CELL<cc>:UL:BWP<bwp>:PUSCh:
 DMTA:PTRS:POWer <PtrsPower>**

**[:SOURCE<hw>]:BB:NR5G:UBWP:USER<us>:CELL<cc>:UL:BWP<bwp>:PUSCh:
 DMTB:PTRS:POWer <PtrsPower>**

Sets the parameter `ptrs-Power` and thus defines the PUSCH to PTRS power ratio per layer per resource element.

Parameters:

<PtrsPower> P00 | P01
 *RST: P00

Example:

SOURce1:BB:NR5G:UBWP:USER0:CELL0:UL:BWP0:PUSCh:
 DMTB:PTRS:POWer P00

Manual operation: See ["Power"](#) on page 177

[:SOURce<hw>]:BB:NR5G:UBWP:USER<us>:CELL<cc>:UL:BWP<bwp>:PUSCh:
 DMTA:PTRS:PORT <PtrsMaxNrofPort>

[:SOURce<hw>]:BB:NR5G:UBWP:USER<us>:CELL<cc>:UL:BWP<bwp>:PUSCh:
 DMTB:PTRS:PORT <PtrsMaxNrofPort>

Sets the maximum number of configured PTRS ports.

Parameters:

<PtrsMaxNrofPort> P1 | P2
 *RST: P1

Example:

SOURce1:BB:NR5G:UBWP:USER0:CELL0:UL:BWP0:PUSCh:
 DMTB:PTRS:PORT P1

Manual operation: See ["Max Number of Ports"](#) on page 177

[:SOURce<hw>]:BB:NR5G:UBWP:USER<us>:CELL<cc>:UL:BWP<bwp>:PUSCh:
 DMTA:PTRS:MCS1 <PtrsImcs1>

[:SOURce<hw>]:BB:NR5G:UBWP:USER<us>:CELL<cc>:UL:BWP<bwp>:PUSCh:
 DMTA:PTRS:MCS2 <PtrsImcs2>

[:SOURce<hw>]:BB:NR5G:UBWP:USER<us>:CELL<cc>:UL:BWP<bwp>:PUSCh:
 DMTA:PTRS:MCS3 <PtrsImcs3>

[:SOURce<hw>]:BB:NR5G:UBWP:USER<us>:CELL<cc>:UL:BWP<bwp>:PUSCh:
 DMTB:PTRS:MCS1 <PtrsImcs1>

[:SOURce<hw>]:BB:NR5G:UBWP:USER<us>:CELL<cc>:UL:BWP<bwp>:PUSCh:
 DMTB:PTRS:MCS2 <PtrsImcs2>

[:SOURce<hw>]:BB:NR5G:UBWP:USER<us>:CELL<cc>:UL:BWP<bwp>:PUSCh:
 DMTB:PTRS:MCS3 <PtrsImcs3>

[:SOURce<hw>]:BB:NR5G:UBWP:USER<us>:CELL<cc>:DL:BWP<bwp>:PDSCh:
 DMTA:PTRS:MCS1 <PtrsImcs1>

[:SOURce<hw>]:BB:NR5G:UBWP:USER<us>:CELL<cc>:DL:BWP<bwp>:PDSCh:
 DMTA:PTRS:MCS2 <PtrsImcs2>

[:SOURce<hw>]:BB:NR5G:UBWP:USER<us>:CELL<cc>:DL:BWP<bwp>:PDSCh:
 DMTA:PTRS:MCS3 <PtrsImcs3>

[:SOURce<hw>]:BB:NR5G:UBWP:USER<us>:CELL<cc>:DL:BWP<bwp>:PDSCh:
 DMTB:PTRS:MCS1 <PtrsImcs1>

[:SOURce<hw>]:BB:NR5G:UBWP:USER<us>:CELL<cc>:DL:BWP<bwp>:PDSCh:
 DMTB:PTRS:MCS2 <PtrsImcs2>

[:SOURce<hw>]:BB:NR5G:UBWP:USER<us>:CELL<cc>:DL:BWP<bwp>:PDSCh:
 DMTB:PTRS:MCS3 <PtrsImcs3>

Sets the threshold values ptrs-MCS_l with $l = \{1, 2, 3\}$.

Parameters:

<PtrsImcs3> integer
 Range: 0 to 29
 *RST: 0

Example: See [Example"Configuring the PDSCH incl. PTRS and Precoding settings"](#) on page 393.

Manual operation: See "[I_MCS_1/I_MCS_2/I_MCS_3](#)" on page 129

```
[:SOURce<hw>]:BB:NR5G:UBWP:USER<us>:CELL<cc>:UL:BWP<bwp>:PUSCh:
  DMTA:PTRS:RB0 <PtrsNrb0>
[:SOURce<hw>]:BB:NR5G:UBWP:USER<us>:CELL<cc>:UL:BWP<bwp>:PUSCh:
  DMTA:PTRS:RB1 <PtrsNrb1>
[:SOURce<hw>]:BB:NR5G:UBWP:USER<us>:CELL<cc>:UL:BWP<bwp>:PUSCh:
  DMTB:PTRS:RB0 <PtrsNrb0>
[:SOURce<hw>]:BB:NR5G:UBWP:USER<us>:CELL<cc>:UL:BWP<bwp>:PUSCh:
  DMTB:PTRS:RB1 <PtrsNrb1>
[:SOURce<hw>]:BB:NR5G:UBWP:USER<us>:CELL<cc>:DL:BWP<bwp>:PDSCh:
  DMTA:PTRS:RB0 <PtrsNrb0>
[:SOURce<hw>]:BB:NR5G:UBWP:USER<us>:CELL<cc>:DL:BWP<bwp>:PDSCh:
  DMTA:PTRS:RB1 <PtrsNrb1>
[:SOURce<hw>]:BB:NR5G:UBWP:USER<us>:CELL<cc>:DL:BWP<bwp>:PDSCh:
  DMTB:PTRS:RB0 <PtrsNrb0>
[:SOURce<hw>]:BB:NR5G:UBWP:USER<us>:CELL<cc>:DL:BWP<bwp>:PDSCh:
  DMTB:PTRS:RB1 <PtrsNrb1>
```

Sets the threshold values NRB_l with $l = \{0, 1\}$.

Parameters:

<PtrsNrb1> integer
 Range: 1 to 276
 *RST: 276

Example: See [Example"Configuring the PDSCH incl. PTRS and Precoding settings"](#) on page 393.

Manual operation: See "[N_RB_1/N_RB_2](#)" on page 129

10.19.3 RMC commands

```
[:SOURce<hw>]:BB:NR5G:UBWP:USER<us>:CELL<cc>:DL:BWP<bwp>:RMC:CQI..... 528
[:SOURce<hw>]:BB:NR5G:UBWP:USER<us>:CELL<cc>:DL:BWP<bwp>:RMC:ID.....528
[:SOURce<hw>]:BB:NR5G:UBWP:USER<us>:CELL<cc>:DL:BWP<bwp>:RMC:
  MODulation?..... 529
[:SOURce<hw>]:BB:NR5G:UBWP:USER<us>:CELL<cc>:DL:BWP<bwp>:RMC:SCS?..... 529
[:SOURce<hw>]:BB:NR5G:UBWP:USER<us>:CELL<cc>:DL:BWP<bwp>:RMC:STATe.....529
```

**[:SOURce<hw>]:BB:NR5G:UBWP:USER<us>:CELL<cc>:DL:BWP<bwp>:RMC:
CQI <CQIIndex>**

Selects the CQI index available for certain RMCs.

Prerequisites for this command

- Select an RMC that supports the CQI index ([:SOURce<hw>] :BB:NR5G:UBWP:USER<us>:CELL<cc>:DL:BWP<bwp>:RMC:ID on page 528).

Parameters:

<CQIIndex> integer
 Range: 1 to 15
 *RST: 1

Manual operation: See "CQI Index" on page 134

**[:SOURce<hw>]:BB:NR5G:UBWP:USER<us>:CELL<cc>:DL:BWP<bwp>:RMC:ID
<RmclD>**

This command selects a reference measurement channel.

The availability of RMCs depends on the subcarrier spacing of the bandwidth part you are configuring.

Parameters:

<RmclD> FQ15 | FQ30 | FQ60 | F615 | F630 | F660 | F215 | F230 | F260 |
 TQ15 | TQ30 | TQ60 | T615 | T630 | T660 | T215 | T230 | T260 |
 TS38176_FR1A311 | TS38176_FR1A312 | TS38176_FR1A313 |
 TS38176_FR1A314 | TS38176_FR1A315 | TS38176_FR2A311 |
 TS38176_FR2A312 | TS38176_FR2A313 |
 TS38176_FR1A321 | TS38176_FR2A321 |
 TS38176_FR2A322 | TS38176_FR1A331 | FR2TQ60 |
 FR2TQ120 | FR2T660 | FR2T6120 | FR2T260 | FR2T2120 |
 TS38176_FR1A351 | TS38176_FR1A352 |
 TS38176_FR1A353 | TS38176_FR1A354 |
 TS38176_FR1A355 | TS38176_FR1A356 |
 TS38176_FR2A351 | TS38176_FR2A352 |
 TS38176_FR2A353 | TS38176_FR1A341 |
 TS38176_FR1A342 | TS38176_FR1A343 |
 TS38176_FR2A341 | TS38176_FR2A342 | TS38176_FR2A343

The logic of the labels is as follows:

No prefix = 38.521 FR1 RMCs

Prefix FR2 = 38.521 FR2 RMCs

F / T = duplexing (FDD or TDD)

Q / 6 / 2 = modulation (QPSK, 64QAM or 256 QAM)

15 / 30 / 60 = subcarrier spacing (15, 30 or 60 kHz)

For example "T615" corresponds to FR1 RMC with the name "TS 38.521: A.3.3.3-1 (15 kHz)".

The RMCs from 38.176 are basically a shortened form of the names of the RMCs. For example "TS38176_FR1A352" corresponds to RMC with the name "TS 38.176: M-FR1-A3_5_2".

*RST: FQ30

Manual operation: See "RMC" on page 134

**[:SOURce<hw>]:BB:NR5G:UBWP:USER<us>:CELL<cc>:DL:BWP<bwp>:RMC:
MODulation?**

Queries the modulation of the reference measurement channel (RMC) you have selected.

Prerequisites for this command

- Turn on use of RMCs ([:SOURce<hw>] :BB:NR5G:UBWP:USER<us>:CELL<cc>:DL:BWP<bwp>:RMC:STATE).
- Select a RMC ([:SOURce<hw>] :BB:NR5G:UBWP:USER<us>:CELL<cc>:DL:BWP<bwp>:RMC:ID).

Return values:

<RmcModulation> QPSK | QAM64 | QAM256

*RST: QPSK

Usage: Query only

Manual operation: See "RMC" on page 134

**[:SOURce<hw>]:BB:NR5G:UBWP:USER<us>:CELL<cc>:DL:BWP<bwp>:RMC:
SCS?**

Queries the subcarrier spacing of the reference measurement channel (RMC) you have selected.

Prerequisites for this command

- Turn on use of RMCs ([:SOURce<hw>] :BB:NR5G:UBWP:USER<us>:CELL<cc>:DL:BWP<bwp>:RMC:STATE).
- Select a RMC ([:SOURce<hw>] :BB:NR5G:UBWP:USER<us>:CELL<cc>:DL:BWP<bwp>:RMC:ID).

Return values:

<RmcScs> N15 | N30 | N60

*RST: N30

Usage: Query only

Manual operation: See "RMC" on page 134

**[:SOURce<hw>]:BB:NR5G:UBWP:USER<us>:CELL<cc>:DL:BWP<bwp>:RMC:
STATE <State>**

Turns reference measurement channels on and off.

Parameters:

<State> 1 | ON | 0 | OFF
 *RST: 0

Manual operation: See "State" on page 134

10.19.4 PDCCH commands

[:SOURce<hw>]:BB:NR5G:UBWP:USER<us>:CELL<cc>:DL:BWP<bwp>:RNTI:INT.....	530
[:SOURce<hw>]:BB:NR5G:UBWP:USER<us>:CELL<cc>:DL:BWP<bwp>:PDCCh: NUMPreempt.....	530
[:SOURce<hw>]:BB:NR5G:UBWP:USER<us>:CELL<cc>:UL:BWP<bwp>:PUCCh:UR16.....	530
[:SOURce<hw>]:BB:NR5G:UBWP:USER<us>:CELL<cc>:UL:BWP<bwp>:PUCCh:BRIND.....	531
[:SOURce<hw>]:BB:NR5G:UBWP:USER<us>:CELL<cc>:UL:BWP<bwp>:PUCCh: CPEXt:NCPXt.....	531
[:SOURce<hw>]:BB:NR5G:UBWP:USER<us>:CELL<cc>:UL:BWP<bwp>:PUCCh: CPEXt:VAL<gr0>.....	531
[:SOURce<hw>]:BB:NR5G:UBWP:USER<us>:CELL<cc>:UL:BWP<bwp>:PUCCh:UITL.....	532

**[:SOURce<hw>]:BB:NR5G:UBWP:USER<us>:CELL<cc>:DL:BWP<bwp>:RNTI:
INT <IntRnti>**

Sets the INT-RNTI of the user.

Parameters:

<IntRnti> integer
 Range: 1 to 65519
 *RST: 1

Example: See [Example "DCI format 2_0, 2_1 and 2_2"](#) on page 401.

Manual operation: See "INT-RNTI" on page 135

**[:SOURce<hw>]:BB:NR5G:UBWP:USER<us>:CELL<cc>:DL:BWP<bwp>:PDCCh:
NUMPreempt <NumPreEmptionIn>**

Sets how many pre-emption indication fields are transmitted in the DCI format 2_1.

Parameters:

<NumPreEmptionIn> integer
 Range: 1 to 9
 *RST: 1

Example: See [Example "DCI format 2_0, 2_1 and 2_2"](#) on page 401.

Manual operation: See "Number of Pre-Emption Indications" on page 139

**[:SOURce<hw>]:BB:NR5G:UBWP:USER<us>:CELL<cc>:UL:BWP<bwp>:PUCCh:
UR16 <State>**

Turns the higher layer parameter "dmrs-uplink-r16" on and off.

Parameters:

<State> 1 | ON | 0 | OFF
 *RST: 0

Manual operation: See ["Use R16 DMRS"](#) on page 157

**[:SOURce<hw>]:BB:NR5G:UBWP:USER<us>:CELL<cc>:UL:BWP<bwp>:PUCCh:
 BRINd <BitsResourceInd>**

Defines the bit length of the DCI field "PUCCH Resource Indicator" available in DCI format 1_2.

Parameters:

<BitsResourceInd> integer
 Range: 0 to 3
 *RST: 0

Manual operation: See ["Bits for Resource Indicator"](#) on page 159

**[:SOURce<hw>]:BB:NR5G:UBWP:USER<us>:CELL<cc>:UL:BWP<bwp>:PUCCh:
 CPEXt:NCPXt <NumCPext>**

Defines the number of entries of the "Channel-Access-Cpext" DCI field.

Prerequisites for this command

- Turn on shared spectrum access ([\[:SOURce<hw>\]:BB:NR5G:NODE:CELL<cc>:SHSPec](#) on page 438).

Parameters:

<NumCPext> integer
 Range: 0 to 16
 *RST: 0

Manual operation: See ["Number of Entries"](#) on page 160

**[:SOURce<hw>]:BB:NR5G:UBWP:USER<us>:CELL<cc>:UL:BWP<bwp>:PUCCh:
 CPEXt:VAL<gr0> <Value>**

Defines the value for each "Channel-Access-Cpext" DCI field.

Prerequisites for this command

- Turn on shared spectrum access ([\[:SOURce<hw>\]:BB:NR5G:NODE:CELL<cc>:SHSPec](#) on page 438).

Suffix:

<gr0> 0...15
 Range depends on the number of entries ([\[:SOURce<hw>\]:BB:NR5G:UBWP:USER<us>:CELL<cc>:UL:BWP<bwp>:PUCCh:CPEXt:NCPXt](#)).

Parameters:

<Value> integer
 Range: 0 to 15
 *RST: 0

Manual operation: See "Value <x>" on page 160

**[:SOURce<hw>]:BB:NR5G:UBWP:USER<us>:CELL<cc>:UL:BWP<bwp>:PUCCh:
 UITL <State>**

Configures the higher layer parameter `useInterlacePUCCH-PUSCH` as defined in 3GPP 38.331.

Parameters:

<State> 1 | ON | 0 | OFF
 *RST: 0

Manual operation: See "Use Interlace" on page 158

10.19.5 DL control information commands

[:SOURce<hw>]:BB:NR5G:UBWP:USER<us>:CELL<cc>:DL:BWP<bwp>:RNTI:PUCCh.....533
 [:SOURce<hw>]:BB:NR5G:UBWP:USER<us>:CELL<cc>:DL:BWP<bwp>:RNTI:PUSCh.....533
 [:SOURce<hw>]:BB:NR5G:UBWP:USER<us>:CELL<cc>:DL:BWP<bwp>:RNTI:SRS.....533
 [:SOURce<hw>]:BB:NR5G:UBWP:USER<us>:CELL<cc>:DL:BWP<bwp>:PUCCh:TPAS.....533
 [:SOURce<hw>]:BB:NR5G:UBWP:USER<us>:CELL<cc>:DL:BWP<bwp>:PUSCh:TPAS.....533
 [:SOURce<hw>]:BB:NR5G:UBWP:USER<us>:CELL<cc>:DL:BWP<bwp>:PUCCh:BD22.....533
 [:SOURce<hw>]:BB:NR5G:UBWP:USER<us>:CELL<cc>:DL:BWP<bwp>:PUSCh:BD22.....533
 [:SOURce<hw>]:BB:NR5G:UBWP:USER<us>:CELL<cc>:DL:BWP<bwp>:CSI:LRESponse..534
 [:SOURce<hw>]:BB:NR5G:UBWP:USER<us>:CELL<cc>:DL:BWP<bwp>:DCI:DAI2.....534
 [:SOURce<hw>]:BB:NR5G:UBWP:USER<us>:CELL<cc>:DL:BWP<bwp>:DCI:DAI3.....534
 [:SOURce<hw>]:BB:NR5G:UBWP:USER<us>:CELL<cc>:DL:BWP<bwp>:DCI:DS42.....534
 [:SOURce<hw>]:BB:NR5G:UBWP:USER<us>:CELL<cc>:DL:BWP<bwp>:DCI:HAENabler...535
 [:SOURce<hw>]:BB:NR5G:UBWP:USER<us>:CELL<cc>:DL:BWP<bwp>:DCI:LTEChan.....535
 [:SOURce<hw>]:BB:NR5G:UBWP:USER<us>:CELL<cc>:DL:BWP<bwp>:DCI:PNPPEi.....535
 [:SOURce<hw>]:BB:NR5G:UBWP:USER<us>:CELL<cc>:DL:BWP<bwp>:DCI:PRC2.....535
 [:SOURce<hw>]:BB:NR5G:UBWP:USER<us>:CELL<cc>:DL:BWP<bwp>:DCI:PS27.....536
 [:SOURce<hw>]:BB:NR5G:UBWP:USER<us>:CELL<cc>:DL:BWP<bwp>:DCI:PTPSlots.....536
 [:SOURce<hw>]:BB:NR5G:UBWP:USER<us>:CELL<cc>:DL:BWP<bwp>:DCI:SGPO.....536
 [:SOURce<hw>]:BB:NR5G:UBWP:USER<us>:CELL<cc>:DL:BWP<bwp>:DCI:SOIN.....536
 [:SOURce<hw>]:BB:NR5G:UBWP:USER<us>:CELL<cc>:DL:BWP<bwp>:DCI:SRI2.....537
 [:SOURce<hw>]:BB:NR5G:UBWP:USER<us>:CELL<cc>:DL:BWP<bwp>:DCI:SRINd.....537
 [:SOURce<hw>]:BB:NR5G:UBWP:USER<us>:CELL<cc>:DL:BWP<bwp>:DCI:TAINd.....537
 [:SOURce<hw>]:BB:NR5G:UBWP:USER<us>:CELL<cc>:DL:BWP<bwp>:PDCCh:
 NMA Daption.....537
 [:SOURce<hw>]:BB:NR5G:UBWP:USER<us>:CELL<cc>:DL:BWP<bwp>:PDCCh:NT3C.....538
 [:SOURce<hw>]:BB:NR5G:UBWP:USER<us>:CELL<cc>:UL:BWP<bwp>:PUSCh:OI01.....538

```
[:SOURce<hw>]:BB:NR5G:UBWP:USER<us>:CELL<cc>:DL:BWP<bwp>:RNTI:
  PUCCh <PucchTpcRnti>
[:SOURce<hw>]:BB:NR5G:UBWP:USER<us>:CELL<cc>:DL:BWP<bwp>:RNTI:
  PUSCh <PuschTpcRnti>
[:SOURce<hw>]:BB:NR5G:UBWP:USER<us>:CELL<cc>:DL:BWP<bwp>:RNTI:
  SRS <TpcSrsRnti>
```

Sets the corresponding RNTI of the user.

Parameters:

```
<TpcSrsRnti>      integer
                  Range:    1 to 65519
                  *RST:     1
```

Example: See [Example"DCI format 2_0, 2_1 and 2_2"](#) on page 401.

Manual operation: See ["TPC-SRS-RNTI"](#) on page 140

```
[:SOURce<hw>]:BB:NR5G:UBWP:USER<us>:CELL<cc>:DL:BWP<bwp>:PUCCh:
  TPAS <TwoPcAdjustment>
[:SOURce<hw>]:BB:NR5G:UBWP:USER<us>:CELL<cc>:DL:BWP<bwp>:PUSCh:
  TPAS <TwoPcAdjustment>
```

If enabled, the DCI format 2_2 filed closed loop indicator is transmitted.

Parameters:

```
<TwoPcAdjustment> 1 | ON | 0 | OFF
                  *RST:    0
```

Example: See [Example"DCI format 2_0, 2_1 and 2_2"](#) on page 401.

Manual operation: See ["TwoPUSCH-PC Adjustment"](#) on page 140

```
[:SOURce<hw>]:BB:NR5G:UBWP:USER<us>:CELL<cc>:DL:BWP<bwp>:PUCCh:
  BD22 <NumBlocksInDci2>
[:SOURce<hw>]:BB:NR5G:UBWP:USER<us>:CELL<cc>:DL:BWP<bwp>:PUSCh:
  BD22 <NumBlocksInDci2>
```

Sets the number of blocks in the DCI format 2_2.

Parameters:

```
<NumBlocksInDci2> integer
                  Range:    1 to 22
                  *RST:     1
```

Example: See [Example"DCI format 2_0, 2_1 and 2_2"](#) on page 401.

Manual operation: See ["Number of PUSCH Blocks"](#) on page 139

**[:SOURce<hw>]:BB:NR5G:UBWP:USER<us>:CELL<cc>:DL:BWP<bwp>:CSI:
LResponse <State>**

Turns the "LSBs of SFN" DCI field in DCI formats 1_0 available for for MsgB-RNTI on and off.

Parameters:

<State> 1 | ON | 0 | OFF
*RST: 0

Manual operation: See "[Large Response Window](#)" on page 138

**[:SOURce<hw>]:BB:NR5G:UBWP:USER<us>:CELL<cc>:DL:BWP<bwp>:DCI:
DAI2 <BitLength>**

Defines the bit length of the "2nd Downlink Assignment Index" field.

Parameters:

<BitLength> L0 | L2 | L4
*RST: L0

Manual operation: See "[Max. Bits for 2nd Downlink Assignment Index](#)"
on page 137

**[:SOURce<hw>]:BB:NR5G:UBWP:USER<us>:CELL<cc>:DL:BWP<bwp>:DCI:
DAI3 <Value>**

Turns the "3rd Downlink Assignment Index" field on and off and defines its size.

Parameters:

<Value> integer
Range: 0 to 2
*RST: 0

Manual operation: See "[Bits for 3rd Downlink Assignment Index](#)" on page 137

**[:SOURce<hw>]:BB:NR5G:UBWP:USER<us>:CELL<cc>:DL:BWP<bwp>:DCI:
DS42 <Value>**

Defines the number of bits in the DCI format 4_2.

Parameters:

<Value> integer
Range: 20 to 128
*RST: 20

Manual operation: See "[Minimum Size](#)" on page 144

[:SOURce<hw>]:BB:NR5G:UBWP:USER<us>:CELL<cc>:DL:BWP<bwp>:DCI:HAENabler <State>

Turns the DCI field "HARQ-FeedbackEnabler" on and off.

Parameters:

<State> 1 | ON | 0 | OFF
*RST: 0

Manual operation: See "[HARQ-FeedbackEnabler](#)" on page 144

[:SOURce<hw>]:BB:NR5G:UBWP:USER<us>:CELL<cc>:DL:BWP<bwp>:DCI:LTEChan <Subchannels>

Sets the maximum number of LTE subchannels in a V2X transmission.

Parameters:

<Subchannels> S1 | S3 | S5 | S8 | S10 | S15 | S20
*RST: S1

Manual operation: See "[Max LTE Subchannels](#)" on page 143

[:SOURce<hw>]:BB:NR5G:UBWP:USER<us>:CELL<cc>:DL:BWP<bwp>:DCI:PNPPEi <FieldNumber>

Selects the higher layer parameter `po-NumPerPEI-r17` that defines the number of "Paging Early Indicator" fields in DCI format 2_7.

Parameters:

<FieldNumber> N1 | N2 | N4 | N8
Parameter availability depends on the payload size ([:SOURce<hw>]:BB:NR5G:UBWP:USER<us>:CELL<cc>:DL:BWP<bwp>:DCI:PS27).
*RST: N1

Manual operation: See "[PO Number per PEI](#)" on page 143

[:SOURce<hw>]:BB:NR5G:UBWP:USER<us>:CELL<cc>:DL:BWP<bwp>:DCI:PRC2 <Value>

Turns the "2nd Precoding Information and Number of Layer" field on and off and defines its size.

Parameters:

<Value> integer
Range: 0 to 5
*RST: 0

Manual operation: See "[Bits for 2nd Precoding Information](#)" on page 136

[:SOURce<hw>]:BB:NR5G:UBWP:USER<us>:CELL<cc>:DL:BWP<bwp>:DCI:PS27 <Value>

Defines the payload size of DCI format 2_7.

Parameters:

<Value> integer
 Range: 1 to 43
 *RST: 43

Manual operation: See ["Payload Size"](#) on page 143

[:SOURce<hw>]:BB:NR5G:UBWP:USER<us>:CELL<cc>:DL:BWP<bwp>:DCI:PTPSlots <Slots>

Defines the value of the `s1-PSFCH-ToPUCCH` parameter

Parameters:

<Slots> integer
 Range: 2 to 8
 *RST: 2

Manual operation: See ["Number of s1-PSFCH-ToPUCCH-Slots"](#) on page 143

[:SOURce<hw>]:BB:NR5G:UBWP:USER<us>:CELL<cc>:DL:BWP<bwp>:DCI:SGPO <Value>

Defines the higher layer parameter `subgroupConfig-r17` that has an effect on the number of bits you can use for the "Early Indicator" DCI fields.

Parameters:

<Value> integer
 The value range depends on the payload size ([:SOURce<hw>]:BB:NR5G:UBWP:USER<us>:CELL<cc>:DL:BWP<bwp>:DCI:PS27).
 Range: 1 to 8
 *RST: 1

Manual operation: See ["Number of Subgroups per PO"](#) on page 142

[:SOURce<hw>]:BB:NR5G:UBWP:USER<us>:CELL<cc>:DL:BWP<bwp>:DCI:SOIN <Value>

Turns the "SRS Offset Indicator" field on and off and defines its size.

Parameters:

<Value> integer
 Range: 0 to 2
 *RST: 0

Manual operation: See ["Bits for SRS Offset Indicator"](#) on page 137

[:SOURce<hw>]:BB:NR5G:UBWP:USER<us>:CELL<cc>:DL:BWP<bwp>:DCI: SRI2 <Value>

Turns the "2nd SRS Resource Indicator" field on and off and defines its size.

Parameters:

<Value> integer
 Range: 0 to 4
 *RST: 0

Manual operation: See ["Bits for 2nd SRS Resource Indication"](#) on page 137

[:SOURce<hw>]:BB:NR5G:UBWP:USER<us>:CELL<cc>:DL:BWP<bwp>:DCI: SRINd <State>

Turns the "SRS Resource Set Indicator" field on and off.

Parameters:

<State> 1 | ON | 0 | OFF
 *RST: 0

Manual operation: See ["Bits for SRS Resource Set Indication"](#) on page 137

[:SOURce<hw>]:BB:NR5G:UBWP:USER<us>:CELL<cc>:DL:BWP<bwp>:DCI: TAINd <Value>

Selects the number of bits that you can use for the "TRS availability indication" DCI field.

Parameters:

<Value> integer
 The value range depends on the payload size ([:SOURce<hw>]:BB:NR5G:UBWP:USER<us>:CELL<cc>:DL:BWP<bwp>:DCI:PS27).
 Range: 0 to 6
 *RST: 0

Manual operation: See ["Bits for TRS Availability Indication"](#) on page 138

[:SOURce<hw>]:BB:NR5G:UBWP:USER<us>:CELL<cc>:DL:BWP<bwp>:PDCCh: NMADaption <Value>

Defines the size of the "Monitoring Adaption Indication" DCI field.

Parameters:

<Value> integer
 Range: 0 to 2
 *RST: 0

Manual operation: See ["Bits for PDCCH Monitoring Adaptation Indication"](#) on page 136

**[:SOURce<hw>]:BB:NR5G:UBWP:USER<us>:CELL<cc>:DL:BWP<bwp>:PDCCh:
NT3C <Value>**

Turns the "Enhanced Type 3 Codebook Indicator" field on and off and defines its size.

Parameters:

<Value> integer
Range: 0 to 3
*RST: 0

Manual operation: See ["Bits for Enhanced Type 3 Codebook Indicator"](#)
on page 139

**[:SOURce<hw>]:BB:NR5G:UBWP:USER<us>:CELL<cc>:UL:BWP<bwp>:PUSCh:
OI01 <MinAppOffsetInd>**

Enables/disables the configuration of the minimum applicable scheduling offset indicator in the DCI format 0_1.

Parameters:

<MinAppOffsetInd> 0 | 1 | OFF | ON
*RST: 0

Example: See [Example"Configuring the PUSCH settings"](#) on page 402.

Options: R&S SMM-K148

10.19.6 ZP and NZP CSI-RS commands

[:SOURce<hw>]:BB:NR5G:UBWP:USER<us>:CELL<cc>:DL:BWP<bwp>:CSI:RTSize	539
[:SOURce<hw>]:BB:NR5G:UBWP:USER<us>:CELL<cc>:DL:BWP<bwp>:CSIRs:ZP: STATE	540
[:SOURce<hw>]:BB:NR5G:UBWP:USER<us>:CELL<cc>:DL:BWP<bwp>:CSIRs:NZP: STATE	540
[:SOURce<hw>]:BB:NR5G:UBWP:USER<us>:CELL<cc>:DL:BWP<bwp>:CSIRs:ZP: SET<gr0>:NRESources	540
[:SOURce<hw>]:BB:NR5G:UBWP:USER<us>:CELL<cc>:DL:BWP<bwp>:CSIRs:NZP: SET<gr0>:NRESources	540
[:SOURce<hw>]:BB:NR5G:UBWP:USER<us>:CELL<cc>:DL:BWP<bwp>:CSIRs:ZP: SET<gr0>:RES<user0>:PER	540
[:SOURce<hw>]:BB:NR5G:UBWP:USER<us>:CELL<cc>:DL:BWP<bwp>:CSIRs:NZP: SET<gr0>:RES<user0>:PER	540
[:SOURce<hw>]:BB:NR5G:UBWP:USER<us>:CELL<cc>:DL:BWP<bwp>:CSIRs:ZP: SET<gr0>:RES<user0>:OFFSet	541
[:SOURce<hw>]:BB:NR5G:UBWP:USER<us>:CELL<cc>:DL:BWP<bwp>:CSIRs:NZP: SET<gr0>:RES<user0>:OFFSet	541
[:SOURce<hw>]:BB:NR5G:UBWP:USER<us>:CELL<cc>:DL:BWP<bwp>:CSIRs:ZP: SET<gr0>:RES<user0>:RBNumber	541
[:SOURce<hw>]:BB:NR5G:UBWP:USER<us>:CELL<cc>:DL:BWP<bwp>:CSIRs:NZP: SET<gr0>:RES<user0>:RBNumber	541

BWP configuration commands

[:SOURce<hw>]:BB:NR5G:UBWP:USER<us>:CELL<cc>:DL:BWP<bwp>:CSIRs:ZP: SET<gr0>:RES<user0>:SRBNumber.....	541
[:SOURce<hw>]:BB:NR5G:UBWP:USER<us>:CELL<cc>:DL:BWP<bwp>:CSIRs:NZP: SET<gr0>:RES<user0>:SRBNumber.....	541
[:SOURce<hw>]:BB:NR5G:UBWP:USER<us>:CELL<cc>:DL:BWP<bwp>:CSIRs:ZP: SET<gr0>:RES<user0>:ROW.....	542
[:SOURce<hw>]:BB:NR5G:UBWP:USER<us>:CELL<cc>:DL:BWP<bwp>:CSIRs:NZP: SET<gr0>:RES<user0>:ROW.....	542
[:SOURce<hw>]:BB:NR5G:UBWP:USER<us>:CELL<cc>:DL:BWP<bwp>:CSIRs:ZP: SET<gr0>:RES<user0>:PORTs?.....	542
[:SOURce<hw>]:BB:NR5G:UBWP:USER<us>:CELL<cc>:DL:BWP<bwp>:CSIRs:NZP: SET<gr0>:RES<user0>:PORTs?.....	542
[:SOURce<hw>]:BB:NR5G:UBWP:USER<us>:CELL<cc>:DL:BWP<bwp>:CSIRs:ZP: SET<gr0>:RES<user0>:DENSity.....	542
[:SOURce<hw>]:BB:NR5G:UBWP:USER<us>:CELL<cc>:DL:BWP<bwp>:CSIRs:NZP: SET<gr0>:RES<user0>:DENSity.....	542
[:SOURce<hw>]:BB:NR5G:UBWP:USER<us>:CELL<cc>:DL:BWP<bwp>:CSIRs:ZP: SET<gr0>:RES<user0>:CDMType?.....	543
[:SOURce<hw>]:BB:NR5G:UBWP:USER<us>:CELL<cc>:DL:BWP<bwp>:CSIRs:NZP: SET<gr0>:RES<user0>:CDMType?.....	543
[:SOURce<hw>]:BB:NR5G:UBWP:USER<us>:CELL<cc>:DL:BWP<bwp>:CSIRs:ZP: SET<gr0>:RES<user0>:BITMap.....	543
[:SOURce<hw>]:BB:NR5G:UBWP:USER<us>:CELL<cc>:DL:BWP<bwp>:CSIRs:NZP: SET<gr0>:RES<user0>:BITMap.....	543
[:SOURce<hw>]:BB:NR5G:UBWP:USER<us>:CELL<cc>:DL:BWP<bwp>:CSIRs:ZP: SET<gr0>:RES<user0>:I0.....	543
[:SOURce<hw>]:BB:NR5G:UBWP:USER<us>:CELL<cc>:DL:BWP<bwp>:CSIRs:ZP: SET<gr0>:RES<user0>:I1.....	543
[:SOURce<hw>]:BB:NR5G:UBWP:USER<us>:CELL<cc>:DL:BWP<bwp>:CSIRs:NZP: SET<gr0>:RES<user0>:I0.....	543
[:SOURce<hw>]:BB:NR5G:UBWP:USER<us>:CELL<cc>:DL:BWP<bwp>:CSIRs:NZP: SET<gr0>:RES<user0>:I1.....	543
[:SOURce<hw>]:BB:NR5G:UBWP:USER<us>:CELL<cc>:DL:BWP<bwp>:CSIRs:NZP: SET<gr0>:RES<user0>:SCID.....	544
[:SOURce<hw>]:BB:NR5G:UBWP:USER<us>:CELL<cc>:DL:BWP<bwp>:CSIRs:NZP: SET<gr0>:RES<user0>:PWR.....	544
[:SOURce<hw>]:BB:NR5G:UBWP:USER<us>:CELL<cc>:DL:BWP<bwp>:CSIRs:NZP: SET<gr0>:RES<user0>:APMap:AP<ap>:ROW<apr>:REAL.....	544
[:SOURce<hw>]:BB:NR5G:UBWP:USER<us>:CELL<cc>:DL:BWP<bwp>:CSIRs:NZP: SET<gr0>:RES<user0>:APMap:AP<ap>:ROW<apr>:IMAGinary.....	544
[:SOURce<hw>]:BB:NR5G:UBWP:USER<us>:CELL<cc>:DL:BWP<bwp>:CSIRs:NZP: SET<gr0>:RES<user0>:APMap:AP<ap>:ROW<apr>:MAGNitude.....	545
[:SOURce<hw>]:BB:NR5G:UBWP:USER<us>:CELL<cc>:DL:BWP<bwp>:CSIRs:NZP: SET<gr0>:RES<user0>:APMap:AP<ap>:ROW<apr>:PHASe.....	545

**[:SOURce<hw>]:BB:NR5G:UBWP:USER<us>:CELL<cc>:DL:BWP<bwp>:CSI:
RTSize <RepTrigSize>**

Sets the trigger size of the CSI (channel state information) request field in DCI (bits).

Parameters:

<RepTrigSize> integer
 Range: 0 to 6
 *RST: 0

Example: See [Example"Configuring the PDSCH incl. PTRS and Precoding settings"](#) on page 393

Manual operation: See ["Report Trigger Size"](#) on page 137

```
[:SOURce<hw>]:BB:NR5G:UBWP:USER<us>:CELL<cc>:DL:BWP<bwp>:CSI-Rs:
  ZP:STATE <State>
[:SOURce<hw>]:BB:NR5G:UBWP:USER<us>:CELL<cc>:DL:BWP<bwp>:CSI-Rs:
  NZP:STATE <State>
```

Enables the NZP/ZP CSI-RS transmission.

Parameters:

<State> 1 | ON | 0 | OFF
 *RST: 0

Example: See [Example"Configuring the CSI-RS settings"](#) on page 396.

Manual operation: See ["State"](#) on page 148

```
[:SOURce<hw>]:BB:NR5G:UBWP:USER<us>:CELL<cc>:DL:BWP<bwp>:CSI-Rs:
  ZP:SET<gr0>:NRESources <Resources>
[:SOURce<hw>]:BB:NR5G:UBWP:USER<us>:CELL<cc>:DL:BWP<bwp>:CSI-Rs:
  NZP:SET<gr0>:NRESources <Resources>
```

Sets the number of CSI-RS resources.

Parameters:

<Resources> integer
 Range: 0 to 64
 *RST: 0

Example: See [Example"Configuring the CSI-RS settings"](#) on page 396.

Manual operation: See ["Resources"](#) on page 148

```
[:SOURce<hw>]:BB:NR5G:UBWP:USER<us>:CELL<cc>:DL:BWP<bwp>:CSI-Rs:
  ZP:SET<gr0>:RES<user0>:PER <Periodicity>
[:SOURce<hw>]:BB:NR5G:UBWP:USER<us>:CELL<cc>:DL:BWP<bwp>:CSI-Rs:
  NZP:SET<gr0>:RES<user0>:PER <Periodicity>
```

Sets the periodicity $T_{\text{CSI-RS}}$ (in slots).

Parameters:

<Periodicity> 4 | 5 | 8 | 10 | 16 | 20 | 32 | 40 | 64 | 80 | 160 | 320 | 640
 *RST: 4

Example: See [Example"Configuring the CSI-RS settings"](#) on page 396.

Manual operation: See ["Periodicity"](#) on page 149

```
[:SOURce<hw>]:BB:NR5G:UBWP:USER<us>:CELL<cc>:DL:BWP<bwp>:CSIrs:
  ZP:SET<gr0>:RES<user0>:OFFSet <Offset>
[:SOURce<hw>]:BB:NR5G:UBWP:USER<us>:CELL<cc>:DL:BWP<bwp>:CSIrs:
  NZP:SET<gr0>:RES<user0>:OFFSet <Offset>
```

Sets the slot offset T_{offset} .

Parameters:

<Offset> integer
 Range: 0 to 639
 *RST: 0

Example: See [Example"Configuring the CSI-RS settings"](#) on page 396.

Manual operation: See ["Offset"](#) on page 149

```
[:SOURce<hw>]:BB:NR5G:UBWP:USER<us>:CELL<cc>:DL:BWP<bwp>:CSIrs:
  ZP:SET<gr0>:RES<user0>:RBNumber <CsiRsZpNumRB>
[:SOURce<hw>]:BB:NR5G:UBWP:USER<us>:CELL<cc>:DL:BWP<bwp>:CSIrs:
  NZP:SET<gr0>:RES<user0>:RBNumber <CsiRsNZpNumRB>
```

Sets the number of resource blocks the CSI-RS spans.

Parameters:

<CsiRsNZpNumRB> integer
 Range: 24 to 273
 *RST: = number of RB in the BWP

Example: See [Example"Configuring the CSI-RS settings"](#) on page 396.

Manual operation: See ["No. RBs"](#) on page 149

```
[:SOURce<hw>]:BB:NR5G:UBWP:USER<us>:CELL<cc>:DL:BWP<bwp>:CSIrs:
  ZP:SET<gr0>:RES<user0>:SRBNumber <CsiRsZpStartRb>
[:SOURce<hw>]:BB:NR5G:UBWP:USER<us>:CELL<cc>:DL:BWP<bwp>:CSIrs:
  NZP:SET<gr0>:RES<user0>:SRBNumber <CsiRsNZpStartRB>
```

Sets the first resource block the CSI-RS occupies.

Parameters:

<CsiRsNZpStartRB> integer
 Range: 0 to 273
 *RST: 0

Example: See [Example"Configuring the CSI-RS settings"](#) on page 396.

Manual operation: See ["Start RB"](#) on page 149

```
[:SOURce<hw>]:BB:NR5G:UBWP:USER<us>:CELL<cc>:DL:BWP<bwp>:CSIRs:
  ZP:SET<gr0>:RES<user0>:ROW <Row>
[:SOURce<hw>]:BB:NR5G:UBWP:USER<us>:CELL<cc>:DL:BWP<bwp>:CSIRs:
  NZP:SET<gr0>:RES<user0>:ROW <Row>
```

Sets the parameter row.

Parameters:

<Row> integer
 Range: 1 to 18
 *RST: 1

Example: See [Example"Configuring the CSI-RS settings"](#) on page 396.

Manual operation: See ["Row"](#) on page 149

```
[:SOURce<hw>]:BB:NR5G:UBWP:USER<us>:CELL<cc>:DL:BWP<bwp>:CSIRs:
  ZP:SET<gr0>:RES<user0>:PORTs?
[:SOURce<hw>]:BB:NR5G:UBWP:USER<us>:CELL<cc>:DL:BWP<bwp>:CSIRs:
  NZP:SET<gr0>:RES<user0>:PORTs?
```

Sets the number of ports x.

Return values:

<Ports> 1 | 2 | 4 | 8 | 12 | 16 | 24 | 32
 *RST: 1

Example: See [Example"Configuring the CSI-RS settings"](#) on page 396.

Usage: Query only

Manual operation: See ["Ports"](#) on page 150

```
[:SOURce<hw>]:BB:NR5G:UBWP:USER<us>:CELL<cc>:DL:BWP<bwp>:CSIRs:
  ZP:SET<gr0>:RES<user0>:DENSity <Density>
[:SOURce<hw>]:BB:NR5G:UBWP:USER<us>:CELL<cc>:DL:BWP<bwp>:CSIRs:
  NZP:SET<gr0>:RES<user0>:DENSity <Density>
```

Sets the parameter density.

Parameters:

<Density> EVE5 | ODD5 | DEN1 | DEN3
 *RST: DEN3

Example: See [Example"Configuring the CSI-RS settings"](#) on page 396.

Manual operation: See ["Density"](#) on page 150

```
[ :SOURce<hw>]:BB:NR5G:UBWP:USER<us>:CELL<cc>:DL:BWP<bwp>:CSIRs:
  ZP:SET<gr0>:RES<user0>:CDMType?
[ :SOURce<hw>]:BB:NR5G:UBWP:USER<us>:CELL<cc>:DL:BWP<bwp>:CSIRs:
  NZP:SET<gr0>:RES<user0>:CDMType?
```

Queries the higher-level parameter `cdm-Type`.

The value is automatically, depending on the value set with the command [:
[SOURce<hw>\]:BB:NR5G:UBWP:USER<us>:CELL<cc>:DL:BWP<bwp>:CSIRs:](#)
[NZP:SET<gr0>:RES<user0>:ROW](#) on page 542

Return values:

```
<CDMType>          NOCDm | CDM2 | CDM4 | CDM8
                    *RST:      NOCDm
```

Example: See [Example"Configuring the CSI-RS settings"](#) on page 396.

Usage: Query only

Manual operation: See ["CDM-Type"](#) on page 150

```
[ :SOURce<hw>]:BB:NR5G:UBWP:USER<us>:CELL<cc>:DL:BWP<bwp>:CSIRs:
  ZP:SET<gr0>:RES<user0>:BITMap <Pattern>, <BitCount>
[ :SOURce<hw>]:BB:NR5G:UBWP:USER<us>:CELL<cc>:DL:BWP<bwp>:CSIRs:
  NZP:SET<gr0>:RES<user0>:BITMap <Pattern>, <BitCount>
```

Sets the location of the ZP CSI-RS in the frequency domain.

Parameters:

```
<Pattern>          12 bits
                    *RST:      #H0

<BitCount>        integer
                    Range:      1 to 12
                    *RST:      1
```

Example: See [Example"Configuring the CSI-RS settings"](#) on page 396.

Manual operation: See ["Bitmap"](#) on page 150

```
[ :SOURce<hw>]:BB:NR5G:UBWP:USER<us>:CELL<cc>:DL:BWP<bwp>:CSIRs:
  ZP:SET<gr0>:RES<user0>:I0 <I0>
[ :SOURce<hw>]:BB:NR5G:UBWP:USER<us>:CELL<cc>:DL:BWP<bwp>:CSIRs:
  ZP:SET<gr0>:RES<user0>:I1 <I1>
[ :SOURce<hw>]:BB:NR5G:UBWP:USER<us>:CELL<cc>:DL:BWP<bwp>:CSIRs:
  NZP:SET<gr0>:RES<user0>:I0 <I0>
[ :SOURce<hw>]:BB:NR5G:UBWP:USER<us>:CELL<cc>:DL:BWP<bwp>:CSIRs:
  NZP:SET<gr0>:RES<user0>:I1 <I1>
```

Sets the parameters I_0 and I_1 and define the ZP CSI-RS location relative to the start of as slot.

Parameters:

<l1> integer
 Range: 2 to 12
 *RST: 11

Example: See [Example"Configuring the CSI-RS settings"](#) on page 396.

Manual operation: See ["I0/I1"](#) on page 151

**[:SOURce<hw>]:BB:NR5G:UBWP:USER<us>:CELL<cc>:DL:BWP<bwp>:CSIRs:
 NZP:SET<gr0>:RES<user0>:SCID <ScramblingId>**

Sets the parameter n_{ID} (scrambling ID).

Parameters:

<ScramblingId> integer
 Range: 0 to 1023
 *RST: 0

Example: See [Example"Configuring the CSI-RS settings"](#) on page 396.

Manual operation: See ["Scrambling ID"](#) on page 151

**[:SOURce<hw>]:BB:NR5G:UBWP:USER<us>:CELL<cc>:DL:BWP<bwp>:CSIRs:
 NZP:SET<gr0>:RES<user0>:PWR <NZpPower>**

Sets the power of the NZP resource relative to the PDSCH power.

Parameters:

<NZpPower> float
 Range: -80 to 10
 Increment: 0.01
 *RST: 0

Example: See [Example"Configuring the CSI-RS settings"](#) on page 396.

Manual operation: See ["Power"](#) on page 150

**[:SOURce<hw>]:BB:NR5G:UBWP:USER<us>:CELL<cc>:DL:BWP<bwp>:CSIRs:
 NZP:SET<gr0>:RES<user0>:APMap:AP<ap>:ROW<apr>:REAL
 <APMapDataReal>**

**[:SOURce<hw>]:BB:NR5G:UBWP:USER<us>:CELL<cc>:DL:BWP<bwp>:CSIRs:
 NZP:SET<gr0>:RES<user0>:APMap:AP<ap>:ROW<apr>:IMAGinary
 <APMapDataImag>**

Sets the mapping of the antenna ports (AP).

Suffix:

<s2us0> AP3000
 Antenna port

Parameters:

<APMapDataImag> float

The REAL (magnitude) and IMAGinary (phase) values are interdependent. Their value ranges change depending on each other and so that the resulting complex value is as follows:

$$|\text{REAL} + j * \text{IMAGinary}| \leq 1$$

Otherwise, the values are normalized to magnitude = 1.

Range: -1 to 1

Increment: 0.001

*RST: 0

Example: See [Example"Configuring the CSI-RS settings"](#) on page 396.**Manual operation:** See ["Mapping table"](#) on page 152

```
[ :SOURce<hw>]:BB:NR5G:UBWP:USER<us>:CELL<cc>:DL:BWP<bwp>:CSIRs:
  NZP:SET<gr0>:RES<user0>:APMap:AP<ap>:ROW<apr>:MAGNitude
  <APMapDataMagn>
```

Sets the mapping of the antenna ports (AP).

Parameters:

<APMapDataMagn> float

Range: 0 to 1

Increment: 0.001

*RST: 0

Example: See [Example"Configuring the CSI-RS settings"](#) on page 396.**Manual operation:** See ["Mapping table"](#) on page 152

```
[ :SOURce<hw>]:BB:NR5G:UBWP:USER<us>:CELL<cc>:DL:BWP<bwp>:CSIRs:
  NZP:SET<gr0>:RES<user0>:APMap:AP<ap>:ROW<apr>:PHASe
  <APMapDataPhase>
```

Sets the mapping of the antenna ports (AP).

Parameters:

<APMapDataPhase> float

Range: 0 to 360

Increment: 0.1

*RST: 0

Example: See [Example"Configuring the CSI-RS settings"](#) on page 396.**Manual operation:** See ["Mapping table"](#) on page 152

10.19.7 Rate match commands

<code>[:SOURce<hw>]:BB:NR5G:UBWP:USER<us>:CELL<cc>:DL:BWP<bwp>:RATM:STATe</code>	546
<code>[:SOURce<hw>]:BB:NR5G:UBWP:USER<us>:CELL<cc>:DL:BWP<bwp>:RATM: NRESources</code>	546
<code>[:SOURce<hw>]:BB:NR5G:UBWP:USER<us>:CELL<cc>:DL:BWP<bwp>:RATM: GRPNumber</code>	547
<code>[:SOURce<hw>]:BB:NR5G:UBWP:USER<us>:CELL<cc>:DL:BWP<bwp>:RATM: RS<gr0>:RBDList</code>	547
<code>[:SOURce<hw>]:BB:NR5G:UBWP:USER<us>:CELL<cc>:DL:BWP<bwp>:RATM: RS<gr0>:RBPatt</code>	547
<code>[:SOURce<hw>]:BB:NR5G:UBWP:USER<us>:CELL<cc>:DL:BWP<bwp>:RATM: RS<gr0>:SLOT</code>	548
<code>[:SOURce<hw>]:BB:NR5G:UBWP:USER<us>:CELL<cc>:DL:BWP<bwp>:RATM: RS<gr0>:SLTPatt</code>	548
<code>[:SOURce<hw>]:BB:NR5G:UBWP:USER<us>:CELL<cc>:DL:BWP<bwp>:RATM: RS<gr0>:PER</code>	548
<code>[:SOURce<hw>]:BB:NR5G:UBWP:USER<us>:CELL<cc>:DL:BWP<bwp>:RATM: RS<gr0>:PERPatt</code>	548
<code>[:SOURce<hw>]:BB:NR5G:UBWP:USER<us>:CELL<cc>:DL:BWP<bwp>:RATM: RS<gr0>:GRID</code>	549

**`[:SOURce<hw>]:BB:NR5G:UBWP:USER<us>:CELL<cc>:DL:BWP<bwp>:RATM:
STATe <RateMatchState>`**

Enables the configuration of rate match groups.

Parameters:

`<RateMatchState>` 1 | ON | 0 | OFF
*RST: 0

Example: See [Example"Configuring the DL BWP rate match settings"](#) on page 397.

Manual operation: See ["State"](#) on page 153

**`[:SOURce<hw>]:BB:NR5G:UBWP:USER<us>:CELL<cc>:DL:BWP<bwp>:RATM:
NRESources <RateMatResource>`**

Sets the number of rate match resources.

Parameters:

`<RateMatResource>` integer
Range: 0 to 8
*RST: 0

Example: See [Example"Configuring the DL BWP rate match settings"](#) on page 397.

Manual operation: See ["Resources"](#) on page 154

```
[ :SOURce<hw>]:BB:NR5G:UBWP:USER<us>:CELL<cc>:DL:BWP<bwp>:RATM:
  GRPNumber <RateMatNoOfGrps>
```

Sets the number of rate match pattern groups

Parameters:

```
<RateMatNoOfGrps> integer
Range:      0 to 2
*RST:      0
```

Example: See [Example"Configuring the DL BWP rate match settings"](#) on page 397.

Manual operation: See ["Number of Groups"](#) on page 153

```
[ :SOURce<hw>]:BB:NR5G:UBWP:USER<us>:CELL<cc>:DL:BWP<bwp>:RATM:
  RS<gr0>:RBDList <RateRBPattDLList>
```

Selects an existing data list file from the default directory or from the specific directory.

Parameters:

```
<RateRBPattDLList> string
Filename incl. file extension or complete file path
```

Example: See [Example"Configuring the DL BWP rate match settings"](#) on page 397.

Manual operation: See ["RB Pattern"](#) on page 154

```
[ :SOURce<hw>]:BB:NR5G:UBWP:USER<us>:CELL<cc>:DL:BWP<bwp>:RATM:
  RS<gr0>:RBPatt <Pattern>, <Bitcount>
```

Sets the resource block level bitmap pattern directly, alternatively to loading a data list with the command [\[:SOURce<hw>\]:BB:NR5G:UBWP:USER<us>:CELL<cc>:DL:BWP<bwp>:RATM:RS<gr0>:RBDList](#).

Parameters:

```
<Pattern>      275 bits
*RST:          #H0

<Bitcount>    integer
Range:        275 to 275
*RST:          0
```

Example: See [Example"Configuring the DL BWP rate match settings"](#) on page 397.

Manual operation: See ["RB Pattern"](#) on page 154

```
[ :SOURce<hw>]:BB:NR5G:UBWP:USER<us>:CELL<cc>:DL:BWP<bwp>:RATM:
  RS<gr0>:SLOT <RateMatchSlot>
```

Sets the number of slots.

Parameters:

```
<RateMatchSlot>  integer
                   Range:    1 to 2
                   *RST:     1
```

Example: See [Example "Configuring the DL BWP rate match settings"](#) on page 397.

Manual operation: See ["Slot"](#) on page 154

```
[ :SOURce<hw>]:BB:NR5G:UBWP:USER<us>:CELL<cc>:DL:BWP<bwp>:RATM:
  RS<gr0>:SLTPatt <RateMatSlotPatt>, <Bitcount>
```

Set the slots to be used as a pattern.

Parameters:

```
<RateMatSlotPatt> 28 bits
                   *RST:    #H0

<Bitcount>        integer
                   Range:    14 to 28
                   *RST:    14
```

Example: See [Example "Configuring the DL BWP rate match settings"](#) on page 397.

Manual operation: See ["Slot Pattern"](#) on page 154

```
[ :SOURce<hw>]:BB:NR5G:UBWP:USER<us>:CELL<cc>:DL:BWP<bwp>:RATM:
  RS<gr0>:PER <RateMatchPeriod>
```

Sets the time-domain pattern.

Parameters:

```
<RateMatchPeriod> 1 | 2 | 5 | 4 | 8 | 10 | 20 | 40
                   *RST:    2
```

Example: See [Example "Configuring the DL BWP rate match settings"](#) on page 397.

Manual operation: See ["Periodicity"](#) on page 155

```
[ :SOURce<hw>]:BB:NR5G:UBWP:USER<us>:CELL<cc>:DL:BWP<bwp>:RATM:
  RS<gr0>:PERPatt <RateMatPerdPatt>, <BitCount>
```

Sets the periodicity in a pattern form.

Parameters:

<RateMatPerdPatt> 40 bits
 <BitCount> integer
 Range: 1 to 40
 *RST: 2

Example: See [Example"Configuring the DL BWP rate match settings"](#) on page 397.

Manual operation: See ["Periodicity Pattern"](#) on page 155

[:SOURce<hw>]:BB:NR5G:UBWP:USER<us>:CELL<cc>:DL:BWP<bwp>:RATM:RS<gr0>:GRID <RateMatchGrpID>

Sets the group identifier for the selected rate match pattern.

Parameters:

<RateMatchGrpID> N | G1 | G2
 *RST: N

Example: See [Example"Configuring the DL BWP rate match settings"](#) on page 397.

Manual operation: See ["Group ID"](#) on page 155

10.19.8 PUCCH commands

[:SOURce<hw>]:BB:NR5G:UBWP:USER<us>:CELL<cc>:UL:BWP<bwp>:PUCCh:A12List...	549
[:SOURce<hw>]:BB:NR5G:UBWP:USER<us>:CELL<cc>:UL:BWP<bwp>:PUCCh:ADMRs:STATe.....	550
[:SOURce<hw>]:BB:NR5G:UBWP:USER<us>:CELL<cc>:UL:BWP<bwp>:PUCCh:BPSK:STATe.....	550
[:SOURce<hw>]:BB:NR5G:UBWP:USER<us>:CELL<cc>:UL:BWP<bwp>:PUCCh:HACK:STATe.....	550
[:SOURce<hw>]:BB:NR5G:UBWP:USER<us>:CELL<cc>:UL:BWP<bwp>:PUCCh:PDSHarq:NTMentry.....	550
[:SOURce<hw>]:BB:NR5G:UBWP:USER<us>:CELL<cc>:UL:BWP<bwp>:PUCCh:PDSHarq:TMIValue<gr0>.....	551
[:SOURce<hw>]:BB:NR5G:UBWP:USER<us>:CELL<cc>:UL:BWP<bwp>:PUCCh:U2TPc.....	551

[:SOURce<hw>]:BB:NR5G:UBWP:USER<us>:CELL<cc>:UL:BWP<bwp>:PUCCh:A12List <Value>

Configures the higher layer parameter `ul-AccessConfigListDCI1-2` as defined in 3GPP 38.331.

Parameters:

<Value> integer
 Range: 0 to 16
 *RST: 0

Manual operation: See ["ul-AccessConfigList DCI1_2"](#) on page 160

**[:SOURCE<hw>]:BB:NR5G:UBWP:USER<us>:CELL<cc>:UL:BWP<bwp>:PUCCh:
ADMRs:STATe <AdditionalDMRS>**

Defines if additional DMRS is used for PUCCH format 3 and 4.

Parameters:

<AdditionalDMRS> 1 | ON | 0 | OFF
*RST: 0

Example: See [Example"Configuring the PUCCH settings"](#) on page 406.

Manual operation: See ["Additional DMRS"](#) on page 157

**[:SOURCE<hw>]:BB:NR5G:UBWP:USER<us>:CELL<cc>:UL:BWP<bwp>:PUCCh:
BPSK:STATe <PiBpsk>**

If enabled, the $\pi/2$ - BPSK modulation order is used for PUCCH, instead of the default QPSK.

Parameters:

<PiBpsk> 1 | ON | 0 | OFF
*RST: 0

Example: See [Example"Configuring the PUCCH settings"](#) on page 406.

Manual operation: See ["π/2 - BPSK"](#) on page 157

**[:SOURCE<hw>]:BB:NR5G:UBWP:USER<us>:CELL<cc>:UL:BWP<bwp>:PUCCh:
HACK:STATe <PucchHarAckCSI>**

Reserved for future use.

Parameters:

<PucchHarAckCSI> 0
*RST: 0

Example: See [Example"Configuring the PUCCH settings"](#) on page 406.

Manual operation: See ["Simultaneous HARQ-ACK-CSI"](#) on page 158

**[:SOURCE<hw>]:BB:NR5G:UBWP:USER<us>:CELL<cc>:UL:BWP<bwp>:PUCCh:
PDSHarq:NTMentry <NumUIBpPucchACK>**

Sets the number of entries in the sequence of PDSCH to HARQ timing values.

The value set here defines the available suffixes in the command `[:SOURCE<hw>] :
BB:NR5G:UBWP:USER<us>:CELL<cc>:UL:BWP<bwp>:PUCCh:PDSHarq:
TMIValue<gr0>`.

Parameters:`<NumUIBpPucchACK> float`

Range: 0 to 8

Example:

See `[:SOURce<hw>] :BB:NR5G:UBWP:USER<us> :CELL<cc> :UL:BWP<bwp> :PUCCh:PDSHarq:TMIValue<gr0>` on page 551.

Manual operation: See "Number of Entries" on page 159

`[:SOURce<hw>] :BB:NR5G:UBWP:USER<us> :CELL<cc> :UL:BWP<bwp> :PUCCh:PDSHarq:TMIValue<gr0> <UserUIBwpPucchD>`

Sets the individual timing values.

Suffix:`<gr0>`

0 to 7

Indicator number

Value range depends on the value set with the command `[:SOURce<hw>] :BB:NR5G:UBWP:USER<us> :CELL<cc> :UL:`

`BWP<bwp> :PUCCh:PDSHarq:NTMentry.`

Parameters:`<UserUIBwpPucchD> float`

Range: 0 to 15

Example:

`SOURce1:BB:NR5G:UBWP:USER0:CELL0:UL:BWP0:PUCCh:PDSHarq:NTMentry 3`
`SOURce1:BB:NR5G:UBWP:USER0:CELL0:UL:BWP0:PUCCh:PDSHarq:TMIValue0 1`
`SOURce1:BB:NR5G:UBWP:USER0:CELL0:UL:BWP0:PUCCh:PDSHarq:TMIValue1 0`
`SOURce1:BB:NR5G:UBWP:USER0:CELL0:UL:BWP0:PUCCh:PDSHarq:TMIValue2 15`

Manual operation: See "Value of Indicator x" on page 159

`[:SOURce<hw>] :BB:NR5G:UBWP:USER<us> :CELL<cc> :UL:BWP<bwp> :PUCCh:U2TPc <State>`

Turns the "2nd TPC Command for Scheduled PUCCH" DCI field on and off.

Parameters:`<State>`

1 | ON | 0 | OFF

*RST: 0

Manual operation: See "Use 2nd TPC Command" on page 160

10.19.9 FRC commands

`[:SOURce<hw>] :BB:NR5G:UBWP:USER<us> :CELL<cc> :UL:BWP<bwp> :FRC:STATE..... 552`
`[:SOURce<hw>] :BB:NR5G:UBWP:USER<us> :CELL<cc> :UL:BWP<bwp> :FRC:TYPE..... 552`
`[:SOURce<hw>] :BB:NR5G:UBWP:USER<us> :CELL<cc> :UL:BWP<bwp> :FRC:SCS?..... 555`
`[:SOURce<hw>] :BB:NR5G:UBWP:USER<us> :CELL<cc> :UL:BWP<bwp> :FRC:ALRB?..... 555`
`[:SOURce<hw>] :BB:NR5G:UBWP:USER<us> :CELL<cc> :UL:BWP<bwp> :FRC:BW?..... 555`

[:SOURce<hw>]:BB:NR5G:UBWP:USER<us>:CELL<cc>:UL:BWP<bwp>:FRC: MODulation?.....	556
[:SOURce<hw>]:BB:NR5G:UBWP:USER<us>:CELL<cc>:UL:BWP<bwp>:FRC:PASize?.....	556
[:SOURce<hw>]:BB:NR5G:UBWP:USER<us>:CELL<cc>:UL:BWP<bwp>:FRC:RBOffset.....	556
[:SOURce<hw>]:BB:NR5G:UBWP:USER<us>:CELL<cc>:UL:BWP<bwp>:FRC:MAPType.....	557
[:SOURce<hw>]:BB:NR5G:UBWP:USER<us>:CELL<cc>:UL:BWP<bwp>:FRC:PTRS: STATe.....	557

**[:SOURce<hw>]:BB:NR5G:UBWP:USER<us>:CELL<cc>:UL:BWP<bwp>:FRC:
 STATe <FrcState>**

Enables the fixed reference measurement channels (FRC), as defined in TS 38.141.

Parameters:

<FrcState> 1 | ON | 0 | OFF
*RST: 0

Example: See [Example "Fixed reference channels"](#) on page 392.

Manual operation: See ["FRC State"](#) on page 161

**[:SOURce<hw>]:BB:NR5G:UBWP:USER<us>:CELL<cc>:UL:BWP<bwp>:FRC:
 TYPE <FrcType>**

Selects the fixed reference measurement channel (FRC).

The currently available FRCs depend on the selected BWP subcarrier spacing (SCS) and selected number of resource blocks.

Parameters:

<FrcType>

FR1A11 | FR1A12 | FR1A13 | FR1A14 | FR1A15 | FR1A16 |
FR1A17 | FR1A18 | FR1A19 | FR2A11 | FR2A12 | FR2A13 |
FR2A14 | FR2A15 | FR1A21 | FR1A22 | FR1A23 | FR1A24 |
FR1A25 | FR1A26 | NA | FR1A38 | FR1A39 | FR1A310 |
FR1A311 | FR1A312 | FR1A313 | FR1A314 | FR1A322 |
FR1A323 | FR1A324 | FR1A325 | FR1A326 | FR1A327 |
FR1A328 | FR1A48 | FR1A49 | FR1A410 | FR1A411 |
FR1A412 | FR1A413 | FR1A414 | FR1A422 | FR1A423 |
FR1A424 | FR1A425 | FR1A426 | FR1A427 | FR1A428 |
FR1A58 | FR1A59 | FR1A510 | FR1A511 | FR1A512 |
FR1A513 | FR1A514 | FR1A331 | FR1A332 | FR2A31 |
FR2A32 | FR2A33 | FR2A34 | FR2A35 | FR2A36 | FR2A37 |
FR2A38 | FR2A39 | FR2A310 | FR2A311 | FR2A312 | FR2A41 |
FR2A42 | FR2A43 | FR2A44 | FR2A45 | FR2A46 | FR2A47 |
FR2A48 | FR2A49 | FR2A410 | FR2A51 | FR2A52 | FR2A53 |
FR2A54 | FR2A55 | FR2A313 | FR2A314 | FR2A315 |
FR2A316 | FR2A317 | FR2A318 | FR2A319 | FR2A320 |
FR2A321 | FR2A322 | FR2A323 | FR2A324 | FR2A411 |
FR2A412 | FR2A413 | FR2A414 | FR2A415 | FR2A416 |
FR2A417 | FR2A418 | FR2A419 | FR2A420 | FR2A56 |
FR2A57 | FR2A58 | FR2A59 | FR2A510 | FR1A31 | FR1A32 |
FR1A33 | FR1A34 | FR1A35 | FR1A36 | FR1A37 | FR1A315 |
FR1A316 | FR1A317 | FR1A318 | FR1A319 | FR1A320 |
FR1A321 | FR1A329 | FR1A330 | FR1A41 | FR1A42 | FR1A43 |
FR1A44 | FR1A45 | FR1A46 | FR1A47 | FR1A415 | FR1A416 |
FR1A417 | FR1A418 | FR1A419 | FR1A420 | FR1A421 |
FR1A51 | FR1A52 | FR1A53 | FR1A54 | FR1A55 | FR1A56 |
FR1A57 | FR1A110 | FR1A111 | FR1A333 | FR1A333A |
FR1A334 | FR1A334A | FR2A71 | FR2A72 | FR2A73 | FR2A74 |
FR2A75 | FR2A76 | FR2A77 | FR2A78 | FR2A79 | FR2A710 |
FR1A429 | FR1A429A | FR1A430 | FR1A430A | FR1A431A |
FR1A431 | FR1A432A | FR1A432 | FR1A3A1 | FR1A3A2 |
FR1A3A3 | FR1A3A4 | FR1A3B1 | FR1A3B2 | FR1A3B3 |
FR1A3B4 | TS381411_FR1A71 | TS381411_FR1A72 |
TS381411_FR1A73 | TS381411_FR1A74 | TS381412_FR1A81 |
TS381412_FR1A82 | TS381412_FR1A83 |
TS381412_FR1A84 | FR2A325 | FR2A326 | FR2A3A1 |
FR2A3A2 | FR2A3A3 | FR2A3A4 | FR2A3A5 | FR2A3A6 |
FR2A3A7 | FR2A3A8 | TS38176_FR1A211 |
TS38176_FR1A212 | TS38176_FR1A213 |
TS38176_FR1A214 | TS38176_FR1A215 |
TS38176_FR1A216 | TS38176_FR1A217 |
TS38176_FR1A218 | TS38176_FR1A219 |
TS38176_FR1A2110 | TS38176_FR1A2111 |
TS38176_FR1A2112 | TS38176_FR1A2113 |
TS38176_FR1A2114 | TS38176_FR1A2115 |
TS38176_FR1A2116 | TS38176_FR1A231 |
TS38176_FR1A232 | TS38176_FR1A233 |
TS38176_FR1A234 | TS38176_FR1A235 |

TS38176_FR1A236 | TS38176_FR1A237 |
TS38176_FR1A238 | TS38176_FR1A239 |
TS38176_FR1A2310 | TS38176_FR1A2311 |
TS38176_FR1A2312 | TS38176_FR1A2313 |
TS38176_FR1A2314 | TS38176_FR1A241 |
TS38176_FR1A242 | TS38176_FR1A243 |
TS38176_FR1A244 | TS38176_FR1A245 |
TS38176_FR1A246 | TS38176_FR1A247 | TS38176_FR2A211 |
TS38176_FR2A212 | TS38176_FR2A213 |
TS38176_FR2A214 | TS38176_FR2A215 |
TS38176_FR2A216 | TS38176_FR2A217 |
TS38176_FR2A218 | TS38176_FR2A219 |
TS38176_FR2A2110 | TS38176_FR2A2111 |
TS38176_FR2A2112 | TS38176_FR2A2113 |
TS38176_FR2A2114 | TS38176_FR2A2115 |
TS38176_FR2A2116 | TS38176_FR2A2117 |
TS38176_FR2A2118 | TS38176_FR2A2119 |
TS38176_FR2A2120 | TS38176_FR2A2121 |
TS38176_FR2A2122 | TS38176_FR2A2123 |
TS38176_FR2A2124 | TS38176_FR2A221 |
TS38176_FR2A222 | TS38176_FR2A223 |
TS38176_FR2A224 | TS38176_FR2A225 |
TS38176_FR2A226 | TS38176_FR2A227 |
TS38176_FR2A228 | TS38176_FR2A229 |
TS38176_FR2A2210 | TS38176_FR2A231 |
TS38176_FR2A232 | TS38176_FR2A233 |
TS38176_FR2A234 | TS38176_FR2A235 |
TS38176_FR2A236 | TS38176_FR2A237 |
TS38176_FR2A238 | TS38176_FR2A239 |
TS38176_FR2A2310 | TS38176_FR2A2311 |
TS38176_FR2A2312 | TS38176_FR2A2313 |
TS38176_FR2A2314 | TS38176_FR2A2315 |
TS38176_FR2A2316 | TS38176_FR2A2317 |
TS38176_FR2A2318 | TS38176_FR2A2319 |
TS38176_FR2A2320 | TS38176_FR2A241 |
TS38176_FR2A242 | TS38176_FR2A243 |
TS38176_FR2A244 | TS38176_FR2A245 |
TS38176_FR2A246 | TS38176_FR2A247 |
TS38176_FR2A248 | TS38176_FR2A249 |
TS38176_FR2A2410 | FR1A112 | FR1A113 | FR1A114 |
FR1A115 | FR1A116 | FR1A117 | FR1A118 | FR1A119 |
FR1A27 | FR1A28 | FR1A29 | FR1A210 | FR1A211 | FR1A212 |
FR1A213 | FR1A214 | FR1A215 | FR1A216 |
TS381411_FR1A82 | TS381411_FR1A83 | TS381411_FR1A84 |
TS381411_FR1A81 | TS381411_FR1A85 | TS381412_FR1A91 |
TS381412_FR1A92 | TS381412_FR1A93 |
TS381412_FR1A94 | TS381412_FR1A95 | TS38181_FR1A11 |
TS38181_FR1A12 | TS38181_FR1A13 | TS38181_FR1A14 |
TS38181_FR1A15 | TS38181_FR1A16 | TS38181_FR1A17 |
TS38181_FR1A18 | TS38181_FR1A19 | TS38181_FR1A21 |

TS38181_FR1A22 | TS38181_FR1A23 | TS38181_FR1A24 |
 TS38181_FR1A25 | TS38181_FR1A26 | TS38181_FR1A31 |
 TS38181_FR1A32 | TS38181_FR1A33 | TS38181_FR1A34 |
 TS38181_FR1A35 | TS38181_FR1A36 | TS38181_FR1A3A1 |
 TS38181_FR1A3A3 | FR2A101 | FR2A102 | FR2A103 |
 FR2A105 | FR2A104 | FR2A106 | FR2A107 | FR2A108 |
 FR2A109 | FR2A1010 | FR2A1011 | FR2A1012 | FR1A335 |
 FR1A337 | FR1A336 | FR1A338 | FR1A3B5 | FR1A3B6 |
 FR1A3B7 | FR1A3B8 | FR2A327 | FR2A3B1 | FR2A3B2
 *RST: FR1A12

Example: See [Example "Fixed reference channels"](#) on page 392.

Manual operation: See ["FRC"](#) on page 161

**[:SOURce<hw>]:BB:NR5G:UBWP:USER<us>:CELL<cc>:UL:BWP<bwp>:FRC:
SCS?**

Queries the SCS of the selected FRC.

Return values:

<SubcarrierSpac> N15 | N30 | N60 | X60 | N120 | N240 | N480 | N960
 *RST: N30

Example: See [Example "Fixed reference channels"](#) on page 392.

Usage: Query only

Options: N480 and N960 require R&S SMM-K171

Manual operation: See ["Subcarrier Spacing"](#) on page 162

**[:SOURce<hw>]:BB:NR5G:UBWP:USER<us>:CELL<cc>:UL:BWP<bwp>:FRC:
ALRB?**

Queries the number of used RBs of the selected FRC.

Return values:

<AllocRB> integer
 Range: 6 to 273
 *RST: 11

Example: See [Example "Fixed reference channels"](#) on page 392.

Usage: Query only

Manual operation: See ["Allocated Resource Blocks"](#) on page 162

**[:SOURce<hw>]:BB:NR5G:UBWP:USER<us>:CELL<cc>:UL:BWP<bwp>:FRC:
BW?**

Queries the channel bandwidth of the selected FRC.

Return values:

<ChannelBw> BW3 | BW5 | BW10 | BW15 | BW20 | BW25 | BW30 | BW35 |
 BW40 | BW45 | BW50 | BW60 | BW70 | BW80 | BW90 | BW100 |
 BW200 | BW400 | BW800 | BW1600 | BW2000
 *RST: BW100

Usage: Query only

Manual operation: See "[Channel Bandwidth](#)" on page 162

**[:SOURce<hw>]:BB:NR5G:UBWP:USER<us>:CELL<cc>:UL:BWP<bwp>:FRC:
 MODulation?**

Queries the modulation scheme used by the selected FRC.

Return values:

<Modulation> BPSK | BPSK2 | QPSK | QAM16 | QAM64 | QAM256 |
 QAM1024
 *RST: QPSK

Example: See [Example"Fixed reference channels"](#) on page 392.

Usage: Query only

Manual operation: See "[Modulation](#)" on page 162

**[:SOURce<hw>]:BB:NR5G:UBWP:USER<us>:CELL<cc>:UL:BWP<bwp>:FRC:
 PASize?**

Queries the payload size of the selected FRC.

Return values:

<PayloadSize> integer
 Range: 528 to 217128
 *RST: 984

Example: See [Example"Fixed reference channels"](#) on page 392.

Usage: Query only

Manual operation: See "[Payload Size](#)" on page 163

**[:SOURce<hw>]:BB:NR5G:UBWP:USER<us>:CELL<cc>:UL:BWP<bwp>:FRC:
 RBOffset <ResourceBlocks>**

Sets the RB offset for the selected FRC.

Parameters:

<ResourceBlocks> integer
 Range: 0 to dynamic
 *RST: 0

Example: See [Example"Fixed reference channels"](#) on page 392.

Manual operation: See ["RB Offset"](#) on page 163

[:SOURce<hw>]:BB:NR5G:UBWP:USER<us>:CELL<cc>:UL:BWP<bwp>:FRC:MAPType <MappingType>

Sets the PUSCH mapping type for the selected FRC.

Parameters:

<MappingType> A | B
*RST: A

Example: See [Example "Fixed reference channels"](#) on page 392.

Manual operation: See ["Mapping Type"](#) on page 163

[:SOURce<hw>]:BB:NR5G:UBWP:USER<us>:CELL<cc>:UL:BWP<bwp>:FRC:PTRS:STATE <FrcPtrsState>

Enables PTRS for the selected FRC.

Parameters:

<FrcPtrsState> 1 | ON | 0 | OFF
*RST: 0

Example: See [Example "Fixed reference channels"](#) on page 392.

Manual operation: See ["PTRS"](#) on page 163

10.19.10 PUSCH commands

[:SOURce<hw>]:BB:NR5G:UBWP:USER<us>:CELL<cc>:UL:BWP<bwp>:PUSCh:A02List...	559
[:SOURce<hw>]:BB:NR5G:UBWP:USER<us>:CELL<cc>:UL:BWP<bwp>:PUSCh:ACCList..	560
[:SOURce<hw>]:BB:NR5G:UBWP:USER<us>:CELL<cc>:UL:BWP<bwp>:PUSCh:APPResent.....	560
[:SOURce<hw>]:BB:NR5G:UBWP:USER<us>:CELL<cc>:UL:BWP<bwp>:PUSCh:BRV.....	560
[:SOURce<hw>]:BB:NR5G:UBWP:USER<us>:CELL<cc>:UL:BWP<bwp>:PUSCh:BHARq....	560
[:SOURce<hw>]:BB:NR5G:UBWP:USER<us>:CELL<cc>:UL:BWP<bwp>:PUSCh:DMTA:BSAMe.....	561
[:SOURce<hw>]:BB:NR5G:UBWP:USER<us>:CELL<cc>:UL:BWP<bwp>:PUSCh:DMTB:CTYPE.....	561
[:SOURce<hw>]:BB:NR5G:UBWP:USER<us>:CELL<cc>:UL:BWP<bwp>:PUSCh:DMTA:CTYPE.....	561
[:SOURce<hw>]:BB:NR5G:UBWP:USER<us>:CELL<cc>:UL:BWP<bwp>:PUSCh:DMTB:MLENght.....	561
[:SOURce<hw>]:BB:NR5G:UBWP:USER<us>:CELL<cc>:UL:BWP<bwp>:PUSCh:DMTA:MLENght.....	561
[:SOURce<hw>]:BB:NR5G:UBWP:USER<us>:CELL<cc>:UL:BWP<bwp>:PUSCh:DMTA:PUID.....	562
[:SOURce<hw>]:BB:NR5G:UBWP:USER<us>:CELL<cc>:UL:BWP<bwp>:PUSCh:DMTB:PUID.....	562

BWP configuration commands

[SOURce<hw>]:BB:NR5G:UBWP:USER<us>:CELL<cc>:UL:BWP<bwp>:PUSCh: DMTB:APINdex.....	562
[SOURce<hw>]:BB:NR5G:UBWP:USER<us>:CELL<cc>:UL:BWP<bwp>:PUSCh: DMTA:APINdex.....	562
[SOURce<hw>]:BB:NR5G:UBWP:USER<us>:CELL<cc>:UL:BWP<bwp>:PUSCh: DMTA:SID0.....	562
[SOURce<hw>]:BB:NR5G:UBWP:USER<us>:CELL<cc>:UL:BWP<bwp>:PUSCh: DMTA:SID1.....	562
[SOURce<hw>]:BB:NR5G:UBWP:USER<us>:CELL<cc>:UL:BWP<bwp>:PUSCh: DMTB:SID0.....	562
[SOURce<hw>]:BB:NR5G:UBWP:USER<us>:CELL<cc>:UL:BWP<bwp>:PUSCh: DMTB:SID1.....	562
[SOURce<hw>]:BB:NR5G:UBWP:USER<us>:CELL<cc>:UL:BWP<bwp>:PUSCh: MCBGroups.....	562
[SOURce<hw>]:BB:NR5G:UBWP:USER<us>:CELL<cc>:UL:BWP<bwp>:PUSCh: DMTB:UR16.....	563
[SOURce<hw>]:BB:NR5G:UBWP:USER<us>:CELL<cc>:UL:BWP<bwp>:PUSCh: DMTA:UR16.....	563
[SOURce<hw>]:BB:NR5G:UBWP:USER<us>:CELL<cc>:UL:BWP<bwp>:PUSCh:DSINit.....	563
[SOURce<hw>]:BB:NR5G:UBWP:USER<us>:CELL<cc>:UL:BWP<bwp>:PUSCh:HP5Bits...	564
[SOURce<hw>]:BB:NR5G:UBWP:USER<us>:CELL<cc>:UL:BWP<bwp>:PUSCh:TPSTate..	564
[SOURce<hw>]:BB:NR5G:UBWP:USER<us>:CELL<cc>:UL:BWP<bwp>:PUSCh:MRANK...	564
[SOURce<hw>]:BB:NR5G:UBWP:USER<us>:CELL<cc>:UL:BWP<bwp>:PUSCh: TXConfig.....	564
[SOURce<hw>]:BB:NR5G:UBWP:USER<us>:CELL<cc>:UL:BWP<bwp>:PUSCh: CBSubset.....	565
[SOURce<hw>]:BB:NR5G:UBWP:USER<us>:CELL<cc>:UL:BWP<bwp>:PUSCh: MCSTable.....	565
[SOURce<hw>]:BB:NR5G:UBWP:USER<us>:CELL<cc>:UL:BWP<bwp>:PUSCh: MTTPrecoding.....	565
[SOURce<hw>]:BB:NR5G:UBWP:USER<us>:CELL<cc>:UL:BWP<bwp>:PUSCh: RESalloc.....	566
[SOURce<hw>]:BB:NR5G:UBWP:USER<us>:CELL<cc>:DL:BWP<bwp>:PUSCh: RBGSize.....	566
[SOURce<hw>]:BB:NR5G:UBWP:USER<us>:CELL<cc>:UL:BWP<bwp>:PUSCh: SCRambling:STATe.....	566
[SOURce<hw>]:BB:NR5G:UBWP:USER<us>:CELL<cc>:UL:BWP<bwp>:PUSCh:DSID.....	566
[SOURce<hw>]:BB:NR5G:UBWP:USER<us>:CELL<cc>:UL:BWP<bwp>:PUSCh:FHOP.....	567
[SOURce<hw>]:BB:NR5G:UBWP:USER<us>:CELL<cc>:UL:BWP<bwp>:PUSCh: FHOffsets:NOFFsets.....	567
[SOURce<hw>]:BB:NR5G:UBWP:USER<us>:CELL<cc>:UL:BWP<bwp>:PUSCh: FHOffsets:OFFSet<gr0>.....	567
[SOURce<hw>]:BB:NR5G:UBWP:USER<us>:CELL<cc>:UL:BWP<bwp>:PUSCh:PI01.....	568
[SOURce<hw>]:BB:NR5G:UBWP:USER<us>:CELL<cc>:UL:BWP<bwp>:PUSCh:PI02.....	568
[SOURce<hw>]:BB:NR5G:UBWP:USER<us>:CELL<cc>:UL:BWP<bwp>:PUSCh:ISIN.....	568
[SOURce<hw>]:BB:NR5G:UBWP:USER<us>:CELL<cc>:UL:BWP<bwp>:PUSCh:OI01.....	569
[SOURce<hw>]:BB:NR5G:UBWP:USER<us>:CELL<cc>:UL:BWP<bwp>:PUSCh:OLPC.....	569
[SOURce<hw>]:BB:NR5G:UBWP:USER<us>:CELL<cc>:UL:BWP<bwp>:PUSCh:PPSL.....	569
[SOURce<hw>]:BB:NR5G:UBWP:USER<us>:CELL<cc>:UL:BWP<bwp>:PUSCh:T1GRan..	569
[SOURce<hw>]:BB:NR5G:UBWP:USER<us>:CELL<cc>:UL:BWP<bwp>:PUSCh:FPTR.....	570

BWP configuration commands

[SOURce<hw>]:BB:NR5G:UBWP:USER<us>:CELL<cc>:UL:BWP<bwp>:PUSCh:UITL?.....	570
[SOURce<hw>]:BB:NR5G:UBWP:USER<us>:CELL<cc>:UL:BWP<bwp>:PUSCh: DMTA:PTRS:TP:STATe.....	570
[SOURce<hw>]:BB:NR5G:UBWP:USER<us>:CELL<cc>:UL:BWP<bwp>:PUSCh: DMTB:PTRS:TP:STATe.....	570
[SOURce<hw>]:BB:NR5G:UBWP:USER<us>:CELL<cc>:UL:BWP<bwp>:PUSCh: DMTA:PTRS:TP:TMDensity.....	571
[SOURce<hw>]:BB:NR5G:UBWP:USER<us>:CELL<cc>:UL:BWP<bwp>:PUSCh: DMTB:PTRS:TP:TMDensity.....	571
[SOURce<hw>]:BB:NR5G:UBWP:USER<us>:CELL<cc>:UL:BWP<bwp>:PUSCh: DMTA:PTRS:TP:SCID.....	571
[SOURce<hw>]:BB:NR5G:UBWP:USER<us>:CELL<cc>:UL:BWP<bwp>:PUSCh: DMTB:PTRS:TP:SCID.....	571
[SOURce<hw>]:BB:NR5G:UBWP:USER<us>:CELL<cc>:UL:BWP<bwp>:PUSCh: DMTA:PTRS:TP:RB0.....	571
[SOURce<hw>]:BB:NR5G:UBWP:USER<us>:CELL<cc>:UL:BWP<bwp>:PUSCh: DMTA:PTRS:TP:RB1.....	571
[SOURce<hw>]:BB:NR5G:UBWP:USER<us>:CELL<cc>:UL:BWP<bwp>:PUSCh: DMTA:PTRS:TP:RB2.....	571
[SOURce<hw>]:BB:NR5G:UBWP:USER<us>:CELL<cc>:UL:BWP<bwp>:PUSCh: DMTA:PTRS:TP:RB3.....	571
[SOURce<hw>]:BB:NR5G:UBWP:USER<us>:CELL<cc>:UL:BWP<bwp>:PUSCh: DMTA:PTRS:TP:RB4.....	571
[SOURce<hw>]:BB:NR5G:UBWP:USER<us>:CELL<cc>:UL:BWP<bwp>:PUSCh: DMTB:PTRS:TP:RB0.....	571
[SOURce<hw>]:BB:NR5G:UBWP:USER<us>:CELL<cc>:UL:BWP<bwp>:PUSCh: DMTB:PTRS:TP:RB1.....	572
[SOURce<hw>]:BB:NR5G:UBWP:USER<us>:CELL<cc>:UL:BWP<bwp>:PUSCh: DMTB:PTRS:TP:RB2.....	572
[SOURce<hw>]:BB:NR5G:UBWP:USER<us>:CELL<cc>:UL:BWP<bwp>:PUSCh: DMTB:PTRS:TP:RB3.....	572
[SOURce<hw>]:BB:NR5G:UBWP:USER<us>:CELL<cc>:UL:BWP<bwp>:PUSCh: DMTB:PTRS:TP:RB4.....	572
[SOURce<hw>]:BB:NR5G:UBWP:USER<us>:CELL<cc>:UL:BWP<bwp>:PUSCh:U2TPc....	572
[SOURce<hw>]:BB:NR5G:UBWP:USER<us>:CELL<cc>:UL:BWP<bwp>:PUSCh: XOVerhead.....	572
[SOURce<hw>]:BB:NR5G:UBWP:USER<us>:CELL<cc>:UL:BWP<bwp>:PDSCh: TDANum.....	572
[SOURce<hw>]:BB:NR5G:UBWP:USER<us>:CELL<cc>:UL:BWP<bwp>:PDSCh: DC02:TDANum.....	573
[SOURce<hw>]:BB:NR5G:UBWP:USER<us>:CELL<cc>:UL:BWP<bwp>:PDSCh: MULTi:TDANum.....	573
[SOURce<hw>]:BB:NR5G:UBWP:USER<us>:CELL<cc>:UL:BWP<bwp>:PDSCh: MULTi:PLEN.....	573

**[SOURce<hw>]:BB:NR5G:UBWP:USER<us>:CELL<cc>:UL:BWP<bwp>:PUSCh:
A02List <Value>**

Configures the higher layer parameter `ul-AccessConfigListDCI0-2` as defined in 3GPP 38.331.

Parameters:

<Value> integer
 Range: 0 to 64
 *RST: 0

Manual operation: See "[ul-AccessConfigList DCIO_2](#)" on page 171

**[:SOURCE<hw>]:BB:NR5G:UBWP:USER<us>:CELL<cc>:UL:BWP<bwp>:PUSCh:
 ACCList <Value>**

Configures the higher layer parameter `ul-AccessConfigListDCI0-1` as defined in 3GPP 38.331.

Parameters:

<Value> integer
 Range: 0 to 64
 *RST: 0

Manual operation: See "[ul-AccessConfigList DCIO_1](#)" on page 171

**[:SOURCE<hw>]:BB:NR5G:UBWP:USER<us>:CELL<cc>:UL:BWP<bwp>:PUSCh:
 APPresent <APortsPresent>**

Turns the "Antenna Ports" DCI field in DCI format 0_2 on and off.

Parameters:

<APortsPresent> 1 | ON | 0 | OFF
 *RST: 0

Manual operation: See "[Antenna Ports Present DCIO_2](#)" on page 172

**[:SOURCE<hw>]:BB:NR5G:UBWP:USER<us>:CELL<cc>:UL:BWP<bwp>:PUSCh:
 BRV <BitLength>**

Defines the bit length of the DCI field "Redundancy Version" available in DCI format 0_2.

Parameters:

<BitLength> integer
 Range: 0 to 2
 *RST: 0

Manual operation: See "[Bits For Redundancy Version DCIO_2](#)" on page 171

**[:SOURCE<hw>]:BB:NR5G:UBWP:USER<us>:CELL<cc>:UL:BWP<bwp>:PUSCh:
 BHARq <BitLength>**

Defines the bit length of the DCI field "HARQ Process Number" available in DCI formats 0_2.

Parameters:

<BitLength> integer
 Range: 0 to 4
 *RST: 0

**[:SOURce<hw>]:BB:NR5G:UBWP:USER<us>:CELL<cc>:UL:BWP<bwp>:PUSCh:
 DMTA:BSAMe <SameDmrsSetting>**

Per default, the same configuration applies for DMRS mapping type A and B. Disable "Same Settings for Type A and Type B" to modify the mapping type B settings.

Mapping type A and B define the DMRS position in the PUSCH, the starting symbol and length. The UE informs the BS about the mapping type supportability via the UE capability information message. Before modifying Mapping Type B settings this state has to be deactivated.

Parameters:

<SameDmrsSetting> 1 | ON | 0 | OFF
 *RST: 1

Example: See [Example"Configuring the PUSCH settings"](#) on page 402

Manual operation: See ["Same Settings for Type A and Type B"](#) on page 173

**[:SOURce<hw>]:BB:NR5G:UBWP:USER<us>:CELL<cc>:UL:BWP<bwp>:PUSCh:
 DMTB:CTYPe <TypeBConfigType>
 [:SOURce<hw>]:BB:NR5G:UBWP:USER<us>:CELL<cc>:UL:BWP<bwp>:PUSCh:
 DMTA:CTYPe <TypeAConfigType>**

Sets the configuration type (type 1 or type 2) and defines the mapping of the DMRS to the physical resource elements

Parameters:

<TypeAConfigType> T1 | T2
 *RST: T1

Example: See [Example"Configuring the PUSCH settings"](#) on page 402.

Manual operation: See ["Config Type"](#) on page 173

**[:SOURce<hw>]:BB:NR5G:UBWP:USER<us>:CELL<cc>:UL:BWP<bwp>:PUSCh:
 DMTB:MLENgtH <TypeBMaxLength>
 [:SOURce<hw>]:BB:NR5G:UBWP:USER<us>:CELL<cc>:UL:BWP<bwp>:PUSCh:
 DMTA:MLENgtH <TypeAMaxLength>**

Sets if single- or double-symbol DMRS is used.

Parameters:

<TypeAMaxLength> integer
 Range: 1 to 2
 *RST: 2

Example: See [Example"Configuring the PUSCH settings"](#) on page 402.

Manual operation: See ["Max Length"](#) on page 174

```
[:SOURce<hw>]:BB:NR5G:UBWP:USER<us>:CELL<cc>:UL:BWP<bwp>:PUSCh:
  DMTA:PUID <TypeAPuschID>
[:SOURce<hw>]:BB:NR5G:UBWP:USER<us>:CELL<cc>:UL:BWP<bwp>:PUSCh:
  DMTB:PUID <TypeBPuschID>
```

Sets the PUSCH ID value used for DMRS sequence generation.

Parameters:

<TypeBPuschID> integer
 Range: 0 to 1007
 *RST: 0

Example: See [Example"Configuring the PUSCH settings"](#) on page 402.

Manual operation: See ["NPusch ID"](#) on page 174

```
[:SOURce<hw>]:BB:NR5G:UBWP:USER<us>:CELL<cc>:UL:BWP<bwp>:PUSCh:
  DMTB:APIndex <TypeBAddPosIdx>
[:SOURce<hw>]:BB:NR5G:UBWP:USER<us>:CELL<cc>:UL:BWP<bwp>:PUSCh:
  DMTA:APIndex <TypeAAddPosIdx>
```

Sets the additional position index.

Parameters:

<TypeAAddPosIdx> integer
 Range: 0 to 3
 *RST: 0

Example: See [Example"Configuring the PUSCH settings"](#) on page 402.

Manual operation: See ["Additional Position Index"](#) on page 174

```
[:SOURce<hw>]:BB:NR5G:UBWP:USER<us>:CELL<cc>:UL:BWP<bwp>:PUSCh:
  DMTA:SID0 <ScramID0>
[:SOURce<hw>]:BB:NR5G:UBWP:USER<us>:CELL<cc>:UL:BWP<bwp>:PUSCh:
  DMTA:SID1 <ScramID1>
[:SOURce<hw>]:BB:NR5G:UBWP:USER<us>:CELL<cc>:UL:BWP<bwp>:PUSCh:
  DMTB:SID0 <ScramID0>
[:SOURce<hw>]:BB:NR5G:UBWP:USER<us>:CELL<cc>:UL:BWP<bwp>:PUSCh:
  DMTB:SID1 <ScramID1>
[:SOURce<hw>]:BB:NR5G:UBWP:USER<us>:CELL<cc>:UL:BWP<bwp>:PUSCh:
  MCBGroups <UIMaxCBGperTB>
```

Limits the number of code block groups per transport block.

In 5G NR a huge TB (transport block) is split into multiple code blocks (CB). Multiples CBs are grouped into one code block group (CBG). The number of code blocks grouped into the CBG can be limited by the "Max Code Block Groups Per Transport Block" setting.

Parameters:

<UIMaxCBGperTB> G2 | G4 | DISabled | G6 | G8

G2

Limits the number of code block groups per transport block to 2.

G4

Limits the number of code block groups per transport block to 4.

DISabled

Default value, which disabled the limitation of code block groups per transport block.

G6

Limits the number of code block groups per transport block to 6.

G8

Limits the number of code block groups per transport block to 8.

*RST: DISabled

Example:

See: [Example"Configuring the PUSCH settings"](#) on page 402

Manual operation:

See ["Max Code Block Groups Per Transport Block"](#) on page 119

See ["Max Code Block Groups Per Transport Block"](#) on page 167

[<SOURce<hw>]:BB:NR5G:UBWP:USER<us>:CELL<cc>:UL:BWP<bwp>:PUSCh:
DMTB:UR16 <State>

[<SOURce<hw>]:BB:NR5G:UBWP:USER<us>:CELL<cc>:UL:BWP<bwp>:PUSCh:
DMTA:UR16 <State>

Turns the higher layer parameter "dmrs-uplink-r16" on and off.

Parameters:

<State> 1 | ON | 0 | OFF

*RST: 0

Manual operation:

See ["Use R16 DMRS"](#) on page 175

[<SOURce<hw>]:BB:NR5G:UBWP:USER<us>:CELL<cc>:UL:BWP<bwp>:PUSCh:
DSINit <DmrsSeqInit>

Turns the "DMRS Sequence Initialization" DCI field in DCI format 0_2 on and off.

Parameters:

<DmrsSeqInit> 1 | ON | 0 | OFF

*RST: 0

Manual operation:

See ["DMRS Sequence Initialization DCI0_2"](#) on page 172

**[:SOURce<hw>]:BB:NR5G:UBWP:USER<us>:CELL<cc>:UL:BWP<bwp>:PUSCh:
HP5Bits <BitLength>**

Selects the size of the "HARQ Process Number" DCI field in DCI format 1_1.

Parameters:

<BitLength> **OFF | 0**
 4 bits

 ON | 1
 5 bits
*RST: 0

Manual operation: See "[Harq-ProcessNumberSizeDCI0_1](#)" on page 170

**[:SOURce<hw>]:BB:NR5G:UBWP:USER<us>:CELL<cc>:UL:BWP<bwp>:PUSCh:
TPSTate <TransformPrec>**

Enables the precoding operation and thus enables the DFT-s-OFDM.

Parameters:

<TransformPrec> 1 | ON | 0 | OFF

 0|OFF
 Enables the CP-OFDM.

 1|ON
 Enables the DFT-s-OFDM.
*RST: 0

Example: See [Example"Configuring the PUSCH settings"](#) on page 402.

Manual operation: See "[Transform Precoding](#)" on page 164

**[:SOURce<hw>]:BB:NR5G:UBWP:USER<us>:CELL<cc>:UL:BWP<bwp>:PUSCh:
MRANK <MaximumRank>**

Sets the parameter max rank.

Parameters:

<MaximumRank> integer

 Range: 1 to 4
*RST: 4

Example: See [Example"Configuring the PUSCH settings"](#) on page 402.

Manual operation: See "[Max Rank](#)" on page 164

**[:SOURce<hw>]:BB:NR5G:UBWP:USER<us>:CELL<cc>:UL:BWP<bwp>:PUSCh:
TXConfig <TxConfig>**

Sets if codebook-based (CB) or non-codebook-based (NCB) transmission is used.

Parameters:

<TxConfig> NCB | CB
 *RST: NCB

Example: See [Example"Configuring the PUSCH settings"](#) on page 402.

Manual operation: See ["TxConfig"](#) on page 165

**[:SOURCE<hw>]:BB:NR5G:UBWP:USER<us>:CELL<cc>:UL:BWP<bwp>:PUSCh:
 CBSubset <CodebookSubset>**

Sets the higher layer parameter `codebookSubset`.

Parameters:

<CodebookSubset> FPNC | PNC | NC
FPNC
 Fully-and-partial-and-non-coherent
PNC
 Partial-non-coherent
NC
 Non-coherent
 *RST: FPNC

Example: See [Example"Configuring the PUSCH settings"](#) on page 402.

Manual operation: See ["Codebook Subset"](#) on page 165

**[:SOURCE<hw>]:BB:NR5G:UBWP:USER<us>:CELL<cc>:UL:BWP<bwp>:PUSCh:
 MCSTable <Modulation>**

Sets the MSC table and defines the used modulation scheme.

Parameters:

<Modulation> QAM64 | QAM256 | QAM64LSE
 *RST: QAM64

Example: See [Example"Configuring the PUSCH settings"](#) on page 402.

Manual operation: See ["MCS Table"](#) on page 165

**[:SOURCE<hw>]:BB:NR5G:UBWP:USER<us>:CELL<cc>:UL:BWP<bwp>:PUSCh:
 MTTPrecoding <PuschMcsTableTP>**

Sets the MCS table.

Parameters:

<PuschMcsTableTP> QAM64 | QAM256 | QAM64LSE
 *RST: QAM64

Example: See [Example"Configuring the PUSCH settings"](#) on page 402.

Manual operation: See ["MCS Table Transform Precoding"](#) on page 166

```
[ :SOURce<hw>]:BB:NR5G:UBWP:USER<us>:CELL<cc>:UL:BWP<bwp>:PUSCh:
RESalloc <UIBwpPuschResAl>
```

Sets the used resource allocation type.

Parameters:

```
<UIBwpPuschResAl> T0 | T1 | DS
                    *RST:    T1
```

Example: See [Example "Scheduling PUSCH type 0 allocation"](#) on page 395.

Manual operation: See ["Resource Allocation"](#) on page 118

```
[ :SOURce<hw>]:BB:NR5G:UBWP:USER<us>:CELL<cc>:DL:BWP<bwp>:PUSCh:
RBGSize <PuschRBGSize>
```

Sets the size of the resource block group.

Parameters:

```
<PuschRBGSize>    C2 | C1
```

Example: See [Example "Scheduling PUSCH type 0 allocation"](#) on page 395.

Manual operation: See ["Resource Block Group Size"](#) on page 118

```
[ :SOURce<hw>]:BB:NR5G:UBWP:USER<us>:CELL<cc>:UL:BWP<bwp>:PUSCh:
SCRambling:STATe <UseScramblingId>
```

Sets if a data scrambling ID is used for the initialization of the generator of the PUSCH scrambling sequence.

Parameters:

```
<UseScramblingId> 1 | ON | 0 | OFF
                    *RST:    0
```

Example: See [Example "Configuring the PUSCH settings"](#) on page 402.

Manual operation: See ["Use PUSCH Scrambling ID"](#) on page 165

```
[ :SOURce<hw>]:BB:NR5G:UBWP:USER<us>:CELL<cc>:UL:BWP<bwp>:PUSCh:
DSID <DataScrambleId>
```

If `[:SOURce<hw>]:BB:NR5G:UBWP:USER<us>:CELL<cc>:UL:BWP<bwp>:PUSCh:SCRambling:STATe 1`, sets the data scrambling ID.

Parameters:

```
<DataScrambleId>  integer
                    Range:    0 to 1023
                    *RST:    0
```

Example: See [Example "Configuring the PUSCH settings"](#) on page 402.

Manual operation: See ["Data Scrambling ID"](#) on page 165

**[:SOURCE<hw>]:BB:NR5G:UBWP:USER<us>:CELL<cc>:UL:BWP<bwp>:PUSCh:
FHOP <SelFreqHopp>**

Disables or enables inter- or intra-slot frequency hopping.

Parameters:

<SelFreqHopp> DIS | INTRA | INTER

DIS

Disable frequency hopping.

INTRA

Enable intra slot frequency hopping. Both intra- and inter-sub-frame hopping are performed. The PUSCH position in terms of used resource blocks is changed each slot and each subframe.

INTER

Enable inter-slot frequency hopping. The PUSCH position in terms of used resource blocks is changed each subframe.

*RST: DIS

Example: See: [Example"Configuring the PUSCH settings"](#) on page 402

Manual operation: See ["Frequency Hopping"](#) on page 167

**[:SOURCE<hw>]:BB:NR5G:UBWP:USER<us>:CELL<cc>:UL:BWP<bwp>:PUSCh:
FHOFfsets:NOFFsets <NumFreqHopOff>**

Defines the number off frequency hopping offsets.

- If the size of the active BWP is fewer than 50 PRBs, one of two higher layer configured offsets are indicated in the UL grant.
- If the size of the active BWP is equal to or greater than 50 PRBs, one of four higher layer configured offsets are indicated in the UL grant.

Parameters:

<NumFreqHopOff> integer

Range: 2 to 4

*RST: 4

Example: See: [Example"Configuring the PUSCH settings"](#) on page 402

Manual operation: See ["Number of Offsets"](#) on page 168

**[:SOURCE<hw>]:BB:NR5G:UBWP:USER<us>:CELL<cc>:UL:BWP<bwp>:PUSCh:
FHOFfsets:OFFSet<gr0> <FreqHopOffset>**

Sets the value of the available frequency hopping offsets.

The number of offsets is set automatically to 2 or 4 depending on the size of the active BWP. See [Number of Offsets](#).

Suffix:
 <gr0> 0 to 3
 Defines to which offset the frequency hopping value is applied.

Parameters:
 <FreqHopOffset> integer
 Range: 1 to 274
 *RST: 1

Example: See: [Example"Configuring the PUSCH settings"](#) on page 402

Manual operation: See ["Offset Values"](#) on page 168

**[:SOURce<hw>]:BB:NR5G:UBWP:USER<us>:CELL<cc>:UL:BWP<bwp>:PUSCh:
 PI01 <State>**

Turns the "Priority Indicator" DCI field in DCI formats 0_1 on and off.

Parameters:
 <State> 1 | ON | 0 | OFF
 *RST: 0

Manual operation: See ["Priority Indicator DCI0_1 / DCI0_2"](#) on page 170

**[:SOURce<hw>]:BB:NR5G:UBWP:USER<us>:CELL<cc>:UL:BWP<bwp>:PUSCh:
 PI02 <State>**

Turns the "Priority Indicator" DCI field in DCI formats 0_2 on and off.

Parameters:
 <State> 1 | ON | 0 | OFF
 *RST: 0

Manual operation: See ["Priority Indicator DCI0_1 / DCI0_2"](#) on page 170

**[:SOURce<hw>]:BB:NR5G:UBWP:USER<us>:CELL<cc>:UL:BWP<bwp>:PUSCh:
 ISIN <State>**

Turns the "Invalid Symbol Pattern Indicator" DCI field in DCI formats 0_1 and 0_2 on and off.

Parameters:
 <State> 1 | ON | 0 | OFF
 *RST: 0

Manual operation: See ["Invalid Symbol Indicator"](#) on page 170

**[:SOURce<hw>]:BB:NR5G:UBWP:USER<us>:CELL<cc>:UL:BWP<bwp>:PUSCh:
OI01 <Value>**

Turns the configuration of the minimum applicable scheduling offset indicator for the DCI format 0_1 on and off.

Parameters:

<Value> integer
Range: 0 to 2
*RST: 0

Manual operation: See "[Minimum Scheduling Offset K2](#)" on page 170

**[:SOURce<hw>]:BB:NR5G:UBWP:USER<us>:CELL<cc>:UL:BWP<bwp>:PUSCh:
OLPC <OlpcParamSet>**

Parameters:

<OlpcParamSet> SNC | S1 | S2
*RST: SNC

Manual operation: See "[olpc-ParameterSet](#)" on page 170

**[:SOURce<hw>]:BB:NR5G:UBWP:USER<us>:CELL<cc>:UL:BWP<bwp>:PUSCh:
PPSL <Value>**

Configures the higher layer parameter `p0-PUSCH-SetList` as defined in 3GPP 38.331.

Parameters:

<Value> integer
Range: 0 to 16
*RST: 0

Manual operation: See "[p0-PUSCH-SetList](#)" on page 171

**[:SOURce<hw>]:BB:NR5G:UBWP:USER<us>:CELL<cc>:UL:BWP<bwp>:PUSCh:
T1GRan <State>**

Configures the higher layer parameter `resourceAllocationType1GranularityDCI-0-2` as defined in 3GPP 38.331.

Parameters:

<State> NCON | N2 | N4 | N8 | N16
NCON
Not configured.
N2|N4|N8|N16
Granularity as defined by 3GPP.
*RST: NCON

Manual operation: See "[Type 1 Allocation Granularity DCI 0_2](#)" on page 172

**[:SOURce<hw>]:BB:NR5G:UBWP:USER<us>:CELL<cc>:UL:BWP<bwp>:PUSCh:
FPTR <State>**

Configures the higher layer parameter `ul-FullPowerTransmission` as defined in 3GPP 38.331.

Parameters:

<State> FP | FPM1 | FPM2 | NCON
NCON
 Not configured.
FP|FPM1|FPM2
 Full power mode type.
 *RST: NCON

Manual operation: See ["Full Power Transmission"](#) on page 168

**[:SOURce<hw>]:BB:NR5G:UBWP:USER<us>:CELL<cc>:UL:BWP<bwp>:PUSCh:
UITL?**

Queries the state of the higher layer parameter `useInterlacePUCCH-PUSCH` as defined in 3GPP 38.331.

Return values:

<State> 1 | ON | 0 | OFF
 *RST: 0

Usage: Query only

Manual operation: See ["Use Interlace"](#) on page 169

**[:SOURce<hw>]:BB:NR5G:UBWP:USER<us>:CELL<cc>:UL:BWP<bwp>:PUSCh:
DMTA:PTRS:TP:STATe <PtrsTpState>**

**[:SOURce<hw>]:BB:NR5G:UBWP:USER<us>:CELL<cc>:UL:BWP<bwp>:PUSCh:
DMTB:PTRS:TP:STATe <PtrsTpPtrsState>**

Simulates the transmission of the higher-layer parameter `transformPrecoderEnabled`.

Parameters:

<PtrsTpPtrsState> 1 | ON | 0 | OFF
 *RST: 0

Example: See [Example"Configuring the PUSCH PTRS with enabled transform precoding"](#) on page 404.

Manual operation: See ["State"](#) on page 178

```
[:SOURce<hw>]:BB:NR5G:UBWP:USER<us>:CELL<cc>:UL:BWP<bwp>:PUSCh:
  DMTA:PTRS:TP:TMDensity <PtrsTpTimeDens>
[:SOURce<hw>]:BB:NR5G:UBWP:USER<us>:CELL<cc>:UL:BWP<bwp>:PUSCh:
  DMTB:PTRS:TP:TMDensity <PtrsTpTimeDens>
```

Sets the PTRS time density.

Parameters:

```
<PtrsTpTimeDens> TD1 | TD2
                *RST: TD1
```

Example: See [Example "Configuring the PUSCH PTRS with enabled transform precoding"](#) on page 404.

Manual operation: See ["Time Density"](#) on page 179

```
[:SOURce<hw>]:BB:NR5G:UBWP:USER<us>:CELL<cc>:UL:BWP<bwp>:PUSCh:
  DMTA:PTRS:TP:SCID <TpPtrsScramId>
[:SOURce<hw>]:BB:NR5G:UBWP:USER<us>:CELL<cc>:UL:BWP<bwp>:PUSCh:
  DMTB:PTRS:TP:SCID <TpPtrsScramId>
```

Sets whether the PTRS Scrambling ID value used for PTRS sequence generation is configured by the [NPusch ID](#) (higher layer) or by the cell ID.

Parameters:

```
<TpPtrsScramId> CID | PUID
                CID
                  Sets the cell ID as the scrambling ID for PTRS sequence generation.
                PUID
                  Sets the NPusch ID as the scrambling ID for PTRS sequence generation.
                *RST: CID
```

Example: See [Example "Configuring the PUSCH PTRS with enabled transform precoding"](#) on page 404.

Manual operation: See ["Scrambling ID"](#) on page 179

```
[:SOURce<hw>]:BB:NR5G:UBWP:USER<us>:CELL<cc>:UL:BWP<bwp>:PUSCh:
  DMTA:PTRS:TP:RB0 <PtrsTpNumRB0>
[:SOURce<hw>]:BB:NR5G:UBWP:USER<us>:CELL<cc>:UL:BWP<bwp>:PUSCh:
  DMTA:PTRS:TP:RB1 <PtrsTpNumRB1>
[:SOURce<hw>]:BB:NR5G:UBWP:USER<us>:CELL<cc>:UL:BWP<bwp>:PUSCh:
  DMTA:PTRS:TP:RB2 <PtrsTpNumRB2>
[:SOURce<hw>]:BB:NR5G:UBWP:USER<us>:CELL<cc>:UL:BWP<bwp>:PUSCh:
  DMTA:PTRS:TP:RB3 <PtrsTpNumRB3>
[:SOURce<hw>]:BB:NR5G:UBWP:USER<us>:CELL<cc>:UL:BWP<bwp>:PUSCh:
  DMTA:PTRS:TP:RB4 <PtrsTpNumRB4>
[:SOURce<hw>]:BB:NR5G:UBWP:USER<us>:CELL<cc>:UL:BWP<bwp>:PUSCh:
  DMTB:PTRS:TP:RB0 <PtrsTpNumRB0>
```

```
[:SOURce<hw>]:BB:NR5G:UBWP:USER<us>:CELL<cc>:UL:BWP<bwp>:PUSCh:
  DMTB:PTRS:TP:RB1 <PtrsTpNumRB0>
[:SOURce<hw>]:BB:NR5G:UBWP:USER<us>:CELL<cc>:UL:BWP<bwp>:PUSCh:
  DMTB:PTRS:TP:RB2 <PtrsTpNumRB2>
[:SOURce<hw>]:BB:NR5G:UBWP:USER<us>:CELL<cc>:UL:BWP<bwp>:PUSCh:
  DMTB:PTRS:TP:RB3 <PtrsTpNumRB3>
[:SOURce<hw>]:BB:NR5G:UBWP:USER<us>:CELL<cc>:UL:BWP<bwp>:PUSCh:
  DMTB:PTRS:TP:RB4 <PtrsTpNumRB4>
```

Sets the corresponding parameter `sampleDensity`.

Parameters:

```
<PtrsTpNumRB4> integer
Range: 1 to 276
*RST: RB0 = 1/RB4 = 276
```

Example: See [Example"Configuring the PUSCH PTRS with enabled transform precoding"](#) on page 404.

Manual operation: See "[N_RB_x](#)" on page 179

```
[:SOURce<hw>]:BB:NR5G:UBWP:USER<us>:CELL<cc>:UL:BWP<bwp>:PUSCh:
  U2TPc <State>
```

Turns the "2nd TPC Command for Scheduled PUSCH" DCI field on and off.

Parameters:

```
<State> 1 | ON | 0 | OFF
*RST: 0
```

Manual operation: See "[Use 2nd TPC Command](#)" on page 172

```
[:SOURce<hw>]:BB:NR5G:UBWP:USER<us>:CELL<cc>:UL:BWP<bwp>:PUSCh:
  XOverhead <XOverhead>
```

Selects the value for the "xOverhead" parameter.

Parameters:

```
<XOverhead> N0 | N6 | N12 | N18
*RST: N0
```

Example: See: [Example"Configuring the PUSCH settings"](#) on page 402

Manual operation: See "[xOverhead](#)" on page 167

```
[:SOURce<hw>]:BB:NR5G:UBWP:USER<us>:CELL<cc>:UL:BWP<bwp>:PDSCh:
  TDANum <Allocations>
```

Sets the number of time domain allocations used to calculate the bitwidth of the [Time Domain Resource Assignment](#) for the UL DCI format 0_1 as specified in [TS 38.214](#).

Parameters:

<Allocations> integer
 Range: 0 to 16
 *RST: 0

Example:

SOURce1:BB:NR5G:UBWP:USER0:CELL0:UL:BWP0:PDsch:TDANum 2

Manual operation: See "[Time Domain Allocations DCI0_1](#)" on page 180

**[:SOURce<hw>]:BB:NR5G:UBWP:USER<us>:CELL<cc>:UL:BWP<bwp>:PDsch:
 DC02:TDANum <Allocations>**

Sets the number of time domain allocations used to calculate the bitwidth of the [Time Domain Resource Assignment](#) for the UL DCI format 0_2 as specified in [TS 38.214](#).

Parameters:

<Allocations> integer
 Range: 0 to 64
 *RST: 0

Manual operation: See "[Time Domain Allocations DCI0_2](#)" on page 180

**[:SOURce<hw>]:BB:NR5G:UBWP:USER<us>:CELL<cc>:UL:BWP<bwp>:PDsch:
 MULTi:TDANum <Value>**

Configures the higher layer parameter
 pusch-TimeDomainAllocationListForMultiPUSCH.

Parameters:

<Value> integer
 Range: 0 to 64
 *RST: 0

Manual operation: See "[Time Domain Allocations Multi-PUSCH](#)" on page 180

**[:SOURce<hw>]:BB:NR5G:UBWP:USER<us>:CELL<cc>:UL:BWP<bwp>:PDsch:
 MULTi:PLEN <Value>**

Parameters:

<Value> integer
 Range: 1 to 8
 *RST: 1

Manual operation: See "[Multi-PUSCH Length](#)" on page 180

10.19.11 PUSCH UCI commands

[:SOURce<hw>]:BB:NR5G:UBWP:USER<us>:CELL<cc>:UL:BWP<bwp>:UCI:STATe.....	574
[:SOURce<hw>]:BB:NR5G:UBWP:USER<us>:CELL<cc>:UL:BWP<bwp>:UCI:MODE.....	574
[:SOURce<hw>]:BB:NR5G:UBWP:USER<us>:CELL<cc>:UL:BWP<bwp>:UCI:ALPHA.....	575
[:SOURce<hw>]:BB:NR5G:UBWP:USER<us>:CELL<cc>:UL:BWP<bwp>:UCI:HARQ: OFF0.....	575
[:SOURce<hw>]:BB:NR5G:UBWP:USER<us>:CELL<cc>:UL:BWP<bwp>:UCI:HARQ: OFF1.....	575
[:SOURce<hw>]:BB:NR5G:UBWP:USER<us>:CELL<cc>:UL:BWP<bwp>:UCI:HARQ: OFF2.....	575
[:SOURce<hw>]:BB:NR5G:UBWP:USER<us>:CELL<cc>:UL:BWP<bwp>:UCI:CGUCi: OFFSet.....	575
[:SOURce<hw>]:BB:NR5G:UBWP:USER<us>:CELL<cc>:UL:BWP<bwp>:UCI:CGUCi: STATe.....	575
[:SOURce<hw>]:BB:NR5G:UBWP:USER<us>:CELL<cc>:UL:BWP<bwp>:UCI:CSI:OF10.....	576
[:SOURce<hw>]:BB:NR5G:UBWP:USER<us>:CELL<cc>:UL:BWP<bwp>:UCI:CSI:OF11.....	576
[:SOURce<hw>]:BB:NR5G:UBWP:USER<us>:CELL<cc>:UL:BWP<bwp>:UCI:CSI:OF20.....	576
[:SOURce<hw>]:BB:NR5G:UBWP:USER<us>:CELL<cc>:UL:BWP<bwp>:UCI:CSI:OF21.....	576

**[:SOURce<hw>]:BB:NR5G:UBWP:USER<us>:CELL<cc>:UL:BWP<bwp>:UCI:
STATe <UCIState>**

Enables the transmission and the configuration of the uplink control information (UCI).

Parameters:

<UCIState> 1 | ON | 0 | OFF
 *RST: 0

Example: See [Example"Configuring the PUSCH settings"](#) on page 402.

Manual operation: See ["State"](#) on page 181

**[:SOURce<hw>]:BB:NR5G:UBWP:USER<us>:CELL<cc>:UL:BWP<bwp>:UCI:
MODE <PuschUciMode>**

Defines the information transmitted on the PUSCH.

Parameters:

<PuschUciMode> UCLSch | UCInly

UCLSch

Control information and data are multiplexed into the PUSCH.

UCInly

Only uplink control information is transmitted on PUSCH.

*RST: UCLSch

Example: See [Example"Configuring the PUSCH settings"](#) on page 402.

Manual operation: See ["Mode"](#) on page 181

```
[:SOURce<hw>]:BB:NR5G:UBWP:USER<us>:CELL<cc>:UL:BWP<bwp>:UCI:
  ALPHa <PuschUciAlpha>
```

Sets the scaling parameter alpha.

Parameters:

```
<PuschUciAlpha>  A0_5 | A0_65 | A0_8 | A1_0
                  *RST:      A05
```

Example: See [Example"Configuring the PUSCH settings"](#) on page 402.

Manual operation: See ["Scaling Alpha"](#) on page 182

```
[:SOURce<hw>]:BB:NR5G:UBWP:USER<us>:CELL<cc>:UL:BWP<bwp>:UCI:
  HARQ:OFF0 <PuschUciHArqOff>
```

```
[:SOURce<hw>]:BB:NR5G:UBWP:USER<us>:CELL<cc>:UL:BWP<bwp>:UCI:
  HARQ:OFF1 <PuschUciHarqOf1>
```

```
[:SOURce<hw>]:BB:NR5G:UBWP:USER<us>:CELL<cc>:UL:BWP<bwp>:UCI:
  HARQ:OFF2 <PuschUciHarq2Of>
```

Sets the HARQ information offsets `OFF0` | `OFF1` | `OFF2`, each used for the multiplexing of defined number of HARQ-ACK information bits.

Parameters:

```
<PuschUciHarq2Of> integer
                  Range:    0 to 15
                  *RST:    0
```

Example: See [Example"Configuring the PUSCH settings"](#) on page 402.

Manual operation: See ["I_HARQ_Offset,x"](#) on page 182

```
[:SOURce<hw>]:BB:NR5G:UBWP:USER<us>:CELL<cc>:UL:BWP<bwp>:UCI:
  CGUCi:OFFSet <Offset>
```

Defines an offset for the CG-UCI.

Parameters:

```
<Offset>          integer
                  Range:    0 to 15
                  *RST:    0
```

Example: See [Example"Configuring the PUSCH settings"](#) on page 402.

Manual operation: See ["I_CG-UCI_Offset"](#) on page 182

```
[:SOURce<hw>]:BB:NR5G:UBWP:USER<us>:CELL<cc>:UL:BWP<bwp>:UCI:
  CGUCi:STATe <State>
```

Turns transmission of the configured grant UCI (CG-UCI) on and off.

Parameters:

<State> 1 | ON | 0 | OFF
 *RST: 0

Example: See [Example"Configuring the PUSCH settings"](#) on page 402.

Manual operation: See ["Use CG-UCI"](#) on page 182

[:SOURce<hw>]:BB:NR5G:UBWP:USER<us>:CELL<cc>:UL:BWP<bwp>:UCI:CSI:OF10 <PuschUciCsiOf10>

[:SOURce<hw>]:BB:NR5G:UBWP:USER<us>:CELL<cc>:UL:BWP<bwp>:UCI:CSI:OF11 <PuschUciCsiOf11>

[:SOURce<hw>]:BB:NR5G:UBWP:USER<us>:CELL<cc>:UL:BWP<bwp>:UCI:CSI:OF20 <PuschUciCsiOf20>

[:SOURce<hw>]:BB:NR5G:UBWP:USER<us>:CELL<cc>:UL:BWP<bwp>:UCI:CSI:OF21 <PuschUciCsiOf21>

Sets the CSI part 1 (OF10|OF11) and CSI part 2 (OF20|OF21) information offsets, where the OF10|OF20 are used if up to 11 CSI bits are multiplexed and OF11|OF21 otherwise.

Parameters:

<PuschUciCsiOf21> integer
 Range: 0 to 18
 *RST: 0

Example: See [Example"Configuring the PUSCH settings"](#) on page 402.

Manual operation: See ["I_CSI1_Offset,x, I_CSI2_Offset,x"](#) on page 183

10.19.12 SRS commands

[:SOURce<hw>]:BB:NR5G:UBWP:USER<us>:CELL<cc>:UL:BWP<bwp>:SRS:STATe.....	577
[:SOURce<hw>]:BB:NR5G:UBWP:USER<us>:CELL<cc>:UL:BWP<bwp>:SRS:RS:NRSets..	578
[:SOURce<hw>]:BB:NR5G:UBWP:USER<us>:CELL<cc>:UL:BWP<bwp>:SRS:CONFig.....	578
[:SOURce<hw>]:BB:NR5G:UBWP:USER<us>:CELL<cc>:UL:BWP<bwp>:SRS:RE02.....	578
[:SOURce<hw>]:BB:NR5G:UBWP:USER<us>:CELL<cc>:UL:BWP<bwp>:SRS:REQuest.....	579
[:SOURce<hw>]:BB:NR5G:UBWP:USER<us>:CELL<cc>:UL:BWP<bwp>:SRS:RS: SET<gr0>:RES<user0>:FS:FSFactor.....	579
[:SOURce<hw>]:BB:NR5G:UBWP:USER<us>:CELL<cc>:UL:BWP<bwp>:SRS:RS: SET<gr0>:RES<user0>:FS:SRIDx.....	579
[:SOURce<hw>]:BB:NR5G:UBWP:USER<us>:CELL<cc>:UL:BWP<bwp>:SRS:RS: SET<gr0>:RSType.....	580
[:SOURce<hw>]:BB:NR5G:UBWP:USER<us>:CELL<cc>:UL:BWP<bwp>:SRS:RS: SET<gr0>:USAGe.....	580
[:SOURce<hw>]:BB:NR5G:UBWP:USER<us>:CELL<cc>:UL:BWP<bwp>:SRS:RS: SET<gr0>:NRESources.....	580
[:SOURce<hw>]:BB:NR5G:UBWP:USER<us>:CELL<cc>:UL:BWP<bwp>:SRS:RS: SET<gr0>:RES<user0>:PER.....	581

BWP configuration commands

[:SOURce<hw>]:BB:NR5G:UBWP:USER<us>:CELL<cc>:UL:BWP<bwp>:SRS:RS: SET<gr0>:RES<user0>:OFFSet.....	581
[:SOURce<hw>]:BB:NR5G:UBWP:USER<us>:CELL<cc>:UL:BWP<bwp>:SRS:RS: SET<gr0>:RES<user0>:SPOS.....	581
[:SOURce<hw>]:BB:NR5G:UBWP:USER<us>:CELL<cc>:UL:BWP<bwp>:SRS:RS: SET<gr0>:RES<user0>:SYMNumber.....	581
[:SOURce<hw>]:BB:NR5G:UBWP:USER<us>:CELL<cc>:UL:BWP<bwp>:SRS:RS: SET<gr0>:RES<user0>:FPOS.....	582
[:SOURce<hw>]:BB:NR5G:UBWP:USER<us>:CELL<cc>:UL:BWP<bwp>:SRS:RS: SET<gr0>:RES<user0>:FQSHift.....	582
[:SOURce<hw>]:BB:NR5G:UBWP:USER<us>:CELL<cc>:UL:BWP<bwp>:SRS:RS: SET<gr0>:RES<user0>:BSRS.....	582
[:SOURce<hw>]:BB:NR5G:UBWP:USER<us>:CELL<cc>:UL:BWP<bwp>:SRS:RS: SET<gr0>:RES<user0>:CSRS.....	583
[:SOURce<hw>]:BB:NR5G:UBWP:USER<us>:CELL<cc>:UL:BWP<bwp>:SRS:RS: SET<gr0>:RES<user0>:BHOP.....	583
[:SOURce<hw>]:BB:NR5G:UBWP:USER<us>:CELL<cc>:UL:BWP<bwp>:SRS:RS: SET<gr0>:RES<user0>:REFactor.....	583
[:SOURce<hw>]:BB:NR5G:UBWP:USER<us>:CELL<cc>:UL:BWP<bwp>:SRS:RS: SET<gr0>:RES<user0>:TRTComb.....	583
[:SOURce<hw>]:BB:NR5G:UBWP:USER<us>:CELL<cc>:UL:BWP<bwp>:SRS:RS: SET<gr0>:RES<user0>:COFFset.....	584
[:SOURce<hw>]:BB:NR5G:UBWP:USER<us>:CELL<cc>:UL:BWP<bwp>:SRS:RS: SET<gr0>:RES<user0>:SEQ:CYCShift.....	584
[:SOURce<hw>]:BB:NR5G:UBWP:USER<us>:CELL<cc>:UL:BWP<bwp>:SRS:RS: SET<gr0>:RES<user0>:SEQ:ID.....	584
[:SOURce<hw>]:BB:NR5G:UBWP:USER<us>:CELL<cc>:UL:BWP<bwp>:SRS:RS: SET<gr0>:RES<user0>:SEQ:HOPPing.....	585
[:SOURce<hw>]:BB:NR5G:UBWP:USER<us>:CELL<cc>:UL:BWP<bwp>:SRS:RS: SET<gr0>:RES<user0>:NAPort.....	585
[:SOURce<hw>]:BB:NR5G:UBWP:USER<us>:CELL<cc>:UL:BWP<bwp>:SRS:RS: SET<gr0>:RES<user0>:POWer.....	585
[:SOURce<hw>]:BB:NR5G:UBWP:USER<us>:CELL<cc>:UL:BWP<bwp>:SRS:RS: SET<gr0>:RES<user0>:PTRS.....	586
[:SOURce<hw>]:BB:NR5G:UBWP:USER<us>:CELL<cc>:UL:BWP<bwp>:SRS:RS: SET<gr0>:RES<user0>:APMap:AP<ap>:ROW<apr>:REAL.....	586
[:SOURce<hw>]:BB:NR5G:UBWP:USER<us>:CELL<cc>:UL:BWP<bwp>:SRS:RS: SET<gr0>:RES<user0>:APMap:AP<ap>:ROW<apr>:IMAGinary.....	586
[:SOURce<hw>]:BB:NR5G:UBWP:USER<us>:CELL<cc>:UL:BWP<bwp>:SRS:RS: SET<gr0>:RES<user0>:APMap:AP<ap>:ROW<apr>:MAGNitude.....	587
[:SOURce<hw>]:BB:NR5G:UBWP:USER<us>:CELL<cc>:UL:BWP<bwp>:SRS:RS: SET<gr0>:RES<user0>:APMap:AP<ap>:ROW<apr>:PHASe.....	587

**[:SOURce<hw>]:BB:NR5G:UBWP:USER<us>:CELL<cc>:UL:BWP<bwp>:SRS:
STATE <SrsState>**

Enables the SRS transmission.

Parameters:

<SrsState> 1 | ON | 0 | OFF
 *RST: 0

Example: See [Example"Configuring one SRS resource set"](#) on page 397.

Manual operation: See ["State"](#) on page 185

**[:SOURce<hw>]:BB:NR5G:UBWP:USER<us>:CELL<cc>:UL:BWP<bwp>:SRS:RS:
 NRsets <SrsResourceSets>**

Sets the number of SRS sets.

Parameters:

<SrsResourceSets> integers
 Range: 0 to 15
 *RST: 0

Example: See [Example"Configuring one SRS resource set"](#) on page 397.

Manual operation: See ["Resource Sets"](#) on page 185

**[:SOURce<hw>]:BB:NR5G:UBWP:USER<us>:CELL<cc>:UL:BWP<bwp>:SRS:
 CONFIG <SrsConfig>**

Selects the 3GPP release the SRS is based on.

Parameters:

<SrsConfig> **IE**
 Standard SRS configuration.
IER16
 Release 16 SRS configuration, including positioning functionality.
IENPR16
 Release 16 SRS configuration, without positioning functionality.
IER17
 Release 17 SRS configuration.
 *RST: IE

Manual operation: See ["Configured By"](#) on page 185

**[:SOURce<hw>]:BB:NR5G:UBWP:USER<us>:CELL<cc>:UL:BWP<bwp>:SRS:
 RE02 <BitLength>**

Configures the higher layer parameter `srs-RequestDCI0-2` available for DCI format 0_2.

Parameters:

<BitLength> RNON | R1 | R2
RNON
 Not configured.

R1|R2

Number of bits for "SRS Request" DCI field.

*RST: RNON

Manual operation: See ["Request DCI0_2"](#) on page 186

**[:SOURce<hw>]:BB:NR5G:UBWP:USER<us>:CELL<cc>:UL:BWP<bwp>:SRS:
REQuest <BitLength>**

Configures the higher layer parameter `srs-RequestDCI1-2` available for DCI format 0_2.

Parameters:

<BitLength> RNON | R1 | R2

RNON

Not configured.

R1|R2

Number of bits for "SRS Request" DCI field.

*RST: RNON

Manual operation: See ["Request DCI1_2"](#) on page 186

**[:SOURce<hw>]:BB:NR5G:UBWP:USER<us>:CELL<cc>:UL:BWP<bwp>:SRS:RS:
SET<gr0>:RES<user0>:FS:FSFactor <Value>**

Selects the frequency scaling factor for the SRS defined in 3GPP 38.211, chapter 6.4.1.4.3.

Parameters:

<Value> PF1 | PF2 | PF4

*RST: PF1

Manual operation: See ["Frequency Scaling Factor"](#) on page 190

**[:SOURce<hw>]:BB:NR5G:UBWP:USER<us>:CELL<cc>:UL:BWP<bwp>:SRS:RS:
SET<gr0>:RES<user0>:FS:SRIDx <Value>**

Defines the start RB index defined in 3GPP 38.331.

Parameters:

<Value> integer

Range: 0 to Depends on frequency scaling fator

*RST: 0

Manual operation: See ["Start RB Index"](#) on page 190

```
[:SOURce<hw>]:BB:NR5G:UBWP:USER<us>:CELL<cc>:UL:BWP<bwp>:SRS:RS:
SET<gr0>:RSType <Mode>
```

Sets the SRS transmission type.

Parameters:

<Mode>

APER
not supported

PER
Periodic transmission of the SRS.

SP
not supported

*RST: PER

Example: See [Example"Configuring one SRS resource set"](#) on page 397.

Manual operation: See ["Resource Type"](#) on page 187

```
[:SOURce<hw>]:BB:NR5G:UBWP:USER<us>:CELL<cc>:UL:BWP<bwp>:SRS:RS:
SET<gr0>:USAGe <SrsRsSetUsage>
```

Queries the type of the SRS transmission.

Parameters:

<SrsRsSetUsage> ASW | BM | CB | NCB

NCB = non-codebook based
CB = codebook
BM = beam management (reserved for futute use)
ASW = antenna switching (reserved for futute use)

*RST: NCB

Example: See [Example"Configuring one SRS resource set"](#) on page 397.

Manual operation: See ["Usage"](#) on page 187

```
[:SOURce<hw>]:BB:NR5G:UBWP:USER<us>:CELL<cc>:UL:BWP<bwp>:SRS:RS:
SET<gr0>:NRESources <SrsResPerSet>
```

Sets the number of SRS resources in the SRS resource set.

Parameters:

<SrsResPerSet> integer

Range: 0 to 63

*RST: 1

Example: See [Example"Configuring one SRS resource set"](#) on page 397.

Manual operation: See ["Resources"](#) on page 187

```
[ :SOURce<hw>]:BB:NR5G:UBWP:USER<us>:CELL<cc>:UL:BWP<bwp>:SRS:RS:
SET<gr0>:RES<user0>:PER <SrsRsPeriodicit>
```

Sets the SRS repetition factor.

Parameters:

```
<SrsRsPeriodicit>  SL1 | SL2 | SL4 | SL5 | SL8 | SL10 | SL16 | SL20 | SL32 | SL40 |
                    SL64 | SL80 | SL160 | SL320 | SL640 | SL1280 | SL2560 |
                    SL81920 | SL40960 | SL10240 | SL5120
                    *RST:      SL1
```

Example: See [Example"Configuring one SRS resource set"](#) on page 397.

Manual operation: See ["Periodicity"](#) on page 188
See ["Periodicity"](#) on page 284

```
[ :SOURce<hw>]:BB:NR5G:UBWP:USER<us>:CELL<cc>:UL:BWP<bwp>:SRS:RS:
SET<gr0>:RES<user0>:OFFSet <SrsRsOffset>
```

Sets time position of first SRS allocation within an SRS periodicity.

Parameters:

```
<SrsRsOffset>      integer
                    Range:      0 to 81919
                    *RST:      0
```

Example: See [Example"Configuring one SRS resource set"](#) on page 397.

Manual operation: See ["Offset"](#) on page 188

```
[ :SOURce<hw>]:BB:NR5G:UBWP:USER<us>:CELL<cc>:UL:BWP<bwp>:SRS:RS:
SET<gr0>:RES<user0>:SPOS <SrsRsSPosition>
```

Sets the starting position (the OFDM symbol number) of the SRS allocation within a slot.

Parameters:

```
<SrsRsSPosition>  integer
                    Range:      0 to 13
                    *RST:      0
```

Example: See [Example"Configuring one SRS resource set"](#) on page 397.

Manual operation: See ["Start Pos."](#) on page 188

```
[ :SOURce<hw>]:BB:NR5G:UBWP:USER<us>:CELL<cc>:UL:BWP<bwp>:SRS:RS:
SET<gr0>:RES<user0>:SYMNumber <SrsRsNumSymb>
```

Sets the number of consecutive OFDM symbols the SRS resource spans.

Parameters:

<SrsRsNumSymb> SYM1 | SYM2 | SYM4 | SYM12 | SYM8 | SYM10 | SYM14
 *RST: SYM1

Example: See [Example"Configuring one SRS resource set"](#) on page 397.

Manual operation: See ["No. Sym."](#) on page 188

**[:SOURce<hw>]:BB:NR5G:UBWP:USER<us>:CELL<cc>:UL:BWP<bwp>:SRS:RS:
 SET<gr0>:RES<user0>:FPOS <SrsRsFPosition>**

Sets the starting position of the SRS allocation in the frequency domain.

Parameters:

<SrsRsFPosition> integer
 Range: 0 to 67
 *RST: 0

Example: See [Example"Configuring one SRS resource set"](#) on page 397.

Manual operation: See ["Freq. Pos."](#) on page 188

**[:SOURce<hw>]:BB:NR5G:UBWP:USER<us>:CELL<cc>:UL:BWP<bwp>:SRS:RS:
 SET<gr0>:RES<user0>:FQSHift <SrsRsFreqShift>**

Sets the frequency shift.

Parameters:

<SrsRsFreqShift> integert
 Range: 0 to 268
 *RST: 0

Example: See [Example"Configuring one SRS resource set"](#) on page 397.

Manual operation: See ["Freq. Shift"](#) on page 188

**[:SOURce<hw>]:BB:NR5G:UBWP:USER<us>:CELL<cc>:UL:BWP<bwp>:SRS:RS:
 SET<gr0>:RES<user0>:BSRS <SrsRsBSrs>**

Sets the parameter b-SRS needed to define the length of the SRS sequence.

Parameters:

<SrsRsBSrs> integer
 Range: 0 to 3
 *RST: 0

Example: See [Example"Configuring one SRS resource set"](#) on page 397.

Manual operation: See ["B SRS"](#) on page 189

```
[ :SOURce<hw>]:BB:NR5G:UBWP:USER<us>:CELL<cc>:UL:BWP<bwp>:SRS:RS:
SET<gr0>:RES<user0>:CSRS <SrsRsCSrs>
```

Sets the parameter c-SRS to define the length of the SRS sequence.

Parameters:

```
<SrsRsCSrs>      integer
                  Range:    0 to 63
                  *RST:     0
```

Example: See [Example"Configuring one SRS resource set"](#) on page 397.

Manual operation: See ["C SRS"](#) on page 189

```
[ :SOURce<hw>]:BB:NR5G:UBWP:USER<us>:CELL<cc>:UL:BWP<bwp>:SRS:RS:
SET<gr0>:RES<user0>:BHOP <SrsRsBHop>
```

Sets the parameter b_{Hop} that defines the frequency hopping of the SRS.

Parameters:

```
<SrsRsBHop>      integer
                  Range:    0 to 3
                  *RST:     0
```

Example: See [Example"Configuring one SRS resource set"](#) on page 397.

Manual operation: See ["B Hop"](#) on page 189

```
[ :SOURce<hw>]:BB:NR5G:UBWP:USER<us>:CELL<cc>:UL:BWP<bwp>:SRS:RS:
SET<gr0>:RES<user0>:REFactor <SrsRsRepFactor>
```

Sets how many times the SRS symbols are repeated.

Parameters:

```
<SrsRsRepFactor> REP1 | REP2 | REP4 | REP5 | REP6 | REP7 | REP8 | REP10 |
                  REP12 | REP14
                  *RST:     REP1
```

Example: See [Example"Configuring one SRS resource set"](#) on page 397.

Manual operation: See ["Rep. Factor"](#) on page 189

```
[ :SOURce<hw>]:BB:NR5G:UBWP:USER<us>:CELL<cc>:UL:BWP<bwp>:SRS:RS:
SET<gr0>:RES<user0>:TRTCComb <SrsRsTransCombo>
```

Sets the transmission comb (k_{TC}).

Parameters:

```
<SrsRsTransCombo> TC2 | TC4 | TC8
                  *RST:     TC2
```

Example: See [Example"Configuring one SRS resource set"](#) on page 397.

Manual operation: See ["Trans. Comb"](#) on page 189

**[:SOURCE<hw>]:BB:NR5G:UBWP:USER<us>:CELL<cc>:UL:BWP<bwp>:SRS:RS:
SET<gr0>:RES<user0>:COFFset <SrsRsCombOffset>**

Sets the parameter transmission comb offset.

Parameters:

<SrsRsCombOffset> integer
 Range: 0 to 7
 *RST: 0

Example: See [Example"Configuring one SRS resource set"](#) on page 397.

Manual operation: See ["Comb Offset"](#) on page 189

**[:SOURCE<hw>]:BB:NR5G:UBWP:USER<us>:CELL<cc>:UL:BWP<bwp>:SRS:RS:
SET<gr0>:RES<user0>:SEQ:CYCShift <SrsRsCyclicShif>**

Sets the number of cyclic shifts, required for the SRS sequence generation.

Parameters:

<SrsRsCyclicShif> float
 Range: 0 to 11
 *RST: 0

Example: See [Example"Configuring one SRS resource set"](#) on page 397.

Manual operation: See ["Cyclic Shift"](#) on page 190

**[:SOURCE<hw>]:BB:NR5G:UBWP:USER<us>:CELL<cc>:UL:BWP<bwp>:SRS:RS:
SET<gr0>:RES<user0>:SEQ:ID <SrsRsSequld>**

Sets the higher-layer parameter sequence ID required for the SRS sequence generation.

Parameters:

<SrsRsSequld> integer
 Range: 0 to 65535
 *RST: 0

Example: See [Example"Configuring one SRS resource set"](#) on page 397.

Manual operation: See ["Sequence ID"](#) on page 190

```
[:SOURce<hw>]:BB:NR5G:UBWP:USER<us>:CELL<cc>:UL:BWP<bwp>:SRS:RS:
  SET<gr0>:RES<user0>:SEQ:HOPping <SrsRsHopping>
```

Sets the higher-layer parameter `groupOrSequenceHopping` that defines the sequence group, required for the SRS sequence generation.

Parameters:

```
<SrsRsHopping>      N | GRP | SEQ
                    N
                    Neither
                    GRP
                    Group hopping (reserved for future use)
                    SEQ
                    Sequence hopping (reserved for future use)
                    *RST:      N
```

Example: See [Example"Configuring one SRS resource set"](#) on page 397.

Manual operation: See ["Group or Sequence Hopping"](#) on page 190

```
[:SOURce<hw>]:BB:NR5G:UBWP:USER<us>:CELL<cc>:UL:BWP<bwp>:SRS:RS:
  SET<gr0>:RES<user0>:NAPort <SrsNumAp>
```

Sets how many antenna ports (AP) are used for every SRS transmission.

Parameters:

```
<SrsNumAp>          AP1 | AP2 | AP4
                    *RST:      AP1
```

Example: See [Example"Configuring one SRS resource set"](#) on page 397.

Manual operation: See ["No. Ports"](#) on page 191

```
[:SOURce<hw>]:BB:NR5G:UBWP:USER<us>:CELL<cc>:UL:BWP<bwp>:SRS:RS:
  SET<gr0>:RES<user0>:POWER <SrsRsPower>
```

Sets the SRS power.

Parameters:

```
<SrsRsPower>        float
                    Range:      -80 to 10
                    Increment:  0.01
                    *RST:      0
```

Example: See [Example"Configuring one SRS resource set"](#) on page 397.

Manual operation: See ["Power"](#) on page 191

```
[:SOURce<hw>]:BB:NR5G:UBWP:USER<us>:CELL<cc>:UL:BWP<bwp>:SRS:RS:
SET<gr0>:RES<user0>:PTRS <SrsPtrsPortIdx>
```

Sets the PTRS antenna port index.

Parameters:

<SrsPtrsPortIdx> P1 | P0
 *RST: P0

Example: See [Example "Configuring one SRS resource set"](#) on page 397.

Manual operation: See ["PTRS Port Idx"](#) on page 191

```
[:SOURce<hw>]:BB:NR5G:UBWP:USER<us>:CELL<cc>:UL:BWP<bwp>:SRS:RS:
SET<gr0>:RES<user0>:APMap:AP<ap>:ROW<apr>:REAL
<SrAPMapDataReal>
```

Define the mapping of the antenna ports to the physical antennas.

Suffix:

<s2us0> 1000 to 1003
 Defines the antenna port
 Value range depends on the selected number of antenna ports
 as follows
 $\langle s2us0 \rangle = 1000 + \{0 \text{ to } N_{APort} - 1\}$

Parameters:

<SrAPMapDataReal> float

The REAL (magnitude) and IMAGinary (phase) values are interdependent. Their value ranges change depending on each other and so that the resulting complex value is as follows:

$$|\text{REAL} + j \cdot \text{IMAGinary}| \leq 1$$

Otherwise, the values are normalized to magnitude = 1.

Range: -1 to 1

Increment: 0.001

*RST: 0

Example: See [Example "Configuring one SRS resource set"](#) on page 397.

Manual operation: See ["Mapping table"](#) on page 192
 See ["Mapping table"](#) on page 272
 See ["Mapping table"](#) on page 287

```
[:SOURce<hw>]:BB:NR5G:UBWP:USER<us>:CELL<cc>:UL:BWP<bwp>:SRS:RS:
SET<gr0>:RES<user0>:APMap:AP<ap>:ROW<apr>:IMAGinary
<SrsAPMapDataIma>
```

Define the mapping of the antenna ports to the physical antennas.

Suffix:

<s2us0>

1000 to 1003

Defines the antenna port

Value range depends on the selected number of antenna ports as follows

 $\langle s2us0 \rangle = 1000 + \{0 \text{ to } N_{APort} - 1\}$ **Parameters:**

<SrsAPMapDataIma> float

The REAL (magnitude) and IMAGinary (phase) values are interdependent. Their value ranges change depending on each other and so that the resulting complex value is as follows:

 $|\text{REAL} + j \cdot \text{IMAGinary}| \leq 1$

Otherwise, the values are normalized to magnitude = 1.

Range: -1 to 1

Increment: 0.001

*RST: 0

Example:See [Example "Configuring one SRS resource set"](#) on page 397.**Manual operation:**See ["Mapping table"](#) on page 192See ["Mapping table"](#) on page 272See ["Mapping table"](#) on page 287

```
[:SOURce<hw>]:BB:NR5G:UBWP:USER<us>:CELL<cc>:UL:BWP<bwp>:SRS:RS:
SET<gr0>:RES<user0>:APMap:AP<ap>:ROW<apr>:MAGNitude
<SrsAPMapDataMag>
```

Defines the mapping of the antenna ports to the physical antennas, cylindrical mapping coordinates are used.

Parameters:

<SrsAPMapDataMag>float

Range: 0 to 1

Increment: 0.001

*RST: 0

Example:See [Example "Configuring one SRS resource set"](#) on page 397.**Manual operation:**See ["Mapping table"](#) on page 192See ["Mapping table"](#) on page 272See ["Mapping table"](#) on page 287

```
[:SOURce<hw>]:BB:NR5G:UBWP:USER<us>:CELL<cc>:UL:BWP<bwp>:SRS:RS:
SET<gr0>:RES<user0>:APMap:AP<ap>:ROW<apr>:PHASe
<SrsAPMapDataPha>
```

Defines the mapping of the antenna ports to the physical antennas, if cylindrical mapping coordinates are used.

Parameters:

<SrsAPMapDataPha>float

Range: 0 to 360

Increment: 0.1

*RST: 0

Example:See [Example"Configuring one SRS resource set"](#) on page 397.**Manual operation:**See ["Mapping table"](#) on page 192See ["Mapping table"](#) on page 272See ["Mapping table"](#) on page 287**10.19.13 Bandwidth part configuration for sidelink commands**

[:SOURce<hw>]:BB:NR5G:UBWP:USER<us>:CELL<cc>:SL:BWP<bwp>:RESPool: NRESpool.....	589
[:SOURce<hw>]:BB:NR5G:UBWP:USER<us>:CELL<cc>:SL:BWP<bwp>:RESPool: RES<gr0>:AMCS.....	589
[:SOURce<hw>]:BB:NR5G:UBWP:USER<us>:CELL<cc>:SL:BWP<bwp>:RESPool: RES<gr0>:BOF1.....	589
[:SOURce<hw>]:BB:NR5G:UBWP:USER<us>:CELL<cc>:SL:BWP<bwp>:RESPool: RES<gr0>:BOF2.....	589
[:SOURce<hw>]:BB:NR5G:UBWP:USER<us>:CELL<cc>:SL:BWP<bwp>:RESPool: RES<gr0>:BOF3.....	589
[:SOURce<hw>]:BB:NR5G:UBWP:USER<us>:CELL<cc>:SL:BWP<bwp>:RESPool: RES<gr0>:BOF4.....	589
[:SOURce<hw>]:BB:NR5G:UBWP:USER<us>:CELL<cc>:SL:BWP<bwp>:RESPool: RES<gr0>:INDicator.....	590
[:SOURce<hw>]:BB:NR5G:UBWP:USER<us>:CELL<cc>:SL:BWP<bwp>:RESPool: RES<gr0>:MNPRes.....	590
[:SOURce<hw>]:BB:NR5G:UBWP:USER<us>:CELL<cc>:SL:BWP<bwp>:RESPool: RES<gr0>:MREServe.....	590
[:SOURce<hw>]:BB:NR5G:UBWP:USER<us>:CELL<cc>:SL:BWP<bwp>:RESPool: RES<gr0>:MSCTable.....	590
[:SOURce<hw>]:BB:NR5G:UBWP:USER<us>:CELL<cc>:SL:BWP<bwp>:RESPool: RES<gr0>:NPRB.....	591
[:SOURce<hw>]:BB:NR5G:UBWP:USER<us>:CELL<cc>:SL:BWP<bwp>:RESPool: RES<gr0>:NSUBchannels.....	591
[:SOURce<hw>]:BB:NR5G:UBWP:USER<us>:CELL<cc>:SL:BWP<bwp>:RESPool: RES<gr0>:PAT2.....	591
[:SOURce<hw>]:BB:NR5G:UBWP:USER<us>:CELL<cc>:SL:BWP<bwp>:RESPool: RES<gr0>:PAT3.....	591
[:SOURce<hw>]:BB:NR5G:UBWP:USER<us>:CELL<cc>:SL:BWP<bwp>:RESPool: RES<gr0>:PAT4.....	591
[:SOURce<hw>]:BB:NR5G:UBWP:USER<us>:CELL<cc>:SL:BWP<bwp>:RESPool: RES<gr0>:REPList.....	592
[:SOURce<hw>]:BB:NR5G:UBWP:USER<us>:CELL<cc>:SL:BWP<bwp>:RESPool: RES<gr0>:RESBits.....	592

<code>[:SOURce<hw>]:BB:NR5G:UBWP:USER<us>:CELL<cc>:SL:BWP<bwp>:RESPool:RES<gr0>:SCALing</code>	592
<code>[:SOURce<hw>]:BB:NR5G:UBWP:USER<us>:CELL<cc>:SL:BWP<bwp>:RESPool:RES<gr0>:SCHSize</code>	593
<code>[:SOURce<hw>]:BB:NR5G:UBWP:USER<us>:CELL<cc>:SL:BWP<bwp>:RESPool:RES<gr0>:STRB</code>	593

`[:SOURce<hw>]:BB:NR5G:UBWP:USER<us>:CELL<cc>:SL:BWP<bwp>:RESPool:NRESpool <ResourcePools>`

Defines the number of resource pools in a sidelink bandwidth part.

Parameters:

`<ResourcePools>` integer
 Range: 1 to 8
 *RST: 1

Example: See [Example "Configuring a sidelink signal"](#) on page 412.

Manual operation: See ["Number of Resource Pools"](#) on page 193

`[:SOURce<hw>]:BB:NR5G:UBWP:USER<us>:CELL<cc>:SL:BWP<bwp>:RESPool:RES<gr0>:AMCS <AdditionalMCS>`

Selects the MCS table additionally used by the resource pool.

Parameters:

`<AdditionalMCS>` integer
 Range: 0 to 2
 *RST: 0

Example: See [Example "Configuring a sidelink signal"](#) on page 412.

Manual operation: See ["Additional MCS Table"](#) on page 195

`[:SOURce<hw>]:BB:NR5G:UBWP:USER<us>:CELL<cc>:SL:BWP<bwp>:RESPool:RES<gr0>:BOF1 <Value>`

`[:SOURce<hw>]:BB:NR5G:UBWP:USER<us>:CELL<cc>:SL:BWP<bwp>:RESPool:RES<gr0>:BOF2 <Value>`

`[:SOURce<hw>]:BB:NR5G:UBWP:USER<us>:CELL<cc>:SL:BWP<bwp>:RESPool:RES<gr0>:BOF3 <Value>`

`[:SOURce<hw>]:BB:NR5G:UBWP:USER<us>:CELL<cc>:SL:BWP<bwp>:RESPool:RES<gr0>:BOF4 <Value>`

Defines beta-offset values to determine the number of coded modulation symbols for second stage SCI (SCI2).

Parameters:

`<Value>` integer
 Range: 0 to 31
 *RST: 0

Example: See [Example"Configuring a sidelink signal"](#) on page 412.

Manual operation: See "[betaOffset1 ... 4](#)" on page 197

**[:SOURce<hw>]:BB:NR5G:UBWP:USER<us>:CELL<cc>:SL:BWP<bwp>:
RESPool:RES<gr0>:INDicator <ID>**

Defines an ID for the selected resource pool.

Parameters:

<ID> integer
Range: 0 to 639
*RST: 0

Example: See [Example"Configuring a sidelink signal"](#) on page 412.

Manual operation: See "[ID](#)" on page 194

**[:SOURce<hw>]:BB:NR5G:UBWP:USER<us>:CELL<cc>:SL:BWP<bwp>:
RESPool:RES<gr0>:MNPRes <Resources>**

Defines the maximum number of reserved PSCCH/PSSCH resources that can be indicated by an SCI.

Parameters:

<Resources> integer
Range: 2 to 3
*RST: 2

Example: See [Example"Configuring a sidelink signal"](#) on page 412.

Manual operation: See "[Max Number per Reserve](#)" on page 195

**[:SOURce<hw>]:BB:NR5G:UBWP:USER<us>:CELL<cc>:SL:BWP<bwp>:
RESPool:RES<gr0>:MREServe <State>**

Turns the multi reserve resource for a resource pool on and off.

Parameters:

<State> 1 | ON | 0 | OFF
*RST: 1

Example: See [Example"Configuring a sidelink signal"](#) on page 412.

Manual operation: See "[Multi Reserve Resource](#)" on page 195

**[:SOURce<hw>]:BB:NR5G:UBWP:USER<us>:CELL<cc>:SL:BWP<bwp>:
RESPool:RES<gr0>:MSCTable <McsTable>**

Selects the modulation (MCS table) for the resource pool.

Parameters:

<McsTable> QAM64 | QAM256 | QAM64LSE
 *RST: QAM64

Example: See [Example"Configuring a sidelink signal"](#) on page 412.

Manual operation: See ["MCS Table"](#) on page 195

**[:SOURce<hw>]:BB:NR5G:UBWP:USER<us>:CELL<cc>:SL:BWP<bwp>:
 RESPool:RES<gr0>:NPRB <PRBs>**

Defines the number of physical resource blocks a resource pool uses.

Parameters:

<PRBs> integer
 Range: 10 to 273
 *RST: 10

Example: See [Example"Configuring a sidelink signal"](#) on page 412.

Manual operation: See ["Number of PRBs"](#) on page 194

**[:SOURce<hw>]:BB:NR5G:UBWP:USER<us>:CELL<cc>:SL:BWP<bwp>:
 RESPool:RES<gr0>:NSUBchannels <Subchannels>**

Defines the number of subchannels in the resource pool.

Parameters:

<Subchannels> integer
 The available number of subchannels depends on the number of PRBs the resource pool uses ([\[:SOURce<hw>\]:BB:NR5G:UBWP:USER<us>:CELL<cc>:SL:BWP<bwp>:RESPool:RES<gr0>:NPRB](#)) and the size of a subchannel ([\[:SOURce<hw>\]:BB:NR5G:UBWP:USER<us>:CELL<cc>:SL:BWP<bwp>:RESPool:RES<gr0>:SCHSize](#)).

Range: 1 to 27
 *RST: 1

Example: See [Example"Configuring a sidelink signal"](#) on page 412.

Manual operation: See ["Number of Subchannels"](#) on page 194

**[:SOURce<hw>]:BB:NR5G:UBWP:USER<us>:CELL<cc>:SL:BWP<bwp>:
 RESPool:RES<gr0>:PAT2 <State>**
**[:SOURce<hw>]:BB:NR5G:UBWP:USER<us>:CELL<cc>:SL:BWP<bwp>:
 RESPool:RES<gr0>:PAT3 <State>**
**[:SOURce<hw>]:BB:NR5G:UBWP:USER<us>:CELL<cc>:SL:BWP<bwp>:
 RESPool:RES<gr0>:PAT4 <State>**

Turns DMRS time domain patterns in the first stage SCI (SCI1A) on and off.

Parameters:

<State> 1 | ON | 0 | OFF
 *RST: 1

Example: See [Example"Configuring a sidelink signal"](#) on page 412.

Manual operation: See ["DMRS Pattern 2 ... 4"](#) on page 196

**[:SOURce<hw>]:BB:NR5G:UBWP:USER<us>:CELL<cc>:SL:BWP<bwp>:
 RESPool:RES<gr0>:REPList <Period>**

Defines the possible resource reservation period allowed in the resource pool in the unit of ms.

Parameters:

<Period> integer
 Range: 1 to 16
 *RST: 1

Example: See [Example"Configuring a sidelink signal"](#) on page 412.

Manual operation: See ["Reserve Resource Period List"](#) on page 195

**[:SOURce<hw>]:BB:NR5G:UBWP:USER<us>:CELL<cc>:SL:BWP<bwp>:
 RESPool:RES<gr0>:RESBits <Value>**

Defines the number of reserved bits in the first stage SCI pattern (SCI1A).

Parameters:

<Value> integer
 Range: 2 to 4
 *RST: 2

Example: See [Example"Configuring a sidelink signal"](#) on page 412.

Manual operation: See ["Reserved Bits"](#) on page 197

**[:SOURce<hw>]:BB:NR5G:UBWP:USER<us>:CELL<cc>:SL:BWP<bwp>:
 RESPool:RES<gr0>:SCALing <ScalingFactor>**

Selects a scaling factor to limit the number of resource elements assigned to the second stage SCI on PSSCH.

Parameters:

<ScalingFactor> FP5 | FP8 | FP65 | F1
 *RST: FP5

Example: See [Example"Configuring a sidelink signal"](#) on page 412.

Manual operation: See ["Scaling Factor"](#) on page 196

```
[ :SOURce<hw>]:BB:NR5G:UBWP:USER<us>:CELL<cc>:SL:BWP<bwp>:
  RESPool:RES<gr0>:SCHSize <ResourceBlocks>
```

Selects the size of a resource pool in terms of resource blocks.

Parameters:

<ResourceBlocks> R10 | R12 | R15 | R20 | R25 | R50 | R75

The available sizes depend on the number of PRBs the resource pool uses ([:SOURce<hw>] :BB:NR5G:UBWP:USER<us>:CELL<cc>:SL:BWP<bwp>:RESPool:RES<gr0>:NPRB).

*RST: R10

Example: See [Example "Configuring a sidelink signal"](#) on page 412.

Manual operation: See ["Subchannel Size"](#) on page 194

```
[ :SOURce<hw>]:BB:NR5G:UBWP:USER<us>:CELL<cc>:SL:BWP<bwp>:
  RESPool:RES<gr0>:STRB <ResourceBlock>
```

Defines the first resource block the resource pool uses.

Parameters:

<ResourceBlock> integer

The value range depends on the number of PRBs the resource pool uses ([:SOURce<hw>] :BB:NR5G:UBWP:USER<us>:CELL<cc>:SL:BWP<bwp>:RESPool:RES<gr0>:NPRB).

Range: 0 to 265

*RST: 0

Example: See [Example "Configuring a sidelink signal"](#) on page 412.

Manual operation: See ["Start RB"](#) on page 194

10.20 Scheduling commands

Depending on the allocation you want to configure or query, you have to use a different command syntax.

The logic goes like this:

- Use commands with the following syntax structure to **configure common allocations** (e.g. puncturing allocations):
SOURce:NR5G:SCHEd:CELL:SUBF:ALLOc:...
- Use commands with the following syntax structure to **query common allocations** whose characteristics are automatically configured or configured elsewhere in the user interface (e.g. dummy RE allocations):
SOURce:NR5G:SCHEd:CELL:SUBF:COMMon:ALLOc:...
Commands with this syntax are queries only.
Note that the suffix at ALLOc starts a 0 for the first automatically generated allocation.

- Use commands with the following syntax structure to **configure user allocations** (e.g. PDSCH allocations):
`SOURce:NR5G:SCHeD:CELL:SUBF:USER:BWPart:ALLoc:...`
- Use commands with the following syntax structure to **query user allocations** whose characteristics are automatically configured or configured elsewhere in the user interface (e.g. CSI-RS allocations):
`SOURce:NR5G:SCHeD:CELL:SUBF:USER:BWPart:RESulting:ALLoc:...`
 Commands with this syntax are queries only.
 Note that the suffix at `ALLOc` starts at 0 for the first automatically generated allocation.
- Use commands with the following syntax structure to specifically **configure PRACH user allocations**:
`SOURce:NR5G:SCHeD:CELL:SUBF:USER:BWPart:ALLoc:PRACH:...`
 (only for a few selected entries in the scheduling table as indicated by the command list below; most of the PRACH allocation settings work with the commands used to configure other user allocations like the PDSCH)
- Use commands with the following syntax structure to specifically **configure RIM-RS user allocations**:
`SOURce:NR5G:SCHeD:CELL:SUBF:USER:BWPart:ALLoc:RIMRs:...`
 (only for a few selected entries in the scheduling table as indicated by the command list below; most of the RIM-RS allocation settings work with the commands used to configure other user allocations like the PDSCH)

Note that not all allocation types support all four syntax variants, e.g. it is not possible to define the power of puncturing allocations or query the repetition characteristics of common allocations (for common allocations whose repetitions you cannot configure, the repetition is always fix).

<code>[SOURce<hw>]:BB:NR5G:SCHeDuling:MODE</code>	596
<code>[SOURce<hw>]:BB:NR5G:SCHeDuling:RSSPace</code>	597
<code>[SOURce<hw>]:BB:NR5G:SCHeDuling:SFN:STATE</code>	597
<code>[SOURce<hw>]:BB:NR5G:SCHeD:CELL<cc>:SUBF<sf>:USER<us>:BWPart<bwp>:RESulting:ALLoc<al>:FACTs?</code>	597
<code>[SOURce<hw>]:BB:NR5G:SCHeD:CELL<cc>:SUBF<sf>:USER<us>:BWPart<bwp>:ALLoc<al>:FACTs?</code>	597
<code>[SOURce<hw>]:BB:NR5G:SCHeD:CELL<cc>:SUBF<sf>:COMMOn:ALLoc<al>:CONTent?...</code>	598
<code>[SOURce<hw>]:BB:NR5G:SCHeD:CELL<cc>:SUBF<sf>:USER<us>:BWPart<bwp>:RESulting:ALLoc<al>:CONTent?</code>	598
<code>[SOURce<hw>]:BB:NR5G:SCHeD:CELL<cc>:SUBF<sf>:ALLoc<al>:CONTent</code>	598
<code>[SOURce<hw>]:BB:NR5G:SCHeD:CELL<cc>:SUBF<sf>:USER<us>:BWPart<bwp>:ALLoc<al>:CONTent</code>	598
<code>[SOURce<hw>]:BB:NR5G:SCHeD:CELL<cc>:SUBF<sf>:USER<us>:BWPart<bwp>:ALLoc<al>:COPYto:APPLY</code>	598
<code>[SOURce<hw>]:BB:NR5G:SCHeD:CELL<cc>:SUBF<sf>:USER<us>:BWPart<bwp>:ALLoc<al>:COPYto:SLOT</code>	599
<code>[SOURce<hw>]:BB:NR5G:SCHeD:CELL<cc>:SUBF<sf>:USER<us>:BWPart<bwp>:ALLoc<al>:COPYto:SUBF</code>	599
<code>[SOURce<hw>]:BB:NR5G:SCHeD:CELL<cc>:SUBF<sf>:ALLoc<al>:DURation</code>	599
<code>[SOURce<hw>]:BB:NR5G:SCHeD:CELL<cc>:SUBF<sf>:USER<us>:BWPart<bwp>:ALLoc<al>:DURation</code>	599

Scheduling commands

[:SOURce<hw>]:BB:NR5G:SCHed:CELL<cc>:SUBF<sf>:USER<us>:BWPart<bwp>: ALLoc<al>:FMT.....	600
[:SOURce<hw>]:BB:NR5G:SCHed:CELL<cc>:SUBF<sf>:USER<us>:BWPart<bwp>: RESulting:ALLoc<al>:INFO?.....	600
[:SOURce<hw>]:BB:NR5G:SCHed:CELL<cc>:SUBF<sf>:USER<us>:BWPart<bwp>: ALLoc<al>:INFO?.....	600
[:SOURce<hw>]:BB:NR5G:SCHed:CELL<cc>:SUBF<sf>:USER<us>:BWPart<bwp>: RESulting:ALLoc<al>:MAPType?.....	601
[:SOURce<hw>]:BB:NR5G:SCHed:CELL<cc>:SUBF<sf>:USER<us>:BWPart<bwp>: ALLoc<al>:MAPType.....	601
[:SOURce<hw>]:BB:NR5G:SCHed:CELL<cc>:SUBF<sf>:USER<us>:BWPart<bwp>: RESulting:ALLoc<al>:POWer?.....	602
[:SOURce<hw>]:BB:NR5G:SCHed:CELL<cc>:SUBF<sf>:USER<us>:BWPart<bwp>: ALLoc<al>:POWer.....	602
[:SOURce<hw>]:BB:NR5G:SCHed:CELL<cc>:SUBF<sf>:ALLoc<al>:PERiod.....	602
[:SOURce<hw>]:BB:NR5G:SCHed:CELL<cc>:SUBF<sf>:USER<us>:BWPart<bwp>: ALLoc<al>:PERiod.....	602
[:SOURce<hw>]:BB:NR5G:SCHed:CELL<cc>:SUBF<sf>:COMMon:ALLoc<al>: RBNumber?.....	602
[:SOURce<hw>]:BB:NR5G:SCHed:CELL<cc>:SUBF<sf>:USER<us>:BWPart<bwp>: RESulting:ALLoc<us>:RBNumber?.....	602
[:SOURce<hw>]:BB:NR5G:SCHed:CELL<cc>:SUBF<sf>:USER<us>:BWPart<bwp>: ALLoc<al>:PRACH:RBNumber?.....	603
[:SOURce<hw>]:BB:NR5G:SCHed:CELL<cc>:SUBF<sf>:ALLoc<al>:RBNumber.....	603
[:SOURce<hw>]:BB:NR5G:SCHed:CELL<cc>:SUBF<sf>:USER<us>:BWPart<bwp>: ALLoc<al>:RBNumber.....	603
[:SOURce<hw>]:BB:NR5G:SCHed:CELL<cc>:SUBF<sf>:COMMon:ALLoc<al>:RBOFset?..	603
[:SOURce<hw>]:BB:NR5G:SCHed:CELL<cc>:SUBF<sf>:USER<us>:BWPart<bwp>: RESulting:ALLoc<al>:RBOFset?.....	603
[:SOURce<hw>]:BB:NR5G:SCHed:CELL<cc>:SUBF<sf>:ALLoc<al>:RBOFset.....	603
[:SOURce<hw>]:BB:NR5G:SCHed:CELL<cc>:SUBF<sf>:USER<us>:BWPart<bwp>: ALLoc<al>:RBOFset.....	603
[:SOURce<hw>]:BB:NR5G:SCHed:CELL<cc>:SUBF<sf>:ALLoc<al>:REPetitions.....	603
[:SOURce<hw>]:BB:NR5G:SCHed:CELL<cc>:SUBF<sf>:USER<us>:BWPart<bwp>: ALLoc<al>:REPetitions.....	603
[:SOURce<hw>]:BB:NR5G:SCHed:CELL<cc>:SUBF<sf>:COMMon:ALLoc<al>:RIMRs: SCSPacing.....	604
[:SOURce<hw>]:BB:NR5G:SCHed:CELL<cc>:SUBF<sf>:COMMon:ALLoc<al>: SCSPacing?.....	604
[:SOURce<hw>]:BB:NR5G:SCHed:CELL<cc>:SUBF<sf>:USER<us>:BWPart<bwp>: RESulting:ALLoc<al>:PRACH:SCSPacing?.....	604
[:SOURce<hw>]:BB:NR5G:SCHed:CELL<cc>:SUBF<sf>:USER<us>:BWPart<bwp>: RESulting:ALLoc<al>:SCSPacing?.....	604
[:SOURce<hw>]:BB:NR5G:SCHed:CELL<cc>:SUBF<sf>:ALLoc<al>:SCSPacing.....	604
[:SOURce<hw>]:BB:NR5G:SCHed:CELL<cc>:SUBF<sf>:USER<us>:BWPart<bwp>: ALLoc<al>:SEQLength.....	605
[:SOURce<hw>]:BB:NR5G:SCHed:CELL<cc>:SUBF<sf>:COMMon:ALLoc<al>:SLOT?.....	605
[:SOURce<hw>]:BB:NR5G:SCHed:CELL<cc>:SUBF<sf>:USER<us>:BWPart<bwp>: RESulting:ALLoc<al>:SLOT?.....	605
[:SOURce<hw>]:BB:NR5G:SCHed:CELL<cc>:SUBF<sf>:ALLoc<al>:SLOT.....	605

[:SOURce<hw>]:BB:NR5G:SCHed:CELL<cc>:SUBF<sf>:USER<us>:BWPart<bwp>: ALLoc<al>:SLOT.....	605
[:SOURce<hw>]:BB:NR5G:SCHed:CELL<cc>:SUBF<sf>:RESulting:ALLoc<al>:SOSF?.....	605
[:SOURce<hw>]:BB:NR5G:SCHed:CELL<cc>:SUBF<sf>:USER<us>:BWPart<bwp>: RESulting:ALLoc<al>:SOSF?.....	605
[:SOURce<hw>]:BB:NR5G:SCHed:CELL<cc>:SUBF<sf>:USER<us>:BWPart<bwp>: RESulting:ALLoc<al>:STATe?.....	606
[:SOURce<hw>]:BB:NR5G:SCHed:CELL<cc>:SUBF<sf>:USER<us>:BWPart<bwp>: ALLoc<al>:STATe.....	606
[:SOURce<hw>]:BB:NR5G:SCHed:CELL<cc>:SUBF<sf>:COMMon:ALLoc<al>: SYMNumber?.....	606
[:SOURce<hw>]:BB:NR5G:SCHed:CELL<cc>:SUBF<sf>:USER<us>:BWPart<bwp>: RESulting:ALLoc<al>:SYMNumber?.....	606
[:SOURce<hw>]:BB:NR5G:SCHed:CELL<cc>:SUBF<sf>:ALLoc<al>:SYMNumber.....	606
[:SOURce<hw>]:BB:NR5G:SCHed:CELL<cc>:SUBF<sf>:USER<us>:BWPart<bwp>: ALLoc<al>:SYMNumber.....	606
[:SOURce<hw>]:BB:NR5G:SCHed:CELL<cc>:SUBF<sf>:COMMon:ALLoc<al>:SYMoffset?..	606
[:SOURce<hw>]:BB:NR5G:SCHed:CELL<cc>:SUBF<sf>:USER<us>:BWPart<bwp>: RESulting:ALLoc<al>:SYMoffset?.....	606
[:SOURce<hw>]:BB:NR5G:SCHed:CELL<cc>:SUBF<sf>:ALLoc<al>:SYMoffset.....	606
[:SOURce<hw>]:BB:NR5G:SCHed:CELL<cc>:SUBF<sf>:USER<us>:BWPart<bwp>: ALLoc<al>:SYMoffset.....	606
[:SOURce<hw>]:BB:NR5G:SCHed:CELL<cc>:SUBF<sf>:USER<us>:BWPart<bwp>: ALLoc<al>:TPSTate.....	607
[:SOURce<hw>]:BB:NR5G:SCHed:CELL<cc>:SUBF<sf>:NALLoc.....	607
[:SOURce<hw>]:BB:NR5G:SCHed:CELL<cc>:SUBF<sf>:USER<us>:BWPart<bwp>: NALLoc.....	607
[:SOURce<hw>]:BB:NR5G:SCHed:CELL<cc>:SUBF<sf>:USER<us>:BWPart<bwp>: RESulting:ALLoc<al>:INFO?.....	607
[:SOURce<hw>]:BB:NR5G:SCHed:CELL<cc>:SUBF<sf>:USER<us>:BWPart<bwp>: ALLoc<al>:INFO?.....	607

[:SOURce<hw>]:BB:NR5G:SCHeduling:MODE <SchedulingMode>

Defines how the scheduling and the content of the different PDSCH allocations is defined and performed.

Parameters:

<SchedulingMode> MANual | AUTO

MANual

No cross-reference between the settings made for the CORE-SET DCIs and the PDSCHs settings.

Configure the PDSCH allocations manually.

AUTO

Content and scheduling of the PDSCH according to the configuration of the CORESET DCIs.

*RST: MANual

Example:

See [Example"Configuring the configurable allocations in the users and BWPs groups"](#) on page 392.

Manual operation: See ["PDSCH Scheduling"](#) on page 50

[:SOURce<hw>]:BB:NR5G:SCHeDuling:RSSPace <RestrToSSpace>

If enabled, the CCE start index is selected automatically to be within the current search space.

Parameters:

<RestrToSSpace> 1 | ON | 0 | OFF
*RST: 0

Example: See [Example"Search space configuration"](#) on page 398.

Manual operation: See ["Restrict to Search Space"](#) on page 50

[:SOURce<hw>]:BB:NR5G:SCHeDuling:SFN:STATe <SysFrameNum>

Enables the full counting of the system frame number carried by the PBCH block from 0 to 1023, independent from the configured ARB [Sequence Length](#).

If [System Frame Number Offset](#) is set, the counting starts at the configured SFN offset value and restarts when the SFN offset value is reached again as follows: offset, (offset+1), (offset+ 2), ..., 1023, 0, 1, 2, ..., (offset-1).

Parameters:

<SysFrameNum> 1 | ON | 0 | OFF
*RST: 0

Example: See [Example"Configuring the SS/PBCH"](#) on page 389.

Options: R&S SMM-K148.

Manual operation: See ["Count Full System Frame Number"](#) on page 50

**[:SOURce<hw>]:BB:NR5G:SCHeD:CELL<cc>:SUBF<sf>:USER<us>:
BWPart<bwp>:RESulting:ALLoc<al>:FACTs?
[:SOURce<hw>]:BB:NR5G:SCHeD:CELL<cc>:SUBF<sf>:USER<us>:
BWPart<bwp>:ALLoc<al>:FACTs?**

Queries the status of an allocation.

Return values:

<AllocFacts> **BURST**
Indicates that an allocation is used as reference for the burst power mode.

CONF
Indicates a conflict between allocations (overlapping allocations).

NONE
No conflict and no special use of the allocation.

*RST: NONE

Example: SOURCE1:BB:NR5G:SCHEd:CELL0:SUBF0:USER0:BWPart0:ALLoc0:FACTs?
// NONE

Usage: Query only

Manual operation: See "[Conflict](#)" on page 201

[:SOURCE<hw>]:BB:NR5G:SCHEd:CELL<cc>:SUBF<sf>:COMMOn:ALLoc<al>:CONTent?

[:SOURCE<hw>]:BB:NR5G:SCHEd:CELL<cc>:SUBF<sf>:USER<us>:BWPart<bwp>:RESulting:ALLoc<al>:CONTent?

[:SOURCE<hw>]:BB:NR5G:SCHEd:CELL<cc>:SUBF<sf>:ALLoc<al>:CONTent<Content>

[:SOURCE<hw>]:BB:NR5G:SCHEd:CELL<cc>:SUBF<sf>:USER<us>:BWPart<bwp>:ALLoc<al>:CONTent <Content>

Selects the allocation type.

Note that the available parameters for this set of commands depends on the allocation you want to configure. For example, you can only configure puncturing allocations in the common allocations. Therefore, the setting command for common allocations only supports the `PUNcturing` parameter. Likewise, the commands to configure or query user allocation only support the parameters that represent user allocations (e.g. `PDSch`, `COREset` etc.)

For an overview of all allocation types and their availability, see "[Content](#)" on page 201. Note that some allocation types require a specific firmware option.

Parameters:

<Content>

PDSCh | COREset | SPBCh | DUMRe | CSIRs | PRS | LTECrS | PUNcturing

Downlink allocation types.

PUSCh | PUCCh | PRACH | DUMRe | SRS | PUNcturing

Uplink allocation types.

SSSPbch | PSBCh | PSCCh | PSSCh | PSFCh | PSCSs

Sidelink allocation types

*RST: depends on command

Example: See [Example"Configuring the configurable allocations in the users and BWPs groups"](#) on page 392.

Manual operation: See "[Content](#)" on page 201

[:SOURCE<hw>]:BB:NR5G:SCHEd:CELL<cc>:SUBF<sf>:USER<us>:BWPart<bwp>:ALLoc<al>:COPYto:APPLy

Start the copy progress. The selected line from the scheduling settings table will be copied to the selected subframe and slot.

Example: See [Example"Configuring the configurable allocations in the users and BWPs groups"](#) on page 392.

Usage: Event

Manual operation: See ["Apply"](#) on page 204

**[:SOURce<hw>]:BB:NR5G:SCHed:CELL<cc>:SUBF<sf>:USER<us>:
BWPart<bwp>:ALLoc<al>:COPYto:SLOT <UserAllcCpyToSL>**

Select the slot the data from the selected line from the scheduling settings table will be copied to.

Parameters:

<UserAllcCpyToSL> integer
Range: 0 to 31
*RST: 0

Example: See [Example"Configuring the configurable allocations in the users and BWPs groups"](#) on page 392.

Manual operation: See ["Slot"](#) on page 204

**[:SOURce<hw>]:BB:NR5G:SCHed:CELL<cc>:SUBF<sf>:USER<us>:
BWPart<bwp>:ALLoc<al>:COPYto:SUBF <UserAllcCpyToSF>**

Select the slot the data from the selected line from the scheduling settings table will be copied to.

Parameters:

<UserAllcCpyToSF> integer
Range: 0 to 99
*RST: 0

Example: See [Example"Configuring the configurable allocations in the users and BWPs groups"](#) on page 392.

Manual operation: See ["Subframe"](#) on page 204

**[:SOURce<hw>]:BB:NR5G:SCHed:CELL<cc>:SUBF<sf>:ALLoc<al>:DURation
<Slots>
[:SOURce<hw>]:BB:NR5G:SCHed:CELL<cc>:SUBF<sf>:USER<us>:
BWPart<bwp>:ALLoc<al>:DURation <Slots>**

Defines in how many consecutive slots within a frame the allocation is repeated.

Prerequisites for this command

- Select custom repetition type ([\[:SOURce<hw>\]:BB:NR5G:SCHed:CELL<cc>:
SUBF<sf>:USER<us>:BWPart<bwp>:ALLoc<al>:REPetitions](#)).

Parameters:

<Slots> integer
Range: 1 to 10
*RST: 1

Example: See `[:SOURce<hw>] :BB:NR5G:SCHed:CELL<cc> :
SUBF<sf>:USER<us>:BWPart<bwp>:ALLoc<al>:
REPetitions.`

Manual operation: See ["Duration"](#) on page 211

`[:SOURce<hw>] :BB:NR5G:SCHed:CELL<cc> :SUBF<sf>:USER<us> :
BWPart<bwp>:ALLoc<al>:FMT <Format>`

In uplink, selects the PUCCH format.

Parameters:

<Format> F0 | F1 | F2 | F3 | F4
*RST: F0

Example: See [Example"Configuring the PUCCH settings"](#) on page 406.

Manual operation: See ["Format"](#) on page 206

`[:SOURce<hw>] :BB:NR5G:SCHed:CELL<cc> :SUBF<sf>:USER<us> :
BWPart<bwp>:RESulting:ALLoc<al>:INFO?
[:SOURce<hw>] :BB:NR5G:SCHed:CELL<cc> :SUBF<sf>:USER<us> :
BWPart<bwp>:ALLoc<al>:INFO?`

Queries information on the current configuration.

Return values:

<UserAllocInfo> string

Example:

```
SOURce1:BB:NR5G:SCHed:CELL0:SUBF0:USER0:BWPart0:ALLoc1:INFO?
```

Response:

```
{
  "common_settings": {
    "power_dB": 0.0,
    "slot_in_frame": 0
  },
  "content_type": "PXsch",
  "content": {
    "frequency_domain_allocation_type": "FrequencyAllocationType1",
    "frequency_domain_allocation": {
      "vrb_offset": 0,
      "vrb_num": 273
    },
    "transport_block_settings_no_coding": [
      {
        "modulation": "QAM16"
      },
      {
        "modulation": "QAM64"
      }
    ],
    "ptrs_settings": {
      "antenna_port": [
        1002
      ]
    }
  }
}
```

Usage: Query only

Manual operation: See ["Info"](#) on page 208
See ["Info"](#) on page 236

```
[:SOURce<hw>]:BB:NR5G:SCHed:CELL<cc>:SUBF<sf>:USER<us>:  
  BWPart<bwp>:RESulting:ALLoc<al>:MAPType?
```

```
[:SOURce<hw>]:BB:NR5G:SCHed:CELL<cc>:SUBF<sf>:USER<us>:  
  BWPart<bwp>:ALLoc<al>:MAPType <MappingType>
```

Defines to which symbols of the PDSCH/PUSCH allocation the demodulation reference signals (DMRS) are mapped.

Parameters:

<MappingType> A | B
*RST: A

Example: See [Example"Configuring the PDSCH incl. PTRS and Precoding settings"](#) on page 393.

Manual operation: See ["Mapping Type"](#) on page 205

```
[:SOURce<hw>]:BB:NR5G:SCHEd:CELL<cc>:SUBF<sf>:USER<us>:
  BWPart<bwp>:RESulting:ALLoc<al>:POWER?
[:SOURce<hw>]:BB:NR5G:SCHEd:CELL<cc>:SUBF<sf>:USER<us>:
  BWPart<bwp>:ALLoc<al>:POWER <Power>
```

Sets the power for the selected allocation relative to the power of the other allocations.

Parameters:

<Power> float
 Range: -80 to 10.0
 Increment: 0.01
 *RST: 0.0

Example: See [Example "Configuring the configurable allocations in the users and BWPs groups"](#) on page 392.

Manual operation: See ["Power"](#) on page 209

```
[:SOURce<hw>]:BB:NR5G:SCHEd:CELL<cc>:SUBF<sf>:ALLoc<al>:PERiod
  <Slots>
[:SOURce<hw>]:BB:NR5G:SCHEd:CELL<cc>:SUBF<sf>:USER<us>:
  BWPart<bwp>:ALLoc<al>:PERiod <Slots>
```

Sets the repetition periodicity.

Prerequisites for this command

- Select custom repetition type (`[:SOURce<hw>] :BB:NR5G:SCHEd:CELL<cc> : SUBF<sf>:USER<us>:BWPart<bwp>:ALLoc<al>:REPetitions`).

Parameters:

<Slots> integer
 Range: 1 to max*
 *RST: 10
 *) Max repetition period is calculated as follows:
 $RepPeriod_{max} = \#SlotsPerFrame * "SequenceLength"$, where:
 #SlotsPerFrame: is the number of available slots and depends on the used subcarrier spacing.
 "SequenceLength": is the ARB sequence length as set with the command `[:SOURce<hw>] :BB:NR5G:OUTPut:SEQLen`.

Example: See `[:SOURce<hw>] :BB:NR5G:SCHEd:CELL<cc> : SUBF<sf>:USER<us>:BWPart<bwp>:ALLoc<al>: REPetitions`.

Manual operation: See ["Period"](#) on page 211

```
[:SOURce<hw>]:BB:NR5G:SCHEd:CELL<cc>:SUBF<sf>:COMMOn:ALLoc<al>:
  RBNumber?
[:SOURce<hw>]:BB:NR5G:SCHEd:CELL<cc>:SUBF<sf>:USER<us>:
  BWPart<bwp>:RESulting:ALLoc<us>:RBNumber?
```

```
[ :SOURce<hw>]:BB:NR5G:SCHed:CELL<cc>:SUBF<sf>:USER<us>:
  BWPart<bwp>:ALLoc<al>:PRACh:RBNumber?
[:SOURce<hw>]:BB:NR5G:SCHed:CELL<cc>:SUBF<sf>:ALLoc<al>:RBNumber
  <ResourceBlocks>
[:SOURce<hw>]:BB:NR5G:SCHed:CELL<cc>:SUBF<sf>:USER<us>:
  BWPart<bwp>:ALLoc<al>:RBNumber <ResourceBlocks>
```

Sets the number of resource blocks (RB) the allocation uses.

Parameters:

<ResourceBlocks> integer

Note that there are restrictions to the number of resource block you can use for different types of allocations. For more information, see "No. RB" on page 207.

Range: 20 to 275

*RST: 20

Example: See [Example"Configuring the configurable allocations in the users and BWPs groups"](#) on page 392.

Manual operation: See "No. RB" on page 207

```
[ :SOURce<hw>]:BB:NR5G:SCHed:CELL<cc>:SUBF<sf>:COMMOn:ALLoc<al>:
  RBOffset?
[:SOURce<hw>]:BB:NR5G:SCHed:CELL<cc>:SUBF<sf>:USER<us>:
  BWPart<bwp>:RESulting:ALLoc<al>:RBOffset?
[:SOURce<hw>]:BB:NR5G:SCHed:CELL<cc>:SUBF<sf>:ALLoc<al>:RBOffset
  <Offset>
[:SOURce<hw>]:BB:NR5G:SCHed:CELL<cc>:SUBF<sf>:USER<us>:
  BWPart<bwp>:ALLoc<al>:RBOffset <FrequencyOffset>
```

Adds a frequency offset and sets the start resource block of the selected allocation.

Parameters:

<FrequencyOffset> integer

Range: 0 to 255

*RST: 0

Example: See [Example"Configuring the configurable allocations in the users and BWPs groups"](#) on page 392.

Manual operation: See "RB Offset" on page 208

```
[ :SOURce<hw>]:BB:NR5G:SCHed:CELL<cc>:SUBF<sf>:ALLoc<al>:REPetitions
  <RepetitionType>
[:SOURce<hw>]:BB:NR5G:SCHed:CELL<cc>:SUBF<sf>:USER<us>:
  BWPart<bwp>:ALLoc<al>:REPetitions <RepetitionType>
```

Defines if and how often the allocation is repeated.

Parameters:

<RepetitionType> OFF | SLOT | SUBFrame | FRAME | CUSTom | TA

OFF

Repetition is off.

SLOT | SUBFrame | FRAME

Repetition every slot / subframe or frame.

CUSTOM

Custom repetition pattern.

*RST: depends on allocation number

Example: See [Example "Configuring the configurable allocations in the users and BWPs groups"](#) on page 392.

Example: `SOURce1:BB:NR5G:SCHEd:CELL0:SUBF0:USER1:BWPart0:ALLoc0:REPetitions CUSTOM`
`SOURce1:BB:NR5G:SCHEd:CELL0:SUBF0:USER1:BWPart0:ALLoc0:PERiod 2`
`SOURce1:BB:NR5G:SCHEd:CELL0:SUBF0:USER1:BWPart0:ALLoc0:DURation 5`

Manual operation: See ["Repetition/Repetition Type"](#) on page 210
 See ["Repetition Type"](#) on page 210

```
[ :SOURce<hw>]:BB:NR5G:SCHEd:CELL<cc>:SUBF<sf>:COMMOn:ALLoc<al>:
  RIMRs:SCSPacing <SubcarrierSpacing>
[ :SOURce<hw>]:BB:NR5G:SCHEd:CELL<cc>:SUBF<sf>:COMMOn:ALLoc<al>:
  SCSPacing?
[ :SOURce<hw>]:BB:NR5G:SCHEd:CELL<cc>:SUBF<sf>:USER<us>:
  BWPart<bwp>:RESulting:ALLoc<al>:PRACH:SCSPacing?
  <SubcarrierSpacing>
[ :SOURce<hw>]:BB:NR5G:SCHEd:CELL<cc>:SUBF<sf>:USER<us>:
  BWPart<bwp>:RESulting:ALLoc<al>:SCSPacing?
[ :SOURce<hw>]:BB:NR5G:SCHEd:CELL<cc>:SUBF<sf>:ALLoc<al>:SCSPacing
  <SubcarrierSpacing>
```

Defines the subcarrier spacing for the selected allocation.

To define the subcarrier spacings for the complete bandwidth part and thus its user allocations in the various link directions, use the following commands:

- Downlink: `[:SOURce<hw>]:BB:NR5G:UBWP:USER<us>:CELL<cc>:DL:
 BWP<bwp>:SCSPacing`
- Uplink: `[:SOURce<hw>]:BB:NR5G:UBWP:USER<us>:CELL<cc>:UL:
 BWP<bwp>:SCSPacing`
- Sidelink: `[:SOURce<hw>]:BB:NR5G:UBWP:USER<us>:CELL<cc>:SL:
 BWP<bwp>:SCSPacing`

Parameters:

<SubcarrierSpacing> SCS15 | SCS30 | SCS60 | SCS120 | SCS240 | N15 | N30 |
 N60 | N120 | N240 | SCS480 | SCS960

Available subcarrier spacings depend on the channel type.

*RST: SCS30

Options: SCS480 and SCS960 require R&S SMM-K171

```
[ :SOURce<hw>]:BB:NR5G:SCHeD:CELL<cc>:SUBF<sf>:USER<us>:
  BWPart<bwp>:ALLoc<al>:SEQLength <SequenceLength>
```

Selects the PRACH sequence length.

Prerequisites for this command

- Turn on shared spectrum access (`[:SOURce<hw>]:BB:NR5G:NODE:CELL<cc>:SHSPec`).

If shared spectrum access is off, the PRACH sequence length is a fix value depending on its subcarrier spacing.

Parameters:

```
<SequenceLength>  L139 | L571 | L839 | L1151
                  *RST:    L139
```

Manual operation: See ["Map Type / Format / Seq. Len."](#) on page 206

```
[ :SOURce<hw>]:BB:NR5G:SCHeD:CELL<cc>:SUBF<sf>:COMMon:ALLoc<al>:
  SLOT?
[ :SOURce<hw>]:BB:NR5G:SCHeD:CELL<cc>:SUBF<sf>:USER<us>:
  BWPart<bwp>:RESulting:ALLoc<al>:SLOT?
[ :SOURce<hw>]:BB:NR5G:SCHeD:CELL<cc>:SUBF<sf>:ALLoc<al>:SLOT <Slot>
[ :SOURce<hw>]:BB:NR5G:SCHeD:CELL<cc>:SUBF<sf>:USER<us>:
  BWPart<bwp>:ALLoc<al>:SLOT <Slot>
```

Sets the start slot for the selected allocation.

Parameters:

```
<Slot>            integer
                  Range:    0 to 31
                  *RST:    0
```

Example: See [Example"Configuring the configurable allocations in the users and BWPs groups"](#) on page 392.

Manual operation: See ["Slot"](#) on page 205

```
[ :SOURce<hw>]:BB:NR5G:SCHeD:CELL<cc>:SUBF<sf>:RESulting:ALLoc<al>:
  SOSF?
[ :SOURce<hw>]:BB:NR5G:SCHeD:CELL<cc>:SUBF<sf>:USER<us>:
  BWPart<bwp>:RESulting:ALLoc<al>:SOSF?
```

Queries the source subframe of automatically generated common or user allocations.

Return values:

```
<Subframe>       float
```

Usage: Query only

```
[:SOURce<hw>]:BB:NR5G:SCHEd:CELL<cc>:SUBF<sf>:USER<us>:
  BWPart<bwp>:RESulting:ALLoc<al>:STATe?
[:SOURce<hw>]:BB:NR5G:SCHEd:CELL<cc>:SUBF<sf>:USER<us>:
  BWPart<bwp>:ALLoc<al>:STATe <State>
```

Activates the allocation.

Parameters:

<State> 1 | ON | 0 | OFF
 *RST: 0

Example: See [Example"Configuring the configurable allocations in the users and BWPs groups"](#) on page 392.

Manual operation: See ["State"](#) on page 209

```
[:SOURce<hw>]:BB:NR5G:SCHEd:CELL<cc>:SUBF<sf>:COMMon:ALLoc<al>:
  SYMNumber?
[:SOURce<hw>]:BB:NR5G:SCHEd:CELL<cc>:SUBF<sf>:USER<us>:
  BWPart<bwp>:RESulting:ALLoc<al>:SYMNumber?
[:SOURce<hw>]:BB:NR5G:SCHEd:CELL<cc>:SUBF<sf>:ALLoc<al>:SYMNumber
  <Symbols>
[:SOURce<hw>]:BB:NR5G:SCHEd:CELL<cc>:SUBF<sf>:USER<us>:
  BWPart<bwp>:ALLoc<al>:SYMNumber <Symbols>
```

Sets the number of symbols the allocation spans.

Parameters:

<Symbols> integer
 Range: 1 to 14
 *RST: 13

Example: See [Example"Configuring the configurable allocations in the users and BWPs groups"](#) on page 392.

Manual operation: See ["No. Sym."](#) on page 206

```
[:SOURce<hw>]:BB:NR5G:SCHEd:CELL<cc>:SUBF<sf>:COMMon:ALLoc<al>:
  SYMoffset?
[:SOURce<hw>]:BB:NR5G:SCHEd:CELL<cc>:SUBF<sf>:USER<us>:
  BWPart<bwp>:RESulting:ALLoc<al>:SYMoffset?
[:SOURce<hw>]:BB:NR5G:SCHEd:CELL<cc>:SUBF<sf>:ALLoc<al>:SYMoffset
  <Offset>
[:SOURce<hw>]:BB:NR5G:SCHEd:CELL<cc>:SUBF<sf>:USER<us>:
  BWPart<bwp>:ALLoc<al>:SYMoffset <Offset>
```

Sets the allocation's start (OFDM symbol) within the slot.

Parameters:

<Offset> integer
 Range: 0 to 13
 *RST: 1

Example: See [Example"Configuring the configurable allocations in the users and BWPs groups"](#) on page 392.

Manual operation: See ["Sym. Offset"](#) on page 207

```
[:SOURce<hw>]:BB:NR5G:SCHed:CELL<cc>:SUBF<sf>:USER<us>:
  BWPart<bwp>:ALLoc<al>:TPState <TrPrecState>
```

In UL, enables the optional DFT-s-OFDM instead of CP-OFDM per PUSCH.

Parameters:

<TrPrecState> 0 | 1 | OFF | ON
*RST: 0

Example:

```
SOURce1:BB:NR5G:LINK UP
SOURce1:BB:NR5G:SCHed:CELL0:SUBF0:USER1:BWPart0:ALLoc0:TPState 1
```

Manual operation: See ["Transform Precoding"](#) on page 208

```
[:SOURce<hw>]:BB:NR5G:SCHed:CELL<cc>:SUBF<sf>:NALLoc <Allocations>
[:SOURce<hw>]:BB:NR5G:SCHed:CELL<cc>:SUBF<sf>:USER<us>:
  BWPart<bwp>:NALLoc <Allocations>
```

Sets the number of configurable allocations in the selected
USER<dir0>:BWPart<gr0> group.

Parameters:

<Allocations> integer
Range: 0 to 64
*RST: 0

Example: See [Example"Configuring the configurable allocations in the users and BWPs groups"](#) on page 392.

Manual operation: See ["No. of Allocations"](#) on page 203

```
[:SOURce<hw>]:BB:NR5G:SCHed:CELL<cc>:SUBF<sf>:USER<us>:
  BWPart<bwp>:RESulting:ALLoc<al>:INFO?
[:SOURce<hw>]:BB:NR5G:SCHed:CELL<cc>:SUBF<sf>:USER<us>:
  BWPart<bwp>:ALLoc<al>:INFO?
```

Queries information on the current configuration.

Return values:

<UserAllocInfo> string

Example:

```
SOURcel:BB:NR5G:Sched:CELL0:SUBF0:USER0:BWPart0:ALLoc1:INFO?
```

Response:

```
{
  "common_settings": {
    "power_dB": 0.0,
    "slot_in_frame": 0
  },
  "content_type": "PXsch",
  "content": {
    "frequency_domain_allocation_type": "FrequencyAllocationType1",
    "frequency_domain_allocation": {
      "vrb_offset": 0,
      "vrb_num": 273
    },
    "transport_block_settings_no_coding": [
      {
        "modulation": "QAM16"
      },
      {
        "modulation": "QAM64"
      }
    ],
    "ptrs_settings": {
      "antenna_port": [
        1002
      ]
    }
  }
}
```

Usage: Query only

Manual operation: See ["Info"](#) on page 208
See ["Info"](#) on page 236

10.21 PDSCH and PUSCH scheduling commands

- [General PDSCH and PUSCH scheduling commands](#)..... 609
- [PDSCH and PUSCH Tx scheme commands](#).....616
- [PDSCH and PUSCH DMRS commands](#).....622
- [PDSCH and PUSCH channel coding commands](#)..... 628
- [PUSCH UCI commands](#).....630
- [PDSCH and PUSCH PTRS commands](#).....632
- [PDSCH and PUSCH antenna port configuration commands](#).....638

10.21.1 General PDSCH and PUSCH scheduling commands

Note that some of the commands in the following list are available for both PDSCH and PUSCH scheduling, while others are exclusive to PDSCH or PUSCH scheduling.

<code>[SOURce<hw>]:BB:NR5G:SCHed:CELL<cc>:SUBF<sf>:USER<us>:BWPart<bwp>:ALLoc<al>:CPEXt</code>	609
<code>[SOURce<hw>]:BB:NR5G:SCHed:CELL<cc>:SUBF<sf>:USER<us>:BWPart<bwp>:ALLoc<al>:CW<cw>:MOD</code>	610
<code>[SOURce<hw>]:BB:NR5G:SCHed:CELL<cc>:SUBF<sf>:USER<us>:BWPart<bwp>:ALLoc<al>:CW<cw>:PHYSbits?</code>	610
<code>[SOURce<hw>]:BB:NR5G:SCHed:CELL<cc>:SUBF<sf>:USER<us>:BWPart<bwp>:ALLoc<al>:PDSCh:NCW</code>	610
<code>[SOURce<hw>]:BB:NR5G:SCHed:CELL<cc>:SUBF<sf>:USER<us>:BWPart<bwp>:ALLoc<al>:PDSCh:PATGrp</code>	611
<code>[SOURce<hw>]:BB:NR5G:SCHed:CELL<cc>:SUBF<sf>:USER<us>:BWPart<bwp>:ALLoc<al>:PDSCh:PRECg</code>	611
<code>[SOURce<hw>]:BB:NR5G:SCHed:CELL<cc>:SUBF<sf>:USER<us>:BWPart<bwp>:ALLoc<al>:PDSCh:SBCZero:STATE</code>	612
<code>[SOURce<hw>]:BB:NR5G:SCHed:CELL<cc>:SUBF<sf>:USER<us>:BWPart<bwp>:ALLoc<al>:PDSCh PUSCh:BMAid</code>	612
<code>[SOURce<hw>]:BB:NR5G:SCHed:CELL<cc>:SUBF<sf>:USER<us>:BWPart<bwp>:ALLoc<al>:PDSCh PUSCh:RESalloc</code>	612
<code>[SOURce<hw>]:BB:NR5G:SCHed:CELL<cc>:SUBF<sf>:USER<us>:BWPart<bwp>:ALLoc<al>:PDSCh PUSCh:RESalloc:PATTem</code>	613
<code>[SOURce<hw>]:BB:NR5G:SCHed:CELL<cc>:SUBF<sf>:USER<us>:BWPart<bwp>:ALLoc<al>:PDSCh PUSCh:TYPE</code>	613
<code>[SOURce<hw>]:BB:NR5G:SCHed:CELL<cc>:SUBF<sf>:USER<us>:BWPart<bwp>:ALLoc<al>:PUSCh:FHOI</code>	613
<code>[SOURce<hw>]:BB:NR5G:SCHed:CELL<cc>:SUBF<sf>:USER<us>:BWPart<bwp>:ALLoc<al>:PUSCh:FHOP:STATE</code>	613
<code>[SOURce<hw>]:BB:NR5G:SCHed:CELL<cc>:SUBF<sf>:USER<us>:BWPart<bwp>:ALLoc<al>:PUSCh:HPRNumber</code>	614
<code>[SOURce<hw>]:BB:NR5G:SCHed:CELL<cc>:SUBF<sf>:USER<us>:BWPart<bwp>:ALLoc<al>:PUSCh:INT<il>:INTL</code>	614
<code>[SOURce<hw>]:BB:NR5G:SCHed:CELL<cc>:SUBF<sf>:USER<us>:BWPart<bwp>:ALLoc<al>:PUSCh:NINT</code>	614
<code>[SOURce<hw>]:BB:NR5G:SCHed:CELL<cc>:SUBF<sf>:USER<us>:BWPart<bwp>:ALLoc<al>:TBM<tbm>:SLOTS</code>	615
<code>[SOURce<hw>]:BB:NR5G:SCHed:CELL<cc>:SUBF<sf>:USER<us>:BWPart<bwp>:ALLoc<al>:TBOMs</code>	615
<code>[SOURce<hw>]:BB:NR5G:SCHed:CELL<cc>:SUBF<sf>:USER<us>:BWPart<bwp>:ALLoc<al>:TOFFset</code>	616

`[SOURce<hw>]:BB:NR5G:SCHed:CELL<cc>:SUBF<sf>:USER<us>:BWPart<bwp>:ALLoc<al>:CPEXt <Time>`

Defines a cyclic prefix extension for PUCCH allocations.

Parameters:

<Time> float
 Range: 0 to 100
 Increment: 0.1
 *RST: 0
 Default unit: s

Example: See [Example"Configuring the PUCCH settings"](#) on page 406.

Manual operation: See ["Cyclic Prefix Extension"](#) on page 217
 See ["Cyclic Prefix Extension"](#) on page 276

**[:SOURce<hw>]:BB:NR5G:SCHed:CELL<cc>:SUBF<sf>:USER<us>:
 BWPart<bwp>:ALLoc<al>[:CW<cw>]:MOD <Modulation>**

Sets the modulation scheme.

Parameters:

<Modulation> BPSK | BPSK2 | QPSK | QAM16 | QAM64 | QAM256 |
 QAM1024
 Supported modulations depend on the channel.
 *RST: BPSK

Example: See [Example"Configuring the PDSCH incl. PTRS and Precoding settings"](#) on page 393.

Manual operation: See ["Modulation"](#) on page 218

**[:SOURce<hw>]:BB:NR5G:SCHed:CELL<cc>:SUBF<sf>:USER<us>:
 BWPart<bwp>:ALLoc<al>[:CW<cw>]:PHYSbits?**

Queries the size of the selected allocation in bits.

Return values:

<AllocPhysBits> integer
 Range: 0 to 65535
 *RST: 0

Example: See [Example"Configuring the PDSCH incl. PTRS and Precoding settings"](#) on page 393.

Usage: Query only

Manual operation: See ["Phys. Bits"](#) on page 219

**[:SOURce<hw>]:BB:NR5G:SCHed:CELL<cc>:SUBF<sf>:USER<us>:
 BWPart<bwp>:ALLoc<al>:PDSCh:NCW <NumUserAllocCW>**

For PDSCH, sets if one or two codewords are used.

Parameters:

<NumUserAllocCW> integer
 Range: 1 to 2
 *RST: 1

Example: See [Example"Configuring the PDSCH incl. PTRS and Precoding settings"](#) on page 393.

Manual operation: See ["Number of Codewords"](#) on page 214

**[:SOURCE<hw>]:BB:NR5G:SCHed:CELL<cc>:SUBF<sf>:USER<us>:
 BWPart<bwp>:ALLoc<al>:PDSCh:PATGrp <RateMatPattGrp>**

For PDSCH allocations, selects one of the configured rate match patters groups.

Parameters:

<RateMatPattGrp> N | G1 | G2
 N = none
 *RST: N

Example: See [Example"Configuring the PDSCH incl. PTRS and Precoding settings"](#) on page 393.

Manual operation: See ["Rate Match Pattern Group"](#) on page 215

**[:SOURCE<hw>]:BB:NR5G:SCHed:CELL<cc>:SUBF<sf>:USER<us>:
 BWPart<bwp>:ALLoc<al>:PDSCh:PRECg <UserAllocPDSCHP>**

For PDSCH allocations, the precoding granularity can be adjusted. Precondition is that the precoding for the PDSCH is enabled under "User/BWP Settings > DL BWP Config > PDSCH > General Settings > Static Bundle Size".

Parameters:

<UserAllocPDSCHP> N2 | N4 | WIDeband
N2
 Precoding granularity is set to N2.
N4
 Precoding granularity is set to N4.
 This setting is not available if:
 - [VRB-to-PRB Interleaver](#) equals 2 or
 - [Resource Block Group Size](#) equals Config1 and BWP size ≤ 36 RBs
WIDeband
 Precoding granularity is set to wideband.
 *RST: N2

Example: See: [Example"Configuring the PDSCH incl. PTRS and Precoding settings"](#) on page 393

Manual operation: See ["Precoding Granularity"](#) on page 216

```
[:SOURce<hw>]:BB:NR5G:SCHEd:CELL<cc>:SUBF<sf>:USER<us>:
  BWPart<bwp>:ALLoc<al>:PDSCh:SBCZero:STATe <UserAllocPdschS>
```

Sets if the PDSCH settings are scheduled by CORESET 0 or not.

Parameters:

```
<UserAllocPdschS> 1 | ON | 0 | OFF
*RST:             0
```

Example: See [Example"Configuring the PDSCH incl. PTRS and Precoding settings"](#) on page 393.

Manual operation: See ["Scheduled by CORESET 0"](#) on page 214

```
[:SOURce<hw>]:BB:NR5G:SCHEd:CELL<cc>:SUBF<sf>:USER<us>:
  BWPart<bwp>:ALLoc<al>:PDSCh|PUSCh:BMAid <BurstRefAllocID>
```

Sets the bandwidth of the given allocation as reference for the "Burst" power mode.

Parameters:

```
<BurstRefAllocID> 1 | ON | 0 | OFF
0|OFF
```

Disables the given allocation as burst reference for the "Burst" power mode.

```
1|ON
```

Sets the given allocation as burst reference for the "Burst" power mode.

```
*RST:             0
```

Example: See: [Example"Configuring the PDSCH incl. PTRS and Precoding settings"](#) on page 393 and [Example"Configuring the PUCCH settings"](#) on page 406.

Manual operation: See ["Burst Mode Ref Alloc Identifier"](#) on page 215

```
[:SOURce<hw>]:BB:NR5G:SCHEd:CELL<cc>:SUBF<sf>:USER<us>:
  BWPart<bwp>:ALLoc<al>:PDSCh|PUSCh:RESalloc <UserAllocPXschR>
```

Sets the resource allocation type.

Parameters:

```
<UserAllocPXschR> T0 | T1 | T2
*RST:             T1
```

Example: See [Example"Scheduling PxSCH type 0 allocation"](#) on page 395.

Manual operation: See ["Resource Allocation"](#) on page 215

```
[ :SOURce<hw>]:BB:NR5G:SCHed:CELL<cc>:SUBF<sf>:USER<us>:
  BWPart<bwp>:ALLoc<al>:PDSCh|PUSCh:RESalloc:PATtern
  <ResAllocType0BM>, <BitCount>
```

If [:SOURce<hw>]:BB:NR5G:SCHed:CELL<cc>:SUBF<sf>:USER<us>: BWPart<bwp>:ALLoc<al>:PDSCh|PUSCh:RESalloc on page 612 T0, sets the PDSCH resource block groups allocation as bit pattern.

Parameters:

<ResAllocType0BM> 19 bits
 *RST: #H0

<BitCount> integer
 Range: 0 to 19
 *RST: 18

Example: See [Example "Scheduling Pxsch type 0 allocation"](#) on page 395.

Manual operation: See ["Resource Block Group Bitmap"](#) on page 218

```
[ :SOURce<hw>]:BB:NR5G:SCHed:CELL<cc>:SUBF<sf>:USER<us>:
  BWPart<bwp>:ALLoc<al>:PDSCh|PUSCh:TYPE <PXschType>
```

Defines the PDSCH/PUSCH type by selecting the DCI format by that the PDSCH/PUSCH content is defined.

Parameters:

<PXschType> F00 | F01 | F10 | F11 | F02 | F12
 *RST: F00

Example: See [Example "Configuring the PDSCH incl. PTRS and Precoding settings"](#) on page 393.

Manual operation: See ["PDSCH Type/PUSCH Type"](#) on page 214

```
[ :SOURce<hw>]:BB:NR5G:SCHed:CELL<cc>:SUBF<sf>:USER<us>:
  BWPart<bwp>:ALLoc<al>:PUSCh:FHOI <AllocPuschFHOld>
```

Sets the frequency hopping offset index.

Parameters:

<AllocPuschFHOld> float

Example: See [Example "Configuring the PUSCH settings"](#) on page 402

Manual operation: See ["Index to Frequency Hopping Offset"](#) on page 216

```
[ :SOURce<hw>]:BB:NR5G:SCHed:CELL<cc>:SUBF<sf>:USER<us>:
  BWPart<bwp>:ALLoc<al>:PUSCh:FHOP:STATe <AllocPUSCHDoFH>
```

Enable or disable the frequency hopping.

Parameters:

<AllocPUSCHDoFH> 1 | ON | 0 | OFF
 *RST: 0

Example: See [Example"Configuring the PUSCH settings"](#) on page 402

Manual operation: See ["Frequency Hopping"](#) on page 216

**[:SOURce<hw>]:BB:NR5G:SCHed:CELL<cc>:SUBF<sf>:USER<us>:
 BWPart<bwp>:ALLoc<al>:PUSCh:HPRNumber <ProcessNumber>**

Sets the HARQ process number for the relevant DCI.

Only accessible when the "HPN Mode" is enabled in the "Node Settings > Feedback".

Parameters:

<ProcessNumber> integer
 Range: 0 to 15 (UL) / 31 (DL)
 *RST: 0

Example: See [Example"Configuring the PUSCH settings"](#) on page 402

Manual operation: See ["HARQ Process Number"](#) on page 219

**[:SOURce<hw>]:BB:NR5G:SCHed:CELL<cc>:SUBF<sf>:USER<us>:
 BWPart<bwp>:ALLoc<al>:PUSCh:INT<il>:INTL <Interlace>**

Defines the interlace value for PUSCH allocations.

Parameters:

<Interlace> integer
 Range: 0 to 9
 *RST: 0

Example: See [Example"Configuring the PUSCH settings"](#) on page 402

Manual operation: See ["Value"](#) on page 216

**[:SOURce<hw>]:BB:NR5G:SCHed:CELL<cc>:SUBF<sf>:USER<us>:
 BWPart<bwp>:ALLoc<al>:PUSCh:NINT <Interlaces>**

Defines the number of interlaces for PUSCH allocations.

Prerequisites for this command

- Turn on interlacing ([:SOURce<hw>]:BB:NR5G:UBWP:USER<us>:CELL<cc>:UL:BWP<bwp>:PUCCh:UITL).
- Use resource allocation type 2 ([:SOURce<hw>]:BB:NR5G:SCHed:CELL<cc>:SUBF<sf>:USER<us>:BWPart<bwp>:ALLoc<al>:PDSCh|PUSCh:RESalloc).

Parameters:

<Interlaces> integer
 Range: 1 to 10
 *RST: 1

Example: See [Example "Configuring the PUSCH settings"](#) on page 402

Manual operation: See ["Number of Interlaces"](#) on page 216

**[:SOURce<hw>]:BB:NR5G:SCHed:CELL<cc>:SUBF<sf>:USER<us>:
 BWPart<bwp>:ALLoc<al>:TBM<tbm>:SLOTs <SlotOffset>**

Defines the slots that carry the transport block for non-consecutive slot usage.

Suffix:

<tbm> 0 ... 7
 Selects one of the slots the transport block uses. The value range depends on the number of slots the transport block is spread over.

Parameters:

<SlotOffset> integer
 Offset in slots relative to the previous slot. See the example in ["Number of Slots TBoMS"](#) on page 217 for more in information about the logic behind this feature.
 Range: 0 to 9
 *RST: 0

Manual operation: See ["Number of Slots TBoMS"](#) on page 217

**[:SOURce<hw>]:BB:NR5G:SCHed:CELL<cc>:SUBF<sf>:USER<us>:
 BWPart<bwp>:ALLoc<al>:TBOMs <Slots>**

Selects the number of slots the PUSCH transport block is transmitted on.

Prerequisites for this command

- [:SOURce<hw>] :BB:NR5G:UBWP:USER<us>:CELL<cc>:UL:BWP<bwp>:UCI:MODE = UCLS
- [:SOURce<hw>] :BB:NR5G:UBWP:REStart on page 483 = COAL
- [:SOURce<hw>] :BB:NR5G:UBWP:USER<us>:USCH:CCODing:STATe = ON

Parameters:

<Slots> N1 | N2 | N4 | N8
 *RST: N1

Example: //Select number of slots for PUSCH transport block transmission
 SOURce1:BB:NR5G:UBWP:USER0:CELL0:UL:BWP0:UCI:
 MODE UCLS
 SOURce1:BB:NR5G:UBWP:REStart COAL
 SOURce1:BB:NR5G:UBWP:USER0:USCH:CCoding:STATE 1
 SOURce1:BB:NR5G:SCHed:CELL0:USER0:BWPart0:
 ALLoc0:TBOMs N4

Manual operation: See "Number of Slots TBoMS" on page 217

**[:SOURce<hw>]:BB:NR5G:SCHed:CELL<cc>:SUBF<sf>:USER<us>:
 BWPart<bwp>:ALLoc<al>:TOFFset <Offset>**

Defines a time offset for PUSCH allocations.

Parameters:

<Offset> float
 Range: -3E-4 to 3E-4
 Increment: 1E-8
 *RST: 0
 Default unit: s

Manual operation: See "Time Offset" on page 217

10.21.2 PDSCH and PUSCH Tx scheme commands

Note that some of the commands in the following list are available for both PDSCH and PUSCH scheduling, while others are exclusive to PDSCH or PUSCH scheduling.

[:SOURce<hw>]:BB:NR5G:SCHed:CELL<cc>:SUBF<sf>:USER<us>:BWPart<bwp>:
 ALLoc<al>:PDSCh:TXScheme:APCSirs..... 617

[:SOURce<hw>]:BB:NR5G:SCHed:CELL<cc>:SUBF<sf>:USER<us>:BWPart<bwp>:
 ALLoc<al>:PDSCh:TXScheme:CBMD..... 617

[:SOURce<hw>]:BB:NR5G:SCHed:CELL<cc>:SUBF<sf>:USER<us>:BWPart<bwp>:
 ALLoc<al>:PDSCh:TXScheme:CBType?..... 618

[:SOURce<hw>]:BB:NR5G:SCHed:CELL<cc>:SUBF<sf>:USER<us>:BWPart<bwp>:
 ALLoc<al>:PDSCh|PUSCh:TXScheme:CDMData..... 618

[:SOURce<hw>]:BB:NR5G:SCHed:CELL<cc>:SUBF<sf>:USER<us>:BWPart<bwp>:
 ALLoc<al>:PDSCh:TXScheme:INTervp..... 618

[:SOURce<hw>]:BB:NR5G:SCHed:CELL<cc>:SUBF<sf>:USER<us>:BWPart<bwp>:
 ALLoc<al>:PDSCh|PUSCh:TXScheme:NLAYers..... 619

[:SOURce<hw>]:BB:NR5G:SCHed:CELL<cc>:SUBF<sf>:USER<us>:BWPart<bwp>:
 ALLoc<al>:PDSCh:TXScheme:PCN1..... 619

[:SOURce<hw>]:BB:NR5G:SCHed:CELL<cc>:SUBF<sf>:USER<us>:BWPart<bwp>:
 ALLoc<al>:PDSCh:TXScheme:PCN2?..... 619

[:SOURce<hw>]:BB:NR5G:SCHed:CELL<cc>:SUBF<sf>:USER<us>:BWPart<bwp>:
 ALLoc<al>:PDSCh:TXScheme:SPCB<s2us0>:I11..... 620

[:SOURce<hw>]:BB:NR5G:SCHed:CELL<cc>:SUBF<sf>:USER<us>:BWPart<bwp>:
 ALLoc<al>:PDSCh:TXScheme:SPCB<s2us0>:I12..... 620

<code>[:SOURCE<hw>] : BB : NR5G : SChed : CELL <cc> : SUBF <sf> : USER <us> : BWPart <bwp> : ALLoc <al> : PDSCh : TXScheme : SPCB <s2us0> : I13</code>	621
<code>[:SOURCE<hw>] : BB : NR5G : SChed : CELL <cc> : SUBF <sf> : USER <us> : BWPart <bwp> : ALLoc <al> : PDSCh : TXScheme : SPCB <s2us0> : I2</code>	621
<code>[:SOURCE<hw>] : BB : NR5G : SChed : CELL <cc> : SUBF <sf> : USER <us> : BWPart <bwp> : ALLoc <al> : PUSCh : TXScheme : SRI</code>	621
<code>[:SOURCE<hw>] : BB : NR5G : SChed : CELL <cc> : SUBF <sf> : USER <us> : BWPart <bwp> : ALLoc <al> : PUSCh : TXScheme : TPMidx</code>	622

[:SOURCE<hw>] : BB : NR5G : SChed : CELL <cc> : SUBF <sf> : USER <us> : BWPart <bwp> : ALLoc <al> : PDSCh : TXScheme : APCSirs <AntennaPorts>

Selects the number of antenna ports the CSI-RS is transmitted on.

Prerequisites for this command

- Select precoding based on a codebook (`[:SOURCE<hw>] : BB : NR5G : UBWP : USER <us> : CELL <cc> : DL : BWP <bwp> : PDSCh : PREC : MOD`).

Parameters:

<code><AntennaPorts></code>	N1 CSI-RS transmission on one antenna port.
	N2 CSI-RS transmission on two antenna ports.
	N4 CSI-RS transmission on four antenna ports.
<code>*RST:</code>	N1

Manual operation: See "[Number of CSI-RS Antenna Ports](#)" on page 221

[:SOURCE<hw>] : BB : NR5G : SChed : CELL <cc> : SUBF <sf> : USER <us> : BWPart <bwp> : ALLoc <al> : PDSCh : TXScheme : CBMD <CodebookMode>

Selects the "Codebook Mode" precoding parameter.

Prerequisites for this command

- Select precoding based on a codebook (`[:SOURCE<hw>] : BB : NR5G : UBWP : USER <us> : CELL <cc> : DL : BWP <bwp> : PDSCh : PREC : MOD`).
- Select > 2 CSI-RS antenna ports (`[:SOURCE<hw>] : BB : NR5G : SChed : CELL <cc> : SUBF <sf> : USER <us> : BWPart <bwp> : ALLoc <al> : PDSCh : TXScheme : APCSirs`).

Parameters:

<code><CodebookMode></code>	N1 N2
<code>*RST:</code>	N1

Manual operation: See "[Precoding configuration](#)" on page 222

**[:SOURce<hw>]:BB:NR5G:SCHed:CELL<cc>:SUBF<sf>:USER<us>:
BWPart<bwp>:ALLoc<al>:PDSCh:TXScheme:CBType?**

Queries the selected codebook type.

Prerequisites for this command

- Select precoding based on a codebook ([:SOURce<hw>] :BB:NR5G:UBWP :
USER<us>:CELL<cc>:DL:BWP<bwp>:PDSCh:PREC:MOD).

Return values:

<CodebookType> T1SP
*RST: T1SP

Example: See [Example"Configuring the PDSCH incl. PTRS and Precoding settings"](#) on page 393

Usage: Query only

Manual operation: See ["Codebook Type"](#) on page 221

**[:SOURce<hw>]:BB:NR5G:SCHed:CELL<cc>:SUBF<sf>:USER<us>:
BWPart<bwp>:ALLoc<al>:PDSCh|PUSCh:TXScheme:CDMData
<CDMGroupData>**

For DCI format 0_1, sets the number of DMRS CDM groups without data.

Parameters:

<CDMGroupData> integer
Range: 0 to 2
*RST: 1

Example: See [Example"Configuring the PDSCH incl. PTRS and Precoding settings"](#) on page 393.

Manual operation: See ["CDM Groups w/o Data"](#) on page 220

**[:SOURce<hw>]:BB:NR5G:SCHed:CELL<cc>:SUBF<sf>:USER<us>:
BWPart<bwp>:ALLoc<al>:PDSCh:TXScheme:INTervp <UserAllocPdschV>**

If [:SOURce<hw>] :BB:NR5G:UBWP:USER<us>:CELL<cc>:DL:BWP<bwp> :
PDSCh:VPINterVP2|VP4, enables interleaved VRB-to-PRB mapping.

Parameters:

<UserAllocPdschV> 1 | ON | 0 | OFF

Example: See [Example"Configuring the PDSCH incl. PTRS and Precoding settings"](#) on page 393.

Example: SOURce1:BB:NR5G:UBWP:USER0:CELL0:DL:BWP0:PDSCh:
VPINter VP2
SOURce1:BB:NR5G:SCHed:CELL0:SUBF0:USER0:
BWPart0:ALLoc1:PDSCh:TXScheme:INTervp 1

Manual operation: See ["Interleaved VRB-to-PRB"](#) on page 221

```
[:SOURce<hw>]:BB:NR5G:SCHed:CELL<cc>:SUBF<sf>:USER<us>:
  BWPart<bwp>:ALLoc<al>:PDSCh|PUSCh:TXScheme:NLAYers <Layers>
```

For DCI format 0_1, sets the number of precoding layers.

Parameters:

<Layers> integer
 Range: 1 to 8
 *RST: 1

Example: See [Example"Configuring the PDSCH incl. PTRS and Precoding settings"](#) on page 393.

```
[:SOURce<hw>]:BB:NR5G:SCHed:CELL<cc>:SUBF<sf>:USER<us>:
  BWPart<bwp>:ALLoc<al>:PDSCh:TXScheme:PCN1 <Value>
```

Selects the "N1" precoding parameter.

Prerequisites for this command

- Select precoding based on a codebook ([:SOURce<hw>] :BB:NR5G:UBWP:USER<us>:CELL<cc>:DL:BWP<bwp>:PDSCh:PREC:MOD).
- Select > 1 CSI-RS antenna ports ([:SOURce<hw>] :BB:NR5G:SCHed:CELL<cc>:SUBF<sf>:USER<us>:BWPart<bwp>:ALLoc<al>:PDSCh:TXScheme:APCSirs).

Parameters:

<Value> N16 | N12 | N8 | N6 | N4 | N3 | N2 | N1
 *RST: N1

Example: See: [Example"Configuring the PDSCH incl. PTRS and Precoding settings"](#) on page 393

Manual operation: See ["Precoding configuration"](#) on page 222

```
[:SOURce<hw>]:BB:NR5G:SCHed:CELL<cc>:SUBF<sf>:USER<us>:
  BWPart<bwp>:ALLoc<al>:PDSCh:TXScheme:PCN2?
```

Queries the "N2" precoding parameter.

Prerequisites for this command

- Select precoding based on a codebook ([:SOURce<hw>] :BB:NR5G:UBWP:USER<us>:CELL<cc>:DL:BWP<bwp>:PDSCh:PREC:MOD).
- Select > 1 CSI-RS antenna ports ([:SOURce<hw>] :BB:NR5G:SCHed:CELL<cc>:SUBF<sf>:USER<us>:BWPart<bwp>:ALLoc<al>:PDSCh:TXScheme:APCSirs).

Return values:

<Value> N1 | N2 | N3 | N4
 *RST: N1

- Example:** See: [Example"Configuring the PDSCH incl. PTRS and Precoding settings"](#) on page 393
- Usage:** Query only
- Manual operation:** See "[Precoding configuration](#)" on page 222

**[:SOURce<hw>]:BB:NR5G:SCHed:CELL<cc>:SUBF<sf>:USER<us>:
BWPart<bwp>:ALLoc<al>:PDsch:TXScheme:SPCB<s2us0>:I11 <Value>**

Selects the "Codebook Index 1_1" precoding parameter.

Prerequisites for this command

- Select precoding based on a codebook ([:SOURce<hw>]:BB:NR5G:UBWP:USER<us>:CELL<cc>:DL:BWP<bwp>:PDsch:PREC:MOD).
- Select > 1 CSI-RS antenna ports ([:SOURce<hw>]:BB:NR5G:SCHed:CELL<cc>:SUBF<sf>:USER<us>:BWPart<bwp>:ALLoc<al>:PDsch:TXScheme:APCSirs).

Parameters:

<Value> integer
Range: 0 to 15
*RST: 0

- Example:** See: [Example"Configuring the PDSCH incl. PTRS and Precoding settings"](#) on page 393
- Manual operation:** See "[Precoding configuration](#)" on page 222

**[:SOURce<hw>]:BB:NR5G:SCHed:CELL<cc>:SUBF<sf>:USER<us>:
BWPart<bwp>:ALLoc<al>:PDsch:TXScheme:SPCB<s2us0>:I12 <Value>**

Selects the "Codebook Index 1_1" precoding parameter.

Prerequisites for this command

- Select precoding based on a codebook ([:SOURce<hw>]:BB:NR5G:UBWP:USER<us>:CELL<cc>:DL:BWP<bwp>:PDsch:PREC:MOD).
- Select > 1 CSI-RS antenna ports ([:SOURce<hw>]:BB:NR5G:SCHed:CELL<cc>:SUBF<sf>:USER<us>:BWPart<bwp>:ALLoc<al>:PDsch:TXScheme:APCSirs).

Parameters:

<Value> integer
Range: 0 to 15
*RST: 0

- Example:** See: [Example"Configuring the PDSCH incl. PTRS and Precoding settings"](#) on page 393
- Manual operation:** See "[Precoding configuration](#)" on page 222

**[:SOURce<hw>]:BB:NR5G:SCHed:CELL<cc>:SUBF<sf>:USER<us>:
BWPart<bwp>:ALLoc<al>:PDSCh:TXScheme:SPCB<s2us0>:I13 <Value>**

Selects the "Codebook Index 1_1" precoding parameter.

Prerequisites for this command

- Select precoding based on a codebook (`[:SOURce<hw>] :BB:NR5G:UBWP:USER<us>:CELL<cc>:DL:BWP<bwp>:PDSCh:PREC:MOD`).
- Select > 1 CSI-RS antenna ports (`[:SOURce<hw>] :BB:NR5G:SCHed:CELL<cc>:SUBF<sf>:USER<us>:BWPart<bwp>:ALLoc<al>:PDSCh:TXScheme:APCSirs`).

Parameters:

<Value> integer
 Range: 0 to 15
 *RST: 0

Example: See: [Example"Configuring the PDSCH incl. PTRS and Precoding settings"](#) on page 393

Manual operation: See "[Precoding configuration](#)" on page 222

**[:SOURce<hw>]:BB:NR5G:SCHed:CELL<cc>:SUBF<sf>:USER<us>:
BWPart<bwp>:ALLoc<al>:PDSCh:TXScheme:SPCB<s2us0>:I2 <Value>**

Selects the "Codebook Index 1_1" precoding parameter.

Prerequisites for this command

- Select precoding based on a codebook (`[:SOURce<hw>] :BB:NR5G:UBWP:USER<us>:CELL<cc>:DL:BWP<bwp>:PDSCh:PREC:MOD`).
- Select > 1 CSI-RS antenna ports (`[:SOURce<hw>] :BB:NR5G:SCHed:CELL<cc>:SUBF<sf>:USER<us>:BWPart<bwp>:ALLoc<al>:PDSCh:TXScheme:APCSirs`).

Parameters:

<Value> integer
 Range: 0 to 15
 *RST: 0

Example: See: [Example"Configuring the PDSCH incl. PTRS and Precoding settings"](#) on page 393

Manual operation: See "[Precoding configuration](#)" on page 222

**[:SOURce<hw>]:BB:NR5G:SCHed:CELL<cc>:SUBF<sf>:USER<us>:
BWPart<bwp>:ALLoc<al>:PUSCh:TXScheme:SRI <AllocPuschSri>**

Selects the SRS resource to be used.

Parameters:

<AllocPuschSri> integer
 The max value depends on the number of SRS resources, as set with the command [:SOURce<hw>] :BB:NR5G:UBWP: USER<us>:CELL<cc>:UL:BWP<bwp>:SRS:RS:SET<gr0>: NRESources.
 Range: 0 to 15
 *RST: 0

Example: See [Example"Configuring the PUSCH settings"](#) on page 402.

Manual operation: See ["SRS Resource Indicator"](#) on page 221

[:SOURce<hw>] :BB:NR5G:SCHed:CELL<cc>:SUBF<sf>:USER<us>: BWPart<bwp>:ALLoc<al>:PUSCh:TXScheme:TPMidx <TxTPMIIndex>

For PUSCH DCI format 0_1, sets the TPMI index, required to select the precoding matrix.

Parameters:

<TxTPMIIndex> integer
 Range: 0 to 27
 *RST: 0

Example: See [Example"Configuring the PUSCH settings"](#) on page 402.

Manual operation: See ["TPMI"](#) on page 220

10.21.3 PDSCH and PUSCH DMRS commands

Note that some of the commands in the following list are available for both PDSCH and PUSCH scheduling, while others are exclusive to PDSCH or PUSCH scheduling.

[:SOURce<hw>] :BB:NR5G:SCHed:CELL<cc>:SUBF<sf>:USER<us>:BWPart<bwp>: ALLoc<al>:PDSCh PUSCh:DMRS:APIndex.....	623
[:SOURce<hw>] :BB:NR5G:SCHed:CELL<cc>:SUBF<sf>:USER<us>:BWPart<bwp>: ALLoc<al>:PDSCh[:DMRS]:APSelect<s2us0>.....	623
[:SOURce<hw>] :BB:NR5G:SCHed:CELL<cc>:SUBF<sf>:USER<us>:BWPart<bwp>: ALLoc<al>:PDSCh PUSCh:DMRS:CTYPE.....	623
[:SOURce<hw>] :BB:NR5G:SCHed:CELL<cc>:SUBF<sf>:USER<us>:BWPart<bwp>: ALLoc<al>:PUSCh:DMR:NIDSel.....	624
[:SOURce<hw>] :BB:NR5G:SCHed:CELL<cc>:SUBF<sf>:USER<us>:BWPart<bwp>: ALLoc<al>:PDSCh PUSCh:DMRS:LENGth.....	624
[:SOURce<hw>] :BB:NR5G:SCHed:CELL<cc>:SUBF<sf>:USER<us>:BWPart<bwp>: ALLoc<al>:PDSCh PUSCh:DMRS:MODE.....	625
[:SOURce<hw>] :BB:NR5G:SCHed:CELL<cc>:SUBF<sf>:USER<us>:BWPart<bwp>: ALLoc<al>:PDSCh PUSCh:DMRS:NSID.....	625
[:SOURce<hw>] :BB:NR5G:SCHed:CELL<cc>:SUBF<sf>:USER<us>:BWPart<bwp>: ALLoc<al>:PDSCh PUSCh:DMRS:POWER.....	625
[:SOURce<hw>] :BB:NR5G:SCHed:CELL<cc>:SUBF<sf>:USER<us>:BWPart<bwp>: ALLoc<al>:PDSCh PUSCh:DMRS:SEQGen.....	626

<code>[:SOURce<hw>]:BB:NR5G:SCHed:CELL<cc>:SUBF<sf>:USER<us>:BWPart<bwp>:ALLoc<al>:PDSCh PUSCh:DMRS:SEQHopping</code>	626
<code>[:SOURce<hw>]:BB:NR5G:SCHed:CELL<cc>:SUBF<sf>:USER<us>:BWPart<bwp>:ALLoc<al>:PDSCh PUSCh:DMRS:SLTSymbols?</code>	626
<code>[:SOURce<hw>]:BB:NR5G:SCHed:CELL<cc>:SUBF<sf>:USER<us>:BWPart<bwp>:ALLoc<al>:PDSCh PUSCh:DMRS:TAPos</code>	627
<code>[:SOURce<hw>]:BB:NR5G:SCHed:CELL<cc>:SUBF<sf>:USER<us>:BWPart<bwp>:ALLoc<al>:PUSCh[:DMRS]:APSelect<s2us0></code>	627

`[:SOURce<hw>]:BB:NR5G:SCHed:CELL<cc>:SUBF<sf>:USER<us>:BWPart<bwp>:ALLoc<al>:PDSCh|PUSCh:DMRS:APIndex <Value>`

Defines the additional position index for the DMRS.

Prerequisites for this command

- `[:SOURce<hw>]:BB:NR5G:SCHed:CELL<cc>:SUBF<sf>:USER<us>:BWPart<bwp>:ALLoc<al>:PDSCh|PUSCh:DMRS:MODE = MAN`

Parameters:

<Value> integer
 Range: 0 to 3
 *RST: 0

Example: See `[:SOURce<hw>]:BB:NR5G:SCHed:CELL<cc>:SUBF<sf>:USER<us>:BWPart<bwp>:ALLoc<al>:PDSCh|PUSCh:DMRS:MODE`

Manual operation: See "Additional Position Index" on page 225

`[:SOURce<hw>]:BB:NR5G:SCHed:CELL<cc>:SUBF<sf>:USER<us>:BWPart<bwp>:ALLoc<al>:PDSCh[:DMRS]:APSelect<s2us0> <PdschAPSel>`

Each layer of a PDSCH allocation is mapped to a certain antenna port. By the command the antenna ports are selected which are used for the transmission of the PDSCH allocation.

Parameters:

<PdschAPSel> AP1000 | AP1001 | AP1002 | AP1003 | AP1004 | AP1005 | AP1006 | AP1007 | AP1008 | AP1009 | AP1010 | AP1011
 *RST: AP1000

Example: See [Example"Configuring the PDSCH incl. PTRS and Precoding settings"](#) on page 393.

Manual operation: See "DMRS Antenna Ports ..." on page 225

`[:SOURce<hw>]:BB:NR5G:SCHed:CELL<cc>:SUBF<sf>:USER<us>:BWPart<bwp>:ALLoc<al>:PDSCh|PUSCh:DMRS:CTYPe <Configuration>`

Selects the DMRS configuration type.

Prerequisites for this command

- `[:SOURce<hw>] :BB:NR5G:SCHed:CELL<cc>:SUBF<sf>:USER<us>:BWPart<bwp>:ALLoc<al>:PDSCh|PUSCh:DMRS:MODE = MAN`

Parameters:

<Configuration> T1 | T2
*RST: T1

Example:

See `[:SOURce<hw>] :BB:NR5G:SCHed:CELL<cc>:SUBF<sf>:USER<us>:BWPart<bwp>:ALLoc<al>:PDSCh|PUSCh:DMRS:MODE`

Manual operation: See "Config Type" on page 225

`[:SOURce<hw>] :BB:NR5G:SCHed:CELL<cc>:SUBF<sf>:USER<us>:BWPart<bwp>:ALLoc<al>:PUSCh:DMR:NIDSel <PuschDmrsIdSel>`

Sets whether the variable n_{ID}^{CELL} or n_{ID}^{PUSCH} is used by the generation of the DMRS sequence.

Parameters:

<PuschDmrsIdSel> CID | PUID
CID
 n_{ID}^{CELL} is used by the generation of the DMRS sequence
PUID
 n_{ID}^{PUSCH} is used by the generation of the DMRS sequence
*RST: CID

Example: [Example"Configuring the PUSCH settings"](#) on page 402

Manual operation: See "[N_ID^RS](#)" on page 224

`[:SOURce<hw>] :BB:NR5G:SCHed:CELL<cc>:SUBF<sf>:USER<us>:BWPart<bwp>:ALLoc<al>:PDSCh|PUSCh:DMRS:LENGth <DmrsLen>`

Defines whether single- or double-symbol DMRS is used.

Parameters:

<DmrsLen> integer
Range: 1 to 2
*RST: 1

Example: See [Example"Configuring the PDSCH incl. PTRS and Precoding settings"](#) on page 393.

Manual operation: See "[Length](#)" on page 225

```
[ :SOURce<hw>]:BB:NR5G:SCHEd:CELL<cc>:SUBF<sf>:USER<us>:
  BWPart<bwp>:ALLoc<al>:PDSCh|PUSCh:DMRS:MODE <Mode>
```

Selects the DMRS configuration mode.

Parameters:

<Mode>

AUTO
Applies the same DMRS settings to all allocations.

MAN
Each allocation can have different DMRS settings.

*RST: AUTO

Example:

```
//Define PDSCH DMRS settings for a specific allocation
SOURCE1:BB:NR5G:SCHEd:CELL0:SUBF0:USER0:
BWPart0:ALLoc1:PDSCH:DMRS:MODE MAN
SOURCE1:BB:NR5G:SCHEd:CELL0:SUBF0:USER0:
BWPart0:ALLoc1:PDSCH:DMRS:TAPos 3
SOURCE1:BB:NR5G:SCHEd:CELL0:SUBF0:USER0:
BWPart0:ALLoc1:PDSCH:DMRS:CTYPE T2
SOURCE1:BB:NR5G:SCHEd:CELL0:SUBF0:USER0:
BWPart0:ALLoc1:PDSCH:DMRS:APINDEX 2
```

Manual operation: See "[Mode](#)" on page 223

```
[ :SOURce<hw>]:BB:NR5G:SCHEd:CELL<cc>:SUBF<sf>:USER<us>:
  BWPart<bwp>:ALLoc<al>:PDSCh|PUSCh:DMRS:NSID <NScid>
```

Sets the scrambling ID (N_{ID}).

Parameters:

<NScid>

integer

Range: 0 to 1

*RST: 0

Example: See [Example"Configuring the PDSCH incl. PTRS and Precoding settings"](#) on page 393.

Manual operation: See "[N_SCID](#)" on page 224

```
[ :SOURce<hw>]:BB:NR5G:SCHEd:CELL<cc>:SUBF<sf>:USER<us>:
  BWPart<bwp>:ALLoc<al>:PDSCh|PUSCh:DMRS:POWER <DmrsPower>
```

Sets the power of the PDSCH/PUSCH, relative to the power of the other channels.

Parameters:

<DmrsPower>

float

Range: -80.00 to 10.00

Increment: 0.001

*RST: 0

Example: See [Example"Configuring the PDSCH incl. PTRS and Precoding settings"](#) on page 393.

Manual operation: See ["Power"](#) on page 225

```
[:SOURce<hw>]:BB:NR5G:SCHed:CELL<cc>:SUBF<sf>:USER<us>:
  BWPart<bwp>:ALLoc<al>:PDSCh|PUSCh:DMRS:SEQGen <SeqGen>
```

Sets how the scrambling ID for DMRS is derived.

Parameters:

<SeqGen> CELLid | DMRSid

DMRSid
 N_{ID}^{DMRS} : Scrambling ID (i.e. n_{ID}) = DMRS scrambling ID (i.e. N_{ID}^{DMRS})

CELLid
 N_{ID}^{Cell} : Scrambling ID (i.e. n_{ID}) = cell ID (i.e. N_{ID}^{Cell})

*RST: CELLid

Example: See [Example"Configuring the PDSCH incl. PTRS and Precoding settings"](#) on page 393.

Manual operation: See ["Sequence Generation"](#) on page 223

```
[:SOURce<hw>]:BB:NR5G:SCHed:CELL<cc>:SUBF<sf>:USER<us>:
  BWPart<bwp>:ALLoc<al>:PDSCh|PUSCh:DMRS:SEQHopping
  <DmrsGrpSeqHopp>
```

Sets the higher-layer parameter `groupOrSequenceHopping` that defines the sequence group, required for the DMRS sequence generation according to [TS 38.211](#).

Parameters:

<DmrsGrpSeqHopp> NEITHer | GRP | SEQUENCE

NEITHer
 Disables the group and sequence hopping for the DMRS sequence generation.

GRP
 Enables the group hopping for the DMRS sequence generation.

SEQUENCE
 Enables the sequence hopping for the DMRS sequence generation.

*RST: NEITHer

Example: See [Example"Configuring the PUSCH settings"](#) on page 402.

Manual operation: See ["Group or Sequence Hopping"](#) on page 224

```
[:SOURce<hw>]:BB:NR5G:SCHed:CELL<cc>:SUBF<sf>:USER<us>:
  BWPart<bwp>:ALLoc<al>:PDSCh|PUSCh:DMRS:SLTSymbols?
```

Queries the slot number of DMRS symbols.

Return values:

<PxschDmrsSlotSy> string
 Range: 0 char to 256 char

Example: See [Example"Configuring the PDSCH incl. PTRS and Precoding settings"](#) on page 393.

Usage: Query only

Manual operation: See "[Slot Symbols](#)" on page 225

**[:SOURce<hw>]:BB:NR5G:SCHed:CELL<cc>:SUBF<sf>:USER<us>:
 BWPart<bwp>:ALLoc<al>:PDSCh|PUSCh:DMRS:TAPos <Value>**

Defines the DMRS position.

Prerequisites for this command

- [:SOURce<hw>] :BB:NR5G:SCHed:CELL<cc>:SUBF<sf>:USER<us>:
 BWPart<bwp>:ALLoc<al>:PDSCh|PUSCh:DMRS:MODE = MAN

Parameters:

<Value> integer
 Range: 2 to 3
 *RST: 2

Example: See [:SOURce<hw>] :BB:NR5G:SCHed:CELL<cc>:
 SUBF<sf>:USER<us>:BWPart<bwp>:ALLoc<al>:
 PDSCh|PUSCh:DMRS:MODE

Manual operation: See "[TypeA Position](#)" on page 224

**[:SOURce<hw>]:BB:NR5G:SCHed:CELL<cc>:SUBF<sf>:USER<us>:
 BWPart<bwp>:ALLoc<al>:PUSCh[:DMRS]:APSelect<s2us0> <PuschAPSel>**

Each layer of a PUSCH allocation is mapped to a certain antenna port. By the command the antenna ports are selected which are used for the transmission of the PUSCH allocation.

Parameters:

<PuschAPSel> AP0 | AP1 | AP2 | AP3 | AP4 | AP5 | AP6 | AP7 | AP8 | AP9 |
 AP10 | AP11
 *RST: AP0

Example: See:[Example"Configuring the PUSCH settings"](#) on page 402

Manual operation: See "[DMRS Antenna Ports ...](#)" on page 225

10.21.4 PDSCH and PUSCH channel coding commands

<code>[:SOURce<hw>]:BB:NR5G:SCHed:CELL<cc>:SUBF<sf>:USER<us>:BWPart<bwp>:ALLoc<al>[:CW<cw>]:PDSCh PUSCh:CCODing:FRCR</code>	628
<code>[:SOURce<hw>]:BB:NR5G:SCHed:CELL<cc>:SUBF<sf>:USER<us>:BWPart<bwp>:ALLoc<al>[:CW<cw>]:PDSCh PUSCh:CCODing:IMCS</code>	628
<code>[:SOURce<hw>]:BB:NR5G:SCHed:CELL<cc>:SUBF<sf>:USER<us>:BWPart<bwp>:ALLoc<al>[:CW<cw>]:PDSCh PUSCh:CCODing:RVINdex</code>	629
<code>[:SOURce<hw>]:BB:NR5G:SCHed:CELL<cc>:SUBF<sf>:USER<us>:BWPart<bwp>:ALLoc<al>[:CW<cw>]:PDSCh PUSCh:CCODing:TBSFactor</code>	629
<code>[:SOURce<hw>]:BB:NR5G:SCHed:CELL<cc>:SUBF<sf>:USER<us>:BWPart<bwp>:ALLoc<al>[:CW<cw>]:PDSCh PUSCh:CCODing:TBSize?</code>	629
<code>[:SOURce<hw>]:BB:NR5G:SCHed:CELL<cc>:SUBF<sf>:USER<us>:BWPart<bwp>:ALLoc<al>[:CW<cw>]:PDSCh PUSCh:CCODing:TCRate</code>	629
<code>[:SOURce<hw>]:BB:NR5G:SCHed:CELL<cc>:SUBF<sf>:USER<us>:BWPart<bwp>:ALLoc<al>[:CW<cw>]:RMCStable?</code>	630

```
[ :SOURce<hw> ]:BB:NR5G:SCHed:CELL<cc>:SUBF<sf>:USER<us>:
  BWPart<bwp>:ALLoc<al>[:CW<cw>]:PDSCh|PUSCh:CCODing:FRCR
  <State>
```

Turns custom coderate definition on and off.

If on, you can define the coderate with `[:SOURce<hw>]:BB:NR5G:SCHed:CELL<cc>:SUBF<sf>:USER<us>:BWPart<bwp>:ALLoc<al>[:CW<cw>]:PDSCh|PUSCh:CCODing:TCRate`.

Parameters:

<State> 1 | ON | 0 | OFF
 *RST: 0

Manual operation: See "[Manually Defined Coderate](#)" on page 227

```
[ :SOURce<hw> ]:BB:NR5G:SCHed:CELL<cc>:SUBF<sf>:USER<us>:
  BWPart<bwp>:ALLoc<al>[:CW<cw>]:PDSCh|PUSCh:CCODing:IMCS
  <ChanCodingIMCS>
```

Sets the modulation and coding scheme index.

Parameters:

<ChanCodingIMCS> integer
 Range: 0 to 28
 *RST: 0

Example: See [Example "Configuring the PDSCH incl. PTRS and Precoding settings"](#) on page 393.

Manual operation: See "[I_MCS](#)" on page 227

```
[ :SOURce<hw>]:BB:NR5G:SCHed:CELL<cc>:SUBF<sf>:USER<us>:
  BWPart<bwp>:ALLoc<al>[:CW<cw>]:PDSCh|PUSCh:CCODing:RVIndex
  <Index>
```

Sets the redundancy version index.

Parameters:

<Index> integer
 Range: 1 to 2
 *RST: 0

Example: See [Example"Configuring the PDSCH incl. PTRS and Precoding settings"](#) on page 393.

Manual operation: See ["Redundancy Version Index"](#) on page 228

```
[ :SOURce<hw>]:BB:NR5G:SCHed:CELL<cc>:SUBF<sf>:USER<us>:
  BWPart<bwp>:ALLoc<al>[:CW<cw>]:PDSCh|PUSCh:CCODing:TBSFactor
  <ScalingFactor>
```

Selects the TB scaling factor S.

Parameters:

<ScalingFactor> S1 | S5 | S25
 *RST: S1

Example: See [Example"Configuring the PDSCH incl. PTRS and Precoding settings"](#) on page 393.

Manual operation: See ["TBS Scaling Factor"](#) on page 228

```
[ :SOURce<hw>]:BB:NR5G:SCHed:CELL<cc>:SUBF<sf>:USER<us>:
  BWPart<bwp>:ALLoc<al>[:CW<cw>]:PDSCh|PUSCh:CCODing:TBSize?
```

Queries the resulting transport block size (TBS).

Return values:

<TransBlockSize> integer
 Range: 0 to 3824
 *RST: 0

Example: See [Example"Configuring the PDSCH incl. PTRS and Precoding settings"](#) on page 393.

Usage: Query only

Manual operation: See ["Transport Block Size"](#) on page 228

```
[ :SOURce<hw>]:BB:NR5G:SCHed:CELL<cc>:SUBF<sf>:USER<us>:
  BWPart<bwp>:ALLoc<al>[:CW<cw>]:PDSCh|PUSCh:CCODing:TCRate
  <CodeRate>
```

Queries the target code rate for the selected modulation and coding scheme.

Setting the coderate is possible when you turn on manual coderate definition ([: SOURce<hw>] : BB:NR5G:SCHed:CELL<cc>:SUBF<sf>:USER<us>: BWPart<bwp>:ALLoc<al> [: CW<cw>] : PDSCh | PUSCh:CCODing:FRCR on page 628).

Parameters:

<CodeRate> float
 Range: 0.0 to 1.0
 Increment: 0.001
 *RST: 0.0

Example: See [Example"Configuring the PDSCH incl. PTRS and Precoding settings"](#) on page 393.

Manual operation: See ["Target Code Rate"](#) on page 227

[: SOURce<hw>] : BB:NR5G:SCHed:CELL<cc>:SUBF<sf>:USER<us> : BWPart<bwp>:ALLoc<al> [: CW<cw>] : RMCStable?

Queries the MCS table that corresponds to the signal configuration.

Prerequisites for this command

- Turn off manual coderate definition ([: SOURce<hw>] : BB:NR5G:SCHed:CELL<cc>:SUBF<sf>:USER<us>:BWPart<bwp>:ALLoc<al> [: CW<cw>] : PDSCh | PUSCh:CCODing:FRCR).

Return values:

<ResultingMcs> T1 | T2 | T3 | TTP1 | TTP2
 *RST: T1

Usage: Query only

Manual operation: See ["Resulting MCS Table"](#) on page 228

10.21.5 PUSCH UCI commands

[: SOURce<hw>] : BB:NR5G:SCHed:CELL<cc>:SUBF<sf>:USER<us>:BWPart<bwp>:ALLoc<al>:PUSCh:UCI:CSI1:BITS..... 631
 [: SOURce<hw>] : BB:NR5G:SCHed:CELL<cc>:SUBF<sf>:USER<us>:BWPart<bwp>:ALLoc<al>:PUSCh:UCI:CSI2:BITS..... 631
 [: SOURce<hw>] : BB:NR5G:SCHed:CELL<cc>:SUBF<sf>:USER<us>:BWPart<bwp>:ALLoc<al>:PUSCh:UCI:ACK:BITS..... 631
 [: SOURce<hw>] : BB:NR5G:SCHed:CELL<cc>:SUBF<sf>:USER<us>:BWPart<bwp>:ALLoc<al>:PUSCh:UCI:CSI1:PATtern..... 631
 [: SOURce<hw>] : BB:NR5G:SCHed:CELL<cc>:SUBF<sf>:USER<us>:BWPart<bwp>:ALLoc<al>:PUSCh:UCI:CSI2:PATtern..... 631

<code>[:SOURce<hw>]:BB:NR5G:SCHed:CELL<cc>:SUBF<sf>:USER<us>:BWPart<bwp>:ALLoc<al>:PUSCh:UCI:ACK:PATtern</code>	631
<code>[:SOURce<hw>]:BB:NR5G:SCHed:CELL<cc>:SUBF<sf>:USER<us>:BWPart<bwp>:ALLoc<al>:PUSCh:UCI:CGUCi:BITS</code>	632
<code>[:SOURce<hw>]:BB:NR5G:SCHed:CELL<cc>:SUBF<sf>:USER<us>:BWPart<bwp>:ALLoc<al>:PUSCh:UCI:CGUCi:PATtern</code>	632

**[:SOURce<hw>]:BB:NR5G:SCHed:CELL<cc>:SUBF<sf>:USER<us>:
BWPart<bwp>:ALLoc<al>:PUSCh:UCI:CSI1:BITS <PuschUciCSI1Bit>**

**[:SOURce<hw>]:BB:NR5G:SCHed:CELL<cc>:SUBF<sf>:USER<us>:
BWPart<bwp>:ALLoc<al>:PUSCh:UCI:CSI2:BITS <PuschUCiCSI2Bit>**

**[:SOURce<hw>]:BB:NR5G:SCHed:CELL<cc>:SUBF<sf>:USER<us>:
BWPart<bwp>:ALLoc<al>:PUSCh:UCI:ACK:BITS <PuschUciAckBit>**

Sets the number of ACK/CSI 1/CSI 2 bits.

Parameters:

<PuschUciAckBit> float
 Range: 0 to 128
 Increment: 1
 *RST: 0

Example: See [Example "Configuring the PUSCH settings"](#) on page 402.

Manual operation: See ["Number of ACK Bits"](#) on page 229

**[:SOURce<hw>]:BB:NR5G:SCHed:CELL<cc>:SUBF<sf>:USER<us>:
BWPart<bwp>:ALLoc<al>:PUSCh:UCI:CSI1:PATtern <CSI1Pattern>,
<CSI1Bitcount>**

**[:SOURce<hw>]:BB:NR5G:SCHed:CELL<cc>:SUBF<sf>:USER<us>:
BWPart<bwp>:ALLoc<al>:PUSCh:UCI:CSI2:PATtern <CSI2Pattern>,
<CSI2Bitcount>**

**[:SOURce<hw>]:BB:NR5G:SCHed:CELL<cc>:SUBF<sf>:USER<us>:
BWPart<bwp>:ALLoc<al>:PUSCh:UCI:ACK:PATtern <AckPattern>,
<AckBitcount>**

Sets the ACK/CSI 1/CSI 2 bits in pattern form.

Parameters:

<AckPattern> 128 bits
 Bit pattern
 *RST: #H0

<AckBitcount> integer
 Pattern length, should be the same as the length set with the
 command `[:SOURce<hw>]:BB:NR5G:SCHed:CELL<cc>:
SUBF<sf>:USER<us>:BWPart<bwp>:ALLoc<al>:PUSCh:
UCI:ACK:BITS`.

Range: 0 to 128
 *RST: 0

Example: See [Example"Configuring the PUSCH settings"](#) on page 402.

Manual operation: See ["ACK Pattern"](#) on page 229

```
[ :SOURce<hw>]:BB:NR5G:SCHed:CELL<cc>:SUBF<sf>:USER<us>:
  BWPart<bwp>:ALLoc<al>:PUSCh:UCI:CGUCi:BITS <UciCgUciBits>
```

Sets the number of CG-UCI bits.

Parameters:

<UciCgUciBits> integer
 Range: 0 to 1024
 *RST: 1

Example: See [Example"Configuring the PUSCH settings"](#) on page 402.

Manual operation: See ["Number of CG-UCI Bits"](#) on page 229

```
[ :SOURce<hw>]:BB:NR5G:SCHed:CELL<cc>:SUBF<sf>:USER<us>:
  BWPart<bwp>:ALLoc<al>:PUSCh:UCI:CGUCi:PATtern <CGUCIPattern>,
  <CGUCIBitcount>
```

Sets the ACK/CSI 1/CSI 2 bits in pattern form.

Parameters:

<CGUCIPattern> 1024 bits
 Bit pattern
 *RST: #H0

<CGUCIBitcount> integer
 Pattern length, should be the same as the length set with the
 command [\[:SOURce<hw>\]:BB:NR5G:SCHed:CELL<cc>:SUBF<sf>:USER<us>:BWPart<bwp>:ALLoc<al>:PUSCh:UCI:CGUCi:BITS](#).
 Range: 0 to 1024
 *RST: 0

Example: See [Example"Configuring the PUSCH settings"](#) on page 402.

Manual operation: See ["CG-UCI Pattern"](#) on page 230

10.21.6 PDSCH and PUSCH PTRS commands

Note that some of the commands in the following list are available for both PDSCH and PUSCH scheduling, while others are exclusive to PDSCH or PUSCH scheduling.

PDSCH and PUSCH scheduling commands

<code>[SOURce<hw>]:BB:NR5G:SCHed:CELL<cc>:SUBF<sf>:USER<us>:BWPart<bwp>:ALLoc<al>:PDSCh:PTRS:EPRE</code>	633
<code>[SOURce<hw>]:BB:NR5G:SCHed:CELL<cc>:SUBF<sf>:USER<us>:BWPart<bwp>:ALLoc<al>:PDSCh PUSCh:PTRS:FRQDen</code>	633
<code>[SOURce<hw>]:BB:NR5G:SCHed:CELL<cc>:SUBF<sf>:USER<us>:BWPart<bwp>:ALLoc<al>:PDSCh PUSCh:PTRS:MODE</code>	634
<code>[SOURce<hw>]:BB:NR5G:SCHed:CELL<cc>:SUBF<sf>:USER<us>:BWPart<bwp>:ALLoc<al>:PDSCh PUSCh:PTRS:REOF</code>	634
<code>[SOURce<hw>]:BB:NR5G:SCHed:CELL<cc>:SUBF<sf>:USER<us>:BWPart<bwp>:ALLoc<al>:PDSCh PUSCh:PTRS:STATE</code>	634
<code>[SOURce<hw>]:BB:NR5G:SCHed:CELL<cc>:SUBF<sf>:USER<us>:BWPart<bwp>:ALLoc<al>:PDSCh PUSCh:PTRS:TMDen</code>	635
<code>[SOURce<hw>]:BB:NR5G:SCHed:CELL<cc>:SUBF<sf>:USER<us>:BWPart<bwp>:ALLoc<al>:PUSCh:PTRS:PORT</code>	635
<code>[SOURce<hw>]:BB:NR5G:SCHed:CELL<cc>:SUBF<sf>:USER<us>:BWPart<bwp>:ALLoc<al>:PUSCh:PTRS:POWEr</code>	635
<code>[SOURce<hw>]:BB:NR5G:SCHed:CELL<cc>:SUBF<sf>:USER<us>:BWPart<bwp>:ALLoc<al>:PUSCh:PTRS:PTDMrs</code>	635
<code>[SOURce<hw>]:BB:NR5G:SCHed:CELL<cc>:SUBF<sf>:USER<us>:BWPart<bwp>:ALLoc<al>:PUSCh:PTRS:TP:MODE</code>	636
<code>[SOURce<hw>]:BB:NR5G:SCHed:CELL<cc>:SUBF<sf>:USER<us>:BWPart<bwp>:ALLoc<al>:PUSCh:PTRS:TP:NGRPs</code>	636
<code>[SOURce<hw>]:BB:NR5G:SCHed:CELL<cc>:SUBF<sf>:USER<us>:BWPart<bwp>:ALLoc<al>:PUSCh:PTRS:TP:SCID</code>	636
<code>[SOURce<hw>]:BB:NR5G:SCHed:CELL<cc>:SUBF<sf>:USER<us>:BWPart<bwp>:ALLoc<al>:PUSCh:PTRS:TP:SPPG</code>	637
<code>[SOURce<hw>]:BB:NR5G:SCHed:CELL<cc>:SUBF<sf>:USER<us>:BWPart<bwp>:ALLoc<al>:PUSCh:PTRS:TP:STATE</code>	637
<code>[SOURce<hw>]:BB:NR5G:SCHed:CELL<cc>:SUBF<sf>:USER<us>:BWPart<bwp>:ALLoc<al>:PUSCh:PTRS:TP:TMDensity</code>	637

`[SOURce<hw>]:BB:NR5G:SCHed:CELL<cc>:SUBF<sf>:USER<us>:BWPart<bwp>:ALLoc<al>:PDSCh:PTRS:EPRE <EpreRatio>`

Sets the parameter EPRE ratio.

Parameters:

`<EpreRatio>` RAT0 | RAT1
 *RST: RAT0

Example: See [Example"Configuring the PDSCH incl. PTRS and Precoding settings"](#) on page 393.

Manual operation: See ["EPRE Ratio"](#) on page 232

`[SOURce<hw>]:BB:NR5G:SCHed:CELL<cc>:SUBF<sf>:USER<us>:BWPart<bwp>:ALLoc<al>:PDSCh|PUSCh:PTRS:FRQDen <PtrsFreqDensity>`

Sets the parameter frequency density.

Parameters:

<PtrsFreqDensity> FD2 | FD4
 *RST: FD2

Example: See [Example"Configuring the PDSCH incl. PTRS and Precoding settings"](#) on page 393.

Manual operation: See ["Frequency Density \(K_PTRS\)"](#) on page 232

**[:SOURCE<hw>]:BB:NR5G:SCHed:CELL<cc>:SUBF<sf>:USER<us>:
 BWPart<bwp>:ALLoc<al>:PDSCh|PUSCh:PTRS:MODE <PtrsMode>**

Sets if the PTRS configuration is defined, manually (with the . . . PDSCH:PTRS: . . . commands) or automatically (from the current PDSCH DMRS settings).

Parameters:

<PtrsMode> MANual | AUTO
 *RST: MANual

Manual operation: See ["Mode"](#) on page 231

**[:SOURCE<hw>]:BB:NR5G:SCHed:CELL<cc>:SUBF<sf>:USER<us>:
 BWPart<bwp>:ALLoc<al>:PDSCh|PUSCh:PTRS:REOF <PtrsREOffset>**

Sets the parameter resource element offset.

Parameters:

<PtrsREOffset> RE00 | RE01 | RE10 | RE11
 *RST: RE00

Example: See [Example"Configuring the PDSCH incl. PTRS and Precoding settings"](#) on page 393.

Manual operation: See ["RE-offset"](#) on page 232

**[:SOURCE<hw>]:BB:NR5G:SCHed:CELL<cc>:SUBF<sf>:USER<us>:
 BWPart<bwp>:ALLoc<al>:PDSCh|PUSCh:PTRS:STATe <PXschPtrsState>**

Enables the transmission of phase-tracking reference signals.

Parameters:

<PXschPtrsState> 1 | ON | 0 | OFF
 *RST: 0

Example: See [Example"Configuring the PDSCH incl. PTRS and Precoding settings"](#) on page 393.

Manual operation: See ["State"](#) on page 232

```
[ :SOURce<hw>]:BB:NR5G:SCHEd:CELL<cc>:SUBF<sf>:USER<us>:
  BWPart<bwp>:ALLOc<al>:PUSCh|PTRS:TMDen <PtrsTimeDensity>
```

Sets the parameter time density.

Parameters:

```
<PtrsTimeDensity>  TD1 | TD2 | TD4
                    *RST:    TD1
```

Example: See [Example "Configuring the PDSCH incl. PTRS and Precoding settings"](#) on page 393.

Manual operation: See ["Time Density \(L_PTRS\)"](#) on page 232

```
[ :SOURce<hw>]:BB:NR5G:SCHEd:CELL<cc>:SUBF<sf>:USER<us>:
  BWPart<bwp>:ALLOc<al>:PUSCh:PTRS:PORT <MaxNrofPorts>
```

Sets the maximum number of configured PTRS ports.

Parameters:

```
<MaxNrofPorts>    P1 | P2
                    *RST:    P1
```

Example: `SOURce1:BB:NR5G:SCHEd:CELL0:SUBF0:USER0:
BWPart0:ALLOc0:PUSCh:PTRS:PORT P1`

Manual operation: See ["Max Number of Ports"](#) on page 233

```
[ :SOURce<hw>]:BB:NR5G:SCHEd:CELL<cc>:SUBF<sf>:USER<us>:
  BWPart<bwp>:ALLOc<al>:PUSCh:PTRS:POWer <PtrsPower>
```

Sets the parameter `ptrs-Power` and thus defines the PUSCH to PTRS power ratio per layer per resource element.

Parameters:

```
<PtrsPower>       P00 | P01
                    *RST:    P00
```

Example: `SOURce1:BB:NR5G:SCHEd:CELL0:SUBF0:USER0:
BWPart0:ALLOc0:PUSCh:PTRS:POWer P00`

Manual operation: See ["Power"](#) on page 233

```
[ :SOURce<hw>]:BB:NR5G:SCHEd:CELL<cc>:SUBF<sf>:USER<us>:
  BWPart<bwp>:ALLOc<al>:PUSCh:PTRS:PTDMrs <PtrsDmrsAssocia>
```

Sets the PTRS-DMRS association.

Parameters:

```
<PtrsDmrsAssocia> integer
                    Range:    0 to 3
                    *RST:    0
```

Example: SOURce1:BB:NR5G:SCHEd:CELL0:SUBF0:USER0:
 BWPart0:ALLoc0:PUSCh:PTRS:PTDMrs 0

Manual operation: See "[PTRS-DMRS Association](#)" on page 232

**[:SOURce<hw>]:BB:NR5G:SCHEd:CELL<cc>:SUBF<sf>:USER<us>:
 BWPart<bwp>:ALLoc<al>:PUSCh:PTRS:TP:MODE <PtrsTpMode>**

Sets if the PTRS configuration is defined, manually (with the . . . PUSCh:PTRS:TP: . . . commands) or automatically (from the current PUSCH DMRS settings).

Parameters:

<PtrsTpMode> MANual | AUTO
 *RST: MANual

Example: See [Example "Configuring the PUSCH PTRS with enabled transform precoding"](#) on page 404.

Manual operation: See "[Mode](#)" on page 234

**[:SOURce<hw>]:BB:NR5G:SCHEd:CELL<cc>:SUBF<sf>:USER<us>:
 BWPart<bwp>:ALLoc<al>:PUSCh:PTRS:TP:NGRPs <PtrsTpNumGroups>**

Sets the number of PTRS groups.

Parameters:

<PtrsTpNumGroups> G2 | G4 | G8
 *RST: G2

Example: See [Example "Configuring the PUSCH PTRS with enabled transform precoding"](#) on page 404.

Manual operation: See "[Number of PTRS Groups](#)" on page 234

**[:SOURce<hw>]:BB:NR5G:SCHEd:CELL<cc>:SUBF<sf>:USER<us>:
 BWPart<bwp>:ALLoc<al>:PUSCh:PTRS:TP:SCID <TpPtrsScramId>**

Sets whether the PTRS Scrambling ID value used for the PTRS sequence generation is configured by the [NPusch ID](#) (higher layer) or by the cell ID.

Parameters:

<TpPtrsScramId> CID | PUID
 CID
 Sets the cell ID as the scrambling ID for PTRS sequence generation.
 PUID
 Sets the [NPusch ID](#) as the scrambling ID for PTRS sequence generation.
 *RST: CID

Example: See [Example"Configuring the PUSCH PTRS with enabled transform precoding"](#) on page 404.

Manual operation: See ["PTRS Scrambling ID"](#) on page 234

**[:SOURCE<hw>]:BB:NR5G:SCHed:CELL<cc>:SUBF<sf>:USER<us>:
BWPart<bwp>:ALLoc<al>:PUSCh:PTRS:TP:SPPG <PtrsTpSamplesPG>**

Sets the number of samples per PTRS group.

Parameters:

<PtrsTpSamplesPG> S4 | S2

*RST: S2

Example: See [Example"Configuring the PUSCH PTRS with enabled transform precoding"](#) on page 404.

Manual operation: See ["Samples Per PTRS Group"](#) on page 235

**[:SOURCE<hw>]:BB:NR5G:SCHed:CELL<cc>:SUBF<sf>:USER<us>:
BWPart<bwp>:ALLoc<al>:PUSCh:PTRS:TP:STATE <PtrsTPState>**

Enables the transmission of phase-tracking reference signals.

Parameters:

<PtrsTPState> 1 | ON | 0 | OFF

*RST: 0

Example: See [Example"Configuring the PUSCH PTRS with enabled transform precoding"](#) on page 404.

Manual operation: See ["State"](#) on page 234

**[:SOURCE<hw>]:BB:NR5G:SCHed:CELL<cc>:SUBF<sf>:USER<us>:
BWPart<bwp>:ALLoc<al>:PUSCh:PTRS:TP:TMDensity <PtrsTpTimeDens>**

Sets the higher-layer parameter `timeDensity`.

Parameters:

<PtrsTpTimeDens> TD1 | TD2

TD1

$L_{PT-RS} = 1$

TD2

$L_{PT-RS} = 2$

*RST: TD1

Example: See [Example"Configuring the PUSCH PTRS with enabled transform precoding"](#) on page 404.

Manual operation: See ["Time Density \(L_PTRS\)"](#) on page 234

10.21.7 PDSCH and PUSCH antenna port configuration commands

<code>[:SOURCE<hw>]:BB:NR5G:SCHed:CELL<cc>:SUBF<sf>:USER<us>:BWPart<bwp>: ALLoc<al>:APMap:COL<apc>:ROW<apr>:MAGNitude</code>	638
<code>[:SOURCE<hw>]:BB:NR5G:SCHed:CELL<cc>:SUBF<sf>:USER<us>:BWPart<bwp>: ALLoc<al>:APMap:COL<apc>:ROW<apr>:PHASe</code>	638
<code>[:SOURCE<hw>]:BB:NR5G:SCHed:CELL<cc>:SUBF<sf>:USER<us>:BWPart<bwp>: ALLoc<al>:APMap:COL<apc>:ROW<apr>:IMAGinary</code>	639
<code>[:SOURCE<hw>]:BB:NR5G:SCHed:CELL<cc>:SUBF<sf>:USER<us>:BWPart<bwp>: ALLoc<al>:APMap:COL<apc>:ROW<apr>:REAL</code>	639

**[:SOURCE<hw>]:BB:NR5G:SCHed:CELL<cc>:SUBF<sf>:USER<us>:
BWPart<bwp>:ALLoc<al>:APMap:COL<apc>:ROW<apr>:MAGNitude
<Magnitude>**

Defines the mapping of the antenna ports to the physical antennas, cylindrical mapping coordinates are used.

Suffix:

<apc> 0 to 7
Defines the antenna port (i.e. the column in the antenna port-mapping table)
Value range depends on the selected number of layers

Parameters:

<Magnitude> float
Range: 0 to 1
Increment: 0.001
*RST: 0

Example:

See `[:SOURCE<hw>] :BB:NR5G:SCHed:CELL<cc>:
SUBF<sf>:USER<us>:BWPart<bwp>:ALLoc<al>:APMap:
COL<apc>:ROW<apr>:PHASe` on page 638.

Manual operation: See "Mapping Table" on page 235

**[:SOURCE<hw>]:BB:NR5G:SCHed:CELL<cc>:SUBF<sf>:USER<us>:
BWPart<bwp>:ALLoc<al>:APMap:COL<apc>:ROW<apr>:PHASe <Phase>**

Defines the mapping of the antenna ports to the physical antennas, if cylindrical mapping coordinates are used.

Suffix:

<apc> 0 to 7
Defines the antenna port (i.e. the column in the antenna port-mapping table)
Value range depends on the selected number of layers

Parameters:

<Phase> float
 Range: 0 to 360
 Increment: 0.1
 *RST: 0

Example:

```
SOURce1:BB:NR5G:SCHed:CELL0:SUBF0:USER0:
BWPart0:ALLOc1:APMap:MAPCoordinates CYL
SOURce1:BB:NR5G:SCHed:CELL0:SUBF0:USER0:
BWPart0:ALLOc1:APMap:COL0:ROW0:PHASe 0
SOURce1:BB:NR5G:SCHed:CELL0:SUBF0:USER0:
BWPart0:ALLOc1:APMap:COL0:ROW0:MAGNitude 1
```

Manual operation: See "Mapping Table" on page 235

```
[:SOURce<hw>]:BB:NR5G:SCHed:CELL<cc>:SUBF<sf>:USER<us>:
  BWPart<bwp>:ALLOc<al>:APMap:COL<apc>:ROW<apr>:IMAGinary
  <ImaginaryValue>
[:SOURce<hw>]:BB:NR5G:SCHed:CELL<cc>:SUBF<sf>:USER<us>:
  BWPart<bwp>:ALLOc<al>:APMap:COL<apc>:ROW<apr>:REAL
  <RealValue>
```

Define the mapping of the antenna ports to the physical antennas.

Suffix:

<apc> 0 to 7
 Defines the antenna port (i.e. the column in the antenna port mapping table)
 Value range depends on the selected number of layers

Parameters:

<RealValue> float
 The REAL (Magnitude) and IMAGinary (Phase) values are interdependent. Their value ranges change depending on each other and so that the resulting complex value is as follows:
 $|\text{REAL}+j*\text{IMAGinary}| \leq 1$
 Otherwise, the values are normalized to Magnitude = 1.
 Range: -1 to 1
 Increment: 0.001
 *RST: 0

Example: See [Example"Antenna port settings"](#) on page 396.

Manual operation: See "Mapping Table" on page 235

10.22 CORESET scheduling commands

- [General CORESET scheduling commands](#)..... 640
- [CORESET payload scheduling commands](#)..... 644
- [DCI field configuration commands](#)..... 652

10.22.1 General CORESET scheduling commands

[SOURce<hw>]:BB:NR5G:SCHed:CELL<cc>:SUBF<sf>:USER<us>:BWPart<bwp>: ALLoc<al>:CS:DMRS:SCRam:ID.....	640
[SOURce<hw>]:BB:NR5G:SCHed:CELL<cc>:SUBF<sf>:USER<us>:BWPart<bwp>: ALLoc<al>:CS:DMRS:SCRam:STATe.....	640
[SOURce<hw>]:BB:NR5G:SCHed:CELL<cc>:SUBF<sf>:USER<us>:BWPart<bwp>: ALLoc<al>:CS:DMRS:SPACe<s2us0>:AGGLevel?.....	641
[SOURce<hw>]:BB:NR5G:SCHed:CELL<cc>:SUBF<sf>:USER<us>:BWPart<bwp>: ALLoc<al>:CS:DMRS:SPACe<s2us0>:MAXCandidate.....	641
[SOURce<hw>]:BB:NR5G:SCHed:CELL<cc>:SUBF<sf>:USER<us>:BWPart<bwp>: ALLoc<al>:CS:REFDmrs.....	641
[SOURce<hw>]:BB:NR5G:SCHed:CELL<cc>:SUBF<sf>:USER<us>:BWPart<bwp>: ALLoc<al>:CS:ID.....	642
[SOURce<hw>]:BB:NR5G:SCHed:CELL<cc>:SUBF<sf>:USER<us>:BWPart<bwp>: ALLoc<al>:CS:IL:BUNSize.....	642
[SOURce<hw>]:BB:NR5G:SCHed:CELL<cc>:SUBF<sf>:USER<us>:BWPart<bwp>: ALLoc<al>:CS:IL:SHIDx.....	642
[SOURce<hw>]:BB:NR5G:SCHed:CELL<cc>:SUBF<sf>:USER<us>:BWPart<bwp>: ALLoc<al>:CS:IL:SIZE.....	642
[SOURce<hw>]:BB:NR5G:SCHed:CELL<cc>:SUBF<sf>:USER<us>:BWPart<bwp>: ALLoc<al>:CS:IL:STATe.....	643
[SOURce<hw>]:BB:NR5G:SCHed:CELL<cc>:SUBF<sf>:USER<us>:BWPart<bwp>: ALLoc<al>:CS:PREGran.....	643
[SOURce<hw>]:BB:NR5G:SCHed:CELL<cc>:SUBF<sf>:USER<us>:BWPart<bwp>: ALLoc<al>:CS:PUNCTuring.....	643
[SOURce<hw>]:BB:NR5G:SCHed:CELL<cc>:SUBF<sf>:USER<us>:BWPart<bwp>: ALLoc<al>:CS:RESalloc:BITMap.....	644
[SOURce<hw>]:BB:NR5G:SCHed:CELL<cc>:SUBF<sf>:USER<us>:BWPart<bwp>: ALLoc<al>:CS:RESalloc:STATe.....	644

**[SOURce<hw>]:BB:NR5G:SCHed:CELL<cc>:SUBF<sf>:USER<us>:
BWPart<bwp>:ALLoc<al>:CS:DMRS:SCRam:ID <DmrsScramId>**

Sets the DMRS scrambling ID.

Parameters:

<DmrsScramId> integer
 Range: 0 to 65535
 *RST: 0

Example: See [Example "Configuring the CORESET settings"](#) on page 398.

Manual operation: See "ID" on page 239

**[SOURce<hw>]:BB:NR5G:SCHed:CELL<cc>:SUBF<sf>:USER<us>:
BWPart<bwp>:ALLoc<al>:CS:DMRS:SCRam:STATe <CSDmrsScramStat>**

If enabled, the DMRS ID is used to calculate the PUCCH scrambling sequence.

Parameters:

<CSDmrsScramStat> 1 | ON | 0 | OFF
 *RST: 0

Example: See [Example"Configuring the CORESET settings"](#) on page 398.

Manual operation: See ["Use DMRS Scrambling ID"](#) on page 239

**[:SOURce<hw>]:BB:NR5G:SCHed:CELL<cc>:SUBF<sf>:USER<us>:
 BWPart<bwp>:ALLoc<al>:CS:DMRS:SPACe<s2us0>:AGGLLevel?**

Queries the possible aggregation levels.

Return values:

<AggrLevel> AL1 | AL2 | AL4 | AL8 | AL16
 *RST: AL1

Example: See [Example"Configuring the CORESET settings"](#) on page 398.

Usage: Query only

Manual operation: See ["Aggregation Level"](#) on page 241

**[:SOURce<hw>]:BB:NR5G:SCHed:CELL<cc>:SUBF<sf>:USER<us>:
 BWPart<bwp>:ALLoc<al>:CS:DMRS:SPACe<s2us0>:MAXCandidate
 <MaxCandidate>**

Sets the maximum number of candidates allowed for the selected aggregation level.

Parameters:

<MaxCandidate> 1 | 2 | 3 | 4 | 5 | 6 | 8
 *RST: 1

Example: See [Example"Configuring the CORESET settings"](#) on page 398.

Manual operation: See ["Max Candidates"](#) on page 242

**[:SOURce<hw>]:BB:NR5G:SCHed:CELL<cc>:SUBF<sf>:USER<us>:
 BWPart<bwp>:ALLoc<al>:CS:REFDmrs <Reference>**

Selects the reference point for the DMRS.

Parameters:

<Reference> **CS**
 CORESET start
POIN
 Reference point A
 *RST: POIN

Manual operation: See ["DMRS Reference Point"](#) on page 240

```
[ :SOURce<hw>]:BB:NR5G:SCHeD:CELL<cc>:SUBF<sf>:USER<us>:
  BWPart<bwp>:ALLoc<al>:CS:ID <ID>
```

Sets the CORESET ID.

Parameters:

<ID> integer
 Range: 0 to 11
 *RST: 1

Example: See [Example "Configuring the CORESET settings"](#) on page 398.

Manual operation: See ["CORESET ID"](#) on page 239

```
[ :SOURce<hw>]:BB:NR5G:SCHeD:CELL<cc>:SUBF<sf>:USER<us>:
  BWPart<bwp>:ALLoc<al>:CS:IL:BUNSize <BundleSize>
```

Sets the bundle size L.

Parameters:

<BundleSize> BS2 | BS3 | BS6
 *RST: BS6

Example: See [Example "Configuring the CORESET settings"](#) on page 398.

Manual operation: See ["Bundle Size"](#) on page 240

```
[ :SOURce<hw>]:BB:NR5G:SCHeD:CELL<cc>:SUBF<sf>:USER<us>:
  BWPart<bwp>:ALLoc<al>:CS:IL:SHIDx <CSIntlShiftIdx>
```

Sets the shift index n_{shift} .

Parameters:

<CSIntlShiftIdx> integer
 Range: 0 to 274
 *RST: 0

Example: See [Example "Configuring the CORESET settings"](#) on page 398.

Manual operation: See ["Shift Index"](#) on page 240

```
[ :SOURce<hw>]:BB:NR5G:SCHeD:CELL<cc>:SUBF<sf>:USER<us>:
  BWPart<bwp>:ALLoc<al>:CS:IL:SIZE <CSIntlSize>
```

Sets the interleaver size R.

Parameters:

<CSIntlSize> IS2 | IS3 | IS6
 *RST: IS2

Example: See [Example "Configuring the CORESET settings"](#) on page 398.

Manual operation: See ["Size"](#) on page 241

```
[ :SOURce<hw>]:BB:NR5G:SCHed:CELL<cc>:SUBF<sf>:USER<us>:
  BWPart<bwp>:ALLoc<al>:CS:IL:STATe <CSIntlState>
```

If enabled, the CCE-to-REG mapping is interleaved.

Parameters:

<CSIntlState> 1 | ON | 0 | OFF

Example: See [Example"Configuring the CORESET settings"](#) on page 398.

Manual operation: See ["Interleaving State"](#) on page 240

```
[ :SOURce<hw>]:BB:NR5G:SCHed:CELL<cc>:SUBF<sf>:USER<us>:
  BWPart<bwp>:ALLoc<al>:CS:PREGran <PrecoderGranula>
```

Sets the value of the higher-layer parameter `precoderGranularity`, as defined in [TS 38.211](#).

Parameters:

<PrecoderGranula> REG | ACRB

REG

REG bundle (`sameAsREG-bundle`)

ACRB

All contiguous RBs (`allContiguousRBs`)

*RST: REG

Example: See [Example"Configuring the CORESET settings"](#) on page 398.

Manual operation: See ["Precoder Granularity"](#) on page 238

```
[ :SOURce<hw>]:BB:NR5G:SCHed:CELL<cc>:SUBF<sf>:USER<us>:
  BWPart<bwp>:ALLoc<al>:CS:PUNcturing <Puncturing>
```

Turns puncturing of the CORESET on and off.

Prerequisites for this command

- Select a 5 MHz channel bandwidth (`[:SOURce<hw>]:BB:NR5G:NODE:CELL<cc>:CBW`).
- Select a 15 kHz subcarrier spacing (`[:SOURce<hw>]:BB:NR5G:NODE:CELL<cc>:TXBW:S15K:USE`).

Parameters:

<Puncturing> OFF | ON | 1 | 0

*RST: OFF

Manual operation: See ["Puncturing"](#) on page 240

**[:SOURce<hw>]:BB:NR5G:SCHed:CELL<cc>:SUBF<sf>:USER<us>:
BWPart<bwp>:ALLoc<al>:CS:RESalloc:BITMap <ResAllocBitMap>,
<BitCount>**

If [:SOURce<hw>]:BB:NR5G:SCHed:CELL<cc>:SUBF<sf>:USER<us>:
BWPart<bwp>:ALLoc<al>:CS:RESalloc:STATE 1, sets the CORESET allocation
in the frequency domain.

Parameters:

<ResAllocBitMap> 45 bits
*RST: #H0

<BitCount> integer
Range: 45 to 45
*RST: 45

Example: See [:SOURce<hw>]:BB:NR5G:SCHed:CELL<cc>:
SUBF<sf>:USER<us>:BWPart<bwp>:ALLoc<al>:CS:
RESalloc:STATE on page 644.

Manual operation: See "Frequency Domain Resources" on page 239

**[:SOURce<hw>]:BB:NR5G:SCHed:CELL<cc>:SUBF<sf>:USER<us>:
BWPart<bwp>:ALLoc<al>:CS:RESalloc:STATE <State>**

If enabled, the CORESET frequency allocation is set as a bitmap, defined with the
command [:SOURce<hw>]:BB:NR5G:SCHed:CELL<cc>:SUBF<sf>:USER<us>:
BWPart<bwp>:ALLoc<al>:CS:RESalloc:BITMap.

Parameters:

<State> 1 | ON | 0 | OFF
*RST: 0
Default unit: OFF

Example: SOURce1:BB:NR5G:SCHed:CELL0:SUBF0:USER0:
BWPart0:ALLoc0:CS:RESalloc:STATE 1
SOURce1:BB:NR5G:SCHed:CELL0:SUBF0:USER0:
BWPart0:ALLoc0:CS:RESalloc:BITMap
#H1FFFFFFFFFFFF, 45

Manual operation: See "Use Bitmap for Resources in Frequency Domain"
on page 239

10.22.2 CORESET payload scheduling commands

[:SOURce<hw>]:BB:NR5G:SCHed:CELL<cc>:SUBF<sf>:USER<us>:BWPart<bwp>:
ALLoc<al>:CS:AULBwp.....645

[:SOURce<hw>]:BB:NR5G:SCHed:CELL<cc>:SUBF<sf>:USER<us>:BWPart<bwp>:
ALLoc<al>:CS:DCCes:DATA.....646

[:SOURce<hw>]:BB:NR5G:SCHed:CELL<cc>:SUBF<sf>:USER<us>:BWPart<bwp>:
ALLoc<al>:CS:DCCes:DLISt.....646

[:SOURce<hw>]:BB:NR5G:SCHed:CELL<cc>:SUBF<sf>:USER<us>:BWPart<bwp>: ALLoc<al>:CS:DCCes:PATtern.....	646
[:SOURce<hw>]:BB:NR5G:SCHed:CELL<cc>:SUBF<sf>:USER<us>:BWPart<bwp>: ALLoc<al>:CS:DCCes:STATe.....	646
[:SOURce<hw>]:BB:NR5G:SCHed:CELL<cc>:SUBF<sf>:USER<us>:BWPart<bwp>: ALLoc<al>:CS:DCI<dci>:AGGLLevel.....	647
[:SOURce<hw>]:BB:NR5G:SCHed:CELL<cc>:SUBF<sf>:USER<us>:BWPart<bwp>: ALLoc<al>:CS:DCI<dci>:CANDidate.....	647
[:SOURce<hw>]:BB:NR5G:SCHed:CELL<cc>:SUBF<sf>:USER<us>:BWPart<bwp>: ALLoc<al>:CS:DCI<dci>:CPDSch.....	647
[:SOURce<hw>]:BB:NR5G:SCHed:CELL<cc>:SUBF<sf>:USER<us>:BWPart<bwp>: ALLoc<al>:CS:DCI<dci>:DMSS?.....	648
[:SOURce<hw>]:BB:NR5G:SCHed:CELL<cc>:SUBF<sf>:USER<us>:BWPart<bwp>: ALLoc<al>:CS:DCI<dci>:FMT.....	648
[:SOURce<hw>]:BB:NR5G:SCHed:CELL<cc>:SUBF<sf>:USER<us>:BWPart<bwp>: ALLoc<al>:CS:DCI<dci>:HBTS?.....	648
[:SOURce<hw>]:BB:NR5G:SCHed:CELL<cc>:SUBF<sf>:USER<us>:BWPart<bwp>: ALLoc<al>:CS:DCI<dci>:INDex.....	649
[:SOURce<hw>]:BB:NR5G:SCHed:CELL<cc>:SUBF<sf>:USER<us>:BWPart<bwp>: ALLoc<al>:CS:DCI<dci>:MULTable.....	649
[:SOURce<hw>]:BB:NR5G:SCHed:CELL<cc>:SUBF<sf>:USER<us>:BWPart<bwp>: ALLoc<al>:CS:DCI<dci>:POWer.....	649
[:SOURce<hw>]:BB:NR5G:SCHed:CELL<cc>:SUBF<sf>:USER<us>:BWPart<bwp>: ALLoc<al>:CS:DCI<dci>:RNTI.....	650
[:SOURce<hw>]:BB:NR5G:SCHed:CELL<cc>:SUBF<sf>:USER<us>:BWPart<bwp>: ALLoc<al>:CS:DCI<dci>:SSP.....	650
[:SOURce<hw>]:BB:NR5G:SCHed:CELL<cc>:SUBF<sf>:USER<us>:BWPart<bwp>: ALLoc<al>:CS:TCI.....	650
[:SOURce<hw>]:BB:NR5G:SCHed:CELL<cc>:SUBF<sf>:USER<us>:BWPart<bwp>: ALLoc<al>:CS:DCI<dci>:USAGe.....	650
[:SOURce<hw>]:BB:NR5G:SCHed:CELL<cc>:SUBF<sf>:USER<us>:BWPart<bwp>: ALLoc<al>:CS:NDCI.....	651
[:SOURce<hw>]:BB:NR5G:SCHed:CELL<cc>:SUBF<sf>:USER<us>:BWPart<bwp>: ALLoc<al>:CS:TS12.....	652

**[:SOURce<hw>]:BB:NR5G:SCHed:CELL<cc>:SUBF<sf>:USER<us>:
BWPart<bwp>:ALLoc<al>:CS:AULBwp <ActiveULBwp>**

Sets the index of the UL BWP used for the calculation of the DCI bit size.

Parameters:

<ActiveULBwp>	integer
	Range: 0 to 3
	*RST: 0

Example: See [Example "Configuring the CORESET settings"](#) on page 398.

Manual operation: See ["Active UL BWP"](#) on page 244

```
[ :SOURce<hw>]:BB:NR5G:SCHed:CELL<cc>:SUBF<sf>:USER<us>:
      BWPart<bwp>:ALLoc<al>:CS:DCCes:DATA <DummyCceDataSrc>
```

Sets the data source for the dummy CCEs.

Parameters:

```
<DummyCceDataSrc>PN9 | PN11 | PN15 | PN16 | PN20 | PN21 | PN23 | PATtern |
                  DLISt | ZERO | ONE
*RST:            PN9
```

Example: See [Example"Configuring the CORESET settings"](#) on page 398.

Manual operation: See ["Dummy CCEs Data Source"](#) on page 244

```
[ :SOURce<hw>]:BB:NR5G:SCHed:CELL<cc>:SUBF<sf>:USER<us>:
      BWPart<bwp>:ALLoc<al>:CS:DCCes:DLISt <DummyCceDataLst>
```

Selects an existing data list file from the default directory or from the specific directory.

Parameters:

```
<DummyCceDataLst>string
                  Filename incl. file extension or complete file path
```

Example: See [Example"Configuring the CORESET settings"](#) on page 398.

Manual operation: See ["Dummy CCEs Data Source"](#) on page 244

```
[ :SOURce<hw>]:BB:NR5G:SCHed:CELL<cc>:SUBF<sf>:USER<us>:
      BWPart<bwp>:ALLoc<al>:CS:DCCes:PATtern <Pattern>, <BitCount>
```

Sets a bit pattern as a data source.

Parameters:

```
<Pattern>          64 bits
                  *RST:      #H0

<BitCount>        integer
                  Range:     1 to 64
                  *RST:     1
```

Example: See [Example"Configuring the CORESET settings"](#) on page 398.

Manual operation: See ["Dummy CCEs Data Source"](#) on page 244

```
[ :SOURce<hw>]:BB:NR5G:SCHed:CELL<cc>:SUBF<sf>:USER<us>:
      BWPart<bwp>:ALLoc<al>:CS:DCCes:STATe <DummyCceState>
```

Defines if unused CORESET resources (CCEs) are used for data transmission or not.

Parameters:

```
<DummyCceState>  0 | 1 | ALLowpdsch
                  0
                  Disables data transmission in the unused CCEs.
```

1

Fills unused CCEs with dummy data, as set with the command
`[:SOURce<hw>] :BB:NR5G:SCHed:CELL<cc>:SUBF<sf>:USER<us>:BWPart<bwp>:ALLoc<al>:CS:DCCes:DATA.`

ALLowpdsch

Allows PDSCH transmission in the unused CCEs.

*RST: 1

Example: See [Example"Configuring the CORESET settings"](#) on page 398.

Manual operation: See ["Unused CCEs"](#) on page 243

`[:SOURce<hw>]:BB:NR5G:SCHed:CELL<cc>:SUBF<sf>:USER<us>:
BWPart<bwp>:ALLoc<al>:CS:DCI<dci>:AGGLLevel <DciAggLvl>`

Sets the aggregation level for the selected DCI.

Parameters:

<DciAggLvl> AL1 | AL2 | AL4 | AL8 | AL16

*RST: 4

Example: See [Example"Search space configuration"](#) on page 398.

Manual operation: See ["Aggregation Level"](#) on page 248

`[:SOURce<hw>]:BB:NR5G:SCHed:CELL<cc>:SUBF<sf>:USER<us>:
BWPart<bwp>:ALLoc<al>:CS:DCI<dci>:CANDidate <Candidate>`

Selects the candidate number for the selected aggregation level, where the maximum number of candidates per aggregation level are set with the command `[:SOURce<hw>] :BB:NR5G:SCHed:CELL<cc>:SUBF<sf>:USER<us>:BWPart<bwp>:ALLoc<al>:CS:DMRS:SPACe<s2us0>:MAXCandidate.`

Parameters:

<Candidate> integer

Range: 0 to 8

*RST: 0

Example: See [Example"Search space configuration"](#) on page 398.

Manual operation: See ["Candidate"](#) on page 248

`[:SOURce<hw>]:BB:NR5G:SCHed:CELL<cc>:SUBF<sf>:USER<us>:
BWPart<bwp>:ALLoc<al>:CS:DCI<dci>:CPDSch <CreatePDSCH>`

Use this command to create the content and scheduling of the PDSCH automatically, as configured with the DCI format 1_0 parameters.

Parameters:

<CreatePDSCH> 1 | ON | 0 | OFF

*RST: 0

Example: See [Example"Configuring the CORESET settings"](#) on page 398.

Manual operation: See ["Create PDSCH"](#) on page 249

**[:SOURce<hw>]:BB:NR5G:SCHed:CELL<cc>:SUBF<sf>:USER<us>:
BWPart<bwp>:ALLoc<al>:CS:DCI<dci>:DMSS?**

Queries the PDSCH DMRS symbols a DCI uses.

Suffix:

<dci> Index number of the DCI. The range depends on the number of DCIs you have configured.

Return values:

<Symbols> string
Range: 0 char to 256 char

Usage: Query only

Manual operation: See ["PDSCH DMRS Symbols"](#) on page 249

**[:SOURce<hw>]:BB:NR5G:SCHed:CELL<cc>:SUBF<sf>:USER<us>:
BWPart<bwp>:ALLoc<al>:CS:DCI<dci>:FMT <Format>**

Sets the DCI format.

Parameters:

<Format> F00 | F01 | F02 | F10 | F11 | F12 | F20 | F21 | F22 | F23 | F24 |
F25 | F26 | F27 | F30 | F31 | F40 | F41 | F42 | CUSTom
*RST: F00

Example: See [Example"Configuring the CORESET settings"](#) on page 398.

Options: F24 to F26 require R&S SMM-K148

Manual operation: See ["DCI Format"](#) on page 246

**[:SOURce<hw>]:BB:NR5G:SCHed:CELL<cc>:SUBF<sf>:USER<us>:
BWPart<bwp>:ALLoc<al>:CS:DCI<dci>:HBTS?**

Queries the resulting bit data as selected with the DCI format parameters.

Return values:

<PatternHigh> 64 bits

Example: See [Example"Configuring the CORESET settings"](#) on page 398.

Usage: Query only

Manual operation: See ["Bit Data > Pattern"](#) on page 250

**[:SOURce<hw>] :BB:NR5G:SCHEd:CELL<cc>:SUBF<sf>:USER<us>:
BWPart<bwp>:ALLoc<al>:CS:DCI<dci>:INDex <DciCCEIdx>**

If [:SOURce<hw>] :BB:NR5G:SCHEduling:RSSPace 0, sets the index and thus the position of the first CCE of the PDCCH.

Parameters:

<DciCCEIdx> integer
Range: 0 to 10
*RST: 0

Example: See [Example "Search space configuration"](#) on page 398.

Manual operation: See ["CCE Index"](#) on page 249

**[:SOURce<hw>] :BB:NR5G:SCHEd:CELL<cc>:SUBF<sf>:USER<us>:
BWPart<bwp>:ALLoc<al>:CS:DCI<dci>:MULTable <Table>**

Selects the time domain resource allocation table for the PDSCH.

Prerequisites for this command

- Select DCI format 1_0 or 1_1 ([:SOURce<hw>] :BB:NR5G:SCHEd:CELL<cc>:SUBF<sf>:USER<us>:BWPart<bwp>:ALLoc<al>:CS:DCI<dci>:FMT).

Parameters:

<Table> Available tables depend on the selected search space and RNTI.

TABA | TABB | TABC

Table A, B or C

TDAL

Time domain allocation

*RST: TABA

Manual operation: See ["Multiplexing Table"](#) on page 249

**[:SOURce<hw>] :BB:NR5G:SCHEd:CELL<cc>:SUBF<sf>:USER<us>:
BWPart<bwp>:ALLoc<al>:CS:DCI<dci>:POWER <DciPower>**

Defines the power of PDSCH allocations according to the CORESET DCI.

Prerequisites for this command

- Select Auto DCI mode ([:SOURce<hw>] :BB:NR5G:SCHEduling:MODE).
- Select one of the DCI formats for PDSCH scheduling ([:SOURce<hw>] :BB:NR5G:SCHEd:CELL<cc>:SUBF<sf>:USER<us>:BWPart<bwp>:ALLoc<al>:CS:DCI<dci>:FMT).

Parameters:

<DciPower> float
Range: -80 to 10
Increment: 0.01
*RST: 0

Manual operation: See "PDSCH Power /dB" on page 250

**[:SOURCE<hw>]:BB:NR5G:SCHed:CELL<cc>:SUBF<sf>:USER<us>:
BWPart<bwp>:ALLoc<al>:CS:DCI<dci>:RNTI <RNTI>**

Queries the current applicable RNTI of the associated user

Parameters:

<RNTI> integer
Range: 0 to 65535
*RST: 0

Example: See [Example"Configuring the CORESET settings"](#) on page 398.

Manual operation: See "RNTI" on page 245

**[:SOURCE<hw>]:BB:NR5G:SCHed:CELL<cc>:SUBF<sf>:USER<us>:
BWPart<bwp>:ALLoc<al>:CS:DCI<dci>:SSP <SearchSpace>**

Sets the search space for the selected DCI.

Parameters:

<SearchSpace> USS | CSS0 | CSS1 | CSS2 | CSS3 | CSS0A
*RST: USS

Example: See [Example"Configuring the CORESET settings"](#) on page 398.

Manual operation: See "Search Space" on page 247

**[:SOURCE<hw>]:BB:NR5G:SCHed:CELL<cc>:SUBF<sf>:USER<us>:
BWPart<bwp>:ALLoc<al>:CS:TCI <Nr5gCSTCInDCI>**

Enables support of quasi co-location TCI field in DCI format 1_1.

Parameters:

<Nr5gCSTCInDCI> 1 | ON | 0 | OFF

Example:

SOURCE1:BB:NR5G:SCHed:CELL0:SUBF0:USER0:BWPart0:ALLoc0:CS:TC 1
SOURCE1:BB:NR5G:SCHed:CELL0:SUBF0:USER0:BWPart0:ALLoc0:CS:DCI0:TCI 1

Manual operation: See "TCI Present In DCI" on page 245

**[:SOURCE<hw>]:BB:NR5G:SCHed:CELL<cc>:SUBF<sf>:USER<us>:
BWPart<bwp>:ALLoc<al>:CS:DCI<dci>:USAGe <Usage>**

Sets the RNTI type used to scramble the CRC.

Parameters:

<Usage> The RNTI type is defined as follows:
C
Cell RNTI

CS

Configured scheduling RNTI

P

Paging RNTI

SI

System information RNTI

RA

Random access RNTI

TC

Temporary cell RNTI

SPCS

Semi-persistent scheduling cell RNTI

SFI

Slot format indication RNTI

INT

Interruption RNTI

TPUS

Transmit power control-PUSCH RNTI

TPUC

Transmit power control-PUCCH RNTI

TSRS

Transmit power control-SRS RNTI

MCSC

Modulation coding scheme cell RNTI

CI

Cancellation indication RNTI

PS

Power saving RNTI

AI

Availability indication RNTI

MSGB

MsgB RNTI

CUSTom

Custom DCI format

*RST: C

Example: See [Example"Configuring the CORESET settings"](#) on page 398.**Options:** CI and PS require R&S SMM-K148**Manual operation:** See ["Usage"](#) on page 245

```
[:SOURce<hw>]:BB:NR5G:SCHed:CELL<cc>:SUBF<sf>:USER<us>:
  BWPart<bwp>:ALLoc<al>:CS:NDCI <NumDci>
```

Sets the number of DCIs.

Parameters:

<NumDci> integer
 Range: 1 to 4
 *RST: 1
 With R&S SMM-K148, the range increases to 32 DCIs.

Example: See [Example"Configuring the CORESET settings"](#) on page 398.

Manual operation: See ["Number of DCIs"](#) on page 245

**[:SOURCE<hw>]:BB:NR5G:SCHed:CELL<cc>:SUBF<sf>:USER<us>:
 BWPart<bwp>:ALLoc<al>:CS:TS12 <TCISizeInDci12>**

Defines the bit length of the DCI field "Transmission Configuration Index" available in DCI format 1_2.

Parameters:

<TCISizeInDci12> UNCF | TC11 | TC12 | TC13
UNCF
 TCI not configured.
TC11 | TC12 | TC13
 1, 2 or 3 bits used for TCI.
 *RST: UNCF

Manual operation: See ["TCI Size in DCI1_2"](#) on page 245

10.22.3 DCI field configuration commands

• DCI format 0_0	653
• DCI format 0_1	656
• DCI format 0_2	663
• DCI format 1_0	665
• DCI format 1_1	668
• DCI format 1_2	673
• DCI format 2_0	674
• DCI format 2_1	677
• DCI format 2_2	677
• DCI format 2_3	679
• DCI format 2_4	679
• DCI format 2_5	680
• DCI format 2_6	681
• DCI format 2_7	682
• DCI format 3_0	683
• DCI format 3_1	685
• DCI format 4_0	687
• DCI format 4_1	687
• DCI format 4_2	688
• Custom DCI format	689

10.22.3.1 DCI format 0_0

<code>[SOURce<hw>]:BB:NR5G:SCHed:CELL<cc>:SUBF<sf>:USER<us>:BWPart<bwp>:ALLoc<al>:CS:DCI<dci>:CACPext</code>	653
<code>[SOURce<hw>]:BB:NR5G:SCHed:CELL<cc>:SUBF<sf>:USER<us>:BWPart<bwp>:ALLoc<al>:CS:DCI<dci>:FRDRes</code>	653
<code>[SOURce<hw>]:BB:NR5G:SCHed:CELL<cc>:SUBF<sf>:USER<us>:BWPart<bwp>:ALLoc<al>:CS:DCI<dci>:FRHFlag</code>	654
<code>[SOURce<hw>]:BB:NR5G:SCHed:CELL<cc>:SUBF<sf>:USER<us>:BWPart<bwp>:ALLoc<al>:CS:DCI<dci>:HAPRoc</code>	654
<code>[SOURce<hw>]:BB:NR5G:SCHed:CELL<cc>:SUBF<sf>:USER<us>:BWPart<bwp>:ALLoc<al>:CS:DCI<dci>:IDENTifier</code>	654
<code>[SOURce<hw>]:BB:NR5G:SCHed:CELL<cc>:SUBF<sf>:USER<us>:BWPart<bwp>:ALLoc<al>:CS:DCI<dci>:SAI</code>	654
<code>[SOURce<hw>]:BB:NR5G:SCHed:CELL<cc>:SUBF<sf>:USER<us>:BWPart<bwp>:ALLoc<al>:CS:DCI<dci>:TB1:MCS</code>	655
<code>[SOURce<hw>]:BB:NR5G:SCHed:CELL<cc>:SUBF<sf>:USER<us>:BWPart<bwp>:ALLoc<al>:CS:DCI<dci>:TB2:MCS</code>	655
<code>[SOURce<hw>]:BB:NR5G:SCHed:CELL<cc>:SUBF<sf>:USER<us>:BWPart<bwp>:ALLoc<al>:CS:DCI<dci>:TB1:NDI</code>	655
<code>[SOURce<hw>]:BB:NR5G:SCHed:CELL<cc>:SUBF<sf>:USER<us>:BWPart<bwp>:ALLoc<al>:CS:DCI<dci>:TB2:NDI</code>	655
<code>[SOURce<hw>]:BB:NR5G:SCHed:CELL<cc>:SUBF<sf>:USER<us>:BWPart<bwp>:ALLoc<al>:CS:DCI<dci>:TB1:RV</code>	655
<code>[SOURce<hw>]:BB:NR5G:SCHed:CELL<cc>:SUBF<sf>:USER<us>:BWPart<bwp>:ALLoc<al>:CS:DCI<dci>:TB2:RV</code>	655
<code>[SOURce<hw>]:BB:NR5G:SCHed:CELL<cc>:SUBF<sf>:USER<us>:BWPart<bwp>:ALLoc<al>:CS:DCI<dci>:TIDRes</code>	655
<code>[SOURce<hw>]:BB:NR5G:SCHed:CELL<cc>:SUBF<sf>:USER<us>:BWPart<bwp>:ALLoc<al>:CS:DCI<dci>:TPUSch</code>	656
<code>[SOURce<hw>]:BB:NR5G:SCHed:CELL<cc>:SUBF<sf>:USER<us>:BWPart<bwp>:ALLoc<al>:CS:DCI<dci>:USINd</code>	656

`[SOURce<hw>]:BB:NR5G:SCHed:CELL<cc>:SUBF<sf>:USER<us>:BWPart<bwp>:ALLoc<al>:CS:DCI<dci>:CACPext <ChanAccessCPext>`

Sets the DCI field "Channel-Access-CPext".

Parameters:

`<ChanAccessCPext>` integer

Range: 0 to 15

*RST: 0

`[SOURce<hw>]:BB:NR5G:SCHed:CELL<cc>:SUBF<sf>:USER<us>:BWPart<bwp>:ALLoc<al>:CS:DCI<dci>:FRDRes <FreqDomResAssig>`

Sets the DCI field frequency domain resource assignment.

Parameters:

<FreqDomResAssig> integer

Range: 0 to 262143

*RST: 0

Example: See [Example"Configuring the CORESET settings"](#) on page 398.

**[:SOURce<hw>]:BB:NR5G:SCHed:CELL<cc>:SUBF<sf>:USER<us>:
BWPart<bwp>:ALLoc<al>:CS:DCI<dci>:FRHFlag <FreqHopFlag>**

Sets the DCI field frequency hopping flag.

Parameters:

<FreqHopFlag> 1 | ON | 0 | OFF

*RST: 0

Example: See [Example"Configuring the CORESET settings"](#) on page 398.

**[:SOURce<hw>]:BB:NR5G:SCHed:CELL<cc>:SUBF<sf>:USER<us>:
BWPart<bwp>:ALLoc<al>:CS:DCI<dci>:HAPRoc <HarqProc>**

Sets the DCI field HARQ process number.

Parameters:

<HarqProc> integer

Range: 0 to 15

*RST: 0

Example: See [Example"Configuring the CORESET settings"](#) on page 398.

**[:SOURce<hw>]:BB:NR5G:SCHed:CELL<cc>:SUBF<sf>:USER<us>:
BWPart<bwp>:ALLoc<al>:CS:DCI<dci>:IDENtifier <Identifier>**

Queries the identifier flag (first bit of the bit pattern) for DCI formats 0_x and 1_x.

Parameters:

<Identifier> 0

1st bit is a "0" (identifier for DCI formats 0_x).

1

1st bit is a "1" (identifier for DCI formats 1_x).

*RST: 0

**[:SOURce<hw>]:BB:NR5G:SCHed:CELL<cc>:SUBF<sf>:USER<us>:
BWPart<bwp>:ALLoc<al>:CS:DCI<dci>:SAI <BitLength>**

Defines the bit length of the DCI field "Sidelink Assignment Index" available in DCI formats 3_0.

Parameters:

<BitLength> integer
 Range: 0 to 3
 *RST: 0

```
[ :SOURce<hw>]:BB:NR5G:SCHed:CELL<cc>:SUBF<sf>:USER<us>:
  BWPart<bwp>:ALLoc<al>:CS:DCI<dci>:TB1:MCS <MCSTB1>
[ :SOURce<hw>]:BB:NR5G:SCHed:CELL<cc>:SUBF<sf>:USER<us>:
  BWPart<bwp>:ALLoc<al>:CS:DCI<dci>:TB2:MCS <MCSTB2>
```

Sets the DCI field modulation and coding scheme per transport block (TB).

Parameters:

<MCSTB2> integer
 Range: 0 to 31
 *RST: 0

Example: See [Example"Configuring the CORESET settings"](#) on page 398.

```
[ :SOURce<hw>]:BB:NR5G:SCHed:CELL<cc>:SUBF<sf>:USER<us>:
  BWPart<bwp>:ALLoc<al>:CS:DCI<dci>:TB1:NDI <NDITB1>
[ :SOURce<hw>]:BB:NR5G:SCHed:CELL<cc>:SUBF<sf>:USER<us>:
  BWPart<bwp>:ALLoc<al>:CS:DCI<dci>:TB2:NDI <NDITB2>
```

Sets the DCI field new data indicator per transport block (TB).

Parameters:

<NDITB2> 1 | ON | 0 | OFF
 *RST: 0

Example: See [Example"Configuring the CORESET settings"](#) on page 398.

```
[ :SOURce<hw>]:BB:NR5G:SCHed:CELL<cc>:SUBF<sf>:USER<us>:
  BWPart<bwp>:ALLoc<al>:CS:DCI<dci>:TB1:RV <RVTB1>
[ :SOURce<hw>]:BB:NR5G:SCHed:CELL<cc>:SUBF<sf>:USER<us>:
  BWPart<bwp>:ALLoc<al>:CS:DCI<dci>:TB2:RV <RVTB2>
```

Sets the DCI field redundancy version per transport block (TB).

Parameters:

<RVTB2> integer
 Range: 0 to 3
 *RST: 0

Example: See [Example"Configuring the CORESET settings"](#) on page 398.

```
[ :SOURce<hw>]:BB:NR5G:SCHed:CELL<cc>:SUBF<sf>:USER<us>:
  BWPart<bwp>:ALLoc<al>:CS:DCI<dci>:TIDRes <Value>
```

Sets the DCI field time domain resource assignment.

Parameters:

<Value> integer
 Range: 0 to 15
 *RST: 0

Example: See [Example"Configuring the CORESET settings"](#) on page 398.

**[:SOURce<hw>]:BB:NR5G:SCHed:CELL<cc>:SUBF<sf>:USER<us>:
 BWPart<bwp>:ALLoc<al>:CS:DCI<dci>:TPUSch <TpcPusch>**

Sets the DCI field TPC command for scheduling PUSCH.

Parameters:

<TpcPusch> integer
 Range: 0 to 3
 *RST: 0

Example: See [Example"Configuring the CORESET settings"](#) on page 398.

**[:SOURce<hw>]:BB:NR5G:SCHed:CELL<cc>:SUBF<sf>:USER<us>:
 BWPart<bwp>:ALLoc<al>:CS:DCI<dci>:USINd <UISullnd>**

If [:SOURce<hw>]:BB:NR5G:NODE:CELL<cc>:SYINfo:SUL:STATe 1, sets the DCI field UL/SUL indicator.

Parameters:

<UISullnd> 1 | ON | 0 | OFF
 *RST: 0

Example: See [Example"Configuring the CORESET settings"](#) on page 398.

10.22.3.2 DCI format 0_1

Commands to configure DCI format 0_1 described elsewhere:

- [:SOURce<hw>]:BB:NR5G:SCHed:CELL<cc>:SUBF<sf>:USER<us>:
 BWPart<bwp>:ALLoc<al>:CS:DCI<dci>:CACPext
- [:SOURce<hw>]:BB:NR5G:SCHed:CELL<cc>:SUBF<sf>:USER<us>:
 BWPart<bwp>:ALLoc<al>:CS:DCI<dci>:DI<x> (:DI1 only)
- [:SOURce<hw>]:BB:NR5G:SCHed:CELL<cc>:SUBF<sf>:USER<us>:
 BWPart<bwp>:ALLoc<al>:CS:DCI<dci>:FRHFlag
- [:SOURce<hw>]:BB:NR5G:SCHed:CELL<cc>:SUBF<sf>:USER<us>:
 BWPart<bwp>:ALLoc<al>:CS:DCI<dci>:FRDRes
- [:SOURce<hw>]:BB:NR5G:SCHed:CELL<cc>:SUBF<sf>:USER<us>:
 BWPart<bwp>:ALLoc<al>:CS:DCI<dci>:HAPRoc
- [:SOURce<hw>]:BB:NR5G:SCHed:CELL<cc>:SUBF<sf>:USER<us>:
 BWPart<bwp>:ALLoc<al>:CS:DCI<dci>:IDENTifier
- [:SOURce<hw>]:BB:NR5G:SCHed:CELL<cc>:SUBF<sf>:USER<us>:
 BWPart<bwp>:ALLoc<al>:CS:DCI<dci>:TB1:MCS

CORESET scheduling commands

- [:SOURce<hw>]:BB:NR5G:SCHed:CELL<cc>:SUBF<sf>:USER<us>:
BWPart<bwp>:ALLoc<al>:CS:DCI<dcI>:TB1:NDI
- [:SOURce<hw>]:BB:NR5G:SCHed:CELL<cc>:SUBF<sf>:USER<us>:
BWPart<bwp>:ALLoc<al>:CS:DCI<dcI>:TB1:RV
- [:SOURce<hw>]:BB:NR5G:SCHed:CELL<cc>:SUBF<sf>:USER<us>:
BWPart<bwp>:ALLoc<al>:CS:DCI<dcI>:TIDRes
- [:SOURce<hw>]:BB:NR5G:SCHed:CELL<cc>:SUBF<sf>:USER<us>:
BWPart<bwp>:ALLoc<al>:CS:DCI<dcI>:TPUSch
- [:SOURce<hw>]:BB:NR5G:SCHed:CELL<cc>:SUBF<sf>:USER<us>:
BWPart<bwp>:ALLoc<al>:CS:DCI<dcI>:USINd

[:SOURce<hw>]:BB:NR5G:SCHed:CELL<cc>:SUBF<sf>:USER<us>:BWPart<bwp>: ALLoc<al>:CS:DCI<dcI>:ANTPorts.....	658
[:SOURce<hw>]:BB:NR5G:SCHed:CELL<cc>:SUBF<sf>:USER<us>:BWPart<bwp>: ALLoc<al>:CS:DCI<dcI>:BOINd.....	658
[:SOURce<hw>]:BB:NR5G:SCHed:CELL<cc>:SUBF<sf>:USER<us>:BWPart<bwp>: ALLoc<al>:CS:DCI<dcI>:BWIND.....	658
[:SOURce<hw>]:BB:NR5G:SCHed:CELL<cc>:SUBF<sf>:USER<us>:BWPart<bwp>: ALLoc<al>:CS:DCI<dcI>:CAINd.....	659
[:SOURce<hw>]:BB:NR5G:SCHed:CELL<cc>:SUBF<sf>:USER<us>:BWPart<bwp>: ALLoc<al>:CS:DCI<dcI>:CBGTi.....	659
[:SOURce<hw>]:BB:NR5G:SCHed:CELL<cc>:SUBF<sf>:USER<us>:BWPart<bwp>: ALLoc<al>:CS:DCI<dcI>:CSIRequest.....	659
[:SOURce<hw>]:BB:NR5G:SCHed:CELL<cc>:SUBF<sf>:USER<us>:BWPart<bwp>: ALLoc<al>:CS:DCI<dcI>:DAI3.....	659
[:SOURce<hw>]:BB:NR5G:SCHed:CELL<cc>:SUBF<sf>:USER<us>:BWPart<bwp>: ALLoc<al>:CS:DCI<dcI>:DAI2.....	659
[:SOURce<hw>]:BB:NR5G:SCHed:CELL<cc>:SUBF<sf>:USER<us>:BWPart<bwp>: ALLoc<al>:CS:DCI<dcI>:DAI1.....	659
[:SOURce<hw>]:BB:NR5G:SCHed:CELL<cc>:SUBF<sf>:USER<us>:BWPart<bwp>: ALLoc<al>:CS:DCI<dcI>:DFIFlag.....	660
[:SOURce<hw>]:BB:NR5G:SCHed:CELL<cc>:SUBF<sf>:USER<us>:BWPart<bwp>: ALLoc<al>:CS:DCI<dcI>:DMSQinit.....	660
[:SOURce<hw>]:BB:NR5G:SCHed:CELL<cc>:SUBF<sf>:USER<us>:BWPart<bwp>: ALLoc<al>:CS:DCI<dcI>:INSPatt.....	660
[:SOURce<hw>]:BB:NR5G:SCHed:CELL<cc>:SUBF<sf>:USER<us>:BWPart<bwp>: ALLoc<al>:CS:DCI<dcI>:MOFFs.....	660
[:SOURce<hw>]:BB:NR5G:SCHed:CELL<cc>:SUBF<sf>:USER<us>:BWPart<bwp>: ALLoc<al>:CS:DCI<dcI>:OLINdicator.....	661
[:SOURce<hw>]:BB:NR5G:SCHed:CELL<cc>:SUBF<sf>:USER<us>:BWPart<bwp>: ALLoc<al>:CS:DCI<dcI>:PINdicator.....	661
[:SOURce<hw>]:BB:NR5G:SCHed:CELL<cc>:SUBF<sf>:USER<us>:BWPart<bwp>: ALLoc<al>:CS:DCI<dcI>:PMADaption.....	661
[:SOURce<hw>]:BB:NR5G:SCHed:CELL<cc>:SUBF<sf>:USER<us>:BWPart<bwp>: ALLoc<al>:CS:DCI<dcI>:PRC2.....	661
[:SOURce<hw>]:BB:NR5G:SCHed:CELL<cc>:SUBF<sf>:USER<us>:BWPart<bwp>: ALLoc<al>:CS:DCI<dcI>:PRECinfo.....	661
[:SOURce<hw>]:BB:NR5G:SCHed:CELL<cc>:SUBF<sf>:USER<us>:BWPart<bwp>: ALLoc<al>:CS:DCI<dcI>:PTDMrs.....	662

<code>[SOURce<hw>]:BB:NR5G:SCHed:CELL<cc>:SUBF<sf>:USER<us>:BWPart<bwp>:ALLoc<al>:CS:DCI<dci>:SOIN</code>	662
<code>[SOURce<hw>]:BB:NR5G:SCHed:CELL<cc>:SUBF<sf>:USER<us>:BWPart<bwp>:ALLoc<al>:CS:DCI<dci>:SRI2</code>	662
<code>[SOURce<hw>]:BB:NR5G:SCHed:CELL<cc>:SUBF<sf>:USER<us>:BWPart<bwp>:ALLoc<al>:CS:DCI<dci>:SRINd</code>	662
<code>[SOURce<hw>]:BB:NR5G:SCHed:CELL<cc>:SUBF<sf>:USER<us>:BWPart<bwp>:ALLoc<al>:CS:DCI<dci>:SRSRequest</code>	662
<code>[SOURce<hw>]:BB:NR5G:SCHed:CELL<cc>:SUBF<sf>:USER<us>:BWPart<bwp>:ALLoc<al>:CS:DCI<dci>:SRSResind</code>	663
<code>[SOURce<hw>]:BB:NR5G:SCHed:CELL<cc>:SUBF<sf>:USER<us>:BWPart<bwp>:ALLoc<al>:CS:DCI<dci>:T2PS</code>	663
<code>[SOURce<hw>]:BB:NR5G:SCHed:CELL<cc>:SUBF<sf>:USER<us>:BWPart<bwp>:ALLoc<al>:CS:DCI<dci>:ULSChind</code>	663

`[SOURce<hw>]:BB:NR5G:SCHed:CELL<cc>:SUBF<sf>:USER<us>:BWPart<bwp>:ALLoc<al>:CS:DCI<dci>:ANTPorts <AntPorts>`

Sets the DCI field antenna ports.

Parameters:

`<AntPorts>` integer
 Range: 0 to 31
 *RST: 0

Example: See [Example"Configuring the CORESET settings"](#) on page 398.

`[SOURce<hw>]:BB:NR5G:SCHed:CELL<cc>:SUBF<sf>:USER<us>:BWPart<bwp>:ALLoc<al>:CS:DCI<dci>:BOINd <Value>`

Sets the DCI field beta offset indicator.

Parameters:

`<Value>` integer
 Range: 0 to 3
 *RST: 0

Example: See [Example"Configuring the CORESET settings"](#) on page 398

`[SOURce<hw>]:BB:NR5G:SCHed:CELL<cc>:SUBF<sf>:USER<us>:BWPart<bwp>:ALLoc<al>:CS:DCI<dci>:BWIND <BWPInd>`

Sets the DCI field BWP indicator.

Parameters:

`<BWPInd>` integer
 Range: 0 to 3
 *RST: 0

```
[ :SOURce<hw>]:BB:NR5G:SCHed:CELL<cc>:SUBF<sf>:USER<us>:
      BWPart<bwp>:ALLoc<al>:CS:DCI<dci>:CAINd <Value>
```

Sets the carrier indicator value.

Parameters:

```
<Value>          integer
                  Range:    0 to 7
                  *RST:     0
```

Example: See [Example"Configuring the CORESET settings"](#) on page 398.

```
[ :SOURce<hw>]:BB:NR5G:SCHed:CELL<cc>:SUBF<sf>:USER<us>:
      BWPart<bwp>:ALLoc<al>:CS:DCI<dci>:CBGTi <CBGTI>
```

Sets the DCI field CBG transmission information (CBGTI).

Parameters:

```
<CBGTI>          integer
                  Range:    0 to 255
                  *RST:     0
```

```
[ :SOURce<hw>]:BB:NR5G:SCHed:CELL<cc>:SUBF<sf>:USER<us>:
      BWPart<bwp>:ALLoc<al>:CS:DCI<dci>:CSIRequest <Value>
```

Sets the DCI field CSI request.

Parameters:

```
<Value>          integer
                  Range:    0 to 63
                  *RST:     0
```

Example: See [Example"Configuring the CORESET settings"](#) on page 398

```
[ :SOURce<hw>]:BB:NR5G:SCHed:CELL<cc>:SUBF<sf>:USER<us>:
      BWPart<bwp>:ALLoc<al>:CS:DCI<dci>:DAI3 <Value>
[ :SOURce<hw>]:BB:NR5G:SCHed:CELL<cc>:SUBF<sf>:USER<us>:
      BWPart<bwp>:ALLoc<al>:CS:DCI<dci>:DAI2 <DAI2>
[ :SOURce<hw>]:BB:NR5G:SCHed:CELL<cc>:SUBF<sf>:USER<us>:
      BWPart<bwp>:ALLoc<al>:CS:DCI<dci>:DAI1 <DAI1>
```

Sets the DCI filed DL assignment index.

Parameters:

```
<DAI1>          integer
                  Range:    0 to 3
                  *RST:     0
```

Example: See [Example"Configuring the CORESET settings"](#) on page 398.

```
[ :SOURce<hw>]:BB:NR5G:SCHed:CELL<cc>:SUBF<sf>:USER<us>:
  BWPart<bwp>:ALLoc<al>:CS:DCI<dci>:DFIFlag <State>
```

Turns the DCI field "Downlink Feedback Indicator" on and off.

Parameters:

```
<State>          1 | ON | 0 | OFF
*RST:           0
```

```
[ :SOURce<hw>]:BB:NR5G:SCHed:CELL<cc>:SUBF<sf>:USER<us>:
  BWPart<bwp>:ALLoc<al>:CS:DCI<dci>:DMSQinit <DmrsSeqInit>
```

If [:SOURce<hw>] :BB:NR5G:UBWP:USER<us>:CELL<cc>:UL:BWP<bwp>: PUSCh:TPState 0, sets the DCI field DMRS sequence initialization.

Parameters:

```
<DmrsSeqInit>   1 | ON | 0 | OFF
*RST:           0
```

Example: See [Example"Configuring the CORESET settings"](#) on page 398.

```
[ :SOURce<hw>]:BB:NR5G:SCHed:CELL<cc>:SUBF<sf>:USER<us>:
  BWPart<bwp>:ALLoc<al>:CS:DCI<dci>:INSPatt <State>
```

Sets the DCI field invalid symbol pattern indicator.

Parameters:

```
<State>          1 | ON | 0 | OFF
*RST:           0
```

```
[ :SOURce<hw>]:BB:NR5G:SCHed:CELL<cc>:SUBF<sf>:USER<us>:
  BWPart<bwp>:ALLoc<al>:CS:DCI<dci>:MOFFs <MinApplOffsInd>
```

Enables the minimum applicable scheduling offset indicator for the DCIs 0_1 and 1_1.

This 1-bit indicator is used to determine the minimum applicable K0 for the active DL BWP and the minimum applicable K2 for the active UL BWP.

This 1-bit indicator influences the calculation of the PDSCH triggering offsets and A-CSI RS triggering offsets.

Parameters:

```
<MinApplOffsInd> 1 | ON | 0 | OFF
*RST:           0
```

Example: See [Example"Configuring the CORESET settings"](#) on page 398

Options: R&S SMM-K148

**[:SOURce<hw>]:BB:NR5G:SCHed:CELL<cc>:SUBF<sf>:USER<us>:
BWPart<bwp>:ALLoc<al>:CS:DCI<dci>:OLINdicator <OpenLoopPCPInd>**

Sets the DCI field "Open-Loop Power Control Parameter Indication".

Parameters:

<OpenLoopPCPInd> integer
 Range: 0 to 3
 *RST: 0

**[:SOURce<hw>]:BB:NR5G:SCHed:CELL<cc>:SUBF<sf>:USER<us>:
BWPart<bwp>:ALLoc<al>:CS:DCI<dci>:PINdicator <PriorityIndicat>**

Sets the DCI field priority indicator.

Parameters:

<PriorityIndicat> 1 | ON | 0 | OFF
 *RST: 0

**[:SOURce<hw>]:BB:NR5G:SCHed:CELL<cc>:SUBF<sf>:USER<us>:
BWPart<bwp>:ALLoc<al>:CS:DCI<dci>:PMADaption <Value>**

Defines the bit pattern for the "Monitoring Adaption Indication" DCI field.

Parameters:

<Value> integer
 Range: 0 to 3
 *RST: 0

**[:SOURce<hw>]:BB:NR5G:SCHed:CELL<cc>:SUBF<sf>:USER<us>:
BWPart<bwp>:ALLoc<al>:CS:DCI<dci>:PRC2 <Value>**

Defines the bit pattern for the "2nd Precoding Information and Number of Layers" DCI field.

Parameters:

<Value> integer
 Range: 0 to 31
 *RST: 0

**[:SOURce<hw>]:BB:NR5G:SCHed:CELL<cc>:SUBF<sf>:USER<us>:
BWPart<bwp>:ALLoc<al>:CS:DCI<dci>:PRECinfo <Preclnfo>**

Sets the precoding info and number of layers (TPMI) value.

Parameters:

<Preclnfo> integer
 Range: 0 to 63
 *RST: 0

Example: See: [Example"Configuring the CORESET settings"](#) on page 398

**[:SOURce<hw>]:BB:NR5G:SCHEd:CELL<cc>:SUBF<sf>:USER<us>:
BWPart<bwp>:ALLOc<al>:CS:DCI<dci>:PTDMrs <PtrsDmrs>**

If [:SOURce<hw>] :BB:NR5G:UBWP:USER<us>:CELL<cc>:UL:BWP<bwp>:PUSCh:MRANk#1, sets the DCI field PTRS-DMRS association.

Parameters:

<PtrsDmrs> integer
Range: 0 to 3
*RST: 0

Example: See [Example"Configuring the CORESET settings"](#) on page 398.

**[:SOURce<hw>]:BB:NR5G:SCHEd:CELL<cc>:SUBF<sf>:USER<us>:
BWPart<bwp>:ALLOc<al>:CS:DCI<dci>:SOIN <Value>**

Defines the bit pattern for the "SRS Offset Indicator" DCI field.

Parameters:

<Value> integer
Range: 0 to 3
*RST: 0

**[:SOURce<hw>]:BB:NR5G:SCHEd:CELL<cc>:SUBF<sf>:USER<us>:
BWPart<bwp>:ALLOc<al>:CS:DCI<dci>:SR12 <Value>**

Defines the bit pattern for the "2nd SRS Resource Indicator" DCI field.

Parameters:

<Value> integer
Range: 0 to 15
*RST: 0

**[:SOURce<hw>]:BB:NR5G:SCHEd:CELL<cc>:SUBF<sf>:USER<us>:
BWPart<bwp>:ALLOc<al>:CS:DCI<dci>:SRINd <Value>**

Defines the bit pattern for the "SRS Resource Set Indicator" DCI field.

Parameters:

<Value> integer
Range: 0 to 3
*RST: 0

**[:SOURce<hw>]:BB:NR5G:SCHEd:CELL<cc>:SUBF<sf>:USER<us>:
BWPart<bwp>:ALLOc<al>:CS:DCI<dci>:SRSRequest <SRSRequest>**

Sets the DCI field SRS request.

Parameters:

<SRSRequest> integer
 Range: 0 to 3
 *RST: 0

Example: See [Example"Configuring the CORESET settings"](#) on page 398.

**[:SOURce<hw>]:BB:NR5G:SCHed:CELL<cc>:SUBF<sf>:USER<us>:
 BWPart<bwp>:ALLoc<al>:CS:DCI<dci>:SRSResInd <SRSResInd>**

Sets the SRS resource indicator value.

When multiple SRS resources are configured, an SRS resource indicator field in uplink DCI is used to indicate the selected SRS resource over whose antenna ports are used by the network to derive the precoding for uplink transmission.

Parameters:

<SRSResInd> integer
 Range: 0 to 255
 *RST: 0

Example: See: [Example"Configuring the CORESET settings"](#) on page 398

**[:SOURce<hw>]:BB:NR5G:SCHed:CELL<cc>:SUBF<sf>:USER<us>:
 BWPart<bwp>:ALLoc<al>:CS:DCI<dci>:T2PS <BitLength>**

Defines the bit length of the "2nd TPC Command for Scheduled PUSCH".

Parameters:

<BitLength> integer
 Range: 0 to 3
 *RST: 0

**[:SOURce<hw>]:BB:NR5G:SCHed:CELL<cc>:SUBF<sf>:USER<us>:
 BWPart<bwp>:ALLoc<al>:CS:DCI<dci>:ULSchInd <State>**

Turns the DCI field "UL-SCH Indicator" on and off.

Parameters:

<State> 1 | ON | 0 | OFF
 *RST: 0

10.22.3.3 DCI format 0_2

Commands to configure DCI format 0_2 described elsewhere:

- `[:SOURce<hw>] :BB:NR5G:SCHed:CELL<cc>:SUBF<sf>:USER<us>:
 BWPart<bwp>:ALLoc<al>:CS:DCI<dci>:ANTPorts`
- `[:SOURce<hw>] :BB:NR5G:SCHed:CELL<cc>:SUBF<sf>:USER<us>:
 BWPart<bwp>:ALLoc<al>:CS:DCI<dci>:BOINd`

CORESET scheduling commands

- [:SOURce<hw>] :BB:NR5G:SCHed:CELL<cc>:SUBF<sf>:USER<us>:
BWPart<bwp>:ALLoc<al>:CS:DCI<dci>:BWINd
- [:SOURce<hw>] :BB:NR5G:SCHed:CELL<cc>:SUBF<sf>:USER<us>:
BWPart<bwp>:ALLoc<al>:CS:DCI<dci>:CAINd
- [:SOURce<hw>] :BB:NR5G:SCHed:CELL<cc>:SUBF<sf>:USER<us>:
BWPart<bwp>:ALLoc<al>:CS:DCI<dci>:CSIRequest
- [:SOURce<hw>] :BB:NR5G:SCHed:CELL<cc>:SUBF<sf>:USER<us>:
BWPart<bwp>:ALLoc<al>:CS:DCI<dci>:DAI1
[:SOURce<hw>] :BB:NR5G:SCHed:CELL<cc>:SUBF<sf>:USER<us>:
BWPart<bwp>:ALLoc<al>:CS:DCI<dci>:DAI2 on page 659
- [:SOURce<hw>] :BB:NR5G:SCHed:CELL<cc>:SUBF<sf>:USER<us>:
BWPart<bwp>:ALLoc<al>:CS:DCI<dci>:DAI3
- [:SOURce<hw>] :BB:NR5G:SCHed:CELL<cc>:SUBF<sf>:USER<us>:
BWPart<bwp>:ALLoc<al>:CS:DCI<dci>:DMSQinit
- [:SOURce<hw>] :BB:NR5G:SCHed:CELL<cc>:SUBF<sf>:USER<us>:
BWPart<bwp>:ALLoc<al>:CS:DCI<dci>:FRDRes
- [:SOURce<hw>] :BB:NR5G:SCHed:CELL<cc>:SUBF<sf>:USER<us>:
BWPart<bwp>:ALLoc<al>:CS:DCI<dci>:FRHFlag
- [:SOURce<hw>] :BB:NR5G:SCHed:CELL<cc>:SUBF<sf>:USER<us>:
BWPart<bwp>:ALLoc<al>:CS:DCI<dci>:HAPRoc
- [:SOURce<hw>] :BB:NR5G:SCHed:CELL<cc>:SUBF<sf>:USER<us>:
BWPart<bwp>:ALLoc<al>:CS:DCI<dci>:IDENTifier
- [:SOURce<hw>] :BB:NR5G:SCHed:CELL<cc>:SUBF<sf>:USER<us>:
BWPart<bwp>:ALLoc<al>:CS:DCI<dci>:INSPatt
- [:SOURce<hw>] :BB:NR5G:SCHed:CELL<cc>:SUBF<sf>:USER<us>:
BWPart<bwp>:ALLoc<al>:CS:DCI<dci>:OLINdicator
- [:SOURce<hw>] :BB:NR5G:SCHed:CELL<cc>:SUBF<sf>:USER<us>:
BWPart<bwp>:ALLoc<al>:CS:DCI<dci>:PINDicator
- [:SOURce<hw>] :BB:NR5G:SCHed:CELL<cc>:SUBF<sf>:USER<us>:
BWPart<bwp>:ALLoc<al>:CS:DCI<dci>:PMADaption
- [:SOURce<hw>] :BB:NR5G:SCHed:CELL<cc>:SUBF<sf>:USER<us>:
BWPart<bwp>:ALLoc<al>:CS:DCI<dci>:PRC2
- [:SOURce<hw>] :BB:NR5G:SCHed:CELL<cc>:SUBF<sf>:USER<us>:
BWPart<bwp>:ALLoc<al>:CS:DCI<dci>:PRECinfo
- [:SOURce<hw>] :BB:NR5G:SCHed:CELL<cc>:SUBF<sf>:USER<us>:
BWPart<bwp>:ALLoc<al>:CS:DCI<dci>:PTDMrs
- [:SOURce<hw>] :BB:NR5G:SCHed:CELL<cc>:SUBF<sf>:USER<us>:
BWPart<bwp>:ALLoc<al>:CS:DCI<dci>:SRI2
- [:SOURce<hw>] :BB:NR5G:SCHed:CELL<cc>:SUBF<sf>:USER<us>:
BWPart<bwp>:ALLoc<al>:CS:DCI<dci>:SRINd
- [:SOURce<hw>] :BB:NR5G:SCHed:CELL<cc>:SUBF<sf>:USER<us>:
BWPart<bwp>:ALLoc<al>:CS:DCI<dci>:SRSRequest

- [:SOURCE<hw>]:BB:NR5G:SCHEd:CELL<cc>:SUBF<sf>:USER<us>:BWPart<bwp>:ALLoc<al>:CS:DCI<dci>:SOIN
- [:SOURCE<hw>]:BB:NR5G:SCHEd:CELL<cc>:SUBF<sf>:USER<us>:BWPart<bwp>:ALLoc<al>:CS:DCI<dci>:SRSResind
- [:SOURCE<hw>]:BB:NR5G:SCHEd:CELL<cc>:SUBF<sf>:USER<us>:BWPart<bwp>:ALLoc<al>:CS:DCI<dci>:TB1:MCS
- [:SOURCE<hw>]:BB:NR5G:SCHEd:CELL<cc>:SUBF<sf>:USER<us>:BWPart<bwp>:ALLoc<al>:CS:DCI<dci>:TB1:NDI
- [:SOURCE<hw>]:BB:NR5G:SCHEd:CELL<cc>:SUBF<sf>:USER<us>:BWPart<bwp>:ALLoc<al>:CS:DCI<dci>:TB1:RV
- [:SOURCE<hw>]:BB:NR5G:SCHEd:CELL<cc>:SUBF<sf>:USER<us>:BWPart<bwp>:ALLoc<al>:CS:DCI<dci>:T2PS
- [:SOURCE<hw>]:BB:NR5G:SCHEd:CELL<cc>:SUBF<sf>:USER<us>:BWPart<bwp>:ALLoc<al>:CS:DCI<dci>:TIDRes
- [:SOURCE<hw>]:BB:NR5G:SCHEd:CELL<cc>:SUBF<sf>:USER<us>:BWPart<bwp>:ALLoc<al>:CS:DCI<dci>:TPUSch on page 656
- [:SOURCE<hw>]:BB:NR5G:SCHEd:CELL<cc>:SUBF<sf>:USER<us>:BWPart<bwp>:ALLoc<al>:CS:DCI<dci>:ULSchind
- [:SOURCE<hw>]:BB:NR5G:SCHEd:CELL<cc>:SUBF<sf>:USER<us>:BWPart<bwp>:ALLoc<al>:CS:DCI<dci>:USINd

10.22.3.4 DCI format 1_0

Commands to configure DCI format 1_0 described elsewhere:

- [:SOURCE<hw>]:BB:NR5G:SCHEd:CELL<cc>:SUBF<sf>:USER<us>:BWPart<bwp>:ALLoc<al>:CS:DCI<dci>:CACPext
- [:SOURCE<hw>]:BB:NR5G:SCHEd:CELL<cc>:SUBF<sf>:USER<us>:BWPart<bwp>:ALLoc<al>:CS:DCI<dci>:DAI1
- [:SOURCE<hw>]:BB:NR5G:SCHEd:CELL<cc>:SUBF<sf>:USER<us>:BWPart<bwp>:ALLoc<al>:CS:DCI<dci>:FRDRes
- [:SOURCE<hw>]:BB:NR5G:SCHEd:CELL<cc>:SUBF<sf>:USER<us>:BWPart<bwp>:ALLoc<al>:CS:DCI<dci>:HAPRoc
- [:SOURCE<hw>]:BB:NR5G:SCHEd:CELL<cc>:SUBF<sf>:USER<us>:BWPart<bwp>:ALLoc<al>:CS:DCI<dci>:IDENtifier
- [:SOURCE<hw>]:BB:NR5G:SCHEd:CELL<cc>:SUBF<sf>:USER<us>:BWPart<bwp>:ALLoc<al>:CS:DCI<dci>:TB1:MCS
- [:SOURCE<hw>]:BB:NR5G:SCHEd:CELL<cc>:SUBF<sf>:USER<us>:BWPart<bwp>:ALLoc<al>:CS:DCI<dci>:TB1:NDI
- [:SOURCE<hw>]:BB:NR5G:SCHEd:CELL<cc>:SUBF<sf>:USER<us>:BWPart<bwp>:ALLoc<al>:CS:DCI<dci>:TB1:RV
- [:SOURCE<hw>]:BB:NR5G:SCHEd:CELL<cc>:SUBF<sf>:USER<us>:BWPart<bwp>:ALLoc<al>:CS:DCI<dci>:TIDRes

<code>[:SOURce<hw>]:BB:NR5G:SCHed:CELL<cc>:SUBF<sf>:USER<us>:BWPart<bwp>:ALLoc<al>:CS:DCI<dci>:LSBSfn</code>	666
<code>[:SOURce<hw>]:BB:NR5G:SCHed:CELL<cc>:SUBF<sf>:USER<us>:BWPart<bwp>:ALLoc<al>:CS:DCI<dci>:PDSHarq</code>	666
<code>[:SOURce<hw>]:BB:NR5G:SCHed:CELL<cc>:SUBF<sf>:USER<us>:BWPart<bwp>:ALLoc<al>:CS:DCI<dci>:PUCResind</code>	666
<code>[:SOURce<hw>]:BB:NR5G:SCHed:CELL<cc>:SUBF<sf>:USER<us>:BWPart<bwp>:ALLoc<al>:CS:DCI<dci>:RESVed</code>	667
<code>[:SOURce<hw>]:BB:NR5G:SCHed:CELL<cc>:SUBF<sf>:USER<us>:BWPart<bwp>:ALLoc<al>:CS:DCI<dci>:SIInd</code>	667
<code>[:SOURce<hw>]:BB:NR5G:SCHed:CELL<cc>:SUBF<sf>:USER<us>:BWPart<bwp>:ALLoc<al>:CS:DCI<dci>:SMINd</code>	667
<code>[:SOURce<hw>]:BB:NR5G:SCHed:CELL<cc>:SUBF<sf>:USER<us>:BWPart<bwp>:ALLoc<al>:CS:DCI<dci>:SMSGs</code>	668
<code>[:SOURce<hw>]:BB:NR5G:SCHed:CELL<cc>:SUBF<sf>:USER<us>:BWPart<bwp>:ALLoc<al>:CS:DCI<dci>:TBSCaling</code>	668
<code>[:SOURce<hw>]:BB:NR5G:SCHed:CELL<cc>:SUBF<sf>:USER<us>:BWPart<bwp>:ALLoc<al>:CS:DCI<dci>:TPUCch</code>	668
<code>[:SOURce<hw>]:BB:NR5G:SCHed:CELL<cc>:SUBF<sf>:USER<us>:BWPart<bwp>:ALLoc<al>:CS:DCI<dci>:VTPRb</code>	668

`[:SOURce<hw>]:BB:NR5G:SCHed:CELL<cc>:SUBF<sf>:USER<us>:BWPart<bwp>:ALLoc<al>:CS:DCI<dci>:LSBSfn <DciLSBsOfSFN>`

Sets the DCI field "LSBs of SFN".

Parameters:

`<DciLSBsOfSFN>` integer
 Range: 0 to 3
 *RST: 0

`[:SOURce<hw>]:BB:NR5G:SCHed:CELL<cc>:SUBF<sf>:USER<us>:BWPart<bwp>:ALLoc<al>:CS:DCI<dci>:PDSHarq <PdschToHarq>`

Sets the DCI field PDSCH-to-HARQ feedback timing Indicator.

Parameters:

`<PdschToHarq>` integer
 Range: 0 to 7
 *RST: 0

Example: See [Example"Configuring the CORESET settings"](#) on page 398.

`[:SOURce<hw>]:BB:NR5G:SCHed:CELL<cc>:SUBF<sf>:USER<us>:BWPart<bwp>:ALLoc<al>:CS:DCI<dci>:PUCResind <PucchResInd>`

Sets the DCI field PUCCH resource indicator.

Parameters:

<PucchResInd> integer
 Range: 0 to 7
 *RST: 0

Example: See [Example"Configuring the CORESET settings"](#) on page 398.

**[:SOURCE<hw>]:BB:NR5G:SCHed:CELL<cc>:SUBF<sf>:USER<us>:
 BWPart<bwp>:ALLoc<al>:CS:DCI<dci>:RESVed <Pattern>, <BitCount>**

Sets the DCI padding and reserved bits.

Parameters:

<Pattern> 32 bits
 *RST: #H0

<BitCount> integer
 Range: 1 to 32
 *RST: 1

Example: See [Example"Configuring the CORESET settings"](#) on page 398.
 See [Example"DCI format 2_6"](#) on page 402.

Options: DCI formats 2_4 and 2_6 require R&S SMM-K148.

**[:SOURCE<hw>]:BB:NR5G:SCHed:CELL<cc>:SUBF<sf>:USER<us>:
 BWPart<bwp>:ALLoc<al>:CS:DCI<dci>:SIINd <Silnd>**

Sets the DCI field system information indicator.

Parameters:

<Silnd> 1 | ON | 0 | OFF
 *RST: 0

Example: See [Example"Configuring the CORESET settings"](#) on page 398.

**[:SOURCE<hw>]:BB:NR5G:SCHed:CELL<cc>:SUBF<sf>:USER<us>:
 BWPart<bwp>:ALLoc<al>:CS:DCI<dci>:SMINd <ShortMsgInd>**

Sets the DCI field short message indicator.

Parameters:

<ShortMsgInd> integer
 Range: 0 to 3
 *RST: 0

Example: See [Example"Configuring the CORESET settings"](#) on page 398.

```
[ :SOURce<hw>]:BB:NR5G:SCHed:CELL<cc>:SUBF<sf>:USER<us>:
  BWPart<bwp>:ALLoc<al>:CS:DCI<dci>:SMSGs <BitLength>
```

Sets the DCI field "Short Messages".

Parameters:

```
<BitLength>          integer
                      Range:    0 to 255
                      *RST:     0
```

```
[ :SOURce<hw>]:BB:NR5G:SCHed:CELL<cc>:SUBF<sf>:USER<us>:
  BWPart<bwp>:ALLoc<al>:CS:DCI<dci>:TBSCaling <TBScaling>
```

Sets the DCI field new data indicator per transport block (TB).

Parameters:

```
<TBScaling>          integer
                      Range:    0 to 3
                      *RST:     0
```

Example: See [Example"Configuring the CORESET settings"](#) on page 398.

```
[ :SOURce<hw>]:BB:NR5G:SCHed:CELL<cc>:SUBF<sf>:USER<us>:
  BWPart<bwp>:ALLoc<al>:CS:DCI<dci>:TPUCch <TpcPucch>
```

Sets the DCI field TPC command for scheduling PUCCH.

Parameters:

```
<TpcPucch>          integer
                      Range:    0 to 3
                      *RST:     0
```

Example: See [Example"Configuring the CORESET settings"](#) on page 398.

```
[ :SOURce<hw>]:BB:NR5G:SCHed:CELL<cc>:SUBF<sf>:USER<us>:
  BWPart<bwp>:ALLoc<al>:CS:DCI<dci>:VTPRb <VrbToPrb>
```

Sets the DCI field VRB-to-PRB mapping.

Parameters:

```
<VrbToPrb>          1 | ON | 0 | OFF
                      *RST:     0
```

Example: See [Example"Configuring the CORESET settings"](#) on page 398.

10.22.3.5 DCI format 1_1

Commands to configure DCI format 1_1 described elsewhere:

- `[:SOURce<hw>]:BB:NR5G:SCHed:CELL<cc>:SUBF<sf>:USER<us>:
 BWPart<bwp>:ALLoc<al>:CS:DCI<dci>:ANTPorts`

CORESET scheduling commands

- [:SOURCE<hw>]:BB:NR5G:SCHEd:CELL<cc>:SUBF<sf>:USER<us>:
BWPart<bwp>:ALLoc<al>:CS:DCI<dci>:BWINd
- [:SOURCE<hw>]:BB:NR5G:SCHEd:CELL<cc>:SUBF<sf>:USER<us>:
BWPart<bwp>:ALLoc<al>:CS:DCI<dci>:CACPext
- [:SOURCE<hw>]:BB:NR5G:SCHEd:CELL<cc>:SUBF<sf>:USER<us>:
BWPart<bwp>:ALLoc<al>:CS:DCI<dci>:CAINd
- [:SOURCE<hw>]:BB:NR5G:SCHEd:CELL<cc>:SUBF<sf>:USER<us>:
BWPart<bwp>:ALLoc<al>:CS:DCI<dci>:CBGTi
- [:SOURCE<hw>]:BB:NR5G:SCHEd:CELL<cc>:SUBF<sf>:USER<us>:
BWPart<bwp>:ALLoc<al>:CS:DCI<dci>:DAI1
- [:SOURCE<hw>]:BB:NR5G:SCHEd:CELL<cc>:SUBF<sf>:USER<us>:
BWPart<bwp>:ALLoc<al>:CS:DCI<dci>:DI<x> (:DI1 only)
- [:SOURCE<hw>]:BB:NR5G:SCHEd:CELL<cc>:SUBF<sf>:USER<us>:
BWPart<bwp>:ALLoc<al>:CS:DCI<dci>:DMSQinit
- [:SOURCE<hw>]:BB:NR5G:SCHEd:CELL<cc>:SUBF<sf>:USER<us>:
BWPart<bwp>:ALLoc<al>:CS:DCI<dci>:FRDRes
- [:SOURCE<hw>]:BB:NR5G:SCHEd:CELL<cc>:SUBF<sf>:USER<us>:
BWPart<bwp>:ALLoc<al>:CS:DCI<dci>:HAPRoc
- [:SOURCE<hw>]:BB:NR5G:SCHEd:CELL<cc>:SUBF<sf>:USER<us>:
BWPart<bwp>:ALLoc<al>:CS:DCI<dci>:IDENTifier
- [:SOURCE<hw>]:BB:NR5G:SCHEd:CELL<cc>:SUBF<sf>:USER<us>:
BWPart<bwp>:ALLoc<al>:CS:DCI<dci>:MOFFs
- [:SOURCE<hw>]:BB:NR5G:SCHEd:CELL<cc>:SUBF<sf>:USER<us>:
BWPart<bwp>:ALLoc<al>:CS:DCI<dci>:PDSHarq
- [:SOURCE<hw>]:BB:NR5G:SCHEd:CELL<cc>:SUBF<sf>:USER<us>:
BWPart<bwp>:ALLoc<al>:CS:DCI<dci>:PINDicator
- [:SOURCE<hw>]:BB:NR5G:SCHEd:CELL<cc>:SUBF<sf>:USER<us>:
BWPart<bwp>:ALLoc<al>:CS:DCI<dci>:PMADaption
- [:SOURCE<hw>]:BB:NR5G:SCHEd:CELL<cc>:SUBF<sf>:USER<us>:
BWPart<bwp>:ALLoc<al>:CS:DCI<dci>:PUCResind
- [:SOURCE<hw>]:BB:NR5G:SCHEd:CELL<cc>:SUBF<sf>:USER<us>:
BWPart<bwp>:ALLoc<al>:CS:DCI<dci>:SRSRequest
- [:SOURCE<hw>]:BB:NR5G:SCHEd:CELL<cc>:SUBF<sf>:USER<us>:
BWPart<bwp>:ALLoc<al>:CS:DCI<dci>:TB1:MCS
[:SOURCE<hw>]:BB:NR5G:SCHEd:CELL<cc>:SUBF<sf>:USER<us>:
BWPart<bwp>:ALLoc<al>:CS:DCI<dci>:TB2:MCS
- [:SOURCE<hw>]:BB:NR5G:SCHEd:CELL<cc>:SUBF<sf>:USER<us>:
BWPart<bwp>:ALLoc<al>:CS:DCI<dci>:TB1:NDI
[:SOURCE<hw>]:BB:NR5G:SCHEd:CELL<cc>:SUBF<sf>:USER<us>:
BWPart<bwp>:ALLoc<al>:CS:DCI<dci>:TB2:NDI
- [:SOURCE<hw>]:BB:NR5G:SCHEd:CELL<cc>:SUBF<sf>:USER<us>:
BWPart<bwp>:ALLoc<al>:CS:DCI<dci>:TB1:RV

[:SOURce<hw>] :BB:NR5G:SCHed:CELL<cc>:SUBF<sf>:USER<us>: BWPart<bwp>:ALLoc<al>:CS:DCI<dcI>:TB2:RV	
• [:SOURce<hw>] :BB:NR5G:SCHed:CELL<cc>:SUBF<sf>:USER<us>: BWPart<bwp>:ALLoc<al>:CS:DCI<dcI>:TIDRes	
• [:SOURce<hw>] :BB:NR5G:SCHed:CELL<cc>:SUBF<sf>:USER<us>: BWPart<bwp>:ALLoc<al>:CS:DCI<dcI>:TPUCch	
• [:SOURce<hw>] :BB:NR5G:SCHed:CELL<cc>:SUBF<sf>:USER<us>: BWPart<bwp>:ALLoc<al>:CS:DCI<dcI>:VTPRb	
[:SOURce<hw>] :BB:NR5G:SCHed:CELL<cc>:SUBF<sf>:USER<us>:BWPart<bwp>: ALLoc<al>:CS:DCI<dcI>:CBGFi.....	670
[:SOURce<hw>] :BB:NR5G:SCHed:CELL<cc>:SUBF<sf>:USER<us>:BWPart<bwp>: ALLoc<al>:CS:DCI<dcI>:HARTind.....	670
[:SOURce<hw>] :BB:NR5G:SCHed:CELL<cc>:SUBF<sf>:USER<us>:BWPart<bwp>: ALLoc<al>:CS:DCI<dcI>:HQAResult.....	671
[:SOURce<hw>] :BB:NR5G:SCHed:CELL<cc>:SUBF<sf>:USER<us>:BWPart<bwp>: ALLoc<al>:CS:DCI<dcI>:NFIndicator.....	671
[:SOURce<hw>] :BB:NR5G:SCHed:CELL<cc>:SUBF<sf>:USER<us>:BWPart<bwp>: ALLoc<al>:CS:DCI<dcI>:NRPGroups.....	671
[:SOURce<hw>] :BB:NR5G:SCHed:CELL<cc>:SUBF<sf>:USER<us>:BWPart<bwp>: ALLoc<al>:CS:DCI<dcI>:PGIndex.....	671
[:SOURce<hw>] :BB:NR5G:SCHed:CELL<cc>:SUBF<sf>:USER<us>:BWPart<bwp>: ALLoc<al>:CS:DCI<dcI>:PCInd.....	671
[:SOURce<hw>] :BB:NR5G:SCHed:CELL<cc>:SUBF<sf>:USER<us>:BWPart<bwp>: ALLoc<al>:CS:DCI<dcI>:PRBBundling.....	672
[:SOURce<hw>] :BB:NR5G:SCHed:CELL<cc>:SUBF<sf>:USER<us>:BWPart<bwp>: ALLoc<al>:CS:DCI<dcI>:RMInd.....	672
[:SOURce<hw>] :BB:NR5G:SCHed:CELL<cc>:SUBF<sf>:USER<us>:BWPart<bwp>: ALLoc<al>:CS:DCI<dcI>:T2PC.....	672
[:SOURce<hw>] :BB:NR5G:SCHed:CELL<cc>:SUBF<sf>:USER<us>:BWPart<bwp>: ALLoc<al>:CS:DCI<dcI>:T3CBind.....	672
[:SOURce<hw>] :BB:NR5G:SCHed:CELL<cc>:SUBF<sf>:USER<us>:BWPart<bwp>: ALLoc<al>:CS:DCI<dcI>:TCI.....	672
[:SOURce<hw>] :BB:NR5G:SCHed:CELL<cc>:SUBF<sf>:USER<us>:BWPart<bwp>: ALLoc<al>:CS:DCI<dcI>:ZCRTrigg.....	673

**[:SOURce<hw>] :BB:NR5G:SCHed:CELL<cc>:SUBF<sf>:USER<us>:
BWPart<bwp>:ALLoc<al>:CS:DCI<dcI>:CBGFi <CBGFI>**

Sets the DCI field CBG flushing out information (CBGFI).

Parameters:

<CBGFI> 1 | ON | 0 | OFF
*RST: 0

**[:SOURce<hw>] :BB:NR5G:SCHed:CELL<cc>:SUBF<sf>:USER<us>:
BWPart<bwp>:ALLoc<al>:CS:DCI<dcI>:HARTind <State>**

Turns the "HARQ-ACK Retransmission Indicator" bit on and off.

Parameters:

<State> 1 | ON | 0 | OFF
 *RST: 0

**[:SOURce<hw>]:BB:NR5G:SCHed:CELL<cc>:SUBF<sf>:USER<us>:
 BWPart<bwp>:ALLoc<al>:CS:DCI<dci>:HQARequest <State>**

Sets the DCI field "One-Shot HARQ-ACK Request".

Parameters:

<State> 1 | ON | 0 | OFF
 *RST: 0

**[:SOURce<hw>]:BB:NR5G:SCHed:CELL<cc>:SUBF<sf>:USER<us>:
 BWPart<bwp>:ALLoc<al>:CS:DCI<dci>:NFIndicator <NewFbIndicator>**

Sets the DCI field "New Feedback Indicator".

Parameters:

<NewFbIndicator> integer
 Range: 0 to 3
 *RST: 0

**[:SOURce<hw>]:BB:NR5G:SCHed:CELL<cc>:SUBF<sf>:USER<us>:
 BWPart<bwp>:ALLoc<al>:CS:DCI<dci>:NRPGroups <State>**

Sets the DCI field "Number of Requested PDSCH Groups".

Parameters:

<State> 1 | ON | 0 | OFF
 *RST: 0

**[:SOURce<hw>]:BB:NR5G:SCHed:CELL<cc>:SUBF<sf>:USER<us>:
 BWPart<bwp>:ALLoc<al>:CS:DCI<dci>:PGIndex <State>**

Sets the DCI field "PDSCH Group Index".

Parameters:

<State> 1 | ON | 0 | OFF
 *RST: 0

**[:SOURce<hw>]:BB:NR5G:SCHed:CELL<cc>:SUBF<sf>:USER<us>:
 BWPart<bwp>:ALLoc<al>:CS:DCI<dci>:PCInd <State>**

Turns the "PUCCH Cell Indicator" field on and off.

Parameters:

<State> 1 | ON | 0 | OFF
 *RST: 0

**[:SOURce<hw>]:BB:NR5G:SCHed:CELL<cc>:SUBF<sf>:USER<us>:
BWPart<bwp>:ALLoc<al>:CS:DCI<dci>:PRBBundling <PRBBundling>**

Sets the DCI field PRB bundling size indicator.

Parameters:

<PRBBundling> 1 | ON | 0 | OFF
*RST: 0

**[:SOURce<hw>]:BB:NR5G:SCHed:CELL<cc>:SUBF<sf>:USER<us>:
BWPart<bwp>:ALLoc<al>:CS:DCI<dci>:RMInd <RMInd>**

Sets the DCI field rate matching indicator.

Parameters:

<RMInd> integer
Range: 0 to 3
*RST: 0

**[:SOURce<hw>]:BB:NR5G:SCHed:CELL<cc>:SUBF<sf>:USER<us>:
BWPart<bwp>:ALLoc<al>:CS:DCI<dci>:T2PC <BitLength>**

Defines the bit length of the "2nd TPC Command for Scheduled PUCCH".

Parameters:

<BitLength> integer
Range: 0 to 3
*RST: 0

**[:SOURce<hw>]:BB:NR5G:SCHed:CELL<cc>:SUBF<sf>:USER<us>:
BWPart<bwp>:ALLoc<al>:CS:DCI<dci>:T3CBind <Type3CbInd>**

Parameters:

<Type3CbInd> integer
Range: 0 to 7
*RST: 0

**[:SOURce<hw>]:BB:NR5G:SCHed:CELL<cc>:SUBF<sf>:USER<us>:
BWPart<bwp>:ALLoc<al>:CS:DCI<dci>:TCI <TCI>**

Sets the DCI field transmission configuration indication.

Parameters:

<TCI> integer
 Values 1 to 7 are available if [:SOURce<hw>]:BB:NR5G:SCHEd:CELL<cc>:SUBF<sf>:USER<us>:BWPart<bwp>:ALLoc<al>:CS:TCI 1.
 Range: 0 to 7
 *RST: 0

[:SOURce<hw>]:BB:NR5G:SCHEd:CELL<cc>:SUBF<sf>:USER<us>:BWPart<bwp>:ALLoc<al>:CS:DCI<dci>:ZPCsiRsTrigg <ZpCsiRsTrigg>

Sets the DCI field ZP CSI-RS trigger.

Parameters:

<ZpCsiRsTrigg> integer
 Range: 0 to 3
 *RST: 0

10.22.3.6 DCI format 1_2

Commands to configure DCI format 1_2 described elsewhere:

- [:SOURce<hw>]:BB:NR5G:SCHEd:CELL<cc>:SUBF<sf>:USER<us>:BWPart<bwp>:ALLoc<al>:CS:DCI<dci>:ANTPorts
- [:SOURce<hw>]:BB:NR5G:SCHEd:CELL<cc>:SUBF<sf>:USER<us>:BWPart<bwp>:ALLoc<al>:CS:DCI<dci>:BWiNd
- [:SOURce<hw>]:BB:NR5G:SCHEd:CELL<cc>:SUBF<sf>:USER<us>:BWPart<bwp>:ALLoc<al>:CS:DCI<dci>:CAINd
- [:SOURce<hw>]:BB:NR5G:SCHEd:CELL<cc>:SUBF<sf>:USER<us>:BWPart<bwp>:ALLoc<al>:CS:DCI<dci>:DAI1
- [:SOURce<hw>]:BB:NR5G:SCHEd:CELL<cc>:SUBF<sf>:USER<us>:BWPart<bwp>:ALLoc<al>:CS:DCI<dci>:DMSQinit
- [:SOURce<hw>]:BB:NR5G:SCHEd:CELL<cc>:SUBF<sf>:USER<us>:BWPart<bwp>:ALLoc<al>:CS:DCI<dci>:FRDRes
- [:SOURce<hw>]:BB:NR5G:SCHEd:CELL<cc>:SUBF<sf>:USER<us>:BWPart<bwp>:ALLoc<al>:CS:DCI<dci>:HAPRoc
- [:SOURce<hw>]:BB:NR5G:SCHEd:CELL<cc>:SUBF<sf>:USER<us>:BWPart<bwp>:ALLoc<al>:CS:DCI<dci>:HARTind
- [:SOURce<hw>]:BB:NR5G:SCHEd:CELL<cc>:SUBF<sf>:USER<us>:BWPart<bwp>:ALLoc<al>:CS:DCI<dci>:IDENTifier
- [:SOURce<hw>]:BB:NR5G:SCHEd:CELL<cc>:SUBF<sf>:USER<us>:BWPart<bwp>:ALLoc<al>:CS:DCI<dci>:PCINd
- [:SOURce<hw>]:BB:NR5G:SCHEd:CELL<cc>:SUBF<sf>:USER<us>:BWPart<bwp>:ALLoc<al>:CS:DCI<dci>:PDSHarq

CORESET scheduling commands

- [:SOURce<hw>] :BB:NR5G:SCHed:CELL<cc>:SUBF<sf>:USER<us>: BWPart<bwp>:ALLoc<al>:CS:DCI<dci>:PINDicator
- [:SOURce<hw>] :BB:NR5G:SCHed:CELL<cc>:SUBF<sf>:USER<us>: BWPart<bwp>:ALLoc<al>:CS:DCI<dci>:PMADaption
- [:SOURce<hw>] :BB:NR5G:SCHed:CELL<cc>:SUBF<sf>:USER<us>: BWPart<bwp>:ALLoc<al>:CS:DCI<dci>:PRBBundling
- [:SOURce<hw>] :BB:NR5G:SCHed:CELL<cc>:SUBF<sf>:USER<us>: BWPart<bwp>:ALLoc<al>:CS:DCI<dci>:PUCResind
- [:SOURce<hw>] :BB:NR5G:SCHed:CELL<cc>:SUBF<sf>:USER<us>: BWPart<bwp>:ALLoc<al>:CS:DCI<dci>:RMIND
- [:SOURce<hw>] :BB:NR5G:SCHed:CELL<cc>:SUBF<sf>:USER<us>: BWPart<bwp>:ALLoc<al>:CS:DCI<dci>:SRSRequest
- [:SOURce<hw>] :BB:NR5G:SCHed:CELL<cc>:SUBF<sf>:USER<us>: BWPart<bwp>:ALLoc<al>:CS:DCI<dci>:TB1:MCS
- [:SOURce<hw>] :BB:NR5G:SCHed:CELL<cc>:SUBF<sf>:USER<us>: BWPart<bwp>:ALLoc<al>:CS:DCI<dci>:TB1:NDI
- [:SOURce<hw>] :BB:NR5G:SCHed:CELL<cc>:SUBF<sf>:USER<us>: BWPart<bwp>:ALLoc<al>:CS:DCI<dci>:TB1:RV
- [:SOURce<hw>] :BB:NR5G:SCHed:CELL<cc>:SUBF<sf>:USER<us>: BWPart<bwp>:ALLoc<al>:CS:DCI<dci>:T2PC
- [:SOURce<hw>] :BB:NR5G:SCHed:CELL<cc>:SUBF<sf>:USER<us>: BWPart<bwp>:ALLoc<al>:CS:DCI<dci>:T3CBind
- [:SOURce<hw>] :BB:NR5G:SCHed:CELL<cc>:SUBF<sf>:USER<us>: BWPart<bwp>:ALLoc<al>:CS:DCI<dci>:TCI
- [:SOURce<hw>] :BB:NR5G:SCHed:CELL<cc>:SUBF<sf>:USER<us>: BWPart<bwp>:ALLoc<al>:CS:DCI<dci>:TIDRes
- [:SOURce<hw>] :BB:NR5G:SCHed:CELL<cc>:SUBF<sf>:USER<us>: BWPart<bwp>:ALLoc<al>:CS:DCI<dci>:TPUCch
- [:SOURce<hw>] :BB:NR5G:SCHed:CELL<cc>:SUBF<sf>:USER<us>: BWPart<bwp>:ALLoc<al>:CS:DCI<dci>:VTPRb
- [:SOURce<hw>] :BB:NR5G:SCHed:CELL<cc>:SUBF<sf>:USER<us>: BWPart<bwp>:ALLoc<al>:CS:DCI<dci>:ZCRTrigg

10.22.3.7 DCI format 2_0

Commands to configure DCI format 2_0 described elsewhere:

- [:SOURce<hw>] :BB:NR5G:SCHed:CELL<cc>:SUBF<sf>:USER<us>: BWPart<bwp>:ALLoc<al>:CS:DCI<dci>:RESVed

<code>[:SOURce<hw>]:BB:NR5G:SCHed:CELL<cc>:SUBF<sf>:USER<us>:BWPart<bwp>:ALLoc<al>:CS:DCI<dci>:AR<x></code>	675
<code>[:SOURce<hw>]:BB:NR5G:SCHed:CELL<cc>:SUBF<sf>:USER<us>:BWPart<bwp>:ALLoc<al>:CS:DCI<dci>:CD<x></code>	675
<code>[:SOURce<hw>]:BB:NR5G:SCHed:CELL<cc>:SUBF<sf>:USER<us>:BWPart<bwp>:ALLoc<al>:CS:DCI<dci>:SGS<x></code>	676
<code>[:SOURce<hw>]:BB:NR5G:SCHed:CELL<cc>:SUBF<sf>:USER<us>:BWPart<bwp>:ALLoc<al>:CS:DCI<dci>:SI<x></code>	676

[:SOURce<hw>]:BB:NR5G:SCHed:CELL<cc>:SUBF<sf>:USER<us>:BWPart<bwp>:ALLoc<al>:CS:DCI<dci>:AR<x> <Value>

Defines the bit pattern for the "Available RB Set Indicator" DCI field.

Prerequisites for this command

- Select DCI format 2_0.
- Define a number of RB set indicators > 0 (`[:SOURce<hw>]:BB:NR5G:UBWP:USER<us>:DSCH:NRBS`).

Suffix:

<x> 1...16
 Selects the instance of the DCI field.
 The value range depends on the number of RB set indicators you have defined.

Parameters:

<Value> integer
 Range: 0 to 31
 *RST: 0

Example:

```
//Define bit pattern of 2nd available RB set indicator field
BB:NR5G:UBWP:USER:DSCH:NRBS 2
BB:NR5G:SCH:CELL:SUBF:USER:BWP:ALL:CS:DCI:AR2 8
```

[:SOURce<hw>]:BB:NR5G:SCHed:CELL<cc>:SUBF<sf>:USER<us>:BWPart<bwp>:ALLoc<al>:CS:DCI<dci>:CD<x> <Value>

Defines the bit pattern for the "COT Duration Indicator" DCI field.

Prerequisites for this command

- Select DCI format 2_0.
- Define a number of COT duration indicators > 0 (`[:SOURce<hw>]:BB:NR5G:UBWP:USER<us>:DSCH:CDIN`).

Suffix:

<x> 1...16
 Selects the instance of the DCI field.
 The value range depends on the number of COT duration indicators you have defined.

Parameters:

<Value> integer
 Range: 0 to 63
 *RST: 0

Example:

```
//Define bit pattern of 2nd available COT duration indicator field
BB:NR5G:UBWP:USER:DSCH:CDIN 2
BB:NR5G:SCH:CELL:SUBF:USER:BWP:ALL:CS:DCI:CD2 8
```

**[:SOURCE<hw>]:BB:NR5G:SCHed:CELL<cc>:SUBF<sf>:USER<us>:
 BWPart<bwp>:ALLoc<al>:CS:DCI<dci>:SGS<x> <State>**

Turns the "Search Space Group Switching Flag" DCI field on and off.

Prerequisites for this command

- Select DCI format 2_0.
- Define a number of search space switching flags > 0 ([:SOURCE<hw>] :BB:NR5G:UBWP:USER<us>:DSCH:NSSF).

Suffix:

<x> 1...4
 Selects the instance of the DCI field.
 The value range depends on the number of search space switching flags you have defined.

Parameters:

<State> 1 | ON | 0 | OFF
 *RST: 0

Example:

```
//Define state of 2nd search space group switching flag field
BB:NR5GUBWP:USER:DSCH:NSSF 2
BB:NR5G:SCH:CELL:SUBF:USER:BWP:ALL:CS:DCI:SGS2
ON
```

**[:SOURCE<hw>]:BB:NR5G:SCHed:CELL<cc>:SUBF<sf>:USER<us>:
 BWPart<bwp>:ALLoc<al>:CS:DCI<dci>:SI<x> <Value>**

Defines the bit pattern for the "Slot Format Indicator" DCI field.

Prerequisites for this command

- Select DCI format 2_0.

Suffix:

<x> 1...16
 Selects the instance of the DCI field.
 The value range depends on the number of slot format indicators you have defined ([:SOURCE<hw>] :BB:NR5G:UBWP:USER<us>:NUMSfi).

Parameters:

<Value> integer
 Range: 0 to 255
 *RST: 0

Example:

```
//Define bit pattern of 2nd slot format indicator field
BB:NR5G:UBWP:USER:DSCH:NUMS 2
BB:NR5G:SCH:CELL:SUBF:USER:BWP:ALL:CS:DCI:SI2 8
```

10.22.3.8 DCI format 2_1

```
[ :SOURce<hw>]:BB:NR5G:SCHed:CELL<cc>:SUBF<sf>:USER<us>:BWPart<bwp>:
  ALLoc<al>:CS:DCI<dci>:PE<x>..... 677
```

```
[ :SOURce<hw>]:BB:NR5G:SCHed:CELL<cc>:SUBF<sf>:USER<us>:
  BWPart<bwp>:ALLoc<al>:CS:DCI<dci>:PE<x> <Value>
```

Defines the bit pattern for the "Pre-Emption Indicator" DCI field.

Prerequisites for this command

- Select DCI format 2_1.

Suffix:

<x> 1...9
 Selects the instance of the DCI field.
 The value range depends on the number of pre-emption indicators you have defined ([:SOURce<hw>]:BB:NR5G:UBWP:USER<us>:CELL<cc>:DL:BWP<bwp>:PDCC:NUMPreempt).

Parameters:

<Value> integer
 Range: 0 to 16383
 *RST: 0

Example:

```
//Define bit pattern of 2nd pre-emption indicator field
BB:NR5G:UBWP:USER:CELL:DL:BWP:PDCC:NUMP 2
BB:NR5G:SCH:CELL:SUBF:USER:BWP:ALL:CS:DCI:PE2
64
```

10.22.3.9 DCI format 2_2

```
[ :SOURce<hw>]:BB:NR5G:SCHed:CELL<cc>:SUBF<sf>:USER<us>:BWPart<bwp>:
  ALLoc<al>:CS:DCI<dci>:CL<x>..... 677
```

```
[ :SOURce<hw>]:BB:NR5G:SCHed:CELL<cc>:SUBF<sf>:USER<us>:BWPart<bwp>:
  ALLoc<al>:CS:DCI<dci>:TP<x>..... 678
```

```
[ :SOURce<hw>]:BB:NR5G:SCHed:CELL<cc>:SUBF<sf>:USER<us>:
  BWPart<bwp>:ALLoc<al>:CS:DCI<dci>:CL<x> <State>
```

Turns the "Closed Loop Indicator" DCI field on and off.

Prerequisites for this command

- Select DCI format 2_2.
- Turn on TwoPUSCH PC adjustment for TPC-PUSCH-RNTI ([:SOURce<hw>]:BB:NR5G:UBWP:USER<us>:CELL<cc>:DL:BWP<bwp>:PUSCh:TPAS).
- Turn on TwoPUCCH PC adjustment for TPC-PUCCH-RNTI ([:SOURce<hw>]:BB:NR5G:UBWP:USER<us>:CELL<cc>:DL:BWP<bwp>:PUCCh:TPAS).

Suffix:

<x> 1...22
 Selects the instance of the DCI field.
 The value range depends on the number of closed loop indicators you have defined.
 For TPC-PUSCH-RNTI: [:SOURce<hw>]:BB:NR5G:UBWP:USER<us>:CELL<cc>:DL:BWP<bwp>:PUSCh:BD22.
 For TPC-PUCCH-RNTI: [:SOURce<hw>]:BB:NR5G:UBWP:USER<us>:CELL<cc>:DL:BWP<bwp>:PUCCh:BD22

Parameters:

<State> 1 | ON | 0 | OFF
 *RST: 0

Example:

```
//Define state of 2nd closed loop indicator field in TPC-PUSCH-RNTI
BB:NR5GUBWP:USER:CELL:DL:BWP:PUSCh:TPAS ON
BB:NR5GUBWP:USER:CELL:DL:BWP:PUSCh:BD22 4
BB:NR5G:SCH:CELL:SUBF:USER:BWP:ALL:CS:DCI:CL2
ON
```

[:SOURce<hw>]:BB:NR5G:SCHed:CELL<cc>:SUBF<sf>:USER<us>:BWPpart<bwp>:ALLoc<al>:CS:DCI<dci>:TP<x> <Value>

Defines the bit pattern for the "TPC command" DCI field.

Prerequisites for this command

- Select DCI format 2_2.

Suffix:

<x> 1...22
 Selects the instance of the DCI field.
 The value range depends on the number of PUSCH blocks (TPC-PUSCH-RNTI) or PUCCH blocks (TPC-PUCCH-RNTI) you have defined.
 PUSCH blocks: [:SOURce<hw>]:BB:NR5G:UBWP:USER<us>:CELL<cc>:DL:BWP<bwp>:PUSCh:BD22.
 PUCCH blocks: [:SOURce<hw>]:BB:NR5G:UBWP:USER<us>:CELL<cc>:DL:BWP<bwp>:PUCCh:BD22

Parameters:

<Value> integer
 Range: 0 to 3
 *RST: 0

Example:

```
//Define bit pattern of 2nd TPC command field in TPC-PUSCH-
RNTI
BB:NR5GUBWP:USER:CELL:DL:BWP:PUSC:TPAS ON
BB:NR5GUBWP:USER:CELL:DL:BWP:PUSC:BD22 4
BB:NR5G:SCH:CELL:SUBF:USER:BWP:ALL:CS:DCI:TP2 2
```

10.22.3.10 DCI format 2_3

Commands to configure DCI format 2_3 described elsewhere:

- [:SOURCE<hw>]:BB:NR5G:SCHed:CELL<cc>:SUBF<sf>:USER<us>:
 BWPart<bwp>:ALLoc<al>:CS:DCI<dci>:TP<x>

```
[:SOURCE<hw>]:BB:NR5G:SCHed:CELL<cc>:SUBF<sf>:USER<us>:BWPart<bwp>:  

  ALLoc<al>:CS:DCI<dci>:SR<x>.....679
```

```
[:SOURCE<hw>]:BB:NR5G:SCHed:CELL<cc>:SUBF<sf>:USER<us>:  

  BWPart<bwp>:ALLoc<al>:CS:DCI<dci>:SR<x> <Value>
```

Defines the bit pattern for the "SRS Request" DCI field.

Suffix:

<x> 1...11
 Selects the instance of the DCI field.
 The value range depends on the number of blocks you have
 defined ([:SOURCE<hw>]:BB:NR5G:UBWP:USER<us>:
 CELL<cc>:DL:BWP<bwp>:SRS:BD23).

Parameters:

<Value> integer
 Range: 0 to 3
 *RST: 0

Example:

```
//Define bit pattern of 2nd slot format indicator field
BB:NR5G:UBWP:USER:CELL:DL:BWP:SRS:BD23 2
BB:NR5G:SCH:CELL:SUBF:USER:BWP:ALL:CS:DCI:SR2 2
```

10.22.3.11 DCI format 2_4

Commands to configure DCI format 2_4 described elsewhere:

- [:SOURCE<hw>]:BB:NR5G:SCHed:CELL<cc>:SUBF<sf>:USER<us>:
 BWPart<bwp>:ALLoc<al>:CS:DCI<dci>:RESVed

```
[:SOURCE<hw>]:BB:NR5G:SCHed:CELL<cc>:SUBF<sf>:USER<us>:BWPart<bwp>:  

  ALLoc<al>:CS:DCI<dci>:CI<x>.....680
```

**[:SOURce<hw>]:BB:NR5G:SCHed:CELL<cc>:SUBF<sf>:USER<us>:
BWPart<bwp>:ALLoc<al>:CS:DCI<dci>:CI<x> <Pattern>, <BitCount>**

Defines the bit pattern for the "Cancellation Indication" DCI field.

Prerequisites for this command

- Select DCI format 2_4.

Suffix:

<x> 1...16
Selects the instance of the DCI field.
The value range depends on the number of cancellation indicators you have defined (`[:SOURce<hw>] :BB:NR5G:UBWP:USER<us>:CELL<cc>:DL:BWP<bwp>:NCINd`).

Parameters:

<Pattern> 7 bits
Bit pattern for the cancellation indication.
*RST: #H0

<BitCount> integer
Range: 1 to 7
*RST: 1

Example: //Define bit pattern of 2nd cancellation indicator field
BB:NR5G:UBWP:USER:CELL:DL:BWP:NCIN 2
BB:NR5G:SCH:CELL:SUBF:USER:BWP:ALL:CS:DCI:CI2
#H33, 6

Options: R&S SMM-K148.

10.22.3.12 DCI format 2_5

Commands to configure DCI format 2_5 described elsewhere:

- `[:SOURce<hw>] :BB:NR5G:SCHed:CELL<cc>:SUBF<sf>:USER<us>:
BWPart<bwp>:ALLoc<al>:CS:DCI<dci>:RESVed`

`[:SOURce<hw>]:BB:NR5G:SCHed:CELL<cc>:SUBF<sf>:USER<us>:BWPart<bwp>:
ALLoc<al>:CS:DCI<dci>:AI<x>..... 680`

**[:SOURce<hw>]:BB:NR5G:SCHed:CELL<cc>:SUBF<sf>:USER<us>:
BWPart<bwp>:ALLoc<al>:CS:DCI<dci>:AI<x> <Value>**

Defines the bit pattern for the "Availability Indication" DCI field.

Prerequisites for this command

- Select DCI format 2_5.

Suffix:

<x> 1...16

Selects the instance of the DCI field.

The value range depends on the number of availability indicators you have defined ([:SOURce<hw>] :BB:NR5G:UBWP:USER<us>:CELL<cc>:DL:BWP<bwp>:NAIND).

Parameters:

<Value> integer

Range: 0 to 7

*RST: 0

Example:

//Define bit pattern of 2nd availability indicator field

BB:NR5G:UBWP:USER:DSCH:NAIND 2

BB:NR5G:SCH:CELL:SUBF:USER:BWP:ALL:CS:DCI:AI2 4

Options:

R&S SMM-K148.

10.22.3.13 DCI format 2_6

Commands to configure DCI format 2_6 described elsewhere:

- [:SOURce<hw>] :BB:NR5G:SCHed:CELL<cc>:SUBF<sf>:USER<us>:BWPart<bwp>:ALLoc<al>:CS:DCI<dcI>:RESVed

```
[ :SOURce<hw>]:BB:NR5G:SCHed:CELL<cc>:SUBF<sf>:USER<us>:BWPart<bwp>:
  ALLoc<al>:CS:DCI<dcI>:DI<x>..... 681
```

```
[ :SOURce<hw>]:BB:NR5G:SCHed:CELL<cc>:SUBF<sf>:USER<us>:BWPart<bwp>:
  ALLoc<al>:CS:DCI<dcI>:WA<x>..... 682
```

```
[ :SOURce<hw>]:BB:NR5G:SCHed:CELL<cc>:SUBF<sf>:USER<us>:
  BWPart<bwp>:ALLoc<al>:CS:DCI<dcI>:DI<x> <Value>
```

Defines the bit pattern for the "SCell Dormancy Indication" DCI field.

Prerequisites for this command

- Select DCI format 2_6.
- Define a number of SCell groups outside active time > 0 ([:SOURce<hw>] :BB:NR5G:UBWP:USER<us>:CELL<cc>:DL:BWP<bwp>:SRS:NSCG).

Suffix:

<x> 1...10

Selects the instance of the DCI field.

The value range depends on the number of SCell dormancy indicators you have defined ([:SOURce<hw>] :BB:NR5G:UBWP:USER<us>:CELL<cc>:DL:BWP<bwp>:SRS:NB26).

Parameters:

<Value> integer

Range: 0 to 31

*RST: 0

Example: //Define bit pattern of 2nd SCell dormancy indicator field
 BB:NR5G:UBWP:USER:CELL:DL:BWP:SRS:NSCG 2
 BB:NR5G:UBWP:USER:CELL:DL:BWP:SRS:NB26 2
 BB:NR5G:SCH:CELL:SUBF:USER:BWP:ALL:CS:DCI:DI2
 12

Options: R&S SMM-K148.

**[:SOURce<hw>]:BB:NR5G:SCHed:CELL<cc>:SUBF<sf>:USER<us>:
 BWPart<bwp>:ALLoc<al>:CS:DCI<dci>:WA<x> <State>**

Turns the "Wakeup Indication" DCI field on and off.

Prerequisites for this command

- Select DCI format 2_6.

Suffix:

<x> 1...10
 Selects the instance of the DCI field.
 The value range depends on the number of SCell dormancy indicators you have defined ([:SOURce<hw>] :BB:NR5G:UBWP:USER<us>:CELL<cc>:DL:BWP<bwp>:SRS:NB26).

Parameters:

<State> 1 | ON | 0 | OFF
 *RST: 0

Example: //Define state of 2nd wakeup indicator field
 BB:NR5G:UBWP:USER:CELL:DL:BWP:SRS:NB26 2
 BB:NR5G:SCH:CELL:SUBF:USER:BWP:ALL:CS:DCI:WA2
 ON

Options: R&S SMM-K148.

10.22.3.14 DCI format 2_7

[:SOURce<hw>]:BB:NR5G:SCHed:CELL<cc>:SUBF<sf>:USER<us>:BWPart<bwp>:
 ALLoc<al>:CS:DCI<dci>:PEI<x>..... 682
 [:SOURce<hw>]:BB:NR5G:SCHed:CELL<cc>:SUBF<sf>:USER<us>:BWPart<bwp>:
 ALLoc<al>:CS:DCI<dci>:TRAV..... 683

**[:SOURce<hw>]:BB:NR5G:SCHed:CELL<cc>:SUBF<sf>:USER<us>:
 BWPart<bwp>:ALLoc<al>:CS:DCI<dci>:PEI<x> <Value>**

Defines the bit pattern for the "Paging Early Indicator" DCI field.

Prerequisites for this command

- Select DCI format 2_7.

Suffix:

<x>

1...8

Selects the instance of the DCI field.

The value range depends on the PO number per PEI you have defined (`[:SOURce<hw>] :BB:NR5G:UBWP:USER<us> :CELL<cc> :DL:BWP<bwp> :DCI:PNPPEi`).

Parameters:

<Value>

integer

The value range depends on the number of subgroups per PO (`[:SOURce<hw>] :BB:NR5G:UBWP:USER<us> :CELL<cc> :DL:BWP<bwp> :DCI:SGPO`).

Range: 0 to 255

*RST: 0

Example:

```
//Define bit pattern of 2nd paging early indicator field
BB:NR5G:UBWP:USER:CELL:DL:BWP:DCI:SGPO 4
BB:NR5G:UBWP:USER:CELL:DL:BWP:DCI:PNPP 2
BB:NR5G:SCH:CELL:SUBF:USER:BWP:ALL:CS:DCI:PEI2
4
```

**[:SOURce<hw>] :BB:NR5G:SCHed:CELL<cc> :SUBF<sf> :USER<us> :
BWPart<bwp> :ALLoc<al> :CS:DCI<dci> :TRAV <TrsAvailability>**

Configures the bit pattern for the "TRS availability indication" DCI field.

Prerequisites for this command

- Bits for TRS availability indication must be > 1 (`[:SOURce<hw>] :BB:NR5G:UBWP:USER<us> :CELL<cc> :DL:BWP<bwp> :DCI:TAINd`).

Parameters:

<TrsAvailability>

integer

The value range depends on the number of bits for TRS availability indication.

Range: 0 to 63

*RST: 0

10.22.3.15 DCI format 3_0

Commands to configure DCI format 3_0 described elsewhere:

- `[:SOURce<hw>] :BB:NR5G:SCHed:CELL<cc> :SUBF<sf> :USER<us> :BWPart<bwp> :ALLoc<al> :CS:DCI<dci> :HAPRoc`
- `[:SOURce<hw>] :BB:NR5G:SCHed:CELL<cc> :SUBF<sf> :USER<us> :BWPart<bwp> :ALLoc<al> :CS:DCI<dci> :TB1:NDI`
`[:SOURce<hw>] :BB:NR5G:SCHed:CELL<cc> :SUBF<sf> :USER<us> :BWPart<bwp> :ALLoc<al> :CS:DCI<dci> :TB2:NDI`
- `[:SOURce<hw>] :BB:NR5G:SCHed:CELL<cc> :SUBF<sf> :USER<us> :BWPart<bwp> :ALLoc<al> :CS:DCI<dci> :FRDRes`

CORESET scheduling commands

- [:SOURce<hw>] :BB:NR5G:SCHed:CELL<cc>:SUBF<sf>:USER<us>:
BWPart<bwp>:ALLoc<al>:CS:DCI<dci>:TIDRes
 - [:SOURce<hw>] :BB:NR5G:SCHed:CELL<cc>:SUBF<sf>:USER<us>:
BWPart<bwp>:ALLoc<al>:CS:DCI<dci>:PUCResind
- [:SOURce<hw>]:BB:NR5G:SCHed:CELL<cc>:SUBF<sf>:USER<us>:BWPart<bwp>:
ALLoc<al>:CS:DCI<dci>:CAINdex..... 684
- [:SOURce<hw>]:BB:NR5G:SCHed:CELL<cc>:SUBF<sf>:USER<us>:BWPart<bwp>:
ALLoc<al>:CS:DCI<dci>:COINdex..... 684
- [:SOURce<hw>]:BB:NR5G:SCHed:CELL<cc>:SUBF<sf>:USER<us>:BWPart<bwp>:
ALLoc<al>:CS:DCI<dci>:FSCChannel..... 684
- [:SOURce<hw>]:BB:NR5G:SCHed:CELL<cc>:SUBF<sf>:USER<us>:BWPart<bwp>:
ALLoc<al>:CS:DCI<dci>:PTHFeedback..... 685
- [:SOURce<hw>]:BB:NR5G:SCHed:CELL<cc>:SUBF<sf>:USER<us>:BWPart<bwp>:
ALLoc<al>:CS:DCI<dci>:RPINdex..... 685
- [:SOURce<hw>]:BB:NR5G:SCHed:CELL<cc>:SUBF<sf>:USER<us>:BWPart<bwp>:
ALLoc<al>:CS:DCI<dci>:TGAP..... 685

**[:SOURce<hw>]:BB:NR5G:SCHed:CELL<cc>:SUBF<sf>:USER<us>:
BWPart<bwp>:ALLoc<al>:CS:DCI<dci>:CAINdex <Value>**

Sets the DCI field counter sidelink assignment index.

Parameters:

<Value> integer
 Range: 0 to 7
 *RST: 0

**[:SOURce<hw>]:BB:NR5G:SCHed:CELL<cc>:SUBF<sf>:USER<us>:
BWPart<bwp>:ALLoc<al>:CS:DCI<dci>:COINdex <Value>**

Sets the DCI field configuration index.

Parameters:

<Value> integer
 Range: 0 to 7
 *RST: 0

**[:SOURce<hw>]:BB:NR5G:SCHed:CELL<cc>:SUBF<sf>:USER<us>:
BWPart<bwp>:ALLoc<al>:CS:DCI<dci>:FSCChannel <Value>**

Sets the DCI field first subchannel.

Parameters:

<Value> integer
 Range: 0 to 27
 *RST: 0

```
[ :SOURce<hw>]:BB:NR5G:SCHed:CELL<cc>:SUBF<sf>:USER<us>:
  BWPart<bwp>:ALLoc<al>:CS:DCI<dci>:PTHFeedback <Value>
```

Sets the DCI field PSFCH-to-HARQ feedback.

Parameters:

```
<Value>          integer
                  Range:    0 to 7
                  *RST:     0
```

```
[ :SOURce<hw>]:BB:NR5G:SCHed:CELL<cc>:SUBF<sf>:USER<us>:
  BWPart<bwp>:ALLoc<al>:CS:DCI<dci>:RPIndex <ResPoolIndex>
```

Sets the DCI field resource pool index.

Parameters:

```
<ResPoolIndex>  integer
                  Range:    0 to 7
                  *RST:     0
```

```
[ :SOURce<hw>]:BB:NR5G:SCHed:CELL<cc>:SUBF<sf>:USER<us>:
  BWPart<bwp>:ALLoc<al>:CS:DCI<dci>:TGAP <Value>
```

Sets the DCI field time gap.

Parameters:

```
<Value>          integer
                  Range:    0 to 15
                  *RST:     0
```

10.22.3.16 DCI format 3_1

Commands to configure DCI format 3_1 described elsewhere:

- [:SOURce<hw>] :BB:NR5G:SCHed:CELL<cc>:SUBF<sf>:USER<us>:
 BWPart<bwp>:ALLoc<al>:CS:DCI<dci>:CAINd
- [:SOURce<hw>] :BB:NR5G:SCHed:CELL<cc>:SUBF<sf>:USER<us>:
 BWPart<bwp>:ALLoc<al>:CS:DCI<dci>:FSCHannel
- [:SOURce<hw>] :BB:NR5G:SCHed:CELL<cc>:SUBF<sf>:USER<us>:
 BWPart<bwp>:ALLoc<al>:CS:DCI<dci>:TGAP

<code>[SOURce<hw>]:BB:NR5G:SCHed:CELL<cc>:SUBF<sf>:USER<us>:BWPart<bwp>:ALLoc<al>:CS:DCI<dci>:ARINd</code>	686
<code>[SOURce<hw>]:BB:NR5G:SCHed:CELL<cc>:SUBF<sf>:USER<us>:BWPart<bwp>:ALLoc<al>:CS:DCI<dci>:FRRLoc</code>	686
<code>[SOURce<hw>]:BB:NR5G:SCHed:CELL<cc>:SUBF<sf>:USER<us>:BWPart<bwp>:ALLoc<al>:CS:DCI<dci>:SLINdex</code>	686
<code>[SOURce<hw>]:BB:NR5G:SCHed:CELL<cc>:SUBF<sf>:USER<us>:BWPart<bwp>:ALLoc<al>:CS:DCI<dci>:SPSConf</code>	686
<code>[SOURce<hw>]:BB:NR5G:SCHed:CELL<cc>:SUBF<sf>:USER<us>:BWPart<bwp>:ALLoc<al>:CS:DCI<dci>:TOFFset</code>	687

`[SOURce<hw>]:BB:NR5G:SCHed:CELL<cc>:SUBF<sf>:USER<us>:BWPart<bwp>:ALLoc<al>:CS:DCI<dci>:ARINd <State>`

Turns the DCI field activation / release indication on and off.

Parameters:

<State> 1 | ON | 0 | OFF
 *RST: 0

`[SOURce<hw>]:BB:NR5G:SCHed:CELL<cc>:SUBF<sf>:USER<us>:BWPart<bwp>:ALLoc<al>:CS:DCI<dci>:FRRLoc <Value>`

Sets the DCI field frequency resource allocation.

Parameters:

<Value> integer
 Range: 0 to 7
 *RST: 0

`[SOURce<hw>]:BB:NR5G:SCHed:CELL<cc>:SUBF<sf>:USER<us>:BWPart<bwp>:ALLoc<al>:CS:DCI<dci>:SLINdex <Value>`

Sets the DCI field SL index.

Parameters:

<Value> integer
 Range: 0 to 7
 *RST: 0

`[SOURce<hw>]:BB:NR5G:SCHed:CELL<cc>:SUBF<sf>:USER<us>:BWPart<bwp>:ALLoc<al>:CS:DCI<dci>:SPSConf <Value>`

Sets the DCI field SL SPS configuration index.

Parameters:

<Value> integer
 Range: 0 to 7
 *RST: 0

**[:SOURce<hw>]:BB:NR5G:SCHEd:CELL<cc>:SUBF<sf>:USER<us>:
BWPart<bwp>:ALLoc<al>:CS:DCI<dci>:TOFFset <Value>**

Sets the DCI field timing offset.

Parameters:

<Value> integer
 Range: 0 to 7
 *RST: 0

10.22.3.17 DCI format 4_0

Commands to configure DCI format 4_0 described elsewhere:

- [:SOURce<hw>] :BB:NR5G:SCHEd:CELL<cc>:SUBF<sf>:USER<us>:
BWPart<bwp>:ALLoc<al>:CS:DCI<dci>:FRDRes
- [:SOURce<hw>] :BB:NR5G:SCHEd:CELL<cc>:SUBF<sf>:USER<us>:
BWPart<bwp>:ALLoc<al>:CS:DCI<dci>:TIDRes
- [:SOURce<hw>] :BB:NR5G:SCHEd:CELL<cc>:SUBF<sf>:USER<us>:
BWPart<bwp>:ALLoc<al>:CS:DCI<dci>:VTPRb
- [:SOURce<hw>] :BB:NR5G:SCHEd:CELL<cc>:SUBF<sf>:USER<us>:
BWPart<bwp>:ALLoc<al>:CS:DCI<dci>:TB1:MCS
- [:SOURce<hw>] :BB:NR5G:SCHEd:CELL<cc>:SUBF<sf>:USER<us>:
BWPart<bwp>:ALLoc<al>:CS:DCI<dci>:TB1:RV

[:SOURce<hw>]:BB:NR5G:SCHEd:CELL<cc>:SUBF<sf>:USER<us>:BWPart<bwp>:
ALLoc<al>:CS:DCI<dci>:MCCH..... 687

**[:SOURce<hw>]:BB:NR5G:SCHEd:CELL<cc>:SUBF<sf>:USER<us>:
BWPart<bwp>:ALLoc<al>:CS:DCI<dci>:MCCH <Value>**

Defines the value of the "MCCH Change Notifications" DCI field.

Parameters:

<Value> integer
 Range: 0 to 3
 *RST: 0

10.22.3.18 DCI format 4_1

Commands to configure DCI format 4_1 described elsewhere:

- [:SOURce<hw>] :BB:NR5G:SCHEd:CELL<cc>:SUBF<sf>:USER<us>:
BWPart<bwp>:ALLoc<al>:CS:DCI<dci>:FRDRes
- [:SOURce<hw>] :BB:NR5G:SCHEd:CELL<cc>:SUBF<sf>:USER<us>:
BWPart<bwp>:ALLoc<al>:CS:DCI<dci>:TIDRes
- [:SOURce<hw>] :BB:NR5G:SCHEd:CELL<cc>:SUBF<sf>:USER<us>:
BWPart<bwp>:ALLoc<al>:CS:DCI<dci>:VTPRb

- [:SOURce<hw>] :BB:NR5G:SCHed:CELL<cc>:SUBF<sf>:USER<us>: BWPart<bwp>:ALLoc<al>:CS:DCI<dci>:TB1:MCS
- [:SOURce<hw>] :BB:NR5G:SCHed:CELL<cc>:SUBF<sf>:USER<us>: BWPart<bwp>:ALLoc<al>:CS:DCI<dci>:TB1:NDI
- [:SOURce<hw>] :BB:NR5G:SCHed:CELL<cc>:SUBF<sf>:USER<us>: BWPart<bwp>:ALLoc<al>:CS:DCI<dci>:TB1:RV
- [:SOURce<hw>] :BB:NR5G:SCHed:CELL<cc>:SUBF<sf>:USER<us>: BWPart<bwp>:ALLoc<al>:CS:DCI<dci>:HAPRoc
- [:SOURce<hw>] :BB:NR5G:SCHed:CELL<cc>:SUBF<sf>:USER<us>: BWPart<bwp>:ALLoc<al>:CS:DCI<dci>:DAI1
- [:SOURce<hw>] :BB:NR5G:SCHed:CELL<cc>:SUBF<sf>:USER<us>: BWPart<bwp>:ALLoc<al>:CS:DCI<dci>:PUCResind
- [:SOURce<hw>] :BB:NR5G:SCHed:CELL<cc>:SUBF<sf>:USER<us>: BWPart<bwp>:ALLoc<al>:CS:DCI<dci>:PDSHarq
- [:SOURce<hw>] :BB:NR5G:SCHed:CELL<cc>:SUBF<sf>:USER<us>: BWPart<bwp>:ALLoc<al>:CS:DCI<dci>:RESVed

10.22.3.19 DCI format 4_2

Commands to configure DCI format 4_2 described elsewhere:

- [:SOURce<hw>] :BB:NR5G:SCHed:CELL<cc>:SUBF<sf>:USER<us>: BWPart<bwp>:ALLoc<al>:CS:DCI<dci>:FRDRes
- [:SOURce<hw>] :BB:NR5G:SCHed:CELL<cc>:SUBF<sf>:USER<us>: BWPart<bwp>:ALLoc<al>:CS:DCI<dci>:TIDRes
- [:SOURce<hw>] :BB:NR5G:SCHed:CELL<cc>:SUBF<sf>:USER<us>: BWPart<bwp>:ALLoc<al>:CS:DCI<dci>:VTPRb
- [:SOURce<hw>] :BB:NR5G:SCHed:CELL<cc>:SUBF<sf>:USER<us>: BWPart<bwp>:ALLoc<al>:CS:DCI<dci>:PRBBundling
- [:SOURce<hw>] :BB:NR5G:SCHed:CELL<cc>:SUBF<sf>:USER<us>: BWPart<bwp>:ALLoc<al>:CS:DCI<dci>:RMIND
- [:SOURce<hw>] :BB:NR5G:SCHed:CELL<cc>:SUBF<sf>:USER<us>: BWPart<bwp>:ALLoc<al>:CS:DCI<dci>:ZCRTrigg
- [:SOURce<hw>] :BB:NR5G:SCHed:CELL<cc>:SUBF<sf>:USER<us>: BWPart<bwp>:ALLoc<al>:CS:DCI<dci>:TB1:MCS
- [:SOURce<hw>] :BB:NR5G:SCHed:CELL<cc>:SUBF<sf>:USER<us>: BWPart<bwp>:ALLoc<al>:CS:DCI<dci>:TB2:MCS
- [:SOURce<hw>] :BB:NR5G:SCHed:CELL<cc>:SUBF<sf>:USER<us>: BWPart<bwp>:ALLoc<al>:CS:DCI<dci>:TB1:NDI
- [:SOURce<hw>] :BB:NR5G:SCHed:CELL<cc>:SUBF<sf>:USER<us>: BWPart<bwp>:ALLoc<al>:CS:DCI<dci>:TB2:NDI
- [:SOURce<hw>] :BB:NR5G:SCHed:CELL<cc>:SUBF<sf>:USER<us>: BWPart<bwp>:ALLoc<al>:CS:DCI<dci>:TB1:RV

- [:SOURce<hw>] :BB:NR5G:SCHed:CELL<cc>:SUBF<sf>:USER<us>:
BWPart<bwp>:ALLoc<al>:CS:DCI<dci>:TB2:RV
- [:SOURce<hw>] :BB:NR5G:SCHed:CELL<cc>:SUBF<sf>:USER<us>:
BWPart<bwp>:ALLoc<al>:CS:DCI<dci>:HAPRoc
- [:SOURce<hw>] :BB:NR5G:SCHed:CELL<cc>:SUBF<sf>:USER<us>:
BWPart<bwp>:ALLoc<al>:CS:DCI<dci>:DAI1
- [:SOURce<hw>] :BB:NR5G:SCHed:CELL<cc>:SUBF<sf>:USER<us>:
BWPart<bwp>:ALLoc<al>:CS:DCI<dci>:PUCResind
- [:SOURce<hw>] :BB:NR5G:SCHed:CELL<cc>:SUBF<sf>:USER<us>:
BWPart<bwp>:ALLoc<al>:CS:DCI<dci>:PDSHarq
- [:SOURce<hw>] :BB:NR5G:SCHed:CELL<cc>:SUBF<sf>:USER<us>:
BWPart<bwp>:ALLoc<al>:CS:DCI<dci>:ANTPorts
- [:SOURce<hw>] :BB:NR5G:SCHed:CELL<cc>:SUBF<sf>:USER<us>:
BWPart<bwp>:ALLoc<al>:CS:DCI<dci>:RESVed
- [:SOURce<hw>] :BB:NR5G:SCHed:CELL<cc>:SUBF<sf>:USER<us>:
BWPart<bwp>:ALLoc<al>:CS:DCI<dci>:TCI
- [:SOURce<hw>] :BB:NR5G:SCHed:CELL<cc>:SUBF<sf>:USER<us>:
BWPart<bwp>:ALLoc<al>:CS:DCI<dci>:DMSQinit

[:SOURce<hw>] :BB:NR5G:SCHed:CELL<cc>:SUBF<sf>:USER<us>:BWPart<bwp>:
ALLoc<al>:CS:DCI<dci>:HAFB..... 689

**[:SOURce<hw>] :BB:NR5G:SCHed:CELL<cc>:SUBF<sf>:USER<us>:
BWPart<bwp>:ALLoc<al>:CS:DCI<dci>:HAFB <State>**

Turns the DCI field "Enabling HARQ_ACK Feedback Indication" on and off.

Parameters:

<State> 1 | ON | 0 | OFF
*RST: 0

10.22.3.20 Custom DCI format

[:SOURce<hw>] :BB:NR5G:SCHed:CELL<cc>:SUBF<sf>:USER<us>:BWPart<bwp>:
ALLoc<al>:CS:DCI<dci>:BITLength..... 690

[:SOURce<hw>] :BB:NR5G:SCHed:CELL<cc>:SUBF<sf>:USER<us>:BWPart<bwp>:
ALLoc<al>:CS:DCI<dci>:DATA..... 690

[:SOURce<hw>] :BB:NR5G:SCHed:CELL<cc>:SUBF<sf>:USER<us>:BWPart<bwp>:
ALLoc<al>:CS:DCI<dci>:DLISt..... 690

[:SOURce<hw>] :BB:NR5G:SCHed:CELL<cc>:SUBF<sf>:USER<us>:BWPart<bwp>:
ALLoc<al>:CS:DCI<dci>:INITpattern..... 690

[:SOURce<hw>] :BB:NR5G:SCHed:CELL<cc>:SUBF<sf>:USER<us>:BWPart<bwp>:
ALLoc<al>:CS:DCI<dci>:PATtern..... 691

[:SOURce<hw>] :BB:NR5G:SCHed:CELL<cc>:SUBF<sf>:USER<us>:BWPart<bwp>:
ALLoc<al>:CS:DCI<dci>:STATe..... 691

```
[ :SOURce<hw>]:BB:NR5G:SCHed:CELL<cc>:SUBF<sf>:USER<us>:
  BWPart<bwp>:ALLoc<al>:CS:DCI<dci>:BITLength <PatternLength>
```

If channel coding is enabled ([:SOURce<hw>] :BB:NR5G:SCHed:CELL<cc>:SUBF<sf>:USER<us>:BWPart<bwp>:ALLoc<al>:CS:DCI<dci>:STATE 1), sets the number of DCI bits in the custom DCI.

Parameters:

<PatternLength> integer
 Range: 12 to 128
 *RST: 84

Example: See [Example"Configuring the CORESET settings"](#) on page 398.

Manual operation: See ["Pattern Length"](#) on page 268

```
[ :SOURce<hw>]:BB:NR5G:SCHed:CELL<cc>:SUBF<sf>:USER<us>:
  BWPart<bwp>:ALLoc<al>:CS:DCI<dci>:DATA <DataSource>
```

Sets the data source for the custom DCI.

Parameters:

<DataSource> PN9 | PN11 | PN15 | PN16 | PN20 | PN21 | PN23 | PATtern |
 DLISt | ZERO | ONE
 *RST: PN9

Example: See [Example"Configuring the CORESET settings"](#) on page 398.

Manual operation: See ["Data Source"](#) on page 267

```
[ :SOURce<hw>]:BB:NR5G:SCHed:CELL<cc>:SUBF<sf>:USER<us>:
  BWPart<bwp>:ALLoc<al>:CS:DCI<dci>:DLISt <DataList>
```

Selects an existing data list file from the default directory or from the specific directory.

Parameters:

<DataList> string
 Filename incl. file extension or complete file path

Example: See [Example"Configuring the CORESET settings"](#) on page 398.

Manual operation: See ["Data Source"](#) on page 267

```
[ :SOURce<hw>]:BB:NR5G:SCHed:CELL<cc>:SUBF<sf>:USER<us>:
  BWPart<bwp>:ALLoc<al>:CS:DCI<dci>:INITpattern <Pattern>
```

Sets an initialization value for the second m-sequence in the PN sequence of the custom DCI.

Parameters:

<Pattern> integer
 Range: 1 to #H7ffff
 *RST: 1

Example: See [Example"Custom DCI"](#) on page 401.

Manual operation: See ["Initialization"](#) on page 268

**[:SOURce<hw>]:BB:NR5G:SCHed:CELL<cc>:SUBF<sf>:USER<us>:
 BWPart<bwp>:ALLoc<al>:CS:DCI<dci>:PATTern <Pattern>, <BitCount>**

Sets the content of the custom DCI as a bit pattern.

Parameters:

<Pattern> 128 bits
 Corresponds to the value set with the command [\[:SOURce<hw>\]:BB:NR5G:SCHed:CELL<cc>:SUBF<sf>:USER<us>:BWPart<bwp>:ALLoc<al>:CS:DCI<dci>:BITLength](#).
 *RST: #H0

<BitCount> integer
 Range: 1 to 128
 *RST: 1

Example: See [Example"Configuring the CORESET settings"](#) on page 398.

Manual operation: See ["Data Source"](#) on page 267

**[:SOURce<hw>]:BB:NR5G:SCHed:CELL<cc>:SUBF<sf>:USER<us>:
 BWPart<bwp>:ALLoc<al>:CS:DCI<dci>:STATe <ChanCodingState>**

Enables channel coding for the DCI type custom.

Parameters:

<ChanCodingState> 1 | ON | 0 | OFF
 *RST: 1

Example: See [Example"Configuring the CORESET settings"](#) on page 398.

Manual operation: See ["Channel Coding"](#) on page 267

10.23 CSI-RS scheduling commands

The following commands configure the CSI-RS in the scheduling table. When you configure the CSI-RS in the "User / BWP" dialog, use the commands referenced in [Chapter 10.19.6, "ZP and NZP CSI-RS commands"](#), on page 538.

<code>[:SOURce<hw>]:BB:NR5G:SCHed:CELL<cc>:SUBF<sf>:USER<us>:BWPart<bwp>:ALLoc<al>:BITMap</code>	692
<code>[:SOURce<hw>]:BB:NR5G:SCHed:CELL<cc>:SUBF<sf>:USER<us>:BWPart<bwp>:ALLoc<al>:DENSity</code>	692
<code>[:SOURce<hw>]:BB:NR5G:SCHed:CELL<cc>:SUBF<sf>:USER<us>:BWPart<bwp>:ALLoc<al>:I0</code>	692
<code>[:SOURce<hw>]:BB:NR5G:SCHed:CELL<cc>:SUBF<sf>:USER<us>:BWPart<bwp>:ALLoc<al>:I1</code>	693
<code>[:SOURce<hw>]:BB:NR5G:SCHed:CELL<cc>:SUBF<sf>:USER<us>:BWPart<bwp>:ALLoc<al>:ISZPower</code>	693
<code>[:SOURce<hw>]:BB:NR5G:SCHed:CELL<cc>:SUBF<sf>:USER<us>:BWPart<bwp>:ALLoc<al>:ROW</code>	693
<code>[:SOURce<hw>]:BB:NR5G:SCHed:CELL<cc>:SUBF<sf>:USER<us>:BWPart<bwp>:ALLoc<al>:SCID</code>	693

`[:SOURce<hw>]:BB:NR5G:SCHed:CELL<cc>:SUBF<sf>:USER<us>:BWPart<bwp>:ALLoc<al>:BITMap <Pattern>,<BitCount>`

Defines the bitmap setting for the CSI-RS.

Parameters:

<code><Pattern></code>	12 bits
	*RST: #H0
<code><BitCount></code>	integer
	Range: 1 to 12
	*RST: 1

Manual operation: See "[Bitmap](#)" on page 271

`[:SOURce<hw>]:BB:NR5G:SCHed:CELL<cc>:SUBF<sf>:USER<us>:BWPart<bwp>:ALLoc<al>:DENSity <Density>`

Selects the density configuration for the CSI-RS.

Parameters:

<code><Density></code>	EVE5 ODD5 DEN1 DEN3
	*RST: DEN3

Manual operation: See "[Density](#)" on page 271

`[:SOURce<hw>]:BB:NR5G:SCHed:CELL<cc>:SUBF<sf>:USER<us>:BWPart<bwp>:ALLoc<al>:I0 <Value>`

Defines parameter I_0 of the CSI-RS.

Parameters:

<code><Value></code>	integer
	Range: 0 to 13
	*RST: 9

Manual operation: See "I0/I1" on page 271

**[:SOURce<hw>]:BB:NR5G:SCHeD:CELL<cc>:SUBF<sf>:USER<us>:
BWPart<bwp>:ALLOc<al>:I1 <Value>**

Defines parameter I₁ of the CSI-RS.

Parameters:

<Value> integer
Range: 2 to 12
*RST: 11

Manual operation: See "I0/I1" on page 271

**[:SOURce<hw>]:BB:NR5G:SCHeD:CELL<cc>:SUBF<sf>:USER<us>:
BWPart<bwp>:ALLOc<al>:ISZPower <State>**

Turns zero power transmission for the CSI-RS on and off.

Parameters:

<State> 1 | ON | 0 | OFF
*RST: 0

Manual operation: See "Zero Power" on page 270

**[:SOURce<hw>]:BB:NR5G:SCHeD:CELL<cc>:SUBF<sf>:USER<us>:
BWPart<bwp>:ALLOc<al>:ROW <Value>**

Defines the location setting for the CSI-RS.

Effects of this command

- Selecting a location setting has effects on the range and availability of the other CSI-RS parameters.

Parameters:

<Value> integer
Range: 1 to 18
*RST: 1

Manual operation: See "Row" on page 270

**[:SOURce<hw>]:BB:NR5G:SCHeD:CELL<cc>:SUBF<sf>:USER<us>:
BWPart<bwp>:ALLOc<al>:SCID <ScramblingId>**

Defines the seed value for the CSI-RS sequence generation.

Parameters:

<ScramblingId> integer
Range: 0 to 1023
*RST: 0

Manual operation: See "Scrambling ID" on page 271

10.24 RIM-RS scheduling commands

<code>[:SOURce<hw>]:BB:NR5G:SCHed:CELL<cc>:SUBF<sf>:USER<us>:BWPart<bwp>:RESulting:ALLoc<al>:RIMRs:DELTA</code>	694
<code>[:SOURce<hw>]:BB:NR5G:SCHed:CELL<cc>:SUBF<sf>:USER<us>:BWPart<bwp>:RESulting:ALLoc<al>:RIMRs:GAMMA</code>	694
<code>[:SOURce<hw>]:BB:NR5G:SCHed:CELL<cc>:SUBF<sf>:USER<us>:BWPart<bwp>:RESulting:ALLoc<al>:RIMRs:NTRim</code>	694
<code>[:SOURce<hw>]:BB:NR5G:SCHed:CELL<cc>:SUBF<sf>:USER<us>:BWPart<bwp>:RESulting:ALLoc<al>:RIMRs:SCID</code>	695

`[:SOURce<hw>]:BB:NR5G:SCHed:CELL<cc>:SUBF<sf>:USER<us>:BWPart<bwp>:RESulting:ALLoc<al>:RIMRs:DELTA` <Value>

Defines the offset δ as defined in 3GPP 38.211, chapter 7.4.1.6.2 that has an effect on the sequence generation of the RIM-RS.

Parameters:

<Value> integer
 Range: 0 to 2147483647
 *RST: 0

Manual operation: See "Delta" on page 273

`[:SOURce<hw>]:BB:NR5G:SCHed:CELL<cc>:SUBF<sf>:USER<us>:BWPart<bwp>:RESulting:ALLoc<al>:RIMRs:GAMMA` <Value>

Defines the multiplier factor γ as defined in 3GPP 38.211, chapter 7.4.1.6.2 that has an effect on the sequence generation of the RIM-RS.

Parameters:

<Value> integer
 Range: 0 to 2147483647
 *RST: 0

Manual operation: See "Gamma" on page 273

`[:SOURce<hw>]:BB:NR5G:SCHed:CELL<cc>:SUBF<sf>:USER<us>:BWPart<bwp>:RESulting:ALLoc<al>:RIMRs:NTRim` <Value>

Defines the number of RIM-RS transmission periods since a certain reference time as defined in 3GPP 38.211, chapter 7.4.1.6.2.

Parameters:

<Value> integer
 Range: 0 to 2147483647
 *RST: 0

Manual operation: See "NTRim" on page 273

**[:SOURce<hw>]:BB:NR5G:SCHed:CELL<cc>:SUBF<sf>:USER<us>:
BWPart<bwp>:RESulting:ALLoc<al>:RIMRs:SCID <ScramblingID>**

Defines the scrambling ID for the RIM reference signal sequence generation.

Parameters:

<ScramblingID> integer
Range: 0 to 1023
*RST: 0

Manual operation: See "NScid" on page 273

10.25 PUCCH scheduling commands

- [General PUCCH scheduling commands](#).....695
- [PUCCH payload scheduling commands](#).....699

10.25.1 General PUCCH scheduling commands

Commands to configure the PUCCH described elsewhere.

- [\[:SOURce<hw> \] :BB:NR5G:SCHed:CELL<cc>:SUBF<sf>:USER<us>:
BWPart<bwp>:ALLoc<al>:CPEXt](#)
- [\[:SOURce<hw> \] :BB:NR5G:SCHed:CELL<cc>:SUBF<sf>:USER<us>:
BWPart<bwp>:ALLoc<al>:TOFFset](#)

[:SOURce<hw>]:BB:NR5G:SCHed:CELL<cc>:SUBF<sf>:USER<us>:BWPart<bwp>: ALLoc<al>:PUCCh:FS:CYCShift.....	696
[:SOURce<hw>]:BB:NR5G:SCHed:CELL<cc>:SUBF<sf>:USER<us>:BWPart<bwp>: ALLoc<al>:PUCCh:FS:OCCindex.....	696
[:SOURce<hw>]:BB:NR5G:SCHed:CELL<cc>:SUBF<sf>:USER<us>:BWPart<bwp>: ALLoc<al>:PUCCh:FS:OCCLength.....	696
[:SOURce<hw>]:BB:NR5G:SCHed:CELL<cc>:SUBF<sf>:USER<us>:BWPart<bwp>: ALLoc<al>:PUCCh:FS:FMT2:OCCLength.....	697
[:SOURce<hw>]:BB:NR5G:SCHed:CELL<cc>:SUBF<sf>:USER<us>:BWPart<bwp>: ALLoc<al>:PUCCh:FS:FMT3:OCCLength.....	697
[:SOURce<hw>]:BB:NR5G:SCHed:CELL<cc>:SUBF<sf>:USER<us>:BWPart<bwp>: ALLoc<al>:PUCCh:FS:TDOCC.....	697
[:SOURce<hw>]:BB:NR5G:SCHed:CELL<cc>:SUBF<sf>:USER<us>:BWPart<bwp>: ALLoc<al>:PUCCh:GRPHopping.....	697
[:SOURce<hw>]:BB:NR5G:SCHed:CELL<cc>:SUBF<sf>:USER<us>:BWPart<bwp>: ALLoc<al>:PUCCh:HOPid.....	698
[:SOURce<hw>]:BB:NR5G:SCHed:CELL<cc>:SUBF<sf>:USER<us>:BWPart<bwp>: ALLoc<al>:PUCCh:INT<il>:INTL.....	698

<code>[:SOURce<hw>]:BB:NR5G:SCHed:CELL<cc>:SUBF<sf>:USER<us>:BWPart<bwp>: ALLoc<al>:PUCCh:ISFHopping.....</code>	698
<code>[:SOURce<hw>]:BB:NR5G:SCHed:CELL<cc>:SUBF<sf>:USER<us>:BWPart<bwp>: ALLoc<al>:PUCCh:NINT.....</code>	698
<code>[:SOURce<hw>]:BB:NR5G:SCHed:CELL<cc>:SUBF<sf>:USER<us>:BWPart<bwp>: ALLoc<al>:PUCCh:SHOPping.....</code>	699

**`[:SOURce<hw>]:BB:NR5G:SCHed:CELL<cc>:SUBF<sf>:USER<us>:
BWPart<bwp>:ALLoc<al>:PUCCh:FS:CYCShift <InitialCyclicSh>`**

For PUCCH format F0 and F1, sets the initial cyclic shift.

Parameters:

`<InitialCyclicSh>` integer
 Range: 0 to 11
 *RST: 0

Example: `SOURce1:BB:NR5G:SCHed:CELL0:SUBF0:USER0:
BWPart0:ALLoc1:FMT F1
SOURce1:BB:NR5G:SCHed:CELL0:SUBF0:USER0:
BWPart0:ALLoc1:PUCCh:FS:CYCShift 1`

Manual operation: See ["Initial Cyclic Shift"](#) on page 276

**`[:SOURce<hw>]:BB:NR5G:SCHed:CELL<cc>:SUBF<sf>:USER<us>:
BWPart<bwp>:ALLoc<al>:PUCCh:FS:OCCindex <OCCindex>`**

For PUCCH format F4, sets the OCC index.

Parameters:

`<OCCindex>` integer
 Range: 0 to 6
 *RST: 0

Example: See [Example"Configuring the PUCCH settings"](#) on page 406.

Manual operation: See ["OCC Index"](#) on page 277

**`[:SOURce<hw>]:BB:NR5G:SCHed:CELL<cc>:SUBF<sf>:USER<us>:
BWPart<bwp>:ALLoc<al>:PUCCh:FS:OCCLength <PucchOCCLength>`**

For PUCCH format F4, sets the OCC length.

Parameters:

`<PucchOCCLength>` L2 | L4
 *RST: L2

Example: See [Example"Configuring the PUCCH settings"](#) on page 406.

Manual operation: See ["OCC Length"](#) on page 277

```
[ :SOURce<hw>]:BB:NR5G:SCHed:CELL<cc>:SUBF<sf>:USER<us>:
      BWPart<bwp>:ALLoc<al>:PUCCh:FS:FMT2:OCCLength <Fmt2OccLength>
```

For PUCCH format F2, sets the OCC length.

Parameters:

```
<Fmt2OccLength>  L4 | L2 | L1
                  *RST:      L1
```

Manual operation: See "[OCC Length](#)" on page 277

```
[ :SOURce<hw>]:BB:NR5G:SCHed:CELL<cc>:SUBF<sf>:USER<us>:
      BWPart<bwp>:ALLoc<al>:PUCCh:FS:FMT3:OCCLength <Fmt3OccLength>
```

For PUCCH format F3, sets the OCC length.

Parameters:

```
<Fmt3OccLength>  L4 | L2 | L1
                  *RST:      L1
```

Manual operation: See "[OCC Length](#)" on page 277

```
[ :SOURce<hw>]:BB:NR5G:SCHed:CELL<cc>:SUBF<sf>:USER<us>:
      BWPart<bwp>:ALLoc<al>:PUCCh:FS:TDOCC <TimeDomainOcclD>
```

For PUCCH format F1, sets the time domain OCC index.

Parameters:

```
<TimeDomainOcclD> integer
                   Range:    0 to 6
                   *RST:    0
```

Example:

```
SOURce1:BB:NR5G:SCHed:CELL0:SUBF0:USER0:BWPart0:ALLoc1:FMT F1
SOURce1:BB:NR5G:SCHed:CELL0:SUBF0:USER0:BWPart0:ALLoc1:PUCCh:FS:TDOCC 1
```

Manual operation: See "[Time Domain OCC Index](#)" on page 277

```
[ :SOURce<hw>]:BB:NR5G:SCHed:CELL<cc>:SUBF<sf>:USER<us>:
      BWPart<bwp>:ALLoc<al>:PUCCh:GRPHopping <PucchGrpHopping>
```

Sets the higher-layer parameter `pucch-GroupHopping`.

Parameters:

```
<PucchGrpHopping> N | ENA | DIS
                  N = neither
                  ENA = enable
                  DIS = disable
                  *RST:      N
```

Example: See [Example "Configuring the PUCCH settings"](#) on page 406.

Manual operation: See "[Group Hopping](#)" on page 275

```
[ :SOURce<hw>]:BB:NR5G:SCHed:CELL<cc>:SUBF<sf>:USER<us>:
  BWPart<bwp>:ALLoc<al>:PUCCh:HOPid <PucchHoppingId>
```

Sets the parameter hopping ID.

Parameters:

```
<PucchHoppingId> integer
                    Range:    0 to 1024
                    Increment: 0
                    *RST:    0
```

Example: See [Example"Configuring the PUCCH settings"](#) on page 406.

Manual operation: See ["Hopping ID"](#) on page 275

```
[ :SOURce<hw>]:BB:NR5G:SCHed:CELL<cc>:SUBF<sf>:USER<us>:
  BWPart<bwp>:ALLoc<al>:PUCCh:INT<il>:INTL <Interlace>
```

Defines the interlace value for PUSCH allocations.

Suffix:

```
<il>                Selects the interlace. The range depends on the number of inter-
                    laces.
```

Parameters:

```
<Interlace>        integer
                    Range:    0 to 9
                    *RST:    0
```

Example: See [Example"Configuring the PUCCH settings"](#) on page 406.

Manual operation: See ["Interlace <x>"](#) on page 276

```
[ :SOURce<hw>]:BB:NR5G:SCHed:CELL<cc>:SUBF<sf>:USER<us>:
  BWPart<bwp>:ALLoc<al>:PUCCh:ISFHopping <PucchISFreqHop>
```

Enables intra-slot frequency hopping.

Parameters:

```
<PucchISFreqHop>  1 | ON | 0 | OFF
                    *RST:    0
```

Example: See [Example"Configuring the PUCCH settings"](#) on page 406.

Manual operation: See ["Intra Slot Frequency Hopping"](#) on page 275

```
[ :SOURce<hw>]:BB:NR5G:SCHed:CELL<cc>:SUBF<sf>:USER<us>:
  BWPart<bwp>:ALLoc<al>:PUCCh:NINT <Interlaces>
```

Defines the number of interlaces for PUCCH allocations.

Prerequisites for this command

- Turn on interlacing ([:SOURce<hw>]:BB:NR5G:UBWP:USER<us>:CELL<cc>:UL:BWP<bwp>:PUCCh:UITL on page 532).

Parameters:

<Interlaces> integer
 Range: 1 to 2
 *RST: 1

Example: See [Example"Configuring the PUCCH settings"](#) on page 406.

Manual operation: See ["Number of Interlaces"](#) on page 276

**[:SOURce<hw>]:BB:NR5G:SCHed:CELL<cc>:SUBF<sf>:USER<us>:
 BWPart<bwp>:ALLoc<al>:PUCCh:SHOPping <SecongHoppingPR>**

Sets the physical resource block (PRB) of the second hop.

Parameters:

<SecongHoppingPR> float
 Range: 0 to 273
 Increment: 1
 *RST: 0

Example: See [Example"Configuring the PUCCH settings"](#) on page 406.

Manual operation: See ["Second Hop PRB"](#) on page 276

10.25.2 PUCCH payload scheduling commands

[:SOURce<hw>]:BB:NR5G:SCHed:CELL<cc>:SUBF<sf>:USER<us>:BWPart<bwp>: ALLoc<al>:PUCCh:PL:ACK:BITS	699
[:SOURce<hw>]:BB:NR5G:SCHed:CELL<cc>:SUBF<sf>:USER<us>:BWPart<bwp>: ALLoc<al>:PUCCh:PL:ACK:PATtern	700
[:SOURce<hw>]:BB:NR5G:SCHed:CELL<cc>:SUBF<sf>:USER<us>:BWPart<bwp>: ALLoc<al>:PUCCh:PL:SRCount	700
[:SOURce<hw>]:BB:NR5G:SCHed:CELL<cc>:SUBF<sf>:USER<us>:BWPart<bwp>: ALLoc<al>:PUCCh:PL:UCI:BITS	700
[:SOURce<hw>]:BB:NR5G:SCHed:CELL<cc>:SUBF<sf>:USER<us>:BWPart<bwp>: ALLoc<al>:PUCCh:PL:UCI:PATtern	701

**[:SOURce<hw>]:BB:NR5G:SCHed:CELL<cc>:SUBF<sf>:USER<us>:
 BWPart<bwp>:ALLoc<al>:PUCCh:PL:ACK:BITS <BitLength>**

Defines the number of ACK bits.

Parameters:

<BitLength> float
 Range: 0 to 128
 Increment: 1
 *RST: 0

Example: See [Example"Configuring the PUCCH settings"](#) on page 406.

Manual operation: See ["Number of ACK Bits"](#) on page 278

```
[ :SOURce<hw>]:BB:NR5G:SCHed:CELL<cc>:SUBF<sf>:USER<us>:
  BWPart<bwp>:ALLoc<al>:PUCCh:PL:ACK:PATtern <AckPattern>,
  <Bitcount>
```

Defines the ACK bit pattern.

Parameters:

<AckPattern> 128 bits
Bit pattern
*RST: #H0

<Bitcount> integer
Pattern length, should be the same as the length set with the command [:SOURce<hw>]:BB:NR5G:SCHed:CELL<cc>:SUBF<sf>:USER<us>:BWPart<bwp>:ALLoc<al>:PUCCh:PL:ACK:BITS.
Range: 1 to 128
*RST: 0

Example: See [Example"Configuring the PUCCH settings"](#) on page 406.

Manual operation: See ["ACK Pattern"](#) on page 279

```
[ :SOURce<hw>]:BB:NR5G:SCHed:CELL<cc>:SUBF<sf>:USER<us>:
  BWPart<bwp>:ALLoc<al>:PUCCh:PL:SRCount <SrCount>
```

Sets the number of positive scheduling requests (SR).

Parameters:

<SrCount> integer
Range: 0 to 10
*RST: 0

Example: See [Example"Configuring the PUCCH settings"](#) on page 406.

Manual operation: See ["Positive SR Count"](#) on page 278

```
[ :SOURce<hw>]:BB:NR5G:SCHed:CELL<cc>:SUBF<sf>:USER<us>:
  BWPart<bwp>:ALLoc<al>:PUCCh:PL:UCI:BITS <BitLength>
```

Defines the number of bits for the UCI.

Parameters:

<BitLength> integer
Range: 0 to 128
*RST: 0

Manual operation: See ["Number of UCI Bits"](#) on page 279

```
[ :SOURce<hw>]:BB:NR5G:SCHed:CELL<cc>:SUBF<sf>:USER<us>:
  BWPart<bwp>:ALLoc<al>:PUCCh:PL:UCI:PATtern <Pattern>, <BitCount>
```

Defines the bit pattern for the UCI.

Parameters:

```
<Pattern>          128 bits
                   *RST:      #H0

<BitCount>        integer
                   Range:     0 to 128
                   *RST:      0
```

Manual operation: See "[UCI Pattern](#)" on page 279

10.26 PRACH scheduling commands

[:SOURce<hw>]:BB:NR5G:SCHed:CELL<cc>:SUBF<sf>:USER<us>:BWPart<bwp>: ALLoc<al>:PRACH:SCSPacing.....	701
[:SOURce<hw>]:BB:NR5G:SCHed:CELL<cc>:SUBF<sf>:USER<us>:BWPart<bwp>: ALLoc<al>:PRACH:BMAid.....	702
[:SOURce<hw>]:BB:NR5G:SCHed:CELL<cc>:SUBF<sf>:USER<us>:BWPart<bwp>: ALLoc<al>:PRACH:FORMat.....	702
[:SOURce<hw>]:BB:NR5G:SCHed:CELL<cc>:SUBF<sf>:USER<us>:BWPart<bwp>: ALLoc<al>:PRACH:RSET.....	702
[:SOURce<hw>]:BB:NR5G:SCHed:CELL<cc>:SUBF<sf>:USER<us>:BWPart<bwp>: ALLoc<al>:PRACH:RSEquence.....	703
[:SOURce<hw>]:BB:NR5G:SCHed:CELL<cc>:SUBF<sf>:USER<us>:BWPart<bwp>: ALLoc<al>:PRACH:ZCZone.....	703
[:SOURce<hw>]:BB:NR5G:SCHed:CELL<cc>:SUBF<sf>:USER<us>:BWPart<bwp>: ALLoc<al>:PRACH:PRINdex.....	703
[:SOURce<hw>]:BB:NR5G:SCHed:CELL<cc>:SUBF<sf>:USER<us>:BWPart<bwp>: ALLoc<al>:PRACH:RBNumber?.....	703
[:SOURce<hw>]:BB:NR5G:SCHed:CELL<cc>:SUBF<sf>:USER<us>:BWPart<bwp>: ALLoc<al>:PRACH:TOFFset.....	704

```
[ :SOURce<hw>]:BB:NR5G:SCHed:CELL<cc>:SUBF<sf>:USER<us>:
  BWPart<bwp>:ALLoc<al>:PRACH:SCSPacing <PrachNumerology>
```

Selects a combination of the subcarrier spacing (SCS) and the cyclic prefix (CP) for PRACH.

Parameters:

```
<PrachNumerology> N1_25 | N5 | N15 | N30 | N60 | N120 | N480 | N960
                   *RST:      N30
```

Example: See [Example"Configuring the PRACH settings"](#) on page 407.

Options: N480 and N960 require R&S SMM-K171

```
[ :SOURce<hw>]:BB:NR5G:SCHeD:CELL<cc>:SUBF<sf>:USER<us>:
  BWPart<bwp>:ALLoc<al>:PRACH:BMAid <RefLevelIdentif>
```

Sets the bandwidth of the given allocation as reference for the "Burst" power mode.

Parameters:

<RefLevelIdentif> 1 | ON | 0 | OFF

0|OFF

Disables the given allocation as burst reference for the "Burst" power mode.

1|ON

Sets the given allocation as burst reference for the "Burst" power mode.

*RST: 0

Example: See [Example"Configuring the PRACH settings"](#) on page 407.

Manual operation: See ["Burst Mode Ref Alloc Identifier"](#) on page 282

```
[ :SOURce<hw>]:BB:NR5G:SCHeD:CELL<cc>:SUBF<sf>:USER<us>:
  BWPart<bwp>:ALLoc<al>:PRACH:FORMat <PrachFormat>
```

Selects the PRACH format.

Parameters:

<PrachFormat> F0 | F1 | F2 | F3 | FA1 | FA2 | FA3 | FB1 | FB2 | FB3 | FB4 |
FC0 | FC2

*RST: FA1

Example: See [Example"Configuring the PRACH settings"](#) on page 407.

Manual operation: See ["Format"](#) on page 281

```
[ :SOURce<hw>]:BB:NR5G:SCHeD:CELL<cc>:SUBF<sf>:USER<us>:
  BWPart<bwp>:ALLoc<al>:PRACH:RSET <RestrictedSet>
```

Sets the higher-layer parameter `restrictedSetConfig` that defines the type of restricted sets (unrestricted, restricted type A, restricted type B).

Parameters:

<RestrictedSet> ARES | BRES | URES

URES = Unrestricted

ARES = Restricted Type A

BRES = Restricted Type B

*RST: URES

Example: See [Example"Configuring the PRACH settings"](#) on page 407.

Manual operation: See ["Restricted Set"](#) on page 281

```
[:SOURce<hw>]:BB:NR5G:SCHed:CELL<cc>:SUBF<sf>:USER<us>:
  BWPart<bwp>:ALLoc<al>:PRACH:RSEquence <LogicalRootSeq>
```

Sets the starting logical root sequence index.

Parameters:

```
<LogicalRootSeq>  integer
                   Range:    0 to 837
                   *RST:     0
```

Example: See [Example"Configuring the PRACH settings"](#) on page 407.

Manual operation: See ["Logical Root Sequence"](#) on page 281

```
[:SOURce<hw>]:BB:NR5G:SCHed:CELL<cc>:SUBF<sf>:USER<us>:
  BWPart<bwp>:ALLoc<al>:PRACH:ZCZone <ZeroCorrZone>
```

Sets the parameter `zeroCorrelationZoneConfig` according to [TS 38.211](#).

Parameters:

```
<ZeroCorrZone>   integer
                   Range:    0 to 15
                   *RST:     0
```

Example: See [Example"Configuring the PRACH settings"](#) on page 407.

Manual operation: See ["Zero Correlation Zone"](#) on page 281

```
[:SOURce<hw>]:BB:NR5G:SCHed:CELL<cc>:SUBF<sf>:USER<us>:
  BWPart<bwp>:ALLoc<al>:PRACH:PRINdex <PreambleIndex>
```

Sets the PRACH preamble index and thus defines which one of the 64 PRACH preambles is used.

Parameters:

```
<PreambleIndex>  integer
                   Range:    0 to 63
                   *RST:     0
```

Example: See [Example"Configuring the PRACH settings"](#) on page 407.

Manual operation: See ["Preamble Index"](#) on page 281

```
[:SOURce<hw>]:BB:NR5G:SCHed:CELL<cc>:SUBF<sf>:USER<us>:
  BWPart<bwp>:ALLoc<al>:PRACH:RBNumber?
```

Queries the number of resource blocks the PRACH allocation spans.

Return values:

```
<UserAllocRBNum> integer
                   Range:    3 to 24
                   *RST:     12
```

Example: See [Example "Configuring the PRACH settings"](#) on page 407.

Usage: Query only

Manual operation: See ["No. RB"](#) on page 207

```
[ :SOURce<hw>]:BB:NR5G:SCHed:CELL<cc>:SUBF<sf>:USER<us>:
  BWPart<bwp>:ALLoc<al>:PRACH:TOffset <PrachTimeOffset>
```

Sets the timing offset base value for PRACH.

Parameters:

```
<PrachTimeOffset> float
                    Range:    -3E-4 to 3E-4
                    Increment: 1E-8
                    *RST:     0
```

Example: See [Example "Configuring the PRACH settings"](#) on page 407.

Manual operation: See ["Time Offset"](#) on page 282

10.27 SRS scheduling commands

The following commands configure the SRS in the scheduling table. When you configure the SRS in the "User / BWP" dialog, use the commands referenced in [Chapter 10.19.12, "SRS commands"](#), on page 576.

[:SOURce<hw>]:BB:NR5G:SCHed:CELL<cc>:SUBF<sf>:USER<us>:BWPart<bwp>: ALLoc<al>:BHOP.....	705
[:SOURce<hw>]:BB:NR5G:SCHed:CELL<cc>:SUBF<sf>:USER<us>:BWPart<bwp>: ALLoc<al>:BSRS.....	705
[:SOURce<hw>]:BB:NR5G:SCHed:CELL<cc>:SUBF<sf>:USER<us>:BWPart<bwp>: ALLoc<al>:COFFset.....	705
[:SOURce<hw>]:BB:NR5G:SCHed:CELL<cc>:SUBF<sf>:USER<us>:BWPart<bwp>: ALLoc<al>:CONFig.....	706
[:SOURce<hw>]:BB:NR5G:SCHed:CELL<cc>:SUBF<sf>:USER<us>:BWPart<bwp>: ALLoc<al>:CSRS.....	706
[:SOURce<hw>]:BB:NR5G:SCHed:CELL<cc>:SUBF<sf>:USER<us>:BWPart<bwp>: ALLoc<al>:FPOS.....	706
[:SOURce<hw>]:BB:NR5G:SCHed:CELL<cc>:SUBF<sf>:USER<us>:BWPart<bwp>: ALLoc<al>:FQSHift.....	706
[:SOURce<hw>]:BB:NR5G:SCHed:CELL<cc>:SUBF<sf>:USER<us>:BWPart<bwp>: ALLoc<al>:FSFactor.....	707
[:SOURce<hw>]:BB:NR5G:SCHed:CELL<cc>:SUBF<sf>:USER<us>:BWPart<bwp>: ALLoc<al>:OFFSet.....	707
[:SOURce<hw>]:BB:NR5G:SCHed:CELL<cc>:SUBF<sf>:USER<us>:BWPart<bwp>: ALLoc<al>:PER.....	707
[:SOURce<hw>]:BB:NR5G:SCHed:CELL<cc>:SUBF<sf>:USER<us>:BWPart<bwp>: ALLoc<al>:PORTs.....	708

<code>[:SOURce<hw>]:BB:NR5G:SCHed:CELL<cc>:SUBF<sf>:USER<us>:BWPart<bwp>:ALLoc<al>:REFactor</code>	708
<code>[:SOURce<hw>]:BB:NR5G:SCHed:CELL<cc>:SUBF<sf>:USER<us>:BWPart<bwp>:ALLoc<al>:RSType</code>	708
<code>[:SOURce<hw>]:BB:NR5G:SCHed:CELL<cc>:SUBF<sf>:USER<us>:BWPart<bwp>:ALLoc<al>:SEQ:CYCShift</code>	708
<code>[:SOURce<hw>]:BB:NR5G:SCHed:CELL<cc>:SUBF<sf>:USER<us>:BWPart<bwp>:ALLoc<al>:SEQ:HOPPing</code>	709
<code>[:SOURce<hw>]:BB:NR5G:SCHed:CELL<cc>:SUBF<sf>:USER<us>:BWPart<bwp>:ALLoc<al>:SEQ:ID</code>	709
<code>[:SOURce<hw>]:BB:NR5G:SCHed:CELL<cc>:SUBF<sf>:USER<us>:BWPart<bwp>:ALLoc<al>:SRIDx</code>	709
<code>[:SOURce<hw>]:BB:NR5G:SCHed:CELL<cc>:SUBF<sf>:USER<us>:BWPart<bwp>:ALLoc<al>:TRTCComb</code>	709

`[:SOURce<hw>]:BB:NR5G:SCHed:CELL<cc>:SUBF<sf>:USER<us>:BWPart<bwp>:ALLoc<al>:BHOP <SrsBhop>`

Sets the parameter b_{Hop} that defines the frequency hopping of the SRS.

Parameters:

<code><SrsBhop></code>	integer
	Range: 0 to 3
	*RST: 0

Manual operation: See "B Hop" on page 285

`[:SOURce<hw>]:BB:NR5G:SCHed:CELL<cc>:SUBF<sf>:USER<us>:BWPart<bwp>:ALLoc<al>:BSRS <SrsBSrs>`

Sets the parameter b-SRS needed to define the length of the SRS sequence.

Parameters:

<code><SrsBSrs></code>	integer
	Range: 0 to 3
	*RST: 0

Manual operation: See "B SRS" on page 285

`[:SOURce<hw>]:BB:NR5G:SCHed:CELL<cc>:SUBF<sf>:USER<us>:BWPart<bwp>:ALLoc<al>:COFFset <ComboOffset>`

Sets the parameter transmission comb offset.

Parameters:

<code><ComboOffset></code>	integer
	Range: 0 to 7
	*RST: 0

Manual operation: See "Comb Offset" on page 285

```
[:SOURce<hw>]:BB:NR5G:SCHEd:CELL<cc>:SUBF<sf>:USER<us>:
  BWPart<bwp>:ALlOc<al>:CONFig <SrsConfig>
```

Parameters:

<SrsConfig>	IE Standard SRS configuration.
	IER16 Release 16 SRS configuration, including positioning functionality.
	IENPR16 Release 16 SRS configuration, without positioning functionality.
	IER17 Release 17 SRS configuration.
	*RST: IE

Manual operation: See "[Config](#)" on page 283

```
[:SOURce<hw>]:BB:NR5G:SCHEd:CELL<cc>:SUBF<sf>:USER<us>:
  BWPart<bwp>:ALlOc<al>:CSRS <SrsCSrs>
```

Sets the parameter c-SRS to define the length of the SRS sequence.

Parameters:

<SrsCSrs>	integer
	Range: 0 to 63
	*RST: 0

Manual operation: See "[C SRS](#)" on page 285

```
[:SOURce<hw>]:BB:NR5G:SCHEd:CELL<cc>:SUBF<sf>:USER<us>:
  BWPart<bwp>:ALlOc<al>:FPOS <FreqPos>
```

Sets the starting position of the SRS allocation in the frequency domain.

Parameters:

<FreqPos>	integer
	Range: 0 to 67
	*RST: 0

Manual operation: See "[Frequency Position](#)" on page 284

```
[:SOURce<hw>]:BB:NR5G:SCHEd:CELL<cc>:SUBF<sf>:USER<us>:
  BWPart<bwp>:ALlOc<al>:FQSHift <SrsFreqShift>
```

Sets the frequency shift.

Parameters:

<SrsFreqShift>	integer
	Range: 0 to 268
	*RST: 0

Manual operation: See "Frequency Shift" on page 284

**[:SOURce<hw>]:BB:NR5G:SCHeD:CELL<cc>:SUBF<sf>:USER<us>:
BWPart<bwp>:ALLoc<al>:FSFactor <Value>**

Selects the frequency scaling factor for the SRS defined in 3GPP 38.211, chapter 6.4.1.4.3.

Parameters:

<Value> PF1 | PF2 | PF4
*RST: PF1

Manual operation: See "Frequency Scaling Factor" on page 286

**[:SOURce<hw>]:BB:NR5G:SCHeD:CELL<cc>:SUBF<sf>:USER<us>:
BWPart<bwp>:ALLoc<al>:OFFSet <Offset>**

Sets time position of first SRS allocation within an SRS periodicity.

Prerequisites for this command

- Select periodic SRS transmission ([:SOURce<hw>]:BB:NR5G:SCHeD:CELL<cc>:SUBF<sf>:USER<us>:BWPart<bwp>:ALLoc<al>:RSType).
- Select periodicity > 1 ([:SOURce<hw>]:BB:NR5G:SCHeD:CELL<cc>:SUBF<sf>:USER<us>:BWPart<bwp>:ALLoc<al>:PER).

Parameters:

<Offset> integer
Range: 0 to 81919
*RST: 0

Manual operation: See "Offset" on page 284

**[:SOURce<hw>]:BB:NR5G:SCHeD:CELL<cc>:SUBF<sf>:USER<us>:
BWPart<bwp>:ALLoc<al>:PER <Periodicity>**

Sets the SRS repetition factor.

Prerequisites for this command

- Select periodic SRS transmission ([:SOURce<hw>]:BB:NR5G:SCHeD:CELL<cc>:SUBF<sf>:USER<us>:BWPart<bwp>:ALLoc<al>:RSType).

Parameters:

<Periodicity> SL1 | SL2 | SL4 | SL5 | SL8 | SL10 | SL16 | SL20 | SL32 | SL40 |
SL64 | SL80 | SL160 | SL320 | SL640 | SL1280 | SL2560 |
SL81920 | SL40960 | SL10240 | SL5120
*RST: SL1

```
[ :SOURce<hw>]:BB:NR5G:SCHEd:CELL<cc>:SUBF<sf>:USER<us>:
  BWPart<bwp>:ALLoc<al>:PORTs <SrsPorts>
```

Selects the number of antenna ports used by the SRS.

Parameters:

```
<SrsPorts>      AP1 | AP2 | AP4
                *RST:      AP1
```

Manual operation: See "[Ports](#)" on page 287

```
[ :SOURce<hw>]:BB:NR5G:SCHEd:CELL<cc>:SUBF<sf>:USER<us>:
  BWPart<bwp>:ALLoc<al>:REFactor <SrsRepFactor>
```

Sets how many times the SRS symbols are repeated.

Parameters:

```
<SrsRepFactor>  REP1 | REP2 | REP4 | REP5 | REP6 | REP7 | REP8 | REP10 |
                REP12 | REP14
                *RST:      REP1
```

Manual operation: See "[Repetition Factor](#)" on page 285

```
[ :SOURce<hw>]:BB:NR5G:SCHEd:CELL<cc>:SUBF<sf>:USER<us>:
  BWPart<bwp>:ALLoc<al>:RSType <Mode>
```

Sets the SRS transmission type.

Parameters:

```
<Mode>          APER
                Aperiodic transmission of the SRS.
                *RST:      PER
```

Manual operation: See "[Resource Type](#)" on page 284

```
[ :SOURce<hw>]:BB:NR5G:SCHEd:CELL<cc>:SUBF<sf>:USER<us>:
  BWPart<bwp>:ALLoc<al>:SEQ:CYCShft <SeqCyclicShft>
```

Sets the number of cyclic shifts, required for the SRS sequence generation.

Parameters:

```
<SeqCyclicShft> integer
                Range:      0 to 11
                *RST:      0
```

Manual operation: See "[Sequence Cyclic Shift](#)" on page 286

```
[:SOURce<hw>]:BB:NR5G:SCHed:CELL<cc>:SUBF<sf>:USER<us>:
  BWPart<bwp>:ALLoc<al>:SEQ:HOPPing <SrsGrpHopping>
```

Sets the higher-layer parameter `groupOrSequenceHopping` that defines the sequence group, required for the SRS sequence generation.

Parameters:

```
<SrsGrpHopping>  GRP
                  Group hopping.
                  N
                  No hopping.
                  SEQ
                  Sequence hopping.
                  *RST:    N
```

Manual operation: See "[Group or Sequence Hopping](#)" on page 286

```
[:SOURce<hw>]:BB:NR5G:SCHed:CELL<cc>:SUBF<sf>:USER<us>:
  BWPart<bwp>:ALLoc<al>:SEQ:ID <SrsSequenceID>
```

Sets the higher-layer parameter sequence ID required for the SRS sequence generation.

Parameters:

```
<SrsSequenceID> integer
                  Range:    0 to 65535
                  *RST:    0
```

Manual operation: See "[Sequence ID](#)" on page 286

```
[:SOURce<hw>]:BB:NR5G:SCHed:CELL<cc>:SUBF<sf>:USER<us>:
  BWPart<bwp>:ALLoc<al>:SRIDx <Value>
```

Defines the start RB index defined in 3GPP 38.331.

Parameters:

```
<Value>          integer
                  Range:    0 to Depends on frequency scaling factor
                  *RST:    0
```

Manual operation: See "[Start RB Index](#)" on page 286

```
[:SOURce<hw>]:BB:NR5G:SCHed:CELL<cc>:SUBF<sf>:USER<us>:
  BWPart<bwp>:ALLoc<al>:TRTCComb <SrsTransComb>
```

Sets the transmission comb (k_{TC}).

Parameters:

```
<SrsTransComb>  TC2 | TC4 | TC8
                  *RST:    TC2
```

Manual operation: See ["Transmission Comb"](#) on page 285

10.28 PSSCH / PSCCH scheduling commands

10.28.1 PSSCH / PSCCH general configuration commands

<code>[SOURce<hw>]:BB:NR5G:SCHed:CELL<cc>:SUBF<sf>:USER<us>:BWPart<bwp>:ALLoc<al>:PSCCh:BDWidth</code>	710
<code>[SOURce<hw>]:BB:NR5G:SCHed:CELL<cc>:SUBF<sf>:USER<us>:BWPart<bwp>:ALLoc<al>:PSCCh:SCRid</code>	710
<code>[SOURce<hw>]:BB:NR5G:SCHed:CELL<cc>:SUBF<sf>:USER<us>:BWPart<bwp>:ALLoc<al>:PSCCh:SYMLength</code>	711
<code>[SOURce<hw>]:BB:NR5G:SCHed:CELL<cc>:SUBF<sf>:USER<us>:BWPart<bwp>:ALLoc<al>:PSSCh:MOD</code>	711
<code>[SOURce<hw>]:BB:NR5G:SCHed:CELL<cc>:SUBF<sf>:USER<us>:BWPart<bwp>:ALLoc<al>:PSSCh:NDMRs</code>	711
<code>[SOURce<hw>]:BB:NR5G:SCHed:CELL<cc>:SUBF<sf>:USER<us>:BWPart<bwp>:ALLoc<al>:PSSCh:NSUBchan</code>	711
<code>[SOURce<hw>]:BB:NR5G:SCHed:CELL<cc>:SUBF<sf>:USER<us>:BWPart<bwp>:ALLoc<al>:PSSCh:POOL</code>	712

[SOURce<hw>]:BB:NR5G:SCHed:CELL<cc>:SUBF<sf>:USER<us>:BWPart<bwp>:ALLoc<al>:PSCCh:BDWidth <ResourceBlocks>

Selects the size of the PSCCH in physical resource blocks.

Parameters:

<ResourceBlocks> RB10 | RB12 | RB15 | RB20 | RB25
10, 12, 15, 20 or 25 resource blocks.
*RST: RB10

Example: See [Example"Configuring a sidelink signal"](#) on page 412.

Manual operation: See ["Bandwidth \(PRBs\)"](#) on page 290

[SOURce<hw>]:BB:NR5G:SCHed:CELL<cc>:SUBF<sf>:USER<us>:BWPart<bwp>:ALLoc<al>:PSCCh:SCRid <ScramblingID>

Defines the PSCCH DMRS scramble ID.

Parameters:

<ScramblingID> integer
Range: 0 to 65535
*RST: 0

Example: See [Example"Configuring a sidelink signal"](#) on page 412.

Manual operation: See ["DMRS Scramble ID"](#) on page 290

```
[ :SOURce<hw>]:BB:NR5G:SCHed:CELL<cc>:SUBF<sf>:USER<us>:
  BWPart<bwp>:ALLoc<al>:PSCCh:SYMLength <Symbols>
```

Defines the number of the symbols for the PSCCH (excluding AGC symbols).

Parameters:

<Symbols> integer
 Range: 2 to 3
 *RST: 2

Example: See [Example"Configuring a sidelink signal"](#) on page 412.

Manual operation: See ["Symbol Length"](#) on page 290

```
[ :SOURce<hw>]:BB:NR5G:SCHed:CELL<cc>:SUBF<sf>:USER<us>:
  BWPart<bwp>:ALLoc<al>:PSSCh:MOD <Modulation>
```

Selects the modulation scheme for the PSSCH.

Parameters:

<Modulation> QPSK | QAM16 | QAM64 | QAM256
 *RST: QPSK

Example: See [Example"Configuring a sidelink signal"](#) on page 412.

Manual operation: See ["Modulation"](#) on page 290

```
[ :SOURce<hw>]:BB:NR5G:SCHed:CELL<cc>:SUBF<sf>:USER<us>:
  BWPart<bwp>:ALLoc<al>:PSSCh:NDMRs <DMRSs>
```

Defines the number of PSSCH DMRS.

Parameters:

<DMRSs> integer
 Range: 2 to 4
 *RST: 2

Example: See [Example"Configuring a sidelink signal"](#) on page 412.

Manual operation: See ["Number of DMRS"](#) on page 289

```
[ :SOURce<hw>]:BB:NR5G:SCHed:CELL<cc>:SUBF<sf>:USER<us>:
  BWPart<bwp>:ALLoc<al>:PSSCh:NSUBchan <Subchannels>
```

Defines the number of subchannels the PSSCH uses.

Prerequisites for this command

- Configure the bandwidth with more than 1 subchannel (`[:SOURce<hw>]:BB:NR5G:UBWP:USER<us>:CELL<cc>:SL:BWP<bwp>:RESPool:RES<gr0>:NSUBchannels`).

Parameters:

<Subchannels> integer
 Range: 1 to 27
 *RST: 1

Example: See [Example"Configuring a sidelink signal"](#) on page 412.

Manual operation: See ["Number of Subchannels"](#) on page 289

**[:SOURce<hw>]:BB:NR5G:SCHed:CELL<cc>:SUBF<sf>:USER<us>:
 BWPart<bwp>:ALLoc<al>:PSSCh:POOL <ResourcePool>**

Selects the resource pool the PSxCH settings apply to.

Prerequisites for this command

- Configure more than one resource pool for a bandwidth part ([:SOURce<hw>] : BB:NR5G:UBWP:USER<us>:CELL<cc>:SL:BWPart<bwp>:RESPool:NRSPool on page 589).

Parameters:

<ResourcePool> integer
 Range: 0 to 7
 *RST: 0

Example: See [Example"Configuring a sidelink signal"](#) on page 412.

Manual operation: See ["Resource Pool"](#) on page 289

10.28.2 SCI1A configuration commands

[:SOURce<hw>]:BB:NR5G:SCHed:CELL<cc>:SUBF<sf>:USER<us>:BWPart<bwp>: ALLoc<al>:SCI:AMCSind.....	713
[:SOURce<hw>]:BB:NR5G:SCHed:CELL<cc>:SUBF<sf>:USER<us>:BWPart<bwp>: ALLoc<al>:SCI:BOINd.....	713
[:SOURce<hw>]:BB:NR5G:SCHed:CELL<cc>:SUBF<sf>:USER<us>:BWPart<bwp>: ALLoc<al>:SCI:DPATterns.....	713
[:SOURce<hw>]:BB:NR5G:SCHed:CELL<cc>:SUBF<sf>:USER<us>:BWPart<bwp>: ALLoc<al>:SCI:DPORTs.....	713
[:SOURce<hw>]:BB:NR5G:SCHed:CELL<cc>:SUBF<sf>:USER<us>:BWPart<bwp>: ALLoc<al>:SCI:FRDRes.....	714
[:SOURce<hw>]:BB:NR5G:SCHed:CELL<cc>:SUBF<sf>:USER<us>:BWPart<bwp>: ALLoc<al>:SCI:MCS.....	714
[:SOURce<hw>]:BB:NR5G:SCHed:CELL<cc>:SUBF<sf>:USER<us>:BWPart<bwp>: ALLoc<al>:SCI:PAT1.....	714
[:SOURce<hw>]:BB:NR5G:SCHed:CELL<cc>:SUBF<sf>:USER<us>:BWPart<bwp>: ALLoc<al>:SCI:PFOVerhead.....	714
[:SOURce<hw>]:BB:NR5G:SCHed:CELL<cc>:SUBF<sf>:USER<us>:BWPart<bwp>: ALLoc<al>:SCI:PRTY.....	715
[:SOURce<hw>]:BB:NR5G:SCHed:CELL<cc>:SUBF<sf>:USER<us>:BWPart<bwp>: ALLoc<al>:SCI:RESVed.....	715

<code>[:SOURce<hw>]:BB:NR5G:SCHed:CELL<cc>:SUBF<sf>:USER<us>:BWPart<bwp>:ALLoc<al>:SCI:RREPeriod.....</code>	715
<code>[:SOURce<hw>]:BB:NR5G:SCHed:CELL<cc>:SUBF<sf>:USER<us>:BWPart<bwp>:ALLoc<al>:SCI:S2FMt.....</code>	715
<code>[:SOURce<hw>]:BB:NR5G:SCHed:CELL<cc>:SUBF<sf>:USER<us>:BWPart<bwp>:ALLoc<al>:SCI:TIDRes.....</code>	716

`[:SOURce<hw>]:BB:NR5G:SCHed:CELL<cc>:SUBF<sf>:USER<us>:BWPart<bwp>:ALLoc<al>:SCI:AMCSind <Value>`

Defines the value for the SCI field "Additional MCS Indicator".

Parameters:

<Value> integer
 Range: 0 to 7
 *RST: 0

Example: See [Example"Configuring a sidelink signal"](#) on page 412.

`[:SOURce<hw>]:BB:NR5G:SCHed:CELL<cc>:SUBF<sf>:USER<us>:BWPart<bwp>:ALLoc<al>:SCI:BOInd <Value>`

Defines the value for the SCI field "Beta Offset Indicator".

Parameters:

<Value> integer
 Range: 0 to 3
 *RST: 0

Example: See [Example"Configuring a sidelink signal"](#) on page 412.

`[:SOURce<hw>]:BB:NR5G:SCHed:CELL<cc>:SUBF<sf>:USER<us>:BWPart<bwp>:ALLoc<al>:SCI:DPATterns <Value>`

Defines the value for the SCI field "DMRS Patterns".

Parameters:

<Value> integer
 Value range depends on active DMRS patterns (`[:SOURce<hw>]:BB:NR5G:UBWP:USER<us>:CELL<cc>:SL:BWP<bwp>:RESPool:RES<gr0>:PAT4`).

Range: 0 to 3
 *RST: 0

Example: See [Example"Configuring a sidelink signal"](#) on page 412.

`[:SOURce<hw>]:BB:NR5G:SCHed:CELL<cc>:SUBF<sf>:USER<us>:BWPart<bwp>:ALLoc<al>:SCI:DPORts <Value>`

Defines the value for the SCI field "DMRS Ports".

Parameters:

<Value> integer
 Range: 0 to 1
 *RST: 0

Example: See [Example"Configuring a sidelink signal"](#) on page 412.

**[:SOURCE<hw>]:BB:NR5G:SCHed:CELL<cc>:SUBF<sf>:USER<us>:
 BWPart<bwp>:ALLoc<al>:SCI:FRDRes <Value>**

Defines the value for the SCI field "Frequency Domain Resource Assignment".

Parameters:

<Value> integer
 Range: 0 to 8192
 *RST: 0

Example: See [Example"Configuring a sidelink signal"](#) on page 412.

**[:SOURCE<hw>]:BB:NR5G:SCHed:CELL<cc>:SUBF<sf>:USER<us>:
 BWPart<bwp>:ALLoc<al>:SCI:MCS <Value>**

Defines the value for the SCI field "Modulation and Coding Scheme".

Parameters:

<Value> integer
 Range: 0 to 31
 *RST: 0

Example: See [Example"Configuring a sidelink signal"](#) on page 412.

Manual operation: See ["I_MCS"](#) on page 296

**[:SOURCE<hw>]:BB:NR5G:SCHed:CELL<cc>:SUBF<sf>:USER<us>:
 BWPart<bwp>:ALLoc<al>:SCI:PAT1 <Pattern>, <BitCount>**

Queries the bit pattern for SCI1A.

Parameters:

<Pattern> 23 Bits
 <BitCount> Range: 1 to 23
 *RST: 1

Example: See [Example"Configuring a sidelink signal"](#) on page 412.

**[:SOURCE<hw>]:BB:NR5G:SCHed:CELL<cc>:SUBF<sf>:USER<us>:
 BWPart<bwp>:ALLoc<al>:SCI:PFOVerhead <State>**

Turns the SCI field "Additional MCS Indicator" on and off.

Parameters:

<State> 1 | ON | 0 | OFF
 *RST: 0

**[:SOURce<hw>]:BB:NR5G:SCHed:CELL<cc>:SUBF<sf>:USER<us>:
 BWPart<bwp>:ALLoc<al>:SCI:PRTY <Value>**

Defines the value for the SCI field "Priority".

Parameters:

<Value> integer
 Range: 0 to 7
 *RST: 0

Example: See [Example"Configuring a sidelink signal"](#) on page 412.

**[:SOURce<hw>]:BB:NR5G:SCHed:CELL<cc>:SUBF<sf>:USER<us>:
 BWPart<bwp>:ALLoc<al>:SCI:RESVed <Value>**

Defines the value for the SCI field "Reserved Bits".

Parameters:

<Value> 32 bits

Example: See [Example"Configuring a sidelink signal"](#) on page 412.

**[:SOURce<hw>]:BB:NR5G:SCHed:CELL<cc>:SUBF<sf>:USER<us>:
 BWPart<bwp>:ALLoc<al>:SCI:RREPeriod <Value>**

Defines the value for the SCI field "Resource Reservation Period".

Prerequisites for this command

- Select RRP list > 1 ([:SOURce<hw>]:BB:NR5G:UBWP:USER<us>:CELL<cc>:SL:BWP<bwp>:RESPool:RES<gr0>:REPList).

Parameters:

<Value> integer
 Range: 0 to 7
 *RST: 0

Example: See [Example"Configuring a sidelink signal"](#) on page 412.

**[:SOURce<hw>]:BB:NR5G:SCHed:CELL<cc>:SUBF<sf>:USER<us>:
 BWPart<bwp>:ALLoc<al>:SCI:S2FMt <Value>**

Defines the value for the SCI field "2nd Stage SCI Format".

Parameters:

<Value> integer
 Range: 0 to 7
 *RST: 0

Example: See [Example"Configuring a sidelink signal"](#) on page 412.

```
[:SOURce<hw>]:BB:NR5G:SCHed:CELL<cc>:SUBF<sf>:USER<us>:
  BWPart<bwp>:ALLoc<al>:SCI:TIDRes <Value>
```

Defines the value for the SCI field "Time Domain Resource Assignment".

Parameters:

<Value> integer
 Range: 0 to 511
 *RST: 0

Example: See [Example"Configuring a sidelink signal"](#) on page 412.

10.28.3 SCI2A configuration commands

Commands to configure SCI2A described elsewhere.

- SCI2 format selection: [:SOURce<hw>]:BB:NR5G:SCHed:CELL<cc>:SUBF<sf>:USER<us>:BWPart<bwp>:ALLoc<al>:SCI:S2FMT

[:SOURce<hw>]:BB:NR5G:SCHed:CELL<cc>:SUBF<sf>:USER<us>:BWPart<bwp>:ALLoc<al>:SCI:CSIReq.....	716
[:SOURce<hw>]:BB:NR5G:SCHed:CELL<cc>:SUBF<sf>:USER<us>:BWPart<bwp>:ALLoc<al>:SCI:CTINd.....	717
[:SOURce<hw>]:BB:NR5G:SCHed:CELL<cc>:SUBF<sf>:USER<us>:BWPart<bwp>:ALLoc<al>:SCI:DESTid.....	717
[:SOURce<hw>]:BB:NR5G:SCHed:CELL<cc>:SUBF<sf>:USER<us>:BWPart<bwp>:ALLoc<al>:SCI:HARFb.....	717
[:SOURce<hw>]:BB:NR5G:SCHed:CELL<cc>:SUBF<sf>:USER<us>:BWPart<bwp>:ALLoc<al>:SCI:HARProc.....	717
[:SOURce<hw>]:BB:NR5G:SCHed:CELL<cc>:SUBF<sf>:USER<us>:BWPart<bwp>:ALLoc<al>:SCI:NDI.....	717
[:SOURce<hw>]:BB:NR5G:SCHed:CELL<cc>:SUBF<sf>:USER<us>:BWPart<bwp>:ALLoc<al>:SCI2:PATtern.....	718
[:SOURce<hw>]:BB:NR5G:SCHed:CELL<cc>:SUBF<sf>:USER<us>:BWPart<bwp>:ALLoc<al>:SCI:REDundancy.....	718
[:SOURce<hw>]:BB:NR5G:SCHed:CELL<cc>:SUBF<sf>:USER<us>:BWPart<bwp>:ALLoc<al>:SCI:SOURid.....	718

```
[:SOURce<hw>]:BB:NR5G:SCHed:CELL<cc>:SUBF<sf>:USER<us>:
  BWPart<bwp>:ALLoc<al>:SCI:CSIReq <State>
```

Turns SCI field "CSI Request" on and off.

Parameters:

<State> 1 | ON | 0 | OFF
 *RST: 0

Example: See [Example"Configuring a sidelink signal"](#) on page 412.

```
[:SOURce<hw>]:BB:NR5G:SCHed:CELL<cc>:SUBF<sf>:USER<us>:
  BWPart<bwp>:ALLoc<al>:SCI:CTINd <Value>
```

Turns SCI field "Cast Type Indicator" on and off.

Parameters:

```
<Value>          integer
                  Range:    0 to 3
                  *RST:     0
```

Example: See [Example "Configuring a sidelink signal"](#) on page 412.

```
[:SOURce<hw>]:BB:NR5G:SCHed:CELL<cc>:SUBF<sf>:USER<us>:
  BWPart<bwp>:ALLoc<al>:SCI:DESTid <Value>
```

Defines the value for SCI field "Destination ID".

Parameters:

```
<Value>          integer
                  Range:    0 to 65535
                  *RST:     0
```

Example: See [Example "Configuring a sidelink signal"](#) on page 412.

```
[:SOURce<hw>]:BB:NR5G:SCHed:CELL<cc>:SUBF<sf>:USER<us>:
  BWPart<bwp>:ALLoc<al>:SCI:HARFb <State>
```

Turns SCI field "Harq Feedback" on and off.

Parameters:

```
<State>          1 | ON | 0 | OFF
                  *RST:     0
```

Example: See [Example "Configuring a sidelink signal"](#) on page 412.

```
[:SOURce<hw>]:BB:NR5G:SCHed:CELL<cc>:SUBF<sf>:USER<us>:
  BWPart<bwp>:ALLoc<al>:SCI:HARProc <Value>
```

Defines the value for SCI field "Harq Process".

Parameters:

```
<Value>          integer
                  Range:    0 to 15
                  *RST:     0
```

Example: See [Example "Configuring a sidelink signal"](#) on page 412.

```
[:SOURce<hw>]:BB:NR5G:SCHed:CELL<cc>:SUBF<sf>:USER<us>:
  BWPart<bwp>:ALLoc<al>:SCI:NDI <State>
```

Turns SCI field "New Data Indicator" on and off.

Parameters:

<State> 1 | ON | 0 | OFF
 *RST: 0

Example: See [Example"Configuring a sidelink signal"](#) on page 412.

**[:SOURce<hw>]:BB:NR5G:SCHed:CELL<cc>:SUBF<sf>:USER<us>:
 BWPart<bwp>:ALLoc<al>:SCI2:PATtern <Pattern>, <BitCount>**

Queries the bit pattern for SCI2.

Parameters:

<Pattern> 48 bits
 <BitCount> Range: 1 to 48
 *RST: 1

Example: See [Example"Configuring a sidelink signal"](#) on page 412.

**[:SOURce<hw>]:BB:NR5G:SCHed:CELL<cc>:SUBF<sf>:USER<us>:
 BWPart<bwp>:ALLoc<al>:SCI:REDundancy <Value>**

Defines the value for SCI field "Redundancy Version".

Parameters:

<Value> integer
 Range: 0 to 3
 *RST: 0

Example: See [Example"Configuring a sidelink signal"](#) on page 412.

**[:SOURce<hw>]:BB:NR5G:SCHed:CELL<cc>:SUBF<sf>:USER<us>:
 BWPart<bwp>:ALLoc<al>:SCI:SOURid <Value>**

Defines the value for SCI field "Source ID".

Parameters:

<Value> integer
 Range: 0 to 255
 *RST: 0

Example: See [Example"Configuring a sidelink signal"](#) on page 412.

10.28.4 SCI2B configuration commands

Commands to configure SCI2A described elsewhere.

- Bit pattern: `[:SOURce<hw>]:BB:NR5G:SCHed:CELL<cc>:SUBF<sf>:USER<us>:BWPart<bwp>:ALLoc<al>:SCI2:PATtern` on page 718
- `[:SOURce<hw>]:BB:NR5G:SCHed:CELL<cc>:SUBF<sf>:USER<us>:BWPart<bwp>:ALLoc<al>:SCI:HARProc`

- [:SOURce<hw>] :BB:NR5G:SCHed:CELL<cc>:SUBF<sf>:USER<us>:
BWPart<bwp>:ALLoc<al>:SCI:NDI
- [:SOURce<hw>] :BB:NR5G:SCHed:CELL<cc>:SUBF<sf>:USER<us>:
BWPart<bwp>:ALLoc<al>:SCI:REDundancy
- [:SOURce<hw>] :BB:NR5G:SCHed:CELL<cc>:SUBF<sf>:USER<us>:
BWPart<bwp>:ALLoc<al>:SCI:SOURid

[:SOURce<hw>]:BB:NR5G:SCHed:CELL<cc>:SUBF<sf>:USER<us>:BWPart<bwp>:
ALLoc<al>:SCI:CORReq..... 719

[:SOURce<hw>]:BB:NR5G:SCHed:CELL<cc>:SUBF<sf>:USER<us>:BWPart<bwp>:
ALLoc<al>:SCI:ZONEid..... 719

**[:SOURce<hw>]:BB:NR5G:SCHed:CELL<cc>:SUBF<sf>:USER<us>:
BWPart<bwp>:ALLoc<al>:SCI:CORReq <Value>**

Defines the value for SCI field "Communication Range Requirement".

Parameters:

<Value> integer
Range: 0 to 15
*RST: 0

Example: See [Example "Configuring a sidelink signal"](#) on page 412.

**[:SOURce<hw>]:BB:NR5G:SCHed:CELL<cc>:SUBF<sf>:USER<us>:
BWPart<bwp>:ALLoc<al>:SCI:ZONEid <Value>**

Defines the value for SCI field "Zone ID".

Parameters:

<Value> integer
Range: 0 to 4095
*RST: 0

Example: See [Example "Configuring a sidelink signal"](#) on page 412.

10.28.5 TxScheme configuration commands

[:SOURce<hw>]:BB:NR5G:SCHed:CELL<cc>:SUBF<sf>:USER<us>:BWPart<bwp>:
ALLoc<al>:PDsch|PUSCh|PSSCh:TXScheme:NLAYers..... 719

**[:SOURce<hw>]:BB:NR5G:SCHed:CELL<cc>:SUBF<sf>:USER<us>:
BWPart<bwp>:ALLoc<al>:PDsch|PUSCh|PSSCh:TXScheme:NLAYers
<Layers>**

Defines the number of precoding layers.

Parameters:

<Layers> integer
 Range: 1 to 8
 *RST: 1

Example: See [Example"Configuring the PDSCH incl. PTRS and Precoding settings"](#) on page 393.

Manual operation: See ["Number of Layers"](#) on page 220
 See ["Number of Layers"](#) on page 294

10.28.6 DMRS configuration commands

[:SOURce<hw>]:BB:NR5G:SCHed:CELL<cc>:SUBF<sf>:USER<us>:BWPart<bwp>:
 ALLoc<al>:PSSCh:DMRS:APSel.....720

[:SOURce<hw>]:BB:NR5G:SCHed:CELL<cc>:SUBF<sf>:USER<us>:
 BWPart<bwp>:ALLoc<al>:PSSCh:DMRS:APSel <AntennaPort>

Selects the antenna port the PSSCH DMRS is transmitted on.

Parameters:

<AntennaPort> **P1000**
 Antenna port 1000 (available if number of precoding layers = 1).
P1001
 Antenna port 1001 (available if number of precoding layers = 1).
PBOTH
 Antenna port 1000 and 1001 (if number of precoding layers = 2).
 *RST: P1000

Example: See [Example"Configuring a sidelink signal"](#) on page 412.

Manual operation: See ["DMRS Port"](#) on page 295

10.28.7 PSxCH channel coding commands

Commands to configure PSxCH channel coding described elsewhere.

- [:SOURce<hw>]:BB:NR5G:SCHed:CELL<cc>:SUBF<sf>:USER<us>:
 BWPart<bwp>:ALLoc<al>:SCI:MCS

[:SOURce<hw>]:BB:NR5G:SCHed:CELL<cc>:SUBF<sf>:USER<us>:BWPart<bwp>:
 ALLoc<al>:SL:PHYSbits?.....721

[:SOURce<hw>]:BB:NR5G:SCHed:CELL<cc>:SUBF<sf>:USER<us>:BWPart<bwp>:
 ALLoc<al>[:CW<cw>]:PSSCh:CCODing:FRCR.....721

[:SOURce<hw>]:BB:NR5G:SCHed:CELL<cc>:SUBF<sf>:USER<us>:BWPart<bwp>:
 ALLoc<al>[:CW<cw>]:PSSCh:CCODing:RVIndex.....722

<code>[:SOURce<hw>]:BB:NR5G:SCHed:CELL<cc>:SUBF<sf>:USER<us>:BWPart<bwp>:ALLoc<al>[:CW<cw>]:PSSCh:CCODing:TBSFactor.....</code>	722
<code>[:SOURce<hw>]:BB:NR5G:SCHed:CELL<cc>:SUBF<sf>:USER<us>:BWPart<bwp>:ALLoc<al>[:CW<cw>]:PSSCh:CCODing:TBSize?.....</code>	722
<code>[:SOURce<hw>]:BB:NR5G:SCHed:CELL<cc>:SUBF<sf>:USER<us>:BWPart<bwp>:ALLoc<al>[:CW<cw>]:PSSCh:CCODing:TCRate.....</code>	723

`[:SOURce<hw>]:BB:NR5G:SCHed:CELL<cc>:SUBF<sf>:USER<us>:BWPart<bwp>:ALLoc<al>:SL:PHYSbits?`

Queries the size of the selected allocation in bits.

Prerequisites for this command

- Turn on channel coding (`[:SOURce<hw>]:BB:NR5G:UBWP:USER<us>:SSCH:CCODing:STATE`).

Return values:

<Bits> integer
 Range: 0 to 2147483647
 *RST: 0

Example: See [Example "Configuring a sidelink signal"](#) on page 412.

Usage: Query only

Manual operation: See ["Number of Physical Bits"](#) on page 296

`[:SOURce<hw>]:BB:NR5G:SCHed:CELL<cc>:SUBF<sf>:USER<us>:BWPart<bwp>:ALLoc<al>[:CW<cw>]:PSSCh:CCODing:FRCR <State>`

Turns manual definition of the target code rate on and off.

Prerequisites for this command

- Turn on channel coding (`[:SOURce<hw>]:BB:NR5G:UBWP:USER<us>:SSCH:CCODing:STATE`).

Parameters:

<State> 1 | ON | 0 | OFF
0 | OFF
 Target code rate is automatically calculated base on the I_MCS.
1 | ON
 Definition of target code rate is possible with `[:SOURce<hw>]:BB:NR5G:SCHed:CELL<cc>:SUBF<sf>:USER<us>:BWPart<bwp>:ALLoc<al>[:CW<cw>]:PSSCh:CCODing:TCRate`
 *RST: 0

Example: See [Example "Configuring a sidelink signal"](#) on page 412.

Manual operation: See ["Manually Defined Code Rate"](#) on page 296

```
[ :SOURce<hw>]:BB:NR5G:SCHeD:CELL<cc>:SUBF<sf>:USER<us>:
  BWPart<bwp>:ALLOc<al>[:CW<cw>]:PSSCh:CCODing:RVINdex <Index>
```

Defines the redundancy version index.

Prerequisites for this command

- Turn on channel coding ([:SOURce<hw>] :BB:NR5G:UBWP:USER<us>:SSCH:CCODing:STATE).

Parameters:

<Index> integer
 Range: 0 to 3
 *RST: 0

Example: See [Example"Configuring a sidelink signal"](#) on page 412.

Manual operation: See ["Redundancy Version Index"](#) on page 297

```
[ :SOURce<hw>]:BB:NR5G:SCHeD:CELL<cc>:SUBF<sf>:USER<us>:
  BWPart<bwp>:ALLOc<al>[:CW<cw>]:PSSCh:CCODing:TBSFactor
  <ScalingFactor>
```

Selects the transport block scaling factor.

Prerequisites for this command

- Turn on channel coding ([:SOURce<hw>] :BB:NR5G:UBWP:USER<us>:SSCH:CCODing:STATE).

Parameters:

<ScalingFactor> S1 | S5 | S25
 *RST: S1

Example: See [Example"Configuring a sidelink signal"](#) on page 412.

Manual operation: See ["TBS Scaling Factor"](#) on page 297

```
[ :SOURce<hw>]:BB:NR5G:SCHeD:CELL<cc>:SUBF<sf>:USER<us>:
  BWPart<bwp>:ALLOc<al>[:CW<cw>]:PSSCh:CCODing:TBSize?
```

Queries the transport block size.

Prerequisites for this command

- Turn on channel coding ([:SOURce<hw>] :BB:NR5G:UBWP:USER<us>:SSCH:CCODing:STATE).

Return values:

<TransBlockSize> integer
 Range: 0 to 2147483647
 *RST: 0

Example: See [Example"Configuring a sidelink signal"](#) on page 412.

Usage: Query only

Manual operation: See ["Transport Block Size"](#) on page 296

```
[ :SOURce<hw>]:BB:NR5G:SCHed:CELL<cc>:SUBF<sf>:USER<us>:
  BWPart<bwp>:ALLoc<al>[:CW<cw>]:PSSCh:CCODing:TCRate <CodeRate>
```

Defines the target code rate.

Prerequisites for this command

- Turn on channel coding (`[:SOURce<hw>]:BB:NR5G:UBWP:USER<us>:SSCh:CCODing:STATe`).
- Turn on custom code rate definition (`[:SOURce<hw>]:BB:NR5G:SCHed:CELL<cc>:SUBF<sf>:USER<us>:BWPart<bwp>:ALLoc<al>[:CW<cw>]:PSSCh:CCODing:FRcR`).

Parameters:

```
<CodeRate>          float
                    Range:    0 to 3
                    Increment: 0.001
                    *RST:     1
```

Example: See [Example"Configuring a sidelink signal"](#) on page 412.

Manual operation: See ["Target Code Rate"](#) on page 296

10.29 PSFCH scheduling commands

<code>[:SOURce<hw>]:BB:NR5G:SCHed:CELL<cc>:SUBF<sf>:USER<us>:BWPart<bwp>:ALLoc<al>:PSFCh:CYCShift</code>	723
<code>[:SOURce<hw>]:BB:NR5G:SCHed:CELL<cc>:SUBF<sf>:USER<us>:BWPart<bwp>:ALLoc<al>:PSFCh:HARQ</code>	724
<code>[:SOURce<hw>]:BB:NR5G:SCHed:CELL<cc>:SUBF<sf>:USER<us>:BWPart<bwp>:ALLoc<al>:PSFCh:HOPid</code>	724
<code>[:SOURce<hw>]:BB:NR5G:SCHed:CELL<cc>:SUBF<sf>:USER<us>:BWPart<bwp>:ALLoc<al>:PSFCh:TRAN</code>	724
<code>[:SOURce<hw>]:BB:NR5G:SCHed:CELL<cc>:SUBF<sf>:USER<us>:BWPart<bwp>:ALLoc<al>:PSFCh:TYPE</code>	725

```
[ :SOURce<hw>]:BB:NR5G:SCHed:CELL<cc>:SUBF<sf>:USER<us>:
  BWPart<bwp>:ALLoc<al>:PSFCh:CYCShift <Value>
```

Defines the initial cyclic shift for the PSFCH hopping sequence.

Parameters:

```
<Value>          integer
                    Range:    0 to 5
                    *RST:     0
```

Manual operation: See ["Initial Cyclic Shift"](#) on page 299

**[:SOURce<hw>]:BB:NR5G:SCHed:CELL<cc>:SUBF<sf>:USER<us>:
BWPart<bwp>:ALLoc<al>:PSFCh:HARQ <Information>**

Selects the type of acknowledgement information that the PSFCH carries.

Prerequisites for this command

- Select PSFCH type = ACK / NACK ([:SOURce<hw>] :BB:NR5G:SCHed:CELL<cc>:SUBF<sf>:USER<us>:BWPart<bwp>:ALLoc<al>:PSFCh:TYPE).

Parameters:

<Information> **ACK**
PSFCH carries ACK information.

NACK
PSFCH carries NACK information.

*RST: ACK

Manual operation: See "[Harq ACK](#)" on page 299

**[:SOURce<hw>]:BB:NR5G:SCHed:CELL<cc>:SUBF<sf>:USER<us>:
BWPart<bwp>:ALLoc<al>:PSFCh:HOPid <Value>**

Defines the hopping ID for the PSFCH.

Parameters:

<Value> integer

 Range: 0 to 1023

*RST: 0

Manual operation: See "[Hopping ID](#)" on page 299

**[:SOURce<hw>]:BB:NR5G:SCHed:CELL<cc>:SUBF<sf>:USER<us>:
BWPart<bwp>:ALLoc<al>:PSFCh:TRAN <PsfchTrans>**

Selects the PSFCH transmission structure.

Parameters:

<PsfchTrans> **COMM**
Common interlace

DED
Dedicated interlace

*RST: COMM

Manual operation: See "[Transmission Structure](#)" on page 300

**[:SOURce<hw>]:BB:NR5G:SCHEd:CELL<cc>:SUBF<sf>:USER<us>:
BWPart<bwp>:ALLoc<al>:PSFCh:TYPe <Type>**

Selects the type of information that the PSFCH transmits.

Parameters:

<Type>

ACKN
PSFCH transmits ACK or NACK information.

CONF
PSFCH transmits conflict information.

NACK
PSFCH transmits only NACK information.

*RST: ACKN

Manual operation: See "PSFCH Type" on page 299

10.30 Output commands

[:SOURce<hw>]:BB:NR5G:OUTPut:SEQLen.....	726
[:SOURce<hw>]:BB:NR5G:OUTPut:SUSLen.....	726
[:SOURce<hw>]:BB:NR5G:OUTPut:SSOC:STATe.....	726
[:SOURce<hw>]:BB:NR5G:OUTPut:FMODe.....	727
[:SOURce<hw>]:BB:NR5G:FMODe:USRFile.....	727
[:SOURce<hw>]:BB:NR5G:OUTPut:SAMRmode.....	727
[:SOURce<hw>]:BB:NR5G:OUTPut:BBConf:ROW<apr>:SRATe?	728
[:SOURce<hw>]:BB:NR5G:OUTPut:BBConf:ROW<apr>:CONFLict.....	728
[:SOURce<hw>]:BB:NR5G:OUTPut:BBConf:CONFLict?	728
[:SOURce<hw>]:BB:NR5G:OUTPut:BBConf:ROW<apr>:PBRate.....	728
[:SOURce<hw>]:BB:NR5G:OUTPut:BBConf:ROW<apr>:VARiatiOn.....	729
[:SOURce<hw>]:BB:NR5G:OUTPut:CLEVel.....	729
[:SOURce<hw>]:BB:NR5G:OUTPut:CMODe.....	729
[:SOURce<hw>]:BB:NR5G:TDWind:STATe.....	730
[:SOURce<hw>]:BB:NR5G:OUTPut:TDWind:SE60K:TRTime.....	730
[:SOURce<hw>]:BB:NR5G:OUTPut:TDWind:S15K:TRTime.....	730
[:SOURce<hw>]:BB:NR5G:OUTPut:TDWind:S30K:TRTime.....	730
[:SOURce<hw>]:BB:NR5G:OUTPut:TDWind:S60K:TRTime.....	730
[:SOURce<hw>]:BB:NR5G:OUTPut:TDWind:S120K:TRTime.....	730
[:SOURce<hw>]:BB:NR5G:OUTPut:TDWind:S240K:TRTime.....	730
[:SOURce<hw>]:BB:NR5G:OUTPut:TDWind:SE60K:TRTSamples?	730
[:SOURce<hw>]:BB:NR5G:OUTPut:TDWind:S15K:TRTSamples?	730
[:SOURce<hw>]:BB:NR5G:OUTPut:TDWind:S30K:TRTSamples?	730
[:SOURce<hw>]:BB:NR5G:OUTPut:TDWind:S120K:TRTSamples?	730
[:SOURce<hw>]:BB:NR5G:OUTPut:TDWind:S60K:TRTSamples?	730
[:SOURce<hw>]:BB:NR5G:OUTPut:TDWind:S240K:TRTSamples?	730
[:SOURce<hw>]:BB:NR5G:OUTPut:POWer:BBConf:ROW<apr>:AVRL?	731
[:SOURce<hw>]:BB:NR5G:OUTPut:POWer:MODe.....	731
[:SOURce<hw>]:BB:NR5G:OUTPut:POWer:RSBW.....	732
[:SOURce<hw>]:BB:NR5G:OUTPut:POWer:S120K:ACRL?	732

<code>[SOURce<hw>]:BB:NR5G:OUTPut:POWer:S15K:ACRL?</code>	732
<code>[SOURce<hw>]:BB:NR5G:OUTPut:POWer:S240K:ACRL?</code>	732
<code>[SOURce<hw>]:BB:NR5G:OUTPut:POWer:S30K:ACRL?</code>	732
<code>[SOURce<hw>]:BB:NR5G:OUTPut:POWer:S60K:ACRL?</code>	732
<code>[SOURce<hw>]:BB:NR5G:OUTPut:POWer:BWRef:ACRL?</code>	732
<code>[SOURce<hw>]:BB:NR5G:OUTPut:CFReduction:ALGorithm</code>	732
<code>[SOURce<hw>]:BB:NR5G:OUTPut:CFReduction:CPBWidth</code>	733
<code>[SOURce<hw>]:BB:NR5G:OUTPut:CFReduction:TRBWidth</code>	733
<code>[SOURce<hw>]:BB:NR5G:OUTPut:CFReduction:ITERations</code>	733
<code>[SOURce<hw>]:BB:NR5G:OUTPut:CFReduction:OCFactor?</code>	734
<code>[SOURce<hw>]:BB:NR5G:OUTPut:CFReduction:RCFactor?</code>	734
<code>[SOURce<hw>]:BB:NR5G:OUTPut:CFReduction:STATe</code>	734
<code>[SOURce<hw>]:BB:NR5G:OUTPut:CFReduction:TCRFactor</code>	735

`[SOURce<hw>]:BB:NR5G:OUTPut:SEQLen <SeqLen>`

Sets the sequence length of the signal in number of frames.

Parameters:

<code><SeqLen></code>	integer
	Range: 1 to depends on settings
	*RST: 1

Example: See [Example "Output settings"](#) on page 408.

`[SOURce<hw>]:BB:NR5G:OUTPut:SUSLen <Subframes>`

Sets the sequence length of the signal in terms of subframes.

Parameters:

<code><Subframes></code>	integer
	Range: 1 to device dependent
	*RST: 10

Manual operation: See ["Sequence Length"](#) on page 315

`[SOURce<hw>]:BB:NR5G:OUTPut:SSOC:STATe <SupSCOnOPCtr>`

If enabled, the subcarriers that use the same frequency as the center frequency of the baseband output are not transmitted.

Parameters:

<code><SupSCOnOPCtr></code>	1 ON 0 OFF
	*RST: 0

Example: See [Example "Output settings"](#) on page 408.

Manual operation: See ["Suppress Subcarrier on Output Center"](#) on page 315

[[:SOURce<hw>]:BB:NR5G:OUTPut:FMODe <FilterBWP>

Defines if and how the filter is applied, on the whole channel bandwidth or on the individual BWPs separately.

Parameters:

<FilterBWP> CBW | BWP | OFF | FAST | 2 | 1 | 0 | USER | EVM

BWP | 1

Applies a filter to each bandwidth part.

CBW | 0

Applies the channel BW filter.

EVM

Applies a filter to optimize the EVM.

FAST | 2

Applies fast filtering.

OFF

No filter.

USER

Applies a custom filter.

*RST: 0

Example: See [Example "Output settings"](#) on page 408.

Manual operation: See ["Filter Mode"](#) on page 315

[[:SOURce<hw>]:BB:NR5G:FMODe:USRFile <FilterFileName>

Loads the file from the default or the specified directory.

Loaded are files with extension *.vaf or *.dat.

Parameters:

<FilterFileName> string

Complete file path incl. filename and extension

Example:

SOURce:BB:NR5G:OUTPut:FMODe USER

SOURce:BB:NR5G:FMODe:USRFile "/var/user/my_filter.dat"

Manual operation: See ["Load User Filter"](#) on page 316

[[:SOURce<hw>]:BB:NR5G:OUTPut:SAMRmode <SampRateMode>

Sets the sample rate mode.

Parameters:

<SampRateMode> MIN | FFT

*RST: FFT

Manual operation: See ["Sample Rate Mode"](#) on page 317

[:SOURce<hw>]:BB:NR5G:OUTPut:BBConf:ROW<apr>:SRATe?

Queries the resulting sample rate.

Suffix:

<ch0> 0 to 7

Return values:

<SampleRate> integer

Among others, value range depends on the selected deployment scenario and channel bandwidth.

Range: 4E6 to 5E8

*RST: 4E6

Example: See [Example"Output settings"](#) on page 408.

Usage: Query only

Manual operation: See ["Sample Rate"](#) on page 317

[:SOURce<hw>]:BB:NR5G:OUTPut:BBConf:ROW<apr>:CONFLICT <Conflict>

Queries if there are conflicts caused by mismatch between the nominal sample rate, playback rate and sample rate in the given row.

Parameters:

<Conflict> 1 | ON | 0 | OFF

*RST: 0

Example: See [Example"Output settings"](#) on page 408.

Manual operation: See ["Conflict"](#) on page 318

[:SOURce<hw>]:BB:NR5G:OUTPut:BBConf:CONFLICT?

Queries if there are existing output conflicts caused by mismatch between the nominal sample rate, playback rate and sample rate in any of the outputs of the baseband block.

Return values:

<AnyOutpConflict> 1 | ON | 0 | OFF

*RST: 0

Example: See: [Example"Output settings"](#) on page 408.

Usage: Query only

Manual operation: See ["Conflict"](#) on page 318

[:SOURce<hw>]:BB:NR5G:OUTPut:BBConf:ROW<apr>:PBRate <PlaybackRate>

Defines the playback rate.

Prerequisites for this command

- Turn on `[:SOURce<hw>] :BB:NR5G:OUTPut:BBConf:ROW<apr>:VARIation`.

Parameters:

<PlaybackRate> integer
 Per default, the playback rate is the same as the calculated sample rate but the value range also depends on the installed options.
 Range: 0 to 24e8
 *RST: same as the calculated sample rate

Example: See [Example"Output settings"](#) on page 408.

Manual operation: See ["Playback Rate"](#) on page 318

[:SOURce<hw>] :BB:NR5G:OUTPut:BBConf:ROW<apr>:VARIation
 <SRateVariation>

Activates sample rate variation.

Parameters:

<SRateVariation> 0 | 1 | OFF | ON
 *RST: 0

Example: See [Example"Output settings"](#) on page 408.

Manual operation: See ["Sample Rate Variation"](#) on page 318

[:SOURce<hw>] :BB:NR5G:OUTPut:CLeVel <ClippingLevel>

Sets the limit for level clipping.

Parameters:

<ClippingLevel> integer
 Range: 1 to 100
 *RST: 100

Example: See [Example"Output settings"](#) on page 408.

Manual operation: See ["Clipping Level"](#) on page 317

[:SOURce<hw>] :BB:NR5G:OUTPut:CMODE <ClippingMode>

Sets the method for level clipping.

Parameters:

<ClippingMode> VECTor | SCALar
 *RST: VECTor

Example: See [Example"Output settings"](#) on page 408.

Manual operation: See ["Clipping Mode"](#) on page 317

```
[ :SOURce<hw>]:BB:NR5G:TDWind:STATe <TDWindow>
```

Enables time domain windowing.

Parameters:

```
<TDWindow>      1 | ON | 0 | OFF
                 *RST:      0
```

Example: See [Example "Time domain windowing"](#) on page 407.

Manual operation: See ["Time Domain Windowing \(WOLA\)"](#) on page 319

```
[ :SOURce<hw>]:BB:NR5G:OUTPut:TDWind:SE60K:TRTime <TransitionTime>
[ :SOURce<hw>]:BB:NR5G:OUTPut:TDWind:S15K:TRTime <TransitionTime>
[ :SOURce<hw>]:BB:NR5G:OUTPut:TDWind:S30K:TRTime <TransitionTime>
[ :SOURce<hw>]:BB:NR5G:OUTPut:TDWind:S60K:TRTime <TransitionTime>
[ :SOURce<hw>]:BB:NR5G:OUTPut:TDWind:S120K:TRTime <TransitionTime>
[ :SOURce<hw>]:BB:NR5G:OUTPut:TDWind:S240K:TRTime <TransitionTime>
```

Sets the transition time when time domain windowing is active.

The next to last block in the command syntax indicates the used SCS and CP combination.

- DL: SE<SCS>K, where E indicates the extended CP or for normal CP, the designation is omitted

Parameters:

```
<TransitionTime> float
                  Range:      0 to 1E-5
                  Increment:  1E-7
                  *RST:      5E-6
```

Example: See [Example "Time domain windowing"](#) on page 407.

Manual operation: See ["Transition Time"](#) on page 319

```
[ :SOURce<hw>]:BB:NR5G:OUTPut:TDWind:SE60K:TRTSamples?
[ :SOURce<hw>]:BB:NR5G:OUTPut:TDWind:S15K:TRTSamples?
[ :SOURce<hw>]:BB:NR5G:OUTPut:TDWind:S30K:TRTSamples?
[ :SOURce<hw>]:BB:NR5G:OUTPut:TDWind:S120K:TRTSamples?
[ :SOURce<hw>]:BB:NR5G:OUTPut:TDWind:S60K:TRTSamples?
[ :SOURce<hw>]:BB:NR5G:OUTPut:TDWind:S240K:TRTSamples?
```

Queries the number of transition samples.

The next to last block in the command syntax indicates the used SCS and CP combination.

- DL: SE<SCS>K, where E indicates the extended CP or for normal CP, the designation is omitted

Return values:

<TransitionSampl> integer
 Range: 0 to 1000
 *RST: 0

Example: See [Example "Time domain windowing"](#) on page 407.

Usage: Query only

Manual operation: See ["Transition BB A Samples"](#) on page 320

[:SOURce<hw>]:BB:NR5G:OUTPut:POWer:BBConf:ROW<apr>:AVRL?

Queries the available basebands with their average power.

Return values:

<PowPerBBRelLvl> float
 Range: -80 to 10
 Increment: 0.001
 *RST: 0

Example: See [Example "Output settings"](#) on page 408.

Usage: Query only

Manual operation: See ["Average Power"](#) on page 327

[:SOURce<hw>]:BB:NR5G:OUTPut:POWer:MODE <PowerMode>

Sets how the first output is leveled.

Parameters:

<PowerMode>

AAS

Average power in the active signal

AVG

Average RMS power

ACTvsf

Average power in the active subframes

PSDConst

The absolute power of a particular allocation is set by multiplying the configured power spectral density (PSD) with the bandwidth of the particular allocation.

Burst

The "Burst" mode is a special case of the "Constant PSD" mode in the sense that it computes automatically a reference bandwidth based on the chosen allocation.

*RST: AVG

Example:

```
SOURce1:BB:NR5G:OUTPut:POWer:MODE PSDConst
SOURce1:BB:NR5G:OUTPut:POWer:RSBW 1000000
```

Manual operation: See ["Power Mode"](#) on page 327

[:SOURce<hw>]:BB:NR5G:OUTPut:POWER:RSBW <RefSystemBW>

Sets the reference bandwidth used by the leveling of the output signal at the first output.

Parameters:

<RefSystemBW> float
 Range: 15E3 to 400E6
 Increment: 1
 *RST: 1E6

Example: See [:SOURce<hw>]:BB:NR5G:OUTPut:POWER:MODE on page 731.

Manual operation: See "Reference System Bandwidth" on page 327

[:SOURce<hw>]:BB:NR5G:OUTPut:POWER:S120K:ACRL?
[:SOURce<hw>]:BB:NR5G:OUTPut:POWER:S15K:ACRL?
[:SOURce<hw>]:BB:NR5G:OUTPut:POWER:S240K:ACRL?
[:SOURce<hw>]:BB:NR5G:OUTPut:POWER:S30K:ACRL?
[:SOURce<hw>]:BB:NR5G:OUTPut:POWER:S60K:ACRL?
[:SOURce<hw>]:BB:NR5G:OUTPut:POWER:BWRef:ACRL?

Queries the bandwidths/numerologies with their power levels.

Return values:

<ActPowRelLvIPBW> float
 Range: -80 to 10
 Increment: 0.001
 *RST: 0

Example: See [Example "Output settings"](#) on page 408.

Usage: Query only

Manual operation: See "Active Power" on page 328

[:SOURce<hw>]:BB:NR5G:OUTPut:CFReduction:ALgorithm <CFRAAlgorithm>

Selects the algorithm used for the crest factor reduction.

Parameters:

<CFRAAlgorithm> **CLF**
 Clipping and filtering algorithm
PC
 Peak cancellation algorithm
 *RST: CLF

Example: See [Example "Output settings"](#) on page 408.

Options: R&S SMM-K548

Manual operation: See "Algorithm" on page 329

[:SOURce<hw>]:BB:NR5G:OUTPut:CFReduction:CPBWidth <CancelPulseBw>

Sets the bandwidth of the cancellation pulse.

Prerequisites for this command

- [\[:SOURce<hw>\]:BB:NR5G:OUTPut:CFReduction:ALGORITHM](#) on page 732 = PC

Parameters:

<CancelPulseBw> float
 Range: 0 to 500e6
 Increment: 0.1
 *RST: 98304001.4648438

Example: //Set pulse bandwidth
 SOURce1:BB:NR5G:OUTPut:CFReduction:ALGORITHM PC
 SOURce1:BB:NR5G:OUTPut:CFReduction:CPBWidth
 1228800

Manual operation: See "[Cancellation Pulse Bandwidth](#)" on page 330

[:SOURce<hw>]:BB:NR5G:OUTPut:CFReduction:TRBWidth <TransitBw>

Sets the transition bandwidth of the cancellation pulse.

Prerequisites for this command

- [\[:SOURce<hw>\]:BB:NR5G:OUTPut:CFReduction:ALGORITHM](#) on page 732 = PC

Parameters:

<TransitBw> float
 Range: 0 to 500e6
 Increment: 0.1
 *RST: 1228799.97253418

Example: //Set transition bandwidth
 SOURce1:BB:NR5G:OUTPut:CFReduction:ALGORITHM PC
 SOURce1:BB:NR5G:OUTPut:CFReduction:TRBWidth
 98304000

Manual operation: See "[Transition Bandwidth](#)" on page 330

[:SOURce<hw>]:BB:NR5G:OUTPut:CFReduction:ITERations <MaxIteration>

Sets the number of iterations that are used for calculating the resulting crest factor. The iteration process is stopped when the desired crest factor is achieved by 0.1 dB.

Parameters:

<MaxIteration> integer
 Range: 0 to 20
 *RST: 5

Example: See [Example"Output settings"](#) on page 408.

Options: R&S SMM-K548

Manual operation: See ["Max Iterations"](#) on page 329

[:SOURce<hw>]:BB:NR5G:OUTPut:CFReduction:OCFactor?

Queries the original crest factor of the waveform after the calculation of the resulting crest factor is completed.

The original crest factor is calculated as an average over the whole waveform, including any idle periods that might be present in TDD waveforms.

Return values:

<OriginalCFR> integer
 Range: 0 to 100
 *RST: 0

Example: See [Example"Output settings"](#) on page 408.

Usage: Query only

Options: R&S SMM-K548

Manual operation: See ["Original Crest Factor"](#) on page 329

[:SOURce<hw>]:BB:NR5G:OUTPut:CFReduction:RCFactor?

Queries the resulting crest factor of the waveform after the calculations are completed. The resulting crest factor is calculated as an average over the whole waveform, including any idle periods that might be present in TDD waveforms.

Return values:

<ResultingCFR> integer
 Range: 0 to 100
 *RST: 0

Example: See [Example"Output settings"](#) on page 408.

Usage: Query only

Options: R&S SMM-K548

Manual operation: See ["Resulting Crest Factor"](#) on page 330

[:SOURce<hw>]:BB:NR5G:OUTPut:CFReduction:STATE <CrestFactorStat>

Enables the crest factor reduction calculation.

Parameters:

<CrestFactorStat> 1 | ON | 0 | OFF
 *RST: 0

Example: See [Example"Output settings"](#) on page 408.

Options: R&S SMM-K548

Manual operation: See ["State"](#) on page 329

[:SOURce<hw>]:BB:NR5G:OUTPut:CFReduction:TCRFactor <TargetCRF>

Sets the desired crest factor value.

Parameters:

<TargetCRF>	float
	Range: 0 to 30
	Increment: 0.1
	*RST: 10

Example: See [Example"Output settings"](#) on page 408.

Options: R&S SMM-K548

Manual operation: See ["Target Crest Factor"](#) on page 329

10.31 Trigger commands

[:SOURce<hw>]:BB:NR5G[:TRIGger]:SEQUence	735
[:SOURce<hw>]:BB:NR5G:TRIGger:SOURce	736
[:SOURce<hw>]:BB:NR5G:TRIGger:EXTernal:SYNChronize:OUTPut	736
[:SOURce<hw>]:BB:NR5G:TRIGger:DELay:UNIT	736
[:SOURce<hw>]:BB:NR5G:TRIGger[:EXTernal]:DELay	737
[:SOURce<hw>]:BB:NR5G:TRIGger[:EXTernal]:INHibit	737
[:SOURce<hw>]:BB:NR5G:TRIGger:EXTernal:RDELay?	737
[:SOURce<hw>]:BB:NR5G:TRIGger:EXTernal:TDELay	737
[:SOURce<hw>]:BB:NR5G:TRIGger:ARM:EXECute	738
[:SOURce<hw>]:BB:NR5G:TRIGger:EXECute	738
[:SOURce<hw>]:BB:NR5G:TRIGger:RMODE?	738
[:SOURce<hw>]:BB:NR5G:TRIGger:SLENgth	739
[:SOURce<hw>]:BB:NR5G:TRIGger:SLUNit	739
[:SOURce<hw>]:BB:NR5G:TRIGger:TIME:DATE	739
[:SOURce<hw>]:BB:NR5G:TRIGger:TIME:TIME	740
[:SOURce<hw>]:BB:NR5G:TRIGger:TIME[:STATe]	740

[:SOURce<hw>]:BB:NR5G[:TRIGger]:SEQUence <TrigMode>

Sets the trigger mode.

Parameters:

<TrigMode>	AUTO RETRigger AAUTO ARETrigger SINGLE
	*RST: AUTO

Example: See [Example"Configure and enable triggering"](#) on page 409.

Manual operation: See ["Mode"](#) on page 302

[[:SOURce<hw>]:BB:NR5G:TRIGger:SOURce <TrigSource>

Selects the trigger signal source and determines the way the triggering is executed. Provided are:

- Internal triggering by a command (INTernal)
- External trigger signal via one of the local or global connectors
 - EGT1 | EGT2: External global trigger
 - EGC1 | EGC2: External global clock
- In primary-secondary instrument mode, the external baseband synchronization signal (BBSY)
- OBASeband | BEXTernal | EXTernal: Setting only
 Provided only for backward compatibility with other Rohde & Schwarz signal generators.
 The R&S SMM100A accepts these values and maps them automatically as follows:
 EXTernal = EGT1, BEXTernal = EGT2, OBASeband = INTA

Parameters:

<TrigSource> INTernal|EGT1|EGT2|EGC1|EGC2|EXTernal|BBSY
 *RST: INTernal

Example: See [Example"Configure and enable triggering"](#) on page 409.

Manual operation: See ["Source"](#) on page 304

[[:SOURce<hw>]:BB:NR5G:TRIGger:EXTernal:SYNChronize:OUTPut <TrigSyncOutpSta>

Enables signal output synchronous to the trigger event.

Parameters:

<TrigSyncOutpSta> 1 | ON | 0 | OFF
 *RST: 1

Example: See [Example"Configure and enable triggering"](#) on page 409.

Manual operation: See ["Sync. Output to External Trigger/Sync. Output to Trigger"](#) on page 304

[[:SOURce<hw>]:BB:NR5G:TRIGger:DELay:UNIT <TrigDelUnit>

Sets the units the trigger delay is expressed in.

Parameters:

<TrigDelUnit> SAMPlE | TIME
 *RST: SAMPlE

Example: See [Example"Specifying delay and inhibit values in time units"](#) on page 409.

Manual operation: See ["\(External\) Delay Unit"](#) on page 305

[[:SOURce<hw>]:BB:NR5G:TRIGger[:EXTernal]:DELay <TrigExtDelay>

Sets the trigger delay.

Parameters:

<TrigExtDelay> float
 Range: 0 to 2147483647
 Increment: 0.01
 *RST: 0

Example: See [Example "Configure and enable triggering"](#) on page 409.

Manual operation: See ["\(Specified\) External Delay/\(Specified\) Trigger Delay"](#) on page 306

[[:SOURce<hw>]:BB:NR5G:TRIGger[:EXTernal]:INHibit <TrigExtInhibit>

Specifies the duration by which a restart is inhibited.

Parameters:

<TrigExtInhibit> integer
 Range: 0 to dynamic
 *RST: 0

Example: See [Example "Configure and enable triggering"](#) on page 409.

Manual operation: See ["External Inhibit/Trigger Inhibit"](#) on page 305

[[:SOURce<hw>]:BB:NR5G:TRIGger:EXTernal:RDELay?

Queries the time (in seconds) an external trigger event is delayed for.

Return values:

<ResExtDelaySec> float
 Range: 0 to 688
 Increment: 250E-12
 *RST: 0

Example: See [Example "Specifying delay and inhibit values in time units"](#) on page 409.

Usage: Query only

Manual operation: See ["Actual Trigger Delay/Actual External Delay"](#) on page 306

[[:SOURce<hw>]:BB:NR5G:TRIGger:EXTernal:TDELay <TrigExtTimeDel>

Specifies the trigger delay for external triggering. The value affects all external trigger signals.

Parameters:

<TrigExtTimeDel> float
 Range: 0 to 688
 Increment: 250E-12
 *RST: 0

Example: See [Example "Specifying delay and inhibit values in time units"](#) on page 409.

Manual operation: See ["\(Specified\) External Delay/\(Specified\) Trigger Delay"](#) on page 306

[:SOURce<hw>]:BB:NR5G:TRIGger:ARM:EXECute

Stops signal generation; a subsequent trigger event restarts signal generation.

Example:

```
SOURce1:BB:NR5G:TRIGger:SOURce INT
SOURce1:BB:NR5G:TRIGger:SEquence ARETrigger
SOURce1:BB:NR5G:TRIGger:EXEcute
// executes a trigger, signal generation starts
SOURce1:BB:NR5G:TRIGger:ARM:EXEcute
// signal generation stops
SOURce1:BB:NR5G:TRIGger:EXEcute
// executes a trigger, signal generation starts again
```

Usage: Event

Manual operation: See ["Arm"](#) on page 304

[:SOURce<hw>]:BB:NR5G:TRIGger:EXEcute

Executes a trigger.

Example: See [Example "Configure and enable triggering"](#) on page 409.

Usage: Event

Manual operation: See ["Execute Trigger"](#) on page 304

[:SOURce<hw>]:BB:NR5G:TRIGger:RMODE?

Queries the signal generation status.

Return values:

<TrigRunMode> STOP | RUN
 *RST: STOP

Example: SOURce1:BB:NR5G:TRIGger:RMODE?

Usage: Query only

Manual operation: See ["Running/Stopped"](#) on page 303

```
[ :SOURce<hw>]:BB:NR5G:TRIGger:SLENgth <TrigSeqLen>
```

Defines the length of the signal sequence that is output in the `SINGLE` trigger mode.

Parameters:

```
<TrigSeqLen>      integer
                   Range:    1 to dynamic
                   *RST:     1
```

Example: See [Example "Configure and enable triggering"](#) on page 409.

Manual operation: See ["Signal Duration"](#) on page 303

```
[ :SOURce<hw>]:BB:NR5G:TRIGger:SLUNit <TrigSeqLenUnit>
```

Defines the unit for the entry of the signal sequence length.

Parameters:

```
<TrigSeqLenUnit> SEQUENCE | SAMPLE
                   *RST:     SEQUENCE
```

Example:

```
SOURce1:BB:NR5G:TRIGger:SEQUENCE SING
SOURce1:BB:NR5G:TRIGger:SLUNit SEQ
SOURce1:BB:NR5G:TRIGger:SLENgth 2
```

Manual operation: See ["Signal Duration Unit"](#) on page 303

```
[ :SOURce<hw>]:BB:NR5G:TRIGger:TIME:DATE <Year>, <Month>, <Day>
```

Sets the date for a time-based trigger signal. For trigger modes `single` or `armed auto`, you can activate triggering at this date via the following command:

```
SOURce<hw>:BB:<DigStd>:TRIGger:TIME:STATe
```

`<DigStd>` is the mnemonic for the digital standard, for example, `ARB`. Time-based triggering behaves analogously for all digital standards that support this feature.

Parameters:

```
<Year>            integer
                   Range:    1980 to 9999

<Month>          integer
                   Range:    1 to 12

<Day>            integer
                   Range:    1 to 31
```

Example: See R&S SMM100A user manual.

Manual operation: See ["Trigger Time"](#) on page 303

[[:SOURce<hw>]:BB:NR5G:TRIGger:TIME:TIME <Hour>, <Minute>, <Second>

Sets the time for a time-based trigger signal. For trigger modes single or armed auto, you can activate triggering at this time via the following command:

SOURce<hw>:BB:<DigStd>:TRIGger:TIME:STATe

<DigStd> is the mnemonic for the digital standard, for example, ARB. Time-based triggering behaves analogously for all digital standards that support this feature.

Parameters:

<Hour>	integer	
	Range:	0 to 23
<Minute>	integer	
	Range:	0 to 59
<Second>	integer	
	Range:	0 to 59

Example: See R&S SMM100A user manual.

Manual operation: See ["Trigger Time"](#) on page 303

[[:SOURce<hw>]:BB:NR5G:TRIGger:TIME[:STATe] <State>

Activates time-based triggering with a fixed time reference. If activated, the R&S SMM100A triggers signal generation when its operating system time matches a specified time.

Specify the trigger date and trigger time with the following commands:

SOURce<hw>:BB:<DigStd>:TRIGger:TIME:DATE

SOURce<hw>:BB:<DigStd>:TRIGger:TIME:TIME

<DigStd> is the mnemonic for the digital standard, for example, ARB. Time-based triggering behaves analogously for all digital standards that support this feature.

Parameters:

<State>	1 ON 0 OFF
*RST:	0

Example: See R&S SMM100A user manual.

Manual operation: See ["Time Based Trigger"](#) on page 303

10.32 Marker commands

[:SOURce<hw>]:BB:NR5G:TRIGger:OUTPut<ch>:MODE.....	741
[:SOURce<hw>]:BB:NR5G:TRIGger:OUTPut<ch>:DElay.....	741
[:SOURce<hw>]:BB:NR5G:TRIGger:OUTPut<ch>:DINSec?.....	742
[:SOURce<hw>]:BB:NR5G:TRIGger:OUTPut<ch>:PERiod.....	742

[:SOURce<hw>]:BB:NR5G:TRIGger:OUTPut<ch>:DINSec?

Queries the marker delay in microseconds.

You can define a marker delay in samples with `[:SOURce<hw>]:BB:NR5G:TRIGger:OUTPut<ch>:DELay`.

Return values:

<Delay> float
 Range: 0 to 16777215
 Increment: 1E-3
 *RST: 0

Usage: Query only

Manual operation: See "[Delay \(Time\)](#)" on page 309

[:SOURce<hw>]:BB:NR5G:TRIGger:OUTPut<ch>:PERiod <MarkUsrPer>

Sets the period of the user-defined period marker.

Parameters:

<MarkUsrPer> integer
 Range: 1 to 4294967295
 *RST: 2

Example: See [Example "Configure and enable standard marker signals"](#) on page 410.

Manual operation: See "[Marker Mode](#)" on page 307

**[:SOURce<hw>]:BB:NR5G:TRIGger:OUTPut<ch>:ROFFset <MarkRiseOffs>
[:SOURce<hw>]:BB:NR5G:TRIGger:OUTPut<ch>:FOFFset <MarkFallOffs>**

Sets the rise/fall offset.

Parameters:

<MarkFallOffs> integer
 Range: -640000 to 640000
 *RST: 0

Example: See [Example "Configure and enable standard marker signals"](#) on page 410.

Manual operation: See "[Rise/Fall Offset](#)" on page 308

**[:SOURce<hw>]:BB:NR5G:TRIGger:OUTPut<ch>:ONTime <MarkTimeOn>
[:SOURce<hw>]:BB:NR5G:TRIGger:OUTPut<ch>:OFFTime <MarkTimeOff>**

Sets the number of samples during which the marker output is on or off.

Parameters:

<MarkTimeOff> integer
 Range: 1 to 16777215
 *RST: 1

Example: See [Example "Configure and enable standard marker signals"](#) on page 410.

Manual operation: See ["Marker Mode"](#) on page 307

[:SOURce<hw>]:BB:NR5G:TRIGger:OUTPut<ch>:INVert <Invert>

Turns inversion of the marker signal on and off.

Parameters:

<Invert> 1 | ON | 0 | OFF
1 | ON
 Marker is on a falling edge.
0 | OFF
 Marker is on a rising edge.
 *RST: 0

Example: See [Example "Configure and enable standard marker signals"](#) on page 410.

Manual operation: See ["Invert"](#) on page 309

[:SOURce<hw>]:BB:NR5G:TRIGger:OUTPut<ch>:DUPLexing <Duplexing>

Defines the duplexing mode for a UL/DL pattern containing a marker.

Parameters:

<Duplexing> TDD | FDD
TDD
 Sets TDD (time division duplex) as the duplexing mode.
FDD
 Sets FDD (frequency division duplex) as the duplexing mode.
 *RST: FDD

Example: See [Example "Configure and enable an UL/DL marker"](#) on page 410.

Manual operation: See ["Duplexing"](#) on page 311

[:SOURce<hw>]:BB:NR5G:TRIGger:OUTPut<ch>:ECPState <ScsECPState>

Enables/disables the extended cyclic prefix (ECP) for a UL/DL pattern containing a marker.

Parameters:

<ScsECPState> 1 | ON | 0 | OFF

0|OFF

Disables the ECP.

1|ON

Enables the ECP.

*RST: 0

Example: See [Example "Configure and enable an UL/DL marker"](#) on page 410.

Manual operation: See ["Use Extended Cyclic Prefix"](#) on page 311

[[:SOURce<hw>]:BB:NR5G:TRIGger:OUTPut<ch>:MMODE <Mode>

Queries the marker configuration mode.

The configuration mode is always "ULDL" ("UL/DL Configuration").

Parameters:

<Mode> ULDL
*RST: ULDL

Manual operation: See ["Configuration Mode"](#) on page 310

[[:SOURce<hw>]:BB:NR5G:TRIGger:OUTPut<ch>:NDLSlots <NumDISlots>

Sets the number of DL slots in a UL/DL pattern containing a marker.

Parameters:

<NumDISlots> integer
Range: 0 to 10
*RST: 10

Example: See [Example "Configure and enable an UL/DL marker"](#) on page 410.

Manual operation: See ["Number of DL Slots"](#) on page 311

[[:SOURce<hw>]:BB:NR5G:TRIGger:OUTPut<ch>:NSSLots?

Queries the number of special slots in a UL/DL pattern containing a marker.

Return values:

<NumSpecialSlots> integer
Range: 0 to 1
*RST: 0

Example: See [Example "Configure and enable an UL/DL marker"](#) on page 410.

Usage: Query only

Manual operation: See ["Number of Special Slots"](#) on page 312

[[:SOURce<hw>]:BB:NR5G:TRIGger:OUTPut<ch>:NULSlots <Slots>

Sets the number of UL slots in a UL/DL pattern containing a marker.

Parameters:

<Slots> integer
 Range: 0 to 10
 *RST: 0

Example: See [Example "Configure and enable an UL/DL marker"](#) on page 410.

Manual operation: See ["Number of UL Slots"](#) on page 312

[[:SOURce<hw>]:BB:NR5G:TRIGger:OUTPut<ch>:SCSPacing <Scs>

Defines the subcarrier spacing (SCS) value for a UL/DL pattern containing a marker.

The available values depend on the set [Deployment](#) value.

Parameters:

<Scs> SCS15 | SCS30 | SCS60 | SCS120 | SCS240 | SCS480 | SCS960
 *RST: SCS30

Example: See [Example "Configure and enable an UL/DL marker"](#) on page 410.

Manual operation: See ["Subcarrier Spacing"](#) on page 311

[[:SOURce<hw>]:BB:NR5G:TRIGger:OUTPut<ch>:SLInt <Slots>

Sets the duration of a UL/DL pattern containing a marker.

Parameters:

<Slots> integer
 Range: 1 to 20
 *RST: 10

Example: See [Example "Configure and enable an UL/DL marker"](#) on page 410.

Manual operation: See ["Slot Period"](#) on page 311

[[:SOURce<hw>]:BB:NR5G:TRIGger:OUTPut<ch>:IAB:STATE <State>

Turns usage of the IAB frame format on and off.

Parameters:

<State> 1 | ON | 0 | OFF
 *RST: 0

Example: See [Example "Configure and enable standard marker signals"](#) on page 410.

Manual operation: See ["Use IAB Format"](#) on page 311

[:SOURce<hw>]:BB:NR5G:TRIGger:OUTPut<ch>:SSC:NDLSymbols <Symbols>

Defines the number of uplink symbols in a special slot that contains a marker.

Prerequisites to define the number of downlink symbols:

- Enter uplink mode ([:SOURce<hw>] :BB:NR5G:LINK).
- Turn off usage of special slot format ([:SOURce<hw>] :BB:NR5G:TRIGger:OUTPut<ch>:SSC:SFI:STATE).

Otherwise, the command is a query only.

Parameters:

<Symbols> integer
 Range: 0 to 14
 *RST: 14

Example: See [Example"Configure and enable an UL/DL marker"](#) on page 410.

Manual operation: See ["Number of DL Symbols"](#) on page 312

[:SOURce<hw>]:BB:NR5G:TRIGger:OUTPut<ch>:SSC:NGSYmbols?

Queries the number of guarded symbols in the special slot of a UL/DL pattern containing a marker.

Return values:

<GuardedSymbols> integer
 Range: 0 to 14
 *RST: 0

Example: See [Example"Configure and enable an UL/DL marker"](#) on page 410.

Usage: Query only

Manual operation: See ["Number of Guarded Symbols"](#) on page 313

[:SOURce<hw>]:BB:NR5G:TRIGger:OUTPut<ch>:SSC:NULSymbols <Symbols>

Defines the number of uplink symbols in a special slot that contains a marker.

Prerequisites to define the number of downlink symbols:

- Enter uplink mode ([:SOURce<hw>] :BB:NR5G:LINK).
- Turn off usage of special slot format ([:SOURce<hw>] :BB:NR5G:TRIGger:OUTPut<ch>:SSC:SFI:STATE).

Otherwise, the command is a query only.

Parameters:

<Symbols> integer
 Range: 0 to 14
 *RST: n.a. (no preset. default: 0)

Example: See [Example"Configure and enable an UL/DL marker"](#) on page 410.

Manual operation: See ["Number of UL Symbols"](#) on page 313

[:SOURce<hw>]:BB:NR5G:TRIGger:OUTPut<ch>:SSC:SFI:STATe <State>

Turns usage of the special slot format on and off.

If on, select a special frame as defined by 3GPP with [\[:SOURce<hw>\]:BB:NR5G:TRIGger:OUTPut<ch>:SSC:SLFMt](#).

If off, select the number of symbols with

- Downlink: [\[:SOURce<hw>\]:BB:NR5G:TRIGger:OUTPut<ch>:SSC:NDLSymbols](#)
- Uplink: [\[:SOURce<hw>\]:BB:NR5G:TRIGger:OUTPut<ch>:SSC:NULSymbols](#)

Parameters:

<State> 1 | ON | 0 | OFF
 *RST: 1

Example: See [Example"Configure and enable an UL/DL marker"](#) on page 410.

Manual operation: See ["Use Special Format Index"](#) on page 312

[:SOURce<hw>]:BB:NR5G:TRIGger:OUTPut<ch>:SSC:SLFMt <SpecSlotFmtIdx>

Sets the special slot format index of the special slot included in a UL/DL pattern containing a marker according to [TS 38.213](#).

Parameters:

<SpecSlotFmtIdx> integer
 Range: 0 to 45
 *RST: 0

Example: See [Example"Configure and enable an UL/DL marker"](#) on page 410.

Manual operation: See ["Slot Format Index"](#) on page 312

10.33 Clock commands

[\[:SOURce<hw>\]:BB:NR5G:CLOCK:SOURce.....](#)748

[:SOURce<hw>] :BB:NR5G:CLOCK:SOURce <ClockSour>

Selects the clock source:

- INTernal: Internal clock reference
- ELCLock: External local clock
- EXTernal = ELCLock: Setting only
Provided for backward compatibility with other Rohde & Schwarz signal generators

Parameters:

<ClockSour> INTernal
 *RST: INTernal

Example: See [Example "Clock settings"](#) on page 410.

Manual operation: See ["Clock Source"](#) on page 314

10.34 Test case wizard remote-control commands

The signal generator gives you the opportunity to use predefined settings which enable base station tests in line with the 3GPP standard. In particular, it allows you to execute 5G test cases described in the specifications [TS 38.141-1](#) and [TS 38.141-2](#). The settings take effect only after execution of command `[:SOURce<hw>] :BB:NR5G:TCW:APPLY`.

<code>[:SOURce<hw>] :BB:NR5G:TCW:APPLY</code>	749
<code>[:SOURce<hw>] :BB:NR5G:TCW:ANT:RXAntennas</code>	749
<code>[:SOURce<hw>] :BB:NR5G:TCW:ANT:TXAntennas</code>	750
<code>[:SOURce<hw>] :BB:NR5G:TCW:AWGN:PLEVel?</code>	750
<code>[:SOURce<hw>] :BB:NR5G:TCW:BEWPhi</code>	750
<code>[:SOURce<hw>] :BB:NR5G:TCW:BEWThet</code>	750
<code>[:SOURce<hw>] :BB:NR5G:TCW:BSCLass</code>	751
<code>[:SOURce<hw>] :BB:NR5G:TCW:BSTYpe</code>	751
<code>[:SOURce<hw>] :BB:NR5G:TCW:DCLDirection</code>	751
<code>[:SOURce<hw>] :BB:NR5G:TCW:IS:DISTance</code>	752
<code>[:SOURce<hw>] :BB:NR5G:TCW:E50</code>	752
<code>[:SOURce<hw>] :BB:NR5G:TCW:FA:FRALlocation</code>	752
<code>[:SOURce<hw>] :BB:NR5G:TCW:GENSignal</code>	752
<code>[:SOURce<hw>] :BB:NR5G:TCW:IS:BAND</code>	753
<code>[:SOURce<hw>] :BB:NR5G:TCW:IS:CHBW?</code>	753
<code>[:SOURce<hw>] :BB:NR5G:TCW:IS:DUPLex</code>	753
<code>[:SOURce<hw>] :BB:NR5G:TCW:IS:OFN</code>	753
<code>[:SOURce<hw>] :BB:NR5G:TCW:OPTStr?</code>	753
<code>[:SOURce<hw>] :BB:NR5G:TCW:IS2:PLEVel?</code>	754
<code>[:SOURce<hw>] :BB:NR5G:TCW:IS:PLEVel?</code>	754
<code>[:SOURce<hw>] :BB:NR5G:TCW:IS2:RFFRequency?</code>	754
<code>[:SOURce<hw>] :BB:NR5G:TCW:IS:RFFRequency</code>	754
<code>[:SOURce<hw>] :BB:NR5G:TCW:IS:TMODeL?</code>	754
<code>[:SOURce<hw>] :BB:NR5G:TCW:IS:UEID</code>	754
<code>[:SOURce<hw>] :BB:NR5G:TCW:MARKerconfig</code>	755

Test case wizard remote-control commands

[SOURce<hw>]:BB:NR5G:TCW:MEIS.....	755
[SOURce<hw>]:BB:NR5G:TCW:MUE:TSRS.....	755
[SOURce<hw>]:BB:NR5G:TCW:RELease.....	756
[SOURce<hw>]:BB:NR5G:TCW:SPEC.....	756
[SOURce<hw>]:BB:NR5G:TCW:TC.....	756
[SOURce<hw>]:BB:NR5G:TCW:TRIGgerconfig.....	757
[SOURce<hw>]:BB:NR5G:TCW:WS:ADMRs:STATe.....	758
[SOURce<hw>]:BB:NR5G:TCW:WS:CBW.....	758
[SOURce<hw>]:BB:NR5G:TCW:WS:CELLid.....	758
[SOURce<hw>]:BB:NR5G:TCW:WS:DUPLex.....	759
[SOURce<hw>]:BB:NR5G:TCW:WS:FMTHroughput.....	759
[SOURce<hw>]:BB:NR5G:TCW:WS:FRC:TYPE.....	759
[SOURce<hw>]:BB:NR5G:TCW:WS:FROffset.....	762
[SOURce<hw>]:BB:NR5G:TCW:WS:MAPType.....	762
[SOURce<hw>]:BB:NR5G:TCW:WS:MODE.....	762
[SOURce<hw>]:BB:NR5G:TCW:WS:PLEVel.....	763
[SOURce<hw>]:BB:NR5G:TCW:WS:PRACH:FORMat.....	763
[SOURce<hw>]:BB:NR5G:TCW:WS:PRACH:SCSPacing.....	763
[SOURce<hw>]:BB:NR5G:TCW:WS:PROCondition.....	764
[SOURce<hw>]:BB:NR5G:TCW:WS:RBOffset.....	764
[SOURce<hw>]:BB:NR5G:TCW:WS:RFFRequency.....	764
[SOURce<hw>]:BB:NR5G:TCW:WS:RSET.....	764
[SOURce<hw>]:BB:NR5G:TCW:WS:SCSPacing.....	765
[SOURce<hw>]:BB:NR5G:TCW:WS:SYMNumber.....	765
[SOURce<hw>]:BB:NR5G:TCW:WS:TAPos.....	766
[SOURce<hw>]:BB:NR5G:TCW:WS:TIOBase?.....	766
[SOURce<hw>]:BB:NR5G:TCW:WS:TSETup.....	766
[SOURce<hw>]:BB:NR5G:TCW:WS:UCI:BITS.....	766
[SOURce<hw>]:BB:NR5G:TCW:WS:UCI:CGUCi:PATtern.....	767
[SOURce<hw>]:BB:NR5G:TCW:WS:UCI:CSI1:PATtern.....	767
[SOURce<hw>]:BB:NR5G:TCW:WS:UCI:CSI2:PATtern.....	767
[SOURce<hw>]:BB:NR5G:TCW:WS:UCI:CSIPart.....	767
[SOURce<hw>]:BB:NR5G:TCW:WS:UEID.....	767
[SOURce<hw>]:BB:NR5G:TCW:WS:TREquire.....	768
[SOURce<hw>]:BB:NR5G:TCW:WS:VDRF.....	768
[SOURce<hw>]:BB:NR5G:TCW:SUE:TSRS.....	768

[SOURce<hw>]:BB:NR5G:TCW:APPLY

Activates the current settings of the test case wizard.

Note: The settings of the selected test case become active only after executing this command.

Usage: Event

Manual operation: See "Apply,OK" on page 343

[SOURce<hw>]:BB:NR5G:TCW:ANT:RXAntennas <RXAntennas>

Shows or sets the number of Rx antennas used for test case.

Parameters:

<RXAntennas> ANT1 | ANT2 | ANT4 | ANT8
 *RST: ANT2

[[:SOURce<hw>]:BB:NR5G:TCW:ANT:TXAntennas <TXAntennas>

Shows or sets the number of Tx antennas used for test case.

Parameters:

<TXAntennas> ANT1 | ANT2
 *RST: ANT1

[[:SOURce<hw>]:BB:NR5G:TCW:AWGN:PLEvel?

Queries the AWGN power level.

Return values:

<AwgnPowLev> string
 Default unit: dBm

Usage: Query only

Manual operation: See "[Power Level](#)" on page 360

[[:SOURce<hw>]:BB:NR5G:TCW:BEWPhi <BeWPhiRefsens>

Sets the angle of the beamwidth for to the OTA REFSENS RoAoA in the φ -axis ($BeW_{\theta,REFSENS}$), applicable for FR1 only.

Parameters:

<BeWPhiRefsens> float
 Range: 0.1 to 360
 Increment: 0.1
 *RST: 300

Manual operation: See "[BeW\(\$\varphi\$ REFSENS\)](#)" on page 346

[[:SOURce<hw>]:BB:NR5G:TCW:BEWThet <BeWThetRefsens>

Sets the angle of the beamwidth for to the OTA REFSENS RoAoA in the θ -axis ($BeW_{\theta,REFSENS}$), applicable for FR1 only.

Parameters:

<BeWThetRefsens> float
 Range: 0.1 to 360
 Increment: 0.1
 *RST: 300

Manual operation: See "[BeW\(\$\theta\$ REFSENS\)](#)" on page 346

[:SOURce<hw>]:BB:NR5G:TCW:BSClass <BSClass>

Sets the NR base station class.

Parameters:

<BSClass> WIDE | MED | LOC
 *RST: WIDE

Example:

```
SOURce1:BB:NR5G:TCW:TC TS381411_TC741
SOURce1:BB:NR5G:TCW:BSClass LOC
SOURce1:BB:NR5G:TCW:WS:PLEVel?
Response: "-87.8 dBm"
```

Manual operation: See "[Base Station Class](#)" on page 344

[:SOURce<hw>]:BB:NR5G:TCW:BSType <BsType>

Sets the base station type for the OTA settings as specified in [TS 38.141-2 D.5](#).

Parameters:

<BsType> BT1H | BT1O | BT2O

BT1

Sets the BS type 1-H (FR1, hybrid) for the OTA settings.

BT1O

Sets the BS type 1-O (FR1) for the OTA settings.

BT2O

Sets the BS type 2-O (FR2) for the OTA settings.

*RST: BT1O

Manual operation: See "[Base Station Type](#)" on page 345

[:SOURce<hw>]:BB:NR5G:TCW:DCLDirection <DeclaredDir>

Sets the reference for the OSDD.

Parameters:

<DeclaredDir> OTHD | MREFD | OREFD

OTHD

Sets a value different than the minSENS and REFSENS as the reference for the OSDD.

MREFD

Sets the OTA minimum sensitivity (minSENS) value as the reference for the OSDD.

OREFD

Sets the OTA reference sensitivity (REFSENS) value as the reference for the OSDD.

*RST: MREFD

Manual operation: See "[Declared Direction](#)" on page 345

[:SOURce<hw>]:BB:NR5G:TCW:IS:DISTance <Distance>

Sets the distance between the test object and test antenna injecting the interferer signal.

Parameters:

<Distance> integer
Range: 1 to 300
*RST: 100

[:SOURce<hw>]:BB:NR5G:TCW:E50 <EIS50M>

Sets the $EIS_{REFSENS_50M}$ level value applicable in the OTA REFSENS RoAoA as specified in [TS 38.141-2 D.28](#).

The $EIS_{REFSENS_50M}$ value is the declared OTA reference sensitivity basis level for FR2 based on a reference measurement channel with 50MHz BS channel bandwidth.

Parameters:

<EIS50M> float
Range: -119 to -86
Increment: 0.1
*RST: -101

Manual operation: See "[EIS 50M](#)" on page 346

[:SOURce<hw>]:BB:NR5G:TCW:FA:FRAllocation <FreqAlloc>

Sets the frequency allocation to FR1 or FR2.

Parameters:

<FreqAlloc> LOW | HIGH
*RST: HIGH

Manual operation: See "[Frequency Allocation of the Interfering signal](#)" on page 354

[:SOURce<hw>]:BB:NR5G:TCW:GENSignal <Signal>

Selects the generated signal.

Parameters:

<Signal> **ALL**
Generates both the wanted and the interferer signal.
IF
Generates only the interferer signal.
WS
Generates only the wanted signal.
*RST: ALL

Manual operation: See "[Generated Signal](#)" on page 348

[:SOURce<hw>]:BB:NR5G:TCW:IS:BAND <Band>

Set the frequency band (n1 to n86) for the interfering signal.

Parameters:

<Band> N1 | N2 | N3 | N5 | N7 | N8 | N12 | N20 | N25 | N28 | N34 | N38 |
 N39 | N40 | N41 | N50 | N51 | N66 | N70 | N71 | N74 | N75 |
 N76 | N77 | N78 | N79 | N80 | N81 | N82 | N83 | N84 | N86
 *RST: N1

Manual operation: See "[Band](#)" on page 355

[:SOURce<hw>]:BB:NR5G:TCW:IS:CHBW?

Queries the channel bandwidth of the interfering signal.

Return values:

<ISCHBW> BW3 | BW5 | BW10 | BW15 | BW20 | BW25 | BW30 | BW35 |
 BW40 | BW45 | BW50 | BW60 | BW70 | BW80 | BW90 | BW100 |
 BW200 | BW400 | BW800 | BW1600 | BW2000
 *RST: BW5

Usage: Query only

Manual operation: See "[Channel Bandwidth](#)" on page 356

[:SOURce<hw>]:BB:NR5G:TCW:IS:DUPLex <ISDuplexing>

The duplexing mechanism used for the interfering signal can be switched between FDD and TDD.

Parameters:

<ISDuplexing> FDD | TDD
 *RST: FDD

Manual operation: See "[Duplexing](#)" on page 355

[:SOURce<hw>]:BB:NR5G:TCW:IS:OFN <OffsetFactorN>

Set the offset factor for the interfering signal.

Parameters:

<OffsetFactorN> OFN_1 | OFN_2 | OFN_3
 *RST: OFN_1

Manual operation: See "[n](#)" on page 355

[:SOURce<hw>]:BB:NR5G:TCW:OPTStr?

Queries missing options for the selected test case if there are any.

Return values:

<Options> string

Usage: Query only

[:SOURce<hw>]:BB:NR5G:TCW:IS2:PLEVel?

[:SOURce<hw>]:BB:NR5G:TCW:IS:PLEVel?

Queries the power level of the interfering signal.

Return values:

<ISPowLevel> float

Range: -145 to 20

Increment: 0.1

*RST: -52

Default unit: dBm

Usage: Query only**Manual operation:** See ["Power Level"](#) on page 357See ["Power Level"](#) on page 359

[:SOURce<hw>]:BB:NR5G:TCW:IS2:RFFFrequency?

[:SOURce<hw>]:BB:NR5G:TCW:IS:RFFFrequency <ISRFFreq>

Queries the center frequency of the interfering signal 1 and 2.

Parameters:

<ISRFFreq> integer

Range: 100e+03 to 6e+09

*RST: 1.9575075e+09

Default unit: Hz

Manual operation: See ["RF Frequency"](#) on page 356

[:SOURce<hw>]:BB:NR5G:TCW:IS:TMODeI?

Shows the test model set for the test case. The NR-TMs for FR1 are defined in TS 38.141-1 section 4.9.2.

Return values:

<TestModel> TM1_1

*RST: TM1_1

Usage: Query only**Manual operation:** See ["Test Model"](#) on page 355

[:SOURce<hw>]:BB:NR5G:TCW:IS:UEID <ISUEID>

Sets the UE ID/n_RNTI for the interfering signal.

Parameters:

<ISUEID> integer
 Range: 0 to 65535
 *RST: 0

Manual operation: See ["UE ID"](#) on page 359

[[:SOURce<hw>]:BB:NR5G:TCW:MARKerconfig <MarkerConfig>

Selects the marker configuration. The marker can be used to synchronize the measuring equipment to the signal generator.

Parameters:

<MarkerConfig> FRAM | UNCH

FRAM
 The marker settings are customized for the selected test case. "Radio Frame Start" markers are output; the marker delays are set equal to zero.

UNCH
 The current marker settings of the signal generator are retained unchanged.

*RST: FRAM

Manual operation: See ["Marker Configuration"](#) on page 347

[[:SOURce<hw>]:BB:NR5G:TCW:MEIS <MinimumEIS>

Sets the lowest equivalent isotropic sensitivity value ($EIS_{\min\text{SENS}}$) for the OSDD as specified in [TS 38.141-2 D.27](#).

Parameters:

<MinimumEIS> float
 Range: -145 to -10
 Increment: 0.1
 *RST: -101

Manual operation: See ["Minimum EIS"](#) on page 346

[[:SOURce<hw>]:BB:NR5G:TCW:MUE:TSRS <TransmitSRS>

Turns transmission of the sounding reference signal for 3GPP test cases on and off.

Parameters:

<TransmitSRS> 1 | ON | 0 | OFF
 *RST: 0

Manual operation: See ["Transmit SRS"](#) on page 358

[:SOURCE<hw>]:BB:NR5G:TCW:RELease <Release>

Sets the 3GPP test specification used as a guideline for the test cases.

Parameters:

<Release> REL15 | REL16 | REL17
*RST: REL15

Manual operation: See "[Release](#)" on page 344

[:SOURCE<hw>]:BB:NR5G:TCW:SPEC <TestSpec>

Specifies the 3GPP test specification.

Parameters:

<TestSpec> TS38141_1 | TS38141_2 | TS38104
*RST: TS38141_1

Manual operation: See "[Test Specification](#)" on page 344

[:SOURCE<hw>]:BB:NR5G:TCW:TC <TestCase>

Selects the test case.

Parameters:

<TestCase> TS381411_TC72 | TS381411_TC73 | TS381411_TC741 |
 TS381411_TC742A | TS381411_TC742B | TS381411_TC75 |
 TS381411_TC77 | TS381411_TC78 | TS381411_TC821 |
 TS381411_TC822 | TS381411_TC823 | TS381411_TC831 |
 TS381411_TC8321 | TS381411_TC8322 | TS381411_TC8331 |
 TS381411_TC8332 | TS381411_TC834 | TS381411_TC835 |
 TS381411_TC8361A | TS381411_TC8361B |
 TS381411_TC841 | TS381411_TC67 | TS381412_TC72 |
 TS381412_TC73 | TS381412_TC74 | TS381412_TC751 |
 TS381412_TC752A | TS381412_TC752B | TS381412_TC76 |
 TS381412_TC78 | TS381412_TC79 | TS381412_TC821 |
 TS381412_TC822 | TS381412_TC823 | TS381412_TC831 |
 TS381412_TC8321 | TS381412_TC8322 | TS381412_TC8331 |
 TS381412_TC8332 | TS381412_TC834 | TS381412_TC835 |
 TS381412_TC8361A | TS381412_TC8361B |
 TS381412_TC841 | TS381412_TC68 | TS381411_TC824 |
 TS381411_TC825 | TS381411_TC826 | TS381411_TC827 |
 TS381411_TC828 | TS381411_TC829 | TS381412_TC824 |
 TS381412_TC825 | TS381412_TC826 | TS381412_TC827 |
 TS381412_TC828 | TS381412_TC829 | TS381411_TC8210 |
 TS381412_TC8210 | TS381411_TC8211 | TS381412_TC8211 |
 TS381411_TC837 | TS381412_TC837 | TS381411_TC8381 |
 TS381412_TC8381 | TS381411_TC8382 | TS381412_TC8382 |
 TS381411_TC839 | TS381412_TC839 | TS381411_TC8310 |
 TS381412_TC8310 | TS381411_TC8212 | TS381412_TC8212 |
 TS381411_TC8213 | TS381412_TC8213 | TS381411_TC8311 |
 TS381412_TC8311 | TS381411_TC83122 |
 TS381411_TC83121 | TS381412_TC83121 |
 TS381411_TC8313 | TS381412_TC83122 | TS381412_TC8313

The first part of the parameter indicates the standard document and the second part the chapter in which the test case is defined. For example, TS381411_TC72 defines the test case specified in [TS 38.141-1](#) chapter 7.2.

*RST: TS381411_TC72

Manual operation: See "[Test Case](#)" on page 344

[:SOURce<hw>]:BB:NR5G:TCW:TRIGgerconfig <TrigConfig>

Selects the trigger configuration. The trigger is used to synchronize the signal generator to the other equipment.

Parameters:

<TrigConfig> AAUT | UNCH

AAUT

The trigger settings are customized for the selected test case. The trigger setting "Armed Auto" with external trigger source is used; the trigger delay is set to zero.

Thus, the base station frame timing is able to synchronize the signal generator by a periodic trigger.

UNCH

The current trigger settings of the signal generator are retained unchanged.

*RST: AAUT

Manual operation: See ["Trigger Configuration"](#) on page 347

[[:SOURce<hw>]:BB:NR5G:TCW:WS:ADMRs:STATe <AddDmrs>

Enables or disabled the additional DMRS.

Additional DMRS signals increase the probability that the UE receives the demodulation reference symbols. It leads to a support of lower SNR conditions.

Parameters:

<AddDmrs> 1 | ON | 0 | OFF

*RST: 0

Manual operation: See ["Additional DMRS"](#) on page 349

[[:SOURce<hw>]:BB:NR5G:TCW:WS:CBW <WSChBw>

Selects the channel bandwidth.

Parameters:

<WSChBw> BW3 | BW5 | BW10 | BW15 | BW20 | BW25 | BW30 | BW35 |
BW40 | BW45 | BW50 | BW60 | BW70 | BW80 | BW90 | BW100 |
BW200 | BW400 | BW800 | BW1600 | BW2000

Bandwidth in MHz

*RST: BW10

Manual operation: See ["Channel Bandwidth"](#) on page 349
See ["Channel Bandwidth"](#) on page 358

[[:SOURce<hw>]:BB:NR5G:TCW:WS:CELLid <WSCellId>

Sets the cell ID.

Parameters:

<WSCellId> integer

Range: 0 to 1007

*RST: 0

Manual operation: See ["Cell ID"](#) on page 349
See ["Cell ID"](#) on page 358

[:SOURce<hw>]:BB:NR5G:TCW:WS:DUPLex <Duplexing>

The duplexing mechanism used can be switched between FDD and TDD.

Parameters:

<Duplexing> FDD | TDD
*RST: FDD

Manual operation: See "[Duplexing](#)" on page 350
 See "[Duplexing](#)" on page 358

[:SOURce<hw>]:BB:NR5G:TCW:WS:FMTHroughput <FMT>

The required throughput is expressed as a fraction of maximum throughput for the FRC. The performance requirements assume HARQ retransmissions.

The throughput shall be equal to or larger than the fraction of maximum throughput for the FRCs at the given SNR.

Parameters:

<FMT> FMT70 | FMT30
*RST: FMT70

Manual operation: See "[Fraction of Max. Throughput](#)" on page 350

[:SOURce<hw>]:BB:NR5G:TCW:WS:FRC:TYPE <WSFrc>

Queries the fixed reference channel (FRC) used.

See also 3GPP TS 138 141-1, annex A (normative): Reference measurement channels.

Parameters:

<WSFrc>

FR1A11 | FR1A12 | FR1A13 | FR1A14 | FR1A15 | FR1A16 |
 FR1A17 | FR1A18 | FR1A19 | FR2A11 | FR2A12 | FR2A13 |
 FR2A14 | FR2A15 | FR1A21 | FR1A22 | FR1A23 | FR1A24 |
 FR1A25 | FR1A26 | NA | FR1A38 | FR1A39 | FR1A310 |
 FR1A311 | FR1A312 | FR1A313 | FR1A314 | FR1A322 |
 FR1A323 | FR1A324 | FR1A325 | FR1A326 | FR1A327 |
 FR1A328 | FR1A48 | FR1A49 | FR1A410 | FR1A411 |
 FR1A412 | FR1A413 | FR1A414 | FR1A422 | FR1A423 |
 FR1A424 | FR1A425 | FR1A426 | FR1A427 | FR1A428 |
 FR1A58 | FR1A59 | FR1A510 | FR1A511 | FR1A512 |
 FR1A513 | FR1A514 | FR1A331 | FR1A332 | FR2A31 |
 FR2A32 | FR2A33 | FR2A34 | FR2A35 | FR2A36 | FR2A37 |
 FR2A38 | FR2A39 | FR2A310 | FR2A311 | FR2A312 | FR2A41 |
 FR2A42 | FR2A43 | FR2A44 | FR2A45 | FR2A46 | FR2A47 |
 FR2A48 | FR2A49 | FR2A410 | FR2A51 | FR2A52 | FR2A53 |
 FR2A54 | FR2A55 | FR2A313 | FR2A314 | FR2A315 |
 FR2A316 | FR2A317 | FR2A318 | FR2A319 | FR2A320 |
 FR2A321 | FR2A322 | FR2A323 | FR2A324 | FR2A411 |
 FR2A412 | FR2A413 | FR2A414 | FR2A415 | FR2A416 |
 FR2A417 | FR2A418 | FR2A419 | FR2A420 | FR2A56 |
 FR2A57 | FR2A58 | FR2A59 | FR2A510 | FR1A31 | FR1A32 |
 FR1A33 | FR1A34 | FR1A35 | FR1A36 | FR1A37 | FR1A315 |
 FR1A316 | FR1A317 | FR1A318 | FR1A319 | FR1A320 |
 FR1A321 | FR1A329 | FR1A330 | FR1A41 | FR1A42 | FR1A43 |
 FR1A44 | FR1A45 | FR1A46 | FR1A47 | FR1A415 | FR1A416 |
 FR1A417 | FR1A418 | FR1A419 | FR1A420 | FR1A421 |
 FR1A51 | FR1A52 | FR1A53 | FR1A54 | FR1A55 | FR1A56 |
 FR1A57 | FR1A110 | FR1A111 | FR1A333 | FR1A333A |
 FR1A334 | FR1A334A | FR2A71 | FR2A72 | FR2A73 | FR2A74 |
 FR2A75 | FR2A76 | FR2A77 | FR2A78 | FR2A79 | FR2A710 |
 FR1A429 | FR1A429A | FR1A430 | FR1A430A | FR1A431A |
 FR1A431 | FR1A432A | FR1A432 | FR1A3A1 | FR1A3A2 |
 FR1A3A3 | FR1A3A4 | FR1A3B1 | FR1A3B2 | FR1A3B3 |
 FR1A3B4 | TS381411_FR1A71 | TS381411_FR1A72 |
 TS381411_FR1A73 | TS381411_FR1A74 | TS381412_FR1A81 |
 TS381412_FR1A82 | TS381412_FR1A83 |
 TS381412_FR1A84 | FR2A325 | FR2A326 | FR2A3A1 |
 FR2A3A2 | FR2A3A3 | FR2A3A4 | FR2A3A5 | FR2A3A6 |
 FR2A3A7 | FR2A3A8 | TS38176_FR1A211 |
 TS38176_FR1A212 | TS38176_FR1A213 |
 TS38176_FR1A214 | TS38176_FR1A215 |
 TS38176_FR1A216 | TS38176_FR1A217 |
 TS38176_FR1A218 | TS38176_FR1A219 |
 TS38176_FR1A2110 | TS38176_FR1A2111 |
 TS38176_FR1A2112 | TS38176_FR1A2113 |
 TS38176_FR1A2114 | TS38176_FR1A2115 |
 TS38176_FR1A2116 | TS38176_FR1A231 |
 TS38176_FR1A232 | TS38176_FR1A233 |
 TS38176_FR1A234 | TS38176_FR1A235 |

Test case wizard remote-control commands

TS38176_FR1A236 | TS38176_FR1A237 |
TS38176_FR1A238 | TS38176_FR1A239 |
TS38176_FR1A2310 | TS38176_FR1A2311 |
TS38176_FR1A2312 | TS38176_FR1A2313 |
TS38176_FR1A2314 | TS38176_FR1A241 |
TS38176_FR1A242 | TS38176_FR1A243 |
TS38176_FR1A244 | TS38176_FR1A245 |
TS38176_FR1A246 | TS38176_FR1A247 | TS38176_FR2A211 |
TS38176_FR2A212 | TS38176_FR2A213 |
TS38176_FR2A214 | TS38176_FR2A215 |
TS38176_FR2A216 | TS38176_FR2A217 |
TS38176_FR2A218 | TS38176_FR2A219 |
TS38176_FR2A2110 | TS38176_FR2A2111 |
TS38176_FR2A2112 | TS38176_FR2A2113 |
TS38176_FR2A2114 | TS38176_FR2A2115 |
TS38176_FR2A2116 | TS38176_FR2A2117 |
TS38176_FR2A2118 | TS38176_FR2A2119 |
TS38176_FR2A2120 | TS38176_FR2A2121 |
TS38176_FR2A2122 | TS38176_FR2A2123 |
TS38176_FR2A2124 | TS38176_FR2A221 |
TS38176_FR2A222 | TS38176_FR2A223 |
TS38176_FR2A224 | TS38176_FR2A225 |
TS38176_FR2A226 | TS38176_FR2A227 |
TS38176_FR2A228 | TS38176_FR2A229 |
TS38176_FR2A2210 | TS38176_FR2A231 |
TS38176_FR2A232 | TS38176_FR2A233 |
TS38176_FR2A234 | TS38176_FR2A235 |
TS38176_FR2A236 | TS38176_FR2A237 |
TS38176_FR2A238 | TS38176_FR2A239 |
TS38176_FR2A2310 | TS38176_FR2A2311 |
TS38176_FR2A2312 | TS38176_FR2A2313 |
TS38176_FR2A2314 | TS38176_FR2A2315 |
TS38176_FR2A2316 | TS38176_FR2A2317 |
TS38176_FR2A2318 | TS38176_FR2A2319 |
TS38176_FR2A2320 | TS38176_FR2A241 |
TS38176_FR2A242 | TS38176_FR2A243 |
TS38176_FR2A244 | TS38176_FR2A245 |
TS38176_FR2A246 | TS38176_FR2A247 |
TS38176_FR2A248 | TS38176_FR2A249 |
TS38176_FR2A2410 | FR1A112 | FR1A113 | FR1A114 |
FR1A115 | FR1A116 | FR1A117 | FR1A118 | FR1A119 |
FR1A27 | FR1A28 | FR1A29 | FR1A210 | FR1A211 | FR1A212 |
FR1A213 | FR1A214 | FR1A215 | FR1A216 |
TS381411_FR1A82 | TS381411_FR1A83 | TS381411_FR1A84 |
TS381411_FR1A81 | TS381411_FR1A85 | TS381412_FR1A91 |
TS381412_FR1A92 | TS381412_FR1A93 |
TS381412_FR1A94 | TS381412_FR1A95 | TS38181_FR1A11 |
TS38181_FR1A12 | TS38181_FR1A13 | TS38181_FR1A14 |
TS38181_FR1A15 | TS38181_FR1A16 | TS38181_FR1A17 |
TS38181_FR1A18 | TS38181_FR1A19 | TS38181_FR1A21 |

TS38181_FR1A22 | TS38181_FR1A23 | TS38181_FR1A24 |
 TS38181_FR1A25 | TS38181_FR1A26 | TS38181_FR1A31 |
 TS38181_FR1A32 | TS38181_FR1A33 | TS38181_FR1A34 |
 TS38181_FR1A35 | TS38181_FR1A36 | TS38181_FR1A3A1 |
 TS38181_FR1A3A3 | FR2A101 | FR2A102 | FR2A103 |
 FR2A105 | FR2A104 | FR2A106 | FR2A107 | FR2A108 |
 FR2A109 | FR2A1010 | FR2A1011 | FR2A1012 | FR1A335 |
 FR1A337 | FR1A336 | FR1A338 | FR1A3B5 | FR1A3B6 |
 FR1A3B7 | FR1A3B8 | FR2A327 | FR2A3B1 | FR2A3B2

FRxAyz: FRC G-FRx-Ay-z

*RST: FR1A12

Example:

SOURce1:BB:NR5G:TCW:WS:FRC:TYPE?

FR1A23 means G-FR1-A2-3

Manual operation:

See "FRC" on page 350

See "FRC" on page 358

[:SOURce<hw>]:BB:NR5G:TCW:WS:FROffset <FreqOffset>

Sets the frequency offset used for the PRACH.

Parameters:

<FreqOffset> FO_0 | FO_400 | FO_4000 | FO_625 | FO_1340 | FO_1740 |
 FO_2334 | FO_3334 | FO_19444

*RST: FO_0

Manual operation:

See "Frequency Offset" on page 350

[:SOURce<hw>]:BB:NR5G:TCW:WS:MAPType <MapType>

Sets the mapping type A or B for the PUSCH.

Parameters:

<MapType> A | B

*RST: A

Manual operation:

See "Mapping Type" on page 350

See "Mapping Type" on page 358

[:SOURce<hw>]:BB:NR5G:TCW:WS:MODE <Mode>

Switches between the detection rate (Pd) and the false detection rate (Pfa).

Parameters:

<Mode> DRAT | FDR

DRAT

Pd is defined as the probability of detection of preamble.

FDR

Pfa is defined as the total probability of false detection of the preamble.

*RST: DRAT

Manual operation: See ["Mode"](#) on page 351

[[:SOURce<hw>]:BB:NR5G:TCW:WS:PLEVel <WSPowLev>

Specifies the power level of the wanted signal.

Parameters:

<WSPowLev> float
 Range: -145 to 20
 Increment: 0.1
 *RST: -101.1
 Default unit: dB

Manual operation: See ["Power Level"](#) on page 351
 See ["Power Level"](#) on page 359

[[:SOURce<hw>]:BB:NR5G:TCW:WS:PRACH:FORMat <PrachFormat>

Sets the designated PRACH preamble format.

The preamble is used to obtain the UL synchronization. In 5G NR, there are 64 preambles defined in each time-frequency PRACH occasion. The preamble consists of two parts cyclic prefix (CP) and preamble sequence.

In 5G NR, there are 13 types of preamble format supported known as format 0, format 1, format 2, format 3, format A1, format A2, format A3, format B1, format B2, format B3, format B4, format C0, format C1.

Parameters:

<PrachFormat> F0 | FA1 | FA2 | FA3 | FB4 | FC0 | FC2
 *RST: FA1

Manual operation: See ["Preamble Format"](#) on page 351

[[:SOURce<hw>]:BB:NR5G:TCW:WS:PRACH:SCSPacing <PrachSCS>

Sets the subcarrier spacing using normal cyclic prefix (NCP) or extended cyclic prefix (ECP).

Parameters:

<PrachSCS> N1_25 | N15 | N30 | N60 | N120
 *RST: N30

Manual operation: See ["Sub Carrier Spacing \(PRACH\)"](#) on page 352

[:SOURce<hw>]:BB:NR5G:TCW:WS:PROCondition <PropagCond>

The propagation conditions define the multipath fading environment.

They indicated as a combination of channel model name and maximum Doppler frequency, i.e. TDLA<DS>-<Doppler> where <DS> indicates the desired delay spread and <Doppler> indicates the maximum Doppler frequency.

Parameters:

<PropagCond> TDLB100D400 | TDLC300D100 | TDLA30D10 | AWGN |
 TDLA30D300 | TDLA30D75 | HST1NR350 | HST3NR350 |
 HST1NR500 | HST3NR500 | TDLC300D600 | TDLC300D1200 |
 MPX | MPY | MPZ
 *RST: TDLB100D400

Manual operation: See "[Propagation Conditions](#)" on page 351
 See "[Propagation Conditions](#)" on page 358

[:SOURce<hw>]:BB:NR5G:TCW:WS:RBOffset <WSRbOffset>

Sets the resource block offset of the wanted signal.

Parameters:

<WSRbOffset> integer
 Number of resource blocks.
 Range: 0 to 273
 *RST: 0

Manual operation: See "[RB Offset](#)" on page 351

[:SOURce<hw>]:BB:NR5G:TCW:WS:RFFrequency <WSRFFreq>

Sets the RF frequency of the wanted signal.

Parameters:

<WSRFFreq> integer
 Range: 100e+03 to 6e+09
 *RST: 1.95e+09

Manual operation: See "[RF Frequency](#)" on page 352
 See "[RF Frequency](#)" on page 357

[:SOURce<hw>]:BB:NR5G:TCW:WS:RSET <RestrictedSet>

Selects the restricted set type for the PRACH.

Prerequisites for this command

- Select high speed train mode (`[:SOURce<hw>]:BB:NR5G:TCW:WS:TREquire`).

- Select preamble format 0 (`[:SOURce<hw>] :BB:NR5G:TCW:WS:PRAC:h:FORMat`).

Parameters:

<RestrictedSet> ARES | BRES

ARES
Restricted set type A.

BRES
Restricted set type B.

*RST: ARES

Example:

```
//Configure restricted set
SOURce:BB:NR5G:TCW:SPEC TS38141_1
SOURce:BB:NR5G:TCW:TC TS381411_TC841
SOURce:BB:NR5G:TCW:WS:TREquire HST
SOURce:BB:NR5G:TCW:WS:PRAC:FORM 0
SOURce:BB:NR5G:TCW:WS:RSET ARES
```

Manual operation: See ["Restricted Set"](#) on page 352

[:SOURce<hw>] :BB:NR5G:TCW:WS:SCSPacing <WSSubCarSpacing>

Sets the subcarrier spacing.

Parameters:

<WSSubCarSpacing> N15 | N30 | N60 | X60 | N120 | N240 | N480 | N960

N15, N30, N60, N120, N240, N480, N960
Normal cyclic prefix, value in kHz

E60
Extended cyclic prefix, 60 kHz

*RST: N30

Manual operation: See ["Sub Carrier Spacing / Sub Carrier Spacing \(BWP\)"](#) on page 352
See ["Sub Carrier Spacing"](#) on page 358

[:SOURce<hw>] :BB:NR5G:TCW:WS:SYMNumber <SymbolNumber>

Sets the number of used OFDM symbols.

The starting symbol index is 13 for 1 OFDM symbol and 12 for 2 OFDM symbols.

Parameters:

<SymbolNumber> integer

Range: 1 to 14

*RST: 14

Manual operation: See ["Number of OFDM Symbols"](#) on page 351

[[:SOURce<hw>]:BB:NR5G:TCW:WS:TAPos <WSTypeAPos>

Sets the position of first DM-RS symbol for PUSCH (and PDSCH) mapping type A (dmrs-TypeA-Position).

Parameters:

<WSTypeAPos> integer
Range: 2 to 3
*RST: 2

Manual operation: See "[DMRS Type A Position](#)" on page 350

[[:SOURce<hw>]:BB:NR5G:TCW:WS:TIOBase?

Queries the timing off base value.

Return values:

<TimingOffBase> float
Range: 0 to 6.2
Increment: 0.1
*RST: 0

Usage: Query only

Manual operation: See "[Timing Offset Base Value](#)" on page 353

[[:SOURce<hw>]:BB:NR5G:TCW:WS:TSETup <TestSetup>

With the test setup selector, the signal definitions can be switched.

Parameters:

<TestSetup> TS_1 | TS_2
*RST: TS_1

Manual operation: See "[Test Setup](#)" on page 352

[[:SOURce<hw>]:BB:NR5G:TCW:WS:UCI:BITS <UCIBits>

Set the number of UCI bits used.

Defines the size of the uplink control information bits carried in the PUCCH channel. They consist of the HARQ feedback, CSI and SR.

Parameters:

<UCIBits> B_7 | B_40
*RST: B_7

Manual operation: See "[UCI Bits](#)" on page 353

[:SOURce<hw>]:BB:NR5G:TCW:WS:UCI:CGUCi:PATtern <CGUCIPattern>, <CGUCIBitCount>

Defines the CG-UCI pattern.

Parameters:

<CGUCIPattern> 18 bits
 Bit pattern.
 *RST: #H04800

<CGUCIBitCount> integer
 Pattern length.
 Range: 18 to 18
 *RST: 18

Manual operation: See "[CG-UCI Pattern](#)" on page 353

[:SOURce<hw>]:BB:NR5G:TCW:WS:UCI:CSI1:PATtern <CSI1Pattern>

Defines the frequency and time domain of the CSI part 1 subcarrier location.

Parameters:

<CSI1Pattern> Nr5gPUCCHUcidataPattLenMax bits

Manual operation: See "[CSI 1 Pattern](#)" on page 349

[:SOURce<hw>]:BB:NR5G:TCW:WS:UCI:CSI2:PATtern <CSI2Pattern>

Defines the frequency and time domain of the CSI part 2 subcarrier location.

Parameters:

<CSI2Pattern> Nr5gPUCCHUcidataPattLenMax bits

Manual operation: See "[CSI 2 Pattern](#)" on page 349

[:SOURce<hw>]:BB:NR5G:TCW:WS:UCI:CSIPart <CSIPart>

Defines the CSI part selected for the test case.

The PUCCH-based CSI and the PUSCH-based CSI reporting, always padding the CSI report to the worst-case UCI payload size would result in too large overhead. For these cases, the CSI content is instead divided into two CSI parts.

Parameters:

<CSIPart> CSIP_1 | CSIP_2
 *RST: CSIP_1

Manual operation: See "[CSI Part](#)" on page 349

[:SOURce<hw>]:BB:NR5G:TCW:WS:UEID <WSUeld>

Sets the UE ID.

Parameters:

<WSUeld> integer
 Range: 0 to 65535
 *RST: 0

Manual operation: See "UE ID" on page 353
 See "UE ID" on page 358

[[:SOURce<hw>]:BB:NR5G:TCW:WS:TREQUIRE <TestRequirement>

Selects the test requirement for 3GPP test cases.

Parameters:

<TestRequirement> NORM | HST
 *RST: NORM

Manual operation: See "Test Requirement" on page 352
 See "Test requirement" on page 358

[[:SOURce<hw>]:BB:NR5G:TCW:WS:VDRF <VirtualDIRF>

Sets the virtual downlink RF frequency

Parameters:

<VirtualDIRF> integer
 Range: 100e+03 to 6e+09
 *RST: 1.00e+09

Manual operation: See "Virtual Downlink RF Frequency" on page 353

[[:SOURce<hw>]:BB:NR5G:TCW:SUE:TSRS <State>

Turns transmission of the sounding reference signal for 3GPP test cases on and off.

Parameters:

<State> 1 | ON | 0 | OFF
 *RST: 0

Manual operation: See "Transmit SRS" on page 359

Glossary: Abbreviations

Symbols

5G NR: 5G new radio

B

BW: Bandwidth

BWP: Carrier bandwidth part

C

CP: Cyclic prefix

CP-OFDM: Cyclic prefix OFDM, as known from LTE

D

DFT-s-OFDM: Discrete Fourier transform spread OFDM

DMRS: Demodulation reference signal

E

ECP: Extended cyclic prefix

F

FR: Frequency range

G

gNB: 5G NR base station

N

NCP: Normal cyclic prefix

P

PSS: Primary synchronisation signal

PTRS: Phase tracking reference signal

R

RB: Resource block

RE: Resource element

RS: Reference signal

S

SCS: Subcarrier spacing

SRS: Sounding reference signal

SS: Synchronisation signal

SSS: Secondary synchronisation signal

Glossary: 5G NR 3GPP specification references

Symbols

[1]: Rohde & Schwarz
Poster "Be ahead in 5G. Demystifying 5G NR"

T

TS 38.101: "User Equipment (UE) radio transmission and reception"

TS 38.104: "Base Station (BS) radio transmission and reception"

TS 38.133: "Requirements for support of radio resource management"

TS 38.141: "Base Station (BS) conformance testing"

TS 38.141-1: "Base Station (BS) conformance testing Part 1: Conducted conformance testing"

TS 38.141-2: "Base Station (BS) conformance testing Part 2: Radiated conformance testing"

TS 38.176: "Integrated Access and Backhaul (IAB) conformance testing"

TS 38.201: "Physical layer; General description"

TS 38.211: "Physical channels and modulation"

TS 38.212: "Multiplexing and channel coding"

TS 38.213: "Physical layer procedures for data"

TS 38.214: "Physical layer measurements"

TS 38.306: "User Equipment (UE) radio access capabilities"

TS 38.331: "Radio Resource Control (RRC) protocol specification "

TS 38.521: "Radio transmission and reception; Part 1, 2, 3"

TS 38.523: "User Equipment (UE) conformance specification; Part 1, 2, 3"

List of commands

[:SOURce]:BB:NR5G:PLVersion?.....	415
[:SOURce]:BB:NR5G:VERSion?.....	420
[:SOURce<hw>]:BB:NR5G:ANALyzer:CONTeNT.....	415
[:SOURce<hw>]:BB:NR5G:CLOCK:SOURce.....	748
[:SOURce<hw>]:BB:NR5G:FMODE:USRFile.....	727
[:SOURce<hw>]:BB:NR5G:LINK.....	415
[:SOURce<hw>]:BB:NR5G:NODE:CARMapping:AP4000[:ROW<ch0>].....	452
[:SOURce<hw>]:BB:NR5G:NODE:CC:ADD.....	440
[:SOURce<hw>]:BB:NR5G:NODE:CC:CINfo?.....	440
[:SOURce<hw>]:BB:NR5G:NODE:CC:CPYFrom.....	441
[:SOURce<hw>]:BB:NR5G:NODE:CC:CPYSel.....	441
[:SOURce<hw>]:BB:NR5G:NODE:CC:CPYTo?.....	441
[:SOURce<hw>]:BB:NR5G:NODE:CC:LOAD.....	441
[:SOURce<hw>]:BB:NR5G:NODE:CC:NEWCarriers.....	442
[:SOURce<hw>]:BB:NR5G:NODE:CELL<cc>:CARDeplY.....	437
[:SOURce<hw>]:BB:NR5G:NODE:CELL<cc>:CBW.....	437
[:SOURce<hw>]:BB:NR5G:NODE:CELL<cc>:CELLid.....	435
[:SOURce<hw>]:BB:NR5G:NODE:CELL<cc>:CIF.....	436
[:SOURce<hw>]:BB:NR5G:NODE:CELL<cc>:CIFPresent.....	436
[:SOURce<hw>]:BB:NR5G:NODE:CELL<cc>:CINdicator.....	436
[:SOURce<hw>]:BB:NR5G:NODE:CELL<cc>:DFReq.....	438
[:SOURce<hw>]:BB:NR5G:NODE:CELL<cc>:DUMRes:APMap:COL<apc>:ROW<apr>:IMAGinary.....	473
[:SOURce<hw>]:BB:NR5G:NODE:CELL<cc>:DUMRes:APMap:COL<apc>:ROW<apr>:MAGNidute.....	474
[:SOURce<hw>]:BB:NR5G:NODE:CELL<cc>:DUMRes:APMap:COL<apc>:ROW<apr>:PHASe.....	474
[:SOURce<hw>]:BB:NR5G:NODE:CELL<cc>:DUMRes:APMap:COL<apc>:ROW<apr>:REAL.....	475
[:SOURce<hw>]:BB:NR5G:NODE:CELL<cc>:DUMRes:DATA.....	472
[:SOURce<hw>]:BB:NR5G:NODE:CELL<cc>:DUMRes:DLISt.....	472
[:SOURce<hw>]:BB:NR5G:NODE:CELL<cc>:DUMRes:MODulation.....	471
[:SOURce<hw>]:BB:NR5G:NODE:CELL<cc>:DUMRes:NAPS.....	475
[:SOURce<hw>]:BB:NR5G:NODE:CELL<cc>:DUMRes:PATTeRN.....	473
[:SOURce<hw>]:BB:NR5G:NODE:CELL<cc>:DUMRes:POWeR.....	471
[:SOURce<hw>]:BB:NR5G:NODE:CELL<cc>:DUMRes:PREC:STATe.....	476
[:SOURce<hw>]:BB:NR5G:NODE:CELL<cc>:DUMRes:SCSPacing.....	471
[:SOURce<hw>]:BB:NR5G:NODE:CELL<cc>:DUMRes:STATe.....	471
[:SOURce<hw>]:BB:NR5G:NODE:CELL<cc>:DUMRes:TPSTate.....	472
[:SOURce<hw>]:BB:NR5G:NODE:CELL<cc>:LTE:NPAT.....	448
[:SOURce<hw>]:BB:NR5G:NODE:CELL<cc>:LTE:PATT<st0>:CBW.....	449
[:SOURce<hw>]:BB:NR5G:NODE:CELL<cc>:LTE:PATT<st0>:NAP.....	449
[:SOURce<hw>]:BB:NR5G:NODE:CELL<cc>:LTE:PATT<st0>:POINta.....	450
[:SOURce<hw>]:BB:NR5G:NODE:CELL<cc>:LTE:PATT<st0>:VSHift.....	450
[:SOURce<hw>]:BB:NR5G:NODE:CELL<cc>:LTE:STATe.....	449
[:SOURce<hw>]:BB:NR5G:NODE:CELL<cc>:MAPPed.....	438
[:SOURce<hw>]:BB:NR5G:NODE:CELL<cc>:N1ID?.....	437
[:SOURce<hw>]:BB:NR5G:NODE:CELL<cc>:N2ID?.....	437
[:SOURce<hw>]:BB:NR5G:NODE:CELL<cc>:NSSPbch.....	452
[:SOURce<hw>]:BB:NR5G:NODE:CELL<cc>:OFFSet.....	451
[:SOURce<hw>]:BB:NR5G:NODE:CELL<cc>:PCFReq.....	439

[:SOURce<hw>]:BB:NR5G:NODE:CELL<cc>:PRS:NRSets.....	465
[:SOURce<hw>]:BB:NR5G:NODE:CELL<cc>:PRS:RSET<st0>:CMBSize.....	465
[:SOURce<hw>]:BB:NR5G:NODE:CELL<cc>:PRS:RSET<st0>:NRESources.....	465
[:SOURce<hw>]:BB:NR5G:NODE:CELL<cc>:PRS:RSET<st0>:PER.....	466
[:SOURce<hw>]:BB:NR5G:NODE:CELL<cc>:PRS:RSET<st0>:RBNumber.....	466
[:SOURce<hw>]:BB:NR5G:NODE:CELL<cc>:PRS:RSET<st0>:RBTart.....	466
[:SOURce<hw>]:BB:NR5G:NODE:CELL<cc>:PRS:RSET<st0>:REPFactor.....	466
[:SOURce<hw>]:BB:NR5G:NODE:CELL<cc>:PRS:RSET<st0>:RES<dir0>:APMap:COL<apc>: ROW<apr>:IMAGinary.....	467
[:SOURce<hw>]:BB:NR5G:NODE:CELL<cc>:PRS:RSET<st0>:RES<dir0>:APMap:COL<apc>: ROW<apr>:MAGNitude.....	467
[:SOURce<hw>]:BB:NR5G:NODE:CELL<cc>:PRS:RSET<st0>:RES<dir0>:APMap:COL<apc>: ROW<apr>:PHASe.....	467
[:SOURce<hw>]:BB:NR5G:NODE:CELL<cc>:PRS:RSET<st0>:RES<dir0>:APMap:COL<apc>: ROW<apr>:REAL.....	467
[:SOURce<hw>]:BB:NR5G:NODE:CELL<cc>:PRS:RSET<st0>:RES<dir0>:NSYMBOL.....	468
[:SOURce<hw>]:BB:NR5G:NODE:CELL<cc>:PRS:RSET<st0>:RES<dir0>:POWER.....	468
[:SOURce<hw>]:BB:NR5G:NODE:CELL<cc>:PRS:RSET<st0>:RES<dir0>:REOffset.....	468
[:SOURce<hw>]:BB:NR5G:NODE:CELL<cc>:PRS:RSET<st0>:RES<dir0>:SLOffset.....	468
[:SOURce<hw>]:BB:NR5G:NODE:CELL<cc>:PRS:RSET<st0>:RES<dir0>:SQID.....	469
[:SOURce<hw>]:BB:NR5G:NODE:CELL<cc>:PRS:RSET<st0>:RES<dir0>:SYOffset.....	469
[:SOURce<hw>]:BB:NR5G:NODE:CELL<cc>:PRS:RSET<st0>:SLOffset.....	469
[:SOURce<hw>]:BB:NR5G:NODE:CELL<cc>:PRS:RSET<st0>:TGAP.....	470
[:SOURce<hw>]:BB:NR5G:NODE:CELL<cc>:PRS:SCSPacing.....	470
[:SOURce<hw>]:BB:NR5G:NODE:CELL<cc>:PRS:STATe.....	470
[:SOURce<hw>]:BB:NR5G:NODE:CELL<cc>:RFPHase:REFeRence.....	439
[:SOURce<hw>]:BB:NR5G:NODE:CELL<cc>:SCHBy.....	439
[:SOURce<hw>]:BB:NR5G:NODE:CELL<cc>:SHSPec.....	438
[:SOURce<hw>]:BB:NR5G:NODE:CELL<cc>:SSPBch<ssb>:BSPeriodicty.....	455
[:SOURce<hw>]:BB:NR5G:NODE:CELL<cc>:SSPBch<ssb>:CASE.....	454
[:SOURce<hw>]:BB:NR5G:NODE:CELL<cc>:SSPBch<ssb>:CCODing:DATA.....	458
[:SOURce<hw>]:BB:NR5G:NODE:CELL<cc>:SSPBch<ssb>:CCODing:DLISt.....	458
[:SOURce<hw>]:BB:NR5G:NODE:CELL<cc>:SSPBch<ssb>:CCODing:PATtern.....	459
[:SOURce<hw>]:BB:NR5G:NODE:CELL<cc>:SSPBch<ssb>:CCODing:STATe.....	458
[:SOURce<hw>]:BB:NR5G:NODE:CELL<cc>:SSPBch<ssb>:DFReq?.....	453
[:SOURce<hw>]:BB:NR5G:NODE:CELL<cc>:SSPBch<ssb>:HFRMidx.....	455
[:SOURce<hw>]:BB:NR5G:NODE:CELL<cc>:SSPBch<ssb>:L.....	454
[:SOURce<hw>]:BB:NR5G:NODE:CELL<cc>:SSPBch<ssb>:MIB:ASOF:STATe.....	460
[:SOURce<hw>]:BB:NR5G:NODE:CELL<cc>:SSPBch<ssb>:MIB:CBARred.....	461
[:SOURce<hw>]:BB:NR5G:NODE:CELL<cc>:SSPBch<ssb>:MIB:CSZero.....	460
[:SOURce<hw>]:BB:NR5G:NODE:CELL<cc>:SSPBch<ssb>:MIB:IFRResel.....	461
[:SOURce<hw>]:BB:NR5G:NODE:CELL<cc>:SSPBch<ssb>:MIB:SCOFset.....	460
[:SOURce<hw>]:BB:NR5G:NODE:CELL<cc>:SSPBch<ssb>:MIB:SCSC.....	459
[:SOURce<hw>]:BB:NR5G:NODE:CELL<cc>:SSPBch<ssb>:MIB:SFOFset?.....	460
[:SOURce<hw>]:BB:NR5G:NODE:CELL<cc>:SSPBch<ssb>:MIB:SPARe:STATe.....	461
[:SOURce<hw>]:BB:NR5G:NODE:CELL<cc>:SSPBch<ssb>:MIB:SSZero.....	461
[:SOURce<hw>]:BB:NR5G:NODE:CELL<cc>:SSPBch<ssb>:MIB:STATe.....	459
[:SOURce<hw>]:BB:NR5G:NODE:CELL<cc>:SSPBch<ssb>:POSition:APMap<dir0>:COL<apc>: ROW<apr>:IMAGinary.....	456

[:SOURce<hw>]:BB:NR5G:NODE:CELL<cc>:SSPBch<ssb>:POSition:APMap<dir0>:COL<apc>: ROW<apr>:MAGNitude.....	457
[:SOURce<hw>]:BB:NR5G:NODE:CELL<cc>:SSPBch<ssb>:POSition:APMap<dir0>:COL<apc>: ROW<apr>:PHASe.....	457
[:SOURce<hw>]:BB:NR5G:NODE:CELL<cc>:SSPBch<ssb>:POSition:APMap<dir0>:COL<apc>: ROW<apr>:REAL.....	456
[:SOURce<hw>]:BB:NR5G:NODE:CELL<cc>:SSPBch<ssb>:POSition:PATtern.....	454
[:SOURce<hw>]:BB:NR5G:NODE:CELL<cc>:SSPBch<ssb>:POWER.....	455
[:SOURce<hw>]:BB:NR5G:NODE:CELL<cc>:SSPBch<ssb>:PSSPow.....	455
[:SOURce<hw>]:BB:NR5G:NODE:CELL<cc>:SSPBch<ssb>:RBOFFset.....	453
[:SOURce<hw>]:BB:NR5G:NODE:CELL<cc>:SSPBch<ssb>:SCOFFset.....	453
[:SOURce<hw>]:BB:NR5G:NODE:CELL<cc>:SSPBch<ssb>:SCSPacing.....	452
[:SOURce<hw>]:BB:NR5G:NODE:CELL<cc>:SSPBch<ssb>:SL:BINPeriod.....	462
[:SOURce<hw>]:BB:NR5G:NODE:CELL<cc>:SSPBch<ssb>:SL:INCoverage.....	463
[:SOURce<hw>]:BB:NR5G:NODE:CELL<cc>:SSPBch<ssb>:SL:INTerval.....	463
[:SOURce<hw>]:BB:NR5G:NODE:CELL<cc>:SSPBch<ssb>:SL:SBITs.....	463
[:SOURce<hw>]:BB:NR5G:NODE:CELL<cc>:SSPBch<ssb>:SL:TDDConf.....	464
[:SOURce<hw>]:BB:NR5G:NODE:CELL<cc>:SSPBch<ssb>:SL:TOFFs.....	464
[:SOURce<hw>]:BB:NR5G:NODE:CELL<cc>:SSPBch<ssb>:SSSPow.....	455
[:SOURce<hw>]:BB:NR5G:NODE:CELL<cc>:SSPBch<ssb>:STATE.....	452
[:SOURce<hw>]:BB:NR5G:NODE:CELL<cc>:SYINfo:HACBook.....	442
[:SOURce<hw>]:BB:NR5G:NODE:CELL<cc>:SYINfo:HACR.....	443
[:SOURce<hw>]:BB:NR5G:NODE:CELL<cc>:SYINfo:INDSize.....	444
[:SOURce<hw>]:BB:NR5G:NODE:CELL<cc>:SYINfo:IS02.....	444
[:SOURce<hw>]:BB:NR5G:NODE:CELL<cc>:SYINfo:SUL:STATE.....	443
[:SOURce<hw>]:BB:NR5G:NODE:CELL<cc>:TAPos.....	440
[:SOURce<hw>]:BB:NR5G:NODE:CELL<cc>:TMPH:CTOFFset.....	444
[:SOURce<hw>]:BB:NR5G:NODE:CELL<cc>:TMPH:PHOFFset.....	444
[:SOURce<hw>]:BB:NR5G:NODE:CELL<cc>:TMPH:SFOFFset.....	445
[:SOURce<hw>]:BB:NR5G:NODE:CELL<cc>:TMPH:SSBTOFFset.....	445
[:SOURce<hw>]:BB:NR5G:NODE:CELL<cc>:TMPH:SYFNOffset.....	445
[:SOURce<hw>]:BB:NR5G:NODE:CELL<cc>:TXBW:CONFLict?.....	446
[:SOURce<hw>]:BB:NR5G:NODE:CELL<cc>:TXBW:POINta.....	446
[:SOURce<hw>]:BB:NR5G:NODE:CELL<cc>:TXBW:RESolve.....	447
[:SOURce<hw>]:BB:NR5G:NODE:CELL<cc>:TXBW:S15K:KOMU?.....	448
[:SOURce<hw>]:BB:NR5G:NODE:CELL<cc>:TXBW:S15K:NRB?.....	447
[:SOURce<hw>]:BB:NR5G:NODE:CELL<cc>:TXBW:S15K:OFFSet.....	448
[:SOURce<hw>]:BB:NR5G:NODE:CELL<cc>:TXBW:S15K:USE.....	447
[:SOURce<hw>]:BB:NR5G:NODE:CELL<cc>:TXBW:S30K:KOMU?.....	448
[:SOURce<hw>]:BB:NR5G:NODE:CELL<cc>:TXBW:S30K:NRB?.....	447
[:SOURce<hw>]:BB:NR5G:NODE:CELL<cc>:TXBW:S30K:OFFSet.....	448
[:SOURce<hw>]:BB:NR5G:NODE:CELL<cc>:TXBW:S30K:USE.....	447
[:SOURce<hw>]:BB:NR5G:NODE:CELL<cc>:TXBW:S60K:KOMU?.....	448
[:SOURce<hw>]:BB:NR5G:NODE:CELL<cc>:TXBW:S60K:NRB?.....	447
[:SOURce<hw>]:BB:NR5G:NODE:CELL<cc>:TXBW:S60K:OFFSet.....	448
[:SOURce<hw>]:BB:NR5G:NODE:CELL<cc>:TXBW:S60K:USE.....	447
[:SOURce<hw>]:BB:NR5G:NODE:CELL<cc>:TXBW:S120K:KOMU?.....	448
[:SOURce<hw>]:BB:NR5G:NODE:CELL<cc>:TXBW:S120K:NRB?.....	447
[:SOURce<hw>]:BB:NR5G:NODE:CELL<cc>:TXBW:S120K:OFFSet.....	448
[:SOURce<hw>]:BB:NR5G:NODE:CELL<cc>:TXBW:S120K:USE.....	447

[:SOURce<hw>]:BB:NR5G:NODE:CELL<cc>:TXBW:S240K:USE.....	447
[:SOURce<hw>]:BB:NR5G:NODE:CELL<cc>:TXBW:S480K:USE.....	447
[:SOURce<hw>]:BB:NR5G:NODE:CELL<cc>:TXBW:S960K:USE.....	447
[:SOURce<hw>]:BB:NR5G:NODE:CELL<cc>[:TMPH]:TAOFset.....	445
[:SOURce<hw>]:BB:NR5G:NODE:NCARrier.....	435
[:SOURce<hw>]:BB:NR5G:NODE:RFPHase:MODE.....	435
[:SOURce<hw>]:BB:NR5G:OUTPut:BBConf:CONFLict?.....	728
[:SOURce<hw>]:BB:NR5G:OUTPut:BBConf:ROW<apr>:CONFLict.....	728
[:SOURce<hw>]:BB:NR5G:OUTPut:BBConf:ROW<apr>:PBRate.....	728
[:SOURce<hw>]:BB:NR5G:OUTPut:BBConf:ROW<apr>:SRATe?.....	728
[:SOURce<hw>]:BB:NR5G:OUTPut:BBConf:ROW<apr>:VARiatiOn.....	729
[:SOURce<hw>]:BB:NR5G:OUTPut:CFReduction:ALGorithm.....	732
[:SOURce<hw>]:BB:NR5G:OUTPut:CFReduction:CPBWidth.....	733
[:SOURce<hw>]:BB:NR5G:OUTPut:CFReduction:ITERatiOns.....	733
[:SOURce<hw>]:BB:NR5G:OUTPut:CFReduction:OCFactor?.....	734
[:SOURce<hw>]:BB:NR5G:OUTPut:CFReduction:RCFactor?.....	734
[:SOURce<hw>]:BB:NR5G:OUTPut:CFReduction:STATe.....	734
[:SOURce<hw>]:BB:NR5G:OUTPut:CFReduction:TCRFactor.....	735
[:SOURce<hw>]:BB:NR5G:OUTPut:CFReduction:TRBWidth.....	733
[:SOURce<hw>]:BB:NR5G:OUTPut:CLEVel.....	729
[:SOURce<hw>]:BB:NR5G:OUTPut:CMODE.....	729
[:SOURce<hw>]:BB:NR5G:OUTPut:FMODE.....	727
[:SOURce<hw>]:BB:NR5G:OUTPut:POWer:BBConf:ROW<apr>:AVRL?.....	731
[:SOURce<hw>]:BB:NR5G:OUTPut:POWer:BWRef:ACRL?.....	732
[:SOURce<hw>]:BB:NR5G:OUTPut:POWer:MODE.....	731
[:SOURce<hw>]:BB:NR5G:OUTPut:POWer:RSBW.....	732
[:SOURce<hw>]:BB:NR5G:OUTPut:POWer:S15K:ACRL?.....	732
[:SOURce<hw>]:BB:NR5G:OUTPut:POWer:S30K:ACRL?.....	732
[:SOURce<hw>]:BB:NR5G:OUTPut:POWer:S60K:ACRL?.....	732
[:SOURce<hw>]:BB:NR5G:OUTPut:POWer:S120K:ACRL?.....	732
[:SOURce<hw>]:BB:NR5G:OUTPut:POWer:S240K:ACRL?.....	732
[:SOURce<hw>]:BB:NR5G:OUTPut:SAMRmode.....	727
[:SOURce<hw>]:BB:NR5G:OUTPut:SEQLen.....	726
[:SOURce<hw>]:BB:NR5G:OUTPut:SSOC:STATe.....	726
[:SOURce<hw>]:BB:NR5G:OUTPut:SUSLen.....	726
[:SOURce<hw>]:BB:NR5G:OUTPut:TDWind:S15K:TRTime.....	730
[:SOURce<hw>]:BB:NR5G:OUTPut:TDWind:S15K:TRTSamples?.....	730
[:SOURce<hw>]:BB:NR5G:OUTPut:TDWind:S30K:TRTime.....	730
[:SOURce<hw>]:BB:NR5G:OUTPut:TDWind:S30K:TRTSamples?.....	730
[:SOURce<hw>]:BB:NR5G:OUTPut:TDWind:S60K:TRTime.....	730
[:SOURce<hw>]:BB:NR5G:OUTPut:TDWind:S60K:TRTSamples?.....	730
[:SOURce<hw>]:BB:NR5G:OUTPut:TDWind:S120K:TRTime.....	730
[:SOURce<hw>]:BB:NR5G:OUTPut:TDWind:S120K:TRTSamples?.....	730
[:SOURce<hw>]:BB:NR5G:OUTPut:TDWind:S240K:TRTime.....	730
[:SOURce<hw>]:BB:NR5G:OUTPut:TDWind:S240K:TRTSamples?.....	730
[:SOURce<hw>]:BB:NR5G:OUTPut:TDWind:SE60K:TRTime.....	730
[:SOURce<hw>]:BB:NR5G:OUTPut:TDWind:SE60K:TRTSamples?.....	730
[:SOURce<hw>]:BB:NR5G:PRESet.....	416
[:SOURce<hw>]:BB:NR5G:QCKSet:APPLY.....	434
[:SOURce<hw>]:BB:NR5G:QCKSet:DISCard.....	434

[:SOURce<hw>]:BB:NR5G:QCKSet:FRMFormat:IAB:STATe.....	431
[:SOURce<hw>]:BB:NR5G:QCKSet:FRMFormat:NDLSlots.....	431
[:SOURce<hw>]:BB:NR5G:QCKSet:FRMFormat:NSSLots?.....	432
[:SOURce<hw>]:BB:NR5G:QCKSet:FRMFormat:NULSlots.....	432
[:SOURce<hw>]:BB:NR5G:QCKSet:FRMFormat:SLINT.....	431
[:SOURce<hw>]:BB:NR5G:QCKSet:FRMFormat:SSC:NDLSymbols.....	432
[:SOURce<hw>]:BB:NR5G:QCKSet:FRMFormat:SSC:NGSYmbols?.....	433
[:SOURce<hw>]:BB:NR5G:QCKSet:FRMFormat:SSC:NULSymbols.....	433
[:SOURce<hw>]:BB:NR5G:QCKSet:FRMFormat:SSC:SFI:STATe.....	434
[:SOURce<hw>]:BB:NR5G:QCKSet:FRMFormat:SSC:SLFMt.....	432
[:SOURce<hw>]:BB:NR5G:QCKSet:GENeral:CARDePLY.....	427
[:SOURce<hw>]:BB:NR5G:QCKSet:GENeral:CBW.....	427
[:SOURce<hw>]:BB:NR5G:QCKSet:GENeral:CCTModel.....	427
[:SOURce<hw>]:BB:NR5G:QCKSet:GENeral:CHRaster.....	427
[:SOURce<hw>]:BB:NR5G:QCKSet:GENeral:CHSPacing.....	428
[:SOURce<hw>]:BB:NR5G:QCKSet:GENeral:DUPLexing.....	429
[:SOURce<hw>]:BB:NR5G:QCKSet:GENeral:ECPState.....	428
[:SOURce<hw>]:BB:NR5G:QCKSet:GENeral:ES:CS:STATe.....	429
[:SOURce<hw>]:BB:NR5G:QCKSet:GENeral:ES:CSLength.....	430
[:SOURce<hw>]:BB:NR5G:QCKSet:GENeral:ES:MOD.....	429
[:SOURce<hw>]:BB:NR5G:QCKSet:GENeral:ES:RBConfig.....	430
[:SOURce<hw>]:BB:NR5G:QCKSet:GENeral:ES:RBNumber.....	430
[:SOURce<hw>]:BB:NR5G:QCKSet:GENeral:ES:RBOFFset.....	430
[:SOURce<hw>]:BB:NR5G:QCKSet:GENeral:ES:TP:STATe.....	431
[:SOURce<hw>]:BB:NR5G:QCKSet:GENeral:NCARier.....	429
[:SOURce<hw>]:BB:NR5G:QCKSet:GENeral:SCSPacing.....	428
[:SOURce<hw>]:BB:NR5G:QCKSet:GENeral:SFFM:STATe.....	431
[:SOURce<hw>]:BB:NR5G:SCHed:CELL<cc>:SUBF<sf>:ALLoc<al>:CONTent.....	598
[:SOURce<hw>]:BB:NR5G:SCHed:CELL<cc>:SUBF<sf>:ALLoc<al>:DURation.....	599
[:SOURce<hw>]:BB:NR5G:SCHed:CELL<cc>:SUBF<sf>:ALLoc<al>:PERiod.....	602
[:SOURce<hw>]:BB:NR5G:SCHed:CELL<cc>:SUBF<sf>:ALLoc<al>:RBNumber.....	603
[:SOURce<hw>]:BB:NR5G:SCHed:CELL<cc>:SUBF<sf>:ALLoc<al>:RBOFFset.....	603
[:SOURce<hw>]:BB:NR5G:SCHed:CELL<cc>:SUBF<sf>:ALLoc<al>:REPetitions.....	603
[:SOURce<hw>]:BB:NR5G:SCHed:CELL<cc>:SUBF<sf>:ALLoc<al>:SCSPacing.....	604
[:SOURce<hw>]:BB:NR5G:SCHed:CELL<cc>:SUBF<sf>:ALLoc<al>:SLOT.....	605
[:SOURce<hw>]:BB:NR5G:SCHed:CELL<cc>:SUBF<sf>:ALLoc<al>:SYMNumber.....	606
[:SOURce<hw>]:BB:NR5G:SCHed:CELL<cc>:SUBF<sf>:ALLoc<al>:SYMoffset.....	606
[:SOURce<hw>]:BB:NR5G:SCHed:CELL<cc>:SUBF<sf>:COMMOn:ALLoc<al>:CONTent?.....	598
[:SOURce<hw>]:BB:NR5G:SCHed:CELL<cc>:SUBF<sf>:COMMOn:ALLoc<al>:RBNumber?.....	602
[:SOURce<hw>]:BB:NR5G:SCHed:CELL<cc>:SUBF<sf>:COMMOn:ALLoc<al>:RBOFFset?.....	603
[:SOURce<hw>]:BB:NR5G:SCHed:CELL<cc>:SUBF<sf>:COMMOn:ALLoc<al>:RIMRs:SCSPacing.....	604
[:SOURce<hw>]:BB:NR5G:SCHed:CELL<cc>:SUBF<sf>:COMMOn:ALLoc<al>:SCSPacing?.....	604
[:SOURce<hw>]:BB:NR5G:SCHed:CELL<cc>:SUBF<sf>:COMMOn:ALLoc<al>:SLOT?.....	605
[:SOURce<hw>]:BB:NR5G:SCHed:CELL<cc>:SUBF<sf>:COMMOn:ALLoc<al>:SYMNumber?.....	606
[:SOURce<hw>]:BB:NR5G:SCHed:CELL<cc>:SUBF<sf>:COMMOn:ALLoc<al>:SYMoffset?.....	606
[:SOURce<hw>]:BB:NR5G:SCHed:CELL<cc>:SUBF<sf>:NALLoc.....	607
[:SOURce<hw>]:BB:NR5G:SCHed:CELL<cc>:SUBF<sf>:RESulting:ALLoc<al>:SOSF?.....	605
[:SOURce<hw>]:BB:NR5G:SCHed:CELL<cc>:SUBF<sf>:USER<us>:BWPart<bwp>:ALLoc<al>: APMap:COL<apc>:ROW<apr>:IMAGinary.....	639

[:SOURce<hw>]:BB:NR5G:SCHed:CELL<cc>:SUBF<sf>:USER<us>:BWPart<bwp>:ALLoc<al>: APMap:COL<apc>:ROW<apr>:MAGNitude.....	638
[:SOURce<hw>]:BB:NR5G:SCHed:CELL<cc>:SUBF<sf>:USER<us>:BWPart<bwp>:ALLoc<al>: APMap:COL<apc>:ROW<apr>:PHASe.....	638
[:SOURce<hw>]:BB:NR5G:SCHed:CELL<cc>:SUBF<sf>:USER<us>:BWPart<bwp>:ALLoc<al>: APMap:COL<apc>:ROW<apr>:REAL.....	639
[:SOURce<hw>]:BB:NR5G:SCHed:CELL<cc>:SUBF<sf>:USER<us>:BWPart<bwp>:ALLoc<al>:BHOP....	705
[:SOURce<hw>]:BB:NR5G:SCHed:CELL<cc>:SUBF<sf>:USER<us>:BWPart<bwp>:ALLoc<al>:BITMap.	692
[:SOURce<hw>]:BB:NR5G:SCHed:CELL<cc>:SUBF<sf>:USER<us>:BWPart<bwp>:ALLoc<al>:BSRS....	705
[:SOURce<hw>]:BB:NR5G:SCHed:CELL<cc>:SUBF<sf>:USER<us>:BWPart<bwp>:ALLoc<al>: COFFset.....	705
[:SOURce<hw>]:BB:NR5G:SCHed:CELL<cc>:SUBF<sf>:USER<us>:BWPart<bwp>:ALLoc<al>:CONFig.	706
[:SOURce<hw>]:BB:NR5G:SCHed:CELL<cc>:SUBF<sf>:USER<us>:BWPart<bwp>:ALLoc<al>: CONTent.....	598
[:SOURce<hw>]:BB:NR5G:SCHed:CELL<cc>:SUBF<sf>:USER<us>:BWPart<bwp>:ALLoc<al>: COPYto:APPLY.....	598
[:SOURce<hw>]:BB:NR5G:SCHed:CELL<cc>:SUBF<sf>:USER<us>:BWPart<bwp>:ALLoc<al>: COPYto:SLOT.....	599
[:SOURce<hw>]:BB:NR5G:SCHed:CELL<cc>:SUBF<sf>:USER<us>:BWPart<bwp>:ALLoc<al>: COPYto:SUBF.....	599
[:SOURce<hw>]:BB:NR5G:SCHed:CELL<cc>:SUBF<sf>:USER<us>:BWPart<bwp>:ALLoc<al>:CPEXt....	609
[:SOURce<hw>]:BB:NR5G:SCHed:CELL<cc>:SUBF<sf>:USER<us>:BWPart<bwp>:ALLoc<al>: CS:AULBwp.....	645
[:SOURce<hw>]:BB:NR5G:SCHed:CELL<cc>:SUBF<sf>:USER<us>:BWPart<bwp>:ALLoc<al>: CS:DCCes:DATA.....	646
[:SOURce<hw>]:BB:NR5G:SCHed:CELL<cc>:SUBF<sf>:USER<us>:BWPart<bwp>:ALLoc<al>: CS:DCCes:DLISt.....	646
[:SOURce<hw>]:BB:NR5G:SCHed:CELL<cc>:SUBF<sf>:USER<us>:BWPart<bwp>:ALLoc<al>: CS:DCCes:PATtern.....	646
[:SOURce<hw>]:BB:NR5G:SCHed:CELL<cc>:SUBF<sf>:USER<us>:BWPart<bwp>:ALLoc<al>: CS:DCCes:STATe.....	646
[:SOURce<hw>]:BB:NR5G:SCHed:CELL<cc>:SUBF<sf>:USER<us>:BWPart<bwp>:ALLoc<al>: CS:DCI<dcI>:AGGLevel.....	647
[:SOURce<hw>]:BB:NR5G:SCHed:CELL<cc>:SUBF<sf>:USER<us>:BWPart<bwp>:ALLoc<al>: CS:DCI<dcI>:AI<x>.....	680
[:SOURce<hw>]:BB:NR5G:SCHed:CELL<cc>:SUBF<sf>:USER<us>:BWPart<bwp>:ALLoc<al>: CS:DCI<dcI>:ANTPorts.....	658
[:SOURce<hw>]:BB:NR5G:SCHed:CELL<cc>:SUBF<sf>:USER<us>:BWPart<bwp>:ALLoc<al>: CS:DCI<dcI>:AR<x>.....	675
[:SOURce<hw>]:BB:NR5G:SCHed:CELL<cc>:SUBF<sf>:USER<us>:BWPart<bwp>:ALLoc<al>: CS:DCI<dcI>:ARINd.....	686
[:SOURce<hw>]:BB:NR5G:SCHed:CELL<cc>:SUBF<sf>:USER<us>:BWPart<bwp>:ALLoc<al>: CS:DCI<dcI>:BITLength.....	690
[:SOURce<hw>]:BB:NR5G:SCHed:CELL<cc>:SUBF<sf>:USER<us>:BWPart<bwp>:ALLoc<al>: CS:DCI<dcI>:BOINd.....	658
[:SOURce<hw>]:BB:NR5G:SCHed:CELL<cc>:SUBF<sf>:USER<us>:BWPart<bwp>:ALLoc<al>: CS:DCI<dcI>:BWINd.....	658
[:SOURce<hw>]:BB:NR5G:SCHed:CELL<cc>:SUBF<sf>:USER<us>:BWPart<bwp>:ALLoc<al>: CS:DCI<dcI>:CACPExt.....	653

[:SOURce<hw>]:BB:NR5G:SCHed:CELL<cc>:SUBF<sf>:USER<us>:BWPart<bwp>:ALLoc<al>: CS:DCI<dcI>:CAINd.....	659
[:SOURce<hw>]:BB:NR5G:SCHed:CELL<cc>:SUBF<sf>:USER<us>:BWPart<bwp>:ALLoc<al>: CS:DCI<dcI>:CAINdex.....	684
[:SOURce<hw>]:BB:NR5G:SCHed:CELL<cc>:SUBF<sf>:USER<us>:BWPart<bwp>:ALLoc<al>: CS:DCI<dcI>:CANDidate.....	647
[:SOURce<hw>]:BB:NR5G:SCHed:CELL<cc>:SUBF<sf>:USER<us>:BWPart<bwp>:ALLoc<al>: CS:DCI<dcI>:CBGFi.....	670
[:SOURce<hw>]:BB:NR5G:SCHed:CELL<cc>:SUBF<sf>:USER<us>:BWPart<bwp>:ALLoc<al>: CS:DCI<dcI>:CBGTi.....	659
[:SOURce<hw>]:BB:NR5G:SCHed:CELL<cc>:SUBF<sf>:USER<us>:BWPart<bwp>:ALLoc<al>: CS:DCI<dcI>:CD<x>.....	675
[:SOURce<hw>]:BB:NR5G:SCHed:CELL<cc>:SUBF<sf>:USER<us>:BWPart<bwp>:ALLoc<al>: CS:DCI<dcI>:CI<x>.....	680
[:SOURce<hw>]:BB:NR5G:SCHed:CELL<cc>:SUBF<sf>:USER<us>:BWPart<bwp>:ALLoc<al>: CS:DCI<dcI>:CL<x>.....	677
[:SOURce<hw>]:BB:NR5G:SCHed:CELL<cc>:SUBF<sf>:USER<us>:BWPart<bwp>:ALLoc<al>: CS:DCI<dcI>:COINdex.....	684
[:SOURce<hw>]:BB:NR5G:SCHed:CELL<cc>:SUBF<sf>:USER<us>:BWPart<bwp>:ALLoc<al>: CS:DCI<dcI>:CPDSch.....	647
[:SOURce<hw>]:BB:NR5G:SCHed:CELL<cc>:SUBF<sf>:USER<us>:BWPart<bwp>:ALLoc<al>: CS:DCI<dcI>:CSIRequest.....	659
[:SOURce<hw>]:BB:NR5G:SCHed:CELL<cc>:SUBF<sf>:USER<us>:BWPart<bwp>:ALLoc<al>: CS:DCI<dcI>:DAI1.....	659
[:SOURce<hw>]:BB:NR5G:SCHed:CELL<cc>:SUBF<sf>:USER<us>:BWPart<bwp>:ALLoc<al>: CS:DCI<dcI>:DAI2.....	659
[:SOURce<hw>]:BB:NR5G:SCHed:CELL<cc>:SUBF<sf>:USER<us>:BWPart<bwp>:ALLoc<al>: CS:DCI<dcI>:DAI3.....	659
[:SOURce<hw>]:BB:NR5G:SCHed:CELL<cc>:SUBF<sf>:USER<us>:BWPart<bwp>:ALLoc<al>: CS:DCI<dcI>:DATA.....	690
[:SOURce<hw>]:BB:NR5G:SCHed:CELL<cc>:SUBF<sf>:USER<us>:BWPart<bwp>:ALLoc<al>: CS:DCI<dcI>:DFIFlag.....	660
[:SOURce<hw>]:BB:NR5G:SCHed:CELL<cc>:SUBF<sf>:USER<us>:BWPart<bwp>:ALLoc<al>: CS:DCI<dcI>:DI<x>.....	681
[:SOURce<hw>]:BB:NR5G:SCHed:CELL<cc>:SUBF<sf>:USER<us>:BWPart<bwp>:ALLoc<al>: CS:DCI<dcI>:DLISt.....	690
[:SOURce<hw>]:BB:NR5G:SCHed:CELL<cc>:SUBF<sf>:USER<us>:BWPart<bwp>:ALLoc<al>: CS:DCI<dcI>:DMSQinit.....	660
[:SOURce<hw>]:BB:NR5G:SCHed:CELL<cc>:SUBF<sf>:USER<us>:BWPart<bwp>:ALLoc<al>: CS:DCI<dcI>:DMSS?.....	648
[:SOURce<hw>]:BB:NR5G:SCHed:CELL<cc>:SUBF<sf>:USER<us>:BWPart<bwp>:ALLoc<al>: CS:DCI<dcI>:FMT.....	648
[:SOURce<hw>]:BB:NR5G:SCHed:CELL<cc>:SUBF<sf>:USER<us>:BWPart<bwp>:ALLoc<al>: CS:DCI<dcI>:FRDRes.....	653
[:SOURce<hw>]:BB:NR5G:SCHed:CELL<cc>:SUBF<sf>:USER<us>:BWPart<bwp>:ALLoc<al>: CS:DCI<dcI>:FRHFlag.....	654
[:SOURce<hw>]:BB:NR5G:SCHed:CELL<cc>:SUBF<sf>:USER<us>:BWPart<bwp>:ALLoc<al>: CS:DCI<dcI>:FRRLoc.....	686
[:SOURce<hw>]:BB:NR5G:SCHed:CELL<cc>:SUBF<sf>:USER<us>:BWPart<bwp>:ALLoc<al>: CS:DCI<dcI>:FSCHannel.....	684

[:SOURce<hw>]:BB:NR5G:SCHed:CELL<cc>:SUBF<sf>:USER<us>:BWPart<bwp>:ALLoc<al>: CS:DCI<dcI>:HAFB.....	689
[:SOURce<hw>]:BB:NR5G:SCHed:CELL<cc>:SUBF<sf>:USER<us>:BWPart<bwp>:ALLoc<al>: CS:DCI<dcI>:HAPRoc.....	654
[:SOURce<hw>]:BB:NR5G:SCHed:CELL<cc>:SUBF<sf>:USER<us>:BWPart<bwp>:ALLoc<al>: CS:DCI<dcI>:HARTind.....	670
[:SOURce<hw>]:BB:NR5G:SCHed:CELL<cc>:SUBF<sf>:USER<us>:BWPart<bwp>:ALLoc<al>: CS:DCI<dcI>:HBTS?.....	648
[:SOURce<hw>]:BB:NR5G:SCHed:CELL<cc>:SUBF<sf>:USER<us>:BWPart<bwp>:ALLoc<al>: CS:DCI<dcI>:HQAResquest.....	671
[:SOURce<hw>]:BB:NR5G:SCHed:CELL<cc>:SUBF<sf>:USER<us>:BWPart<bwp>:ALLoc<al>: CS:DCI<dcI>:IDENTifier.....	654
[:SOURce<hw>]:BB:NR5G:SCHed:CELL<cc>:SUBF<sf>:USER<us>:BWPart<bwp>:ALLoc<al>: CS:DCI<dcI>:INDEX.....	649
[:SOURce<hw>]:BB:NR5G:SCHed:CELL<cc>:SUBF<sf>:USER<us>:BWPart<bwp>:ALLoc<al>: CS:DCI<dcI>:INITpattern.....	690
[:SOURce<hw>]:BB:NR5G:SCHed:CELL<cc>:SUBF<sf>:USER<us>:BWPart<bwp>:ALLoc<al>: CS:DCI<dcI>:INSPatt.....	660
[:SOURce<hw>]:BB:NR5G:SCHed:CELL<cc>:SUBF<sf>:USER<us>:BWPart<bwp>:ALLoc<al>: CS:DCI<dcI>:LSBSfn.....	666
[:SOURce<hw>]:BB:NR5G:SCHed:CELL<cc>:SUBF<sf>:USER<us>:BWPart<bwp>:ALLoc<al>: CS:DCI<dcI>:MCCH.....	687
[:SOURce<hw>]:BB:NR5G:SCHed:CELL<cc>:SUBF<sf>:USER<us>:BWPart<bwp>:ALLoc<al>: CS:DCI<dcI>:MOFFs.....	660
[:SOURce<hw>]:BB:NR5G:SCHed:CELL<cc>:SUBF<sf>:USER<us>:BWPart<bwp>:ALLoc<al>: CS:DCI<dcI>:MULTable.....	649
[:SOURce<hw>]:BB:NR5G:SCHed:CELL<cc>:SUBF<sf>:USER<us>:BWPart<bwp>:ALLoc<al>: CS:DCI<dcI>:NFINDicator.....	671
[:SOURce<hw>]:BB:NR5G:SCHed:CELL<cc>:SUBF<sf>:USER<us>:BWPart<bwp>:ALLoc<al>: CS:DCI<dcI>:NRPGroups.....	671
[:SOURce<hw>]:BB:NR5G:SCHed:CELL<cc>:SUBF<sf>:USER<us>:BWPart<bwp>:ALLoc<al>: CS:DCI<dcI>:OLINDicator.....	661
[:SOURce<hw>]:BB:NR5G:SCHed:CELL<cc>:SUBF<sf>:USER<us>:BWPart<bwp>:ALLoc<al>: CS:DCI<dcI>:PATtern.....	691
[:SOURce<hw>]:BB:NR5G:SCHed:CELL<cc>:SUBF<sf>:USER<us>:BWPart<bwp>:ALLoc<al>: CS:DCI<dcI>:PCIND.....	671
[:SOURce<hw>]:BB:NR5G:SCHed:CELL<cc>:SUBF<sf>:USER<us>:BWPart<bwp>:ALLoc<al>: CS:DCI<dcI>:PDSHarq.....	666
[:SOURce<hw>]:BB:NR5G:SCHed:CELL<cc>:SUBF<sf>:USER<us>:BWPart<bwp>:ALLoc<al>: CS:DCI<dcI>:PE<x>.....	677
[:SOURce<hw>]:BB:NR5G:SCHed:CELL<cc>:SUBF<sf>:USER<us>:BWPart<bwp>:ALLoc<al>: CS:DCI<dcI>:PEI<x>.....	682
[:SOURce<hw>]:BB:NR5G:SCHed:CELL<cc>:SUBF<sf>:USER<us>:BWPart<bwp>:ALLoc<al>: CS:DCI<dcI>:PGINDEX.....	671
[:SOURce<hw>]:BB:NR5G:SCHed:CELL<cc>:SUBF<sf>:USER<us>:BWPart<bwp>:ALLoc<al>: CS:DCI<dcI>:PINDicator.....	661
[:SOURce<hw>]:BB:NR5G:SCHed:CELL<cc>:SUBF<sf>:USER<us>:BWPart<bwp>:ALLoc<al>: CS:DCI<dcI>:PMADaption.....	661
[:SOURce<hw>]:BB:NR5G:SCHed:CELL<cc>:SUBF<sf>:USER<us>:BWPart<bwp>:ALLoc<al>: CS:DCI<dcI>:POWER.....	649

[:SOURce<hw>]:BB:NR5G:SCHed:CELL<cc>:SUBF<sf>:USER<us>:BWPart<bwp>:ALLoc<al>: CS:DCI<dci>:PRBBundling.....	672
[:SOURce<hw>]:BB:NR5G:SCHed:CELL<cc>:SUBF<sf>:USER<us>:BWPart<bwp>:ALLoc<al>: CS:DCI<dci>:PRC2.....	661
[:SOURce<hw>]:BB:NR5G:SCHed:CELL<cc>:SUBF<sf>:USER<us>:BWPart<bwp>:ALLoc<al>: CS:DCI<dci>:PREInfo.....	661
[:SOURce<hw>]:BB:NR5G:SCHed:CELL<cc>:SUBF<sf>:USER<us>:BWPart<bwp>:ALLoc<al>: CS:DCI<dci>:PTDMrs.....	662
[:SOURce<hw>]:BB:NR5G:SCHed:CELL<cc>:SUBF<sf>:USER<us>:BWPart<bwp>:ALLoc<al>: CS:DCI<dci>:PTHFeedback.....	685
[:SOURce<hw>]:BB:NR5G:SCHed:CELL<cc>:SUBF<sf>:USER<us>:BWPart<bwp>:ALLoc<al>: CS:DCI<dci>:PUCResind.....	666
[:SOURce<hw>]:BB:NR5G:SCHed:CELL<cc>:SUBF<sf>:USER<us>:BWPart<bwp>:ALLoc<al>: CS:DCI<dci>:RESVed.....	667
[:SOURce<hw>]:BB:NR5G:SCHed:CELL<cc>:SUBF<sf>:USER<us>:BWPart<bwp>:ALLoc<al>: CS:DCI<dci>:RMIND.....	672
[:SOURce<hw>]:BB:NR5G:SCHed:CELL<cc>:SUBF<sf>:USER<us>:BWPart<bwp>:ALLoc<al>: CS:DCI<dci>:RNTI.....	650
[:SOURce<hw>]:BB:NR5G:SCHed:CELL<cc>:SUBF<sf>:USER<us>:BWPart<bwp>:ALLoc<al>: CS:DCI<dci>:RPINDEX.....	685
[:SOURce<hw>]:BB:NR5G:SCHed:CELL<cc>:SUBF<sf>:USER<us>:BWPart<bwp>:ALLoc<al>: CS:DCI<dci>:SAI.....	654
[:SOURce<hw>]:BB:NR5G:SCHed:CELL<cc>:SUBF<sf>:USER<us>:BWPart<bwp>:ALLoc<al>: CS:DCI<dci>:SGS<x>.....	676
[:SOURce<hw>]:BB:NR5G:SCHed:CELL<cc>:SUBF<sf>:USER<us>:BWPart<bwp>:ALLoc<al>: CS:DCI<dci>:SI<x>.....	676
[:SOURce<hw>]:BB:NR5G:SCHed:CELL<cc>:SUBF<sf>:USER<us>:BWPart<bwp>:ALLoc<al>: CS:DCI<dci>:SIIND.....	667
[:SOURce<hw>]:BB:NR5G:SCHed:CELL<cc>:SUBF<sf>:USER<us>:BWPart<bwp>:ALLoc<al>: CS:DCI<dci>:SLINDEX.....	686
[:SOURce<hw>]:BB:NR5G:SCHed:CELL<cc>:SUBF<sf>:USER<us>:BWPart<bwp>:ALLoc<al>: CS:DCI<dci>:SMIND.....	667
[:SOURce<hw>]:BB:NR5G:SCHed:CELL<cc>:SUBF<sf>:USER<us>:BWPart<bwp>:ALLoc<al>: CS:DCI<dci>:SMSGS.....	668
[:SOURce<hw>]:BB:NR5G:SCHed:CELL<cc>:SUBF<sf>:USER<us>:BWPart<bwp>:ALLoc<al>: CS:DCI<dci>:SOIN.....	662
[:SOURce<hw>]:BB:NR5G:SCHed:CELL<cc>:SUBF<sf>:USER<us>:BWPart<bwp>:ALLoc<al>: CS:DCI<dci>:SPSConf.....	686
[:SOURce<hw>]:BB:NR5G:SCHed:CELL<cc>:SUBF<sf>:USER<us>:BWPart<bwp>:ALLoc<al>: CS:DCI<dci>:SR<x>.....	679
[:SOURce<hw>]:BB:NR5G:SCHed:CELL<cc>:SUBF<sf>:USER<us>:BWPart<bwp>:ALLoc<al>: CS:DCI<dci>:SRI2.....	662
[:SOURce<hw>]:BB:NR5G:SCHed:CELL<cc>:SUBF<sf>:USER<us>:BWPart<bwp>:ALLoc<al>: CS:DCI<dci>:SRIND.....	662
[:SOURce<hw>]:BB:NR5G:SCHed:CELL<cc>:SUBF<sf>:USER<us>:BWPart<bwp>:ALLoc<al>: CS:DCI<dci>:SRSRequest.....	662
[:SOURce<hw>]:BB:NR5G:SCHed:CELL<cc>:SUBF<sf>:USER<us>:BWPart<bwp>:ALLoc<al>: CS:DCI<dci>:SRSResind.....	663
[:SOURce<hw>]:BB:NR5G:SCHed:CELL<cc>:SUBF<sf>:USER<us>:BWPart<bwp>:ALLoc<al>: CS:DCI<dci>:SSP.....	650

[:SOURce<hw>]:BB:NR5G:SHed:CELL<cc>:SUBF<sf>:USER<us>:BWPart<bwp>:ALLoc<al>: CS:DCI<dci>:STATe.....	691
[:SOURce<hw>]:BB:NR5G:SHed:CELL<cc>:SUBF<sf>:USER<us>:BWPart<bwp>:ALLoc<al>: CS:DCI<dci>:T2PC.....	672
[:SOURce<hw>]:BB:NR5G:SHed:CELL<cc>:SUBF<sf>:USER<us>:BWPart<bwp>:ALLoc<al>: CS:DCI<dci>:T2PS.....	663
[:SOURce<hw>]:BB:NR5G:SHed:CELL<cc>:SUBF<sf>:USER<us>:BWPart<bwp>:ALLoc<al>: CS:DCI<dci>:T3CBind.....	672
[:SOURce<hw>]:BB:NR5G:SHed:CELL<cc>:SUBF<sf>:USER<us>:BWPart<bwp>:ALLoc<al>: CS:DCI<dci>:TB1:MCS.....	655
[:SOURce<hw>]:BB:NR5G:SHed:CELL<cc>:SUBF<sf>:USER<us>:BWPart<bwp>:ALLoc<al>: CS:DCI<dci>:TB1:NDI.....	655
[:SOURce<hw>]:BB:NR5G:SHed:CELL<cc>:SUBF<sf>:USER<us>:BWPart<bwp>:ALLoc<al>: CS:DCI<dci>:TB1:RV.....	655
[:SOURce<hw>]:BB:NR5G:SHed:CELL<cc>:SUBF<sf>:USER<us>:BWPart<bwp>:ALLoc<al>: CS:DCI<dci>:TB2:MCS.....	655
[:SOURce<hw>]:BB:NR5G:SHed:CELL<cc>:SUBF<sf>:USER<us>:BWPart<bwp>:ALLoc<al>: CS:DCI<dci>:TB2:NDI.....	655
[:SOURce<hw>]:BB:NR5G:SHed:CELL<cc>:SUBF<sf>:USER<us>:BWPart<bwp>:ALLoc<al>: CS:DCI<dci>:TB2:RV.....	655
[:SOURce<hw>]:BB:NR5G:SHed:CELL<cc>:SUBF<sf>:USER<us>:BWPart<bwp>:ALLoc<al>: CS:DCI<dci>:TBSCaling.....	668
[:SOURce<hw>]:BB:NR5G:SHed:CELL<cc>:SUBF<sf>:USER<us>:BWPart<bwp>:ALLoc<al>: CS:DCI<dci>:TCI.....	672
[:SOURce<hw>]:BB:NR5G:SHed:CELL<cc>:SUBF<sf>:USER<us>:BWPart<bwp>:ALLoc<al>: CS:DCI<dci>:TGAP.....	685
[:SOURce<hw>]:BB:NR5G:SHed:CELL<cc>:SUBF<sf>:USER<us>:BWPart<bwp>:ALLoc<al>: CS:DCI<dci>:TIDRes.....	655
[:SOURce<hw>]:BB:NR5G:SHed:CELL<cc>:SUBF<sf>:USER<us>:BWPart<bwp>:ALLoc<al>: CS:DCI<dci>:TOFFset.....	687
[:SOURce<hw>]:BB:NR5G:SHed:CELL<cc>:SUBF<sf>:USER<us>:BWPart<bwp>:ALLoc<al>: CS:DCI<dci>:TP<x>.....	678
[:SOURce<hw>]:BB:NR5G:SHed:CELL<cc>:SUBF<sf>:USER<us>:BWPart<bwp>:ALLoc<al>: CS:DCI<dci>:TPUCch.....	668
[:SOURce<hw>]:BB:NR5G:SHed:CELL<cc>:SUBF<sf>:USER<us>:BWPart<bwp>:ALLoc<al>: CS:DCI<dci>:TPUSch.....	656
[:SOURce<hw>]:BB:NR5G:SHed:CELL<cc>:SUBF<sf>:USER<us>:BWPart<bwp>:ALLoc<al>: CS:DCI<dci>:TRAV.....	683
[:SOURce<hw>]:BB:NR5G:SHed:CELL<cc>:SUBF<sf>:USER<us>:BWPart<bwp>:ALLoc<al>: CS:DCI<dci>:ULSchind.....	663
[:SOURce<hw>]:BB:NR5G:SHed:CELL<cc>:SUBF<sf>:USER<us>:BWPart<bwp>:ALLoc<al>: CS:DCI<dci>:USAGe.....	650
[:SOURce<hw>]:BB:NR5G:SHed:CELL<cc>:SUBF<sf>:USER<us>:BWPart<bwp>:ALLoc<al>: CS:DCI<dci>:USINd.....	656
[:SOURce<hw>]:BB:NR5G:SHed:CELL<cc>:SUBF<sf>:USER<us>:BWPart<bwp>:ALLoc<al>: CS:DCI<dci>:VTPRb.....	668
[:SOURce<hw>]:BB:NR5G:SHed:CELL<cc>:SUBF<sf>:USER<us>:BWPart<bwp>:ALLoc<al>: CS:DCI<dci>:WA<x>.....	682
[:SOURce<hw>]:BB:NR5G:SHed:CELL<cc>:SUBF<sf>:USER<us>:BWPart<bwp>:ALLoc<al>: CS:DCI<dci>:ZCRTrigg.....	673

[:SOURce<hw>]:BB:NR5G:SCHed:CELL<cc>:SUBF<sf>:USER<us>:BWPart<bwp>:ALLoc<al>: CS:DMRS:SCRam:ID.....	640
[:SOURce<hw>]:BB:NR5G:SCHed:CELL<cc>:SUBF<sf>:USER<us>:BWPart<bwp>:ALLoc<al>: CS:DMRS:SCRam:STATE.....	640
[:SOURce<hw>]:BB:NR5G:SCHed:CELL<cc>:SUBF<sf>:USER<us>:BWPart<bwp>:ALLoc<al>: CS:DMRS:SPACe<s2us0>:AGGLLevel?.....	641
[:SOURce<hw>]:BB:NR5G:SCHed:CELL<cc>:SUBF<sf>:USER<us>:BWPart<bwp>:ALLoc<al>: CS:DMRS:SPACe<s2us0>:MAXCandidate.....	641
[:SOURce<hw>]:BB:NR5G:SCHed:CELL<cc>:SUBF<sf>:USER<us>:BWPart<bwp>:ALLoc<al>:CS:ID....	642
[:SOURce<hw>]:BB:NR5G:SCHed:CELL<cc>:SUBF<sf>:USER<us>:BWPart<bwp>:ALLoc<al>: CS:IL:BUNSize.....	642
[:SOURce<hw>]:BB:NR5G:SCHed:CELL<cc>:SUBF<sf>:USER<us>:BWPart<bwp>:ALLoc<al>: CS:IL:SHIDx.....	642
[:SOURce<hw>]:BB:NR5G:SCHed:CELL<cc>:SUBF<sf>:USER<us>:BWPart<bwp>:ALLoc<al>: CS:IL:SIZE.....	642
[:SOURce<hw>]:BB:NR5G:SCHed:CELL<cc>:SUBF<sf>:USER<us>:BWPart<bwp>:ALLoc<al>: CS:IL:STATE.....	643
[:SOURce<hw>]:BB:NR5G:SCHed:CELL<cc>:SUBF<sf>:USER<us>:BWPart<bwp>:ALLoc<al>: CS:NDCI.....	651
[:SOURce<hw>]:BB:NR5G:SCHed:CELL<cc>:SUBF<sf>:USER<us>:BWPart<bwp>:ALLoc<al>: CS:PREGran.....	643
[:SOURce<hw>]:BB:NR5G:SCHed:CELL<cc>:SUBF<sf>:USER<us>:BWPart<bwp>:ALLoc<al>: CS:PUNcturing.....	643
[:SOURce<hw>]:BB:NR5G:SCHed:CELL<cc>:SUBF<sf>:USER<us>:BWPart<bwp>:ALLoc<al>: CS:REFDmrs.....	641
[:SOURce<hw>]:BB:NR5G:SCHed:CELL<cc>:SUBF<sf>:USER<us>:BWPart<bwp>:ALLoc<al>: CS:RESalloc:BITMap.....	644
[:SOURce<hw>]:BB:NR5G:SCHed:CELL<cc>:SUBF<sf>:USER<us>:BWPart<bwp>:ALLoc<al>: CS:RESalloc:STATE.....	644
[:SOURce<hw>]:BB:NR5G:SCHed:CELL<cc>:SUBF<sf>:USER<us>:BWPart<bwp>:ALLoc<al>:CS:TCl..	650
[:SOURce<hw>]:BB:NR5G:SCHed:CELL<cc>:SUBF<sf>:USER<us>:BWPart<bwp>:ALLoc<al>: CS:TS12.....	652
[:SOURce<hw>]:BB:NR5G:SCHed:CELL<cc>:SUBF<sf>:USER<us>:BWPart<bwp>:ALLoc<al>:CSRS....	706
[:SOURce<hw>]:BB:NR5G:SCHed:CELL<cc>:SUBF<sf>:USER<us>:BWPart<bwp>:ALLoc<al>:DENsity	692
[:SOURce<hw>]:BB:NR5G:SCHed:CELL<cc>:SUBF<sf>:USER<us>:BWPart<bwp>:ALLoc<al>: DURation.....	599
[:SOURce<hw>]:BB:NR5G:SCHed:CELL<cc>:SUBF<sf>:USER<us>:BWPart<bwp>:ALLoc<al>:FACTs?..	597
[:SOURce<hw>]:BB:NR5G:SCHed:CELL<cc>:SUBF<sf>:USER<us>:BWPart<bwp>:ALLoc<al>:FMT.....	600
[:SOURce<hw>]:BB:NR5G:SCHed:CELL<cc>:SUBF<sf>:USER<us>:BWPart<bwp>:ALLoc<al>:FPOS....	706
[:SOURce<hw>]:BB:NR5G:SCHed:CELL<cc>:SUBF<sf>:USER<us>:BWPart<bwp>:ALLoc<al>:FQSHift.	706
[:SOURce<hw>]:BB:NR5G:SCHed:CELL<cc>:SUBF<sf>:USER<us>:BWPart<bwp>:ALLoc<al>: FSFactor.....	707
[:SOURce<hw>]:BB:NR5G:SCHed:CELL<cc>:SUBF<sf>:USER<us>:BWPart<bwp>:ALLoc<al>:I0.....	692
[:SOURce<hw>]:BB:NR5G:SCHed:CELL<cc>:SUBF<sf>:USER<us>:BWPart<bwp>:ALLoc<al>:I1.....	693
[:SOURce<hw>]:BB:NR5G:SCHed:CELL<cc>:SUBF<sf>:USER<us>:BWPart<bwp>:ALLoc<al>:INFO?...	600
[:SOURce<hw>]:BB:NR5G:SCHed:CELL<cc>:SUBF<sf>:USER<us>:BWPart<bwp>:ALLoc<al>:INFO?...	607
[:SOURce<hw>]:BB:NR5G:SCHed:CELL<cc>:SUBF<sf>:USER<us>:BWPart<bwp>:ALLoc<al>: ISZPower.....	693
[:SOURce<hw>]:BB:NR5G:SCHed:CELL<cc>:SUBF<sf>:USER<us>:BWPart<bwp>:ALLoc<al>: MAPType.....	601

[:SOURce<hw>]:BB:NR5G:SCHed:CELL<cc>:SUBF<sf>:USER<us>:BWPart<bwp>:ALLoc<al>:OFFSet.	707
[:SOURce<hw>]:BB:NR5G:SCHed:CELL<cc>:SUBF<sf>:USER<us>:BWPart<bwp>:ALLoc<al>: PDSCh:NCW.....	610
[:SOURce<hw>]:BB:NR5G:SCHed:CELL<cc>:SUBF<sf>:USER<us>:BWPart<bwp>:ALLoc<al>: PDSCh:PATGrp.....	611
[:SOURce<hw>]:BB:NR5G:SCHed:CELL<cc>:SUBF<sf>:USER<us>:BWPart<bwp>:ALLoc<al>: PDSCh:PRECg.....	611
[:SOURce<hw>]:BB:NR5G:SCHed:CELL<cc>:SUBF<sf>:USER<us>:BWPart<bwp>:ALLoc<al>: PDSCh:PTRS:EPRE.....	633
[:SOURce<hw>]:BB:NR5G:SCHed:CELL<cc>:SUBF<sf>:USER<us>:BWPart<bwp>:ALLoc<al>: PDSCh:SBCZero:STAtE.....	612
[:SOURce<hw>]:BB:NR5G:SCHed:CELL<cc>:SUBF<sf>:USER<us>:BWPart<bwp>:ALLoc<al>: PDSCh:TXScheme:APCSirs.....	617
[:SOURce<hw>]:BB:NR5G:SCHed:CELL<cc>:SUBF<sf>:USER<us>:BWPart<bwp>:ALLoc<al>: PDSCh:TXScheme:CBMD.....	617
[:SOURce<hw>]:BB:NR5G:SCHed:CELL<cc>:SUBF<sf>:USER<us>:BWPart<bwp>:ALLoc<al>: PDSCh:TXScheme:CBTYpe?.....	618
[:SOURce<hw>]:BB:NR5G:SCHed:CELL<cc>:SUBF<sf>:USER<us>:BWPart<bwp>:ALLoc<al>: PDSCh:TXScheme:INTervp.....	618
[:SOURce<hw>]:BB:NR5G:SCHed:CELL<cc>:SUBF<sf>:USER<us>:BWPart<bwp>:ALLoc<al>: PDSCh:TXScheme:PCN1.....	619
[:SOURce<hw>]:BB:NR5G:SCHed:CELL<cc>:SUBF<sf>:USER<us>:BWPart<bwp>:ALLoc<al>: PDSCh:TXScheme:PCN2?.....	619
[:SOURce<hw>]:BB:NR5G:SCHed:CELL<cc>:SUBF<sf>:USER<us>:BWPart<bwp>:ALLoc<al>: PDSCh:TXScheme:SPCB<s2us0>:I2.....	621
[:SOURce<hw>]:BB:NR5G:SCHed:CELL<cc>:SUBF<sf>:USER<us>:BWPart<bwp>:ALLoc<al>: PDSCh:TXScheme:SPCB<s2us0>:I11.....	620
[:SOURce<hw>]:BB:NR5G:SCHed:CELL<cc>:SUBF<sf>:USER<us>:BWPart<bwp>:ALLoc<al>: PDSCh:TXScheme:SPCB<s2us0>:I12.....	620
[:SOURce<hw>]:BB:NR5G:SCHed:CELL<cc>:SUBF<sf>:USER<us>:BWPart<bwp>:ALLoc<al>: PDSCh:TXScheme:SPCB<s2us0>:I13.....	621
[:SOURce<hw>]:BB:NR5G:SCHed:CELL<cc>:SUBF<sf>:USER<us>:BWPart<bwp>:ALLoc<al>: PDSCh[:DMRS]:APSelect<s2us0>.....	506
[:SOURce<hw>]:BB:NR5G:SCHed:CELL<cc>:SUBF<sf>:USER<us>:BWPart<bwp>:ALLoc<al>: PDSCh[:DMRS]:APSelect<s2us0>.....	623
[:SOURce<hw>]:BB:NR5G:SCHed:CELL<cc>:SUBF<sf>:USER<us>:BWPart<bwp>:ALLoc<al>: PDSCh PUSCh:BMAid.....	612
[:SOURce<hw>]:BB:NR5G:SCHed:CELL<cc>:SUBF<sf>:USER<us>:BWPart<bwp>:ALLoc<al>: PDSCh PUSCh:DMRS:APINdex.....	623
[:SOURce<hw>]:BB:NR5G:SCHed:CELL<cc>:SUBF<sf>:USER<us>:BWPart<bwp>:ALLoc<al>: PDSCh PUSCh:DMRS:CTYPe.....	623
[:SOURce<hw>]:BB:NR5G:SCHed:CELL<cc>:SUBF<sf>:USER<us>:BWPart<bwp>:ALLoc<al>: PDSCh PUSCh:DMRS:LENGth.....	624
[:SOURce<hw>]:BB:NR5G:SCHed:CELL<cc>:SUBF<sf>:USER<us>:BWPart<bwp>:ALLoc<al>: PDSCh PUSCh:DMRS:MODE.....	625
[:SOURce<hw>]:BB:NR5G:SCHed:CELL<cc>:SUBF<sf>:USER<us>:BWPart<bwp>:ALLoc<al>: PDSCh PUSCh:DMRS:NSID.....	625
[:SOURce<hw>]:BB:NR5G:SCHed:CELL<cc>:SUBF<sf>:USER<us>:BWPart<bwp>:ALLoc<al>: PDSCh PUSCh:DMRS:POWer.....	625

[:SOURce<hw>]:BB:NR5G:SCHed:CELL<cc>:SUBF<sf>:USER<us>:BWPart<bwp>:ALLoc<al>: PDSCh PUSCh:DMRS:SEQGen.....	626
[:SOURce<hw>]:BB:NR5G:SCHed:CELL<cc>:SUBF<sf>:USER<us>:BWPart<bwp>:ALLoc<al>: PDSCh PUSCh:DMRS:SEQHopping.....	626
[:SOURce<hw>]:BB:NR5G:SCHed:CELL<cc>:SUBF<sf>:USER<us>:BWPart<bwp>:ALLoc<al>: PDSCh PUSCh:DMRS:SLTSymbols?.....	626
[:SOURce<hw>]:BB:NR5G:SCHed:CELL<cc>:SUBF<sf>:USER<us>:BWPart<bwp>:ALLoc<al>: PDSCh PUSCh:DMRS:TAPos.....	627
[:SOURce<hw>]:BB:NR5G:SCHed:CELL<cc>:SUBF<sf>:USER<us>:BWPart<bwp>:ALLoc<al>: PDSCh PUSCh:PTRS:FRQDen.....	633
[:SOURce<hw>]:BB:NR5G:SCHed:CELL<cc>:SUBF<sf>:USER<us>:BWPart<bwp>:ALLoc<al>: PDSCh PUSCh:PTRS:MODE.....	634
[:SOURce<hw>]:BB:NR5G:SCHed:CELL<cc>:SUBF<sf>:USER<us>:BWPart<bwp>:ALLoc<al>: PDSCh PUSCh:PTRS:REOF.....	634
[:SOURce<hw>]:BB:NR5G:SCHed:CELL<cc>:SUBF<sf>:USER<us>:BWPart<bwp>:ALLoc<al>: PDSCh PUSCh:PTRS:STATE.....	634
[:SOURce<hw>]:BB:NR5G:SCHed:CELL<cc>:SUBF<sf>:USER<us>:BWPart<bwp>:ALLoc<al>: PDSCh PUSCh:PTRS:TMDen.....	635
[:SOURce<hw>]:BB:NR5G:SCHed:CELL<cc>:SUBF<sf>:USER<us>:BWPart<bwp>:ALLoc<al>: PDSCh PUSCh:RESalloc.....	612
[:SOURce<hw>]:BB:NR5G:SCHed:CELL<cc>:SUBF<sf>:USER<us>:BWPart<bwp>:ALLoc<al>: PDSCh PUSCh:RESalloc:PATtern.....	613
[:SOURce<hw>]:BB:NR5G:SCHed:CELL<cc>:SUBF<sf>:USER<us>:BWPart<bwp>:ALLoc<al>: PDSCh PUSCh:TXScheme:CDMData.....	618
[:SOURce<hw>]:BB:NR5G:SCHed:CELL<cc>:SUBF<sf>:USER<us>:BWPart<bwp>:ALLoc<al>: PDSCh PUSCh:TXScheme:NLAYers.....	619
[:SOURce<hw>]:BB:NR5G:SCHed:CELL<cc>:SUBF<sf>:USER<us>:BWPart<bwp>:ALLoc<al>: PDSCh PUSCh:TYPE.....	613
[:SOURce<hw>]:BB:NR5G:SCHed:CELL<cc>:SUBF<sf>:USER<us>:BWPart<bwp>:ALLoc<al>: PDSCh PUSCh PSSCh:TXScheme:NLAYers.....	719
[:SOURce<hw>]:BB:NR5G:SCHed:CELL<cc>:SUBF<sf>:USER<us>:BWPart<bwp>:ALLoc<al>:PER.....	707
[:SOURce<hw>]:BB:NR5G:SCHed:CELL<cc>:SUBF<sf>:USER<us>:BWPart<bwp>:ALLoc<al>:PERiod..	602
[:SOURce<hw>]:BB:NR5G:SCHed:CELL<cc>:SUBF<sf>:USER<us>:BWPart<bwp>:ALLoc<al>:PORTs..	708
[:SOURce<hw>]:BB:NR5G:SCHed:CELL<cc>:SUBF<sf>:USER<us>:BWPart<bwp>:ALLoc<al>:POWer..	602
[:SOURce<hw>]:BB:NR5G:SCHed:CELL<cc>:SUBF<sf>:USER<us>:BWPart<bwp>:ALLoc<al>: PRCh:BMAid.....	702
[:SOURce<hw>]:BB:NR5G:SCHed:CELL<cc>:SUBF<sf>:USER<us>:BWPart<bwp>:ALLoc<al>: PRCh:FORMat.....	702
[:SOURce<hw>]:BB:NR5G:SCHed:CELL<cc>:SUBF<sf>:USER<us>:BWPart<bwp>:ALLoc<al>: PRCh:PRINdex.....	703
[:SOURce<hw>]:BB:NR5G:SCHed:CELL<cc>:SUBF<sf>:USER<us>:BWPart<bwp>:ALLoc<al>: PRCh:RBNumber?.....	603
[:SOURce<hw>]:BB:NR5G:SCHed:CELL<cc>:SUBF<sf>:USER<us>:BWPart<bwp>:ALLoc<al>: PRCh:RBNumber?.....	703
[:SOURce<hw>]:BB:NR5G:SCHed:CELL<cc>:SUBF<sf>:USER<us>:BWPart<bwp>:ALLoc<al>: PRCh:RSEQuence.....	703
[:SOURce<hw>]:BB:NR5G:SCHed:CELL<cc>:SUBF<sf>:USER<us>:BWPart<bwp>:ALLoc<al>: PRCh:RSET.....	702
[:SOURce<hw>]:BB:NR5G:SCHed:CELL<cc>:SUBF<sf>:USER<us>:BWPart<bwp>:ALLoc<al>: PRCh:SCSPacing.....	701

[:SOURce<hw>]:BB:NR5G:SCHed:CELL<cc>:SUBF<sf>:USER<us>:BWPart<bwp>:ALLoc<al>: PRCh:TOFFset.....	704
[:SOURce<hw>]:BB:NR5G:SCHed:CELL<cc>:SUBF<sf>:USER<us>:BWPart<bwp>:ALLoc<al>: PRCh:ZCZone.....	703
[:SOURce<hw>]:BB:NR5G:SCHed:CELL<cc>:SUBF<sf>:USER<us>:BWPart<bwp>:ALLoc<al>: PSCCh:BDWidth.....	710
[:SOURce<hw>]:BB:NR5G:SCHed:CELL<cc>:SUBF<sf>:USER<us>:BWPart<bwp>:ALLoc<al>: PSCCh:SCRid.....	710
[:SOURce<hw>]:BB:NR5G:SCHed:CELL<cc>:SUBF<sf>:USER<us>:BWPart<bwp>:ALLoc<al>: PSCCh:SYMLength.....	711
[:SOURce<hw>]:BB:NR5G:SCHed:CELL<cc>:SUBF<sf>:USER<us>:BWPart<bwp>:ALLoc<al>: PSFCh:CYCShift.....	723
[:SOURce<hw>]:BB:NR5G:SCHed:CELL<cc>:SUBF<sf>:USER<us>:BWPart<bwp>:ALLoc<al>: PSFCh:HARQ.....	724
[:SOURce<hw>]:BB:NR5G:SCHed:CELL<cc>:SUBF<sf>:USER<us>:BWPart<bwp>:ALLoc<al>: PSFCh:HOPid.....	724
[:SOURce<hw>]:BB:NR5G:SCHed:CELL<cc>:SUBF<sf>:USER<us>:BWPart<bwp>:ALLoc<al>: PSFCh:TRAN.....	724
[:SOURce<hw>]:BB:NR5G:SCHed:CELL<cc>:SUBF<sf>:USER<us>:BWPart<bwp>:ALLoc<al>: PSFCh:TYPe.....	725
[:SOURce<hw>]:BB:NR5G:SCHed:CELL<cc>:SUBF<sf>:USER<us>:BWPart<bwp>:ALLoc<al>: PSSCh:DMRS:APSel.....	720
[:SOURce<hw>]:BB:NR5G:SCHed:CELL<cc>:SUBF<sf>:USER<us>:BWPart<bwp>:ALLoc<al>: PSSCh:MOD.....	711
[:SOURce<hw>]:BB:NR5G:SCHed:CELL<cc>:SUBF<sf>:USER<us>:BWPart<bwp>:ALLoc<al>: PSSCh:NDMRs.....	711
[:SOURce<hw>]:BB:NR5G:SCHed:CELL<cc>:SUBF<sf>:USER<us>:BWPart<bwp>:ALLoc<al>: PSSCh:NSUBchan.....	711
[:SOURce<hw>]:BB:NR5G:SCHed:CELL<cc>:SUBF<sf>:USER<us>:BWPart<bwp>:ALLoc<al>: PSSCh:POOL.....	712
[:SOURce<hw>]:BB:NR5G:SCHed:CELL<cc>:SUBF<sf>:USER<us>:BWPart<bwp>:ALLoc<al>: PUCCh:FS:CYCShift.....	696
[:SOURce<hw>]:BB:NR5G:SCHed:CELL<cc>:SUBF<sf>:USER<us>:BWPart<bwp>:ALLoc<al>: PUCCh:FS:FMT2:OCCLength.....	697
[:SOURce<hw>]:BB:NR5G:SCHed:CELL<cc>:SUBF<sf>:USER<us>:BWPart<bwp>:ALLoc<al>: PUCCh:FS:FMT3:OCCLength.....	697
[:SOURce<hw>]:BB:NR5G:SCHed:CELL<cc>:SUBF<sf>:USER<us>:BWPart<bwp>:ALLoc<al>: PUCCh:FS:OCCindex.....	696
[:SOURce<hw>]:BB:NR5G:SCHed:CELL<cc>:SUBF<sf>:USER<us>:BWPart<bwp>:ALLoc<al>: PUCCh:FS:OCCLength.....	696
[:SOURce<hw>]:BB:NR5G:SCHed:CELL<cc>:SUBF<sf>:USER<us>:BWPart<bwp>:ALLoc<al>: PUCCh:FS:TDOcc.....	697
[:SOURce<hw>]:BB:NR5G:SCHed:CELL<cc>:SUBF<sf>:USER<us>:BWPart<bwp>:ALLoc<al>: PUCCh:GRPHopping.....	697
[:SOURce<hw>]:BB:NR5G:SCHed:CELL<cc>:SUBF<sf>:USER<us>:BWPart<bwp>:ALLoc<al>: PUCCh:HOPid.....	698
[:SOURce<hw>]:BB:NR5G:SCHed:CELL<cc>:SUBF<sf>:USER<us>:BWPart<bwp>:ALLoc<al>: PUCCh:INT<ij>:INTL.....	698
[:SOURce<hw>]:BB:NR5G:SCHed:CELL<cc>:SUBF<sf>:USER<us>:BWPart<bwp>:ALLoc<al>: PUCCh:ISFHopping.....	698

[:SOURce<hw>]:BB:NR5G:SCHed:CELL<cc>:SUBF<sf>:USER<us>:BWPart<bwp>:ALLoc<al>: PUCCh:NINT.....	698
[:SOURce<hw>]:BB:NR5G:SCHed:CELL<cc>:SUBF<sf>:USER<us>:BWPart<bwp>:ALLoc<al>: PUCCh:PL:ACK:BITS.....	699
[:SOURce<hw>]:BB:NR5G:SCHed:CELL<cc>:SUBF<sf>:USER<us>:BWPart<bwp>:ALLoc<al>: PUCCh:PL:ACK:PATtern.....	700
[:SOURce<hw>]:BB:NR5G:SCHed:CELL<cc>:SUBF<sf>:USER<us>:BWPart<bwp>:ALLoc<al>: PUCCh:PL:SRCount.....	700
[:SOURce<hw>]:BB:NR5G:SCHed:CELL<cc>:SUBF<sf>:USER<us>:BWPart<bwp>:ALLoc<al>: PUCCh:PL:UCI:BITS.....	700
[:SOURce<hw>]:BB:NR5G:SCHed:CELL<cc>:SUBF<sf>:USER<us>:BWPart<bwp>:ALLoc<al>: PUCCh:PL:UCI:PATtern.....	701
[:SOURce<hw>]:BB:NR5G:SCHed:CELL<cc>:SUBF<sf>:USER<us>:BWPart<bwp>:ALLoc<al>: PUCCh:SHOPping.....	699
[:SOURce<hw>]:BB:NR5G:SCHed:CELL<cc>:SUBF<sf>:USER<us>:BWPart<bwp>:ALLoc<al>: PUSCh:DMR:NIDSel.....	624
[:SOURce<hw>]:BB:NR5G:SCHed:CELL<cc>:SUBF<sf>:USER<us>:BWPart<bwp>:ALLoc<al>: PUSCh:FHOI.....	613
[:SOURce<hw>]:BB:NR5G:SCHed:CELL<cc>:SUBF<sf>:USER<us>:BWPart<bwp>:ALLoc<al>: PUSCh:FHOP:STATe.....	613
[:SOURce<hw>]:BB:NR5G:SCHed:CELL<cc>:SUBF<sf>:USER<us>:BWPart<bwp>:ALLoc<al>: PUSCh:HPRNumber.....	614
[:SOURce<hw>]:BB:NR5G:SCHed:CELL<cc>:SUBF<sf>:USER<us>:BWPart<bwp>:ALLoc<al>: PUSCh:INT<i>:INTL.....	614
[:SOURce<hw>]:BB:NR5G:SCHed:CELL<cc>:SUBF<sf>:USER<us>:BWPart<bwp>:ALLoc<al>: PUSCh:NINT.....	614
[:SOURce<hw>]:BB:NR5G:SCHed:CELL<cc>:SUBF<sf>:USER<us>:BWPart<bwp>:ALLoc<al>: PUSCh:PTRS:PORT.....	635
[:SOURce<hw>]:BB:NR5G:SCHed:CELL<cc>:SUBF<sf>:USER<us>:BWPart<bwp>:ALLoc<al>: PUSCh:PTRS:POWer.....	635
[:SOURce<hw>]:BB:NR5G:SCHed:CELL<cc>:SUBF<sf>:USER<us>:BWPart<bwp>:ALLoc<al>: PUSCh:PTRS:PTDMrs.....	635
[:SOURce<hw>]:BB:NR5G:SCHed:CELL<cc>:SUBF<sf>:USER<us>:BWPart<bwp>:ALLoc<al>: PUSCh:PTRS:TP:MODE.....	636
[:SOURce<hw>]:BB:NR5G:SCHed:CELL<cc>:SUBF<sf>:USER<us>:BWPart<bwp>:ALLoc<al>: PUSCh:PTRS:TP:NGRPs.....	636
[:SOURce<hw>]:BB:NR5G:SCHed:CELL<cc>:SUBF<sf>:USER<us>:BWPart<bwp>:ALLoc<al>: PUSCh:PTRS:TP:SCID.....	636
[:SOURce<hw>]:BB:NR5G:SCHed:CELL<cc>:SUBF<sf>:USER<us>:BWPart<bwp>:ALLoc<al>: PUSCh:PTRS:TP:SPPG.....	637
[:SOURce<hw>]:BB:NR5G:SCHed:CELL<cc>:SUBF<sf>:USER<us>:BWPart<bwp>:ALLoc<al>: PUSCh:PTRS:TP:STATe.....	637
[:SOURce<hw>]:BB:NR5G:SCHed:CELL<cc>:SUBF<sf>:USER<us>:BWPart<bwp>:ALLoc<al>: PUSCh:PTRS:TP:TMDensity.....	637
[:SOURce<hw>]:BB:NR5G:SCHed:CELL<cc>:SUBF<sf>:USER<us>:BWPart<bwp>:ALLoc<al>: PUSCh:TXScheme:SRI.....	621
[:SOURce<hw>]:BB:NR5G:SCHed:CELL<cc>:SUBF<sf>:USER<us>:BWPart<bwp>:ALLoc<al>: PUSCh:TXScheme:TPMidx.....	622
[:SOURce<hw>]:BB:NR5G:SCHed:CELL<cc>:SUBF<sf>:USER<us>:BWPart<bwp>:ALLoc<al>: PUSCh:UCI:ACK:BITS.....	631

[:SOURce<hw>]:BB:NR5G:SCHed:CELL<cc>:SUBF<sf>:USER<us>:BWPart<bwp>:ALLoc<al>: PUSCh:UCI:ACK:PATtern.....	631
[:SOURce<hw>]:BB:NR5G:SCHed:CELL<cc>:SUBF<sf>:USER<us>:BWPart<bwp>:ALLoc<al>: PUSCh:UCI:CGUCi:BITS.....	632
[:SOURce<hw>]:BB:NR5G:SCHed:CELL<cc>:SUBF<sf>:USER<us>:BWPart<bwp>:ALLoc<al>: PUSCh:UCI:CGUCi:PATtern.....	632
[:SOURce<hw>]:BB:NR5G:SCHed:CELL<cc>:SUBF<sf>:USER<us>:BWPart<bwp>:ALLoc<al>: PUSCh:UCI:CSI1:BITS.....	631
[:SOURce<hw>]:BB:NR5G:SCHed:CELL<cc>:SUBF<sf>:USER<us>:BWPart<bwp>:ALLoc<al>: PUSCh:UCI:CSI1:PATtern.....	631
[:SOURce<hw>]:BB:NR5G:SCHed:CELL<cc>:SUBF<sf>:USER<us>:BWPart<bwp>:ALLoc<al>: PUSCh:UCI:CSI2:BITS.....	631
[:SOURce<hw>]:BB:NR5G:SCHed:CELL<cc>:SUBF<sf>:USER<us>:BWPart<bwp>:ALLoc<al>: PUSCh:UCI:CSI2:PATtern.....	631
[:SOURce<hw>]:BB:NR5G:SCHed:CELL<cc>:SUBF<sf>:USER<us>:BWPart<bwp>:ALLoc<al>: PUSCh[:DMRS]:APSelect<s2us0>.....	627
[:SOURce<hw>]:BB:NR5G:SCHed:CELL<cc>:SUBF<sf>:USER<us>:BWPart<bwp>:ALLoc<al>: RBNumber.....	603
[:SOURce<hw>]:BB:NR5G:SCHed:CELL<cc>:SUBF<sf>:USER<us>:BWPart<bwp>:ALLoc<al>: RBOffset.....	603
[:SOURce<hw>]:BB:NR5G:SCHed:CELL<cc>:SUBF<sf>:USER<us>:BWPart<bwp>:ALLoc<al>: REFactor.....	708
[:SOURce<hw>]:BB:NR5G:SCHed:CELL<cc>:SUBF<sf>:USER<us>:BWPart<bwp>:ALLoc<al>: REPetitions.....	603
[:SOURce<hw>]:BB:NR5G:SCHed:CELL<cc>:SUBF<sf>:USER<us>:BWPart<bwp>:ALLoc<al>:ROW.....	693
[:SOURce<hw>]:BB:NR5G:SCHed:CELL<cc>:SUBF<sf>:USER<us>:BWPart<bwp>:ALLoc<al>:RSType	708
[:SOURce<hw>]:BB:NR5G:SCHed:CELL<cc>:SUBF<sf>:USER<us>:BWPart<bwp>:ALLoc<al>: SCI:AMCSind.....	713
[:SOURce<hw>]:BB:NR5G:SCHed:CELL<cc>:SUBF<sf>:USER<us>:BWPart<bwp>:ALLoc<al>: SCI:BOINd.....	713
[:SOURce<hw>]:BB:NR5G:SCHed:CELL<cc>:SUBF<sf>:USER<us>:BWPart<bwp>:ALLoc<al>: SCI:CORReq.....	719
[:SOURce<hw>]:BB:NR5G:SCHed:CELL<cc>:SUBF<sf>:USER<us>:BWPart<bwp>:ALLoc<al>: SCI:CSIReq.....	716
[:SOURce<hw>]:BB:NR5G:SCHed:CELL<cc>:SUBF<sf>:USER<us>:BWPart<bwp>:ALLoc<al>: SCI:CTINd.....	717
[:SOURce<hw>]:BB:NR5G:SCHed:CELL<cc>:SUBF<sf>:USER<us>:BWPart<bwp>:ALLoc<al>: SCI:DESTId.....	717
[:SOURce<hw>]:BB:NR5G:SCHed:CELL<cc>:SUBF<sf>:USER<us>:BWPart<bwp>:ALLoc<al>: SCI:DPATterns.....	713
[:SOURce<hw>]:BB:NR5G:SCHed:CELL<cc>:SUBF<sf>:USER<us>:BWPart<bwp>:ALLoc<al>: SCI:DPORTs.....	713
[:SOURce<hw>]:BB:NR5G:SCHed:CELL<cc>:SUBF<sf>:USER<us>:BWPart<bwp>:ALLoc<al>: SCI:FRDRes.....	714
[:SOURce<hw>]:BB:NR5G:SCHed:CELL<cc>:SUBF<sf>:USER<us>:BWPart<bwp>:ALLoc<al>: SCI:HARFb.....	717
[:SOURce<hw>]:BB:NR5G:SCHed:CELL<cc>:SUBF<sf>:USER<us>:BWPart<bwp>:ALLoc<al>: SCI:HARProc.....	717
[:SOURce<hw>]:BB:NR5G:SCHed:CELL<cc>:SUBF<sf>:USER<us>:BWPart<bwp>:ALLoc<al>: SCI:MCS.....	714

[[:SOURce<hw>]:BB:NR5G:SCHed:CELL<cc>:SUBF<sf>:USER<us>:BWPart<bwp>:ALLoc<al>:SCI:NDI.	717
[[:SOURce<hw>]:BB:NR5G:SCHed:CELL<cc>:SUBF<sf>:USER<us>:BWPart<bwp>:ALLoc<al>: SCI:PAT1.....	714
[[:SOURce<hw>]:BB:NR5G:SCHed:CELL<cc>:SUBF<sf>:USER<us>:BWPart<bwp>:ALLoc<al>: SCI:PFOVerhead.....	714
[[:SOURce<hw>]:BB:NR5G:SCHed:CELL<cc>:SUBF<sf>:USER<us>:BWPart<bwp>:ALLoc<al>: SCI:PRTY.....	715
[[:SOURce<hw>]:BB:NR5G:SCHed:CELL<cc>:SUBF<sf>:USER<us>:BWPart<bwp>:ALLoc<al>: SCI:REDundancy.....	718
[[:SOURce<hw>]:BB:NR5G:SCHed:CELL<cc>:SUBF<sf>:USER<us>:BWPart<bwp>:ALLoc<al>: SCI:RESVed.....	715
[[:SOURce<hw>]:BB:NR5G:SCHed:CELL<cc>:SUBF<sf>:USER<us>:BWPart<bwp>:ALLoc<al>: SCI:RREPeriod.....	715
[[:SOURce<hw>]:BB:NR5G:SCHed:CELL<cc>:SUBF<sf>:USER<us>:BWPart<bwp>:ALLoc<al>: SCI:S2FMT.....	715
[[:SOURce<hw>]:BB:NR5G:SCHed:CELL<cc>:SUBF<sf>:USER<us>:BWPart<bwp>:ALLoc<al>: SCI:SOURid.....	718
[[:SOURce<hw>]:BB:NR5G:SCHed:CELL<cc>:SUBF<sf>:USER<us>:BWPart<bwp>:ALLoc<al>: SCI:TIDRes.....	716
[[:SOURce<hw>]:BB:NR5G:SCHed:CELL<cc>:SUBF<sf>:USER<us>:BWPart<bwp>:ALLoc<al>: SCI:ZONeid.....	719
[[:SOURce<hw>]:BB:NR5G:SCHed:CELL<cc>:SUBF<sf>:USER<us>:BWPart<bwp>:ALLoc<al>: SCI2:PATtern.....	718
[[:SOURce<hw>]:BB:NR5G:SCHed:CELL<cc>:SUBF<sf>:USER<us>:BWPart<bwp>:ALLoc<al>:SCID.....	693
[[:SOURce<hw>]:BB:NR5G:SCHed:CELL<cc>:SUBF<sf>:USER<us>:BWPart<bwp>:ALLoc<al>: SEQ:CYCShift.....	708
[[:SOURce<hw>]:BB:NR5G:SCHed:CELL<cc>:SUBF<sf>:USER<us>:BWPart<bwp>:ALLoc<al>: SEQ:HOPping.....	709
[[:SOURce<hw>]:BB:NR5G:SCHed:CELL<cc>:SUBF<sf>:USER<us>:BWPart<bwp>:ALLoc<al>:SEQ:ID..	709
[[:SOURce<hw>]:BB:NR5G:SCHed:CELL<cc>:SUBF<sf>:USER<us>:BWPart<bwp>:ALLoc<al>: SEQLength.....	605
[[:SOURce<hw>]:BB:NR5G:SCHed:CELL<cc>:SUBF<sf>:USER<us>:BWPart<bwp>:ALLoc<al>: SL:PHYSbits?.....	721
[[:SOURce<hw>]:BB:NR5G:SCHed:CELL<cc>:SUBF<sf>:USER<us>:BWPart<bwp>:ALLoc<al>:SLOT....	605
[[:SOURce<hw>]:BB:NR5G:SCHed:CELL<cc>:SUBF<sf>:USER<us>:BWPart<bwp>:ALLoc<al>:SRIDx...	709
[[:SOURce<hw>]:BB:NR5G:SCHed:CELL<cc>:SUBF<sf>:USER<us>:BWPart<bwp>:ALLoc<al>:STATE...	606
[[:SOURce<hw>]:BB:NR5G:SCHed:CELL<cc>:SUBF<sf>:USER<us>:BWPart<bwp>:ALLoc<al>: SYMNumber.....	606
[[:SOURce<hw>]:BB:NR5G:SCHed:CELL<cc>:SUBF<sf>:USER<us>:BWPart<bwp>:ALLoc<al>: SYMOffset.....	606
[[:SOURce<hw>]:BB:NR5G:SCHed:CELL<cc>:SUBF<sf>:USER<us>:BWPart<bwp>:ALLoc<al>: TBM<tbm>:SLOTs.....	615
[[:SOURce<hw>]:BB:NR5G:SCHed:CELL<cc>:SUBF<sf>:USER<us>:BWPart<bwp>:ALLoc<al>:TBOMs...	615
[[:SOURce<hw>]:BB:NR5G:SCHed:CELL<cc>:SUBF<sf>:USER<us>:BWPart<bwp>:ALLoc<al>:TOFFset	616
[[:SOURce<hw>]:BB:NR5G:SCHed:CELL<cc>:SUBF<sf>:USER<us>:BWPart<bwp>:ALLoc<al>:TPState	607
[[:SOURce<hw>]:BB:NR5G:SCHed:CELL<cc>:SUBF<sf>:USER<us>:BWPart<bwp>:ALLoc<al>: TRTComb.....	709
[[:SOURce<hw>]:BB:NR5G:SCHed:CELL<cc>:SUBF<sf>:USER<us>:BWPart<bwp>:ALLoc<al>[: CW<cw>]:MOD.....	610

[:SOURCE<hw>]:BB:NR5G:SCHed:CELL<cc>:SUBF<sf>:USER<us>:BWPart<bwp>:ALLoc<al>[: CW<cw>]:PDSCh PUSCh:CCODing:FRCR.....	628
[:SOURCE<hw>]:BB:NR5G:SCHed:CELL<cc>:SUBF<sf>:USER<us>:BWPart<bwp>:ALLoc<al>[: CW<cw>]:PDSCh PUSCh:CCODing:IMCS.....	628
[:SOURCE<hw>]:BB:NR5G:SCHed:CELL<cc>:SUBF<sf>:USER<us>:BWPart<bwp>:ALLoc<al>[: CW<cw>]:PDSCh PUSCh:CCODing:RVIndex.....	629
[:SOURCE<hw>]:BB:NR5G:SCHed:CELL<cc>:SUBF<sf>:USER<us>:BWPart<bwp>:ALLoc<al>[: CW<cw>]:PDSCh PUSCh:CCODing:TBSFactor.....	629
[:SOURCE<hw>]:BB:NR5G:SCHed:CELL<cc>:SUBF<sf>:USER<us>:BWPart<bwp>:ALLoc<al>[: CW<cw>]:PDSCh PUSCh:CCODing:TBSSize?.....	629
[:SOURCE<hw>]:BB:NR5G:SCHed:CELL<cc>:SUBF<sf>:USER<us>:BWPart<bwp>:ALLoc<al>[: CW<cw>]:PDSCh PUSCh:CCODing:TCRate.....	629
[:SOURCE<hw>]:BB:NR5G:SCHed:CELL<cc>:SUBF<sf>:USER<us>:BWPart<bwp>:ALLoc<al>[: CW<cw>]:PHYSbits?.....	610
[:SOURCE<hw>]:BB:NR5G:SCHed:CELL<cc>:SUBF<sf>:USER<us>:BWPart<bwp>:ALLoc<al>[: CW<cw>]:PSSCh:CCODing:FRCR.....	721
[:SOURCE<hw>]:BB:NR5G:SCHed:CELL<cc>:SUBF<sf>:USER<us>:BWPart<bwp>:ALLoc<al>[: CW<cw>]:PSSCh:CCODing:RVIndex.....	722
[:SOURCE<hw>]:BB:NR5G:SCHed:CELL<cc>:SUBF<sf>:USER<us>:BWPart<bwp>:ALLoc<al>[: CW<cw>]:PSSCh:CCODing:TBSFactor.....	722
[:SOURCE<hw>]:BB:NR5G:SCHed:CELL<cc>:SUBF<sf>:USER<us>:BWPart<bwp>:ALLoc<al>[: CW<cw>]:PSSCh:CCODing:TBSSize?.....	722
[:SOURCE<hw>]:BB:NR5G:SCHed:CELL<cc>:SUBF<sf>:USER<us>:BWPart<bwp>:ALLoc<al>[: CW<cw>]:PSSCh:CCODing:TCRate.....	723
[:SOURCE<hw>]:BB:NR5G:SCHed:CELL<cc>:SUBF<sf>:USER<us>:BWPart<bwp>:ALLoc<al>[: CW<cw>]:RMCStable?.....	630
[:SOURCE<hw>]:BB:NR5G:SCHed:CELL<cc>:SUBF<sf>:USER<us>:BWPart<bwp>:NALLoc.....	607
[:SOURCE<hw>]:BB:NR5G:SCHed:CELL<cc>:SUBF<sf>:USER<us>:BWPart<bwp>:RESulting: ALLoc<al>:CONTent?.....	598
[:SOURCE<hw>]:BB:NR5G:SCHed:CELL<cc>:SUBF<sf>:USER<us>:BWPart<bwp>:RESulting: ALLoc<al>:FACTs?.....	597
[:SOURCE<hw>]:BB:NR5G:SCHed:CELL<cc>:SUBF<sf>:USER<us>:BWPart<bwp>:RESulting: ALLoc<al>:INFO?.....	600
[:SOURCE<hw>]:BB:NR5G:SCHed:CELL<cc>:SUBF<sf>:USER<us>:BWPart<bwp>:RESulting: ALLoc<al>:INFO?.....	607
[:SOURCE<hw>]:BB:NR5G:SCHed:CELL<cc>:SUBF<sf>:USER<us>:BWPart<bwp>:RESulting: ALLoc<al>:MAPType?.....	601
[:SOURCE<hw>]:BB:NR5G:SCHed:CELL<cc>:SUBF<sf>:USER<us>:BWPart<bwp>:RESulting: ALLoc<al>:POWer?.....	602
[:SOURCE<hw>]:BB:NR5G:SCHed:CELL<cc>:SUBF<sf>:USER<us>:BWPart<bwp>:RESulting: ALLoc<al>:PRACH:SCSPacing?.....	604
[:SOURCE<hw>]:BB:NR5G:SCHed:CELL<cc>:SUBF<sf>:USER<us>:BWPart<bwp>:RESulting: ALLoc<al>:RBOffset?.....	603
[:SOURCE<hw>]:BB:NR5G:SCHed:CELL<cc>:SUBF<sf>:USER<us>:BWPart<bwp>:RESulting: ALLoc<al>:RIMRs:DELTA.....	694
[:SOURCE<hw>]:BB:NR5G:SCHed:CELL<cc>:SUBF<sf>:USER<us>:BWPart<bwp>:RESulting: ALLoc<al>:RIMRs:GAMMa.....	694
[:SOURCE<hw>]:BB:NR5G:SCHed:CELL<cc>:SUBF<sf>:USER<us>:BWPart<bwp>:RESulting: ALLoc<al>:RIMRs:NTRim.....	694

[:SOURce<hw>]:BB:NR5G:SCHed:CELL<cc>:SUBF<sf>:USER<us>:BWPart<bwp>:RESulting: ALLoc<al>:RIMRs:SCID.....	695
[:SOURce<hw>]:BB:NR5G:SCHed:CELL<cc>:SUBF<sf>:USER<us>:BWPart<bwp>:RESulting: ALLoc<al>:SCSPacing?.....	604
[:SOURce<hw>]:BB:NR5G:SCHed:CELL<cc>:SUBF<sf>:USER<us>:BWPart<bwp>:RESulting: ALLoc<al>:SLOT?.....	605
[:SOURce<hw>]:BB:NR5G:SCHed:CELL<cc>:SUBF<sf>:USER<us>:BWPart<bwp>:RESulting: ALLoc<al>:SOSF?.....	605
[:SOURce<hw>]:BB:NR5G:SCHed:CELL<cc>:SUBF<sf>:USER<us>:BWPart<bwp>:RESulting: ALLoc<al>:STAtE?.....	606
[:SOURce<hw>]:BB:NR5G:SCHed:CELL<cc>:SUBF<sf>:USER<us>:BWPart<bwp>:RESulting: ALLoc<al>:SYMNumber?.....	606
[:SOURce<hw>]:BB:NR5G:SCHed:CELL<cc>:SUBF<sf>:USER<us>:BWPart<bwp>:RESulting: ALLoc<al>:SYMoffset?.....	606
[:SOURce<hw>]:BB:NR5G:SCHed:CELL<cc>:SUBF<sf>:USER<us>:BWPart<bwp>:RESulting: ALLoc<us>:RBNumber?.....	602
[:SOURce<hw>]:BB:NR5G:SCHeduling:MODE.....	596
[:SOURce<hw>]:BB:NR5G:SCHeduling:RSSPace.....	597
[:SOURce<hw>]:BB:NR5G:SCHeduling:SFN:STAtE.....	597
[:SOURce<hw>]:BB:NR5G:SETTing:CATalog?.....	416
[:SOURce<hw>]:BB:NR5G:SETTing:DEL.....	416
[:SOURce<hw>]:BB:NR5G:SETTing:LOAD.....	416
[:SOURce<hw>]:BB:NR5G:SETTing:STORe.....	417
[:SOURce<hw>]:BB:NR5G:SETTing:TMODeL:DL.....	417
[:SOURce<hw>]:BB:NR5G:SETTing:TMODeL:DL:CATalog?.....	417
[:SOURce<hw>]:BB:NR5G:SETTing:TMODeL:FILTer:BW.....	417
[:SOURce<hw>]:BB:NR5G:SETTing:TMODeL:FILTer:CATalog.....	418
[:SOURce<hw>]:BB:NR5G:SETTing:TMODeL:FILTer:DUPLexing.....	418
[:SOURce<hw>]:BB:NR5G:SETTing:TMODeL:FILTer:FREQ.....	418
[:SOURce<hw>]:BB:NR5G:SETTing:TMODeL:FILTer:SCS.....	419
[:SOURce<hw>]:BB:NR5G:SETTing:TMODeL:FILTer:TCASe.....	419
[:SOURce<hw>]:BB:NR5G:SETTing:TMODeL:FILTer:TMODeL.....	419
[:SOURce<hw>]:BB:NR5G:SETTing:TMODeL:FILTer:TMSTandard.....	420
[:SOURce<hw>]:BB:NR5G:SETTing:TMODeL:UL.....	417
[:SOURce<hw>]:BB:NR5G:SETTing:TMODeL:UL:CATalog?.....	417
[:SOURce<hw>]:BB:NR5G:SIMPlE.....	420
[:SOURce<hw>]:BB:NR5G:STAtE.....	420
[:SOURce<hw>]:BB:NR5G:TCW:ANT:RXAntennas.....	749
[:SOURce<hw>]:BB:NR5G:TCW:ANT:TXAntennas.....	750
[:SOURce<hw>]:BB:NR5G:TCW:APPLy.....	749
[:SOURce<hw>]:BB:NR5G:TCW:AWGN:PLEVel?.....	750
[:SOURce<hw>]:BB:NR5G:TCW:BEWPhi.....	750
[:SOURce<hw>]:BB:NR5G:TCW:BEWThet.....	750
[:SOURce<hw>]:BB:NR5G:TCW:BSCLass.....	751
[:SOURce<hw>]:BB:NR5G:TCW:BSTYpe.....	751
[:SOURce<hw>]:BB:NR5G:TCW:DCLDirection.....	751
[:SOURce<hw>]:BB:NR5G:TCW:E50.....	752
[:SOURce<hw>]:BB:NR5G:TCW:FA:FRAllocation.....	752
[:SOURce<hw>]:BB:NR5G:TCW:GENSignal.....	752
[:SOURce<hw>]:BB:NR5G:TCW:IS:BAND.....	753

[SOURce<hw>]:BB:NR5G:TCW:IS:CHBW?	753
[SOURce<hw>]:BB:NR5G:TCW:IS:DIStance	752
[SOURce<hw>]:BB:NR5G:TCW:IS:DUPLex	753
[SOURce<hw>]:BB:NR5G:TCW:IS:OFN	753
[SOURce<hw>]:BB:NR5G:TCW:IS:PLEVel?	754
[SOURce<hw>]:BB:NR5G:TCW:IS:RFFRequency	754
[SOURce<hw>]:BB:NR5G:TCW:IS:TMODeL?	754
[SOURce<hw>]:BB:NR5G:TCW:IS:UEID	754
[SOURce<hw>]:BB:NR5G:TCW:IS2:PLEVel?	754
[SOURce<hw>]:BB:NR5G:TCW:IS2:RFFRequency?	754
[SOURce<hw>]:BB:NR5G:TCW:MARKerconfig	755
[SOURce<hw>]:BB:NR5G:TCW:MEIS	755
[SOURce<hw>]:BB:NR5G:TCW:MUE:TSRS	755
[SOURce<hw>]:BB:NR5G:TCW:OPTStr?	753
[SOURce<hw>]:BB:NR5G:TCW:RELease	756
[SOURce<hw>]:BB:NR5G:TCW:SPEC	756
[SOURce<hw>]:BB:NR5G:TCW:SUE:TSRS	768
[SOURce<hw>]:BB:NR5G:TCW:TC	756
[SOURce<hw>]:BB:NR5G:TCW:TRIGgerconfig	757
[SOURce<hw>]:BB:NR5G:TCW:WS:ADMRs:STATe	758
[SOURce<hw>]:BB:NR5G:TCW:WS:CBW	758
[SOURce<hw>]:BB:NR5G:TCW:WS:CELLid	758
[SOURce<hw>]:BB:NR5G:TCW:WS:DUPLex	759
[SOURce<hw>]:BB:NR5G:TCW:WS:FMTHroughput	759
[SOURce<hw>]:BB:NR5G:TCW:WS:FRC:TYPE	759
[SOURce<hw>]:BB:NR5G:TCW:WS:FROFfset	762
[SOURce<hw>]:BB:NR5G:TCW:WS:MAPType	762
[SOURce<hw>]:BB:NR5G:TCW:WS:MODE	762
[SOURce<hw>]:BB:NR5G:TCW:WS:PLEVel	763
[SOURce<hw>]:BB:NR5G:TCW:WS:PRACH:FORMat	763
[SOURce<hw>]:BB:NR5G:TCW:WS:PRACH:SCSPacing	763
[SOURce<hw>]:BB:NR5G:TCW:WS:PROCondition	764
[SOURce<hw>]:BB:NR5G:TCW:WS:RBOFfset	764
[SOURce<hw>]:BB:NR5G:TCW:WS:RFFRequency	764
[SOURce<hw>]:BB:NR5G:TCW:WS:RSET	764
[SOURce<hw>]:BB:NR5G:TCW:WS:SCSPacing	765
[SOURce<hw>]:BB:NR5G:TCW:WS:SYMNumber	765
[SOURce<hw>]:BB:NR5G:TCW:WS:TAPos	766
[SOURce<hw>]:BB:NR5G:TCW:WS:TIOBase?	766
[SOURce<hw>]:BB:NR5G:TCW:WS:TREQuire	768
[SOURce<hw>]:BB:NR5G:TCW:WS:TSETup	766
[SOURce<hw>]:BB:NR5G:TCW:WS:UCI:BITS	766
[SOURce<hw>]:BB:NR5G:TCW:WS:UCI:CGUCi:PATtern	767
[SOURce<hw>]:BB:NR5G:TCW:WS:UCI:CSI1:PATtern	767
[SOURce<hw>]:BB:NR5G:TCW:WS:UCI:CSI2:PATtern	767
[SOURce<hw>]:BB:NR5G:TCW:WS:UCI:CSIPart	767
[SOURce<hw>]:BB:NR5G:TCW:WS:UEID	767
[SOURce<hw>]:BB:NR5G:TCW:WS:VDRF	768
[SOURce<hw>]:BB:NR5G:TDWind:STATe	730
[SOURce<hw>]:BB:NR5G:TRIGger:ARM:EXECute	738

[:SOURce<hw>]:BB:NR5G:TRIGger:DELAy:UNIT.....	736
[:SOURce<hw>]:BB:NR5G:TRIGger:EXECute.....	738
[:SOURce<hw>]:BB:NR5G:TRIGger:EXTerنال:RDELAy?.....	737
[:SOURce<hw>]:BB:NR5G:TRIGger:EXTerنال:SYNChronize:OUTPut.....	736
[:SOURce<hw>]:BB:NR5G:TRIGger:EXTerنال:TDELAy.....	737
[:SOURce<hw>]:BB:NR5G:TRIGger:OUTPut<ch>:DELAy.....	741
[:SOURce<hw>]:BB:NR5G:TRIGger:OUTPut<ch>:DINSec?.....	742
[:SOURce<hw>]:BB:NR5G:TRIGger:OUTPut<ch>:DUPLExing.....	743
[:SOURce<hw>]:BB:NR5G:TRIGger:OUTPut<ch>:ECPState.....	743
[:SOURce<hw>]:BB:NR5G:TRIGger:OUTPut<ch>:FOFFset.....	742
[:SOURce<hw>]:BB:NR5G:TRIGger:OUTPut<ch>:IAB:STATe.....	745
[:SOURce<hw>]:BB:NR5G:TRIGger:OUTPut<ch>:INVert.....	743
[:SOURce<hw>]:BB:NR5G:TRIGger:OUTPut<ch>:MMODE.....	744
[:SOURce<hw>]:BB:NR5G:TRIGger:OUTPut<ch>:MODE.....	741
[:SOURce<hw>]:BB:NR5G:TRIGger:OUTPut<ch>:NDLSlots.....	744
[:SOURce<hw>]:BB:NR5G:TRIGger:OUTPut<ch>:NSSLots?.....	744
[:SOURce<hw>]:BB:NR5G:TRIGger:OUTPut<ch>:NULSlots.....	745
[:SOURce<hw>]:BB:NR5G:TRIGger:OUTPut<ch>:OFFTime.....	742
[:SOURce<hw>]:BB:NR5G:TRIGger:OUTPut<ch>:ONTime.....	742
[:SOURce<hw>]:BB:NR5G:TRIGger:OUTPut<ch>:PERiod.....	742
[:SOURce<hw>]:BB:NR5G:TRIGger:OUTPut<ch>:ROFFset.....	742
[:SOURce<hw>]:BB:NR5G:TRIGger:OUTPut<ch>:SCSPacing.....	745
[:SOURce<hw>]:BB:NR5G:TRIGger:OUTPut<ch>:SLINt.....	745
[:SOURce<hw>]:BB:NR5G:TRIGger:OUTPut<ch>:SSC:NDLSymbols.....	746
[:SOURce<hw>]:BB:NR5G:TRIGger:OUTPut<ch>:SSC:NGSYmbols?.....	746
[:SOURce<hw>]:BB:NR5G:TRIGger:OUTPut<ch>:SSC:NULSymbols.....	746
[:SOURce<hw>]:BB:NR5G:TRIGger:OUTPut<ch>:SSC:SFI:STATe.....	747
[:SOURce<hw>]:BB:NR5G:TRIGger:OUTPut<ch>:SSC:SLFMt.....	747
[:SOURce<hw>]:BB:NR5G:TRIGger:RMODE?.....	738
[:SOURce<hw>]:BB:NR5G:TRIGger:SLENgth.....	739
[:SOURce<hw>]:BB:NR5G:TRIGger:SLUNit.....	739
[:SOURce<hw>]:BB:NR5G:TRIGger:SOURce.....	736
[:SOURce<hw>]:BB:NR5G:TRIGger:TIME:DATE.....	739
[:SOURce<hw>]:BB:NR5G:TRIGger:TIME:TIME.....	740
[:SOURce<hw>]:BB:NR5G:TRIGger:TIME[:STATe].....	740
[:SOURce<hw>]:BB:NR5G:TRIGger[:EXTerنال]:DELAy.....	737
[:SOURce<hw>]:BB:NR5G:TRIGger[:EXTerنال]:INHibit.....	737
[:SOURce<hw>]:BB:NR5G:UBWP:NUSer.....	477
[:SOURce<hw>]:BB:NR5G:UBWP:REStart.....	483
[:SOURce<hw>]:BB:NR5G:UBWP:REStart:SIDX:INTErval.....	478
[:SOURce<hw>]:BB:NR5G:UBWP:REStart:SIDX:STATe.....	478
[:SOURce<hw>]:BB:NR5G:UBWP:SINTErval.....	478
[:SOURce<hw>]:BB:NR5G:UBWP:SOFFset.....	479
[:SOURce<hw>]:BB:NR5G:UBWP:USER<us>:CELL<cc>:DL:BWP<bwp>:CILENgth.....	496
[:SOURce<hw>]:BB:NR5G:UBWP:USER<us>:CELL<cc>:DL:BWP<bwp>:CSI:LRESponse.....	534
[:SOURce<hw>]:BB:NR5G:UBWP:USER<us>:CELL<cc>:DL:BWP<bwp>:CSI:RTSize.....	539
[:SOURce<hw>]:BB:NR5G:UBWP:USER<us>:CELL<cc>:DL:BWP<bwp>:CSIRs:NZP:SET<gr0>: NRESources.....	540
[:SOURce<hw>]:BB:NR5G:UBWP:USER<us>:CELL<cc>:DL:BWP<bwp>:CSIRs:NZP:SET<gr0>: RES<user0>:APMap:AP<ap>:ROW<apr>:IMAGinary.....	544

[:SOURce<hw>]:BB:NR5G:UBWP:USER<us>:CELL<cc>:DL:BWP<bwp>:CSIRs:NZP:SET<gr0>: RES<user0>:APMap:AP<ap>:ROW<apr>:MAGNitude.....	545
[:SOURce<hw>]:BB:NR5G:UBWP:USER<us>:CELL<cc>:DL:BWP<bwp>:CSIRs:NZP:SET<gr0>: RES<user0>:APMap:AP<ap>:ROW<apr>:PHASe.....	545
[:SOURce<hw>]:BB:NR5G:UBWP:USER<us>:CELL<cc>:DL:BWP<bwp>:CSIRs:NZP:SET<gr0>: RES<user0>:APMap:AP<ap>:ROW<apr>:REAL.....	544
[:SOURce<hw>]:BB:NR5G:UBWP:USER<us>:CELL<cc>:DL:BWP<bwp>:CSIRs:NZP:SET<gr0>: RES<user0>:BITMap.....	543
[:SOURce<hw>]:BB:NR5G:UBWP:USER<us>:CELL<cc>:DL:BWP<bwp>:CSIRs:NZP:SET<gr0>: RES<user0>:CDMType?.....	543
[:SOURce<hw>]:BB:NR5G:UBWP:USER<us>:CELL<cc>:DL:BWP<bwp>:CSIRs:NZP:SET<gr0>: RES<user0>:DENSity.....	542
[:SOURce<hw>]:BB:NR5G:UBWP:USER<us>:CELL<cc>:DL:BWP<bwp>:CSIRs:NZP:SET<gr0>: RES<user0>:I0.....	543
[:SOURce<hw>]:BB:NR5G:UBWP:USER<us>:CELL<cc>:DL:BWP<bwp>:CSIRs:NZP:SET<gr0>: RES<user0>:I1.....	543
[:SOURce<hw>]:BB:NR5G:UBWP:USER<us>:CELL<cc>:DL:BWP<bwp>:CSIRs:NZP:SET<gr0>: RES<user0>:OFFSet.....	541
[:SOURce<hw>]:BB:NR5G:UBWP:USER<us>:CELL<cc>:DL:BWP<bwp>:CSIRs:NZP:SET<gr0>: RES<user0>:PER.....	540
[:SOURce<hw>]:BB:NR5G:UBWP:USER<us>:CELL<cc>:DL:BWP<bwp>:CSIRs:NZP:SET<gr0>: RES<user0>:PORTs?.....	542
[:SOURce<hw>]:BB:NR5G:UBWP:USER<us>:CELL<cc>:DL:BWP<bwp>:CSIRs:NZP:SET<gr0>: RES<user0>:PWR.....	544
[:SOURce<hw>]:BB:NR5G:UBWP:USER<us>:CELL<cc>:DL:BWP<bwp>:CSIRs:NZP:SET<gr0>: RES<user0>:RBNumber.....	541
[:SOURce<hw>]:BB:NR5G:UBWP:USER<us>:CELL<cc>:DL:BWP<bwp>:CSIRs:NZP:SET<gr0>: RES<user0>:ROW.....	542
[:SOURce<hw>]:BB:NR5G:UBWP:USER<us>:CELL<cc>:DL:BWP<bwp>:CSIRs:NZP:SET<gr0>: RES<user0>:SCID.....	544
[:SOURce<hw>]:BB:NR5G:UBWP:USER<us>:CELL<cc>:DL:BWP<bwp>:CSIRs:NZP:SET<gr0>: RES<user0>:SRBNumber.....	541
[:SOURce<hw>]:BB:NR5G:UBWP:USER<us>:CELL<cc>:DL:BWP<bwp>:CSIRs:NZP:STATe.....	540
[:SOURce<hw>]:BB:NR5G:UBWP:USER<us>:CELL<cc>:DL:BWP<bwp>:CSIRs:ZP:SET<gr0>: NRESources.....	540
[:SOURce<hw>]:BB:NR5G:UBWP:USER<us>:CELL<cc>:DL:BWP<bwp>:CSIRs:ZP:SET<gr0>: RES<user0>:BITMap.....	543
[:SOURce<hw>]:BB:NR5G:UBWP:USER<us>:CELL<cc>:DL:BWP<bwp>:CSIRs:ZP:SET<gr0>: RES<user0>:CDMType?.....	543
[:SOURce<hw>]:BB:NR5G:UBWP:USER<us>:CELL<cc>:DL:BWP<bwp>:CSIRs:ZP:SET<gr0>: RES<user0>:DENSity.....	542
[:SOURce<hw>]:BB:NR5G:UBWP:USER<us>:CELL<cc>:DL:BWP<bwp>:CSIRs:ZP:SET<gr0>: RES<user0>:I0.....	543
[:SOURce<hw>]:BB:NR5G:UBWP:USER<us>:CELL<cc>:DL:BWP<bwp>:CSIRs:ZP:SET<gr0>: RES<user0>:I1.....	543
[:SOURce<hw>]:BB:NR5G:UBWP:USER<us>:CELL<cc>:DL:BWP<bwp>:CSIRs:ZP:SET<gr0>: RES<user0>:OFFSet.....	541
[:SOURce<hw>]:BB:NR5G:UBWP:USER<us>:CELL<cc>:DL:BWP<bwp>:CSIRs:ZP:SET<gr0>: RES<user0>:PER.....	540

[:SOURce<hw>]:BB:NR5G:UBWP:USER<us>:CELL<cc>:DL:BWP<bwp>:CSIRs:ZP:SET<gr0>: RES<user0>:PORTs?.....	542
[:SOURce<hw>]:BB:NR5G:UBWP:USER<us>:CELL<cc>:DL:BWP<bwp>:CSIRs:ZP:SET<gr0>: RES<user0>:RBNumber.....	541
[:SOURce<hw>]:BB:NR5G:UBWP:USER<us>:CELL<cc>:DL:BWP<bwp>:CSIRs:ZP:SET<gr0>: RES<user0>:ROW.....	542
[:SOURce<hw>]:BB:NR5G:UBWP:USER<us>:CELL<cc>:DL:BWP<bwp>:CSIRs:ZP:SET<gr0>: RES<user0>:SRBNumber.....	541
[:SOURce<hw>]:BB:NR5G:UBWP:USER<us>:CELL<cc>:DL:BWP<bwp>:CSIRs:ZP:STATe.....	540
[:SOURce<hw>]:BB:NR5G:UBWP:USER<us>:CELL<cc>:DL:BWP<bwp>:DCI:DAI2.....	534
[:SOURce<hw>]:BB:NR5G:UBWP:USER<us>:CELL<cc>:DL:BWP<bwp>:DCI:DAI3.....	534
[:SOURce<hw>]:BB:NR5G:UBWP:USER<us>:CELL<cc>:DL:BWP<bwp>:DCI:DS42.....	534
[:SOURce<hw>]:BB:NR5G:UBWP:USER<us>:CELL<cc>:DL:BWP<bwp>:DCI:HAENabler.....	535
[:SOURce<hw>]:BB:NR5G:UBWP:USER<us>:CELL<cc>:DL:BWP<bwp>:DCI:HARTind.....	505
[:SOURce<hw>]:BB:NR5G:UBWP:USER<us>:CELL<cc>:DL:BWP<bwp>:DCI:LTEChan.....	535
[:SOURce<hw>]:BB:NR5G:UBWP:USER<us>:CELL<cc>:DL:BWP<bwp>:DCI:PNPPEi.....	535
[:SOURce<hw>]:BB:NR5G:UBWP:USER<us>:CELL<cc>:DL:BWP<bwp>:DCI:PRC2.....	535
[:SOURce<hw>]:BB:NR5G:UBWP:USER<us>:CELL<cc>:DL:BWP<bwp>:DCI:PRINdicator.....	506
[:SOURce<hw>]:BB:NR5G:UBWP:USER<us>:CELL<cc>:DL:BWP<bwp>:DCI:PS27.....	536
[:SOURce<hw>]:BB:NR5G:UBWP:USER<us>:CELL<cc>:DL:BWP<bwp>:DCI:PSSCdyn.....	506
[:SOURce<hw>]:BB:NR5G:UBWP:USER<us>:CELL<cc>:DL:BWP<bwp>:DCI:PTPSlots.....	536
[:SOURce<hw>]:BB:NR5G:UBWP:USER<us>:CELL<cc>:DL:BWP<bwp>:DCI:SGPO.....	536
[:SOURce<hw>]:BB:NR5G:UBWP:USER<us>:CELL<cc>:DL:BWP<bwp>:DCI:SOIN.....	536
[:SOURce<hw>]:BB:NR5G:UBWP:USER<us>:CELL<cc>:DL:BWP<bwp>:DCI:SRI2.....	537
[:SOURce<hw>]:BB:NR5G:UBWP:USER<us>:CELL<cc>:DL:BWP<bwp>:DCI:SRINd.....	537
[:SOURce<hw>]:BB:NR5G:UBWP:USER<us>:CELL<cc>:DL:BWP<bwp>:DCI:TAINd.....	537
[:SOURce<hw>]:BB:NR5G:UBWP:USER<us>:CELL<cc>:DL:BWP<bwp>:DFReq?.....	500
[:SOURce<hw>]:BB:NR5G:UBWP:USER<us>:CELL<cc>:DL:BWP<bwp>:INDicator.....	495
[:SOURce<hw>]:BB:NR5G:UBWP:USER<us>:CELL<cc>:DL:BWP<bwp>:NAINd.....	497
[:SOURce<hw>]:BB:NR5G:UBWP:USER<us>:CELL<cc>:DL:BWP<bwp>:NCINd.....	496
[:SOURce<hw>]:BB:NR5G:UBWP:USER<us>:CELL<cc>:DL:BWP<bwp>:PDCCh:NMADaption.....	537
[:SOURce<hw>]:BB:NR5G:UBWP:USER<us>:CELL<cc>:DL:BWP<bwp>:PDCCh:NT3C.....	538
[:SOURce<hw>]:BB:NR5G:UBWP:USER<us>:CELL<cc>:DL:BWP<bwp>:PDCCh:NUMPreempt.....	530
[:SOURce<hw>]:BB:NR5G:UBWP:USER<us>:CELL<cc>:DL:BWP<bwp>:PDSCh:AG12.....	514
[:SOURce<hw>]:BB:NR5G:UBWP:USER<us>:CELL<cc>:DL:BWP<bwp>:PDSCh:AP12.....	513
[:SOURce<hw>]:BB:NR5G:UBWP:USER<us>:CELL<cc>:DL:BWP<bwp>:PDSCh:CBGF:STATe.....	506
[:SOURce<hw>]:BB:NR5G:UBWP:USER<us>:CELL<cc>:DL:BWP<bwp>:PDSCh:DI12.....	513
[:SOURce<hw>]:BB:NR5G:UBWP:USER<us>:CELL<cc>:DL:BWP<bwp>:PDSCh:DMTA:APINdex.....	507
[:SOURce<hw>]:BB:NR5G:UBWP:USER<us>:CELL<cc>:DL:BWP<bwp>:PDSCh:DMTA:BSAMe.....	507
[:SOURce<hw>]:BB:NR5G:UBWP:USER<us>:CELL<cc>:DL:BWP<bwp>:PDSCh:DMTA:CTYPe.....	507
[:SOURce<hw>]:BB:NR5G:UBWP:USER<us>:CELL<cc>:DL:BWP<bwp>:PDSCh:DMTA:MLENgtH.....	508
[:SOURce<hw>]:BB:NR5G:UBWP:USER<us>:CELL<cc>:DL:BWP<bwp>:PDSCh:DMTA:PTRS:EPRE.....	525
[:SOURce<hw>]:BB:NR5G:UBWP:USER<us>:CELL<cc>:DL:BWP<bwp>:PDSCh:DMTA:PTRS:MCS1.....	526
[:SOURce<hw>]:BB:NR5G:UBWP:USER<us>:CELL<cc>:DL:BWP<bwp>:PDSCh:DMTA:PTRS:MCS2.....	526
[:SOURce<hw>]:BB:NR5G:UBWP:USER<us>:CELL<cc>:DL:BWP<bwp>:PDSCh:DMTA:PTRS:MCS3.....	526
[:SOURce<hw>]:BB:NR5G:UBWP:USER<us>:CELL<cc>:DL:BWP<bwp>:PDSCh:DMTA:PTRS:RB0.....	527
[:SOURce<hw>]:BB:NR5G:UBWP:USER<us>:CELL<cc>:DL:BWP<bwp>:PDSCh:DMTA:PTRS:RB1.....	527
[:SOURce<hw>]:BB:NR5G:UBWP:USER<us>:CELL<cc>:DL:BWP<bwp>:PDSCh:DMTA:PTRS:REOF.....	525
[:SOURce<hw>]:BB:NR5G:UBWP:USER<us>:CELL<cc>:DL:BWP<bwp>:PDSCh:DMTA:PTRS:STATe.....	524
[:SOURce<hw>]:BB:NR5G:UBWP:USER<us>:CELL<cc>:DL:BWP<bwp>:PDSCh:DMTA:SID0.....	508

[:SOURce<hw>]:BB:NR5G:UBWP:USER<us>:CELL<cc>:DL:BWP<bwp>:PDSCh:DMTA:SID1.....	508
[:SOURce<hw>]:BB:NR5G:UBWP:USER<us>:CELL<cc>:DL:BWP<bwp>:PDSCh:DMTA:UR16.....	509
[:SOURce<hw>]:BB:NR5G:UBWP:USER<us>:CELL<cc>:DL:BWP<bwp>:PDSCh:DMTB:APINdex.....	507
[:SOURce<hw>]:BB:NR5G:UBWP:USER<us>:CELL<cc>:DL:BWP<bwp>:PDSCh:DMTB:CTYPe.....	507
[:SOURce<hw>]:BB:NR5G:UBWP:USER<us>:CELL<cc>:DL:BWP<bwp>:PDSCh:DMTB:MLENgtH.....	508
[:SOURce<hw>]:BB:NR5G:UBWP:USER<us>:CELL<cc>:DL:BWP<bwp>:PDSCh:DMTB:PTRS:EPRE.....	525
[:SOURce<hw>]:BB:NR5G:UBWP:USER<us>:CELL<cc>:DL:BWP<bwp>:PDSCh:DMTB:PTRS:MCS1.....	526
[:SOURce<hw>]:BB:NR5G:UBWP:USER<us>:CELL<cc>:DL:BWP<bwp>:PDSCh:DMTB:PTRS:MCS2.....	526
[:SOURce<hw>]:BB:NR5G:UBWP:USER<us>:CELL<cc>:DL:BWP<bwp>:PDSCh:DMTB:PTRS:MCS3.....	526
[:SOURce<hw>]:BB:NR5G:UBWP:USER<us>:CELL<cc>:DL:BWP<bwp>:PDSCh:DMTB:PTRS:RB0.....	527
[:SOURce<hw>]:BB:NR5G:UBWP:USER<us>:CELL<cc>:DL:BWP<bwp>:PDSCh:DMTB:PTRS:RB1.....	527
[:SOURce<hw>]:BB:NR5G:UBWP:USER<us>:CELL<cc>:DL:BWP<bwp>:PDSCh:DMTB:PTRS:REOF.....	525
[:SOURce<hw>]:BB:NR5G:UBWP:USER<us>:CELL<cc>:DL:BWP<bwp>:PDSCh:DMTB:PTRS:STATe.....	524
[:SOURce<hw>]:BB:NR5G:UBWP:USER<us>:CELL<cc>:DL:BWP<bwp>:PDSCh:DMTB:SID0.....	508
[:SOURce<hw>]:BB:NR5G:UBWP:USER<us>:CELL<cc>:DL:BWP<bwp>:PDSCh:DMTB:SID1.....	508
[:SOURce<hw>]:BB:NR5G:UBWP:USER<us>:CELL<cc>:DL:BWP<bwp>:PDSCh:DMTB:UR16.....	509
[:SOURce<hw>]:BB:NR5G:UBWP:USER<us>:CELL<cc>:DL:BWP<bwp>:PDSCh:DSID.....	516
[:SOURce<hw>]:BB:NR5G:UBWP:USER<us>:CELL<cc>:DL:BWP<bwp>:PDSCh:HA12.....	513
[:SOURce<hw>]:BB:NR5G:UBWP:USER<us>:CELL<cc>:DL:BWP<bwp>:PDSCh:HP5Bits.....	509
[:SOURce<hw>]:BB:NR5G:UBWP:USER<us>:CELL<cc>:DL:BWP<bwp>:PDSCh:LSElecteD.....	520
[:SOURce<hw>]:BB:NR5G:UBWP:USER<us>:CELL<cc>:DL:BWP<bwp>:PDSCh:MAOFset:NMOFset.....	511
[:SOURce<hw>]:BB:NR5G:UBWP:USER<us>:CELL<cc>:DL:BWP<bwp>:PDSCh:MAOFset:VAL<gr0>.....	511
[:SOURce<hw>]:BB:NR5G:UBWP:USER<us>:CELL<cc>:DL:BWP<bwp>:PDSCh:MCBGroups.....	509
[:SOURce<hw>]:BB:NR5G:UBWP:USER<us>:CELL<cc>:DL:BWP<bwp>:PDSCh:MCSTable.....	517
[:SOURce<hw>]:BB:NR5G:UBWP:USER<us>:CELL<cc>:DL:BWP<bwp>:PDSCh:MCWDci.....	516
[:SOURce<hw>]:BB:NR5G:UBWP:USER<us>:CELL<cc>:DL:BWP<bwp>:PDSCh:PI11.....	512
[:SOURce<hw>]:BB:NR5G:UBWP:USER<us>:CELL<cc>:DL:BWP<bwp>:PDSCh:PI12.....	512
[:SOURce<hw>]:BB:NR5G:UBWP:USER<us>:CELL<cc>:DL:BWP<bwp>:PDSCh:PREC:BBSet1.....	510
[:SOURce<hw>]:BB:NR5G:UBWP:USER<us>:CELL<cc>:DL:BWP<bwp>:PDSCh:PREC:BSIZe.....	511
[:SOURce<hw>]:BB:NR5G:UBWP:USER<us>:CELL<cc>:DL:BWP<bwp>:PDSCh:PREC:BSSet2.....	510
[:SOURce<hw>]:BB:NR5G:UBWP:USER<us>:CELL<cc>:DL:BWP<bwp>:PDSCh:PREC:BTYPe.....	512
[:SOURce<hw>]:BB:NR5G:UBWP:USER<us>:CELL<cc>:DL:BWP<bwp>:PDSCh:PREC:MOD.....	516
[:SOURce<hw>]:BB:NR5G:UBWP:USER<us>:CELL<cc>:DL:BWP<bwp>:PDSCh:PREC:STATe.....	515
[:SOURce<hw>]:BB:NR5G:UBWP:USER<us>:CELL<cc>:DL:BWP<bwp>:PDSCh:RBGSize.....	517
[:SOURce<hw>]:BB:NR5G:UBWP:USER<us>:CELL<cc>:DL:BWP<bwp>:PDSCh:RESalloc.....	517
[:SOURce<hw>]:BB:NR5G:UBWP:USER<us>:CELL<cc>:DL:BWP<bwp>:PDSCh:RV12.....	513
[:SOURce<hw>]:BB:NR5G:UBWP:USER<us>:CELL<cc>:DL:BWP<bwp>:PDSCh:SCRambling:STATe.....	516
[:SOURce<hw>]:BB:NR5G:UBWP:USER<us>:CELL<cc>:DL:BWP<bwp>:PDSCh:TCI:NTCP.....	514
[:SOURce<hw>]:BB:NR5G:UBWP:USER<us>:CELL<cc>:DL:BWP<bwp>:PDSCh:TCI:TCV<gr0>:ID1.....	514
[:SOURce<hw>]:BB:NR5G:UBWP:USER<us>:CELL<cc>:DL:BWP<bwp>:PDSCh:TCI:TCV<gr0>:ID2.....	514
[:SOURce<hw>]:BB:NR5G:UBWP:USER<us>:CELL<cc>:DL:BWP<bwp>:PDSCh:TCI:TCV<gr0>:STATe.....	515
[:SOURce<hw>]:BB:NR5G:UBWP:USER<us>:CELL<cc>:DL:BWP<bwp>:PDSCh:TD<grp0>:KNULl.....	518
[:SOURce<hw>]:BB:NR5G:UBWP:USER<us>:CELL<cc>:DL:BWP<bwp>:PDSCh:TD<grp0>:LENGth.....	519
[:SOURce<hw>]:BB:NR5G:UBWP:USER<us>:CELL<cc>:DL:BWP<bwp>:PDSCh:TD<grp0>:MAPPING.....	518
[:SOURce<hw>]:BB:NR5G:UBWP:USER<us>:CELL<cc>:DL:BWP<bwp>:PDSCh:TD<grp0>:SLIV?.....	519
[:SOURce<hw>]:BB:NR5G:UBWP:USER<us>:CELL<cc>:DL:BWP<bwp>:PDSCh:TD<grp0>:START.....	518
[:SOURce<hw>]:BB:NR5G:UBWP:USER<us>:CELL<cc>:DL:BWP<bwp>:PDSCh:TDALists.....	520
[:SOURce<hw>]:BB:NR5G:UBWP:USER<us>:CELL<cc>:DL:BWP<bwp>:PDSCh:TDANum.....	518
[:SOURce<hw>]:BB:NR5G:UBWP:USER<us>:CELL<cc>:DL:BWP<bwp>:PDSCh:TDML<grp0>: TD<user0>:KNULl.....	521

[:SOURce<hw>]:BB:NR5G:UBWP:USER<us>:CELL<cc>:DL:BWP<bwp>:PDSCh:TDML<grp0>: TD<user0>:LENGth.....	522
[:SOURce<hw>]:BB:NR5G:UBWP:USER<us>:CELL<cc>:DL:BWP<bwp>:PDSCh:TDML<grp0>: TD<user0>:MAPPing.....	521
[:SOURce<hw>]:BB:NR5G:UBWP:USER<us>:CELL<cc>:DL:BWP<bwp>:PDSCh:TDML<grp0>: TD<user0>:SLIV?.....	522
[:SOURce<hw>]:BB:NR5G:UBWP:USER<us>:CELL<cc>:DL:BWP<bwp>:PDSCh:TDML<grp0>: TD<user0>:START.....	522
[:SOURce<hw>]:BB:NR5G:UBWP:USER<us>:CELL<cc>:DL:BWP<bwp>:PDSCh:TDML<grp0>: TDANum.....	520
[:SOURce<hw>]:BB:NR5G:UBWP:USER<us>:CELL<cc>:DL:BWP<bwp>:PDSCh:VPINter.....	519
[:SOURce<hw>]:BB:NR5G:UBWP:USER<us>:CELL<cc>:DL:BWP<bwp>:PDSCh:XOVerhead.....	515
[:SOURce<hw>]:BB:NR5G:UBWP:USER<us>:CELL<cc>:DL:BWP<bwp>:PRBoffset?.....	500
[:SOURce<hw>]:BB:NR5G:UBWP:USER<us>:CELL<cc>:DL:BWP<bwp>:PUCCh:BD22.....	533
[:SOURce<hw>]:BB:NR5G:UBWP:USER<us>:CELL<cc>:DL:BWP<bwp>:PUCCh:TPAS.....	533
[:SOURce<hw>]:BB:NR5G:UBWP:USER<us>:CELL<cc>:DL:BWP<bwp>:PUSCh:BD22.....	533
[:SOURce<hw>]:BB:NR5G:UBWP:USER<us>:CELL<cc>:DL:BWP<bwp>:PUSCh:RBGSize.....	566
[:SOURce<hw>]:BB:NR5G:UBWP:USER<us>:CELL<cc>:DL:BWP<bwp>:PUSCh:TPAS.....	533
[:SOURce<hw>]:BB:NR5G:UBWP:USER<us>:CELL<cc>:DL:BWP<bwp>:RATM:GRPNumber.....	547
[:SOURce<hw>]:BB:NR5G:UBWP:USER<us>:CELL<cc>:DL:BWP<bwp>:RATM:NRESources.....	546
[:SOURce<hw>]:BB:NR5G:UBWP:USER<us>:CELL<cc>:DL:BWP<bwp>:RATM:RS<grp0>:GRID.....	549
[:SOURce<hw>]:BB:NR5G:UBWP:USER<us>:CELL<cc>:DL:BWP<bwp>:RATM:RS<grp0>:PER.....	548
[:SOURce<hw>]:BB:NR5G:UBWP:USER<us>:CELL<cc>:DL:BWP<bwp>:RATM:RS<grp0>:PERPatt.....	548
[:SOURce<hw>]:BB:NR5G:UBWP:USER<us>:CELL<cc>:DL:BWP<bwp>:RATM:RS<grp0>:RBDList.....	547
[:SOURce<hw>]:BB:NR5G:UBWP:USER<us>:CELL<cc>:DL:BWP<bwp>:RATM:RS<grp0>:RBPatt.....	547
[:SOURce<hw>]:BB:NR5G:UBWP:USER<us>:CELL<cc>:DL:BWP<bwp>:RATM:RS<grp0>:SLOT.....	548
[:SOURce<hw>]:BB:NR5G:UBWP:USER<us>:CELL<cc>:DL:BWP<bwp>:RATM:RS<grp0>:SLTPatt.....	548
[:SOURce<hw>]:BB:NR5G:UBWP:USER<us>:CELL<cc>:DL:BWP<bwp>:RATM:STATE.....	546
[:SOURce<hw>]:BB:NR5G:UBWP:USER<us>:CELL<cc>:DL:BWP<bwp>:RBNumber.....	499
[:SOURce<hw>]:BB:NR5G:UBWP:USER<us>:CELL<cc>:DL:BWP<bwp>:RBOffset.....	500
[:SOURce<hw>]:BB:NR5G:UBWP:USER<us>:CELL<cc>:DL:BWP<bwp>:RMC:CQI.....	528
[:SOURce<hw>]:BB:NR5G:UBWP:USER<us>:CELL<cc>:DL:BWP<bwp>:RMC:ID.....	528
[:SOURce<hw>]:BB:NR5G:UBWP:USER<us>:CELL<cc>:DL:BWP<bwp>:RMC:MODulation?.....	529
[:SOURce<hw>]:BB:NR5G:UBWP:USER<us>:CELL<cc>:DL:BWP<bwp>:RMC:SCS?.....	529
[:SOURce<hw>]:BB:NR5G:UBWP:USER<us>:CELL<cc>:DL:BWP<bwp>:RMC:STATE.....	529
[:SOURce<hw>]:BB:NR5G:UBWP:USER<us>:CELL<cc>:DL:BWP<bwp>:RNTI:AIRNti.....	497
[:SOURce<hw>]:BB:NR5G:UBWP:USER<us>:CELL<cc>:DL:BWP<bwp>:RNTI:CIRNti.....	496
[:SOURce<hw>]:BB:NR5G:UBWP:USER<us>:CELL<cc>:DL:BWP<bwp>:RNTI:INT.....	530
[:SOURce<hw>]:BB:NR5G:UBWP:USER<us>:CELL<cc>:DL:BWP<bwp>:RNTI:PSRNti.....	497
[:SOURce<hw>]:BB:NR5G:UBWP:USER<us>:CELL<cc>:DL:BWP<bwp>:RNTI:PUCCh.....	533
[:SOURce<hw>]:BB:NR5G:UBWP:USER<us>:CELL<cc>:DL:BWP<bwp>:RNTI:PUSCh.....	533
[:SOURce<hw>]:BB:NR5G:UBWP:USER<us>:CELL<cc>:DL:BWP<bwp>:RNTI:SRS.....	533
[:SOURce<hw>]:BB:NR5G:UBWP:USER<us>:CELL<cc>:DL:BWP<bwp>:SCSPacing.....	497
[:SOURce<hw>]:BB:NR5G:UBWP:USER<us>:CELL<cc>:DL:BWP<bwp>:SRS:BD23.....	498
[:SOURce<hw>]:BB:NR5G:UBWP:USER<us>:CELL<cc>:DL:BWP<bwp>:SRS:GTYPe.....	499
[:SOURce<hw>]:BB:NR5G:UBWP:USER<us>:CELL<cc>:DL:BWP<bwp>:SRS:NB26.....	498
[:SOURce<hw>]:BB:NR5G:UBWP:USER<us>:CELL<cc>:DL:BWP<bwp>:SRS:NSCG.....	498
[:SOURce<hw>]:BB:NR5G:UBWP:USER<us>:CELL<cc>:DL:NBWParts.....	495
[:SOURce<hw>]:BB:NR5G:UBWP:USER<us>:CELL<cc>:SL:BWP<bwp>:DFReq?.....	501
[:SOURce<hw>]:BB:NR5G:UBWP:USER<us>:CELL<cc>:SL:BWP<bwp>:INDicator.....	501

[SOURce<hw>]:BB:NR5G:UBWP:USER<us>:CELL<cc>:SL:BWP<bwp>:PAOfset?	501
[SOURce<hw>]:BB:NR5G:UBWP:USER<us>:CELL<cc>:SL:BWP<bwp>:RBNumber	502
[SOURce<hw>]:BB:NR5G:UBWP:USER<us>:CELL<cc>:SL:BWP<bwp>:RBOffset	502
[SOURce<hw>]:BB:NR5G:UBWP:USER<us>:CELL<cc>:SL:BWP<bwp>:RESPool:NRESpool	589
[SOURce<hw>]:BB:NR5G:UBWP:USER<us>:CELL<cc>:SL:BWP<bwp>:RESPool:RES<gr0>:AMCS	589
[SOURce<hw>]:BB:NR5G:UBWP:USER<us>:CELL<cc>:SL:BWP<bwp>:RESPool:RES<gr0>:BOF1	589
[SOURce<hw>]:BB:NR5G:UBWP:USER<us>:CELL<cc>:SL:BWP<bwp>:RESPool:RES<gr0>:BOF2	589
[SOURce<hw>]:BB:NR5G:UBWP:USER<us>:CELL<cc>:SL:BWP<bwp>:RESPool:RES<gr0>:BOF3	589
[SOURce<hw>]:BB:NR5G:UBWP:USER<us>:CELL<cc>:SL:BWP<bwp>:RESPool:RES<gr0>:BOF4	589
[SOURce<hw>]:BB:NR5G:UBWP:USER<us>:CELL<cc>:SL:BWP<bwp>:RESPool:RES<gr0>:INDicator	590
[SOURce<hw>]:BB:NR5G:UBWP:USER<us>:CELL<cc>:SL:BWP<bwp>:RESPool:RES<gr0>:MNPRes	590
[SOURce<hw>]:BB:NR5G:UBWP:USER<us>:CELL<cc>:SL:BWP<bwp>:RESPool:RES<gr0>: MREServe	590
[SOURce<hw>]:BB:NR5G:UBWP:USER<us>:CELL<cc>:SL:BWP<bwp>:RESPool:RES<gr0>: MSCTable	590
[SOURce<hw>]:BB:NR5G:UBWP:USER<us>:CELL<cc>:SL:BWP<bwp>:RESPool:RES<gr0>:NPRB	591
[SOURce<hw>]:BB:NR5G:UBWP:USER<us>:CELL<cc>:SL:BWP<bwp>:RESPool:RES<gr0>: NSUBchannels	591
[SOURce<hw>]:BB:NR5G:UBWP:USER<us>:CELL<cc>:SL:BWP<bwp>:RESPool:RES<gr0>:PAT2	591
[SOURce<hw>]:BB:NR5G:UBWP:USER<us>:CELL<cc>:SL:BWP<bwp>:RESPool:RES<gr0>:PAT3	591
[SOURce<hw>]:BB:NR5G:UBWP:USER<us>:CELL<cc>:SL:BWP<bwp>:RESPool:RES<gr0>:PAT4	591
[SOURce<hw>]:BB:NR5G:UBWP:USER<us>:CELL<cc>:SL:BWP<bwp>:RESPool:RES<gr0>:REPList	592
[SOURce<hw>]:BB:NR5G:UBWP:USER<us>:CELL<cc>:SL:BWP<bwp>:RESPool:RES<gr0>:RESBits	592
[SOURce<hw>]:BB:NR5G:UBWP:USER<us>:CELL<cc>:SL:BWP<bwp>:RESPool:RES<gr0>:SCALing	592
[SOURce<hw>]:BB:NR5G:UBWP:USER<us>:CELL<cc>:SL:BWP<bwp>:RESPool:RES<gr0>:SCHSize	593
[SOURce<hw>]:BB:NR5G:UBWP:USER<us>:CELL<cc>:SL:BWP<bwp>:RESPool:RES<gr0>:STRB	593
[SOURce<hw>]:BB:NR5G:UBWP:USER<us>:CELL<cc>:SL:BWP<bwp>:SCSPacing	502
[SOURce<hw>]:BB:NR5G:UBWP:USER<us>:CELL<cc>:SL:NBWParts	503
[SOURce<hw>]:BB:NR5G:UBWP:USER<us>:CELL<cc>:UL:BWP<bwp>:DFReq?	500
[SOURce<hw>]:BB:NR5G:UBWP:USER<us>:CELL<cc>:UL:BWP<bwp>:FRC:ALRB?	555
[SOURce<hw>]:BB:NR5G:UBWP:USER<us>:CELL<cc>:UL:BWP<bwp>:FRC:BW?	555
[SOURce<hw>]:BB:NR5G:UBWP:USER<us>:CELL<cc>:UL:BWP<bwp>:FRC:MAPType	557
[SOURce<hw>]:BB:NR5G:UBWP:USER<us>:CELL<cc>:UL:BWP<bwp>:FRC:MODulation?	556
[SOURce<hw>]:BB:NR5G:UBWP:USER<us>:CELL<cc>:UL:BWP<bwp>:FRC:PASize?	556
[SOURce<hw>]:BB:NR5G:UBWP:USER<us>:CELL<cc>:UL:BWP<bwp>:FRC:PTRS:STATe	557
[SOURce<hw>]:BB:NR5G:UBWP:USER<us>:CELL<cc>:UL:BWP<bwp>:FRC:RBOffset	556
[SOURce<hw>]:BB:NR5G:UBWP:USER<us>:CELL<cc>:UL:BWP<bwp>:FRC:SCS?	555
[SOURce<hw>]:BB:NR5G:UBWP:USER<us>:CELL<cc>:UL:BWP<bwp>:FRC:STATe	552
[SOURce<hw>]:BB:NR5G:UBWP:USER<us>:CELL<cc>:UL:BWP<bwp>:FRC:TYPE	552
[SOURce<hw>]:BB:NR5G:UBWP:USER<us>:CELL<cc>:UL:BWP<bwp>:FRC:WDEployment	421
[SOURce<hw>]:BB:NR5G:UBWP:USER<us>:CELL<cc>:UL:BWP<bwp>:FRC:WMAType	422
[SOURce<hw>]:BB:NR5G:UBWP:USER<us>:CELL<cc>:UL:BWP<bwp>:FRC:WMODulation?	422
[SOURce<hw>]:BB:NR5G:UBWP:USER<us>:CELL<cc>:UL:BWP<bwp>:FRC:WPASize?	422
[SOURce<hw>]:BB:NR5G:UBWP:USER<us>:CELL<cc>:UL:BWP<bwp>:FRC:WPTRs:STATe	422
[SOURce<hw>]:BB:NR5G:UBWP:USER<us>:CELL<cc>:UL:BWP<bwp>:FRC:WROffset	423
[SOURce<hw>]:BB:NR5G:UBWP:USER<us>:CELL<cc>:UL:BWP<bwp>:FRC:WSCSpacing?	423
[SOURce<hw>]:BB:NR5G:UBWP:USER<us>:CELL<cc>:UL:BWP<bwp>:FRC:WTYP	423
[SOURce<hw>]:BB:NR5G:UBWP:USER<us>:CELL<cc>:UL:BWP<bwp>:INDicator	495
[SOURce<hw>]:BB:NR5G:UBWP:USER<us>:CELL<cc>:UL:BWP<bwp>:PDSCh:DC02:TDANum	573
[SOURce<hw>]:BB:NR5G:UBWP:USER<us>:CELL<cc>:UL:BWP<bwp>:PDSCh:MULTi:PLEN	573

[:SOURce<hw>]:BB:NR5G:UBWP:USER<us>:CELL<cc>:UL:BWP<bwp>:PDSCh:MULTi:TDANum.....	573
[:SOURce<hw>]:BB:NR5G:UBWP:USER<us>:CELL<cc>:UL:BWP<bwp>:PDSCh:TDANum.....	572
[:SOURce<hw>]:BB:NR5G:UBWP:USER<us>:CELL<cc>:UL:BWP<bwp>:PRBOffset?.....	500
[:SOURce<hw>]:BB:NR5G:UBWP:USER<us>:CELL<cc>:UL:BWP<bwp>:PUCCh:A12List.....	549
[:SOURce<hw>]:BB:NR5G:UBWP:USER<us>:CELL<cc>:UL:BWP<bwp>:PUCCh:ADMRs:STATe.....	550
[:SOURce<hw>]:BB:NR5G:UBWP:USER<us>:CELL<cc>:UL:BWP<bwp>:PUCCh:BPSK:STATe.....	550
[:SOURce<hw>]:BB:NR5G:UBWP:USER<us>:CELL<cc>:UL:BWP<bwp>:PUCCh:BRINd.....	531
[:SOURce<hw>]:BB:NR5G:UBWP:USER<us>:CELL<cc>:UL:BWP<bwp>:PUCCh:CPEXt:NCPXt.....	531
[:SOURce<hw>]:BB:NR5G:UBWP:USER<us>:CELL<cc>:UL:BWP<bwp>:PUCCh:CPEXt:VAL<gr0>.....	531
[:SOURce<hw>]:BB:NR5G:UBWP:USER<us>:CELL<cc>:UL:BWP<bwp>:PUCCh:HACK:STATe.....	550
[:SOURce<hw>]:BB:NR5G:UBWP:USER<us>:CELL<cc>:UL:BWP<bwp>:PUCCh:PDSHarq:NTMentry....	550
[:SOURce<hw>]:BB:NR5G:UBWP:USER<us>:CELL<cc>:UL:BWP<bwp>:PUCCh:PDSHarq: TMIValue<gr0>.....	551
[:SOURce<hw>]:BB:NR5G:UBWP:USER<us>:CELL<cc>:UL:BWP<bwp>:PUCCh:U2TPc.....	551
[:SOURce<hw>]:BB:NR5G:UBWP:USER<us>:CELL<cc>:UL:BWP<bwp>:PUCCh:UITL.....	532
[:SOURce<hw>]:BB:NR5G:UBWP:USER<us>:CELL<cc>:UL:BWP<bwp>:PUCCh:UR16.....	530
[:SOURce<hw>]:BB:NR5G:UBWP:USER<us>:CELL<cc>:UL:BWP<bwp>:PUSCh:A02List.....	559
[:SOURce<hw>]:BB:NR5G:UBWP:USER<us>:CELL<cc>:UL:BWP<bwp>:PUSCh:ACCList.....	560
[:SOURce<hw>]:BB:NR5G:UBWP:USER<us>:CELL<cc>:UL:BWP<bwp>:PUSCh:APPResent.....	560
[:SOURce<hw>]:BB:NR5G:UBWP:USER<us>:CELL<cc>:UL:BWP<bwp>:PUSCh:BHARq.....	560
[:SOURce<hw>]:BB:NR5G:UBWP:USER<us>:CELL<cc>:UL:BWP<bwp>:PUSCh:BRV.....	560
[:SOURce<hw>]:BB:NR5G:UBWP:USER<us>:CELL<cc>:UL:BWP<bwp>:PUSCh:CBSubset.....	565
[:SOURce<hw>]:BB:NR5G:UBWP:USER<us>:CELL<cc>:UL:BWP<bwp>:PUSCh:DMTA:APINdex.....	562
[:SOURce<hw>]:BB:NR5G:UBWP:USER<us>:CELL<cc>:UL:BWP<bwp>:PUSCh:DMTA:BSAMe.....	561
[:SOURce<hw>]:BB:NR5G:UBWP:USER<us>:CELL<cc>:UL:BWP<bwp>:PUSCh:DMTA:CTYPe.....	561
[:SOURce<hw>]:BB:NR5G:UBWP:USER<us>:CELL<cc>:UL:BWP<bwp>:PUSCh:DMTA:MLENgtH.....	561
[:SOURce<hw>]:BB:NR5G:UBWP:USER<us>:CELL<cc>:UL:BWP<bwp>:PUSCh:DMTA:PTRS:MCS1....	526
[:SOURce<hw>]:BB:NR5G:UBWP:USER<us>:CELL<cc>:UL:BWP<bwp>:PUSCh:DMTA:PTRS:MCS2....	526
[:SOURce<hw>]:BB:NR5G:UBWP:USER<us>:CELL<cc>:UL:BWP<bwp>:PUSCh:DMTA:PTRS:MCS3....	526
[:SOURce<hw>]:BB:NR5G:UBWP:USER<us>:CELL<cc>:UL:BWP<bwp>:PUSCh:DMTA:PTRS:PORT....	526
[:SOURce<hw>]:BB:NR5G:UBWP:USER<us>:CELL<cc>:UL:BWP<bwp>:PUSCh:DMTA:PTRS:POWer...525	525
[:SOURce<hw>]:BB:NR5G:UBWP:USER<us>:CELL<cc>:UL:BWP<bwp>:PUSCh:DMTA:PTRS:RB0.....	527
[:SOURce<hw>]:BB:NR5G:UBWP:USER<us>:CELL<cc>:UL:BWP<bwp>:PUSCh:DMTA:PTRS:RB1.....	527
[:SOURce<hw>]:BB:NR5G:UBWP:USER<us>:CELL<cc>:UL:BWP<bwp>:PUSCh:DMTA:PTRS:REOF....	525
[:SOURce<hw>]:BB:NR5G:UBWP:USER<us>:CELL<cc>:UL:BWP<bwp>:PUSCh:DMTA:PTRS:STATe....	524
[:SOURce<hw>]:BB:NR5G:UBWP:USER<us>:CELL<cc>:UL:BWP<bwp>:PUSCh:DMTA:PTRS:TP:RB0..	571
[:SOURce<hw>]:BB:NR5G:UBWP:USER<us>:CELL<cc>:UL:BWP<bwp>:PUSCh:DMTA:PTRS:TP:RB1..	571
[:SOURce<hw>]:BB:NR5G:UBWP:USER<us>:CELL<cc>:UL:BWP<bwp>:PUSCh:DMTA:PTRS:TP:RB2..	571
[:SOURce<hw>]:BB:NR5G:UBWP:USER<us>:CELL<cc>:UL:BWP<bwp>:PUSCh:DMTA:PTRS:TP:RB3..	571
[:SOURce<hw>]:BB:NR5G:UBWP:USER<us>:CELL<cc>:UL:BWP<bwp>:PUSCh:DMTA:PTRS:TP:RB4..	571
[:SOURce<hw>]:BB:NR5G:UBWP:USER<us>:CELL<cc>:UL:BWP<bwp>:PUSCh:DMTA:PTRS:TP:SCID	571
[:SOURce<hw>]:BB:NR5G:UBWP:USER<us>:CELL<cc>:UL:BWP<bwp>:PUSCh:DMTA:PTRS: TP:STATe.....	570
[:SOURce<hw>]:BB:NR5G:UBWP:USER<us>:CELL<cc>:UL:BWP<bwp>:PUSCh:DMTA:PTRS: TP:TMDensity.....	571
[:SOURce<hw>]:BB:NR5G:UBWP:USER<us>:CELL<cc>:UL:BWP<bwp>:PUSCh:DMTA:PUID.....	562
[:SOURce<hw>]:BB:NR5G:UBWP:USER<us>:CELL<cc>:UL:BWP<bwp>:PUSCh:DMTA:SID0.....	562
[:SOURce<hw>]:BB:NR5G:UBWP:USER<us>:CELL<cc>:UL:BWP<bwp>:PUSCh:DMTA:SID1.....	562
[:SOURce<hw>]:BB:NR5G:UBWP:USER<us>:CELL<cc>:UL:BWP<bwp>:PUSCh:DMTA:UR16.....	563
[:SOURce<hw>]:BB:NR5G:UBWP:USER<us>:CELL<cc>:UL:BWP<bwp>:PUSCh:DMTB:APINdex.....	562

[SOURce<hw>]:BB:NR5G:UBWP:USER<us>:CELL<cc>:UL:BWP<bwp>:PUSCh:DMTB:CTYPe.....	561
[SOURce<hw>]:BB:NR5G:UBWP:USER<us>:CELL<cc>:UL:BWP<bwp>:PUSCh:DMTB:MLENgtH.....	561
[SOURce<hw>]:BB:NR5G:UBWP:USER<us>:CELL<cc>:UL:BWP<bwp>:PUSCh:DMTB:PTRS:MCS1....	526
[SOURce<hw>]:BB:NR5G:UBWP:USER<us>:CELL<cc>:UL:BWP<bwp>:PUSCh:DMTB:PTRS:MCS2....	526
[SOURce<hw>]:BB:NR5G:UBWP:USER<us>:CELL<cc>:UL:BWP<bwp>:PUSCh:DMTB:PTRS:MCS3....	526
[SOURce<hw>]:BB:NR5G:UBWP:USER<us>:CELL<cc>:UL:BWP<bwp>:PUSCh:DMTB:PTRS:PORT....	526
[SOURce<hw>]:BB:NR5G:UBWP:USER<us>:CELL<cc>:UL:BWP<bwp>:PUSCh:DMTB:PTRS:POWer..	525
[SOURce<hw>]:BB:NR5G:UBWP:USER<us>:CELL<cc>:UL:BWP<bwp>:PUSCh:DMTB:PTRS:RB0.....	527
[SOURce<hw>]:BB:NR5G:UBWP:USER<us>:CELL<cc>:UL:BWP<bwp>:PUSCh:DMTB:PTRS:RB1.....	527
[SOURce<hw>]:BB:NR5G:UBWP:USER<us>:CELL<cc>:UL:BWP<bwp>:PUSCh:DMTB:PTRS:REOF....	525
[SOURce<hw>]:BB:NR5G:UBWP:USER<us>:CELL<cc>:UL:BWP<bwp>:PUSCh:DMTB:PTRS:STATe....	524
[SOURce<hw>]:BB:NR5G:UBWP:USER<us>:CELL<cc>:UL:BWP<bwp>:PUSCh:DMTB:PTRS:TP:RB0..	571
[SOURce<hw>]:BB:NR5G:UBWP:USER<us>:CELL<cc>:UL:BWP<bwp>:PUSCh:DMTB:PTRS:TP:RB1..	572
[SOURce<hw>]:BB:NR5G:UBWP:USER<us>:CELL<cc>:UL:BWP<bwp>:PUSCh:DMTB:PTRS:TP:RB2..	572
[SOURce<hw>]:BB:NR5G:UBWP:USER<us>:CELL<cc>:UL:BWP<bwp>:PUSCh:DMTB:PTRS:TP:RB3..	572
[SOURce<hw>]:BB:NR5G:UBWP:USER<us>:CELL<cc>:UL:BWP<bwp>:PUSCh:DMTB:PTRS:TP:RB4..	572
[SOURce<hw>]:BB:NR5G:UBWP:USER<us>:CELL<cc>:UL:BWP<bwp>:PUSCh:DMTB:PTRS:TP:SCID	571
[SOURce<hw>]:BB:NR5G:UBWP:USER<us>:CELL<cc>:UL:BWP<bwp>:PUSCh:DMTB:PTRS: TP:STATe.....	570
[SOURce<hw>]:BB:NR5G:UBWP:USER<us>:CELL<cc>:UL:BWP<bwp>:PUSCh:DMTB:PTRS: TP:TMDensity.....	571
[SOURce<hw>]:BB:NR5G:UBWP:USER<us>:CELL<cc>:UL:BWP<bwp>:PUSCh:DMTB:PUID.....	562
[SOURce<hw>]:BB:NR5G:UBWP:USER<us>:CELL<cc>:UL:BWP<bwp>:PUSCh:DMTB:SID0.....	562
[SOURce<hw>]:BB:NR5G:UBWP:USER<us>:CELL<cc>:UL:BWP<bwp>:PUSCh:DMTB:SID1.....	562
[SOURce<hw>]:BB:NR5G:UBWP:USER<us>:CELL<cc>:UL:BWP<bwp>:PUSCh:DMTB:UR16.....	563
[SOURce<hw>]:BB:NR5G:UBWP:USER<us>:CELL<cc>:UL:BWP<bwp>:PUSCh:DSID.....	566
[SOURce<hw>]:BB:NR5G:UBWP:USER<us>:CELL<cc>:UL:BWP<bwp>:PUSCh:DSINit.....	563
[SOURce<hw>]:BB:NR5G:UBWP:USER<us>:CELL<cc>:UL:BWP<bwp>:PUSCh:FHOFFsets:NOFFsets.	567
[SOURce<hw>]:BB:NR5G:UBWP:USER<us>:CELL<cc>:UL:BWP<bwp>:PUSCh:FHOFFsets: OFFSet<gr0>.....	567
[SOURce<hw>]:BB:NR5G:UBWP:USER<us>:CELL<cc>:UL:BWP<bwp>:PUSCh:FHOP.....	567
[SOURce<hw>]:BB:NR5G:UBWP:USER<us>:CELL<cc>:UL:BWP<bwp>:PUSCh:FPTR.....	570
[SOURce<hw>]:BB:NR5G:UBWP:USER<us>:CELL<cc>:UL:BWP<bwp>:PUSCh:HP5Bits.....	564
[SOURce<hw>]:BB:NR5G:UBWP:USER<us>:CELL<cc>:UL:BWP<bwp>:PUSCh:ISIN.....	568
[SOURce<hw>]:BB:NR5G:UBWP:USER<us>:CELL<cc>:UL:BWP<bwp>:PUSCh:MCBGroups.....	562
[SOURce<hw>]:BB:NR5G:UBWP:USER<us>:CELL<cc>:UL:BWP<bwp>:PUSCh:MCSTable.....	565
[SOURce<hw>]:BB:NR5G:UBWP:USER<us>:CELL<cc>:UL:BWP<bwp>:PUSCh:MRank.....	564
[SOURce<hw>]:BB:NR5G:UBWP:USER<us>:CELL<cc>:UL:BWP<bwp>:PUSCh:MTTPrecoding.....	565
[SOURce<hw>]:BB:NR5G:UBWP:USER<us>:CELL<cc>:UL:BWP<bwp>:PUSCh:OI01.....	538
[SOURce<hw>]:BB:NR5G:UBWP:USER<us>:CELL<cc>:UL:BWP<bwp>:PUSCh:OI01.....	569
[SOURce<hw>]:BB:NR5G:UBWP:USER<us>:CELL<cc>:UL:BWP<bwp>:PUSCh:OLPC.....	569
[SOURce<hw>]:BB:NR5G:UBWP:USER<us>:CELL<cc>:UL:BWP<bwp>:PUSCh:PI01.....	568
[SOURce<hw>]:BB:NR5G:UBWP:USER<us>:CELL<cc>:UL:BWP<bwp>:PUSCh:PI02.....	568
[SOURce<hw>]:BB:NR5G:UBWP:USER<us>:CELL<cc>:UL:BWP<bwp>:PUSCh:PPSL.....	569
[SOURce<hw>]:BB:NR5G:UBWP:USER<us>:CELL<cc>:UL:BWP<bwp>:PUSCh:RESAlloc.....	566
[SOURce<hw>]:BB:NR5G:UBWP:USER<us>:CELL<cc>:UL:BWP<bwp>:PUSCh:SCRambling:STATe....	566
[SOURce<hw>]:BB:NR5G:UBWP:USER<us>:CELL<cc>:UL:BWP<bwp>:PUSCh:T1GRan.....	569
[SOURce<hw>]:BB:NR5G:UBWP:USER<us>:CELL<cc>:UL:BWP<bwp>:PUSCh:TPState.....	564
[SOURce<hw>]:BB:NR5G:UBWP:USER<us>:CELL<cc>:UL:BWP<bwp>:PUSCh:TXConfig.....	564
[SOURce<hw>]:BB:NR5G:UBWP:USER<us>:CELL<cc>:UL:BWP<bwp>:PUSCh:U2TPc.....	572

[:SOURce<hw>]:BB:NR5G:UBWP:USER<us>:CELL<cc>:UL:BWP<bwp>:PUSCh:UITL?.....	570
[:SOURce<hw>]:BB:NR5G:UBWP:USER<us>:CELL<cc>:UL:BWP<bwp>:PUSCh:XOverhead.....	572
[:SOURce<hw>]:BB:NR5G:UBWP:USER<us>:CELL<cc>:UL:BWP<bwp>:RBNumber.....	499
[:SOURce<hw>]:BB:NR5G:UBWP:USER<us>:CELL<cc>:UL:BWP<bwp>:RBOffset.....	500
[:SOURce<hw>]:BB:NR5G:UBWP:USER<us>:CELL<cc>:UL:BWP<bwp>:SCSPacing.....	497
[:SOURce<hw>]:BB:NR5G:UBWP:USER<us>:CELL<cc>:UL:BWP<bwp>:SRS:CONFig.....	578
[:SOURce<hw>]:BB:NR5G:UBWP:USER<us>:CELL<cc>:UL:BWP<bwp>:SRS:RE02.....	578
[:SOURce<hw>]:BB:NR5G:UBWP:USER<us>:CELL<cc>:UL:BWP<bwp>:SRS:REQuest.....	579
[:SOURce<hw>]:BB:NR5G:UBWP:USER<us>:CELL<cc>:UL:BWP<bwp>:SRS:RS:NRSets.....	578
[:SOURce<hw>]:BB:NR5G:UBWP:USER<us>:CELL<cc>:UL:BWP<bwp>:SRS:RS:SET<gr0>: NRESources.....	580
[:SOURce<hw>]:BB:NR5G:UBWP:USER<us>:CELL<cc>:UL:BWP<bwp>:SRS:RS:SET<gr0>: RES<user0>:APMap:AP<ap>:ROW<apr>:IMAGinary.....	586
[:SOURce<hw>]:BB:NR5G:UBWP:USER<us>:CELL<cc>:UL:BWP<bwp>:SRS:RS:SET<gr0>: RES<user0>:APMap:AP<ap>:ROW<apr>:MAGNitude.....	587
[:SOURce<hw>]:BB:NR5G:UBWP:USER<us>:CELL<cc>:UL:BWP<bwp>:SRS:RS:SET<gr0>: RES<user0>:APMap:AP<ap>:ROW<apr>:PHASe.....	587
[:SOURce<hw>]:BB:NR5G:UBWP:USER<us>:CELL<cc>:UL:BWP<bwp>:SRS:RS:SET<gr0>: RES<user0>:APMap:AP<ap>:ROW<apr>:REAL.....	586
[:SOURce<hw>]:BB:NR5G:UBWP:USER<us>:CELL<cc>:UL:BWP<bwp>:SRS:RS:SET<gr0>: RES<user0>:BHOP.....	583
[:SOURce<hw>]:BB:NR5G:UBWP:USER<us>:CELL<cc>:UL:BWP<bwp>:SRS:RS:SET<gr0>: RES<user0>:BSRS.....	582
[:SOURce<hw>]:BB:NR5G:UBWP:USER<us>:CELL<cc>:UL:BWP<bwp>:SRS:RS:SET<gr0>: RES<user0>:COFFset.....	584
[:SOURce<hw>]:BB:NR5G:UBWP:USER<us>:CELL<cc>:UL:BWP<bwp>:SRS:RS:SET<gr0>: RES<user0>:CSRS.....	583
[:SOURce<hw>]:BB:NR5G:UBWP:USER<us>:CELL<cc>:UL:BWP<bwp>:SRS:RS:SET<gr0>: RES<user0>:FPOS.....	582
[:SOURce<hw>]:BB:NR5G:UBWP:USER<us>:CELL<cc>:UL:BWP<bwp>:SRS:RS:SET<gr0>: RES<user0>:FQShifT.....	582
[:SOURce<hw>]:BB:NR5G:UBWP:USER<us>:CELL<cc>:UL:BWP<bwp>:SRS:RS:SET<gr0>: RES<user0>:FS:FSFactor.....	579
[:SOURce<hw>]:BB:NR5G:UBWP:USER<us>:CELL<cc>:UL:BWP<bwp>:SRS:RS:SET<gr0>: RES<user0>:FS:SRIDx.....	579
[:SOURce<hw>]:BB:NR5G:UBWP:USER<us>:CELL<cc>:UL:BWP<bwp>:SRS:RS:SET<gr0>: RES<user0>:NAPort.....	585
[:SOURce<hw>]:BB:NR5G:UBWP:USER<us>:CELL<cc>:UL:BWP<bwp>:SRS:RS:SET<gr0>: RES<user0>:OFFSet.....	581
[:SOURce<hw>]:BB:NR5G:UBWP:USER<us>:CELL<cc>:UL:BWP<bwp>:SRS:RS:SET<gr0>: RES<user0>:PER.....	581
[:SOURce<hw>]:BB:NR5G:UBWP:USER<us>:CELL<cc>:UL:BWP<bwp>:SRS:RS:SET<gr0>: RES<user0>:POWer.....	585
[:SOURce<hw>]:BB:NR5G:UBWP:USER<us>:CELL<cc>:UL:BWP<bwp>:SRS:RS:SET<gr0>: RES<user0>:PTRS.....	586
[:SOURce<hw>]:BB:NR5G:UBWP:USER<us>:CELL<cc>:UL:BWP<bwp>:SRS:RS:SET<gr0>: RES<user0>:REFactor.....	583
[:SOURce<hw>]:BB:NR5G:UBWP:USER<us>:CELL<cc>:UL:BWP<bwp>:SRS:RS:SET<gr0>: RES<user0>:SEQ:CYCShifT.....	584

[SOURce<hw>]:BB:NR5G:UBWP:USER<us>:CELL<cc>:UL:BWP<bwp>:SRS:RS:SET<gr0>: RES<user0>:SEQ:HOPPIng.....	585
[SOURce<hw>]:BB:NR5G:UBWP:USER<us>:CELL<cc>:UL:BWP<bwp>:SRS:RS:SET<gr0>: RES<user0>:SEQ:ID.....	584
[SOURce<hw>]:BB:NR5G:UBWP:USER<us>:CELL<cc>:UL:BWP<bwp>:SRS:RS:SET<gr0>: RES<user0>:SPOS.....	581
[SOURce<hw>]:BB:NR5G:UBWP:USER<us>:CELL<cc>:UL:BWP<bwp>:SRS:RS:SET<gr0>: RES<user0>:SYMNumber.....	581
[SOURce<hw>]:BB:NR5G:UBWP:USER<us>:CELL<cc>:UL:BWP<bwp>:SRS:RS:SET<gr0>: RES<user0>:TRTComb.....	583
[SOURce<hw>]:BB:NR5G:UBWP:USER<us>:CELL<cc>:UL:BWP<bwp>:SRS:RS:SET<gr0>:RSType....	580
[SOURce<hw>]:BB:NR5G:UBWP:USER<us>:CELL<cc>:UL:BWP<bwp>:SRS:RS:SET<gr0>:USAGe....	580
[SOURce<hw>]:BB:NR5G:UBWP:USER<us>:CELL<cc>:UL:BWP<bwp>:SRS:STATe.....	577
[SOURce<hw>]:BB:NR5G:UBWP:USER<us>:CELL<cc>:UL:BWP<bwp>:UCI:ALPHA.....	575
[SOURce<hw>]:BB:NR5G:UBWP:USER<us>:CELL<cc>:UL:BWP<bwp>:UCI:CGUCi:OFFSet.....	575
[SOURce<hw>]:BB:NR5G:UBWP:USER<us>:CELL<cc>:UL:BWP<bwp>:UCI:CGUCi:STATe.....	575
[SOURce<hw>]:BB:NR5G:UBWP:USER<us>:CELL<cc>:UL:BWP<bwp>:UCI:CSI:OF10.....	576
[SOURce<hw>]:BB:NR5G:UBWP:USER<us>:CELL<cc>:UL:BWP<bwp>:UCI:CSI:OF11.....	576
[SOURce<hw>]:BB:NR5G:UBWP:USER<us>:CELL<cc>:UL:BWP<bwp>:UCI:CSI:OF20.....	576
[SOURce<hw>]:BB:NR5G:UBWP:USER<us>:CELL<cc>:UL:BWP<bwp>:UCI:CSI:OF21.....	576
[SOURce<hw>]:BB:NR5G:UBWP:USER<us>:CELL<cc>:UL:BWP<bwp>:UCI:HARQ:OFF0.....	575
[SOURce<hw>]:BB:NR5G:UBWP:USER<us>:CELL<cc>:UL:BWP<bwp>:UCI:HARQ:OFF1.....	575
[SOURce<hw>]:BB:NR5G:UBWP:USER<us>:CELL<cc>:UL:BWP<bwp>:UCI:HARQ:OFF2.....	575
[SOURce<hw>]:BB:NR5G:UBWP:USER<us>:CELL<cc>:UL:BWP<bwp>:UCI:MODE.....	574
[SOURce<hw>]:BB:NR5G:UBWP:USER<us>:CELL<cc>:UL:BWP<bwp>:UCI:STATe.....	574
[SOURce<hw>]:BB:NR5G:UBWP:USER<us>:CELL<cc>:UL:NBWParts.....	495
[SOURce<hw>]:BB:NR5G:UBWP:USER<us>:DSCH:ANFMode.....	489
[SOURce<hw>]:BB:NR5G:UBWP:USER<us>:DSCH:CCODing:STATe.....	488
[SOURce<hw>]:BB:NR5G:UBWP:USER<us>:DSCH:CDIN.....	491
[SOURce<hw>]:BB:NR5G:UBWP:USER<us>:DSCH:CODS.....	492
[SOURce<hw>]:BB:NR5G:UBWP:USER<us>:DSCH:DA02.....	490
[SOURce<hw>]:BB:NR5G:UBWP:USER<us>:DSCH:DAIT.....	490
[SOURce<hw>]:BB:NR5G:UBWP:USER<us>:DSCH:DATA.....	488
[SOURce<hw>]:BB:NR5G:UBWP:USER<us>:DSCH:DAUL.....	490
[SOURce<hw>]:BB:NR5G:UBWP:USER<us>:DSCH:DLISt.....	488
[SOURce<hw>]:BB:NR5G:UBWP:USER<us>:DSCH:HARTind.....	490
[SOURce<hw>]:BB:NR5G:UBWP:USER<us>:DSCH:INITpattern.....	489
[SOURce<hw>]:BB:NR5G:UBWP:USER<us>:DSCH:NRBS.....	491
[SOURce<hw>]:BB:NR5G:UBWP:USER<us>:DSCH:NSSF.....	492
[SOURce<hw>]:BB:NR5G:UBWP:USER<us>:DSCH:PATtern.....	489
[SOURce<hw>]:BB:NR5G:UBWP:USER<us>:DSCH:PH1F.....	490
[SOURce<hw>]:BB:NR5G:UBWP:USER<us>:DSCH:PSSCdyn.....	491
[SOURce<hw>]:BB:NR5G:UBWP:USER<us>:DSCH:RBIS.....	491
[SOURce<hw>]:BB:NR5G:UBWP:USER<us>:DSCH:SCGW.....	489
[SOURce<hw>]:BB:NR5G:UBWP:USER<us>:DSCH:SCRambling:STATe.....	488
[SOURce<hw>]:BB:NR5G:UBWP:USER<us>:DSPC:STATe.....	479
[SOURce<hw>]:BB:NR5G:UBWP:USER<us>:NUMSfi.....	487
[SOURce<hw>]:BB:NR5G:UBWP:USER<us>:ORAN:TC.....	479
[SOURce<hw>]:BB:NR5G:UBWP:USER<us>:ORAN:USDS.....	480
[SOURce<hw>]:BB:NR5G:UBWP:USER<us>:PUPLoad:DATA.....	480

[:SOURce<hw>]:BB:NR5G:UBWP:USER<us>:PUPLoad:DLISt.....	480
[:SOURce<hw>]:BB:NR5G:UBWP:USER<us>:PUPLoad:DSUNique.....	480
[:SOURce<hw>]:BB:NR5G:UBWP:USER<us>:PUPLoad:INITpattern.....	481
[:SOURce<hw>]:BB:NR5G:UBWP:USER<us>:PUPLoad:PATtern.....	481
[:SOURce<hw>]:BB:NR5G:UBWP:USER<us>:PUUCi:DATA.....	481
[:SOURce<hw>]:BB:NR5G:UBWP:USER<us>:PUUCi:DLISt.....	482
[:SOURce<hw>]:BB:NR5G:UBWP:USER<us>:PUUCi:DSUNique.....	482
[:SOURce<hw>]:BB:NR5G:UBWP:USER<us>:PUUCi:INITpattern.....	482
[:SOURce<hw>]:BB:NR5G:UBWP:USER<us>:PUUCi:PATtern.....	483
[:SOURce<hw>]:BB:NR5G:UBWP:USER<us>:RNTI:CS.....	484
[:SOURce<hw>]:BB:NR5G:UBWP:USER<us>:RNTI:G.....	484
[:SOURce<hw>]:BB:NR5G:UBWP:USER<us>:RNTI:GCS.....	484
[:SOURce<hw>]:BB:NR5G:UBWP:USER<us>:RNTI:MCCH.....	484
[:SOURce<hw>]:BB:NR5G:UBWP:USER<us>:RNTI:MCSC.....	485
[:SOURce<hw>]:BB:NR5G:UBWP:USER<us>:RNTI:MSGB.....	485
[:SOURce<hw>]:BB:NR5G:UBWP:USER<us>:RNTI:PEI.....	485
[:SOURce<hw>]:BB:NR5G:UBWP:USER<us>:RNTI:RA.....	485
[:SOURce<hw>]:BB:NR5G:UBWP:USER<us>:RNTI:SFI.....	486
[:SOURce<hw>]:BB:NR5G:UBWP:USER<us>:RNTI:SL.....	486
[:SOURce<hw>]:BB:NR5G:UBWP:USER<us>:RNTI:SLCS.....	487
[:SOURce<hw>]:BB:NR5G:UBWP:USER<us>:RNTI:SPCSi.....	486
[:SOURce<hw>]:BB:NR5G:UBWP:USER<us>:RNTI:TC.....	486
[:SOURce<hw>]:BB:NR5G:UBWP:USER<us>:RNTI:V.....	487
[:SOURce<hw>]:BB:NR5G:UBWP:USER<us>:SSCH:CCODing:STATe.....	492
[:SOURce<hw>]:BB:NR5G:UBWP:USER<us>:SSCH:DATA.....	493
[:SOURce<hw>]:BB:NR5G:UBWP:USER<us>:SSCH:DLISt.....	493
[:SOURce<hw>]:BB:NR5G:UBWP:USER<us>:SSCH:INITpattern.....	493
[:SOURce<hw>]:BB:NR5G:UBWP:USER<us>:SSCH:PATtern.....	494
[:SOURce<hw>]:BB:NR5G:UBWP:USER<us>:SSCH:SCRambling:STATe.....	494
[:SOURce<hw>]:BB:NR5G:UBWP:USER<us>:UEID.....	487
[:SOURce<hw>]:BB:NR5G:UBWP:USER<us>:USCH:CCODing:STATe.....	488
[:SOURce<hw>]:BB:NR5G:UBWP:USER<us>:USCH:DATA.....	488
[:SOURce<hw>]:BB:NR5G:UBWP:USER<us>:USCH:DLISt.....	488
[:SOURce<hw>]:BB:NR5G:UBWP:USER<us>:USCH:INITpattern.....	489
[:SOURce<hw>]:BB:NR5G:UBWP:USER<us>:USCH:NSAS.....	492
[:SOURce<hw>]:BB:NR5G:UBWP:USER<us>:USCH:PATtern.....	489
[:SOURce<hw>]:BB:NR5G:UBWP:USER<us>:USCH:SCRambling:STATe.....	488
[:SOURce<hw>]:BB:NR5G:UPLane:STATe.....	420
[:SOURce<hw>]:BB:NR5G:WAVeform:CREate.....	421
[:SOURce<hw>]:BB:NR5G[:TRIGger]:SEQuence.....	735

Index

Symbols

*.dat file	316
5G new radio in LTE bands	
Omitting CRS	65

A

Allocation	
Bandwidth	207
Bandwidth shift	208
Channel power	209
Content	201
DFT-s	208
First slot	205
First symbol	207
Modulation	218
Number of RBs	207
Number of symbols	206
RB offset	208
Repetition	210
Size	219, 227
State	209
Antenna ports	
Mapping table	235
Application cards	15
Application notes	15
Arm	304
Armed_Auto	302
Armed_Retrigger	302
Auto	302

B

Base station class	344
Base station type	345
BeW(θ REFSSENS)	346
BeW(φ REFSSENS)	346
Brochures	14
BWP	
Number of RBs	110, 112

C

Calibration certificate	15
Carrier	
..... 63, 67, 69, 76, 79, 84, 109, 112, 114, 156, 193, 200, 332	
Carrier aggregation	
Enable	52
Settings	27
Catalog	
User filter	316
Cell	
..... 63, 67, 69, 76, 79, 84, 109, 112, 114, 156, 193, 200, 332	
Cell ID	349
Channel bandwidth	349, 352
Clipping	
Level	317
Mode	317
Clock	
Source	314
Conventions	
SCPI commands	383

CORESET	
Bitmap	239
Frequency domain allocation	239
Interleaving	240
Precoder granularity modes	238
Settings	237
CSI-RS	
Frequency occupation	146, 149
Smaller bandwidth than BWP	146, 149

D

Data sheets	14
DCI format	
Bits	250
Padding	250
Declared direction	345
Default settings	
5G New Radio	42
Delay	
Marker	309
Trigger	306
Delete	
User filter	316
Delta frequency	
Offset to DC carrier	71, 78, 110, 113
dmrs-Type	126, 173
dmrs-TypeA-Position	57
Documentation overview	13
Dynamic range	368

E

EIS 50M	346
External trigger	305
External trigger delay	306

F

Fall offset	308
Filter	
Apply on whole channel	315
Apply per BWP	315
First subframe	332
FRC	350
freqDomainShift	188
Frequency allocation	354

G

Generate	
Waveform file	42
Getting started	13

H

Help	13
------------	----

I

Installation	12
Instrument help	13
Instrument security procedures	14

- K**
- k TC 189
- L**
- Link direction 44
 - Load
 - User filter 316
 - LTE-CRS
 - Configure 67, 68
 - Enable 67
- M**
- Mapping coordinates 75, 83, 152, 191, 235, 272, 287
 - Marker configuration 347
 - Marker Delay 309
 - MIB
 - Barred cell 91
 - CORESET 91
 - DMRS 90
 - Frequency reselection 91
 - SCS common 90
 - Search space 91
 - SFN start offset 91
 - Spare bit 92
 - SS/PBCH subcarrier offset 91
 - Minimum EIS 346
- N**
- No. of Subframe 332
 - Non-zero-power CSI-RS
 - Settings 147
- O**
- Open source acknowledgment (OSA) 15
 - Orthogonal sequence 277
 - OTA Dynamic range 378
 - OTA reference sensitivity level 377
 - OTA sensitivity 376
 - OTA transmitter intermodulation 370
- P**
- PBCH
 - Channel coding 89
 - Dummy MIB 88
 - Power 74
 - Settings 74, 87
 - PDSCH
 - Additional position index 127
 - Codewords, number of 117
 - Enable interleaved VRB-to-PRB mapping 117
 - Mapping type 205
 - Max length 127
 - MSC table 118
 - n_ID 116
 - Resource allocation 118, 166
 - Scrambling ID 116, 117
 - Settings 212
 - Size of resource block group 118, 166
 - VRB-to-PRB 117
 - Phase-tracking reference signals
 - see PTRS 128, 175, 178
 - Power
 - Mode 327
 - PBCH 74
 - PSS 74
 - SSS 74
 - Power level 351
 - PRACH
 - Settings 280
 - PSS
 - Power 74
 - PT-RS
 - see PTRS 128, 175, 178
 - PTRS
 - Transform precoding 178
 - PTRS-Downlink config 129
 - PTRS-DownlinkConfig 129, 176
 - PTRS-UplinkConfig 177
 - PUCCH
 - Format 206
 - Settings 273
 - PUSCH
 - Mapping type 205
 - n_ID 165
 - Scrambling ID 165
- R**
- RB offset 351
 - Receiver characteristics
 - Tests overview 336
 - Reference sensitivity levels 367
 - Release notes 15
 - Resource block
 - Offset 70, 77
 - Retrigger 302
 - RF frequency 352
 - Rise offset 308
 - RMSI-PDCCH-Config 91
- S**
- Safety instructions 14
 - Save/Recall
 - 5G New Radio 42
 - Scheduling
 - Allocation number 203
 - Subframe 201
 - Security procedures 14
 - Selective preset 343
 - Sequence length 315
 - Service manual 14
 - Set to default
 - 5G candidates 42
 - Signal duration unit 303
 - Signal generation status 303
 - Single 302
 - Specifications 14
 - SS/PBCH
 - Burst length 72
 - Case 71
 - Number of blocks 72
 - Position 72
 - State 75
 - Switch off 75
 - SSPBCH Subcarrier Offset
 - Set automatically 90

SSS	
Power	74
Standard settings	
5G New Radio	42
State	
5G New Radio	41
Subcarrier	
Offset	71
Suppress if on output center	315, 327
Support for quasi co-location TCI	245
Supported test cases	335
T	
TDD	
Configure	210
Test case	344
Test frequencies	338
Time domain windowing	
Activate	319
Time plan	
Zoom in/zoom out	332
Transition	
Samples	320
Time	319
Transmission comb	189
Transmitter characteristics	
Tests overview	336
Transmitter intermodulation	363
Trigger	
Synchronize output	304
Trigger configuration	347
Trigger delay	306
Actual	306
Expressed in time	305
Resulting	306
Unit	305
Trigger mode	302
Trigger signal duration	303
Trigger source	304
U	
U-Plane	48
UE ID	353
User	43, 96, 105, 108, 112, 114, 156, 193
User filter	
Create file	316
File format	316
User manual	13
User plane	48
V	
Version	
3GPP standard	31
Videos	15
W	
Waveform file	
Create	42
White papers	15
Z	
Zero-power CSI-RS	
Settings	144