

R&S® FPL1-K70

Vector Signal Analysis

User Manual



1178936102
Version 09



This manual applies to the following R&S®FPL1000 models with firmware version 2.10 and later:

- R&S®FPL1003 (1304.0004K03) - FPL1000 with maximum frequency 3 GHz
- R&S®FPL1007 (1304.0004K07) - FPL1000 with maximum frequency 7.5 GHz
- R&S®FPL1014 (1304.0004K14) - FPL1000 with maximum frequency 14 GHz
- R&S®FPL1026 (1304.0004K26) - FPL1000 with maximum frequency 26.5 GHz

The following firmware options are described:

- R&S FPL1000-K70 (1323.1748.02)
- R&S FPL1000-K70P (1323.1631.02)
- R&S FPL1000-K70M (1323.1625.02)

© 2023 Rohde & Schwarz GmbH & Co. KG
Muehldorfstr. 15, 81671 Muenchen, Germany
Phone: +49 89 41 29 - 0
Email: info@rohde-schwarz.com
Internet: www.rohde-schwarz.com

Subject to change – data without tolerance limits is not binding.

R&S® is a registered trademark of Rohde & Schwarz GmbH & Co. KG.

The Bluetooth® word mark and logos are registered trademarks owned by Bluetooth SIG, Inc. and any use of such marks by Rohde & Schwarz is under license.

CDMA2000® is a registered trademark of the Telecommunications Industry Association (TIA-USA).

DOCSIS® is a registered trademark of the Cable Television Laboratories, Inc.

All other trademarks are the properties of their respective owners.

1178.9361.02 | Version 09 | R&S®FPL1-K70 | COMPANY RESTRICTED

Throughout this manual, products from Rohde & Schwarz are indicated without the ® symbol, e.g. R&S®FPL1000 is indicated as R&S FPL1000.

Contents

1	Documentation overview.....	13
1.1	Getting started manual.....	13
1.2	User manuals and help.....	13
1.3	Service manual.....	13
1.4	Instrument security procedures.....	14
1.5	Printed safety instructions.....	14
1.6	Data sheets and brochures.....	14
1.7	Release notes and open source acknowledgment (OSA).....	14
1.8	Application notes, application cards, white papers, etc.....	14
1.9	Video tutorials.....	15
1.10	Calibration certificate.....	15
2	Welcome to the R&S FPL1000 VSA application.....	16
2.1	Introduction to vector signal analysis.....	17
2.2	Starting the VSA application.....	17
2.3	Understanding the display information.....	18
3	Measurements and result displays.....	21
3.1	Evaluation data sources in VSA.....	21
3.2	Result types in VSA.....	25
3.2.1	Bit error rate (BER).....	27
3.2.2	Channel frequency response group delay.....	29
3.2.3	Channel frequency response magnitude.....	30
3.2.4	Constellation frequency.....	30
3.2.5	Constellation I/Q.....	31
3.2.6	Constellation I/Q (rotated).....	33
3.2.7	Error vector magnitude (EVM).....	34
3.2.8	Eye diagram frequency.....	35
3.2.9	Eye diagram imag (Q).....	36
3.2.10	Eye diagram real (I).....	38
3.2.11	Frequency absolute.....	39
3.2.12	Frequency relative.....	40
3.2.13	Frequency error absolute.....	41

3.2.14	Frequency error relative.....	43
3.2.15	Frequency response group delay.....	44
3.2.16	Frequency response magnitude.....	45
3.2.17	Frequency response phase.....	45
3.2.18	Impulse response magnitude.....	46
3.2.19	Impulse response phase.....	47
3.2.20	Impulse response real/imag.....	48
3.2.21	Magnitude absolute.....	48
3.2.22	Magnitude relative.....	49
3.2.23	Magnitude error.....	50
3.2.24	Phase error.....	51
3.2.25	Phase wrap.....	52
3.2.26	Phase unwrap.....	53
3.2.27	Real/imag (I/Q).....	54
3.2.28	Result summary.....	55
3.2.29	Spectrum (capture buffer + error).....	59
3.2.30	Spectrum (measurement + error).....	61
3.2.31	Symbol table.....	62
3.2.32	Vector frequency.....	64
3.2.33	Vector I/Q.....	64
3.3	Predefined display configuration.....	66
3.4	Common parameters in VSA.....	67
4	Measurement basics.....	69
4.1	Filters and bandwidths during signal processing.....	69
4.1.1	I/Q bandwidth.....	70
4.1.2	Demodulation bandwidth (measurement bandwidth).....	71
4.1.3	Modulation and demodulation filters.....	71
4.1.4	Measurement filters.....	72
4.1.5	Customized filters.....	74
4.2	Sample rate, symbol rate and I/Q bandwidth.....	76
4.2.1	Sample rate and maximum usable I/Q bandwidth for RF input.....	77
4.2.1.1	Relationship between sample rate, record length and usable I/Q bandwidth.....	78
4.3	Symbol mapping.....	78

4.3.1	Phase shift keying (PSK).....	79
4.3.2	Rotating PSK.....	83
4.3.3	Differential PSK.....	86
4.3.4	Rotating differential PSK modulation.....	87
4.3.5	Offset QPSK.....	89
4.3.6	Shaped offset QPSK.....	90
4.3.7	Frequency shift keying (FSK).....	91
4.3.8	Minimum shift keying (MSK).....	96
4.3.9	Quadrature amplitude modulation (QAM).....	97
4.3.10	ASK.....	109
4.3.11	APSK.....	110
4.3.12	User-defined modulation.....	111
4.4	Overview of the demodulation process.....	112
4.4.1	Burst search.....	115
4.4.2	I/Q pattern search.....	116
4.4.3	Demodulation and symbol decisions.....	117
4.4.4	Pattern symbol check.....	120
4.4.5	Synchronization and the reference signal.....	121
4.4.6	The equalizer.....	123
4.5	Signal model, estimation and modulation errors.....	125
4.5.1	PSK, QAM and MSK modulation.....	126
4.5.1.1	Error model.....	126
4.5.1.2	Estimation.....	127
4.5.1.3	Modulation errors.....	128
4.5.2	FSK modulation.....	137
4.5.2.1	Error model.....	139
4.5.2.2	Estimation.....	140
4.5.2.3	Modulation errors.....	141
4.6	Measurement ranges.....	142
4.6.1	Result range.....	143
4.6.2	Evaluation range.....	145
4.7	Display points vs estimation points per symbol.....	147
4.8	Capture buffer display.....	148

4.9	Known data files - dependencies and restrictions.....	148
4.10	Known data from PRBS generators.....	150
4.11	Multi-modulation analysis (R&S FPL1000-K70M).....	152
5	Configuration.....	159
5.1	Configuration overview.....	159
5.2	Configuration according to digital standards.....	163
5.3	Signal description.....	165
5.3.1	Modulation.....	165
5.3.2	Signal structure.....	169
5.3.3	Frame structure.....	171
5.3.3.1	General frame structure settings.....	172
5.3.3.2	Frame configuration.....	175
5.3.4	Known data.....	180
5.4	Input, output and frontend settings.....	183
5.4.1	Input settings.....	183
5.4.1.1	Radio frequency input.....	184
5.4.1.2	Settings for input from I/Q data files.....	186
5.4.2	Independent CW source settings.....	187
5.4.3	Output settings.....	188
5.4.4	Frequency settings.....	190
5.4.5	Amplitude and vertical axis configuration.....	191
5.4.5.1	Amplitude settings.....	191
5.4.5.2	Scaling.....	195
5.4.5.3	Units.....	199
5.5	Signal capture.....	200
5.5.1	Data acquisition.....	200
5.5.2	Trigger settings.....	201
5.5.3	Sweep settings.....	204
5.6	Burst and pattern configuration.....	206
5.6.1	Burst search.....	207
5.6.2	Pattern search.....	209
5.6.3	Pattern configuration.....	210
5.6.4	Pattern definition.....	213

5.7	Result range configuration.....	216
5.8	Demodulation settings.....	218
5.8.1	Demodulation - compensation and equalizer.....	218
5.8.2	Advanced demodulation (synchronization).....	222
5.9	Measurement filter settings.....	226
5.10	Evaluation range configuration.....	228
5.11	Adjusting settings automatically.....	229
5.12	Restoring factory settings for vector signal analysis.....	231
6	Analysis.....	233
6.1	Trace settings.....	233
6.2	Trace export settings.....	238
6.3	Markers.....	240
6.3.1	Individual marker settings.....	240
6.3.2	Marker search settings.....	242
6.3.3	Marker positioning functions.....	243
6.4	Limit and display lines.....	244
6.4.1	Display lines for eye diagrams.....	244
6.4.2	Modulation accuracy limit lines.....	246
6.5	Display and window configuration.....	248
6.5.1	Result window configuration.....	249
7	I/Q data import and export.....	253
8	How to perform vector signal analysis.....	254
8.1	How to perform VSA according to digital standards.....	254
8.2	How to perform customized VSA measurements.....	256
8.2.1	How to define the result range.....	257
8.2.2	How to select user-defined filters.....	258
8.2.3	How to perform pattern searches.....	259
8.2.3.1	How to assign patterns to a standard.....	260
8.2.3.2	How to define a new pattern.....	260
8.2.3.3	How to manage patterns.....	263
8.2.4	How to work with known data files.....	264
8.2.4.1	How to load known data files.....	265

8.2.4.2	How to create known data files.....	265
8.2.5	How to work with PRBS as known data.....	267
8.3	How to analyze the measured data.....	268
8.3.1	How to change the display scaling.....	269
8.3.1.1	How to scale time and spectrum diagrams.....	269
8.3.1.2	How to scale statistics diagrams.....	270
8.3.2	How to measure the size of an eye.....	272
8.3.3	How to check limits for modulation accuracy.....	273
8.3.4	How to export the trace data to a file.....	274
9	Measurement examples.....	275
9.1	Connecting the transmitter and analyzer.....	275
9.2	Measurement example 1: continuous QPSK signal.....	276
9.2.1	Transmitter settings.....	276
9.2.2	Analyzer settings.....	277
9.2.3	Changing the display configuration.....	278
9.2.4	Navigating through the capture buffer.....	279
9.2.5	Averaging several evaluations.....	280
9.3	Measurement example 2: burst GSM EDGE signals.....	281
9.3.1	Transmitter settings.....	281
9.3.2	Analyzer settings.....	283
9.3.3	Navigating through the capture buffer.....	284
9.3.4	Evaluating the rising and falling edges.....	285
9.3.5	Setting the evaluation range.....	286
9.3.6	Comparing the measurement signal to the reference signal.....	287
10	Troubleshooting the measurement.....	289
10.1	Flow chart for troubleshooting.....	289
10.2	Explanation of status bar messages.....	291
10.3	Frequently asked questions.....	300
10.3.1	Issues with graphical results.....	300
10.3.2	Issues with numeric results.....	305
10.3.3	Synchronization and demodulation problems.....	309
11	Remote commands for VSA.....	311

11.1	Introduction.....	311
11.1.1	Conventions used in descriptions.....	312
11.1.2	Long and short form.....	313
11.1.3	Numeric suffixes.....	313
11.1.4	Optional keywords.....	313
11.1.5	Alternative keywords.....	314
11.1.6	SCPI parameters.....	314
11.1.6.1	Numeric values.....	314
11.1.6.2	Boolean.....	315
11.1.6.3	Character data.....	315
11.1.6.4	Character strings.....	316
11.1.6.5	Block data.....	316
11.2	Common suffixes.....	316
11.3	Activating vector signal analysis.....	316
11.4	Digital standards.....	320
11.5	Configuring VSA.....	322
11.5.1	Signal description.....	322
11.5.1.1	Modulation.....	323
11.5.1.2	Signal structure.....	331
11.5.1.3	Frame structure.....	334
11.5.1.4	Known data.....	346
11.5.2	Input, output and frontend settings.....	350
11.5.2.1	RF input.....	350
11.5.2.2	Configuring file input.....	353
11.5.2.3	Independent CW source commands.....	354
11.5.2.4	Output settings.....	355
11.5.2.5	Frequency.....	357
11.5.2.6	Amplitude settings.....	358
11.5.2.7	Scaling and units.....	364
11.5.3	Signal capture.....	370
11.5.4	Triggering measurements.....	372
11.5.5	Configuring sweeps.....	375
11.5.6	Configuring bursts and patterns.....	376

11.5.6.1	Burst search.....	377
11.5.6.2	Pattern searches.....	379
11.5.6.3	Configuring patterns.....	381
11.5.7	Defining the result range.....	384
11.5.8	Demodulation settings.....	387
11.5.9	Measurement filter settings.....	396
11.5.10	Defining the evaluation range.....	398
11.5.11	Adjusting settings automatically.....	399
11.6	Performing a measurement.....	403
11.7	Analysis.....	407
11.7.1	Configuring traces.....	407
11.7.2	Working with markers.....	411
11.7.2.1	Individual marker settings.....	411
11.7.2.2	Marker search and positioning settings.....	415
11.7.3	Configuring display lines for eye diagrams.....	423
11.7.4	Configuring modulation accuracy limit lines.....	427
11.7.4.1	General commands.....	427
11.7.4.2	Defining limits.....	428
11.8	Configuring the result display.....	433
11.8.1	General window commands.....	433
11.8.2	Working with windows in the display.....	434
11.8.3	VSA window configuration.....	441
11.9	Retrieving results.....	448
11.9.1	Retrieving trace data and marker values.....	449
11.9.2	Measurement results for TRACe<n>[:DATA]? TRACE<n>.....	454
11.9.2.1	Capture buffer results.....	455
11.9.2.2	Cartesian diagrams.....	455
11.9.2.3	Polar diagrams.....	455
11.9.2.4	Symbols.....	456
11.9.2.5	Result summary.....	456
11.9.2.6	Equalizer.....	457
11.9.2.7	Multi source.....	457
11.9.3	Retrieving general burst and pattern information.....	457

11.9.4	Retrieving parameter values.....	462
11.9.5	Retrieving limit check results.....	477
11.10	Importing and exporting I/Q data and results.....	479
11.11	Status reporting system.....	480
11.11.1	STATus:QUESTionable:SYNC<n> register.....	483
11.11.2	STATus:QUESTionable:MODulation<n> register.....	483
11.11.3	STATus:QUESTionable:MODulation<n>:EVM register.....	483
11.11.4	STATus:QUESTionable:MODulation<n>:PHASe register.....	484
11.11.5	STATus:QUESTionable:MODulation<n>:MAGnitude register.....	484
11.11.6	STATus:QUESTionable:MODulation<n>:CFRequency register.....	485
11.11.7	STATus:QUESTionable:MODulation<n>:IQRHO register.....	485
11.11.8	STATus:QUESTionable:MODulation<n>:FSK register.....	486
11.11.9	Querying the status registers.....	486
11.12	Deprecated commands.....	491
11.13	Programming examples.....	492
11.13.1	Measurement example 1: user-defined measurement of continuous QPSK signal....	493
11.13.2	Measurement example 2: GSM EDGE burst measurement based on a digital standard	495
11.13.3	Measurement example 3: user-defined pattern search and limit check.....	498
	Annex.....	501
A	Abbreviations.....	501
B	Predefined standards and settings.....	502
C	Predefined measurement and tx filters.....	511
C.1	Transmit filters.....	511
C.2	Measurement filters.....	512
C.3	Typical combinations of tx and measurement filters.....	513
D	ASCII file export format for VSA data.....	514
E	Known data file syntax description.....	516
F	Formulae.....	518
F.1	Trace-based evaluations.....	518
F.2	Result summary evaluations.....	520

F.2.1	PSK, QAM and MSK modulation.....	520
F.2.2	FSK modulation.....	522
F.3	Statistical evaluations for the result summary.....	523
F.4	Trace averaging.....	523
F.5	Analytically calculated filters.....	524
F.6	Standard-specific filters.....	525
F.6.1	Transmit filter.....	525
F.6.2	Measurement filter.....	525
F.6.2.1	EDGE measurement filters.....	525
F.6.2.2	Low-isi filters.....	528
	List of Remote Commands (VSA).....	532
	Index.....	543

1 Documentation overview

This section provides an overview of the R&S FPL1000 user documentation. Unless specified otherwise, you find the documents at:

www.rohde-schwarz.com/manual/FPL1000

1.1 Getting started manual

Introduces the R&S FPL1000 and describes how to set up and start working with the product. Includes basic operations, typical measurement examples, and general information, e.g. safety instructions, etc.

A printed version is delivered with the instrument. A PDF version is available for download on the Internet.

1.2 User manuals and help

Separate user manuals are provided for the base unit and the firmware applications:

- **Base unit manual**
Contains the description of all instrument modes and functions. It also provides an introduction to remote control, a complete description of the remote control commands with programming examples, and information on maintenance, instrument interfaces and error messages. Includes the contents of the getting started manual.
- **Firmware application manual**
Contains the description of the specific functions of a firmware application, including remote control commands. Basic information on operating the R&S FPL1000 is not included.

The contents of the user manuals are available as help in the R&S FPL1000. The help offers quick, context-sensitive access to the complete information for the base unit and the firmware applications.

All user manuals are also available for download or for immediate display on the Internet.

1.3 Service manual

Describes the performance test for checking compliance with rated specifications, firmware update, troubleshooting, adjustments, installing options and maintenance.

The service manual is available for registered users on the global Rohde & Schwarz information system (GLORIS):

<https://gloris.rohde-schwarz.com>

Application notes, application cards, white papers, etc.

1.4 Instrument security procedures

Deals with security issues when working with the R&S FPL1000 in secure areas. It is available for download on the internet.

1.5 Printed safety instructions

Provides safety information in many languages. The printed document is delivered with the product.

1.6 Data sheets and brochures

The data sheet contains the technical specifications of the R&S FPL1000. It also lists the firmware applications and their order numbers, and optional accessories.

The brochure provides an overview of the instrument and deals with the specific characteristics.

See www.rohde-schwarz.com/brochure-datasheet/FPL1000

1.7 Release notes and open source acknowledgment (OSA)

The release notes list new features, improvements and known issues of the current firmware version, and describe the firmware installation.

The software makes use of several valuable open source software packages. An open source acknowledgment document provides verbatim license texts of the used open source software.

See www.rohde-schwarz.com/firmware/FPL1000

1.8 Application notes, application cards, white papers, etc.

These documents deal with special applications or background information on particular topics.

See www.rohde-schwarz.com/application/FPL1000

1.9 Video tutorials

Video tutorials that show you how to get started and perform basic tasks with the R&S FPL1000 are available on the Rohde & Schwarz internet site:

https://www.rohde-schwarz.com/manual/r-s-fpl1000-trying-out-basic-measurement-tasks-manuals_78701-567115.html

1.10 Calibration certificate

The document is available on <https://gloris.rohde-schwarz.com/calcert>. You need the device ID of your instrument, which you can find on a label on the rear panel.

2 Welcome to the R&S FPL1000 VSA application

The R&S FPL1-K70 is a firmware application that adds functionality to perform vector signal analysis (VSA) to the R&S FPL1000.

The R&S FPL1000 VSA application performs vector and scalar measurements on digitally modulated single-carrier signals. To perform the measurements, it converts RF signals into the complex baseband.

The R&S FPL1000 VSA application features:

- Flexible modulation analysis from MSK to 1024QAM
- Numerous standard-specific default settings
- Various graphical, numerical and statistical evaluations and result displays
- Spectrum analyses of the measurement and error signal
- Flexible burst search for the analysis of complex signal combinations, short bursts or signal mix

This user manual contains a description of the functionality that the application provides, including remote control operation.

General R&S FPL1000 functions

The application-independent functions for general tasks on the R&S FPL1000 are also available for VSA measurements and are described in the R&S FPL1000 user manual. In particular, this comprises the following functionality:

- Data management
- Test report functionality
- General software preferences and information

The latest version is available for download at the product homepage

<http://www.rohde-schwarz.com/product/FPL1000.html>.

Additional information

Several application notes discussing vector signal analysis using the R&S FPL1000 VSA application are available from the Rohde & Schwarz website:

[1EF93: Modulation Accuracy Measurements of DVB-S2 and DVB-S2X Signals](#)

[1EF55: EVM Measurements for ZigBee signals in the 2.4 GHz band](#)

[1MA171: How to use Rohde & Schwarz Instruments in MATLAB](#)

Installation

You can find detailed installation instructions in the R&S FPL1000 Getting Started manual or in the Release Notes.

- [Introduction to vector signal analysis](#)..... 17
- [Starting the VSA application](#)..... 17
- [Understanding the display information](#)..... 18

2.1 Introduction to vector signal analysis

The goal of vector signal analysis is to determine the quality of the signal that is transmitted by the device under test (DUT) by comparing it against an ideal signal. The DUT is usually connected with the analyzer via a cable. The key task of the analyzer is to determine the ideal signal. Hence, the analyzer aims to reconstruct the ideal signal from the measured signal that is transmitted by the DUT. This ideal signal is commonly referred to as the *reference signal*, while the signal from the DUT is called the *measurement signal*.

After extracting the reference signal, the R&S FPL1000 VSA application compares the measurement signal and the reference signal, and the results of this comparison are displayed.

Example:

The most common vector signal analysis measurement is the EVM ("Error Vector Magnitude") measurement. Here, the complex baseband reference signal is subtracted from the complex baseband measurement signal. The magnitude of this error vector represents the EVM value. The EVM has the advantage that it "summarizes" all potential errors and distortions in one single value. If the EVM value is low, the signal quality of the DUT is high.

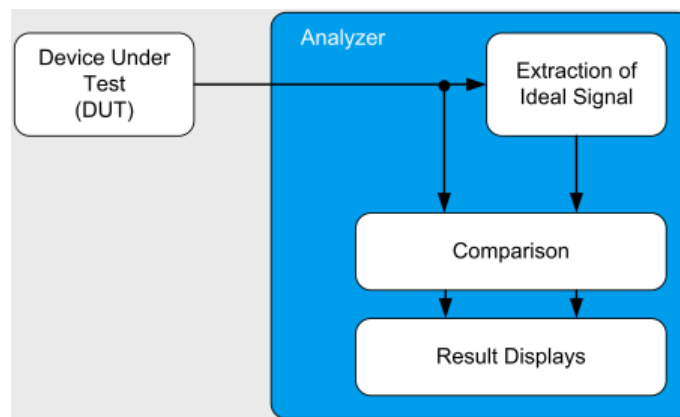


Figure 2-1: Simplified schema of vector signal analysis

2.2 Starting the VSA application

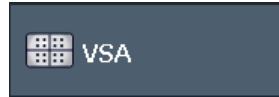
The VSA application adds a new application to the R&S FPL1000.

To activate the VSA application

1. Select the [MODE] key.

A dialog box opens that contains all operating modes and applications currently available on your R&S FPL1000.

2. Select the "VSA" item.



The R&S FPL1000 opens a new measurement channel for the VSA application.


The measurement is started immediately with the default settings. It can be configured in the VSA "Overview" dialog box, which is displayed when you select the "Overview" softkey from any menu (see [Chapter 5.1, "Configuration overview"](#), on page 159).

Multiple Measurement Channels and Sequencer Function

When you activate an application, a new measurement channel is created which determines the measurement settings for that application. The same application can be activated with different measurement settings by creating several channels for the same application.

The number of channels that can be configured at the same time depends on the available memory on the instrument.

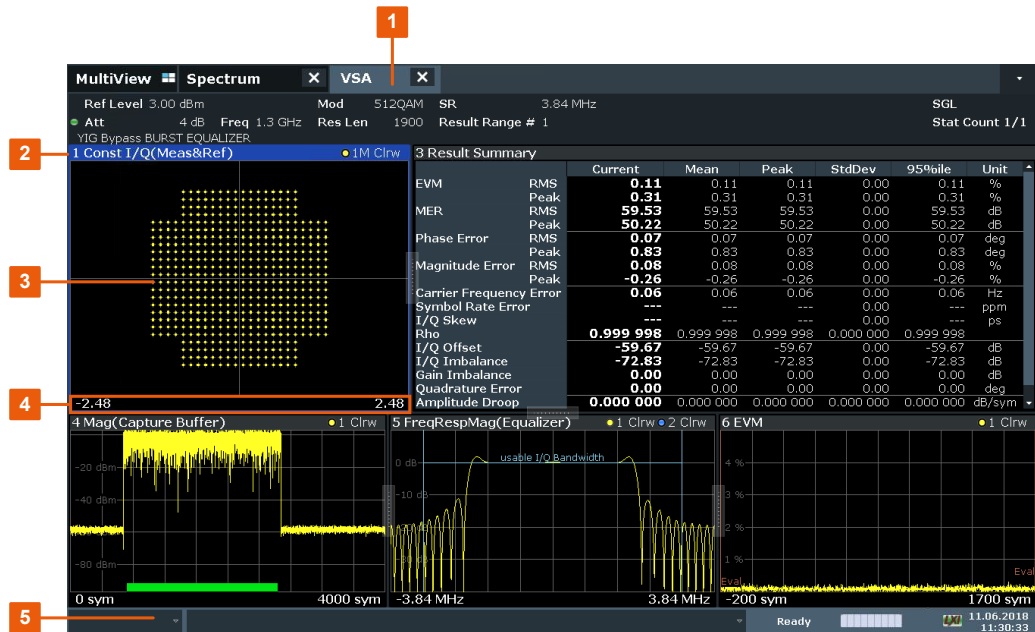
Only one measurement can be performed at any time, namely the one in the currently active channel. However, to perform the configured measurements consecutively, a Sequencer function is provided.

If activated, the measurements configured in the currently active channels are performed one after the other in the order of the tabs. The currently active measurement is indicated by a  symbol in the tab label. The result displays of the individual channels are updated in the tabs (as well as the "MultiView") as the measurements are performed. Sequential operation itself is independent of the currently *displayed* tab.

For details on the Sequencer function, see the R&S FPL1000 User Manual.

2.3 Understanding the display information

The following figure shows a measurement diagram during analyzer operation. All different information areas are labeled. They are explained in more detail in the following sections.



- 1 = Channel bar for firmware and measurement settings
- 2 = Window title bar with diagram-specific (trace) information
- 3 = Diagram area
- 4 = Diagram footer with diagram-specific information, depending on measurement application
- 5 = Instrument status bar with error messages, progress bar and date/time display

Channel bar information

In VSA application, the R&S FPL1000 shows the following settings:

Table 2-1: Information displayed in the channel bar in VSA application

Ref Level	Reference level
Offset	Reference level offset (if not 0)
Cap Len	Capture Length (instead of result length for "Capture Buffer" display), see "Capture Length Settings" on page 200
Std/Mod	Selected measurement standard or, if no standard selected, modulation type or loaded user-defined modulation file
Res Len	Result Length
Att	Mechanical and electronic RF attenuation
Freq	Center frequency for the RF signal
SR	Symbol Rate
Tx filter	Transmit filter, see "Transmit Filter Type" on page 168
Res Rng #	Number of the selected result range for burst signals, see Chapter 4.6.1, "Result range" , on page 143
Count	Statistics count for averaging and other statistical operations, see "Statistic Count" on page 205; cannot be edited directly

Input	Input type of the signal source See Chapter 5.4.1, "Input settings" , on page 183
Burst	Burst search active (see "Enabling Burst Searches" on page 207)
Pattern	Pattern search active (see "Enabling Pattern Searches" on page 209)
Equalizer	"Equalizer" active (see "State" on page 221)
SGL	The sweep is set to single sweep mode.

In addition, the channel bar also displays information on instrument settings that affect the measurement results even though this is not immediately apparent from the display of the measured values (e.g. transducer or trigger settings). This information is displayed only when applicable for the current measurement.

For details see the R&S FPL1000 Getting Started manual.

Window title bar information

For each diagram, the header provides the following information:



Figure 2-2: Window title bar information in VSA application

- 1 = Window name
- 2 = Result type
- 3 = Data source type
- 4 = Trace color
- 5 = Trace number
- 6 = Displayed signal for Meas&Ref or multi data source: "M" (Meas), "R" (Ref), "C" (Capture buffer), "E" (Error)
- 7 = Trace mode

Diagram area

The diagram area displays the results according to the selected result displays (see [Chapter 3, "Measurements and result displays"](#), on page 21).

Diagram footer information

The diagram footer (beneath the diagram) contains the start and stop symbols or time of the evaluation range.

Status bar information

Global instrument settings, the instrument status and any irregularities are indicated in the status bar beneath the diagram. Furthermore, the progress of the current operation is displayed in the status bar.

3 Measurements and result displays

Various different result displays for VSA measurements are available. Which result types are available depends on the selected data source. You can define which part of the measured signal is to be evaluated and displayed.

The determined result and evaluation ranges are included in the result displays (where useful) to visualize the basis of the displayed values and traces.

For background information on the result and evaluation ranges, see [Chapter 4.6, "Measurement ranges"](#), on page 142.)

- [Evaluation data sources in VSA](#).....21
- [Result types in VSA](#)..... 25
- [Predefined display configuration](#).....66
- [Common parameters in VSA](#)..... 67

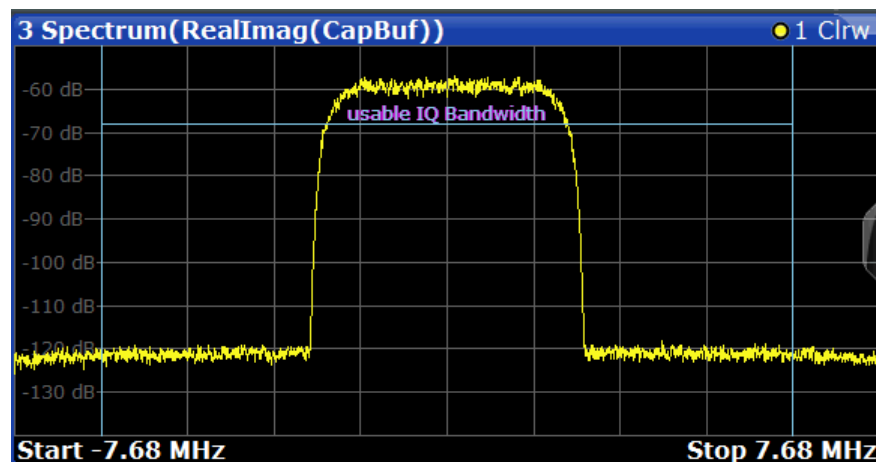
3.1 Evaluation data sources in VSA

All data sources for evaluation available for VSA are displayed in the evaluation bar in SmartGrid mode.

The data source determines which result types are available (see [Table 3-1](#)). For details on selecting the data source for evaluation, see [Chapter 6.5, "Display and window configuration"](#), on page 248.



In diagrams in the frequency domain (Spectrum transformation, see ["Result Type Transformation"](#) on page 250) the usable I/Q bandwidth is indicated by vertical blue lines.



- [Capture Buffer](#)..... 22
- [Measurement & Reference Signal](#)..... 22
- [Symbols](#)..... 23
- [Error Vector](#)..... 23

Modulation Errors.....	23
Modulation Accuracy.....	24
Equalizer.....	24
Multi Source.....	24

Capture Buffer

Displays the captured I/Q data.

In "Capture Buffer" result diagrams, the result ranges are indicated by green bars along the time axis. The currently displayed result range is indicated by a blue bar.

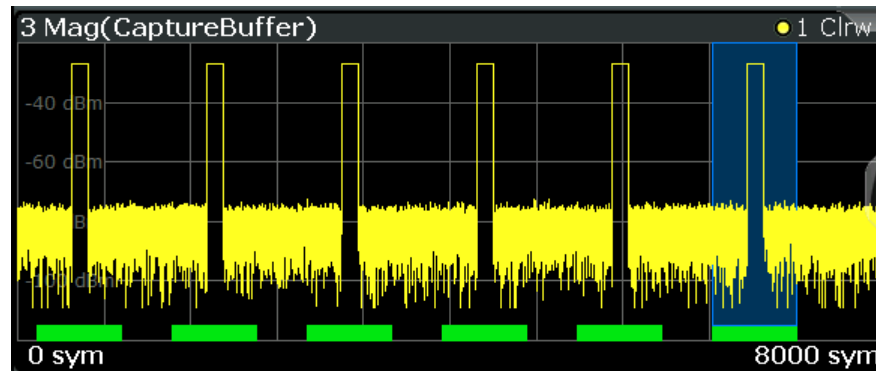


Figure 3-1: Result ranges for a burst signal

Note: You can use the "Capture Buffer" display to navigate through the available result ranges (using [Select Result Rng](#) function), and analyze the individual result ranges in separate windows.

Once the sweep has stopped, you can change the position of the result range quickly and easily. Drag the blue bar representing the result range to a different position in the "Capture Buffer".

The default result type is "Magnitude Absolute".

The following result types are available:

- [Chapter 3.2.21, "Magnitude absolute"](#), on page 48
- [Chapter 3.2.27, "Real/imag \(I/Q\)"](#), on page 54
- [Chapter 3.2.11, "Frequency absolute"](#), on page 39
- [Chapter 3.2.33, "Vector I/Q"](#), on page 64

Remote command:

LAY:ADD? '1',BEL,TCAP(see [LAYout:ADD\[:WINDOW\]?](#) on page 434)

Measurement & Reference Signal

The measurement signal or the ideal reference signal (or both)

The default result type is "Magnitude Relative".

The following result types are available:

- [Chapter 3.2.21, "Magnitude absolute"](#), on page 48
- [Chapter 3.2.22, "Magnitude relative"](#), on page 49
- [Chapter 3.2.25, "Phase wrap"](#), on page 52
- [Chapter 3.2.26, "Phase unwrap"](#), on page 53
- [Chapter 3.2.11, "Frequency absolute"](#), on page 39
- [Chapter 3.2.12, "Frequency relative"](#), on page 40

- [Chapter 3.2.27, "Real/imag \(I/Q\)", on page 54](#)
- [Chapter 3.2.10, "Eye diagram real \(I\)", on page 38](#)
- [Chapter 3.2.9, "Eye diagram imag \(Q\)", on page 36](#)
- [Chapter 3.2.8, "Eye diagram frequency", on page 35](#)
- [Chapter 3.2.5, "Constellation I/Q", on page 31](#)
- [Chapter 3.2.33, "Vector I/Q", on page 64](#)
- [Chapter 3.2.4, "Constellation frequency", on page 30](#)
- [Chapter 3.2.32, "Vector frequency", on page 64](#)

Remote command:

LAY:ADD? '1',BEL,REF(see [LAYout:ADD\[:WINDow\]?](#) on page 434)

Symbols

The detected symbols (i.e. the detected bits) displayed in a table.

The default result type is a hexadecimal symbol table.

Other formats for the symbol table are available, but no other result types (see [Chapter 3.2.31, "Symbol table", on page 62](#)).

Remote command:

LAY:ADD? '1',BEL,SYMB(see [LAYout:ADD\[:WINDow\]?](#) on page 434)

Error Vector

The modulated difference between the complex measurement signal and the complex reference signal:

Modulation (measurement signal - reference signal)

For example: $EVM = \text{Mag}(\text{meas} - \text{ref})$

The default result type is "EVM".

The following result types are available:

- [Chapter 3.2.7, "Error vector magnitude \(EVM\)", on page 34](#)
- [Chapter 3.2.27, "Real/imag \(I/Q\)", on page 54](#)
- [Chapter 3.2.33, "Vector I/Q", on page 64](#)

Remote command:

LAY:ADD? '1',BEL,EVEC(see [LAYout:ADD\[:WINDow\]?](#) on page 434)

Modulation Errors

The difference between the modulated complex samples in the measurement and the modulated reference signal:

Modulation (measurement signal) - Modulation (reference signal)

For example: $\text{Magnitude Error} = \text{Mag}(\text{meas}) - \text{Mag}(\text{ref})$

The default result type is "Magnitude Error".

The following result types are available:

- [Chapter 3.2.21, "Magnitude absolute", on page 48](#)
- [Chapter 3.2.24, "Phase error", on page 51](#)
- [Chapter 3.2.13, "Frequency error absolute", on page 41](#)
- [Chapter 3.2.14, "Frequency error relative", on page 43](#)

Remote command:

LAY:ADD? '1',BEL,MERR(see [LAYout:ADD\[:WINDow\]?](#) on page 434)

Modulation Accuracy

Parameters that characterize the accuracy of modulation.

The default result type is "Result Summary".

The following result types are available:

- [Chapter 3.2.28, "Result summary"](#), on page 55
- [Chapter 3.2.1, "Bit error rate \(BER\)"](#), on page 27

The results of a "modulation accuracy" measurement can be checked for violation of defined limits automatically. If limit check is activated and the measured values exceed the limits, those values are indicated in red in the "Result Summary" table. If limit check is activated and no values exceed the limits, the checked values are indicated in green.

1 Result Summary		Current	Peak	Unit
EVM	RMS	12.59	12.59	%
*	Peak	103.31*	103.31	%
MER	RMS	18.00	18.00	dB
	Peak	-0.28	-0.28	dB
Phase Error	RMS	6.62	6.62	deg
	Peak	44.67	44.67	deg
Magnitude Error	RMS	5.04	5.04	%
	Peak	48.74	48.74	%
Carrier Frequency Error		-201.04	-201.04	Hz
Rho		0.984 404	0.984 404	
I/Q Offset		-40.15	-40.15	dB
I/Q Imbalance		-57.56	-57.56	dB
Gain Imbalance		0.01	0.01	dB
Quadrature Error		0.14	0.14	deg
Amplitude Droop		-0.000 53	0.000 005	dB/sym

Remote command:

LAY:ADD? '1', BEL, MACC(see [LAYout:ADD\[:WINDow\]?](#) on page 434)

Equalizer

Filter characteristics of the "equalizer" used to compensate for channel distortion and parameters of the distortion itself.

The following result types are available:

- [Chapter 3.2.18, "Impulse response magnitude"](#), on page 46
- [Chapter 3.2.19, "Impulse response phase"](#), on page 47
- [Chapter 3.2.20, "Impulse response real/imag"](#), on page 48
- [Chapter 3.2.16, "Frequency response magnitude"](#), on page 45
- [Chapter 3.2.17, "Frequency response phase"](#), on page 45
- [Chapter 3.2.15, "Frequency response group delay"](#), on page 44
- [Chapter 3.2.3, "Channel frequency response magnitude"](#), on page 30
- [Chapter 3.2.2, "Channel frequency response group delay"](#), on page 29

The default result type is "Frequency Response Magnitude".

Remote command:

LAY:ADD? '1', BEL, EQU(see [LAYout:ADD\[:WINDow\]?](#) on page 434)

Multi Source

Combines two data sources in one diagram, with (initially) one trace for each data source. This display allows you to compare the errors to the captured or measured data directly in the diagram.

Furthermore, for carrier-in-carrier measurements, this data source makes both carriers visible.

The default result type is "Spec (Meas+Error)".

The following result types are available:

- [Chapter 3.2.29, "Spectrum \(capture buffer + error\)"](#), on page 59
- [Chapter 3.2.30, "Spectrum \(measurement + error\)"](#), on page 61

Remote command:

LAY:ADD? '1', RIGH, MCOM, see [LAYout:ADD\[:WINDow\]?](#) on page 434

3.2 Result types in VSA

The available result types for a window depend on the selected evaluation data source.



The SCPI parameters in the following table refer to the `CALC:FORM` command, see [CALCulate<n>:FORMat](#) on page 444.

Table 3-1: Available result types depending on data source

Evaluation data source	Result type	SCPI parameter
"Capture Buffer"	"Magnitude Absolute"	MAGNitude
	"Real/Imag (I/Q)"	RIMag
	"Frequency Absolute"	FREQuency
	"Vector I/Q"	COMP
"Meas & Ref Signal"	"Magnitude Absolute"	MAGNitude
	"Magnitude Relative"	MAGNitude
	"Phase Wrap"	PHASe
	"Phase Unwrap"	UPHase
	"Frequency Absolute"	FREQuency
	"Frequency Relative"	FREQuency
	"Real/Imag (I/Q)"	RIMag
	"Eye Diagram Real (I)"	IEYE
	"Eye Diagram Imag (Q)"	QEYE
	"Eye Diagram Frequency"	FEYE
	"Constellation I/Q"	CONS
	"Constellation I/Q (Rotated)"	RCON
	"Vector I/Q"	COMP
	"Constellation Frequency"	CONF

Evaluation data source	Result type	SCPI parameter
	"Vector Frequency"	COVF
"Symbols"	"Binary"	-
	"Octal"	-
	"Decimal"	-
	"Hexadecimal"	-
"Error Vector"	"EVM"	MAGNitude
	"Real/Imag (I/Q)"	RIMag
	"Vector I/Q"	COMP
"Modulation Errors"	"Magnitude Error"	MAGNitude
	"Phase Error"	PHASe
	"Frequency Error Absolute"	FREQuency
	"Frequency Error Relative"	FREQuency
"Modulation Accuracy"	"Bit Error Rate"	BERate
	"Result Summary"	RSUM
"Equalizer"	"Impulse Response Magnitude"	MAGNitude
	"Impulse Response Phase"	UPHase
	"Impulse Response Real/Imag"	RIMag
	"Frequency Response Magnitude"	MAGNitude
	"Frequency Response Phase"	UPHase
	"Frequency Response Group Delay"	GDELay
	"Channel Frequency Response Magnitude"	MAGNitude
	"Channel Frequency Response Group Delay"	GDELay
"Multi Source"	"Spectrum (Real/Imag) (Capture buffer + Error)"	RIMag (query only)
	"Spectrum (Real/Imag) (Measurement + Error)"	RIMag (query only)

For details on selecting the data source and result types for evaluation, see [Chapter 6.5, "Display and window configuration"](#), on page 248.

Remote command:

[CALCulate<n>:FORMat](#) on page 444

- [Bit error rate \(BER\)](#)..... 27
- [Channel frequency response group delay](#)..... 29
- [Channel frequency response magnitude](#)..... 30

• Constellation frequency.....	30
• Constellation I/Q.....	31
• Constellation I/Q (rotated).....	33
• Error vector magnitude (EVM).....	34
• Eye diagram frequency.....	35
• Eye diagram imag (Q).....	36
• Eye diagram real (I).....	38
• Frequency absolute.....	39
• Frequency relative.....	40
• Frequency error absolute.....	41
• Frequency error relative.....	43
• Frequency response group delay.....	44
• Frequency response magnitude.....	45
• Frequency response phase.....	45
• Impulse response magnitude.....	46
• Impulse response phase.....	47
• Impulse response real/imag.....	48
• Magnitude absolute.....	48
• Magnitude relative.....	49
• Magnitude error.....	50
• Phase error.....	51
• Phase wrap.....	52
• Phase unwrap.....	53
• Real/imag (I/Q).....	54
• Result summary.....	55
• Spectrum (capture buffer + error).....	59
• Spectrum (measurement + error).....	61
• Symbol table.....	62
• Vector frequency.....	64
• Vector I/Q.....	64

3.2.1 Bit error rate (BER)

A bit error rate (BER) measurement compares the transmitted bits with the determined symbol decision bits:

$$\text{BER} = \text{error bits} / \text{number of analyzed bits}$$

As a prerequisite for this measurement, the VSA application must know which bit sequences are correct, i.e. which bit sequences can occur. This knowledge must be provided as a list of possible data sequences in xml format, which is loaded in the VSA application (see [Chapter 4.9, "Known data files - dependencies and restrictions"](#), on page 148).



Auxiliary tool to create known data files

An auxiliary tool to create known data files from data that is already available in the R&S FPL1000 VSA application is provided with the instrument free of charge.

See [Chapter 8.2.4.2, "How to create known data files"](#), on page 265.

Alternatively, for data generated by a pseudo-random bit sequence (PRBS) generator, you can specify the algorithm used to generate the data, so the R&S FPL1000 VSA application knows which sequences can occur. This function requires the R&S FPL1000-K70P option. See [Chapter 4.10, "Known data from PRBS generators"](#), on page 150.

If known data is specified in the application, the BER result display is available for the following source types:

- "Modulation Accuracy"



Note that this measurement can take some time, as each symbol decision must be compared to the possible data sequences one by one.

The BER measurement is an indicator for the quality of the demodulated signal. High BER values indicate problems such as:

- Inadequate demodulation settings
- Poor quality in the source data
- False or missing sequences in the known data file
- Result range alignment leads to a mismatch of the input data with the defined sequences

A BER value of 0.5 means that for at least one measurement no matching sequence was found.

See also [Chapter 4.4.3, "Demodulation and symbol decisions"](#), on page 117 and the application sheet [R&S®FSW-K70 Measuring the BER and the EVM for Signals with Low SNR](#) on the Rohde & Schwarz Internet site.

4 Bit Error Rate		
	Current	Accumulative
Bit Error Rate	0.002 252 252	0.002 252 252
Total # of Errors	1	1
Total # of Bits	444	444

The following information is provided in the "Bit Error Rate" result display:

- "Bit Error Rate": error bits / number of analyzed bits
- "Total # of Errors": number of detected bit errors (known data compared to symbol decisions)
- "Total # of Bits": number of analyzed bits

For each of these results, the following values are provided:

BER result	Description
Current	Value for current result range
Minimum	Minimum "Current" value during the current measurement
Maximum	Maximum "Current" value during the current measurement
Accumulative	Total value over several measurements; For BER: "Total # of Errors" / "Total # of Bits" (similar to average function)

Remote commands:

```
LAY:ADD? '1',BEL,MACC
```

To define the required source type (see [LAYout:ADD\[:WINDow\]?](#) on page 434).

```
CALC:FORM BER
```

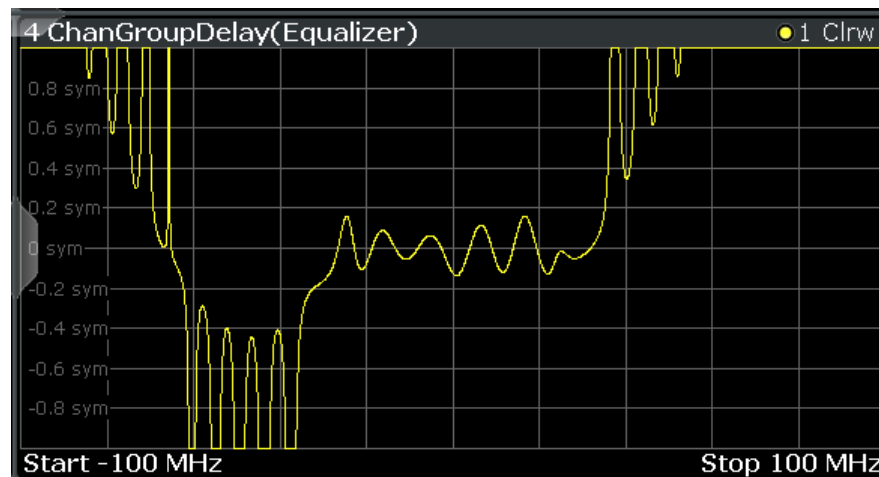
To define the result type (see [CALCulate<n>:FORMat](#) on page 444).

```
CALC:BER?
```

To query the results (see [CALCulate<n>:BERate?](#) on page 462).

3.2.2 Channel frequency response group delay

The frequency response group delay of the channel is the derivation of phase over frequency for the original input signal. It is a measure of phase distortion.

**Remote commands:**

```
LAY:ADD? '1',BEL,EQU
```

To define the required source type (see [LAYout:ADD\[:WINDow\]?](#) on page 434).

```
CALC:FEED 'XFR:DDEM:IRAT'
```

To define the channel frequency response result type (see [CALCulate<n>:FEED](#) on page 443).

```
CALC:FORM GDEL
```

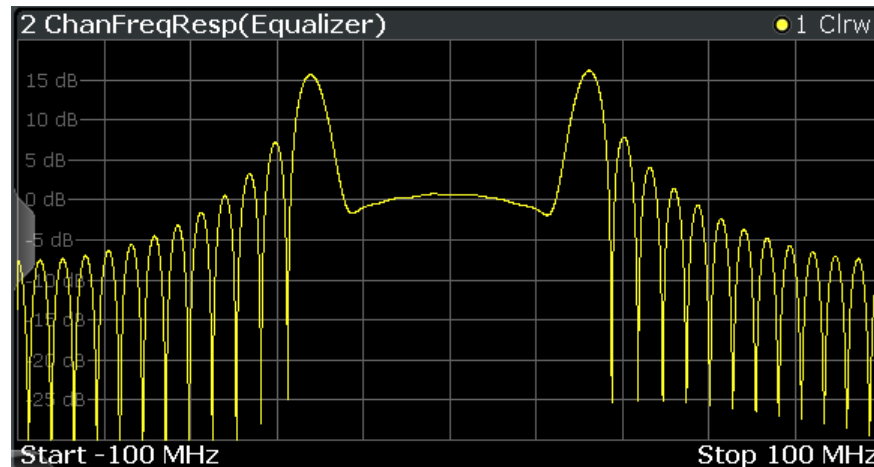
To define the group delay result type (see [CALCulate<n>:FORMat](#) on page 444).

```
TRAC:DATA? TRACE1
```

To query the trace results (see [TRACe<n>\[:DATA\]? TRACE<n>](#) and [Chapter 11.9.2.6, "Equalizer"](#), on page 457).

3.2.3 Channel frequency response magnitude

The frequency response magnitude of the channel indicates which distortions occurred during transmission of the input signal. It is only determined if the equalizer is activated.



The bandwidth for which the channel transfer function can be estimated is not only limited by the usable I/Q bandwidth, but also by the bandwidth of the analyzed input signal. Areas with low reception power, e.g. at the filter edges, can suffer from less accurate estimation results.

Remote commands:

```
LAY:ADD? '1',BEL,EQU
```

To define the required source type (see [LAYout:ADD\[:WINDow\]?](#) on page 434).

```
CALC:FEED 'XFR:DDEM:IRAT'
```

To define the channel frequency response result type (see [CALCulate<n>:FEED](#) on page 443).

```
CALC:FORM MAGN
```

To define the magnitude result type (see [CALCulate<n>:FORMat](#) on page 444).

```
TRAC:DATA? TRACE1
```

To query the trace results (see [TRACe<n>\[:DATA\]?](#) [TRACE<n>](#) and [Chapter 11.9.2.6, "Equalizer"](#), on page 457).

3.2.4 Constellation frequency

Depending on the modulation type, the source signal (without inter-symbol interference) as an X/Y plot; only the symbol decision instants are drawn and not connected.

Available for source types:

- "Meas & Ref Signal"

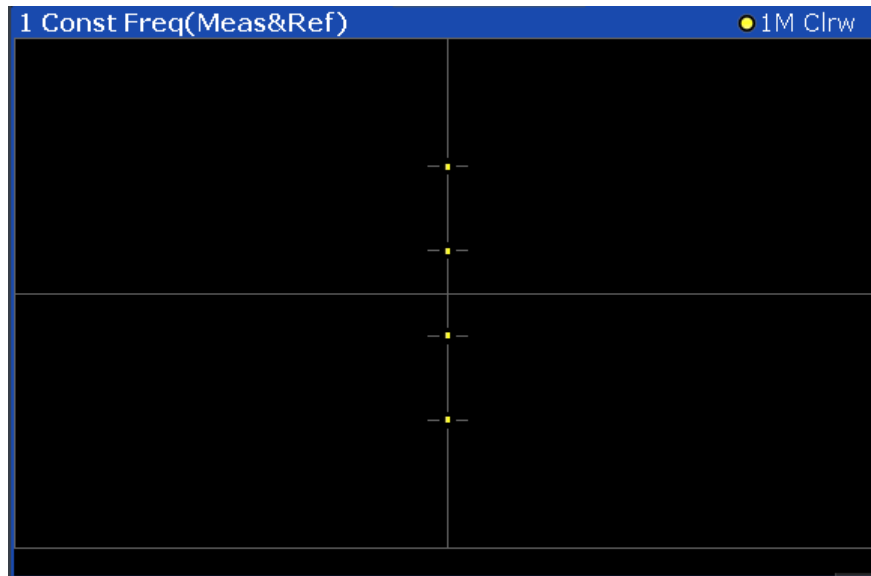


Figure 3-2: Constellation Frequency result display

A special density trace mode is available for this diagram. The occurrence of each value within the current result range or evaluation range is indicated by color.

Remote commands:

LAY:ADD? '1', BEL, MEAS

To define the required source type (see [LAYout:ADD\[:WINDow\]?](#) on page 434)

CALC:FORM CONF

To define the result type (see [CALCulate<n>:FORMat](#) on page 444)

TRAC:DATA? TRACE1

To query the trace results (see [TRACe<n>\[:DATA\]? TRACE<n>](#) and [Chapter 11.9.2.3, "Polar diagrams"](#), on page 455)

3.2.5 Constellation I/Q

The complex source signal (without inter-symbol interference) as an X/Y plot; only the (de-rotated) symbol decision instants are drawn and not connected

Available for source types:

- "Meas & Ref Signal"



Figure 3-3: Constellation I/Q diagram for QPSK modulated signal

Markers in the Constellation diagram

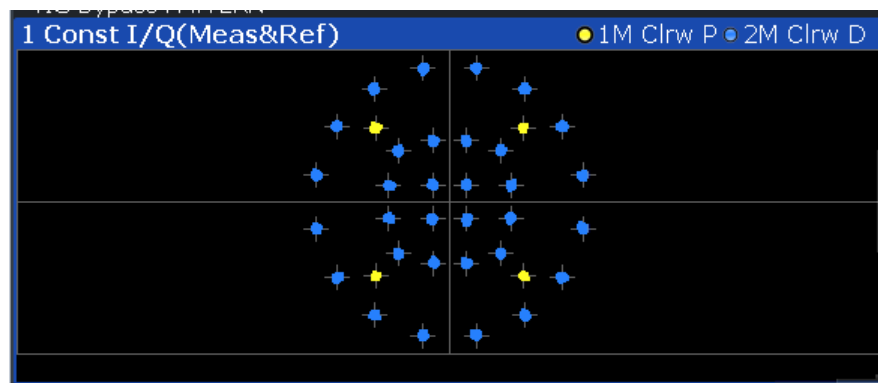
Using markers you can detect individual constellation points for a specific symbol. When you activate a marker in the Constellation diagram, its position is defined by the symbol the point belongs to. However, the marker result indicates the I and Q values of the point.



Constellation for subframe or symbol types in multi-modulation signals

For signals with a user-defined frame structure (see [Chapter 4.11, "Multi-modulation analysis \(R&S FPL1000-K70M\)"](#), on page 152), the constellation diagram displays all symbols in the entire frame by default. However, if you restrict the evaluation range to the symbols of a particular subframe, only those constellation points are displayed (see [Chapter 5.10, "Evaluation range configuration"](#), on page 228).

You can also define different colored traces for different symbol types (see [Chapter 6.1, "Trace settings"](#), on page 233).



Density trace

A special density trace mode is available for this diagram. The occurrence of each value within the current result range or evaluation range is indicated by color.

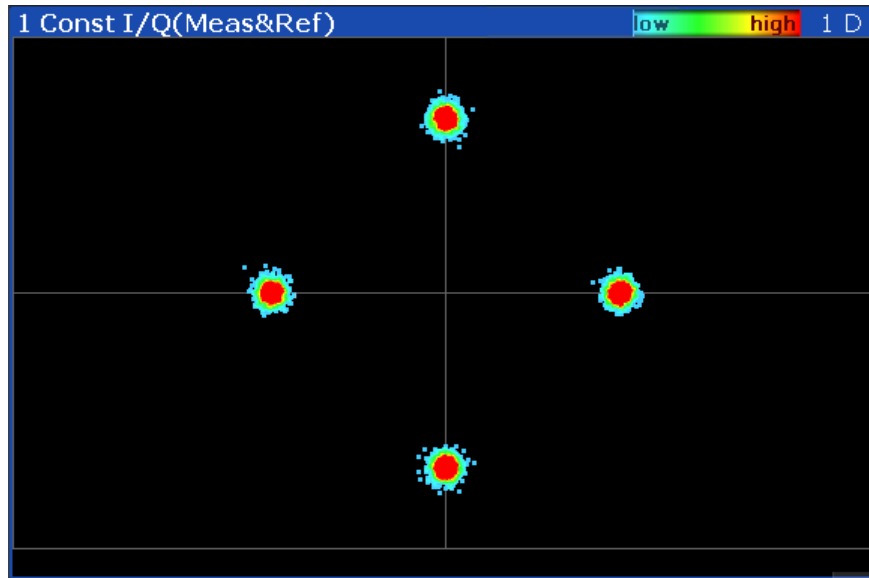


Figure 3-4: Example for a density constellation trace

Remote commands:

```
LAY:ADD? '1',BEL,MEAS
```

To define the required source type (see [LAYout:ADD\[:WINDow\]?](#) on page 434).

```
CALC:FORM CONS
```

To define the result type (see [CALCulate<n>:FORMat](#) on page 444).

```
TRAC:DATA? TRACE1
```

To query the trace results (see [TRACe<n>\[:DATA\]? TRACE<n>](#) and [Chapter 11.9.2.3, "Polar diagrams"](#), on page 455).

[CALCulate<n>:MARKer<m>:Y?](#) on page 413

To query the marker I/Q values.

3.2.6 Constellation I/Q (rotated)

The complex source signal as an X/Y plot. As opposed to the common "Constellation I/Q" display, the symbol decision instants, *including the rotated ones*, are drawn and not connected.

Available for source types:

- "Meas & Ref Signal"
This result type is only available for signals with a rotating modulation.



Figure 3-5: Constellation I/Q (Rotated) result display vs. common Constellation I/Q for $3\pi/8$ -8PSK modulation

A special density trace mode is available for this diagram. The occurrence of each value within the current result range or evaluation range is indicated by color.

Remote commands:

LAY:ADD? '1',BEL,MEAS

To define the required source type (see LAYout:ADD[:WINDow]? on page 434).

CALC:FORM RCON

To define the result type (see CALCulate<n>:FORMat on page 444).

TRAC:DATA? TRACE1

To query the trace results (see TRACe<n>[:DATA]? TRACE<n> and Chapter 11.9.2.3, "Polar diagrams", on page 455).

3.2.7 Error vector magnitude (EVM)

Displays the error vector magnitude as a function of symbols or time.

$$EVM(t) = \frac{|EV(t)|}{C}$$

with $t = n \cdot T_D$ and T_D = the duration of one sampling period at the sample rate defined by the display points per symbol parameter (see "Display Points/Sym" on page 251).

The normalization constant C is chosen according to the EVM normalization. By default C^2 is the mean power of the reference signal.

$$C = \sqrt{\frac{1}{K} \sum_k |REF(k \cdot T)|^2}$$

and

T = duration of symbol periods

Note that $k=0.5 \cdot n \cdot T$ for Offset QPSK with inactive [Offset EVM](#).

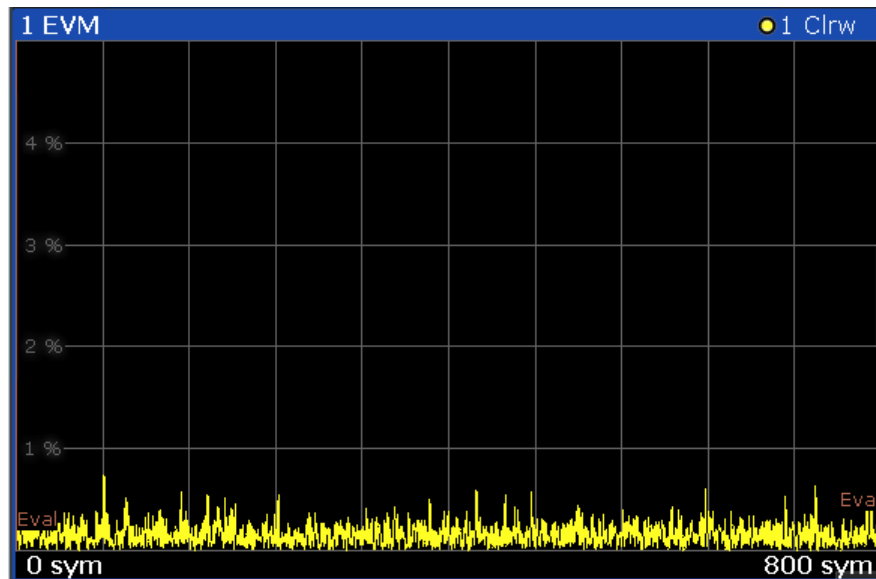


Figure 3-6: Error Vector Magnitude result display

For signals with a user-defined frame structure (see [Chapter 4.11, "Multi-modulation analysis \(R&S FPL1000-K70M\)"](#), on page 152), the individual subframes are indicated by vertical green lines.

Available for source types:

- "Error Vector"

Remote commands:

```
LAY:ADD? '1',BEL,EVEC
```

To define the required source type (see [LAYout:ADD\[:WINDow\]?](#) on page 434).

```
CALC:FORM MAGN
```

To define the result type (see [CALCulate<n>:FORMat](#) on page 444).

```
TRAC:DATA? TRACE1
```

To query the trace results (see [TRACe<n>\[:DATA\]? TRACE<n>](#) and [Chapter 11.9.2.2, "Cartesian diagrams"](#), on page 455).

3.2.8 Eye diagram frequency

The eye diagram of the currently measured frequencies and/or the reference signal. The time span of the data depends on the evaluation range (capture buffer).

Available for source types:

- "Meas & Ref Signal"



Display lines are available in eye diagrams which allow you to determine the size of the eye, see also [Chapter 8.3.2, "How to measure the size of an eye"](#), on page 272.

A special density trace mode is available for this diagram. The occurrence of each value within the current result range or evaluation range is indicated by color.

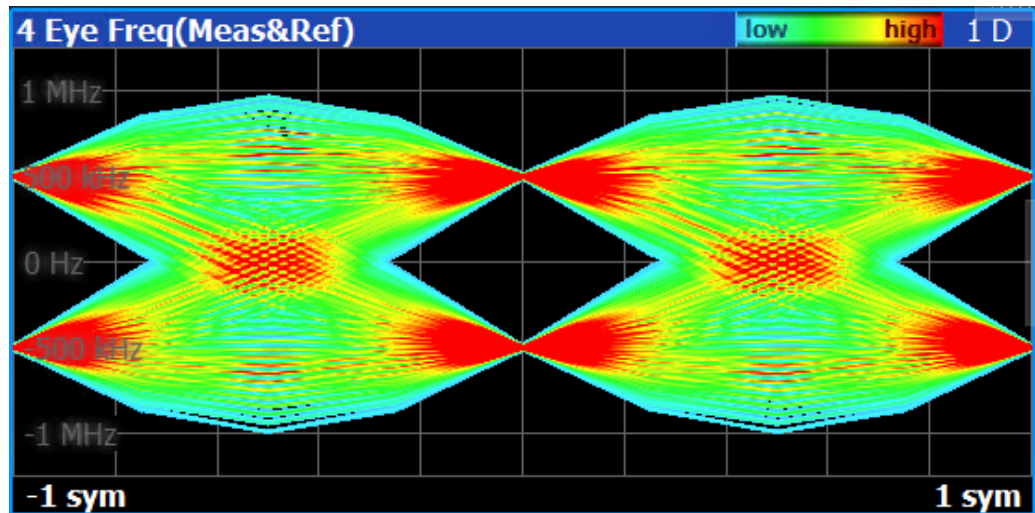


Figure 3-7: Eye Diagram Frequency result display with density trace

Remote commands:

```
LAY:ADD? '1',BEL,MEAS
```

To define the required source type (see [LAYout:ADD\[:WINDOW\]?](#) on page 434).

```
CALC:FORM FEYE
```

To define the result type (see [CALCulate<n>:FORMat](#) on page 444).

```
TRAC:DATA? TRACE1
```

To query the trace results (see [TRACe<n>\[:DATA\]? TRACE<n>](#) and [Chapter 11.9.2.2, "Cartesian diagrams"](#), on page 455).

[Chapter 11.7.3, "Configuring display lines for eye diagrams"](#), on page 423

3.2.9 Eye diagram imag (Q)

The eye pattern of the quadrature (Q) channel; the x-axis range is from -1 to +1 symbols (MSK: -2 to +2)

Available for source types:

- "Meas & Ref Signal"

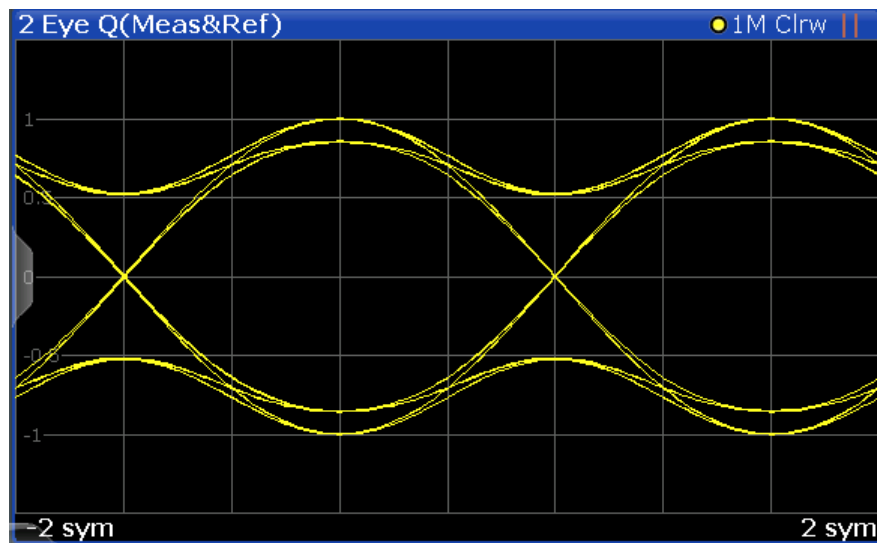


Figure 3-8: Eye Diagram Imag (Q) result display



Display lines are available in eye diagrams which allow you to determine the size of the eye, see also [Chapter 8.3.2, "How to measure the size of an eye"](#), on page 272.

A special density trace mode is available for this diagram. The occurrence of each value within the current result range or evaluation range is indicated by color.

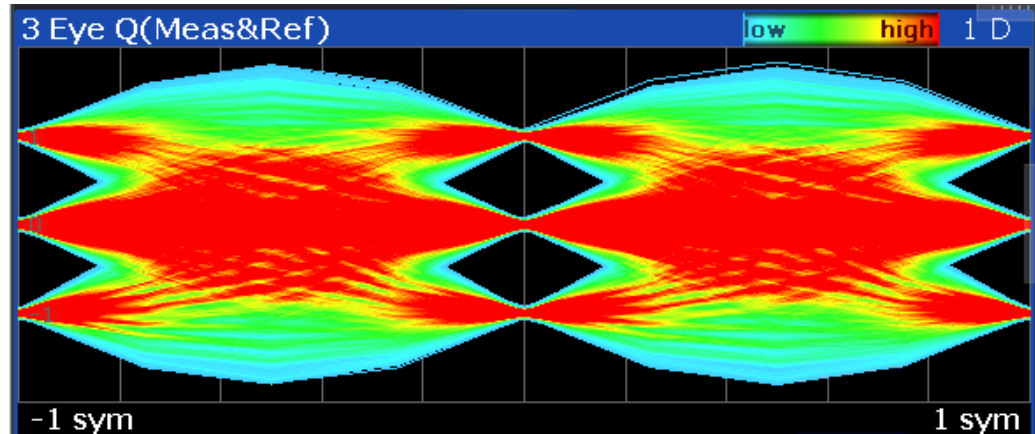


Figure 3-9: Eye Diagram Imag (Q) result display with density trace

Remote commands:

```
LAY:ADD? '1',BEL,MEAS
```

To define the required source type (see [LAYout:ADD\[:WINDow\]?](#) on page 434).

```
CALC:FORM QEYE
```

To define the result type (see [CALCulate<n>:FORMat](#) on page 444).

```
TRAC:DATA? TRACE1
```

To query the trace results (see [TRACe<n>\[:DATA\]? TRACE<n>](#) and [Chapter 11.9.2.2, "Cartesian diagrams"](#), on page 455).

[Chapter 11.7.3, "Configuring display lines for eye diagrams"](#), on page 423

3.2.10 Eye diagram real (I)

The eye pattern of the inphase (I) channel; the x-axis value range is from -1 to +1 symbols (MSK: -2 to +2)

Available for source types:

- "Meas & Ref Signal"

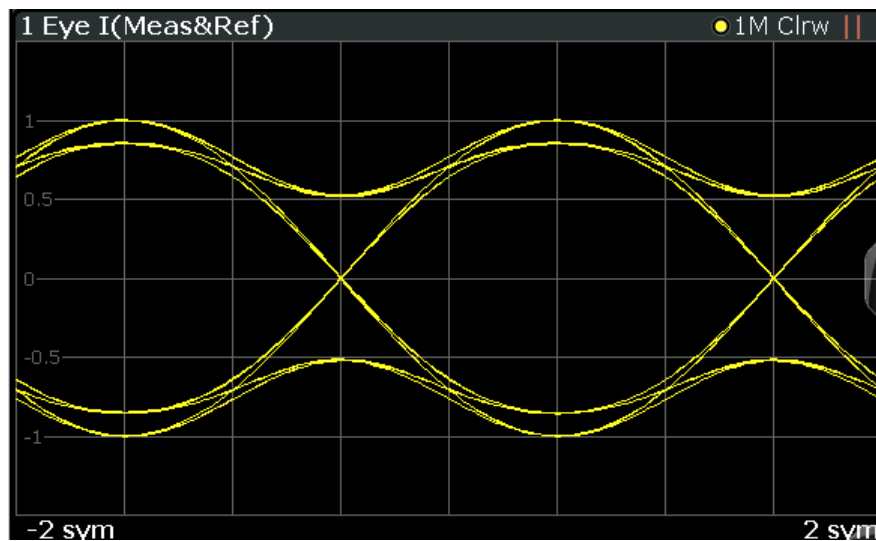


Figure 3-10: Eye Diagram Real (I) result display



Display lines are available in eye diagrams which allow you to determine the size of the eye, see also [Chapter 8.3.2, "How to measure the size of an eye"](#), on page 272.

A special density trace mode is available for this diagram. The occurrence of each value within the current result range or evaluation range is indicated by color.

Remote commands:

```
LAY:ADD? '1',BEL,MEAS
```

To define the required source type (see [LAYout:ADD\[:WINDow\]?](#) on page 434).

```
CALC:FORM IEYE
```

To define the result type (see [CALCulate<n>:FORMat](#) on page 444).

```
TRAC:DATA? TRACE1
```

To query the trace results (see [TRACe<n>\[:DATA\]? TRACE<n>](#) and [Chapter 11.9.2.2, "Cartesian diagrams"](#), on page 455).

Chapter 11.7.3, "Configuring display lines for eye diagrams", on page 423

3.2.11 Frequency absolute

The instantaneous frequency of the signal source; the absolute value is displayed in Hz.

Available for source types:

- "Meas & Ref Signal"
- "Capture Buffer"

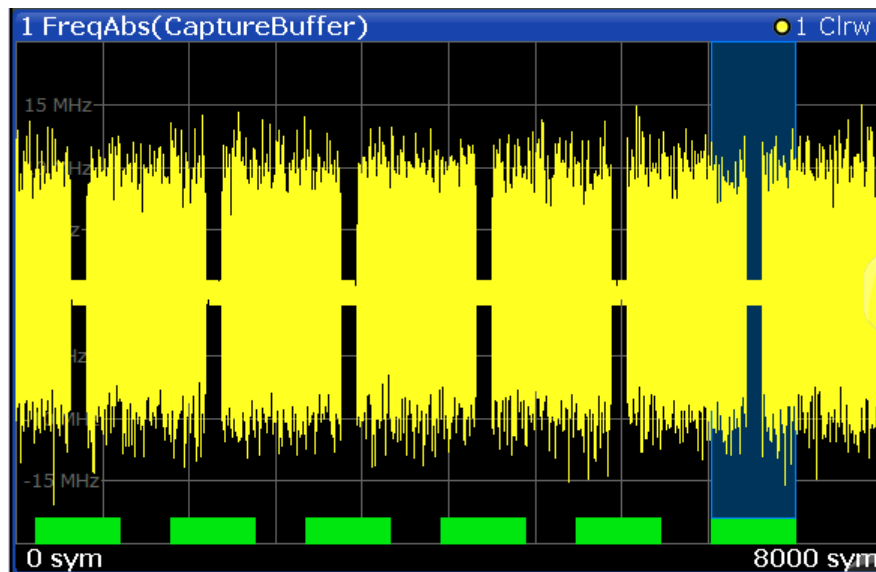


Figure 3-11: Frequency Absolute result display

Meas&Ref signal:

$$FREQ_{MEAS}(t) = \frac{1}{2 \cdot \pi} \frac{d}{dt} \angle MEAS(t)$$

with $t = n \cdot T_D$ and T_D = the duration of one sampling period at the sample rate defined by the display points per symbol parameter (see "Display Points/Sym" on page 251).

For signals with a user-defined frame structure (see Chapter 4.11, "Multi-modulation analysis (R&S FPL1000-K70M)", on page 152), and based on the "Meas and Ref" signal, the individual subframes are indicated by vertical green lines.

Capture buffer:

$$FREQ_{CAPT.}(t) = \frac{1}{2 \cdot \pi} \frac{d}{dt} \angle Capt(t)$$

When evaluating the capture buffer, the absolute frequency is derived from the measured phase, with T_D =the duration of one sampling period at the sample rate (see "Sample Rate" on page 201).

Note that this result display is based on an individual capture buffer *range*. If more than 256 000 samples are captured, overlapping ranges with a size of 256 000 each are created. Only one range at a time can be displayed in the "Frequency Absolute" result display. For details see [Chapter 4.8, "Capture buffer display"](#), on page 148.



This measurement is mainly of interest when using the MSK or FSK modulation, but can also be used for the PSK/QAM modulations. However, since these modulations can have transitions through zero in the I/Q plane, in this case, possibly you notice uncritical spikes. The reason is that the phase of zero (or a complex value close to zero) is of limited significance, but still influences the result of the instantaneous frequency measurement.

Remote commands:

```
LAY:ADD? '1',BEL,MEAS
```

To define the required source type (see [LAYout:ADD\[:WINDow\]?](#) on page 434).

```
CALC:FORM FREQ
```

To define the result type (see [CALCulate<n>:FORMat](#) on page 444).

```
TRAC:DATA? TRACE1
```

To query the trace results (see [TRACe<n>\[:DATA\]? TRACE<n>](#) and [Chapter 11.9.2.1, "Capture buffer results"](#), on page 455/[Chapter 11.9.2.2, "Cartesian diagrams"](#), on page 455).

3.2.12 Frequency relative

The instantaneous frequency of the signal source.

The results are normalized to the symbol rate (PSK and QAM modulated signals), the estimated FSK deviation (FSK modulated signals) or one quarter of the symbol rate (MSK modulated signals).

$$FREQ_{MEAS}(t) = \frac{1}{2 \cdot \pi} \frac{d}{dt} \angle MEAS(t)$$

with $t=n \cdot T_D$ and T_D =the duration of one sampling period at the sample rate defined by the display points per symbol parameter (see ["Display Points/Sym"](#) on page 251).



This measurement is mainly of interest when using the MSK or FSK modulation, but can also be used for the PSK/QAM modulations. See also the note for [Chapter 3.2.11, "Frequency absolute"](#), on page 39.

Available for source types:

- "Meas & Ref Signal"

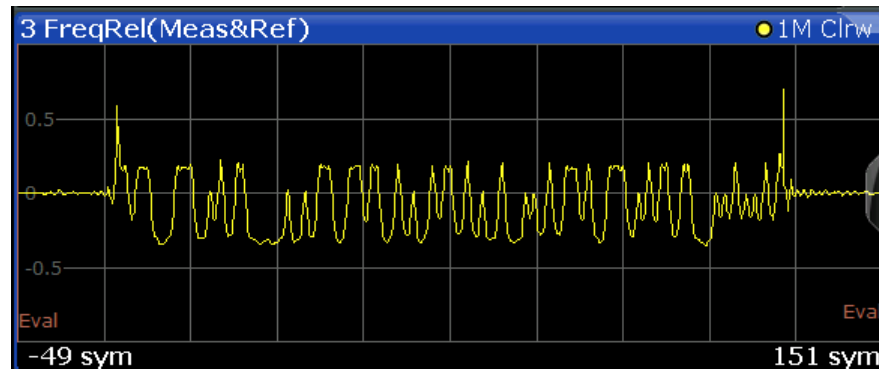


Figure 3-12: Frequency Relative result display

For signals with a user-defined frame structure (see [Chapter 4.11, "Multi-modulation analysis \(R&S FPL1000-K70M\)"](#), on page 152), the individual subframes are indicated by vertical green lines.

Remote commands:

```
LAY:ADD? '1',BEL,MEAS
```

To define the required source type (see [LAYout:ADD\[:WINDOW\]?](#) on page 434).

```
CALC:FORM FREQ
```

To define the result type (see [CALCulate<n>:FORMat](#) on page 444).

```
DISP:TRAC:Y:MODE REL
```

To define relative values (see [DISPlay\[:WINDOW<n>\]\[:SUBWindow<w>\]:TRACe<t>:Y\[:SCALE\]:MODE](#) on page 448).

```
TRAC:DATA? TRACE1
```

To query the trace results (see [TRACe<n>\[:DATA\]? TRACE<n>](#) and [Chapter 11.9.2.2, "Cartesian diagrams"](#), on page 455).

3.2.13 Frequency error absolute

Displays the error of the instantaneous frequency in Hz of the measurement signal with respect to the reference signal as a function of symbols over time.

$$FREQ_ERR(t) = FREQ_{MEAS}(t) - FREQ_{REF}(t)$$

with $t = n \cdot T_D$ and T_D = the duration of one sampling period at the sample rate defined by the display points per symbol parameter (see ["Display Points/Sym"](#) on page 251).

Note that this measurement does not consider a possible carrier frequency offset. It has already been compensated for in the measurement signal.



This measurement is mainly of interest when using the MSK or FSK modulation, but can also be used for the PSK/QAM modulations. However, since these modulations can have transitions through zero in the I/Q plane, in this case, you possibly notice uncritical spikes. The reason is that the phase of zero (or a complex value close to zero) has in fact limited significance, but still influences the result of the current frequency measurement.

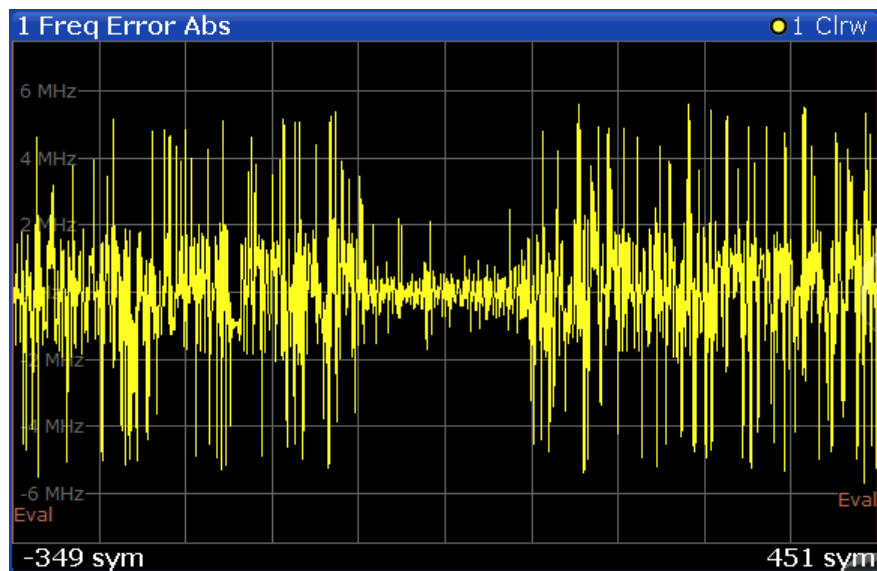


Figure 3-13: Frequency Error Absolute result display

Available for source types:

- "Modulation Errors"

For signals with a user-defined frame structure (see [Chapter 4.11, "Multi-modulation analysis \(R&S FPL1000-K70M\)"](#), on page 152), the individual subframes are indicated by vertical green lines.

Remote commands:

```
LAY:ADD? '1',BEL,MERR
```

To define the required source type (see [LAYout:ADD\[:WINDow\]?](#) on page 434).

```
CALC:FORM FREQ
```

To define the result type (see [CALCulate<n>:FORMat](#) on page 444).

```
TRAC:DATA? TRACE1
```

To query the trace results (see [TRACe<n>\[:DATA\]? TRACE<n>](#) and [Chapter 11.9.2.2, "Cartesian diagrams"](#), on page 455).

3.2.14 Frequency error relative

Displays the error of the instantaneous frequency of the measurement signal with respect to the reference signal as a function of symbols over time.

The results are normalized to the symbol rate (PSK and QAM modulated signals), the estimated FSK deviation (FSK modulated signals) or one quarter of the symbol rate (MSK modulated signals).

$$FREQ_ERR(t) = FREQ_{MEAS}(t) - FREQ_{REF}(t)$$

with $t = n \cdot T_D$ and T_D = the duration of one sampling period at the sample rate defined by the display points per symbol parameter (see "Display Points/Sym" on page 251).



This measurement is mainly of interest when using the MSK or FSK modulation, but can also be used for the PSK/QAM modulations. See also the note for [Chapter 3.2.13, "Frequency error absolute"](#), on page 41.

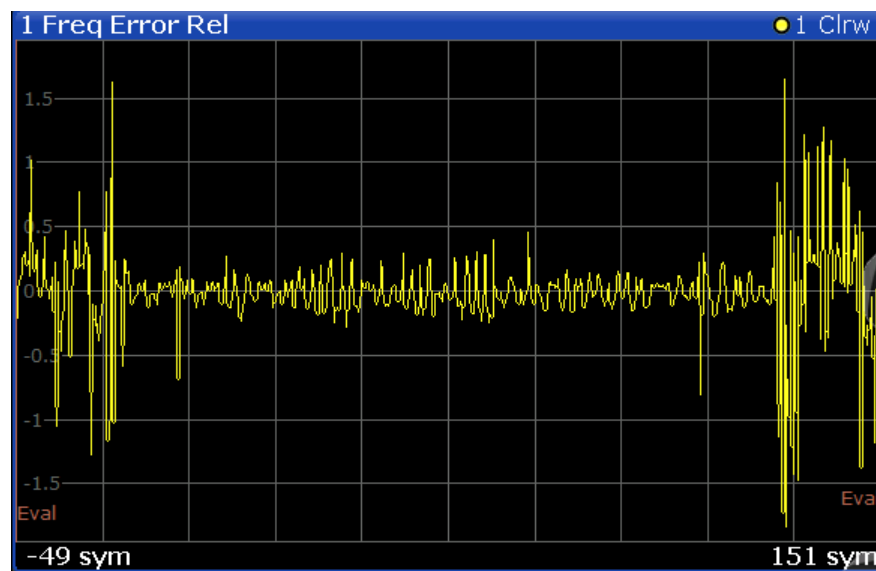


Figure 3-14: Frequency Error Relative result display

Available for source types:

- "Modulation Errors"

For signals with a user-defined frame structure (see [Chapter 4.11, "Multi-modulation analysis \(R&S FPL1000-K70M\)"](#), on page 152), the individual subframes are indicated by vertical green lines.

Remote commands:

```
LAY:ADD? '1',BEL,MERR
```

To define the required source type (see [LAYout:ADD\[:WINDOW\]?](#) on page 434).

```
CALC:FORM FREQ
```

To define the result type (see `CALCulate<n>:FORMat` on page 444).

```
DISP:TRAC:Y:MODE REL
```

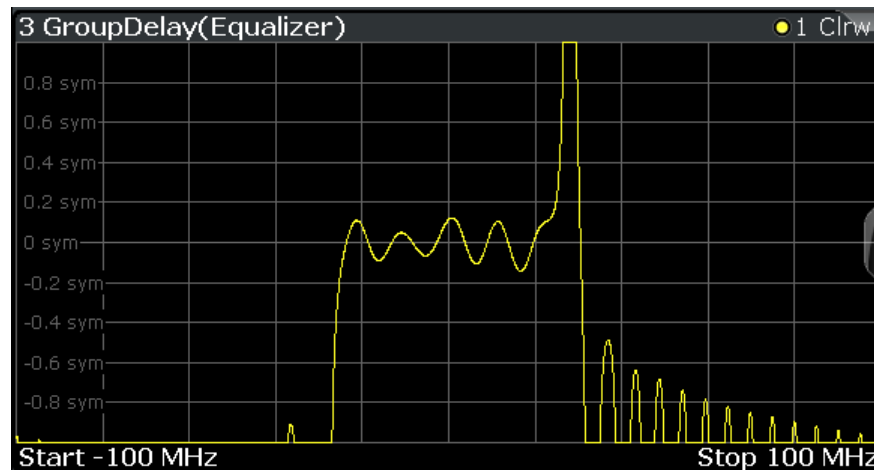
To define relative values (see `DISPlay[:WINDow<n>][:SUBWindow<w>]:TRACe<t>:Y[:SCALE]:MODE` on page 448).

```
TRAC:DATA? TRACE1
```

To query the trace results (see `TRACe<n>[:DATA]? TRACE<n>` and [Chapter 11.9.2.2, "Cartesian diagrams"](#), on page 455).

3.2.15 Frequency response group delay

The Frequency Response Group Delay of the "equalizer" is the derivation of phase over frequency. It is a measure of phase distortion.



Available for source types:

- "Equalizer"

Remote commands:

```
LAY:ADD? '1',BEL,EQU
```

To define the required source type (see `LAYout:ADD[:WINDow]?` on page 434)

```
CALC:FEED 'XFR:DDEM:RAT'
```

To define the frequency response result type (see `CALCulate<n>:FEED` on page 443).

```
CALC:FORM GDEL
```

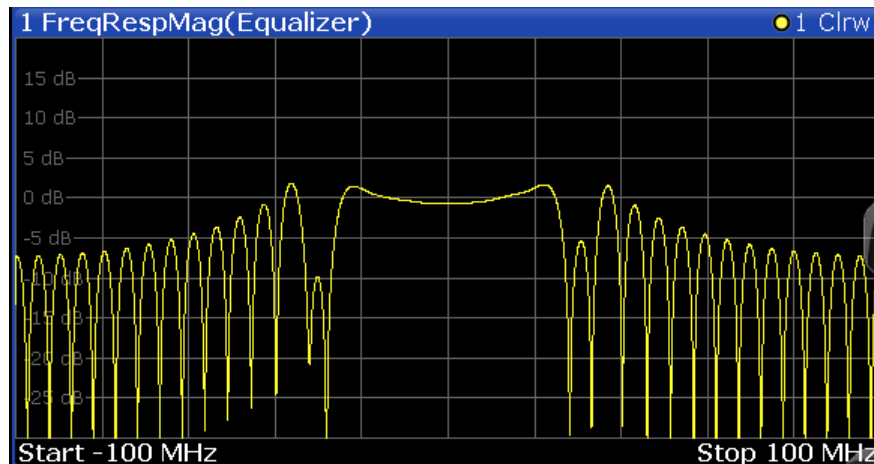
To define the group delay result type (see `CALCulate<n>:FORMat` on page 444).

```
TRAC:DATA? TRACE1
```

To query the trace results (see `TRACe<n>[:DATA]? TRACE<n>` and [Chapter 11.9.2.6, "Equalizer"](#), on page 457).

3.2.16 Frequency response magnitude

Magnitude of the frequency response of the current equalizer. Note that the frequency response of the equalizer is not a pure inverted function of the channel response, as both functions are calculated independently. The frequency response is calculated by determining an optimal EVM for the input signal.



Available for source types:

- "Equalizer"

Remote commands:

```
LAY:ADD? '1',BEL,EQU
```

To define the required source type (see [LAYout:ADD\[:WINDow\]?](#) on page 434).

```
CALC:FEED 'XFR:DDEM:RAT'
```

To define the frequency response result type (see [CALCulate<n>:FEED](#) on page 443).

```
CALC:FORM MAGN
```

To define the magnitude result type (see [CALCulate<n>:FORMat](#) on page 444).

```
TRAC:DATA? TRACE1
```

To query the trace results (see [TRACe<n>\[:DATA\]? TRACE<n>](#) and [Chapter 11.9.2.6, "Equalizer"](#), on page 457).

3.2.17 Frequency response phase

Phase of the frequency response of the current "equalizer".

Available for source types:

- "Equalizer"

Remote commands:

```
LAY:ADD? '1',BEL,EQU
```

To define the required source type (see [LAYout:ADD\[:WINDow\]?](#) on page 434).

```
CALC:FEED 'XFR:DDEM:RAT'
```

To define the frequency response result type (see [CALCulate<n>:FEED](#) on page 443).

```
CALC:FORM UPH
```

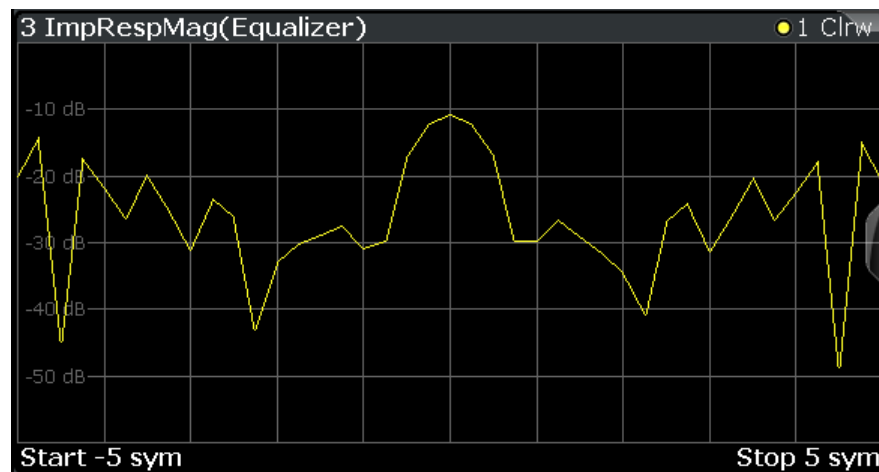
To define the unwrapped phase result type (see [CALCulate<n>:FORMat](#) on page 444).

```
TRAC:DATA? TRACE1
```

To query the trace results (see [TRACe<n>\[:DATA\]? TRACE<n>](#) and [Chapter 11.9.2.6, "Equalizer"](#), on page 457).

3.2.18 Impulse response magnitude

The "Impulse Response Magnitude" shows the magnitude of the equalizer filter in the time domain.



Available for source types:

- "Equalizer"

Remote commands:

```
LAY:ADD? '1',BEL,EQU
```

To define the required source type (see [LAYout:ADD\[:WINDow\]?](#) on page 434).

```
CALC:FEED 'XTIM:DDEM:IMP'
```

To define the "Impulse Response" result type (see [CALCulate<n>:FEED](#) on page 443).

CALC:FORM MAGN

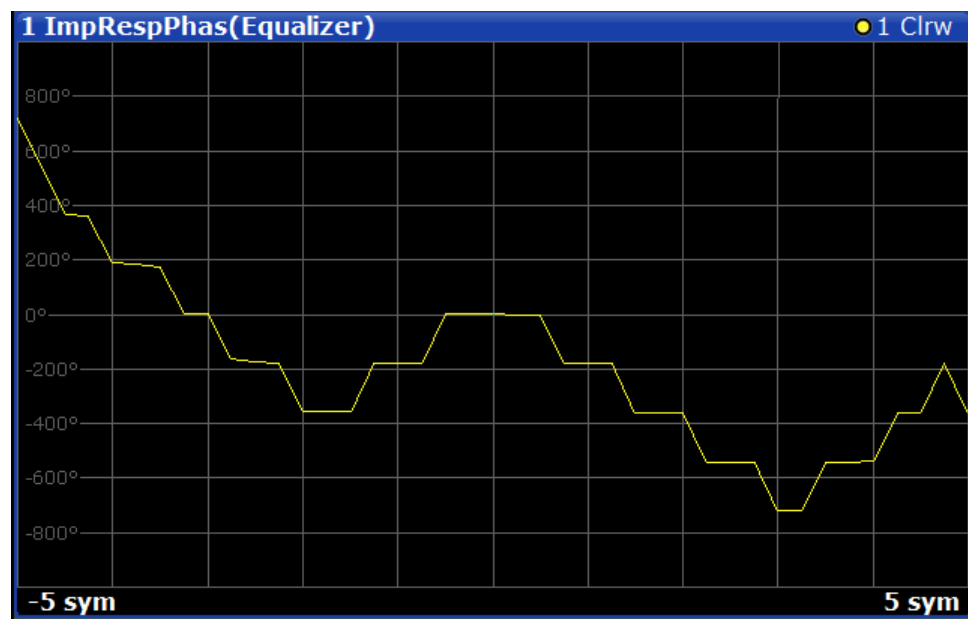
To define the "Magnitude" result type (see [CALCulate<n>:FORMat](#) on page 444).

TRAC:DATA? TRACE1

To query the trace results (see [TRACe<n>\[:DATA\]? TRACE<n>](#) and [Chapter 11.9.2.6, "Equalizer"](#), on page 457).

3.2.19 Impulse response phase

The "Impulse Response Phase" shows the phase of the equalizer coefficients in the time domain.



Available for source types:

- "Equalizer"

Remote commands:

LAY:ADD? '1',BEL,EQU

To define the required source type (see [LAYout:ADD\[:WINDow\]?](#) on page 434).

CALC:FEED 'XTIM:DDEM:IMP'

To define the "Impulse Response" result type (see [CALCulate<n>:FEED](#) on page 443).

CALC:FORM UPH

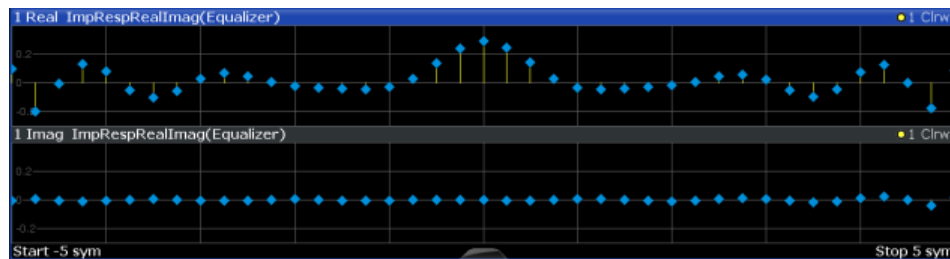
To define the "Phase" result type (see [CALCulate<n>:FORMat](#) on page 444).

TRAC:DATA? TRACE1

To query the trace results (see [TRACe<n>\[:DATA\]? TRACE<n>](#) and [Chapter 11.9.2.6, "Equalizer"](#), on page 457).

3.2.20 Impulse response real/imag

The "Real/Imag" diagram of the impulse response is a stem diagram. It displays the filter characteristics in the time domain for both the I and the Q branches individually. Using this information the equalizer is uniquely characterized and can be recreated by other applications.



Available for source types:

- "Equalizer"

Remote commands:

```
LAY:ADD? '1',BEL,EQU
```

To define the required source type (see [LAYout:ADD\[:WINDow\]?](#) on page 434).

```
CALC:FEED 'XTIM:DDEM:IMP'
```

To define the impulse response result type (see [CALCulate<n>:FEED](#) on page 443).

```
CALC:FORM RIM
```

To define the real/imag result type (see [CALCulate<n>:FORMat](#) on page 444).

```
TRAC:DATA? TRACE1
```

To query the trace results (see [TRACe<n>\[:DATA\]? TRACE<n>](#) and [Chapter 11.9.2.6, "Equalizer"](#), on page 457).

3.2.21 Magnitude absolute

Source type Capture Buffer:

"Magnitude absolute", that is: the actual signal amplitude, of the captured signal in the capture buffer.

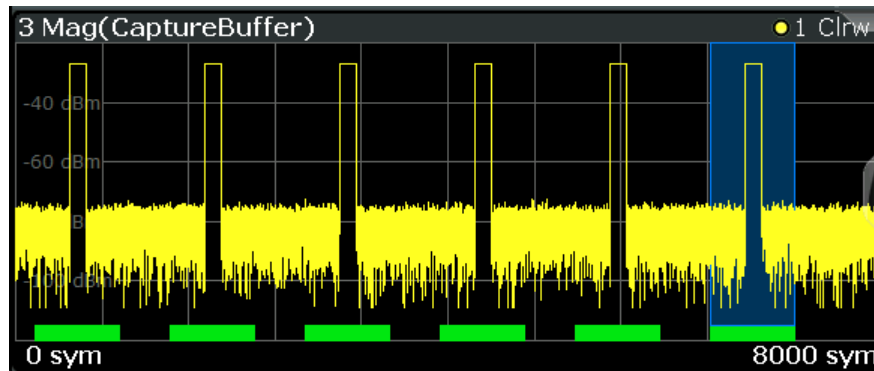


Figure 3-15: Magnitude Absolute result display for capture buffer data

Source type Meas & Ref Signal:

The actual signal amplitude is displayed:

$$Mag_{MEAS}(t) = |MEAS(t)|$$

with $t = n \cdot T_D$ and

T_D = the duration of one sampling period at the defined sample rate defined by the display points per symbol parameter (see "Display Points/Sym" on page 251)

For signals with a user-defined frame structure (see Chapter 4.11, "Multi-modulation analysis (R&S FPL1000-K70M)", on page 152), and based on the "Meas and Ref" signal, the individual subframes are indicated by vertical green lines.

Remote commands:

LAY:ADD? '1',BEL,CBUF

To define the required source type (see LAYout:ADD[:WINDow]? on page 434).

CALC:FORM MAGN

To define the result type (see CALCulate<n>:FORMat on page 444).

TRAC:DATA? TRACE1

To query the trace results (see TRACe<n>[:DATA]? TRACE<n> and Chapter 11.9.2.1, "Capture buffer results", on page 455).

To query the start of the result range:

[SENSe:]DDEMod:SEARCh:MBURst:START[:SYMBOLs]? on page 460

[SENSe:]DDEMod:SEARCh:MBURst:START:SAMPLEs? on page 461

3.2.22 Magnitude relative

Magnitude of the source signal; the signal amplitude is scaled to the ideal reference signal

Available for source types:

- "Meas & Ref Signal"

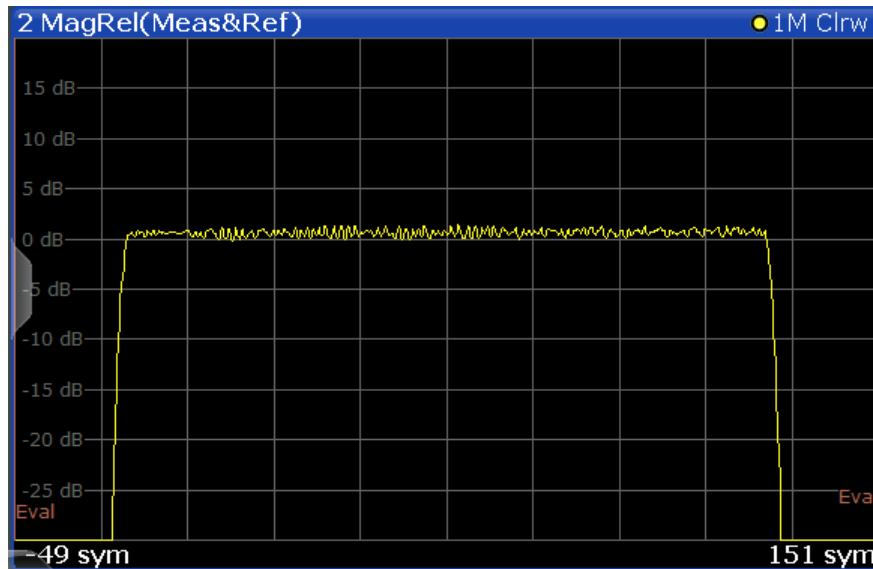


Figure 3-16: Magnitude Relative result display

For signals with a user-defined frame structure (see [Chapter 4.11, "Multi-modulation analysis \(R&S FPL1000-K70M\)"](#), on page 152), and based on the "Meas and Ref" signal, the individual subframes are indicated by vertical green lines.

Remote commands:

```
LAY:ADD? '1',BEL,MEAS
```

To define the required source type (see [LAYout:ADD\[:WINDOW\]?](#) on page 434).

```
CALC:FORM MAGN
```

To define the result type (see [CALCulate<n>:FORMat](#) on page 444).

```
DISP:TRAC:Y:MODE REL
```

To define relative values (see [DISPlay\[:WINDOW<n>\]\[:SUBWindow<w>\]:TRACe<t>:Y\[:SCALE\]:MODE](#) on page 448).

```
TRAC:DATA? TRACE1
```

To query the trace results (see [TRACe<n>\[:DATA\]? TRACE<n>](#) and [Chapter 11.9.2.2, "Cartesian diagrams"](#), on page 455).

3.2.23 Magnitude error

Displays the magnitude error of the measurement signal with respect to the reference signal (as a function of symbols over time)

$$MAG_ERR(t) = MAG_{MEAS}(t) - MAG_{REF}(t)$$

with $t=n \cdot T_D$ and T_D =the duration of one sampling period at the sample rate defined by the display points per symbol parameter (see "Display Points/Sym" on page 251).

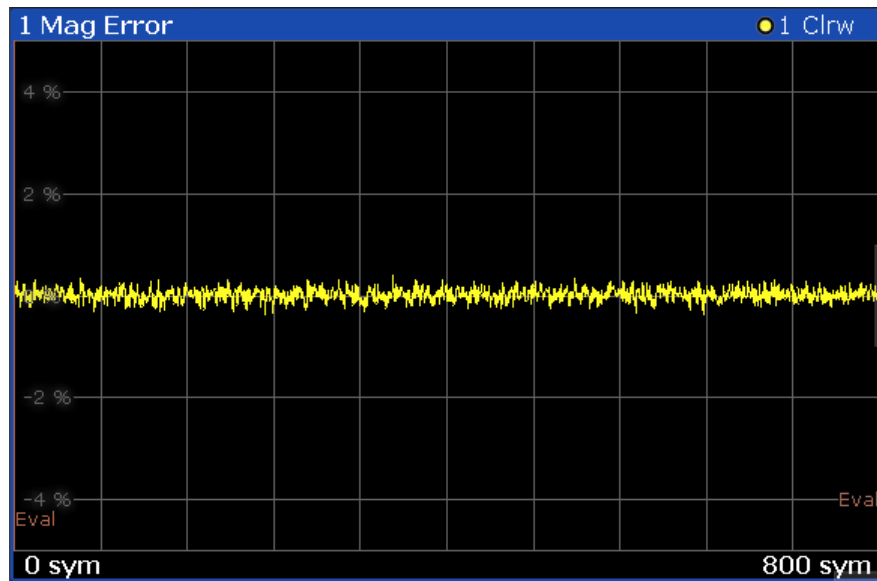


Figure 3-17: Magnitude Error result display

Available for source types:

- "Modulation Errors"

For signals with a user-defined frame structure (see Chapter 4.11, "Multi-modulation analysis (R&S FPL1000-K70M)", on page 152), the individual subframes are indicated by vertical green lines.

Remote commands:

```
LAY:ADD? '1',BEL,MERR
```

To define the required source type (see LAYout:ADD[:WINDow]? on page 434).

```
CALC:FORM MAGN
```

To define the result type (see CALCulate<n>:FORMat on page 444).

```
TRAC:DATA? TRACE1
```

To query the trace results (see TRACe<n>[:DATA]? TRACE<n> and Chapter 11.9.2.2, "Cartesian diagrams", on page 455).

3.2.24 Phase error

Displays the phase error of the measurement signal with respect to the reference signal as a function of symbols over time.

$$PHASE_ERR(t) = PHASE_{MEAS}(t) - PHASE_{REF}(t)$$

with $t=n \cdot T_D$ and T_D =the duration of one sampling period at the sample rate defined by the display points per symbol parameter (see "Display Points/Sym" on page 251).

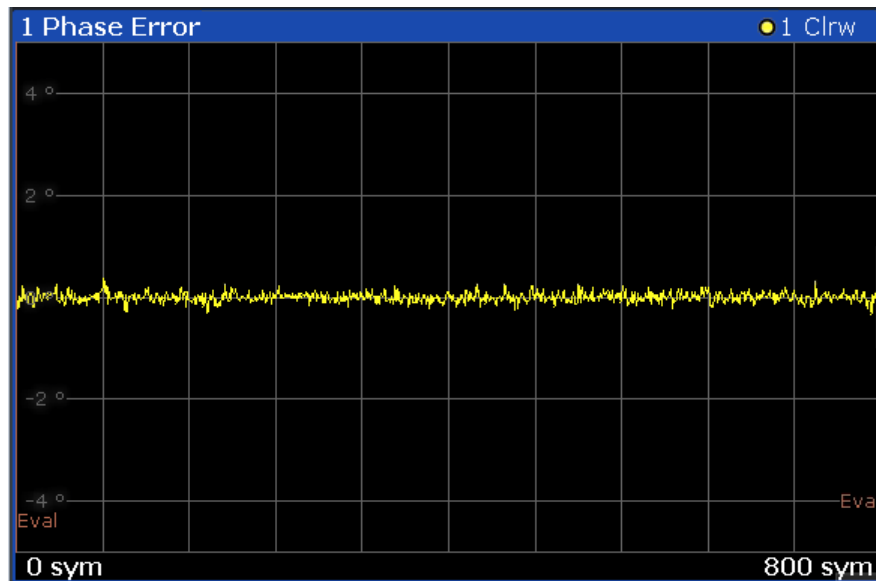


Figure 3-18: Phase Error result display

Available for source types:

- "Modulation Errors"

For signals with a user-defined frame structure (see Chapter 4.11, "Multi-modulation analysis (R&S FPL1000-K70M)", on page 152), the individual subframes are indicated by vertical green lines.

Remote commands:

```
LAY:ADD? '1',BEL,MERR
```

To define the required source type (see LAYout:ADD[:WINDow]? on page 434).

```
CALC:FORM PHAS
```

To define the result type (see CALCulate<n>:FORMat on page 444).

```
TRAC:DATA? TRACE1
```

To query the trace results (see TRACe<n>[:DATA]? TRACE<n> and Chapter 11.9.2.2, "Cartesian diagrams", on page 455).

3.2.25 Phase wrap

The phase or argument of the signal; the display is limited to the phase value range of $[-180^\circ, 180^\circ]$

$$Phase_{MEAS}(t) = \angle(MEAS(t))$$

with $t=n \cdot T_D$ and T_D =the duration of one sampling period at the sample rate defined by the display points per symbol parameter (see "Display Points/Sym" on page 251).

Available for source types:

- "Meas & Ref Signal"

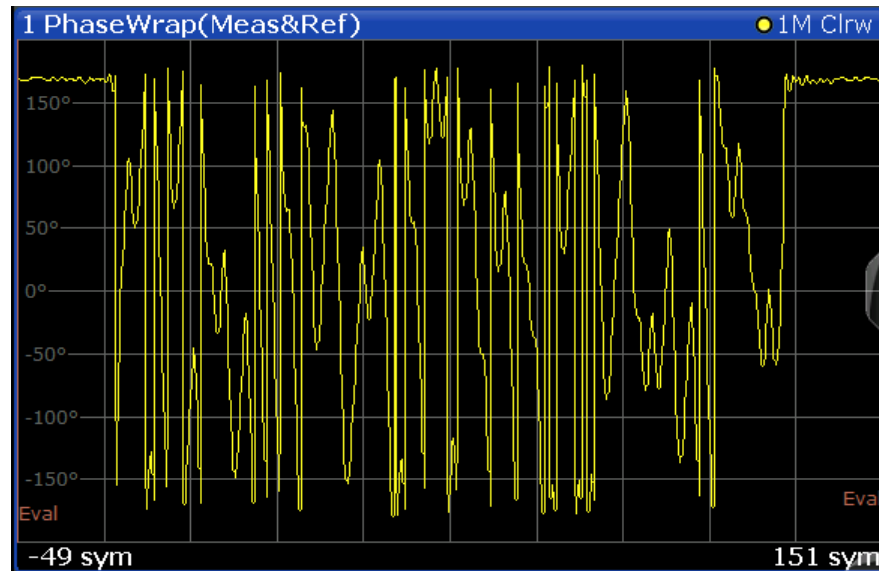


Figure 3-19: Phase Wrap result display

For signals with a user-defined frame structure (see Chapter 4.11, "Multi-modulation analysis (R&S FPL1000-K70M)", on page 152), the individual subframes are indicated by vertical green lines.

Remote commands:

```
LAY:ADD? '1',BEL,REF
```

To define the required source type (see LAYout:ADD[:WINDow]? on page 434).

```
CALC:FORM PHASe
```

To define the result type (see CALCulate<n>:FORMat on page 444).

```
TRAC:DATA? TRACE1
```

To query the trace results (see TRACe<n>[:DATA]? TRACE<n> and Chapter 11.9.2.2, "Cartesian diagrams", on page 455).

3.2.26 Phase unwrap

The phase of the signal; the display is not limited to $[-180^\circ, 180^\circ]$.

Available for source types:

- "Meas & Ref Signal"

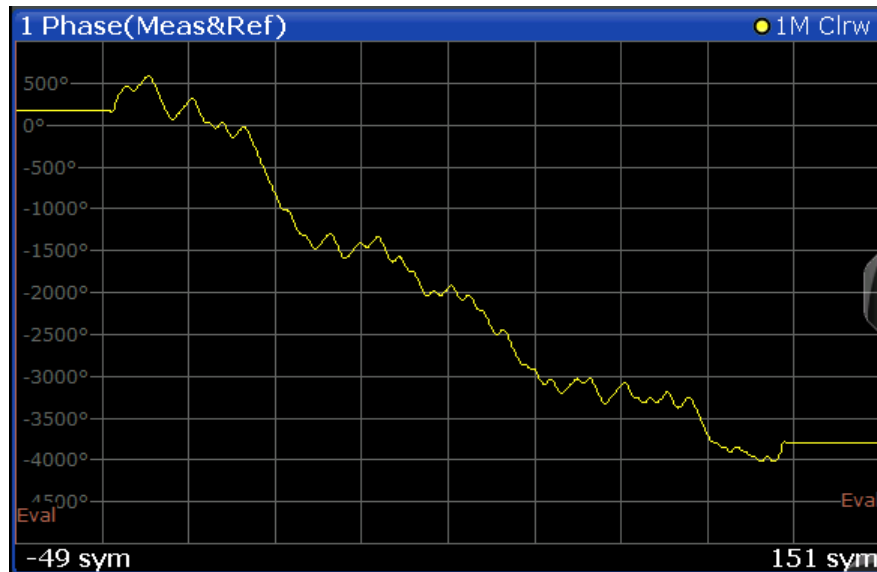


Figure 3-20: Phase Unwrap result display

For signals with a user-defined frame structure (see [Chapter 4.11, "Multi-modulation analysis \(R&S FPL1000-K70M\)"](#), on page 152), the individual subframes are indicated by vertical green lines.

Remote commands:

```
LAY:ADD? '1',BEL,MEAS
```

To define the required source type (see [LAYout:ADD\[:WINDow\]?](#) on page 434).

```
CALC:FORM UPHase
```

To define the result type (see [CALCulate<n>:FORMat](#) on page 444).

```
TRAC:DATA? TRACE1
```

To query the trace results (see [TRACe<n>\[:DATA\]?](#) [TRACE<n>](#) and [Chapter 11.9.2.2, "Cartesian diagrams"](#), on page 455).

3.2.27 Real/imag (I/Q)

Real and imaginary part of the measurement or reference signal in separate measurement diagrams; the x-axis (scaled in time units or symbols) is identical for both diagrams.

Available for source types:

- "Capture Buffer"
- "Meas & Ref Signal"
- "Error Vector"

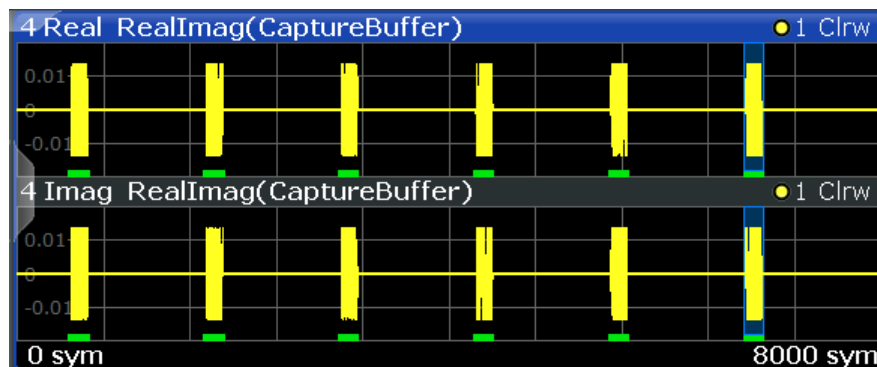


Figure 3-21: Real/Imag (I/Q) result display

Capture buffer display

Note that this result display is based on an individual capture buffer *range*. If more than 256 000 samples are captured, overlapping ranges with a size of 256 000 each are created. Only one range at a time can be displayed in the "Real/Imag" result display. For details see [Chapter 4.8, "Capture buffer display"](#), on page 148.

The scaling of the capture buffer depends on the input source:

- Scaling is relative to the current reference level for RF input.
- Scaling is relative to the full scale level for I/Q input.

Remote commands:

```
LAY:ADD? '1',BEL,MEAS
```

To define the required source type (see [LAYout:ADD\[:WINDow\]?](#) on page 434).

```
CALC:FORM RIMag
```

To define the result type (see [CALCulate<n>:FORMat](#) on page 444).

```
TRAC:DATA? TRACE1
```

To query the trace results (see [TRACe<n>\[:DATA\]? TRACE<n>](#) and [Chapter 11.9.2.2, "Cartesian diagrams"](#), on page 455).

3.2.28 Result summary

The "Modulation Accuracy" results in a table. For details on the parameters see [Chapter 3.4, "Common parameters in VSA"](#), on page 67.



"Freezing" the displayed values

You can freeze the contents of the "Result Summary" after a measurement to maintain the values on the display, while the measurement continues or is restarted. As for graphical displays, set the [Trace Mode](#) for the "Result Summary" to "View". The table is no longer updated. The "View" trace mode is indicated in the window title. To update the "Result Summary" as usual, set the trace mode back to "Clear Write".

Basis of evaluation

Most values that are displayed in the "Result Summary" are calculated over the "Evaluation Range" (see [Chapter 5.10, "Evaluation range configuration"](#), on page 228). They are evaluated according to the setting of the [Display Points/Sym](#) parameter. For example, if "Display Points/Symbol" is "1", only the symbol instants contribute to the result displayed in the "Result Summary".

Table 3-2: Results calculated over the evaluation range

PSK, MSK, QAM	FSK
"EVM"	"Frequency Error"
"MER"	"Magnitude Error"
"Phase Error"	"Power"
"Magnitude Error"	
"Rho"	
"Power"	

The following results that are based on internal estimation algorithms (see [Chapter 4.5, "Signal model, estimation and modulation errors"](#), on page 125) are calculated over the "Estimation range" (see also [Chapter 4.5.1.2, "Estimation"](#), on page 127).

Table 3-3: Results calculated over the estimation range

PSK, MSK, QAM	FSK
"Carrier Frequency Error"	"FSK Deviation Error"
"Symbol Rate Error"	
"I/Q Skew"	
"I/Q Offset"	"FSK Measurement Deviation"
"I/Q Imbalance"	"Carrier Frequency Error"
"Gain Imbalance"	"Carrier Frequency Drift"
"Quadrature Error"	
"Amplitude Droop"	

Current value

In the "Current" column, the value evaluation for the current evaluation is displayed. For example, the "EVM Peak" value in the current sweep corresponds to the peak of the trace values within the evaluation range for the current sweep (as indicated by marker 1 in [Figure 3-22](#)).

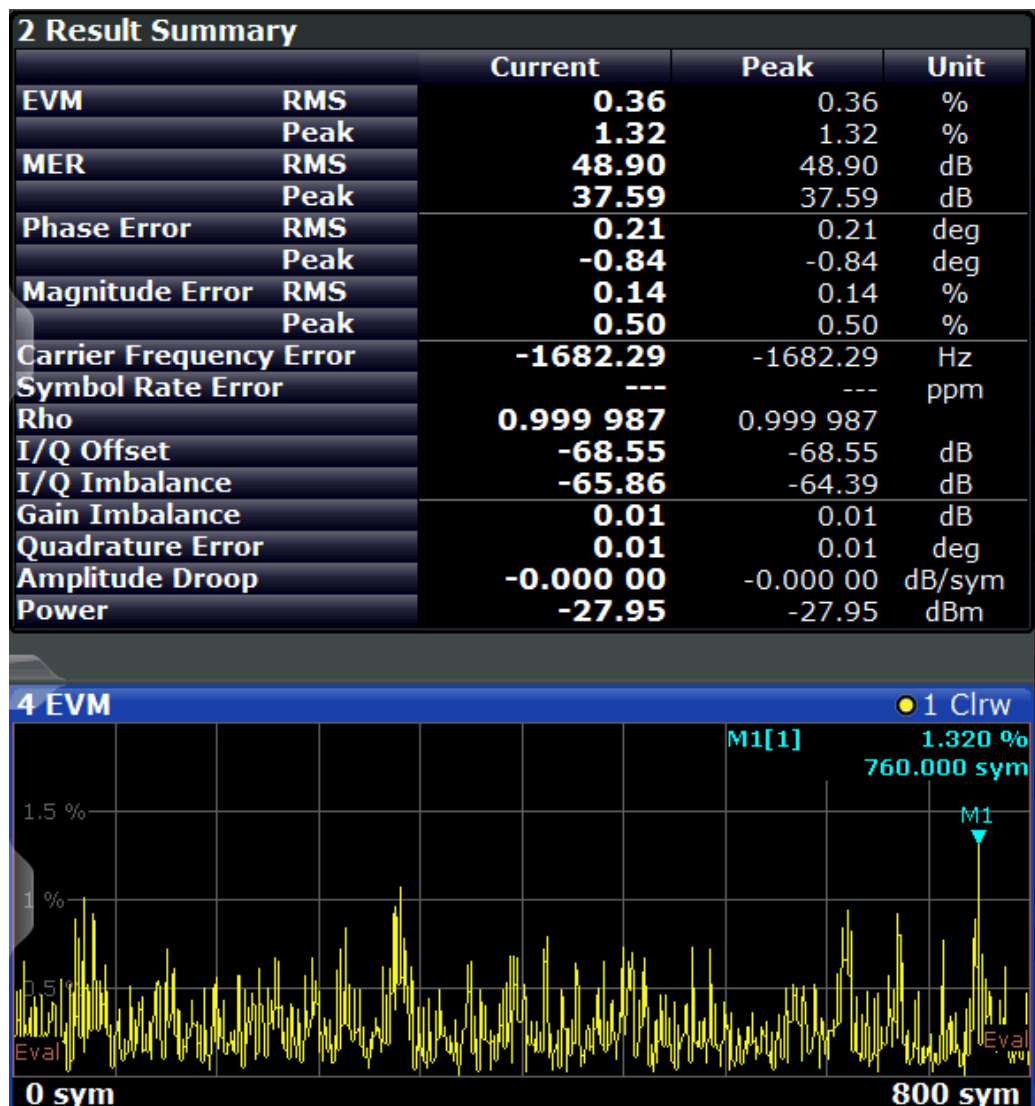


Figure 3-22: Example for Result Summary with current EVM peak value marked

If you want to compare the trace values to the results of the "Result Summary", make sure to match the displayed points per symbol of the trace and of the "Result Summary". Refer to "Display Points/Sym" on page 251 for details.

Mean value

In the "Mean" column, the linear mean of the values that are in the "Current" column is displayed. Note that if the values are in a logarithmic representation, e.g. the I/Q Offset, the linear values are averaged.

Peak value

In the "Peak" column, the maximum value that occurred during several evaluations is displayed. Note that when the value can be positive and negative, e.g. the phase error, the maximum absolute value (maintaining its sign) is displayed. The peak value of

"Rho" is handled differently, since its minimum value represents the worst case. In that case, the minimum value is displayed.

Standard Deviation

The value for the standard deviation is calculated on the linear values and then converted to the displayed unit.

95-percentile

The 95-percentile value is based on the distribution of the current values. Since the phase error and the magnitude error can usually be assumed to be distributed around zero, the 95-Percentile for these values is calculated based on their absolute values. Again, the "Rho" value is handled differently. Here, the 5-Percentile is displayed, since the lowest rho value represents the worst case.

Remote commands:

```
LAY:ADD? '1',BEL, MACC
```

To define the required source type (see [LAYout:ADD\[:WINDow\]?](#) on page 434).

```
CALC:FORM RSUM
```

To define the result type (see [CALCulate<n>:FORMat](#) on page 444).

```
TRAC:DATA? TRACE1
```

To query the trace results (see [TRACe<n>\[:DATA\]](#) on page 453 and [Chapter 11.9.2.5, "Result summary"](#), on page 456).

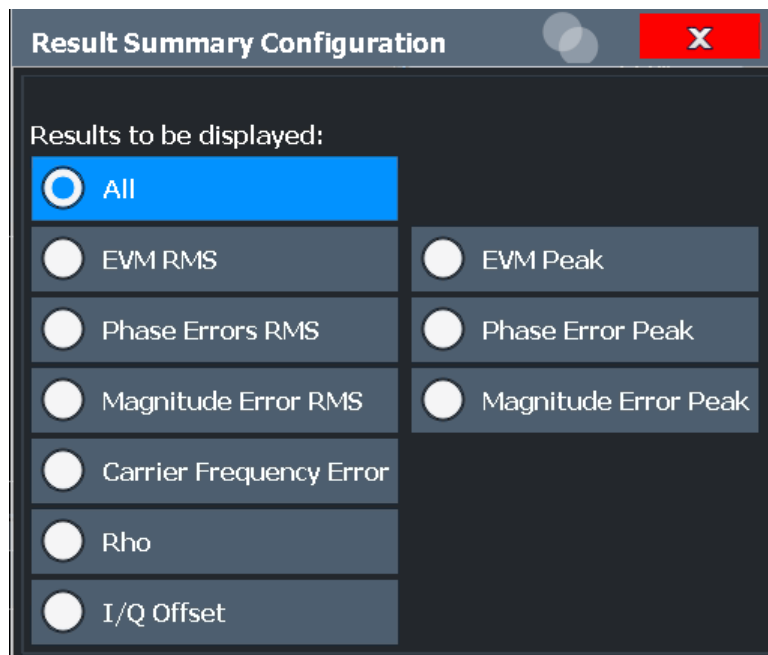
```
CALC:MARK:FUNC:DDEM:STAT:<parameter>
```

To query individual parameter values (see [Chapter 11.9.4, "Retrieving parameter values"](#), on page 462).

Result Summary - Individual Results

The "Result Summary" can display either all or only a single modulation accuracy parameter. Only the most important parameters can be displayed individually, namely the parameters for which modulation accuracy limits can be defined (see ["Limit Value"](#) on page 247).

To select individual results for display, tap the "Result Summary" table header (only once - a double-tap maximizes the "Result Summary" window). A "Table Configuration" dialog box is displayed in which you can select the parameter to be displayed.



By default, all parameters are displayed. If you select a specific parameter, the "Result Summary" display is replaced by the individual result display.

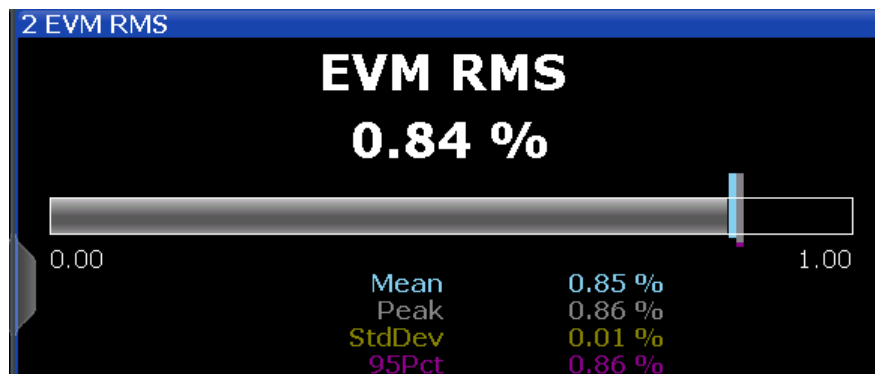


Figure 3-23: Result display for individual value in Result Summary

In addition to the current measurement value, the statistical results (see [Chapter 3.2.28, "Result summary"](#), on page 55) and the peak limit value (see ["Limit Value"](#) on page 247) for the selected parameter are displayed.

For details on the displayed results, see [Chapter 3.4, "Common parameters in VSA"](#), on page 67.

Remote command:

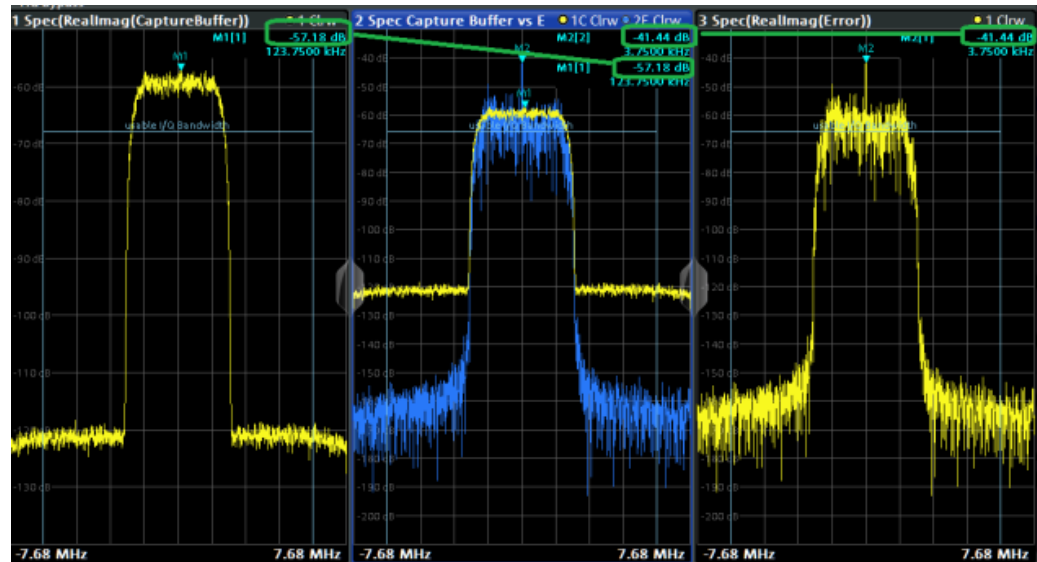
`DISPlay[:WINDow<n>]:ITEM[:LINE][:VALue]` on page 446

3.2.29 Spectrum (capture buffer + error)

This display combines two diagrams in one. The first trace displays the spectrum of the real/imaginary data in the capture buffer. The second trace displays the spectrum of

the real/imaginary data of the error. Optionally, the data source of the traces can be switched. Which source is currently displayed for which trace is indicated in the window title bar.

(See also [Figure 2-2](#)).



Carrier-in-carrier signals

For carrier-in-carrier measurements, this result display makes both carriers visible. The following example shows two superimposed QPSK signals: one with a symbol rate of 10 MHz (the analyzed signal, yellow), one with a symbol rate of 3 MHz, whose spectrum becomes visible in the error trace (blue).

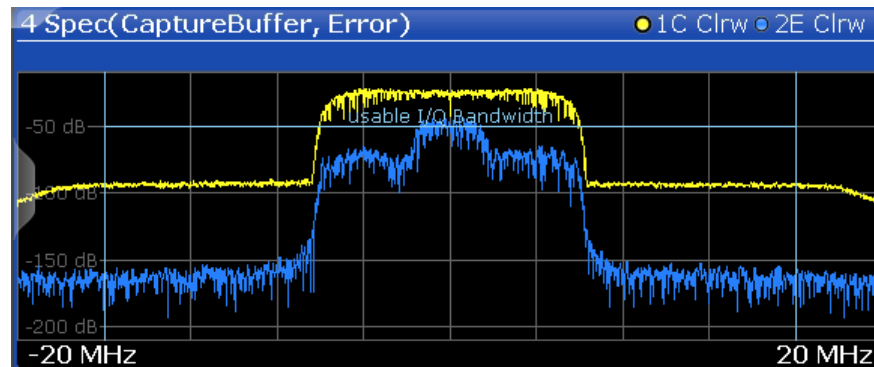


Figure 3-24: Example of a carrier-in-carrier signal in a multi source result display.

Similarly, the "Spectrum (Measurement + Error)" result display can be used to reveal carrier-in-carrier signals.

Remote commands:

```
LAY:ADD? '1',BEL, MCOM
```

To define the required source type (see [LAYout:ADD\[:WINDow\]?](#) on page 434).

```
CALC:FEED 'XTIM:DDEM:TCAP:ERR'
```

To define the result type (see [CALCulate<n>:FEED](#) on page 443).

```
CALC:TRAC TCAP; CALC:TRAC2 ERR
```

To define trace1 to be based on the capture buffer data and trace 2 on the error (default, see [CALCulate<n>:TRACe<t>\[:VALue\]](#) on page 407).

```
TRAC:DATA? TRACE1
```

To query the trace results for capture buffer data (see [TRACe<n>\[:DATA\]?](#) [TRACe<n>](#) and [Chapter 11.9.2.4, "Symbols"](#), on page 456).

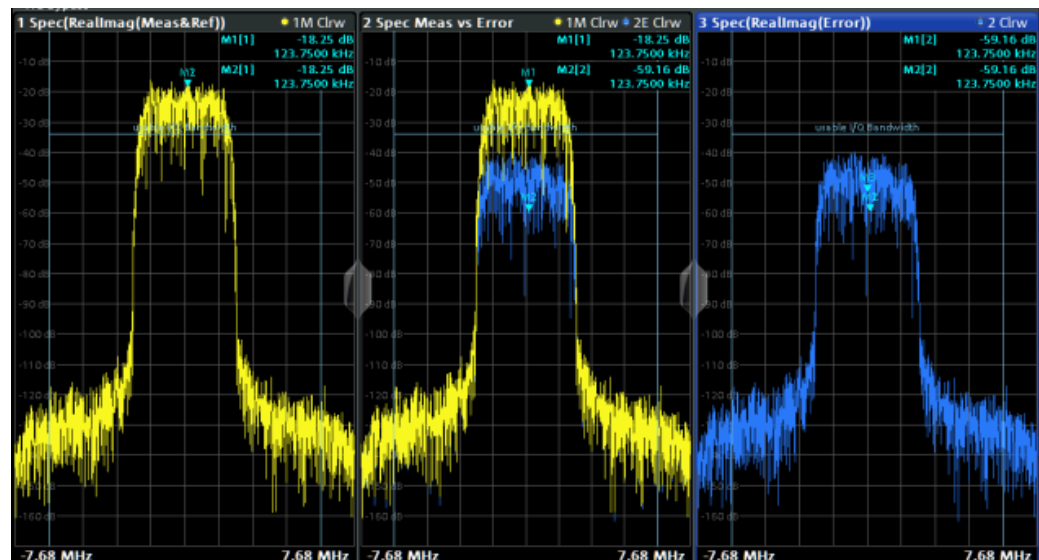
```
TRAC:DATA? TRACE2
```

To query the trace results for error data.

3.2.30 Spectrum (measurement + error)

This display combines two diagrams in one. The first trace displays the spectrum of the real/imaginary data from the measured signal. The second trace displays the spectrum of the real/imaginary data of the error. Optionally, the data source of the traces can be switched. Which source is currently displayed for which trace is indicated in the window title bar.

(See also [Figure 2-2](#)).



Remote commands:

```
LAY:ADD? '1', BEL, MCOM
```

To define the required source type (see [LAYout:ADD\[:WINDow\]?](#) on page 434).

```
CALC:FEED 'XTIM:DDEM:MEAS:ERR'
```

To define the result type (see [CALCulate<n>:FEED](#) on page 443).

```
CALC:TRAC MEAS; CALC:TRAC2 ERR
```

To define trace1 to be based on the measurement data and trace 2 on the error (default, see [CALCulate<n>:TRACe<t>\[:VALue\]](#) on page 407).

```
TRAC:DATA? TRACE1
```

To query the trace results for measurement data (see [TRACe<n>\[:DATA\]? TRACE<n>](#) and [Chapter 11.9.2.4, "Symbols"](#), on page 456).

```
TRAC:DATA? TRACE2
```

To query the trace results for error data.

3.2.31 Symbol table

Symbol numbers are displayed as a table. Each symbol is represented by an entry in the table. The symbols can be displayed in binary, octal, hexadecimal or decimal format (for individual tables, see ["Symbol format"](#) on page 215). You can configure the order of the transmitted bits to be most significant bit first (MSB, default) or least significant bit first (LSB), see ["Bit Ordering"](#) on page 225. Depending on the selected bit ordering, the symbols are displayed and must be interpreted as MSB first or LSB first.

Example:

4 Symbols				(Hexadecimal) (LSB)													
	+	1	+	3	+	5	+	7	+	9	+	11	+	13	+	15	
0	3	3	0	3	0	3	3	0	3	0	2	1	2	1	2	1	
16	1	0	3	1	3	2	3	2	3	0	0	1	3	1	1	2	
32	1	3	3	2	1	1	0	1	3	3	2	1	0	0	1	0	
48	1	0	3	3	0	3	2	2	0	2	1	0	0	3	0	1	
64	3	3	2	0	1	0	3	2	3	0	1	0	0	2	1	1	
80	0	1	2	1	3	3	0	3	2	1	0	0	1	0	3	1	
96	0	3	2	3	3	0	1	2	3	0	1	2	3	3	0	3	
112	0	3	2	3	0	3	0	3	1	0	3	0	3	0	1	2	
128	1	3	0	1	2	1	2	3	0	3	1	2	3	3	0	1	
144	3	0	3	2	0	3	0	3	2	1	3	0	1	2	1	.	

Figure 3-25: Symbols result display in hexadecimal mode

The evaluation range is indicated by red brackets.

Any marked symbols are highlighted by a blue frame (also coupled markers in other windows, see ["Couple Windows"](#) on page 241). Deltamarkers on symbols are indicated by a dotted blue frame.

If a pattern search is active, a found pattern is indicated by a green background in the symbol table. If, during demodulation, individual symbols do not match the pattern after all, these symbols are indicated by red values.

If known data is loaded as a reference, symbols which do not match this data are also indicated by red values.

4 Symbols																(Hexadecimal)			
	+	1	+	3	+	5	+	7	+	9	+	11	+	13	+	15			
0	7	7	7	5	1	1	7	2	7	2	4	2	2	0	6	3			
16	4	1	3	6	6	6	3	2	0	7	3	6	0	7	7	7			
32	0	1	7	3	7	0	5	6	3	1	0	1	1	2	3	5			
48	5	0	7	4	7	6	3	3	0	5	2	2	1	7	7	1			
64	7	7	1	7	1	1	1	7	7	7	7	1	7	7	7	1			
80	7	7	1	7	1	1	1	6	1	5	5	2	7	0	4	6			
96	1	0	4	0	0	4	1	0	6	0	4	7	1	2	5				

Figure 3-26: Symbol errors in the symbol table

Tip: If you assume that a signal has a pattern, but do not know it in advance, you can identify it using the symbol table. Measure the signal and check for a pattern in the symbol table. Then you can copy the symbols from the symbol table to the pattern definition for subsequent measurements (see "Import Symbols" on page 215).

Signals with two different modulation types

For signals with two different modulation types (requires option R&S FPL1000-K70M), the color of the symbol field indicates the used **Modulation** and **Type**:

- **Green background:** Pattern modulation and pattern type (for pattern only)
- **Green frame:** Pattern modulation and data type (for meta data)
- **No highlighting:** Data modulation and data type (for payload data)

Remote commands:

To define the required source type (see `LAYout:ADD[:WINDow]?` on page 434):

```
LAY:ADD? '1',BEL, 'XTIM:DDEM:SYMB'
```

To define the symbol format:

```
CALCulate<n>:FORMat on page 444
```

To query the results (see `TRACe<n>[:DATA]` on page 453 and [Chapter 11.9.2.4, "Symbols"](#), on page 456):

Symbols:

```
TRAC1:DATA? or TRAC1:DATA? STR
```

Symbol errors:

```
TRAC1:DATA? MSTR
```

Pattern errors:

```
TRAC1:DATA? PSTR
```

3.2.32 Vector frequency

The instantaneous frequency of the source signal as an X/Y plot; all available samples (as defined by the display points per symbol parameter (see "Display Points/Sym" on page 251)) are drawn and connected.

Available for source types:

- "Meas & Ref Signal"

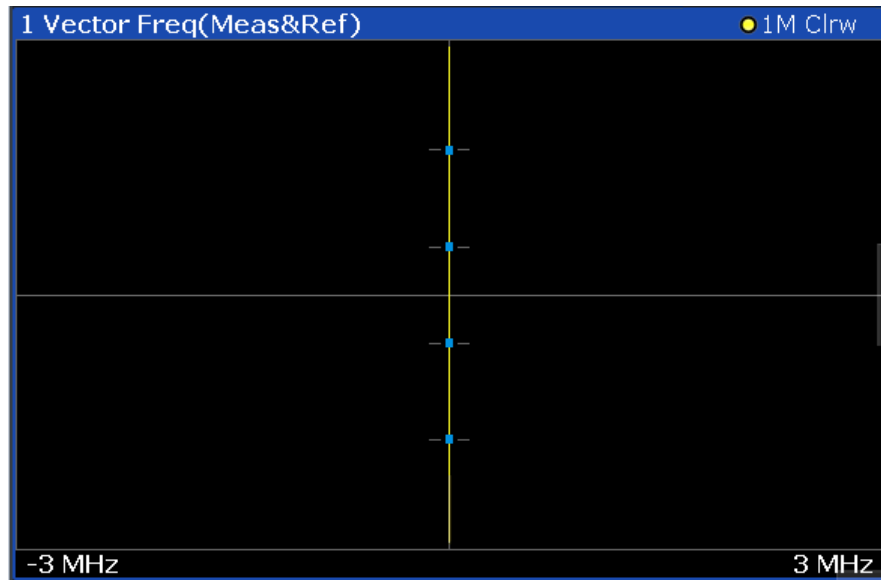


Figure 3-27: Vector Frequency result display

A special density trace mode is available for this diagram. The occurrence of each value within the current result range or evaluation range is indicated by color.

Remote commands:

```
LAY:ADD? '1',BEL,MEAS
```

To define the required source type (see [LAYout:ADD\[:WINDow\]?](#) on page 434)

```
CALC:FORM COVF
```

To define the result type (see [CALCulate<n>:FORMat](#) on page 444)

```
TRAC:DATA? TRACE1
```

To query the trace results (see [TRACe<n>\[:DATA\]? TRACE<n>](#) and [Chapter 11.9.2.3, "Polar diagrams"](#), on page 455)

3.2.33 Vector I/Q

The complex source signal as an X/Y plot; all available samples (as defined by the display points per symbol parameter, see "Display Points/Sym" on page 251) are drawn and connected.



The scaling of the capture buffer depends on the input source:

- Scaling is relative to the current reference level for RF input.
- Scaling is relative to the full scale level for I/Q input.

Available for source types:

- "Capture Buffer"
- "Meas & Ref Signal"
- "Error Vector"

Capture buffer display

Note that this result display is based on an individual capture buffer *range*. If more than 256 000 samples are captured, overlapping ranges with a size of 256 000 each are created. Only one range at a time can be displayed in the "Vector I/Q" result display. For details see [Chapter 4.8, "Capture buffer display"](#), on page 148.

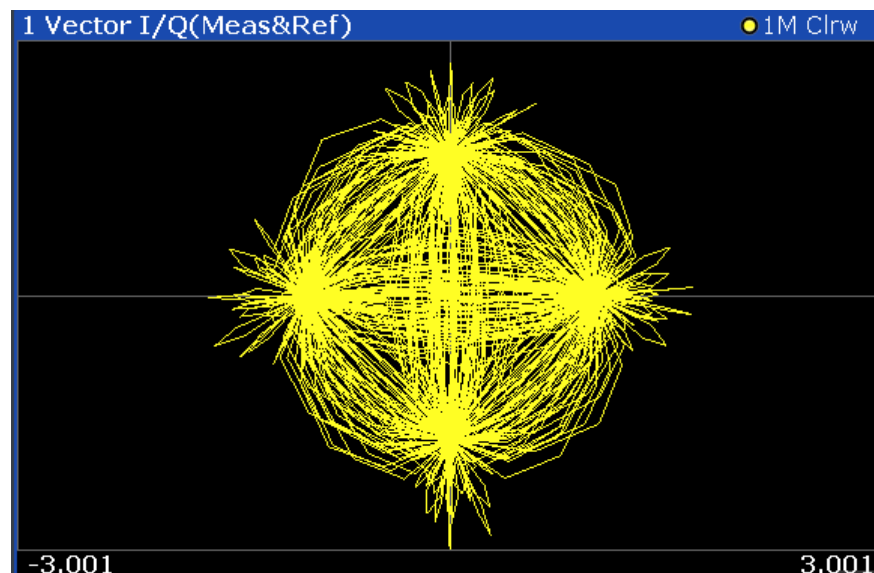


Figure 3-28: Vector I/Q result display

A special density trace mode is available for this diagram. The occurrence of each value within the current result range or evaluation range is indicated by color.

Remote commands:

```
LAY:ADD? '1',BEL,MEAS
```

To define the required source type (see [LAYout:ADD\[:WINDow\]?](#) on page 434).

```
CALC:FORM COMP
```

To define the result type (see [CALCulate<n>:FORMat](#) on page 444).

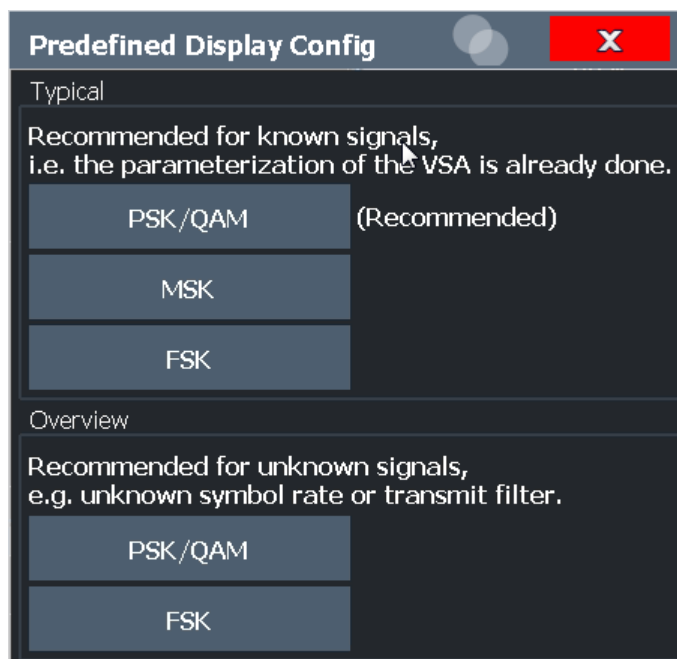
```
TRAC:DATA? TRACE1
```

To query the trace results (see [TRACe<n>\[:DATA\]? TRACE<n>](#) and [Chapter 11.9.2.3, "Polar diagrams"](#), on page 455).

3.3 Predefined display configuration

Access: [MEAS] > "Predefined Display Config"

The R&S FPL1000 VSA application allows you to configure the screen layout very flexibly according to your specific measurement requirements. To get started, some typical and useful display configurations are predefined. Select the required scenario and the display is configured suitably.



To store your personal typical screen layout, save your current measurement settings (including the screen layout) as a standard.

See ["To store settings as a standard file"](#) on page 255.

Typical

Provides several result displays for the most frequently required results when measuring a known signal using a specific modulation.

Overview

Provides useful result displays to determine the relevant signal characteristics of an unknown signal.

See also the application sheet [R&S®FSW-K70 Analyzing Unknown Signals](#) on the Rohde & Schwarz Internet site.

Remote command:

[\[SENSe:\] DDEMod:PRESet:CALC](#) on page 442

3.4 Common parameters in VSA

Depending on the modulation type you are using, different signal parameters are determined during vector signal analysis and displayed in the [Result summary](#).

Details concerning the calculation of individual parameters can be found in [Chapter 4.5, "Signal model, estimation and modulation errors"](#), on page 125 and [Chapter F, "Formulae"](#), on page 518.

Table 3-4: Parameters for PSK, QAM and MSK modulation

Parameter	Description	SCPI parameter
"EVM - RMS/Peak"	"Error Vector" Magnitude, normalized to mean reference power by default (see "Normalize EVM to" on page 223)	EVM
"MER - RMS/Peak"	Modulation Error Ratio (MER)	SNR
"Phase Error - RMS"/"Peak"	The phase difference between the measurement vector and the reference vector	PErr
"Magnitude Error - RMS"/"Peak"	The average (RMS) and peak magnitude error in %. The magnitude error is the difference of the measured magnitude to the magnitude of the reference signal. The magnitude error is normalized to the mean magnitude of the reference signal.	MERRor
"Carrier Frequency Error"	The mean carrier frequency offset in Hz	CFError
"Symbol Rate Error"	Difference between the currently measured symbol rate and the defined symbol rate in ppm. (Only if compensation for SRE is activated, see "Compensate for... [(PSK, MSK, ASK, QAM)]" on page 220)	SRER
"I/Q Skew"	Constant time difference between the I and Q data, for example due to different cable lengths (Only if compensation for I/Q skew is activated, see "Compensate for... [(PSK, MSK, ASK, QAM)]" on page 220)	IQSK
"Rho"		RHO
"I/Q Offset"	Offset in the original input	OOFset
"I/Q Imbalance"	Not for BPSK.	IQIMbalance
"Gain Imbalance"	Not for BPSK.	GIMBalance
"Quadrature Error"	Not for BPSK.	QERRor
"Amplitude Droop"	The decrease of the signal power over time in the transmitter	ADRoop
"Power"	The power of the measured signal	MPower

Table 3-5: Parameters for FSK modulation only

Parameter	Description	SCPI parameter
"Frequency Error - RMS"/"Peak"	The average (RMS) and peak frequency error in %. The frequency error is the difference of the measured frequency and the reference frequency. The frequency error is normalized to the estimated FSK deviation.	FSK:DERror
"FSK Deviation Error"	The deviation error of FSK modulated signals in Hz, i.e. the difference of the measured FSK deviation and the user-defined FSK reference deviation.	FDError
"FSK Meas Deviation"	The estimated deviation of FSK modulated signals in Hz.	FSK:MDEviation
"FSK Ref Deviation"	The reference deviation you have set in Hz.	FSK:RDEviation
"Carrier Frequency Drift"	The mean carrier frequency drift in Hz per symbol.	FSK:CFDRift

Remote command:

```
CALCulate<n>:MARKer<m>:FUNction:DDEMod:STATistic:<Parameter>?
```

4 Measurement basics

Some background knowledge on basic terms and principles used in VSA is provided here for a better understanding of the required configuration settings.

For information on the basic processing of I/Q data in the R&S FPL1000, see the R&S FPL1000 I/Q Analyzer User Manual.

- [Filters and bandwidths during signal processing](#)..... 69
- [Sample rate, symbol rate and I/Q bandwidth](#)..... 76
- [Symbol mapping](#)..... 78
- [Overview of the demodulation process](#)..... 112
- [Signal model, estimation and modulation errors](#)..... 125
- [Measurement ranges](#)..... 142
- [Display points vs estimation points per symbol](#)..... 147
- [Capture buffer display](#)..... 148
- [Known data files - dependencies and restrictions](#)..... 148
- [Known data from PRBS generators](#)..... 150
- [Multi-modulation analysis \(R&S FPL1000-K70M\)](#)..... 152

4.1 Filters and bandwidths during signal processing

This section describes the used filters in vector signal analysis with an R&S FPL1000, and the bandwidth after each filter.

The relevant filters for vector signal analysis are shown in [Figure 4-1](#).

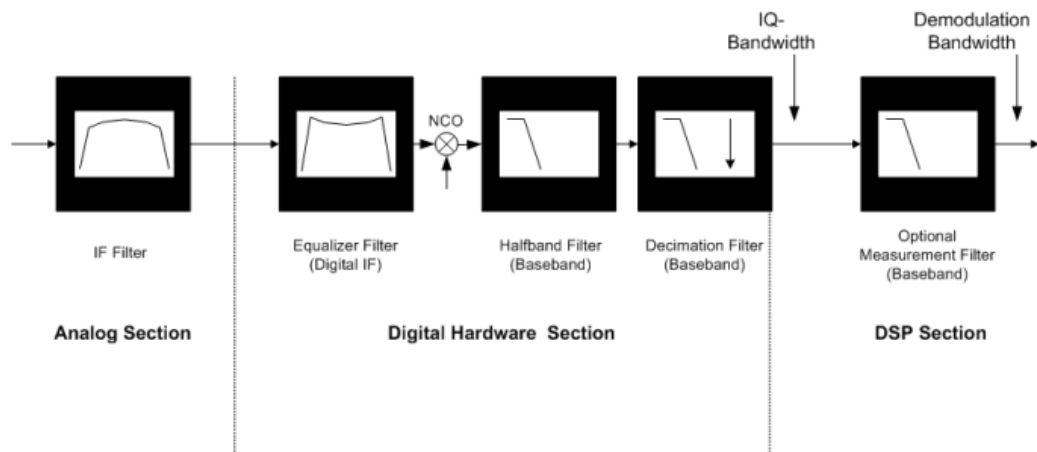


Figure 4-1: Block diagram of bandwidth-relevant filters for vector signal analysis

- After the IF Filter (only for RF input operation): bandwidth = 12.8 MHz or 40 MHz, depending on the [Data acquisition](#) settings and the installed bandwidth options
- After the digital hardware section:
The phase and amplitude distortions of the IF filter have been compensated for. Usually, the I/Q data has a usable bandwidth of about:

0.8 * sample rate

For details, refer to [Chapter 4.1.1, "I/Q bandwidth"](#), on page 70.

The I/Q data sample rate and bandwidth are automatically adjusted to the set symbol rate. For most modulated signals, even the smallest allowed value for the sample rate leads to a sufficient I/Q data bandwidth. The whole spectrum of the input signal is captured, but most adjacent channels and interferers are effectively suppressed. Only for very wide signals (FSK, no TX-filter used) it can be necessary to try higher values for the sample rate (see [Chapter 4.2, "Sample rate, symbol rate and I/Q bandwidth"](#), on page 76), increasing the I/Q bandwidth. The I/Q data delivered to the DSP section has no considerable amplitude or phase distortion and a suitable bandwidth.



The "Signal Capture" dialog box ("Data Acquisition" tab) shows the sample rate and the usable I/Q bandwidth achieved for the current settings (see ["Usable I/Q Bandwidth"](#) on page 201).

- After the optional measurement filter:
Various measurement filters which have different bandwidths can filter the measurement signal and the reference signal.

The filters described above are the ones that directly affect the bandwidth of the captured I/Q data and the final measurement signal and reference signal. Note, however, that several other filters are also involved in the DSP section but are not mentioned above:

- Receive filter to prevent ISI (intersymbol-interference)
- Filters necessary for various estimators
- Others

4.1.1 I/Q bandwidth

The bandwidth of the I/Q data used as input for the vector signal analysis is filtered as described in [Chapter 4.1, "Filters and bandwidths during signal processing"](#), on page 69. Its flat, usable bandwidth (no considerable amplitude or phase distortion) depends on:

- The used sample rate, which depends on:
 - The defined "Symbol Rate" (see ["Symbol Rate"](#) on page 168)
 - The defined "Sample Rate" parameter (see ["Sample Rate"](#) on page 201)

For details on the maximum usable bandwidth, see [Chapter 4.2, "Sample rate, symbol rate and I/Q bandwidth"](#), on page 76.



The sample rate and the usable I/Q bandwidth achieved for the current settings is displayed in the "Signal Capture" dialog, see [Chapter 5.5.1, "Data acquisition"](#), on page 200.

4.1.2 Demodulation bandwidth (measurement bandwidth)

Some modulation systems do not use a receive filter. In these cases, take special care that no interference or adjacent channels occur within the demodulation bandwidth. Set the "Sample rate" parameter to a low value (see "Sample Rate" on page 201).



Typical communication systems demand special receive or measurement filters (e.g. root-raised cosine receive filter or EDGE measurement filter).

If no such filtering is performed, make sure that interfering signals or adjacent channels do not fall within the demodulation bandwidth.

4.1.3 Modulation and demodulation filters

For demodulation, the analyzer requires sample points at which only information of the current symbol and none of neighboring symbols is present (symbol points). These points are also called ISI-free points (ISI = intersymbol interference). If the transmitter does not provide an ISI-free signal after the transmit filter (**TX filter**), the analyzer can filter the input signal using a **receive filter** or **Rx filter**. If the transmitter uses an RRC (root-raised cosine) filter, the analyzer must also use an RRC filter to obtain ISI-free points.

In many PSK systems, RRC filters are used as transmit, receive and measurement filters. To determine the I/Q modulation error, the measurement signal must be compared with the corresponding ideal signal. Therefore, the analyzer calculates a **reference filter** by convolving the coefficient of the transmit filter ("**Tx filter**") and the "**Meas filter**" (see Figure 4-2).

When measuring unfiltered signals (e.g. to determine nonlinear signal distortions), no measurement filter is switched into the signal path and the **reference filter** is identical to the **transmit filter** (see Figure 4-2).

In the baseband block diagrams (see Figure 4-2), the system-theoretical transmitter and analyzer filters are shown for PSK and QAM demodulation. For the sake of clarity, RF stages, IF filters and the filter stages of the **digital hardware section** are not shown.

For a correct demodulation, the following filters have to be accurately specified for the analyzer:

- Transmit filter: filter characteristic of transmitter
- Measurement filter:
 - PSK, QAM, UserQAM, MSK:
The I and the Q part of the measurement and the reference signal are filtered with this filter.
 - FSK:
The instantaneous frequency of the measurement reference signal is filtered.

In many applications, the measurement filter is identical to the receive filter.

The receive filter (also referred to as an *ISI filter*) is configured internally depending on the transmit filter. The goal is to produce intersymbol-interference-free points for the demodulation.

The reference filter generates the ideal transmitted signal (after meas filtering). The analyzer calculates the reference filter from the above filters (convolution operation **transmit filter * meas filter**).

Typical combinations of transmit and measurement filters are shown in [Table C-3](#); they can be set in the R&S FPL1000 VSA application using "Meas filter = AUTO" (see ["Using the Transmit Filter as a Measurement Filter \(Auto\)"](#) on page 226). For some filters, a roll-off factor is required:

Filter type	Required parameters
RC (raised cosine)	Alpha
RRC (root-raised cosine)	Alpha
Gaussian	BT

Typically the Alpha/BT value of the measurement filter is the same as the value of the transmission filter.

4.1.4 Measurement filters

The measurement filter can be used to filter the following two signals in the same way:

- The measurement signal (after coarse frequency, phase and timing synchronization have been achieved)
- The reference signal, i.e the I/Q symbols that have been determined in the demodulator and have already been filtered with the Transmit filter;

For FSK, the measurement filter filters the instantaneous frequency of the signal, not the I/Q signal.

For MSK, PSK, QAM and User QAM the measurement filter filters the real part and imaginary part of these signals (i.e. not the instantaneous frequency or magnitude of the signal).

The R&S FPL1000 VSA application defines the error signal as the difference between the reference signal and the measurement signal. Thus, the measurement filter also shapes the spectrum of the error signal, which is used to calculate the EVM, for example.

In many applications, the measurement filter is the same as the RX filter. However, unlike the measurement filter, the RX filter is not relevant for the measurement, but is only required to create the reference signal optimally.

If possible, the RX filter and the transmit filter are chosen such that their combination results in an Inter-Symbol Interference (ISI) free system (see [Figure 4-2](#) and [Figure 4-3](#)).

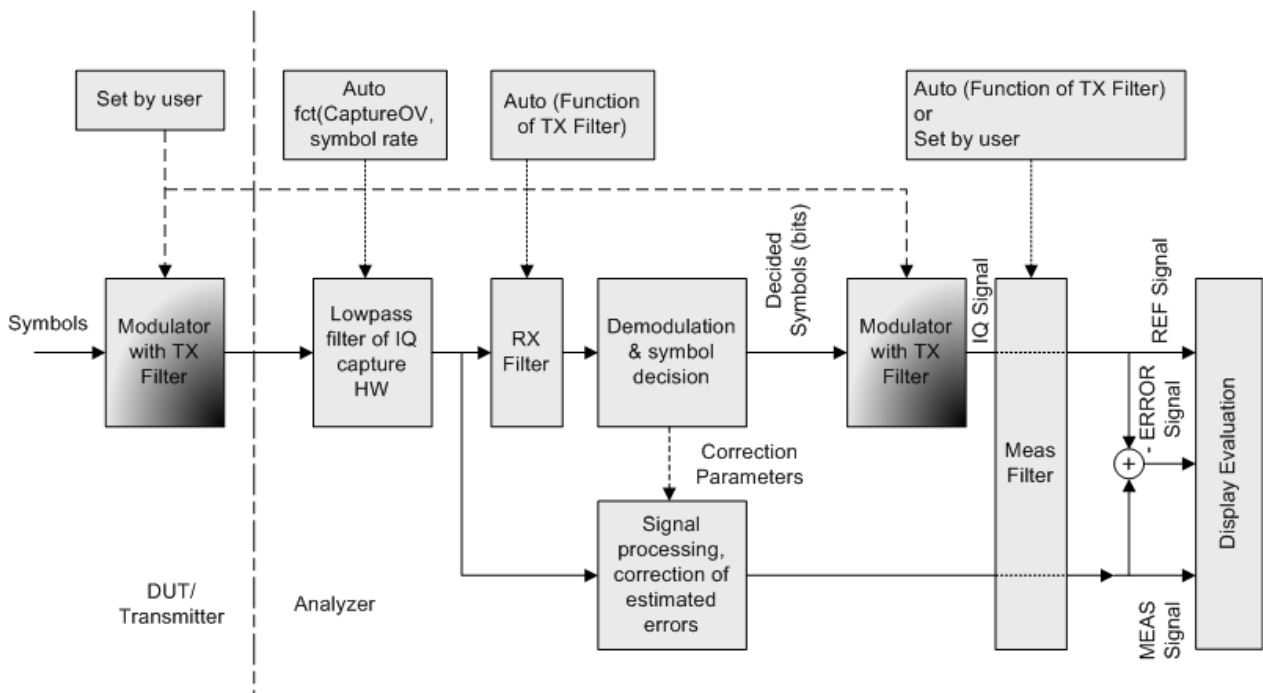


Figure 4-2: Measurement filter in the block diagram (MSK, PSK, QAM and UserQAM)

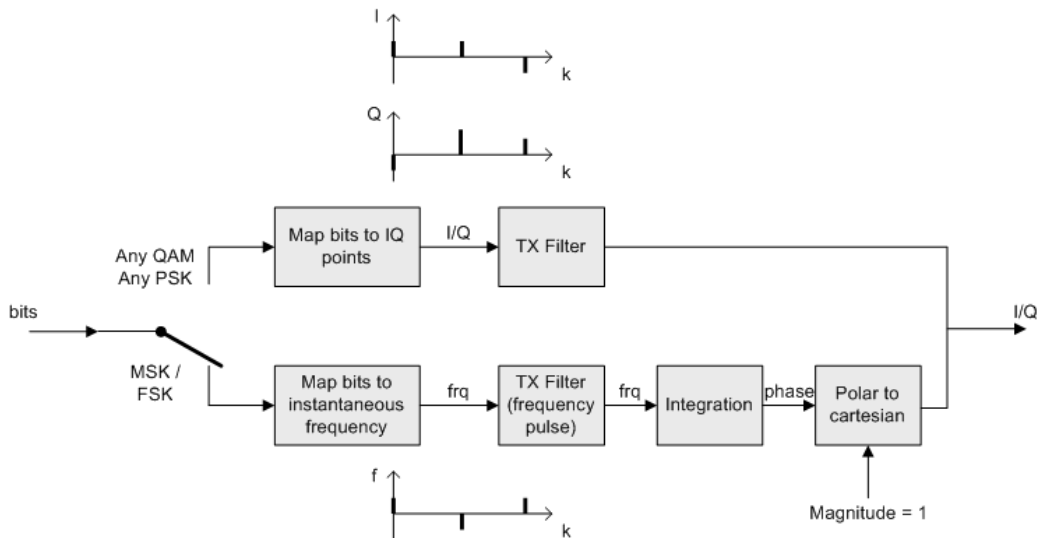


Figure 4-3: Modulator with Transmit filter in detail

As the measurement filters of the R&S FPL1000 VSA application have low-pass characteristics, they suppress high frequency distortion components in the Meas/Ref/Error signal. The errors are weighted spectrally. Thus, turning off the measurement filter can have an influence on the numeric and graphical error values. However, to measure non-linear distortions, which usually produce high frequency components, switch off the measurement filter.

Predefined measurement filters

The most frequently required measurement filters are provided by the R&S FPL1000 VSA application (see [Chapter C.2, "Measurement filters"](#), on page 512).

The frequency response of the available standard-specific measurement filters is shown in [Chapter F.6.2, "Measurement filter"](#), on page 525.

4.1.5 Customized filters

The analytical filter types RC (raised cosine), RRC (root-raised cosine), GAUSSIAN, and the most important standard-specific filters, are already integrated in the R&S FPL1000 VSA application. In addition, it is possible to use user-defined measurement and transmit filters. Customized filters are useful for the following purposes:

- Developing new networks and modulation methods for which no filters are defined yet
- Measuring transmitter characteristics with slightly modified (e.g. shortened) transmitter filters

An external program ("FILTWIZ") is offered to convert user-defined filters. This program generates filter files (*.vaf) which can be transferred to the analyzer with a USB device, for example. The program can be downloaded together with a detailed description as a precompiled MATLAB® file (MATLAB pcode) on the Internet, at <http://www.rohde-schwarz.com> (search term "FILTWIZ").

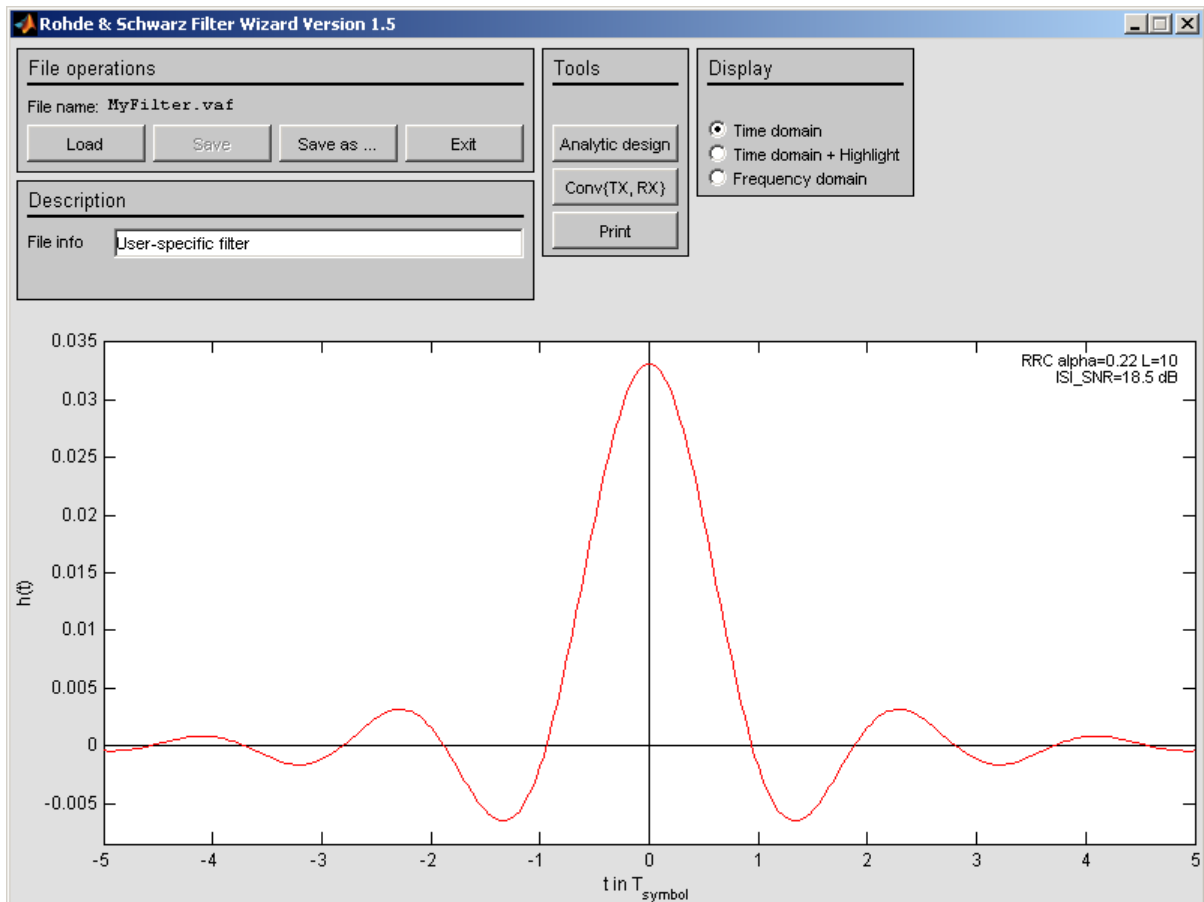


Figure 4-4: FILTWIZ - filter tool for VSA

It is possible to load customized transmit filters and customized measurement filters. If you select a customized transmit filter, the internal receive filter coefficients are calculated automatically right away.



Unlike the R&S FPL1000 VSA application, the R&S FSQ-K70 required you to transfer a user-defined receive filter, as well.

If you upload a customized transmit filter and leave the measurement filter set to "automatic", the internally calculated receive filter is used as a measurement filter. Note that this filter is not necessarily suitable for your specific signal. The filter is optimized such that the intersymbol interference is low. Hence, you probably see a clear eye diagram and a "Vector I/Q" diagram with a recognizable constellation. However, a filter that has low intersymbol interference can lead to noise enhancement, which is commonly undesirable for a measurement filter.

To avoid noise enhancement, it is recommended that you do one of the following:

- Design your own measurement filter and upload it as a user filter.
- Select a suitable measurement filter from the list.

Transferring filter files to the R&S FPL1000

You can transfer the (.vaf) filter files to the R&S FPL1000 using a USB memory device.

4.2 Sample rate, symbol rate and I/Q bandwidth

The "Symbol Rate" defined in the "Signal Description" settings determines how many symbols are captured and demodulated during a certain measurement time. However, for each symbol more than one sample can be captured, so that the sample rate can be higher than the symbol rate.

The "Sample Rate" parameter in the "Signal Capture" settings defines the **number of samples to capture per symbol**. (Do not confuse this number with the estimation points per symbol or display points per symbol, see [Chapter 4.7, "Display points vs estimation points per symbol"](#), on page 147). The resulting sample rate (depending on the "Symbol Rate") is indicated behind the parameter.



The number of samples to capture per symbol is commonly referred to as the **"Capture Oversampling"** value in Rohde & Schwarz signal and spectrum analyzers.

The resulting sample rate, also referred to as the user or output sample rate, is the rate at which the I/Q data is demodulated and analyzed. The sample rate also affects the demodulation (measurement) bandwidth. If the bandwidth is too narrow, the signal is not displayed completely. If the bandwidth is too wide, interference from outside the actual signal to be measured can distort the result. Thus, for signals with a large frequency spectrum (e.g. FSK modulated signals), a higher sample rate can be necessary.

(For further details, see [Chapter 4.1, "Filters and bandwidths during signal processing"](#), on page 69.)

For an indication of the required sample rate, view the "Real/Imag (I/Q)" display of the capture buffer with a "Spectrum" transformation. If the complete signal is displayed within the usable I/Q bandwidth, the selected value is suitable.

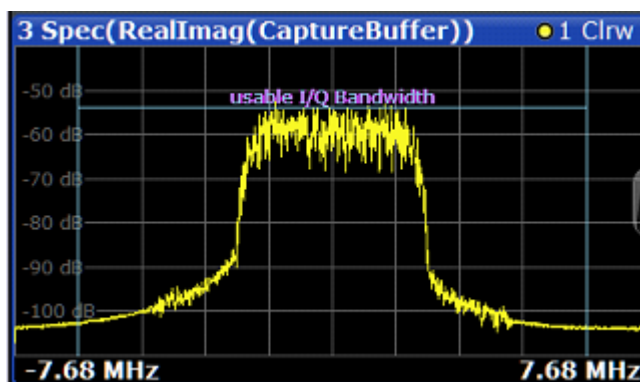


Figure 4-5: Determining the I/Q bandwidth: Real/Imag (I/Q) display of the capture buffer with a spectrum transformation

If the signal is cut off, increase the sample rate.

If the signal is too small, decrease the sample rate by changing one of the following settings:

- The "Symbol Rate" defined in the "Signal Description" settings
- The "Sample Rate" in the "Data Acquisition" settings

As described above, the sample rate defines the number of samples to capture per symbol. Thus, the maximum sample rate depends on the maximum number of symbols to be captured (the **symbol rate**) and vice versa.

The maximum sample rate for the R&S FPL1000 is 100 MHz (see below). Thus, the maximum symbol rate is:

Table 4-1: Maximum symbol rate depending on sample rate parameter

Sample rate parameter	Max. symbol rate
2* symbol rate	50 Msymbols
4* symbol rate	25 Msymbols
8* symbol rate	12.5 Msymbols
16* symbol rate	6.25 Msymbols
32* symbol rate	3.125 Msymbols
64* symbol rate	1.5625 Msymbols
128* symbol rate	781.25 ksymbols

4.2.1 Sample rate and maximum usable I/Q bandwidth for RF input

Definitions

- **Input sample rate (ISR):** the sample rate of the useful data provided by the device connected to the input of the R&S FPL1000
- (User, Output) **Sample rate (SR):** the user-defined sample rate (e.g. in the "Data Acquisition" dialog box in the "I/Q Analyzer" application) which is used as the basis for analysis or output
- **Usable I/Q (Analysis) bandwidth:** the bandwidth range in which the signal remains undistorted in regard to amplitude characteristic and group delay; this range can be used for accurate analysis by the R&S FPL1000
- **Record length:** Number of I/Q samples to capture during the specified measurement time; calculated as the measurement time multiplied by the sample rate

For the I/Q data acquisition, digital decimation filters are used internally in the R&S FPL1000. The passband of these digital filters determines the *maximum usable I/Q bandwidth*. In consequence, signals within the usable I/Q bandwidth (passband) remain unchanged, while signals outside the usable I/Q bandwidth (passband) are suppressed. Usually, the suppressed signals are noise, artifacts, and the second IF side band. If frequencies of interest to you are also suppressed, try to increase the output sample rate, which increases the maximum usable I/Q bandwidth.



Bandwidth extension options

You can extend the maximum usable I/Q bandwidth provided by the R&S FPL1000 in the basic installation by adding options. These options can either be included in the initial installation (B-options) or updated later (U-options). The maximum bandwidth provided by the individual option is indicated by its number, for example, B40 extends the bandwidth to 40 MHz.

As a rule, the usable I/Q bandwidth is proportional to the output sample rate. Yet, when the I/Q bandwidth reaches the bandwidth of the analog IF filter (at very high output sample rates), the curve breaks.

- [Relationship between sample rate, record length and usable I/Q bandwidth..... 78](#)

4.2.1.1 Relationship between sample rate, record length and usable I/Q bandwidth

Up to the maximum bandwidth, the following rule applies:

$$\text{Usable I/Q bandwidth} = 0.8 * \text{Output sample rate}$$

Regarding the record length, the following rule applies:

$$\text{Record length} = \text{Measurement time} * \text{sample rate}$$

The [Figure 4-6](#) shows the maximum usable I/Q bandwidths depending on the output sample rates.

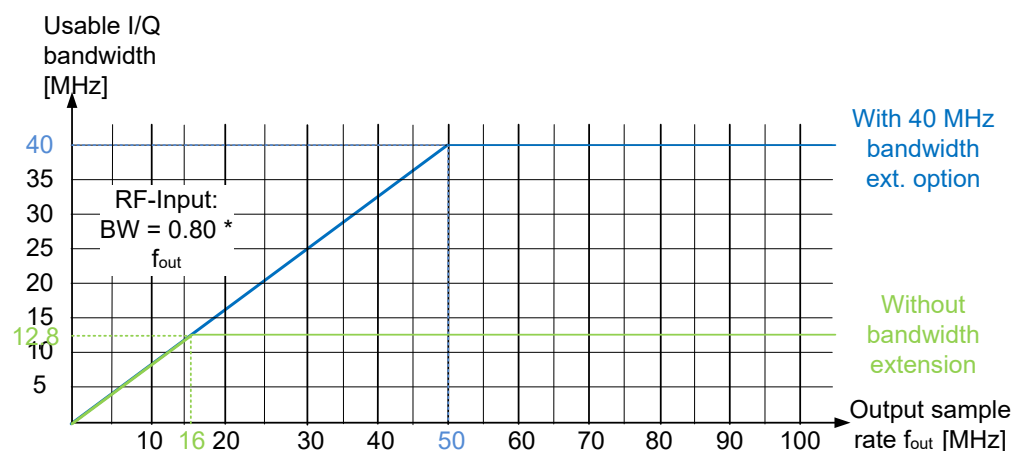


Figure 4-6: Relationship between maximum usable I/Q bandwidth and output sample rate

4.3 Symbol mapping

Mapping or symbol mapping means that symbol numbers are assigned to constellation points or transitions in the I/Q plane (e.g. PSK and QAM).

In the analyzer, the mapping is required to decode the transmitted symbols from the sampled I/Q or frequency/time data records.

The mappings for all standards used in the analyzer and for all employed modulation modes are described in the following. Unless indicated otherwise, symbol numbers are specified in hexadecimal form (MSB at the left).

• Phase shift keying (PSK).....	79
• Rotating PSK.....	83
• Differential PSK.....	86
• Rotating differential PSK modulation.....	87
• Offset QPSK.....	89
• Shaped offset QPSK.....	90
• Frequency shift keying (FSK).....	91
• Minimum shift keying (MSK).....	96
• Quadrature amplitude modulation (QAM).....	97
• ASK.....	109
• APSK.....	110
• User-defined modulation.....	111

4.3.1 Phase shift keying (PSK)

With this type of modulation, the information is represented by the absolute phase position of the received signal at the decision points. All transitions in the I/Q diagram are possible. The complex constellation diagram is shown. The symbol numbers are entered in the diagram according to the mapping rule.

BPSK (NATURAL, SMx)

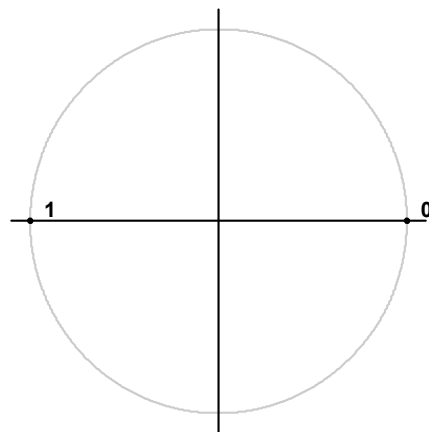


Figure 4-7: Constellation diagram for BPSK including the symbol mapping



BPSK (NATURAL) is the BPSK mapping used by supported R&S SMx signal generators when using PRBS algorithms. See "[Symbol mapping in accordance with the PRBS generator](#)" on page 152.

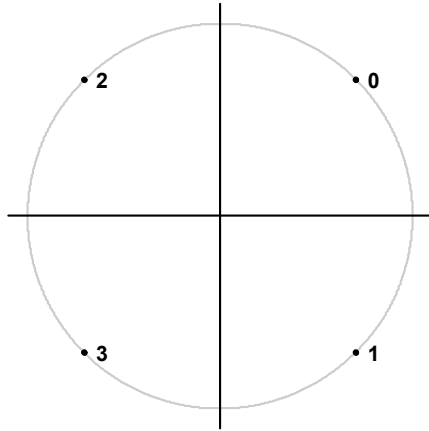
QPSK

Figure 4-8: Constellation diagram for QPSK including the symbol mapping for CDMA2000 FWD, DVB-S2 and DVB-RCS2

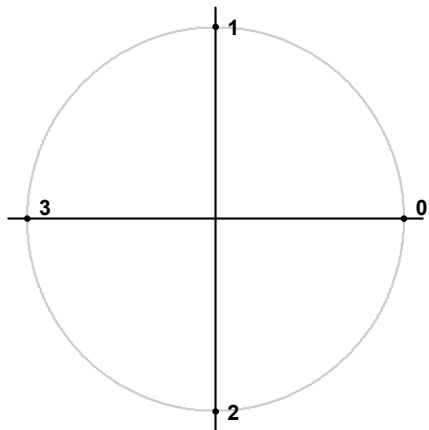


Figure 4-9: Constellation diagram for QPSK (GRAY) including the symbol mapping

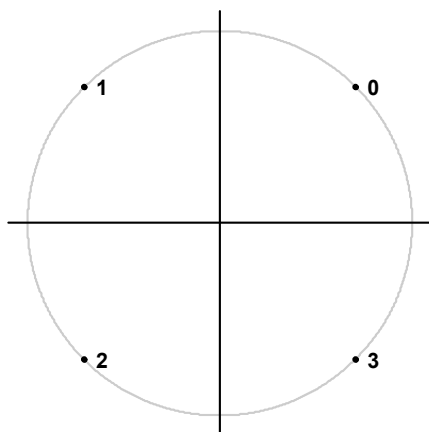


Figure 4-10: Constellation diagram for QPSK (NATURAL, SMx) including the symbol mapping



QPSK (NATURAL) is the QPSK mapping used by supported R&S SMx signal generators when using PRBS algorithms. See ["Symbol mapping in accordance with the PRBS generator"](#) on page 152.

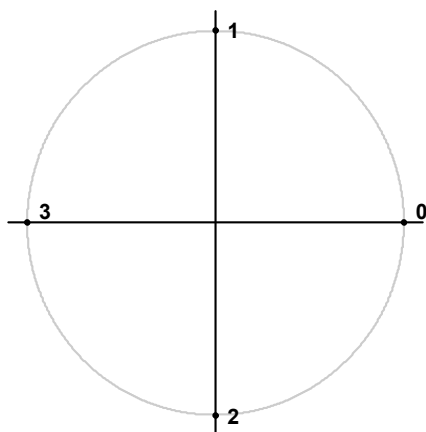


Figure 4-11: Constellation diagram for QPSK including the symbol mapping for WCDMA

8PSK

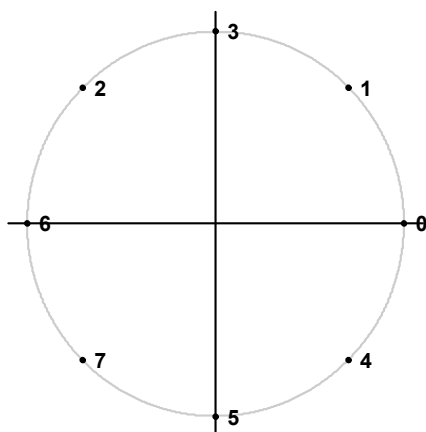


Figure 4-12: Constellation diagram for 8PSK (GRAY) including the symbol mapping

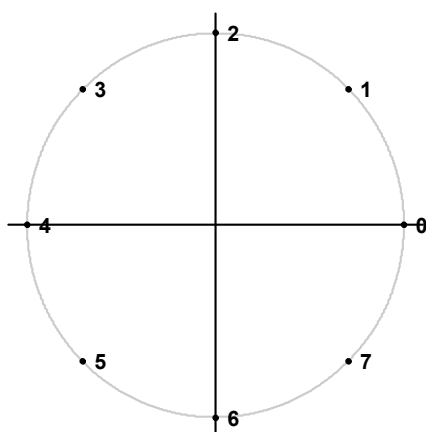


Figure 4-13: Constellation diagram for 8PSK (NATURAL, SMx) including the symbol mapping

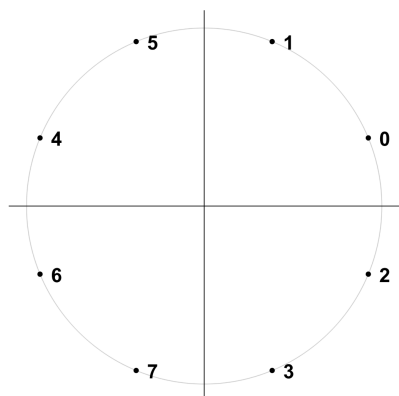


Figure 4-14: Constellation diagram for 8PSK including the symbol mapping for DVB-RCS2



8PSK (NATURAL) is the 8PSK mapping used by supported R&S SMx signal generators when using PRBS algorithms. See ["Symbol mapping in accordance with the PRBS generator"](#) on page 152.

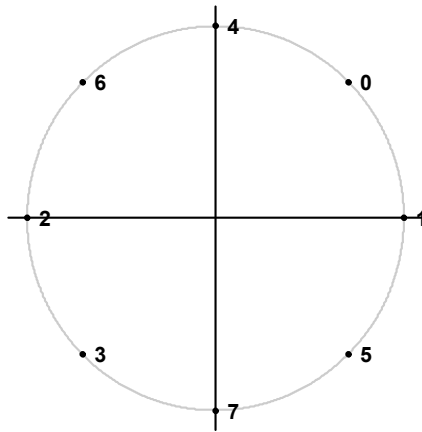


Figure 4-15: Constellation diagram for 8PSK including the symbol mapping for DVB-S2

4.3.2 Rotating PSK

A rotating PSK modulation is basically a PSK modulation in which additional phase shifts occur. These phase shifts depend on the symbol number, e.g. for a $\pi/4$ -QPSK, the third symbol has an additional phase offset of $(3-1)*\pi/4$. This offset has the same effect as a rotation of the basic system of coordinates by the offset angle after each symbol.

The method is highly important in practical applications because it prevents signal transitions through the zeros in the I/Q plane. This reduces the dynamic range of the modulated signal and the linearity requirements for the amplifier.

In practice, the method is used for $3\pi/8$ -8PSK, for example, and (in conjunction with phase-differential coding) for $\pi/4$ -DQPSK.

Symbol mapping

The logical constellation diagram for $3\pi/8$ -8PSK comprises 8 points that correspond to the modulation level (see Figure 4-16). A counter-clockwise offset (rotation) of $3\pi/8$ is inserted after each symbol transition.

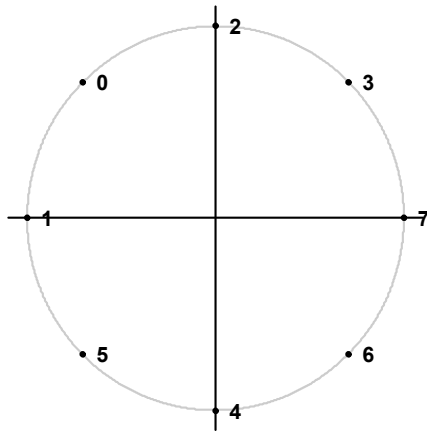


Figure 4-16: Constellation diagram for $3\pi/8$ 8PSK before rotation including the symbol mapping for EDGE

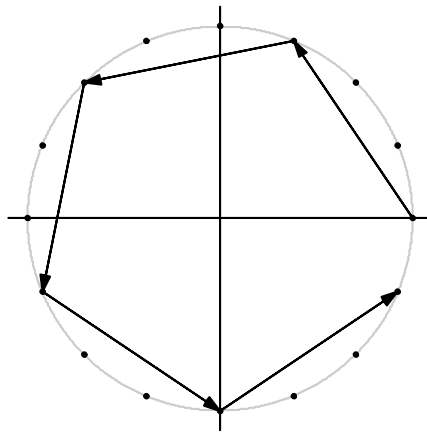


Figure 4-17: I/Q symbol stream after $3\pi/8$ rotation in I/Q plane if the symbol number "7" is transmitted six times in a row

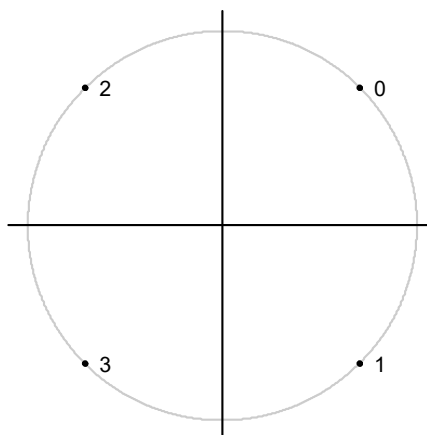


Figure 4-18: Constellation diagram for $3\pi/4$ QPSK including the symbol mapping for EDGE

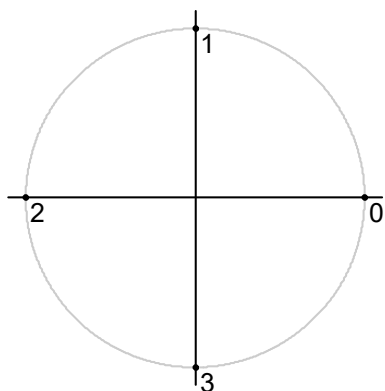


Figure 4-19: Constellation diagram for $\pi/4$ QPSK (Natural) including the symbol mapping

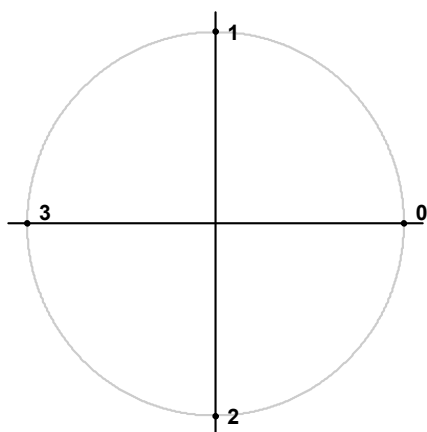


Figure 4-20: Constellation diagram for $\pi/4$ QPSK (GRAY) including the symbol mapping

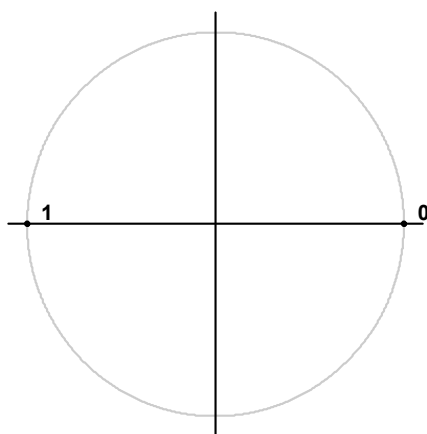


Figure 4-21: Constellation diagram for $\pi/2$ BPSK (Natural, DVB-RCS2) and $-\pi/2$ BPSK including the symbol mapping

4.3.3 Differential PSK

With differential PSK, the information is represented in the phase shift between two consecutive decision points. The absolute position of the complex sample value at the decision point does not carry information.

In the physical constellation diagram, the constellation points at the symbol decision points obtained after ISI-free demodulation are shown (as with common PSK methods). This diagram corresponds to the display on the analyzer. The position of the constellation points is standard-specific. For example, some QPSK standards define the constellation points on the diagonals, while other standards define the coordinate axes.

In [Table 4-2](#), the symbols are assigned to phase shifts. The QPSK (INMARSAT) mapping corresponds to simple QPSK with phase-differential coding.

Tables [Table 4-3](#) and [Table 4-4](#) show two types of differential 8PSK modulation.

Differential coding according to VDL is shown in [Table 4-5](#). It can be used for modulation types with 3 bits/symbol, e.g. 8PSK.

Other types of modulation using differential coding method are described in [Chapter 4.3.4, "Rotating differential PSK modulation"](#), on page 87.

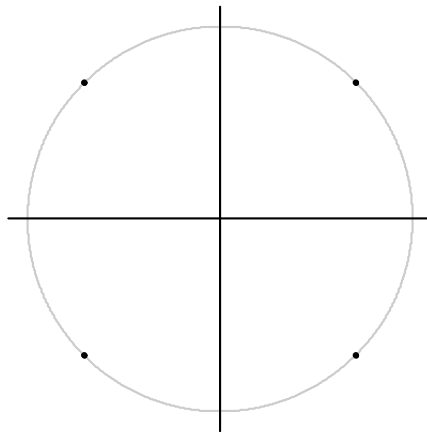


Figure 4-22: Constellation diagram for DQPSK (INMARSAT and NATURAL) including the symbol mapping

Table 4-2: DQPSK (INMARSAT)

Logical symbol mapping				
Modulation symbol (binary indication: MSB, LSB)	00	01	10	11
Phase shift	0°	-90°	+90°	180°

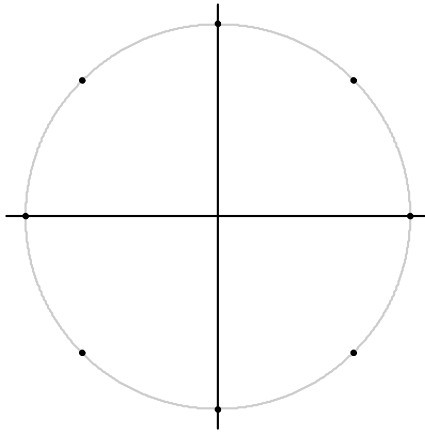


Figure 4-23: Constellation diagram for D8PSK including the symbol mapping for APCO25, APCO25 Phase 2, GRAY, NATURAL and TETRA

Table 4-3: D8PSK (NATURAL)

Logical symbol mapping								
Modulation symbol (binary indication: MSB, LSB)	000	001	010	011	100	101	110	111
Phase shift	0°	45°	90°	135°	180°	225°	270°	315°

Table 4-4: D8PSK (GRAY)

Logical symbol mapping								
Modulation symbol (binary indication: MSB, LSB)	000	001	010	011	100	101	110	111
Phase shift	0°	45°	135°	90°	270°	315°	225°	180°

Table 4-5: D8PSK (VDL)

Logical symbol mapping								
Modulation symbol (binary indication: MSB, LSB)	000	001	010	011	100	101	110	111
Phase shift	0°	45°	135°	90°	315°	270°	180°	225°

4.3.4 Rotating differential PSK modulation

Phase-differential modulation is frequently combined with an additional phase shift (e.g. $\pi/4$ DQPSK = $\pi/4$ phase shift modulation + differential modulated 4PSK).

The logical mapping diagram corresponds to the diagram for DPSK.

The physical constellation diagram shows the symbol decision points obtained after ISI-free demodulation.

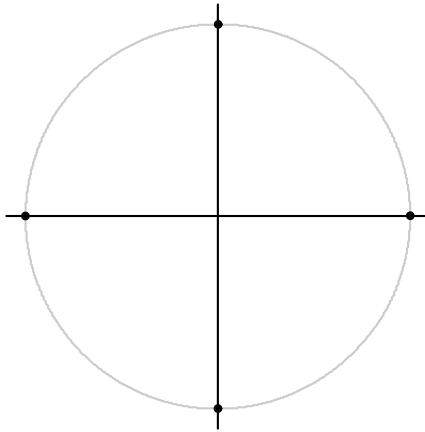


Figure 4-24: Constellation diagram for $\pi/4$ DQPSK including the symbol mapping for APCO25 Phase 2, NADC, NATURAL, PDC, PHS, TETRA and TFTS; the $\pi/4$ rotation is already compensated for

Table 4-6: $\pi/4$ DQPSK (NADC, PDC, PHS, TETRA)

Logical symbol mapping				
Modulation symbol (binary indication: MSB, LSB)	00	01	10	11
Phase shift	$0^\circ+45^\circ$	$90^\circ+45^\circ$	$-90^\circ+45^\circ$	$-180^\circ+45^\circ$

Table 4-7: $\pi/4$ DQPSK (TFTS)

Logical symbol mapping				
Modulation symbol (binary indication: MSB, LSB)	00	01	10	11
Phase shift	$-180^\circ+45^\circ$	$90^\circ+45^\circ$	$-90^\circ+45^\circ$	$0^\circ+45^\circ$

Table 4-8: $\pi/4$ DQPSK (NATURAL, SMx)

Logical symbol mapping				
Modulation symbol (binary indication: MSB, LSB)	00	01	10	11
Phase shift	$0^\circ+45^\circ$	$90^\circ+45^\circ$	$-180^\circ+45^\circ$	$-90^\circ+45^\circ$

Table 4-9: $\pi/4$ DQPSK (APCO25 and APCO25Phase2)

Logical symbol mapping				
Modulation symbol (binary indication: MSB, LSB)	00	01	10	11
Phase shift	$0^\circ+45^\circ$	$90^\circ+45^\circ$	$-90^\circ+45^\circ$	$-180^\circ+45^\circ$

Table 4-10: $\pi/2$ DBPSK

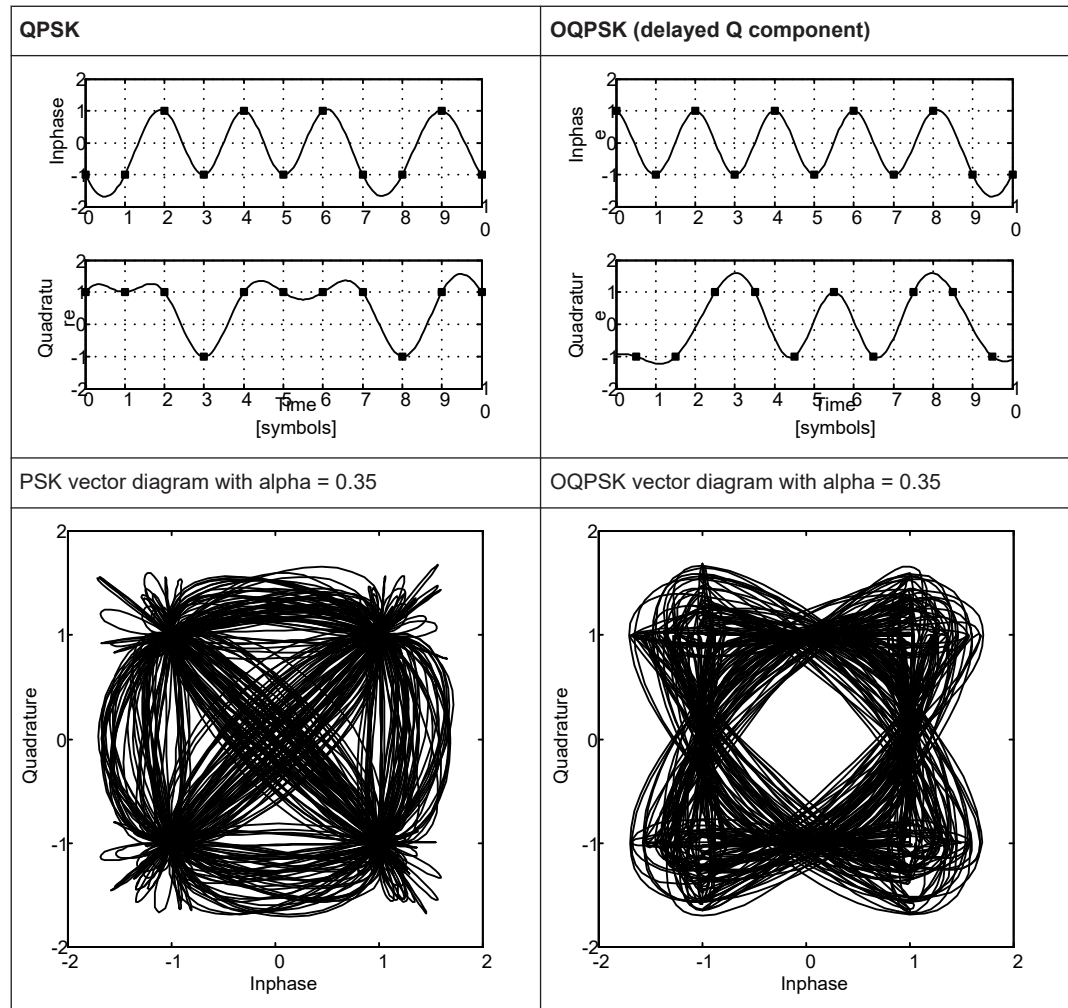
Logical symbol mapping		
Modulation symbol (binary indication: MSB, LSB)	0	1
Phase shift	$0^\circ+90^\circ$	$-180^\circ+90^\circ$

4.3.5 Offset QPSK

Offset QPSK differs from "normal" QPSK in the fact that the Q component is delayed by half a symbol period against the I component in the time domain. Hence, the symbol time instants of the I and the Q component do not coincide. The concept of Offset QPSK is illustrated in the diagrams below.

Derivation of OQPSK

Table 4-11: I/Q diagram and constellation diagram



Offset QPSK reduces the dynamic range of the modulated signal (compared to "normal" QPSK) and, therefore, the demands on amplifier linearity by avoiding zero crossings.

A distinction is made in the analyzer display:

In the "Vector I/Q" result display of the measurement (or reference) signal, the time delay is not compensated for. The display corresponds to the physical diagram shown in (Table 4-11)

In the "Constellation I/Q" result display of the measurement (or reference) signal, the time delay is compensated for. The display corresponds to the logical mapping as in [Figure 4-25](#).

OQPSK

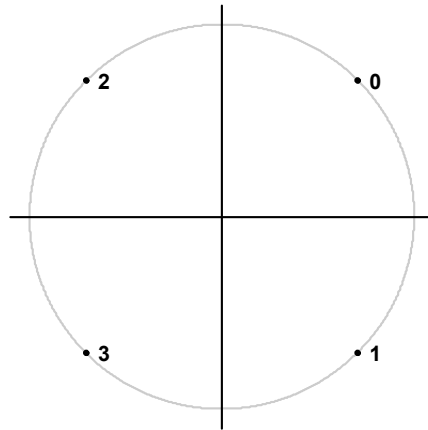


Figure 4-25: Constellation diagram for OQPSK (GRAY) including the symbol mapping

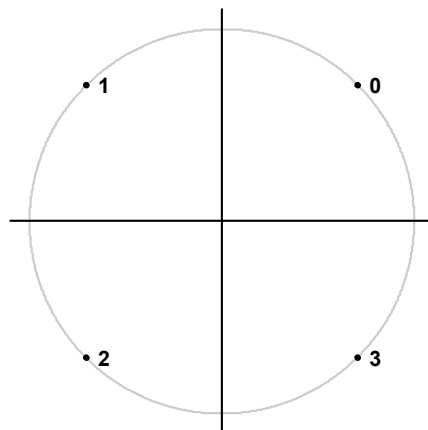


Figure 4-26: Constellation diagram for OQPSK (NATURAL, SMx) including the symbol mapping



OQPSK (NATURAL) is the OQPSK mapping used by supported R&S SMx signal generators when using PRBS algorithms. See ["Symbol mapping in accordance with the PRBS generator"](#) on page 152.

4.3.6 Shaped offset QPSK

Shaped Offset QPSK is a constant envelope modulation whose phase at any instant in time is either stationary or is moving at a rate of one-quarter of the bit rate. It can therefore also be interpreted as a ternary CPM.

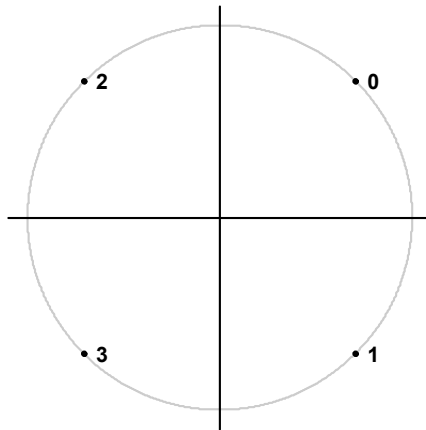


Figure 4-27: Constellation diagram for Shaped Offset QPSK including the symbol mapping

4.3.7 Frequency shift keying (FSK)

To illustrate symbol mappings for FSK modulations, the symbol numbers are marked in the logical mapping diagram versus the instantaneous frequency. An instantaneous frequency of zero in the baseband corresponds to the input frequency of the analyzer.

2FSK (NATURAL)

With 2FSK, the symbol decision is made by a simple frequency discriminator:

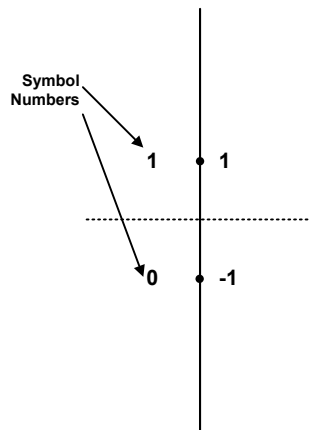


Figure 4-28: Constellation diagram for 2FSK (NATURAL, SMx) including the logical symbol mapping



2FSK (NATURAL) is the 2FSK mapping used by supported R&S SMx signal generators when using PRBS algorithms. See "[Symbol mapping in accordance with the PRBS generator](#)" on page 152.

4FSK

With 4FSK, the symbol decision is made by a frequency discriminator with 3 decision thresholds ($-2/3$; 0 ; $+2/3$) normalized to the FSK reference deviation.

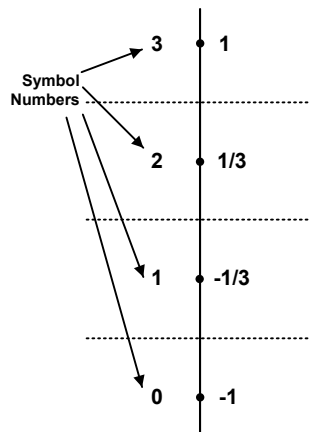


Figure 4-29: Constellation diagram for 4FSK (NATURAL, SMx) including the logical symbol mapping



4FSK (NATURAL) is the 4FSK mapping used by supported R&S SMx signal generators when using PRBS algorithms. See ["Symbol mapping in accordance with the PRBS generator"](#) on page 152.

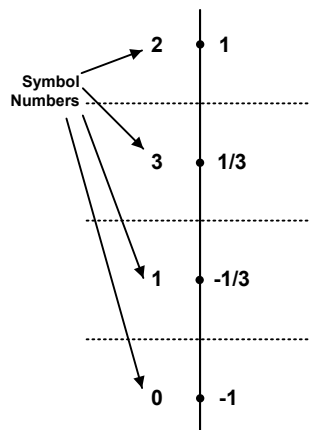


Figure 4-30: Constellation diagram for 4FSK (GRAY) including the logical symbol mapping

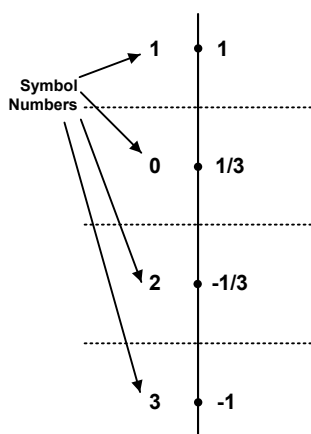


Figure 4-31: Constellation diagram for 4FSK for APCO C4FM and APCO Phase 2 including the logical symbol mapping

8FSK (NATURAL)

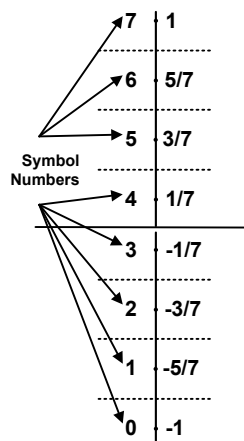


Figure 4-32: Constellation diagram for 8FSK (NATURAL) including the logical symbol mapping

16 FSK

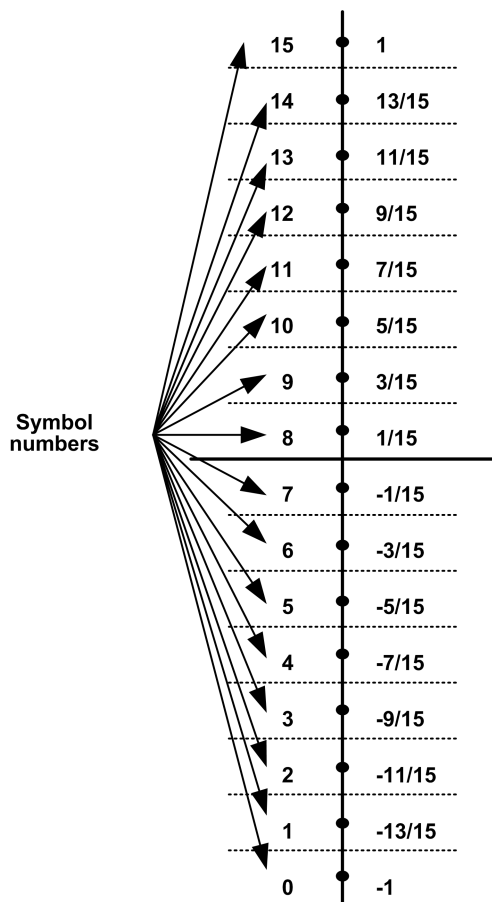


Figure 4-33: Constellation diagram for 16FSK including the logical symbol mapping

32FSK

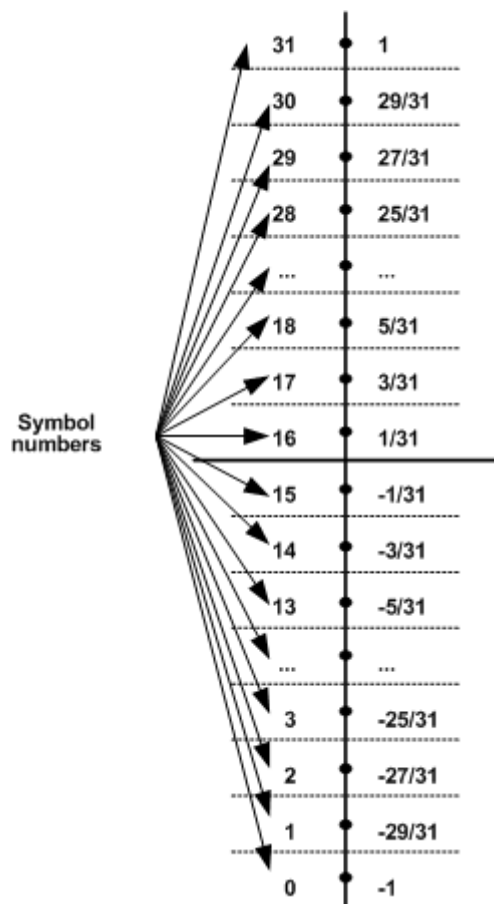


Figure 4-34: Constellation diagram for 32FSK including the logical symbol mapping

64FSK

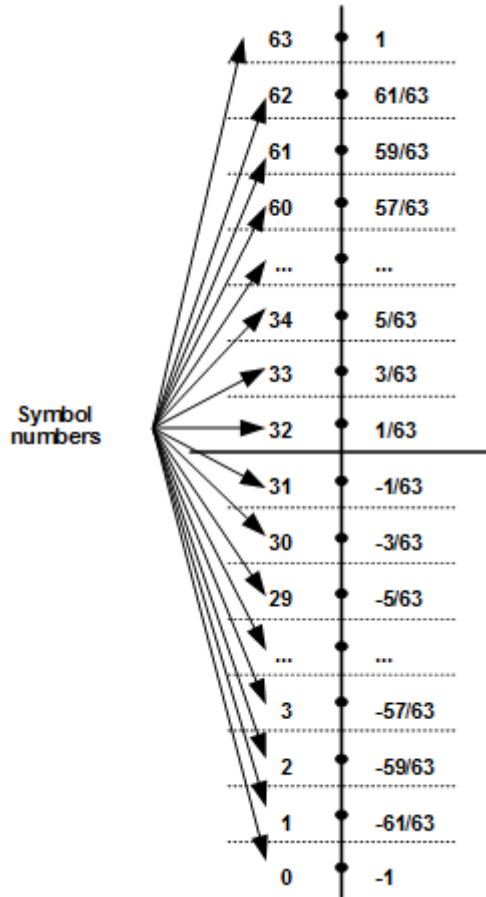


Figure 4-35: Constellation diagram for 64FSK including the logical symbol mapping

4.3.8 Minimum shift keying (MSK)

MSK modulation causes modulation-dependent phase shifts of $\pm 90^\circ$ which can be shown in a "Constellation I/Q" diagram. As with PSK, the phase positions are evaluated during demodulation.

Table 4-12: MSK (NATURAL)

Logical symbol mapping		
Modulation symbol (binary indication: MSB, LSB)	0	1
Phase shift	-90°	$+90^\circ$

Table 4-13: MSK (GSM)

Logical symbol mapping		
Modulation symbol (binary indication: MSB, LSB)	0	1
Phase shift	$+90^\circ$	-90°

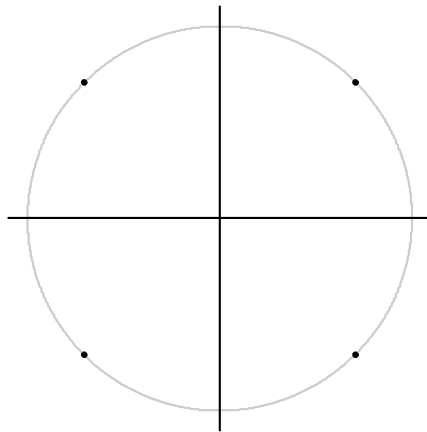


Figure 4-36: MSK (for GSM and NATURAL) and DMSK Constellation Diagram including the symbol mapping

Similar to PSK, differential coding can also be used with MSK. In this case, too, the information is represented by the transition of two consecutive symbols. The block diagram of the coder is shown below.

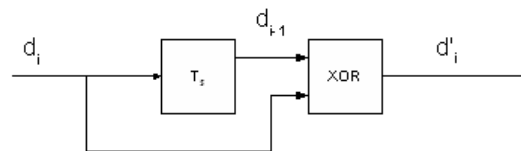


Figure 4-37: DMSK: differential encoder in the transmitter

d_i input symbol $\{0;1\}$ of differential encoder

d_{i-1} input symbol delayed by the symbol period T_s

d'_i output symbol $\{0;1\}$ of differential encoder

The logical symbol mapping is then performed on the XOR-coded bitstream d' .

4.3.9 Quadrature amplitude modulation (QAM)

With QAM, the information is represented by the signal amplitude and phase.

The symbols are arranged in a square constellation in the I/Q plane.



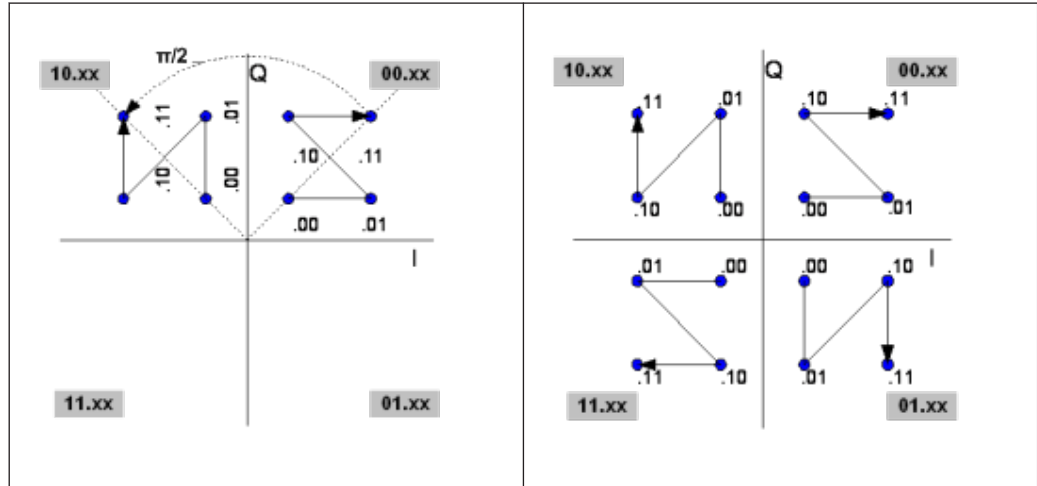
To ensure reliable demodulation, symbol numbers should be distributed evenly across the symbol alphabet.

As a rule of thumb, the **result length** should correspond to at least 8 times the modulation order. For example, with 64 QAM, a result length of at least $8 \cdot 64 = 512$ symbols should be used.

QAM Mappings

The following QAM mappings are obtained from the mapping of the first quadrant. The subsequent quadrants are always rotated by $\pi/2$ and supplemented by a (GRAY-coded) prefix for each quadrant.

Table 4-14: Derivation of QAM mappings



In the following diagrams, the symbol mappings are indicated in hexadecimal and binary form.

• 0	• 1	• 3	• 2	• 0000	• 0001	• 0011	• 0010
• 4	• 5	• 7	• 6	• 0100	• 0101	• 0111	• 0110
• C	• D	• F	• E	• 1100	• 1101	• 1111	• 1110
• 8	• 9	• B	• A	• 1000	• 1001	• 1011	• 1010

Figure 4-38: Constellation diagram for 16QAM (GRAY) including the logical symbol mapping (hexadecimal and binary)

• B	• 9	• 1	• 3	1011	1001	0001	0011
• A	• 8	• 0	• 2	1010	1000	0000	0010
• E	• C	• 4	• 6	1110	1100	0100	0110
• F	• D	• 5	• 7	1111	1101	0101	0111

Figure 4-39: Constellation diagram for 16QAM including the logical symbol mapping for EDGE (hexadecimal and binary)

• B	• 9	• 2	• 3	1011	1001	0010	0011
• A	• 8	• 0	• 1	1010	1000	0000	0001
• D	• C	• 4	• 6	1101	1100	0100	0110
• F	• E	• 5	• 7	1111	1110	0101	0111

Figure 4-40: Constellation diagram for 16QAM including the logical symbol mapping for DVB-C (hexadecimal and binary)



16QAM DVB-C is the 16QAM mapping used by supported R&S SMx signal generators when using PRBS algorithms. See "[Symbol mapping in accordance with the PRBS generator](#)" on page 152.

• 7	• 3	• B	• F	0111	0011	1011	1111
• 6	• 2	• A	• E	0110	0010	1010	1110
• 4	• 0	• 8	• C	0100	0000	1000	1100
• 5	• 1	• 9	• D	0101	0001	1001	1101

Figure 4-41: Constellation diagram for 16QAM including the logical symbol mapping for DVB-RCS2 (hexadecimal and binary)

• 17	• 13	• 06	• 02								
• 12	• 15	• 11	• 04	• 05	• 07	10111	10011	00110	00010		
• 16	• 14	• 10	• 00	• 01	• 03	10010	10101	10001	00100	00101	00111
• 1B	• 19	• 18	• 08	• 0C	• 0E	10110	10100	10000	00000	00001	00011
• 1F	• 1D	• 1C	• 09	• 0D	• 0A	11011	11001	11000	01000	01100	01110
• 1A	• 1E	• 0B	• 0F			11111	11101	11100	01001	01101	01010
						11010	11110		01011	01111	

Figure 4-42: Constellation diagram for 32QAM including the logical symbol mapping for DVB-C (hexadecimal and binary)



32QAM DVB-C is the 32QAM mapping used by supported R&S SMx signal generators when using PRBS algorithms. See "[Symbol mapping in accordance with the PRBS generator](#)" on page 152.

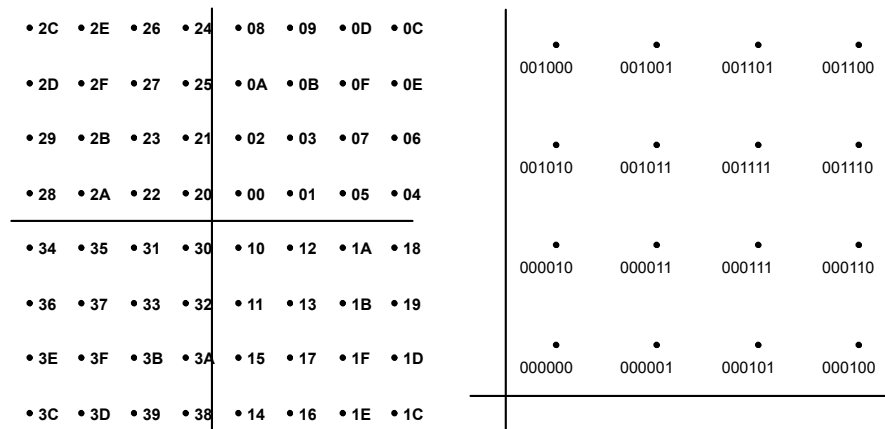


Figure 4-43: Constellation diagram for 64QAM including the logical symbol mapping for DVB-C (hexadecimal and binary); the binary form shows the upper right section of the diagram only.



64QAM DVB-C is the 64QAM mapping used by supported R&S SMx signal generators when using PRBS algorithms. See ["Symbol mapping in accordance with the PRBS generator"](#) on page 152.



Figure 4-44: Constellation diagram for 64QAM including the logical symbol mapping for DOCSIS 3.0, North American Cable Downstream according to ITU-T J.83-B (hexadecimal)

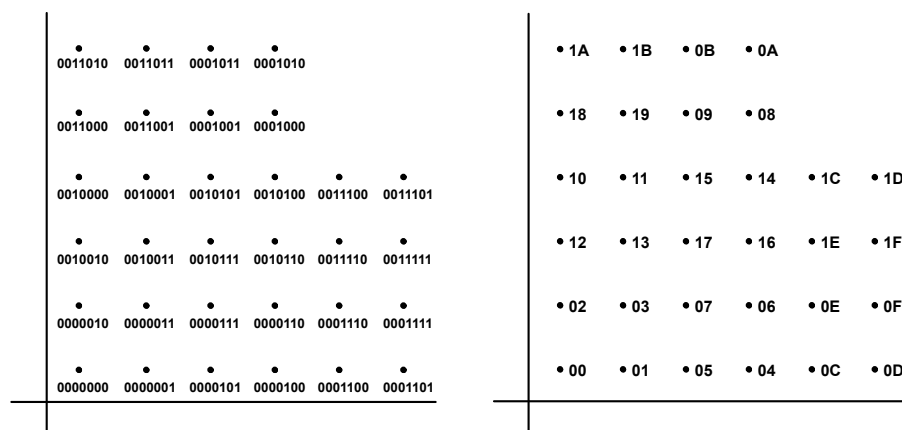


Figure 4-45: Constellation diagram for 128QAM (GRAY, SMx) including the logical symbol mapping (hexadecimal and binary); the figure shows the upper right sections of the diagram only



128QAM GRAY is the 128QAM mapping used by supported R&S SMx signal generators when using PRBS algorithms. See ["Symbol mapping in accordance with the PRBS generator"](#) on page 152.

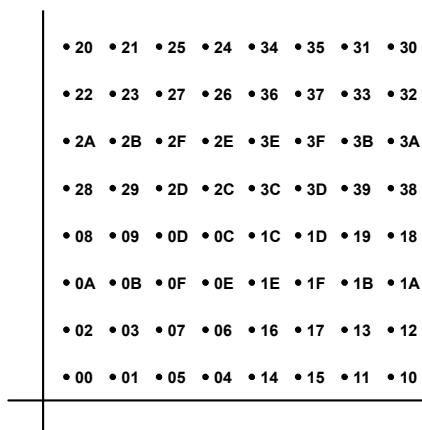


Figure 4-46: Constellation diagram for 256QAM (GRAY, SMx) including the logical symbol mapping (hexadecimal); the figure shows the upper right section of the diagram only



256QAM GRAY is the 256QAM mapping used by supported R&S SMx signal generators when using PRBS algorithms. See ["Symbol mapping in accordance with the PRBS generator"](#) on page 152.

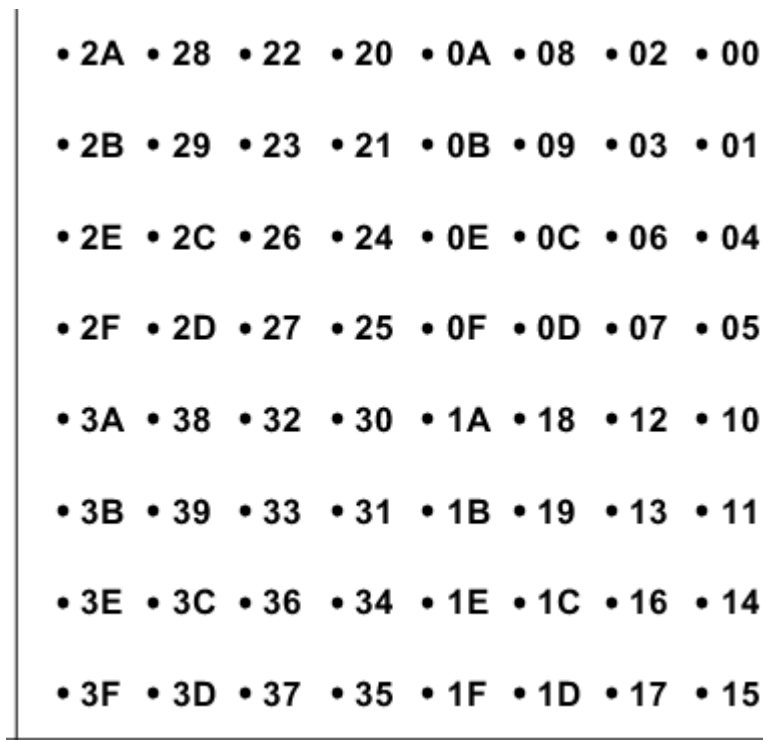


Figure 4-47: Constellation diagram for 256QAM DOCSIS 3.0, North American Cable Downstream according to ITU-T J.83-B, including the logical symbol mapping (hexadecimal)



Figure 4-48: Constellation diagram for 512QAM (NATURAL, SMx), including the logical symbol mapping (hexadecimal); the figure shows the upper right section of the diagram only

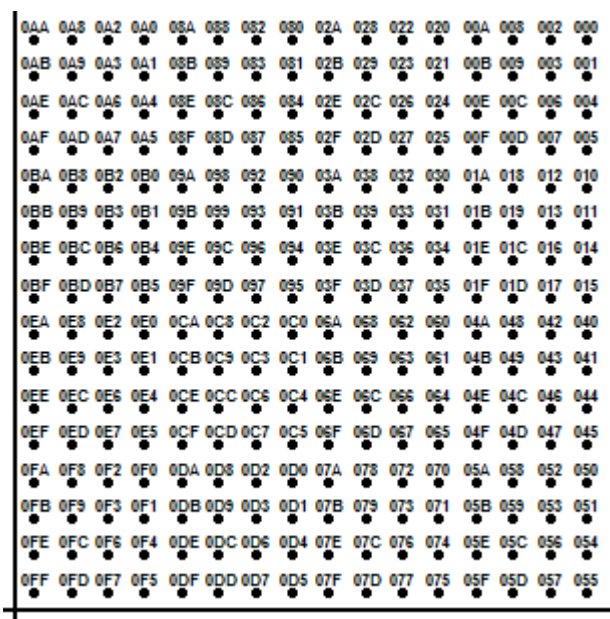


Figure 4-49: Constellation diagram for 1024QAM including the logical symbol mapping (hexadecimal); the figure shows the upper right section of the diagram only

• 080 • 081 • 085 • 084 • 094 • 095 • 091 • 090 • 0D0 • 0D1 • 0D5 • 0D4 • 0C4 • 0C5 • 0C1 • 0C0
 • 082 • 083 • 087 • 086 • 096 • 097 • 093 • 092 • 0D2 • 0D3 • 0D7 • 0D6 • 0C6 • 0C7 • 0C3 • 0C2
 • 08A • 08B • 08F • 08E • 09E • 09F • 09B • 09A • 0DA • 0DB • 0DF • 0DE • 0CE • 0CF • 0CB • 0CA
 • 088 • 089 • 08D • 08C • 09C • 09D • 099 • 098 • 0D8 • 0D9 • 0DD • 0DC • 0CC • 0CD • 0C9 • 0C8
 • 0A8 • 0A9 • 0AD • 0AC • 0BC • 0BD • 0B9 • 0B8 • 0F8 • 0F9 • 0FD • 0FC • 0EC • 0ED • 0E9 • 0E8
 • 0AA • 0AB • 0AF • 0AE • 0BE • 0BF • 0BB • 0BA • 0FA • 0FB • 0FF • 0FE • 0EE • 0EF • 0EB • 0EA
 • 0A2 • 0A3 • 0A7 • 0A6 • 0B6 • 0B7 • 0B3 • 0B2 • 0F2 • 0F3 • 0F7 • 0F6 • 0E6 • 0E7 • 0E3 • 0E2
 • 0A0 • 0A1 • 0A5 • 0A4 • 0B4 • 0B5 • 0B1 • 0B0 • 0F0 • 0F1 • 0F5 • 0F4 • 0E4 • 0E5 • 0E1 • 0E0
 • 020 • 021 • 025 • 024 • 034 • 035 • 031 • 030 • 070 • 071 • 075 • 074 • 064 • 065 • 061 • 060
 • 022 • 023 • 027 • 026 • 036 • 037 • 033 • 032 • 072 • 073 • 077 • 076 • 066 • 067 • 063 • 062
 • 02A • 02B • 02F • 02E • 03E • 03F • 03B • 03A • 07A • 07B • 07F • 07E • 06E • 06F • 06B • 06A
 • 028 • 029 • 02D • 02C • 03C • 03D • 039 • 038 • 078 • 079 • 07D • 07C • 06C • 06D • 069 • 068
 • 008 • 009 • 00D • 00C • 01C • 01D • 019 • 018 • 058 • 059 • 05D • 05C • 04C • 04D • 049 • 048
 • 00A • 00B • 00F • 00E • 01E • 01F • 01B • 01A • 05A • 05B • 05F • 05E • 04E • 04F • 04B • 04A
 • 002 • 003 • 007 • 006 • 016 • 017 • 013 • 012 • 052 • 053 • 057 • 056 • 046 • 047 • 043 • 042
 • 000 • 001 • 005 • 004 • 014 • 015 • 011 • 010 • 050 • 051 • 055 • 054 • 044 • 045 • 041 • 040

Figure 4-50: Constellation diagram for 1024QAM (GRAY, SMx) including the logical symbol mapping (hexadecimal); the figure shows the upper right section of the diagram only



1024QAM GRAY is the 1024QAM mapping used by supported R&S SMx signal generators when using PRBS algorithms. See "[Symbol mapping in accordance with the PRBS generator](#)" on page 152.

• 178 • 170 • 171 • 160 • 15A • 132 • 12A • 12B • 11A • 114 • 060 • 058 • 059 • 048 • 042 • 00A
 • 177 • 16E • 16F • 15F • 159 • 131 • 128 • 129 • 119 • 113 • 05F • 056 • 057 • 047 • 041 • 009
 • 176 • 16C • 16D • 15E • 158 • 130 • 126 • 127 • 118 • 112 • 05E • 054 • 055 • 046 • 040 • 008
 • 175 • 16A • 16B • 15D • 157 • 12F • 124 • 125 • 117 • 111 • 05D • 052 • 053 • 045 • 03F • 007
 • 174 • 168 • 169 • 15C • 156 • 12E • 122 • 123 • 116 • 110 • 05C • 050 • 051 • 044 • 03E • 006
 • 179 • 172 • 173 • 161 • 15B • 133 • 12C • 12D • 11B • 115 • 061 • 05A • 05B • 049 • 043 • 00B
 • 180 • 17A • 17B • 165 • 162 • 13A • 134 • 135 • 11F • 11C • 068 • 062 • 063 • 04D • 04A • 00D
 • 182 • 17E • 17F • 167 • 164 • 13C • 138 • 139 • 121 • 11E • 06A • 066 • 067 • 04F • 04C • 010
 • 181 • 17C • 17D • 166 • 163 • 13B • 136 • 137 • 120 • 11D • 069 • 064 • 065 • 04E • 04B • 00E • 00F • 00C • 005 • 000 • 001 • 002 • 003 • 004
 • 191 • 18D • 18E • 185 • 183 • 14B • 147 • 148 • 13F • 13D • 079 • 075 • 076 • 06D • 06B • 031 • 032 • 02F • 01B • 011 • 012 • 013 • 014 • 015
 • 192 • 18F • 190 • 186 • 184 • 14C • 149 • 14A • 140 • 13E • 07A • 077 • 078 • 06E • 06C • 033 • 034 • 030 • 01C • 016 • 017 • 018 • 019 • 01A
 • 19A • 195 • 196 • 18B • 188 • 154 • 14F • 150 • 145 • 142 • 082 • 07D • 07E • 073 • 070 • 03A • 03B • 036 • 02D • 022 • 023 • 024 • 025 • 026
 • 199 • 193 • 194 • 18A • 187 • 153 • 14D • 14E • 144 • 141 • 081 • 07B • 07C • 072 • 06F • 038 • 039 • 035 • 02C • 01D • 01E • 01F • 020 • 021
 • 19B • 197 • 198 • 18C • 189 • 155 • 151 • 152 • 146 • 143 • 083 • 07F • 080 • 074 • 071 • 03C • 03D • 037 • 02E • 027 • 028 • 029 • 02A • 02B
 • 1DC • 1D8 • 1D9 • 1D0 • 1CE • 1AA • 1A6 • 1A7 • 19E • 19C • 0EC • 0E8 • 0E9 • 0E0 • 0DE • 0A4 • 0A5 • 0A2 • 08E • 084 • 085 • 086 • 087 • 088
 • 1DD • 1DA • 1DB • 1D1 • 1CF • 1AB • 1A8 • 1A9 • 19F • 19D • 0ED • 0EA • 0EB • 0E1 • 0DF • 0A6 • 0A7 • 0A3 • 08F • 089 • 08A • 08B • 08C • 08D
 • 1E5 • 1E0 • 1E1 • 1D6 • 1D3 • 1B3 • 1AE • 1AF • 1A4 • 1A1 • 0F5 • 0F0 • 0F1 • 0E6 • 0E3 • 0AD • 0AE • 0A9 • 0A0 • 095 • 096 • 097 • 098 • 099
 • 1E4 • 1DE • 1DF • 1D5 • 1D2 • 1B2 • 1AC • 1AD • 1A3 • 1A0 • 0F4 • 0EE • 0EF • 0E5 • 0E2 • 0AB • 0AC • 0A8 • 09F • 090 • 091 • 092 • 093 • 094
 • 1E6 • 1E2 • 1E3 • 1D7 • 1D4 • 1B4 • 1B0 • 1B1 • 1A5 • 1A2 • 0F6 • 0F2 • 0F3 • 0E7 • 0E4 • 0AF • 0B0 • 0AA • 0A1 • 09A • 09B • 09C • 09D • 09E
 • 1F5 • 1F1 • 1F2 • 1E9 • 1E7 • 1C3 • 1BF • 1C0 • 1B7 • 1B5 • 105 • 101 • 102 • 0F9 • 0F7 • 0D1 • 0D2 • 0CF • 0BB • 0B1 • 0B2 • 0B3 • 0B4 • 0B5
 • 1F6 • 1F3 • 1F4 • 1EA • 1E8 • 1C4 • 1C1 • 1C2 • 1B8 • 1B6 • 106 • 103 • 104 • 0FA • 0F8 • 0D3 • 0D4 • 0D0 • 0BC • 0B6 • 0B7 • 0B8 • 0B9 • 0BA
 • 1FE • 1F9 • 1FA • 1EF • 1EC • 1CC • 1C7 • 1C8 • 1BD • 1BA • 10E • 109 • 10A • 0FF • 0FC • 0DA • 0DB • 0D6 • 0CD • 0C2 • 0C3 • 0C4 • 0C5 • 0C6
 • 1FD • 1F7 • 1F8 • 1EE • 1EB • 1CB • 1C5 • 1C6 • 1BC • 1B9 • 10D • 107 • 108 • 0FE • 0FB • 0D8 • 0D9 • 0D5 • 0CC • 0BD • 0BE • 0BF • 0C0 • 0C1
 • 1FF • 1FB • 1FC • 1F0 • 1ED • 1CD • 1C9 • 1CA • 1BE • 1BB • 10F • 10B • 10C • 100 • 0FD • 0DC • 0DD • 0D7 • 0CE • 0C7 • 0C8 • 0C9 • 0CA • 0CB

Figure 4-51: Constellation diagram for 2048QAM (NATURAL, SMx) including the logical symbol mapping (hexadecimal); the figure shows the upper right section of the diagram only

• 200 • 201 • 205 • 204 • 214 • 215 • 211 • 210 • 250 • 251 • 255 • 254 • 244 • 245 • 241 • 240 • 340 • 341 • 345 • 344 • 354 • 355 • 351 • 350 • 310 • 311 • 315 • 314 • 304 • 305 • 301 • 300
 • 202 • 203 • 207 • 206 • 216 • 217 • 213 • 212 • 252 • 253 • 257 • 256 • 246 • 247 • 243 • 242 • 342 • 343 • 347 • 346 • 356 • 357 • 353 • 352 • 312 • 313 • 317 • 316 • 306 • 307 • 303 • 302
 • 20A • 20B • 20F • 20E • 21E • 21F • 21B • 21A • 25A • 25B • 25F • 25E • 24E • 24F • 24B • 24A • 34A • 34B • 34F • 34E • 35E • 35F • 35B • 35A • 31A • 31B • 31F • 31E • 30E • 30F • 30B • 30A
 • 208 • 209 • 20D • 20C • 21C • 21D • 219 • 218 • 258 • 259 • 25D • 25C • 24C • 24D • 249 • 248 • 348 • 349 • 34D • 34C • 35C • 35D • 359 • 358 • 318 • 319 • 31D • 31C • 30C • 30D • 309 • 308
 • 228 • 229 • 22D • 22C • 23C • 23D • 239 • 238 • 278 • 279 • 27D • 27C • 26C • 26D • 269 • 268 • 368 • 369 • 36D • 36C • 37C • 37D • 379 • 378 • 338 • 339 • 33D • 33C • 32C • 32D • 329 • 328
 • 22A • 22B • 22F • 22E • 23E • 23F • 23B • 23A • 27A • 27B • 27F • 27E • 26E • 26F • 26B • 26A • 36A • 36B • 36F • 36E • 37E • 37F • 37B • 37A • 33A • 33B • 33F • 33E • 32E • 32F • 32B • 32A
 • 222 • 223 • 227 • 226 • 236 • 237 • 233 • 232 • 272 • 273 • 277 • 276 • 266 • 267 • 263 • 262 • 362 • 363 • 367 • 366 • 376 • 377 • 373 • 372 • 332 • 333 • 337 • 336 • 326 • 327 • 323 • 322
 • 220 • 221 • 225 • 224 • 234 • 235 • 231 • 230 • 270 • 271 • 275 • 274 • 264 • 265 • 261 • 260 • 360 • 361 • 365 • 364 • 374 • 375 • 371 • 370 • 330 • 331 • 335 • 334 • 324 • 325 • 321 • 320
 • 2A0 • 2A1 • 2A5 • 2A4 • 2B4 • 2B5 • 2B1 • 2B0 • 2F0 • 2F1 • 2F5 • 2F4 • 2E4 • 2E5 • 2E1 • 2E0 • 3E0 • 3E1 • 3E5 • 3E4 • 3F4 • 3F5 • 3F1 • 3F0 • 3B0 • 3B1 • 3B5 • 3B4 • 3A4 • 3A5 • 3A1 • 3A0
 • 2A2 • 2A3 • 2A7 • 2A6 • 2B6 • 2B7 • 2B3 • 2B2 • 2F2 • 2F3 • 2F7 • 2F6 • 2E6 • 2E7 • 2E3 • 2E2 • 3E2 • 3E3 • 3E7 • 3E6 • 3F6 • 3F7 • 3F3 • 3F2 • 3B2 • 3B3 • 3B7 • 3B6 • 3A6 • 3A7 • 3A3 • 3A2
 • 2AA • 2AB • 2AF • 2AE • 2BE • 2BF • 2BB • 2BA • 2FA • 2FB • 2FF • 2FE • 2EB • 2EF • 2EB • 2EA • 3EA • 3EB • 3EF • 3EB • 3FE • 3FF • 3FB • 3FA • 3BA • 3BB • 3BF • 3BE • 3AE • 3AF • 3AB • 3AA
 • 2A8 • 2A9 • 2AD • 2AC • 2BC • 2BD • 2B9 • 2B8 • 2F8 • 2F9 • 2FD • 2FC • 2EC • 2ED • 2E9 • 2E8 • 3E8 • 3E9 • 3ED • 3EC • 3FC • 3FD • 3F9 • 3F8 • 3B8 • 3B9 • 3BD • 3BC • 3AC • 3AD • 3A9 • 3A8
 • 288 • 289 • 28D • 28C • 29C • 29D • 299 • 298 • 2D8 • 2D9 • 2DD • 2DC • 2CC • 2CD • 2C9 • 2C8 • 3C8 • 3C9 • 3CD • 3CC • 3DC • 3DD • 3D9 • 3D8 • 398 • 399 • 39D • 39C • 38C • 38D • 389 • 388
 • 28A • 28B • 28F • 28E • 29E • 29F • 29B • 29A • 2DA • 2DB • 2DF • 2DE • 2CB • 2CF • 2CB • 2CA • 3CA • 3CB • 3CF • 3CB • 3DE • 3DF • 3DB • 3DA • 39A • 39B • 39F • 39E • 38E • 38F • 38B • 38A
 • 282 • 283 • 287 • 286 • 296 • 297 • 293 • 292 • 2D2 • 2D3 • 2D7 • 2D6 • 2C6 • 2C7 • 2C3 • 2C2 • 3C2 • 3C3 • 3C7 • 3C6 • 3D6 • 3D7 • 3D3 • 3D2 • 392 • 393 • 397 • 396 • 386 • 387 • 383 • 382
 • 280 • 281 • 285 • 284 • 294 • 295 • 291 • 290 • 2D0 • 2D1 • 2D5 • 2D4 • 2C4 • 2C5 • 2C1 • 2C0 • 3C0 • 3C1 • 3C5 • 3C4 • 3D4 • 3D5 • 3D1 • 3D0 • 390 • 391 • 395 • 394 • 384 • 385 • 381 • 380
 • 080 • 081 • 085 • 084 • 094 • 095 • 091 • 090 • 0D0 • 0D1 • 0D5 • 0D4 • 0C4 • 0C5 • 0C1 • 0C0 • 1C0 • 1C1 • 1C5 • 1C4 • 1D4 • 1D5 • 1D1 • 1D0 • 190 • 191 • 195 • 194 • 184 • 185 • 181 • 180
 • 082 • 083 • 087 • 086 • 096 • 097 • 093 • 092 • 0D2 • 0D3 • 0D7 • 0D6 • 0C6 • 0C7 • 0C3 • 0C2 • 1C2 • 1C3 • 1C7 • 1C6 • 1D6 • 1D7 • 1D3 • 1D2 • 192 • 193 • 197 • 196 • 186 • 187 • 183 • 182
 • 08A • 08B • 08F • 08E • 09E • 09F • 09B • 09A • 0DA • 0DB • 0DF • 0DE • 0CB • 0CF • 0CB • 0CA • 1CA • 1CB • 1CF • 1CB • 1DE • 1DF • 1DB • 1DA • 19A • 19B • 19F • 19E • 18E • 18F • 18B • 18A
 • 088 • 089 • 08D • 08C • 09C • 09D • 099 • 098 • 0D8 • 0D9 • 0DD • 0DC • 0CC • 0CD • 0C9 • 0C8 • 1C8 • 1C9 • 1CD • 1CG • 1DG • 1DD • 1D9 • 1D8 • 198 • 199 • 19D • 19C • 18C • 18D • 189 • 188
 • 0A8 • 0A9 • 0AD • 0AC • 0BC • 0BD • 0B9 • 0B8 • 0F8 • 0F9 • 0FD • 0FC • 0E0 • 0ED • 0E9 • 0E8 • 1E8 • 1E9 • 1ED • 1E0 • 1FC • 1FD • 1F9 • 1F8 • 1B8 • 1B9 • 1BD • 1B0 • 1AC • 1AD • 1A9 • 1A8
 • 0AA • 0AB • 0AF • 0AE • 0BE • 0BF • 0BB • 0BA • 0FA • 0FB • 0FF • 0FE • 0EB • 0EF • 0EB • 0EA • 1EA • 1EB • 1EF • 1EB • 1FE • 1FF • 1FB • 1FA • 1BA • 1BB • 1BF • 1BE • 1AE • 1AF • 1AB • 1AA
 • 0A2 • 0A3 • 0A7 • 0A6 • 0B6 • 0B7 • 0B3 • 0B2 • 0F2 • 0F3 • 0F7 • 0F6 • 0E6 • 0E7 • 0E3 • 0E2 • 1E2 • 1E3 • 1E7 • 1E6 • 1F6 • 1F7 • 1F3 • 1F2 • 1B2 • 1B3 • 1B7 • 1B6 • 1A6 • 1A7 • 1A3 • 1A2
 • 0A0 • 0A1 • 0A5 • 0A4 • 0B4 • 0B5 • 0B1 • 0B0 • 0F0 • 0F1 • 0F5 • 0F4 • 0E4 • 0E5 • 0E1 • 0E0 • 1E0 • 1E1 • 1E5 • 1E4 • 1F4 • 1F5 • 1F1 • 1F0 • 1B0 • 1B1 • 1B5 • 1B4 • 1A4 • 1A5 • 1A1 • 1A0
 • 020 • 021 • 025 • 024 • 034 • 035 • 031 • 030 • 070 • 071 • 075 • 074 • 064 • 065 • 061 • 060 • 160 • 161 • 165 • 164 • 174 • 175 • 171 • 170 • 130 • 131 • 135 • 134 • 124 • 125 • 121 • 120
 • 022 • 023 • 027 • 026 • 036 • 037 • 033 • 032 • 072 • 073 • 077 • 076 • 066 • 067 • 063 • 062 • 162 • 163 • 167 • 166 • 176 • 177 • 173 • 172 • 132 • 133 • 137 • 136 • 126 • 127 • 123 • 122
 • 02A • 02B • 02F • 02E • 03E • 03F • 03B • 03A • 07A • 07B • 07F • 07E • 06E • 06F • 06B • 06A • 16A • 16B • 16F • 16E • 17E • 17F • 17B • 17A • 13A • 13B • 13F • 13E • 12E • 12F • 12B • 12A
 • 028 • 029 • 02D • 02C • 03C • 03D • 039 • 038 • 078 • 079 • 07D • 07C • 06C • 06D • 069 • 068 • 168 • 169 • 16D • 16C • 17C • 17D • 179 • 178 • 138 • 139 • 13D • 13C • 12C • 12D • 129 • 128
 • 008 • 009 • 00D • 00C • 01C • 01D • 019 • 018 • 058 • 059 • 05D • 05C • 04C • 04D • 049 • 048 • 148 • 149 • 14D • 14C • 15C • 15D • 159 • 158 • 118 • 119 • 11D • 11C • 10C • 10D • 109 • 108
 • 00A • 00B • 00F • 00E • 01E • 01F • 01B • 01A • 05A • 05B • 05F • 05E • 04E • 04F • 04B • 04A • 14A • 14B • 14F • 14E • 15E • 15F • 15B • 15A • 11A • 11B • 11F • 11E • 10E • 10F • 10B • 10A
 • 002 • 003 • 007 • 006 • 016 • 017 • 013 • 012 • 052 • 053 • 057 • 056 • 046 • 047 • 043 • 042 • 142 • 143 • 147 • 146 • 156 • 157 • 153 • 152 • 112 • 113 • 117 • 116 • 106 • 107 • 103 • 102
 • 000 • 001 • 005 • 004 • 014 • 015 • 011 • 010 • 050 • 051 • 055 • 054 • 044 • 045 • 041 • 040 • 140 • 141 • 145 • 144 • 154 • 155 • 151 • 150 • 110 • 111 • 115 • 114 • 104 • 105 • 101 • 100

Figure 4-52: Constellation diagram for 4096QAM (GRAY, SMx) including the logical symbol mapping (hexadecimal); the figure shows the upper right section of the diagram only



4096QAM GRAY is the 4096QAM mapping used by supported R&S SMx signal generators when using PRBS algorithms. See ["Symbol mapping in accordance with the PRBS generator"](#) on page 152.

4.3.10 ASK

2ASK (OOK)

ASK stands for Amplitude Shift Keying, 2ASK (binary) is often also referred to as "On Off Keying" (OOK). With this type of modulation, the information is solely represented by the absolute amplitude of the received signal at the decision points.

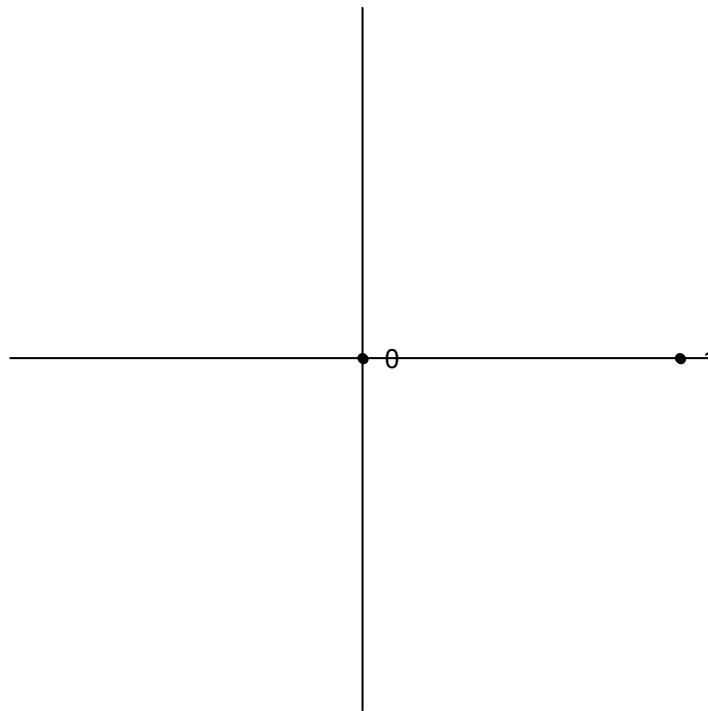


Figure 4-53: Constellation diagram for 2ASK

4ASK

4ASK is a 4-ary Amplitude Shift Keying mapping type. With this type of modulation, the information is solely represented by the absolute amplitude of the received signal at the decision points.

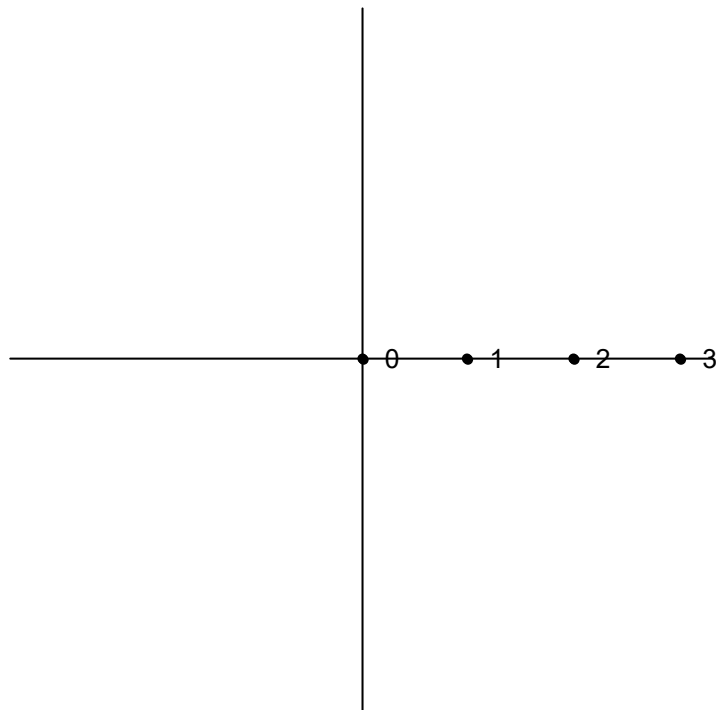


Figure 4-54: Constellation diagram for 4ASK

4.3.11 APSK

With Amplitude Phase Shift Keying (APSK) modulation, the information is represented by the signal amplitude and the signal phase.

16APSK

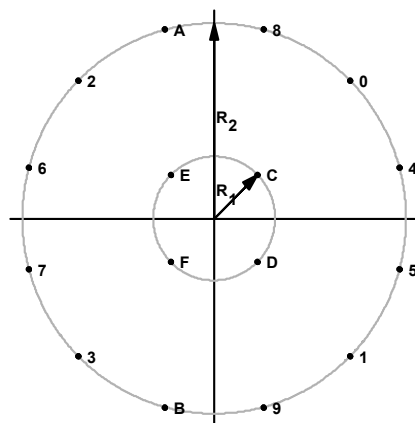


Figure 4-55: Constellation diagram for 16APSK including the logical symbol mapping for DVB-S2

For DVB-S2 16APSK mappings, the ratio of the outer circle radius to the inner circle radius ($\gamma = R_2/R_1$) depends on the utilized code rate and complies with [Figure 4-55](#).

Table 4-15: Optimum constellation radius ratio γ (linear channel) for 16APSK

Code Rate	Modulation / coding spectral efficiency	γ
2/3	2.66	3.15
3/4	2.99	2.85
4/5	3.19	2.75
5/6	3.32	2.70
8/9	3.55	2.60
9/10	3.59	2.57

32APSK

For DVB-S2 32APSK mappings, the ratio of the middle circle radius to the inner circle radius is specified as $\gamma_1 = R_2/R_1$. The ratio of the outer circle radius to the inner circle radius is specified as γ_2 . Both ratios depend on the used code rate and comply with [Table 4-16](#).

Table 4-16: Optimum constellation radius ratios γ_1 and γ_2 (linear channel) for 32APSK

Code Rate	Modulation / coding spectral efficiency	γ_1	γ_2
2/3	3.74	2.84	5.27
3/4	3.99	2.72	4.87
4/5	4.15	2.64	4.64
5/6	4.43	2.54	4.33
8/9	4.49	2.53	4.30

4.3.12 User-defined modulation

In addition to the modulation types defined by the standards, modulation (including symbol mappings) can also be defined according to user requirements. In this case, the mapping is defined and stored in a specific format (*.vam file format) and then loaded to the R&S FPL1000 VSA application. Modulation files in .vam format can be defined using a mapping wizard ("mapwiz"), an auxiliary tool provided by R&S via Internet free of charge. This tool is a precompiled MATLAB® file (MATLAB pcode). To download the tool together with a detailed description, see <http://www.rohde-schwarz.com> (search term "mapwiz").

4.4 Overview of the demodulation process

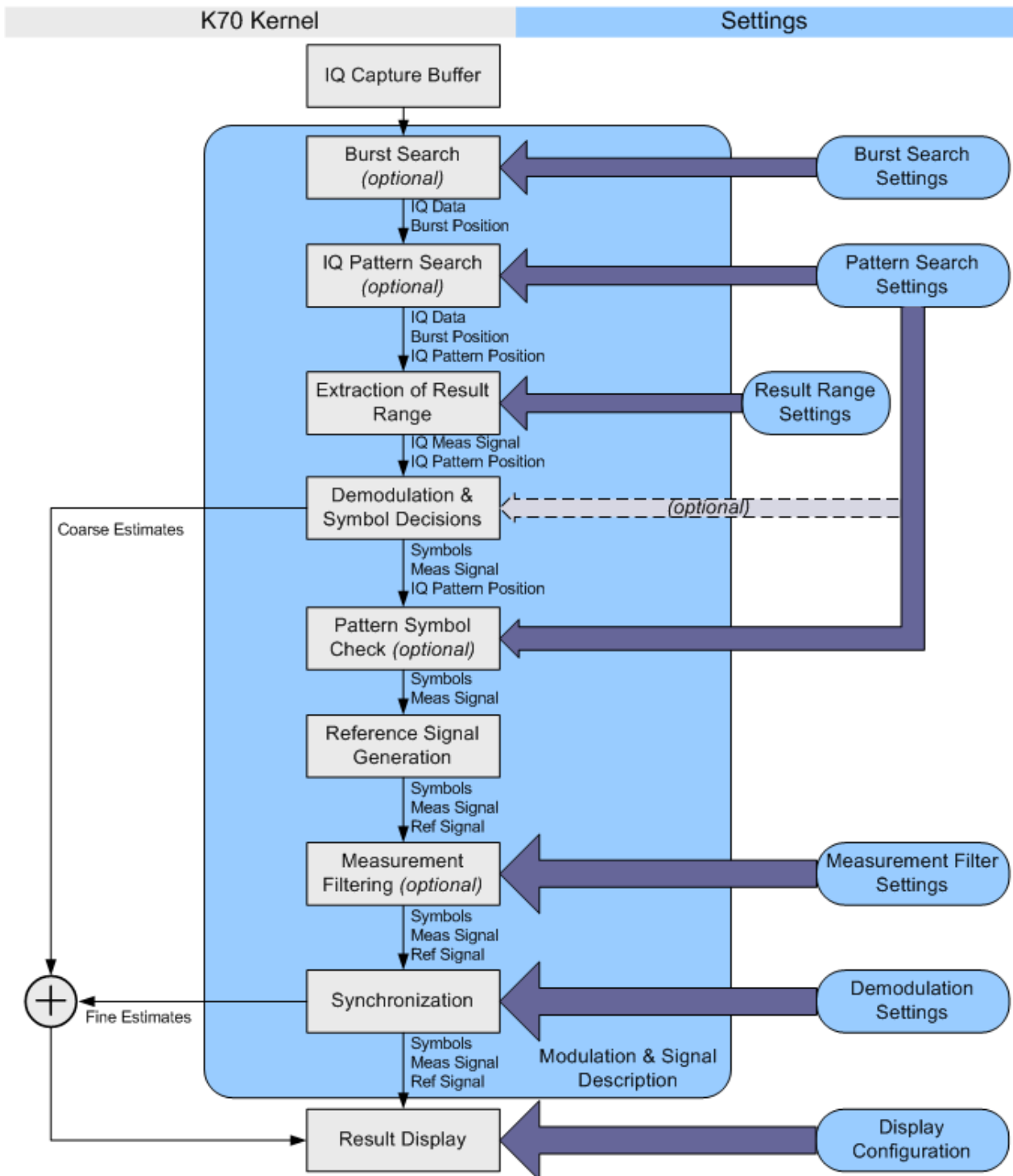


Figure 4-56: Demodulation stages of the vector signal analysis option

The [Figure 4-56](#) provides an overview of the demodulation stages of the vector signal analysis option. The function blocks of the signal processing kernel can be found at the left (in grey) and their appropriate settings at the right (in blue).

A more detailed description of the most important stages is given in the following sections.

Burst Search

In this stage, the capture buffer is searched for bursts that comply with the signal description. The search itself can be switched on or off via the "Burst Search" dialog (see ["Enabling Burst Searches"](#) on page 207). A list of the detected bursts is passed on to the next processing stage.

I/Q Pattern Search

The "I/Q Pattern Search" is performed on the capture buffer. The R&S FPL1000 VSA application modulates the selected pattern according to the transmit filter (Tx filter) and the modulation scheme. Then, it searches the capture buffer for this I/Q pattern, i.e. the I/Q waveform of the pattern. It is assumed that patterns can only appear within bursts, i.e. the I/Q pattern search range is limited to the bursts detected by the burst search stage. If the burst search is switched off, the whole capture buffer is searched for the I/Q pattern. A list of all detected I/Q patterns is passed on to the next processing stage. It is important to note that the R&S FPL1000 VSA application can only search for one pattern at a time.

The pattern search can be switched on or off via the "Pattern Search" dialog (see ["Enabling Pattern Searches"](#) on page 209).

Extraction of Result Range

The result range can be aligned to a burst, an I/Q pattern, or simply the start of the capture buffer (see ["Reference"](#) on page 217). Within this stage, the result range is cut from the capture buffer starting at a user-defined point, e.g. the start of a detected burst. The R&S FPL1000 VSA application automatically takes filter settling times into account by making the internal buffers sufficiently longer than the selected result range.

Demodulation & Symbol Decisions

This stage operates on the extracted result range and aims at making the correct symbol decisions to generate the correct reference signal. Within this stage, a coarse synchronization of the carrier frequency offset, the carrier phase, the scaling and the timing takes place. Furthermore, an automatically selected internal receive filter (Rx filter) is used to remove the intersymbol interference as effectively as possible. The outputs of this stage are the (coarsely) synchronized measurement signal and the symbol decisions (bits). The symbol decisions are later used for the "Pattern Symbol Check" stage and for the "Reference Signal Generation" stage.

Pattern Symbol Check

The "I/Q Pattern Search" stage can only detect whether the similarity between the I/Q pattern and the capture buffer exceeds a certain threshold. Thus, it finds the most likely positions for a pattern.

Within this stage, the R&S FPL1000 VSA application checks whether the pattern symbols (bits) really coincide with the symbol decisions at the pre-detected position. For example, if one out of 20 symbols does not coincide, the "I/Q Pattern Search" stage might detect this I/Q pattern, but the "Pattern Symbol Check" stage will decline it.

Note that this stage is only active if the pattern search is switched on.

If the I/Q pattern is not found, the error message "Pattern waveform not found" is displayed in the status bar

(See ["Message: Pattern Waveform Not Found"](#) on page 294).

If individual symbols do not match the pattern, these symbols are indicated by a red frame in the symbol table.

Reference Signal Generation

The ideal reference signal is generated based on the detected symbols and the specifications of the signal model, i.e. the modulation scheme and the transmit filter (Tx filter). Optionally, a predefined known data sequence or pattern can be used to generate the reference signal (see [Chapter 4.4.5, "Synchronization and the reference signal"](#), on page 121).

Measurement Filtering

Both the measurement signal and the reference signal are filtered with the specified measurement filter.

Synchronization

In this stage, the measurement signal and the reference signal are correlated. For PSK, QAM and MSK modulated signals, an estimation algorithm is used to obtain estimates for the following parameters:

- Signal amplitude
- Signal timing
- Carrier frequency error
- "Phase error"
- I/Q offset
- Gain imbalance
- Quadrature error
- Amplitude droop
- Symbol rate error (optionally)

For more information on synchronization, see

- [Chapter 4.4.5, "Synchronization and the reference signal"](#), on page 121

- [Chapter 4.5.1.2, "Estimation"](#), on page 127
- [Chapter 5.8.2, "Advanced demodulation \(synchronization\)"](#), on page 222

Result Display

The selected measurement results are displayed in the windows. Configuration of the windows can be performed via the result window configuration dialog (see [Chapter 6.5, "Display and window configuration"](#), on page 248).

- [Burst search](#)..... 115
- [I/Q pattern search](#)..... 116
- [Demodulation and symbol decisions](#)..... 117
- [Pattern symbol check](#)..... 120
- [Synchronization and the reference signal](#)..... 121
- [The equalizer](#)..... 123

4.4.1 Burst search

The burst search is performed only if it is switched on. Otherwise, this stage is skipped. If the signal is bursted, it is recommended that you switch the burst search on. This ensures that all internal estimators are operated in time ranges where the burst power ramping is up.

To eliminate amplitude variations caused by noise or the modulation itself, the instantaneous power of the whole capture buffer is calculated. Then a moving average filter is applied. The length of this filter is automatically determined with the help of the user settings.

The filtered power of the capture buffer is then compared to an automatically chosen threshold and the rising and falling edges of bursts are identified. With the help of the detected edges and some further processing, it is possible to decide whether the burst "candidates" comply with the user settings.

All bursts must have a length between ("Min Burst Length" – "Search Tolerance") and ("Max Burst Length" + "Search Tolerance") to be accepted. See ["Burst Settings"](#) on page 170 and [Chapter 5.6.1, "Burst search"](#), on page 207 for a more detailed description of these parameters.

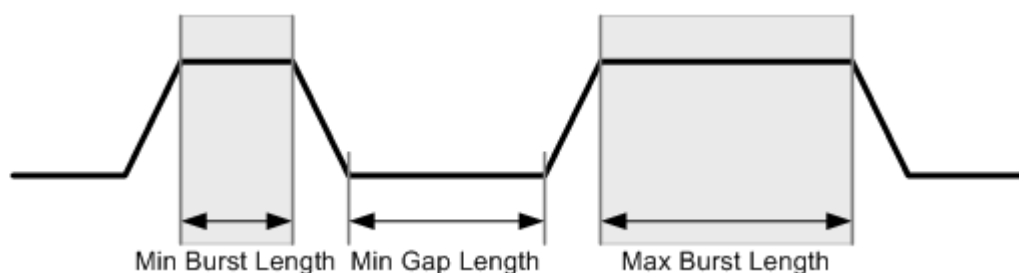



Figure 4-57: Burst Search parameters

 You can influence the robustness of the burst search directly by entering the correct minimum gap length, minimum burst length and maximum burst length (see "[Burst Settings](#)" on page 170 and "[Min Gap Length](#)" on page 208).

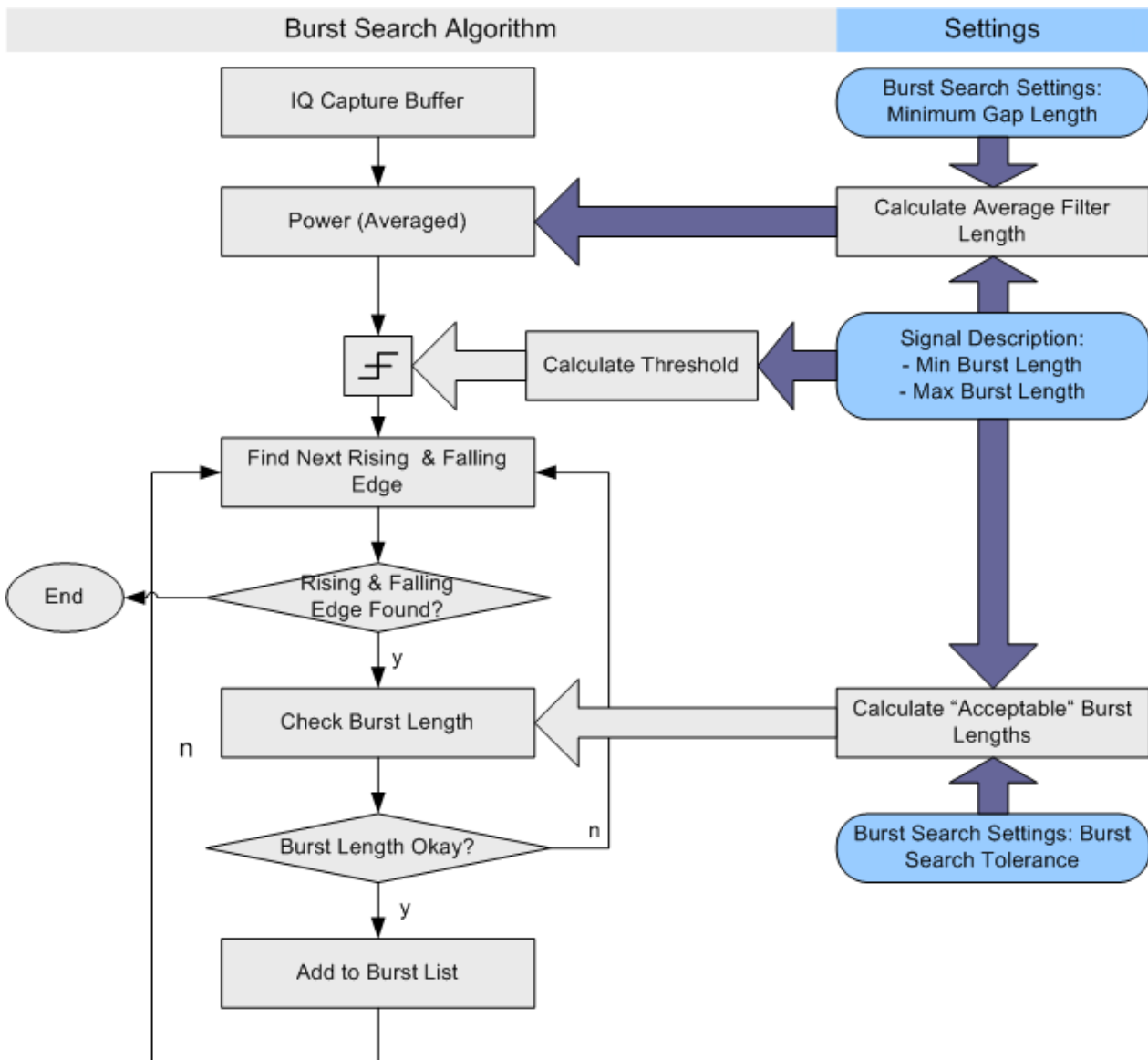


Figure 4-58: Burst search algorithm

4.4.2 I/Q pattern search

The I/Q pattern search is performed only if it is switched on. Otherwise, this stage is skipped. The main benefit of the I/Q pattern search is that it enables an alignment of the result range to the pattern. Furthermore, this stage can function as a filter, so only bursts with the correct pattern are demodulated. Switch the burst search and I/Q pat-

tern search on, and set the parameter "Meas Only If Pattern Symbols Correct" to true (see ["Meas only if Pattern Symbols Correct"](#) on page 210).

During the I/Q pattern search stage, the capture buffer is searched for an I/Q pattern by trying different time and frequency hypotheses. The I/Q pattern is generated internally, based on the specified symbol number of the pattern and the signal description (i.e. modulation scheme and transmit filter). The I/Q pattern search can also be referred to as the pattern waveform search. An I/Q pattern is considered detected if the correlation metric, i.e. the correlation value between the ideal I/Q pattern and capture buffer, exceeds a specified "I/Q Correlation Threshold" (see ["I/Q Correlation Threshold"](#) on page 210.)

If the burst search is switched on, the I/Q pattern search only searches the I/Q pattern in bursts previously detected by the burst search. Furthermore, it only finds the first I/Q pattern within each burst. If the burst search is switched off, the I/Q pattern search searches for the I/Q pattern in the entire capture buffer.

Predefined Patterns

Common standards usually have predefined pattern lists with standard-specific patterns. You select the patterns required for the current measurement from this list. You can also add patterns that are already available in the R&S FPL1000 or newly created patterns to the list.

4.4.3 Demodulation and symbol decisions

This stage operates on the result range and aims to make the correct symbol decisions. The algorithm is illustrated in [Figure 4-59](#) using the example of a QPSK modulation. After timing and scaling recovery, a frequency offset and phase offset estimator is employed.

After this coarse synchronization, the R&S FPL1000 VSA application makes symbol decisions, i.e. recovers which symbols were transmitted by the device under test (DUT).

Typically, the employed estimators are "non-data-aided" (NDA) estimators. NDA means that they operate on an unknown data sequence. Since the local oscillators (LO) of the transmitter (device under test) and the receiver (R&S FPL1000) are normally not coupled, their phase offset with respect to each other is unknown. The unknown transmission delay between DUT and R&S FPL1000 adds a further unknown phase offset.

Due to this unknown phase offset and the rotational symmetry of, e.g., a PSK constellation, the result of the demodulation can be ambiguous concerning the absolute phase position. For example, for non-differential QPSK modulation, the measurement signal, the reference signal and the decided I/Q symbols can have a constant phase offset of $\{0, \pi/2, \pi, \text{ or } 3\pi/2\}$. This offset can only be detected and eliminated if a pattern was successfully detected at symbol level (see also [Chapter 4.4.4, "Pattern symbol check"](#), on page 120).

If modulation types are used where the information is represented by the phase transition, e.g. differential PSK or MSK, the absolute phase position is not an issue. Thus,

the ambiguity of the starting phase does not have an influence on the symbol decisions.

If the measurement signal contains a known pattern, it is also possible to use a "data-aided" (DA) estimator at this stage. DA means that the estimator operates on a known data sequence, i.e. the pattern. If the signal contains a pattern, it is possible to choose between the above-described non-data-aided estimator and the data-aided estimator with the setting "**Coarse Synchronization**: Pattern". If the data-aided estimator is employed, the phase ambiguity can be resolved at this stage.

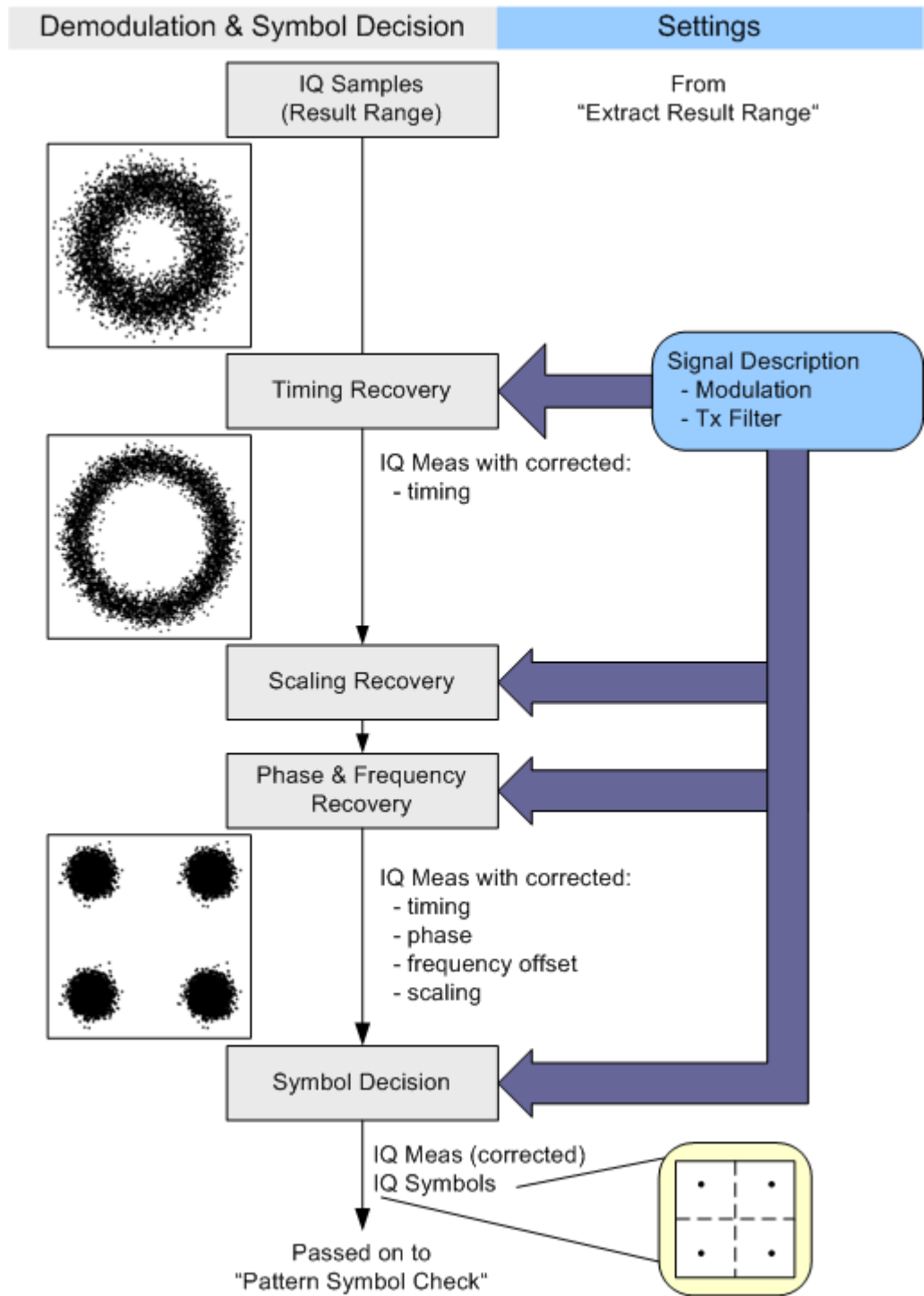


Figure 4-59: Demodulation and Symbol Decision algorithm

4.4.4 Pattern symbol check

This stage performs a bit-by-bit comparison between the selected pattern and the demodulated bits. It is important to note that this comparison is only performed at positions that the I/Q pattern search identified as possible pattern positions. The algorithm and a simple example are illustrated in [Figure 4-60](#).

First, the pattern candidate bits are extracted from the whole bitstream calculated by the "Demodulation & Symbol Decisions" stage. The symbol stream is cut at the position that the [I/Q pattern search](#) detected as the start of the pattern. The extracted sequence is then compared to the selected pattern.

If the demodulation was ambiguous regarding the absolute phase position, the extracted sequence must be compared to all possible rotated versions of the selected pattern. For example, for QPSK modulation, the rotational symmetry has the order four, i.e. there are four pattern hypotheses. If the extracted sequence coincides with one of the hypotheses, the pattern is declared as "found" and the absolute phase corresponding to the appropriate hypothesis is passed on. Both the symbol decisions and the I/Q measurement signal are then rotated with this pattern phase (for the whole result range), thus resolving the phase ambiguity.

For more information refer to:

- [Chapter 4.4.3, "Demodulation and symbol decisions"](#), on page 117
- [Chapter 4.4.2, "I/Q pattern search"](#), on page 116

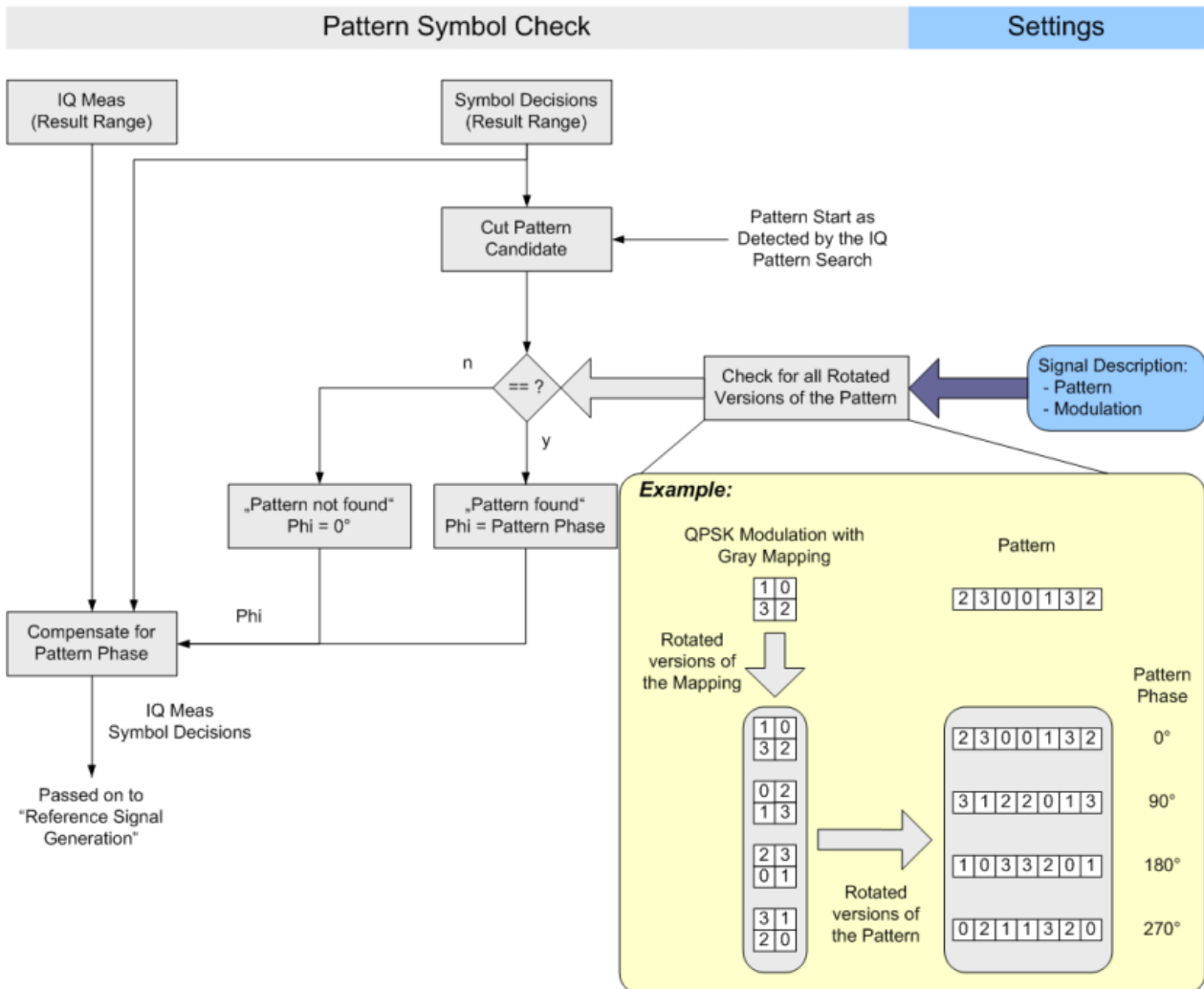


Figure 4-60: Pattern Symbol Check algorithm

4.4.5 Synchronization and the reference signal

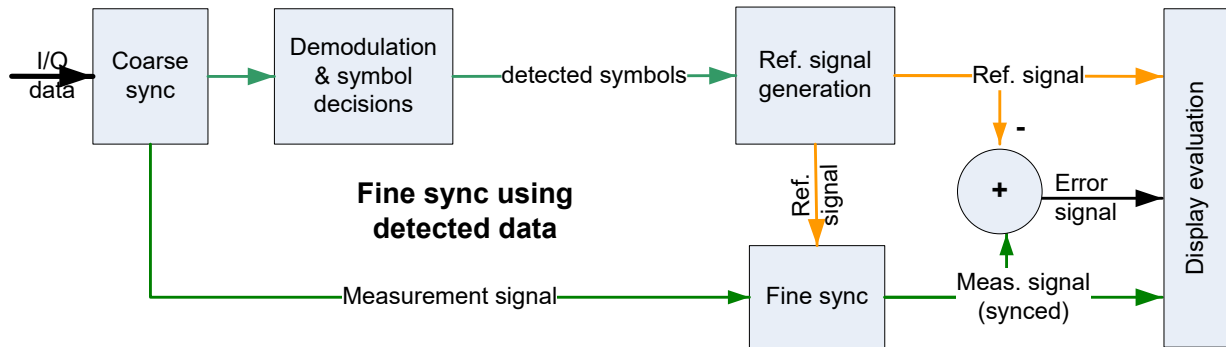
The R&S FPL1000 VSA application generates the ideal reference signal based on the detected symbols and the specifications of the signal model, that is: the modulation scheme, the transmit filter (Tx filter), and the transmitted symbols. In the fine synchronization stage, the measurement signal and the reference signal are correlated to obtain a more precisely synchronized measurement signal.

The results of the correlation are used to calculate various results, e.g. the EVM and BER. Various methods are available to determine the reference signal and perform fine synchronization.

Fine synchronization using detected data

By default, the reference signal is estimated from the detected data. However, if the signal has a poor transmission quality or a high noise level, false symbol decisions are

more frequent. False decisions can cause spikes in the EVM results and lead to a false reference signal.



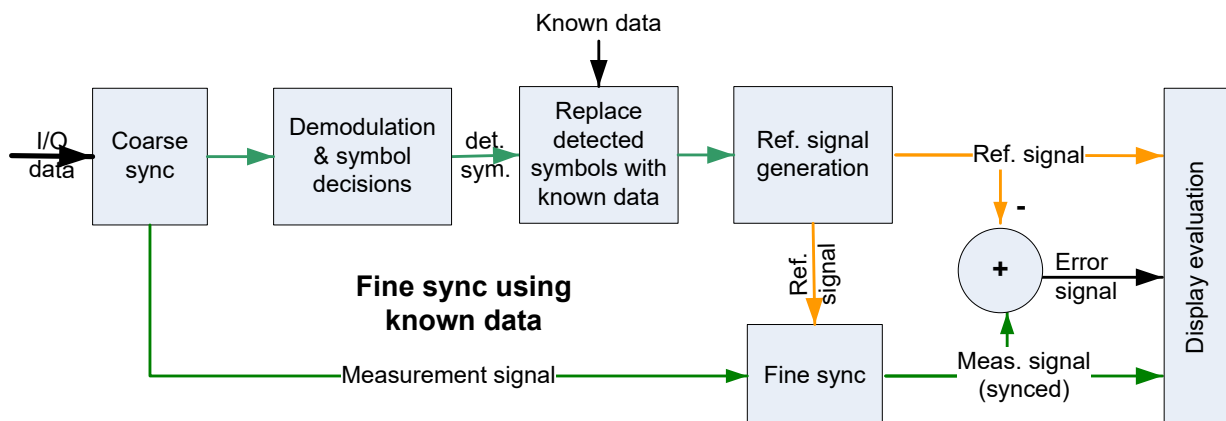
To improve the symbol decisions in poor signals, in particular when multiple detection errors occur, the reference signal can be estimated from a smaller area that includes a known symbol sequence in the input signal. In this case, the results for the limited reference area are more precise, at the cost of less accurate results outside this area. The reference area can be defined either using a pattern or using a known data sequence from a Known Data file. If no predefined data sequences are available for the signal, the detected data is used by default.

Fine synchronization using known data

If the data sequences to be expected in the signal are known in advance, they can be loaded to the R&S FPL1000 VSA application and used for comparison with the measured signal. The reference signal is then defined as the data sequence from the file that most closely matches the measured data.

Additionally, you can define a maximum symbol error rate (SER) for the known sequence in reference to the measured data. If the SER of the known sequence exceeds this limit, the default synchronization using the detected data is performed.

Thus, assuming a perfect match exists in the known data, this sequence is the ideal reference signal, with no detection errors. The EVM is calculated correctly and fine synchronization is very precise.

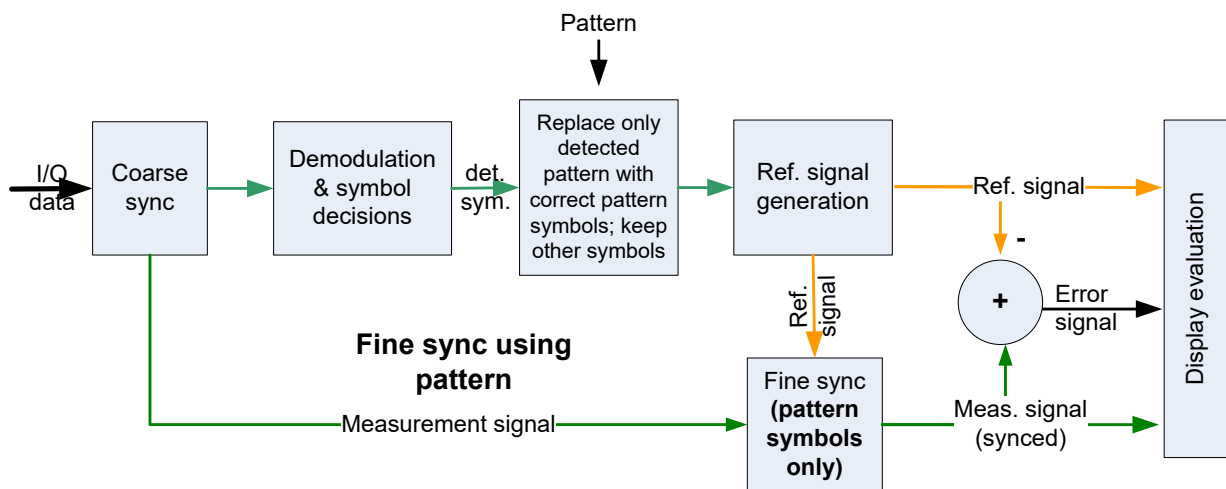


Fine synchronization using a pattern

Sometimes, the data sequence to be expected in the entire result range is not known in advance; however, a specific symbol pattern that always occurs is known. In this case, the reference signal can be estimated from the defined pattern where available, while all data outside the pattern is estimated using the detected symbols. Detection errors within the pattern are corrected. The EVM is calculated using the complete reference signal; it is correct only within the pattern.

Fine synchronization, on the other hand, is performed only within the pattern range, which is usually much shorter than the result range. The fewer the symbols on which synchronization is based, the less accurate it becomes.

To obtain correct results for all evaluated data, it is recommended that you reduce the result range to the length of the pattern.



4.4.6 The equalizer

A possible source of high "modulation errors" of the DUT with PSK and QAM signals is a non-flat frequency response or ripple in frequency response within the modulation bandwidth.

The following components of the DUT can cause these effects:

- Analog filter sections
- Digital filter sections, if a shortened filter length is used
- Digital arithmetic sections, if a shortened bit-length is used

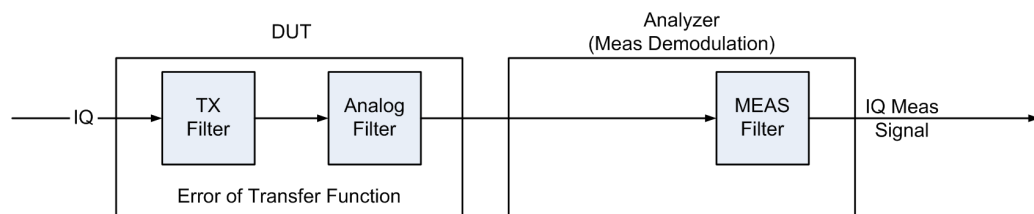


Figure 4-61: General processing in the modulation- and demodulation stages

To improve the modulation analysis results, an "equalizer" filter with a reverse frequency response characteristic can compensate less-distorted frequency responses (see Figure 4-62).

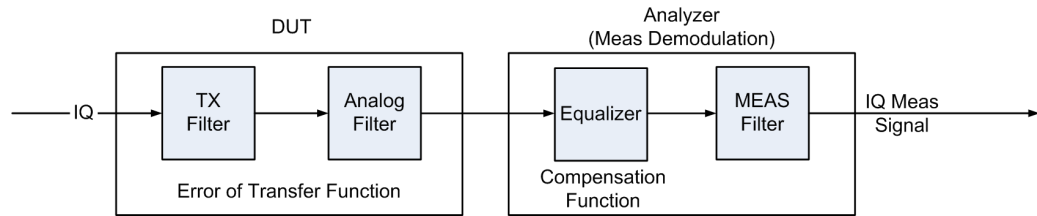


Figure 4-62: Compensation of the transfer function error by inserting an equalizer in the receive path

For small distortions, the reference signal can be determined correctly without pre-equalization. The "equalizer" can be calculated by comparing the reference signal and the measured signal. It is only applied to the measured signal, which is referred to as **normal equalizer mode**. Note that the resulting equalizer function is not simply the inverted distortion function.

For more complex distortions, the reference signal is possibly not determined correctly due to wrong symbol decisions. Despite the resulting imperfect equalizer calculation, the estimated equalizer is often good enough to improve the reference signal creation in the subsequent sweep. Thus, the new equalizer is improved successively. This processing mode of the equalizer is called **tracking mode**. After only a few sweeps, the results are sufficiently accurate and the learning phase is completed. Then the equalizer can be used without additional calculations as long as the input signal remains stable. If an unstable input has led to an unusable equalizer filter, reset the equalizer with the "Reset" button.

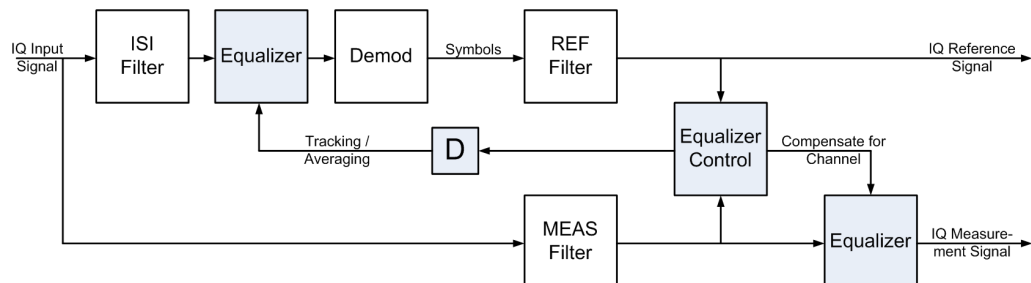


Figure 4-63: An equalizer filter can be activated in the reference and measurement signal path. The filter coefficients are determined in such a way that the error vector magnitude (EVM) is minimized.

If the result range used for equalizer calculation is too short, the equalizer can provide unstable impulse responses. For time-invariant channels, the estimation length can be extended using **Averaging mode**. In this case, the statistics from *all* previously determined reference signals and measurement signals are averaged to determine the current equalizer function. Thus, the results of previous sweeps are continuously considered to calculate the current equalizer values. Averaging is only restarted when the R&S FPL1000 is switched off or when the user manually resets the equalizer. Obviously, this method requires a stable input signal for the entire duration of the measurement, as otherwise previous results distort the current equalizer.

This process requires extended calculation time so that the measurement update rate of the R&S FPL1000 decreases distinctly. When the distortions are compensated sufficiently, this averaging process can be stopped. The current filter is **frozen**, that means it is no longer changed.

Keep in mind that in tracking and averaging mode, for sweep counts > 1, repeated analysis of past result ranges can lead to different results.

The "equalizer" algorithm is limited to PSK and QAM modulation schemes, as the optimization criterion of the algorithm is based on minimizing the mean square "error vector" magnitude. Thus it cannot be used for FSK modulation.

User-defined equalizers

Instead of tracking equalizer values repeatedly for different input signals, you can store existing values to a file and load them again later. Storing data is useful if signals from the same input source are measured frequently. In this case, you only have to calculate a filter once and can use the same equalizer filter again and again.

Filter length

The length of the "equalizer" can be defined in symbols. The longer the equalizer the higher the resolution in the frequency domain is and the more distortion can be compensated. The shorter the filter length, the less calculation time the equalizer requires during the tracking or averaging phase.

Estimation points per symbol

You can define how many sample points are used for the "equalizer" calculation at each symbol ("Estimation points per symbol", see [Chapter 4.7, "Display points vs estimation points per symbol"](#), on page 147). Typically, it is one point per symbol (= **symbol rate**) or a factor of 2.

Channel EVM

The equalizer not only compensates for distortions in the measurement signal, but also improves the accuracy of the estimated ideal reference signal. Thus, it is recommended that you enable the equalizer once you have analyzed the original input signal on the R&S FPL1000. By default, the error results are calculated using the compensated values if the equalizer is enabled. However, to analyze the actual error values obtained from the distorted channel, you can disable the compensation for channel results.

4.5 Signal model, estimation and modulation errors

This section describes the signal and error models used within the R&S FPL1000 VSA application. The estimation algorithms used to quantify specific modulation errors are then outlined. The descriptions vary depending on the modulation type.

- [PSK, QAM and MSK modulation](#)..... 126
- [FSK modulation](#)..... 137

4.5.1 PSK, QAM and MSK modulation

4.5.1.1 Error model

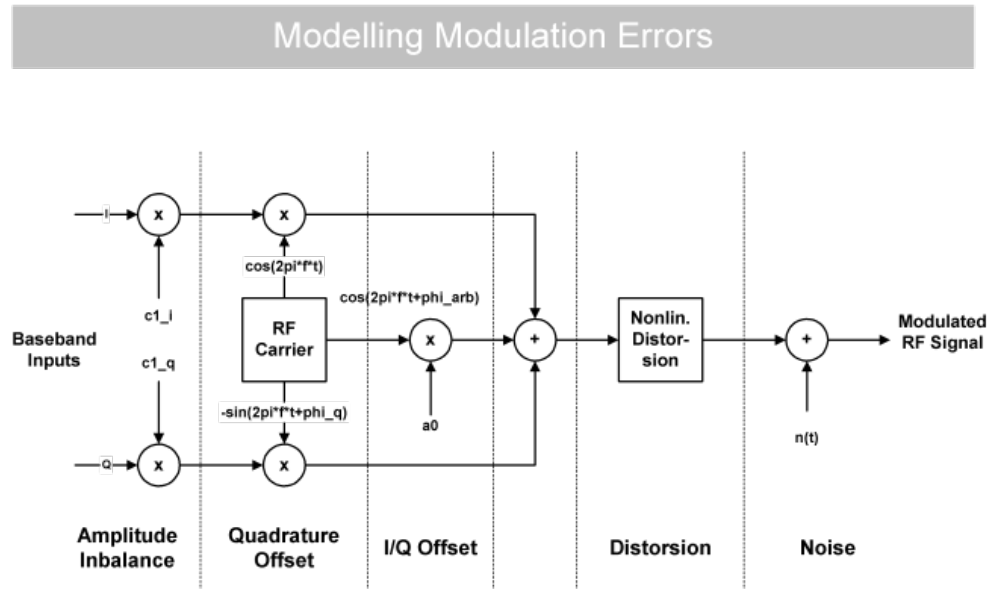


Figure 4-64: Modeling Modulation Errors

The measured signal model for PSK, QAM and MSK modulation is shown in Figure 4-64 and can be expressed as:

$$Meas(t) = (g_I \cdot REF_I(t - \tau_I) + c_I + j \cdot (g_Q \cdot REF_Q(t - \tau_Q) + c_Q) \cdot e^{j\vartheta}) e^{j \cdot (2\pi f_0 t + \varphi) - \alpha t} + n(t)$$

Where:

$REF_I(t)$ and $REF_Q(t)$: the inphase and quadrature component of the reference signal

g_I and g_Q : the effects of the gain imbalance

c_I and c_Q : the effects of an I/Q offset

ϑ : the quadrature error

α : the amplitude droop

f_0 : the carrier frequency offset

φ : the carrier phase offset

τ_I / τ_Q : the timing offset for the inphase / quadrature components

$n(t)$: a disturbing additive noise process of unknown power

4.5.1.2 Estimation

The R&S FPL1000 VSA application includes two synchronization stages. The first stage has already been described in the context of the "Demodulation & Symbol Decisions" block (see [Chapter 4.4.3, "Demodulation and symbol decisions"](#), on page 117).

The second stage is realized within the "Synchronization" block. Here, the measurement signal is matched to the reference signal by minimizing the mean square of the error vector magnitude. To do so, the optimum parameter vector \hat{x} is determined:

$$\hat{x} = \arg \min_{\tilde{x}} \left\{ \sum_t |MEAS(t) - REF(t, \tilde{x})|^2 \right\}$$

The minimization takes place at the sample instants specified by the [Estimation Points/Sym](#) parameter, i.e.

$$t = n \cdot T_E$$

With T_E : the sampling period used for estimation

Then, the measurement signal is corrected with the determined parameter vector. Note that with a subset of the parameters, you can enable or disable correction (see [Chapter 5.8.1, "Demodulation - compensation and equalizer"](#), on page 218).

Estimation ranges

The "estimation ranges" are determined internally according to the signal description:

- For continuous signals, the estimation range corresponds to the entire result range, since it can then be assumed that the signal consists of valid modulated symbols at all time instants.
- For bursted signals, the estimation range corresponds to the overlapping area of the detected burst and the "Result Range". Furthermore, the Run-In/Run-Out ranges (see ["Burst Settings"](#) on page 170) are explicitly excluded from the estimation range.

In rare cases, the signal is specified as a "burst signal", but is so highly distorted that the burst search cannot detect a burst. In this case, the estimation range corresponds to the pattern. If an offset of the pattern relative to the burst start is specified, this range is also part of the estimation range.

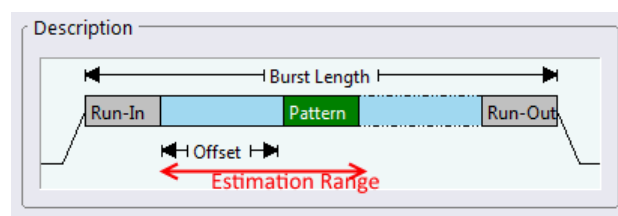


Figure 4-65: Estimation range for a bursted signal with a pattern offset

4.5.1.3 Modulation errors

Error vector (EV)

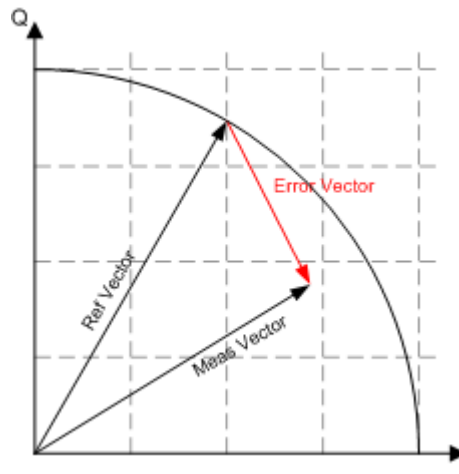


Figure 4-66: Modulation error: error vector

The "error vector" is the difference between the measurement signal vector (Meas vector) and the reference signal vector (Ref vector).

Error Vector Magnitude (EVM)

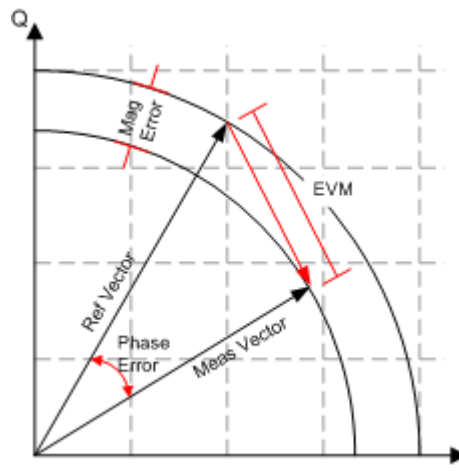


Figure 4-67: Modulation error: EVM, magnitude error, phase error

The magnitude of the error vector in the diagram is specified as the error vector magnitude (EVM). It is commonly normalized to the mean reference power, or alternatively to the maximum reference power or the mean or maximum constellation power (power at the symbol instants, see "[Normalize EVM to](#)" on page 223). Do not confuse the EVM with the magnitude error, see below.

Magnitude Error

The magnitude error is defined as the difference between the measurement vector magnitude and the reference vector magnitude (see [Figure 4-67](#)).

Phase Error

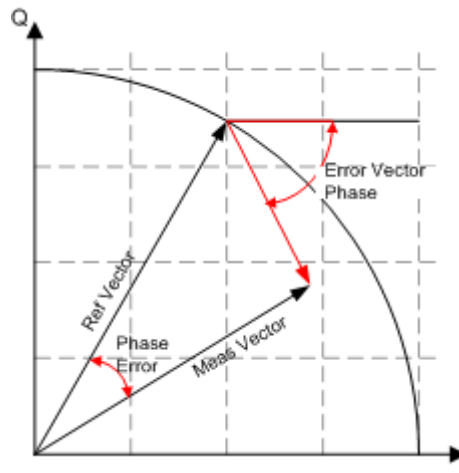


Figure 4-68: Modulation error: Phase error, error vector phase

The phase error is the phase difference between the measurement vector and the reference vector.

$$PHASE_ERR(t) = PHASE_{MEAS}(t) - PHASE_{REF}(t)$$

This measurement parameter is of great importance for MSK modulation measurements.

Do not confuse the phase error with the error vector phase. The error vector phase is the absolute phase of the error vector (see [Figure 4-68](#)).

The effects of the different "modulation errors" in the transmitter on the result display of the analyzer are described in the next topics. All diagrams show the equivalent, complex baseband signal.

Modulation Error Ratio (MER)

The modulation error ratio (MER) is closely related to EVM:

$$MER = -20 \cdot \log_{10}(EVM) \text{ dB}$$

Where the EVM is normalized to the mean reference power.

Symbol Rate Error (SRE)

The symbol rate error (SRE) describes the difference between the defined (reference) symbol rate and the currently measured symbol rate in relation to the reference symbol rate. The value is given in parts per million (ppm).

$$SRE = \frac{SR_{Meas} - SR_{Ref}}{SR_{Ref}}$$

The SRE is only calculated if compensation for SRE is activated (see [Chapter 5.8.1, "Demodulation - compensation and equalizer"](#), on page 218), and not for FSK modulation.

Example:

For a defined symbol rate of $SR_{Ref} = 1 \text{ MHz}$, and a measured symbol rate of $SR_{Meas} = 999.9 \text{ kHz}$, the symbol rate error is:

$$SRE = [(999.9 - 1000) / 1000] * 1\,000\,000 \text{ ppm} = -100 \text{ ppm}$$

I/Q Offset (Origin Offset)

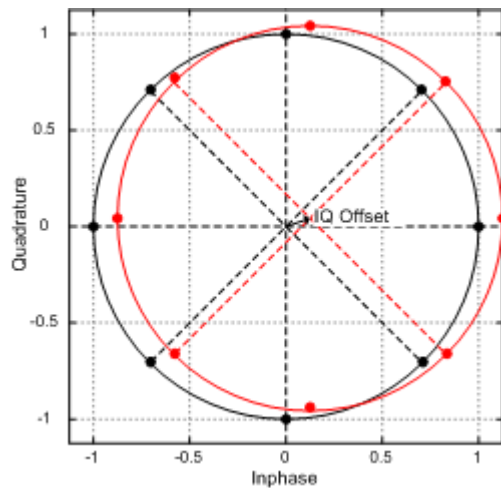


Figure 4-69: Effect of an I/Q or origin offset after demodulation and error compensation

The effect of an I/Q offset in the transmitter is shown in [Figure 4-69](#).

If the corresponding option is selected in the demodulation settings, the I/Q offset can be compensated for. In this case, the offset does not affect the EVM.

Example:

The following figures compare the results for a compensated I/Q offset of 2.5% and a non-compensated offset.

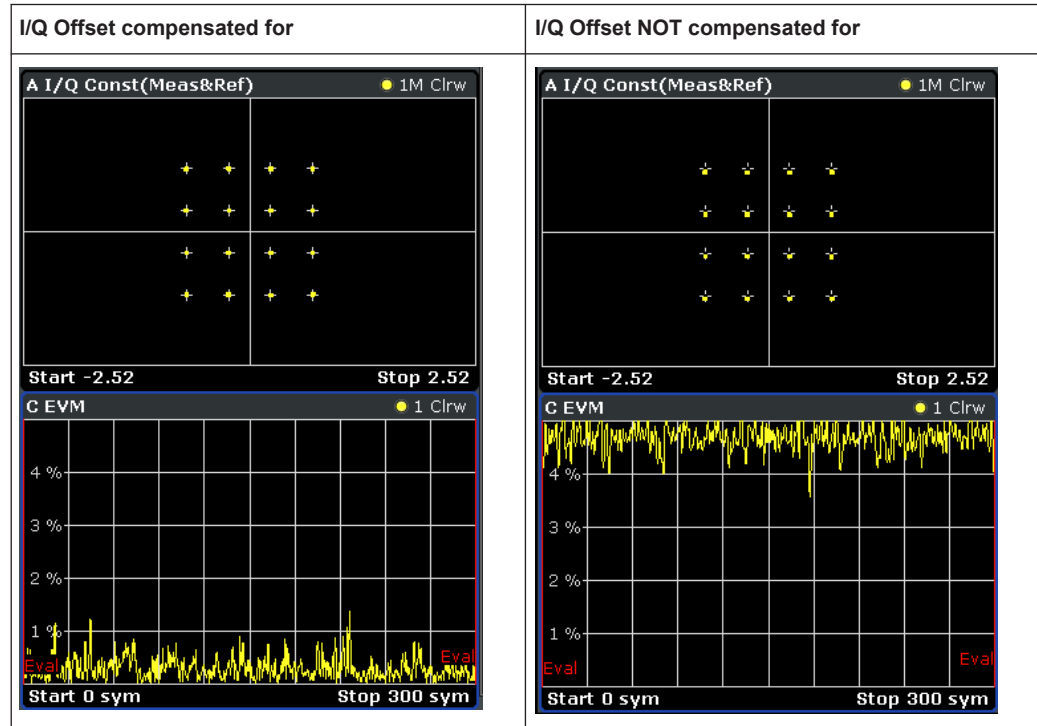
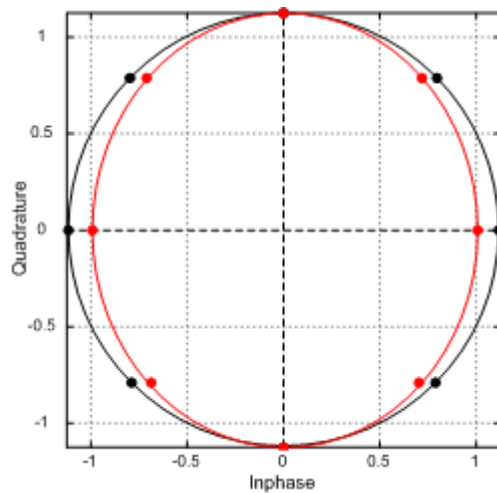
**Gain Imbalance**

Figure 4-70: Effect of gain imbalance

The gain difference in the I and Q channels during signal generation in the transmitter is referred to as gain imbalance. The effect of this error on the constellation diagram and the unit circle are shown in Figure 4-70. In the example, the gain in the I channel is slightly reduced which causes a distortion of coordinates in the I direction. The unit circle of the ideal constellation points has an elliptic shape.

If the corresponding option is selected in the demodulation settings, the gain imbalance can be compensated for. In this case, the imbalance does not affect the EVM.

Note that the gain imbalance is not estimated (and cannot be compensated for) in a BPSK signal.



Preconditions for Gain Imbalance and Quadrature Error measurements

The distortions "gain imbalance" and "quadrature error" can only be measured without ambiguity, if the following two conditions are fulfilled:

- A pattern is detected
- The modulation is a non-differential, non-rotating QAM or PSK

Otherwise, only the measurement parameter "I/Q Imbalance", which is a combination of the gain imbalance and the quadrature error, is significant.

Quadrature Error

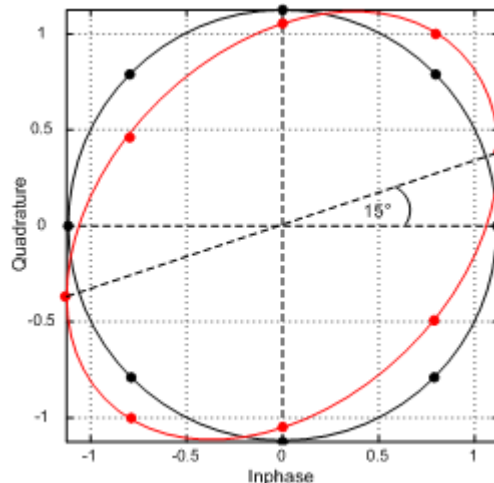


Figure 4-71: Effect of Quadrature Error

The quadrature error is another modulation error which is shown in [Figure 4-71](#).

In this diagram, the I and Q components of the modulated carrier are of identical amplitude but the phase between the two components deviates from 90° .

This error also distorts the coordinates. In the example in [Figure 4-71](#), the Q-axis is shifted.

Note that the quadrature error is not estimated (and cannot be compensated for) in a BPSK signal.

I/Q Imbalance

The effects of quadrature error and gain imbalance are combined to form the error parameter I/Q imbalance.

$$B_{[lin]} = \frac{|g_I - g_Q \cdot e^{j\theta}|}{|g_I + g_Q \cdot e^{j\theta}|}$$

Where g_I and g_Q are the gain of the inphase and the quadrature component and θ represents the quadrature error.

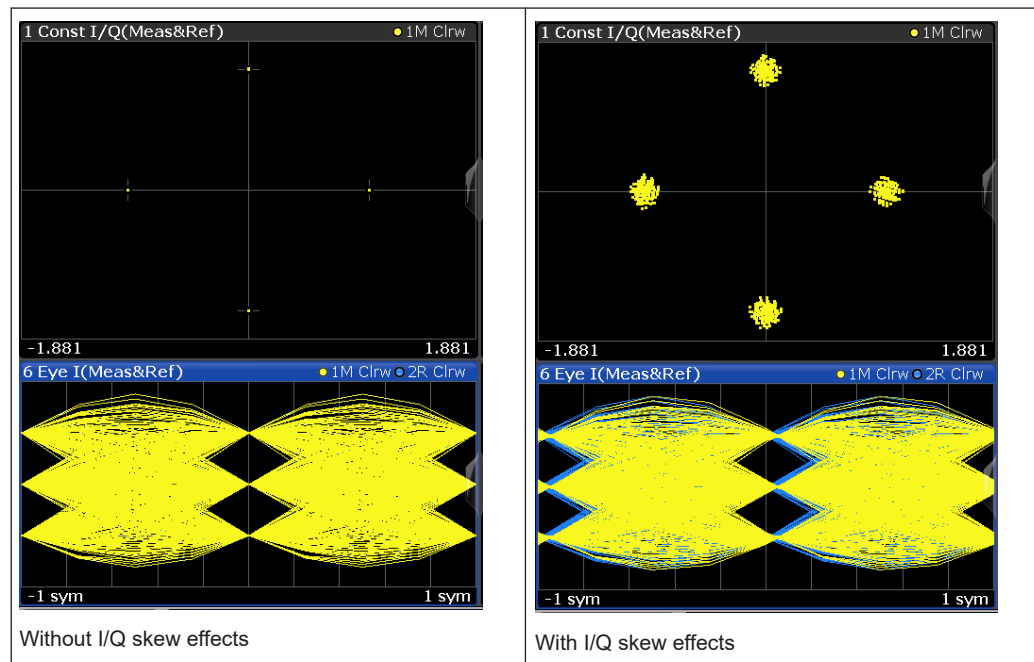
If the corresponding option is selected in the demodulation settings, the I/Q imbalance can be compensated for. In this case, the I/Q imbalance does not affect the EVM.

Note that the I/Q imbalance is not estimated (and cannot be compensated for) in a BPSK signal.

I/Q Skew

I/Q skew is a constant time difference between the I and the Q data, for example due to different cable lengths.

Table 4-17: Effects of I/Q skew



I/Q skew results depend on modulation

The I/Q skew estimation primarily targets signals with modulations that have a rotation symmetry of $\pi/2$, such as QPSK, 16QAM, or 64QAM. Phase ambiguities that are not a multiple of $\pi/2$ cannot be resolved. Thus, to measure I/Q skew for an 8PSK modulation, for example, it is essential to provide an absolute phase reference. You can provide this reference using a pattern.

Furthermore, I/Q skew cannot be determined for signals whose constellation points all have the same I or Q values, for example using BPSK modulation. In this case, no value is available for the I/Q skew result in the "Result Summary".

Amplitude Droop

The decrease of the signal power over time in the transmitter is referred to amplitude droop.

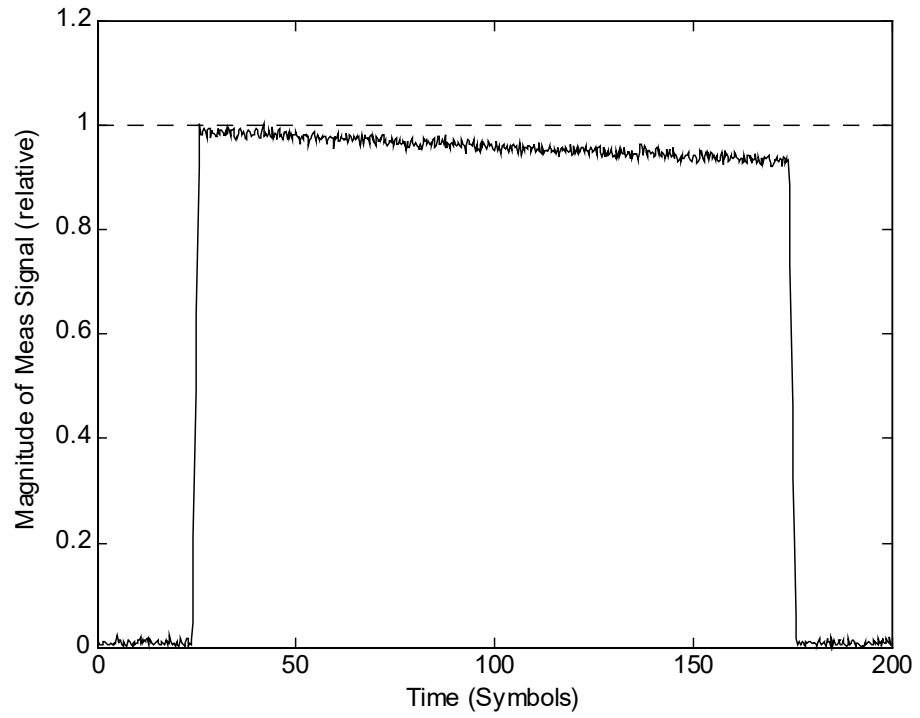


Figure 4-72: Effect of amplitude droop

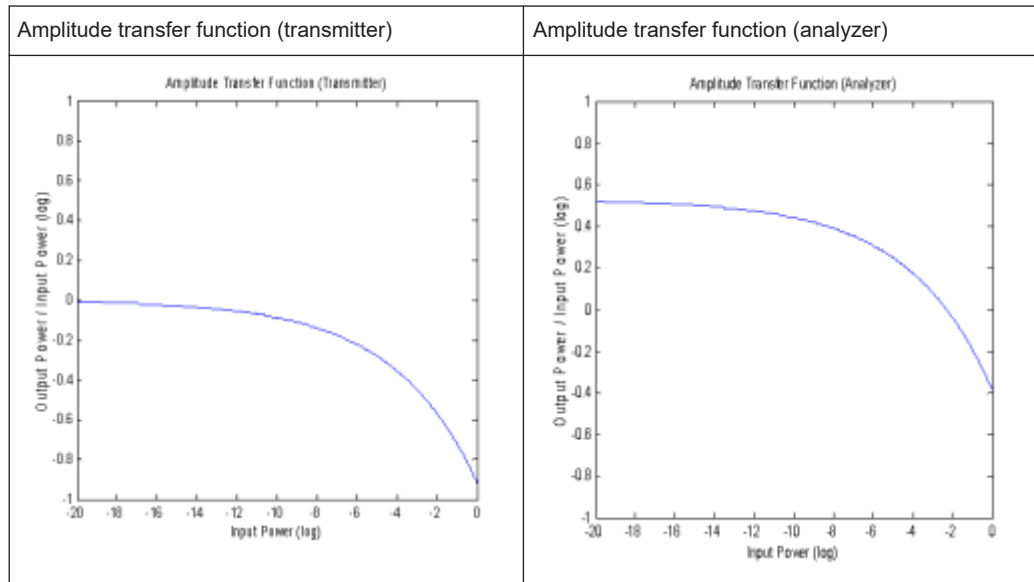
Gain Distortion

Table 4-18: Effect of nonlinear amplitude distortions

Nonlinear distortions: amplitude distortion (transmitter)	Amplitude distortion (analyzer)

The effect of nonlinear amplitude distortions on a 64QAM signal is illustrated in [Table 4-18](#) (only the first quadrant is shown). The transfer function is level-dependent: the highest effects occur at high input levels while low signal levels are hardly affected. The signal is scaled in the analyzer so that the average square magnitude of the error vector is minimized. The second column shows the signal after scaling.

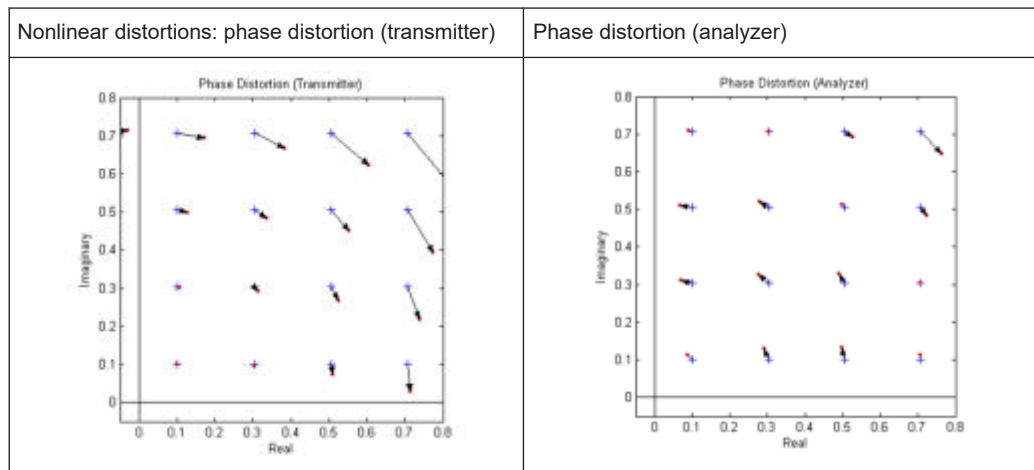
Table 4-19: Amplitude transfer functions



A logarithmic display of the amplitude transfer functions is shown in [Table 4-19](#). The analyzer trace is shifted against the transmitter trace by this scale factor.

Phase Distortion

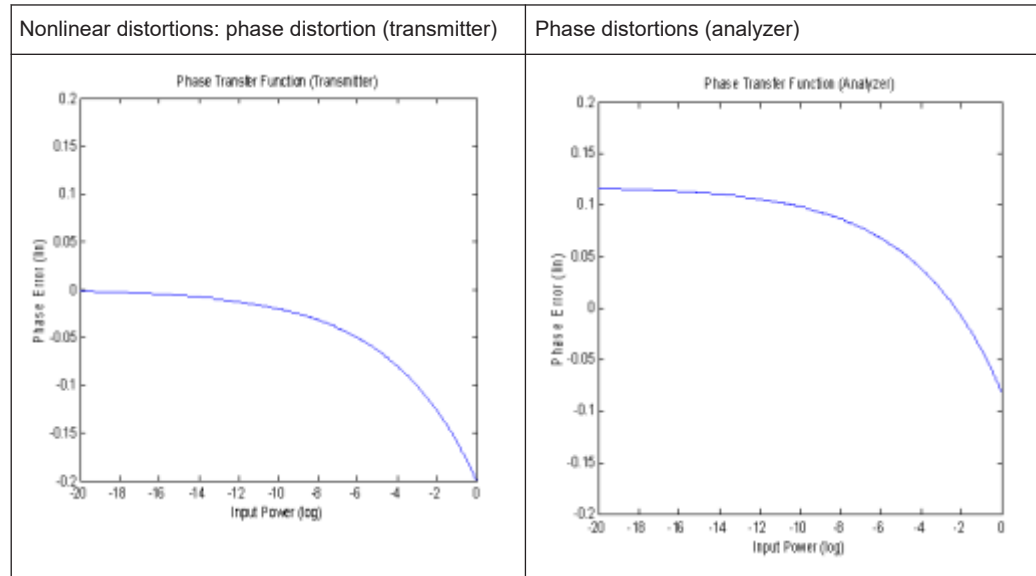
Table 4-20: Effect of nonlinear phase distortions



The effect of nonlinear phase distortions on a 64QAM signal is illustrated in [Table 4-20](#) (only the first quadrant is shown). The transfer function is level-dependent: the highest effects occur at high input levels while low signal levels are hardly affected. These effects are caused, for instance, by saturation in the transmitter output stages. The sig-

nal is scaled in the analyzer so that the average square magnitude of the error vector is minimized. The second column shows the signal after scaling.

Table 4-21: Phase transfer functions



A logarithmic display of the phase transfer functions is shown in [Table 4-21](#). The analyzer trace is shifted by the phase described above compared to the transmitter trace.

Noise

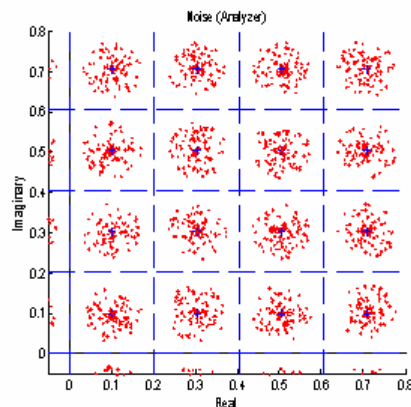


Figure 4-73: Additive noise

A 64QAM signal with additive noise is shown in [Figure 4-73](#) (only the first quadrant is shown). The symbol decision thresholds are also shown.

The noise signal forms a "cloud" around the ideal symbol point in the constellation diagram. If the symbol decision boundaries are exceeded, wrong symbol decisions are made, increasing the bit error rate.

Similar displays are obtained for incorrect transmitter filter settings. When an incorrect filter is selected, crosstalk occurs between neighboring symbol decision points instead

of the ISI-free points. The effect increases the more the filtering deviates from actual requirements.

The two effects described cannot be distinguished in the "Constellation I/Q" diagram but in statistical and spectral analyses of the error signal.

Channel (transmission) distortion

During transmission, disturbances in the transmission channel can cause distortions in the input signal at the R&S FPL1000. Such influences are included in the EVM calculation. However, if the ideal (reference) signal can be estimated with sufficient accuracy by the R&S FPL1000 (e.g. using the equalizer), the channel distortions can be compensated for and deducted from the EVM.

4.5.2 FSK modulation

Signal Model

Frequency shift keying (FSK) involves the encoding of information in the frequency of a transmitted signal. As opposed to other modulation formats such as PSK and QAM, the FSK process is a non-linear transformation of the transmitted data into the transmitted waveform.

A sequence of symbols $\{s_i\}$ are modulated using a "frequency pulse" $g(t)$ to form the instantaneous frequency of the transmitted complex baseband waveform, denoted by $f_{REF}(t)$ and defined as:

$$f_{REF}(t) = h \cdot \sum_i s_i g(t - i \cdot T)$$

Where $f_{Symb} = 1/T$ is the symbol rate and h is a scaling factor, termed the modulation index. The transmitted (or reference) FSK signal is created by frequency modulation of the instantaneous frequency:

$$REF(t) = e^{j \cdot 2 \cdot \pi \cdot \int_{-\infty}^t f_{REF}(u) du} = e^{j \cdot \varphi_{REF}(t)}$$

Where $\varphi_{REF}(t)$ denotes the phase of the transmitted waveform. In the R&S FPL1000 VSA application, a continuous-phase FSK signal is assumed, which is ensured by the integral in the expression for $REF(t)$. A graphical depiction of the reference waveform generation is shown below in [Figure 4-74](#).

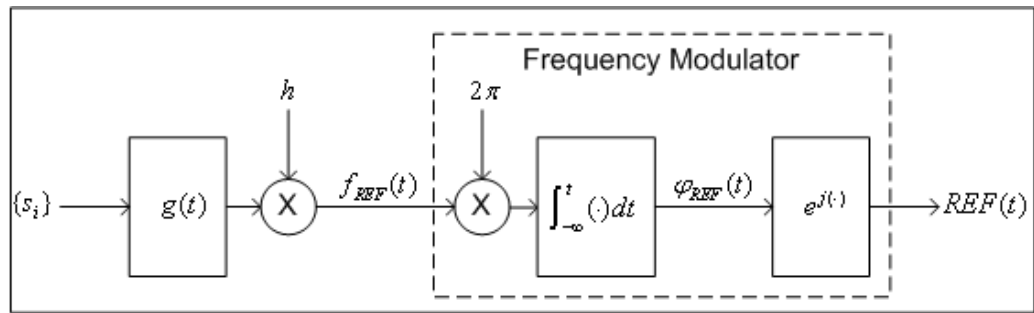


Figure 4-74: Reference complex baseband FSK signal generation

Reference Deviation

The transmitted symbols $\{s_i\}$ are assumed to be chosen from a finite and real-valued constellation of M values; $\{\zeta_1, \zeta_2, \dots, \zeta_M\}$. The maximum absolute constellation point is denoted by ζ_{MAX} . The maximum phase contribution of a data symbol is given by:

$$\phi_{MAX} = 2 \cdot \pi \cdot h \cdot \zeta_{MAX} \int_{-\infty}^{\infty} g(t) \cdot dt$$

The reference deviation of the FSK signal is defined as:

$$\Lambda_{REF} = \frac{\phi_{MAX}}{2 \cdot \pi \cdot T} = \frac{1}{T} h \cdot \zeta_{MAX} \int_{-\infty}^{\infty} g(t) \cdot dt$$

In the R&S FPL1000 VSA application, the frequency pulse filter is normalized such that:

$$\int_{-\infty}^{\infty} g(t) \cdot dt = \frac{1}{2}$$

The constellation for M FSK is assumed to be $\{\pm 1, \pm 3, \dots, \pm(M-1)\}$, which implies $\zeta_{MAX} = M-1$. The expression for the [reference deviation](#) in terms of the modulation index is therefore given by:

$$\Lambda_{REF} = \frac{1}{2} \cdot h \cdot (M-1) \cdot f_{Symb}$$

The above formula provides the necessary calculation for measurement of an FSK signal with known symbol rate and modulation index.

Calculation examples:

The GSM standard describes the transmission of binary data using MSK (i.e. 2FSK) modulation with a modulation index of $h=1/2$ at a symbol rate of 270.8333 KHz. The reference deviation is therefore given by:

$$\Lambda_{REF} = \frac{1}{2} \cdot \left(\frac{1}{2}\right) \cdot (2-1) \cdot (270.8333 \text{ kHz}) = 67.7083 \text{ kHz}$$

The APCO Project 25 standard (phase 2) defines an H-CPM signal (i.e. 4FSK) with a modulation index of $h=1/3$ and a symbol rate of 6 KHz. The reference deviation is:

$$\Lambda_{REF} = \frac{1}{2} \cdot \left(\frac{1}{3}\right) \cdot (4 - 1) \cdot (6 \text{ kHz}) = 3 \text{ kHz}$$

4.5.2.1 Error model

The FSK measurement model used assumes that signal distortions in both the magnitude and phase/frequency are present, as well as additive noise. The measured signal model is expressed as:

$$MEAS(t) = A_{DIST}(t) \cdot e^{j\varphi_{DIST}(t)} + n(t)$$

With

- $n(t)$ is a disturbing additive noise process of unknown power
- $A_{DIST}(t)$ is the distorted magnitude model
- $\varphi^{DIST(t)}$ is the distorted phase model

The magnitude model is given by:

$$A_{DIST}(t) = K \cdot e^{-\alpha t}$$

With

- K is a constant scaling factor which can be interpreted as the system gain
- α is the amplitude droop in Nepers per second

The phase model is given by:

$$\varphi_{DIST}(t) = B \cdot \varphi_{REF}(t - \tau) + C \cdot t + \frac{1}{2} D \cdot t^2 + \phi$$

With

- B is a scaling factor which results in a reference deviation error
- C is a carrier frequency offset in radians per second
- D is a frequency drift in radians per second per second
- τ is a timing offset in seconds
- ϕ is a phase offset in radians

For the phase model above, an equivalent frequency distortion model can be expressed as:

$$f_{DIST}(t) = B \cdot f_{REF}(t - \tau) + f_0 + f_d \cdot t$$

With:

- B is the scaling factor which results in a reference deviation error
- $f_0 = C/(2 \cdot \pi)$ is a carrier frequency offset in Hz
- $f_d = D/(2 \cdot \pi)$ is a frequency drift in Hz per second

- τ is the timing offset in seconds

The measured signal model in terms of the instantaneous frequency and all distortion parameters is given by:

$$MEAS(t) = K \cdot e^{-\alpha \cdot t} \cdot e^{j\phi} \cdot e^{j \cdot 2 \cdot \pi \cdot \left[B \cdot \int_{-\infty}^t f_{REF}(u-\tau) du + f_0 \cdot t + \frac{1}{2} f_d \cdot t^2 \right]} + n(t)$$

4.5.2.2 Estimation

The estimation of the distortion parameters listed previously is performed separately for the magnitude and phase/frequency distortions, as illustrated in Figure 4-75. Note that the estimation of the timing offset is performed only on the frequency of the signal, as the reference magnitude is assumed to be constant over the estimation range. For details on the estimation range, see "Estimation ranges" on page 127.

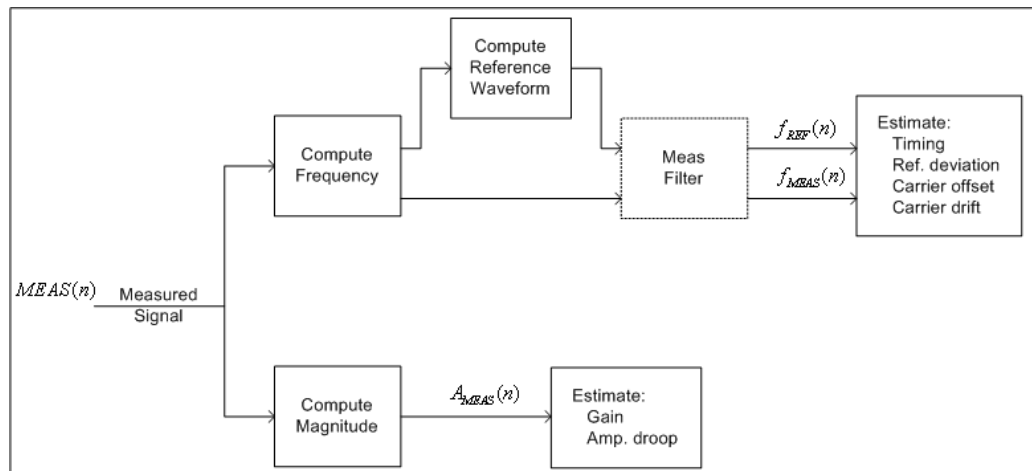


Figure 4-75: FSK Estimation Strategy

In Figure 4-75 $MEAS(n)$ denotes the sampled (complex baseband) measured signal waveform. The magnitude samples are denoted $A_{MEAS}(n)$, while the instantaneous frequency samples of the measured and reference signals are denoted by $f_{MEAS}(n)$ and $f_{REF}(n)$ respectively. The dashed outline of the "Meas Filter" block indicates that this operation is optionally (de-) activated based on the corresponding user settings (see "Type" on page 227).

For the estimation of the magnitude parameters, the following least-squares criterion is minimized regarding the model parameters K and α :

$$C_{MAG}(K, \alpha) = \sum_n \left| A_{MEAS}(n) - K \cdot e^{-\alpha \cdot n \cdot T_E} \right|^2$$

Where T_E denotes the sampling period used for estimation (see "Estimation Points/Sym" on page 223)

For estimation of the frequency parameters, the following least-squares criterion is minimized regarding the model parameters B , f_0 , f_d and τ .

$$C_{FREQ}(B, f_0, f_d, \tau) = \sum_n |f_{MEAS}(n) - [B \cdot f_{REF}(n; \tau) + f_0 + f_d \cdot n \cdot T_E]|^2$$

The term denotes the reference instantaneous frequency with a (possibly fractional) delay of samples.



For FSK modulation, the default sampling period used for estimation is the capture sampling period.

4.5.2.3 Modulation errors

A 2FSK signal is generated using a GMSK frequency pulse. Examples of carrier drift and reference deviation are shown in [Figure 4-76](#) and [Figure 4-77](#), respectively.

Carrier frequency drift

A carrier frequency drift is modeled as a linear change in the carrier frequency over time. The effect of carrier drift on the instantaneous frequency of an FSK signal is illustrated in [Figure 4-76](#).

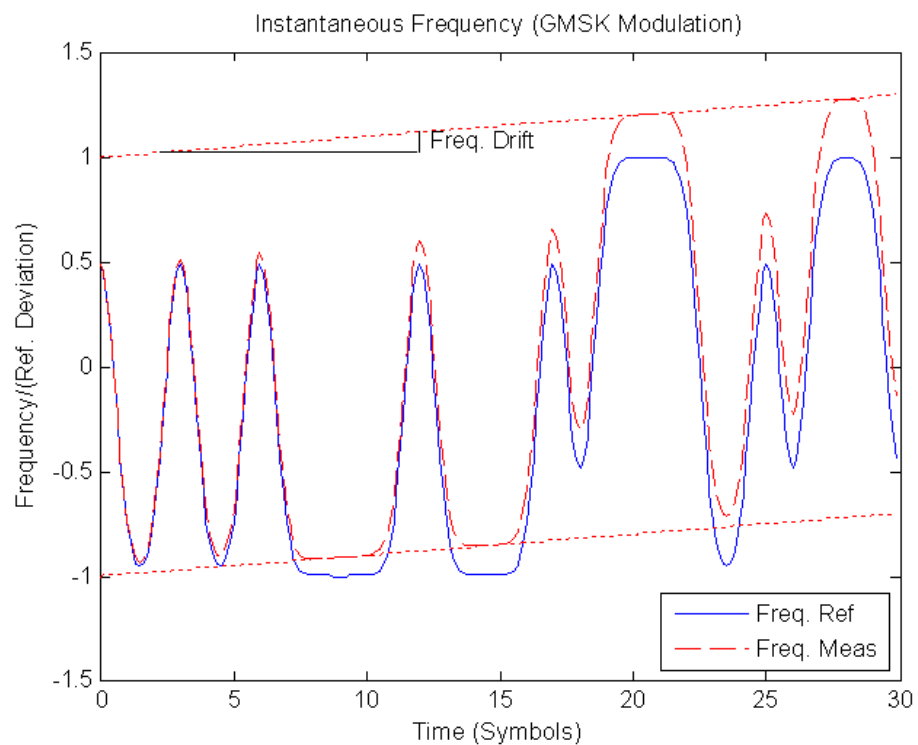


Figure 4-76: The reference and distorted instantaneous frequency of a GMSK signal with a carrier frequency drift

FSK deviation error

The FSK deviation error is the difference between the measured frequency deviation and the user-defined reference frequency deviation (see "FSK Ref Deviation (FSK only)" on page 167). The evidence of a deviation error in the instantaneous frequency of an FSK signal is demonstrated in Figure 4-77.

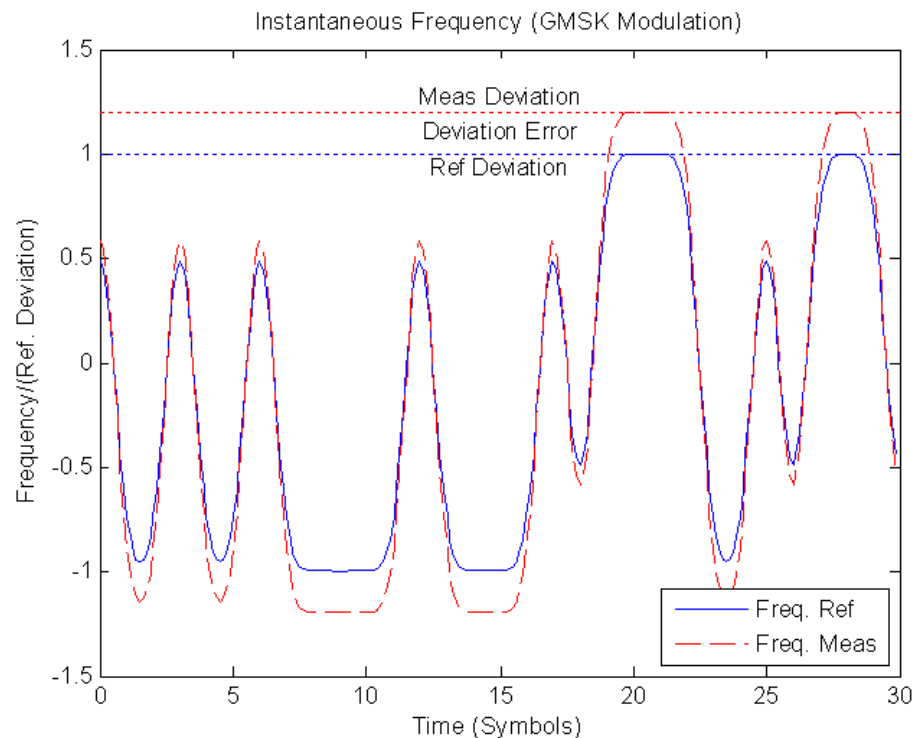


Figure 4-77: The reference and measured instantaneous frequency of a GMSK signal with reference deviation error

4.6 Measurement ranges

You must define three measurement ranges in the R&S FPL1000 VSA application:

- Capture Buffer Length**
 The length of the capture buffer specifies how many data points are captured during a single VSA measurement.
 To measure a bursted signal, define the capture length long enough to ensure that each capture buffer includes at least one entire burst.
 The maximum capture buffer length is 64 000 symbols (for a sample rate of $4 \times$ symbol rate) or 256 000 samples.
- Result Range**
 The result range defines the symbols from the capture buffer that are to be demodulated and analyzed together.

For example, bursted signals have intervals between the bursts that are not of interest when analyzing peaks or overshoots. Thus, the result range usually coincides with the range of the capture buffer in which the burst is located.

The maximum result range length is 64 000 symbols (for a sample rate of 4 * symbol rate) or 256 000 samples.

- **Evaluation Range**

The evaluation range defines the symbols from the result range that are to be included in the evaluation of specific parameters, e.g. error vectors.

For example, you want to display the ramps of a burst and thus include them in the result range. However, they do not contribute to the "error vector"s or power levels. Thus, you do not include them in the evaluation range.

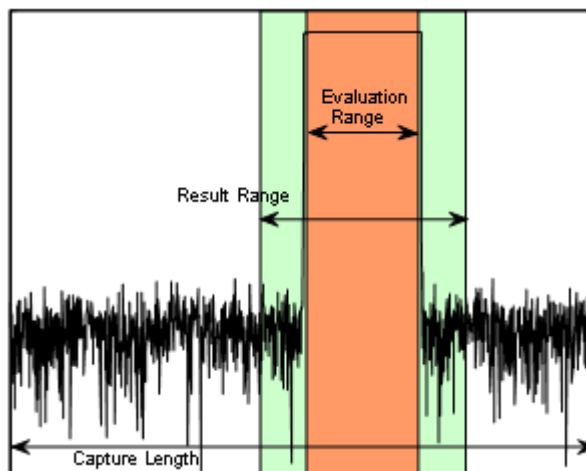


Figure 4-78: Schematic overview of Capture Length, Result Range, and Evaluation Range

The determined result and evaluation ranges are included in the result displays (where useful) to visualize the basis of the displayed values and traces.

4.6.1 Result range

The result range defines the symbols from the capture buffer that are to be demodulated and analyzed together.

Sometimes, the data in the capture buffer contains parts that are not relevant for the evaluation task at hand. Thus, you can exclude them from the result range (see [Chapter 5.7, "Result range configuration"](#), on page 216).

Result range display

The result ranges are indicated by green bars along the time axis of the capture buffer result diagrams.

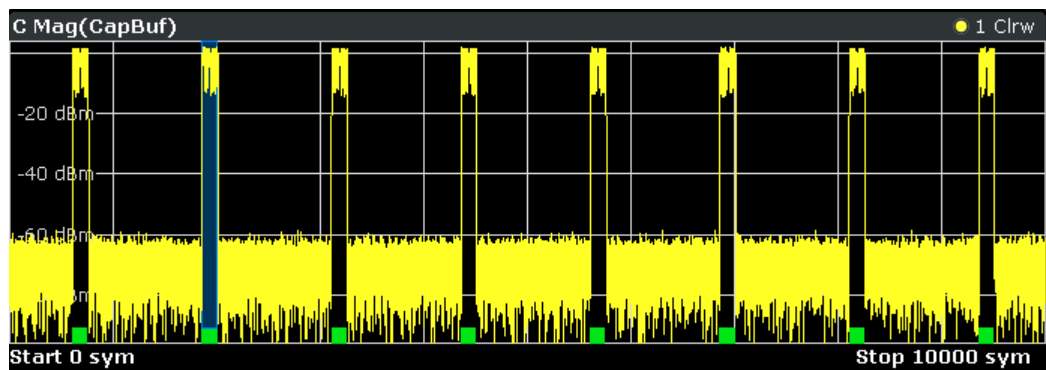


Figure 4-79: Result ranges for a burst signal

Result displays whose source is not the capture buffer are based on a single result range. Examples are the "EVM vs. Time" display or the data in the "Current" column of the "Result Summary". In this case, you can use the capture buffer display to navigate through the available result ranges ([Select Result Rng](#) function), and analyze the individual result ranges in separate windows. The currently displayed result range is indicated by a blue bar in the capture buffer display.

You can change the position of the result range quickly and easily by dragging the blue bar representing the result range to a different position in the capture buffer.

Continuous and discrete result ranges

Depending on the type of signal and your result range definition, the result ranges can be continuous or discrete. Bursted signals commonly have several discrete result ranges at the bursts. They can have intervals during the noise periods which should not be included in the results (see [Figure 4-79](#)).

Continuous signals, however, have result ranges that cover the entire or a specific part of the capture buffer without intervals.

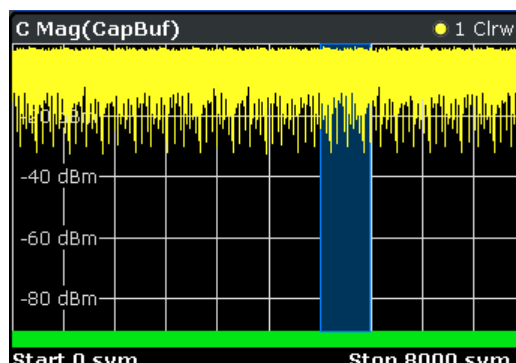


Figure 4-80: Result ranges for a continuous signal

Result Range Length

The result range length is defined by the number of symbols that are to be demodulated. All traces over time are displayed over the result range. For example, if you have a

burst of 100 symbols and you define the result length as 200 symbols, you can examine the burst ramps in detail. Select the alignment "Burst:Center".

The maximum result range length is 64 000 symbols (for a sample rate of 4 * symbol rate) or 256 000 samples.

Result Range Alignment

You can define an offset of the x-axis (in addition to the one defined for the signal structure). Define the number of the symbol which marks the beginning of the reference source used for alignment (burst, capture buffer or pattern, see "Offset" on page 217).

For example, align the result to the center of the pattern. Set the "Symbol Number at Pattern Start" to "0". Now you can easily find the pattern start in the EVM measurement simply by moving a marker to the symbol number "0".



When you define the "Symbol Number at <Reference> Start", remember to take the offset defined for the signal structure into consideration (see "Offset" on page 217). Assume an offset of the pattern in relation to the useful part of the burst in the signal description. Align the result to the pattern. In this case, the "Symbol Number at Pattern Start" refers to the first symbol of the useful part of the burst, not the first symbol of the pattern.

Run-In / Run-Out Time

The parameter "Run-In/-Out" can be used to influence the range over which the EVM is minimized. The (internal) synchronization range is the overlapping area of the result range and the burst excluding its "Run-In/-Out" areas. The "Run-In/-Out" areas can be used to exclude symbols from influencing the synchronization. Hence, this parameter also allows for demodulation of bursts with mixed modulations, e.g. Bluetooth.

Useful length

The burst excluding its Run-In/-Out areas is sometimes referred to as the "useful part". The minimum length of the useful part must be at least 10 symbols.

$$RR \text{ Length} - \text{Run-In} - \text{Run-Out} \geq 10$$

Remote commands:

A remote command is provided to determine the position of the current result range within the capture buffer:

`[SENSe:] DDEMod:SEARCH:MBURst:START[:SYMBOLs]? on page 460`

4.6.2 Evaluation range

In some scenarios, the result range contains symbols that are not supposed to be considered for the EVM or other calculated parameters that are displayed in the "Result Summary".

For example, you want to display the ramps of a burst and thus include them in the result range. However, they do not contribute to the "error vector"s or power levels. Thus, you do not include them in the evaluation range.

(See also [Chapter 9.3.5, "Setting the evaluation range"](#), on page 286.)

The evaluation range is always equal to or smaller than the result range and defines:

- The range over which traces that do not have a time axis are displayed, e.g. polar diagrams
- The range over which the following parameters are calculated for the "Result Summary":
 - "EVM"
 - "MER"
 - "Phase Error"
 - "Magnitude Error"
 - "Power"

Evaluation range display

In all displays over time, except for capture buffer displays, the evaluation range is indicated by red lines.

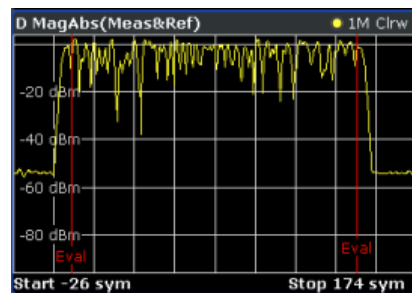


Figure 4-81: Evaluation lines in absolute magnitude diagram

In symbol tables, the evaluated symbols are indicated by red square brackets.

D Symbol Table (Hexadecimal)										
	+	1	+	3	+	5	+	7	+	9
0	1E	1E	0E	0E	05	15	1E	15	08	02
10	12	17	12	1D	18	03	13	14	13	1A
20	1D	08	12	03	07	01	0F	0D	13	08
30	0E	1E	03	1F	18	07	17	18	17	06
40	08	04	14	1D	14	0F	07	19	16	05
50	09	03	11	16	15	18	13	02	04	00
60	08	08	18	09	19	0A	18	0D	1D	06
70	1C	11	08	00	12	00	12	12	00	00
80	00	12	12	12	00	00	12	00	00	12
90	12	00	12	00	00	00	00	00	00	00
100	12	00	12	12	0A	1A	0F	1B	04	..

In other result displays that are based on the evaluation range only, two red vertical lines are displayed in the diagram header to indicate a limited evaluation basis.

B Result Summary

4.7 Display points vs estimation points per symbol

Estimation points per symbol

During synchronization, the measurement signal is matched to the reference signal. Various signal parameters are calculated, as well as the optional "equalizer". You can define how many sample points are used for this calculation at each symbol. Typically, it is one point per symbol (= **symbol rate**) or all captured samples (= **sample rate**).

Display points per symbol

The number of points per symbol used for estimation can vary from the number of points used to display the results of the calculation. If more points per symbol are selected than the defined sample rate, the additional points are interpolated for the display. The more points are displayed per symbol, the more detailed the trace becomes, as illustrated in [Figure 4-82](#).

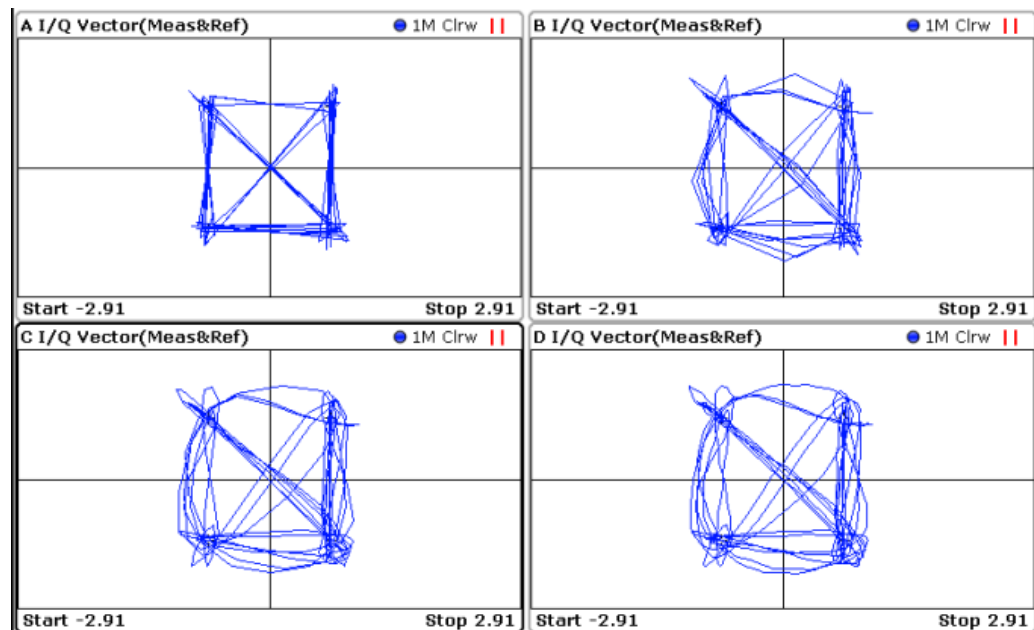


Figure 4-82: Result display with different numbers of display points per symbol

window A = 1
 window B = 2
 window C = 4
 window D = 16



The displayed points per symbol also determine how many values are returned when you query the trace data using a remote command (see [TRACe<n>\[:DATA\]](#) on page 453).

For results based on the **capture buffer**, one point is displayed for each sample taken, that is: the number of display points per symbol is always identical to the capture oversampling value. The capture oversampling is defined as the ratio between sample rate and symbol rate. The default capture oversampling is 4, that is: $\text{sample rate} = 4 * \text{symbol rate}$.

For the "Result Summary", the default number of display points corresponds to the estimation points per symbol. (By default, 1 for QAM and PSK modulated signals and the capture oversampling for MSK and FSK modulated signals.) This value controls which samples are considered for the peak and RMS values and the power result.

For most other result displays, the default number of displayed points per symbol is identical to the capture oversampling value.



For very large capture oversampling rates (≥ 64), a lower number of display points per symbol is used by default. That avoids prolonged display times and extremely large amounts of trace data.

4.8 Capture buffer display

Up to 64 000 symbols can be captured and processed at a time.

Remote commands:

Remote commands are provided to determine the first and last values currently displayed in a particular window:

`DISPlay[:WINDow<n>]:TRACe<t>:X[:SCALe]:START?` on page 450

`DISPlay[:WINDow<n>]:TRACe<t>:X[:SCALe]:STOP?` on page 451

And to determine the position of the current result range within the capture buffer:

`[SENSe:]DDEMod:SEARch:MBURst:STARt[:SYMBOLs]?` on page 460

4.9 Known data files - dependencies and restrictions

For various vector signal analysis functions the measured signal is compared to a defined ideal reference signal. The more precise the reference signal, the more precise the results become. In the best case, the possible data sequences within the signal to analyze are known in advance and can be used to compare the measured data to. This is similar to defining a pattern for the entire result range. Thus, a falsely estimated reference signal (due to false symbol decisions) is avoided and does not influence the error calculation.

You can load XML files containing the possible sequences to the R&S FPL1000 VSA application and use them to compare the measured data to.

Alternatively, for data generated by a pseudo-random bit sequence (PRBS) generator, you can specify the algorithm used to generate the data, so the R&S FPL1000 VSA application knows which sequences can occur. This function requires the R&S FPL1000-K70P option. See [Chapter 4.10, "Known data from PRBS generators"](#), on page 150.

In particular, you can use known data for the following functions:

- Fine synchronization during the demodulation process (see [Figure 4-56](#) and "[Fine Synchronization](#)" on page 224)
- Calculation of the Bit Error Rate (BER), see [Chapter 3.2.1, "Bit error rate \(BER\)"](#), on page 27

For details on working with Known Data files, see [Chapter 8.2.4, "How to work with known data files"](#), on page 264



Auxiliary tool to create Known Data files

An auxiliary tool to create Known Data files from data that is already available in the R&S FPL1000 VSA application is provided with the R&S FPL1000 free of charge.

See [Chapter 8.2.4.2, "How to create known data files"](#), on page 265.

The syntax for Known Data files is described in [Chapter E, "Known data file syntax description"](#), on page 516.

When you use Known Data files as a reference, some dependencies to other settings and restrictions for other functions apply.

Modulation Order

The "Modulation Order" selected in the "Modulation" settings in the R&S FPL1000 VSA application must correspond to the modulation order value specified in the XML file (<ModulationOrder> element).

Demodulation

Demodulation using synchronization to the Known Data can increase the measurement duration, as each detected symbol must be compared to each possible sequence in the data file.

Result Length

The "Result Length" specified in the "Result Range" dialog box in the R&S FPL1000 VSA application must be identical to the length of the specified symbol sequences in the XML file (<ResultLength> element).

Result Range Alignment

- **Bursted signals**
Due to the uncertainty of the burst search, when you align the result range to a bursted signal, the determined result range can start up to 2 symbols before or after the actual burst. However, an offset of only one symbol means that the syn-

chronization process cannot detect any of the predefined symbol sequences in the Known Data file. To avoid synchronization failure, try one of the following:

- Align the result range to a pattern instead of the burst.
- Use a precise external trigger and align the result range to the capture buffer. The trigger timing must be very precise, otherwise the result range start can be incorrect again.

- **Continuous signals**

For continuous signals without a pattern, the result range is aligned randomly. Thus, a very large number of possible sequences must be predefined.

Use a precise external trigger and align the result range to the capture buffer. The trigger timing must be very precise, otherwise the result range start can be incorrect again.

4.10 Known data from PRBS generators

Known data files require all possible data sequences to be defined in a file. For data generated by a pseudo-random bit sequence (PRBS) generator, the number of possible sequences can be very large and defining them in a file can be very tedious.

However, if you can specify the algorithm used to generate the data, the R&S FPL1000 VSA application can determine the possible sequences without a file. This function requires the R&S FPL1000-K70P option.

PRBS data

PRBS generators deliver pseudo-random binary sequences of differing length and duration. They are also known as maximum length sequences. PRBS sequences are generated with the aid of ring shift registers with feedback points determined by the polynomial.

The pseudo-random sequence from a PRBS generator is uniquely defined by the register number and the feedback. The [Table 4-22](#) describes the standard PRBS generators supported by the R&S FPL1000 VSA application, as specified in the ITU-T standard.

Table 4-22: Overview of PRBS generators

PRBS type	Generator Polynomial (default)	Length in bits	Feedback from	Negate Feedback Path (default)
PRBS7	7; 6; 0	$2^7 - 1 = 127$	Registers 6, 0	false
PRBS9	9; 4; 0	$2^9 - 1 = 511$	Registers 4, 0	false
PRBS11	11; 2; 0	$2^{11} - 1 = 2047$	Registers 2, 0	false
PRBS15	15; 1; 0	$2^{15} - 1 = 32767$	Registers 1, 0	true
PRBS16	16; 5; 3; 2; 0	$2^{16} - 1 = 65535$	Registers 5, 3, 2, 0	false
PRBS20	20; 3; 0	$2^{20} - 1 = 1048575$	Registers 3, 0	false
PRBS21	21; 2; 0	$2^{21} - 1 = 2097151$	Registers 2, 0	false

PRBS type	Generator Polynomial (default)	Length in bits	Feedback from	Negate Feedback Path (default)
PRBS23	23; 5; 0	$2^{23} - 1 = 8388607$	Registers 5, 0	true
PRBS31	31; 28; 0	$2^{31} - 1$	Registers 28, 0	false

Example:

Figure 4-83 shows a 9-bit generator with feedback to registers 4 and 0 (output). The generated serial data is converted internally, e.g. 2 bit/symbol if QPSK is used.

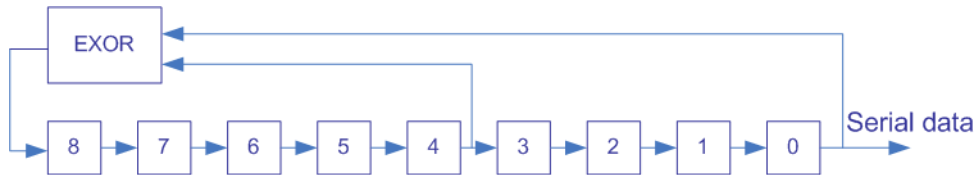


Figure 4-83: A 9-bit PRBS generator

Defining the used algorithm in the R&S FPL1000 VSA application

If the PRBS data is generated in accordance with the ITU-T standard, it is sufficient to specify the type of the PRBS data. The R&S FPL1000 VSA application then automatically determines the corresponding generator polynomial. You can also define the polynomial manually.

The type of the model defines the degree, complexity and number of terms in the polynomial model. In general, a polynomial of type N is defined as:

$$y = a_0 + a_1x + a_2x^2 + \dots + a_Nx^N$$

The required input for the polynomial in the R&S FPL1000 VSA application is the coefficients a_0, \dots, a_N . These values also define the feedback positions in the algorithm.

To select a specific subset of polynomial coefficients, do one of the following:

- Define a range of coefficients (e.g. "0 - 5", in that case the application applies all coefficients in that range).
Note that the coefficients must be defined in descending order (e.g. 9;4;0 not 0;4;9)
- Define a set of individual coefficients only (e.g. "1;3;5;7", in that case the application applies those coefficients only). Use the "." key on the front panel for the ";" character.
- Define a combination of the methods mentioned above (e.g. "1;3;5-7")



If the manually defined polynomial does not define a valid PRBS algorithm, the default ITU-T standard generator polynomial for the selected type is used.



Symbol mapping in accordance with the PRBS generator

When using PRBS generators, you must specify the identical symbol mapping used by the R&S SMx signal generator in the signal description of the R&S FPL1000 VSA application. In this case, select the `_SMx` mapping, which is used by the R&S SMBV and the R&S SMW signal generators, and possibly also other Rohde & Schwarz signal generators. See "[Modulation Mapping](#)" on page 167 for details.

4.11 Multi-modulation analysis (R&S FPL1000-K70M)

In the default configuration, the R&S FPL1000 VSA application assumes that the input signal uses the same modulation type for all symbols. Therefore, for signals modulated using two different modulations, one of the modulation types is not demodulated correctly. However, if the additional Multi-Modulation Analysis option (R&S FPL1000-K70M) is installed, you can decode signals with two different modulation types.

The following conditions apply:

- PSK and QAM types only
- Not offset PSK
- For rotating PSK/QAM, the same additional phase shift must occur in both modulation ranges

Usually, you can easily identify a signal with two different modulations in the magnitude display:

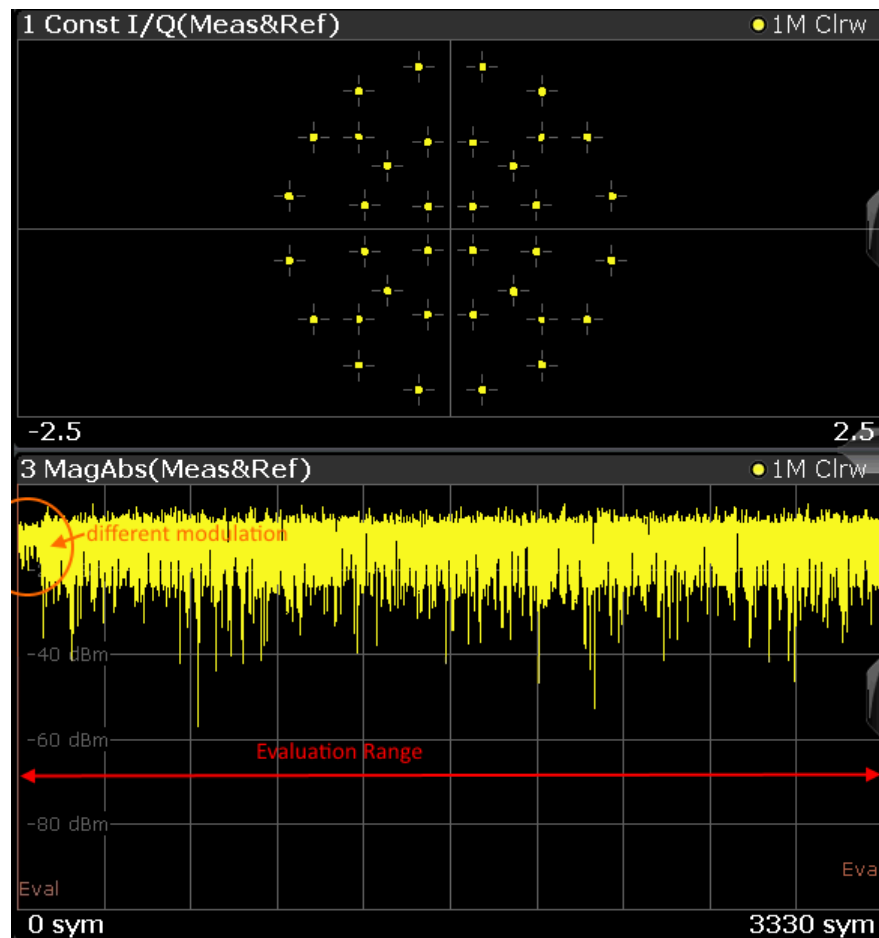


Figure 4-84: Signal with two different modulations

If the multi-modulation mode is active, the R&S FPL1000 VSA application assumes that the loaded pattern symbols have the pattern modulation, and all other symbols have the modulation defined for the data symbols. If not, for example if unknown information is transmitted via header symbols that also have the pattern modulation, you must provide the frame structure of the signal manually (see below).

User-defined frame structure

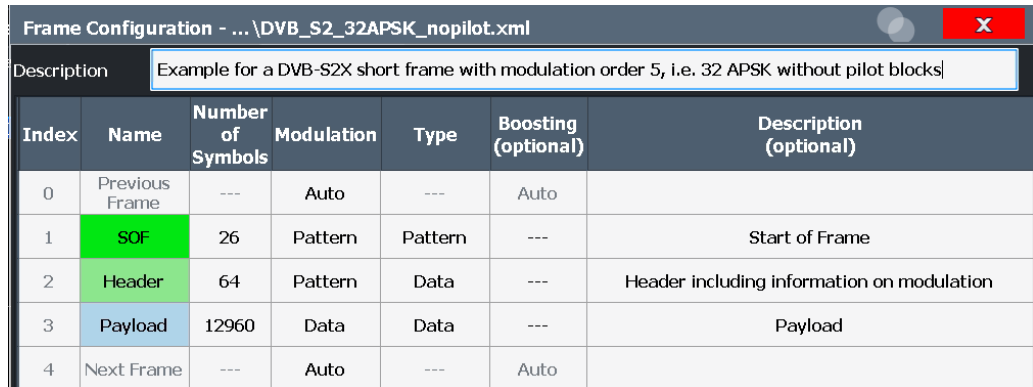
To demodulate signals with two different modulation types, you can provide the frame structure of the signal with the used modulation type per frame yourself. Each frame is defined by a specified number of symbols. In addition to the modulation type, you must also define whether the frame contains known symbols (that is: a pattern), or unknown data.

By default, the power in all subframes is assumed to be identical. However, pilots are transmitted with higher power some times to ensure correct synchronization. Since the R&S FPL1000 VSA application calculates the EVM and other parameters of the signal in reference to the reference power (see [Chapter 3.4, "Common parameters in VSA"](#), on page 67), it must consider deviating power for individual subframes. By default, a "boosting" factor of 1.000 - relative to the reference power - is defined. For subframes

with different gain values, define a different boosting factor to be applied to the reference power.

Only if the frame structure is configured correctly, the R&S FPL1000 VSA application can demodulate the signal correctly and determine an accurate EVM and other modulation error results.

Basic frame structures can be configured quickly directly in the R&S FPL1000 VSA application.



Index	Name	Number of Symbols	Modulation	Type	Boosting (optional)	Description (optional)
0	Previous Frame	---	Auto	---	Auto	
1	SOF	26	Pattern	Pattern	---	Start of Frame
2	Header	64	Pattern	Data	---	Header including information on modulation
3	Payload	12960	Data	Data	---	Payload
4	Next Frame	---	Auto	---	Auto	

Figure 4-85: Example of a basic frame structure consisting of a start-of-frame-pattern, a header with unknown data, and payload data

Complex frame structures are more easily defined in an XML file and imported to the R&S FPL1000 VSA application.

Frame Configuration - ... \DVB_S2_32APSK_pilots.xml						
Description: Example for a DVB-S2X with pilots						
Index	Name	Number of Symbols	Modulation	Type	Boosting (optional)	Description (optional)
0	Previous Frame	---	Auto	---	Auto	
1	SOF	26	Pattern	Pattern	---	Start of Frame
2	Header	64	Pattern	Data	---	Header including information on modulation
3	Payload	1440	Data	Data	---	Payload
4	Pilots	36	Pattern	Data	---	Inserted Pilots
5	Payload	1440	Data	Data	---	Payload
6	Pilots	36	Pattern	Data	---	Inserted Pilots
7	Payload	1440	Data	Data	---	Payload
8	Pilots	36	Pattern	Data	---	Inserted Pilots
9	Payload	1440	Data	Data	---	Payload
10	Pilots	36	Pattern	Data	---	Inserted Pilots
11	Payload	1440	Data	Data	---	Payload

Figure 4-86: Example of a complex frame structure consisting of a start-of-frame-pattern, a header with unknown data, and payload data with inserted pilots



The R&S FPL1000 VSA application provides frequently used frame configurations for DVB-S2X in sample files. You can load one of the files for a sample configuration in the R&S FPL1000 VSA application (see ["Load File"](#) on page 175).

Furthermore, you can use a tool provided with the R&S FPL1000 VSA application firmware. It automates the configuration and provides the variety of different constellations that are used within DVB-S2(X). See [Chapter 5.2, "Configuration according to digital standards"](#), on page 163.

Result range and evaluation range for multi-modulation signals

The frame configuration implicitly also defines the result range (see also [Chapter 4.6.1, "Result range"](#), on page 143). By default, the result range length corresponds to the number of symbols in one entire frame. However, you can restrict it to fewer symbols, e.g. to an individual subframe. In result displays based on symbols, for example the EVM, the subframes are indicated by vertical green lines.

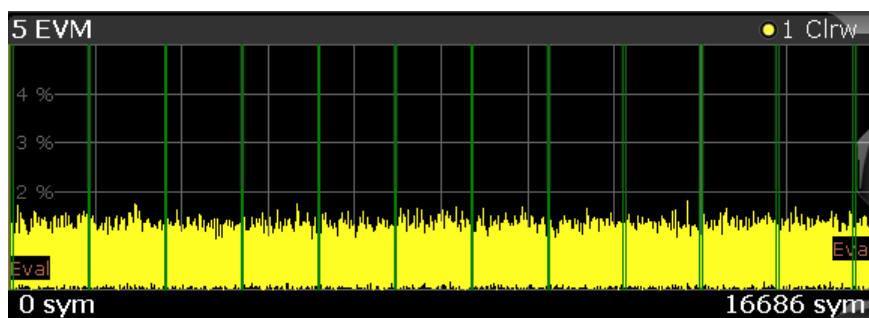


Figure 4-87: EVM with indicated subframes

Similarly, the evaluation range is set to the entire result range by default (see also [Chapter 4.6.2, "Evaluation range"](#), on page 145). However, you can also restrict the evaluation range to a subset of symbols, for example a specific subframe. In all displays over time, except for capture buffer displays, the evaluation range is indicated by vertical red lines. Drag the red evaluation range lines so they are aligned to the green subframe lines to restrict the result display to a single subframe.

Example:

In the following example, the evaluation range is set to the header subframe only (see [Example of a basic frame structure consisting of a start-of-frame-pattern, a header with unknown data, and payload data](#)). The Constellation diagram shows only the symbol points for the header.

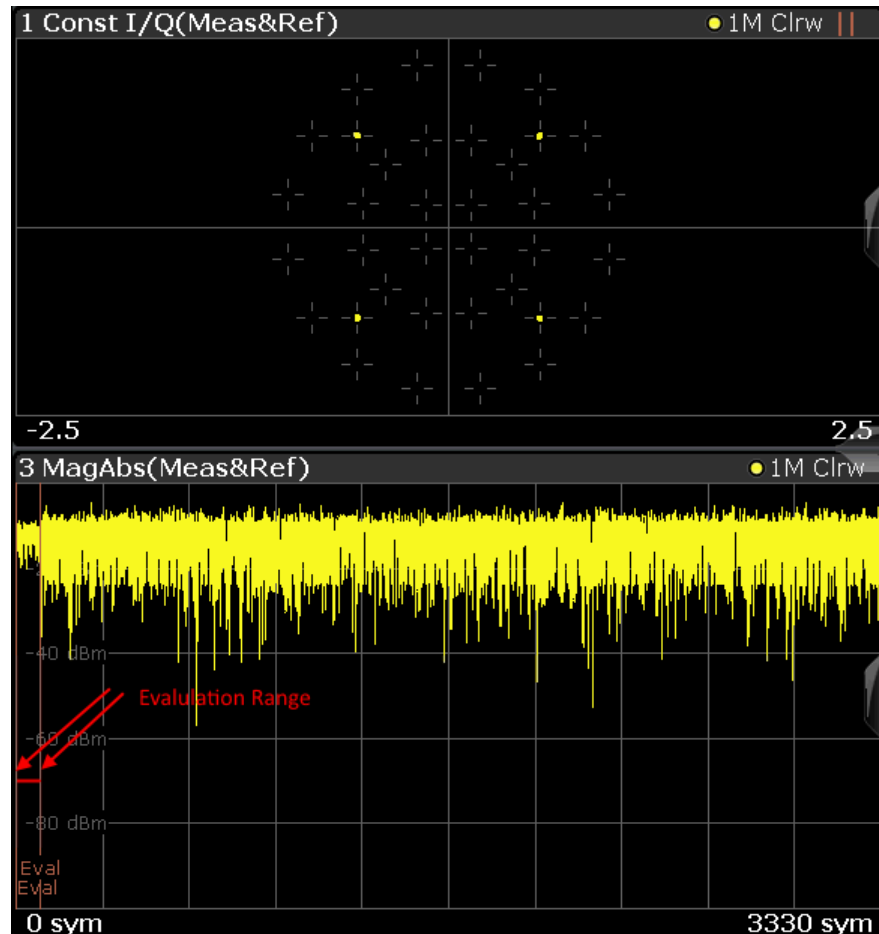


Figure 4-88: Evaluation range set to subframe only

In the symbol table, different modulation and data types are also displayed differently (see [Chapter 3.2.31, "Symbol table"](#), on page 62).

Typical applications for two-modulated signals

Some signal modulations provide additional information (metadata) on the subsequently transmitted data to allow for the receiver to demodulate the useful data correctly. Some examples for metadata are:

- Patterns indicating the frame start
- Header data describing the type, length, or structure of the useful data
- Pilots inserted within the useful data to improve synchronization for a long data package

Since this metadata is essential for accurate demodulation, it is important that the metadata is received correctly. However, the metadata has no inherent error protection like the useful data. Therefore, a very robust modulation type must be used to transmit the metadata. The useful data, on the other hand, can be modulated using a more efficient, but less robust, modulation.

5 Configuration





Access: [Meas Config] > "Overview"

When you activate a measurement channel for the R&S FPL1000 VSA application, a VSA measurement for the input signal is started automatically with the default configuration. The "VSA" menu is displayed and provides access to the most important configuration functions.

Importing and Exporting I/Q Data

The I/Q data to be evaluated in VSA cannot only be measured by the R&S FPL1000 VSA application itself, it can also be imported to the application, provided it has the correct format. Furthermore, the evaluated I/Q data from the R&S FPL1000 VSA application can be exported for further analysis in external applications.

The import and export functions are available in the "Save/Recall" menu which is displayed when you select the  "Save" or  "Open" icon in the toolbar.

For details on importing and exporting I/Q data, see the R&S FPL1000 User Manual.

- [Configuration overview](#)..... 159
- [Configuration according to digital standards](#)..... 163
- [Signal description](#)..... 165
- [Input, output and frontend settings](#)..... 183
- [Signal capture](#)..... 200
- [Burst and pattern configuration](#)..... 206
- [Result range configuration](#)..... 216
- [Demodulation settings](#)..... 218
- [Measurement filter settings](#)..... 226
- [Evaluation range configuration](#)..... 228
- [Adjusting settings automatically](#)..... 229
- [Restoring factory settings for vector signal analysis](#)..... 231

5.1 Configuration overview



Access: "Meas Config" > "Overview"

As explained in [Chapter 2.1, "Introduction to vector signal analysis"](#), on page 17, the key task of the vector signal analysis application is to reconstruct the ideal signal. It tries to perform this reconstruction based on the knowledge about the DUT that you provide.

Using the R&S FPL1000 VSA application you can perform vector signal analysis measurements using predefined standard setting files, or independently of digital standards using user-defined measurement settings. Such settings can be stored for recurrent use.

Thus, configuring VSA measurements requires one of the following tasks:

- Selecting an existing standard settings file and, if necessary, adapting the measurement settings to your specific requirements.

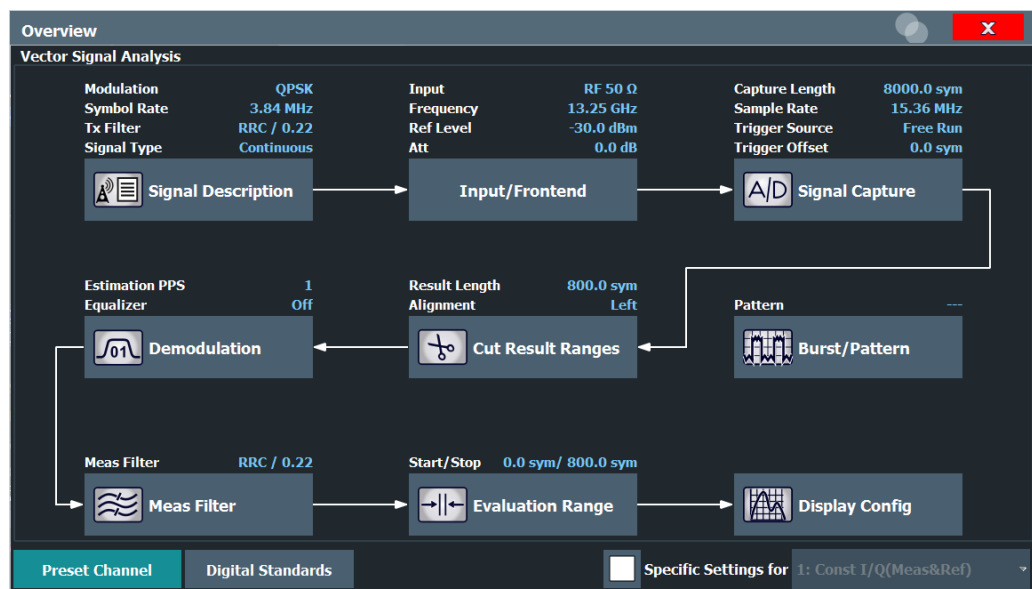
- Configuring the measurement settings and, if necessary, storing the settings in a file.

In this case, you must describe your signal manually:

- Whether you have a continuous or a bursted signal
- The modulation of your signal
- The symbol rate
- The transmit filter
- Whether your signal contains a known training sequence (pattern)
- Etc.

"Overview" window

Throughout the measurement channel configuration, an overview of the most important currently defined settings is provided in the "Overview".



In addition to the main measurement settings, the "Overview" provides quick access to the main settings dialog boxes. The individual configuration steps are displayed in the order of the data flow. Once you have provided the signal description, the remaining settings are preconfigured accordingly. For example, the burst search is deactivated if you specify a continuous signal.

Thus, you can easily configure an entire measurement channel from input over processing to output and analysis by stepping through the dialog boxes as indicated in the "Overview". When you have covered all steps in the "Overview", you can be sure that you have not missed any important settings.

In particular, the "Overview" provides quick access to the following configuration dialog boxes (listed in the recommended order of processing):

1. Signal Description

This is the most important block for configuring the VSA measurement. Here you describe the structure of your signal, that is: its modulation, its transmit filter,

whether the signal is bursted or continuous, etc. Based on this description, the R&S FPL1000 VSA application configures most remaining blocks automatically. See [Chapter 5.3, "Signal description"](#), on page 165

2. Input and Frontend Settings

Includes major settings for the frontend of the analyzer, such as the center frequency.

See [Chapter 5.4, "Input, output and frontend settings"](#), on page 183

3. Signal Capture (including Triggering)

This block specifies how many I/Q data points to capture. With a higher number, you can cover a larger bandwidth.

See [Chapter 5.5, "Signal capture"](#), on page 200

4. Burst/Pattern Configuration

You can manually enable/disable the burst and pattern search here. However, based on your signal description, this block is automatically configured correctly. So there is usually no need to change the configuration manually.

See [Chapter 5.6, "Burst and pattern configuration"](#), on page 206

5. Result Range Definition

The result range specifies how many symbols to analyze together. For example, if the signal is bursted, the result range usually coincides with the burst length.

See [Chapter 5.7, "Result range configuration"](#), on page 216

6. Demodulation Settings

Includes advanced settings regarding the demodulation. For example, whether a potential I/Q offset is compensated for prior to result calculation.

See [Chapter 5.8, "Demodulation settings"](#), on page 218

7. Measurement Filter Settings

The type of measurement filter and its usage is specified here. It limits the measurement signal, the reference signal, and therefore also the error signal in bandwidth. By default, the R&S FPL1000 VSA application selects a suitable measurement filter the transmit filter specified in the signal description.

See [Chapter 5.9, "Measurement filter settings"](#), on page 226

8. Evaluation Range Definition

The evaluation range is always equal to or smaller than the result range and defines:

- The range used by traces that do not have a time axis, e.g. polar diagrams
- The range over which the following parameters are calculated for the "Result Summary":
 - "EVM"
 - "MER"
 - "Phase Error"
 - "Magnitude Error"
 - "Power"

See [Chapter 5.10, "Evaluation range configuration"](#), on page 228

9. Display Configuration

Here you select which measurement results are displayed for vector signal analysis.

The "Display Config" button is only available in the general overview, not in the window-specific overview (see "Specific Settings for" on page 162).

See [Chapter 6.5, "Display and window configuration"](#), on page 248

10. Analysis

The "Analysis" button is only available in the window-specific overview, not in the general overview (see "Specific Settings for" on page 162).

Which functions are provided depends on the window type.

See [Chapter 6.5, "Display and window configuration"](#), on page 248

See [Chapter 6, "Analysis"](#), on page 233

To configure settings

- ▶ Select any button in the "Overview" to open the corresponding dialog box.
Select a setting in the channel bar (at the top of the measurement channel tab) to change a specific setting.

For step-by-step instructions on configuring VSA measurements, see [Chapter 8, "How to perform vector signal analysis"](#), on page 254.

Preset Channel setup

Select the "Preset Channel" button in the lower left-hand corner of the "Overview" to restore all measurement settings *in the current channel setup* to their default values.

Note: Do not confuse the "Preset Channel" button with the [Preset] key, which restores the entire instrument to its default values and thus closes *all channel setups* on the R&S FPL1000 (except for the default channel setup)!

Remote command:

`SYSTem:PRESet:CHANnel[:EXEC]` on page 320

Specific Settings for

The channel setup can contain several windows for different results. Thus, the settings indicated in the "Overview" and configured in the dialog boxes vary depending on the selected window.

Select an active window from the "Specific Settings for" selection list that is displayed in the "Overview" and in all window-specific configuration dialog boxes.

Enable the "Specific Settings for" option.

The "Overview" and dialog boxes are updated to indicate the settings for the selected window.

The indicated data flow is updated for the selected data source.

If the "Specific Settings for" option is not enabled, the overview displays the default data flow and the general settings independently of the selected window.

Note: The "Display Config" button is only available in the general overview, not in the window-specific overview.

Digital Standards

Opens a file selection dialog to manage predefined measurement settings for conventional mobile radio standards. See [Chapter 5.2, "Configuration according to digital standards"](#), on page 163

5.2 Configuration according to digital standards

Access: "Meas Config" > "Overview" > "Digital Standards"

Various predefined settings files for common digital standards are provided for use with the R&S FPL1000 VSA application. In addition, you can create your own settings files for user-specific measurements.

For an overview of predefined standards and settings, see [Chapter B, "Predefined standards and settings"](#), on page 502. For detailed instructions, see [Chapter 8.1, "How to perform VSA according to digital standards"](#), on page 254

Selecting Storage Location - Drive/ Path/ Files.....	163
New Folder.....	163
File Name.....	163
Comment.....	164
Load Standard.....	164
Save Standard.....	164
Delete Standard.....	164
Restore Standard Files.....	164
DVB-S2(X) Config.....	164

Selecting Storage Location - Drive/ Path/ Files

Select the storage location of the file on the instrument or an external drive.

The default storage location for the standards files is:

```
C:\Users\Public\Documents\Rohde-Schwarz\Analyzer\user\vsa\
Standards.
```

New Folder

Creates a new folder in the file system with the specified name in which you can save the settings file.

File Name

Contains the name of the data file without the path or extension.

By default, the name of a user file consists of a base name followed by an underscore. Multiple files with the same base name are extended by three numbers, e.g.

```
limit_lines_005.
```

File names must be compatible with the Windows conventions for file names. In particular, they must not contain special characters such as ":", "*", "?".

For details on the filename and location, see the "Data Management" topic in the R&S FPL1000 User Manual.

Comment

An optional description for the data file. A maximum of 60 characters can be displayed.

Remote command:

[\[SENSe:\] DDEMod:STANdard:COMMeNt](#) on page 321

Load Standard

Loads the selected measurement settings file.

Note: When you load a standard, the usage of a known data file, if available, is automatically deactivated.

Remote command:

[\[SENSe:\] DDEMod:PRESet\[:STANdard\]](#) on page 321

Save Standard

Saves the current measurement settings for a specific standard as a file with the defined name.

Remote command:

[\[SENSe:\] DDEMod:STANdard:SAVE](#) on page 322

Delete Standard

Deletes the selected standard. Standards predefined by Rohde & Schwarz can also be deleted. A confirmation query is displayed to avoid unintentional deletion of the standard.

Note: Restoring predefined standard files. The standards predefined by Rohde & Schwarz available at the time of delivery can be restored using the "Restore Standard Files" function (see "[Restore Standard Files](#)" on page 164).

Remote command:

[\[SENSe:\] DDEMod:STANdard:DELeTe](#) on page 321

Restore Standard Files

Restores the standards predefined by Rohde & Schwarz available at the time of delivery.

Note that this function overwrites customized standards that have the same name as predefined standards.

Remote command:

[\[SENSe:\] DDEMod:FACTory\[:VALue\]](#) on page 320

DVB-S2(X) Config

Access: [MEAS]

Starts a tool which automates the configuration and provides the variety of different constellations that are used within DVB-S2(X). This tool is provided with the R&S FPL1000 VSA application firmware and stored on the instrument.

For details see the Rohde & Schwarz application note: [1EF93: Modulation Accuracy Measurements of DVB-S2 and DVB-S2X Signals](#)

5.3 Signal description

Access: "Overview" > "Signal Description"

or: [MEAS CONFIG] > "Signal Description"

The signal description provides information on the expected input signal, which optimizes burst and pattern detection and allows for the application to calculate an ideal reference signal. The signal description consists of information on the used modulation and on the signal's structure.

- [Modulation](#).....165
- [Signal structure](#).....169
- [Frame structure](#).....171
- [Known data](#).....180

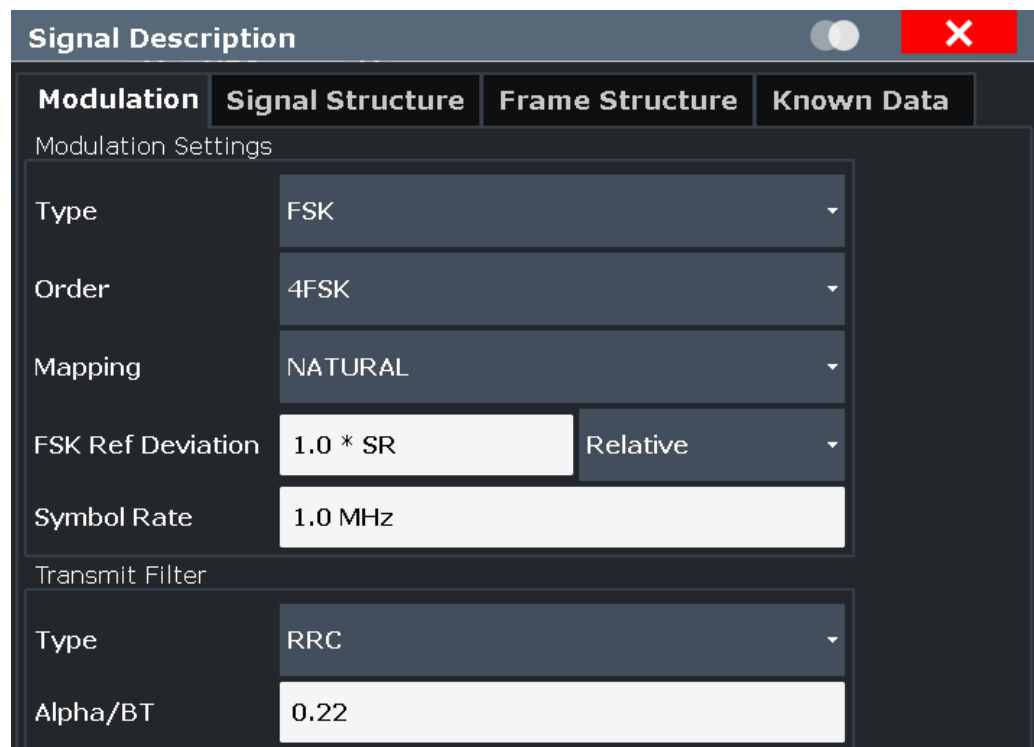
5.3.1 Modulation

Access: "Overview" > "Signal Description" > "Modulation"

or: [MEAS CONFIG] > "Signal Description" > "Modulation"

The "Modulation" settings contain modulation and transmit filter settings.

The modulation settings vary depending on the selected modulation type; in particular, FSK modulation provides some additional settings.



Signal Description	
Modulation	Signal Structure
Frame Structure	Known Data
Modulation Settings	
Type	FSK
Order	4FSK
Mapping	NATURAL
FSK Ref Deviation	1.0 * SR
	Relative
Symbol Rate	1.0 MHz
Transmit Filter	
Type	RRC
Alpha/BT	0.22

Figure 5-1: Signal modulation settings for FSK modulation

Modulation Type.....	166
↳ Load User Modulation.....	166
Modulation Order.....	166
FSK Ref Deviation (FSK only).....	167
Modulation Mapping.....	167
Symbol Rate.....	168
Transmit Filter Type.....	168
↳ Load User Filter.....	168
Alpha/BT.....	168

Modulation Type

Defines the modulation type of the vector signal. The following types are available:

- PSK
- MSK
- QAM
- FSK
- ASK
- APSK
- User Modulation
Uses the selected user-defined modulation loaded from a file.
The currently loaded file is indicated in the channel bar.

For more information on these modulation types, see [Chapter 4.3, "Symbol mapping"](#), on page 78.

Remote command:

[SENSe:] DDEMod: FORMat on page 325

Load User Modulation ← Modulation Type

This function is only available if the modulation type "User Modulation" is selected.

Opens a file selection dialog box to select the file that contains the user-defined modulation (*.vam file).

For details on user-defined modulation files, see [Chapter 4.3.12, "User-defined modulation"](#), on page 111.

Remote command:

SENS:DDEM:FORM UQAM (see [SENSe:] DDEMod: FORMat on page 325)

[SENSe:] DDEMod: USER:NAME on page 331

Modulation Order

Depending on the [Modulation Type](#), various orders of modulation are available:

Type	Available orders		
PSK	BPSK	3Pi/4-QPSK	Pi/8-D8PSK
	QPSK	8PSK	DQPSK
	Offset QPSK	3Pi/8-8PSK	Pi/4-DQPSK
	Shaped Offset QPSK	D8PSK	Pi/4-QPSK
	Pi/2-BPSK	Pi/2-DBPSK	

Type	Available orders		
MSK	MSK	DMSK	
QAM	16QAM	Pi/4-16QAM	32QAM
	-Pi/4-32QAM	64QAM	128QAM
	256QAM	512QAM	1024QAM
	2048QAM	4096QAM	
FSK	2FSK	4FSK	8FSK
	16FSK	32FSK	64FSK
ASK	2ASK	4ASK	
APSK	16APSK	32APSK	

Remote command:

PSK:

[\[SENSe:\] DDEMod:PSK:FORMat](#) on page 327

[\[SENSe:\] DDEMod:PSK:NSTate](#) on page 328

[\[SENSe:\] DDEMod:QPSK:FORMat](#) on page 329

MSK: [\[SENSe:\] DDEMod:MSK:FORMat](#) on page 327

QAM:

[\[SENSe:\] DDEMod:QAM:FORMat](#) on page 328

[\[SENSe:\] DDEMod:QAM:NSTate](#) on page 328

FSK: [\[SENSe:\] DDEMod:FSK:NSTate](#) on page 326

ASK: [\[SENSe:\] DDEMod:ASK:NSTate](#) on page 324

APSK: [\[SENSe:\] DDEMod:APSK:NSTate](#) on page 324

FSK Ref Deviation (FSK only)

The FSK Reference Deviation sets the deviation to the reference frequency.

For 2FSK, it indicates the distance from the reference frequency to the positive /negative deviation frequency and for 4FSK, the distance to the outer positive/negative deviation frequency.

To set the deviation as a multiple of the symbol rate ($x \cdot SR$), select "Relative" mode. To set the deviation as an absolute value in Hz, select "Absolute" mode.

Note that this parameter is available only for FSK modulated signals.

Remote command:

[CALCulate<n>:FSK:DEVIation:REference\[:VALue\]](#) on page 324

[CALCulate<n>:FSK:DEVIation:REference:RELative](#) on page 323

Modulation Mapping

The available mapping types depend on the [Modulation Type](#) and [Modulation Order](#).

Note: When using PRBS generators, select the SM_x mapping, which corresponds to the mapping used by R&S SM_x signal generators.

For more information on the modulation mapping, refer to [Chapter 4.3, "Symbol mapping"](#), on page 78

Remote command:

[SENSe:] DDEMod:MAPPING[:VALue] on page 327

[SENSe:] DDEMod:MAPPING:CATalog? on page 326

Symbol Rate

The symbol rate also determines the I/Q bandwidth of the data recording and demodulation. You can change the default rate by entering a value in Hz.

The minimum symbol rate is 25 Hz. The maximum symbol rate depends on the defined [Sample Rate](#) (see [Chapter 4.2, "Sample rate, symbol rate and I/Q bandwidth"](#), on page 76).

Remote command:

[SENSe:] DDEMod:SRATe on page 330

Transmit Filter Type

Defines the type of transmit filter

An overview of available transmit filters is provided in [Chapter C.1, "Transmit filters"](#), on page 511.

For more information on transmit filters, see [Chapter 4.1.3, "Modulation and demodulation filters"](#), on page 71.

Remote command:

[SENSe:] DDEMod:TFILter:NAME on page 330

To define the name of the transmit filter to be used.

[SENSe:] DDEMod:TFILter[:STATe] on page 331

To switch off the transmit filter.

[SENSe:] DDEMod:TFILter:USER on page 331

To select a user-defined filter.

Load User Filter ← Transmit Filter Type

Opens a file-selection dialog box to select the user-defined transmit filter to be used.

Note: If a user-defined transmit filter is selected and the measurement filter is defined automatically (see ["Using the Transmit Filter as a Measurement Filter \(Auto\)"](#) on page 226), a Low-ISI measurement filter according to the selected user filter is calculated and used.

For details, see [Chapter 4.1.5, "Customized filters"](#), on page 74.

For detailed instructions on working with user-defined filters, see [Chapter 8.2.2, "How to select user-defined filters"](#), on page 258.

Remote command:

[SENSe:] DDEMod:TFILter:USER on page 331

[SENSe:] DDEMod:TFILter:NAME on page 330

Alpha/BT

Defines the roll-off factor (Alpha) or the filter bandwidth (BT).

The roll-off factor and filter bandwidth for transmit filter is available for RC, RRC, Gauss and GMSK filter.

Remote command:

[SENSe:] DDEMod:TFILter:ALPHa on page 330

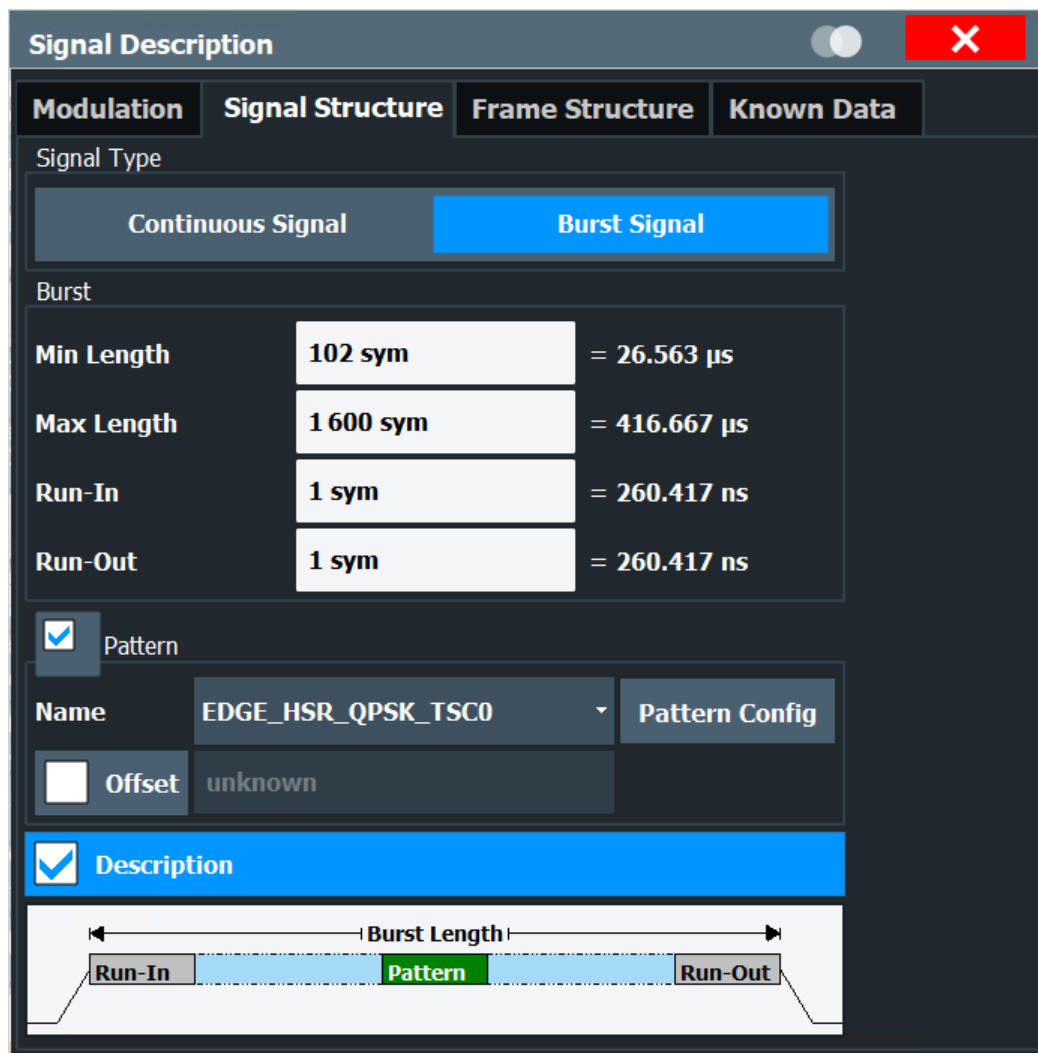
5.3.2 Signal structure

Access: "Overview" > "Signal Description" > "Signal Structure"

or: [MEAS CONFIG] > "Signal Description" > "Signal Structure"

The "Signal Structure" settings describe the expected input signal and determine which settings are available for configuration. You can define a pattern to which the instrument can be synchronized, thus adapting the result range.

Activate "Description" to display a visualization of the currently defined signal structure at the bottom of the dialog box.



Signal Type.....	170
Burst Settings.....	170
└ Min Length / Max Length.....	170
└ Run-In.....	170
└ Run-Out.....	170
Pattern Settings.....	170

L	Name.....	170
L	Pattern Configuration.....	171
L	Offset.....	171

Signal Type

Determines whether the signal is continuous or contains bursts.

Remote command:

[\[SENSe:\] DDEMod: SIGNAL\[:VALue\]](#) on page 334

Burst Settings

For bursts, further settings are available.

Min Length / Max Length ← Burst Settings

Shortest and longest expected burst length in symbols (≤ 128000). The symbols are converted to seconds for reference.

Shortest and longest expected burst length in symbols (≤ 128000). The symbols are converted to seconds for reference.

Remote command:

[\[SENSe:\] DDEMod: SEARCH: BURSt: LENGth: MAXimum](#) on page 332

[\[SENSe:\] DDEMod: SEARCH: BURSt: LENGth\[:MINimum\]](#) on page 332

Run-In ← Burst Settings

The number of symbols before the signal is assumed to have valid modulated symbols.

The symbols are converted to seconds for reference.

Remote command:

[\[SENSe:\] DDEMod: SEARCH: BURSt: SKIP: RISing](#) on page 333

Run-Out ← Burst Settings

The number of symbols before the falling edge that do not necessarily need to have a valid modulation.

The symbols are converted to seconds for reference.

Remote command:

[\[SENSe:\] DDEMod: SEARCH: BURSt: SKIP: FALLing](#) on page 332

Pattern Settings

If the signal is expected to have a specific pattern, enable the "Pattern" option to define the pattern settings.

Note: The pattern search itself must be enabled separately in the "Pattern Search Settings", see ["Enabling Pattern Searches"](#) on page 209. By default, the pattern search is active if the signal description contains a pattern.

Name ← Pattern Settings

Specifies the pattern name from the list of defined patterns. You can also configure new patterns, see [Chapter 5.6.3, "Pattern configuration"](#), on page 210.

Remote command:

[\[SENSe:\] DDEMod: SIGNAL: PATtern](#) on page 333

Pattern Configuration ← Pattern Settings

Displays the "Pattern Configuration" dialog box (see [Chapter 5.6.3, "Pattern configuration"](#), on page 210).

Offset ← Pattern Settings

The offset of the pattern is defined in relation to the start of the useful part of the burst (see ["Useful length"](#) on page 145). If the position of the pattern within the burst is known, it is recommended that you define the offset. That accelerates the pattern search and enhance the accuracy of the burst search.

Remote command:

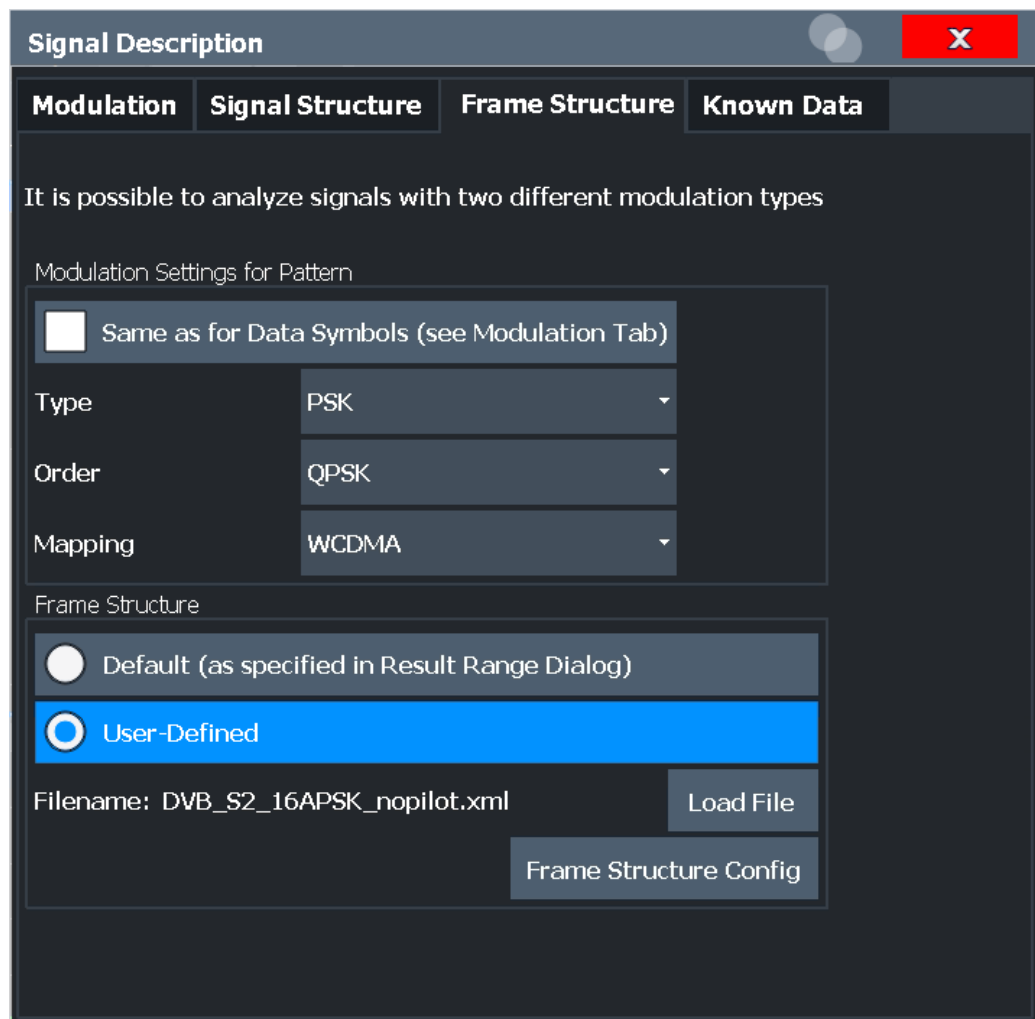
[\[SENSe:\] DDEMod: STANdard: SYNC: OFFSet: STATe](#) on page 334

[\[SENSe:\] DDEMod: STANdard: SYNC: OFFSet \[:VALue\]](#) on page 334

5.3.3 Frame structure

Access: "Overview" > "Signal Description" > "Frame Structure"

This tab is only available if the additional Multi-Modulation Analysis option (R&S FPL1000-K70M) is installed, and only for PSK and QAM types.



- [General frame structure settings](#)..... 172
- [Frame configuration](#)..... 175

5.3.3.1 General frame structure settings

The general frame structure settings determine whether more than one modulation is used and where the frame structure is configured.

Modulation Settings for Pattern: Same as for Data Symbols	173
Modulation Type	173
└ Load User Modulation	173
Modulation Order	173
Modulation Mapping	174
Frame Structure	174
└ Load File	175
└ Frame Structure Config	175

Modulation Settings for Pattern: Same as for Data Symbols

By default, the R&S FPL1000 VSA application assumes that only one modulation type is used for both the pattern and the data symbols. In this case, the modulation configured in the [Modulation](#) tab is indicated for reference only, and no other settings are available.

If deactivated, the pattern symbols are demodulated using different settings than the data symbols. In this case, the data symbols are demodulated using the settings configured in the [Modulation](#) tab. The modulation settings for the pattern symbols are configured here.

Remote command:

[\[SENSe:\] DDEMod: PATTern \[:STATe\]](#) on page 346

Modulation Type

Defines the modulation type used for the pattern symbols. The following types are available:

- ASK
- APSK
- PSK
- QAM
- User Modulation
 - Uses the selected user-defined modulation loaded from a file.
 - The currently loaded file is indicated in the channel bar.

For more information on these modulation types, see [Chapter 4.3, "Symbol mapping"](#), on page 78.

Remote command:

[\[SENSe:\] DDEMod: PATTern: FORMat](#) on page 336

Load User Modulation ← Modulation Type

This function is only available if the modulation type "User Modulation" is selected for the pattern.

Opens a file selection dialog box to select the file that contains the user-defined modulation (*.vam file).

For details on user-defined modulation files, see [Chapter 4.3.12, "User-defined modulation"](#), on page 111.

Remote command:

SENS:DDEM:PATT:FORM UQAM (see [\[SENSe:\] DDEMod: PATTern: FORMat](#) on page 336)

[\[SENSe:\] DDEMod: PATTern: USER: NAME](#) on page 345

Modulation Order

Depending on the [Modulation Type](#) for the pattern symbols, various orders of modulation are available:

Type	Available orders		
PSK	BPSK	3Pi/4-QPSK	Pi/8-D8PSK
	QPSK	8PSK	DQPSK

Type	Available orders		
	Pi/2-BPSK	3Pi/8-8PSK	Pi/4-DQPSK
	Pi/2-DBPSK	D8PSK	Pi/4-QPSK
ASK	2ASK	4ASK	
APSK	16APSK	32APSK	
QAM	16QAM	Pi/4-16QAM	32QAM
	-Pi/4-32QAM	64QAM	128QAM
	256QAM	512QAM	1024QAM
	2048QAM	4096QAM	

Remote command:

PSK:

[SENSe:] DDEMod: PATtern: PSK: FORMat on page 343

[SENSe:] DDEMod: PATtern: PSK: NSTate on page 343

[SENSe:] DDEMod: PATtern: QPSK: FORMat on page 345

ASK:

[SENSe:] DDEMod: PATtern: ASK: NSTate on page 336

APSK:

[SENSe:] DDEMod: PATtern: APSK: NSTate on page 335

QAM:

[SENSe:] DDEMod: PATtern: QAM: FORMat on page 344

[SENSe:] DDEMod: PATtern: QAM: NSTate on page 344

Modulation Mapping

The available mapping types depend on the [Modulation Type](#) and [Modulation Order](#) of the pattern symbols.

For more information on the modulation mapping, refer to [Chapter 4.3, "Symbol mapping"](#), on page 78

Remote command:

[SENSe:] DDEMod: PATtern: MAPPING[:VALue] on page 343

[SENSe:] DDEMod: PATtern: MAPPING:CATalog? on page 342

Frame Structure

Determines whether the frame structure of the signal is configured in reference to the result range or user-defined.

"Default" A single frame is assumed to correspond to the result range defined in the [Chapter 5.7, "Result range configuration"](#), on page 216.

"User-Defined" A frame is defined manually as a succession of subframes with specified characteristics. In this case, the result range is assumed to be a single frame as specified here. The [Chapter 5.7, "Result range configuration"](#), on page 216 settings are not available.

The frame structure can be defined directly in the R&S FPL1000 VSA application, or externally in an XML file which is loaded to the application. If no structure is configured or loaded yet, the result range definition is used (as for "Default").

Remote command:

[\[SENSe:\] DDEMod: PATTern: FRAMe: MODE](#) on page 342

Load File ← Frame Structure

Loads a user-defined frame structure configuration from an XML file. The default storage location for such files is

```
C:\Users\Public\Documents\Rohde-Schwarz\Analyzer\user\vsa\
FrameRangeStructure.
```

Remote command:

[\[SENSe:\] DDEMod: PATTern: FRAMe: LOAD](#) on page 342

Frame Structure Config ← Frame Structure

Opens the Frame Configuration dialog box to configure a user-defined frame structure in the R&S FPL1000 VSA application.

Remote command:

[\[SENSe:\] DDEMod: PATTern: FRAMe: EDIT](#) on page 336

[\[SENSe:\] DDEMod: PATTern: FRAMe: EDIT: STRUcture](#) on page 339

5.3.3.2 Frame configuration

A frame is defined manually as a succession of subframes with specified characteristics. The frame structure can be defined directly in the R&S FPL1000 VSA application.

Frame Configuration - ... \DVB_S2_16APSK_nopilot.xml

Description

Index	Name	Number of Symbols	Modulation	Type	Boosting (optional)	Description (optional)
0	Previous Frame	---	Auto	---	Auto	
1	SOF	26	Pattern	Pattern	---	Start of Frame
2	Header	64	Pattern	Data	---	Header including information on modulation
3	Payload	16200	Data	Data	---	Payload
4	Next Frame	---	Auto	---	Auto	

Insert Above Insert Below Delete Row New Open Save Save As Apply Cancel



By default, at least three subframes are required: the main signal frame, plus one frame before ("previous frame"), and one after ("next frame") this frame. The previous and next frames are required to demodulate the first and last symbols in the main frame correctly. For these frames, only the modulation and boosting can be configured.

Description..... 176

Index..... 177

Name..... 177

Number of Symbols..... 177

Modulation..... 177

Type..... 178

Boosting (optional)..... 178

Description (optional)..... 179

Insert Above..... 179

Insert Below..... 179

Delete Row..... 179

New..... 179

Open..... 179

Save..... 179

Save As..... 179

Apply..... 180

Cancel..... 180

Description

Optional description for the overall frame configuration.

Remote command:

[\[SENSe:\] DDEMod: PATtern: FRAMe: EDIT: TEXT](#) on page 341

Index

Successive number of the individual subframe or region of the signal.

Remote command:

[\[SENSe:\] DDEMod: PATtern: FRAMe: EDIT: STRucture](#) on page 339

Name

Name of the subframe. Duplicate names are allowed.

The names for the subframes "Previous Frame" and "Next Frame" are not editable.

The color of the name field indicates the used [Modulation](#) and [Type](#):

- **Green:** Pattern modulation and pattern type
- **Light green:** Pattern modulation and data type
- **Blue:** Data modulation and data type

Remote command:

[\[SENSe:\] DDEMod: PATtern: FRAMe: EDIT: STRucture](#) on page 339

Number of Symbols

The number of symbols the subframe consists of. For pattern subframes, the number of symbols must correspond to the [Pattern configuration](#).

In result displays based on the result range, the individual subframes (defined by the number of symbols) are indicated by vertical green lines.

Remote command:

[\[SENSe:\] DDEMod: PATtern: FRAMe: EDIT: STRucture](#) on page 339

Modulation

Determines which modulation type is used to demodulate the subframe. The modulation defined here determines the color of the [Name](#) field and the cell color in the "Symbol table".

You must also define the modulation for the previous (before the first subframe) and next (after the last subframe) frames.

"Data"	The modulation type defined for data symbols in the Modulation tab is used.
"Pattern"	The modulation type defined for pattern symbols in the General frame structure settings tab is used.

"Auto"

For previous and next frames only: the signal is assumed to be a succession of frames. In this case, the previous frame has the same modulation as the last subframe of the frame configuration. The next frame has the same modulation as the first subframe in the frame configuration.

Index	Name	Number of Symbols	Modulation
0	Previous Frame	---	Data
1	Start Of Frame	26	Pattern
2	Header Symbols	64	Pattern
3	Data Symbols	3240	Data
4	Next Frame	---	Pattern

Remote command:

[\[SENSe:\] DDEMod: PATtern: FRAME: EDIT: STRucture](#) on page 339

[\[SENSe:\] DDEMod: PATtern: FRAME: EDIT: PREvious: MODulation](#) on page 338

[\[SENSe:\] DDEMod: PATtern: FRAME: EDIT: NEXT: MODulation](#) on page 337

Type

Determines whether the demodulated data in the subframe is known or unknown by the R&S FPL1000 VSA application. This is particularly of interest for the EVM calculation. If unknown data is compared to expected data, for example, the EVM is poor.

The data type defined here also determines the color of the [Name](#) field and the cell color in the "Symbol table".

"Pattern" The data is assumed to correspond with the pattern definition in the ["Pattern Settings"](#) on page 170. Not available for [Modulation](#) type: "Data". Only one subframe is allowed to be of type "Pattern".

"Data" The data is unknown. Used for data symbols or header information.

Remote command:

[\[SENSe:\] DDEMod: PATtern: FRAME: EDIT: STRucture](#) on page 339

Boosting (optional)

By default, the power in all subframes is assumed to be identical. However, pilots are often transmitted with higher power to ensure correct synchronization, for example. Since the R&S FPL1000 VSA application calculates the EVM and other parameters of the signal in reference to the reference power (see [Chapter 3.4, "Common parameters in VSA"](#), on page 67), it must consider deviating power for individual subframes.

By default, a "boosting" factor of 1.000 - relative to the reference power - is defined. For subframes with different gain values, define a different boosting factor to be applied to the reference power.

The more accurate the boosting is defined, the more accurate the EVM and other results in the R&S FPL1000 VSA application.

Remote command:

[\[SENSe:\] DDEMod: PATTern: FRAMe: EDIT: STRucture](#) on page 339

[\[SENSe:\] DDEMod: PATTern: FRAMe: EDIT: PREVIOUS: BOOSTing](#) on page 338

[\[SENSe:\] DDEMod: PATTern: FRAMe: EDIT: NEXT: BOOSTing](#) on page 337

Description (optional)

Optional description for an individual subframe.

The descriptions for the subframes "Previous Frame" and "Next Frame" are not editable.

Remote command:

[\[SENSe:\] DDEMod: PATTern: FRAMe: EDIT: STRucture](#) on page 339

Insert Above

Inserts a new subframe above the currently selected subframe.

Insert Below

Inserts a new subframe below the currently selected subframe.

Delete Row

Deletes the currently selected subframe.

New

Restores the default frame configuration with one data frame for the entire result length. Before any current settings are removed, you are asked if you want to save them.

Remote command:

[\[SENSe:\] DDEMod: PATTern: FRAMe: EDIT](#) on page 336

Open

Opens an existing frame configuration from an XML file. The default storage location for such files is

```
C:\Users\Public\Documents\Rohde-Schwarz\Analyzer\user\vsas\
FrameRangeStructure.
```

Remote command:

[\[SENSe:\] DDEMod: PATTern: FRAMe: EDIT](#) on page 336

Save

Saves the current frame configuration to the currently loaded file.

Remote command:

[\[SENSe:\] DDEMod: PATTern: FRAMe: EDIT: SAVE](#) on page 338

Save As

Saves the current frame configuration to a new XML file. The default storage location for such files is

```
C:\Users\Public\Documents\Rohde-Schwarz\Analyzer\user\vsas\
FrameRangeStructure.
```

Remote command:

[SENSe:] DDEMod: PATtern: FRAMe: EDIT: SAVE on page 338

Apply

Uses the previously loaded frame configuration for the current measurement.

Cancel

Closes the "Frame Configuration" dialog box without saving any changes.

5.3.4 Known data

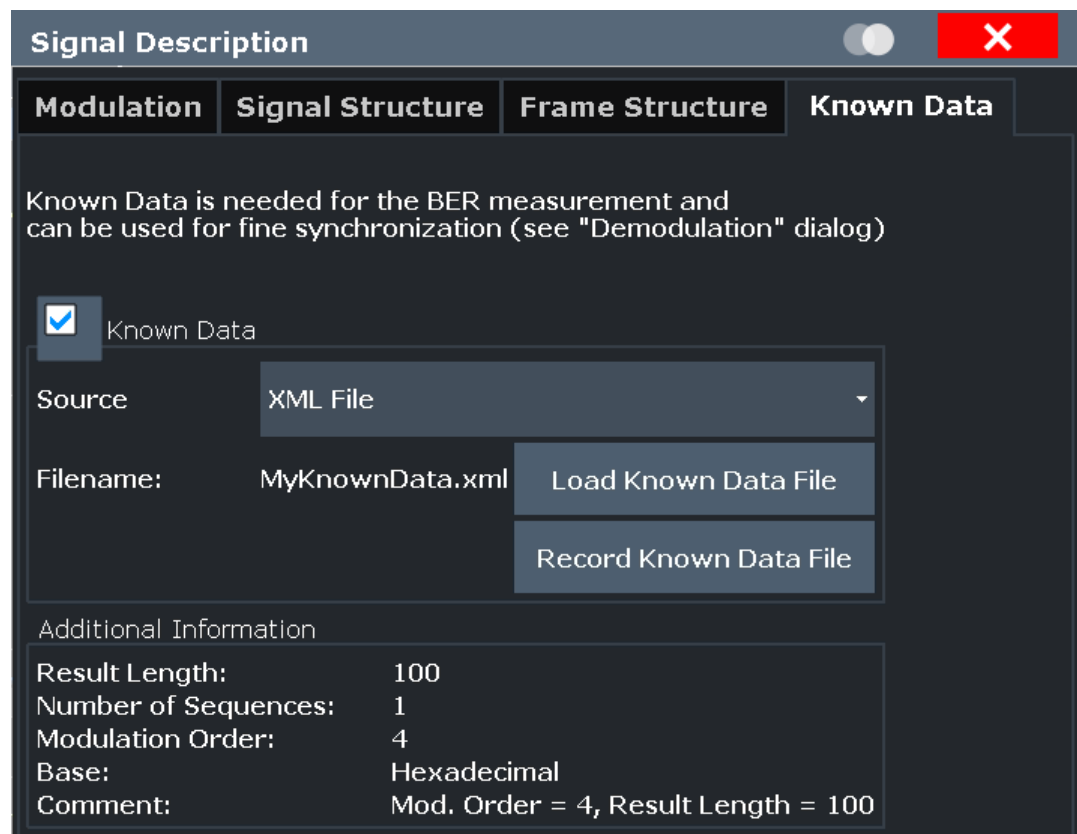
Access: "Overview" > "Signal Description" > "Known Data"

or: [MEAS CONFIG] > "Signal Description" > "Known Data"

The "Known Data" settings allow you to load a file that describes the possible data sequences in the input signal.

(See [Chapter 8.2.4, "How to work with known data files"](#), on page 264).

Additional information provided by the loaded file is displayed at the bottom of the dialog box. This information is not editable directly.





Auxiliary tool to create Known Data files

An auxiliary tool to create Known Data files from data that is already available in the VSA application is provided on the instrument free of charge.

See ["To create a Known Data file using the recording tool for sequences"](#) on page 266.

Alternatively, for data generated by a pseudo-random bit sequence (PRBS) generator, you can specify the algorithm used to generate the data, so the R&S FPL1000 VSA application knows which sequences can occur. This function requires the R&S FPL1000-K70P option. See [Chapter 4.10, "Known data from PRBS generators"](#), on page 150.

The screenshot shows the 'Signal Description' dialog box with the 'Known Data' tab selected. The dialog contains the following settings:

- Known Data:** (checked)
- Source:** PRBS (dropdown menu)
- PRBS Type:** 9 (dropdown menu)
- Generator Polynomial:** Auto (checked), 9; 4; 0
- Negate Feedback Path:** Auto (checked), On (selected), Off
- Pattern Symbols are Part of PRBS:** Auto (checked), On (selected), Off

Known Data	181
Source	182
Load Data File	182
Record Known Data File	182
PRBS Type	182
Generator Polynomial	182
Negate Feedback Path	183
Pattern Symbols are Part of PRBS	183

Known Data

Activates or deactivates the use of the loaded data file (if available), or the PRBS data, depending on the selected ["Source"](#) on page 182.

When deactivated, the additional information from the previously loaded data file is removed. Any references to the known data in the "Demodulation" dialog box are replaced by the default parameter values (see [Chapter 5.8.2, "Advanced demodulation \(synchronization\)"](#), on page 222).

Note: When a standard is loaded, the use of a Known Data file is automatically deactivated.

Remote command:

[SENSe:] DDEMod:KDATa:STATe on page 346

Source

Determines whether the known data is taken from a loaded file or a PRBS generator. If the PRBS generator is used, further settings are available.

This function requires the R&S FPL1000-K70P option.

Remote command:

[SENSe:] DDEMod:KDATa:SOURce on page 349

Load Data File

If [Known Data](#) is activated, this function displays a file selection dialog box to select the XML file that contains the known data. Once a file has been selected, any additional information provided by the file is displayed at the bottom of the dialog box.

Remote command:

[SENSe:] DDEMod:KDATa[:NAME] on page 347

Record Known Data File

Opens the auxiliary tool to create Known Data files from data that is already available in the R&S FPL1000 VSA application.

See ["To create a Known Data file using the recording tool for sequences"](#) on page 266.

PRBS Type

Defines the type of the used PRBS model. The type of the model defines the degree, complexity and number of terms in the polynomial model. If the PRBS data is generated in accordance with the ITU-T standard, no further settings are required.

Remote command:

[SENSe:] DDEMod:KDATa:PRBS[:TYPE] on page 349

Generator Polynomial

Determines the coefficients of the polynomial and thus the feedback positions for the PRBS algorithm.

If the PRBS data is generated in accordance with the ITU-T standard, it is sufficient to specify the [PRBS Type](#). By default, the R&S FPL1000 VSA application automatically determines the corresponding generator polynomial.

If "Auto" is deactivated, specify the coefficients a_0, \dots, a_N of the polynomial manually.

Note that the coefficients must be defined in descending order (e.g. 9;4;0 not 0;4;9)

Remote command:

[SENSe:] DDEMod:KDATa:PRBS:POLYnomial:AUTO on page 348

[SENSe:] DDEMod:KDATa:PRBS:POLYnomial[:ORDER] on page 349

Negate Feedback Path

The feedback bit consists of the xor connected bits from the specified feedback positions. If "Negate Feedback Path" is enabled, this bit is inverted before it is fed into the last shift register. By default, this setting is defined automatically according to the standard for the used PRBS type.

Remote command:

[SENSe:] DDEMod:KDATA:PRBS:FEEDback[:STATe] on page 347

[SENSe:] DDEMod:KDATA:PRBS:FEEDback:AUTO on page 347

Pattern Symbols are Part of PRBS

Determines whether the pattern symbols are part of the PRBS sequence and are thus treated as data symbols.

If the pattern is part of the PRBS (default), the pattern consists of a valid PRBS sequence as specified in the dialog. In this case, the pattern symbols are treated as data symbols. Bit errors in the patterns are weighted as bit errors in the data sequence.

If the pattern is not part of the PRBS, the pattern does not consist of a valid PRBS sequence. In this case, bit errors in the pattern symbols are ignored.

In Auto mode, the pattern is assumed to be part of the PRBS sequence.

Note: If the result range consists only of pattern symbols, the BER result is empty, because no BER can be calculated.

For multi-modulation measurements, not only symbols with "Modulation" = "Pattern", "Type" = "Pattern" are excluded from the BER calculation. Also frames with "Modulation" = "Pattern" and "Type" = "Data".

Remote command:

[SENSe:] DDEMod:KDATA:PRBS:PATtern[:STATe] on page 348

[SENSe:] DDEMod:KDATA:PRBS:PATtern:AUTO on page 348

5.4 Input, output and frontend settings

Access: "Overview" > "Input/Frontend"

or: [INPUT/OUTPUT]

The R&S FPL1000 can evaluate signals from different input sources.

The frequency and amplitude settings represent the "frontend" of the measurement setup.

- [Input settings](#).....183
- [Independent CW source settings](#).....187
- [Output settings](#).....188
- [Frequency settings](#).....190
- [Amplitude and vertical axis configuration](#).....191

5.4.1 Input settings

Access: "Overview" > "Input/Frontend" > "Input"

or: [INPUT/OUTPUT]

Some settings are also available in the "Amplitude" tab of the "Amplitude" dialog box.

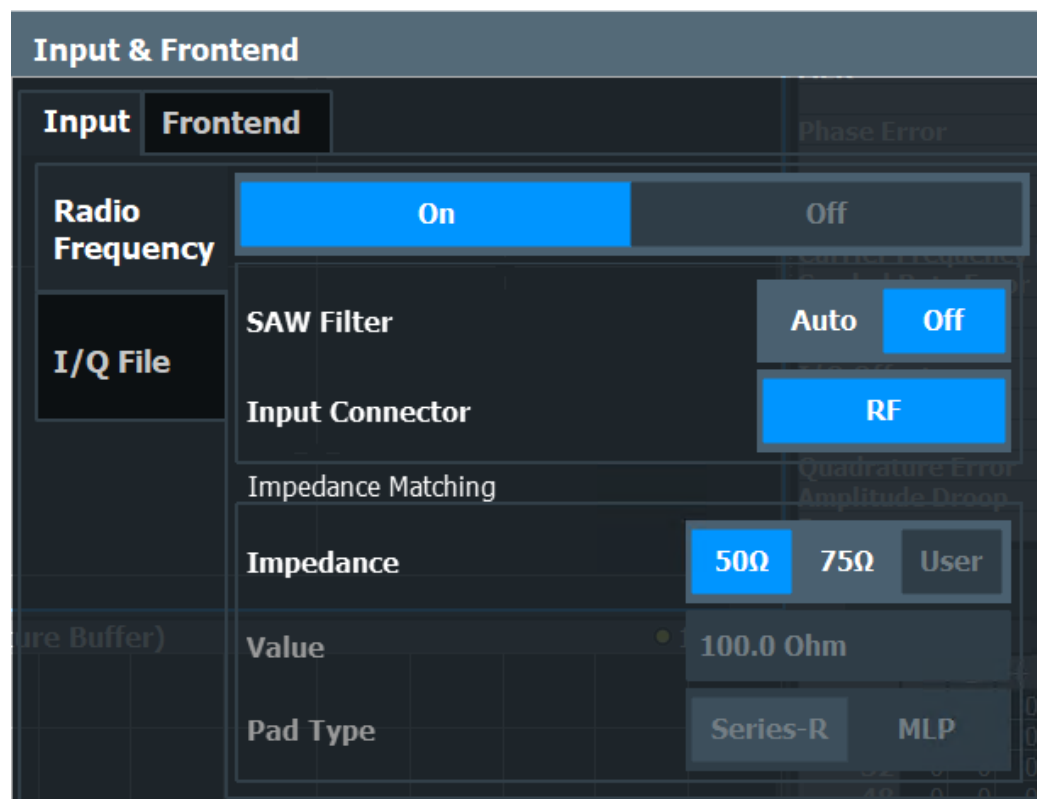
- [Radio frequency input](#)..... 184
- [Settings for input from I/Q data files](#)..... 186

5.4.1.1 Radio frequency input

Access: "Overview" > "Input/Frontend" > "Input" > "Radio Frequency"

or: [INPUT/OUTPUT] > "Input Source Config" > "Input" > "Radio Frequency"

The default input source for the R&S FPL1000 is the radio frequency.





RF Input Protection

The RF input connector of the R&S FPL1000 must be protected against signal levels that exceed the ranges specified in the data sheet. Therefore, the R&S FPL1000 is equipped with an overload protection mechanism. This mechanism becomes active as soon as the power at the input mixer exceeds the specified limit. It ensures that the connection between RF input and input mixer is cut off.

The RF input connector of the R&S FPL1000 must be protected against signal levels that exceed the ranges specified in the data sheet. Therefore, the R&S FPL1000 is equipped with an overload protection mechanism for DC and signal frequencies up to 30 MHz. This mechanism becomes active as soon as the power at the input mixer exceeds the specified limit. It ensures that the connection between RF input and input mixer is cut off.

When the overload protection is activated, an error message is displayed in the status bar ("INPUT OVLD"), and a message box informs you that the RF input was disconnected. Furthermore, a status bit (bit 3) in the `STAT:QUES:POW` status register is set. In this case, you must decrease the level at the RF input connector and then close the message box. Then measurement is possible again. Reactivating the RF input is also possible via the remote command `INPut:ATTenuation:PROTection:RESet`.

Radio Frequency State.....	185
SAW filter.....	185
Input Connector.....	185
Impedance.....	186
YIG-Preselector.....	186

Radio Frequency State

Activates input from the "RF Input" connector.

Remote command:

`INPut<ip>:SELEct` on page 353

SAW filter

The R&S FPL1000 hardware contains both a wide and a narrow IF path. Depending on the used analysis bandwidth, the R&S FPL1000 determines which IF path to use automatically. The wide IF path allows for a smoother signal at the center frequency, while the narrow IF path suppresses possibly distorting signals further away from the center frequency. Using this setting, you can affect which IF path is used.

"Auto" The R&S FPL1000 determines which IF path to use automatically, depending on the used analysis bandwidth.

"Off" The wide IF path is always used.

Remote command:

`INPut<ip>:FILTer:SAW` on page 351

Input Connector

Determines which connector the input data for the measurement is taken from.

"RF" (Default:) The "RF Input" connector

Remote command:

[INPut<ip>:CONNector](#) on page 350

Impedance

The R&S FPL1000 has an internal impedance of 50 Ω. However, some applications use other impedance values. To match the impedance of an external application to the impedance of the R&S FPL1000, an *impedance matching pad* can be inserted at the input. If the type and impedance value of the used matching pad is known to the R&S FPL1000, it can convert the measured units accordingly so that the results are calculated correctly.

The impedance conversion does not affect the level of the output signals (such as IF, video, demod, digital I/Q output).

"50Ω"	(Default:) no conversion takes place
"75Ω"	The 50 Ω input impedance is transformed to a higher impedance using a 75 Ω adapter of the selected "Pad Type": "Series-R" (default) or "MLP" (Minimum Loss Pad)
"User"	The 50 Ω input impedance is transformed to a user-defined impedance value according to the selected "Pad Type": "Series-R" (default) or "MLP" (Minimum Loss Pad)

Remote command:

[INPut<ip>:IMPedance](#) on page 352

[INPut<ip>:IMPedance:PTYPe](#) on page 352

YIG-Preselector

Enables or disables the YIG-preselector.

This setting requires an additional option on the R&S FPL1000.

An internal YIG-preselector at the input of the R&S FPL1000 ensures that image frequencies are rejected. However, image rejection is only possible for a restricted bandwidth. To use the maximum bandwidth for signal analysis you can disable the YIG-preselector at the input of the R&S FPL1000, which can lead to image-frequency display.

Note: Note that the YIG-preselector is active only on frequencies greater than 6 GHz (for models R&S FPL1014 and R&S FPL1026). Therefore, switching the YIG-preselector on or off has no effect if the frequency is below that value.

Note:

For the following measurements, the YIG-"Preselector" is off by default (if available).

- I/Q Analyzer
- VSA

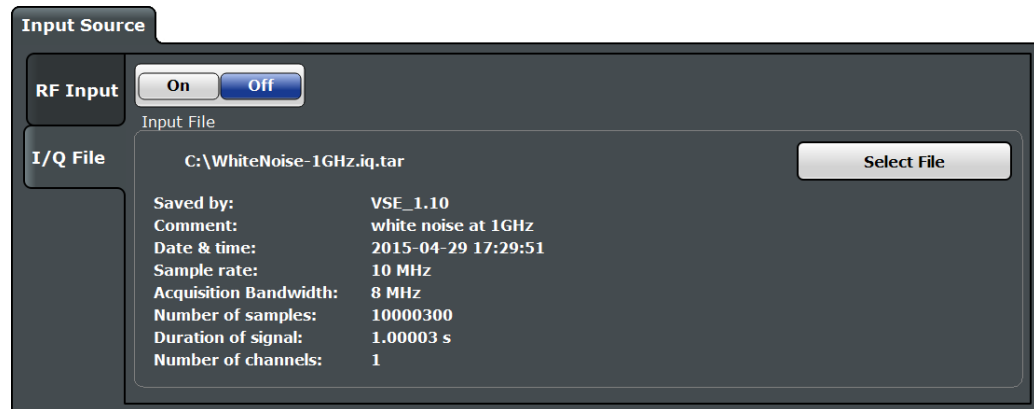
Remote command:

[INPut<ip>:FILTer:YIG\[:STATe\]](#) on page 352

5.4.1.2 Settings for input from I/Q data files

Access: "Overview" > "Input/Frontend" > "Input Source" > "I/Q File"

Or: [INPUT/OUTPUT] > "Input Source Config" > "Input Source" > "I/Q File"



I/Q Input File State.....	187
Select I/Q data file.....	187

I/Q Input File State

Enables input from the selected I/Q input file.

If enabled, the application performs measurements on the data from this file. Thus, most measurement settings related to data acquisition (attenuation, center frequency, measurement bandwidth, sample rate) cannot be changed. The measurement time can only be decreased to perform measurements on an extract of the available data only.

Note: Even when the file input is disabled, the input file remains selected and can be enabled again quickly by changing the state.

Remote command:

[INPut<ip>:SElect](#) on page 353

Select I/Q data file

Opens a file selection dialog box to select an input file that contains I/Q data.

The I/Q data must have a specific format (.iq.tar) as described in R&S FPL1000 I/Q Analyzer and I/Q Input user manual.

The default storage location for I/Q data files is

C:\Users\Public\Documents\Rohde-Schwarz\Analyzer\user.

Remote command:

[INPut<ip>:FILE:PATH](#) on page 353

5.4.2 Independent CW source settings

Access: Toolbar > "Generator Config"

The independent CW signal is available in all R&S FPL1000 applications if the optional Internal Generator R&S FPL1-B9 is installed.

For details, see the R&S FPL1000 User Manual.

State.....	188
Level.....	188
Level Offset.....	188
CW Frequency.....	188

State

Enables or disables the internal generator. The generator signal is output at the GEN Output 50 Ω connector on the front panel.

Remote command:

`OUTPut<up>[:STATe]` on page 354

Level

Defines the output power of the internal generator.

The default output power is -20 dBm. The range is from -60 dBm to +10 dBm.

Remote command:

`SOURce<si>:POWer[:LEVel][:IMMediate][:AMPLitude]` on page 355

Level Offset

Defines an offset to the output power of the internal generator.

Used to adapt the level display, for example to cable loss.

Remote command:

`SOURce<si>:POWer[:LEVel][:IMMediate]:OFFSet` on page 355

CW Frequency

Defines the frequency of the independent CW source. The step size depends on the measurement mode.

If the internal generator is used as a tracking generator, the frequency is coupled to the frequency of the analyzer. Thus, this setting is not available.

Remote command:

`SOURce<si>:INTernal:FREQuency` on page 354

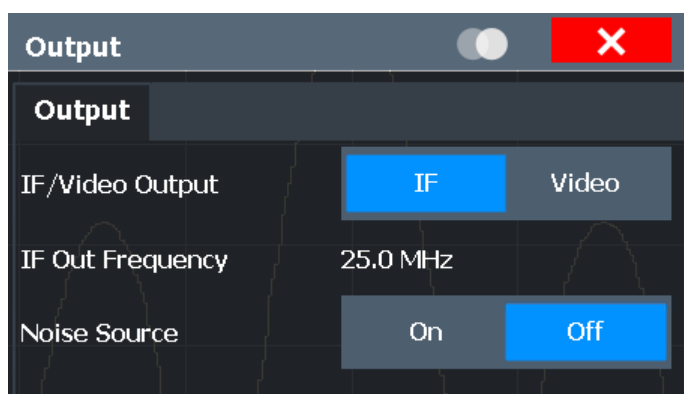
5.4.3 Output settings

Access: [INPUT/OUTPUT] > "OUTPUT Config"

The R&S FPL1000 VSA application can provide output to special connectors for other devices.

For details on connectors, refer to the R&S FPL1000 Getting Started manual, "Front / Rear Panel View" chapters.

Output settings can be configured via the [Input/Output] key or in the "Outputs" dialog box.



Data Output.....	189
Noise Source Control.....	189

Data Output

Defines the type of signal available at one of the output connectors of the R&S FPL1000.

For restrictions and additional information, see the R&S FPL1000 I/Q Analyzer and I/Q Input User Manual.

This connector is only available if the R&S FPL1-B5 option is installed.

"IF"	The measured IF value is provided at the IF/VIDEO output connector. The output is provided at a fixed frequency of 25 MHz. IF and video output is only available in the time domain (zero span).
"Video"	The displayed video signal (i.e. the filtered and detected IF signal, 200mV) is available at the IF/VIDEO output connector. This setting is required to provide demodulated audio frequencies at the output. It is not available for frequency sweeps or I/Q measurements. The video output is a signal of 1 V. It can be used, for example, to control demodulated audio frequencies.

Remote command:

[OUTPut<up>:IF\[:SOURce\]](#) on page 356

[OUTPut<up>:IF:IFFrequency?](#) on page 356

Noise Source Control

Enables or disables the 28 V voltage supply for an external noise source connected to the "Noise source control / Power sensor") connector. By switching the supply voltage for an external noise source on or off in the firmware, you can enable or disable the device as required.

This connector is only available if the R&S FPL1-B5 option is installed.

External noise sources are useful when you are measuring power levels that fall below the noise floor of the R&S FPL1000 itself, for example when measuring the noise level of an amplifier.

In this case, you can first connect an external noise source (whose noise power level is known in advance) to the R&S FPL1000 and measure the total noise power. From this value, you can determine the noise power of the R&S FPL1000. Then when you measure the power level of the actual DUT, you can deduct the known noise level from the total power to obtain the power level of the DUT.

Remote command:

[DIAGnostic:SERVice:NSource](#) on page 356

5.4.4 Frequency settings

Access: [FREQ] > "Frequency Config"

Center Frequency	190
Center Frequency Stepsize	190
Frequency Offset	191

Center Frequency

Defines the center frequency of the signal in Hertz.

The allowed range of values for the center frequency depends on the frequency span.

$$\text{span} > 0: \text{span}_{\min}/2 \leq f_{\text{center}} \leq f_{\max} - \text{span}_{\min}/2$$

f_{\max} and span_{\min} depend on the instrument and are specified in the data sheet.

Remote command:

[\[SENSe:\] FREQuency: CENTer](#) on page 357

Center Frequency Stepsize

Defines the step size when scrolling through center frequency values. The step size can be set to a predefined value, or it can be manually set to a user-defined value.

- | | |
|----------|--|
| "Auto" | The step size is set to the default value: <ul style="list-style-type: none"> • using the rotary knob: 100 kHz • using the arrow keys: 1 MHz |
| "Manual" | Defines a user-defined step size for the center frequency. Enter the step size in the "Value" field. |

Remote command:

[SENSe:] FREQuency:CENTer:STEP:AUTO on page 358

[SENSe:] FREQuency:CENTer:STEP on page 357

Frequency Offset

Shifts the displayed frequency range along the x-axis by the defined offset.

This parameter has no effect on the instrument's hardware, on the captured data, or on data processing. It is simply a manipulation of the final results in which absolute frequency values are displayed. Thus, the x-axis of a spectrum display is shifted by a constant offset if it shows absolute frequencies. However, if it shows frequencies relative to the signal's center frequency, it is not shifted.

A frequency offset can be used to correct the display of a signal that is slightly distorted by the measurement setup, for example.

The allowed values range from -1 THz to 1 THz. The default setting is 0 Hz.

Remote command:

[SENSe:] FREQuency:OFFSet on page 358

5.4.5 Amplitude and vertical axis configuration

Access: [AMPT] > "Amplitude Config"

Amplitude and scaling settings allow you to configure the vertical (y-) axis display and for some result displays also the horizontal (x-) axis.

- [Amplitude settings](#)..... 191
- [Scaling](#)..... 195
- [Units](#)..... 199

5.4.5.1 Amplitude settings

Access: [AMPT] > "Amplitude Config"

Amplitude settings affect the signal power or error levels.



Note that amplitude settings are not window-specific, as opposed to the scaling and unit settings.

Reference Level.....	192
└ Shifting the Display (Offset).....	193
└ Unit.....	193
└ Setting the Reference Level Automatically (Auto Level).....	193
Input Settings.....	194
└ Preamplifier.....	194
└ Input Coupling.....	194
RF Attenuation.....	194
└ Attenuation Mode / Value.....	194
Optimization.....	195
Using Electronic Attenuation.....	195

Reference Level

Defines the expected maximum reference level. Signal levels above this value are possibly not measured correctly. Signals above the reference level are indicated by an "IF Overload" status display.

The reference level can also be used to scale power diagrams; the reference level is then used for the calculation of the maximum on the y-axis.

Since the hardware of the R&S FPL1000 is adapted according to this value, it is recommended that you set the reference level close above the expected maximum signal level. Thus you ensure an optimal measurement (no compression, good signal-to-noise ratio).

Remote command:

`DISPlay[:WINDow<n>][:SUBWindow<w>]:TRACe<t>:Y[:SCALe]:RLEVel`

on page 359

Shifting the Display (Offset) ← Reference Level

Defines an arithmetic level offset. This offset is added to the measured level. In some result displays, the scaling of the y-axis is changed accordingly.

Define an offset if the signal is attenuated or amplified before it is fed into the R&S FPL1000 so the application shows correct power results. All displayed power level results are shifted by this value.

The setting range is ± 200 dB in 0.01 dB steps.

Note, however, that the *internal* reference level (used to adjust the hardware settings to the expected signal) ignores any "Reference Level Offset". Thus, it is important to keep in mind the actual power level the R&S FPL1000 must handle. Do not rely on the displayed reference level (internal reference level = displayed reference level - offset).

Remote command:

`DISPlay[:WINDow<n>][:SUBWindow<w>]:TRACe<t>:Y[:SCALe]:RLEVel:`

`OFFSet` on page 360

Unit ← Reference Level

The R&S FPL1000 measures the signal voltage at the RF input.

The following units are available and directly convertible:

- dBm
- dBmV
- dB μ V

Remote command:

`INPut<ip>:IMPedance` on page 352

`CALCulate<n>:UNIT:POWer` on page 359

Setting the Reference Level Automatically (Auto Level) ← Reference Level

Automatically determines a reference level which ensures that no overload occurs at the R&S FPL1000 for the current input data. At the same time, the internal attenuators are adjusted. As a result, the signal-to-noise ratio is optimized, while signal compression and clipping are minimized.

To determine the required reference level, a level measurement is performed on the R&S FPL1000.

If necessary, you can optimize the reference level further. Decrease the attenuation level manually to the lowest possible value before an overload occurs, then decrease the reference level in the same way.

You can change the measurement time for the level measurement if necessary (see "Changing the Automatic Measurement Time (Meas Time Manual)" on page 230).

Remote command:

[\[SENSe:\]ADJust:LEVel](#) on page 402

Input Settings

Some input settings affect the measured amplitude of the signal, as well.

For information on other input settings, see [Chapter 5.4.1, "Input settings"](#), on page 183.

Preamplifier ← Input Settings

If the (optional) internal preamplifier hardware is installed on the R&S FPL1000, a preamplifier can be activated for the RF input signal.

You can use a preamplifier to analyze signals from DUTs with low output power.

Note: If an optional external preamplifier is activated, the internal preamplifier is automatically disabled, and vice versa.

The input signal is amplified by 20 dB if the preamplifier option is activated.

Remote command:

[INPut<ip>:GAIN:STATe](#) on page 361

Input Coupling ← Input Settings

The RF input of the R&S FPL1000 can be coupled by alternating current (AC) or direct current (DC).

AC coupling blocks any DC voltage from the input signal. AC coupling is activated by default to prevent damage to the instrument. Very low frequencies in the input signal can be distorted.

However, some specifications require DC coupling. In this case, you must protect the instrument from damaging DC input voltages manually. For details, refer to the data sheet.

Remote command:

[INPut<ip>:COUPling](#) on page 351

RF Attenuation

Defines the mechanical attenuation for RF input.

Attenuation Mode / Value ← RF Attenuation

Defines the attenuation applied to the RF input of the R&S FPL1000.

The RF attenuation can be set automatically as a function of the selected reference level (Auto mode). Automatic attenuation ensures that no overload occurs at the RF Input connector for the current reference level. It is the default setting.

In "Manual" mode, you can set the RF attenuation in 5 dB steps down to 0 dB (with option R&S FPL1-B25: in 1 dB steps). Other entries are rounded to the next integer value. The range is specified in the data sheet. If the defined reference level cannot be set for the defined RF attenuation, the reference level is adjusted accordingly and the warning "limit reached" is displayed.

NOTICE! Risk of hardware damage due to high power levels. When decreasing the attenuation manually, ensure that the power level does not exceed the maximum level allowed at the RF input, as an overload can lead to hardware damage.

Remote command:

[INPut<ip>:ATTenuation](#) on page 362

[INPut<ip>:ATTenuation:AUTO](#) on page 362

Optimization

Selects the priority for signal processing *after* the RF attenuation has been applied.

"Low distortion"

(Default:) Optimized for low distortion by avoiding intermodulation

"Low noise"

Optimized for high sensitivity and low noise levels

If this setting is selected, "Low noise" is indicated in the channel information bar.

Remote command:

[INPut<ip>:ATTenuation:AUTO:MODE](#) on page 360

Using Electronic Attenuation

If the (optional) Electronic Attenuation hardware is installed on the R&S FPL1000, you can also activate an electronic attenuator.

In "Auto" mode, the settings are defined automatically; in "Manual" mode, you can define the mechanical and electronic attenuation separately.

Note: Electronic attenuation is not available for stop frequencies (or center frequencies in zero span) above 7 GHz.

In "Auto" mode, RF attenuation is provided by the electronic attenuator as much as possible to reduce the amount of mechanical switching required. Mechanical attenuation can provide a better signal-to-noise ratio, however.

When you switch off electronic attenuation, the RF attenuation is automatically set to the same mode (auto/manual) as the electronic attenuation was set to. Thus, the RF attenuation can be set to automatic mode, and the full attenuation is provided by the mechanical attenuator, if possible.

The electronic attenuation can be varied in 1 dB steps. If the electronic attenuation is on, the mechanical attenuation can be varied in 5 dB steps. Other entries are rounded to the next lower integer value.

If the defined reference level cannot be set for the given attenuation, the reference level is adjusted accordingly and the warning "limit reached" is displayed in the status bar.

Remote command:

[INPut<ip>:EATT:STATE](#) on page 363

[INPut<ip>:EATT:AUTO](#) on page 363

[INPut<ip>:EATT](#) on page 363

5.4.5.2 Scaling

Access: [AMPT] > "Scale Config"

Depending on the type of display (time, spectrum or statistics), various scaling functions are available to adapt the result display to the current data.



Note that scaling settings are window-specific, as opposed to the amplitude settings.

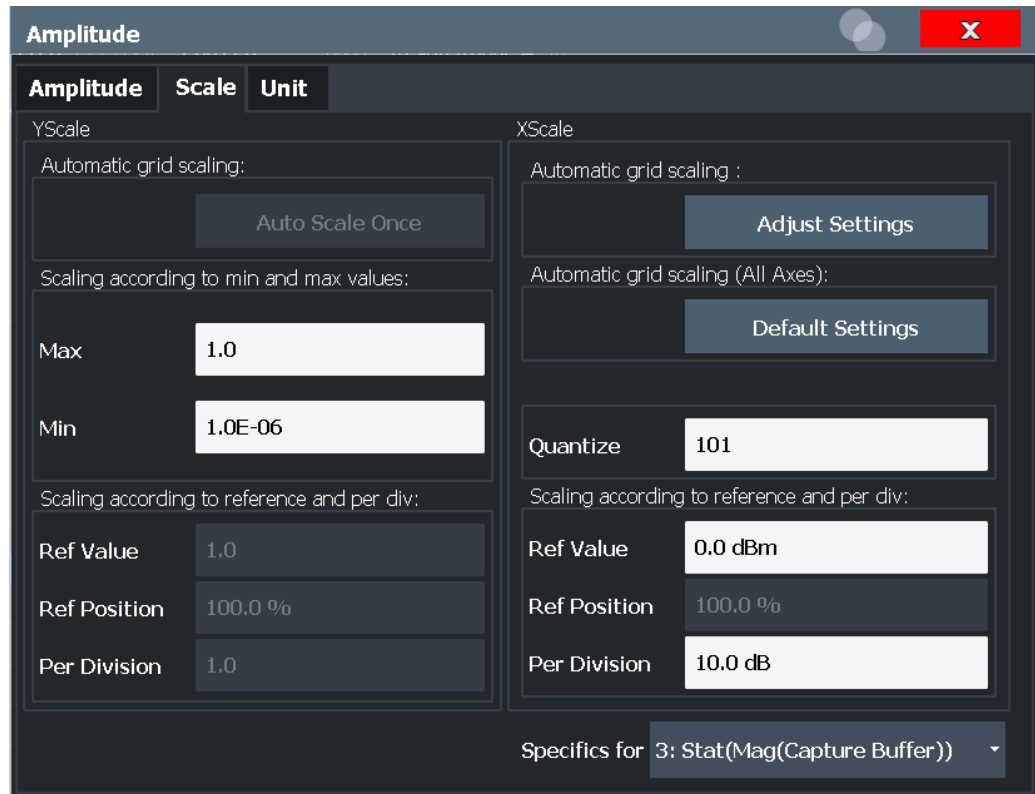


Figure 5-2: Scaling settings for statistical evaluation

For details on the different methods to configure the scaling see [Chapter 8.3.1, "How to change the display scaling"](#), on page 269.

A visualization of the diagram scaling with the current settings is displayed at the right side of the dialog box.

Auto Scale Once/Auto Scale Window	197
Defining Min and Max Values	197
Configuring a Reference Point and Divisions	197
L Y-Axis Reference Value	197
L Y-Axis Reference Position	197
L Range per Division	198
X-Axis Scaling	198
L Adjust Settings	198
L Default Settings	198
L Quantize	198
L X-Axis Reference Value	198
L X-Axis Reference Position	198
L Range per Division	199

Auto Scale Once/Auto Scale Window

If enabled, both the x-axis and y-axis are automatically adapted to the current measurement results (only once, not dynamically) in the selected window.

To adapt the range of all screens together, use the [Auto Scale All](#) function.

Remote command:

For statistics (result type transformation): `CALCulate<n>:STATistics:SCALE: AUTO ONCE` on page 365

For all other results: `DISPlay[:WINDow<n>][:SUBWindow<w>]:TRACe<t>:Y[:SCALE]:AUTO ONCE` on page 400

Defining Min and Max Values

Indicates the current range borders according to the current settings (for information only).

For statistical evaluations only: defines the displayed range using minimum and maximum values.

Values in the range $1e^{-9} < value < 0.1$ are allowed. The y-axis unit is defined via the "[Y-Axis Unit](#)" on page 199 setting. The distance between max and min value must be at least one decade.

Remote command:

`CALCulate<n>:STATistics:SCALE:Y:UPPer` on page 366

`CALCulate<n>:STATistics:SCALE:Y:LOWer` on page 365

Configuring a Reference Point and Divisions

Defines the displayed range using a reference point and the size of the divisions.

For details on the different methods to configure the scaling see [Chapter 8.3.1, "How to change the display scaling"](#), on page 269.

Y-Axis Reference Value ← Configuring a Reference Point and Divisions

Defines a reference value on the y-axis in the current unit. The y-axis is adapted so that the reference value is displayed at the "[Y-Axis Reference Position](#)" on page 197.

For details on the different methods to configure the scaling see [Chapter 8.3.1, "How to change the display scaling"](#), on page 269.

Remote command:

`DISPlay[:WINDow<n>][:SUBWindow<w>]:TRACe<t>:Y[:SCALE]:RVALue` on page 369

Y-Axis Reference Position ← Configuring a Reference Point and Divisions

Defines the position of the [Y-Axis Reference Value](#) on the y-axis. The position is defined as a percentage value, where 0 % refers to the bottom edge, 100 % refers to the top edge of the screen. The y-axis is adapted so that the reference value is displayed at the reference position.

For details on the different methods to configure the scaling see [Chapter 8.3.1, "How to change the display scaling"](#), on page 269.

Remote command:

`DISPlay[:WINDow<n>][:SUBWindow<w>]:TRACe<t>:Y[:SCALE]:RPOSITION` on page 369

Range per Division ← Configuring a Reference Point and Divisions

Defines the value range to be displayed per division. Since the display consists of 10 divisions by default, the displayed range is:

$$\text{Range} = 10 * \langle \text{Range per Division} \rangle$$

Note: If fewer divisions are displayed (e.g. because the window is reduced in height), the range per division is increased to display the same result range in the smaller window. In this case, the per division value does not correspond to the actual display.

Remote command:

`DISPlay[:WINDow<n>][:SUBWindow<w>]:TRACe<t>:Y[:SCALe]:PDIVision` on page 368

X-Axis Scaling

For statistics, a histogram is displayed. For these diagrams, the x-axis can be configured, as well.

Adjust Settings ← X-Axis Scaling

Adjusts the x-axis scaling to the occurring statistical values.

Remote command:

`CALCulate<n>:STATistics:SCALe:AUTO ONCE` on page 365

Default Settings ← X-Axis Scaling

Resets the x- and y-axis scalings to their preset values for the current measurement window.

Remote command:

`CALCulate<n>:STATistics:PRESet` on page 365

Quantize ← X-Axis Scaling

Defines the number of bars to be displayed in the graph, i.e. the granularity of classifications.

Remote command:

`CALCulate<n>:STATistics:SCALe:X:BCOunt` on page 365

X-Axis Reference Value ← X-Axis Scaling

Defines a reference value on the x-axis in the current unit.

Remote command:

`DISPlay[:WINDow<n>]:TRACe<t>:X[:SCALe]:RVALue` on page 368

X-Axis Reference Position ← X-Axis Scaling

Defines the position of the **X-Axis Reference Value** on the x-axis. The position is defined as a percentage value, where 0 % refers to the beginning (left side), 100 % refers to the end (right side) of the diagram. The x-axis is adapted so that the reference value is displayed at the reference position.

Remote command:

`DISPlay[:WINDow<n>]:TRACe<t>:X[:SCALe]:RPOSition` on page 367

Range per Division ← X-Axis Scaling

Defines the value range to be displayed per division on the x-axis. Since the display consists of 10 divisions by default, the displayed range is:

$$\text{Range} = 10 * \langle \text{Range per Division} \rangle$$

Note: If fewer divisions are displayed (e.g. because the window is reduced in width), the range per division is increased to display the same result range in the smaller window. In this case, the per division value does not correspond to the actual display.

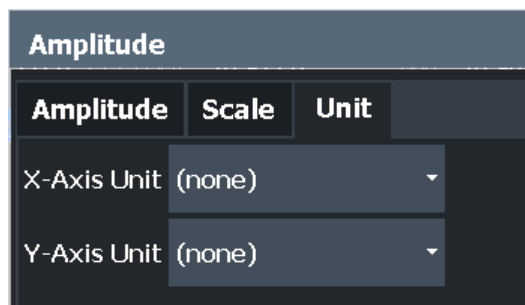
Remote command:

[DISPlay\[:WINDow<n>\]:TRACe<t>:X\[:SCALe\]:PDIVision](#) on page 367

5.4.5.3 Units

Access: [AMPT] > "Unit Config"

You can configure the units for both axes of the diagrams.



Note that unit settings are window-specific, as opposed to the amplitude settings.

X-Axis Unit	199
Y-Axis Unit	199

X-Axis Unit

Defines the unit of the x-axis in the current result diagram.

Remote command:

[CALCulate<n>:X:UNIT:TIME](#) on page 367

Y-Axis Unit

Defines the unit of the y-axis in the current result diagram.

Remote command:

[DISPlay\[:WINDow<n>\]\[:SUBWindow<w>\]:TRACe<t>:Y:SPACing](#) on page 370

For phase diagrams: [CALCulate<n>:UNIT:ANGLE](#) on page 366

For statistics: [CALCulate<n>:STATistics:SCALE:Y:UNIT](#) on page 366

For "equalizer" group delay diagrams: [CALCulate<n>:Y:UNIT:TIME](#) on page 367

5.5 Signal capture

Access: "Overview" > "Signal Capture"

or: [MEAS CONFIG] > "Signal Capture"

The "Signal Capture" settings define how much, how and when data is captured from the input signal.

- [Data acquisition](#).....200
- [Trigger settings](#)..... 201
- [Sweep settings](#).....204

5.5.1 Data acquisition

Access: "Overview" > "Signal Capture" > "Data Acquisition"

or: [MEAS CONFIG] > "Signal Capture"

The "Data Acquisition" settings define how much and how data is captured from the input signal.

The screenshot shows the 'Signal Capture' configuration window with two tabs: 'Data Acquisition' (selected) and 'Trigger'. Under 'Data Acquisition', there are four settings:

- Capture Length:** A radio button for 'Auto' is selected. To its right is a text input field containing '8000.0 sym' and a dropdown menu set to 'sym'. To the right of the dropdown is the text '= 2.083 ms'.
- Sample Rate:** A dropdown menu is set to '4 * Symbol Rate' and '15.36 MHz'.
- Usable I/Q Bandwidth:** A text field containing '12.288 MHz'.
- Swap I/Q:** Two buttons, 'On' and 'Off', with 'Off' being highlighted in blue.

Capture Length Settings	200
Sample Rate	201
Usable I/Q Bandwidth	201
Swap I/Q	201

Capture Length Settings

The capture length defines how many symbols are captured during each measurement.

Enable the "Auto" option to define the capture length automatically according to the burst and pattern length settings and the statistics count. Thus, a minimal capture length is used, which improves performance.

If the capture length is not defined automatically, enter the number of symbols or seconds to be captured and select the used unit. The defined number is converted to the alternative unit (seconds/symbols) for reference.

Up to 128000 symbols can be captured and processed during each measurement.

Remote command:

[SENSe:] DDEMod:RLENgth:AUTO on page 371

[SENSe:] DDEMod:RLENgth[:VALue] on page 371

[SENSe:] DDEMod:RLENgth:SYMBols[:VALue] on page 372

Sample Rate

Defines the number of samples to capture per symbol. The sample rate in MHz is indicated for reference. This parameter affects the demodulation bandwidth and thus the usable I/Q bandwidth.

The maximum sample rate depends on the defined [Symbol Rate](#) (see [Chapter 4.2, "Sample rate, symbol rate and I/Q bandwidth"](#), on page 76).

For details on selecting the suitable sample rate, see [Chapter 4.2, "Sample rate, symbol rate and I/Q bandwidth"](#), on page 76.

Remote command:

[SENSe:] DDEMod:PRATe on page 370

Usable I/Q Bandwidth

Shows the usable I/Q bandwidth which depends on the selected sample rate. For details see [Chapter 4.2, "Sample rate, symbol rate and I/Q bandwidth"](#), on page 76.

This information is provided for reference only.

Note:

In diagrams in the frequency domain (Spectrum transformation, see ["Result Type Transformation"](#) on page 250) the usable I/Q bandwidth is indicated by vertical blue lines.

Remote command:

TRACe:IQ:BWIDth on page 372

Swap I/Q

Activates or deactivates the inverted I/Q modulation. If the I and Q parts of the signal from the DUT are interchanged, the R&S FPL1000 can do the same to compensate for it.

On	I and Q signals are interchanged Inverted sideband, $Q+j*I$
Off	I and Q signals are not interchanged Normal sideband, $I+j*Q$

Remote command:

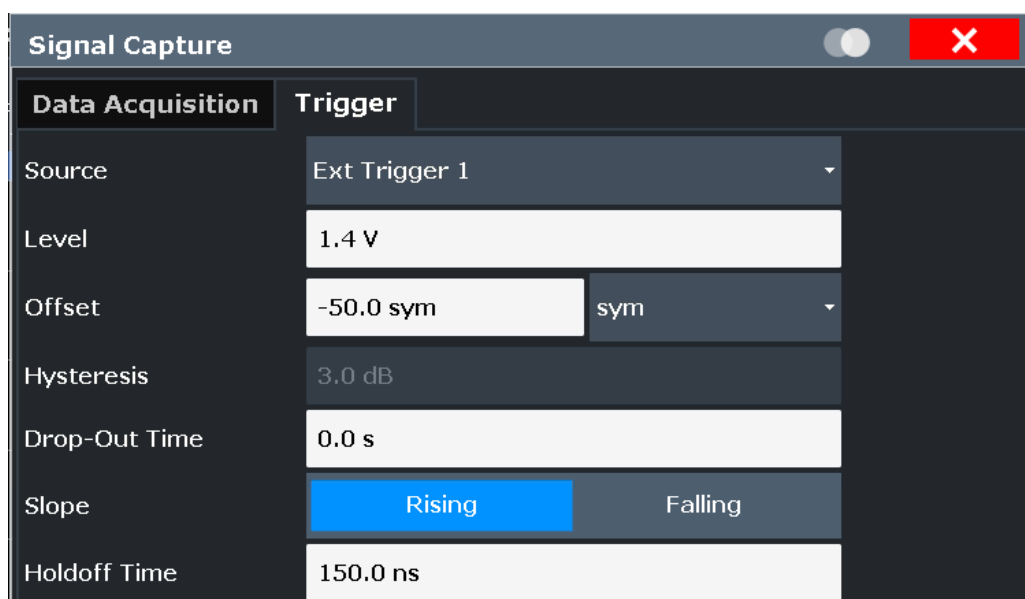
[SENSe:] SWAPiq on page 372

5.5.2 Trigger settings

Access: "Overview" > "Signal Capture" > "Trigger"

or: [TRIG] > "Trigger Config"

The trigger settings define the beginning of a measurement.



For step-by-step instructions on configuring triggered measurements, see the R&S FPL1000 User Manual.

Trigger Source.....	202
L Free Run.....	202
L External Trigger 1.....	202
L IF Power.....	203
L I/Q Power.....	203
Trigger Offset.....	203
Hysteresis.....	203
Drop-Out Time.....	204
Slope.....	204
Trigger Holdoff.....	204

Trigger Source

Defines the trigger source. If a trigger source other than "Free Run" is set, "TRG" is displayed in the channel bar and the trigger source is indicated.

Remote command:

`TRIGger [:SEquence] :SOURce` on page 374

Free Run ← Trigger Source

No trigger source is considered. Data acquisition is started manually or automatically and continues until stopped explicitly.

Remote command:

`TRIG:SOUR IMM`, see `TRIGger [:SEquence] :SOURce` on page 374

External Trigger 1 ← Trigger Source

Data acquisition starts when the TTL signal fed into the specified input connector meets or exceeds the specified trigger level.

For details, see the "Instrument Tour" chapter in the R&S FPL1000 Getting Started manual.

Remote command:

TRIG:SOUR EXT

See [TRIGger\[:SEquence\]:SOURce](#) on page 374

IF Power ← Trigger Source

The R&S FPL1000 starts capturing data as soon as the trigger level is exceeded around the third intermediate frequency.

For frequency sweeps, the third IF represents the start frequency. The trigger threshold depends on the defined trigger level, as well as on the RF attenuation and preamplification. A reference level offset, if defined, is also considered. The trigger bandwidth at the intermediate frequency depends on the RBW and sweep type. For details on available trigger levels and trigger bandwidths, see the instrument data sheet.

For measurements on a fixed frequency (e.g. zero span or I/Q measurements), the third IF represents the center frequency.

This trigger source is only available for RF input.

For details on available trigger levels and trigger bandwidths, see the data sheet.

Remote command:

TRIG:SOUR IFP, see [TRIGger\[:SEquence\]:SOURce](#) on page 374

I/Q Power ← Trigger Source

Triggers the measurement when the magnitude of the sampled I/Q data exceeds the trigger threshold.

The trigger bandwidth corresponds to the "Usable I/Q Bandwidth" setting for data acquisition (see ["Usable I/Q Bandwidth"](#) on page 201).

Remote command:

TRIG:SOUR IQP, see [TRIGger\[:SEquence\]:SOURce](#) on page 374

Trigger Offset

Defines the time offset between the trigger event and the start of the measurement.

Enter the time in seconds or in symbols.

Offset > 0:	Start of the measurement is delayed
Offset < 0:	Measurement starts earlier (pretrigger) Only possible for zero span (e.g. I/Q Analyzer application) and gated trigger switched off Maximum allowed range limited by the measurement time: $\text{Pretrigger}_{\text{max}} = \text{measurement time}_{\text{max}}$

Remote command:

[TRIGger\[:SEquence\]:HOLDoff\[:TIME\]](#) on page 373

Hysteresis

Defines the distance in dB to the trigger level that the trigger source must exceed before a trigger event occurs. Setting a hysteresis avoids unwanted trigger events caused by noise oscillation around the trigger level.

This setting is only available for "IF Power" trigger sources. The range of the value is between 3 dB and 50 dB with a step width of 1 dB.

(For details see the R&S FPL1000 I/Q Analyzer and I/Q Input User Manual.)

Remote command:

[TRIGger\[:SEquence\]:IFPower:HYSteresis](#) on page 374

Drop-Out Time

Defines the time that the input signal must stay below the trigger level before triggering again.

Remote command:

[TRIGger\[:SEquence\]:DTIME](#) on page 373

Slope

For all trigger sources except time, you can define whether triggering occurs when the signal rises to the trigger level or falls down to it.

Remote command:

[TRIGger\[:SEquence\]:SLOPe](#) on page 374

Trigger Holdoff

Defines the minimum time (in seconds) that must pass between two trigger events. Trigger events that occur during the holdoff time are ignored.

Remote command:

[TRIGger\[:SEquence\]:IFPower:HOLDoff](#) on page 373

5.5.3 Sweep settings

Access: [Sweep]

The sweep settings define how often data from the input signal is acquired and then evaluated.

Continuous Sweep / Run Cont	204
Single Sweep / Run Single	205
Continue Single Sweep	205
Refresh	205
Statistic Count	205
Select Result Rng	206

Continuous Sweep / Run Cont

After triggering, starts the measurement and repeats it continuously until stopped.

While the measurement is running, the "Continuous Sweep" softkey and the [RUN CONT] key are highlighted. The running measurement can be aborted by selecting the highlighted softkey or key again. The results are not deleted until a new measurement is started.

Note: Sequencer. If the Sequencer is active, the "Continuous Sweep" softkey only controls the sweep mode for the currently selected channel setup. However, the sweep mode only takes effect the next time the Sequencer activates that channel setup, and only for a channel-defined sequence. In this case, a channel setup in continuous sweep mode is swept repeatedly.

Furthermore, the [RUN CONT] key controls the Sequencer, not individual sweeps. [RUN CONT] starts the Sequencer in continuous mode.

For details on the Sequencer, see the R&S FPL1000 User Manual.

Remote command:

`INITiate<n>:CONTinuous` on page 404

Single Sweep / Run Single

After triggering, starts the number of evaluations set in "Statistics Count". The measurement stops after the defined number of evaluations has been performed.

While the measurement is running, the "Single Sweep" softkey and the [RUN SINGLE] key are highlighted. The running measurement can be aborted by selecting the highlighted softkey or key again.

Note: Sequencer. If the Sequencer is active, the "Single Sweep" softkey only controls the sweep mode for the currently selected channel setup. However, the sweep mode only takes effect the next time the Sequencer activates that channel setup, and only for a channel-defined sequence. In this case, the Sequencer sweeps a channel setup in single sweep mode only once.

Furthermore, the [RUN SINGLE] key controls the Sequencer, not individual sweeps. [RUN SINGLE] starts the Sequencer in single mode.

If the Sequencer is off, only the evaluation for the currently displayed channel setup is updated.

For details on the Sequencer, see the R&S FPL1000 User Manual.

Remote command:

`INITiate<n>[:IMMEDIATE]` on page 405

Continue Single Sweep

After triggering, repeats the number of evaluations set in "Statistics Count", without deleting the trace of the last measurement.

While the measurement is running, the "Continue Single Sweep" softkey and the [RUN SINGLE] key are highlighted. The running measurement can be aborted by selecting the highlighted softkey or key again.

Remote command:

`INITiate<n>:CONMeas` on page 404

Refresh

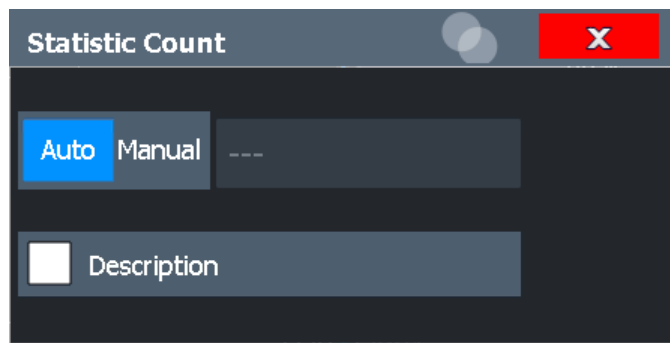
Repeats the evaluation of the data currently in the capture buffer without capturing new data.

Remote command:

`INITiate:REFMeas` on page 405

Statistic Count

Defines the number of measurements to be considered for statistical evaluations. The behavior depends on the active sweep mode.



Activate "Description" to display a visualization of the behavior of the current settings.

Note: If the "Statistic Count" is set to 1, trace averaging is not performed; Max Hold and Min Hold, however, remain active, unlike in the Spectrum application.

- | | |
|----------|--|
| "Auto" | In single sweep mode: captures the I/Q data once and evaluates it
In continuous sweep mode: captures I/Q data continuously; for each evaluation, the average is calculated over the last 10 capture sets (moving average) |
| "Manual" | In single sweep mode: captures I/Q data until the defined number of evaluations have been performed
In continuous sweep mode: captures I/Q data continuously; if trace averaging is selected, the average is calculated over the defined number of capture sets (moving average); |

Remote command:

[SENSe:] SWEEp:COUNT on page 375

Select Result Rng

Selects the result range from the capture buffer that you want to evaluate.

This function is available in single sweep mode only.

Result displays based on the capture buffer display the results over all result ranges that have been captured in the signal capturing process and are in the R&S FPL1000's memory. Some result displays are based on an individual result range, e.g. to analyze a particular burst. By selecting a different range number, you can move through the result ranges in the display.

Which ranges are available depends on the number of result ranges you have captured previously.

For more information, refer also to [Chapter 4.6, "Measurement ranges"](#), on page 142.

Remote command:

[SENSe:] DDEMod:SEARch:MBURst:CALC on page 375

5.6 Burst and pattern configuration

Access: "Overview" > "Burst/Pattern"

or: [MEAS CONFIG] > "Burst/Pattern Search"

Information on known patterns and bursts in the captured signal improve the accuracy of the determined ideal reference signal, and calculation of the signal parameters becomes quicker.

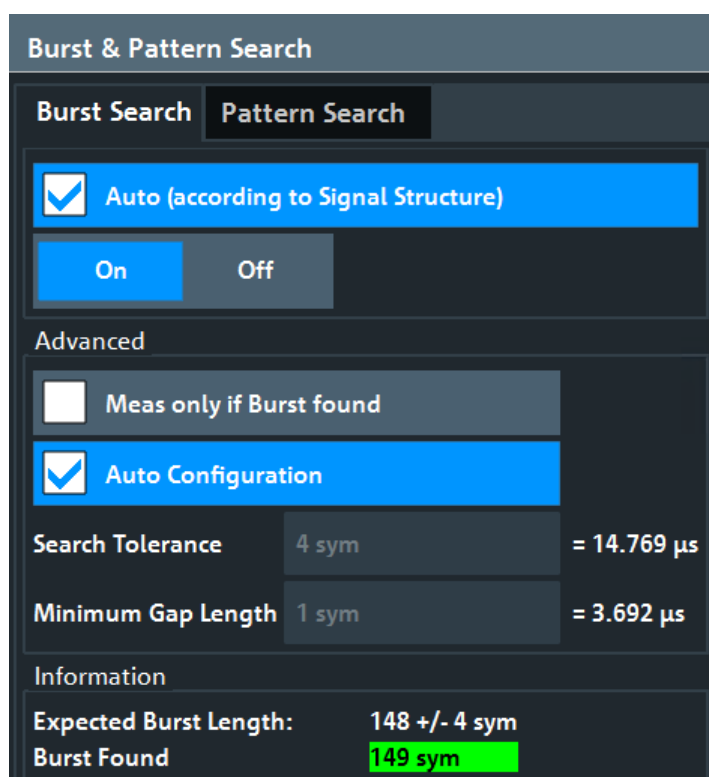
For details on burst and patterns see [Chapter 4.4, "Overview of the demodulation process"](#), on page 112.

5.6.1 Burst search

Access: "Overview" > "Burst/Pattern" > "Burst Search"

or: [MEAS CONFIG] > "Burst/Pattern Search" > "Burst Search" tab

The "Burst Search" settings define when a burst is detected in the evaluated signal.



Enabling Burst Searches.....	207
Measuring only if burst was found.....	208
Burst Configuration.....	208
└ Search Tolerance.....	208
└ Min Gap Length.....	208
Expected Burst Length / Burst Found.....	208

Enabling Burst Searches

Enables or disables burst searches. If "Auto" is selected, burst search is enabled only if the signal structure defines a bursted signal (in the "Signal Structure" tab of the "Modulation & Signal Description" dialog box, see ["Signal Type"](#) on page 170).

Remote command:

[SENSe:] DDEMod:SEARCh:BURSt:AUTO on page 377

Measuring only if burst was found

If enabled, measurement results are only displayed (and are only averaged) if a valid burst has been found. When measuring bursted signals that are averaged over several measurements, it is recommended that you enable this option so that erroneous measurements do not affect the result of averaging.

Remote command:

[SENSe:] DDEMod:SEARCh:BURSt:MODE on page 378

Burst Configuration

The conditions under which a burst is detected in the captured data can be configured either manually or automatically according to the defined signal structure settings (see "Burst Settings" on page 170).

Remote command:

[SENSe:] DDEMod:SEARCh:BURSt:CONFigure:AUTO on page 377

Search Tolerance ← Burst Configuration

Defines the number of symbols that may differ from the burst length without influencing the burst detection. A search tolerance of 5, for example, with a minimum and maximum burst length of 100, will detect bursts that are 95 to 100 symbols long. (The minimum and maximum burst length is defined in the [Signal structure settings](#))

Note: Due to the fact that the VSA does not have knowledge of the ramp length, there is an uncertainty in the burst search algorithm. Thus, setting this parameter to "0" will result in a failed burst search for most signals.

Remote command:

[SENSe:] DDEMod:SEARCh:BURSt:TOLerance on page 378

Min Gap Length ← Burst Configuration

Represents the minimum distance (in symbols) between adjacent bursts. The default value is 1 symbol in order to make sure that the burst search finds bursts that are very close to each other. However, in case the "capture buffer" does not contain very close bursts, it is recommended that you increase the value. This makes the burst search faster and also more robust for highly distorted signals.

Note that this parameter only influences the robustness of the burst search. It should not be used to explicitly exclude certain bursts from the measurement. For example, setting the minimum gap length to 100 symbols does not ensure that the burst search does not find bursts that have a very small gap.

Remote command:

[SENSe:] DDEMod:SEARCh:BURSt:GLENgth[:MINimum] on page 377

Expected Burst Length / Burst Found

These fields are for information only and indicate the expected burst length as defined in the [Burst Settings](#), and if a burst is detected, its length.

Remote command:

[CALCulate<n>:DDEM:BURSt:LENGth?](#) on page 463

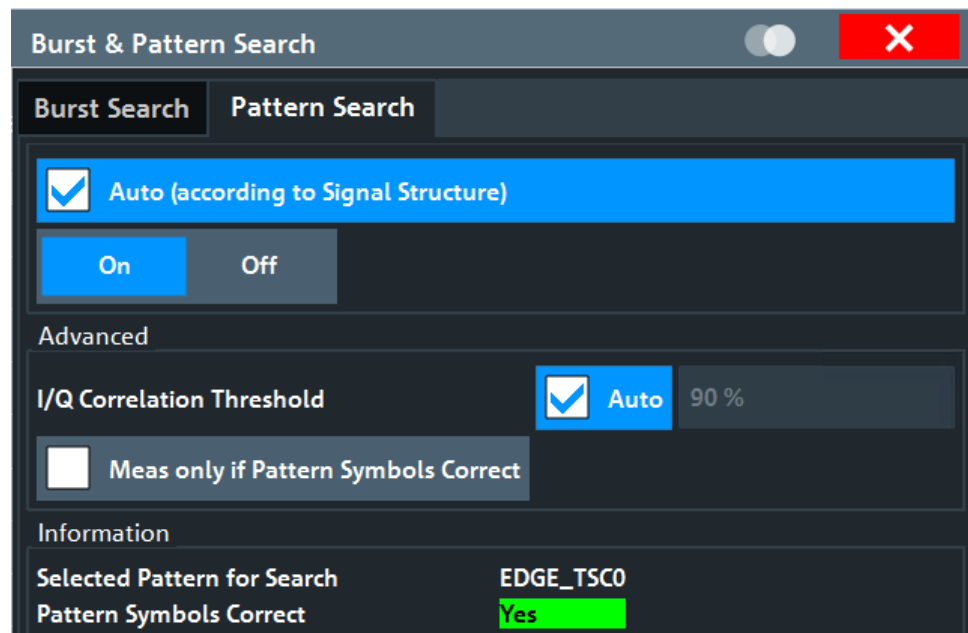
[CALCulate<n>:DSP:RESult:RRANge:CURRent:BURSt:LENGth?](#) on page 458

5.6.2 Pattern search

Access: "Overview" > "Burst/Pattern" > "Pattern Search"

or: [MEAS CONFIG] > "Burst/Pattern Search" > "Pattern Search" tab

The "Pattern Search" settings define when a pattern is detected in the evaluated signal.



Enabling Pattern Searches.....	209
I/Q Correlation Threshold.....	210
Meas only if Pattern Symbols Correct.....	210
Selected Pattern for Search.....	210
Pattern Symbols Correct.....	210

Enabling Pattern Searches

Enables or disables pattern searches. If "Auto" is selected, pattern search is enabled only if the signal structure defines a pattern in the signal (in the "Signal Structure" tab of the "Modulation & Signal Description" dialog box, see ["Pattern Settings"](#) on page 170).

Remote command:

[\[SENSe:\] DDEMod: SEARch: SYNC: STAtE](#) on page 380

[\[SENSe:\] DDEMod: SEARch: SYNC: AUtO](#) on page 379

I/Q Correlation Threshold

The I/Q correlation threshold decides whether a match is accepted or not during a pattern search (see also [Chapter 4.4.2, "I/Q pattern search"](#), on page 116). If the parameter is set to 100%, only I/Q patterns that match totally with the input signal are found. This is only the case for infinite SNR.

If the threshold "Auto" option is enabled, the default value of 90% is used. As long as the pattern is found, there is no need to change this parameter. However, if the pattern is very short (approximately < 10 symbols) or if the signal is highly distorted, tuning this parameter helps the pattern search to succeed. To define a threshold manually, disable the "Auto" option.

Remote command:

[\[SENSe:\] DDEMod: SEARCh: SYNC: IQCThreshold](#) on page 379

[\[SENSe:\] DDEMod: SEARCh: PATTern: CONFIgure: AUTO](#) on page 379

Actual correlation:

[CALCulate<n>: DSP: RESult: RRANge: CURRent: PATTern: CONFidence?](#)
on page 459

Meas only if Pattern Symbols Correct

If enabled, measurement results are only displayed (and are only averaged) if a valid pattern has been found. When measuring signals that contain a pattern and are averaged over several measurements, it is recommended that you enable this option so that erroneous measurements do not affect the result of averaging.

Remote command:

[\[SENSe:\] DDEMod: SEARCh: SYNC: MODE](#) on page 379

Selected Pattern for Search

Indicates which of the patterns that are assigned to the current standard is selected and will be searched for.

The selected pattern is indicated for information only and cannot be edited here, only in the "Signal Structure" settings, see ["Name"](#) on page 170).

Remote command:

[\[SENSe:\] DDEMod: SEARCh: SYNC: SElect](#) on page 380

Pattern Symbols Correct

Indicates whether a correct pattern was found in the currently captured data.

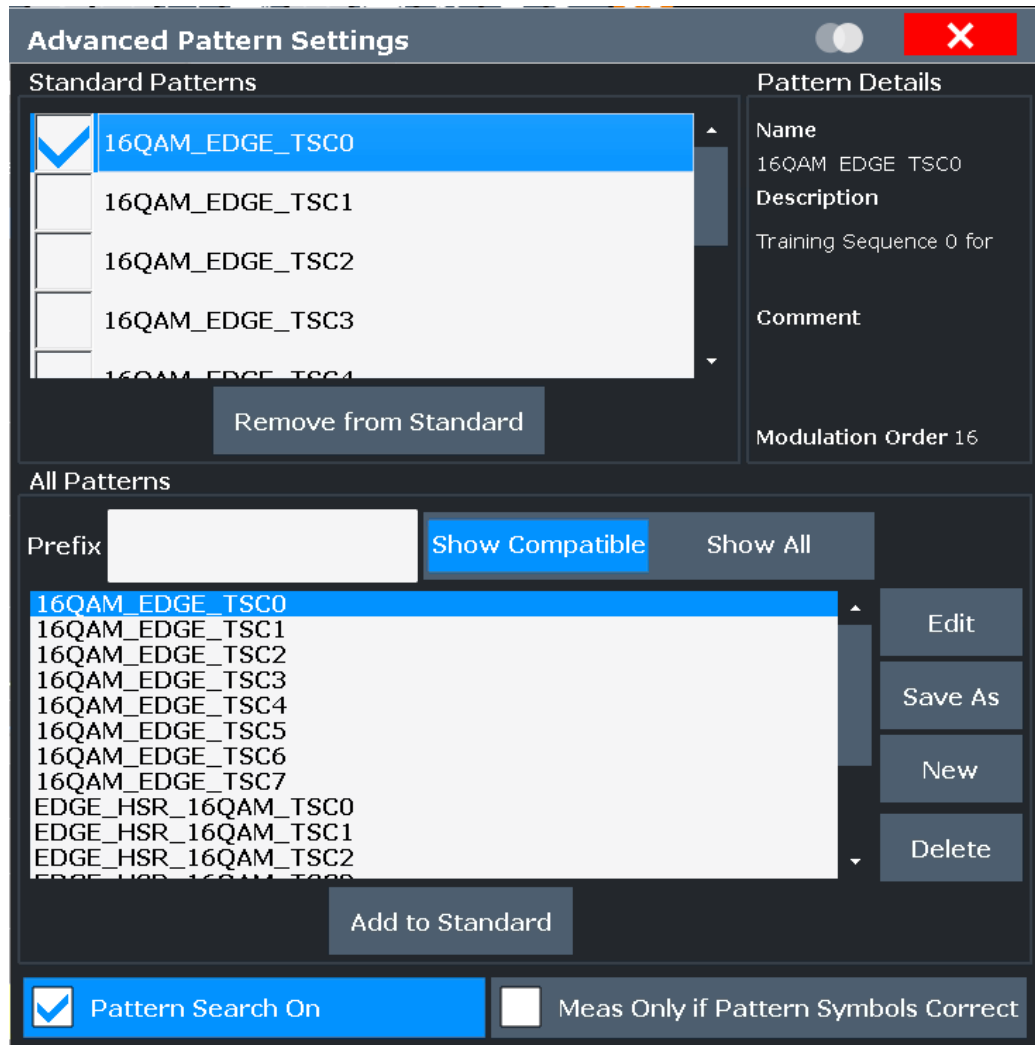
Remote command:

[CALCulate<n>: DSP: RESult: RRANge: CURRent: PATTern: CORRect?](#)
on page 459

5.6.3 Pattern configuration

Access: "Meas Config" > "Pattern Config"

For common signal standards, the patterns to be searched for in the captured signal are predefined in the VSA application. In addition, new patterns can be defined and assigned to a signal standard manually.



Standard Patterns - selecting an assigned pattern.....	211
Removing patterns from a standard.....	212
Adding patterns to a standard.....	212
Displaying available patterns.....	212
L Prefix.....	212
L Show Compatible/ Show All.....	212
Edit.....	212
Save As.....	212
New.....	213
Delete.....	213
Pattern details.....	213
Pattern Search On.....	213
Meas only if Pattern Symbols Correct.....	213

Standard Patterns - selecting an assigned pattern

The "Standard Patterns" are the patterns assigned to the currently selected standard. You can add existing patterns to the standard or remove patterns already assigned to the standard. The highlighted pattern is currently selected for pattern search.

Remote command:

[SENSe:] DDEMod:SEARCh:SYNC:SELeCt on page 380

Removing patterns from a standard

Removes the assignment of the selected patterns to the standard. The patterns are removed from the "Standard Patterns" list, but not deleted.

Remote command:

[SENSe:] DDEMod:SEARCh:SYNC:PATTErn:REMOve on page 383

Adding patterns to a standard

Adds the selected patterns in the list of available patterns ("All Patterns") to the list of assigned patterns ("Standard Patterns").

For details see ["To add a predefined pattern to a standard"](#) on page 260.

Remote command:

[SENSe:] DDEMod:SEARCh:SYNC:PATTErn:ADD on page 383

Displaying available patterns

The "All Patterns" list contains the patterns available in the VSA application.

You can assign available patterns to the selected standard, edit existing or define new patterns.

For details on managing standard patterns, see [Chapter 8.2.3.3, "How to manage patterns"](#), on page 263

The list can be filtered using the following functions:

Prefix ← Displaying available patterns

Shows only patterns that contain the specified prefix.

Show Compatible/ Show All ← Displaying available patterns

Shows only patterns that are compatible to the selected modulation mode or all patterns (regardless of the selected standard).

Edit

Opens the "Edit Pattern" dialog box to edit the pattern definition. See [Chapter 5.6.4, "Pattern definition"](#), on page 213.

For details on defining a pattern, see [Example "Defining a pattern"](#) on page 262.

Remote command:

[SENSe:] DDEMod:SEARCh:SYNC:NAME on page 382

[SENSe:] DDEMod:SEARCh:SYNC:COMMEnt on page 381

[SENSe:] DDEMod:SEARCh:SYNC:DATA on page 382

[SENSe:] DDEMod:SEARCh:SYNC:TEXT on page 383

Save As

Saves a copy of an existing pattern under a new name.

Remote command:

[SENSe:] DDEMod:SEARCh:SYNC:COpy on page 381

New

Opens the "Pattern" dialog box to create a new pattern definition. See [Chapter 5.6.4, "Pattern definition"](#), on page 213.

For details on defining a pattern, see [Example "Defining a pattern"](#) on page 262.

Remote command:

[\[SENSe:\] DDEMod: SEARCh: SYNC: NAME](#) on page 382

[\[SENSe:\] DDEMod: SEARCh: SYNC: COMMeNt](#) on page 381

[\[SENSe:\] DDEMod: SEARCh: SYNC: DATA](#) on page 382

[\[SENSe:\] DDEMod: SEARCh: SYNC: TEXT](#) on page 383

Delete

Deletes the selected patterns. Any existing assignments to other standards are removed.

Remote command:

[\[SENSe:\] DDEMod: SEARCh: SYNC: DELeTe](#) on page 382

Pattern details

Pattern details for the currently focused pattern are displayed at the upper right-hand side of the dialog box. You can refer to these details, for example, when you want to add a new pattern to the standard and want to make sure you have selected the correct one.

Pattern Search On

If enabled, the VSA application searches for the selected pattern. This setting is identical to the setting in the "Pattern Search" dialog box (see ["Enabling Pattern Searches"](#) on page 209).

Remote command:

[\[SENSe:\] DDEMod: SEARCh: SYNC: STATe](#) on page 380

Meas only if Pattern Symbols Correct

If enabled, measurement results are only displayed (and are only averaged) if a valid pattern has been found. When measuring signals that contain a pattern and are averaged over several measurements, it is recommended that you enable this option so that erroneous measurements do not affect the result of averaging.

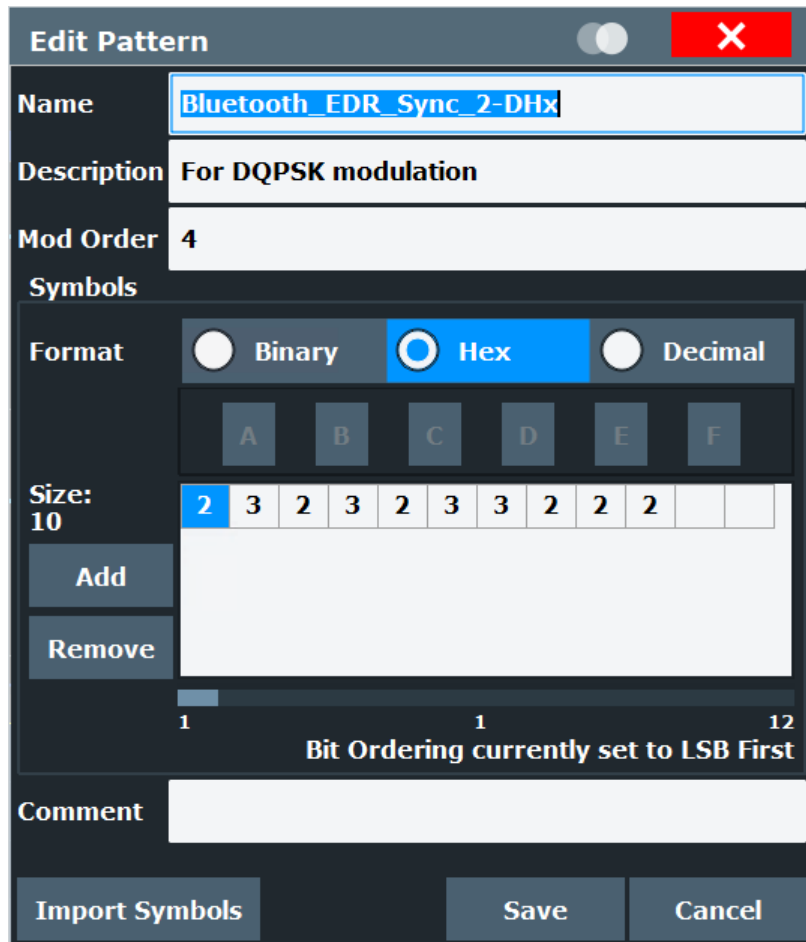
Remote command:

[\[SENSe:\] DDEMod: SEARCh: SYNC: MODE](#) on page 379

5.6.4 Pattern definition

Access: "Meas Config" > "Pattern Config" > "New"

New patterns can be defined and then assigned to a standard.



For details on defining a pattern, see [Example"Defining a pattern"](#) on page 262.

Name	214
Description	214
Mod. order	215
Symbols	215
L Symbol format	215
L Adding symbols	215
L Removing symbols	215
Comment	215
Import Symbols	215

Name

Pattern name that will be displayed in selection list

Remote command:

[SENSe:] DDEMod: SEARCh: SYNC: NAME on page 382

Description

Optional description of the pattern which is displayed in the pattern details

Remote command:

[SENSe:] DDEMod: SEARCh: SYNC: TEXT on page 383

Mod. order

The order of modulation, e.g. 8 for an 8-PSK.

Remote command:

[SENSe:] DDEMod:SEARCh:SYNC:NState on page 383

Symbols

The pattern definition is a symbol table consisting of one or more symbols. The number of symbols is indicated as the "Size" to the left of the symbol table.

A scrollbar beneath the input area allows you to scroll through the table for long patterns. The numbers beneath the scrollbar indicate the sequential number of the following symbols, from left to right:

- the first symbol
- the currently selected symbol
- the last symbol

Whether the symbols are interpreted as LSB first or MSB first depends on the [Bit Ordering](#) setting, see [Chapter 5.8.2, "Advanced demodulation \(synchronization\)"](#), on page 222. By default, they are displayed as MSB first.

Remote command:

[SENSe:] DDEMod:SEARCh:SYNC:DATA on page 382

Symbol format ← Symbols

Defines the format in which each symbol is defined: hexadecimal, decimal or binary

Adding symbols ← Symbols

Adds a new symbol in the symbol table to the left of the currently selected symbol.

Removing symbols ← Symbols

Removes the currently selected symbol in the symbol table.

Comment

Optional comment for the pattern, displayed in the pattern details (kept for compatibility with FSQ)

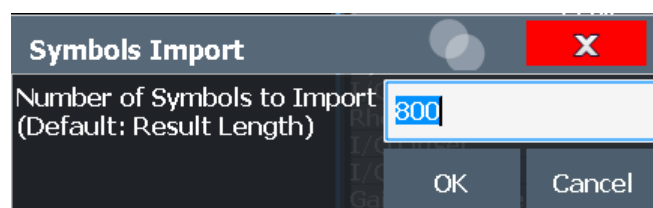
Remote command:

[SENSe:] DDEMod:SEARCh:SYNC:COMMeNt on page 381

Import Symbols

Symbols from a displayed [Symbol table](#) can be imported as a pattern. Select the number of symbols (starting from the first one) to be used as a pattern. By default, the entire [Result Length](#) is used.

This function is only available in single measurement mode and only if the [Symbol table](#) is currently displayed.



Tip: If you do not know the pattern in advance, measure the signal and identify the pattern in the symbol table. Then align the result range to the pattern by defining an offset. The [Symbol table](#) is aligned to the result range, and thus starts with the pattern. Now use the "Import Symbols" function to define the pattern for subsequent measurements.

5.7 Result range configuration

Access: "Overview" > "Cut Result Ranges"

or: [MEAS CONFIG] > "Range Settings" > "Result Range" tab

The result range determines which part of the capture buffer, burst or pattern is displayed. For more information, see [Chapter 4.6, "Measurement ranges"](#), on page 142.

For multi-modulation analysis (requires option R&S FPL1000-K70M, see [Chapter 4.11, "Multi-modulation analysis \(R&S FPL1000-K70M\)"](#), on page 152), the result length is set to the total number of symbols in the frame structure configuration by default (see [Chapter 5.3.3.2, "Frame configuration"](#), on page 175). The number can be decreased to exclude symbols at the beginning or end of the frame. The alignment and offset of the result range are automatically taken from the frame structure configuration and cannot be edited.

Activate "Visualization" to display a visualization of the currently defined signal structure at the bottom of the dialog box.

Result Length	217
↳ According to Frame Structure File	217
Reference	217
Alignment	217
Offset	217
Symbol Number at <Reference> Start	218

Result Length

Defines the number of symbols that are to be demodulated. All traces over time are displayed over the result range.

Remote command:

[\[SENSe:\] DDEMod:TIME](#) on page 386

According to Frame Structure File ← Result Length

The result length is determined by the total number of symbols in the frame structure configuration.

This setting is only available if the additional Multi-Modulation Analysis option (R&S FPL1000-K70M) is installed.

Remote command:

[\[SENSe:\] DDEMod:TIME:AUTO](#) on page 386

Reference

Defines the reference for the result range alignment.

The result of the current setting is displayed in the visualization area of the dialog box.

"Capture"	The capture buffer
"Burst"	The detected burst
"Pattern Wave-form"	The detected pattern

Remote command:

[CALCulate<n>:TRACe<t>:ADJust\[:VALue\]](#) on page 385

Alignment

Defines the type of alignment of the result range to the reference source. The result of the current setting is displayed in the visualization area of the dialog box.

Remote command:

[CALCulate<n>:TRACe<t>:ADJust:ALIGNment\[:DEFault\]](#) on page 384

Offset

Defines the offset of the result range to the alignment reference. The result of the current setting is displayed in the visualization area of the dialog box.

Note: Note the following restrictions to this parameter:

- An offset < 0 is not possible if you align the result range to the left border of the capture buffer.
- An offset that moves the pattern outside the result range is not allowed. For example, if you align the result to the left border of the pattern, only offsets ≤ 0 are allowed. Otherwise, you would never be able to find the pattern within the result range.

Remote command:

[CALCulate<n>:TRACe<t>:ADJust:ALIGNment:OFFSet](#) on page 385

Symbol Number at <Reference> Start

Defines the number of the symbol which marks the beginning of the alignment reference source (burst, capture buffer or pattern). The result of the current setting is displayed in the visualization area of the dialog box.

In effect, this setting defines an offset of the x-axis (in addition to the one defined for the signal structure, see "Offset" on page 171).

Note: When you define the "Symbol Number at <Reference> Start" remember to take the offset defined for the signal structure into consideration (see "Offset" on page 171). The "Symbol Number at Pattern Start" refers to the first symbol of the pattern offset, not the first symbol of the pattern.

Remote command:

`DISPlay[:WINDow<n>]:TRACe<t>:X[:SCALE]:VOFFset` on page 385

5.8 Demodulation settings

Access: "Overview" > "Demodulation"

Or: [MEAS CONFIG] > "Demod/Meas Filter" > "Demodulation" tab

During demodulation of the vector signal, some undesired effects that can occur during transmission can be compensated for. Furthermore, you can influence the synchronization process.

- [Demodulation - compensation and equalizer](#).....218
- [Advanced demodulation \(synchronization\)](#)..... 222

5.8.1 Demodulation - compensation and equalizer

Access: "Overview" > "Demodulation" > "Demodulation"

Or: [MEAS CONFIG] > "Demod/Meas Filter" > "Demodulation" tab



Note that compensation for all the listed distortions can result in lower EVM values.

Demodulation settings depend on the used modulation.

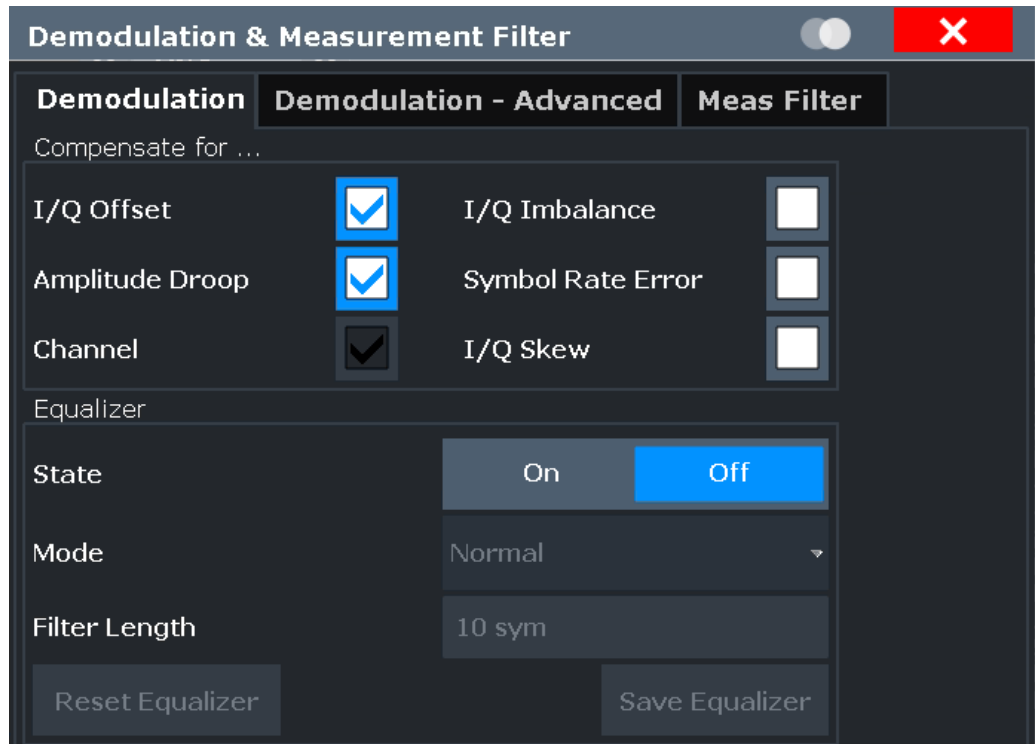


Figure 5-3: Demodulation settings for PSK, MSK and QAM modulation

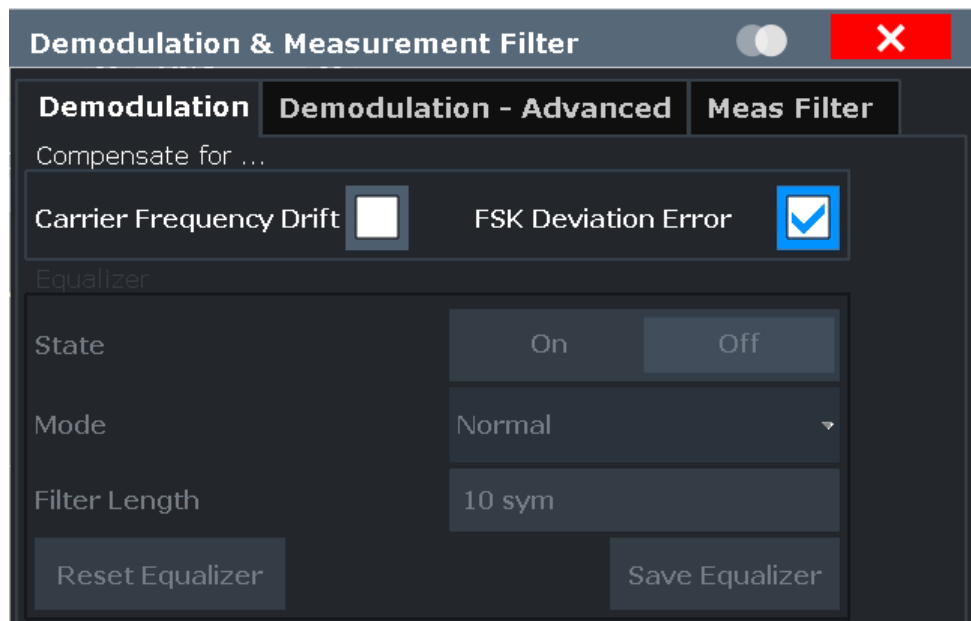


Figure 5-4: Demodulation settings for FSK modulation

Compensate for... [(PSK, MSK, ASK, QAM)]..... 220

Compensate for... [(FSK)]..... 220

Equalizer Settings..... 220

 └ State..... 221

L Mode.....	221
L Filter Length.....	221
L Reset Equalizer.....	221
L Save/Load Equalizer.....	222

Compensate for... [(PSK, MSK, ASK, QAM)]

If enabled, compensation for various effects is considered during demodulation. Thus, these distortions are not shown in the calculated error values.

Note: Note that compensation for all the listed distortions can result in lower EVM values.

- "I/Q Offset" (default: on)
- "I/Q Imbalance"
- "Amplitude Droop" (default: on)
- "Symbol Rate Error" (required to display the SRE in the "Result Summary")
- "Channel" (default: on)

Note that channel distortion can only be determined if the "Equalizer" is on (see ["State"](#) on page 221). Thus, compensation can only be disabled if the equalizer is on.

By default, channel compensation is enabled to improve accuracy of the error results. If compensation is disabled, the EVM is calculated from the original input signal with channel distortions.

- "I/Q Skew" (PSK/ QAM/ Offset QPSK only, see also ["I/Q skew results depend on modulation"](#) on page 133)

For details on these effects see [Chapter 4.5.1.3, "Modulation errors"](#), on page 128.

Remote command:

[\[SENSe:\] DDEMod:NORMAlize:IQOffset](#) on page 395

[\[SENSe:\] DDEMod:NORMAlize:IQIMbalance](#) on page 394

[\[SENSe:\] DDEMod:NORMAlize:IQSkew](#) on page 395

[\[SENSe:\] DDEMod:NORMAlize:ADRoop](#) on page 393

[\[SENSe:\] DDEMod:NORMAlize:SRErRor](#) on page 395

[\[SENSe:\] DDEMod:NORMAlize:CHANnel](#) on page 394

Compensate for... [(FSK)]

If enabled, compensation for various effects is considered during demodulation. Thus, these distortions are not shown in the calculated error values.

- "Carrier Frequency Drift"
- "FSK Deviation Error"

For details on these effects see [Chapter 4.5.2.3, "Modulation errors"](#), on page 141.

Remote command:

[\[SENSe:\] DDEMod:NORMAlize:CFDRift](#) on page 393

[\[SENSe:\] DDEMod:NORMAlize:FDERror](#) on page 394

Equalizer Settings

The "Equalizer" can compensate for a distorted transmission of the input signal or improve accuracy in estimating the reference signal.

For details see [Chapter 4.4.6, "The equalizer"](#), on page 123.

State ← Equalizer Settings

Activates or deactivates the "Equalizer" to compensate for a distorted channel.

Note: for FSK modulated signals, the "Equalizer" is not available.

Remote command:

[\[SENSe:\] DDEMod:EQUalizer\[:STATe\]](#) on page 392

Mode ← Equalizer Settings

Defines the operating mode of the "Equalizer".

"Normal"	Determines the filter values from the difference between the ideal (reference) signal and the measured signal. Normal mode is sufficient for small distortions and performance remains high.
"Tracking"	The results of the equalizer in the previous sweep are considered to calculate the new filter until adequate results are obtained. This "learning" effect allows for powerful removal of larger distortions within a minimum of sweeps. During the tracking phase, calculation of the equalizer requires additional processing time.
"Freeze"	The filter is no longer changed, the current "equalizer" values are used for subsequent sweeps.
"User"	A user-defined "equalizer" loaded from a file is used.
"Averaging"	The results of the equalizer in all previous sweeps (since the instrument was switched on or the equalizer was reset) are considered to calculate the new filter. To start a new averaging process, select the Reset Equalizer button. Calculation of the equalizer requires additional processing time.

Remote command:

[\[SENSe:\] DDEMod:EQUalizer:MODE](#) on page 391

Filter Length ← Equalizer Settings

Defines the length of the "equalizer" in symbols. The longer the equalizer, the more accurate the filter becomes and the more distortion can be compensated. However, longer filters require extended calculation time. The shorter the filter length, the less calculation time is required during the equalizer's tracking or averaging phase.

Remote command:

[\[SENSe:\] DDEMod:EQUalizer:LENGth](#) on page 390

Reset Equalizer ← Equalizer Settings

Deletes the data of the currently selected "equalizer". After deletion, averaging and tracking starts anew.

Resetting is useful in the rare case that calculation takes a wrong symbol decision into consideration and distorts the signal such that the original signal can no longer be determined.

This function is only available if the "equalizer" is active and in "Tracking" or "Averaging" mode (see ["Mode"](#) on page 221).


Remote command:

[\[SENSe:\] DDEMod:EQUalizer:RESet](#) on page 391

Save/Load Equalizer ← Equalizer Settings

Saves the current equalizer results to a file, or loads a user-defined equalizer.

To load a file, the "equalizer" **Mode** must be set to **USER**.

To save the file, the measurement must be stopped and the configuration must be valid (no  icon displayed in the tab label for the R&S FPL1000 VSA application).

The file can be stored in the following formats:

- `.vae`: to be used as an equalizer file in VSA applications
- `.fres`: to be used as a user-defined frequency response correction file in any other application that supports it

Remote command:

[SENSe:] DDEMod:EQUalizer:SAVE on page 391

[SENSe:] DDEMod:EQUalizer:LOAD on page 390

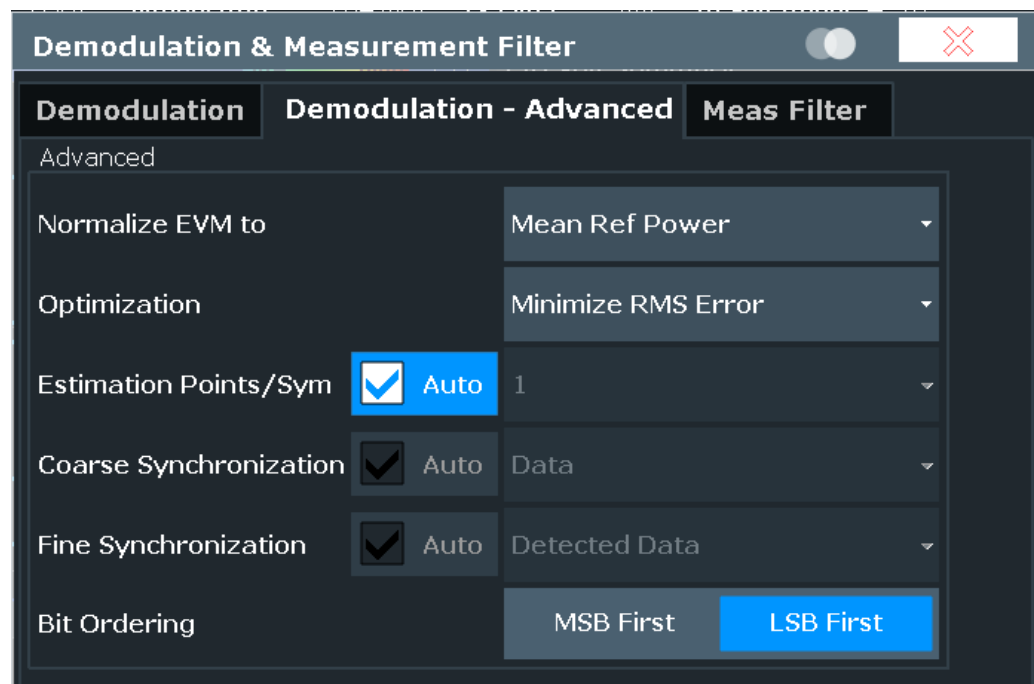
[SENSe:] DDEMod:EQUalizer:FILE:FORMat on page 390

5.8.2 Advanced demodulation (synchronization)

Access: "Overview" > "Demodulation" > "Demodulation - Advanced"

Or: [MEAS CONFIG] > "Demod/Meas Filter" > "Demodulation - Advanced" tab

You can influence the synchronization process and calculation of error values during demodulation.



Normalize EVM to.....	223
Optimization.....	223
Estimation Points/Sym.....	223
Coarse Synchronization.....	224
Fine Synchronization.....	224

Bit Ordering.....	225
If SER ≤.....	225
Offset EVM.....	225

Normalize EVM to

Normalizes the EVM to the specified power value.

This setting is not available for MSK or FSK modulation.

- **Max Ref Power**
Maximum power of the reference signal at the symbol instants.
- **Mean Ref Power**
mean power of the reference signal at the symbol instants.
- **Mean Constellation Power**
Mean expected power of the measurement signal at the symbol instants
- **Max Constellation Power**
The maximum expected power of the measurement signal at the symbol instants

Remote command:

[SENSe:]DDEMod:ECALc[:MODE] on page 388

Optimization

Determines the method used to calculate the result parameters. The required method depends on the used standard and is set according to the selected standard by default.

"Minimize RMS Error" Optimizes calculation such that the RMS of the "error vector" is minimal.

"Minimize EVM" Optimizes calculation such that EVM is minimal.

Remote command:

[SENSe:]DDEMod:OPTimization on page 396

Estimation Points/Sym

During synchronization, the measurement signal is matched to the reference signal and various signal parameters are calculated. You can define how many sample points are used for this calculation at each symbol.

For more information on estimation points per symbol, see [Chapter 4.7, "Display points vs estimation points per symbol"](#), on page 147.

You can set the estimation points manually or let the VSA application decide how many estimation points to use.

If automatic mode is enabled, the VSA application uses the following settings, depending on the modulation type:

Modulation	Est. Points
PSK, QAM	1
Offset QPSK	2
FSK, MSK	Capture Oversampling

For manual mode, the following settings are available:

- "1" The estimation algorithm takes only the symbol time instants into account.
- "2" Two points per symbol instant are used (required for Offset QPSK)
- "Capture Oversampling"
The number of samples per symbol defined in the signal capture settings is used (see "Sample Rate" on page 201), i.e. all sample time instants are weighted equally.

Remote command:

[SENSe:] DDEMod: EPRate: AUTO on page 389

[SENSe:] DDEMod: EPRate [:VALue] on page 389

Coarse Synchronization

It is not only possible to check whether the pattern is part of the signal, but also to use the pattern for synchronization, to obtain the correct reference signal.

For details on synchronization see [Chapter 4.4, "Overview of the demodulation process"](#), on page 112.

If "Auto" mode is selected, the detected data is used. In manual mode you can select one of the following settings:

- "Data" (Default): the detected data is used for synchronization, i.e. unknown symbols
- Use this setting if:
- No pattern is available
 - The pattern is short
 - The pattern does not have suitable synchronization properties, e.g. a pattern that consists of only one repeated symbol
- "Pattern" Known symbols from a defined pattern are used for synchronization. Depending on the signal, using the pattern can speed up your measurement considerably and make it more robust against high carrier frequency offsets.
- Make sure that the pattern is suitable for synchronization, e.g. a GSM pattern.

Remote command:

[SENSe:] DDEMod: SEARCh: PATTern: SYNC: AUTO on page 396

[SENSe:] DDEMod: SEARCh: PATTern: SYNC [:STATe] on page 396

Fine Synchronization

In addition to the coarse synchronization used for symbol decisions, a fine synchronization is available to calculate various results from the reference signal, e.g. the EVM. However, when the signal is known to have a poor transmission quality or has a high noise level, false symbol decisions are more frequent, which can cause spikes in the EVM results. In this case, you can restrict the synchronization to a known symbol sequence or pattern, if available.

For details on synchronization see [Chapter 4.4.5, "Synchronization and the reference signal"](#), on page 121.

If "Auto" mode is selected and a Known Data file has been loaded and activated for use, the known data sequences are used. Otherwise, the detected data is used.

Note: You can define a maximum symbol error rate (SER) for the known data in reference to the evaluated data. If the SER of the known data exceeds this limit, the default synchronization using the detected data is performed (see "If SER ≤" on page 225).

"Detected Data"	(Default) The reference signal is estimated from the detected symbols.
"Known Data"	The reference signal is defined as the data sequence from the loaded Known Data file that most closely matches the measured data.
"Pattern"	The reference signal is estimated from the defined pattern. Note: particularly (but not only) for shaped offset QPSK modulated signals, it is not recommended that you use a pattern that is significantly shorter than the result range for fine synchronization. Imprecise synchronization can be the result.

Remote command:

[SENSe:] DDEMod:FSYNc:AUTO on page 392

[SENSe:] DDEMod:FSYNc[:MODE] on page 393

[SENSe:] DDEMod:FSYNc:RESult? on page 392

Bit Ordering

Determines how the bits in the symbols are ordered in all symbol displays.

"LSB"	Least significant bit first (used in Bluetooth specification, for example)
"MSB"	Most significant bit first (default)

Remote command:

[SENSe:] DDEMod:BORDering on page 388

If SER ≤

This setting is only available if "Known Data" is selected for "Fine Synchronization". You can define a maximum symbol error rate for the known data in reference to the evaluated data. Thus, if a wrong file was mistakenly loaded or the file proves to be unsuitable, it is not used for synchronization. Otherwise the results would be strongly distorted. If the SER of the known data exceeds this limit, the default synchronization using the detected data is performed.

Remote command:

[SENSe:] DDEMod:FSYNc:LEVel on page 392

Offset EVM

The "Offset EVM" is only available for (shaped or normal) Offset QPSK modulated signals.

Unlike QPSK modulation, the Q component of Offset QPSK modulation is delayed by half a symbol period against the I component in the time domain. The symbol time instants of the I and the Q component therefore do not coincide.

The "Offset EVM" controls the calculation of all results that are based on the "error vector". It affects the "EVM", "Real/Imag" and "Vector I/Q" result displays as well as the EVM results in the "Result Summary" (EVM and MER).

You can configure the way the VSA application calculates the "error vector" results.

If "Offset EVM" is disabled, the VSA application subtracts the measured signal from the reference signal to calculate the error vector. This method results in the fact that the error vector contains two symbol instants per symbol period: one that corresponds to the I component and one that corresponds to the Q component.

If "Offset EVM" is enabled, however, the VSA application compensates the delay of the Q component with respect to the I component in the measurement signal as well as the reference signal **before** calculating the error vector. That means that the error vector contains only one symbol instant per symbol period.

Remote command:

[SENSe:] DDEMod:ECALc:OFFSet on page 388

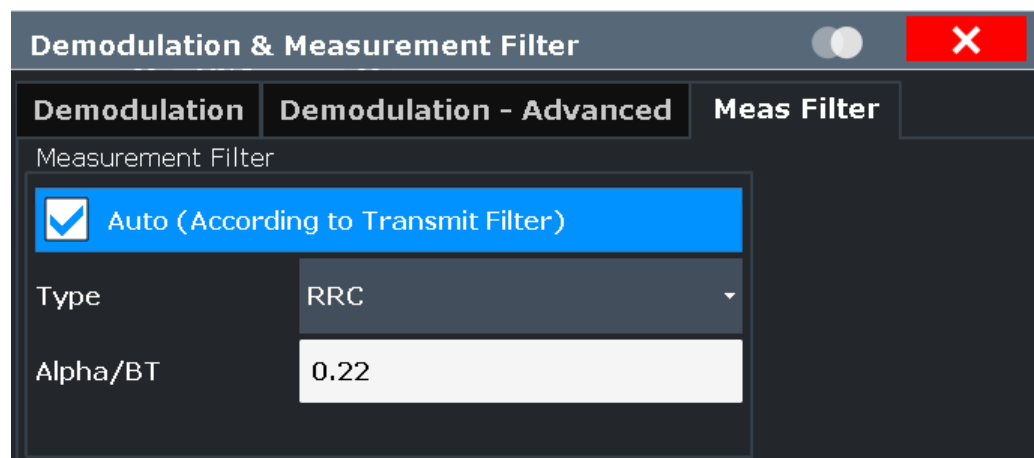
5.9 Measurement filter settings

Access: "Overview" > "Meas Filter"

or: [MEAS CONFIG] > "Demod/Meas Filter" > "Meas Filter" tab

The measurement filter can be used to filter both the measured signal and the reference signal, and thus the "error vector". You can configure the measurement filter to be used.

For more information on measurement filters, see [Chapter 4.1.4, "Measurement filters"](#), on page 72.



Using the Transmit Filter as a Measurement Filter (Auto).....	226
Type.....	227
└ Load User Filter.....	227
└ Alpha/BT.....	227

Using the Transmit Filter as a Measurement Filter (Auto)

If the "Auto" option is enabled, the measurement filter is defined automatically depending on the transmit filter specified in the "Modulation" settings (see ["Transmit Filter Type"](#) on page 168).

Note: If a user-defined transmit filter is selected and the measurement filter is defined automatically, a Low-ISI measurement filter according to the selected user filter is calculated and used.

Remote command:

[SENSe:] DDEMod:MFILter:AUTO on page 397

Type

Defines the measurement filter type, if the [Using the Transmit Filter as a Measurement Filter \(Auto\)](#) setting is not enabled.

"<Predefined Filter>"	The selected predefined filter is used. An overview of available measurement filters is provided in Chapter C.2, "Measurement filters" , on page 512. (For SOQPSK modulated signals, no low-ISI measurement filter is available. If selected, the used filter does not provide low-ISI results!
"User"	User-defined filter. Define the filter using the Load User Filter function or the [SENSe:] DDEMod:MFILter:USER command. For more information on user-defined filters, see Chapter 4.1.5, "Customized filters" , on page 74.
"None"	No measurement filter is used.

Remote command:

[SENSe:] DDEMod:MFILter[:STATE] on page 398

To turn off the measurement filter.

[SENSe:] DDEMod:MFILter:USER on page 398

To use a user-defined filter.

[SENSe:] DDEMod:MFILter:NAME on page 397

To define the name of the measurement filter.

Load User Filter ← Type

Opens a file-selection dialog box to select the user-defined measurement filter to be used.

This setting is only available if "User" is selected as the "Filter Type".

Remote command:

[SENSe:] DDEMod:MFILter:USER on page 398

Alpha/BT ← Type

Defines the roll-off factor (Alpha) or the filter bandwidth (BT).

The roll-off factor or filter bandwidth are available for RC, RRC and Gauss filters.

If the measurement mode is automatically selected according to the transmit filter, this setting is identical to the "Alpha/BT" value in the modulation settings (see ["Alpha/BT"](#) on page 168).

Remote command:

Measurement filter: [SENSe:] DDEMod:MFILter:ALPHA on page 397

Transmit filter: [SENSe:] DDEMod:TFILter:ALPHA on page 330

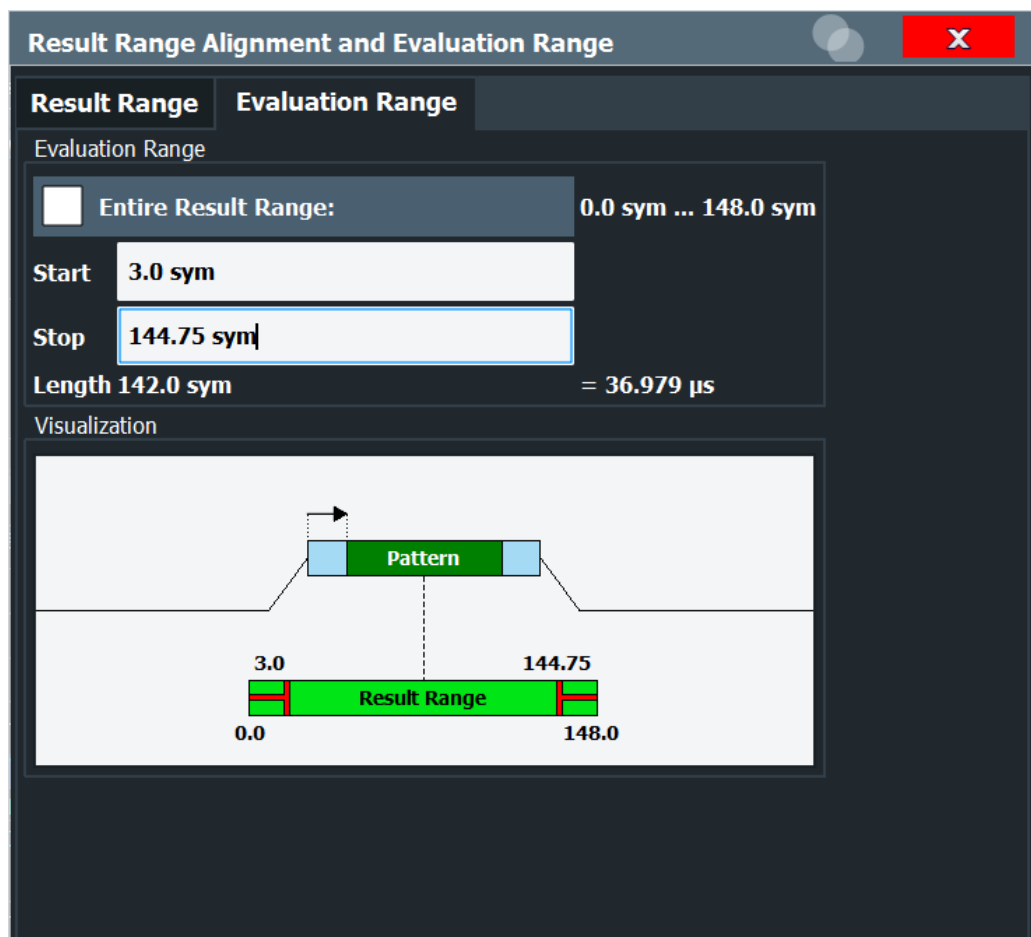
5.10 Evaluation range configuration

Access: "Overview" > "Evaluation Range"

or: [MEAS CONFIG] > "Range Settings" > "Evaluation Range" tab

The evaluation range defines which range of the result is to be evaluated - either the entire result range or only a specified part of it. The calculated length of the specified range is indicated beneath the entries.

Enable "Visualization" to display a preview of the evaluation range (in relation to the result range) with the current settings at the bottom of the dialog box. The green bar below the trace indicates the defined result range, indented red lines indicate defined start and stop symbols (see "Evaluation range display" on page 146). The visualization is not editable directly.



For details on the evaluation range, see [Chapter 4.6, "Measurement ranges"](#), on page 142.

For an example on setting the evaluation range, see [Chapter 9.3.5, "Setting the evaluation range"](#), on page 286.

Evaluating the Entire Result Range	229
Start / Stop	229

Evaluating the Entire Result Range

If enabled, the entire result range is evaluated.

If disabled, you can define a specific part of the result range to be evaluated.

Remote command:

`CALCulate<n>:ELIN<ri>:STATe` on page 398

Start / Stop

Defines the symbol in the result range at which evaluation is started and stopped. The start and stop symbols themselves are included in the evaluation range.

Note: Note that the start and stop values are defined with respect to the x-axis including an optional offset defined via the [Symbol Number at <Reference> Start](#) parameter.

Remote command:

`CALCulate<n>:ELIN<ri>[:VALue]` on page 399

5.11 Adjusting settings automatically

Access: [AUTO SET]

Some settings can be adjusted by the R&S FPL1000 automatically according to the current measurement settings. To do so, a measurement is performed. The duration of this measurement can be defined automatically or manually.

To activate the automatic adjustment of a setting, select the corresponding function in the [AUTO SET] menu or in the configuration dialog box for the setting, where available.

**Adjusting settings automatically during triggered measurements**

When you select an auto adjust function a measurement is performed to determine the optimal settings. If you select an auto adjust function for a triggered measurement, you are asked how the R&S FPL1000 should behave:

- (default:) The measurement for adjustment waits for the next trigger
- The measurement for adjustment is performed without waiting for a trigger. The trigger source is temporarily set to "Free Run". After the measurement is completed, the original trigger source is restored. The trigger level is adjusted as follows for IF Power and RF Power triggers:
Trigger Level = Reference Level - 15 dB

Remote command:

`[SENSe:]ADJust:CONFigure:TRIGger` on page 402

Setting the Reference Level Automatically (Auto Level)	230
Resetting the Automatic Measurement Time (Meas Time Auto)	230
Changing the Automatic Measurement Time (Meas Time Manual)	230
Upper Level Hysteresis	230

Lower Level Hysteresis.....	231
Auto Scale Once/Auto Scale Window.....	231
Auto Scale All.....	231

Setting the Reference Level Automatically (Auto Level)

Automatically determines a reference level which ensures that no overload occurs at the R&S FPL1000 for the current input data. At the same time, the internal attenuators are adjusted. As a result, the signal-to-noise ratio is optimized, while signal compression and clipping are minimized.

To determine the required reference level, a level measurement is performed on the R&S FPL1000.

If necessary, you can optimize the reference level further. Decrease the attenuation level manually to the lowest possible value before an overload occurs, then decrease the reference level in the same way.

You can change the measurement time for the level measurement if necessary (see "Changing the Automatic Measurement Time (Meas Time Manual)" on page 230).

Remote command:

`[SENSe:]ADJust:LEVel` on page 402

Resetting the Automatic Measurement Time (Meas Time Auto)

Resets the measurement duration for automatic settings to the default value.

Remote command:

`[SENSe:]ADJust:CONFigure:LEVel:DURation:MODE` on page 401

Changing the Automatic Measurement Time (Meas Time Manual)

This function allows you to change the measurement duration for automatic setting adjustments. Enter the value in seconds.

Note: The maximum measurement duration depends on the currently selected measurement and the installed (optional) hardware. Thus, the measurement duration actually used to determine the automatic settings can be shorter than the value you define here.

Remote command:

`[SENSe:]ADJust:CONFigure:LEVel:DURation:MODE` on page 401

`[SENSe:]ADJust:CONFigure:LEVel:DURation` on page 400

Upper Level Hysteresis

When the reference level is adjusted automatically using the [Auto Level](#) function, the internal attenuators and the preamplifier are also adjusted. To avoid frequent adaptation due to small changes in the input signal, you can define a hysteresis. This setting defines an upper threshold that the signal must exceed (compared to the last measurement) before the reference level is adapted automatically.

Remote command:

`[SENSe:]ADJust:CONFigure:HYSTeresis:UPPer` on page 402

Lower Level Hysteresis

When the reference level is adjusted automatically using the [Auto Level](#) function, the internal attenuators and the preamplifier are also adjusted. To avoid frequent adaptation due to small changes in the input signal, you can define a hysteresis. This setting defines a lower threshold that the signal must fall below (compared to the last measurement) before the reference level is adapted automatically.

Remote command:

`[SENSe:]ADJust:CONFigure:HYSTeresis:LOWer` on page 401

Auto Scale Once/Auto Scale Window

If enabled, both the x-axis and y-axis are automatically adapted to the current measurement results (only once, not dynamically) in the selected window.

To adapt the range of all screens together, use the [Auto Scale All](#) function.

Remote command:

For statistics (result type transformation): `CALCulate<n>:STATistics:SCALE: AUTO ONCE` on page 365

For all other results: `DISPlay[:WINDow<n>][:SUBWindow<w>]:TRACe<t>:Y[:SCALE]:AUTO ONCE` on page 400

Auto Scale All

Adapts the x-axis and y-axis to the current measurement values (only once, not dynamically) in all measurement windows.

Remote command:

`DISPlay[:WINDow<n>]:TRACe<t>:Y[:SCALE]:AUTO:ALL` on page 400

5.12 Restoring factory settings for vector signal analysis

Access: [Meas]

Apart from the "Preset Channel" function (see ["Preset Channel setup"](#) on page 162), the following functions are available to restore factory settings to the VSA application:

Restore Factory Settings	231
L Restore Standard Files	231
L Restore Pattern Files	232

Restore Factory Settings

Opens a submenu that allows you to restore all standards and pattern settings on the instrument to the values predefined by Rohde & Schwarz available at the time of delivery.

Restore Standard Files ← Restore Factory Settings

Restores the standards predefined by Rohde & Schwarz available at the time of delivery.

Note that this function overwrites customized standards that have the same name as predefined standards.

Remote command:

[SENSe:] DDEMod:FACTory[:VALue] on page 320

Restore Pattern Files ← Restore Factory Settings

Restores the pattern files predefined by Rohde&Schwarz available at the time of delivery.

Remote command:

[SENSe:] DDEMod:FACTory[:VALue] on page 320

6 Analysis

Access: "Overview" > "Analysis"

General result analysis settings concerning the trace, markers, windows etc. can be configured. They are identical to the analysis functions in the base unit except for the special window functions.



Window-specific configuration

The settings in the "Analysis" dialog box are specific to the selected window. Thus, the "Analysis" button is only available in the "Overview" if the "Specifics for" option is enabled. To configure the settings for a different VSA window, select the window outside the displayed dialog box, or select the window from the "Specifics for" selection list in the dialog box.

- [Trace settings](#).....233
- [Trace export settings](#).....238
- [Markers](#).....240
- [Limit and display lines](#).....244
- [Display and window configuration](#).....248

6.1 Trace settings

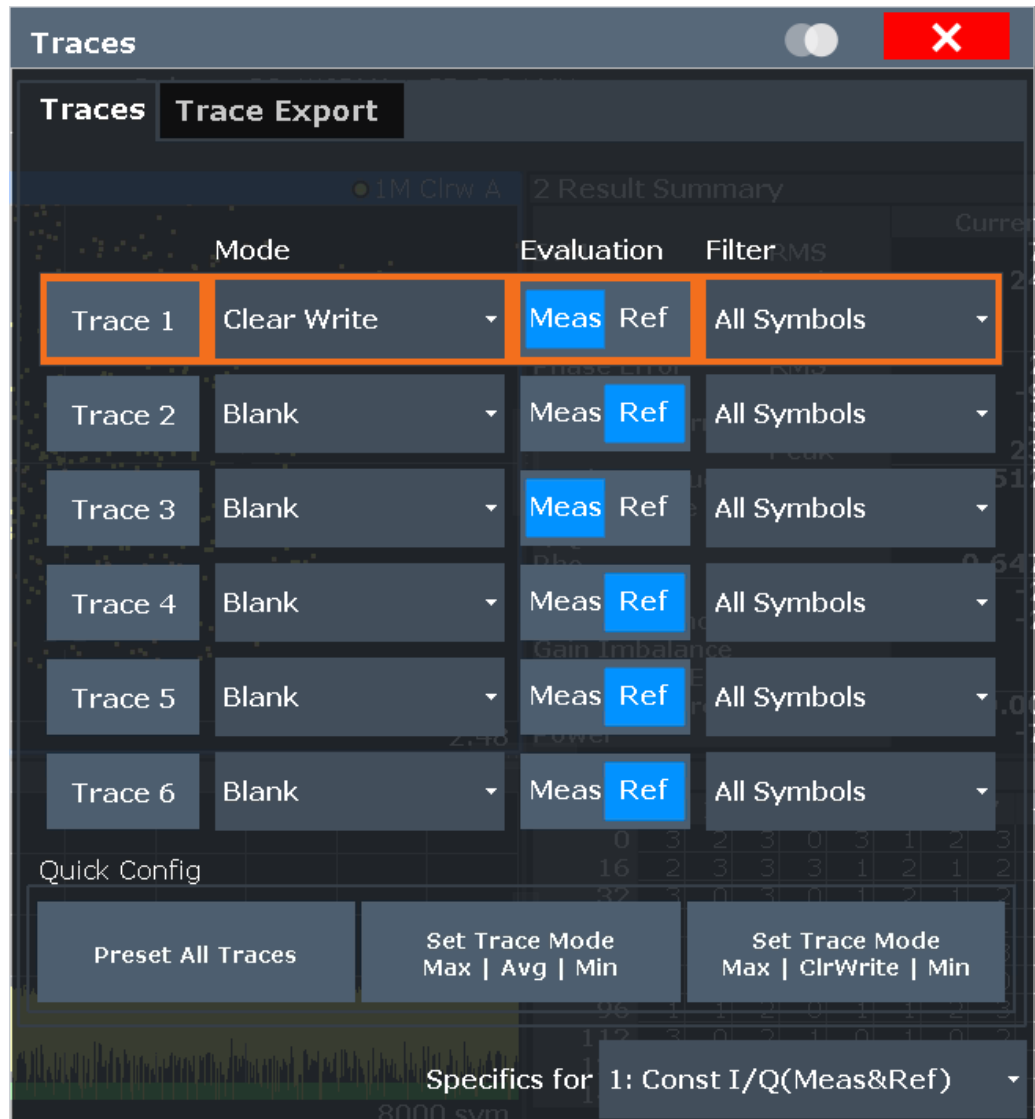
Access: "Overview" > "Analysis" > "Traces"

or: [TRACE] > "Trace Config"

The trace settings determine how the measured data is analyzed and displayed in the window. Depending on the result display, between 1 and 6 traces can be displayed.



Trace data can also be exported to an ASCII file for further analysis. For details, see [Chapter 6.2, "Trace export settings"](#), on page 238.



Trace 1/Trace 2/Trace 3/Trace 4/Trace 5/Trace 6.....	234
Trace Mode.....	234
Evaluation.....	236
Filter (I/Q Constellation, K70M only).....	236
Predefined Trace Settings - Quick Config.....	237
Trace 1/ Trace 2/ Trace 3/ Trace 4 (Softkeys).....	237

Trace 1/Trace 2/Trace 3/Trace 4/Trace 5/Trace 6

Selects the corresponding trace for configuration. The currently selected trace is highlighted orange.

Remote command:

`DISPlay[:WINDow<n>][:SUBWindow<w>]:TRACe<t>[:STATe]` on page 410

Selected via numeric suffix of `TRACe<t>` commands

Trace Mode

Defines the update mode for subsequent traces.

The available trace modes depend on the selected result display. Not all evaluations support all trace modes.

"Clear/ Write"	<p>Overwrite mode (default): the trace is overwritten by each measurement.</p> <p>All available detectors can be selected.</p>
"Max Hold"	<p>The maximum value is determined over several measurements and displayed. The R&S FPL1000 saves the measurement result in the trace memory only if the new value is greater than the previous one.</p>
"Min Hold"	<p>The minimum value is determined from several measurements and displayed. The R&S FPL1000 saves the measurement result in the trace memory only if the new value is lower than the previous one.</p>
"Average"	<p>The average is formed over several measurements.</p> <p>The Statistic Count determines the number of averaging procedures.</p>
"View"	<p>The current contents of the trace memory are frozen and displayed.</p> <p>Note: If a trace is frozen, you can change the measurement settings, apart from scaling settings, without impact on the displayed trace. The fact that the displayed trace no longer matches the current measurement settings is indicated by a yellow asterisk * on the tab label. If you change any parameters that affect the scaling of the diagram axes, the R&S FPL1000 automatically adapts the trace data to the changed display range. Thus, you can zoom into the diagram after the measurement to show details of the trace.</p> <p>If you change the trace mode to "View" for a density trace, the density coloring is removed. The result is identical to freezing the "Clear/ Write" trace.</p> <p>For "View" trace mode, the Filter (I/Q Constellation, K70M only) and the Evaluation cannot be changed. They remain set to the value that was most recently set.</p>
"Blank"	<p>Removes the selected trace from the display.</p>

"Density"

The occurrence of each value within the current result range or evaluation range is indicated by color.

This trace mode is only available for constellation, vector, and eye diagrams.

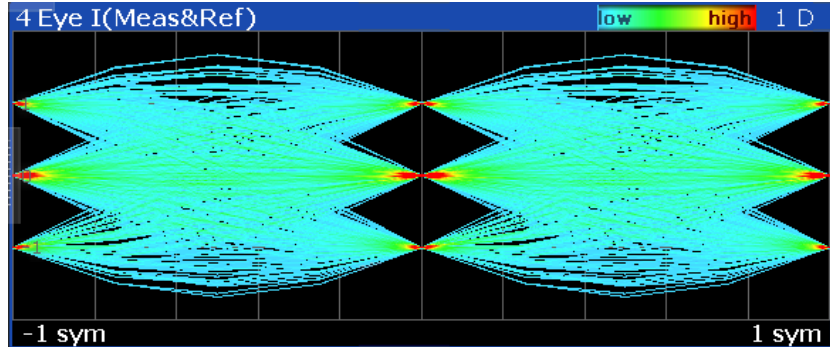


Figure 6-1: Example: eye diagram with density trace

Note that you cannot "freeze" the density trace using the "View" trace mode.

Remote command:

`DISPlay[:WINDow<n>][:SUBWindow<w>]:TRACe<t>:MODE` on page 409

Evaluation

Defines whether the trace displays the evaluation of the measured signal or the reference signal (if "Meas & Ref Signal" is used as the evaluation data source, see "Signal Source" on page 249).

For multi-source results, the data source for each trace can be defined as "Error" or "Capture Buffer"/"Measurement" (depending on the result type, see "Multi Source" on page 24).

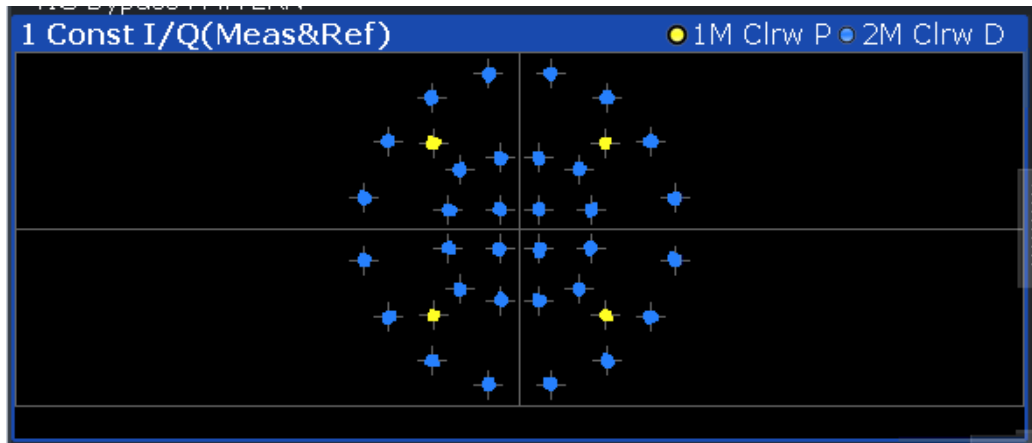
For **Trace Mode**: "View", the data source to be evaluated cannot be changed. It remains set to the value that was most recently set.

Remote command:

`CALCulate<n>:TRACe<t>[:VALue]` on page 407

Filter (I/Q Constellation, K70M only)

For multi-modulation analysis, the I/Q constellation diagram can display different colored traces for different symbol types.



Note: For **Trace Mode:** "View", the filter setting cannot be changed. It remains set to the value that was most recently set.

"All symbols" Trace consists of constellation points for all symbols

"Only pattern" Trace consists of only pattern symbols

"Only data" Trace consists of only data symbols

Remote command:

[CALCulate<n>:TRACe<t>:SYMBOLs](#) on page 408

Predefined Trace Settings - Quick Config

Commonly required trace settings have been predefined and can be applied very quickly by selecting the appropriate button.

Function	Trace Settings	
Preset All Traces	Trace 1:	Clear Write
	Traces 2-6:	Blank
Set Trace Mode Max Avg Min	Trace 1:	Max Hold
	Trace 2:	Average
	Trace 3:	Min Hold
	Traces 4-6:	Blank
Set Trace Mode Max ClrWrite Min	Trace 1:	Max Hold
	Trace 2:	Clear Write
	Trace 3:	Min Hold
	Traces 4-6:	Blank

Trace 1/ Trace 2/ Trace 3/ Trace 4 (Softkeys)

Displays the "Traces" settings and focuses the "Mode" list for the selected trace.

Remote command:

[DISPlay\[:WINDow<n>\]\[:SUBWindow<w>\]:TRACe<t>\[:STATe\]](#) on page 410

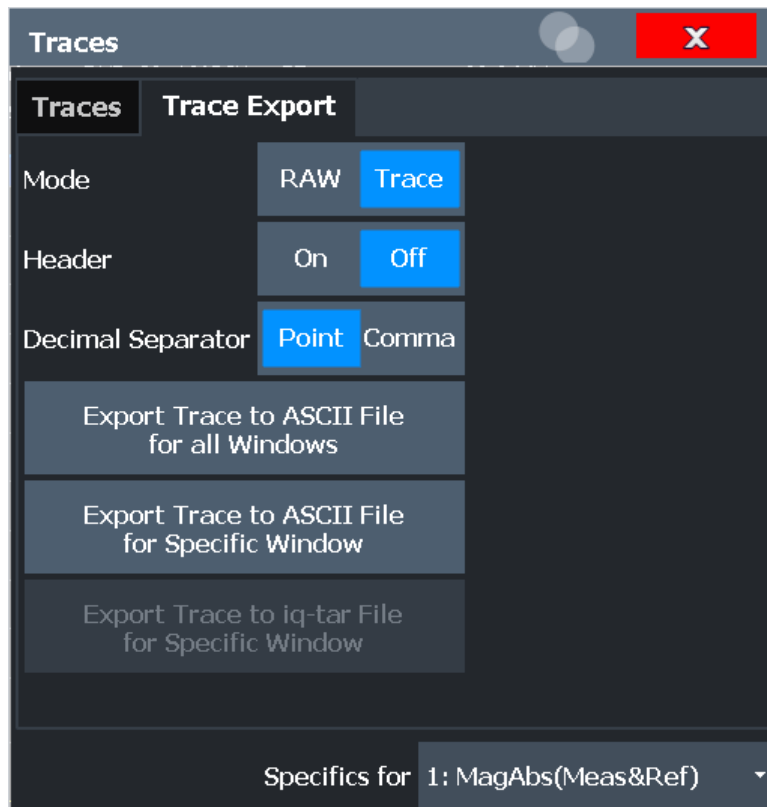
6.2 Trace export settings

Access: "Overview" > "Analysis" > "Traces" > "Trace Export"

or: [TRACE] > "Trace Export Config"

The captured (trace) data can also be exported to an ASCII file. The format of these files can be configured.

For step-by-step instructions on how to export a trace, see [Chapter 8.3.4, "How to export the trace data to a file"](#), on page 274.



Data Export Mode	238
Header	238
Decimal Separator	239
Export Trace to ASCII File	239
Export Trace to iq-tar File for Specific Window	239

Data Export Mode

Defines whether raw I/Q data (as captured) or trace data (evaluated) is stored.

Remote command:

[FORMat:DEXPort:MODE](#) on page 452

Header

If enabled, a header with scaling information etc. is included in the file.

Remote command:

[FORMat:DEXPort:HEADer](#) on page 451

Decimal Separator

Defines the decimal separator for floating-point numerals for the data export/import files. Evaluation programs require different separators in different languages.

Remote command:

[FORMat:DEXPort:DSEParator](#) on page 451

Export Trace to ASCII File

Opens a file selection dialog box and saves the traces of the captured data in ASCII format to the specified file and directory.

Either the traces for the selected window only (see ["Specific Settings for"](#) on page 162) are exported, or the traces of all windows are exported, one after the other.

For details on the file format, see [Chapter D, "ASCII file export format for VSA data"](#), on page 514.

Remote command:

[MMEMory:STORe<n>:TRACe](#) on page 452

Export Trace to iq-tar File for Specific Window

This function is only available for result types that provide I/Q data based on the "error vector", such as the "Vector I/Q" or Real/Imag displays. If activated, the I/Q data for the displayed trace in the selected window is stored to a file in `iq.tar` format.

See the R&S FPL1000 I/Q Analyzer and I/Q Input User Manual for details.

This function is useful to analyze carrier in carrier measurements, for example. In this case, one carrier signal is "hidden" behind another. To analyze the hidden signal, you must first determine the error vector between the measured signal and the reference signal. Then you can export the error vector trace to an `iq.tar` file, which you then load into the capture buffer.

Note: The trace values do not have a unit. However, in the `iq.tar` file the values are stored in the unit Volt. The trace values are multiplied by a scaling factor according to the following equation before they are stored:

I/Q values = trace values · scaling factor

where:

$$\sqrt{\frac{P_{lin}}{1000}} \cdot InputImpedance [\Omega]$$

$$P_{lin} = 10^{(RefLevel[dBm]/10)}$$

Remote command:

[MMEMory:STORe<n>:IQ:TRACe](#) on page 452

6.3 Markers

Access: "Overview" > "Analysis" > "Marker"

or: [MKR]

Markers help you analyze your measurement results by determining particular values in the diagram. Thus you can extract numeric values from a graphical display.

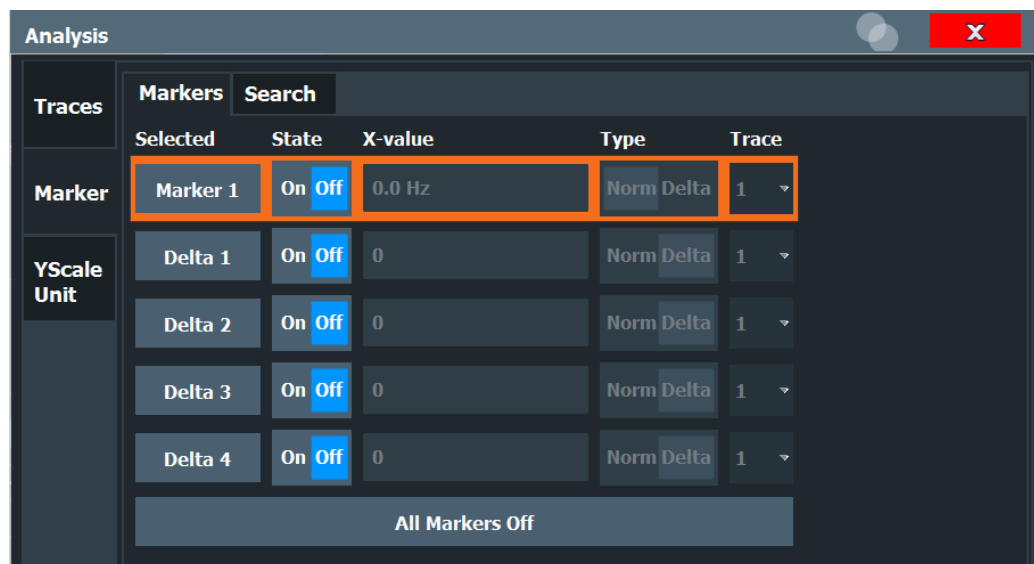
- [Individual marker settings](#)..... 240
- [Marker search settings](#).....242
- [Marker positioning functions](#)..... 243

6.3.1 Individual marker settings

Access: "Overview" > "Analysis" > "Marker" > "Markers"

or: [MKR] > "Marker Config"

In VSA evaluations, up to 5 markers can be activated in each diagram at any time.



Selected Marker	240
Marker State	241
X-value	241
Marker Type	241
Assigning the Marker to a Trace	241
All Markers Off	241
Couple Windows	241

Selected Marker

Marker name. The marker which is currently selected for editing is highlighted orange.

Remote command:

Marker selected via suffix <m> in remote commands.

Marker State

Activates or deactivates the marker in the diagram.

Remote command:

[CALCulate<n>:MARKer<m>\[:STATe\]](#) on page 412

[CALCulate<n>:DELTAmarker<m>\[:STATe\]](#) on page 414

X-value

Defines the position of the marker on the x-axis.

Remote command:

[CALCulate<n>:DELTAmarker<m>:X](#) on page 414

[CALCulate<n>:MARKer<m>:X](#) on page 413

Marker Type

Toggles the marker type.

The type for marker 1 is always "Normal", the type for delta marker 1 is always "Delta". These types cannot be changed.

Note: If normal marker 1 is the active marker, switching the "Mkr Type" activates an additional delta marker 1. For any other marker, switching the marker type does not activate an additional marker, it only switches the type of the selected marker.

"Normal" A normal marker indicates the absolute value at the defined position in the diagram.

"Delta" A delta marker defines the value of the marker relative to the specified reference marker (marker 1 by default).

Remote command:

[CALCulate<n>:MARKer<m>\[:STATe\]](#) on page 412

[CALCulate<n>:DELTAmarker<m>\[:STATe\]](#) on page 414

Assigning the Marker to a Trace

The "Trace" setting assigns the selected marker to an active trace. The trace determines which value the marker shows at the marker position. If the marker was previously assigned to a different trace, the marker remains on the previous frequency or time, but indicates the value of the new trace.

If a trace is turned off, the assigned markers and marker functions are also deactivated.

Remote command:

[CALCulate<n>:MARKer<m>:TRACe](#) on page 412

All Markers Off

Deactivates all markers in one step.

Remote command:

[CALCulate<n>:MARKer<m>:AOFF](#) on page 411

Couple Windows

If enabled, markers in all diagrams with the same x-axis (time or symbols) have coupled x-values (except for "Capture Buffer" display). That means, if you move the marker in one diagram, it is moved in all coupled diagrams.

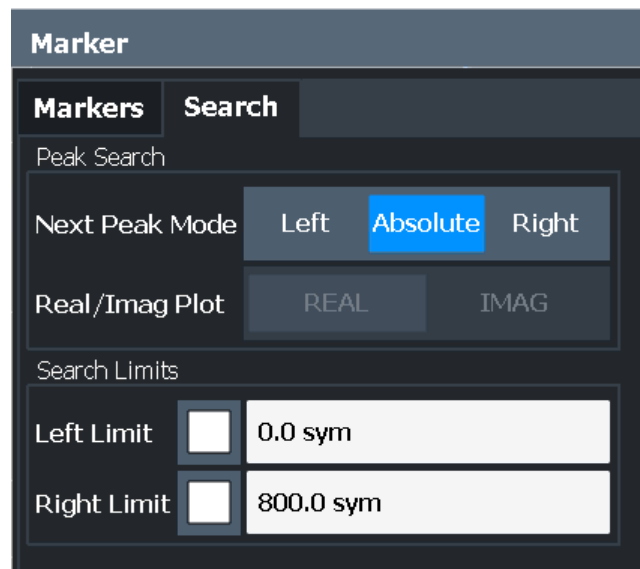
Remote command:

[CALCulate<n>:MARKer<m>:LINK](#) on page 412

6.3.2 Marker search settings

Access: [MKR TO] > "Search Config"

Several functions are available to set the marker to a specific position very quickly and easily. To determine the required marker position, searches can be performed. The search results can be influenced by special settings.



Search Mode for Next Peak	242
Real / Imag Plot	242
Search Limits (Left / Right)	243

Search Mode for Next Peak

Selects the search mode for the next peak search.

"Left"	Determines the next maximum/minimum to the left of the current peak.
"Absolute"	Determines the next maximum/minimum to either side of the current peak.
"Right"	Determines the next maximum/minimum to the right of the current peak.

Remote command:

[Chapter 11.7.2.2, "Marker search and positioning settings"](#), on page 415

Real / Imag Plot

Defines whether marker search functions are performed on the real or imaginary trace of the "Real/Imag" measurement.

Remote command:

[CALCulate<n>:MARKer<m>:SEARch](#) on page 421

Search Limits (Left / Right)

If activated, limit lines are defined and displayed for the search. Only results within the limited search range are considered.

Remote command:

[CALCulate<n>:MARKer<m>:X:SLIMits\[:STATE\]](#) on page 422

[CALCulate<n>:MARKer<m>:X:SLIMits:LEFT](#) on page 421

[CALCulate<n>:MARKer<m>:X:SLIMits:RIGHT](#) on page 422

6.3.3 Marker positioning functions

The following functions set the currently selected marker to the result of a peak search.

Access: [MKR ->]

Peak Search	243
Search Next Peak	243
Max Peak 	243
Search Minimum	243
Search Next Minimum	244
Selected Result Rng	244

Peak Search

Sets the selected marker/delta marker to the maximum of the trace. If no marker is active, marker 1 is activated.

Remote command:

[CALCulate<n>:MARKer<m>:MAXimum\[:PEAK\]](#) on page 419

[CALCulate<n>:DELTamarker<m>:MAXimum\[:PEAK\]](#) on page 417

Search Next Peak

Sets the selected marker/delta marker to the next (lower) maximum of the assigned trace. If no marker is active, marker 1 is activated.

Remote command:

[CALCulate<n>:MARKer<m>:MAXimum:NEXT](#) on page 419

[CALCulate<n>:MARKer<m>:MAXimum:RIGHT](#) on page 419

[CALCulate<n>:MARKer<m>:MAXimum:LEFT](#) on page 419

[CALCulate<n>:DELTamarker<m>:MAXimum:NEXT](#) on page 416

[CALCulate<n>:DELTamarker<m>:MAXimum:RIGHT](#) on page 417

[CALCulate<n>:DELTamarker<m>:MAXimum:LEFT](#) on page 416

Max |Peak|

Sets the active marker/delta marker to the largest absolute peak value (maximum or minimum) of the selected trace.

Remote command:

[CALCulate<n>:MARKer<m>:MAXimum:APEak](#) on page 418

Search Minimum

Sets the selected marker/delta marker to the minimum of the trace. If no marker is active, marker 1 is activated.

Remote command:

`CALCulate<n>:MARKer<m>:MINimum[:PEAK]` on page 421

`CALCulate<n>:DELTamarker<m>:MINimum[:PEAK]` on page 418

Search Next Minimum

Sets the selected marker/delta marker to the next (higher) minimum of the selected trace. If no marker is active, marker 1 is activated.

Remote command:

`CALCulate<n>:MARKer<m>:MINimum:NEXT` on page 420

`CALCulate<n>:MARKer<m>:MINimum:LEFT` on page 420

`CALCulate<n>:MARKer<m>:MINimum:RIGHT` on page 420

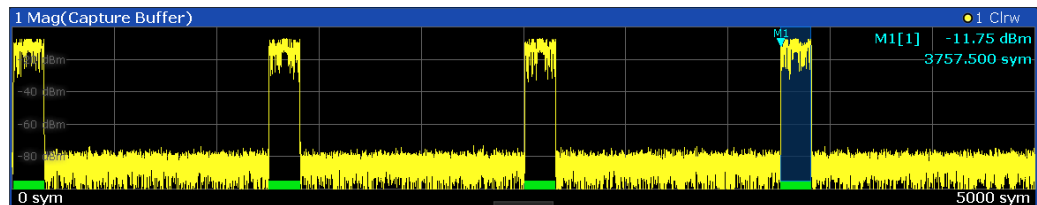
`CALCulate<n>:DELTamarker<m>:MINimum:NEXT` on page 418

`CALCulate<n>:DELTamarker<m>:MINimum:LEFT` on page 417

`CALCulate<n>:DELTamarker<m>:MINimum:RIGHT` on page 418

Selected Result Rng

Sets a marker to the start symbol of the currently selected result range. This function is useful to determine the start position of the selected result range within the capture buffer.



This function is only available in result diagrams based on the capture buffer.

Remote command:

`CALCulate<n>:MARKer<m>:MBURst:START` on page 420

`CALCulate<n>:DELTamarker<m>:MBURst:START` on page 417

6.4 Limit and display lines

Access: [LINES] > "Lines/Limits"

The results of a "modulation accuracy" measurement can be checked for violation of defined limits automatically (see "Modulation Accuracy" on page 24).

For eye diagrams, display lines allow you to measure the size of the eye in the diagram.

6.4.1 Display lines for eye diagrams

For eye diagrams (see Chapter 3.2, "Result types in VSA", on page 25), display lines allow you to measure the size of the eye in the diagram. For other result displays, lines are not available.

For a detailed description on the use of display lines in eye diagrams, see [Chapter 8.3.2, "How to measure the size of an eye"](#), on page 272.

Vertical Line	245
Horizontal Line	245

Vertical Line

Displays an absolute or relative vertical line in an eye diagram (see [Chapter 3.2, "Result types in VSA"](#), on page 25). A relative line is only available if an absolute vertical line is already displayed.

The position of the lines can be defined numerically or by dragging the line to a new position in the diagram.

The absolute x-value of the eye diagram at the position of the first line is indicated in the diagram. The relative x-value of the eye diagram at the position of the second line, in relation to the x-value at the first line, is also indicated. The unit of the vertical lines depends on the unit of the x-axis in the diagram.

If you position the lines at the left and right edges of the eye, the relative line value represents the width of the eye.

See also [Chapter 8.3.2, "How to measure the size of an eye"](#), on page 272.

Remote command:

`CALCulate<n>:TLABs:STATe` on page 425

`CALCulate<n>:TLABs[:VALue]` on page 425

`CALCulate<n>:TLRel:STATe` on page 426

`CALCulate<n>:TLRel[:VALue]` on page 426

Horizontal Line

Displays an absolute or relative horizontal line in an eye diagram (see [Chapter 3.2, "Result types in VSA"](#), on page 25). A relative line is only available if an absolute horizontal line is already displayed.

The position of the lines can be defined numerically or by dragging the line to a new position in the diagram.

The absolute y-value of the eye diagram at the position of the first line is indicated in the diagram. The relative y-value of the eye diagram at the position of the second line, in relation to the y-value at the first line, is also indicated. The unit of the vertical lines depends on the unit of the y-axis in the diagram.

If you position the lines at the top and the bottom of the eye, the relative line value represents the height of the eye.

See also [Chapter 8.3.2, "How to measure the size of an eye"](#), on page 272.

Remote command:

`CALCulate<n>:DLABs:STATe` on page 423

`CALCulate<n>:DLABs[:VALue]` on page 423

`CALCulate<n>:DLRel:STATe` on page 424

`CALCulate<n>:DLRel[:VALue]` on page 424

6.4.2 Modulation accuracy limit lines

Access: [LINES] > "ModAcc Limits Config"

The results of a "modulation accuracy" measurement can be checked for violation of defined limits automatically (see "Modulation Accuracy" on page 24).

	Current	Mean	Peak	Limit Value	Check
Frequency Error RMS				1.5 %	<input type="checkbox"/>
Frequency Error Peak				2.5 %	<input type="checkbox"/>
Magnitude Error RMS				1.5 %	<input type="checkbox"/>
Magnitude Error Peak				2.5 %	<input type="checkbox"/>
FSK Deviation Error				1.0 kHz	<input type="checkbox"/>
Carrier Frequency Error				1.0 kHz	<input type="checkbox"/>

Note: Limits for Current and Peak are always equal!

For details on working with limits, see [Chapter 8.3.3, "How to check limits for modulation accuracy"](#), on page 273.

Checking Modulation Accuracy Limits	246
Set to Default	247
Current/Mean/Peak	247
↳ Limit Value	247
↳ Check	248

Checking Modulation Accuracy Limits

Activates or deactivates evaluation of "modulation accuracy" limits in the "Result Summary".

For details on working with limits, see [Chapter 8.3.3, "How to check limits for modulation accuracy"](#), on page 273.

Remote command:

[CALCulate<n>:LIMit:MACCuracy:STAtE](#) on page 427

Set to Default

Restores the default limits and deactivates all checks.

Remote command:

[CALCulate<n>:LIMit:MACCuracy:DEFault](#) on page 427

Current/Mean/Peak

Defines and activates the limits for the currently measured value, the mean and the peak value on separate tabs. Note that the limits for the current and peak values are always the same.

For details on working with limits, see [Chapter 8.3.3, "How to check limits for modulation accuracy"](#), on page 273.

Limit Value ← Current/Mean/Peak

Define the limit with which the currently measured, mean or peak value is to be compared. A different limit value can be defined for each result type. Depending on the modulation type, different result types are available.

Result type	Remote command
PSK, MSK, QAM:	
"EVM RMS"	CALCulate<n>:LIMit:MACCuracy:EVM:RCURrent:VALue on page 430
"EVM Peak"	CALCulate<n>:LIMit:MACCuracy:EVM:PCURrent:VALue on page 430
"Phase Err Rms"	CALCulate<n>:LIMit:MACCuracy:PERRor:RCURrent:VALue on page 432
"Phase Err Peak"	CALCulate<n>:LIMit:MACCuracy:PERRor:PCURrent:VALue on page 432
"Magnitude Err Rms"	CALCulate<n>:LIMit:MACCuracy:MERRor:RCURrent:VALue on page 431
"Magnitude Err Peak"	CALCulate<n>:LIMit:MACCuracy:MERRor:PCURrent:VALue on page 431
"Carr Freq Err"	CALCulate<n>:LIMit:MACCuracy:CFERRor:CURRent:VALue on page 430
"Rho"	CALCulate<n>:LIMit:MACCuracy:RHO:CURRent:VALue on page 432
"IQ Offset"	CALCulate<n>:LIMit:MACCuracy:OOFSet:CURRent:VALue on page 431
FSK modulation only:	
"Freq Err Rms"	CALCulate<n>:LIMit:MACCuracy:FERRor:RCURrent:VALue on page 431
"Freq Err Peak"	CALCulate<n>:LIMit:MACCuracy:FERRor:PCURrent:VALue on page 431
"Magnitude Err Rms"	CALCulate<n>:LIMit:MACCuracy:MERRor:RCURrent:VALue on page 431

Result type	Remote command
"Magnitude Err Peak"	CALCulate<n>:LIMit:MACCuracy:MERRor:PCURrent:VALue on page 431
"FSK Dev Err"	CALCulate<n>:LIMit:MACCuracy:FERRor:PCURrent:VALue on page 431
"Carr Freq Err"	CALCulate<n>:LIMit:MACCuracy:CFERRor:CURRent:VALue on page 430

For details on working with limits, see [Chapter 8.3.3, "How to check limits for modulation accuracy"](#), on page 273.

Check ← Current/Mean/Peak

Considers the defined limit value in the limit check, if checking is activated.

For details on working with limits, see [Chapter 8.3.3, "How to check limits for modulation accuracy"](#), on page 273.

Remote command:

[CALCulate<n>:LIMit:MACCuracy:<ResultType>:<LimitType>:STATe](#)
on page 429

6.5 Display and window configuration

The captured I/Q data can be evaluated using various different methods without having to start a new measurement.



To get started, some typical and useful display configurations are predefined. Select the required scenario and the display is configured suitably.

See [Chapter 3.3, "Predefined display configuration"](#), on page 66

As opposed to the R&S FPL1000 I/Q Analyzer application or other applications, in VSA configuring the result display requires two steps:

1. **Display Configuration:** In the first step, you select the data source for the evaluation and the window placement in the SmartGrid.
The SmartGrid mode is activated automatically when you select the "Display Config" softkey from the main VSA menu or the "Display Config" button in the Overview. Note, however, that this button is only displayed in the general "Overview", not for window-specific configuration ("Specifics for" must be disabled).
The default evaluation for the selected data source is displayed in the window. You can display up to 16 result displays simultaneously in separate windows. The VSA evaluation methods are described in [Chapter 3, "Measurements and result displays"](#), on page 21.
For details on working with the SmartGrid, see the R&S FPL1000 Getting Started manual.

2. **(Result) Window Configuration:** In a second step, you can select a different evaluation method (result type) for the window, based on the data source selected in the "Display Configuration".

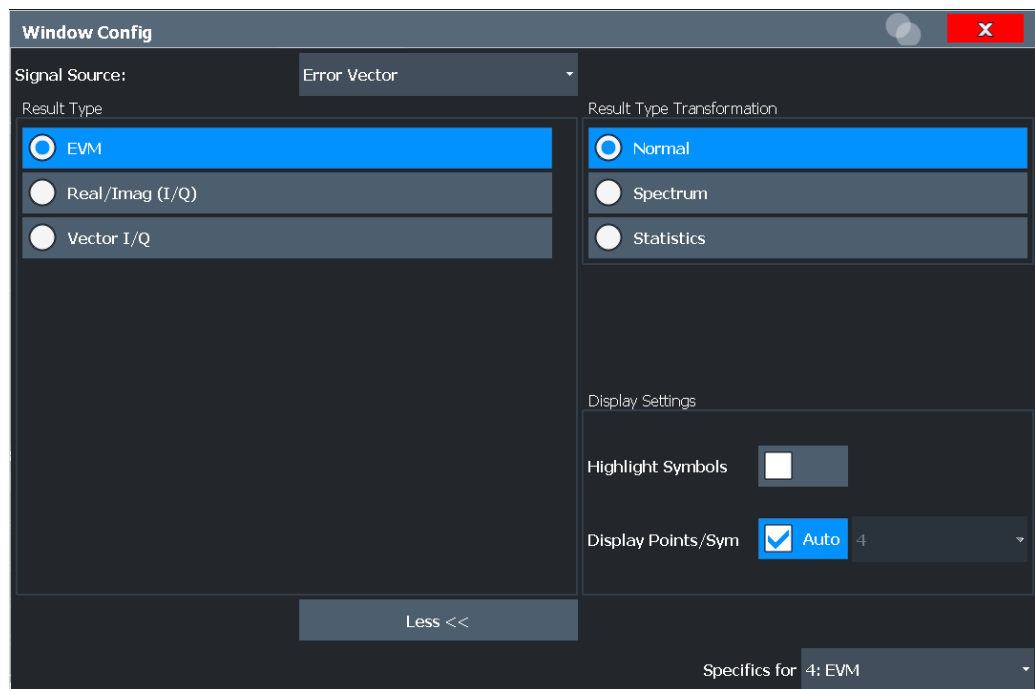
6.5.1 Result window configuration

Access: "Overview" > "Display Config"

For each result window you can select a different evaluation method (result type), based on the data source selected in the "Display Configuration". Further window settings are available for some result types.



Some settings are only displayed after you select the "More" button in the dialog box. To hide these settings, select the "Less" button.



Signal Source.....	249
Result Type.....	250
└ Symbol format.....	250
Result Type Transformation.....	250
Highlight Symbols.....	250
Display Points/Sym.....	251
Oversampling.....	251

Signal Source

Data source as selected in the "Display Configuration" (see [Chapter 3, "Measurements and result displays"](#), on page 21). If you change the signal source setting here, the default result type for the new data source is activated for the current window.

Remote command:

[LAYout:ADD\[:WINDow\]? on page 434](#)

[CALCulate<n>:FORMat on page 444](#)

Result Type

The result type defines the evaluation method used in the current window.

The available result types in VSA are described in [Chapter 3.2, "Result types in VSA"](#), on page 25.

Remote command:

[CALCulate<n>:FORMat on page 444](#)

Symbol format ← Result Type

Defines the format in which each symbol is defined: hexadecimal, decimal or binary

Result Type Transformation

For certain result types, it is not only possible to see the common "over time" representation of the measurement. You can also display the spectrum or the statistics (in form of a histogram), which are the transformations of the results.

These settings are not available for symbol evaluation, i.e. the following signal sources:

- Symbols
- "Modulation Accuracy"
- "Equalizer"

"Normal" Evaluation in time domain
X-axis displays time values.

"Spectrum" Evaluation in frequency domain
X-axis displays frequency values. The usable I/Q bandwidth is indicated in the display.

"Statistics" Statistical evaluation (histogram)
X-axis displays former y-values. Y-axis displays statistical information:

- Trace 1: the probability of occurrence of a certain value is plotted against the value
- Trace 2: the cumulated probability of occurrence is plotted against the value.

Remote command:

[CALCulate<n>:DDEM:SPECTrum\[:STATe\] on page 442](#)

[CALCulate<n>:STATistics:CCDF\[:STATe\] on page 445](#)

Highlight Symbols

If enabled, the symbol instants are highlighted as squares in the window for measured and reference signals in time (normal) display, and error displays.

Only evaluations that are based on symbols (e.g. constellations or traces, not eye diagrams) support this function.

Remote command:

[DISPlay\[:WINDow<n>\]:TRACe<t>:SYMBOL on page 447](#)

Display Points/Sym

Defines the number of display points that are displayed per symbol. If more points per symbol are selected than the defined [Sample Rate](#), the additional points are interpolated for the display. The more points are displayed per symbol, the more detailed the trace becomes.

For more information, see [Chapter 4.7, "Display points vs estimation points per symbol"](#), on page 147.

Note: If the capture buffer is used as the signal source, the [Sample Rate](#) defines the number of displayed points per symbol; the "Display Points/Sym" parameter is not available.

If "Auto" is enabled, optimal number of points, depending on the result display, is used - usually, the [Sample Rate](#) value.

Alternatively, select the number of points to be displayed per symbol manually. The available values depend on the source type.

"1" Only the symbol time instants are displayed.

"2, 4, 8, 16, 32" More points are displayed than symbols.

"Capture Oversampling"

The number of samples per symbol defined in the signal capture settings are displayed (see ["Sample Rate"](#) on page 201).

For very large numbers of capture points (≥ 64), use a lower number of display points per symbol to avoid prolonged display times and extremely large amounts of trace data.

Remote command:

[DISPlay\[:WINDow<n>\]:PRATe\[:VALue\]](#) on page 447

[DISPlay\[:WINDow<n>\]:PRATe:AUTO](#) on page 447

Oversampling

Defines the sample basis for statistical evaluation. This setting is only available for the result type transformation "Statistics".



Figure 6-2: Statistics measurement: window 1: measured signal (symbols highlighted); window 3: statistics for symbol instants only; window 4: statistics for all trace points;

- "Symbols only" Statistics are calculated for symbol instants only.
See window 3 in [Figure 6-2](#).
- "Infinite" Statistics are calculated for all trace points (symbol instants and intermediate times).
See window 4 in [Figure 6-2](#).
- "Auto" Oversampling is automatically set to "Symbols only" (Statistics are calculated for symbol instants only).

Remote command:

`CALCulate<n>:STATistics:MODE` on page 445

7 I/Q data import and export

Baseband signals mostly occur as so-called complex baseband signals, i.e. a signal representation that consists of two channels; the inphase (I) and the quadrature (Q) channel. Such signals are referred to as I/Q signals. The complete modulation information and even distortion that originates from the RF, IF or baseband domains can be analyzed in the I/Q baseband.

Importing and exporting I/Q signals is useful for various applications:

- Generating and saving I/Q signals in an RF or baseband signal generator or in external software tools to analyze them with the R&S FPL1000 later.
- Capturing and saving I/Q signals with the R&S FPL1000 to analyze them with the R&S FPL1000 or an external software tool later

As opposed to storing trace data, which can be averaged or restricted to peak values, I/Q data is stored as it was captured, without further processing. Multi-channel data is not supported.

The data is stored as complex values in 32-bit floating-point format. The I/Q data is stored in a format with the file extension `.iq.tar`.

For a detailed description, see the R&S FPL1000 I/Q Analyzer and I/Q Input User Manual.

For example, you can capture I/Q data using the I/Q Analyzer application, if available, and then analyze that data later using the R&S FPL1000 VSA application.



An application note on converting Rohde & Schwarz I/Q data files is available from the Rohde & Schwarz website:

[1EF85: Converting R&S I/Q data files](#)

8 How to perform vector signal analysis

Using the VSA option you can perform vector signal analysis measurements using predefined standard setting files, or independently of digital standards using user-defined measurement settings. Such settings can be stored for recurrent use.

Thus, configuring VSA measurements requires one of the following tasks:

- Selecting an existing standard settings file and, if necessary, adapting the measurement settings to your specific requirements.
- Configuring the measurement settings and, if necessary, storing the settings in a file.
- [How to perform VSA according to digital standards](#).....254
- [How to perform customized VSA measurements](#)..... 256
- [How to analyze the measured data](#).....268

8.1 How to perform VSA according to digital standards

To perform vector signal analysis as specified in digital standards, various predefined settings files for common digital standards are provided for use with the VSA option. In addition, you can create your own settings files for user-specific measurements.

For an overview of predefined standards and settings see [Chapter B, "Predefined standards and settings"](#), on page 502.

This section provides instructions for the following tasks:

- ["To perform a measurement according to a standard"](#) on page 254
- ["To load predefined settings files"](#) on page 255
- ["To store settings as a standard file"](#) on page 255
- ["To delete standard files"](#) on page 255
- ["To restore standard files"](#) on page 255

To perform a measurement according to a standard

1. Press the [MODE] key and select the "VSA" application.
2. Press the [MEAS] key and select the "Digital Standards" softkey.
3. Select the required settings file and then "Load" (see ["To load predefined settings files"](#) on page 255).

The instrument is adjusted to the stored settings for the selected standard and a measurement is started immediately.

4. Press the [RUN SINGLE] key to stop the continuous measurement mode and start a defined number of measurements.

The measured data is stored in the capture buffer and can be analyzed (see [Chapter 8.3, "How to analyze the measured data"](#), on page 268).

To load predefined settings files

1. In the "Meas" menu, select the "Digital Standards" softkey.
2. In the file selection dialog box, select the standard whose settings you want to load.
To change the path, press the arrow icons at the right end of the "Path" field and select the required folder from the file system.
3. Press the "Load" button.
The dialog box is closed and the instrument is adjusted to the stored settings for the selected standard.

To store settings as a standard file

1. Configure the measurement as required (see [Chapter 8.2, "How to perform customized VSA measurements"](#), on page 256).
2. In the "Meas" menu, select the "Digital Standards" softkey.
3. In the "File Name" field, enter the name of the standard for which you want to store settings.
To change the path, press the arrow icons at the right end of the "Path" field and select the required folder from the file system.
To insert a new folder, select the "New Folder" button and enter a name in the "New Folder" dialog box.
4. Press the "Save" button.
The dialog box is closed and the current measurement settings are stored in a standard file.

To delete standard files

1. In the "Meas" menu, select the "Digital Standards" softkey.
2. In the "Manage VSA Standards" file selection dialog box, select the standard whose settings file you want to delete. You can also delete standards predefined by Rohde & Schwarz.
To change the path, press the arrow icons at the right end of the "Path" field and select the required folder from the file system.
3. Press the "Delete" button.
4. Confirm the message to avoid unintentionally deleting a standard.
The standard file is removed from the folder.

To restore standard files

1. To restore the predefined standard files, do one of the following:
 - In the "Meas" menu, select the "Digital Standards" softkey.
The "Manage VSA Standards" file selection dialog box is displayed.
 - In the "Meas" menu, select the "Restore Factory Settings" softkey.

2. Select "Restore Standard Files".

The standards predefined by Rohde & Schwarz available at the time of delivery are restored to the `Standards` folder.

8.2 How to perform customized VSA measurements

In addition to performing vector signal analysis strictly according to specific digital standards, you can configure the analysis settings for customized tasks. The general process for a typical VSA measurement is described here.

1. Press the [MODE] key and select the "VSA" application.
2. Select the "Overview" softkey to display the "Overview" for VSA.
3. Select the "Signal Description" button and configure the expected signal characteristics.
If the input data is largely known in advance, define files with the known data to compare the measured data to (see [Chapter 8.2.4, "How to work with known data files"](#), on page 264). This can improve demodulation significantly.
Note: Make sure that the input signal contains an adequate number of uncorrelated (random!) bits to ensure correct demodulation.
4. Select the "Input/Frontend" button to define the input signal's center frequency, amplitude and other basic settings.
5. Select the "Signal Capture" button and define how much and which data to capture:
 - "Capture length": the duration or number of symbols to capture
 - "Sample rate": how many points to capture for each symbol
6. Optionally, select the "Trigger" tab and define a trigger for data acquisition, for example an external trigger to start capturing data only when a useful signal is transmitted.
7. For bursted signals, select the "Burst/Pattern" button and define the criteria to detect the individual bursts within the input signal (see [Chapter 8.2.3, "How to perform pattern searches"](#), on page 259).
8. Select the "Cut Result Ranges" button and define which of the captured data to demodulate (see [Chapter 8.2.1, "How to define the result range"](#), on page 257).
9. Select the "Demodulation" button to configure and optimize the synchronization process.
10. Select the "Meas filter" button to select a different or user-defined measurement filter to improve the accuracy of the error vector (see [Chapter 8.2.2, "How to select user-defined filters"](#), on page 258).

11. Select the "Evaluation Range" button to define which part of the demodulated data to evaluate and display.
12. Press the [RUN SINGLE] key to stop the continuous sweep and start a new sweep with the new configuration.

The measured data is stored in the capture buffer and can be analyzed (see [Chapter 8.3, "How to analyze the measured data"](#), on page 268)

8.2.1 How to define the result range

You can define which part of the source signal is analyzed ("Result Range") with reference to the captured data, a detected burst or a detected pattern.

(For details on the functions see [Chapter 5.7, "Result range configuration"](#), on page 216.)

1. In the "Overview", select "Range Settings".
2. Select the "Result Range" tab.
3. Define the "Result Length", i.e. the number of symbols from the result to analyze. Note that when you use known data files as a reference, the "Result Length" specified here must be identical to the length of the specified symbol sequences in the xml file (<ResultLength> element). See [Chapter 4.9, "Known data files - dependencies and restrictions"](#), on page 148.
4. Define the "Reference" for the result range, i.e. the source to align the result to. The reference can be the captured data, a detected burst or a detected pattern.
5. Define the "Alignment" of the result range to the reference source, i.e. whether the result starts at the beginning of the reference source, ends with the reference source, or is centered with the reference source.
6. Optionally, define an offset of the result range to the reference source, e.g. to ignore the first few symbols of the captured data.
7. Optionally, define the number of the symbol which marks the beginning of the reference source to change the scaling of the x-axis. This offset is added to the one defined for the signal description.

Example: Defining the result range

In [Figure 8-1](#), a result range is defined for the first 100 symbols of the capture buffer, starting at the second symbol, which has the symbol number 1 (the capture buffer starts at symbol number 1, the first displayed symbol is the second symbol due to the offset: $1+1=2$).

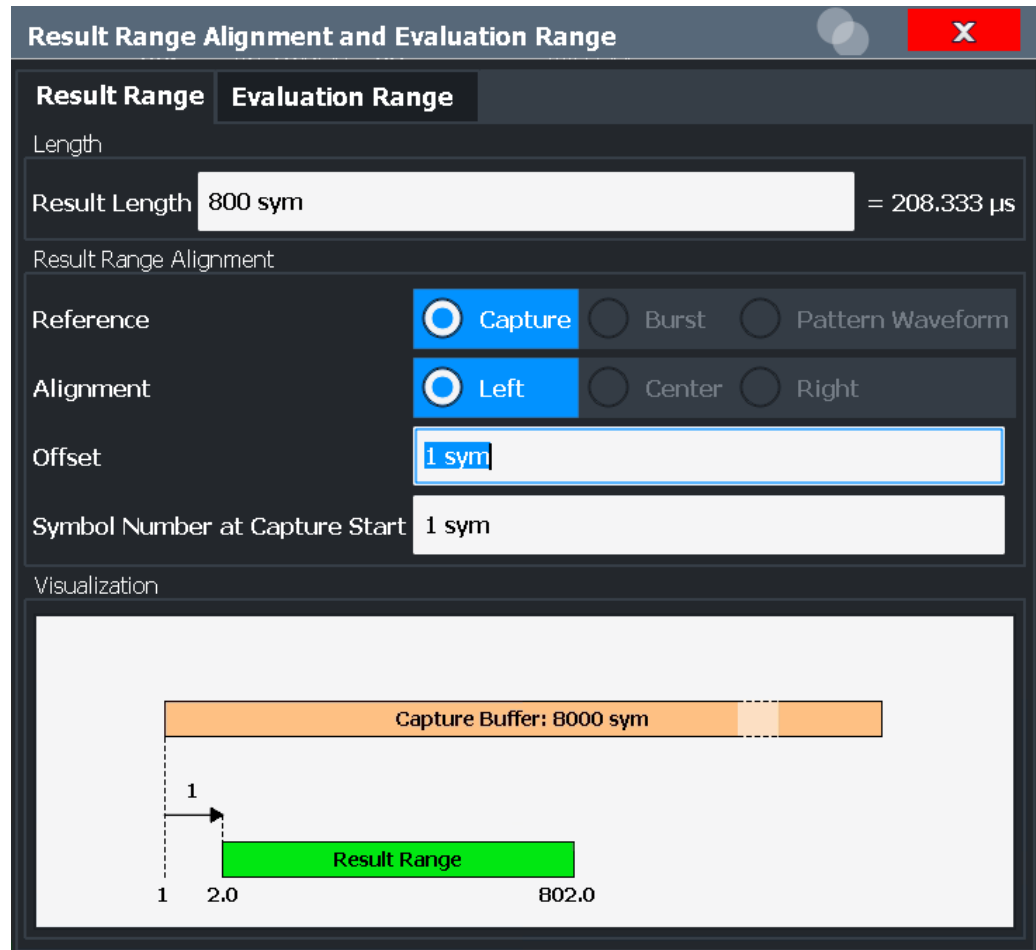


Figure 8-1: Example: Defining the Result Range



The result range is indicated by a green bar along the time axis in "Capture Buffer" result displays, see [Chapter 4.6, "Measurement ranges"](#), on page 142.

8.2.2 How to select user-defined filters

The most frequently required measurement and TX filters required for vector signal analysis according to digital standards are provided by the R&S FPL1000 VSA application. However, you can also load user-defined filters.

To load a user measurement filter

1. In the "Overview", select the "Meas Filter" button.

2. In the "Meas Filter" tab of the "Demodulation & Measurement Filter" dialog box, select "Type": *User*.
3. Select "Load User Filter".
4. Load your `.vaf` file from the USB stick.

To load a user transmit (TX) filter

1. In the "Overview", select the "Signal Description" button.
2. In the "Modulation" tab of the "Signal Description" dialog box, select "Transmit Filter Type": *User*.
3. Select "Load User Filter".
4. Load your `.vaf` file from the USB stick.

8.2.3 How to perform pattern searches

To configure a pattern search

1. In the "Overview", select "Signal Description".
2. Select the "Signal Structure" tab.
3. Select the "Burst Signal" signal type.
4. Enable the "Pattern" option.
5. From the "Name" selection list, select a pattern to assign to the currently defined standard.
6. If the pattern you require is not available, continue with ["To add a predefined pattern to a standard"](#) on page 260 or [Chapter 8.2.3.2, "How to define a new pattern"](#), on page 260.
7. Optionally, select the "Offset" option and enter the number of symbols in the signal to ignore during the pattern search.
8. Close the "Signal Description" dialog box.
9. In the "Overview" dialog box, select "Burst / Pattern" and switch to the "Pattern Search" tab.
10. Select "On" to enable the search.
To enable a search only if a pattern is part of the signal description, enable the "Auto" option.
Whether a pattern was detected or not is indicated in the "Information" area.
11. If necessary, adapt the I/Q correlation threshold. If patterns are not detected, reduce the threshold; if false patterns are detected, increase the threshold.

12. Optionally, enable the "Meas only if pattern symbols correct" option. In this case, measurement results are only displayed if a valid pattern has been detected.
13. Close the dialog box.

The selected pattern is used for a pattern search in the next measurement.

8.2.3.1 How to assign patterns to a standard

Only patterns that are assigned to the currently selected VSA standard are available for the pattern search.

To add a predefined pattern to a standard

1. In the "Overview", select "Signal Description" and switch to the "Signal Structure" tab.
2. Select "Pattern Config" to display the "Advanced Pattern Settings" dialog box.
3. In the list of "All Patterns", select the required pattern.
If the required pattern is not displayed, see ["To change the display for the list of patterns"](#) on page 263.
4. Select "Add to Standard".
The selected pattern is inserted in the list of "Standard Patterns".
5. Select the pattern to use for the pattern search from the list of "Standard Patterns".

To remove a predefined pattern from a standard

1. In the "Overview", select "Signal Description" and switch to the "Signal Structure" tab.
2. Select "Pattern Config" to display the "Advanced Pattern Settings" dialog box.
3. Select the pattern from the list of "Standard Patterns".
4. Select "Remove from Standard".
The pattern is removed from the list of "Standard Patterns" and is no longer assigned to the current standard, but is still available for assignment from the list of "All Patterns".

8.2.3.2 How to define a new pattern

1. Select [MEAS CONFIG] > "Pattern Config".
The "Advanced Pattern Settings" dialog box is displayed.
2. Select the "New" button.
The pattern definition dialog box is displayed.
3. Define the following pattern settings:

Setting	Description
Name	Pattern name displayed in selection list
Description	Optional description of the pattern which is displayed in the pattern details
Modulation order	Number of values each symbol can represent, e.g. 8 for 8-PSK
Comment	Optional comment for the pattern, displayed in the pattern details (kept for compatibility with FSQ)

4. Define the format used to define the individual symbols of the pattern.
5. Define the symbols of the pattern.
 - a) Select the symbol field you want to define.
If necessary, add a new symbol field by selecting "Add".
 - b) Enter a value using the keyboard. Depending on the "Modulation Order" $\langle n \rangle$, the value can be in the range 0 to $\langle n \rangle - 1$.
 - c) Select the next symbol field, or insert a new one, and continue to define the other symbols. To scroll through the fields for long patterns, use the scrollbar beneath the input area. The number beneath the scrollbar at the right end indicates the sequential number of the last symbol field, the number in the center indicates the sequential number of the currently selected symbol field.
To remove a symbol field, select it and press "Remove".
6. Select "Save" to save the pattern under the specified name. The pattern is stored on the instrument as an XML file named $\langle \text{Name} \rangle . \text{xml}$ under
`C:\ProgramData\Rohde-Schwarz\ZNL-FPL\vsa\Pattern.`



If you copy this file to another location, you can restore the pattern later, e.g. after deletion.

Example: Defining a pattern
Figure 8-2: Pattern definition

If you assume that a signal has a pattern, but do not know it in advance, you can determine it using the [Symbol table](#). Measure the signal and check for a pattern in the symbol table. Then you can copy the symbols from the symbol table to the pattern definition for subsequent measurements (see "[Import Symbols](#)" on page 215).

How to Copy a Pattern from the Symbol Table

1. In the "Overview", select "Display Config".
2. Add a "Symbols Table" to the display.
3. Exit the SmartGrid mode.
4. Select Run Single to perform a single measurement.
5. Analyze the symbol table and find the pattern.

6. In the "Overview", select "Cut Result Ranges".
7. Define an offset for the result range alignment so that the result range starts with the first pattern symbol.
8. Select [MEAS CONFIG] > "Pattern Config".
The "Advanced Pattern Settings" dialog box is displayed.
9. Select the "New" button.
The pattern definition dialog box is displayed.
10. Define the following pattern settings:

Setting	Description
Name	Pattern name displayed in selection list
Description	Optional description of the pattern which is displayed in the pattern details
Modulation order	Number of values each symbol can represent, e.g. 8 for 8-PSK
Comment	Optional comment for the pattern, displayed in the pattern details (kept for compatibility with FSQ)

11. Define the format used to define the individual symbols of the pattern.
12. Select "Import Symbols".
13. Select the number of symbols the detected pattern in the symbol table consists of.
14. Select "OK".
The symbols from the symbol table are copied to the pattern definition dialog box.
15. Select "Save" to save the pattern under the specified name. The pattern is stored on the instrument as an XML file named <Name>.xml under
C:\ProgramData\Rohde-Schwarz\ZNL-FPL\vsa\Pattern.

8.2.3.3 How to manage patterns

To change the display for the list of patterns

1. In the "Overview", select "Signal Description" and switch to the "Signal Structure" tab.
2. Select "Pattern Config" to display the "Advanced Pattern Settings" dialog box.
3. To display all available patterns, select "Show All".
To display all patterns that are compatible to the defined standard, select "Show Compatible".
To display only patterns that contain a specific prefix, enter the "Prefix" in the edit field.

To edit a predefined pattern

1. In the "Overview", select "Signal Description" and switch to the "Signal Structure" tab.
2. Select "Pattern Config" to display the "Advanced Pattern Settings" dialog box.
3. Select the pattern from the list of "All Patterns".
4. Press "Edit Pattern".
5. Change the settings as required as described in [Chapter 8.2.3.2, "How to define a new pattern"](#), on page 260.

To delete a predefined pattern

1. In the "Overview", select "Signal Description" and switch to the "Signal Structure" tab.
2. Select "Pattern Config" to display the "Advanced Pattern Settings" dialog box.
3. Select the pattern from the list of "All Patterns".
4. Press "Delete Pattern".

The pattern is removed from the lists of available and assigned patterns and can no longer be assigned to any standard. Any existing assignments to other standards are removed, as well.

To restore predefined patterns

Default patterns provided by Rohde&Schwarz can be restored.

1. Press the [MEAS] key.
2. Select the "Restore Factory Settings" softkey.
3. Select the "Restore Pattern Files" softkey.

The patterns as defined by Rohde & Schwarz at the time of delivery are restored.



Restoring user-defined patterns

User-defined patterns can only be restored if you have a copy of the pattern file created during creation. In this case, copy the file named <Patternname>.xml back to C:\ProgramData\Rohde-Schwarz\ZNL-FPL/vsa/standards. After a preset or after performing certain operations (e.g. changing the modulation settings), the pattern is included in the list of "All Patterns" again.

8.2.4 How to work with known data files

You can load XML files containing the possible sequences to the VSA application and use them to compare the measured data to. In particular, you can use known data for the following functions:

- Fine synchronization during the demodulation process (see [Figure 4-56](#) and "[Fine Synchronization](#)" on page 224)
- Calculation of the Bit Error Rate (BER), see [Chapter 3.2.1, "Bit error rate \(BER\)"](#), on page 27

8.2.4.1 How to load known data files

Known Data files are loaded in the "Modulation & Signal Description" settings.

To load an existing Known Data file

1. In the "Overview", select "Signal Description".
2. Switch to the "Known Data" tab.
3. Activate the usage of a Known Data file by enabling the "Known Data" option.
The "Load Data File" function is enabled.
4. Select the "Source": "XML file".
The "Load Data File" function is enabled.
5. Select the "Load Data File" button.
A file selection dialog box is displayed.
6. Select the XML file which contains the possible data sequences of the input signal.
The file must comply with the syntax described in [Chapter E, "Known data file syntax description"](#), on page 516.

The header information of the XML file is displayed in the dialog box.

Once a Known Data file has been loaded, the Bit Error Rate result display becomes available.

If the "Fine Synchronization" setting in the "Demodulation" dialog box is set to "Auto" mode, the known data is also used for synchronization. Otherwise it can be selected manually. Defining a maximum symbol error rate for the known data in reference to the analyzed data avoids using a falsely selected or unsuitable file for synchronization (see also "[If SER ≤](#)" on page 225).

8.2.4.2 How to create known data files

You must create the Known Data files yourself according to the possible data sequences of the input signal. Use any xml editing tool you like, following the rules described in [Chapter E, "Known data file syntax description"](#), on page 516. Before loading the file to the VSA application, make sure that the syntax of your file is valid.



Auxiliary tool to create Known Data files

An auxiliary tool to create Known Data files from data that is already available in the R&S FPL1000 VSA application is provided on the instrument free of charge.

You can copy this tool to a PC and work with it locally, as well.

To create a Known Data file using the recording tool for sequences

1. Import or input data for which stable demodulation results are available to the VSA application. If necessary, adapt the demodulation settings until you obtain the requested results.

Tip: Considerations for the measurement to be recorded.

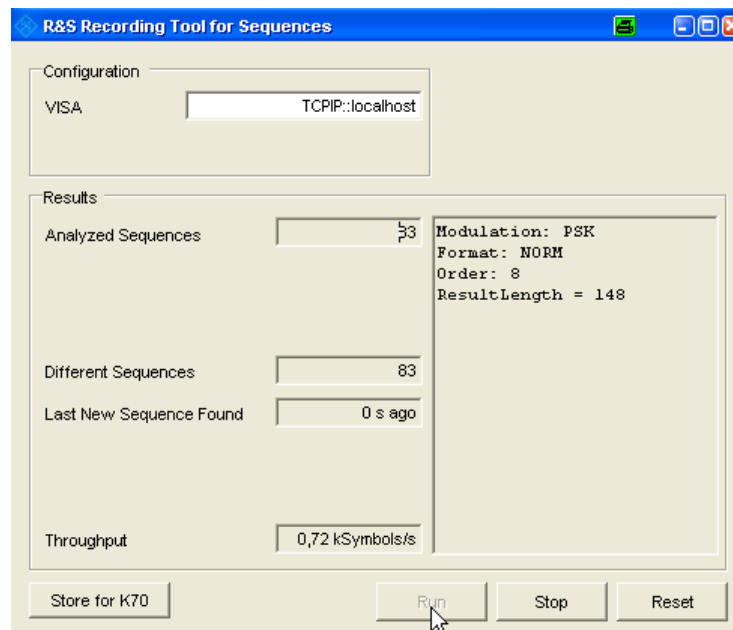
- Be careful when you use an external reference during recording. If there is no pattern within the signal, the recording can miss phase ambiguities.
- Be careful when you use a trigger during recording. In this case, you need to make sure that only one measurement is performed within the capture buffer. (The recording tool only records the first result range within the capture buffer.)

2. Start the "R&S Recording Tool for Sequences" from the Windows task bar on the R&S FPL1000, or execute the file

C:\ProgramData\Rohde-Schwarz\ZNL-FPL\

RecordingToolforSequences.EXE on the instrument.

The "R&S Recording Tool for Sequences" window is displayed.



3. Define the VISA resource string to connect to the instrument:
 - If you start the tool directly from the instrument: enter `TCPIP::localhost` (default).
 - If you start the tool from a computer: enter the TCPIP address or name of the computer in the VISA resource string (e.g. `TCPIP::123.4.5.6`).
4. Start a measurement in the R&S FPL1000 VSA application.
5. In the tool window, select "Run".
The tool records the demodulated data sequences and provides the following result information:

- **Analyzed Sequences:** number of data sequences analyzed since the tool was started
- **Different Sequences:** number of unique sequences detected in the measured data
- **Last New Sequence Found:** time that has passed since the most recent unique sequence was detected
- **Throughput:** current data processing speed of the tool

Note that while the tool is running, the R&S FPL1000 is set to remote mode, i.e. the manual interface is not available. As soon as the tool is closed, the remote mode is automatically deactivated.

6. When all known possible sequences have been detected, or when a significantly large amount of time has passed to assume that no more sequences will be detected, stop the tool by selecting "Stop".
7.
 - If the results are acceptable, select "Store for K70" to store a valid XML file with the recorded data sequences on the instrument. A file selection dialog box is displayed in which you can select the storage location and file name. You can also add an optional comment to the file.
 - Otherwise, reset the tool to start a new recording, possibly after changing the demodulation settings or input data.
8. Close the tool window to return to normal operation of the VSA application.

The created XML file can now be loaded in the VSA application as described in [Chapter 8.2.4.1, "How to load known data files"](#), on page 265.

8.2.5 How to work with PRBS as known data

Known data files require all possible data sequences to be defined in a file. For data generated by a pseudo-random bit sequence (PRBS) generator, the number of possible sequences can be very large and defining them in a file can be very tedious.

However, if you can specify the algorithm used to generate the data, the R&S FPL1000 VSA application can determine the possible sequences without a file. This function requires the R&S FPL1000-K70P option.

To define a PRBS algorithm as known data

1. In the "Overview", select "Signal Description".
2. Switch to the "Known Data" tab.
3. Activate the usage of Known Data by enabling the "Known Data" option.
4. Select the "Source": "PRBS".
Further settings for the PRBS algorithm are displayed.
5. Select the "PRBS Type" of the algorithm used to generate the random data.

The other algorithm settings are defined automatically according to the ITU-T standard. Unless your polynomial deviates from the standard, no further settings are required.

6. Switch to the "Modulation" tab.
7. Select "Mapping": "SMx" to use the same mapping in the R&S FPL1000 VSA application as the PRBS signal generator.

Once a polynomial has been specified, the Bit Error Rate result display becomes available.

If the "Fine Synchronization" setting in the "Demodulation" dialog box is set to "Auto" mode, the known data is also used for synchronization. Otherwise it can be selected manually. Defining a maximum symbol error rate for the known data in reference to the analyzed data avoids using a falsely selected or unsuitable file for synchronization (see also "If SER ≤" on page 225).

8.3 How to analyze the measured data

Once the data has been stored in the capture buffer, the results can be analyzed in numerous ways. The following tasks are meant to make you familiar with the most common VSA application features. For a description of all analysis functions and settings, see [Chapter 6, "Analysis"](#), on page 233.

1. Press the [MEAS CONFIG] key to display the VSA menu.
2. Select the "Display Config" button in the "Overview" or the "Display Config" softkey and select the data sources for evaluation that are of interest to you (see [Chapter 6.5, "Display and window configuration"](#), on page 248).
Arrange them on the display to suit your preferences.
For each data source, a window with the default result type for that data source is displayed.
3. Exit the SmartGrid mode.
4. Select the "Window Config" softkey to change the result types and other display settings for the selected window. To change the settings in other windows, select a different window from the "Specifics for" list in the "Window Config" dialog box.
5. Select the "Overview" softkey to display the "Overview".
Enable the "Specifics for" option to access the analysis functions for the selected window.
6. Select the "Analysis" button in the "Overview" to configure special analysis settings for the individual result displays, for example:
 - Configure markers and delta markers to determine deviations and offsets within the results, e.g. when comparing errors or peaks.
 - Configure the trace to display the average over a series of measurements. If necessary, increase the "Statistics Count" defined in the "Sweep" menu.

7. Press the [SWEEP] key and select "Selected Result Rng" to select a specific burst to evaluate.

The result displays are updated to show the results for the selected burst.

Tip: You can use a capture buffer display to navigate through the available result ranges, and analyze the individual result ranges in another window. The currently displayed result range is indicated by a blue bar in the capture buffer display.

8. Optionally, zoom into a diagram to enlarge an area of the displayed data.
9. Optionally, change the display scaling for diagrams (see [Chapter 8.3.1, "How to change the display scaling"](#), on page 269).
10. Optionally, check the "modulation accuracy" against specified limits (see [Chapter 8.3.3, "How to check limits for modulation accuracy"](#), on page 273).
11. Optionally, export the trace data of the measured signal to a file (see [Chapter 8.3.4, "How to export the trace data to a file"](#), on page 274).

8.3.1 How to change the display scaling

Depending on the type of display (time, spectrum or statistics), various scaling functions are available to adapt the result display to the current data.

8.3.1.1 How to scale time and spectrum diagrams

The range of the displayed y-axis for time and spectral diagrams can be defined in the following ways:

- manually, by defining the range size, reference values and positions
- automatically, according to the current results

To define the scaling manually using a reference point

With this method, you define a reference value and a position at which this value is to be displayed on the y-axis.

1. Focus the result window.
2. Select "AMPT > YScale Config > Y-Axis Reference Value".
3. Enter a reference value for the y-axis in the current unit.
4. Select "AMPT > YScale Config > Y-Axis Reference Position" .
5. Enter the position to display this value on the y-axis. The position is a percentage of the entire length, where 100 % refers to the top edge.
6. Select "AMPT > YScale Config > Y-Axis Range".

Example:

If you want to analyze errors greater than 95%, you can define the y-axis range as 5 % and position the y-axis to start at 95%. To do so, enter the reference value 95 % and the reference position 0%.

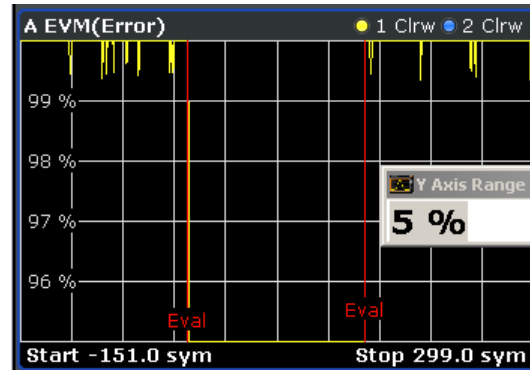


Figure 8-3: Defining the y-axis scaling using a reference point

To define the scaling automatically

1. Focus the result window.
2. Select "AMPT > Y-Axis Auto Scale".

The y-axis is adapted to display the current results optimally (only once, not dynamically).

8.3.1.2 How to scale statistics diagrams

Statistic diagrams show the distribution (i.e. probabilities of occurrence) of the values as a set of bars. You can define the number of bars to be displayed, i.e. the granularity of classifications. Additionally, you can specify whether absolute or percentage values are displayed. For statistics measurements, both the x-axis and the y-axis can be scaled to optimize the display.

The range of the displayed x-axis for statistics diagrams can be defined in the following ways:

- manually, by defining reference values and positions
- automatically, according to the current results

The range of the displayed y-axis can be defined in the following ways:

- manually, by defining the minimum and maximum values to be displayed
- automatically, according to the current results

After changing the scaling, you can restore the default settings.

To define the number of bars

1. Focus the result window.
2. Select "AMPT > XScale Config > X-Axis Quantize".

3. Enter the number of bars to display.

The diagram is adapted to display the specified number of bars.

To define the x-axis scaling manually using a reference point and divisions

With this method, you define a reference value on the x-axis to be displayed at the "Ref Position" of the y-axis. (The reference value is determined internally according to the displayed data and cannot be changed. The beginning of the diagram is at the position 0%, the end is at 100%.) Additionally, you define the range to be displayed in each of the 10 divisions of the display, which determines the total range to be displayed on the x-axis.

1. Focus the result window.
2. Select "AMPT > Scale Config > Reference Value".
3. Enter a reference value on the x axis in the current unit.
4. Define the range to display per division (total range/10).

The x-axis is adapted so that it displays the defined range, with the reference value at the specified position.

Example:

If you want to analyze the probabilities of occurrence for errors greater than 95 %, enter the reference value 95 %.

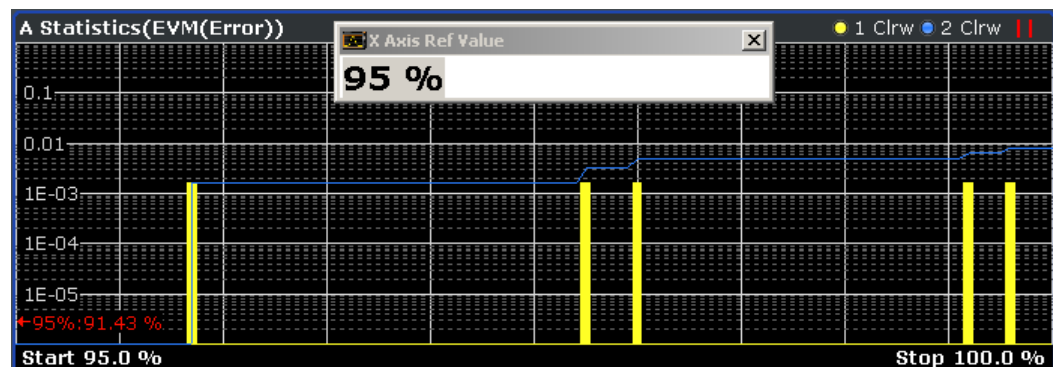


Figure 8-4: Defining the x-axis scaling using a reference point

To define the x-axis scaling automatically

1. Focus the result window.
2. Select "AMPT > XScale Config > Auto Scale".

The x-axis is adapted to display the current results optimally (only once, not dynamically).

To define the y-axis range manually

With this method, you define the upper and lower limits of the displayed probability range. Values on the y-axis are normalized which means that the maximum value is 1.0. If the y-axis has logarithmic scale, the distance between max and min value must be at least one decade.

1. Focus the result window.
2. Select "AMPT > YScale Config > Y-Axis Min Value".
3. Enter the lower limit in the current unit.
4. Select "AMPT > YScale Config > Y-Axis Max Value".
5. Enter the upper limit in the current unit.

The y-axis is adapted to display the specified range. Probabilities of occurrence located outside the display area are applied to the bars at the left or right borders of the display.

8.3.2 How to measure the size of an eye

Display lines are available for eye diagrams, which allow you to determine the size of the eye.

1. Configure a window with "Meas & Ref" as the "Source".
2. Select the "Window Config" softkey for the window and select an eye diagram as the result type.
3. Select [Lines] > "Vertical Line Absolute".
4. Move the line to the left edge of the eye.
5. Select [Lines] > "Vertical Line Rel".
6. Move the line to the right edge of the eye.

The relative position of the line is indicated in the diagram, which corresponds to the width of the eye (see [Figure 8-5](#)).

7. Select [Lines] > "Horizontal Line Absolute".
8. Move the line to the top of the eye.
9. Select [Lines] > "Horizontal Line Rel".
10. Move the line to the bottom of the eye.

The relative position of the line is indicated in the diagram, which corresponds to the height of the eye (see [Figure 8-5](#)).

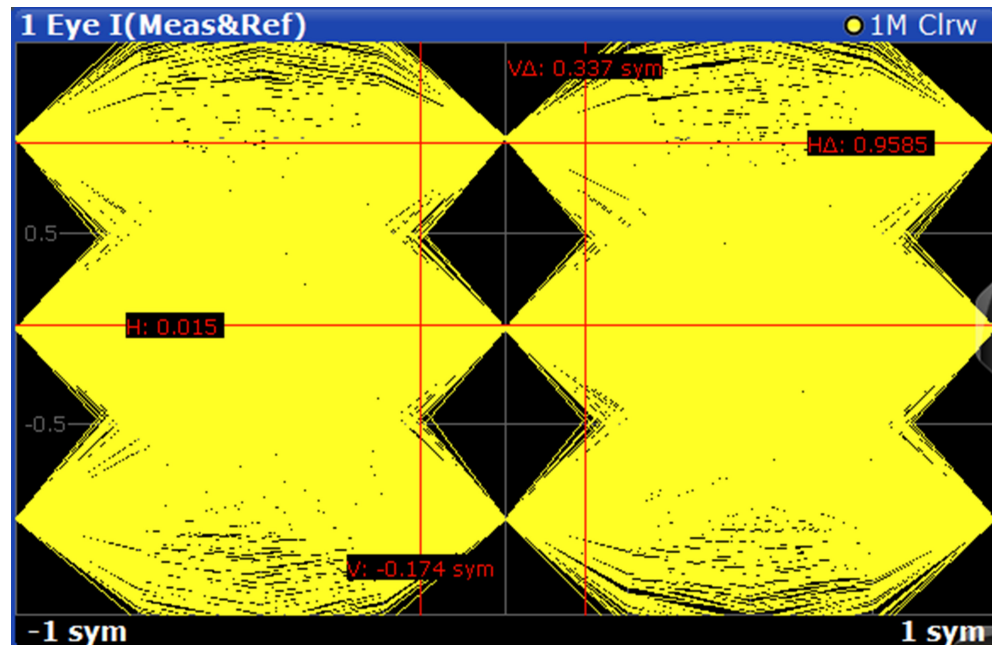


Figure 8-5: Size of an eye, calculated using display lines

8.3.3 How to check limits for modulation accuracy

The results of a "modulation accuracy" measurement can be checked for violation of defined limits automatically. If limit check is activated and the measured values exceed the limits, those values are indicated in red in the "Result Summary" table. If limit check is activated and no values exceed the limits, the checked values are indicated in green.

B Result Summary							
		Current	Mean	Peak	StdDev	95%ile	Unit
EVM	RMS	100.00	100.00	100.00	0.00	100.00	%
	Peak	100.00	100.00	100.00	0.00	100.00	%
Phase Error	RMS	0.00	0.00	0.00	0.00	0.00	deg
	Peak	0.00	0.00	0.00	0.00	0.00	deg
Carrier Frequency Error		-0.00	-0.00	-0.00	0.00	-0.00	Hz
Rho		1.000 000	1.000 000	1.000 000	0.000 000	1.000 000	
IQ Offset		---	---	---	---	---	dB
Gain Imbalance		0.00	0.00	0.00	-193.01	0.00	dB
Quadrature Error		0.00	0.00	0.00	0.00	0.00	deg
Amplitude Droop		0.000 000	0.000 000	0.000 000	-193.010300	0.000 000	dB/sym
Power		-200.00	-200.00	-200.00	-200.00	-200.00	dBm

For details on the limit check functions and settings, see [Chapter 6.4.2, "Modulation accuracy limit lines"](#), on page 246.

To define a limit check

1. Configure a window with "Modulation Accuracy" as the "Source" (see [Chapter 6.5, "Display and window configuration"](#), on page 248).
2. Press the [Lines] key.

3. Press the "ModAcc Limits Config" softkey in the "Limits" menu.
4. In the "Current" tab, define limits that the current value should not exceed for any or all of the result types.
Note: the limits for the current value are automatically also defined for the peak value and vice versa. However, you can enable the limit check individually for current or peak values.
5. Enable the "Check" option for each result type to include in the limit check.
6. If necessary, define limits and enable the limit check for the mean values of the different result types on the "Mean" tab.
7. If necessary, enable the limit check for the peak values of the different result types on the "Peak" tab.
8. To reset the limits to their default values, press "Set to Default".
9. Enable the "Limit Checking On" option, or press the "ModAcc Limits On" softkey in the "Limits" menu.

The limit check is performed immediately on the current "modulation accuracy" measurement results and for all subsequent measurements until it is disabled. The results of the limit check are indicated by red or green values in the "Result Summary".

8.3.4 How to export the trace data to a file

The measured data can be stored to an ASCII file, either as raw data (directly from the capture buffer) or as displayed in the diagrams (evaluated trace data). Optionally, a header can be included with additional information on the used measurement settings.

1. Press the [Trace] key and select the "Trace Export Config" softkey.
2. Define which type of data to export (raw or trace). By default, trace data is exported.
3. Optionally, enable the header information to include.
4. To export the traces in **all windows**, select "Export Trace to ASCII File for all Windows".
To export the traces only for **the currently selected window**, select "Export Trace to ASCII File for Specific Window". To export the data from another window, select it from the "Specifics for" list, then export again.
In either case, **all** traces of the selected windows are exported.
5. Define a file name and storage location and select "OK".

The data is stored in a file and can be analyzed in an external application.

9 Measurement examples

Some sample measurements for the digital GSM and EDGE standards provide a quick introduction to typical vector analyzer measurements. The individual measurements are in logical order and are meant to familiarize you gradually with the measurements required of general vector signal analysis.

The following equipment is required in addition to the R&S FPL1000 with option R&S FPL1-K70:

- 1 test transmitter (GSM-compatible for Measurement 2), preferably R&S SMW200A (1412.0000.02), with the digital standard option GSM/EDGE (order number 1413.3684.02)
- 1 RF cable with 2 male N connectors
- 2 power cables

Transmitter operation is only described as far as required for performing the measurements. For more details on the measurements, refer to the test transmitter documentation.

9.1 Connecting the transmitter and analyzer

To perform measurements with the R&S FPL1-K70, you require a test transmitter to emulate a DUT. For [Measurement example 2: burst GSM EDGE signals](#), the test transmitter needs to be GSM-compatible.

Connect the RF output of the R&S SMW200A with the RF input of the R&S FPL1000.

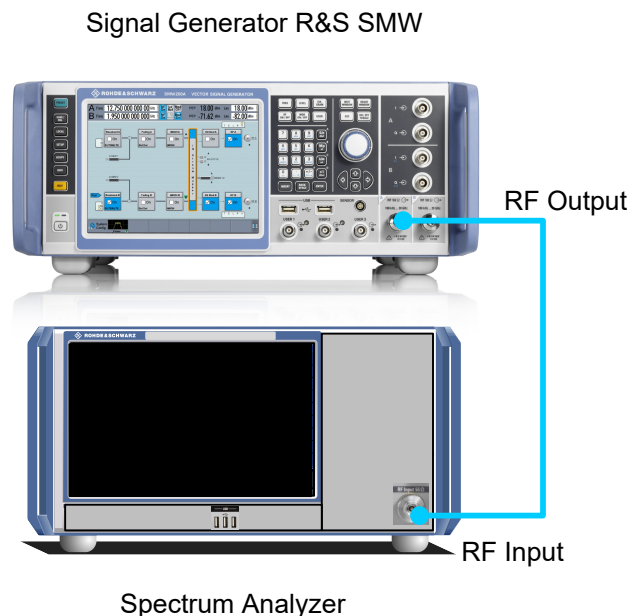


Figure 9-1: Connection to a test transmitter (for example R&S SMW200A)

9.2 Measurement example 1: continuous QPSK signal

In this measurement example, a continuous QPSK (Quadrature Phase Shift Keying) signal is measured and evaluated. QPSK is used in several standards such as DVB-S2, APCO25, WCDMA, CDMA2000. For the description (characterization) of a continuous QPSK signal, the following parameters are the most important:

- Carrier Frequency
- Level
- Symbol Rate
- Transmit Filter

9.2.1 Transmitter settings

This section summarizes the necessary transmitter settings. It contains a list of the parameters and step-by-step instructions for the R&S SMW200A. If you are interested in a more detailed description or background information, refer to the user manual of the R&S SMW200A, which can be downloaded from the Rohde&Schwarz website: <http://www.rohde-schwarz.com/downloads/manuals/smw200A.html>.

Frequency	1 GHz
Level	0 dBm
Modulation	QPSK
Symbol Rate	1 Msym/s
Filter	Root Raised Cosine with Roll-Off 0.35

To define the settings for the R&S SMW200A

1. Press the [PRESET] key to start from a defined state.
2. Press the [FREQ] key and enter *1 GHz*.
3. Press the [LEVEL] key and enter *0 dBm*.
4. Press the [DIAGRAM] key.
5. Select the "Baseband A" block.
6. Select "Custom Digital Mod...".
7. In the "General" tab, define the following settings:

Measurement example 1: continuous QPSK signal

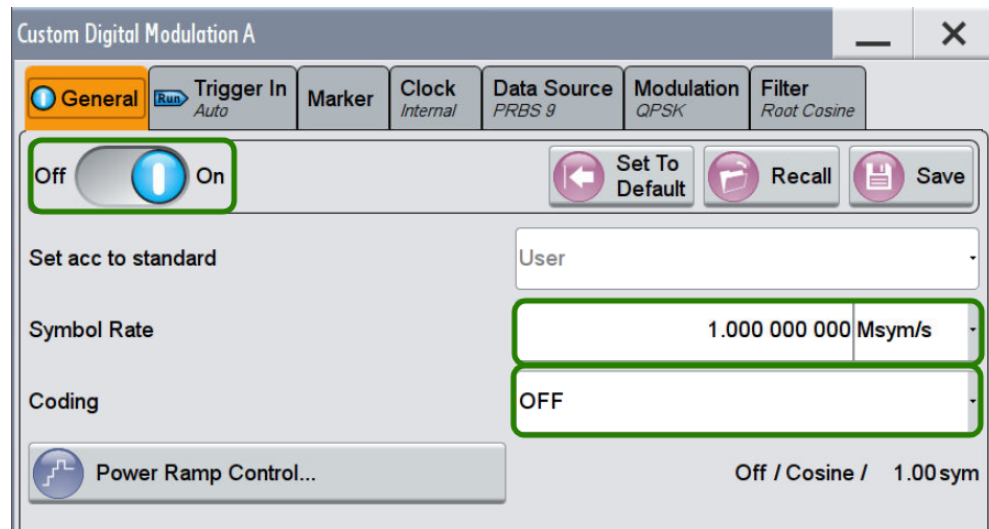


Figure 9-2: R&S SMW200A: Custom Digital Modulation Dialog

- a) Toggle the "State" to "On".
 - b) Enter the "Symbol Rate": 1 MHz.
 - c) Set the "Coding" to "Off".
8. In the "Modulation" tab, select "Modulation Type": "PSK" > "QPSK".
 9. In the "Filter" tab, select the "Filter": "Root Cosine".
 10. Press the [RF ON/OFF] key to switch the RF transmission on.

9.2.2 Analyzer settings

This section helps you get your first valid measurement. It starts with step-by-step instructions and continues with a more detailed description of further functionality.

Frequency	1 GHz
Ref Level	4 dBm
Modulation	QPSK
Symbol Rate	1 MHz
Tx Filter	Root Raised Cosine with Alpha BT 0.35

To define the settings on the R&S FPL1000

1. Press the [PRESET] key to start from a defined state.
2. Press the [FREQ] key and enter 1 GHz.
3. Press the [AMPT] key, and enter 4 dBm as the reference level. This value corresponds approximately to the peak envelope power of the signal.
4. Start the VSA application by pressing the [MODE] key and then selecting "VSA".

Measurement example 1: continuous QPSK signal

5. Select the "Overview" softkey to display the "Overview" for VSA.
6. Select the "Signal Description" button and configure the expected signal characteristics.
 - a) In the "Modulation Settings" section, ensure that the "Type" is "PSK" and that the "Order" is "QPSK". The "Mapping" defines the mapping of the bits to the QPSK symbols. It is relevant if you are interested in a bit stream measurement but does not affect the other measurement results. Hence, you do not need to change it here.
 - b) Enter the "Symbol Rate" 1 MHz.
 - c) In the "Transmit Filter" section, select "RRC" as "Type" and enter the "Alpha/BT" value 0.35.
7. Close all open dialog boxes. By default, four measurement windows showing different measurement results are displayed.

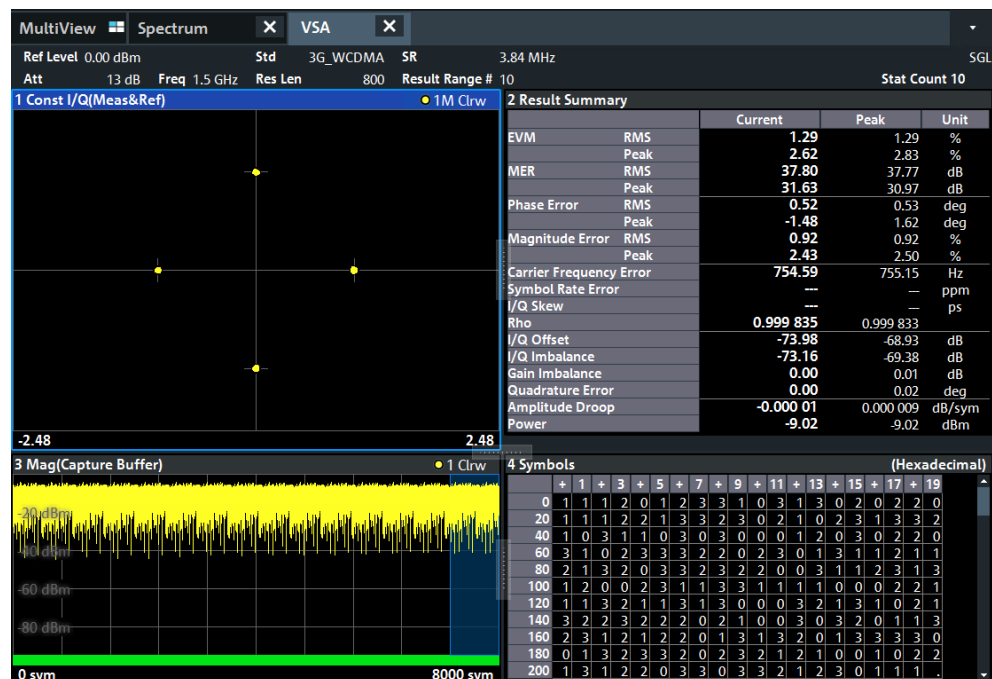


Figure 9-3: Default window layout for Measurement Example 1


9.2.3 Changing the display configuration

1. To change the window layout, i.e. the display configuration, do one of the following:
 - Select the "Display Config" softkey in the main VSA menu.
 - Select the "Display Configuration" block in the "Overview" (only if "Specifics for" option is disabled).



Measurement example 1: continuous QPSK signal

Select the "SmartGrid" icon from the toolbar.

2. Replace window 1 by an eye diagram of the inphase component of the measurement signal.
 - a) Select the "Meas & Ref" data source from the SmartGrid selection bar and drag it over window 1.
 - b) 

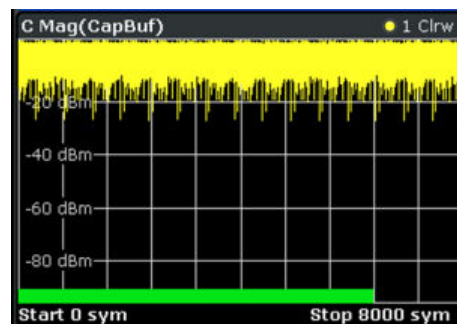
Close the SmartGrid mode by selecting the "Close" icon at the top-right corner of the toolbar.

- c) Select the "Window Config" softkey.
 - d) Select the result type: "Eye Diagram Real (I)".
3. Close the dialog to look at your new display configuration.

9.2.4 Navigating through the capture buffer

In this measurement example, you can navigate through the capture buffer, i.e. control which part of the capture buffer is currently analyzed. (Note: In the Spectrum application, this functionality is referred to as "gating".)

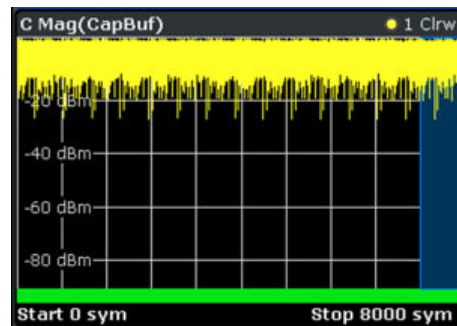
1. In the measurement display, take a closer look at window 3 (magnitude of the capture buffer). The green bar shows how far the current measurement has already proceeded, i.e. how much of the signal has been evaluated.



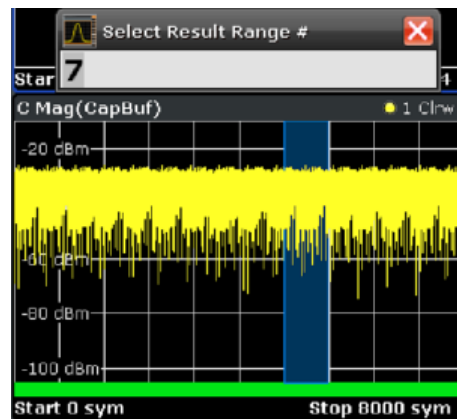
2. Press the [Run Single] key.

Since the signal you are currently analyzing is continuous (as opposed to containing bursts), the entire capture buffer is analyzed, and hence is marked with the green bar. The last evaluated result range (i.e. the currently evaluated result range at the time the measurement stopped) is highlighted in blue.

Measurement example 1: continuous QPSK signal



- To go back to a previously evaluated result range within the same capture buffer, press the [SWEEP] key and then the "Select Result Rng" softkey. By selecting different result ranges (for example using the rotary knob), you can move the highlighted blue area through the capture buffer and choose your currently demodulated result range.



The results for this range are displayed in the "Current" column in the Result Summary, in the eye diagram and in the symbol table.

Note: Generally, all Clear/Write traces and the are affected by this selection.

9.2.5 Averaging several evaluations

By default, all measurement windows are displayed with a single trace, which is the Clear/Write trace. This trace displays the result of the current evaluation, i.e. the highlighted blue area from the example in [Chapter 9.2.4, "Navigating through the capture buffer"](#), on page 279. However, for most real-world measurement tasks, you need to obtain a result that is averaged over a certain number of evaluations, or a worst-case result of a certain number of evaluations. This section explains how to achieve those results.

To evaluate EVM vs. Time

- Configure window 1 such that it displays the EVM versus time measurement (Source: "Error Vector", Result Type: "EVM", see [Chapter 9.2.3, "Changing the display configuration"](#), on page 278). Select the window to set the focus on it.

Measurement example 2: burst GSM EDGE signals

2. To display the trace averaged over several measurements, or the maximum hold trace over several measurements, press the [TRACE] key.
3. Add further traces by pressing the [TRACE] key and then either using the "Trace 2/3..." or the "Trace Config" softkeys.
Set the second trace to "Average" and the third trace to "Max Hold".
Note that the configured traces appear in the window title.

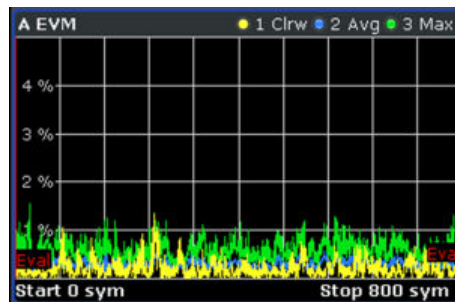


Figure 9-4: Several traces in one window

4. Press [Run Single] again.
The current capture buffer is evaluated for this trace setup. In the channel information bar, you can see the number of completed evaluations ("Stat Count").



5. To change the number of evaluations, press the [SWEEP] key and select "Statistic Count Config".
Select "Manual" and enter the desired number of evaluations, e.g. 12. When you press [Run Single], the R&S FPL1000 VSA application captures I/Q data until 12 evaluations are completed.

9.3 Measurement example 2: burst GSM EDGE signals

In this measurement example a bursted GSM EDGE signal will be measured and evaluated. The goal of this section is to familiarize you with the VSA application features that are relevant specifically for the analysis of bursted signals.

9.3.1 Transmitter settings

This section summarizes the necessary transmitter settings. It contains a list of the parameters and step-by-step instructions for the R&S SMW200A. If you are interested in a more detailed description or background information, refer to the user manual of

Measurement example 2: burst GSM EDGE signals

the R&S SMW200A, which can be downloaded from the Rohde & Schwarz website:
<http://www.rohde-schwarz.com/downloads/manuals/smw200A.html>.

Frequency	1 GHz
Level	0 dBm
Standard	GSM EDGE Burst with normal symbol rate

To define the settings for the R&S SMW200A

1. Press the [PRESET] key to start from a defined state.
2. Press the [FREQ] key and enter *1 GHz*.
3. Press the [LEVEL] key and enter *0 dBm*.
4. To define the standard:
 - a) Select the "Baseband A" block.
 - b) Under "TSMA standards", select "GSM/EDGE...".
5. To configure the burst type in the "GSM/EDGE A" dialog box:
 - a) In the "Framed (Single) Configuration" tab, highlight the first slot in the frame diagram.

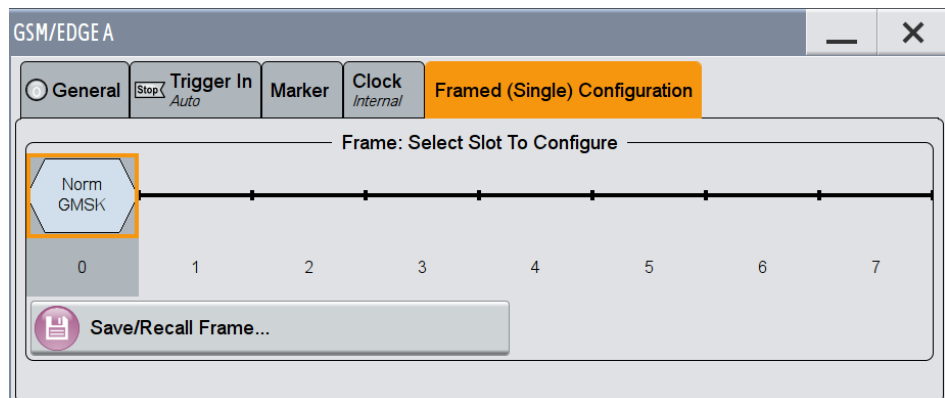
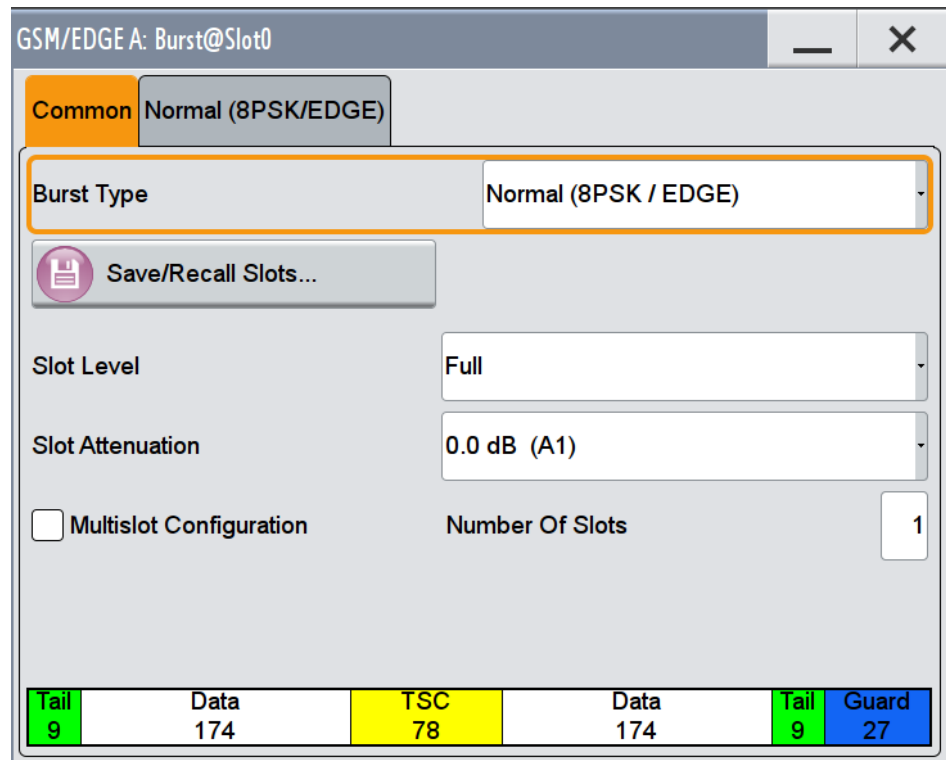


Figure 9-5: R&S SMW200A: GSM/EDGE frame configuration settings

Measurement example 2: burst GSM EDGE signals

- b) In the "GSM/EDGE A: Burst@Slot0" dialog box, select the "Burst Type": "Normal (8PSK / EDGE)".



- c) Close the "GSM/EDGE: Burst@Slot0" dialog box.
6. In the "General" tab, toggle the "State" to "On" to switch the modulation on.
 7. Close the "GSM/EDGE A" dialog box.
 8. Select the "RF A" signal output to switch the RF transmission on.

9.3.2 Analyzer settings

This section helps you get your first valid measurement with a bursted signal. It starts with step-by-step instructions and continues with a more detailed description of further functionality.

Frequency	1 GHz
Ref Level	4 dBm
Standard	GSM 8PSK EDGE

To define the settings on the R&S FPL1000

1. Press the [PRESET] key to start from a defined state.
2. Press the [FREQ] key and enter *1 GHz*.

Measurement example 2: burst GSM EDGE signals

3. Press the [AMPT] key, and enter 4 dBm as the reference level. This corresponds approximately to the peak envelope power of the signal.
4. Start the VSA application by pressing the [MODE] key and then selecting "VSA".
5. Select the "Overview" softkey to display the "Overview" for VSA.
6. Press the [MEAS] key, then select the "Digital Standards" softkey.
7. From the file selection list, select the GSM folder and then the file EDGE_8PSK. Select "Load".

Predefined settings corresponding to the selected standard are loaded. The VSA application should show good measurement results.



Figure 9-6: Default display configuration for GSM 8PSK EDGE



8. In window 3, you see the currently evaluated burst marked with a green bar. To include more bursts in the display, you need to increase the capture length.
 - a) Press the [MEAS CONFIG] key and then the "Overview" softkey.
 - b) Select "Signal Capture".
 - c) Increase the "Capture Length", e.g. to 10000 symbols.

You see that more bursts are now contained in the capture buffer. They are all marked with a green bar, meaning that they are all evaluated.

9.3.3 Navigating through the capture buffer

This example describes how to navigate through the capture buffer for a continuous signal. This navigation feature is especially important for bursted signals. Therefore, we provide a further navigation example for the GSM EDGE signal.

Measurement example 2: burst GSM EDGE signals

1. To see more details in the capture buffer, close window 4.
 - a) Press the "Display Config" softkey, or the "Display Configuration" button in the "Overview".
 - b) Select the  "Delete" icon for window 4.
 - c) 

Close the SmartGrid mode by selecting the "Close" icon at the top-right corner of the toolbar.
2. Increase the capture length to 10 000 symbols to capture multiple bursts within the capture buffer.
 - a) Select [MEAS CONFIG] > "Signal Capture".
 - b) Define "Capture Length" = 10000 symbols.
3. Press the [Run Single] key.
4. In the "EVM vs. Time" display (window 1), add a maximum hold trace by pressing the [TRACE] key and then selecting the "Trace Config" softkey (see [Chapter 9.2.5, "Averaging several evaluations"](#), on page 280).
5. Use the "Select Result Rng" function in the "Sweep" menu to navigate through your capture buffer. Thus, you can determine which peak was caused by which burst.

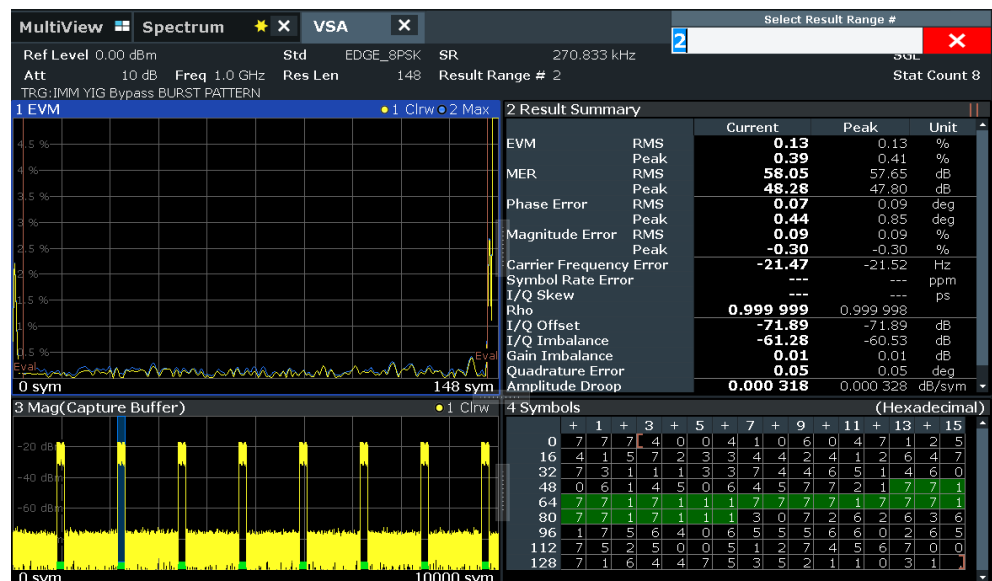


Figure 9-7: Navigation through the capture buffer

9.3.4 Evaluating the rising and falling edges

The "Result Length" is the number of symbols that are to be demodulated and analyzed together. In most common applications, only the parts of the capture buffer containing the bursts need to be analyzed. Hence, for bursted signals the "Result Length" usually coincides with the burst length. However, there are certain scenarios where the

Measurement example 2: burst GSM EDGE signals

rising and falling edge of a burst are also of interest, e.g. checking the power ramping of the device under test. For this measurement task, it is useful to choose a "Result Length" that exceeds the burst length.

- To include the rising and falling edges of the bursts in the EVM vs Time display (window 1), you need to increase the "Result Length". In the "Overview", select "Cut Result Range" and increase the "Result Length" to 200 symbols.
- To evaluate the rising and falling edges further, display the absolute magnitude values of the measured signal in window 4 (Source: "Meas&Ref Signal", Result type: "Magnitude Absolute", see [Chapter 9.2.3, "Changing the display configuration"](#), on page 278).
- Press [Run Single].

The rising and falling edges of the burst in the selected result range are displayed in window 4. You could now add an average trace to evaluate the rising and falling edges further.



Figure 9-8: Result range that exceeds the burst length

9.3.5 Setting the evaluation range

In some scenarios, such as in [Evaluating the rising and falling edges](#), the result range contains symbols that are not supposed to be considered for the EVM or other calculated parameters that are displayed in the "Result Summary". Thus, you would not include them in the evaluation range.

Measurement example 2: burst GSM EDGE signals

To change the evaluated data

1. Start from the configuration described in [Chapter 9.3.4, "Evaluating the rising and falling edges"](#), on page 285.
2. Display the I/Q constellation diagram of the signal in window 1 (Source: "Meas&Ref Signal", Result type: "Constellation I/Q", see [Chapter 9.2.3, "Changing the display configuration"](#), on page 278).

A clear 8PSK constellation is displayed.

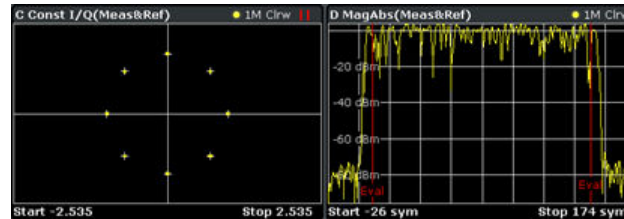


Figure 9-9: Evaluation lines properly adjusted

3. To understand the effect of an incorrectly set evaluation range, change the evaluation range to include the entire result range.
 - a) In the "Overview", select "Evaluation Range".
 - b) Enable the "Entire Result Range" option.

The displayed constellation diagram is no longer clear, it contains additional points. This is because the constellation diagram now displays symbol instants that are beyond the burst.

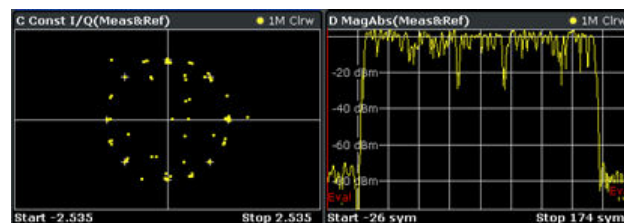
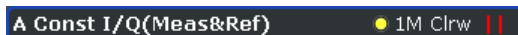


Figure 9-10: Evaluation lines not properly adjusted



All measurement windows that consider the evaluation range are marked with two small red lines in the title bar.



9.3.6 Comparing the measurement signal to the reference signal

You have seen that it is possible to add different traces such as maximum hold or average to each window. When evaluating the measurement signal, it is also possible to display the ideal reference signal as an additional trace. This can be a significant help when troubleshooting, since it allows for an immediate comparison.

Measurement example 2: burst GSM EDGE signals



1. Start from the configuration described in [Chapter 9.3.4, "Evaluating the rising and falling edges"](#), on page 285.
2. Select window 4 to set the focus on it.
3. Press the [TRACE] key and then the "Trace 2" softkey.
4. Select "Clear Write" as the "Trace Mode" and "Evaluation: Ref" to a second trace to your result display. This trace is the ideal reference signal that you can compare to the measurement signal (see [Figure 9-11](#)).
5. To view the traces in more detail, enlarge the window using the "Split/Maximize" key () . Then zoom into the display using the  icon in the toolbar (see the dotted rectangle in [Figure 9-11](#)).



Figure 9-11: Zooming

Now you can compare the measured and the ideal reference signal.

10 Troubleshooting the measurement

If the results do not meet your expectations, the following tips help you troubleshoot the measurement.



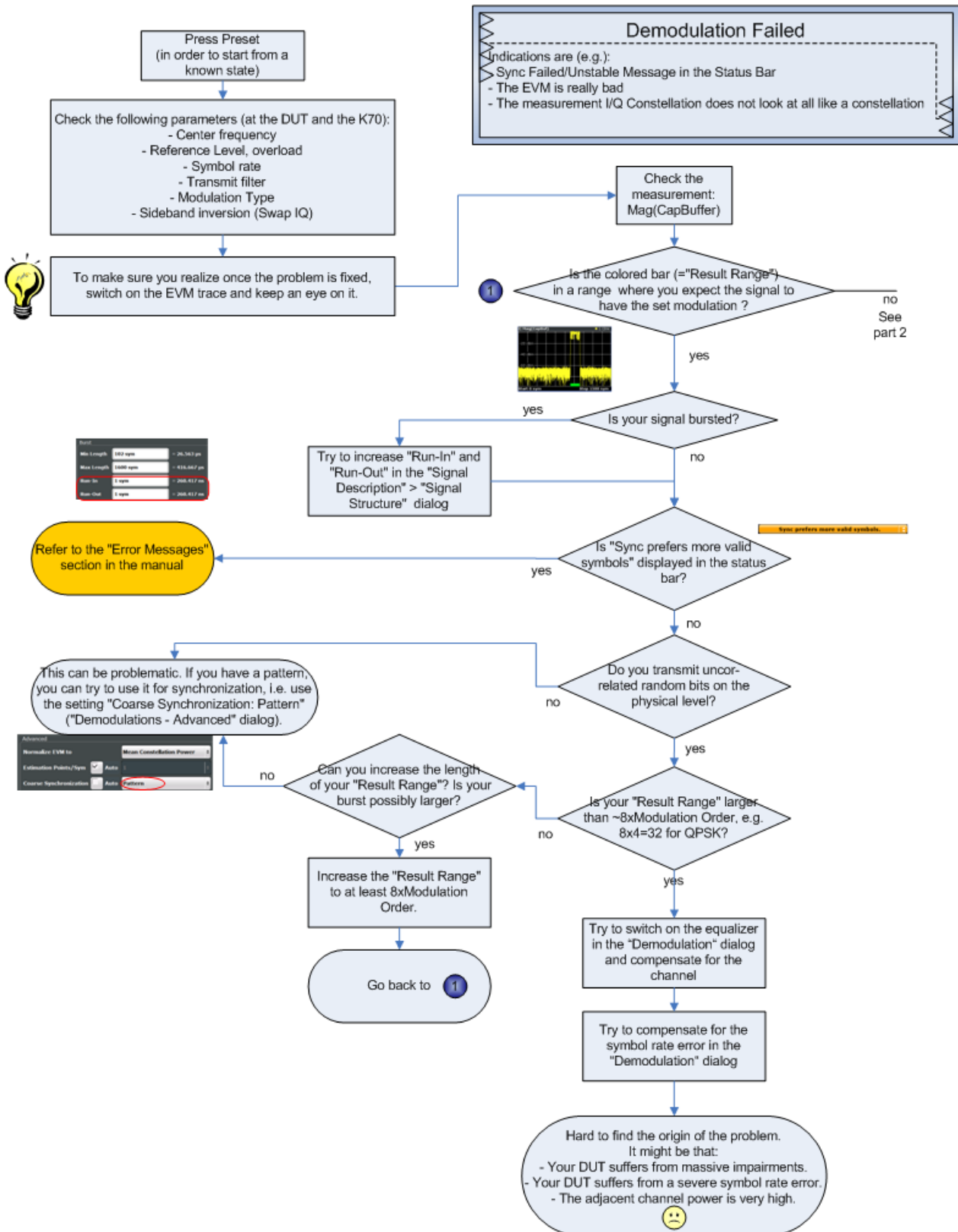
To query all errors that have occurred during a measurement in remote operation, use the `SYSTem:ERRor:EXTended? ALL` command.

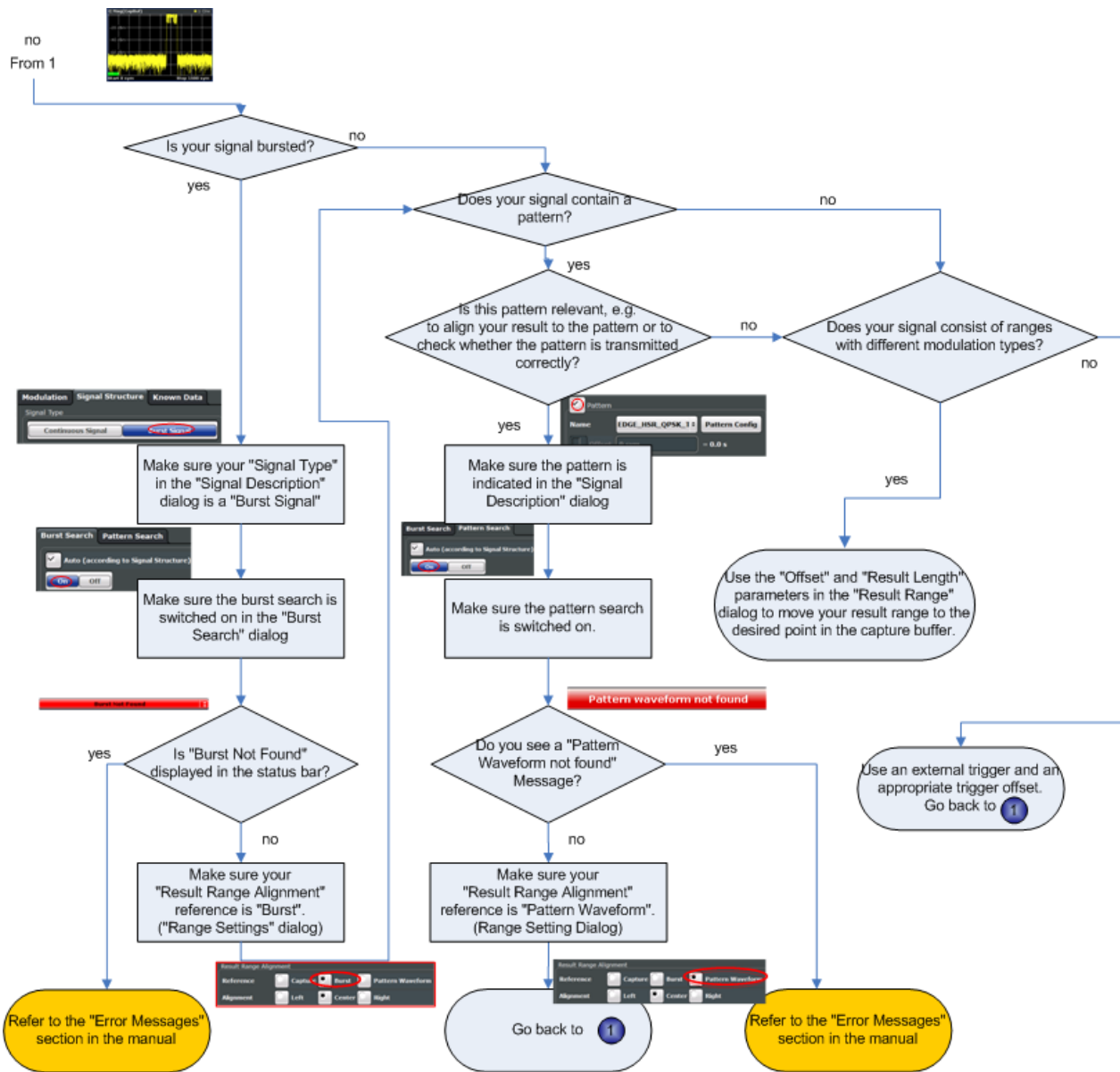
- [Flow chart for troubleshooting](#).....289
- [Explanation of status bar messages](#)..... 291
- [Frequently asked questions](#)..... 300

10.1 Flow chart for troubleshooting

If you experience a concrete measurement problem, try solving it with the help of the flow chart.

Troubleshooting Overview





10.2 Explanation of status bar messages

The following section describes error messages and warnings displayed in the status bar by the application firmware, and possible causes.

Message: Burst Not Found.....	292
Message: Pattern Waveform Not Found.....	294
Message: Pattern Symbols Incorrect.....	295
Message: Result Alignment Failed.....	295
Message: Sync failed. Check for all zero signal.....	296
Message: All zero signal. Transmit uncorrelated random data bits.....	296
Message: Pattern Search On, But No Pattern Selected.....	296

Message: Pattern Not (Entirely) Within Result Range.....	296
Message: Short Pattern: Pattern Search Might Fail.....	297
Message: Sync Prefers More Valid Symbols.....	297
Message: Sync Prefers Longer Pattern.....	299
Message: Result Ranges Overlap.....	299
Message: Symbol rate exceeds usable I/Q bandwidth.....	299
Message: Data Sequences have Incorrect # Symbols.....	299
Message: [...] The Polynomial is Patched to the Default.....	299

Message: Burst Not Found

The "Burst Not Found" error message can have several causes:

- **Burst search is active, but the signal is not bursted**

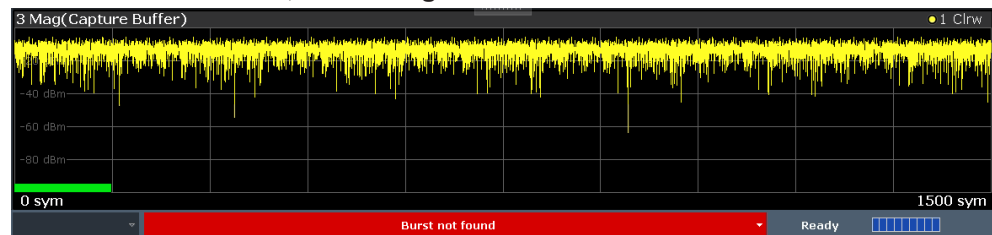


Figure 10-1: Example for active burst search with continuous signal

Solution: Select "Continuous Signal" as the signal type.

For more information, see

- "Signal Type" on page 170.

- **Signal is bursted, but bursts have not been captured completely**

The burst search can only find bursts that start and end within the capture buffer. It ignores bursts that are cut off.



Figure 10-2: Example for incomplete burst capture

Solution: Change the trigger settings and/or enlarge the capture length.

For more information, see

- Chapter 5.5, "Signal capture", on page 200

- **The settings do not match the signal**

To allow you to select certain bursts, the burst search only searches for bursts that have a length between "Min Length" and "Max Length" (plus a tolerance that you can set in the "Burst Search" Dialog). In case the burst is, e.g. shorter than the "Burst Min Length", the burst search fails.

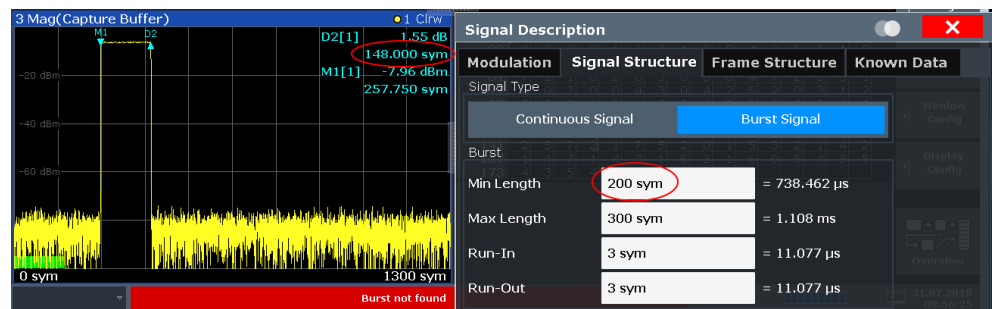


Figure 10-3: Example for a failed burst search due to a burst that is too short

Solution: try one of the following:

- Switch on the "Magnitude (Capture Buffer)" result display. Move a marker to the start of the burst. Move a delta marker to the end of the burst and compare the burst length to the settings in the "Signal Description" dialog.
- Increase the search tolerance in the "Burst Search" dialog. Keep an eye on the green/red field. If the burst search succeeds, you can see the length of the found bursts.
- Set the minimum burst length to 50 and the maximum burst length to 5000.

For more information, see:

- ["Burst Settings"](#) on page 170
- ["Burst Configuration"](#) on page 208
- **The signal is highly distorted and/or has modulation noise**
One possibility to enhance the robustness of the burst search is to increase the minimum gap length. If the bursts within your capture buffer are not closely spaced, it makes sense to increase the value of this parameter.

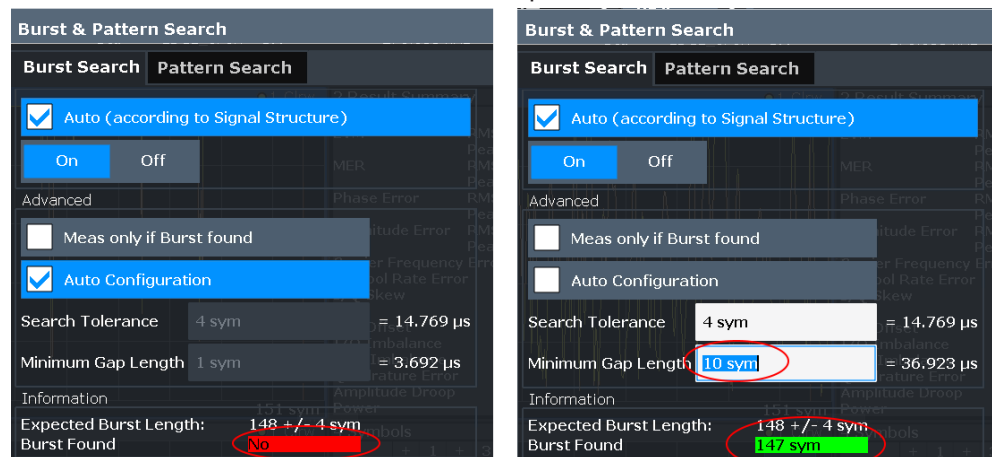


Figure 10-4: Example for adjusting the minimum gap length

For more information, see ["Min Gap Length"](#) on page 208

- **The pattern search is switched on, fails and the alignment is with reference to the pattern.**

If the pattern search is enabled and the pattern (not the burst) is used as the reference for alignment, but no pattern is detected, the result range starts at the beginning of the capture buffer. Hence, if the burst does not start right at the beginning of the capture buffer, you see a "Burst Not Found" Message.

Solution:

- Refer to ["Message: Pattern Waveform Not Found"](#) on page 294
- Switch the pattern search off.
- Choose "Burst" as the reference for the result range alignment.

Message: Pattern Waveform Not Found

The "Pattern waveform not found" error message can have several causes:

- **The pattern is too short/ the SNR is too low**
Solution: decrease the I/Q correlation threshold in the "Pattern Search" dialog box (see ["I/Q Correlation Threshold"](#) on page 210)
- **The burst search has failed**
If burst and pattern search are active, the application looks for patterns only within the found bursts. Hence, in case the burst search fails, the pattern search also fails.

Solution: Try one of the following:

- Make sure that the burst search is successful.
- Deactivate the burst search but keep the pattern search active.

For more information, see

- ["Message: Burst Not Found"](#) on page 292
[Chapter 5.6.1, "Burst search"](#), on page 207
- **The offset of the pattern within the burst is incorrectly set**
You can set a pattern offset to speed up the pattern search. The offset of the pattern is the offset of the pattern start from the start of the useful part of the burst. However, if the entered offset is not correct (within about 4 symbols of tolerance), the pattern is not found.

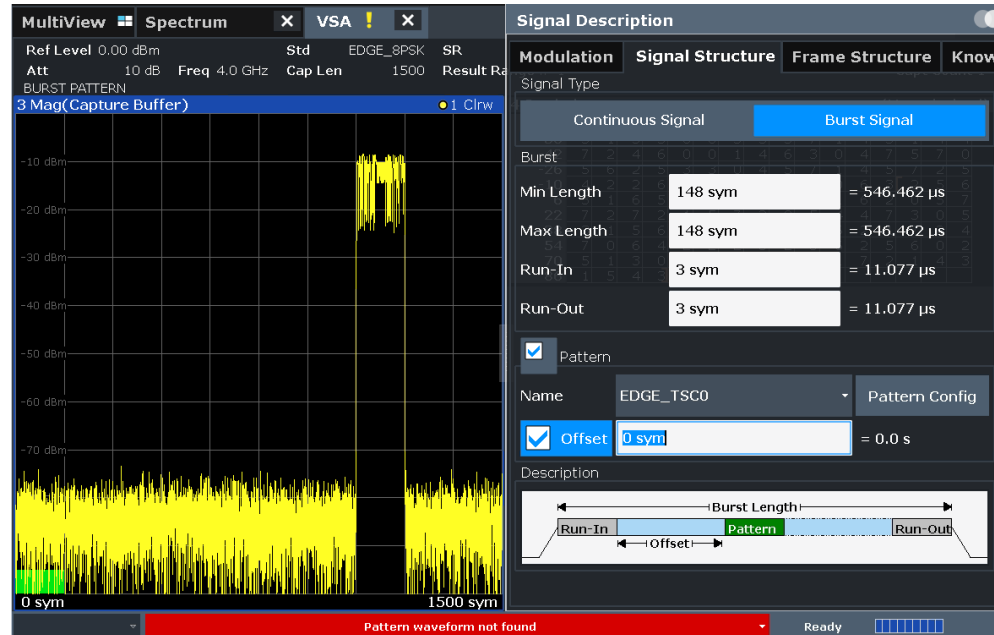


Figure 10-5: GSM EDGE burst; Pattern is actually located in the middle of the burst. The correct value for "Offset" here would be 58.

Solution: Try one of the following:

- Remove the offset ('unknown').

- Enter the correct offset (within about 4 symbols of tolerance).

For more information, see

- "Offset" on page 171

- The specified pattern does not coincide with the pattern in your signal:
In the R&S FSQ-K70 it is possible to search for multiple patterns at the same time. For example, in a GSM measurement, the capture buffer can be checked for all TSCs simultaneously. This is not possible in the R&S FPL1-K70.

Solution:

Make sure that the correct pattern is specified in the "Signal Description" dialog.

For more information, see

- Chapter 5.3, "Signal description", on page 165

Message: Pattern Symbols Incorrect

This message can only appear if the pattern waveform has already been found. It indicates that the measured signal contains a pattern that is similar (but not identical) to the pattern specified in the signal description dialog. Technically speaking, the correlation of the signal with the pattern waveform gives a value above the specified I/Q correlation threshold specified in the pattern search dialog. However, not all symbols match the pattern specified in the signal description dialog.

Solution:

Make sure that the correct pattern is specified in the "Signal Description" dialog.

Message: Result Alignment Failed

The result range alignment is not possible for the particular capture buffer. The result range needs I/Q data that has not been captured.

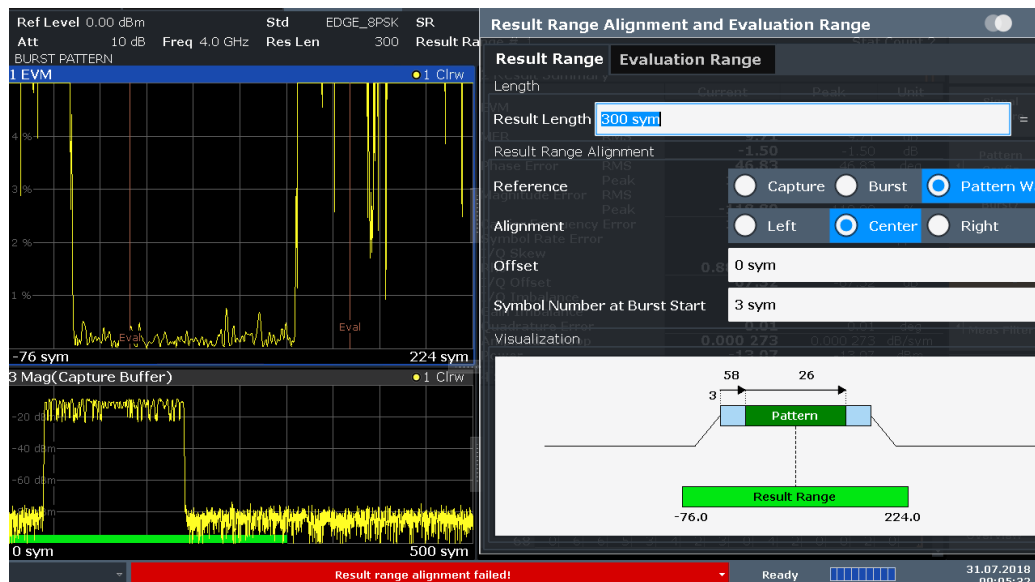


Figure 10-6: Example for failed alignment

In this screenshot, the alignment of the long result range to the burst center is not possible. There are not enough samples in the capture buffer before the burst starts. In this scenario, change the trigger settings so that the burst is in the middle of the capture buffer.

Solution: Change the trigger settings and/or increase the capture length.

For more information, see:

- [Chapter 5.5, "Signal capture"](#), on page 200

Message: Sync failed. Check for all zero signal.

A prerequisite for correct synchronization is a random data sequence of an adequate size.

Solution: Make sure that the input signal contains an adequate number of uncorrelated (random!) bits. (Not 0 0 0 0 0, 1 1 1 1 1, or 01 01 01 01 01, for example.)

For QAM modulation, the result length (the data on which synchronization is based) should correspond to at least 8 times the modulation order (see ["Result Length"](#) on page 217).

Message: All zero signal. Transmit uncorrelated random data bits.

See ["Message: Sync failed. Check for all zero signal."](#) on page 296.

Message: Pattern Search On, But No Pattern Selected

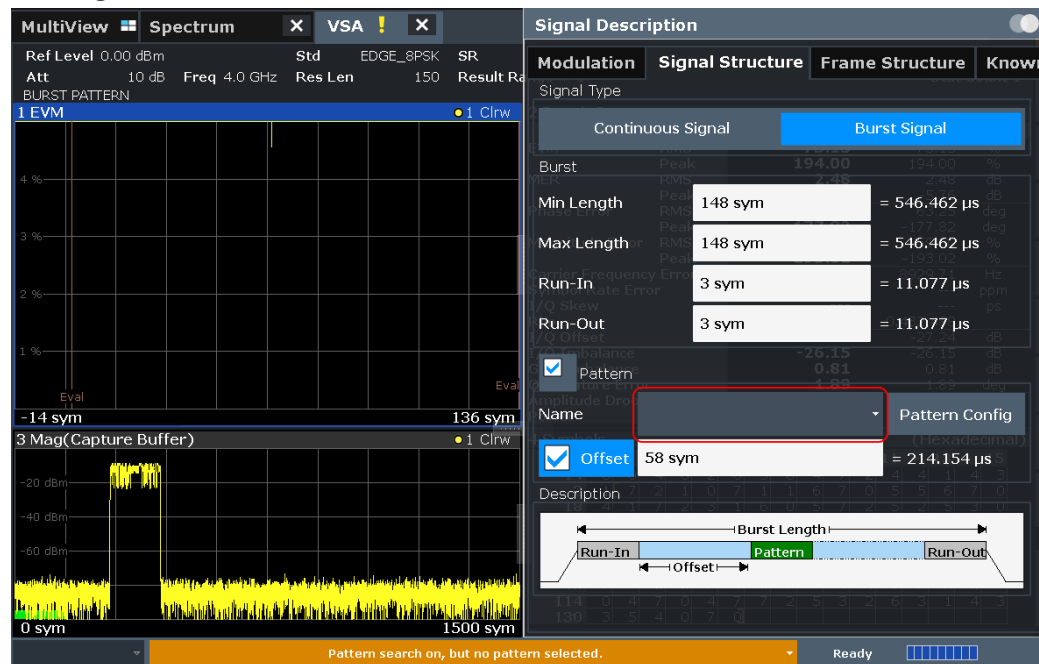


Figure 10-7: The red circle shows the place where you can specify a pattern

Solution: Select an existing pattern (or create a new pattern) that you expect to be within the signal.

For more information, see

- ["Pattern Settings"](#) on page 170
- [Chapter 8.2.3, "How to perform pattern searches"](#), on page 259

Message: Pattern Not (Entirely) Within Result Range

A pattern can only be found if it is entirely within the result range. Therefore, this error message always occurs with a "Pattern Waveform Not Found" error.

Solution: Choose the pattern as reference of your result range alignment. Then, the pattern is always part of your result range and the pattern search can succeed.

For more information, see

- [Chapter 5.7, "Result range configuration"](#), on page 216
- [Chapter 8.2.1, "How to define the result range"](#), on page 257

Message: Short Pattern: Pattern Search Might Fail

The R&S FPL1000 performs the pattern search in two stages.

- Stage 1 involves the generation of an I/Q pattern waveform by modulating the pattern symbol sequence. The I/Q pattern is then correlated with the measured signal. At positions where the correlation metric exceeds the "I/Q Correlation Threshold" the I/Q pattern is found.
- Stage 2 demodulates the measured signal at the I/Q pattern location and the transmitted symbols are checked for correctness against the pattern symbol sequence.

For a very short pattern, i.e. a pattern length in the order of the inter-symbol interference (ISI) duration, various issues can arise:

- False positive
The I/Q pattern is found at positions where the transmitted symbols differ from the pattern symbols.
Solution: Try one of the following:
 - Activate "Meas only if Pattern Symbols Correct".
 - Increase the "I/Q Correlation Threshold" (see [Chapter 5.6.2, "Pattern search"](#), on page 209).
- False negative
The I/Q pattern search misses a position where transmitted symbols match the pattern symbols.
Solution:
 - Decrease the "I/Q Correlation Threshold" (see [Chapter 5.6.2, "Pattern search"](#), on page 209).

For bursted signals, the pattern search finds only the first occurrence of the I/Q pattern within each burst. If a false positive occurs in this situation, using "Meas only if pattern symbols correct" does not provide a satisfactory solution.

In this case do the following:

- Increase the "I/Q Correlation Threshold".
- Specify the expected position of the pattern within the burst by adjusting the "Offset" parameter.

Message: Sync Prefers More Valid Symbols

Note: Note that this message does not necessarily indicate a problem. Its purpose is to inform you that you can possibly get a more stable demodulation and/or better measurement results by improving your setup.

The R&S FPL1000 VSA application performs synchronization in two stages: coarse synchronization that precedes the reference signal generation, and fine synchronization based on the reference signal.

- The coarse synchronization stage is either data-aided (i.e. based on a known pattern) or non-data-aided (i.e. based on the unknown data symbols). The default is a non-data-aided coarse synchronization. If a pattern is part of the signal, you can switch to data-aided synchronization.
- The fine synchronization stage is always data-aided.

"Sync Prefers More Valid Symbols" indicates that one of the synchronization stages has too few symbols to ensure that the synchronization is robust.

The message is provided in the following cases:

- Coarse Synchronization = Non-Data-Aided (User Pattern for Sync = Off):
Estimation range shorter than 40 symbols
(see [Chapter 4.5.1.2, "Estimation"](#), on page 127)
- Fine Synchronization:
Estimation range shorter than 10 symbols
(see [Chapter 4.5.1.2, "Estimation"](#), on page 127)

Solution:

- If the signal contains a pattern, set "Coarse Synchronization: Pattern".
(see ["Coarse Synchronization"](#) on page 224).

Example: measurement of a GSM EDGE pattern that has a length of 26 symbols.

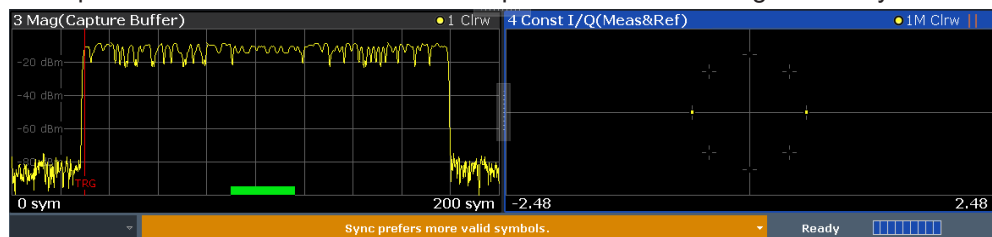


Figure 10-8: User Pattern for Sync = Off

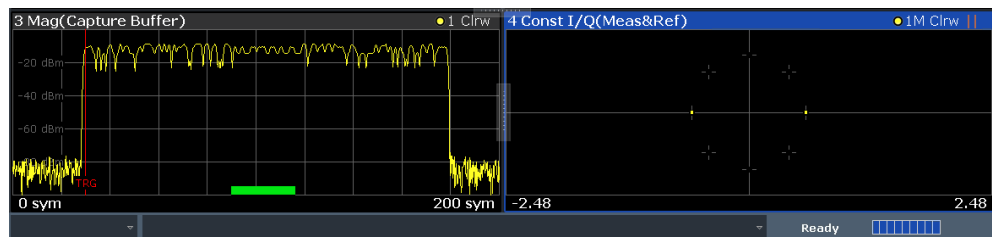


Figure 10-9: User Pattern for Sync = On

- Choose a longer "Result Range".
- If the signal is bursted and the bursts are short:
 - Make sure your "Result Range" comprises the entire burst.
 - Make sure that "Run-In/Out" is not chosen too large, since the "Run-In/Out" ranges are excluded from the synchronization.
- If the signal is bursted and contains a pattern:
Only switch off the burst search if absolutely necessary. If you need to switch it off, align your "Result Range" to the pattern, make sure it does not exceed the burst ramps and choose "Continuous Signal" as the "Signal Type" in the "Signal Description" dialog.

For more information, see

- [Chapter 4.4, "Overview of the demodulation process"](#), on page 112

Message: Sync Prefers Longer Pattern

This message can only occur if the coarse synchronization is data-aided, i.e. is based on a known pattern. In case the pattern is very short, pattern-based coarse synchronization can be unstable. If demodulation is stable, e.g. you get a reasonable EVM, there is no need to change anything. Otherwise, you have two options:

- Switch to the non-pattern-based mode by setting the parameter "Coarse Synchronization: Data" (see ["Coarse Synchronization"](#) on page 224)
- If possible, use a longer pattern.

For more information, see

- [Chapter 4.4, "Overview of the demodulation process"](#), on page 112

Message: Result Ranges Overlap

This message does not indicate an error. It is merely displayed to inform you that the defined result ranges in the capture buffer overlap. Thus, some captured data is evaluated more than once. For example, the same peak value can be listed several times if it is included in several result ranges, and averaging is performed on (partially) duplicate values. However, a negative influence on the measurement results is not to be expected.

Message: Symbol rate exceeds usable I/Q bandwidth

The occupied bandwidth of a signal mostly depends on its symbol rate (see also [Chapter 4.2, "Sample rate, symbol rate and I/Q bandwidth"](#), on page 76). If the available usable I/Q bandwidth is too small, part of the signal is not captured. Thus, the demodulation is distorted.

Solution:

- Decrease the symbol rate (see ["Symbol Rate"](#) on page 168)
- Decrease the sample rate (see ["Sample Rate"](#) on page 201)
- Install additional bandwidth extension options

Message: Data Sequences have Incorrect # Symbols

The length of the data sequences taken from a known data file does not correspond with the specified result range length (see ["Result Length"](#) on page 217). Specify the correct number of symbols as the result length.

Tip: the result length of the data sequences in the known data file is indicated in the "Signal Description" dialog box, in the "Known Data" tab (see [Chapter 5.3.4, "Known data"](#), on page 180).

Message: [...] The Polynomial is Patched to the Default.

You can define the polynomial used for PRBS data manually. To comply with the ITU-T standard, the defined coefficients must comply with specific rules. If the manually entered polynomial does not define a known PRBS model, the default for the selected PRBS type is used. The broken rule is indicated in the message.

10.3 Frequently asked questions

- [Issues with graphical results](#)..... 300
- [Issues with numeric results](#)..... 305
- [Synchronization and demodulation problems](#)..... 309

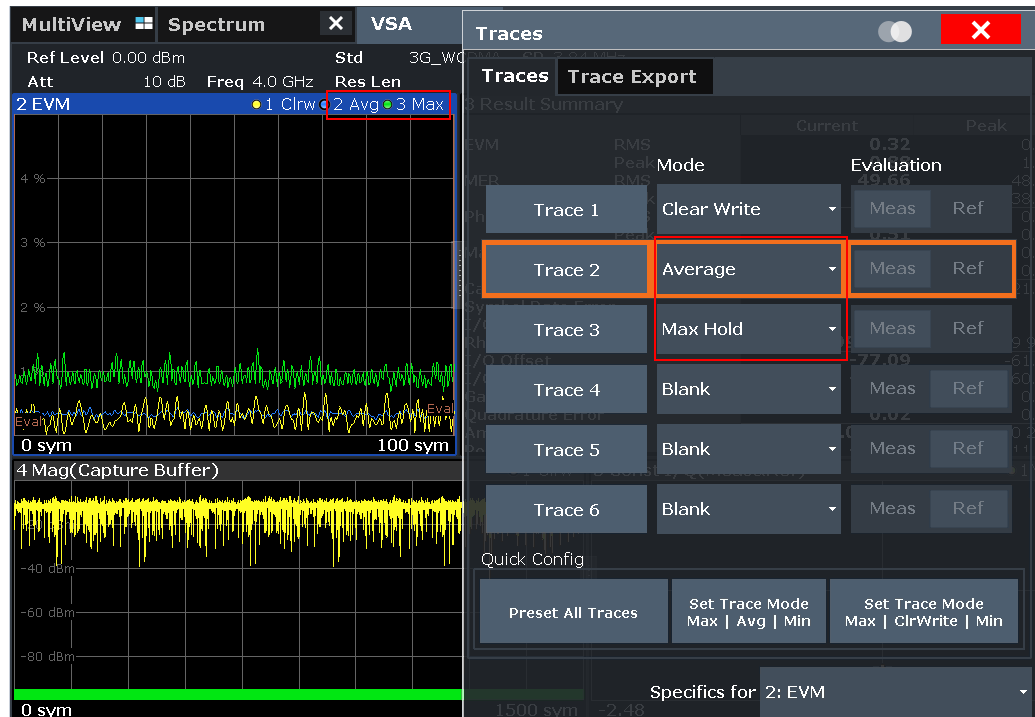
10.3.1 Issues with graphical results

- [Problem: The measurement window does not show average results](#)..... 300
- [Question: Why do not the symbols in the Symbol Table match the symbols sent by my IRIG-106 conform device?](#)..... 301
- [Question: The y-axis unit for the spectrum of the measurement signal can be chosen to be "dB". What level is it relative to?](#)..... 301
- [Problem: The PSK/QAM signal shows spikes in the Frequency Error result display](#)..302
- [Problem: The Constellation I/Q measurement result display has a different number of constellation points in the R&S FSQ-K70 and the R&S FPL1-K70](#)..... 302
- [Problem: The Constellation I/Q result display and the Vector I/Q result display look different](#)..... 303
- [Problem: The spectrum is not displayed in the logarithmic domain](#)..... 304
- [Problem: The trace of the measurement signal is visible in the measurement window; the trace of the reference signal is not](#)..... 304
- [Problem: The trace is not entirely visible within the measurement window](#)..... 305

Problem: The measurement window does not show average results

Solution:

- 1. Select the measurement window.
- 2. Press the [TRACE] key.
- 3. Press the "Trace Config" softkey.
- 4. Select a second trace and choose the preferred "Trace Mode", e.g. "Max Hold" or "Average".



Question: Why do not the symbols in the Symbol Table match the symbols sent by my IRIG-106 conform device?

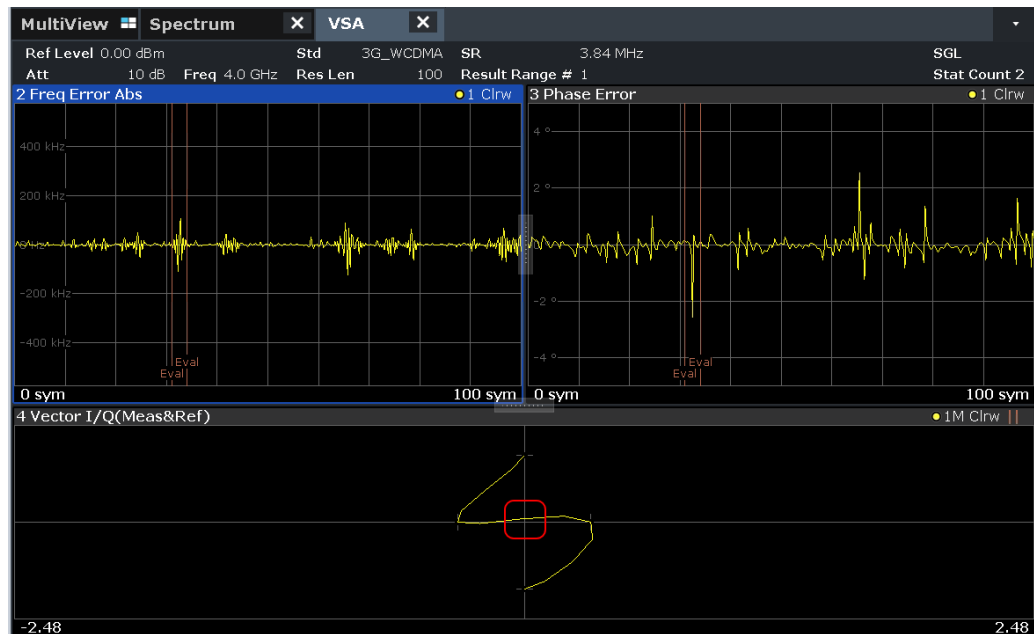
The predefined standard file for shaped offset QPSK (SOQPSK) was implemented according to the IRIG-106 standard, however without the differential precoding. Thus, the bit values of the symbols are not decoded according to the standard in the "Symbol Table". All other result displays show appropriate results.

Question: The y-axis unit for the spectrum of the measurement signal can be chosen to be "dB". What level is it relative to?

Answer:

"Spectrum (Reallmag, Meas&Ref)" calculates the FFT of the "Reallmag(Meas&Ref)" result. "Reallmag(Meas&Ref)" has the unit "none". In this case, "none" means that the measured signal has been scaled such that it matches the ideal corresponding reference signal as well as possible. The reference signal in turn is scaled such that $\max(\text{abs}(\text{at symbol instants})) = 1.0$.

Problem: The PSK/QAM signal shows spikes in the Frequency Error result display



Solution:

These spikes are usually uncritical and are caused by zero-transitions in the I/Q Plane.

Problem: The Constellation I/Q measurement result display has a different number of constellation points in the R&S FSQ-K70 and the R&S FPL1-K70

Reason:

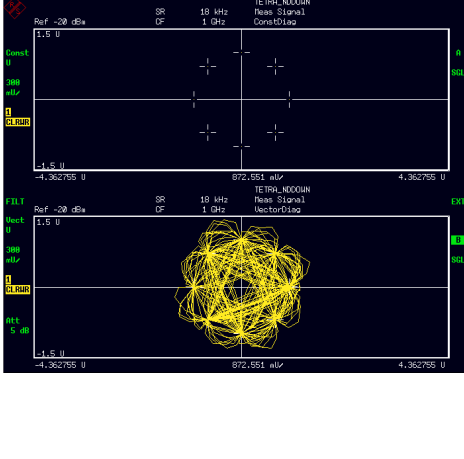
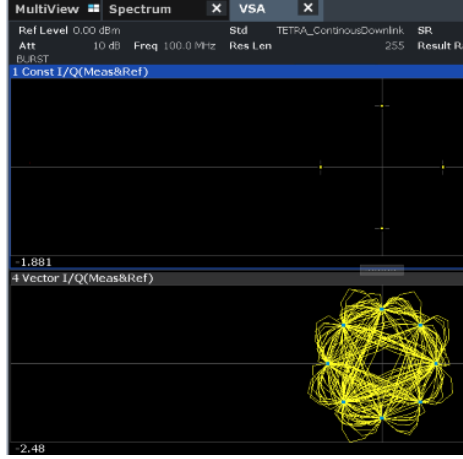
In the FSQ-K70, the "Constellation I/Q" measurement displays the symbol instants of the "Vector I/Q" measurement. Hence, this is a rotated constellation, e.g. for a $\pi/4$ -DQPSK, 8 points are displayed.

In the R&S FPL1-K70, the "Constellation I/Q" diagram shows the de-rotated constellation (i.e. for a $\pi/4$ -DQPSK, 4 instead of 8 points are displayed). The inter-symbol interference has been removed.

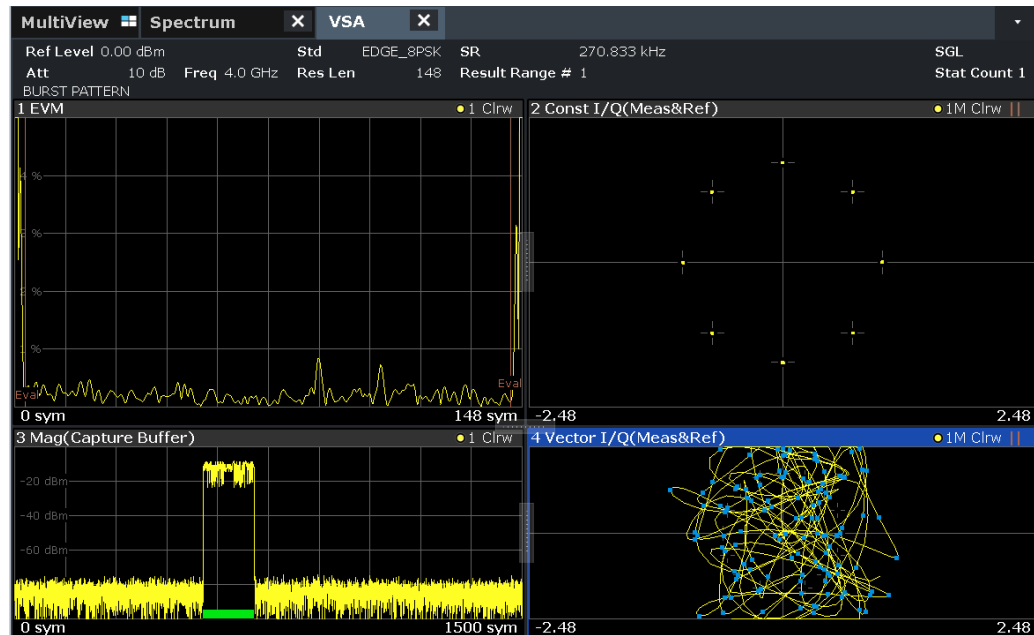
Note: The "I/Q Constellation (Rotated)" result display displays the rotated constellation, as the R&S FSQ-K70 does.

For details on the "Constellation I/Q" diagram in the R&S FPL1-K70, see [Chapter 3.2.5, "Constellation I/Q"](#), on page 31.

Table 10-1: Constellation I/Q and Vector I/Q for $\pi/4$ -DQPSK modulation

	
R&S FSQ-K70	R&S FPL1-K70

Problem: The Constellation I/Q result display and the Vector I/Q result display look different



Reason:

- The "Vector I/Q" diagram shows the measurement signal after the measurement filter and synchronization.
- The "Constellation I/Q" diagram shows the de-rotated constellation (i.e. for a $\pi/4$ -DQPSK, 4 instead of 8 points are displayed). The inter-symbol interference has been removed.

In case the measurement filter does not remove the inter-symbol interference, the windows show measurements that are significantly different.

Problem: The spectrum is not displayed in the logarithmic domain

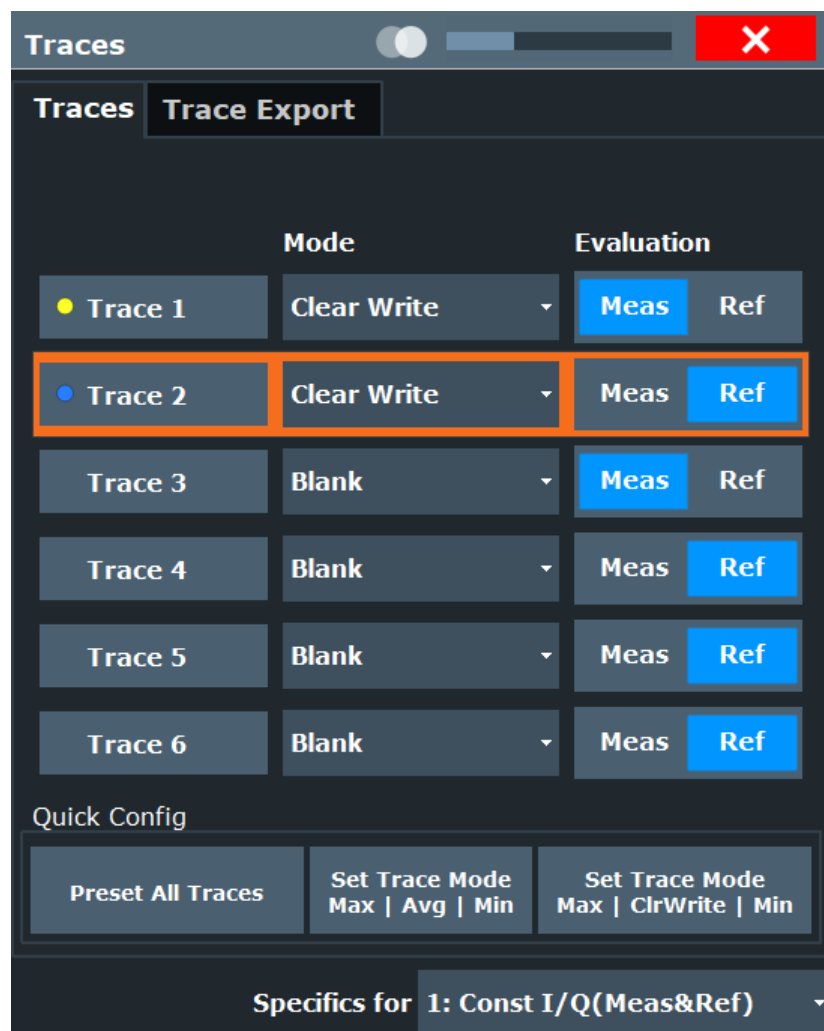
Solution:

- 1. Select the measurement window.
- 2. Press the [AMPT] key.
- 3. Press the "Unit" softkey.
- 4. Press the "Y-Axis Unit" softkey.
- 5. Select dB.

Problem: The trace of the measurement signal is visible in the measurement window; the trace of the reference signal is not

Solution:

- 1. Select the measurement window.
- 2. Press the [TRACE] key.
- 3. Press the "Trace Config" softkey.
- 4. Select a second trace, choose "Clear Write" as "Trace Mode" and toggle to "Ref" in the "Evaluation" column.



Problem: The trace is not entirely visible within the measurement window

Solution:

- 1. Select the measurement window.
- 2. Press the [AUTO] key.
- 3. Press the "Y-Axis Auto Scale" softkey.

10.3.2 Issues with numeric results

Problem: The I/Q skew estimate is not displayed as expected, even though I activated the compensation in the Demodulation settings.....	305
Question: How do I calculate the differential EVM (DEV M) for Bluetooth?.....	305
Question: Why does not my BER measurement provide results?.....	306
Question: How long do I need to measure to get a reliable BER?.....	306
Question: Why do the EVM results for my FSK-modulated signal look wrong?.....	306
Question: How can I get the demodulated symbols of all my GSM bursts in the capture buffer in remote control?.....	306
Question: Why is not the FSK Deviation Error in R&S FPL1-K70 identical to the FSK DEV ERROR in R&S FSQ-K70?.....	307
Problem: The EVM trace looks okay, but the EVM in the Result Summary is significantly different.....	307
Question: Why cannot I select the capture oversampling value as the number of display points per symbol for my EVM trace?.....	309

Problem: The I/Q skew estimate is not displayed as expected, even though I activated the compensation in the Demodulation settings**Possible reasons:**

- Phase ambiguities that are not a multiple of $\pi/2$ cannot be resolved. Thus, to measure I/Q skew for an 8PSK modulation, for example, it is essential to provide an absolute phase reference. You can provide this reference using a pattern.
- If you are providing the I/Q skew by a signal generator, make sure that the constellation in your generator matches the constellation in the R&S FPL1000 VSA application, including the absolute phase.
- I/Q skew cannot be determined for signals whose constellation points all have the same I or Q values, for example using BPSK modulation. In this case, no value is available for the I/Q skew result in the "Result Summary".

Question: How do I calculate the differential EVM (DEV M) for Bluetooth?

The following sample MATLAB® script shows you how to calculate the DEV M according to the instructions in "Bluetooth Spec. v2.0 Appendix C".

Note: "h_FSW" refers to the corresponding VISA object.

```
fprintf(h_FSW, 'DDEM: PRES ' 'Bluetooth_2-DH1' '*OPC?');
query(h_FSW, 'INIT: IMM; *OPC?');

% Query the Meas and the Ref Trace
I_Meas = str2num(query(h_FSW, 'TRAC4: DATA? TRACE1R'));
Q_Meas = str2num(query(h_FSW, 'TRAC4: DATA? TRACE1I'));
I_Ref = str2num(query(h_FSW, 'TRAC4: DATA? TRACE2R'));
Q_Ref = str2num(query(h_FSW, 'TRAC4: DATA? TRACE2I'));
```

```

% Calculate differential EVM according to Bluetooth Spec. v2.0 Appendix C
Zk = I_Meas + 1j*Q_Meas;
Sk = I_Ref + 1j*Q_Ref;

% Q: received signal is compensated for the ideal phase changes between
% symbols by multiplying it with the complex conjugate of the reference
% symbol sequence
Qk = Zk .* conj(Sk);

%DEVM
RMS_DEVM = sqrt(sum(abs(diff(Qk)).^2) / sum(abs(Qk).^2));

DEVM_k = sqrt(abs(diff(Qk)).^2) / (sum(abs(Qk).^2)/length(Qk));
Peak_DEVM = max(DEVM_k);

% 99%-percentile of DEVM
DEVM_99 = prctile(DEVM_k,99);

```

Question: Why does not my BER measurement provide results?

As a prerequisite for the BER measurement, the R&S FPL1000 VSA application must know which bit sequences can occur. You can provide this data in a known data file (see [Chapter 8.2.4, "How to work with known data files"](#), on page 264). If the measurement fails despite a loaded known data file, check the following issues:

- If you used an external reference during recording and there is no pattern within the signal, possibly the recording missed some phase ambiguities.
- If you used a trigger during recording and more than one measurement was performed within the capture buffer, possibly the required sequence was not recorded. The recording tool only records the first result range within the capture buffer.

Question: How long do I need to measure to get a reliable BER?

Answer:

As a rule of thumb, 100 bit errors should occur. For example, for an expected BER of 10^{-7} , 10^9 bits should be processed.

Question: Why do the EVM results for my FSK-modulated signal look wrong?

Answer:

For an FSK-modulated signal, the signal processing differs to an PSK/QAM/MSK-modulated signal. The estimation model does not minimize the EVM but the error of the instantaneous frequency (see [Chapter 4.5.2.1, "Error model"](#), on page 139). Therefore, the measurement value that corresponds to the EVM value for FSK is the "Frequency Error (Absolute/Relative)". (Source type: "Modulation Error"; Result type: "Frequency Error (Absolute/Relative)")

Question: How can I get the demodulated symbols of all my GSM bursts in the capture buffer in remote control?

Answer:

Use the following remote commands:

```
:SENSe1:DDEMod:PRESet 'GSM_NB'
```

Load the GSM standard.

```
:SENSe1:DDEMod:RLENgth 10000 SYM
```

Enlarge the capture buffer length such that all the bursts you want to demodulate can be seen within the capture buffer.

```
:INITiate1:CONTinuous OFF
```

Go to single sweep mode.

```
:SENSe1:SWEep:COUNT 0
```

Set the "Statistic Count" to "Auto" mode.

```
:INITiate1:IMMediate
```

Do single sweep.

```
:SENSe1:SWEep:COUNT:CURRent?
```

Query the number of demodulated bursts within the capture buffer.

```
For n = 1:NumberOfBursts
    :SENSe1:DDEMod:SEARch:MBURst:CALC n
    :TRACe4? TRACe1 'Query the result symbols in window D
End
```

Step through all bursts and query the demodulated symbols.

Question: Why is not the FSK Deviation Error in R&S FPL1-K70 identical to the FSK DEV ERROR in R&S FSQ-K70?

Solution:

The FSK deviation error in the R&S FPL1-K70 is calculated as the difference between the measured frequency deviation and the reference frequency deviation as entered by the user (see ["FSK Ref Deviation \(FSK only\)"](#) on page 167). What is referred to as the "FSK DEV ERROR" in the R&S FSQ-K70, is calculated differently (see the R&S FSQ-K70 Software Manual) and is comparable to the "Freq Err RMS" in the R&S FPL1-K70. However, while the "FSK DEV ERROR" in the R&S FSQ-K70 is given in Hz, the "Freq Err RMS" in the R&S FPL1-K70 is given in percent, i.e. relative to the "FSK Meas Deviation".

Problem: The EVM trace looks okay, but the EVM in the Result Summary is significantly different

Solution:

- Make sure that the position of the "Evaluation Lines" is reasonable. The "Result Summary" only evaluates sample instants that are within the evaluation lines. Hence, in the case the "Result Range" covers the burst ramps, it is important to adjust the "Evaluation Range" appropriately.

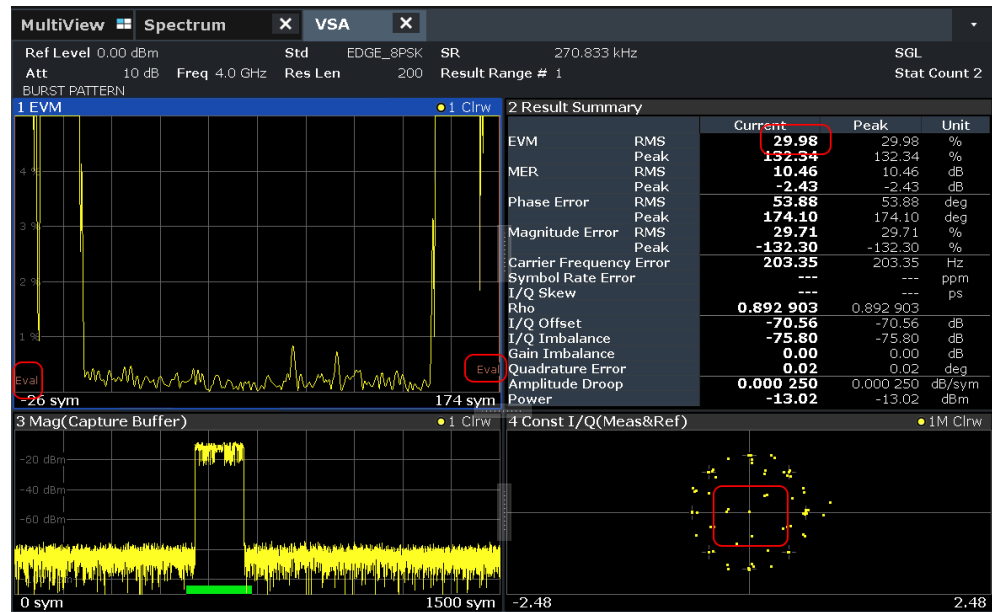


Figure 10-10: Problem: EVM in Result Summary does not correspond with trace display

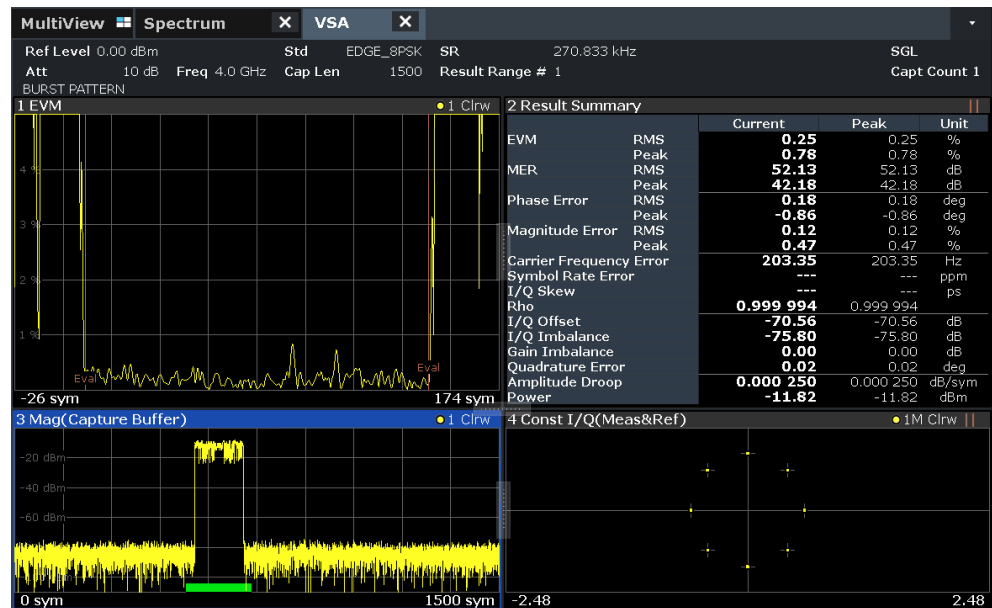
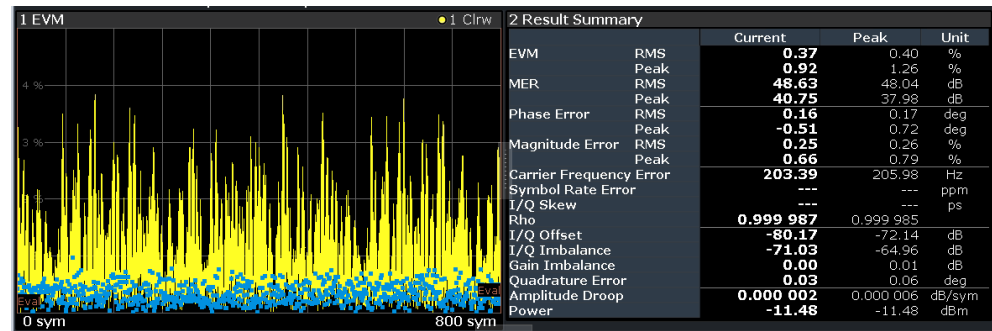


Figure 10-11: Solution: Result Summary with correct evaluation range setting

- Make sure that the same samples are evaluated. By default, the EVM trace displays all sample instants, e.g. if the sample rate is 4 * symbol rate, the EVM trace shows 4 samples per symbol. The "Result Summary" does not automatically evaluate all sample instants. For example, for a PSK modulation, by default only symbol instants contribute to the EVM result.



Question: Why cannot I select the capture oversampling value as the number of display points per symbol for my EVM trace?

For very large numbers of capture points (≥ 64), a lower number of display points per symbol must be used to avoid prolonged display times and extremely large amounts of trace data.

10.3.3 Synchronization and demodulation problems

[Question: Why does the pattern search fail for my IRIG-106 conform signal?.....](#) 309

[Problem: The MSK/FSK signal demodulates on the R&S FSQ-K70, but not on the R&S FPL1-K70 or: Why do I have to choose different transmit filters in the R&S FSQ-K70 and the R&S FPL1-K70?.....](#) 309

[Question: How can I demodulate an FSK modulated signal using the "Manchester" code?.....](#) 310

[Problem: Synchronization seems to fail for all zero/all one/ 0 1 0 1 0 1... bit sequence.....](#) 310

[Problem: Synchronization fails despite correct settings.....](#) 310

Question: Why does the pattern search fail for my IRIG-106 conform signal?

The predefined standard file for shaped offset QPSK (SOQPSK) was implemented according to the IRIG-106 standard, however without the differential precoding. Thus, the bit values of the symbols are not decoded according to the standard, and in particular, a specified pattern is possibly not detected.

Problem: The MSK/FSK signal demodulates on the R&S FSQ-K70, but not on the R&S FPL1-K70 or: Why do I have to choose different transmit filters in the R&S FSQ-K70 and the R&S FPL1-K70?

When generating an MSK/FSK reference signal, the R&S FSQ-K70 automatically replaces the Dirac pulses generated by the frequency mapper with square pulses with the length of one symbol. In the R&S FPL1-K70, however, this "replacement" is part of the transmit filter routine. Thus, the R&S FSQ and the R&S FPL1 require different transmit filters for measuring the same FSK/MSK signal.

Example:

- If your transmit filter for the R&S FSQ-K70 was "NONE", you need to choose "Rectangular" as the transmit filter type in the R&S FPL1.
- If your transmit filter for the R&S FSQ-K70 was "GAUSS", you need to choose "GMSK" as the transmit filter type in the R&S FPL1.

Question: How can I demodulate an FSK modulated signal using the "Manchester" code?

The R&S FPL1000 VSA application does not provide a specific configuration setting to support this code. However, if you configure FSK modulation and use twice the usual symbol rate, the signal is demodulated correctly. Remember to consider the double symbol rate when evaluating the results, however! Only the [Symbol table](#) and the bit-stream results returned by the `TRACe<n>[:DATA]` command are not interpreted correctly and must be demodulated manually (for example using a script).

Problem: Synchronization seems to fail for all zero/all one/ 0 1 0 1 0 1... bit sequence

See ["Problem: Synchronization fails despite correct settings"](#) on page 310.

Problem: Synchronization fails despite correct settings

A prerequisite for correct synchronization is a random data sequence of an adequate size.

Solution:

Make sure that the input signal contains an adequate number of uncorrelated (random!) bits. (Not 0 0 0 0 0, 1 1 1 1 1, or 01 01 01 01 01, for example.)

For QAM modulation, the result length (the data on which synchronization is based) should correspond to at least 8 times the modulation order (see ["Result Length"](#) on page 217).

For more solutions, see [Chapter 10.1, "Flow chart for troubleshooting"](#), on page 289.

11 Remote commands for VSA

The following commands are required to perform measurements in VSA in a remote environment.

It is assumed that the R&S FPL1000 has already been set up for remote control in a network as described in the R&S FPL1000 User Manual.



Note that basic tasks that are also performed in the base unit in the same way are not described here. For a description of such tasks, see the R&S FPL1000 User Manual.

In particular, this includes:

- Managing Settings and Results, i.e. storing and loading settings and result data
- Basic instrument configuration, e.g. checking the system configuration, customizing the screen layout, or configuring networks and remote operation
- Using the common status registers

The following tasks specific to VSA are described here:

• Introduction	311
• Common suffixes	316
• Activating vector signal analysis	316
• Digital standards	320
• Configuring VSA	322
• Performing a measurement	403
• Analysis	407
• Configuring the result display	433
• Retrieving results	448
• Importing and exporting I/Q data and results	479
• Status reporting system	480
• Deprecated commands	491
• Programming examples	492

11.1 Introduction

Commands are program messages that a controller (e.g. a PC) sends to the instrument or software. They operate its functions ('setting commands' or 'events') and request information ('query commands'). Some commands can only be used in one way, others work in two ways (setting and query). If not indicated otherwise, the commands can be used for settings and queries.

The syntax of a SCPI command consists of a header and, usually, one or more parameters. To use a command as a query, you have to append a question mark after the last header element, even if the command contains a parameter.

A header contains one or more keywords, separated by a colon. Header and parameters are separated by a "white space" (ASCII code 0 to 9, 11 to 32 decimal, e.g. blank).

If there is more than one parameter for a command, they are separated by a comma from one another.

Only the most important characteristics that you need to know when working with SCPI commands are described here. For a more complete description, refer to the user manual of the R&S FPL1000.



Remote command examples

Note that some remote command examples mentioned in this general introduction are possibly not supported by this particular application.

11.1.1 Conventions used in descriptions

The following conventions are used in the remote command descriptions:

- **Command usage**
If not specified otherwise, commands can be used both for setting and for querying parameters.
If a command can be used for setting or querying only, or if it initiates an event, the usage is stated explicitly.
- **Parameter usage**
If not specified otherwise, a parameter can be used to set a value and it is the result of a query.
Parameters required only for setting are indicated as **Setting parameters**.
Parameters required only to refine a query are indicated as **Query parameters**.
Parameters that are only returned as the result of a query are indicated as **Return values**.
- **Conformity**
Commands that are taken from the SCPI standard are indicated as **SCPI confirmed**. All commands used by the R&S FPL1000 follow the SCPI syntax rules.
- **Asynchronous commands**
A command which does not automatically finish executing before the next command starts executing (overlapping command) is indicated as an **Asynchronous command**.
- **Reset values (*RST)**
Default parameter values that are used directly after resetting the instrument (*RST command) are indicated as ***RST values**, if available.
- **Default unit**
The default unit is used for numeric values if no other unit is provided with the parameter.
- **Manual operation**
If the result of a remote command can also be achieved in manual operation, a link to the description is inserted.

11.1.2 Long and short form

The keywords have a long and a short form. You can use either the long or the short form, but no other abbreviations of the keywords.

The short form is emphasized in uppercase letters. Note however, that this emphasis only serves the purpose to distinguish the short from the long form in the manual. For the instrument, the case does not matter.

Example:

`SENSe:FREQuency:CENTer` is the same as `SENS:FREQ:CENT`.

11.1.3 Numeric suffixes

Some keywords have a numeric suffix if the command can be applied to multiple instances of an object. In that case, the suffix selects a particular instance (e.g. a measurement window).

Numeric suffixes are indicated by angular brackets (<n>) next to the keyword.

If you do not quote a suffix for keywords that support one, a 1 is assumed.

Example:

`DISPlay[:WINDow<1...4>]:ZOOM:STATe` enables the zoom in a particular measurement window, selected by the suffix at `WINDow`.

`DISPlay:WINDow4:ZOOM:STATe ON` refers to window 4.

11.1.4 Optional keywords

Some keywords are optional and are only part of the syntax because of SCPI compliance. You can include them in the header or not.



If an optional keyword has a numeric suffix and you need to use the suffix, you have to include the optional keyword. Otherwise, the suffix of the missing keyword is assumed to be the value 1.

Optional keywords are emphasized with square brackets.

Example:

Without a numeric suffix in the optional keyword:

`[SENSe:]FREQuency:CENTer` is the same as `FREQuency:CENTer`

With a numeric suffix in the optional keyword:

`DISPlay[:WINDow<1...4>]:ZOOM:STATe`

`DISPlay:ZOOM:STATe ON` enables the zoom in window 1 (no suffix).

`DISPlay:WINDow4:ZOOM:STATe ON` enables the zoom in window 4.

11.1.5 Alternative keywords

A vertical stroke indicates alternatives for a specific keyword. You can use both keywords to the same effect.

Example:

```
[SENSe:]BANDwidth|BWIDth[:RESolution]
```

In the short form without optional keywords, `BAND 1MHZ` would have the same effect as `BWID 1MHZ`.

11.1.6 SCPI parameters

Many commands feature one or more parameters.

If a command supports more than one parameter, they are separated by a comma.

Example:

```
LAYout:ADD:WINDow Spectrum,LEFT,MTABLE
```

Parameters can have different forms of values.

- [Numeric values](#)..... 314
- [Boolean](#)..... 315
- [Character data](#)..... 315
- [Character strings](#)..... 316
- [Block data](#)..... 316

11.1.6.1 Numeric values

Numeric values can be entered in any form, i.e. with sign, decimal point or exponent. For physical quantities, you can also add the unit. If the unit is missing, the command uses the basic unit.

Example:

With unit: `SENSe:FREQuency:CENTer 1GHZ`

Without unit: `SENSe:FREQuency:CENTer 1E9` would also set a frequency of 1 GHz.

Values exceeding the resolution of the instrument are rounded up or down.

If the number you have entered is not supported (e.g. for discrete steps), the command returns an error.

Instead of a number, you can also set numeric values with a text parameter in special cases.

- MIN/MAX
Defines the minimum or maximum numeric value that is supported.
- DEF
Defines the default value.

- **UP/DOWN**
Increases or decreases the numeric value by one step. The step size depends on the setting. Sometimes, you can customize the step size with a corresponding command.

Querying numeric values

When you query numeric values, the system returns a number. For physical quantities, it applies the basic unit (e.g. Hz for frequencies). The number of digits after the decimal point depends on the type of numeric value.

Example:

Setting: `SENSe:FREQuency:CENTer 1GHZ`

Query: `SENSe:FREQuency:CENTer?` would return `1E9`

Sometimes, numeric values are returned as text.

- **INF/NINF**
Infinity or negative infinity. Represents the numeric values `9.9E37` or `-9.9E37`.
- **NAN**
Not a number. Represents the numeric value `9.91E37`. NAN is returned if errors occur.

11.1.6.2 Boolean

Boolean parameters represent two states. The "on" state (logically true) is represented by "ON" or the numeric value 1. The "off" state (logically untrue) is represented by "OFF" or the numeric value 0.

Querying Boolean parameters

When you query Boolean parameters, the system returns either the value 1 ("ON") or the value 0 ("OFF").

Example:

Setting: `DISPlay:WINDow:ZOOM:STATe ON`

Query: `DISPlay:WINDow:ZOOM:STATe?` would return `1`

11.1.6.3 Character data

Character data follows the syntactic rules of keywords. You can enter text using a short or a long form. For more information, see [Chapter 11.1.2, "Long and short form"](#), on page 313.

Querying text parameters

When you query text parameters, the system returns its short form.

Example:

Setting: `SENSE:BANDwidth:RESolution:TYPE NORMal`

Query: `SENSE:BANDwidth:RESolution:TYPE?` would return `NORM`

11.1.6.4 Character strings

Strings are alphanumeric characters. They have to be in straight quotation marks. You can use a single quotation mark (') or a double quotation mark (").

Example:

`INSTRument:DELeTe 'Spectrum'`

11.1.6.5 Block data

Block data is a format which is suitable for the transmission of large amounts of data.

The ASCII character # introduces the data block. The next number indicates how many of the following digits describe the length of the data block. The data bytes follow. During the transmission of these data bytes, all end or other control signs are ignored until all bytes are transmitted. #0 specifies a data block of indefinite length. The use of the indefinite format requires an `NL^END` message to terminate the data block. This format is useful when the length of the transmission is not known or if speed or other considerations prevent segmentation of the data into blocks of definite length.

11.2 Common suffixes

In the R&S FPL1000 VSA application, the following common suffixes are used in remote commands:

Table 11-1: Common suffixes used in remote commands in the R&S FPL1000 VSA application

Suffix	Value range	Description
<m>	1 to 4	Marker
<n>	1 to 16	Window (in the currently selected channel setup)
<t>	1 to 6	Trace
	1 to 8	Limit line

11.3 Activating vector signal analysis

Vector signal analysis requires a special application on the R&S FPL1000. A measurement is started immediately with the default settings.

INSTrument:CREate:DUPLicate	317
INSTrument:CREate[:NEW]	317
INSTrument:CREate:REPLace	317
INSTrument:DELeTe	318
INSTrument:LIST?	318
INSTrument:REName	319
INSTrument[:SELect]	319
SYSTem:PRESet:CHANnel[:EXEC]	320

INSTrument:CREate:DUPLicate

This command duplicates the currently selected channel setup, i.e creates a new channel setup of the same type and with the identical measurement settings. The name of the new channel setup is the same as the copied channel setup, extended by a consecutive number (e.g. "IQAnalyzer" -> "IQAnalyzer 2").

The channel setup to be duplicated must be selected first using the `INST:SEL` command.

Example:

```
INST:SEL 'IQAnalyzer'
```

```
INST:CRE:DUPL
```

Duplicates the channel setup named 'IQAnalyzer' and creates a new channel setup named 'IQAnalyzer2'.

Usage: Event

INSTrument:CREate[:NEW] <ChannelType>, <ChannelName>

This command adds a measurement channel. You can configure up to 10 measurement channels at the same time (depending on available memory).

Parameters:

<ChannelType> Channel type of the new channel.
For a list of available channel types, see [INSTrument:LIST?](#) on page 318.

<ChannelName> String containing the name of the channel.
Note that you cannot assign an existing channel name to a new channel. If you do, an error occurs.

Example:

```
INST:CRE SAN, 'Spectrum 2'
```

Adds a spectrum display named "Spectrum 2".

INSTrument:CREate:REPLace <ChannelName1>,<ChannelType>,<ChannelName2>

This command replaces a channel setup with another one.

Setting parameters:

<ChannelName1> String containing the name of the channel setup you want to replace.

<ChannelType>	Channel type of the new channel setup. For a list of available channel setup types, see INSTrument:LIST? on page 318.
<ChannelName2>	String containing the name of the new channel setup. Note: If the specified name for a new channel setup already exists, the default name, extended by a sequential number, is used for the new channel setup (see INSTrument:LIST? on page 318). Channel names can have a maximum of 31 characters, and must be compatible with the Windows conventions for file names. In particular, they must not contain special characters such as ":", "*", "?".
Example:	<pre>INST:CRE:REPL 'IQAnalyzer2', IQ, 'IQAnalyzer'</pre> Replaces the channel setup named "IQAnalyzer2" by a new channel setup of type "IQ Analyzer" named "IQAnalyzer".
Usage:	Setting only

INSTrument:DELeTe <ChannelName>

This command deletes a channel setup.

Setting parameters:

<ChannelName>	String containing the name of the channel setup you want to delete. A channel setup must exist to delete it.
---------------	---

Usage: Setting only

INSTrument:LIST?

This command queries all active channel setups. The query is useful to obtain the names of the existing channel setups, which are required to replace or delete the channel setups.

Return values:

<ChannelType>, <ChannelName>	For each channel setup, the command returns the channel setup type and channel setup name (see tables below). Tip: to change the channel setup name, use the INSTrument:REName command.
---------------------------------	--

Example:

```
INST:LIST?
```

Result for 3 channel setups:

```
'ADEM', 'Analog Demod', 'IQ', 'IQ Analyzer', 'IQ', 'IQ Analyzer2'
```

Usage: Query only

Table 11-2: Available channel setup types and default channel setup names

Application	<ChannelType> Parameter	Default Channel setup Name*)
Spectrum	SANALYZER	Spectrum
AM/FM/PM Modulation Analysis	ADEM	Analog Demod
I/Q Analyzer	IQ	IQ Analyzer
Noise Figure Measurements	NOISE	Noise
Vector Signal Analysis (VSA)	DDEM	VSA

Note: the default channel setup name is also listed in the table. If the specified name for a new channel setup already exists, the default name, extended by a sequential number, is used for the new channel setup.

INSTrument:REName <ChannelName1>, <ChannelName2>

This command renames a channel setup.

Setting parameters:

<ChannelName1> String containing the name of the channel setup you want to rename.

<ChannelName2> String containing the new channel setup name.
Note that you cannot assign an existing channel setup name to a new channel setup. If you do, an error occurs.
Channel names can have a maximum of 31 characters, and must be compatible with the Windows conventions for file names. In particular, they must not contain special characters such as ":", "*", "?".

Example: `INST:REN 'IQAnalyzer2', 'IQAnalyzer3'`
Renames the channel setup with the name 'IQAnalyzer2' to 'IQAnalyzer3'.

Usage: Setting only

INSTrument[:SElect] <ChannelType>

Selects the application (channel type) for the current channel.

See also [INSTrument:CREate\[:NEW\]](#) on page 317.

For a list of available channel types see [INSTrument:LIST?](#) on page 318.

Parameters:

<ChannelType> **VSA**
VSA, R&S FPL1-K70

SYSTem:PRESet:CHANnel[:EXEC]

This command restores the default instrument settings in the current channel setup.

Use `INST:SEL` to select the channel setup.

Example: `INST:SEL 'Spectrum2'`
 Selects the channel setup for "Spectrum2".
 `SYST:PRESet:CHAN:EXEC`
 Restores the factory default settings to the "Spectrum2" channel
 setup.

Usage: Event

Manual operation: See "[Preset Channel setup](#)" on page 162

11.4 Digital standards

Various predefined settings files for common digital standards are provided for use with the VSA application. In addition, you can create your own settings files for user-specific measurements.

Manual configuration of digital standards is described in [Chapter 5.2, "Configuration according to digital standards"](#), on page 163.

[SENSe:]DDEMod:FACTory[:VALue]	320
[SENSe:]DDEMod:PRESet[:STANdard]	321
[SENSe:]DDEMod:STANdard:COMMeNt	321
[SENSe:]DDEMod:STANdard:DELeTe	321
[SENSe:]DDEMod:STANdard:PRESet[:VALue]	322
[SENSe:]DDEMod:STANdard:SAVE	322

[SENSe:]DDEMod:FACTory[:VALue] <Factory>

This command restores the factory settings of standards or patterns for the VSA application.

Setting parameters:

<Factory> ALL | STANdard | PATTeRn

ALL

Restores both standards and patterns.

*RST: ALL

Example: `:SENS:DDEM:FACT GST`

Usage: Setting only

Manual operation: See "[Restore Standard Files](#)" on page 164
 See "[Restore Pattern Files](#)" on page 232

[SENSe:]DDEMod:PRESet[:STANdard] <Standard>

This command selects an automatic setting of all modulation parameters according to a standardized transmission method or a user-defined transmission method. The standardized transmission methods are available in the instrument as predefined standards.

Parameters:

<Standard> Specifies the file name that contains the transmission method without the extension. For user-defined standards, the file path must be included. Default standards predefined by Rohde&Schwarz do not require a path definition. A list of predefined standards (including short forms) is provided in the annex (see [Chapter B, "Predefined standards and settings"](#), on page 502).

Example:

```
DDEM:PRES 'TETRA_NDDOWN'
```

Switches the predefined digital standard "TETRA_DiscontinuousDownlink" on.

```
DDEM:PRES 'C:\R_S\Instr\usr\standards\USER_GSM'
```

Switches the user-defined digital standard "USER_GSM" on.

Example:

See [Chapter 11.13.2, "Measurement example 2: GSM EDGE burst measurement based on a digital standard"](#), on page 495.

Manual operation: See ["Load Standard"](#) on page 164

[SENSe:]DDEMod:STANdard:COMMeNt <Comment>

This command enters the comment for a new standard. The comment is stored with the standard and is only displayed in the selection menu (manual operation). In remote control, the string is deleted after the standard has been stored, allowing a new comment to be entered for the next standard. In this case a blank string is returned when for the query.

Parameters:

<Comment>

Manual operation: See ["Comment"](#) on page 164

[SENSe:]DDEMod:STANdard:DELeTe <FileName>

This command deletes a specified digital standard file in the vector signal analysis.

Setting parameters:

<FileName> File name including the path for the digital standard file

Example:

```
SENS:DDEM:STAN:DEL 'C:\path\standardname'
```

Usage:

Setting only

Manual operation: See ["Delete Standard"](#) on page 164

[SENSe:]DDEMod:STANdard:PRESet[:VALue]

This command restores the default settings of the currently selected standard.

Usage: Event

[SENSe:]DDEMod:STANdard:SAVE <FileName>

This command stores the current settings of the vector signal analysis as a new user-defined digital standard. If the name of the digital standard is already in use, an error message is output and a new name has to be selected. It is recommended that you define a comment before storing the standard.

Setting parameters:

<FileName> The path and file name to which the settings are stored.

Example: DDEM:STAN:COMM 'GSM_AccessBurst with Pattern'
 Defines a comment for the settings.
 DDEM:STAN:SAVE 'C:
 \R_S\Instr\usr\standards\USER_GSM'
 Stores the settings in the user-defined digital standard
 "USER_GSM".

Example: See [Chapter 11.13.3, "Measurement example 3: user-defined pattern search and limit check"](#), on page 498.

Usage: Setting only

Manual operation: See ["Save Standard"](#) on page 164

11.5 Configuring VSA

• Signal description	322
• Input, output and frontend settings	350
• Signal capture	370
• Triggering measurements	372
• Configuring sweeps	375
• Configuring bursts and patterns	376
• Defining the result range	384
• Demodulation settings	387
• Measurement filter settings	396
• Defining the evaluation range	398
• Adjusting settings automatically	399

11.5.1 Signal description

The signal description provides information on the expected input signal, which optimizes pattern and burst detection and the calculation of the ideal reference signal.

Manual configuration of the signal description is described in [Chapter 5.3, "Signal description"](#), on page 165.

• Modulation	323
• Signal structure	331
• Frame structure	334
• Known data	346

11.5.1.1 Modulation

The modulation settings vary depending on the selected modulation type; in particular, FSK modulation provides some additional settings.

CALCulate<n>:FSK:DEVIation:REFerence:RELative	323
CALCulate<n>:FSK:DEVIation:REFerence[:VALue]	324
[SENSe:]DDEMod:APSK:NSTate	324
[SENSe:]DDEMod:ASK:NSTate	324
[SENSe:]DDEMod:FILTer:ALPHA	325
[SENSe:]DDEMod:FILTer[:STATe]	325
[SENSe:]DDEMod:FORMat	325
[SENSe:]DDEMod:FSK:NSTate	326
[SENSe:]DDEMod:MAPPing:CATalog?	326
[SENSe:]DDEMod:MAPPing[:VALue]	327
[SENSe:]DDEMod:MSK:FORMat	327
[SENSe:]DDEMod:PSK:FORMat	327
[SENSe:]DDEMod:PSK:NSTate	328
[SENSe:]DDEMod:QAM:FORMat	328
[SENSe:]DDEMod:QAM:NSTate	328
[SENSe:]DDEMod:QPSK:FORMat	329
[SENSe:]DDEMod:SRATe	330
[SENSe:]DDEMod:TFILTer:ALPHA	330
[SENSe:]DDEMod:TFILTer:NAME	330
[SENSe:]DDEMod:TFILTer[:STATe]	331
[SENSe:]DDEMod:TFILTer:USER	331
[SENSe:]DDEMod:USER:NAME	331

CALCulate<n>:FSK:DEVIation:REFerence:RELative <FSKRefDev>

This command defines the deviation to the reference frequency for FSK modulation as a multiple of the symbol rate.

Suffix:

<n> 1..n
[Window](#)

Parameters:

<FSKRefDev> Range: 0.1 to 60
 *RST: 1
 Default unit: none

Manual operation: See "[FSK Ref Deviation \(FSK only\)](#)" on page 167

CALCulate<n>:FSK:DEVIation:REFerence[:VALue] <FSKRefDevAbsRes>

This command defines the deviation to the reference frequency for FSK modulation as an absolute value in Hz.

Suffix:

<n> 1..n
[Window](#)

Parameters:

<FSKRefDevAbsRes>Range: 10.0 to 256e9
 *RST: 100e9
 Default unit: HZ

Manual operation: See "[FSK Ref Deviation \(FSK only\)](#)" on page 167

[SENSe:]DDEMod:APSK:NState <APSKNstate>

This command defines the specific demodulation mode for APSK.

Parameters:

<APSKNstate> 16 | 32
16
 16APSK
32
 32APSK
 *RST: 16

Example:

```
DDEM:FORM APSK
Switch APSK demodulation on.
DDEMd:APSK:NST 32
Switch 32APSK demodulation on.
```

Manual operation: See "[Modulation Order](#)" on page 166

[SENSe:]DDEMod:ASK:NState <ASKNstate>

This command defines the specific demodulation mode for ASK.

Parameters:

<ASKNstate> 2 | 4
2
 OOK
4
 4ASK
 *RST: 2

Example:

```
DDEM:FORM ASK
Switch ASK demodulation on.
DDEMd:ASK:NST 2
Switch OOK demodulation on.
```

Manual operation: See "Modulation Order" on page 166

[SENSe:]DDEMod:FILTer:ALPHa <MeasFilterAlphaBT>

This command determines the filter characteristic (ALPHA/BT).

Parameters:

<MeasFilterAlphaBT> Range: 0.03 to 1.0
 Increment: 0.01
 *RST: 0.22

Example: DDEM:FILT:ALPH 0.5
 Sets ALPHA/BT to 0.5

[SENSe:]DDEMod:FILTer[:STATe] <State>

This command defines whether the input signal that is evaluated is filtered by the measurement filter. This command has no effect on the transmit filter.

Parameters:

<State> **ON | 1**
 [SENSe:]DDEMod:MFILTer:AUTO is activated.
OFF | 0
 The input signal is not filtered. [SENSe:]DDEMod:MFILTer:AUTO is deactivated.

[SENSe:]DDEMod:FORMat <Group>

This command selects the digital demodulation mode.

Parameters:

<Group> MSK | PSK | QAM | QPSK | FSK | ASK | APSK | UQAM
QPSK
 Quad Phase Shift Key
PSK
 Phase Shift Key
MSK
 Minimum Shift Key
QAM
 Quadrature Amplitude Modulation
FSK
 Frequency Shift Key
ASK
 Amplitude Shift Keying
APSK
 Amplitude Phase Shift Keying

UQAM

User-defined modulation (loaded from file, see [SENSe:]DDEMod:USER:NAME on page 331)

- Example:** SENS:DDEM:FORM QAM
- Example:** See [Chapter 11.13.1, "Measurement example 1: user-defined measurement of continuous QPSK signal"](#), on page 493.
- Example:** See [Chapter 11.13.3, "Measurement example 3: user-defined pattern search and limit check"](#), on page 498.
- Manual operation:** See ["Modulation Type"](#) on page 166
See ["Load User Modulation"](#) on page 166

[SENSe:]DDEMod:FSK:NState <FSKNstate>

This command defines the demodulation of the FSK modulation scheme.

Parameters:

<FSKNstate> 2 | 4 | 8 | 16
2
 2FSK
4
 4FSK
8
 8FSK
16
 16FSK
 *RST: 2

Manual operation: See ["Modulation Order"](#) on page 166

[SENSe:]DDEMod:MAPPING:CATalog?

This command queries the names of all mappings that are available for the current modulation type and order. A mapping describes the assignment of constellation points to symbols.

Return values:

<Mappings> <list>
 A comma-separated list of strings, with one string for each mapping name.

Example: :SENSe:DDEMod:MAPPING:CATalog?
 Result:
 'CDMA2K_FWD', 'DVB_S2', 'GRAY', 'NATURAL', 'WCDMA'

Example: See [Chapter 11.13.1, "Measurement example 1: user-defined measurement of continuous QPSK signal"](#), on page 493.

Usage: Query only

Manual operation: See ["Modulation Mapping"](#) on page 167

[SENSe:]DDEMod:MAPPING[:VALue] <Mapping>

This command selects the mapping for digital demodulation. The mapping describes the assignment of constellation points to symbols.

Parameters:

<Mapping> To obtain a list of available symbol mappings for the current modulation type use the `[SENSe:]DDEMod:MAPPING:CATalog??` query.

Example: `SENS:DDEM:MAPP 'GSM'`
Sets mapping to GSM.

Example: See [Chapter 11.13.1, "Measurement example 1: user-defined measurement of continuous QPSK signal"](#), on page 493.

Example: See [Chapter 11.13.3, "Measurement example 3: user-defined pattern search and limit check"](#), on page 498.

Manual operation: See ["Modulation Mapping"](#) on page 167

[SENSe:]DDEMod:MSK:FORMat <MSKformat>

This command defines the specific demodulation order for MSK.

Parameters:

<MSKformat> TYPE1 | TYPE2 | NORMal | DIFFerential
TYPE1 | NORMal
Demodulation order MSK is used.
TYPE2 | DIFFerential
Demodulation order DMSK is used.

Manual operation: See ["Modulation Order"](#) on page 166

[SENSe:]DDEMod:PSK:FORMat <PSKformat>

Together with `DDEMod:PSK:NST`, this command defines the demodulation order for PSK (see also `[SENSe:]DDEMod:PSK:NSTate` on page 328). Depending on the demodulation format and state, the following orders are available:

NSTATE	<PSKformat>	Order
2	NORMal	BPSK
2	NPI2	Pi/2-BPSK
2	MNPI2	-Pi/2-BPSK
2	DPI2	Pi/2-DBPSK
8	NORMal	8PSK

NSTATE	<PSKformat>	Order
8	DIFFerential	D8PSK
8	N3Pi8	3pi/8-8PSK (EDGE)
8	PI8D8PSK	Pi/8-D8PSK

Parameters:

<PSKformat> NORMal | DIFFerential | N3Pi8 | PI8D8psk | NPI2 | DPI2 |
MNPi2

Manual operation: See "[Modulation Order](#)" on page 166

[SENSe:]DDEMod:PSK:NSTATE <PSKNstate>

Together with DDEMod:PSK:FORMat, this command defines the demodulation order for PSK (see also [[SENSe:\]DDEMod:PSK:FORMat](#) on page 327).

Parameters:

<PSKNstate> 2 | 8
*RST: 2

Manual operation: See "[Modulation Order](#)" on page 166

[SENSe:]DDEMod:QAM:FORMat <QAMformat>

This command defines the specific demodulation order for QAM.

Parameters:

<QAMformat> NORMal | DIFFerential | NPI4 | MNPI4

NORMal
Demodulation order QAM is used.

DIFFerential
Demodulation order DQAM is used.

NPI4
Demodulation order $\pi/4$ -16QAM is used.

MNPI4
Demodulation order $-\pi/4$ -32QAM is used.

Manual operation: See "[Modulation Order](#)" on page 166

[SENSe:]DDEMod:QAM:NSTATE <QAMNState>

This command defines the demodulation order for QAM.

<QAMNState>	Order
16	16QAM
16	Pi/4-16QAM

<QAMNState>	Order
32	32QAM
32	Pi/4-32QAM
64	64QAM
128	128QAM
256	256QAM
512	512QAM
1024	1024QAM

Parameters:

<QAMNState>

Manual operation: See "[Modulation Order](#)" on page 166**[SENSe:]DDEMod:QPSK:FORMat <QPSKformat>**

This command defines the demodulation order for QPSK.

Parameters:

<QPSKformat> NORMAL | DIFFerential | NPI4 | DPI4 | OFFSet | SOFFset | N3PI4

NORMAL

Demodulation order QPSK is used.

DIFFerential

Demodulation order DQPSK is used.

NPI4Demodulation order $\pi/4$ QPSK is used.**DPI4**Demodulation order $\pi/4$ DQPSK is used.**OFFSet**

Demodulation order OQPSK is used.

N3PI4Demodulation order $3\pi/4$ QPSK is used.**SOFFset**

Shaped Offset QPSK

Example:

DDEMod:FORM QPSK

Switches QPSK demodulation on.

DDEMod:QPSK:FORM DPI4

Switches $\pi/4$ DQPSK demodulation order on.**Example:**See [Chapter 11.13.1, "Measurement example 1: user-defined measurement of continuous QPSK signal"](#), on page 493.**Example:**See [Chapter 11.13.3, "Measurement example 3: user-defined pattern search and limit check"](#), on page 498.

Manual operation: See ["Modulation Order"](#) on page 166

[SENSe:]DDEMod:SRATe <SymbolRate>

This command defines the symbol rate.

The minimum symbol rate is 25 Hz. The maximum symbol rate depends on the defined [Sample Rate](#) (see [Chapter 4.2, "Sample rate, symbol rate and I/Q bandwidth"](#), on page 76).

Parameters:

<SymbolRate> Range: 25 to 250e6
 Default unit: HZ

Example: See [Chapter 11.13.1, "Measurement example 1: user-defined measurement of continuous QPSK signal"](#), on page 493.

Example: See [Chapter 11.13.3, "Measurement example 3: user-defined pattern search and limit check"](#), on page 498.

Manual operation: See ["Symbol Rate"](#) on page 168

[SENSe:]DDEMod:TFILter:ALPHa <Alpha>

This command determines the TX filter characteristic (ALPHA/BT).

Parameters:

<Alpha> Range: 0.03 to 1.0
 Increment: 0.01
 *RST: 0.22

Example: See [Chapter 11.13.1, "Measurement example 1: user-defined measurement of continuous QPSK signal"](#), on page 493.

Manual operation: See ["Alpha/BT"](#) on page 168
 See ["Alpha/BT"](#) on page 227

[SENSe:]DDEMod:TFILter:NAME <Name>

This command selects a transmit filter and automatically switches it on.

For more information on transmit filters, refer to [Chapter C.1, "Transmit filters"](#), on page 511.

Parameters:

<Name> string
 Name of the Transmit filter; an overview of available transmit filters is provided in [Chapter C.1, "Transmit filters"](#), on page 511.

Example: See [Chapter 11.13.1, "Measurement example 1: user-defined measurement of continuous QPSK signal"](#), on page 493.

Manual operation: See ["Transmit Filter Type"](#) on page 168
 See ["Load User Filter"](#) on page 168

[SENSe:]DDEMod:TFILter[:STATe] <State>

Use this command to switch the transmit filter off. To switch a transmit filter on, use the [\[SENSe:\]DDEMod:TFILter:NAME](#) command.

Parameters:

<State>	OFF 0 Switches the transmit filter off.
	ON 1 Switches the transmit filter specified by [SENSe:]DDEMod:TFILter:NAME on. However, this command is not necessary, as the [SENSe:]DDEMod:TFILter:NAME command automatically switches the filter on.
*RST:	ON

Manual operation: See ["Transmit Filter Type"](#) on page 168

[SENSe:]DDEMod:TFILter:USER <FilterName>

This command selects a user-defined transmit filter file.

Parameters:

<FilterName>	The name of the transmit filter file.
--------------	---------------------------------------

Manual operation: See ["Transmit Filter Type"](#) on page 168
See ["Load User Filter"](#) on page 168

[SENSe:]DDEMod:USER:NAME <FileName>

Selects the file that contains the user-defined modulation to be loaded.

Parameters:

<FileName>	Path and file name of the *.vam file The default storage location for user-defined modulations is C:\Users\Public\Documents\Rohde-Schwarz\Analyzer\user\vsa\Constellation.
------------	--

Example:

```
SENS:DDEM:FORM UQAM
Define the use of a user-defined modulation
SENS:DDEM:USER:NAME 'D:\MyModulation.vam'
Select the file name to be loaded
```

Manual operation: See ["Load User Modulation"](#) on page 166

11.5.1.2 Signal structure

The signal structure commands describe the expected input signal and determine which settings are available for configuration. You can define a pattern to which the instrument can be synchronized, thus adapting the result range.

[SENSe:]DDEMod:SEARch:BURSt:LENGth:MAXimum.....	332
[SENSe:]DDEMod:SEARch:BURSt:LENGth[:MINimum].....	332
[SENSe:]DDEMod:SEARch:BURSt:SKIP:FALLing.....	332
[SENSe:]DDEMod:SEARch:BURSt:SKIP:RISing.....	333
[SENSe:]DDEMod:SEARch:SYNC:CATalog.....	333
[SENSe:]DDEMod:SIGNal:PATtern.....	333
[SENSe:]DDEMod:SIGNal[:VALue].....	334
[SENSe:]DDEMod:STANdard:SYNC:OFFSet:STATe.....	334
[SENSe:]DDEMod:STANdard:SYNC:OFFSet[:VALue].....	334

[SENSe:]DDEMod:SEARch:BURSt:LENGth:MAXimum <MaxLength>

Parameters:

<MaxLength> Range: 0 to 128000
 *RST: 1600
 Default unit: SYM

Manual operation: See "[Min Length / Max Length](#)" on page 170

[SENSe:]DDEMod:SEARch:BURSt:LENGth[:MINimum] <UsefulLength>

This command defines the minimum useful length of a burst. Only those bursts will be recognized that exceed this length. The default unit is symbols. The value can also be given in seconds.

Note the difference to manual operation:

$\langle \text{Min_length} \rangle_{\text{Manual}} = \langle \text{Min_Useful_Length} \rangle + \langle \text{Run-In} \rangle + \langle \text{Run-Out} \rangle$

Setting parameters:

<UsefulLength> numeric value
 Range: 10 to 32000
 *RST: 100
 Default unit: Sym

Manual operation: See "[Min Length / Max Length](#)" on page 170

[SENSe:]DDEMod:SEARch:BURSt:SKIP:FALLing <RunOut>

This command defines the length of the falling burst edge which is not considered when evaluating the result.

Parameters:

<RunOut> Range: 1
 Default unit: SYM

Example:

DDEM:SEAR:BURS:SKIP:FALL 5US
 5 us of the rising burst edge are not considered

Manual operation: See "[Run-Out](#)" on page 170

[SENSe:]DDEMod:SEARch:BURSt:SKIP:RISing <RunIn>**Parameters:**

<RunIn> Range: 0 to 31990
 *RST: 1
 Default unit: SYM

Example: DDEM:SEAR:BURSt:SKIP:RIS 5US
 5 us of the rising burst edge are not considered

Manual operation: See ["Run-In"](#) on page 170

[SENSe:]DDEMod:SEARch:SYNC:CATalog <Patterns>

This command reads the names of all patterns stored on the hard disk. The file names are returned as a comma-separated list of strings, one for each file name (without the file extension).

Parameters:

<Patterns> CURRent | ALL
CURRent
 Only patterns that belong to the current standard
ALL
 All patterns
 *RST: ALL

Example: :DDEM:SEAR:SYNC:CAT? CURR
 Result:
 'GSM_AB0', 'GSM_AB1', 'GSM_AB2', 'GSM_TSC1'

Example: See [Chapter 11.13.3, "Measurement example 3: user-defined pattern search and limit check"](#), on page 498.

[SENSe:]DDEMod:SIGNal:PATTern <State>

This command specifies whether the signal contains a pattern or not.

Parameters:

<State> ON | OFF | 0 | 1
OFF | 0
 The signal does not contain a pattern.
ON | 1
 The signal contains a pattern.
 *RST: 0

Example: See [Chapter 11.13.3, "Measurement example 3: user-defined pattern search and limit check"](#), on page 498.

Manual operation: See ["Name"](#) on page 170

[SENSe:]DDEMod:SIGNal[:VALue] <SignalType>

Parameters:

<SignalType> CONTInuous | BURSted

Example: See [Chapter 11.13.3, "Measurement example 3: user-defined pattern search and limit check"](#), on page 498.

Manual operation: See ["Signal Type"](#) on page 170

[SENSe:]DDEMod:STANdard:SYNC:OFFSet:STATe <State>

This command (de)activates the pattern offset.

Parameters:

<State> ON | OFF | 0 | 1

OFF | 0

Switches the function off

ON | 1

Switches the function on

*RST: 0

Example: See [Chapter 11.13.3, "Measurement example 3: user-defined pattern search and limit check"](#), on page 498.

Manual operation: See ["Offset"](#) on page 171

[SENSe:]DDEMod:STANdard:SYNC:OFFSet[:VALue] <Offset>

This command defines a number of symbols which are ignored before the comparison with the pattern starts.

Parameters:

<Offset> Range: 0 to 15000

*RST: 0

Default unit: SYMB

Example: See [Chapter 11.13.3, "Measurement example 3: user-defined pattern search and limit check"](#), on page 498.

Manual operation: See ["Offset"](#) on page 171

11.5.1.3 Frame structure

The following commands are only available if the additional Multi-Modulation Analysis option (R&S FPL1000-K70M) is installed, and only for PSK and QAM types.

Useful commands for multi-modulation analysis described elsewhere:

- [\[SENSe:\]DDEMod:TIME:AUTO](#) on page 386

Remote commands exclusive to frame structure configuration:

[SENSe:]DDEMod:PATtern:APSK:NSTate.....	335
[SENSe:]DDEMod:PATtern:ASK:NSTate.....	336
[SENSe:]DDEMod:PATtern:FORMat.....	336
[SENSe:]DDEMod:PATtern:FRAMe:EDIT.....	336
[SENSe:]DDEMod:PATtern:FRAMe:EDIT:NEXt:BOOSting.....	337
[SENSe:]DDEMod:PATtern:FRAMe:EDIT:NEXt:MODulation.....	337
[SENSe:]DDEMod:PATtern:FRAMe:EDIT:PREVious:BOOSting.....	338
[SENSe:]DDEMod:PATtern:FRAMe:EDIT:PREVious:MODulation.....	338
[SENSe:]DDEMod:PATtern:FRAMe:EDIT:SAVE.....	338
[SENSe:]DDEMod:PATtern:FRAMe:EDIT:STRUcture.....	339
[SENSe:]DDEMod:PATtern:FRAMe:EDIT:TEXT.....	341
[SENSe:]DDEMod:PATtern:FRAMe:LOAD.....	342
[SENSe:]DDEMod:PATtern:FRAMe:MODE.....	342
[SENSe:]DDEMod:PATtern:MAPPing:CATalog?.....	342
[SENSe:]DDEMod:PATtern:MAPPing[:VALue].....	343
[SENSe:]DDEMod:PATtern:PSK:FORMat.....	343
[SENSe:]DDEMod:PATtern:PSK:NSTate.....	343
[SENSe:]DDEMod:PATtern:QAM:FORMat.....	344
[SENSe:]DDEMod:PATtern:QAM:NSTate.....	344
[SENSe:]DDEMod:PATtern:QPSK:FORMat.....	345
[SENSe:]DDEMod:PATtern:USER:NAME.....	345
[SENSe:]DDEMod:PATtern[:STATe].....	346

[SENSe:]DDEMod:PATtern:APSK:NSTate <APSKNstate>

This command defines the demodulation order for APSK for the pattern (see also [\[SENSe:\]DDEMod:PATtern:FORMat](#) on page 336).

Depending on the demodulation state, the following orders are available:

<APSKNstate>	Order
16	16APSK
32	32APSK

Parameters:

<APSKNstate> 16 | 32
*RST: 16

Example:

```
DDEM:PATT:FORM APSK
Switch APSK demodulation on.
DDEM:PATT:APSK:NST 16
Switch 16APSK demodulation on.
```

Manual operation: See "[Modulation Order](#)" on page 173

[SENSe:]DDEMod:PATtern:ASK:NState <ASKNstate>

This command defines the demodulation order for ASK for the pattern (see also [\[SENSe:\]DDEMod:PATtern:FORMat](#) on page 336).

Depending on the demodulation state, the following orders are available:

<ASKNstate>	Order
2	2ASK
4	4ASK

Parameters:

<ASKNstate> 2 | 4
*RST: 2

Example:

```
DDEM:PATT:FORM ASK
Switch ASK demodulation on.
DDEM:PATT:ASK:NST 2
Switch 2ASK demodulation on.
```

Manual operation: See "[Modulation Order](#)" on page 173

[SENSe:]DDEMod:PATtern:FORMat <Group>

This command selects the pattern demodulation mode. Some modes can only be queried as they are not supported for the two modulations feature, but could be set when 'Same as Data Symbols' is selected.

Parameters:

<Group> MSK | PSK | QAM | QPSK | FSK | ASK | APSK | UQAM

Example:

```
SENS:DDEM:PATtern:FORM QAM
```

Manual operation: See "[Modulation Type](#)" on page 173
See "[Load User Modulation](#)" on page 173

[SENSe:]DDEMod:PATtern:FRAMe:EDIT <FileName>

Specifies an xml file for a user-defined frame structure configuration. The default storage location for such files is

```
C:\Users\Public\Documents\Rohde-Schwarz\Analyzer\user\vsa\
FrameRangeStructure.
```

If the specified file already exists, it is loaded for subsequent editing. Note that this command is a prerequisite to editing the frame structure of an existing file (using [\[SENSe:\]DDEMod:PATtern:FRAMe:EDIT:STRUcture](#) or any other command starting with [\[SENS:\]DDEM:PATT:FRAM:EDIT](#)). It does not load the file for use in the current measurement (see [\[SENSe:\]DDEMod:PATtern:FRAMe:LOAD](#) on page 342). Therefore, you can edit a frame structure while simultaneously performing a measurement with another frame structure configuration.

If the file does not yet exist, a new frame structure is created and will be stored to the specified file when the `[SENSe:]DDEMod:PATtern:FRAMe:EDIT:SAVE` command is executed.

Parameters:

<FileName> string
Path and file name of the xml file containing the frame structure configuration.

Example:

```
SENS:DDEM:PATT:FRAM:MODE USER
SENS:DDEM:PATT:FRAM:EDIT 'D:
\MyFrameStructure.xml'
```

Manual operation: See ["Frame Structure Config"](#) on page 175
See ["New"](#) on page 179
See ["Open"](#) on page 179

[SENSe:]DDEMod:PATtern:FRAMe:EDIT:NEXT:BOOSTing <Boosting>

Determines which boosting is used to demodulate the frame next to the last configured subframe.

Parameters:

<Boosting> Range: 0.1 to 60
*RST: 1.000

Example:

```
SENS:DDEM:PATT:FRAM:EDIT:NEXT:BOOS 2
```

Sets boosting for the next frame to 2.

Manual operation: See ["Boosting \(optional\)"](#) on page 178

[SENSe:]DDEMod:PATtern:FRAMe:EDIT:NEXT:MODulation <Modulation>

Determines which modulation type is used to demodulate the frame after to the last configured subframe.

Parameters:

<Modulation> AUTO | DATA | PATtern

Data

The modulation type defined for data symbols is used (see [\[SENSe:\]DDEMod:MAPPING\[:VALue\]](#) on page 327)

Pattern

The modulation type defined for pattern symbols is used (see [\[SENSe:\]DDEMod:PATtern:MAPPING\[:VALue\]](#) on page 343).

Auto

The nextt frame uses the same modulation as the first subframe of the frame configuration.

*RST: PATT

Example: SENS : DDEM : PATT : MAPP : VAL ' QPSK '
 SENS : DDEM : PATT : FRAM : EDIT : NEXT : MOD PATT
 The next frame uses the same modulation as the pattern:
 QPSK.

Manual operation: See "[Modulation](#)" on page 177

[SENSe:]DDEMod:PATtern:FRAMe:EDIT:PREVious:BOOSting <Boosting>

Determines which boosting is used to demodulate the frame previous to the first configured subframe.

Parameters:

<Boosting> Range: 0.1 to 60
 *RST: 1.000

Example: SENS : DDEM : PATT : FRAM : EDIT : PREV : BOOS 2
 Sets boosting for the previous frame to 2.

Manual operation: See "[Boosting \(optional\)](#)" on page 178

[SENSe:]DDEMod:PATtern:FRAMe:EDIT:PREVious:MODulation <Modulation>

Determines which modulation type is used to demodulate the frame previous to the first configured subframe.

Parameters:

<Modulation> AUTO | DATA | PATtern

Data

The modulation type defined for data symbols is used (see [\[SENSe:\]DDEMod:MAPPING\[:VALue\]](#) on page 327)

Pattern

The modulation type defined for pattern symbols is used (see [\[SENSe:\]DDEMod:PATtern:MAPPING\[:VALue\]](#) on page 343).

Auto

The previous frame uses the same modulation as the last subframe of the frame configuration.

*RST: DATA

Example: SENS : DDEM : MAPP : VAL ' 16QAM '
 SENS : DDEM : PATT : FRAM : EDIT : PREV : MOD DATA
 The previous frame uses the same modulation as the data:
 16QAM.

Manual operation: See "[Modulation](#)" on page 177

[SENSe:]DDEMod:PATtern:FRAMe:EDIT:SAVE [<FileName>]

Stores the current frame structure configuration to the specified file.

If no path is provided it is saved to the file selected previously by [\[SENSe:\]DDEMod:PATtern:FRAMe:EDIT](#) on page 336.

Setting parameters:

<FileName> string
Optional parameter: Path and file name of the xml file.

Example:

```
SENS:DDEM:PATT:FRAM:MODE USER
SENS:DDEM:PATT:FRAM:EDIT 'D:\MyFrameStructure.xml'
SENSe1:DDEMod:PATtern:FRAMe:EDIT:PREVIOUS:MODulation PATT
SENSe1:DDEMod:PATtern:FRAMe:EDIT:PREVIOUS:BOOSting 2
SENSe1:DDEMod:PATtern:FRAMe:EDIT:NEXT:MODulation DATA
SENSe1:DDEMod:PATtern:FRAMe:EDIT:NEXT:BOOSting 3
SENSe1:DDEMod:PATtern:FRAMe:EDIT:STRucture 'One', 10, PATTERN,
PATTERN, 1, 'Range One', 'Two', 20, PATTERN, DATA, 5,
'Range Two', 'Three', 30, DATA, DATA, 0.5, 'Range Three'
SENS:DDEM:PATT:FRAM:EDIT:SAVE 'D:\MyFrameStructureEdited.xml'
```

Usage: Setting only

Manual operation: See ["Save"](#) on page 179
See ["Save As"](#) on page 179

[SENSe:]DDEMod:PATtern:FRAMe:EDIT:STRucture {<Name>, <NOFSymbols>, <Modulation>, <Type>, <Boosting>, <Description>}...

Defines the frame structure for a previously loaded file. For each subframe, *all* parameters must be defined.

Note that the file must be loaded *for editing* before the structure can be defined using this command (see [\[SENSe:\]DDEMod:PATtern:FRAMe:EDIT](#) on page 336). Loading the file for use in the current measurement is not sufficient (see [\[SENSe:\]DDEMod:PATtern:FRAMe:LOAD](#) on page 342). Therefore, you can edit a frame structure while simultaneously performing a measurement with another frame structure configuration.

The configuration is only stored by a subsequent [\[SENSe:\]DDEMod:PATtern:FRAMe:EDIT:SAVE](#) command.

The modulation for the "previous frame" and "next frame" are defined by separate commands (see [\[SENS:\]DDEM:PATT:FRAM:PREV:...](#) and [\[SENS:\]DDEM:PATT:FRAM:NEXT:...](#)).

Parameters:

<Name> string
Name of the subframe. Duplicate names are allowed.

<NOFSymbols>	integer The number of symbols the subframe consists of. For pattern subframes, the number of symbols must correspond to the number of symbols defined using [SENSe:]DDEMod:SEARCH:SYNC:DATA on page 382.
<Modulation>	DATA PATTErn Determines which modulation type is used to demodulate the subframe. The modulation for the "previous frame" and "next frame" are defined by separate commands (see [SENSe:]DDEMod:PATTErn:FRAME:EDIT:PREVIOUS:MODULATION on page 338 and [SENSe:]DDEMod:PATTErn:FRAME:EDIT:NEXT:MODULATION on page 337). DATA The modulation type defined for data symbols is used (see [SENSe:]DDEMod:MAPPING[:VALUE] on page 327). PATTErn The modulation type defined for patterns is used (see [SENSe:]DDEMod:PATTErn:MAPPING[:VALUE] on page 343).
<Type>	DATA PATTErn Determines whether the demodulated data in the subframe is known or unknown by the R&S FPL1000 VSA application. PATTErn The data is assumed to correspond with the pattern definition (see [SENSe:]DDEMod:SEARCH:SYNC:DATA on page 382). Not available for modulation type: "DATA". Only one subframe is allowed to be of type "PATTErn". DATA The data is unknown. Used for data symbols or header information.
<Boosting>	numeric value For subframes with gain values different to the data symbols, define a different boosting factor to be applied to the reference power. Range: 0.1 to 60 *RST: 1.000
<Description>	string Description for an individual subframe. Use an empty string ("") to leave out the description.

Example:

```

SENS:DDEM:PATT:FRAM:MODE USER
DDEM:PATT:FRAM:EDIT 'D:\MyFrameStructure.xml'
DDEM:PATT:FRAM:EDIT:STR 'Start of Frame', 26,
PATTERN, PATTERN, 1, 'Start of Frame Pattern',
'Header Symbols', 64, PATTERN, DATA, 5, 'Block
with header symbols that contains the frame
information', 'Data Symbols', 3240, DATA, DATA,
0.5, 'Block with 32APSK data symbols'
DDEM:PATT:FRAM:EDIT:SAVE

```

Manual operation: See ["Frame Structure Config"](#) on page 175
 See ["Index"](#) on page 177
 See ["Name"](#) on page 177
 See ["Number of Symbols"](#) on page 177
 See ["Modulation"](#) on page 177
 See ["Type"](#) on page 178
 See ["Boosting \(optional\)"](#) on page 178
 See ["Description \(optional\)"](#) on page 179

The example defines the following frame structure:

Name	No. of symbols	Modulation	Type	Boosting	Description
'Start of Frame'	26	PATTERN	PATTERN	1	'Start of Frame Pattern'
'Header Symbols'	64	PATTERN	DATA	5	'Block with header symbols that contains the frame information'
'Data Symbols'	3240	DATA	DATA	0.5	'Block with 32APSK data symbols'

[SENSe:]DDEMod:PATtern:FRAMe:EDIT:TEXT <FileName>

Defines the description for the frame structure in a previously loaded file.

Note that the file must be loaded *for editing* before the description can be defined using this command (see [\[SENSe:\]DDEMod:PATtern:FRAMe:EDIT](#) on page 336).

Parameters:

<FileName> string

Example:

```

SENS:DDEM:PATT:FRAM:MODE USER
SENS:DDEM:PATT:FRAM:EDIT 'D:\MyFrameStructure.xml'
SENSe:DDEMod:PATtern:FRAMe:EDIT:TEXT
'description for the frame structure'

```

Manual operation: See ["Description"](#) on page 176

[SENSe:]DDEMod:PATtern:FRAMe:LOAD <FileName>

Loads a user-defined frame structure configuration to be used by the measurement from an xml file. The default storage location for such files is

C:\Users\Public\Documents\Rohde-Schwarz\Analyzer\user\vsa\
FrameRangeStructure.

Parameters:

<FileName> string
 Path and file name of the xml file.
 The default storage location for frame structures is
 C:\Users\Public\Documents\Rohde-Schwarz\Analyzer\user\
 vsa\FramRange_Structure.

Example:

```
DDEM:PATT:FRAM:MODE USER
SENS:DDEM:PATT:FRAM:LOAD 'D:
\MyFrameStructure.xml'
```

Manual operation: See "[Load File](#)" on page 175

[SENSe:]DDEMod:PATtern:FRAMe:MODE <FrameMode>

Determines whether the frame structure of the signal is configured in reference to the result range or user-defined.

Parameters:

<FrameMode> DEFault | USER

Default

A single frame is assumed to correspond to the result range defined by [\[SENSe:\]DDEMod:TIME](#) on page 386.

User-Defined

A frame is defined manually as a succession of subframes with specified characteristics. In this case, the result range is assumed to be a single frame as specified by [\[SENSe:\]DDEMod:PATtern:FRAMe:EDIT:STRUcture](#) on page 339.

If no structure is configured or loaded yet, the result range definition is used (as for "Default").

Example:

```
DDEM:PATT:FRAM:MODE DEF
The default result range is used.
```

Manual operation: See "[Frame Structure](#)" on page 174

[SENSe:]DDEMod:PATtern:MAPPing:CATalog?

This command queries the names of all mappings that are available for the pattern for the current modulation type and order. A mapping describes the assignment of constellation points to symbols.

Return values:

<Mappings> <list>

A comma-separated list of strings, with one string for each mapping name.

Example:

SENS:DDEM:PATT:MAPP:CAT?

Result:

'CDMA2K_FWD', 'DVB_S2', 'GRAY', 'NATURAL', 'SMx', 'WCDMA'

Usage:

Query only

Manual operation: See ["Modulation Mapping"](#) on page 174**[SENSe:]DDEMod:PATtern:MAPPing[:VALue] <Mapping>**

This command selects the mapping for pattern demodulation.

Parameters:

<Mapping> To obtain a list of available symbol mappings for the current modulation type use the [\[SENSe:\]DDEMod:PATtern:MAPPing:CATalog??](#) query.

Example:

DDEM:PATT:MAPP 'GSM'

Sets mapping to GSM.

Manual operation: See ["Modulation Mapping"](#) on page 174**[SENSe:]DDEMod:PATtern:PSK:FORMat <PSKformat>**

Together with [DDEMod:PATT:PSK:NST](#), this command defines the demodulation order for PSK for the pattern (see also [\[SENSe:\]DDEMod:PATtern:PSK:NState](#) on page 343).

NSTATE	<PSKformat>	Order
2	NORMAL	BPSK
8	NORMAL	8PSK
8	DIFFerential	D8PSK

Parameters:

<PSKformat> NORMAL | DIFFerential
*RST: NORMAL

Manual operation: See ["Modulation Order"](#) on page 173**[SENSe:]DDEMod:PATtern:PSK:NSTate <PSKNstate>**

Together with [DDEMod:PATT:PSK:FORMat](#), this command defines the demodulation order for PSK for the pattern (see also [\[SENSe:\]DDEMod:PATtern:PSK:FORMat](#) on page 343).

Depending on the demodulation format and state, the following orders are available:

<PSKNSTATE>	FORMat	Order
2	any	BPSK
8	NORMal	8PSK
8	DIFFerential	D8PSK

Parameters:

<PSKNstate> 2 | 8

Example:

```
DDEM:PATT:FORM PSK
Switch PSK demodulation on.
DDEM:PATT:PSK:FORM DIFF
DDEMd:PATT:PSK:NST 8
Switch D8PSK demodulation on.
```

Manual operation: See "[Modulation Order](#)" on page 173

[SENSe:]DDEMod:PATtern:QAM:FORMat <QAMformat>

This command defines the specific demodulation order for QAM for the pattern.

Parameters:

<QAMformat> NORMal | DIFFerential

NORMal

Demodulation order QAM is used.

DIFFerential

Demodulation order DQAM is used.

Example:

```
DDEM:PATT:FORM QAM
Switches QAM demodulation on.
DDEM:PATT:QAM:FORM DQAM
Switches DQAM on.
```

Manual operation: See "[Modulation Order](#)" on page 173

[SENSe:]DDEMod:PATtern:QAM:NState <QAMNState>

This command defines the demodulation order for QAM for the pattern.

<QAMNState>	Order
16	16QAM
16	Pi/4-16QAM
32	32QAM
32	Pi/4-32QAM
64	64QAM

<QAMNState>	Order
128	128QAM
256	256QAM
512	512QAM
1024	1024QAM

Parameters:

<QAMNState>

Example:

```
DDEM:PATT:FORM QAM
Selects QAM demodulation for the pattern.
DDEM:PATT:QAM:NST 64
Selects 64QAM demodulation for the pattern.
```

Manual operation: See "[Modulation Order](#)" on page 173**[SENSe:]DDEMod:PATtern:QPSK:FORMat <QPSKformat>**

This command defines the demodulation order for QPSK for the pattern.

Parameters:

<QPSKformat> NORMAL | DIFFerential

NORMAL

Demodulation order QPSK is used.

DIFFerential

Demodulation order DQPSK is used.

Example:

```
DDEM:PATT:FORM QPSK
Selects QPSK demodulation for the pattern.
```

Manual operation: See "[Modulation Order](#)" on page 173**[SENSe:]DDEMod:PATtern:USER:NAME <Name>**

Selects the file that contains a user-defined modulation.

For details on user-defined modulation files see [Chapter 4.3.12, "User-defined modulation"](#), on page 111.

The default storage location for user-defined modulations is

```
C:\Users\Public\Documents\Rohde-Schwarz\Analyzer\user\vsa\
Constellation.
```

Parameters:

<Name> string

Path and file name of the *.vam file.

Example:

```
SENS:DDEM:PATT:FORM UQAM
SENS:DDEM:PATT:USER:NAME 'D:\MyModulation.vam'
```

Manual operation: See "[Load User Modulation](#)" on page 173

[SENSe:]DDEMod:PATtern[:STATe] <State>

Determines whether the pattern uses a different modulation type than the data symbols.

Parameters:

<State> ON | OFF | 0 | 1

OFF | 0

The pattern uses the same modulation as the data symbols, defined by [SENSe:]DDEMod:MAPPING[:VALue] on page 327.

ON | 1

The pattern uses a different modulation, configured by [SENSe:]DDEMod:PATtern:MAPPING[:VALue] on page 343.

*RST: 0

Example:

SENS:DDEM:PATT:STAT ON

The pattern uses a different modulation than the data symbols.

Manual operation: See "Modulation Settings for Pattern: Same as for Data Symbols" on page 173

11.5.1.4 Known data

The following commands are required to provide known data to the R&S FPL1000 VSA application.

[SENSe:]DDEMod:KDATA:STATe.....	346
[SENSe:]DDEMod:KDATA[:NAME].....	347
[SENSe:]DDEMod:KDATA:PRBS:FEEDback:AUTO.....	347
[SENSe:]DDEMod:KDATA:PRBS:FEEDback[:STATe].....	347
[SENSe:]DDEMod:KDATA:PRBS:PATtern:AUTO.....	348
[SENSe:]DDEMod:KDATA:PRBS:PATtern[:STATe].....	348
[SENSe:]DDEMod:KDATA:PRBS:POLYnomial:AUTO.....	348
[SENSe:]DDEMod:KDATA:PRBS:POLYnomial[:ORDER].....	349
[SENSe:]DDEMod:KDATA:PRBS[:TYPE].....	349
[SENSe:]DDEMod:KDATA:SOURce.....	349

[SENSe:]DDEMod:KDATA:STATe <State>

This command selects the Known Data state. The use of known data is a prerequisite for the BER measurement and can also be used for the fine sync.

Parameters:

<State> ON | OFF | 0 | 1

OFF | 0

Switches the function off

ON | 1

Switches the function on

*RST: 0

Example:
 DDEM:KDAT:STAT ON
 DDEM:KDAT 'C:\TEMP\KNOWNDATA'

Manual operation: See "[Known Data](#)" on page 181

[SENSe:]DDEMod:KDATA[:NAME] <FileName>

This command selects the Known Data file. Note that known data must be activated ([\[SENSe:\]DDEMod:KDATA:STATE](#)) before you can select a file.

Parameters:
 <FileName>

Example:
 DDEM:KDAT:STAT ON
 DDEM:KDAT 'C:\TEMP\KNOWNDATA'

Manual operation: See "[Load Data File](#)" on page 182

[SENSe:]DDEMod:KDATA:PRBS:FEEDback:AUTO <State>

Determines how the feedback value is calculated.

Parameters:
 <State>

ON | OFF | 0 | 1

OFF | 0

The setting defined by [\[SENSe:\]DDEMod:KDATA:PRBS:FEEDback\[:STATE\]](#) on page 347 is used for all PRBS types.

ON | 1

The feedback value is negated or not, depending on the standard for the used PRBS type.

*RST: 1

Example:
 DDEM:KDAT:PRBS:FEED:AUTO ON

Manual operation: See "[Negate Feedback Path](#)" on page 183

[SENSe:]DDEMod:KDATA:PRBS:FEEDback[:STATE] <State>

Determines how the feedback bit is calculated.

Parameters:
 <State>

ON | OFF | 0 | 1

OFF | 0

The xor connected bit from the specified feedback positions is fed into the last shift register.

ON | 1

The xor connected bit from the specified feedback positions is inverted before it is fed into the last shift register.

*RST: 0

Example:
 DDEM:KDAT:PRBS:FEED:STAT ON

Manual operation: See ["Negate Feedback Path"](#) on page 183

[SENSe:]DDEMod:KDATa:PRBS:PATtern:AUTO <State>

If enabled, the R&S FPL1000 VSA application assumes the pattern is part of the PRBS sequence.

If disabled, configure the setting using the [\[SENSe:\]DDEMod:KDATa:PRBS:PATtern\[:STATe\]](#) command.

Parameters:

<State> ON | OFF | 0 | 1
OFF | 0
 Switches the function off
ON | 1
 Switches the function on
 *RST: 1

Example: SENS:DDEM:KDAT:PRBS:PATT:AUTO ON

Manual operation: See ["Pattern Symbols are Part of PRBS"](#) on page 183

[SENSe:]DDEMod:KDATa:PRBS:PATtern[:STATe] <State>

Determines whether the pattern symbols are part of the PRBS sequence and are thus treated as data symbols.

Parameters:

<State> ON | OFF | 0 | 1
OFF | 0
 The pattern is not part of the PRBS
ON | 1
 The pattern is part of the PRBS
 *RST: 1

Example: SENS:DDEM:KDAT:PRBS:PATT:STAT ON

Manual operation: See ["Pattern Symbols are Part of PRBS"](#) on page 183

[SENSe:]DDEMod:KDATa:PRBS:POLYnomial:AUTO <State>

Determines the coefficients of the polynomial and thus the feedback positions for the PRBS algorithm.

Parameters:

<State> ON | OFF | 0 | 1
OFF | 0
 The coefficients a_0, \dots, a_N of the polynomial must be defined manually using [\[SENSe:\]DDEMod:KDATa:PRBS:POLYnomial\[:ORDER\]](#) on page 349.

ON | 1

Polynomial is defined automatically according to the PRBS type specified by [SENSe:]DDEMod:KDATa:PRBS[:TYPE] on page 349.

*RST: 1

Example: SENS:DDEM:KDAT:PRBS:POLY:AUTO OFF

Manual operation: See "[Generator Polynomial](#)" on page 182

[SENSe:]DDEMod:KDATa:PRBS:POLYnomial[:ORDer] <PRBSPolyOrder>

Determines the coefficients of the polynomial and thus the feedback positions for the PRBS algorithm.

Parameters:

<PRBSPolyOrder> list of polynomial coefficients, separated by semi-colons (;) in descending order

*RST: 9;4;0

Example: SENS:DDEM:KDAT:PRBS:POLY:AUTO OFF

Example: DDEM:KDAT:PRBS:POLY:ORD 9;4;0;

Manual operation: See "[Generator Polynomial](#)" on page 182

[SENSe:]DDEMod:KDATa:PRBS[:TYPE] <PRBSType>

Defines the type of the used PRBS model. The type of the model defines the degree, complexity and number of terms in the polynomial model. If the PRBS data is generated in accordance with the ITU-T standard, no further settings are required.

Parameters:

<PRBSType> 7 | 9 | 11 | 15 | 16 | 20 | 21 | 23 | 31

*RST: 9

Example: DDEM:KDAT:PRBS:TYPE 11

Manual operation: See "[PRBS Type](#)" on page 182

[SENSe:]DDEMod:KDATa:SOURce <SourceFilePRBS>

This command gets/selects the Known Data source

Parameters:

<SourceFilePRBS> FILE | PRBS

Manual operation: See "[Source](#)" on page 182

11.5.2 Input, output and frontend settings

The R&S FPL1000 can analyze signals from different input sources. The frequency and amplitude settings represent the "frontend" of the measurement setup.

Manual configuration of the input and frontend is described in [Chapter 5.4, "Input, output and frontend settings"](#), on page 183.

• RF input.....	350
• Configuring file input.....	353
• Independent CW source commands.....	354
• Output settings.....	355
• Frequency.....	357
• Amplitude settings.....	358
• Scaling and units.....	364

11.5.2.1 RF input

INPut:ATTenuation:PROTection:RESet.....	350
INPut<ip>:CONNector.....	350
INPut<ip>:COUPling.....	351
INPut<ip>:FILTer:SAW.....	351
INPut<ip>:FILTer:YIG[:STATe].....	352
INPut<ip>:IMPedance.....	352
INPut<ip>:IMPedance:PTYPe.....	352
INPut<ip>:SELect.....	353

INPut:ATTenuation:PROTection:RESet

This command resets the attenuator and reconnects the RF input with the input mixer for the R&S FPL1000 after an overload condition occurred and the protection mechanism intervened. The error status bit (bit 3 in the `STAT:QUES:POW` status register) and the `INPUT OVLd` message in the status bar are cleared.

(For details on the status register see the R&S FPL1000 base unit user manual).

The command works only if the overload condition has been eliminated first.

Example: `INP:ATT:PROT:RES`

INPut<ip>:CONNector <ConnType>

Determines which connector the input for the measurement is taken from.

Suffix:

<ip>	1 2
	irrelevant

Parameters:

<ConnType>	RF
	RF input connector

RFProbe

Active RF probe

*RST: RF

Example:

INP:CONN RF

Selects input from the RF input connector.

Manual operation: See "[Input Connector](#)" on page 185**INPut<ip>:COUPling <CouplingType>**

This command selects the coupling type of the RF input.

Suffix:<ip> 1 | 2
irrelevant**Parameters:**<CouplingType> AC | DC
AC
AC coupling
DC
DC coupling
*RST: AC**Example:**

INP:COUP DC

Manual operation: See "[Input Coupling](#)" on page 194**INPut<ip>:FILTer:SAW <State>**

Determines which IF path the R&S FPL1000 hardware uses.

Suffix:<ip> 1 | 2
irrelevant**Parameters:**<State> AUTO | OFF
AUTO
The R&S FPL1000 determines which IF path to use automatically, depending on the used analysis bandwidth.
OFF
The wide IF path is always used.
*RST: I/Q Analyzer: AUTO; VSA: OFF**Example:**

INP:FILT:SAW AUTO

Manual operation: See "[SAW filter](#)" on page 185

INPut<ip>:FILTer:YIG[:STATe] <State>

Enables or disables the YIG filter.

Suffix:

<ip> 1 | 2
 irrelevant

Parameters:

<State> ON | OFF | 0 | 1

Example:

INP:FILT:YIG OFF
Deactivates the YIG-preselector.

Manual operation: See "[YIG-Preselector](#)" on page 186

INPut<ip>:IMPedance <Impedance>

This command selects the nominal input impedance of the RF input. In some applications, only 50 Ω are supported.

Suffix:

<ip> 1 | 2
 irrelevant

Parameters:

<Impedance> 50 | 75

numeric value

User-defined impedance from 50 Ohm to 100000000 Ohm (=100 MOhm)

User-defined values are only available for the Spectrum application, the I/Q Analyzer, and some optional applications.

*RST: 50 Ω

Default unit: OHM

Example:

INP:IMP 75

Manual operation: See "[Impedance](#)" on page 186
See "[Unit](#)" on page 193

INPut<ip>:IMPedance:PTYPe <PadType>

Defines the type of matching pad used for impedance conversion for RF input.

Suffix:

<ip> 1 | 2
 irrelevant

Parameters:

<PadType> SRESistor | MLPad

SRESistor

Series-R

MLPad

Minimum Loss Pad

*RST: SRESistor

Example:

INP:IMP 100

INP:IMP:PTYP MLP

Manual operation: See "[Impedance](#)" on page 186**INPut<ip>:SElect <Source>**

This command selects the signal source for measurements, i.e. it defines which connector is used to input data to the R&S FPL1000.

If no additional input options are installed, only RF input or file input is supported.

Tip: The I/Q data to be analyzed for VSA cannot only be measured by the R&S FPL1000 VSA application itself, it can also be imported to the application, provided it has the correct format. Furthermore, the analyzed I/Q data from the R&S FPL1000 VSA application can be exported for further analysis in external applications.

For details, see the R&S FPL1000 I/Q Analyzer and I/Q Input User Manual.

Suffix:

<ip> 1 | 2
irrelevant

Parameters:

<Source> **RF**
Radio Frequency ("RF INPUT" connector)
*RST: RF

Manual operation: See "[Radio Frequency State](#)" on page 185
See "[I/Q Input File State](#)" on page 187

11.5.2.2 Configuring file input

The following commands are required to define input from a file.

Useful commands for configuring file input described elsewhere:

- [INPut<ip>:SElect](#) on page 353

Remote commands exclusive to configuring input from files:

[INPut<ip>:FILE:PATH](#)..... 353

INPut<ip>:FILE:PATH <FileName>[, <AnalysisBW>]

This command selects the I/Q data file to be used as input for further measurements.

The I/Q data must have a specific format as described in R&S FPL1000 I/Q Analyzer and I/Q Input User Manual.

Suffix:

<ip> 1 | 2
irrelevant

Parameters:

<FileName> String containing the path and name of the source file.
The file extension is *.iq.tar.

<AnalysisBW> Optionally: The analysis bandwidth to be used by the measurement. The bandwidth must be smaller than or equal to the bandwidth of the data that was stored in the file.
Default unit: HZ

Example:

INP:FILE:PATH 'C:\R_S\Instr\user\data.iq.tar'
Uses I/Q data from the specified file as input.

Manual operation: See "[Select I/Q data file](#)" on page 187

11.5.2.3 Independent CW source commands

The following commands are required to configure an internal generator as an independent CW source.

OUTPut<up>[:STATe]	354
SOURce<si>:INTernal:FREQuency	354
SOURce<si>:POWer[:LEVel][:IMMEDIATE][:AMPLitude]	355
SOURce<si>:POWer[:LEVel][:IMMEDIATE]:OFFSet	355

OUTPut<up>[:STATe] <State>

Enables or disables the internal generator. The generator signal is output at the GEN Output 50 Ω connector on the front panel.

Suffix:

<up>

Parameters:

<State> ON | OFF | 0 | 1
OFF | 0
Switches the function off
ON | 1
Switches the function on
*RST: 0

Example:

OUTP ON

Manual operation: See "[State](#)" on page 188

SOURce<si>:INTernal:FREQuency <Frequency>

Defines the frequency of the internal generator signal.

Suffix:

<si> irrelevant

Parameters:

<Frequency> Range: 5 kHz to 3 GHz
 Increment: 0.1 Hz
 *RST: 1 GHz
 Default unit: HZ

Example:

SOUR:INT:FREQ 2 GHz

Manual operation: See "[CW Frequency](#)" on page 188**SOURce<si>:POWER[:LEVel][:IMMediate][:AMPLitude] <Amplitude>**

Defines the output power of the internal generator.

Suffix:

<si> irrelevant

Parameters:

<Amplitude> Range: -60 dBm to +10 dBm
 Increment: 0.1 dB
 *RST: -20 dBm
 Default unit: DBM

Example:

SOUR:POW -30dBm

Manual operation: See "[Level](#)" on page 188**SOURce<si>:POWER[:LEVel][:IMMediate]:OFFSet <Offset>**

This command defines a level offset for the internal generator level. Thus, for example, attenuators or amplifiers at the output of the internal generator can be considered for the setting.

Suffix:

<si> irrelevant

Parameters:

<Offset> Range: -200 dB to +200 dB
 *RST: 0dB
 Default unit: DB

Example:

SOUR:POW:OFFS -10dB

Manual operation: See "[Level Offset](#)" on page 188**11.5.2.4 Output settings**

The following commands are required to query or provide output at the R&S FPL1000 connectors.

DIAGnostic:SERVice:NSO <State>

This command turns the 28 V supply of the BNC connector labeled [noise source control] on the R&S FPL1000 on and off.

Parameters:

<State> ON | OFF | 0 | 1
 OFF | 0
 Switches the function off
 ON | 1
 Switches the function on

Example: DIAG:SERV:NSO ON

Manual operation: See "[Noise Source Control](#)" on page 189

OUTPut<up>:IF:IFFRequency?

This command queries the frequency for the IF output of the R&S FPL1000. The IF output frequency is fixed and cannot be changed.

This command is available in the time domain and if the IF/VIDEO output is configured for IF.

Suffix:

<up>

Return values:

<Frequency> *RST: 25.0 MHz
 Default unit: HZ

Usage: Query only

Manual operation: See "[Data Output](#)" on page 189

OUTPut<up>:IF[:SOURce] <Source>

Defines the type of signal available at one of the output connectors of the R&S FPL1000.

Suffix:

<up>

Parameters:

<Source> **IF**
 The measured IF value is available at the IF/VIDEO output connector.
 This connector is only available if the R&S FPL1-B5 option is installed.
 The frequency at which the IF value is provided is defined using the [OUTPut<up>:IF:IFFRequency?](#) command.

VIDeo

The displayed video signal (i.e. the filtered and detected IF signal, 200mV) is available at the IF/VIDEO output connector. This setting is required to provide demodulated audio frequencies at the output.

*RST: IF

Example:

OUTP:IF VID

Selects the video signal for the IF/VIDEO output connector.

Manual operation: See "Data Output" on page 189

11.5.2.5 Frequency

[SENSe:]FREQuency:CENTer.....	357
[SENSe:]FREQuency:CENTer:STEP.....	357
[SENSe:]FREQuency:CENTer:STEP:AUTO.....	358
[SENSe:]FREQuency:OFFSet.....	358

[SENSe:]FREQuency:CENTer <Frequency>

This command defines the center frequency.

Parameters:

<Frequency> The allowed range and f_{\max} is specified in the data sheet.

*RST: fmax/2

Default unit: Hz

Example:

FREQ:CENT 100 MHz

FREQ:CENT:STEP 10 MHz

FREQ:CENT UP

Sets the center frequency to 110 MHz.

Manual operation: See "Center Frequency" on page 190

[SENSe:]FREQuency:CENTer:STEP <StepSize>

This command defines the center frequency step size.

You can increase or decrease the center frequency quickly in fixed steps using the SENS:FREQ UP AND SENS:FREQ DOWN commands, see [SENSe:]FREQuency:CENTer on page 357.

Parameters:

<StepSize> f_{\max} is specified in the data sheet.

Range: 1 to fMAX

*RST: 0.1 x span

Default unit: Hz

Example: //Set the center frequency to 110 MHz.
 FREQ:CENT 100 MHz
 FREQ:CENT:STEP 10 MHz
 FREQ:CENT UP

Manual operation: See "[Center Frequency Stepsize](#)" on page 190

[SENSe:]FREQuency:CENTer:STEP:AUTO <State>

Defines the step width of the center frequency.

Parameters:

<State> **ON | 1**
 Links the step width to the current standard (currently 1 MHz for all standards)

OFF | 0
 Sets the step width as defined using the FREQ:CENT:STEP command (see [SENSe:]FREQuency:CENTer:STEP on page 357).

Manual operation: See "[Center Frequency Stepsize](#)" on page 190

[SENSe:]FREQuency:OFFSet <Offset>

This command defines a frequency offset.

If this value is not 0 Hz, the application assumes that the input signal was frequency shifted outside the application. All results of type "frequency" will be corrected for this shift numerically by the application.

See also "[Frequency Offset](#)" on page 191.

Parameters:

<Offset> Range: -1 THz to 1 THz
 *RST: 0 Hz
 Default unit: HZ

Example: FREQ:OFFS 1GHZ

Manual operation: See "[Frequency Offset](#)" on page 191

11.5.2.6 Amplitude settings

Amplitude and scaling settings allow you to configure the vertical (y-)axis display and for some result displays also the horizontal (x-)axis.

Useful commands for amplitude settings described elsewhere:

- [INPut<ip>:COUPling](#) on page 351
- [INPut<ip>:IMPedance](#) on page 352
- [INPut<ip>:IMPedance:PTYPe](#) on page 352
- [\[SENSe:\]ADJust:LEVel](#) on page 402

Remote commands exclusive to amplitude settings:

CALCulate<n>:UNIT:POWer.....	359
DISPlay[:WINDow<n>][:SUBWindow<w>]:TRACe<t>:Y[:SCALe]:RLEVel.....	359
DISPlay[:WINDow<n>][:SUBWindow<w>]:TRACe<t>:Y[:SCALe]:RLEVel:OFFSet.....	360
[SENSe:]DDEMod:PRESet:RLEVel.....	360
INPut<ip>:ATTenuation:AUTO:MODE.....	360
INPut<ip>:EGain[:STATe].....	361
INPut<ip>:GAIN:STATe.....	361
INPut<ip>:ATTenuation.....	362
INPut<ip>:ATTenuation:AUTO.....	362
INPut<ip>:EATT.....	363
INPut<ip>:EATT:AUTO.....	363
INPut<ip>:EATT:STATe.....	363

CALCulate<n>:UNIT:POWer <Unit>

This command selects the unit of the y-axis.

The unit applies to all power-based measurement windows with absolute values.

Suffix:

<n> irrelevant

Parameters:

<Unit> DBM | V | A | W | DBPW | WATT | DBUV | DBMV | VOLT |
 DBUA | AMPere
 (Units based on 1 MHz require installed R&S FPL1-K54 (EMI
 measurements) option.)
 *RST: dBm

Example:

CALC:UNIT:POW DBM
 Sets the power unit to dBm.

Manual operation: See "Unit" on page 193

**DISPlay[:WINDow<n>][:SUBWindow<w>]:TRACe<t>:Y[:SCALe]:RLEVel
 <ReferenceLevel>**

This command defines the reference level (for all traces in all windows).

With a reference level offset $\neq 0$, the value range of the reference level is modified by the offset.

Suffix:

<n> irrelevant
 <w> subwindow
 Not supported by all applications
 <t> irrelevant

Parameters:

<ReferenceLevel> The unit is variable.
 Range: see datasheet
 *RST: 0 dBm
 Default unit: DBM

Example: DISP:TRAC:Y:RLEV -60dBm

Manual operation: See ["Reference Level"](#) on page 192

DISPlay[:WINDow<n>][:SUBWindow<w>]:TRACe<t>:Y[:SCALe]:RLEVel:OFFSet
 <Offset>

This command defines a reference level offset (for all traces in all windows).

Suffix:

<n> irrelevant
 <w> subwindow
 Not supported by all applications
 <t> irrelevant

Parameters:

<Offset> Range: -200 dB to 200 dB
 *RST: 0dB
 Default unit: DB

Example: DISP:TRAC:Y:RLEV:OFFS -10dB

Manual operation: See ["Shifting the Display \(Offset\)"](#) on page 193

[SENSe:]DDEMod:PRESet:RLEVel

This command initiates a measurement that evaluates and sets the ideal reference level for the current measurement. This ensures that the settings of the RF attenuation and the reference level are optimally adjusted to the signal level without overloading the R&S FPL1000 or limiting the dynamic range by an S/N ratio that is too small.

Usage: Event

INPut<ip>:ATTenuation:AUTO:MODE <OptMode>

Selects the priority for signal processing *after* the RF attenuation has been applied.

Suffix:

<ip> 1 | 2
 irrelevant

Parameters:

<OptMode> LNOise | LDISTortion
LNOise
 Optimized for high sensitivity and low noise levels

LDIStortion

Optimized for low distortion by avoiding intermodulation

*RST: LDIStortion (WLAN application: LNOise)

Example: INP:ATT:AUTO:MODE LNO

Manual operation: See "[Optimization](#)" on page 195

INPut<ip>:EGAI[n]:STATe] <State>

Before this command can be used, the external preamplifier must be connected to the R&S FPL1000. See the preamplifier's documentation for details.

When activated, the R&S FPL1000 automatically compensates the magnitude and phase characteristics of the external preamplifier in the measurement results.

Note that when an optional external preamplifier is activated, the internal preamplifier is automatically disabled, and vice versa.

When deactivated, no compensation is performed even if an external preamplifier remains connected.

Suffix:

<ip> 1 | 2
irrelevant

Parameters:

<State> ON | OFF | 0 | 1
OFF | 0
No data correction is performed based on the external preamplifier
ON | 1
Performs data corrections based on the external preamplifier
*RST: 0

Example: INP:EGA ON

INPut<ip>:GAIN:STATe <State>

This command turns the internal preamplifier on and off. It requires the optional preamplifier hardware.

If activated, the input signal is amplified by 20 dB. The preamplifier is only active below 3 GHz (R&S FPL1003) or 7.5 GHz (R&S FPL1007).

Suffix:

<ip> 1 | 2
irrelevant

Parameters:

<State> ON | OFF | 0 | 1
OFF | 0
Switches the function off

ON | 1

Switches the function on

*RST: 0

Example:

INP:GAIN:STAT ON

Switches on 20 dB preamplification.

Manual operation: See "[Preamplifier](#)" on page 194**INPut<ip>:ATTenuation <Attenuation>**

This command defines the total attenuation for RF input.

If you set the attenuation manually, it is no longer coupled to the reference level, but the reference level is coupled to the attenuation. Thus, if the current reference level is not compatible with an attenuation that has been set manually, the command also adjusts the reference level.

Suffix:

<ip> 1 | 2
irrelevant

Parameters:

<Attenuation> Range: see data sheet
Increment: 5 dB (with optional electr. attenuator: 1 dB)
*RST: 10 dB (AUTO is set to ON)
Default unit: DB

Example:

INP:ATT 30dB

Defines a 30 dB attenuation and decouples the attenuation from the reference level.

Manual operation: See "[Attenuation Mode / Value](#)" on page 194**INPut<ip>:ATTenuation:AUTO <State>**

This command couples or decouples the attenuation to the reference level. Thus, when the reference level is changed, the R&S FPL1000 determines the signal level for optimal internal data processing and sets the required attenuation accordingly.

For the R&S FPL1000, these commands are identical.

Suffix:

<ip> 1 | 2
irrelevant

Parameters:

<State> ON | OFF | 0 | 1
*RST: 1

Example:

INP:ATT:AUTO ON

Couples the attenuation to the reference level.

Manual operation: See "[Attenuation Mode / Value](#)" on page 194

INPut<ip>:EATT <Attenuation>

This command defines an electronic attenuation manually. Automatic mode must be switched off (`INP:EATT:AUTO OFF`, see `INPut<ip>:EATT:AUTO` on page 363).

If the current reference level is not compatible with an attenuation that has been set manually, the command also adjusts the reference level.

This command requires the electronic attenuation hardware option.

Suffix:

<ip> 1 | 2
irrelevant

Parameters:

<Attenuation> attenuation in dB
Range: see data sheet
Increment: 1 dB
*RST: 0 dB (OFF)
Default unit: DB

Example:

```
INP:EATT:AUTO OFF
INP:EATT 10 dB
```

Manual operation: See ["Using Electronic Attenuation"](#) on page 195

INPut<ip>:EATT:AUTO <State>

This command turns automatic selection of the electronic attenuation on and off.

If on, electronic attenuation reduces the mechanical attenuation whenever possible.

This command requires the electronic attenuation hardware option.

Suffix:

<ip> 1 | 2
irrelevant

Parameters:

<State> ON | OFF | 0 | 1
OFF | 0
Switches the function off
ON | 1
Switches the function on
*RST: 1

Example:

```
INP:EATT:AUTO OFF
```

Manual operation: See ["Using Electronic Attenuation"](#) on page 195

INPut<ip>:EATT:STATe <State>

This command turns the electronic attenuator on and off.

This command requires the electronic attenuation hardware option.

Suffix:

<ip> 1 | 2
irrelevant

Parameters:

<State> ON | OFF | 0 | 1
OFF | 0
Switches the function off
ON | 1
Switches the function on
*RST: 0

Example:

INP:EATT:STAT ON
Switches the electronic attenuator into the signal path.

Manual operation: See ["Using Electronic Attenuation"](#) on page 195

11.5.2.7 Scaling and units

Useful commands for scaling described elsewhere:

- [DISPlay\[:WINDow<n>\]\[:SUBWindow<w>\]:TRACe<t>:Y\[:SCALE\]:AUTO ONCE](#) on page 400
- [DISPlay\[:WINDow<n>\]:TRACe<t>:X\[:SCALE\]:VOFFset](#) on page 385
- [CALCulate<n>:UNIT:POWer](#) on page 359

Remote commands exclusive to scaling and units:

CALCulate<n>:STATistics:PRESet	365
CALCulate<n>:STATistics:SCALE:AUTO ONCE	365
CALCulate<n>:STATistics:SCALE:X:BCOunt	365
CALCulate<n>:STATistics:SCALE:Y:LOWer	365
CALCulate<n>:STATistics:SCALE:Y:UPPer	366
CALCulate<n>:STATistics:SCALE:Y:UNIT	366
CALCulate<n>:UNIT:ANGLE	366
CALCulate<n>:X:UNIT:TIME	367
CALCulate<n>:Y:UNIT:TIME	367
DISPlay[:WINDow<n>]:TRACe<t>:X[:SCALE]:PDIVision	367
DISPlay[:WINDow<n>]:TRACe<t>:X[:SCALE]:RPOSition	367
DISPlay[:WINDow<n>]:TRACe<t>:X[:SCALE]:RVALue	368
DISPlay[:WINDow<n>][:SUBWindow<w>]:TRACe<t>:Y[:SCALE]	368
DISPlay[:WINDow<n>][:SUBWindow<w>]:TRACe<t>:Y[:SCALE]:PDIVision	368
DISPlay[:WINDow<n>][:SUBWindow<w>]:TRACe<t>:Y[:SCALE]:RPOSition	369
DISPlay[:WINDow<n>][:SUBWindow<w>]:TRACe<t>:Y[:SCALE]:RVALue	369
DISPlay[:WINDow<n>][:SUBWindow<w>]:TRACe<t>:Y:SPACing	370

CALCulate<n>:STATistics:PRESet**Suffix:**

<n> 1..n
[Window](#)

Usage: Event

Manual operation: See "[Default Settings](#)" on page 198

CALCulate<n>:STATistics:SCALE:AUTO ONCE

This command initiates an automatic scaling of the diagram (x- and y-axis).

To obtain maximum resolution, the level range is set as a function of the measured spacing between peak power and the minimum power for the APD measurement and of the spacing between peak power and mean power for the CCDF measurement. In addition, the probability scale for the number of test points is adapted.

To get valid results, you have to perform a complete sweep with synchronization to the end of the auto range process. This is only possible in single sweep mode.

Suffix:

<n> [Window](#)

Manual operation: See "[Auto Scale Once/Auto Scale Window](#)" on page 197
See "[Adjust Settings](#)" on page 198

CALCulate<n>:STATistics:SCALE:X:BCOunt <StatNofColumns>

This command defines the number of columns for the statistical distribution.

Suffix:

<n> 1..n
[Window](#)

Parameters:

<StatNofColumns> Range: 2 to 1024
*RST: 101
Default unit: none

Manual operation: See "[Quantize](#)" on page 198

CALCulate<n>:STATistics:SCALE:Y:LOWer <Magnitude>

This command defines the lower vertical limit of the diagram.

Suffix:

<n> [Window](#)

Parameters:

<Magnitude> The number is a statistical value and therefore dimensionless.
Range: 1E-9 to 0.1
*RST: 1E-6

Example: `CALC:STAT:SCAL:Y:LOW 0.001`

Manual operation: See ["Defining Min and Max Values"](#) on page 197

CALCulate<n>:STATistics:SCALe:Y:UPPer <Magnitude>

This command defines the upper vertical limit of the diagram.

Suffix:

<n> [Window](#)

Parameters:

<Magnitude> The number is a statistical value and therefore dimensionless.

Range: 1E-5 to 1.0

*RST: 1.0

Example: `CALC:STAT:SCAL:Y:UPP 0.01`

Manual operation: See ["Defining Min and Max Values"](#) on page 197

CALCulate<n>:STATistics:SCALe:Y:UNIT <Unit>

This command selects the unit of the y-axis.

Suffix:

<n> [Window](#)

Parameters:

<Unit> PCT | ABS

*RST: ABS

Example: `CALC:STAT:SCAL:Y:UNIT PCT`
Sets the percentage scale.

Manual operation: See ["Y-Axis Unit"](#) on page 199

CALCulate<n>:UNIT:ANGLe <Unit>

This command selects the global unit for phase results.

Suffix:

<n> irrelevant

Setting parameters:

<Unit> DEG | RAD

*RST: RAD

Manual operation: See ["Y-Axis Unit"](#) on page 199

CALCulate<n>:X:UNIT:TIME <Unit>**Suffix:**

<n> 1..n
[Window](#)

Parameters:

<Unit> S | SYM

Manual operation: See "[X-Axis Unit](#)" on page 199

CALCulate<n>:Y:UNIT:TIME <Unit>**Suffix:**

<n> 1..n
[Window](#)

Parameters:

<Unit> S | SYM

Manual operation: See "[Y-Axis Unit](#)" on page 199

DISPlay[:WINDow<n>]:TRACe<t>:X[:SCALe]:PDIVision <PDiv>

This command defines the scaling of the x-axis for statistical result displays.

For all other result displays, this command is only available as a query.

Suffix:

<n> 1..n
[Window](#)

<t> 1..6
[Trace](#)

Parameters:

<PDiv> Defines the range per division (total range = 10* \langle PDiv \rangle)

Manual operation: See "[Range per Division](#)" on page 199

DISPlay[:WINDow<n>]:TRACe<t>:X[:SCALe]:RPOSition <RPos>

This command defines the position of the reference value for the X axis.

Setting the position of the reference value is possible only for statistical result displays. All other result displays support the query only.

Suffix:

<n> 1..n
[Window](#)

<t> 1..6
[Trace](#)

Parameters:

<RPos> <numeric_value>
 Default unit: PCT

Example:

DISP:TRAC:X:RPOS 30 PCT
 The reference value is shifted by 30% towards the left.

Manual operation: See "[X-Axis Reference Position](#)" on page 198

DISPlay[:WINDow<n>]:TRACe<t>:X[:SCALe]:RVALue <RVal>

This command defines the reference value for the x-axis for statistical result displays.
 For all other result displays, this command is only available as a query.

Suffix:

<n> 1..n
 [Window](#)

<t> 1..6
 [Trace](#)

Parameters:

<RVal> Reference value for the x-axis

Manual operation: See "[X-Axis Reference Value](#)" on page 198

DISPlay[:WINDow<n>][:SUBWIndow<w>]:TRACe<t>:Y[:SCALe] <Range>

This command defines the display range of the y-axis (for all traces).

Suffix:

<n> [Window](#)

<w> subwindow
 Not supported by all applications

<t> irrelevant

Example: DISP:TRAC:Y 110dB

DISPlay[:WINDow<n>][:SUBWIndow<w>]:TRACe<t>:Y[:SCALe]:PDIVision
 <Value>

This remote command determines the grid spacing on the Y-axis for all diagrams, where possible.

In spectrum displays, for example, this command is not available.

Suffix:

<n> [Window](#)

<w> subwindow
 Not supported by all applications

<t> irrelevant

Parameters:

<Value> numeric value WITHOUT UNIT (unit according to the result display)
 Defines the range per division (total range = 10*<Value>)
 *RST: depends on the result display
 Default unit: DBM

Example:

DISP:TRAC:Y:PDIV 10
 Sets the grid spacing to 10 units (e.g. dB) per division

Manual operation: See "[Range per Division](#)" on page 198

DISPlay[:WINDow<n>][:SUBWindow<w>]:TRACe<t>:Y[:SCALe]:RPOsition
 <Position>

This command defines the vertical position of the reference level on the display grid (for all traces).

The R&S FPL1000 adjusts the scaling of the y-axis accordingly.

Suffix:

<n> [Window](#)
 <w> subwindow
 Not supported by all applications
 <t> irrelevant

Parameters:

<Position> 0 PCT corresponds to the lower display border, 100 percent corresponds to the upper display border.
 *RST: frequency display: 90 PCT; time display: 50 PCT;
 AF spectrum display (K7): 100 PCT;
 Default unit: PCT

Example:

DISP:TRAC:Y:RPOS 50PCT

Manual operation: See "[Y-Axis Reference Position](#)" on page 197

DISPlay[:WINDow<n>][:SUBWindow<w>]:TRACe<t>:Y[:SCALe]:RVALue <Value>

This command defines the reference value assigned to the reference position in the specified window. Separate reference values are maintained for the various displays.

Suffix:

<n> [Window](#)
 <w> subwindow
 <t> irrelevant

Parameters:

<Value> Default unit: DB

Example: `DISP:TRAC:Y:RVAL 0`
Sets the value assigned to the reference position to 0 Hz

Manual operation: See "[Y-Axis Reference Value](#)" on page 197

DISPlay[:WINDow<n>][:SUBWindow<w>]:TRACe<t>:Y:SPACing <ScalingType>

This command selects the scaling of the y-axis (for all traces, <t> is irrelevant).

Suffix:

<n> [Window](#)
<w> subwindow
<t> [Trace](#)

Parameters:

<ScalingType> **LOGarithmic**
Logarithmic scaling.
LINear
Linear scaling in %.
LDB
Linear scaling in the specified unit.
PERCent
Linear scaling in %.
*RST: `LOGarithmic`

Example: `DISP:TRAC:Y:SPAC LIN`
Selects linear scaling in %.

Manual operation: See "[Y-Axis Unit](#)" on page 199

11.5.3 Signal capture

The signal capture commands define how much, how and when data is captured from the input signal.

The tasks for manual operation are described in [Chapter 5.5, "Signal capture"](#), on page 200.

[SENSe:]DDEMod:PRATe	370
[SENSe:]DDEMod:RENgth:AUTO	371
[SENSe:]DDEMod:RENgth[:VALue]	371
[SENSe:]DDEMod:RENgth:SYMBOLs[:VALue]	372
[SENSe:]SWAPiq	372
TRACe:IQ:BWIDth	372

[SENSe:]DDEMod:PRATe <CaptOverSampling>

Defines the number of samples that are captured per symbol, i.e. the factor by which the symbol rate is multiplied to obtain the sample rate. This parameter also affects the demodulation bandwidth and thus the usable I/Q bandwidth.

The sample rate depends on the defined [Symbol Rate](#) (see [Chapter 4.2, "Sample rate, symbol rate and I/Q bandwidth"](#), on page 76).

Parameters:

<CaptOverSampling> | 2 | 4 | 8 | 16 | 32 | 64 | 128

The factor by which the symbol rate is multiplied to obtain the sample rate, e.g. 4 samples per symbol:
sample rate = 4*symbol rate

Example:

DDEM:PRAT 8
Captures 8 points per symbol.

Manual operation: See ["Sample Rate"](#) on page 201

[SENSe:]DDEMod:RLENgth:AUTO <State>

If enabled, the capture length is automatically adapted as required according to the current result length, burst and pattern search settings, and network-specific characteristics (e.g. burst and frame structures).

Parameters:

<State>

Manual operation: See ["Capture Length Settings"](#) on page 200

[SENSe:]DDEMod:RLENgth[:VALue] <RecordLength>

This command defines or queries the capture length for further processing, e.g. for burst search.

Note that the maximum capture length depends on the sample rate for signal capture (see [\[SENSe:\]DDEMod:PRATe](#) on page 370).

Parameters:

<RecordLength> The capture length can be defined in time (seconds) or symbols (SYM). The return value is always in time (s). To query the capture length in symbols, use the [\[SENSe:\]DDEMod:RLENgth:SYMBOLs\[:VALue\]](#) command.

Default unit: S

Example:

```
DDEM:RLEN 1000 SYM
// Sets a capture length of 1000 symbols.
:SENSe1:DDEMod:RLENgth:VALue?
// Returns the capture length in seconds:
0.00026041667
DDEM:RLEN 10
// Sets a capture length of 10 seconds.
```

Example: See [Chapter 11.13.2, "Measurement example 2: GSM EDGE burst measurement based on a digital standard"](#), on page 495

Manual operation: See ["Capture Length Settings"](#) on page 200

[SENSe:]DDEMod:RENgth:SYMBOLs[:VALue] <RecordLength>

This command defines the capture length for further processing, e.g. for burst search, in symbols.

Note that the maximum record length depends on the sample rate for signal capture (see [SENSe:]DDEMod:PRATe on page 370). The maximum record length (in symbols) can be calculated as:

$$\text{Recordlength}_{\text{MAX}} = 256000 / \text{<points per symbol>}$$

Parameters:

<RecordLength> Default unit: SYM

Example: DDEMod:RENgth:SYMB 1000

Manual operation: See "[Capture Length Settings](#)" on page 200

[SENSe:]SWAPiq <State>

This command defines whether or not the recorded I/Q pairs should be swapped (I<->Q) before being processed. Swapping I and Q inverts the sideband.

This is useful if the DUT interchanged the I and Q parts of the signal; then the R&S FPL1000 can do the same to compensate for it.

Parameters:

<State> **ON | 1**
 I and Q signals are interchanged
 Inverted sideband, Q+j*I
 OFF | 0
 I and Q signals are not interchanged
 Normal sideband, I+j*Q
 *RST: 0

Manual operation: See "[Swap I/Q](#)" on page 201

TRACe:IQ:BWIDth <Bandwidth>

This command queries the bandwidth in Hz of the resampling filter ("Usable I/Q Bandwidth").

Parameters:

<Bandwidth> Usable I/Q bandwidth
 Default unit: Hz

Example: TRAC1:IQ:BWID?

Manual operation: See "[Usable I/Q Bandwidth](#)" on page 201

11.5.4 Triggering measurements

The trigger commands define the beginning of a measurement.

Tasks for manual configuration are described in [Chapter 5.5.2, "Trigger settings"](#), on page 201.

TRIGger[:SEQuence]:DTIME	373
TRIGger[:SEQuence]:HOLDoff[:TIME]	373
TRIGger[:SEQuence]:IFPower:HOLDoff	373
TRIGger[:SEQuence]:IFPower:HYSTeresis	374
TRIGger[:SEQuence]:SLOPe	374
TRIGger[:SEQuence]:SOURce	374

TRIGger[:SEQuence]:DTIME <DropoutTime>

Defines the time the input signal must stay below the trigger level before a trigger is detected again.

Parameters:

<DropoutTime> Dropout time of the trigger.
 Range: 0 s to 10.0 s
 *RST: 0 s
 Default unit: S

Manual operation: See "[Drop-Out Time](#)" on page 204

TRIGger[:SEQuence]:HOLDoff[:TIME] <Offset>

Defines the time offset between the trigger event and the start of the measurement.

Parameters:

<Offset> The allowed range is 0 s to 30 s.
 *RST: 0 s
 Default unit: S

Example: TRIG:HOLD 500us

Manual operation: See "[Trigger Offset](#)" on page 203

TRIGger[:SEQuence]:IFPower:HOLDoff <Period>

This command defines the holding time before the next trigger event.

Note that this command can be used for **any trigger source**, not just IF Power (despite the legacy keyword).

Note: If you perform gated measurements in combination with the IF Power trigger, the R&S FPL1000 ignores the holding time for frequency sweep, FFT sweep, zero span and I/Q data measurements.

Parameters:

<Period> Range: 0 s to 10 s
 *RST: 0 s
 Default unit: S

Example: TRIG:SOUR EXT
Sets an external trigger source.
TRIG:IFP:HOLD 200 ns
Sets the holding time to 200 ns.

Manual operation: See "[Trigger Holdoff](#)" on page 204

TRIGger[:SEQuence]:IFPower:HYSTeresis <Hysteresis>

This command defines the trigger hysteresis, which is only available for "IF Power" trigger sources.

Parameters:

<Hysteresis> Range: 3 dB to 50 dB
 *RST: 3 dB
 Default unit: DB

Example: TRIG:SOUR IFP
Sets the IF power trigger source.
TRIG:IFP:HYST 10DB
Sets the hysteresis limit value.

Manual operation: See "[Hysteresis](#)" on page 203

TRIGger[:SEQuence]:SLOPe <Type>

For all trigger sources except time, you can define whether triggering occurs when the signal rises to the trigger level or falls down to it.

Parameters:

<Type> POSitive | NEGative
POSitive
Triggers when the signal rises to the trigger level (rising edge).
NEGative
Triggers when the signal drops to the trigger level (falling edge).
*RST: POSitive

Example: TRIG:SLOP NEG

Manual operation: See "[Slope](#)" on page 204

TRIGger[:SEQuence]:SOURce <Source>

This command selects the trigger source.

Note on external triggers:

If a measurement is configured to wait for an external trigger signal in a remote control program, remote control is blocked until the trigger is received and the program can continue. Make sure that this situation is avoided in your remote control programs.

Parameters:

<Source>

IMMediate
Free Run

EXTernal
Trigger signal from the "Trigger Input" connector.
Trigger signal from the "Trigger In" connector.

IFPower
Second intermediate frequency

*RST: IMMediate

Example:

TRIG:SOUR EXT
Selects the external trigger input as source of the trigger signal

Manual operation:

See ["Trigger Source"](#) on page 202
See ["Free Run"](#) on page 202
See ["External Trigger 1"](#) on page 202
See ["IF Power"](#) on page 203
See ["I/Q Power"](#) on page 203

11.5.5 Configuring sweeps

The sweep commands define how often data from the input signal is acquired and then evaluated.

Manual configuration of the sweeps is described in [Chapter 5.5.3, "Sweep settings"](#), on page 204.

[SENSe:]DDEMod:SEARch:MBURst:CALC	375
[SENSe:]SWEep:COUNT	375
[SENSe:]SWEep:COUNT:CURRent?	376

[SENSe:]DDEMod:SEARch:MBURst:CALC <SelectResRangeNr>

Sets the result range to be displayed after a single sweep (e.g. a burst number).

Parameters:

<SelectResRangeNr>

Example:

See [Chapter 11.13.2, "Measurement example 2: GSM EDGE burst measurement based on a digital standard"](#), on page 495.

Manual operation:

See ["Select Result Rng"](#) on page 206

[SENSe:]SWEep:COUNT <SweepCount>

This command defines the number of measurements that the application uses to average traces.

In continuous measurement mode, the application calculates the moving average over the average count.

In single measurement mode, the application stops the measurement and calculates the average after the average count has been reached.

Parameters:

<SweepCount> When you set a sweep count of 0 or 1, the R&S FPL1000 performs one single measurement in single measurement mode. In continuous measurement mode, if the sweep count is set to 0, a moving average over 10 measurements is performed.

Range: 0 to 200000

*RST: 0

Example:

SWE:COUN 64

Sets the number of measurements to 64.

INIT:CONT OFF

Switches to single measurement mode.

INIT;*WAI

Starts a measurement and waits for its end.

Manual operation: See "[Statistic Count](#)" on page 205

[SENSe:]SWEep:COUNT:CURRent? <Counter>

This command queries the current statistics counter value which indicates how many result ranges have been evaluated. For results that use the capture buffer as a source, the number of used capture buffers can be queried.

Parameters:

<Value> The number of evaluated result ranges or capture buffers.

Query parameters:

<Counter> CAPTure | STATistics

STATistics

Returns the number of result ranges that have been evaluated.

CAPTure

Returns the number of used capture buffers evaluated.

*RST: STATistics

Example:

SWE:COUN:CURR? CAPT

Usage:

Query only

11.5.6 Configuring bursts and patterns

The burst and pattern search settings can be configured, and new patterns can be defined.

Manual configuration of bursts and patterns is described in [Chapter 5.6, "Burst and pattern configuration"](#), on page 206.

- [Burst search](#).....377
- [Pattern searches](#).....379
- [Configuring patterns](#).....381

11.5.6.1 Burst search

The burst search commands define when a burst is detected in the analyzed signal.

[SENSe:]DDEMod:SEARch:BURSt:AUTO	377
[SENSe:]DDEMod:SEARch:BURSt:CONFigure:AUTO	377
[SENSe:]DDEMod:SEARch:BURSt:GLENgtH[:MINimum]	377
[SENSe:]DDEMod:SEARch:BURSt:MODE	378
[SENSe:]DDEMod:SEARch:BURSt:STATe	378
[SENSe:]DDEMod:SEARch:BURSt:TOLerance	378

[SENSe:]DDEMod:SEARch:BURSt:AUTO <AutoBurstSearch>

This command links the burst search to the type of signal. When a signal is marked as bursted, burst search is switched on automatically.

Parameters:

<AutoBurstSearch> AUTO | MANual

Example:

```
:DDEM:SEAR:BURS:AUTO AUTO
Enables auto burst search
```

Manual operation: See ["Enabling Burst Searches"](#) on page 207

[SENSe:]DDEMod:SEARch:BURSt:CONFigure:AUTO <State>

This command sets the search tolerance and the min gap length to their default values.

Parameters:

<State> ON | OFF | 0 | 1
OFF | 0
 Switches the function off
ON | 1
 Switches the function on
 *RST: 1

Example:

```
SENS:DDEM:SEAR:BURS:CONF:AUTO ON
```

Manual operation: See ["Burst Configuration"](#) on page 208

[SENSe:]DDEMod:SEARch:BURSt:GLENgtH[:MINimum] <MinGapLength>

This command defines the minimum time between two bursts. A minimum time with decreased level must occur between two bursts. The default unit is symbol. The value can also be given in seconds.

Parameters:

<MinGapLength> Range: 1 to 15000
 *RST: 1
 Default unit: SYM

Manual operation: See "[Min Gap Length](#)" on page 208

[SENSe:]DDEMod:SEARch:BURSt:MODE <MeasOnlyOnBurst>

This command sets the vector analyzer so that a measurement is performed only if a burst is found. The command is available only if the burst search is activated (see [\[SENSe:\]DDEMod:SEARch:BURSt:STATe](#) on page 378).

Parameters:

<MeasOnlyOnBurst> MEAS | BURS

MEAS
 Measurement is always performed

BURS
 Measurement is performed only if a burst is found

Manual operation: See "[Measuring only if burst was found](#)" on page 208

[SENSe:]DDEMod:SEARch:BURSt:STATe <State>

This command switches the search for a signal burst on or off.

Parameters:

<State> ON | OFF | 0 | 1

OFF | 0
 Switches the function off

ON | 1
 Switches the function on

*RST: 0

Example: DDEMod:SEAR:BURSt:STATe OFF
 Switch burst search off.

[SENSe:]DDEMod:SEARch:BURSt:TOLerance <Tolerance>

This command controls burst search tolerance.

Parameters:

<Tolerance> Range: 1 to 15000
 *RST: 1
 Default unit: SYM

Example: :DDEMod:SEAR:BURSt:TOL 1
 Sets the burst tolerance to 1

Manual operation: See "[Search Tolerance](#)" on page 208

11.5.6.2 Pattern searches

The pattern search commands define when a pattern is detected in the analyzed signal.

[SENSe:]DDEMod:SEARch:PATtern:CONFigure:AUTO.....	379
[SENSe:]DDEMod:SEARch:SYNC:AUTO.....	379
[SENSe:]DDEMod:SEARch:SYNC:IQCThreshold.....	379
[SENSe:]DDEMod:SEARch:SYNC:MODE.....	379
[SENSe:]DDEMod:SEARch:SYNC:SElect.....	380
[SENSe:]DDEMod:SEARch:SYNC:STATe.....	380

[SENSe:]DDEMod:SEARch:PATtern:CONFigure:AUTO <State>

Parameters:

<State>

Manual operation: See "[I/Q Correlation Threshold](#)" on page 210

[SENSe:]DDEMod:SEARch:SYNC:AUTO <AutoPattSearch>

This command links the pattern search to the type of signal. When a signal is marked as patterned, pattern search is switched on automatically.

Parameters:

<AutoPattSearch> AUTO | MANual
 *RST: AUTO

Example: DDEM:SEAR:SYNC AUTO
 Enables auto pattern search

Manual operation: See "[Enabling Pattern Searches](#)" on page 209

[SENSe:]DDEMod:SEARch:SYNC:IQCThreshold <CorrelationLev>

This command sets the I/Q correlation threshold for pattern matching in percent. A high level means stricter matching.

Parameters:

<CorrelationLev> Range: 10.0 to 100.0
 *RST: 90.0
 Default unit: PCT

Example: SENS:DDEM:SEAR:SYNC:IQCT 85.5

Manual operation: See "[I/Q Correlation Threshold](#)" on page 210

[SENSe:]DDEMod:SEARch:SYNC:MODE <MeasOnlyOnPatt>

This command sets the vector analyzer so that the measurement is performed only if the measurement was synchronous to the selected sync pattern.

The command is available only if the pattern search is activated (see [SENSe:]DDEMod:SEARch:SYNC:STATe on page 380).

Parameters:

<MeasOnlyOnPatt> MEAS | SYNC

MEAS

The measurement is performed independently of successful synchronization

SYNC

The measured values are displayed and considered in the error evaluation only if the set sync pattern was found. Bursts with a wrong sync pattern (sync not found) are ignored. If an invalid or no sync pattern is found, the measurement waits and resumes running only when a valid sync pattern is found.

Manual operation: See "[Meas only if Pattern Symbols Correct](#)" on page 210

[SENSe:]DDEMod:SEARch:SYNC:SElect <Filename>

This command selects a predefined sync pattern file.

Parameters:

<Filename>

Example: DDEM:SEAR:SYNC:SEL 'GSM_TSC0'

Example: See [Chapter 11.13.3, "Measurement example 3: user-defined pattern search and limit check"](#), on page 498.

Manual operation: See "[Selected Pattern for Search](#)" on page 210
See "[Standard Patterns - selecting an assigned pattern](#)" on page 211

[SENSe:]DDEMod:SEARch:SYNC:STATe <State>

This command switches the search for a sync sequence on or off.

Parameters:

<State> ON | OFF | 0 | 1

OFF | 0

Switches the function off

ON | 1

Switches the function on

*RST: 0

Example: DDEM:SEAR:SYNC ON 'Switches the sync search on.'

Manual operation: See "[Enabling Pattern Searches](#)" on page 209
See "[Pattern Search On](#)" on page 213

11.5.6.3 Configuring patterns

New patterns can be defined and assigned to a signal standard.

Useful commands for configuring patterns described elsewhere:

- [\[SENSe:\]DDEMod:SEARch:SYNC:STATe](#) on page 380
- [\[SENSe:\]DDEMod:SEARch:SYNC:CATalog](#) on page 333
- [\[SENSe:\]DDEMod:BORDERing](#) on page 388

Remote commands exclusive to configuring patterns:

[SENSe:]DDEMod:SEARch:SYNC:COMMeNt	381
[SENSe:]DDEMod:SEARch:SYNC:COpy	381
[SENSe:]DDEMod:SEARch:SYNC:DELeTe	382
[SENSe:]DDEMod:SEARch:SYNC:DATA	382
[SENSe:]DDEMod:SEARch:SYNC:NAME	382
[SENSe:]DDEMod:SEARch:SYNC:NSTate	383
[SENSe:]DDEMod:SEARch:SYNC:PATTeRn:ADD	383
[SENSe:]DDEMod:SEARch:SYNC:PATTeRn:REMOve	383
[SENSe:]DDEMod:SEARch:SYNC:TEXT	383

[SENSe:]DDEMod:SEARch:SYNC:COMMeNt <Comment>

This command defines a comment to a sync pattern. The pattern must have been selected before using [\[SENSe:\]DDEMod:SEARch:SYNC:NAME](#) on page 382.

Parameters:

<Comment>

Example: See [Chapter 11.13.3, "Measurement example 3: user-defined pattern search and limit check"](#), on page 498.

Manual operation: See ["Edit"](#) on page 212
 See ["New"](#) on page 213
 See ["Comment"](#) on page 215

[SENSe:]DDEMod:SEARch:SYNC:COpy <Pattern>

This command copies a pattern file. The pattern to be copied must have been selected before using [\[SENSe:\]DDEMod:SEARch:SYNC:NAME](#) on page 382.

Tip: In manual operation, a pattern can be copied in the editor by storing it under a new name.

Setting parameters:

<Pattern>

Example: : DDEMod:SEAR:SYNC:NAME 'GSM_TSC0'
 Selects the pattern.
 : DDEMod:SEAR:SYNC:COpy 'GSM_PATT'
 Copies "GSM_TSC0" to GSM_PATT.

Usage: Setting only

Manual operation: See ["Save As"](#) on page 212

[SENSe:]DDEMod:SEARch:SYNC:DELeTe

This command deletes a sync sequence. The sync sequence to be deleted must have been selected before using [\[SENSe:\]DDEMod:SEARch:SYNC:NAME](#) on page 382.

Usage: Event

Manual operation: See ["Delete"](#) on page 213

[SENSe:]DDEMod:SEARch:SYNC:DATA <Data>

This command defines the sync sequence of a sync pattern. The pattern must have been selected before using [\[SENSe:\]DDEMod:SEARch:SYNC:NAME](#) on page 382.

Important: The value range of a symbol depends on the degree of modulation, e.g. for an 8PSK modulation the value range is from 0 to 7. The degree of modulation belongs to the pattern and is set using the `DDEM:SEAR:SYNC:NST` command (see [\[SENSe:\]DDEMod:SEARch:SYNC:NSTate](#) on page 383).

Parameters:

<Data> Four values represent a symbol (hexadecimal format). The value range of a symbol depends on the degree of modulation.
 With a degree of modulation of 4, all symbols have a value range of: 0000, 0001, 0002, 0003
 With a degree of modulation of 8:
 0000, 0001, 0002, 0003, 0004, 0005, 0006, 0007

Example: `DDEM:SEAR:SYNC:DATA '00010000FFFF'`
 Defines the pattern data.

Example: See [Chapter 11.13.3, "Measurement example 3: user-defined pattern search and limit check"](#), on page 498.

Manual operation: See ["Edit"](#) on page 212
 See ["New"](#) on page 213
 See ["Symbols"](#) on page 215

[SENSe:]DDEMod:SEARch:SYNC:NAME <Name>

Parameters:

<Name>

Example: See [Chapter 11.13.3, "Measurement example 3: user-defined pattern search and limit check"](#), on page 498.

Manual operation: See ["Edit"](#) on page 212
 See ["New"](#) on page 213
 See ["Name"](#) on page 214

[SENSe:]DDEMod:SEARch:SYNC:NStAtE <NState>

This command selects the degree of modulation (number of permitted states). The pattern must have been selected before using [\[SENSe:\]DDEMod:SEARch:SYNC:NAME](#) on page 382.

The number of permitted states depends on the modulation mode.

Parameters:

<NState>

Example: See [Chapter 11.13.3, "Measurement example 3: user-defined pattern search and limit check"](#), on page 498.

Manual operation: See ["Mod. order"](#) on page 215

[SENSe:]DDEMod:SEARch:SYNC:PATtern:ADD <AddPattern>

This command adds a pattern to the current standard. Using the `DDEMod:SEAR:SYNC:SEL` command, only those patterns can be selected which belong to the current standard (see [\[SENSe:\]DDEMod:SEARch:SYNC:SElect](#) on page 380).

Setting parameters:

<AddPattern>

Example: See [Chapter 11.13.3, "Measurement example 3: user-defined pattern search and limit check"](#), on page 498.

Usage: Setting only

Manual operation: See ["Adding patterns to a standard"](#) on page 212

[SENSe:]DDEMod:SEARch:SYNC:PATtern:REMOve <Pattern>

This command deletes one or all patterns from the current standard.

Setting parameters:

<Pattern>

Example: `SENS:DDEMod:SEAR:SYNC:PATT:REM 'pattern'`

Usage: Setting only

Manual operation: See ["Removing patterns from a standard"](#) on page 212

[SENSe:]DDEMod:SEARch:SYNC:TEXT <Text>

This command defines a text to explain the pattern. The text is displayed only in the selection menu (manual control). This text should be short and concise. Detailed information about the pattern is given in the comment (see [\[SENSe:\]DDEMod:SEARch:SYNC:COMMeNt](#) on page 381).

Parameters:

<Text>

- Example:** See [Chapter 11.13.3, "Measurement example 3: user-defined pattern search and limit check"](#), on page 498.
- Manual operation:** See ["Edit"](#) on page 212
 See ["New"](#) on page 213
 See ["Description"](#) on page 214

11.5.7 Defining the result range

The result range determines which part of the capture buffer, burst or pattern is displayed.

Manual configuration of the result range is described in [Chapter 5.7, "Result range configuration"](#), on page 216.

Useful commands for result ranges described elsewhere:

- [\[SENSe:\]DDEMod:SEARCH:MBURst:START\[:SYMBOLs\]?](#) on page 460
- [DISPlay\[:WINDOW<n>\]:TRACe<t>:X\[:SCALE\]:STOP?](#) on page 451

Remote commands exclusive to defining result ranges:

CALCulate<n>:TRACe<t>:ADJust:ALIGNment[:DEFault]	384
CALCulate<n>:TRACe<t>:ADJust:ALIGNment:OFFSet	385
CALCulate<n>:TRACe<t>:ADJust:VALue	385
DISPlay[:WINDOW<n>]:TRACe<t>:X[:SCALE]:VOFFset	385
[SENSe:]DDEMod:TIME	386
[SENSe:]DDEMod:TIME:AUTO	386

CALCulate<n>:TRACe<t>:ADJust:ALIGNment[:DEFault] <Alignment>

This command defines where the reference point is to appear in the result range.

Suffix:

<n>	1..n Window
<t>	1..6 Trace

Parameters:

<Alignment>	LEFT CENTer RIGHT
	LEFT
	The reference point is at the start of the result range.
	CENTer
	The reference point is in the middle of the result range.
	RIGHT
	The reference point is displayed at the end of the result range.
	*RST: LEFT

- Example:** See [Chapter 11.13.2, "Measurement example 2: GSM EDGE burst measurement based on a digital standard"](#), on page 495.

Manual operation: See ["Alignment"](#) on page 217

CALCulate<n>:TRACe<t>:ADJJust:ALIGNment:OFFSet <FitOffset>

Suffix:

<n>	1..n Window
<t>	1..6 Trace

Parameters:

<FitOffset> Default unit: SYM

Example: See [Chapter 11.13.2, "Measurement example 2: GSM EDGE burst measurement based on a digital standard"](#), on page 495.

Manual operation: See ["Offset"](#) on page 217

CALCulate<n>:TRACe<t>:ADJJust[:VALue] <Reference>

This command defines the reference point for the display.

Suffix:

<n>	1..n Window
<t>	1..6 Trace

Parameters:

<Reference> TRIGger | BURSt | PATtern

TRIGger

The reference point is defined by the start of the capture buffer.

BURSt

The reference point is defined by the start/center/end of the burst.

PATtern

The instrument selects the reference point and the alignment.

*RST: TRIGger

Example: See [Chapter 11.13.2, "Measurement example 2: GSM EDGE burst measurement based on a digital standard"](#), on page 495.

Manual operation: See ["Reference"](#) on page 217

DISPlay[:WINDow<n>]:TRACe<t>:X[:SCALe]:VOFFset <VOffset>

This command defines an offset to numbering of the symbols (Except capture buffer).

Suffix:

<n> 1..n
Window

<t> 1..6
Trace

Parameters:

<VOffset> Range: -100000 to 100000
*RST: 0
Default unit: none

Example: See [Chapter 11.13.2, "Measurement example 2: GSM EDGE burst measurement based on a digital standard"](#), on page 495.

Example: :DISP:TRAC:X:VOFF 20
Adds an offset of 20 to the number of the symbols.

Manual operation: See ["Symbol Number at <Reference> Start"](#) on page 218

[SENSe:]DDEMod:TIME <ResultLength>

The command determines the number of displayed symbols (result length).

Setting parameters:

<ResultLength> numeric value
Range: 10 to 64000
*RST: 800
Default unit: Sym

Example: See [Chapter 11.13.2, "Measurement example 2: GSM EDGE burst measurement based on a digital standard"](#), on page 495.

Manual operation: See ["Result Length"](#) on page 217

[SENSe:]DDEMod:TIME:AUTO <State>

Determines how the result length is defined for multi-modulation analysis.

This command is only available if the additional Multi-Modulation Analysis option (R&S FPL1000-K70M) is installed.

Parameters:

<State> ON | OFF | 0 | 1
OFF | 0
The result length is specified by [\[SENSe:\]DDEMod:TIME](#).
ON | 1
The result length is set to the number defined in the currently loaded Frame Structure file.
*RST: 0

Example: `DDEM:TIME:AUTO ON`
The result range is the value determined by the loaded Frame Structure file.

Manual operation: See ["According to Frame Structure File"](#) on page 217

11.5.8 Demodulation settings

During demodulation of the vector signal some undesired effects that may occur during transmission can be compensated for. Furthermore, you can influence the synchronization process.

Manual configuration of the demodulation process is described in [Chapter 5.8, "Demodulation settings"](#), on page 218.

Useful commands for demodulation described elsewhere:

- [Chapter 11.5.1.4, "Known data"](#), on page 346

Remote commands exclusive to demodulation:

<code>[SENSe:]DDEMod:BORDERing</code>	388
<code>[SENSe:]DDEMod:ECALc[:MODE]</code>	388
<code>[SENSe:]DDEMod:ECALc:OFFSet</code>	388
<code>[SENSe:]DDEMod:EPRate:AUTO</code>	389
<code>[SENSe:]DDEMod:EPRate[:VALue]</code>	389
<code>[SENSe:]DDEMod:EQUalizer:FILE:FORMat</code>	390
<code>[SENSe:]DDEMod:EQUalizer:LENGth</code>	390
<code>[SENSe:]DDEMod:EQUalizer:LOAD</code>	390
<code>[SENSe:]DDEMod:EQUalizer:MODE</code>	391
<code>[SENSe:]DDEMod:EQUalizer:RESet</code>	391
<code>[SENSe:]DDEMod:EQUalizer:SAVE</code>	391
<code>[SENSe:]DDEMod:EQUalizer[:STATe]</code>	392
<code>[SENSe:]DDEMod:FSYNc:AUTO</code>	392
<code>[SENSe:]DDEMod:FSYNc:LEVel</code>	392
<code>[SENSe:]DDEMod:FSYNc:RESult?</code>	392
<code>[SENSe:]DDEMod:FSYNc[:MODE]</code>	393
<code>[SENSe:]DDEMod:NORMalize:ADRoop</code>	393
<code>[SENSe:]DDEMod:NORMalize:CFDRift</code>	393
<code>[SENSe:]DDEMod:NORMalize:CHANnel</code>	394
<code>[SENSe:]DDEMod:NORMalize:FDERror</code>	394
<code>[SENSe:]DDEMod:NORMalize:IQIMbalance</code>	394
<code>[SENSe:]DDEMod:NORMalize:IQOFFset</code>	395
<code>[SENSe:]DDEMod:NORMalize:IQSKew</code>	395
<code>[SENSe:]DDEMod:NORMalize:SRERror</code>	395
<code>[SENSe:]DDEMod:OPTimization</code>	396
<code>[SENSe:]DDEMod:SEARch:PATtern:SYNc:AUTO</code>	396
<code>[SENSe:]DDEMod:SEARch:PATtern:SYNc[:STATe]</code>	396

[SENSe:]DDEMod:BORDERing <BitOrdering>

Determines how the bits in the symbols are ordered in all symbol displays.

Parameters:

<BitOrdering> MSB | LSB

LSB

Least-significant bit first (used in Bluetooth specification, for example)

MSB

Most significant bit first (default)

*RST: MSB

Example: DDEM:BORD LSB

Manual operation: See "[Bit Ordering](#)" on page 225

[SENSe:]DDEMod:ECALc[:MODE] <EvmCalc>

This command defines the calculation formula for EVM.

Parameters:

<EvmCalc> SIGNal | SYMBol | MECPower | MACPower

SIGNal

Calculation normalized to the mean power of the reference signal at the symbol instants.

SYMBol

Calculation normalized to the maximum power of the reference signal at the symbol instants.

MECPower

Calculation normalized to the mean expected power of the measurement signal at the symbol instants

MACPower

Calculation normalized to the maximum expected power of the measurement signal at the symbol instants

*RST: SIGNal

Manual operation: See "[Normalize EVM to](#)" on page 223

[SENSe:]DDEMod:ECALc:OFFSet <State>

Configures the way the VSA application calculates the error vector results for offset QPSK.

Parameters:

<State>

ON | 1

VSA application compensates the delay of the Q component with respect to the I component in the measurement signal as well as the reference signal before calculating the error vector. That means that the error vector contains only one symbol instant per symbol period.

OFF | 0

The VSA application subtracts the measured signal from the reference signal to calculate the error vector. This method results in the fact that the error vector contains two symbol instants per symbol period: one that corresponds to the I component and one that corresponds to the Q component.

Manual operation: See ["Offset EVM"](#) on page 225

[SENSe:]DDEMod:EPRate:AUTO <State>

Defines how many sample points are used at each symbol to calculate modulation accuracy results automatically.

If enabled, the VSA application uses the following settings, depending on the modulation type:

Modulation	Est. Points
PSK, QAM	1
Offset QPSK	2
FSK, MSK	Sample rate (see [SENSe:]DDEMod:PRATe on page 370)

Parameters:

<State>

Manual operation: See ["Estimation Points/Sym"](#) on page 223

[SENSe:]DDEMod:EPRate[:VALue] <EstOverSampling>

Defines how many sample points are used at each symbol to calculate modulation accuracy results.

For more information see ["Estimation points per symbol"](#) on page 147.

You can also let the VSA application decide how many estimation points to use, see [\[SENSe:\]DDEMod:EPRate:AUTO](#) on page 389.

Parameters:

<EstOverSampling> **1**
the estimation algorithm takes only the symbol time instants into account

2
two points per symbol instant are used (required for Offset QPSK)

4 | 8 | 16 | 32

the number of samples per symbol defined in the signal capture settings is used (see [SENSe:]DDEMod:PRATe on page 370), i.e. all sample time instants are weighted equally

*RST: 1

Manual operation: See "Estimation Points/Sym" on page 223

[SENSe:]DDEMod:EQualizer:FILE:FORMat <EqFormat>

Determines the file format for stored equalizer results.

Parameters:

<EqFormat>

VAE | FRES

VAE

To be used as an equalizer file in VSA applications

FRES

To be used as a user-defined frequency response correction file in any other application that supports it

*RST: VAE

Example: DDEM:EQU:FILE:FORM FRES

Manual operation: See "Save/Load Equalizer" on page 222

[SENSe:]DDEMod:EQualizer:LENGth <Length>

This command defines the length of the equalizer in terms of symbols.

Parameters:

<Length>

Range: 1 to 256

*RST: 10

Default unit: SYMB

Example: DDEM:EQU:LENG 101

Sets the equalizer length to 101 symbols.

Manual operation: See "Filter Length" on page 221

[SENSe:]DDEMod:EQualizer:LOAD <FileName>

This command selects a user-defined equalizer. The equalizer mode is automatically switched to USER (see [SENSe:]DDEMod:EQualizer:MODE on page 391).

Parameters:

<FileName>

Path and file name (without extension)

Example:

DDEM:EQU:LOAD 'D:\MyEqualizer'

Selects equalizer named MyEqualizer in directory D.

Manual operation: See "Save/Load Equalizer" on page 222

[SENSe:]DDEMod:EQualizer:MODE <Mode>

Switches between the equalizer modes.

For details see [Chapter 4.4.6, "The equalizer"](#), on page 123.

Parameters:

<Mode>

NORMal

Switches the equalizer on for the next sweep.

TRACking

Switches the equalizer on; the results of the equalizer in the previous sweep are considered to calculate the new filter.

FREeze

The filter is no longer changed, the current equalizer values are used for subsequent sweeps.

USER

A user-defined equalizer loaded from a file is used.

AVERaging

Switches the equalizer on; the results of the equalizer in all previous sweeps (since the instrument was switched on or the equalizer was reset) are considered to calculate the new filter.

To start a new averaging process, use the [\[SENSe:\]DDEMod:EQualizer:RESet](#) on page 391 command.

*RST: TRACking

Example:

```
DDEM:EQU:MODE TRAC
```

Activates the tracking mode of the equalizer.

Manual operation: See ["Mode"](#) on page 221

[SENSe:]DDEMod:EQualizer:RESet

This command deletes the data of the currently selected equalizer. After deletion, training can start again using the command `DDEM:EQU:MODE TRA` (see [\[SENSe:\]DDEMod:EQualizer:MODE](#) on page 391).

Usage: Event

Manual operation: See ["Reset Equalizer"](#) on page 221

[SENSe:]DDEMod:EQualizer:SAVE <FileName>

This command saves the current equalizer results to a file.

Parameters:

<FileName> File name

Example:

```
DDEM:EQU:SAVE 'D:\MyEqualizer'
```

Saves the current equalizer results to `D:\MyEqualizer.vae`.

Manual operation: See ["Save/Load Equalizer"](#) on page 222

[SENSe:]DDEMod:EQualizer[:STATe] <State>

This command activates or deactivates the equalizer.

For more information on the equalizer see [Chapter 4.4.6, "The equalizer"](#), on page 123.

Parameters:

<State> *RST: 0

Example: DDEM: EQU OFF

Manual operation: See "[State](#)" on page 221

[SENSe:]DDEMod:FSYNc:AUTO <State>

This command selects manual or automatic Fine Sync

Parameters:

<State> ON | OFF | 0 | 1
OFF | 0
Switches the function off
ON | 1
Switches the function on
*RST: 0

Example: SENS: DDEM: FSYN: AUTO ON

Manual operation: See "[Fine Synchronization](#)" on page 224

[SENSe:]DDEMod:FSYNc:LEVel <SERLevel>

This command sets the Fine Sync Level if fine sync works on Known Data

Parameters:

<SERLevel> Range: 0.0 to 100.0
*RST: 10.0
Default unit: PCT

Example: SENSe: DDEMod: FSYNc: LEVel 10.0

Manual operation: See "[If SER ≤](#)" on page 225

[SENSe:]DDEMod:FSYNc:RESult?

Queries the result of the fine sync.

Return values:

<Result> ON | OFF | 0 | 1
OFF | 0
fine sync with known data failed
ON | 1
fine sync with known data successful

Usage: Query only

Manual operation: See "[Fine Synchronization](#)" on page 224

[SENSe:]DDEMod:FSYNc[:MODE] <FineSync>

This command defines the fine synchronization mode used to calculate results, e.g. the bit error rate.

Note: You can define a maximum symbol error rate (SER) for the known data in reference to the analyzed data. If the SER of the known data exceeds this limit, the default synchronization using the detected data is performed. See [\[SENSe:\]DDEMod:FSYNc:LEVel](#) on page 392.

Parameters:

<FineSync> KDATA | PATTErn | DDATA

KDATA

(Default) The reference signal is defined as the data sequence from the loaded Known Data file that most closely matches the measured data.

PATTErn

The reference signal is estimated from the defined pattern.

This setting requires an activated pattern search, see [\[SENSe:\]DDEMod:SEARCh:SYNC:STATe](#) on page 380.

DDATA

The reference signal is estimated from the detected data.

Manual operation: See "[Fine Synchronization](#)" on page 224

[SENSe:]DDEMod:NORMALize:ADRooP <State>

Parameters:

<State>

Manual operation: See "[Compensate for... \[\(PSK, MSK, ASK, QAM\)\]](#)" on page 220

[SENSe:]DDEMod:NORMALize:CFDRift <State>

This command defines whether the carrier frequency drift is compensated for FSK modulation.

Parameters:

<State>

Manual operation: See "[Compensate for... \[\(FSK\)\]](#)" on page 220

[SENSe:]DDEMod:NORMAlize:CHANnel <State>

This command switches the channel compensation on or off. (With equalizer only)

Parameters:

<State> ON | OFF | 0 | 1
 OFF | 0
 Switches the function off
 ON | 1
 Switches the function on
 *RST: 0

Example: DDEM:NORM:CHAN OFF
 Switches the compensation off.

Manual operation: See "[Compensate for... \[\(PSK, MSK, ASK, QAM\)\]](#)" on page 220

[SENSe:]DDEMod:NORMAlize:FDERror <State>

This command defines whether the deviation error is compensated for when calculating the frequency error for FSK modulation.

Parameters:

<State> ON | 1
 Scales the reference signal to the actual deviation of the measurement signal.
 OFF | 0
 Uses the entered nominal deviation for the reference signal.

Manual operation: See "[Compensate for... \[\(FSK\)\]](#)" on page 220

[SENSe:]DDEMod:NORMAlize:IQIMbalance <State>

This command switches the compensation of the I/Q imbalance on or off.

Parameters:

<State> ON | OFF | 0 | 1
 OFF | 0
 Switches the function off
 ON | 1
 Switches the function on
 *RST: 0

Example: DDEM:NORM:IQIM OFF
 Switches the compensation off.

Manual operation: See "[Compensate for... \[\(PSK, MSK, ASK, QAM\)\]](#)" on page 220

[SENSe:]DDEMod:NORMAlize:IQOffset <State>

This command switches the compensation of the I/Q offset on or off.

Parameters:

<State> ON | OFF | 0 | 1
 OFF | 0
 Switches the function off
 ON | 1
 Switches the function on
 *RST: 0

Example: DDEM:NORM:IQOF OFF
 Switches the compensation off.

Manual operation: See "[Compensate for... \[\(PSK, MSK, ASK, QAM\)\]](#)" on page 220

[SENSe:]DDEMod:NORMAlize:IQSkew <State>

This command switches the compensation of the I/Q skew on or off.

Parameters:

<State> ON | OFF | 0 | 1
 OFF | 0
 Switches the function off
 ON | 1
 Switches the function on
 *RST: 0

Manual operation: See "[Compensate for... \[\(PSK, MSK, ASK, QAM\)\]](#)" on page 220

[SENSe:]DDEMod:NORMAlize:SRERror <State>

This command switches the compensation for symbol rate error on or off

Parameters:

<State> ON | OFF | 0 | 1
 OFF | 0
 Switches the function off
 ON | 1
 Switches the function on
 *RST: 0

Example: DDEM:NORM:SRER OFF
 Switches the compensation for symbol rate error off.

Manual operation: See "[Compensate for... \[\(PSK, MSK, ASK, QAM\)\]](#)" on page 220

[SENSe:]DDEMod:OPTimization <Criterion>

This command determines the optimization criteria for the demodulation.

Parameters:

<Criterion> RMSMin | EVMMin

RMSMin

Optimizes calculation such that the RMS of the error vector is minimal.

EVMMin

Optimizes calculation such that EVM is minimal.

*RST: RMSMin (depends on selected standard)

Example:

DDEM:OPT RMSMin

Minimizes the RMS of the error vector.

Manual operation: See "[Optimization](#)" on page 223

[SENSe:]DDEMod:SEARch:PATtern:SYNC:AUTO <UseWfmForSync>

This command selects manual or automatic synchronization with a pattern waveform to speed up measurements.

Parameters:

<UseWfmForSync> AUTO | MANual

Manual operation: See "[Coarse Synchronization](#)" on page 224

[SENSe:]DDEMod:SEARch:PATtern:SYNC[:STATe] <State>

This command switches fast synchronization on and off, if you manually synchronize with a waveform pattern.

Parameters:

<State> ON | OFF | 0 | 1

OFF | 0

Switches the function off

ON | 1

Switches the function on

*RST: 0

Manual operation: See "[Coarse Synchronization](#)" on page 224

11.5.9 Measurement filter settings

You can configure the measurement filter to be used.

Manual configuration of the measurement filter is described in [Chapter 5.9, "Measurement filter settings"](#), on page 226.

For more information on measurement filters, refer to [Chapter 4.1.4, "Measurement filters"](#), on page 72.

Useful commands for defining measurement filters described elsewhere:

- [\[SENSe:\]DDEMod:FILTer:ALPHa](#) on page 325
- [\[SENSe:\]DDEMod:FILTer\[:STATe\]](#) on page 325

Remote commands exclusive to configuring measurement filters:

[SENSe:]DDEMod:MFILter:ALPHa	397
[SENSe:]DDEMod:MFILter:AUTO	397
[SENSe:]DDEMod:MFILter:NAME	397
[SENSe:]DDEMod:MFILter[:STATe]	398
[SENSe:]DDEMod:MFILter:USER	398

[SENSe:]DDEMod:MFILter:ALPHa <MeasFiltAlphaBT>

This command sets the alpha value of the measurement filter.

Parameters:

<MeasFiltAlphaBT> Range: 0.03 to 1.0
 *RST: 0.22
 Default unit: none

Manual operation: See ["Alpha/BT"](#) on page 227

[SENSe:]DDEMod:MFILter:AUTO <State>

If this command is set to "ON", the measurement filter is defined automatically depending on the transmit filter (see [\[SENSe:\]DDEMod:TFILter:NAME](#) on page 330).

Parameters:

<State> *RST: 1

Manual operation: See ["Using the Transmit Filter as a Measurement Filter \(Auto\)"](#) on page 226

[SENSe:]DDEMod:MFILter:NAME <Name>

This command selects a measurement filter and automatically sets its state to "ON".

Parameters:

<Name> Name of the measurement filter or 'User' for a user-defined filter.
 An overview of available measurement filters is provided in [Chapter C.2, "Measurement filters"](#), on page 512.

Manual operation: See ["Type"](#) on page 227

[SENSe:]DDEMod:MFILter[:STATe] <State>

Use this command to switch the measurement filter off. To switch a measurement filter on, use the `[SENSe:]DDEMod:MFILter:NAME` command.

Parameters:

<State>	OFF 0 Switches the measurement filter off.
	ON 1 Switches the measurement filter specified by <code>[SENSe:]DDEMod:MFILter:NAME</code> on. However, this command is not necessary, as the <code>[SENSe:]DDEMod:MFILter:NAME</code> command automatically switches the selected filter on.
	*RST: ON

Manual operation: See "Type" on page 227

[SENSe:]DDEMod:MFILter:USER <FilterName>

This command selects the user-defined measurement filter.

For details on user-defined filters, see [Chapter 4.1.5, "Customized filters"](#), on page 74.

Parameters:

<FilterName> Name of the user-defined filter

Example:

```
SENS:DDEM:MFIL:NAME 'USER'
Selects user filter mode for the meas filter
ENS:DDEM:MFIL:USER 'D:\MyMeasFilter'
Selects the user-defined meas filter
```

Manual operation: See "Type" on page 227
See "Load User Filter" on page 227

11.5.10 Defining the evaluation range

The evaluation range defines which range of the result is to be evaluated.

Manual configuration of the evaluation range is described in [Chapter 5.10, "Evaluation range configuration"](#), on page 228.

<code>CALCulate<n>:ELIN<ri>:STATe</code>	398
<code>CALCulate<n>:ELIN<ri>[:VALue]</code>	399

CALCulate<n>:ELIN<ri>:STATe <State>

This command restricts the evaluation range. The evaluation range is considered for the following display types:

- eye diagrams
- constellation diagrams
- modulation accuracy

- statistic displays
- spectrum displays

Suffix:

<n> 1..n
Window

<ri> 1..n
irrelevant

Parameters:

<State> **ON | 1**
The evaluation range extends from the start value defined by `CALC:ELIN1:VAL` to the stop value defined by `CALC:ELIN2:VAL` (see `CALCulate<n>:ELIN<ri>[:VALue]` on page 399).

OFF | 0

The complete result area is evaluated.

*RST: 0

Example: See [Chapter 11.13.2, "Measurement example 2: GSM EDGE burst measurement based on a digital standard"](#), on page 495.

Manual operation: See ["Evaluating the Entire Result Range"](#) on page 229

CALCulate<n>:ELIN<ri>[:VALue] <LeftDisp>

Defines the start and stop values for the evaluation range (see `CALCulate<n>:ELIN<ri>:STATe` on page 398).

Suffix:

<n> 1..n
Window

<ri> 1..n
1: start value, 2: stop value

Parameters:

<LeftDisp> Range: 0 to 1000000
*RST: 0
Default unit: SYM

Example: See [Chapter 11.13.2, "Measurement example 2: GSM EDGE burst measurement based on a digital standard"](#), on page 495.

Manual operation: See ["Start / Stop"](#) on page 229

11.5.11 Adjusting settings automatically

Some settings can be adjusted by the R&S FPL1000 automatically according to the current measurement settings.

Manual execution of automatic adjustment functions is described in [Chapter 5.11, "Adjusting settings automatically"](#), on page 229.

DISPlay[:WINDow<n>][:SUBWindow<w>]:TRACe<t>:Y[:SCALe]:AUTO ONCE.....	400
DISPlay[:WINDow<n>]:TRACe<t>:Y[:SCALe]:AUTO:ALL.....	400
[SENSe:]ADJust:CONFIgure:LEVel:DURation.....	400
[SENSe:]ADJust:CONFIgure:LEVel:DURation:MODE.....	401
[SENSe:]ADJust:CONFIgure:HYSteresis:LOWer.....	401
[SENSe:]ADJust:CONFIgure:HYSteresis:UPPer.....	402
[SENSe:]ADJust:CONFIgure:TRIGger.....	402
[SENSe:]DDEMod:PRESet:RLEVel.....	402
[SENSe:]ADJust:LEVel.....	402

DISPlay[:WINDow<n>][:SUBWindow<w>]:TRACe<t>:Y[:SCALe]:AUTO ONCE

Automatic scaling of the y-axis is performed once, then switched off again (for all traces).

(Not available for statistical results.)

Suffix:

<n>	Window
<t>	irrelevant

Manual operation: See ["Auto Scale Once/Auto Scale Window"](#) on page 197

DISPlay[:WINDow<n>]:TRACe<t>:Y[:SCALe]:AUTO:ALL

Automatic scaling of the y-axis is performed once in all windows, then switched off again.

Suffix:

<n>	1..n Window
<t>	1..6 Trace

Usage: Event

Manual operation: See ["Auto Scale All"](#) on page 231

[SENSe:]ADJust:CONFIgure:LEVel:DURation <Duration>

To determine the ideal reference level, the R&S FPL1000 performs a measurement on the current input data. This command defines the length of the measurement if [\[SENSe:\]ADJust:CONFIgure:LEVel:DURation:MODE](#) is set to `MANual`.

Parameters:

<Duration>	Numeric value in seconds
	Range: 0.001 to 16000.0
	*RST: 0.001
	Default unit: s

Example: `ADJ:CONF:DUR:MODE MAN`
 Selects manual definition of the measurement length.
`ADJ:CONF:LEV:DUR 5ms`
 Length of the measurement is 5 ms.

Manual operation: See "[Changing the Automatic Measurement Time \(Meas Time Manual\)](#)" on page 230

[SENSe:]ADJust:CONFigure:LEVel:DURation:MODE <Mode>

To determine the ideal reference level, the R&S FPL1000 performs a measurement on the current input data. This command selects the way the R&S FPL1000 determines the length of the measurement .

Parameters:

<Mode>

AUTO

The R&S FPL1000 determines the measurement length automatically according to the current input data.

MANual

The R&S FPL1000 uses the measurement length defined by [\[SENSe:\]ADJust:CONFigure:LEVel:DURation](#) on page 400.

*RST: AUTO

Manual operation: See "[Resetting the Automatic Measurement Time \(Meas Time Auto\)](#)" on page 230
 See "[Changing the Automatic Measurement Time \(Meas Time Manual\)](#)" on page 230

[SENSe:]ADJust:CONFigure:HYSTeresis:LOWer <Threshold>

When the reference level is adjusted automatically using the [\[SENSe:\]ADJust:LEVel](#) on page 402 command, the internal attenuators and the preamplifier are also adjusted. To avoid frequent adaptation due to small changes in the input signal, you can define a hysteresis. This setting defines a lower threshold the signal must fall below (compared to the last measurement) before the reference level is adapted automatically.

Parameters:

<Threshold>

Range: 0 dB to 200 dB

*RST: +1 dB

Default unit: dB

Example: `SENS:ADJ:CONF:HYST:LOW 2`

For an input signal level of currently 20 dBm, the reference level is only adjusted when the signal level falls below 18 dBm.

Manual operation: See "[Lower Level Hysteresis](#)" on page 231

[SENSe:]ADJust:CONFigure:HYSTeresis:UPPer <Threshold>

When the reference level is adjusted automatically using the [\[SENSe:\]ADJust:LEVel](#) on page 402 command, the internal attenuators and the preamplifier are also adjusted. To avoid frequent adaptation due to small changes in the input signal, you can define a hysteresis. This setting defines an upper threshold the signal must exceed (compared to the last measurement) before the reference level is adapted automatically.

Parameters:

<Threshold> Range: 0 dB to 200 dB
 *RST: +1 dB
 Default unit: dB

Example: SENS:ADJ:CONF:HYST:UPP 2

Example: For an input signal level of currently 20 dBm, the reference level is only adjusted when the signal level rises above 22 dBm.

Manual operation: See "[Upper Level Hysteresis](#)" on page 230

[SENSe:]ADJust:CONFigure:TRIGger <State>

Defines the behavior of the measurement when adjusting a setting automatically (using SENS:ADJ:LEV ON, for example).

Parameters:

<State> ON | OFF | 0 | 1
 OFF | 0
 Switches the function off
 ON | 1
 Switches the function on

[SENSe:]DDEMod:PRESet:RLEVel**[SENSe:]ADJust:LEVel**

Initiates a single (internal) measurement that evaluates and sets the ideal reference level for the current input data and measurement settings. Thus, the settings of the RF attenuation and the reference level are optimized for the signal level. The R&S FPL1000 is not overloaded and the dynamic range is not limited by an S/N ratio that is too small.

Example: ADJ:LEV

Manual operation: See "[Setting the Reference Level Automatically \(Auto Level\)](#)" on page 193

11.6 Performing a measurement

When the VSA application is activated, a continuous sweep is performed automatically. However, you can stop and start a new measurement any time.

Furthermore, you can perform a sequence of measurements using the Sequencer (see "Multiple Measurement Channels and Sequencer Function" on page 18).

ABORt.....	403
INITiate<n>:CONMeas.....	404
INITiate<n>:CONTinuous.....	404
INITiate<n>[:IMMEDIATE].....	405
INITiate:REFMeas.....	405
INITiate:SEQuencer:ABORt.....	405
INITiate:SEQuencer:IMMEDIATE.....	405
INITiate:SEQuencer:MODE.....	406
SYSTem:SEQuencer.....	406

ABORt

This command aborts the measurement in the current channel setup and resets the trigger system.

To prevent overlapping execution of the subsequent command before the measurement has been aborted successfully, use the *OPC? or *WAI command after ABOR and before the next command.

For details on overlapping execution see [Remote control via SCPI](#).

To abort a sequence of measurements by the Sequencer, use the `INITiate:SEQuencer:ABORt` command.

Note on blocked remote control programs:

If a sequential command cannot be completed, for example because a triggered sweep never receives a trigger, the remote control program will never finish and the remote channel to the R&S FPL1000 is blocked for further commands. In this case, you must interrupt processing on the remote channel first in order to abort the measurement.

To do so, send a "Device Clear" command from the control instrument to the R&S FPL1000 on a parallel channel to clear all currently active remote channels. Depending on the used interface and protocol, send the following commands:

- **Visa:** `viClear()`

Now you can send the `ABORt` command on the remote channel performing the measurement.

Example:

```
ABOR; :INIT:IMM
```

Aborts the current measurement and immediately starts a new one.

Example: ABOR; *WAI
 INIT: IMM
 Aborts the current measurement and starts a new one once
 abortion has been completed.

Usage: Event

INITiate<n>:CONMeas

This command restarts a (single) measurement that has been stopped (using `ABORT`) or finished in single measurement mode.

The measurement is restarted at the beginning, not where the previous measurement was stopped.

Suffix:
 <n> irrelevant

Manual operation: See "[Continue Single Sweep](#)" on page 205

INITiate<n>:CONTInuous <State>

This command controls the measurement mode for an individual channel setup.

Note that in single measurement mode, you can synchronize to the end of the measurement with `*OPC`, `*OPC?` or `*WAI`. In continuous measurement mode, synchronization to the end of the measurement is not possible. Thus, it is not recommended that you use continuous measurement mode in remote control, as results like trace data or markers are only valid after a single measurement end synchronization.

For details on synchronization see [Remote control via SCPI](#).

If the measurement mode is changed for a channel setup while the Sequencer is active (see [INITiate:SEQuencer:IMMediate](#) on page 405), the mode is only considered the next time the measurement in that channel setup is activated by the Sequencer.

Suffix:
 <n> irrelevant

Parameters:
 <State> ON | OFF | 0 | 1
 ON | 1
 Continuous measurement
 OFF | 0
 Single measurement
 *RST: 1 (some applications can differ)

Example: INIT:CONT OFF
 Switches the measurement mode to single measurement.
 INIT:CONT ON
 Switches the measurement mode to continuous measurement.

Manual operation: See "[Continuous Sweep / Run Cont](#)" on page 204

INITiate<n>[:IMMEDIATE]

This command starts a (single) new measurement.

For a statistics count > 0, this means a restart of the corresponding number of measurements. With trace mode MAXHold, MINHold and AVERage, the previous results are reset on restarting the measurement.

You can synchronize to the end of the measurement with *OPC, *OPC? or *WAI.

For details on synchronization see [Remote control via SCPI](#).

Suffix:

<n> irrelevant

Manual operation: See "[Single Sweep / Run Single](#)" on page 205

INITiate:REFMeas

Repeats the evaluation of the data currently in the capture buffer without capturing new data.

Usage: Event

Manual operation: See "[Refresh](#)" on page 205

INITiate:SEQuencer:ABORt

This command stops the currently active sequence of measurements.

You can start a new sequence any time using [INITiate:SEQuencer:IMMEDIATE](#) on page 405.

Usage: Event

INITiate:SEQuencer:IMMEDIATE

This command starts a new sequence of measurements by the Sequencer.

Before this command can be executed, the Sequencer must be activated (see [SYSTem:SEQuencer](#) on page 406).

Example:

```
SYST:SEQ ON
```

Activates the Sequencer.

```
INIT:SEQ:MODE SING
```

Sets single sequence mode so each active measurement is performed once.

```
INIT:SEQ:IMM
```

Starts the sequential measurements.

INITiate:SEQuencer:MODE <Mode>

Defines the capture mode for the entire measurement sequence and all measurement groups and channels it contains.

Note: To synchronize to the end of a measurement sequence using *OPC, *OPC? or *WAI, use **SINGLe** Sequencer mode.

Parameters:

<Mode>

SINGle

Each measurement group is started one after the other in the order of definition. All measurement channels in a group are started simultaneously and performed once. After *all* measurements are completed, the next group is started. After the last group, the measurement sequence is finished.

CONTInuous

Each measurement group is started one after the other in the order of definition. All measurement channels in a group are started simultaneously and performed once. After *all* measurements are completed, the next group is started. After the last group, the measurement sequence restarts with the first one and continues until it is stopped explicitly.

*RST: CONTInuous

SYSTem:SEQuencer <State>

This command turns the Sequencer on and off. The Sequencer must be active before any other Sequencer commands (**INIT:SEQ...**) are executed, otherwise an error occurs.

A detailed programming example is provided in the "Operating Modes" chapter in the R&S FPL1000 User Manual.

Parameters:

<State>

ON | OFF | 0 | 1

ON | 1

The Sequencer is activated and a sequential measurement is started immediately.

OFF | 0

The Sequencer is deactivated. Any running sequential measurements are stopped. Further Sequencer commands (**INIT:SEQ...**) are not available.

*RST: 0

Example:

```

SYST:SEQ ON
Activates the Sequencer.
INIT:SEQ:MODE SING
Sets single Sequencer mode so each active measurement is
performed once.
INIT:SEQ:IMM
Starts the sequential measurements.
SYST:SEQ OFF

```

11.7 Analysis

General result analysis settings concerning the trace, markers, windows etc. can be configured.

- [Configuring traces](#).....407
- [Working with markers](#).....411
- [Configuring display lines for eye diagrams](#)..... 423
- [Configuring modulation accuracy limit lines](#).....427

11.7.1 Configuring traces

The trace settings determine how the measured data is analyzed and displayed on the screen. Depending on the result display, between 1 and 6 traces may be displayed.

Manual configuration of traces is described in [Chapter 6.1, "Trace settings"](#), on page 233.



Commands for storing trace data are described in [Chapter 11.9.1, "Retrieving trace data and marker values"](#), on page 449.

Useful commands for trace configuration described elsewhere:

- `DISPlay[:WINDow<n>][:SUBWindow<w>]:TRACe<t>:Y[:SCALe]`
on page 368

Remote commands exclusive to trace configuration:

<code>CALCulate<n>:TRACe<t>[:VALue]</code>	407
<code>CALCulate<n>:TRACe<t>:SYMBOLs</code>	408
<code>DISPlay[:WINDow<n>][:SUBWindow<w>]:TRACe<t>:MODE</code>	409
<code>DISPlay[:WINDow<n>][:SUBWindow<w>]:TRACe<t>[:STATE]</code>	410
<code>DISPlay[:WINDow<n>][:SUBWindow<w>]:TRACe<t>:PRESet</code>	410

`CALCulate<n>:TRACe<t>[:VALue]` <TraceRefType>

This commands selects the signal to be used as the data source for a trace.

For `DISPlay[:WINDow<n>][:SUBWIndow<w>]:TRACe<t>:MODE` View, the data source to be evaluated cannot be changed. It remains set to the value that was most recently set.

Suffix:

<n> [Window](#)

<t> [Trace](#)

Parameters:

<TraceRefType> MEAS | REF | ERRor | TCAP

MEAS

Measurement signal

REF

Reference signal

ERR

Error

TCAP

Capture buffer

*RST: Depends on the current measurement.

Manual operation: See "[Evaluation](#)" on page 236

CALCulate<n>:TRACe<t>:SYMBOLs <SymbolSelection>

This commands selects which symbols are displayed by a trace (in a constellation graph with 2 modulations).

For `DISPlay[:WINDow<n>][:SUBWIndow<w>]:TRACe<t>:MODE` View, the symbol selection cannot be changed. It remains set to the value that was most recently set.

Suffix:

<n> 1..n
[Window](#)

<t> 1..6
[Trace](#)

Parameters:

<SymbolSelection> ALL | PATTern | DATA

ALL

Trace consists of constellation points for all symbols

PATTern

Trace consists of only pattern symbols

DATA

Trace consists of only data symbols

*RST: ALL

Example:

`CALC2:TRAC5 PATTern`

Displays only the pattern symbols on trace 5.

Manual operation: See "[Filter \(I/Q Constellation, K70M only\)](#)" on page 236

DISPlay[:WINDow<n>][:SUBWindow<w>]:TRACe<t>:MODE <Mode>

This command selects the trace mode. If necessary, the selected trace is also activated.

For max hold, min hold or average trace mode, you can set the number of single measurements with `[SENSe:]SWEep:COUNT`. Note that synchronization to the end of the measurement is possible only in single sweep mode. Depending on the result display, not all trace modes are available.

Suffix:

<n>	Window
<w>	subwindow Not supported by all applications
<t>	Trace

Parameters:

<Mode>

WRITE

(default:) Overwrite mode: the trace is overwritten by each sweep.

AVERage

The average is formed over several sweeps. The "Sweep/Average Count" determines the number of averaging procedures.

MAXHold

The maximum value is determined over several sweeps and displayed. The R&S FPL1000 saves the sweep result in the trace memory only if the new value is greater than the previous one.

MINHold

The minimum value is determined from several measurements and displayed. The R&S FPL1000 saves the sweep result in the trace memory only if the new value is lower than the previous one.

VIEW

The current contents of the trace memory are frozen and displayed.

BLANK

Hides the selected trace.

DENSity

The occurrence of each value within the current result range or evaluation range is indicated by color.

This trace mode is only available for constellation, vector, and eye diagrams.

*RST: Trace 1: WRITE, Trace 2-6: BLANK

Example:

```
INIT:CONT OFF
Switching to single sweep mode.
SWE:COUN 16
Sets the number of measurements to 16.
DISP:TRAC3:MODE WRIT
Selects clear/write mode for trace 3.
INIT;*WAI
Starts the measurement and waits for the end of the measurement.
```

Manual operation: See ["Trace Mode"](#) on page 234

DISPlay[:WINDow<n>][:SUBWindow<w>]:TRACe<t>[:STATe] <State>

This command turns a trace on and off.

The measurement continues in the background.

Suffix:

<n>	Window
<w>	subwindow Not supported by all applications
<t>	Trace

Parameters:

<State>	ON OFF 0 1
	OFF 0 Switches the function off
	ON 1 Switches the function on

Example: DISP:TRAC3 ON

Manual operation: See ["Trace 1/Trace 2/Trace 3/Trace 4/Trace 5/Trace 6"](#) on page 234
See ["Trace 1/ Trace 2/ Trace 3/ Trace 4 \(Softkeys\)"](#) on page 237

DISPlay[:WINDow<n>][:SUBWindow<w>]:TRACe<t>:PRESet <ResultType>

Applies predefined, commonly required trace settings to the selected window.

Suffix:

<n>	1..n Window
<w>	1..n subwindow

<t>	1..n Trace
Parameters:	
<ResultType>	ALL Preset All Traces
	MAM Max Avg Min
	MCM Max ClrWrite Min

Example: DISP:WIND3:TRAC:PRES MCM
 In window 3, the traces are set to the following modes:
 Trace 1: Max Hold
 Trace 2: Clear Write
 Trace 3: Min Hold

11.7.2 Working with markers

Markers help you analyze your measurement results by determining particular values in the diagram. Thus you can extract numeric values from a graphical display.

Manual configuration of markers is described in [Chapter 6.3, "Markers"](#), on page 240.

- [Individual marker settings](#).....411
- [Marker search and positioning settings](#).....415

11.7.2.1 Individual marker settings

In VSA evaluations, up to 5 markers can be activated in each diagram at any time.

CALCulate<n>:MARKer<m>:AOFF.....	411
CALCulate<n>:MARKer<m>:LINK.....	412
CALCulate<n>:MARKer<m>[:STATE].....	412
CALCulate<n>:MARKer<m>:TRACe.....	412
CALCulate<n>:MARKer<m>:X.....	413
CALCulate<n>:MARKer<m>:Y?.....	413
CALCulate<n>:DELTamarker<m>:AOFF.....	413
CALCulate<n>:DELTamarker<m>:X.....	414
CALCulate<n>:DELTamarker<m>:Y?.....	414
CALCulate<n>:DELTamarker<m>[:STATE].....	414
CALCulate<n>:DELTamarker<m>:TRACe.....	415

CALCulate<n>:MARKer<m>:AOFF

This command turns off all markers.

Suffix:	
<n>	Window
<m>	Marker

Example: `CALC:MARK:AOFF`
Switches off all markers.

Manual operation: See ["All Markers Off"](#) on page 241

CALCulate<n>:MARKer<m>:LINK <MarkerCoupling>

With this command markers between several screens can be coupled, i.e. use the same x-value. All screens can be linked with the marker x-value scaled in symbols or time, except those showing the capture buffer. If several capture buffer measurements are visible, their markers are coupled, too.

Suffix:

<n> [Window](#)
<m> [Marker](#)

Setting parameters:

<MarkerCoupling> ON | OFF | 1 | 0
*RST: 0

Manual operation: See ["Couple Windows"](#) on page 241

CALCulate<n>:MARKer<m>[:STATe] <State>

This command turns markers on and off. If the corresponding marker number is currently active as a delta marker, it is turned into a normal marker.

Suffix:

<n> [Window](#)
<m> [Marker](#)

Parameters:

<State> ON | OFF | 0 | 1
OFF | 0
Switches the function off
ON | 1
Switches the function on

Example: `CALC:MARK3 ON`
Switches on marker 3.

Manual operation: See ["Marker State"](#) on page 241
See ["Marker Type"](#) on page 241

CALCulate<n>:MARKer<m>:TRACe <Trace>

This command selects the trace the marker is positioned on.

Note that the corresponding trace must have a trace mode other than "Blank".

If necessary, the command activates the marker first.

Suffix:<n> [Window](#)<m> [Marker](#)**Parameters:**<Trace> **1 to 6**
Trace number the marker is assigned to.**Example:** //Assign marker to trace 1
CALC:MARK3:TRAC 2**Manual operation:** See "[Assigning the Marker to a Trace](#)" on page 241**CALCulate<n>:MARKer<m>:X <Position>**

This command moves a marker to a specific coordinate on the x-axis.

If necessary, the command activates the marker.

If the marker has been used as a delta marker, the command turns it into a normal marker.

Suffix:<n> [Window](#)<m> [Marker](#)**Parameters:**<Position> Numeric value that defines the marker position on the x-axis.
The unit depends on the result display.Range: The range depends on the current x-axis range.
Default unit: Hz**Example:** CALC:MARK2:X 1.7MHz
Positions marker 2 to frequency 1.7 MHz.**Manual operation:** See "[X-value](#)" on page 241**CALCulate<n>:MARKer<m>:Y?**

Queries the result at the position of the specified marker.

Suffix:

<n> 1..n

<m> 1..n

Return values:

<Result> Default unit: DBM

Usage: Query only**CALCulate<n>:DELTamarker<m>:AOFF**This command turns off *all* delta markers.

Suffix:
 <n> [Window](#)
 <m> irrelevant
Example: `CALC:DELT:AOFF`
 Turns off all delta markers.

CALCulate<n>:DELTamarker<m>:X <Position>

This command moves a delta marker to a particular coordinate on the x-axis.

If necessary, the command activates the delta marker and positions a reference marker to the peak power.

Suffix:
 <n> [Window](#)
 <m> [Marker](#)
Example: `CALC:DELT:X?`
 Outputs the absolute x-value of delta marker 1.
Manual operation: See "[X-value](#)" on page 241

CALCulate<n>:DELTamarker<m>:Y?

Queries the result at the position of the specified delta marker.

Suffix:
 <n> 1..n
 <m> 1..n
Return values:
 <Result> Result at the position of the delta marker.
 The unit is variable and depends on the one you have currently set.
 Default unit: DBM
Usage: Query only

CALCulate<n>:DELTamarker<m>[:STATe] <State>

This command turns delta markers on and off.

If necessary, the command activates the delta marker first.

No suffix at DELTmarker turns on delta marker 1.

Suffix:
 <n> [Window](#)

<m>	Marker
Parameters:	
<State>	ON OFF 0 1 OFF 0 Switches the function off ON 1 Switches the function on
Example:	CALC:DELT2 ON Turns on delta marker 2.
Manual operation:	See "Marker State" on page 241 See "Marker Type" on page 241

CALCulate<n>:DELTaMarker<m>:TRACe <Trace>

This command selects the trace a delta marker is positioned on.

Note that the corresponding trace must have a trace mode other than "Blank".

If necessary, the command activates the marker first.

Suffix:

<n> Window

<m> Marker

Parameters:

<Trace> Trace number the marker is assigned to.

Example: CALC:DELT2:TRAC 2
Positions delta marker 2 on trace 2.

11.7.2.2 Marker search and positioning settings

Several functions are available to set the marker to a specific position very quickly and easily. In order to determine the required marker position, searches may be performed. The search results can be influenced by special settings.

Useful commands for positioning markers described elsewhere:

- CALCulate<n>:MARKer<m>:TRACe on page 412
- CALCulate<n>:DELTaMarker<m>:TRACe on page 415

Remote commands exclusive to positioning markers:

CALCulate<n>:DELTaMarker<m>:MAXimum:APEak.....	416
CALCulate<n>:DELTaMarker<m>:MAXimum:LEFT.....	416
CALCulate<n>:DELTaMarker<m>:MAXimum:NEXT.....	416
CALCulate<n>:DELTaMarker<m>:MAXimum[:PEAK].....	417
CALCulate<n>:DELTaMarker<m>:MAXimum:RIGHT.....	417
CALCulate<n>:DELTaMarker<m>:MBURst:START.....	417
CALCulate<n>:DELTaMarker<m>:MINimum:LEFT.....	417

CALCulate<n>:DELTaMarker<m>:MINimum:NEXT.....	418
CALCulate<n>:DELTaMarker<m>:MINimum[:PEAK].....	418
CALCulate<n>:DELTaMarker<m>:MINimum:RIGHT.....	418
CALCulate<n>:MARKer<m>:MAXimum:APEak.....	418
CALCulate<n>:MARKer<m>:MAXimum:LEFT.....	419
CALCulate<n>:MARKer<m>:MAXimum:NEXT.....	419
CALCulate<n>:MARKer<m>:MAXimum:RIGHT.....	419
CALCulate<n>:MARKer<m>:MAXimum[:PEAK].....	419
CALCulate<n>:MARKer<m>:MBURst:START.....	420
CALCulate<n>:MARKer<m>:MINimum:LEFT.....	420
CALCulate<n>:MARKer<m>:MINimum:NEXT.....	420
CALCulate<n>:MARKer<m>:MINimum:RIGHT.....	420
CALCulate<n>:MARKer<m>:MINimum[:PEAK].....	421
CALCulate<n>:MARKer<m>:SEARch.....	421
CALCulate<n>:MARKer<m>:X:SLIMits:LEFT.....	421
CALCulate<n>:MARKer<m>:X:SLIMits:RIGHT.....	422
CALCulate<n>:MARKer<m>:X:SLIMits[:STATe].....	422

CALCulate<n>:DELTaMarker<m>:MAXimum:APEak

This command positions the active marker or delta marker on the largest absolute peak value (maximum or minimum) of the selected trace.

Suffix:

<n> Window

<m> Marker

Usage: Event

CALCulate<n>:DELTaMarker<m>:MAXimum:LEFT

This command moves a delta marker to the next positive peak value.

The search includes only measurement values to the left of the current marker position.

Suffix:

<n> Window

<m> Marker

Manual operation: See "Search Next Peak" on page 243

CALCulate<n>:DELTaMarker<m>:MAXimum:NEXT

This command moves a marker to the next positive peak value.

Suffix:

<n> 1..n
 Window

<m> 1..n
Marker

Manual operation: See ["Search Next Peak"](#) on page 243

CALCulate<n>:DELTaMarker<m>:MAXimum[:PEAK]

This command moves a delta marker to the highest level.

If the marker is not yet active, the command first activates the marker.

Suffix:

<n> Window

<m> Marker

Manual operation: See ["Peak Search"](#) on page 243

CALCulate<n>:DELTaMarker<m>:MAXimum:RIGHT

This command moves a delta marker to the next positive peak value on the trace.

The search includes only measurement values to the right of the current marker position.

Suffix:

<n> Window

<m> Marker

Manual operation: See ["Search Next Peak"](#) on page 243

CALCulate<n>:DELTaMarker<m>:MBURst:START

This command moves the marker m to the start of the selected result range.

Suffix:

<n> Window

<m> Marker

Example:

CALC4:DELT2:MBUR:STAR

Moves delta marker 2 to the start of the selected result range.

Usage:

Event

Manual operation: See ["Selected Result Rng"](#) on page 244

CALCulate<n>:DELTaMarker<m>:MINimum:LEFT

This command moves a delta marker to the next minimum peak value.

The search includes only measurement values to the right of the current marker position.

Suffix:<n> [Window](#)<m> [Marker](#)**Manual operation:** See "[Search Next Minimum](#)" on page 244

CALCulate<n>:DELTamarker<m>:MINimum:NEXT

This command moves a marker to the next minimum peak value.

Suffix:<n> [Window](#)<m> [Marker](#)**Manual operation:** See "[Search Next Minimum](#)" on page 244

CALCulate<n>:DELTamarker<m>:MINimum[:PEAK]

This command moves a delta marker to the minimum level.

If the marker is not yet active, the command first activates the marker.

Suffix:<n> [Window](#)<m> [Marker](#)**Manual operation:** See "[Search Minimum](#)" on page 243

CALCulate<n>:DELTamarker<m>:MINimum:RIGHT

This command moves a delta marker to the next minimum peak value.

The search includes only measurement values to the right of the current marker position.

Suffix:<n> [Window](#)<m> [Marker](#)**Manual operation:** See "[Search Next Minimum](#)" on page 244

CALCulate<n>:MARKer<m>:MAXimum:APEak

sets the marker to the largest absolute peak value (maximum or minimum) of the selected trace.

Suffix:<n> [Window](#)<m> [Marker](#)**Usage:** Event

Manual operation: See "[Max |Peak|](#)" on page 243

CALCulate<n>:MARKer<m>:MAXimum:LEFT

This command moves a marker to the next positive peak.

The search includes only measurement values to the left of the current marker position.

Suffix:

<n> [Window](#)

<m> [Marker](#)

Manual operation: See "[Search Next Peak](#)" on page 243

CALCulate<n>:MARKer<m>:MAXimum:NEXT

This command moves a marker to the next positive peak.

Suffix:

<n> [Window](#)

<m> [Marker](#)

Manual operation: See "[Search Next Peak](#)" on page 243

CALCulate<n>:MARKer<m>:MAXimum:RIGHT

This command moves a marker to the next positive peak.

The search includes only measurement values to the right of the current marker position.

Suffix:

<n> [Window](#)

<m> [Marker](#)

Manual operation: See "[Search Next Peak](#)" on page 243

CALCulate<n>:MARKer<m>:MAXimum[:PEAK]

This command moves a marker to the highest level.

If the marker is not yet active, the command first activates the marker.

Suffix:

<n> [Window](#)

<m> [Marker](#)

Manual operation: See "[Peak Search](#)" on page 243

CALCulate<n>:MARKer<m>:MBURst:START

This command moves the marker m to the start of the selected result range.

Suffix:

<n> [Window](#)

<m> [Marker](#)

Example:

CALC4:MARK2:MBUR:STAR

Moves marker 2 to the start of the selected result range

Usage:

Event

Manual operation: See "[Selected Result Rng](#)" on page 244

CALCulate<n>:MARKer<m>:MINimum:LEFT

This command moves a marker to the next minimum peak value.

The search includes only measurement values to the right of the current marker position.

Suffix:

<n> [Window](#)

<m> [Marker](#)

Manual operation: See "[Search Next Minimum](#)" on page 244

CALCulate<n>:MARKer<m>:MINimum:NEXT

This command moves a marker to the next minimum peak value.

Suffix:

<n> [Window](#)

<m> [Marker](#)

Manual operation: See "[Search Next Minimum](#)" on page 244

CALCulate<n>:MARKer<m>:MINimum:RIGHT

This command moves a marker to the next minimum peak value.

The search includes only measurement values to the right of the current marker position.

Suffix:

<n> [Window](#)

<m> [Marker](#)

Manual operation: See "[Search Next Minimum](#)" on page 244

CALCulate<n>:MARKer<m>:MINimum[:PEAK]

This command moves a marker to the minimum level.

If the marker is not yet active, the command first activates the marker.

Suffix:

<n> [Window](#)

<m> [Marker](#)

Manual operation: See "[Search Minimum](#)" on page 243

CALCulate<n>:MARKer<m>:SEARch <MarkReallmag>

This command specifies whether the marker search works on the real or the imag trace (for all markers).

Suffix:

<n> 1..n
[Window](#)

<m> 1..4
[Marker](#)

Parameters:

<MarkReallmag> REAL | IMAG
*RST: REAL

Manual operation: See "[Real / Imag Plot](#)" on page 242

CALCulate<n>:MARKer<m>:X:SLIMits:LEFT <SearchLimit>

This command defines the left limit of the marker search range for *all* markers in *all* windows.

If you perform a measurement in the time domain, this command limits the range of the trace to be analyzed.

Suffix:

<n> irrelevant

<m> irrelevant

Parameters:

<SearchLimit> The value range depends on the frequency range or measurement time.
The unit is Hz for frequency domain measurements and s for time domain measurements.

*RST: left diagram border

Default unit: HZ

<Limit> Range: -1e9 to 1e9
*RST: 0.0

Example: `CALC:MARK:X:SLIM ON`
 Switches the search limit function on.
 `CALC:MARK:X:SLIM:LEFT 10MHz`
 Sets the left limit of the search range to 10 MHz.

Manual operation: See "[Search Limits \(Left / Right\)](#)" on page 243

CALCulate<n>:MARKer<m>:X:SLIMits:RIGHT <SearchLimit>

This command defines the right limit of the marker search range for *all* markers in *all* windows.

If you perform a measurement in the time domain, this command limits the range of the trace to be analyzed.

Suffix:

<n> irrelevant

<m> irrelevant

Parameters:

<Limit> The value range depends on the frequency range or measurement time.

The unit is Hz for frequency domain measurements and s for time domain measurements.

Range: -1e9 to 1e9

*RST: 800.0

Example: `CALC:MARK:X:SLIM ON`
 Switches the search limit function on.
 `CALC:MARK:X:SLIM:RIGH 20MHz`
 Sets the right limit of the search range to 20 MHz.

Manual operation: See "[Search Limits \(Left / Right\)](#)" on page 243

CALCulate<n>:MARKer<m>:X:SLIMits[:STATe] <State>

This command turns marker search limits on and off for *all* markers in *all* windows.

If you perform a measurement in the time domain, this command limits the range of the trace to be analyzed.

Suffix:

<n> irrelevant

<m> irrelevant

Parameters:

<State> ON | OFF | 0 | 1

OFF | 0

Switches the function off

ON | 1

Switches the function on

Example: CALC:MARK:X:SLIM ON
Switches on search limitation.

Manual operation: See "[Search Limits \(Left / Right\)](#)" on page 243

11.7.3 Configuring display lines for eye diagrams

For eye diagrams, display lines allow you to measure the size of the eye in the diagram. For other result displays, lines are not available.

CALCulate<n>:DLABs:STATe.....	423
CALCulate<n>:DLABs[:VALue].....	423
CALCulate<n>:DLRel:STATe.....	424
CALCulate<n>:DLRel[:VALue].....	424
CALCulate<n>:TLABs:STATe.....	425
CALCulate<n>:TLABs[:VALue].....	425
CALCulate<n>:TLRel:STATe.....	426
CALCulate<n>:TLRel[:VALue].....	426

CALCulate<n>:DLABs:STATe <State>

Displays an absolute horizontal line in the specified window. This command is only available for eye diagrams.

Suffix:

<n> 1..n
[Window](#)

Parameters:

<State> ON | OFF | 1 | 0
*RST: 0

Example: Display eye diagram in window 2.
LAY:ADD? '1',BEL,MEAS
CALC2:FORM QEYE
Display absolute horizontal line.
CALC2:DLAB:STAT ON
Query y-value of absolute horizontal line.
CALC2:DLAB:VAL?

Manual operation: See "[Horizontal Line](#)" on page 245

CALCulate<n>:DLABs[:VALue] <horLineAbsPos>

Defines value of horizontal absolute line

Suffix:

<n> 1..n
[Window](#)

Parameters:

<horLineAbsPos> Y-value of the absolute horizontal line.
*RST: 0

Example:

Display eye diagram in window 2.
LAY:ADD? '1',BEL,MEAS
CALC2:FORM QEYE
Display absolute horizontal line.
CALC2:DLAB:STAT ON
Query y-value of absolute horizontal line.
CALC2:DLAB:VAL?

Manual operation: See "[Horizontal Line](#)" on page 245

CALCulate<n>:DLRel:STATe <State>

Displays a relative horizontal line in the specified window. This command is only available for eye diagrams, and only if an absolute horizontal line is already available in the same diagram (see [CALCulate<n>:DLABs:STATe](#) on page 423).

Suffix:

<n> 1..n
[Window](#)

Parameters:

<State> ON | OFF | 1 | 0
*RST: 0

Example:

Display eye diagram in window 2.
LAY:ADD? '1',BEL,MEAS
CALC2:FORM QEYE
Display absolute horizontal line.
CALC2:DLAB:STAT ON
Display relative horizontal line.
CALC2:DLR:STAT:ON
Query y-value of relative horizontal line.
CALC2:DLR:VAL?

Manual operation: See "[Horizontal Line](#)" on page 245

CALCulate<n>:DLRel[:VALue] <LineRelPosRel>

Defines or queries the y-value of the relative horizontal line in the specified window. This command is only available for eye diagrams, and only if an absolute horizontal line and a relative horizontal line are already available in the same diagram (see [CALCulate<n>:DLABs:STATe](#) on page 423 and [CALCulate<n>:DLRel:STATe](#) on page 424).

Suffix:

<n> 1..n

Parameters:

<LineRelPosRel> Relative distance of the second horizontal line to the first (absolute) horizontal line.

Example:

Display eye diagram in window 2.

```
LAY:ADD? '1',BEL,MEAS
```

```
CALC2:FORM QEYE
```

Display absolute horizontal line.

```
CALC2:DLAB:STAT ON
```

Display relative horizontal line.

```
CALC2:DLR:STAT:ON
```

Query y-value of relative horizontal line.

```
CALC2:DLR:VAL?
```

Manual operation: See "[Horizontal Line](#)" on page 245

CALCulate<n>:TLABs:STATe <State>

Displays an absolute vertical line in the specified window. This command is only available for eye diagrams.

Suffix:

<n> 1..n
[Window](#)

Parameters:

<State> ON | OFF | 1 | 0
*RST: 0

Example:

Display eye diagram in window 2.

```
LAY:ADD? '1',BEL,MEAS
```

```
CALC2:FORM QEYE
```

Display absolute vertical line.

```
CALC2:TLAB:STAT ON
```

Query y-value of absolute vertical line.

```
CALC2:TLAB:VAL?
```

Manual operation: See "[Vertical Line](#)" on page 245

CALCulate<n>:TLABs[:VALue] <vertLineAbsPos>

Defines or queries the x-value of the absolute vertical line in the specified window. This command is only available for eye diagrams, and only if an absolute vertical line is already available in the diagram (see [CALCulate<n>:TLABs:STATe](#) on page 425).

Suffix:

<n> 1..n
[Window](#)

Parameters:

<vertLineAbsPos> X-value of the absolute vertical line.
Default unit: SYMB

Example: Display eye diagram in window 2.
 LAY:ADD? '1',BEL,MEAS
 CALC2:FORM QEYE
 Display absolute vertical line.
 CALC2:TLAB:STAT ON
 Query y-value of absolute vertical line.
 CALC2:TLAB:VAL?

Manual operation: See "[Vertical Line](#)" on page 245

CALCulate<n>:TLRel:STATe <State>

Displays a relative vertical line in the specified window. This command is only available for eye diagrams, and only if an absolute vertical line is already available in the same diagram (see [CALCulate<n>:TLABs:STATe](#) on page 425).

Suffix:

<n> 1..n
[Window](#)

Parameters:

<State> ON | OFF | 1 | 0
 *RST: 0

Example: Display eye diagram in window 2.
 LAY:ADD? '1',BEL,MEAS
 CALC2:FORM QEYE
 Display absolute vertical line.
 CALC2:TLAB:STAT ON
 Display relative vertical line.
 CALC2:TLR:STAT ON
 Query x-value of relative vertical line.
 CALC2:TLR:VAL?

Manual operation: See "[Vertical Line](#)" on page 245

CALCulate<n>:TLRel[:VALue] <LineRelPosRel>

Defines or queries the x-value of the relative vertical line in the specified window. This command is only available for eye diagrams, and only if an absolute vertical line and a relative vertical line are already available in the same diagram (see [CALCulate<n>:TLABs:STATe](#) on page 425 and [CALCulate<n>:TLRel:STATe](#) on page 426).

Suffix:

<n> 1..n
[Window](#)

Parameters:

<LineRelPosRel> Relative distance of the second vertical line to the first (absolute) vertical line.
 Default unit: SYMB

Example: Display eye diagram in window 2.
 LAY:ADD? '1',BEL,MEAS
 CALC2:FORM QEYE
 Display absolute vertical line.
 CALC2:TLAB:STAT ON
 Display relative vertical line.
 CALC2:TLR:STAT:ON
 Query x-value of relative vertical line.
 CALC2:TLR:VAL?

Manual operation: See "[Vertical Line](#)" on page 245

11.7.4 Configuring modulation accuracy limit lines

The results of a modulation accuracy measurement can be checked for violation of defined limits automatically.

Manual configuration of limit lines is described in [Chapter 6.4.2, "Modulation accuracy limit lines"](#), on page 246.

- [General commands](#).....427
- [Defining limits](#).....428

11.7.4.1 General commands

The following commands determine the general behavior of the limit line check.

CALCulate<n>:LIMit:MACCuracy:DEFault	427
CALCulate<n>:LIMit:MACCuracy:STATe	427

CALCulate<n>:LIMit:MACCuracy:DEFault

Restores the default limits and deactivates all checks in all windows.

Suffix:

<n>	1..n
	irrelevant

Usage: Event

Manual operation: See "[Set to Default](#)" on page 247

CALCulate<n>:LIMit:MACCuracy:STATe <State>

Limits checks for all evaluations based on modulation accuracy (e.g. "Result Summary") are enabled or disabled.

Suffix:

<n> 1..n
irrelevant

Parameters:

<State> ON | OFF | 0 | 1
OFF | 0
Switches the function off
ON | 1
Switches the function on
*RST: 0

Example: See [Chapter 11.13.2, "Measurement example 2: GSM EDGE burst measurement based on a digital standard"](#), on page 495.

Manual operation: See ["Checking Modulation Accuracy Limits"](#) on page 246

11.7.4.2 Defining limits

The following commands are required to define limits for specific results.

CALCulate<n>:LIMit:MACCuracy:CFERror:CURRent:STATe <State>
CALCulate<n>:LIMit:MACCuracy:CFERror:MEAN:STATe <State>
CALCulate<n>:LIMit:MACCuracy:CFERror:PEAK:STATe <State>
CALCulate<n>:LIMit:MACCuracy:EVM:PCURrent:STATe <State>
CALCulate<n>:LIMit:MACCuracy:EVM:PMEan:STATe <State>
CALCulate<n>:LIMit:MACCuracy:EVM:PPEak:STATe <State>
CALCulate<n>:LIMit:MACCuracy:EVM:RCURrent:STATe <State>
CALCulate<n>:LIMit:MACCuracy:EVM:RMEan:STATe <State>
CALCulate<n>:LIMit:MACCuracy:EVM:RPEak:STATe <State>
CALCulate<n>:LIMit:MACCuracy:FDERror:CURRent:STATe <State>
CALCulate<n>:LIMit:MACCuracy:FDERror:MEAN:STATe <State>
CALCulate<n>:LIMit:MACCuracy:FDERror:PEAK:STATe <State>
CALCulate<n>:LIMit:MACCuracy:FERRor:PCURrent:STATe <State>
CALCulate<n>:LIMit:MACCuracy:FERRor:PMEan:STATe <State>
CALCulate<n>:LIMit:MACCuracy:FERRor:PPEak:STATe <State>
CALCulate<n>:LIMit:MACCuracy:FERRor:RCURrent:STATe <State>
CALCulate<n>:LIMit:MACCuracy:FERRor:RMEan:STATe <State>
CALCulate<n>:LIMit:MACCuracy:FERRor:RPEak:STATe <State>
CALCulate<n>:LIMit:MACCuracy:MERRor:PCURrent:STATe <State>
CALCulate<n>:LIMit:MACCuracy:MERRor:PMEan:STATe <State>
CALCulate<n>:LIMit:MACCuracy:MERRor:PPEak:STATe <State>
CALCulate<n>:LIMit:MACCuracy:MERRor:RCURrent:STATe <State>
CALCulate<n>:LIMit:MACCuracy:MERRor:RMEan:STATe <State>
CALCulate<n>:LIMit:MACCuracy:MERRor:RPEak:STATe <State>
CALCulate<n>:LIMit:MACCuracy:OOFfset:CURRent:STATe <State>
CALCulate<n>:LIMit:MACCuracy:OOFfset:MEAN:STATe <State>
CALCulate<n>:LIMit:MACCuracy:OOFfset:PEAK:STATe <State>
CALCulate<n>:LIMit:MACCuracy:PERRor:PCURrent:STATe <State>
CALCulate<n>:LIMit:MACCuracy:PERRor:PMEan:STATe <State>

CALCulate<n>:LIMit:MACCuracy:PERRor:PPEak:STATe <State>
CALCulate<n>:LIMit:MACCuracy:PERRor:RCURrent:STATe <State>
CALCulate<n>:LIMit:MACCuracy:PERRor:RMEan:STATe <State>
CALCulate<n>:LIMit:MACCuracy:PERRor:RPEak:STATe <State>
CALCulate<n>:LIMit:MACCuracy:RHO:CURRent:STATe <State>
CALCulate<n>:LIMit:MACCuracy:RHO:MEAN:STATe <State>
CALCulate<n>:LIMit:MACCuracy:RHO:PEAK:STATe <State>
CALCulate<n>:LIMit:MACCuracy:<ResultType>:<LimitType>:STATe <LimitState>

This command switches the limit check for the selected result type and limit type on or off.

Suffix:

<n> [Window](#)
 <ResultType> CFERror = "Carrier Frequency Error"
 EVM = "Error Vector Magnitude"
 FERRor = "Frequency error" (FSK only)
 FDERRor = "Frequency deviation error" (FSK only)
 MERRor = "Magnitude Error"
 OOFFset = "I/Q Offset"
 PERRor = "Phase Error"
 RHO = "Rho"
 <LimitType> **For CFERror, OOFFset, RHO:**
 CURRent
 MEAN
 PEAK
For EVM, FERRor, MERRor, PERRor:
 PCURRent = Peak current value
 PMEan = Peak mean value
 PPEak = Peak peak value
 RCURRent = RMS current value
 RMEan = RMS mean value
 RPEak = RMS peak value

Setting parameters:

<LimitState> ON | OFF | 1 | 0
 Activates a limit check for the selected result and limit type.
 *RST: 0

Example:

```

CALC2:FEED 'XTIM:DDEM:MACC'
Switch on "Result Summary" in screen 2
CALC2:LIM:MACC:CFER:CURR:VAL 100 Hz
Define a limit of [-100;100]
CALC2:LIM:MACC:CFER:CURR:STAT ON
Switch limit check ON
  
```

Manual operation: See ["Check"](#) on page 248

CALCulate<n>:LIMit:MACCuracy:CFERror:CURRENT:VALue <LimitValue>

CALCulate<n>:LIMit:MACCuracy:CFERror:MEAN:VALue <LimitValue>

CALCulate<n>:LIMit:MACCuracy:CFERror:PEAK:VALue <LimitValue>

This command defines the limit for the current, peak or mean center frequency error limit. Note that the limits for the current and the peak value are always kept identical.

Suffix:

<n> 1..n
[Window](#)

Parameters:

<LimitValue> the value x (x>0) defines the interval [-x; x]
 Range: 0.0 to 1000000
 *RST: 1000.0 (mean: 750.0)
 Default unit: Hz

CALCulate<n>:LIMit:MACCuracy:EVM:PCURRENT:VALue <LimitValue>

CALCulate<n>:LIMit:MACCuracy:EVM:PMEAN:VALue <LimitValue>

CALCulate<n>:LIMit:MACCuracy:EVM:PPEAK:VALue <LimitValue>

CALCulate<n>:LIMit:MACCuracy:EVM:RCURRENT:VALue <LimitValue>

CALCulate<n>:LIMit:MACCuracy:EVM:RMEAN:VALue <LimitValue>

CALCulate<n>:LIMit:MACCuracy:EVM:RPEAK:VALue <LimitValue>

This command defines the value for the current, peak or mean EVM (peak or RMS) limit. Note that the limits for the current and the peak value are always kept identical.

Suffix:

<n> 1..n
[Window](#)

Parameters:

<LimitValue> Range: 0.0 to 100
 *RST: 1.5
 Default unit: %

CALCulate<n>:LIMit:MACCuracy:FDERror:CURRENT:VALue <LimitValue>

CALCulate<n>:LIMit:MACCuracy:FDERror:MEAN:VALue <LimitValue>

CALCulate<n>:LIMit:MACCuracy:FDERror:PEAK:VALue <LimitValue>

This command defines the lower limit for the current, peak or mean center frequency deviation error. Note that the limits for the current and the peak value are always kept identical.

This command is available for FSK modulation only.

Suffix:

<n> 1..n
[Window](#)

Parameters:

<LimitValue> Range: 0.0 to 1000000
 *RST: 1kHz

```

CALCulate<n>:LIMit:MACCuracy:FERRor:PCURrent:VALue <LimitValue>
CALCulate<n>:LIMit:MACCuracy:FERRor:PMEan:VALue <LimitValue>
CALCulate<n>:LIMit:MACCuracy:FERRor:PPEak:VALue <LimitValue>
CALCulate<n>:LIMit:MACCuracy:FERRor:RCURrent:VALue <LimitValue>
CALCulate<n>:LIMit:MACCuracy:FERRor:RMEan:VALue <LimitValue>
CALCulate<n>:LIMit:MACCuracy:FERRor:RPEak:VALue <LimitValue>

```

This command defines the value for the current, peak or mean frequency error (peak or RMS) limit. Note that the limits for the current and the peak value are always kept identical.

This command is available for FSK modulation only.

Suffix:

<n> 1..n
[Window](#)

Parameters:

<LimitValue> the value x (x>0) defines the interval [-x; x]
 Range: 0.0 to 100
 *RST: 1.5 (mean: 1.0)
 Default unit: Hz

```

CALCulate<n>:LIMit:MACCuracy:MERRor:PCURrent:VALue <LimitValue>
CALCulate<n>:LIMit:MACCuracy:MERRor:PMEan:VALue <LimitValue>
CALCulate<n>:LIMit:MACCuracy:MERRor:PPEak:VALue <LimitValue>
CALCulate<n>:LIMit:MACCuracy:MERRor:RCURrent:VALue <LimitValue>
CALCulate<n>:LIMit:MACCuracy:MERRor:RMEan:VALue <LimitValue>
CALCulate<n>:LIMit:MACCuracy:MERRor:RPEak:VALue <LimitValue>

```

This command defines the value for the current, peak or mean magnitude error (peak or RMS) limit. Note that the limits for the current and the peak value are always kept identical.

Suffix:

<n> 1..n
[Window](#)

Parameters:

<LimitValue> the value x (x>0) defines the interval [-x; x]
 Range: 0.0 to 100
 *RST: 1.5
 Default unit: %

```

CALCulate<n>:LIMit:MACCuracy:OOFfset:CURRent:VALue <LimitValue>
CALCulate<n>:LIMit:MACCuracy:OOFfset:MEAN:VALue <LimitValue>
CALCulate<n>:LIMit:MACCuracy:OOFfset:PEAK:VALue <LimitValue>

```

This command defines the upper limit for the current, peak or mean I/Q offset. Note that the limits for the current and the peak value are always kept identical.

Suffix:

<n> 1..n
[Window](#)

Parameters:

<LimitValue> Range: -200.0 to 0.0
 *RST: -40.0 (mean: -45.0)
 Default unit: DB

CALCulate<n>:LIMit:MACCuracy:PERRor:PCURrent:VALue <LimitValue>

CALCulate<n>:LIMit:MACCuracy:PERRor:PMEan:VALue <LimitValue>

CALCulate<n>:LIMit:MACCuracy:PERRor:PPEak:VALue <LimitValue>

CALCulate<n>:LIMit:MACCuracy:PERRor:RCURrent:VALue <LimitValue>

CALCulate<n>:LIMit:MACCuracy:PERRor:RMEan:VALue <LimitValue>

CALCulate<n>:LIMit:MACCuracy:PERRor:RPEak:VALue <LimitValue>

This command defines the value for the current, peak or mean phase error (peak or RMS) limit. Note that the limits for the current and the peak value are always kept identical.

Suffix:

<n> 1..n
[Window](#)

Parameters:

<LimitValue> the value x (x>0) defines the interval [-x; x]
 Range: 0.0 to 360
 *RST: 3.5 (RMS: 1.5)
 Default unit: deg

CALCulate<n>:LIMit:MACCuracy:RHO:CURRent:VALue <LimitValue>

CALCulate<n>:LIMit:MACCuracy:RHO:MEAN:VALue <LimitValue>

CALCulate<n>:LIMit:MACCuracy:RHO:PEAK:VALue <LimitValue>

This command defines the lower limit for the current, peak or mean Rho limit. Note that the limits for the current and the peak value are always kept identical.

Suffix:

<n> 1..n
[Window](#)

Parameters:

<LimitValue> Range: 0.0 to 1.0
 *RST: 0.999 (mean: 0.9995)
 Default unit: none

11.8 Configuring the result display

The following commands are required to configure the result display in a remote environment. The tasks for manual operation are described in [Chapter 6.5, "Display and window configuration"](#), on page 248.

- [General window commands](#).....433
- [Working with windows in the display](#).....434
- [VSA window configuration](#)..... 441

11.8.1 General window commands

The following commands are required to configure general window layout, independent of the application.

Note that the suffix <n> always refers to the window *in the currently selected channel setup* (see [INSTrument\[:SElect\]](#) on page 319).

DISPlay[:WINDow<n>]:SIZE	433
DISPlay[:WINDow<n>][:SUBWindow<w>]:SElect	433

DISPlay[:WINDow<n>]:SIZE <Size>

This command maximizes the size of the selected result display window *temporarily*. To change the size of several windows on the screen permanently, use the [LAY:SPL](#) command (see [LAYout:SPLitter](#) on page 438).

Suffix:

<n> [Window](#)

Parameters:

<Size>

LARGE

Maximizes the selected window to full screen.
Other windows are still active in the background.

SMALI

Reduces the size of the selected window to its original size.
If more than one measurement window was displayed originally, these are visible again.

*RST: SMALI

Example:

DISP:WIND2:SIZE LARG

DISPlay[:WINDow<n>][:SUBWindow<w>]:SElect

This command sets the focus on the selected result display window.

This window is then the active window.

For measurements with multiple results in subwindows, the command also selects the subwindow. Use this command to select the (sub)window before querying trace data.

Suffix:	
<n>	Window
<w>	subwindow Not supported by all applications
Example:	//Put the focus on window 1 DISP:WIND1:SEL
Example:	//Put the focus on subwindow 2 in window 1 DISP:WIND1:SUBW2:SEL

11.8.2 Working with windows in the display

The following commands are required to change the evaluation type and rearrange the screen layout for a channel setup as you do using the SmartGrid in manual operation. Since the available evaluation types depend on the selected application, some parameters for the following commands also depend on the selected channel setup.

Note that the suffix <n> always refers to the window *in the currently selected channel setup*.

(See [INSTrument\[:SElect\]](#) on page 319).

LAYout:ADD[:WINDow]?	434
LAYout:CATalog[:WINDow]?	436
LAYout:IDENtify[:WINDow]?	436
LAYout:MOVE[:WINDow]	436
LAYout:REMove[:WINDow]	437
LAYout:REPLace[:WINDow]	437
LAYout:SPLitter	438
LAYout:WINDow<n>:ADD?	439
LAYout:WINDow<n>:IDENtify?	440
LAYout:WINDow<n>:REMove	440
LAYout:WINDow<n>:REPLace	440
LAYout:WINDow<n>:TYPE	441

LAYout:ADD[:WINDow]? <WindowName>, <Direction>, <WindowType>

This command adds a window to the display in the active channel setup.

This command is always used as a query so that you immediately obtain the name of the new window as a result.

To replace an existing window, use the [LAYout:REPLace\[:WINDow\]](#) command.

Query parameters:

<WindowName> String containing the name of the existing window the new window is inserted next to.
By default, the name of a window is the same as its index. To determine the name and index of all active windows, use the [LAYout:CATalog\[:WINDow\]?](#) query.

<Direction> LEFT | RIGHT | ABOVE | BELOW
 Direction the new window is added relative to the existing window.

<WindowType> text value
 Type of result display (evaluation method) you want to add.
 See the table below for available parameter values.

Return values:

<NewWindowName> When adding a new window, the command returns its name (by default the same as its number) as a result.

Example: LAY:ADD:WIND? '1', RIGHT, SYMB
 Adds a "Symbol Table" display to the right of window 1.

Usage: Query only

Manual operation: See ["Capture Buffer"](#) on page 22
 See ["Measurement & Reference Signal"](#) on page 22
 See ["Symbols"](#) on page 23
 See ["Error Vector"](#) on page 23
 See ["Modulation Errors"](#) on page 23
 See ["Modulation Accuracy"](#) on page 24
 See ["Equalizer"](#) on page 24
 See ["Multi Source"](#) on page 24
 See ["Signal Source"](#) on page 249

For a detailed example, see [Chapter 11.13.1, "Measurement example 1: user-defined measurement of continuous QPSK signal"](#), on page 493.

Table 11-3: <WindowType> parameter values for VSA application

Parameter value	Data source (+ default result display)
CBUFFer	Capture buffer ("Magnitude absolute")
MEAS	Meas & Ref ("Magnitude relative")
REF	
EQUALizer	"Equalizer"
EVEctor	Error vector ("EVM")
MACCuracy	Modulation Accuracy ("Result Summary")
MCOMbination	Multi Source ("Spec (Meas+Error)")
MERRor	Modulation Errors ("Magnitude error")
NOTes	"Notes" display
SYMB	"Symbols (Hexadecimal)"

LAYout:CATalog[:WINDow]?

This command queries the name and index of all active windows in the active channel setup from top left to bottom right. The result is a comma-separated list of values for each window, with the syntax:

<WindowName_1>,<WindowIndex_1>..<WindowName_n>,<WindowIndex_n>

Return values:

<WindowName> string
Name of the window.
In the default state, the name of the window is its index.

<WindowIndex> **numeric value**
Index of the window.

Example:

LAY:CAT?

Result:

'2',2,'1',1

Two windows are displayed, named '2' (at the top or left), and '1' (at the bottom or right).

Usage: Query only

LAYout:IDENtify[:WINDow]? <WindowName>

This command queries the **index** of a particular display window in the active channel setup.

Note: to query the **name** of a particular window, use the [LAYout:WINDow<n>:IDENtify?](#) query.

Query parameters:

<WindowName> String containing the name of a window.

Return values:

<WindowIndex> Index number of the window.

Example:

LAY:IDEN:WIND? '2'

Queries the index of the result display named '2'.

Response:

2

Usage: Query only

LAYout:MOVE[:WINDow] <WindowName>, <WindowName>, <Direction>**Setting parameters:**

<WindowName> String containing the name of an existing window that is to be moved.
By default, the name of a window is the same as its index. To determine the name and index of all active windows in the active channel setup, use the [LAYout:CATalog\[:WINDow\]?](#) query.

<WindowName>	String containing the name of an existing window the selected window is placed next to or replaces. By default, the name of a window is the same as its index. To determine the name and index of all active windows in the active channel setup, use the <code>LAYout:CATalog[:WINDow]?</code> query.
<Direction>	LEFT RIGHT ABOVE BELOW REPLACE Destination the selected window is moved to, relative to the reference window.
Example:	<code>LAY:MOVE '4', '1', LEFT</code> Moves the window named '4' to the left of window 1.
Example:	<code>LAY:MOVE '1', '3', REPL</code> Replaces the window named '3' by window 1. Window 3 is deleted.
Usage:	Setting only

LAYout:REMOve[:WINDow] <WindowName>

This command removes a window from the display in the active channel.

Setting parameters:

<WindowName>	String containing the name of the window. In the default state, the name of the window is its index.
Example:	<code>LAY:REM '2'</code> Removes the result display in the window named '2'.
Usage:	Setting only

LAYout:REPLace[:WINDow] <WindowName>, <WindowType>

This command replaces the window type (for example from "Diagram" to "Result Summary") of an already existing window in the active channel setup while keeping its position, index and window name.

To add a new window, use the `LAYout:ADD[:WINDow]?` command.

Setting parameters:

<WindowName>	String containing the name of the existing window. By default, the name of a window is the same as its index. To determine the name and index of all active windows in the active channel setup, use the <code>LAYout:CATalog[:WINDow]?</code> query.
<WindowType>	Type of result display you want to use in the existing window. See <code>LAYout:ADD[:WINDow]?</code> on page 434 for a list of available window types.
Example:	<code>LAY:REPL:WIND '1', MTAB</code> Replaces the result display in window 1 with a marker table.
Usage:	Setting only

LAYout:SPLitter <Index1>, <Index2>, <Position>

This command changes the position of a splitter and thus controls the size of the windows on each side of the splitter.

Note that windows must have a certain minimum size. If the position you define conflicts with the minimum size of any of the affected windows, the command does not work, but does not return an error.

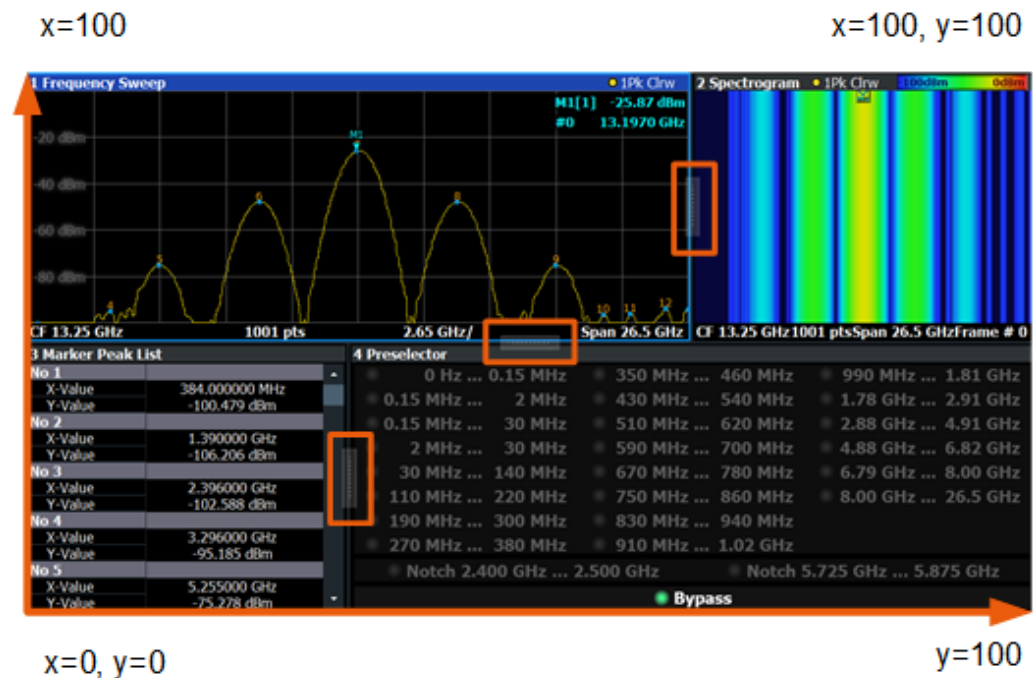


Figure 11-1: SmartGrid coordinates for remote control of the splitters

Setting parameters:

- <Index1> The index of one window the splitter controls.
- <Index2> The index of a window on the other side of the splitter.
- <Position> New vertical or horizontal position of the splitter as a fraction of the screen area (without channel and status bar and softkey menu).
The point of origin ($x = 0$, $y = 0$) is in the lower left corner of the screen. The end point ($x = 100$, $y = 100$) is in the upper right corner of the screen. (See Figure 11-1.)
The direction in which the splitter is moved depends on the screen layout. If the windows are positioned horizontally, the splitter also moves horizontally. If the windows are positioned vertically, the splitter also moves vertically.
- Range: 0 to 100

Example: `LAY:SPL 1,3,50`
 Moves the splitter between window 1 ('Frequency Sweep') and 3 ('Marker Table') to the center (50%) of the screen, i.e. in the figure above, to the left.

Example: `LAY:SPL 1,4,70`
 Moves the splitter between window 1 ('Frequency Sweep') and 3 ('Marker Peak List') towards the top (70%) of the screen. The following commands have the exact same effect, as any combination of windows above and below the splitter moves the splitter vertically.

`LAY:SPL 3,2,70`

`LAY:SPL 4,1,70`

`LAY:SPL 2,1,70`

Usage: Setting only

LAYout:WINDow<n>:ADD? <Direction>,<WindowType>

This command adds a measurement window to the display. Note that with this command, the suffix <n> determines the existing window next to which the new window is added. Unlike `LAYout:ADD[:WINDow]?`, for which the existing window is defined by a parameter.

To replace an existing window, use the `LAYout:WINDow<n>:REPLace` command.

This command is always used as a query so that you immediately obtain the name of the new window as a result.

Suffix:

<n> [Window](#)

Query parameters:

<Direction> LEFT | RIGHT | ABOVE | BELOW

<WindowType> Type of measurement window you want to add.
 See `LAYout:ADD[:WINDow]?` on page 434 for a list of available window types.

Return values:

<NewWindowName> When adding a new window, the command returns its name (by default the same as its number) as a result.

Example: `LAY:WIND1:ADD? LEFT,MTAB`
 Result:
 '2'
 Adds a new window named '2' with a marker table to the left of window 1.

Usage: Query only

LAYout:WINDow<n>:IDENTify?

This command queries the **name** of a particular display window (indicated by the <n> suffix) in the active channel setup.

Note: to query the **index** of a particular window, use the [LAYout:IDENTify\[:WINDow\]?](#) command.

Suffix:

<n> [Window](#)

Return values:

<WindowName> String containing the name of a window.
In the default state, the name of the window is its index.

Example:

LAY:WIND2:IDEN?
Queries the name of the result display in window 2.
Response:
'2'

Usage:

Query only

LAYout:WINDow<n>:REMOve

This command removes the window specified by the suffix <n> from the display in the active channel setup.

The result of this command is identical to the [LAYout:REMOve\[:WINDow\]](#) command.

Suffix:

<n> [Window](#)

Example:

LAY:WIND2:REM
Removes the result display in window 2.

Usage:

Event

LAYout:WINDow<n>:REPLace <WindowType>

This command changes the window type of an existing window (specified by the suffix <n>) in the active channel setup.

The effect of this command is identical to the [LAYout:REPLace\[:WINDow\]](#) command.

To add a new window, use the [LAYout:WINDow<n>:ADD?](#) command.

Suffix:

<n> [Window](#)

Setting parameters:

<WindowType> Type of measurement window you want to replace another one with.
See [LAYout:ADD\[:WINDow\]?](#) on page 434 for a list of available window types.

Example: `LAY:WIND2:REPL MTAB`
Replaces the result display in window 2 with a marker table.

Usage: Setting only

LAYout:WINDow<n>:TYPE <WindowType>

Queries or defines the window type of the window specified by the index <n>. The window type determines which results are displayed. For a list of possible window types, see [LAYout:ADD\[:WINDow\]?](#) on page 434.

Note that this command is not available in all applications and measurements.

Suffix:

<n> 1..n
[Window](#)

Parameters:

<WindowType>

Example: `LAY:WIND2:TYPE?`
Response:
MACC
Modulation accuracy

11.8.3 VSA window configuration

For each window you can select a different evaluation method (result type), based on the data source selected in the "Display Configuration". Further window settings are available for some result types.

Manual configuration of VSA windows is described in [Chapter 6.5.1, "Result window configuration"](#), on page 249.

Useful commands for configuring the window described elsewhere:

- [LAYout:ADD\[:WINDow\]?](#) on page 434

Remote commands exclusive to configuring VSA windows:

[SENSe:]DDEMod:PRESet:CALC	442
CALCulate<n>:DDEM:SPECTrum[:STATe]	442
CALCulate<n>:FEED	443
CALCulate<n>:FORMat	444
CALCulate<n>:STATistics:CCDF[:STATe]	445
CALCulate<n>:STATistics:MODE	445
DISPlay[:WINDow<n>]:ITEM[:LINE][:VALue]	446
DISPlay[:WINDow<n>]:PRATe:AUTO	447
DISPlay[:WINDow<n>]:PRATe[:VALue]	447
DISPlay[:WINDow<n>]:TRACe<t>:SYMBOL	447
DISPlay[:WINDow<n>]:SUBWindow<w>:TRACe<t>:Y[:SCALE]:MODE	448

[SENSe:]DDEMod:PRESet:CALC

This command selects a predefined "signal overview" consisting of four windows. The top left window (1) shows magnitude data from capture buffer, the top right window (2) spectrum data from capture buffer, the bottom left window (3) the "Result Summary" and the bottom right window (4) constellation I/Q data. Using this setup, scripts written for R&S FSV instruments will continue to work.

1: Mag (Capture Buffer)	2: Spec(Reallmag(Capture Buffer))
3: Result Summary	4: Const I/Q (Meas&Ref)

Usage: Event

Manual operation: See ["Overview"](#) on page 66

CALCulate<n>:DDEM:SPECTrum[:STATe] <State>

This command switches the result type transformation to spectrum mode. Spectral evaluation is available for the following result types:

- MAGNitude
- PHASe/UPHase
- FREQuency
- Real/Imag (RIMAG)

The result types are defined using the `CALC:FORM` command (see [CALCulate<n>:FORMat](#) on page 444).

Suffix:

<n> 1..n
[Window](#)

Parameters:

<State> ON | OFF | 0 | 1
OFF | 0
Switches the function off
ON | 1
Switches the function on
*RST: 0

Example:

```
CALC:FEED 'XTIM:DDEM:MEAS'
```

Selects the meas signal.

```
CALC:FORM PHAS
```

Selects the phase measurement.

```
CALC:DDEM:SPEC:STAT ON
```

Selects the spectral display of the phase.

Manual operation: See ["Result Type Transformation"](#) on page 250

CALCulate<n>:FEED <Feed>

Selects the signal source (and for the equalizer also the result type) for evaluation.

Note that this command is maintained for compatibility reasons only. Use the `LAYout` commands for new remote control programs (see [Chapter 11.8.2, "Working with windows in the display"](#), on page 434).

Only for the "Equalizer Impulse Response" and "Equalizer Frequency Response", as well as the multi-source diagrams, this command is required.

Suffix:

<n> 1..n
[Window](#)

Parameters:

<Feed> string

'XTIM:DDEM:MEAS'
Measured signal

'XTIM:DDEM:REF'
Reference signal

'XTIM:DDEM:ERR:VECT'
Error vector

'XTIM:DDEM:ERR:MPH'
Modulation errors

'XTIM:DDEM:MACC'
Modulation accuracy

'XTIM:DDEM:SYMB'
Symbol table

'TCAP'
Capture buffer

'XTIM:DDEM:IMP'
Equalizer Impulse Response

'XFR:DDEM:RAT'
Equalizer Frequency Response

'XFR:DDEM:IRAT'
Equalizer Channel Frequency Response Group Delay

XTIM:DDEM:TCAP:ERR
Spectrum of Real/Imag for capture buffer and error vector

XTIM:DDEM:MEAS:ERR

Spectrum of Real/Imag for measurement and error vector

CALCulate<n>:FORMat <Format>

This command defines the result type of the traces. Which parameters are available depends on the setting for the data source (see [LAYout:ADD\[:WINDow\]?](#) on page 434 and [Table 3-1](#)).

Whether the result type shows absolute or relative values is defined using the `DISP:WIND:TRAC:Y:MODE` command (see [DISPlay\[:WINDow<n>\]\[:SUBWindow<w>\]:TRACe<t>:Y\[:SCALE\]:MODE](#) on page 448).

Suffix:

<n> 1..n
[Window](#)

Parameters:

<Format> MAGNitude | PHASe | UPHase | RIMag | FREQuency | COMP | CONS | IEYE | QEYE | FEYE | CONF | COVF | RCONStellation | RSUMmary | BERate | GDELay | MOVerview | BIN | OCT | DEC | HEX | NONE

MAGNitude

Magnitude Absolute

PHASe

"Phase Wrap"

UPHase

"Phase Unwrap"

RIMag

"Real/Imag (I/Q)"

FREQuency

"Frequency Absolute"

COMP

"Vector I/Q"

CONS

"Constellation I/Q"

IEYE

"Eye Diagram Real (I)"

QEYE

"Eye Diagram Imag (Q)"

FEYE

"Eye Diagram Frequency"

CONF

"Constellation Frequency"

COVF

"Vector Frequency"

RCONStellation

"Constellation I/Q (Rotated)"

RSUMmary

"Result summary"

BERate

"Bit error rate"

GDELay

"Frequency Response Group Delay"

BIN

"Symbol table" in binary format

OCT

"Symbol table" in octal format

DEC

"Symbol table" in decimal format

HEX

"Symbol table" in hexadecimal format

Example: See [Chapter 11.13.1, "Measurement example 1: user-defined measurement of continuous QPSK signal"](#), on page 493.

Manual operation: See ["Signal Source"](#) on page 249
See ["Result Type"](#) on page 250

CALCulate<n>:STATistics:CCDF[:STATe] <State>

This command switches the measurement of the statistical distribution of magnitude, phase or frequency values on or off.

Suffix:

<n> 1..n
[Window](#)

Parameters:

<State> ON | OFF | 0 | 1
OFF | 0
Switches the function off
ON | 1
Switches the function on
*RST: 0

Example: `CALC:STAT:CCDF ON`
Switches the STATISTIC measurements on.

Manual operation: See ["Result Type Transformation"](#) on page 250

CALCulate<n>:STATistics:MODE <StatisticMode>

This command defines whether only the symbol points or all points are considered for the statistical calculations.

Suffix:

<n> 1..n
[Window](#)

Parameters:

<StatisticMode> SONLy | INFinite
SONLy
 Symbol points only are used
INFinite
 All points are used

Manual operation: See "[Oversampling](#)" on page 251

DISPlay[:WINDow<n>]:ITEM[:LINE][:VALue] <SingleValue>

This commands switches between the whole "Result Summary" and the diagram showing only a single value, e.g. the EVM RMS value as a bargraph. The same parameters are available as those for which modulation accuracy limits can be defined (see "[Limit Value](#)" on page 247).

Suffix:

<n> 1..n
[Window](#)

Parameters:

<SingleValue> ALL | EVMR | EVMP | PERM | PEP | MERM | MEP | CFER |
 RHO | IQOF | FERM | FEP | FDER
ALL
 Complete "Result Summary"
EVMR
 RMS EVM
EVMP
 Peak EVM
PERM
 RMS Phase error
PEP
 Peak phase error
MERM
 RMS Magnitude error
MEP
 Peak magnitude error
CFER
 Carrier frequency error
RHO
 RHO
IQOF
 I/Q offset

FERM

RMS frequency error

FEP

Peak frequency error

FDER

FSK deviation error

Manual operation: See ["Result Summary - Individual Results"](#) on page 58**DISPlay[:WINDow<n>]:PRATe:AUTO** <DisplayPPSMoDe>

Defines the number of display points that are displayed per symbol automatically, i.e. according to [\[SENSe:\]DDEMod:PRATe](#) on page 370. To define a different number of points per symbol for display, use the [MANual](#) parameter and the [DISPlay\[:WINDow<n>\]:PRATe\[:VALue\]](#) command.

Suffix:

<n> 1..n
[Window](#)

Parameters:

<DisplayPPSMoDe> AUTO | MANual

Manual operation: See ["Display Points/Sym"](#) on page 251**DISPlay[:WINDow<n>]:PRATe[:VALue]** <DisplayPPS>

This command determines the number of points to be displayed per symbol if manual mode is selected (see [DISPlay\[:WINDow<n>\]:PRATe:AUTO](#) on page 447).

This command is not available for result displays based on the capture buffer; in this case, the displayed points per symbol are defined by the sample rate ([\[SENSe:\]DDEMod:PRATe](#) command).

Suffix:

<n> 1..n
[Window](#)

Parameters:

<DisplayPPS> 1, 2, 4, 8, 16 or 32
1
 only the symbol time instants are displayed
2, 4, 8, 16, 32
 more points are displayed than symbols

Manual operation: See ["Display Points/Sym"](#) on page 251**DISPlay[:WINDow<n>]:TRACe<t>:SYMBOL** <Symbols>

This command enables the display of the decision instants (time when the signals occurred) as dots on the trace.

Suffix:

<n> 1..n
Window

<t> 1..6
Trace

Parameters:

<Symbols> ON | OFF | 0 | 1
OFF | 0
Symbols are displayed.
ON | 1
Symbols are not displayed.
*RST: 0

Manual operation: See "[Highlight Symbols](#)" on page 250

DISPlay[:WINDow<n>][:SUBWindow<w>]:TRACe<t>:Y[:SCALe]:MODE <Mode>

This command selects the type of scaling of the y-axis (for all traces).

When the display update during remote control is off, this command has no immediate effect.

Suffix:

<n> Window

<w> subwindow

<t> irrelevant

Parameters:

<Mode> **ABSolute**
absolute scaling of the y-axis
RELative
relative scaling of the y-axis
*RST: ABSolute

Example: DISP:TRAC:Y:MODE REL

11.9 Retrieving results

The following commands are required to retrieve the calculated VSA parameters.



All results that are not based on the capture buffer data are calculated for a single result range only (see [Chapter 4.6.1, "Result range"](#), on page 143). To retrieve the results for several result ranges, use the `[SENSe:]DDEMod:SEARch:MBURst:CALC` on page 375 command to move from one result range to the next.

- Retrieving trace data and marker values..... 449
- Measurement results for TRACe<n>[:DATA]? TRACE<n>.....454
- Retrieving general burst and pattern information.....457
- Retrieving parameter values.....462
- Retrieving limit check results.....477

11.9.1 Retrieving trace data and marker values

In order to retrieve the trace and marker results in a remote environment, use the following commands:

Useful commands for retrieving results described elsewhere:

- [CALCulate<n>:MARKer<m>:Y?](#) on page 413

Remote commands exclusive to retrieving results:

CALCulate<n>:DELTaMarker<m>:X:ABSolute?	449
CALCulate<n>:DELTaMarker<m>:X:RELative?	449
CALCulate<n>:MEAS:DIRTy?	450
DISPlay[:WINDow<n>]:TRACe<t>:X[:SCALe]:START?	450
DISPlay[:WINDow<n>]:TRACe<t>:X[:SCALe]:STOP?	451
FORMat:DEXPort:DSEParator	451
FORMat:DEXPort:HEADer	451
FORMat:DEXPort:MODE	452
MMEMory:STORe<n>:IQ:TRACe	452
MMEMory:STORe<n>:TRACe	452
TRACe<n>[:DATA]	453

[CALCulate<n>:DELTaMarker<m>:X:ABSolute?](#)

This command queries the absolute x-value of the selected delta marker in the specified window. The command activates the corresponding delta marker, if necessary.

Suffix:

<n> [Window](#)

Usage: Query only

[CALCulate<n>:DELTaMarker<m>:X:RELative?](#)

This command queries the relative position of a delta marker on the x-axis.

If necessary, the command activates the delta marker first.

Suffix:

<n> [Window](#)

<m> [Marker](#)

Return values:

<Position> Position of the delta marker in relation to the reference marker.

Example: `CALC:DELT3:X:REL?`
Outputs the frequency of delta marker 3 relative to marker 1 or relative to the reference position.

Usage: Query only

CALCulate<n>:MEAS:DIRTY?

Queries the validity of the measurement data, as indicated in the channel bar in manual operation.

Suffix:

<n> 1..n
[Window](#)

Return values:

<State> ON | OFF | 0 | 1

OFF | 0

The measurement results are valid.

ON | 1

Invalid or inconsistent data is displayed, that is: the trace no longer matches the displayed instrument settings.

*RST: 0

Usage: Query only

DISPlay[:WINDow<n>]:TRACe<t>:X[:SCALe]:START?

This command queries the first value of the x-axis in the specified window in symbols or time, depending on the unit setting for the x-axis.

Note: using the `CALCulate<n>:TRACe<t>:ADJust:ALIGnment:OFFSet` command, the burst is shifted in the diagram; the x-axis thus no longer begins on the left at 0 symbols but at a selectable value.

Suffix:

<n> 1..n
[Window](#)

<t> 1..6
[Trace](#)

Return values:

<Start>

Example: See [Chapter 11.13.2, "Measurement example 2: GSM EDGE burst measurement based on a digital standard"](#), on page 495.

Usage: Query only

DISPlay[:WINDow<n>]:TRACe<t>:X[:SCALe]:STOP?

This command queries the last value of the x-axis in the specified window in symbols or time, depending on the unit setting for the x-axis.

Note: If the burst is shifted (using the `CALC:TRAC:ALIG` commands) the x-axis no longer begins at 0 symbols on the left, but at a user-defined value.

Suffix:

<n> 1..n
Window

<t> 1..6
Trace

Return values:

<Stop>

Example:

```
CALC:TRAC:ADJ BURS
Defines the burst as the reference for the screen display
CALC:TRAC:ADJ:ALIG CENT
Position the burst at the center of the screen
DISP:TRAC:X:STOP?
Queries the stop value of the x-axis
```

Usage: Query only

FORMat:DEXPort:DSEParator <Separator>

This command selects the decimal separator for data exported in ASCII format.

Parameters:

<Separator> POINT | COMMa
COMMa
Uses a comma as decimal separator, e.g. 4,05.
POINT
Uses a point as decimal separator, e.g. 4.05.
***RST:** *RST has no effect on the decimal separator.
Default is POINT.

Example:

```
FORM:DEXP:DSEP POIN
Sets the decimal point as separator.
```

Manual operation: See "[Decimal Separator](#)" on page 239

FORMat:DEXPort:HEADer <State>

This command defines if a file header (including start frequency, sweep time, detector, etc.) is created or not. A short header with the instrument model, the version and the date is always transferred.

Parameters:

<State> ON | OFF | 0 | 1

OFF | 0

Switches the function off

ON | 1

Switches the function on

*RST: 0

Example: See [Chapter 11.13.2, "Measurement example 2: GSM EDGE burst measurement based on a digital standard"](#), on page 495.

Manual operation: See ["Header"](#) on page 238

FORMat:DEXPort:MODE <Mode>

This command defines which data are transferred, raw I/Q data or trace data.

Parameters:

<Mode> RAW | TRACe

Example: See [Chapter 11.13.2, "Measurement example 2: GSM EDGE burst measurement based on a digital standard"](#), on page 495.

Example: FORM:DEXP:MODE RAW

Manual operation: See ["Data Export Mode"](#) on page 238

MMEMory:STORe<n>:IQ:TRACe 1, <Filename>Stores the I/Q data for the displayed trace in the selected window to a file in `iq.tar` format.

This command is only available for result types that provide I/Q data based on the error vector, such as the "Vector I/Q" or Real/Imag displays.

Suffix:<n> 1..n
[Window](#)**Setting parameters:**

<Filename> String containing the path and name of the target file.

Example: MMEM:STOR1:TRAC 1, 'C:\TEST.iq.tar'
Stores trace data from window 1 in the file `TEST.iq.tar`.

Usage: Setting only

Manual operation: See ["Export Trace to iq-tar File for Specific Window"](#) on page 239

MMEMory:STORe<n>:TRACe <Trace>, <FileName>

This command exports trace data from the specified window to an ASCII file.

Suffix:<n> [Window](#)

Parameters:

<Trace> Number of the trace to be stored

<FileName> String containing the path and name of the target file.

Example:

```
MMEM:STOR1:TRAC 1, 'C:\TEST.ASC'
```

Stores trace 1 from window 1 in the file TEST.ASC.

Manual operation: See ["Export Trace to ASCII File"](#) on page 239

TRACe<n>[:DATA] <Trace>

This command queries the trace data.

Which data is returned depends on the result display in the window specified by the suffix <n>.

For details see [Chapter 11.9.2, "Measurement results for TRACe<n>\[:DATA\]? TRACE<n>"](#), on page 454.

Suffix:

<n> 1..n
[Window](#)

Query parameters:

<Trace> TRACE1 | TRACE2 | TRACE3 | TRACE4 | TRACE5 | TRACE6 |
 TRACe1r | TRACe1i | TRACe2r | TRACe2i | TRACe3r |
 TRACe3i | STRace | MSTRace | PSTRace

TRACE1 | TRACE2 | TRACE3 | TRACE4 | TRACE5 | TRACE6

The complete data from the corresponding trace.

TRACE1r/TRACE2r/TRACE3r

The real data from the corresponding trace. The parameters are available for the Real/Imaginary result types.

TRACE1i/TRACE2i/TRACE3i

The imaginary data from the corresponding trace. The parameters are available for the Real/Imaginary result types.

STRace

For symbol result types.

The symbols are returned in the currently defined symbol format (see [CALCulate<n>:FORMat](#) on page 444 and [\[SENSe:\]DDEMod:BORDerIng](#) on page 388).

If no parameter is specified, the command always returns the values in the decimal format.

MSTR

Returns a list of boolean values, one for each symbol, indicating whether the symbol matches the corresponding symbol in the known data (1) or not (0).

This setting requires a known data file to be loaded.

This setting requires a known data file to be loaded, or a PRBS definition.

11.9.2.1 Capture buffer results

For the result displays based on the capture buffer, the command returns the y-axis values of the data that is stored in the capture buffer. The number of returned values depends on the size of the capture buffer and the sample rate. For example, a capture buffer size of 500 symbols in combination with a sample rate of 4 would return 2000 level values.

The scaling of the capture buffer depends on the input source:

- Scaling is relative to the current reference level for RF input and file input.
- Scaling is relative to the full-scale level for I/Q input.

The unit is dBm.

Note that the trace results return only the values for the currently displayed capture buffer *range* (see also [Chapter 4.8, "Capture buffer display"](#), on page 148).



You can query the x-value that relates to the first value of the y-axis using `DISPlay[:WINDow<n>]:TRACe<t>:X[:SCALE]:START?` on page 450.

11.9.2.2 Cartesian diagrams

For cartesian diagrams (**magnitude, phase, frequency, real/imag, eye diagrams**), the command returns the y-values of the trace. The number of returned values is the product of the "Result Length" and the display points per symbol. The unit depends on the specified unit.

(See [Chapter 11.5.2.7, "Scaling and units"](#), on page 364).



You can query the x-value that relates to the first value of the y-axis using `DISPlay[:WINDow<n>]:TRACe<t>:X[:SCALE]:START?` on page 450.

The eye diagram result displays are the same as the real/imag result display; the results for eye diagrams are merely superimposed in the display.

11.9.2.3 Polar diagrams

For polar diagrams, the command returns a pair of values for each trace point. The first value is the real part, the second value the imaginary part. The number of returned value pairs depends on the result type:

- "Vector I/Q":
Evaluation range length * display points per symbol
- "Constellation I/Q":
Evaluation range length
- "Constellation Frequency" and "Vector Frequency": one value for each trace point on the y-axis

11.9.2.4 Symbols

For the "Symbol table" result diagrams, the command returns one value for each number in the table. The number of returned values depends on the modulation scheme that you have selected.

If no parameter is specified, the command always returns the values in the decimal format. If the parameter `STRace` is used, the format depends on the currently defined symbol format (see `CALCulate<n>:FORMat` on page 444).

The bits are interpreted according to the `[SENSe:]DDEMod:BOrDering` on page 388 setting.

11.9.2.5 Result summary

For the "Result Summary", the command returns all values listed in the result table from top to bottom, i.e.:

For PSK, MSK and QAM modulation:

<EVM_RMS>,<EVM_Peak>,<MER_RMS>,<MER_Peak>,<Phase Error RMS>,<Phase Error Peak>,<MagError_RMS>,<MagError_Peak>,<Carrier Frequency Error>,<Rho>,<I/Q Offset>,<I/Q Imbalance>,<Gain Imbalance>,<Quadrature Error>,<Amplitude Droop>,<Power>,<**Symbol Rate Error**>,<**I/Q_Skew**>

(Note that the "Symbol Rate Error" and "I/Q skew" were appended at the end to provide compatibility to previous versions and instruments. Consider the notes on I/Q skew results described in ["I/Q skew results depend on modulation"](#) on page 133.)

For FSK modulation:

<Freq_Error_RMS>,<Freq_Error_Peak>,<Mag_Error_RMS>,<Mag_Error_Peak>,<FSK Deviation Error>,<FSK Meas Deviation>,<FSK Ref Deviation>,<Carrier Frequency Error>,<Carrier Frequency Drift>,<Power>

For each result type, both the current and statistical values are provided. The order of the results is as follows:

<result1_current>,<result1_mean>,<result1_peak>,<result1_stddev>,<result1_95%ile>,<

<result2_current>,<result2_mean>,<...>

Empty cells in the table return nothing. The number of returned values depends on the modulation scheme. PSK, MSK and QAM modulation returns 85 values (17 results x 5 statistical values), FSK modulation returns 55 values (11 results x 5 statistical values).

For more details on the individual results, see [Chapter 3.2.28, "Result summary"](#), on page 55.

11.9.2.6 Equalizer

For "Equalizer" diagrams, the command returns the y-axis values of the equalizer trace. The number of returned values depends on the result type:

- For "Impulse Response" diagrams:
(filter length * sample rate) + 1
- For "Frequency Response", "Channel and Group Delay" diagrams: 4096 values



You can query the x-value that relates to the first value of the y-axis using `DISPlay[:WINDow<n>]:TRACe<t>:X[:SCALE]:START?` on page 450.

11.9.2.7 Multi source

For "multi source" diagrams, the data for one source is provided in one trace, the data for the other source in another trace. By default, trace 1 in the spectrum of the Real/Imag display shows the data from the capture buffer or measurement. Trace 2 shows the error data. However, you can change the data sources for the traces (see `CALCulate<n>:TRACe<t>[:VALUE]` on page 407).

For details on the results for real/imag traces, see [Chapter 11.9.2.2, "Cartesian diagrams"](#), on page 455.

11.9.3 Retrieving general burst and pattern information

<code>CALCulate<n>:DSP:RESult:CAPTure:BURSts?</code>	457
<code>CALCulate<n>:DSP:RESult:CAPTure:PATterns?</code>	458
<code>CALCulate<n>:DSP:RESult:RRANge:CURRent:BURSt:LENGth?</code>	458
<code>CALCulate<n>:DSP:RESult:RRANge:CURRent:BURSt:PRESent?</code>	458
<code>CALCulate<n>:DSP:RESult:RRANge:CURRent:BURSt:STARt?</code>	459
<code>CALCulate<n>:DSP:RESult:RRANge:CURRent:PATtern:CONFidence?</code>	459
<code>CALCulate<n>:DSP:RESult:RRANge:CURRent:PATtern:CORRect?</code>	459
<code>CALCulate<n>:DSP:RESult:RRANge:CURRent:PATtern:PRESent?</code>	460
<code>CALCulate<n>:DSP:RESult:RRANge:CURRent:PATtern:STARt?</code>	460
<code>[SENSe:]DDEMod:SEARch:MBURst:STARt[:SYMBOLs]?</code>	460
<code>[SENSe:]DDEMod:SEARch:MBURst:STARt:SAMPles?</code>	461

`CALCulate<n>:DSP:RESult:CAPTure:BURSts?`

Queries the number of bursts found across the internal capture buffer. Note that the internal capture buffer is slightly larger than the displayed capture buffer in order to allow for sufficient filter settling times for further processing.

Suffix:

<n> irrelevant

Return values:

<Bursts> integer
Number of bursts

Example: `CALC:DSP:RES:CAPT:BURS?`

Usage: Query only

CALCulate<n>:DSP:RESult:CAPTURE:PATTERns?

Queries the number of patterns found across the internal capture buffer. Note that the internal capture buffer is slightly larger than the displayed capture buffer in order to allow for sufficient filter settling times for further processing.

Suffix:

<n> irrelevant

Return values:

<Patterns> integer
Number of patterns

Example: `CALC:DSP:RES:CAPT:PATT?`

Usage: Query only

CALCulate<n>:DSP:RESult:RRANge:CURRent:BURSt:LENGth?

Queries the length of the burst in the current result range.

Suffix:

<n> irrelevant

Return values:

<Length> Burst length in samples
Default unit: none

Example: `CALC:DSP:RES:RRAN:CURR:BURS:LENG?`

Usage: Query only

Manual operation: See "[Expected Burst Length / Burst Found](#)" on page 208

CALCulate<n>:DSP:RESult:RRANge:CURRent:BURSt:PRESent?

Queries whether a burst is present or not in the current result range.

Suffix:

<n> irrelevant

Return values:

<Present> ON | OFF | 0 | 1
OFF | 0
Burst not available.
ON | 1
Burst available

Example: `CALC:DSP:RES:RRAN:CURR:BURS:PRES?`

Usage: Query only

CALCulate<n>:DSP:RESult:RRANge:CURRent:BURSt:STARt?

Queries the burst start in the current result range as an offset to the capture buffer start.

Tip: To determine the capture buffer start, use the `DISPlay[:WINDow<n>]:TRACe<t>:X[:SCALe]:STARt?` command for a window with a capture buffer display.

Suffix:

<n> irrelevant

Return values:

<Start> Offset in symbols from the capture buffer start.
Default unit: sym

Example: Query the capture buffer start as the first x-value in the window with a capture buffer display.

`DISP:WIND2:TRAC1:X:SCAL:STAR?`

Query the start of the burst within the result range.

`CALC:DSP:RES:RRAN:CURR:BURS:STAR?`

Usage: Query only

CALCulate<n>:DSP:RESult:RRANge:CURRent:PATtern:CONFidence?

Queries the confidence with which the pattern was detected in the current result range.

Suffix:

<n> irrelevant

Return values:

<Confidence> Percentage of correct identification of pattern
Range: 0 to 100
Default unit: percent

Example: `CALC:DSP:RES:RRAN:CURR:PATT:CONF?`

Usage: Query only

Manual operation: See "[I/Q Correlation Threshold](#)" on page 210

CALCulate<n>:DSP:RESult:RRANge:CURRent:PATtern:CORRect?

Queries whether the pattern is correct or not in the current result range.

Suffix:

<n> irrelevant

Return values:

<Correct> ON | OFF | 0 | 1
OFF | 0
Pattern not correct.

ON | 1

Pattern correct

Example: `CALC:DSP:RES:RRAN:CURR:PATT:CORR?`**Usage:** Query only**Manual operation:** See "[Pattern Symbols Correct](#)" on page 210**CALCulate<n>:DSP:RESult:RRANge:CURRent:PATTern:PRESEnt?**

Queries whether a pattern is present or not in the current result range.

Suffix:

<n> irrelevant

Return values:

<Present> ON | OFF | 0 | 1

OFF | 0

Pattern not available.

ON | 1

Pattern available

Example: `CALC:DSP:RES:RRAN:CURR:PATT:PRES?`**Usage:** Query only**CALCulate<n>:DSP:RESult:RRANge:CURRent:PATTern:STARt?**

Queries the pattern start in the current result range as an offset to the capture buffer start.

Tip: To determine the capture buffer start, use the `DISPlay[:WINDow<n>]:TRACe<t>:X[:SCALe]:STARt?` command for a window with a capture buffer display.**Suffix:**

<n> irrelevant

Return values:

<Start> Offset in symbols from the capture buffer start.

Default unit: sym

Example: Query the capture buffer start as the first x-value in the window with a capture buffer display.`DISP:WIND2:TRAC1:X:SCAL:STAR?`

Query the start of the pattern within the result range.

`CALC:DSP:RES:RRAN:CURR:PATT:STAR?`**Usage:** Query only**[SENSe:]DDEMod:SEARCh:MBURst:STARt[:SYMBOLs]?**

This command queries the start symbol of the current result range within the capture buffer.

Tip: to query the start *sample*, use `[SENSe:]DDEMod:SEARch:MBURst:START:SAMPles?` on page 461.

Return values:

<Start>

Example:

```
INIT:CONT OFF
//switch to single sweep mode
INIT;*WAI
//perform single sweep
SENS:DDEM:SEAR:MBUR:CALC 1
//switch to first result range
SENS:DDEM:SEAR:MBUR:START?
//query start of current (=first) result range
// in the capture buffer
SENS:DDEM:SEAR:MBUR:CALC 2
//switch to second result range
SENS:DDEM:SEAR:MBUR:START?
//query start of current (=second) result range
// in the capture buffer
```

Usage: Query only**[SENSe:]DDEMod:SEARch:MBURst:START:SAMPles?**

This command queries the start sample of the current result range within the capture buffer.

Tip: to query the start *symbol*, use `[SENSe:]DDEMod:SEARch:MBURst:START[:SYMBOLs]?` on page 460.

Return values:

<Start>

Example:

```
INIT:CONT OFF
//switch to single sweep mode
INIT;*WAI
//perform single sweep
SENS:DDEM:SEAR:MBUR:CALC 1
//switch to first result range
SENS:DDEM:SEAR:MBUR:START:SAMP?
//query start of current (=first) result range
// in the capture buffer
SENS:DDEM:SEAR:MBUR:CALC 2
//switch to second result range
SENS:DDEM:SEAR:MBUR:START:SAMP?
//query start of current (=second) result range
// in the capture buffer
```

Usage: Query only

11.9.4 Retrieving parameter values

For each parameter, the VSA application calculates and shows various statistical values:

- Current value
- Mean value
Calculated as the average of the number of results defined by the [Statistic Count](#).
- Peak value
- Standard deviation
- 95 percentile
Unlike the mean value, the 95%ile is a result of all measurement results since the last start of a single or continuous sweep, or of all measurements since the last change of a measurement parameter.

For details on the individual parameters see [Chapter 3.4, "Common parameters in VSA"](#), on page 67 and [Chapter F, "Formulae"](#), on page 518.

CALCulate<n>:BERate?	462
CALCulate<n>:DDEM:BURSt:LENGth?	463
CALCulate<n>:MARKer<m>:FUNcTion:DDEMod:STATistic:ADRoop?	464
CALCulate<n>:MARKer<m>:FUNcTion:DDEMod:STATistic:ALL?	464
CALCulate<n>:MARKer<m>:FUNcTion:DDEMod:STATistic:CFERror?	465
CALCulate<n>:MARKer<m>:FUNcTion:DDEMod:STATistic:EVM?	466
CALCulate<n>:MARKer<m>:FUNcTion:DDEMod:STATistic:FDERror?	467
CALCulate<n>:MARKer<m>:FUNcTion:DDEMod:STATistic:FSK:CFDRift?	467
CALCulate<n>:MARKer<m>:FUNcTion:DDEMod:STATistic:FSK:DERRor?	468
CALCulate<n>:MARKer<m>:FUNcTion:DDEMod:STATistic:FSK:MDEViation?	469
CALCulate<n>:MARKer<m>:FUNcTion:DDEMod:STATistic:FSK:RDEViation?	469
CALCulate<n>:MARKer<m>:FUNcTion:DDEMod:STATistic:GIMBalance?	470
CALCulate<n>:MARKer<m>:FUNcTion:DDEMod:STATistic:IQIMbalance?	470
CALCulate<n>:MARKer<m>:FUNcTion:DDEMod:STATistic:IQSKew?	471
CALCulate<n>:MARKer<m>:FUNcTion:DDEMod:STATistic:MERRor?	471
CALCulate<n>:MARKer<m>:FUNcTion:DDEMod:STATistic:MPOWer?	472
CALCulate<n>:MARKer<m>:FUNcTion:DDEMod:STATistic:OOFFset?	473
CALCulate<n>:MARKer<m>:FUNcTion:DDEMod:STATistic:PERRor?	473
CALCulate<n>:MARKer<m>:FUNcTion:DDEMod:STATistic:QERRor?	474
CALCulate<n>:MARKer<m>:FUNcTion:DDEMod:STATistic:RHO?	475
CALCulate<n>:MARKer<m>:FUNcTion:DDEMod:STATistic:SNR?	475
CALCulate<n>:MARKer<m>:FUNcTion:DDEMod:STATistic:SRERror?	476

CALCulate<n>:BERate? <Format>

Queries the Bit Error Rate results. The available results are described in [Chapter 3.2.1, "Bit error rate \(BER\)"](#), on page 27.

Note that the specified window suffix must refer to a BER result display.

Suffix:

<n> 1..n
[Window](#)
 BER result display

Query parameters:

<Format> Specifies a particular BER result to be queried. If no parameter is specified, the current bit error rate is returned.
 The parameters for these results are listed in [Table 11-4](#).

DSINdex

Queries the index of the identified data sequence found in a known data file. The index starts with 0, that is: the first data sequence in the file is returned as "0".

Example:

CALC:BER? TEC
 Queries the number of bit errors in the current measurement.

Usage:

Query only

Table 11-4: Parameters for BER result values

Result	Current	Min	Max	Acc
Bit Error Rate	CURRent	MIN	MAX	TOTal
Number of bits in result range	TCURrent	TMIN	TMAX	TTOTal
Number of bit errors	TECurent	TEMin	TEMax	TETotal
Number of symbol errors	SECurent	SEMin	SEMax	SETotal

CALCulate<n>:DDEM:BURSt:LENGth?

This command queries the length of a detected burst.

Note that since the R&S FPL1000 VSA application has no knowledge on the ramp length, there is an uncertainty in the burst search algorithm.

Suffix:

<n> [Window](#)

Return values:

<Length> integer
 Number of symbols

Example:

```
INIT:CONT OFF
//switches to single sweep
SENS:DDEM:SIGN:VAL BURS
//switches bursted signal on
INIT:IMM;*WAI
//starts single sweep and waits for result
CALC:DDEM:BURS:LENG?
//returns detected burst length
```

Usage: Query only

Manual operation: See "[Expected Burst Length / Burst Found](#)" on page 208

CALCulate<n>:MARKer<m>:FUNction:DDEMod:STATistic:ADRoop?
<ResultType>

This command queries the results of the amplitude droop error measurement performed for digital demodulation. The output values are the same as those provided in the "Modulation Accuracy" table (see [Chapter 3.2.28, "Result summary"](#), on page 55).

Suffix:

<n> 1..n
[Window](#)

<m> 1..4
[Marker](#)

Query parameters:

<ResultType> **<none>**
Amplitude droop in dB/symbol (for current sweep)

AVG
Amplitude droop in dB/symbol, evaluating the linear average value over several sweeps

RPE
Peak value for amplitude droop over several sweeps

SDEV
Standard deviation of amplitude droop

PCTL
95 percentile value of amplitude droop

Return values:

<Result>

CALCulate<n>:MARKer<m>:FUNction:DDEMod:STATistic:ALL?

The command queries all results of the "Result Summary".

Suffix:

<n> 1..n
[Window](#)

<m> 1..4
[Marker](#)

Return values:

<Results> Comma-separated list of result values in the order described below. Note the last rows differ from the Result Summary display.

Usage: Query only

Table 11-5: Results of the query

```

<EVM_RMS_Curr>,<EVM_RMS_Mean>,<EVM_RMS_Peak>,<EVM_RMS_StdDev>,<EVM_RMS_95%>,
<EVM_Peak_Curr>,<EVM_Peak_Mean>,<EVM_Peak_Peak>,<EVM_Peak_StdDev>,<EVM_Peak_95%>,
<MER_RMS_Curr>,<MER_RMS_Mean>,<MER_RMS_Peak>,<MER_RMS_StdDev>,<MER_RMS_95%>,
<MER_Peak_Curr>,<MER_Peak_Mean>,<MER_Peak_Peak>,<MER_Peak_StdDev>,<MER_Peak_95%>,
<PhaseErr_RMS_Curr>,<PhaseErr_RMS_Mean>,<PhaseErr_RMS_Peak>,<PhaseErr_RMS_StdDev>,<PhaseErr_RMS_95%>,
<PhaseErr_Peak_Curr>,<PhaseErr_Peak_Mean>,<PhaseErr_Peak_Peak>,<PhaseErr_Peak_StdDev>,<PhaseErr_Peak_95%>,
<MagnErr_RMS_Curr>,<MagnErr_RMS_Mean>,<MagnErr_RMS_Peak>,<MagnErr_RMS_StdDev>,<MagnErr_RMS_95%>,
<MagnErr_Peak_Curr>,<MagnErr_Peak_Mean>,<MagnErr_Peak_Peak>,<MagnErr_Peak_StdDev>,<MagnErr_Peak_95%>,
<CarrFreqErr_Curr>,<CarrFreqErr_Mean>,<CarrFreqErr_Peak>,<CarrFreqErr_StdDev>,<CarrFreqErr_95%>,
<Rho_Curr>,<Rho_Mean>,<Rho_Peak>,<Rho_StdDev>,<Rho_95%>,
<IQOffset_Curr>,<IQOffset_Mean>,<IQOffset_Peak>,<IQOffset_StdDev>,<IQOffset_95%>,
<IQImb_Curr>,<IQImb_Mean>,<IQImb_Peak>,<IQImb_StdDev>,<IQImb_95%>,
<GainImb_Curr>,<GainImb_Mean>,<GainImb_Peak>,<GainImb_StdDev>,<GainImb_95%>,
<QuadErr_Curr>,<QuadErr_Mean>,<QuadErr_Peak>,<QuadErr_StdDev>,<QuadErr_95%>,
<AmpDroop_Curr>,<AmpDroop_Mean>,<AmpDroop_Peak>,<AmpDroop_StdDev>,<AmpDroop_95%>,
<Power_Curr>,<Power_Mean>,<Power_Peak>,<Power_StdDev>,<Power_95%>,
<SymRateErr_Curr>,<SymRateErr_Mean>,<SymRateErr_Peak>,<SymRateErr_StdDev>,<SymRateErr_95%>,
<IQSkew_Curr>,<IQSkew_Mean>,<IQSkew_Peak>,<IQSkew_StdDev>,<IQSkew_95%>

```

CALCulate<n>:MARKer<m>:FUNCTION:DDEMod:STATistic:CFERror?

<ResultType>

This command queries the results of the carrier frequency error measurement performed for digital demodulation.

The output values are the same as those provided in the "Modulation Accuracy" table.

Suffix:

<n> 1..n
[Window](#)

<m> 1..4
[Marker](#)

Query parameters:

<ResultType> <none>
Carrier frequency error for current sweep

AVG
Average carrier frequency error over several sweeps

RPE
Peak carrier frequency error over several sweeps

SDEV
Standard deviation of frequency error

PCTL
95 percentile value of frequency error

Return values:

<Result>

Example: See [Chapter 11.13.2, "Measurement example 2: GSM EDGE burst measurement based on a digital standard"](#), on page 495.

CALCulate<n>:MARKer<m>:FUNCtion:DDEMod:STATistic:EVM? <ResultType>

This command queries the results of the error vector magnitude measurement of digital demodulation. The output values are the same as those provided in the "Modulation Accuracy" table .

Suffix:

<n> 1..n
[Window](#)

<m> 1..4
[Marker](#)

Query parameters:

<ResultType> **<none>**
 RMS EVM value of display points of current sweep

AVG
 Average of RMS EVM values over several sweeps

PAVG
 Average of maximum EVM values over several sweeps

PCTL
 95% percentile of RMS EVM value over several sweeps

PEAK
 Maximum EVM over all symbols of current sweep

PPCT
 95% percentile of maximum EVM values over several sweeps

PSD
 Standard deviation of maximum EVM values over several sweeps

RPE
 Maximum value of RMS EVM over several sweeps

SDEV
 Standard deviation of EVM values over several sweeps

TPE
 Maximum EVM over all display points over several sweeps

Return values:

<Result>

Example: See [Chapter 11.13.2, "Measurement example 2: GSM EDGE burst measurement based on a digital standard"](#), on page 495.

CALCulate<n>:MARKer<m>:FUNCTION:DDEMod:STATistic:FDERror?
 <ResultType>

This command queries the results of the FSK deviation error of FSK modulated signals.

Suffix:

<n>	1..n Window
<m>	1..4 Marker

Query parameters:

<ResultType>	<none> Deviation error for current sweep.
	AVG Average FSK deviation error.
	RPE Peak FSK deviation error.
	SDEV Standard deviation of FSK deviation error.
	PCTL 95 percentile value of FSK deviation error.

Return values:

<Result>

CALCulate<n>:MARKer<m>:FUNCTION:DDEMod:STATistic:FSK:CFDRift?
 <ResultType>

This command queries the results of the carrier frequency drift for FSK modulated signals.

Suffix:

<n>	1..n Window
<m>	1..4 Marker

Query parameters:

<ResultType>	<none> Carrier frequency drift for current sweep.
	AVG Average FSK carrier frequency drift over several sweeps.
	RPE Peak FSK carrier frequency drift over several sweeps.
	SDEV Standard deviation of FSK carrier frequency drift.

PCTL

95 percentile value of FSK carrier frequency drift.

Return values:

<Result>

CALCulate<n>:MARKer<m>:FUNction:DDEMod:STATistic:FSK:DERRor?
<ResultType>

This command queries the results of the frequency error of FSK modulated signals.

Suffix:

<n>	1..n Window
<m>	1..4 Marker

Query parameters:

<ResultType>	<none> RMS frequency error of display points of current sweep
	AVG Average of frequency errors over several sweeps
	PAVG Average of maximum frequency errors over several sweeps
	PCTL 95% percentile of frequency error over several sweeps
	PEAK Maximum frequency error over all symbols of current sweep
	PPCT 95% percentile of maximum frequency errors over several sweeps
	PSD Standard deviation of maximum frequency errors over several sweeps
	RPE Maximum value of frequency error over several sweeps
	SDEV Standard deviation of frequency errors over several sweeps
	TPE Maximum frequency error over all display points over several sweeps

Return values:

<Result>

CALCulate<n>:MARKer<m>:FUNCTION:DDEMod:STATistic:FSK:MDEVIation?
<ResultType>

This command queries the results of the measurement deviation of FSK modulated signals.

Suffix:

<n> 1..n
[Window](#)

<m> 1..4
[Marker](#)

Query parameters:

<ResultType> **<none>**
Measurement deviation for current sweep.

AVG
Average FSK measurement deviation over several sweeps.

RPE
Peak FSK measurement deviation over several sweeps.

SDEV
Standard deviation of FSK measurement deviation.

PCTL
95 percentile value of FSK measurement deviation.

Return values:

<Result>

CALCulate<n>:MARKer<m>:FUNCTION:DDEMod:STATistic:FSK:RDEVIation?
<ResultType>

This command queries the results of the reference deviation of FSK modulated signals.

Suffix:

<n> 1..n
[Window](#)

<m> 1..4
[Marker](#)

Query parameters:

<ResultType> **<none>**
Measurement deviation for current sweep.

AVG
Average FSK measurement deviation over several sweeps.

RPE
Peak FSK measurement deviation over several sweeps.

SDEV
Standard deviation of FSK measurement deviation.

PCTL
95 percentile value of FSK measurement deviation.

Return values:

<Result>

CALCulate<n>:MARKer<m>:FUNCTION:DDEMod:STATistic:GIMBalance?

<ResultType>

This command queries the results of the Gain Imbalance error measurement of digital demodulation. The output values are the same as those provided in the "Modulation Accuracy" table .

Suffix:

<n> 1..n
[Window](#)

<m> 1..4
[Marker](#)

Query parameters:

<ResultType> **<none>**
 Gain imbalance error for current sweep

AVG
 Average gain imbalance error over several sweeps

RPE
 Peak gain imbalance error over several sweeps

SDEV
 Standard deviation of gain imbalance error

PCTL
 95 percentile value of gain imbalance error

Return values:

<Result>

CALCulate<n>:MARKer<m>:FUNCTION:DDEMod:STATistic:IQIMBalance?

<ResultType>

This command queries the results of the I/Q imbalance error measurement of digital demodulation.

Suffix:

<n> 1..n
[Window](#)

<m> 1..4
[Marker](#)

Query parameters:

<ResultType> **<none>**
 I/Q imbalance error (for current sweep)

AVG
 Average I/Q imbalance error over several sweeps

RPE

Peak I/Q imbalance error over several sweeps

SDEV

Standard deviation of I/Q imbalance error

PCTL

95 percentile value of I/Q imbalance error

Return values:

<Result>

CALCulate<n>:MARKer<m>:FUNction:DDEMod:STATistic:IQSkew?

<ResultType>

This command queries the results of the I/Q skew error measurement of digital demodulation.

Suffix:

<n> 1..n
Window

<m> 1..4
Marker

Query parameters:

<ResultType> <none>
I/Q skew error (for current sweep)

AVG

Average I/Q skew error over several sweeps

RPE

Peak I/Q skew error over several sweeps

SDEV

Standard deviation of I/Q skew error

PCTL

95 percentile value of I/Q skew error

Return values:

<Result>

CALCulate<n>:MARKer<m>:FUNction:DDEMod:STATistic:MERRor?

<ResultType>

This command queries the results of the magnitude error measurement of digital demodulation.

Suffix:

<n> 1..n
Window

<m> 1..4
Marker

Query parameters:

<ResultType> **<none>**
RMS magnitude error of display points of current sweep

AVG
Average of magnitude errors over several sweeps

PAVG
Average of maximum magnitude errors over several sweeps

PCTL
95% percentile of magnitude error over several sweeps

PEAK
Maximum magnitude errors over all symbols of current sweep

PPCT
95% percentile of maximum magnitude errors over several sweeps

PSD
Standard deviation of maximum magnitude errors over several sweeps

RPE
Maximum value of magnitude errors over several sweeps

SDEV
Standard deviation of magnitude errors over several sweeps

TPE
Maximum magnitude errors over all display points over several sweeps

Return values:

<Result>

CALCulate<n>:MARKer<m>:FUNction:DDEMod:STATistic:MPOWER?

<ResultType>

This command queries the results of the power measurement of digital demodulation.

Suffix:

<n> 1..n
Window

<m> 1..4
Marker

Query parameters:

<ResultType> **<none>**
power measurement (for current sweep)

AVG
Average of power measurement over several sweeps

RPE

Peak of power measurement over several sweeps

SDEV

Standard deviation of power measurement

PCTL

95 percentile value of power measurement

Return values:

<Result>

CALCulate<n>:MARKer<m>:FUNCtion:DDEMod:STATistic:OOffset?

<ResultType>

This command queries the results of the I/Q offset measurement performed for digital demodulation.

Suffix:

<n> 1..n
Window

<m> 1..4
Marker

Query parameters:

<ResultType> <none>
Origin offset error (for current sweep)

AVG
Average origin offset error over several sweeps

RPE
Peak origin offset error over several sweeps

SDEV
Standard deviation of origin offset error

PCTL
95 percentile value of origin offset error

Return values:

<Result>

CALCulate<n>:MARKer<m>:FUNCtion:DDEMod:STATistic:PERror?

<ResultType>

This command queries the results of the phase error measurement performed for digital demodulation.

Suffix:

<n> 1..n
Window

<m> 1..4
Marker

Query parameters:

<ResultType> <none>
"Phase error" of display points of current sweep

AVG
Average of phase errors over several sweeps

PAVG
Average of maximum phase errors over several sweeps

PCTL
95% percentile of phase error over several sweeps

PEAK
Maximum phase error over all symbols of current sweep

PPCT
95% percentile of maximum phase errors over several sweeps

PSD
Standard deviation of maximum phase errors over several sweeps

RPE
Maximum value of phase error over several sweeps

SDEV
Standard deviation of phase errors over several sweeps

TPE
Maximum phase error over all display points over several sweeps

Return values:

<Result>

CALCulate<n>:MARKer<m>:FUNction:DDEMod:STATistic:QERRor?
<ResultType>

This command queries the results of the Quadrature error measurement performed for digital demodulation.

Suffix:

<n> 1..n
Window

<m> 1..4
Marker

Query parameters:

<ResultType> <none>
Quadrature error (for current sweep)

AVG
Average quadrature error over several sweeps

RPE

Peak quadrature error over several sweeps

SDEV

Standard deviation of quadrature error

PCTL

95 percentile value of quadrature error

Return values:

<Result>

CALCulate<n>:MARKer<m>:FUNction:DDEMod:STATistic:RHO? <ResultType>

This command queries the results of the Rho factor measurement performed for digital demodulation.

Suffix:

<n> 1..n
[Window](#)

<m> 1..4
[Marker](#)

Query parameters:

<ResultType> **<none>**
 Rho factor (for current sweep)

AVG
 Average rho factor over several sweeps

RPE
 Peak rho factor over several sweeps

SDEV
 Standard deviation of rho factor

PCTL
 95 percentile value of rho factor

Return values:

<Result>

CALCulate<n>:MARKer<m>:FUNction:DDEMod:STATistic:SNR? <ResultType>

This command queries the results of the SNR error measurement performed for digital demodulation.

Suffix:

<n> 1..n
[Window](#)

<m> 1..4
Marker

Query parameters:

<ResultType> <none>
SNR value of display points of current sweep

AVG
Average of SNR values over several sweeps

PAVG
Average of maximum SNR values over several sweeps

PCTL
95% percentile of SNR value over several sweeps

PEAK
Maximum SNR over all symbols of current sweep

PPCT
95% percentile of maximum SNR values over several sweeps

PSD
Standard deviation of maximum SNR values over several sweeps

RPE
Maximum value of SNR over several sweeps

SDEV
Standard deviation of SNR values over several sweeps

TPE
Maximum SNR over all display points over several sweeps

Return values:

<Result>

CALCulate<n>:MARKer<m>:FUNction:DDEMod:STATistic:SRERror?
<ResultType>

This command queries the symbol rate error

Suffix:

<n> 1..n
Window

<m> 1..4
Marker

Query parameters:

<ResultType> PEAK | AVG | SDEV | PCTL | TPEak | RPEak | PAVG | PSDev | PPCTI
<none>
Symbol rate error (for current sweep)

AVG
Average symbol rate error over several sweeps

RPE

Peak symbol rate error over several sweeps

SDEV

Standard deviation of symbol rate error

PCTL

95 percentile value of symbol rate error

Return values:

<Result>

11.9.5 Retrieving limit check results

The "modulation accuracy" parameters can be checked against defined limits. The following commands are required to query the results of these limit checks.

```

CALCulate<n>:LIMit:MACCuracy:CFERror:CURRent[:RESult]?
CALCulate<n>:LIMit:MACCuracy:CFERror:MEAN[:RESult]?
CALCulate<n>:LIMit:MACCuracy:CFERror:PEAK[:RESult]?
CALCulate<n>:LIMit:MACCuracy:EVM:PCURrent[:RESult]?
CALCulate<n>:LIMit:MACCuracy:EVM:PMEan[:RESult]?
CALCulate<n>:LIMit:MACCuracy:EVM:PPEak[:RESult]?
CALCulate<n>:LIMit:MACCuracy:EVM:RCURrent[:RESult]?
CALCulate<n>:LIMit:MACCuracy:EVM:RMEan[:RESult]?
CALCulate<n>:LIMit:MACCuracy:EVM:RPEak[:RESult]?
CALCulate<n>:LIMit:MACCuracy:FDERror:CURRent[:RESult]?
CALCulate<n>:LIMit:MACCuracy:FDERror:MEAN[:RESult]?
CALCulate<n>:LIMit:MACCuracy:FDERror:PEAK[:RESult]?
CALCulate<n>:LIMit:MACCuracy:FERRor:PCURrent[:RESult]?
CALCulate<n>:LIMit:MACCuracy:FERRor:PMEan[:RESult]?
CALCulate<n>:LIMit:MACCuracy:FERRor:PPEak[:RESult]?
CALCulate<n>:LIMit:MACCuracy:FERRor:RCURrent[:RESult]?
CALCulate<n>:LIMit:MACCuracy:FERRor:RMEan[:RESult]?
CALCulate<n>:LIMit:MACCuracy:FERRor:RPEak[:RESult]?
CALCulate<n>:LIMit:MACCuracy:MERRor:PCURrent[:RESult]?
CALCulate<n>:LIMit:MACCuracy:MERRor:PMEan[:RESult]?
CALCulate<n>:LIMit:MACCuracy:MERRor:PPEak[:RESult]?
CALCulate<n>:LIMit:MACCuracy:MERRor:RCURrent[:RESult]?
CALCulate<n>:LIMit:MACCuracy:MERRor:RMEan[:RESult]?
CALCulate<n>:LIMit:MACCuracy:MERRor:RPEak[:RESult]?
CALCulate<n>:LIMit:MACCuracy:OOFfset:CURRent[:RESult]?
CALCulate<n>:LIMit:MACCuracy:OOFfset:MEAN[:RESult]?
CALCulate<n>:LIMit:MACCuracy:OOFfset:PEAK[:RESult]?
CALCulate<n>:LIMit:MACCuracy:PERRor:PCURrent[:RESult]?
CALCulate<n>:LIMit:MACCuracy:PERRor:PMEan[:RESult]?
CALCulate<n>:LIMit:MACCuracy:PERRor:PPEak[:RESult]?
CALCulate<n>:LIMit:MACCuracy:PERRor:RCURrent[:RESult]?
CALCulate<n>:LIMit:MACCuracy:PERRor:RMEan[:RESult]?
CALCulate<n>:LIMit:MACCuracy:PERRor:RPEak[:RESult]?
CALCulate<n>:LIMit:MACCuracy:RHO:CURRent[:RESult]?

```

CALCulate<n>:LIMit:MACCuracy:RHO:MEAN[:RESult]?
CALCulate<n>:LIMit:MACCuracy:RHO:PEAK[:RESult]?
CALCulate<n>:LIMit:MACCuracy:<ResultType>:<LimitType>[:RESult]

This command queries whether the limit for the specified result type and limit type was violated.

For details on result types and limit types see [Chapter 3.2.28, "Result summary"](#), on page 55.

Suffix:

<n>	Window
<ResultType>	CFERror EVM FDERror FERRor MERRor OOFFset PERRor RHO CFERror = Carrier Frequency Error EVM = "Error Vector" Magnitude FDERror = Frequency deviation error (FSK only) FERRor = Frequency error (FSK only) MERRor = Magnitude Error OOFFset = I/Q Offset PERRor = Phase Error RHO = Rho
<LimitType>	CURRent MEAN PEAK PCURRent PMEan PPEak RCURRent RMEan RPEak For CFERror, OOFFset, RHO: CURRent MEAN PEAK For EVM, FDERror, FERRor, MERRor, PERRor: PCURRent = Peak current value PMEan = Peak mean value PPEak = Peak peak value RCURRent = RMS current value RMEan = RMS mean value RPEak = RMS peak value

Return values:

<LimitResult>	NONE PASS FAIL MARGIN NONE No limit check result available yet. PASS All values have passed the limit check. FAIL At least one value has exceeded the limit. MARGIN currently not used *RST: NONE
---------------	--

11.10 Importing and exporting I/Q data and results

The I/Q data to be evaluated in the VSA application can not only be measured by the VSA application itself, it can also be imported to the application, provided it has the correct format. Furthermore, the evaluated I/Q data from the VSA application can be exported for further analysis in external applications.

For details see [Chapter 7, "I/Q data import and export"](#), on page 253.

MMEMory:LOAD:IQ:STATe.....	479
MMEMory:STORe<n>:IQ:COMMeNt.....	479
MMEMory:STORe<n>:IQ:FORMat.....	479
MMEMory:STORe<n>:IQ:STATe.....	480

MMEMory:LOAD:IQ:STATe 1, <FileName>

This command restores I/Q data from a file.

The file extension is *.iq.tar.

Setting parameters:

<FileName>	string
	String containing the path and name of the source file.

Example: MMEM:LOAD:IQ:STAT 1, 'C:
 \R_S\Instr\user\data.iq.tar'
 Loads IQ data from the specified file.

Usage: Setting only

MMEMory:STORe<n>:IQ:COMMeNt <Comment>

This command adds a comment to a file that contains I/Q data.

Suffix:

<n>	irrelevant
-----	------------

Parameters:

<Comment>	String containing the comment.
-----------	--------------------------------

Example: MMEM:STOR:IQ:COMM 'Device test 1b'
 Creates a description for the export file.
 MMEM:STOR:IQ:STAT 1, 'C:
 \R_S\Instr\user\data.iq.tar'
 Stores I/Q data and the comment to the specified file.

MMEMory:STORe<n>:IQ:FORMat <Format>,<DataFormat>

This command sets or queries the format of the I/Q data to be stored.

Suffix:

<n> irrelevant

Parameters:

<Format> **FLOat32**
32-bit floating point format.

INT32
32-bit integer format.

*RST: FLOat32

<DataFormat> **COMPLex**
Exports complex data.

REAL
Exports real data.

*RST: COMPLex

Example:

```
MMEM:STOR:IQ:FORM INT32,REAL
```

MMEMory:STORe<n>:IQ:STATe <1>, <FileName>

This command writes the captured I/Q data to a file.

The file extension is *.iq.tar. By default, the contents of the file are in 32-bit floating point format.

Suffix:

<n> 1..n

Parameters:

<1>

<FileName> String containing the path and name of the target file.

Example:

```
MMEM:STOR:IQ:STAT 1, 'C:\R_S\Instr\user\data.iq.tar'
Stores the captured I/Q data to the specified file.
```

11.11 Status reporting system

The status reporting system stores all information on the current operating state of the instrument, e.g. information on errors or limit violations which have occurred. This information is stored in the status registers and in the error queue. The status registers and the error queue can be queried via IEC bus.

In this section, only the status registers/bits specific to the VSA application are described.

For details on the common R&S FPL1000 status registers refer to the description of remote control basics in the R&S FPL1000 User Manual.



*RST does not influence the status registers.

Description of the Status Registers

In addition to the registers provided by the base system, the following registers are used in the VSA application:

- `STATUS:QUESTIONABLE:SYNC<n>` - contains application-specific information about synchronization errors or errors during burst detection.
- `STATUS:QUESTIONABLE:MODULATION<n>` – provides information on any limit violations that occur after demodulation in one of the 4 windows
- `STATUS:QUESTIONABLE:MODULATION<n>:EVM` - limit violations in EVM evaluation
- `STATUS:QUESTIONABLE:MODULATION<n>:PHASE` - limit violations in Phase Error evaluation
- `STATUS:QUESTIONABLE:MODULATION<n>:MAGNITUDE` - limit violations in Magnitude Error evaluation
- `STATUS:QUESTIONABLE:MODULATION<n>:CFREQUENCY` - limit violations in Carrier Frequency evaluation
- `STATUS:QUESTIONABLE:MODULATION<n>:IQRHO` - limit violations in I/Q-Offset and RHO evaluation
- `STATUS:QUESTIONABLE:MODULATION<n>:FSK` - limit violations in FSK evaluation



The `STATUS:QUESTIONABLE` register "sums up" the information from all subregisters (e.g. bit 11 sums up the information for all `STATUS:QUESTIONABLE:SYNC` registers). For some subregisters, there may be separate registers for each active channel. Thus, if a status bit in the `STATUS:QUESTIONABLE` register indicates an error, the error may have occurred in any of the channel-specific subregisters. In this case, you must check the subregister of each channel to determine which channel caused the error. By default, querying the status of a subregister always returns the result for the currently selected channel.

The commands to query the contents of the following status registers are described in [Chapter 11.11.9, "Querying the status registers"](#), on page 486.

11.11.1 STATUS:QUESTIONABLE:SYNC<n> register

This register contains application-specific information about synchronization errors or errors during burst detection for each window in each VSA channel. It can be queried with commands `STATUS:QUESTIONABLE:SYNC:CONDITION?` on page 488 and `STATUS:QUESTIONABLE:SYNC[:EVENT]?` on page 489.

Table 11-6: Status error bits in STATUS:QUESTIONABLE:SYNC register for R&S FPL1-K70

Bit	Definition
0	Burst not found. This bit is set if a burst could not be detected.
1	Sync not found This bit is set if the sync sequence (pattern) of the midamble could not be detected.
2 to 14	Not used.
15	This bit is always 0.

11.11.2 STATUS:QUESTIONABLE:MODULATION<n> register

This register comprises information about any limit violations that may occur after demodulation in any of the VSA windows. It can be queried with commands `STATUS:QUESTIONABLE:MODULATION<n>:CONDITION?` on page 488 and `STATUS:QUESTIONABLE:MODULATION<n>[:EVENT]?` on page 488.



The status of the `STATUS:QUESTIONABLE:MODULATION` register is indicated in bit 7 of the "STATUS:QUESTIONABLE" register. It can be queried using the `STATUS:QUESTIONABLE:EVENT` command.

Bit No	Meaning
0	Error in EVM evaluation
1	Error in Phase Error evaluation
2	Error in Magnitude Error evaluation
3	Error in Carrier Frequency evaluation
4	Error in I/Q offset or RHO evaluation
5	Error in FSK evaluation
6-15	These bits are not used

11.11.3 STATUS:QUESTIONABLE:MODULATION<n>:EVM register

This register comprises information about limit violations in EVM evaluation. It can be queried with commands

STATus:QUESTionable:MODulation<n>:EVM:CONDition and
 STATus:QUESTionable:MODulation<n>:EVM[:EVENT].

Bit No	Meaning
0	Error in current RMS value
1	Error in mean RMS value
2	Error in peak RMS value
3-4	These bits are not used
5	Error in current peak value
6	Error in mean peak value
7	Error in peak peak value
8-15	These bits are not used

11.11.4 STATus:QUESTionable:MODulation<n>:PHASe register

This register comprises information about limit violations in Phase Error evaluation. It can be queried with commands

STATus:QUESTionable:MODulation<n>:PHASe:CONDition and
 STATus:QUESTionable:MODulation<n>:PHASe[:EVENT].

Bit No	Meaning
0	Error in current RMS value
1	Error in mean RMS value
2	Error in peak RMS value
3-4	These bits are not used
5	Error in current peak value
6	Error in mean peak value
7	Error in peak peak value
8-15	These bits are not used

11.11.5 STATus:QUESTionable:MODulation<n>:MAGNitude register

This register comprises information about limit violations in Magnitude Error evaluation. It can be queried with commands

STATus:QUESTionable:MODulation<n>:MAGNitude:CONDition and
 STATus:QUESTionable:MODulation<n>:MAGNitude[:EVENT].

Bit No	Meaning
0	Error in current RMS value
1	Error in mean RMS value
2	Error in peak RMS value
3-4	These bits are not used
5	Error in current peak value
6	Error in mean peak value
7	Error in peak peak value
8-15	These bits are not used

11.11.6 STATUS:QUESTIONable:MODulation<n>:CFRequency register

This register comprises information about limit violations in Carrier Frequency evaluation. It can be queried with commands

STATUS:QUESTIONable:MODulation<n>:CFREquency:CONDition and
STATUS:QUESTIONable:MODulation<n>:CFREquency[:EVENT].

Bit No	Meaning
0	Error in current value
1	Error in mean value
2	Error in peak value
3-15	These bits are not used

11.11.7 STATUS:QUESTIONable:MODulation<n>:IQRHO register

This register comprises information about limit violations in I/Q offset or RHO evaluation. It can be queried with commands

STATUS:QUESTIONable:MODulation<n>:IQRHO:CONDition and
STATUS:QUESTIONable:MODulation<n>:IQRHO[:EVENT].

Bit No	Meaning
0	Error in current RHO value
1	Error in mean RHO value
2	Error in peak RHO value
3-4	These bits are not used
5	Error in current I/Q offset value
6	Error in mean I/Q offset value

Bit No	Meaning
7	Error in peak I/Q offset value
8-15	These bits are not used

11.11.8 STATus:QUESTionable:MODulation<n>:FSK register

This register comprises information about limit violations in FSK evaluation. It can be queried with commands

STATus:QUESTionable:MODulation<n>:FSK:CONDition and
STATus:QUESTionable:MODulation<n>:FSK[:EVENT].

Bit No	Meaning
0	Error in current Frequency Error RMS value
1	Error in mean Frequency Error RMS value
2	Error in peak Frequency Error RMS value
3-4	These bits are not used
5	Error in current Frequency Error peak value
6	Error in mean Frequency Error peak value
7	Error in peak Frequency Error peak value
8-9	These bits are not used
10	Error in current Frequency Deviation value
11	Error in mean Frequency Deviation value
12	Error in peak Frequency Deviation value
13-15	These bits are not used

11.11.9 Querying the status registers

The following commands query the contents of the individual status registers.

STATus:QUESTionable:ACPLimit:CONDition?	488
STATus:QUESTionable:DIQ:CONDition?	488
STATus:QUESTionable:FREQuency:CONDition?	488
STATus:QUESTionable:LIMit:CONDition?	488
STATus:QUESTionable:LMARgin:CONDition?	488
STATus:QUESTionable:MODulation<n>:CONDition?	488
STATus:QUESTionable:MODulation<n>:CFREquency:CONDition?	488
STATus:QUESTionable:MODulation<n>:EVM:CONDition?	488
STATus:QUESTionable:MODulation<n>:FSK:CONDition?	488
STATus:QUESTionable:MODulation<n>:IQRHo:CONDition?	488
STATus:QUESTionable:MODulation<n>:MAGNitude:CONDition?	488
STATus:QUESTionable:MODulation<n>:PHASe:CONDition?	488

STATus:QUEStionable:POWer:CONDition?	488
STATus:QUEStionable:SYNC:CONDition?	488
STATus:QUEStionable:ACPLimit[:EVENT]?	488
STATus:QUEStionable:DIQ[:EVENT]?	488
STATus:QUEStionable:FREQuency[:EVENT]?	488
STATus:QUEStionable:LIMit[:EVENT]?	488
STATus:QUEStionable:LMARgin[:EVENT]?	488
STATus:QUEStionable:MODulation<n>[:EVENT]?	488
STATus:QUEStionable:MODulation<n>:CFRequency[:EVENT]?	488
STATus:QUEStionable:MODulation<n>:EVM[:EVENT]?	488
STATus:QUEStionable:MODulation<n>:FSK[:EVENT]?	488
STATus:QUEStionable:MODulation<n>:IQRHo[:EVENT]?	488
STATus:QUEStionable:MODulation<n>:MAGNitude[:EVENT]?	488
STATus:QUEStionable:MODulation<n>:PHASe[:EVENT]?	488
STATus:QUEStionable:POWer[:EVENT]?	489
STATus:QUEStionable:SYNC[:EVENT]?	489
STATus:QUEStionable:ACPLimit:ENABle	489
STATus:QUEStionable:DIQ:ENABle	489
STATus:QUEStionable:FREQuency:ENABle	489
STATus:QUEStionable:LIMit:ENABle	489
STATus:QUEStionable:LMARgin:ENABle	489
STATus:QUEStionable:MODulation<n>:ENABle	489
STATus:QUEStionable:MODulation<n>:CFRequency:ENABle	489
STATus:QUEStionable:MODulation<n>:EVM:ENABle	489
STATus:QUEStionable:MODulation<n>:FSK:ENABle	489
STATus:QUEStionable:MODulation<n>:IQRHo:ENABle	489
STATus:QUEStionable:MODulation<n>:MAGNitude:ENABle	489
STATus:QUEStionable:MODulation<n>:PHASe:ENABle	489
STATus:QUEStionable:POWer:ENABle	489
STATus:QUEStionable:SYNC:ENABle	489
STATus:QUEStionable:ACPLimit:NTRansition	489
STATus:QUEStionable:DIQ:NTRansition	489
STATus:QUEStionable:FREQuency:NTRansition	489
STATus:QUEStionable:LIMit:NTRansition	490
STATus:QUEStionable:LMARgin:NTRansition	490
STATus:QUEStionable:MODulation<n>:NTRansition	490
STATus:QUEStionable:MODulation<n>:CFRequency:NTRansition	490
STATus:QUEStionable:MODulation<n>:EVM:NTRansition	490
STATus:QUEStionable:MODulation<n>:FSK:NTRansition	490
STATus:QUEStionable:MODulation<n>:IQRHo:NTRansition	490
STATus:QUEStionable:MODulation<n>:MAGNitude:NTRansition	490
STATus:QUEStionable:MODulation<n>:PHASe:NTRansition	490
STATus:QUEStionable:POWer:NTRansition	490
STATus:QUEStionable:SYNC:NTRansition	490
STATus:QUEStionable:ACPLimit:PTRansition	490
STATus:QUEStionable:DIQ:PTRansition	490
STATus:QUEStionable:FREQuency:PTRansition	490
STATus:QUEStionable:LIMit:PTRansition	490
STATus:QUEStionable:LMARgin:PTRansition	490
STATus:QUEStionable:MODulation<n>:PTRansition	490

STATus:QUESTionable:MODulation<n>:CFRequency:PTRansition.....	490
STATus:QUESTionable:MODulation<n>:EVM:PTRansition.....	490
STATus:QUESTionable:MODulation<n>:FSK:PTRansition.....	490
STATus:QUESTionable:MODulation<n>:IQRHo:PTRansition.....	490
STATus:QUESTionable:MODulation<n>:MAGNitude:PTRansition.....	490
STATus:QUESTionable:MODulation<n>:PHASe:PTRansition.....	490
STATus:QUESTionable:POWer:PTRansition.....	491
STATus:QUESTionable:SYNC:PTRansition.....	491

STATus:QUESTionable:ACPLimit:CONDition?
STATus:QUESTionable:DIQ:CONDition? <ChannelName>
STATus:QUESTionable:FREquency:CONDition?
STATus:QUESTionable:LIMit:CONDition?
STATus:QUESTionable:LMARgin:CONDition?
STATus:QUESTionable:MODulation<n>:CONDition? <ChannelName>
STATus:QUESTionable:MODulation<n>:CFRequency:CONDition?
 <ChannelName>
STATus:QUESTionable:MODulation<n>:EVM:CONDition? <ChannelName>
STATus:QUESTionable:MODulation<n>:FSK:CONDition? <ChannelName>
STATus:QUESTionable:MODulation<n>:IQRHo:CONDition? <ChannelName>
STATus:QUESTionable:MODulation<n>:MAGNitude:CONDition? <ChannelName>
STATus:QUESTionable:MODulation<n>:PHASe:CONDition? <ChannelName>
STATus:QUESTionable:POWer:CONDition? [<ChannelName>]
STATus:QUESTionable:SYNC:CONDition? <ChannelName>

This command reads out the CONDition section of the status register.

The command does not delete the contents of the EVENT section.

Query parameters:

<ChannelName> String containing the name of the channel.
 The parameter is optional. If you omit it, the command works for the currently active channel.

Usage: Query only

STATus:QUESTionable:ACPLimit[:EVENT]?
STATus:QUESTionable:DIQ[:EVENT]? <ChannelName>
STATus:QUESTionable:FREquency[:EVENT]?
STATus:QUESTionable:LIMit[:EVENT]?
STATus:QUESTionable:LMARgin[:EVENT]?
STATus:QUESTionable:MODulation<n>[:EVENT]? <ChannelName>
STATus:QUESTionable:MODulation<n>:CFRequency[:EVENT]? <ChannelName>
STATus:QUESTionable:MODulation<n>:EVM[:EVENT]? <ChannelName>
STATus:QUESTionable:MODulation<n>:FSK[:EVENT]? <ChannelName>
STATus:QUESTionable:MODulation<n>:IQRHo[:EVENT]? <ChannelName>
STATus:QUESTionable:MODulation<n>:MAGNitude[:EVENT]? <ChannelName>
STATus:QUESTionable:MODulation<n>:PHASe[:EVENT]? <ChannelName>

STATus:QUESTIONable:POWer[:EVENT]? [<ChannelName>]

STATus:QUESTIONable:SYNC[:EVENT]? <ChannelName>

This command reads out the EVENT section of the status register.

The command also deletes the contents of the EVENT section.

Query parameters:

<ChannelName> String containing the name of the channel.
The parameter is optional. If you omit it, the command works for the currently active channel.

Usage: Query only

STATus:QUESTIONable:ACPLimit:ENABLE <SumBit>[, <ChannelName>]

STATus:QUESTIONable:DIQ:ENABLE <BitDefinition>, <ChannelName>

STATus:QUESTIONable:FREQUENCY:ENABLE <SumBit>[, <ChannelName>]

STATus:QUESTIONable:LIMit:ENABLE <SumBit>[, <ChannelName>]

STATus:QUESTIONable:LMARgin:ENABLE <SumBit>[, <ChannelName>]

STATus:QUESTIONable:MODulation<n>:ENABLE <BitDefinition>, <ChannelName>

STATus:QUESTIONable:MODulation<n>:CFREquency:ENABLE <BitDefinition>,
<ChannelName>

STATus:QUESTIONable:MODulation<n>:EVM:ENABLE <BitDefinition>,
<ChannelName>

STATus:QUESTIONable:MODulation<n>:FSK:ENABLE <BitDefinition>,
<ChannelName>

STATus:QUESTIONable:MODulation<n>:IQRHo:ENABLE <BitDefinition>,
<ChannelName>

STATus:QUESTIONable:MODulation<n>:MAGNitude:ENABLE <BitDefinition>,
<ChannelName>

STATus:QUESTIONable:MODulation<n>:PHASe:ENABLE <BitDefinition>,
<ChannelName>

STATus:QUESTIONable:POWer:ENABLE <SumBit>[, <ChannelName>]

STATus:QUESTIONable:SYNC:ENABLE <BitDefinition>, <ChannelName>

This command controls the ENABLE part of a register.

The ENABLE part allows true conditions in the EVENT part of the status register to be reported in the summary bit. If a bit is 1 in the enable register and its associated event bit transitions to true, a positive transition will occur in the summary bit reported to the next higher level.

Parameters:

<BitDefinition> Range: 0 to 65535

<ChannelName> String containing the name of the channel.
The parameter is optional. If you omit it, the command works for the currently active channel.

STATus:QUESTIONable:ACPLimit:NTRansition <SumBit>[, <ChannelName>]

STATus:QUESTIONable:DIQ:NTRansition <BitDefinition>, <ChannelName>

STATus:QUESTIONable:FREQUENCY:NTRansition <SumBit>[, <ChannelName>]

STATus:QUESTionable:LIMit:NTRansition <SumBit>[, <ChannelName>]
STATus:QUESTionable:LMARgin:NTRansition <SumBit>[, <ChannelName>]
STATus:QUESTionable:MODulation<n>:NTRansition <BitDefinition>,
 <ChannelName>
STATus:QUESTionable:MODulation<n>:CFRequency:NTRansition <BitDefinition>,
 <ChannelName>
STATus:QUESTionable:MODulation<n>:EVM:NTRansition <BitDefinition>,
 <ChannelName>
STATus:QUESTionable:MODulation<n>:FSK:NTRansition <BitDefinition>,
 <ChannelName>
STATus:QUESTionable:MODulation<n>:IQRHo:NTRansition <BitDefinition>,
 <ChannelName>
STATus:QUESTionable:MODulation<n>:MAGNitude:NTRansition <BitDefinition>,
 <ChannelName>
STATus:QUESTionable:MODulation<n>:PHASe:NTRansition <BitDefinition>,
 <ChannelName>
STATus:QUESTionable:POWer:NTRansition <SumBit>[, <ChannelName>]
STATus:QUESTionable:SYNC:NTRansition <BitDefinition>[, <ChannelName>]

This command controls the Negative TRansition part of a register.

Setting a bit causes a 1 to 0 transition in the corresponding bit of the associated register. The transition also writes a 1 into the associated bit of the corresponding EVENT register.

Parameters:

<BitDefinition> Range: 0 to 65535
 <ChannelName> String containing the name of the channel.
 The parameter is optional. If you omit it, the command works for
 the currently active channel.

STATus:QUESTionable:ACPLimit:PTRansition <SumBit>[, <ChannelName>]
STATus:QUESTionable:DIQ:PTRansition <BitDefinition>[, <ChannelName>]
STATus:QUESTionable:FREquency:PTRansition <SumBit>[, <ChannelName>]
STATus:QUESTionable:LIMit:PTRansition <SumBit>[, <ChannelName>]
STATus:QUESTionable:LMARgin:PTRansition <SumBit>[, <ChannelName>]
STATus:QUESTionable:MODulation<n>:PTRansition <BitDefinition>,
 <ChannelName>
STATus:QUESTionable:MODulation<n>:CFRequency:PTRansition <BitDefinition>,
 <ChannelName>
STATus:QUESTionable:MODulation<n>:EVM:PTRansition <BitDefinition>,
 <ChannelName>
STATus:QUESTionable:MODulation<n>:FSK:PTRansition <BitDefinition>,
 <ChannelName>
STATus:QUESTionable:MODulation<n>:IQRHo:PTRansition <BitDefinition>,
 <ChannelName>
STATus:QUESTionable:MODulation<n>:MAGNitude:PTRansition <BitDefinition>,
 <ChannelName>
STATus:QUESTionable:MODulation<n>:PHASe:PTRansition <BitDefinition>,
 <ChannelName>

STATus:QUESTionable:POWER:PTRansition <SumBit>[, <ChannelName>]

STATus:QUESTionable:SYNC:PTRansition <BitDefinition>[,<ChannelName>]

These commands control the Positive TRansition part of a register.

Setting a bit causes a 0 to 1 transition in the corresponding bit of the associated register. The transition also writes a 1 into the associated bit of the corresponding EVENT register.

Parameters:

<BitDefinition> Range: 0 to 65535

<ChannelName> String containing the name of the channel.
The parameter is optional. If you omit it, the command works for the currently active channel.

11.12 Deprecated commands

The following commands are maintained for compatibility reasons with previous R&S analyzers only. Use the specified alternative commands for new remote control programs.

CALCulate<n>:FSK:DEVIation:COMPensation	491
DISPlay[:WINDow<n>]:STATe	491
[SENSe:]DDEMod:NORMalize[:VALue]	492
[SENSe:]DDEMod:SBANd	492

CALCulate<n>:FSK:DEVIation:COMPensation <State>

This command defines whether the deviation error is compensated for when calculating the frequency error for FSK modulation.

Note that this command is maintained for compatibility reasons only. For newer remote programs, use [\[SENSe:\]DDEMod:NORMalize:FDError](#) on page 394.

Suffix:

<n> 1..n
[Window](#)

Parameters:

<State> **ON | 1**
Scales the reference signal to the actual deviation of the measurement signal.

OFF | 0
Uses the entered nominal deviation for the reference signal.

DISPlay[:WINDow<n>]:STATe <State>

Activates or deactivates the specified window.

Note that this command is maintained for compatibility reasons only. Use the `LAYout` commands for new remote control programs (see [Chapter 11.8.2, "Working with windows in the display"](#), on page 434).

Suffix:

<n> [Window](#)

[SENSe:]DDEMod:NORMAlize[:VALue] <State>

This command switches the compensation of the IQ offset and the compensation of amplitude droop on or off.

Note that this command is maintained for compatibility reasons only. Use the more specific `[SENSe:]DDEMod:NORMAlize` commands for new remote control programs (see [Chapter 11.5.8, "Demodulation settings"](#), on page 387).

Parameters:

<State> **OFF | 0**
 No compensation for amplitude droop nor I/Q offset
 ON | 1
 Compensation for amplitude droop and I/Q offset enabled
 *RST: 1

[SENSe:]DDEMod:SBANd <SidebandPos>

This command selects the sideband for the demodulation.

Note that this command is maintained for compatibility reasons only. Use the `SENS:SWAP:IQ` command for new remote control programs (see [\[SENSe:\]SWAPiq](#) on page 372).

Parameters:

<SidebandPos> **NORMal | INVerse**
 NORMal
 Normal (non-inverted) position
 INVerse
 Inverted position

11.13 Programming examples

The following examples demonstrate how to perform vector signal analysis in a remote environment.

These examples are meant to demonstrate the use of the most common remote commands for vector signal analysis. Note that not all commands executed here are actually necessary, as they may reflect default settings.

- [Measurement example 1: user-defined measurement of continuous QPSK signal](#) 493
- [Measurement example 2: GSM EDGE burst measurement based on a digital standard](#).....495
- [Measurement example 3: user-defined pattern search and limit check](#).....498

11.13.1 Measurement example 1: user-defined measurement of continuous QPSK signal

The following example describes a scenario similar to the one for manual operation described in

[Chapter 9.2, "Measurement example 1: continuous QPSK signal"](#), on page 276.

```
//-----Configuring the measurement -----
//Reset the instrument
*RST
//Set the center frequency.
FREQ:CENT 1GHz
//Set the reference level
DISP:TRAC:Y:RLEV 4dBm
//Create new measurement channel for vector signal analysis named "MyVSA"
INST:CRE:NEW DDEM, 'MyVSA'

//-----Configuring the measurement -----

//Reset the instrument
*RST
//Set the center frequency.
FREQ:CENT 1GHz
//Set the reference level
DISP:TRAC:Y:RLEV 4dBm
//Create new measurement channel for vector signal analysis named "MyVSA"
INST:CRE:NEW DDEM, 'MyVSA'

//----- Configuring the expected input signal -----

//Set the modulation type
DDEM:FORM QPSK
//Set the modulation order
DDEM:QPSK:FORM NORM
//Query the available symbol mappings for QPSK modulation
DDEM:MAPP:CAT?
//Set the symbol mapping to WCDMA
DDEM:MAPP 'WCDMA'
//Set the symbol rate
DDEM:SRAT 1 MHz
//Select the RRC transmit filter
DDEM:TFIL:NAME 'RRC'
DDEM:TFIL:ALPH 0.35
```

```

//----- Configuring an averaged EVM vs Time result display -----

//Create new window to the right of I/Q constellation (window 1) with
//error vector as data type
LAY:ADD? '1',RIGH,EVEC
//Result: '5'
//Set result type for window 5 to magnitude = EVM
CALC5:FORM MAGN
//Add a second trace in average mode
DISPlay:WINDow5:TRACe2:MODE AVER
//Add a third trace in max hold mode
DISPlay:WINDow5:TRACe3:MODE MAXH
//Calculate an average over 10 sweeps
SWE:COUN 10

//-----Performing the measurement-----

//Select single sweep mode.
INIT:CONT OFF
//Initiate a new measurement and wait until the 10 sweeps have finished.
INIT;*WAI

//-----Storing the Constellation I/Q diagram to a file -----

//Display the I/Q Constellation result display (window 1) in full screen.
DISP:WIND1:SIZE LARG
//Define the destination of the screenshot as a file.
HCOP:DEST 'MMEM'
//Select bmp as the file format.
HCOP:DEV:LANG BMP
//Select the file name for the printout.
MMEM:NAME 'C:\R_S\INST\USER\IQConstellation.bmp'
//Print all screen elements
HCOP:ITEM:ALL
//Store the printout in a file called 'IQConstellation.bmp'.
HCOP
//Restore the I/Q Constellation result display to one subwindow.
DISP:WIND5:SIZE SMAL

//-----Storing the EVM trace data to a file-----

//Include a header in the trace export file
FORM:DEXP:HEAD ON
//Export the trace data, not raw I/Q data
FORM:DEXP:MODE TRAC
//Save the detected symbol values (x-values are not exported with trace data)
MMEM:STOR4:TRAC 1,'AverageEVM'

```

```
//Save the EVM values (window 5) to an ascii file.
MMEM:STOR5:TRAC 1, 'AverageEVM'
```

11.13.2 Measurement example 2: GSM EDGE burst measurement based on a digital standard

The following example describes a scenario similar to the one for manual operation described in

[Chapter 9.3, "Measurement example 2: burst GSM EDGE signals"](#), on page 281



Note that although this example uses the settings from a predefined digital standard, the configuration is changed to demonstrate the possibilities of the VSA application. A measurement that is performed strictly according to the standard requires much fewer programming efforts.

The rising and falling edges of a GSM burst are analyzed using the following result range settings:

Result Range Alignment and Evaluation Range
☰
✕

Result Range

Evaluation Range

Length

Result Length

= 738.462 μ s

Result Range Alignment

Reference

Capture
 Burst
 Pattern Waveform

Alignment

Left
 Center
 Right

Offset

-10 sym

Symbol Number at Burst Start

10 sym

Visualization

The diagram illustrates the measurement setup. A blue trapezoidal signal labeled 'Burst' is shown with a peak of 10 and a trough of -10. Below it, a green rectangular signal labeled 'Result Range' is shown, spanning from 0.0 to 200.0. The burst starts at 10 sym. The result range is aligned to the left of the burst start, with an offset of -10 sym.

```

//-----Configuring the measurement -----

//Reset the instrument
*RST
//Set the center frequency.
FREQ:CENT 1GHz
//Set the reference level
DISP:TRAC:Y:RLEV 4dBm
//Create new measurement channel for vector signal analysis named "VSA"
INST:CRE:NEW DDEM,'VSA'

//-----Loading the required digital standard -----

//Loads the GSM EDGE_8PSK standard file and the settings defined there
DDEM:PRES 'EDGE_NB'

//-----Changing data acquisition settings -----

DDEM:RLEN 10000 sym

//----- Defining the result range -----
//Define the result length as 200 symbols.
DDEMod:TIME 200
//Define the burst as the reference for the result range
CALC:TRAC:ADJ BURS
//Align the result range to the left edge of the burst
CALC:TRAC:ADJ:ALIG LEFT
//Define an offset of 10 symbols from the burst start
CALC:TRAC:ADJ:ALIG:OFFS -10
//Define the symbol number 10 as the result range start
DISP:TRAC:X:VOFF 10

//-----Defining the evaluation range -----

//Evaluation range starts at symbol 13 and ends at symbol 155
CALC:ELIN:STAT ON
CALC:ELIN1 13
CALC:ELIN2 155

//----- Changing the result display -----

//Close symbol table display (window 4)
LAY:WIND4:REM
//Add a second trace in max hold mode to EVM vs Time display (window 1)
DISPlay:WINDow1:TRACe2:MODE MAXH
//Create new window to the right of capture buffer (window 3) with
//measurement signal as data type
LAY:ADD? '3',RIGH,MEAS
//Result: '4'

```



```

//Set result type for window 4 to magnitude
CALC4:FORM MAGN
//Add a second trace in clear/write mode for the reference signal
DISPlay:WINDow4:TRACe2:MODE WRIT
CALC4:TRAC2 REF

//----- Activating limit checks for modulation accuracy -----

//Activate limit checks for all values in the Result Summary
CALC:LIM:MACC:STAT ON

//-----Performing the measurement -----

//Select single sweep mode.
INIT:CONT OFF
//Initiate a new measurement and wait until the 10 sweeps have finished.
INIT;*WAI

//----- Retrieving Results -----

//Query the value and check the limit for the EVM RMS value in the
//result summary for the current evaluation range
CALC2:MARK:FUNC:DDEM:STAT:EVM? AVG
CALC:LIM:MACC:EVM:RCUR?

//Query the value and check the limit for the largest error vector magnitude
//in the measurement.
CALC2:MARK:FUNC:DDEM:STAT:EVM? PAVG
CALC:LIM:MACC:EVM:PPE?

//Query the value and check the limit for the mean carrier frequency offset
//in the result summary for the current evaluation range
CALC2:MARK:FUNC:DDEM:STAT:CFER? AVG
CALC:LIM:MACC:CFER:MEAN?

//----- Storing trace data to a file -----

//Include a header in the trace export file
FORM:DEXP:HEAD ON
//Export the trace data, not raw I/Q data
FORM:DEXP:MODE TRAC
//Query the first value of the x-axis for the current result range
//(x-values are not exported with trace data)
DISP:WIND1:TRAC2:X:STAR?

//Save the measurement signal values (trace 1 in window 4) to an ascii file.
MMEM:STOR4:TRAC 1,'Measurement signal'
//Save the reference signal values (trace 2 in window 4) to an ascii file.
MMEM:STOR4:TRAC 2,'Reference signal'
//Save the result summary values (window 2) for the current result range

```

```
//to an ascii file.
MDEM:STOR2:TRAC 1,'Result Summary'

//----- Retrieving results for further result ranges ----->

//Query the number of result ranges (current is last)
DDEM:SEAR:MBUR:CALC?
//Use variable <x> to determine number of previous result range
//DDEM:SEAR:MBUR:CALC <x>
//Move to next result range and repeat section "retrieving results" for
//range-specific results
```

11.13.3 Measurement example 3: user-defined pattern search and limit check

In this example a user-defined pattern is used to detect bursts and the calculated measurement results are checked against defined limits. The configuration settings are stored as a user-defined standard.

```
//-----Configuring the measurement -----

//Reset the instrument
*RST
//Set the center frequency.
FREQ:CENT 1GHz
//Set the reference level
DISP:TRAC:Y:RLEV 4dBm
//Create new measurement channel for vector signal analysis named "VSA"
INST:CRE:NEW DDEM,'VSA'

//-----Loading the required digital standard -----
//Load the GSM EDGE_8PSK standard file and the settings defined there
DDEM:PRES 'EDGE_NB'

//----- Creating a pattern -----
//Create new pattern
DDEM:SEAR:SYNC:NAME 'EDGE_TSC0_1stSymbolWrong'
DDEM:SEAR:SYNC:NST 8
DDEM:SEAR:SYNC:DATA '00060007000100070007000100070001000100010007000700070007
000100070007000700010007000700010007000100010001'
DDEM:SEAR:SYNC:COMM 'Customized pattern'
DDEM:SEAR:SYNC:TEXT 'manipulated pattern that matches the EDGE_TSC0 pattern except
//for the first symbol (correct: 7, manipulated 6)'
//Add new pattern to current standard
DDEM:SEAR:SYNC:PATT:ADD 'EDGE_TSC0_1stSymbolWrong'
//Select new pattern
DDEM:SEAR:SYNC:SEL 'EDGE_TSC0_1stSymbolWrong'

//Select single sweep mode.
INIT:CONT OFF
```

```

//Initiate a new measurement
INIT;*WAI

//--- Configuring the expected input signal manually (for demonstration purposes)---
//Configure an 8PSK EDGE GSM input signal manually
//Set the modulation
DDEM:FORM PSK
DDEMod:PSK:NST 8
DDEM:PSK:FORM N3P
DDEM:MAPP 'EDGE'

//Set the symbol rate
DDEM:SRAT 270833.333
//Set Result Length
DDEMod:TIME 148
//Set Transmit Filter
DDEMod:TFILTER:NAME 'GMSK_LINEARIZED'
//Define input signal as burst signal with Burst Length 148 and 3 symbols run-in/out
DDEM:SIGN BURS
DDEM:SEAR:BURS:LENG:MAX 148
DDEM:SEAR:BURS:SKIP:RIS 3
DDEM:SEAR:BURS:SKIP:FALL 3
DDEM:SEAR:BURS:LENG:MIN 142
//Define that the input signal has a pattern
DDEM:SIGN:PATT ON
//Query the names of all defined patterns assigned to the current standard
DDEM:SEAR:SYNC:CAT? CURR
//Select a pattern
DDEM:SEAR:SYNC:SEL 'EDGE_TSC0_1stSymbolWrong'
//Ignore the first 58 symbols of the signal before comparing pattern
DDEM:STAN:SYNC:OFFS 58
DDEM:STAN:SYNC:OFFS:STAT ON
//Define the pattern waveform as the reference for the result range
DDEM:SEAR:SYNC:STAT ON
//Align the result range to the center of the pattern
CALC:TRAC:ADJ PATT
CALC:TRAC:ADJ:ALIG CENT
//Define values on x-Axis
DISPlay:WINDow:TRACe:X:SCALE:VOFFset 3
//Evaluation range starts at symbol 3 and ends at symbol 144.75
CALC:ELIN:STAT ON
CALC:ELIN1 3
CALC:ELIN2 144.75

//----- Storing the new settings as a user-defined standard -----
DDEM:STAN:SAVE 'C:\TEMP\CustomizedBurstMeas'

//-----Performing the measurement -----

```

```
//Select single sweep mode.  
INIT:CONT OFF  
//Initiate a new measurement and wait until it has finished.  
INIT;*WAI  
  
//----- Retrieving Results -----  
//Query the trace results of the capture buffer display.  
TRAC3:DATA? TRACE1  
//Query the results of the result summary.  
TRAC2:DATA? TRACE1
```

Annex

A Abbreviations

The following abbreviations are commonly used in the description of the R&S FPL1-K70 option.

Abbreviation	Meaning	See section
FSK	Frequency Shift Keying Modulation mode for which the information is encrypted in the frequency.	Frequency Shift Keying (FSK)
ISI	Inter-symbol Interference	
ISI-free demodulation	Demodulation structure in which the signal is no longer influenced by adjacent symbols at the decision instants after signal-adapted filtering.	System-Theoretical Modulation and Demodulation Filters
MEAS filter	Measurement Filter Weighting filter for the measurement.	System-Theoretical Modulation and Demodulation Filters
MSK	Minimum Shift Keying Modulation mode.	Minimum Shift Keying (MSK)
NDA Demodulator	Non Data Aided Demodulator Demodulation without any knowledge of the sent data contents.	Demodulation and Algorithms
PSK	Phase Shift Keying Modulation mode for which the information lies within the phase or within the phase transitions.	Phase Shift Keying (PSK)
QAM	Quadrature Amplitude Modulation Modulation mode for which the information is encrypted both in the amplitude and phase.	Quadrature Amplitude Modulation (QAM)
RMS	Root Mean Square	Averaging RMS Quantities
RX filter	Receive Filter Baseband filter in analyzer used for signal-adapted filtering.	System-Theoretical Modulation and Demodulation Filters
Transmit filter	Transmitter Filter Digital impulse shaping filter in signal processing unit of transmitter.	System-Theoretical Modulation and Demodulation Filters
VSA	Vector Signal Analysis Measurement at complex modulated RF carriers.	

B Predefined standards and settings

In the "Digital Standards" menu, predefined basic settings for standards can be selected and user-defined standards stored (see [Chapter 5.2, "Configuration according to digital standards"](#), on page 163).

The most common measurements are predefined as standard settings for a large number of mobile radio networks. The instrument comes prepared with the following settings for those standards:

- Capture length and result length
- Signal description
- Modulation
- Transmit filter and measurement filter
- Burst/Pattern search configuration
- Result range alignment
- Evaluation range settings
- Display configuration

The standard settings are grouped in folders to facilitate selecting a standard.

Table B-1: List of predefined standards and settings

Folder	Standard (SCPI) ¹⁾	Modulation Mapping	Symbol rate	Transmit Filter Meas. Filter	Alpha/BT	Search for Burst	Search for Pattern	Pattern	Result length	Alignment	Evaluation Range
GSM	GSM_Nor- malBurst (GSM)	DMSK GSM	270.83333 kHz	GMSK NONE	0.3	✓	✓	GSM_TSC0 (...) GSM_TSC7	148	Pattern to Center	0.5 - 147.25
	GSM_Syn- chronization- Burst (GSM_SB)	DMSK GSM	270.83333 kHz	GMSK NONE	0.3	✓	✓	GSM_SB0 (...) GSM_SB2	148	Pattern to Center	3 - 144
	GSM_Fre- quencyBurst (GSM_FB)	DMSK GSM	270.83333 kHz	GMSK NONE	0.3	✓	✓	GSM_FB0 GSM_FB01	148	Pattern to Center	3 - 144
	GSM_Acces- sBurst (GSM_AB)	DMSK GSM	270.83333 kHz	GMSK NONE	0.3	✓	✓	GSM_AB0 (...) GSM_AB2	88	Pattern to Center	8 - 85
	EDGE_8PS K (EDGE_NB, EDGE_Nor- malburst)	3 π /8-8PSK EDGE	270.833 kHz	Linear- ized GMSK EDGE_N SR	-	✓	✓	EDGE_TSC0 (...) EDGE_TS7	148	Pattern to Center	3-144.75
	EDGE_16Q AM	π /4-16QAM EDGE	270.833 kHz	Linear- ized GMSK EDGE_N SR	-	✓	✓	16QAM_EDGE_TSC0 (...) 16QAM_EDGE_TS7	148	Pattern to Center	3-144.75

1) The SCPI parameter for remote commands is provided where it differs from the standard name or a short form is available.

2) According to Shaped offset QPSK TG (IRIG 106-13) standard, without differential precoding; sample rate = 1 MHz (not defined in standard)

3) Requires bandwidth extension option B40

Folder	Standard (SCPI) ¹⁾	Modulation Mapping	Symbol rate	Transmit Filter Meas. Filter	Alpha/BT	Search for Burst	Search for Pattern	Pattern	Result length	Alignment	Evaluation Range
	EDGE_32QAM	$\pi/4$ -32QAM EDGE	270.833 kHz	Linearized GMSK EDGE_N SR	-	✓	✓	32QAM_EDGE_TSC0 (...) 32QAM_EDGE_TS7	148	Pattern to Center	3-144.75
	EDGE_QPSK_HSR_NarrowPulse	$3\pi/4$ -QPSK EDGE	325 kHz	EDGE Narrow Pulse Shape EDGE HSR (Narrow Pulse)	-	✓	✓	EDGE_HSR_QPSK_TSC0 (...) EDGE_HSR_QPSK_TSC1..7	177	Pattern to Center	4- 172.75
	EDGE_QPSK_HSR_WidePulse	$3\pi/4$ -QPSK EDGE	325 kHz	EDGE Wide Pulse Shape EDGE HSR (Wide Pulse)	-	✓	✓	EDGE_HSR_QPSK_TSC0 (...) EDGE_HSR_QPSK_TSC1..7	177	Pattern to Center	4- 172.75
	EDGE_16QAM_HSR_NarrowPulse	$\pi/4$ -16QAM EDGE	325 kHz	EDGE Narrow Pulse Shape EDGE HSR (Narrow Pulse)	-	✓	✓	EDGE_HSR_16QAM_TSC0 (...) EDGE_HSR_16QAM_TSC1..7	177	Pattern to Center	4- 172.75

1) The SCPI parameter for remod commands is provided where it differs from the standard name or a short form is available.

2) According to Shaped offset QPSK TG (RIG 106-13) standard, without differential precoding; sample rate = 1 MHz (not defined in standard)

3) Requires bandwidth extension option B40

Folder	Standard (SCPI) ¹	Modulation Mapping	Symbol rate	Transmit Filter Meas. Filter	Alpha/BT	Search for Burst	Search for Pattern	Pattern	Result length	Alignment	Evaluation Range
	EDGE_16QAM_HSR_WidePulse	$\pi/4$ -16QAM EDGE	325 kHz	EDGE Wide Pulse Shape EDGE HSR (Wide Pulse)	-	✓	✓	EDGE_HSR_16QAM_TSC0 (...) EDGE_HSR_16QAM_TSC1..7	177	Pattern to Center	4- 172.75
	EDGE_32QAM_HSR_NarrowPulse	$-\pi/4$ -32QAM EDGE	325 kHz	EDGE Narrow Pulse Shape EDGE HSR (Narrow Pulse)	-	✓	✓	EDGE_HSR_32QAM_TSC0 (...) EDGE_HSR_32QAM_TSC1..7	177	Pattern to Center	4- 172.75
	EDGE_32QAM_HSR_WidePulse	$-\pi/4$ -32QAM EDGE	325 kHz	EDGE Wide Pulse Shape EDGE HSR (Wide Pulse)	-	✓	✓	EDGE_HSR_32QAM_TSC0 (...) EDGE_HSR_32QAM_TSC1..7	177	Pattern to Center	4- 172.75
TETRA	TETRA_Discontinuous-Downlink (TETRA_ND DOWN)	$\pi/4$ -DQPSK TETRA	18 kHz	RRC RRC	0.35	✓	-	TETRA_S1 ... TETRA_S3	246	Burst to Center	0 - 244

1) The SCPI parameter for remote commands is provided where it differs from the standard name or a short form is available.

2) According to Shaped offset QPSK TG (RIG 106-13) standard, without differential precoding; sample rate = 1 MHz (not defined in standard)

3) Requires bandwidth extension option B40

Folder	Standard (SCPI) ¹	Modulation Mapping	Symbol rate	Transmit Filter Meas. Filter	Alpha/BT	Search for Burst	Search for Pattern	Pattern	Result length	Alignment	Evaluation Range
	TETRA_Con tinuous- Downlink (TETRA_NC DOWN)	$\pi/4$ -DQPSK TETRA	18 kHz	RRC RRC	0.35	✓	-	TETRA_E TETRA_S	255	Burst to Center	0 - 244
3GPP	3G_WCDMA (3G_WCDM A_FWD, 3G_WCDMA _REV)	QPSK WCDMA	3.84 MHz	RRC RRC	0.22	-	-	-	800	Capture/ Left	-
SOQPS K ²⁾	SOQPSK- TG	GRAY	1 MHz	Shaped Offset QPSK TG None	0.7 (fixed)	-	-	-	1000	Capture/ Left	-
CDMA	CDMA2000_ 1X_FWD (F1CD, CDMA2K_1 X_FWD)	QPSK CDMA2K_F WD	1.2288 MHz	CDMA 2000 1X FWD Low ISI Meas Fil- ter	-	-	-	-	800	Capture/ Left	-
	CDMA2000_ 1X_REV (R1CD)	Offset QPSK Gray	1.2288 MHz	CDMA 2000 1X Reverse Low ISI Meas Fil- ter	-	-	-	-	800	Capture/ Left	-
APCO2 5	APCO25_C QPSK	$\pi/4$ DQPSK APCO25	4.8 kHz	RC NONE	0.2 -	-	-	-	200	Capture/ Left	-

¹⁾ The SCPI parameter for remote commands is provided where it differs from the standard name or a short form is available.

²⁾ According to Shaped offset QPSK TG (IRIG 106-13) standard, without differential precoding; sample rate = 1 MHz (not defined in standard)

³⁾ Requires bandwidth extension option B40

Folder	Standard (SCPI) ¹⁾	Modulation Mapping	Symbol rate	Transmit Filter Meas. Filter	Alpha/BT	Search for Burst	Search for Pattern	Pattern	Result length	Alignment	Evaluation Range
	APCO25_C4 FM	4FSK APCO25	4.8 kHz	APCO25 C4FM Rectangular	-	-	-	-	200	Capture/ Left	-
	APCO_P2_H-CDM	4FSK APCO_25_Phase_2	6 kHz	APCO2 5 H-CPM Rectangular	-	✓	-	-	168	Burst/ Center	entire result range
	APCO_P2_H-DQPSK	4FSK APCO_25_Phase_2	6 kHz	NONE Rectangular	-	-	-	-	180	Capture/ Left	entire result range
Blue-tooth	Blue-tooth_DH1	2FSK Natural	1 MHz	GMSK None	0.5	✓	-	-	366	Burst to Center	2 - 363.75
	Blue-tooth_DH3	2FSK Natural	1 MHz	GMSK None	0.5	✓	-	-	1622	Burst to Center	2 - 1619.75
	Blue-tooth_DH5	2FSK Natural	1 MHz	GMSK None	0.5	✓	-	-	2870	Burst to Center	2 - 2867.75
	Blue-tooth_Low Energy	2FSK Natural	1 MHz	GMSK None	0.5	✓	-	-	376	Burst to Center	60 - 347.75
	Bluetooth_2-DH1	$\pi/4$ -DQPSK BT_EDR2	1 MHz	RRC RRC	0.4	✓	✓	Bluetooth_EDR_Sync_2-DHx	242	Pattern / Left	-
	Bluetooth_2-DH3	$\pi/4$ -DQPSK BT_EDR2	1 MHz	RRC RRC	0.4	✓	✓	Bluetooth_EDR_Sync_2-DHx	1494	Pattern / Left	-

1) The SCPI parameter for remote commands is provided where it differs from the standard name or a short form is available.

2) According to Shaped offset QPSK TG (IRIG 106-13) standard, without differential precoding; sample rate = 1 MHz (not defined in standard)

3) Requires bandwidth extension option B40

Folder	Standard (SCPI) ¹	Modulation Mapping	Symbol rate	Transmit Filter Meas. Filter	Alpha/BT	Search for Burst	Search for Pattern	Pattern	Result length	Alignment	Evaluation Range
	Bluetooth_2-DH5	$\pi/4$ -DQPSK BT_EDR2	1 MHz	RRC RRC	0.4	✓	✓	Bluetooth_EDR_Sync_2-DHX	2742	Pattern / Left	-
	Bluetooth_3-DH1	$\pi/4$ -DQPSK BT_EDR3	1 MHz	RRC RRC	0.4	✓	✓	Bluetooth_EDR_Sync_3-DHX	242	Pattern / Left	-
	Bluetooth_3-DH3	$\pi/4$ -DQPSK BT_EDR3	1 MHz	RRC RRC	0.4	✓	✓	Bluetooth_EDR_Sync_3-DHX	1494	Pattern / Left	-
	Bluetooth_3-DH5	$\pi/4$ -DQPSK BT_EDR3	1 MHz	RRC RRC	0.4	✓	✓	Bluetooth_EDR_Sync_3-DHX	2742	Pattern / Left	-
	Bluetooth_5_LE1 M	2FSK Natural	1 MHz	GMSK None	0.5	✓	✓	BT-LE-Sync	376	Pattern Left (-8 Symbols Offset)	56 - 351.75
	Bluetooth_5_LE2 M	2FSK Natural	2 MHz	GMSK None	0.5	✓	✓	BT-LE-Sync	384	Pattern Left (-16 Symbols Offset)	64 - 359.75
DECT	DECT_P32_FixedPart (DECT_FP)	2FSK Natural	1.152 MHz	GMSK None	0.5	✓	✓	DECT_PP DECT_PP_Prolonged	424	Capture Left	0 - 799.75
	DECT_P32_PortablePart	2FSK Natural	1.152 MHz	GMSK None	0.5	✓	✓	DECT_FP DECT_FP_Prolonged	424	Capture Left	-
DVB-S2 3)	DVB_S2_8P SK	8PSK DVB_S2_8P SK	20 MHz	RRC RRC	0.35	-	-	-	90	Capture Left	-

1) The SCPI parameter for remote commands is provided where it differs from the standard name or a short form is available.

2) According to Shaped offset QPSK TG (IRIG 106-13) standard, without differential precoding; sample rate = 1 MHz (not defined in standard)

3) Requires bandwidth extension option B40

Folder	Standard (SCPI) ¹⁾	Modulation Mapping	Symbol rate	Transmit Filter Meas. Filter	Alpha/BT	Search for Burst	Search for Pattern	Pattern	Result length	Alignment	Evaluation Range
	DVB_S2_16_APSK	UserQAM 16ary DVB_S2_16_APSK_34	20 MHz	RRC RRC	0.35	-	-	-	180	Capture Left	-
	DVB_S2_32_APSK	UserQAM 32ary DVB_S2_32_APSK_34	20 MHz	RRC RRC	0.35	-	-	-	270	Capture Left	-
	DVB_S2_Q_PSK	QPSK DVB_S2_Q_PSK	20 MHz	RRC RRC	0.35	-	-	-	90	Capture Left	-
ZIGBEE	ZIG-BEE_BPSK_868M_300K	BPSK Natural	300 kHz	RC None	1.0	✓	-	-	1000	Burst to Center	-
	ZIG-BEE_OQPSK_915M_600K	BPSK Natural	600 kHz	RC None	1.0	✓	-	-	1000	Burst to Center	-
	ZIG-BEE_OQPSK_2450M_1M	Offset-QPSK Gray	1 MHz	Half Sine -	-	✓	-	-	1000	Burst to Center	-
DOCSIS_30	DS_DOCSIS_256QAM	256QAM DOCSIS	5.360537 MHz	RRC RRC	0.12	✓	-	-	800	Capture Left	entire result range
3)	DS_DOCSIS_64QAM	64QAM DOCSIS	5.056941 MHz	RRC RRC	0.18	✓	-	-	800	Capture Left	entire result range

1) The SCPI parameter for remote commands is provided where it differs from the standard name or a short form is available.

2) According to Shaped offset QPSK TG (RIG 106-13) standard, without differential precoding; sample rate = 1 MHz (not defined in standard)

3) Requires bandwidth extension option B40

Folder	Standard (SCPI) ¹	Modulation Mapping	Symbol rate	Transmit Filter Meas. Filter	Alpha/BT	Search for Burst	Search for Pattern	Pattern	Result length	Alignment	Evaluation Range
	DS_Euro-DOCSIS_25 6QAM	DVB-C	6.952 MHz	RRC RRC	0.15	✓	-	-	800	Capture Left	entire result range
	DS_Euro-DOCSIS_64 QAM	64QAM DVB-C	6.952 MHz	RRC RRC	0.15	✓	-	-	800	Capture Left	entire result range
GBAS	GBAS	D8PSK VDL	10.5 kHz	RC/None	0.6 / --	✓	✓	GBAS_Sync	67	Pattern / Left	-
DMR	DMR.xml	4FSK APCO25_C 4FM	4.8 kHz	RRC RRC	0.2	✓	✓	DMR_BS_sourced_Voice DMR_BS_sourced_Data DMR_MS_sourced_Voice DMR_MS_sourced_Data DMR_MS_sourced_RCsync DMR_TDMA_dm_TS1_Voice DMR_TDMA_dm_TS1_Data DMR_TDMA_dm_TS2_Voice DMR_TDMA_dm_TS2_Data	120	Pattern to Center	-

1) The SCPI parameter for remote commands is provided where it differs from the standard name or a short form is available.
2) According to Shaped offset QPSK TG (RIG 106-13) standard, without differential precoding; sample rate = 1 MHz (not defined in standard)
3) Requires bandwidth extension option B40

C Predefined measurement and tx filters

The most frequently required measurement and TX filters required for vector signal analysis according to digital standards are provided by the R&S FPL1000 VSA application.

For general information on the use of these filters see [Chapter 4.1, "Filters and bandwidths during signal processing"](#), on page 69.

C.1 Transmit filters

The transmit filters required for common standards are predefined in the VSA application.

Table C-1: Overview of predefined Transmit filters

RC	Raised cosine
RRC	Root raised cosine
Gauss	Gauss filter
GMSK	Gauss filter convolved with a rectangular filter; typically used for MSK
Linearized GMSK	Standard-specific filter for GSM EDGE (3GPP TS 45.004), normal symbol rate
EDGE Narrow Pulse Shape	Standard-specific filter for GSM EDGE (higher symbol rate)
EDGE Wide Pulse Shape	Standard-specific filter for GSM EDGE (higher symbol rate)
Half Sine	Half Sine filter
APCO25 C4FM	Filter for the APCO25 C4FM standard.
APCO25 H-CPM	Filter for the APCO25 Phase 2 standard.
APCO25 H-DQPSK	Filter for the APCO25 Phase 2 standard.
APCO25 H-D8PSK Narrow	Filter for the APCO25 Phase 2 standard.
APCO25 H-D8PSK Wide	Filter for the APCO25 Phase 2 standard.
CDMA2000 1X Forward	Filter for CDMA ONE forward link (TIA/EIA/IS-95-A May 1995) and CDMA2000 1X forward link (http://www.3gpp2.org/Public_html/specs/C.S0002-C_v1.0.pdf 28/05/2002)
CDMA2000 1X Reverse	Filter for CDMA ONE forward link (TIA/EIA/IS-95-A May 1995) and CDMA2000 1X reverse link (http://www.3gpp2.org/Public_html/specs/C.S0002-C_v1.0.pdf 28/05/2002)
Rectangular	Rectangular filter in the time domain with a length of 1 symbol period
Shaped Offset QPSK TG	Filter for shaped offset QPSK TG standard

None	No filter is used.
USER	User-defined filter. Define the filter using the <code>[SENSe:]DDEMod:TFILter:USER</code> command.

C.2 Measurement filters

The most frequently required measurement filters are predefined in the VSA application.

Table C-2: Overview of predefined measurement filters

EDGE NSR	Measurement filter required for the "EDGE, Normal Symbol Rate" standard. (see 3GPP TS 45.005, chapter 4.6 "Modulation Accuracy"). The resulting system is NOT inter-symbol interference free.
EDGE HSR (Narrow Pulse)	Measurement filter required for the "EDGE, High Symbol Rate, Narrow Pulse" standard.
EDGE HSR (Wide Pulse)	Measurement filter required for the "EDGE, High Symbol Rate, Wide Pulse" standard.
Gauss	Classic Gauss filter with an adjustable BT
Low ISI Meas Filter	Measurement filter implemented to retain a low intersymbol interference. Best suited for eye diagrams or I/Q vector diagrams. Not necessarily suited for EVM evaluation due to amplification in the pass band. (Not available for SOQPSK modulated signals. If selected, the used filter does not provide low-ISI results!)
Low Pass (Narrow)	Pass band up to $F_{\text{symbol}}/2$ Stop band starts at F_{symbol} (-40dB)
Low Pass (Wide)	Pass band up to F_{symbol} Stop band starts at $1.5 \cdot F_{\text{symbol}}$ (-40dB)
Rectangular	Rectangular filter in the time domain with a length of 1 symbol period; integrate and dump effect
RRC	Root Raised Cosine Filter. The roll-off parameter "Alpha" is set according to the Transmit filter if the "Auto (according to Transmit filter)" option is enabled (see "Using the Transmit Filter as a Measurement Filter (Auto)" on page 226). Otherwise it must be set manually. If the Transmit filter is also a Root Raised Cosine filter with the same roll-off parameter, the resulting system is inter-symbol interference free.
USER	User-defined filter. Define the filter using the <code>Load User Filter</code> function or the <code>[SENSe:]DDEMod:MFILter:USER</code> command. For details see Chapter 8.2.2, "How to select user-defined filters" , on page 258.
NONE	No measurement filter is used.

Typical combinations of tx and measurement filters

The frequency response of the available standard-specific measurement filters is shown in [Chapter F.6.2, "Measurement filter"](#), on page 525.

C.3 Typical combinations of tx and measurement filters

Typical combinations of Tx and Meas filters are shown in [Table C-3](#); they can be set in the VSA application using "Meas filter = AUTO" (see ["Using the Transmit Filter as a Measurement Filter \(Auto\)"](#) on page 226).

Table C-3: Typical combinations of Tx and Meas filters

Transmit filter	Measurement filter (analyzer)	Remarks
RC (raised cosine)	-	filter combination without intersymbol interference (ISI)
RRC (root raised cosine)	RRC	filter combination without ISI
GMSK	-	filter combination with low ISI
Linearized GMSK	EDGE NSR	standard specific filter; filter combination with ISI
Gauss	-	filter combination with low ISI
Rectangular	-	filter combination without ISI
Half Sine	-	filter combination without ISI
CDMA2000 1X FORWARD	Low ISI Meas Filter	filter combination without ISI
CDMA2000 1X REVERSE	Low ISI Meas Filter	filter combination without ISI
APCO25 C4FM	Rectangular	filter combination without ISI
APCO25 H-CPM	Rectangular	filter combination without ISI
APCO25 H-DQPSK	Low ISI Meas Filter	filter combination without ISI
APCO25 H-D8PSK Narrow	Low ISI Meas Filter	filter combination without ISI
APCO25 H-D8PSK Wide	Low ISI Meas Filter	filter combination without ISI
EDGE Narrow Pulse Shape	EDGE HSR (Narrow Pulse)	standard specific filter; filter combination with ISI
EDGE Wide Pulse Shape	EDGE HSR (Wide Pulse)	standard specific filter; filter combination with ISI
User	Low ISI Meas Filter	filter combination with low ISI

D ASCII file export format for VSA data

The data of the file header consist of three columns, each separated by a semicolon: parameter name; numeric value; basic unit. The data section starts with the keyword "Trace <n>" (<n> = number of stored trace), followed by the measured data in one or several columns (depending on the result type) which are also separated by a semicolon.

If several traces in several windows are exported to one file, the data for each window is listed subsequently. Within the data for a single window, the data for the individual traces is listed subsequently.

For details on which data is stored for which result display, see [TRACe<n> \[: DATA \]](#) on page 453.

Table D-1: ASCII file format for VSA trace data export

File contents	Description
Header	
	Instrument model
Version;1.40;	Firmware version
Date;01.Apr 2012;	Date of data set storage
Header section for individual window	
Screen;1;	Window name
Points per Symbol;4;	Points per symbol
x Axis Start;-13;sym;	Start value of the x axis
x Axis Stop;135;sym;	Stop value of the x axis
y per div;0.22000000000000003;	Y axis range per division
Ref value y axis;-10.00;dBm;	Y axis reference value
Ref value position;100;%;	Y axis reference position
Start of result range in capture buffer;6400;sym	Number of symbol at which exported capture buffer range begins
Header section for individual trace	
Trace; 1;	First trace
Meas Result;IQ;	Result type
Meas Signal;Meas;	Data source (measurement or reference data)
Demodulator;Offset QPSK;	Demodulation type
ResultMode;Trace;	Result mode
x unit;sym;	Unit of the x axis
y unit;dBm;	Unit of the y axis
Trace Mode;Clear Write;	Trace mode

File contents	Description
Values;800;	Number of measurement points
Data section for individual trace	
10000;-10.3;-15.7 10130;-11.5;-16.9 10360;-12.0;-17.4 ...;...;	Measured values: <x value>, <y1>, <y2>; <y2> is only available with detector AUTOPEAK and contains the smallest of the two measured values for a measurement point
Header section for individual trace	
Trace; 2;	Next trace in same window
Meas Result;IQ;	Result type
Meas Signal;Meas;	Data source (measurement or reference data)
Demodulator;Offset QPSK;	Demodulation type
ResultMode;Trace;	Result mode
x unit;sym;	Unit of the x axis
y unit;dBm;	Unit of the y axis
Trace Mode;Clear Write;	Trace mode
Values;800;	Number of measurement points
Data section for individual trace	
...	
Header section for individual window	
Screen;2;	Name of next window
...	
Header section for individual trace	
Trace; 1;	First trace in second window
Data section for individual trace	
...	

E Known data file syntax description

When you load a Known Data file, the R&S FPL1-K70 application checks whether the file complies with the following syntax:

Table E-1: Known Data File Syntax

Syntax	Possible Values	Description
<RS_VSA_KNOWN_DATA_FILE Version="01.00">	as specified	File Header
<Comment></Comment>	arbitrary	Optional file description
<Base></Base>	2 16	The base used to specify the <Data> values (binary or hexadecimal) For <ModulationOrder> values ≥ 32 , use binary (2).
<ModulationOrder></ModulationOrder>	2 4 8 16 32 64 128 256	Number of values each symbol can represent (order of modulation), e.g. 8 for 8-PSK For <ModulationOrder> values ≥ 32 , use <Base> = 2.
<ResultLength></ResultLength>	1 ... up to 2000 ^{*)}	Number of symbols in each <Data> element The number must be identical to the "Result Length" setting in the "Result Range" dialog box, i.e. the number of symbols to be demodulated.
<Data></Data>	One character per symbol in the sequence Possible characters are: 0 to n-1, where n is the <ModulationOrder> Spaces, tabs and line breaks are ignored	One possible sequence of symbols that can be demodulated from the input signal Up to 6000 ^{*)} different sequences, i.e. <Data>-elements, can be defined in total
</RS_VSA_KNOWN_DATA_FILE>	as specified	File End

^{*)} the exact number also depends on available memory space

Sample xml file for known data

```
<RS_VSA_KNOWN_DATA_FILE Version="01.00">

  <Comment> Standard EDGE_8PSK </Comment>
  <Base>          16          </Base>
  <ModulationOrder> 8          </ModulationOrder>
  <ResultLength>  148        </ResultLength>

  <Data>
    777 511 727 242 206 341 366 632 073 607
    770 173 705 631 011 235 507 476 330 522
    177 177 171 117 777 177 717 717 111 615
    527 046 104 004 106 047 125 415 723 344
    241 264 773 111 337 446 514 600 677 7      </Data>

  <Data>
    77 511 727 242 206 341 366 632 073 607
    770 173 705 631 011 235 507 476 330 522
```

```
177 177 171 117 777 177 717 717 111 615
527 046 104 004 106 047 125 415 723 344
241 264 773 111 337 446 514 600 677 7 7 </Data>

<Data> 7 511 727 242 206 341 366 632 073 607
770 173 705 631 011 235 507 476 330 522
177 177 171 117 777 177 717 717 111 615
527 046 104 004 106 047 125 415 723 344
241 264 773 111 337 446 514 600 677 7 77 </Data>

<Data> 7 777 511 727 242 206 341 366 632 073 607
770 173 705 631 011 235 507 476 330 522
177 177 171 117 777 177 717 717 111 615
527 046 104 004 106 047 125 415 723 344
241 264 773 111 337 446 514 600 677 </Data>

<Data> 77 777 511 727 242 206 341 366 632 073 607
770 173 705 631 011 235 507 476 330 522
177 177 171 117 777 177 717 717 111 615
527 046 104 004 106 047 125 415 723 344
241 264 773 111 337 446 514 600 67 </Data>

</RS_VSA_KNOWN_DATA_FILE>
```

F Formulae

• Trace-based evaluations.....	518
• Result summary evaluations.....	520
• Statistical evaluations for the result summary.....	523
• Trace averaging.....	523
• Analytically calculated filters.....	524
• Standard-specific filters.....	525

F.1 Trace-based evaluations

The trace-based evaluations all take place at the sample rate defined by the "Display Points Per Symbol" parameter (see "Display Points/Sym" on page 251). The sampling instants at this rate are referred to as "t" here, i.e.

$$t = n \cdot T_D$$

Where T_D equals the duration of one sampling period at the sample rate defined by the "Display Points Per Symbol" parameter.

Test parameter	Formula
Error vector	$EV(t) = MEAS(t) - REF(t)$
"Error Vector" Magnitude (EVM)	$EVM(t) = \frac{ EV(t) }{C}$ <p>with the normalization constant C depends on your setting. By default C^2 is the mean power of the reference signal.</p> $C = \sqrt{\frac{1}{K} \sum_k REF(k \cdot T) ^2}$ <p>T = duration of symbol periods</p>
Magnitude	$Mag_{MEAS}(t) = MEAS(t) $ $Mag_{REF}(t) = REF(t) $
Phase	$Phase_{MEAS}(t) = \angle(MEAS(t))$ $Phase_{REF}(t) = \angle(REF(t))$
Frequency	$FREQ_{MEAS}(t) = \frac{1}{2 \cdot \pi} \frac{d}{dt} \angle MEAS(t)$ $FREQ_{REF}(t) = \frac{1}{2 \cdot \pi} \frac{d}{dt} \angle REF(t)$

Test parameter	Formula
"Magnitude error"	$MAG_ERR(t) = MAG_{MEAS}(t) - MAG_{REF}(t)$
"Phase error"	$PHASE_ERR(t) = PHASE_{MEAS}(t) - PHASE_{REF}(t)$
Frequency error	$FREQ_ERR(t) = FREQ_{MEAS}(t) - FREQ_{REF}(t)$

FSK Modulation

The trace-based results for FSK signals are the same as those available for linear modulation types. However, as the signal processing for FSK signals is performed on the magnitude and instantaneous frequency, the I/Q based results first require a reconstruction of the reference and measured I/Q waveforms, as illustrated in [Reconstruction of the reference and measured I/Q waveforms for FSK modulation](#).

The dashed outline of the "compensate" blocks indicate that these operations are optionally (de-)activated depending on the corresponding user settings. With respect to FSK measurements, the optional compensation parameters are:

- [FSK Reference deviation](#)
- [Carrier frequency drift](#)

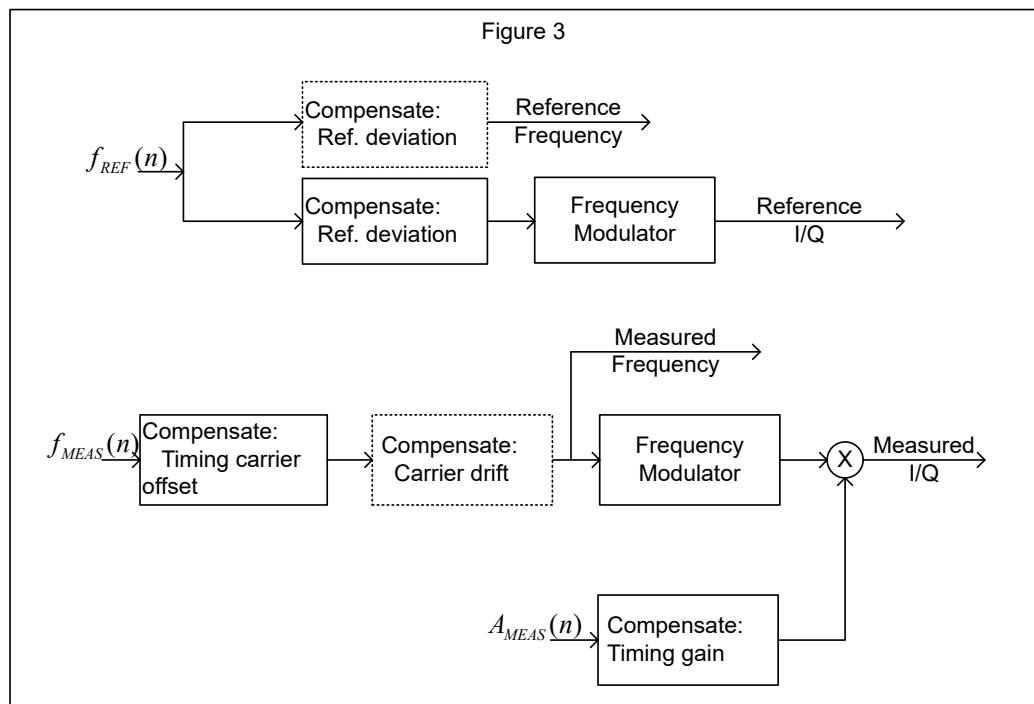


Figure F-1: Reconstruction of the reference and measured I/Q waveforms for FSK modulation

Note that a reference deviation error is corrected in the reference frequency trace. This ensures that the frequency deviation in the measured frequency trace corresponds to that of the originally measured signal. With respect to the I/Q reconstruction, the measured magnitude is timing compensated using the timing offset estimated from the

measured instantaneous frequency. This ensures that the measured magnitude and frequency remain synchronized in the reconstructed I/Q waveform.

F.2 Result summary evaluations

The evaluations for the result summary take place at the sample rate defined by the "Display Points Per Symbol" parameter (see "Display Points/Sym" on page 251). This value can be one of the following:

- "1": only the symbol instant contributes to the result
- "2": two samples per symbol instant contribute to the result (required for offset QPSK)
- The "Sample rate" defined for data acquisition (see "Sample Rate" on page 201): all samples contribute to the result equally

The results are determined by the evaluation range.

The sampling instants at this rate are referred to as "t" here, i.e.

$$t=n \cdot T_D$$

Where T_D equals the duration of one sampling period at the sample rate defined by the "Display Points Per Symbol" parameter

F.2.1 PSK, QAM and MSK modulation

For PSK, QAM and MSK modulation the estimation model is described in detail in chapter [Chapter 4.5.1, "PSK, QAM and MSK modulation"](#), on page 126. The parameters of the PSK, QAM and MSK-specific result summary table can be related to the distortion model parameters as follows:

Table F-1: Evaluation of results in the PSK, QAM and MSK result summary

EVM	RMS	$\sqrt{\frac{1}{N} \sum_n EVM(n \cdot T_D)^2}$
	Peak	$\max(EVM(n \cdot T_D))$
Modulation error	RMS	$-20 \cdot \log_{10} \left(\frac{\sqrt{\frac{1}{N} \sum_n EV(n \cdot T_D) ^2}}{\sqrt{\frac{1}{K} \sum_k REF(k \cdot T) ^2}} \right)$

	Peak	$\min(MER(n \cdot T_D))$ $\text{with } MER(n \cdot T_D) = -20 \cdot \log_{10} \left(\frac{\sqrt{\frac{1}{N} \sum_n EV(n \cdot T_D) ^2}}{\sqrt{\frac{1}{K} \sum_k REF(k \cdot T) ^2}} \right)$
"Magnitude error"	RMS	$\sqrt{\frac{1}{N} \sum_n MAG_ERR(n \cdot T_D) ^2}$
	Peak	$\max(MAG_ERR(n \cdot T_D))$
"Phase error"	RMS	$\sqrt{\frac{1}{N} \sum_n PHASE_ERR(n \cdot T_D) ^2}$
	Peak	$\max(PHASE_ERR(n \cdot T_D))$
RHO (correlation coefficient)		$\rho = \frac{\left \sum_n REF^*(n) \cdot MEAS(n) \right ^2}{\sum_n REF(n) ^2 \cdot \sum_n MEAS(n) ^2} = \frac{ KKF(MEAS, REF) ^2}{AKF(REF) \cdot AKF(MEAS)}$
IQ Offset C		$C_{[lin]} = \frac{\left(\frac{c_I}{g_I} \right)^2 + \left(\frac{c_Q}{g_Q} \right)^2}{\frac{1}{K} \sum_k REF(k \cdot T) ^2}$ $C = 10 \cdot \log_{10}(C_{[lin]})[\text{dB}]$
IQ Imbalance B		$B_{[lin]} = \frac{ g_I - g_Q \cdot e^{j\theta} }{ g_I + g_Q \cdot e^{j\theta} }$ $B = 20 \cdot \log_{10}(B_{[lin]})[\text{dB}]$
Gain Imbalance G		$G_{[lin]} = \frac{g_Q}{g_I}$ $G = 20 \cdot \log_{10}(G_{[lin]})[\text{dB}]$

Quadrature Error Θ		$\theta_{[lin]} = \vartheta / \pi \cdot 180^\circ$ $\theta = \theta_{[lin]} [\text{deg}]$
Amplitude Droop A		$A_{[lin]} = e^{-\alpha T}$ $A = 20 \cdot \log_{10}(A_{[lin]}) [\text{dB/Sym}]$

F.2.2 FSK modulation

For FSK modulation the estimation model is described in detail in section [Chapter 4.5.2, "FSK modulation"](#), on page 137. The parameters of the FSK-specific result summary table can be related to the distortion model parameters as follows:

Table F-2: Evaluation of results in the FSK result summary

Frequency Error	RMS	$\sqrt{\frac{1}{N} \sum_n FREQ_ERR(n \cdot T_D) ^2}$
	Peak	$\max(FREQ_ERR(n \cdot T_D))$
Magnitude Error	RMS	$\sqrt{\frac{1}{N} \sum_n MAG_ERR(n \cdot T_D) ^2}$
	Peak	$\max(MAG_ERR(n \cdot T_D))$
FSK Deviation Error Λ_{ERR}		$\Lambda_{ERR} = \Lambda_{MEAS} - \Lambda_{REF} = (B - 1) \cdot \Lambda_{REF}$ Estimated FSK deviation error [Hz].
FSK Measurement Deviation Λ_{MEAS}		$\Lambda_{MEAS} = B \cdot \Lambda_{REF}$ Estimated FSK deviation of the meas signal [Hz].
FSK Reference Deviation Λ_{REF}		FSK reference deviation as entered by the user [Hz].
Carrier Frequency Error f_0		$f_0 = \frac{C}{2 \cdot \pi}$ The carrier frequency error of the measured signal [Hz].
Carrier Frequency Drift f_d		$f_d = \frac{D}{2 \cdot \pi \cdot T}$ The drift in the carrier frequency of the measured signal [Hz/Sym].

F.3 Statistical evaluations for the result summary

The statistical evaluations in the result summary are based on the measurement results that are displayed in the "Current" column. Hence, the index "m" here represents the current evaluation, "M" is the total number of evaluations. In single sweep mode, M corresponds to the statistics count.

If the measurement values are represented in the logarithmic domain, the linear values are averaged. The result is then subsequently converted back into logarithmic domain. The linear values are indicated by the subscript [lin] in [Chapter F.2.1, "PSK, QAM and MSK modulation"](#), on page 520.

	Mathematical expression	Calculation in R&S FPL1000
Mean \hat{x}_M	$\bar{x}_M = \frac{1}{M} \sum_m x_m$	$\bar{x}_M = \frac{(M-1) \cdot \bar{x}_{M-1} + x_M}{M}$ with $\bar{x}_0 = 0$
Peak \hat{x}_M	$\hat{x}_M = x_{idx}$ with $idx = \arg \max_m x_m $	$\hat{x}_M = x_M \text{ if } x_M > \hat{x}_{M-1} $ $\hat{x}_M = x_{M-1} \text{ if } x_M \leq \hat{x}_{M-1} $ with $\bar{x}_0 = 0$
StdDev σ_M	$\sigma_M = \sqrt{\frac{1}{M} \sum_m (x_m - \bar{x}_M)^2}$ with $\bar{x}_M = \frac{1}{M} \sum_m x_m$	$\sigma_M = \sqrt{\frac{(M-1) \cdot \sigma_{M-1}^2 + \frac{M}{M-1} (x_M - \bar{x}_M)^2}{M}}$ with $\sigma_0 = 0$
95%ile $x_{95,M}$	$x_{95,M} = \{x \Pr(x_m \leq x) = 0.95\}$ Pr() denotes the probability	Sorting the values and giving the 95%ile.

F.4 Trace averaging

The index "m" represents the current evaluation, "M" is the total number of evaluations. In single sweep mode, M corresponds to the statistics count. The index "s" represents the sth sample within the trace.

If the measurement results are represented in logarithmic domain, the average operation is performed on the linear values. The result is then subsequently converted back into logarithmic domain.

	Measurements	Calculation in R&S FPL1000
RMS Average $\bar{x}_{s,M}$	<ul style="list-style-type: none"> Error Vector Magnitude (EVM) Meas/Ref magnitude Capture Buffer magnitude 	$\bar{x}_{s,M} = \sqrt{\frac{(M-1) \cdot \bar{x}_{s,M-1}^2 + x_{s,M}^2}{M}}$
Linear Average $\bar{x}_{s,M}$	All measurements where trace averaging is possible except for the measurements listed for RMS averaging	$\bar{x}_{s,M} = \frac{(M-1) \cdot \bar{x}_{s,M-1} + x_{s,M}}{M}$

F.5 Analytically calculated filters

The following filters are calculated during runtime of the unit and as a function of the operating parameter Alpha or BT.

Filter Type	Setting Parameter	Impulse Response
Raised cosine (RC)	Alpha (α)	$h(t) = \frac{\sin\left(\frac{\pi t}{T}\right)}{\left(\frac{\pi t}{T}\right)} \cdot \frac{\cos\left(\frac{\pi \alpha t}{T}\right)}{1 - 4\left(\frac{\alpha t}{T}\right)^2}$
Root raised cosine (RRC)	Alpha (α)	$h(t) = 4\alpha \frac{\cos((1+\alpha)\pi t/T) + \frac{\sin((1-\alpha)\pi t/T)}{4\alpha t/T}}{\pi \sqrt{T} \left(1 - (4\alpha t/T)^2\right)}$
Gaussian filter (Gauss) ETSI TS 100 959 (V8.3.0)	BT	$h(t) = \frac{\exp\left(\frac{-t^2}{2\rho^2 T^2}\right)}{\sqrt{(2\pi) \cdot \rho T}}$ <p>with</p> $\rho = \frac{\sqrt{\ln 2}}{2\pi BT}$

F.6 Standard-specific filters

F.6.1 Transmit filter

EDGE Tx filter ETSI TS 300 959 (V8.1.2) (Linearized GMSK)

$$c_0(t) = \begin{cases} \prod_{i=0}^3 S(t+iT) & \text{for } 0 \leq t \leq 5T \\ 0 & \text{else} \end{cases}$$

$$S(t) = \begin{cases} \sin\left(\pi \int_0^t g(t') dt'\right) & \text{for } 0 \leq t \leq 4T \\ \sin\left(\frac{\pi}{2} - \pi \int_0^{t-4T} g(t') dt'\right) & \text{for } 4T < t \leq 8T \\ 0 & \text{else} \end{cases}$$

$$g(t) = \frac{1}{2T} \left(Q\left(2\pi \cdot 0.3 \frac{t-5T/2}{T\sqrt{\ln(2)}}\right) - Q\left(2\pi \cdot 0.3 \frac{t-3T/2}{T\sqrt{\ln(2)}}\right) \right)$$

$$Q(t) = \frac{1}{\sqrt{2\pi}} \int_t^{\infty} e^{-\frac{\tau^2}{2}} d\tau$$

$c_0(t)$ is the impulse response of the EDGE transmit filter

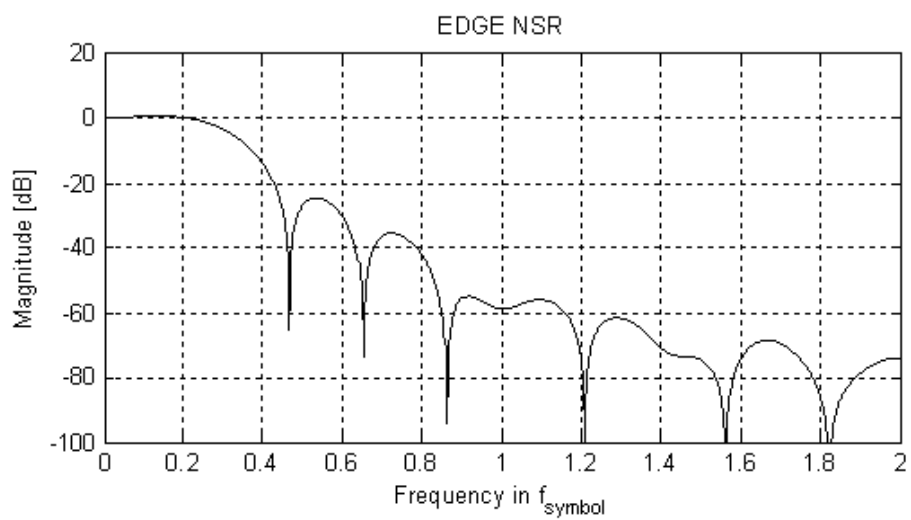
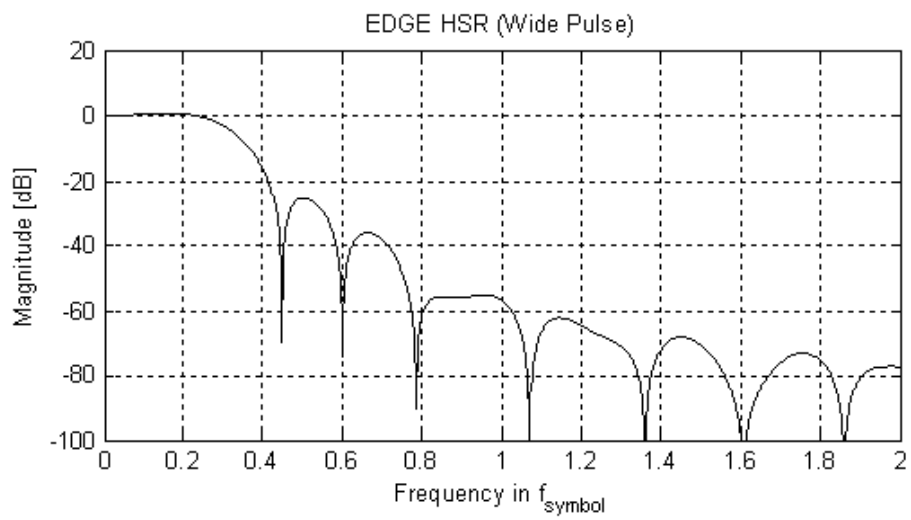
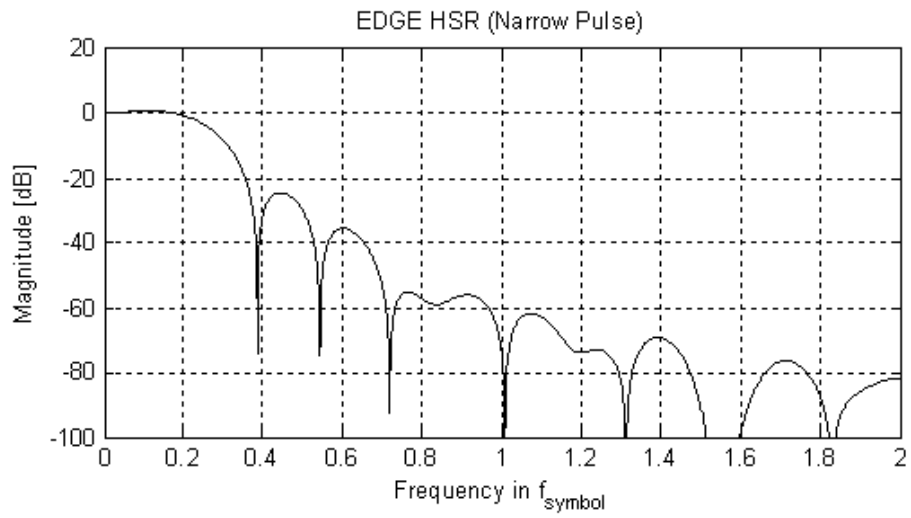
F.6.2 Measurement filter

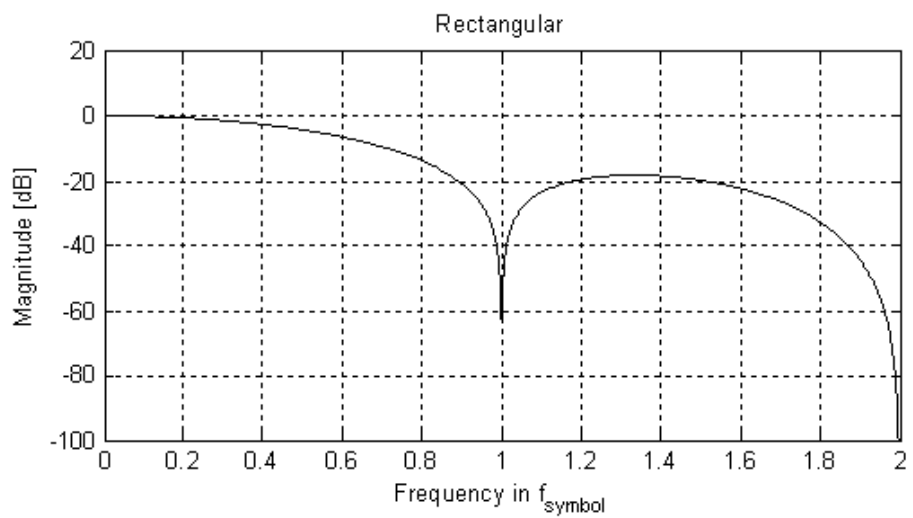
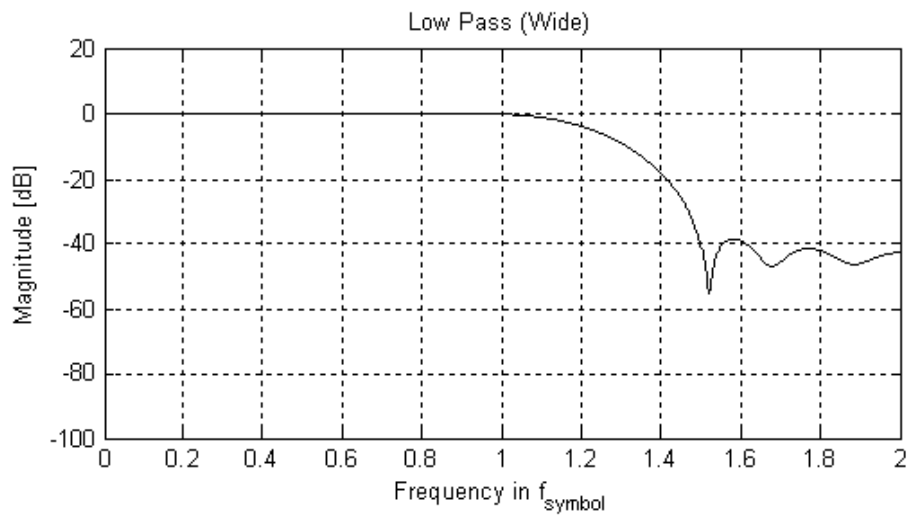
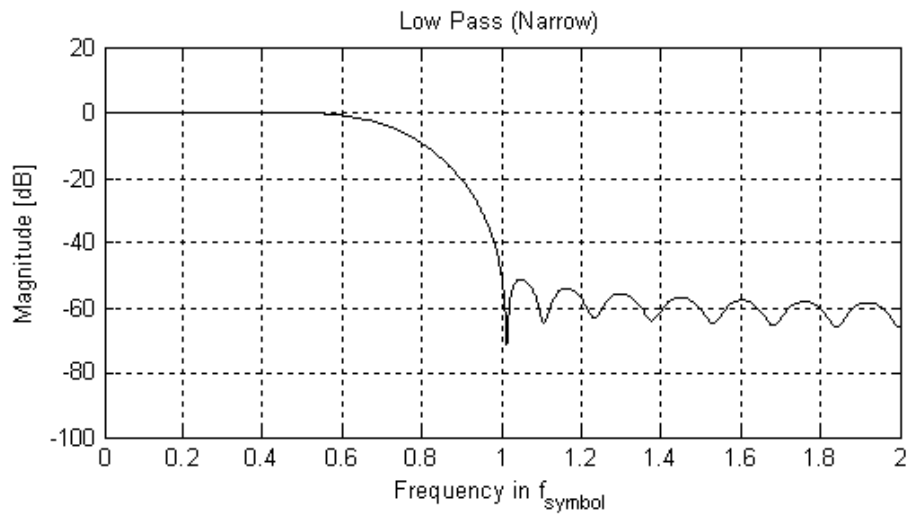
F.6.2.1 EDGE measurement filters

RC filter, Alpha = 0.25, single-side-band 6 dB bandwidth = 90 kHz Windowing by multiplying the impulse response according to the following equation:

$$w(t) = \begin{cases} 1, & 0 \leq |t| \leq 1.5T \\ 0.5 \left(1 + \cos\left[\pi \left(|t| - 1.5T \right) / 2.25T \right] \right) & 1.5T < |t| < 3.75T \\ 0, & |t| \geq 3.75T \end{cases}$$

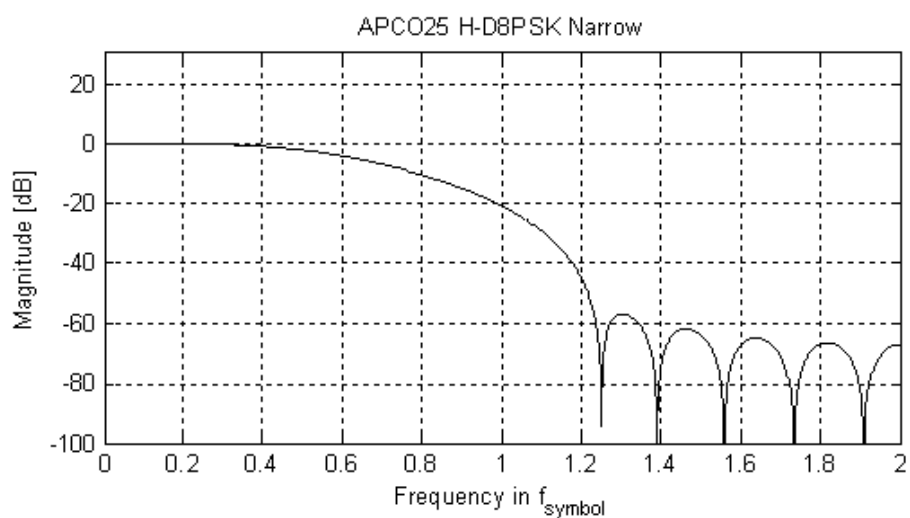
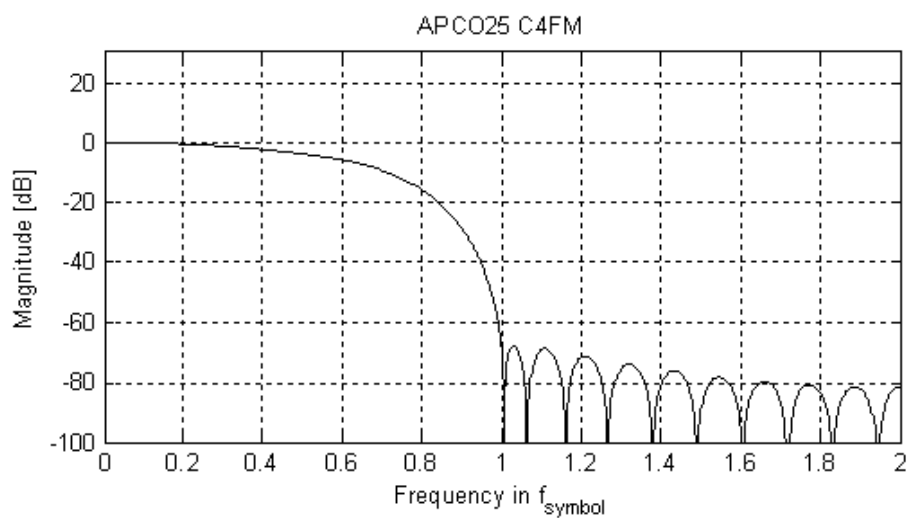
The following figure shows the frequency response of the standard-specific measurement filters.

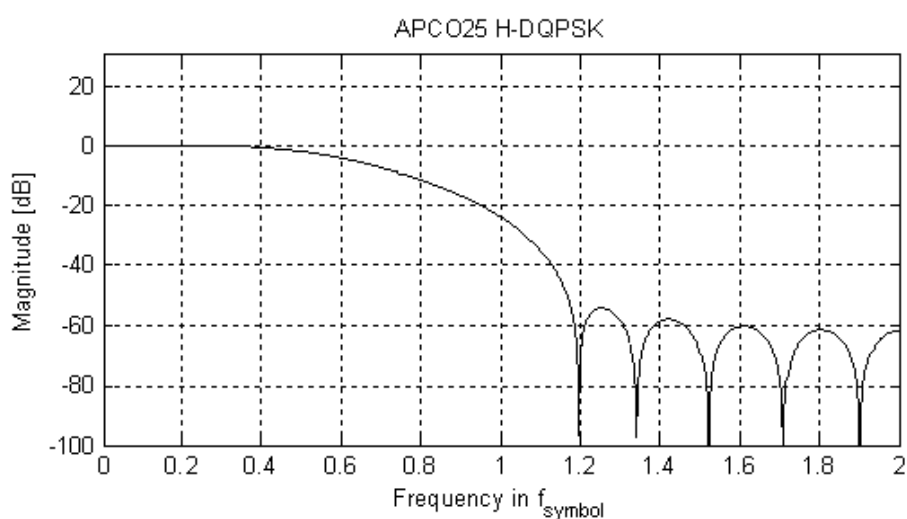
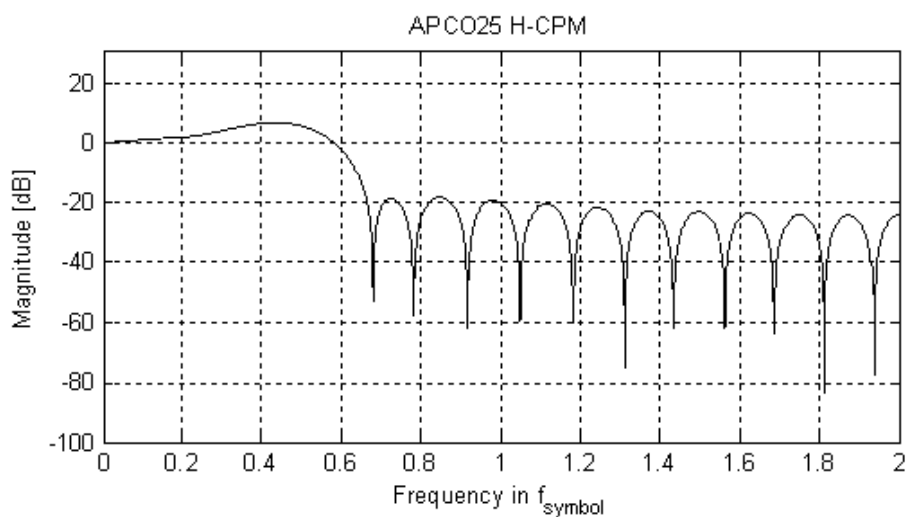
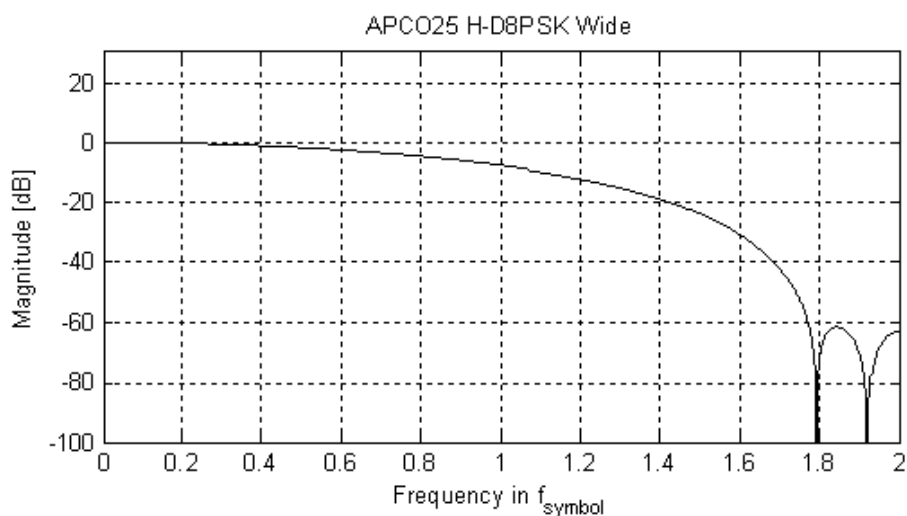


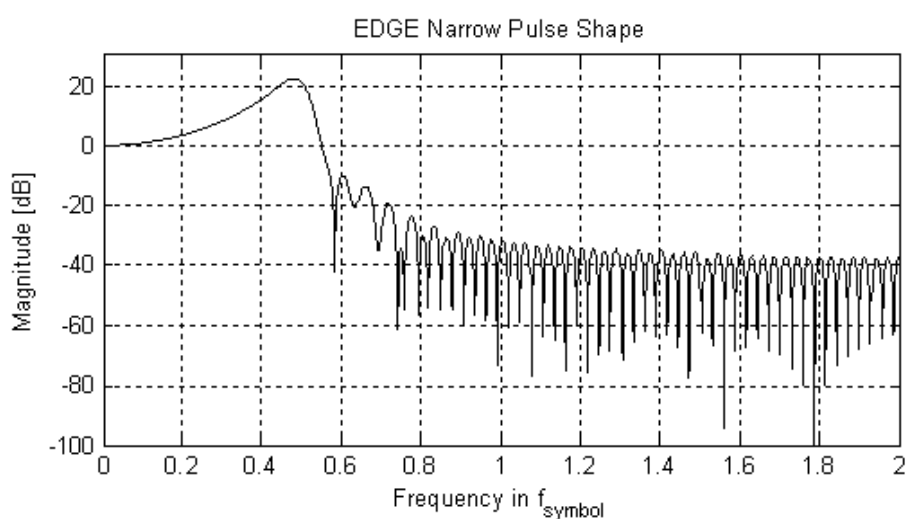
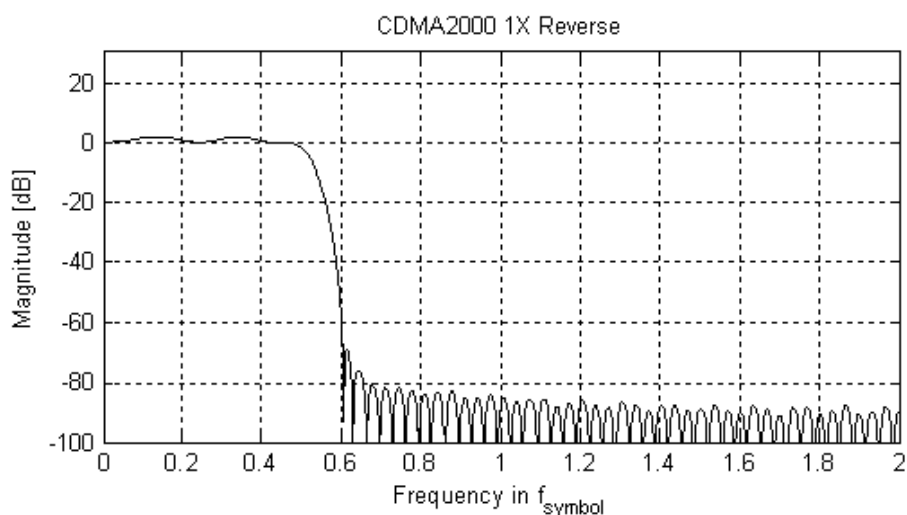
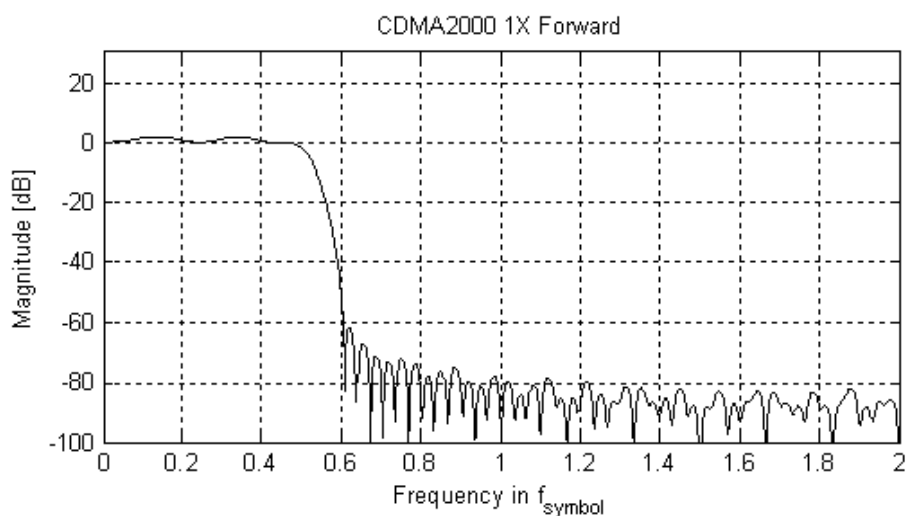


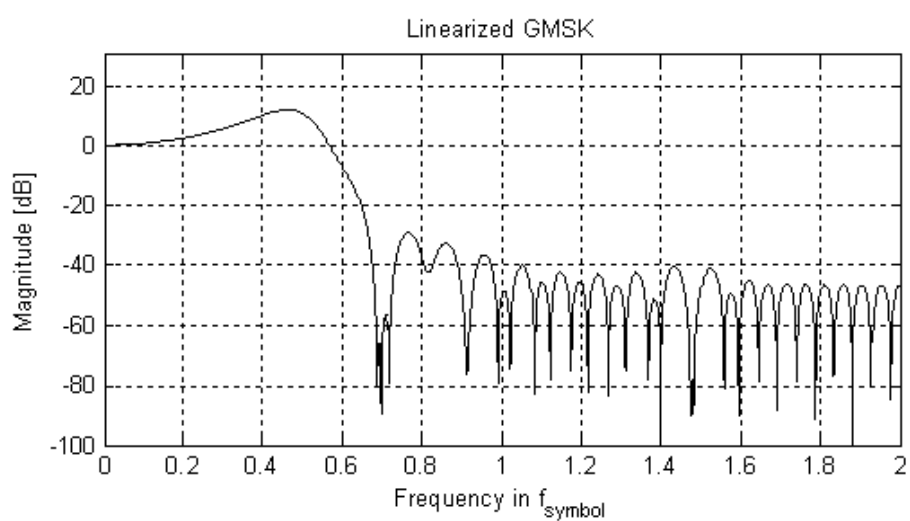
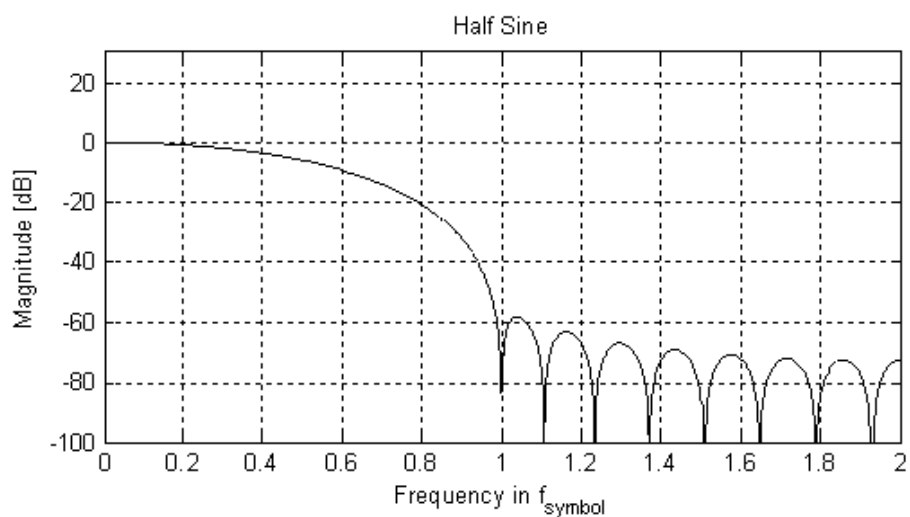
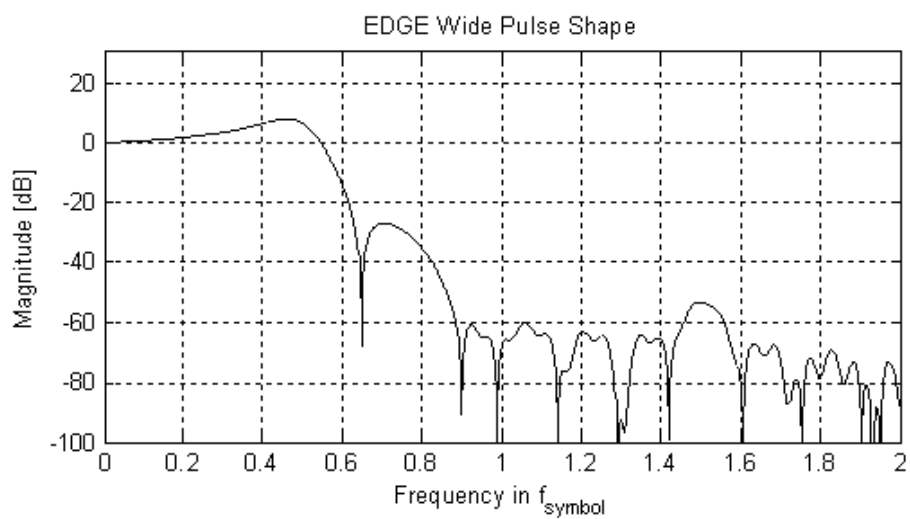
F.6.2.2 Low-isi filters

The following frequency responses are obtained when using a low-ISI measurement filter and the Transmit filter indicated in the title of each diagram.









List of Remote Commands (VSA)

[SENSe:]ADJust:CONFigure:HYSTeresis:LOWer.....	401
[SENSe:]ADJust:CONFigure:HYSTeresis:UPPer.....	402
[SENSe:]ADJust:CONFigure:LEVel:DURation.....	400
[SENSe:]ADJust:CONFigure:LEVel:DURation:MODE.....	401
[SENSe:]ADJust:CONFigure:TRIGger.....	402
[SENSe:]ADJust:LEVel.....	402
[SENSe:]DDEMod:APSK:NState.....	324
[SENSe:]DDEMod:ASK:NState.....	324
[SENSe:]DDEMod:BORDering.....	388
[SENSe:]DDEMod:ECALc:OFFSet.....	388
[SENSe:]DDEMod:ECALc[:MODE].....	388
[SENSe:]DDEMod:EPRate:AUTO.....	389
[SENSe:]DDEMod:EPRate[:VALue].....	389
[SENSe:]DDEMod:EQUalizer:FILE:FORMat.....	390
[SENSe:]DDEMod:EQUalizer:LENGth.....	390
[SENSe:]DDEMod:EQUalizer:LOAD.....	390
[SENSe:]DDEMod:EQUalizer:MODE.....	391
[SENSe:]DDEMod:EQUalizer:RESet.....	391
[SENSe:]DDEMod:EQUalizer:SAVE.....	391
[SENSe:]DDEMod:EQUalizer[:STATe].....	392
[SENSe:]DDEMod:FACTory[:VALue].....	320
[SENSe:]DDEMod:FILTer:ALPHa.....	325
[SENSe:]DDEMod:FILTer[:STATe].....	325
[SENSe:]DDEMod:FORMat.....	325
[SENSe:]DDEMod:FSK:NState.....	326
[SENSe:]DDEMod:FSYnc:AUTO.....	392
[SENSe:]DDEMod:FSYnc:LEVel.....	392
[SENSe:]DDEMod:FSYnc:RESult?.....	392
[SENSe:]DDEMod:FSYnc[:MODE].....	393
[SENSe:]DDEMod:KDATA:PRBS:FEEDback:AUTO.....	347
[SENSe:]DDEMod:KDATA:PRBS:FEEDback[:STATe].....	347
[SENSe:]DDEMod:KDATA:PRBS:PATtern:AUTO.....	348
[SENSe:]DDEMod:KDATA:PRBS:PATtern[:STATe].....	348
[SENSe:]DDEMod:KDATA:PRBS:POLYnomial:AUTO.....	348
[SENSe:]DDEMod:KDATA:PRBS:POLYnomial[:ORDer].....	349
[SENSe:]DDEMod:KDATA:PRBS[:TYPE].....	349
[SENSe:]DDEMod:KDATA:SOURce.....	349
[SENSe:]DDEMod:KDATA:STATe.....	346
[SENSe:]DDEMod:KDATA[:NAME].....	347
[SENSe:]DDEMod:MAPPING:CATalog?.....	326
[SENSe:]DDEMod:MAPPING[:VALue].....	327
[SENSe:]DDEMod:MFILter:ALPHa.....	397
[SENSe:]DDEMod:MFILter:AUTO.....	397
[SENSe:]DDEMod:MFILter:NAME.....	397
[SENSe:]DDEMod:MFILter:USER.....	398
[SENSe:]DDEMod:MFILter[:STATe].....	398
[SENSe:]DDEMod:MSK:FORMat.....	327

[SENSe:]DDEMod:NORMAlize:ADRoop.....	393
[SENSe:]DDEMod:NORMAlize:CFDRift.....	393
[SENSe:]DDEMod:NORMAlize:CHANnel.....	394
[SENSe:]DDEMod:NORMAlize:FDERror.....	394
[SENSe:]DDEMod:NORMAlize:IQIMbalance.....	394
[SENSe:]DDEMod:NORMAlize:IQOFset.....	395
[SENSe:]DDEMod:NORMAlize:IQSKew.....	395
[SENSe:]DDEMod:NORMAlize:SRError.....	395
[SENSe:]DDEMod:NORMAlize[:VALue].....	492
[SENSe:]DDEMod:OPTimization.....	396
[SENSe:]DDEMod:PATtern:APSK:NSTate.....	335
[SENSe:]DDEMod:PATtern:ASK:NSTate.....	336
[SENSe:]DDEMod:PATtern:FORMat.....	336
[SENSe:]DDEMod:PATtern:FRAMe:EDIT.....	336
[SENSe:]DDEMod:PATtern:FRAMe:EDIT:NEXT:BOOSting.....	337
[SENSe:]DDEMod:PATtern:FRAMe:EDIT:NEXT:MODulation.....	337
[SENSe:]DDEMod:PATtern:FRAMe:EDIT:PREVious:BOOSting.....	338
[SENSe:]DDEMod:PATtern:FRAMe:EDIT:PREVious:MODulation.....	338
[SENSe:]DDEMod:PATtern:FRAMe:EDIT:SAVE.....	338
[SENSe:]DDEMod:PATtern:FRAMe:EDIT:STRUcture.....	339
[SENSe:]DDEMod:PATtern:FRAMe:EDIT:TEXT.....	341
[SENSe:]DDEMod:PATtern:FRAMe:LOAD.....	342
[SENSe:]DDEMod:PATtern:FRAMe:MODE.....	342
[SENSe:]DDEMod:PATtern:MAPPing:CATalog?.....	342
[SENSe:]DDEMod:PATtern:MAPPing[:VALue].....	343
[SENSe:]DDEMod:PATtern:PSK:FORMat.....	343
[SENSe:]DDEMod:PATtern:PSK:NSTate.....	343
[SENSe:]DDEMod:PATtern:QAM:FORMat.....	344
[SENSe:]DDEMod:PATtern:QAM:NSTate.....	344
[SENSe:]DDEMod:PATtern:QPSK:FORMat.....	345
[SENSe:]DDEMod:PATtern:USER:NAME.....	345
[SENSe:]DDEMod:PATtern[:STATe].....	346
[SENSe:]DDEMod:PRATe.....	370
[SENSe:]DDEMod:PRESet:CALC.....	442
[SENSe:]DDEMod:PRESet:RLEVel.....	360
[SENSe:]DDEMod:PRESet:RLEVel.....	402
[SENSe:]DDEMod:PRESet[:STANdard].....	321
[SENSe:]DDEMod:PSK:FORMat.....	327
[SENSe:]DDEMod:PSK:NSTate.....	328
[SENSe:]DDEMod:QAM:FORMat.....	328
[SENSe:]DDEMod:QAM:NSTate.....	328
[SENSe:]DDEMod:QPSK:FORMat.....	329
[SENSe:]DDEMod:RLENgth:AUTO.....	371
[SENSe:]DDEMod:RLENgth:SYMBols[:VALue].....	372
[SENSe:]DDEMod:RLENgth[:VALue].....	371
[SENSe:]DDEMod:SBANd.....	492
[SENSe:]DDEMod:SEARch:BURSt:AUTO.....	377
[SENSe:]DDEMod:SEARch:BURSt:CONFigure:AUTO.....	377
[SENSe:]DDEMod:SEARch:BURSt:GLENgth[:MINimum].....	377
[SENSe:]DDEMod:SEARch:BURSt:LENgth:MAXimum.....	332

[SENSe:]DDEMod:SEARch:BURSt:LENGth[:MINimum].....	332
[SENSe:]DDEMod:SEARch:BURSt:MODE.....	378
[SENSe:]DDEMod:SEARch:BURSt:SKIP:FALLing.....	332
[SENSe:]DDEMod:SEARch:BURSt:SKIP:RISing.....	333
[SENSe:]DDEMod:SEARch:BURSt:STATe.....	378
[SENSe:]DDEMod:SEARch:BURSt:TOLerance.....	378
[SENSe:]DDEMod:SEARch:MBURst:CALC.....	375
[SENSe:]DDEMod:SEARch:MBURst:START:SAMPles?.....	461
[SENSe:]DDEMod:SEARch:MBURst:START[:SYMBols]?.....	460
[SENSe:]DDEMod:SEARch:PATtern:CONFigure:AUTO.....	379
[SENSe:]DDEMod:SEARch:PATtern:SYNC:AUTO.....	396
[SENSe:]DDEMod:SEARch:PATtern:SYNC[:STATe].....	396
[SENSe:]DDEMod:SEARch:SYNC:AUTO.....	379
[SENSe:]DDEMod:SEARch:SYNC:CATalog.....	333
[SENSe:]DDEMod:SEARch:SYNC:COMMeNt.....	381
[SENSe:]DDEMod:SEARch:SYNC:COpy.....	381
[SENSe:]DDEMod:SEARch:SYNC:DATA.....	382
[SENSe:]DDEMod:SEARch:SYNC:DELeTe.....	382
[SENSe:]DDEMod:SEARch:SYNC:IQCThreshold.....	379
[SENSe:]DDEMod:SEARch:SYNC:MODE.....	379
[SENSe:]DDEMod:SEARch:SYNC:NAME.....	382
[SENSe:]DDEMod:SEARch:SYNC:NState.....	383
[SENSe:]DDEMod:SEARch:SYNC:PATtern:ADD.....	383
[SENSe:]DDEMod:SEARch:SYNC:PATtern:REMOve.....	383
[SENSe:]DDEMod:SEARch:SYNC:SELeCt.....	380
[SENSe:]DDEMod:SEARch:SYNC:STATe.....	380
[SENSe:]DDEMod:SEARch:SYNC:TEXT.....	383
[SENSe:]DDEMod:SIGNal:PATtern.....	333
[SENSe:]DDEMod:SIGNal[:VALue].....	334
[SENSe:]DDEMod:SRATe.....	330
[SENSe:]DDEMod:STANdard:COMMeNt.....	321
[SENSe:]DDEMod:STANdard:DELeTe.....	321
[SENSe:]DDEMod:STANdard:PRESet[:VALue].....	322
[SENSe:]DDEMod:STANdard:SAVE.....	322
[SENSe:]DDEMod:STANdard:SYNC:OFFSet:STATe.....	334
[SENSe:]DDEMod:STANdard:SYNC:OFFSet[:VALue].....	334
[SENSe:]DDEMod:TFILter:ALPHa.....	330
[SENSe:]DDEMod:TFILter:NAME.....	330
[SENSe:]DDEMod:TFILter:USER.....	331
[SENSe:]DDEMod:TFILter[:STATe].....	331
[SENSe:]DDEMod:TIME.....	386
[SENSe:]DDEMod:TIME:AUTO.....	386
[SENSe:]DDEMod:USER:NAME.....	331
[SENSe:]FREQuency:CENTer.....	357
[SENSe:]FREQuency:CENTer:STEP.....	357
[SENSe:]FREQuency:CENTer:STEP:AUTO.....	358
[SENSe:]FREQuency:OFFSet.....	358
[SENSe:]SWAPiq.....	372
[SENSe:]SWEep:COUNt.....	375
[SENSe:]SWEep:COUNt:CURRent?.....	376

ABORT.....	403
CALCulate<n>:BERate?.....	462
CALCulate<n>:DDEM:BURSt:LENGth?.....	463
CALCulate<n>:DDEM:SPECTrum[:STATe].....	442
CALCulate<n>:DELTamarker<m>:AOFF.....	413
CALCulate<n>:DELTamarker<m>:MAXimum:APEak.....	416
CALCulate<n>:DELTamarker<m>:MAXimum:LEFT.....	416
CALCulate<n>:DELTamarker<m>:MAXimum:NEXT.....	416
CALCulate<n>:DELTamarker<m>:MAXimum:RIGHT.....	417
CALCulate<n>:DELTamarker<m>:MAXimum[:PEAK].....	417
CALCulate<n>:DELTamarker<m>:MBURst:START.....	417
CALCulate<n>:DELTamarker<m>:MINimum:LEFT.....	417
CALCulate<n>:DELTamarker<m>:MINimum:NEXT.....	418
CALCulate<n>:DELTamarker<m>:MINimum:RIGHT.....	418
CALCulate<n>:DELTamarker<m>:MINimum[:PEAK].....	418
CALCulate<n>:DELTamarker<m>:TRACe.....	415
CALCulate<n>:DELTamarker<m>:X.....	414
CALCulate<n>:DELTamarker<m>:X:ABSolute?.....	449
CALCulate<n>:DELTamarker<m>:X:RELative?.....	449
CALCulate<n>:DELTamarker<m>:Y?.....	414
CALCulate<n>:DELTamarker<m>[:STATe].....	414
CALCulate<n>:DLABs:STATe.....	423
CALCulate<n>:DLABs[:VALue].....	423
CALCulate<n>:DLRel:STATe.....	424
CALCulate<n>:DLRel[:VALue].....	424
CALCulate<n>:DSP:RESult:CAPTure:BURSts?.....	457
CALCulate<n>:DSP:RESult:CAPTure:PATterns?.....	458
CALCulate<n>:DSP:RESult:RRANge:CURRent:BURSt:LENGth?.....	458
CALCulate<n>:DSP:RESult:RRANge:CURRent:BURSt:PRESent?.....	458
CALCulate<n>:DSP:RESult:RRANge:CURRent:BURSt:START?.....	459
CALCulate<n>:DSP:RESult:RRANge:CURRent:PATtern:CONFidence?.....	459
CALCulate<n>:DSP:RESult:RRANge:CURRent:PATtern:CORRect?.....	459
CALCulate<n>:DSP:RESult:RRANge:CURRent:PATtern:PRESent?.....	460
CALCulate<n>:DSP:RESult:RRANge:CURRent:PATtern:START?.....	460
CALCulate<n>:ELIN<ri>:STATe.....	398
CALCulate<n>:ELIN<ri>[:VALue].....	399
CALCulate<n>:FEED.....	443
CALCulate<n>:FORMat.....	444
CALCulate<n>:FSK:DEVIation:COMPensation.....	491
CALCulate<n>:FSK:DEVIation:REFerence:RELative.....	323
CALCulate<n>:FSK:DEVIation:REFerence[:VALue].....	324
CALCulate<n>:LIMit:MACCuracy:<ResultType>:<LimitType>:STATe.....	429
CALCulate<n>:LIMit:MACCuracy:<ResultType>:<LimitType>[:RESUlt].....	478
CALCulate<n>:LIMit:MACCuracy:CFERror:CURRent:STATe.....	428
CALCulate<n>:LIMit:MACCuracy:CFERror:CURRent:VALue.....	430
CALCulate<n>:LIMit:MACCuracy:CFERror:CURRent[:RESUlt]?.....	477
CALCulate<n>:LIMit:MACCuracy:CFERror:MEAN:STATe.....	428
CALCulate<n>:LIMit:MACCuracy:CFERror:MEAN:VALue.....	430
CALCulate<n>:LIMit:MACCuracy:CFERror:MEAN[:RESUlt]?.....	477
CALCulate<n>:LIMit:MACCuracy:CFERror:PEAK:STATe.....	428

CALCulate<n>:LIMit:MACCuracy:CFERror:PEAK:VALue.....	430
CALCulate<n>:LIMit:MACCuracy:CFERror:PEAK[:RESult]?	477
CALCulate<n>:LIMit:MACCuracy:DEFault.....	427
CALCulate<n>:LIMit:MACCuracy:EVM:PCURrent:STATe.....	428
CALCulate<n>:LIMit:MACCuracy:EVM:PCURrent:VALue.....	430
CALCulate<n>:LIMit:MACCuracy:EVM:PCURrent[:RESult]?	477
CALCulate<n>:LIMit:MACCuracy:EVM:PMEan:STATe.....	428
CALCulate<n>:LIMit:MACCuracy:EVM:PMEan:VALue.....	430
CALCulate<n>:LIMit:MACCuracy:EVM:PMEan[:RESult]?	477
CALCulate<n>:LIMit:MACCuracy:EVM:PPEak:STATe.....	428
CALCulate<n>:LIMit:MACCuracy:EVM:PPEak:VALue.....	430
CALCulate<n>:LIMit:MACCuracy:EVM:PPEak[:RESult]?	477
CALCulate<n>:LIMit:MACCuracy:EVM:RCURrent:STATe.....	428
CALCulate<n>:LIMit:MACCuracy:EVM:RCURrent:VALue.....	430
CALCulate<n>:LIMit:MACCuracy:EVM:RCURrent[:RESult]?	477
CALCulate<n>:LIMit:MACCuracy:EVM:RMEan:STATe.....	428
CALCulate<n>:LIMit:MACCuracy:EVM:RMEan:VALue.....	430
CALCulate<n>:LIMit:MACCuracy:EVM:RMEan[:RESult]?	477
CALCulate<n>:LIMit:MACCuracy:EVM:RPEak:STATe.....	428
CALCulate<n>:LIMit:MACCuracy:EVM:RPEak:VALue.....	430
CALCulate<n>:LIMit:MACCuracy:EVM:RPEak[:RESult]?	477
CALCulate<n>:LIMit:MACCuracy:FDERror:CURRent:STATe.....	428
CALCulate<n>:LIMit:MACCuracy:FDERror:CURRent:VALue.....	430
CALCulate<n>:LIMit:MACCuracy:FDERror:CURRent[:RESult]?	477
CALCulate<n>:LIMit:MACCuracy:FDERror:MEAN:STATe.....	428
CALCulate<n>:LIMit:MACCuracy:FDERror:MEAN:VALue.....	430
CALCulate<n>:LIMit:MACCuracy:FDERror:MEAN[:RESult]?	477
CALCulate<n>:LIMit:MACCuracy:FDERror:PEAK:STATe.....	428
CALCulate<n>:LIMit:MACCuracy:FDERror:PEAK:VALue.....	430
CALCulate<n>:LIMit:MACCuracy:FDERror:PEAK[:RESult]?	477
CALCulate<n>:LIMit:MACCuracy:FERRor:PCURrent:STATe.....	428
CALCulate<n>:LIMit:MACCuracy:FERRor:PCURrent:VALue.....	431
CALCulate<n>:LIMit:MACCuracy:FERRor:PCURrent[:RESult]?	477
CALCulate<n>:LIMit:MACCuracy:FERRor:PMEan:STATe.....	428
CALCulate<n>:LIMit:MACCuracy:FERRor:PMEan:VALue.....	431
CALCulate<n>:LIMit:MACCuracy:FERRor:PMEan[:RESult]?	477
CALCulate<n>:LIMit:MACCuracy:FERRor:PPEak:STATe.....	428
CALCulate<n>:LIMit:MACCuracy:FERRor:PPEak:VALue.....	431
CALCulate<n>:LIMit:MACCuracy:FERRor:PPEak[:RESult]?	477
CALCulate<n>:LIMit:MACCuracy:FERRor:RCURrent:STATe.....	428
CALCulate<n>:LIMit:MACCuracy:FERRor:RCURrent:VALue.....	431
CALCulate<n>:LIMit:MACCuracy:FERRor:RCURrent[:RESult]?	477
CALCulate<n>:LIMit:MACCuracy:FERRor:RMEan:STATe.....	428
CALCulate<n>:LIMit:MACCuracy:FERRor:RMEan:VALue.....	431
CALCulate<n>:LIMit:MACCuracy:FERRor:RMEan[:RESult]?	477
CALCulate<n>:LIMit:MACCuracy:FERRor:RPEak:STATe.....	428
CALCulate<n>:LIMit:MACCuracy:FERRor:RPEak:VALue.....	431
CALCulate<n>:LIMit:MACCuracy:FERRor:RPEak[:RESult]?	477
CALCulate<n>:LIMit:MACCuracy:MERRor:PCURrent:STATe.....	428
CALCulate<n>:LIMit:MACCuracy:MERRor:PCURrent:VALue.....	431

CALCulate<n>:LIMit:MACCuracy:MERRor:PCURrent[:RESult]?	477
CALCulate<n>:LIMit:MACCuracy:MERRor:PMEan:STATe	428
CALCulate<n>:LIMit:MACCuracy:MERRor:PMEan:VALue	431
CALCulate<n>:LIMit:MACCuracy:MERRor:PMEan[:RESult]?	477
CALCulate<n>:LIMit:MACCuracy:MERRor:PPEak:STATe	428
CALCulate<n>:LIMit:MACCuracy:MERRor:PPEak:VALue	431
CALCulate<n>:LIMit:MACCuracy:MERRor:PPEak[:RESult]?	477
CALCulate<n>:LIMit:MACCuracy:MERRor:RCURrent:STATe	428
CALCulate<n>:LIMit:MACCuracy:MERRor:RCURrent:VALue	431
CALCulate<n>:LIMit:MACCuracy:MERRor:RCURrent[:RESult]?	477
CALCulate<n>:LIMit:MACCuracy:MERRor:RMEan:STATe	428
CALCulate<n>:LIMit:MACCuracy:MERRor:RMEan:VALue	431
CALCulate<n>:LIMit:MACCuracy:MERRor:RMEan[:RESult]?	477
CALCulate<n>:LIMit:MACCuracy:MERRor:RPEak:STATe	428
CALCulate<n>:LIMit:MACCuracy:MERRor:RPEak:VALue	431
CALCulate<n>:LIMit:MACCuracy:MERRor:RPEak[:RESult]?	477
CALCulate<n>:LIMit:MACCuracy:OOFfset:CURRent:STATe	428
CALCulate<n>:LIMit:MACCuracy:OOFfset:CURRent:VALue	431
CALCulate<n>:LIMit:MACCuracy:OOFfset:CURRent[:RESult]?	477
CALCulate<n>:LIMit:MACCuracy:OOFfset:MEAN:STATe	428
CALCulate<n>:LIMit:MACCuracy:OOFfset:MEAN:VALue	431
CALCulate<n>:LIMit:MACCuracy:OOFfset:MEAN[:RESult]?	477
CALCulate<n>:LIMit:MACCuracy:OOFfset:PEAK:STATe	428
CALCulate<n>:LIMit:MACCuracy:OOFfset:PEAK:VALue	431
CALCulate<n>:LIMit:MACCuracy:OOFfset:PEAK[:RESult]?	477
CALCulate<n>:LIMit:MACCuracy:PERRor:PCURrent:STATe	428
CALCulate<n>:LIMit:MACCuracy:PERRor:PCURrent:VALue	432
CALCulate<n>:LIMit:MACCuracy:PERRor:PCURrent[:RESult]?	477
CALCulate<n>:LIMit:MACCuracy:PERRor:PMEan:STATe	428
CALCulate<n>:LIMit:MACCuracy:PERRor:PMEan:VALue	432
CALCulate<n>:LIMit:MACCuracy:PERRor:PMEan[:RESult]?	477
CALCulate<n>:LIMit:MACCuracy:PERRor:PPEak:STATe	429
CALCulate<n>:LIMit:MACCuracy:PERRor:PPEak:VALue	432
CALCulate<n>:LIMit:MACCuracy:PERRor:PPEak[:RESult]?	477
CALCulate<n>:LIMit:MACCuracy:PERRor:RCURrent:STATe	429
CALCulate<n>:LIMit:MACCuracy:PERRor:RCURrent:VALue	432
CALCulate<n>:LIMit:MACCuracy:PERRor:RCURrent[:RESult]?	477
CALCulate<n>:LIMit:MACCuracy:PERRor:RMEan:STATe	429
CALCulate<n>:LIMit:MACCuracy:PERRor:RMEan:VALue	432
CALCulate<n>:LIMit:MACCuracy:PERRor:RMEan[:RESult]?	477
CALCulate<n>:LIMit:MACCuracy:PERRor:RPEak:STATe	429
CALCulate<n>:LIMit:MACCuracy:PERRor:RPEak:VALue	432
CALCulate<n>:LIMit:MACCuracy:PERRor:RPEak[:RESult]?	477
CALCulate<n>:LIMit:MACCuracy:RHO:CURRent:STATe	429
CALCulate<n>:LIMit:MACCuracy:RHO:CURRent:VALue	432
CALCulate<n>:LIMit:MACCuracy:RHO:CURRent[:RESult]?	477
CALCulate<n>:LIMit:MACCuracy:RHO:MEAN:STATe	429
CALCulate<n>:LIMit:MACCuracy:RHO:MEAN:VALue	432
CALCulate<n>:LIMit:MACCuracy:RHO:MEAN[:RESult]?	478
CALCulate<n>:LIMit:MACCuracy:RHO:PEAK:STATe	429

CALCulate<n>:LIMit:MACCuracy:RHO:PEAK:VALue.....	432
CALCulate<n>:LIMit:MACCuracy:RHO:PEAK[:RESult]?	478
CALCulate<n>:LIMit:MACCuracy:STATe.....	427
CALCulate<n>:MARKer<m>:AOFF.....	411
CALCulate<n>:MARKer<m>:FUNction:DDEMod:STATistic:ADRooP?	464
CALCulate<n>:MARKer<m>:FUNction:DDEMod:STATistic:ALL?	464
CALCulate<n>:MARKer<m>:FUNction:DDEMod:STATistic:CFERror?	465
CALCulate<n>:MARKer<m>:FUNction:DDEMod:STATistic:EVM?	466
CALCulate<n>:MARKer<m>:FUNction:DDEMod:STATistic:FDERror?	467
CALCulate<n>:MARKer<m>:FUNction:DDEMod:STATistic:FSK:CFDRift?	467
CALCulate<n>:MARKer<m>:FUNction:DDEMod:STATistic:FSK:DERRor?	468
CALCulate<n>:MARKer<m>:FUNction:DDEMod:STATistic:FSK:MDEVIation?	469
CALCulate<n>:MARKer<m>:FUNction:DDEMod:STATistic:FSK:RDEVIation?	469
CALCulate<n>:MARKer<m>:FUNction:DDEMod:STATistic:GIMBalance?	470
CALCulate<n>:MARKer<m>:FUNction:DDEMod:STATistic:IQIMbalance?	470
CALCulate<n>:MARKer<m>:FUNction:DDEMod:STATistic:IQSKew?	471
CALCulate<n>:MARKer<m>:FUNction:DDEMod:STATistic:MERRor?	471
CALCulate<n>:MARKer<m>:FUNction:DDEMod:STATistic:MPOWer?	472
CALCulate<n>:MARKer<m>:FUNction:DDEMod:STATistic:OOFFset?	473
CALCulate<n>:MARKer<m>:FUNction:DDEMod:STATistic:PERror?	473
CALCulate<n>:MARKer<m>:FUNction:DDEMod:STATistic:QERRor?	474
CALCulate<n>:MARKer<m>:FUNction:DDEMod:STATistic:RHO?	475
CALCulate<n>:MARKer<m>:FUNction:DDEMod:STATistic:SNR?	475
CALCulate<n>:MARKer<m>:FUNction:DDEMod:STATistic:SRERror?	476
CALCulate<n>:MARKer<m>:LINK.....	412
CALCulate<n>:MARKer<m>:MAXimum:APEak.....	418
CALCulate<n>:MARKer<m>:MAXimum:LEFT.....	419
CALCulate<n>:MARKer<m>:MAXimum:NEXT.....	419
CALCulate<n>:MARKer<m>:MAXimum:RIGHT.....	419
CALCulate<n>:MARKer<m>:MAXimum[:PEAK].....	419
CALCulate<n>:MARKer<m>:MBURst:STARt.....	420
CALCulate<n>:MARKer<m>:MINimum:LEFT.....	420
CALCulate<n>:MARKer<m>:MINimum:NEXT.....	420
CALCulate<n>:MARKer<m>:MINimum:RIGHT.....	420
CALCulate<n>:MARKer<m>:MINimum[:PEAK].....	421
CALCulate<n>:MARKer<m>:SEARch.....	421
CALCulate<n>:MARKer<m>:TRACe.....	412
CALCulate<n>:MARKer<m>:X.....	413
CALCulate<n>:MARKer<m>:X:SLIMits:LEFT.....	421
CALCulate<n>:MARKer<m>:X:SLIMits:RIGHT.....	422
CALCulate<n>:MARKer<m>:X:SLIMits[:STATe].....	422
CALCulate<n>:MARKer<m>:Y?.....	413
CALCulate<n>:MARKer<m>[:STATe].....	412
CALCulate<n>:MEAS:DIRTY?.....	450
CALCulate<n>:STATistics:CCDF[:STATe].....	445
CALCulate<n>:STATistics:MODE.....	445
CALCulate<n>:STATistics:PRESet.....	365
CALCulate<n>:STATistics:SCALE:AUTO ONCE.....	365
CALCulate<n>:STATistics:SCALE:X:BCOunt.....	365
CALCulate<n>:STATistics:SCALE:Y:LOWer.....	365

CALCulate<n>:STATistics:SCALE:Y:UNIT.....	366
CALCulate<n>:STATistics:SCALE:Y:UPPer.....	366
CALCulate<n>:TLABs:STATe.....	425
CALCulate<n>:TLABs[:VALue].....	425
CALCulate<n>:TLRel:STATe.....	426
CALCulate<n>:TLRel[:VALue].....	426
CALCulate<n>:TRACe<t>:ADJust:ALIGNment:OFFSet.....	385
CALCulate<n>:TRACe<t>:ADJust:ALIGNment[:DEFault].....	384
CALCulate<n>:TRACe<t>:ADJust[:VALue].....	385
CALCulate<n>:TRACe<t>:SYMBOLs.....	408
CALCulate<n>:TRACe<t>[:VALue].....	407
CALCulate<n>:UNIT:ANGLE.....	366
CALCulate<n>:UNIT:POWER.....	359
CALCulate<n>:X:UNIT:TIME.....	367
CALCulate<n>:Y:UNIT:TIME.....	367
DIAGnostic:SERVice:NSource.....	356
DISPlay[:WINDow<n>]:ITEM[:LINE][:VALue].....	446
DISPlay[:WINDow<n>]:PRATe:AUTO.....	447
DISPlay[:WINDow<n>]:PRATe[:VALue].....	447
DISPlay[:WINDow<n>]:SIZE.....	433
DISPlay[:WINDow<n>]:STATe.....	491
DISPlay[:WINDow<n>]:TRACe<t>:SYMBOL.....	447
DISPlay[:WINDow<n>]:TRACe<t>:X[:SCALE]:PDIVision.....	367
DISPlay[:WINDow<n>]:TRACe<t>:X[:SCALE]:RPOSITION.....	367
DISPlay[:WINDow<n>]:TRACe<t>:X[:SCALE]:RVALue.....	368
DISPlay[:WINDow<n>]:TRACe<t>:X[:SCALE]:START?.....	450
DISPlay[:WINDow<n>]:TRACe<t>:X[:SCALE]:STOP?.....	451
DISPlay[:WINDow<n>]:TRACe<t>:X[:SCALE]:VOFFset.....	385
DISPlay[:WINDow<n>]:TRACe<t>:Y[:SCALE]:AUTO:ALL.....	400
DISPlay[:WINDow<n>][:SUBWindow<w>]:SElect.....	433
DISPlay[:WINDow<n>][:SUBWindow<w>]:TRACe<t>:MODE.....	409
DISPlay[:WINDow<n>][:SUBWindow<w>]:TRACe<t>:PRESet.....	410
DISPlay[:WINDow<n>][:SUBWindow<w>]:TRACe<t>:Y:SPACing.....	370
DISPlay[:WINDow<n>][:SUBWindow<w>]:TRACe<t>:Y[:SCALE].....	368
DISPlay[:WINDow<n>][:SUBWindow<w>]:TRACe<t>:Y[:SCALE]:AUTO ONCE.....	400
DISPlay[:WINDow<n>][:SUBWindow<w>]:TRACe<t>:Y[:SCALE]:MODE.....	448
DISPlay[:WINDow<n>][:SUBWindow<w>]:TRACe<t>:Y[:SCALE]:PDIVision.....	368
DISPlay[:WINDow<n>][:SUBWindow<w>]:TRACe<t>:Y[:SCALE]:RLEVel.....	359
DISPlay[:WINDow<n>][:SUBWindow<w>]:TRACe<t>:Y[:SCALE]:RLEVel:OFFSet.....	360
DISPlay[:WINDow<n>][:SUBWindow<w>]:TRACe<t>:Y[:SCALE]:RPOSITION.....	369
DISPlay[:WINDow<n>][:SUBWindow<w>]:TRACe<t>:Y[:SCALE]:RVALue.....	369
DISPlay[:WINDow<n>][:SUBWindow<w>]:TRACe<t>[:STATe].....	410
FORMat:DEXPort:DSEParator.....	451
FORMat:DEXPort:HEADer.....	451
FORMat:DEXPort:MODE.....	452
INITiate:REFMeas.....	405
INITiate:SEQuencer:ABORT.....	405
INITiate:SEQuencer:IMMediate.....	405
INITiate:SEQuencer:MODE.....	406
INITiate<n>:CONMeas.....	404

INITiate<n>:CONTinuous.....	404
INITiate<n>[:IMMediate].....	405
INPut:ATTenuation:PROTection:RESet.....	350
INPut<ip>:ATTenuation.....	362
INPut<ip>:ATTenuation:AUTO.....	362
INPut<ip>:ATTenuation:AUTO:MODE.....	360
INPut<ip>:CONNector.....	350
INPut<ip>:COUPling.....	351
INPut<ip>:EATT.....	363
INPut<ip>:EATT:AUTO.....	363
INPut<ip>:EATT:STATe.....	363
INPut<ip>:EGAI[:STATe].....	361
INPut<ip>:FILE:PATH.....	353
INPut<ip>:FILTer:SAW.....	351
INPut<ip>:FILTer:YIG[:STATe].....	352
INPut<ip>:GAIN:STATe.....	361
INPut<ip>:IMPedance.....	352
INPut<ip>:IMPedance:PTYPE.....	352
INPut<ip>:SELEct.....	353
INSTrument:CREate:DUPLicate.....	317
INSTrument:CREate:REPLace.....	317
INSTrument:CREate[:NEW].....	317
INSTrument:DELeTe.....	318
INSTrument:LIST?.....	318
INSTrument:REName.....	319
INSTrument[:SELEct].....	319
LAYout:ADD[:WINDow]?.....	434
LAYout:CATalog[:WINDow]?.....	436
LAYout:IDENtify[:WINDow]?.....	436
LAYout:MOVE[:WINDow].....	436
LAYout:REMOve[:WINDow].....	437
LAYout:REPLace[:WINDow].....	437
LAYout:SPLitter.....	438
LAYout:WINDow<n>:ADD?.....	439
LAYout:WINDow<n>:IDENtify?.....	440
LAYout:WINDow<n>:REMOve.....	440
LAYout:WINDow<n>:REPLace.....	440
LAYout:WINDow<n>:TYPE.....	441
MMEMory:LOAD:IQ:STATe.....	479
MMEMory:STORe<n>:IQ:COMMeNt.....	479
MMEMory:STORe<n>:IQ:FORMat.....	479
MMEMory:STORe<n>:IQ:STATe.....	480
MMEMory:STORe<n>:IQ:TRACe.....	452
MMEMory:STORe<n>:TRACe.....	452
OUTPut<up>:IF:IFFRequency?.....	356
OUTPut<up>:IF[:SOURce].....	356
OUTPut<up>[:STATe].....	354
SOURce<si>:INTErnal:FREQUency.....	354
SOURce<si>:POWEr[:LEVEl][[:IMMediate]:OFFSet.....	355
SOURce<si>:POWEr[:LEVEl][[:IMMediate]:AMPLitude].....	355

STATus:QUEStionable:ACPLimit:CONDition?	488
STATus:QUEStionable:ACPLimit:ENABle	489
STATus:QUEStionable:ACPLimit:NTRansition	489
STATus:QUEStionable:ACPLimit:PTRansition	490
STATus:QUEStionable:ACPLimit[:EVENT]?	488
STATus:QUEStionable:DIQ:CONDition?	488
STATus:QUEStionable:DIQ:ENABle	489
STATus:QUEStionable:DIQ:NTRansition	489
STATus:QUEStionable:DIQ:PTRansition	490
STATus:QUEStionable:DIQ[:EVENT]?	488
STATus:QUEStionable:FREQuency:CONDition?	488
STATus:QUEStionable:FREQuency:ENABle	489
STATus:QUEStionable:FREQuency:NTRansition	489
STATus:QUEStionable:FREQuency:PTRansition	490
STATus:QUEStionable:FREQuency[:EVENT]?	488
STATus:QUEStionable:LIMit:CONDition?	488
STATus:QUEStionable:LIMit:ENABle	489
STATus:QUEStionable:LIMit:NTRansition	490
STATus:QUEStionable:LIMit:PTRansition	490
STATus:QUEStionable:LIMit[:EVENT]?	488
STATus:QUEStionable:LMARgin:CONDition?	488
STATus:QUEStionable:LMARgin:ENABle	489
STATus:QUEStionable:LMARgin:NTRansition	490
STATus:QUEStionable:LMARgin:PTRansition	490
STATus:QUEStionable:LMARgin[:EVENT]?	488
STATus:QUEStionable:MODulation<n>:CFREquency:CONDition?	488
STATus:QUEStionable:MODulation<n>:CFREquency:ENABle	489
STATus:QUEStionable:MODulation<n>:CFREquency:NTRansition	490
STATus:QUEStionable:MODulation<n>:CFREquency:PTRansition	490
STATus:QUEStionable:MODulation<n>:CFREquency[:EVENT]?	488
STATus:QUEStionable:MODulation<n>:CONDition?	488
STATus:QUEStionable:MODulation<n>:ENABle	489
STATus:QUEStionable:MODulation<n>:EVM:CONDition?	488
STATus:QUEStionable:MODulation<n>:EVM:ENABle	489
STATus:QUEStionable:MODulation<n>:EVM:NTRansition	490
STATus:QUEStionable:MODulation<n>:EVM:PTRansition	490
STATus:QUEStionable:MODulation<n>:EVM[:EVENT]?	488
STATus:QUEStionable:MODulation<n>:FSK:CONDition?	488
STATus:QUEStionable:MODulation<n>:FSK:ENABle	489
STATus:QUEStionable:MODulation<n>:FSK:NTRansition	490
STATus:QUEStionable:MODulation<n>:FSK:PTRansition	490
STATus:QUEStionable:MODulation<n>:FSK[:EVENT]?	488
STATus:QUEStionable:MODulation<n>:IQRHo:CONDition?	488
STATus:QUEStionable:MODulation<n>:IQRHo:ENABle	489
STATus:QUEStionable:MODulation<n>:IQRHo:NTRansition	490
STATus:QUEStionable:MODulation<n>:IQRHo:PTRansition	490
STATus:QUEStionable:MODulation<n>:IQRHo[:EVENT]?	488
STATus:QUEStionable:MODulation<n>:MAGNitude:CONDition?	488
STATus:QUEStionable:MODulation<n>:MAGNitude:ENABle	489
STATus:QUEStionable:MODulation<n>:MAGNitude:NTRansition	490

STATus:QUESTionable:MODulation<n>:MAGNitude:PTRansition.....	490
STATus:QUESTionable:MODulation<n>:MAGNitude[:EVENT]?.....	488
STATus:QUESTionable:MODulation<n>:NTRansition.....	490
STATus:QUESTionable:MODulation<n>:PHASe:CONDition?.....	488
STATus:QUESTionable:MODulation<n>:PHASe:ENABLE.....	489
STATus:QUESTionable:MODulation<n>:PHASe:NTRansition.....	490
STATus:QUESTionable:MODulation<n>:PHASe:PTRansition.....	490
STATus:QUESTionable:MODulation<n>:PHASe[:EVENT]?.....	488
STATus:QUESTionable:MODulation<n>:PTRansition.....	490
STATus:QUESTionable:MODulation<n>[:EVENT]?.....	488
STATus:QUESTionable:POWer:CONDition?.....	488
STATus:QUESTionable:POWer:ENABLE.....	489
STATus:QUESTionable:POWer:NTRansition.....	490
STATus:QUESTionable:POWer:PTRansition.....	491
STATus:QUESTionable:POWer[:EVENT]?.....	489
STATus:QUESTionable:SYNC:CONDition?.....	488
STATus:QUESTionable:SYNC:ENABLE.....	489
STATus:QUESTionable:SYNC:NTRansition.....	490
STATus:QUESTionable:SYNC:PTRansition.....	491
STATus:QUESTionable:SYNC[:EVENT]?.....	489
SYSTem:PRESet:CHANnel[:EXEC].....	320
SYSTem:SEQuencer.....	406
TRACe:IQ:BWIDth.....	372
TRACe<n>[:DATA].....	453
TRIGger[:SEQuence]:DTIME.....	373
TRIGger[:SEQuence]:HOLDoff[:TIME].....	373
TRIGger[:SEQuence]:IFPower:HOLDoff.....	373
TRIGger[:SEQuence]:IFPower:HYSTeresis.....	374
TRIGger[:SEQuence]:SLOPe.....	374
TRIGger[:SEQuence]:SOURce.....	374

Index

Symbols

4ASK	
Constellation diagram	109
8PSK	
Constellation diagram	81
16APSK	
Constellation diagram	110
95%ile	
Formula	523

A

Aborting	
Sweep	204, 205
AC/DC coupling	194
Activating	
VSA (remote)	316
Alignment	
Result range	217
Alpha/BT	168, 227
Amplitude	
Configuration	191
Configuration (remote)	358
Distortion, effect	134
Settings	191
Amplitude droop	
Compensation	220
Definition	134
Formula	520
Analysis	
Bandwidth, definition	77
Button	233
Analyzing	
Measured data	268
Application cards	14
Application notes	14
APSK	
Modulation type	166, 173
Symbol mapping	110
ASCII Trace export	514
ASK	
Modulation type	166, 173
Symbol mapping	109
Attenuation	194
Auto	194
Electronic	195
Manual	194
Option	195
Protective (remote)	350
Audio signals	
Output (remote)	189, 356
Auto adjustment	
Triggered measurement	402
Auto level	
Hysteresis	230, 231
Reference level	193, 230
Softkey	193, 230
Auto settings	
Meastime Auto	230
Meastime Manual	230

Automatic	
Configuration	229
Configuration (remote)	399
Averaging	
Measurements	208, 210, 213

B

Bandwidth	
Demodulation	71
Extension options	78
Maximum usable	77
Relationship to sample rate	78
Signal processing	69
Usable (max.)	77
Bit error rate (BER)	
Result type	27
Bluetooth	
DEVm	305
Brochures	14
Burst GSM EDGE	
Measurement example	281
Burst search	
Algorithm	116
Auto configuration	208
Configuration	207
Demodulation process	113
Enabling	207, 208
Errors	291
Gap length	208
Parameters	115
Process	115
Remote	377
Robustness	116
Tolerance	208
Burst signal	170
Bursts	
Display	19
Information	208
Length (min/max)	170
Programming example	495
Reference for result range	217
Run-in	170
Signal structure	170
Useful length	145

C

Calibration certificate	15
Capture buffer	
Data source	22
Display	148
Length	142
Navigating	279
Reference for result range	217
Result types	22
Capture Buffer	
Display	148
Capture length	
Data acquisition	200
Display	19
Capture oversampling	
see also: Sample rate	76

- Carrier frequency drift
 - Compensation 220
 - Definition 141
 - Formula 522
 - Carrier frequency error
 - Formula 522
 - Carrier in carrier measurement 239
 - Carrier-in-carrier 60
 - Carrier-in-Carrier 24
 - Center frequency 190
 - Softkey 190
 - Step size 190
 - Channel Frequency Response Group Delay
 - Result type 29
 - Channel Frequency Response Magnitude
 - Result type 30
 - Channel setup
 - Creating (remote) 317
 - Deleting (remote) 318
 - Duplicating (remote) 317
 - Querying (remote) 318
 - Renaming (remote) 319
 - Replacing (remote) 317
 - Closing
 - Channel setups (remote) 318
 - Windows (remote) 440
 - Coarse Synchronization 224
 - Compatible
 - Patterns 212
 - Compensation
 - Demodulation 218, 220
 - Modulation errors 128
 - Remote 387
 - Constellation
 - Frequency (result type) 30
 - Constellation I/Q
 - Result type 31
 - Rotated, Result type 33
 - Constellation points
 - Symbol mapping 78
 - Continue single sweep
 - Softkey 205
 - Continuous signal 170
 - Continuous sweep
 - Softkey 204
 - Conventions
 - SCPI commands 312
 - Copying
 - Channel setup (remote) 317
 - Couple Windows
 - Markers 241
 - Customized
 - Measurement, performing 256
- D**
- Data acquisition
 - Capture length 200
 - Configuration 200
 - Sample rate 201
 - Usable I/Q Bandwidth 201
 - Data sheets 14
 - Data source
 - Capture buffer 22
 - Display 20
 - Equalizer 24
 - Error vector 23
 - Evaluation method 21
 - Meas & Ref 22
 - Modulation accuracy 24
 - Modulation errors 23
 - Multi Source 24
 - Result types 25
 - Symbols 23
 - Decimal separator
 - Trace export 239
 - Default values
 - Preset 231
 - Scaling 198
 - Deleting
 - Settings files 164
 - Standards 164
 - Delta markers
 - Defining 241
 - Demodulation
 - Advanced 222
 - Bandwidth 71
 - Compensation 218, 220
 - Configuration 218
 - Estimation points per symbol 223
 - Known data 149
 - Normalization 223
 - Offset EVM 225
 - Process 112
 - Remote 387
 - Synchronization 222, 224
 - DEVM
 - Bluetooth 305
 - Diagram footer information 20
 - Differential EVM
 - see DEVM 305
 - Differential PSK (DPSK)
 - Symbol mapping 86
 - Digital standards
 - Assigned patterns 211
 - Assigning patterns 212
 - Configuration 163
 - Performing measurement according to 254
 - Predefined 502
 - Remote 320
 - Removing assigned patterns 212
 - VSA measurements 163
 - Display
 - Configuration 248
 - Information 18
 - Points per symbol 147, 251, 518, 520
 - Display lines
 - see Lines 244
 - Drop-out time
 - Trigger 204
 - Duplicating
 - Channel setup (remote) 317
 - DVB-S2
 - Configuration tool 164
- E**
- EDGE
 - Filters, frequency response 525
 - Measurement example 281
 - Electronic input attenuation 194, 195
 - Equalizer
 - Basics 123
 - Data source 24

Loading	222
Result types	24
Storing	222
Error messages	
Explanation	291
Error model	
FSK	139
PSK, QAM, MSK	126
Error vector	239
Data source	23
Definition	128
Formula	518
Result types	23
Error Vector Magnitude (EVM)	
Definition	128
Formula	518
Result type	34
RMS, peak (formulae)	520
Errors	
IF OVLD	192
Estimation	
Algorithms	125
FSK	140
Points per symbol	127, 147, 223
PSK, QAM, MSK	127
Ranges	127
Evaluation	
Refreshing	205
Specific range	206
Traces	236
Evaluation methods	
Data source	21
Remote	434
Evaluation range	
Configuration	228
Configuration (remote)	398
Definition	145
Display	146
Entire result range	229
Start/stop values	229
Export format	514
Exporting	
I/Q data	253
I/Q data (remote)	479
Trace data	274
Exporting I/Q data	239
External trigger	202
Eye diagram	
Display lines	244
Eye size	244
Frequency (result type)	35
Imag (Q) (result type)	36
Measuring eye size	272
Real (I) (result type)	38
F	
Factory settings	
Restoring	231
filename	
Settings	163
Files	
I/Q data input	186
Filter bandwidth (BT)	
Measurement filter	227
Transmit filter	168
Filters	
(De-) Modulation	71
Customized	74
Customized, creating	74
Customized, selecting	258
Formulae	524
Measurement	71, 72, 512
Measurement (formulae)	525
Predefined	511
Receive	71
Reference	71
Signal processing	69
Standard-specific (formulae)	525
Transmit	71, 511
Transmit (formulae)	525
Typical combinations	513
YIG (remote)	352
FILTWIZ	74
Fine Synchronization	224
Folders	
Digital standards	163
Formulae	
Analytically calculated filters	524
Evaluation	518
Measurement filters	525
Parameters	518
Result Summary parameters	520
Result Summary parameters (FSK)	522
Standard-specific filters	525
Statistics	523
Trace averaging	523
Transmit filters	525
Free Run	
Trigger	202
Frequency	
Absolute (result type)	39
Configuration	190
Configuration (remote)	357
Formula	518
IF Out	189
Offset	191
Relative (result type)	40
Frequency error	
Absolute (result type)	41
Formula	518
Relative (result type)	43
RMS, peak (formulae)	522
Frequency response	
Channel (result type)	30
EDGE filters	525
Low-ISI filters	528
Magnitude (result type)	45
Phase (result type)	45
Frequency Response Group Delay	
Channel (result type)	29
Result type	44
Frequency shift keying (FSK)	
Symbol mapping	91
Frontend	
Configuration	183
Configuration (remote)	350
FSK	
Calculating errors	519
Compensation	519
Deviation error (formula)	522
Error model	139
Estimation	140

- Manchester code 310
- Measurement deviation (formula) 522
- Modulation type 166, 173
- Reference deviation 167
- Signal model 137
- FSK deviation error
 - Compensation 220
 - Definition 142
- FSK reference deviation
 - Formula 522
- G**
- Gain distortion
 - Effect 134
- Gain imbalance
 - Definition 131
 - Effect 131
 - Formula 520
 - Preconditions for measurement 132
- Gating 279
- Getting started 13
- GSM
 - Programming example 495
- H**
- Hardware settings
 - Displayed 19
- Horizontal line
 - Eye diagram 245
- Hysteresis
 - Lower (Auto level) 231
 - Trigger 203
 - Upper (Auto level) 230
- I**
- I/Q bandwidth
 - Usable 70, 201
- I/Q correlation threshold
 - Pattern search 210
- I/Q data
 - Exporting (remote) 479
 - Importing (remote) 479
 - Importing/Exporting 253
 - Input file 187
 - Input files 186
 - Maximum bandwidth 77
 - Sample rate 77
- I/Q imbalance
 - Compensation 220
 - Definition 132
 - Formula 520
- I/Q offset
 - (Origin Offset) Definition 130
 - Compensating 130
 - Compensation 220
 - Formula 520
- I/Q pattern search
 - see Pattern search 116
- I/Q Power
 - Trigger 203
- I/Q skew
 - Definition 133
- IF frequency
 - Output 189
 - Output (remote) 356
- IF Out Frequency 189
- IF output 189
 - Remote 356
- IF Power
 - Trigger 203
- Impedance
 - Setting 186
- Importing
 - I/Q data 253
 - I/Q data (remote) 479
- Impulse response
 - Magnitude (result type) 46
 - Phase (result type) 47
 - Real/Imag (result type) 48
- Input
 - Configuration 183
 - Configuration (remote) 350
 - Coupling 194
 - I/Q data files 187
 - Overload (remote) 350
 - RF 185
 - Settings 183, 194
 - Source Configuration 183
- Input sample rate (ISR)
 - Definition 77
- Input sources
 - I/Q data file 187
 - I/Q data files 186
 - Radio frequency 184
- Installation 16
- Instrument security procedures 14
- Intersymbol interference (ISI) 71
 - Filter 71
- iq.tar files 239
- ISI-free system 72
- ITU-T
 - PRBS data 150
- K**
- Keys
 - MKR -> 243
 - Peak Search 243
 - RUN CONT 204
 - RUN SINGLE 205
- Known data 180
 - Creating files 265
 - Dependencies, restrictions 148
 - Enabling 181
 - File syntax 516
 - Files 264
 - Fine synchronization 224, 225
 - Loading 182
 - PRBS 150, 182, 267
 - Recording tool 266
 - Symbol decisions 118
 - Working with 264
- L**
- Limit lines
 - Current/mean/peak values 247
 - Default 247
 - Enabling 246

- Modulation accuracy 246
- Peak search 243
- Values 247
- Values, checking 248
- Limits
 - Configuring 273
 - Defining (remote) 428
 - Modulation Accuracy 273
 - Retrieving check results (remote) 477
- Linear average
 - Formula 523
- Lines
 - Eye diagram 244
 - Horizontal 245
 - Limit checking 246
 - Vertical 245
- Loading
 - Settings files 164
- Low-ISI filters
 - Frequency response 528
- Lower Level Hysteresis 231
- M**
- Magnitude
 - Formula 518
- Magnitude (Selected CB Section)
 - Result types 48
- Magnitude Absolute
 - Result type 48, 148
- Magnitude error
 - Definition 129
 - Formula 518
 - Result type 50, 51
 - RMS, peak (formulae) 520, 522
- Magnitude Relative
 - Result type 49
- Manchester code 310
- Mapping
 - see Symbol mapping 78
- Mapping wizard (mapwiz) 111
- Marker to Trace 241
- Markers
 - Absolute peak 243
 - Assigned trace 241
 - Configuring 240
 - Coupling 241
 - Deactivating 241
 - Delta markers 241
 - General settings (remote) 415
 - Minimum 243
 - Next minimum 244
 - Next peak 243
 - Peak 243
 - Positioning 243
 - Retrieving values (remote) 449
 - Search settings 242
 - Settings (remote) 411
 - State 241
 - Type 241
 - X-value 241
- Matched filter 71
- Max Peak 243
- Maximizing
 - Windows (remote) 433
- Mean
 - Formula 523
- Meas & Ref
 - Data source 22
 - Result types 22
- MEAS filter 71
- Meas only if burst was found 208
- Measurement bandwidth 71
- Measurement example
 - Burst GSM EDGE Signals 281
 - Continuous QPSK 276
- Measurement examples
 - Burst GSM EDGE signal (remote) 495
 - Continuous QPSK signal (remote) 493
- Measurement filter 72
 - Alpha/BT 227
 - Configuration 226
 - Configuration (remote) 396
 - Demodulation process 114
 - Enabling 226
 - Loading 227
 - Predefined 227, 512
 - Type 227
 - User-defined 227
- Measurement ranges
 - Comparison 142
 - Definition 142
- Measurement signal
 - Evaluating 236
- Measurement time
 - Auto settings 230
- Min Gap Length
 - Bursts 208
- Min/max values
 - Y-axis 197
- Minimum 243
 - Marker positioning 243
 - Next 244
- Minimum shift keying (MSK)
 - Symbol mapping 96
- MKR ->
 - Key 243
- ModAcc Limits 246
- Modulation
 - Configuration 165
 - Display 19
 - Errors, FSK 141
 - Inverted (I/Q, remote) 372
 - Inverted (I/Q) 201
 - Mapping 167, 174
 - Order 166, 173
 - Remote 323
 - Symbol Rate 168
 - Type 166, 173
 - User-defined 111
- Modulation accuracy
 - Data source 24
 - Individual results 58
 - Limit checking 246
 - Limit checking, enabling 246
 - Limit lines (remote) 427
 - Limits 273
 - Result types 24
- Modulation Error Ratio (MER)
 - Definition 129
- Modulation errors 125, 128
 - Data source 23
 - Formula 520

PSK, QAM, MSK	126
Result types	23
Modulation order	
Known data	149
Pattern symbols	215
Modulation type	
FSK	137
MSK	
Error model	126
Modulation type	166, 173
Multi Source	
Data source	24
Multiple	
Measurement channels	18
N	
Next Minimum	244
Marker positioning	244
Next Peak	243
Marker positioning	243
Noise	
Effect	136
Source	189
Normalization	
Demodulation	223
O	
Offset	
EVM	225
Frequency	191
Pattern	171
QPSK	89
QPSK, symbol mapping	89
Reference level	193
Result range	217
On Off Keying (OOK)	
Constellation diagram	109
OOK	
Symbol mapping	109
Optimization	
Demodulation	223
Options	
Bandwidth extension	78
Electronic attenuation	195
Preamplifier	194
OQPSK	
Constellation diagram	89
Output	
Audio	356
Configuration	183
Configuration (softkey)	188
IF frequency (remote)	356
IF Out Frequency	189
IF source (remote)	356
Noise source	189
Sample rate, definition	77
Settings	188
Video	189, 356
Overload	
RF input (remote)	350
Oversampling	
Statistics	251
Overview	
Configuration	159

P

Parameters	
Description	67, 68
FSK	68
PSK, QAM, MSK	67
Retrieving results (remote)	462
SCPI parameters	67, 68
Pattern search	
Configuration	209
Demodulation process	113
Display	19
Enabling	209, 213
Errors	291
Found pattern	210
I/Q correlation threshold	210
Performing	259
Process	116
Remote	379
Selected pattern	210
Patterns	
Adding to standard	212
Assigning to standard	260
Available	212
Coarse synchronization	224
Compatible	212
Configuration	171, 210
Copying	212
Creating	213
Definition	213
Definition (remote)	381
Deleting	213
Details	213
Displaying	212
Editing	212
Enabling	210, 213
Fine synchronization	224
Managing	263
Name	170, 214
Offset	171
Prefix	212
Reference for result range	217
Removing from standard	212
Restoring	232
Selected	211
Standard	211
Symbol check	120
Symbol check (demodulation process)	114
Symbol format	215, 250
Symbols	215
Working with	259
Peak search	
Key	243
Limits	243
Mode	242
Peaks	
Absolute	243
Formula	523
Marker positioning	243
Next	243
Softkey	243
Phase	
Distortion, effect	135
Formula	518
Wrap (result type)	52

- Phase error
 - Definition 129
 - Formula 518
 - Result type 51
 - RMS, peak (formulae) 520
- Phase Error
 - Result type 52
- Phase shift keying
 - see PSK 79
- Phase unwrap
 - Unwrap (result type) 53
- PRBS
 - ITU-T 150
 - Known data 150, 182, 267
- Preamplifier
 - Setting 194
 - Softkey 194
- Prefix
 - Patterns 212
- Presetting
 - Channels 162
 - Default values 231
- Pretrigger 203
- Programming examples
 - Burst GSM EDGE signal 495
 - Continuous QPSK signal 493
- Protection
 - RF input (remote) 350
- PSK
 - Differential 86
 - Error model 126
 - Mixed forms 87
 - Modulation type 166, 173
 - Rotating 83
 - Rotating differential 87
 - Symbol mapping 79
- Q**
- QAM
 - Error model 126
 - Modulation type 166, 173
 - Symbol mapping 97
- QPSK
 - Continuous 276
 - Measurement example 276
 - Offset 89
 - Offset, symbol mapping 89
 - Programming example 493
 - Shaped offset 90
- Quadrature Amplitude Modulation
 - see QAM 97
- Quadrature error
 - Definition 132
 - Effect 132
 - Formula 520
 - Preconditions for measurement 132
- Quick Config
 - Traces 237
- R**
- Range
 - X-axis 199
- Range per division
 - Y-axis 198
- Raw data
 - Exporting 238
- Real/Imag (I/Q)
 - Result type 54
- Receive filter 71
- Record length
 - Definition 77
 - Relationship to sample rate 78
- Recording tool
 - Known data 266
- Reference
 - Result range 217
- Reference deviation
 - Definition 138
 - FSK 167
- Reference filter 72
- Reference level 192
 - Auto level 193, 230
 - Offset 193
 - Unit 192, 193
 - Value 192
- Reference position
 - X-axis 198
 - Y-axis 197
- Reference signal 127
 - Demodulation process 114
 - Evaluating 236
 - Generating 114
- Reference value
 - X-axis 198
 - Y-axis 197
- Refresh
 - Softkey 205
- Release notes 14
- Remote commands
 - Basics on syntax 311
 - Boolean values 315
 - Capitalization 313
 - Character data 315
 - Data blocks 316
 - Numeric values 314
 - Optional keywords 313
 - Parameters 314
 - Strings 316
 - Suffixes 313
- Resetting
 - RF input protection 350
- Restoring
 - Channel settings 162
 - Factory settings 231
 - Pattern files 232
 - Standard files 164, 231
- Result display
 - Configuration (remote) 433
 - Troubleshooting 300
- Result displays
 - Data sources 21
- Result length 144
 - Display 19
 - Known data 149
 - QAM modulation 97
 - Ranges 217
- Result range
 - Alignment 145, 217, 218
 - Alignment (known data) 149
 - Configuration 216
 - Defining 257

Definition	143
Demodulation process	113
Display	143
Evaluating	229
Length	144, 217
Offset	217
Overlapping	299
Reference	217
Remote	384
Run-In/out	145
Selecting	206
Result Summary	
Configuration	58
Display points per symbol	148
Evaluations	520
Formulae	520
Formulae (FSK)	522
Result type	55
Result type	
Display	20
Transformation	250
Window configuration	250
Result types	
Bit error rate (BER)	27
Capture buffer	22
Channel Frequency Response Group Delay	29
Channel Frequency Response Magnitude	30
Constellation Frequency	30
Constellation I/Q	31
Constellation I/Q (Rotated)	33
Equalizer	24
Error vector	23
Error Vector Magnitude (EVM)	34
Eye Diagram Frequency	35
Eye Diagram Imag (Q)	36
Eye Diagram Real (I)	38
Frequency Absolute	39
Frequency Error Absolute	41
Frequency Error Relative	43
Frequency Relative	40
Frequency Response Group Delay	44
Frequency Response Magnitude	45
Frequency Response Phase	45
Impulse Response Magnitude	46
Impulse Response Phase	47
Impulse Response Real/Imag	48
Magnitude (Selected CB Section)	48
Magnitude Absolute	48
Magnitude Error	50
Magnitude Relative	49
Meas & Ref	22
Modulation accuracy	24
Modulation errors	23
Multi Source	24
Overview	25
Phase Error	51
Phase Unwrap	53
Phase Wrap	52
Real/Imag (I/Q)	54
Result Summary	55
SCPI parameters	25
Spectrum (Capture Buffer + Error)	59
Spectrum (Meas+Error)	61
Symbol Table	62
Symbols	23
Vector Frequency	64
Vector I/Q	64
Results	
Retrieving (remote)	448
RF attenuation	
Auto	194
Manual	194
RF input	184
Overload protection (remote)	350
Remote	350
RHO	
Formula	520
RMS average	
Formula	523
Roll-off factor (Alpha)	
Measurement filter	227
Transmit filter	168
Rotating Differential PSK	
Symbol mapping	87
Rotating PSK	
Symbol mapping	83
RRC filter	71
RUN CONT	
Key	204
RUN SINGLE	
Key	205
Run-in	
Bursts	170
S	
Safety instructions	14
Sample rate	71, 147
Basics	69
Definition	76, 77
Max. usable I/Q bandwidth	77
Maximum	77
Relationship to bandwidth	78
Relationship to symbol rate	77
Remote	370
Setting	201
Saving	
Settings	164
Scaling	
Automatically	197, 231
Diagrams, changing	269
X-axis	195, 270
X-axis (automatically)	198
X-axis, y-axis (default)	198
Y-axis	195, 269, 270
Y-axis (remote control)	370
Y-axis (statistics)	197
Search	
Direction (Real or Imag)	242
Tolerance (Burst Search)	208
Search Limits	
Activating	243
Security procedures	14
Select Result Rng	
Softkey	206
Sequencer	18
Activating (remote)	405
Remote	404
Sequences	
Aborting (remote)	405
Mode (remote)	406
Service manual	13

- Settings
 - filename 163
 - Restoring files 164, 231
 - Storage location 163
- Settings files
 - Deleting 164
 - Loading 164
 - Saving 164
- Shaped offset QPSK 90
- Signal capture 200
 - Remote control 370
- Signal description
 - Configuration 165
 - Configuration (remote) 322
 - Pattern 170
 - Softkey 165
- Signal model 125
 - FSK 137
- Signal structure
 - Burst settings 170
 - Configuration 169
 - Remote 331
- Signal type
 - Continuous/Burst Signal 170
- Single sweep
 - Softkey 205
- Slope
 - Trigger 204, 374
- Softkeys
 - Auto Level 193, 230
 - Center 190
 - Continue Single Sweep 205
 - Continuous Sweep 204
 - Display configuration 248
 - External 202
 - Free Run 202
 - IF Power 203
 - Lower Level Hysteresis 231
 - Marker Config 240
 - Marker to Trace 241
 - Meastime Auto 230
 - Meastime Manual 230
 - Min 243
 - ModAcc Limits 246
 - Next Min 244
 - Next Peak 243
 - Norm/Delta 241
 - Outputs Config 188
 - Peak 243
 - Preamp 194
 - Ref Level 192
 - Ref Level Offset 193
 - RF Atten Auto 194
 - RF Atten Manual 194
 - Signal Description 165
 - Single Sweep 205
 - Trace 1/2/3/4 237
 - Trace Config 233
 - Trigger Offset 203
 - Trigger/Gate Config 201
 - Upper Level Hysteresis 230
 - Window configuration 248
- Specifics for
 - Configuration 162
- Spectrum
 - Result type transformation 250
- Spectrum (Capture Buffer + Error)
 - Result type 59
- Spectrum (Meas+Error)
 - Result type 61
- SR
 - see Symbol rate 19
- Standards
 - see Digital standards 163
- Statistic count 205
 - Display 19
- Statistics
 - Formulae 523
 - Oversampling 251
 - Result type transformation 250
- Status registers
 - Description 481
 - Querying 486
 - STAT:QUES:POW 350
- Status reporting system 480
- StdDev
 - Formula 523
- Storage location
 - Settings 163
- Suffixes
 - Common 316
 - Remote commands 313
- Swap I/Q 201
 - Remote 372
- Sweep
 - Aborting 204, 205
 - Configuration (remote) 375, 403
 - Count, see Statistic count 205
 - Settings 204
- Symbol check
 - Algorithm 120
 - Demodulation 120
 - Patterns 120
- Symbol decisions
 - Algorithm 117
 - Demodulation 117
 - Demodulation process 113
 - Known data 118
- Symbol error rate (SER)
 - Fine synchronization 225
- Symbol mapping 78, 167, 174
 - APSK 110
 - ASK 109
 - Differential PSK 86
 - FSK 91
 - MSK 96
 - Offset QPSK 89
 - OOK 109
 - PSK 79
 - QAM 97
 - Rotating differential PSK 87
 - Rotating PSK 83
 - User-defined 111
 - Wizard (mapwiz) 111
- Symbol number
 - Result range start 218
- Symbol rate 147, 168
 - Basics 69
 - Display 19
 - Relationship to sample rate 77
 - Remote 330
- Symbol Rate Error (SRE) 220
 - Definition 129

- Symbol tables
 - Result type 62
- symbols
 - Highlighting 250
 - Window Configuration 250
- Symbols
 - Data source 23
 - Format, patterns 215, 250
 - Patterns 215
 - Result types 23
- Synchronization 127
 - Coarse 224
 - Demodulation 222
 - Demodulation process 114
 - Fails, troubleshooting 310
 - Fine 224
 - Known data 224, 225
 - Patterns 224
 - Remote 387
 - Symbol error rate (SER) 225
- Syntax
 - Known data files 516
- T**
- Trace Export
 - Configuration 238
 - Data mode 238
 - Header information 238
 - Storage location 239
- Traces 237
 - Averaging, formulae 523
 - Capture Buffer (remote) 455
 - Cartesian Diagrams (remote) 455
 - Configuration 233
 - Configuring (remote control) 407
 - Equalizer (remote) 457
 - Evaluation 236
 - Export format 239
 - Exporting 239
 - Exporting data 274
 - Measurement signal 236
 - Mode 234
 - Mode (remote) 409
 - Multi Source (remote) 457
 - Polar Diagrams (remote) 455
 - Reference signal 236
 - Result Summary (remote) 456
 - Retrieving data (remote) 449
 - Selecting 234
 - Settings (remote control) 407
 - Settings, predefined 237
 - Symbols (remote) 456
 - Troubleshooting 300
- Transmit filter 71
 - Alpha/BT 168
 - Predefined 511
 - Type 168
 - User-defined 168
 - Using as measurement filter 226
- Trigger
 - Configuration 201
 - Drop-out time 204
 - External (remote) 374
 - Holdoff 204
 - Hysteresis 203
 - Offset 203
 - Remote control 372
 - Slope 204, 374
 - Trigger source 202
 - External 202
 - Free Run 202
 - I/Q Power 203
 - IF Power 203
- Troubleshooting
 - Burst search 291
 - Flow chart 289
 - Frequently asked questions 300
 - Input overload 350
 - Pattern search 291
 - Result display 300
 - Traces 300
- U**
- Units
 - Reference level 192, 193
 - X-axis 199
 - X-axis, y-axis 199
 - Y-axis 199
- Upper Level Hysteresis 230
- Usable I/Q bandwidth
 - Definition 77
 - Result display 21, 201
- Useful length
 - Bursts 145
- User filters
 - Loading 168
- User QAM
 - Modulation type 166, 173
- User sample rate
 - Definition 77
- V**
- Vector frequency
 - Result type 64
- Vector I/Q
 - Result type 64
- Vertical line
 - Eye diagram 245
- Video output 189, 356
- W**
- White papers 14
- Window configuration 248, 249
 - Data source 249
 - Remote 441
 - Result type 250
 - Result type transformation 250
- Window title bar information 20
- Windows
 - Adding (remote) 434
 - Closing (remote) 440
 - Configuring 162
 - Layout (remote) 438
 - Maximizing (remote) 433
 - Querying (remote) 436
 - Replacing (remote) 437
 - Splitting (remote) 433
 - Types (remote) 434

X

X-axis

Quantize	198
Range	199
Reference position	198, 271
Reference value	198, 271
Scaling	195
Scaling (default)	198
Scaling automatically	198
Scaling, auto	197, 231
Scaling, auto all windows	231
Units	199

X-value

Marker	241
--------------	-----

Y

Y-axis

Mix, max values	197
Range	272
Range per division	198
Reference position	197, 269
Reference value	197, 269
Scaling	195
Scaling (statistics)	197
Scaling, auto	197, 231, 270, 271
Scaling, auto all windows	231
Units	199

YIG-preselector

Activating/Deactivating	186
Activating/Deactivating (remote)	352