

R&S® FSV3-K10x (LTE Downlink) LTE Downlink Measurement Application User Manual



1178921002
Version 09



This manual applies to the following R&S®FSV3000 and R&S®FSVA3000 models with firmware version 2.10 and higher:

- R&S®FSV3004 (1330.5000K04) / R&S®FSVA3004 (1330.5000K05)
- R&S®FSV3007 (1330.5000K07) / R&S®FSVA3007 (1330.5000K08)
- R&S®FSV3013 (1330.5000K13) / R&S®FSVA3013 (1330.5000K14)
- R&S®FSV3030 (1330.5000K30) / R&S®FSVA3030 (1330.5000K31)
- R&S®FSV3044 (1330.5000K43) / R&S®FSVA3044 (1330.5000K44)
- R&S®FSV3050 (1330.5000K50) / R&S®FSVA3050 (1330.5000K51)

The following firmware options are described:

- R&S®FSV3-K100 (EUTRA/LTE FDD downlink measurement application) (order no. 1330.5145.02)
- R&S®FSV3-K102 (EUTRA/LTE Advanced and MIMO Downlink Measurement Application) (order no. 1330.5168.02)
- R&S®FSV3-K104 (EUTRA/LTE TDD downlink measurement application) (order no. 1330.5174.02)

© 2023 Rohde & Schwarz GmbH & Co. KG
Muehldorfstr. 15, 81671 Muenchen, Germany
Phone: +49 89 41 29 - 0
Email: info@rohde-schwarz.com
Internet: www.rohde-schwarz.com

Subject to change – data without tolerance limits is not binding.

R&S® is a registered trademark of Rohde & Schwarz GmbH & Co. KG.

Trade names are trademarks of the owners.

1178.9210.02 | Version 09 | R&S®FSV3-K10x (LTE Downlink)

Throughout this manual, products from Rohde & Schwarz are indicated without the ® symbol , e.g. R&S®FSW is indicated as R&S FSW.

Contents

1	Documentation overview.....	7
1.1	Getting started manual.....	7
1.2	User manuals and help.....	7
1.3	Service manual.....	8
1.4	Instrument security procedures.....	8
1.5	Printed safety instructions.....	8
1.6	Data sheets and brochures.....	8
1.7	Release notes and open-source acknowledgment (OSA).....	8
1.8	Application notes, application cards, white papers, etc.....	9
1.9	Videos.....	9
2	Welcome to the LTE measurement application.....	10
2.1	Overview of the LTE applications.....	10
2.2	Installation.....	12
2.3	Starting the LTE measurement application.....	12
2.4	Understanding the display information.....	12
3	Measurements and result displays.....	15
3.1	Selecting measurements.....	15
3.2	Selecting result displays.....	16
3.3	Performing measurements.....	17
3.4	I/Q measurements.....	17
3.5	Time alignment error measurements.....	38
3.6	Transmit on / off power measurement.....	39
3.7	Frequency sweep measurements.....	43
3.8	3GPP test scenarios.....	52
4	Measurement Basics.....	55
4.1	Symbols and variables.....	55
4.2	Overview.....	56
4.3	The LTE downlink analysis measurement application.....	56
4.3.1	Synchronization.....	56
4.3.2	Channel estimation and equalization.....	58

4.3.3	Analysis.....	58
4.4	Performing time alignment measurements.....	59
4.5	Performing transmit on/off power measurements.....	61
4.6	O-RAN measurement guide.....	62
5	Configuration.....	64
5.1	Configuration overview.....	64
5.2	I/Q Measurements.....	66
5.2.1	Signal characteristics.....	67
5.2.2	Test scenarios.....	74
5.2.3	Configuring MIMO setups.....	75
5.2.4	PDSCH demodulation.....	77
5.2.5	PDSCH subframe configuration.....	78
5.2.6	Synchronization signal configuration.....	85
5.2.7	Reference signal configuration.....	86
5.2.8	Positioning reference signal configuration.....	87
5.2.9	Channel state information reference signal configuration.....	89
5.2.10	PDSCH resource block symbol offset.....	91
5.2.11	PBCH configuration.....	92
5.2.12	PCFICH configuration.....	93
5.2.13	PHICH configuration.....	94
5.2.14	PDCCH configuration.....	97
5.2.15	EPDCCH configuration.....	98
5.2.16	Shared channel configuration.....	100
5.2.17	MBSFN characteristics.....	100
5.2.18	Input source configuration.....	103
5.2.19	Frequency configuration.....	105
5.2.20	Amplitude configuration.....	106
5.2.21	Data capture.....	110
5.2.22	Trigger configuration.....	112
5.2.23	Parameter estimation and tracking.....	114
5.2.24	Measurement error compensation.....	115
5.2.25	Demodulation.....	116
5.2.26	Automatic configuration.....	118

5.3	Time Alignment Error Measurements.....	119
5.4	On / Off Power Measurements.....	119
5.5	Frequency Sweep Measurements.....	120
5.5.1	ACLR Signal Description.....	120
5.5.2	SEM and Multi-Carrier SEM Signal Description.....	121
5.5.3	Cumulative ACLR.....	123
5.5.4	MC ACLR.....	123
6	Analysis.....	125
6.1	General analysis tools.....	125
6.1.1	Data export.....	125
6.1.2	Microservice export.....	126
6.1.3	Diagram scale.....	126
6.1.4	Zoom.....	127
6.1.5	Markers.....	127
6.2	Analysis tools for I/Q measurements.....	128
6.2.1	Layout of numerical results.....	128
6.2.2	Evaluation range.....	129
6.2.3	Result settings.....	132
6.3	Analysis tools for frequency sweep measurements.....	133
7	Remote control.....	134
7.1	Common suffixes.....	134
7.2	Introduction.....	135
7.2.1	Conventions used in descriptions.....	136
7.2.2	Long and short form.....	136
7.2.3	Numeric suffixes.....	137
7.2.4	Optional keywords.....	137
7.2.5	Alternative keywords.....	137
7.2.6	SCPI parameters.....	138
7.3	LTE application selection.....	140
7.4	Screen layout.....	143
7.4.1	General layout.....	143
7.4.2	Layout of a single channel.....	145
7.5	Measurement control.....	153

7.5.1	Measurements.....	153
7.5.2	Measurement sequences.....	156
7.6	Trace data readout.....	157
7.6.1	The TRACe[:DATA] command.....	157
7.6.2	Result readout.....	175
7.7	Numeric result readout.....	176
7.7.1	Frame results.....	176
7.7.2	Result for selection.....	179
7.7.3	Time alignment error.....	185
7.7.4	Marker table.....	186
7.7.5	CCDF table.....	189
7.8	Limit check result readout.....	190
7.8.1	Limits for graphical result displays.....	190
7.8.2	Limits for numerical result display.....	198
7.9	Configuration.....	205
7.9.1	General configuration.....	205
7.9.2	I/Q measurements.....	207
7.9.3	Time alignment error measurements.....	261
7.9.4	Transmit on/off power measurements.....	262
7.9.5	Frequency sweep measurements.....	264
7.10	Analysis.....	268
7.10.1	Trace export.....	268
7.10.2	Microservice export.....	270
7.10.3	Evaluation range.....	270
7.10.4	Y-axis scale.....	274
7.10.5	Result settings.....	276
	List of Commands (LTE DL).....	278
	Index.....	285

1 Documentation overview

This section provides an overview of the R&S FSV/A user documentation. Unless specified otherwise, you find the documents at:

www.rohde-schwarz.com/manual/FSVA3000

www.rohde-schwarz.com/manual/FSV3000

Further documents are available at:

www.rohde-schwarz.com/product/FSVA3000

www.rohde-schwarz.com/product/FSV3000

1.1 Getting started manual

Introduces the R&S FSV/A and describes how to set up and start working with the product. Includes basic operations, typical measurement examples, and general information, e.g. safety instructions, etc.

A printed version is delivered with the instrument. A PDF version is available for download on the Internet.

1.2 User manuals and help

Separate user manuals are provided for the base unit and the firmware applications:

- **Base unit manual**
Contains the description of all instrument modes and functions. It also provides an introduction to remote control, a complete description of the remote control commands with programming examples, and information on maintenance, instrument interfaces and error messages. Includes the contents of the getting started manual.
- **Firmware application manual**
Contains the description of the specific functions of a firmware application, including remote control commands. Basic information on operating the R&S FSV/A is not included.

The contents of the user manuals are available as help in the R&S FSV/A. The help offers quick, context-sensitive access to the complete information for the base unit and the firmware applications.

All user manuals are also available for download or for immediate display on the Internet.

1.3 Service manual

Describes the performance test for checking the rated specifications, module replacement and repair, firmware update, troubleshooting and fault elimination, and contains mechanical drawings and spare part lists.

The service manual is available for registered users on the global Rohde & Schwarz information system (GLORIS):

[R&S®FSVA3000/FSV3000 Service manual](#)

1.4 Instrument security procedures

Deals with security issues when working with the R&S FSV/A in secure areas. It is available for download on the internet.

1.5 Printed safety instructions

Provides safety information in many languages. The printed document is delivered with the product.

1.6 Data sheets and brochures

The data sheet contains the technical specifications of the R&S FSV/A. It also lists the firmware applications and their order numbers, and optional accessories.

The brochure provides an overview of the instrument and deals with the specific characteristics.

See www.rohde-schwarz.com/brochure-datasheet/FSV3000/

www.rohde-schwarz.com/brochure-datasheet/FSVA3000

1.7 Release notes and open-source acknowledgment (OSA)

The release notes list new features, improvements and known issues of the current firmware version, and describe the firmware installation.

The software makes use of several valuable open source software packages. An open-source acknowledgment document provides verbatim license texts of the used open source software.

See www.rohde-schwarz.com/firmware/FSV3000/

www.rohde-schwarz.com/firmware/FSVA3000

1.8 Application notes, application cards, white papers, etc.

These documents deal with special applications or background information on particular topics.

See www.rohde-schwarz.com/application/FSV3000 /

www.rohde-schwarz.com/application/FSVA3000

1.9 Videos

Find various videos on Rohde & Schwarz products and test and measurement topics on YouTube: <https://www.youtube.com/@RohdeundSchwarz>

2 Welcome to the LTE measurement application

The R&S FSV/A-K100, -K102 and -K104 are firmware applications that add functionality to perform measurements on LTE signals according to the 3GPP standard to the R&S FSV/A.

This user manual contains a description of the functionality that the application provides, including remote control operation. Functions that are not discussed in this manual are the same as in the Spectrum application and are described in the R&S FSV/A User Manual. The latest versions of the manuals are available for download at the product homepage.

<https://www.rohde-schwarz.com/manual/fsv3000>.

- [Overview of the LTE applications](#)..... 10
- [Installation](#)..... 12
- [Starting the LTE measurement application](#)..... 12
- [Understanding the display information](#)..... 12

2.1 Overview of the LTE applications

You can equip the R&S FSV/A with one or more LTE applications. Each of the applications provides functionality for specific measurement tasks.

R&S FSV/A-K100

The R&S FSV/A-K100 is designed to measure LTE FDD signals on the downlink.

The application has the following features:

- Basic signal characteristics (like frequency, channel bandwidth or cyclic prefix).
- Demodulation and configuration of the PDSCH transmitted over a single antenna and without precoding functionality.
- Characteristics of the Synchronization and Reference signals.
- Consideration of various control channels in the measurement (for example the PBCH or the PPDCH).
- Analysis of individual antennas in a MIMO setup.
- Tools to refine and filter the measurement results.
- Various result displays that show the measured signal characteristics in a diagram or a numeric result table.
- Available measurements: EVM, ACLR and SEM.

R&S FSV/A-K101

The R&S FSV/A-K101 is designed to measure LTE FDD signals on the uplink.

The application has the following features:

- Basic signal characteristics (like frequency, channel bandwidth or cyclic prefix).
- Demodulation and configuration of the subframes transmitted over a single antenna.
- Characteristics of the demodulation and sounding reference signals.
- Consideration of the PUSCH, PUCCH and PRACH channels.
- Analysis of individual antennas in a MIMO setup.
- Tools to refine and filter the measurement results.
- Various result displays that show the measured signal characteristics in a diagram or a numeric result table.
- Available measurements: EVM, ACLR and SEM.

R&S FSV/A-K102

The R&S FSV/A-K102 is designed to measure LTE Advanced systems and MIMO systems on the downlink.

Note that this application only works in combination with either R&S FSV/A-K100 or -K104.

The application has the following features:

- Support of 1024QAM modulation.
- Consideration of the precoding schemes defined in the 3GPP standard.
- Support of carrier aggregation.
- Measurements on multimedia broadcast single frequency networks (MBSFNs).
- Additional measurements: time alignment error, multi-carrier ACLR, cumulative ACLR and multi-SEM.

R&S FSV/A-K103

The R&S FSV/A-K103 is designed to measure LTE Advanced systems on the uplink.

Note that this application only works in combination with either R&S FSV/A-K101 or -K105.

The application has the following features:

- Support of 256QAM modulation.
- Consideration of the enhanced PUSCH and PUCCH characteristics.
- Support of carrier aggregation.
- Additional measurements: time alignment error, multi-carrier ACLR and multi SEM.

R&S FSV/A-K104

The R&S FSV/A-K104 is designed to measure LTE TDD signals on the downlink.

The features are basically the same as in the R&S FSV/A-K100 with additional features that allow you to configure TDD subframes. It also provides tools to measure the On/Off Power.

R&S FSV/A-K105

The R&S FSV/A-K105 is designed to measure LTE TDD signals on the uplink.

The features are basically the same as in the R&S FSV/A-K101 with additional features that allow you to configure TDD subframes.

2.2 Installation

Find detailed installing instructions in the Getting Started or the release notes of the R&S FSV/A.

2.3 Starting the LTE measurement application

The LTE measurement application adds a new application to the R&S FSV/A.

To activate the application

1. Press the [MODE] key on the front panel of the R&S FSV/A.

A dialog box opens that contains all operating modes and applications currently available on your R&S FSV/A.

2. Select the "LTE" item.



The R&S FSV/A opens a new measurement channel for the LTE measurement application.

The measurement is started immediately with the default settings. It can be configured in the "Overview" dialog box, which is displayed when you select the "Overview" soft-key from any menu.

For more information see [Chapter 5, "Configuration"](#), on page 64.

2.4 Understanding the display information

The following figure shows a measurement diagram during analyzer operation. All different information areas are labeled. They are explained in more detail in the following sections.

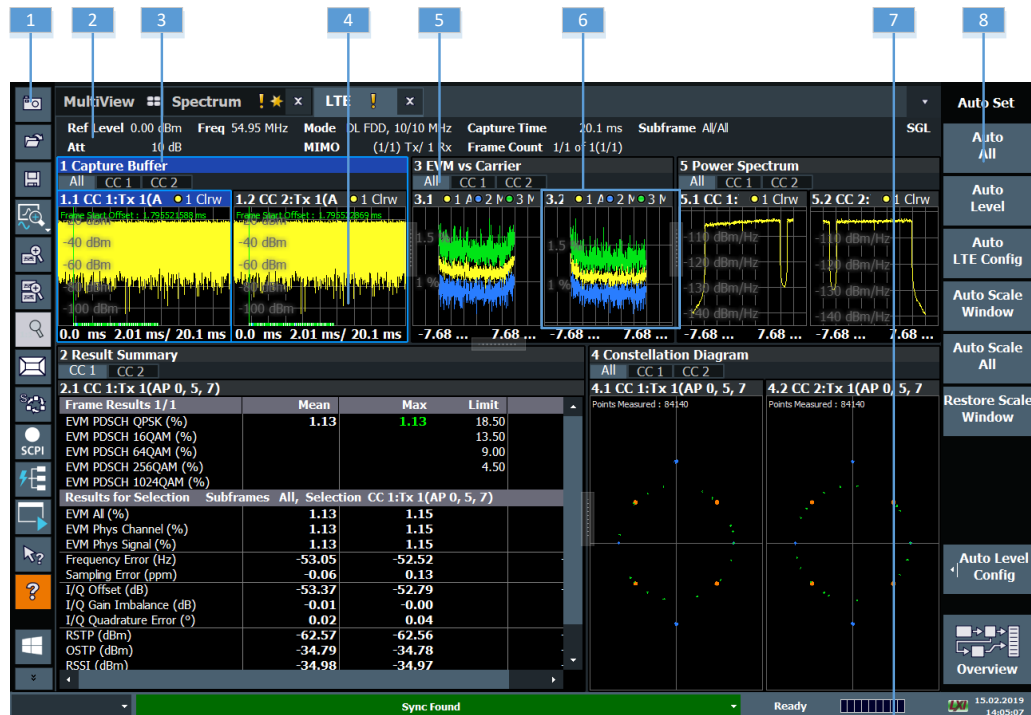

- 1 = Toolbar
- 2 = Channel bar
- 3 = Diagram header
- 4 = Result display
- 5 = Tabs to select displayed information for multiple data streams
- 6 = Subwindows (if more than one data stream is displayed at the same time)
- 7 = Status bar
- 8 = Softkeys

Channel bar information

In the LTE measurement application, the R&S FSV/A shows the following settings:

Table 2-1: Information displayed in the channel bar in the LTE measurement application

Ref Level	Reference level
Att	Mechanical and electronic RF attenuation
Freq	Frequency
Mode	LTE standard
MIMO	Number of Tx and Rx antennas in the measurement setup
Capture Time	Signal length that has been captured
Frame Count	Number of frames that have been captured
Selected Subframe	Subframe considered in the signal analysis

In addition, the channel bar also displays information on instrument settings that affect the measurement results even though this is not immediately apparent from the display of the measured values (e.g. transducer or trigger settings). This information is dis-

played only when applicable for the current measurement. For details see the R&S FSV/A Getting Started manual.

Window title bar information

The information in the window title bar depends on the result display.

The "Constellation Diagram", for example, shows the number of points that have been measured.

Status bar information

Global instrument settings, the instrument status and any irregularities are indicated in the status bar beneath the diagram. Furthermore, the progress of the current operation is displayed in the status bar.

Regarding the synchronization state, the application shows the following labels.

- Sync OK
The synchronization was successful. The status bar is green.
- Sync Failed
The synchronization was not successful. The status bar is red.
There can be three different synchronization errors.
 - Sync Failed (Cyclic Prefix): The cyclic prefix correlation failed.
 - Sync Failed (P-SYNC): The P-SYNC correlation failed.
 - Sync Failed (S-SYNC): The S-SYNC correlation failed.

3 Measurements and result displays

The LTE measurement application measures and analyzes various aspects of an LTE signal.

It features several measurements and result displays. Measurements represent different ways of processing the captured data during the digital signal processing. Result displays are different representations of the measurement results. They may be diagrams that show the results as a graph or tables that show the results as numbers.

Remote command:

Measurement selection: `CONFigure[:LTE]:MEASurement` on page 206

Result display selection: `LAYout:ADD[:WINDow]?` on page 145

• Selecting measurements	15
• Selecting result displays	16
• Performing measurements	17
• I/Q measurements	17
• Time alignment error measurements	38
• Transmit on / off power measurement	39
• Frequency sweep measurements	43
• 3GPP test scenarios	52

3.1 Selecting measurements

Access: "Overview" > "Select Measurement"

The "Select Measurement" dialog box contains several buttons. Each button represents a measurement. A measurement in turn is a set of result displays that thematically belong together and that have a particular display configuration. If these predefined display configurations do not suit your requirements, you can add or remove result displays as you like. For more information about selecting result displays, see [Chapter 3.2, "Selecting result displays"](#), on page 16.

Depending on the measurement, the R&S FSV/A changes the way it captures and processes the raw signal data.

EVM

EVM measurements record, process and demodulate the signal's I/Q data. The result displays available for EVM measurements show various aspects of the LTE signal quality.

For EVM measurements, you can combine the result displays in any way.

For more information on the result displays, see [Chapter 3.4, "I/Q measurements"](#), on page 17.

Remote command:

`CONFigure[:LTE]:MEASurement` on page 206

Time alignment error

Time alignment error (TAE) measurements record, process and demodulate the signal's I/Q data. The result displays available for TAE measurements indicate how well the antennas in a multi-antenna system are aligned.

For TAE measurements, you can combine the result displays in any way.

For more information on the result displays, see [Chapter 3.5, "Time alignment error measurements"](#), on page 38.

Remote command:

`CONFigure[:LTE]:MEASurement` on page 206

Channel power ACLR

(includes multi carrier ACLR and cumulative ACLR measurements)

ACLR measurements sweep the frequency spectrum instead of processing I/Q data.

The ACLR measurements evaluates the leakage ratio of neighboring channels and evaluates if the signal is within the defined limits. The measurement provides several result displays. You can combine the result displays in any way.

For more information on the result displays, see [Chapter 3.7, "Frequency sweep measurements"](#), on page 43.

Remote command:

`CONFigure[:LTE]:MEASurement` on page 206

SEM

(includes multi carrier SEM measurements)

SEM measurements sweep the frequency spectrum instead of processing I/Q data.

The SEM measurements tests the signal against a spectrum emission mask and evaluates if the signal is within the defined limits. The measurement provides several result displays. You can combine the result displays in any way.

For more information on the result displays, see [Chapter 3.7, "Frequency sweep measurements"](#), on page 43.

Remote command:

`CONFigure[:LTE]:MEASurement` on page 206

3.2 Selecting result displays

Access: 

The R&S FSV/A opens a menu (the SmartGrid) to select result displays. For more information on the SmartGrid functionality, see the R&S FSV/A Getting Started.

In the default state of the application, it shows several conventional result displays.

- Capture Buffer
- EVM vs Carrier
- Power Spectrum
- Result Summary

- Constellation Diagram

From that predefined state, add and remove result displays as you like from the Smart-Grid menu.

Remote command: `LAYout:ADD[:WINDow]?` on page 145



Measuring several data streams

When you capture more than one data stream (for example component carriers), each result display is made up out of several tabs.

The first tab shows the results for all data streams. The other tabs show the results for each individual data stream. By default, the tabs are coupled to one another - if you select a certain data stream in one display, the application also selects this data stream in the other result displays (see [Subwindow Coupling](#)).

The number of tabs depends on the number of data streams.

3.3 Performing measurements

By default, the application measures the signal continuously. In "Continuous Sweep" mode, the R&S FSV/A captures and analyzes the data again and again.

- For I/Q measurements, the amount of captured data depends on the [capture time](#).
- For frequency sweep measurement, the amount of captured data depends on the sweep time.

In "Single Sweep" mode, the R&S FSV/A stops measuring after it has captured the data once. The amount of data again depends on the capture time.

Refreshing captured data

You can also repeat a measurement based on the data that has already been captured with the "Refresh" function. Repeating a measurement with the same data can be useful, for example, if you want to apply different modulation settings to the same I/Q data.

For more information, see the documentation of the R&S FSV/A.

3.4 I/Q measurements

Access: [MEAS] > "EVM/Frequency Err/Power"

You can select the result displays from the evaluation bar and arrange them as you like with the SmartGrid functionality.

Remote command:

Measurement selection: `CONFigure[:LTE]:MEASurement` on page 206

Result display selection: `LAYout:ADD[:WINDow]?` on page 145

- Capture Buffer..... 18
- EVM vs Carrier..... 19
- EVM vs Symbol..... 20
- EVM vs RB..... 20
- EVM vs Subframe..... 21
- Frequency Error vs Symbol..... 22
- Power Spectrum..... 22
- Power vs Resource Block PDSCH..... 23
- Power vs Resource Block RS..... 23
- Channel Flatness..... 24
- Group Delay..... 24
- Channel Flatness Difference..... 24
- Constellation Diagram..... 25
- CCDF..... 26
- Allocation Summary..... 26
- Bitstream..... 27
- Channel Decoder Results..... 28
- EVM vs Symbol x Carrier..... 30
- Power vs Symbol x Carrier..... 30
- Allocation ID vs Symbol x Carrier..... 31
- UE RS Magnitude..... 31
- UE RS Phase..... 31
- Cell RS Magnitude..... 32
- Cell RS Phase..... 33
- CSI RS Magnitude..... 33
- CSI RS Phase..... 34
- Beamform Allocation Summary..... 34
- Result Summary..... 35
- Marker Table..... 37

Capture Buffer

The "Capture Buffer" shows the complete range of captured data for the last data capture.

The x-axis represents time. The maximum value of the x-axis is equal to the [Capture Time](#).

The y-axis represents the amplitude of the captured I/Q data in dBm (for RF input).

The capture buffer uses the auto peak detector to evaluate the measurement data. The auto peak detector determines the maximum and the minimum value of the measured levels for each measurement point and combines both values in one sample point.

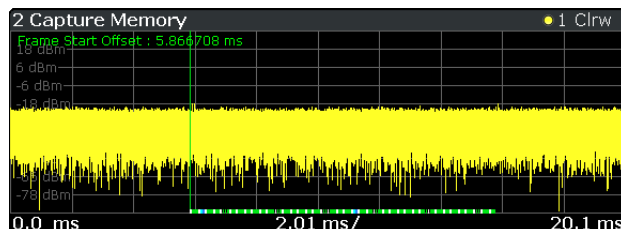





Figure 3-1: Capture buffer without zoom

A colored bar at the bottom of the diagram represents the frame that is currently analyzed. Different colors indicate the OFDM symbol type.

-  Indicates the data stream.
-  Indicates the reference signal and data.
-  Indicates the P-Sync and data.
-  Indicates the S-Sync and data.

A green vertical line at the beginning of the green bar in the capture buffer represents the subframe start. The diagram also contains the "Start Offset" value. This value is the time difference between the subframe start and capture buffer start.

When you zoom into the diagram, you will see that the bar is interrupted at certain positions. Each small bar indicates the useful parts of the OFDM symbol.

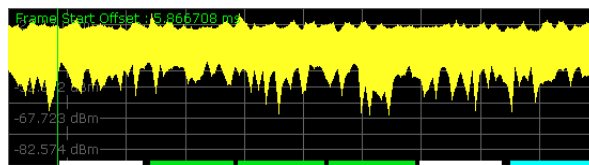

Figure 3-2: Capture buffer after a zoom has been applied

Remote command:

Selection: `LAY:ADD ? '1', LEFT, CBUF`

Query (y-axis): `TRACe:DATA?`

Query (x-axis): `TRACe<n>[:DATA]:X?` on page 174

Subframe start offset: `FETCh[:CC<cc>]:SUMMary:TFRame?` on page 184

EVM vs Carrier

The "EVM vs Carrier" result display shows the error vector magnitude (EVM) of the subcarriers. With the help of a marker, you can use it as a debugging technique to identify any subcarriers whose EVM is too high.

The results are based on an average EVM that is calculated over the resource elements for each subcarrier. This average subcarrier EVM is determined for each analyzed subframe in the capture buffer.

If you analyze all subframes, the result display contains three traces.

- Average EVM
This trace shows the subcarrier EVM, averaged over all subframes.
- Minimum EVM
This trace shows the lowest (average) subcarrier EVM that has been found over the analyzed subframes.
- Maximum EVM
This trace shows the highest (average) subcarrier EVM that has been found over the analyzed subframes.

If you select and analyze one subframe only, the result display contains one trace that shows the subcarrier EVM for that subframe only. Average, minimum and maximum values in that case are the same. For more information, see "[Subframe Selection](#)" on page 130.

The x-axis represents the center frequencies of the subcarriers. The y-axis shows the EVM in % or in dB, depending on the [EVM Unit](#).

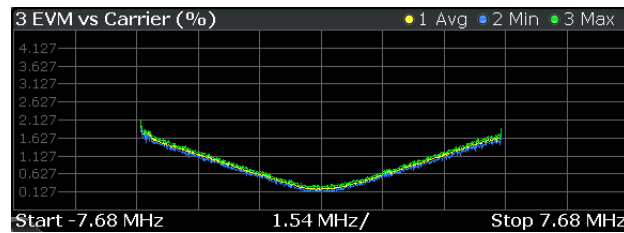

Remote command:

Selection `LAY:ADD ? '1',LEFT,EVCA`

Query (y-axis): `TRACe:DATA?`

Query (x-axis): `TRACe<n>[:DATA]:X?` on page 174

EVM vs Symbol

The "EVM vs Symbol" result display shows the error vector magnitude (EVM) of the OFDM symbols. You can use it as a debugging technique to identify any symbols whose EVM is too high.

The results are based on an average EVM that is calculated over all subcarriers that are part of a certain OFDM symbol. This average OFDM symbol EVM is determined for all OFDM symbols in each analyzed subframe.

The x-axis represents the OFDM symbols, with each symbol represented by a dot on the line. Any missing connections from one dot to another mean that the R&S FSV/A could not determine the EVM for that symbol.

The number of displayed symbols depends on the subframe selection and the length of the cyclic prefix.

For TDD signals, the result display does not show OFDM symbols that are not part of the measured link direction.

On the y-axis, the EVM is plotted either in % or in dB, depending on the [EVM Unit](#).

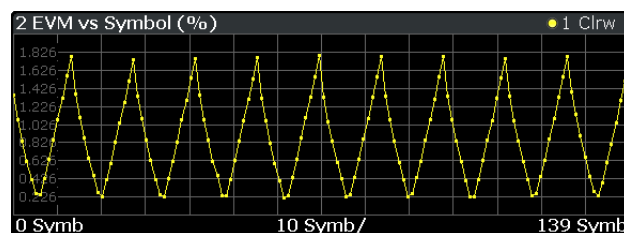

Remote command:

Selection: `LAY:ADD ? '1',LEFT,EVSY`

Query (y-axis): `TRACe:DATA?`

Query (x-axis): `TRACe<n>[:DATA]:X?` on page 174

EVM vs RB

The "EVM vs RB" result display shows the Error Vector Magnitude (EVM) for all resource blocks that can be occupied by the PDSCH.

The results are based on an average EVM that is calculated over all resource elements in the resource block. This average resource block EVM is determined for each analyzed subframe. If you analyze all subframes, the result display contains three traces.

- Average EVM
This trace shows the resource block EVM, averaged over all subframes.
- Minimum EVM
This trace shows the lowest (average) resource block EVM that has been found over the analyzed subframes.
- Maximum EVM
This trace shows the highest (average) resource block EVM that has been found over the analyzed subframes.

If you select and analyze one subframe only, the result display contains one trace that shows the resource block EVM for that subframe only. Average, minimum and maximum values in that case are the same. For more information, see "[Subframe Selection](#)" on page 130.

The x-axis represents the PDSCH resource blocks. On the y-axis, the EVM is plotted either in % or in dB, depending on the [EVM Unit](#).

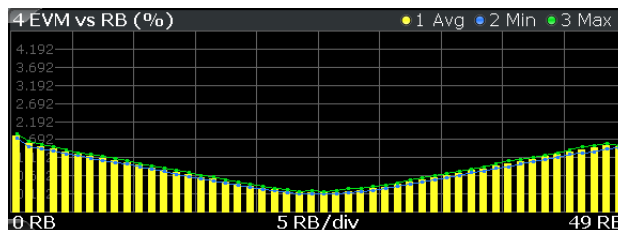

Remote command:

Selection: `LAY:ADD ? '1',LEFT,EVRP`

Query (y-axis): `TRACe:DATA?`

Query (x-axis): `TRACe<n>[:DATA]:X?` on page 174

EVM vs Subframe

The "EVM vs Subframe" result display shows the Error Vector Magnitude (EVM) for each subframe. You can use it as a debugging technique to identify a subframe whose EVM is too high.

The result is an average over all subcarriers and symbols of a specific subframe.

The x-axis represents the subframes, with the number of displayed subframes being 10.

On the y-axis, the EVM is plotted either in % or in dB, depending on the [EVM Unit](#).

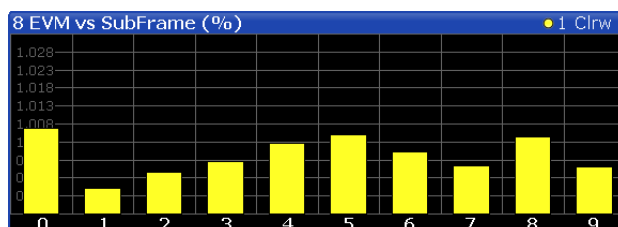

Remote command:

Selection: `LAY:ADD ? '1',LEFT,EVSU`

Query (y-axis): `TRACe:DATA?`

Query (x-axis): `TRACe<n>[:DATA]:X?` on page 174

Frequency Error vs Symbol

The "Frequency Error vs Symbol" result display shows the frequency error of each symbol. You can use it as a debugging technique to identify any frequency errors within symbols.

The result is an average over all subcarriers in the symbol.

The x-axis represents the OFDM symbols, with each symbol represented by a dot on the line. The number of displayed symbols depends on the [subframe selection](#) and the length of the [cyclic prefix](#). Any missing connections from one dot to another mean that the R&S FSV/A could not determine the frequency error for that symbol.

On the y-axis, the frequency error is plotted in Hz.

Note that the variance of the measurement results in this result display can be much higher compared to the frequency error display in the numerical result summary, depending on the PDSCH and control channel configuration. The potential difference is caused by the number of available resource elements for the measurement on symbol level.

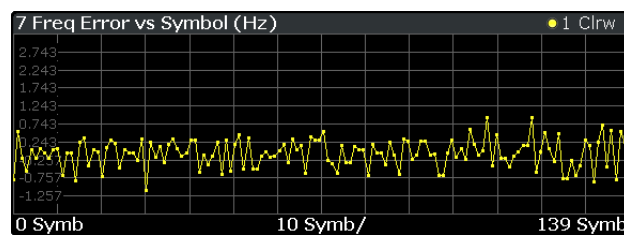

Remote command:

Selection: `LAY:ADD ? '1',LEFT,FEVS`

Query (y-axis): `TRACe:DATA?`

Query (x-axis): `TRACe<n>[:DATA]:X?` on page 174

Power Spectrum

The "Power Spectrum" shows the power density of the complete capture buffer in dBm/Hz.

The displayed bandwidth depends on the selected [channel bandwidth](#).

The x-axis represents the frequency. On the y-axis, the power level is plotted.

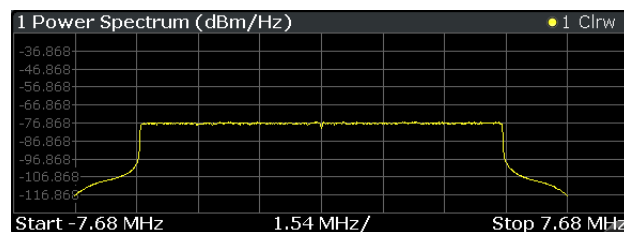

Remote command:

Selection: `LAY:ADD ? '1',LEFT,PSPE`

Query (y-axis): `TRACe:DATA?`

Query (x-axis): `TRACe<n>[:DATA]:X?` on page 174

Power vs Resource Block PDSCH

The "Power vs Resource Block PDSCH" result display shows the power of the physical downlink shared channel per resource element averaged over one resource block.

By default, three traces are shown. One trace shows the average power. The second and the third traces show the minimum and maximum powers respectively. You can select to display the power for a specific subframe in the Subframe Selection dialog box. In that case, the application shows the powers of that subframe only.

The x-axis represents the resource blocks. The displayed number of resource blocks depends on the channel bandwidth or number of resource blocks you have set. On the y-axis, the power is plotted in dBm.

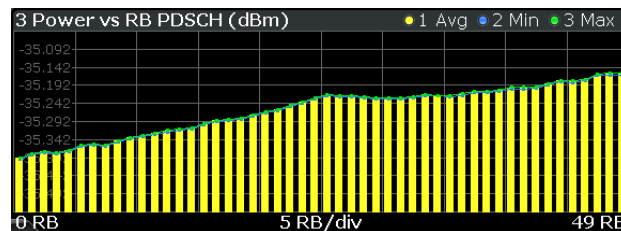

Remote command:

Selection: `LAY:ADD ? '1',LEFT,PCR`

Query (y-axis): `TRACe:DATA?`

Query (x-axis): `TRACe<n>[:DATA]:X?` on page 174

Power vs Resource Block RS

The "Power vs Resource Block RS" result display shows the power of the reference signal per resource element averaged over one resource block.

By default, three traces are shown. One trace shows the average power. The second and the third traces show the minimum and maximum powers respectively. You can select to display the power for a specific subframe in the Subframe Selection dialog box. In that case, the application shows the power of that subframe only.

The x-axis represents the resource blocks. The displayed number of resource blocks depends on the channel bandwidth or number of resource blocks you have set. On the y-axis, the power is plotted in dBm.

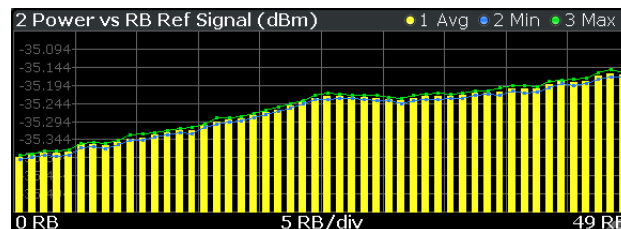

Remote command:

Selection: `LAY:ADD ? '1', LEFT, PVRR`

Query (y-axis): `TRACe:DATA?`

Query (x-axis): `TRACe<n>[:DATA]:X?` on page 174

Channel Flatness

The "Channel Flatness" shows the relative power offset caused by the transmit channel.

The currently selected subframe depends on your [selection](#).

The x-axis represents the frequency. On the y-axis, the channel flatness is plotted in dB.

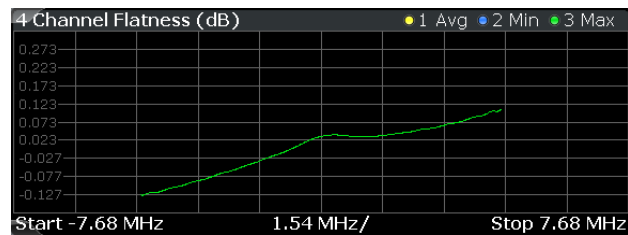

Remote command:

Selection: `LAY:ADD ? '1', LEFT, FLAT`

Query (y-axis): `TRACe:DATA?`

Query (x-axis): `TRACe<n>[:DATA]:X?` on page 174

Group Delay

This "Group Delay" shows the group delay of each subcarrier.

The measurement is evaluated over the currently selected slot in the currently selected subframe.

The currently selected subframe depends on your [selection](#).

The x-axis represents the frequency. On the y-axis, the group delay is plotted in ns.

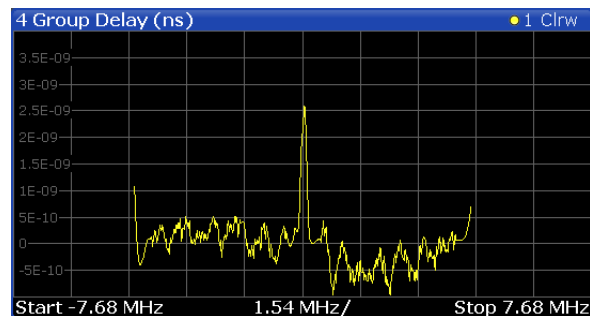

Remote command:

Selection: `LAY:ADD ? '1', LEFT, GDEL`

Query (y-axis): `TRACe:DATA?`

Query (x-axis): `TRACe<n>[:DATA]:X?` on page 174

Channel Flatness Difference

The "Channel Flatness Difference" shows the level difference in the spectrum flatness result between two adjacent physical subcarriers.

The currently selected subframe depends on your [selection](#).

The x-axis represents the frequency. On the y-axis, the power is plotted in dB.

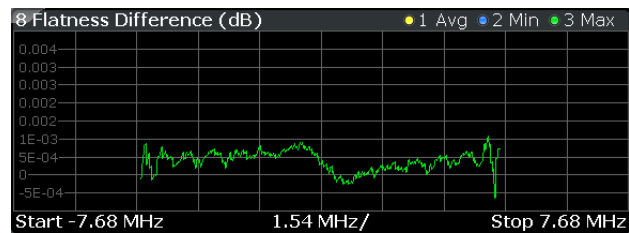

Remote command:

Selection: `LAY:ADD ? '1', LEFT, FDI`

Query (y-axis): `TRACe:DATA?`

Query (x-axis): `TRACe<n> [:DATA] :X?` on page 174

Constellation Diagram

The "Constellation Diagram" shows the in-phase and quadrature phase results and is an indicator of the quality of the modulation of the signal.

In the default state, the result display evaluates the full range of the measured input data.

Each color represents a modulation type.

- ■: BPSK
- ■: RBPSK
- ■: MIXTURE
- ■: QPSK
- ■: 16QAM
- ■: 64QAM
- ■: 256QAM
- ■: 1024QAM
- ■: PSK (CAZAC)

You can filter the results by changing the [evaluation range](#).

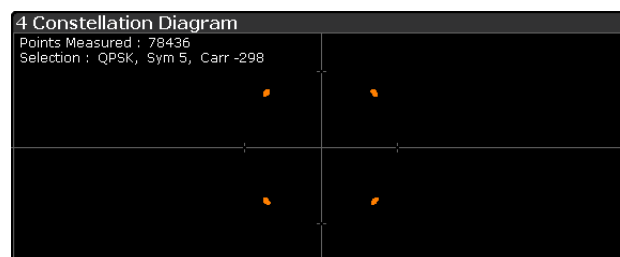

The constellation diagram also contains information about the current [evaluation range](#), including the number of points that are displayed in the diagram.

Remote command:

Selection: `LAY:ADD ? '1', LEFT, CONS`

Query: `TRACe:DATA?`

CCDF

The "Complementary Cumulative Distribution Function (CCDF)" shows the probability of an amplitude exceeding the mean power. For the measurement, the complete capture buffer is used.

The x-axis represents the power relative to the measured mean power. On the y-axis, the probability is plotted in %.

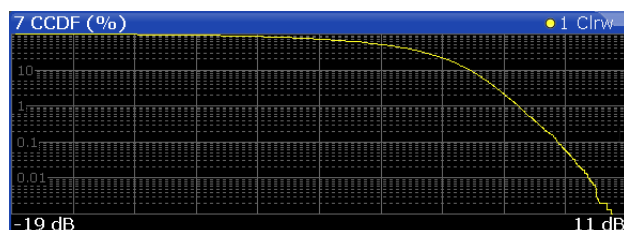

In addition to the diagram, the results for the CCDF measurement are summarized in the CCDF table.

Mean	Mean power
Peak	Peak power
Crest	Crest factor (peak power – mean power)
10 %	10 % probability that the level exceeds mean power + [x] dB
1 %	1 % probability that the level exceeds mean power + [x] dB
0.1 %	0.1 % probability that the level exceeds mean power + [x] dB
0.01 %	0.01 % probability that the level exceeds mean power + [x] dB

Remote command:

Selection: `LAY:ADD ? '1',LEFT,CCDF`

Query (y-axis): `TRACe:DATA?`

Numerical results: `CALCulate<n>:STATistics:CCDF:X<t>?` on page 189

Numerical results: `CALCulate<n>:STATistics:RESult<res>?` on page 190

Allocation Summary

The "Allocation Summary" shows various parameters of the measured allocations in a table.

Each row in the allocation table corresponds to an allocation. A set of several allocations make up a subframe. A horizontal line indicates the beginning of a new subframe.

Special allocations summarize the characteristics of all allocations in a subframe ("ALL") and the complete frame (allocation "ALL" at the end of the table).

1 Allocation Summary						
Sub-Frame	Allocation ID	No. of RBs	Rel. Power/dB	Modulation	Power per RE/[dBm]	EVM [%]
0	RS-Ant1		0.00	QPSK	-35.33	0.98
	P-SYNC		0.00	CAZAC	-35.29	0.22
	S-SYNC		0.00	RBPSK	-35.29	0.20
	PBCH		-0.00	QPSK	-35.30	0.24
	PCFICH		0.00	QPSK	-35.35	1.28
	PHICH			MIXTURE	-35.36	2.05
	PDCCH			QPSK	-35.33	1.19
	PDSCH 0	50	0.00	QPSK	-35.33	1.00

The columns of the table show the following properties for each allocation.

- The location of the allocation (subframe number).
- The ID of the allocation (channel type).
- Number of resource blocks used by the allocation.
- The relative power of the allocation in dB.
The R&S FSV/A does not calculate the **PHICH power** if you turn on **boosting estimation**.
- The modulation of the allocation.
- The power of each resource element in the allocation in dBm.
- The EVM of the allocation.
The unit depends on the **EVM unit**
- The EVM over all codewords in a layer. The layer EVM is calculated for all data allocations, and not for the DMRS or other physical signals.
The unit depends on the **EVM unit**

For PDSCH allocations that use **beamforming**, the table contains two values. One for the PDSCH, and one for the UE-specific reference signal (UE RS).

Click **once** on the header row to open a dialog box that allows you to add and remove columns.

Remote command:

Selection: `LAY:ADD ? '1',LEFT,ASUM`

Query: `TRACe:DATA?`

Bitstream

The "Bitstream" shows the demodulated data stream for the data allocations.

At the end of the table is a summary of the bitstream for certain configurations.

- Total number of bits or symbols
- Total number of coded bits
- Total number of bit errors
- Bit error rate (BER) in percent
- Bits per second (= coded bits - bit errors)
The totals are calculated over all PDSCH allocations that contribute to the bitstream. If the crc fails for one of the allocations, the R&S FSV/A returns NAN for the total numbers.

The bitstream summary is displayed under the following conditions.

- Select an ORAN test case.
The PDSCH **reference data** must be "ORAN PN23".

Depending on the **bitstream format**, the numbers represent either bits (bit order) or symbols (symbol order).

- For the bit format, each number represents one raw bit.
- For the symbol format, the bits that belong to one symbol are shown as hexadecimal numbers with two digits.
(1024QAM: hexadecimal number with three digits)

Resource elements that do not contain data or are not part of the transmission are represented by a "-".

If a symbol could not be decoded because the number of layers exceeds the number of receive antennas, the application shows a "#" sign.

2 Bit Stream					
Sub-Frame	Allocation ID	Code-word	Modulation	Symbol Index	
0	PBCH	1/1	QPSK	0	00 00 02 00 00
0	PBCH	1/1	QPSK	18	00 03 01 01 00
0	PBCH	1/1	QPSK	36	00 00 00 00 01
0	PBCH	1/1	QPSK	54	01 01 00 00 02
0	PBCH	1/1	QPSK	72	00 02 01 01 01
0	PBCH	1/1	QPSK	90	03 01 00 00 02
0	PBCH	1/1	QPSK	108	02 03 03 00 02

The table contains the following information:

- **Subframe**
Number of the subframe the bits belong to.
- **Allocation ID**
Channel the bits belong to.
- **Codeword**
Code word of the allocation.
- **Modulation**
Modulation type of the channels.
- **Symbol Index or Bit Index**
Indicates the position of the table row's first bit or symbol within the complete stream.
- **Bit Stream**
The actual bit stream.

Remote command:

Selection: `LAY:ADD ? '1',LEFT,BSTR`

Query: `TRACe:DATA?`

Channel Decoder Results

The "Channel Decoder" result display is a numerical result display that shows the characteristics of various channels for a specific subframe.

- Protocol information of the PBCH, PCFICH and PHICH.
- Information about the DCIs in the PDCCH.
- Decoded bitstream for each PDCCH.
- Decoded bitstream for each PDSCH.

The size of the table thus depends on the number of subframes in the signal.

Note that a complete set of results for the control channels is available only under certain circumstances.

- The corresponding control channel (PBCH, PCFICH or PHICH) has to be present and enabled.
- Each channel must have a certain configuration (see list below).

4 Channel Decoder Results			
Sub-Frame	Allocation ID	Data	
0	PBCH	1 Tx Ant., Bandwidth 10 MHz, Frame Number 0 PHICH normal duration, PHICH resource 1/6	
	PCFICH	2 symbols for PDCCH	
	PHICH	ACK(1)/NACK(0)	Rel. Power/dB
		0--- 0---	-3.01 - - -3.0
		0--- 0---	-3.01 - - -3.0

For each channel, the table shows a different set of values.

- PBCH

For the PBCH, the Channel Decoder provides the following results.

- The MIMO configuration of the DUT (1, 2 or 4 TX antennas)
- The Transmission bandwidth
- The Duration of the PHICH (normal or extended)
- The PHICH resource which is the same as PHICH N_g (1/6, 1/2, 1 or 2)
- System frame number

If the CRC is not valid, a corresponding message is shown instead of the results. Results for the PBCH can only be determined if the [PHICH Duration](#) or the [PHICH \$N_g\$](#) are automatically determined ("Auto") or if [automatic decoding of all control channels](#) is turned on.

- PCFICH

For the PCFICH, the Channel Decoder provides the number of OFDM symbols that are used for PDCCH at the beginning of a subframe.

- PHICH

The PHICH carries the hybrid-ARQ ACK/NACK. Multiple PHICHs mapped to the same set of resource elements are a PHICH group. The PHICHs within one group are separated by different orthogonal sequences.

For the PHICH, the Channel Decoder provides the ACK/NACK pattern for the PHICH group and the relative power for each PHICH in the PHICH group. Each line in the result table represents one PHICH group. The columns on the left show the ACK/NACK pattern of the PHICH group. The columns on the right show the relative powers for each PHICH.

If a PHICH is not transmitted, the table contains a "-" sign. Otherwise, the ACK/NACK pattern is either a "1" (acknowledgement) or a "0" (not acknowledged). The relative power is a numeric value in dB.

- PDCCH

For each PDCCH that has been detected, the Channel Decoder shows several results. Each line in the table represents one PDCCH.

- RNTI
- DCI Format

Shows the Downlink Control Information (DCI) format. The DCI contains information about the resource assignment for the UEs.

The following DCI formats are supported: 0, 1, 1A, 1B, 1C, 2, 2A, 2C, 2D, 3, 3A.

The DCI format is determined by the length of the DCI. Because they have the same length, the Channel Decoder is not able to distinguish formats 0, 3 and 3A. Note that a DCI that consist of only zero bits cannot be decoded.
- PDCCH format used to transmit the DCI
- CCE Offset

The CCE Offset represents the position of the current DCI in the PDCCH bit stream.
- Rel. Power

Relative power of the corresponding PDCCH.

Results for the PDCCH can only be determined if the [PDSCH subframe configuration](#) is detected by the "PDCCH Protocol" or if [automatic decoding of all control channels](#) is turned on.

- PDSCH

For each decoded PDSCH allocation, there is a PDCCH DCI. The DCI contains parameters that are required for the decoding process. If the channel could be decoded successfully, the result display shows the bit stream for each codeword. If the Cyclic Redundancy Check (CRC) fails, the result display shows an error message instead.

Results for the PDSCH can only be determined if the [PDSCH subframe configuration](#) is detected by the "PDCCH Protocol" or if [automatic decoding of all control channels](#) is turned on.

Remote command:

Selection: `LAY:ADD ? '1', LEFT, CDEC`

Query: `TRACe:DATA?`

EVM vs Symbol x Carrier

The "EVM vs Symbol x Carrier" result display shows the EVM for each carrier in each symbol.

The x-axis represents the symbols. The y-axis represents the subcarriers. Different colors in the diagram area represent the EVM. A color map in the diagram header indicates the corresponding power levels.

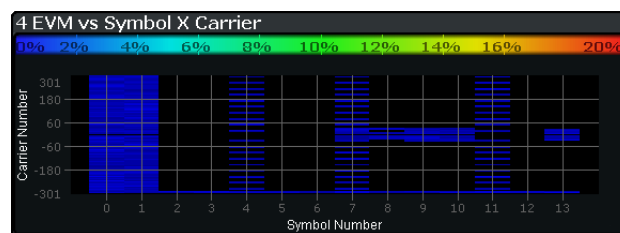

Remote command:

Selection: `LAY:ADD ? '1', LEFT, EVSC`

Query: `TRACe:DATA?`

Power vs Symbol x Carrier

The "Power vs Symbol x Carrier" result display shows the power for each carrier in each symbol.

The x-axis represents the symbols. The y-axis represents the subcarriers. Different colors in the diagram area represent the power. A color map in the diagram header indicates the corresponding power levels.

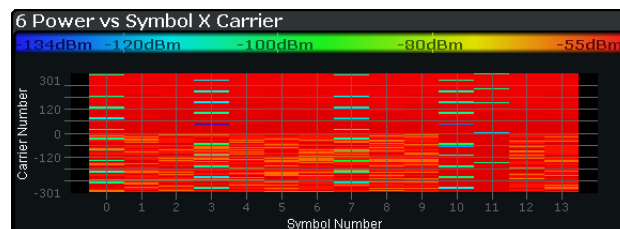

Remote command:

Selection: `LAY:ADD ? '1', LEFT, PVSC`

Query: `TRACe:DATA?`

Allocation ID vs Symbol x Carrier

The "Allocation ID vs Symbol x Carrier" result display is a graphical representation of the structure of the analyzed frame. It shows the allocation type of each subcarrier in each symbol of the received signal.

The x-axis represents the OFDM symbols. The y-axis represents the subcarriers.

Each type of allocation is represented by a different color. The legend above the diagram indicates the colors used for each allocation. You can also use a marker to get more information about the type of allocation.

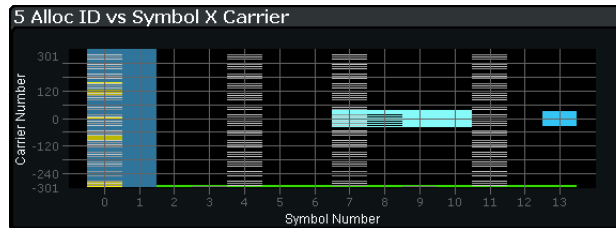

Remote command:

Selection: `LAY:ADD ? '1',LEFT,AISC`

Query: `TRACe:DATA?`

UE RS Magnitude

The "UE RS Weights Magnitude" result display shows the magnitude of the measured weights of the UE-specific reference signal carriers. You can use it to calculate the magnitude difference between different antenna ports.

The x-axis represents the frequency, with the unit depending on your selection. The y-axis shows the amplitude of each reference signal in dB.

Because the beamforming configuration can change between the subframes of one frame, the contents of this result display for `Subframe Selection = 'All'` might be invalid. Thus, it is recommended to select the precise subframe to be evaluated in order to get valid results.

You can select the antenna port you want to show the information for from the corresponding `beamforming selection` dropdown menu.

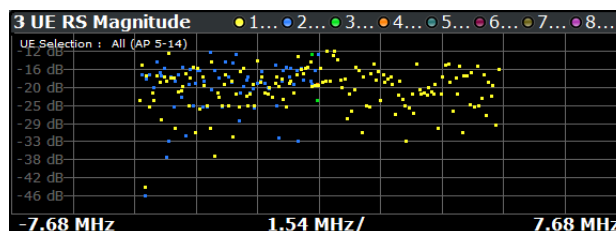

Remote command:

Selection: `LAY:ADD ? '1',LEFT,URWM`

Querying results: `TRACe:DATA?`

UE RS Phase

The "UE RS Weights Phase" result display shows the phase of the measured weights of the UE specific reference signal carriers. You can use it to calculate the phase difference between different antenna ports.

The x-axis represents the frequency, with the unit depending on your [selection](#). The y-axis shows the phase of each reference signal in degree.

Because the beamforming configuration can change between the subframes of one frame, the contents of this result display for [Subframe Selection](#) = 'All' might be invalid. Thus, it is recommended to select the precise subframe to be evaluated in order to get valid results.

You can select the antenna port you want to show the information for from the corresponding [beamforming selection](#) dropdown menu.

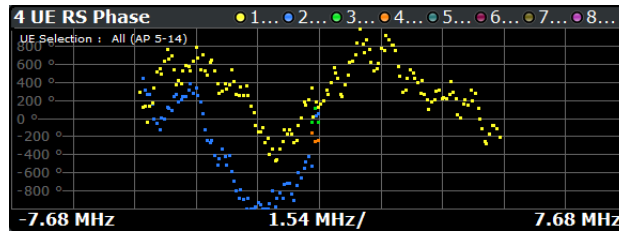

Remote command:

Selection: `LAY:ADD ? '1',LEFT,URWP`

Query: `TRACe:DATA?`

Cell RS Magnitude

The "Cell RS Weights Magnitude" result display shows the magnitude of the measured weights of the reference signal (RS) carriers specific to the cell. This measurement enables magnitude measurements on antenna port 0 using, for example, the enhanced test models like E-TM 1.1.

You can use the result display to calculate the magnitude difference between different antenna ports.

The x-axis represents the frequency, with the unit depending on your [selection](#). The y-axis shows the amplitude of each reference signal in dB.

Because the beamforming configuration can change between the subframes of one frame, the contents of this result display for [Subframe Selection](#) = 'All' might be invalid. Thus, it is recommended to select the precise subframe to be evaluated in order to get valid results.

You can select the antenna port you want to show the information for from the corresponding [beamforming selection](#) dropdown menu.

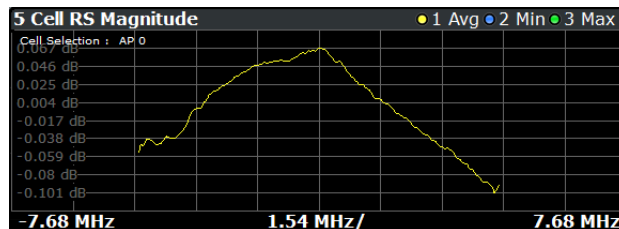

Remote command:

Selection: `LAY:ADD ? '1',LEFT,CRWM`

Query: `TRACe:DATA?`

Cell RS Phase

The "Cell RS Weights Phase" result display shows the phase of the measured weights of the reference signal (RS) carriers specific to the cell. This measurement enables phase measurements on antenna port 0 using, for example, the enhanced test models like E-TM 1.1.

You can use the result display to calculate the phase difference between different antenna ports.

The x-axis represents the frequency, with the unit depending on your [selection](#). The y-axis shows the phase of each reference signal in degree.

Because the beamforming configuration can change between the subframes of one frame, the contents of this result display for [Subframe Selection](#) = 'All' might be invalid. Thus, it is recommended to select the precise subframe to be evaluated in order to get valid results.

You can select the antenna port you want to show the information for from the corresponding [beamforming selection](#) dropdown menu.

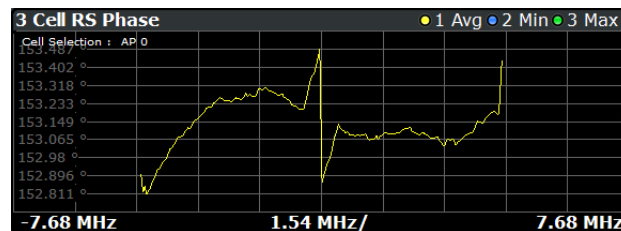

Remote command:

Selection: `LAY:ADD ? '1',LEFT,CRWP`

Query: `TRACe:DATA?`

CSI RS Magnitude

The "CSI RS Weights Magnitude" result display shows the magnitude of the measured weights of the CSI-specific reference signal carriers. You can use it to calculate the magnitude difference between different antenna ports.

The x-axis represents the frequency, with the unit depending on your [selection](#). The y-axis shows the amplitude of each reference signal in dB.

Because the beamforming configuration can change between the subframes of one frame, the contents of this result display for [Subframe Selection](#) = 'All' might be invalid. Thus, it is recommended to select the precise subframe to be evaluated in order to get valid results.

You can select the antenna port you want to show the information for from the corresponding [beamforming selection](#) dropdown menu.

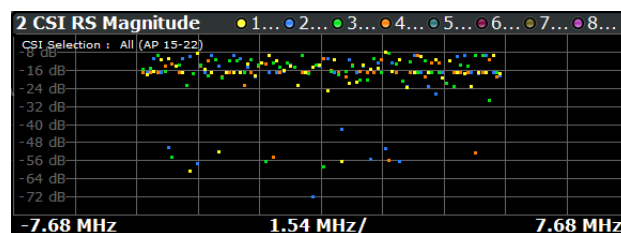

Remote command:

Selection: `LAY:ADD ? '1', LEFT, IRWM`

Query: `TRACe:DATA?`

CSI RS Phase

The "CSI RS Weights Phase" result display shows the phase of the measured weights of the CSI-specific reference signal carriers. You can use it to calculate the phase difference between different antenna ports.

The x-axis represents the frequency, with the unit depending on your [selection](#). The y-axis shows the phase of each reference signal in degree.

Because the beamforming configuration can change between the subframes of one frame, the contents of this result display for [Subframe Selection](#) = 'All' might be invalid. Thus, it is recommended to select the precise subframe to be evaluated in order to get valid results.

You can select the antenna port you want to show the information for from the corresponding [beamforming selection](#) dropdown menu.

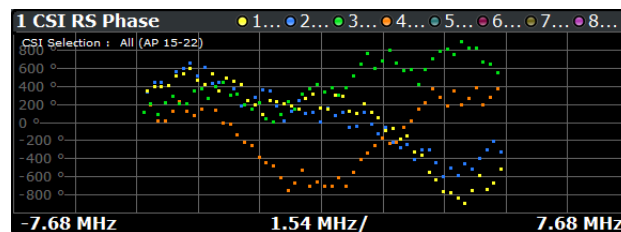

Remote command:

Selection: `LAY:ADD ? '1', LEFT, IRWP`

Query: `TRACe:DATA?`

Beamform Allocation Summary

The "Beamform Allocation Summary" shows the phase characteristics for each PDSCH and (if available) EPDCCH allocation used by the UE-specific reference signals in numerical form.

Sub-frame	Allocation ID	Antenna Port	Phase [°]	Phase Diff [°]
0	RS-Ant1	AP 0	153.136	
1	RS-Ant1	AP 0	153.136	
2	RS-Ant1	AP 0	153.136	
3	RS-Ant1	AP 0	153.136	

The rows in the table represent the allocations. A set of allocations form a subframe. The subframes are separated by a dashed line. The columns of the table contain the following information:

- **Subframe**
Shows the subframe number.
- **Allocation ID**
Shows the type / ID of the allocation.
- **Antenna Port**
Shows the antenna port used by the allocation.

- **Phase**
Shows the phase of the allocation.
- **Phase Diff(erence)**
Shows the phase difference of the allocation relative to the first antenna.

Remote command:

Selection: `LAY:ADD ? '1',LEFT,URWA`

Query: `TRACe:DATA?`

Result Summary

The Result Summary shows all relevant measurement results in numerical form, combined in one table.

Remote command:

`LAY:ADD ? '1',LEFT,RSUM`

Contents of the result summary

1 Result Summary				
Frame Result 1/1	Mean	Max	Limit	Min
EVM PDSCH QPSK (%)	0.98			
EVM PDSCH 16QAM (%)				
EVM PDSCH 64QAM (%)				
Results for Selection Subframe(s) ALL, Selection Antenna 1, Frame Result 1/1				
EVM All (%)	1.00	1.01		0.99
EVM Phys. Channel (%)	1.00	1.01		0.99
EVM Phys. Signal (%)	0.95	0.99		0.86
Frequency Error (Hz)	-1997.42	-1997.29		-1997.51
Sampling Error (ppm)	-2.00	-1.95		-2.04
IQ Offset (dB)	-71.88	-70.88		-72.54
IQ Gain Imbalance (dB)	0.00	0.00		0.00
IQ Quadrature Error (°)	0.02	0.02		0.01
RSTP (%)	-35.39	-35.39		-35.39
OSTP (dBm)	-7.60	-7.60		-7.60
Power (dBm)	-7.66	-7.65		-7.68
Crest Factor (dB)	10.30			

The table is split in two parts. The first part shows results that refer to the complete frame. For each result, the minimum, mean and maximum values are displayed. It also indicates limit check results where available. The font of 'Pass' results is green and that of 'Fail' results is red.

In addition to the red font, the application also puts a red star (*** -25.60**) in front of failed results.

EVM PDSCH QPSK

Shows the EVM for all QPSK-modulated resource elements of the PDSCH channel in the analyzed frame.

[FETCh\[:CC<cc>\]:SUMMARY:EVM:DSQP\[:AVERage\]? on page 177](#)

EVM PDSCH 16QAM

Shows the EVM for all 16QAM-modulated resource elements of the PDSCH channel in the analyzed frame.

[FETCh\[:CC<cc>\]:SUMMARY:EVM:DSST\[:AVERage\]? on page 177](#)

EVM PDSCH 64QAM

Shows the EVM for all 64QAM-modulated resource elements of the PDSCH channel in the analyzed frame.

[FETCh\[:CC<cc>\]:SUMMARY:EVM:DSSF\[:AVERage\]? on page 178](#)

EVM PDSCH 256QAM	Shows the EVM for all 256QAM-modulated resource elements of the PDSCH channel in the analyzed frame. FETCh[:CC<cc>]:SUMMARY:EVM:DSTS[:AVERage]? on page 178
EVM PDSCH 1024QAM	Shows the EVM for all 1024QAM-modulated resource elements of the PDSCH channel in the analyzed frame. FETCh[:CC<cc>]:SUMMARY:EVM:DS1K[:AVERage]? on page 178

By default, all EVM results are in %. To view the EVM results in dB, change the [EVM Unit](#).

The second part of the table shows results that refer to a specific selection of the frame.

The statistic is always evaluated over the subframes.

The header row of the table contains information about the selection you have made (like the subframe).

EVM All	Shows the EVM for all resource elements in the analyzed frame. FETCh[:CC<cc>]:SUMMARY:EVM[:ALL][:AVERage]? on page 180
EVM Phys Channel	Shows the EVM for all physical channel resource elements in the analyzed frame. A physical channel corresponds to a set of resource elements carrying information from higher layers. PDSCH, PBCH or PDCCH, for example, are physical channels. For more information, see 3GPP 36.211. FETCh[:CC<cc>]:SUMMARY:EVM:PCHannel[:AVERage]? on page 180
EVM Phys Signal	Shows the EVM for all physical signal resource elements in the analyzed frame. The reference signal, for example, is a physical signal. For more information, see 3GPP 36.211. FETCh[:CC<cc>]:SUMMARY:EVM:PSIGNAL[:AVERage]? on page 180
Frequency Error	Shows the difference in the measured center frequency and the reference center frequency. FETCh[:CC<cc>]:SUMMARY:FERRor[:AVERage]? on page 181
Sampling Error	Shows the difference in measured symbol clock and reference symbol clock relative to the system sampling rate. FETCh[:CC<cc>]:SUMMARY:SERRor[:AVERage]? on page 184
I/Q Offset	Shows the power at spectral line 0 normalized to the total transmitted power. FETCh[:CC<cc>]:SUMMARY:IQOFFset[:AVERage]? on page 182
I/Q Gain Imbalance	Shows the logarithm of the gain ratio of the Q-channel to the I-channel. FETCh[:CC<cc>]:SUMMARY:GIMBalance[:AVERage]? on page 181
I/Q Quadrature Error	Shows the measure of the phase angle between Q-channel and I-channel deviating from the ideal 90 degrees. FETCh[:CC<cc>]:SUMMARY:QUADerror[:AVERage]? on page 183

RSTP	Shows the reference signal transmit power as defined in 3GPP TS 36.141. It is required for the "DL RS Power" test. It is an average power and accumulates the powers of the reference symbols within a subframe divided by the number of reference symbols within a subframe. FETCh[:CC<cc>]:SUMMARY:RSTP[:AVERage]? on page 184
OSTP	Shows the OFDM symbol transmit power as defined in 3GPP TS 36.141. It accumulates all subcarrier powers of the 4th OFDM symbol. The 4th (out of 14 OFDM symbols within a subframe (for frame type 1, normal CP length)) contains exclusively PDSCH. FETCh[:CC<cc>]:SUMMARY:OSTP[:AVERage]? on page 182
RSSI	Shows the Received Signal Strength Indicator. The RSSI is the complete signal power of the channel that has been measured, regardless of the origin of the signal. FETCh[:CC<cc>]:SUMMARY:RSSI[:AVERage]? on page 183
Power	Shows the average time domain power of the analyzed signal. FETCh[:CC<cc>]:SUMMARY:POWer[:AVERage]? on page 182
Crest Factor	Shows the peak-to-average power ratio of captured signal. FETCh[:CC<cc>]:SUMMARY:CRESt[:AVERage]? on page 179

Marker Table

Displays a table with the current marker values for the active markers.

This table is displayed automatically if configured accordingly.

Wnd	Shows the window the marker is in.
Type	Shows the marker type and number ("M" for a normal marker, "D" for a delta marker).
Trc	Shows the trace that the marker is positioned on.
Ref	Shows the reference marker that a delta marker refers to.
X- / Y-Value	Shows the marker coordinates (usually frequency and level).
Z-EVM	Shows the "EVM", power and allocation type at the marker position. Only in 3D result displays (for example "EVM vs Symbol x Carrier").
Z-Power	
Z-Alloc ID	

5 Marker Table	
2 - M1	
Trace	1
X-value	Symbol 84
Y-value	Carrier 14
Z-EVM	772.99 %
Z-Power	-47.12 dBm
Z-Alloc ID	PHICH
4 - M1	
Trace	1
X-value	-495.000 kHz
Y-value	0.32 dB

Tip: To navigate within long marker tables, simply scroll through the entries with your finger on the touchscreen.

Remote command:

LAY:ADD? '1',RIGH, MTAB, see LAYout:ADD[:WINDow]? on page 145

Results:

[CALCulate<n>:MARKer<m>:X](#) on page 187

[CALCulate<n>:MARKer<m>:Y](#) on page 187

[CALCulate<n>:MARKer<m>:Z?](#) on page 188

[CALCulate<n>:MARKer<m>:Z:ALL?](#) on page 188

3.5 Time alignment error measurements

Access: [MEAS] > "Time Alignment Error"

The Time Alignment Error measurement captures and analyzes new I/Q data when you select it.

Note that the time alignment error measurement only work in a MIMO setup (2 or 4 antennas) or in a system with component carriers. Therefore, you have to mix the signal of the antennas into one cable that you can connect to the R&S FSV/A. For more information on configuring and performing a time alignment error measurement see [Chapter 4.4, "Performing time alignment measurements"](#), on page 59.

In addition to the result displays mentioned in this section, the time alignment error measurement also supports the following result displays described elsewhere.

- ["Capture Buffer"](#) on page 18
- ["Power Spectrum"](#) on page 22
- ["Marker Table"](#) on page 37

You can select the result displays from the evaluation bar and arrange them as you like with the SmartGrid functionality.

Remote command:

Measurement selection: [CONFigure\[:LTE\]:MEASurement](#) on page 206

Result display selection: `LAYout:ADD[:WINDow]?` on page 145

[Time Alignment Error](#)..... 39

Time Alignment Error

The [time alignment](#) is an indicator of how well the transmission antennas in a MIMO system and component carriers are synchronized. The time alignment error is either the time delay between a reference antenna (for example antenna 1) and another antenna or the time delay between a reference component carrier and other component carriers.

The application shows the results in a table.

Each row in the table represents one antenna. The reference antenna is not shown.

For each antenna, the maximum, minimum and average time delay that has been measured is shown. The minimum and maximum results are calculated only if the measurement covers more than one frame.

If you perform the measurement on a system with carrier aggregation, each row represents one antenna. The number of lines increases because of multiple carriers. The reference antenna of the main component carrier (CC1) is not shown.

In any case, results are only displayed if the transmission power of both antennas is within 15 dB of each other. Likewise, if only one antenna transmits a signal, results will not be displayed (for example if the cabling on one antenna is faulty).

For more information on configuring this measurement, see [Chapter 5.3, "Time Alignment Error Measurements"](#), on page 119.

The "Limit" value shown in the result display is the maximum time delay that may occur for each antenna (only displayed for systems without carrier aggregation).

2 Time Alignment Error			
Reference Antenna : Antenna 1		Limit : 90 ns	
Antenna	Min	Mean	Max
Antenna 2	19.54 ns	19.54 ns	19.54 ns
Antenna 3	6.51 ns	6.51 ns	6.51 ns
Antenna 4	13.03 ns	13.03 ns	13.03 ns

You can select the reference antenna from the dropdown menu in the result display. You can also select the reference antenna in the [MIMO Setup](#) - if you change them in one place, they are also changed in the other.

In the default layout, the application also shows the "Capture Buffer" and "Power Spectrum" result displays for each component carrier.

Remote command:

Selection: `LAY:ADD ? '1', LEFT, TAL`

Query: `FETCH:TAERror[:CC<cc>]:ANTenna<ant>[:AVERage]?` on page 185

Reference antenna: `CONFIGure[:LTE]:DL[:CC<cc>]:MIMO:ASElection` on page 215

3.6 Transmit on / off power measurement

Access: [MEAS] > "Transmit On/Off Power"

The transmit on / off power measurement captures and analyzes new I/Q data when you select it.

The transmit on / off power measurement consists of several result displays that you can select from the evaluation bar. You can arrange them as you like with the Smart-Grid functionality.

Remote command:

Measurement selection: `CONF:LTE:MEASUREMENT` on page 206

Result display selection: `LAYOUT:ADD[:WINDOW]?` on page 145

Transmit On / Off Power.....	40
L Numerical results.....	40
L Transmit power on / off diagram.....	42
L Transition diagram.....	42
L Adjust Timing.....	43
L Noise Cancellation.....	43

Transmit On / Off Power

The transmit on / off power measurement analyzes the transition from transmission ("on" periods) to reception ("off" periods) of an LTE TDD signal over time. Because this transition must happen very fast to use resources efficiently, it can be an issue in TDD systems.

During the transmit power on / off measurement, the R&S FSV/A verifies if the "off" periods (= no signal transmission) comply to the limits defined by 3GPP. Note that you have to apply a signal to the RF input for this measurement, because the R&S FSV/A has to capture new I/Q data instead of using the data other I/Q measurements are based on.

For more information on setting up the measurement, see [Chapter 4.5, "Performing transmit on/off power measurements"](#), on page 61.

The results for the transmit on / off power measurement are available in the following displays.

- ["Numerical results"](#) on page 40
- ["Transmit power on / off diagram"](#) on page 42
- ["Transition diagram"](#) on page 42

Remote command:

Selection: `CONF:MEAS TPOO`

Query: `TRACe:DATA?`

Unit: `UNIT:OPOWER` on page 263

Numerical results ← Transmit On / Off Power

The result summary shows the measurement results in a table. Each line in the table corresponds to one "off" period.

The result summary shows the following information for each "off" period.

- "Start Off Period Limit"
Shows the beginning of the "off" period relative to the frame start (0 seconds).
- "Stop Off Period Limit"
Shows the end of the "off" period relative to the frame start (0 seconds).

The time from the start to the stop of the "off" period is the period over which the limits are checked. It corresponds to the yellow trace in the diagram.

- "Time at Δ to Limit"
Shows the trace point at which the lowest distance between trace and limit line has been detected. The result is a time relative to the frame start.
- "OFF Power"
Shows the absolute power of the signal at the trace point with the lowest distance to the limit line.
You can display the "OFF Power" either as an absolute value in dBm or a relative value in dBm/MHz. To select the unit, use the "Power Unit (dBm/MHz)" softkey available in the "Meas Config" menu.
- "OFF Power Δ to Limit"
Shows the distance between the trace and the limit line of the trace point with the lowest distance to the limit line in dB.
- "Falling Transition Period"
Shows the length of the falling transient.
- "Rising Transition Period"
Shows the length of the rising transient.

Results that comply with the limits are displayed in green. Any results that violate the limits defined by 3GPP are displayed in red.

6 Transmit ON/OFF Power List						
Start OFF Period Limit	Stop OFF Period Limit	Time at Δ to Limit	OFF Power Abs [dBm]	OFF Power Δ to Limit	Falling Trans Period	Rising Trans Period
1.267 ms	4.948 ms	4.786523 ms	-92.41 dBm	17.41 dB	2.73 μ s	2.80 μ s
6.267 ms	9.948 ms	8.799381 ms	-92.32 dBm	17.32 dB	2.73 μ s	2.77 μ s

Note that the beginning and end of a transition period is determined based on the "Off Power Density Limit". This limit is defined in 3GPP 36.141 as the maximum allowed mean power spectral density. The length of the transient from "on" to "off" period is, for example, the distance from the detected end of the subframe to the last time that the signal power is above the measured mean power spectral density.

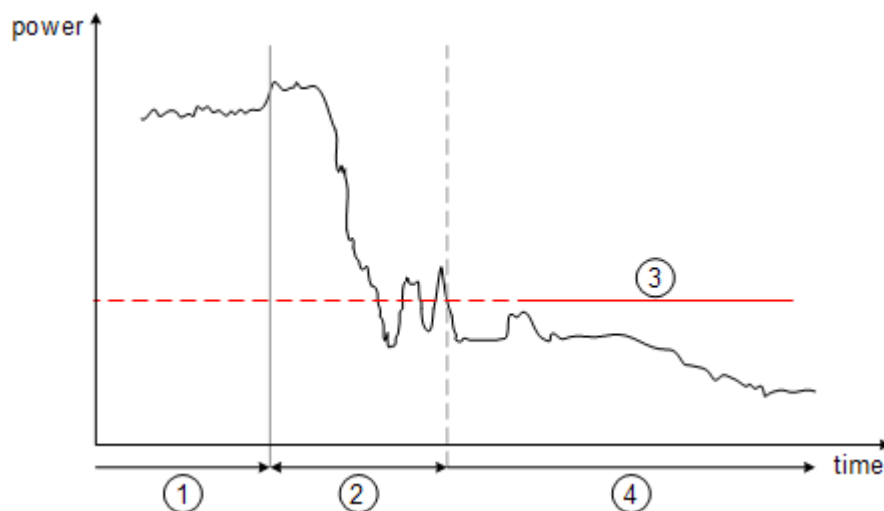

Figure 3-3: Power profile of a TD-LTE On-to-Off transition. The transition lasts from the end of the ON period until the signal is completely below the off power density limit.

- 1 = subframe ("on" power period)
- 2 = transient (transition length)
- 3 = "off" power density limit
- 4 = "off" power period

Transmit power on / off diagram ← Transmit On / Off Power

The diagram shows all TDD frames that were captured and analyzed and contains several elements.

- Yellow trace
The yellow trace represents the signal power during the "off" periods. The calculation of the trace also accounts for filtering as defined in 3GPP 36.141.
- Blue trace
The blue trace represents the transition periods (falling and rising). Note that the blue trace might not be visible in the diagram because of its steep flank and small horizontal dimensions. You can see the falling and rising transitions in [separate diagrams](#).
- Blue rectangles
The blue rectangles represent the "on" periods. Because of the overload during the "on" periods, the actual signal power is only hinted at, not shown.
- Red lines
Limits as defined by 3GPP.
- Other information
In addition to these elements, the diagram also shows the overall limit check, the average count and the limit for the mean power spectral density ("Off Power Density Limit").
The overall limit check only passes if all "off" periods (including the transients) comply with the limits.

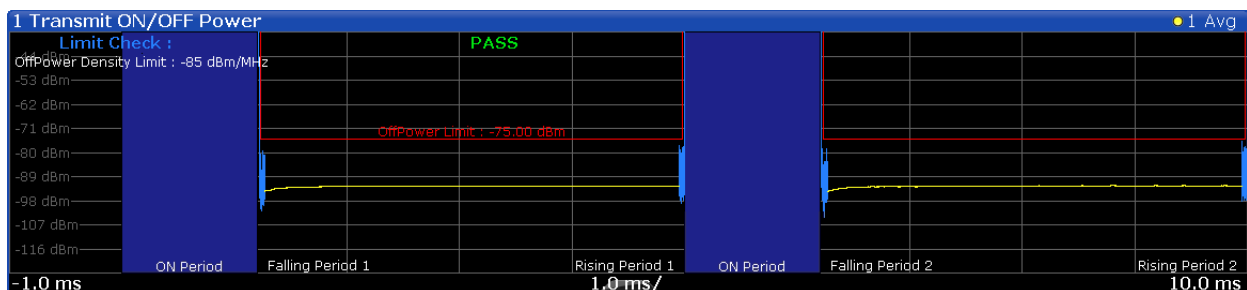

Transition diagram ← Transmit On / Off Power

The transition diagrams show the rising and falling periods for each TDD frame in more detail.

You can display the transitions for up to two TDD frames.

The diagrams contain the following elements.

- Blue trace
The blue trace represents the transition periods (falling and rising).
- Red lines
Limits as defined by 3GPP.

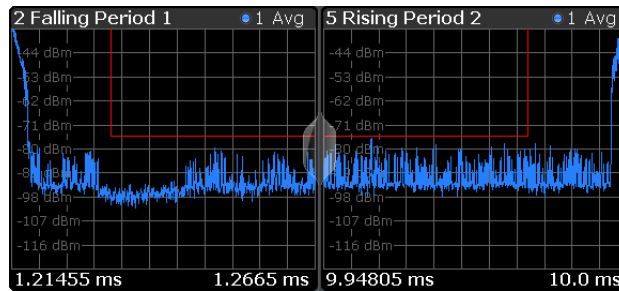

Adjust Timing ← Transmit On / Off Power

Access: [Sweep] > "Adjust Timing"

If you are using an external trigger for the on / off power measurement, you have to determine the offset of the trigger time to the time the LTE frame starts. You can do this with the "Adjust Timing" function. When the application has determined the offset, it corrects the results of the on / off power measurement accordingly.

Adjust timing also captures data with a reference level optimized for the "on" period to increase the probability for successful synchronization.

Remote command:

[\[SENSe:\] \[LTE:\] OOPower:ATIMing](#) on page 155

Noise Cancellation ← Transmit On / Off Power

Access: [Meas Config] > "Noise Cancellation"

Noise cancellation corrects the results by removing the inherent noise of the analyzer, which increases the dynamic range. To do this, the R&S FSV/A measures its inherent noise and subtracts the measured noise power from the power in the channel that is being analyzed.

Noise cancellation is valid for the current measurement configuration. If you change the measurement configuration in any way, you have to repeat noise cancellation.

Remote command:

[\[SENSe:\] \[LTE:\] OOPower:NCORrection](#) on page 263

3.7 Frequency sweep measurements

Access (ACLR): [MEAS] > "Channel Power ACLR"

Access (MC ACLR): [MEAS] > "Multi Carrier ACLR"

Access (Cumulative ACLR): [MEAS] > "Cumulative ACLR"

Access (SEM): [MEAS] > "Spectrum Emission Mask"

Access (Multi Carrier SEM): [MEAS] > "Multi Carrier SEM"

The LTE application supports the following frequency sweep measurements.

- Adjacent channel leakage ratio (ACLR)
- Spectrum emission mask (SEM)

Instead of using I/Q data, the frequency sweep measurements sweep the spectrum every time you run a new measurement. Therefore, it is mandatory to feed a signal into the RF input for these measurements. Using previously acquired I/Q data for the frequency sweep measurements is not possible (and vice-versa).

Because each of the frequency sweep measurements uses different settings to obtain signal data it is also not possible to run a frequency sweep measurement and view the results in another frequency sweep measurement.

Make sure to have sufficient bandwidth to be able to capture the whole signal, including neighboring channels.

In addition to the specific diagrams and table (see description below), frequency sweep measurements support the following result displays.

- "Marker Table" on page 37
- Marker peak list
Both result displays have the same contents as the spectrum application.

Remote command:

Measurement selection: `CONF:LTE:MEASUREMENT` on page 206

Result display selection: `LAYOUT:ADD[:WINDOW]?` on page 145

Adjacent Channel Leakage Ratio (ACLR).....	44
L Result diagram.....	45
L Result summary.....	45
Cumulative ACLR.....	46
L Result diagram.....	46
L Result summary.....	47
Multi Carrier ACLR (MC ACLR).....	48
L Result diagram.....	48
L Result summary.....	49
Spectrum Emission Mask (SEM).....	50
L Result diagram.....	50
L Result summary.....	51
Marker Peak List.....	52

Adjacent Channel Leakage Ratio (ACLR)

The adjacent channel leakage ratio (ACLR) measurement is designed to analyze signals that contain multiple signals for different radio standards. Using the ACLR measurement, you can determine the power of the transmit (Tx) channel and the power of the neighboring (adjacent) channels to the left and right of the Tx channel. Thus, the ACLR measurement provides information about the power in the adjacent channels as well as the leakage into these adjacent channels.

When you measure the ACLR in the LTE application, the R&S FSV/A automatically selects appropriate ACLR settings based on the selected channel bandwidth.

For a comprehensive description of the ACLR measurement, refer to the user manual of the R&S FSV/A.

Remote command:

Selection: `CONF:MEAS ACLR`

Result diagram ← Adjacent Channel Leakage Ratio (ACLR)

The result diagram is a graphic representation of the signals with a trace that shows the measured signal. Individual channels (Tx and adjacent channels) are indicated by vertical lines and corresponding labels.

In addition, the R&S FSV/A highlights the channels (blue: Tx channel, green: adjacent channels).

The x-axis represents the frequency with a frequency span that relates to the specified LTE channel and adjacent channel bandwidths. On the y-axis, the power is plotted in dBm.

The power for the Tx channel is an absolute value in dBm. The power of the adjacent channels is relative to the power of the Tx channel.

In addition, the R&S FSV/A tests the ACLR measurement results against the limits defined by 3GPP.

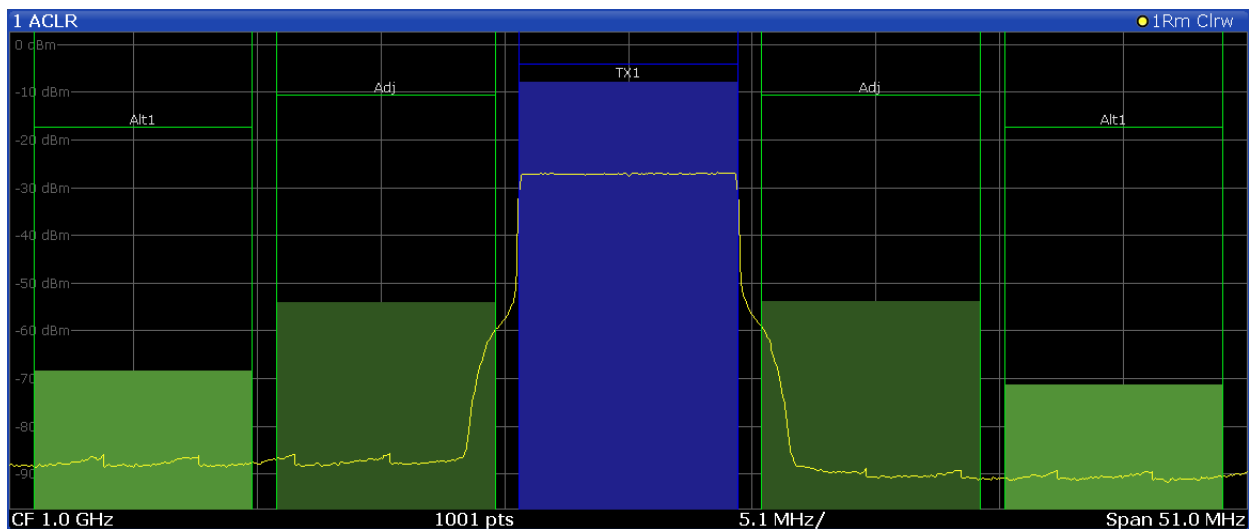

Remote command:

Result query: `TRACe:DATA?`

Result summary ← Adjacent Channel Leakage Ratio (ACLR)

The result summary shows the signal characteristics in numerical form. Each row in the table corresponds to a certain channel type (Tx, adjacent channel). The columns contain the channel characteristics.

- **Channel**
Shows the channel type (Tx, adjacent or alternate channel).
- **Bandwidth**
Shows the channel bandwidth.
- **Offset**
Shows the channel spacing.
- **Power**
Shows the power of the Tx channel.
- **Lower / Upper**
Shows the relative power of the lower and upper adjacent and alternate channels. The values turn red if the power violates the limits.
- **Limit**

Shows the limit of that channel, if one is defined.

2 Result Summary		EUTRA/LTE Square		
Channel	Bandwidth	Offset	Power	
TX1 (Ref)	9.015 MHz		-7.82 dBm	
Tx Total			-7.82 dBm	
Channel	Bandwidth	Offset	Lower	Upper
Adj	9.015 MHz	10.000 MHz	-46.34 dB	-46.04 dB
Alt1	9.015 MHz	20.000 MHz	-60.57 dB	-63.57 dB

Remote command:

Result query: `CALCulate<n>:MARKer<m>:FUNCTION:POWER<sb>:RESULT[:CURRENT]?`

Cumulative ACLR

The cumulative ACLR measurement is designed to measure the cumulative ACLR test requirement for non-contiguous spectrum in 36.141. It calculates the cumulative ACLR of the gaps as defined in 3GPP 36.141. Note that this measurement is only useful for two non-contiguous carriers.

The gap channels are labeled "Gap<x>U" or "Gap<x>L", with <x> representing the number of the gap channels and "U" and "L" standing for "Upper" and "Lower". The number of analyzed gap channels depends on the channel spacing between the carriers as defined in the test specification.

Remote command:

Selection: `CONF:MEAS CCAC`

Result diagram ← Cumulative ACLR

The result diagram is a graphic representation of the signals with a trace that shows the measured signal. Individual channels (Tx and adjacent channels) are indicated by vertical lines and corresponding labels.

In addition, the R&S FSV/A highlights the channels (blue: Tx channel, green: adjacent channels).

The x-axis represents the frequency. Note that the application automatically determines the center frequency and span of the measurement according to the frequencies of the carriers.

On the y-axis, the power is plotted in dBm. The power for the Tx channels is an absolute value in dBm. The power of the gap channels is an absolute value relative to the cumulative power of the Tx channels. The power of the channels is automatically tested against the limits defined by 3GPP.

The result display contains several additional elements.

- Blue and green lines:
Represent the bandwidths of the carriers (blue lines) and those of the gap channels (green lines). Note that the channels can overlap each other.
- Blue and green bars:
Represent the integrated power of the transmission channels (blue bars) and gap channels (green bars).

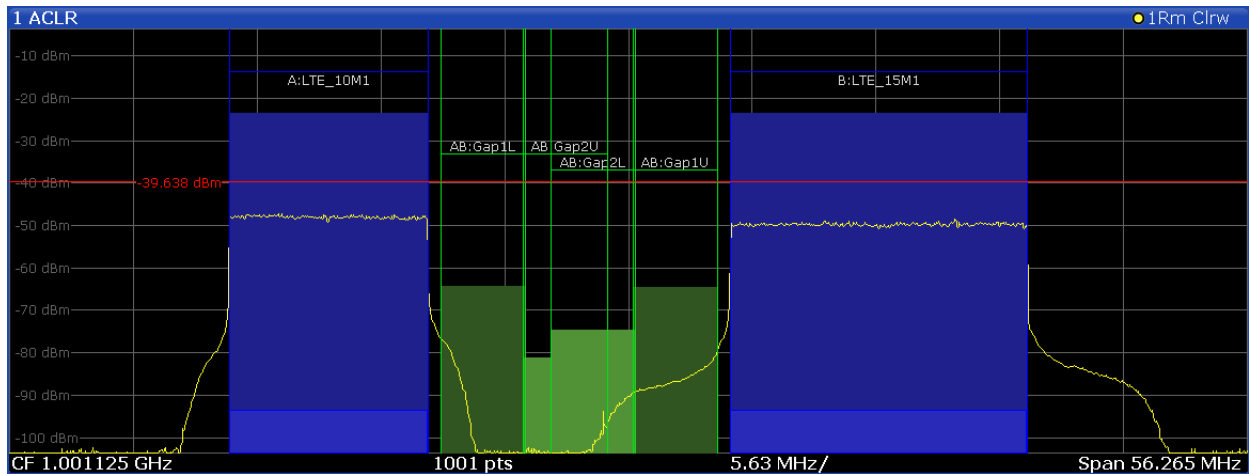

Remote command:

TRACe:DATA?

Result summary ← Cumulative ACLR

The result summary shows the signal characteristics in numerical form. Each row in the table corresponds to a certain channel type (Tx, adjacent channel). The columns contain the channel characteristics.

A table in the result display contains information about the measurement in numerical form:

- **Channel**
Shows the type of channel.
Channel "A" and "B" represent the component carriers. For each of the channels, the application also shows the "Total", which should be the same as that for the channel.
The other rows ("AB:Gap") represent the gap channels.
- **Bandwidth**
Shows the bandwidth of the channel.
The bandwidth of the carrier is the sum of the two component carriers.
- **Frequency**
Shows the frequency of the carrier.
Available for the aggregated carriers.
- **Offset**
Frequency offset relative to the center frequency of the aggregated carrier.
Available for the gap channels.
- **Power / Lower / Upper**
Shows the power of the carrier and the power of the lower and upper gap channels relative to the power of the aggregated carrier.

2 Result Summary		Multi-Standard Radio		
Channel	Bandwidth	Frequency	Power	
A:LTE_10M1	9.015 MHz	987.500 MHz	-23.63 dBm	
Sub Block A Total			-23.63 dBm	
Channel	Bandwidth	Frequency	Power	
B:LTE_15M1 (Ref)	13.515 MHz	1.012 GHz	-23.61 dBm	
Sub Block B Total			-23.61 dBm	
CACLR Channel	Bandwidth	Offset	Lower	Upper
AB:Gap1*	3.840 MHz	2.500 MHz	-43.68 dB *	-43.87 dB *
AB:Gap2	3.840 MHz	7.500 MHz	-54.18 dB	-60.67 dB

Remote command:

Result query: `CALCulate<n>:MARKer<m>:FUNCTION:POWER<sb>:RESult[:CURRent]`? on page 175

Limit check adjacent: `CALCulate<n>:LIMit:ACPower:ACHannel:RESult?` on page 191

Limit check alternate: `CALCulate<n>:LIMit:ACPower:ALternate<alt>:RESult?` on page 192

Multi Carrier ACLR (MC ACLR)

The MC ACLR measurement is basically the same as the [Adjacent Channel Leakage Ratio \(ACLR\)](#) measurement: it measures the power of the transmission channels and neighboring channels and their effect on each other. Instead of measuring a single carrier, the MC ACLR measures several component carriers and the gaps in between. The component carriers do not necessarily have to be next to each other.

In its default state, the MC ACLR measurement measures one neighboring channel above and below the carrier. You can select the type and bandwidth of the neighboring channel (it is either an UTRA or E-UTRA channel) in the [Carrier Aggregation](#) panel.

Note that you can configure a different neighboring channel setup with the tools provided by the measurement. These tools are the same as those in the spectrum application. For more information, refer to the documentation of the R&S FSV/A.

The configuration in its default state complies with the test specifications defined in 36.141.

Remote command:

Selection: `CONF:MEAS MCAC`

Result diagram ← Multi Carrier ACLR (MC ACLR)

The result diagram is a graphic representation of the signals with a trace that shows the measured signal. Individual channels (Tx and adjacent channels) are indicated by vertical lines and corresponding labels.

In addition, the R&S FSV/A highlights the channels (blue: Tx channel, green: adjacent channels).

The x-axis represents the frequency with a frequency span that relates to the LTE channel characteristics and adjacent channel bandwidths. Note that the application automatically determines the center frequency of the measurement according to the frequencies of the carriers.

On the y-axis, the power is plotted in dBm. The power for the TX channels is an absolute value in dBm. The powers of the adjacent channels are values relative to the power of the TX channel. The power of the channels is automatically tested against the limits defined by 3GPP.

The result display contains several additional elements.

- Blue and green lines:
Represent the bandwidths of the carriers (blue lines) and those of the neighboring channels (green lines). Note that the channels can overlap each other.
- Blue and green bars:
Represent the integrated power of the transmission channels (blue bars) and neighboring channels (green bars).

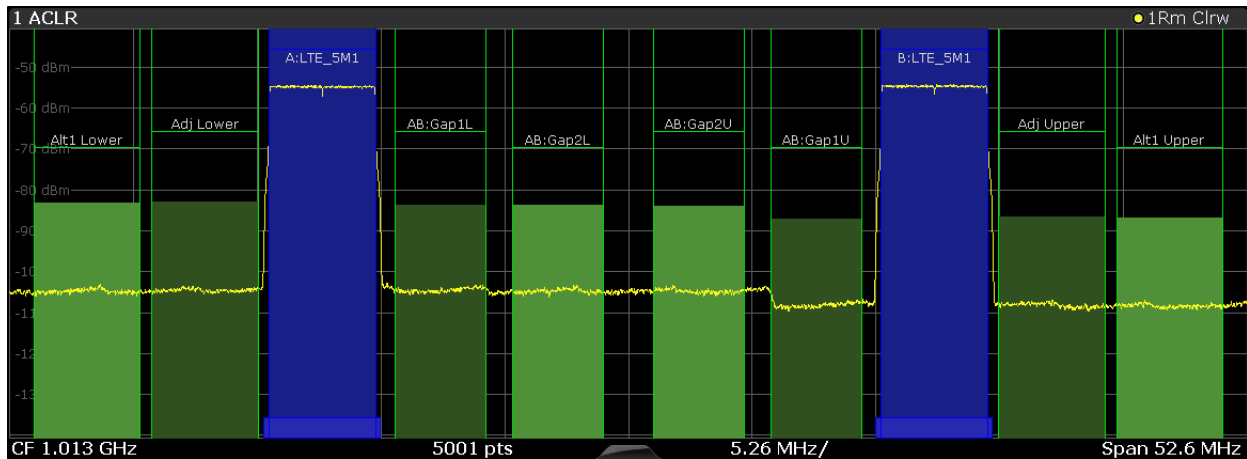

Remote command:

`TRACe:DATA?`

Result summary ← Multi Carrier ACLR (MC ACLR)

The result summary shows the signal characteristics in numerical form. Each row in the table corresponds to a certain channel type (Tx, adjacent channel). The columns contain the channel characteristics.

A table above the result display contains information about the measurement in numerical form:

- **Channel**

Shows the type of channel.

The first rows represent the characteristics of the component carriers. The label also indicates their respective bandwidths (for example: LTE_10M1 means the first LTE channel ("_10M1") with a 10 MHz bandwidth ("_10M1")). The information also includes the total power of all component carriers.

The other rows represent the neighboring channels (Adj Lower / Upper and Alt1 Lower / Upper).

- **Bandwidth**

Shows the bandwidth of the channel.

The bandwidth of the carrier is the sum of the two component carriers.

- **Frequency**

Shows the center frequency of the component carriers.

- **Offset**

Frequency offset relative to the center frequency of the aggregated carrier.

- **Power / Lower / Upper / Gap**

Shows the power of the carrier and the power of the lower and upper neighboring channels relative to the power of the aggregated carrier.

2 Result Summary		Multi-Standard Radio		
Channel	Bandwidth	Frequency	Power	
A:LTE_5M1	4.515 MHz	1.000 GHz	-33.30 dBm	
Sub Block A Total			-33.30 dBm	
Channel	Bandwidth	Frequency	Power	
B:LTE_5M1 (Ref)	4.515 MHz	1.026 GHz	-33.16 dBm	
Sub Block B Total			-33.16 dBm	
Adj Channels		Offset	ACLR Power	
Adj Lower	4.515 MHz	5.000 MHz	-83.01 dBm	
Adj Upper	4.515 MHz	5.000 MHz	-86.63 dBm	
Alt1 Lower	4.515 MHz	10.000 MHz	-83.23 dBm	

Note that the font of the results turns red if the signal violates the limits defined by 3GPP.

Remote command:

Result query: `CALCulate<n>:MARKer<m>:FUNction:POWer<sb>:RESult[:CURRent]?` on page 175

Limit check adjacent: `CALCulate<n>:LIMit:ACPoweR:ACHannel:RESult?` on page 191

Limit check alternate: `CALCulate<n>:LIMit:ACPoweR:ALTernate<alt>:RESult?` on page 192

Spectrum Emission Mask (SEM)

Note: The application also provides multi-SEM measurements as a separate measurement. This measurement is basically the same as the SEM measurement, with the difference that it analyzes several sub blocks, each with its own power class definition. The multi-SEM measurement also supports [Carrier Aggregation](#).

The "Spectrum Emission Mask" (SEM) measurement shows the quality of the measured signal by comparing the power values in the frequency range near the carrier against a spectral mask that is defined by the 3GPP specifications. In this way, you can test the performance of the DUT and identify the emissions and their distance to the limit.

For a comprehensive description of the SEM measurement, refer to the user manual of the R&S FSV/A.

Remote command:

Selection (SEM): `CONF:MEAS ESP`

Selection (Multi-SEM): `CONF:MEAS MCES`

Result diagram ← Spectrum Emission Mask (SEM)

The result diagram is a graphic representation of the signal with a trace that shows the measured signal. The SEM is represented by a red line.

If any measured power levels are above that limit line, the test fails. If all power levels are inside the specified limits, the test passes. The application labels the limit line to indicate whether the limit check has passed or failed.

The x-axis represents the frequency with a frequency span that relates to the specified LTE channel bandwidths. The y-axis shows the signal power in dBm.

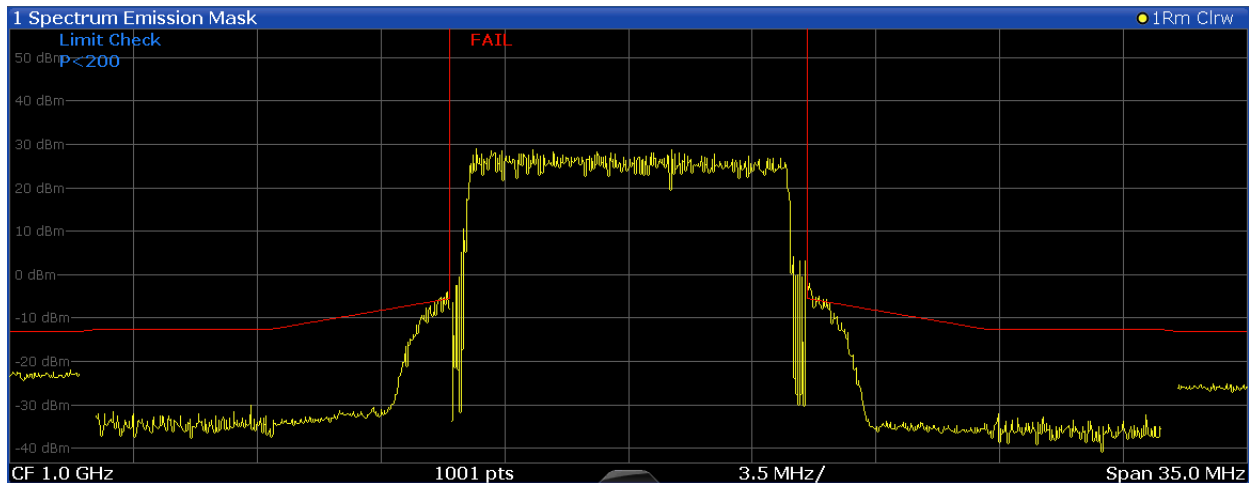

Remote command:

Result query: [TRACe:DATA?](#)

Result summary ← Spectrum Emission Mask (SEM)

The result summary shows the signal characteristics in numerical form. Each row in the table corresponds to a certain SEM range. The columns contain the range characteristics. If a limit fails, the range characteristics turn red.

- **Start / Stop Freq Rel**
Shows the start and stop frequency of each section of the spectrum emission mask relative to the center frequency.
- **RBW**
Shows the resolution bandwidth of each section of the spectrum emission mask.
- **Freq at Δ to Limit**
Shows the absolute frequency whose power measurement being closest to the limit line for the corresponding frequency segment.
- **Power Abs**
Shows the absolute measured power of the frequency whose power is closest to the limit. The application evaluates this value for each frequency segment.
- **Power Rel**
Shows the distance from the measured power to the limit line at the frequency whose power is closest to the limit. The application evaluates this value for each frequency segment.
- **Δ to Limit**
Shows the minimal distance of the tolerance limit to the SEM trace for the corresponding frequency segment. Negative distances indicate that the trace is below the tolerance limit, positive distances indicate that the trace is above the tolerance limit.

Note that when you perform a multi-SEM measurement, the table is expanded to show information about the subblocks.

2 Result Summary				LTE Category A (Freq. > 1GHz) DL		
Tx Power		45.24 dBm		Tx Bandwidth		10.000 MHz
				RBW		100.000 kHz
Range Low	Range Up	RBW	Frequency	Power Abs	Power Rel	ΔLimit
-17.500 MHz	-15.500 MHz	1.000 MHz	982.51724 MHz	-21.93 dBm	-67.17 dB	-8.93 dB
-15.050 MHz	-10.050 MHz	100.000 kHz	988.81054 MHz	-31.93 dBm	-77.17 dB	-19.43 dB
-10.050 MHz	-5.050 MHz	100.000 kHz	994.89898 MHz*	-4.10 dBm*	-49.33 dB*	1.47 dB*
5.050 MHz	10.050 MHz	100.000 kHz	1.00510 GHz*	-2.10 dBm*	-47.33 dB*	3.47 dB*
10.050 MHz	15.050 MHz	100.000 kHz	1.01044 GHz	-32.06 dBm	-77.29 dB	-19.56 dB
15.500 MHz	17.500 MHz	1.000 MHz	1.01690 GHz	-25.05 dBm	-70.29 dB	-12.05 dB

Marker Peak List

The marker peak list determines the frequencies and levels of peaks in the spectrum or time domain. How many peaks are displayed can be defined, as well as the sort order. In addition, the detected peaks can be indicated in the diagram. The peak list can also be exported to a file for analysis in an external application.

3 Marker Peak List				
Wnd	No	X-Value	Y-Value	
2	1	1.086245 ms	-75.810 dBm	
2	2	2.172490 ms	-6.797 dBm	
2	3	3.258736 ms	-76.448 dBm	
2	4	4.831918 ms	-76.676 dBm	
2	5	6.255274 ms	-76.482 dBm	
2	6	6.798397 ms	-6.800 dBm	
2	7	9.233084 ms	-76.519 dBm	
2	8	10.075861 ms	-76.172 dBm	
2	9	11.405574 ms	-6.801 dBm	

Tip: To navigate within long marker peak lists, simply scroll through the entries with your finger on the touchscreen.

Remote command:

LAY:ADD? '1',RIGH, PEAK, see LAYout:ADD[:WINDow]? on page 145

Results:

CALCulate<n>:MARKer<m>:X on page 187

CALCulate<n>:MARKer<m>:Y on page 187

3.8 3GPP test scenarios

3GPP defines several test scenarios for measuring base stations. These test scenarios are described in detail in 3GPP TS 36.141.

The following table provides an overview which measurements available in the LTE application are suited to use for the test scenarios in the 3GPP documents.

Table 3-1: Test scenarios for E-TMs as defined by 3GPP (3GPP TS 36.141)

Test Model	Test scenario	Test described in	Measurement
E-TM1.1	Base station output power	chapter 6.2	Power (→ "Result Summary")
	Transmit on/off power	chapter 6.4	On/Off Power

Test Model	Test scenario	Test described in	Measurement
	DL RS power	chapter 6.5.4	RSTP (→ "Result Summary")
	Time alignment	chapter 6.5.3	Time alignment error
	Transmitter intermodulation	chapter 6.7	ACLR
	Occupied bandwidth	chapter 6.6.1	Occupied bandwidth ¹
	ACLR	chapter 6.6.2	ACLR
	Operating band unwanted emissions	chapter 6.6.3	Spectrum emission mask
	Transmitter spurious emissions	chapter 6.6.4	Spurious emissions ¹
E-TM1.2	ACLR	chapter 6.6.2	ACLR
	Operating band unwanted emissions	chapter 6.6.2	Spectrum emission mask
E-TM2	RE power control dynamic range	chapter 6.3.1	Power results
	Frequency error	chapter 6.5.1	Frequency Error (→ "Result Summary")
	Total power dynamic range	chapter 6.3.2	OSTP (→ "Result Summary")
	Error vector magnitude	chapter 6.5.2	EVM results
E-TM2a	Total power dynamic range	chapter 6.3.2	OSTP (→ "Result Summary")
	Error vector magnitude	chapter 6.5.2	EVM results
	Frequency error	chapter 6.5.1	Frequency error (→ "Result Summary")
E-TM2b	Total power dynamic range	chapter 6.3.2	OSTP (→ "Result Summary")
	Error vector magnitude	chapter 6.5.2	EVM results
	Frequency error	chapter 6.5.1	OSTP (→ "Result Summary")
E-TM3.1	RE power control dynamic range	chapter 6.3.1	Power results
	Total power dynamic range	chapter 6.3.2	OSTP (→ "Result Summary")
	Frequency error	chapter 6.5.1	Frequency error (→ "Result Summary")
	Error vector magnitude	chapter 6.5.2	EVM results
E-TM3.1a	Total power dynamic range	chapter 6.3.2	OSTP (→ "Result Summary")
	Error vector magnitude	chapter 6.5.2	EVM results
	Frequency error	chapter 6.5.1	Frequency error (→ "Result Summary")
E-TM3.1b	Total power dynamic range	chapter 6.3.2	OSTP (→ "Result Summary")
	Error vector magnitude	chapter 6.5.2	EVM results

Test Model	Test scenario	Test described in	Measurement
	Frequency error	chapter 6.5.1	OSTP (→ "Result Summary")
E-TM3.2	RE power control dynamic range	chapter 6.3.1	Power results
	Frequency error	chapter 6.5.1	Frequency error (→ "Result Summary")
	Error vector magnitude	chapter 6.5.2	EVM results
E-TM3.3	RE power control dynamic range	chapter 6.3.1	Power results
	Frequency error	chapter 6.5.1	Frequency error (→ "Result Summary")
	Error vector magnitude	chapter 6.5.2	EVM results

¹these measurements are available in the spectrum application of the Rohde & Schwarz signal and spectrum analyzers (for example the R&S FSW)

4 Measurement Basics

• Symbols and variables	55
• Overview	56
• The LTE downlink analysis measurement application	56
• Performing time alignment measurements	59
• Performing transmit on/off power measurements	61
• O-RAN measurement guide	62

4.1 Symbols and variables

The following chapters use various symbols and variables in the equations that the measurements are based on. The table below explains these symbols for a better understanding of the measurement principles.

$a_{l,k}, \hat{a}_{l,k}$	data symbol (actual, decided)
$b_{l,k}$	boosting factor
$\Delta f, \Delta \hat{f}_{\text{coarse}}$	carrier frequency offset between transmitter and receiver (actual, coarse estimate)
Δf_{res}	residual carrier frequency offset
ζ	relative sampling frequency offset
$H_{l,k}, \hat{H}_{l,k}$	channel transfer function (actual, estimate)
i	time index
$\hat{t}_{\text{coarse}}, \hat{t}_{\text{fine}}$	timing estimate (coarse, fine)
k	subcarrier index
l	OFDM symbol index
N_{FFT}	length of FFT
N_g	number of samples in cyclic prefix (guard interval)
N_s	number of Nyquist samples
N_{RE}	number of resource elements
n	subchannel index, subframe index
$n_{l,k}$	noise sample
Φ_l	common phase error
$r(i)$	received sample in the time domain
$r_{l,k}, r'_{l,k}, r''_{l,k}$	received sample (uncompensated, partially compensated, equalized) in the frequency domain
T	useful symbol time

T_g	guard time
T_s	symbol time

4.2 Overview

The digital signal processing (DSP) involves several stages until the software can present results like the EVM.



The contents of this chapter are structured like the DSP.

4.3 The LTE downlink analysis measurement application

The block diagram in [Figure 4-1](#) shows the EUTRA/LTE downlink measurement application from the capture buffer containing the I/Q data to the actual analysis block. The outcome of the fully compensated reference path (orange) is the estimate $\hat{a}_{i,k}$ of the transmitted data symbols $a_{i,k}$. Depending on the user-defined compensation, the received samples $r_{i,k}$ of the measurement path (blue) still contain the transmitted signal impairments of interest. The analysis block reveals these impairments by comparing the reference and the measurement path. Prior to the analysis, diverse synchronization and channel estimation tasks have to be accomplished.

4.3.1 Synchronization

The first of the synchronization tasks is to estimate the OFDM symbol timing, which coarsely estimates both timing and carrier frequency offset. The frame synchronization block determines the position of the P-/S-Sync symbols in time and frequency by using the coarse fractional frequency offset compensated capture buffer and the timing estimate \hat{t}_{coarse} to position the window of the FFT. If no P-/S-Sync is available in the signal, the reference signal is used for synchronization. The fine timing block prior to the FFT allows a timing improvement and makes sure that the EVM window is centered on the measured cyclic prefix of the considered OFDM symbol. For the 3GPP EVM calculation according to 3GPP TS 36.211 (v8.9.0), the block “window” produces three signals taken at the timing offsets Δt^c , Δt^i and Δt^h . For the reference path, only the signal taken at the timing offset Δt^c is used.

The LTE downlink analysis measurement application

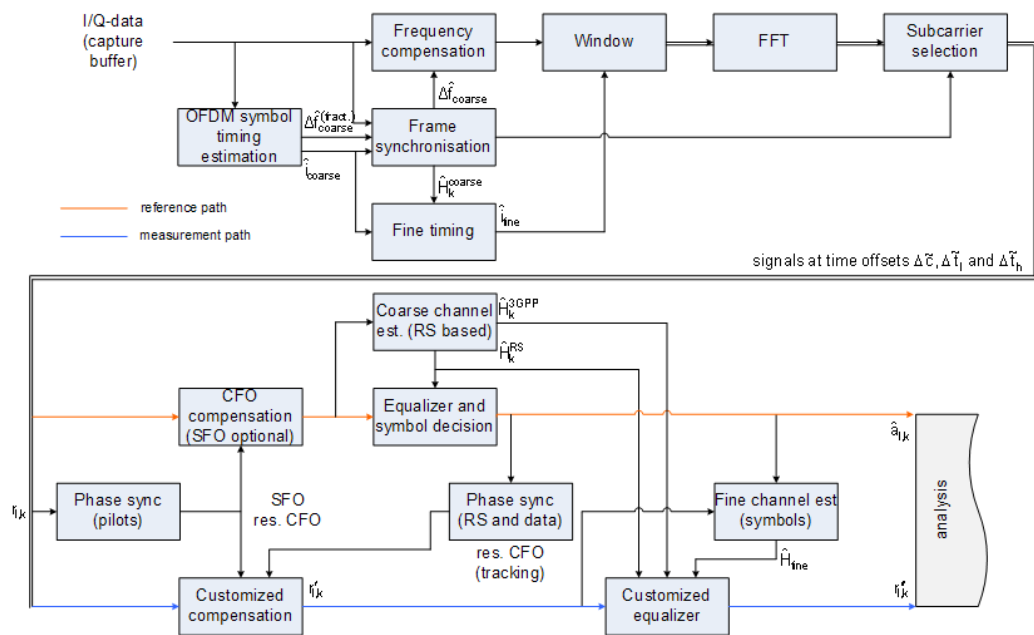

Figure 4-1: Block diagram for the LTE DL measurement application

After the time to frequency transformation by an FFT of length N_{FFT} , the phase synchronization block is used to estimate the following:

- The relative sampling frequency offset ζ (SFO)
- The residual carrier frequency offset Δf_{res} (CFO)
- The common phase error Φ_l (CPE)

According to 3GPP TS 25.913 and 3GPP TR 25.892, the uncompensated samples can be expressed as

$$R_{l,k} = A_{l,k} \cdot H_{l,k} \cdot \underbrace{e^{j\Phi_l}}_{CPE} \cdot \underbrace{e^{j2\pi \cdot N_s / N_{FFT} \cdot \zeta \cdot k \cdot l}}_{SFO} \cdot \underbrace{e^{j2\pi \cdot N_s / N_{FFT} \cdot \Delta f_{res} \cdot T \cdot l}}_{res.CFO} + N_{l,k}$$

Equation 4-1:

where

- The data symbol is $a_{l,k}$, on subcarrier k at OFDM symbol l
- The channel transfer function is $H_{l,k}$
- The number of Nyquist samples is N_s within the symbol time T_s
- The useful symbol time $T = T_s - T_g$
- The independent and Gaussian distributed noise sample is $n_{l,k}$

Within one OFDM symbol, both the CPE and the residual CFO cause the same phase rotation for each subcarrier, while the rotation due to the SFO depends linearly on the subcarrier index. A linear phase increase in symbol direction can be observed for the residual CFO as well as for the SFO.

The results of the tracking estimation block are used to compensate the samples $r_{l,k}$

Whereas a full compensation is performed in the reference path, the signal impairments that are of interest to the user are left uncompensated in the measurement path.

After having decided the data symbols in the reference path, an additional phase tracking can be utilized to refine the CPE estimation.

4.3.2 Channel estimation and equalization

As shown in [Figure 4-1](#), there is one coarse and one fine channel estimation block. The reference signal-based coarse estimation is tapped behind the CFO compensation block (SFO compensation can optionally be enabled) of the reference path. The coarse estimation block uses the reference signal symbols to determine estimates of the channel transfer function by interpolation in both time and frequency direction. A special channel estimation (\hat{h}_k^{3GPP}) as defined in 3GPP TS 36.211 is additionally generated. The coarse estimation results are used to equalize the samples of the reference path prior to symbol decision. Based on the decided data symbols, a fine channel estimation is optimally performed and then used to equalize the partially compensated samples of the measurement path.

4.3.3 Analysis

The analysis block of the EUTRA/LTE downlink measurement application allows to compute a variety of measurement variables.

EVM

The error vector magnitude (EVM) measurement results 'EVM PDSCH QPSK/16-QAM/64-QAM' are calculated according to the specification in 3GPP TS 36.211.

All other EVM measurement results are calculated according to

$$EVM_{l,k} = \frac{|r_{l,k}'' - \hat{a}_{l,k}|}{b_{l,k} \sqrt{E \left\{ \left| \frac{a_{l,k}}{b_{l,k}} \right|^2 \right\}}}$$

Equation 4-2:

on subcarrier k at OFDM symbol l, where $b_{l,k}$ is the boosting factor. Since the average power of all possible constellations is 1 when no boosting is applied, the equation can be rewritten as

$$EVM_{n,l} = \frac{|r_{l,k}'' - \hat{a}_{l,k}|}{b_{l,k}}$$

Equation 4-3:

The average EVM of all data subcarriers is then

$$EVM_{data} = \sqrt{\frac{1}{N_{REdata}} \sum_l \sum_{k_{data}} EVM_{l,k_{data}}^2}$$

Equation 4-4:

The number of resource elements taken into account is denoted by $N_{RE\ data}$.

I/Q imbalance

The I/Q imbalance can be written as

$$r(t) = I \Re\{s(t)\} + jQ \Im\{s(t)\}$$

Equation 4-5:

where $s(t)$ is the transmit signal, $r(t)$ is the received signal, and I and Q are the weighting factors. We define that $I:=1$ and $Q:=1+\Delta Q$.

The I/Q imbalance estimation makes it possible to evaluate the

$$\text{modulator gain balance} = |1 + \Delta Q|$$

Equation 4-6:

and the

$$\text{quadrature mismatch} = \arg\{1 + \Delta Q\}$$

Equation 4-7:

based on the complex-valued estimate $\Delta \hat{Q}$.

Other measurement variables

Without going into detail, the EUTRA/LTE downlink measurement application additionally provides the following results.

- Total power
- Constellation diagram
- Group delay
- I/Q offset
- Crest factor
- Spectral flatness

4.4 Performing time alignment measurements

The measurement application allows you to perform time alignment measurements between different antennas.

The measurement supports setups of up to four Tx antennas.

The result of the measurement is the time alignment error. The time alignment error is the time offset between a reference antenna (for example antenna 1) and another antenna.

The time alignment error results are summarized in the corresponding [result display](#).

A schematic description of the results is provided in [Figure 4-2](#).

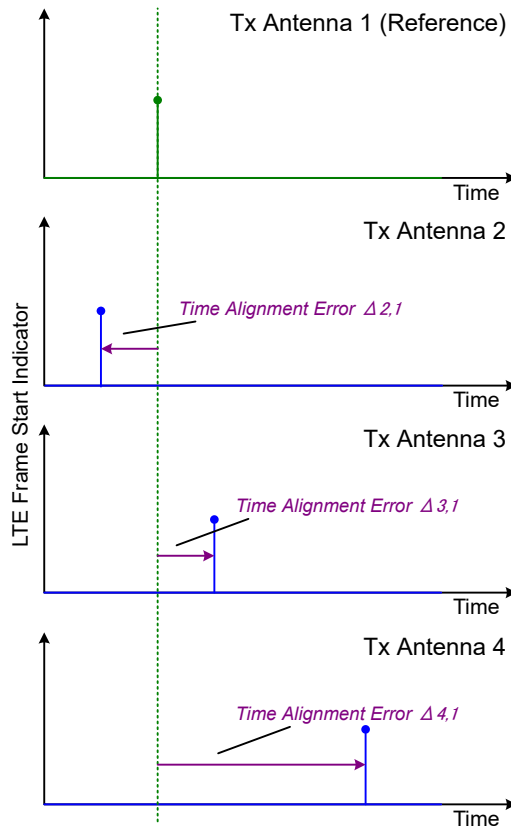

Figure 4-2: Time Alignment Error (4 Tx antennas)

Test setup

Successful Time Alignment measurements require a correct test setup.

A typical hardware test setup is shown in [Figure 4-3](#). Note that the dashed connections are only required for MIMO measurements on 4 Tx antennas.

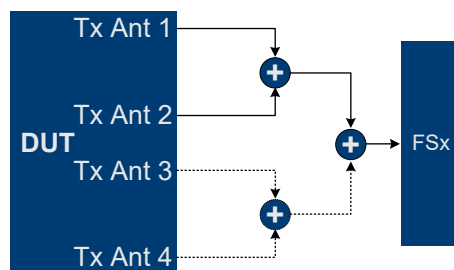

Figure 4-3: Hardware setup

For best measurement result accuracy, it is recommended to use cables of the same length and identical combiners as adders.

In the application, make sure to correctly apply the following settings.

- Select a reference antenna in the [MIMO Configuration](#) dialog box (**not** "All")
- Set the [Subframe Selection](#) to "All"
- Turn on [Compensate Crosstalk](#) in the "Demodulation Settings"
- Note that the Time Alignment measurement only evaluates the reference signal and therefore ignores any PDSCH settings - for example, it does not have an influence on this measurement if the PDSCH MIMO scheme is set to transmit diversity or spatial multiplexing.

4.5 Performing transmit on/off power measurements

The technical specification in 3GPP TS 36.141 describes the measurement of the transmitter "Off" power and the transmitter transient period of an EUTRA/LTE TDD base transceiver station (BTS) operating at its specified maximum output power.

A special hardware setup is required for this measurement. During the transmitter "Off" periods (the interesting parts of the signal for this measurement), the signal power is very low - measuring such low powers requires a low attenuation at the RF input. On the other hand, the signal power is very high during the transmitter "On" periods - in fact the signal power is usually higher than the maximum allowed RF input level. Measuring high signal levels requires an appropriate test setup as described below.

NOTICE

Risk of instrument damage

The signal power during the "On" transmitter periods in this test scenario is usually higher than the maximum power allowed at the RF input of a spectrum analyzer.

Make sure to set up the measurement appropriately. Not doing so can cause severe damage to the spectrum analyzer.

Test setup

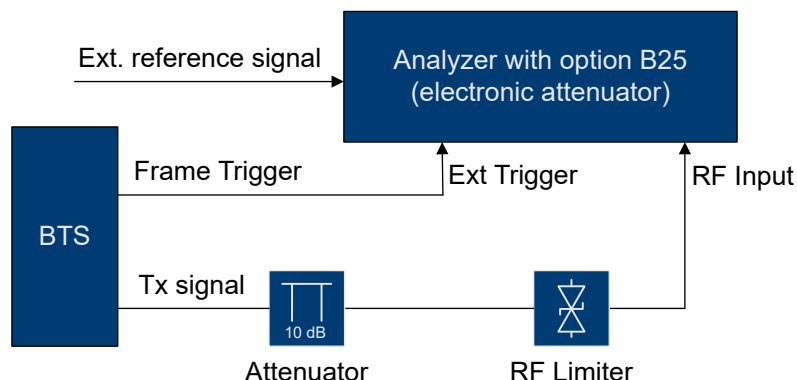

Figure 4-4: Test setup for transmit on / off power measurement

- Connect an RF limiter to the RF input to protect the RF input from damage (see [Figure 4-4](#)).
[Table 4-1](#) shows the specifications that the limiter has to fulfill.
- Insert an additional 10 dB attenuator in front of the RF limiter to absorb possible reflected waves (because of the high VSWR of the limiter). The maximum allowed CW input power of the attenuator must be lower than the maximum output power of the BTS.

Table 4-1: Specifications of the RF limiter in the test setup

Min. acceptable CW input power	BTS output power minus 10 dB
Min. acceptable peak input power	BTS peak output power minus 10 dB
Max. output leakage	20 dBm
Max. response time	1 μ s
Max. recovery time	1 μ s

Measuring the on / off power

- Use test model E-TM1.1 for transmit on / off power measurements according to 36.141, 6.4.
For more information about loading test model settings, see [Chapter 5.2.2, "Test scenarios"](#), on page 74.
- If you are using an external trigger, you have to [adjust the timing](#) before you can start the actual measurement.
The status message in the diagram header shows if timing adjustment is required or not. After timing was successfully adjusted, you can start the measurement. Note that relevant changes of settings might require another timing adjustment. If timing adjustment fails for any reason, the application shows a corresponding message in the diagram header. To find out what causes the synchronization failure, you should perform a regular EVM measurement (i.e. leave the ON/OFF Power measurement). Then you can use all the measurement results like "EVM vs Carrier" to get more detailed information about the failure. The timing adjustment will succeed if the synchronization state in the header is OK.
- If you are using an R&S FSQ or R&S FSG for the measurement, it is recommended to use the external trigger mode, because for high power signals a successful synchronization is not guaranteed under certain circumstances.

When you start the measurement ("Run Single"), the R&S FSV/A starts the measurement. The number of measurements that trace averaging is based on depends on the [number of frames](#) you have defined. When all measurements are done, the R&S FSV/A indicates in the numerical result table if the measurement has failed or passed.

4.6 O-RAN measurement guide

The O-RAN alliance specifies specific signal configurations (test cases) for standardized testing of O-RAN equipment. The R&S FSV/A provides these O-RAN test cases.

When you apply one of them, the measurement configuration automatically adjusts to the values of the selected test case.

Basically, you can verify O-RAN based signals by certain bit sequences in the PDSCH and the positions of those sequences. The position of the bit sequence in the PDSCH is unique for each test case.

The [type of bit sequence](#) depends on the test case.

- Some test cases use a bit sequence of all 0's.
- Some test cases use an O-RAN specific PN23 bit sequence.

In addition, the [data demodulation](#) depends on the test case (before or after descrambling).

As pointed out, these settings are automatically selected, depending on the selected test case.

For valid measurement results, it is essential that the measured signal complies with the selected test case and uses the correct bit sequences in the correct locations. If you get unexpected measurement results, check if the signal is configured correctly. You can do a quick check to validate the signal as follows.

- Check if the selected test case in the "Advanced Settings" is the same as the test case in the "Test Models" dialog.
- Use the [Allocation ID vs Symbol x Carrier](#) result display to verify if the correct PDSCH allocations are analyzed. If the signal contains the correct bit sequence, the EVM should be good.
- Use the [Bitstream](#) result display to verify if the bits match the O-RAN specifications. Each test case has a typical bit sequence. Make sure to select the bit sequence as the [bitstream format](#).

5 Configuration

LTE measurements require a special application on the R&S FSV/A, which you activate using the [MODE] key on the front panel.

When you start the LTE application, the R&S FSV/A starts to measure the input signal with the default configuration or the configuration of the last measurement (when you haven't performed a preset since then). After you have started an instance of the LTE application, the application displays the "Meas Config" menu which contains functions to define the characteristics of the signal you are measuring.



Automatic refresh of preview and visualization in dialog boxes after configuration changes

The R&S FSV/A supports you in finding the correct measurement settings quickly and easily - after each change in settings in dialog boxes, the preview and visualization areas are updated immediately and automatically to reflect the changes. Thus, you can see if the setting is appropriate or not before accepting the changes.



Unavailable hardkeys

Note that the [SPAN], [BW], [TRACE], [LINES] and [MKR FUNC] keys have no contents and no function in the LTE application.

- [Configuration overview](#).....64
- [I/Q Measurements](#).....66
- [Time Alignment Error Measurements](#)..... 119
- [On / Off Power Measurements](#)..... 119
- [Frequency Sweep Measurements](#)..... 120

5.1 Configuration overview



Throughout the measurement channel configuration, an overview of the most important currently defined settings is provided in the "Overview". The "Overview" is displayed when you select the "Overview" icon, which is available at the bottom of all softkey menus.

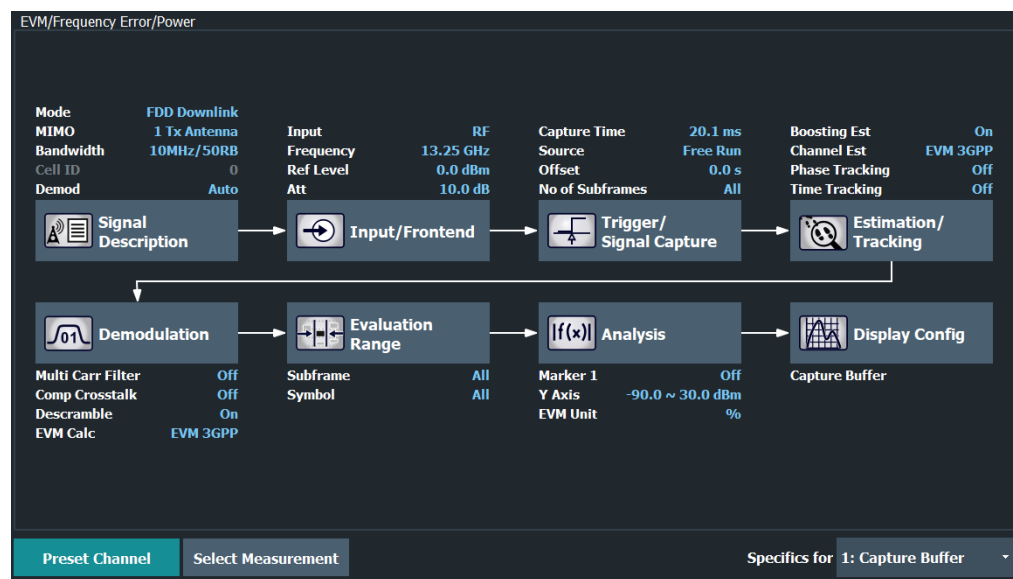

In addition to the main measurement settings, the "Overview" provides quick access to the main settings dialog boxes. The individual configuration steps are displayed in the order of the data flow. Thus, you can easily configure an entire measurement channel from input over processing to output and analysis by stepping through the dialog boxes as indicated in the "Overview".

In particular, the "Overview" provides quick access to the following configuration dialog boxes (listed in the recommended order of processing):

1. Signal Description
See [Chapter 5.2.1, "Signal characteristics"](#), on page 67.
2. Input / Frontend
See [Chapter 5.2.18, "Input source configuration"](#), on page 103.
3. Trigger / Signal Capture
See [Chapter 5.2.22, "Trigger configuration"](#), on page 112.
See [Chapter 5.2.21, "Data capture"](#), on page 110
4. Estimation / Tracking
See [Chapter 5.2.24, "Measurement error compensation"](#), on page 115.
5. Demodulation
See [Chapter 5.2.25, "Demodulation"](#), on page 116.
6. Evaluation Range
See [Chapter 6.2.2, "Evaluation range"](#), on page 129.
7. Analysis
See [Chapter 6, "Analysis"](#), on page 125.
8. Display Configuration
See [Chapter 3, "Measurements and result displays"](#), on page 15.

In addition, the dialog box provides the "Select Measurement" button that serves as a shortcut to select the measurement type.

Note that the "Overview" dialog box for frequency sweep measurement is similar to that of the Spectrum mode.

For more information refer to the documentation of the R&S FSV/A.

To configure settings

- ▶ Select any button in the "Overview" to open the corresponding dialog box. Select a setting in the channel bar (at the top of the measurement channel tab) to change a specific setting.

Preset Channel

Select the "Preset Channel" button in the lower left-hand corner of the "Overview" to restore all measurement settings *in the current channel* to their default values.

Note: Do not confuse the "Preset Channel" button with the [Preset] key, which restores the entire instrument to its default values and thus closes *all channels* on the R&S FSV/A (except for the default channel)!

Remote command:

`SYSTem:PRESet:CHANnel[:EXEC]` on page 207

Select Measurement

Opens a dialog box to select the type of measurement.

For more information about selecting measurements, see [Chapter 3.1, "Selecting measurements"](#), on page 15.

Remote command:

`CONFigure[:LTE]:MEASurement` on page 206

Specific Settings for

The channel can contain several windows for different results. Thus, the settings indicated in the "Overview" and configured in the dialog boxes vary depending on the selected window.

Select an active window from the "Specific Settings for" selection list that is displayed in the "Overview" and in all window-specific configuration dialog boxes.

The "Overview" and dialog boxes are updated to indicate the settings for the selected window.

5.2 I/Q Measurements

- [Signal characteristics](#)..... 67
- [Test scenarios](#)..... 74
- [Configuring MIMO setups](#)..... 75
- [PDSCH demodulation](#)..... 77
- [PDSCH subframe configuration](#)..... 78
- [Synchronization signal configuration](#)..... 85

- Reference signal configuration.....86
- Positioning reference signal configuration..... 87
- Channel state information reference signal configuration..... 89
- PDSCH resource block symbol offset..... 91
- PBCH configuration.....92
- PCFICH configuration..... 93
- PHICH configuration..... 94
- PDCCH configuration.....97
- EPDCCH configuration..... 98
- Shared channel configuration..... 100
- MBSFN characteristics.....100
- Input source configuration.....103
- Frequency configuration.....105
- Amplitude configuration.....106
- Data capture..... 110
- Trigger configuration.....112
- Parameter estimation and tracking.....114
- Measurement error compensation..... 115
- Demodulation..... 116
- Automatic configuration..... 118

5.2.1 Signal characteristics

Access: "Overview" > "Signal Description" > "Signal Description"

The general signal characteristics contain settings to describe the general physical attributes of the signal.

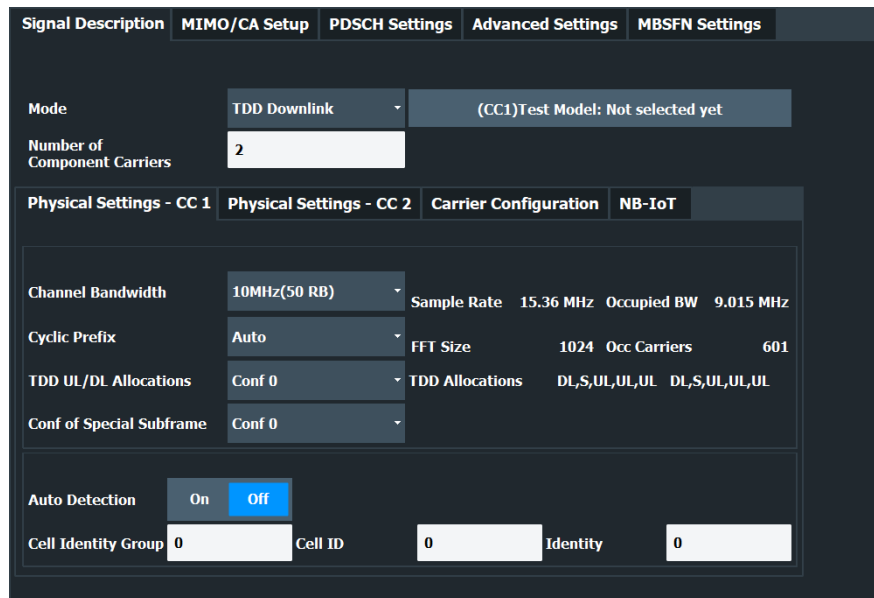

- Selecting the LTE mode..... 68
- Carrier Aggregation.....68
 - ↳ Basic component carrier configuration.....69

L Features of the I/Q measurements.....	70
L Features of the time alignment error measurement.....	70
L Features of the cumulative and MC ACLR measurement.....	70
L Remote commands to configure carrier aggregation.....	71
Channel Bandwidth / Number of Resource Blocks.....	71
Cyclic Prefix.....	72
Configuring TDD Frames.....	72
L TDD UL/DL Allocations.....	72
L Conf. of Special Subframe.....	73
Configuring the Physical Layer Cell Identity.....	73
Exclude Inband NB-IoT.....	74

Selecting the LTE mode

The "Mode" selects the LTE standard you are testing.

The choices you have depend on the set of options you have installed.

- Option xxx-K100 enables testing of 3GPP LTE FDD signals on the downlink
- Option xxx-K101 enables testing of 3GPP LTE FDD signals on the uplink
- Option xxx-K102 enables testing of 3GPP LTE MIMO signals on the downlink
- Option xxx-K103 enables testing of 3GPP MIMO signals on the uplink
- Option xxx-K104 enables testing of 3GPP LTE TDD signals on the downlink
- Option xxx-K105 enables testing of 3GPP LTE TDD signals on the uplink
- Option xxx-K106 enables testing of 3GPP LTE NB-IoT TDD signals on the downlink

FDD and TDD are **duplexing** methods.

- FDD mode uses different frequencies for the uplink and the downlink.
- TDD mode uses the same frequency for the uplink and the downlink.

Downlink (DL) and Uplink (UL) describe the **transmission path**.

- Downlink is the transmission path from the base station to the user equipment. The physical layer mode for the downlink is always OFDMA.
- Uplink is the transmission path from the user equipment to the base station. The physical layer mode for the uplink is always SC-FDMA.

The application shows the currently selected LTE mode (including the bandwidth) in the channel bar.

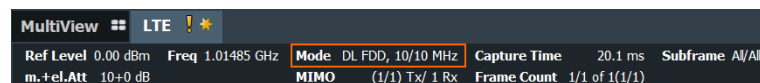

Remote command:

Link direction: `CONFigure[:LTE]:LDIRection` on page 212

Duplexing mode: `CONFigure[:LTE]:DUPLexing` on page 208

Carrier Aggregation

Carrier aggregation has been introduced in the LTE standard to increase the bandwidth. In those systems, several carriers can be used to transmit a signal.

Each carrier usually has one of the **channel bandwidths** defined by 3GPP.

The R&S FSV/A features several measurements that support contiguous and non-contiguous intra-band carrier aggregation (the carriers are in the same frequency band).

- I/Q based measurements (EVM, frequency error, etc.) (downlink)
- I/Q based measurements (EVM, frequency error, etc.) (uplink)

- Time alignment error (downlink)
- Time alignment error (uplink)
- Cumulative ACLR (downlink, non-contiguous intra-band carrier aggregation)
- Multi carrier ACLR (downlink, non-contiguous intra-band carrier aggregation)
- Multi carrier ACLR (uplink, contiguous intra-band carrier aggregation)
- SEM (downlink, non-contiguous intra-band carrier aggregation)
- SEM (uplink, contiguous intra-band carrier aggregation)

The way to configure these measurements is similar (but not identical, the differences are indicated below).

- ["Basic component carrier configuration"](#) on page 69
- ["Features of the I/Q measurements"](#) on page 70
- ["Features of the time alignment error measurement"](#) on page 70
- ["Features of the cumulative and MC ACLR measurement"](#) on page 70
- ["Remote commands to configure carrier aggregation"](#) on page 71

Basic component carrier configuration ← Carrier Aggregation

The number of component carriers (CCs) you can select depends on the measurement.

- I/Q based measurements (EVM etc.): up to 5 CCs
- Time alignment error: up to 2 CCs
- Multi-carrier ACLR: up to 5 CCs
- Cumulative ACLR: up to 5 CCs
- Multi-carrier SEM: up to 5 CCs

You can define the characteristics of the CCs in the table in the "Carrier Configuration" panel (in the "Signal Characteristics" dialog box). Depending on the "Number of Component Carriers", the application adjusts the size of the table. Each line corresponds to a component carrier.

- The "Center Frequency" defines the carrier frequency of the carriers.
- For each carrier, you can select the "Bandwidth" from the corresponding dropdown menu.
- For all component carriers, the R&S FSV/A also shows the "Frequency Offset" relative to the center frequency of the first carrier.
If you define a different frequency offset, the application adjusts the center frequency accordingly.

Note that the actual measurement frequency differs from the carrier frequencies: the application calculates that frequency based on the carrier frequencies. It is somewhere in between the carrier frequencies.

The measurement frequency is displayed in the channel bar.

For each component carrier, you can select one of the **channel bandwidths** defined by 3GPP from the "Bandwidth" dropdown menus. The combination of bandwidths is arbitrary.

When the defined carrier configuration is not supported by the application, a corresponding error message is displayed. This can be the case, for example, if the carriers occupy a bandwidth that is too large.

Features of the I/Q measurements ← Carrier Aggregation

For measurements on component carriers, results are shown for each component carrier separately. The layout of the diagrams is adjusted like this:

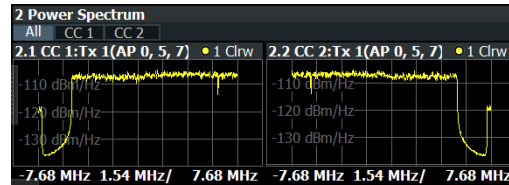

- The first tab ("All") shows the results for all component carriers.
- The other tabs ("CC <x>") show the results for each component carrier individually.

The application also shows the "Occupied Bandwidth" of the aggregated carriers and the "Sample Rate" in a read-only field below the carrier configuration.

Sample Rate	15.36 MHz	Occupied BW	9.015 MHz
FFT Size	1024	Occ Carriers	601

Features of the time alignment error measurement ← Carrier Aggregation

When you perform a TAE measurement, you can capture the data of the component carriers either on one R&S FSV/A ("wideband capture") or on two R&S FSV/A. When you capture the data with only one R&S FSV/A, make sure that it has a bandwidth wide enough to capture all component carriers in a single measurement.

You can define the number of devices to measure in the corresponding input field.

You can configure [additional signal characteristics](#) of the first and second carrier in the "CC1" and "CC2" tabs.

In case you are testing a MIMO DUT, you can also select the number of antennas the DUT supports. When you select "1 Tx Antenna", the application measures the timing difference between two SISO carriers, when you select more than one antenna, it measures the timing difference between the antennas. In that case, you can select the reference antenna from the dropdown menu in the time alignment error result display.

Note that the application shows measurement results for the second component carrier even if only one antenna of the second component carrier is attached (i.e. no combiner is used).

Features of the cumulative and MC ACLR measurement ← Carrier Aggregation

The diagram at the bottom of the dialog box represents the current configuration.

When you change the bandwidth of a carrier (represented by blue bars), the application adjusts the bandwidth of the carriers in the diagram accordingly.

In the MC ACLR measurement, you can also define the bandwidth characteristics of the **upper** and **lower** neighboring channels (not represented in the diagram).

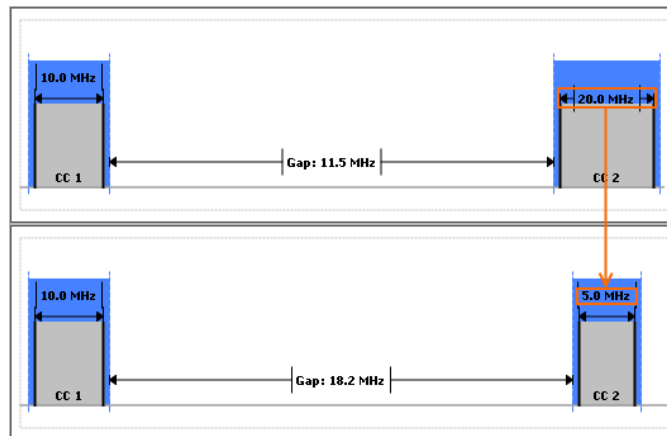

Remote commands to configure carrier aggregation ← Carrier Aggregation

Remote command:

Number of carriers: `CONFigure[:LTE]:NOCC` on page 262

Carrier frequency: `[SENSe:]FREQuency:CENTer[:CC<cc>]` on page 243

Measurement frequency: `SENSe:FREQuency:CENTer?`

Offset: `[SENSe:]FREQuency:CENTer[:CC<cc>]:OFFSet` on page 243

Channel bandwidth: `CONFigure[:LTE]:DL[:CC<cc>]:BW` on page 208

Number of devices: `CONFigure[:LTE]:NDEVICES` on page 264

Lower adjacent channel BW: `[SENSe:]POWER:ACHannel:AACHannel` on page 264

Upper adjacent channel BW: `[SENSe:]POWER:ACHannel:UAACHannel`

on page 265

Channel Bandwidth / Number of Resource Blocks

Specifies the channel bandwidth and number of resource blocks (RB).

The channel bandwidth and number of resource blocks (RB) are interdependent. Currently, the LTE standard recommends six bandwidths (see table below).

Tip: The "Auto LTE Config" feature (available in the "Auto Set" menu) automatically detects the channel bandwidth.

The application also calculates the FFT size, sampling rate, occupied bandwidth and occupied carriers from the channel bandwidth. Those are read only.

Channel Bandwidth [MHz]	1.4	3	5	10	15	20
Number of Resource Blocks	6	15	25	50	75	100
Sample Rate [MHz]	1.92	3.84	7.68	15.36	30.72	30.72
FFT Size	128	256	512	1024	2048	2048

For more information about configuring aggregated carriers, see "[Carrier Aggregation](#)" on page 68.

The application shows the currently selected LTE mode (including the bandwidth) in the channel bar.

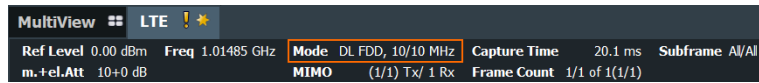

Remote command:

`CONFigure[:LTE]:DL[:CC<cc>]:BW` on page 208

Cyclic Prefix

The cyclic prefix serves as a guard interval between OFDM symbols to avoid interferences. The standard specifies two cyclic prefix modes with a different length each.

The cyclic prefix mode defines the number of OFDM symbols in a slot.

- Normal
A slot contains 7 OFDM symbols.
- Extended
A slot contains 6 OFDM symbols.
The extended cyclic prefix is able to cover larger cell sizes with higher delay spread of the radio channel.
- Auto
The application automatically detects the cyclic prefix mode in use.

Remote command:

`CONFigure[:LTE]:DL[:CC<cc>]:CYCPrefix` on page 209

Configuring TDD Frames

TDD frames contain both uplink and downlink information separated in time with every subframe being responsible for either uplink or downlink transmission. The standard specifies several subframe configurations or resource allocations for TDD systems.

TDD UL/DL Allocations ← Configuring TDD Frames

Selects the configuration of the subframes in a radio frame in TDD systems.

The UL/DL configuration (or allocation) defines the way each subframe is used: for uplink, downlink or if it is a special subframe. The standard specifies seven different configurations.

Configuration	Subframe Number and Usage									
	0	1	2	3	4	5	6	7	8	9
0	D	S	U	U	U	D	S	U	U	U
1	D	S	U	U	D	D	S	U	U	D
2	D	S	U	D	D	D	S	U	D	D
3	D	S	U	U	U	D	D	D	D	D
4	D	S	U	U	D	D	D	D	D	D
5	D	S	U	D	D	D	D	D	D	D
6	D	S	U	U	U	D	S	U	U	D

U = uplink

D = downlink

S = special subframe

Remote command:

Subframe: `CONFigure[:LTE]:DL[:CC<cc>]:TDD:UDConf` on page 212

Conf. of Special Subframe ← Configuring TDD Frames

In combination with the cyclic prefix, the special subframes serve as guard periods for switches from uplink to downlink. They contain three parts or fields.

- DwPTS
The DwPTS is the downlink part of the special subframe. It is used to transmit downlink data.
- GP
The guard period makes sure that there are no overlaps of up- and downlink signals during a switch.
- UpPTS
The UpPTS is the uplink part of the special subframe. It is used to transmit uplink data.

The length of the three fields is variable. This results in several possible configurations of the special subframe. The LTE standard defines 10 different configurations for the special subframe. However, configurations 8 and 9 only work for a normal cyclic prefix.

If you select configurations 8 or 9 using an extended cyclic prefix or automatic detection of the cyclic prefix, the application will show an error message.

Remote command:

Special subframe: `CONFigure[:LTE]:DL[:CC<cc>]:TDD:SPSC` on page 211

Configuring the Physical Layer Cell Identity

The "Cell ID", "Cell Identity Group" and physical layer "Identity" are interdependent parameters. In combination, they are responsible for synchronization between network and user equipment.

The physical layer cell ID identifies a particular radio cell in the LTE network. The cell identities are divided into 168 unique cell identity groups. Each group consists of 3 physical layer identities. According to:

$$N_{ID}^{cell} = 3 \cdot N_{ID}^{(1)} + N_{ID}^{(2)}$$

$N^{(1)}$ = cell identity group, {0...167}

$N^{(2)}$ = physical layer identity, {0...2}

there is a total of 504 different cell IDs.

If you change one of these three parameters, the application automatically updates the other two.

For automatic detection of the cell ID, turn on the "Auto" function.

Before it can establish a connection, the user equipment must synchronize to the radio cell it is in. For this purpose, two synchronization signals are transmitted on the downlink. These two signals are reference signals whose content is defined by the "Physical Layer Identity" and the "Cell Identity Group".

The first signal is one of 3 possible Zadoff-Chu sequences. The sequence that is used is defined by the physical layer identity. It is part of the P-Sync.

The second signal is one of 168 unique sequences. The sequence is defined by the cell identity group. This sequence is part of the S-Sync.

In addition to the synchronization information, the cell ID also determines:

- The cyclic shifts for PCFICH, PHICH and PDCCH mapping,
- The frequency shifts of the reference signal.

Remote command:

Cell ID: [CONFigure\[:LTE\]:DL\[:CC<cc>\]:PLC:CID](#) on page 210

Cell Identity Group (setting): [CONFigure\[:LTE\]:DL\[:CC<cc>\]:PLC:CIDGroup](#) on page 210

Cell Identity Group (query): [FETCh\[:CC<cc>\]:PLC:CIDGroup?](#) on page 213

Identity (setting): [CONFigure\[:LTE\]:DL\[:CC<cc>\]:PLC:PLID](#) on page 211

Identity (query): [FETCh\[:CC<cc>\]:PLC:PLID?](#) on page 213

Exclude Inband NB-IoT

The 3GPP standard specifies several operating modes, or deployments, for NB-IoT transmission. The deployment specifies where the NB-IoT signal is located in the frequency spectrum.

One of these deployments is the inband deployment. In that case, the The NB-IoT signal uses resource blocks within an LTE carrier.

You can exclude the resource blocks used by the NB-IoT signal from the measurement results when you turn on "Exclude Inband NB-IoT". When you turn on this feature, you can also define the location of the NB-IoT signal within the LTE carrier as an resource block offset. The resource block offset is a value relative to resource block 0.

This feature is available for automatic [PDSCH demodulation](#).

Remote command:

State: [CONFigure\[:LTE\]:DL\[:CC<cc>\]:EINBIot\[:STATE\]](#) on page 209

Offset: [CONFigure\[:LTE\]:DL\[:CC<cc>\]:NRBoffset](#) on page 210

5.2.2 Test scenarios

Access: "Overview" > "Signal Description" > "Test Models"

Test scenarios are descriptions of specific LTE signals for standardized testing of DUTs. These test scenarios are stored in `.allocation` files. You can select, manage and create test scenarios in the "Test Models" dialog box.

3GPP test models

Test models are certain signal descriptions defined by 3GPP for various test scenarios. 3GPP calls them E-TM. These E-TM are defined in 3GPP 36.141.

There are three main test model groups (E-TM1, E-TM2 and E-TM3). Each of these main groups in turn contain signal descriptions for specific signal configurations (different transmission type, different bandwidth etc.).

Test models are defined by the following characteristics.

- Single antenna port, single code word, single layer and no precoding
- Duration of one frame
- Normal cyclic prefix

- Localized virtual resource blocks, no intra-subframe hopping for PDSCH
- UE-specific reference signal not used

The data content of the physical channels and signals is defined by 3GPP. Each E-TM is defined for all bandwidths defined in the standard (1.4 MHz / 3 MHz / 5 MHz / 10 MHz / 15 MHz / 20 MHz).

For an overview of the test scenarios, see [Chapter 3.8, "3GPP test scenarios"](#), on page 52.

Remote command:

`MMEMemory:LOAD[:CC<cc>]:TMOD:DL` on page 214

ORAN test cases

O-RAN test cases are available for [FDD](#) signals.

In addition to the 3GPP test models, you can also use O-RAN test cases. O-RAN test cases are defined by the O-RAN alliance for standardized measurements.

The test cases comply with O-RAN specification O-RAN.WG4.CONF.0-v05.00.

The O-RAN test cases are based on the 3GPP test models (downlink) and fixed reference channels (uplink) and are customized for the O-RAN applications.

For more information about the test cases themselves, see the O-RAN specifications available on the O-RAN website.

For more information about using O-RAN test cases in measurements with the R&S FSV/A, see [Chapter 4.6, "O-RAN measurement guide"](#), on page 62.

Remote command:

`MMEMemory:LOAD[:CC<cc>]:TMOD:DL` on page 214

User defined test scenarios

User defined test scenarios are custom signal descriptions for standardized measurements that you can save and restore as you like. To create a custom test scenario, describe a signal as required and then save it with the corresponding button. The R&S FSV/A stores custom scenarios in `.allocation` files.

If you do not need test scenarios any longer, you can also delete them.

Remote command:

Save: `MMEMemory:STORE<n>[:CC<cc>]:DEModsetting` on page 214

Restore: `MMEMemory:LOAD[:CC<cc>]:DEModsetting` on page 213

5.2.3 Configuring MIMO setups

Access: "Overview" > "Signal Description" > "MIMO / CA Setup"

MIMO measurements need a special setup that you can configure with the settings available in the MIMO configuration dialog box.

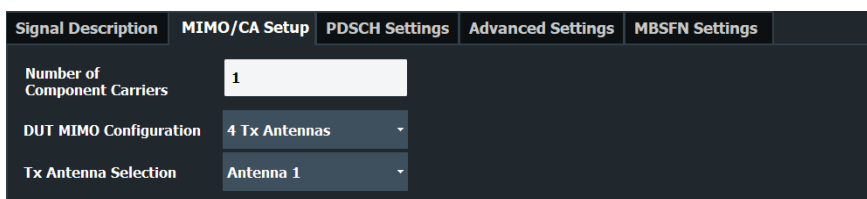

The "Auto LTE Config" feature (available in the "Auto Set" menu) automatically detects the MIMO configuration.



Configuring component carriers

When you are doing measurements on [aggregated carriers](#), you can configure each carrier separately.

When available, each carrier in the dialog boxes is represented by an additional tab labeled "CC<x>", with <x> indicating the number of the component carrier.

Note that the additional tabs are only added to the user interface after you have selected more than "1" component carrier.

Functions in the "MIMO Setup" dialog box described elsewhere:

- "Number Of Component Carrier", see ["Carrier Aggregation"](#) on page 68.

[DUT MIMO Configuration](#).....76
[Tx Antenna Selection](#).....76

DUT MIMO Configuration

The "DUT MIMO Configuration" selects the number of antennas in the system you are analyzing.

The number of antennas corresponds to the number of cell-specific reference signals.

The R&S FSV/A supports measurements on one, two or four antennas.

Remote command:

[CONFigure\[:LTE\]:DL\[:CC<cc>\]:MIMO:CONFig](#) on page 215

Tx Antenna Selection

The "Tx Antenna Selection" selects the antenna(s) you want to analyze. The number of menu items depends on the [number of antennas](#) in the system.

Each antenna corresponds to a cell-specific reference signal.

For automatic detection, the R&S FSV/A analyzes the reference signal to select the antenna. It also determines the order in which the antennas are tested.

Antenna 1	Tests antenna 1 only.
Antenna 2	Tests antenna 2 only.
Antenna 3	Tests antenna 3 only.
Antenna 4	Tests antenna 4 only.
Auto	Analyzes the reference signal to select the correct antenna.

The antenna you have selected is also the reference antenna for [time alignment](#) measurements.

Remote command:

[CONFigure\[:LTE\]:DL\[:CC<cc>\]:MIMO:ASElection](#) on page 215

5.2.4 PDSCH demodulation

Access: "Overview" > "Signal Description" > "PDSCH Settings"

The Physical Layer Shared Channel (PDSCH) carries user data, broadcast system information and paging messages. It is always present in a downlink transmission.

The application allows you to automatically demodulate the PDSCH and detect the subframe configuration of the signal you are testing.

For more information on manual PDSCH configuration, see [Chapter 5.2.5, "PDSCH subframe configuration"](#), on page 78.

ID / N_RNTI	Code Word	Modulation	Enhanced Settings	VRB GAP	Number of RBs	Offset RB	Rho A (Power)/dB	Conflict
0	1/1	256QAM	...	0	2	0	4.4204 dB	
1	1/1	16QAM	...	0	2	5	-8.4859 dB	
2	1/1	64QAM	...	0	1	9	-5.5911 dB	
3	1/1	256QAM	...	0	1	10	4.4204 dB	
4	1/1	16QAM	...	0	1	14	-10.9015 dB	

PDSCH Subframe Configuration Detection	77
Auto PDSCH Demodulation	78

PDSCH Subframe Configuration Detection

Selects the method of identifying the PDSCH resource allocation.

- Off
Uses the user configuration to demodulate the PDSCH subframe. If the user configuration does not match the frame that was measured, a bad EVM will result.
- PDCCH protocol
Sets the PDSCH configuration according to the data in the protocol of the PDCCH DCIs.
When you use this method, the application measures the boosting for each PDCCH it has detected. The result is displayed in the [Channel Decoder Results](#).
- Physical detection
The physical detection is based on power and modulation detection.

Physical detection makes measurements on TDD E-TMs without a 20 ms trigger signal possible.

[More information.](#)

Remote command:

[SENSe:] [LTE:] DL:FORMat:PSCD on page 216

Auto PDSCH Demodulation

Turns automatic demodulation of the PDSCH on and off.

When you turn on this feature, the application automatically detects the PDSCH resource allocation. This is possible by analyzing the protocol information in the PDCCH or by analyzing the physical signal. The application then writes the results into the [PDSCH Configuration Table](#).

You can set the way the application identifies the PDSCH resource allocation with [PDSCH Subframe Configuration Detection](#).

When you turn off automatic demodulation of the PDSCH, you have to configure the PDSCH manually. In that case, the application compares the demodulated LTE frame to the customized configuration. If the "PDSCH Subframe Configuration Detection" is not turned off, the application analyzes the frame only if both configurations are the same.

Remote command:

[SENSe:] [LTE:] DL:DEMod:AUTO on page 216

5.2.5 PDSCH subframe configuration

Access: "Overview" > "Signal Description" > "PDSCH Settings"

The application allows you to configure individual subframes that are used to carry the information of the PDSCH. The PDSCH (Physical Downlink Shared Channel) primarily carries all general user data. It therefore takes up most of the space in a radio frame.

When you turn on "Auto Demodulation", the application automatically determines the subframe configuration for the PDSCH. In the default state, automatic configuration is on (→ [More information](#)).



Configuring component carriers

When you are doing measurements on [aggregated carriers](#), you can configure each carrier separately.

When available, each carrier in the dialog boxes is represented by an additional tab labeled "CC<x>", with <x> indicating the number of the component carrier.

Note that the additional tabs are only added to the user interface after you have selected more than "1" component carrier.

Every LTE frame (FDD and TDD) contains 10 subframes. (In TDD systems, some subframes are used by the uplink, however.) Each downlink subframe consists of one or more (resource) allocations. The application shows the contents for each subframe in the configuration table. In the configuration table, each row corresponds to one allocation.

ID / N_RNTI	Code Word	Modulation	Enhanced Settings	VRB GAP	Number of RBs	Offset RB	Rho A (Power)/dB	Conflict
0	1/1	64QAM	...	0	1	0	4.1708 dB	
1	1/1	64QAM	...	0	1	1	-2.3281 dB	
2	1/1	16QAM	...	0	2	5	-8.4859 dB	
3	1/1	64QAM	...	0	2	9	-3.5142 dB	
4	1/1	16QAM	...	0	1	14	-10.9015 dB	
5	1/1	64QAM	...	0	1	21	-6.0326 dB	
6	1/1	64QAM	...	0	1	30	0.5231 dB	
7	1/1	64QAM	...	0	2	33	-3.0506 dB	
8	1/1	64QAM	...	0	2	35	1.8419 dB	

If there are any errors or conflicts between allocations in one or more subframes, the application shows the corrupt subframe in the "Error in Subframes" field, which appears below the table and is highlighted red if an error occurs. In addition, it shows the conflicting rows of the configuration table. It does not show the kind of error.

ID / N_RNTI	Code Word	Modulation	Enhanced Settings	VRB GAP	Number of RBs	Offset RB	Rho A (Power)/dB	Conflict
0	1/1	64QAM	...	0	1	0	4.1708 dB	Collision : 1
1	1/1	64QAM	...	0	1	0	4.1708 dB	Collision : 0
2	1/1	64QAM	...	0	1	1	4.1708 dB	
3	1/1	QPSK	...	0	1	2	4.1708 dB	
4	1/1	QPSK	...	0	5	4	4.1708 dB	Exceeds BW

Before you start to work on the contents of each subframe, you should define the number of subframes you want to customize with the "Configurable Subframes" parameter. The application supports the configuration of up to 40 subframes.

Then you can select a particular subframe that you want to customize in the "Selected Subframe" field. Enter the number of the subframe (starting with 0). The application updates the contents of the configuration table to the selected subframe.

Remote command:

Number of subframes: `CONFigure[:LTE]:DL[:CC<cc>]:CSUBframes`
on page 217

Number of allocations: `CONFigure[:LTE]:DL[:CC<cc>]:SUBFrame<sf>:`
`ALCount` on page 217

- [PDSCH allocations](#).....79
- [Enhanced settings](#).....82

5.2.5.1 PDSCH allocations

In the default state, each subframe contains one allocation. Add allocations with the "Used Allocations" parameter. The application expands the configuration table accordingly with one row representing one allocation. You can define a different number of allocations for each subframe you want to configure and configure up to 110 allocations in every subframe.

The configuration table contains the settings to configure the allocations.

ID/N_RNTI	80
Code Word	80
Modulation	80
Enhanced Settings	80

VRB Gap.....	81
Number of RB.....	81
Offset RB.....	81
Power.....	81
Conflict.....	82

ID/N_RNTI

Selects the allocation's ID. The ID corresponds to the N_RNTI.

By default, the application assigns consecutive numbers starting with 0.

The ID, or N_RNTI, is the user equipment identifier for the corresponding allocation and is a number in the range from 0 to 65535. The order of the numbers is irrelevant. You can combine allocations by assigning the same number more than once. Combining allocations assigns those allocations to the same user.

Allocations with the same N_RNTI have the same modulation scheme and power settings.

Remote command:

```
CONFigure[:LTE]:DL[:CC<cc>]:SUBFrame<sf>:ALLoc<al>:UEID
on page 222
```

Code Word

Shows the code word of the allocation.

The code word is made up out of two numbers. The first number is the number of the code word in the allocation. The second number is the total number of code words that the allocation contains. Thus, a table entry of "1/2" would mean that the row corresponds to code word 1 out of 2 code words in the allocation.

Usually one allocation corresponds to one code word. In case of measurements on a MIMO system (2 or 4 antennas) in combination with the "Spatial Multiplexing" precoding value, however, you can change the number of layers. Selecting 2 or more layers assigns two code words to the allocation. This results in an expansion of the configuration table. The allocation with the spatial multiplexing then comprises two rows instead of only one. Except for the modulation of the code word, which can be different, the contents of the second code word (row) are the same as the contents of the first code word.

Modulation

Selects the modulation scheme for the corresponding allocation.

The modulation scheme for the PDSCH is either QPSK, 16QAM, 64QAM, 256QAM or 1024QAM.

Remote command:

```
CONFigure[:LTE]:DL[:CC<cc>]:SUBFrame<sf>:ALLoc<al>[:CW<cw>]:
MODulation on page 222
```

Enhanced Settings

Opens a dialog box to configure MIMO functionality.

For more information see [Chapter 5.2.5.2, "Enhanced settings"](#), on page 82.

VRB Gap

Turns the use of virtual resource blocks (VRB) on and off.

The standard defines two types of VRBs. Localized VRBs and distributed VRBs. While localized VRBs have a direct mapping to the PRBs, distributed VRBs result in a better frequency diversity.

Three values of VRB gap are allowed.

- **0** = Localized VRBs are used.
- **1** = Distributed VRBs are used and the first gap is applied.
- **2** = Distributed VRBs are used and the second gap is applied (for channel bandwidths > 50 resource blocks).

The second gap has a smaller size compared to the first gap.

If on, the VRB Gap determines the distribution and mapping of the VRB pairs to the physical resource blocks (PRB) pairs.

The distribution of the VRBs is performed in a way that consecutive VRBs are spread over the frequencies and are not mapped to PRBs whose frequencies are next to each other. Each VRB pair is split into two parts which results in a frequency gap between the two VRB parts. This method corresponds to frequency hopping on a slot basis.

The information whether localized or distributed VRBs are applied is carried in the PDCCH. The DCI formats 1A, 1B and 1D provide a special 1-bit flag for this purpose ("Localized / Distributed VRB Assignment"). Another bit in the DCI formats controls whether the first or second bit is applied.

Remote command:

[CONFigure\[:LTE\]:DL\[:CC<cc>\]:SUBFrame<sf>:ALLoc<al>:GAP](#) on page 217

Number of RB

Defines the number of resource blocks the allocation covers. The number of resource blocks defines the size or bandwidth of the allocation.

If you allocate too many resource blocks compared to the bandwidth you have set, the application shows an error message in the "Conflicts" column and the "Error in Sub-frames" field.

Remote command:

[CONFigure\[:LTE\]:DL\[:CC<cc>\]:SUBFrame<sf>:ALLoc<al>:RBCount](#) on page 221

Offset RB

Sets the resource block at which the allocation begins.

A wrong offset for any allocation would lead to an overlap of allocations. In that case, the application shows an error message.

Remote command:

[CONFigure\[:LTE\]:DL\[:CC<cc>\]:SUBFrame<sf>:ALLoc<al>:RBOffset](#) on page 221

Power

Sets the boosting of the allocation.

Boosting is the allocation's power relative to the reference signal power.

Remote command:

`CONFigure [:LTE] :DL[:CC<cc>] :SUBFrame<sf>:ALLoc<al>:POWer`

on page 218

Conflict

In case of a conflict, the application shows the type of conflict and the ID of the allocations that are affected. Possible conflicts are:

- bandwidth error ("**>BW**")
A bandwidth error occurs when the number of resource blocks in the subframe exceeds the bandwidth you have set.

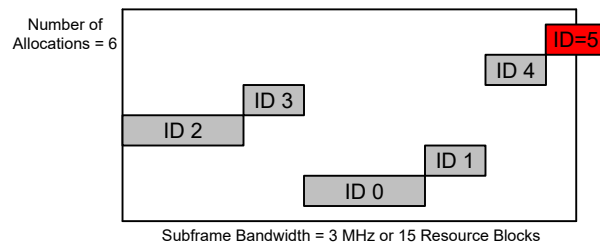

- RB overlap errors
An RB overlap error occurs if one or more allocations overlap. In that case, check if the length and offset values of the allocations are correct.

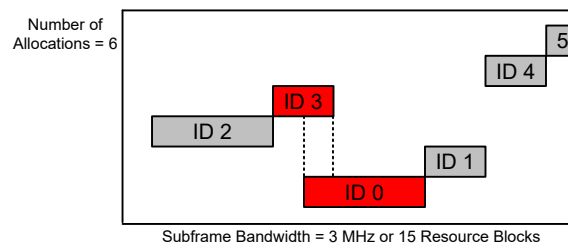

5.2.5.2 Enhanced settings

The "Enhanced Settings" contain mostly functionality to configure the precoding scheme of a physical channel. The application supports several precoding schemes that you can select from a dropdown menu.

In addition, you can configure PDSCH allocations that use carrier aggregation.

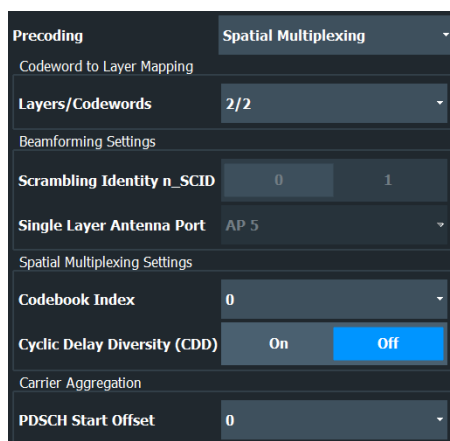

None.....83
 Transmit Diversity.....83
 Spatial Multiplexing.....83
 Beamforming (UE Spec RS).....84
 Carrier Aggregation.....84

None

Turns off precoding.

Remote command:

```
CONFigure[:LTE]:DL[:CC<cc>]:SUBFrame<sf>:ALLoc<al>:PRECoding[:SCHeme] on page 220
```

Transmit Diversity

Turns on precoding for transmit diversity according to 3GPP TS 36.211.

Remote command:

```
CONFigure[:LTE]:DL[:CC<cc>]:SUBFrame<sf>:ALLoc<al>:PRECoding[:SCHeme] on page 220
```

Spatial Multiplexing

Turns on precoding for spatial multiplexing according to 3GPP TS 36.211.

If you are using spatial multiplexing, you can also define the number of layers for any allocation and the codebook index.

The number of layers of an allocation in combination with the number of code words determines the layer mapping. The available number of layers depends on the number of transmission antennas. Thus, the maximum number of layers you can select is eight.

The codebook index determines the precoding matrix. The available number of indices depends on the number of transmission antennas in use. The range is from 0 to 15. The application automatically selects the codebook index if you turn on the "Cyclic Delay Diversity" (CDD).

Remote command:

`CONFigure[:LTE]:DL[:CC<cc>]:SUBFrame<sf>:ALLoc<al>:PRECoding[:SCHeme]` on page 220

`CONFigure[:LTE]:DL[:CC<cc>]:SUBFrame<sf>:ALLoc<al>:PRECoding:CLMapping` on page 219

`CONFigure[:LTE]:DL[:CC<cc>]:SUBFrame<sf>:ALLoc<al>:PRECoding:CBIndex` on page 218

`CONFigure[:LTE]:DL[:CC<cc>]:SUBFrame<sf>:ALLoc<al>:PRECoding:CDD` on page 219

Beamforming (UE Spec RS)

Turns on the precoding for beamforming.

If you are using beamforming, you can also define the number of layers and code-words (see [Spatial Multiplexing](#)), the scrambling identity and the single layer antenna port.

The mapping of antenna port to the physical antenna is fixed:

- Port 5 and 7: Antenna 1
- Port 8: Antenna 2
- Port 9: Antenna 3
- Port 10: Antenna 4

The scrambling identity (n_{SCID}) is available for antenna ports 7 and 8. It is used to initialize the sequence that generates UE specific reference signals according to 36.211 (section 6.10.3.1).

The single layer antenna port selects the preconfigured antenna port in single layer beamforming scenarios. Available if the codeword to layer mapping is "1/1".

Remote command:

`CONFigure[:LTE]:DL[:CC<cc>]:SUBFrame<sf>:ALLoc<al>:PRECoding[:SCHeme]` on page 220

`CONFigure[:LTE]:DL[:CC<cc>]:SUBFrame<sf>:ALLoc<al>:PRECoding:CLMapping` on page 219

`CONFigure[:LTE]:DL[:CC<cc>]:SUBFrame<sf>:ALLoc<al>:PRECoding:SCID` on page 220

`CONFigure[:LTE]:DL[:CC<cc>]:SUBFrame<sf>:ALLoc<al>:PRECoding:AP` on page 218

Carrier Aggregation

Defines the PDSCH start offset for the selected PDSCH allocation in a system that uses carrier aggregation.

For cross-scheduled UEs, the PDSCH start offset for the secondary carrier is usually not defined for each subframe individually but is constant over several subframes. In case the control channel region of the secondary component carrier is longer than the PDSCH start offset you have defined for the primary carrier, PDSCH resource elements might be overwritten by the resource elements of the control channel. Note that the bit stream result displays labels these resource elements with a "#" sign.

Remote command:

`CONFigure[:LTE]:DL[:CC<cc>]:SUBFrame<sf>:ALLoc<al>:PSOffset` on page 221

5.2.6 Synchronization signal configuration

Access: "Overview" > "Signal Description" > "Advanced Settings" > "Synchronization Signal"

The synchronization signal settings contain settings to describe the physical attributes and structure of the synchronization signal.

Signal Description	MIMO/CA Setup	PDSCH Settings	Advanced Settings	MBSFN Settings
Synchronization Signal	P-/S SYNC Tx Antenna	All		
Reference Signal	P-SYNC Rel Power	0.0 dB		
	S-SYNC Rel Power	0.0 dB		
Control Channel				
Enhanced Control Channel				
Shared Channel				



Configuring component carriers

When you are doing measurements on [aggregated carriers](#), you can configure each carrier separately.

When available, each carrier in the dialog boxes is represented by an additional tab labeled "CC<x>", with <x> indicating the number of the component carrier.

Note that the additional tabs are only added to the user interface after you have selected more than "1" component carrier.

P-/S-SYNC Tx Antenna.....	85
P-Sync Relative Power.....	85
S-Sync Relative Power.....	86
Custom Sync Weight.....	86

P-/S-SYNC Tx Antenna

Selects the antenna that transmits the synchronization signal (P-SYNC or S-SYNC).

When selecting the antenna, you implicitly select the synchronization method. If the selected antenna transmits no synchronization signal, the application uses the reference signal to synchronize. Note that automatic cell ID detection is not available if synchronization is based on the reference signal.

Remote command:

`CONFigure[:LTE]:DL[:CC<cc>]:SYNC:ANTenna` on page 223

P-Sync Relative Power

Defines the power of the primary synchronization signal (P-Sync) relative to the reference signal.

Remote command:

`CONFigure[:LTE]:DL[:CC<cc>]:SYNC:PPower` on page 225

S-Sync Relative Power

Defines the power of the secondary synchronization signal (S-Sync) relative to the reference signal.

Remote command:

`CONFigure[:LTE]:DL[:CC<cc>]:SYNC:SPOWer` on page 225

Custom Sync Weight

Turns custom weighting of the (primary and secondary) synchronization signals on and off (for example for beamforming scenarios).

If you turn on custom weights, you can define the weights applied to the first and second half frames. The signal weights are a complex number and are therefore defined by the real and imaginary parts of the signal.

Remote command:

State: `CONFigure[:LTE]:DL[:CC<cc>]:SYNC:CSWeight[:STATe]` on page 225

1st 1/2 frame real: `CONFigure[:LTE]:DL[:CC<cc>]:SYNC:CSWeight:FHFFrame:REAL` on page 224

1st 1/2 frame imaginary: `CONFigure[:LTE]:DL[:CC<cc>]:SYNC:CSWeight:FHFFrame:IMAGinary` on page 223

2nd 1/2 frame real: `CONFigure[:LTE]:DL[:CC<cc>]:SYNC:CSWeight:SHFFrame:REAL` on page 224

2nd 1/2 frame imaginary: `CONFigure[:LTE]:DL[:CC<cc>]:SYNC:CSWeight:SHFFrame:IMAGinary` on page 224

5.2.7 Reference signal configuration

Access: "Overview" > "Signal Description" > "Advanced Settings" > "Reference Signal"

The reference signal settings contain settings to describe the physical attributes and structure of the reference signal.

Signal Description	MIMO/CA Setup	PDSCH Settings	Advanced Settings	MBSFN Settings
Synchronization Signal	Reference Signal			
	Rel Power	0.0 dB		
Reference Signal	Positioning Reference Signal			
	Present	<input checked="" type="checkbox"/> On <input type="checkbox"/> Off	Rel Power	0.0 dB
Control Channel	Bandwidth	1.4MHz(6 RB)	No Subframes(N_PRS)	1
	Configuration Index	0	Frame Number Offset	0
Enhanced Control Channel	CSI Reference Signal			
	Present	<input checked="" type="checkbox"/> On <input type="checkbox"/> Off	Rel Power	0.0 dB
Shared Channel	Antenna Ports	1 Antenna Port	Subframe Configuration	0
	Configuration Index	0	Frame Number Offset	0
	Overwrite PDSCH	<input checked="" type="checkbox"/> On <input type="checkbox"/> Off		



Configuring component carriers

When you are doing measurements on [aggregated carriers](#), you can configure each carrier separately.

When available, each carrier in the dialog boxes is represented by an additional tab labeled "CC<x>", with <x> indicating the number of the component carrier.

Note that the additional tabs are only added to the user interface after you have selected more than "1" component carrier.

[Rel Power \(Reference Signal\)](#).....87

Rel Power (Reference Signal)

Defines the relative power of the reference signal compared to all the other physical signals and physical channels.

Note that this setting gives you an offset to all other relative power settings.

Remote command:

`CONFigure[:LTE]:DL[:CC<cc>]:REFSig:POWer` on page 226

5.2.8 Positioning reference signal configuration

Access: "Overview" > "Signal Description" > "Advanced Settings" > "Reference Signal"

The positioning reference signal settings contain settings to describe the physical attributes and structure of the positioning reference signal.

Signal Description	MIMO/CA Setup	PDSCH Settings	Advanced Settings	MBSFN Settings
Synchronization Signal	Reference Signal			
	Rel Power	0.0 dB		
Reference Signal	Positioning Reference Signal			
	Present	<input checked="" type="checkbox"/> On <input type="checkbox"/> Off	Rel Power	0.0 dB
Control Channel	Bandwidth	1.4MHz(6 RB)	No Subframes(N_PRS)	1
	Configuration Index	0	Frame Number Offset	0
Enhanced Control Channel	CSI Reference Signal			
	Present	<input checked="" type="checkbox"/> On <input type="checkbox"/> Off	Rel Power	0.0 dB
Shared Channel	Antenna Ports	1 Antenna Port	Subframe Configuration	0
	Configuration Index	0	Frame Number Offset	0
	Overwrite PDSCH	<input checked="" type="checkbox"/> On <input type="checkbox"/> Off		



Configuring component carriers

When you are doing measurements on [aggregated carriers](#), you can configure each carrier separately.

When available, each carrier in the dialog boxes is represented by an additional tab labeled "CC<x>", with <x> indicating the number of the component carrier.

Note that the additional tabs are only added to the user interface after you have selected more than "1" component carrier.

Present	88
Bandwidth	88
Configuration Index	88
Num. Subframes (N_PRS)	88
Relative Power (Positioning Reference Signal)	88
Frame Number Offset	88

Present

Turns the positioning reference signal on and off.

Remote command:

[CONFigure\[:LTE\]:DL\[:CC<cc>\]:PRSS:STATE](#) on page 228

Bandwidth

Defines the bandwidth and thus the number of resource blocks the positioning reference signal occupies.

Note that the PRS bandwidth has to be smaller than the channel bandwidth.

Remote command:

[CONFigure\[:LTE\]:DL\[:CC<cc>\]:PRSS:BW](#) on page 226

Configuration Index

Defines the PRS Configuration Index I_{PRS} as defined in 3GPP TS 36.211, table 6.10.4.3-1.

Remote command:

[CONFigure\[:LTE\]:DL\[:CC<cc>\]:PRSS:CI](#) on page 227

Num. Subframes (N_PRS)

Defines the number of consecutive DL subframes in that PRS are transmitted.

Remote command:

[CONFigure\[:LTE\]:DL\[:CC<cc>\]:PRSS:NPRS](#) on page 227

Relative Power (Positioning Reference Signal)

Defines the power of a PRS resource element in relation to the power of a common reference signal resource element.

Remote command:

[CONFigure\[:LTE\]:DL\[:CC<cc>\]:PRSS:POWer](#) on page 227

Frame Number Offset

Defines the system frame number of the current frame that you want to analyze.

Because the positioning reference signal and the CSI reference signal usually have a periodicity of several frames, for some reference signal configurations it is necessary to change the expected system frame number of the frame to be analyzed.

Note that if you define the frame number offset for either reference signal, it is automatically defined for both reference signals.

Remote command:

`CONFigure[:LTE]:DL[:CC<cc>]:SFNO` on page 228

5.2.9 Channel state information reference signal configuration

Access: "Overview" > "Signal Description" > "Advanced Settings" > "Reference Signal"

The channel state information reference signal (CSI-RS) settings contain settings to describe the physical attributes and structure of the Channel State Information Reference Signal (CSI-RS).

CSI-RS are used to estimate the channel properties of the signal propagation channel from the base station to the user equipment. This information is quantized and fed back to the base station. The base station makes use of this information for example to adjust the beamforming parameters.

The mapping of up to four antenna ports to the physical antenna is as follows:

- Port 15: antenna 1
- Port 16: antenna 2
- Port 17: antenna 3
- Port 18: antenna 4

Resource elements used by CSI-RS are shown in yellow color in the Allocation ID versus Symbol X Carrier measurement.

Signal Description	MIMO/CA Setup	PDSCH Settings	Advanced Settings	MBSFN Settings
Synchronization Signal	Reference Signal			
	Rel Power	0.0 dB		
Reference Signal	Positioning Reference Signal			
	Present	<input checked="" type="checkbox"/> On <input type="checkbox"/> Off	Rel Power	0.0 dB
Control Channel	Bandwidth	1.4MHz(6 RB)	No Subframes(N_PRS)	1
Enhanced Control Channel	Configuration Index	0	Frame Number Offset	0
Shared Channel	CSI Reference Signal			
	Present	<input checked="" type="checkbox"/> On <input type="checkbox"/> Off	Rel Power	0.0 dB
	Antenna Ports	1 Antenna Port	Subframe Configuration	0
	Configuration Index	0	Frame Number Offset	0
	Overwrite PDSCH	<input type="checkbox"/> On <input checked="" type="checkbox"/> Off		



Configuring component carriers

When you are doing measurements on [aggregated carriers](#), you can configure each carrier separately.

When available, each carrier in the dialog boxes is represented by an additional tab labeled "CC<x>", with <x> indicating the number of the component carrier.

Note that the additional tabs are only added to the user interface after you have selected more than "1" component carrier.

Present	90
Antenna Ports	90
Configuration Index	90
Overwrite PDSCH	90
Relative Power (CSI Reference Signal)	91
Subframe Configuration	91
Frame Number Offset	91

Present

Turns the CSI reference signal on and off.

Remote command:

[CONFigure\[:LTE\]:DL\[:CC<cc>\]:CSIRs:STATE](#) on page 230

Antenna Ports

Defines the number of antenna ports that transmit the CSI reference signal.

The CSI reference signals are transmitted on one, two, four or eight antenna ports using

- p = 15
- p = 15 to 16
- p = 15 to 18
- p = 15 to 22

Remote command:

[CONFigure\[:LTE\]:DL\[:CC<cc>\]:CSIRs:NAP](#) on page 229

Configuration Index

Defines the CSI reference signal configuration as defined in 3GPP TS 36.211, table 6.10.5.2-1/2

Remote command:

[CONFigure\[:LTE\]:DL\[:CC<cc>\]:CSIRs:CI](#) on page 228

Overwrite PDSCH

Turns overwriting of PDSCH resource elements for UEs that do not consider the CSI reference signal on and off.

If on, the application assumes that the UE is not configured to consider CSI reference signals. Thus, resource elements of the CSI reference signal overwrite the PDSCH resource elements. Note that the bit stream result displays labels these resource elements with a "#" sign.

Remote command:

[CONFigure\[:LTE\]:DL\[:CC<cc>\]:CSIRs:OPDSch](#) on page 229

Relative Power (CSI Reference Signal)

Defines the power of a CSI reference signal resource element in relation to the power of a common reference signal resource element.

Remote command:

[CONFigure\[:LTE\]:DL\[:CC<cc>\]:CSIRs:POWer](#) on page 229

Subframe Configuration

Defines the CSI reference signal subframe configuration index (I_CSI-RS) as defined in 3GPP TS 36.211, table 6.10.5.3-1.

Remote command:

[CONFigure\[:LTE\]:DL\[:CC<cc>\]:CSIRs:SCI](#) on page 230

Frame Number Offset

Defines the system frame number of the current frame that you want to analyze.

Because the positioning reference signal and the CSI reference signal usually have a periodicity of several frames, for some reference signal configurations it is necessary to change the expected system frame number of the frame to be analyzed.

Note that if you define the frame number offset for either reference signal, it is automatically defined for both reference signals.

Remote command:

[CONFigure\[:LTE\]:DL\[:CC<cc>\]:SFNO](#) on page 228

5.2.10 PDSCH resource block symbol offset

Access: "Overview" > "Signal Description" > "Advanced Settings" > "Control Channel"

Signal Description	MIMO/CA Setup	PDSCH Settings	Advanced Settings	MBSFN Settings
Synchronization Signal				
Reference Signal		PRB Symbol Offset (Control Region for PDCCH)	Auto (PCFICH)	
Control Channel	PBCH Present	<input checked="" type="checkbox"/> On <input type="checkbox"/> Off	PBCH Rel Power	0.0 dB
	PCFICH Present	<input checked="" type="checkbox"/> On <input type="checkbox"/> Off	PCFICH Rel Power	0.0 dB
Enhanced Control Channel	PHICH Duration	Normal		
Shared Channel	PHICH N_g	Custom	PHICH No of Groups	0
	PHICH Rel Power	0.0 dB	PDCCH Format	2
	No of PDCCHs	0	PDCCH Rel Power	0.0 dB



Configuring component carriers

When you are doing measurements on [aggregated carriers](#), you can configure each carrier separately.

When available, each carrier in the dialog boxes is represented by an additional tab labeled "CC<x>", with <x> indicating the number of the component carrier.

Note that the additional tabs are only added to the user interface after you have selected more than "1" component carrier.

[PRB Symbol Offset](#)..... 92

PRB Symbol Offset

PRB Symbol Offset specifies the symbol offset of the PDSCH allocations relative to the subframe start. This setting applies to all subframes in a frame.

With this setting, the number of OFDM symbols used for control channels is defined, too. For example, if this parameter is set to "2" and the PDCCH is enabled, the number of OFDM symbols actually used by the PDCCH is "2".

Special control channels like the PCFICH or PHICH require a minimum number of control channel OFDM symbols at the beginning of each subframe. If PRB Symbol Offset is lower than the required value, the control channel data overwrites some resource elements of the PDSCH.

If Auto is selected, the Control Region for PDCCH (PRB Symbol Offset) value is detected from the PCFICH. For correct demodulation of a PCFICH signal conforming to 3GPP, the Scrambling of Coded Bits has to be enabled.

Remote command:

[CONFigure\[:LTE\]:DL\[:CC<cc>\]:PSOffset](#) on page 236

5.2.11 PBCH configuration

Access: "Overview" > "Signal Description" > "Advanced Settings" > "Control Channel"

The physical broadcast channel (PBCH) carries system information for the user equipment. You can include or exclude the PBCH in the test setup and define the relative power of this channel.

Signal Description	MIMO/CA Setup	PDSCH Settings	Advanced Settings	MBSFN Settings
Synchronization Signal	PRB Symbol Offset (Control Region for PDCCH) Auto (PCFICH)			
Reference Signal				
Control Channel	PBCH Present	On	Off	PBCH Rel Power 0.0 dB
	PCFICH Present	On	Off	PCFICH Rel Power 0.0 dB
Enhanced Control Channel	PHICH Duration	Normal		
	PHICH N_g	Custom	PHICH No of Groups	0
Shared Channel	PHICH Rel Power	0.0 dB	PDCCH Format	2
	No of PDCCHs	0	PDCCH Rel Power	0.0 dB



Configuring component carriers

When you are doing measurements on [aggregated carriers](#), you can configure each carrier separately.

When available, each carrier in the dialog boxes is represented by an additional tab labeled "CC<x>", with <x> indicating the number of the component carrier.

Note that the additional tabs are only added to the user interface after you have selected more than "1" component carrier.

PBCH Present	93
PBCH Relative Power	93

PBCH Present

Includes or excludes the PBCH from the test setup.

Remote command:

`CONFigure[:LTE]:DL[:CC<cc>]:PBCH:STAT` on page 232

PBCH Relative Power

Defines the power of the PBCH relative to the reference signal.

Remote command:

`CONFigure[:LTE]:DL[:CC<cc>]:PBCH:POWer` on page 232

5.2.12 PCFICH configuration

Access: "Overview" > "Signal Description" > "Advanced Settings" > "Control Channel"

The physical control format indicator channel (PCFICH) carries information about the format of the PDCCH. You can include or exclude the PCFICH in the test setup and define the relative power of this channel.

Signal Description	MIMO/CA Setup	PDSCH Settings	Advanced Settings	MBSFN Settings
Synchronization Signal				
Reference Signal	PRB Symbol Offset (Control Region for PDCCH)	Auto (PCFICH) ▾		
Control Channel	PBCH Present	<input checked="" type="checkbox"/> On	<input type="checkbox"/> Off	PBCH Rel Power: 0.0 dB
	PCFICH Present	<input checked="" type="checkbox"/> On	<input type="checkbox"/> Off	PCFICH Rel Power: 0.0 dB
Enhanced Control Channel	PHICH Duration	Normal ▾		
Shared Channel	PHICH N_g	Custom ▾		
	PHICH Rel Power	0.0 dB	PHICH No of Groups	0
	No of PDCCHs	0	PDCCH Format	2 ▾
			PDCCH Rel Power	0.0 dB



Configuring component carriers

When you are doing measurements on [aggregated carriers](#), you can configure each carrier separately.

When available, each carrier in the dialog boxes is represented by an additional tab labeled "CC<x>", with <x> indicating the number of the component carrier.

Note that the additional tabs are only added to the user interface after you have selected more than "1" component carrier.

PCFICH Present	94
PCFICH Relative Power	94

PCFICH Present

Includes or excludes the PCFICH from the test setup.

Remote command:

[CONFigure\[:LTE\]:DL\[:CC<cc>\]:PCFich:STAT](#) on page 233

PCFICH Relative Power

Defines the power of the PCFICH relative to the reference signal.

Remote command:

[CONFigure\[:LTE\]:DL\[:CC<cc>\]:PCFich:POWer](#) on page 233

5.2.13 PHICH configuration

Access: "Overview" > "Signal Description" > "Advanced Settings" > "Control Channel"

The physical hybrid ARQ indicator channel (PHICH) contains the hybrid ARQ indicator. The hybrid ARQ indicator contains the acknowledgement / negative acknowledgments for uplink blocks.

You can set several specific parameters for the PHICH.



Turning off the PHICH

If you set the value of the **PHICH N_g** to "Custom" and at the same time define "0" **PHICH groups**, the PHICH is excluded from the signal.

Signal Description	MIMO/CA Setup	PDSCH Settings	Advanced Settings	MBSFN Settings
Synchronization Signal	PRB Symbol Offset (Control Region for PDCCH) Auto (PCFICH)			
Reference Signal				
Control Channel	PBCH Present	On Off	PBCH Rel Power	0.0 dB
	PCFICH Present	On Off	PCFICH Rel Power	0.0 dB
Enhanced Control Channel	PHICH Duration Normal			
Shared Channel	PHICH N _g	Custom	PHICH No of Groups	0
	PHICH Rel Power	0.0 dB	PDCCH Format	2
	No of PDCCHs	0	PDCCH Rel Power	0.0 dB



Configuring component carriers

When you are doing measurements on **aggregated carriers**, you can configure each carrier separately.

When available, each carrier in the dialog boxes is represented by an additional tab labeled "CC<x>", with <x> indicating the number of the component carrier.

Note that the additional tabs are only added to the user interface after you have selected more than "1" component carrier.

PHICH Duration.....	95
PHICH TDD m _i =1 (E-TM).....	96
PHICH N _g	96
PHICH Number of Groups.....	96
PHICH Rel Power.....	96

PHICH Duration

Selects the duration of the PHICH. Normal and extended durations are supported.

With a normal duration, all resource element groups of the PHICH are allocated on the first OFDM symbol.

With an extended duration, the resource element groups of the PHICH are distributed over three OFDM symbols for a normal subframe or over two symbols within a special subframe.

If you select Auto, the duration of PHICH is automatically determined and based on the PBCH decoding results.

Note that you have to turn on the PBCH for an automatic determination of the PHICH duration.

Remote command:

`CONFigure[:LTE]:DL[:CC<cc>]:PHICH:DURation` on page 234

PHICH TDD $m_i=1$ (E-TM)

Turns the special setting of the PHICH for the enhanced test models on and off.

The special setting is defined in 36.141 V9.0.0, 6.1.2.6: "For frame structure type 2 the factor m_i shall not be set as per TS36.211, Table 6.9-1, but instead shall be set to $m_i=1$ for all transmitted subframes".

The parameter is available if you have selected TDD.

Remote command:

[CONFigure\[:LTE\]:DL\[:CC<cc>\]:PHICH:MITM](#) on page 235

PHICH N_g

Defines the variable N_g .

N_g in combination with the number of resource blocks defines the number of PHICH groups in a downlink subframe. The standard specifies several values for N_g that you can select from the dropdown menu.

If you need a customized configuration, you can set the number of PHICH groups in a subframe by selecting the "Custom" menu item and define the number of PHICH groups directly with [PHICH Number of Groups](#).

Remote command:

[CONFigure\[:LTE\]:DL\[:CC<cc>\]:PHICH:NGParameter](#) on page 235

PHICH Number of Groups

Defines the number of PHICH groups in a subframe.

To select the number of groups, you have to set the [PHICH \$N_g\$](#) to "Custom".

Remote command:

[CONFigure\[:LTE\]:DL\[:CC<cc>\]:PHICH:NOGRoups](#) on page 235

PHICH Rel Power

Defines the power of all PHICHs in a PHICH group relative to the reference signal.

The application measures a separate relative power for each PHICH if [Boosting Estimation](#) is on. In that case, the "Rel. Power / dB" result in the Allocation Summary stays empty, because it refers to the common relative power for all PHICHs. The relative powers for each PHICH in the group are displayed in the Channel Decoder Results.

Note that the PHICH power results are quantized to 1 dB steps based on the PHICH relative power, because only a few PHICH symbols are available for boosting estimation.

Example:

The "PHICH Rel Power" is -3.01 dB.

In that case, possible PHICH boostings are -4.01 dB, -3.01 dB, -2.01 dB, etc.

Remote command:

[CONFigure\[:LTE\]:DL\[:CC<cc>\]:PHICH:POWer](#) on page 236

5.2.14 PDCCH configuration

Access: "Overview" > "Signal Description" > "Advanced Settings" > "Control Channel"

The physical downlink control channel (PDCCH) carries the downlink control information (for example the information about the PDSCH resource allocation).

You can define several specific parameters for the PDCCH.

Signal Description	MIMO/CA Setup	PDSCH Settings	Advanced Settings	MBSFN Settings
Synchronization Signal				
Reference Signal	PRB Symbol Offset (Control Region for PDCCH)	Auto (PCFICH) ▾		
Control Channel	PBCH Present	<input checked="" type="checkbox"/> On	<input type="checkbox"/> Off	PBCH Rel Power: 0.0 dB
	PCFICH Present	<input checked="" type="checkbox"/> On	<input type="checkbox"/> Off	PCFICH Rel Power: 0.0 dB
Enhanced Control Channel	PHICH Duration	Normal ▾		
Shared Channel	PHICH N _g	Custom ▾		
	PHICH Rel Power	0.0 dB	PDCCH Format	2 ▾
	No of PDCCHs	0	PDCCH Rel Power	0.0 dB



Configuring component carriers

When you are doing measurements on **aggregated carriers**, you can configure each carrier separately.

When available, each carrier in the dialog boxes is represented by an additional tab labeled "CC<x>", with <x> indicating the number of the component carrier.

Note that the additional tabs are only added to the user interface after you have selected more than "1" component carrier.

PDCCH Format.....	97
Number of PDCCHs.....	97
PDCCH Rel Power.....	98

PDCCH Format

Defines the format of the PDCCH (physical downlink control channel).

Note that PDCCH format "-1" is not defined in the standard. This format corresponds to the transmission of one PDCCH on all available resource element groups. As a special case for this PDCCH format, the center of the constellation diagram is treated as a valid constellation point.

Remote command:

```
CONFigure[:LTE]:DL[:CC<cc>]:PDCCh:FORMat on page 233
```

Number of PDCCHs

Sets the number of physical downlink control channels.

This parameter is available if the PDCCH format is -1.

Remote command:

`CONFigure [:LTE] :DL[:CC<cc>] :PDCCh:NOPD` on page 234

PDCCH Rel Power

Defines the power of the PDCCH relative to the reference signal.

Remote command:

`CONFigure [:LTE] :DL[:CC<cc>] :PDCCh:POWer` on page 234

5.2.15 EPDCCH configuration

Access: "Overview" > "Signal Description" > "Advanced Settings" > "Enhanced Control Channel"

The enhanced physical downlink control channel (EPDCCH) carries the downlink control information. Compared to the PDCCH, the EPDCCH uses resource blocks normally reserved for the PDSCH.



Shared resource blocks of PDSCH and EPDCCH

PDSCH allocations overwrite the EPDCCH if they occupy the same resource blocks.

The EPDCCH is always transmitted in an EPDCCH-PRB set. For each cell and user, you can define one or two EPDCCH-PRB sets. An EPDCCH-PRB set is made up out of two or more resource blocks that are combined logically.

Note that you have to measure one EPDCCH-PRB set at a time. If you have to measure a signal with more than one EPDCCH-PRB set, you have to configure each set separately and refresh the I/Q data for each set.

You can define several parameters for the EPDCCH.

Signal Description	MIMO/CA Setup	PDSCH Settings	Advanced Settings	MBSFN Settings
Synchronization Signal				
Reference Signal	EPDCCH PRB Pairs	Disabled	EPDCCH Set ID	0
	EPDCCH Rel Power	0.0 dB	EPDCCH RB Assign	0
Control Channel	EPDCCH Localized	On	Off	
Enhanced Control Channel				
Shared Channel				



Configuring component carriers

When you are doing measurements on [aggregated carriers](#), you can configure each carrier separately.

When available, each carrier in the dialog boxes is represented by an additional tab labeled "CC<x>", with <x> indicating the number of the component carrier.

Note that the additional tabs are only added to the user interface after you have selected more than "1" component carrier.

EPDCCH PRB Pairs	99
EPDCCH Set ID	99
EPDCCH Rel Power	99
EPDCCH RB Assignment	99
EPDCCH Localized	99

EPDCCH PRB Pairs

Selects the number of resource blocks used in an EPDCCH-PRB set.

If you select the "Disabled" item, the EPDCCH is turned off.

For more information, see 3GPP TS 36.213 ([numberPRBPairs-r11](#)).

Remote command:

[CONFigure\[:LTE\]:DL\[:CC<cc>\]:EPDCch:NPRB](#) on page 231

EPDCCH Set ID

Defines the EPDCCH set ID.

The set ID controls the generation of reference symbols for the EPDCCH. For more information see TS36.211, 6.10.3A.1.

Remote command:

[CONFigure\[:LTE\]:DL\[:CC<cc>\]:EPDCch:SID](#) on page 232

EPDCCH Rel Power

Defines the power of the EPDCCH relative to the reference signal.

Remote command:

[CONFigure\[:LTE\]:DL\[:CC<cc>\]:EPDCch:POWer](#) on page 231

EPDCCH RB Assignment

Defines the location of the resource blocks that the EPDCCH is transmitted in.

For more information, see 3GPP TS 36.213 ([resourceBlockAssignment-r11](#)).

Remote command:

[CONFigure\[:LTE\]:DL\[:CC<cc>\]:EPDCch:RBASsign](#) on page 232

EPDCCH Localized

Turns localized transmission of the EPDCCH on and off.

Localized transmission is useful for known channel conditions. In that case, the scheduling and MIMO precoding can be optimized.

If the channel conditions are unknown, distributed transmission is used. Distributed transmission utilizes the frequency diversity in that the information is distributed over the selected frequency range.

Remote command:

[CONFigure\[:LTE\]:DL\[:CC<cc>\]:EPDCch:LOCalized](#) on page 231

5.2.16 Shared channel configuration

Access: "Overview" > "Signal Description" > "Advanced Settings" > "Shared Channel"

[PDSCH Power Ratio](#)..... 100

PDSCH Power Ratio

Selects the PDSCH P_B parameter that defines the cell-specific ratio of rho_B to rho_A according to 3GPP TS 36.213, table 5.2-1.

The table below shows the resulting values as a function of the number of antennas.

PDSCH P_B	1 Tx antenna	2 and 4 Tx antennas
0	0.000 dB	0.969 dB
1	-0.969 dB	0.000 dB
2	-2.218 dB	-1.249 dB
3	-3.979 dB	-3.010 dB

If you select "p_B/p_A=1", the ratio is always 1, regardless of the number of antennas.

Remote command:

[CONFigure\[:LTE\]:DL\[:CC<cc>\]:PDSCh:PB](#) on page 237

5.2.17 MBSFN characteristics

Access: "Overview" > "Signal Description" > "MBSFN Settings"

The MBSFN settings contain settings to configure Multimedia Broadcast Single Frequency Networks (MBSFNs).

- [MBSFN configuration](#)..... 100
- [MBSFN subframes](#)..... 102

5.2.17.1 MBSFN configuration

The general MBSFN settings contain settings that apply to all subframes that contain MBSFN information.

Signal Description	MIMO/CA Setup	PDSCH Settings	Advanced Settings	MBSFN Settings
Present	<input checked="" type="checkbox"/> On <input type="checkbox"/> Off			
Rel Power	0.0 dB			
Area ID	0			
Non-MBSFN region length	2			



Configuring component carriers

When you are doing measurements on [aggregated carriers](#), you can configure each carrier separately.

When available, each carrier in the dialog boxes is represented by an additional tab labeled "CC<x>", with <x> indicating the number of the component carrier.

Note that the additional tabs are only added to the user interface after you have selected more than "1" component carrier.

Present	101
MBSFN Relative Power	101
Area ID	101
Non-MBSFN Region Length	101

Present

Includes or excludes an MBSFN from the test setup.

Remote command:

[CONFigure\[:LTE\]:DL\[:CC<cc>\]:MBSFn:STATe](#) on page 238

MBSFN Relative Power

Defines the power of the MBSFN transmission relative to the reference signal.

Remote command:

[CONFigure\[:LTE\]:DL\[:CC<cc>\]:MBSFn:POWer](#) on page 238

Area ID

Defines the ID for an MBSFN area.

Radio cells that transmit the same content to multiple users will form a so called MBSFN area. Multiple cells can belong to such an area, and every cell can be part of up to eight MBSFN areas. There could be up to 256 different MBSFN areas defined, each one with an own identity.

The area ID (N_{ID}^{MBSFN}) is defined in 3GPP 36.211.

Remote command:

[CONFigure\[:LTE\]:DL\[:CC<cc>\]:MBSFn:AI:ID](#) on page 237

Non-MBSFN Region Length

Selects the length of the MBSFN control data region at the start of the MBSFN sub-frame.

If you select a region length of '1', the first symbol in an MBSFN subframe carries data of the control channel. All other symbols of an MBSFN region may be used by the PMCH.

If you select a region length of '2', the first two symbols in an MBSFN subframe carry data of the control channel.

Remote command:

[CONFigure\[:LTE\]:DL\[:CC<cc>\]:MBSFn:AI:NMRL](#) on page 237

5.2.17.2 MBSFN subframes

If you are testing systems that support MBSFN, 3GPP allows you to reserve one or more subframes for multimedia broadcasting.

MBSFN Subframe	Active		PMCH Present		Modulation
	On	Off	On	Off	
1	On	Off	On	Off	QPSK
2	On	Off	On	Off	QPSK
3	On	Off	On	Off	QPSK
6	On	Off	On	Off	QPSK
7	On	Off	On	Off	QPSK
8	On	Off	On	Off	QPSK

MBSFN Subframe.....	102
Active.....	102
PMCH Present.....	102
Modulation.....	103

MBSFN Subframe

Shows the subframe number that may contain MBSFN data.

Note that 3GPP only allows to turn selected subframes into MBSFN subframes. Depending on the configuration (for example the TDD configuration), different subframe numbers are available for MBSFN transmissions.

Active

Turns a subframe into an MBSFN subframe.

If active, the corresponding subframe contains MBSFN data.

Remote command:

[CONFigure\[:LTE\]:DL\[:CC<cc>\]:MBSFn:SUBFrame<sf>:STATE](#) on page 239

PMCH Present

Turns the Physical Multicast Channel (PMCH) on and off.

If you turn on the PMCH, the resource elements of the MBSFN subframe are used by the PMCH.

If you turn off the PMCH, the resource elements of the MBSFN subframe may be used by the PDSCH.

Remote command:

[CONFigure\[:LTE\]:DL\[:CC<cc>\]:MBSFn:SUBFrame<sf>:PMCH:STATE](#) on page 239

Modulation

Selects the modulation scheme for the MBSFN subframe.

Remote command:

`CONFigure[:LTE]:DL[:CC<cc>]:MBSFN:SUBFrame<sf>:PMCH:MODulation`

on page 238

5.2.18 Input source configuration

The R&S FSV/A supports several input sources and outputs.

For a comprehensive description of the supported inputs and outputs, refer to the R&S FSV/A user manual.

- [RF input](#).....103
- [External frontends](#).....103
- [I/Q file](#).....104

5.2.18.1 RF input

Access: "Overview" > "Input / Frontend" > "Input Source" > "Radio Frequency"

Functions to configure the RF input described elsewhere:

- ["Input Coupling"](#) on page 109
- ["Impedance"](#) on page 109

[YIG-Preselector](#).....103

YIG-Preselector

Enables or disables the YIG-preselector.

This setting requires an additional option R&S FSV3-B11 on the R&S FSV/A.

An internal YIG-preselector at the input of the R&S FSV/A ensures that image frequencies are rejected. However, image rejection is only possible for a restricted bandwidth. To use the maximum bandwidth for signal analysis, you can disable the YIG-preselector at the input of the R&S FSV/A, which can lead to image-frequency display.

Note: Note that the YIG-preselector is active only on frequencies greater than 7.5 GHz. Therefore, switching the YIG-preselector on or off has no effect if the frequency is below that value.

For frequencies above 50 GHz (requires option R&S FSV3-B54G, for R&S FSVA3050 only), the YIG-preselector is automatically switched off (internally, not indicated in the display). In this case, image frequencies can occur, as specified in the data sheet.

Remote command:

`INPut<ip>:FILTer:YIG[:STATe]` on page 241

5.2.18.2 External frontends

Access: "Overview" > "Input / Frontend" > "Input Source" > "Ext. Frontend"

Controlling external frontends is available with the optional external generator control. The functionality is the same as in the I/Q analyzer application.

For more information about using external frontends, refer to the R&S FSV/A I/Q analyzer user manual.

5.2.18.3 I/Q file

Access: "Overview" > "Input / Frontend" > "Input Source" > "I/Q File"

As an alternative to capturing the measurement (I/Q) data live, you can also load previously recorded I/Q data stored in an `iq.tar` file. The file is then used as the input source for the application.

Available for I/Q based measurements.

For details, see the user manual of the I/Q analyzer.

I/Q Input File State.....	104
Select I/Q data file.....	104
File Repetitions.....	104
Selected Channel.....	105

I/Q Input File State

Enables input from the selected I/Q input file.

If enabled, the application performs measurements on the data from this file. Thus, most measurement settings related to data acquisition (attenuation, center frequency, measurement bandwidth, sample rate) cannot be changed. The measurement time can only be decreased to perform measurements on an extract of the available data only.

Note: Even when the file input is disabled, the input file remains selected and can be enabled again quickly by changing the state.

Remote command:

`INPut<ip>:SElect` on page 241

Select I/Q data file

Opens a file selection dialog box to select an input file that contains I/Q data.

The I/Q data must have a specific format (`.iq.tar`) as described in R&S FSV/A I/Q Analyzer and I/Q Input user manual.

The default storage location for I/Q data files is `C:\R_S\INSTR\USER`.

Remote command:

`INPut:FILE:PATH` on page 240

File Repetitions

Determines how often the data stream is repeatedly copied in the I/Q data memory to create a longer record. If the available memory is not sufficient for the specified number of repetitions, the largest possible number of complete data streams is used.

Remote command:

`TRACe:IQ:FILE:REPetition:COUNT` on page 242

Selected Channel

Only available for files that contain more than one data stream from multiple channels: selects the data stream to be used as input for the currently selected channel.

In "Auto" mode (default), the first data stream in the file is used as input for the channel. Applications that support multiple data streams use the first data stream in the file for the first input stream, the second for the second stream etc.

Remote command:

`MMEMory:LOAD:IQ:STReam` on page 242

`MMEMory:LOAD:IQ:STReam:AUTO` on page 242

`MMEMory:LOAD:IQ:STReam:LIST?` on page 242

5.2.19 Frequency configuration

Access: "Overview" > "Input / Frontend" > "Frequency"

Frequency settings define the frequency characteristics of the signal at the RF input. They are part of the "Frequency" tab of the "Signal Characteristics" dialog box.

The screenshot shows the 'Frequency' configuration dialog box. It has a dark background with white text. The 'Center' field is a text input box containing '851.25 MHz'. Below it, 'Center Frequency Stepsize' is a section header. Underneath, 'Stepsize' is a dropdown menu set to 'Manual', followed by a 'Value' field containing '1.0 MHz'. At the bottom, 'Frequency Offset' is a section header, and the 'Value' field contains '0.0 Hz'.

The remote commands required to configure the frequency are described in [Chapter 7.9.2.3, "Frequency configuration"](#), on page 243.

Signal Frequency.....	105
L Center Frequency.....	105
L Frequency Stepsize.....	106

Signal Frequency

For measurements with an RF input source, you have to match the **center frequency** of the analyzer to the frequency of the signal.

Center Frequency ← Signal Frequency

Defines the center frequency of the signal and thus the frequency the R&S FSV/A tunes to.

The frequency range depends on the hardware configuration of the analyzer you are using.

Remote command:

Center frequency: `[SENSe:]FREQuency:CENTer[:CC<cc>]` on page 243

Frequency offset: `[SENSe:]FREQuency:CENTer[:CC<cc>]:OFFSet` on page 243

Frequency Stepsize ← Signal Frequency

In addition to the frequency itself, you can also define a frequency stepsize. The frequency stepsize defines the extent of a frequency change if you change it, for example with the rotary knob.

You can define the stepsize in two ways.

- = Center
One frequency step corresponds to the current center frequency.
- Manual
Define any stepsize you need.

Remote command:

Frequency stepsize: [SENSE:] FREQUENCY:CENTER:STEP on page 244

5.2.20 Amplitude configuration

Access: "Overview" > "Input / Frontend" > "Amplitude"

Amplitude settings define the expected level characteristics of the signal at the RF input.

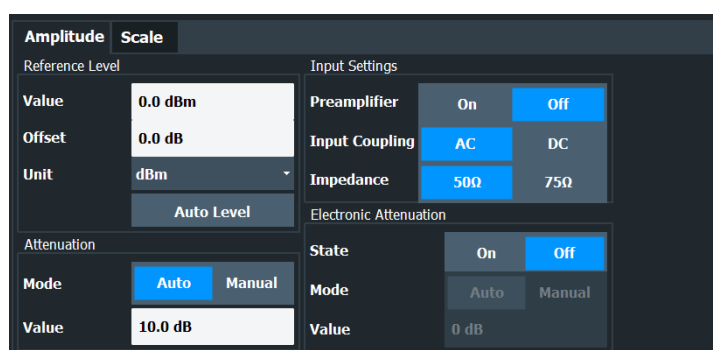

The remote commands required to configure the amplitude are described in [Chapter 7.9.2.4, "Amplitude configuration"](#), on page 245.

Reference Level.....	106
L Auto Level.....	107
L Reference Level Offset.....	107
Attenuating the Signal.....	107
L RF Attenuation.....	108
L Electronic Attenuation.....	108
Preamplifier.....	109
Input Coupling.....	109
Impedance.....	109

Reference Level

The reference level is the power level the analyzer expects at the RF input. Keep in mind that the power level at the RF input is the peak envelope power for signals with a high crest factor like LTE.

To get the best dynamic range, you have to set the reference level as low as possible. At the same time, make sure that the maximum signal level does not exceed the reference level. If it does, it will overload the A/D converter, regardless of the signal power. Measurement results can deteriorate (e.g. EVM), especially for measurements with more than one active channel near the one you are trying to measure (± 6 MHz).

Note that the signal level at the A/D converter can be stronger than the level the application displays, depending on the current resolution bandwidth. This is because the resolution bandwidths are implemented digitally after the A/D converter.

The reference level is a value in dBm.

Remote command:

Reference level: `DISPlay[:WINDow<n>][:SUBWindow<w>]:TRACe<t>:Y[:SCALE]:RLEVel` on page 245

Auto Level ← Reference Level

Automatically determines the ideal reference level. The automatic leveling process measures the signal and defines the ideal reference signal for the measured signal.

Automatic level detection also optimizes RF attenuation.

Auto leveling slightly increases the measurement time, because of the extra leveling measurement prior to each sweep. By default, the R&S FSV/A automatically defines the time for auto leveling, but you can also define it manually (`[Auto Set] > "Auto Level Config" > "Meas Time"`).

The application shows the current reference level (including RF and external attenuation) in the channel bar.

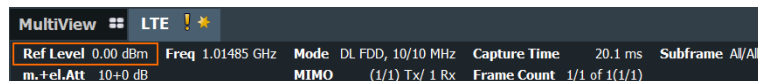

Remote command:

Automatic: `[SENSe:]ADJust:LEVel<ant>` on page 261

Auto level mode: `[SENSe:]ADJust:CONFigure:LEVel:DURation:MODE` on page 260

Auto level time: `[SENSe:]ADJust:CONFigure:LEVel:DURation` on page 260

Reference Level Offset ← Reference Level

The reference level offset is an arithmetic level offset. A level offset is useful if the signal is attenuated or amplified before it is fed into the analyzer. All displayed power level results are shifted by this value. Note however, that the reference value ignores the level offset. Thus, it is still mandatory to define the actual power level that the analyzer has to handle as the reference level.

Remote command:

`DISPlay[:WINDow<n>][:SUBWindow<w>]:TRACe<t>:Y[:SCALE]:RLEVel:OFFSet` on page 245

Attenuating the Signal

Attenuation of the signal becomes necessary if you have to reduce the power of the signal that you have applied. Power reduction is necessary, for example, to prevent an overload of the input mixer.

For a comprehensive information about signal attenuation, refer to the user manual of the R&S FSV/A.

The LTE measurement application provides several attenuation modes.

RF Attenuation ← Attenuating the Signal

Controls the RF (or mechanical) attenuator at the RF input.

If you select automatic signal attenuation, the attenuation level is coupled to the reference level.

If you select manual signal attenuation, you can define an arbitrary attenuation (within the supported value range).

Positive values correspond to signal attenuation and negative values correspond to signal gain.

Note that when you are using an external frontend, you can define attenuation for the analyzer and the external frontend separately. For more information about external frontends, refer to the user manual of the I/Q analyzer.

The application shows the attenuation level (mechanical and electronic) in the channel bar.

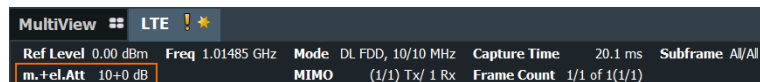

Remote command:

State: `INPut<ip>:ATTenuation<ant>:AUTO` on page 246

Level: `INPut<ip>:ATTenuation<ant>` on page 246

Electronic Attenuation ← Attenuating the Signal

Controls the optional electronic attenuator.

If you select automatic signal attenuation, the attenuation level is coupled to the reference level.

If you select manual signal attenuation, you can define an arbitrary attenuation (within the supported value range).

Positive values correspond to signal attenuation and negative values correspond to signal gain.

Note that the frequency range must not exceed the specification of the electronic attenuator for it to work.

The application shows the attenuation level (mechanical and electronic) in the channel bar.



Remote command:

Electronic attenuation: `INPut<ip>:EATT<ant>:STATE` on page 249

Electronic attenuation: `INPut<ip>:EATT<ant>:AUTO` on page 248

Electronic attenuation: `INPut<ip>:EATT<ant>` on page 248

Preamplifier

If the (optional) internal preamplifier hardware is installed on the R&S FSV/A, a preamplifier can be activated for the RF input signal.

You can use a preamplifier to analyze signals from DUTs with low output power.

For an active external frontend, a preamplifier is not available.

For R&S FSV/A, the following settings are available:

"Off"	Deactivates the preamplifier.
"15 dB"	The RF input signal is amplified by about 15 dB.
"30 dB"	The RF input signal is amplified by about 30 dB.

For R&S FSV/A44 models, the preamplifier is only available under the following conditions:

- In zero span, the maximum center frequency is 43.5 GHz
- For frequency spans, the maximum stop frequency is 43.5 GHz
- For I/Q measurements, the maximum center frequency depends on the analysis bandwidth:

$$f_{center} \leq 43.5 \text{ GHz} - (<Analysis_bw> / 2)$$

If any of the conditions no longer apply after you change a setting, the preamplifier is automatically deactivated.

Using the preamplifier with the order number 1330.3465.02, only 30 dB preamplification is available.

Remote command:

[INPut<ip>:GAIN:STATe](#) on page 247

[INPut<ip>:GAIN\[:VALue\]](#) on page 247

Input Coupling

The RF input of the R&S FSV/A can be coupled by alternating current (AC) or direct current (DC).

For an active external frontend, input coupling is always DC.

AC coupling blocks any DC voltage from the input signal. AC coupling is activated by default to prevent damage to the instrument. Very low frequencies in the input signal can be distorted.

However, some specifications require DC coupling. In this case, you must protect the instrument from damaging DC input voltages manually. For details, refer to the data sheet.

Remote command:

[INPut<ip>:COUPling](#) on page 246

Impedance

For some measurements, the reference impedance for the measured levels of the R&S FSV/A can be set to 50 Ω or 75 Ω.

For an active external frontend, impedance is always 50 Ω.

Select 75 Ω if the 50 Ω input impedance is transformed to a higher impedance using a 75 Ω adapter of the RAZ type. (That corresponds to 25 Ω in series to the input impedance of the instrument.) The correction value in this case is 1.76 dB = 10 log (75 Ω /50 Ω).

This value also affects the unit conversion.

Remote command:

`INPut<ip>:IMPedance` on page 248

5.2.21 Data capture

Access: "Overview" > "Trig / Sig Capture" > "Signal Capture"

The data capture settings contain settings that control the data capture.

The data capture settings are part of the "Signal Capture" tab of the "Trigger/Signal Capture" dialog box.

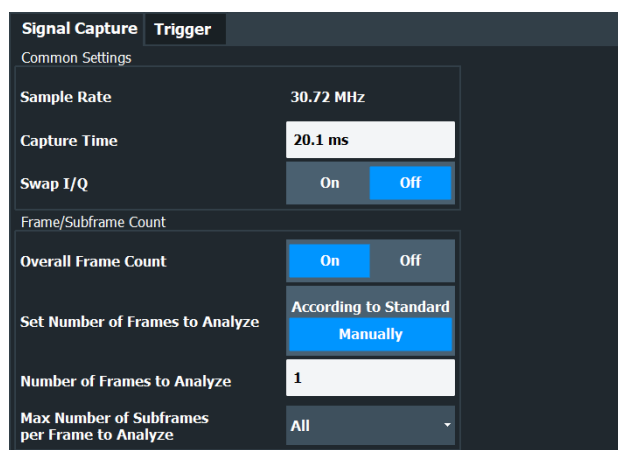

Capture Time.....	110
Swap I/Q.....	111
Overall Frame Count.....	111
Auto According to Standard.....	111
Number of Frames to Analyze.....	111
Maximum Number of Subframes per Frame to Analyze.....	112

Capture Time

The "Capture Time" corresponds to the time of one measurement. Therefore, it defines the amount of data the application captures during a single measurement (or sweep).

By default, the application captures 20.1 ms of data to make sure that at least one complete LTE frame is captured in the measurement.

The application shows the current capture time in the channel bar.

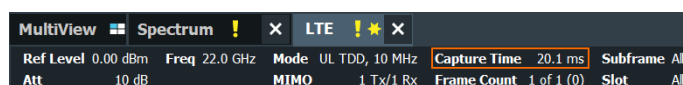

Remote command:

[SENSe:] SWEep:TIME on page 251

Swap I/Q

Swaps the real (I branch) and the imaginary (Q branch) parts of the signal.

Remote command:

[SENSe:] SWAPiQ on page 251

Overall Frame Count

The "Overall Frame Count" turns the manual selection of the number of frames to capture (and analyze) on and off.

When you turn on the overall frame count, you can define the [number of frames to capture and analyze](#). The measurement runs until all frames have been analyzed, even if it takes more than one capture.

The results are an average of the captured frames.

When you turn off the overall frame count, the application analyzes all LTE frames found in one capture buffer.

The overall frame count is always off when you measure component carrier signals.

The application shows the current frame count in the channel bar.

MultiView	Spectrum	LTE					
Ref Level	0.00 dBm	Freq	22.0 GHz	Mode	UL TDD, 10 MHz	Capture Time	20.1 ms
Att	10 dB	MIMO	1 Tx/1 Rx	Frame Count	1 of 1 (0)	Slot	AI

Remote command:

[SENSe:] [LTE:] FRAME:COUNT:STATE on page 250

Auto According to Standard

Turns automatic selection of the number of frames to capture and analyze on and off.

When you turn on this feature, the R&S FSV/A captures and evaluates a number of frames the 3GPP standard specifies for EVM tests.

If you want to analyze an arbitrary number of frames, turn off the feature.

This parameter is not available when the overall frame count is inactive.

Remote command:

[SENSe:] [LTE:] FRAME:COUNT:AUTO on page 250

Number of Frames to Analyze

Defines the number of frames you want to capture and analyze.

If the number of frames you have set last longer than a [single measurement](#), the application continues the measurement until all frames have been captured.

The parameter is read only in the following cases:

- If you turn off the [overall frame count](#).
- If you capture the data [according to the standard](#).

Remote command:

[SENSe:] [LTE:] FRAME:COUNT on page 249

Maximum Number of Subframes per Frame to Analyze

Selects the maximum number of subframes that the application analyzes and therefore improves measurement speed.

Reducing the number of analyzed subframes may become necessary if you define a capture time of less than 20.1 ms. For successful synchronization, all subframes that you want to analyze must be in the capture buffer. You can make sure that this is the case by using, for example, an external frame trigger signal.

For maximum measurement speed, the application turns off [Auto According to Standard](#) and sets the [Number of Frames to Analyze](#) to 1. These settings prevent the application from capturing more than once for a single run measurement.

Remote command:

[SENSe:] [LTE:] FRAMe:SCOunt on page 250

5.2.22 Trigger configuration

Access: "Overview" > "Trig / Sig Capture" > "Trigger"

A trigger allows you to capture those parts of the signal that you are really interested in.

While the application runs freely and analyzes all signal data in its default state, no matter if the signal contains information or not, a trigger initiates a measurement only under certain circumstances (the trigger event).

Except for the available trigger sources, the functionality is the same as that of the R&S FSV/A base system. For MIMO measurements, the application provides additional features to trigger more than one instrument.

For a comprehensive description of the available trigger settings not described here, refer to the documentation of the R&S FSV/A.



Gated measurements

In addition to the general trigger functions, the frequency sweep measurements (for example ACLR) also support gated measurements.

The functionality is basically the same as in the spectrum application. However, the LTE application automatically selects the correct gate settings (delay and length) according to the [TDD configuration](#).

Signal Capture		Trigger	
Trigger Source		Trigger In/Out	
Source	Ext Trigger 1	Drop-Out Time	0.0 s
Level	1.4 V	Slope	<input checked="" type="radio"/> Rising <input type="radio"/> Falling
Offset	0.0 s	Holdoff	0.0 s
Hysteresis	3.0 dB		

Trigger Source..... 113

Trigger Source

The application supports several trigger modes or sources.

- **Free Run**
Starts the measurement immediately and measures continuously.
- **External <x>**
The trigger event is the level of an external trigger signal. The measurement starts when this signal meets or exceeds a specified trigger level at the trigger input. Some measurement devices have several trigger ports. When you use one of these, several external trigger sources are available.
- **I/Q Power**
The trigger event is the magnitude of the sampled I/Q data. The measurement starts when the magnitude of the I/Q data meets or exceeds the trigger level.
- **IF Power**
The trigger event is the level of the intermediate frequency (IF). The measurement starts when the level of the IF meets or exceeds the trigger level.
- **RF Power**
The trigger event is the level measured at the RF input. The measurement starts when the level of the signal meets or exceeds the trigger level.

For all trigger sources, except "Free Run", you can define several trigger characteristics.

- The trigger "Level" defines the signal level that initiates the measurement.
- The trigger "Offset" is the time that must pass between the trigger event and the start of the measurement. This can be a negative value (a pretrigger).
- The trigger "Drop-out Time" defines the time the input signal must stay below the trigger level before triggering again.
- The trigger "Slope" defines whether triggering occurs when the signal rises to the trigger level or falls down to it.
- The trigger "Holdoff" defines a time period that must at least pass between one trigger event and the next.
- The trigger "Hysteresis" is available for the IF power trigger. It defines a distance to the trigger level that the input signal must stay below to fulfill the trigger condition.

For a detailed description of the trigger parameters, see the user manual of the I/Q analyzer.

Remote command:

Source: `TRIGger[:SEquence]:SOURce<ant>` on page 255

Level (external): `TRIGger[:SEquence]:LEVel<ant>[:EXTernal<tp>]`
on page 253

Level (I/Q power): `TRIGger[:SEquence]:LEVel<ant>:IQPower` on page 254

Level (IF power): `TRIGger[:SEquence]:LEVel<ant>:IFPower` on page 253

Level (RF power): `TRIGger[:SEquence]:LEVel<ant>:RFPower` on page 254

Offset: `TRIGger[:SEquence]:HOLDoff<ant>[:TIME]` on page 252

Hysteresis: `TRIGger[:SEquence]:IFPower:HYSteresis` on page 253

Drop-out time: `TRIGger[:SEquence]:DTIME` on page 252

Slope: `TRIGger[:SEquence]:SLOPe` on page 255

Holdoff: `TRIGger[:SEquence]:IFPower:HOLDoff` on page 252

5.2.23 Parameter estimation and tracking

Access: "Overview" > "Estimation / Tracking"

Parameter estimation and tracking provides functionality to estimate various settings based on the measured signal and functionality to compensate for errors in the signal.

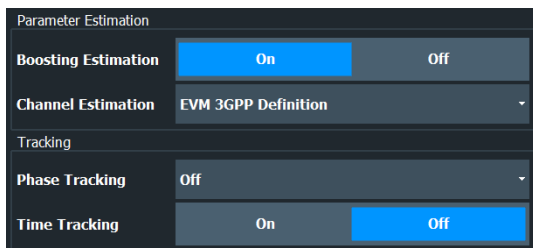

[Boosting Estimation](#)..... 114
[Channel Estimation](#)..... 114
[Phase](#)..... 114
[Time Tracking](#)..... 115

Boosting Estimation

Turns boosting estimation on and off.

Boosting estimation, when you turn it on, automatically sets the relative power settings of all physical channels, the P-Sync and S-Sync by analyzing the signal.

Remote command:

[\[SENSe:\] \[LTE:\] DL:DEMod:BEStimation](#) on page 258

Channel Estimation

Selects the method of channel estimation.

- **EVM 3GPP Definition**
Channel estimation according to 3GPP TS 36.141. This method is based on averaging in frequency direction and linear interpolation. Examines the reference signal only.
- **Optimal, Pilot only**
Optimal channel estimation method. Examines the reference signal only.
- **Optimal, Pilot and Payload**
Optimal channel estimation method. Examines both the reference signal and the payload resource elements.
- **Off**
Turns off channel estimation.

Remote command:

[\[SENSe:\] \[LTE:\] DL:DEMod:CEStimation](#) on page 259

Phase

Turns phase tracking on and off.

When you turn on phase tracking, the application compensates the measurement results for the phase error on a symbol level.

"Off" Phase tracking is not applied.

"Pilot Only"	Only the reference signal is used for the estimation of the phase error.
"Pilot and Payload"	Both reference signal and payload resource elements are used for the estimation of the phase error.

Remote command:

[SENSe:] [LTE:] DL:TRACking:PHASe on page 259

Time Tracking

Turns time tracking on and off.

Clock deviations (slower or faster sampling time) lead to a drift of the ideal sampling instant over time, causing a rotating constellation diagram.

When you turn on time tracking, the application compensates the measurement results for timing errors on a symbol level.

Remote command:

[SENSe:] [LTE:] DL:TRACking:TIME on page 259

5.2.24 Measurement error compensation

Access: "Overview" > "Estimation / Tracking"

The tracking settings contain settings that compensate for various common measurement errors that may occur.

Phase.....	115
Time Tracking.....	115

Phase

Turns phase tracking on and off.

When you turn on phase tracking, the application compensates the measurement results for the phase error on a symbol level.

"Off"	Phase tracking is not applied.
"Pilot Only"	Only the reference signal is used for the estimation of the phase error.
"Pilot and Payload"	Both reference signal and payload resource elements are used for the estimation of the phase error.

Remote command:

[SENSe:] [LTE:] DL:TRACking:PHASe on page 259

Time Tracking

Turns time tracking on and off.

Clock deviations (slower or faster sampling time) lead to a drift of the ideal sampling instant over time, causing a rotating constellation diagram.

When you turn on time tracking, the application compensates the measurement results for timing errors on a symbol level.

Remote command:

[SENSe:] [LTE:] DL:TRACking:TIME on page 259

5.2.25 Demodulation

Access: "Overview" > "Demodulation"

Demodulation settings contain settings that describe signal processing and the way the signal is measured.

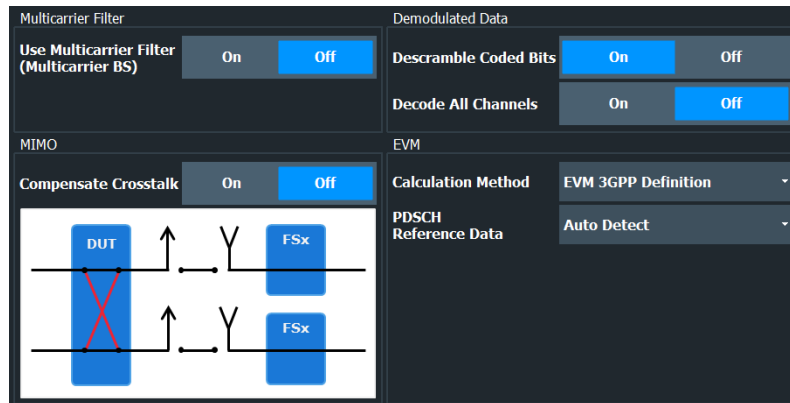

Multicarrier Filter.....	116
Compensate Crosstalk.....	116
Scrambling of Coded Bits.....	117
Decode All Channels.....	117
EVM Calculation Method.....	117
PDSCH Reference Data.....	118
Suppress Interferer for Synchronization.....	118

Multicarrier Filter

Turns the suppression of interference of neighboring carriers for tests on multiradio base stations on and off (e.g. LTE, WCDMA, GSM etc.).

The R&S FSV/A automatically selects the multicarrier filter when you analyze more than 1 component carrier.

Remote command:

`[SENSe:] [LTE:] DL:DEMod:MCFilter` on page 257

Compensate Crosstalk

Turns compensation of crosstalk produced by one of the components in the test setup on and off.

Turn on this feature, if you expect crosstalk from the DUT or another component in the test setup. This can become necessary, for example, for over-the-air measurements.

If you connect the DUT to the analyzer by cable, turn off crosstalk compensation. In that case, the only crosstalk results from the DUT itself and contributes as distortion to the measurement results.

Crosstalk compensation must be activated for Time Alignment Error measurements. For more information, see [Chapter 4.4, "Performing time alignment measurements"](#), on page 59.

Remote command:

`CONFigure[:LTE]:DL[:CC<cc>]:MIMO:CROSstalk` on page 256

Scrambling of Coded Bits

Turns the scrambling of coded bits for all physical channels like PDSCH on and off.

The scrambling of coded bits affects the bitstream results.

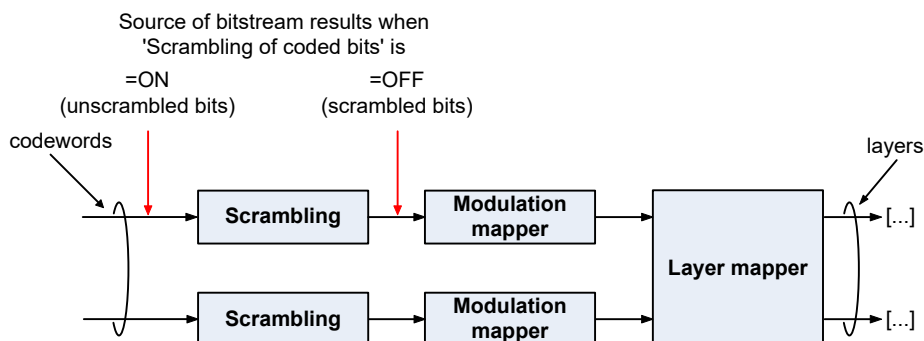

Figure 5-1: Source for bitstream results if scrambling for coded bits is on and off

Remote command:

[\[SENSe:\] \[LTE:\] DL:DEMod:CBScrambling](#) on page 257

Decode All Channels

Turns the decoding of all physical channels on and off.

When you turn on this feature, the application shows the decoding results in the "Channel Decoder Results" result display.

In addition, the application only measures the EPDCCH resource blocks that are actually used.

When you turn off the feature,

- the PBCH is decoded only if the [PHICH Duration](#) or the [PHICH N_g](#) are automatically determined
- the PDCCH is decoded only if the [PDSCH Subframe Configuration Detection](#) is set to PDCCH protocol.

If decoding of all control channels is off, measurement speed will increase.

Remote command:

[\[SENSe:\] \[LTE:\] DL:DEMod:DACHannels](#) on page 257

EVM Calculation Method

Selects the way the EVM is calculated.

"EVM 3GPP Definition" Calculates the EVM according to 3GPP TS 36.141. Evaluates the EVM at two trial timing positions and then uses the higher EVM of the two.

"At Optimal Timing Position" Calculates the EVM using the optimal timing position.

Remote command:

[\[SENSe:\] \[LTE:\] DL:DEMod:EVMCalc](#) on page 257

PDSCH Reference Data

Selects the type of reference data to calculate the EVM for the PDSCH.

By default, the R&S FSV/A automatically detects the PDSCH reference values and maps the measured values to the nearest reference point.

"Auto Detect"	Automatically detects the PDSCH reference values.
"All 0"	Assumes the PDSCH to be all 0's, according to test model definitions.
"ORAN PN23"	Assumes the PDSCH to be based on the pseudo random sequence 23, as defined by the ORAN alliance. Note that this type of reference data is automatically selected when you select an ORAN test case. The R&S FSV/A assumes that the measured signal actually contains the corresponding ORAN PN23 sequence. For this option, each PDSCH has an individual sequence.
"ORAN PN23 All Slots"	Assumes the PDSCH to be based on the pseudo random sequence 23, as defined by the ORAN alliance. Note that this type of reference data is automatically selected when you select an ORAN test case. The R&S FSV/A assumes that the measured signal actually contains the corresponding ORAN PN23 sequence. For this option, all PDSCH / PDCCH have the same sequence.

Remote command:

[\[SENSe:\] \[LTE:\] DL:DEMod:PRData](#) on page 258

Suppress Interferer for Synchronization

Turns the suppression of 5G resources with a 30 kHz subcarrier spacing in signals that use dynamic spectrum sharing on and off.

Measuring LTE signals that contain 5G resources with 30 kHz subcarrier spacing can cause synchronization to fail. Turn on this setting to synchronize such signals successfully.

Remote command:

[\[SENSe:\] \[LTE:\] DL:DEMod:SISync](#) on page 258

5.2.26 Automatic configuration

Access: [AUTO SET]

The R&S FSV/A features several automatic configuration routines. When you use one of those, the R&S FSV/A configures different parameters based on the signal that you are measuring.

Auto leveling

You can use the auto leveling routine for a quick determination of preliminary amplitude settings for the current LTE input signal.

Remote command:

[\[SENSe:\] ADJust:LEVel<ant>](#) on page 261

Auto LTE

Determines various signal characteristics, and configures the application accordingly.

- [Channel bandwidth](#)
- [MIMO configuration](#)

Remote command:

`[SENSe:]ADJust:CONFigure:LTE` on page 261

Auto Scaling

Scales the y-axis for best viewing results. Also see "[Automatic scaling of the y-axis](#)" on page 127.

Remote command:

`DISPlay[:WINDow<n>] [:SUBWindow<w>]:TRACe<t>:Y[:SCALE]:AUTO`
on page 274

5.3 Time Alignment Error Measurements

Most settings supported by time alignment error measurements are the same as those for I/Q measurements. For a comprehensive description of those, refer to the following chapters.

- [Chapter 5.2.1, "Signal characteristics"](#), on page 67
- [Chapter 5.2.6, "Synchronization signal configuration"](#), on page 85
(note that the time alignment error measurement does not support all synchronization signal settings)
- [Chapter 5.2.18, "Input source configuration"](#), on page 103
- [Chapter 5.2.19, "Frequency configuration"](#), on page 105
- [Chapter 5.2.20, "Amplitude configuration"](#), on page 106
- [Chapter 5.2.21, "Data capture"](#), on page 110
- [Chapter 5.2.22, "Trigger configuration"](#), on page 112
- [Chapter 5.2.25, "Demodulation"](#), on page 116

For more information about configuring component carriers in the time alignment error measurement see [Carrier Aggregation](#).

5.4 On / Off Power Measurements

Several settings supported by on / off power measurements are the same as those for I/Q measurements. For a comprehensive description of those, refer to the following chapters.

- [Chapter 5.2.1, "Signal characteristics"](#), on page 67
- [Chapter 5.2.6, "Synchronization signal configuration"](#), on page 85
(Note that the on / off power measurement does not support all synchronization signal settings.)
- [Chapter 5.2.18, "Input source configuration"](#), on page 103
- [Chapter 5.2.19, "Frequency configuration"](#), on page 105

- [Chapter 5.2.20, "Amplitude configuration"](#), on page 106
- [Chapter 5.2.21, "Data capture"](#), on page 110
- [Chapter 5.2.22, "Trigger configuration"](#), on page 112

The application also provides several settings that are exclusive to Power On / Off measurements.

For more information about configuring component carriers in the on / off power measurement see [Carrier Aggregation](#).

Number of Frames	120
Noise Correction	120

Number of Frames

Defines the number of frames that are averaged to calculate a reliable power trace for On/Off Power measurements.

Remote command:

[CONFigure\[:LTE\]:OOPower:NFRames](#) on page 263

Noise Correction

Turns noise correction for on / off power measurements on and off.

For more information see the manual of the R&S FSV/A.

Remote command:

[\[SENSe:\] \[LTE:\]OOPower:NCORrection](#) on page 263

5.5 Frequency Sweep Measurements

After starting one of the frequency sweep measurements, the application automatically loads the configuration required by measurements according to the 3GPP standard: the spectral mask as defined in the 3GPP standard for SEM measurements and the channel configuration defined in the standard for the ACLR measurement.

If you need a different measurement configuration, you can change all parameters as required. Except for the dialog box described below, the measurement configuration menus for the frequency sweep measurements are the same as in the Spectrum application.

Please refer to the User Manual of the R&S FSV/A for a detailed description on how to configure ACLR and SEM measurements.

• ACLR Signal Description	120
• SEM and Multi-Carrier SEM Signal Description	121
• Cumulative ACLR	123
• MC ACLR	123

5.5.1 ACLR Signal Description

Access: [MEAS CONFIG] > "Signal Description"

The signal description for ACLR measurements contains settings to describe general physical characteristics of the signal you are measuring.

Functions in the "Signal Description" dialog box described elsewhere:

- [LTE mode](#)
- [Test Model](#)
- [Channel bandwidth](#)

All other settings available for the ACLR measurement are the same as in the spectrum application. For more information, refer to the user manual of the R&S FSV/A.

[Assumed Adjacent Channel Carrier](#)..... 121

Assumed Adjacent Channel Carrier

Selects the assumed adjacent channel carrier for the ACLR measurement.

The supported types are EUTRA of same bandwidth, 1.28 Mcps UTRA, 3.84 Mcps UTRA and 7.68 Mcps UTRA.

Note that not all combinations of LTE channel bandwidth settings and assumed adjacent channel carrier settings are defined in the 3GPP standard.

Remote command:

[\[SENSe:\] POWER:ACHannel:AACHannel](#) on page 264

5.5.2 SEM and Multi-Carrier SEM Signal Description

Access: [MEAS CONFIG] > "Signal Description"

The signal description for SEM measurements contains settings to describe general physical characteristics of the signal you are measuring.

Functions in the "Signal Description" dialog box described elsewhere:

- [LTE mode](#)
- [Test Model](#)
- [Channel bandwidth](#)
- [Cyclic prefix](#)
- [TDD configuration](#)
- [Component carriers](#)
(Multi-SEM only)

All other settings available for the SEM measurement are the same as in the spectrum application. For more information, refer to the user manual of the R&S FSV/A.

[Category](#)..... 121
[Aggregated Maximum Power Of All TX Ports \(P\)](#)..... 122
[Tx Power](#)..... 122

Category

Selects the type and category and option of the limit definitions for SEM measurements.

The software supports limit definitions for the following types of base stations:

- Wide areas base stations (category A and B)
- Local area base stations
- Home base stations
- Medium range base stations

Categories A and B are defined in ITU-R recommendation SM.329. For category B operating band unwanted emissions, there are two options for the limits that can be applied regionally (Opt1 and Opt2).

The type and category you should use for the measurement depends on the category and option that the base station you are testing supports.

For home area base stations, you can define an additional [Aggregated Maximum Power Of All TX Ports \(P\)](#) for all antenna ports of a home area base station. The aggregated maximum power is the aggregated power of all antenna ports and defines the shape of the SEM.

For medium range base station, you can automatically measure or manually enter the power of the carrier [Tx Power](#).

If you want to check against limits not covered by the "Category", turn on "Check Additional Operating Band Limit". The "Category" feature will be greyed out. Instead, you can select an "Operating Band" for which limits are defined. The R&S FSV/A then tests against the limits defined in 3GPP 36.141 for the corresponding operating band.

Remote command:

[\[SENSe:\] POWER:SEM:CATegory](#) on page 266

Home BS power: [\[SENSe:\] POWER:SEM:CHBS:AMPower](#) on page 266

Medium BS power mode: [\[SENSe:\] POWER:SEM:CHBS:AMPower:AUTO](#) on page 267

Medium BS power value: [\[SENSe:\] POWER:SEM:CHBS:AMPower](#) on page 266

Operating band limit: [\[SENSe:\] POWER:SEM:OBAND:STATE](#) on page 267

Operating band selection: [\[SENSe:\] POWER:SEM:OBAND](#) on page 267

Aggregated Maximum Power Of All TX Ports (P)

Defines the aggregated maximum power of all TX ports of home base stations. The aggregate maximum power is required to calculate limit line values for SEM measurements on home base stations.

The parameter is available only if you have selected [SEM Category](#) "Home".

Remote command:

[\[SENSe:\] POWER:SEM:CHBS:AMPower](#) on page 266

Tx Power

Defines the Tx channel power for medium range base stations. The selected channel power has an effect on the shape of the SEM limit line.

You can define the channel power either manually or automatically. For automatic detection, the R&S FSV/A measures the power of the transmission channel.

Remote command:

State: [\[SENSe:\] POWER:SEM:CHBS:AMPower:AUTO](#) on page 267

Power: [\[SENSe:\] POWER:SEM:CHBS:AMPower](#) on page 266

5.5.3 Cumulative ACLR

Access: "Overview" > "Signal Description" > "Physical Settings CC<x>" / "Carrier Configuration"

You can configure the characteristics of the carriers in the "Carrier Configuration" tab.

Note: the "Carrier Configuration" button in the "Physical Settings" tab also opens the "Carrier Configuration" tab.

The signal description for cumulative ACLR measurements contains settings to describe general physical characteristics of the signal you are measuring.

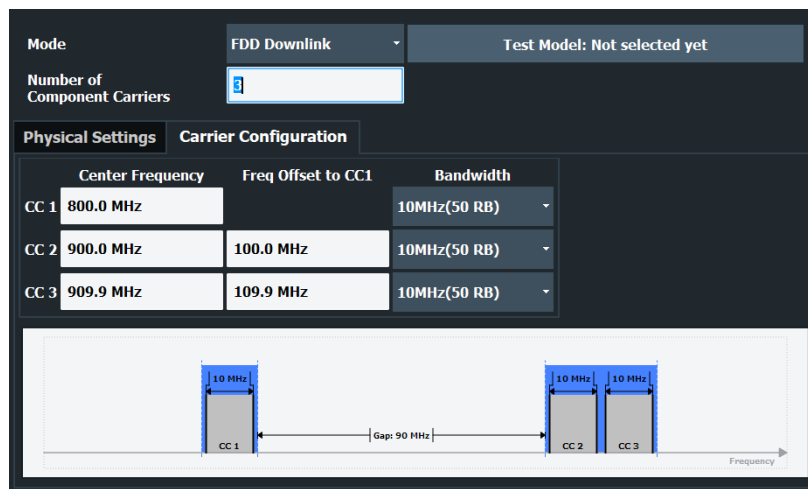

Functions in the "Signal Description" dialog box described elsewhere:

- [LTE mode](#)
- [Test Model](#)
- [Channel bandwidth](#)
- [Cyclic prefix](#)
- [TDD configuration](#)
- [Component carriers](#)

5.5.4 MC ACLR

Access: "Overview" > "Signal Description" > "Physical Settings CC<x>" / "Carrier Configuration"

You can configure the characteristics of the carriers in the "Carrier Configuration" tab.

Note: the "Carrier Configuration" button in the "Physical Settings" tab also opens the "Carrier Configuration" tab.

The signal description for Multi Carrier (MC) ACLR measurements contains settings to describe general physical characteristics of the signal you are measuring.

Mode: TDD Downlink | Test Model: Not selected yet

Number of Component Carriers: 2

Physical Settings | Carrier Configuration

	Center Frequency	Freq Offset to CC1	Bandwidth	Lower	Upper
CC 1	800.0 MHz		5MHz(25 RB)	E-UTRA of same BW	
CC 2	900.0 MHz	100.0 MHz	10MHz(50 RB)	E-UTRA of same BW	E-UTRA of same BW

Frequency diagram showing CC 1 (5 MHz) and CC 2 (10 MHz) with a Gap of 92.5 MHz.

Functions in the "Signal Description" dialog box described elsewhere:

- [LTE mode](#)
- [Test Model](#)
- [Channel bandwidth](#)
- [Cyclic prefix](#)
- [TDD configuration](#)
- [Component carriers](#)

6 Analysis

The R&S FSV/A provides various tools to analyze the measurement results.

- [General analysis tools](#)..... 125
- [Analysis tools for I/Q measurements](#)..... 128
- [Analysis tools for frequency sweep measurements](#)..... 133

6.1 General analysis tools

The general analysis tools are tools available for all measurements.

- [Data export](#)..... 125
- [Microservice export](#)..... 126
- [Diagram scale](#)..... 126
- [Zoom](#)..... 127
- [Markers](#)..... 127

6.1.1 Data export

Access: [TRACE] > "Trace Export Config"

You can export the measurement results to an ASCII file, for example to backup the results or analyze the results with external applications (for example in a Microsoft Excel spreadsheet).

You can also export the I/Q data itself, for example if you want to keep it for later reevaluation.

The data export is available for:

- I/Q measurements
- Time alignment error measurements
- Transmit power on / off measurements

Exporting trace data

1. Select the "Trace Export Config" dialog box via the [TRACE] key.
2. Select the data you would like to export.
3. Select the results you would like to export from the "Specifics For" dropdown menu.
4. Export the data with the "Export Trace to ASCII File" feature.
5. Select the location where you would like to save the data (as a `.dat` file).

Note that the measurement data stored in the file depend on the selected result display ("Specifics For" selection).

Exporting I/Q data

1. Select the disk icon in the toolbar.
2. Select "Export" > "I/Q Export".
3. Define a file name and location for the I/Q data.
The file type is `iq.tar`.
4. Later on, you can import the I/Q data using the [I/Q file input source](#).

Data import and export

The basic principle for both trace export and I/Q data export and import is the same as in the spectrum application. For a comprehensive description, refer to the R&S FSV/A user manual.

Remote command:

Trace export: `TRACe<n>[:DATA]?` on page 174

I/Q export: `MMEMory:STORe<n>:IQ:STATe` on page 206

I/Q import: `INPut:FILE:PATH` on page 240

6.1.2 Microservice export

Access:  /  > "Export" > "Microservice Export"

In addition to [exporting the signal configuration](#) locally, you can export the signal configuration in a file format compatible to the cloud-based microservice (`.m5g` file extension).

For a comprehensive description of the microservice, refer to the microservice user manual.

Remote command:

`MMEMory:STORe<n>:MSERvice` on page 270

6.1.3 Diagram scale

Access: "Overview" > "Analysis" > "Scale"

You can change the scale of the y-axis in various diagrams. The y-axis scale determines the vertical resolution of the measurement results.

The scale of the x-axis in the diagrams is fix. If you want to get a better resolution of the x-axis, you have to [zoom](#) into the diagram.

The remote commands required to configure the y-axis scale are described in [Chapter 7.10.4, "Y-axis scale"](#), on page 274.

Manual scaling of the y-axis	126
Automatic scaling of the y-axis	127

Manual scaling of the y-axis

The "Y Minimum" and "Y Maximum" properties define a custom scale of the y-axis.

The "Y Minimum" corresponds to the value at the origin. The "Y Maximum" corresponds to the last value on the y-axis. The scale you select applies to the currently active window.

You can restore the original scale anytime with the "Restore Scale" button.

Remote command:

`DISPlay[:WINDow<n>][:SUBWindow<w>]:TRACe<t>:Y[:SCALe]:MAXimum`
on page 275

`DISPlay[:WINDow<n>][:SUBWindow<w>]:TRACe<t>:Y[:SCALe]:MINimum`
on page 275

Automatic scaling of the y-axis

Usually, the best way to view the results is if they fit ideally in the diagram area and display the complete trace. The "Auto Scale Once" automatically determines the scale of the y-axis that fits this criteria in the currently active window.

Tip: You can also scale the windows in the "Auto Set" menu. In addition to scaling the selected window ("Auto Scale Window"), you can change the scale of all windows at the same time ("Auto Scale All").

You can restore the original scale anytime with the "Restore Scale" button.

Remote command:



`DISPlay[:WINDow<n>][:SUBWindow<w>]:TRACe<t>:Y[:SCALe]:AUTO`
on page 274

6.1.4 Zoom

The zoom feature allows you to zoom into any graphical result display. This can be a useful tool if you want to analyze certain parts of a diagram in more detail.

The zoom functionality is the same as in the spectrum application.

The following zoom functions are supported.

- : Magnifies the selected diagram area.
- : Magnifies the selected diagram area, but keeps the original diagram in a separate window.
- : Restores the original diagram.

Note that the zoom is a graphical feature that magnifies the data in the capture buffer. Zooming into the diagram does not reevaluate the I/Q data.

For a comprehensive description of the zoom, refer to the R&S FSV/A user manual.

6.1.5 Markers

Access: "Overview" > "Analysis" > "Marker"

Markers are a tool that help you to identify measurement results at specific trace points. When you turn on a marker, it gives you the coordinates of its position, for example the frequency and its level value or the symbol and its EVM value.

In general, the marker functionality of setting and positioning markers is similar to the spectrum application.

For I/Q measurement, the R&S FSV/A supports up to four markers, for frequency sweep measurements there are more. Markers give either absolute values (normal markers) or values relative to the first marker (deltamarkers). If a result display has more than one trace, for example the "EVM vs Symbol" result display, you can position the marker on either trace. By default, all markers are positioned on trace 1.

Note that if you analyze more than one bandwidth part, each bandwidth part is represented by a different trace.

The R&S FSV/A also supports several automatic positioning mechanisms that allow you to move the marker to the maximum trace value (peak), the minimum trace value or move it from peak to subsequent peak.

The [marker table](#) summarizes the marker characteristics.

For a comprehensive description, refer to the R&S FSV/A user manual.

Markers in result displays with a third quantity

In result displays that show a third quantity, for example the "EVM vs Symbol x Carrier" result, the R&S FSV/A provides an extended marker functionality.

You can position the marker on a specific resource element, whose position is defined by the following coordinates:

- The "Symbol" input field selects the symbol.
- The "Carrier" input field selects the carrier.

Alternatively, you can define the marker position in the "Marker Configuration" dialog box, which is expanded accordingly.

The marker information shows the EVM, the power and the allocation ID of the resource element you have selected as the marker position.

6.2 Analysis tools for I/Q measurements

- [Layout of numerical results](#)..... 128
- [Evaluation range](#)..... 129
- [Result settings](#)..... 132

6.2.1 Layout of numerical results

You can customize the displayed information of some numerical result displays or tables, for example the [allocation summary](#).

- ▶ Select some point in the header row of the table.

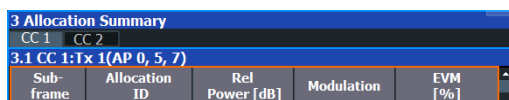

The application opens a dialog box to add or remove columns.

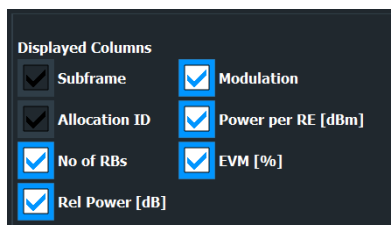

Add and remove columns as required.

6.2.2 Evaluation range

Access (general): "Overview" > "Evaluation Range" > "Global / Constellation"

Access (beamforming): "Overview" > "Evaluation Range" > "Beamforming"

The evaluation range defines the signal parts that are considered during signal analysis.

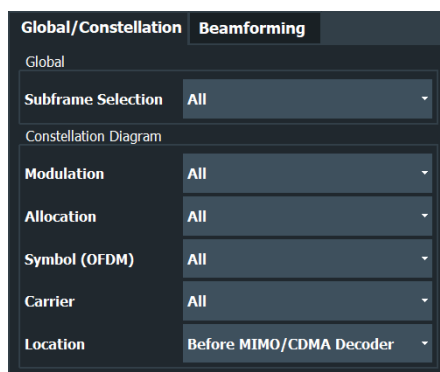

Configuring component carriers

When you are doing measurements on [aggregated carriers](#), you can configure each carrier separately.

When available, each carrier in the dialog boxes is represented by an additional tab labeled "CC<x>", with <x> indicating the number of the component carrier.

Note that the additional tabs are only added to the user interface after you have selected more than "1" component carrier.

Subframe Selection	130
Evaluation range for the constellation diagram	130
Beamforming Selection	131

Subframe Selection

The "Subframe" selection filters the results by a specific subframe number.

If you apply the filter, only the results for the subframe you have selected are displayed. Otherwise, the R&S FSV/A shows the results for all subframes that have been analyzed.

The R&S FSV/A shows three traces if you display the results for all subframes.

- One trace ("Min") shows the minimum values measured over all analyzed subframes.
- One trace ("Max") shows the maximum values measured over all analyzed subframes.
- One trace ("Avg") shows the average values measured over all subframes.

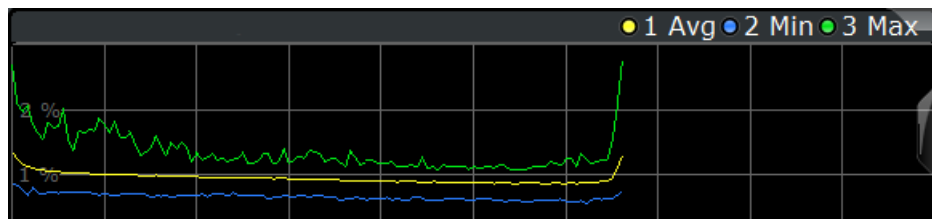

If you filter by a single subframe, the R&S FSV/A shows one trace that represents the values measured for that subframe only.

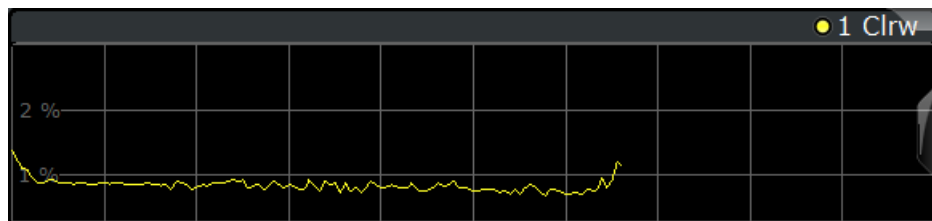

You can apply the filter to the following result displays.

- Result Summary
- EVM vs Carrier / EVM vs Symbol / EVM vs Symbol X Carrier
- Channel Flatness / Channel Flatness Difference
- Group Delay
- Power vs Symbol X Carrier
- Constellation Diagram
- Allocation Summary
- Bit Stream
- Time Alignment Error

Remote command:

`[SENSe:] [LTE:] [CC<cc>:] SUBFrame:SElect` on page 273

Evaluation range for the constellation diagram

The "Evaluation Range" for the constellation diagram selects the information displayed in the [constellation diagram](#).

By default, the constellation diagram contains the constellation points of the complete data that has been analyzed. However, you can filter the results by several aspects.

- Modulation
Filters the results by the selected type of modulation.

- Allocation
Filters the results by a certain type of allocation.
- Symbol (OFDM)
Filters the results by a certain OFDM symbol.
Filtering by OFDM symbols is available for constellations created before MIMO decoding.
- Carrier
Filters the results by a certain subcarrier.
Filtering by carrier is available for constellations created before MIMO decoding.
- Symbol (code word)
Filters the results by a certain codeword symbol.
Filtering by codeword symbols is available for constellations created after MIMO decoding.
- Codeword
Filters the results by a certain codeword.
Filtering by codeword is available for constellations created after MIMO decoding.
- Location
Selects the point in the signal processing at which the constellation diagram is created, before or after the MIMO encoding.
For spatial multiplexing, symbols of different encoding schemes are merged in the MIMO encoder. Thus you get a mix of different modulation alphabets. When you filter these symbols to show a modulation "MIXTURE", you get the mixed symbols only if you have selected the "Before MIMO/CDMA Decoder" option.
Note that the PHICH is CDMA encoded. Thus, the constellation points for the PHICH are either created before or after CDMA encoding.
If you have selected "After MIMO/CDMA Decoder", filtering by "Symbol" and "Carrier" is not available. Instead, you can filter by "Symbol" and "Codeword".

Remote command:

Modulation: `[SENSe:] [LTE:] [CC<cc>:]MODulation:SElect` on page 273

Allocation: `[SENSe:] [LTE:] [CC<cc>:]ALLocation:SElect` on page 272

Symbol: `[SENSe:] [LTE:] [CC<cc>:]SYMBOL:SElect` on page 274

Carrier: `[SENSe:] [LTE:] [CC<cc>:]CARRier:SElect` on page 272

Location: `[SENSe:] [LTE:] [CC<cc>:]LOCation:SElect` on page 273

Beamforming Selection

Filters the displayed results to include only certain antenna port(s).

The availability of antenna ports depends on the number of transmission antennas and the number of beamforming layers you are testing.

In addition, you can select the antenna port for each type of reference signal separately (UE reference signal, cell reference signal and CSI reference signal).

Remote command:

Cell RS: `CONFigure[:LTE]:DL[:CC<cc>]:BF:AP:CELL` on page 270

UE RS: `CONFigure[:LTE]:DL[:CC<cc>]:BF:AP[:UERS]` on page 271

CSI RS: `CONFigure[:LTE]:DL[:CC<cc>]:BF:AP:CSI` on page 271

6.2.3 Result settings

Access: "Overview" > "Analysis" > "Result Settings"

Result settings define the way certain measurement results are displayed.

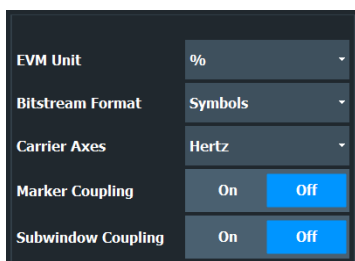

EVM Unit..... 132
 Bit Stream Format..... 132
 Carrier Axes..... 133
 Marker Coupling..... 133
 Subwindow Coupling..... 133

EVM Unit

The "EVM Unit" selects the unit for the EVM measurement results in diagrams and numerical result displays.

Possible units are dB and %.

Remote command:

`UNIT: EVM` on page 277

Bit Stream Format

Selects the way the bit stream is displayed.

The bit stream is either a stream of raw bits or of symbols. In case of the symbol format, the bits that belong to a symbol are shown as hexadecimal numbers with two digits.

Example:

Subframe(s)	ALL	Bit Stream
Sub- Allocation	Code- Modulation	Symbol Index
frame ID	word	
0 PBCH 1/1	QPSK	0 02 00 00 00 01 00 00 02 00 03 00 00 02 01 03 00
0 PBCH 1/1	QPSK	16 02 02 02 03 00 00 03 01 03 02 02 01 02 03 02 01
0 PBCH 1/1	QPSK	32 00 01 01 00 00 02 02 03 01 00 03 03 03 01 02 01
0 PBCH 1/1	QPSK	48 00 02 01 01 02 03 03 03 00 02 01 02 02 02 01 02

Figure 6-1: Bit stream display in downlink application if the bit stream format is set to "symbols"

Subframe(s)	ALL	Bit Stream
Sub- Allocation	Code- Modulation	Bit Index
frame ID	word	
0 PBCH 1/1	QPSK	0 100000000100001000110000100111001010101100001101
0 PBCH 1/1	QPSK	48 11101001101110010001010000101011010011111011001
0 PBCH 1/1	QPSK	96 001001011011111100100110101001100110000000110001
0 PBCH 1/1	QPSK	144 10010100011010010111111010001011000111010110010

Figure 6-2: Bit stream display in downlink application if the bit stream format is set to "bits"

Remote command:

`UNIT: BSTR` on page 277

Carrier Axes

The "Carrier Axes" selects the unit of the x-axis in result displays that show results over the subcarriers.

- "Hertz"
X-axis shows the results in terms of the subcarrier frequency.
- "Subcarrier Number"
X-axis shows the results in terms of the subcarrier number.

Remote command:

[UNIT:CAxes](#) on page 277

Marker Coupling

Couples or decouples markers that are active in multiple result displays.

When you turn on this feature, the application moves the marker to its new position in all active result displays.

When you turn it off, you can move the markers in different result displays independent from each other.

Remote command:

[CALCulate<n>:MARKer<m>:COUPling](#) on page 276

Subwindow Coupling

Couples or decouples result display tabs (subwindows).

If the coupling is on and you select another tab in a result display, the application automatically selects the same tab for all result displays.

Subwindow coupling is available for measurements with multiple data streams (for example carrier aggregation).

Remote command:

[DISPlay\[:WINDow<n>\]\[:SUBWindow<w>\]:COUPling](#) on page 276

6.3 Analysis tools for frequency sweep measurements

Access: "Overview" > "Analysis"

Access: "Overview" > "Analysis"

The analysis tools available for the frequency sweep measurements are the same as in the spectrum analyzer.

For more information, refer to the R&S FSV/A user manual.

7 Remote control

The following remote control commands are required to configure and perform LTE measurements in a remote environment. The R&S FSV/A must already be set up for remote operation in a network as described in the base unit manual.



Universal functionality

Note that basic tasks that are also performed in the base unit in the same way are not described here. For a description of such tasks, see the R&S FSV/A User Manual.

In particular, this includes:

- Managing Settings and Results, i.e. storing and loading settings and result data.
- Basic instrument configuration, e.g. checking the system configuration, customizing the screen layout, or configuring networks and remote operation.
- Using the common status registers (specific status registers for Pulse measurements are not used).



SCPI Recorder - automating tasks with remote command scripts

The LTE measurement application also supports the SCPI Recorder functionality.

Using the SCPI Recorder functions, you can create a SCPI script directly on the instrument and then export the script for use on the controller. You can also edit or write a script manually, using a suitable editor on the controller. For manual creation, the instrument supports you by showing the corresponding command syntax for the current setting value.

For details see the "Network and Remote Operation" chapter in the R&S FSV/A User Manual.

• Common suffixes	134
• Introduction	135
• LTE application selection	140
• Screen layout	143
• Measurement control	153
• Trace data readout	157
• Numeric result readout	176
• Limit check result readout	190
• Configuration	205
• Analysis	268

7.1 Common suffixes

In the LTE measurement application, the following common suffixes are used in remote commands:

Table 7-1: Common suffixes used in remote commands in the LTE measurement application

Suffix	Value range	Description
<m>	1..4	Marker
<n>	1..16	Window (in the currently selected channel)
<t>	1..6	Trace
	1 to 8	Limit line
<al>	0..110	Selects a subframe allocation.
<in>	1..4	Selects an instrument for MIMO measurements.
<ant>	1..4	Selects an antenna for MIMO measurements.
<cc>	1..5	Selects a component carrier. The actual number of supported component carriers depends on the selected measurement
<cluster>	1..2	Selects a cluster (uplink only).
<cw>	1..n	Selects a codeword.
<k>	---	Selects a limit line. Irrelevant for the LTE application.
<sf>	DL: 0..49 UL: 0..9	Selects a subframe.

7.2 Introduction

Commands are program messages that a controller (e.g. a PC) sends to the instrument or software. They operate its functions ('setting commands' or 'events') and request information ('query commands'). Some commands can only be used in one way, others work in two ways (setting and query). If not indicated otherwise, the commands can be used for settings and queries.

The syntax of a SCPI command consists of a header and, usually, one or more parameters. To use a command as a query, you have to append a question mark after the last header element, even if the command contains a parameter.

A header contains one or more keywords, separated by a colon. Header and parameters are separated by a "white space" (ASCII code 0 to 9, 11 to 32 decimal, e.g. blank). If there is more than one parameter for a command, they are separated by a comma from one another.

Only the most important characteristics that you need to know when working with SCPI commands are described here. For a more complete description, refer to the user manual of the R&S FSV/A.



Remote command examples

Note that some remote command examples mentioned in this general introduction are possibly not supported by this particular application.

7.2.1 Conventions used in descriptions

The following conventions are used in the remote command descriptions:

- **Command usage**
If not specified otherwise, commands can be used both for setting and for querying parameters.
If a command can be used for setting or querying only, or if it initiates an event, the usage is stated explicitly.
- **Parameter usage**
If not specified otherwise, a parameter can be used to set a value and it is the result of a query.
Parameters required only for setting are indicated as **Setting parameters**.
Parameters required only to refine a query are indicated as **Query parameters**.
Parameters that are only returned as the result of a query are indicated as **Return values**.
- **Conformity**
Commands that are taken from the SCPI standard are indicated as **SCPI confirmed**. All commands used by the R&S FSV/A follow the SCPI syntax rules.
- **Asynchronous commands**
A command which does not automatically finish executing before the next command starts executing (overlapping command) is indicated as an **Asynchronous command**.
- **Reset values (*RST)**
Default parameter values that are used directly after resetting the instrument (*RST command) are indicated as ***RST** values, if available.
- **Default unit**
The default unit is used for numeric values if no other unit is provided with the parameter.
- **Manual operation**
If the result of a remote command can also be achieved in manual operation, a link to the description is inserted.

7.2.2 Long and short form

The keywords have a long and a short form. You can use either the long or the short form, but no other abbreviations of the keywords.

The short form is emphasized in uppercase letters. Note however, that this emphasis only serves the purpose to distinguish the short from the long form in the manual. For the instrument, the case does not matter.

Example:

SENSe:FREQuency:CENTer is the same as SENS:FREQ:CENT.

7.2.3 Numeric suffixes

Some keywords have a numeric suffix if the command can be applied to multiple instances of an object. In that case, the suffix selects a particular instance (e.g. a measurement window).

Numeric suffixes are indicated by angular brackets (<n>) next to the keyword.

If you do not quote a suffix for keywords that support one, a 1 is assumed.

Example:

`DISPlay[:WINDow<1...4>]:ZOOM:STATe` enables the zoom in a particular measurement window, selected by the suffix at `WINDow`.

`DISPlay:WINDow4:ZOOM:STATe ON` refers to window 4.

7.2.4 Optional keywords

Some keywords are optional and are only part of the syntax because of SCPI compliance. You can include them in the header or not.



If an optional keyword has a numeric suffix and you need to use the suffix, you have to include the optional keyword. Otherwise, the suffix of the missing keyword is assumed to be the value 1.

Optional keywords are emphasized with square brackets.

Example:

Without a numeric suffix in the optional keyword:

`[SENSe:]FREQuency:CENTer` is the same as `FREQuency:CENTer`

With a numeric suffix in the optional keyword:

`DISPlay[:WINDow<1...4>]:ZOOM:STATe`

`DISPlay:ZOOM:STATe ON` enables the zoom in window 1 (no suffix).

`DISPlay:WINDow4:ZOOM:STATe ON` enables the zoom in window 4.

7.2.5 Alternative keywords

A vertical stroke indicates alternatives for a specific keyword. You can use both keywords to the same effect.

Example:

`[SENSe:]BANDwidth|BWIDth[:RESolution]`

In the short form without optional keywords, `BAND 1MHZ` would have the same effect as `BWID 1MHZ`.

7.2.6 SCPI parameters

Many commands feature one or more parameters.

If a command supports more than one parameter, they are separated by a comma.

Example:

```
LAYout:ADD:WINDow Spectrum,LEFT,MTABLE
```

Parameters can have different forms of values.

- [Numeric values](#)..... 138
- [Boolean](#)..... 139
- [Character data](#)..... 139
- [Character strings](#)..... 139
- [Block data](#)..... 140

7.2.6.1 Numeric values

Numeric values can be entered in any form, i.e. with sign, decimal point or exponent. For physical quantities, you can also add the unit. If the unit is missing, the command uses the basic unit.

Example:

With unit: `SENSe:FREQuency:CENTer 1GHZ`

Without unit: `SENSe:FREQuency:CENTer 1E9` would also set a frequency of 1 GHz.

Values exceeding the resolution of the instrument are rounded up or down.

If the number you have entered is not supported (e.g. for discrete steps), the command returns an error.

Instead of a number, you can also set numeric values with a text parameter in special cases.

- **MIN/MAX**
Defines the minimum or maximum numeric value that is supported.
- **DEF**
Defines the default value.
- **UP/DOWN**
Increases or decreases the numeric value by one step. The step size depends on the setting. Sometimes, you can customize the step size with a corresponding command.

Querying numeric values

When you query numeric values, the system returns a number. For physical quantities, it applies the basic unit (e.g. Hz for frequencies). The number of digits after the decimal point depends on the type of numeric value.

Example:

Setting: `SENSe:FREQuency:CENTer 1GHZ`

Query: `SENSe:FREQuency:CENTer?` would return `1E9`

Sometimes, numeric values are returned as text.

- **INF/NINF**
Infinity or negative infinity. Represents the numeric values `9.9E37` or `-9.9E37`.
- **NAN**
Not a number. Represents the numeric value `9.91E37`. NAN is returned if errors occur.

7.2.6.2 Boolean

Boolean parameters represent two states. The "on" state (logically true) is represented by "ON" or the numeric value 1. The "off" state (logically untrue) is represented by "OFF" or the numeric value 0.

Querying Boolean parameters

When you query Boolean parameters, the system returns either the value 1 ("ON") or the value 0 ("OFF").

Example:

Setting: `DISPlay:WINDow:ZOOM:STATe ON`

Query: `DISPlay:WINDow:ZOOM:STATe?` would return `1`

7.2.6.3 Character data

Character data follows the syntactic rules of keywords. You can enter text using a short or a long form. For more information, see [Chapter 7.2.2, "Long and short form"](#), on page 136.

Querying text parameters

When you query text parameters, the system returns its short form.

Example:

Setting: `SENSe:BANDwidth:RESolution:TYPE NORMAL`

Query: `SENSe:BANDwidth:RESolution:TYPE?` would return `NORM`

7.2.6.4 Character strings

Strings are alphanumeric characters. They have to be in straight quotation marks. You can use a single quotation mark (') or a double quotation mark (").

Example:

```
INSTRument:DELeTe 'Spectrum'
```

7.2.6.5 Block data

Block data is a format which is suitable for the transmission of large amounts of data.

The ASCII character # introduces the data block. The next number indicates how many of the following digits describe the length of the data block. The data bytes follow. During the transmission of these data bytes, all end or other control signs are ignored until all bytes are transmitted. #0 specifies a data block of indefinite length. The use of the indefinite format requires an NL^END message to terminate the data block. This format is useful when the length of the transmission is not known or if speed or other considerations prevent segmentation of the data into blocks of definite length.

7.3 LTE application selection

INSTRument:CREate:DUPLicate.....	140
INSTRument:CREate[:NEW].....	140
INSTRument:CREate:REPLace.....	141
INSTRument:DELeTe.....	141
INSTRument:LIST?.....	141
INSTRument:REName.....	142
INSTRument[:SELeCt].....	143

INSTRument:CREate:DUPLicate

Duplicates the currently selected channel, i.e. creates a new channel of the same type and with the identical measurement settings. The name of the new channel is the same as the copied channel, extended by a consecutive number (e.g. "IQAnalyzer" -> "IQAnalyzer 2").

The channel to be duplicated must be selected first using the `INST:SEL` command.

Example:

```
INST:SEL 'IQAnalyzer'
INST:CRE:DUPL
```

Duplicates the channel named 'IQAnalyzer' and creates a new channel named 'IQAnalyzer2'.

Usage:

Event

INSTRument:CREate[:NEW] <ChannelType>, <ChannelName>

Adds a measurement channel. You can configure up to 10 measurement channels at the same time (depending on available memory).

Parameters:

- <ChannelType> Channel type of the new channel.
For a list of available channel types, see [INSTrument:LIST?](#) on page 141.
- <ChannelName> String containing the name of the channel.
Note that you cannot assign an existing channel name to a new channel. If you do, an error occurs.

Example:

```
INST:CRE SAN, 'Spectrum 2'
```

Adds a spectrum display named "Spectrum 2".

INSTrument:CREate:REPLace <ChannelName1>, <ChannelType>,
<ChannelName2>

Replaces a channel with another one.

Setting parameters:

- <ChannelName1> String containing the name of the channel you want to replace.
- <ChannelType> Channel type of the new channel.
For a list of available channel types, see [INSTrument:LIST?](#) on page 141.
- <ChannelName2> String containing the name of the new channel.
Note: If the specified name for a new channel already exists, the default name, extended by a sequential number, is used for the new channel (see [INSTrument:LIST?](#) on page 141).
Channel names can have a maximum of 31 characters, and must be compatible with the Windows conventions for file names. In particular, they must not contain special characters such as ":", "*", "?".

Example:

```
INST:CRE:REPL 'IQAnalyzer2', IQ, 'IQAnalyzer'
```

Replaces the channel named "IQAnalyzer2" by a new channel of type "IQ Analyzer" named "IQAnalyzer".

Usage:

Setting only

INSTrument:DELeTe <ChannelName>

Deletes a channel.

Setting parameters:

- <ChannelName> String containing the name of the channel you want to delete.
A channel must exist to delete it.

Usage:

Setting only

INSTrument:LIST?

Queries all active channels. The query is useful to obtain the names of the existing channels, which are required to replace or delete the channels.

Return values:

<ChannelType>
<ChannelName>

For each channel, the command returns the channel type and channel name (see tables below).

Tip: to change the channel name, use the [INSTrument:REName](#) command.

Example:

```
INST:LIST?
```

Result for 3 channels:

```
'ADEM', 'Analog Demod', 'IQ', 'IQ Analyzer', 'IQ', 'IQ Analyzer2'
```

Usage:

Query only

Table 7-2: Available channel types and default channel names

Application	<ChannelType> Parameter	Default Channel Name*)
Spectrum	SANALYZER	Spectrum
5G NR (R&S FSV3-K144)	NR5G	5G NR
3GPP FDD BTS (R&S FSV3-K72)	BWCD	3G FDD BTS
3GPP FDD UE (R&S FSV3-K73)	MWCD	3G FDD UE
Amplifier Measurements (R&S FSV3-K18)	AMPLifier	Amplifier
AM/FM/PM Modulation Analysis	ADEM	Analog Demod
Bluetooth (R&S FSV/A-K8)	BTO	Bluetooth
GSM (R&S FSV3-K10)	GSM	GSM
I/Q Analyzer	IQ	IQ Analyzer
LTE (R&S FSV3-K10x)	LTE	LTE
NB-IoT (R&S FSV3-K106)	NIOT	NB-IoT
Noise Figure Measurements	NOISE	Noise
Phase Noise (R&S FSV3-K40)	PNOISE	Phase Noise
Pulse (R&S FSV3-K6)	PULSE	Pulse
Vector Signal Analysis (VSA, R&S FSV3-K70)	DDEM	VSA
WLAN (R&S FSV3-K91)	WLAN	WLAN

Note: the default channel name is also listed in the table. If the specified name for a new channel already exists, the default name, extended by a sequential number, is used for the new channel.

INSTrument:REName <ChannelName1>, <ChannelName2>

Renames a channel.

Setting parameters:

<ChannelName1> String containing the name of the channel you want to rename.

<ChannelName2> String containing the new channel name.

Note that you cannot assign an existing channel name to a new channel. If you do, an error occurs.

Channel names can have a maximum of 31 characters, and must be compatible with the Windows conventions for file names. In particular, they must not contain special characters such as ":", "*", "?".

Example:

```
INST:REN 'IQAnalyzer2', 'IQAnalyzer3'
```

Renames the channel with the name 'IQAnalyzer2' to 'IQAnalyzer3'.

Usage:

Setting only

INSTrument[:SElect] <ChannelType>

Selects a new measurement channel with the defined channel type.

Parameters:

<ChannelType> **LTE**
LTE measurement channel

Example:

```
//Select LTE application
INST LTE
```

7.4 Screen layout

- [General layout](#)..... 143
- [Layout of a single channel](#)..... 145

7.4.1 General layout

The following commands are required to configure general window layout, independent of the application.

Note that the suffix <n> always refers to the window *in the currently selected measurement channel*.

[DISPlay:FORMat](#)..... 144
[DISPlay\[:WINDow<n>\]:SIZE](#)..... 144
[DISPlay\[:WINDow<n>\]\[:SUBWindow<w>\]:SElect](#)..... 144
[DISPlay\[:WINDow<n>\]:TAB<tab>:SElect](#)..... 145

DISPlay:FORMat <Format>

Determines which tab is displayed.

Parameters:

<Format>

SPLit

Displays the MultiView tab with an overview of all active channels

SINGle

Displays the measurement channel that was previously focused.

*RST: SING

Example:

```
DISP:FORM SPL
```

DISPlay[:WINDow<n>]:SIZE <Size>

Maximizes the size of the selected result display window *temporarily*. To change the size of several windows on the screen permanently, use the `LAY:SPL` command (see [LAYout:SPLitter](#) on page 150).

Suffix:

<n>

[Window](#)**Parameters:**

<Size>

LARGE

Maximizes the selected window to full screen. Other windows are still active in the background.

SMALI

Reduces the size of the selected window to its original size. If more than one measurement window was displayed originally, these are visible again.

*RST: SMALI

Example:

```
DISP:WIND2:SIZE LARG
```

DISPlay[:WINDow<n>][:SUBWindow<w>]:SElect

Sets the focus on the selected result display window.

This window is then the active window.

For measurements with multiple results in subwindows, the command also selects the subwindow. Use this command to select the (sub)window before querying trace data.

Suffix:

<n>

[Window](#)

<w>

subwindow

Not supported by all applications

Example:

```
//Put the focus on window 1
```

```
DISP:WIND1:SEL
```

Example: //Put the focus on subwindow 2 in window 1
DISP:WIND1:SUBW2:SEL

DISPlay[:WINDow<n>]:TAB<tab>:SElect

Selects a tab in diagrams with multiple subwindows (or views).

Note that selecting a tab does not actually select a subwindow. To select a subwindow, for example to query the results of a subwindow, use `DISPlay[:WINDow<n>][:SUBWindow<w>]:SElect`.

Suffix:

<n>	Window
<tab>	1..n Tab

Example: //Select a tab
DISP:WIND2:TAB2:SEL

7.4.2 Layout of a single channel

The following commands are required to change the evaluation type and rearrange the screen layout for a measurement channel as you do using the SmartGrid in manual operation. Since the available evaluation types depend on the selected application, some parameters for the following commands also depend on the selected measurement channel.

Note that the suffix <n> always refers to the window *in the currently selected measurement channel*.

LAYout:ADD[:WINDow]?	145
LAYout:CATalog[:WINDow]?	148
LAYout:IDENtify[:WINDow]?	149
LAYout:REMOve[:WINDow]	149
LAYout:REPLace[:WINDow]	149
LAYout:SPLitter	150
LAYout:WINDow<n>:ADD?	151
LAYout:WINDow<n>:IDENtify?	152
LAYout:WINDow<n>:REMOve	152
LAYout:WINDow<n>:REPLace	152
LAYout:WINDow<n>:TYPE	153

LAYout:ADD[:WINDow]? <WindowName>, <Direction>, <WindowType>

Adds a window to the display in the active channel.

Is always used as a query so that you immediately obtain the name of the new window as a result.

To replace an existing window, use the `LAYout:REPLace[:WINDow]` command.

Note: Use this command to select a result display instead of `CALCulate:FEED` (still supported for compatibility reasons, but deprecated).

Query parameters:

<WindowName>	String containing the name of the existing window the new window is inserted next to. By default, the name of a window is the same as its index. To determine the name and index of all active windows, use the LAYout:CATaLog[:WINDow]? query.
<Direction>	LEFT RIGHT ABOVE BELOW Direction the new window is added relative to the existing window.
<WindowType>	text value Type of result display (evaluation method) you want to add. See the table below for available parameter values.

Return values:

<NewWindowName> When adding a new window, the command returns its name (by default the same as its number) as a result.

Example:

```
LAY:ADD? '1', LEFT, MTAB
```

Result:

```
'2'
```

Adds a new window named '2' with a marker table to the left of window 1.

Usage:

Query only

Manual operation:	See "Capture Buffer" on page 18
	See "EVM vs Carrier" on page 19
	See "EVM vs Symbol" on page 20
	See "EVM vs RB" on page 20
	See "EVM vs Subframe" on page 21
	See "Frequency Error vs Symbol" on page 22
	See "Power Spectrum" on page 22
	See "Power vs Resource Block PDSCH" on page 23
	See "Power vs Resource Block RS" on page 23
	See "Channel Flatness" on page 24
	See "Group Delay" on page 24
	See "Channel Flatness Difference" on page 24
	See "Constellation Diagram" on page 25
	See "CCDF" on page 26
	See "Allocation Summary" on page 26
	See "Bitstream" on page 27
	See "Channel Decoder Results" on page 28
	See "EVM vs Symbol x Carrier" on page 30
	See "Power vs Symbol x Carrier" on page 30
	See "Allocation ID vs Symbol x Carrier" on page 31
	See "UE RS Magnitude" on page 31
	See "UE RS Phase" on page 31
	See "Cell RS Magnitude" on page 32
	See "Cell RS Phase" on page 33
	See "CSI RS Magnitude" on page 33
	See "CSI RS Phase" on page 34
	See "Beamform Allocation Summary" on page 34
	See "Marker Table" on page 37
	See "Time Alignment Error" on page 39
	See "Marker Peak List" on page 52

Table 7-3: <WindowType> parameter values for LTE downlink measurement application

Parameter value	Window type
I/Q measurements	
AISC	"Allocation ID vs. Symbol X Carrier"
ASUM	"Allocation Summary"
BSTR	"Bitstream"
CBUF	"Capture Buffer"
CCDF	"CCDF"
CDEC	"Channel Decoder Results"
FLAT	"Channel Flatness"
CONS	"Constellation" Diagram
CRWM	"Cell RS Magnitude"
CRWP	"Cell RS Phase"
EVCA	"EVM vs. Carrier"

Parameter value	Window type
EVRP	"EVM vs. RB"
EVSC	"EVM vs. Symbol X Carrier"
EVSU	"EVM vs. Subframe"
EVSY	"EVM vs. Symbol"
FEVS	"Frequency Error vs. Symbol"
IRWM	"CSI RS Magnitude"
IRWP	"CSI RS Phase"
GDEL	"Group Delay"
MTAB	"Marker Table"
PSPE	"Power Spectrum"
PVRP	"Power vs. RB PDSCH"
PVRR	"Power vs. RB RS"
PVSC	"Power vs. Symbol X Carrier"
RSUM	"Result Summary"
URWA	"Beamforming Allocation Summary"
URWM	"UE RS Magnitude"
URWP	"UE RS Phase"
Time alignment error	
CBUF	"Capture Buffer"
MTAB	"Marker Table"
PSPE	"Power Spectrum"
TAL	"Time Alignment Error"
ACLR and SEM measurements	
DIAG	"Diagram"
PEAK	"Peak List"
MTAB	"Marker Table"
RSUM	"Result Summary"

LAYout:CATalog[:WINDow]?

Queries the name and index of all active windows in the active channel from top left to bottom right. The result is a comma-separated list of values for each window, with the syntax:

```
<WindowName_1>,<WindowIndex_1>..<WindowName_n>,<WindowIndex_n>
```

Return values:

<WindowName> string
Name of the window.
In the default state, the name of the window is its index.

<WindowIndex> **numeric value**
Index of the window.

Example:

LAY:CAT?

Result:

'2',2,'1',1

Two windows are displayed, named '2' (at the top or left), and '1' (at the bottom or right).

Usage: Query only

LAYout:IDENTify[:WINDow]? <WindowName>

Queries the **index** of a particular display window in the active channel.

Note: to query the **name** of a particular window, use the [LAYout:WINDow<n>:IDENTify?](#) query.

Query parameters:

<WindowName> String containing the name of a window.

Return values:

<WindowIndex> Index number of the window.

Example:

LAY:IDEN:WIND? '2'

Queries the index of the result display named '2'.

Response:

2

Usage: Query only

LAYout:REMOve[:WINDow] <WindowName>

Removes a window from the display in the active channel.

Setting parameters:

<WindowName> String containing the name of the window. In the default state, the name of the window is its index.

Example:

LAY:REM '2'

Removes the result display in the window named '2'.

Usage: Setting only

LAYout:REPLace[:WINDow] <WindowName>,<WindowType>

Replaces the window type (for example from "Diagram" to "Result Summary") of an already existing window in the active channel while keeping its position, index and window name.

To add a new window, use the `LAYout:ADD[:WINDow]?` command.

Setting parameters:

- <WindowName> String containing the name of the existing window.
By default, the name of a window is the same as its index. To determine the name and index of all active windows in the active channel, use the `LAYout:CATalog[:WINDow]?` query.
- <WindowType> Type of result display you want to use in the existing window.
See `LAYout:ADD[:WINDow]?` on page 145 for a list of available window types.

Example: `LAY:REPL:WIND '1',MTAB`
Replaces the result display in window 1 with a marker table.

Usage: Setting only

LAYout:SPLitter <Index1>, <Index2>, <Position>

Changes the position of a splitter and thus controls the size of the windows on each side of the splitter.

Note that windows must have a certain minimum size. If the position you define conflicts with the minimum size of any of the affected windows, the command does not work, but does not return an error.

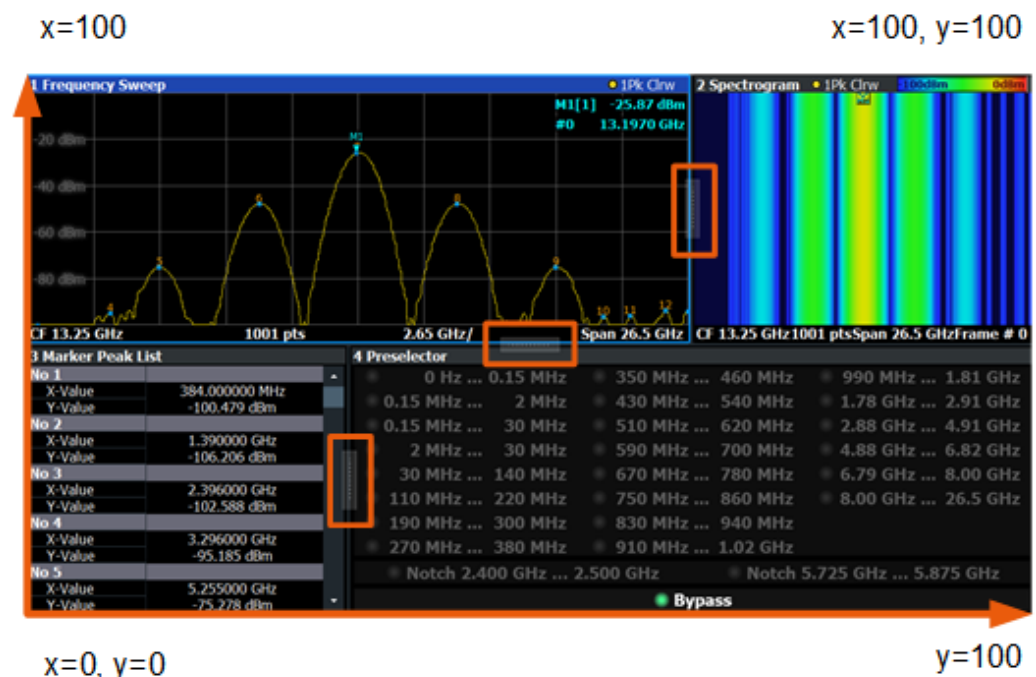

Figure 7-1: SmartGrid coordinates for remote control of the splitters

Setting parameters:

- <Index1> The index of one window the splitter controls.

<Index2>	The index of a window on the other side of the splitter.
<Position>	<p>New vertical or horizontal position of the splitter as a fraction of the screen area (without channel and status bar and softkey menu).</p> <p>The point of origin (x = 0, y = 0) is in the lower left corner of the screen. The end point (x = 100, y = 100) is in the upper right corner of the screen. (See Figure 7-1.)</p> <p>The direction in which the splitter is moved depends on the screen layout. If the windows are positioned horizontally, the splitter also moves horizontally. If the windows are positioned vertically, the splitter also moves vertically.</p> <p>Range: 0 to 100</p>
Example:	<pre>LAY:SPL 1,3,50</pre> <p>Moves the splitter between window 1 ('Frequency Sweep') and 3 ('Marker Table') to the center (50%) of the screen, i.e. in the figure above, to the left.</p>
Example:	<pre>LAY:SPL 1,4,70</pre> <p>Moves the splitter between window 1 ('Frequency Sweep') and 3 ('Marker Peak List') towards the top (70%) of the screen.</p> <p>The following commands have the exact same effect, as any combination of windows above and below the splitter moves the splitter vertically.</p> <pre>LAY:SPL 3,2,70 LAY:SPL 4,1,70 LAY:SPL 2,1,70</pre>
Usage:	Setting only

LAYout:WINDow<n>:ADD? <Direction>,<WindowType>

Adds a measurement window to the display. Note that with this command, the suffix <n> determines the existing window next to which the new window is added. Unlike [LAYout:ADD\[:WINDow\]?](#), for which the existing window is defined by a parameter.

To replace an existing window, use the [LAYout:WINDow<n>:REPLace](#) command.

Is always used as a query so that you immediately obtain the name of the new window as a result.

Suffix:

<n> [Window](#)

Query parameters:

<Direction> LEFT | RIGHT | ABOVE | BELOW

<WindowType> Type of measurement window you want to add.
See [LAYout:ADD\[:WINDow\]?](#) on page 145 for a list of available window types.

Return values:

<NewWindowName> When adding a new window, the command returns its name (by default the same as its number) as a result.

Example:

```
LAY:WIND1:ADD? LEFT,MTAB
```

Result:

```
'2'
```

Adds a new window named '2' with a marker table to the left of window 1.

Usage:

Query only

LAYout:WINDow<n>:IDENtify?

Queries the **name** of a particular display window (indicated by the <n> suffix) in the active channel.

Note: to query the **index** of a particular window, use the [LAYout:IDENtify\[:WINDow\]?](#) command.

Suffix:

<n> [Window](#)

Return values:

<WindowName> String containing the name of a window.
In the default state, the name of the window is its index.

Example:

```
LAY:WIND2:IDEN?
```

Queries the name of the result display in window 2.

Response:

```
'2'
```

Usage:

Query only

LAYout:WINDow<n>:REMOve

Removes the window specified by the suffix <n> from the display in the active channel.

The result of this command is identical to the [LAYout:REMOve\[:WINDow\]](#) command.

Suffix:

<n> [Window](#)

Example:

```
LAY:WIND2:REM
```

Removes the result display in window 2.

Usage:

Event

LAYout:WINDow<n>:REPLace <WindowType>

Changes the window type of an existing window (specified by the suffix <n>) in the active channel.

The effect of this command is identical to the `LAYout:REPLace[:WINDow]` command.

To add a new window, use the `LAYout:WINDow<n>:ADD?` command.

Suffix:

<n> [Window](#)

Setting parameters:

<WindowType> Type of measurement window you want to replace another one with.
See `LAYout:ADD[:WINDow]?` on page 145 for a list of available window types.

Example:

`LAY:WIND2:REPL MTAB`

Replaces the result display in window 2 with a marker table.

Usage:

Setting only

LAYout:WINDow<n>:TYPE <WindowType>

Queries or defines the window type of the window specified by the index <n>. The window type determines which results are displayed. For a list of possible window types, see `LAYout:ADD[:WINDow]?` on page 145.

Note that this command is not available in all applications and measurements.

Suffix:

<n> 1..n
[Window](#)

Parameters:

<WindowType>

Example:

`LAY:WIND2:TYPE?`

7.5 Measurement control

7.5.1 Measurements

<code>ABORt</code>	153
<code>INITiate<n>:CONTinuous</code>	154
<code>INITiate<n>[:IMMediate]</code>	155
<code>[SENSe:] [LTE:] JOOPower:ATIMing</code>	155
<code>[SENSe:] SYNC[:CC<cc>][:STATE]?</code>	155

ABORt

Aborts the measurement in the current channel and resets the trigger system.

To prevent overlapping execution of the subsequent command before the measurement has been aborted successfully, use the `*OPC?` or `*WAI` command after `ABOR` and before the next command.

For details on overlapping execution see [Remote control via SCPI](#).

Note on blocked remote control programs:

If a sequential command cannot be completed, for example because a triggered sweep never receives a trigger, the remote control program will never finish and the remote channel to the R&S FSV/A is blocked for further commands. In this case, you must interrupt processing on the remote channel first in order to abort the measurement.

To do so, send a "Device Clear" command from the control instrument to the R&S FSV/A on a parallel channel to clear all currently active remote channels. Depending on the used interface and protocol, send the following commands:

- **Visa:** `viClear()`

Now you can send the `ABORT` command on the remote channel performing the measurement.

Example: `ABOR; :INIT:IMM`
Aborts the current measurement and immediately starts a new one.

Example: `ABOR; *WAI`
`INIT:IMM`
Aborts the current measurement and starts a new one once abortion has been completed.

Usage: Event

INITiate<n>:CONTInuous <State>

Controls the measurement mode for an individual channel.

Note that in single measurement mode, you can synchronize to the end of the measurement with `*OPC`, `*OPC?` or `*WAI`. In continuous measurement mode, synchronization to the end of the measurement is not possible. Thus, it is not recommended that you use continuous measurement mode in remote control, as results like trace data or markers are only valid after a single measurement end synchronization.

For details on synchronization see [Remote control via SCPI](#).

Suffix:
<n> irrelevant

Parameters:
<State> `ON | OFF | 0 | 1`
ON | 1
Continuous measurement
OFF | 0
Single measurement
***RST:** 1 (some applications can differ)

Example:

```
INIT:CONT OFF
Switches the measurement mode to single measurement.
INIT:CONT ON
Switches the measurement mode to continuous measurement.
```

INITiate<n>[:IMMEDIATE]

Starts a (single) new measurement.

You can synchronize to the end of the measurement with *OPC, *OPC? or *WAI.

For details on synchronization see [Remote control via SCPI](#).

Suffix:

<n> irrelevant

Usage: Asynchronous command

[SENSe:][LTE:]OOPower:ATIMing

Adjusts the timing for on / off power measurements.

Example:

```
//Adjust the on / off power timing
OOP:ATIM
```

Manual operation: See "[Adjust Timing](#)" on page 43

[SENSe:]SYNC[:CC<cc>][:STATe]?

Queries the current synchronization state.

Suffix:

<cc> irrelevant

Return values:

<State>

The string contains the following information:

- <OFDMSymbolTiming> is the coarse symbol timing
- <P-SYNCSynchronization> is the P-SYNC synchronization state
- <S-SYNCSynchronization> is the S-SYNC synchronization state

A zero represents a failure and a one represents a successful synchronization.

Example:

```
//Query synchronization state
SYNC:STAT?
Would return, e.g. '1,1,0' if coarse timing and P-SYNC were successful but S-SYNC failed.
```

Usage: Query only

7.5.2 Measurement sequences

INITiate:SEQuencer:ABORt	156
INITiate:SEQuencer:IMMediate	156
INITiate:SEQuencer:MODE	156
SYSTem:SEQuencer	157

INITiate:SEQuencer:ABORt

Stops the currently active sequence of measurements.

You can start a new sequence any time using [INITiate:SEQuencer:IMMediate](#) on page 156.

Usage: Event

INITiate:SEQuencer:IMMediate

Starts a new sequence of measurements by the Sequencer.

Before this command can be executed, the Sequencer must be activated (see [SYSTem:SEQuencer](#) on page 157).

Example: `SYST:SEQ ON`
 Activates the Sequencer.
 `INIT:SEQ:MODE SING`
 Sets single sequence mode so each active measurement is performed once.
 `INIT:SEQ:IMM`
 Starts the sequential measurements.

INITiate:SEQuencer:MODE <Mode>

Defines the capture mode for the entire measurement sequence and all measurement groups and channels it contains.

Note: To synchronize to the end of a measurement sequence using `*OPC`, `*OPC?` or `*WAI`, use `SINGLE` Sequencer mode.

Parameters:

<Mode>

SINGLE

Each measurement group is started one after the other in the order of definition. All measurement channels in a group are started simultaneously and performed once. After *all* measurements are completed, the next group is started. After the last group, the measurement sequence is finished.

CONTInuous

Each measurement group is started one after the other in the order of definition. All measurement channels in a group are started simultaneously and performed once. After *all* measurements are completed, the next group is started. After the last group, the measurement sequence restarts with the first one and continues until it is stopped explicitly.

*RST: CONTInuous

SYSTem:SEQuencer <State>

Turns the Sequencer on and off. The Sequencer must be active before any other Sequencer commands (`INIT:SEQ...`) are executed, otherwise an error occurs.

A detailed programming example is provided in the "Operating Modes" chapter in the R&S FSV/A User Manual.

Parameters:

<State> ON | OFF | 0 | 1

ON | 1

The Sequencer is activated and a sequential measurement is started immediately.

OFF | 0

The Sequencer is deactivated. Any running sequential measurements are stopped. Further Sequencer commands (`INIT:SEQ...`) are not available.

*RST: 0

Example:

`SYST:SEQ ON`

Activates the Sequencer.

`INIT:SEQ:MODE SING`

Sets single Sequencer mode so each active measurement is performed once.

`INIT:SEQ:IMM`

Starts the sequential measurements.

`SYST:SEQ OFF`

7.6 Trace data readout

- [The TRACe\[:DATA\] command](#)..... 157
- [Result readout](#)..... 175

7.6.1 The TRACe[:DATA] command

This chapter contains information on the `TRACe:DATA` command and a detailed description of the characteristics of that command.

The `TRACe:DATA` command queries the trace data or results of the currently active measurement or result display. The type, number and structure of the return values are specific for each result display. In case of results that have any kind of unit, the command returns the results in the unit you have currently set for that result display.

Note also that return values for results that are available for both downlink and uplink may be different.

For several result displays, the command also supports various SCPI parameters in combination with the query. If available, each SCPI parameter returns a different aspect of the results. If SCPI parameters are supported, you have to quote one in the query.

Example:

```
TRAC2:DATA? TRACE1
```

The format of the return values is either in ASCII or binary characters and depends on the format you have set with `FORMat[:DATA]`.

Following this detailed description, you will find a short summary of the most important functions of the command (`TRACe<n>[:DATA]?`).



Selecting a measurement window

Before querying results, you have to select the measurement window with the suffix `<n>` at `TRACe`. The range of `<n>` depends on the number of active measurement windows.

On an R&S FSQ or R&S FSV, the suffix `<n>` was not supported. On these instruments, you had to select the measurement window with `DISPlay:WINDow<n>:SElect` first.

For measurements on aggregated carriers or multiple antennas, where each measurement window has subwindows, you have to select the subwindow first with `DISPlay[:WINDow<n>][:SUBWindow<w>]:SElect`.

- [Adjacent channel leakage ratio](#)..... 159
- [Allocation ID vs symbol x carrier](#)..... 159
- [Allocation summary](#)..... 159
- [Beamform allocation summary](#)..... 161
- [Bit stream](#)..... 161
- [Capture buffer](#)..... 162
- [CCDF](#)..... 162
- [Cell RS weights phase](#)..... 163
- [Cell RS weights magnitude](#)..... 163
- [Channel decoder results](#)..... 163
- [Channel and spectrum flatness](#)..... 164
- [Channel and spectrum flatness difference](#)..... 165
- [Group delay](#)..... 165
- [Constellation diagram](#)..... 165
- [CSI RS weights magnitude](#)..... 166
- [CSI RS weights phase](#)..... 166
- [EVM vs carrier](#)..... 166

• EVM vs RB.....	167
• EVM vs subframe.....	167
• EVM vs symbol.....	167
• EVM vs symbol x carrier.....	168
• Frequency error vs symbol.....	168
• On/off power.....	168
• Power spectrum.....	169
• Power vs RB RS.....	169
• Power vs RB PDSCH.....	169
• Power vs symbol x carrier.....	170
• Spectrum emission mask.....	170
• UE RS weights magnitude.....	170
• UE RS weights phase.....	171
• Return value codes.....	171

7.6.1.1 Adjacent channel leakage ratio

For the ACLR result display, the number and type of returns values depend on the parameter.

- TRAC:DATA TRACE1
Returns one value for each trace point.

7.6.1.2 Allocation ID vs symbol x carrier

For the allocation ID vs symbol x carrier, the command returns one value for each resource element.

```
<ID[Symbol(0),Carrier(1)]>, ..., <ID[Symbol(0),Carrier(n)]>,
<ID[Symbol(1),Carrier(1)]>, ..., <ID[Symbol(1),Carrier(n)]>,
...
<ID[Symbol(n),Carrier(1)]>, ..., <ID[Symbol(n),Carrier(n)]>
```

The <allocation ID> is encoded.

For the code assignment, see [Chapter 7.6.1.31, "Return value codes"](#), on page 171.

The following parameters are supported.

- TRAC:DATA TRACE1

7.6.1.3 Allocation summary

For the allocation summary, the command returns several values for each line of the table.

- <subframe>
- <allocation ID>
- <number of RB>
- <relative power>

- <modulation>
- <absolute power>
- <EVM>
- <LayerEVM>

The data format of the return values is always ASCII.

The return values have the following characteristics.

- The <allocation ID is encoded.
For the code assignment, see [Chapter 7.6.1.31, "Return value codes"](#), on page 171.
- The unit for <relative power> is always dB.
- The <modulation> is encoded.
For the code assignment, see [Chapter 7.6.1.31, "Return value codes"](#), on page 171.
- The unit for <absolute power> is always dBm.
- The unit for <EVM> depends on `UNIT:EVM`.
- The unit for <LayerEVM> depends on `UNIT:EVM`.

Example:

Allocation Summary		Selection		Antenna: 1		
Sub-frame	Alloc. ID	Number of RB	Rel. Power/dB	Modulation	Power per RE/dBm	EVM/%
0	BS Ant1		0,000	QPSK	-45,546	0,733
	P-SYNC		-0,007	CAZAC	-42,558	0,254
	S-SYNC		0,005	RBPSK	-42,546	0,251

TRAC:DATA? TRACE1 would return:

```
0, -5, 0, 0.00000000000000, 2, -45.5463829153428, 7.33728660354122E-05, 8.2587600145187E-05
0, -3, 0, 0.0073997452251, 6, -42.5581007463452, 2.54197349219455E-05, 2.9270188222955E-05
0, -4, 0, 0.0052647197362, 1, -42.5464220485716, 2.51485275782241E-05, 2.5002471912438E-05
...
```

Additional information "ALL"

The allocation summary contains additional lines "ALL" that summarize the number of RB analyzed in each subframe and the average EVM measured in that subframe. This information is added to the return values after all allocations of the subframe have been returned. The "ALL" information has the allocation ID code "-2".

In addition, there is a line at the end of the allocation summary that shows the average EVM over all analyzed subframes. This information is also added as the last return values. The "ALL" information has the subframe ID and allocation ID code "-2".

A query result would thus look like this, for example:

```
//For subframe 0:
0, -40, 10, 2, 2, -84.7431947342849, 2.68723483754626E-06,
0, -41, 0, 0, 6, -84.7431432845264, 2.37549449584568E-06,
(...)
//ALL for subframe 0:
```



```

0,-2,20,,,,,2.45581475911678E-06
//For subframe 1:
1, -40, 10, 2, 2, -84.7431947342849, 2.68723483754626E-06,
1, -41, 0, 0, 6, -84.7431432845264, 2.37549449584568E-06,
(...)
//ALL for subframe 1:
1,-2,20,,,,,2.45581475911678E-06
(...)
//ALL for all subframes
-2,-2,,,,,2.13196434228374E-06

```

7.6.1.4 Beamform allocation summary

For the beamform allocation summary result display, the command returns four values for each allocation that has been found.

<Subframe>, <AllocationID>, <Phase>, <PhaseDifference>, ...

The unit for <Phase> and <PhaseDifference> is always degrees. The <Subframe> has no unit.

The <allocation ID> is encoded. For the code assignment see [Chapter 7.6.1.31, "Return value codes"](#), on page 171.

7.6.1.5 Bit stream

For the bitstream result display, the number of return values depends on the parameter.

- TRACE:DATA TRACE1
Returns several values and the bitstream for each line of the table.
<subframe>, <allocation ID>, <codeword>, <modulation>, <# of symbols/bits>, <hexadecimal/binary numbers>,...
- TRACE:DATA TRACE2
Returns all informative values of an allocation, including the totals over all PDSCH allocations that contribute to the bitstream, but not the bitstream itself.
<subframe>, <allocation ID>, <codeword>, <modulation>, <# of symbols/bits>, <hexadecimal/binary numbers>, ..., <total # bits>, <total # bit errors>, <total # decoded bits>, <total bit error rate>
- TRACE:DATA TRACE3
Returns all informative values of an allocation, including the totals over all PDSCH allocations that contribute to the bitstream, but not the bitstream itself. The difference to TRACE2 is that this query also includes the Bit/s result.
<subframe>, <allocation ID>, <codeword>, <modulation>, <# of symbols/bits>, <hexadecimal/binary numbers>, ..., <total # bits>, <total # bit errors>, <total # decoded bits>, <total bit error rate>, <bits/second>

All values have no unit. The format of the bit stream depends on [Bit Stream Format](#).

The <allocation ID>, <codeword> and <modulation> are encoded. For the code assignment see [Chapter 7.6.1.31, "Return value codes"](#), on page 171.

For symbols or bits that are not transmitted, the command returns

- "FFF" if the bit stream format is "Symbols"
- "9" if the bit stream format is "Bits".

For symbols or bits that could not be decoded because the number of layer exceeds the number of receive antennas, the command returns

- "FFE" if the bit stream format is "Symbols"
- "8" if the bit stream format is "Bits".

Note that the data format of the return values is always ASCII.

Example:

Sub-frame	Allocation ID	Code-word	Modulation	Symbol Index	Bit Stream
0	PBCH	1/1	QPSK	0	01 01 00 02 03 00 01 02 01 02 01 00 03 00 02 02
0	PBCH	1/1	QPSK	16	02 03 02 03 03 03 00 02 00 03 00 02 02 03 01 01
0	PBCH	1/1	QPSK	32	03 02 03 03 03 03 01 03 00 03 00 03 03 00 03 02

TRAC:DATA? TRACE1 would return:

```
0, -12, 0, 2, 0, 01, 01, 00, 02, 03, 00, 01, 02, 01, 02, 01, ...
<continues like this until the next data block starts or the end of data is reached>
0, -12, 0, 2, 32, 03, 02, 03, 03, 03, 03, 01, 03, 00, 03, ...
```

7.6.1.6 Capture buffer

For the capture buffer result display, the command returns one value for each I/Q sample in the capture buffer.

<absolute power>, ...

The unit is always dBm.

The following parameters are supported.

- TRAC:DATA TRACE1

Note that the command returns positive peak values only.

7.6.1.7 CCDF

For the CCDF result display, the type of return values depends on the parameter.

- TRAC:DATA TRACE1
Returns the probability values (y-axis).
<# of values>, <probability>, ...
The unit is always %.
The first value that is returned is the number of the following values.
- TRAC:DATA TRACE2
Returns the corresponding power levels (x-axis).
<# of values>, <relative power>, ...

The unit is always dB.

The first value that is returned is the number of the following values.

7.6.1.8 Cell RS weights phase

For the cell RS weights magnitude result display, the command returns one value for each subcarrier that has been analyzed.

<Phase>, ...

The unit degree.

The following parameters are supported.

- TRAC:DATA TRACE1
Returns the phase of the measured weights of the reference signal (RS) carriers over one subframe.

7.6.1.9 Cell RS weights magnitude

For the cell RS weights magnitude result display, the command returns one value for each subcarrier that has been analyzed.

<Magnitude>, ...

The unit is dB.

The following parameters are supported.

- TRAC:DATA TRACE1
Returns the magnitude of the measured weights of the reference signal (RS) carriers over one subframe.

7.6.1.10 Channel decoder results

For the channel decoder results, the number and type of return values depend on the parameter.

- TRAC:DATA PBCH
Returns the results for the PBCH if PBCH decoding (or CRC check) was successful. The results are made up out of six values.
<subframe>, <# of antennas>, <system bandwidth>, <frame>, <PHICH duration>, <PHICH resource>
The unit for <system bandwidth> is Hz. All other values have no unit.
The <PHICH duration> and <PHICH resource> are encoded. For the code assignment see [Chapter 7.6.1.31, "Return value codes"](#), on page 171.
If PBCH decoding was not successful, the command returns NAN.
- TRAC:DATA PCFICH
Returns the results for the PCFICH. The results are made up out of two parameters.
<subframe>, <number of symbols for PDCCH>
The values have no unit.
- TRAC:DATA PHICH

Returns the results for the PHICH. The results are made up out of three values for each line of the table.

<subframe>, <ACK/NACK>, <relative power>

The unit for <relative power> is dB. All other values have no unit.

The <ACK/NACK> is encoded. For the code assignment see [Chapter 7.6.1.31, "Return value codes"](#), on page 171.

- TRAC:DATA PDCCH

Returns the results for the PDCCH. The results are made up out of seven values for each line of the table.

<subframe>, <RNTI>, <DCI format>, <PDCCH format>, <CCE offset>, <# of transmitted bits>, [stream of binary numbers]

The values have no unit.

The [stream of binary numbers] is a list of binary numbers separated by comma.

The <DCI format> and <PDCCH format> are encoded. For the code assignment see [Chapter 7.6.1.31, "Return value codes"](#), on page 171.

- TRAC:DATA PDSCH

Returns the results for the PDSCH. The results are made up out of five values for each line of the table.

<subframe>, <allocationID>, <codeword>, <# of transmitted bits>, [stream of binary numbers]

The values have no unit.

The [stream of binary numbers] is a list of binary numbers separated by comma.

If the PDSCH could not be decoded, the NAN is returned instead of the <# of transmitted bits>. The [stream of binary numbers] is not shown.

The <allocationID> and <codeword> are encoded. For the code assignment see [Chapter 7.6.1.31, "Return value codes"](#), on page 171.

7.6.1.11 Channel and spectrum flatness

For the channel flatness result display, the command returns one value for each trace point.

<relative power>, ...

The unit is always dB.

The following parameters are supported.

- TRAC:DATA TRACE1

Returns the average power over all subframes.

- TRAC:DATA TRACE2

Returns the minimum power found over all subframes. If you are analyzing a particular subframe, it returns nothing.

- TRAC:DATA TRACE3

Returns the maximum power found over all subframes. If you are analyzing a particular subframe, it returns nothing.

7.6.1.12 Channel and spectrum flatness difference

For the channel flatness difference result display, the command returns one value for each trace point.

<relative power>, ...

The unit is always dB. The number of values depends on the selected LTE bandwidth.

The following parameters are supported.

- TRAC:DATA TRACE1
Returns the average power over all subframes.
- TRAC:DATA TRACE2
Returns the minimum power found over all subframes. If you are analyzing a particular subframe, it returns nothing.
- TRAC:DATA TRACE3
Returns the maximum power found over all subframes. If you are analyzing a particular subframe, it returns nothing.

7.6.1.13 Group delay

For the group delay result display, the command returns one value for each trace point.

<group delay>, ...

The unit is always ns. The number of values depends on the selected LTE bandwidth.

The following parameters are supported.

- TRAC:DATA TRACE1
Returns the group delay.

7.6.1.14 Constellation diagram

For the constellation diagram, the command returns two values for each constellation point.

```
<I[SF0][Sym0][Carrier1]>, <Q[SF0][Sym0][Carrier1]>, ..., <I[SF0][Sym0][Carrier(n)]>, <Q[SF0][Sym0][Carrier(n)]>,
<I[SF0][Sym1][Carrier1]>, <Q[SF0][Sym1][Carrier1]>, ..., <I[SF0][Sym1][Carrier(n)]>, <Q[SF0][Sym1][Carrier(n)]>,
<I[SF0][Sym(n)][Carrier1]>, <Q[SF0][Sym(n)][Carrier1]>, ..., <I[SF0][Sym(n)][Carrier(n)]>, <Q[SF0][Sym(n)][Carrier(n)]>,
<I[SF1][Sym0][Carrier1]>, <Q[SF1][Sym0][Carrier1]>, ..., <I[SF1][Sym0][Carrier(n)]>, <Q[SF1][Sym0][Carrier(n)]>,
<I[SF1][Sym1][Carrier1]>, <Q[SF1][Sym1][Carrier1]>, ..., <I[SF1][Sym1][Carrier(n)]>, <Q[SF1][Sym1][Carrier(n)]>,
<I[SF(n)][Sym(n)][Carrier1]>, <Q[SF(n)][Sym(n)][Carrier1]>, ..., <I[SF(n)][Sym(n)][Carrier(n)]>, <Q[SF(n)][Sym(n)][Carrier(n)]>
```

With SF = subframe and Sym = symbol of that subframe.

The I and Q values have no unit.

The number of return values depends on the constellation selection. By default, it returns all resource elements including the DC carrier.

The following parameters are supported.

- `TRAC:DATA TRACE1`
Returns all constellation points included in the selection.

7.6.1.15 CSI RS weights magnitude

For the CSI RS weights magnitude result display, the command returns one value for each subcarrier that has been analyzed.

<Magnitude>, ...

The unit dB.

The following parameters are supported.

- `TRAC:DATA TRACE1`
Returns the magnitude of the measured weights of the reference signal (RS) carriers over one subframe.

7.6.1.16 CSI RS weights phase

For the CSI RS weights phase result display, the command returns one value for each subcarrier that has been analyzed.

<Phase>, ...

The unit degrees.

The following parameters are supported.

- `TRAC:DATA TRACE1`
Returns the phase of the measured weights of the reference signal (RS) carriers over one subframe.

7.6.1.17 EVM vs carrier

For the EVM vs carrier result display, the command returns one value for each subcarrier that has been analyzed.

<EVM>, ...

The unit depends on [UNIT:EVM](#).

The following parameters are supported.

- `TRAC:DATA TRACE1`
Returns the average EVM over all subframes
- `TRAC:DATA TRACE2`
Returns the minimum EVM found over all subframes. If you are analyzing a particular subframe, it returns nothing.
- `TRAC:DATA TRACE3`

Returns the maximum EVM found over all subframes. If you are analyzing a particular subframe, it returns nothing.

7.6.1.18 EVM vs RB

For the EVM vs RB result display, the command returns one value for each resource block that has been analyzed.

<EVM>, ...

The unit depends on [UNIT:EVM](#).

The following parameters are supported.

- `TRAC:DATA TRACE1`
Returns the average EVM for each resource block over all subframes.
- `TRAC:DATA TRACE2`
Returns the minimum EVM found over all subframes. If you are analyzing a single subframe, it returns nothing.
- `TRAC:DATA TRACE3`
Returns the maximum EVM found over all subframes. If you are analyzing a single subframe, it returns nothing.

7.6.1.19 EVM vs subframe

For the EVM vs subframe result display, the command returns one value for each subframe that has been analyzed.

<EVM>, ...

The unit depends on [UNIT:EVM](#).

The following parameters are supported.

- `TRAC:DATA TRACE1`

7.6.1.20 EVM vs symbol

For the EVM vs symbol result display, the command returns one value for each OFDM symbol that has been analyzed.

<EVM>, ...

For measurements on a single subframe, the command returns the symbols of that subframe only.

The unit depends on [UNIT:EVM](#).

The following parameters are supported.

- `TRAC:DATA TRACE1`

7.6.1.21 EVM vs symbol x carrier

For the EVM vs symbol x carrier, the command returns one value for each resource element.

```
<EVM[Symbol(0),Carrier(1)]>, ..., <EVM[Symbol(0),Carrier(n)]>,
<EVM[Symbol(1),Carrier(1)]>, ..., <EVM[Symbol(1),Carrier(n)]>,
...
<EVM[Symbol(n),Carrier(1)]>, ..., <EVM[Symbol(n),Carrier(n)]>
```

The unit depends on [UNIT:EVM](#).

Resource elements that are unused return NAN.

The following parameters are supported.

- TRAC:DATA TRACE1

7.6.1.22 Frequency error vs symbol

For the frequency error vs symbol result display, the command returns one value for each OFDM symbol that has been analyzed.

```
<frequency error>,...
```

The unit is always Hz.

The following parameters are supported.

- TRAC:DATA TRACE1

7.6.1.23 On/off power

For the on/off power measurement, the number and type of return values depend on the parameter.

- TRAC:DATA TRACE1
Returns the power for the Off power regions.
<absolute power>, ...
The unit is always dBm.
- TRAC:DATA TRACE2
Returns the power for the transient regions.
<absolute power>, ...
The unit is always dBm.
- TRAC:DATA LIST
Returns the contents of the on/off power table. For each line, it returns seven values.
<off period start limit>, <off period stop limit>, <time at delta to limit>, <absolute off power>, <distance to limit>, <falling transient period>, <rising transient period>, ...
The unit for the <absolute off power> is dBm. The unit for the <distance to limit> is dB. All other values have the unit s.

7.6.1.24 Power spectrum

For the power spectrum result display, the command returns one value for each trace point.

`<power>, ...`

The unit is always dBm/Hz.

The following parameters are supported.

- `TRAC:DATA TRACE1`

7.6.1.25 Power vs RB RS

For the power vs RB RS result display, the command returns one value for each resource block of the reference signal that has been analyzed.

`<absolute power>, ...`

The unit is always dBm.

The following parameters are supported.

- `TRAC:DATA TRACE1`
Returns the average power over all subframes
- `TRAC:DATA TRACE2`
Returns the minimum power found over all subframes. If you are analyzing a particular subframe, it returns nothing.
- `TRAC:DATA TRACE3`
Returns the maximum power found over all subframes. If you are analyzing a particular subframe, it returns nothing.

7.6.1.26 Power vs RB PDSCH

For the power vs RB PDSCH result display, the command returns one value for each resource block of the PDSCH that has been analyzed.

`<absolute power>, ...`

The unit is always dBm.

The following parameters are supported.

- `TRAC:DATA TRACE1`
Returns the average power over all subframes
- `TRAC:DATA TRACE2`
Returns the minimum power found over all subframes. If you are analyzing a particular subframe, it returns nothing.
- `TRAC:DATA TRACE3`
Returns the maximum power found over all subframes. If you are analyzing a particular subframe, it returns nothing.

7.6.1.27 Power vs symbol x carrier

For the power vs symbol x carrier, the command returns one value for each resource element.

```
<P[Symbol(0),Carrier(1)]>, ..., <P[Symbol(0),Carrier(n)]>,
<P[Symbol(1),Carrier(1)]>, ..., <P[Symbol(1),Carrier(n)]>,
...
<P[Symbol(n),Carrier(1)]>, ..., <P[Symbol(n),Carrier(n)]>
```

with P = Power of a resource element.

The unit is always dBm.

Resource elements that are unused return NAN.

The following parameters are supported.

- TRAC:DATA TRACE1

7.6.1.28 Spectrum emission mask

For the SEM measurement, the number and type of returns values depend on the parameter.

- TRAC:DATA TRACE1
Returns one value for each trace point.
<absolute power>, ...
The unit is always dBm.
- TRAC:DATA LIST
Returns the contents of the SEM table. For every frequency in the spectrum emission mask, it returns 11 values.
<index>, <start frequency in Hz>, <stop frequency in Hz>, <RBW in Hz>, <limit fail frequency in Hz>, <absolute power in dBm>, <relative power in dBc>, <limit distance in dB>, <limit check result>, <reserved>, <reserved>...
The <limit check result> is either a 0 (for PASS) or a 1 (for FAIL).

7.6.1.29 UE RS weights magnitude

For the UE RS weights magnitude result display, the command returns one value for each subcarrier that has been analyzed.

```
<Magnitude>, ...
```

The unit dB.

The following parameters are supported.

- TRAC:DATA TRACE1
Returns the magnitude of the measured weights of the reference signal (RS) carriers over one subframe.

7.6.1.30 UE RS weights phase

For the UE RS phase result display, the command returns one value for each subcarrier that has been analyzed.

<Phase>, ...

The unit degrees.

The following parameters are supported.

- `TRAC:DATA TRACE1`
Returns the phase of the measured weights of the reference signal (RS) carriers over one subframe.

7.6.1.31 Return value codes

<number of symbols or bits>

In hexadecimal mode, this represents the number of symbols to be transmitted. In binary mode, it represents the number of bits to be transmitted.

<ACK/NACK>

The range is {-1...1}.

- 1 = ACK
- 0 = NACK
- -1 = DTX

<allocation ID>

Represents the allocation ID. The range is as follows.

- 0 - 65535 = PDSCH
- -1 = Invalid / not used
- -2 = All
- -3 = P-Sync
- -4 = S-Sync
- -5 = Reference Signal (Antenna 1)
- -6 = Reference Signal (Antenna 2)
- -7 = Reference Signal (Antenna 3)
- -8 = Reference Signal (Antenna 4)
- -9 = PCFICH
- -10 = PHICH
- -11 = PDCCH
- -12 = PBCH
- -13 = PMCH
- -14 = Positioning Reference Signal

- **-15** = CSI Reference Signal (Port 15 and 16)
 - **-16** = CSI Reference Signal (Port 17 and 18)
 - **-17** = CSI Reference Signal (Port 19 and 20)
 - **-18** = CSI Reference Signal (Port 21 and 22)
 - **-19** = EPDCCH
 - **-20** = EPDCCH DMRS1
 - **-21** = EPDCCH DMRS2
 - **-22** = PMCH Reference Signal
 - **-1xxxxx** = UE Reference Signal (Port 5)
 - **-2xxxxx** = UE Reference Signal 1 (Port 7, 8, 11, 12)
 - **-3xxxxx** = UE Reference Signal 2 (Port 9, 10, 13, 14, signals with more than 2 layers)
- Note. **xxxxx** is a placeholder for the ID of the PDSCH.
If the PDSCH has, for example, the ID 22, the return value would be -100022, -200022 or -300022 (depending on the configuration)

<channel type>

- **0** = TX channel
- **1** = adjacent channel
- **2** = alternate channel

<codeword>

Represents the codeword of an allocation. The range is {0...6}.

- **0** = 1/1
- **1** = 1/2
- **2** = 2/2
- **3** = 1/4
- **4** = 2/4
- **5** = 3/4
- **6** = 4/4

<DCI format>

Represents the DCI format. The value is a number in the range {0...103}.

- **0** = DCI format 0
- **10** = DCI format 1
- **11** = DCI format 1A
- **12** = DCI format 1B
- **13** = DCI format 1C
- **14** = DCI format 1D
- **20** = DCI format 2
- **21** = DCI format 2A

- **22** = DCI format 2B
- **23** = DCI format 2C
- **24** = DCI format 2D
- **30** = DCI format 3
- **31** = DCI format A
- **103** = DCI format 0/3/3A

<modulation>

Represents the modulation scheme.

- **0** = unrecognized
- **1** = RBPSK
- **2** = QPSK
- **3** = 16QAM
- **4** = 64QAM
- **5** = 8PSK
- **6** = CAZAC
- **7** = mixed modulation
- **8** = BPSK
- **14** = 256QAM
- **15** = 1024QAM

<PHICH duration>

Represents the PHICH duration. The range is {1...2}.

- **1** = normal
- **2** = extended

<PHICH resource>

Represents the parameter N_g . The range is {1...4}.

- **1** = N_g 1/6
- **2** = N_g 1/2
- **3** = N_g 1
- **4** = N_g 2

FORMat[:DATA].....	173
TRACe<n>[:DATA]?.....	174
TRACe<n>[:DATA]:X?.....	174

FORMat[:DATA] <Format>

Selects the data format for the data transmission between the R&S FSV/A and the remote client.

Parameters:

<Format> ASCII | REAL
 *RST: ASCII

Example:

```
//Select data format
FORM REAL
```

TRACe<n>[:DATA]? <Result>

This command queries the trace data for each measurement point (y-axis values).

In combination with [TRACe<n> \[: DATA\] : X?](#), you can thus query the coordinates of each measurement point.

Suffix:

<n> [Window](#)

Query parameters:

<TraceNumber> **TRACE1 | TRACE2 | TRACE3**
 Queries the trace data of the corresponding trace.

LIST Queries the results for the SEM measurement.

PBCH Queries the results for the PBCH in the channel decoder.

PCFICH Queries the results for the PCFICH in the channel decoder.

PHICH Queries the results for the PHICH in the channel decoder.

PDCCH Queries the results for the PDCCH in the channel decoder.

Return values:

<TraceData> For more information about the type of return values in the different result displays, see [Chapter 7.6.1, "The TRACe\[:DATA\] command"](#), on page 157.

Example:

```
//Query results of the second measurement window. The type of
data that is returned by the parameter (TRACE1) depends on the
result display shown in measurement window 2.
TRAC2? TRACE1
```

Usage:

Query only

Manual operation: See ["Data import and export"](#) on page 126

TRACe<n>[:DATA]:X? <Result>

Queries the horizontal trace data for each measurement point (x-axis values).

In combination with [TRACe<n> \[: DATA\] ?](#), you can thus query the coordinates of each measurement point.

Suffix:

<n> [Window](#)

Query parameters:

<TraceNumber> TRACe1 | TRACe2 | TRACe3 | TRACe4 | TRACe5 | TRACe6

Return values:	
<TraceData>	The type of value depends on the information displayed on the x-axis of the result display whose contents you query.
Example:	//Query trace data of trace 1 in window 2 TRAC2? TRACE1 TRAC2:X? TRACE1
Usage:	Query only
Manual operation:	See "Capture Buffer" on page 18 See "EVM vs Carrier" on page 19 See "EVM vs Symbol" on page 20 See "EVM vs RB" on page 20 See "EVM vs Subframe" on page 21 See "Frequency Error vs Symbol" on page 22 See "Power Spectrum" on page 22 See "Power vs Resource Block PDSCH" on page 23 See "Power vs Resource Block RS" on page 23 See "Channel Flatness" on page 24 See "Group Delay" on page 24 See "Channel Flatness Difference" on page 24

7.6.2 Result readout

[CALCulate<n>:MARKer<m>:FUNction:POWer<sb>:RESult\[:CURRent\]?.....](#) 175

**CALCulate<n>:MARKer<m>:FUNction:POWer<sb>:RESult[:CURRent]?
[<Measurement>]**

Queries the results of the ACLR measurement or the total signal power level of the SEM measurement.

To get a valid result, you have to perform a complete measurement with synchronization to the end of the measurement before reading out the result. This is only possible for single sweeps.

Suffix:

<n>	Window
<m>	Marker
<sb>	irrelevant

Query parameters:

<Measurement>	CPOW This parameter queries the channel power of the reference range.
	MCAC Queries the channel powers of the ACLR, MC ACLR and Cumulative ACLR measurements as shown in the ACLR table. Where available, this parameter also queries the power of the adjacent channels (for example in the ACLR measurement).

GACLR

Queries the ACLR values for each gap channel in the MC ACLR measurement.

Return values:

<Result>

Results for the Spectrum Emission Mask measurement:

Power level in dBm.

Results for the ACLR measurements:

Relative power levels of the ACLR channels. The number of return values depends on the number of transmission and adjacent channels. The order of return values is:

- <TXChannelPower> is the power of the transmission channel in dBm
- <LowerAdjChannelPower> is the relative power of the lower adjacent channel in dB
- <UpperAdjChannelPower> is the relative power of the upper adjacent channel in dB
- <1stLowerAltChannelPower> is the relative power of the first lower alternate channel in dB
- <1stUpperAltChannelPower> is the relative power of the first lower alternate channel in dB
- (...)
- <nthLowerAltChannelPower> is the relative power of a subsequent lower alternate channel in dB
- <nthUpperAltChannelPower> is the relative power of a subsequent lower alternate channel in dB

Example:

CALC1:MARK:FUNC:POW:RES? MCAC

Returns the current ACLR measurement results.

Usage:

Query only

Manual operation:

See "[Result summary](#)" on page 45

See "[Result summary](#)" on page 47

See "[Result summary](#)" on page 49

7.7 Numeric result readout

- [Frame results](#)..... 176
- [Result for selection](#)..... 179
- [Time alignment error](#)..... 185
- [Marker table](#)..... 186
- [CCDF table](#)..... 189

7.7.1 Frame results

- [FETCh\[:CC<cc>\]:SUMMary:EVM:DSQP:MAXimum?](#)..... 177
- [FETCh\[:CC<cc>\]:SUMMary:EVM:DSQP:MINimum?](#)..... 177
- [FETCh\[:CC<cc>\]:SUMMary:EVM:DSQP\[:AVERage\]?](#)..... 177

FETCh[:CC<cc>]:SUMMary:EVM:DSST:MAXimum?	177
FETCh[:CC<cc>]:SUMMary:EVM:DSST:MINimum?	177
FETCh[:CC<cc>]:SUMMary:EVM:DSST[:AVERage]?	177
FETCh[:CC<cc>]:SUMMary:EVM:DSSF:MAXimum?	178
FETCh[:CC<cc>]:SUMMary:EVM:DSSF:MINimum?	178
FETCh[:CC<cc>]:SUMMary:EVM:DSSF[:AVERage]?	178
FETCh[:CC<cc>]:SUMMary:EVM:DSTS:MAXimum?	178
FETCh[:CC<cc>]:SUMMary:EVM:DSTS:MINimum?	178
FETCh[:CC<cc>]:SUMMary:EVM:DSTS[:AVERage]?	178
FETCh[:CC<cc>]:SUMMary:EVM:DS1K:MAXimum?	178
FETCh[:CC<cc>]:SUMMary:EVM:DS1K:MINimum?	178
FETCh[:CC<cc>]:SUMMary:EVM:DS1K[:AVERage]?	178

FETCh[:CC<cc>]:SUMMary:EVM:DSQP:MAXimum?**FETCh[:CC<cc>]:SUMMary:EVM:DSQP:MINimum?****FETCh[:CC<cc>]:SUMMary:EVM:DSQP[:AVERage]?**

Queries the EVM of all PDSCH resource elements with a QPSK modulation.

Suffix:

<cc> [Component Carrier](#)

Return values:

<EVM> <numeric value>
EVM in % or dB, depending on the unit you have set.

Example:

```
//Query EVM
FETC : SUMM : EVM : DSQP ?
```

Usage:

Query only

FETCh[:CC<cc>]:SUMMary:EVM:DSST:MAXimum?**FETCh[:CC<cc>]:SUMMary:EVM:DSST:MINimum?****FETCh[:CC<cc>]:SUMMary:EVM:DSST[:AVERage]?**

Queries the EVM of all PDSCH resource elements with a 16QAM modulation.

Suffix:

<cc> [Component Carrier](#)

Return values:

<EVM> <numeric value>
EVM in % or dB, depending on the unit you have set.

Example:

```
//Query EVM
FETC : SUMM : EVM : DSST ?
```

Usage:

Query only

FETCh[:CC<cc>]:SUMMary:EVM:DSSF:MAXimum?
FETCh[:CC<cc>]:SUMMary:EVM:DSSF:MINimum?
FETCh[:CC<cc>]:SUMMary:EVM:DSSF[:AVERage]?

Queries the EVM of all PDSCH resource elements with a 64QAM modulation.

Suffix:

<cc> [Component Carrier](#)

Return values:

<EVM> <numeric value>
 EVM in % or dB, depending on the unit you have set.

Example: //Query EVM
 FETC : SUMM : EVM : DSSF ?

Usage: Query only

FETCh[:CC<cc>]:SUMMary:EVM:DSTS:MAXimum?
FETCh[:CC<cc>]:SUMMary:EVM:DSTS:MINimum?
FETCh[:CC<cc>]:SUMMary:EVM:DSTS[:AVERage]?

Queries the EVM of all PDSCH resource elements with a 256QAM modulation.

Suffix:

<cc> [Component Carrier](#)

Return values:

<EVM> <numeric value>
 EVM in % or dB, depending on the unit you have set.

Example: //Query EVM
 FETC : SUMM : EVM : DSTS ?

Usage: Query only

FETCh[:CC<cc>]:SUMMary:EVM:DS1K:MAXimum?
FETCh[:CC<cc>]:SUMMary:EVM:DS1K:MINimum?
FETCh[:CC<cc>]:SUMMary:EVM:DS1K[:AVERage]?

Queries the EVM of all resource elements of the PDSCH with a 1024QAM modulation.

Suffix:

<cc> [Component Carrier](#)

Return values:

<EVM> <numeric value>
 EVM in % or dB, depending on the unit you have set.

Example: //Query EVM
 FETC : SUMM : EVM : DS1K ?

Usage: Query only

7.7.2 Result for selection

FETCh[:CC<cc>]:SUMMary:CRESt[:AVERAge]?	179
FETCh[:CC<cc>]:SUMMary:EVM[:ALL]:MAXimum?	180
FETCh[:CC<cc>]:SUMMary:EVM[:ALL]:MINimum?	180
FETCh[:CC<cc>]:SUMMary:EVM[:ALL]:AVERAge]?	180
FETCh[:CC<cc>]:SUMMary:EVM:PCHannel:MAXimum?	180
FETCh[:CC<cc>]:SUMMary:EVM:PCHannel:MINimum?	180
FETCh[:CC<cc>]:SUMMary:EVM:PCHannel[:AVERAge]?	180
FETCh[:CC<cc>]:SUMMary:EVM:PSIGnal:MAXimum?	180
FETCh[:CC<cc>]:SUMMary:EVM:PSIGnal:MINimum?	180
FETCh[:CC<cc>]:SUMMary:EVM:PSIGnal[:AVERAge]?	180
FETCh[:CC<cc>]:SUMMary:FERRor:MAXimum?	181
FETCh[:CC<cc>]:SUMMary:FERRor:MINimum?	181
FETCh[:CC<cc>]:SUMMary:FERRor[:AVERAge]?	181
FETCh[:CC<cc>]:SUMMary:GIMBalance:MAXimum?	181
FETCh[:CC<cc>]:SUMMary:GIMBalance:MINimum?	181
FETCh[:CC<cc>]:SUMMary:GIMBalance[:AVERAge]?	181
FETCh[:CC<cc>]:SUMMary:IQOFfset:MAXimum?	182
FETCh[:CC<cc>]:SUMMary:IQOFfset:MINimum?	182
FETCh[:CC<cc>]:SUMMary:IQOFfset[:AVERAge]?	182
FETCh[:CC<cc>]:SUMMary:OSTP:MAXimum?	182
FETCh[:CC<cc>]:SUMMary:OSTP:MINimum?	182
FETCh[:CC<cc>]:SUMMary:OSTP[:AVERAge]?	182
FETCh[:CC<cc>]:SUMMary:POWer:MAXimum?	182
FETCh[:CC<cc>]:SUMMary:POWer:MINimum?	182
FETCh[:CC<cc>]:SUMMary:POWer[:AVERAge]?	182
FETCh[:CC<cc>]:SUMMary:QUADerror:MAXimum?	183
FETCh[:CC<cc>]:SUMMary:QUADerror:MINimum?	183
FETCh[:CC<cc>]:SUMMary:QUADerror[:AVERAge]?	183
FETCh[:CC<cc>]:SUMMary:RSSI:MAXimum?	183
FETCh[:CC<cc>]:SUMMary:RSSI:MINimum?	183
FETCh[:CC<cc>]:SUMMary:RSSI[:AVERAge]?	183
FETCh[:CC<cc>]:SUMMary:RSTP:MAXimum?	184
FETCh[:CC<cc>]:SUMMary:RSTP:MINimum?	184
FETCh[:CC<cc>]:SUMMary:RSTP[:AVERAge]?	184
FETCh[:CC<cc>]:SUMMary:SERRor:MAXimum?	184
FETCh[:CC<cc>]:SUMMary:SERRor:MINimum?	184
FETCh[:CC<cc>]:SUMMary:SERRor[:AVERAge]?	184
FETCh[:CC<cc>]:SUMMary:TFRame?	184

FETCh[:CC<cc>]:SUMMary:CRESt[:AVERAge]?

Queries the average crest factor as shown in the result summary.

Suffix:

<cc> Component Carrier

Return values:

<CrestFactor> <numeric value>
Crest Factor in dB.

Example: //Query crest factor
FETC : SUMM : CRES ?

Usage: Query only

FETCh[:CC<cc>]:SUMMary:EVM[:ALL]:MAXimum?
FETCh[:CC<cc>]:SUMMary:EVM[:ALL]:MINimum?
FETCh[:CC<cc>]:SUMMary:EVM[:ALL][:AVERage]?

Queries the EVM of all resource elements.

Suffix:
 <cc> [Component Carrier](#)

Return values:
 <EVM> <numeric value>
 Minimum, maximum or average EVM, depending on the last command syntax element.
 The unit is % or dB, depending on your selection.

Example: //Query EVM
FETC : SUMM : EVM ?

Usage: Query only

FETCh[:CC<cc>]:SUMMary:EVM:PCHannel:MAXimum?
FETCh[:CC<cc>]:SUMMary:EVM:PCHannel:MINimum?
FETCh[:CC<cc>]:SUMMary:EVM:PCHannel[:AVERage]?

Queries the EVM of all physical channel resource elements.

Suffix:
 <cc> [Component Carrier](#)

Return values:
 <EVM> <numeric value>
 EVM in % or dB, depending on the unit you have set.

Example: //Query EVM
FETC : SUMM : EVM : PCH ?

Usage: Query only

FETCh[:CC<cc>]:SUMMary:EVM:PSIGnal:MAXimum?
FETCh[:CC<cc>]:SUMMary:EVM:PSIGnal:MINimum?
FETCh[:CC<cc>]:SUMMary:EVM:PSIGnal[:AVERage]?

Queries the EVM of all physical signal resource elements.

Suffix:
 <cc> [Component Carrier](#)

Return values:

<EVM> <numeric value>
 Minimum, maximum or average EVM, depending on the last command syntax element.
 The unit is % or dB, depending on your selection.

Example:

```
//Query EVM
FETC:SUMM:EVM:PSIG?
```

Usage:

Query only

FETCh[:CC<cc>]:SUMMary:FERRor:MAXimum?

FETCh[:CC<cc>]:SUMMary:FERRor:MINimum?

FETCh[:CC<cc>]:SUMMary:FERRor[:AVERage]?

Queries the frequency error.

Suffix:

<cc> [Component Carrier](#)

Return values:

<FrequencyError> <numeric value>
 Minimum, maximum or average frequency error, depending on the last command syntax element.
 Default unit: Hz

Example:

```
//Query average frequency error
FETC:SUMM:FERR?
```

Usage:

Query only

FETCh[:CC<cc>]:SUMMary:GIMBalance:MAXimum?

FETCh[:CC<cc>]:SUMMary:GIMBalance:MINimum?

FETCh[:CC<cc>]:SUMMary:GIMBalance[:AVERage]?

Queries the I/Q gain imbalance.

Suffix:

<cc> [Component Carrier](#)

Return values:

<GainImbalance> <numeric value>
 Minimum, maximum or average I/Q imbalance, depending on the last command syntax element.
 Default unit: dB

Example:

```
//Query average gain imbalance
FETC:SUMM:GIMB?
```

Usage:

Query only

FETCh[:CC<cc>]:SUMMary:IQOFfset:MAXimum?
FETCh[:CC<cc>]:SUMMary:IQOFfset:MINimum?
FETCh[:CC<cc>]:SUMMary:IQOFfset[:AVERage]?

Queries the I/Q offset.

Suffix:

<cc> [Component Carrier](#)

Return values:

<IQOffset> <numeric value>

Minimum, maximum or average I/Q offset, depending on the last command syntax element.

Default unit: dB

Example:

//Query average IQ offset
 FETC:SUMM:IQOF?

Usage:

Query only

FETCh[:CC<cc>]:SUMMary:OSTP:MAXimum?
FETCh[:CC<cc>]:SUMMary:OSTP:MINimum?
FETCh[:CC<cc>]:SUMMary:OSTP[:AVERage]?

Queries the OSTP.

Suffix:

<cc> [Component Carrier](#)

Return values:

<OSTP> <numeric value>

Minimum, maximum or average OSTP, depending on the last command syntax element.

Default unit: dBm

Example:

//Query average OSTP
 FETC:SUMM:OSTP?

Usage:

Query only

FETCh[:CC<cc>]:SUMMary:POWER:MAXimum?
FETCh[:CC<cc>]:SUMMary:POWER:MINimum?
FETCh[:CC<cc>]:SUMMary:POWER[:AVERage]?

Queries the total power.

Suffix:

<cc> [Component Carrier](#)

Return values:

<Power> <numeric value>
 Minimum, maximum or average power, depending on the last command syntax element.
 Default unit: dBm

Example: //Query average total power
 FETC : SUMM : POW ?

Usage: Query only

FETCh[:CC<cc>]:SUMMary:QUADerror:MAXimum?
FETCh[:CC<cc>]:SUMMary:QUADerror:MINimum?
FETCh[:CC<cc>]:SUMMary:QUADerror[:AVERage]?

Queries the quadrature error.

Suffix:

<cc> [Component Carrier](#)

Return values:

<QuadratureError> <numeric value>
 Minimum, maximum or average quadrature error, depending on the last command syntax element.
 Default unit: deg

Example: //Query average quadrature error
 FETC : SUMM : QUAD ?

Usage: Query only

FETCh[:CC<cc>]:SUMMary:RSSI:MAXimum?
FETCh[:CC<cc>]:SUMMary:RSSI:MINimum?
FETCh[:CC<cc>]:SUMMary:RSSI[:AVERage]?

Queries the RSSI.

Suffix:

<cc> [Component Carrier](#)

Return values:

<RSSI> <numeric value>
 Minimum, maximum or average sampling error, depending on the last command syntax element.
 Default unit: dBm

Example: //Query average RSSI
 FETC : SUMM : RSSI ?

Usage: Query only

FETCh[:CC<cc>]:SUMMary:RSTP:MAXimum?
FETCh[:CC<cc>]:SUMMary:RSTP:MINimum?
FETCh[:CC<cc>]:SUMMary:RSTP[:AVERage]?

Queries the RSTP.

Suffix:

<cc> [Component Carrier](#)

Return values:

<RSTP> <numeric value>
 Default unit: dBm

Example: //Query RSTP
 FETC:SUMM:RSTP?

Usage: Query only

FETCh[:CC<cc>]:SUMMary:SERRor:MAXimum?
FETCh[:CC<cc>]:SUMMary:SERRor:MINimum?
FETCh[:CC<cc>]:SUMMary:SERRor[:AVERage]?

Queries the sampling error.

Suffix:

<cc> [Component Carrier](#)

Return values:

<SamplingError> <numeric value>
 Minimum, maximum or average sampling error, depending on the last command syntax element.
 Default unit: ppm

Example: //Query average sampling error
 FETC:SUMM:SERR?

Usage: Query only

FETCh[:CC<cc>]:SUMMary:TFRame?

Queries the (sub)frame start offset as shown in the capture buffer.

Suffix:

<cc> [Component Carrier](#)

Return values:

<Offset> Time difference between the (sub)frame start and capture buffer start.
 Default unit: s

Example: //Query subframe start offset
 FETC:SUMM:TFR?

Usage: Query only

Manual operation: See ["Capture Buffer"](#) on page 18

7.7.3 Time alignment error

FETCh:FERRor[:CC<cc>][:AVERage]?	185
FETCh:TAERror[:CC<cc>]:ANTenna<ant>:MAXimum?	185
FETCh:TAERror[:CC<cc>]:ANTenna<ant>:MINimum?	185
FETCh:TAERror[:CC<cc>]:ANTenna<ant>[:AVERage]?	185

FETCh:FERRor[:CC<cc>][:AVERage]?

Queries the carrier frequency error.

Suffix:

<cc> [Component Carrier](#)

Return values:

<FrequencyError> <numeric value>

Average, minimum or maximum frequency error, depending on the command syntax.

Default unit: Hz

Example:

//Query frequency error.

FETC:FERR?

Usage:

Query only

FETCh:TAERror[:CC<cc>]:ANTenna<ant>:MAXimum?

FETCh:TAERror[:CC<cc>]:ANTenna<ant>:MINimum?

FETCh:TAERror[:CC<cc>]:ANTenna<ant>[:AVERage]?

Queries the time alignment error.

Suffix:

<cc> [Component Carrier](#)

<ant> [Antenna](#)

Return values:

<TAE> Minimum, maximum or average time alignment error, depending on the last command syntax element.

Default unit: s

Example:

//Query average TAE between reference antenna and antenna 2

FETC:TAER:ANT2?

Usage:

Query only

Manual operation: See ["Time Alignment Error"](#) on page 39

7.7.4 Marker table

CALCulate<n>:DELTamarker<m>:X.....	186
CALCulate<n>:DELTamarker<m>:Y?.....	186
CALCulate<n>:MARKer<m>:X.....	187
CALCulate<n>:MARKer<m>:Y.....	187
CALCulate<n>:MARKer<m>:Z?.....	188
CALCulate<n>:MARKer<m>:Z:ALL?.....	188

CALCulate<n>:DELTamarker<m>:X <Position>

Moves a delta marker to a particular coordinate on the x-axis.

If necessary, the command activates the delta marker and positions a reference marker to the peak power.

Suffix:

<n> Window

<m> Marker

Parameters:

<Position> Numeric value that defines the marker position on the x-axis.
 Range: The value range and unit depend on the measurement and scale of the x-axis.

Example:

CALC:DELT:X?

Outputs the absolute x-value of delta marker 1.

CALCulate<n>:DELTamarker<m>:Y?

Queries the position of a deltamarker on the y-axis.

If necessary, the command activates the deltamarker first.

To get a valid result, you have to perform a complete measurement with synchronization to the end of the measurement before reading out the result. This is only possible for single measurement mode.

See also [INITiate<n>:CONTinuous](#) on page 154.

Note that result displays with a third aspect (for example "EVM vs Symbol x Carrier") do not support deltamarkers.

Suffix:

<n> Window

<m> Marker

Return values:

<Result> <numeric value>

Result at the deltamarker position. The return value is a value relative to the position of marker 1.

The type of value and its unit depend on the selected result display.

Example: //Query coordinates of deltamarker 2 in window 4
 CALC4:DELT2:X?
 CALC4:DELT2:Y?

Usage: Query only

CALCulate<n>:MARKer<m>:X <Position>

Moves a marker to a specific coordinate on the x-axis.

If necessary, the command activates the marker.

If the marker has been used as a delta marker, the command turns it into a normal marker.

Suffix:

<n> [Window](#)

<m> [Marker](#)

Note that 3D diagrams only support one marker.

Parameters:

<Position> Numeric value that defines the marker position on the x-axis.
 The unit depends on the result display.

Range: The range depends on the current x-axis range.
 Default unit: Hz

Example: CALC:MARK2:X 1.7MHz
 Positions marker 2 to frequency 1.7 MHz.

Manual operation: See ["Marker Table"](#) on page 37
 See ["Marker Peak List"](#) on page 52

CALCulate<n>:MARKer<m>:Y <Result>

Queries the position of a marker on the y-axis.

In result displays with a third aspect (for example "EVM vs Symbol x Carrier"), you can also use the command to define the position of the marker on the y-axis.

If necessary, the command activates the marker first.

To get a valid result, you have to perform a complete measurement with synchronization to the end of the measurement before reading out the result. This is only possible for single measurement mode.

See also [INITiate<n>:CONTinuous](#) on page 154.

Suffix:

<n> [Window](#)

<m> [Marker](#)

Note that 3D diagrams only support one marker.

Parameters:

<Result> <numeric value>
 Result at the marker position.
 The type of value and its unit depend on the selected result display.

Example: //Query coordinates of marker 2 in window 4
 CALC4:MARK2:X?
 CALC4:MARK2:Y?

Example: //Define position of marker in 3D diagram
 CALC:MARK:X 16
 CALC:MARK:Y 6

Manual operation: See "[Marker Table](#)" on page 37
 See "[Marker Peak List](#)" on page 52

CALCulate<n>:MARKer<m>:Z?

Queries the marker position on the z-axis of three-dimensional result displays.

Returns the type of value displayed in the selected result display (EVM, Power or Allocation ID).

Suffix:

<n> [Window](#)

<m> [Marker](#)

Return values:

<Position> <numeric value>
 Default unit: Depends on result display

Example: //Query marker position
 CALC:MARK:Z?

Usage: Query only

Manual operation: See "[Marker Table](#)" on page 37

CALCulate<n>:MARKer<m>:Z:ALL?

Queries the marker position on the z-axis of three-dimensional result displays.

Instead of returning a certain type of value (EVM, Power **or** Allocation ID), which is possible with [CALCulate<n>:MARKer<m>:Z?](#), this command returns all types of values (EVM, Power **and** Allocation ID), regardless of the result display type.

Suffix:

<n> [Window](#)

<m> irrelevant

Return values:

<Position> <numeric value>

EVM

EVM at the marker position.

Power

Power at the marker position.

Allocation ID

Allocation ID at the marker position.

Modulation

Modulation type at the marker position.

Example: //Query EVM, Power and Allocation ID at the marker position.
CALC:MARK:Z:ALL?

Usage: Query only

Manual operation: See "[Marker Table](#)" on page 37

7.7.5 CCDF table

CALCulate<n>:STATistics:CCDF:X<t>?	189
CALCulate<n>:STATistics:RESult<res>?	190

CALCulate<n>:STATistics:CCDF:X<t>? <Probability>

Queries the results of the CCDF.

Suffix:<n> [Window](#)<t> [Trace](#)**Query parameters:**

<Probability> **P0_01**
Level value for 0.01 % probability

P0_1
Level value for 0.1 % probability

P1
P1: Level value for 1 % probability

P10
Level value for 10 % probability

Return values:

<CCDF Result>

Example: CALC:STAT:CCDF:X1? P10
Returns the level values that are over 10 % above the mean value.

Usage: Query only**Manual operation:** See "[CCDF](#)" on page 26

CALCulate<n>:STATistics:RESult<res>? <ResultType>

Queries the results of a measurement for a specific trace.

Suffix:

<n> [Window](#)

<res> [Trace](#)

Query parameters:

<ResultType>

MEAN

Average (=RMS) power in dBm measured during the measurement time.

PEAK

Peak power in dBm measured during the measurement time.

CFACTOR

Determined crest factor (= ratio of peak power to average power) in dB.

ALL

Results of all three measurements mentioned before, separated by commas: <mean power>,<peak power>,<crest factor>

Example:

`CALC:STAT:RES2? ALL`

Reads out the three measurement results of trace 2. Example of answer string: 5.56,19.25,13.69 i.e. mean power: 5.56 dBm, peak power 19.25 dBm, crest factor 13.69 dB

Usage:

Query only

Manual operation: See "[CCDF](#)" on page 26

7.8 Limit check result readout

- [Limits for graphical result displays](#)..... 190
- [Limits for numerical result display](#)..... 198

7.8.1 Limits for graphical result displays

CALCulate<n>:LIMit:ACPower:ACHannel:RESult?	191
CALCulate<n>:LIMit:ACPower:ACHannel:RESult:ABSolute	191
CALCulate<n>:LIMit:ACPower:ACHannel:RESult:RELative	192
CALCulate<n>:LIMit:ACPower:ALTernate<alt>:RESult?	192
CALCulate<n>:LIMit:ACPower:ALTernate<ch>:RESult:ABSolute	193
CALCulate<n>:LIMit:ACPower:ALTernate<ch>:RESult:RELative	193
CALCulate<n>:LIMit:ACPower:GAP<gap>:ACLR:RESult?	194
CALCulate<n>:LIMit:ACPower:GAP<gap>:ACLR:RESult:ABSolute?	194
CALCulate<n>:LIMit:ACPower:GAP<gap>:ACLR:RESult:RELative?	195
CALCulate<n>:LIMit:ACPower:GAP<gap>[:CACLR]:RESult?	196
CALCulate<n>:LIMit:ACPower:GAP<gap>[:CACLR]:RESult:ABSolute?	196

CALCulate<n>:LIMit:ACPpower:GAP<gap>[:CACLR]:RESult:RELative?.....	197
CALCulate<n>:LIMit:OOPower:OFFPower?.....	197
CALCulate<n>:LIMit:OOPower:TRANSient?.....	198

CALCulate<n>:LIMit:ACPpower:ACHannel:RESult? [<Result>]

Queries the limit check results for the adjacent channels during ACLR measurements.

Suffix:

<n>	irrelevant
	irrelevant

Query parameters:

<Result>	REL Queries the channel power limit check results.
	ABS Queries the distance to the limit line.

Return values:

<LimitCheck>	Returns two values, one for the upper and one for the lower adjacent channel.
	PASSED Limit check has passed.
	FAILED Limit check has failed.

Example: //Query results of the adjacent channel limit check
CALC:LIM:ACP:ACH:RES?

Example: //Query results of the adjacent channel limit check
CALC:LIM:ACP:ACH:RES? ABS

Usage: Query only

Manual operation: See "Result summary" on page 47
See "Result summary" on page 49

CALCulate<n>:LIMit:ACPpower:ACHannel:RESult:ABSolute

Queries the absolute limit check results for adjacent channels (ACLR measurements).

Prerequisites for this command

- Select absolute limit check mode evaluation mode
ACLR: CALCulate<n>:LIMit:ACPpower:PMODE.

Suffix:

<n>	irrelevant
-----	------------

 irrelevant

Return values:

<LimitCheck> Returns two values, one for the upper and one for the lower adjacent channel.

PASSED

Limit check has passed.

FAILED

Limit check has failed.

Example:

//Query results of the adjacent channel limit check
CALC:LIM:ACP:ACH:RES:ABS?

CALCulate<n>:LIMit:ACPpower:ACHannel:RESult:RELative

Queries the relative limit check results for the adjacent channels (ACLR measurements).

Prerequisites for this command

- Select relative limit check mode
ACLR: CALCulate<n>:LIMit:ACPpower:PMODE.

Suffix:

<n> irrelevant

 irrelevant

Return values:

<LimitCheck> Returns two values, one for the upper and one for the lower adjacent channel.

PASSED

Limit check has passed.

FAILED

Limit check has failed.

Example:

//Query results of the adjacent channel limit check
CALC:LIM:ACP:ACH:RES:REL?

CALCulate<n>:LIMit:ACPpower:ALternate<alt>:RESult? [<Result>]

Queries the limit check results for the alternate channels during ACLR measurements.

Suffix:

<n> irrelevant

 irrelevant

<alt> irrelevant

Query parameters:

<Result>

REL

Queries the channel power limit check results.

ABS

Queries the distance to the limit line.

Return values:

<LimitCheck> Returns two values, one for the upper and one for the lower alternate channel.

PASSED

Limit check has passed.

FAILED

Limit check has failed.

Example:

```
//Query results of the alternate channel limit check
CALC:LIM:ACP:ALT:RES?
```

Example:

```
//Query results of the alternate channel limit check
CALC:LIM:ACP:ACH:RES? ABS
```

Usage:

Query only

Manual operation:

See ["Result summary"](#) on page 47

See ["Result summary"](#) on page 49

CALCulate<n>:LIMit:ACPpower:ALternate<ch>:RESult:ABSolute

Queries the absolute limit check results for the alternate channels (MC ACLR measurements).

Prerequisites for this command

- Select absolute limit check mode
ACLR: [CALCulate<n>:LIMit:ACPpower:PMODE](#).

Suffix:

<n> irrelevant

 irrelevant

<ch> irrelevant

Return values:

<LimitCheck> Returns two values, one for the upper and one for the lower adjacent channel.

PASSED

Limit check has passed.

FAILED

Limit check has failed.

Example:

```
//Query results of the alternate channel limit check
CALC:LIM:ACP:ALT:RES:ABS?
```

CALCulate<n>:LIMit:ACPpower:ALternate<ch>:RESult:RELative

Queries the relative limit check results for the alternate channels (MC ACLR measurements).

Prerequisites for this command

- Select relative limit check mode
ACLR: `CALCulate<n>:LIMit:ACPpower:PMODE`.

Suffix:

<n> irrelevant

 irrelevant

<ch> irrelevant

Return values:

<LimitCheck> Returns two values, one for the upper and one for the lower adjacent channel.

PASSED

Limit check has passed.

FAILED

Limit check has failed.

Example:

```
//Query results of the alternate channel limit check
CALC:LIM:ACP:ALT:RES:REL?
```

CALCulate<n>:LIMit:ACPpower:GAP<gap>:ACLR:RESult?

Queries the ACLR power limit check results for the gap channels (MC ACLR measurements).

Suffix:

<n> irrelevant

 irrelevant

<gap> irrelevant

Return values:

<LimitCheck> Returns two values, one for the upper and one for the lower adjacent channel.

PASSED

Limit check has passed.

FAILED

Limit check has failed.

Example:

```
//Query results of the gap channel limit check
CALC:LIM:ACP:GAP:ACLR:RES?
```

Usage:

Query only

CALCulate<n>:LIMit:ACPpower:GAP<gap>:ACLR:RESult:ABSolute?

Queries the absolute power limit check results for the gap channels (MC ACLR measurements).

Prerequisites for this command

- Select absolute limit check mode evaluation mode
ACLR: `CALCulate<n>:LIMit:ACPower:PMODE.`

Suffix:

<n> irrelevant
 irrelevant
<gap> irrelevant

Return values:

<LimitCheck> Returns two values, one for the upper and one for the lower adjacent channel.

PASSED

Limit check has passed.

FAILED

Limit check has failed.

Example:

```
//Query results of the gap channel limit check
CALC:LIM:ACP:GAP:ACLR:RES:ABS?
```

Usage:

Query only

CALCulate<n>:LIMit:ACPower:GAP<gap>:ACLR:RESult:RELative?

Queries the relative power limit check results for the gap channels (MC ACLR measurements).

Prerequisites for this command

- Select relative limit check mode evaluation mode
ACLR: `CALCulate<n>:LIMit:ACPower:PMODE.`

Suffix:

<n> irrelevant
 irrelevant
<gap> irrelevant

Return values:

<LimitCheck> Returns two values, one for the upper and one for the lower adjacent channel.

PASSED

Limit check has passed.

FAILED

Limit check has failed.

Example:

```
//Query results of the gap channel limit check
CALC:LIM:ACP:GAP:ACLR:RES:REL?
```

Usage:

Query only

CALCulate<n>:LIMit:ACPpower:GAP<gap>[:CACLR]:RESult?

Queries the limit check results for the gap channels (MC ACLR measurements).

Suffix:

<n>	irrelevant
	irrelevant
<gap>	irrelevant

Return values:

<LimitCheck> Returns two values, one for the upper and one for the lower adjacent channel.

PASSED

Limit check has passed.

FAILED

Limit check has failed.

Example:

```
//Query results of the gap channel limit check
CALC:LIM:ACP:GAP:RES?
```

Usage:

Query only

CALCulate<n>:LIMit:ACPpower:GAP<gap>[:CACLR]:RESult:ABSolute?

Queries the absolute limit check results for the gap channels (MC ACLR measurements).

Prerequisites for this command

- Select absolute limit check mode evaluation mode

ACLR: [CALCulate<n>:LIMit:ACPpower:PMODE.](#)

Suffix:

<n>	irrelevant
	irrelevant
<gap>	irrelevant

Return values:

<LimitCheck> Returns two values, one for the upper and one for the lower adjacent channel.

PASSED

Limit check has passed.

FAILED

Limit check has failed.

Example:

```
//Query results of the gap channel limit check
CALC:LIM:ACP:GAP:RES:ABS?
```

Usage:

Query only

CALCulate<n>:LIMit:ACPpower:GAP<gap>[:CACLR]:RESult:RELative?

Queries the relative limit check results for the gap channels (MC ACLR measurements).

Prerequisites for this command

- Select relative limit check mode evaluation mode
ACLR: `CALCulate<n>:LIMit:ACPpower:PMODE.`

Suffix:

<n>	irrelevant
	irrelevant
<gap>	irrelevant

Return values:

<LimitCheck> Returns two values, one for the upper and one for the lower adjacent channel.

PASSED

Limit check has passed.

FAILED

Limit check has failed.

Example:

```
//Query results of the gap channel limit check
CALC:LIM:ACP:GAP:RES:REL?
```

Usage:

Query only

CALCulate<n>:LIMit:OOPower:OFFPower?

Queries the results of the limit check in the "Off" periods of On/Off Power measurements.

Suffix:

<n>	irrelevant
	irrelevant

Return values:

<Results> Returns one value for every "Off" period.

PASSED

Limit check has passed.

FAILED

Limit check has failed.

Example:

```
//Query the results for the limit check during the signal OFF periods
CALC:LIM:OOP:OFFP?
```

Usage:

Query only

CALCulate<n>:LIMit:OOPower:TRANsient? <Result>

Queries the results of the limit check during the transient periods of the On/Off power measurement.

Suffix:

<n> irrelevant

 irrelevant

Query parameters:

<Result> **ALL**
Queries the overall limit check results.

FALLing

Queries the limit check results of falling transients.

RISing

Queries the limit check results of rising transients.

Return values:

<LimitCheck> Returns one value for every "Off" period.

PASSED

Limit check has passed.

FAILED

Limit check has failed.

Example:

//Query the limit check result of rising transients

```
CALC:LIM:OOP:TRAN? RIS
```

Usage:

Query only

7.8.2 Limits for numerical result display

CALCulate<n>:LIMit[:CC<cc>]:SUMMARY:EVM[:ALL]:MAXimum:RESult?	199
CALCulate<n>:LIMit[:CC<cc>]:SUMMARY:EVM[:ALL]:AVERage:RESult?	199
CALCulate<n>:LIMit[:CC<cc>]:SUMMARY:EVM:DSQP:MAXimum:RESult?	199
CALCulate<n>:LIMit[:CC<cc>]:SUMMARY:EVM:DSQP:AVERage:RESult?	199
CALCulate<n>:LIMit[:CC<cc>]:SUMMARY:EVM:DSSF:MAXimum:RESult?	200
CALCulate<n>:LIMit[:CC<cc>]:SUMMARY:EVM:DSSF:AVERage:RESult?	200
CALCulate<n>:LIMit[:CC<cc>]:SUMMARY:EVM:DSST:MAXimum:RESult?	200
CALCulate<n>:LIMit[:CC<cc>]:SUMMARY:EVM:DSST:AVERage:RESult?	200
CALCulate<n>:LIMit[:CC<cc>]:SUMMARY:EVM:DSTS:MAXimum:RESult?	201
CALCulate<n>:LIMit[:CC<cc>]:SUMMARY:EVM:DSTS:AVERage:RESult?	201
CALCulate<n>:LIMit[:CC<cc>]:SUMMARY:EVM:DS1K:MAXimum:RESult?	201
CALCulate<n>:LIMit[:CC<cc>]:SUMMARY:EVM:DS1K:AVERage:RESult?	201
CALCulate<n>:LIMit[:CC<cc>]:SUMMARY:EVM:PCHannel:MAXimum:RESult?	202
CALCulate<n>:LIMit[:CC<cc>]:SUMMARY:EVM:PCHannel:AVERage:RESult?	202
CALCulate<n>:LIMit[:CC<cc>]:SUMMARY:EVM:PSIGnal:MAXimum:RESult?	202
CALCulate<n>:LIMit[:CC<cc>]:SUMMARY:EVM:PSIGnal:AVERage:RESult?	202
CALCulate<n>:LIMit[:CC<cc>]:SUMMARY:FERRor:MAXimum:RESult?	203
CALCulate<n>:LIMit[:CC<cc>]:SUMMARY:FERRor:AVERage:RESult?	203
CALCulate<n>:LIMit[:CC<cc>]:SUMMARY:GIMBalance:MAXimum:RESult?	203

CALCulate<n>:LIMit[:CC<cc>]:SUMMARY:GIMBalance[:AVERage]:RESult?.....	203
CALCulate<n>:LIMit[:CC<cc>]:SUMMARY:IQOffset:MAXimum:RESult?.....	204
CALCulate<n>:LIMit[:CC<cc>]:SUMMARY:IQOffset[:AVERage]:RESult?.....	204
CALCulate<n>:LIMit[:CC<cc>]:SUMMARY:QUADerror:MAXimum:RESult?.....	204
CALCulate<n>:LIMit[:CC<cc>]:SUMMARY:QUADerror[:AVERage]:RESult?.....	204
CALCulate<n>:LIMit[:CC<cc>]:SUMMARY:SERRor:MAXimum:RESult?.....	205
CALCulate<n>:LIMit[:CC<cc>]:SUMMARY:SERRor[:AVERage]:RESult?.....	205

CALCulate<n>:LIMit[:CC<cc>]:SUMMARY:EVM[:ALL]:MAXimum:RESult?
CALCulate<n>:LIMit[:CC<cc>]:SUMMARY:EVM[:ALL][:AVERage]:RESult?

Queries the results of the EVM limit check of all resource elements.

Suffix:

<n>	irrelevant
	irrelevant
<cc>	Component Carrier

Return values:

<LimitCheck> The type of limit (average or maximum) that is queried depends on the last syntax element.

FAILED

Limit check has failed.

PASSED

Limit check has passed.

NOTEVALUATED

Limits have not been evaluated.

Example:

```
//Query EVM limit check results
CALC:LIM:SUMM:EVM:RES?
```

Usage:

Query only

CALCulate<n>:LIMit[:CC<cc>]:SUMMARY:EVM:DSQP:MAXimum:RESult?
CALCulate<n>:LIMit[:CC<cc>]:SUMMARY:EVM:DSQP[:AVERage]:RESult?

Queries the results of the EVM limit check of all PDSCH resource elements with a QPSK modulation.

Suffix:

<n>	irrelevant
	irrelevant
<cc>	Component Carrier

Return values:

<LimitCheck> The type of limit (average or maximum) that is queried depends on the last syntax element.

FAILED

Limit check has failed.

PASSED

Limit check has passed.

NOTEVALUATED

Limits have not been evaluated.

Example: //Query EVM limit check results
CALC:LIM:SUMM:EVM:DSQP:RES?

Usage: Query only

CALCulate<n>:LIMit[:CC<cc>]:SUMMary:EVM:DSSF:MAXimum:RESult?
CALCulate<n>:LIMit[:CC<cc>]:SUMMary:EVM:DSSF[:AVERage]:RESult?

Queries the results of the EVM limit check of all PDSCH resource elements with a 64QAM modulation.

Suffix:

<n> irrelevant

 irrelevant

<cc> [Component Carrier](#)

Return values:

<LimitCheck> The type of limit (average or maximum) that is queried depends on the last syntax element.

FAILED

Limit check has failed.

PASSED

Limit check has passed.

NOTEVALUATED

Limits have not been evaluated.

Example: //Query EVM limit check results
CALC:LIM:SUMM:EVM:DSSF:RES?

Usage: Query only

CALCulate<n>:LIMit[:CC<cc>]:SUMMary:EVM:DSST:MAXimum:RESult?
CALCulate<n>:LIMit[:CC<cc>]:SUMMary:EVM:DSST[:AVERage]:RESult?

Queries the results of the EVM limit check of all PDSCH resource elements with a 16QAM modulation.

Suffix:

<n> irrelevant

 irrelevant

<cc> [Component Carrier](#)

Return values:

<LimitCheck> The type of limit (average or maximum) that is queried depends on the last syntax element.

FAILED

Limit check has failed.

PASSED

Limit check has passed.

NOTEVALUATED

Limits have not been evaluated.

Example: //Query EVM limit check results
CALC:LIM:SUMM:EVM:DSST:RES?

Usage: Query only

CALCulate<n>:LIMit[:CC<cc>]:SUMMary:EVM:DSTS:MAXimum:RESult?
CALCulate<n>:LIMit[:CC<cc>]:SUMMary:EVM:DSTS[:AVERage]:RESult?

Queries the results of the EVM limit check of all PDSCH resource elements with a 256QAM modulation.

Suffix:

<n> irrelevant
 irrelevant
 <cc> [Component Carrier](#)

Return values:

<LimitCheck> The type of limit (average or maximum) that is queried depends on the last syntax element.

FAILED

Limit check has failed.

PASSED

Limit check has passed.

NOTEVALUATED

Limits have not been evaluated.

Example: //Query EVM limit check results
CALC:LIM:SUMM:EVM:DSTS:RES?

Usage: Query only

CALCulate<n>:LIMit[:CC<cc>]:SUMMary:EVM:DS1K:MAXimum:RESult?
CALCulate<n>:LIMit[:CC<cc>]:SUMMary:EVM:DS1K[:AVERage]:RESult?

Queries the results of the EVM limit check of all PDSCH resource elements with a 1024QAM modulation.

Suffix:

<n> irrelevant
 irrelevant

<cc> [Component Carrier](#)

Return values:

<LimitCheck> The type of limit (average or maximum) that is queried depends on the last syntax element.

FAILED

Limit check has failed.

PASSED

Limit check has passed.

NOTEVALUATED

Limits have not been evaluated.

Example:

```
//Query EVM limit check results
CALC:LIM:SUMM:EVM:DS1K:RES?
```

Usage:

Query only

CALCulate<n>:LIMit[:CC<cc>]:SUMMary:EVM:PCHannel:MAXimum:RESult?
CALCulate<n>:LIMit[:CC<cc>]:SUMMary:EVM:PCHannel[:AVERage]:RESult?

Queries the results of the EVM limit check of all physical channel resource elements.

Suffix:

<n> irrelevant

 irrelevant

<cc> [Component Carrier](#)

Return values:

<LimitCheck> The type of limit (average or maximum) that is queried depends on the last syntax element.

FAILED

Limit check has failed.

PASSED

Limit check has passed.

NOTEVALUATED

Limits have not been evaluated.

Example:

```
//Query physical channel limit check result
CALC:LIM:SUMM:EVM:PCH:RES?
```

Usage:

Query only

CALCulate<n>:LIMit[:CC<cc>]:SUMMary:EVM:PSIGNal:MAXimum:RESult?
CALCulate<n>:LIMit[:CC<cc>]:SUMMary:EVM:PSIGNal[:AVERage]:RESult?

Queries the results of the EVM limit check of all physical signal resource elements.

Suffix:

<n> irrelevant

 irrelevant

<cc> [Component Carrier](#)

Return values:

<LimitCheck> The type of limit (average or maximum) that is queried depends on the last syntax element.

FAILED

Limit check has failed.

PASSED

Limit check has passed.

NOTEVALUATED

Limits have not been evaluated.

Example: //Query physical signal limit check result
CALC:LIM:SUMM:EVM:PSIG:RES?

Usage: Query only

CALCulate<n>:LIMit[:CC<cc>]:SUMMary:FERRor:MAXimum:RESult?
CALCulate<n>:LIMit[:CC<cc>]:SUMMary:FERRor[:AVERage]:RESult?

Queries the result of the frequency error limit check.

Suffix:

<n> irrelevant

 irrelevant

<cc> [Component Carrier](#)

Return values:

<LimitCheck> The type of limit (average or maximum) that is queried depends on the last syntax element.

FAILED

Limit check has failed.

PASSED

Limit check has passed.

NOTEVALUATED

Limits have not been evaluated.

Example: //Query frequency error limit check result
CALC:LIM:SUMM:SERR:RES?

Usage: Query only

CALCulate<n>:LIMit[:CC<cc>]:SUMMary:GIMBalance:MAXimum:RESult?
CALCulate<n>:LIMit[:CC<cc>]:SUMMary:GIMBalance[:AVERage]:RESult?

Queries the result of the gain imbalance limit check.

Suffix:

<n> irrelevant

 irrelevant

<cc> [Component Carrier](#)

Return values:

<LimitCheck>

The type of limit (average or maximum) that is queried depends on the last syntax element.

FAILED

Limit check has failed.

PASSED

Limit check has passed.

NOTEVALUATED

Limits have not been evaluated.

Example:

```
//Query gain imbalance limit check result
CALC:LIM:SUMM:GIMB:RES?
```

Usage:

Query only

CALCulate<n>:LIMit[:CC<cc>]:SUMMary:IQOFfset:MAXimum:RESult?

CALCulate<n>:LIMit[:CC<cc>]:SUMMary:IQOFfset[:AVERAge]:RESult?

Queries the result of the I/Q offset limit check.

Suffix:

<n> irrelevant

 irrelevant

<cc> [Component Carrier](#)

Return values:

<LimitCheck>

The type of limit (average or maximum) that is queried depends on the last syntax element.

FAILED

Limit check has failed.

PASSED

Limit check has passed.

NOTEVALUATED

Limits have not been evaluated.

Example:

```
//Query I/Q offset limit check result
CALC:LIM:SUMM:IQOF:MAX:RES?
```

Usage:

Query only

CALCulate<n>:LIMit[:CC<cc>]:SUMMary:QUADerror:MAXimum:RESult?

CALCulate<n>:LIMit[:CC<cc>]:SUMMary:QUADerror[:AVERAge]:RESult?

Queries the result of the quadrature error limit check.

Suffix:

<n> irrelevant

 irrelevant

<cc>	Component Carrier
Return values:	
<LimitCheck>	The type of limit (average or maximum) that is queried depends on the last syntax element. FAILED Limit check has failed. PASSED Limit check has passed. NOTEVALUATED Limits have not been evaluated.
Example:	//Query quadrature error limit check results CALC:LIM:SUMM:QUAD:RES?
Usage:	Query only

CALCulate<n>:LIMit[:CC<cc>]:SUMMary:SERRor:MAXimum:RESult?
CALCulate<n>:LIMit[:CC<cc>]:SUMMary:SERRor[:AVERage]:RESult?

Queries the results of the sampling error limit check.

Suffix:

<n>	irrelevant
	irrelevant
<cc>	Component Carrier

Return values:

<LimitCheck>	The type of limit (average or maximum) that is queried depends on the last syntax element. FAILED Limit check has failed. PASSED Limit check has passed. NOTEVALUATED Limits have not been evaluated.
Example:	//Query sample error limit check result CALC:LIM:SUMM:SERR:RES?
Usage:	Query only

7.9 Configuration

7.9.1 General configuration

The following remote control command control general configuration of the application.

The remote control commands to select the result displays for I/Q measurements are described in [Chapter 7.4, "Screen layout"](#), on page 143.

CONFigure[:LTE]:MEASurement	206
MMEMory:STORe<n>:IQ:STATe	206
SYSTem:PRESet:CHANnel[:EXEC]	207

CONFigure[:LTE]:MEASurement <Measurement>

Selects the measurement.

Parameters:

<Measurement>	ACLR Selects the Adjacent Channel Leakage Ratio measurement.
	CACLR Selects the Cumulative ACLR measurement.
	ESpectrum Selects the Spectrum Emission Mask measurement.
	EVM Selects I/Q measurements.
	MCAClr Selects Multi-Carrier ACLR measurement.
	MCESpectrum Selects Multi-Carrier SEM measurement.
	TAERor Selects the Time Alignment Error measurement.
	TPOO Selects the Transmit On/Off Power measurement.
	*RST: EVM

Example: //Select measurement
 CONF:MEAS EVM

Manual operation: See ["EVM"](#) on page 15
 See ["Time alignment error"](#) on page 16
 See ["Channel power ACLR"](#) on page 16
 See ["SEM"](#) on page 16
 See ["Transmit On / Off Power"](#) on page 40
 See ["Adjacent Channel Leakage Ratio \(ACLR\)"](#) on page 44
 See ["Cumulative ACLR"](#) on page 46
 See ["Multi Carrier ACLR \(MC ACLR\)"](#) on page 48
 See ["Spectrum Emission Mask \(SEM\)"](#) on page 50
 See ["Select Measurement"](#) on page 66

MMEMory:STORe<n>:IQ:STATe <Value>,<FileName>

Saves I/Q data to a file.

Suffix:

<n> irrelevant

Parameters:

<Value> 1
 <FileName> String containing the path and name of the target file.

Example:

```
MMEM:STOR:IQ:STAT 'C:
\R_S\Instr\user\data.iq.tar'
```

Saves I/Q data to the specified file.

Manual operation: See ["Data import and export"](#) on page 126

SYSTem:PRESet:CHANnel[:EXEC]

Restores the default application settings in the current channel.

Use `INST:SEL` to select the channel.

Example:

```
INST:SEL 'Spectrum2'
```

Selects the channel for "Spectrum2".

```
SYST:PRESet:CHAN:EXEC
```

Restores the factory default settings to the "Spectrum2"channel.

Usage: Event

Manual operation: See ["Preset Channel"](#) on page 66

7.9.2 I/Q measurements

• Signal description	207
• Input configuration	240
• Frequency configuration	243
• Amplitude configuration	245
• Data capture	249
• Trigger	251
• Demodulation	256
• Estimation & compensation	258
• Automatic configuration	260

7.9.2.1 Signal description

• Signal characteristics	208
• MIMO setup	215
• PDSCH settings	216
• Synchronization signal	223
• Reference signal	226
• Positioning reference signal	226
• CSI reference signal	228
• Control channel	230
• Shared channel	236
• MBSFN characteristics	237

Signal characteristics

CONFigure[:LTE]:DUPLexing.....	208
CONFigure[:LTE]:DL[:CC<cc>]:BW.....	208
CONFigure[:LTE]:DL[:CC<cc>]:CYCPrefix.....	209
CONFigure[:LTE]:DL[:CC<cc>]:EINBiot[:STAtE].....	209
CONFigure[:LTE]:DL[:CC<cc>]:NRBoffset.....	210
CONFigure[:LTE]:DL[:CC<cc>]:PLC:CID.....	210
CONFigure[:LTE]:DL[:CC<cc>]:PLC:CIDGroup.....	210
CONFigure[:LTE]:DL[:CC<cc>]:PLC:PLID.....	211
CONFigure[:LTE]:DL[:CC<cc>]:TDD:SPSC.....	211
CONFigure[:LTE]:DL[:CC<cc>]:TDD:UDConf.....	212
CONFigure[:LTE]:LDIRection.....	212
FETCh[:CC<cc>]:CYCPrefix?.....	212
FETCh[:CC<cc>]:PLC:CIDGroup?.....	213
FETCh[:CC<cc>]:PLC:PLID?.....	213
MMEMory:LOAD[:CC<cc>]:DEModsetting.....	213
MMEMory:LOAD[:CC<cc>]:TMOD:DL.....	214
MMEMory:STORe<n>[:CC<cc>]:DEModsetting.....	214

CONFigure[:LTE]:DUPLexing <Duplexing>

Selects the duplexing mode.

Parameters:

<Duplexing>	TDD Time division duplex
	FDD Frequency division duplex
	*RST: FDD

Example: //Select time division duplex
CONF:DUPL TDD

Manual operation: See "Selecting the LTE mode" on page 68

CONFigure[:LTE]:DL[:CC<cc>]:BW <Bandwidth>

Selects the channel bandwidth.

Suffix:

<cc>	Component Carrier
------	-------------------

Parameters:

<Bandwidth>	BW1_40 BW3_00 BW5_00 BW10_00 BW15_00 BW20_00 NB_1rb NB_6rb
	*RST: BW10_00

Example: //Single carrier measurement:
//Define channel bandwidth
CONF:DL:BW BW1_40

Example: //Aggregated carrier measurement:
 //Selects two carriers, one with a bandwidth of 5 MHz, the other with 10 MHz.
 CONF:NOCC 2
 CONF:DL:CC1:BW BW10_00
 CONF:DL:CC2:BW BW5_00

Manual operation: See ["Remote commands to configure carrier aggregation"](#) on page 71
 See ["Channel Bandwidth / Number of Resource Blocks"](#) on page 71

CONFigure[:LTE]:DL[:CC<cc>]:CYCPrefix <PrefixLength>

Selects the cyclic prefix.

Suffix:

<cc> [Component Carrier](#)

Parameters:

<PrefixLength> **NORM**
 Normal cyclic prefix length
EXT
 Extended cyclic prefix length
AUTO
 Automatic cyclic prefix length detection
 *RST: AUTO

Example: //Single carrier measurements:
 //Select an extended cyclic prefix
 CONF:DL:CYCP EXT

Manual operation: See ["Cyclic Prefix"](#) on page 72

CONFigure[:LTE]:DL[:CC<cc>]:EINBiot[::STATE] <State>

Turns the exclusion of resource blocks used by an NB-IoT inband deployment from the LTE measurement results on and off.

Suffix:

<cc> [Component Carrier](#)

Parameters:

<State> ON | OFF | 1 | 0
 *RST: OFF

Example: //Exclude resource blocks used for NB-IoT
 CONF:DL:EINB ON

Manual operation: See ["Exclude Inband NB-IoT"](#) on page 74

CONFigure[:LTE]:DL[:CC<cc>]:NRBoffset <Offset>

Defines an the location of the NB-IoT signal within the LTE carrier as a resource block offset.

Prerequisites for this command

- Turn on exclusion of inband NB-IoT (`CONFigure[:LTE]:DL[:CC<cc>]:EINBiot[:STATE]`).

Suffix:

<cc> [Component Carrier](#)

Parameters:

<Offset> <numeric value> (integer only)

*RST: 0

Example:

```
//Define offset for NB-IoT carrier
CONF:DL:EINB ON
CONF:DL:NRB 12
```

Manual operation: See "[Exclude Inband NB-IoT](#)" on page 74

CONFigure[:LTE]:DL[:CC<cc>]:PLC:CID <CellID>

Defines the cell ID.

Suffix:

<cc> [Component Carrier](#)

Parameters:

<CellID> **AUTO**
Automatically defines the cell ID.

<numeric value> (integer only)
Number of the cell ID.
Range: 0 to 503

Example:

```
//Select two carriers an define a cell ID for each
CONF:NOCC 2
CONF:DL:CC1:PLC:CID 12
CONF:DL:CC2:PLC:CID 15
```

Selects 2 carriers and defines a cell ID for each one.

Manual operation: See "[Configuring the Physical Layer Cell Identity](#)" on page 73

CONFigure[:LTE]:DL[:CC<cc>]:PLC:CIDGroup <GroupNumber>

Selects the cell ID group.

Suffix:`<cc>` [Component Carrier](#)**Parameters:**

`<GroupNumber>` **AUTO**
Automatic selection

0...167 (integer only)
Manual selection

*RST: AUTO

Example:

```
//Select cell identity group
CONF:DL:PLC:CIDG 134
//Turn on automatic cell identity group detection
CONF:DL:PLC:CIDG AUTO
```

Manual operation: See ["Configuring the Physical Layer Cell Identity"](#) on page 73

CONFigure[LTE]:DL[:CC<cc>]:PLC:PLID <Identity>

Defines the physical layer cell identity for downlink signals.

Suffix:`<cc>` [Component Carrier](#)**Parameters:**

`<Identity>` **AUTO**
Automatic selection

0...2 (integer only)
Manual selection

*RST: AUTO

Example:

```
//Select physical layer cell identity
CONF:DL:PLC:PLID 1
```

Manual operation: See ["Configuring the Physical Layer Cell Identity"](#) on page 73

CONFigure[LTE]:DL[:CC<cc>]:TDD:SPSC <Configuration>

Selects the special TDD subframe configuration.

Suffix:`<cc>` [Component Carrier](#)**Parameters:**

`<Configuration>` `<numeric value>` (integer only)
Numeric value that defines the subframe configuration.
Subframe configurations 7 and 8 are only available if the cyclic prefix is normal.

Range: 0 to 8

*RST: 0

Example: //Single carrier measurements:
 //Select subframe configuration 7, available only with a normal
 cyclic prefix
 CONF:DL:CYCP NORM
 CONF:DL:TDD:SPSC 7

Manual operation: See "[Conf. of Special Subframe](#)" on page 73

CONFigure[:LTE]:DL[:CC<cc>]:TDD:UDConf <Configuration>

Selects the subframe configuration for TDD signals.

Suffix:

<cc> [Component Carrier](#)

Parameters:

<Configuration> <numeric value> (integer only)

Range: 0 to 6

*RST: 0

Example: //Single carrier measurements:
 //Selects allocation configuration
 CONF:DL:TDD:UDC 4

Manual operation: See "[TDD UL/DL Allocations](#)" on page 72

CONFigure[:LTE]:LDIRection <Direction>

Selects the link direction.

Parameters:

<Direction> **DL**
 Selects the mode to analyze downlink signals.

UL
 Selects the mode to analyze uplink signals.

Example: //Select downlink mode
 CONF:LDIR DL

Manual operation: See "[Selecting the LTE mode](#)" on page 68

FETCH[:CC<cc>]:CYCPrefix?

Queries the cyclic prefix type that has been detected.

Suffix:

<cc>

Return values:

<PrefixType> The command returns -1 if no valid result has been detected yet.

NORM

Normal cyclic prefix length detected

EXT

Extended cyclic prefix length detected

Example: //Query current cyclic prefix length type
FETC:CYCP?

Usage: Query only

FETCH[:CC<cc>]:PLC:CIDGroup?

Queries the cell identity group that has been detected.

Suffix:

<cc> [Component Carrier](#)

Return values:

<CIDGroup> The command returns -1 if no valid result has been detected yet.
Range: 0 to 167

Example: //Query the current cell identity group
FETC:PLC:CIDG?

Usage: Query only

Manual operation: See "[Configuring the Physical Layer Cell Identity](#)" on page 73

FETCH[:CC<cc>]:PLC:PLID?

Queries the cell identity that has been detected.

Suffix:

<cc> [Component Carrier](#)

Return values:

<Identity> The command returns -1 if no valid result has been detected yet.
Range: 0 to 2

Example: //Query the current cell identity
FETC:PLC:PLID?

Usage: Query only

Manual operation: See "[Configuring the Physical Layer Cell Identity](#)" on page 73

MMEMory:LOAD[:CC<cc>]:DEModing <File>

Restores previously saved demodulation settings.

The file must be of type `.allocation` and depends on the link direction that was currently selected when the file was saved. You can load only files with correct link directions.

Suffix:

<cc> [Component Carrier](#)

Parameters:

<File> String containing the path and name of the file.

Example:

```
//Load allocation file
MME:LOAD:DEM 'D:\USER\Settingsfile.allocation'
```

Manual operation: See ["User defined test scenarios"](#) on page 75

MME:LOAD[:CC<cc>]:TMOD:DL <TestModel>

Loads an EUTRA test model (E-TM).

The EUTRA test models are in accordance with 3GPP 36.141.

You can also select an O-RAN test case with the command.

Suffix:

<cc> [Component Carrier](#)

Setting parameters:

<TestModel> **<string>**
String that contains the name of the test model, e.g. 'E-TM1_1__20MHz' (E-TM1.1). To select a test model for a different bandwidth, replace "20MHz" with either "1_4MHz", "3MHz", "5MHz", "10MHz" or "15MHz".
Alternatively, a string that contains the name of the O-RAN test case, e.g. 'TC 3.2.3.7.1'.

Example:

```
//Select test model 2 for a 10 MHz bandwidth.
MME:LOAD:TMOD:DL 'E-TM2__10MHz'
```

Example:

```
//Select O-RAN test case
MME:LOAD:TMOD:DL 'TC 3.2.3.7.1'
```

Usage:

Setting only

Manual operation: See ["3GPP test models"](#) on page 74
See ["ORAN test cases"](#) on page 75

MME:STORE<n>[:CC<cc>]:DEModsetting <FileName>

Saves the signal description.

Suffix:

<n> irrelevant

<cc> irrelevant

Parameters:

<FileName> String containing the path and name of the file.
The file extension is .allocation.

Example:

```
//Save signal description
MME:STOR:DEM 'c:\TestSignal.allocation'
```

Manual operation: See ["User defined test scenarios"](#) on page 75

MIMO setup

CONFigure[:LTE]:DL[:CC<cc>]:MIMO:ASElection.....	215
CONFigure[:LTE]:DL[:CC<cc>]:MIMO:CONFig.....	215

CONFigure[:LTE]:DL[:CC<cc>]:MIMO:ASElection <Antenna>

Selects the antenna for measurements with MIMO setups.

For time alignment error measurements, the command selects the reference antenna.

Suffix:

<cc> [Component Carrier](#)

Parameters:

<Antenna>

ANT1 | ANT2 | ANT3 | ANT4

Select a single antenna to be analyzed

AUTO

Automatically selects the antenna(s) to be analyzed.

*RST: ANT1

Example:

//Select a MIMO setup with two antennas and test antenna number two

```
CONF:DL:MIMO:CONF TX2
```

```
CONF:DL:MIMO:ASEL ANT2
```

Manual operation:

See ["Time Alignment Error"](#) on page 39

See ["Tx Antenna Selection"](#) on page 76

CONFigure[:LTE]:DL[:CC<cc>]:MIMO:CONFig <NoOfAntennas>

Sets the number of antennas in the MIMO setup.

Suffix:

<cc> [Component Carrier](#)

Parameters:

<NoOfAntennas>

TX1

Use one Tx-antenna

TX2

Use two Tx-antennas

TX4

Use four Tx-antennas

*RST: TX1

Example:

//Select MIMO configuration with two antennas

```
CONF:DL:MIMO:CONF TX2
```

Manual operation:

See ["DUT MIMO Configuration"](#) on page 76

PDSCH settings

[SENSe:][LTE:]DL:FORMat:PSCD.....	216
[SENSe:][LTE:]DL:DEMod:AUTO.....	216
CONFigure[:LTE:]DL[:CC<cc>]:CSUBframes.....	217
CONFigure[:LTE:]DL[:CC<cc>]:SUBFrame<sf>:ALCount.....	217
CONFigure[:LTE:]DL[:CC<cc>]:SUBFrame<sf>:ALLoc<al>:GAP.....	217
CONFigure[:LTE:]DL[:CC<cc>]:SUBFrame<sf>:ALLoc<al>:POWer.....	218
CONFigure[:LTE:]DL[:CC<cc>]:SUBFrame<sf>:ALLoc<al>:PRECoding:AP.....	218
CONFigure[:LTE:]DL[:CC<cc>]:SUBFrame<sf>:ALLoc<al>:PRECoding:CBIndex.....	218
CONFigure[:LTE:]DL[:CC<cc>]:SUBFrame<sf>:ALLoc<al>:PRECoding:CDD.....	219
CONFigure[:LTE:]DL[:CC<cc>]:SUBFrame<sf>:ALLoc<al>:PRECoding:CLMapping.....	219
CONFigure[:LTE:]DL[:CC<cc>]:SUBFrame<sf>:ALLoc<al>:PRECoding:SCID.....	220
CONFigure[:LTE:]DL[:CC<cc>]:SUBFrame<sf>:ALLoc<al>:PRECoding[:SCHeme].....	220
CONFigure[:LTE:]DL[:CC<cc>]:SUBFrame<sf>:ALLoc<al>:PSOFfset.....	221
CONFigure[:LTE:]DL[:CC<cc>]:SUBFrame<sf>:ALLoc<al>:RBCount.....	221
CONFigure[:LTE:]DL[:CC<cc>]:SUBFrame<sf>:ALLoc<al>:RBOFfset.....	221
CONFigure[:LTE:]DL[:CC<cc>]:SUBFrame<sf>:ALLoc<al>:UEID.....	222
CONFigure[:LTE:]DL[:CC<cc>]:SUBFrame<sf>:ALLoc<al>[:CW<cw>]:MODulation.....	222

[SENSe:][LTE:]DL:FORMat:PSCD <Format>

Selects the method of identifying the PDSCH resource allocation.

Parameters:

<Format>

OFF

Applies the user configuration of the PDSCH subframe regardless of the signal characteristics.

PDCCH

Identifies the configuration according to the data in the PDCCH DCIs.

PHYDET

Manual PDSCH configuration: analysis only if the actual subframe configuration matches the configured one.

Automatic PDSCH configuration: physical detection of the configuration.

*RST: PHYD

Example:

```
//Select user configuration and do not check the received signal
DL:FORM:PSCD OFF
```

Manual operation: See "[PDSCH Subframe Configuration Detection](#)" on page 77

[SENSe:][LTE:]DL:DEMod:AUTO <State>

Turns automatic demodulation on and off.

Parameters:

<State>

ON | OFF | 1 | 0

*RST: ON

Example: //Turn on auto demodulation
DL:DEM:AUTO ON

Manual operation: See "[Auto PDSCH Demodulation](#)" on page 78

CONFigure[LTE]:DL[:CC<cc>]:CSUBframes <Subframes>

Selects the number of configurable subframes in the downlink signal.

Suffix:

<cc> [Component Carrier](#)

Parameters:

<Subframes> Range: 0 to 39
*RST: 1

Example: //Define the number of configurable subframes
CONF:DL:CSUB 5

CONFigure[LTE]:DL[:CC<cc>]:SUBFrame<sf>:ALCount <Allocations>

Defines the number of allocations in a downlink subframe.

Suffix:

<cc> [Component Carrier](#)

<sf> [Subframe](#)

Parameters:

<Allocations> <numeric value>
*RST: 1

Example: //Define number of allocations in a subframe
CONF:DL:SUBF2:ALC 5

CONFigure[LTE]:DL[:CC<cc>]:SUBFrame<sf>:ALLoc<al>:GAP <VRBGap>

Turns the VRB Gap on and off.

Suffix:

<cc> [Component Carrier](#)

<sf> [Subframe](#)

<al> [Allocation](#)

Parameters:

<VRBGap> **0**
Selects localized VRBs

1
Selects distributed VRBs and applies the first gap

2
Selects distributed VRBs and applies the second gap (for channel bandwidths > 50 resource blocks)

*RST: 0

Example: //Select localized VRBs for allocation 5 in subframe 2
CONF:DL:SUBF2:ALL5:GAP 0

Manual operation: See "[VRB Gap](#)" on page 81

CONFigure[LTE]:DL[:CC<cc>]:SUBFrame<sf>:ALLoc<al>:POWER <Power>

Defines the (relative) power of an allocation in a downlink subframe.

Suffix:

<cc> [Component Carrier](#)

<sf> [Subframe](#)

<al> [Allocation](#)

Parameters:

<Power> <numeric value>
*RST: 0 dB
Default unit: dB

Example: //Define relative power for allocation 5 in subframe 2.
CONF:DL:SUBF2:ALL5:POW -1.3

Manual operation: See "[Power](#)" on page 81

CONFigure[LTE]:DL[:CC<cc>]:SUBFrame<sf>:ALLoc<al>:PRECoding:AP <Port>

Selects the antenna port for the beamforming scheme.

The command is available for measurements on a single antenna.

Suffix:

<cc> [Component Carrier](#)

<sf> [Subframe](#)

<al> [Allocation](#)

Parameters:

<Port> 5 | 7 | 8

Example: //Select antenna port for beamforming in allocation 3 in subframe 2.
CONF:DL:SUBF2:ALL3:PREC:AP 5

Manual operation: See "[Beamforming \(UE Spec RS\)](#)" on page 84

CONFigure[LTE]:DL[:CC<cc>]:SUBFrame<sf>:ALLoc<al>:PRECoding:CBIndex <CodebookIndex>

Selects the codebook index for an allocation with spatial multiplexing precoding scheme.

Suffix:

<cc> Component Carrier

<sf> Subframe

<al> Allocation

Parameters:

<CodebookIndex> 0...15

*RST: 1

Example:

```
//Select codebook index for allocation 4 in subframe number 2.
CONF:DL:SUBF2:ALL4:PREC:CBIN 3
```

Manual operation: See "Spatial Multiplexing" on page 83
CONFigure[:LTE]:DL[:CC<cc>]:SUBFrame<sf>:ALLoc<al>:PRECoding:CDD
 <State>

Turns the cyclic delay diversity of an allocation with spatial multiplexing precoding scheme on and off.

Suffix:

<cc> Component Carrier

<sf> Subframe

<al> Allocation

Parameters:

<State> ON | OFF | 1 | 0

*RST: OFF

Example:

```
//Turn on cyclic delay diversity for allocation 3 in subframe 2
CONF:DL:SUBF2:ALL3:PREC:CDD ON
```

Manual operation: See "Spatial Multiplexing" on page 83
CONFigure[:LTE]:DL[:CC<cc>]:SUBFrame<sf>:ALLoc<al>:PRECoding:
CLMapping <Mapping>

Selects the codeword to layer mapping.

Suffix:

<cc> Component Carrier

<sf> Subframe

<al> Allocation

Parameters:
 <Mapping> LC11 | LC21 | LC22 | LC31 | LC32 | LC41 | LC42 | LC52 | LC62 |
 LC72 | LC82

Example: //Select codeword-to-layer mapping for allocation 3 in subframe 2.

```
CONF:DL:SUBF2:ALL3:PREC:CLM LC11
```

Manual operation: See "[Spatial Multiplexing](#)" on page 83
See "[Beamforming \(UE Spec RS\)](#)" on page 84

CONFigure[:LTE]:DL[:CC<cc>]:SUBFrame<sf>:ALLoc<al>:PRECoding:SCID
<Identity>

Selects the scrambling identity (nSCID).

The command is available for antenna ports 7 and 8.

Suffix:

<cc> [Component Carrier](#)

<sf> [Subframe](#)

<al> [Allocation](#)

Parameters:

<Identity> 0 | 1

Example: //Select scrambling identity for allocation 4 in subframe 2

```
CONF:DL:SUBF2:ALL4:PREC:SCID 1
```

Manual operation: See "[Beamforming \(UE Spec RS\)](#)" on page 84

CONFigure[:LTE]:DL[:CC<cc>]:SUBFrame<sf>:ALLoc<al>:PRECoding[:SCHeme]
<Scheme>

Selects the precoding scheme of an allocation.

Suffix:

<cc> [Component Carrier](#)

<sf> [Subframe](#)

<al> [Allocation](#)

Parameters:

<Scheme> **NONE**
Do not use a precoding scheme.

BF
Use beamforming scheme.

SPM
Use spatial multiplexing scheme.

TXD
Use transmit diversity scheme.

*RST: NONE

Example: //Select precoding scheme for allocation 3 in subframe 2

```
CONF:DL:SUBF2:ALL3:PREC:SCH SPM
```

Manual operation: See "None" on page 83
 See "Transmit Diversity" on page 83
 See "Spatial Multiplexing" on page 83
 See "Beamforming (UE Spec RS)" on page 84

CONFigure[:LTE]:DL[:CC<cc>]:SUBFrame<sf>:ALLoc<al>:PSOffset <StartOffset>

Defines the PDSCH start offset for a particular PDSCH allocation.

Suffix:

<cc> [Component Carrier](#)
 <sf> [Subframe](#)
 <al> [Allocation](#)

Parameters:

<StartOffset> <numeric value>
 Number between 0 and 4.

COMM

Common PDSCH start offset.

Example: //Defines a PDSCH start offset for the allocation 2 in subframe 2
 CONF:DL:SUBF2:ALL2:PSOF 0

Manual operation: See "[Carrier Aggregation](#)" on page 84

CONFigure[:LTE]:DL[:CC<cc>]:SUBFrame<sf>:ALLoc<al>:RBCCount <ResourceBlocks>

Selects the number of resource blocks of an allocation in a downlink subframe.

Suffix:

<cc> [Component Carrier](#)
 <sf> [Subframe](#)
 <al> [Allocation](#)

Parameters:

<ResourceBlocks> <numeric value>
 *RST: 6

Example: //Define resource blocks for allocation 5 in subframe 2
 CONF:DL:SUBF2:ALL5:RBC 25

Manual operation: See "[Number of RB](#)" on page 81

CONFigure[:LTE]:DL[:CC<cc>]:SUBFrame<sf>:ALLoc<al>:RBOffset <Offset>

Defines the resource block offset of an allocation in a downlink subframe.

Suffix:

<cc> [Component Carrier](#)

<sf> [Subframe](#)

<al> [Allocation](#)

Parameters:

<Offset> <numeric value>

*RST: 0

Example: //Define resource block offset for allocation 5 in subframe 2
CONF:DL:SUBF2:ALL5:RBOF 3

Manual operation: See "[Offset RB](#)" on page 81

CONFigure[LTE]:DL[:CC<cc>]:SUBFrame<sf>:ALLoc<al>:UEID <ID>

Defines the ID or N_RNTI.

Suffix:

<cc> [Component Carrier](#)

<sf> [Subframe](#)

<al> [Allocation](#)

Parameters:

<ID> ID of the user equipment.

Example: //Assign ID to allocation 5 in subframe 2
CONF:DL:SUBF2:ALL5:UEID 5

Manual operation: See "[ID/N_RNTI](#)" on page 80

**CONFigure[LTE]:DL[:CC<cc>]:SUBFrame<sf>:ALLoc<al>[:CW<cw>]:MODulation
<Modulation>**

Selects the modulation of an allocation in a downlink subframe.

Suffix:

<cc> [Component Carrier](#)

<sf> [Subframe](#)

<al> [Allocation](#)

<cw> [Codeword](#)

Parameters:

<Modulation> **QPSK**
QPSK modulation

QAM16
16QAM modulation

QAM64
64QAM modulation

QAM256
256QAM modulation

Q1K

1024QAM modulation

*RST: QPSK

Example: //Select modulation for the second codeword in allocation 5 in subframe 2
 CONF:DL:SUBF2:ALL5: CW2:MOD QAM64

Manual operation: See "[Modulation](#)" on page 80

Synchronization signal

CONFigure[:LTE]:DL[:CC<cc>]:SYNC:ANTenna.....	223
CONFigure[:LTE]:DL[:CC<cc>]:SYNC:CSWeight:FHFRAme:IMAGinary.....	223
CONFigure[:LTE]:DL[:CC<cc>]:SYNC:CSWeight:FHFRAme:REAL.....	224
CONFigure[:LTE]:DL[:CC<cc>]:SYNC:CSWeight:SHFRAme:IMAGinary.....	224
CONFigure[:LTE]:DL[:CC<cc>]:SYNC:CSWeight:SHFRAme:REAL.....	224
CONFigure[:LTE]:DL[:CC<cc>]:SYNC:CSWeight[:STATe].....	225
CONFigure[:LTE]:DL[:CC<cc>]:SYNC:PPOWer.....	225
CONFigure[:LTE]:DL[:CC<cc>]:SYNC:SPOWer.....	225

CONFigure[:LTE]:DL[:CC<cc>]:SYNC:ANTenna <Antenna>

Selects the antenna that transmits the P-SYNC and the S-SYNC.

Suffix:

<cc> [Component Carrier](#)

Parameters:

<Antenna> ANT1 | ANT2 | ANT3 | ANT4 | ALL | NONE

*RST: ALL

Example: //Transmit the P-SYNC and S-SYNC on all antennas

CONF:DL:SYNC:ANT ALL

Manual operation: See "[P-/S-SYNC Tx Antenna](#)" on page 85

CONFigure[:LTE]:DL[:CC<cc>]:SYNC:CSWeight:FHFRAme:IMAGinary <Imaginary>

Defines the signal weight for the imaginary part of the signal in the first half frame.

Prerequisites for this command

- Turn on custom sync signal weight (CONFigure[:LTE]:DL[:CC<cc>]:SYNC:CSWeight[:STATe]).

Suffix:

<cc> [Component Carrier](#)

Parameters:

<Imaginary> Range: -1 to 1

*RST: 0.000

Example: //Define imaginary part of sync signal weight
 CONF:DL:SYNC:CSW ON
 CONF:DL:SYNC:CSW:FHFR:IMAG 0.500

Manual operation: See ["Custom Sync Weight"](#) on page 86

CONFigure[LTE]:DL[:CC<cc>]:SYNC:CSWeight:FHFFrame:REAL <Real>

Defines the signal weight for the real part of the signal in the first half frame.

Prerequisites for this command

- Turn on custom sync signal weight ([CONFigure\[:LTE\]:DL\[:CC<cc>\]:SYNC:CSWeight\[:STATE\]](#)).

Suffix:

<cc> [Component Carrier](#)

Parameters:

<Real> Range: -1 to 1
 *RST: 1.000

Example: //Define imaginary part of sync signal weight
 CONF:DL:SYNC:CSW ON
 CONF:DL:SYNC:CSW:FHFR:REAL 0.500

Manual operation: See ["Custom Sync Weight"](#) on page 86

CONFigure[LTE]:DL[:CC<cc>]:SYNC:CSWeight:SHFFrame:IMAGinary <Imaginary>

Defines the signal weight for the imaginary part of the signal in the second half frame.

Prerequisites for this command

- Turn on custom sync signal weight ([CONFigure\[:LTE\]:DL\[:CC<cc>\]:SYNC:CSWeight\[:STATE\]](#)).

Suffix:

<cc> [Component Carrier](#)

Parameters:

<Imaginary> Range: -1 to 1
 *RST: 0.000

Example: //Define imaginary part of sync signal weight
 CONF:DL:SYNC:CSW ON
 CONF:DL:SYNC:CSW:SHFR:IMAG 0.500

Manual operation: See ["Custom Sync Weight"](#) on page 86

CONFigure[LTE]:DL[:CC<cc>]:SYNC:CSWeight:SHFFrame:REAL <Real>

Defines the signal weight for the real part of the signal in the second half frame.

Prerequisites for this command

- Turn on custom sync signal weight (`CONF:DL:SYNC:DL[:CC<cc>]:SYNC:CSWeight[:STATE]`).

Suffix:

<cc> [Component Carrier](#)

Parameters:

<Real> Range: -1 to 1
*RST: 1.000

Example: //Define imaginary part of sync signal weight
CONF:DL:SYNC:CSW ON
CONF:DL:SYNC:CSW:SHFR:REAL 0.500

Manual operation: See "[Custom Sync Weight](#)" on page 86

CONF:DL:SYNC:DL[:CC<cc>]:SYNC:CSWeight[:STATE] <State>

Turns custom synchronization signal weighting on and off.

Suffix:

<cc> [Component Carrier](#)

Parameters:

<State> ON | OFF | 1 | 0
*RST: OFF

Example: //Turn on synchronization signal weighting
CONF:DL:SYNC:CSW ON

Manual operation: See "[Custom Sync Weight](#)" on page 86

CONF:DL:SYNC:DL[:CC<cc>]:SYNC:PPOW <Power>

Defines the relative power of the P-SYNC.

Suffix:

<cc> [Component Carrier](#)

Parameters:

<Power> <numeric value>
*RST: 0 dB
Default unit: dB

Example: //Define relative power for P-SYNC
CONF:DL:SYNC:PPOW 0.5

Manual operation: See "[P-Sync Relative Power](#)" on page 85

CONF:DL:SYNC:DL[:CC<cc>]:SYNC:SPOW <Power>

Defines the relative power of the S-SYNC.

Suffix:`<cc>` [Component Carrier](#)**Parameters:**

`<Power>` `<numeric value>`
 `*RST: 0 dB`
 Default unit: dB

Example:

`//Define relative power for S-SYNC`
`CONF:DL:SYNC:SPOW 0.5`

Manual operation: See "[S-Sync Relative Power](#)" on page 86

Reference signal

[CONFigure\[:LTE\]:DL\[:CC<cc>\]:REFSig:POWer](#).....226

CONFigure[:LTE]:DL[:CC<cc>]:REFSig:POWer `<Power>`

Defines the relative power of the reference signal.

Suffix:`<cc>` [Component Carrier](#)**Parameters:**

`<Power>` `<numeric value>`
 `*RST: 0 dB`
 Default unit: dB

Example:

`//Define a relative power for reference signal`
`CONF:DL:REFS:POW -1.2`

Manual operation: See "[Rel Power \(Reference Signal\)](#)" on page 87

Positioning reference signal

[CONFigure\[:LTE\]:DL\[:CC<cc>\]:PRSS:BW](#)..... 226
[CONFigure\[:LTE\]:DL\[:CC<cc>\]:PRSS:Cl](#)..... 227
[CONFigure\[:LTE\]:DL\[:CC<cc>\]:PRSS:NPRS](#)..... 227
[CONFigure\[:LTE\]:DL\[:CC<cc>\]:PRSS:POWer](#)..... 227
[CONFigure\[:LTE\]:DL\[:CC<cc>\]:PRSS:STAtE](#)..... 228
[CONFigure\[:LTE\]:DL\[:CC<cc>\]:SFNO](#)..... 228

CONFigure[:LTE]:DL[:CC<cc>]:PRSS:BW `<Bandwidth>`

Defines the bandwidth of the positioning reference signal.

Suffix:`<cc>` [Component Carrier](#)

Parameters:

<Bandwidth> BW1_40 | BW3_00 | BW5_00 | BW10_00 | BW15_00 |
 BW20_00
 *RST: BW1_40
 Default unit: MHz

Example:

//Define bandwidth for the positioning reference signal
 CONF:DL:PRSS:BW BW5_00

Manual operation: See "[Bandwidth](#)" on page 88

CONFigure[:LTE]:DL[:CC<cc>]:PRSS:CI <Configuration>

Selects the configuration index of the positioning reference signal.

Suffix:

<cc> [Component Carrier](#)

Parameters:

<Configuration> <numeric value> (integer only)
 *RST: 0

Example:

//Select configuration index for the positioning reference signal
 CONF:DL:PRSS:CI 2

Manual operation: See "[Configuration Index](#)" on page 88

CONFigure[:LTE]:DL[:CC<cc>]:PRSS:NPRS <Subframes>

Defines the number of subframes the positioning reference signal occupies.

Suffix:

<cc> [Component Carrier](#)

Parameters:

<Subframes> 1 | 2 | 4 | 6

Example:

//Define subframes used by positioning reference signal
 CONF:DL:PRSS:NPRS 1

Manual operation: See "[Num. Subframes \(N_PRSS\)](#)" on page 88

CONFigure[:LTE]:DL[:CC<cc>]:PRSS:POWER <Power>

Defines the relative power of the positioning reference signal.

Suffix:

<cc> [Component Carrier](#)

Parameters:

<Power> Default unit: dB

Example:

//Define relative power of positioning reference signal
 CONF:DL:PRSS:POW 1

Manual operation: See ["Relative Power \(Positioning Reference Signal\)"](#) on page 88

CONFigure[:LTE]:DL[:CC<cc>]:PRSS:STATE <State>

Turns the positioning reference signal on and off.

Suffix:

<cc> [Component Carrier](#)

Parameters:

<State> ON | OFF | 1 | 0
*RST: OFF

Example: //Turn on the positioning reference signal.
CONF:DL:PRSS:STAT ON

Manual operation: See ["Present"](#) on page 88

CONFigure[:LTE]:DL[:CC<cc>]:SFNO <Offset>

Defines the frame number offset for the positioning reference signal.

Suffix:

<cc> [Component Carrier](#)

Parameters:

<Offset> <numeric value> (integer only)

Example: //Define frame number offset
CONF:DL:SFNO 4

Manual operation: See ["Frame Number Offset"](#) on page 88

CSI reference signal

CONFigure[:LTE]:DL[:CC<cc>]:CSIRs:CI.....	228
CONFigure[:LTE]:DL[:CC<cc>]:CSIRs:NAP.....	229
CONFigure[:LTE]:DL[:CC<cc>]:CSIRs:OPDSch.....	229
CONFigure[:LTE]:DL[:CC<cc>]:CSIRs:POWer.....	229
CONFigure[:LTE]:DL[:CC<cc>]:CSIRs:SCI.....	230
CONFigure[:LTE]:DL[:CC<cc>]:CSIRs:STATE.....	230

CONFigure[:LTE]:DL[:CC<cc>]:CSIRs:CI <Index>

Selects the configuration index for the CSI reference signal.

Suffix:

<cc> [Component Carrier](#)

Parameters:

<Index> Number of the configuration index.
Range: 0 to 31

Example: //Select configuration index
CONF:DL:CSIR:CI 12

Manual operation: See "[Configuration Index](#)" on page 90

CONFigure[:LTE]:DL[:CC<cc>]:CSIRs:NAP <AntennaPorts>

Selects the number of antenna ports that transmit the CSI reference signal.

Suffix:
<cc> [Component Carrier](#)

Parameters:
<AntennaPorts> **TX1**
TX2
TX4
TX8

Example: //Select 2 antenna ports for CSI reference signal transmission
CONF:DL:CSIR:NAP TX2

Manual operation: See "[Antenna Ports](#)" on page 90

CONFigure[:LTE]:DL[:CC<cc>]:CSIRs:OPDSch <State>

Turns overwriting of PDSCH resource elements for UEs that do not consider the CSI reference signal on and off.

Suffix:
<cc> [Component Carrier](#)

Parameters:
<State> **ON | 1**
The CSI reference signal overwrites PDSCH resource elements.
OFF | 0
PDSCH resource elements remain.
***RST: OFF**

Example: //Overwrite PDSCH resource elements if necessary
CONF:DL:CSIR:OPDS ON

Manual operation: See "[Overwrite PDSCH](#)" on page 90

CONFigure[:LTE]:DL[:CC<cc>]:CSIRs:POWER <Power>

Defines the relative power of the CSI reference signal.

Suffix:
<cc> [Component Carrier](#)

Parameters:
<Power> ***RST: 0**
Default unit: dB

Example: //Define relative power for the CSI reference signal.
CONF:DL:CSIR:POW 1

Manual operation: See "[Relative Power \(CSI Reference Signal\)](#)" on page 91

CONFigure[:LTE]:DL[:CC<cc>]:CSIRs:SCI <Configuration>

Defines the subframe configuration for the CSI reference signal.

Suffix:

<cc> [Component Carrier](#)

Parameters:

<Configuration> Number that selects the subframe configuration.
Range: 0 to 154

Example: //Select subframe configuration for CSI reference signal
CONF:DL:CSIR:SCI 4

Manual operation: See "[Subframe Configuration](#)" on page 91

CONFigure[:LTE]:DL[:CC<cc>]:CSIRs:STATE <State>

Turns the CSI reference signal on and off.

Suffix:

<cc> [Component Carrier](#)

Parameters:

<State> ON | OFF | 1 | 0
*RST: OFF

Example: //Turn on CSI reference signal
CONF:DL:CSIR:STAT ON

Manual operation: See "[Present](#)" on page 90

Control channel

CONFigure[:LTE]:DL[:CC<cc>]:EPDCch:LOCalized.....	231
CONFigure[:LTE]:DL[:CC<cc>]:EPDCch:NPRB.....	231
CONFigure[:LTE]:DL[:CC<cc>]:EPDCch:POWer.....	231
CONFigure[:LTE]:DL[:CC<cc>]:EPDCch:RBASsign.....	232
CONFigure[:LTE]:DL[:CC<cc>]:EPDCch:SID.....	232
CONFigure[:LTE]:DL[:CC<cc>]:PBCH:POWer.....	232
CONFigure[:LTE]:DL[:CC<cc>]:PBCH:STAT.....	232
CONFigure[:LTE]:DL[:CC<cc>]:PCFich:POWer.....	233
CONFigure[:LTE]:DL[:CC<cc>]:PCFich:STAT.....	233
CONFigure[:LTE]:DL[:CC<cc>]:PDCCh:FORMat.....	233
CONFigure[:LTE]:DL[:CC<cc>]:PDCCh:NOPD.....	234
CONFigure[:LTE]:DL[:CC<cc>]:PDCCh:POWer.....	234
CONFigure[:LTE]:DL[:CC<cc>]:PHICh:DURation.....	234
CONFigure[:LTE]:DL[:CC<cc>]:PHICh:MITM.....	235

CONFigure[:LTE]:DL[:CC<cc>]:PHICH:NGParameter.....	235
CONFigure[:LTE]:DL[:CC<cc>]:PHICH:NOGRoups.....	235
CONFigure[:LTE]:DL[:CC<cc>]:PHICH:POWer.....	236
CONFigure[:LTE]:DL[:CC<cc>]:PSOFFset.....	236

CONFigure[:LTE]:DL[:CC<cc>]:EPDCch:LOCalized <State>

Turns localized transmission of the EPDCCH on and off.

Suffix:

<cc> [Component Carrier](#)

Parameters:

<State> ON | OFF | 1 | 0
*RST: ON

Example: //Turn on distributed transmission of the EPDCCH
CONF:DL:EPDC:LOC OFF

Manual operation: See "[EPDCCH Localized](#)" on page 99

CONFigure[:LTE]:DL[:CC<cc>]:EPDCch:NPRB <ResourceBlocks>

Selects the number of resource blocks that the EPDCCH-PRB set uses.

Suffix:

<cc> [Component Carrier](#)

Parameters:

<ResourceBlocks> 0 | 2 | 4 | 8
When you select "0", the EPDCCH is not active.

Example: //Select number of EPDCCH-PRB resource blocks
CONF:DL:EPDC:NPRB 4

Manual operation: See "[EPDCCH PRB Pairs](#)" on page 99

CONFigure[:LTE]:DL[:CC<cc>]:EPDCch:POWer <Power>

Defines the relative power of the EPDCCH.

Suffix:

<cc> [Component Carrier](#)

Parameters:

<Power> <numeric value>
*RST: 0 dB
Default unit: DB

Example: //Define relative power of EPDCCH
CONF:DL:EPDC:POW -0.5

Manual operation: See "[EPDCCH Rel Power](#)" on page 99

CONFigure[:LTE]:DL[:CC<cc>]:EPDCch:RBASsign <ResourceBlocks>

Defines the resource blocks that the EPDCCH uses.

Suffix:

<cc> [Component Carrier](#)

Parameters:

<ResourceBlocks>

Example:

```
//Define number of EPDCCH resource blocks
CONF:DL:EPDC:RBAS 2
```

Manual operation: See "[EPDCCH RB Assignment](#)" on page 99

CONFigure[:LTE]:DL[:CC<cc>]:EPDCch:SID <SetID>

Defines the EPDCCH set ID used to generate EPDCCH reference symbols.

Suffix:

<cc> [Component Carrier](#)

Parameters:

<SetID> Range: 0 to 503
*RST: 0

Example:

```
//Select EPDCC set ID
CONF:DL:EPDC:SID 10
```

Manual operation: See "[EPDCCH Set ID](#)" on page 99

CONFigure[:LTE]:DL[:CC<cc>]:PBCH:POWER <Power>

Defines the relative power of the PBCH.

Suffix:

<cc> [Component Carrier](#)

Parameters:

<Power> <numeric value>
*RST: 0 dB
Default unit: dB

Example:

```
//Define PBCH power
CONF:DL:PBCH:POW -1.1
```

Manual operation: See "[PBCH Relative Power](#)" on page 93

CONFigure[:LTE]:DL[:CC<cc>]:PBCH:STAT <State>

Turns the PBCH on and off.

Suffix:

<cc> [Component Carrier](#)

Parameters:

<State> ON | OFF | 1 | 0
 *RST: ON

Example:

```
//Turn on PBCH
CONF:DL:PBCH:STAT ON
```

Manual operation: See "[PBCH Present](#)" on page 93

CONFigure[:LTE]:DL[:CC<cc>]:PCFich:POWer <Power>

Defines the relative power of the PCFICH.

Suffix:

<cc> [Component Carrier](#)

Parameters:

<Power> <numeric value>
 *RST: 0 dB
 Default unit: dB

Example:

```
//Define relative PCFICH power
CONF:DL:PCF:POW 0
```

Manual operation: See "[PCFICH Relative Power](#)" on page 94

CONFigure[:LTE]:DL[:CC<cc>]:PCFich:STAT <State>

Turns the PCFICH on and off.

Suffix:

<cc> [Component Carrier](#)

Parameters:

<State> ON | OFF | 1 | 0
 *RST: ON

Example:

```
//Turn on PCFICH
CONF:DL:PCF:STAT ON
```

Manual operation: See "[PCFICH Present](#)" on page 94

CONFigure[:LTE]:DL[:CC<cc>]:PDCCh:FORMat <Format>

Selects the PDCCH format.

Suffix:

<cc> [Component Carrier](#)

Parameters:

<Format> -1 | 0 | 1 | 2 | 3
 *RST: -1

Example: //Select PDCCH format
CONF:DL:PDCCH:FORM 0

Manual operation: See "[PDCCH Format](#)" on page 97

CONFigure[:LTE]:DL[:CC<cc>]:PDCCh:NOPD <Quantity>

Sets the number of PDCCHs.

Suffix:
<cc> [Component Carrier](#)

Parameters:
<Quantity> <numeric value>
*RST: 0

Example: //Select number of PDCCHs
CONF:DL:PDCCH:NOPD 3

Manual operation: See "[Number of PDCCHs](#)" on page 97

CONFigure[:LTE]:DL[:CC<cc>]:PDCCh:POWer <Power>

Defines the relative power of the PDCCH.

Suffix:
<cc> [Component Carrier](#)

Parameters:
<Power> <numeric value>
*RST: 0 dB
Default unit: dB

Example: //Define relative power for PDCCH
CONF:DL:PDCCH:POW -1.2

Manual operation: See "[PDCCH Rel Power](#)" on page 98

CONFigure[:LTE]:DL[:CC<cc>]:PHICH:DURation <Duration>

Selects the PHICH duration.

Suffix:
<cc> [Component Carrier](#)

Parameters:
<Duration> **NORM**
Normal
EXT
Extended
*RST: NORM

Example: //Select PHICH duration
CONF:DL:PHIC:DUR NORM

Manual operation: See "[PHICH Duration](#)" on page 95

CONFigure[LTE]:DL[:CC<cc>]:PHICH:MITM <State>

Includes or excludes the use of the PHICH special setting for enhanced test models.

Suffix:
<cc> [Component Carrier](#)

Parameters:
<State> ON | OFF | 1 | 0
*RST: OFF

Example: //Activate PHICH TDD m_i=1 (E-TM)
CONF:DL:PHIC:MITM ON

Manual operation: See "[PHICH TDD m_i=1 \(E-TM\)](#)" on page 96

CONFigure[LTE]:DL[:CC<cc>]:PHICH:NGParameter <Method>

Selects the method that determines the number of PHICH groups in a subframe.

Suffix:
<cc> [Component Carrier](#)

Parameters:
<Method> AUTO | NG1_6 | NG1_2 | NG1 | NG2 | NGCustom
Select NGCUSTOM to customize N_g . You can then define the number of PHICH groups with [CONFigure\[:LTE\]:DL\[:CC<cc>\]:PHICH:NOGRoups](#).
*RST: NG1_6

Example: //Number of PHICH groups in the subframe depends on the number of resource blocks
CONF:DL:PHIC:NGP NG1_6
//Define a custom number of PHICH groups
CONF:DL:PHIC:NGP NGCUSTOM
CONF:DL:PHIC:NOGR 5

Manual operation: See "[PHICH \$N_g\$](#) " on page 96

CONFigure[LTE]:DL[:CC<cc>]:PHICH:NOGRoups <NoOfGroups>

Defines the number of PHICH groups.

Suffix:
<cc> [Component Carrier](#)

Parameters:

<NoOfGroups> <numeric value> (integer only)
 *RST: 0

Example:

//Define number of PHICH groups
 CONF:DL:PHIC:NOGR 5

Manual operation: See "PHICH Number of Groups" on page 96

CONFigure[:LTE]:DL[:CC<cc>]:PHICH:POWer <Power>

Defines the relative power of the PHICH.

Suffix:

<cc> [Component Carrier](#)

Parameters:

<Power> <numeric value>
 *RST: -3.01 dB
 Default unit: DB

Example:

//Define the relative power of the PHICH
 CONF:DL:PHIC:POW -1.3

Manual operation: See "PHICH Rel Power" on page 96

CONFigure[:LTE]:DL[:CC<cc>]:PSOffset <Offset>

Defines the symbol offset for PDSCH allocations relative to the start of the subframe.

The offset applies to all subframes.

Suffix:

<cc> [Component Carrier](#)

Parameters:

<Offset> **AUTO**
 Automatically determines the symbol offset.
<numeric value>
 Manual selection of the symbol offset.
 Range: 0 to 4
 *RST: AUTO

Example:

//Define PRB symbol offset
 CONF:DL:PSOF 2

Manual operation: See "PRB Symbol Offset" on page 92

Shared channel

[CONFigure\[:LTE\]:DL\[:CC<cc>\]:PDSCh:PB](#)..... 237

CONFigure[:LTE]:DL[:CC<cc>]:PDSCh:PB <PowerRatio>

Selects the PDSCH power ratio.

Note that the power ratio depends on the number of antennas in the system.

Suffix:

<cc> [Component Carrier](#)

Parameters:

<PowerRatio> Numeric value that defines PDSCH P_B which defines the power ratio in dB.

0 | 1 | 2 | 3

See [PDSCH Power Ratio](#) for an overview of resulting power ratios.

RAT1

Ratio = 1, regardless of the number of antennas.

Example:

```
//Select PDSCH P_B
CONF:DL:PDSCh:PB 3
```

Manual operation: See "[PDSCH Power Ratio](#)" on page 100

MBSFN characteristics

CONFigure[:LTE]:DL[:CC<cc>]:MBSFn:AI:ID	237
CONFigure[:LTE]:DL[:CC<cc>]:MBSFn:AI:NMRL	237
CONFigure[:LTE]:DL[:CC<cc>]:MBSFn:POWer	238
CONFigure[:LTE]:DL[:CC<cc>]:MBSFn:STATe	238
CONFigure[:LTE]:DL[:CC<cc>]:MBSFn:SUBFrame<sf>:PMCH:MODulation	238
CONFigure[:LTE]:DL[:CC<cc>]:MBSFn:SUBFrame<sf>:PMCH:STATe	239
CONFigure[:LTE]:DL[:CC<cc>]:MBSFn:SUBFrame<sf>:STATe	239

CONFigure[:LTE]:DL[:CC<cc>]:MBSFn:AI:ID <ID>

Defines the ID of an MBFSN area.

Suffix:

<cc> [Component Carrier](#)

Parameters:

<ID> Range: 0 to 255

Example:

```
//Select an area for the multimedia broadcast network
CONF:DL:MBSF:AI:ID 2
```

Manual operation: See "[Area ID](#)" on page 101

CONFigure[:LTE]:DL[:CC<cc>]:MBSFn:AI:NMRL <Configuration>

Selects the length of the control data region in an MBSFN subframe.

Suffix:`<cc>` [Component Carrier](#)**Parameters:**

`<Configuration>` **1**
The first symbol in a subframe carries data of the control channel.

2
The first two symbols in a subframe carry data of the control channel.

Example:

```
//Select length of control channel data
CONF:DL:MBSF:AI:NMRL 2
```

Manual operation: See ["Non-MBSFN Region Length"](#) on page 101**CONFigure[:LTE]:DL[:CC<cc>]:MBSFn:POWer <Power>**

Defines the relative power of the MBSFN transmission.

Suffix:`<cc>` [Component Carrier](#)**Parameters:**

`<Power>` *RST: 0 dB
Default unit: dB

Example:

```
//Define relative power for MBSFN transmission
CONF:DL:MBSF:POW -1.5
```

Manual operation: See ["MBSFN Relative Power"](#) on page 101**CONFigure[:LTE]:DL[:CC<cc>]:MBSFn:STATe <State>**

Includes or excludes an MBSFN from the test setup.

Suffix:`<cc>` [Component Carrier](#)**Parameters:**

`<State>` ON | OFF | 1 | 0
*RST: OFF

Example:

```
//Include an MBSFN in the test setup
CONF:DL:MBSF:STAT ON
```

Manual operation: See ["Present"](#) on page 101**CONFigure[:LTE]:DL[:CC<cc>]:MBSFn:SUBFrame<sf>:PMCH:MODulation <Modulation>**

Selects the modulation type for an MBSFN subframe.

Suffix:

<cc> [Component Carrier](#)

<sf> [Subframe](#)

Parameters:

<Modulation> *RST: QPSK

Example:

//Selects modulation for MBSFN subframe
CONF:DL:MBSF:SUBF2:PMCH:MOD QPSK

Manual operation: See "[Modulation](#)" on page 103

CONFigure[:LTE]:DL[:CC<cc>]:MBSFn:SUBFrame<sf>:PMCH:STATe <State>

Turns the PMCH in an MBSFN subframe on and off.

Note that you first have to turn a subframe into an MBSFN subframe with
[CONFigure\[:LTE\]:DL\[:CC<cc>\]:MBSFn:SUBFrame<sf>:STATe](#).

Suffix:

<cc> [Component Carrier](#)

<sf> [Subframe](#)

Parameters:

<State> ON | OFF | 1 | 0
*RST: OFF

Example:

//Turn on PMCH in second subframe
CONF:DL:MBSF:SUBF2:PMCH:STAT ON

Manual operation: See "[PMCH Present](#)" on page 102

CONFigure[:LTE]:DL[:CC<cc>]:MBSFn:SUBFrame<sf>:STATe <State>

Turns a subframe into an MBSFN subframe.

Suffix:

<cc> [Component Carrier](#)

<sf> [Subframe](#)

Parameters:

<State> ON | OFF | 1 | 0
*RST: OFF

Example:

//Turn the second subframe into an MBSFN subframe
CONF:DL:MBSF:SUBF2:STAT ON

Manual operation: See "[Active](#)" on page 102

7.9.2.2 Input configuration

Remote commands to configure the input described elsewhere:

- `INPut<ip>:COUPling` on page 246
- `INPut<ip>:IMPedance` on page 248

<code>INPut:FILE:PATH</code>	240
<code>INPut<ip>:FILTer:YIG[:STATe]</code>	241
<code>INPut<ip>:SELEct</code>	241
<code>MMEMory:LOAD:IQ:STReam</code>	242
<code>MMEMory:LOAD:IQ:STReam:AUTO</code>	242
<code>MMEMory:LOAD:IQ:STReam:LIST?</code>	242
<code>TRACe:IQ:FILE:REPetition:COUNT</code>	242

`INPut:FILE:PATH <FileName>[, <AnalysisBW>]`

Selects the I/Q data file to be used as input for further measurements.

The I/Q data file must be in one of the following supported formats:

- `.iq.tar`
- `.iqw`
- `.csv`
- `.mat`
- `.wv`
- `.aid`

Only a single data stream or channel can be used as input, even if multiple streams or channels are stored in the file.

For some file formats that do not provide the sample rate and measurement time or record length, you must define these parameters manually. Otherwise the traces are not visible in the result displays.

Parameters:

<code><FileName></code>	String containing the path and name of the source file. The file extension is <code>*.iq.tar</code> .
<code><AnalysisBW></code>	Optionally: The analysis bandwidth to be used by the measurement. The bandwidth must be smaller than or equal to the bandwidth of the data that was stored in the file. Default unit: HZ

Example:

```
INP:FILE:PATH 'C:\R_S\Instr\user\data.iq.tar'
```

Uses I/Q data from the specified file as input.

Example:

```
//Load an IQW file
INP:SEL:FIQ
INP:FILE:PATH 'C:\R_S\Instr\user\data.iqw'
//Define the sample rate
TRAC:IQ:SRAT 10MHz
//Define the measurement time
SENSe:SWEEp:TIME 0.001001
//Start the measurement
INIT:IMM
```

Manual operation: See ["Select I/Q data file"](#) on page 104
See ["Data import and export"](#) on page 126

INPut<ip>:FILTer:YIG[:STATe] <State>

Enables or disables the YIG filter.

Suffix:

<ip> 1 | 2
 irrelevant

Parameters:

<State> ON | OFF | 0 | 1

Example:

```
INP:FILT:YIG OFF
Deactivates the YIG-preselector.
```

Manual operation: See ["YIG-Preselector"](#) on page 103

INPut<ip>:SELect <Source>

Selects the signal source for measurements, i.e. it defines which connector is used to input data to the R&S FSV/A.

If no additional input options are installed, only RF input or file input is supported.

Suffix:

<ip> 1 | 2
 irrelevant

Parameters:

<Source> **RF**
 Radio Frequency ("RF INPUT" connector)
FIQ
 I/Q data file
 (selected by [INPut:FILE:PATH](#) on page 240)
***RST:** RF

Manual operation: See ["I/Q Input File State"](#) on page 104

MMEMory:LOAD:IQ:STReam <Channel>

Only available for files that contain more than one data stream from multiple channels: selects the data stream to be used as input for the currently selected channel.

Automatic mode (**MMEMory:LOAD:IQ:STReam:AUTO**) is set to OFF.

Parameters:

<Channel> String containing the channel name.

Example:

```
MMEM:LOAD:IQ:STR?
//Result: 'Channel1','Channel2'
MMEM:LOAD:IQ:STR 'Channel2'
```

Manual operation: See "[Selected Channel](#)" on page 105

MMEMory:LOAD:IQ:STReam:AUTO <State>

Only available for files that contain more than one data stream from multiple channels: automatically defines which data stream in the file is used as input for the channel.

Parameters:

<State> ON | OFF | 0 | 1

OFF | 0

The data stream specified by **MMEMory:LOAD:IQ:STReam** is used as input for the channel.

ON | 1

The first data stream in the file is used as input for the channel. Applications that support multiple data streams use the first data stream in the file for the first input stream, the second for the second stream etc.

*RST: 1

Manual operation: See "[Selected Channel](#)" on page 105

MMEMory:LOAD:IQ:STReam:LIST?

Returns the available channels in the currently loaded input file.

Example:

```
MMEM:LOAD:IQ:STR?
//Result: 'Channel1','Channel2'
```

Usage:

Query only

Manual operation: See "[Selected Channel](#)" on page 105

TRACe:IQ:FILE:REPetition:COUNT <RepetitionCount>

Determines how often the data stream is repeatedly copied in the I/Q data memory. If the available memory is not sufficient for the specified number of repetitions, the largest possible number of complete data streams is used.

Parameters:`<RepetitionCount>` integer**Example:**

TRAC:IQ:FILE:REP:COUN 3

Manual operation: See ["File Repetitions"](#) on page 104**7.9.2.3 Frequency configuration**[\[SENSe:\]FREQuency:CENTer\[:CC<cc>\]](#).....243[\[SENSe:\]FREQuency:CENTer\[:CC<cc>\]:OFFSet](#)..... 243[\[SENSe:\]FREQuency:CENTer:STEP](#).....244

[SENSe:]FREQuency:CENTer[:CC<cc>] <Frequency>

Sets the center frequency for RF measurements.

Component carrier measurements

- Defining or querying the frequency of the first carrier is possible with `FREQ:CENT:CC1`. The `CC1` part of the syntax is mandatory in that case.
- `FREQ:CENT?` queries the measurement frequency (center of the two carriers).

Suffix:`<cc>` [Component Carrier](#)**Parameters:**`<Frequency>` <numeric value>

Range: fmin to fmax

*RST: 1 GHz

Default unit: Hz

Example:

//Define frequency for measurement on one carrier:

FREQ:CENT 1GHZ

Example:

//Define frequency for measurement on aggregated carriers:

FREQ:CENT:CC1 850MHZ

Manual operation:See ["Remote commands to configure carrier aggregation"](#)
on page 71See ["Center Frequency"](#) on page 105

[SENSe:]FREQuency:CENTer[:CC<cc>]:OFFSet <Offset>

Defines the general frequency offset.

For measurements on multiple component carriers, the command defines the frequency offset for a component carrier. The effect of the command depends on the syntax:

- When you omit the `[CC<cc>]` syntax element, the command defines the overall frequency offset.

In that case, the value is added to the measurement frequency and, in case of measurements with component carriers, the center frequency of the component carriers.

- When you include the `[CC<cc>]` syntax element, the command defines the offset of the component carrier relative the first component carrier. In that case, the command is not available for the first component carrier - thus, `...:CC1:...` is not possible.

Suffix:

<cc> [Component Carrier](#)

Parameters:

<Offset> <numeric value>

- General frequency offset: frequency offset in Hz.
- Component carrier offset: frequency offset relative to the first component carrier in Hz.

Default unit: Hz

Example: //Add a frequency offset of 50 Hz to the measurement frequency.
//If you are measuring component carriers, the value is also added to the center frequencies of those carriers.
`FREQ:CENT:OFFS 50HZ`

Example: //Define a frequency offset of 15 MHz for the second component carrier relative to the first component carrier.
`FREQ:CENT:CC2:OFFS 15MHZ`

Manual operation: See ["Remote commands to configure carrier aggregation"](#) on page 71
See ["Center Frequency"](#) on page 105

[SENSe:]FREQuency:CENTer:STEP <StepSize>

Defines the center frequency step size.

You can increase or decrease the center frequency quickly in fixed steps using the `SENS:FREQ UP` and `SENS:FREQ DOWN` commands, see [\[SENSe:\]FREQuency:CENTer\[:CC<cc>\]](#) on page 243.

Parameters:

<StepSize> f_{\max} is specified in the data sheet.

Range: 1 to fMAX
*RST: 0.1 x span
Default unit: Hz

Example: //Set the center frequency to 110 MHz.
`FREQ:CENT 100 MHz`
`FREQ:CENT:STEP 10 MHz`
`FREQ:CENT UP`

Manual operation: See ["Frequency Stepsize"](#) on page 106

7.9.2.4 Amplitude configuration

DISPlay[:WINDow<n>][:SUBWindow<w>]:TRACe<t>:Y[:SCALe]:RLEVel.....	245
DISPlay[:WINDow<n>][:SUBWindow<w>]:TRACe<t>:Y[:SCALe]:RLEVel:OFFSet.....	245
INPut<ip>:ATTenuation<ant>.....	246
INPut<ip>:ATTenuation<ant>:AUTO.....	246
INPut<ip>:COUPling.....	246
INPut<ip>:GAIN:STATe.....	247
INPut<ip>:GAIN[:VALue].....	247
INPut<ip>:IMPedance.....	248
INPut<ip>:EATT<ant>.....	248
INPut<ip>:EATT<ant>:AUTO.....	248
INPut<ip>:EATT<ant>:STATe.....	249

DISPlay[:WINDow<n>][:SUBWindow<w>]:TRACe<t>:Y[:SCALe]:RLEVel <ReferenceLevel>

Defines the reference level (for all traces in all windows).

With a reference level offset $\neq 0$, the value range of the reference level is modified by the offset.

Suffix:

<n>	irrelevant
<w>	subwindow Not supported by all applications
<t>	irrelevant

Parameters:

<ReferenceLevel>	The unit is variable. Range: see datasheet *RST: 0 dBm Default unit: DBM
------------------	---

Example: DISP:TRAC:Y:RLEV -60dBm

Manual operation: See "[Reference Level](#)" on page 106

DISPlay[:WINDow<n>][:SUBWindow<w>]:TRACe<t>:Y[:SCALe]:RLEVel:OFFSet <Offset>

Defines a reference level offset (for all traces in all windows).

Suffix:

<n>	irrelevant
<w>	subwindow Not supported by all applications
<t>	irrelevant

Parameters:

<Offset> Range: -200 dB to 200 dB
 *RST: 0dB
 Default unit: DB

Example: DISP:TRAC:Y:RLEV:OFFS -10dB

Manual operation: See "[Reference Level Offset](#)" on page 107

INPut<ip>:ATTenuation<ant> <Attenuation>

Defines the RF attenuation level.

Prerequisites for this command

- Decouple attenuation from reference level (`INPut<ip>:ATTenuation<ant>:AUTO`).

Suffix:

<ip> irrelevant

<ant> irrelevant

Parameters:

<Attenuation> *RST: 10 dB
 Default unit: dB

Example: //Define RF attenuation
 INP:ATT:AUTO OFF
 INP:ATT 10

Manual operation: See "[RF Attenuation](#)" on page 108

INPut<ip>:ATTenuation<ant>:AUTO <State>

Couples and decouples the RF attenuation to the reference level.

Suffix:

<ip> irrelevant

<ant> irrelevant

Parameters:

<State> ON | OFF | 1 | 0
 *RST: ON

Example: //Couple attenuation to reference level (auto attenuation)
 INP:ATT:AUTO ON

Manual operation: See "[RF Attenuation](#)" on page 108

INPut<ip>:COUPLing <CouplingType>

Selects the coupling type of the RF input.

If an external frontend is active, the coupling is automatically set to AC.

Suffix:

<ip> 1 | 2
irrelevant

Parameters:

<CouplingType> AC | DC
AC
AC coupling
DC
DC coupling
*RST: AC

Example: INP:COUP DC

Manual operation: See "[Input Coupling](#)" on page 109

INPut<ip>:GAIN:STATe <State>

Turns the internal preamplifier on and off. It requires the optional preamplifier hardware.

For R&S FSV/A44 or higher models, note the restrictions described in "[Preamplifier](#)" on page 109.

Suffix:

<ip> 1 | 2
irrelevant

Parameters:

<State> ON | OFF | 0 | 1
OFF | 0
Switches the function off
ON | 1
Switches the function on
*RST: 0

Example: INP:GAIN:STAT ON
INP:GAIN:VAL 15
Switches on 15 dB preamplification.

Manual operation: See "[Preamplifier](#)" on page 109

INPut<ip>:GAIN[:VALue] <Gain>

Selects the "gain" if the preamplifier is activated (INP:GAIN:STAT ON, see [INPut<ip>:GAIN:STATe](#) on page 247).

The command requires the additional preamplifier hardware option.

Suffix:

<ip> 1 | 2
irrelevant

Example: INP:GAIN:STAT ON
 INP:GAIN:VAL 30
 Switches on 30 dB preamplification.

Manual operation: See "[Preamplifier](#)" on page 109

INPut<ip>:IMPedance <Impedance>

Selects the nominal input impedance of the RF input. In some applications, only 50 Ω are supported.

Suffix:
 <ip> 1 | 2
 irrelevant

Parameters:
 <Impedance> 50 | 75
 *RST: 50 Ω
 Default unit: OHM

Example: INP:IMP 75

Manual operation: See "[Impedance](#)" on page 109

INPut<ip>:EATT<ant> <Attenuation>

Defines the electronic attenuation level.

If the current reference level is not compatible with an attenuation that has been set manually, the command also adjusts the reference level.

Suffix:
 <ip> irrelevant
 <ant> Connected instrument

Parameters:
 <Attenuation> Attenuation level in dB.
 Default unit: dB

Example: //Define signal attenuation
 INP:EATT 10

Manual operation: See "[Electronic Attenuation](#)" on page 108

INPut<ip>:EATT<ant>:AUTO <State>

Turns automatic selection of the electronic attenuation on and off.

If on, electronic attenuation reduces the mechanical attenuation whenever possible.

Suffix:
 <ip> irrelevant

<ant>	1...4 Connected instrument
Parameters:	
<State>	ON OFF 1 0 *RST: OFF
Example:	//Turn on automatic selection of electronic attenuation INP:EATT:AUTO ON
Manual operation:	See " Electronic Attenuation " on page 108

INPut<ip>:EATT<ant>:STATe <State>

Turns the electronic attenuator on and off.

Suffix:

<ip>	irrelevant
<ant>	1...4 Connected instrument

Parameters:

<State>	ON OFF *RST: OFF
---------	-----------------------

Example: //Turn on electronic attenuation
INP:EATT:STAT ON

Manual operation: See "[Electronic Attenuation](#)" on page 108

7.9.2.5 Data capture

[SENSe:][LTE:]FRAMe:COUNT.....	249
[SENSe:][LTE:]FRAMe:COUNT:AUTO.....	250
[SENSe:][LTE:]FRAMe:COUNT:STATe.....	250
[SENSe:][LTE:]FRAMe:SCOunt.....	250
[SENSe:]SWAPiq.....	251
[SENSe:]SWEep:TIME.....	251

[SENSe:][LTE:]FRAMe:COUNT <Subframes>

Defines the number of frames you want to analyze.

Prerequisites for this command

- Turn on overall frame count ([SENSe:] [LTE:] FRAMe:COUNT:STATe).
- Turn on manual selection of frames to analyze ([SENSe:] [LTE:] FRAMe:COUNT: AUTO).

Parameters:

<Subframes>	<numeric value> (integer only) *RST: 1
-------------	---

Example: //Define number of frames to analyze manually
 FRAM:COUN:STAT ON
 FRAM:COUN:AUTO OFF
 FRAM:COUN 20

Manual operation: See ["Number of Frames to Analyze"](#) on page 111

[SENSe:][LTE:]FRAMe:COUNT:AUTO <State>

Turns automatic selection of the number of frames to analyze on and off.

Parameters:

<State> **ON | 1**
 Selects the analyzed number of frames according to the LTE standard.

OFF | 0
 Turns on manual selection of the number of frames.

Example: //Turn on automatic selection of analyzed frames
 FRAM:COUN:AUTO ON

Manual operation: See ["Auto According to Standard"](#) on page 111

[SENSe:][LTE:]FRAMe:COUNT:STATe <State>

Turns manual selection of the number of frames you want to analyze on and off.

Parameters:

<State> **ON | 1**
 You can set the number of frames to analyze.

OFF | 0
 The R&S FSV/A analyzes the frames captured in a single sweep.

*RST: ON

Example: //Turn on manual selection of number of frames
 FRAM:COUN:STAT ON

Manual operation: See ["Overall Frame Count"](#) on page 111

[SENSe:][LTE:]FRAMe:SCOUnt <Subframes>

Selects the maximum number of subframes to analyze.

Selecting a number of subframes different from the default one may become necessary if the capture time is less than 20.1 ms.

Parameters:

<Subframes> **ALL**
 Analyzes all subframes of a frame (10).

<numeric value> (integer only)
 Number of subframes that the application analyzes.

Range: 1 to 9
 *RST: ALL

Example: //Select number of analyzed subframes
 FRAM:SCO 3

Manual operation: See "[Maximum Number of Subframes per Frame to Analyze](#)" on page 112

[SENSe:]SWAPiq <State>

Turns a swap of the I and Q branches on and off.

Parameters:

<State> ON | OFF | 1 | 0
 *RST: OFF

Example: //Swap I and Q branches
 SWAP ON

Manual operation: See "[Swap I/Q](#)" on page 111

[SENSe:]SWEep:TIME <CaptureLength>

Defines the capture time.

Parameters:

<CaptureLength> <numeric value>
 *RST: 20.1 ms / 40.1 ms (DL TDD)
 Default unit: s

Example: //Define capture time
 SWE:TIME 40ms

Manual operation: See "[Capture Time](#)" on page 110

7.9.2.6 Trigger

The trigger functionality of the LTE measurement application is the same as that of the R&S FSV/A.

For a comprehensive description of the available remote control commands for trigger configuration, see the documentation of the R&S FSV/A.

TRIGger[:SEQuence]:DTIME.....	252
TRIGger[:SEQuence]:HOLDoff<ant>[:TIME].....	252
TRIGger[:SEQuence]:IFPower:HOLDoff.....	252
TRIGger[:SEQuence]:IFPower:HYSTeresis.....	253
TRIGger[:SEQuence]:LEVel<ant>[:EXTernal<tp>].....	253
TRIGger[:SEQuence]:LEVel<ant>:IFPower.....	253
TRIGger[:SEQuence]:LEVel<ant>:IQPower.....	254
TRIGger[:SEQuence]:LEVel<ant>:RFPower.....	254

TRIGger[:SEQuence]:PORT<ant>.....	255
TRIGger[:SEQuence]:SLOPe.....	255
TRIGger[:SEQuence]:SOURce<ant>.....	255

TRIGger[:SEQuence]:DTIME <DropoutTime>

Defines the time the input signal must stay below the trigger level before a trigger is detected again.

Parameters:

<DropoutTime> Dropout time of the trigger.
 Range: 0 s to 10.0 s
 *RST: 0 s
 Default unit: S

Manual operation: See "[Trigger Source](#)" on page 113

TRIGger[:SEQuence]:HOLDoff<ant>[:TIME] <Offset>

Defines the trigger offset.

Suffix:

<ant> [Instrument](#)

Parameters:

<Offset> <numeric value>
 *RST: 0 s
 Default unit: s

Example: //Define trigger offset
 TRIG:HOLD 5MS

Manual operation: See "[Trigger Source](#)" on page 113

TRIGger[:SEQuence]:IFPower:HOLDoff <Period>

Defines the holding time before the next trigger event.

Note that this command can be used for **any trigger source**, not just IF Power (despite the legacy keyword).

Parameters:

<Period> Range: 0 s to 10 s
 *RST: 0 s
 Default unit: S

Example: TRIG:SOUR EXT
 Sets an external trigger source.
 TRIG:IFP:HOLD 200 ns
 Sets the holding time to 200 ns.

Manual operation: See "[Trigger Source](#)" on page 113

TRIGger[:SEQuence]:IFPower:HYSTeresis <Hysteresis>

Defines the trigger hysteresis, which is only available for "IF Power" trigger sources.

Parameters:

<Hysteresis> Range: 3 dB to 50 dB
 *RST: 3 dB
 Default unit: DB

Example:

```
TRIG:SOUR IFP
Sets the IF power trigger source.
TRIG:IFP:HYST 10DB
Sets the hysteresis limit value.
```

Manual operation: See "[Trigger Source](#)" on page 113

TRIGger[:SEQuence]:LEVel<ant>[:EXtErnal<tp>] <Level>

Defines the level for an external trigger.

Suffix:

<ant> [Instrument](#)
 <tp> [Trigger port](#)

Parameters:

<Level> Range: 0.5 V to 3.5 V
 *RST: 1.4 V
 Default unit: V

Example:

```
//Define trigger level
TRIG:LEV 2V
```

Manual operation: See "[Trigger Source](#)" on page 113

TRIGger[:SEQuence]:LEVel<ant>:IFPower <Level>

Defines the power level at the third intermediate frequency that must be exceeded to cause a trigger event.

Note that any RF attenuation or preamplification is considered when the trigger level is analyzed. If defined, a reference level offset is also considered.

Suffix:

<ant> [Instrument](#)

Parameters:

<Level> <numeric value>

For details on available trigger levels and trigger bandwidths see the data sheet.

*RST: -10 dBm
 Default unit: dBm

Example: //Define trigger level
 TRIG:SOUR IFP
 TRIG:LEV:IFP -30dBm

Manual operation: See "[Trigger Source](#)" on page 113

TRIGger[:SEQuence]:LEVel<ant>:IQPower <Level>

Defines the magnitude the I/Q data must exceed to cause a trigger event.

Note that any RF attenuation or preamplification is considered when the trigger level is analyzed. If defined, a reference level offset is also considered.

Suffix:
 <ant> [Instrument](#)

Parameters:
 <Level> <numeric value>
 Range: -130 dBm to 30 dBm
 *RST: -20 dBm
 Default unit: dBm

Example: //Define trigger level
 TRIG:SOUR IQP
 TRIG:LEV:IQP -30dBm

Manual operation: See "[Trigger Source](#)" on page 113

TRIGger[:SEQuence]:LEVel<ant>:RFPower <Level>

Defines the power level the RF input must exceed to cause a trigger event. Note that any RF attenuation or preamplification is considered when the trigger level is analyzed. If defined, a reference level offset is also considered.

The input signal must be between 500 MHz and 8 GHz.

Suffix:
 <ant> [Instrument](#)

Parameters:
 <Level> <numeric value>
 For details on available trigger levels and trigger bandwidths see the data sheet.
 *RST: -20 dBm
 Default unit: dBm

Example: //Define trigger level
 TRIG:SOUR RFP
 TRIG:LEV:RFP -30dBm

Manual operation: See "[Trigger Source](#)" on page 113

TRIGger[:SEQuence]:PORT<ant> <port>

Selects the trigger port for measurements with devices that have several trigger ports.

Suffix:

<ant> [Analyzer](#)

Parameters:

<port> **PORT1**
PORT2
PORT3

Example: //Select trigger port 1
TRIG:PORT PORT1

TRIGger[:SEQuence]:SLOPe <Type>

Selects the trigger slope.

Parameters:

<Type> POSitive | NEGative
POSitive
Triggers when the signal rises to the trigger level (rising edge).
NEGative
Triggers when the signal drops to the trigger level (falling edge).
*RST: POSitive

Example: TRIG:SLOP NEG

Manual operation: See "[Trigger Source](#)" on page 113

TRIGger[:SEQuence]:SOURce<ant> <Source>

Selects the trigger source.

Note on external triggers:

If a measurement is configured to wait for an external trigger signal in a remote control program, remote control is blocked until the trigger is received and the program can continue. Make sure this situation is avoided in your remote control programs.

Suffix:

<ant> [Analyzer](#)

Parameters:

<Source> **IMMediate**
Free run (no trigger event to start a measurement).
EXTernal
Measurement starts when the external trigger signal exceeds a certain level.
Trigger signal from the "Trigger Input/Output" connector.
Note: Connector must be configured for "Input".

EXT2

Trigger signal from the "Trigger Input / Output" connector.
Note: Connector must be configured for "Input".

RFPower

Measurement starts when the first intermediate frequency exceeds a certain level.
(Frequency and time domain measurements only.)

IFPower

Measurement starts when the second intermediate frequency exceeds a certain level.

IQPower

Measurement starts when the sampled I/Q data exceeds a certain magnitude.
For applications that process I/Q data, such as the I/Q analyzer or optional applications.

PSEN

External power sensor

*RST: IMMEDIATE

Manual operation: See "[Trigger Source](#)" on page 113

7.9.2.7 Demodulation

CONFigure[:LTE]:DL[:CC<cc>]:MIMO:CROStalk	256
[SENSe:][LTE:]DL:DEMod:MCFilter	257
[SENSe:][LTE:]DL:DEMod:CBSCrambling	257
[SENSe:][LTE:]DL:DEMod:DACHannels	257
[SENSe:][LTE:]DL:DEMod:EVMCalc	257
[SENSe:][LTE:]DL:DEMod:PRData	258
[SENSe:][LTE:]DL:DEMod:SISync	258

CONFigure[:LTE]:DL[:CC<cc>]:MIMO:CROStalk <State>

Turns MIMO crosstalk compensation on and off.

Suffix:

<cc> [Component Carrier](#)

Parameters:

<State> ON | OFF | 1 | 0
*RST: OFF

Example:

```
//Turn on crosstalk compensation
CONF:DL:MIMO:CROS ON
```

Manual operation: See "[Compensate Crosstalk](#)" on page 116

[SENSe:][LTE:]DL:DEMod:MCFilter <State>

Turns suppression of interfering neighboring carriers on and off (e.g. LTE, WCDMA, GSM etc).

Parameters:

<State> ON | OFF | 1 | 0
*RST: OFF

Example: //Turn on interference suppression
DL:DEM:MCF ON

Manual operation: See "[Multicarrier Filter](#)" on page 116

[SENSe:][LTE:]DL:DEMod:CBSCrambling <State>

Turns scrambling of coded bits on and off.

Parameters:

<State> ON | OFF | 1 | 0
*RST: ON

Example: //Descramble coded bits
DL:DEM:CBSC ON

Manual operation: See "[Scrambling of Coded Bits](#)" on page 117

[SENSe:][LTE:]DL:DEMod:DACHannels <State>

Turns the decoding of all control channels on and off.

Parameters:

<State> ON | OFF | 1 | 0
*RST: OFF

Example: //Turn on decoding of all control channels
DL:DEM:DACH ON

Manual operation: See "[Decode All Channels](#)" on page 117

[SENSe:][LTE:]DL:DEMod:EVMCalc <Calculation>

Selects the EVM calculation method.

Parameters:

<Calculation> **TGPP**
3GPP definition
OTP
Optimal timing position
*RST: TGPP

Example: //Select EVM calculation method
DL:DEM:EVMC TGPP

Manual operation: See ["EVM Calculation Method"](#) on page 117

[SENSe:][LTE:]DL:DEMod:PRData <Reference>

Selects the type of reference data to calculate the EVM for the PDSCH.

Parameters:

<Reference>

AUTO

Automatic identification of reference data.

ALLO

Reference data is 0, according to the test model definition.

Example:

//Select reference data for PDSCH demodulation

DL:DEM:PRD ALLO

Manual operation: See ["PDSCH Reference Data"](#) on page 118

[SENSe:][LTE:]DL:DEMod:SISync <State>

Turns suppression of 5G resources with a 30 kHz subcarrier spacing (dynamic spectrum sharing) on and off.

Parameters:

<State>

ON | OFF | 1 | 0

*RST: OFF

Example:

//Turn on suppression

DL:DEM:SISY ON

Manual operation: See ["Suppress Interferer for Synchronization"](#) on page 118

7.9.2.8 Estimation & compensation

Parameter estimation

[\[SENSe:\]\[LTE:\]DL:DEMod:BESTimation](#)..... 258

[\[SENSe:\]\[LTE:\]DL:DEMod:CESTimation](#)..... 259

[SENSe:][LTE:]DL:DEMod:BESTimation <State>

Turns boosting estimation on and off.

Parameters:

<State>

ON | OFF | 1 | 0

*RST: ON

Example:

//Turn on boosting estimation

DL:DEM:BEST ON

Manual operation: See ["Boosting Estimation"](#) on page 114

[SENSe:][LTE:]DL:DEMod:CESTimation <Type>

Selects the channel estimation type.

Parameters:

<Type>	OFF
	Turns off channel estimation.
	PIL
	Optimal, pilot only
	PILP
	Optimal, pilot and payload
	TGPP
	3GPP EVM definition
*RST:	TGPP

Example: //Select channel estimation type
DL:DEM:CEST TGPP

Manual operation: See "[Channel Estimation](#)" on page 114

Error compensation

[SENSe:][LTE:]DL:TRACking:PHASe.....	259
[SENSe:][LTE:]DL:TRACking:TIME.....	259

[SENSe:][LTE:]DL:TRACking:PHASe <Type>

Selects the phase tracking type.

Parameters:

<Type>	OFF
	Deactivate phase tracking
	PIL
	Pilot only
	PILP
	Pilot and payload
*RST:	OFF

Example: //Select phase tracking type
DL:TRAC:PHAS PILPAY

Manual operation: See "[Phase](#)" on page 114

[SENSe:][LTE:]DL:TRACking:TIME <State>

Turns timing tracking on and off.

Parameters:

<State>	ON OFF 1 0
*RST:	OFF

Example: //Turn on timing tracking
DL:TRAC:TIME ON

Manual operation: See "Time Tracking" on page 115

7.9.2.9 Automatic configuration

Commands to configure the application automatically described elsewhere.

- `DISPlay[:WINDow<n>][:SUBWindow<w>]:TRACe<t>:Y[:SCALE]:AUTO`

<code>[SENSe:]ADJust:CONFigure:LEVel:DURation</code>	260
<code>[SENSe:]ADJust:CONFigure:LEVel:DURation:MODE</code>	260
<code>[SENSe:]ADJust:CONFigure:LTE</code>	261
<code>[SENSe:]ADJust:LEVel<ant></code>	261

`[SENSe:]ADJust:CONFigure:LEVel:DURation <Duration>`

To determine the ideal reference level, the R&S FSV/A performs a measurement on the current input data. This command defines the length of the measurement if `[SENSe:]ADJust:CONFigure:LEVel:DURation:MODE` is set to `MANual`.

Parameters:

<Duration> Numeric value in seconds
 Range: 0.001 to 16000.0
 *RST: 0.001
 Default unit: s

Example: `ADJ:CONF:DUR:MODE MAN`
 Selects manual definition of the measurement length.
`ADJ:CONF:LEV:DUR 5ms`
 Length of the measurement is 5 ms.

Manual operation: See "Auto Level" on page 107

`[SENSe:]ADJust:CONFigure:LEVel:DURation:MODE <Mode>`

To determine the ideal reference level, the R&S FSV/A performs a measurement on the current input data. This command selects the way the R&S FSV/A determines the length of the measurement .

Parameters:

<Mode> **AUTO**
 The R&S FSV/A determines the measurement length automatically according to the current input data.

MANual
 The R&S FSV/A uses the measurement length defined by `[SENSe:]ADJust:CONFigure:LEVel:DURation` on page 260.
 *RST: AUTO

Manual operation: See "Auto Level" on page 107

[SENSe:]ADJust:CONFigure:LTE

Automatically detects several signal characteristics and selects the appropriate parameters in the application.

The following signal characteristics are automatically detected.

- Carrier bandwidth

Example: //Determine signal characteristics based on the measurement signal
 ADJ:CONF:LTE

Usage: Event

Manual operation: See "Auto LTE" on page 118

[SENSe:]ADJust:LEVel<ant>

Initiates a single (internal) measurement that evaluates and sets the ideal reference level for the current input data and measurement settings. This ensures that the settings of the RF attenuation and the reference level are optimally adjusted to the signal level without overloading the R&S FSV/A or limiting the dynamic range by an S/N ratio that is too small.

Suffix:
<ant> 1...4
 Connected instrument

Example: //Auto level on one instrument
 ADJ:LEV2

Usage: Event

Manual operation: See "Auto Level" on page 107
 See "Auto leveling" on page 118

7.9.3 Time alignment error measurements

All commands specific to the time alignment error measurement are listed below.

Commands to configure the time alignment error measurement described elsewhere:

- [\[SENSe:\]FREQuency:CENTer\[:CC<cc>\]](#) on page 243
- Commands in "Signal characteristics" on page 208
- Commands in "Synchronization signal" on page 223

[CONFigure\[:LTE\]:CAGGregation:STATe](#)..... 261
[CONFigure\[:LTE\]:NOCC](#)..... 262

CONFigure[:LTE]:CAGGregation:STATe <State>

Turns carrier aggregation for time alignment error measurements on and off.

You can select the number of component carriers with [CONFigure\[:LTE\]:NOCC](#).

Parameters:

<State> ON | OFF | 1 | 0
 *RST: OFF

Example:

```
//Select 2 component carrier
CONF:CAGG:STAT ON
CONF:NOCC 2
```

CONFigure[:LTE]:NOCC <Carrier>

Selects the number of component carriers analyzed in the measurement.

Parameters:

<Carrier> Number of the component carriers that you would like to measure. The range depends on the measurement. For more information see "[Carrier Aggregation](#)" on page 68.
 *RST: 1

Example:

```
//Select number of component carriers
CONF:NOCC 2
```

Manual operation: See "[Remote commands to configure carrier aggregation](#)" on page 71

7.9.4 Transmit on/off power measurements

All commands specific to the transmit on/off Power measurement are listed below.

Commands to configure transmit on/off Power measurement described elsewhere:

- CONFigure[:LTE]:DL[:CC<cc>]:BW
- CONFigure[:LTE]:DL[:CC<cc>]:CYCPrefix
- CONFigure[:LTE]:DL[:CC<cc>]:MIMO:ASElection
- CONFigure[:LTE]:DL[:CC<cc>]:MIMO:CONFig
- CONFigure[:LTE]:DL[:CC<cc>]:PLC:CID
- CONFigure[:LTE]:DL[:CC<cc>]:PLC:CIDGroup
- CONFigure[:LTE]:DL[:CC<cc>]:PLC:PLID
- CONFigure[:LTE]:DL[:CC<cc>]:SYNC:ANTenna
- CONFigure[:LTE]:DL[:CC<cc>]:SYNC:PPOWer
- CONFigure[:LTE]:DL[:CC<cc>]:SYNC:SPOWer
- CONFigure[:LTE]:DL[:CC<cc>]:TDD:SPSC
- CONFigure[:LTE]:DL[:CC<cc>]:TDD:UDConf
- CONFigure[:LTE]:DUPLexing
- CONFigure[:LTE]:LDIRection
- FETCh[:CC<cc>]:PLC:CIDGroup?
- FETCh[:CC<cc>]:PLC:PLID?

- `MMEMemory:LOAD[:CC<cc>]:TMOD:DL`
- `[SENSe:]FREQuency:CENTer[:CC<cc>]` on page 243
- `[SENSe:]FREQuency:CENTer[:CC<cc>]:OFFSet` on page 243
- `[SENSe:]SWAPiq`
- Commands in [Chapter 7.9.2.4, "Amplitude configuration"](#), on page 245

<code>CONFigure[:LTE]:OOPower:NFRames</code>	263
<code>[SENSe:][LTE:]OOPower:NCORrection</code>	263
<code>UNIT:OPOWer</code>	263

`CONFigure[:LTE]:OOPower:NFRames <Frames>`

Defines the number of frames that are analyzed for On/Off Power measurements.

Parameters:

`<Frames>` `<numeric value>`

Example: `//Select frames to be analyzed`
`CONF:OOP:NFR 10`

Manual operation: See ["Number of Frames"](#) on page 120

`[SENSe:][LTE:]OOPower:NCORrection <State>`

Turns noise correction for on/off power measurements on and off.

Parameters:

`<State>` `ON | OFF | 1 | 0`
`*RST: OFF`

Example: `//Turn on noise correction`
`OOP:NCOR ON`

Manual operation: See ["Noise Cancellation"](#) on page 43
 See ["Noise Correction"](#) on page 120

`UNIT:OPOWer <Unit>`

Selects the unit the off power (transmit on / off power measurements) is displayed in.

Parameters:

`<Unit>` **DBM**
 Displays the power as an absolute value in dBm.
DMHZ
 Displays the power as a relative value in dBm/MHz.
`*RST: DBM`

Example: `//Select the unit dBm.`
`UNIT:OPOW DBM`

Manual operation: See ["Transmit On / Off Power"](#) on page 40

7.9.5 Frequency sweep measurements

Please refer to the documentation of the R&S FSV/A base unit for a comprehensive list and description of remote commands necessary to configure and perform frequency sweep measurements (ACLR and SEM).

All commands specific to the LTE application are listed below.

Commands to configure frequency sweep measurements described elsewhere:

- `[SENSe:]FREQuency:CENTer[:CC<cc>]:OFFSet` on page 243

<code>CONFigure[:LTE]:NDEVices</code>	264
<code>[SENSe:]POWer:ACHannel:AACHannel</code>	264
<code>[SENSe:]POWer:ACHannel:UAACHannel</code>	265
<code>[SENSe:]POWer:SEM:CATegory</code>	266
<code>[SENSe:]POWer:SEM:CHBS:AMPower</code>	266
<code>[SENSe:]POWer:SEM:CHBS:AMPower:AUTO</code>	267
<code>[SENSe:]POWer:SEM:OBANd</code>	267
<code>[SENSe:]POWer:SEM:OBANd:STATe</code>	267
<code>CALCulate<n>:LIMit:ACPowEr:PMODE</code>	268

`CONFigure[:LTE]:NDEVices <Devices>`

Selects the number of R&S FSV/A used in a time alignment error measurement with carrier aggregation.

Parameters:

<code><Devices></code>	1	Performs a broadband measurement over all component carriers on a single R&S FSV/A.
	2	Performs a measurement on two R&S FSV/A, each one analyzing a single component carrier.
<code>*RST:</code>	1	

Example: `//Select broadband measurement over all CCs`
`CONF:NDEV 1`

Manual operation: See "[Remote commands to configure carrier aggregation](#)" on page 71

`[SENSe:]POWer:ACHannel:AACHannel <Channel>`

Selects the bandwidth of the adjacent channel for ACLR measurements.

For MC ACLR measurements, the command selects the bandwidth of the lower adjacent channel.

Parameters:

<code><Channel></code>	EUTRA	Selects an EUTRA signal of the same bandwidth like the TX channel as assumed adjacent channel carrier.
------------------------------	--------------	--

UTRA128

Selects an UTRA signal with a bandwidth of 1.28MHz as assumed adjacent channel carrier.

UTRA384

Selects an UTRA signal with a bandwidth of 3.84MHz as assumed adjacent channel carrier.

UTRA768

Selects an UTRA signal with a bandwidth of 7.68MHz as assumed adjacent channel carrier.

*RST: EUTRA

Example: //Select assumed adjacent channel
POW:ACH:AACH UTRA384

Manual operation: See ["Remote commands to configure carrier aggregation"](#) on page 71
See ["Assumed Adjacent Channel Carrier"](#) on page 121

[SENSe:]POWer:ACHannel:UAChannel <Bandwidth>

For MC ACLR measurements, the command selects the bandwidth of the upper adjacent channel.

Parameters:

<Bandwidth>

EUTRA

Selects an EUTRA signal of the same bandwidth like the TX channel as assumed adjacent channel carrier.

UTRA128

Selects an UTRA signal with a bandwidth of 1.28MHz as assumed adjacent channel carrier.

UTRA384

Selects an UTRA signal with a bandwidth of 3.84MHz as assumed adjacent channel carrier.

UTRA768

Selects an UTRA signal with a bandwidth of 7.68MHz as assumed adjacent channel carrier.

*RST: EUTRA

Example: //Select bandwidth of assumed adjacent channel carrier.
POW:ACH:UAAC UTRA384

Manual operation: See ["Remote commands to configure carrier aggregation"](#) on page 71

[SENSe:]POWer:SEM:CATegory <Category>

Selects the SEM limit category as defined in 3GPP TS 36.104.

Parameters:

<Category>	A Category A (wide area base station)
	B1 Category B Opt 1 (wide area base station)
	B2 Category B Opt 2 (wide area base station)
	HOME Home base station
	LARE Local area base station
	MED Medium range base station
	*RST: A

Example: //Select base station category
POW:SEM:CAT MED

Manual operation: See "[Category](#)" on page 121

[SENSe:]POWer:SEM:CHBS:AMPower <Power>

Defines the aggregated maximum power for home base stations or the Tx power for medium range base stations.

Prerequisites for this command

- Select medium range base stations ([\[SENSe:\]POWer:SEM:CATegory](#)).
- Turn off automatic power determination ([\[SENSe:\]POWer:SEM:CHBS:AMPower: **AUTO**](#)).

Parameters:

<Power>	<numeric value>
	Default unit: dBm

Example: //Define base station power
POW:SEM:CAT MED
POW:SEM:CHBS:AMP:AUTO OFF
POW:SEM:CHBS:AMP 0

Manual operation: See "[Category](#)" on page 121
See "[Aggregated Maximum Power Of All TX Ports \(P\)](#)" on page 122
See "[Tx Power](#)" on page 122

[SENSe:]POWer:SEM:CHBS:AMPower:AUTO <State>

Turn automatic detection of the TX channel power on and off.

Prerequisites for this command

- Select medium range base stations ([\[SENSe:\]POWer:SEM:CATegory](#)).

When you turn off automatic detection, you can define the TX channel power manually with [\[SENSe:\]POWer:SEM:CHBS:AMPower](#).

Parameters:

<State> ON | OFF | 1 | 0
 *RST: OFF

Example:

```
//Turn on automatic detection of the TX channel power
POW:SEM:CAT MED
POW:SEM:CHBS:AMP:AUTO ON
```

Manual operation: See "[Category](#)" on page 121
 See "[Tx Power](#)" on page 122

[SENSe:]POWer:SEM:OBANd <OperatingBand>

Selects the SEM for a specific operating band.

Prerequisites for this command

- Turn on selection of operating band related SEM limits ([\[SENSe:\]POWer:SEM:OBANd:STATe](#)).

Parameters:

<OperatingBand> <numeric value> (integer only)

Example:

```
//Select SEM for operating band
POW:SEM:OBAN:STAT ON
POW:SEM:OBAN 2
```

Manual operation: See "[Category](#)" on page 121

[SENSe:]POWer:SEM:OBANd:STATe <State>

Turns SEM limits defined for specific operating bands on and off.

Effects of this command

- Selecting a base station category to test against becomes unavailable ([\[SENSe:\]POWer:SEM:CATegory](#)).

Parameters:

<State> ON | OFF | 1 | 0
 You can select an operating band with [\[SENSe:\]POWer:SEM:OBANd](#).
 *RST: OFF

Example: //Turn on operating band related SEM limits
 POW:SEM:OBAN:STAT ON

Manual operation: See "[Category](#)" on page 121

CALCulate<n>:LIMit:ACPpower:PMODE <Mode>

Selects the limit evaluation mode for ACLR measurements.

Supported for ACLR measurements in the LTE and 5G applications.

Suffix:

<n> irrelevant

 irrelevant

Parameters:

<Mode>

AND

Overall limit check passes if both absolute and relative limit checks pass.

OR

Overall limit check passes if either absolute or relative limit checks pass.

*RST: AND

Example: //Select evaluation mode
 CALC:LIM:ACP:PMOD AND

7.10 Analysis

- [Trace export](#).....268
- [Microservice export](#).....270
- [Evaluation range](#).....270
- [Y-axis scale](#).....274
- [Result settings](#).....276

7.10.1 Trace export

- [FORMat:DEXPort:DSEParator](#).....268
- [FORMat:DEXPort:HEADer](#).....269
- [FORMat:DEXPort:TRACes](#).....269
- [MMEMory:STORe<n>:TRACe](#).....269

FORMat:DEXPort:DSEParator <Separator>

Selects the decimal separator for data exported in ASCII format.

Parameters:

<Separator> POINT | COMMa

COMMa

Uses a comma as decimal separator, e.g. 4,05.

POINT

Uses a point as decimal separator, e.g. 4.05.

*RST: *RST has no effect on the decimal separator.
Default is POINT.

Example:

```
FORM:DEXP:DSEP POIN
```

Sets the decimal point as separator.

FORMat:DEXPort:HEADer <State>

If enabled, additional instrument and measurement settings are included in the header of the export file for result data. If disabled, only the pure result data from the selected traces and tables is exported.

Parameters:

<State> ON | OFF | 0 | 1
*RST: 1

FORMat:DEXPort:TRACes <Selection>

Selects the data to be included in a data export file (see [MMEMory:STORe<n>:TRACe](#) on page 269).

Parameters:

<Selection> SINGle | ALL

SINGle

Only a single trace is selected for export, namely the one specified by the [MMEMory:STORe<n>:TRACe](#) command.

ALL

Selects all active traces and result tables (e.g. "Result Summary", marker peak list etc.) in the current application for export to an ASCII file.

The <trace> parameter for the [MMEMory:STORe<n>:TRACe](#) command is ignored.

*RST: SINGle

MMEMory:STORe<n>:TRACe <Trace>, <FileName>

Exports trace data from the specified window to an ASCII file.

Secure User Mode

In secure user mode, settings that are stored on the instrument are stored to volatile memory, which is restricted to 256 MB. Thus, a "memory limit reached" error can occur although the hard disk indicates that storage space is still available.

To store data permanently, select an external storage location such as a USB memory device.

For details, see "Protecting Data Using the Secure User Mode" in the "Data Management" section of the R&S FSW base unit user manual.

Suffix:

<n> [Window](#)

Parameters:

<Trace> Number of the trace to be stored

<FileName> String containing the path and name of the target file.

Example:

```
MME:STOR1:TRAC 1, 'C:\TEST.ASC'
```

Stores trace 1 from window 1 in the file TEST.ASC.

7.10.2 Microservice export

[MMEMory:STORe<n>:MSERvice.....](#) 270

MMEMory:STORe<n>:MSERvice <FileName>

Exports the signal configuration to the microservice.

Suffix:

<n> irrelevant

Parameters:

<FileName> String containing the path and name of the file.
The file extension is .m5g.

Example:

```
//Export to microservice
```

```
MME:STOR:MSER 'signal.xxx'
```

7.10.3 Evaluation range

[CONFigure\[:LTE\]:DL\[:CC<cc>\]:BF:AP:CELL.....](#) 270

[CONFigure\[:LTE\]:DL\[:CC<cc>\]:BF:AP:CSI.....](#) 271

[CONFigure\[:LTE\]:DL\[:CC<cc>\]:BF:AP\[:UERS\].....](#) 271

[\[SENSe:\]\[LTE:\]\[CC<cc>:\]ALLocation:SElect.....](#) 272

[\[SENSe:\]\[LTE:\]\[CC<cc>:\]CARRier:SElect.....](#) 272

[\[SENSe:\]\[LTE:\]\[CC<cc>:\]LOCation:SElect.....](#) 273

[\[SENSe:\]\[LTE:\]\[CC<cc>:\]MODulation:SElect.....](#) 273

[\[SENSe:\]\[LTE:\]\[CC<cc>:\]SUBFrame:SElect.....](#) 273

[\[SENSe:\]\[LTE:\]\[CC<cc>:\]SYMBOL:SElect.....](#) 274

CONFigure[:LTE]:DL[:CC<cc>]:BF:AP:CELL <Port>

Selects the antenna port for which beamforming measurement results are displayed.

The availability of ports depends on the number of transmit antennas and number of beamforming layers.

Suffix:
<cc> [Component Carrier](#)

Parameters:
<Port> Antenna port used by the cell reference signal.
ALL
Shows the results for all antenna ports.
AP_0 | AP_1 | AP_2 | AP_3
Shows the results for antenna port 0, 1, 2 or 3 only.
***RST: ALL**

Example: //Display results for all antenna ports
CONF:DL:BF:AP:CELL ALL

Manual operation: See "[Beamforming Selection](#)" on page 131

CONFigure[:LTE]:DL[:CC<cc>]:BF:AP:CSI <Port>

Selects the antenna port for which beamforming measurement results are displayed.
The availability of ports depends on the number of transmit antennas and number of beamforming layers.

Suffix:
<cc> [Component Carrier](#)

Parameters:
<Port> Antenna port used by the CSI reference signal.
ALL
Shows the results for all antenna ports.
AP_15 | AP_16 | AP_17 | AP_18 | AP_19 | AP20 | AP21 | AP22
Shows the results for antenna port 15 to antenna port 22 only.
***RST: ALL**

Example: //Display results for all antenna ports
CONF:DL:BF:AP:CSI ALL

Manual operation: See "[Beamforming Selection](#)" on page 131

CONFigure[:LTE]:DL[:CC<cc>]:BF:AP[:UERS] <Port>

Selects the antenna port for which beamforming measurement results are displayed.
The availability of ports depends on the number of transmit antennas and number of beamforming layers.

Suffix:
<cc> [Component Carrier](#)

Parameters:
<Port> Antenna port used by the UE reference signal.

ALL

Shows the results for all antenna ports.

AP_5_7 | AP_8 | AP_9 | AP_10 | AP_11 | AP_12 | AP_13 | AP_14

Shows the results for antenna port 5/7, 8, 9, 10, 11, 12, 13 or 14 only.

*RST: ALL

Example: //Display results for all antenna ports
CONF:DL:BF:AP:UERS ALL

Manual operation: See "[Beamforming Selection](#)" on page 131

[SENSe:][LTE:][CC<cc>:]ALlocation:SElect <Allocation>

Filters the displayed results in the constellation diagram by a certain type of allocation.

Suffix:

<cc> [Component Carrier](#)

Parameters:

<Allocation>

ALL

Shows the results for all allocations.

<numeric_value> (integer only)

Shows the results for a single allocation type.

Allocation types are mapped to numeric values. For the code assignment, see [Chapter 7.6.1.31, "Return value codes"](#), on page 171.

*RST: ALL

Example: //Display results for PDCCH
ALL:SEL -11

Manual operation: See "[Evaluation range for the constellation diagram](#)" on page 130

[SENSe:][LTE:][CC<cc>:]CARRier:SElect <Carrier>

Filters the results in the constellation diagram by a certain subcarrier.

Suffix:

<cc> [Component Carrier](#)

Parameters:

<Carrier>

ALL

Shows the results for all subcarriers.

<numeric_value> (integer only)

Shows the results for a single subcarrier.

*RST: ALL

Example: //Display results for subcarrier 1
CARR:SEL 1

Manual operation: See ["Evaluation range for the constellation diagram"](#) on page 130

[SENSe:][LTE:][CC<cc>:]LOCation:SElect <Location>

Selects the data source of the constellation diagram.

Suffix:

<cc> [Component Carrier](#)

Parameters:

<Location> **AMD**
After the MIMO decoder

BMD
Before the MIMO decoder

*RST: BMD

Example: //Use data from after the MIMO decoder
LOC:SEL AMD

Manual operation: See ["Evaluation range for the constellation diagram"](#) on page 130

[SENSe:][LTE:][CC<cc>:]MODulation:SElect <Modulation>

Filters the results in the constellation diagram by a certain type of modulation.

Suffix:

<cc> [Component Carrier](#)

Parameters:

<Modulation> **ALL**
Shows the results for all modulation types.

<numeric_value> (integer only)
Shows the results for a single modulation type.
Modulation types are mapped to numeric values. For the code assignment, see [Chapter 7.6.1.31, "Return value codes"](#), on page 171.

*RST: ALL

Example: //Display results for all elements with a QPSK modulation
MOD:SEL 2

Manual operation: See ["Evaluation range for the constellation diagram"](#) on page 130

[SENSe:][LTE:][CC<cc>:]SUBFrame:SElect <Subframe>

Selects the subframe to be analyzed.

Suffix:

<cc> [Component Carrier](#)

Parameters:

<Subframe> ALL | <numeric value>

ALL

Select all subframes

0...39

Select a single subframe

*RST: ALL

Example:

//Display results for all subframes

SUBF:SEL ALL

Manual operation: See ["Subframe Selection"](#) on page 130

[SENSe:][LTE:][CC<cc>:]SYMBOL:SElect <Symbol>

Filters the results in the constellation diagram by a certain OFDM symbol.

Suffix:

<cc> [Component Carrier](#)

Parameters:

<Symbol>

ALL

Shows the results for all subcarriers.

<numeric_value> (integer only)

Shows the results for a single OFDM symbol.

*RST: ALL

Example:

//Display result for OFDM symbol 2

SYMB:SEL 2

Manual operation: See ["Evaluation range for the constellation diagram"](#) on page 130

7.10.4 Y-axis scale

[DISPlay\[:WINDow<n>\]\[:SUBWindow<w>\]:TRACe<t>:Y\[:SCALe\]:AUTO](#)..... 274

[DISPlay\[:WINDow<n>\]\[:SUBWindow<w>\]:TRACe<t>:Y\[:SCALe\]:MAXimum](#)..... 275

[DISPlay\[:WINDow<n>\]\[:SUBWindow<w>\]:TRACe<t>:Y\[:SCALe\]:MINimum](#)..... 275

DISPlay[:WINDow<n>][:SUBWindow<w>]:TRACe<t>:Y[:SCALe]:AUTO <ONCE>

Automatically scales the y-axis of a diagram based on the displayed results.

Suffix:

<n> [Window](#)

<w> [Subwindow](#)

<t> irrelevant

Setting parameters:

<ONCE> **ALL**
Scales the y-axis in all windows for an ideal viewing experience.

DEFault
Restores the default scale of the y-axis.

ONCE
Scales the y-axis in a specific window for an ideal viewing experience.

Example: //Automatically scale the y-axis in subwindow 2 of window 2
DISP:WIND2:SUBW2:TRAC:Y:AUTO ONCE

Usage: Setting only

Manual operation: See ["Auto Scaling"](#) on page 119
See ["Automatic scaling of the y-axis"](#) on page 127

DISPlay[:WINDow<n>][:SUBWindow<w>]:TRACe<t>:Y[:SCALE]:MAXimum
<Value>

Defines the maximum value displayed on the y-axis of a diagram.

Suffix:

<n> [Window](#)

<w> [Subwindow](#)

<t> irrelevant

Parameters:

<Value> Maximum displayed value. The unit and value range depend on the selected diagram.

Example: //Define maximum value on y-axis in subwindow 2 of window 2
DISP:WIND2:SUBW2:TRAC:Y:MAX 0

Manual operation: See ["Manual scaling of the y-axis"](#) on page 126

DISPlay[:WINDow<n>][:SUBWindow<w>]:TRACe<t>:Y[:SCALE]:MINimum
<Value>

Defines the minimum value displayed on the vertical diagram axis.

Suffix:

<n> [Window](#)

<w> [Subwindow](#)

<t> irrelevant

Parameters:

<Value> Minimum displayed value. The unit and value range depend on the selected diagram.

Example: //Define minimum value on y-axis in subwindow 2 of window 2
 DISP:WIND2:SUBW2:TRAC:Y:MIN -50

Manual operation: See ["Manual scaling of the y-axis"](#) on page 126

7.10.5 Result settings

CALCulate<n>:MARKer<m>:COUPling.....	276
DISPlay[:WINDow<n>][:SUBWindow<w>]:COUPling.....	276
UNIT:BSTR.....	277
UNIT:CAXes.....	277
UNIT:EVM.....	277

CALCulate<n>:MARKer<m>:COUPling <State>

Couples or decouples markers in different result displays to each other.

Suffix:

<n> irrelevant

<m> irrelevant

Parameters:

<State> ON | OFF | 1 | 0

*RST: OFF

Example: //Couple markers to each other.

CALC:MARK:COUP ON

Manual operation: See ["Marker Coupling"](#) on page 133

DISPlay[:WINDow<n>][:SUBWindow<w>]:COUPling <State>

Couples or decouples result display tabs (subwindows).

Subwindow coupling is available for measurements with multiple data streams (like carrier aggregation).

Suffix:

<n> [Window](#)

<w> [Subwindow](#)

Parameters:

<State> ON | OFF | 1 | 0

*RST: OFF

Example: //Turn on subwindow coupling

DISP:COUP ON

Manual operation: See ["Subwindow Coupling"](#) on page 133

UNIT:BSTR <Unit>

Selects the way the bit stream is displayed.

Parameters:

<Unit>

SYMBOLS

Displays the bit stream using symbols

BITS

Displays the bit stream using bits

*RST: SYMBOLS

Example:

//Display bit stream as bits

UNIT:BSTR BIT

Manual operation: See ["Bit Stream Format"](#) on page 132

UNIT:CAXes <Unit>

Selects the scale of the x-axis for result displays that show subcarrier results.

Parameters:

<Unit>

CARR

Shows the number of the subcarriers on the x-axis.

HZ

Shows the frequency of the subcarriers on the x-axis.

Example:

//Display frequency on the x-axis

UNIT:CAX HZ

Manual operation: See ["Carrier Axes"](#) on page 133

UNIT:EVM <Unit>

Selects the EVM unit.

Parameters:

<Unit>

DB

EVM results returned in dB

PCT

EVM results returned in %

*RST: PCT

Example:

//Display EVM results in %

UNIT:EVM PCT

Manual operation: See ["EVM Unit"](#) on page 132

List of Commands (LTE DL)

[SENSe:]LTE:]CC<cc>:]ALLocation:SElect.....	272
[SENSe:]LTE:]CC<cc>:]CARRier:SElect.....	272
[SENSe:]LTE:]CC<cc>:]LOCation:SElect.....	273
[SENSe:]LTE:]CC<cc>:]MODulation:SElect.....	273
[SENSe:]LTE:]CC<cc>:]SUBFrame:SElect.....	273
[SENSe:]LTE:]CC<cc>:]SYMBOL:SElect.....	274
[SENSe:]LTE:]DL:DEMod:AUTO.....	216
[SENSe:]LTE:]DL:DEMod:BEStimation.....	258
[SENSe:]LTE:]DL:DEMod:CBSCrambling.....	257
[SENSe:]LTE:]DL:DEMod:CEStimation.....	259
[SENSe:]LTE:]DL:DEMod:DACHannels.....	257
[SENSe:]LTE:]DL:DEMod:EVMCalc.....	257
[SENSe:]LTE:]DL:DEMod:MCFilter.....	257
[SENSe:]LTE:]DL:DEMod:PRData.....	258
[SENSe:]LTE:]DL:DEMod:SISync.....	258
[SENSe:]LTE:]DL:FORMat:PSCD.....	216
[SENSe:]LTE:]DL:TRACking:PHASe.....	259
[SENSe:]LTE:]DL:TRACking:TIME.....	259
[SENSe:]LTE:]FRAMe:COUNT.....	249
[SENSe:]LTE:]FRAMe:COUNT:AUTO.....	250
[SENSe:]LTE:]FRAMe:COUNT:STATe.....	250
[SENSe:]LTE:]FRAMe:SCOUNT.....	250
[SENSe:]LTE:]OOPower:ATIMing.....	155
[SENSe:]LTE:]OOPower:NCORrection.....	263
[SENSe:]ADJust:CONFigure:LEVel:DURation.....	260
[SENSe:]ADJust:CONFigure:LEVel:DURation:MODE.....	260
[SENSe:]ADJust:CONFigure:LTE.....	261
[SENSe:]ADJust:LEVel<ant>.....	261
[SENSe:]FREQuency:CENTer:STEP.....	244
[SENSe:]FREQuency:CENTer[:CC<cc>].....	243
[SENSe:]FREQuency:CENTer[:CC<cc>]:OFFSet.....	243
[SENSe:]POWer:ACHannel:AACHannel.....	264
[SENSe:]POWer:ACHannel:UAACHannel.....	265
[SENSe:]POWer:SEM:CATegory.....	266
[SENSe:]POWer:SEM:CHBS:AMPower.....	266
[SENSe:]POWer:SEM:CHBS:AMPower:AUTO.....	267
[SENSe:]POWer:SEM:OBANd.....	267
[SENSe:]POWer:SEM:OBANd:STATe.....	267
[SENSe:]SWAPiq.....	251
[SENSe:]SWEep:TIME.....	251
[SENSe:]SYNC[:CC<cc>][:STATe]?.....	155
ABORT.....	153
CALCulate<n>:DELTaMarker<m>:X.....	186
CALCulate<n>:DELTaMarker<m>:Y?.....	186
CALCulate<n>:LIMit:ACPpower:ACHannel:RESult:ABSolute.....	191
CALCulate<n>:LIMit:ACPpower:ACHannel:RESult:RELative.....	192
CALCulate<n>:LIMit:ACPpower:ACHannel:RESult?.....	191

CALCulate<n>:LIMit:ACPoweR:ALTeRnate<alt>:RESult?	192
CALCulate<n>:LIMit:ACPoweR:ALTeRnate<ch>:RESult:ABSolute	193
CALCulate<n>:LIMit:ACPoweR:ALTeRnate<ch>:RESult:RELative	193
CALCulate<n>:LIMit:ACPoweR:GAP<gap>:ACLR:RESult:ABSolute?	194
CALCulate<n>:LIMit:ACPoweR:GAP<gap>:ACLR:RESult:RELative?	195
CALCulate<n>:LIMit:ACPoweR:GAP<gap>:ACLR:RESult?	194
CALCulate<n>:LIMit:ACPoweR:GAP<gap>[:CACLR]:RESult:ABSolute?	196
CALCulate<n>:LIMit:ACPoweR:GAP<gap>[:CACLR]:RESult:RELative?	197
CALCulate<n>:LIMit:ACPoweR:GAP<gap>[:CACLR]:RESult?	196
CALCulate<n>:LIMit:ACPoweR:PMODE	268
CALCulate<n>:LIMit:OOPoweR:OFFPower?	197
CALCulate<n>:LIMit:OOPoweR:TRANSient?	198
CALCulate<n>:LIMit[:CC<cc>]:SUMMary:EVM:DS1K:MAXimum:RESult?	201
CALCulate<n>:LIMit[:CC<cc>]:SUMMary:EVM:DS1K[:AVERAge]:RESult?	201
CALCulate<n>:LIMit[:CC<cc>]:SUMMary:EVM:DSQP:MAXimum:RESult?	199
CALCulate<n>:LIMit[:CC<cc>]:SUMMary:EVM:DSQP[:AVERAge]:RESult?	199
CALCulate<n>:LIMit[:CC<cc>]:SUMMary:EVM:DSSF:MAXimum:RESult?	200
CALCulate<n>:LIMit[:CC<cc>]:SUMMary:EVM:DSSF[:AVERAge]:RESult?	200
CALCulate<n>:LIMit[:CC<cc>]:SUMMary:EVM:DSST:MAXimum:RESult?	200
CALCulate<n>:LIMit[:CC<cc>]:SUMMary:EVM:DSST[:AVERAge]:RESult?	200
CALCulate<n>:LIMit[:CC<cc>]:SUMMary:EVM:DSTS:MAXimum:RESult?	201
CALCulate<n>:LIMit[:CC<cc>]:SUMMary:EVM:DSTS[:AVERAge]:RESult?	201
CALCulate<n>:LIMit[:CC<cc>]:SUMMary:EVM:PCHannel:MAXimum:RESult?	202
CALCulate<n>:LIMit[:CC<cc>]:SUMMary:EVM:PCHannel[:AVERAge]:RESult?	202
CALCulate<n>:LIMit[:CC<cc>]:SUMMary:EVM:PSIGnal:MAXimum:RESult?	202
CALCulate<n>:LIMit[:CC<cc>]:SUMMary:EVM:PSIGnal[:AVERAge]:RESult?	202
CALCulate<n>:LIMit[:CC<cc>]:SUMMary:EVM[:ALL]:MAXimum:RESult?	199
CALCulate<n>:LIMit[:CC<cc>]:SUMMary:EVM[:ALL][:AVERAge]:RESult?	199
CALCulate<n>:LIMit[:CC<cc>]:SUMMary:FERRor:MAXimum:RESult?	203
CALCulate<n>:LIMit[:CC<cc>]:SUMMary:FERRor[:AVERAge]:RESult?	203
CALCulate<n>:LIMit[:CC<cc>]:SUMMary:GIMBalance:MAXimum:RESult?	203
CALCulate<n>:LIMit[:CC<cc>]:SUMMary:GIMBalance[:AVERAge]:RESult?	203
CALCulate<n>:LIMit[:CC<cc>]:SUMMary:IQOffset:MAXimum:RESult?	204
CALCulate<n>:LIMit[:CC<cc>]:SUMMary:IQOffset[:AVERAge]:RESult?	204
CALCulate<n>:LIMit[:CC<cc>]:SUMMary:QUADerror:MAXimum:RESult?	204
CALCulate<n>:LIMit[:CC<cc>]:SUMMary:QUADerror[:AVERAge]:RESult?	204
CALCulate<n>:LIMit[:CC<cc>]:SUMMary:SERRor:MAXimum:RESult?	205
CALCulate<n>:LIMit[:CC<cc>]:SUMMary:SERRor[:AVERAge]:RESult?	205
CALCulate<n>:MARKer<m>:COUPLing	276
CALCulate<n>:MARKer<m>:FUNCTION:POWeR<sb>:RESult[:CURRent]?	175
CALCulate<n>:MARKer<m>:X	187
CALCulate<n>:MARKer<m>:Y	187
CALCulate<n>:MARKer<m>:Z:ALL?	188
CALCulate<n>:MARKer<m>:Z?	188
CALCulate<n>:STATistics:CCDF:X<t>?	189
CALCulate<n>:STATistics:RESult<res>?	190
CONFigure[:LTE]:CAGGregation:STATe	261
CONFigure[:LTE]:DL[:CC<cc>]:BF:AP:CELL	270
CONFigure[:LTE]:DL[:CC<cc>]:BF:AP:CSI	271
CONFigure[:LTE]:DL[:CC<cc>]:BF:AP[:UERS]	271

CONFigure[:LTE]:DL[:CC<cc>]:BW.....	208
CONFigure[:LTE]:DL[:CC<cc>]:CSIRs:CI.....	228
CONFigure[:LTE]:DL[:CC<cc>]:CSIRs:NAP.....	229
CONFigure[:LTE]:DL[:CC<cc>]:CSIRs:OPDSch.....	229
CONFigure[:LTE]:DL[:CC<cc>]:CSIRs:POWer.....	229
CONFigure[:LTE]:DL[:CC<cc>]:CSIRs:SCI.....	230
CONFigure[:LTE]:DL[:CC<cc>]:CSIRs:STATe.....	230
CONFigure[:LTE]:DL[:CC<cc>]:CSUBframes.....	217
CONFigure[:LTE]:DL[:CC<cc>]:CYCPrefix.....	209
CONFigure[:LTE]:DL[:CC<cc>]:EINBiot[:STATe].....	209
CONFigure[:LTE]:DL[:CC<cc>]:EPDCch:LOCalized.....	231
CONFigure[:LTE]:DL[:CC<cc>]:EPDCch:NPRB.....	231
CONFigure[:LTE]:DL[:CC<cc>]:EPDCch:POWer.....	231
CONFigure[:LTE]:DL[:CC<cc>]:EPDCch:RBASsign.....	232
CONFigure[:LTE]:DL[:CC<cc>]:EPDCch:SID.....	232
CONFigure[:LTE]:DL[:CC<cc>]:MBSFn:AI:ID.....	237
CONFigure[:LTE]:DL[:CC<cc>]:MBSFn:AI:NMRL.....	237
CONFigure[:LTE]:DL[:CC<cc>]:MBSFn:POWer.....	238
CONFigure[:LTE]:DL[:CC<cc>]:MBSFn:STATe.....	238
CONFigure[:LTE]:DL[:CC<cc>]:MBSFn:SUBFrame<sf>:PMCH:MODulation.....	238
CONFigure[:LTE]:DL[:CC<cc>]:MBSFn:SUBFrame<sf>:PMCH:STATe.....	239
CONFigure[:LTE]:DL[:CC<cc>]:MBSFn:SUBFrame<sf>:STATe.....	239
CONFigure[:LTE]:DL[:CC<cc>]:MIMO:ASElection.....	215
CONFigure[:LTE]:DL[:CC<cc>]:MIMO:CONFig.....	215
CONFigure[:LTE]:DL[:CC<cc>]:MIMO:CROStalk.....	256
CONFigure[:LTE]:DL[:CC<cc>]:NRBOffset.....	210
CONFigure[:LTE]:DL[:CC<cc>]:PBCH:POWer.....	232
CONFigure[:LTE]:DL[:CC<cc>]:PBCH:STAT.....	232
CONFigure[:LTE]:DL[:CC<cc>]:PCFich:POWer.....	233
CONFigure[:LTE]:DL[:CC<cc>]:PCFich:STAT.....	233
CONFigure[:LTE]:DL[:CC<cc>]:PDCCh:FORMat.....	233
CONFigure[:LTE]:DL[:CC<cc>]:PDCCh:NOPD.....	234
CONFigure[:LTE]:DL[:CC<cc>]:PDCCh:POWer.....	234
CONFigure[:LTE]:DL[:CC<cc>]:PDSCch:PB.....	237
CONFigure[:LTE]:DL[:CC<cc>]:PHICH:DURation.....	234
CONFigure[:LTE]:DL[:CC<cc>]:PHICH:MITM.....	235
CONFigure[:LTE]:DL[:CC<cc>]:PHICH:NGParameter.....	235
CONFigure[:LTE]:DL[:CC<cc>]:PHICH:NOGRoups.....	235
CONFigure[:LTE]:DL[:CC<cc>]:PHICH:POWer.....	236
CONFigure[:LTE]:DL[:CC<cc>]:PLC:CID.....	210
CONFigure[:LTE]:DL[:CC<cc>]:PLC:CIDGroup.....	210
CONFigure[:LTE]:DL[:CC<cc>]:PLC:PLID.....	211
CONFigure[:LTE]:DL[:CC<cc>]:PRSS:BW.....	226
CONFigure[:LTE]:DL[:CC<cc>]:PRSS:CI.....	227
CONFigure[:LTE]:DL[:CC<cc>]:PRSS:NPRS.....	227
CONFigure[:LTE]:DL[:CC<cc>]:PRSS:POWer.....	227
CONFigure[:LTE]:DL[:CC<cc>]:PRSS:STATe.....	228
CONFigure[:LTE]:DL[:CC<cc>]:PSOOffset.....	236
CONFigure[:LTE]:DL[:CC<cc>]:REFSig:POWer.....	226
CONFigure[:LTE]:DL[:CC<cc>]:SFNO.....	228

CONFigure[:LTE]:DL[:CC<cc>]:SUBFrame<sf>:ALCount.....	217
CONFigure[:LTE]:DL[:CC<cc>]:SUBFrame<sf>:ALLoc<al>:GAP.....	217
CONFigure[:LTE]:DL[:CC<cc>]:SUBFrame<sf>:ALLoc<al>:POWer.....	218
CONFigure[:LTE]:DL[:CC<cc>]:SUBFrame<sf>:ALLoc<al>:PRECoding:AP.....	218
CONFigure[:LTE]:DL[:CC<cc>]:SUBFrame<sf>:ALLoc<al>:PRECoding:CBINdex.....	218
CONFigure[:LTE]:DL[:CC<cc>]:SUBFrame<sf>:ALLoc<al>:PRECoding:CDD.....	219
CONFigure[:LTE]:DL[:CC<cc>]:SUBFrame<sf>:ALLoc<al>:PRECoding:CLMapping.....	219
CONFigure[:LTE]:DL[:CC<cc>]:SUBFrame<sf>:ALLoc<al>:PRECoding:SCID.....	220
CONFigure[:LTE]:DL[:CC<cc>]:SUBFrame<sf>:ALLoc<al>:PRECoding[:SCHeme].....	220
CONFigure[:LTE]:DL[:CC<cc>]:SUBFrame<sf>:ALLoc<al>:PSOFfset.....	221
CONFigure[:LTE]:DL[:CC<cc>]:SUBFrame<sf>:ALLoc<al>:RBCount.....	221
CONFigure[:LTE]:DL[:CC<cc>]:SUBFrame<sf>:ALLoc<al>:RBOFfset.....	221
CONFigure[:LTE]:DL[:CC<cc>]:SUBFrame<sf>:ALLoc<al>:UEID.....	222
CONFigure[:LTE]:DL[:CC<cc>]:SUBFrame<sf>:ALLoc<al>[:CW<cw>]:MODulation.....	222
CONFigure[:LTE]:DL[:CC<cc>]:SYNC:ANTenna.....	223
CONFigure[:LTE]:DL[:CC<cc>]:SYNC:CSWeight:FHFRAme:IMAGinary.....	223
CONFigure[:LTE]:DL[:CC<cc>]:SYNC:CSWeight:FHFRAme:REAL.....	224
CONFigure[:LTE]:DL[:CC<cc>]:SYNC:CSWeight:SHFRAme:IMAGinary.....	224
CONFigure[:LTE]:DL[:CC<cc>]:SYNC:CSWeight:SHFRAme:REAL.....	224
CONFigure[:LTE]:DL[:CC<cc>]:SYNC:CSWeight[:STATe].....	225
CONFigure[:LTE]:DL[:CC<cc>]:SYNC:PPOWer.....	225
CONFigure[:LTE]:DL[:CC<cc>]:SYNC:SPOWer.....	225
CONFigure[:LTE]:DL[:CC<cc>]:TDD:SPSC.....	211
CONFigure[:LTE]:DL[:CC<cc>]:TDD:UDConf.....	212
CONFigure[:LTE]:DUPLexing.....	208
CONFigure[:LTE]:LDIRection.....	212
CONFigure[:LTE]:MEASurement.....	206
CONFigure[:LTE]:NDEVices.....	264
CONFigure[:LTE]:NOCC.....	262
CONFigure[:LTE]:OOPower:NFRames.....	263
DISPlay:FORMat.....	144
DISPlay[:WINDow<n>]:SIZE.....	144
DISPlay[:WINDow<n>]:TAB<tab>:SElect.....	145
DISPlay[:WINDow<n>][:SUBWindow<w>]:COUPLing.....	276
DISPlay[:WINDow<n>][:SUBWindow<w>]:SElect.....	144
DISPlay[:WINDow<n>][:SUBWindow<w>]:TRACe<t>:Y[:SCALe]:AUTO.....	274
DISPlay[:WINDow<n>][:SUBWindow<w>]:TRACe<t>:Y[:SCALe]:MAXimum.....	275
DISPlay[:WINDow<n>][:SUBWindow<w>]:TRACe<t>:Y[:SCALe]:MINimum.....	275
DISPlay[:WINDow<n>][:SUBWindow<w>]:TRACe<t>:Y[:SCALe]:RLEVel.....	245
DISPlay[:WINDow<n>][:SUBWindow<w>]:TRACe<t>:Y[:SCALe]:RLEVel:OFFSet.....	245
FETCh:FERRor[:CC<cc>][:AVERAge]?.....	185
FETCh:TAERror[:CC<cc>]:ANTenna<ant>:MAXimum?.....	185
FETCh:TAERror[:CC<cc>]:ANTenna<ant>:MINimum?.....	185
FETCh:TAERror[:CC<cc>]:ANTenna<ant>[:AVERAge]?.....	185
FETCh[:CC<cc>]:CYCPrefix?.....	212
FETCh[:CC<cc>]:PLC:CIDGroup?.....	213
FETCh[:CC<cc>]:PLC:PLID?.....	213
FETCh[:CC<cc>]:SUMMary:CRESt[:AVERAge]?.....	179
FETCh[:CC<cc>]:SUMMary:EVM:DS1K:MAXimum?.....	178
FETCh[:CC<cc>]:SUMMary:EVM:DS1K:MINimum?.....	178

FETCh[:CC<cc>]:SUMMary:EVM:DS1K[:AVERAge]?	178
FETCh[:CC<cc>]:SUMMary:EVM:DSQP:MAXimum?	177
FETCh[:CC<cc>]:SUMMary:EVM:DSQP:MINimum?	177
FETCh[:CC<cc>]:SUMMary:EVM:DSQP[:AVERAge]?	177
FETCh[:CC<cc>]:SUMMary:EVM:DSSF:MAXimum?	178
FETCh[:CC<cc>]:SUMMary:EVM:DSSF:MINimum?	178
FETCh[:CC<cc>]:SUMMary:EVM:DSSF[:AVERAge]?	178
FETCh[:CC<cc>]:SUMMary:EVM:DSST:MAXimum?	177
FETCh[:CC<cc>]:SUMMary:EVM:DSST:MINimum?	177
FETCh[:CC<cc>]:SUMMary:EVM:DSST[:AVERAge]?	177
FETCh[:CC<cc>]:SUMMary:EVM:DSTS:MAXimum?	178
FETCh[:CC<cc>]:SUMMary:EVM:DSTS:MINimum?	178
FETCh[:CC<cc>]:SUMMary:EVM:DSTS[:AVERAge]?	178
FETCh[:CC<cc>]:SUMMary:EVM:PCHannel:MAXimum?	180
FETCh[:CC<cc>]:SUMMary:EVM:PCHannel:MINimum?	180
FETCh[:CC<cc>]:SUMMary:EVM:PCHannel[:AVERAge]?	180
FETCh[:CC<cc>]:SUMMary:EVM:PSIGnal:MAXimum?	180
FETCh[:CC<cc>]:SUMMary:EVM:PSIGnal:MINimum?	180
FETCh[:CC<cc>]:SUMMary:EVM:PSIGnal[:AVERAge]?	180
FETCh[:CC<cc>]:SUMMary:EVM[:ALL]:MAXimum?	180
FETCh[:CC<cc>]:SUMMary:EVM[:ALL]:MINimum?	180
FETCh[:CC<cc>]:SUMMary:EVM[:ALL][:AVERAge]?	180
FETCh[:CC<cc>]:SUMMary:FERRor:MAXimum?	181
FETCh[:CC<cc>]:SUMMary:FERRor:MINimum?	181
FETCh[:CC<cc>]:SUMMary:FERRor[:AVERAge]?	181
FETCh[:CC<cc>]:SUMMary:GIMBalance:MAXimum?	181
FETCh[:CC<cc>]:SUMMary:GIMBalance:MINimum?	181
FETCh[:CC<cc>]:SUMMary:GIMBalance[:AVERAge]?	181
FETCh[:CC<cc>]:SUMMary:IQOFFset:MAXimum?	182
FETCh[:CC<cc>]:SUMMary:IQOFFset:MINimum?	182
FETCh[:CC<cc>]:SUMMary:IQOFFset[:AVERAge]?	182
FETCh[:CC<cc>]:SUMMary:OSTP:MAXimum?	182
FETCh[:CC<cc>]:SUMMary:OSTP:MINimum?	182
FETCh[:CC<cc>]:SUMMary:OSTP[:AVERAge]?	182
FETCh[:CC<cc>]:SUMMary:POWER:MAXimum?	182
FETCh[:CC<cc>]:SUMMary:POWER:MINimum?	182
FETCh[:CC<cc>]:SUMMary:POWER[:AVERAge]?	182
FETCh[:CC<cc>]:SUMMary:QUADerror:MAXimum?	183
FETCh[:CC<cc>]:SUMMary:QUADerror:MINimum?	183
FETCh[:CC<cc>]:SUMMary:QUADerror[:AVERAge]?	183
FETCh[:CC<cc>]:SUMMary:RSSI:MAXimum?	183
FETCh[:CC<cc>]:SUMMary:RSSI:MINimum?	183
FETCh[:CC<cc>]:SUMMary:RSSI[:AVERAge]?	183
FETCh[:CC<cc>]:SUMMary:RSTP:MAXimum?	184
FETCh[:CC<cc>]:SUMMary:RSTP:MINimum?	184
FETCh[:CC<cc>]:SUMMary:RSTP[:AVERAge]?	184
FETCh[:CC<cc>]:SUMMary:SERRor:MAXimum?	184
FETCh[:CC<cc>]:SUMMary:SERRor:MINimum?	184
FETCh[:CC<cc>]:SUMMary:SERRor[:AVERAge]?	184
FETCh[:CC<cc>]:SUMMary:TFRame?	184

FORMat:DEXPort:DSEParator.....	268
FORMat:DEXPort:HEADer.....	269
FORMat:DEXPort:TRACes.....	269
FORMat[:DATA].....	173
INITiate:SEQuencer:ABORT.....	156
INITiate:SEQuencer:IMMediate.....	156
INITiate:SEQuencer:MODE.....	156
INITiate<n>:CONTInuous.....	154
INITiate<n>[:IMMediate].....	155
INPut:FILE:PATH.....	240
INPut<ip>:ATTenuation<ant>.....	246
INPut<ip>:ATTenuation<ant>:AUTO.....	246
INPut<ip>:COUPling.....	246
INPut<ip>:EATT<ant>.....	248
INPut<ip>:EATT<ant>:AUTO.....	248
INPut<ip>:EATT<ant>:STATe.....	249
INPut<ip>:FILTer:YIG[:STATe].....	241
INPut<ip>:GAIN:STATe.....	247
INPut<ip>:GAIN[:VALue].....	247
INPut<ip>:IMPedance.....	248
INPut<ip>:SELEct.....	241
INSTrument:CREate:DUPLicate.....	140
INSTrument:CREate:REPLace.....	141
INSTrument:CREate[:NEW].....	140
INSTrument:DELeTe.....	141
INSTrument:LIST?.....	141
INSTrument:REName.....	142
INSTrument[:SELEct].....	143
LAYout:ADD[:WINDow]?.....	145
LAYout:CATalog[:WINDow]?.....	148
LAYout:IDENtify[:WINDow]?.....	149
LAYout:REMove[:WINDow].....	149
LAYout:REPLace[:WINDow].....	149
LAYout:SPLitter.....	150
LAYout:WINDow<n>:ADD?.....	151
LAYout:WINDow<n>:IDENtify?.....	152
LAYout:WINDow<n>:REMove.....	152
LAYout:WINDow<n>:REPLace.....	152
LAYout:WINDow<n>:TYPE.....	153
MMEMory:LOAD:IQ:STReam.....	242
MMEMory:LOAD:IQ:STReam:AUTO.....	242
MMEMory:LOAD:IQ:STReam:LIST?.....	242
MMEMory:LOAD[:CC<cc>]:DEModing.....	213
MMEMory:LOAD[:CC<cc>]:TMOd:DL.....	214
MMEMory:STORe<n>:IQ:STATe.....	206
MMEMory:STORe<n>:MSERvice.....	270
MMEMory:STORe<n>:TRACe.....	269
MMEMory:STORe<n>[:CC<cc>]:DEModing.....	214
SYSTem:PRESet:CHANnel[:EXEC].....	207
SYSTem:SEQuencer.....	157

TRACe:IQ:FILE:REPetition:COUNT.....	242
TRACe<n>[:DATA]:X?.....	174
TRACe<n>[:DATA]?.....	174
TRIGger[:SEQuence]:DTIME.....	252
TRIGger[:SEQuence]:HOLDoff<ant>[:TIME].....	252
TRIGger[:SEQuence]:IFPower:HOLDoff.....	252
TRIGger[:SEQuence]:IFPower:HYSTeresis.....	253
TRIGger[:SEQuence]:LEVel<ant>:IFPower.....	253
TRIGger[:SEQuence]:LEVel<ant>:IQPower.....	254
TRIGger[:SEQuence]:LEVel<ant>:RFPower.....	254
TRIGger[:SEQuence]:LEVel<ant>[:EXTernal<tp>].....	253
TRIGger[:SEQuence]:PORT<ant>.....	255
TRIGger[:SEQuence]:SLOPe.....	255
TRIGger[:SEQuence]:SOURce<ant>.....	255
UNIT:BSTR.....	277
UNIT:CAXes.....	277
UNIT:EVM.....	277
UNIT:OPower.....	263

Index

A

AC/DC coupling	109
ACLR	44
ACLR (Cumulative)	46
Adjust timing	43
Allocation	
Filter by	130
Allocation ID vs symbol x carrier	31
Allocation summary	26
Amplitude	106
Antenna selection	75
Application cards	9
Application notes	9
Attenuation	107
Auto Detection (Cell Identity)	73
Auto level	106
Auto PDSCH Demodulation	78

B

Beamform Allocation Summary	34
Bit stream	27
Bitstream format	132
Boosting estimation	114
Brochures	8

C

Capture buffer	18
Capture time	110
Carrier	
Filter by	130
Carrier aggregation	68
Carrier axis scale	133
CCDF	26
Cell ID	73
Cell Identity Group	73
Cell RS Weights (Phase)	32, 33
Center frequency	105
Channel	
Creating (remote)	141
Deleting (remote)	141
Duplicating (remote)	140
Querying (remote)	141
Renaming (remote)	142
Replacing (remote)	141
Channel Bandwidth	71
Channel decoder results	28
Channel Estimation	114
Channel flatness	24
Channel flatness difference	24
Channel flatness group delay	24
Closing	
Channels (remote)	141
Windows (remote)	152
Codeword	
Filter by	130
Component carrier	68
Configurable Subframes	78
Configuration Table	78
Constellation diagram	25
Configuration	130

Constellation selection	130
Conventions	
SCPI commands	136
Copying	
Channel (remote)	140
CSI RS Weights (Magnitude)	33
CSI RS Weights (Phase)	34
Cumulative ACLR	46

D

Data format	
Remote	269
Data sheets	8
Demodulation configuration	116
Duplexing	68
Duplicating	
Channel (remote)	140

E

Error in Subframes	78
Estimation	114
Channel	114
Physical channels	114
Evaluation methods	
Remote	145
EVM calculation method	117
EVM unit	132
EVM vs Carrier	19
EVM vs RB	20
EVM vs subframe	21
EVM vs symbol	20
EVM vs symbol x carrier	30
External Attenuation	107

F

Filter	
Interference	116
Filters	
YIG (remote)	241
Format	
Data (remote)	269
Frequency	
Configuration	105
Frequency error vs symbol	22

G

Getting started	7
-----------------------	---

H

Hardware settings	
Displayed	13
Home base station	122

I

I/Q data	
Input file	104
I/Q measurements	17
Identity (Physical Layer)	73

Impedance	
Setting	109
Input	
Coupling	109
I/Q data files	104
Input sources	
I/Q data file	104
Installation	12
Instrument security procedures	8
Interference suppression	116
L	
Level configuration	106
Link direction	68
M	
Marker coupling	133
Marker table	
Evaluation method	37
Markers	
Table (evaluation method)	37
Maximizing	
Windows (remote)	144
MC ACLR	48
Measurement	
ACLR	44
alloc ID vs sym x carrier	31
allocation summary	26
Beamform Allocation Summary	34
bit stream	27
Capture buffer	18
CCDF	26
Cell RS Weights (Phase)	32, 33
channel decoder results	28
channel flatness	24
channel flatness difference	24
channel flatness group delay	24
constellation	25
Continuous	17
CSI RS Weights (Magnitude)	33
CSI RS Weights (Phase)	34
Cumulative ACLR	46
EVM vs carrier	19
EVM vs RB	20
EVM vs subframe	21
EVM vs sym x carr	30
EVM vs symbol	20
freq err vs symbol	22
I/Q	17
MC ACLR	48
numerical	35
on/off power	40
power spectrum	22
power vs RB PDSCH	23
power vs RB RS	23
power vs sym x carr	30
Refresh	17
Result displays	16
result summary	35
Single	17
spectrum mask	50
UE Specific RS Weights (Magnitude)	31
UE Specific RS Weights (Phase)	31
Measurement time	110
MIMO	
Configuration	75
MIMO encoding	130
Modulation	
Filter by	130
Multicarrier filter	116
N	
Noise cancellation	43
Number of RB	71
Numerical results	35
O	
Offset	
Frequency	105
Reference level	106
On/off power	40
Options	
Preamplifier	109
P	
P-/S-SYNC Tx antenna	85
Parameter estimation	114
PBCH	92
PCFICH	93
PDSCH reference data	118
PDSCH subframe detection	77
Peak list	
Evaluation method	52
Phase error	114, 115
PHICH	94
Power spectrum	22
Power vs RB PDSCH	23
Power vs RB RS	23
Power vs symbol x carrier	30
PRB symbol offset	92
Preamplifier	
Setting	109
Softkey	109
Presetting	
Channels	66
R	
Reference Level	106
Relative Power	85, 86
Relative power ()	85, 86
Relative power (reference signal)	87
Release notes	8
Remote commands	
Basics on syntax	135
Boolean values	139
Capitalization	136
Character data	139
Data blocks	140
Numeric values	138
Optional keywords	137
Parameters	138
Strings	139
Suffixes	137
Resource Blocks	71
Restoring	
Channel settings	66

Result displays	16	Specifics for	
Marker table	37	Configuration	66
Peak list	52	Spectrum mask	50
Result summary	35	Standard selection	68
Results		Step size	105
Data format (remote)	269	Subframe Configuration Table	78
S		Subframe Error	78
Safety instructions	8	Subframe selection	130
Scrambling of coded bits	117	Suffixes	
Security procedures	8	Common	134
Selected Subframe	78	Remote commands	137
Sequencer		Swap I/Q	111
Activating (remote)	156	Symbol	
Remote	154	Filter by	130
Sequences		T	
Aborting (remote)	156	TDD UL/DL Allocations	72
Mode (remote)	156	Timing error	115
Service manual	8	Tracking	
Setting		Phase	114, 115
P-/S-SYNC Tx antenna	85	Timing	115
Settings		Transmission path	68
Auto	73	Trigger	
Auto PDSCH Demod	78	Slope	255
Bitstream format	132	Trigger configuration	112
Boosting estimation	114	Trigger source	113
Capture time	110	U	
Carrier axes	133	UE Specific RS Weights (Magnitude)	31
Channel Bandwidth	71	UE Specific RS Weights (Phase)	31
Channel Estimation	114	Used Allocations	78
Configurable Subframes	78	V	
Configuration Table	78	Videos	9
Constellation selection	130	W	
Error in Subframe	78	White papers	9
EVM calculation method	117	Window title bar information	14
EVM unit	132	Windows	
Ext Att	107	Adding (remote)	145
Frequency	105	Closing (remote)	152
ID	73	Configuring	66
Identity	73	Layout (remote)	150
Identity Group	73	Maximizing (remote)	144
Marker coupling	133	Querying (remote)	148, 149
Multicarrier filter	116	Replacing (remote)	149
Number of RB	71	Splitting (remote)	144
PBCH	92	Types (remote)	145
PCFICH	93	Y	
PDSCH reference data	118	YIG-preselector	
PDSCH subframe detection	77	Activating/Deactivating	103
Phase tracking	114, 115	Activating/Deactivating (remote)	241
PHICH	94	Z	
PRB symbol offset	92	Zoom	
Ref Level	106	Capture buffer	18
relative power	85, 86, 87		
Scrambling of coded bits	117		
Selected Subframe	78		
Standard	68		
Subframe selection	130		
Swap I/Q	111		
TDD UL/DL Allocations	72		
Timing error	115		
Used Allocations	78		
Slope			
Trigger	255		
Softkeys			
Preamp	109		