

R&S®FSW-K14x

3GPP 5G NR Uplink Measurement

Application

User Manual



1178804202
Version 15

ROHDE & SCHWARZ
Make ideas real



This manual applies to the following FSW models with firmware version 6.00 and later:

- R&S®FSW8 (1331.5003K08 / 1312.8000K08)
- R&S®FSW13 (1331.5003K13 / 1312.8000K13)
- R&S®FSW26 (1331.5003K26 / 1312.8000K26)
- R&S®FSW43 (1331.5003K43 / 1312.8000K43)
- R&S®FSW50 (1331.5003K50 / 1312.8000K50)
- R&S®FSW67 (1331.5003K67 / 1312.8000K67)
- R&S®FSW85 (1331.5003K85 / 1312.8000K85)

The following firmware options are described:

- R&S®FSW-K145 (5G NR R15 Uplink Measurements) (1338.3612.02)
- R&S®FSW-K147 (5G NR Combined EVM / ACLR / SEM Measurements) (1338.6486.02)
- R&S®FSW-K147C (3GPP 5G-NR FAST Multicarrier Measurement Application 1351.1355.02)
- R&S®FSW-K148 (5G NR R16 Downlink / Uplink Measurements) (1338.6624.02)
- R&S®FSW-K171 (5G NR R17 / R18 Downlink / Uplink Measurements) (1350.7108.02)
- R&S®FSW-K175 (O-RAN Measurements) (1353.2642.02)

© 2024 Rohde & Schwarz

Muehldorfstr. 15, 81671 Muenchen, Germany

Phone: +49 89 41 29 - 0

Email: info@rohde-schwarz.com

Internet: www.rohde-schwarz.com

Subject to change – data without tolerance limits is not binding.

R&S® is a registered trademark of Rohde & Schwarz GmbH & Co. KG.

Trade names are trademarks of the owners.

1178.8042.02 | Version 15 | R&S®FSW-K14x

Throughout this manual, products from Rohde & Schwarz are indicated without the ® symbol , e.g. R&S®FSW is indicated as R&S FSW.

Contents

1	Documentation overview.....	9
1.1	Getting started manual.....	9
1.2	User manuals and help.....	9
1.3	Service manual.....	9
1.4	Instrument security procedures.....	10
1.5	Printed safety instructions.....	10
1.6	Specifications and brochures.....	10
1.7	Release notes and open-source acknowledgment (OSA).....	10
1.8	Application notes, application cards, white papers, etc.....	11
1.9	Videos.....	11
2	Welcome to the 5G NR measurement application.....	12
2.1	Overview of the 5G NR applications.....	12
2.2	Installation.....	15
2.3	5G NR measurement application selection.....	15
2.4	Display information.....	15
3	Measurements and result displays.....	19
3.1	Selecting measurements.....	19
3.2	Selecting result displays.....	20
3.3	Performing measurements.....	21
3.4	Selecting the operating mode.....	21
3.5	Result summary.....	22
3.6	I/Q measurements.....	30
3.7	PRACH analysis.....	45
3.8	Frequency sweep measurements.....	46
3.9	Combined measurements.....	50
3.10	Reference: custom limits.....	53
4	Configuration.....	55
4.1	I/Q measurement.....	55
4.1.1	Configuration overview.....	56
4.1.2	Automatic measurement configuration.....	58

4.1.3	Physical signal description.....	60
4.1.4	Test scenarios.....	62
4.1.5	Component carrier configuration.....	63
4.1.6	Radio frame configuration.....	68
4.1.7	Bandwidth part configuration.....	72
4.1.8	Slot configuration.....	76
4.1.9	PUSCH and PUCCH configuration.....	84
4.1.10	Antenna port configuration.....	100
4.1.11	Advanced settings.....	102
4.1.12	Generator control.....	107
4.1.13	Input source configuration.....	110
4.1.14	Frequency configuration.....	116
4.1.15	Amplitude configuration.....	117
4.1.16	Data capture.....	121
4.1.17	Trigger configuration.....	124
4.1.18	Segmented capture.....	126
4.1.19	Data capture optimization.....	127
4.1.20	Tracking.....	128
4.1.21	Demodulation.....	131
4.2	PRACH analysis.....	134
4.3	Frequency sweep measurement configuration.....	137
4.4	Combined measurement configuration.....	140
4.4.1	Signal description.....	141
4.4.2	Signal capture.....	142
4.4.3	Trigger configuration.....	143
4.5	Combined measurement guide.....	146
4.5.1	General configuration.....	147
4.5.2	Trigger configuration.....	148
4.6	Time trigger measurement guide.....	157
4.7	Microservice export.....	158
4.8	O-RAN measurement guide.....	159
4.9	Reference: structure of .allocation files.....	160
4.10	Basics on input from I/Q data files.....	167

5	Analysis.....	170
5.1	General analysis tools.....	170
5.1.1	Data export.....	170
5.1.2	Diagram scale.....	171
5.1.3	Zoom.....	172
5.1.4	Markers.....	173
5.2	Analysis tools for I/Q measurements.....	174
5.2.1	Layout of numerical results.....	174
5.2.2	Result settings.....	174
5.2.3	Table configuration.....	177
5.2.4	Result views.....	178
5.2.5	Evaluation range.....	180
5.3	Analysis tools for combined measurements.....	183
5.3.1	Event filter.....	184
5.3.2	General analysis tools.....	185
5.4	Analysis tools for frequency sweep measurements.....	185
6	Remote control.....	186
6.1	Common suffixes.....	186
6.2	Introduction.....	187
6.2.1	Conventions used in descriptions.....	188
6.2.2	Long and short form.....	188
6.2.3	Numeric suffixes.....	189
6.2.4	Optional keywords.....	189
6.2.5	Alternative keywords.....	189
6.2.6	SCPI parameters.....	190
6.3	Status register.....	192
6.4	5G NR application selection.....	193
6.5	Screen layout.....	197
6.5.1	General layout.....	197
6.5.2	Layout of a single channel.....	198
6.6	Measurement control.....	206
6.6.1	Measurements.....	206
6.6.2	Measurement sequences.....	208

6.7 Remote commands to retrieve numeric results.....	210
6.7.1 Result summary.....	210
6.7.2 Combined measurements.....	231
6.7.3 Marker table.....	237
6.7.4 CCDF table.....	240
6.8 Limit check results.....	242
6.8.1 EVM limits.....	242
6.8.2 Frequency sweep limits.....	252
6.9 Retrieve trace data.....	258
6.9.1 Using the TRACe[:DATA] command.....	258
6.9.2 Read measurement results.....	272
6.10 Configuration.....	276
6.10.1 General configuration.....	277
6.10.2 Automatic configuration.....	280
6.10.3 Physical settings.....	283
6.10.4 Component carrier configuration.....	288
6.10.5 General radio frame configuration.....	292
6.10.6 Bandwidth part configuration.....	294
6.10.7 Slot configuration.....	298
6.10.8 SRS configuration.....	305
6.10.9 PUCCH allocation configuration.....	313
6.10.10 PUSCH allocation configuration.....	320
6.10.11 Enhanced PUCCH allocation configuration.....	327
6.10.12 Enhanced PUSCH settings: DMRS.....	335
6.10.13 Enhanced PUSCH settings: PTRS.....	345
6.10.14 Enhanced PUSCH settings: scrambling / coding.....	351
6.10.15 Antenna port configuration.....	354
6.10.16 Advanced settings: global.....	355
6.10.17 Advanced settings: reference point A.....	359
6.10.18 Generator control.....	362
6.10.19 Input configuration.....	368
6.10.20 Frequency configuration.....	376
6.10.21 Amplitude configuration.....	378

6.10.22	Data capture.....	383
6.10.23	Trigger.....	386
6.10.24	Segmented capture.....	391
6.10.25	Optimization.....	393
6.10.26	Tracking.....	394
6.10.27	Demodulation.....	396
6.10.28	PRACH analysis.....	399
6.10.29	Frequency sweep measurements.....	402
6.10.30	Combined measurements.....	404
6.11	Analysis.....	411
6.11.1	General analysis tools.....	411
6.11.2	Analysis tools for I/Q measurements.....	424
6.11.3	Analysis tools for combined measurements.....	435
6.12	Reading out status register.....	437
	List of commands (5G NR uplink).....	440
	Index.....	452

1 Documentation overview

This section provides an overview of the FSW user documentation. Unless specified otherwise, you find the documents at:

www.rohde-schwarz.com/manual/FSW

Further documents are available at:

www.rohde-schwarz.com/product/FSW

1.1 Getting started manual

Introduces the FSW and describes how to set up and start working with the product. Includes basic operations, typical measurement examples, and general information, e.g. safety instructions, etc.

A printed version is delivered with the instrument. A PDF version is available for download on the Internet.

1.2 User manuals and help

Separate user manuals are provided for the base unit and the firmware applications:

- Base unit manual
Contains the description of all instrument modes and functions. It also provides an introduction to remote control, a complete description of the remote control commands with programming examples, and information on maintenance, instrument interfaces and error messages. Includes the contents of the getting started manual.
- Firmware application manual
Contains the description of the specific functions of a firmware application, including remote control commands. Basic information on operating the FSW is not included.

The contents of the user manuals are available as help in the FSW. The help offers quick, context-sensitive access to the complete information for the base unit and the firmware applications.

All user manuals are also available for download or for immediate display on the Internet.

1.3 Service manual

Describes the performance test for checking the rated specifications, module replacement and repair, firmware update, troubleshooting and fault elimination, and contains mechanical drawings and spare part lists.

The service manual is available for registered users on the global Rohde & Schwarz information system (GLORIS):

<https://gloris.rohde-schwarz.com>

1.4 Instrument security procedures

Deals with security issues when working with the FSW in secure areas. It is available for download on the internet.

1.5 Printed safety instructions

Provides safety information in many languages. The printed document is delivered with the product.

1.6 Specifications and brochures

The specifications document, also known as the data sheet, contains the technical specifications of the FSW. It also lists the firmware applications and their order numbers, and optional accessories.

The brochure provides an overview of the instrument and deals with the specific characteristics.

See www.rohde-schwarz.com/brochure-datasheet/FSW

1.7 Release notes and open-source acknowledgment (OSA)

The release notes list new features, improvements and known issues of the current software version, and describe the software installation.

The software uses several valuable open source software packages. An open source acknowledgment document provides verbatim license texts of the used open source software.

See www.rohde-schwarz.com/firmware/FSW

1.8 Application notes, application cards, white papers, etc.

These documents deal with special applications or background information on particular topics.

See www.rohde-schwarz.com/application/FSW

1.9 Videos

Find various videos on Rohde & Schwarz products and test and measurement topics on YouTube: <https://www.youtube.com/@RohdeundSchwarz>

2 Welcome to the 5G NR measurement application

The 5G NR application is a firmware application that adds functionality to measure signals according to the 3GPP 5G NR (new radio) standard on the downlink to the FSW.



Bandwidth of 5G NR signals

5G NR signals have a bandwidth between 3 MHz and 400 MHz.

Measuring signals greater than 10 MHz requires an FSW with one of the optional bandwidth extensions (28 MHz or more).

This user manual contains a description of the functionality that the application provides, including remote control operation. Functions that are not discussed in this manual are the same as in the spectrum application and are described in the FSW user manual. The latest versions of the manuals are available for download at the product homepage.

<https://www.rohde-schwarz.com/manual/fsw>

- [Overview of the 5G NR applications](#)..... 12
- [Installation](#)..... 15
- [5G NR measurement application selection](#)..... 15
- [Display information](#)..... 15

2.1 Overview of the 5G NR applications

You can equip the FSW with one or more NR 5G applications. Each of the applications provides functionality for specific measurement tasks.

R&S FSW-K144

The R&S FSW-K144 is designed to measure NR 5G signals on the downlink.

The application supports features up to 3GPP release 15.

- Basic signal characteristics (like multiple component carriers, frequency ranges and channel bandwidths).
- (Automatic) demodulation and configuration of the PDSCH and synchronization signal (SS/PBCH).
- Configuration and analysis of multiple frames and bandwidth parts (multi-numerology).
- Configuration and analysis of special downlink channels and reference signals (like the PDCCH, the CSI-RS or the PT-RS).
- Configuration and analysis of various demodulation reference signals.
- Mapping of channels to different antenna ports.
- LTE coexistence analysis.

- Synchronization of the configuration with a connected Rohde & Schwarz signal generator.
- Tools to refine and filter the measurement results.
- Various result displays that show the measured signal characteristics in a diagram or a numeric result table.
- Available measurements: EVM, ACLR, SEM, time alignment and on / off power.

R&S FSW-K145

The R&S FSW-K145 is designed to measure NR 5G signals on the uplink.

The application supports features up to 3GPP release 15.

- Basic signal characteristics (like multiple component carriers, frequency ranges and channel bandwidths).
- (Automatic) demodulation and configuration of the PUSCH.
- Configuration and analysis of multiple frames and bandwidth parts (multi-numerology).
- Configuration and analysis of special uplink channels and reference signals (like the PUCCH, the PRACH, the SRS or the PT-RS).
- Configuration and analysis of various demodulation reference signals.
- Mapping of channels to different antenna ports.
- Synchronization of the configuration with a connected Rohde & Schwarz signal generator.
- Tools to refine and filter the measurement results.
- Various result displays that show the measured signal characteristics in a diagram or a numeric result table.
- Available measurements: EVM, ACLR and SEM.

R&S FSW-K147

The R&S FSW-K147 is designed to combine different 5G NR measurements in a single measurement sequence, either on the downlink or on the uplink.

Note that this application requires the R&S FSW-K144 or -K145.

The application supports the following features.

- Combined analysis of EVM, ACLR and SEM in a single application.
- Automatic measurement of multiple, subsequent events with a single analyzer.
- Increased measurement speed due to optimized measurement methods.
- Advanced trigger configuration.
- Extended functionality of the result displays that reflect the measurement sequence.
- R&S FSW-K147C unlocks combined measurements for multi-carrier signals. Requires the R&S FSW-K147 license.

R&S FSW-K148

The R&S FSW-K148 extends the functionality of the base application with features introduced with 3GPP release 16.

Note that this application requires the R&S FSW-K144 or -K145.

Release 16 features include:

- Configuration of DCI parameters.
- Configuration and analysis of the PRS.
- New operating bands, slot formats (for IAB) and test models introduced with release 16.
- New channel bandwidth introduced with release 16 (70 MHz).
- Increased PDSCH DMRS length.
- Increased number of SS/PBCH blocks to support shared spectrum access.

R&S FSW-K171

The R&S FSW-K171 extends the functionality of the base application with features introduced with 3GPP release 17.

Note that this application requires the R&S FSW-K144 or -K145 and the R&S FSW-K148.

Release 17 and 18 features include:

- New deployment frequency range (FR2-2, up to 71 GHz).
- New channel bandwidths introduced for FR2-2 (800 MHz, 1600 MHz and 2000 MHz).
- New subcarrier spacings for various channels (user allocations, SS/PBCH, PRACH etc.) introduced with FR2-2.
- New channel bandwidths introduced with release 17 (35 MHz and 45 MHz).
- New channel bandwidths introduced with release 18 (3 MHz).
- Support of 1024QAM modulation in FR1.
- New operating bands, test models and limits for ACLR and SEM measurements introduced with release 17.

R&S FSW-K175

The R&S FSW-K175 extends the functionality of the base application with features that allow measurements based on the O-RAN standard.

Note that this application requires the R&S FSW-K144 or -K145.

The application supports the following features.

- Support of O-RAN test cases.
- Extended features in selected result displays that allow evaluation of O-RAN test cases.
- Automatic configuration of the NR 5G application upon selection of an O-RAN test case.

2.2 Installation

Find detailed installation instructions in the getting started or the release notes of the FSW.

2.3 5G NR measurement application selection

The 5G NR measurement application adds a new application to the FSW.

Starting the application

1. Press the [MODE] key on the front panel of the FSW.

A dialog box opens that contains all operating modes and applications currently available on your FSW.

2. Select the "5G NR" item.



The FSW opens a new measurement channel for the 5G NR measurement application.

The measurement is started immediately with the default settings. It can be configured in the "Overview" dialog box, which is displayed when you select the "Overview" soft-key from any menu.

2.4 Display information

The following figure shows a measurement diagram during analyzer operation. All different information areas are labeled. They are explained in more detail in the following sections.

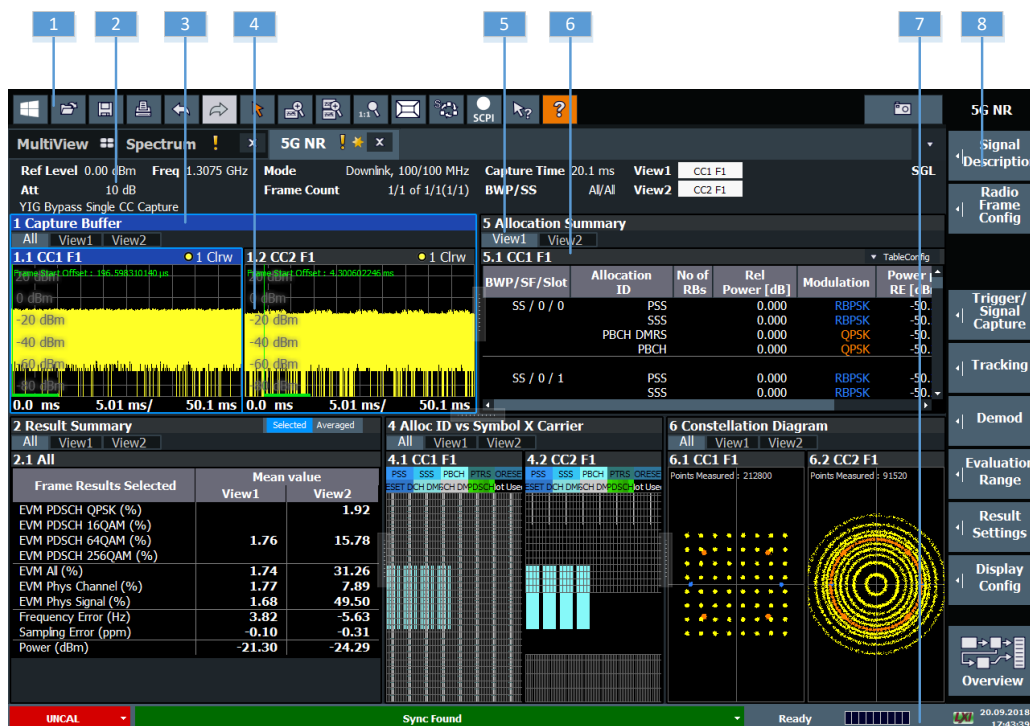

- 1 = Toolbar
- 2 = Channel bar
- 3 = Diagram header
- 4 = Result display
- 5 = Subwindows (Views)
- 6 = Subwindow header
- 7 = Status bar
- 8 = Softkeys



MSRA operating mode

In MSRA operating mode, additional tabs and elements are available. A colored background of the screen behind the measurement channel tabs indicates that you are in MSRA operating mode. Frequency sweep measurements are not available in MSRA operating mode.

For details on the MSRA operating mode, see the FSW MSRA user manual.

Channel bar information

In the 5G NR measurement application, the FSW shows the following settings:

Table 2-1: Information displayed in the channel bar in the 5G NR measurement application

Ref Level	Reference level.
Att	Mechanical and electronic RF attenuation.
Inp: File Freq	Frequency for I/Q file input.
Freq	Frequency for other input sources (RF etc.).
Mode*	5G NR mode (link direction and channel bandwidth).

Frame Count*	<p>The first number represents the number of frames that have already been captured.</p> <p>The second number represents the total number of frames that will be captured.</p> <p>The third number in brackets represents the number of frames currently in the capture buffer.</p>
Capture Time	Signal length that has been captured.
Frame	Selected frame number.
BWP/SS*	<p>Shows the signal part for which results are displayed (evaluation range).</p> <p>SS = synchronization signal</p> <p>BWP = bandwidth part</p>
View<x>	<p>Information about the contents of View 1 and View 2.</p> <p>Select the button for access to the dialog box for view configuration.</p>
SGL	Indicates that single sweep measurement is active.
Auto Demod Once	Select the button to start automatic signal demodulation.
Consecutive CC Meas	<p>Number of component carriers that are measured; the numbers in parentheses indicate the number of component carriers that are analyzed in a single capture.</p> <p>Example: 8 (3 / 3 / 2) means that 8 component carriers are analyzed in three consecutive data captures. The first two data captures analyze the first 6 component carriers (3 CCs each), while the last data capture analyzes the last 2 component carriers.</p>

*If you capture more than one data stream (for example several component carriers), the FSW shows two values separated by a slash. The first number corresponds to the first analyzed data stream, the second number to the second analyzed data stream.

The channel bar also displays information on instrument settings that affect the measurement results even though this is not immediately apparent from the display of the measured values (for example transducer or trigger settings). This information is displayed only when applicable for the current measurement. For details, see the FSW getting started manual.

Diagram header

The information in the diagram header depends on the result display.

- All diagrams show the window number and type of result display.
- Most diagrams contain trace information.
- Some diagrams contain controls to customize the diagram contents. The diagram header of the "Allocation Summary", for example, contains a control to select which columns are displayed.
- If you analyze multiple component carriers or frames, the diagram header shows which CC or frame is analyzed.

Status bar information

Global instrument settings, the instrument status and any irregularities are indicated in the status bar beneath the diagram. Furthermore, the progress of the current operation is displayed in the status bar.

Regarding the synchronization state, the application shows the following labels.

- "Sync OK"
The synchronization was successful. The status bar is green.
- "Sync Failed"
The synchronization was not successful. The status bar is red.
If you are measuring several component carriers, the message also indicates which component carrier could not be synchronized.

3 Measurements and result displays

The 5G NR measurement application measures and analyzes various aspects of a 5G NR signal.

The application provides several measurements and result displays.

- Measurements capture and analyze the signal in a different way.
- Result displays are different representations of the measurement results. They are either diagrams that show the results as a graph or tables that show the results as numbers.

Remote command:

Measurement selection: `CONFigure[:NR5G]:MEASurement` on page 277

Result display selection: `LAYout:ADD[:WINDow]?` on page 199

• Selecting measurements	19
• Selecting result displays	20
• Performing measurements	21
• Selecting the operating mode	21
• Result summary	22
• I/Q measurements	30
• PRACH analysis	45
• Frequency sweep measurements	46
• Combined measurements	50
• Reference: custom limits	53

3.1 Selecting measurements

Access: "Overview" > "Select Measurement"

The "Select Measurement" dialog box contains several buttons. Each button represents a measurement. A measurement in turn is a set of result displays that thematically belong together and that have a particular display configuration. If these predefined display configurations do not suit your requirements, you can add or remove result displays as you like. For more information about selecting result displays, see [Chapter 3.2, "Selecting result displays"](#), on page 20.

Depending on the measurement, the FSW changes the way it captures and processes the raw signal data.

EVM

EVM measurements record, process and demodulate the signal's I/Q data. The result displays available for EVM measurements show various aspects of the 5G NR signal quality.

For EVM measurements, you can combine the result displays in any way.

For more information on the result displays, see [Chapter 3.6, "I/Q measurements"](#), on page 30.

Remote command:

[CONFigure\[:NR5G\]:MEASurement](#) on page 277

PRACH Analysis

EVM measurements record, process and demodulate the PRACH. The result displays available for PRACH measurements show various aspects of the PRACH signal quality.

For PRACH measurements, you can combine the result displays in any way.

Remote command:

[CONFigure\[:NR5G\]:MEASurement](#) on page 277

Combined EVM / ACLR / SEM

Combined measurements are a sequence of individual measurements that evaluate the EVM, ACLR and / or SEM of a DUT.

For more information on the result displays, see [Chapter 3.9, "Combined measurements"](#), on page 50.

Channel Power ACLR

ACLR measurements sweep the frequency spectrum instead of processing I/Q data.

The ACLR measurements evaluates the leakage ratio of neighboring channels and evaluates if the signal is within the defined limits. The measurement provides several result displays. You can combine the result displays in any way.

For more information on the result displays, see [Chapter 3.8, "Frequency sweep measurements"](#), on page 46.

Remote command:

[CONFigure\[:NR5G\]:MEASurement](#) on page 277

SEM

SEM measurements sweep the frequency spectrum instead of processing I/Q data.

The SEM measurements tests the signal against a spectrum emission mask and evaluates if the signal is within the defined limits. The measurement provides several result displays. You can combine the result displays in any way.

For more information on the result displays, see [Chapter 3.8, "Frequency sweep measurements"](#), on page 46.

Remote command:

[CONFigure\[:NR5G\]:MEASurement](#) on page 277

3.2 Selecting result displays

Access: 

The FSW opens a menu (the SmartGrid) to select result displays. For more information on the SmartGrid functionality, see the FSW Getting Started.

In the default state of the application, it shows several conventional result displays.

- Capture Buffer

- EVM vs Carrier
- Power Spectrum
- Result Summary
- Alloc ID vs Symbol x Carrier
- Constellation Diagram

From that predefined state, add and remove result displays as you like from the Smart-Grid menu.

Remote command: `LAYout:ADD[:WINDow]?` on page 199

3.3 Performing measurements

By default, the application measures the signal continuously. In "Continuous Sweep" mode, the FSW captures and analyzes the data again and again.

- For I/Q measurements, the amount of captured data depends on the [capture time](#).
- For frequency sweep measurement, the amount of captured data depends on the sweep time.

In "Single Sweep" mode, the FSW stops measuring after it has captured the data once. The amount of data again depends on the capture time.

Refreshing captured data

You can also repeat a measurement based on the data that has already been captured with the "Refresh" function. Repeating a measurement with the same data can be useful, for example, if you want to apply different modulation settings to the same I/Q data.

For more information, see the documentation of the FSW.

3.4 Selecting the operating mode

Access: [MODE] > "Multi-Standard Radio Analyzer Tab"

The 5G NR application is supported by the Multi Standard Radio Analyzer (MSRA).

In MSRA operating mode, only the MSRA primary actually captures data. The application receives an extract of the captured data for analysis, referred to as the **application data**. The application data range is defined by the same settings used to define the signal capture in "Signal and Spectrum Analyzer" mode. In addition, a capture offset can be defined, i.e. an offset from the start of the captured data to the start of the analysis interval.

If a signal contains multiple data channels for multiple standards, separate applications are used to analyze each data channel. Thus, it is of interest to know which application is analyzing which data channel. The MSRA primary display indicates the data covered by each application by vertical blue lines labeled with the application name. The blue lines correspond to the channel bandwidth.

However, the individual result displays of the application need not analyze the complete data range. The data range that is actually analyzed by the individual result display is referred to as the **analysis interval**.

The analysis interval is automatically determined according to the [Capture Time](#) you have defined. The analysis interval cannot be edited directly in the 5G NR application, but is changed automatically when you change the evaluation range. The currently used analysis interval (in seconds, related to capture buffer start) is indicated in the window header for each result display.

A frequent question when analyzing multi-standard signals is how each data channel is correlated (in time) to others. Thus, an analysis line has been introduced. The analysis line is a common time marker for all MSRA secondary applications. It can be positioned in any MSRA secondary application or the MSRA primary and is then adjusted in all other secondary applications. Thus, you can easily analyze the results at a specific time in the measurement in all secondary applications and determine correlations.

If the analysis interval of the secondary application contains the marked point in time, the line is indicated in all time-based result displays, such as time, symbol, slot or bit diagrams. By default, the analysis line is displayed. However, you can hide it from view manually. In all result displays, the "AL" label in the window title bar indicates whether the analysis line lies within the analysis interval or not:

- **orange "AL"**: the line lies within the interval
- **white "AL"**: the line lies within the interval, but is not displayed (hidden)
- **no "AL"**: the line lies outside the interval

For details on the MSRA operating mode, see the FSW MSRA documentation.

3.5 Result summary

In addition to various graphical results, the FSW provides a numerical result summary for I/Q measurements. The result summary shows a multitude of results that indicate the signal quality, combined in one table.

The result summary is split into several parts.

- Frame statistics, which evaluate the metrics of the resource elements in a complete frame.
Results are averaged over frames.
- Slot and subframe statistics, which evaluate metrics of the resource elements in a single slot or subframe.
Results are averaged over slots / subframes.

Each row in the table corresponds to a certain metric or result parameter. You can [add](#) or [remove](#) results you want to display as necessary.

By default, the FSW evaluates the results over all captured frames, bandwidth parts, subframes and slots. For most results, the result summary therefore contains a mean (average), maximum and minimum value.

3 Result Summary				
Frame Results Averaged	Mean	Limit	Max	Min
EVM PUSCH QPSK (%)	0.50	17.50	0.50	0.50
EVM PUSCH 16QAM (%)		12.50		
EVM PUSCH 64QAM (%)		8.00		
EVM PUSCH 256QAM (%)		4.30		
EVM DMRS PUSCH QPSK (%)	0.50	17.50	0.50	0.50
EVM DMRS PUSCH 16QAM (%)		12.50		
EVM DMRS PUSCH 64QAM (%)		8.00		
EVM DMRS PUSCH 256QAM (%)		4.30		
EVM PUCCH (%)		17.50		
EVM DMRS PUCCH (%)				
Results for Selection BWP All, Subframe All, Slot All				
EVM All (%)	0.50		0.50	0.22
EVM Phys Channel (%)	0.50		0.50	0.50
EVM Phys Signal (%)	0.50		0.51	0.22
Frequency Error (Hz)	-3.72		-3.58	-3.84
Sampling Error (ppm)	-0.00		-0.00	-0.01

Limit check

The FSW also tests several results against limits, if 3GPP has defined limits for a result. Limits are only evaluated if the signal complies to the 3GPP specification regarding the [number of analyzed frames](#) and the results are averaged over all frames.

Depending on the limit test, the results are highlighted.

- If one of the results passes the limit, the value is highlighted green.
- If one of the results violates the limit, the value is highlighted red.
- Results that are not evaluated are not highlighted in a color.

For some results you can define custom limits. For more information, see [Chapter 3.10, "Reference: custom limits"](#), on page 53.

You can check if a result supports limit evaluation in the result descriptions below. The result descriptions also indicate special behavior of the limit check.

Evaluation range and multiple frame analysis

Unavailable for PRACH analysis.

The [evaluation range](#) selects the way the results are evaluated and which values are displayed.

For the **frame statistics**, the evaluation range is irrelevant. However, you can select a specific frame that you want to analyze.

- Select "Frame Averaged" in the result summary header to display the average result over all analyzed frames. The average results relate to all frames, not just those in the capture buffer.
The table also shows the minimum and maximum values over the analyzed frames.
- Select "Selected Frame" in the result summary header to display the results for a [single frame](#).
If you analyze a single frame, the mean, minimum and maximum values are the same.

2 Result Summary

Selected Frame **Frame Averaged**

For the **slot statistics** and subframe statistics, the effects of the evaluation range are as follows.

- Select "Frame Averaged" in the result summary header to display the average results over all analyzed slots in all analyzed frames. The average results relate to all frames, not just those in the capture buffer. The table also shows the minimum and maximum values found in the analyzed frames.
When you select a specific BWP, subframe or slot while in "Frame Averaged" mode, the FSW automatically selects "Selected Frame" mode.
- Select "Selected Frame" in the result summary header to display the results over all analyzed slots in a single frame. The analyzed frame depends on the frame you have selected. In this case, you can filter the evaluation range as you like.

Examples:

- If you select a specific BWP: the FSW takes the average over all slots in the selected BWP.
- If you select a specific subframe: the FSW takes the average over all slots in the selected subframe.
- If you select a specific slot: the FSW shows the result for that slot.
Note that selecting a specific slot for the subframe results (frequency and sampling error) will not make a difference, because those results are always calculated over a complete subframe.

The current evaluation range is indicated in the header row of the slot statistics.

Multiple carrier analysis

Unavailable for PRACH analysis.

For measurements on [multiple carriers](#), the contents of the result summary depend on your configuration, especially the [CC result](#) setting.

- Select "CC Result" = "All" to display information about all component carriers, regardless of the number of component carriers.
 - The "All" tab shows the average results for all component carriers. Each column in the table corresponds to one component carrier.
 - The "View <x>" tabs show the detailed results for the component carriers assigned to the two [views](#).
- Select "CC Result" = "Viewed" to display information about the component carriers assigned to the two views.
 - The "All" tab shows the average results for the two selected component carriers. Depending on your selection in the result summary header, the results are either averaged over all frames, or relate to a single frame.
 - The "View <x>" tabs show the detailed results for the component carriers assigned to the two views. Depending on your selection in the result summary header, the results are either averaged over all frames, or relate to a single, selected frame.
If you analyze only one frame, the results are the same in both cases.

Note that analyzing all component carriers is slower compared analyzing the viewed component carriers, because of the post-processing that occurs during the analysis. Thus, if time is an issue, you can select two component carriers to analyze, and, if you are later interested in the characteristics of another component carrier, analyze that component carrier later (the data of the other carriers is available, just not analyzed).

Units

Most of the units of the results are fixed.

The unit of the EVM results depends on the selected [EVM unit](#).

Remote queries.....	25
EVM PUSCH.....	25
EVM DMRS PUSCH.....	26
EVM PUCCH.....	27
EVM DMRS PUCCH.....	27
BLER (%).....	27
TPUT (%).....	28
EVM PRACH.....	28
Frame Start Offset.....	28
EVM All.....	28
EVM Peak.....	28
EVM Phys Channel.....	29
EVM Phys Signal.....	29
Frequency Error.....	29
Sampling Error.....	29
Power.....	29
I/Q Offset.....	30
I/Q Gain Imbalance.....	30
I/Q Quadrature Error.....	30
Crest Factor.....	30

Remote queries

The remote commands to query individual results and limit check results are indicated in the description of the respective result.

Alternatively, you can query all results or limit check results at the same time using a single command.

Remote command:

Results: `FETCh[:CC<cc>] [:ISRC<ant>] [:FRAMe<fr>] :SUMMary:ALL?`
on page 212

Limit check: `CALCulate<n>:LIMit[:CC<cc>] [:ISRC<ant>] [:FRAMe<fr>] :SUMMary:ALL:RESUlt?` on page 243

EVM PUSCH

Shows the EVM for all PUSCH resource elements with a certain modulation in the analyzed frame (PI/2 BPSK, QPSK, 16QAM, 64QAM, 256QAM).

3GPP release 17 adds 1024QAM modulation.

The values for resource elements with a PI/2 BPSK modulation is only calculated if you turn on [transform precoding](#).

When you turn on transform precoding, the allocations actually contain a PTRS. In that case, the result summary also shows the combined EVM for PUSCH and PTRS.

[Limit](#) evaluation supported.

Unavailable for PRACH analysis.

Remote command:

PI/2 BPSK: `FETCh[:CC<cc>][:ISRC<ant>][:FRAMe<fr>]:SUMMary:EVM:`

`USPB[:AVERAge]?` on page 223

QPSK: `FETCh[:CC<cc>][:ISRC<ant>][:FRAMe<fr>]:SUMMary:EVM:USQP[:`

`AVERAge]?` on page 223

16QAM: `FETCh[:CC<cc>][:ISRC<ant>][:FRAMe<fr>]:SUMMary:EVM:USST[:`

`AVERAge]?` on page 225

64QAM: `FETCh[:CC<cc>][:ISRC<ant>][:FRAMe<fr>]:SUMMary:EVM:USSF[:`

`AVERAge]?` on page 224

256QAM: `FETCh[:CC<cc>][:ISRC<ant>][:FRAMe<fr>]:SUMMary:EVM:`

`USTS[:AVERAge]?` on page 225

1024QAM: `FETCh[:CC<cc>][:ISRC<ant>][:FRAMe<fr>]:SUMMary:EVM:`

`US1K[:AVERAge]?` on page 222

Limit check PI/2 BPSK: `CALCulate<n>:LIMit[:CC<cc>][:ISRC<ant>][:`

`FRAMe<fr>]:SUMMary:EVM:USPB:MAXimum:RESult?` on page 249

Limit check QPSK: `CALCulate<n>:LIMit[:CC<cc>][:ISRC<ant>][:`

`FRAMe<fr>]:SUMMary:EVM:USQP:MAXimum:RESult?` on page 250

Limit check 16QAM: `CALCulate<n>:LIMit[:CC<cc>][:ISRC<ant>][:`

`FRAMe<fr>]:SUMMary:EVM:USST:MAXimum:RESult?` on page 251

Limit check 64QAM: `CALCulate<n>:LIMit[:CC<cc>][:ISRC<ant>][:`

`FRAMe<fr>]:SUMMary:EVM:USSF:MAXimum:RESult?` on page 250

Limit check 256QAM: `CALCulate<n>:LIMit[:CC<cc>][:ISRC<ant>][:`

`FRAMe<fr>]:SUMMary:EVM:USTS:MAXimum:RESult?` on page 251

Limit check 1024QAM: `CALCulate<n>:LIMit[:CC<cc>][:ISRC<ant>][:`

`FRAMe<fr>]:SUMMary:EVM:US1K:MAXimum:RESult?` on page 248

EVM DMRS PUSCH

Shows the EVM for all PUSCH DMRS resource elements with a certain modulation in the analyzed frame (PI/2 BPSK, QPSK, 16QAM, 64QAM, 256QAM).

3GPP release 17 adds 1024QAM modulation.

The values for resource elements with a PI/2 BPSK modulation is only calculated if you turn on [transform precoding](#).

[Limit](#) evaluation supported.

Unavailable for PRACH analysis.

Remote command:

PI/2 BPSK: `FETCh[:CC<cc>][:ISRC<ant>][:FRAMe<fr>]:SUMMary:EVM:`

`SDPB[:AVERAge]?` on page 218

QPSK: `FETCh[:CC<cc>][:ISRC<ant>][:FRAMe<fr>]:SUMMary:EVM:SDQP[:`

`AVERAge]?` on page 218

16QAM: `FETCh[:CC<cc>][:ISRC<ant>][:FRAMe<fr>]:SUMMary:EVM:SDST[:`

`AVERAge]?` on page 220

64QAM: [FETCh\[:CC<cc>\]\[:ISRC<ant>\]\[:FRAMe<fr>\]:SUMMary:EVM:SDSF\[:AVERAge\]? on page 219](#)

256QAM: [FETCh\[:CC<cc>\]\[:ISRC<ant>\]\[:FRAMe<fr>\]:SUMMary:EVM:SDTS\[:AVERAge\]? on page 220](#)

1024QAM: [FETCh\[:CC<cc>\]\[:ISRC<ant>\]\[:FRAMe<fr>\]:SUMMary:EVM:SD1K\[:AVERAge\]? on page 217](#)

Limit check PI/2 BPSK: [CALCulate<n>:LIMit\[:CC<cc>\]\[:ISRC<ant>\]\[:FRAMe<fr>\]:SUMMary:EVM:SDPB:MAXimum:RESult? on page 244](#)

Limit check QPSK: [CALCulate<n>:LIMit\[:CC<cc>\]\[:ISRC<ant>\]\[:FRAMe<fr>\]:SUMMary:EVM:SDQP:MAXimum:RESult? on page 245](#)

Limit check 16QAM: [CALCulate<n>:LIMit\[:CC<cc>\]\[:ISRC<ant>\]\[:FRAMe<fr>\]:SUMMary:EVM:SDST:MAXimum:RESult? on page 246](#)

Limit check 64QAM: [CALCulate<n>:LIMit\[:CC<cc>\]\[:ISRC<ant>\]\[:FRAMe<fr>\]:SUMMary:EVM:SDSF:MAXimum:RESult? on page 246](#)

Limit check 256QAM: [CALCulate<n>:LIMit\[:CC<cc>\]\[:ISRC<ant>\]\[:FRAMe<fr>\]:SUMMary:EVM:SDTS:MAXimum:RESult? on page 247](#)

Limit check 1024QAM: [CALCulate<n>:LIMit\[:CC<cc>\]\[:ISRC<ant>\]\[:FRAMe<fr>\]:SUMMary:EVM:SD1K:MAXimum:RESult? on page 244](#)

EVM PUCCH

Shows the EVM for all PUCCH resource elements in the analyzed frame.

[Limit](#) evaluation supported.

Unavailable for PRACH analysis.

Remote command:

Result: [FETCh\[:CC<cc>\]\[:ISRC<ant>\]\[:FRAMe<fr>\]:SUMMary:EVM:UCCH\[:AVERAge\]? on page 221](#)

Limit check: [CALCulate<n>:LIMit\[:CC<cc>\]\[:ISRC<ant>\]\[:FRAMe<fr>\]:SUMMary:EVM:UCCH:MAXimum:RESult? on page 248](#)

EVM DMRS PUCCH

Shows the EVM for all PUSCH DMRS resource elements in the analyzed frame.

Unavailable for PRACH analysis.

Remote command:

Result: [FETCh\[:CC<cc>\]\[:ISRC<ant>\]\[:FRAMe<fr>\]:SUMMary:EVM:UCCD\[:AVERAge\]? on page 221](#)

Limit check: [CALCulate<n>:LIMit\[:CC<cc>\]\[:ISRC<ant>\]\[:FRAMe<fr>\]:SUMMary:EVM:UCCD:MAXimum:RESult? on page 247](#)

BLER (%)

Shows the block error rate (BLER) for all code blocks used by the PUSCH as a percentage. The BLER is the ratio of the number of erroneously transmitted code blocks to all code blocks in the analyzed frame.

Note that the result is only calculated if the number of bits per code block is identical for all allocations.

To see the BLER results, you have turn on the [throughput measurement](#).

Remote command:

`FETCh[:CC<cc>][:ISRC<ant>][:FRAME<fr>]:SUMMARY:BLER[:AVERAge]?`
on page 213

TPUT (%)

Shows the throughput for all code blocks used by the PUSCH. The BLER is the ratio of the number of successfully transmitted code blocks to all code blocks in the analyzed frame.

Note that the result is only calculated if the number of bits per code block is identical for all allocations.

To see the throughput results, you have turn on the [throughput measurement](#).

Remote command:

`FETCh[:CC<cc>][:ISRC<ant>][:FRAME<fr>]:SUMMARY:TPUT[:AVERAge]?`
on page 230

EVM PRACH

Shows the EVM for all PRACH resource elements in the captured signal.

Available for PRACH analysis.

Remote command:

`FETCh[:CC<cc>][:ISRC<ant>][:FRAME<fr>]:SUMMARY:EVM:PRACH[:AVERAge]?` on page 216

Frame Start Offset

Shows the start of the frame relative to the start of the capture buffer.

Unavailable for "Frame Averaged" results, otherwise refers to the selected frame.

For PRACH analysis, it shows the start of the preamble relative to the start of the capture buffer.

Remote command:

`FETCh[:CC<cc>][:ISRC<ant>][:FRAME<fr>]:SUMMARY:Foffset?`
on page 231

EVM All

Shows the EVM for all resource elements in the selected evaluation range.

The result is a weighted average over all resource elements (PUSCH, DMRS etc.). The number of occupied resource blocks and the number of used symbols of each allocation is taken into account in the calculation of the mean EVM. Therefore, a fully loaded PUSCH across multiple symbols gets a much higher weight than a single symbol DMRS.

Remote command:

`FETCh[:CC<cc>][:ISRC<ant>][:FRAME<fr>]:SUMMARY:EVM[:ALL][:AVERAge]?` on page 214

EVM Peak

Shows the EVM of the resource element with the highest EVM value in the selected evaluation range.

Unavailable for PRACH analysis.

Remote command:

`FETCh[:CC<cc>][:ISRC<ant>][:FRAMe<fr>]:SUMMary:EVM:PEAK[:AVERAge]?` on page 215

EVM Phys Channel

Shows the EVM for all physical channel resource elements in the selected evaluation range.

A physical channel corresponds to a set of resource elements carrying information from higher layers. PDSCH, PUSCH, PBCH or PDCCH, for example, are physical channels.

Unavailable for PRACH analysis.

Remote command:

`FETCh[:CC<cc>][:ISRC<ant>][:FRAMe<fr>]:SUMMary:EVM:PCHannel[:AVERAge]?` on page 215

EVM Phys Signal

Shows the EVM for all physical signal resource elements in the selected evaluation range.

The reference signal is a physical signal, for example.

Unavailable for PRACH analysis.

Frequency Error

Shows the difference in the measured center frequency and the reference center frequency.

The frequency error is calculated over a subframe.

The FSW checks the measured frequency error against the limits defined by 3GPP.

The values are highlighted green (pass) or red (fail) respectively. The color of the mean value indicates the overall limit check passes or fails. Note that if you evaluate a single subframe only, the minimum, maximum and mean values are the same.

Remote command:

Result: `FETCh[:CC<cc>][:ISRC<ant>][:FRAMe<fr>]:SUMMary:FERRor[:AVERAge]?` on page 226

Limit check: `CALCulate<n>:LIMit[:CC<cc>][:ISRC<ant>][:FRAMe<fr>]:SUMMary:EVM:FERRor[:AVERAge]:RESult?` on page 243

Sampling Error

Shows the difference in measured symbol clock and reference symbol clock relative to the system sampling rate.

The sampling error is calculated over a subframe.

Remote command:

`FETCh[:CC<cc>][:ISRC<ant>][:FRAMe<fr>]:SUMMary:SERRor[:AVERAge]?` on page 230

Power

Shows the average time domain power for all resource elements in the selected evaluation range.

Remote command:

`FETCh[:CC<cc>][:ISRC<ant>][:FRAMe<fr>]:SUMMary:POWer[:AVERage]?`
on page 228

I/Q Offset

Shows the power at spectral line 0 normalized to the total transmitted power.

Not available for multiple BWPs.

Remote command:

`FETCh[:CC<cc>][:ISRC<ant>][:FRAMe<fr>]:SUMMary:IQOFfset[:AVERage]?` on page 227

I/Q Gain Imbalance

Shows the logarithm of the gain ratio between the Q-channel and the I-channel.

Not available for multiple BWPs and only calculated if you [turn on the calculation](#).

Remote command:

`FETCh[:CC<cc>][:ISRC<ant>][:FRAMe<fr>]:SUMMary:GIMBalance[:AVERage]?` on page 226

I/Q Quadrature Error

Shows the measure of the phase angle between Q-channel and I-channel deviating from the ideal 90 degrees.

Not available for multiple BWPs and only calculated if you [turn on the calculation](#).

Crest Factor

Shows the peak-to-average power ratio of the captured signal.

The peak power is determined over multiple frames.

Unavailable for PRACH analysis.

Remote command:

`FETCh[:CC<cc>][:ISRC<ant>]:SUMMary:CRESt[:AVERage]?` on page 213

3.6 I/Q measurements

Access: [MEAS] > "EVM/Frequency Err/Power"

You can select the result displays from the evaluation bar and arrange them as you like with the SmartGrid functionality.

Remote command:

Measurement selection: `CONFigure[:NR5G]:MEASurement` on page 277

Result display selection: `LAYout:ADD[:WINDow]?` on page 199

Capture Buffer	31
EVM vs Carrier	32
EVM vs Symbol	32
EVM vs RB	33

Frequency Error vs Symbol.....	34
Frequency Error vs Subframe.....	35
Power Spectrum.....	36
Inband Emission.....	36
Inband Emissions Summary.....	37
Flatness.....	38
CCDF.....	39
Constellation Diagram.....	40
Allocation Summary.....	40
Bitstream.....	41
EVM vs Symbol x Carrier.....	43
Power vs Symbol x Carrier.....	43
Allocation ID vs Symbol x Carrier.....	44
Marker Table.....	44

Capture Buffer

The "Capture Buffer" shows the complete range of captured data for the last data capture.

The x-axis represents time. The maximum value of the x-axis is equal to the [Capture Time](#).

The y-axis represents the amplitude of the captured I/Q data in dBm (for RF input).

The capture buffer uses the auto peak detector to evaluate the measurement data. The auto peak detector determines the maximum and the minimum value of the measured levels for each measurement point and combines both values in one sample point.

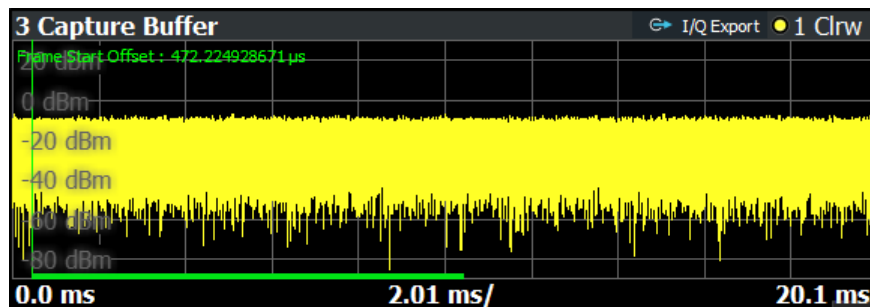

Figure 3-1: Capture buffer without zoom

A green vertical line at the beginning of the green bar in the capture buffer represents the frame start. The diagram also contains the "Start Offset" value. This value is the time difference between the frame start and capture buffer start.

For [PRACH analysis](#), the green line indicates the location of the preamble relative to the start of the capture buffer ("Preamble Start Offset").

If you are using the [segmented capture](#), the capture buffer also contains blue vertical lines to indicate the beginning, the end and the length of a segment. In addition, the footer of the diagram shows the overall measurement time (in brackets) and the time of the displayed data. If the number of segments is > 100, only every other segment is indicated.

The header of the "Capture Buffer" result display contains an "I/Q Export" button that allows you to export I/Q data easily.

Remote command:

Selection: `LAY:ADD ? '1',LEFT,CBUF`

Query (y-axis): `TRACe:DATA?`

Query (x-axis): `TRACe<n>[:DATA]:X?` on page 276

Frame start offset: `FETCh[:CC<cc>][:ISRC<ant>][:FRAMe<fr>]:SUMMary:FOFFset?` on page 231

EVM vs Carrier

The "EVM vs Carrier" result display shows the error vector magnitude (EVM) of the subcarriers. With the help of a marker, you can use it as a debugging technique to identify any subcarriers whose EVM is too high.

The results are based on an average EVM that is calculated over the resource elements for each subcarrier. This average subcarrier EVM is determined for each analyzed slot in the capture buffer.

The contents of the result display depend on the [evaluation range](#).

- If you analyze all bandwidth parts (BWP), the result display contains a variable number of traces that represent the [bandwidth parts](#). The traces show the average EVM of the corresponding signal part. The diagram header contains a legend that shows the information that each trace carries.
- If you analyze only one specific bandwidth part, or a single subframe, the diagram contains three traces. The traces show the following information.
 - The average subcarrier EVM over all slots in the selected signal part.
 - The lowest subcarrier EVM over all slots in the selected signal part.
 - The highest subcarrier EVM over all slots in the selected signal part.
- If you analyze only a single slot, the diagram contains one trace. That trace shows the subcarrier EVM for that slot only. Average, minimum and maximum values in that case are the same.

The x-axis represents the center frequencies of the subcarriers. The y-axis shows the EVM in % or in dB, depending on the [EVM Unit](#).

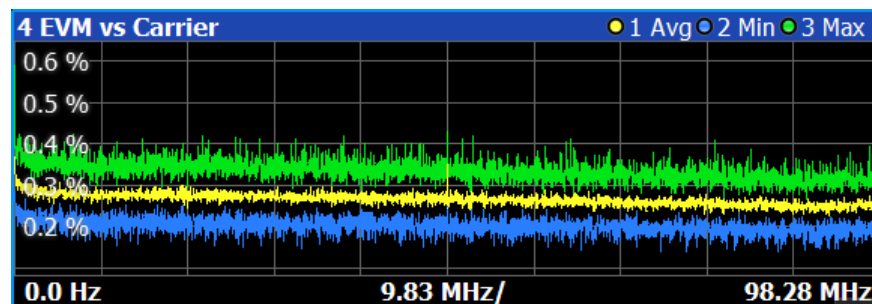

Remote command:

Selection `LAY:ADD ? '1',LEFT,EVCA`

Query (y-axis): `TRACe:DATA?`

Query (x-axis): `TRACe<n>[:DATA]:X?` on page 276

EVM vs Symbol

The "EVM vs Symbol" result display shows the error vector magnitude (EVM) of the OFDM symbols. You can use it as a debugging technique to identify any symbols whose EVM is too high.

The results are based on an average EVM that is calculated over the resource elements for each subcarrier. This average subcarrier EVM is determined for each analyzed slot in the capture buffer.

The contents of the result display depend on the [evaluation range](#).

- If you analyze all bandwidth parts (BWP), the result display contains a variable number of traces that represent the [bandwidth parts](#). The diagram header contains a legend that shows the information that each trace carries.
- If you analyze only one specific bandwidth part, a single subframe or a single slot, the diagram contains one trace. That trace shows the average EVM of the symbols in the selected signal part.

The x-axis represents the OFDM symbols, with each symbol represented by a dot on the line. Any missing connections from one dot to another mean that the FSW could not determine the EVM for that symbol.

On the y-axis, the EVM is plotted either in % or in dB, depending on the [EVM Unit](#).

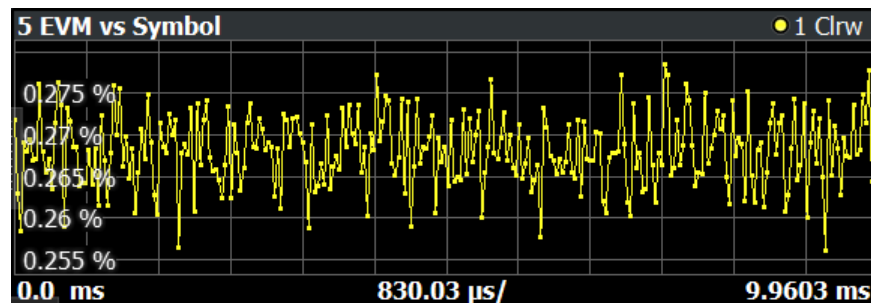

Remote command:

Selection: `LAY:ADD ? '1',LEFT,EVSY`

Query (y-axis): `TRACe:DATA?`

Query (x-axis): `TRACe<n>[:DATA]:X?` on page 276

EVM vs RB

The "EVM vs RB" result display shows the Error Vector Magnitude (EVM) for all resource blocks that can be occupied by the PDSCH.

The contents of the result display depend on the [evaluation range](#).

- If you analyze all bandwidth parts (BWP), the result display contains a variable number of traces that represent the [bandwidth parts](#). The traces show the average EVM of the corresponding signal part. The diagram header contains a legend that shows the information that each trace carries.
- If you analyze only one specific bandwidth part, or a single subframe, the diagram contains three traces. The traces show the following information.
 - The average subcarrier EVM over all slots in the selected signal part.
 - The lowest subcarrier EVM over all slots in the selected signal part.
 - The highest subcarrier EVM over all slots in the selected signal part.
- If you analyze only a single slot, the diagram contains one trace. That trace shows the subcarrier EVM for that slot only. Average, minimum and maximum values in that case are the same.

If you select and analyze one subframe only, the result display contains one trace that shows the resource block EVM for that subframe only. Average, minimum and maximum values in that case are the same. For more information, see "[Subframe Selection](#)" on page 181.

The x-axis represents the PDSCH resource blocks. On the y-axis, the EVM is plotted either in % or in dB, depending on the [EVM Unit](#).

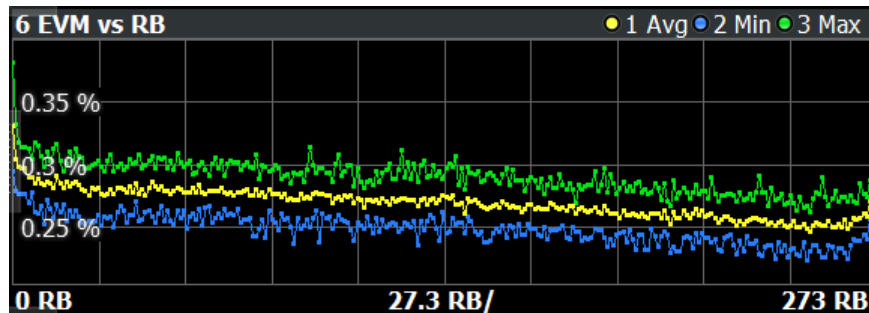

Remote command:

Selection: `LAY:ADD ? '1',LEFT,EVRB`

Query (y-axis): `TRACe:DATA?`

Query (x-axis): `TRACe<n>[:DATA]:X?` on page 276

Frequency Error vs Symbol

The "Frequency Error vs Symbol" result display shows the frequency error of each symbol. You can use it as a debugging technique to identify any frequency errors within symbols.

The result is an average over all subcarriers in the symbol.

The contents of the result display depend on the [evaluation range](#).

- If you analyze all bandwidth parts (BWP), the result display contains a variable number of traces that represent the [bandwidth parts](#). The diagram header contains a legend that shows the information that each trace carries.
- If you analyze only one specific bandwidth part, a single subframe or a single slot, the diagram contains one trace. That trace shows the average frequency error of the symbols in the selected signal part.

The x-axis represents the OFDM symbols, with each symbol represented by a dot on the line. The number of displayed symbols depends on the [subframe selection](#). Any missing connections from one dot to another mean that the FSW could not determine the frequency error for that symbol.

On the y-axis, the frequency error is plotted in Hz.

Note that the variance of the measurement results in this result display can be much higher compared to the frequency error display in the numerical result summary, depending on the PDSCH and control channel configuration. The potential difference is caused by the number of available resource elements for the measurement on symbol level.

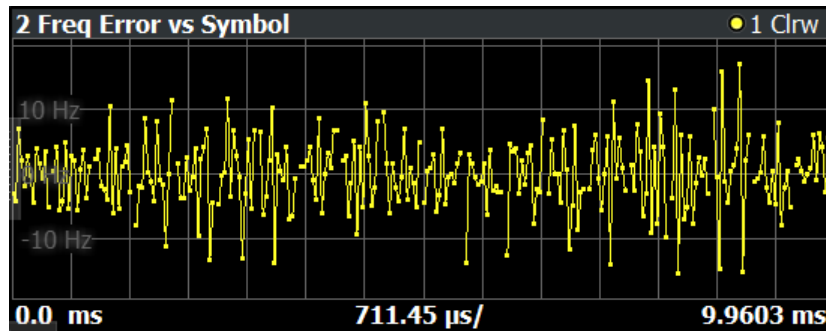

Remote command:

Selection: `LAY:ADD ? '1',LEFT,FEVS`

Query (y-axis): `TRACe:DATA?`

Query (x-axis): `TRACe<n>[:DATA]:X?` on page 276

Frequency Error vs Subframe

The "Frequency Error vs Subframe" result display shows the frequency error of each subframe. You can use it as a debugging technique to identify any frequency errors among subframes.

The result is an average over all subcarriers and symbols of each subframe.

The contents of the result display depend on the [evaluation range](#).

- If you analyze all bandwidth parts (BWP), the result display contains a variable number of traces that represent the [bandwidth parts](#). The diagram header contains a legend that shows the information that each trace carries.
- If you analyze only one specific bandwidth part, the diagram contains one trace. That trace shows the average frequency error of the subframes in the selected signal part. Selecting a specific subframe or slot from the evaluation range has no effects on the contents of the diagram.

The x-axis represents the subframes, with each of the nine subframes represented by a dot on the line.

On the y-axis, the frequency error is plotted in Hz.

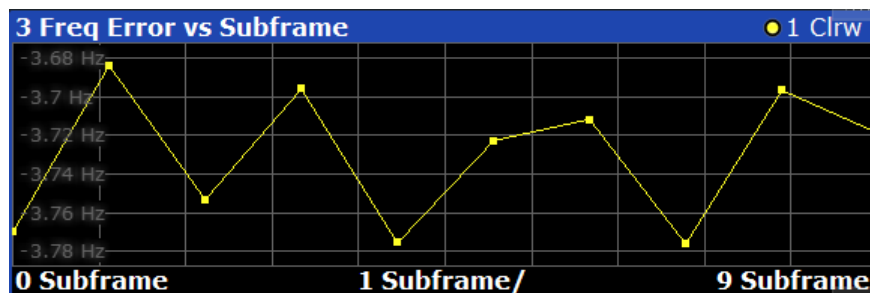

Remote command:

Selection: `LAY:ADD ? '1',LEFT,FEVS`

Query (y-axis): `TRACe:DATA?`

Query (x-axis): `TRACe<n>[:DATA]:X?` on page 276

Power Spectrum

The "Power Spectrum" shows the power density of the complete capture buffer in dBm/Hz.

The displayed bandwidth depends on the [channel bandwidth](#).

The x-axis represents the frequency. On the y-axis, the power level is plotted.

For multi-carrier measurement with a large bandwidth and [automatic selection](#) of the amount of captured data, it can happen that only parts of the signal are displayed.

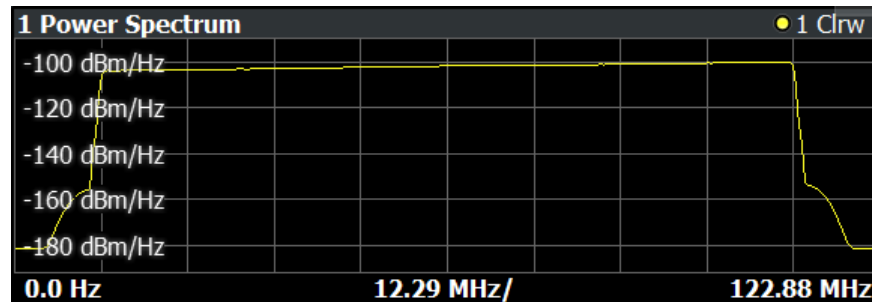

Remote command:

Selection: `LAY:ADD ? '1',LEFT,PSPE`

Query (y-axis): `TRACe:DATA?`

Query (x-axis): `TRACe<n>[:DATA]:X?` on page 276

Inband Emission

The "Inband Emission" result display shows the power of the unused resource blocks relative to the allocated resource blocks (yellow trace). The diagram also shows the inband emission limit lines (red trace). The allocated resource blocks are not evaluated.

The x-axis represents the resource blocks. The numbering of the resource blocks is based on 3GPP 38.521 as a function of the resource block offset from the edge of the allocated uplink transmission bandwidth.

The y-axis shows the measured power for each resource block.

The evaluation method depends on the [evaluation range](#):

- To check against limits, you have evaluate all bandwidth parts, subframes and slots. In that case, the measurement is evaluated over 10 subframes as defined by 3GPP. In addition, analyze a number of frames [according to the standard](#) and [all slots](#) in the frame.
- If you select a specific slot, the inband emissions are evaluated over a single slot. In that case, however, the measurement does not check against limits.

You can only use a single PUSCH or PUCCH allocation to get results for the inband emission.

Limits for the inband emission are specified in 3GPP 38.521-1/2.

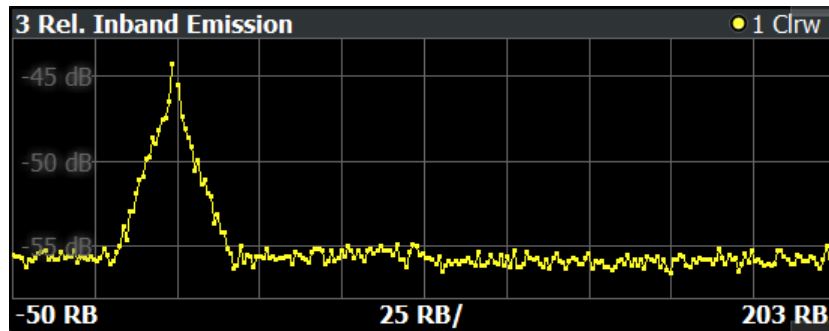

You can also display the inband emissions for the allocated resource block in addition to the unused resource blocks when you select the "Inband Emissions All" result display.

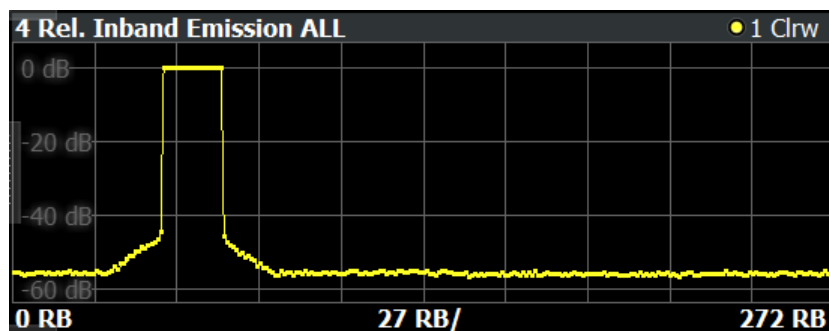

Remote command:

Selection: `LAY:ADD ? '1',LEFT,IE`

Selection: `LAY:ADD ? '1',LEFT,IEA`

Query (y-axis): `TRACe:DATA?`

Query (x-axis): `TRACe<n>[:DATA]:X?` on page 276

Limit check: `CALCulate<n>:LIMit:FAIL?` on page 258

Inband Emissions Summary

The "Inband Emission Summary" result display shows the power of the unused resource blocks relative to the allocated resource blocks as numerical values. This table extends the [inband emissions diagram](#).

4 Rel. Inband Emission Summary			
Parameter Description	RB No.	Power Rel [dB]	Δ Limit [dB]
General	-1	-44.32	35.07
IQ Image	139	-55.52	46.28
Carrier Leakage	67	-55.51	49.32

Each row in the table corresponds to one of the limit categories defined in 3GPP 38.521, table 6.4.3.2.5.

- "General"
Evaluates the limits for all non-allocated resource blocks.

- "IQ Image"
Evaluates the limits for resource blocks on the image frequency.
- "Carrier Leakage"
Evaluates the limits for resource blocks on the carrier leakage frequency.

Each column shows the result of the limit check.

- "RB No."
Resource block whose power is nearest to the limit.
The numbering of the resource blocks is based on 3GPP 38.521 as a function of the resource block offset from the edge of the allocated uplink transmission bandwidth.
- "Power Rel [dB]"
Relative power that was measured on the corresponding resource block.
- "Δ Limit [dB]"
Distance between the measured power and the limit value defined by 3GPP for the corresponding resource block.

You can also check these results in the inband emissions diagram by placing a marker on the corresponding resource block and read out the measured power.

Remote command:

Selection: `LAY:ADD ? '1', LEFT, IEA`

Query: `TRACe:DATA?`

Flatness

The "Spectrum Flatness" result shows the relative power offset caused by the transmit channel for each subcarrier.

The contents of the result display depend on the [evaluation range](#).

- If you analyze all bandwidth parts (BWP), the result display contains a variable number of traces that represent the [bandwidth parts](#). The traces show the average flatness of the corresponding signal part. The diagram header contains a legend that shows the information that each trace carries.
- If you analyze only one specific bandwidth part, a specific frame or a single sub-frame, the diagram contains three traces. The traces show the following information.
 - The average subcarrier flatness over all slots in the selected signal part.
 - The lowest subcarrier flatness over all slots in the selected signal part.
 - The highest subcarrier flatness over all slots in the selected signal part.
- If you analyze only a single slot, the diagram contains one trace. That trace shows the subcarrier flatness for that slot only. Average, minimum and maximum values in that case are the same.

The x-axis represents the frequency. On the y-axis, the channel flatness is plotted in dB.

The spectrum flatness is also tested against the limits defined by 3GPP. Limit evaluation is slot based, so the limit lines (red color) are only displayed in the diagram, if you select a [certain slot](#).

Limits are defined for each operating band. For single carrier scenarios, the FSW automatically determines the operating band based on the center frequency. For multi carrier scenarios, make sure to select the correct [operating band](#). The shape of the limit line also depends on the [operating conditions](#).

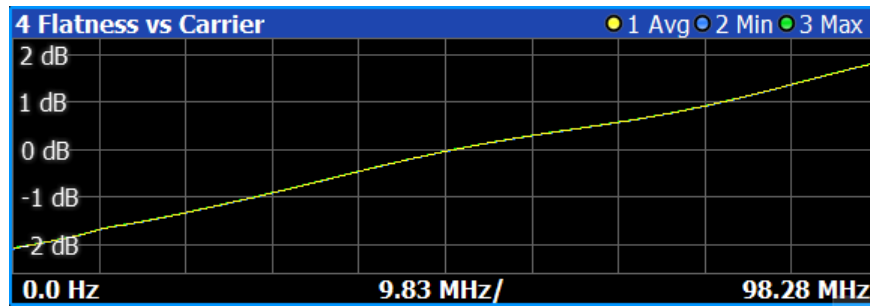

Remote command:

Selecting the result display: `LAY:ADD ? '1', LEFT, SFL`

Querying results:

`TRACe:DATA?`

`TRACe<n>[:DATA]:X?` on page 276

Limit check: `CALCulate<n>:LIMit:FAIL?` on page 258

CCDF

The "Complementary Cumulative Distribution Function (CCDF)" shows the probability of an amplitude exceeding the mean power. For the measurement, the complete capture buffer is used.

The x-axis represents the power relative to the measured mean power. On the y-axis, the probability is plotted in %.

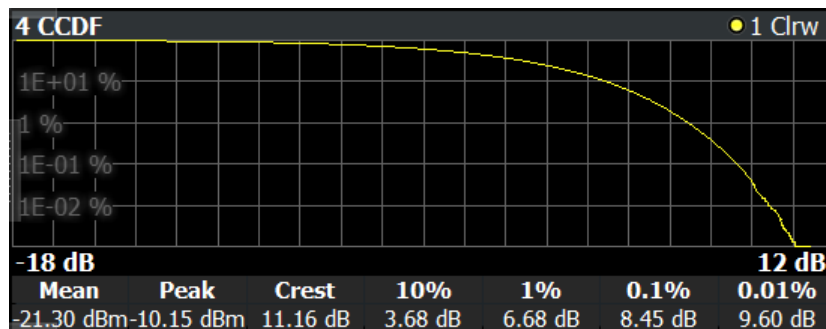

In addition to the diagram, the results for the CCDF measurement are summarized in the CCDF table.

Mean	Mean power
Peak	Peak power
Crest	Crest factor (peak power – mean power)
10 %	10 % probability that the level exceeds mean power + [x] dB
1 %	1 % probability that the level exceeds mean power + [x] dB
0.1 %	0.1 % probability that the level exceeds mean power + [x] dB
0.01 %	0.01 % probability that the level exceeds mean power + [x] dB

Remote command:

Selection: `LAY:ADD ? '1',LEFT,CCDF`

Query (y-axis): `TRACe:DATA?`

Numerical results: `CALCulate<n>:STATistics:CCDF:X<t>?` on page 241

Numerical results: `CALCulate<n>:STATistics:RESult<res>?` on page 241

Constellation Diagram

The "Constellation Diagram" shows the in-phase and quadrature phase results and is an indicator of the quality of the modulation of the signal.

In the default state, the result display evaluates the full range of the measured input data.

If you apply a boosting factor to resources as required by 3GPP for certain test models, the constellation diagram excludes that boosting factor to display the constellation diagram points by default. To consider the boosting factor for the calculation of the constellation points, turn on the [corresponding parameter](#).

The color represent either the modulation type or the allocation type, depending on your selection. The color mapping for modulation is as follows. The color mapping for allocations is the same as in the [allocation ID vs symbol vs carrier](#) result display.

- RBPSK
- pi/2-BPSK
- QPSK
- 16QAM
- 64QAM
- 256QAM
- 1024QAM
- PSK (CAZAC)

You can filter the results by changing the [evaluation range](#).

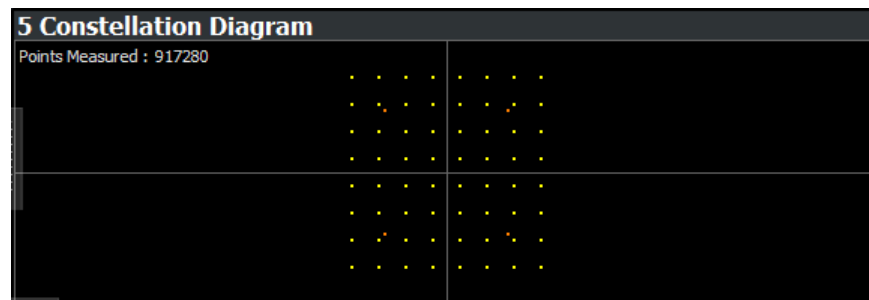

The constellation diagram shows the number of points that are displayed in the diagram.

Remote command:

Selection: `LAY:ADD ? '1',LEFT,CONS`

Query: `TRACe:DATA?`

Allocation Summary

The "Allocation Summary" shows various parameters of the measured allocations in a table.

Each row in the allocation table corresponds to an allocation. A set of several allocations make up a slot. A horizontal line indicates the beginning of a new slot. Special allocations summarize the characteristics of all allocations in a bandwidth part ("BWP ALL") and the radio frame ("TOTAL ALL").

The "BWP ALL" and "TOTAL ALL" values are an average of all EVM values in the table. For example: (EVM PDSCH 1 + EVM PDSCH 2 + EVM PDSCH 3 + EVM DMRS) / 4. Each value has the same weight. Therefore, a fully loaded PUSCH across multiple symbols has the same weight a single symbol DMRS.

2 Allocation Summary							TableConfig
BWP/SF/Slot	Allocation ID	No of RBs	Rel Power [dB]	Modulation	Power per RE [dBm]	EVM [%]	
0 / 0 / 0	PUSCH 0	273	0.000	64QAM	-57.102	0.268	
	PUSCH DMRS 0		0.000	QPSK	-57.101	0.261	
0 / 0 / 1	PUSCH 0	273	0.000	64QAM	-57.097	0.268	
	PUSCH DMRS 0		0.000	QPSK	-57.101	0.258	
0 / 1 / 2	PUSCH 0	273	0.000	64QAM	-57.102	0.269	

The columns of the table show the following properties for each allocation.

- The location of the allocation (slot, subframe, bandwidth part number).
- The ID of the allocation (channel type).
- Number of resource blocks used by the allocation.
- The relative power of the allocation in dB.
- The modulation of the allocation.
- The power of each resource element in the allocation in dBm.
- The EVM of the allocation.

The unit depends on the [EVM unit](#)

Select "TableConfig" to open a dialog box that allows you to add and remove columns.

Remote command:

Selection: `LAY:ADD ? '1',LEFT,ASUM`

Query: `TRACe:DATA?`

Bitstream

The "Bitstream" shows the demodulated data stream for the data allocations.

Each row in the table corresponds to an allocation (PUSCH or PUCCH). A set of several allocations make up a slot.

At the end of the table is a summary of the bitstream for certain configurations.

- Total number of bits or symbols
- Total number of coded bits
- Total number of bit errors
- Bit error rate (BER) in percent
- Bits per second (= coded bits - bit errors)

The totals are calculated over all PUSCH allocations that contribute to the bitstream. If the crc fails for one of the allocations, the FSW returns NAN for the total numbers.

The bitstream summary is displayed under the following conditions.

- Select an ORAN test case.
The PUSCH [reference data](#) must be "ORAN PN23".

- Outside of ORAN test cases:
Select **demodulation data** = "Decoded Payload Data".

Depending on the **bitstream format**, the numbers represent either bits (bit order) or symbols (symbol order).

- For the bit format, each number represents one raw bit.
- For the symbol format, the bits that belong to one symbol are shown as hexadecimal numbers with two digits.
(1024QAM: hexadecimal number with three digits)

Resource elements that do not contain data or are not part of the transmission are represented by a "-".

BWP/Sf/Slot	Allocation ID	Code-word	Modulation	# Symb	Bitstream
0 / 0 / 0	PUSCH 0	1/1	QPSK	44226	00 00 00 00 00 00 00 00
0 / 0 / 1	PUSCH 0	1/1	QPSK	44226	00 00 00 00 00 00 00 00
0 / 1 / 2	PUSCH 0	1/1	QPSK	44226	00 00 00 00 00 00 00 00
0 / 1 / 3	PUSCH 0	1/1	QPSK	44226	00 00 00 00 00 00 00 00

The table contains the following information:

- **BWP / Sf / Slot**
Number of the bandwidth part, subframe and slot the bits belong to.
- **Allocation ID**
Channel the bits belong to.
This is the PUSCH allocation.
- **Codeword**
Code word of the allocation.
- **Modulation**
Modulation type of the channels.
- **# Symbols / # Bits**
Number of symbols in the allocation.
- **Bit Stream**
The actual bit stream.

The table only shows the first few bits for each slot. If you want to see the complete bitstream, you have to select a certain bandwidth part, subframe and slot from the **evaluation range**. When you have done that, you can select "Extended" bitstream from the header row.

# Symbols	Bitstream [Extended] [Compact]
3756	00 00 00 00 00 00 00 00 00 00 00 00 00 00 00 00 ...

Symbol Index	Bitstream [Extended] Compact
0	00 00 00 00 00 00 00 00 00 00 00 00 00 00 00 00
16	00 00 00 00 00 00 00 00 00 00 00 00 00 00 00 00
32	00 00 00 00 00 00 00 00 00 00 00 00 00 00 00 00
48	00 00 00 00 00 00 00 00 00 00 00 00 00 00 00 00
64	00 00 00 00 00 00 00 00 00 00 00 00 00 00 03 00
80	00 00 00 00 00 00 00 00 00 00 00 00 00 00 00 00
96	00 00 00 00 00 00 00 00 00 00 00 00 00 00 00 00

Figure 3-2: Compact vs extended bitstream (symbol format for coded data)

In the extended display, the "# Symbols" / "# Bits" column turns into the "Bit Index" or "Symbol Index" column, which indicates the position of the table row's first bit or symbol within the complete stream.

If you decode the payload data, the FSW shows the number of coded bits (# symbols * Number of bits per symbol) and the number of bit errors at the end of the bitstream. The number of info bits transmitted by the PDCCH is displayed in a dedicated column ("# Bits").

Remote command:

Selection: `LAY:ADD ? '1',LEFT,BSTR`

Query: `TRACe:DATA?`

EVM vs Symbol x Carrier

The "EVM vs Symbol x Carrier" result display shows the EVM for each carrier in each symbol.

The x-axis represents the symbols. The y-axis represents the subcarriers. Different colors in the diagram area represent the EVM. A color map in the diagram header indicates the corresponding power levels.

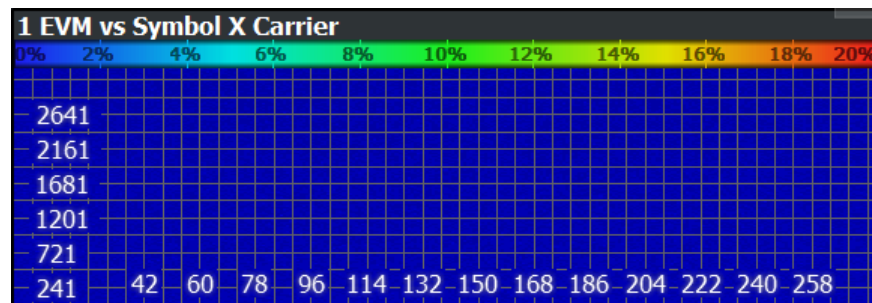

Remote command:

Selection: `LAY:ADD ? '1',LEFT,EVSC`

Query: `TRACe:DATA?`

Power vs Symbol x Carrier

The "Power vs Symbol x Carrier" result display shows the power for each carrier in each symbol.

The x-axis represents the symbols. The y-axis represents the subcarriers. Different colors in the diagram area represent the power. A color map in the diagram header indicates the corresponding power levels.

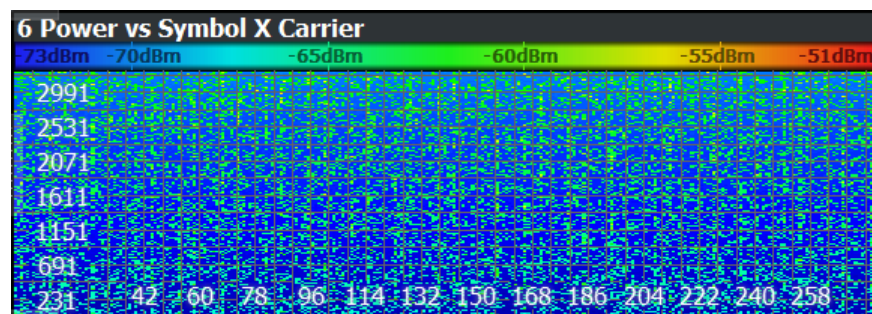

Remote command:

Selection: `LAY:ADD ? '1',LEFT,PVSC`

Query: `TRACe:DATA?`

Allocation ID vs Symbol x Carrier

The "Allocation ID vs Symbol x Carrier" result display is a graphical representation of the structure of the analyzed frame. It shows the allocation type of each subcarrier in each symbol of the received signal.

The x-axis represents the OFDM symbols. The y-axis represents the subcarriers.

Each type of allocation is represented by a different color. The legend above the diagram indicates the colors used for each allocation. You can also use a marker to get more information about the type of allocation.

The color mapping is as follows.

- : PUSCH allocations
- : PUCCH allocations
- : DMRS allocations (PUCCH, PUSCH)
- : PTRS allocations
- : SRS allocations

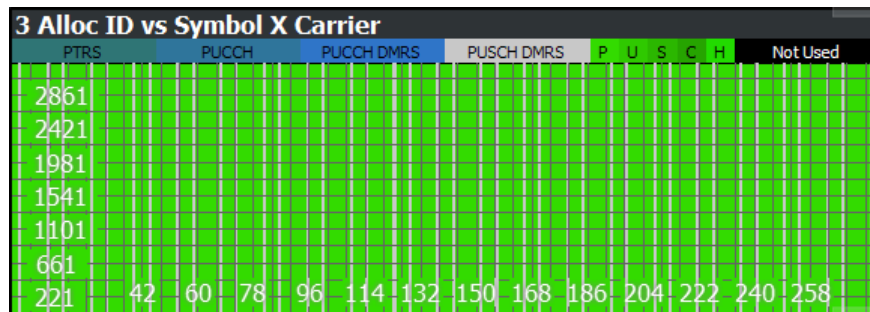

Remote command:

Selection: `LAY:ADD ? '1', LEFT, AISC`

Query: `TRACe:DATA?`

Marker Table

Displays a table with the current marker values for the active markers.

This table is displayed automatically if configured accordingly.

Wnd	Shows the window the marker is in.
Type	Shows the marker type and number ("M" for a normal marker, "D" for a delta marker).
Trc	Shows the trace that the marker is positioned on.
Ref	Shows the reference marker that a delta marker refers to.
X- / Y-Value	Shows the marker coordinates (usually frequency and level).
Z-EVM	Shows the "EVM", power and allocation type at the marker position. Only in 3D result displays (for example "EVM vs Symbol x Carrier").
Z-Power	
Z-Alloc ID	

Tip: To navigate within long marker tables, simply scroll through the entries with your finger on the touchscreen.

Remote command:

LAY:ADD? '1',RIGH, MTAB, see LAYout:ADD[:WINDow]? on page 199

Results:

CALCulate<n>:MARKer<m>:X on page 238

CALCulate<n>:MARKer<m>:Y on page 239

CALCulate<n>:MARKer<m>:Z? on page 239

CALCulate<n>:MARKer<m>:Z:ALL? on page 240

3.7 PRACH analysis

Access: [MEAS] > "PRACH Analysis"

You can select the result displays from the evaluation bar and arrange them as you like with the SmartGrid functionality.

Remote command:

Measurement selection: CONFigure[:NR5G]:MEASurement on page 277

Result display selection: LAYout:ADD[:WINDow]? on page 199

The following result displays carry the same information as those available for I/Q measurements, but for the preambles:

- [Capture buffer](#)
- [Power spectrum](#)
- [Constellation diagram](#)
- [Marker table](#)

The contents of the numerical [result summary](#) are similar (fewer result are available for PRACH analysis). For a comprehensive description, see .

Spectrum Flatness

The "Spectrum Flatness" result shows the relative power offset caused by the transmit channel for each subcarrier.

The contents of the result display depend on the [evaluation range](#).

- If you analyze all preambles, the diagram contains three traces. The traces show the following information.
 - The average subcarrier flatness over all preambles in the selected signal part.
 - The lowest subcarrier flatness over all preambles in the selected signal part.
 - The highest subcarrier flatness over all preambles in the selected signal part.
- If you analyze only a single preamble, the diagram contains one trace. That trace shows the subcarrier flatness for that preamble only. Average, minimum and maximum values in that case are the same.

The x-axis represents the frequency. On the y-axis, the channel flatness is plotted in dB.

Remote command:

Selecting the result display: LAY:ADD ? '1',LEFT,FVCA

Querying results:

TRACe:DATA?

TRACe<n> [:DATA] :X? on page 276

PRACH Allocation Summary

The "Allocation Summary" shows various parameters of the measured allocations in a table.

Each row in the allocation table corresponds to a preamble. A set of several preambles make up the PRACH. The last row summarizes the characteristics of all preambles in the PRACH ("TOTAL ALL").

The columns of the table show the following properties for each allocation.

- An index number of the preamble.
- The allocation ID (always "PRACH").
- Number of resource blocks used by the preamble, expressed as number of resource blocks for PUSCH.
- The relative power of the preamble in dB.
- The modulation of the preamble (always "CAZAC").
- The power of the preamble in dBm.
- The EVM of the preamble.

The unit depends on the [EVM unit](#)

Select "TableConfig" to open a dialog box that allows you to add and remove columns.

Remote command:

Selection: `LAY:ADD ? '1',LEFT,ASUM`

Query: `TRACe:DATA?`

3.8 Frequency sweep measurements

Access (ACLR): [MEAS] > "Channel Power ACLR"

Access (SEM): [MEAS] > "Spectrum Emission Mask"

The 5G NR application supports the following frequency sweep measurements.

- Adjacent channel leakage ratio (ACLR)
- Spectrum emission mask (SEM)

Instead of using I/Q data, the frequency sweep measurements sweep the spectrum every time you run a new measurement. Therefore, it is mandatory to feed a signal into the RF input for these measurements. Using previously acquired I/Q data for the frequency sweep measurements is not possible (and vice-versa).

Because each of the frequency sweep measurements uses different settings to obtain signal data it is also not possible to run a frequency sweep measurement and view the results in another frequency sweep measurement.

Make sure to have sufficient bandwidth to be able to capture the whole signal, including neighboring channels.

Features of the frequency sweep measurements:

- SEM measurements use the FFT sweep type by default. For more information, see the FSW user manual.

In addition to the specific diagrams and table (see description below), frequency sweep measurements support the following result displays.

- "Marker Table" on page 44
- Marker peak list
Both result displays have the same contents as the spectrum application.

Remote command:

Measurement selection: `CONFigure[:NR5G]:MEASurement` on page 277

Result display selection: `LAYout:ADD[:WINDow]?` on page 199

Adjacent Channel Leakage Ratio (ACLR).....	47
L Result diagram.....	47
L Result summary.....	48
Spectrum Emission Mask (SEM).....	48
L Result diagram.....	48
L Result summary.....	49
Marker Peak List.....	49

Adjacent Channel Leakage Ratio (ACLR)

The adjacent channel leakage ratio (ACLR) measurement is designed to analyze signals that contain multiple signals for different radio standards. Using the ACLR measurement, you can determine the power of the transmit (Tx) channel and the power of the neighboring (adjacent) channels to the left and right of the Tx channel. Thus, the ACLR measurement provides information about the power in the adjacent channels as well as the leakage into these adjacent channels.

When you measure the ACLR in the 5G NR application, the FSW automatically selects appropriate ACLR settings based on the selected channel bandwidth.

For a comprehensive description of the ACLR measurement, refer to the user manual of the FSW.

Remote command:

Selection: `CONFigure[:NR5G]:MEASurement` on page 277

Result diagram ← Adjacent Channel Leakage Ratio (ACLR)

The result diagram is a graphic representation of the signals with a trace that shows the measured signal. Individual channels (Tx and adjacent channels) are indicated by vertical lines and corresponding labels.

In addition, the FSW highlights the channels (blue: Tx channel, green: adjacent channels).

The x-axis represents the frequency with a frequency span that relates to the specified 5G NR channel and adjacent channel bandwidths. On the y-axis, the power is plotted in dBm.

The power for the Tx channel is an absolute value in dBm. The power of the adjacent channels is relative to the power of the Tx channel.

In addition, the FSW tests the ACLR measurement results against the limits defined by 3GPP.

Remote command:

Result query: `TRACe:DATA?`

Result summary ← Adjacent Channel Leakage Ratio (ACLR)

The result summary shows the signal characteristics in numerical form. Each row in the table corresponds to a certain channel type (Tx, adjacent channel). The columns contain the channel characteristics.

- **Channel**
Shows the channel type (Tx, adjacent or alternate channel).
- **Bandwidth**
Shows the channel bandwidth.
- **Offset**
Shows the channel spacing.
- **Power**
Shows the power of the Tx channel.
- **Lower / Upper**
Shows the relative power of the lower and upper adjacent and alternate channels. The values turn red if the power violates the limits. Depending on the [evaluation logic](#), the FSW shows either the absolute power in dBm, the relative power in dBc or both power values. The overall limit check passes or fails depending on your selected evaluation logic. The end result of the limit check is displayed in the table header.

Remote command:

Result query: `CALCulate<n>:MARKer<m>:FUNction:POWer<sb>:RESult[:CURRent]?`

Result query details: `CALCulate<n>:MARKer<m>:FUNction:POWer<sb>:RESult:DEtails` on page 273

Limit check: `CALCulate<n>:LIMit:FAIL?` on page 258

Limit check absolute: `CALCulate<n>:LIMit:ACPower:ACHannel:RESult:ABSolute` on page 253

Limit check relative: `CALCulate<n>:LIMit:ACPower:ACHannel:RESult:RELative` on page 253

Spectrum Emission Mask (SEM)

The "Spectrum Emission Mask" (SEM) measurement shows the quality of the measured signal by comparing the power values in the frequency range near the carrier against a spectral mask that is defined by the 3GPP specifications. In this way, you can test the performance of the DUT and identify the emissions and their distance to the limit.

For a comprehensive description of the SEM measurement, refer to the user manual of the FSW.

Remote command:

Selection: `CONFigure[:NR5G]:MEASurement` on page 277

Result diagram ← Spectrum Emission Mask (SEM)

The result diagram is a graphic representation of the signal with a trace that shows the measured signal. The SEM is represented by a red line.

If any measured power levels are above that limit line, the test fails. If all power levels are inside the specified limits, the test passes. The application labels the limit line to indicate whether the limit check has passed or failed.

The x-axis represents the frequency with a frequency span that relates to the specified 5G NR channel bandwidths. The y-axis shows the signal power in dBm.

Remote command:

Result query: [TRACe:DATA?](#)

Result summary ← Spectrum Emission Mask (SEM)

The result summary shows the signal characteristics in numerical form. Each row in the table corresponds to a certain SEM range. The columns contain the range characteristics. If a limit fails, the range characteristics turn red.

- **Start / Stop Freq Rel**
Shows the start and stop frequency of each section of the spectrum emission mask relative to the center frequency.
- **RBW**
Shows the resolution bandwidth of each section of the spectrum emission mask.
- **Freq at Δ to Limit**
Shows the absolute frequency whose power measurement being closest to the limit line for the corresponding frequency segment.
- **Power Abs**
Shows the absolute measured power of the frequency whose power is closest to the limit. The application evaluates this value for each frequency segment.
- **Power Rel**
Shows the distance from the measured power to the limit line at the frequency whose power is closest to the limit. The application evaluates this value for each frequency segment.
- **Δ to Limit**
Shows the minimal distance of the tolerance limit to the SEM trace for the corresponding frequency segment. Negative distances indicate that the trace is below the tolerance limit, positive distances indicate that the trace is above the tolerance limit.

Marker Peak List

The marker peak list determines the frequencies and levels of peaks in the spectrum or time domain. How many peaks are displayed can be defined, as well as the sort order. In addition, the detected peaks can be indicated in the diagram. The peak list can also be exported to a file for analysis in an external application.

2 Marker Peak List		
No	Stimulus	Response
1	64.400000 MHz	-30.352 dBm
2	128.400000 MHz	-51.896 dBm
3	192.300000 MHz	-40.227 dBm
4	257.200000 MHz	-60.699 dBm
5	320.200000 MHz	-44.273 dBm
6	384.100000 MHz	-53.494 dBm
7	448.100000 MHz	-47.460 dBm
8	513.000000 MHz	-55.603 dBm

Tip: To navigate within long marker peak lists, simply scroll through the entries with your finger on the touchscreen.

Remote command:

LAY:ADD? '1',RIGHT, PEAK, see [LAYout:ADD\[:WINDow\]?](#) on page 199

Results:

[CALCulate<n>:MARKer<m>:X](#) on page 238

[CALCulate<n>:MARKer<m>:Y](#) on page 239

3.9 Combined measurements

Access (ACLR): [MEAS] > "Channel Power ACLR"

For an introduction on combined measurements and their application, see [Chapter 4.5, "Combined measurement guide"](#), on page 146.

The measurements (EVM, ACLR and SEM) themselves are the same as in their respective mode. The combined mode supports all result displays that are available for the corresponding measurements (diagrams, tables etc.).

Note that combined measurements are not available for FR2-2 frequency deployment.

For a comprehensive description of the measurements and their result displays, refer to:

- [EVM measurements](#)
- [ACLR measurements](#) (single carrier measurements)
- [SEM measurements](#) (single carrier measurements)

Using the combined EVM / ACLR / SEM results table

Combined measurements show the results of the measurement sequence in a big numerical result summary. This result summary contains a list of all single measurements ([events](#)) in the measurement sequence.

Each line in the result summary corresponds to an event (aka "Meas ID"). Each column shows a certain aspect about the events. By default, the table contains the results of all measurements.

You have several options to work with the table.

1. Filter the results by certain aspects.
2. Add columns (= other results) to the tables.
3. Select a line to view the results for the captured I/Q data of the corresponding event.
When you select a single event, you can view the usual result displays (tables and diagrams) available for the EVM, ACLR and SEM measurements. By default, the FSW only shows the result summaries, but you can add other result displays as well.
4. Select another line to compare the results of different events.
5. Apply different settings to the captured data.
You can apply different settings to all events or the selected event only.
All events: "Sweep" > "Refresh"
Selected event: "Sweep" > "Refresh Current"

The result summary displays a yellow star for all events whose settings deviate from the current setting - if you select a measurement, change the signal configuration, all other measurements get a yellow star.

Yellow stars disappear if you also apply the current signal configuration to other events. To do so, select an event and apply the current configuration.

You can restore the initial settings with "Restore Settings" available in the "Meas Config" softkey menu.

In addition to the results available for EVM, ACLR and SEM measurements, the combined measurements result summary contains the following events aspects.

Meas ID

Shows an index number that identifies each measurement in the measurement sequence.

Remote command:

[TRACe:DATA?](#)

CC

Shows the number of the component carrier that the corresponding measurement refers to.

Available for multi-carrier measurements.

Remote command:

via the suffix at the `CC<cc>` keyword

Time Stamp

Shows the beginning time of the I/Q data capture for the corresponding measurement (= time when the event has occurred).

The time stamp is a value relative to the first event. The first event has a time stamp = 0 seconds.

Remote command:

[FETCh\[:CC<cc>\]\[:ISRC<ant>\]\[:FRAME<fr>\]:SUMMARY:TSTamp?](#) on page 237
[TRACe:DATA?](#)

Time Stamp Delta

Shows the time that has passed between events.

The delta is therefore the difference between the time stamp of two consecutive measurements.

Remote command:

[FETCh\[:CC<cc>\]\[:ISRC<ant>\]\[:FRAME<fr>\]:SUMMARY:TSDelta?](#)
on page 236

Center Frequency

Shows the center frequency of the component carrier.

Available for combined multi-carrier measurements.

Remote command:

`FETCh[:CC<cc>][:ISRC<ant>][:FRAMe<fr>]:SUMMary:CFRequency?`
on page 233

Frequency Offset

Shows the frequency offset of the component carrier relative to the center frequency of the first component carrier.

Available for combined multi-carrier measurements.

Remote command:

`FETCh[:CC<cc>][:ISRC<ant>][:FRAMe<fr>]:SUMMary:FOFFset?`
on page 231

EVM All CCs

Shows the average EVM of all resource elements over all CCs in the corresponding measurement of the measurement sequence.

Available for combined multi-carrier measurements.

Remote command:

`FETCh[:CC<cc>][:ISRC<ant>][:FRAMe<fr>]:SUMMary:EAACcs?` on page 233

Power All CCs

Shows the total power over all CCs in the corresponding measurement of the measurement sequence.

Available for combined multi-carrier measurements.

Remote command:

`FETCh[:CC<cc>][:ISRC<ant>][:FRAMe<fr>]:SUMMary:PACCs?` on page 235

Sync State

Shows the synchronization state for the corresponding measurement.

Remote command:

`FETCh[:CC<cc>][:ISRC<ant>][:FRAMe<fr>]:SUMMary:SState?` on page 236
`TRACe:DATA?`

ACLR Pass / Fail

Shows the limit check results for the ACLR of the corresponding measurement.

You can check the ACLR against the [absolute or relative limits](#) defined by 3GPP. The result summary shows the limit check results that you have selected.

"ACLR Pass / Fail" Shows the overall limit check result.

"ACLR Abs Pass / Fail" Shows the absolute limit check result.

"ACLR Rel Pass / Fail" Shows the relative limit check result.

Remote command:

ACLR absolute or relative: [FETCh\[:CC<cc>\]\[:ISRC<ant>\]\[:FRAMe<fr>\]:SUMMary:APFail?](#) on page 232

ACLR absolute: [FETCh\[:CC<cc>\]\[:ISRC<ant>\]\[:FRAMe<fr>\]:SUMMary:AAPFail?](#) on page 231

ACLR relative: [FETCh\[:CC<cc>\]\[:ISRC<ant>\]\[:FRAMe<fr>\]:SUMMary:ARPFail?](#) on page 232

Trace data: [TRACe:DATA?](#)

SEM Pass / Fail

Shows the overall limit check result for the SEM of the corresponding measurement.

For multi-carrier measurements, the application does not evaluate the SEM.

Remote command:

SEM: [FETCh\[:CC<cc>\]\[:ISRC<ant>\]\[:FRAMe<fr>\]:SUMMary:SPFail?](#) on page 235

Trace data: [TRACe:DATA?](#)

OVL D

Shows a message if an overload status was detected (RF overload, RF input overload, IF overload).

For details about the overload states and what to do about them, see the FSW user manual.

Remote command:

[FETCh\[:CC<cc>\]\[:ISRC<ant>\]\[:FRAMe<fr>\]:SUMMary:OVL D?](#) on page 234

[TRACe:DATA?](#)

3.10 Reference: custom limits

The FSW checks various results against the limits defined by 3GPP. For some of those limits, you can define custom limits.

I/Q measurement [result summary](#)

- EVM PDSCH QPSK / 16QAM / 64QAM / 256QAM
- EVM PUSCH PI/2 BPSK / QPSK / 16QAM / 64QAM
- EVM PUSCH DMRS PI/2 BPSK / QPSK / 16QAM / 64QAM
- EVM PUCCH

Limit values are stored in an xml file that combines the limits for downlink and uplink. The file name must be `Default.nr5G_limits` and is located in the following directory:

```
C:\R_S\instr\user\NR5G\
```

The FSW automatically applies the custom limits after you have copied the file and restarted the FSW

The structure of the file is as follows. You can omit any xml elements you do not want to define, either by making no entry or by deleting the corresponding element.

```

<Limits>
<DL>
  <EVM>
    <PDSCHQPSK Mean="0.185"></PDSCHQPSK>
    <!--Unit: linear (1 = 0 dB, 0.1 = -20 dB)-->
    <PDSCH16QAM Mean="0.135"></PDSCH16QAM>
    <!--Unit: linear (1 = 0 dB, 0.1 = -20 dB)-->
    <PDSCH64QAM Mean="0.09"></PDSCH64QAM>
    <!--Unit: linear (1 = 0 dB, 0.1 = -20 dB)-->
    <PDSCH256QAM Mean="0.045"></PDSCH256QAM>
    <!--Unit: linear (1 = 0 dB, 0.1 = -20 dB)-->
  </EVM>
  <TimeAlignmentError Limit="90"></TimeAlignmentError>
  <!--Unit [ns]-->
  <OffPowSpectralDensity Limit="-82.5"></OffPowSpectralDensity>
  <!--Unit: [dBm/MHz]-->
</DL>
<UL>
  <EVM>
    <PUSCHPI_2BPSK Max="0.3"></PUSCHPI_2BPSK>
    <!--Unit: linear (1 = 0 dB, 0.1 = -20 dB)-->
    <PUSCHQPSK Max="0.175"></PUSCHQPSK>
    <!--Unit: linear (1 = 0 dB, 0.1 = -20 dB)-->
    <PUSCH16QAM Max="0.125"></PUSCH16QAM>
    <!--Unit: linear (1 = 0 dB, 0.1 = -20 dB)-->
    <PUSCH64QAM Max="0.08"></PUSCH64QAM>
    <!--Unit: linear (1 = 0 dB, 0.1 = -20 dB)-->
    <DMRSPUSCHPI_2BPSK Mean="0.3"></DMRSPUSCHPI_2BPSK>
    <!--Unit: linear (1 = 0 dB, 0.1 = -20 dB)-->
    <DMRSPUSCHQPSK Mean="0.175"></DMRSPUSCHQPSK>
    <!--Unit: linear (1 = 0 dB, 0.1 = -20 dB)-->
    <DMRSPUSCH16QAM Mean="0.125"></DMRSPUSCH16QAM>
    <!--Unit: linear (1 = 0 dB, 0.1 = -20 dB)-->
    <DMRSPUSCH64QAM Mean="0.08"></DMRSPUSCH64QAM>
    <!--Unit: linear (1 = 0 dB, 0.1 = -20 dB)-->
    <PUCCH Max="0.175"></PUCCH>
    <!--Unit: linear (1 = 0 dB, 0.1 = -20 dB)-->
  </EVM>
</UL>
</Limits>

```

4 Configuration

3GPP 5G NR measurements require a special application on the FSW, which you activate using the [MODE] key on the front panel.

When you start the 5G NR application, the FSW starts to measure the input signal with the default configuration or the configuration of the last measurement (when you have not performed a preset since then). After you have started an instance of the 5G NR application, the application displays the "Meas Config" menu which contains functions to define the characteristics of the signal you are measuring.



Unavailable hardkeys

Note that the [SPAN], [BW], [TRACE], [LINES] and [MKR FUNC] keys have no contents and no function in the 5G NR application.

• I/Q measurement.....	55
• PRACH analysis.....	134
• Frequency sweep measurement configuration.....	137
• Combined measurement configuration.....	140
• Combined measurement guide.....	146
• Time trigger measurement guide.....	157
• Microservice export.....	158
• O-RAN measurement guide.....	159
• Reference: structure of .allocation files.....	160
• Basics on input from I/Q data files.....	167

4.1 I/Q measurement

• Configuration overview.....	56
• Automatic measurement configuration.....	58
• Physical signal description.....	60
• Test scenarios.....	62
• Component carrier configuration.....	63
• Radio frame configuration.....	68
• Bandwidth part configuration.....	72
• Slot configuration.....	76
• PUSCH and PUCCH configuration.....	84
• Antenna port configuration.....	100
• Advanced settings.....	102
• Generator control.....	107
• Input source configuration.....	110
• Frequency configuration.....	116
• Amplitude configuration.....	117
• Data capture.....	121
• Trigger configuration.....	124
• Segmented capture.....	126

- [Data capture optimization](#)..... 127
- [Tracking](#)..... 128
- [Demodulation](#)..... 131

4.1.1 Configuration overview

Throughout the measurement channel configuration, an overview of the most important currently defined settings is provided in the "Overview". The "Overview" is displayed when you select the "Overview" menu item from the "Meas Setup" menu.

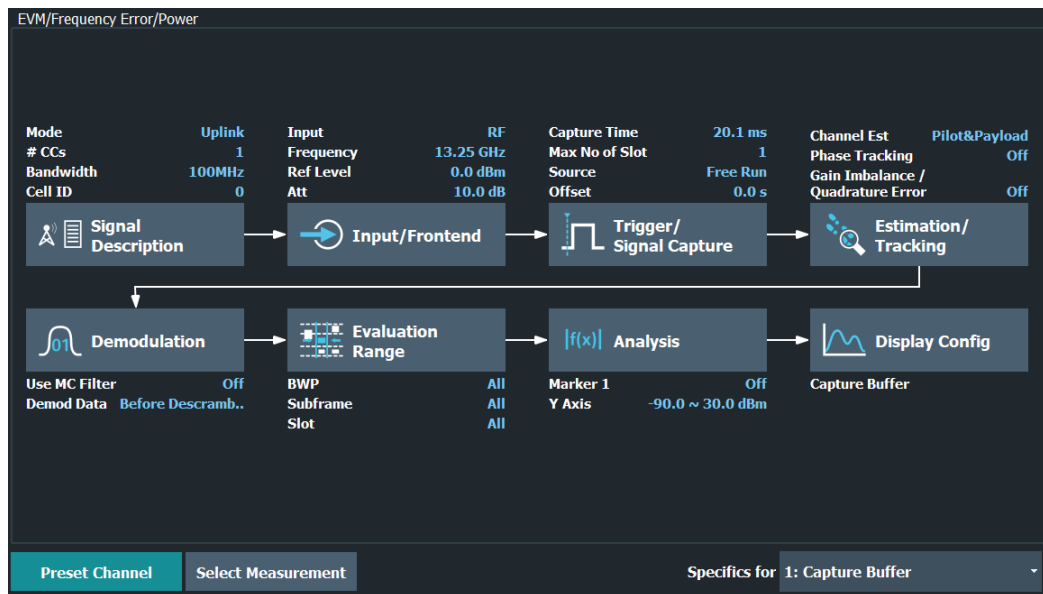

In addition to the main measurement settings, the "Overview" provides quick access to the main settings dialog boxes. The individual configuration steps are displayed in the order of the data flow. Thus, you can easily configure an entire measurement channel from input over processing to output and analysis by stepping through the dialog boxes as indicated in the "Overview".

In particular, the "Overview" provides quick access to the following configuration dialog boxes (listed in the recommended order of processing):

1. Signal Description
See [Chapter 4.1.3, "Physical signal description"](#), on page 60.
2. Input / Frontend
See [Chapter 4.1.13, "Input source configuration"](#), on page 110.
3. Trigger / Signal Capture
See [Chapter 4.1.17, "Trigger configuration"](#), on page 124.
See [Chapter 4.1.16, "Data capture"](#), on page 121.
4. Tracking
See [Chapter 4.1.20, "Tracking"](#), on page 128.
5. Demodulation

See [Chapter 4.1.21, "Demodulation"](#), on page 131.

6. Analysis
See [Chapter 5, "Analysis"](#), on page 170.
7. Display Configuration
See [Chapter 3, "Measurements and result displays"](#), on page 19

In addition, the dialog box provides the "Select Measurement" button that serves as a shortcut to select the measurement type.

Configuring the measurement

- ▶ Select any button in the "Overview" to open the corresponding dialog box.
Select a setting in the channel bar (at the top of the measurement channel tab) to change a specific setting.

Preset Channel	57
Select Measurement	57
Specific Settings for	57

Preset Channel

Select "Preset Channel" in the lower left-hand corner of the "Overview" to restore all measurement settings *in the current channel* to their default values.

Note: Do not confuse "Preset Channel" with the [Preset] key, which restores the entire instrument to its default values and thus closes *all channels* on the FSW (except for the default channel)!

Remote command:

`SYSTem:PRESet:CHANnel[:EXEC]` on page 280

Select Measurement

Opens a dialog box to select the type of measurement.

For more information about selecting measurements, see [Chapter 3.1, "Selecting measurements"](#), on page 19.

Remote command:

`CONFigure[:NR5G]:MEASurement` on page 277

Specific Settings for

The channel can contain several windows for different results. Thus, the settings indicated in the "Overview" and configured in the dialog boxes vary depending on the selected window.

Select an active window from the "Specific Settings for" selection list that is displayed in the "Overview" and in all window-specific configuration dialog boxes.

The "Overview" and dialog boxes are updated to indicate the settings for the selected window.

4.1.2 Automatic measurement configuration

The FSW provides various functions to automatically configure measurements based on the signal you are measuring and thus makes these measurements as easy as possible.

Automatic configuration functions are available in different dialog boxes and softkey menus.

Access: [AUTO SET]

Access (auto demodulation): "Overview" > "Signal Description" > "Signal Description"

Automatic measurement configuration

The automatic measurement configuration functions adjust various general measurement settings to achieve the optimal display of the measurement results.

Automatic signal demodulation

The automatic signal demodulation functions determine the characteristics of the signal you are measuring. Based on the signal characteristics, the FSW is then able to demodulate and analyze the signal.

Signal demodulation is available on several levels.

- Detection of all signal characteristics.
- Detection of the bandwidth part configuration, incl. antenna port configuration.

For an automatic signal demodulation, all frames must have the same configuration.

Auto Level	58
Auto EVM	58
Auto Scale	59
Automatic Signal Demodulation	59

Auto Level

You can use the auto leveling routine for a quick determination of preliminary amplitude settings for the current 5G NR input signal.

For additional information, see "[Auto Level](#)" on page 118.

Remote command:

[SENSe:]ADJust:LEVel on page 282

Auto EVM

Adjusts the amplitude settings to achieve the optimal EVM using the maximum dynamic range.

This routine measures the signal several times at various levels to achieve the best results.

If you measure several component carriers, this routine can take several minutes to finish (depending on the number of component carriers).

You can speed up the auto EVM routine by performing it across a certain number of slots only ("Auto EVM # Of Slots To Analyze").

Select "Auto Set" > "Auto Level Config" > "Meas Time Mode" = "Manual" to access this method.

If you are using this method, make sure to:

- Define an appropriate measurement time that corresponds to the number of selected slots. The minimum measurement time is 1 ms.
- Perform a triggered measurement to reliably capture at least one complete slot.

Remote command:

Run measurement: [\[SENSe:\]ADJust:EVM](#) on page 281

Slots used: [\[SENSe:\]ADJust:EVM:SLOTs](#) on page 282

Auto Scale

Scales the y-axis for best viewing results based on the results.

For more information about y-axis scaling, see ["Automatic scaling of the y-axis"](#) on page 172.

Remote command:

[DISPlay\[:WINDow<n>\]\[:SUBWindow<w>\]:TRACe<t>:Y\[:SCALe\]:AUTO](#)
on page 413

Automatic Signal Demodulation

Automatic signal demodulation determines the complete signal configuration.

Complete signal demodulation includes:

- Detection of the cell ID.
This is only possible when you turn on transform precoding.
When you turn off transform precoding, cell ID = 0 can be detected. If you are using a different cell ID, you have to enter the cell ID manually.
- Detection of the bandwidth part configuration.
- Detection of the slot configuration.
- Detection of the PUSCH and PUCCH configuration, including the enhanced settings.
- Detection of the antenna port configuration.
- Detection of transform precoding.

It is not possible to edit any properties that are automatically detected.

Instead of continuous automatic demodulation, you can demodulate the signal once for a single capture. This method is useful if you want to change individual parameters like the bandwidth part configuration later on without subsequent automatic demodulation. In addition, it increases the measurement speed, because automatic demodulation occurs only once.

To demodulate the signal once, select the corresponding button in the channel bar.

For a one-off demodulation, all properties remain available to edit.

When you turn on automatic signal detection, you only have to define the basic signal characteristics like the deployment frequency range, the channel bandwidth or the number of component carriers.

Note that auto demodulation is not available for FR2-2 frequency deployment.

Remote command:

[CONFigure\[:NR5G\]:UL\[:CC<cc>\]:FRAMe<fr>:BWPart<bwp>:DETection](#)
on page 282

4.1.3 Physical signal description

Access: "Overview" > "Signal Description" > "Signal Description"

The "Signal Description" dialog box contains general signal characteristics.

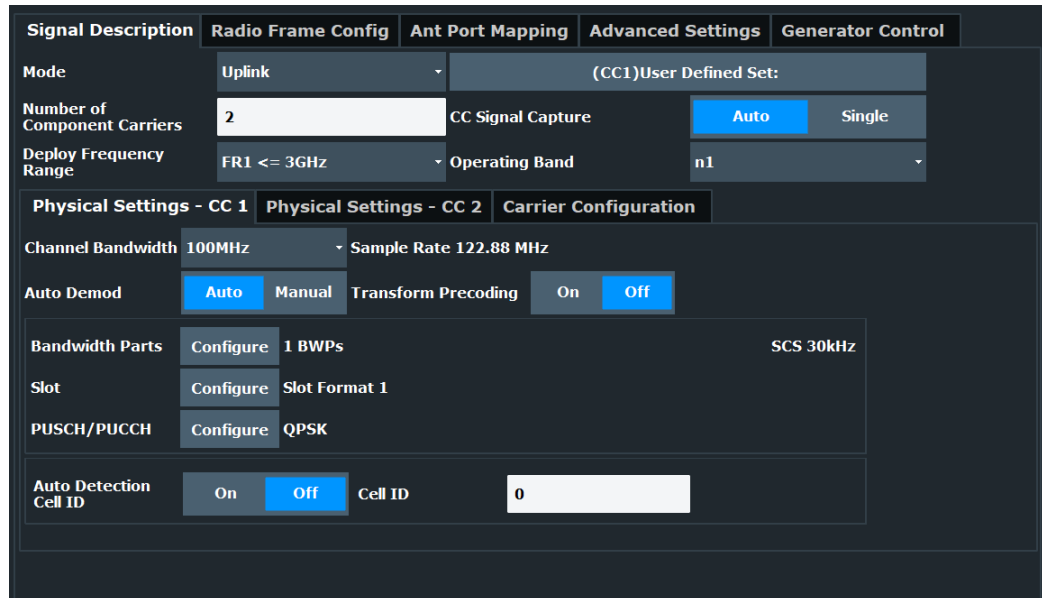

Configuring component carriers

When you are doing measurements on [aggregated carriers](#), you can configure each carrier separately.

When available, each carrier in the dialog boxes is represented by an additional tab labeled "CC<x>", with <x> indicating the number of the component carrier.

Note that the additional tabs are only added to the user interface after you have selected more than "1" component carrier.

The remote commands required to configure the physical signal characteristics are described in [Chapter 6.10.3, "Physical settings"](#), on page 283.

Functions in the "Physical Settings" dialog box described elsewhere:

- [Transform precoding](#)

The remote commands required to query measurement results are described in:

- [Chapter 6.9, "Retrieve trace data"](#), on page 258
- [Chapter 6.7, "Remote commands to retrieve numeric results"](#), on page 210

Selecting the 5G NR mode	60
Deployment Frequency Range	61
Operating Band	61
Physical settings of the signal	61

Selecting the 5G NR mode

The "Mode" selects the 5G NR link direction you are testing.

The choices you have depend on the set of options you have installed.

- Option FSW-K144 enables testing of 3GPP 5G NR signals on the downlink.
- Option FSW-K145 enables testing of 3GPP 5G NR signals on the uplink.

Downlink (DL) and Uplink (UL) describe the **transmission path**.

- Downlink is the transmission path from the base station to the user equipment.
- Uplink is the transmission path from the user equipment to the base station.

The application shows the currently selected 5G NR mode (including the bandwidth) in the channel bar.

Remote command:

Link direction: [CONFigure\[:NR5G\]:LDIRection](#) on page 283

Deployment Frequency Range

A 5G NR signal can be transmitted in several different frequency ranges ("FR").

3GPP release 17 extends the deployment frequency range (FR2-2).

- "FR1 <= 3 GHz": Deployment in frequency range 1 ≤ 3 GHz.
- "FR1 > 3 GHz": Deployment in frequency range 1 above 3 GHz.
- "FR2-1": Deployment in frequency range 2 (high frequencies up to 52.60 GHz).
- "FR2-2": Deployment in frequency range 2 (extra high frequencies up to 71 GHz).

The frequencies that FR1 and FR2 cover are defined by 3GPP.

The selected frequency range has an effect on the following settings.

- Different [channel bandwidths](#) are available in each frequency range.
- Different [subcarrier spacings](#) are available in each frequency range.

Remote command:

[CONFigure\[:NR5G\]:UL\[:CC<cc>\]:DFRange](#) on page 284

Operating Band

Selects the operating band that the carriers are in. The operating bands are defined in 3GPP 38.104: 5.2 "Operating Bands".

Depending on the operating band you select for the transmission, the FSW automatically adjusts the minimum requirements for channel spacing between component carriers, especially the [frequency offset to CC1](#).

If the center frequency of the carriers is not within the selected operating band, the FSW shows a corresponding message in the [carrier configuration](#) dialog box.

For a selected set of operating bands, you can select the [channel raster](#) within the component carrier.

3GPP release 16 unlocks additional operating bands.

3GPP release 17 unlocks additional operating bands.

Remote command:

[CONFigure\[:NR5G\]:OBAND](#) on page 283

Physical settings of the signal

Physical settings describe the basic structure of the signal you are measuring.

The "Channel Bandwidth" is variable with fixed values in the range from 5 MHz to 400 MHz. The numbers next to the dropdown box show the sample rate of the signal.

The sample rate depends on the selected channel bandwidth.

3GPP release 17 extends the channel bandwidths up to 2000 MHz in FR2 and adds additional bandwidths in FR1 (35 MHz and 45 MHz). 3GPP release 18 adds a new channel bandwidth (3 MHz).

The available channel bandwidths depend on the [frequency range](#) you have selected.

Selecting one of the "Configure" buttons opens the [radio frame configuration](#) tab where you can customize the radio frame structure according to your needs.

- "Bandwidth Parts": Configuration of [bandwidth parts](#) (BWP).
The numbers next to the button indicate the number of configured BWPs and their subcarrier spacings.
- "Slot Config": Configuration of individual [slots](#).
The numbers next to the button indicate the slot format used in the BWPs and if a CSI reference signal is present or not.
The slot format determines the usage of the OFDM symbols (UL, DL or flexible).
The slot formats are defined in 3GPP 38.211, table 4.3.2-3.
- "PUSCH / PUCCH Config": Configuration of the [data channel \(PUSCH\)](#) and the control channel (PUCCH)
The numbers next to the button indicate the modulation types used for the allocations in all slots and if a SMUX or phase-tracking reference signal (PT-RS) is present or not.

The physical layer cell ID is responsible for synchronization between network and user equipment. It identifies a specific radio cell in the 5G NR network. The cell ID is a value between 0 and 503.

For automatic detection of the cell ID, turn on the "Auto" function. However, auto detection only works if you turn on [transform precoding](#).

For FR2 [deployments](#), you can also select the power class. The power class (1 to 4) defines the limits for [inband emission](#) tests. The power class you should select depends on the user equipment.

Remote command:

Channel bandwidth: `CONFigure[:NR5G]:UL[:CC<cc>]:BW` on page 284

Auto cell ID: `CONFigure[:NR5G]:UL[:CC<cc>]:PLC:DETection` on page 285

Cell ID: `CONFigure[:NR5G]:UL[:CC<cc>]:PLC:CID` on page 285

Power class: `CONFigure[:NR5G]:UL[:CC<cc>]:PLC:PClass` on page 286

4.1.4 Test scenarios

Access: "Overview" > "Signal Description" > "Test Models"

Test scenarios are descriptions of specific 5G NR signals for standardized testing of DUTs. These test scenarios are stored in `.allocation` files. You can select, manage and create test scenarios in the "Test Models" dialog box.

ORAN test cases

In addition to the 3GPP test models, you can also use O-RAN test cases. O-RAN test cases are defined by the O-RAN alliance for standardized measurements.

The test cases comply with O-RAN specification O-RAN.WG4.CONF.0-v08.00.

The O-RAN test cases are based on the 3GPP test models (downlink) and fixed reference channels (uplink) and are customized for the O-RAN applications.

For more information about the test cases themselves, see the O-RAN specifications available on the O-RAN website.

For more information about using O-RAN test cases in measurements with the FSW, see [Chapter 4.8, "O-RAN measurement guide"](#), on page 159.

Remote command:

`MMEMoRY:LOAD:TMODEl[:CC<cc>]` on page 286

User defined test scenarios

User defined test scenarios are custom signal descriptions for standardized measurements that you can save and restore as you like. To create a custom test scenario, describe a signal as required and then save it with the corresponding button. The FSW stores custom scenarios in `.allocation` files.

If you do not need test scenarios any longer, you can also delete them.

For a description of the `.allocation` files, see [Chapter 4.9, "Reference: structure of .allocation files"](#), on page 160.

Remote command:

Save: `MMEMoRY:STORe<n>:DEModsetting[:CC<cc>]` on page 288

Restore: `MMEMoRY:LOAD:DEModsetting[:CC<cc>]` on page 287

Test scenarios for carrier aggregation

When you measure component carriers, you can describe each component carrier separately and save or restore the scenario for each carrier in the corresponding tab ("CC<x>"). Single carrier scenarios are stored in `.allocation` files.

For easier handling of multiple carriers, however, you can also store the descriptions of all carriers in a single file. To do so, configure all component carriers as required and save the test scenario in "All CCs" tab. Multiple carrier test scenarios are stored in `.ccallocation` files. The advantage of this method is, that you do not have to restore a scenario for each component carrier, but can do so in a single step.

The `.ccallocation` files contain the frequency information of the signal.

Remote command:

Save: `MMEMoRY:STORe<n>:DEModsetting:ALL` on page 287

Restore: `MMEMoRY:LOAD:DEModsetting:ALL` on page 287

4.1.5 Component carrier configuration

Access: "Overview" > "Signal Description"

Carrier aggregation has been introduced in the 5G NR standard to increase the bandwidth. In those systems, you can use several carriers to transmit a signal.

The 5G NR measurement application supports up to 16 component carriers for measurements on contiguous and non-contiguous intra-band carrier aggregation (the carriers are in the same frequency band).

Each carrier has one of the [channel bandwidths](#) defined by 3GPP. You can deploy the component carriers in different [frequency ranges](#).

The radio frame can be different for each component carrier. For more information about configuring 5G NR radio frames, see [Chapter 4.1.6, "Radio frame configuration"](#), on page 68.

Several measurements support contiguous and non-contiguous intra-band carrier aggregation (the carriers are in the same frequency band).

- I/Q Based Measurements (EVM, Frequency Error, etc.)
- Frequency sweep measurements (multi-carrier ACLR, cumulative ACLR and multi SEM)

The screenshot shows the 'Carrier Configuration' interface. It features a table for physical settings and a control panel for carrier configuration.

CC	Center Frequency	Frequency Offset	Bandwidth
1	850 MHz	0 Hz	100MHz
2	1 GHz	150 MHz	100MHz

Control Panel:

- Global MC Frequency: 850.0 MHz (Center)
- MC Setup: Frequency Offset rel. to: CC1
- Frequency Offset Mode: Arbitrary
- Carrier Spacing: 0 Hz
- Fixed CC Offset: On/Off

Diagram: Shows two trapezoidal carriers, CC1 and CC2, on a frequency axis. CC1 has a 100 MHz bandwidth. CC2 also has a 100 MHz bandwidth. There is a 30 MHz gap between them. The total span from the start of CC1 to the end of CC2 is 250 MHz.

The remote commands required to configure component carriers are described in [Chapter 6.10.4, "Component carrier configuration"](#), on page 288.

- Number of component carriers.....64
- Component carrier data capture..... 64
- Views.....65
- Basic component carrier configuration.....65
 - └ Frequency configuration..... 65
 - └ Bandwidth configuration.....66
 - └ Channel Raster.....66
- Nominal Channel Spacing.....67
- Additional tools for frequency configuration..... 67
 - └ Center frequency configuration.....68
 - └ Frequency offset configuration.....68

Number of component carriers

The supported "Number Of Component Carriers" you can measure is in the range from 1 to 16. When you select more than one component carrier, the FSW expands the "Signal Description" dialog box by several tabs.

One tab for each component carrier you can configure and one tab to define [general properties](#) of the component carrier configuration.

Remote command:

`CONFigure[:NR5G]:NOCC` on page 291

Component carrier data capture

Capturing signals with several component carriers can generate big amounts of data.

The 5G NR application thus provides different "CC Signal Capture" modes that allow you to capture even several component carriers with a large bandwidth.

- "Single": Each configured component carrier is captured consecutively by an individual data capture buffer.
- "Auto": The FSW determines how many component carriers it can capture in a single measurement.

If you select "Auto" mode, the FSW captures as many component carriers as it can in a single measurement and captures the rest in subsequent measurements. The maximum number of component carriers the FSW can analyze in a single capture depends on the available bandwidth.

With the optional 500 MHz bandwidth, for example, it can analyze up to 5 100 MHz carriers in a single capture.

When all required measurements are done, the FSW shows the results for all component carriers.

Remote command:

[CONFigure\[:NR5G\]:CSCapture](#) on page 290

Views

Results of component carrier measurements are shown for each component carrier separately. When you measure more than one carrier, each result display shows the information of up to two component carriers. For more than two component carriers, you can select which component carriers are displayed in the [two views](#).

Remote command:

[DISPlay\[:WINDOW<n>\]\[:SUBWindow<w>\]:CCNumber](#) on page 424

Basic component carrier configuration

Access: "Overview" > "Signal Description" > "Carrier Configuration"

The number of component carriers (CCs) you can select depends on the measurement.

- I/Q based measurements (EVM etc.): up to 16 CCs
- Frequency sweep measurements (ACLR etc.): up to 8 CCs

You can define the characteristics of the CCs in the carrier configuration table.

Depending on the "Number of Component Carriers", the application adjusts the size of the table. Each line corresponds to a component carrier.

The FSW shows a preview of the current carrier configuration in a diagram at the bottom of the dialog.

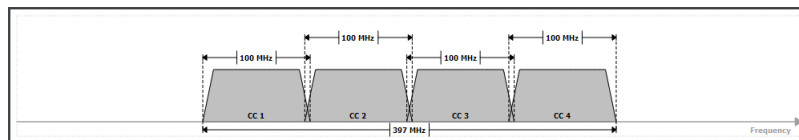

Frequency configuration ← Basic component carrier configuration

The location of each component carrier in the spectrum is defined by a center frequency. The frequencies of the carriers must be in an ascending order.

The FSW indicates if the location of the carriers is compatible to the selected [operating band](#).

- "Carrier within selected NR band"
- "Carrier outside of selected NR band"

The actual measurement frequency differs from the carrier frequencies: the application calculates that frequency based on the carrier frequencies. It is somewhere in between the carrier frequencies.

Note that the measurement frequency can change during a capture. If the signal bandwidth is larger than the available analysis bandwidth, the captured data consists of several captures with a smaller bandwidth, each with a different measurement frequency.

The FSW indicates the actual measurement frequency in the channel bar.

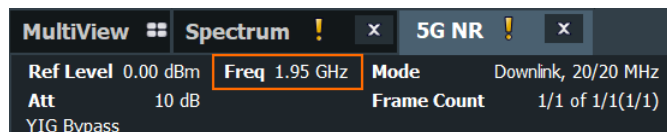

In addition to the carrier's center frequency, you have to define a frequency offset. By default, the frequency offset is an offset relative to the first component carrier and an arbitrary value.

- When you change the offset of a carrier in the table, the FSW adjusts its center frequency.
- When you change the frequency of one of the carriers in the table, the FSW adjusts the offset.

You can use [additional tools](#) to define the frequency characteristics of the component carriers.

Remote command:

Frequency: [\[SENSe:\] FREQuency:CENTer\[:CC<cc>\]](#) on page 376

Offset (ref. point = CC1): [\[SENSe:\] FREQuency:CENTer\[:CC<cc>\]:OFFSet](#) on page 377

Offset (ref. point = global MC freq.): [\[SENSe:\] FREQuency:CENTer\[:CC<cc>\]:MCOFFset](#) on page 292

Bandwidth configuration ← Basic component carrier configuration

For each carrier, select the "Bandwidth" from the corresponding dropdown menu.

The combination of bandwidths is arbitrary. If the total bandwidth of all component carriers is too large, the FSW displays a corresponding message.

The FSW also shows the "Occupied Bandwidth" of the aggregated carriers and the "Sample Rate" in a read-only field next to the carrier configuration.

Remote command:

[CONFigure\[:NR5G\]:UL\[:CC<cc>\]:BW](#) on page 284

Channel Raster ← Basic component carrier configuration

Access: "Overview" > "Signal Description" > "Carrier Configuration" > "Global"

Shows the distance between the RF reference frequencies in the selected [operating band](#). The distance between frequencies depends on the channel raster the operating band belongs to (channel raster are defined by 3GPP).

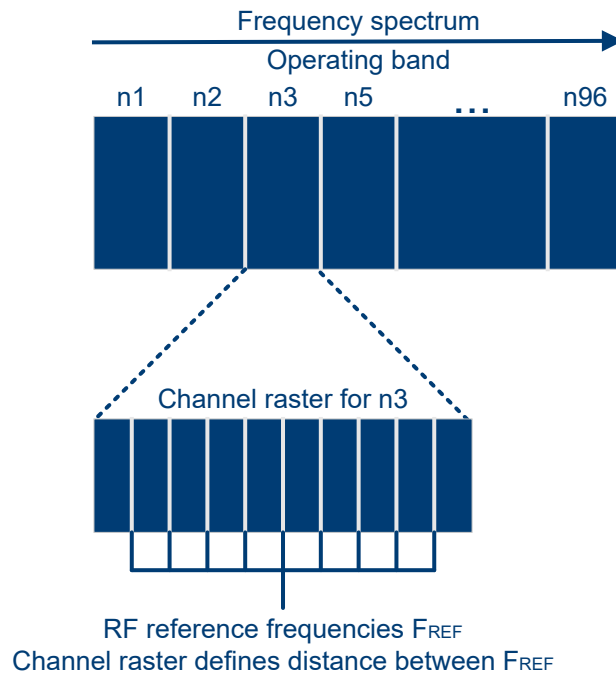

For most operating bands, the channel raster is a fix value of 15 kHz, 60 kHz or 100 kHz.

A few selected operating bands support multiple channel raster.

The channel raster is the basis for the calculation of the channel spacing (distance between component carriers) for intra-band contiguous carrier aggregation.

For details about the channel raster and its effects, see 3GPP 38.104, chapter 5.4.2.

Remote command:

[CONFigure\[:NR5G\]:CRASter](#) on page 289

Nominal Channel Spacing

Resets the channel spacing between component carriers to its default value according to the channel spacings defined by 3GPP.

This setting has an effect if you change the distance (frequency offset) between the component carriers, for example by changing the frequency of one of the carriers.

Remote command:

[CONFigure\[:NR5G\]:NCSPacing](#) on page 290

Additional tools for frequency configuration

Access: "Overview" > "Signal Description" > "Carrier Configuration" > "MC Setup"

You can either define the frequency characteristics of each component carrier separately in the [component carrier table](#), or use the following tools. These tools allow you to change the frequency characteristics of all component carriers at the same time according to a certain logic.

Note that regardless of the changes you make with these tools, the [carrier bandwidth](#) of each carrier remains the same.

Center frequency configuration ← Additional tools for frequency configuration

The global multicarrier frequency is a tool you can use to change the center frequency of all carriers at the same time.

Center frequencies of the component carriers remain the same, as long as you do not change the global MC frequency. When you change the global MC frequency, the center frequencies change and the frequency offset for each carrier remains the same.

You can also synchronize the global MC frequency to the center frequency of all carriers.

Remote command:

Define global MC frequency: [CONFigure\[:NR5G\]:GMCFreq](#) on page 290

Synchronize to center frequency: [CONFigure\[:NR5G\]:CENTer](#) on page 289

Frequency offset configuration ← Additional tools for frequency configuration

The frequency offset configuration tools allow you to change the frequency offset between carriers.

By default, the frequency offset of each component carrier is a frequency relative to the first component carrier (CC1). In that case, the offset of the first carrier is always 0 Hz.

Alternatively, you can set a frequency offset that is relative to the [global multicarrier frequency](#). In that case, the offset can take on negative values if a carrier is on a frequency below the global MC frequency.

For both methods, the offsets are arbitrary values - the spacing between carriers is not equidistant.

If you have a setup in which the distance between carriers is the same, you can use the equidistant frequency offset mode. In this mode, you can define a carrier spacing that is applied to all component carriers. Changing the component carrier's offset separately is no longer possible. Center frequencies of the component carriers are automatically adjusted depending on the carrier spacing you enter.

You can change this logic by turning on a fixed CC offset. When you do, the offset becomes a fixed value (but not necessarily equidistant). Changing the frequency of one carrier adjusts the frequencies of the other carriers. The offset remains the same.

Remote command:

Reference point: [CONFigure\[:NR5G\]:OREL](#) on page 292

Offset mode: [CONFigure\[:NR5G\]:OMODE](#) on page 291

Carrier spacing: [CONFigure\[:NR5G\]:CSPacing](#) on page 289

Fixed offset: [CONFigure\[:NR5G\]:FCOFFset](#) on page 290

4.1.6 Radio frame configuration

Access: "Overview" > "Signal Description" > "Radio Frame Config"

Basic frame structure

A radio frame in the 5G NR standard has a length of 10 ms (same as in LTE). It consists of 10 subframes, each with a length of 1 ms.

A subframe contains a variable number of [slots](#), depending on the [subcarrier spacing](#). A subframe can have different subcarrier spacings in different [bandwidth parts](#).

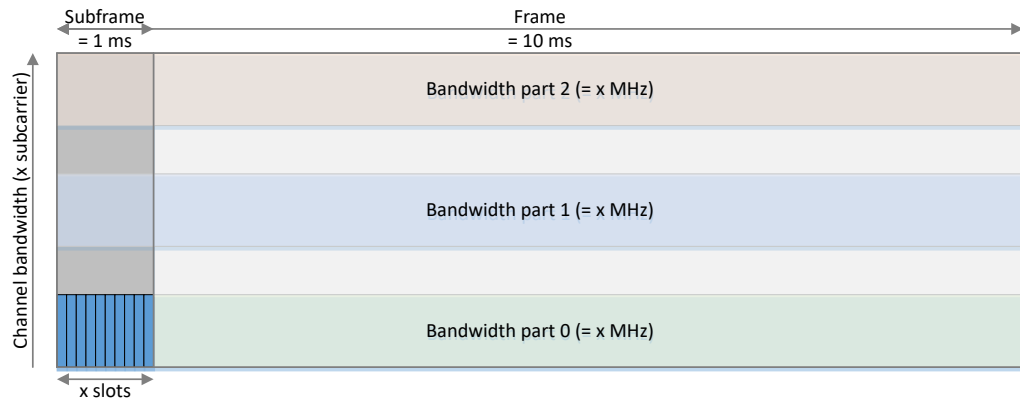

Figure 4-1: Basic frame structure of a 5G NR frame

Slot structure

A slot contains 14 OFDM symbols and has a bandwidth the size of the bandwidth part it is in. A slot can have one of many slot formats, with each slot format representing a different symbol usage. Most of the symbols are usually used by the **PUSCH** for transmission of user data (payload).

Resource blocks

One symbol with a bandwidth of 12 subcarriers makes up a resource block (the size of the subcarrier is variable). One symbol over one subcarrier makes up a resource element, which is the basic quantity in a 5G NR radio frame.

The 5G NR standard differentiates between virtual resource blocks (VRB) and physical resource blocks (PRB). VRBs are all resource blocks that are allocated to the resource grid. PRBs have the same size and number as VRBs, but can be mapped to different subcarriers to according to certain rules defined by 3GPP. Mapping to different subcarriers can be useful to use the resource grid more efficiently.

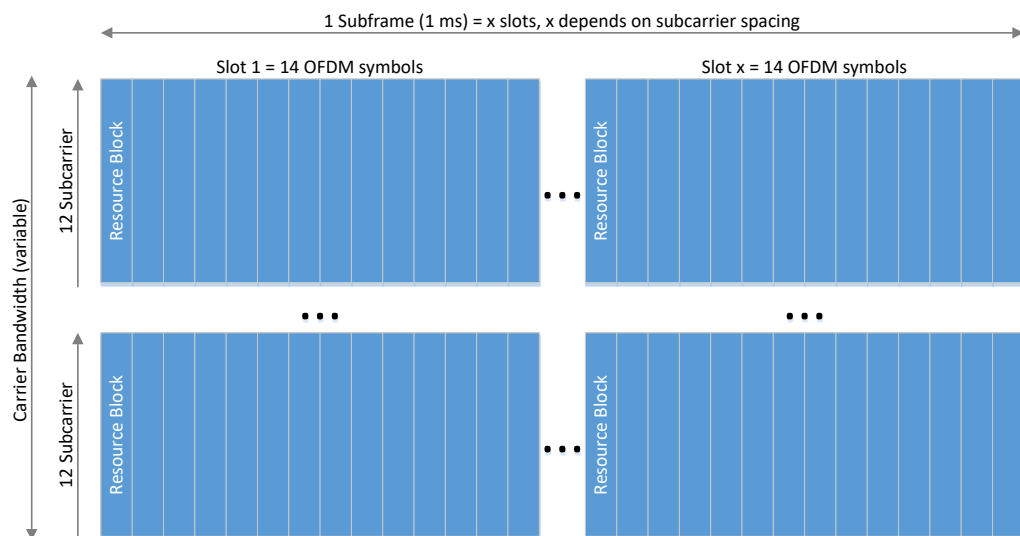

Figure 4-2: Basic slot structure of a 5G NR slot

The radio frame in a 5G NR signal is highly flexible. The location of the synchronization signal is just as variable as the size and number of bandwidth parts and the configuration of each slot in the radio frame.

For more information about configuring the radio frame structure, refer to the following topics.

- [Bandwidth parts](#)
- [Slots](#)
- [PUSCH](#)

Measuring multiple radio frames

You can capture and analyze multiple radio frames. Each radio frame can have a different configuration.



Configuring component carriers

When you are doing measurements on [aggregated carriers](#), you can configure each carrier separately.

When available, each carrier in the dialog boxes is represented by an additional tab labeled "CC<x>", with <x> indicating the number of the component carrier.

Note that the additional tabs are only added to the user interface after you have selected more than "1" component carrier.

Frame Configuration	70
Effects of capturing multiple frames on results	71
Frame Configuration Management	72

Frame Configuration

The "# Frames To Configure" input field defines the number of radio frames with a different configuration. If you select more than one frame to configure, you can assign a different slot configuration and PUSCH configuration for the frames. The bandwidth part configuration is the same for all frames.

To configure a specific frame, enter the corresponding number in the "Selected Frame" field. If you configure only one frame ("# Frames To Configure" = 1), all frames have the same configuration.

After you have configured several frames, you can also select how many frames the FSW actually captures and analyzes with the ["Number of Frames to Analyze"](#) property. If you capture more than the number of configurable frames, the frame configuration is repeated for the surplus frames.

Example:

The number of configurable frames is 2. The number of frames you have captured is 5. In that case, the BWP configuration of frame 0 and 1 is repeated for frames 2 to 4.

If you capture less than the number of configurable frames, only the first frame configurations are applied.

Example:

The number of configurable frames is 3. The number of frames you have captured is 1. In that case, the BWP configuration of frame 0 is used for analysis.

In addition, if the FSW needs more than one capture to analyze all frames, for example if the capture time is too small, the capture always starts with the configuration of the first frame.

Example:

The number of configurable frames is 3. The capture time is 20.1 ms. The number of frames you have captured is 3.

The first capture contains 2 full frames with configuration of frame 0 and 1.

The second capture contains 1 frame, again with configuration of frame 0.

(If you want to capture a frame with the third configuration, you would have to define a capture time of at least 30.1 ms.)

Remote command:

Configurable frames: `CONFigure[:NR5G]:UL[:CC<cc>]:FTConfig` on page 294

Frame selection: via suffix at `FRAMe<fr>`

Effects of capturing multiple frames on results

Analyzing multiple frames has the following effects on results.

- Results in the [result summary](#) are either averaged over all frames or refer to a single frame, depending on your selection.
- All graphical results refer to a single frame.
If there is more than one frame in the capture buffer, you can [select the frame](#) you want to display.
- The FSW can only display graphical results of the last data capture.
If the [capture time](#) is too small to capture all [frames to analyze](#), the FSW captures the signal in multiple capture buffers.
Note that this only applies to graphical results like EVM vs Carrier or the constellation diagram. The result summary still averages over all analyzed frames.

Example:

The capture time is 20.1 ms. The number of frames to analyze is 3. Two data captures are required to analyze all frames.

In that case, the first data capture analyzes the first two frames. The second data capture analyzes the third frame. However, you can only display the results for the third frame in the graphical result displays.

If you analyze multiple component carriers, you can also display the results for a specific frame by assigning a frame to a [view](#).

Remote command:

Select a frame: `[SENSe:]NR5G[:CC<cc>]:FRAMe:SElect` on page 432

Assign frame to a view: `DISPlay[:WINDow<n>][:SUBWindow<w>]:FNUMber` on page 424

Frame Configuration Management

The FSW provides some tools to make frame configuration easier.

- "Copy Frame": Copies the bandwidth part configuration of the selected frame. Note that this includes the [slot configuration](#) and [PUSCH/PUCCH configuration](#) of that frame.
- "Paste Frame": Applies the bandwidth part configuration in the cache to the selected frame.
- "Paste To All": Applies the bandwidth part configuration in the cache to all configurable frames.

Remote command:

Copy: `CONFigure[:NR5G]:UL[:CC<cc>]:FRAMe<fr>:COPY` on page 293

Paste: `CONFigure[:NR5G]:UL[:CC<cc>]:FRAMe<fr>:PASTe[:FRAMe]` on page 293

Paste to all: `CONFigure[:NR5G]:UL[:CC<cc>]:FRAMe<fr>:PASTe:ALL` on page 293

4.1.7 Bandwidth part configuration

Access: "Overview" > "Signal Description" > "Radio Frame Config" > "BWP Config"

One of the defining features of the 5G NR standard is bandwidth parts (BWP). Using bandwidth parts, you can split the complete channel bandwidth into several smaller slices. A bandwidth part is defined as a contiguous set of physical resource blocks that have the same subcarrier spacing (or numerology as the 3GPP standard calls it).

The numerology has several effects on the signal, like the symbol length and the number of slots in a subframe.

Table 4-1: Numerology in 5G NR

Numerology	0	1	2	3	4
Subcarrier spacing	15 kHz	30 kHz	60 kHz	120 kHz	240 kHz
Slot length	1 ms	0.5 ms	0.25 ms	0.125 ms	0.0625 ms
Number of slots in subframe	1	2	4	8	16

Table 4-2: Additional numerology introduced with 3GPP release 17

Numerology	5	6
Subcarrier spacing	480 kHz	960 kHz
Slot length	0.03125 ms	0.015625 ms
Number of slots in subframe	32	64

The number of bandwidth parts you can configure with the FSW is limited to 12. During transmission, each bandwidth part can be assigned to a specific user equipment (UE). Bandwidth parts can overlap, in which case UEs share the resource elements of a bandwidth part.

For measurements on signals with multiple bandwidth parts, it is sufficient to configure only the active bandwidth part.

You can configure bandwidth parts in the bandwidth part configuration table. This table contains the characteristics of all bandwidth parts in the currently selected frame. You can add or remove bandwidth parts and configure them as you like.

Each row in the table corresponds to a bandwidth part.

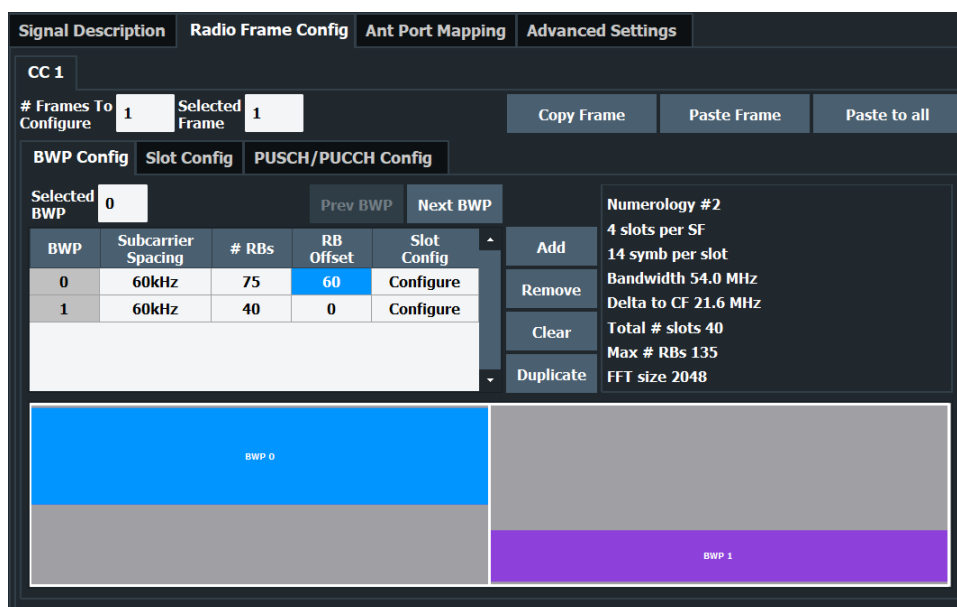

Configuring component carriers

When you are doing measurements on **aggregated carriers**, you can configure each carrier separately.

When available, each carrier in the dialog boxes is represented by an additional tab labeled "CC<x>", with <x> indicating the number of the component carrier.

Note that the additional tabs are only added to the user interface after you have selected more than "1" component carrier.

The remote commands required to configure the bandwidth parts are described in [Chapter 6.10.6, "Bandwidth part configuration"](#), on page 294.

- [BWP configuration table management](#).....73
- [BWP configuration table](#).....74

4.1.7.1 BWP configuration table management

The FSW provides several tools to manage the configuration table and make the configuration of bandwidth parts easier.

- [Bandwidth Part Selection](#)..... 74
- [BWP Configuration Tools](#)..... 74

Bandwidth Part Selection

You can select the bandwidth part you want to configure by entering its number in the "Selected BWP" input field. In the configuration table, the selected bandwidth part is highlighted blue.

You can also select bandwidth parts with the "Prev BWP" and "Next BWP" buttons.

Note that when you select a bandwidth part, the FSW also selects that bandwidth part in the [Slot Config](#) and [PUSCH / PUCCH Config](#) tabs and vice versa.

Remote command:

via suffix at `BWPart<bwp>`

BWP Configuration Tools

The BWP configuration table provides several management tools.

- "Add": Adds a bandwidth part to the table.
- "Remove": Deletes the selected (highlighted) bandwidth part.
- "Clear": Removes all entries from the table.
- "Duplicate": Copies the configuration of the selected bandwidth part to a new bandwidth part.

Note that this includes the [Slot Config](#) and [PUSCH / PUCCH Config](#).

Remote command:

Add BWP: `CONFigure[:NR5G]:UL[:CC<cc>]:FRAME<fr>:BWPart<bwp>:ADD`
on page 294

Remove BWP: `CONFigure[:NR5G]:UL[:CC<cc>]:FRAME<fr>:BWPart<bwp>:REMove`
on page 296

Clear table: `CONFigure[:NR5G]:UL[:CC<cc>]:FRAME<fr>:BWPart<bwp>:CLEar`
on page 295

Duplicate BWP: `CONFigure[:NR5G]:UL[:CC<cc>]:FRAME<fr>:BWPart<bwp>:DUPLicate`
on page 295

4.1.7.2 BWP configuration table

The bandwidth part configuration table consists of several rows, each of which corresponds to a bandwidth part. The size of the table therefore depends on the number of bandwidth parts you have added to the table.

Note that all bandwidth parts must have the same subcarrier spacing.

Preview diagram

The preview diagram shows the distribution and location of the bandwidth parts. The x-axis represents the bandwidth part, the y-axis represent the frequency, with the point of origin of the diagram being the first subcarrier. The color depends on the subcarrier spacing selected for the corresponding bandwidth part.

The width of the bandwidth parts depends on the number of resource blocks it occupies. The location of the bandwidth part on the y-axis depends on the resource block offset.

If two or more bandwidth parts overlap (share the same resource blocks), the corresponding parts of the bandwidth part are highlighted by black lines.

Unused parts of the spectrum remain gray.

Numerology

Next to the bandwidth part configuration table, the FSW displays various information about the numerology in the currently selected bandwidth part.

- "Numerology": Shows the [numerology](#) of the bandwidth part as defined by 3GPP.
- "Slots per SF": Shows the number of slots in a subframe in the selected BWP. The number of slots depends on the selected subcarrier spacing.
- "Symbols Per Slot": Shows the number of symbols in a slot in the selected BWP.
- "Bandwidth": Shows the width of the selected BWP in Hz.
- "Delta To CF": Shows the frequency offset of the BWP relative to the center frequency of the complete signal.
- "Total # Slots": Shows the complete number of slots in the BWP over all subframes. The number of slots depends on the selected subcarrier spacing.
- "Max # RBs": Shows the maximum number of resource blocks that the bandwidth part can have.
- "FFT Size": Shows the FFT size in the selected BWP. The FFT size depends on the selected subcarrier spacing.

BWP Number	75
Subcarrier Spacing (user data)	75
# RBs	76
RB Offset	76
Slot Config	76

BWP Number

The "BWP Number" shows the index number of the corresponding BWP.

The bandwidth part number is a consecutive index number that allows you to identify each bandwidth part. The first bandwidth part has the index number 0.

Remote command:
not supported

Subcarrier Spacing (user data)





The "Subcarrier Spacing" selects the subcarrier spacing for the corresponding BWP.

The available subcarrier spacings depend on the [frequency range](#) you have selected.

- FR1: 15 kHz, 30 kHz, 60 kHz
Note that 15 kHz is only available for channel bandwidths < 60 MHz.
- FR2-1: 60 kHz, 120 kHz
- FR2-2: 120 kHz, 480 kHz, 960 kHz
The following restrictions apply:
 - Channel bandwidth = 100 MHz: 120 kHz
 - Channel bandwidth = 400 MHz: 120 kHz, 480 kHz and 960 kHz
 - Channel bandwidth = 800 MHz and 1600 MHz: 480 kHz and 960 kHz
 - Channel bandwidth = 2000 MHz: 960 kHz

Subcarrier spacings are indicated by different colors in the preview diagram.

- : 15 kHz

-  : 30 kHz
-  : 60 kHz
-  : 120 kHz
-  : 480 kHz
-  : 960 kHz

For bandwidth parts with a 60 kHz subcarrier spacing, you can select if it has a normal cyclic prefix (NCP) or an extended cyclic prefix (ECP). Note that the diagrams only show results if you select the BWP with the extended cyclic prefix from the [evaluation range](#).

Remote command:

`CONFigure[:NR5G]:UL[:CC<cc>]:FRAMe<fr>:BWPart<bwp>:SSPacing`
on page 296

RBs

The "# RBs" defines the number of physical resource blocks (PRB) the bandwidth part occupies. The number of physical resource blocks also defines the frequency width of the bandwidth part.

The maximum number of physical resource blocks for a bandwidth part depends on the selected [subcarrier spacing](#) and the overall [channel bandwidth](#), which in turn depend on the selected [frequency range](#). For a detailed overview, see 3GPP 38.104, tables 5.3.2-1 and 5.3.2-2.

Bandwidth parts can share resource blocks.

Remote command:

`CONFigure[:NR5G]:UL[:CC<cc>]:FRAMe<fr>:BWPart<bwp>:RBCount`
on page 295

RB Offset

The "RB Offset" defines an offset of the first resource block that the bandwidth part uses relative to the first resource block of the channel.

The resource block offset therefore defines the location (frequency) of the bandwidth part in the NR channel.

Remote command:

`CONFigure[:NR5G]:UL[:CC<cc>]:FRAMe<fr>:BWPart<bwp>:RBOFfset`
on page 296

Slot Config

The "Configure" button opens the dialog box to configure the slots in the corresponding bandwidth part.

For details, see [Slot Config](#).

Remote command:

not supported

4.1.8 Slot configuration

Access: "Overview" > "Signal Description" > "Radio Frame Config" > "Slot Config"

Slots

Slots are flexible entities in the 5G NR radio frame, whose characteristics depend on a number of factors.

In the time domain, the length of a slot and the number of slots in a subframe depends on the numerology.

Each slot contains 14 OFDM symbols. Each symbol can have a different scheduling type to make scheduling during transmission as flexible as possible.

Slot configuration table

The slot configuration table represents the frame structure in the time domain. Each row corresponds to one slot, and each slot can have a different configuration.

SF Number	Slot Number	Slot Allocation	Slot Format	PUSCH Allocations	Repeated Slot No	Ref Signals
0	0	Data	1	Configure	User	SRS
	1	Data	1		0	None
1	2	Data	1		0	SRS
	3	Data	1		0	None
2	4	Data	1		0	SRS
	5	Data	1		0	None
3	6	Data	1		0	SRS
	7	Data	1		0	None

Selecting the bandwidth part to configure

- ▶ Enter the number of the bandwidth part you want to configure in the "Bandwidth Part Number" field.

The FSW selects the corresponding bandwidth part.

Note that when you select bandwidth part here, the FSW also selects that bandwidth part in the [BWP Config](#) tab and vice versa.



Configuring component carriers

When you are doing measurements on [aggregated carriers](#), you can configure each carrier separately.

When available, each carrier in the dialog boxes is represented by an additional tab labeled "CC<x>", with <x> indicating the number of the component carrier.

Note that the additional tabs are only added to the user interface after you have selected more than "1" component carrier.

The remote commands required to configure the slots are described in [Chapter 6.10.7, "Slot configuration"](#), on page 298.

• General slot configuration	78
• Slot configuration table	79
• Sounding reference signal	81

4.1.8.1 General slot configuration

The slot configuration table contains a variable number of rows, depending on the bandwidth parts configuration.

Selected Slot	78
Number of Configurable Slots	78
Slot Configuration Tools	78

Selected Slot

You can select the slot you want to configure by entering its number in the "Selected Slot" input field. In the configuration table, the selected slot is highlighted blue.

You can also select slots with the "Prev Slot" and "Next Slot" buttons.

Note that when you select a slot, the FSW also selects that slot in the [PUSCH / PUCCH Config](#) tab and vice versa.

Remote command:

via suffix at `SLOT<sl>`

Number of Configurable Slots

You can configure each slot in the radio frame individually, but when more slots have the same configuration (for example each subframe has the same slot configurations), you can configure just a certain number of slots and repeat this configuration on other slots.

The slots you can edit ("# User Configurable Slots") are always the first slots in the table. For example, if the number of configurable slots is "4", you can edit the first four rows in the table. The cells of slots you can edit are white.

The slot configuration is repeated for all other slots. For example, if you can edit the first four slots, the subsequent four slots have the same configuration and so on. The configuration that a specific slot uses is indicated in the last column of the slot configuration table.

The "Periodicity" shown next to the slot configuration table indicates the length of all customized slots. For example, a periodicity of 1 ms in a BWP with a 30 kHz subcarrier spacing indicates that the first two slots have a custom configuration which is repeated every 1 ms.

Remote command:

[CONFigure](#)[:NR5G]:UL[:CC<cc>]:FRAME<fr>:BWPart<bwp>:CSLot
on page 298

Slot Configuration Tools

The FSW provides some tools to make slot configuration easier.

- "Copy Slot": Copies the slot configuration of the selected slot.

Note that this includes the [PUSCH / PUCCH configuration](#) of that slot.

- "Paste Slot": Applies the slot configuration in the cache to the selected slot.
- "Paste To": Applies the slot configuration to a set of configurable slots.
 - Paste to "Slots": Paste to specific slots or range of slots (e.g. 1,2,5-8)
 - Paste to "Data": Paste to all data slots.
 - Paste to "Unused": Paste to all unused slots (they will turn into data slots).
 - Paste to "Custom": Paste to selected slots according to a certain [logic](#) (period / duration).
- "Paste To All": Applies the slot configuration in the cache to all configurable slots.
- "Reset Slot Config": Restores the default slot configuration (including the PDSCH/ PDCCH configuration).

Remote command:

Copy: `CONFigure[:NR5G]:UL[:CC<cc>]:FRAMe<fr>:BWPart<bwp>:SLOT<sl>:COPY` on page 299

Paste: `CONFigure[:NR5G]:UL[:CC<cc>]:FRAMe<fr>:BWPart<bwp>:SLOT<sl>:PASTe[:SLOT]` on page 304

Paste to all: `CONFigure[:NR5G]:UL[:CC<cc>]:FRAMe<fr>:BWPart<bwp>:SLOT<sl>:PASTe:ALL` on page 300

Paste to selected: `CONFigure[:NR5G]:UL[:CC<cc>]:FRAMe<fr>:BWPart<bwp>:SLOT<sl>:PASTe:TO` on page 302

Reset: `CONFigure[:NR5G]:UL[:CC<cc>]:FRAMe<fr>:BWPart<bwp>:SLOT<sl>:PRESet` on page 304

4.1.8.2 Slot configuration table

The slot configuration table contains the configuration of all slots in the currently selected bandwidth part. The number of rows (slots) depends on the [subcarrier spacing](#) in the selected bandwidth part.

The complete number of slots in the selected bandwidth part is indicated next to the table ("n Slots in BWP x").

SF Number	Slot Number	Slot Allocation	Slot Format	PUSCH Allocations	Repeated Slot No	Ref Signals
0	0	Data	1	Configure	User	SRS
	1	Data	1		0	None
1	2	Data	1		0	SRS
	3	Data	1		0	None
2	4	Data	1		0	SRS
	5	Data	1		0	None
3	6	Data	1		0	SRS
	7	Data	1		0	None

Slot preview

The slot preview shows the scheduling of the OFDM symbols in the selected slot.

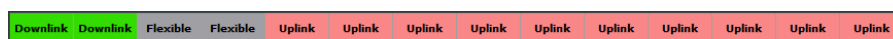

Figure 4-3: Preview of symbol usage for slot format 38 as defined in 3GPP 38.211, table 4.3.2-3

The scheduling depends on the selected [slot format](#).

Subframe Number.....	80
Slot Number.....	80
Slot Allocation.....	80
Slot Format.....	80
PUSCH Allocations.....	81
Repeated Slot No.....	81
Ref Signals.....	81

Subframe Number

The "Subframe Number" shows the index number (0 to 9) of the subframe that the slot belongs to.

The number of subframes is always 10, the number of slots in a subframe varies, depending on the subcarrier spacing / [numerology](#). The first subframe always has the index 0.

Remote command:
not supported

Slot Number

The "Slot Number" shows the index number (0 to n) of the corresponding slot.

The selected slot is highlighted blue.

The number of slots in the frame varies, depending on the subcarrier spacing / [numerology](#). The first slot always has the index 0.

Remote command:
not supported

Slot Allocation

The "Slot Allocation" selects the usage of the corresponding slot.

- "Data": Slot is used for user data transmission.
- "Unused": Slot is not used.

Remote command:

`CONFigure[:NR5G]:UL[:CC<cc>]:FRAME<fr>:BWPart<bwp>:SLOT<sl>:`
[ATYPe](#) on page 299

Slot Format

The "Slot Format" selects one of the slot formats defined by 3GPP for the corresponding slot.

The slot format defines the usage of the OFDM symbols in a slot. Possible symbol usages are:

- Uplink: Symbol carries uplink information.
- Downlink: Symbol carries downlink information.
- Flexible: Symbol usage is undefined and can carry uplink or downlink information.

The symbol usage of the selected slot format is indicated in the [slot preview](#).

For a comprehensive list of all supported slot formats, see 3GPP 38.211, table 4.3.2-3: "Slot formats".

3GPP release 16 unlocks additional slot formats.

Remote command:

CONFigure [:NR5G] :UL[:CC<cc>] :FRAMe<fr>:BWPart<bwp>:SLOT<sl>:
FORMat on page 299

PUSCH Allocations

The "Configure" button opens the dialog box to configure the PUSCH or PUCCH allocations in the corresponding slot.

For details, see [Chapter 4.1.9, "PUSCH and PUCCH configuration"](#), on page 84.

Remote command:

not supported

Repeated Slot No

The "Repeated Slot No" shows the slot number on which the configuration of a slot is based on.

If the table cell says "User", the slot is configured manually.

If the table cell contains a number, the slot configuration is the same as the slot indicated by that number. For example, if the cell contains the number "1", the slot configuration is the same as the slot with the index number 1.

Remote command:

not supported

Ref Signals

Opens a dialog box to configure reference signals transmitted in the corresponding slot.

For details, see [Chapter 4.1.8.3, "Sounding reference signal"](#), on page 81.

Remote command:

not supported

4.1.8.3 Sounding reference signal

The sounding reference signal (SRS) is an uplink reference signal transmitted by the user equipment. The base station uses the SRS to estimate the uplink channel quality for each user.

In the time domain, the SRS occupies 1, 2 or 4 OFDM symbols with a variable starting position. In the frequency domain, the SRS uses only portions of the overall channel bandwidth in a bandwidth part. The subcarriers occupied by the SRS depend on various frequency hopping and transmission comb techniques.

You can define various parameters to describe the physical attributes and structure of the SRS, for example where it is located in the resource grid or how often it occurs in the signal.

The SRS configuration is specific to a bandwidth part. If you assign a SRS to more than one slot in the bandwidth part (repeated transmission), the configuration is the same for each instance of the SRS.

The SRS uses antenna port 1000.

All settings available for the sounding reference signal are based on and specified in detail in 3GPP 38.211.

State		On	Off							
Slot Config	Start Pos	No Sym.	Freq Pos	Freq Shift	Freq Hopping	Rep. Factor	Tr. Comb / Sequence	No Ports	Rel. Power / dB	
Periodic	0	1	0	0	...	1	...	1	0 dB	

The remote commands required to configure the CSI reference signal are described in Chapter 6.10.8, "SRS configuration", on page 305.

SRS State.....	82
Slot Config.....	82
Start Pos.....	82
No. Sym.....	83
Freq Pos.....	83
Freq Shift.....	83
Freq Hopping.....	83
Rep. Factor.....	83
Transmission Comb / Sequence Comb.....	83
No Ports.....	84
Rel Power.....	84

SRS State

Turns the sounding reference signal on and off.

Remote command:

`CONFigure[:NR5G]:UL[:CC<cc>]:FRAME<fr>:BWPart<bwp>:SRS:STATe`
on page 312

Slot Config

Opens a dialog box to configure in which slots the sounding reference signal appears.

The transmission is always periodic. The "Periodicity" selects the slot numbers the SRS appears in. For example, a periodicity of 2 slots assigns the SRS to every other slot.

The "Offset" defines the first slot the SRS appears in.

Remote command:

Periodicity: `CONFigure[:NR5G]:UL[:CC<cc>]:FRAME<fr>:BWPart<bwp>:SRS:SLOT:PERiodicity` on page 311

Offset: `CONFigure[:NR5G]:UL[:CC<cc>]:FRAME<fr>:BWPart<bwp>:SRS:SLOT:POFFset` on page 311

Start Pos

Defines the starting position of the sounding reference signal in the time domain in terms of OFDM symbols.

Remote command:

`CONFigure[:NR5G]:UL[:CC<cc>]:FRAME<fr>:BWPart<bwp>:SRS:SPOS`
on page 311

No. Sym

Selects the number of OFDM symbols used by the sounding reference signal (1, 2 or 4).

Remote command:

`CONFigure [:NR5G] :UL[:CC<cc>] :FRAMe<fr>:BWPart<bwp>:SRS:NSYMBOLs`
on page 308

Freq Pos

Defines the starting position of the SRS allocation in the frequency domain.

Remote command:

`CONFigure [:NR5G] :UL[:CC<cc>] :FRAMe<fr>:BWPart<bwp>:SRS:FPOS`
on page 306

Freq Shift

Defines an offset of the sounding reference signal resource elements in the frequency domain relative to the first subcarrier.

Remote command:

`CONFigure [:NR5G] :UL[:CC<cc>] :FRAMe<fr>:BWPart<bwp>:SRS:FSHift`
on page 307

Freq Hopping

Opens a dialog box to configure in the frequency hopping parameters ("B-SRS", "C-SRS" and "B-Hop").

"B-SRS" and "C-SRS" define the bandwidth and length of the SRS sequence.

"B-Hop" defines the frequency hopping bandwidth of the SRS. Note that frequency hopping is disabled if "B-Hop" > "B-SRS".

Remote command:

`BSRS: CONFigure [:NR5G] :UL[:CC<cc>] :FRAMe<fr>:BWPart<bwp>:SRS: FHOPping:BSRS` on page 306

`CSRS: CONFigure [:NR5G] :UL[:CC<cc>] :FRAMe<fr>:BWPart<bwp>:SRS: FHOPping:CSRS` on page 306

`BHop: CONFigure [:NR5G] :UL[:CC<cc>] :FRAMe<fr>:BWPart<bwp>:SRS: FHOPping:BHOP` on page 305

Rep. Factor

Defines how many times the sounding reference signal is repeated.

Remote command:

`CONFigure [:NR5G] :UL[:CC<cc>] :FRAMe<fr>:BWPart<bwp>:SRS:RFACtor`
on page 309

Transmission Comb / Sequence Comb

Opens a dialog box to configure the transmission comb and the cyclic shift sequence. These settings define the subcarriers the sounding reference signal is transmitted on.

The "Transmission Comb" value selects the number of subcarriers the sounding reference signal occupies. It also defines the maximum number of cyclic shifts. You can also define an "Offset" for the resource elements used by the SRS (odd or even subcarriers).

The group of sequence settings define the sequence of the sounding reference signal. "Cyclic Shift" defines the number of cyclic shifts.

The "Sequence ID" defines the pseudo-random seed value for the SRS sequence generation.

The sounding reference signal supports frequency hopping. You can select the hopping method from the "Group Or Seq Hopping" dropdown menu.

Remote command:

Transmission comb: `CONFigure[:NR5G]:UL[:CC<cc>]:FRAMe<fr>:`

`BWPart<bwp>:SRS:TCOMb[:VALue]` on page 313

Offset: `CONFigure[:NR5G]:UL[:CC<cc>]:FRAMe<fr>:BWPart<bwp>:SRS:TCOMb:OFFSet` on page 312

Cyclic shift: `CONFigure[:NR5G]:UL[:CC<cc>]:FRAMe<fr>:BWPart<bwp>:SRS:SEQUence:CSHift` on page 309

Sequence ID: `CONFigure[:NR5G]:UL[:CC<cc>]:FRAMe<fr>:BWPart<bwp>:SRS:SEQUence:ID` on page 310

Hopping: `CONFigure[:NR5G]:UL[:CC<cc>]:FRAMe<fr>:BWPart<bwp>:SRS:SEQUence:HOPPing` on page 310

No Ports

Selects the number of antenna ports the sounding reference signal uses.

Remote command:

`CONFigure[:NR5G]:UL[:CC<cc>]:FRAMe<fr>:BWPart<bwp>:SRS:NPORTs` on page 307

Rel Power

Defines the relative power of the sounding reference signal in dB.

Remote command:

`CONFigure[:NR5G]:UL[:CC<cc>]:FRAMe<fr>:BWPart<bwp>:SRS:POWer` on page 308

4.1.9 PUSCH and PUCCH configuration

Access: "Overview" > "Signal Description" > "Radio Frame Config" > "PUSCH / PUCCH Config"

Each slot assigned to carry user data contains one or more resource allocations. Resource allocations are the physical channels that carry user data or information about it. The size of an allocation in the resource grid is variable. An allocation covers one or more physical resource blocks.

The physical uplink shared channel (PUSCH) carries the general user data and is therefore the most prominent channel in a radio frame that occupies the most resources.

The physical uplink control channel (PUCCH) carries the uplink control information.

ID	Allocation	Modulation	Enhanced Settings	Number of RBs	Offset RB	Number of Symb	Offset Symb	Rel. Power / dB	Conflict
0	PUCCH	QPSK	...	16	0	2	12	0 dB	
1	PUCCH	QPSK	...	16	4	2	12	0 dB	
0	PUSCH	QPSK	...	16	18	14	0	0 dB	
1	PUSCH	QPSK	...	16	40	14	0	0 dB	



Configuring component carriers

When you are doing measurements on [aggregated carriers](#), you can configure each carrier separately.

When available, each carrier in the dialog boxes is represented by an additional tab labeled "CC<x>", with <x> indicating the number of the component carrier.

Note that the additional tabs are only added to the user interface after you have selected more than "1" component carrier.

The remote commands required to configure the PUSCH and PUCCH are described in [Chapter 6.10.9, "PUCCH allocation configuration"](#), on page 313.

- [General PUSCH / PUCCH configuration](#)..... 85
- [PUSCH / PUCCH configuration table](#)..... 86
- [Enhanced PUCCH settings](#).....89
- [Enhanced PUSCH settings: DMRS](#)..... 92
- [Enhanced PUSCH settings: PTRS](#)..... 96
- [Enhanced PUSCH settings: scrambling / coding](#).....99

4.1.9.1 General PUSCH / PUCCH configuration

The allocations in the table refer to a specific bandwidth part and slot.

Selecting the bandwidth part to configure

- ▶ Enter the number of the bandwidth part you want to configure in the "Bandwidth Part Number" field.

The FSW selects the corresponding bandwidth part.

Note that when you select bandwidth part here, the FSW also selects that bandwidth part in the [BWP Config](#) tab and vice versa.

Selecting the slot to configure

- ▶ Enter the number of the slot you want to configure in the "Selected Slot" field.

Note that when you select a slot here, the FSW also selects that slot in the [Slot Config](#) tab and vice versa.

Defining the number of PUSCH and PUCCH allocations

The FSW allows you to allocate up to 100 individual PUSCH and PUCCH allocations to a slot.

- ▶ Enter the number of allocations in the "# PUSCH Allocations" or "# PUSCH Allocations" field.

The FSW expands the configuration table accordingly.

When you add a PUCCH, the new PUCCH is added after the last existing PUCCH and before the first PUSCH allocation. New PUSCH allocations are always added at the end of the table.

Remote command (PUSCH allocations): `CONFigure[:NR5G]:UL[:CC<cc>]:FRAME<fr>:BWPart<bwp>:SLOT<sl>:ALCount` on page 320

Remote command (PUCCH allocations): `CONFigure[:NR5G]:UL[:CC<cc>]:FRAME<fr>:BWPart<bwp>:SLOT<sl>:UCCCount` on page 319

4.1.9.2 PUSCH / PUCCH configuration table

The configuration table contains the PUSCH and PUCCH allocations. Each row corresponds to an allocation. The first part of the table shows the PUCCH allocations, the second part of the table the PUSCH allocations.

Reusing PDSCH allocations

If you are measuring multiple slots with a different configuration, you can copy allocations to other slots once you have defined them in the first slot.

Prerequisite: [# of configurable slots](#) > 1

1. Select "Copy To" to copy the allocation configuration to the clipboard. The FSW opens a dialog to select the target slots.
2. From the "Copy To" menu, select:
 - "Slots" to copy the allocation to a number of selected slots.
 - "Custom" to copy the allocation to slots based on a certain logic.
3. "Copy To": "Slots":

Select the slots you want to copy the allocation to.

 - Enter a comma-separated list of slots (for example: 1,4,5,7)
 - Enter a range of slots (for example: 3-6)
 - Enter a combination of both (for example: 1,3-5,8)
4. "Copy To": "Custom":

Select the copy logic.

 - "Period": Copy the allocation to every n^{th} slot.
Example: Period = 3 copies the allocation to every 3rd slot, beginning with slot 0 (if selected slot = 0, the copy appears in slots 3,6,9, etc.).

- "Duration": Copy the allocation to n slots in a row.
 Example: Period = 3 and duration = 2 copies the allocation to two slots in a row, every 3rd slot, beginning with slot 0 (if selected slot = 0, the copy appears in slots 1,3,4,6,7,9,10 etc.)

The FSW only copies the allocation to a slot if the slot configuration accepts a [manual configuration](#) (and is not based on the configuration of another slot).

ID	Allocation	Modulation	Enhanced Settings	Number of RBs	Offset RB	Number of Symb	Offset Symb	Rel. Power /dB	Conflict
0	PUCCH	QPSK	...	16	0	2	12	0 dB	
1	PUCCH	QPSK	...	16	4	2	12	0 dB	
0	PUSCH	QPSK	...	16	18	14	0	0 dB	
1	PUSCH	QPSK	...	16	40	14	0	0 dB	

The remote commands required to configure the PUSCH and PUCCH allocations are described in [Chapter 6.10.9, "PUCCH allocation configuration"](#), on page 313 and [Chapter 6.10.10, "PUSCH allocation configuration"](#), on page 320.

ID.....87

Allocation.....87

Modulation.....87

Enhanced Settings..... 88

Number of RBs.....88

Offset RB.....88

Number of Symbols.....88

Offset Symbols.....89

Rel Power / dB..... 89

Copy to.....89

Conflicts..... 89

ID

The "ID" column shows the unique identifier for the corresponding PUCCH or PUSCH allocation.

The counter starts at 0.

Remote command:
not supported

Allocation

The "Allocation" column shows the allocation's channel type (PUCCH or PUSCH).

Remote command:
not supported

Modulation

The "Modulation" selects the modulation type for the corresponding allocation (channel).

"DMRS Only" analyzes the DMRS and ignores the payload data in the allocation.

The PUCCH modulation is always QPSK.

The PUSCH modulation is either QPSK, 16QAM, 64QAM or 256QAM.

If you turn on [transform precoding](#), you can also select a pi/2-BPSK modulation for the PUSCH.

3GPP release 17 adds 1024QAM modulation.

Remote command:

PUCCH: not supported

PUSCH allocations: [CONFigure\[:NR5G\]:UL\[:CC<cc>\]:FRAMe<fr>:](#)

[BWPart<bwp>:SLOT<sl>:ALLocation<al>:MODulation](#) on page 324

Enhanced Settings

Opens the "Enhanced Settings" dialog box.

Enhanced settings for PUCCH allocations:

- [PUCCH DMRS](#)

Enhanced settings for PUSCH allocations:

- [PUSCH DMRS](#)
- [PTRS](#)
- [Channel coding and PUSCH scrambling](#)

Remote command:

not supported

Number of RBs

The "Number of RBs" defines the number of physical resource blocks that the allocation occupies in the resource grid.

The number of RBs a PUCCH can use depends on the [PUCCH format](#).

Remote command:

PUCCH allocation: [CONFigure\[:NR5G\]:UL\[:CC<cc>\]:FRAMe<fr>:](#)

[BWPart<bwp>:SLOT<sl>:PUCCh<cr>:RBCount](#) on page 317

PUSCH allocation: [CONFigure\[:NR5G\]:UL\[:CC<cc>\]:FRAMe<fr>:](#)

[BWPart<bwp>:SLOT<sl>:ALLocation<al>:RBCount](#) on page 325

Offset RB

The "Offset RB" defines the first physical resource block that the allocation uses. The offset is a value relative to the first resource block used by the bandwidth part the allocation is in.

Remote command:

PUCCH allocation: [CONFigure\[:NR5G\]:UL\[:CC<cc>\]:FRAMe<fr>:](#)

[BWPart<bwp>:SLOT<sl>:PUCCh<cr>:RBOffset](#) on page 318

PUSCH allocation: [CONFigure\[:NR5G\]:UL\[:CC<cc>\]:FRAMe<fr>:](#)

[BWPart<bwp>:SLOT<sl>:ALLocation<al>:RBOffset](#) on page 325

Number of Symbols

The "Number of Symbols" defines the number of symbols that the allocation uses.

The number of symbols a PUCCH can use depends on the [PUCCH format](#).

Remote command:

PUCCH allocation: `CONFigure[:NR5G]:UL[:CC<cc>]:FRAMe<fr>:`

`BWPart<bwp>:SLOT<sl>:PUCCh<cr>:SCOunt` on page 318

PUSCH allocation: `CONFigure[:NR5G]:UL[:CC<cc>]:FRAMe<fr>:`

`BWPart<bwp>:SLOT<sl>:ALLocation<al>:SCOunt` on page 326

Offset Symbols

The "Offset Symbols" defines the first symbol that the allocation uses. The offset is a value relative to the first symbol in the slot.

Remote command:

PUCCH allocation: `CONFigure[:NR5G]:UL[:CC<cc>]:FRAMe<fr>:`

`BWPart<bwp>:SLOT<sl>:PUCCh<cr>:SOFFset` on page 319

PUSCH allocation: `CONFigure[:NR5G]:UL[:CC<cc>]:FRAMe<fr>:`

`BWPart<bwp>:SLOT<sl>:ALLocation<al>:SOFFset` on page 326

Rel Power / dB

The "Rel Power / dB" defines the relative power of the corresponding allocation.

Remote command:

PUCCH allocation: `CONFigure[:NR5G]:UL[:CC<cc>]:FRAMe<fr>:`

`BWPart<bwp>:SLOT<sl>:PUCCh<cr>:POWer` on page 317

PUSCH allocation: `CONFigure[:NR5G]:UL[:CC<cc>]:FRAMe<fr>:`

`BWPart<bwp>:SLOT<sl>:ALLocation<al>:POWer` on page 325

Copy to

Opens a dialog to copy the allocation configuration to other slots.

For details, see "[Reusing PDSCH allocations](#)" on page 86.

Remote command:

PUSCH: `CONFigure[:NR5G]:UL[:CC<cc>]:FRAMe<fr>:BWPart<bwp>:`

`SLOT<sl>:ALLocation<al>:COPY` on page 322

PUCCH: `CONFigure[:NR5G]:UL[:CC<cc>]:FRAMe<fr>:BWPart<bwp>:`

`SLOT<sl>:PUCCh<cr>:COPY` on page 315

Conflicts

The FSW indicates a conflict in the following cases.

- If the allocation is located in a symbol reserved for uplink.
- If two or more allocations use the same resource blocks (overlapping allocations).
- If the total number of resource blocks over all allocations is greater than 273.

To remove a conflict, try to reduce the total number of resource blocks or change the RB offset.

Remote command:

not supported

4.1.9.3 Enhanced PUCCH settings

The enhanced PUCCH settings contain settings to configure the PUCCH demodulation reference signal (PUCCH DMRS).

You can also select the PUCCH format here.

The screenshot shows the 'PUCCH DMRS Config' window. At the top, 'PUCCH Format 1' is selected in a dropdown menu. Below this, the configuration is split into two columns: 'General' and 'Format Specific'.

General Settings:

- Rel Power (to PUCCH): 0.0 dB
- Group Hopping: Neither
- Hopping ID: n_ID (dropdown), 0
- Intra Slot Frequency Hopping: On (selected), Off
- Second Hop PRB: 0

Format Specific Settings:

- Sequence Generation: N_ID^DMRS (dropdown), 0
- Initial Cyclic Shift: 0
- Time Domain OCC Index: 0
- OCC Length: n2 (dropdown)
- Additional DMRS: On (selected), Off

The remote commands required to configure the PUCCH are described in [Chapter 6.10.11, "Enhanced PUCCH allocation configuration"](#), on page 327.

PUCCH Format	90
PUCCH DMRS Rel Power	90
Group Hopping	90
Intra Slot Frequency Hopping	91
Initial Cyclic Shift	91
Time Domain OCC Index	91
PUCCH DMRS Sequence Generation	92
OCC Length	92
Additional DMRS	92

PUCCH Format

3GPP defines several PUCCH format. The PUCCH format has an effect on several PUCCH characteristics, like the mapping to physical resource blocks.

You can select a different PUCCH format for each PUCCH allocation.

Depending on the format, you can access different enhanced settings for the PUCCH.

Release 17 adds additional PUCCH formats.

Remote command:

```
CONFigure[:NR5G]:UL[:CC<cc>]:FRAMe<fr>:BWPart<bwp>:SLOT<sl>:
PUCCh<cr>:FORMat on page 334
```

PUCCH DMRS Rel Power

Available for all PUCCH formats.

Defines the power of the PUCCH DMRS relative to the power of the PUCCH resource elements.

Remote command:

```
CONFigure[:NR5G]:UL[:CC<cc>]:FRAMe<fr>:BWPart<bwp>:SLOT<sl>:
PUCCh<cr>:DMRS:POWer on page 332
```

Group Hopping

Available for PUCCH formats 0, 1, 3 and 4.

Turns group and sequence hopping for the PUCCH demodulation reference signal on and off.

- Select "Neither" to use neither group nor sequence hopping.

- Select "Enable" to use group hopping only.
- Select "Disable" to use sequence hopping only.

The frequency hopping index n_{hop} used to calculate the sequence group if you turn on hopping depends on the [intra slot frequency hopping](#) configuration.

The hopping sequence depends on the "Hopping ID" parameter. 3GPP (38.211) defines two methods by which the PUCCH hopping sequence can be calculated.

" $n_{\text{ID}}^{\text{Cell}}$ ":

Calculates the sequence based on the [cell ID](#), if the higher layers provide no value. " $n_{\text{ID}}^{\text{Cell}}$ " has the same value as the cell ID.

" n_{ID} "

Calculates the sequence based on a pseudo-random seed value. You can define the seed value in the input field that becomes available when you select this method.

Remote command:

State: `CONFigure[:NR5G]:UL[:CC<cc>]:FRAMe<fr>:BWPART<bwp>:SLOT<sl>:PUCCh<cr>:DMRS:GHOPping` on page 328

Hopping ID method: `CONFigure[:NR5G]:UL[:CC<cc>]:FRAMe<fr>:BWPART<bwp>:SLOT<sl>:PUCCh<cr>:DMRS:HID` on page 329

Seed value: `CONFigure[:NR5G]:UL[:CC<cc>]:FRAMe<fr>:BWPART<bwp>:SLOT<sl>:PUCCh<cr>:DMRS:NID` on page 330

Intra Slot Frequency Hopping

Turns hopping of the PUCCH demodulation reference signal within a slot on and off.

The state of this parameter controls the value of the frequency hopping index n_{hop} used to calculate the [group hopping](#) sequence.

When you turn on intra slot frequency hopping, you can define the physical resource block offset for the second hop ("Second Hop PRB").

Remote command:

State: `CONFigure[:NR5G]:UL[:CC<cc>]:FRAMe<fr>:BWPART<bwp>:SLOT<sl>:PUCCh<cr>:DMRS:ISFHopping` on page 330

Second hop PRB: `CONFigure[:NR5G]:UL[:CC<cc>]:FRAMe<fr>:BWPART<bwp>:SLOT<sl>:PUCCh<cr>:DMRS:SHPRb` on page 333

Initial Cyclic Shift

Available for PUCCH formats 0 and 1.

As defined in 3GPP 38.211, the value is required to calculate the cyclic shift for the hopping sequence.

Remote command:

`CONFigure[:NR5G]:UL[:CC<cc>]:FRAMe<fr>:BWPART<bwp>:SLOT<sl>:PUCCh<cr>:DMRS:ICSHift` on page 329

Time Domain OCC Index

Available for PUCCH formats 1 and 4.

Defines the orthogonal sequence index l . As defined in 3GPP 38.211, the value is required to select the orthogonal sequence, used for the blockwise spreading.

For PUCCH format 4, the time domain OCC index defines the [initial cyclic shift](#).

Remote command:

CONFigure[:NR5G]:UL[:CC<cc>]:FRAMe<fr>:BWPart<bwp>:SLOT<sl>:
PUCCh<cr>:DMRS:TDOindex on page 334

PUCCH DMRS Sequence Generation

Available for PUCCH format 2.

3GPP (38.211) defines two methods by which the PUCCH DMRS sequence can be calculated. You can select the method with the "Sequence Generation" parameter.

"n_ID^DMRS":

Calculates the sequence based on a pseudo-random seed value. You can define the seed value in the input field that becomes available when you select this method.

"n_ID^Cell":

Calculates the sequence based on the **cell ID**, if the higher layers provide no value. "n_ID^Cell" has the same value as the cell ID.

Remote command:

Method: CONFigure[:NR5G]:UL[:CC<cc>]:FRAMe<fr>:BWPart<bwp>:
SLOT<sl>:PUCCh<cr>:DMRS:SGENeration on page 332

Seed value: CONFigure[:NR5G]:UL[:CC<cc>]:FRAMe<fr>:BWPart<bwp>:
SLOT<sl>:PUCCh<cr>:DMRS:SID on page 333

OCC Length

Available for PUCCH format 4.

Defines the length of the orthogonal cover code ($N^{\text{PUCCH}_{\text{SF}}}$) that the PUCCH transmission includes. The available OCC lengths are defined in 3GPP 38.211.

Remote command:

CONFigure[:NR5G]:UL[:CC<cc>]:FRAMe<fr>:BWPart<bwp>:SLOT<sl>:
PUCCh<cr>:DMRS:OCCLength on page 331

Additional DMRS

Available for PUCCH format 3 and 4.

Turns an additional PUCCH DMRS on and off. The position of this additional DMRS is defined in 3GPP 38.211.

Remote command:

CONFigure[:NR5G]:UL[:CC<cc>]:FRAMe<fr>:BWPart<bwp>:SLOT<sl>:
PUCCh<cr>:DMRS:ADDITIONal on page 327

4.1.9.4 Enhanced PUSCH settings: DMRS

Access: "Overview" > "Signal Description" > "Radio Frame Config" > "PUSCH / PUCCH Config" > "Enhanced Settings" > "PUSCH DMRS Config"

The remote commands required to configure the DMRS are described in [Chapter 6.10.12, "Enhanced PUSCH settings: DMRS"](#), on page 335.

User ID.....	93
PUSCH DMRS Location.....	93
Multi Symbol DMRS.....	94
PUSCH DMRS Sequence Generation (Transform Precoding = Off).....	94
PUSCH DMRS Sequence Generation (Transform Precoding = On).....	94
PUSCH DMRS Rel Power.....	95
Codeword to Layer Mapping.....	95
Antenna Port.....	95
CDM Groups w/o Data.....	96
DMRS-Uplink.....	96

User ID

Selects the radio network temporary identifier (RNTI) used to identify different users currently accessing the network. The corresponding allocation and its configuration is assigned specifically to the ID you select in this field.

By default, the RNTI is the same as the [bandwidth part index](#).

Remote command:

```
CONFigure[:NR5G]:UL[:CC<cc>]:FRAME<fr>:BWPart<bwp>:SLOT<sl>:
ALLocation<al>:UEID on page 344
```

PUSCH DMRS Location

The "Config Type" defines the mapping of the DMRS to physical resource elements as defined in 3GPP 38.211. You can select from configuration "Type 1" or "Type 2".

The "Mapping Type" defines the position of the first DMRS symbol in the resource grid. Mapping "Type A" is a location relative to the start of the slot. Mapping "Type B" is a location relative to the start of the PUSCH resources.

For mapping type A, you can select an additional parameter "Type A Pos" to select the first symbol that the DMRS uses.

The mapping type also limits the [number of symbols](#) the PUSCH allocations can use.

Remote command:

Configuration type: `CONFigure[:NR5G]:UL[:CC<cc>]:FRAMe<fr>:BWPart<bwp>:SLOT<sl>:ALLocation<al>:DMRS:CTYPE` on page 337
 Mapping type: `CONFigure[:NR5G]:UL[:CC<cc>]:FRAMe<fr>:BWPart<bwp>:SLOT<sl>:ALLocation<al>:DMRS:MTYPE` on page 338
 Type A position: `CONFigure[:NR5G]:UL[:CC<cc>]:FRAMe<fr>:BWPart<bwp>:SLOT<sl>:ALLocation<al>:DMRS:TAPos` on page 344

Multi Symbol DMRS

The DMRS can be transmitted on one or two symbols, depending on the "DMRS Length".

You can also add additional DMRS with the "DMRS Add Position Index".

Remote command:

Length: `CONFigure[:NR5G]:UL[:CC<cc>]:FRAMe<fr>:BWPart<bwp>:SLOT<sl>:ALLocation<al>:DMRS:MSYMBOL:LENGTh` on page 338
 Position Index: `CONFigure[:NR5G]:UL[:CC<cc>]:FRAMe<fr>:BWPart<bwp>:SLOT<sl>:ALLocation<al>:DMRS:MSYMBOL:APOSITION` on page 337

PUSCH DMRS Sequence Generation (Transform Precoding = Off)

3GPP (38.211) defines two methods by which the PUSCH DMRS sequence can be calculated when you turn off [transform precoding](#). You can select the method with the "Sequence Generation" parameter.

"n_ID^DMRS":

Calculates the sequence based on a pseudo-random seed value. You can define the seed value in the input field that becomes available when you select this method.

The scrambling ID "N_ID^1" is for low PAPR DMRS transmission. For other transmission types, use the "N_ID^0" scrambling ID.

"N_ID^1" is available if [DMRS-Uplink](#) = "On".

"n_ID^Cell":

Calculates the sequence based on the [cell ID](#), if the higher layers provide no value. "n_ID^Cell" has the same value as the cell ID.

Remote command:

Method: `CONFigure[:NR5G]:UL[:CC<cc>]:FRAMe<fr>:BWPart<bwp>:SLOT<sl>:ALLocation<al>:DMRS:SGENERation` on page 343
 Seed value N_ID^0: `CONFigure[:NR5G]:UL[:CC<cc>]:FRAMe<fr>:BWPart<bwp>:SLOT<sl>:ALLocation<al>:DMRS:NID` on page 339
 Seed value N_ID^1: `CONFigure[:NR5G]:UL[:CC<cc>]:FRAMe<fr>:BWPart<bwp>:SLOT<sl>:ALLocation<al>:DMRS:NIONE`
 Scrambling ID: `CONFigure[:NR5G]:UL[:CC<cc>]:FRAMe<fr>:BWPart<bwp>:SLOT<sl>:ALLocation<al>:DMRS:NSCID` on page 342

PUSCH DMRS Sequence Generation (Transform Precoding = On)

3GPP (38.211) defines three methods by which the PUSCH DMRS sequence can be calculated when you turn on [transform precoding](#). You can select the method with the "n_ID^RS" parameter.

"n_ID^Cell":

Calculates the sequence based on the [cell ID](#), if the higher layers provide no value. "n_ID^Cell" has the same value as the cell ID.

"n_ID^PUSCH":

Calculates the sequence based on a pseudo-random seed value. You can define the seed value in the input field that becomes available when you select this method.

"n_ID^nSCID":

Calculates the sequence using the method defined for [transform precoding = off](#) ("Sequence Generation").

Note that "N_ID^1" for low PAPR transmission is not available in the transform precoding = on case.

Remote command:

Method: `CONFigure[:NR5G]:UL[:CC<cc>]:FRAMe<fr>:BWPart<bwp>:SLOT<sl>:ALLocation<al>:DMRS:NIRS` on page 341

Seed value: `CONFigure[:NR5G]:UL[:CC<cc>]:FRAMe<fr>:BWPart<bwp>:SLOT<sl>:ALLocation<al>:DMRS:NIRid` on page 340

PUSCH DMRS Rel Power

Defines the power of the PUSCH DMRS relative to the power of the PUSCH resource elements.

When you turn on transform precoding after a preset, the FSW automatically changes the relative power to 3 dB, according to 3GPP 38.214.

Remote command:

`CONFigure[:NR5G]:UL[:CC<cc>]:FRAMe<fr>:BWPart<bwp>:SLOT<sl>:ALLocation<al>:DMRS:POWer` on page 342

Codeword to Layer Mapping

Selects the number of layers for a PUSCH allocation and the codebook index. The combination of layers and number of codewords determines the layer mapping. Each layer is transmitted on a separate [antenna port](#).

The number of supported layers depends on:

- [DMRS configuration type](#)
- [DMRS length](#)
- State of [transform precoding](#)

Remote command:

`CONFigure[:NR5G]:UL[:CC<cc>]:FRAMe<fr>:BWPart<bwp>:SLOT<sl>:ALLocation<al>:CLMapping` on page 335

Antenna Port

Each layer of a PUSCH allocation is mapped to a certain antenna port. The "Antenna Port" dropdown menu selects the antenna ports that are used for the transmission of the PUSCH allocation.

Example:

- [DMRS configuration type](#) = 1
- [DMRS length](#) = 2
- [Transform precoding](#)
- [Codeword to layer mapping](#) = 4/1, which corresponds to 4 layers

For this configuration you can map the layers to antenna ports "0,1,4,5", "0,2,4,6" or "2,3,6,7".

The antenna ports (layers) that are actually analyzed depends on the [antenna port configuration](#).

Remote command:

```
CONFigure[:NR5G]:UL[:CC<cc>]:FRAMe<fr>:BWPart<bwp>:SLOT<sl>:
ALLocation<al>:DMRS:AP on page 336
```

CDM Groups w/o Data

Selects the number of CDM groups that are reserved and contain no data. They are therefore not used by the PUSCH for data transmission. In the resource grid, the resource elements for CDM (between PUSCH DMRS resource elements) remain empty.

Note that the different values for this parameter change the default values of the [relative DMRS power](#) according to 3GPP 38.214, table 4.1-1.

Remote command:

```
CONFigure[:NR5G]:UL[:CC<cc>]:FRAMe<fr>:BWPart<bwp>:SLOT<sl>:
ALLocation<al>:DMRS:CGWD on page 337
```

DMRS-Uplink

Turns the higher layer parameter "dmrs-uplink" on and off.

Available when you turn off [transform precoding](#).

This parameter reduces the peak-to-average power ratio (PAPR) of the PUSCH DMRS as defined 3GPP, release 16. Using the low PAPR also results in a different calculation of the DMRS sequence.

Remote command:

```
CONFigure[:NR5G]:UL[:CC<cc>]:FRAMe<fr>:BWPart<bwp>:SLOT<sl>:
ALLocation<al>:DMRS:RST on page 343
```

4.1.9.5 Enhanced PUSCH settings: PTRS

Access: "Overview" > "Signal Description" > "Radio Frame Config" > "PUSCH / PUCCH Config" > "Enhanced Settings" > "Phase-tracking RS Config"

User ID 0	
PUSCH DMRS Config	Phase-tracking RS Config (PTRS) Scrambling/Coding
State	<input checked="" type="radio"/> On <input type="radio"/> Off
Rel Power (to PUSCH)	0.0 dB
L_PTRS	1
K_PTRS	2
UL-PTRS-RE-offset	00

The remote commands required to configure the DMRS are described in [Chapter 6.10.13, "Enhanced PUSCH settings: PTRS"](#), on page 345.

Functions in the "Scrambling / Coding" dialog box described elsewhere:

- "User ID" on page 93

PTRS Configuration (Transform Precoding = Off)	97
PTRS Configuration (Transform Precoding = On)	98

PTRS Configuration (Transform Precoding = Off)

The phase tracking reference signal (PTRS) is a UE-specific reference signal that is used to compensate for the phase noise of the oscillator. The PTRS is transmitted in resource blocks used for the PUSCH.

If the PTRS "State" is on, you can define its "Power" relative to the PUSCH and its location in the resource grid.

The parameters that define the PTRS location depend on the selected [precoding mode](#).

For "Transform Precoding" = "Off", the following parameters define the PTRS location.

The "L_PTRS" defines distance between the PTRS in terms of OFDM symbols (transmission every 1, 2 or 4 OFDM symbols). If the subcarrier used by the PTRS also contains a DMRS, the distance can be larger.

The "K_PTRS" and "DL-PTRS-RE-Offset" define the location of the PTRS in the frequency domain. K_{PTRS} defines the distances between the PTRS in terms of subcarrier. You can also define an additional frequency offset for the PTRS relative to the first subcarrier.

Remote command:

State: `CONFigure[:NR5G]:UL[:CC<cc>]:FRAME<fr>:BWPpart<bwp>:SLOT<sl>:ALLocation<al>:PTRS[:STATE]` on page 350

Power: `CONFigure[:NR5G]:UL[:CC<cc>]:FRAME<fr>:BWPpart<bwp>:SLOT<sl>:ALLocation<al>:PTRS:POWER` on page 349

L_{PTRS} : `CONFigure[:NR5G]:UL[:CC<cc>]:FRAME<fr>:BWPpart<bwp>:SLOT<sl>:ALLocation<al>:PTRS:L` on page 346

K_{PTRS} : `CONFigure[:NR5G]:UL[:CC<cc>]:FRAME<fr>:BWPpart<bwp>:SLOT<sl>:ALLocation<al>:PTRS:K` on page 345

Offset: `CONFigure[:NR5G]:UL[:CC<cc>]:FRAME<fr>:BWPpart<bwp>:SLOT<sl>:ALLocation<al>:PTRS:REOffset` on page 350

PTRS Configuration (Transform Precoding = On)

The phase tracking reference signal (PTRS) is a UE-specific reference signal that is used to compensate for the phase noise of the oscillator. The PTRS is transmitted in resource blocks used for the PUSCH.

If the PTRS "State" is on, you can define its "Power" relative to the PUSCH and its location in the resource grid.

The FSW automatically selects the default power according to 3GPP 38.214, table 6.2.3.2-2. If required, you can also define a different level.

The parameters that define the PTRS location depend on the selected [precoding mode](#).

For "Transform Precoding" = "On", the following parameters define the PTRS location.

The "N_group^PTRS" defines the number of PTRS groups to transmit (2, 4 or 8).

The "N_samp^group" defines the number of samples allocated to an PTRS group (2 or 4). From the number of used samples in a PTRS group, you can deduct the number of samples in a OFDM symbol.

The "L_PTRS" defines distance between the PTRS in terms of OFDM symbols (transmission every 1, 2 or 4 OFDM symbols). If the subcarrier used by the PTRS also contains a DMRS, the distance can be larger.

The "N_ID" selects the scrambling method and seed value.

"n_ID^Cell"

Calculates the sequence based on the [cell ID](#), if the higher layers provide no value.

"n_ID^Cell" has the same value as the cell ID.

"n_ID^PUSCH"

Calculates the sequence based on a pseudo-random seed value. You can define the seed value in the input field that becomes available when you select this method.

Remote command:

State: [CONFigure\[:NR5G\]:UL\[:CC<cc>\]:FRAMe<fr>:BWPART<bwp>:SLOT<sl>:ALLOCATION<al>:PTRS\[:STATE\]](#) on page 350

Power: [CONFigure\[:NR5G\]:UL\[:CC<cc>\]:FRAMe<fr>:BWPART<bwp>:SLOT<sl>:ALLOCATION<al>:PTRS:POWER](#) on page 349

N_group: [CONFigure\[:NR5G\]:UL\[:CC<cc>\]:FRAMe<fr>:BWPART<bwp>:SLOT<sl>:ALLOCATION<al>:PTRS:NGROUPS](#) on page 346

N_samp: [CONFigure\[:NR5G\]:UL\[:CC<cc>\]:FRAMe<fr>:BWPART<bwp>:SLOT<sl>:ALLOCATION<al>:PTRS:NSAMPLES](#) on page 348

L_PTRS: [CONFigure\[:NR5G\]:UL\[:CC<cc>\]:FRAMe<fr>:BWPART<bwp>:SLOT<sl>:ALLOCATION<al>:PTRS:L](#) on page 346

N_ID: [CONFigure\[:NR5G\]:UL\[:CC<cc>\]:FRAMe<fr>:BWPART<bwp>:SLOT<sl>:ALLOCATION<al>:PTRS:NID](#) on page 347

Seed value: [CONFigure\[:NR5G\]:UL\[:CC<cc>\]:FRAMe<fr>:BWPART<bwp>:SLOT<sl>:ALLOCATION<al>:PTRS:NIID](#) on page 348

4.1.9.6 Enhanced PUSCH settings: scrambling / coding

Access: "Overview" > "Signal Description" > "Radio Frame Config" > "PUSCH / PUCCH Config" > "Enhanced Settings" > "Scrambling / Coding"

The screenshot shows a configuration interface for 'Scrambling / Coding'. At the top, 'User ID' is set to 0. Below this are three tabs: 'PUSCH DMRS Config', 'Phase-tracking RS Config (PTRS)', and 'Scrambling / Coding'. The 'Scrambling / Coding' tab is active. Under 'Channel Coding', there are three fields: 'MCS Table' (a dropdown menu showing '64QAM'), 'I_MCS' (an input field with '0'), and 'Redundancy Version Index' (an input field with '0'). Under 'Scrambling', there is one field: 'Data-Scrambling-ID' (a dropdown menu showing '0').

The remote commands required to configure the channel coding and scrambling are described in [Chapter 6.10.14, "Enhanced PUSCH settings: scrambling / coding"](#), on page 351.

Functions in the "Scrambling / Coding" dialog box described elsewhere:

- "User ID" on page 93

Channel Coding	99
PUSCH Scrambling	100

Channel Coding

Channel coding parameters determine the code rate of the PUSCH, which is the ratio between transmitted bits and maximum possible bits in a subframe (or 1 ms transport block). Because the number of bits in a subframe is variable, the target code rate has to be derived from the modulation order in combination with an index I_{MCS} .

You can select the modulation order for the PUSCH (one of several tables, one for each modulation type) from the "MCS Table" dropdown menu and select the corresponding index value (defined in the tables) in the "I_MCS" input field. The target code rates for modulation order and index are defined in 3GPP 38.214, chapter 5.1.3.

In addition to the modulation order and I_{MCS} , the number of transmitted bits depends on the "Redundancy Version Index", which is used to re-transmit data in case of transmission errors. Depending on the redundancy version index, the PUSCH contains a different amount of parity bits for error detection: Index 0 adds 1 sequence of parity bits, index 1 adds two sequences of parity bits etc.

Because redundancy version 1 and 2 do not transmit a complete set of data (only new bits that have not been transmitted correctly before), it is not possible to decode such signals, even if the signal-to-noise ration is perfect. Only redundancy version 3 transmits a complete set of data, and can therefore be decoded without the knowledge of previous data.

Remote command:

Modulation order: `CONFigure[:NR5G]:UL[:CC<cc>]:FRAMe<fr>:
BWPart<bwp>:SLOT<sl>:ALLocation<al>:CCODing:MCSTable` on page 352
 MCS index: `CONFigure[:NR5G]:UL[:CC<cc>]:FRAMe<fr>:BWPart<bwp>:
SLOT<sl>:ALLocation<al>:CCODing:IMCS` on page 351
 Redundancy version: `CONFigure[:NR5G]:UL[:CC<cc>]:FRAMe<fr>:
BWPart<bwp>:SLOT<sl>:ALLocation<al>:CCODing:RVIndex` on page 352

PUSCH Scrambling

3GPP (38.211) defines two methods by which the PUSCH scrambling can be calculated. You can select the method with the "Scrambling" parameter.

- "Data-Scrambling-ID"
Scrambles the PUSCH based on a pseudo-random seed value. You can define the seed value in the input field that becomes available when you select this method.
- "n_ID^Cell"
Scrambles the PUSCH based on the **cell ID**, if the higher layers provide no value for "DMRS-Scrambling-ID". "n_ID^Cell" has the same value as the cell ID.

Remote command:

Method: `CONFigure[:NR5G]:UL[:CC<cc>]:FRAMe<fr>:BWPart<bwp>:
SLOT<sl>:ALLocation<al>:SCRambling` on page 353
 Seed value: `CONFigure[:NR5G]:UL[:CC<cc>]:FRAMe<fr>:BWPart<bwp>:
SLOT<sl>:ALLocation<al>:SCRambling:DSID` on page 353

4.1.10 Antenna port configuration

Access: "Overview" > "Signal Description" > "Ant Port Mapping"

Antenna ports are not physical antennas, but rather are a logical concept. Each antenna port carries certain signal components (= physical channels) that should be transmitted under the same conditions. Physical channels can be transmitted on a single antenna port, or on several antenna ports. Each antenna port in turn can be mapped to one of the physical antennas. Typically, one physical antenna combines several antenna ports. However, one specific antenna port can also be transmitted on more than one physical antenna.

The dialog is designed as a table with two rows representing the physical antennas ("Config 1" and "Config 2").

Only one of the two configurations can be on.

The columns represent the physical channels.

The "Ant Port Mapping" dialog box allows you to map the antenna ports used by the various physical channels defined by 3GPP to one or two layer configurations.

Signal Description	Radio Frame Config	Ant Port Mapping	Advanced Settings		
CC 1					
Antenna Port to Physical Antenna Mapping					
	State	PUSCH DMRS	PUSCH	PUCCH	SRS
Config 1	On	0	1000	2000	1000
Config 2	Off	1	1001	2000	1000

The remote commands required to configure the antenna ports are described in [Chapter 6.10.15, "Antenna port configuration"](#), on page 354.

State.....	101
PUSCH.....	101
PUCCH.....	101
SRS.....	102

State

Turns the corresponding antenna port configuration on and off and applies it to the measurement.

Note that you can currently measure only one of the two configurations (physical antenna). If you turn on one configuration, the other is automatically turned off.

Remote command:

`CONFigure[:NR5G]:UL[:CC<cc>]:PAMapping<cf>:STATE` on page 355

PUSCH

Selects the antenna ports that transmit the PUSCH. You can assign the PUSCH to multiple antenna ports (1000 to 1011).

To select the antenna port that transmits the PUSCH, select the PUSCH DMRS antenna port. Selecting the PUSCH DMRS antenna port (0 to 11) automatically assigns the PUSCH to the corresponding antenna ports (ports 1000 to 1011). For example, mapping the PUSCH DMRS to AP 3, maps the PUSCH to AP 1003.

When you select the table cell, the FSW opens another dialog box in which you can turn the transmission of the PUSCH on certain antenna ports on and off.

By default, the PUSCH is transmitted on antenna port 1000 (for physical antenna 1) and antenna port 1001 (for physical antenna 2).

Thus, the PUSCH DMRS is transmitted on antenna ports 0 and 1, by default.

Remote command:

PUSCH (DMRS): `CONFigure[:NR5G]:UL[:CC<cc>]:PAMapping<cf>:PUSCh:AP<ap>` on page 354

PUCCH

Shows the antenna ports that transmit the PUCCH.

The PUCCH is assumed to be transmitted on antenna port 2000.

Remote command:

not supported

SRS

Shows the antenna ports that transmit the PUCCH.

The SRS is assumed to be transmitted on antenna port 1000.

Remote command:
not supported

4.1.11 Advanced settings

Access: "Overview" > "Signal Description" > "Advanced Settings"

Advanced settings contain settings that are independent of the radio frame configuration.

**Configuring component carriers**

When you are doing measurements on [aggregated carriers](#), you can configure each carrier separately.

When available, each carrier in the dialog boxes is represented by an additional tab labeled "CC<x>", with <x> indicating the number of the component carrier.

Note that the additional tabs are only added to the user interface after you have selected more than "1" component carrier.

- [Global settings](#)..... 102
- [Reference point A](#)..... 106

4.1.11.1 Global settings

Access: "Overview" > "Signal Description" > "Advanced Settings" > "Global Settings"

The global settings contain various settings that have an effect on how the FSW analyzes the signal.

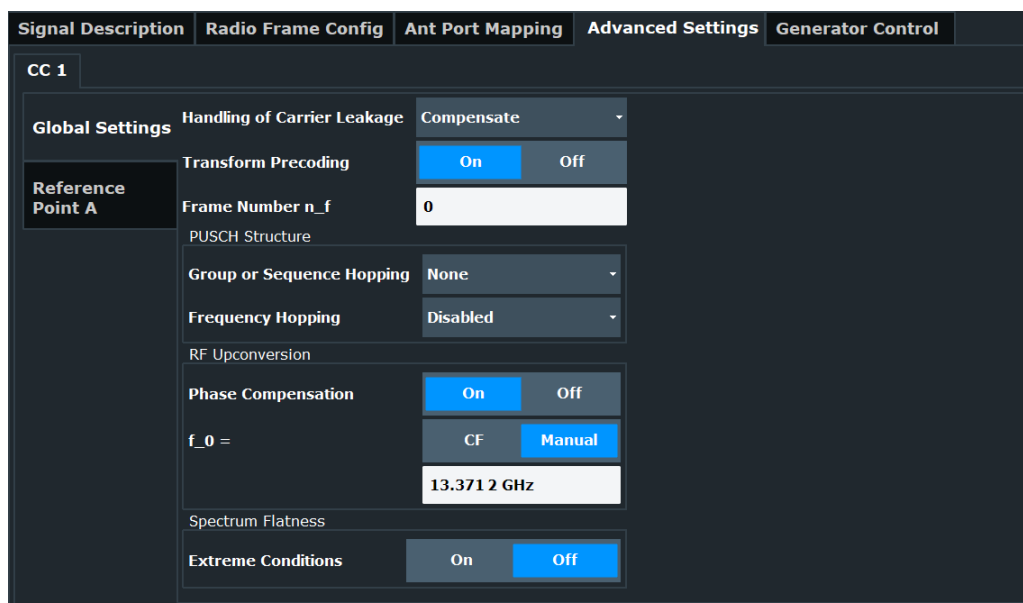

The remote commands required to configure the global settings are described in [Chapter 6.10.16, "Advanced settings: global"](#), on page 355.

Handling of Carrier Leakage	103
Transform Precoding	104
Frame Number n_f	104
PUSCH Hopping	104
PUSCH Frequency Hopping	104
RF Upconversion	105
Extreme Conditions	105
O-RAN Test Case	105

Handling of Carrier Leakage

Controls the way the DC carrier is handled during signal analysis.

You can either leave the DC carrier as it is, remove it from the analysis or compensate for carrier leakage effects.

Removing the DC carrier or compensating leakage effects is useful if the DC carrier is located on a subcarrier, which would have a negative effect on the EVM.

- If you leave the DC carrier as it is, the FSW includes the DC carrier in all results.
- If you ignore the DC carrier, the FSW removes the DC carrier from all results by ignoring the corresponding subcarriers. The DC carrier is assumed to be in the center of the channel bandwidth.
- If you compensate for carrier leakage, the FSW includes the subcarriers used by the DC carrier in the result analysis, but compensates them mathematically.

If you turn on [transform precoding](#), "Ignore DC" is unavailable.

Remote command:

`CONFigure[:NR5G]:UL[:CC<cc>]:IDC` on page 356

Transform Precoding

5G NR supports two channel access methods for uplink signals, CP-OFDM and DFT-s-OFDM. Depending on the use case, one or the other has advantages over the other. For DFT-s-OFDM, an additional signal processing stage, transform precoding, is applied. Transform precoding is the term for the digital Fourier transformation (DFT) used in the 5G NR standard.

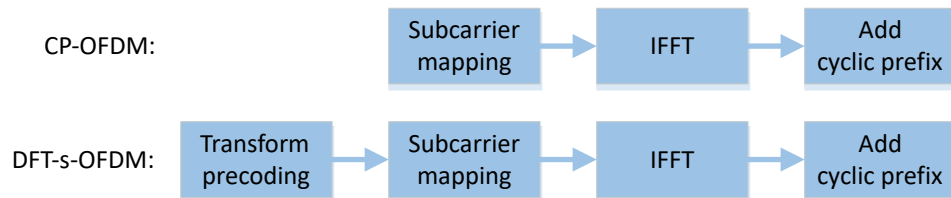

Figure 4-4: Signal processing depending on channel access scheme

With the "Transform Precoding" parameter, you can select which channel access method is analyzed.

- "On": Analysis of the signal with precoding operation (DFT-s-OFDM).
- "Off": Analysis of the signal without precoding operation (CP-OFDM).

Note that the state of the "Transform Precoding" affects the settings available for the PUSCH PTRS.

- Without precoding: ["PTRS Configuration \(Transform Precoding = Off\)"](#) on page 97
- With precoding: ["PTRS Configuration \(Transform Precoding = On\)"](#) on page 98

Remote command:

[CONFigure\[:NR5G\]:UL\[:CC<cc>\]:TPRecoding](#) on page 359

Frame Number n_f

Defines the system frame number n_f in the capture buffer. For multiple frame analysis it defines the system frame number of the first frame you are analyzing.

Remote command:

[CONFigure\[:NR5G\]:UL\[:CC<cc>\]:FNNF](#) on page 356

PUSCH Hopping

Selects a hopping mode for the PUSCH DMRS sequence as defined in 3GPP 38.211: 6.4.1.1.1.2 "Sequence Generation when Transform Precoding is Enabled".

When you turn on [transform precoding](#), you can select one of the following hopping modes.

- "None" (no hopping)
- "Group Hopping"
- "Sequence Hopping"

Remote command:

[CONFigure\[:NR5G\]:UL\[:CC<cc>\]:PUSCh:HOPPing](#) on page 357

PUSCH Frequency Hopping

Selects the PUSCH frequency hopping mode.

- "Disabled": PUSCH always uses the same frequency.
- "Intra-Slot Hopping": PUSCH changes the frequency within a slot.

Intra-slot hopping requires exactly one **PUSCH allocation** in the signal. Using intra-slot hopping adds a secondary PUSCH allocation, which corresponds to the second hop. The secondary allocation has the same characteristics as the primary PUSCH allocation.

You can control the hopping frequencies in terms of the **resource blocks** the allocation is using.

Note that the **DMRS length** is always "1" when you turn on intra-slot hopping.

Remote command:

`CONFigure[:NR5G]:UL[:CC<cc>]:PUSCh:FHOpping` on page 356

RF Upconversion

It is necessary to upconvert the baseband signal to the radio frequency. The upconversion requires a frequency related phase compensation after each symbol according to 3GPP 38.211: 5.4 "Modulation and Upconversion".

When you turn off "Phase Compensation", the FSW assumes that the applied signal is not phase-compensated and analyzes the signal accordingly.

When you turn on "Phase Compensation", the FSW assumes that the applied signal is already phase-compensated for a specific frequency. This frequency is either the current center frequency ("CF") or an arbitrary frequency ("Manual"). You can define the frequency in the corresponding input field.

Remote command:

State: `CONFigure[:NR5G]:UL[:CC<cc>]:RFUC:STAtE` on page 358

Mode: `CONFigure[:NR5G]:UL[:CC<cc>]:RFUC:FZERo:MODE` on page 357

Frequency: `CONFigure[:NR5G]:UL[:CC<cc>]:RFUC:FZERo:FREQuency` on page 357

Extreme Conditions

Turns extreme conditions on and off.

If you turn the extreme conditions on, the FSW adjusts the limits for the limit check of the spectrum flatness evaluation.

Available for deployments in FR1.

Note that the state of this parameter is the same for all component carriers - when you change it for one component carrier, the state is automatically adjusted in the other component carriers.

Remote command:

`CONFigure[:NR5G]:UL[:CC<cc>]:SFLatness:ECONditions` on page 358

O-RAN Test Case

Selects the O-RAN test case that the DSP uses for signal analysis.

Select "None" when you do not measure O-RAN signals.

See [Chapter 4.8, "O-RAN measurement guide"](#), on page 159 for more information about O-RAN measurements.

Remote command:

`CONFigure[:NR5G]:ORAN:TCASe` on page 355

4.1.11.2 Reference point A

Access: "Overview" > "Signal Description" > "Advanced Settings" > "Reference Point A"

Point A, as defined in 3GPP 38.211: 4.4.4.2 "Point A", is a reference point with a fixed frequency. The resource block grid for each subcarrier spacing is defined relative to the reference point A. It is aligned with the center of subcarrier 0 of common resource block 0, independent of the numerology.

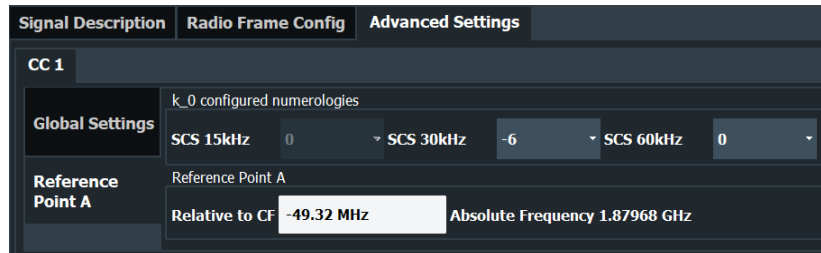

The remote commands required to configure the reference point A are described in [Chapter 6.10.16, "Advanced settings: global"](#), on page 355.

k_0	106
Reference Point A	106

k_0

The `k_0` defines an additional (subcarrier) offset of the resource grid with a specific subcarrier spacing relative to the reference point A.

You can select the offset you require from the "SCS <x> kHz" dropdown menus. Note that the dropdown menus are only available if you are using a bandwidth part with the corresponding subcarrier spacing.

Remote command:

SCS 15 kHz: `CONFigure[:NR5G]:UL[:CC<cc>]:RPA:KZERo:SCFT` on page 360

SCS 30 kHz: `CONFigure[:NR5G]:UL[:CC<cc>]:RPA:KZERo:SCTT` on page 361

SCS 60 kHz: `CONFigure[:NR5G]:UL[:CC<cc>]:RPA:KZERo:SCST` on page 361

SCS 120 kHz: `CONFigure[:NR5G]:UL[:CC<cc>]:RPA:KZERo:SCOT` on page 361

SCS 480 kHz: `CONFigure[:NR5G]:UL[:CC<cc>]:RPA:KZERo:SCFE` on page 360

SCS 960 kHz: `CONFigure[:NR5G]:UL[:CC<cc>]:RPA:KZERo:SCNS` on page 360

Reference Point A

You can define the location of the reference point relative to the center frequency of the carrier with the "Relative to CF" parameter.

The value range is limited, depending on various parameters like [channel bandwidth](#) or used [subcarrier spacing](#). You can change it in steps of 12 times the largest subcarrier spacing.

The FSW also displays absolute frequency location of the reference point A and its offset to the first subcarrier of the channel ("TxBW").

Remote command:

Center frequency: `CONFigure[:NR5G]:UL[:CC<cc>]:RPA:RTCF` on page 362

Absolute frequency: `CONFigure[:NR5G]:UL[:CC<cc>]:RPA:AFrequency?`
on page 359

TxBW offset: `CONFigure[:NR5G]:UL[:CC<cc>]:RPA:TBOffset?` on page 362

4.1.12 Generator control

Access: "Overview" > "Signal Description" > "Generator Control"

Generator control settings provide an easy way to synchronize settings of the analyzer and a connected signal generator that is also equipped with the 5G NR application.

The generator settings become available after a successful connection to the generator.

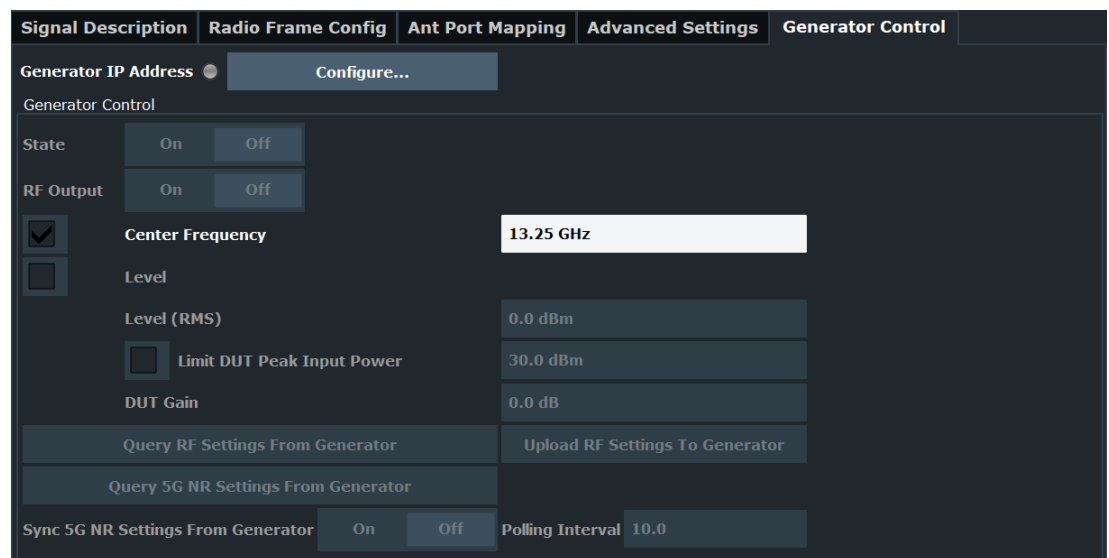

The remote commands required to configure the generator control are described in [Chapter 6.10.18, "Generator control"](#), on page 362.

Generator IP Address	107
Generator Control State	108
RF Output State	108
Center Frequency	108
Level Control State	109
L Level (RMS)	109
L Limit DUT Peak Input Power	109
L DUT Gain	109
Upload RF Settings to Generator	109
Query Settings from Generator	109
Periodic synchronization of 5G NR settings	110

Generator IP Address

Opens a dialog box to configure the network properties of the signal generator.

You can connect to the generator either by entering its IP address ("123" button), or its computer name ("ABC" button).

If you are not sure about the IP address or computer name of your generator, check its user interface or kindly ask your IT administrator to provide them.

After you have entered IP address or computer name, use "Connect" to establish the connection. The FSW shows if the connection state, and, if the connection was successful, the connected generator type.

Remote command:

Define IP address: [CONFigure:GENerator:IPConnection:ADDRESS](#) on page 363

Query connection state: [CONFigure:GENerator:IPConnection:LEDState?](#) on page 363

Generator Control State

Activates or disables control of the signal generator by the FSW.

If a connection was defined in another measurement channel, the connection is maintained when you switch to the 5G NR measurement application. However, generator control is disabled to protect the DUT from possibly erroneous or damaging settings. Check the settings, then enable the control state.

Note: While generator control is active, you cannot change the connection information. Only one channel can control a generator at any time. If you switch on generator control while it is still active in another channel, for example for parameter coupling with a generator, the control is disabled in the other channel.

Exception: The SCPI Recorder maintains control of the generator even if you switch channels.

Remote command:

[CONFigure:GENerator:CONTrol\[:STATe\]](#) on page 368

RF Output State

To protect the instrument from possibly erroneous or damaging settings, you must manually activate the RF output on the signal generator to start providing a signal. Check all settings on the signal generator, in particular the level settings, before activating the RF output.

A red LED on the "Generator Control" tab indicates a setting error on the generator.

Remote command:

[CONFigure:GENerator:RFOutput\[:STATe\]](#) on page 367

Center Frequency

Turns frequency synchronization on and off.

If you change the frequency on the analyzer, the generator automatically adjusts its [frequency](#).

Remote command:

Synchronization state: [CONFigure:GENerator:FREQUENCY:CENTer:SYNC\[:STATe\]](#) on page 363

Center frequency: [\[SENSe:\]FREQUENCY:CENTer\[:CC<cc>\]](#) on page 376

Level Control State

If enabled, the FSW automatically controls the signal level provided by the signal generator as input to the FSW. Initially, the [Level \(RMS\)](#) value is applied. Note that the reference level on the FSW is also affected by the signal level:

$$\text{Ref_level}_{\text{Analyzer}} = \text{Peak envelope power DUT} + \text{DUT Gain}$$

Where the current peak envelope power (PEP) value of the DUT is determined from the generator.

To protect the signal generator from possibly excess power levels, the level setting control is disabled by default.

Remote command:

[CONFigure:GENerator:POWer:LEVel:STATe](#) on page 364

Level (RMS) ← Level Control State

(Default:) The specified power level is used for the output power by the connected signal generator.

Remote command:

[CONFigure:GENerator:POWer:LEVel](#) on page 365

Limit DUT Peak Input Power ← Level Control State

If enabled, the generator does not exceed the maximum input power (peak envelope power, "PEP") that is currently allowed by the DUT and that is specified on the generator. The defined "PEP" value is indicated.

Remote command:

State: [CONFigure:GENerator:LEVel:DUTLimit:STATe](#) on page 365

Limit: [CONFigure:GENerator:LEVel:DUTLimit](#) on page 365

DUT Gain ← Level Control State

The FSW considers a gain due to the DUT when determining the reference level.

During the reference calibration measurement, in which the DUT is removed from the signal path, the generator level is also adjusted according to the DUT gain value.

Remote command:

[CONFigure:GENerator:LEVel:DUTGain](#) on page 364

Upload RF Settings to Generator

Uploads the RF settings available in this dialog to the generator.

Useful when you change the level or frequency on the generator itself. In that case, those settings remain the same on the FSW. To restore the original settings defined within the FSW, use that button to restore the generator settings.

Remote command:

[CONFigure:GENerator:SETTings:UPDate:RF](#) on page 368

Query Settings from Generator

Downloads the generator settings to the FSW. You can synchronize both, basic RF settings and 5G NR settings.

RF settings include the [frequency](#) and the [level](#) settings.

5G NR settings include the complete signal description.

Remote command:

RF settings: [CONFigure:SETTings:RF](#) on page 367

NR settings: [CONFigure:SETTings:NR5G](#) on page 366

Periodic synchronization of 5G NR settings

Instead of downloading the 5G NR settings from the generator once, you can synchronize the settings on a periodic basis. This synchronization makes sure that the analyzer always has the same signal description as the generator.

"Sync 5G NR Settings from Generator" turns the periodic synchronization of the settings on and off. The "Polling Interval" defines how often the synchronization takes place (in seconds).

Polling automatically stops when you change a parameter in the signal description on the analyzer.

Note that this only applies to the 5G NR settings, not the RF settings.

Remote command:

State: [CONFigure:SETTings:NR5G:SYNC](#) on page 367

Interval: [CONFigure:SETTings:NR5G:PINTerval](#) on page 366

4.1.13 Input source configuration

The FSW supports several input sources and outputs.

For a comprehensive description of the supported inputs and outputs, refer to the FSW user manual.

• RF input	110
• External Frontends	112
• External mixer	112
• Digital I/Q input	112
• Analog baseband	113
• Baseband oscilloscope	115
• I/Q file	115

4.1.13.1 RF input

Access: "Overview" > "Input / Frontend" > "Input Source" > "Radio Frequency"

Functions to configure the RF input described elsewhere:

- ["Input Coupling"](#) on page 120
- ["Impedance"](#) on page 120

Direct Path	110
High Pass Filter 1 to 3 GHz	111
YIG-Preselector	111
Input Connector	111

Direct Path

Enables or disables the use of the direct path for small frequencies.

In spectrum analyzers, passive analog mixers are used for the first conversion of the input signal. In such mixers, the LO signal is coupled into the IF path due to its limited isolation. The coupled LO signal becomes visible at the RF frequency 0 Hz. This effect is referred to as LO feedthrough.

To avoid the LO feedthrough the spectrum analyzer provides an alternative signal path to the A/D converter, referred to as the *direct path*. By default, the direct path is selected automatically for RF frequencies close to zero. However, this behavior can be disabled. If "Direct Path" is set to "Off", the spectrum analyzer always uses the analog mixer path.

For an active external frontend, the direct path is always used automatically for frequencies close to zero.

"Auto" (Default) The direct path is used automatically for frequencies close to zero.

"Off" The analog mixer path is always used.

Remote command:

[INPut:DPATH](#) on page 371

High Pass Filter 1 to 3 GHz

Activates an additional internal highpass filter for RF input signals from 1 GHz to 3 GHz. This filter is used to remove the harmonics of the analyzer to measure the harmonics for a DUT, for example.

This function requires an additional hardware option.

Note: For RF input signals outside the specified range, the high-pass filter has no effect. For signals with a frequency of approximately 4 GHz upwards, the harmonics are suppressed sufficiently by the YIG-preselector, if available.)

Remote command:

[INPut:FILTer:HPASs\[:STATe\]](#) on page 373

YIG-Preselector

Enables or disables the YIG-preselector.

This setting requires an additional option on the FSW.

Note: Note that the YIG-preselector is active only on frequencies greater than 8 GHz. Therefore, switching the YIG-preselector on or off has no effect if the frequency is below that value.

To use the optional 90 GHz frequency extension (R&S FSW-B90G), the YIG-preselector must be disabled.

The YIG-"Preselector" is off by default.

Remote command:

[INPut:FILTer:YIG\[:STATe\]](#) on page 373

Input Connector

Determines which connector the input data for the measurement is taken from.

For more information on the optional "Analog Baseband" interface, see the FSW I/Q Analyzer and I/Q Input user manual.

"RF" (Default:) The "RF Input" connector

"RF Probe"	The "RF Input" connector with an adapter for a modular probe This setting is only available if a probe is connected to the "RF Input" connector. It is not available for an active external frontend.
"Baseband Input I"	The optional "Baseband Input I" connector This setting is only available if the optional "Analog Baseband" interface is installed and active for input. It is not available for the FSW67. For FSW85 models with two input connectors, this setting is only available for "Input 1".

Remote command:

[INPut:CONNector](#) on page 369

4.1.13.2 External Frontends

Access: "Overview" > "Input / Frontend" > "Input Source" > "Ext. Frontend"

Controlling external frontends is available with the optional external generator control. The functionality is the same as in the I/Q analyzer application.

For more information about using external frontends, refer to the FSW I/Q analyzer user manual.

4.1.13.3 External mixer

Access: "Overview" > "Input / Frontend" > "Input Source" > "External Mixer"

Controlling external generators is available with the optional external generator control. The functionality is the same as in the spectrum application.

For more information about using external generators, refer to the FSW user manual.

4.1.13.4 Digital I/Q input

Access: "Overview" > "Input / Frontend" > "Input Source" > "Digital IQ"

Digital I/Q Input State	112
Input Sample Rate	112
Full Scale Level	113
Adjust Reference Level to Full Scale Level	113
Connected Instrument	113

Digital I/Q Input State

Enables or disable the use of the "Digital I/Q" input source for measurements.

"Digital I/Q" is only available if the optional "Digital Baseband" is installed.

Remote command:

[INPut:SElect](#) on page 374

Input Sample Rate

Defines the sample rate of the digital I/Q signal source. This sample rate must correspond with the sample rate provided by the connected device, e.g. a generator.

If "Auto" is selected, the sample rate is adjusted automatically by the connected device.

The allowed range is from 100 Hz to 20 GHz.

Remote command:

[INPut:DIQ:SRATe](#) on page 371

[INPut:DIQ:SRATe:AUTO](#) on page 371

Full Scale Level

The "Full Scale Level" defines the level and unit that corresponds to an I/Q sample with the magnitude "1".

If "Auto" is selected, the level is automatically set to the value provided by the connected device.

Remote command:

[INPut:DIQ:RANGe\[:UPPer\]](#) on page 370

[INPut:DIQ:RANGe\[:UPPer\]:UNIT](#) on page 371

[INPut:DIQ:RANGe\[:UPPer\]:AUTO](#) on page 370

Adjust Reference Level to Full Scale Level

If enabled, the reference level is adjusted to the full scale level automatically if any change occurs.

Remote command:

[INPut:DIQ:RANGe:COUPling](#) on page 370

Connected Instrument

Displays the status of the "Digital Baseband" interface connection.

If an instrument is connected, the following information is displayed:

- Name and serial number of the instrument connected to the "Digital Baseband" interface
- Used port
- Sample rate of the data currently being transferred via the "Digital Baseband" interface
- Level and unit that corresponds to an I/Q sample with the magnitude "1" ([Full Scale Level](#)), if provided by connected instrument

Remote command:

[INPut:DIQ:CDEVIce](#) on page 369

4.1.13.5 Analog baseband

Access: "Overview" > "Input / Frontend" > "Input Source" > "Analog BB"

Analog Baseband Input State	114
I/Q Mode	114
Input Configuration	114
High Accuracy Timing Trigger - Baseband - RF	114

Analog Baseband Input State

Enables or disables the use of the "Analog Baseband" input source for measurements. "Analog Baseband" is only available if the optional "Analog Baseband" is installed.

Remote command:

`INPut:SElect` on page 374

I/Q Mode

Defines the format of the input signal.

"I + jQ" The input signal is filtered and resampled to the sample rate of the application.
Two inputs are required for a complex signal, one for the in-phase component, and one for the quadrature component.

"I Only / Low IF I" The input signal at the "Baseband Input I" connector is filtered and resampled to the sample rate of the application.
If the center frequency is set to 0 Hz, the real baseband signal is displayed without down-conversion (**Real Baseband I**).
If a center frequency greater than 0 Hz is set, the input signal is down-converted with the center frequency (**Low IF I**).

"Q Only / Low IF Q" The input signal at the "Baseband Input Q" connector is filtered and resampled to the sample rate of the application.
If the center frequency is set to 0 Hz, the real baseband signal is displayed without down-conversion (**Real Baseband Q**).
If a center frequency greater than 0 Hz is set, the input signal is down-converted with the center frequency (**Low IF Q**).

Remote command:

`INPut:IQ:TYPE` on page 374

Input Configuration

Defines whether the input is provided as a differential signal via all four Analog Baseband connectors or as a plain I/Q signal via two single-ended lines.

Note: Both single-ended and differential probes are supported as input; however, since only one connector is occupied by a probe, the "Single-ended" setting must be used for all probes.

"Single-ended" I, Q data only
"Differential" I, Q and inverse I,Q data
(Not available for FSW85)

Remote command:

`INPut:IQ:BALanced[:STATe]` on page 373

High Accuracy Timing Trigger - Baseband - RF

Activates a mode with enhanced timing accuracy between analog baseband, RF and external trigger signals.

Note: Prerequisites for previous models of FSW.

For FSW models with a serial number lower than 103000, special prerequisites and restrictions apply for high accuracy timing:

- To obtain this high timing precision, trigger port 1 and port 2 must be connected via the Cable for High Accuracy Timing (order number 1325.3777.00).
- As trigger port 1 and port 2 are connected via the cable, only trigger port 3 can be used to trigger a measurement.
- Trigger port 2 is configured as output if the high accuracy timing option is active. Make sure not to activate this option if you use trigger port 2 in your measurement setup.
- When you first enable this setting, you are prompted to connect the cable for high accuracy timing to trigger ports 1 and 2. If you cancel this prompt, the setting remains disabled. As soon as you confirm this prompt, the cable must be in place - the firmware does not check the connection. (In remote operation, the setting is activated without a prompt.)

Remote command:

[CALibration:AIQ:HATiming\[:STATe\]](#) on page 369

4.1.13.6 Baseband oscilloscope

Access: "Overview" > "Input / Frontend" > "Input Source" > "Baseband Oscilloscope"

Capturing I/Q data with an oscilloscope is available with the optional baseband oscilloscope inputs. The functionality is the same as in the spectrum application.

For details, see the user manual of the I/Q analyzer.

4.1.13.7 I/Q file

Access: "Overview" > "Input / Frontend" > "Input Source" > "I/Q File"

As an alternative to capturing the measurement (I/Q) data live, you can also load previously recorded I/Q data stored in an `iq.tar` file. The file is then used as the input source for the application.

Available for I/Q based measurements.

For details, see the user manual of the I/Q analyzer.

I/Q Input File State	115
Select I/Q data file	116
File Repetitions	116
Selected Channel	116

I/Q Input File State

Enables input from the selected I/Q input file.

If enabled, the application performs measurements on the data from this file. Thus, most measurement settings related to data acquisition (attenuation, center frequency, measurement bandwidth, sample rate) cannot be changed. The measurement time can only be decreased to perform measurements on an extract of the available data only.

Note: Even when the file input is disabled, the input file remains selected and can be enabled again quickly by changing the state.

Remote command:

`INPut:SElect` on page 374

Select I/Q data file

Opens a file selection dialog box to select an input file that contains I/Q data.

The default storage location for I/Q data files is `C:\R_S\INSTR\USER`.

Remote command:

`INPut:FILE:PATH` on page 372

File Repetitions

Determines how often the data stream is repeatedly copied in the I/Q data memory to create a longer record. If the available memory is not sufficient for the specified number of repetitions, the largest possible number of complete data streams is used.

Remote command:

`TRACe:IQ:FILE:REPetition:COUNT` on page 376

Selected Channel

Only available for files that contain more than one data stream from multiple channels: selects the data stream to be used as input for the currently selected channel.

In "Auto" mode (default), the first data stream in the file is used as input for the channel. Applications that support multiple data streams use the first data stream in the file for the first input stream, the second for the second stream etc.

Remote command:

`MMEMory:LOAD:IQ:STReam` on page 375

`MMEMory:LOAD:IQ:STReam:AUTO` on page 375

`MMEMory:LOAD:IQ:STReam:LIST?` on page 376

4.1.14 Frequency configuration

Access: "Overview" > "Input / Frontend" > "Frequency"

Frequency settings define the frequency characteristics of the signal at the RF input. They are part of the "Frequency" tab of the "Signal Characteristics" dialog box.

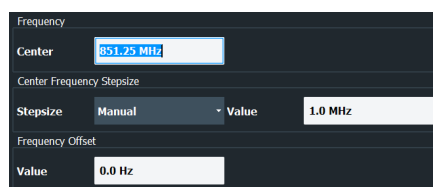

The remote commands required to configure the frequency are described in [Chapter 6.10.20, "Frequency configuration"](#), on page 376.

Signal Frequency.....	117
L Center Frequency.....	117
L Frequency Stepsize.....	117

Signal Frequency

For measurements with an RF input source, you have to match the **center frequency** of the analyzer to the frequency of the signal.

Center Frequency ← Signal Frequency

Defines the center frequency of the signal and thus the frequency the FSW tunes to. The frequency range depends on the hardware configuration of the analyzer you are using.

Remote command:

Center frequency: `[SENSe:] FREQuency:CENTer [:CC<cc>]` on page 376

Frequency offset: `[SENSe:] FREQuency:CENTer [:CC<cc>]:OFFSet` on page 377

Frequency Stepsize ← Signal Frequency

In addition to the frequency itself, you can also define a frequency stepsize. The frequency stepsize defines the extent of a frequency change if you change it, for example with the rotary knob.

You can define the stepsize in two ways.

- = Center
One frequency step corresponds to the current center frequency.
- Manual
Define any stepsize you need.

Remote command:

Frequency stepsize: `[SENSe:] FREQuency:CENTer:STEP` on page 378

4.1.15 Amplitude configuration

Access: "Overview" > "Input / Frontend" > "Amplitude"

Amplitude settings define the expected level characteristics of the signal at the RF input.

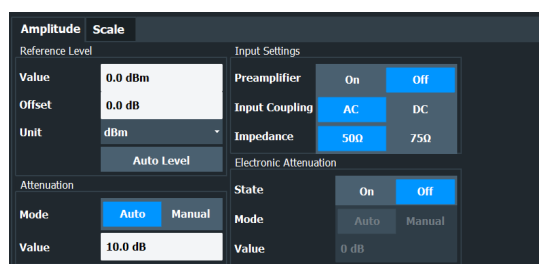

The remote commands required to configure the amplitude are described in [Chapter 6.10.21, "Amplitude configuration"](#), on page 378.

Reference Level.....	118
L Auto Level.....	118
L Reference Level Offset.....	118
Attenuating the Signal.....	119
L RF Attenuation.....	119
L Electronic Attenuation.....	119

Preamplifier.....	120
Input Coupling.....	120
Impedance.....	120

Reference Level

The reference level is the power level the analyzer expects at the RF input. Keep in mind that the power level at the RF input is the peak envelope power for signals with a high crest factor like 5G NR.

To get the best dynamic range, you have to set the reference level as low as possible. At the same time, make sure that the maximum signal level does not exceed the reference level. If it does, it will overload the A/D converter, regardless of the signal power. Measurement results can deteriorate (e.g. EVM), especially for measurements with more than one active channel near the one you are trying to measure (± 6 MHz).

Note that the signal level at the A/D converter can be stronger than the level the application displays, depending on the current resolution bandwidth. This is because the resolution bandwidths are implemented digitally after the A/D converter.

The reference level is a value in dBm.

Remote command:

Reference level: `DISPlay[:WINDow<n>][:SUBWindow<w>]:TRACe<t>:Y[:SCALE]:RLEVel` on page 378

Auto Level ← Reference Level

Automatically determines the ideal reference level. The automatic leveling process measures the signal and defines the ideal reference signal for the measured signal.

Automatic level detection also optimizes RF attenuation.

Auto leveling slightly increases the measurement time, because of the extra leveling measurement prior to each sweep. By default, the FSW automatically defines the time for auto leveling, but you can also define it manually ([Auto Set] > "Auto Level Config" > "Meas Time").

The application shows the current reference level (including RF and external attenuation) in the channel bar.

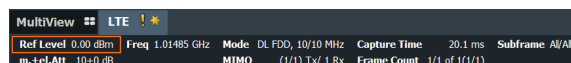

Remote command:

Automatic: `[SENSe:]ADJust:LEVel` on page 282

Auto level mode: `[SENSe:]ADJust:CONFigure:LEVel:DURation:MODE` on page 281

Auto level time: `[SENSe:]ADJust:CONFigure:LEVel:DURation` on page 280

Reference Level Offset ← Reference Level

The reference level offset is an arithmetic level offset. A level offset is useful if the signal is attenuated or amplified before it is fed into the analyzer. All displayed power level results are shifted by this value. Note however, that the reference value ignores the level offset. Thus, it is still mandatory to define the actual power level that the analyzer has to handle as the reference level.

Remote command:

`DISPlay[:WINDow<n>][:SUBWindow<w>]:TRACe<t>:Y[:SCALE]:RLEVel:OFFSet` on page 379

Attenuating the Signal

Attenuation of the signal becomes necessary if you have to reduce the power of the signal that you have applied. Power reduction is necessary, for example, to prevent an overload of the input mixer.

For a comprehensive information about signal attenuation, refer to the user manual of the FSW.

The 5G NR measurement application provides several attenuation modes.

RF Attenuation ← Attenuating the Signal

Controls the RF (or mechanical) attenuator at the RF input.

If you select automatic signal attenuation, the attenuation level is coupled to the reference level.

If you select manual signal attenuation, you can define an arbitrary attenuation (within the supported value range).

Positive values correspond to signal attenuation and negative values correspond to signal gain.

Note that when you are using an external frontend, you can define attenuation for the analyzer and the external frontend separately. For more information about external frontends, refer to the user manual of the I/Q analyzer.

The application shows the attenuation level (mechanical and electronic) in the channel bar.

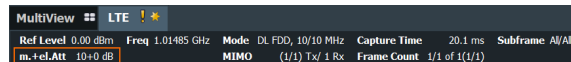

Remote command:

State: `INPut:ATTenuation<ant>:AUTO` on page 380

Level: `INPut:ATTenuation<ant>` on page 379

Electronic Attenuation ← Attenuating the Signal

Controls the optional electronic attenuator.

If you select automatic signal attenuation, the attenuation level is coupled to the reference level.

If you select manual signal attenuation, you can define an arbitrary attenuation (within the supported value range).

Positive values correspond to signal attenuation and negative values correspond to signal gain.

Note that the frequency range must not exceed the specification of the electronic attenuator for it to work.

The application shows the attenuation level (mechanical and electronic) in the channel bar.

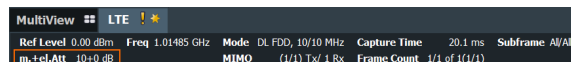

Remote command:

Electronic attenuation: `INPut:EATT<ant>:STATe` on page 382

Electronic attenuation: `INPut:EATT<ant>:AUTO` on page 382

Electronic attenuation: `INPut:EATT<ant>` on page 381

Preamplifier

If the (optional) internal preamplifier hardware is installed on the FSW, a preamplifier can be activated for the RF input signal.

You can use a preamplifier to analyze signals from DUTs with low output power.

Note: If an optional external preamplifier is activated, the internal preamplifier is automatically disabled, and vice versa.

For an active external frontend, a preamplifier is not available.

This function is not available for input from the (optional) "Digital Baseband" interface.

For all FSW models except for FSW85, the following settings are available:

"Off" Deactivates the preamplifier.

"15 dB" The RF input signal is amplified by about 15 dB.

"30 dB" The RF input signal is amplified by about 30 dB.

For FSW85 models, the input signal is amplified by 30 dB if the preamplifier is activated.

Remote command:

`INPut:GAIN:STATe` on page 380

`INPut:GAIN[:VALue]` on page 381

Input Coupling

The RF input of the FSW can be coupled by alternating current (AC) or direct current (DC).

For an active external frontend, input coupling is always AC.

Not available for input from the optional "Analog Baseband" interface.

Not available for input from the optional "Digital Baseband" interface.

AC coupling blocks any DC voltage from the input signal. AC coupling is activated by default to prevent damage to the instrument. Very low frequencies in the input signal can be distorted.

However, some specifications require DC coupling. In this case, you must protect the instrument from damaging DC input voltages manually. For details, refer to the specifications document.

Remote command:

`INPut:COUPling` on page 380

Impedance

For some measurements, the reference impedance for the measured levels of the FSW can be set to 50 Ω or 75 Ω .

For an active external frontend, impedance is always 50 Ω .

Select 75 Ω if the 50 Ω input impedance is transformed to a higher impedance using a 75 Ω adapter of the RAZ type. (That corresponds to 25 Ω in series to the input impedance of the instrument.) The correction value in this case is 1.76 dB = 10 log (75 Ω /50 Ω).

Not available for input from the optional "Digital Baseband" interface.

Not available for input from the optional "Analog Baseband" interface. For analog baseband input, an impedance of 50 Ω is always used.

Remote command:

[INPut: IMPedance](#) on page 381

4.1.16 Data capture

Access: "Overview" > "Trigger / Signal Capture" > "Signal Capture"

The data capture settings contain settings that control various aspects of the data capture.

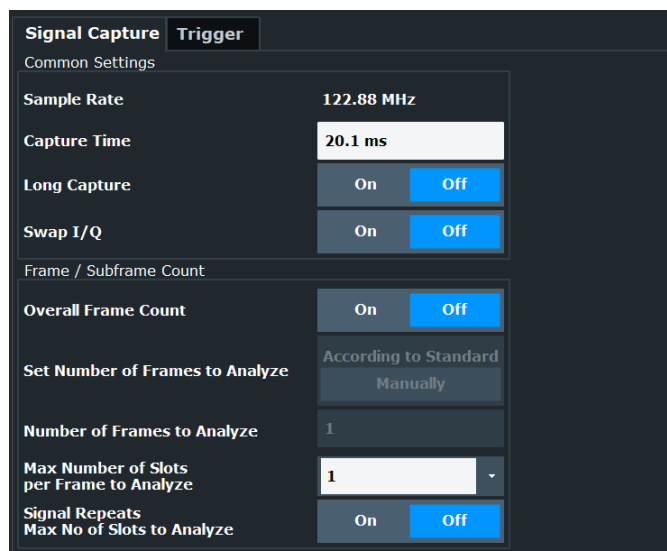

The "Maximum Number of Subframes per Frame to Analyze" setting available in older firmware versions is no longer supported.

The remote commands required to configure the data capture are described in [Chapter 6.10.22, "Data capture"](#), on page 383.

Capture Time	122
Long Capture	122
Swap I/Q	122
Overall Frame Count	123
Auto According to Standard	123
Number of Frames to Analyze	123
Maximum Number of Slots per Frame to Analyze	123
Signal Repeats Max No of Slots to Analyze	124

Capture Time

The "Capture Time" corresponds to the time of one measurement. Therefore, it defines the amount of data the application captures during a single measurement (or sweep).

By default, the application captures 20.1 ms of data to make sure that at least one complete 5G NR frame is captured in the measurement.

The maximum capture time is limited when you are only [measuring slots repeatedly](#).

For measurements in FR2-2, you can let the FSW determine the capture time automatically or enter the capture time manually. For an automatic capture time, the FSW makes the capture as small as possible but also makes sure that the first 80 slots are captured in one piece according to 3GPP specifications. If you are measuring a signals with different subcarrier spacings, the capture time is based on the smallest subcarrier spacing.

The application shows the current capture time in the channel bar.

Note that if you are using the [multi-standard radio analyzer](#), only the MSRA primary channel actually captures the data. The capture time only defines the 5G NR analysis interval.

Remote command:

[\[SENSe:\] SWEEp:TIME](#) on page 386

Capture mode (FR2-2): [\[SENSe:\] SWEEp:CTMode](#) on page 385

Long Capture

Turns a limitation of the [capture time](#) on and off.

When you turn off the long capture, the capture time is limited to 50.1 ms (maximum of 5 frames).

To capture more frames, turn on the long capture. The long capture allows you to capture data up to 1 s. However, the long capture has the following limitations.

- The long capture captures several frames, but analyzes only one. The analyzed frame is indicated by a horizontal green bar in the capture buffer. The analyzed frame depends on your [selection](#).
- Multiple frame configurations are not possible, because every frame must have the same configuration.
- The frame count settings (overall frame count etc.) are unavailable.
- Averaging results over several frames is not supported. Therefore, the FSW does not evaluate EVM limits for long captures.
- Segmented capture is not supported.
- Component carrier measurements are not supported.
- Measurements in FR2-2 are not supported.

Remote command:

[\[SENSe:\] SWEEp:LCAPture](#) on page 385

Swap I/Q

Swaps the real (I branch) and the imaginary (Q branch) parts of the signal.

Remote command:

[\[SENSe:\] SWAPiq](#) on page 384

Overall Frame Count

The "Overall Frame Count" turns the manual selection of the number of frames to capture (and analyze) on and off.

When you turn on the overall frame count, you can define the [number of frames to capture and analyze](#). The measurement runs until all frames have been analyzed, even if it takes more than one capture.

When you turn off the overall frame count, the application analyzes all 5G NR frames found in one capture buffer.

For more information about the effects on the results of capturing more frames than fit in the capture buffer, see [Chapter 4.1.6, "Radio frame configuration"](#), on page 68.

PRACH analysis: Instead of capturing frames, PRACH analysis measurements capture preambles. For PRACH analysis, the "Overall Preamble Count" therefore allows you to turn manual selection of the number of preambles to capture on and off. Turn on this parameter to analyze all preambles in the capture buffer and off to select a certain number of preambles to capture.

The application shows the current frame count in the channel bar.

Remote command:

[\[SENSe:\]NR5G:FRAMe:COUNT:STATe](#) on page 384

Auto According to Standard

Turns automatic selection of the number of frames to capture and analyze on and off.

When you turn on this feature, the FSW captures and evaluates a number of frames the 3GPP standard specifies for EVM tests.

If you want to analyze an arbitrary number of frames, turn off the feature.

This parameter is not available when the overall frame count is inactive.

PRACH analysis: Selects if the number of preambles to analyze is based on the number defined by 3GPP or an arbitrary number.

Remote command:

[\[SENSe:\]NR5G:FRAMe:COUNT:AUTO](#) on page 383

Number of Frames to Analyze

Defines the number of frames you want to capture and analyze.

If the number of frames you have set last longer than a [single measurement](#), the application continues the measurement until all frames have been captured.

The parameter is read only in the following cases:

- If you turn off the [overall frame count](#).
- If you capture the data [according to the standard](#).

PRACH analysis: Because PRACH analysis analyzes preambles instead of frames, the "Number of Preambles to Analyze" allows to define the number of preambles you want to analyze.

Remote command:

[\[SENSe:\]NR5G:FRAMe:COUNT](#) on page 383

Maximum Number of Slots per Frame to Analyze

Selects the number of slots that the application analyzes.

You can select to analyze "All" slots, or a certain number of slots - select the number from the dropdown menu and enter the number of slots to analyze. The maximum number of slots you can analyze depends on the subcarrier spacing.

If you select a certain number of slots, the FSW analyzes the first <x> slots in a frame. By default, the FSW analyzes 80 slots to comply with 3GPP specifications.

Reducing the number of slots to analyze improves measurement speed.

Remote command:

[\[SENSe:\]NR5G:FRAMe:SLOT](#) on page 384

Signal Repeats Max No of Slots to Analyze

Turns analysis of custom signals with repeating slots on and off.

You can use this setting to measure custom (shortened) signals that only contain a few slots per frame. This setting is useful to achieve a high measurement and analysis speed without trigger availability. Multiple frame analysis tailored to the custom signal is also possible.

Example:

Slot 0 | Slot 0 | Slot 0 etc.

Slot 0 | Slot 1 | Slot 0 | Slot 1 etc.

Note that the slot sequence must start with slot number 0.

Measuring such signals is not possible with the standard signal capture settings without a trigger.

Instead, configure the FSW like this.

- Reduce the capture time based on the number of slots in the repeated signal and the subcarrier spacing. Make sure that the slot sequence is contained at least once in the capture buffer.

For example to measure 3 slots with a subcarrier spacing of 30 kHz (length of one slot = 500 μ s), reduce the capture time to 3.1 ms.

Capturing repeating slots limits the maximum allowed capture time based on the maximum number of slots you are capturing.

- Select a maximum number of slots to analyze that matches the number of slots in your signal.
For example: if you have a sequence of three slots being repeated in your signal, select 3 slots to analyze.
- Turn on the "Signal Repeats Max No of Slots to Analyze" setting.

Remote command:

[\[SENSe:\]NR5G:FRAMe:SRSLot](#) on page 384

4.1.17 Trigger configuration

Access: "Overview" > "Trig / Sig Capture" > "Trigger"

A trigger allows you to capture those parts of the signal that you are really interested in.

While the application runs freely and analyzes all signal data in its default state, no matter if the signal contains information or not, a trigger initiates a measurement only under certain circumstances (the trigger event).

For a comprehensive description of the available trigger settings not described here, refer to the documentation of the FSW.



Gated measurements

In addition to the general trigger functions, the frequency sweep measurements (for example ACLR) also support gated measurements.

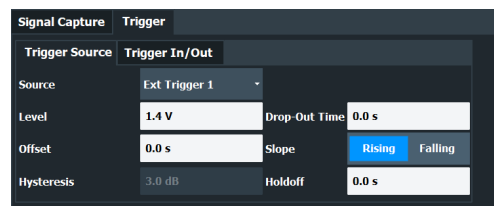

Trigger Source..... 125

Trigger Source

The application supports several trigger modes or sources.

- **Free Run**
Starts the measurement immediately and measures continuously.
- **External <x>**
The trigger event is the level of an external trigger signal. The measurement starts when this signal meets or exceeds a specified trigger level at the trigger input. Some measurement devices have several trigger ports. When you use one of these, several external trigger sources are available.
- **I/Q Power**
The trigger event is the magnitude of the sampled I/Q data. The measurement starts when the magnitude of the I/Q data meets or exceeds the trigger level.
- **IF Power**
The trigger event is the level of the intermediate frequency (IF). The measurement starts when the level of the IF meets or exceeds the trigger level.
- **RF Power**
The trigger event is the level measured at the RF input. The measurement starts when the level of the signal meets or exceeds the trigger level.
- **Time**
The trigger event is a certain time interval (every <x> seconds).

For all trigger sources, except "Free Run", you can define several trigger characteristics.

- The trigger "Level" defines the signal level that initiates the measurement.
- The trigger "Repetition Interval" defines the time interval that initiates a measurement for the time trigger.
- The trigger "Offset" is the time that must pass between the trigger event and the start of the measurement. This can be a negative value (a pretrigger).
- The trigger "Drop-out Time" defines the time the input signal must stay below the trigger level before triggering again.

- The trigger "Slope" defines whether triggering occurs when the signal rises to the trigger level or falls down to it.
- The trigger "Holdoff" defines a time period that must at least pass between one trigger event and the next.
- The trigger "Hysteresis" is available for the IF power trigger. It defines a distance to the trigger level that the input signal must stay below to fulfill the trigger condition.

For a detailed description of the trigger parameters, see the user manual of the I/Q analyzer.

Remote command:

Source: `TRIGger[:SEquence]:SOURce<ant>` on page 390

Level (external): `TRIGger[:SEquence]:LEVel<ant>[:EXternal<tp>]` on page 388

Level (I/Q power): `TRIGger[:SEquence]:LEVel<ant>:IQPower` on page 388

Level (IF power): `TRIGger[:SEquence]:LEVel<ant>:IFPower` on page 388

Level (RF power): `TRIGger[:SEquence]:LEVel<ant>:RFPower` on page 389

Offset: `TRIGger[:SEquence]:HOLDoff<ant>[:TIME]` on page 387

Hysteresis: `TRIGger[:SEquence]:IFPower:HYSteresis` on page 387

Drop-out time: `TRIGger[:SEquence]:DTIME` on page 386

Slope: `TRIGger[:SEquence]:SLOPe` on page 390

Holdoff: `TRIGger[:SEquence]:IFPower:HOLDoff` on page 387

4.1.18 Segmented capture

Access: "Overview" > "Trigger / Signal Capture" > "Trigger" > "Segmented Capture"

Segmented capture is a useful tool for large data captures. For a segmented capture, the FSW measures the signal over the complete measurement time, but only keeps those signal parts in the capture buffer that are of interest for you: the signal itself. This has the advantage that the measurement accumulates less data, and only data that is really relevant. The number of segments you want to capture is arbitrary.

A prerequisite for the segmented data capture is an [external or IF power trigger](#), because the segment characteristics (start, stop and length) are based on a trigger event. You can apply a trigger offset to each segment, thus allowing for post- or pretrigger data to be included in the segment.

Effects on result displays

The [capture buffer](#) only shows the information of the captured segments. The signal information between the segments is no longer displayed. A blue vertical line indicates the start and stop of a segment.

For all other result displays, you can select one of the captured segments whose information is evaluated in the [evaluation range](#).

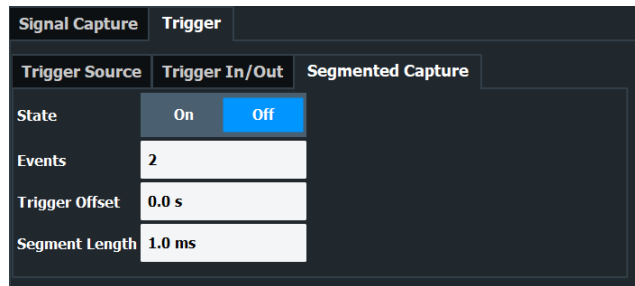

The remote commands required to configure the segmented capture are described in [Chapter 6.10.24, "Segmented capture"](#), on page 391.

[Configuration](#)..... 127

Configuration

Turn the segmented capture on and off with "State".

If you turn on the segmented capture, the FSW captures data for a certain time ("Segment Length") when a trigger event occurs. You can define the number of segments that the FSW captures by defining the number of (trigger) "Events" to consider.

The segmented capture is available for the [external or IF power trigger](#).

Example:

Number of events: 4, segment length: 2 ms

After you start the measurement, the FSW waits until the first trigger event occurs, then captures data for 2 ms. After that, the FSW waits for the second trigger event before it again captures data. This goes on until all 4 segments have been captured.

If no trigger event occurs during the capture time, the FSW captures nothing.

Note that it is not possible to define a [capture time](#) when segmented capture is on.

The "Trigger Offset" defines a time between the trigger event and the actual start of the measurement. For a negative offset, the data capture starts before the actual trigger event.

Example:

Trigger offset: 0.5 ms

The data capture starts 0.5 ms after the trigger event occurs.

Remote command:

State: [\[SENSe:\]SWEep:SCAPture:STATe](#) on page 392

Events: [\[SENSe:\]SWEep:SCAPture:EVENTs](#) on page 391

Length: [\[SENSe:\]SWEep:SCAPture:LENGth\[:TIME\]](#) on page 392

Offset: [\[SENSe:\]SWEep:SCAPture:OFFSet\[:TIME\]](#) on page 392

4.1.19 Data capture optimization

Access: "Overview" > "Trigger / Signal Capture" > "Optimization"

The optimization settings contain settings that control tools to optimize the data capture and processing.

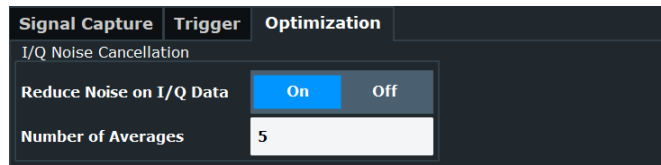

The remote commands required to configure the data capture are described in [Chapter 6.10.22, "Data capture"](#), on page 383.

[Reduce Noise on I/Q Data](#)..... 128

Reduce Noise on I/Q Data

This function requires the R&S FSW-K575 option and a repetitive input signal.

If enabled, initial measurement steps are performed to remove the receiver noise of the spectrum analyzer. The steps include capturing and synchronizing data, averaging the data to estimate the total noise, and measuring the internal noise. Based on these measurements, the I/Q data is corrected so that it only includes the external noise contributions. The number of captures used for averaging is defined by the "Number of Averages".

Using this function, the residual EVM of the signal analyzer can be improved, even for very low signal levels.

If synchronization fails during the initial measurements, the noise cancellation process is not started, and an error message is displayed in the status bar.

If noise cancellation is enabled, "IQNC" is indicated in the channel bar.

For statistical evaluation, the entire noise cancellation process is counted as one measurement.

For details on the concept of I/Q noise cancellation and for troubleshooting tips, see the FSW I/Q Analyzer and I/Q Input User Manual.

Remote command:

[\[SENSe:\]ADJust:NCANcel:AVERage\[:STATe\]](#) on page 393

[\[SENSe:\]ADJust:NCANcel:AVERage\[:COUNT\]](#) on page 393

4.1.20 Tracking

Access: "Overview" > "Tracking"

Tracking settings contain settings that compensate various errors.

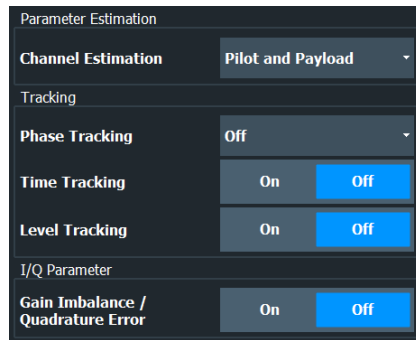

The remote commands required to configure error tracking are described in [Chapter 6.10.26, "Tracking"](#), on page 394.

Channel Estimation	129
Phase	129
Time Tracking	130
Level Tracking	130
Gain Imbalance / Quadrature Error	130
Throughput Measurement State	130

Channel Estimation

Selects the channel estimation method.

"Pilot Only (Linear Interpolation)"	Calculates the equalizer coefficients on all available reference signal subcarriers. All missing subcarriers are interpolated (linear interpolation).
"Pilot And Payload"	Calculates equalizer coefficients on all available resource elements of the reference signal and the payload. This implies that payload symbols could have been demodulated without wrong symbol decisions. If this is not the case, the reference signal generated from the payload is wrong and the calculated equalizer is not ideal. This estimation method improves the equalizer estimate, because more subcarriers and symbols are used. This is beneficial for noisy signals (low SNR). Further subcarriers without pilots are taken into account This method estimates the channel according to the 3GPP definition.
"Off"	Turns off channel estimation. Turning off channel estimation is useful if you want to see the impact of the channel frequency response on the signal quality (EVM).

Remote command:

[\[SENSe:\]NR5G:DEMod:CESTimation](#) on page 394

Phase

Turns phase tracking on and off.

Phase tracking aims to remove random phase fluctuations between OFDM symbols. The phases of all pilot subcarriers are estimated and averaged per symbol.

When you turn on phase tracking, the application removes the phase difference between consecutive symbols.

"Off"	Phase tracking is not applied. Allows you to evaluate the impact of phase noise and phase drifts on the signal quality.
"Pilot Only"	Uses the reference signal (PTRS) for phase tracking. Symbols without PTRS are interpolated (linear interpolation). Unavailable for PRACH analysis.
"Pilot and Payload"	Uses available reference signals (PTRS) and the payload resource elements for phase tracking. Unavailable for PRACH analysis. Allows you to improve tracking results (a better immunity to noise), because of the analysis of the payload. This method does not interpolate symbols without reference signals.
"On"	Uses PRACH resource elements for the estimation of the phase error. Available for PRACH analysis.

Remote command:

[\[SENSe:\]NR5G:TRACking:PHASe](#) on page 395

Time Tracking

Turns time tracking on and off.

Clock deviations (slower or faster sampling time) lead to a drift of the ideal sampling instant over time, causing a rotating constellation diagram.

When you turn on time tracking, the application compensates measurement results for timing errors on a slot level.

Remote command:

[\[SENSe:\]NR5G:TRACking:TIME](#) on page 395

Level Tracking

Turns level tracking on and off.

Gain variations over time, caused for example by temperature drifts in power amplifiers, impact signal quality.

When you turn on level tracking, the FSW corrects a gain value that is constant across frequency on symbol level.

Remote command:

[\[SENSe:\]NR5G:TRACking:LEVel](#) on page 395

Gain Imbalance / Quadrature Error

Turns the calculation of the I/Q gain imbalance and the quadrature error ([result summary](#)) on and off.

Remote command:

[\[SENSe:\]NR5G:IQ:GIQE](#) on page 394

Throughput Measurement State

Turns the throughput and block error rate measurement on and off.

The results of these measurements are displayed in the [result summary](#).

If you turn on the throughput measurement, selecting a [number of frames to analyze](#) according to standard is not supported. If that setting was active when you turn on the throughput measurement, it is automatically set to manual number of frames to analyze.

Remote command:

[SENSe:]NR5G:TRACking:TPUT:STATe on page 395

4.1.21 Demodulation

Access: "Overview" > "Demodulation"

Demodulation settings contain settings that describe signal processing and the way the signal is measured.

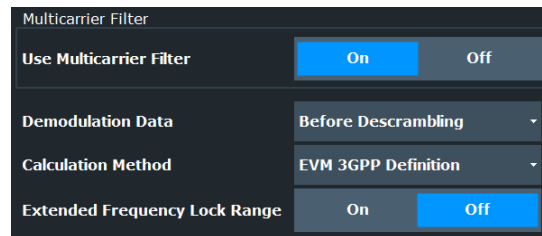

The remote commands required to configure the demodulation are described in [Chapter 6.10.27, "Demodulation"](#), on page 396.

Filter	131
Demodulation Data	131
EVM Calculation Method	132
Transient Period	132
PUSCH Reference Data	133
Extended Frequency Lock Range	133

Filter

Selects the filter to suppress interference of neighboring carriers.

"None"	No suppression of neighboring channels.
"Multicarrier Filter"	Suppresses interference for tests on multiradio base stations (LTE, WCDMA, GSM etc.). The FSW automatically selects the multicarrier filter when you analyze more than 1 component carrier .
"Per BWP"	Suppresses interference for tests on multi BWP signals.

Remote command:

[SENSe:]NR5G:DEMod:FILTer on page 397

Demodulation Data

For the [bitstream](#) results, you can get the data at various points in the signal processing chain.

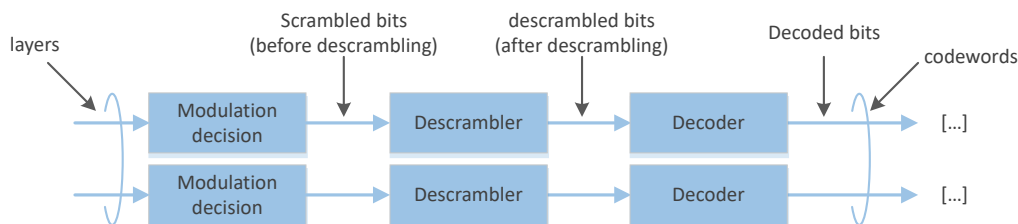

"Before Descrambling" Demodulates the scrambled data.

"After Descrambling" Demodulates the descrambled data.

"Decoded Payload Data" Demodulates the descrambled and decoded PDSCH data.

Remote command:

[\[SENSe:\]NR5G:DEMod:DDATa](#) on page 397

EVM Calculation Method

Selects the way the EVM is calculated.

"EVM 3GPP Definition" Calculates the EVM according to 3GPP TS 38.141-1 / -2. Evaluates the EVM at two trial timing positions and then uses the higher EVM of the two.

"At Optimal Timing Position" Calculates the EVM using the optimal timing position.

"EVM High Timing Position" Calculates the EVM at the high trial position defined by 3GPP.

"EVM Low Timing Position" Calculates the EVM at the low trial position defined by 3GPP.

Remote command:

[\[SENSe:\]NR5G:DEMod:CMETHod](#) on page 396

Transient Period

Opens a dialog to configure the EVM calculation of the symbol before and after the transient periods of the signal.

The "Transient Period" selects the length of the transients.

For a transient period = 10 μ s, the FSW applies no special method to the EVM calculation.

For a transient period \neq 10 μ s, the FSW uses the EVM calculation defined in 3GPP 38.521, chapter 6.4.2.1a. The available transient periods depends on the subcarrier spacing. When you select one of these transient periods, you can define the symbols that the special EVM calculation method is applied to.

- "Symbols Before Transient": Symbol right before the transient period.
- "Symbols After Transient": Symbol right after the transient period.

If you analyze several transient periods, you can define an array of symbols as a comma-separated list (for example "1, 4,8,12").

This feature is available for FR1 and unavailable for multi-numerology scenarios and if transform precoding = on.

The transient period has an effect on the EVM limits evaluated in the [result summary](#).

Remote command:

Period: [\[SENSe:\]NR5G:DEMod:TPERiod](#) on page 399

Symbol before transient: [\[SENSe:\]NR5G:DEMod:SBTRansient](#) on page 398

Symbol after transient: [\[SENSe:\]NR5G:DEMod:SATRansient](#) on page 398

PUSCH Reference Data

Selects the type of reference data to calculate the EVM for the PUSCH.

By default, the FSW automatically detects the PUSCH reference values and maps the measured values to the nearest reference point.

- | | |
|-----------------------|---|
| "Auto Detect" | Automatically detects the PUSCH reference values. |
| "ORAN PN23" | Available when the ORAN application is installed.
Assumes the PUSCH to be based on the pseudo random sequence 23, as defined by the ORAN alliance. Note that this type of reference data is automatically selected when you select an ORAN test case. The FSW assumes that the measured signal actually contains the corresponding ORAN PN23 sequence.
For this option, each PUSCH has an individual sequence. |
| "ORAN PN23 All Slots" | Available when the ORAN application is installed.
Assumes the PUSCH to be based on the pseudo random sequence 23, as defined by the ORAN alliance. Note that this type of reference data is automatically selected when you select an ORAN test case. The FSW assumes that the measured signal actually contains the corresponding ORAN PN23 sequence.
For this option, all PUSCH / PDCCH have the same sequence. |

Remote command:

[\[SENSe:\]NR5G:DEMod:PRData](#) on page 398

Extended Frequency Lock Range

Selects the frequency error tolerance for successful signal synchronization.

Turn the setting off to have a small tolerance (0.5*subcarrier spacing).

Turn the setting on to have a large tolerance (10*subcarrier spacing).

For a large tolerance, we recommend to configure the synchronization signal manually, because the auto demodulation might not work properly depending on the actual frequency error.

Remote command:

[\[SENSe:\]NR5G:DEMod:EFLRange](#) on page 397

4.2 PRACH analysis

Access: [MEAS CONFIG] > "Signal Description"

The Physical Random Access Channel (PRACH) carries the preamble(s) that initiate the communication between user equipment (UE) and base station (the random access). It is therefore the first signal that is sent by the UE after you turn it on. After receiving the PRACH from a user equipment, the base station is able to allocate resources and adjust the uplink timing.

Each PRACH contains a variable number of preambles. A preamble is made up out of a cyclic prefix, the preamble sequence and a guard period at the end of the preamble. The preambles can have different structures, depending on the preamble format. In addition to the structure, the format also defines the length of a preamble (number of occupied symbols) and the available PRACH subcarrier spacings.

The parameters that define the precise mapping to physical resource blocks is defined by various tables in 3GPP 38.211 6.3.3.2.

Verifying the PRACH configuration against the signal

Many PRACH formats are very similar and differ only in their timing. To avoid misleading results, we recommend to verify that the FSW configuration matches the signal's configuration.

1. Configure an external trigger.
2. Define a small capture time.
3. Run the measurement.
4. Verify that the analysis length (green bar at the bottom of the capture buffer) matches the expected signal length (yellow trace).

PRACH settings

The settings for PRACH analysis are similar to the settings of the I/Q measurements.

Signal Description	Advanced Settings	Generator Control	
Mode	Uplink	User Defined Set:	
Deploy Frequency Range	FR1 <= 3GHz	Channel BW	100MHz
		Sample Rate	122.88 MHz
BWP Settings			
Subcarrier Spacing	30kHz NCP		
PRACH Settings			
Format	A1	PRACH SCS	15kHz
L_RA	139	Rel Power	0.0 dB
RB Offset	0	Logical Root Sequence Index	0
Restricted Set	Unrestricted	Preamble Index	0
Zero Correlation Zone	0		

The remote commands required to configure the PRACH are described in [Chapter 6.10.28, "PRACH analysis"](#), on page 399.

Settings for the PRACH analysis described elsewhere (not all settings described in the following chapters are available for the PRACH analysis though):

- [5G NR Mode](#)
- [Signal Description / Test Model](#)
- [Deployment](#)
- [Channel Bandwidth](#)
- [Subcarrier Spacing](#) (of the bandwidth part the PRACH is in; the PRACH itself can use a different subcarrier spacing).
- [Advanced settings](#)
- [Signal capture](#)
Note that all settings for the signal capture that normally refer to a frame, instead refer to a preamble for the PRACH analysis. Otherwise, their effect is the same. For example, the "Overall Frame Count" is called "Overall Preamble Count" and turns manual selection of the number of preambles to capture on and off (instead of frames).
- [Trigger configuration](#)
- [Signal tracking](#)
Note that phase tracking only supports on and off states.
- [Demodulation settings](#)

The following parameters, available in the "Signal Description" dialog box, are exclusive to the PRACH analysis.

Preamble Format	135
Subcarrier Spacing (PRACH)	136
L_RA	136
RB Offset	136
Rel. Power	136
Restricted Set	136
Logical Root Sequ. Idx	136
Zero Correlation Zone	137
Preamble Index	137

Preamble Format

Selects the preamble format. The preamble format defines the length and structure of the preamble.

- Preamble formats 0 to 3: available in FR1 [deployments](#). Supports subcarrier spacings of 1.25 kHz and 5 kHz.
- Preamble formats A1 to C2: available in all frequency ranges. Supports subcarrier spacings up to 960 kHz, depending on the selected frequency range. 3GPP release 17 adds additional subcarrier spacings up to 960 kHz that are also supported.

The preamble format you select has an effect on the other parameters that define the characteristics of the PRACH.

Remote command:

[CONFigure\[:NR5G\]:UL\[:CC<cc>\]:PRACH:FORMat](#) on page 399

Subcarrier Spacing (PRACH)

Selects the subcarrier spacing for the PRACH.

Note that in case of the PRACH analysis, you can define two different subcarrier spacings.

- The [subcarrier spacing](#) of the bandwidth part the PRACH is part of.
- The subcarrier spacing of the PRACH itself. The subcarrier spacings of the PRACH (values between 1.25 kHz and 120 kHz) depend on the [deployment](#) and the [PRACH format](#).

3GPP release 17 adds additional subcarrier spacings up to 960 kHz.

Remote command:

[CONFigure\[:NR5G\]:UL\[:CC<cc>\]:PRACH:SCS](#) on page 401

L_RA

Defines the PRACH sequence length for unlicensed spectrum.

The sequence length depends on the PRACH [format](#) and [subcarrier spacing](#).

Remote command:

[CONFigure\[:NR5G\]:UL\[:CC<cc>\]:PRACH:LRA](#) on page 400

RB Offset

Defines the offset of the PRACH resource element in the frequency domain, relative to the first subcarrier in the resource grid and in terms of the subcarrier spacing of the PUSCH.

Remote command:

[CONFigure\[:NR5G\]:UL\[:CC<cc>\]:PRACH:RBOffset](#) on page 401

Rel. Power

Defines the relative power of the PRACH.

Remote command:

[CONFigure\[:NR5G\]:UL\[:CC<cc>\]:PRACH:POWer](#) on page 400

Restricted Set

This command turns the restricted preamble set on and off.

A restricted preamble set corresponds to high speed mode. An unrestricted preamble set to normal mode.

3GPP defines two types of restricted sets (Type A and B). The availability of restricted set types depends on the selected [PRACH format](#).

Remote command:

[CONFigure\[:NR5G\]:UL\[:CC<cc>\]:PRACH:RSET](#) on page 401

Logical Root Sequ. Idx

Selects the logical root sequence index.

The logical root sequence index is used to generate PRACH preamble sequences. It is provided by higher layers.

Remote command:

[CONFigure\[:NR5G\]:UL\[:CC<cc>\]:PRACH:RSEquence](#) on page 401

Zero Correlation Zone

Selects a value that defines, in combination with the [restricted set](#), the N_{cs} parameter. N_{cs} in turn defines the cyclic shift of the PRACH.

Remote command:

[CONFigure\[:NR5G\]:UL\[:CC<cc>\]:PRACH:ZCZone](#) on page 402

Preamble Index

Defines the preamble index.

The preamble index controls which of the 64 preamble sequences defined by 3GPP is used.

Remote command:

[CONFigure\[:NR5G\]:UL\[:CC<cc>\]:PRACH:PREamble](#) on page 400

4.3 Frequency sweep measurement configuration

Access: [MEAS CONFIG] > "Signal Description"

The signal description for ACLR and SEM measurements contains settings to describe general physical characteristics of the signal you are measuring.



Settings for frequency sweep measurements

When you start the frequency sweep measurement from within the 5G NR application, the FSW automatically configures the measurement and limits according to the specification defined by 3GPP.

Therefore, it is sufficient for you to configure the details of the 5G NR signal description.



Filter type in SEM measurements

The 5G NR application uses a channel filter for SEM measurements by default. The spectrum application on the other hand uses a Gauss filter. If you need a Gauss filter for the SEM measurement in the 5G NR application, change it manually in the sweep list for the corresponding frequency ranges.

Note that ACLR and SEM measurements are currently unavailable for FR2-2 frequency deployment.

Functions in the "Signal Description" dialog box described elsewhere:

- [5G NR Mode](#)
- [Signal Description / Test Model](#)
- [Deployment](#)
- [Channel Bandwidth](#)

- [Subcarrier spacing](#)

All other settings available for the ACLR and SEM measurements are the same as in the spectrum application. For more information, refer to the user manual of the FSW.

Adjacent Channels	138
Power Class	138
Test ID	138
IFF (Indirect Far Field)	138
Total Limit Pass Mode	139

Adjacent Channels

ACLR measurement only

Selects the assumed adjacent channel carrier for the ACLR measurement.

- "NR of Same BW": the neighboring channel is a 5G NR channel with the same bandwidth.
- "3.84 MHz UTRA": the neighboring channel is a WCDMA channel with 5 MHz bandwidth.

Remote command:

[\[SENSe:\] POWER:ACHannel:AACHannel](#) on page 403

Power Class

Selects the type, category and option of the limit definitions for uplink ACLR measurements.

Release 17 adds additional power classes.

The limit definitions for the following types of base stations are supported:

- Power class 1
- Power class 1.5
- Power class 2
- Power class 3

The power class you should use for the measurement depends on the type of user equipment you are testing.

Remote command:

[\[SENSe:\] POWER:PCLass](#) on page 403

Test ID

Selects the test ID for ACLR measurements in FR2. The test ID has an effect on the ACLR limits as defined in 3GPP 38.521, table 6.5.2.3.5-1a.

Remote command:

[\[SENSe:\] POWER:TID](#) on page 404

IFF (Indirect Far Field)

Selects the DUT size, which has an effect on the test tolerance of the SEM limits. You can either ignore the test tolerances during the SEM measurement ("None") or turn on the test tolerances for DUTs ≤ 30 cm.

The IFF values are defined in 3GPP 38.521-2, chapter 6.5.2.1.5.

Available in an FR2 deployment.

Remote command:

[SENSe:] POWER:SEM:IFF on page 403

Total Limit Pass Mode

Supported only by the LTE and 5G application.

Access (ACLR measurement): "Meas Config" > "CP / ACLR Config" > "Channel Settings" > "Limits"

Access (multi-carrier ACLR measurement): "Meas Config" > "CP / ACLR Config" > "MSR General Settings"

The "Total Limit Pass Mode" selects the logic the ACLR limits are evaluated with if you define both absolute limits and relative limits.

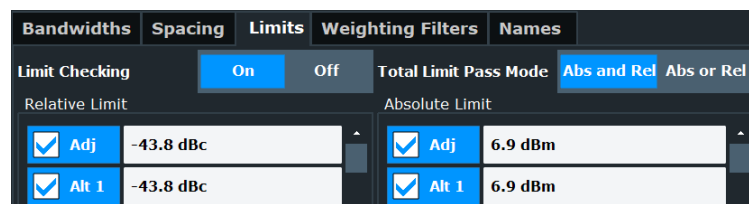

Figure 4-5: Evaluate both absolute and relative limits

If you define only relative or absolute limits, the FSW only evaluates the corresponding limits.

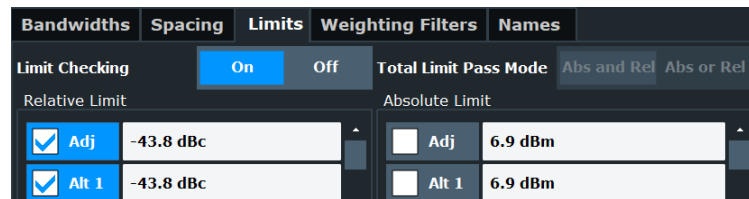

Figure 4-6: Evaluate only relative limits

If you change the limit evaluation method after the measurement, you have to refresh the measurement.

The selected method adjusts the contents of the following result displays.

- ACLR result summary

The default value is according to 3GPP 38.141-1/2.

"Absolute"	Checks the absolute limits defined for the ACLR. The limit check passes when the signal level is within the absolute limits.
"Relative"	Checks the relative limits defined for the ACLR. The limit check passes when the signal level is within the relative limits.
"Absolute and Relative"	The limit check for both, the absolute and the relative limits, must pass to get an overall pass.
"Absolute or Relative"	The limit check for either the absolute or the relative limits must pass to get an overall pass.

Remote command:

CALCulate<n>:LIMit:ACPower:PMODE on page 404

4.4 Combined measurement configuration

Access: "Overview"

The configuration for combined measurements is a combination of the configuration for I/Q measurements, ACLR measurements and SEM measurements with several special settings.

For an introduction on combined measurements and their application, see [Chapter 4.5, "Combined measurement guide"](#), on page 146.

Note that combined measurements are currently unavailable for the FR2-2 frequency deployment.

Channel bar

In combined measurement mode, the [channel bar](#) contains additional information.

Table 4-3: Information displayed in the channel bar in the combined measurement mode

Ref Level	Reference level.
Att	Mechanical and electronic RF attenuation.
Freq	Frequency for other input sources (RF etc.).
Mode*	5G NR mode (link direction and channel bandwidth).
Event Count	The first number represents the number of events that have already been captured. The second number represents the total number of events that will be captured.
Filtered Events	Number of events that have been filtered when you have applies an event filter .
Capture Time	Signal length that has been captured.
Selected Meas ID	Selected measurement.
BWP/SS*	Shows the signal part for which results are displayed (evaluation range). SS = synchronization signal BWP = bandwidth part
I/Q	Shows the type of memory used for I/Q data capture (RAM only).

Functions for combined measurements described elsewhere:

- [Input source settings](#)
- [Frequency settings](#)
- [Level settings](#)
- [Signal tracking](#)
- [Signal demodulation](#)
- [Signal description](#)..... 141
- [Signal capture](#)..... 142
- [Trigger configuration](#)..... 143

4.4.1 Signal description

Access: "Overview" > "Signal Description"

The signal description for combined measurements combines the signal description for I/Q, ACLR and SEM measurements.

Functions in the "Signal Description" dialog box described elsewhere:

- [Auto configuration](#)
- [Signal description](#)
- [Radio frame configuration](#), incl. synchronization signal configuration, bandwidth part configuration, slot configuration and allocation configuration.
- [Antenna port configuration](#)
- [Advanced signal settings](#)
- [Frequency sweep measurement configuration](#)
For single carrier measurements: ACLR and SEM only.
For multi carrier measurements: not supported.

EVM / ACLR / SEM	141
Manage User Standards	141
Restore Settings	141

EVM / ACLR / SEM

Turns the corresponding measurement on and off (blue = on, otherwise = off).

All selected measurements are part of the combined measurement sequence.

Remote command:

EVM state: `CONFigure[:NR5G]:EVM` on page 408

ACLR state: `CONFigure[:NR5G]:ACLR` on page 408

SEM state: `CONFigure[:NR5G]:SEM` on page 408

Manage User Standards

Available for ACLR and SEM measurements.

Opens a dialog that allows you to import custom ACLR or SEM settings from an xml file. The FSW applies the ACLR and SEM settings stored in the selected file.

When you load custom ACLR or SEM settings, exporting I/Q data of an ACLR or SEM measurement also exports the custom settings that the corresponding measurement was done with. The settings are stored in a dedicated `settings.xml` file.

Select "Clear" to remove the file-based settings.

Remote command:

ACLR: `CALCulate<n>:MARKer<m>:FUNction:POWer<sb>:PRESet` on page 407

SEM: `[SENSe:]ESpectrum<sb>:PRESet[:STANdard]` on page 405

Restore Settings

Restores the settings that were active during the last sequence of measurements. This can be a useful feature if you have changed the signal description since the last measurement sequence and want to restore the measurement settings. You can restore settings as long as you do not start a new measurement sequence.

Remote command:

[MMEMoRY:LOAD:SETTings](#) on page 408

4.4.2 Signal capture

Access: "Overview" > "Trigger / Signal Capture" > "Signal Capture"

The data capture settings contain settings that control various aspects of the data capture.

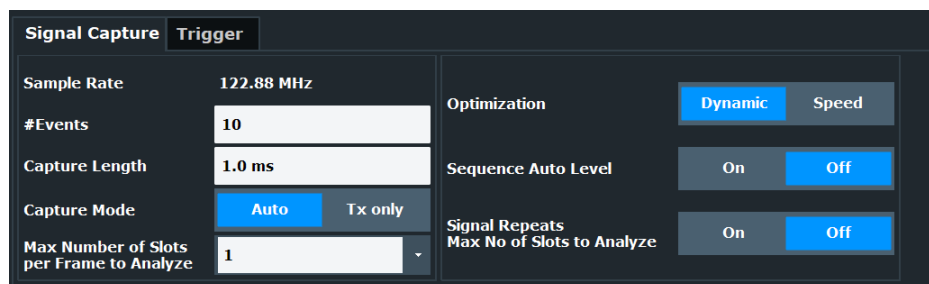

Functions in the "Signal Capture" dialog box described elsewhere:

- [Capture length](#)
- [Max number of slots to analyze](#)
- [Signal repeats max no of slots to analyze](#)

# Events	142
Capture Mode	142
Signal Capture	143
Sequence Auto Level	143

Events

Defines the number of measurements in the measurement sequence. Each event corresponds to one combined measurement. A combined measurement consists of one EVM, ACLR and / or SEM measurement.

Remote command:

[\[SENSe:\] SWEep:EVENT](#) on page 406

Capture Mode

Selects the capture mode for combined measurements. You can define the capture mode if the measurement sequence consists of a series of EVM measurements only ([ACLR and SEM](#) measurements must be inactive).

In "Auto" mode, the FSW captures and analyzes the complete signal, including adjacent and alternate channels. For EVM measurements, these channels can be uninteresting, but their data capture slows down the measurement. To increase the measurement speed for EVM measurements, select "Tx Only". Using this mode, the FSW captures and analyzes only the Tx channel.

Remote command:

[\[SENSe:\] SWEep:MODE](#) on page 407

Signal Capture

Selects the way the FSW the signal data for combined measurements.

- "Single" Captures each carrier individually in an individual capture buffer.
- "Auto" The FSW determines how many carriers it can capture in a single measurement. How many carriers it can capture in a single measurement depends on the bandwidth of the carriers and the available bandwidth on the FSW. Only if the carriers cannot be captured in a single measurement, the FSW uses several captures to analyze the complete signal.

Remote command:

[SENSe:]NR5G:FRAMe:SCAPture on page 406

Sequence Auto Level

Turns [auto leveling](#) prior to each event in the measurement sequence on and off.

Remote command:

[SENSe:]NR5G:FRAMe:SALevel on page 406

4.4.3 Trigger configuration

Access: "Overview" > "Trigger / Signal Capture" > "Trigger"

Combined measurement mode provides an assistant that helps you to find a suitable trigger configuration for your test setup. The resulting trigger configuration depends on the combination of a trigger sequence and the availability of a frame trigger.

The screenshot displays the 'Trigger Setup Helper' interface. At the top, there are two tabs: 'Signal Capture' and 'Trigger'. Under 'Signal Capture', the 'Trigger Setup Helper' section includes a 'Sequence' dropdown set to 'Manual', a 'Frame Trigger' dropdown set to 'Available', and an 'Event Delay' input field set to '1.0 s'. Below this is an 'Advanced >>' button. The 'Trigger Source' section is expanded, showing 'Trigger In/Out' as the selected source. It includes fields for 'Source' (Ext Trigger 1), 'Level' (1.4 V), 'Offset' (0 s), 'Hysteresis' (3.0 dB), 'Drop-Out Time' (0 s), 'Slope' (Falling), and 'Holdoff' (0 s). To the right, the 'Gate Settings' section shows 'Auto Gating' with 'On' and 'Off' buttons, where 'On' is selected.

For a comprehensive description of all predefined trigger configurations, refer to the [combined measurement guide](#). This guide also contains a list of the trigger settings associated with each scenario.

If the assistant does not provide a suitable trigger configuration, you can still set up a custom trigger configuration in the "Advanced" trigger settings. These [advanced settings](#) are the same as for all other measurements.

You can change advanced trigger settings like trigger level, slope or drop-out time, even if the assistant already provides a scenario that fits your needs. However, if you select a different trigger source, gate source or trigger connector usage, the FSW discards the selected trigger sequence and changes back to the "Manual" sequence.

Sequence.....	144
Frame Trigger.....	144
Event Delay.....	145
Delay.....	145
Recalibration Interval.....	145
Send Trigger 3.....	145
Auto Gating.....	146

Sequence

Selects the general sequence of the measurement, including the type of triggers available in the test setup and the number of trigger signals.

For a comprehensive description of the sequences, see [Chapter 4.5, "Combined measurement guide"](#), on page 146.

"Manual"	Custom trigger configuration.
"Periodic"	Measurement sequence defined by an event delay .
"Open-loop"	Measurement sequence that includes a trigger to indicate that the DUT is ready for testing. Trigger is connected to trigger input 2.
"Closed-loop"	Measurement sequence that includes a trigger to indicate that the DUT is ready for testing and a trigger output that indicates that the I/Q data capture is done. Triggers are connected to trigger input 2 and trigger output 3.

Remote command:

[TRIGger:TSHelper:SEquence](#) on page 411

Frame Trigger

Selects the availability of a frame trigger. The availability of a frame trigger basically selects the trigger source.

For a comprehensive description on the effects of this setting, see [Chapter 4.5, "Combined measurement guide"](#), on page 146.

"Available"	Frame trigger is available as an external trigger.
"n/a, Time Trigger"	Periodic measurement using a time trigger synchronized to the frame as the trigger source. Includes automatic calibration.
"n/a, Repeating Slots"	Free run measurement that captures a certain amount of data. The amount of data corresponds to a number of slots that are repeated in the signal.
"Available, event delay"	Frame trigger is available as an external trigger. The FSW sends an additional trigger signal at the end of the I/Q capture that initiates a delay before the next event begins. Available for open-loop sequences.

Remote command:

[TRIGger:TSHelper:FTRigger](#) on page 410

Event Delay

Available for periodic and manual measurement sequences.

The "Event Delay" defines a time period between two events (or combined measurements). Therefore, the event delay is the time period spanning the time when an event occurs and the point in time when a new event can occur.

For a manual [sequence](#), the event delay is available for all trigger sources, except the time trigger.

Remote command:

[TRIGger:TSHelper:EDElay](#) on page 409

Delay

Available for open-loop [sequences](#) that use a frame trigger.

The "Delay" defines a time period between the end of an event (= I/Q data capture finished) and the next event. When the delay is over, the FSW starts the next measurement in the sequence.

See ["Using an open-loop sequence: frame trigger available with a delay between events"](#) on page 152

Remote command:

[TRIGger:TSHelper:DElay](#) on page 409

Recalibration Interval

Available for open- and closed-loop scenarios using a time trigger.

Using a time trigger requires a synchronization to the frame start offset. Because the frame start offset drifts over time, you have to recalibrate the time trigger regularly. In combined measurement mode, this is an automatic process, controlled by the "Recalibration Interval" - on each recalibration, the FSW synchronizes the time trigger to the frame start offset.

The recalibration interval is in terms of events (single measurements).

For example, an interval of "5" recalibrates the time trigger after 5 events in the measurement sequence. To find out an appropriate interval, run several measurements, and check after how many measurements synchronization fails. Define an interval that recalibrates a few measurements before synchronization fails.

Increasing the recalibration interval increases the measurement speed for all events in which no recalibration is performed.

For a manual [sequence](#), the recalibration interval is available for the time trigger source.

Remote command:

[TRIGger:TSHelper:RINterval](#) on page 410

Send Trigger 3

Access: "Trigger" > "Send Trigger 3" (softkey only)

Available for closed-loop [sequences](#).

Sends an initial trigger to start the measurement sequence for setups that use a trigger output to inform the test setup that the FSW is ready for the measurement.

Remote command:

[OUTPut<up>:TRIGger<tp>:PULSe:IMMediate](#) on page 409

Auto Gating

Turns automated gating on and off.

Turning on the auto gating makes sure that the FSW only measures the ACLR and SEM when the Tx channel is transmitted ("On" state). The gate is open during the on periods of the Tx channels that occur in the analysis range. The analysis range begins with a frame start. When the frame start is known, the FSW can detect the on and off periods.

Note that auto gating is not possible for free run measurements on TDD signals and when the signal capture consists of several captures (for example for [single captures](#) or if the available analysis bandwidth is smaller than the signal bandwidth). The FSW shows a corresponding error message in that case.

Remote command:

[\[SENSe:\]SWEep:EGATe:AGATing](#) on page 406

4.5 Combined measurement guide

The combined measurement mode provides functionality to combine several, subsequent EVM, ACLR and (or) SEM measurements in a single sequence of measurement. If you combine the measurements into a sequence, the FSW analyzes the captured data for EVM, ACLR and SEM in parallel (multi-processing) - the data capture itself is processed independent from the analysis. This in turn increases the speed of the measurement evaluation.

These measurements can occur on a single DUT, for example one that changes its position in space. Or they can occur on multiple DUTs, for example as an end test in a production line.

Combined measurements allow you to automate such measurement sequences and to increase the speed of such sequences. The measurement mode also provides tools to evaluate the results. However, combined measurements only work on a DUT whose signal description and center frequency remain the same over the sequence of measurements.

Each single measurement is also called an event. Several events make up the measurement sequence. The number of events you can define depends on the capture length, bandwidth (or sampling rate) and the available memory (RAM). Events are also processed in parallel, which increases the measurement speed even more.

An event can be, for example, a new position of the DUT, or the next DUT in a production line. When the DUT is ready, some kind of trigger initiates the next measurement.

- [General configuration](#)..... 147
- [Trigger configuration](#)..... 148

4.5.1 General configuration

There are some basic settings that you should define for all measurements, regardless of your test setup.

Before you start configuring the application, set up the measurement physically.

Setting up the measurement

1. Enter the combined measurement mode.
("Meas" > "Combined EVM/ACLR/SEM")
2. Select the measurements you want to run.
("Meas Config" > "Signal Description" > "EVM", "ACLR" and / or "SEM")
3. Define the [signal characteristics](#), select a test model or load an allocation file.
Note that handling allocation files for combined measurements is [slightly different](#) compared to other measurements.
("Meas Config" > "Signal Description")
4. Adjust the [amplitude settings](#) to achieve an ideal EVM.
("Auto" > "Auto EVM" softkey).
As an alternative, you can optimize the amplitude settings for each event.
("Meas Config" > "Trigger / Signal Capture" > "Signal Capture" > "Sequence Auto Level")
5. Define the number of [events](#).
("Meas Config" > "Signal Capture" > "Events")
6. Define the [capture length](#) (slightly more than the amount of data you want to analyze).
("Meas Config" > "Signal Capture" > "Capture Time")
7. Select the [capture mode](#).
("Meas Config" > "Signal Description" > "Signal Capture")
8. Define the trigger configuration. The trigger configuration that you apply depends on your setup. For details, see [Chapter 4.5.2, "Trigger configuration"](#), on page 148.
9. Run the measurement.
The FSW initiates the sequence of measurement.
When an event that triggers a combined measurement occurs, the FSW adds a line to the combined EVM / ACLR / SEM [result table](#).
The time until all events have happened varies, depending on your setup.
If you want to reevaluate the measurement sequence or a certain event after the sequence has finished, you can do so by [refreshing](#) the results.
("Sweep" > "Refresh" / "Refresh Current")
10. Evaluate the measurement, for example by:
 - [Filtering the results](#) to view only certain events.
 - [Selecting an event](#) to view the details of that event in graphical result displays.
 - Exporting the results for the whole sequence, selected events or a single event.

- [Exporting the I/Q data](#) for later reevaluation.
You can export the I/Q data for a single event, or the I/Q data for the complete measurement sequence.

Using allocation files in combined measurement mode

[Allocation files](#) are basically the same in combined measurement mode. In combined mode, the allocation files combine the signal description for all selected measurements (EVM, ACLR and SEM). In addition, the allocation file also contains the measurement results for a measurement sequence (only the results, not the I/Q data).

1. Select a file name and location for the allocation file you want to save or load.
2. Select the measurements you want to include.
"General" settings are always included. Otherwise, you can select if you want to include the settings for EVM, ACLR and (or) SEM measurements.
3. Select if you want to include the measurement results ("Combined Result Table").

4.5.2 Trigger configuration

The trigger configuration is a vital part of the combined measurements. The trigger is what makes the automated combined measurements possible in the first place: Wait for the first event to initiate a measurement - run the measurement - wait for the next event - run the measurement and so on.

The FSW provides several [trigger presets](#) for typical combined measurement scenarios. Other than those, you can, of course, use a custom trigger configuration (or even no trigger at all).

The main criteria for the trigger selection are:

- Is a frame trigger available or not?
- Which possibilities do you have to trigger the measurement sequence?



Advanced trigger settings

If you select one of the trigger presets ("Sequence" or "Frame Trigger" menus), and change something in the [advanced trigger settings](#), the preset becomes obsolete ("Sequence" = "Manual").

Using the trigger setup helper

The trigger setup helper allows you to select certain trigger configuration presets. These presets are typical trigger setups for certain test scenarios.

Of course it is also possible to apply a custom trigger configuration.

1. Select the trigger "Sequence".
 - "Manual" = custom trigger configuration
 - "Periodic" = measurements in certain interval
 - "Open-Loop" = an external trigger indicates that the DUT is ready

- "Closed-Loop" = an external trigger indicates that the DUT is ready, plus the analyzer indicates that the data capture is finished
2. Select the frame trigger availability.
 3. For periodic trigger, define the event delay.
 4. For time trigger instead of dedicated frame trigger, define the recalibration interval.

Table 4-4: Trigger presets and their trigger configuration*

Trigger setup helper			Advanced trigger settings			
Sequence	Frame trigger		Trigger source	Source	Trigger 2	Trigger 3
Periodic	n/a	>>	Free run	n/a	n/a	n/a
Periodic	available	>>	Ext. trigger 1	n/a	n/a	n/a
Open-loop	n/a	>>	Free run	Ext. trigger 2	Input	n/a
Open-loop	n/a	>>	Time	Ext. trigger 2	Input	n/a
Open-loop	available	>>	Ext. trigger 1	Ext. trigger 2	Input	n/a
Open-loop	available (with delay)	>>	Ext. trigger 1	Free run	Input	Output
Closed-loop	n/a	>>	Free run	Ext. trigger 2	Input	Output
Closed-loop	n/a	>>	Time	Ext. trigger 2	Input	Output
Closed-loop	available	>>	Ext. trigger 1	Ext. trigger 2	Input	Output

*Changing one of these settings always returns to trigger sequence = manual; you can still change other trigger settings like level, drop-out time etc.



DUT reconfiguration

The following procedures use the term "DUT reconfiguration".

The DUT reconfiguration is a process that depends on your test scenario. For example, the term can refer to the DUT moving into another position or the DUT being replaced by another DUT in a production line.

Using a periodic sequence: no frame trigger

In this scenario, measurements take place periodically, every <x> seconds. A trigger is not available.

This scenario requires a capture time that is at least double the time of the data you want to capture - for example, if you want to capture a single slot with 30 kHz subcarrier spacing (slot length = 0.5 ms), the capture time must be greater than 1 ms.

Note that the number of slots that the signal repeats have to start with slot 0.

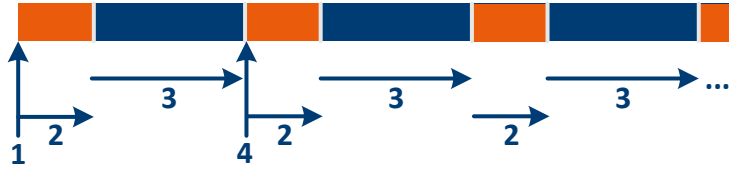

Figure 4-7: Workflow for a periodic measurement without frame trigger

- 1 = Start of measurement
- 2 = I/Q data capture
- 3 = DUT reconfiguration
- 4 = Subsequent I/Q data capture

The time a single measurement event lasts in the sequence is the sum of:

I/Q capture + DUT reconfiguration

Optional auto leveling for each measurement extends the measurement time a little.

The sequence of measurements runs like this:

1. Start of the measurement sequence.
2. The FSW captures the I/Q data.
3. The DUT reconfigures itself.
Note that the event delay starts with the I/Q capture. Thus, make sure to define an event delay that is long enough to include the data capture and the DUT reconfiguration.
4. The I/Q data capture starts again after the event delay is over.
Steps 2 through 4 repeat until all events are captured.

Using a periodic sequence: frame trigger available

In this scenario, measurements take place periodically, every <x> seconds.

The scenario requires an external trigger, connected to trigger input 1. The external trigger is a frame trigger that initiates the I/Q data capture. The trigger event is the frame start.

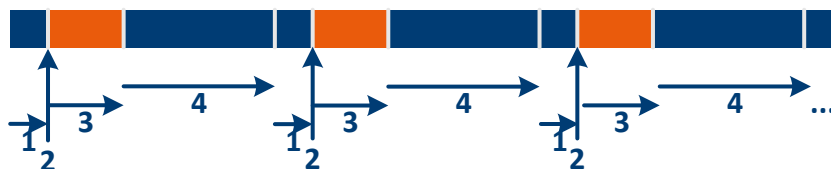

Figure 4-8: Workflow for a periodic measurement with frame trigger

- 1 = Wait for frame start
- 2 = Start of measurement
- 3 = I/Q data capture
- 4 = DUT reconfiguration

The time a single measurement event lasts in the sequence is the sum of:

I/Q capture + DUT reconfiguration + waiting on frame start

Optional auto leveling for each measurement extends the measurement time a little.

The sequence of measurements runs like this:

1. The FSW waits for a frame start.
2. A frame trigger initiates the measurement.
3. The FSW captures the I/Q data.
4. The DUT reconfigures itself.
Note that the event delay starts with the I/Q capture. Thus, make sure to define an event delay that is long enough to include the data capture and the DUT reconfiguration.
The end of the event delay also rearms the frame trigger.
- Steps 1 through 4 repeat until all events are captured.

Using an open-loop sequence: frame trigger available

This scenario needs two trigger sources.

The first is an external frame trigger, connected to trigger input 1, that initiates the I/Q data capture. The trigger event is the frame start.

The second is an external trigger, connected to trigger input 2, that indicates that the DUT is ready for the measurement. This trigger is sent, for example, when the DUT has reached its measurement position.

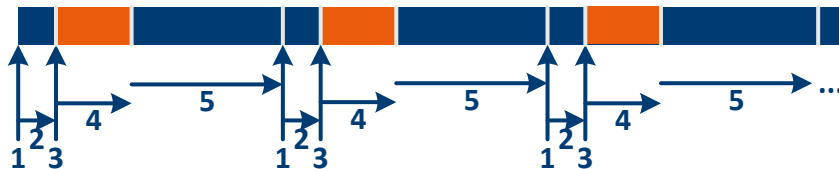

Figure 4-9: Workflow for an open loop measurement with frame trigger

- 1 = DUT ready for measurement
- 2 = Wait for frame start
- 3 = Frame trigger starts measurement
- 4 = I/Q data capture
- 5 = DUT reconfiguration

The time a single measurement event lasts in the sequence is the sum of:

I/Q capture + DUT reconfiguration + waiting on frame start + waiting for DUT ready trigger

Optional auto leveling for each measurement extends the measurement time a little.

The sequence of measurements runs like this:

1. The DUT sends a trigger signal to indicate that it is ready for the measurement.
2. The FSW waits for a frame start.
3. A frame trigger initiates the measurement.

4. The FSW captures the I/Q data.
5. The DUT reconfigures itself.
Steps 1 through 5 repeat until all events are captured.

Using an open-loop sequence: frame trigger available with a delay between events

This scenario needs two trigger sources.

The first is an external frame trigger, connected to trigger input 1, that initiates the I/Q data capture. The trigger event is the frame start.

The second is a trigger output, connected to trigger output 3, that indicates that the I/Q data capture of an event is finished. This trigger signal initiates a delay after which a new measurement starts.

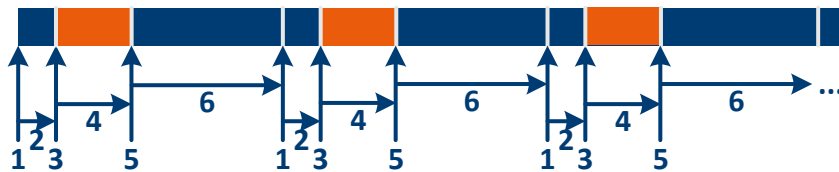

Figure 4-10: Workflow for a open loop measurement with frame trigger

- 1 = DUT ready for measurement
- 2 = Wait for frame start
- 3 = Frame trigger starts measurement
- 4 = I/Q data capture
- 5 = End of I/Q data capture
- 6 = Delay time (DUT reconfiguration)

The time a single measurement event lasts in the sequence is the sum of:

I/Q capture + DUT reconfiguration (delay) + waiting on frame start

Optional auto leveling for each measurement extends the measurement time a little.

The sequence of measurements runs like this:

1. The DUT sends a trigger signal to indicate that it is ready for the measurement.
2. The FSW waits for a frame start.
3. A frame trigger initiates the measurement.
4. The FSW captures the I/Q data.
5. The FSW sends a trigger signal to indicate that the I/Q data is captured.
6. The DUT reconfigures itself during the delay time.
Steps 1 through 6 repeat until all events are captured.

Using an open-loop sequence: using time trigger

This scenario needs two trigger sources.

The first is a **time trigger** that initiates a periodic I/Q data capture. Because the frame start and time trigger drift from each other over time, using the time trigger requires regular recalibration - in combined measurement mode, this is an automated process, defined by the **recalibration interval**. The initial synchronization of the time trigger to the frame start is also an automated process.

The second is an external trigger, connected to trigger input 2, that indicates that the DUT is ready for the measurement. This trigger is sent, for example, when the DUT has reached its measurement position.

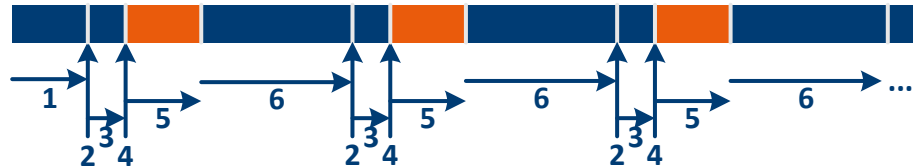

Figure 4-11: Workflow for an open loop measurement with time trigger

- 1 = Initial calibration of time trigger
- 2 = DUT ready for measurement
- 3 = Wait for frame start
- 4 = Start of measurement
- 5 = I/Q data capture
- 6 = DUT reconfiguration

The time a single measurement event lasts in the sequence is the sum of:

I/Q capture + DUT reconfiguration + time trigger recalibration + waiting on frame start + waiting for DUT ready trigger

Optional auto leveling for each measurement extends the measurement time a little.

Before you start the measurement sequence, define an appropriate recalibration interval.

The sequence of measurements runs like this:

1. The FSW calibrates the time trigger by defining a trigger offset = frame start offset.
2. The DUT sends a trigger signal to indicate that it is ready for the measurement.
3. The FSW waits for a frame start.
4. A frame synchronized time trigger initiates the measurement.
5. The FSW captures the I/Q data.
6. The DUT reconfigures itself.
At the same time, the time trigger recalibration occurs.
7. The DUT sends a trigger signal to indicate it is ready for the next measurement.
Steps 2 through 6 repeat themselves until all events are captured.

Using an open-loop sequence: no trigger available (repeating slots)

In this scenario, the DUT uses an external trigger signal to indicate it is ready for a measurement. The trigger signal initiates a (free run) measurement.

This scenario requires a capture time that is at least double the time of the data you want to capture - for example, if you want to capture a single slot with 30 kHz subcarrier spacing (slot length = 0.5 ms), the capture time must be greater than 1 ms.

Note that the number of slots that the signal repeats have to start with slot 0.



Figure 4-12: Workflow for an open-loop measurement without trigger

1 = DUT ready for measurement
2 = I/Q data capture
3 = DUT reconfiguration

The time a single measurement event lasts in the sequence is the sum of:

I/Q capture + DUT reconfiguration + waiting for DUT ready trigger

Optional auto leveling for each measurement extends the measurement time a little.

The sequence of measurements runs like this:

1. The DUT sends a trigger signal to indicate that it is ready for the measurement.
2. The FSW captures the I/Q data.
3. The DUT reconfigures itself.
4. The DUT sends a trigger signal to indicate it is ready for the next measurement.
Steps 1 through 3 repeat themselves until all events are captured.

Using an closed-loop sequence: frame trigger available

This scenario needs two trigger sources and one trigger output.

The first trigger source is an external frame trigger, connected to trigger input 1, that initiates the I/Q data capture. The trigger event is the frame start.

The second trigger source is an external trigger, connected to trigger input 2, that indicates that the DUT is ready for the measurement. This trigger is sent, for example, when the DUT has reached its measurement position.

The trigger output initiates the DUT reconfiguration after the FSW is done capturing the I/Q data. The DUT must have a corresponding trigger interface. This signal is output on trigger 3, which is defined as a user-defined output.

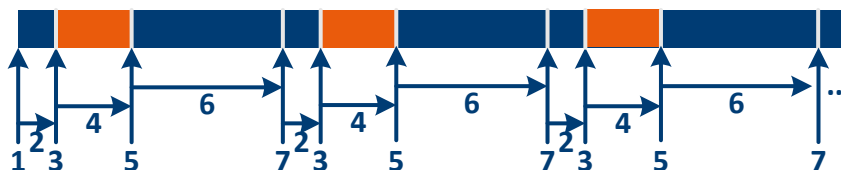

Figure 4-13: Workflow for a closed loop measurement with frame trigger

- 1 = Send initial trigger signal
- 2 = Wait for frame start
- 3 = Frame trigger starts measurement
- 4 = I/Q data capture
- 5 = I/Q data capture done - waiting for DUT reconfiguration
- 6 = DUT reconfiguration
- 7 = DUT ready for measurement

The time a single measurement event lasts in the sequence is the sum of:

I/Q capture + DUT reconfiguration + waiting on frame start + waiting for DUT ready trigger

Optional auto leveling for each measurement extends the measurement time a little.

The sequence of measurements runs like this:

1. Send an initial trigger with "Send Trigger 3" (optional).
2. The FSW waits for a frame start.
3. A frame trigger initiates the measurement.
4. The FSW captures the I/Q data.
5. The FSW sends a trigger signal to the DUT to indicate the I/Q data capture is done.
6. The DUT reconfigures itself.
7. The DUT sends a trigger signal to indicate that it is ready for the measurement.
Steps 2 through 7 repeat until all events are captured.

Using an closed-loop sequence: using time trigger

This scenario needs two trigger sources and one trigger output.

The first is a [time trigger](#) that initiates a periodic I/Q data capture. Because the frame start and time trigger drift from each other over time, using the time trigger requires regular recalibration - in combined measurement mode, this is an automated process, defined by the [recalibration interval](#). The initial synchronization of the time trigger to the frame start is also an automated process.

The second is an external trigger, connected to trigger input 2, that indicates that the DUT is ready for the measurement. This trigger is sent, for example, when the DUT has reached its measurement position.

The trigger output initiates the DUT reconfiguration after the FSW is done capturing the I/Q data. The DUT must have a corresponding trigger interface. This signal is output on trigger 3, which is defined as a user-defined output.

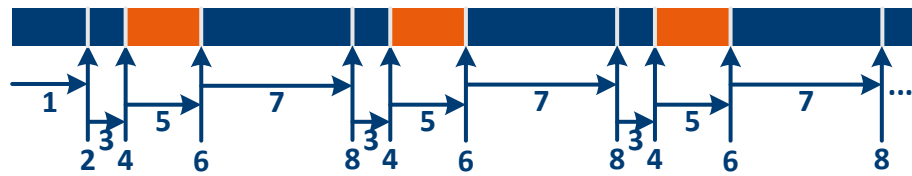

Figure 4-14: Workflow for a closed loop measurement with time trigger

- 1 = Initial calibration of time trigger
- 2 = Send initial trigger signal
- 3 = Wait for frame start
- 4 = Start of measurement
- 5 = I/Q data capture
- 6 = I/Q data capture done - waiting for DUT reconfiguration
- 7 = DUT reconfiguration
- 8 = DUT ready for measurement

The time a single measurement event lasts in the sequence is the sum of:

I/Q capture + DUT reconfiguration + time trigger recalibration + waiting on frame start + waiting for DUT ready trigger

Optional auto leveling for each measurement extends the measurement time a little.

Before you start the measurement sequence, define an appropriate recalibration interval.

The sequence of measurements runs like this:

1. The FSW calibrates the time trigger by defining a trigger offset = frame start offset.
2. Send an initial trigger with "Send Trigger 3" (optional).
3. The FSW waits for a frame start.
4. A frame synchronized time trigger initiates the measurement
5. The FSW captures the I/Q data.
6. The FSW sends a trigger signal to the DUT to indicate the I/Q data capture is done.
7. The DUT reconfigures itself.
At the same time, the time trigger recalibration occurs.
8. The DUT sends a trigger signal to indicate it is ready for the next measurement.
Steps 3 through 8 repeat themselves until all events are captured.

Using an closed-loop sequence: no trigger available (repeating slots)

In this scenario, the DUT uses an external trigger signal to indicate it is ready for a measurement. The trigger signal initiates a (free run) measurement.

In addition, the FSW sends a trigger to the DUT to indicate that the I/Q capture is done.

This scenario requires a capture time that is at least double the time of the data you want to capture - for example, if you want to capture a single slot with 30 kHz subcarrier spacing (slot length = 0.5 ms), the capture time must be greater than 1 ms.

Note that the number of slots that the signal repeats have to start with slot 0.

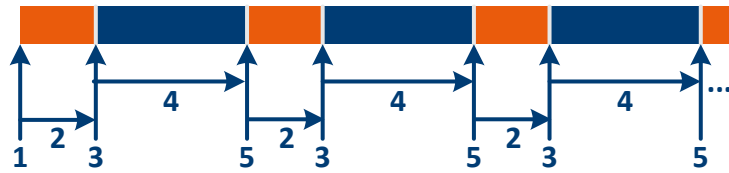

Figure 4-15: Workflow for an closed-loop measurement without trigger

- 1 = Send initial trigger signal
- 2 = I/Q data capture
- 3 = I/Q data capture done - waiting for DUT reconfiguration
- 4 = DUT reconfiguration
- 5 = DUT ready for measurement

The time a single measurement event lasts in the sequence is the sum of:

I/Q capture + DUT reconfiguration + waiting for DUT ready trigger

Optional auto leveling for each measurement extends the measurement time a little.

The sequence of measurements runs like this:

1. Send an initial trigger with "Send Trigger 3" (optional).
2. The FSW captures the I/Q data.
3. The FSW sends a trigger signal to the DUT to indicate the I/Q data capture is done.
4. The DUT reconfigures itself.
5. The DUT sends a trigger signal to indicate it is ready for the next measurement. Steps 2 through 5 repeat themselves until all events are captured.

4.6 Time trigger measurement guide

The time trigger initiates a measurement in certain intervals (every <x> seconds). For the 5G NR application this means that you can use the time trigger to initiate a measurement at the start of each frame (every 10 ms). Therefore, the time trigger is a useful tool when you do not have access to a frame trigger (external trigger source), for example when you test a base station on-site.

Configured correctly, the time trigger also allows you to focus on the analysis of a single slot, which in turn speeds up the measurement. In that case, the idea is to capture only the I/Q data of a single slot (plus a certain tolerance) which increases the measurement speed accordingly.

Since the frequency references of the DUT and the FSW are not necessarily coupled in such a scenario, the frame start and the time trigger may deviate over time. In this case, you can increase the capture time tolerance or readjust the time trigger offset periodically.

Analyzing signals with a time trigger

1. Connect the FSW to the DUT.
2. Select the time trigger as the trigger source.
("Overview" > "Trigger / Signal Capture" > "Trigger" > "Trigger Source" = "Time")
3. Define a repetition interval of 10 ms (capture every frame).
("Overview" > "Trigger / Signal Capture" > "Trigger" > "Repetition Interval" = "10 ms")
4. Run a measurement to get the frame start offset readout in the capture buffer result display.
5. Define a trigger offset with a length that equals the [frame start offset](#) to synchronize the start of the measurement with the first slot in the frame.
("Overview" > "Trigger / Signal Capture" > "Trigger" > "Offset" = frame start offset)
6. Select one slot to analyze.
("Overview" > "Trigger / Signal Capture" > "Signal Capture" > "Set Number of Frames to Analyze" = "Manually")
("Overview" > "Trigger / Signal Capture" > "Signal Capture" > "Number of Frames to Analyze" = "1")
7. Define a capture length that corresponds to one slot (plus tolerance). The slot length depends on the [subcarrier spacing](#).
("Overview" > "Trigger / Signal Capture" > "Signal Capture" > "Capture Time" = slot length)
8. Run the measurement.
If synchronization to the signal fails (see message in the status bar), you have to increase the trigger offset slightly (a few μ s).

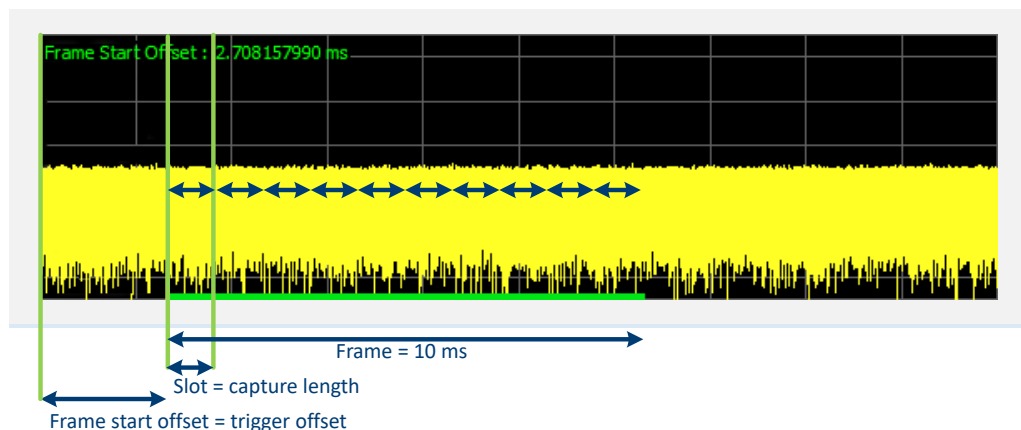

4.7 Microservice export

Access:  /  > "Export" > "Microservice Export"

In addition to [exporting the signal configuration](#) locally, you can export the signal configuration in a file format compatible to the cloud-based microservice (.m5g file extension).

Exporting signal configurations with multiple component carriers writes the configuration of each component carrier into a separate file. The number of files depends on the [analysis mode](#):

- If you analyze the viewed CCs only, the FSW exports those two CCs (two files - config_CC1.m5g, config_CC2.m5g).
- If you analyze all CCs, the FSW exports all CCs. The number of files depends on the number of component carriers (config_CC1.m5g, config_CC2.m5g etc.).

When you change the CC analysis mode (all to viewed or vice versa), you have to either refresh the I/Q data or re-run the sweep to reflect this change in the microservice export.

For a comprehensive description of the microservice, refer to the microservice user manual.

Remote command:

[MMEMory:STORe<n>:MSERvice](#) on page 279

4.8 O-RAN measurement guide

The O-RAN alliance specifies specific signal configurations (test cases) for standardized testing of O-RAN equipment. The FSW provides these O-RAN test cases. When you apply one of them, the measurement configuration automatically adjusts to the values of the selected test case.

Basically, you can verify O-RAN based signals by certain bit sequences in the PUSCH and the positions of those sequences. The position of the bit sequence in the PUSCH is unique for each test case.

The [type of bit sequence](#) depends on the test case.

- Some test cases use a bit sequence of all 0's.
- Some test cases use an O-RAN specific PN23 bit sequence.

In addition, the [data demodulation](#) depends on the test case (before or after descrambling).

As pointed out, these settings are automatically selected, depending on the selected test case.

For valid measurement results, it is essential that the measured signal complies with the selected test case and uses the correct bit sequences in the correct locations. If you get unexpected measurement results, check if the signal is configured correctly. You can do a quick check to validate the signal as follows.

- Check if the selected test case in the "Advanced Settings" is the same as the test case in the "Test Models" dialog.

- Use the [Allocation ID vs Symbol x Carrier](#) result display to verify if the correct PUSCH allocations are analyzed. If the signal contains the correct bit sequence, the EVM should be good.
- Use the [Bitstream](#) result display to verify if the bits match the O-RAN specifications. Each test case has a typical bit sequence. Make sure to select the bit sequence as the [bitstream format](#).

4.9 Reference: structure of .allocation files

.allocation (and .ccallocation) files are basically xml files that follow a certain structure. The structure of the file is based on the structure of the dialogs in the user interface.

Basically, the structure is as follows:

- Each setting is stored in a dedicated element.
Example: <ChannelBandwidth>, <CellID>
- The settings are grouped as in the user interface.
Example: <ChannelBandwidth> and <CellID> belong to the <Physical_Settings> element.
- Some xml elements can occur multiple times.
Examples: <Frame_Config>, <BWP_Config>, <Slot_Config>. The number of occurrences depends on the number of frames, BWPs and slots in the signal.
- The values for all elements are the SCPI parameters of the corresponding setting.
Example: <ChannelBandwidth>BW100</ChannelBandwidth>, <CellID>0</CellID>



Probably the most comfortable way to describe a signal in an xml file is to save an .allocation file after a preset and then change the values within that file.

Root structure

For structure of child elements, see:

- "[<Information> element](#)" on page 161
- "[<PRACH> element](#)" on page 161
- "[<Signal_Description> element](#)" on page 161
- "[<Signal_Capture> element](#)" on page 162
- "[<Parameter_Estimation> element](#)" on page 162
- "[<CCSettings> element](#)" on page 162
- "[<RF_Parameter> element](#)" on page 163
- "[<MultiCarrier> element](#)" on page 164

```
<NR5G>
  <Information/>
  <!-- PRACH settings are relevant in uplink only -->
  <PRACH/>
```



```

<Signal_Description/>
<Signal_Capture/>
<Parameter_Estimation/>
<!-- CCSettings can occur several times -->
<CCSettings/>
<RF_Parameter/>
<!-- MultiCarrier only for multiple carriers -->
<MultiCarrier/>
</NR5G>

```

<Information> element

The <Information> element is a child element of the <NR5G> element.

```

<Information>
  <FWVersion/>
  <Device/>
  <Type/>
  <IQFrequency/>
  <Mode/>
  <ExportIssues/>
</Information>

```

<PRACH> element

The <PRACH> element is a child element of the <NR5G> element.

```

<PRACH>
  <PRACHFormat/>
  <PRACHSCS/>
  <L_RA/>
  <Restricted/>
  <LogicalRootSequenceIndex/>
  <ZeroCorrelationZone/>
  <PreambleIndex/>
  <RelPower/>
  <RBOffset/>
</PRACH>

```

<Signal_Description> element

The <Signal_Description> element is a child element of the <NR5G> element.

```

<Signal_Description>
  <Mode/>
  <DeployFrequencyRange/>
  <NumberOfCC/>
  <NumberOfInputSource/>
  <ORANTestCase/>
  <FreqErrLimitState/>
  <TestModelName/>
</Signal_Description>

```

<Signal_Capture> element

The <Signal_Capture> element is a child element of the <NR5G> element.

```
<Signal_Capture>
  <SwapIQ/>
  <LongCaptureMode/>
  <CaptureTime/>
  <CaptureTimeAuto/>
  <OverallFrameCount/>
  <SetNumberOfFramesToAnalyze/>
  <NumOfFramesToAnalyze/>
  <MaxOfSlotsPerFrameToAnalyze/>
  <AveragedFrame/>
  <SignalRepeatsMaxNoOfSlotsToAnalyze/>
</Signal_Capture>
```

<Parameter_Estimation> element

The <Parameter_Estimation> element is a child element of the <NR5G> element.

```
<Parameter_Estimation>
  <ChannelEstimation/>
  <TrackPhase/>
  <TrackTiming/>
  <TrackLevel/>
  <MultiCarrierFilter/>
  <DemodulatedData/>
  <IQGainImbalance_QuadratureError/>
  <TPUTState/>
  <EVMCalculationMethod/>
  <CORESETReferenceData/>
  <PDSCHReferenceData/>
  <ExtendedFrequencyLockRange/>
  <SymbolTimingPosition/>
  <TransientPeriod/>
  <SymbolsbeforeTransient/>
  <SymbolsafterTransient/>
</Parameter_Estimation>
```

<CCSettings> element

The <CCSettings> element is a child element of the <NR5G> element.

The <CCSettings> element can occur several times, one for each component carrier.

For structure of child elements, see:

- ["<Frame_Config> element"](#) on page 164

```
<CCSettings>
  <AutoBWPDetection/>
  <CCFrequency/>
  <FreqOffsetToCC0/>
```

```

<PhysicalSettings>
  <ChannelBandwidth/>
  <CellID/>
  <PowerClass/>
</PhysicalSettings>
<NumofAntPortMapping/>
<!-- Ant_Port_Mapping occurs several times, once for each AP configuration -->
<Ant_Port_Mapping>
  <State/>
  <PUSCH_APx/>
  <PUCCH_AP/>
  <SRS_AP1000/>
</Ant_Port_Mapping>
<Ant_Port_Mapping_SlaveConfig>
  <Selected_Ant_Port_Mapping/>
</Ant_Port_Mapping_SlaveConfig>
<Advanced_Settings>
  <IgnoreDC/>
  <RFUpconversion_PhaseCompensation/>
  <PUSCHHopping/>
  <RFUpconversion_f_0/>
  <RFUpconversion_f_0_Freq/>
  <FrameNumber_n_f/>
  <RefPointA_SCS15kHz/>
  <RefPointA_SCS30kHz/>
  <RefPointA_SCS60kHz/>
  <RefPointA_SCS120kHz/>
  <RefPointA_SCS480kHz/>
  <RefPointA_SCS960kHz/>
  <RefPointA_RelativeToCF/>
  <TransformPrecoding/>
  <ExtremeConditions/>
  <FrequencyHopping/>
</Advanced_Settings>
<NumofFrame/>
<!-- Frame_Config can occur several times, contents see below -->
<Frame_Config/>
</CCSetting>

```

<RF_Parameter> element

The <RF_Parameter> element is a child element of the <NR5G> element.

```

<RF_Parameter>
  <ACLR>
    <AdjacentChannels/>
    <PowerClass/>
    <LimitCheckMode/>
    <TestID/>
  </ACLR>
  <SEM>

```

```

    <CategoryA/>
    <CategoryBOption/>
    <TxPowerAuto/>
    <TxPowerValue/>
    <N_TXUcountedpercell/>
    <N_TABconnectors/>
    <IFF/>
  </SEM>
</RF_Parameter>

```

<MultiCarrier> element

The <MultiCarrier> element is a child element of the <NR5G> element.

```

<MultiCarrier>
  <CCSignalCapture/>
  <OperatingBand/>
  <CCResult/>
  <View1ComponentCarrierNo/>
  <View1FrameNo/>
  <View2ComponentCarrierNo/>
  <View2FrameNo/>
  <FixedCCOffset/>
  <GlobalMCCenter/>
  <OffsetRelto/>
  <OffsetMode/>
  <CarrierSpacing/>
</MultiCarrier>

```

<Frame_Config> element

The <Frame_Config> element is a child element of the <CCSettings> element.

- The <Frame_Config> element can occur several times, one for each configurable frame.
- Within the <BWP_Config> element, the <Slot_Config> element can occur several times, one for each slot.
- Within the <Slot_Config> element, the <PXCCH> and <PXSCH> elements can occur several times, one for each PXCCH or PXSCH allocation.

For structure of child elements, see:

- "[<PXCCH> element](#)" on page 165
- "[<PXSCH> element](#)" on page 166
- "[<SRS_Settings> element](#)" on page 167

```

<Frame_Config>
  <NumofBWP/>
  <BWP_Config>
    <SubcarrierSpacing/>
    <NumofRBs/>

```

```

<RBOffset/>
<NumberOfUserConfigurableSlots/>
<NumofSlot/>
<!-- Slot_Config can occur several times -->
<Slot_Config>
  <SlotAllocation/>
  <SlotFormat/>
  <CombinePDSCHAllocationsWithSameUserID/>
  <NumofPXCCH/>
  <!-- PXCCH can occur several times, description see below -->
  <PXCCH/>
  <NumofPXSCH/>
  <!-- PXSCH can occur several times, description see below -->
  <PXSCH/>
</Slot_Config>
<SRSSettingsState/>
<!-- Contents of SRS element see below -->
<SRS_Settings/>
</BWP_Config>
</Frame_Config>

```

<PXCCH> element

The <PXCCH> element is a child element of the <Frame_Config> element.

The <PXCCH> element can occur several times, one for each PXCCH allocation.

```

<PXCCH>
  <NumberOfRBs/>
  <OffsetRB/>
  <NumberOfSymbols/>
  <OffsetSymbol/>
  <RelPower_dB/>
  <PUCCHFormat/>
  <DMRS>
    <UseDMRSScramblingID/>
    <ScramblingID/>
    <RelPower/>
    <GroupHopping/>
    <HoppingID/>
    <n_ID/>
    <IntraSlotFreqHopping/>
    <SecondHopPRB/>
    <InitialCyclicShift/>
    <TimeDomainOCCIndex/>
    <AdditionalDMRS/>
    <OCCLength/>
  </DMRS>
</PXCCH>

```

<PXSCH> element

The <PXSCH> element is a child element of the <Slot_Config> element.

The <PXSCH> element can occur several times, one for each PXSCH allocation.

```

<PXSCH>
  <UserID/>
  <Modulation/>
  <NumberOfRBs/>
  <OffsetRB/>
  <NumberOfSymbols/>
  <OffsetSymbol/>
  <RelPower_dB/>
  <ModulationforCodeword2/>
  <DMRS>
    <ConfigType/>
    <FirstDMRSSymbolRelTo/>
    <FirstDMRSSymbol/>
    <DMRSAddPositionIndex/>
    <DMRSLength/>
    <SequenceGeneration/>
    <ScramblingID/>
    <ScramblingID1/>
    <n_SCID/>
    <RelPowerToPDSCH/>
    <Layer_Codewords/>
    <AntennaPort/>
    <CDMGroupWData/>
    <NID_RS/>
    <NID_RS_ID/>
    <DMRS_R16/>
  </DMRS>
  <PTRS>
    <State/>
    <RelPower/>
    <L_PTRS/>
    <K_PTRS/>
    <RE_Offset/>
    <N_Group_PTRS/>
    <N_Sample_Group/>
    <NID/>
    <NID_ID/>
  </PTRS>
  <ChannelCoding>
    <MCSTable/>
    <I_MCS/>
    <RedundancyVersionIndex/>
    <TBScalingFactorS/>
    <TBSizeIncAllocGaps/>
  </ChannelCoding>

```

```

<Scrambling>
  <Type/>
  <DataScramblingID/>
</Scrambling>
</FXSCH>

```

<SRS_Settings> element

The <SRS_Settings> element is a child element of the <BWP_Config> element.

```

<SRS_Settings>
  <SlotConfig>
    <SlotConfigMode/>
    <Periodicity/>
    <Offset/>
  </SlotConfig>
  <StartPos/>
  <NoSym/>
  <FreqPos/>
  <FreqShift/>
  <FreqHoppingConfig/>
    <BSRS/>
    <CSRS/>
    <BHOP/>
  </FreqHoppingConfig>
  <RepFactor/>
  <TransmissionCombSequenceConfig>
    <TransmissionComb/>
    <CombOffset/>
    <CyclicShift/>
    <SequenceID/>
    <GrouporSeqHopping/>
  </TransmissionCombSequenceConfig>
  <NoPorts/>
  <RelPower_dB/>
</SRS_Settings>

```

4.10 Basics on input from I/Q data files

The I/Q data to be evaluated in a particular FSW application cannot only be captured by the application itself, it can also be loaded from a file, provided it has the correct format. The file is then used as the input source for the application.

For example, you can capture I/Q data using the I/Q Analyzer application, store it to a file, and then analyze the signal parameters for that data later using the AM/FM/PM Modulation Analysis application.

The I/Q data file must be in one of the following supported formats:

- .iq.tar

- .iqw
- .csv
- .mat
- .wv
- .aid



An application note on converting Rohde & Schwarz I/Q data files is available from the Rohde & Schwarz website:

[1EF85: Converting R&S I/Q data files](#)

When importing data from an I/Q data file using the import functions provided by some FSW applications, the data is only stored temporarily in the capture buffer. It overwrites the current measurement data and is in turn overwritten by a new measurement. If you use an I/Q data file as input, the stored I/Q data remains available for any number of subsequent measurements. Furthermore, the (temporary) data import requires the current measurement settings in the current application to match the settings that were applied when the measurement results were stored (possibly in a different application). When the data is used as an input source, however, the data acquisition settings in the current application (attenuation, center frequency, measurement bandwidth, sample rate) can be ignored. As a result, these settings cannot be changed in the current application. Only the measurement time can be decreased, to perform measurements on an extract of the available data (from the beginning of the file) only.



For I/Q data which was captured as segmented data, the timing information for the captured segments is also stored during export. It can then be retrieved when the I/Q data file is used as an input source to reproduce results that are consistent with the original measurement.



5G NR signal description

When you export I/Q data from the 5G NR application, the iq.tar file also contains the signal description (.allocation file information). The signal description is included in the I/Q parameter XML file.

Therefore, it is no longer necessary to load the signal description separately before loading the I/Q data.

For input files that contain multiple data streams from different channels, you can define which data stream to be used for the currently selected channel in the input settings. You can define whether the data stream is used only once, or repeatedly, to create a larger amount of input data.

When using input from an I/Q data file, the [RUN SINGLE] function starts a single measurement (i.e. analysis) of the stored I/Q data, while the [RUN CONT] function repeatedly analyzes the same data from the file.



Sample iq.tar files

If you have the optional FSW VSA application (R&S FSW-K70), some sample `iq.tar` files are provided in the `C:\R_S\INSTR\USER\vsa\DemoSignals` directory on the FSW.

Pre-trigger and post-trigger samples

In applications that use pre-triggers or post-triggers, if no pre-trigger or post-trigger samples are specified in the I/Q data file, or too few trigger samples are provided to satisfy the requirements of the application, the missing pre- or post-trigger values are filled up with zeros. Superfluous samples in the file are dropped, if necessary. For pre-trigger samples, values are filled up or omitted at the beginning of the capture buffer. For post-trigger samples, values are filled up or omitted at the end of the capture buffer.

5 Analysis

The FSW provides various tools to analyze the measurement results.

- [General analysis tools](#)..... 170
- [Analysis tools for I/Q measurements](#)..... 174
- [Analysis tools for combined measurements](#)..... 183
- [Analysis tools for frequency sweep measurements](#)..... 185

5.1 General analysis tools

The general analysis tools are tools available for all measurements.



Event-based actions

The 5G NR measurement application supports event-based actions, as described in the FSW User Manual.

When using event based actions, make sure that all frames are included in a single I/Q capture. Event based actions only evaluate the last I/Q capture.

- [Data export](#)..... 170
- [Diagram scale](#)..... 171
- [Zoom](#)..... 172
- [Markers](#)..... 173

5.1.1 Data export

Access: [TRACE] > "Trace Export Config"

You can export the measurement results to an ASCII file, for example to backup the results or analyze the results with external applications (for example in a Microsoft Excel spreadsheet).

You can also export the I/Q data itself, for example if you want to keep it for later reevaluation.

The data export is available for:

- I/Q measurements
- Time alignment error measurements

Exporting trace data

1. Select [TRACE] > "Trace Export Config".
2. Select the data you would like to export.
3. Select the results you would like to export from the "Specifics For" dropdown menu.
4. Export the data with the "Export Trace to ASCII File" feature.

5. Select the location where you would like to save the data (as a `.dat` file).

Note that the measurement data stored in the file depend on the selected result display ("Specifics For" selection).

Exporting I/Q data

1. Select the disk icon in the toolbar.
2. Select "Export" > "I/Q Export".
3. Define a file name and location for the I/Q data.
The default file type is `iq.tar`.
4. Later on, you can import the I/Q data using the [I/Q file input source](#).

Combined measurements have additional features for the I/Q data export and import. You can either

- export I/Q data for specific measurements ("I/Q Export" and import using the I/Q file input source) or
- export and import the I/Q data of all measurements in the sequence ("I/Q Export All" / "I/Q Import All").

If you are using the [I/Q noise cancellation](#) algorithm, you can also export the corrected I/Q data ("IQNC I/Q Export"). Exporting corrected I/Q data is only available in single sweep mode and if I/Q noise cancellation is enabled

Data import and export

The basic principle for both trace export and I/Q data export and import is the same as in the spectrum application. For a comprehensive description, refer to the FSW user manual.

Exporting and importing "all" measurements is available in combined measurement mode - it selects all measurements in a sequence.

For the I/Q data export, you can choose between different file formats (`.iq.tar`, `.aid`, `.csv`, `.iqw` and `.mat` (v4 and v7.3) for single carrier measurements.

Remote command:

Trace export: `TRACe<n>[:DATA]?` on page 275

I/Q data format: `FORMat:DEXPort:FORMat` on page 278

I/Q export: `MMEMorY:STORe<n>:IQ:STATe` on page 278

I/Q export (all): `MMEMorY:STORe<n>:IQ:STATe:ALL` on page 279

I/Q import: `INPut:FILE:PATH` on page 372

I/Q import (all): `MMEMorY:LOAD:IQ:STATe:ALL` on page 278

I/Q noise cancellation: `MMEMorY:STORe<n>:IQNC:STATe` on page 279

5.1.2 Diagram scale

Access: "Overview" > "Analysis" > "Scale"

You can change the scale of the y-axis in various diagrams. The y-axis scale determines the vertical resolution of the measurement results.

The scale of the x-axis in the diagrams is fix. If you want to get a better resolution of the x-axis, you have to **zoom** into the diagram.

The remote commands required to configure the y-axis scale are described in [Chapter 6.11.1.2, "Diagram scale"](#), on page 413.

[Manual scaling of the y-axis](#)..... 172

[Automatic scaling of the y-axis](#)..... 172

Manual scaling of the y-axis

The "Y Minimum" and "Y Maximum" properties define a custom scale of the y-axis.

The "Y Minimum" corresponds to the value at the origin. The "Y Maximum" corresponds to the last value on the y-axis. The scale you select applies to the currently active window.

You can restore the original scale anytime with "Restore Scale".

Remote command:

```
DISPlay[:WINDow<n>][:SUBWindow<w>]:TRACe<t>:Y[:SCALe]:MAXimum
```

on page 414

```
DISPlay[:WINDow<n>][:SUBWindow<w>]:TRACe<t>:Y[:SCALe]:MINimum
```

on page 414

Automatic scaling of the y-axis

Usually, the best way to view the results is if they fit ideally in the diagram area and display the complete trace. The "Auto Scale Once" automatically determines the scale of the y-axis that fits this criteria in the currently active window.

Tip: You can also scale the windows in the "Auto Set" menu. In addition to scaling the selected window ("Auto Scale Window"), you can change the scale of all windows at the same time ("Auto Scale All").

You can restore the original scale anytime with "Restore Scale".

Remote command:

```
DISPlay[:WINDow<n>][:SUBWindow<w>]:TRACe<t>:Y[:SCALe]:AUTO
```



on page 413

5.1.3 Zoom

The zoom feature allows you to zoom into any graphical result display. This can be a useful tool if you want to analyze certain parts of a diagram in more detail.

The zoom functionality is the same as in the spectrum application.

The following zoom functions are supported.

- : Magnifies the selected diagram area.
- : Magnifies the selected diagram area, but keeps the original diagram in a separate window.
- : Restores the original diagram.

Note that the zoom is a graphical feature that magnifies the data in the capture buffer. Zooming into the diagram does not reevaluate the I/Q data.

For a comprehensive description of the zoom, refer to the FSW user manual.

5.1.4 Markers

Access: "Overview" > "Analysis" > "Marker"

Markers are a tool that help you to identify measurement results at specific trace points. When you turn on a marker, it gives you the coordinates of its position, for example the frequency and its level value or the symbol and its EVM value.

In general, the marker functionality of setting and positioning markers is similar to the spectrum application.

For I/Q measurement, the FSW supports up to four markers, for frequency sweep measurements there are more. Markers give either absolute values (normal markers) or values relative to the first marker (deltamarkers). If a result display has more than one trace, for example the "EVM vs Symbol" result display, you can position the marker on either trace. By default, all markers are positioned on trace 1.

Note that if you analyze more than one bandwidth part, each bandwidth part is represented by a different trace.

The FSW also supports several automatic positioning mechanisms that allow you to move the marker to the maximum trace value (peak), the minimum trace value or move it from peak to subsequent peak.

The [marker table](#) summarizes the marker characteristics.

For a comprehensive description, refer to the FSW user manual.

Markers in result displays with a third quantity

In result displays that show a third quantity, for example the "EVM vs Symbol x Carrier" result, the FSW provides an extended marker functionality.

You can position the marker on a specific resource element, whose position is defined by the following coordinates:

- The "BWP/SS" dropdown menu selects the bandwidth part.
- The "Symbol" input field selects the symbol.
- The "Carrier" input field selects the carrier.

Alternatively, you can define the marker position in the "Marker Configuration" dialog box, which is expanded accordingly.

The marker information shows the EVM, the power and the allocation ID of the resource element you have selected as the marker position.

5.2 Analysis tools for I/Q measurements

The following analysis tools are available exclusively for I/Q measurements.

- [Layout of numerical results](#)..... 174
- [Result settings](#)..... 174
- [Table configuration](#)..... 177
- [Result views](#)..... 178
- [Evaluation range](#)..... 180

5.2.1 Layout of numerical results

You can customize the displayed information of some numerical result displays or tables, for example the [allocation summary](#).

You can identify these result display by the "Table Config" button in the result display header.



When you select the "Table Config" button, the FSW opens a dialog box that allows you to add or remove table columns. Note that some columns are mandatory and cannot be removed.

Alternatively, select some point in the header row of the table to open the dialog box.

5.2.2 Result settings

Access: "Overview" > "Analysis" > "Result Settings"

The result settings control the way various results are displayed.

EVM Unit	174
Bit Stream Format	175
Carrier Axes	175
Symbol Axes	175
Carrier Axes Reference	175
EVM Max Hold	176
Subwindow Coupling	176
3D View	176
ACLR Limit Pass Mode	177
Constellation Diagram Relative Power	177
Constellation Color	177

EVM Unit

The "EVM Unit" selects the unit for the EVM measurement results in diagrams and numerical result displays.

Possible units are dB and %.

Remote command:

[UNIT:EVM](#) on page 429

Bit Stream Format

Selects the way the bit stream is displayed.

The bit stream is either a stream of raw bits or of symbols. In case of the symbol format, the bits that belong to a symbol are shown as hexadecimal numbers with two digits.

Selecting the bit stream format is possible when [data demodulation](#) occurs before or after descrambling.

Remote command:

[UNIT:BSTR](#) on page 428

Carrier Axes

The "Carrier Axes" selects the unit of the x-axis in result displays that show results over the subcarriers.

- "Hertz"
X-axis shows the results in terms of the subcarrier frequency.
- "Subcarrier Number"
X-axis shows the results in terms of the subcarrier number.

Remote command:

[UNIT:CAXes](#) on page 429

Symbol Axes

The "Symbol Axes" selects the unit of the x-axis in result displays that show results over the OFDM symbols.

- "Time"
X-axis shows the results in terms of time.
- "Symbol Number"
X-axis shows the results in terms of the symbol number.

Remote command:

[UNIT:SAXes](#) on page 430

Carrier Axes Reference

Selects the way the frequency is displayed in result displays that plot (carrier) frequency information on the x-axis. In these result displays, the x-axis covers the whole [channel bandwidth](#).

"Lowest RB"	Frequency values relative to the first resource block in the channel. The origin of the x-axis (0 Hz) corresponds to the first resource block in the channel.
"Relative to CF"	Frequency values relative to the center frequency of the carrier. The center frequency of the carrier corresponds to 0 Hz, which is displayed at the center of the x-axis.

Remote command:

[UNIT:CAReference](#) on page 429

EVM Max Hold

The "EVM Max Hold" turns the display of the highest EVM values in graphical result displays on and off.

Depending on the result display and the evaluation range, this means that

- either the maximum trace is displayed
- or the highest value in a data bin is displayed instead of the average.

Remote command:

[SENSe:]NR5G:EMHold on page 426

Subwindow Coupling

Couples or decouples result display tabs (subwindows).

If the coupling is on and you select another tab in a result display, the application automatically selects the same tab for all result displays.

Subwindow coupling is available for measurements with multiple data streams (for example carrier aggregation).

Remote command:

DISPlay[:WINDow<n>] [:SUBWindow<w>]:COUPling on page 425

3D View

The "3D View" turns the display of a 3D view of the following result displays on and off.

- "Allocation ID vs Symbol x Carrier" on page 44
- "EVM vs Symbol x Carrier" on page 43
- "Power vs Symbol x Carrier" on page 43

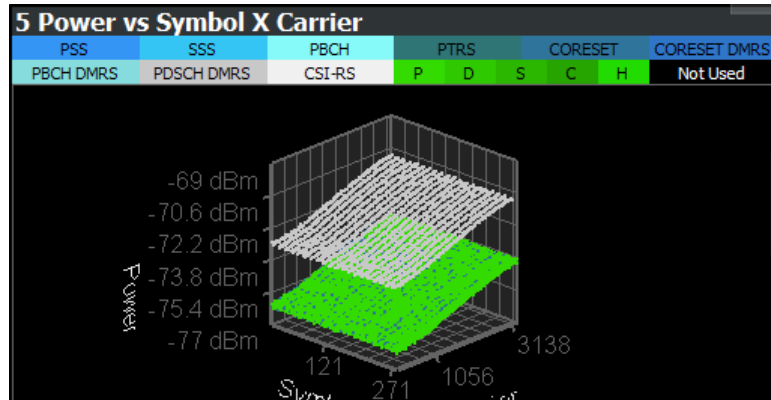

The 3D diagram shows a point cloud of all measurement points in the capture buffer. The information is the same as in the 2D views. The 3D diagram can help you find value distributions more easily, for example.

The 3D view supports the following controls:

- Changing the scale of the axes.
- Turning the diagram in any direction.
The view from the top corresponds to the 2D views.
- Zooming in and out of the diagram to see more details.

Remote command:

[SENSe:]NR5G:TDView on page 428

ACLR Limit Pass Mode

Available for combined measurements.

The "ACLR Limit Pass Mode" selects the method the ACLR limits are evaluated with.

By default, the FSW evaluates the relative and absolute limits according to 3GPP. One of the two must pass for an overall pass.

If you want to evaluate only the absolute or relative limits, select the corresponding evaluation method. If you want to change the limit evaluation method after the measurement, you have to [refresh the measurement](#).

The selected method adjusts the contents [combined result summary](#) and the [ACLR result summary](#) accordingly.

"Absolute"	Checks the absolute limits defined for the ACLR. The limit check passes when the signal level is within the absolute limits.
"Relative"	Checks the relative limits defined for the ACLR. The limit check passes when the signal level is within the relative limits.
"Absolute or Relative"	The limit check for either the absolute or the relative limits must pass to get an overall pass.

Remote command:

[\[SENSe:\]NR5G:ACPower:ALPMode](#) on page 405

Constellation Diagram Relative Power

Turns the consideration of a boosting factor to calculate the constellation points in the [constellation diagram](#) on and off.

Remote command:

[\[SENSe:\]NR5G:CDRPower](#) on page 426

Constellation Color

Selects the information that the colors of the constellation points in the [constellation diagram](#) represent.

"Modulation"	Colors represent modulation types.
"Allocation"	Colors represent allocation types.

Remote command:

[\[SENSe:\]NR5G:CCOLor](#) on page 426

5.2.3 Table configuration

Access: "Result Settings" > "Table Config"

The result summary and allocation summary contain all sorts of results and information. If you only want to see a selected set of results, you can customize the contents of these result displays by adding or removing individual results.



Accessing the "Table Config" tab

Note that the contents of the "Table Config" dialog box are only available after you have selected the "Specifics for: Result Summary" or "Specifics for: Allocation Summary" item from the corresponding dropdown menu at the bottom of the dialog box.

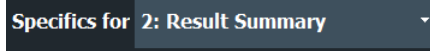

CC Result

Selects the way the FSW analyzes [multiple carriers](#).

The component carrier analysis method also changes the layout of the [result summary](#).

"All"	Analyzes all component carriers and shows information about all of them in the result summary overview ("All" tab). Note that measuring all component carriers can take a while, depending on the number of component carriers.
"Viewed"	Analyzes the two component carriers assigned to the two views . The result summary overview ("All" tab) only shows information about those two component carriers.

Remote command:

[\[SENSe:\]NR5G:RSUMmary:CCResult](#) on page 427

Power Mode

Selects the power averaging mode for the results in the [result summary](#).

Available if the signal only contains a single numerology.

"Average Active Slots"	Averages the power of all OFDM symbols in the slot.
"Average Active Symbols"	Averages the OFDM symbols that are used. If all symbols are occupied, the results are the same as averaging over all symbols. This setting has an effect on TDD signals that combine both downlink and uplink symbols in a slot.

Remote command:

[\[SENSe:\]NR5G:RSUMmary:PMODE](#) on page 427

Result state

Turn individual results on and off by selecting or deselecting the corresponding result labels.

Note that some information is always visible, the corresponding checkboxes are greyed out.

Remote command:

Result selection: [DISPlay\[:WINDow<n>\]:TABLE:ITEM](#) on page 425

5.2.4 Result views

When you capture multiple data streams, for example [several component carriers](#), the FSW displays the results for each single data stream in a separate diagram. Because

this can lead to literally dozens of diagrams in each result display, the FSW only shows two data streams simultaneously.

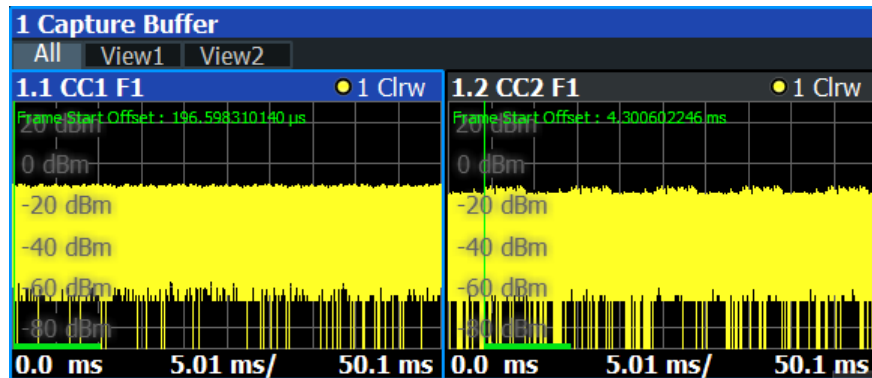

Result displays are made up out of three tabs in such cases.

- The first tab labeled "All" shows the two data streams next to each other, in two subwindows.
- The other two tabs labeled "View <x>" show each of the two data streams in a single window.

There are always just two views, but you can assign the data streams you would like to see to those two views. If you measure more than two data streams, you have to select the data streams you want to display.

If you measure [several frames](#) in addition to multiple data streams, you can also select a specific frame whose information is displayed in the two diagrams.

You can see the currently displayed component carriers in the window title bar and the channel bar.

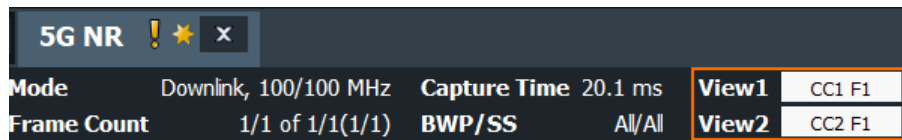

CC = Component carrier number
F = Frame number

Component Carrier No	179
Frame No	179

Component Carrier No

Selects the number of the component carrier that the FSW displays in the two views.

Remote command:

`DISplay[:WINDow<n>] [:SUBWindow<w>]:CCNumber` on page 424

Frame No

Selects the frame that the FSW displays in the two views.

Note that the frame selection in the "Result View" dialog box and the "Evaluation Range" dialog box are coupled.

Remote command:

`DISPlay[:WINDow<n>][:SUBWindow<w>]:FNUMBER` on page 424

5.2.5 Evaluation range

Access: "Overview" > "Evaluation Range" > "Global / Constellation"

You can filter various result displays by the type of information they display.

PRACH analysis has the preamble selection, which in turn is unavailable for other EVM measurements.

The remote commands required to configure the results are described in [Chapter 6.11.2.3, "Evaluation range"](#), on page 430.

Segment Selection	180
Frame Selection	180
Selected Meas ID	180
BWP/SS Selection	181
Subframe Selection	181
Slot Selection	182
Preamble Selection	183
Evaluation range for the constellation diagram	183

Segment Selection

The "Segment" selection filters the results by a certain segment.

If you apply the filter, only the results for the segment you have selected are displayed. Otherwise, the FSW shows the results for the first segment.

The segment filter is available when you are using [segmented capture](#). For more information about this feature and its effect on results, see [Chapter 4.1.18, "Segmented capture"](#), on page 126.

Remote command:

`[SENSe:]NR5G:SEGment:SElect` on page 434

Frame Selection

The "Frame" selection filters the results by a specific frame number.

If you apply the filter, only the results for the frame you have selected are displayed. Otherwise, the FSW shows the results for the first frame.

Note that the frame selection in the "Evaluation Range" dialog box and the ["Result Views"](#) dialog box are coupled.

For more information about the effects on results when you capture multiple frames, see ["Effects of capturing multiple frames on results"](#) on page 71.

Remote command:

`[SENSe:]NR5G[:CC<cc>]:FRAME:SElect` on page 432

Selected Meas ID

Available for combined measurements.

Selects one of the events in the measurement sequence.

Remote command:

[SENSe:]NR5G[:CC<cc>]:SMID on page 435

BWP/SS Selection

The "BWP/SS" selection filters the results by a specific bandwidth part.

If you apply the filter, only the results for the bandwidth part you have selected are displayed. Otherwise, the FSW shows the results for all bandwidth parts that have been analyzed.

Selecting "SS/PBCH Block" shows only the results for the synchronization signal and PBCH block. Selecting one of the numbers only shows the results for the corresponding bandwidth part.

The FSW shows several traces if the filter is not active, one for each bandwidth part and one for SS/PBCH block.

If you apply the filter, the number of traces depends on the result display. For some result displays, the minimum, maximum and average result are displayed in three traces, for others only one trace.

You can apply the filter to the following result displays.

- EVM vs Carrier
- EVM vs Symbol
- Flatness vs Carrier
- Constellation Diagram
- Allocation Summary
- Alloc ID vs Symbol x Carrier
- EVM vs Symbol x Carrier
- Power vs Symbol x Carrier

Remote command:

[SENSe:]NR5G[:CC<cc>]:BWPart:SElect on page 431

Subframe Selection

The "Subframe" selection filters the results by a specific subframe number.

If you apply the filter, only the results for the subframe you have selected are displayed. Otherwise, the FSW shows the results for all subframes that have been analyzed.

The FSW shows three traces if you display the results for all subframes.

- One trace ("Min") shows the minimum values measured over all analyzed subframes.
- One trace ("Max") shows the maximum values measured over all analyzed subframes.
- One trace ("Avg") shows the average values measured over all subframes.

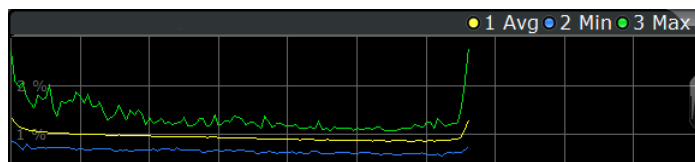

If you filter by a single subframe, the FSW still shows three traces, but with different information.

- One trace ("Min") shows the minimum values measured over all slots in the selected subframe.
- One trace ("Max") shows the maximum values measured over all slots in the selected subframe.
- One trace ("Avg") shows the average values measured over all slots in the selected subframe.

The number of traces is only reduced to one trace if you filter by a single [slot](#).

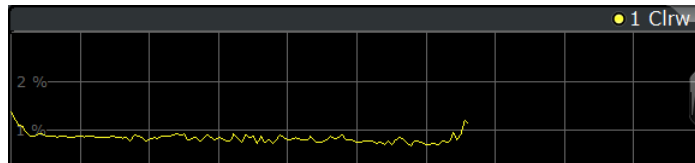

You can apply the filter to the following result displays.

- EVM vs Carrier
- EVM vs Symbol
- Flatness vs Carrier
- Constellation Diagram
- Allocation Summary
- Alloc ID vs Symbol x Carrier
- EVM vs Symbol x Carrier
- Power vs Symbol x Carrier

Remote command:

`[SENSe:]NR5G[:CC<cc>]:SUBFrame:SElect` on page 434

Slot Selection

The "Slot" selection filters the results by a specific slot number.

If you apply the filter, only the results for the slot you have selected are displayed. Otherwise, the FSW shows the results for all slots.

The FSW shows three traces if you display the results for all slots.

- One trace ("Min") shows the minimum values measured over all slots.
- One trace ("Max") shows the maximum values measured over all slots.
- One trace ("Avg") shows the average values measured over all slots.

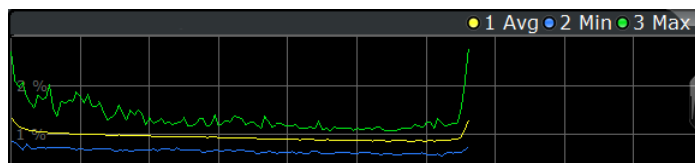

If you filter by a single slot, the FSW shows one trace that represents the values measured for that slot only.

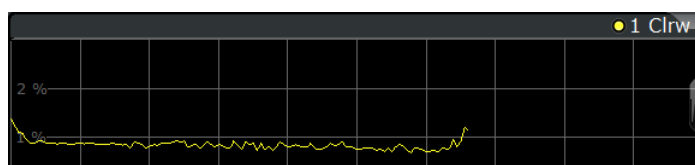

You can apply the filter to the following result displays.

- EVM vs Carrier
- EVM vs Symbol
- Flatness vs Carrier
- Constellation Diagram
- Allocation Summary
- Alloc ID vs Symbol x Carrier
- EVM vs Symbol x Carrier
- Power vs Symbol x Carrier

Remote command:

[\[SENSe:\]NR5G\[:CC<cc>\]:SLOT:SElect](#) on page 433

Preamble Selection

The "Preamble" selection filters the results by a specific preamble.

The FSW shows three traces if you display the results for all preambles.

- One trace ("Min") shows the minimum values measured over all preambles.
- One trace ("Max") shows the maximum values measured over all preambles.
- One trace ("Avg") shows the average values measured over all preambles.

If you filter by a single preamble, the FSW shows one trace that represents the values measured for that preamble only.

Remote command:

[\[SENSe:\]NR5G\[:CC<cc>\]:PREamble:SElect](#) on page 433

Evaluation range for the constellation diagram

The "Evaluation Range" for the constellation diagram selects the information displayed in the [constellation diagram](#).

By default, the constellation diagram contains the constellation points of the complete data that has been analyzed. However, you can filter the results by several aspects.

- Modulation
Filters the results by the selected type of modulation.
- Allocation
Filters the results by a certain type of allocation.
- Symbol (OFDM)
Filters the results by a certain OFDM symbol.
- Carrier
Filters the results by a certain subcarrier.

Remote command:

Modulation: [\[SENSe:\]NR5G\[:CC<cc>\]:MODulation:SElect](#) on page 432

Allocation: [\[SENSe:\]NR5G\[:CC<cc>\]:ALlocation:SElect](#) on page 430

Symbol: [\[SENSe:\]NR5G\[:CC<cc>\]:SYMBOL:SElect](#) on page 434

Carrier: [\[SENSe:\]NR5G\[:CC<cc>\]:CARRIER:SElect](#) on page 431

5.3 Analysis tools for combined measurements

Access: "Overview" > "Analysis"

Access: "Overview" > "Evaluation Range"

Access: [Meas Config] > "Result Settings"

Combined measurements provide several analysis tools. In addition to the tools available in other measurement modes, combined measurement also provide specific tools.

- [Event filter](#)..... 184
- [General analysis tools](#)..... 185

5.3.1 Event filter

Access: [Meas Config] > "Result Settings" > "Table Config" > "Event Filter"

Access: "Table Config" (header of result summary) > "Event Filter"

Depending on your test setup, you can have a lot of measurement events in your measurement sequence. Thus, the result summary for combined measurements can become pretty large. To make the list more manageable, and inspect the results of selected events in detail, you can filter the results by all kinds criteria.

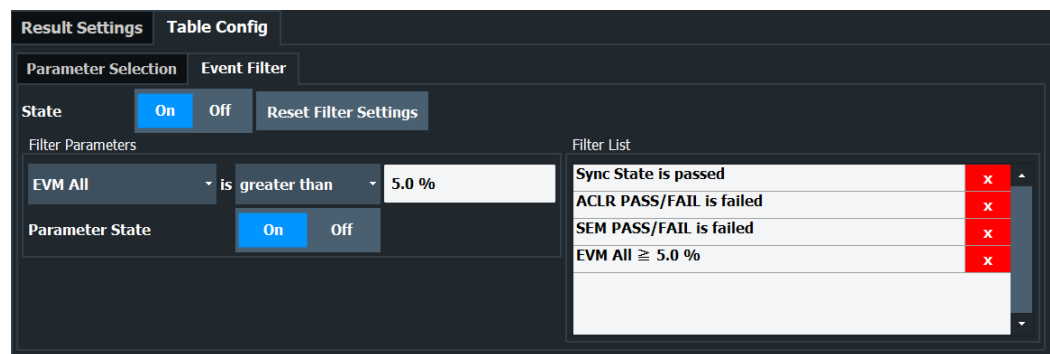

1. Turn on the event filter.
2. Select a filter parameter.
The filter parameter is usually one of the results from combined measurement [result summary](#).
3. Select a filter condition.
4. Turn on the filter to add it to the filter list.
You can add as many filter conditions as you like to the filter list.
You can remove a filter with the x in the filter list or remove all filters with "Reset Filter Settings".

[State](#)..... 184

[Reset Filter Settings](#)..... 185

[Filter Parameters](#)..... 185

State

Turns on the event filter.

Remote command:

[\[SENSe:\]NR5G:EFILter:STATe](#) on page 437

Reset Filter Settings

Clears the filter list.

Remote command:

[\[SENSe:\]NR5G:EFILter:PRESet](#) on page 436

Filter Parameters

Selects the filter conditions.

The filter condition is a combination of a filter parameter and a condition for that parameter, for example "Sync State" = "Passed".

The "Parameter State" adds a filter to the filter list.

Remote command:

Condition: [\[SENSe:\]NR5G:EFILter:FPARAMeters](#) on page 435

State: [\[SENSe:\]NR5G:EFILter:FPARAMeters:STATe](#) on page 436

Query number of filtered events: [\[SENSe:\]NR5G:FEVents:COUNT?](#) on page 437

5.3.2 General analysis tools

Analysis tools described elsewhere:

- [Data and trace export](#)
- [Diagram scale](#)
- [Zoom](#)
- [Markers](#)

Note that the markers you set remain on their position when you browse through the measurements in a sequence.

- [Table layout](#)
- [General result setting](#)
- [Evaluation range](#)

5.4 Analysis tools for frequency sweep measurements

Access: "Overview" > "Analysis"

Access: "Overview" > "Analysis"

The analysis tools available for the frequency sweep measurements are the same as in the spectrum analyzer.

For more information, refer to the FSW user manual.

6 Remote control

The following remote control commands are required to configure and perform 5G NR measurements in a remote environment. The FSW must already be set up for remote operation in a network as described in the base unit manual.



Universal functionality

Note that basic tasks that are also performed in the base unit in the same way are not described here. For a description of such tasks, see the FSW User Manual.

In particular, this includes:

- Managing Settings and Results, i.e. storing and loading settings and result data.
- Basic instrument configuration, e.g. checking the system configuration, customizing the screen layout, or configuring networks and remote operation.
- Using the common status registers.

• Common suffixes	186
• Introduction	187
• Status register	192
• 5G NR application selection	193
• Screen layout	197
• Measurement control	206
• Remote commands to retrieve numeric results	210
• Limit check results	242
• Retrieve trace data	258
• Configuration	276
• Analysis	411
• Reading out status register	437

6.1 Common suffixes

In the 5G NR measurement application, the following common suffixes are used in remote commands:

Table 6-1: Common suffixes used in remote commands in the 5G NR measurement application

Suffix	Value range	Description
<m>	1..4	Marker
<n>	1..16	Window (in the currently selected channel)
<t>	1..6	Trace
	1 to 8	Limit line
<al>	0..99	Selects a subframe allocation.
<bwp>	1..12	Selects a bandwidth part.

Suffix	Value range	Description
<cc>	1..16	Selects a component carrier. (8 CCs for MC ACLR, cum. ACLR and Multi SEM)
<csi>	1..64	Selects a CSI-RS.
<fr>	1..n	Selects a frame. The maximum value depends on the signal configuration.
<k>	---	Selects a limit line. Irrelevant for the 5G NR application.
<sf>	0..n	Selects a subframe. The maximum value depends on the signal configuration.
<sl>	0..n	Selects a slot. The maximum value depends on the signal configuration.
<ss>	0..64	Selects a synchronization signal block (SSB).
<ssb>	1..4	irrelevant
<sym>	0..13	Selects an OFDM symbol
<w>	1..2	Selects a subwindow (view)

6.2 Introduction

Commands are program messages that a controller (e.g. a PC) sends to the instrument or software. They operate its functions ('setting commands' or 'events') and request information ('query commands'). Some commands can only be used in one way, others work in two ways (setting and query). If not indicated otherwise, the commands can be used for settings and queries.

The syntax of a SCPI command consists of a header and, usually, one or more parameters. To use a command as a query, you have to append a question mark after the last header element, even if the command contains a parameter.

A header contains one or more keywords, separated by a colon. Header and parameters are separated by a "white space" (ASCII code 0 to 9, 11 to 32 decimal, e.g. blank). If there is more than one parameter for a command, they are separated by a comma from one another.

Only the most important characteristics that you need to know when working with SCPI commands are described here. For a more complete description, refer to the user manual of the FSW.



Remote command examples

Note that some remote command examples mentioned in this general introduction are possibly not supported by this particular application.

6.2.1 Conventions used in descriptions

The following conventions are used in the remote command descriptions:

- *Command usage*
If not specified otherwise, commands can be used both for setting and for querying parameters.
If a command can be used for setting or querying only, or if it initiates an event, the usage is stated explicitly.
- *Parameter usage*
If not specified otherwise, a parameter can be used to set a value, and it is the result of a query.
Parameters required only for setting are indicated as "Setting parameters".
Parameters required only to refine a query are indicated as "Query parameters".
Parameters that are only returned as the result of a query are indicated as "Return values".
- *Conformity*
Commands that are taken from the SCPI standard are indicated as "SCPI confirmed". All commands used by the FSW follow the SCPI syntax rules.
- *Asynchronous commands*
A command which does not automatically finish executing before the next command starts executing (overlapping command) is indicated as an "Asynchronous command".
- *Reset values (*RST)*
Default parameter values that are used directly after resetting the instrument (*RST command) are indicated as "*RST" values, if available.
- *Default unit*
The default unit is used for numeric values if no other unit is provided with the parameter.
- *Manual operation*
If the result of a remote command can also be achieved in manual operation, a link to the description is inserted.

6.2.2 Long and short form

The keywords have a long and a short form. You can use either the long or the short form, but no other abbreviations of the keywords.

The short form is emphasized in uppercase letters. Note however, that this emphasis only serves the purpose to distinguish the short from the long form in the manual. For the instrument, the case does not matter.

Example:

SENSe:FREQuency:CENTer is the same as SENS:FREQ:CENT.

6.2.3 Numeric suffixes

Some keywords have a numeric suffix if the command can be applied to multiple instances of an object. In that case, the suffix selects a particular instance (e.g. a measurement window).

Numeric suffixes are indicated by angular brackets (<n>) next to the keyword.

If you do not quote a suffix for keywords that support one, a 1 is assumed.

Example:

`DISPlay[:WINDow<1...4>]:ZOOM:STATe` enables the zoom in a particular measurement window, selected by the suffix at `WINDow`.

`DISPlay:WINDow4:ZOOM:STATe ON` refers to window 4.

6.2.4 Optional keywords

Some keywords are optional and are only part of the syntax because of SCPI compliance. You can include them in the header or not.



If an optional keyword has a numeric suffix and you need to use the suffix, you have to include the optional keyword. Otherwise, the suffix of the missing keyword is assumed to be the value 1.

Optional keywords are emphasized with square brackets.

Example:

Without a numeric suffix in the optional keyword:

`[SENSe:]FREQuency:CENTer` is the same as `FREQuency:CENTer`

With a numeric suffix in the optional keyword:

`DISPlay[:WINDow<1...4>]:ZOOM:STATe`

`DISPlay:ZOOM:STATe ON` enables the zoom in window 1 (no suffix).

`DISPlay:WINDow4:ZOOM:STATe ON` enables the zoom in window 4.

6.2.5 Alternative keywords

A vertical stroke indicates alternatives for a specific keyword. You can use both keywords to the same effect.

Example:

`[SENSe:]BANDwidth|BWIDth[:RESolution]`

In the short form without optional keywords, `BAND 1MHZ` would have the same effect as `BWID 1MHZ`.

6.2.6 SCPI parameters

Many commands feature one or more parameters.

If a command supports more than one parameter, they are separated by a comma.

Example:

```
LAYout:ADD:WINDow Spectrum,LEFT,MTABLE
```

Parameters can have different forms of values.

- [Numeric values](#)..... 190
- [Boolean](#)..... 191
- [Character data](#)..... 191
- [Character strings](#)..... 191
- [Block data](#)..... 192

6.2.6.1 Numeric values

Numeric values can be entered in any form, i.e. with sign, decimal point or exponent. For physical quantities, you can also add the unit. If the unit is missing, the command uses the basic unit.

Example:

With unit: `SENSe:FREQuency:CENTer 1GHZ`

Without unit: `SENSe:FREQuency:CENTer 1E9` would also set a frequency of 1 GHz.

Values exceeding the resolution of the instrument are rounded up or down.

If the number you have entered is not supported (e.g. for discrete steps), the command returns an error.

Instead of a number, you can also set numeric values with a text parameter in special cases.

- **MIN/MAX**
Defines the minimum or maximum numeric value that is supported.
- **DEF**
Defines the default value.
- **UP/DOWN**
Increases or decreases the numeric value by one step. The step size depends on the setting. Sometimes, you can customize the step size with a corresponding command.

Querying numeric values

When you query numeric values, the system returns a number. For physical quantities, it applies the basic unit (e.g. Hz for frequencies). The number of digits after the decimal point depends on the type of numeric value.

Example:

Setting: `SENSe:FREQuency:CENTer 1GHZ`

Query: `SENSe:FREQuency:CENTer?` would return `1E9`

Sometimes, numeric values are returned as text.

- **INF/NINF**
Infinity or negative infinity. Represents the numeric values 9.9E37 or -9.9E37.
- **NAN**
Not a number. Represents the numeric value 9.91E37. NAN is returned if errors occur.

6.2.6.2 Boolean

Boolean parameters represent two states. The "on" state (logically true) is represented by "ON" or the numeric value 1. The "off" state (logically untrue) is represented by "OFF" or the numeric value 0.

Querying Boolean parameters

When you query Boolean parameters, the system returns either the value 1 ("ON") or the value 0 ("OFF").

Example:

Setting: `DISPlay:WINDow:ZOOM:STATe ON`

Query: `DISPlay:WINDow:ZOOM:STATe?` would return `1`

6.2.6.3 Character data

Character data follows the syntactic rules of keywords. You can enter text using a short or a long form. For more information, see [Chapter 6.2.2, "Long and short form"](#), on page 188.

Querying text parameters

When you query text parameters, the system returns its short form.

Example:

Setting: `SENSe:BANDwidth:RESolution:TYPE NORMAL`

Query: `SENSe:BANDwidth:RESolution:TYPE?` would return `NORM`

6.2.6.4 Character strings

Strings are alphanumeric characters. They have to be in straight quotation marks. You can use a single quotation mark (') or a double quotation mark (").

Example:

```
INSTRument:DELeTe 'Spectrum'
```

6.2.6.5 Block data

Block data is a format which is suitable for the transmission of large amounts of data.

The ASCII character # introduces the data block. The next number indicates how many of the following digits describe the length of the data block. The data bytes follow. During the transmission of these data bytes, all end or other control signs are ignored until all bytes are transmitted. #0 specifies a data block of indefinite length. The use of the indefinite format requires an `NL^END` message to terminate the data block. This format is useful when the length of the transmission is not known or if speed or other considerations prevent segmentation of the data into blocks of definite length.

6.3 Status register

The 5G NR measurement application uses the standard status registers of the FSW (depending on the measurement type). However, some registers are used differently. Only those differences are described in the following sections.

For details on the common FSW status registers refer to the description of remote control basics in the FSW user manual.



*RST does not influence the status registers.

STATUS:QUESTIONABLE:SYNC register

The `STATUS:QUESTIONABLE:SYNC` register contains application-specific information. If any errors occur in this register, the status bit #11 in the `STATUS:QUESTIONABLE` register is set to 1.



Each active channel uses a separate `STATUS:QUESTIONABLE:SYNC` register. Thus, if the status bit #11 in the `STATUS:QUESTIONABLE` register indicates an error, the error may have occurred in any of the channel-specific `STATUS:QUESTIONABLE:SYNC` registers. In this case, you must check the register of each channel to determine which channel caused the error. By default, querying the status of a register always returns the result for the currently selected channel. However, you can specify any other channel name as a query parameter.

Table 6-2: Meaning of the bits used in the STATUS:QUESTIONABLE:SYNC register

Bit No.	Meaning
0	Synchronization status
1 to 5	Unused

Bit No.	Meaning
7	I/Q noise cancellation error
8 to 14	Unused
15	This bit is always 0

6.4 5G NR application selection

INSTrument:CREate:DUPLicate	193
INSTrument:CREate[:NEW]	193
INSTrument:CREate:REPLace	194
INSTrument:DELeTe	194
INSTrument:LIST?	194
INSTrument:REName	196
INSTrument[:SELeCt]	196

INSTrument:CREate:DUPLicate

Duplicates the currently selected channel, i.e. creates a new channel of the same type and with the identical measurement settings. The name of the new channel is the same as the copied channel, extended by a consecutive number (e.g. "IQAnalyzer" -> "IQAnalyzer 2").

The channel to be duplicated must be selected first using the `INST:SEL` command.

Example:

```
INST:SEL 'IQAnalyzer'
```

```
INST:CRE:DUPL
```

Duplicates the channel named 'IQAnalyzer' and creates a new channel named 'IQAnalyzer2'.

Usage: Event

INSTrument:CREate[:NEW] <ChannelType>, <ChannelName>

Adds a measurement channel. You can configure up to 10 measurement channels at the same time (depending on available memory).

Parameters:

<ChannelType> Channel type of the new channel.
For a list of available channel types, see [INSTrument:LIST?](#) on page 194.

<ChannelName> String containing the name of the channel.
Note that you cannot assign an existing channel name to a new channel. If you do, an error occurs.

Example:

```
INST:CRE SAN, 'Spectrum 2'
```

Adds a spectrum display named "Spectrum 2".

INSTRument:CREate:REPLace <ChannelName1>, <ChannelType>,
<ChannelName2>

Replaces a channel with another one.

Setting parameters:

<ChannelName1> String containing the name of the channel you want to replace.

<ChannelType> Channel type of the new channel.
For a list of available channel types, see [INSTRument:LIST?](#) on page 194.

<ChannelName2> String containing the name of the new channel.
Note: If the specified name for a new channel already exists, the default name, extended by a sequential number, is used for the new channel (see [INSTRument:LIST?](#) on page 194).
Channel names can have a maximum of 31 characters, and must be compatible with the Windows conventions for file names. In particular, they must not contain special characters such as ":", "*", "?".

Example: `INST:CRE:REPL 'IQAnalyzer2',IQ,'IQAnalyzer'`
Replaces the channel named "IQAnalyzer2" by a new channel of type "IQ Analyzer" named "IQAnalyzer".

Usage: Setting only

INSTRument:DELeTe <ChannelName>

Deletes a channel.

If you delete the last channel, the default "Spectrum" channel is activated.

Setting parameters:

<ChannelName> String containing the name of the channel you want to delete.
A channel must exist to delete it.

Example: `INST:DEL 'IQAnalyzer4'`
Deletes the channel with the name 'IQAnalyzer4'.

Usage: Setting only

INSTRument:LIST?

Queries all active channels. The query is useful to obtain the names of the existing channels, which are required to replace or delete the channels.

Return values:

<ChannelType>,
<ChannelName> For each channel, the command returns the channel type and channel name (see tables below).
Tip: to change the channel name, use the [INSTRument:REName](#) command.

Example: INST:LIST?
 Result for 3 channels:
 'ADEM', 'Analog Demod', 'IQ', 'IQ
 Analyzer', 'IQ', 'IQ Analyzer2'

Usage: Query only

Table 6-3: Available channel types and default channel names in Signal and Spectrum Analyzer mode

Application	<ChannelType> parameter	Default Channel name*)
Spectrum	SANALYZER	Spectrum
1xEV-DO BTS (R&S FSW-K84)	BDO	1xEV-DO BTS
1xEV-DO MS (R&S FSW-K85)	MDO	1xEV-DO MS
3GPP FDD BTS (R&S FSW-K72)	BWCD	3G FDD BTS
3GPP FDD UE (R&S FSW-K73)	MWCD	3G FDD UE
802.11ad (R&S FSW-K95)	WIGIG	802.11ad
802.11ay (R&S FSW-K97)	EDMG	802.11ay EDMG
Amplifier Measurements (R&S FSW-K18)	AMPLifier	Amplifier
AM/FM/PM Modulation Analysis (R&S FSW-K7)	ADEM	Analog Demod
Avionics (R&S FSW-K15)	AVIonics	Avionics
Bluetooth (R&S FSW-K8)	BTO	Bluetooth
cdma2000 BTS (R&S FSW-K82)	BC2K	CDMA2000 BTS
cdma2000 MS (R&S FSW-K83)	MC2K	CDMA2000 MS
DOCSIS 3.1 (R&S FSW-K192/193)	DOCSis	DOCSIS 3.1
Fast Spur Search (R&S FSW-K50)	SPUR	Spurious
GSM (R&S FSW-K10)	GSM	GSM
HRP UWB (R&S FSW-K149)	UWB	HRP UWB
I/Q Analyzer	IQ	IQ Analyzer
LTE (R&S FSW-K10x)	LTE	LTE
Multi-Carrier "Group Delay" (R&S FSW-K17)	MCGD	MC "Group Delay"
NB-IoT (R&S FSW-K106)	NIOT	NB-IoT
Noise (R&S FSW-K30)	NOISE	Noise
5G NR (R&S FSW-K144)	NR5G	5G NR
OFDM VSA (R&S FSW-K96)	OFDMVSA	OFDM VSA
OneWeb (R&S FSW-K201)	OWEB	OneWeb
Phase Noise (R&S FSW-K40)	PNOISE	Phase Noise
*) If the specified name for a new channel already exists, the default name, extended by a sequential number, is used for the new channel.		

Application	<ChannelType> parameter	Default Channel name*)
Pulse (R&S FSW-K6)	PULSE	Pulse
"Real-Time Spectrum"	RTIM	"Real-Time Spectrum"
TD-SCDMA BTS (R&S FSW-K76)	BTDS	TD-SCDMA BTS
TD-SCDMA UE (R&S FSW-K77)	MTDS	TD-SCDMA UE
Transient Analysis (R&S FSW-K60)	TA	Transient Analysis
Verizon 5GTF Measurement Application (V5GTF, R&S FSW-K118)	V5GT	V5GT
VSA (R&S FSW-K70)	DDEM	VSA
WLAN (R&S FSW-K91)	WLAN	WLAN
*) If the specified name for a new channel already exists, the default name, extended by a sequential number, is used for the new channel.		

INSTrument:REName <ChannelName1>, <ChannelName2>

Renames a channel.

Setting parameters:

<ChannelName1> String containing the name of the channel you want to rename.

<ChannelName2> String containing the new channel name.
 Note that you cannot assign an existing channel name to a new channel. If you do, an error occurs.
 Channel names can have a maximum of 31 characters, and must be compatible with the Windows conventions for file names. In particular, they must not contain special characters such as ":", "*", "?".

Example: `INST:REN 'IQAnalyzer2', 'IQAnalyzer3'`
 Renames the channel with the name 'IQAnalyzer2' to 'IQAnalyzer3'.

Usage: Setting only

INSTrument[:SElect] <ChannelType>

Selects a new measurement channel with the defined channel type.

Parameters:

<ChannelType> **NR5G**
 5G NR measurement channel

Example: `//Select 5G NR application`
`INST NR5G`

6.5 Screen layout

- [General layout](#)..... 197
- [Layout of a single channel](#)..... 198

6.5.1 General layout

The following commands are required to configure general window layout, independent of the application.

Note that the suffix <n> always refers to the window *in the currently selected measurement channel*.

DISPlay:FORMat	197
DISPlay[:WINDow<n>]:SIZE	197
DISPlay[:WINDow<n>][:SUBWindow<w>]:SElect	198
DISPlay[:WINDow<n>]:TAB<tab>:SElect	198

DISPlay:FORMat <Format>

Determines which tab is displayed.

Parameters:

<Format>

SPLit

Displays the MultiView tab with an overview of all active channels

SINGle

Displays the measurement channel that was previously focused.

*RST: SING

Example:

DISP:FORM SPL

DISPlay[:WINDow<n>]:SIZE <Size>

Maximizes the size of the selected result display window *temporarily*. To change the size of several windows on the screen permanently, use the `LAY:SPL` command (see [LAYout:SPLitter](#) on page 203).

Suffix:

<n>

Window

Parameters:

<Size>

LARGE

Maximizes the selected window to full screen. Other windows are still active in the background.

SMALI

Reduces the size of the selected window to its original size. If more than one measurement window was displayed originally, these are visible again.

*RST: SMALI

Example: `DISP:WIND2:SIZE LARG`

DISPlay[:WINDow<n>][:SUBWindow<w>]:SElect

Sets the focus on the selected result display window.

This window is then the active window.

For measurements with multiple results in subwindows, the command also selects the subwindow. Use this command to select the (sub)window before querying trace data.

Suffix:

<n>	Window
<w>	subwindow Not supported by all applications

Example: `//Put the focus on window 1
DISP:WIND1:SEL`

Example: `//Put the focus on subwindow 2 in window 1
DISP:WIND1:SUBW2:SEL`

DISPlay[:WINDow<n>]:TAB<tab>:SElect

Selects a tab in diagrams with multiple subwindows (or views).

Note that selecting a tab does not actually select a subwindow. To select a subwindow, for example to query the results of a subwindow, use `DISPlay[:WINDow<n>][:SUBWindow<w>]:SElect`.

Suffix:

<n>	Window
<tab>	1..n Tab

Example: `//Select a tab
DISP:WIND2:TAB2:SEL`

6.5.2 Layout of a single channel

The following commands are required to change the evaluation type and rearrange the screen layout for a measurement channel as you do using the SmartGrid in manual operation. Since the available evaluation types depend on the selected application, some parameters for the following commands also depend on the selected measurement channel.

Note that the suffix <n> always refers to the window *in the currently selected measurement channel*.

LAYout:ADD[:WINDow]?	199
LAYout:CATalog[:WINDow]?	201
LAYout:IDENtify[:WINDow]?	202

LAYout:REMove[:WINDow].....	202
LAYout:REPLace[:WINDow].....	202
LAYout:SPLitter.....	203
LAYout:WINDow<n>:ADD?.....	204
LAYout:WINDow<n>:IDENTify?.....	205
LAYout:WINDow<n>:REMove.....	205
LAYout:WINDow<n>:REPLace.....	205
LAYout:WINDow<n>:TYPE.....	206

LAYout:ADD[:WINDow]? <WindowName>, <Direction>, <WindowType>

Adds a window to the display in the active channel.

Is always used as a query so that you immediately obtain the name of the new window as a result.

To replace an existing window, use the `LAYout:REPLace[:WINDow]` command.

Query parameters:

<WindowName>	String containing the name of the existing window the new window is inserted next to. By default, the name of a window is the same as its index. To determine the name and index of all active windows, use the <code>LAYout:CATalog[:WINDow]? query</code> .
<Direction>	LEFT RIGHT ABOVE BELOW Direction the new window is added relative to the existing window.
<WindowType>	text value Type of result display (evaluation method) you want to add. See the table below for available parameter values.

Return values:

<NewWindowName>	When adding a new window, the command returns its name (by default the same as its number) as a result.
-----------------	---

Usage: Query only

- Manual operation:**
- See ["Capture Buffer"](#) on page 31
 - See ["EVM vs Carrier"](#) on page 32
 - See ["EVM vs Symbol"](#) on page 32
 - See ["EVM vs RB"](#) on page 33
 - See ["Frequency Error vs Symbol"](#) on page 34
 - See ["Frequency Error vs Subframe"](#) on page 35
 - See ["Power Spectrum"](#) on page 36
 - See ["Inband Emission"](#) on page 36
 - See ["Inband Emissions Summary"](#) on page 37
 - See ["Flatness"](#) on page 38
 - See ["CCDF"](#) on page 39
 - See ["Constellation Diagram"](#) on page 40
 - See ["Allocation Summary"](#) on page 40
 - See ["Bitstream"](#) on page 41
 - See ["EVM vs Symbol x Carrier"](#) on page 43
 - See ["Power vs Symbol x Carrier"](#) on page 43
 - See ["Allocation ID vs Symbol x Carrier"](#) on page 44
 - See ["Marker Table"](#) on page 44
 - See ["Spectrum Flatness"](#) on page 45
 - See ["PRACH Allocation Summary"](#) on page 46
 - See ["Marker Peak List"](#) on page 49

Table 6-4: <WindowType> parameter values for 5G NR measurement application

Parameter value	Window type
I/Q measurements	
AISC	"Allocation ID vs. Symbol X Carrier"
ASUM	"Allocation Summary"
BSTR	"Bitstream"
CBUF	"Capture Buffer"
CCDF	"CCDF"
CONS	"Constellation Diagram"
EVCA	"EVM vs. Carrier"
EVRB	"EVM vs. RB"
EVSC	"EVM vs. Symbol X Carrier"
EVSY	"EVM vs. Symbol"
FEVS	"Frequency Error vs Symbol"
FVSU	"Frequency Error vs Subframe"
IE	"Inband Emissions"
IEA	"Inband Emissions All"
IESummary	"Inband Emissions Summary"
MTAB	"Marker Table"
PSPE	"Power Spectrum"

Parameter value	Window type
PVSC	"Power vs. Symbol X Carrier"
RSUM	"Result Summary"
SFL	"Spectrum Flatness"
PRACH analysis	
ASUM	"PRACH Allocation Summary"
CBUF	"Capture Buffer"
CONS	"Constellation Diagram"
MTAB	"Marker Table"
PSPE	"Power Spectrum"
RSUM	"Result Summary"
SFL	"Spectrum Flatness"
ACLR and SEM measurements	
DIAG	"Diagram"
PEAK	"Peak List"
MTAB	"Marker Table"
RSUM	"Result Summary"
Combined measurements: same as I/Q measurements, plus:	
ADI	"ACLR Diagram"
ARS	"ACLR Result Summary"
CMS	"Combined EVM / ACLR / SEM Result"
RSUM	"Result Summary EVM"
SDI	"SEM Diagram"
SRS	"SEM Result Summary"

LAYout:CATalog[:WINDow]?

Queries the name and index of all active windows in the active channel from top left to bottom right. The result is a comma-separated list of values for each window, with the syntax:

```
<WindowName_1>,<WindowIndex_1>..<WindowName_n>,<WindowIndex_n>
```

Return values:

<WindowName> string
Name of the window.
In the default state, the name of the window is its index.

<WindowIndex> **numeric value**
Index of the window.

Example: LAY:CAT?
 Result:
 '2',2,'1',1
 Two windows are displayed, named '2' (at the top or left), and '1' (at the bottom or right).

Usage: Query only

LAYout:IDENtify[:WINDow]? <WindowName>

Queries the **index** of a particular display window in the active channel.

Note: to query the **name** of a particular window, use the [LAYout:WINDow<n>:IDENtify?](#) query.

Query parameters:

<WindowName> String containing the name of a window.

Return values:

<WindowIndex> Index number of the window.

Example: LAY:IDEN:WIND? '2'
 Queries the index of the result display named '2'.
 Response:
 2

Usage: Query only

LAYout:REMOve[:WINDow] <WindowName>

Removes a window from the display in the active channel.

Setting parameters:

<WindowName> String containing the name of the window. In the default state, the name of the window is its index.

Example: LAY:REM '2'
 Removes the result display in the window named '2'.

Usage: Setting only

LAYout:REPLace[:WINDow] <WindowName>,<WindowType>

Replaces the window type (for example from "Diagram" to "Result Summary") of an already existing window in the active channel while keeping its position, index and window name.

To add a new window, use the [LAYout:ADD\[:WINDow\]?](#) command.

Setting parameters:

<WindowName> String containing the name of the existing window.
 By default, the name of a window is the same as its index. To determine the name and index of all active windows in the active channel, use the [LAYout:CATalog\[:WINDow\]?](#) query.

<WindowType> Type of result display you want to use in the existing window. See [LAYout:ADD\[:WINDow\]?](#) on page 199 for a list of available window types.

Example: `LAY:REPL:WIND '1',MTAB`
Replaces the result display in window 1 with a marker table.

Usage: Setting only

LAYout:SPLitter <Index1>, <Index2>, <Position>

Changes the position of a splitter and thus controls the size of the windows on each side of the splitter.

Compared to the [DISPlay\[:WINDow<n>\]:SIZE](#) on page 197 command, the `LAYout:SPLitter` changes the size of all windows to either side of the splitter permanently, it does not just maximize a single window temporarily.

Note that windows must have a certain minimum size. If the position you define conflicts with the minimum size of any of the affected windows, the command does not work, but does not return an error.

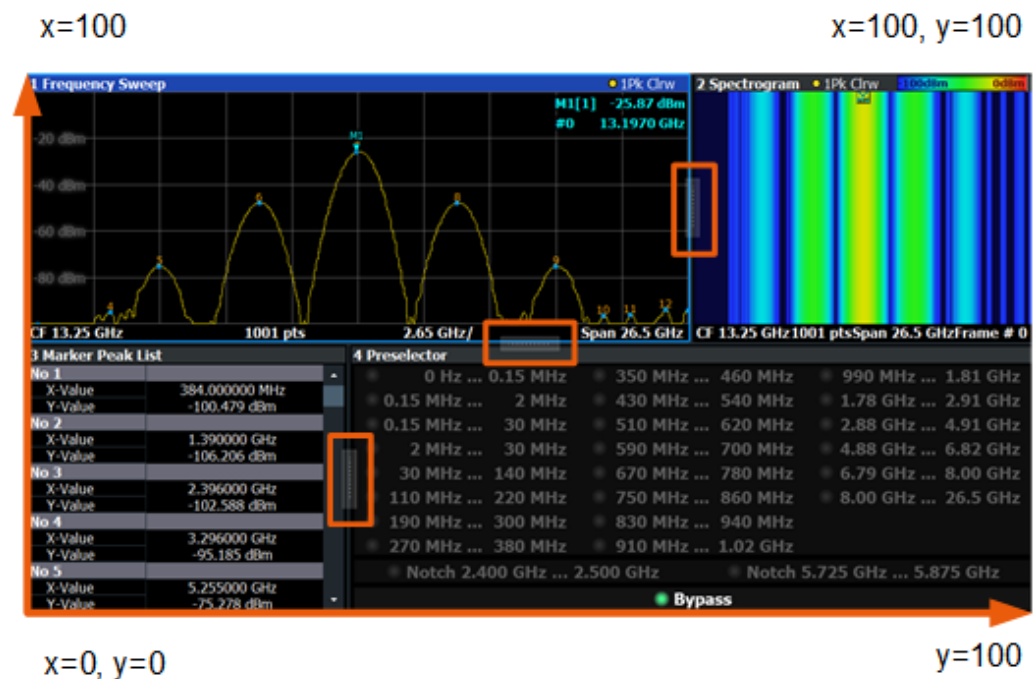

Figure 6-1: SmartGrid coordinates for remote control of the splitters

Setting parameters:

<Index1> The index of one window the splitter controls.

<Index2> The index of a window on the other side of the splitter.

<Position>	<p>New vertical or horizontal position of the splitter as a fraction of the screen area (without channel and status bar and softkey menu).</p> <p>The point of origin (x = 0, y = 0) is in the lower left corner of the screen. The end point (x = 100, y = 100) is in the upper right corner of the screen. (See Figure 6-1.)</p> <p>The direction in which the splitter is moved depends on the screen layout. If the windows are positioned horizontally, the splitter also moves horizontally. If the windows are positioned vertically, the splitter also moves vertically.</p> <p>Range: 0 to 100</p>
Example:	<pre>LAY:SPL 1,3,50</pre> <p>Moves the splitter between window 1 ('Frequency Sweep') and 3 ('Marker Table') to the center (50%) of the screen, i.e. in the figure above, to the left.</p>
Example:	<pre>LAY:SPL 1,4,70</pre> <p>Moves the splitter between window 1 ('Frequency Sweep') and 3 ('Marker Peak List') towards the top (70%) of the screen. The following commands have the exact same effect, as any combination of windows above and below the splitter moves the splitter vertically.</p> <pre>LAY:SPL 3,2,70 LAY:SPL 4,1,70 LAY:SPL 2,1,70</pre>
Usage:	Setting only

LAYout:WINDow<n>:ADD? <Direction>,<WindowType>

Adds a measurement window to the display. Note that with this command, the suffix <n> determines the existing window next to which the new window is added. Unlike [LAYout:ADD\[:WINDow\]?](#), for which the existing window is defined by a parameter.

To replace an existing window, use the [LAYout:WINDow<n>:REPLace](#) command.

Is always used as a query so that you immediately obtain the name of the new window as a result.

Suffix:

<n> [Window](#)

Query parameters:

<Direction> LEFT | RIGHT | ABOVE | BELOW

<WindowType> Type of measurement window you want to add.
See [LAYout:ADD\[:WINDow\]?](#) on page 199 for a list of available window types.

Return values:

<NewWindowName> When adding a new window, the command returns its name (by default the same as its number) as a result.

Example: LAY:WIND1:ADD? LEFT,MTAB
 Result:
 '2'
 Adds a new window named '2' with a marker table to the left of window 1.

Usage: Query only

LAYout:WINDow<n>:IDENtify?

Queries the **name** of a particular display window (indicated by the <n> suffix) in the active channel.

Note: to query the **index** of a particular window, use the [LAYout:IDENtify\[:WINDow\]?](#) command.

Suffix:
 <n> [Window](#)

Return values:
 <WindowName> String containing the name of a window.
 In the default state, the name of the window is its index.

Example: LAY:WIND2:IDEN?
 Queries the name of the result display in window 2.
 Response:
 '2'

Usage: Query only

LAYout:WINDow<n>:REMOve

Removes the window specified by the suffix <n> from the display in the active channel.
 The result of this command is identical to the [LAYout:REMOve\[:WINDow\]](#) command.

Suffix:
 <n> [Window](#)

Example: LAY:WIND2:REM
 Removes the result display in window 2.

Usage: Event

LAYout:WINDow<n>:REPLace <WindowType>

Changes the window type of an existing window (specified by the suffix <n>) in the active channel.

The effect of this command is identical to the [LAYout:REPLace\[:WINDow\]](#) command.

To add a new window, use the [LAYout:WINDow<n>:ADD?](#) command.

Suffix:<n> [Window](#)**Setting parameters:**

<WindowType> Type of measurement window you want to replace another one with.
See [LAYout:ADD\[:WINDow\]?](#) on page 199 for a list of available window types.

Example:

LAY:WIND2:REPL MTAB

Replaces the result display in window 2 with a marker table.

Usage:

Setting only

LAYout:WINDow<n>:TYPE <WindowType>

Queries or defines the window type of the window specified by the index <n>. The window type determines which results are displayed. For a list of possible window types, see [LAYout:ADD\[:WINDow\]?](#) on page 199.

Note that this command is not available in all applications and measurements.

Suffix:<n> 1..n
[Window](#)**Parameters:**

<WindowType>

Example:

LAY:WIND2:TYPE?

6.6 Measurement control

6.6.1 Measurements

ABORt	206
INITiate<n>:CONTinuous	207
INITiate<n>[:IMMEDIATE]	208
[SENSe:]SYNC[:CC<cc>][:STATe]?	208

ABORt

Aborts the measurement in the current channel and resets the trigger system.

To prevent overlapping execution of the subsequent command before the measurement has been aborted successfully, use the `*OPC?` or `*WAI` command after `ABOR` and before the next command.

For details on overlapping execution see [Remote control via SCPI](#).

Note on blocked remote control programs:

If a sequential command cannot be completed, for example because a triggered sweep never receives a trigger, the remote control program will never finish and the remote channel to the FSW is blocked for further commands. In this case, you must interrupt processing on the remote channel first in order to abort the measurement.

To do so, send a "Device Clear" command from the control instrument to the FSW on a parallel channel to clear all currently active remote channels. Depending on the used interface and protocol, send the following commands:

- **Visa:** `viClear()`
- **GPIB:** `ibclr()`
- **RSIB:** `RSDLLibclr()`

Now you can send the `ABORT` command on the remote channel performing the measurement.

Example: `ABOR; :INIT:IMM`
Aborts the current measurement and immediately starts a new one.

Example: `ABOR; *WAI`
`INIT:IMM`
Aborts the current measurement and starts a new one once abortion has been completed.

Usage: Event

INITiate<n>:CONTinuous <State>

Controls the measurement mode for an individual channel.

Note that in single measurement mode, you can synchronize to the end of the measurement with `*OPC`, `*OPC?` or `*WAI`. In continuous measurement mode, synchronization to the end of the measurement is not possible. Thus, it is not recommended that you use continuous measurement mode in remote control, as results like trace data or markers are only valid after a single measurement end synchronization.

For details on synchronization see [Remote control via SCPI](#).

Suffix:
<n> irrelevant

Parameters:
<State> `ON | OFF | 0 | 1`
ON | 1
Continuous measurement
OFF | 0
Single measurement
***RST:** 1 (some applications can differ)

Example:

```
INIT:CONT OFF
Switches the measurement mode to single measurement.
INIT:CONT ON
Switches the measurement mode to continuous measurement.
```

INITiate<n>[:IMMEDIATE]

Starts a (single) new measurement.

You can synchronize to the end of the measurement with *OPC, *OPC? or *WAI.

For details on synchronization see [Remote control via SCPI](#).

Suffix:

<n> irrelevant

Usage: Asynchronous command

[SENSe:]SYNC[:CC<cc>][:STATe]?

Queries the current synchronization state.

Suffix:

<cc> irrelevant

Return values:

<State> The string contains the following information:
A zero represents a failure and a one represents a successful synchronization.

Example:

```
//Query synchronization state
SYNC:STAT?
```

Usage: Query only

6.6.2 Measurement sequences

INITiate:SEQuencer:ABORt	208
INITiate:SEQuencer:IMMEDIATE	209
INITiate:SEQuencer:MODE	209
SYSTem:SEQuencer	209

INITiate:SEQuencer:ABORt

Stops the currently active sequence of measurements.

You can start a new sequence any time using [INITiate:SEQuencer:IMMEDIATE](#) on page 209.

Usage: Event

INITiate:SEQuencer:IMMEDIATE

Starts a new sequence of measurements by the Sequencer.

Its effect is similar to the `INITiate<n>[:IMMEDIATE]` command used for a single measurement.

Before this command can be executed, the Sequencer must be activated (see `SYSTem:SEQuencer` on page 209).

Example:

```
SYST:SEQ ON
```

Activates the Sequencer.

```
INIT:SEQ:MODE SING
```

Sets single sequence mode so each active measurement is performed once.

```
INIT:SEQ:IMM
```

Starts the sequential measurements.

INITiate:SEQuencer:MODE <Mode>

Defines the capture mode for the entire measurement sequence and all measurement groups and channels it contains.

Note: To synchronize to the end of a measurement sequence using `*OPC`, `*OPC?` or `*WAI`, use `SINGLE` Sequencer mode.

Parameters:

<Mode>

SINGLE

Each measurement group is started one after the other in the order of definition. All measurement channels in a group are started simultaneously and performed once. After *all* measurements are completed, the next group is started. After the last group, the measurement sequence is finished.

CONTInuous

Each measurement group is started one after the other in the order of definition. All measurement channels in a group are started simultaneously and performed once. After *all* measurements are completed, the next group is started. After the last group, the measurement sequence restarts with the first one and continues until it is stopped explicitly.

```
*RST: CONTInuous
```

SYSTem:SEQuencer <State>

Turns the Sequencer on and off. The Sequencer must be active before any other Sequencer commands (`INIT:SEQ. . .`) are executed, otherwise an error occurs.

Parameters:

<State>

ON | OFF | 0 | 1

Remote commands to retrieve numeric results

ON | 1

The Sequencer is activated and a sequential measurement is started immediately.

OFF | 0

The Sequencer is deactivated. Any running sequential measurements are stopped. Further Sequencer commands (INIT:SEQ...) are not available.

*RST: 0

Example:

SYST:SEQ ON

Activates the Sequencer.

INIT:SEQ:MODE SING

Sets single Sequencer mode so each active measurement is performed once.

INIT:SEQ:IMM

Starts the sequential measurements.

SYST:SEQ OFF

6.7 Remote commands to retrieve numeric results

- [Result summary](#)..... 210
- [Combined measurements](#)..... 231
- [Marker table](#)..... 237
- [CCDF table](#)..... 240

6.7.1 Result summary

FETCh[:CC<cc>][:ISRC<ant>][:FRAMe<fr>]:SUMMary:ALL?	212
FETCh[:CC<cc>][:ISRC<ant>]:SUMMary:CRESt[:AVERAge]?	213
FETCh:ALL:SUMMary:BLER:MAXimum?	213
FETCh:ALL:SUMMary:BLER:MINimum?	213
FETCh[:CC<cc>][:ISRC<ant>][:FRAMe<fr>]:SUMMary:BLER[:AVERAge]?	213
FETCh:ALL:SUMMary:EVM:ALL?	214
FETCh[:CC<cc>][:ISRC<ant>][:FRAMe<fr>]:SUMMary:EVM[:ALL]:MAXimum?	214
FETCh[:CC<cc>][:ISRC<ant>][:FRAMe<fr>]:SUMMary:EVM[:ALL]:MINimum?	214
FETCh[:CC<cc>][:ISRC<ant>][:FRAMe<fr>]:SUMMary:EVM[:ALL][:AVERAge]?	214
FETCh:ALL:SUMMary:EVM:PCHannel?	214
FETCh[:CC<cc>][:ISRC<ant>][:FRAMe<fr>]:SUMMary:EVM:PCHannel:MAXimum?	214
FETCh[:CC<cc>][:ISRC<ant>][:FRAMe<fr>]:SUMMary:EVM:PCHannel:MINimum?	215
FETCh[:CC<cc>][:ISRC<ant>][:FRAMe<fr>]:SUMMary:EVM:PCHannel[:AVERAge]?	215
FETCh:ALL:SUMMary:EVM:PEAK?	215
FETCh[:CC<cc>][:ISRC<ant>][:FRAMe<fr>]:SUMMary:EVM:PEAK:MAXimum?	215
FETCh[:CC<cc>][:ISRC<ant>][:FRAMe<fr>]:SUMMary:EVM:PEAK:MINimum?	215
FETCh[:CC<cc>][:ISRC<ant>][:FRAMe<fr>]:SUMMary:EVM:PEAK[:AVERAge]?	215
FETCh[:CC<cc>][:ISRC<ant>][:FRAMe<fr>]:SUMMary:EVM:PRACH:MAXimum?	216
FETCh[:CC<cc>][:ISRC<ant>][:FRAMe<fr>]:SUMMary:EVM:PRACH:MINimum?	216
FETCh[:CC<cc>][:ISRC<ant>][:FRAMe<fr>]:SUMMary:EVM:PRACH[:AVERAge]?	216

Remote commands to retrieve numeric results

FETCh:ALL:SUMMary:EVM:PSIGnal?	216
FETCh[:CC<cc>][:ISRC<ant>][:FRAMe<fr>]:SUMMary:EVM:PSIGnal:MAXimum?	216
FETCh[:CC<cc>][:ISRC<ant>][:FRAMe<fr>]:SUMMary:EVM:PSIGnal:MINimum?	216
FETCh[:CC<cc>][:ISRC<ant>][:FRAMe<fr>]:SUMMary:EVM:PSIGnal[:AVERage]?	216
FETCh:ALL:SUMMary:EVM:SD1K?	217
FETCh[:CC<cc>][:ISRC<ant>][:FRAMe<fr>]:SUMMary:EVM:SD1K:MAXimum?	217
FETCh[:CC<cc>][:ISRC<ant>][:FRAMe<fr>]:SUMMary:EVM:SD1K:MINimum?	217
FETCh[:CC<cc>][:ISRC<ant>][:FRAMe<fr>]:SUMMary:EVM:SD1K[:AVERage]?	217
FETCh:ALL:SUMMary:EVM:SDPB?	218
FETCh[:CC<cc>][:ISRC<ant>][:FRAMe<fr>]:SUMMary:EVM:SDPB:MAXimum?	218
FETCh[:CC<cc>][:ISRC<ant>][:FRAMe<fr>]:SUMMary:EVM:SDPB:MINimum?	218
FETCh[:CC<cc>][:ISRC<ant>][:FRAMe<fr>]:SUMMary:EVM:SDPB[:AVERage]?	218
FETCh:ALL:SUMMary:EVM:SDQP?	218
FETCh[:CC<cc>][:ISRC<ant>][:FRAMe<fr>]:SUMMary:EVM:SDQP:MAXimum?	218
FETCh[:CC<cc>][:ISRC<ant>][:FRAMe<fr>]:SUMMary:EVM:SDQP:MINimum?	218
FETCh[:CC<cc>][:ISRC<ant>][:FRAMe<fr>]:SUMMary:EVM:SDQP[:AVERage]?	218
FETCh:ALL:SUMMary:EVM:SDSF?	219
FETCh[:CC<cc>][:ISRC<ant>][:FRAMe<fr>]:SUMMary:EVM:SDSF:MAXimum?	219
FETCh[:CC<cc>][:ISRC<ant>][:FRAMe<fr>]:SUMMary:EVM:SDSF:MINimum?	219
FETCh[:CC<cc>][:ISRC<ant>][:FRAMe<fr>]:SUMMary:EVM:SDSF[:AVERage]?	219
FETCh:ALL:SUMMary:EVM:SDST?	219
FETCh[:CC<cc>][:ISRC<ant>][:FRAMe<fr>]:SUMMary:EVM:SDST:MAXimum?	219
FETCh[:CC<cc>][:ISRC<ant>][:FRAMe<fr>]:SUMMary:EVM:SDST:MINimum?	220
FETCh[:CC<cc>][:ISRC<ant>][:FRAMe<fr>]:SUMMary:EVM:SDST[:AVERage]?	220
FETCh:ALL:SUMMary:EVM:SDTS?	220
FETCh[:CC<cc>][:ISRC<ant>][:FRAMe<fr>]:SUMMary:EVM:SDTS:MAXimum?	220
FETCh[:CC<cc>][:ISRC<ant>][:FRAMe<fr>]:SUMMary:EVM:SDTS:MINimum?	220
FETCh[:CC<cc>][:ISRC<ant>][:FRAMe<fr>]:SUMMary:EVM:SDTS[:AVERage]?	220
FETCh:ALL:SUMMary:EVM:UCCD?	221
FETCh[:CC<cc>][:ISRC<ant>][:FRAMe<fr>]:SUMMary:EVM:UCCD:MAXimum?	221
FETCh[:CC<cc>][:ISRC<ant>][:FRAMe<fr>]:SUMMary:EVM:UCCD:MINimum?	221
FETCh[:CC<cc>][:ISRC<ant>][:FRAMe<fr>]:SUMMary:EVM:UCCD[:AVERage]?	221
FETCh:ALL:SUMMary:EVM:UCCH?	221
FETCh[:CC<cc>][:ISRC<ant>][:FRAMe<fr>]:SUMMary:EVM:UCCH:MAXimum?	221
FETCh[:CC<cc>][:ISRC<ant>][:FRAMe<fr>]:SUMMary:EVM:UCCH:MINimum?	221
FETCh[:CC<cc>][:ISRC<ant>][:FRAMe<fr>]:SUMMary:EVM:UCCH[:AVERage]?	221
FETCh:ALL:SUMMary:EVM:US1K?	222
FETCh[:CC<cc>][:ISRC<ant>][:FRAMe<fr>]:SUMMary:EVM:US1K:MAXimum?	222
FETCh[:CC<cc>][:ISRC<ant>][:FRAMe<fr>]:SUMMary:EVM:US1K:MINimum?	222
FETCh[:CC<cc>][:ISRC<ant>][:FRAMe<fr>]:SUMMary:EVM:US1K[:AVERage]?	222
FETCh:ALL:SUMMary:EVM:USPB?	223
FETCh[:CC<cc>][:ISRC<ant>][:FRAMe<fr>]:SUMMary:EVM:USPB:MAXimum?	223
FETCh[:CC<cc>][:ISRC<ant>][:FRAMe<fr>]:SUMMary:EVM:USPB:MINimum?	223
FETCh[:CC<cc>][:ISRC<ant>][:FRAMe<fr>]:SUMMary:EVM:USPB[:AVERage]?	223
FETCh:ALL:SUMMary:EVM:USQP?	223
FETCh[:CC<cc>][:ISRC<ant>][:FRAMe<fr>]:SUMMary:EVM:USQP:MAXimum?	223
FETCh[:CC<cc>][:ISRC<ant>][:FRAMe<fr>]:SUMMary:EVM:USQP:MINimum?	223
FETCh[:CC<cc>][:ISRC<ant>][:FRAMe<fr>]:SUMMary:EVM:USQP[:AVERage]?	223
FETCh:ALL:SUMMary:EVM:USSF?	224
FETCh[:CC<cc>][:ISRC<ant>][:FRAMe<fr>]:SUMMary:EVM:USSF:MAXimum?	224

Remote commands to retrieve numeric results

FETCh[:CC<cc>][:ISRC<ant>][:FRAMe<fr>]:SUMMary:EVM:USSF:MINimum?.....	224
FETCh[:CC<cc>][:ISRC<ant>][:FRAMe<fr>]:SUMMary:EVM:USSF[:AVERage]?.....	224
FETCh:ALL:SUMMary:EVM:USST?.....	224
FETCh[:CC<cc>][:ISRC<ant>][:FRAMe<fr>]:SUMMary:EVM:USST:MAXimum?.....	224
FETCh[:CC<cc>][:ISRC<ant>][:FRAMe<fr>]:SUMMary:EVM:USST:MINimum?.....	225
FETCh[:CC<cc>][:ISRC<ant>][:FRAMe<fr>]:SUMMary:EVM:USST[:AVERage]?.....	225
FETCh:ALL:SUMMary:EVM:USTS?.....	225
FETCh[:CC<cc>][:ISRC<ant>][:FRAMe<fr>]:SUMMary:EVM:USTS:MAXimum?.....	225
FETCh[:CC<cc>][:ISRC<ant>][:FRAMe<fr>]:SUMMary:EVM:USTS:MINimum?.....	225
FETCh[:CC<cc>][:ISRC<ant>][:FRAMe<fr>]:SUMMary:EVM:USTS[:AVERage]?.....	225
FETCh[:CC<cc>][:ISRC<ant>][:FRAMe<fr>]:SUMMary:FERRor:MAXimum?.....	226
FETCh[:CC<cc>][:ISRC<ant>][:FRAMe<fr>]:SUMMary:FERRor:MINimum?.....	226
FETCh[:CC<cc>][:ISRC<ant>][:FRAMe<fr>]:SUMMary:FERRor[:AVERage]?.....	226
FETCh[:CC<cc>][:ISRC<ant>][:FRAMe<fr>]:SUMMary:GIMBalance:MAXimum?.....	226
FETCh[:CC<cc>][:ISRC<ant>][:FRAMe<fr>]:SUMMary:GIMBalance:MINimum?.....	226
FETCh[:CC<cc>][:ISRC<ant>][:FRAMe<fr>]:SUMMary:GIMBalance[:AVERage]?.....	226
FETCh[:CC<cc>][:ISRC<ant>][:FRAMe<fr>]:SUMMary:IQOFset:MAXimum?.....	227
FETCh[:CC<cc>][:ISRC<ant>][:FRAMe<fr>]:SUMMary:IQOFset:MINimum?.....	227
FETCh[:CC<cc>][:ISRC<ant>][:FRAMe<fr>]:SUMMary:IQOFset[:AVERage]?.....	227
FETCh[:CC<cc>][:ISRC<ant>][:FRAMe<fr>]:SUMMary:OSTP:MAXimum?.....	228
FETCh[:CC<cc>][:ISRC<ant>][:FRAMe<fr>]:SUMMary:OSTP:MINimum?.....	228
FETCh[:CC<cc>][:ISRC<ant>][:FRAMe<fr>]:SUMMary:OSTP[:AVERage]?.....	228
FETCh:ALL:SUMMary:POWer?.....	228
FETCh[:CC<cc>][:ISRC<ant>][:FRAMe<fr>]:SUMMary:POWer:MAXimum?.....	228
FETCh[:CC<cc>][:ISRC<ant>][:FRAMe<fr>]:SUMMary:POWer:MINimum?.....	228
FETCh[:CC<cc>][:ISRC<ant>][:FRAMe<fr>]:SUMMary:POWer[:AVERage]?.....	228
FETCh[:CC<cc>][:ISRC<ant>][:FRAMe<fr>]:SUMMary:QUADerror:MAXimum?.....	229
FETCh[:CC<cc>][:ISRC<ant>][:FRAMe<fr>]:SUMMary:QUADerror:MINimum?.....	229
FETCh[:CC<cc>][:ISRC<ant>][:FRAMe<fr>]:SUMMary:QUADerror[:AVERage]?.....	229
FETCh[:CC<cc>][:ISRC<ant>][:FRAMe<fr>]:SUMMary:SERRor:MAXimum?.....	230
FETCh[:CC<cc>][:ISRC<ant>][:FRAMe<fr>]:SUMMary:SERRor:MINimum?.....	230
FETCh[:CC<cc>][:ISRC<ant>][:FRAMe<fr>]:SUMMary:SERRor[:AVERage]?.....	230
FETCh:ALL:SUMMary:TPUT:MAXimum?.....	230
FETCh:ALL:SUMMary:TPUT:MINimum?.....	230
FETCh[:CC<cc>][:ISRC<ant>][:FRAMe<fr>]:SUMMary:TPUT[:AVERage]?.....	230
FETCh[:CC<cc>][:ISRC<ant>][:FRAMe<fr>]:SUMMary:FOFFset?.....	231

FETCh[:CC<cc>][:ISRC<ant>][:FRAMe<fr>]:SUMMary:ALL?

Queries all results in the numerical result summary.

Suffix:

<cc>	Component Carrier
<ant>	irrelevant
<fr>	Frame

Return values:

<Result> String containing all results in the following format.
 <ResultType>, <AverageResult>, <MaximumResult>,
 <MinimumResult>
 If a result has not been calculated, the command returns NAN.

Example:

```
//Query all numerical results
FETC:SUMM:ALL?
would return, e.g.
EVM PDSCH QPSK,
+2.695721388E-001, +2.695721388E-001,
+2.695721388E-001,
EVM PDSCH 16QAM, NAN, NAN, NAN,
...
```

Usage: Query only

Manual operation: See "[Remote queries](#)" on page 25

FETCh[:CC<cc>][:ISRC<ant>]:SUMMary:CRESt[:AVERAge]?

Queries the average crest factor as shown in the result summary.

Suffix:

<cc> [Component Carrier](#)
 <ant> irrelevant

Return values:

<CrestFactor> Default unit: dB

Example:

```
//Query crest factor
FETC:SUMM:CRES?
```

Usage: Query only

Manual operation: See "[Crest Factor](#)" on page 30

FETCh:ALL:SUMMary:BLER:MAXimum?**FETCh:ALL:SUMMary:BLER:MINimum?****FETCh[:CC<cc>][:ISRC<ant>][:FRAME<fr>]:SUMMary:BLER[:AVERAge]?**

Queries the EVM of all resource elements.

Prerequisites for this command

- Turn on throughput measurement ([\[SENSe:\]NR5G:TRACking:TPUT:STATe](#)).
- Turn on BLER measurement ([DISPlay\[:WINDow<n>\]:TABLE:ITEM](#)).

Suffix:

<cc> [Component Carrier](#)
 <ant> irrelevant
 <fr> [Frame](#)

Return values:

<BLER> Default unit: PCT

Example:

```
//Query BLER
NR5G:TRAC:TPUT:STAT ON
DISP:TABL:ITEM BLER,ON
FETC:CC2:FRAM3:SUMM:BLER?
```

Usage:

Query only

Manual operation: See "BLER (%)" on page 27

FETCh:ALL:SUMMary:EVM:ALL? <Result>

FETCh[:CC<cc>][:ISRC<ant>][:FRAMe<fr>]:SUMMary:EVM[:ALL]:MAXimum?
[<Result>]

FETCh[:CC<cc>][:ISRC<ant>][:FRAMe<fr>]:SUMMary:EVM[:ALL]:MINimum?
[<Result>]

FETCh[:CC<cc>][:ISRC<ant>][:FRAMe<fr>]:SUMMary:EVM[:ALL][:AVERage]?
[<Result>]

Queries the EVM of all resource elements.

FETCh:ALL:SUMMary:EVM:ALL queries the average result over all carriers. Prerequisites:

- Select to evaluate all carriers ([SENSe:]NR5G:RSUMmary:CCResult).

Suffix:

<cc> [Component Carrier](#)

<ant> irrelevant

<fr> [Frame](#)

Query parameters:

<Result> ALL

Available for combined measurements.

Queries the EVM of all events (meas IDs).

Omitting this parameter queries the EVM of the selected event.

Return values:

<EVM> EVM in % or dB.

Example:

```
//Query EVM
FETC:CC2:FRAM3:SUMM:EVM?
```

Usage:

Query only

Manual operation: See "EVM All" on page 28

FETCh:ALL:SUMMary:EVM:PCHannel? <Result>

FETCh[:CC<cc>][:ISRC<ant>][:FRAMe<fr>]:SUMMary:EVM:PCHannel:MAXimum? [<Result>]

FETCh[:CC<cc>][:ISRC<ant>][:FRAMe<fr>]:SUMMary:EVM:PCHannel:MINimum?
 [<Result>]

**FETCh[:CC<cc>][:ISRC<ant>][:FRAMe<fr>]:SUMMary:EVM:PCHannel[:
 AVERAge]?** [<Result>]

Queries the EVM of the physical channel.

FETCh:ALL:SUMMary:EVM:PCHannel queries the average result over all carriers.

Prerequisites:

- Select to evaluate all carriers ([\[SENSe:\]NR5G:RSUMmary:CCResult](#)).

Suffix:

<cc> [Component Carrier](#)

<ant> irrelevant

<fr> [Frame](#)

Query parameters:

<Result> ALL

Available for combined measurements.

Queries the EVM of all events (meas IDs).

Omitting this parameter queries the EVM of the selected event.

Return values:

<EVM> EVM in % or dB.

Example:

//Query EVM

FETC:CC2:FRAM3:SUMM:EVM:PCH?

Usage:

Query only

Manual operation: See "[EVM Phys Channel](#)" on page 29

FETCh:ALL:SUMMary:EVM:PEAK? [<Result>]

FETCh[:CC<cc>][:ISRC<ant>][:FRAMe<fr>]:SUMMary:EVM:PEAK:MAXimum?
 [<Result>]

FETCh[:CC<cc>][:ISRC<ant>][:FRAMe<fr>]:SUMMary:EVM:PEAK:MINimum?
 [<Result>]

FETCh[:CC<cc>][:ISRC<ant>][:FRAMe<fr>]:SUMMary:EVM:PEAK[:AVERAge]?
 [<Result>]

Queries the peak EVM.

FETCh:ALL:SUMMary:EVM:PEAK queries the average result over all carriers. Prereq-

uisites:

- Select to evaluate all carriers ([\[SENSe:\]NR5G:RSUMmary:CCResult](#)).

Suffix:

<cc> [Component Carrier](#)

<ant> irrelevant

<fr> [Frame](#)

Query parameters:

<Result> ALL
 Available for combined measurements.
 Queries the EVM of all events (meas IDs).
 Omitting this parameter queries the EVM of the selected event.

Return values:

<EVM> EVM in % or dB.

Example:

```
//Query peak EVM
FETC:CC2:FRAM3:SUMM:EVM:PEAK?
```

Usage:

Query only

Manual operation: See "EVM Peak" on page 28

```
FETCh[:CC<cc>][:ISRC<ant>][:FRAMe<fr>]:SUMMary:EVM:PRACH:MAXimum?
  [<Result>]
```

```
FETCh[:CC<cc>][:ISRC<ant>][:FRAMe<fr>]:SUMMary:EVM:PRACH:MINimum?
  [<Result>]
```

```
FETCh[:CC<cc>][:ISRC<ant>][:FRAMe<fr>]:SUMMary:EVM:PRACH[:AVERage]?
  [<Result>]
```

Queries the EVM of the PRACH.

Suffix:

<cc> [Component Carrier](#)

<ant> irrelevant

<fr> [Frame](#)

Query parameters:

<Result> ALL

Return values:

<EVM> EVM in % or dB.

Example:

```
//Query EVM
FETC:CC2:FRAM3:SUMM:EVM:PRAC?
```

Usage:

Query only

Manual operation: See "EVM PRACH" on page 28

```
FETCh:ALL:SUMMary:EVM:PSIGnal? <Result>
```

```
FETCh[:CC<cc>][:ISRC<ant>][:FRAMe<fr>]:SUMMary:EVM:PSIGnal:MAXimum?
  [<Result>]
```

```
FETCh[:CC<cc>][:ISRC<ant>][:FRAMe<fr>]:SUMMary:EVM:PSIGnal:MINimum?
  [<Result>]
```

```
FETCh[:CC<cc>][:ISRC<ant>][:FRAMe<fr>]:SUMMary:EVM:PSIGnal[:AVERage]?
  [<Result>]
```

Queries the EVM of the physical signal.

FETCH:ALL:SUMMARY:EVM:PSIGNAL queries the average result over all carriers.

Prerequisites:

- Select to evaluate all carriers ([SENSe:]NR5G:RSUMmary:CCResult).

Suffix:

<cc> [Component Carrier](#)

<ant> irrelevant

<fr> [Frame](#)

Query parameters:

<Result> ALL
Available for combined measurements.
Queries the EVM of all events (meas IDs).
Omitting this parameter queries the EVM of the selected event.

Return values:

<EVM> EVM in % or dB.

Example:

```
//Query EVM
FETCH:CC2:FRAM3:SUMM:EVM:PSIG?
```

Usage:

Query only

```
FETCH:ALL:SUMMARY:EVM:SD1K? <Result>
FETCH[:CC<cc>][:ISRC<ant>][:FRAME<fr>]:SUMMARY:EVM:SD1K:MAXimum?
  [<Result>]
FETCH[:CC<cc>][:ISRC<ant>][:FRAME<fr>]:SUMMARY:EVM:SD1K:MINimum?
  [<Result>]
FETCH[:CC<cc>][:ISRC<ant>][:FRAME<fr>]:SUMMARY:EVM:SD1K[:AVERage]?
  [<Result>]
```

Queries the EVM of all PUSCH DMRS resource elements with a QPSK modulation.

FETCH:ALL:SUMMARY:EVM:SDQP queries the average result over all carriers. Prerequisites:

- Select to evaluate all carriers ([SENSe:]NR5G:RSUMmary:CCResult).

Suffix:

<cc> [Component Carrier](#)

<ant> irrelevant

<fr> [Frame](#)

Query parameters:

<Result> ALL

Return values:

<EVM> EVM in % or dB.

Example:

```
//Query EVM
FETCH:CC2:FRAM3:SUMM:EVM:SDQP?
```

Usage:

Query only

Manual operation: See "EVM DMRS PUSCH" on page 26

```

FETCh:ALL:SUMMary:EVM:SDPB? <Result>
FETCh[:CC<cc>][:ISRC<ant>][:FRAMe<fr>]:SUMMary:EVM:SDPB:MAXimum?
  [<Result>]
FETCh[:CC<cc>][:ISRC<ant>][:FRAMe<fr>]:SUMMary:EVM:SDPB:MINimum?
  [<Result>]
FETCh[:CC<cc>][:ISRC<ant>][:FRAMe<fr>]:SUMMary:EVM:SDPB[:AVERage]?
  [<Result>]

```

Queries the EVM of all PUSCH DMRS resource elements with a PI/2 BPSK modulation.

FETCh:ALL:SUMMary:EVM:SDPB queries the average result over all carriers. Prerequisites:

- Select to evaluate all carriers ([SENSe:]NR5G:RSUMmary:CCResult).

Suffix:

<cc>	Component Carrier
<ant>	irrelevant
<fr>	Frame

Query parameters:

<Result>	ALL
----------	-----

Return values:

<EVM>	EVM in % or dB.
-------	-----------------

Example:

```
//Query EVM
FETC:CC2:FRAM3:SUMM:EVM:SDPB?
```

Usage:

Query only

Manual operation: See "EVM DMRS PUSCH" on page 26

```

FETCh:ALL:SUMMary:EVM:SDQP? <Result>
FETCh[:CC<cc>][:ISRC<ant>][:FRAMe<fr>]:SUMMary:EVM:SDQP:MAXimum?
  [<Result>]
FETCh[:CC<cc>][:ISRC<ant>][:FRAMe<fr>]:SUMMary:EVM:SDQP:MINimum?
  [<Result>]
FETCh[:CC<cc>][:ISRC<ant>][:FRAMe<fr>]:SUMMary:EVM:SDQP[:AVERage]?
  [<Result>]

```

Queries the EVM of all PUSCH DMRS resource elements with a QPSK modulation.

FETCh:ALL:SUMMary:EVM:SDQP queries the average result over all carriers. Prerequisites:

- Select to evaluate all carriers ([SENSe:]NR5G:RSUMmary:CCResult).

Suffix:

<cc>	Component Carrier
<ant>	irrelevant

<fr> [Frame](#)

Query parameters:

<Result> ALL

Return values:

<EVM> EVM in % or dB.

Example:

```
//Query EVM
FETC:CC2:FRAM3:SUMM:EVM:SDQP?
```

Usage: Query only

Manual operation: See "[EVM DMRS PUSCH](#)" on page 26

FETCh:ALL:SUMMary:EVM:SDSF? <Result>

FETCh[:CC<cc>][:ISRC<ant>][:FRAMe<fr>]:SUMMary:EVM:SDSF:MAXimum?
[<Result>]

FETCh[:CC<cc>][:ISRC<ant>][:FRAMe<fr>]:SUMMary:EVM:SDSF:MINimum?
[<Result>]

FETCh[:CC<cc>][:ISRC<ant>][:FRAMe<fr>]:SUMMary:EVM:SDSF[:AVERage]?
[<Result>]

Queries the EVM of all PUSCH DMRS resource elements with a 64QAM modulation.

FETCh:ALL:SUMMary:EVM:SDSF queries the average result over all carriers. Prerequisites:

- Select to evaluate all carriers ([\[SENSe:\]NR5G:RSUMmary:CCResult](#)).

Suffix:

<cc> [Component Carrier](#)

<ant> irrelevant

<fr> [Frame](#)

Query parameters:

<Result> ALL

Return values:

<EVM> EVM in % or dB.

Example:

```
//Query EVM
FETC:CC2:FRAM3:SUMM:EVM:SDSF?
```

Usage: Query only

Manual operation: See "[EVM DMRS PUSCH](#)" on page 26

FETCh:ALL:SUMMary:EVM:SDST? <Result>

FETCh[:CC<cc>][:ISRC<ant>][:FRAMe<fr>]:SUMMary:EVM:SDST:MAXimum?
[<Result>]

FETCh[:CC<cc>][:ISRC<ant>][:FRAMe<fr>]:SUMMary:EVM:SDST:MINimum?
 [<Result>]

FETCh[:CC<cc>][:ISRC<ant>][:FRAMe<fr>]:SUMMary:EVM:SDST[:AVERAge]?
 [<Result>]

Queries the EVM of all PUSCH DMRS resource elements with a 16QAM modulation.

FETCh:ALL:SUMMary:EVM:DSQP queries the average result over all carriers. Prerequisites:

- Select to evaluate all carriers ([\[SENSe:\]NR5G:RSUMmary:CCResult](#)).

Suffix:

<cc> [Component Carrier](#)

<ant> irrelevant

<fr> [Frame](#)

Query parameters:

<Result> ALL

Return values:

<EVM> EVM in % or dB.

Example:

```
//Query EVM
FETC:CC2:FRAM3:SUMM:EVM:SDST?
```

Usage: Query only

Manual operation: See "[EVM DMRS PUSCH](#)" on page 26

FETCh:ALL:SUMMary:EVM:SDTS? <Result>

FETCh[:CC<cc>][:ISRC<ant>][:FRAMe<fr>]:SUMMary:EVM:SDTS:MAXimum?
 [<Result>]

FETCh[:CC<cc>][:ISRC<ant>][:FRAMe<fr>]:SUMMary:EVM:SDTS:MINimum?
 [<Result>]

FETCh[:CC<cc>][:ISRC<ant>][:FRAMe<fr>]:SUMMary:EVM:SDTS[:AVERAge]?
 [<Result>]

Queries the EVM of all PUSCH DMRS resource elements with a 256QAM modulation.

FETCh:ALL:SUMMary:EVM:SDTS queries the average result over all carriers. Prerequisites:

- Select to evaluate all carriers ([\[SENSe:\]NR5G:RSUMmary:CCResult](#)).

Suffix:

<cc> [Component Carrier](#)

<ant> irrelevant

<fr> [Frame](#)

Query parameters:

<Result> ALL

Return values:

<EVM> EVM in % or dB.

Example: //Query EVM
FETC:CC2:FRAM3:SUMM:EVM:SDTS?

Usage: Query only

Manual operation: See "EVM DMRS PUSCH" on page 26

FETCh:ALL:SUMMary:EVM:UCCD? <Result>
FETCh[:CC<cc>][:ISRC<ant>][:FRAMe<fr>]:SUMMary:EVM:UCCD:MAXimum?
 [<Result>]
FETCh[:CC<cc>][:ISRC<ant>][:FRAMe<fr>]:SUMMary:EVM:UCCD:MINimum?
 [<Result>]
FETCh[:CC<cc>][:ISRC<ant>][:FRAMe<fr>]:SUMMary:EVM:UCCD[:AVERage]?
 [<Result>]

Queries the EVM of all PUCCH DMRS resource elements.

FETCh:ALL:SUMMary:EVM:UCCD queries the average result over all carriers. Prerequisites:

- Select to evaluate all carriers ([SENSe:]NR5G:RSUMmary:CCResult).

Suffix:

<cc> [Component Carrier](#)

<ant> irrelevant

<fr> [Frame](#)

Query parameters:

<Result> ALL

Return values:

<EVM> EVM in % or dB.

Example: //Query EVM
FETC:CC2:FRAM3:SUMM:EVM:UCCD?

Usage: Query only

Manual operation: See "EVM DMRS PUCCH" on page 27

FETCh:ALL:SUMMary:EVM:UCCH? <Result>
FETCh[:CC<cc>][:ISRC<ant>][:FRAMe<fr>]:SUMMary:EVM:UCCH:MAXimum?
 [<Result>]
FETCh[:CC<cc>][:ISRC<ant>][:FRAMe<fr>]:SUMMary:EVM:UCCH:MINimum?
 [<Result>]
FETCh[:CC<cc>][:ISRC<ant>][:FRAMe<fr>]:SUMMary:EVM:UCCH[:AVERage]?
 [<Result>]

Queries the EVM of all PUCCH resource elements.

FETCh:ALL:SUMMary:EVM:UCCH queries the average result over all carriers. Prerequisites:

- Select to evaluate all carriers ([SENSe:]NR5G:RSUMmary:CCResult).

Suffix:	
<cc>	Component Carrier
<ant>	irrelevant
<fr>	Frame
Query parameters:	
<Result>	ALL
Return values:	
<EVM>	EVM in % or dB.
Example:	//Query EVM FETC:CC2:FRAM3:SUMM:EVM:UCCH?
Usage:	Query only
Manual operation:	See "EVM PUCCH" on page 27

```
FETCh:ALL:SUMMary:EVM:US1K? <Result>
FETCh[:CC<cc>][:ISRC<ant>][:FRAMe<fr>]:SUMMary:EVM:US1K:MAXimum?
  [<Result>]
FETCh[:CC<cc>][:ISRC<ant>][:FRAMe<fr>]:SUMMary:EVM:US1K:MINimum?
  [<Result>]
FETCh[:CC<cc>][:ISRC<ant>][:FRAMe<fr>]:SUMMary:EVM:US1K[:AVERAge]?
  [<Result>]
```

Queries the EVM of all PUSCH resource elements with a 1024QAM modulation.

FETCh:ALL:SUMMary:EVM:USQP queries the average result over all carriers. Prerequisites:

- Select to evaluate all carriers ([SENSe:]NR5G:RSUMmary:CCResult).

Suffix:	
<cc>	Component Carrier
<ant>	irrelevant
<fr>	Frame
Query parameters:	
<Result>	ALL
Return values:	
<EVM>	EVM in % or dB.
Example:	//Query EVM FETC:CC2:FRAM3:SUMM:EVM:US1K?
Usage:	Query only
Manual operation:	See "EVM PUSCH" on page 25

```

FETCh:ALL:SUMMary:EVM:USPB? <Result>
FETCh[:CC<cc>][:ISRC<ant>][:FRAMe<fr>]:SUMMary:EVM:USPB:MAXimum?
  <Result>
FETCh[:CC<cc>][:ISRC<ant>][:FRAMe<fr>]:SUMMary:EVM:USPB:MINimum?
  <Result>
FETCh[:CC<cc>][:ISRC<ant>][:FRAMe<fr>]:SUMMary:EVM:USPB[:AVERage]?
  <Result>

```

Queries the EVM of all PUSCH resource elements with a pi/2-BPSK modulation.

FETCh:ALL:SUMMary:EVM:USPB queries the average result over all carriers. Prerequisites:

- Select to evaluate all carriers ([SENSe:]NR5G:RSUMmary:CCResult).

Suffix:

<cc> [Component Carrier](#)

<ant> irrelevant

<fr> [Frame](#)

Query parameters:

<Result> ALL

Return values:

<EVM> EVM in % or dB.

Example:

```
//Query EVM
FETC:CC2:FRAM3:SUMM:EVM:USPB?
```

Usage: Query only

Manual operation: See "[EVM PUSCH](#)" on page 25

```

FETCh:ALL:SUMMary:EVM:USQP? <Result>
FETCh[:CC<cc>][:ISRC<ant>][:FRAMe<fr>]:SUMMary:EVM:USQP:MAXimum?
  <Result>
FETCh[:CC<cc>][:ISRC<ant>][:FRAMe<fr>]:SUMMary:EVM:USQP:MINimum?
  <Result>
FETCh[:CC<cc>][:ISRC<ant>][:FRAMe<fr>]:SUMMary:EVM:USQP[:AVERage]?
  <Result>

```

Queries the EVM of all PUSCH resource elements with a QPSK modulation.

FETCh:ALL:SUMMary:EVM:USQP queries the average result over all carriers. Prerequisites:

- Select to evaluate all carriers ([SENSe:]NR5G:RSUMmary:CCResult).

Suffix:

<cc> [Component Carrier](#)

<ant> irrelevant

<fr> [Frame](#)

Query parameters:

<Result> ALL

Return values:

<EVM> EVM in % or dB.

Example:

```
//Query EVM
FETC:CC2:FRAM3:SUMM:EVM:USQP?
```

Usage:

Query only

Manual operation: See "EVM PUSCH" on page 25

```
FETCh:ALL:SUMMary:EVM:USSF? <Result>
FETCh[:CC<cc>][:ISRC<ant>][:FRAMe<fr>]:SUMMary:EVM:USSF:MAXimum?
  [<Result>]
FETCh[:CC<cc>][:ISRC<ant>][:FRAMe<fr>]:SUMMary:EVM:USSF:MINimum?
  [<Result>]
FETCh[:CC<cc>][:ISRC<ant>][:FRAMe<fr>]:SUMMary:EVM:USSF[:AVERage]?
  [<Result>]
```

Queries the EVM of all PUSCH resource elements with a 64QAM modulation.

FETCh:ALL:SUMMary:EVM:USSF queries the average result over all carriers. Prerequisites:

- Select to evaluate all carriers ([SENSe:]NR5G:RSUMmary:CCResult).

Suffix:

<cc> [Component Carrier](#)

<ant> irrelevant

<fr> [Frame](#)

Query parameters:

<Result> ALL

Return values:

<EVM> EVM in % or dB.

Example:

```
//Query EVM
FETC:CC2:FRAM3:SUMM:EVM:USSF?
```

Usage:

Query only

Manual operation: See "EVM PUSCH" on page 25

```
FETCh:ALL:SUMMary:EVM:USST? <Result>
FETCh[:CC<cc>][:ISRC<ant>][:FRAMe<fr>]:SUMMary:EVM:USST:MAXimum?
  [<Result>]
```

FETCh[:CC<cc>][:ISRC<ant>][:FRAMe<fr>]:SUMMary:EVM:USST:MINimum?
 [<Result>]

FETCh[:CC<cc>][:ISRC<ant>][:FRAMe<fr>]:SUMMary:EVM:USST[:AVERage]?
 [<Result>]

Queries the EVM of all PUSCH resource elements with a 16QAM modulation.

FETCh:ALL:SUMMary:EVM:USST queries the average result over all carriers. Prerequisites:

- Select to evaluate all carriers ([\[SENSe:\]NR5G:RSUMmary:CCResult](#)).

Suffix:

<cc> [Component Carrier](#)

<ant> irrelevant

<fr> [Frame](#)

Query parameters:

<Result> ALL

Return values:

<EVM> EVM in % or dB.

Example:

```
//Query EVM
FETC:CC2:FRAM3:SUMM:EVM:USST?
```

Usage: Query only

Manual operation: See "[EVM PUSCH](#)" on page 25

FETCh:ALL:SUMMary:EVM:USTS? <Result>

FETCh[:CC<cc>][:ISRC<ant>][:FRAMe<fr>]:SUMMary:EVM:USTS:MAXimum?
 [<Result>]

FETCh[:CC<cc>][:ISRC<ant>][:FRAMe<fr>]:SUMMary:EVM:USTS:MINimum?
 [<Result>]

FETCh[:CC<cc>][:ISRC<ant>][:FRAMe<fr>]:SUMMary:EVM:USTS[:AVERage]?
 [<Result>]

Queries the EVM of all PUSCH resource elements with a 256QAM modulation.

FETCh:ALL:SUMMary:EVM:USTS queries the average result over all carriers. Prerequisites:

- Select to evaluate all carriers ([\[SENSe:\]NR5G:RSUMmary:CCResult](#)).

Suffix:

<cc> [Component Carrier](#)

<ant> irrelevant

<fr> [Frame](#)

Query parameters:

<Result> ALL

Return values:

<EVM> EVM in % or dB.

Example: //Query EVM
FETC:CC2:FRAM3:SUMM:EVM:USTS?

Usage: Query only

Manual operation: See "EVM PUSCH" on page 25

FETCh[:CC<cc>][:ISRC<ant>][:FRAMe<fr>]:SUMMary:FERRor:MAXimum?
[<Result>]

FETCh[:CC<cc>][:ISRC<ant>][:FRAMe<fr>]:SUMMary:FERRor:MINimum?
[<Result>]

FETCh[:CC<cc>][:ISRC<ant>][:FRAMe<fr>]:SUMMary:FERRor[:AVERage]?
[<Result>]

Queries the frequency error.

Suffix:

<cc> [Component Carrier](#)

<ant> irrelevant

<fr> [Frame](#)

Query parameters:

<Result> ALL
Available for combined measurements.
Queries the frequency error of all events (meas IDs).
Omitting this parameter queries the frequency error of the selected event.

Return values:

<FrequencyError> Default unit: Hz

Example: //Query frequency error
FETC:CC2:FRAM3:SUMM:FERR?

Usage: Query only

Manual operation: See "Frequency Error" on page 29

FETCh[:CC<cc>][:ISRC<ant>][:FRAMe<fr>]:SUMMary:GIMBalance:MAXimum?
[<Result>]

FETCh[:CC<cc>][:ISRC<ant>][:FRAMe<fr>]:SUMMary:GIMBalance:MINimum?
[<Result>]

FETCh[:CC<cc>][:ISRC<ant>][:FRAMe<fr>]:SUMMary:GIMBalance[:AVERage]?
[<Result>]

Queries the gain imbalance.

Suffix:

<cc> [Component Carrier](#)

<ant> irrelevant

<fr> [Frame](#)

Query parameters:

<Result> ALL
 Available for combined measurements.
 Queries the gain imbalance of all events (meas IDs).
 Omitting this parameter queries the gain imbalance of the selected event.

Return values:

<GainImbalance> Default unit: dB

Example:

```
//Query gain imbalance
FETC:CC2:FRAM3:SUMM:GIMB?
```

Usage:

Query only

Manual operation: See "[I/Q Gain Imbalance](#)" on page 30

```
FETCh[:CC<cc>][:ISRC<ant>][:FRAMe<fr>]:SUMMary:IQOFfset:MAXimum?
  [<Result>]
```

```
FETCh[:CC<cc>][:ISRC<ant>][:FRAMe<fr>]:SUMMary:IQOFfset:MINimum?
  [<Result>]
```

```
FETCh[:CC<cc>][:ISRC<ant>][:FRAMe<fr>]:SUMMary:IQOFfset[:AVERage]?
  [<Result>]
```

Queries the I/Q offset.

Suffix:

<cc> [Component Carrier](#)

<ant> irrelevant

<fr> [Frame](#)

Query parameters:

<Result> ALL
 Available for combined measurements.
 Queries the I/Q offset of all events (meas IDs).
 Omitting this parameter queries the I/Q offset of the selected event.

Return values:

<IQOffset> Default unit: dB

Example:

```
//Query I/Q offset
FETC:CC2:FRAM3:SUMM:IQOF?
```

Usage:

Query only

Manual operation: See "[I/Q Offset](#)" on page 30

```

FETCh[:CC<cc>][:ISRC<ant>][:FRAMe<fr>]:SUMMary:OSTP:MAXimum?
  [<Result>]
FETCh[:CC<cc>][:ISRC<ant>][:FRAMe<fr>]:SUMMary:OSTP:MINimum?
  [<Result>]
FETCh[:CC<cc>][:ISRC<ant>][:FRAMe<fr>]:SUMMary:OSTP[:AVERage]?
  [<Result>]

```

Queries the OSTP.

Suffix:

<cc> [Component Carrier](#)

<ant> irrelevant

<fr> [Frame](#)

Query parameters:

<Result> ALL

 Available for combined measurements.

 Queries the OSTP of all events (meas IDs).

 Omitting this parameter queries the OSTP of the selected event.

Return values:

<OSTP> Default unit: dBm

Example:

```
//Query OSTP
FETC:CC2:FRAM3:SUMM:OSTP?
```

Usage:

Query only

```

FETCh:ALL:SUMMary:POWer? <Result>
FETCh[:CC<cc>][:ISRC<ant>][:FRAMe<fr>]:SUMMary:POWer:MAXimum?
  [<Result>]
FETCh[:CC<cc>][:ISRC<ant>][:FRAMe<fr>]:SUMMary:POWer:MINimum?
  [<Result>]
FETCh[:CC<cc>][:ISRC<ant>][:FRAMe<fr>]:SUMMary:POWer[:AVERage]?
  [<Result>]

```

Queries the total signal power.

FETCh:ALL:SUMMary:POWer queries the average result over all carriers. Prerequisites:

- Select to evaluate all carriers ([\[SENSe:\]NR5G:RSUMmary:CCResult](#)).

Suffix:

<cc> [Component Carrier](#)

<ant> irrelevant

<fr> [Frame](#)

Query parameters:

<Result> ALL
 Available for combined measurements.
 Queries the total power of all events (meas IDs).
 Omitting this parameter queries the total power of the selected event.

Return values:

<Power> Default unit: dBm

Example:

```
//Query signal power
FETC:CC2:FRAM3:SUMM:POW?
```

Usage:

Query only

Manual operation: See "Power" on page 29

```
FETCh[:CC<cc>][:ISRC<ant>][:FRAMe<fr>]:SUMMary:QUADerror:MAXimum?
  [<Result>]
```

```
FETCh[:CC<cc>][:ISRC<ant>][:FRAMe<fr>]:SUMMary:QUADerror:MINimum?
  [<Result>]
```

```
FETCh[:CC<cc>][:ISRC<ant>][:FRAMe<fr>]:SUMMary:QUADerror[:AVERage]?
  [<Result>]
```

Queries the quadrature error.

Suffix:

<cc> [Component Carrier](#)

<ant> irrelevant

<fr> [Frame](#)

Query parameters:

<Result> ALL
 Available for combined measurements.
 Queries the quadrature error of all events (meas IDs).
 Omitting this parameter queries the quadrature error of the selected event.

Return values:

<QuadratureError> Default unit: DEG

Example:

```
//Query quadrature error
FETC:CC2:FRAM3:SUMM:QUAD?
```

Usage:

Query only

FETCh[:CC<cc>][:ISRC<ant>][:FRAMe<fr>]:SUMMary:SERRor:MAXimum?
 [<Result>]

FETCh[:CC<cc>][:ISRC<ant>][:FRAMe<fr>]:SUMMary:SERRor:MINimum?
 [<Result>]

FETCh[:CC<cc>][:ISRC<ant>][:FRAMe<fr>]:SUMMary:SERRor[:AVERage]?
 [<Result>]

Queries the sampling error.

Suffix:

<cc> [Component Carrier](#)

<ant> irrelevant

<fr> [Frame](#)

Query parameters:

<Result> ALL
 Available for combined measurements.
 Queries the sampling error of all events (meas IDs).
 Omitting this parameter queries the sampling error of the selected event.

Return values:

<SamplingError> Default unit: ppm

Example: //Query sampling error
 FETC:CC2:FRAM3:SUMM:SERR?

Usage: Query only

Manual operation: See "[Sampling Error](#)" on page 29

FETCh:ALL:SUMMary:TPUT:MAXimum?

FETCh:ALL:SUMMary:TPUT:MINimum?

FETCh[:CC<cc>][:ISRC<ant>][:FRAMe<fr>]:SUMMary:TPUT[:AVERage]?

Queries the EVM of all resource elements.

Prerequisites for this command

- Turn on throughput measurement ([\[SENSe:\]NR5G:TRACking:TPUT:STATe](#)).

Suffix:

<cc> [Component Carrier](#)

<ant> irrelevant

<fr> [Frame](#)

Return values:

<TPUT> Default unit: PCT

Example: //Query BLER
 NR5G:TRAC:TPUT:STAT ON
 FETC:CC2:FRAM3:SUMM:TPUT?

Usage: Query only

Manual operation: See ["TPUT \(%\)"](#) on page 28

FETCh[:CC<cc>][:ISRC<ant>][:FRAMe<fr>]:SUMMary:FOFFset? [<Result>]

Queries the frequency offset of a component carrier evaluated during an event.

Available for combined multi-carrier measurements.

Suffix:

<cc> [Component Carrier](#)

<ant> irrelevant

<fr> [Frame](#)

Query parameters:

<Result> ALL

Available for combined measurements.

Queries the frequency offset of component carriers of all events (meas IDs).

Omitting this parameter queries the frequency offset of a component carrier in the selected event.

Return values:

<Frequency> Default unit: Hz

Example:

//Query frequency offset of a component carrier

FETC:CC2:FRAM3:SUMM:FOFF?

Usage:

Query only

Manual operation:

See ["Frame Start Offset"](#) on page 28

See ["Capture Buffer"](#) on page 31

See ["Frequency Offset"](#) on page 52

6.7.2 Combined measurements

The following commands are exclusive to combined measurements to query results available in the result summary of combined measurements.

Commands to query combined measurement results described elsewhere.

- [Chapter 6.7.1, "Result summary"](#), on page 210
- [Chapter 6.9, "Retrieve trace data"](#), on page 258
- [Chapter 6.8, "Limit check results"](#), on page 242

FETCh[:CC<cc>][:ISRC<ant>][:FRAMe<fr>]:SUMMary:AAPFail? [<Result>]

Queries the absolute ACLR limit check of an event.

Suffix:

<cc> [Component Carrier](#)

<ant> irrelevant

<fr> [Frame](#)

Query parameters:

<Result> ALL
Available for combined measurements.
Queries the ACLR limit check of all events (meas IDs).
Omitting this parameter queries the ACLR limit check of the selected event.

Return values:

<State> 0 | 1

Example: //Query absolute ACLR limit check
FETC:CC2:FRAM3:SUMM:AAPF?

Usage: Query only

Manual operation: See "[ACLR Pass / Fail](#)" on page 52

FETCh[:CC<cc>][:ISRC<ant>][:FRAMe<fr>]:SUMMary:APFail? [<Result>]

Queries the overall ACLR limit check of an event (absolute and relative). If one limit check passes (abs. or rel.), the overall limit check passes as well.

Suffix:

<cc> [Component Carrier](#)

<ant> irrelevant

<fr> [Frame](#)

Query parameters:

<Result> ALL
Available for combined measurements.
Queries the ACLR limit check of all events (meas IDs).
Omitting this parameter queries the ACLR limit check of the selected event.

Return values:

<State> 0 | 1

Example: //Query ACLR limit check
FETC:CC2:FRAM3:SUMM:APF?

Usage: Query only

Manual operation: See "[ACLR Pass / Fail](#)" on page 52

FETCh[:CC<cc>][:ISRC<ant>][:FRAMe<fr>]:SUMMary:ARPFail? [<Result>]

Queries the relative ACLR limit check of an event.

Suffix:

<cc> [Component Carrier](#)

<ant> irrelevant

<fr> [Frame](#)

Query parameters:

<Result> ALL
Available for combined measurements.
Queries the ACLR limit check of all events (meas IDs).
Omitting this parameter queries the ACLR limit check of the selected event.

Return values:

<State> 0 | 1

Example: //Query relative ACLR limit check
FETC:CC2:FRAM3:SUMM:ARPF?

Usage: Query only

Manual operation: See "[ACLR Pass / Fail](#)" on page 52

FETCh[:CC<cc>][:ISRC<ant>][:FRAMe<fr>]:SUMMary:CFRequency? [<Result>]

Queries the center frequency of a component carrier evaluated during an event.
Available for combined multi-carrier measurements.

Suffix:

<cc> [Component Carrier](#)

<ant> irrelevant

<fr> [Frame](#)

Query parameters:

<Result> ALL
Available for combined measurements.
Queries the center frequency of component carriers of all events (meas IDs).
Omitting this parameter queries the center frequency of a component carrier in the selected event.

Return values:

<State> Default unit: Hz

Example: //Query center frequency of a component carrier
FETC:CC2:FRAM3:SUMM:FOFF?

Usage: Query only

Manual operation: See "[Center Frequency](#)" on page 51

FETCh[:CC<cc>][:ISRC<ant>][:FRAMe<fr>]:SUMMary:EAACcs? [<Result>]

Queries the average EVM of all component carriers evaluated during an event.
Available for combined multi-carrier measurements.

Suffix:

<cc> [Component Carrier](#)

<ant> irrelevant

<fr> [Frame](#)

Query parameters:

<Result> ALL
Available for combined measurements.
Queries the EVM of all events (meas IDs).
Omitting this parameter queries the average EVM of the selected event.

Return values:

<AverageEVM> EVM in % or dB.

Example:

```
//Query average EVM over all component carriers analyzed in  
an event  
FETC:CC2:FRAM3:SUMM:EAAC?
```

Usage: Query only

Manual operation: See "[EVM All CCs](#)" on page 52

FETCh[:CC<cc>][:ISRC<ant>][:FRAMe<fr>]:SUMMary:OVLD? [<Result>]

Queries the overload state of an event.

Suffix:

<cc> [Component Carrier](#)

<ant> irrelevant

<fr> [Frame](#)

Query parameters:

<Result> ALL
Available for combined measurements.
Queries the overload state of all events (meas IDs).
Omitting this parameter queries the overload state of the selected event.

Return values:

<State> **NAN**
no overload situation
0
RF OVLD
2
OVLD
3
INPUT OVLD

Example:

```
//Query overload state  
FETC:CC2:FRAM3:SUMM:OVLD?
```

Usage: Query only
Manual operation: See "OVLd" on page 53

FETCh[:CC<cc>][:ISRC<ant>][:FRAMe<fr>]:SUMMary:PACCs? [<Result>]

Queries the total power of all component carriers evaluated during an event.

Available for combined multi-carrier measurements.

Suffix:

<cc> [Component Carrier](#)
 <ant> irrelevant
 <fr> [Frame](#)

Query parameters:

<Result> ALL
 Available for combined measurements.
 Queries the power of all events (meas IDs).
 Omitting this parameter queries the total power of the selected event.

Return values:

<Power> Default unit: dBm

Example: //Query total power over all component carriers analyzed in an event
 FETC:CC2:FRAM3:SUMM:PACC?

Usage: Query only

Manual operation: See "Power All CCs" on page 52

FETCh[:CC<cc>][:ISRC<ant>][:FRAMe<fr>]:SUMMary:SPFail? [<Result>]

Queries the SEM limit check of an event.

Suffix:

<cc> [Component Carrier](#)
 <ant> irrelevant
 <fr> [Frame](#)

Query parameters:

<Result> ALL
 Available for combined measurements.
 Queries the SEM limit check of all events (meas IDs).
 Omitting this parameter queries the SEM limit check of the selected event.

Return values:

<State> 0 | 1

Example: //Query SEM limit check
FETC:CC2:FRAM3:SUMM:SPF?

Usage: Query only

Manual operation: See "[SEM Pass / Fail](#)" on page 53

FETCh[:CC<cc>][:ISRC<ant>][:FRAMe<fr>]:SUMMary:SSTate? [<Result>]

Queries the synchronization state of an event.

Suffix:

<cc> [Component Carrier](#)

<ant> irrelevant

<fr> [Frame](#)

Query parameters:

<Result> ALL
Available for combined measurements.
Queries the synchronization state of all events (meas IDs).
Omitting this parameter queries the synchronization state of the selected event.

Return values:

<State> 0 | 1

Example: //Query synchronization state
FETC:CC2:FRAM3:SUMM:SST?

Usage: Query only

Manual operation: See "[Sync State](#)" on page 52

FETCh[:CC<cc>][:ISRC<ant>][:FRAMe<fr>]:SUMMary:TSDelta? [<Result>]

Queries the time stamp delta of an event.

Suffix:

<cc> [Component Carrier](#)

<ant> irrelevant

<fr> [Frame](#)

Query parameters:

<Result> ALL
Available for combined measurements.
Queries the time stamp delta of all events (meas IDs).
Omitting this parameter queries the time stamp delta of the selected event.

Return values:

<Time> Default unit: s

Example: //Query time stamp
FETC:CC2:FRAM3:SUMM:TSD?

Usage: Query only

Manual operation: See "Time Stamp Delta" on page 51

FETCh[:CC<cc>][:ISRC<ant>][:FRAMe<fr>]:SUMMary:TSTamp? [<Result>]

Queries the time stamp of an event.

Suffix:

<cc> [Component Carrier](#)

<ant> irrelevant

<fr> [Frame](#)

Query parameters:

<Result> ALL
Available for combined measurements.
Queries the time stamp of all events (meas IDs).
Omitting this parameter queries the time stamp of the selected event.

Return values:

<Time> Default unit: s

Example: //Query time stamp
FETC:CC2:FRAM3:SUMM:TST?

Usage: Query only

Manual operation: See "Time Stamp" on page 51

6.7.3 Marker table

CALCulate<n>:DELTaMarker<m>:X.....	237
CALCulate<n>:DELTaMarker<m>:Y?.....	238
CALCulate<n>:MARKer<m>:X.....	238
CALCulate<n>:MARKer<m>:Y.....	239
CALCulate<n>:MARKer<m>:Z?.....	239
CALCulate<n>:MARKer<m>:Z:ALL?.....	240

CALCulate<n>:DELTaMarker<m>:X <Position>

Moves a delta marker to a particular coordinate on the x-axis.

If necessary, the command activates the delta marker and positions a reference marker to the peak power.

Suffix:

<n> [Window](#)

<m> [Marker](#)

Parameters:

<Position> Numeric value that defines the marker position on the x-axis.
 Range: The value range and unit depend on the measurement and scale of the x-axis.

Example:

CALC:DELT:X?
 Outputs the absolute x-value of delta marker 1.

CALCulate<n>:DELTamarker<m>:Y?

Queries the position of a deltamarker on the y-axis.

If necessary, the command activates the deltamarker first.

To get a valid result, you have to perform a complete measurement with synchronization to the end of the measurement before reading out the result. This is only possible for single measurement mode.

See also [INITiate<n>:CONTInuous](#) on page 207.

Note that result displays with a third aspect (for example "EVM vs Symbol x Carrier") do not support deltamarkers.

Suffix:

<n> [Window](#)
 <m> [Marker](#)

Return values:

<Result> <numeric value>
 Result at the deltamarker position. The return value is a value relative to the position of marker 1.
 The type of value and its unit depend on the selected result display.

Example:

```
//Query coordinates of deltamarker 2 in window 4
CALC4:DELT2:X?
CALC4:DELT2:Y?
```

Usage:

Query only

CALCulate<n>:MARKer<m>:X <Position>

Moves a marker to a specific coordinate on the x-axis.

If necessary, the command activates the marker.

If the marker has been used as a delta marker, the command turns it into a normal marker.

Suffix:

<n> [Window](#)
 <m> [Marker](#)

Note that 3D diagrams only support one marker.

Parameters:

<Position> Numeric value that defines the marker position on the x-axis.
The unit depends on the result display.

Range: The range depends on the current x-axis range.
Default unit: Hz

Example:

```
CALC:MARK2:X 1.7MHz
```

Positions marker 2 to frequency 1.7 MHz.

Manual operation:

See "[Marker Table](#)" on page 44

See "[Marker Peak List](#)" on page 49

CALCulate<n>:MARKer<m>:Y <Result>

Queries the position of a marker on the y-axis.

In result displays with a third aspect (for example "EVM vs Symbol x Carrier"), you can also use the command to define the position of the marker on the y-axis.

If necessary, the command activates the marker first.

To get a valid result, you have to perform a complete measurement with synchronization to the end of the measurement before reading out the result. This is only possible for single measurement mode.

See also [INITiate<n>:CONTinuous](#) on page 207.

Suffix:

<n> [Window](#)

<m> [Marker](#)

Note that 3D diagrams only support one marker.

Parameters:

<Result> <numeric value>

Result at the marker position.

The type of value and its unit depend on the selected result display.

Example:

```
//Query coordinates of marker 2 in window 4
```

```
CALC4:MARK2:X?
```

```
CALC4:MARK2:Y?
```

Example:

```
//Define position of marker in 3D diagram
```

```
CALC:MARK:X 16
```

```
CALC:MARK:Y 6
```

Manual operation:

See "[Marker Table](#)" on page 44

See "[Marker Peak List](#)" on page 49

CALCulate<n>:MARKer<m>:Z?

Queries the marker position on the z-axis of three-dimensional result displays.

Returns the type of value displayed in the selected result display (EVM, Power or Allocation ID).

Suffix:

<n> [Window](#)

<m> [Marker](#)

Return values:

<Position> <numeric value>

Default unit: Depends on result display

Example:

//Query marker position

CALC:MARK:Z?

Usage:

Query only

Manual operation: See "[Marker Table](#)" on page 44

CALCulate<n>:MARKer<m>:Z:ALL?

Queries the marker position on the z-axis of three-dimensional result displays.

Instead of returning a certain type of value (EVM, Power or Allocation ID), which is possible with [CALCulate<n>:MARKer<m>:Z?](#), this command returns all types of values (EVM, Power **and** Allocation ID), regardless of the result display type.

Suffix:

<n> [Window](#)

<m> irrelevant

Return values:

<Position> <numeric value>

EVM

EVM at the marker position.

Power

Power at the marker position.

Allocation ID

Allocation ID at the marker position.

Example:

//Query EVM, Power and Allocation ID at the marker position.

CALC:MARK:Z:ALL?

Usage:

Query only

Manual operation: See "[Marker Table](#)" on page 44

6.7.4 CCDF table

CALCulate<n>:STATistics:CCDF:X<t>?	241
CALCulate<n>:STATistics:RESult<res>?	241

CALCulate<n>:STATistics:CCDF:X<t>? <Probability>

Queries the results of the CCDF.

Suffix:

<n> [Window](#)

<t> [Trace](#)

Query parameters:

<Probability> **P0_01**
Level value for 0.01 % probability

P0_1
Level value for 0.1 % probability

P1
P1: Level value for 1 % probability

P10
Level value for 10 % probability

Return values:

<CCDF Result>

Example:

`CALC:STAT:CCDF:X1? P10`

Returns the level values that are over 10 % above the mean value.

Usage: Query only

Manual operation: See "[CCDF](#)" on page 39

CALCulate<n>:STATistics:RESult<res>? <ResultType>

Queries the results of a measurement for a specific trace.

Suffix:

<n> [Window](#)

<res> [Trace](#)

Query parameters:

<ResultType> **MEAN**
Average (=RMS) power in dBm measured during the measurement time.

PEAK
Peak power in dBm measured during the measurement time.

CFACTOR
Determined crest factor (= ratio of peak power to average power) in dB.

ALL
Results of all three measurements mentioned before, separated by commas: <mean power>,<peak power>,<crest factor>

Example:	CALC:STAT:RES2? ALL Reads out the three measurement results of trace 2. Example of answer string: 5.56,19.25,13.69 i.e. mean power: 5.56 dBm, peak power 19.25 dBm, crest factor 13.69 dB
Usage:	Query only
Manual operation:	See "CCDF" on page 39

6.8 Limit check results

- [EVM limits](#)..... 242
- [Frequency sweep limits](#)..... 252

6.8.1 EVM limits

CALCulate<n>:LIMit[:CC<cc>][:ISRC<ant>][:FRAMe<fr>]:SUMMARY:ALL:RESult?.....	243
CALCulate<n>:LIMit[:CC<cc>][:ISRC<ant>][:FRAMe<fr>]:SUMMARY:EVM:FERRor[:AVERAge]:RESult?.....	243
CALCulate<n>:LIMit[:CC<cc>][:ISRC<ant>][:FRAMe<fr>]:SUMMARY:EVM:SD1K:MAXimum:RESult?.....	244
CALCulate<n>:LIMit[:CC<cc>][:ISRC<ant>][:FRAMe<fr>]:SUMMARY:EVM:SDPB:MAXimum:RESult?.....	244
CALCulate<n>:LIMit[:CC<cc>][:ISRC<ant>][:FRAMe<fr>]:SUMMARY:EVM:SDQP:MAXimum:RESult?.....	245
CALCulate<n>:LIMit[:CC<cc>][:ISRC<ant>][:FRAMe<fr>]:SUMMARY:EVM:SDSF:MAXimum:RESult?.....	246
CALCulate<n>:LIMit[:CC<cc>][:ISRC<ant>][:FRAMe<fr>]:SUMMARY:EVM:SDST:MAXimum:RESult?.....	246
CALCulate<n>:LIMit[:CC<cc>][:ISRC<ant>][:FRAMe<fr>]:SUMMARY:EVM:SDTS:MAXimum:RESult?.....	247
CALCulate<n>:LIMit[:CC<cc>][:ISRC<ant>][:FRAMe<fr>]:SUMMARY:EVM:UCCD:MAXimum:RESult?.....	247
CALCulate<n>:LIMit[:CC<cc>][:ISRC<ant>][:FRAMe<fr>]:SUMMARY:EVM:UCCH:MAXimum:RESult?.....	248
CALCulate<n>:LIMit[:CC<cc>][:ISRC<ant>][:FRAMe<fr>]:SUMMARY:EVM:US1K:MAXimum:RESult?.....	248
CALCulate<n>:LIMit[:CC<cc>][:ISRC<ant>][:FRAMe<fr>]:SUMMARY:EVM:USPB:MAXimum:RESult?.....	249
CALCulate<n>:LIMit[:CC<cc>][:ISRC<ant>][:FRAMe<fr>]:SUMMARY:EVM:USQP:MAXimum:RESult?.....	250
CALCulate<n>:LIMit[:CC<cc>][:ISRC<ant>][:FRAMe<fr>]:SUMMARY:EVM:USSF:MAXimum:RESult?.....	250
CALCulate<n>:LIMit[:CC<cc>][:ISRC<ant>][:FRAMe<fr>]:SUMMARY:EVM:USST:MAXimum:RESult?.....	251
CALCulate<n>:LIMit[:CC<cc>][:ISRC<ant>][:FRAMe<fr>]:SUMMARY:EVM:USTS:MAXimum:RESult?.....	251

CALCulate<n>:LIMit[:CC<cc>][:ISRC<ant>][:FRAMe<fr>]:SUMMary:ALL:RESult?

Queries the limits and limit check results for all numerical results that evaluate 3GPP limits.

Suffix:

<n>	irrelevant
	irrelevant
<cc>	irrelevant
<ant>	irrelevant
<fr>	irrelevant

Return values:

<Result> String containing the limit information for all results that evaluate limits.
 For each limit, the command returns the following information:
 <ResultType>, <Limit>, <LimitCheckAverage>, <LimitCheckMin>, <LimitCheckMax>
 For results that are not checked against a limit, the command returns NOTEVALUATED.

Example:

```
//Query limit check information
CALC:LIM:SUMM:ALL:RES?
would return, e.g.
EVM_PDSCH_QPSK,
+1.850000000E+001, PASSED, NOTEVALUATED,
NOTEVALUATED,
EVM_PDSCH_16QAM,
+1.350000000E+001, NOTEVALUATED, NOTEVALUATED,
NOTEVALUATED,
...
```

Usage: Query only

Manual operation: See "[Remote queries](#)" on page 25

CALCulate<n>:LIMit[:CC<cc>][:ISRC<ant>][:FRAMe<fr>]:SUMMary:EVM:FERRor[:AVERage]:RESult?

Queries the limit specified by 3GPP for the frequency error.

Suffix:

<n>	irrelevant
	irrelevant
<cc>	irrelevant
<ant>	irrelevant

<fr> irrelevant

Return values:

<LimitCheck>

FAILED

Limit check has failed.

PASSED

Limit check has passed.

NOTEVALUATED

Limits have not been evaluated.

Example:

```
//Query limit check result
CALC:LIM:SUMM:EVM:FERR:RES?
```

Usage:

Query only

Manual operation: See "[Frequency Error](#)" on page 29

**CALCulate<n>:LIMit[:CC<cc>][:ISRC<ant>][:FRAMe<fr>]:SUMMary:EVM:
SD1K:MAXimum:RESult?**

Queries the limit specified by 3GPP for the EVM of all PUSCH DMRS resource elements with a 1024QAM modulation.

Suffix:

<n> irrelevant

 irrelevant

<cc> irrelevant

<ant> irrelevant

<fr> irrelevant

Return values:

<LimitCheck>

FAILED

Limit check has failed.

PASSED

Limit check has passed.

NOTEVALUATED

Limits have not been evaluated.

Example:

```
//Query limit check result
CALC:LIM:SUMM:EVM:SD1K:MAX:RES?
```

Usage:

Query only

Manual operation: See "[EVM DMRS PUSCH](#)" on page 26

**CALCulate<n>:LIMit[:CC<cc>][:ISRC<ant>][:FRAMe<fr>]:SUMMary:EVM:
SDPB:MAXimum:RESult?**

Queries the limit specified by 3GPP for the EVM of all PUSCH DMRS resource elements with a PI/2 BPSK modulation.

Suffix:

<n>	irrelevant
	irrelevant
<cc>	irrelevant
<ant>	irrelevant
<fr>	irrelevant

Return values:

<LimitCheck>	FAILED Limit check has failed.
	PASSED Limit check has passed.
	NOTEVALUATED Limits have not been evaluated.

Example:

```
//Query limit check result
CALC:LIM:SUMM:EVM:SDPB:MAX:RES?
```

Usage:

Query only

Manual operation: See "EVM DMRS PUSCH" on page 26

**CALCulate<n>:LIMit[:CC<cc>][:ISRC<ant>][:FRAMe<fr>]:SUMMary:EVM:
SDQP:MAXimum:RESult?**

Queries the limit specified by 3GPP for the EVM of all PUSCH DMRS resource elements with a QPSK modulation.

Suffix:

<n>	irrelevant
	irrelevant
<cc>	irrelevant
<ant>	irrelevant
<fr>	irrelevant

Return values:

<LimitCheck>	FAILED Limit check has failed.
	PASSED Limit check has passed.
	NOTEVALUATED Limits have not been evaluated.

Example:

```
//Query limit check result
CALC:LIM:SUMM:EVM:SDQP:MAX:RES?
```

Usage:

Query only

Manual operation: See "EVM DMRS PUSCH" on page 26

**CALCulate<n>:LIMit[:CC<cc>][:ISRC<ant>][:FRAMe<fr>]:SUMMary:EVM:
SDSF:MAXimum:RESult?**

Queries the limit specified by 3GPP for the EVM of all PUSCH DMRS resource elements with a 64QAM modulation.

Suffix:

<n>	irrelevant
	irrelevant
<cc>	irrelevant
<ant>	irrelevant
<fr>	irrelevant

Return values:

<LimitCheck>	FAILED Limit check has failed.
	PASSED Limit check has passed.
	NOTEVALUATED Limits have not been evaluated.

Example: //Query limit check result
CALC:LIM:SUMM:EVM:SDSF:MAX:RES?

Usage: Query only

Manual operation: See "[EVM DMRS PUSCH](#)" on page 26

**CALCulate<n>:LIMit[:CC<cc>][:ISRC<ant>][:FRAMe<fr>]:SUMMary:EVM:
SDST:MAXimum:RESult?**

Queries the limit specified by 3GPP for the EVM of all PUSCH DMRS resource elements with a 16QAM modulation.

Suffix:

<n>	irrelevant
	irrelevant
<cc>	irrelevant
<ant>	1..n
<fr>	irrelevant

Return values:

<LimitCheck>	FAILED Limit check has failed.
	PASSED Limit check has passed.
	NOTEVALUATED Limits have not been evaluated.

Example: //Query limit check result
CALC:LIM:SUMM:EVM:SDST:MAX:RES?

Usage: Query only

Manual operation: See "EVM DMRS PUSCH" on page 26

CALCulate<n>:LIMit[:CC<cc>][:ISRC<ant>][:FRAME<fr>]:SUMMARY:EVM:SDTS:MAXimum:RESult?

Queries the limit specified by 3GPP for the EVM of all PUSCH DMRS resource elements with a 256QAM modulation.

Suffix:

<n>	irrelevant
	irrelevant
<cc>	irrelevant
<ant>	1..n
<fr>	irrelevant

Return values:

<LimitCheck>	FAILED Limit check has failed.
	PASSED Limit check has passed.
	NOTEVALUATED Limits have not been evaluated.

Example: //Query limit check result
CALC:LIM:SUMM:EVM:SDTS:MAX:RES?

Usage: Query only

Manual operation: See "EVM DMRS PUSCH" on page 26

CALCulate<n>:LIMit[:CC<cc>][:ISRC<ant>][:FRAME<fr>]:SUMMARY:EVM:UCCD:MAXimum:RESult?

Queries the limit specified by 3GPP for the EVM of all PUCCH DMRS resource elements.

Suffix:

<n>	irrelevant
	irrelevant
<cc>	irrelevant
<ant>	irrelevant

<fr> irrelevant

Return values:

<LimitCheck>

FAILED

Limit check has failed.

PASSED

Limit check has passed.

NOTEVALUATED

Limits have not been evaluated.

Example:

```
//Query limit check result
CALC:LIM:SUMM:EVM:UCCD:MAX:RES?
```

Usage:

Query only

Manual operation: See "EVM DMRS PUCCH" on page 27

**CALCulate<n>:LIMit[:CC<cc>][:ISRC<ant>][:FRAME<fr>]:SUMMary:EVM:
UCCH:MAXimum:RESult?**

Queries the limit specified by 3GPP for the EVM of all PUCCH resource elements.

Suffix:

<n> irrelevant

 irrelevant

<cc> irrelevant

<ant> irrelevant

<fr> irrelevant

Return values:

<LimitCheck>

FAILED

Limit check has failed.

PASSED

Limit check has passed.

NOTEVALUATED

Limits have not been evaluated.

Example:

```
//Query limit check result
CALC:LIM:SUMM:EVM:UCCH:MAX:RES?
```

Usage:

Query only

Manual operation: See "EVM PUCCH" on page 27

**CALCulate<n>:LIMit[:CC<cc>][:ISRC<ant>][:FRAME<fr>]:SUMMary:EVM:
US1K:MAXimum:RESult?**

Queries the limit specified by 3GPP for the EVM of all PUSCH resource elements with a 1024QAM modulation.

Suffix:

<n>	irrelevant
	irrelevant
<cc>	irrelevant
<ant>	irrelevant
<fr>	irrelevant

Return values:

<LimitCheck>	FAILED Limit check has failed.
	PASSED Limit check has passed.
	NOTEVALUATED Limits have not been evaluated.

Example:

```
//Query limit check result
CALC:LIM:SUMM:EVM:US1K:MAX:RES?
```

Usage:

Query only

Manual operation:

See "EVM PUSCH" on page 25

**CALCulate<n>:LIMit[:CC<cc>][:ISRC<ant>][:FRAMe<fr>]:SUMMery:EVM:
USPB:MAXimum:RESult?**

Queries the limit specified by 3GPP for the EVM of all PDSCH resource elements with a PI/2 BPSK modulation.

Suffix:

<n>	irrelevant
	irrelevant
<cc>	irrelevant
<ant>	irrelevant
<fr>	irrelevant

Return values:

<LimitCheck>	FAILED Limit check has failed.
	PASSED Limit check has passed.
	NOTEVALUATED Limits have not been evaluated.

Example:

```
//Query limit check result
CALC:LIM:SUMM:EVM:USPB:MAX:RES?
```

Usage:

Query only

Manual operation:

See "EVM PUSCH" on page 25

**CALCulate<n>:LIMit[:CC<cc>][:ISRC<ant>][:FRAMe<fr>]:SUMMary:EVM:
USQP:MAXimum:RESult?**

Queries the limit specified by 3GPP for the EVM of all PUSCH resource elements with a QPSK modulation.

Suffix:

<n>	irrelevant
	irrelevant
<cc>	irrelevant
<ant>	irrelevant
<fr>	irrelevant

Return values:

<LimitCheck>	FAILED Limit check has failed.
	PASSED Limit check has passed.
	NOTEVALUATED Limits have not been evaluated.

Example: //Query limit check result
CALC:LIM:SUMM:EVM:USQP:MAX:RES?

Usage: Query only

Manual operation: See "[EVM PUSCH](#)" on page 25

**CALCulate<n>:LIMit[:CC<cc>][:ISRC<ant>][:FRAMe<fr>]:SUMMary:EVM:
USSF:MAXimum:RESult?**

Queries the limit specified by 3GPP for the EVM of all PUSCH resource elements with a 64QAM modulation.

Suffix:

<n>	irrelevant
	irrelevant
<cc>	irrelevant
<ant>	irrelevant
<fr>	irrelevant

Return values:

<LimitCheck>	FAILED Limit check has failed.
	PASSED Limit check has passed.
	NOTEVALUATED Limits have not been evaluated.

Example: //Query limit check result
CALC:LIM:SUMM:EVM:USSF:MAX:RES?

Usage: Query only

Manual operation: See "EVM PUSCH" on page 25

**CALCulate<n>:LIMit[:CC<cc>][:ISRC<ant>][:FRAMe<fr>]:SUMMary:EVM:
USST:MAXimum:RESult?**

Queries the limit specified by 3GPP for the EVM of all PUSCH resource elements with a 16QAM modulation.

Suffix:

<n>	irrelevant
	irrelevant
<cc>	irrelevant
<ant>	irrelevant
<fr>	irrelevant

Return values:

<LimitCheck>	FAILED Limit check has failed.
	PASSED Limit check has passed.
	NOTEVALUATED Limits have not been evaluated.

Example: //Query limit check result
CALC:LIM:SUMM:EVM:USST:MAX:RES?

Usage: Query only

Manual operation: See "EVM PUSCH" on page 25

**CALCulate<n>:LIMit[:CC<cc>][:ISRC<ant>][:FRAMe<fr>]:SUMMary:EVM:
USTS:MAXimum:RESult?**

Queries the limit specified by 3GPP for the EVM of all PUSCH resource elements with a 256QAM modulation.

Suffix:

<n>	irrelevant
	irrelevant
<cc>	irrelevant
<ant>	irrelevant

<fr>	irrelevant
Return values:	
<LimitCheck>	FAILED Limit check has failed.
	PASSED Limit check has passed.
	NOTEVALUATED Limits have not been evaluated.
Example:	//Query limit check result CALC:LIM:SUMM:EVM:USTS:MAX:RES?
Usage:	Query only
Manual operation:	See "EVM PUSCH" on page 25

6.8.2 Frequency sweep limits

CALCulate<n>:LIMit:ACPpower:ACHannel:RESult?	252
CALCulate<n>:LIMit:ACPpower:ACHannel:RESult:ABSolute	253
CALCulate<n>:LIMit:ACPpower:ACHannel:RESult:RELative	253
CALCulate<n>:LIMit:ACPpower:ALternate<alt>:RESult?	254
CALCulate<n>:LIMit:ACPpower:GAP<gap>:ACLR:RESult?	254
CALCulate<n>:LIMit:ACPpower:GAP<gap>:ACLR:RESult:ABSolute?	255
CALCulate<n>:LIMit:ACPpower:GAP<gap>:ACLR:RESult:RELative?	255
CALCulate<n>:LIMit:ACPpower:GAP<gap>[:CACLR]:RESult?	256
CALCulate<n>:LIMit:ACPpower:GAP<gap>[:CACLR]:RESult:ABSolute?	256
CALCulate<n>:LIMit:ACPpower:GAP<gap>[:CACLR]:RESult:RELative?	257
CALCulate<n>:LIMit:FAIL?	258

CALCulate<n>:LIMit:ACPpower:ACHannel:RESult? [<Result>]

Queries the limit check results for the adjacent channels during ACLR measurements.

Suffix:

<n>	irrelevant
	irrelevant

Query parameters:

<Result>	REL Queries the channel power limit check results.
	ABS Queries the distance to the limit line.

Return values:

<LimitCheck>	Returns two values, one for the upper and one for the lower adjacent channel.
	PASSED Limit check has passed.

FAILED

Limit check has failed.

Example: //Query results of the adjacent channel limit check
`CALC:LIM:ACP:ACH:RES?`

Example: //Query results of the adjacent channel limit check
`CALC:LIM:ACP:ACH:RES? ABS`

Usage: Query only

CALCulate<n>:LIMit:ACPpower:ACHannel:RESult:ABSolute

Queries the absolute limit check results for adjacent channels (ACLR measurements).

Prerequisites for this command

- Select absolute limit check mode
 evaluation mode
 ACLR: `CALCulate<n>:LIMit:ACPpower:PMODE.`

Suffix:

<n> irrelevant

 irrelevant

Return values:

<LimitCheck> Returns two values, one for the upper and one for the lower adjacent channel.

PASSED

Limit check has passed.

FAILED

Limit check has failed.

Example: //Query results of the adjacent channel limit check
`CALC:LIM:ACP:ACH:RES:ABS?`

Manual operation: See "[Result summary](#)" on page 48

CALCulate<n>:LIMit:ACPpower:ACHannel:RESult:RELative

Queries the relative limit check results for the adjacent channels (ACLR measurements).

Prerequisites for this command

- Select relative limit check mode
 ACLR: `CALCulate<n>:LIMit:ACPpower:PMODE.`

Suffix:

<n> irrelevant

 irrelevant

Return values:

<LimitCheck> Returns two values, one for the upper and one for the lower adjacent channel.

PASSED

Limit check has passed.

FAILED

Limit check has failed.

Example:

//Query results of the adjacent channel limit check
CALC:LIM:ACP:ACH:RES:REL?

Manual operation: See "[Result summary](#)" on page 48

CALCulate<n>:LIMit:ACPpower:ALternate<alt>:RESult? [<Result>]

Queries the limit check results for the alternate channels during ACLR measurements.

Suffix:

<n> irrelevant

 irrelevant

<alt> irrelevant

Query parameters:

<Result> **REL**
Queries the channel power limit check results.

ABS

Queries the distance to the limit line.

Return values:

<LimitCheck> Returns two values, one for the upper and one for the lower alternate channel.

PASSED

Limit check has passed.

FAILED

Limit check has failed.

Example:

//Query results of the alternate channel limit check
CALC:LIM:ACP:ALT:RES?

Example:

//Query results of the alternate channel limit check
CALC:LIM:ACP:ACH:RES? ABS

Usage:

Query only

CALCulate<n>:LIMit:ACPpower:GAP<gap>:ACLR:RESult?

Queries the ACLR power limit check results for the gap channels (MC ACLR measurements).

Suffix:	
<n>	irrelevant
	irrelevant
<gap>	irrelevant
Return values:	
<LimitCheck>	Returns two values, one for the upper and one for the lower adjacent channel.
	PASSED Limit check has passed.
	FAILED Limit check has failed.
Example:	//Query results of the gap channel limit check CALC:LIM:ACP:GAP:ACLR:RES?
Usage:	Query only

CALCulate<n>:LIMit:ACPpower:GAP<gap>:ACLR:RESult:ABSolute?

Queries the absolute power limit check results for the gap channels (MC ACLR measurements).

Prerequisites for this command

- Select absolute limit check mode evaluation mode
ACLR: `CALCulate<n>:LIMit:ACPpower:PMODE.`

Suffix:	
<n>	irrelevant
	irrelevant
<gap>	irrelevant
Return values:	
<LimitCheck>	Returns two values, one for the upper and one for the lower adjacent channel.
	PASSED Limit check has passed.
	FAILED Limit check has failed.
Example:	//Query results of the gap channel limit check CALC:LIM:ACP:GAP:ACLR:RES:ABS?
Usage:	Query only

CALCulate<n>:LIMit:ACPpower:GAP<gap>:ACLR:RESult:RELative?

Queries the relative power limit check results for the gap channels (MC ACLR measurements).

Prerequisites for this command

- Select relative limit check mode evaluation mode
ACLR: `CALCulate<n>:LIMit:ACPower:PMODE.`

Suffix:

<n> irrelevant
 irrelevant
<gap> irrelevant

Return values:

<LimitCheck> Returns two values, one for the upper and one for the lower adjacent channel.

PASSED

Limit check has passed.

FAILED

Limit check has failed.

Example: `//Query results of the gap channel limit check`
`CALC:LIM:ACP:GAP:ACLR:RES:REL?`

Usage: Query only

CALCulate<n>:LIMit:ACPower:GAP<gap>[:CACLR]:RESult?

Queries the limit check results for the gap channels (MC ACLR measurements).

Suffix:

<n> irrelevant
 irrelevant
<gap> irrelevant

Return values:

<LimitCheck> Returns two values, one for the upper and one for the lower adjacent channel.

PASSED

Limit check has passed.

FAILED

Limit check has failed.

Example: `//Query results of the gap channel limit check`
`CALC:LIM:ACP:GAP:RES?`

Usage: Query only

CALCulate<n>:LIMit:ACPower:GAP<gap>[:CACLR]:RESult:ABSolute?

Queries the absolute limit check results for the gap channels (MC ACLR measurements).

Prerequisites for this command

- Select absolute limit check mode
evaluation mode
ACLR: `CALCulate<n>:LIMit:ACPower:PMODE.`

Suffix:

<n> irrelevant
 irrelevant
<gap> irrelevant

Return values:

<LimitCheck> Returns two values, one for the upper and one for the lower adjacent channel.

PASSED

Limit check has passed.

FAILED

Limit check has failed.

Example: //Query results of the gap channel limit check
`CALC:LIM:ACP:GAP:RES:ABS?`

Usage: Query only

CALCulate<n>:LIMit:ACPower:GAP<gap>[:CACLR]:RESult:RELative?

Queries the relative limit check results for the gap channels (MC ACLR measurements).

Prerequisites for this command

- Select relative limit check mode
evaluation mode
ACLR: `CALCulate<n>:LIMit:ACPower:PMODE.`

Suffix:

<n> irrelevant
 irrelevant
<gap> irrelevant

Return values:

<LimitCheck> Returns two values, one for the upper and one for the lower adjacent channel.

PASSED

Limit check has passed.

FAILED

Limit check has failed.

Example: //Query results of the gap channel limit check
`CALC:LIM:ACP:GAP:RES:REL?`

Usage: Query only

CALCulate<n>:LIMit:FAIL?

Queries the limit check results for all measurements that feature a limit check.

For ACLR measurements: Returns the result of the overall limit check (absolute and relative limit evaluation).

Suffix:

<n>	1..n Window
	irrelevant

Return values:

<LimitCheck>	0 Limit check has passed.
	1 Limit check has failed. For spectrum flatness: Limit out of selected band.
	2 For spectrum flatness: Limit out of band.
	3 For spectrum flatness: Limit check has failed.

Example: //Query the limit check in the active result display
CALC:LIM:FAIL?

Usage: Query only

Manual operation: See "[Inband Emission](#)" on page 36
See "[Flatness](#)" on page 38
See "[Result summary](#)" on page 48

6.9 Retrieve trace data

- [Using the TRACe\[:DATA\] command](#)..... 258
- [Read measurement results](#)..... 272

6.9.1 Using the TRACe[:DATA] command

This chapter contains information on the TRACe:DATA command and a detailed description of the characteristics of that command.

The TRACe:DATA command queries the trace data or results of the currently active measurement or result display. The type, number and structure of the return values are specific for each result display. In case of results that have any kind of unit, the command returns the results in the unit you have currently set for that result display.

For several result displays, the command also supports various SCPI parameters in combination with the query. If available, each SCPI parameter returns a different

aspect of the results. If SCPI parameters are supported, you have to quote one in the query.

Example:

```
TRAC2:DATA? TRACE1
```

The format of the return values is either in ASCII or binary characters and depends on the format you have set with `FORMat [:DATA]`.

Following this detailed description, you will find a short summary of the most important functions of the command (`TRACe<n> [:DATA] ?`).



Selecting a measurement window

Before querying results, you have to select the measurement window with the suffix `<n>` at `TRACe`. The range of `<n>` depends on the number of active measurement windows.

For measurements on aggregated carriers, where each measurement window has subwindows, you have to select the subwindow first with `DISPlay[:WINDow<n>][:SUBWindow<w>]:SElect`.

• Capture buffer.....	259
• EVM vs carrier.....	260
• EVM vs symbol.....	260
• EVM vs RB.....	261
• Frequency error vs symbol.....	262
• Frequency error vs subframe.....	262
• Power spectrum.....	262
• Inband emission.....	263
• Inband emission summary.....	263
• Flatness vs carrier.....	264
• CCDF.....	264
• Constellation diagram.....	264
• Allocation summary.....	265
• Bitstream.....	266
• EVM vs symbol x carrier.....	267
• Power vs symbol x carrier.....	268
• Allocation ID vs symbol x carrier.....	268
• Adjacent channel leakage ratio.....	269
• Spectrum emission mask.....	270
• Combined EVM / ACLR / SEM.....	270
• Return value codes.....	271

6.9.1.1 Capture buffer

For the capture buffer result display, the command returns one value for each I/Q sample in the capture buffer.

```
<absolute power>, ...
```

The unit is always dBm.

The following parameters are supported.

- TRAC:DATA TRACE1

Note that the command returns positive peak values only.

6.9.1.2 EVM vs carrier

For the EVM vs carrier result display, the command returns one value for each subcarrier that has been analyzed.

<EVM>, ...

The unit depends on [UNIT:EVM](#).

The following parameters are supported.

- TRAC:DATA TRACE1

The return values depend on the evaluation range:

- A specific subframe: average EVM of that subframe over all slots.
- A specific slot: EVM of that slot.

- TRAC:DATA TRACE2

The return values depend on the evaluation range:

- A specific subframe: minimum EVM of that subframe over all slots.
- A specific slot: not supported.

- TRAC:DATA TRACE3

The return values depend on the evaluation range:

- A specific subframe: maximum EVM of that subframe over all slots.
- A specific slot: not supported.

6.9.1.3 EVM vs symbol

For the EVM vs symbol result display, the command returns one value for each OFDM symbol that has been analyzed.

<EVM>, ...

The unit depends on [UNIT:EVM](#).

The following parameters are supported.

- TRAC:DATA TRACE1

The return values depend on the evaluation range:

- A specific subframe: EVM of that subframe over all slots.
- A specific slot: EVM of that slot.

6.9.1.4 EVM vs RB

For the EVM vs RB result display, the command returns one value for each resource block that has been analyzed.

<EVM>, ...

The unit depends on [UNIT:EVM](#).

The following parameters are supported.

- TRAC:DATA TRACE1

The return values depend on the evaluation range:

- All bandwidth parts: average EVM of the first bandwidth part if the SS/PBCH block does not exist (if the SS/PBCH block exists, it returns an error).
- A specific bandwidth part: average EVM of the selected BWP over all subframes.
- A specific subframe: average EVM of that subframe over all slots.
- A specific slot: EVM of that slot.

- TRAC:DATA TRACE2

The return values depend on the evaluation range:

- All bandwidth parts: average EVM of the first bandwidth part if the SS/PBCH block does exist. If the SS/PBCH block does not exist, it returns the results of the second bandwidth part).
- A specific bandwidth part: minimum EVM of the selected BWP block over all subframes.
- A specific subframe: minimum EVM of that subframe over all slots.
- A specific slot: not supported.

- TRAC:DATA TRACE3

The return values depend on the evaluation range:

- All bandwidth parts: average EVM of the third BWP over all subframes.
- A specific bandwidth part: maximum EVM of the selected BWP block over all subframes.
- A specific subframe: maximum EVM of that subframe over all slots.
- A specific slot: not supported.

- TRAC:DATA TRACE4 | TRACE5 | TRACE6 | TRACE7 | TRACE8

Only supported for evaluation over all bandwidth parts.

Returns the average EVM of the corresponding bandwidth part over all subframes (for example TRACE4 for the 4th bandwidth part).

The following parameters are supported.

- TRAC:DATA TRACE1

The return values depend on the evaluation range:

- A specific subframe: average EVM of that subframe over all slots.
- A specific slot: EVM of that slot.

- TRAC:DATA TRACE2

The return values depend on the evaluation range:

- A specific subframe: minimum EVM of that subframe over all slots.
- A specific slot: not supported.
- TRAC:DATA TRACE3

The return values depend on the evaluation range:

- A specific subframe: maximum EVM of that subframe over all slots.
- A specific slot: not supported.

6.9.1.5 Frequency error vs symbol

For the frequency error vs symbol result display, the command returns one value for each OFDM symbol that has been analyzed.

<frequency error>,...

The unit is always Hz.

The following parameters are supported.

- TRAC:DATA TRACE1

The return values depend on the evaluation range:

- A specific subframe: Frequency error of that subframe over all slots.
- A specific slot: Frequency error of that slot.

6.9.1.6 Frequency error vs subframe

For the frequency error vs symbol result display, the command returns one value for each of the nine subframes that have been analyzed.

<frequency error>,...

The unit is always Hz.

The following parameters are supported.

- TRAC:DATA TRACE1

The return values depend on the evaluation range:

- All bandwidth parts: Frequency error for the subframes of the selected bandwidth part.
- A specific bandwidth part: Frequency error for the subframes of the selected BWP.

- TRAC:DATA TRACE2 to TRACE8

Only supported for evaluation over all bandwidth parts.

Returns the frequency error for the subframes of the corresponding bandwidth part (for example TRACE3 for the 3rd bandwidth part).

6.9.1.7 Power spectrum

For the power spectrum result display, the command returns one value for each trace point.

<power>, ...

The unit is always dBm/Hz.

The following parameters are supported.

- TRAC:DATA TRACE1

6.9.1.8 Inband emission

For the inband emission result display, the number and type of returns values depend on the parameter.

- TRAC:DATA TRACE1
Returns the relative resource block indices (x-axis values).
<RB index>, ...
The resource block index has no unit.
- TRAC:DATA TRACE2
Returns one value for each resource block index.
<relative power>, ...
The unit of the relative inband emission is dB.
- TRAC:DATA TRACE3
Returns the data points of the upper limit line.
<limit>, ...
The unit is always dB.

Note that you have to select a particular subframe to get results.

6.9.1.9 Inband emission summary

For the inband emission summary result display, the command returns the contents of the table.

The following parameters are supported.

- TRAC:DATA TRACE1
Returns the limit check results (three values) for each limit category (three categories).
<RB_General>, <Power_General>, <DeltaToLimit_General>,
<RB_IQImage>, <Power_IQImage>, <DeltaToLimit_IQImage>,
<RB_CarrierLeakage>, <Power_CarrierLeakage>,
<DeltaToLimit_CarrierLeakage>,

Example:

TRAC:DATA? TRACE1 would return:

```
-1.000000000, -4.432175636E+001, +3.507492542E+001,  
+1.390000000E+002, -5.552246571E+001, +4.627563477E+001,  
+6.700000000E+001, -5.550722122E+001, +4.931751728E+001
```

6.9.1.10 Flatness vs carrier

For the flatness vs carrier result display, the command returns one value for each trace point.

<relative power>, ...

The unit is always dB. The number of values depends on the selected 5G NR bandwidth.

The following parameters are supported.

- TRAC:DATA TRACE1

The return values depend on the evaluation range:

- A specific subframe: average power of that subframe over all slots.
- A specific slot: power of that slot.

- TRAC:DATA TRACE2

The return values depend on the evaluation range:

- A specific subframe: minimum power of that subframe over all slots.
- A specific slot: not supported.

- TRAC:DATA TRACE3

The return values depend on the evaluation range:

- A specific subframe: maximum power of that subframe over all slots.
- A specific slot: not supported.

6.9.1.11 CCDF

For the CCDF result display, the type of return values depends on the parameter.

- TRAC:DATA TRACE1

Returns the probability values (y-axis).

<# of values>, <probability>, ...

The unit is always %.

The first value that is returned is the number of the following values.

- TRAC:DATA TRACE2

Returns the corresponding power levels (x-axis).

<# of values>, <relative power>, ...

The unit is always dB.

The first value that is returned is the number of the following values.

6.9.1.12 Constellation diagram

For the constellation diagram, the command returns two values for each constellation point.

```

<I[SF0][Sym0][Carrier1]>, <Q[SF0][Sym0][Carrier1]>, ..., <I[SF0][Sym0][Carrier(n)]>, <Q[SF0][Sym0][Carrier(n)]>,
<I[SF0][Sym1][Carrier1]>, <Q[SF0][Sym1][Carrier1]>, ..., <I[SF0][Sym1][Carrier(n)]>, <Q[SF0][Sym1][Carrier(n)]>,
<I[SF0][Sym(n)][Carrier1]>, <Q[SF0][Sym(n)][Carrier1]>, ..., <I[SF0][Sym(n)][Carrier(n)]>, <Q[SF0][Sym(n)][Carrier(n)]>,
<I[SF1][Sym0][Carrier1]>, <Q[SF1][Sym0][Carrier1]>, ..., <I[SF1][Sym0][Carrier(n)]>, <Q[SF1][Sym0][Carrier(n)]>,
<I[SF1][Sym1][Carrier1]>, <Q[SF1][Sym1][Carrier1]>, ..., <I[SF1][Sym1][Carrier(n)]>, <Q[SF1][Sym1][Carrier(n)]>,
<I[SF(n)][Sym(n)][Carrier1]>, <Q[SF(n)][Sym(n)][Carrier1]>, ..., <I[SF(n)][Sym(n)][Carrier(n)]>, <Q[SF(n)][Sym(n)][Carrier(n)]>

```

With SF = subframe and Sym = symbol of that subframe.

The I and Q values have no unit.

The number of return values depends on the constellation selection. By default, it returns all resource elements including the DC carrier.

The command returns the values for all resource elements. However, only the allocated resource elements have a value. All others are returned as NAN. If you query the constellation for a signal the stream of values would look like this:

- NAN, NAN, (. . .), RE [BWPO], RE [BWPO], (. . .), NAN, NAN, (. . .)

The following parameters are supported.

- TRAC:DATA TRACE1
Returns all constellation points included in the selection.

6.9.1.13 Allocation summary

For the allocation summary, the command returns several values for each line of the table.

- <bwp>
- <subframe>
- <slot>
- <allocation ID>
- <number of RB>
- <relative power>
- <modulation>
- <absolute power>
- <EVM>

The data format of the return values is always ASCII.

The return values have the following characteristics.

- The <allocation ID> is encoded.
For the code assignment, see [Chapter 6.9.1.21, "Return value codes"](#), on page 271.

- The <modulation> is encoded.
For the code assignment, see [Chapter 6.9.1.21, "Return value codes"](#), on page 271.
- The unit for <absolute power> is always dBm.
- The unit for <EVM> depends on `UNIT:EVM`.

Additional information "ALL"

In addition, there is a line at the end of the allocation summary that shows the average EVM over all analyzed subframes. This information is also added as the last return values. The "ALL" information has the subframe ID and allocation ID code "-2".

A query result would thus look like this, for example:

6.9.1.14 Bitstream

For the bitstream result display, the number of return values depends on the parameter.

- `TRACE:DATA TRACE1`
Returns several values and the bitstream for each line of the table.
<bwp>, <subframe>, <slot>, <allocation ID>, <codeword>, <modulation>, <# of decoded bits>, <# of decoded bit errors>, <# of symbols/bits>, <hexadecimal/binary numbers>,...
- `TRACE:DATA TRACE2`
Returns the CRC status of an allocation, but not the bitstream.
<bwp>, <subframe>, <slot>, <allocation ID>, <codeword>, <crc status>,...
- `TRAC:DATA TRACE3`
Returns all informative values of an allocation, but not the bitstream.
<bwp>, <subframe>, <slot>, <allocation ID>, <codeword>, <crc status>, <modulation>, <# of decoded bits>, <# of decoded bit errors>, <# of symbols/bits>,...
- `TRAC:DATA TRACE4`
Note that this query is only available under certain circumstances. For more information see the description of the [bitstream](#) result display.
Returns all informative values of an allocation, including the totals over all PDSCH allocations that contribute to the bitstream, but not the bitstream itself.
<bwp>, <subframe>, <slot>, <allocation ID>, <codeword>, <crc status>, <modulation>, <# of decoded bits>, <# of decoded bit errors>, <# of symbols/bits>, ..., <total # decoded bits>, <total # bit errors>, <total # bits>, <total bit error rate>
- `TRAC:DATA TRACE5`
Returns the CRC status of an allocation, including the number of bits in the bitstream.
<bwp>, <subframe>, <slot>, <allocation ID>, <codeword>, <crc status>, <#Bits>,...
- `TRAC:DATA TRACE6`

Note that this query is only available under certain circumstances. For more information see the description of the [bitstream](#) result display.

Returns all informative values of an allocation, including the totals over all PDSCH allocations that contribute to the bitstream, but not the bitstream itself. The difference to TRACE3 is that this query includes the Bit/s result.

<bwp>, <subframe>, <slot>, <allocation ID>, <codeword>, <crc status>, <modulation>, <# of decoded bits>, <# of decoded bit errors>, <# of symbols/bits>, ..., <total # decoded bits>, <total # bit errors>, <total # bits>, <total bit error rate>, <bit per second>

All values have no unit. The format of the bitstream depends on the [demodulation data](#) property.

The <allocation ID>, <codeword>, <crc status> and <modulation> are encoded. For the code assignment see [Chapter 6.9.1.21, "Return value codes"](#), on page 271.

For symbols or bits that are not transmitted, the command returns

- "FFFF" if the bitstream is analyzed [before decoding](#)
- "9" if the bitstream is analyzed [after decoding](#).

Note that the data format of the return values is always ASCII.

Example:

Sub-frame	Allocation ID	Codeword	Modulation	Symbol Index	Bit Stream
0	PBCH	1/1	QPSK	0	01 01 00 02 03 00 01 02 01 02 01 00 03 00 02 02
0	PBCH	1/1	QPSK	16	02 03 02 03 03 03 00 02 00 03 00 02 02 03 01 01
0	PBCH	1/1	QPSK	32	03 02 03 03 03 03 01 03 00 03 00 03 03 03 02

TRAC:DATA? TRACE1 would return:

```
-1,0,0,-500200,0,2,0,0,432, 01, 01, 00, 02, 03, 00, 01, 02, 01, 02, 01, ...
<continues like this until the next data block starts or the end of data is reached>
0,0,0,-200000,0,2,0,0,2430,02,03,03,03,01,01, 01, 03, 00, 03, ...
```

6.9.1.15 EVM vs symbol x carrier

For the EVM vs symbol x carrier, the command returns one value for each resource element.

```
<SS/BWP>,<Subcarrier Spacing>,<Symbol Start Offset>,<Freq Start Offset>,<#Symbols>,<#Carriers>,<EVM[Symbol(0),Carrier(1)]>,...,<EVM[Symbol(0),Carrier(n)]>,<EVM[Symbol(1),Carrier(1)]>,...,<EVM[Symbol(1),Carrier(n)]>,...<EVM[Symbol(n),Carrier(1)]>,...,<EVM[Symbol(n),Carrier(n)]>
```

The unit depends on [UNIT:EVM](#).

The number of values depends on the [evaluation range](#).

Resource elements that are unused return NAN.

The following parameters are supported.

- TRAC:DATA TRACE1

The return values depend on the evaluation range:

- All bandwidth parts: EVM of the first bandwidth part.
- A specific bandwidth part: EVM of the selected BWP.

6.9.1.16 Power vs symbol x carrier

For the power vs symbol x carrier, the command returns one value for each resource element.

```
<SS/BWP>,<Subcarrier Spacing>,<Symbol Start Offset>,  
<Freq Start Offset>,<#Symbols>,<#Carriers>,  
<P[Symbol(0),Carrier(1)]>, ..., <P[Symbol(0),Carrier(n)]>,  
<P[Symbol(1),Carrier(1)]>, ..., <P[Symbol(1),Carrier(n)]>,  
...  
<P[Symbol(n),Carrier(1)]>, ..., <P[Symbol(n),Carrier(n)]>,
```

with P = Power of a resource element.

The unit is always dBm.

The number of values depends on the [evaluation range](#).

Resource elements that are unused return NAN.

The following parameters are supported.

- TRAC:DATA TRACE1

The return values depend on the evaluation range:

- All bandwidth parts: EVM of the first bandwidth part.
- A specific bandwidth part: EVM of the selected BWP.

6.9.1.17 Allocation ID vs symbol x carrier

For the allocation ID vs symbol x carrier, the command returns one value for each resource element.

```
<SS/BWP>,<Subcarrier Spacing>,<Symbol Start Offset>,  
<Freq Start Offset>,<#Symbols>,<#Carriers>,  
<ID[Symbol(0),Carrier(1)]>, ..., <ID[Symbol(0),Carrier(n)]>,  
<ID[Symbol(1),Carrier(1)]>, ..., <ID[Symbol(1),Carrier(n)]>,  
...  
<ID[Symbol(n),Carrier(1)]>, ..., <ID[Symbol(n),Carrier(n)]>,
```

The <allocation ID> is encoded.

For the code assignment, see [Chapter 6.9.1.21, "Return value codes"](#), on page 271.

The number of values depends on the [evaluation range](#).

The following parameters are supported.

- TRAC:DATA TRACE1
 - The return values depend on the evaluation range:
 - All bandwidth parts: EVM of the first bandwidth part.
 - A specific bandwidth part: EVM of the selected BWP.

6.9.1.18 Adjacent channel leakage ratio

For the ACLR result display, the number and type of returns values depend on the parameter.

- TRAC:DATA TRACE1
 - Returns one value for each trace point.
- TRAC:DATA RESult
 - Combined mode only. Returns the results for all ACLR measurements in a measurement sequence.
 - For each measurement event, the command returns the following information.

```
<event number>, <channel power>,
<abs. power lower adj. ch.>, <abs. power upper adj. ch.>,
<rel. power lower adj. ch.>, <rel. power upper adj. ch.>,
<abs. power lower alt. ch.>, <abs. power upper alt. ch.>,
<rel. power lower alt. ch.>, <rel. power upper alt. ch.>,
etc.
```
 - The number of values for alternate channels depends on the number of alternate channels in the measurement.
- TRAC:DATA LIMit
 - Combined mode only. Returns the results for all ACLR limit checks in a measurement sequence.
 - For each measurement event, the command returns the following information.

```
<event number>,
<adj. ch. limit check result>,
<abs. limit lower adj. ch.>, <abs. limit upper adj. ch.>,
<rel. limit lower adj. ch.>, <rel. limit upper adj. ch.>,
<alt. ch. limit check result>,
<abs. power lower alt. ch.>, <abs. power upper alt. ch.>,
<rel. power lower alt. ch.>, <rel. power upper alt. ch.>
etc.
```
 - The limit check results are either PASSED or FAILED. The number of results for alternate channels depends on the number of alternate channels in the measurement.

6.9.1.19 Spectrum emission mask

For the SEM measurement, the number and type of returns values depend on the parameter.

- `TRAC:DATA TRACE1`
Returns one value for each trace point.
<absolute power>, ...
The unit is always dBm.
- `TRAC:DATA LIST`
Returns the contents of the SEM table. For every frequency in the spectrum emission mask, it returns 11 values.
<index>, <start frequency in Hz>, <stop frequency in Hz>, <RBW in Hz>, <limit fail frequency in Hz>, <absolute power in dBm>, <relative power in dBc>, <limit distance in dB>, <limit check result>, <reserved>, <reserved>...
The <limit check result> is either a 0 (for PASS) or a 1 (for FAIL).
- `TRAC:DATA RESult`
Combined mode only. Returns the results for all SEM measurements in a measurement sequence.
For each measurement event, the command returns the following information.
<event number>, <channel power>, <range index>, <start frequency in Hz>, <stop frequency in Hz>, <RBW in Hz>, <frequency>, <absolute power in dBm>, <relative power in dBc>, <limit distance in dB>, <limit check result>, <reserved>, <reserved>, etc.
The number of SEM ranges depend on the SEM configuration.
- `TRAC:DATA LIMit`
Combined mode only. Returns the results for all SEM limit checks in a measurement sequence.
For each measurement event, the command returns the following information.
<event number>, <limit check result>, etc.
The limit check results are either PASSED or FAILED.

6.9.1.20 Combined EVM / ACLR / SEM

For combined EVM / ACLR / SEM result summary, the return values depend on the number of carriers.

Single carrier measurements

The command returns the following values for each measurement.

<measID>, <time stamp>, <EVM>, <power>, <sync state>, <ACLR result>, <SEM result>, <OVLd>, ...

Multi carrier measurements

The command returns the following values for each measurement.

<measID>, <cc>, <time stamp>, <EVM>, <power>, <sync state>, <MCACLR result>, <CACLR result>, <MCSEM result>, <OVLD>, ...

Note that <MCACLR result>, <CACLR result>, <MCSEM result> are not evaluated in uplink measurements. Therefore, the return value for these results is always = 0.

The <SyncState>, <ACLR result> and <SEM result> are encoded:

- 1 for a pass and 0 for a fail.

The <OVLD> state is encoded.

- NAN: no overload
- 0: RF OVLD
- 2: IF OVLD
- 3: INPUT OVLD

The following parameters are supported.

- TRAC:DATA TRACE1
Returns the results for all events.
- TRAC:DATA TRACE2
Returns the results for a selected event ([SENSe:]NR5G[:CC<cc>]:SMID).

In addition, you can query individual results (for example the time stamp). To query other results from the combined result summary, use the standard commands to query the results.

For a detailed list, see [Chapter 6.7.1, "Result summary"](#), on page 210.

6.9.1.21 Return value codes

<allocation ID>

Represents the allocation ID. The range is as follows.

- -1 = INVALID
 - -1xxxxx = PUSCH DMRS
 - -2xxxxx = PUCCH
 - -3xxxxx = PUCCH DMRS
 - -4xxxxx = PUSCH PTRS
- Note. xxxxx is a placeholder for the ID of the channel.
If the channel has, for example, the ID 22, the return value would be -100022, -200022 or -300022 (depending on the configuration)

<modulation>

Represents the modulation scheme.

- 0 = unrecognized
- 1 = RBPSK
- 2 = QPSK

- 3 = 16QAM
- 4 = 64QAM
- 14 = 256QAM
- 15 = 1024QAM
- 16 = CAZAC
- 17 = pi/2 BPSK

6.9.2 Read measurement results

CALCulate<n>:MARKer<m>:FUNction:POWer<sb>:RESult[:CURRent]?	272
CALCulate<n>:MARKer<m>:FUNction:POWer<sb>:RESult:DEtails	273
FORMat[:DATA]	274
TRACe<n>:CATalog?	274
TRACe<n>[:DATA]?	275
TRACe<n>[:DATA]:X?	276

CALCulate<n>:MARKer<m>:FUNction:POWer<sb>:RESult[:CURRent]?

[<Measurement>]

Queries the results of the ACLR measurement or the total signal power level of the SEM measurement.

To get a valid result, you have to perform a complete measurement with synchronization to the end of the measurement before reading out the result. This is only possible for single sweeps.

Suffix:

<n>	Window
<m>	Marker
<sb>	irrelevant

Query parameters:

<Measurement>	CPOW This parameter queries the channel power of the reference range.
	MCAC Queries the channel powers of the ACLR measurements as shown in the ACLR table. Where available, this parameter also queries the power of the adjacent channels (for example in the ACLR measurement).

Return values:

<Result>	Results for the Spectrum Emission Mask measurement: Power level in dBm.
----------	---

Results for the ACLR measurements:

Relative power levels of the ACLR channels. The number of return values depends on the number of transmission and adjacent channels. The order of return values is:

- <TXChannelPower> is the power of the transmission channel in dBm
- <LowerAdjChannelPower> is the relative power of the lower adjacent channel in dB
- <UpperAdjChannelPower> is the relative power of the upper adjacent channel in dB
- <1stLowerAltChannelPower> is the relative power of the first lower alternate channel in dB
- <1stUpperAltChannelPower> is the relative power of the first lower alternate channel in dB
- (...)
- <nthLowerAltChannelPower> is the relative power of a subsequent lower alternate channel in dB
- <nthUpperAltChannelPower> is the relative power of a subsequent lower alternate channel in dB

Example:

```
CALC1:MARK:FUNC:POW:RES? MCAC
```

Returns the current ACLR measurement results.

Usage:

Query only

Manual operation:

See "[Result summary](#)" on page 48

CALCulate<n>:MARKer<m>:FUNCtion:POWer<sb>:RESult:DEtails
 <Measurement>

Queries the results of the ACLR measurement.

To get a valid result, you have to perform a complete measurement with synchronization to the end of the measurement before reading out the result. This is only possible for single sweeps.

Prerequisites for this command

- Available for combined measurements only.

Suffix:

<n>	Window
<m>	Marker
<sb>	irrelevant

Parameters:

<Measurement>	ACPower
---------------	---------

Return values:

<Result>

Results for the ACLR measurements:

Absolute and relative power levels of the ACLR channels. The number of return values depends on the number of transmission and adjacent channels. The order of return values is:

- <TXChannelPower> is the power of the transmission channel in dBm
- <LowerAdjChannelPower> is the relative power of the lower adjacent channel in dB
- <UpperAdjChannelPower> is the relative power of the upper adjacent channel in dB
- <1stLowerAltChannelPower> is the relative power of the first lower alternate channel in dB
- <1stUpperAltChannelPower> is the relative power of the first lower alternate channel in dB

(...)

- <nthLowerAltChannelPower> is the relative power of a subsequent lower alternate channel in dB
- <nthUpperAltChannelPower> is the relative power of a subsequent lower alternate channel in dB

Example:

```
//Query the current ACLR measurement results.
CALC1:MARK:FUNC:POW:RES? ACP
```

Manual operation: See "[Result summary](#)" on page 48

FORMat[:DATA] <Format>

Selects the data format for the data transmission between the FSW and the remote client.

Parameters:

```
<Format>      ASCii | REAL
               *RST:      ASCii
```

Example:

```
//Select data format
FORM REAL
```

TRACe<n>:CATalog?

Queries the types of traces in a diagram.

Prerequisites for this command

- Query results in a window that contains one or more line traces.

Suffix:

```
<n>           Window
```

Return values:

```
<TraceType>  CLRW | SSB<x> | BWP<x> | AVG | MIN | MAX
```

CLRW

For result displays with a single trace (for example the capture buffer).

SSB<x> | BWP<x>

For unfiltered result displays that show all signal parts (for example unfiltered EVM vs Carrier).

(SSB = synchronization signal block, BWP = bandwidth part)

AVG | MIN | MAX

For result displays that are filtered by a specific bandwidth part or subframe and show the average, minimum or maximum results of the slots (for example filtered EVM vs Carrier).

Example: //Query trace types
TRAC2:CAT?

Usage: Query only

TRACe<n>[:DATA]? <Result>

This command queries the trace data for each measurement point (y-axis values).

In combination with [TRACe<n>\[:DATA\]:X?](#), you can thus query the coordinates of each measurement point.

Suffix:

<n> [Window](#)

Parameters:

RESult Combined mode only:
Queries the results of all ACLR or SEM measurements in a measurement sequence.

LIMit Combined mode only:
Queries the limit check results of all ACLR or SEM measurements in a measurement sequence.

Query parameters:

<TraceNumber> **TRACE1 | TRACE2 | TRACE3**
Queries the trace data of the corresponding trace.

LIST Queries the results for the SEM measurement.

Return values:

<TraceData> For more information about the type of return values in the different result displays, see [Chapter 6.9.1, "Using the TRACe\[:DATA\] command"](#), on page 258.

Example: //Query results of the second measurement window. The type of data that is returned by the parameter (TRACE1) depends on the result display shown in measurement window 2.
TRAC2? TRACE1

Usage: Query only

Manual operation: See ["Data import and export"](#) on page 171

TRACe<n>[:DATA]:X? <Result>

Queries the horizontal trace data for each measurement point (x-axis values).

In combination with [TRACe<n>\[:DATA\]?](#), you can thus query the coordinates of each measurement point.

Suffix:

<n> [Window](#)

Query parameters:

<TraceNumber> TRACe1 | TRACe2 | TRACe3 | TRACe4 | TRACe5 | TRACe6

Return values:

<TraceData> The type of value depends on the information displayed on the x-axis of the result display whose contents you query.

Example:

```
//Query trace data of trace 1 in window 2
TRAC2? TRACE1
TRAC2:X? TRACE1
```

Usage:

Query only

Manual operation:

See ["Capture Buffer"](#) on page 31
 See ["EVM vs Carrier"](#) on page 32
 See ["EVM vs Symbol"](#) on page 32
 See ["EVM vs RB"](#) on page 33
 See ["Frequency Error vs Symbol"](#) on page 34
 See ["Frequency Error vs Subframe"](#) on page 35
 See ["Power Spectrum"](#) on page 36
 See ["Inband Emission"](#) on page 36
 See ["Flatness"](#) on page 38
 See ["Spectrum Flatness"](#) on page 45

6.10 Configuration

• General configuration	277
• Automatic configuration	280
• Physical settings	283
• Component carrier configuration	288
• General radio frame configuration	292
• Bandwidth part configuration	294
• Slot configuration	298
• SRS configuration	305
• PUCCH allocation configuration	313
• PUSCH allocation configuration	320
• Enhanced PUCCH allocation configuration	327
• Enhanced PUSCH settings: DMRS	335
• Enhanced PUSCH settings: PTRS	345
• Enhanced PUSCH settings: scrambling / coding	351
• Antenna port configuration	354

• Advanced settings: global	355
• Advanced settings: reference point A	359
• Generator control	362
• Input configuration	368
• Frequency configuration	376
• Amplitude configuration	378
• Data capture	383
• Trigger	386
• Segmented capture	391
• Optimization	393
• Tracking	394
• Demodulation	396
• PRACH analysis	399
• Frequency sweep measurements	402
• Combined measurements	404

6.10.1 General configuration

The following remote control command control general configuration of the application.

The remote control commands to select the result displays for I/Q measurements are described in [Chapter 6.5, "Screen layout"](#), on page 197.

CONFigure[:NR5G]:MEASurement	277
FORMat:DEXPort:FORMat	278
MMEMory:LOAD:IQ:STATe:ALL	278
MMEMory:STORe<n>:IQ:STATe	278
MMEMory:STORe<n>:IQ:STATe:ALL	279
MMEMory:STORe<n>:IQNC:STATe	279
MMEMory:STORe<n>:MSERvice	279
SYSTem:PRESet:CHANnel[:EXEC]	280

CONFigure[:NR5G]:MEASurement <Measurement>

Selects the measurement type.

Parameters:

<Measurement>

ACLR

Selects the adjacent channel leakage ratio (ACLR) measurement.

ESpectrum

Selects the spectrum emission mask (SEM) measurement.

EVM

Selects I/Q measurements.

PRACH

Select PRACH analysis measurement.

*RST: EVM

Example:

```
//Select a measurement
CONF:MEAS EVM
```

Manual operation: See ["EVM"](#) on page 19
 See ["PRACH Analysis"](#) on page 20
 See ["Channel Power ACLR"](#) on page 20
 See ["SEM"](#) on page 20
 See ["Adjacent Channel Leakage Ratio \(ACLR\)"](#) on page 47
 See ["Spectrum Emission Mask \(SEM\)"](#) on page 48
 See ["Select Measurement"](#) on page 57

FORMat:DEXPort:FORMat <FileFormat>

Determines the format of the ASCII file to be imported or exported. Depending on the external program that creates the data file or evaluates it, a comma-separated list (CSV) or a plain data format (DAT) file is required.

Parameters:

<FileFormat> CSV | DAT
 *RST: DAT

Example: FORM:DEXP:FORM CSV

Manual operation: See ["Data import and export"](#) on page 171

MMEMory:LOAD:IQ:STATe:ALL 1, <FileName>

Restores the captured I/Q data of all measurements in a combined measurement sequence to a file.

The file extension is *.iq.tar.

Parameters:

1 Fixed value.
 <FileName> String containing the path and name of the target file.

Example: //Import I/Q data
 MMEM:LOAD:IQ:STAT:ALL 1, 'C:
 \R_S\Instr\user\data.iq.tar'

Manual operation: See ["Data import and export"](#) on page 171

MMEMory:STORe<n>:IQ:STATe <Value>,<FileName>

Saves I/Q data to a file.

Suffix:

<n> irrelevant

Parameters:

<Value> 1
 <FileName> String containing the path and name of the target file.

Example: `MMEM:STOR:IQ:STAT 'C:
 \R_S\Instr\user\data.iq.tar'`
 Saves I/Q data to the specified file.

Manual operation: See ["Data import and export"](#) on page 171

MMEMory:STORe<n>:IQ:STATe:ALL 1, <FileName>

Writes the captured I/Q data of all measurements in a combined measurement sequence to a file.

The file extension is *.iq.tar. By default, the contents of the file are in 32-bit floating point format.

Suffix:
 <n> irrelevant

Parameters:
 1 Fixed value.

<FileName> String containing the path and name of the target file.

Example: `//Export I/Q data
 MMEM:STOR:IQ:STAT:ALL 1, 'C:
 \R_S\Instr\user\data.iq.tar'`

Manual operation: See ["Data import and export"](#) on page 171

MMEMory:STORe<n>:IQNC:STATe 1, <FileName>

Exports the I/Q data for a single PPDU with the analyzer noise removed to a file.

Prerequisites for this command:

- Turn on I/Q noise cancellation.
 (See [\[SENSe:\]ADJust:NCANcel:AVERage\[:STATe\]](#)).

Suffix:
 <n> irrelevant

Parameters:
 1

<FileName> String containing the path and name of the file.
 The file extension is .iq.tar.

Example: `//Export corrected I/Q data
 ADJ:NCAN:AVER ON
 MMEM:STOR:IQNC:STAT 1, 'c:\corrected_iqdata'`

Manual operation: See ["Data import and export"](#) on page 171

MMEMory:STORe<n>:MSERvice <FileName>

Exports the signal configuration to the microservice.

Suffix:

<n> irrelevant

Parameters:

<FileName> String containing the path and name of the file.
The file extension is .m5g.

Example:

```
//Export to microservice
MME:STOR:MSE: 'signal.xxx'
```

SYSTem:PRESet:CHANnel[:EXEC]

Restores the default instrument settings in the current channel.

Use `INST:SEL` to select the channel.

Example:

```
INST:SEL 'Spectrum2'
Selects the channel for "Spectrum2".
SYST:PRE:CHAN:EXEC
Restores the factory default settings to the "Spectrum2" channel.
```

Usage: Event

Manual operation: See "Preset Channel" on page 57

6.10.2 Automatic configuration

Commands to automatically configure measurements described elsewhere.

- `DISPlay[:WINDow<n>][:SUBWindow<w>]:TRACe<t>:Y[:SCALE]:AUTO`
on page 413

<code>[SENSe:]ADJust:CONFigure:LEVel:DURation</code>	280
<code>[SENSe:]ADJust:CONFigure:LEVel:DURation:MODE</code>	281
<code>[SENSe:]ADJust:DEMod</code>	281
<code>[SENSe:]ADJust:EVM</code>	281
<code>[SENSe:]ADJust:EVM:SLOTs</code>	282
<code>[SENSe:]ADJust:LEVel</code>	282
<code>CONFigure[:NR5G]:UL[:CC<cc>]:FRAMe<fr>:BWPart<bwp>:DETection</code>	282

[SENSe:]ADJust:CONFigure:LEVel:DURation <Duration>

To determine the ideal reference level, the FSW performs a measurement on the current input data. This command defines the length of the measurement if `[SENSe:]ADJust:CONFigure:LEVel:DURation:MODE` is set to `MANual`.

Parameters:

<Duration> Numeric value in seconds
Range: 0.001 to 16000.0
*RST: 0.001
Default unit: s

Example: ADJ:CONF:DUR:MODE MAN
 Selects manual definition of the measurement length.
 ADJ:CONF:LEV:DUR 5ms
 Length of the measurement is 5 ms.

Manual operation: See "Auto Level" on page 118

[SENSe:]ADJust:CONFigure:LEVel:DURation:MODE <Mode>

To determine the ideal reference level, the FSW performs a measurement on the current input data. This command selects the way the FSW determines the length of the measurement .

Parameters:

<Mode> **AUTO**
 The FSW determines the measurement length automatically according to the current input data.

MANual
 The FSW uses the measurement length defined by [SENSe:]ADJust:CONFigure:LEVel:DURation on page 280.

*RST: AUTO

Manual operation: See "Auto Level" on page 118

[SENSe:]ADJust:DEMod

Automatically demodulates the signal once.

For continuous automatic demodulation, use [CONFigure\[:NR5G\]:UL\[:CC<cc>\]:FRAMe<fr>:BWPart<bwp>:DETection](#) on page 282.

Usage: Event

[SENSe:]ADJust:EVM

Adjusts the amplitude settings, including attenuator and preamplifier, to achieve the optimal EVM using the maximum dynamic range.

Note that this process can up to several minutes, depending on the number of component carriers you are measuring.

For the auto EVM routine, it is sufficient to send this command. It is not necessary to send [INITiate<n>\[:IMMediate\]](#).

Example: //Optimize EVM
 ADJ:EVM

Usage: Event

Manual operation: See "Auto EVM" on page 58

[SENSe:]ADJust:EVM:SLOTs <Slots>

Selects the number of slots to be used during the auto EVM routine.

Prerequisites for this command

- Select manual automatic measurement time mode (`[SENSe:]ADJust:CONFigure:LEVel:DURation:MODE`).
- Define an appropriate automatic measurement time (`[SENSe:]ADJust:CONFigure:LEVel:DURation` on page 280).

Parameters:

<Slots> *RST: 1

Example:

```
//Define number of slots for automatic EVM measurement
CONF:LEV:DUR:MODE MAN
ADJ:EVM:SLOT 2
```

Manual operation: See ["Auto EVM"](#) on page 58

[SENSe:]ADJust:LEVel

Adjusts the level settings, including attenuator and preamplifier, to achieve the best dynamic range.

Compared to `[SENSe:]ADJust:EVM` on page 281, which achieves the best amplitude settings to optimize the EVM, you can use this command for a quick determination of preliminary amplitude settings.

Example: //Adjust level settings
ADJ:LEV

Usage: Event

Manual operation: See ["Auto Level"](#) on page 58
See ["Auto Level"](#) on page 118

CONFigure[:NR5G]:UL[:CC<cc>]:FRAMe<fr>:BWPart<bwp>:DETection <State>

Turns automatic signal demodulation on and off.

Suffix:

<cc> irrelevant
<fr> irrelevant
<bwp> irrelevant

Parameters:

<State> **AUTO**
Automatic signal detection = on.
MANual
Automatic signal detection = off.
*RST: MANual

Example: //Turn on automatic signal detection
CONF:UL:FRAM:BWP:DET ON

Manual operation: See "[Automatic Signal Demodulation](#)" on page 59

6.10.3 Physical settings

CONFigure[:NR5G]:LDIRrection.....	283
CONFigure[:NR5G]:OBANd.....	283
CONFigure[:NR5G]:UL[:CC<cc>]:BW.....	284
CONFigure[:NR5G]:UL[:CC<cc>]:DFRange.....	284
CONFigure[:NR5G]:UL[:CC<cc>]:PLC:CID.....	285
CONFigure[:NR5G]:UL[:CC<cc>]:PLC:DETction.....	285
CONFigure[:NR5G]:UL[:CC<cc>]:PLC:PCLass.....	286
FETCh[:CC<cc>]:PLC:CID?.....	286
MMEMory:LOAD:TMODeI[:CC<cc>].....	286
MMEMory:LOAD:DEModsetting:ALL.....	287
MMEMory:LOAD:DEModsetting[:CC<cc>].....	287
MMEMory:STORe<n>:DEModsetting:ALL.....	287
MMEMory:STORe<n>:DEModsetting[:CC<cc>].....	288

CONFigure[:NR5G]:LDIRrection <Mode>

Selects the link direction you want to analyze.

Parameters:

<Mode>

DL

Selects the downlink application to analyze 5G NR downlink signals.

Requires option FSW-K144.

UL

Selects the uplink application to analyze 5G NR uplink signals.

Requires option FSW-K145.

Example: //Select uplink application
CONF:LDIR UL

Manual operation: See "[Selecting the 5G NR mode](#)" on page 60

CONFigure[:NR5G]:OBANd <OperatingBand>

Selects the operating band.

Prerequisites for this command

- Select at least 2 component carriers ([CONFigure\[:NR5G\]:NOCC](#) on page 291).

Parameters:

<OperatingBand> N1 | N2 | N3 | N5 | N7 | N8 | N12 | N13 | N14 | N18 | N20 | N24 |
 N25 | N26 | N28 | N29 | N30 | N34 | N38 | N39 | N40 | N41 |
 N46 | N48 | N50 | N51 | N53 | N65 | N66 | N67 | N70 | N71 |
 N74 | N75 | N76 | N77 | N78 | N79 | N80 | N81 | N82 | N83 |
 N84 | N85 | N86 | N89 | N90 | N91 | N92 | N93 | N94 | N95 |
 N96 | N97 | N98 | N99 | N100 | N101 | N102 | N257 | N258 |
 N259 | N260 | N261 | N262 | N263
 *RST: n1

Example:

```
//Select operating band
CONF:NOCC 2
CONF:OBAN N20
```

Manual operation: See ["Operating Band"](#) on page 61

CONFigure[:NR5G]:UL[:CC<cc>]:BW <Bandwidth>

Selects the channel bandwidth of the 5G NR carrier.

Suffix:

<cc> [Component Carrier](#)

Parameters:

<Bandwidth> BW3 | BW5 | BW10 | BW15 | BW20 | BW25 | BW30 | BW35 |
 BW40 | BW45 | BW50 | BW60 | BW70 | BW80 | BW90 | BW100 |
 BW200 | BW400 | BW800 | BW1600 | BW2000
 *RST: BW100

Example:

```
//Select carrier bandwidth
CONF:UL:BW BW20
```

Manual operation: See ["Physical settings of the signal"](#) on page 61
 See ["Bandwidth configuration"](#) on page 66

CONFigure[:NR5G]:UL[:CC<cc>]:DFRange <Deployment>

Selects the deployment frequency range of the signal.

Suffix:

<cc> [Component Carrier](#)

Parameters:

<Deployment> **LOW**
 Deployment in FR1 ≤ 3 GHz.
MIDDLE
 Deployment in FR1 > 3 GHz.
HIGH
 Deployment in FR2-1.
EHIGH
 Deployment in FR2-2.

*RST: MIDDLE

Example: //Select frequency range of signal
CONF:UL:DFR LOW

Manual operation: See ["Deployment Frequency Range"](#) on page 61

CONFigure[:NR5G]:UL[:CC<cc>]:PLC:CID <CellID>

Defines the cell ID.

Suffix:
<cc> [Component Carrier](#)

Parameters:
<CellID> **AUTO**
Automatically determines the cell ID.
<numeric value> (integer only)
Number of the cell ID.
Range: 0 to 503

Example: //Define cell ID
CONF:UL:CC2:PLC:CID 12

Manual operation: See ["Physical settings of the signal"](#) on page 61

CONFigure[:NR5G]:UL[:CC<cc>]:PLC:DETection <Detection>

Turns automatic detection of the cell ID on and off.

Prerequisites for this command

- Turn on auto demodulation ([CONFigure\[:NR5G\]:UL\[:CC<cc>\]:FRAMe<fr>:BWPart<bwp>:DETection](#)).
- Turn on transform precoding ([CONFigure\[:NR5G\]:UL\[:CC<cc>\]:TPReCoding](#)).

Suffix:
<cc> [Component Carrier](#)

Parameters:
<Detection> **AUTO**
Auto detection of cell ID.
MANual
Manual entry of cell ID ([CONFigure\[:NR5G\]:UL\[:CC<cc>\]:PLC:CID](#)).

Example: //Turn on auto cell ID detection
CONF:UL:FRAM:BWP:DET ON
CONF:UL:TPR ON
CONF:UL:PLC:DET ON

Manual operation: See ["Physical settings of the signal"](#) on page 61

CONFigure[:NR5G]:UL[:CC<cc>]:PLC:PCLass <PowerClass>

Selects the power class to select the appropriate inband emission limits.

Prerequisites for this command

- Select FR2 deployment (`CONFigure[:NR5G]:UL[:CC<cc>]:DFRange`).

Suffix:

<cc> [Component Carrier](#)

Parameters:

<Power Class> PC1 | PC2 | PC3 | PC4
*RST: PC1

Example:

```
//Select power class
CONF:UL:DFR HIGH
CONF:UL:PLC:PCL PC2
```

Manual operation: See "[Physical settings of the signal](#)" on page 61

FETCh[:CC<cc>]:PLC:CID?

Queries the cell ID.

Suffix:

<cc> [Component Carrier](#)

Return values:

<CellID> <numeric value> (interger only)

Example:

```
//Query cell ID
FETC:PLC:CID?
```

Usage:

Query only

MMEMory:LOAD:TMODeI[:CC<cc>] <TestModel>

Loads an test model (NR-FR-TM) as defined by 3GPP (38.141-1 / -2).

You can also select an O-RAN test case with the command.

Suffix:

<cc> [Component Carrier](#)

Parameters:

<TestModel> String containing the name of the test model (file name).
Alternatively, a string that contains the name of the O-RAN test case, e.g. 'ORAN-FR1-TC32311__FDD_5MHZ_15KHZ'.

Example:

```
//Select test model
:MMEM:LOAD:TMOD:CC1
'NR-FR1-TM1_1__FDD_5MHZ_15KHZ'
```

Example: //Select O-RAN test case
 MMEM:LOAD:TMOD:DL
 'ORAN-FR1-TC32311__FDD_5MHZ_15KHZ'

Manual operation: See ["ORAN test cases"](#) on page 62

MMEMory:LOAD:DEModsetting:ALL <FileName>

Restores the signal description of multiple carriers from a single file.

Parameters:

<FileName> String containing the path and name of the file.
 The file extension is .ccallocation.

Example: //Restore signal description for multiple carriers in a single files
 CONF:NOCC 2
 MMEM:LOAD:DEM:ALL 'c:\TestSignal.ccallocation'

Manual operation: See ["Test scenarios for carrier aggregation"](#) on page 63

MMEMory:LOAD:DEModsetting[:CC<cc>] <FileName>[, <Item>, <Item>, <Item>, <Item>, <Item>]

Restores the signal description.

Suffix:

<cc> [Component Carrier](#)

Parameters:

<FileName> String containing the path and name of the file.
 The file extension is .allocation.

<Item> Not supported

Example: //Restore signal description for a single component carrier
 MMEM:LOAD:DEM 'c:\TestSignal.allocation'

Example: //Restore signal description for multiple carriers in individual files
 CONF:NOCC 2
 MMEM:LOAD:DEM:CC1 'c:\TestSignalCC1.allocation'
 MMEM:LOAD:DEM:CC2 'c:\TestSignalCC2.allocation'

Manual operation: See ["User defined test scenarios"](#) on page 63

MMEMory:STORe<n>:DEModsetting:ALL <FileName>

Saves the signal description of multiple carriers in a single file.

Suffix:

<n> irrelevant

Parameters:

<FileName> String containing the path and name of the file.
 The file extension is .ccallocation.

Example: //Save signal description for multiple carriers in a single files
 CONF:NOCC 2
 MMEM:STOR:DEM:ALL 'c:\TestSignal.ccallocation'

Manual operation: See ["Test scenarios for carrier aggregation"](#) on page 63

MMEMory:STORe<n>:DEModsetting[:CC<cc>] <FileName>

Saves the signal description.

Suffix:

<n> irrelevant

<cc> [Component Carrier](#)

Parameters:

<FileName> String containing the path and name of the file.
 The file extension is .allocation.

Example: //Save signal description for a single component carrier
 MMEM:STOR:DEM 'c:\TestSignal.allocation'

Example: //Save signal description for multiple carriers in individual files
 CONF:NOCC 2
 MMEM:STOR:DEM:CC1 'c:\TestSignalCC1.allocation'
 MMEM:STOR:DEM:CC2 'c:\TestSignalCC2.allocation'

Manual operation: See ["User defined test scenarios"](#) on page 63

6.10.4 Component carrier configuration

Commands to configure component carrier described elsewhere.

- [SENSe:]FREQuency:CENTer[:CC<cc>]
- [SENSe:]FREQuency:CENTer[:CC<cc>]:OFFSet
- CONFigure[:NR5G]:UL[:CC<cc>]:BW

CONFigure[:NR5G]:CENTer.....	289
CONFigure[:NR5G]:CRASter.....	289
CONFigure[:NR5G]:CSPacing.....	289
CONFigure[:NR5G]:CSCapture.....	290
CONFigure[:NR5G]:FCOFFset.....	290
CONFigure[:NR5G]:GMCFreq.....	290
CONFigure[:NR5G]:NCSPacing.....	290
CONFigure[:NR5G]:NOCC.....	291
CONFigure[:NR5G]:OMODe.....	291
CONFigure[:NR5G]:OREL.....	292
[SENSe:]FREQuency:CENTer[:CC<cc>]:MCOFFset.....	292

CONFigure[:NR5G]:CENTer

Synchronizes the global multicarrier frequency to the current center frequency (= center of all carriers).

Use `CONFigure[:NR5G]:GMCFreq` to query the global multicarrier frequency.

Example:

```
//Synchronize global multicarrier frequency
CONF:CENT
//Query global MC frequency
CONF:GMCF?
```

Usage: Event

Manual operation: See "[Center frequency configuration](#)" on page 68

CONFigure[:NR5G]:CRASter <Bandwidth>

Selects the channel raster of a component carrier.

Prerequisites for this command

- Select an operating band that supports different channel raster (`CONFigure[:NR5G]:OBANd`).
For all other operating bands, the command works as a query only.

Parameters:

<Bandwidth>

C15
15 kHz channel raster

C15
100 kHz channel raster

Example:

```
//Select channel raster
CONF:OBAN N90
CONF:CRAS C100
```

Manual operation: See "[Channel Raster](#)" on page 66

CONFigure[:NR5G]:CSPacing <Frequency>

Defines the carrier spacing for equidistant frequency offsets in a multicarrier setup. This frequency offset applies to all component carriers in the setup.

Prerequisites for this command

- Select equidistant frequency offset (`CONFigure[:NR5G]:OMODe`).

Parameters:

<Frequency>

*RST: 0
Default unit: Hz

Example:

```
//Define carrier spacing
CONF:OMOD EQU
CONF:CSP 500MHZ
```

Manual operation: See "[Frequency offset configuration](#)" on page 68

CONFigure[:NR5G]:CSCapture <Mode>

Selects the capture mode for measurements on multiple component carriers.

Parameters:

<Mode>

AUTO

Automatically selects the number of component carriers that can be analyzed in a single capture. If there are more carriers than can be analyzed in a single measurement, the other carriers are analyzed in subsequent measurements.

SINGLE

Capture each component carrier subsequently in individual measurements.

*RST: AUTO

Example:

```
//Select component carrier capture mode
CONF:CSC AUTO
```

Manual operation: See "[Component carrier data capture](#)" on page 64

CONFigure[:NR5G]:FCOOffset <State>

Turns a fixed frequency offset for component carriers on and off.

Parameters:

<State>

ON | OFF | 1 | 0

*RST: OFF

Example:

```
//Turn on fixed frequency offset
CONF:FCOF ON
```

Manual operation: See "[Frequency offset configuration](#)" on page 68

CONFigure[:NR5G]:GMCFreq <Frequency>

Defines the global multicarrier frequency for component carrier setups.

Parameters:

<Frequency>

Default unit: Hz

Example:

```
//Define global MC frequency
CONF:GMCF 950MHZ
```

Manual operation: See "[Center frequency configuration](#)" on page 68

CONFigure[:NR5G]:NCSPacing

Resets the channel spacing of component carriers to its default value.

Example:

```
//Reset channel spacing
CONF:NCSP
```

Usage:

Event

Manual operation: See ["Nominal Channel Spacing"](#) on page 67

CONFigure[:NR5G]:NOCC <Carrier>

Selects the number of component carriers analyzed in the measurement.

Parameters:

<Carrier> Number of the component carriers that you would like to measure. The range depends on the measurement. For more information see [Chapter 4.1.5, "Component carrier configuration"](#), on page 63.

*RST: 1

Example: //Select number of component carriers
CONF:NOCC 2

Manual operation: See ["Number of component carriers"](#) on page 64

CONFigure[:NR5G]:OMODe <Mode>

Selects the frequency offset mode for component carriers in a multicarrier setup.

Parameters:

<Mode>

ARbitrary

Distance between component carriers is arbitrary. You can define the frequency offsets with [\[SENSe:\]FREQuency:CENTer\[:CC<cc>\]:OFFSet](#).

EQUidistant

Component carriers have the same distance between each other.

You can define the spacing between carriers with [CONFigure\[:NR5G\]:CSPacing](#).

*RST: ARB

Example: //Select arbitrary frequency offsets relative to CC1
CONF:OREL CC1
CONF:OMOD ARB
FREQ:CENT:CC2:OFFS 200MHZ
FREQ:CENT:CC3:OFFS 300MHZ
FREQ:CENT:CC4:OFFS 800MHZ

Example: //Select equidistant frequency offsets relative to CC1
CONF:OREL CC1
CONF:OMOD EQU
CONF:CSP 200MHZ

Manual operation: See ["Frequency offset configuration"](#) on page 68

CONFigure[:NR5G]:OREL <Reference>

Selects the reference point for frequency offsets of component carriers in a multicarrier setup.

Parameters:

<Reference>

CC1

Reference point is the center frequency of first component carrier.

GMCFreq

Reference point the global multicarrier frequency.

*RST: CC1

Example:

```
//Select reference point for frequency offsets
CONF:OREL GMCF
```

Manual operation: See "[Frequency offset configuration](#)" on page 68

[SENSe:]FREQuency:CENTer[:CC<cc>]:MCOFfset <Offset>

Defines the frequency offset of a component carrier.

Prerequisites for this command

- Select the global MC frequency as the reference point for the frequency offset ([CONFigure\[:NR5G\]:OREL](#)).

Suffix:

<cc>

[Component Carrier](#)**Parameters:**

<Offset>

<numeric value>

- Component carrier offset: frequency offset relative to the first component carrier in Hz.

Default unit: Hz

Example:

```
//Define a frequency offset of 15 MHz for the second component
carrier relative to the first component carrier.
CONF:OREL GMCF
FREQ:CENT:CC2:OFFS 150MHZ
```

Manual operation: See "[Frequency configuration](#)" on page 65

6.10.5 General radio frame configuration

CONFigure[:NR5G]:UL[:CC<cc>]:FRAMe<fr>:COPY	293
CONFigure[:NR5G]:UL[:CC<cc>]:FRAMe<fr>:PASTe:ALL	293
CONFigure[:NR5G]:UL[:CC<cc>]:FRAMe<fr>:PASTe[:FRAMe]	293
CONFigure[:NR5G]:UL[:CC<cc>]:FTConfig	294

CONFigure[:NR5G]:UL[:CC<cc>]:FRAMe<fr>:COPY

Copies a frame configuration.

Suffix:

<cc>	Component carrier
<fr>	1..n Frame

Example: //Copy configuration of frame 3
CONF:UL:CC2:FRAM3:COPY

Usage: Event

Manual operation: See "[Frame Configuration Management](#)" on page 72

CONFigure[:NR5G]:UL[:CC<cc>]:FRAMe<fr>:PASTe:ALL

Applies an existing frame configuration to all other frames.

Prerequisites for this command

- Copy a frame configuration ([CONFigure\[:NR5G\]:UL\[:CC<cc>\]:FRAMe<fr>:COPY](#) on page 293).

Suffix:

<cc>	Component carrier
<fr>	1..n irrelevant

Example: //Copy configuration of frame 3
CONF:UL:CC2:FRAM3:COPY
//Apply configuration to all other frames
CONF:UL:CC2:FRAM:PAST:ALL

Usage: Event

Manual operation: See "[Frame Configuration Management](#)" on page 72

CONFigure[:NR5G]:UL[:CC<cc>]:FRAMe<fr>:PASTe[:FRAMe]

Applies an existing frame configuration to another one.

Prerequisites for this command

- Copy a frame configuration ([CONFigure\[:NR5G\]:UL\[:CC<cc>\]:FRAMe<fr>:COPY](#) on page 293).

Suffix:

<cc>	Component carrier
<fr>	1..n Frame

Example: //Copy configuration of frame 3
 CONF:UL:CC2:FRAM3:COPY
 //Apply configuration to frame 4
 CONF:UL:CC2:FRAM4:PAST

Usage: Event

Manual operation: See "[Frame Configuration Management](#)" on page 72

CONFigure[:NR5G]:UL[:CC<cc>]:FTConfig <Frames>

Defines the number of configurable frames.

Suffix:

<cc> [Component Carrier](#)

Parameters:

<Frames> <numeric value> (integer only)

*RST: 1

Example: //Define number of configurable frames
 CONF:UL:CC2:FTC 2

Manual operation: See "[Frame Configuration](#)" on page 70

6.10.6 Bandwidth part configuration

CONFigure[:NR5G]:UL[:CC<cc>]:FRAMe<fr>:BWPart<bwp>:ADD	294
CONFigure[:NR5G]:UL[:CC<cc>]:FRAMe<fr>:BWPart<bwp>:CLEar	295
CONFigure[:NR5G]:UL[:CC<cc>]:FRAMe<fr>:BWPart<bwp>:DUPLicate	295
CONFigure[:NR5G]:UL[:CC<cc>]:FRAMe<fr>:BWPart<bwp>:RBCount	295
CONFigure[:NR5G]:UL[:CC<cc>]:FRAMe<fr>:BWPart<bwp>:RBOffset	296
CONFigure[:NR5G]:UL[:CC<cc>]:FRAMe<fr>:BWPart<bwp>:REMOve	296
CONFigure[:NR5G]:UL[:CC<cc>]:FRAMe<fr>:BWPart<bwp>:SSPacing	296
CONFigure[:NR5G]:UL[:CC<cc>]:FRAMe<fr>:BWPCount?	297

CONFigure[:NR5G]:UL[:CC<cc>]:FRAMe<fr>:BWPart<bwp>:ADD

Adds a bandwidth part to the signal configuration.

The new bandwidth part has the highest index number. Index numbers start at 0. For example, if you already have three bandwidth parts and add a fourth one, the new one has the index number 3.

Suffix:

<cc> [Component Carrier](#)

<fr> irrelevant

<bwp> irrelevant

Example: //Add a bandwidth part
 CONF:UL:CC2:FRAM:BWPart:ADD

Usage: Event

Manual operation: See "[BWP Configuration Tools](#)" on page 74

CONFigure[:NR5G]:UL[:CC<cc>]:FRAMe<fr>:BWPart<bwp>:CLEar

Deletes all bandwidth parts.

Suffix:

<cc> [Component Carrier](#)

<fr> irrelevant

<bwp> irrelevant

Example: //Delete all bandwidth parts
CONF : UL : CC2 : FRAM : BWP : CLE

Usage: Event

Manual operation: See "[BWP Configuration Tools](#)" on page 74

CONFigure[:NR5G]:UL[:CC<cc>]:FRAMe<fr>:BWPart<bwp>:DUPLicate

Duplicates an existing bandwidth part.

A duplication of a bandwidth part also duplicates its slot and PDSCH configuration.

Suffix:

<cc> [Component Carrier](#)

<fr> irrelevant

<bwp> [Bandwidth part](#)

Example: //Duplicate a bandwidth part
CONF : UL : CC2 : FRAM : BWP2 : DUPL

Usage: Event

Manual operation: See "[BWP Configuration Tools](#)" on page 74

CONFigure[:NR5G]:UL[:CC<cc>]:FRAMe<fr>:BWPart<bwp>:RBCount <ResourceBlocks>

Defines the number of physical resource blocks a bandwidth part occupies.

Suffix:

<cc> [Component Carrier](#)

<fr> irrelevant

<bwp> [Bandwidth part](#)

Parameters:

<ResourceBlocks> <numeric value> (integer only)

*RST: 10

Example: //Define number of PRB for a BWP
 CONF:UL:CC2:FRAM:BWP2:RBC 20

Manual operation: See "[# RBs](#)" on page 76

CONFigure[:NR5G]:UL[:CC<cc>]:FRAMe<fr>:BWPart<bwp>:RBOffset <Offset>

Defines a resource block offset for a bandwidth part.

Suffix:

<cc> [Component Carrier](#)

<fr> irrelevant

<bwp> [Bandwidth part](#)

Parameters:

<Offset> <numeric value> (integer only)

*RST: 0

Example: //Define resource block offset for BWP
 CONF:UL:CC2:FRAM:BWP2:RBOF 6

Manual operation: See "[RB Offset](#)" on page 76

CONFigure[:NR5G]:UL[:CC<cc>]:FRAMe<fr>:BWPart<bwp>:REMOve

Deletes a bandwidth part.

Suffix:

<cc> [Component Carrier](#)

<fr> irrelevant

<bwp> [Bandwidth part](#)

Example: //Remove a bandwidth part
 CONF:UL:CC2:FRAM:BWP2:REM

Usage: Event

Manual operation: See "[BWP Configuration Tools](#)" on page 74

**CONFigure[:NR5G]:UL[:CC<cc>]:FRAMe<fr>:BWPart<bwp>:SSPacing
 <SubcarrierSpacing>**

Selects the subcarrier spacing of a bandwidth part.

Suffix:

<cc> [Component Carrier](#)

<fr> irrelevant

<bwp> [Bandwidth part](#)

Parameters:

<SubcarrierSpacing> **SS15**
15 kHz subcarrier spacing.
Only for signal deployment in FR1.

SS30
30 kHz subcarrier spacing.
Only for signal deployment in FR1.

SS60
60 kHz subcarrier spacing with normal cyclic prefix.
For all signal deployments.

SS120
120 kHz subcarrier spacing.
Only for signal deployment in FR2.

SS480
480 kHz subcarrier spacing.
Only for signal deployment in FR2-2.

SS960
960 kHz subcarrier spacing.
Only for signal deployment in FR2-2 and a 2000 MHz bandwidth.

X60
60 kHz subcarrier spacing with extended cyclic prefix.
For all signal deployments.

Example:

```
//Select BWP subcarrier spacing
CONF:UL:DFR LOW
CONF:UL:FRAM:BWP2:SSP SS30
```

Manual operation: See "[Subcarrier Spacing \(user data\)](#)" on page 75

CONFigure[:NR5G]:UL[:CC<cc>]:FRAMe<fr>:BWPCount?

Queries the number of analyzed bandwidth parts.

Suffix:

<cc> [Component Carrier](#)

<fr> irrelevant

Return values:

<BWPs> <numeric value> (integer)

Example:

```
//Query number of bandwidth parts
CONF:UL:FRAM:BWPC?
```

Usage: Query only

6.10.7 Slot configuration

CONFigure[:NR5G]:UL[:CC<cc>]:FRAMe<fr>:BWPart<bwp>:CSLot.....	298
CONFigure[:NR5G]:UL[:CC<cc>]:FRAMe<fr>:BWPart<bwp>:SCOunt?.....	298
CONFigure[:NR5G]:UL[:CC<cc>]:FRAMe<fr>:BWPart<bwp>:SLOT<sl>:ATYPe.....	299
CONFigure[:NR5G]:UL[:CC<cc>]:FRAMe<fr>:BWPart<bwp>:SLOT<sl>:COPY.....	299
CONFigure[:NR5G]:UL[:CC<cc>]:FRAMe<fr>:BWPart<bwp>:SLOT<sl>:FORMat.....	299
CONFigure[:NR5G]:UL[:CC<cc>]:FRAMe<fr>:BWPart<bwp>:SLOT<sl>:PASTe:ALL.....	300
CONFigure[:NR5G]:UL[:CC<cc>]:FRAMe<fr>:BWPart<bwp>:SLOT<sl>:PASTe:TO: DURation.....	300
CONFigure[:NR5G]:UL[:CC<cc>]:FRAMe<fr>:BWPart<bwp>:SLOT<sl>:PASTe:TO:MODE...	301
CONFigure[:NR5G]:UL[:CC<cc>]:FRAMe<fr>:BWPart<bwp>:SLOT<sl>:PASTe:TO.....	302
CONFigure[:NR5G]:UL[:CC<cc>]:FRAMe<fr>:BWPart<bwp>:SLOT<sl>:PASTe:TO:PERiod..	303
CONFigure[:NR5G]:UL[:CC<cc>]:FRAMe<fr>:BWPart<bwp>:SLOT<sl>:PASTe:TO:SLOTs...	303
CONFigure[:NR5G]:UL[:CC<cc>]:FRAMe<fr>:BWPart<bwp>:SLOT<sl>:PASTe[:SLOT].....	304
CONFigure[:NR5G]:UL[:CC<cc>]:FRAMe<fr>:BWPart<bwp>:SLOT<sl>:PRESet.....	304

CONFigure[:NR5G]:UL[:CC<cc>]:FRAMe<fr>:BWPart<bwp>:CSLot <Slots>

Defines the number of slots that you can configure.

Suffix:

<cc>	Component Carrier
<fr>	Frame
<bwp>	Bandwidth part

Parameters:

<Slots>	<numeric value> (integer only)
	The maximum number of configurable slots depends on the sub-carrier spacing in the bandwidth part.
*RST:	1

Example: //Select number of custom slots
CONF : UL : CC2 : FRAM3 : BWP2 : CSL 2

Manual operation: See "Number of Configurable Slots" on page 78

CONFigure[:NR5G]:UL[:CC<cc>]:FRAMe<fr>:BWPart<bwp>:SCOunt?

Queries the number of analyzed slots.

Suffix:

<cc>	Component Carrier
<fr>	Frame
<bwp>	Bandwidth part

Return values:

<Slots>	<numeric value> (integer)
---------	---------------------------

Example: //Query number of analyzed slots
CONF:UL:CC2:FRAM3:BWP2:SCO?

Usage: Query only

CONFigure[:NR5G]:UL[:CC<cc>]:FRAMe<fr>:BWPart<bwp>:SLOT<sl>:ATYPe
<SlotAllocation>

Selects the allocation type of a slot.

Suffix:

<cc> [Component Carrier](#)

<fr> [Frame](#)

<bwp> [Bandwidth part](#)

<sl> [Slot](#)

Parameters:

<SlotAllocation> **DATA**
Slot contains information.

UNUSed
Slot contains no information.

*RST: DATA

Example: //Select slot allocation
CONF:UL:CC2:FRAM3:BWP2:SLOT4:ATYP DATA

Manual operation: See "[Slot Allocation](#)" on page 80

CONFigure[:NR5G]:UL[:CC<cc>]:FRAMe<fr>:BWPart<bwp>:SLOT<sl>:COPY

Copies a slot configuration.

Suffix:

<cc> [Component Carrier](#)

<fr> [Frame](#)

<bwp> [Slot](#)

<sl> [Bandwidth part](#)

Example: //Copy configuration of a slot
CONF:UL:CC2:FRAM3:BWP2:SLOT4:COPY

Usage: Event

Manual operation: See "[Slot Configuration Tools](#)" on page 78

CONFigure[:NR5G]:UL[:CC<cc>]:FRAMe<fr>:BWPart<bwp>:SLOT<sl>:FORMat
<SlotFormat>

Selects the slot format for a slot.

Suffix:

<cc>	1..n Component Carrier
<fr>	1..n Frame
<bwp>	<100 Bandwidth part
<sl>	<3200 Slot

Parameters:

<SlotFormat>	<numeric value> (integer only)
	Range: 0 to 61
	*RST: 0

Example:

```
//Select a slot format
CONF:UL:CC2:FRAM3:BWP2:SLOT4:ATYP 6
```

Manual operation: See "Slot Format" on page 80

**CONFigure[:NR5G]:UL[:CC<cc>]:FRAMe<fr>:BWPART<bwp>:SLOT<sl>:PASTe:
ALL**

Applies an existing slot configuration to all other slots.

Prerequisites for this command

- Copy a slot configuration (`CONFigure[:NR5G]:UL[:CC<cc>]:FRAMe<fr>:
BWPART<bwp>:SLOT<sl>:COPY`).

Suffix:

<cc>	Component Carrier
<fr>	Frame
<bwp>	Bandwidth part
<sl>	Bandwidth part

Example:

```
//Copy configuration of slot 4
CONF:UL:CC2:FRAM3:BWP2:SLOT4:COPY
//Apply configuration to all other slots
CONF:UL:CC2:FRAM3:BWP2:SLOT:PAST:ALL
```

Usage: Event

Manual operation: See "Slot Configuration Tools" on page 78

**CONFigure[:NR5G]:UL[:CC<cc>]:FRAMe<fr>:BWPART<bwp>:SLOT<sl>:PASTe:
TO:DURATION <Value>**

Defines to which slots a slot configuration is copied to.

Prerequisites for this command

- A slot configuration is in the clipboard (`CONFigure[:NR5G]:UL[:CC<cc>]:FRAME<fr>:BWPpart<bwp>:SLOT<sl>:COPY`).
- Number of configurable slots > 1 (`CONFigure[:NR5G]:UL[:CC<cc>]:FRAME<fr>:BWPpart<bwp>:CSLot`).
- Select custom paste mode (`CONFigure[:NR5G]:UL[:CC<cc>]:FRAME<fr>:BWPpart<bwp>:SLOT<sl>:PASTE:TO:MODE`).

Suffix:

<cc>	Component Carrier
<fr>	Frame
<bwp>	Bandwidth part
<sl>	Bandwidth part

Parameters:

<Value>	The paste duration corresponds to a certain number of slots in a row.
*RST:	1

Example:

```
//Paste configuration of slot 0 to 2 slots in a row, every 3rd slot
(0,1,3,4,6,7,9,10,12)
CONF:UL:CC2:FRAM3:BWP2:CSL 12
CONF:UL:CC2:FRAM3:BWP2:SLOT0:COPY
CONF:UL:CC2:FRAM3:BWP2:SLOT0:PAST:TO:MODE CUST
CONF:UL:CC2:FRAM3:BWP2:SLOT0:PAST:TO:PER 3
CONF:UL:CC2:FRAM3:BWP2:SLOT0:PAST:TO:DUR 2
```

CONFigure[:NR5G]:UL[:CC<cc>]:FRAME<fr>:BWPpart<bwp>:SLOT<sl>:PASTE:TO:MODE <Mode>

Selects the paste logic when you copy a slot configuration to other slots.

Prerequisites for this command

- A slot configuration is in the clipboard (`CONFigure[:NR5G]:UL[:CC<cc>]:FRAME<fr>:BWPpart<bwp>:SLOT<sl>:COPY`).
- Number of configurable slots > 1 (`CONFigure[:NR5G]:UL[:CC<cc>]:FRAME<fr>:BWPpart<bwp>:CSLot`).

Suffix:

<cc>	Component Carrier
<fr>	Frame
<bwp>	Bandwidth part

<sl> [Bandwidth part](#)

Parameters:

<Mode>

CUSTom

Copies the slot configuration to specific set of slots according to the logic defined with:

- `CONFigure[:NR5G]:UL[:CC<cc>]:FRAMe<fr>:BWPart<bwp>:SLOT<sl>:PASTe:TO:PERiod`
- `CONFigure[:NR5G]:UL[:CC<cc>]:FRAMe<fr>:BWPart<bwp>:SLOT<sl>:PASTe:TO:DURation`

DATA

Copies the slot configuration to all data slots.

SLOTS

Copies the slot configuration to a specific set of slots.

UNUSed

Copies the slot configuration to all unused slots.

Example:

```
//Paste configuration of slot 0 to every DATA slot
CONF:UL:CC2:FRAM3:BWP2:CSL 12
CONF:UL:CC2:FRAM3:BWP2:SLOT0:COPY
CONF:UL:CC2:FRAM3:BWP2:SLOT0:PAST:TO:MODE DATA
```

CONFigure[:NR5G]:UL[:CC<cc>]:FRAMe<fr>:BWPart<bwp>:SLOT<sl>:PASTe:TO

Copies a slot configuration to other slots.

Prerequisites for this command

- A slot configuration is in the clipboard (`CONFigure[:NR5G]:UL[:CC<cc>]:FRAMe<fr>:BWPart<bwp>:SLOT<sl>:COPY`).
- Number of configurable slots > 1 (`CONFigure[:NR5G]:UL[:CC<cc>]:FRAMe<fr>:BWPart<bwp>:CSLot`).
- Select paste mode (`CONFigure[:NR5G]:UL[:CC<cc>]:FRAMe<fr>:BWPart<bwp>:SLOT<sl>:PASTe:TO:MODE`).

Suffix:

<cc> [Component Carrier](#)

<fr> [Frame](#)

<bwp> [Bandwidth part](#)

<sl> [Bandwidth part](#)

Example:

```
//Paste configuration of slot 0 to 2 slots in a row, every 3rd slot
(0,1,3,4,6,7,9,10,12)
CONF:UL:CC2:FRAM3:BWP2:CSL 12
CONF:UL:CC2:FRAM3:BWP2:SLOT0:COPY
CONF:UL:CC2:FRAM3:BWP2:SLOT0:PAST:TO:MODE CUST
CONF:UL:CC2:FRAM3:BWP2:SLOT0:PAST:TO:PER 3
CONF:UL:CC2:FRAM3:BWP2:SLOT0:PAST:TO:DUR 2
CONF:UL:CC2:FRAM3:BWP2:SLOT0:PAST:TO
```

Usage: Event

Manual operation: See "Slot Configuration Tools" on page 78

**CONFigure[:NR5G]:UL[:CC<cc>]:FRAMe<fr>:BWPart<bwp>:SLOT<sl>:PASTe:
TO:PERiod <Period>**

Defines to which slots a slot configuration is copied to.

Prerequisites for this command

- A slot configuration is in the clipboard (`CONFigure[:NR5G]:UL[:CC<cc>]:FRAMe<fr>:BWPart<bwp>:SLOT<sl>:COPY`).
- Number of configurable slots > 1 (`CONFigure[:NR5G]:UL[:CC<cc>]:FRAMe<fr>:BWPart<bwp>:CSLot`).
- Select custom paste mode (`CONFigure[:NR5G]:UL[:CC<cc>]:FRAMe<fr>:BWPart<bwp>:SLOT<sl>:PASTe:TO:MODE`).

Suffix:

<cc> Component Carrier

<fr> Frame

<bwp> Bandwidth part

<sl> Bandwidth part

Parameters:

<Period> The paste period corresponds to every nth slot.

*RST: 1

Example:

```
//Paste configuration of slot 0 to every 3rd slot (0,3,6,9,12)
CONF:UL:CC2:FRAM3:BWP2:CSL 12
CONF:UL:CC2:FRAM3:BWP2:SLOT0:COPY
CONF:UL:CC2:FRAM3:BWP2:SLOT0:PAST:TO:MODE CUST
CONF:UL:CC2:FRAM3:BWP2:SLOT0:PAST:TO:PER 3
```

**CONFigure[:NR5G]:UL[:CC<cc>]:FRAMe<fr>:BWPart<bwp>:SLOT<sl>:PASTe:
TO:SLOTs <Slot>**

Copies a slot configuration to a specific set of slots.

Prerequisites for this command

- Number of configurable slots > 1 (`CONFigure[:NR5G]:UL[:CC<cc>]:FRAMe<fr>:BWPart<bwp>:SLOT<sl>:COPY`).
- Select slot paste mode (`CONFigure[:NR5G]:UL[:CC<cc>]:FRAMe<fr>:BWPart<bwp>:SLOT<sl>:PASTe:TO:MODE`).

Suffix:

<cc> Component Carrier

<fr> Frame

<bwp> Bandwidth part

<sl> Slot

Parameters:

<Slot> String that contains a list of slots either as comma-separated list ("2,5,8"), a range ("3-5") or a combination of both ("2-5,8,10").

Example:

```
//Copy allocation configuration to several slots
CONF:UL:CC2:FRAM3:BWP2:CSL 12
CONF:UL:CC2:FRAM3:BWP2:SLOT0:PAST:TO:MODE SLOT
CONF:UL:CC2:FRAM3:BWP2:SLOT0:PAST:TO:SLOT
"3, 6, 9"
```

CONFigure[:NR5G]:UL[:CC<cc>]:FRAMe<fr>:BWPart<bwp>:SLOT<sl>:PASTe[:SLOT]

Applies an existing slot configuration to another one.

Prerequisites for this command

- Copy a slot configuration (**CONFigure[:NR5G]:UL[:CC<cc>]:FRAMe<fr>:BWPart<bwp>:SLOT<sl>:COPY**).

Suffix:

<cc> Component Carrier

<fr> Frame

<bwp> Bandwidth part

<sl> Bandwidth part

Example:

```
//Copy configuration of slot 4
CONF:UL:CC2:FRAM3:BWP2:SLOT4:COPY
//Apply configuration to slot 3
CONF:UL:CC2:FRAM3:BWP2:SLOT5:PAST
```

Usage: Event

Manual operation: See "Slot Configuration Tools" on page 78

CONFigure[:NR5G]:UL[:CC<cc>]:FRAMe<fr>:BWPart<bwp>:SLOT<sl>:PRESet

Resets the slot configuration of a bandwidth part to its default state.

Suffix:

<cc> Component Carrier

<fr> Frame

<bwp> Bandwidth part

<sl> irrelevant

Example:

```
//Reset the slot configuration
CONF:UL:CC2:FRAM3:BWP2:SLOT:PRESet
```

Usage: Event

Manual operation: See "Slot Configuration Tools" on page 78

6.10.8 SRS configuration

CONFigure[:NR5G]:UL[:CC<cc>]:FRAMe<fr>:BWPart<bwp>:SRS:FHOpping:BHOP.....	305
CONFigure[:NR5G]:UL[:CC<cc>]:FRAMe<fr>:BWPart<bwp>:SRS:FHOpping:BSRS.....	306
CONFigure[:NR5G]:UL[:CC<cc>]:FRAMe<fr>:BWPart<bwp>:SRS:FHOpping:CSRS.....	306
CONFigure[:NR5G]:UL[:CC<cc>]:FRAMe<fr>:BWPart<bwp>:SRS:FPOS.....	306
CONFigure[:NR5G]:UL[:CC<cc>]:FRAMe<fr>:BWPart<bwp>:SRS:FSHift.....	307
CONFigure[:NR5G]:UL[:CC<cc>]:FRAMe<fr>:BWPart<bwp>:SRS:NPORTs.....	307
CONFigure[:NR5G]:UL[:CC<cc>]:FRAMe<fr>:BWPart<bwp>:SRS:NSYMBOLs.....	308
CONFigure[:NR5G]:UL[:CC<cc>]:FRAMe<fr>:BWPart<bwp>:SRS:POWER.....	308
CONFigure[:NR5G]:UL[:CC<cc>]:FRAMe<fr>:BWPart<bwp>:SRS:RFACtor.....	309
CONFigure[:NR5G]:UL[:CC<cc>]:FRAMe<fr>:BWPart<bwp>:SRS:SEquence:CSHift.....	309
CONFigure[:NR5G]:UL[:CC<cc>]:FRAMe<fr>:BWPart<bwp>:SRS:SEquence:HOPping.....	310
CONFigure[:NR5G]:UL[:CC<cc>]:FRAMe<fr>:BWPart<bwp>:SRS:SEquence:ID.....	310
CONFigure[:NR5G]:UL[:CC<cc>]:FRAMe<fr>:BWPart<bwp>:SRS:SLOT:PERiodicity.....	311
CONFigure[:NR5G]:UL[:CC<cc>]:FRAMe<fr>:BWPart<bwp>:SRS:SLOT:POFFset.....	311
CONFigure[:NR5G]:UL[:CC<cc>]:FRAMe<fr>:BWPart<bwp>:SRS:SPOS.....	311
CONFigure[:NR5G]:UL[:CC<cc>]:FRAMe<fr>:BWPart<bwp>:SRS:STATe.....	312
CONFigure[:NR5G]:UL[:CC<cc>]:FRAMe<fr>:BWPart<bwp>:SRS:TCOMb:OFFSet.....	312
CONFigure[:NR5G]:UL[:CC<cc>]:FRAMe<fr>:BWPart<bwp>:SRS:TCOMb[:VALue].....	313

CONFigure[:NR5G]:UL[:CC<cc>]:FRAMe<fr>:BWPart<bwp>:SRS:FHOpping: BHOP <Value>

Defines the frequency hopping bandwidth of the sounding reference signal (B_{HOP}).

Prerequisites for this command

- Turn on SRS (CONFigure[:NR5G]:UL[:CC<cc>]:FRAMe<fr>:
BWPart<bwp>:SRS:STATe).

Suffix:

<cc>	Component Carrier
<fr>	Frame
<bwp>	Bandwidth part

Parameters:

<Value> *RST: 0

Example:

```
//Define B-Hop
CONF:UL:CC2:FRAM3:BWP2:SRS:STAT ON
CONF:UL:CC2:FRAM3:BWP2:SRS:FHOP:BHOP 2
```

Manual operation: See "Freq Hopping" on page 83

**CONFigure[:NR5G]:UL[:CC<cc>]:FRAMe<fr>:BWPart<bwp>:SRS:FHOPping:
BSRS <Value>**

Defines the bandwidth of the sounding reference signal (B_{SRS}).

Prerequisites for this command

- Turn on SRS (`CONFigure[:NR5G]:UL[:CC<cc>]:FRAMe<fr>:BWPart<bwp>:SRS:STATe`).

Suffix:

<cc> [Component Carrier](#)

<fr> [Frame](#)

<bwp> [Bandwidth part](#)

Parameters:

<Value> *RST: 0

Example:

```
//Define B-SRS
CONF:UL:CC2:FRAM3:BWP2:SRS:STAT ON
CONF:UL:CC2:FRAM3:BWP2:SRS:FHOP:BSRS 2
```

Manual operation: See "[Freq Hopping](#)" on page 83

**CONFigure[:NR5G]:UL[:CC<cc>]:FRAMe<fr>:BWPart<bwp>:SRS:FHOPping:
CSRS <Value>**

Defines the bandwidth of the sounding reference signal (B_{SRS}).

Prerequisites for this command

- Turn on SRS (`CONFigure[:NR5G]:UL[:CC<cc>]:FRAMe<fr>:BWPart<bwp>:SRS:STATe`).

Suffix:

<cc> [Component Carrier](#)

<fr> [Frame](#)

<bwp> [Bandwidth part](#)

Parameters:

<Value> *RST: 0

Example:

```
//Define C-SRS
CONF:UL:CC2:FRAM3:BWP2:SRS:STAT ON
CONF:UL:CC2:FRAM3:BWP2:SRS:FHOP:CSRS 2
```

Manual operation: See "[Freq Hopping](#)" on page 83

**CONFigure[:NR5G]:UL[:CC<cc>]:FRAMe<fr>:BWPart<bwp>:SRS:FPOS
<Position>**

Defines the starting position of the sounding reference signal in the frequency domain.

Prerequisites for this command

- Turn on SRS (`CONFigure[:NR5G]:UL[:CC<cc>]:FRAMe<fr>:BWPart<bwp>:SRS:STATe`).

Suffix:

<cc> [Component Carrier](#)

<fr> [Frame](#)

<bwp> [Bandwidth part](#)

Parameters:

<Position> *RST: 0

Example:

```
//Define frequency position
CONF:UL:CC2:FRAM3:BWP2:SRS:STAT ON
CONF:UL:CC2:FRAM3:BWP2:SRS:FPOS 5
```

Manual operation: See "[Freq Pos](#)" on page 83

CONFigure[:NR5G]:UL[:CC<cc>]:FRAMe<fr>:BWPart<bwp>:SRS:FSHift <Shift>

Defines a shift of the sounding reference signal in the frequency domain.

Prerequisites for this command

- Turn on SRS (`CONFigure[:NR5G]:UL[:CC<cc>]:FRAMe<fr>:BWPart<bwp>:SRS:STATe`).

Suffix:

<cc> [Component Carrier](#)

<fr> [Frame](#)

<bwp> [Bandwidth part](#)

Parameters:

<Shift> *RST: 0

Example:

```
//Define frequency shift
CONF:UL:CC2:FRAM3:BWP2:SRS:STAT ON
CONF:UL:CC2:FRAM3:BWP2:SRS:FSH 4
```

Manual operation: See "[Freq Shift](#)" on page 83

CONFigure[:NR5G]:UL[:CC<cc>]:FRAMe<fr>:BWPart<bwp>:SRS:NPORts <Ports>

Defines the number of antenna ports used by the sounding reference signal (1, 2 or 4).

Prerequisites for this command

- Turn on SRS (`CONFigure[:NR5G]:UL[:CC<cc>]:FRAMe<fr>:BWPart<bwp>:SRS:STATe`).

Suffix:

<cc> [Component Carrier](#)

<fr> [Frame](#)

<bwp> [Bandwidth part](#)

Parameters:

<Ports> *RST: 1

Example:

```
//Select number of antenna ports
CONF:UL:CC2:FRAM3:BWP2:SRS:STAT ON
CONF:UL:CC2:FRAM3:BWP2:SRS:NPOR 2
```

Manual operation: See ["No Ports"](#) on page 84

CONFigure[:NR5G]:UL[:CC<cc>]:FRAMe<fr>:BWPart<bwp>:SRS:NSYMBOLS
<Symbols>

Selects the number of OFDM symbols used by the sounding reference signal (1, 2 or 4).

Prerequisites for this command

- Turn on SRS ([CONFigure\[:NR5G\]:UL\[:CC<cc>\]:FRAMe<fr>:BWPart<bwp>:SRS:STATe](#)).

Suffix:

<cc> [Component Carrier](#)

<fr> [Frame](#)

<bwp> [Bandwidth part](#)

Parameters:

<Symbols> *RST: 1

Example:

```
//Select number of symbols
CONF:UL:CC2:FRAM3:BWP2:SRS:STAT ON
CONF:UL:CC2:FRAM3:BWP2:SRS:NSYM 2
```

Manual operation: See ["No. Sym"](#) on page 83

CONFigure[:NR5G]:UL[:CC<cc>]:FRAMe<fr>:BWPart<bwp>:SRS:POWER <Power>

Defines the relative power of the sounding reference signal.

Suffix:

<cc> [Component Carrier](#)

<fr> [Frame](#)

<bwp> [Bandwidth part](#)

Parameters:

<Power> *RST: 0
Default unit: dB

Example:

```
//Define relative power
CONF:UL:CC2:FRAM3:BWP2:SRS:STAT ON
CONF:UL:CC2:FRAM3:BWP2:SRS:POW 3DB
```

Manual operation: See ["Rel Power"](#) on page 84

CONFigure[:NR5G]:UL[:CC<cc>]:FRAMe<fr>:BWPart<bwp>:SRS:RFACtor
<Factor>

Defines the repetition factor of the sounding reference signal (1, 2 or 4).

Prerequisites for this command

- Turn on SRS (`CONFigure[:NR5G]:UL[:CC<cc>]:FRAMe<fr>:BWPart<bwp>:SRS:STATe`).

Suffix:

<cc> [Component Carrier](#)

<fr> [Frame](#)

<bwp> [Bandwidth part](#)

Parameters:

<Factor> *RST: 1

Example:

```
//Define repetition factor
CONF:UL:CC2:FRAM3:BWP2:SRS:STAT ON
CONF:UL:CC2:FRAM3:BWP2:SRS:RFAC 2
```

Manual operation: See "[Rep. Factor](#)" on page 83

CONFigure[:NR5G]:UL[:CC<cc>]:FRAMe<fr>:BWPart<bwp>:SRS:SEQUence:
CSHift <Shift>

Defines the cyclic shift of the sounding reference signal.

Prerequisites for this command

- Turn on SRS (`CONFigure[:NR5G]:UL[:CC<cc>]:FRAMe<fr>:BWPart<bwp>:SRS:STATe`).

Suffix:

<cc> [Component Carrier](#)

<fr> [Frame](#)

<bwp> [Bandwidth part](#)

Parameters:

<Shift> The value range depends on the selected transmission comb
(`CONFigure[:NR5G]:UL[:CC<cc>]:FRAMe<fr>:BWPart<bwp>:SRS:TComb[:VALue]`).

*RST: 0

Example:

```
//Define cyclic shift
CONF:UL:CC2:FRAM3:BWP2:SRS:STAT ON
CONF:UL:CC2:FRAM3:BWP2:SRS:SEQ:CSH 2
```

Manual operation: See "[Transmission Comb / Sequence Comb](#)" on page 83

**CONFigure[:NR5G]:UL[:CC<cc>]:FRAMe<fr>:BWPart<bwp>:SRS:SEQuence:
HOPPing <Hopping>**

Select the frequency hopping method for the sounding reference signal.

Prerequisites for this command

- Turn on SRS (`CONFigure[:NR5G]:UL[:CC<cc>]:FRAMe<fr>:
BWPart<bwp>:SRS:STATe`).

Suffix:

<cc> [Component Carrier](#)

<fr> [Frame](#)

<bwp> [Bandwidth part](#)

Parameters:

<Hopping> **GRoup**
Group hopping.

SEQuence
Sequence hopping.

NONE
No hopping.

*RST: NONE

Example:

```
//Select hopping type
CONF:UL:CC2:FRAM3:BWPart2:SRS:STAT ON
CONF:UL:CC2:FRAM3:BWPart2:SRS:SEQ:HOPP NONE
```

Manual operation: See "[Transmission Comb / Sequence Comb](#)" on page 83

**CONFigure[:NR5G]:UL[:CC<cc>]:FRAMe<fr>:BWPart<bwp>:SRS:SEQuence:ID
<Value>**

Defines the pseudo-random seed value for the SRS sequence generation.

Prerequisites for this command

- Turn on SRS (`CONFigure[:NR5G]:UL[:CC<cc>]:FRAMe<fr>:
BWPart<bwp>:SRS:STATe`).

Suffix:

<cc> [Component Carrier](#)

<fr> [Frame](#)

<bwp> [Bandwidth part](#)

Parameters:

<Value> *RST: 0

Example:

```
//Define B-Hop
CONF:UL:CC2:FRAM3:BWPart2:SRS:STAT ON
CONF:UL:CC2:FRAM3:BWPart2:SRS:SEQ:ID 2
```

Manual operation: See "[Transmission Comb / Sequence Comb](#)" on page 83

CONFigure[:NR5G]:UL[:CC<cc>]:FRAMe<fr>:BWPart<bwp>:SRS:SLOT:PERiodicity <Periodicity>

Defines the periodicity of the sounding reference signal.

Prerequisites for this command

- Turn on SRS (`CONFigure[:NR5G]:UL[:CC<cc>]:FRAMe<fr>:BWPart<bwp>:SRS:STATe`).

Suffix:

<cc> [Component Carrier](#)

<fr> [Frame](#)

<bwp> [Bandwidth part](#)

Parameters:

<Periodicity> SL1 | SL2 | SL4 | SL5 | SL8 | SL10

*RST: SL1

Example:

```
//Select periodicity
CONF:UL:CC2:FRAM3:BWP2:SRS:STAT ON
CONF:UL:CC2:FRAM3:BWP2:SRS:SLOT:PER SL4
```

Manual operation: See "[Slot Config](#)" on page 82

CONFigure[:NR5G]:UL[:CC<cc>]:FRAMe<fr>:BWPart<bwp>:SRS:SLOT:POFFset <Offset>

Selects the first slot the sounding reference signal appears in.

Prerequisites for this command

- Turn on SRS (`CONFigure[:NR5G]:UL[:CC<cc>]:FRAMe<fr>:BWPart<bwp>:SRS:STATe`).

Suffix:

<cc> [Component Carrier](#)

<fr> [Frame](#)

<bwp> [Bandwidth part](#)

Parameters:

<Offset> *RST: 0

Example:

```
//Select offset
CONF:UL:CC2:FRAM3:BWP2:SRS:STAT ON
CONF:UL:CC2:FRAM3:BWP2:SRS:SLOT:POFF 2
```

Manual operation: See "[Slot Config](#)" on page 82

CONFigure[:NR5G]:UL[:CC<cc>]:FRAMe<fr>:BWPart<bwp>:SRS:SPOS <Postion>

Defines the start position of the sounding reference signal in the time domain.

Prerequisites for this command

- Turn on SRS (`CONFigure[:NR5G]:UL[:CC<cc>]:FRAMe<fr>:BWPart<bwp>:SRS:STATe`).

Suffix:

<cc> [Component Carrier](#)
 <fr> [Frame](#)
 <bwp> [Bandwidth part](#)

Parameters:

<Position> *RST: 0

Example:

```
//Define start position
CONF:UL:CC2:FRAM3:BWP2:SRS:STAT ON
CONF:UL:CC2:FRAM3:BWP2:SRS:SPOS 4
```

Manual operation: See "[Start Pos](#)" on page 82

CONFigure[:NR5G]:UL[:CC<cc>]:FRAMe<fr>:BWPart<bwp>:SRS:STATe <State>

Turns the sounding reference signal on and off.

Suffix:

<cc> [Component Carrier](#)
 <fr> [Frame](#)
 <bwp> [Bandwidth part](#)

Parameters:

<State> ON | OFF | 1 | 0
 *RST: OFF

Example:

```
//Turn on sounding reference signal
CONF:UL:CC2:FRAM3:BWP2:SRS:STAT ON
```

Manual operation: See "[SRS State](#)" on page 82

CONFigure[:NR5G]:UL[:CC<cc>]:FRAMe<fr>:BWPart<bwp>:SRS:TCOMb:OFFSet <Offset>

Defines an offset for the transmission comb of the sounding reference signal.

Prerequisites for this command

- Turn on SRS (`CONFigure[:NR5G]:UL[:CC<cc>]:FRAMe<fr>:BWPart<bwp>:SRS:STATe`).

Suffix:

<cc> [Component Carrier](#)
 <fr> [Frame](#)
 <bwp> [Bandwidth part](#)

Parameters:

<Offset> The value range depends on the selected transmission comb
(CONFigure[:NR5G]:UL[:CC<cc>]:FRAMe<fr>:
BWPart<bwp>:SRS:TCOMb[:VALue] on page 313).

*RST: 0

Example:

```
//Define transmission comb offset
CONF:UL:CC2:FRAM3:BWP2:SRS:STAT ON
CONF:UL:CC2:FRAM3:BWP2:SRS:TCOM:OFFS 2
```

Manual operation: See "Transmission Comb / Sequence Comb" on page 83

CONFigure[:NR5G]:UL[:CC<cc>]:FRAMe<fr>:BWPart<bwp>:SRS:TCOMb[: VALue] <Value>

Selects the transmission comb for the sounding reference signal (2 or 4).

Prerequisites for this command

- Turn on SRS (CONFigure[:NR5G]:UL[:CC<cc>]:FRAMe<fr>:
BWPart<bwp>:SRS:STATe).

Suffix:

<cc> Component Carrier

<fr> Frame

<bwp> Bandwidth part

Parameters:

<Value> *RST: 2

Example:

```
//Select transmission comb
CONF:UL:CC2:FRAM3:BWP2:SRS:STAT ON
CONF:UL:CC2:FRAM3:BWP2:SRS:TCOM 2
```

Manual operation: See "Transmission Comb / Sequence Comb" on page 83

6.10.9 PUCCH allocation configuration

CONFigure[:NR5G]:UL[:CC<cc>]:FRAMe<fr>:BWPart<bwp>:SLOT<sl>:PUCCh<cr>: COPY:DURation.....	314
CONFigure[:NR5G]:UL[:CC<cc>]:FRAMe<fr>:BWPart<bwp>:SLOT<sl>:PUCCh<cr>: COPY:MODE.....	314
CONFigure[:NR5G]:UL[:CC<cc>]:FRAMe<fr>:BWPart<bwp>:SLOT<sl>:PUCCh<cr>:COPY.	315
CONFigure[:NR5G]:UL[:CC<cc>]:FRAMe<fr>:BWPart<bwp>:SLOT<sl>:PUCCh<cr>: COPY:PERiod.....	316
CONFigure[:NR5G]:UL[:CC<cc>]:FRAMe<fr>:BWPart<bwp>:SLOT<sl>:PUCCh<cr>: COPY:SLOT.....	316
CONFigure[:NR5G]:UL[:CC<cc>]:FRAMe<fr>:BWPart<bwp>:SLOT<sl>:PUCCh<cr>:POWER	317
CONFigure[:NR5G]:UL[:CC<cc>]:FRAMe<fr>:BWPart<bwp>:SLOT<sl>:PUCCh<cr>: RBCount.....	317

CONFigure[:NR5G]:UL[:CC<cc>]:FRAMe<fr>:BWPart<bwp>:SLOT<sl>:PUCCh<cr>: RBOffset.....	318
CONFigure[:NR5G]:UL[:CC<cc>]:FRAMe<fr>:BWPart<bwp>:SLOT<sl>:PUCCh<cr>: SCOunt.....	318
CONFigure[:NR5G]:UL[:CC<cc>]:FRAMe<fr>:BWPart<bwp>:SLOT<sl>:PUCCh<cr>: SOFFset.....	319
CONFigure[:NR5G]:UL[:CC<cc>]:FRAMe<fr>:BWPart<bwp>:SLOT<sl>:UCCCount.....	319

CONFigure[:NR5G]:UL[:CC<cc>]:FRAMe<fr>:BWPart<bwp>:SLOT<sl>: PUCCh<cr>:COPY:DURation <Value>

Defines to which slots a PUCCH configuration is copied to.

Prerequisites for this command

- Number of configurable slots > 1 (CONFigure[:NR5G]:UL[:CC<cc>]:
FRAMe<fr>:BWPart<bwp>:CSLot).
- Select custom paste mode (CONFigure[:NR5G]:UL[:CC<cc>]:FRAMe<fr>:
BWPart<bwp>:SLOT<sl>:PUCCh<cr>:COPY:MODE).

Suffix:

<cc>	Component Carrier
<fr>	Frame
<bwp>	Bandwidth part
<sl>	Bandwidth part
<cr>	PUCCH

Parameters:

<Value> The paste duration corresponds to a certain number of slots in a row.

*RST: 1

Example: //Paste PUCCH configuration to 2 slots in a row, every 3rd slot
(0,1,3,4,6,7,9,10,12)

```
CONF:UL:CC2:FRAM3:BWP2:CSL 12
```

```
CONF:UL:CC2:FRAM3:BWP2:SLOT0:PUC2:COPY:MODE  
CUST
```

```
CONF:UL:CC2:FRAM3:BWP2:SLOT0:PUC2:COPY:PER 3
```

```
CONF:UL:CC2:FRAM3:BWP2:SLOT0:PUC2:COPY:DUR 2
```

CONFigure[:NR5G]:UL[:CC<cc>]:FRAMe<fr>:BWPart<bwp>:SLOT<sl>: PUCCh<cr>:COPY:MODE <Mode>

Selects the paste logic when you copy a PUCCH configuration to other slots.

Prerequisites for this command

- Number of configurable slots > 1 (CONFigure[:NR5G]:UL[:CC<cc>]:
FRAMe<fr>:BWPart<bwp>:CSLot).

Suffix:

<cc>	Component Carrier
<fr>	Frame
<bwp>	Bandwidth part
<sl>	Bandwidth part
<cr>	PUCCH

Parameters:

<Mode>

CUSTOM

Copies the slot configuration to specific set of slots according to the logic defined with:

- `CONFigure[:NR5G]:UL[:CC<cc>]:FRAME<fr>:BWPart<bwp>:SLOT<sl>:PUCCh<cr>:COPY:PERiod`
- `CONFigure[:NR5G]:UL[:CC<cc>]:FRAME<fr>:BWPart<bwp>:SLOT<sl>:PUCCh<cr>:COPY:DURation`

SLOT

Copies the slot configuration to a specific set of slots.

Select the slots with `CONFigure[:NR5G]:UL[:CC<cc>]:FRAME<fr>:BWPart<bwp>:SLOT<sl>:PUCCh<cr>:COPY:SLOT`.

Example:

```
//Select paste mode
CONF:UL:CC2:FRAM3:BWP2:CSL 12
CONF:UL:CC2:FRAM3:BWP2:SLOT0:PUC2:COPY:MODE
SLOT
```

CONFigure[:NR5G]:UL[:CC<cc>]:FRAME<fr>:BWPart<bwp>:SLOT<sl>:PUCCh<cr>:COPY

Copies a PUCCH configuration to other slots.

Prerequisites for this command

- Number of configurable slots > 1 (`CONFigure[:NR5G]:UL[:CC<cc>]:FRAME<fr>:BWPart<bwp>:CSLot`).
- Select paste mode (`CONFigure[:NR5G]:UL[:CC<cc>]:FRAME<fr>:BWPart<bwp>:SLOT<sl>:PUCCh<cr>:COPY:MODE`).

Suffix:

<cc>	Component Carrier
<fr>	Frame
<bwp>	Bandwidth part
<sl>	Bandwidth part
<cr>	<100 PUCCH

Example: //Paste PUCCH configuration to 2 slots in a row, every 3rd slot (0,1,3,4,6,7,9,10,12)
 CONF:UL:CC2:FRAM3:BWP2:CSL 12
 CONF:UL:CC2:FRAM3:BWP2:SLOT0:PUCCH2:COPY:MODE
 CUST
 CONF:UL:CC2:FRAM3:BWP2:SLOT0:PUCCH2:COPY:PER 3
 CONF:UL:CC2:FRAM3:BWP2:SLOT0:PUCCH2:COPY:DUR 2
 CONF:UL:CC2:FRAM3:BWP2:SLOT0:PUCCH2:COPY

Usage: Event

Manual operation: See "Copy to" on page 89

**CONFigure[:NR5G]:UL[:CC<cc>]:FRAMe<fr>:BWPart<bwp>:SLOT<sl>:
 PUCCh<cr>:COPY:PERiod <Period>**

Defines to which slots a PUCCH configuration is copied to.

Prerequisites for this command

- Number of configurable slots > 1 (CONFigure[:NR5G]:UL[:CC<cc>]:FRAMe<fr>:BWPart<bwp>:CSLot).
- Select custom paste mode (CONFigure[:NR5G]:UL[:CC<cc>]:FRAMe<fr>:BWPart<bwp>:SLOT<sl>:PUCCh<cr>:COPY:MODE).

Suffix:

<cc> Component Carrier
 <fr> Frame
 <bwp> Bandwidth part
 <sl> Bandwidth part
 <cr> PUCCH

Parameters:

<Period> The paste period corresponds to every nth slot.
 *RST: 1

Example: //Paste PUCCH configuration to every 3rd slot (0,3,6,9,12)
 CONF:UL:CC2:FRAM3:BWP2:CSL 12
 CONF:UL:CC2:FRAM3:BWP2:SLOT0:PUCCH2:COPY:MODE
 CUST
 CONF:UL:CC2:FRAM3:BWP2:SLOT0:PUCCH2:COPY:PER 3

**CONFigure[:NR5G]:UL[:CC<cc>]:FRAMe<fr>:BWPart<bwp>:SLOT<sl>:
 PUCCh<cr>:COPY:SLOT <Slot>**

Copies a PUCCH allocation configuration to a specific set of slots.

Prerequisites for this command

- Number of configurable slots > 1 (CONFigure[:NR5G]:UL[:CC<cc>]:FRAMe<fr>:BWPart<bwp>:CSLot).

- Select slot paste mode (CONFigure[:NR5G]:UL[:CC<cc>]:FRAMe<fr>:BWPart<bwp>:SLOT<sl>:PUCCh<cr>:COPY:MODE).

Suffix:

<cc>	Component Carrier
<fr>	Frame
<bwp>	Bandwidth part
<sl>	Slot
<cr>	PUCCH

Parameters:

<Slot> List of slots either as comma-separated list (2,5,8), a range (3-5) or a combination of both (2-5,8,10).

Example:

```
//Copy allocation configuration to several slots
CONF:UL:CC2:FRAM3:BWP2:CSL 12
CONF:UL:CC2:FRAM3:BWP2:SLOT0:PUC2:COPY:MODE
SLOT
CONF:UL:CC2:FRAM3:BWP2:SLOT0:PUC2:COPY:SLOT
'3,6,9'
```

**CONFigure[:NR5G]:UL[:CC<cc>]:FRAMe<fr>:BWPart<bwp>:SLOT<sl>:
PUCCh<cr>:POWer <Power>**

Defines the relative power of a PUCCH.

Suffix:

<cc>	irrelevant
<fr>	irrelevant
<bwp>	Bandwidth part
<sl>	Slot
<cr>	PUCCH

Parameters:

<Power> <numeric value>
*RST: 0
Default unit: dB

Example:

```
//Define PUCCH power
CONF:UL:CC2:FRAM3:BWP2:SLOT4:PUC3:POW 3
```

Manual operation: See "[Rel Power / dB](#)" on page 89

**CONFigure[:NR5G]:UL[:CC<cc>]:FRAMe<fr>:BWPart<bwp>:SLOT<sl>:
PUCCh<cr>:RBCCount <ResourceBlocks>**

Selects the number of resource blocks that a PUCCH allocation occupies.

Suffix:

<cc>	Component Carrier
<fr>	Frame
<bwp>	Bandwidth part
<sl>	Slot
<cr>	PUCCH

Parameters:

<ResourceBlocks> <numeric value> (integer only)
 *RST: 270

Example: //Define number of PUCCH resource blocks
 CONF:UL:CC2:FRAM3:BWP2:SLOT4:PUC3:RBC 40

Manual operation: See "Number of RBs" on page 88

**CONFigure[:NR5G]:UL[:CC<cc>]:FRAMe<fr>:BWPart<bwp>:SLOT<sl>:
 PUCCh<cr>:RBOffset <Offset>**

Defines the resource block offset of a PUCCH allocation.

Suffix:

<cc>	Component Carrier
<fr>	Frame
<bwp>	Bandwidth part
<sl>	Slot
<cr>	PUCCH

Parameters:

<Offset> <numeric value> (integer only)
 The offset is a value relative to the first resource block of the slot.
 *RST: 0

Example: //Define RB offset of PUCCH
 CONF:UL:CC2:FRAM3:BWP2:SLOT4:PUC3:RBOF 10

Manual operation: See "Offset RB" on page 88

**CONFigure[:NR5G]:UL[:CC<cc>]:FRAMe<fr>:BWPart<bwp>:SLOT<sl>:
 PUCCh<cr>:SCOut <Symbols>**

Selects the number of symbols that a PUCCH allocation occupies.

Suffix:

<cc>	Component Carrier
<fr>	Frame

<bwp> Bandwidth part

<sl> Slot

<cr> PUCCH

Parameters:

<Symbols> <numeric value> (integer only)

*RST: 14

Example:

```
//Define number of PUCCH symbols
CONF:UL:CC2:FRAM3:BWP2:SLOT4:PUC3:SCO 7
```

Manual operation: See "Number of Symbols" on page 88

**CONFigure[:NR5G]:UL[:CC<cc>]:FRAMe<fr>:BWPart<bwp>:SLOT<sl>:
PUCCh<cr>:SOFFset <Offset>**

Defines the symbol offset of a PUCCH allocation.

Suffix:

<cc> Component Carrier

<fr> Frame

<bwp> Bandwidth part

<sl> Slot

<cr> PUCCH

Parameters:

<Offset> <numeric value> (integer only)

The offset is a value relative to the first symbol in the slot.

*RST: 0

Example:

```
//Define PUCCH symbol offset
CONF:UL:CC2:FRAM3:BWP2:SLOT4:PUC3:SOFF 2
```

Manual operation: See "Offset Symbols" on page 89

**CONFigure[:NR5G]:UL[:CC<cc>]:FRAMe<fr>:BWPart<bwp>:SLOT<sl>:
UCCCount <PUCCHs>**

Defines the number of PUCCHs in a slot.

Suffix:

<cc> Component Carrier

<fr> Frame

<bwp> Bandwidth part

<sl> Slot

Parameters:

<PUCCHs> <numeric value> (integer only)

Range: 0 to 100

*RST: 1

Example:

//Define number of PUCCH

CONF:UL:CC2:FRAM3:BWP2:SLOT4:UCCC 10

6.10.10 PUSCH allocation configuration

CONFigure[:NR5G]:UL[:CC<cc>]:FRAMe<fr>:BWPart<bwp>:SLOT<sl>:ALCount.....	320
CONFigure[:NR5G]:UL[:CC<cc>]:FRAMe<fr>:BWPart<bwp>:SLOT<sl>: ALLocation<al>:COPY:DURation.....	321
CONFigure[:NR5G]:UL[:CC<cc>]:FRAMe<fr>:BWPart<bwp>:SLOT<sl>: ALLocation<al>:COPY:MODE.....	321
CONFigure[:NR5G]:UL[:CC<cc>]:FRAMe<fr>:BWPart<bwp>:SLOT<sl>: ALLocation<al>:COPY.....	322
CONFigure[:NR5G]:UL[:CC<cc>]:FRAMe<fr>:BWPart<bwp>:SLOT<sl>: ALLocation<al>:COPY:PERiod.....	323
CONFigure[:NR5G]:UL[:CC<cc>]:FRAMe<fr>:BWPart<bwp>:SLOT<sl>: ALLocation<al>:COPY:SLOT.....	323
CONFigure[:NR5G]:UL[:CC<cc>]:FRAMe<fr>:BWPart<bwp>:SLOT<sl>: ALLocation<al>:MODulation.....	324
CONFigure[:NR5G]:UL[:CC<cc>]:FRAMe<fr>:BWPart<bwp>:SLOT<sl>: ALLocation<al>:POWER.....	325
CONFigure[:NR5G]:UL[:CC<cc>]:FRAMe<fr>:BWPart<bwp>:SLOT<sl>: ALLocation<al>:RBCount.....	325
CONFigure[:NR5G]:UL[:CC<cc>]:FRAMe<fr>:BWPart<bwp>:SLOT<sl>: ALLocation<al>:RBOFset.....	325
CONFigure[:NR5G]:UL[:CC<cc>]:FRAMe<fr>:BWPart<bwp>:SLOT<sl>: ALLocation<al>:SCOunt.....	326
CONFigure[:NR5G]:UL[:CC<cc>]:FRAMe<fr>:BWPart<bwp>:SLOT<sl>: ALLocation<al>:SOFFset.....	326

CONFigure[:NR5G]:UL[:CC<cc>]:FRAMe<fr>:BWPart<bwp>:SLOT<sl>:ALCount
<Allocations>

Defines the number of PDSCH allocations in a slot.

Suffix:

<cc>	Component Carrier
<fr>	Frame
<bwp>	Bandwidth part
<sl>	Slot

Parameters:

<Allocations> <numeric value> (integer only)

Range: 0 to 100

*RST: 1

Example:

```
//Define number of PDSCH allocations
CONF:UL:CC2:FRAM3:BWP2:SLOT4:ALC 10
```

**CONFigure[:NR5G]:UL[:CC<cc>]:FRAME<fr>:BWPpart<bwp>:SLOT<sl>:
ALLocation<al>:COPY:DURation <Value>**

Defines to which slots a PUSCH configuration is copied to.

Prerequisites for this command

- Number of configurable slots > 1 (CONFigure[:NR5G]:UL[:CC<cc>]:FRAME<fr>:BWPpart<bwp>:CSLot).
- Select custom paste mode (CONFigure[:NR5G]:UL[:CC<cc>]:FRAME<fr>:BWPpart<bwp>:SLOT<sl>:ALLocation<al>:COPY:MODE).

Suffix:

<cc> [Component Carrier](#)

<fr> [Frame](#)

<bwp> [Bandwidth part](#)

<sl> [Bandwidth part](#)

<al> [Allocation](#)

Parameters:

<Value> The paste duration corresponds to a certain number of slots in a row.

*RST: 1

Example:

```
//Paste PUSCH configuration to 2 slots in a row, every 3rd slot
(0,1,3,4,6,7,9,10,12)
CONF:UL:CC2:FRAM3:BWP2:CSL 12
CONF:UL:CC2:FRAM3:BWP2:SLOT0:ALL2:COPY:MODE
CUST
CONF:UL:CC2:FRAM3:BWP2:SLOT0:ALL2:COPY:PER 3
CONF:UL:CC2:FRAM3:BWP2:SLOT0:ALL2:COPY:DUR 2
```

**CONFigure[:NR5G]:UL[:CC<cc>]:FRAME<fr>:BWPpart<bwp>:SLOT<sl>:
ALLocation<al>:COPY:MODE <Mode>**

Selects the paste logic when you copy a PUSCH configuration to other slots.

Prerequisites for this command

- Number of configurable slots > 1 (CONFigure[:NR5G]:UL[:CC<cc>]:FRAME<fr>:BWPpart<bwp>:CSLot).

Suffix:

<cc>	Component Carrier
<fr>	Frame
<bwp>	Bandwidth part
<sl>	Bandwidth part
<al>	Allocation

Parameters:

<Mode>

CUSTOM

Copies the slot configuration to specific set of slots according to the logic defined with:

- `CONFigure[:NR5G]:UL[:CC<cc>]:FRAMe<fr>:BWPart<bwp>:SLOT<sl>:ALLocation<al>:COPY:PERIOD`
- `CONFigure[:NR5G]:UL[:CC<cc>]:FRAMe<fr>:BWPart<bwp>:SLOT<sl>:ALLocation<al>:COPY:DURATION`

SLOT

Copies the slot configuration to a specific set of slots.

Select the slots with `CONFigure[:NR5G]:UL[:CC<cc>]:FRAMe<fr>:BWPart<bwp>:SLOT<sl>:ALLocation<al>:COPY:SLOT`.

Example:

```
//Select paste mode
CONF:UL:CC2:FRAM3:BWP2:CSL 12
CONF:UL:CC2:FRAM3:BWP2:SLOT0:ALL2:COPY:MODE
SLOT
```

CONFigure[:NR5G]:UL[:CC<cc>]:FRAMe<fr>:BWPart<bwp>:SLOT<sl>:ALLocation<al>:COPY

Copies a PUSCH configuration to other slots.

Prerequisites for this command

- Number of configurable slots > 1 (`CONFigure[:NR5G]:UL[:CC<cc>]:FRAMe<fr>:BWPart<bwp>:CSLOT`).
- Select paste mode (`CONFigure[:NR5G]:UL[:CC<cc>]:FRAMe<fr>:BWPart<bwp>:SLOT<sl>:ALLocation<al>:COPY:MODE`).

Suffix:

<cc>	Component Carrier
<fr>	Frame
<bwp>	Bandwidth part
<sl>	Bandwidth part
<al>	<100 Allocation

Example: //Paste PUSCH configuration to 2 slots in a row, every 3rd slot (0,1,3,4,6,7,9,10,12)
 CONF:UL:CC2:FRAM3:BWP2:CSL 12
 CONF:UL:CC2:FRAM3:BWP2:SLOT0:ALL2:COPY:MODE
 CUST
 CONF:UL:CC2:FRAM3:BWP2:SLOT0:ALL2:COPY:PER 3
 CONF:UL:CC2:FRAM3:BWP2:SLOT0:ALL2:COPY:DUR 2
 CONF:UL:CC2:FRAM3:BWP2:SLOT0:ALL2:COPY

Usage: Event

Manual operation: See "Copy to" on page 89

**CONFigure[:NR5G]:UL[:CC<cc>]:FRAMe<fr>:BWPart<bwp>:SLOT<sl>:
 ALLocation<al>:COPY:PERiod <Period>**

Defines to which slots a PUSCH configuration is copied to.

Prerequisites for this command

- Number of configurable slots > 1 (CONFigure[:NR5G]:UL[:CC<cc>]:FRAMe<fr>:BWPart<bwp>:CSLot).
- Select custom paste mode (CONFigure[:NR5G]:UL[:CC<cc>]:FRAMe<fr>:BWPart<bwp>:SLOT<sl>:ALLocation<al>:COPY:MODE).

Suffix:

<cc> Component Carrier
 <fr> Frame
 <bwp> Bandwidth part
 <sl> Bandwidth part
 <al> Allocation

Parameters:

<Period> The paste period corresponds to every nth slot.
 *RST: 1

Example: //Paste PUSCH configuration to every 3rd slot (0,3,6,9,12)
 CONF:UL:CC2:FRAM3:BWP2:CSL 12
 CONF:UL:CC2:FRAM3:BWP2:SLOT0:ALL2:COPY:MODE
 CUST
 CONF:UL:CC2:FRAM3:BWP2:SLOT0:ALL2:COPY:PER 3

**CONFigure[:NR5G]:UL[:CC<cc>]:FRAMe<fr>:BWPart<bwp>:SLOT<sl>:
 ALLocation<al>:COPY:SLOT <Slot>**

Copies a PUSCH allocation configuration to a specific set of slots.

Prerequisites for this command

- Number of configurable slots > 1 (CONFigure[:NR5G]:UL[:CC<cc>]:FRAMe<fr>:BWPart<bwp>:CSLot).

- Select slot paste mode (`CONFigure[:NR5G]:UL[:CC<cc>]:FRAMe<fr>:BWPart<bwp>:SLOT<sl>:ALLocation<al>:COPY:MODE`).

Suffix:

<cc>	Component Carrier
<fr>	Frame
<bwp>	Bandwidth part
<sl>	Slot
<al>	Allocation

Parameters:

<Slot> String that contains a list of slots either as comma-separated list ("2,5,8"), a range ("3-5") or a combination of both ("2-5,8,10").

Example:

```
//Copy allocation configuration to several slots
CONF:UL:CC2:FRAM3:BWP2:CSL 12
CONF:UL:CC2:FRAM3:BWP2:SLOT0:ALL2:COPY:MODE
SLOT
CONF:UL:CC2:FRAM3:BWP2:SLOT0:ALL2:COPY:SLOT
"3,6,9"
```

CONFigure[:NR5G]:UL[:CC<cc>]:FRAMe<fr>:BWPart<bwp>:SLOT<sl>:ALLocation<al>:MODulation <Modulation>

Selects the modulation of a PUSCH allocation.

Suffix:

<cc>	Component Carrier
<fr>	Frame
<bwp>	Bandwidth part
<sl>	Slot
<al>	Allocation

Parameters:

<Modulation> DMRS | Q1K | QPSK | QAM16 | QAM64 | QAM256 | PITBpsk
 Note: pi/2-BPSK (PITBpsk) is only available if transform precoding is on (`CONFigure[:NR5G]:UL[:CC<cc>]:TPReCoding`).

*RST: QPSK

Example:

```
//Define allocation modulation
CONF:UL:CC2:FRAM3:BWP2:SLOT4:ALL5:MOD QAM16
```

Manual operation: See "Modulation" on page 87

**CONFigure[:NR5G]:UL[:CC<cc>]:FRAMe<fr>:BWPart<bwp>:SLOT<sl>:
 ALLocation<al>:POWER <Power>**

Defines the relative power of a PUSCH allocation.

Suffix:

<cc>	Component Carrier
<fr>	Frame
<bwp>	Bandwidth part
<sl>	Slot
<al>	Allocation

Parameters:

<Power>	<numeric value>
	*RST: 0
	Default unit: dB

Example: //Define relative allocation power
 CONF:UL:CC2:FRAM3:BWP2:SLOT4:ALL5:POW 6

Manual operation: See "[Rel Power / dB](#)" on page 89

**CONFigure[:NR5G]:UL[:CC<cc>]:FRAMe<fr>:BWPart<bwp>:SLOT<sl>:
 ALLocation<al>:RBCount <ResourceBlocks>**

Selects the number of resource blocks that a PUSCH allocation occupies.

Suffix:

<cc>	Component Carrier
<fr>	Frame
<bwp>	Bandwidth part
<sl>	Slot
<al>	Allocation

Parameters:

<ResourceBlocks>	<numeric value> (integer only)
	*RST: 273

Example: //Define number of PUSCH resource blocks
 CONF:UL:CC2:FRAM3:BWP2:SLOT4:ALL5:RBC 40

Manual operation: See "[Number of RBs](#)" on page 88

**CONFigure[:NR5G]:UL[:CC<cc>]:FRAMe<fr>:BWPart<bwp>:SLOT<sl>:
 ALLocation<al>:RBOffset <Offset>**

Defines the resource block offset of a PUSCH allocation.

Suffix:

<cc>	Component Carrier
<fr>	Frame
<bwp>	Bandwidth part
<sl>	Slot
<al>	Allocation

Parameters:

<Offset>	<numeric value> (integer only) The offset is a value relative to the first resource block of the slot. *RST: 0
----------	--

Example: //Define allocation RB offset
CONF:UL:CC2:FRAM3:BWP2:SLOT4:ALL5:RBOF 10

Manual operation: See "Offset RB" on page 88

**CONFigure[:NR5G]:UL[:CC<cc>]:FRAME<fr>:BWPart<bwp>:SLOT<sl>:
ALLocation<al>:SCOunt <Symbols>**

Selects the number of symbols that a PUSCH allocation occupies.

Suffix:

<cc>	Component Carrier
<fr>	Frame
<bwp>	Bandwidth part
<sl>	Slot
<al>	Allocation

Parameters:

<Symbols>	<numeric value> (integer only) *RST: 14
-----------	--

Example: //Define number of allocation symbols
CONF:UL:CC2:FRAM3:BWP2:SLOT4:ALL5:SCO 7

Manual operation: See "Number of Symbols" on page 88

**CONFigure[:NR5G]:UL[:CC<cc>]:FRAME<fr>:BWPart<bwp>:SLOT<sl>:
ALLocation<al>:SOFFset <Offset>**

Defines the symbol offset of a PUSCH allocation.

Suffix:

<cc>	Component Carrier
<fr>	Frame

<bwp> Bandwidth part

<sl> Slot

<al> Allocation

Parameters:

<Offset> <numeric value> (integer only)

The offset is a value relative to the first symbol in the slot.

*RST: 0

Example: //Define allocation symbol offset

CONF:UL:CC2:FRAM3:BWP2:SLOT4:ALL5:SOFF 2

Manual operation: See "Offset Symbols" on page 89

6.10.11 Enhanced PUCCH allocation configuration

CONFigure[:NR5G]:UL[:CC<cc>]:FRAMe<fr>:BWPart<bwp>:SLOT<sl>:PUCCh<cr>: DMRS:ADDITIONal.....	327
CONFigure[:NR5G]:UL[:CC<cc>]:FRAMe<fr>:BWPart<bwp>:SLOT<sl>:PUCCh<cr>: DMRS:GHOPping.....	328
CONFigure[:NR5G]:UL[:CC<cc>]:FRAMe<fr>:BWPart<bwp>:SLOT<sl>:PUCCh<cr>: DMRS:HID.....	329
CONFigure[:NR5G]:UL[:CC<cc>]:FRAMe<fr>:BWPart<bwp>:SLOT<sl>:PUCCh<cr>: DMRS:ICSHift.....	329
CONFigure[:NR5G]:UL[:CC<cc>]:FRAMe<fr>:BWPart<bwp>:SLOT<sl>:PUCCh<cr>: DMRS:ISFHopping.....	330
CONFigure[:NR5G]:UL[:CC<cc>]:FRAMe<fr>:BWPart<bwp>:SLOT<sl>:PUCCh<cr>: DMRS:NID.....	330
CONFigure[:NR5G]:UL[:CC<cc>]:FRAMe<fr>:BWPart<bwp>:SLOT<sl>:PUCCh<cr>: DMRS:OCCLength.....	331
CONFigure[:NR5G]:UL[:CC<cc>]:FRAMe<fr>:BWPart<bwp>:SLOT<sl>:PUCCh<cr>: DMRS:POWer.....	332
CONFigure[:NR5G]:UL[:CC<cc>]:FRAMe<fr>:BWPart<bwp>:SLOT<sl>:PUCCh<cr>: DMRS:SGENeration.....	332
CONFigure[:NR5G]:UL[:CC<cc>]:FRAMe<fr>:BWPart<bwp>:SLOT<sl>:PUCCh<cr>: DMRS:SHPRb.....	333
CONFigure[:NR5G]:UL[:CC<cc>]:FRAMe<fr>:BWPart<bwp>:SLOT<sl>:PUCCh<cr>: DMRS:SID.....	333
CONFigure[:NR5G]:UL[:CC<cc>]:FRAMe<fr>:BWPart<bwp>:SLOT<sl>:PUCCh<cr>: DMRS:TDOindex.....	334
CONFigure[:NR5G]:UL[:CC<cc>]:FRAMe<fr>:BWPart<bwp>:SLOT<sl>:PUCCh<cr>: FORMat.....	334

**CONFigure[:NR5G]:UL[:CC<cc>]:FRAMe<fr>:BWPart<bwp>:SLOT<sl>:
PUCCh<cr>:DMRS:ADDITIONal <State>**

Turns an additional PUCCH DMRS on and off.

Prerequisites for this command

- Select PUCCH format 3 or 4 (`CONFigure[:NR5G]:UL[:CC<cc>]:FRAMe<fr>:BWPart<bwp>:SLOT<sl>:PUCCh<cr>:FORMat`).

Suffix:

<cc>	Component Carrier
<fr>	Frame
<bwp>	Bandwidth part
<sl>	Slot
<cr>	PUCCH

Parameters:

<State>	ON OFF 1 0
*RST:	OFF

Example:

```
//Select additional PUCCH DMRS
CONF:UL:CC2:FRAM3:BWP2:SLOT4:PUC3:FORM 4
CONF:UL:CC2:FRAM3:BWP2:SLOT4:PUC3:DMRS:ADD ON
```

Manual operation: See "Additional DMRS" on page 92

**CONFigure[:NR5G]:UL[:CC<cc>]:FRAMe<fr>:BWPart<bwp>:SLOT<sl>:
PUCCh<cr>:DMRS:GHOPping <Mode>**

Selects the group hopping mode for the PUCCH.

Prerequisites for this command

- Select PUCCH format 0 or 1 (`CONFigure[:NR5G]:UL[:CC<cc>]:FRAMe<fr>:BWPart<bwp>:SLOT<sl>:PUCCh<cr>:FORMat`).

Suffix:

<cc>	Component Carrier
<fr>	Frame
<bwp>	Bandwidth part
<sl>	Slot
<cr>	PUCCH

Parameters:

<Mode>	DISable Use sequence hopping.
	ENABle Use group hopping.
	NEITher Use neither group hopping nor sequence hopping.
*RST:	NEITher

Example: //Select PUCCH group hopping mode
 CONF:UL:CC2:FRAM3:BWP2:SLOT4:PUC3:FORM 1
 CONF:UL:CC2:FRAM3:BWP2:SLOT4:PUC3:DMRS:GHOP
 DIS

Manual operation: See "Group Hopping" on page 90

**CONFigure[:NR5G]:UL[:CC<cc>]:FRAMe<fr>:BWPart<bwp>:SLOT<sl>:
 PUCCh<cr>:DMRS:HID <Method>**

Selects the PUCCH DM-RS hopping ID generation method.

Prerequisites for this command

- Select PUCCH format 0 or 1 (CONFigure[:NR5G]:UL[:CC<cc>]:FRAMe<fr>:
 BWPart<bwp>:SLOT<sl>:PUCCh<cr>:FORMat).

Suffix:

<cc>	Component Carrier
<fr>	Frame
<bwp>	Bandwidth part
<sl>	Slot
<cr>	PUCCH

Parameters:

<Method>	NID Sequence generation based on a pseudo-random seed value.
	NIDCell Sequence generation based on the cell ID.
*RST:	NIDCell

Example: //Select hopping ID generation method
 CONF:UL:CC2:FRAM3:BWP2:SLOT4:PUC3:FORM 1
 CONF:UL:CC2:FRAM3:BWP2:SLOT4:PUC3:DMRS:HID
 NIDC

Manual operation: See "Group Hopping" on page 90

**CONFigure[:NR5G]:UL[:CC<cc>]:FRAMe<fr>:BWPart<bwp>:SLOT<sl>:
 PUCCh<cr>:DMRS:ICSHift <Value>**

Selects the initial cyclic shift.

Prerequisites for this command

- Select PUCCH format 0 or 1 (CONFigure[:NR5G]:UL[:CC<cc>]:FRAMe<fr>:
 BWPart<bwp>:SLOT<sl>:PUCCh<cr>:FORMat).

Suffix:

<cc>	Component Carrier
<fr>	Frame

<bwp> Bandwidth part

<sl> Slot

<cr> PUCCH

Parameters:

<Value> *RST: 0

Example:

```
//Select initial cyclic shift
CONF:UL:CC2:FRAM3:BWP2:SLOT4:PUC3:FORM 1
CONF:UL:CC2:FRAM3:BWP2:SLOT4:PUC3:DMRS:ICSH 1
```

Manual operation: See "Initial Cyclic Shift" on page 91

**CONFigure[:NR5G]:UL[:CC<cc>]:FRAMe<fr>:BWPART<bwp>:SLOT<sl>:
PUCCh<cr>:DMRS:ISFHopping <State>**

Selects the group hopping mode for the PUCCH.

Prerequisites for this command

- Select PUCCH format 0 or 1 (CONFigure[:NR5G]:UL[:CC<cc>]:FRAMe<fr>:
BWPART<bwp>:SLOT<sl>:PUCCh<cr>:FORMat).

Suffix:

<cc> Component Carrier

<fr> Frame

<bwp> Bandwidth part

<sl> Slot

<cr> PUCCH

Parameters:

<State> ON | OFF | 1 | 0
*RST: OFF

Example:

```
//Turn on intra slot frequency hopping
CONF:UL:CC2:FRAM3:BWP2:SLOT4:PUC3:FORM 1
CONF:UL:CC2:FRAM3:BWP2:SLOT4:PUC3:DMRS:ISFH ON
```

Manual operation: See "Intra Slot Frequency Hopping" on page 91

**CONFigure[:NR5G]:UL[:CC<cc>]:FRAMe<fr>:BWPART<bwp>:SLOT<sl>:
PUCCh<cr>:DMRS:NID <Value>**

Defines the seed value for the PUCCH DM-RS hopping ID sequence generation.

Prerequisites for this command

- Select PUCCH format 0 or 1 (CONFigure[:NR5G]:UL[:CC<cc>]:FRAMe<fr>:
BWPART<bwp>:SLOT<sl>:PUCCh<cr>:FORMat).
- Select generation method "n_ID^DMRS" (CONFigure[:NR5G]:UL[:CC<cc>]:
FRAMe<fr>:BWPART<bwp>:SLOT<sl>:PUCCh<cr>:DMRS:HID).

Suffix:

<cc>	Component Carrier
<fr>	Frame
<bw>	Bandwidth part
<sl>	Slot
<cr>	PUCCH

Parameters:

<Value>	<numeric value> (integer only)
	*RST: 0

Example:

```
//Select hopping ID generation method
CONF:UL:CC2:FRAM3:BWP2:SLOT4:PUC3:FORM 1
CONF:UL:CC2:FRAM3:BWP2:SLOT4:PUC3:DMRS:HID
NIDC
CONF:UL:CC2:FRAM3:BWP2:SLOT4:PUC3:DMRS:NID 6
```

Manual operation: See "[Group Hopping](#)" on page 90

**CONFigure[:NR5G]:UL[:CC<cc>]:FRAMe<fr>:BWPART<bw>:SLOT<sl>:
PUCCh<cr>:DMRS:OCCLength <Length>**

Selects the OCC length.

Prerequisites for this command

- Select PUCCH format 4 (CONFigure[:NR5G]:UL[:CC<cc>]:FRAMe<fr>:
BWPART<bw>:SLOT<sl>:PUCCh<cr>:FORMat).

Suffix:

<cc>	Component Carrier
<fr>	Frame
<bw>	Bandwidth part
<sl>	Slot
<cr>	PUCCH

Parameters:

<Length>	N2 N4
	*RST: N2

Example:

```
//Select OCC length
CONF:UL:CC2:FRAM3:BWP2:SLOT4:PUC3:FORM 4
CONF:UL:CC2:FRAM3:BWP2:SLOT4:PUC3:DMRS:OCCL N4
```

Manual operation: See "[OCC Length](#)" on page 92

**CONFigure[:NR5G]:UL[:CC<cc>]:FRAMe<fr>:BWPART<bwp>:SLOT<sl>:
PUCCh<cr>:DMRS:POWER <Power>**

Defines the power of a PUCCH DM-RS relative to the PUCCH.

Suffix:

<cc>	Component Carrier
<fr>	Frame
<bwp>	Bandwidth part
<sl>	Slot
<cr>	PUCCH

Parameters:

<Power>	<numeric value>
	*RST: 0
	Default unit: dB

Example: //Define PUCCH power
CONF:UL:CC2:FRAM3:BWP2:SLOT4:PUC3:DMRS:POW 1.5

Manual operation: See "PUCCH DMRS Rel Power" on page 90

**CONFigure[:NR5G]:UL[:CC<cc>]:FRAMe<fr>:BWPART<bwp>:SLOT<sl>:
PUCCh<cr>:DMRS:SGENERation <Method>**

Selects the PUCCH DM-RS sequence generation method.

Suffix:

<cc>	Component Carrier
<fr>	Frame
<bwp>	Bandwidth part
<sl>	Slot
<cr>	PUCCH

Parameters:

<Method>	DSID Sequence generation based on a pseudo-random seed value.
	NIDCell Sequence generation based on the cell ID.
	*RST: NIDCell

Example: //Select PUCCH sequence generation method
CONF:UL:CC2:FRAM3:BWP2:SLOT4:PUC3:DMRS:SGEN
NIDC

Manual operation: See "PUCCH DMRS Sequence Generation" on page 92

**CONFigure[:NR5G]:UL[:CC<cc>]:FRAMe<fr>:BWPART<bwp>:SLOT<sl>:
PUCCh<cr>:DMRS:SHPRb <Value>**

Selects the second hop PRB.

Prerequisites for this command

- Select PUCCH format 0 or 1 (CONFigure[:NR5G]:UL[:CC<cc>]:FRAMe<fr>:BWPART<bwp>:SLOT<sl>:PUCCh<cr>:FORMat).
- Turn on intra slot frequency hopping (CONFigure[:NR5G]:UL[:CC<cc>]:FRAMe<fr>:BWPART<bwp>:SLOT<sl>:PUCCh<cr>:DMRS:SHPRb).

Suffix:

<cc>	Component Carrier
<fr>	Frame
<bwp>	Bandwidth part
<sl>	Slot
<cr>	PUCCH

Parameters:

<Value> *RST: 0

Example:

```
//Select second hop PRB
CONF:UL:CC2:FRAM3:BWP2:SLOT4:PUC3:FORM 1
CONF:UL:CC2:FRAM3:BWP2:SLOT4:PUC3:DMRS:ISFH ON
CONF:UL:CC2:FRAM3:BWP2:SLOT4:PUC3:DMRS:SHPR ON
```

Manual operation: See "Intra Slot Frequency Hopping" on page 91

**CONFigure[:NR5G]:UL[:CC<cc>]:FRAMe<fr>:BWPART<bwp>:SLOT<sl>:
PUCCh<cr>:DMRS:SID <Value>**

Defines the seed value for the PUCCH DM-RS sequence generation.

Prerequisites for this command

- Select sequence generation method DMRS-Scrambling-ID (CONFigure[:NR5G]:UL[:CC<cc>]:FRAMe<fr>:BWPART<bwp>:SLOT<sl>:PUCCh<cr>:DMRS:SGENERation).

Suffix:

<cc>	Component Carrier
<fr>	Frame
<bwp>	Bandwidth part
<sl>	Slot
<cr>	PUCCH

Parameters:

<Value> <numeric value> (integer only)

*RST: 0

Example: //Define seed value
 CONF:UL:CC2:FRAM3:BWP2:SLOT4:PUC3:DMRS:SGEN
 DSID
 CONF:UL:CC2:FRAM3:BWP2:SLOT4:PUC3:DMRS:SID 15

Manual operation: See "[PUCCH DMRS Sequence Generation](#)" on page 92

**CONFigure[:NR5G]:UL[:CC<cc>]:FRAMe<fr>:BWPart<bwp>:SLOT<sl>:
 PUCCh<cr>:DMRS:TDOindex <Index>**

Selects the initial cyclic shift.

Prerequisites for this command

- Select PUCCH format 1 (CONFigure[:NR5G]:UL[:CC<cc>]:FRAMe<fr>:
 BWPart<bwp>:SLOT<sl>:PUCCh<cr>:FORMat).

Suffix:

<cc>	Component Carrier
<fr>	Frame
<bwp>	Bandwidth part
<sl>	Slot
<cr>	PUCCH

Parameters:

<Index>	*RST: 0
---------	---------

Example: //time domain index
 CONF:UL:CC2:FRAM3:BWP2:SLOT4:PUC3:FORM 1
 CONF:UL:CC2:FRAM3:BWP2:SLOT4:PUC3:DMRS:TDO 2

Manual operation: See "[Time Domain OCC Index](#)" on page 91

**CONFigure[:NR5G]:UL[:CC<cc>]:FRAMe<fr>:BWPart<bwp>:SLOT<sl>:
 PUCCh<cr>:FORMat <Format>**

Selects the format of a PUCCH allocation.

Suffix:

<cc>	Component Carrier
<fr>	Frame
<bwp>	Bandwidth part
<sl>	Slot
<cr>	PUCCH

Parameters:

<Format>	0 1 2 3 4
----------	-------------------

Example: //Select PUCCH format
 CONF:UL:CC2:FRAM3:BWP2:SLOT4:PUC3:FORM 2

Manual operation: See "PUCCH Format" on page 90

6.10.12 Enhanced PUSCH settings: DMRS

CONFigure[:NR5G]:UL[:CC<cc>]:FRAMe<fr>:BWPART<bwp>:SLOT<sl>: ALLocation<al>:CLMapping.....	335
CONFigure[:NR5G]:UL[:CC<cc>]:FRAMe<fr>:BWPART<bwp>:SLOT<sl>: ALLocation<al>:DMRS:AP.....	336
CONFigure[:NR5G]:UL[:CC<cc>]:FRAMe<fr>:BWPART<bwp>:SLOT<sl>: ALLocation<al>:DMRS:CGWD.....	337
CONFigure[:NR5G]:UL[:CC<cc>]:FRAMe<fr>:BWPART<bwp>:SLOT<sl>: ALLocation<al>:DMRS:CTYPe.....	337
CONFigure[:NR5G]:UL[:CC<cc>]:FRAMe<fr>:BWPART<bwp>:SLOT<sl>: ALLocation<al>:DMRS:MSYMBOL:APOSITION.....	337
CONFigure[:NR5G]:UL[:CC<cc>]:FRAMe<fr>:BWPART<bwp>:SLOT<sl>: ALLocation<al>:DMRS:MSYMBOL:LENGTh.....	338
CONFigure[:NR5G]:UL[:CC<cc>]:FRAMe<fr>:BWPART<bwp>:SLOT<sl>: ALLocation<al>:DMRS:MTYPe.....	338
CONFigure[:NR5G]:UL[:CC<cc>]:FRAMe<fr>:BWPART<bwp>:SLOT<sl>: ALLocation<al>:DMRS:NID.....	339
CONFigure[:NR5G]:UL[:CC<cc>]:FRAMe<fr>:BWPART<bwp>:SLOT<sl>: ALLocation<al>:DMRS:NIONe.....	339
CONFigure[:NR5G]:UL[:CC<cc>]:FRAMe<fr>:BWPART<bwp>:SLOT<sl>: ALLocation<al>:DMRS:NIRid.....	340
CONFigure[:NR5G]:UL[:CC<cc>]:FRAMe<fr>:BWPART<bwp>:SLOT<sl>: ALLocation<al>:DMRS:NIRS.....	341
CONFigure[:NR5G]:UL[:CC<cc>]:FRAMe<fr>:BWPART<bwp>:SLOT<sl>: ALLocation<al>:DMRS:NSCid.....	342
CONFigure[:NR5G]:UL[:CC<cc>]:FRAMe<fr>:BWPART<bwp>:SLOT<sl>: ALLocation<al>:DMRS:POWer.....	342
CONFigure[:NR5G]:UL[:CC<cc>]:FRAMe<fr>:BWPART<bwp>:SLOT<sl>: ALLocation<al>:DMRS:RST.....	343
CONFigure[:NR5G]:UL[:CC<cc>]:FRAMe<fr>:BWPART<bwp>:SLOT<sl>: ALLocation<al>:DMRS:SGENERation.....	343
CONFigure[:NR5G]:UL[:CC<cc>]:FRAMe<fr>:BWPART<bwp>:SLOT<sl>: ALLocation<al>:DMRS:TAPos.....	344
CONFigure[:NR5G]:UL[:CC<cc>]:FRAMe<fr>:BWPART<bwp>:SLOT<sl>: ALLocation<al>:UEID.....	344

CONFigure[:NR5G]:UL[:CC<cc>]:FRAMe<fr>:BWPART<bwp>:SLOT<sl>: ALLocation<al>:CLMapping <Mapping>

Selects the codeword to layer mapping.

Suffix:

<cc>	Component Carrier
<fr>	Frame
<bwp>	Bandwidth part

<sl>	Slot
<al>	Allocation
Parameters:	
<Mapping>	LC11 LC21 LC31 LC41 LC51 LC61 LC71 LC81 LC91 LC101 LC111 LC121 LC22 LC32 LC42 LC52 LC62 LC72 LC82 The availability of codeword to layer mappings depends on: <ul style="list-style-type: none"> • DM-RS configuration type (CONFigure[:NR5G]:UL[:CC<cc>]:FRAMe<fr>:BWPart<bwp>:SLOT<sl>:ALLocation<al>:DMRS:CTYPe) • DM-RS length (CONFigure[:NR5G]:UL[:CC<cc>]:FRAMe<fr>:BWPart<bwp>:SLOT<sl>:ALLocation<al>:DMRS:MSYMBOL:LENGTh) • Transmit precoding (CONFigure[:NR5G]:UL[:CC<cc>]:TPReCoding) *RST: LC11
Example:	//Select codeword to layer mapping CONF:UL:CC2:FRAM3:BWP2:SLOT4:ALL5:CLM LC21
Manual operation:	See "Codeword to Layer Mapping" on page 95

CONFigure[:NR5G]:UL[:CC<cc>]:FRAMe<fr>:BWPart<bwp>:SLOT<sl>:ALLocation<al>:DMRS:AP <AntennaPorts>...

Selects the antenna ports for PUSCH transmission.

Suffix:

<cc>	Component Carrier
<fr>	Frame
<bwp>	Bandwidth part
<sl>	Slot
<al>	Allocation

Parameters:

<AntennaPorts>	The number of numeric values depends on how many layers you have. For a single layer, add one value. For two layers, add two values etc. The value range depends on the codeword to layer mapping you have selected (CONFigure[:NR5G]:UL[:CC<cc>]:FRAMe<fr>:BWPart<bwp>:SLOT<sl>:ALLocation<al>:CLMapping).
----------------	--

Example: //Map layers to antenna ports
 CONF:UL:CC2:FRAM3:BWP2:SLOT4:ALL5:CLM LC21
 CONF:UL:CC2:FRAM3:BWP2:SLOT4:ALL5:DMRS:AP 0,2

Manual operation: See "Antenna Port" on page 95

**CONFigure[:NR5G]:UL[:CC<cc>]:FRAMe<fr>:BWPart<bwp>:SLOT<sl>:
 ALLocation<al>:DMRS:CGWD <CDMGroups>**

Select the CMD groups that contain no data.

Suffix:

<cc>	Component Carrier
<fr>	Frame
<bwp>	Bandwidth part
<sl>	Slot
<al>	Allocation

Parameters:

<CDMGroups> *RST: 1

Example:

```
//Select CMD groups without data
CONF:UL:CC2:FRAM3:BWP2:SLOT4:ALL5:DMRS:CGWD 2
```

Manual operation: See "[CDM Groups w/o Data](#)" on page 96

**CONFigure[:NR5G]:UL[:CC<cc>]:FRAMe<fr>:BWPart<bwp>:SLOT<sl>:
 ALLocation<al>:DMRS:CTYPe <Configuration>**

Selects the PDSCH DM-RS configuration type.

Suffix:

<cc>	Component Carrier
<fr>	Frame
<bwp>	Bandwidth part
<sl>	Slot
<al>	Allocation

Parameters:

<Configuration> 1 | 2
 *RST: 1

Example:

```
//Define DM-RS configuration
CONF:UL:CC2:FRAM3:BWP2:SLOT4:ALL5:DMRS:CTYP 1
```

Manual operation: See "[PUSCH DMRS Location](#)" on page 93

**CONFigure[:NR5G]:UL[:CC<cc>]:FRAMe<fr>:BWPart<bwp>:SLOT<sl>:
 ALLocation<al>:DMRS:MSYMBOL:APOSITION <Symbol>**

Defines the position of additional DM-RS.

Suffix:

<cc>	Component Carrier
<fr>	Frame

<bwp> Bandwidth part

<sl> Slot

<al> Allocation

Parameters:

<Symbol> 0 | 1 | 2 | 3

Example:

```
//Define position of additional DM-RS
CONF:UL:CC2:FRAM3:BWP2:SLOT4:ALL5:DMRS:MSYM:
APOS 3
```

Manual operation: See "[Multi Symbol DMRS](#)" on page 94

**CONFigure[:NR5G]:UL[:CC<cc>]:FRAMe<fr>:BWPART<bwp>:SLOT<sl>:
ALLOCATION<al>:DMRS:MSYMBOL:LENGTh <Symbols>**

Defines the length of the DM-RS.

Suffix:

<cc> Component Carrier

<fr> Frame

<bwp> Bandwidth part

<sl> Slot

<al> Allocation

Parameters:

<Symbols> **1**
DM-RS transmitted on 1 symbol.

2
DM-RS transmitted on 2 symbols.

*RST: 1

Example:

```
//Define DM-RS length
CONF:UL:CC2:FRAM3:BWP2:SLOT4:ALL5:DMRS:MSYM:
LENG 2
```

Manual operation: See "[Multi Symbol DMRS](#)" on page 94

**CONFigure[:NR5G]:UL[:CC<cc>]:FRAMe<fr>:BWPART<bwp>:SLOT<sl>:
ALLOCATION<al>:DMRS:MTYPE <Mapping>**

Selects the mapping type of the PDSCH DM-RS.

Suffix:

<cc> Component Carrier

<fr> Frame

<bwp> Bandwidth part

<sl> Slot

<al> [Allocation](#)

Parameters:

<Mapping>

A

Location of DM-RS relative to the start of the slot.

B

Location relative to the start of the PDSCH resource elements.

*RST: A

Example:

//Define DM-RS mapping

```
CONF:UL:CC2:FRAM3:BWP2:SLOT4:ALL5:DMRS:MTYP B
```

Manual operation: See "[PUSCH DMRS Location](#)" on page 93

**CONFigure[:NR5G]:UL[:CC<cc>]:FRAME<fr>:BWPpart<bwp>:SLOT<sl>:
ALLocation<al>:DMRS:NID <Value>**

Defines the seed value ("N_ID^0") for the PUSCH DM-RS sequence generation.

Prerequisites for this command

- Select sequence generation method n_ID^DMRS ([CONFigure\[:NR5G\]:UL\[:CC<cc>\]:FRAME<fr>:BWPpart<bwp>:SLOT<sl>:ALLocation<al>:DMRS:SGENeration](#)).

Suffix:

<cc> [Component Carrier](#)

<fr> [Frame](#)

<bwp> [Bandwidth part](#)

<sl> [Slot](#)

<al> [Allocation](#)

Parameters:

<Value> <numeric value> (integer only)

*RST: 0

Example:

//Define seed value

```
CONF:UL:CC2:FRAM3:BWP2:SLOT4:ALL5:DMRS:SGEN  
NIDD
```

```
CONF:UL:CC2:FRAM3:BWP2:SLOT4:ALL5:DMRS:SID 15
```

Manual operation: See "[PUSCH DMRS Sequence Generation \(Transform Precoding = Off\)](#)" on page 94

**CONFigure[:NR5G]:UL[:CC<cc>]:FRAME<fr>:BWPpart<bwp>:SLOT<sl>:
ALLocation<al>:DMRS:NIONE <Value>**

Defines the scrambling ID ("N_ID^1") for the PUSCH DM-RS sequence generation.

Prerequisites for this command

- Turn off transform precoding (`CONFigure[:NR5G]:UL[:CC<cc>]:TPRecoding`).
- Select sequence generation method "n_ID^DMRS" (`CONFigure[:NR5G]:UL[:CC<cc>]:FRAMe<fr>:BWPpart<bwp>:SLOT<sl>:ALLocation<al>:DMRS:SGENeration`).
- Turn on "DMRS-Uplink" (`CONFigure[:NR5G]:UL[:CC<cc>]:FRAMe<fr>:BWPpart<bwp>:SLOT<sl>:ALLocation<al>:DMRS:RST`).

Suffix:

<cc>	Component Carrier
<fr>	Frame
<bwp>	Bandwidth part
<sl>	Slot
<al>	Allocation

Parameters:

<Value>	<numeric value> (integer only)
*RST:	0

Example:

```
//Define seed value
CONF:UL:CC2:TPR OFF
CONF:UL:CC2:FRAM3:BWP2:SLOT4:ALL5:DMRS:SGEN
NIDD
CONF:UL:CC2:FRAM3:BWP2:SLOT4:ALL5:DMRS:RST ON
CONF:UL:CC2:FRAM3:BWP2:SLOT4:ALL5:DMRS:NION 15
```

Manual operation: See "PUSCH DMRS Sequence Generation (Transform Precoding = Off)" on page 94

CONFigure[:NR5G]:UL[:CC<cc>]:FRAMe<fr>:BWPpart<bwp>:SLOT<sl>:ALLocation<al>:DMRS:NIRid <Value>

Defines the seed value for the PUSCH DM-RS sequence generation (transform precoding = on).

Prerequisites for this command

- Turn on transform precoding (`CONFigure[:NR5G]:UL[:CC<cc>]:TPRecoding`).
- Select sequence generation method n_ID^PUSCH (`CONFigure[:NR5G]:UL[:CC<cc>]:FRAMe<fr>:BWPpart<bwp>:SLOT<sl>:ALLocation<al>:DMRS:NIRS`).

Suffix:

<cc>	Component Carrier
<fr>	Frame
<bwp>	Bandwidth part

<sl> Slot

<al> Allocation

Parameters:

<Value> <numeric value> (integer only)

*RST: 0

Example:

```
//Define seed value
CONF:UL:TPR ON
CONF:UL:CC2:FRAM3:BWP2:SLOT4:ALL5:DMRS:SGEN
NIDP
CONF:UL:CC2:FRAM3:BWP2:SLOT4:ALL5:DMRS:SID 10
```

Manual operation: See "PUSCH DMRS Sequence Generation (Transform Precoding = On)" on page 94

**CONFigure[:NR5G]:UL[:CC<cc>]:FRAMe<fr>:BWPart<bwp>:SLOT<sl>:
ALLocation<al>:DMRS:NIRS <Method>**

Selects the PDSCH DM-RS sequence generation method.

Prerequisites for this command

- Turn on transform precoding (CONFigure[:NR5G]:UL[:CC<cc>]:TPRecoding).

Suffix:

<cc> Component Carrier

<fr> Frame

<bwp> Bandwidth part

<sl> Slot

<al> Allocation

Parameters:

<Method>

NIDCell

Sequence generation based on the cell ID.

NIDPsch

Sequence generation based on a pseudo-random seed value.

NIDNscid

Sequence generation as defined with commands for precoding = off:

```
CONFigure[:NR5G]:UL[:CC<cc>]:FRAMe<fr>:  
BWPart<bwp>:SLOT<sl>:ALLocation<al>:DMRS:  
SGENeration  
CONFigure[:NR5G]:UL[:CC<cc>]:FRAMe<fr>:  
BWPart<bwp>:SLOT<sl>:ALLocation<al>:DMRS:NID
```

*RST: NIDCell

Example: //Define sequence generation method
 CONF:UL:TPR ON
 CONF:UL:CC2:FRAM3:BWP2:SLOT4:ALL5:DMRS:SGEN
 NIDP

Manual operation: See "PUSCH DMRS Sequence Generation (Transform Precoding = On)" on page 94

**CONFigure[:NR5G]:UL[:CC<cc>]:FRAMe<fr>:BWPart<bwp>:SLOT<sl>:
 ALLocation<al>:DMRS:NSCid <Value>**

Defines the scrambling ID for the PDSCH DM-RS sequence generation.

Prerequisites for this command

- Select sequence generation method "n_ID^DMRS" (CONFigure[:NR5G]:UL[:CC<cc>]:FRAMe<fr>:BWPart<bwp>:SLOT<sl>:ALLocation<al>:DMRS:SGENeration).

Suffix:

<cc> Component Carrier
 <fr> Frame
 <bwp> Bandwidth part
 <sl> Bandwidth part
 <al> Allocation

Parameters:

<Value> 0 | 1

Example: //Define DM-RS scrambling ID
 CONF:UL:CC2:FRAM3:BWP2:SLOT4:ALL5:DMRS:SGEN
 DSID
 CONF:UL:CC2:FRAM3:BWP2:SLOT4:ALL5:DMRS:NSC 1

Manual operation: See "PUSCH DMRS Sequence Generation (Transform Precoding = Off)" on page 94

**CONFigure[:NR5G]:UL[:CC<cc>]:FRAMe<fr>:BWPart<bwp>:SLOT<sl>:
 ALLocation<al>:DMRS:POWER <Power>**

Defines the PDSCH DM-RS power relative to the PDSCH.

Suffix:

<cc> Component Carrier
 <fr> Frame
 <bwp> Bandwidth part
 <sl> Slot
 <al> Allocation

Parameters:

<Power> <numeric value>

When you turn on transform precoding after a preset, the FSW automatically changes the relative power to 3 dB, according to 3GPP 38.214.

*RST: 0

Default unit: dB

Example:

//Define DM-RS power

CONF:UL:CC2:FRAM3:BWP2:SLOT4:ALL5:DMRS:POW 0.5

Manual operation: See "[PUSCH DMRS Rel Power](#)" on page 95

**CONFigure[[NR5G](#)]:UL[[CC](#)<cc>]:FRAMe<fr>:BWPart<bwp>:SLOT<sl>:
ALLOcation<al>:DMRS:RST <State>**

Turns low peak to average power ratio for the PUSCH DMRS on and off.

Suffix:

<cc> [Component Carrier](#)

<fr> [Frame](#)

<bwp> [Bandwidth part](#)

<sl> [Slot](#)

<al> [Allocation](#)

Parameters:

<State> ON | OFF | 1 | 0

*RST: OFF

Example:

//Turn on dmrs-uplink-r16

CONF:UL:CC2:FRAM3:BWP2:SLOT4:ALL5:DMRS:RST ON

Manual operation: See "[DMRS-Uplink](#)" on page 96

**CONFigure[[NR5G](#)]:UL[[CC](#)<cc>]:FRAMe<fr>:BWPart<bwp>:SLOT<sl>:
ALLOcation<al>:DMRS:SGENeration <Method>**

Selects the PDSCH DM-RS sequence generation method.

Suffix:

<cc> [Component Carrier](#)

<fr> [Frame](#)

<bwp> [Bandwidth part](#)

<sl> [Slot](#)

<al> [Allocation](#)

Parameters:

<Method>

NIDCell

Sequence generation based on the cell ID.

NIDDmrs

Sequence generation based on a pseudo-random seed value.

*RST: NIDCell

Example:

```
//Define DM-RS sequence type
CONF:UL:CC2:FRAM3:BWP2:SLOT4:ALL5:DMRS:SGEN
NIDC
```

Manual operation: See "[PUSCH DMRS Sequence Generation \(Transform Precoding = Off\)](#)" on page 94

**CONFigure[:NR5G]:UL[:CC<cc>]:FRAMe<fr>:BWPart<bwp>:SLOT<sl>:
ALLocation<al>:DMRS:TAPos <Symbol>**

Defines the first symbol that the DM-RS uses.

Prerequisites for this command

- Select DM-RS mapping type A (`CONFigure[:NR5G]:UL[:CC<cc>]:FRAMe<fr>:BWPart<bwp>:SLOT<sl>:ALLocation<al>:DMRS:MTYPE`).

Suffix:

<cc> [Component Carrier](#)

<fr> [Frame](#)

<bwp> [Bandwidth part](#)

<sl> [Slot](#)

<al> [Allocation](#)

Parameters:

<Symbol> 2 | 3

Example:

```
//Define position of DM-RS
CONF:UL:CC2:FRAM3:BWP2:SLOT4:ALL5:DMRS:MTYP A
CONF:UL:CC2:FRAM3:BWP2:SLOT4:ALL5:DMRS:TAP 3
```

Manual operation: See "[PUSCH DMRS Location](#)" on page 93

**CONFigure[:NR5G]:UL[:CC<cc>]:FRAMe<fr>:BWPart<bwp>:SLOT<sl>:
ALLocation<al>:UEID <ID>**

Defines the user ID of a PUSCH allocation.

Suffix:

<cc> [Component Carrier](#)

<fr> [Frame](#)

<bwp> [Bandwidth part](#)

<sl>	Slot
<al>	Allocation
Parameters:	
<ID>	<numeric value> (integer only)
Example:	//Define allocation ID CONF:UL:CC2:FRAM3:BWP2:SLOT4:ALL5:UEID 8
Manual operation:	See "User ID" on page 93

6.10.13 Enhanced PUSCH settings: PTRS

Commands to configure the PTRS described elsewhere.

- `CONFigure[:NR5G]:UL[:CC<cc>]:FRAMe<fr>:BWPart<bwp>:SLOT<sl>:ALLocation<al>:UEID`

<code>CONFigure[:NR5G]:UL[:CC<cc>]:FRAMe<fr>:BWPart<bwp>:SLOT<sl>:ALLocation<al>:PTRS:K.....</code>	345
<code>CONFigure[:NR5G]:UL[:CC<cc>]:FRAMe<fr>:BWPart<bwp>:SLOT<sl>:ALLocation<al>:PTRS:L.....</code>	346
<code>CONFigure[:NR5G]:UL[:CC<cc>]:FRAMe<fr>:BWPart<bwp>:SLOT<sl>:ALLocation<al>:PTRS:NGRoups.....</code>	346
<code>CONFigure[:NR5G]:UL[:CC<cc>]:FRAMe<fr>:BWPart<bwp>:SLOT<sl>:ALLocation<al>:PTRS:NID.....</code>	347
<code>CONFigure[:NR5G]:UL[:CC<cc>]:FRAMe<fr>:BWPart<bwp>:SLOT<sl>:ALLocation<al>:PTRS:NIID.....</code>	348
<code>CONFigure[:NR5G]:UL[:CC<cc>]:FRAMe<fr>:BWPart<bwp>:SLOT<sl>:ALLocation<al>:PTRS:NSAMples.....</code>	348
<code>CONFigure[:NR5G]:UL[:CC<cc>]:FRAMe<fr>:BWPart<bwp>:SLOT<sl>:ALLocation<al>:PTRS:POWer.....</code>	349
<code>CONFigure[:NR5G]:UL[:CC<cc>]:FRAMe<fr>:BWPart<bwp>:SLOT<sl>:ALLocation<al>:PTRS:REOfset.....</code>	350
<code>CONFigure[:NR5G]:UL[:CC<cc>]:FRAMe<fr>:BWPart<bwp>:SLOT<sl>:ALLocation<al>:PTRS[:STATe].....</code>	350

CONFigure[:NR5G]:UL[:CC<cc>]:FRAMe<fr>:BWPart<bwp>:SLOT<sl>:ALLocation<al>:PTRS:K <Value>

Defines an offset for the PTRS in the frequency domain.

Prerequisites for this command

- Turn off transform precoding (`CONFigure[:NR5G]:UL[:CC<cc>]:TPRecoding`).
- Turn on PTRS (`CONFigure[:NR5G]:UL[:CC<cc>]:FRAMe<fr>:BWPart<bwp>:SLOT<sl>:ALLocation<al>:PTRS[:STATe]`).

Suffix:

<cc>	Component Carrier
<fr>	Frame

<bwp> Bandwidth part
 <sl> Slot
 <al> Allocation

Parameters:

<Value> 2 | 4 [subcarrier]
 *RST: 1

Example: //Define PTRS offset
 CONF:UL:CC2:FRAM3:BWP2:SLOT4:ALL5:PTRS ON
 CONF:UL:CC2:FRAM3:BWP2:SLOT4:ALL5:PTRS:K 4

Manual operation: See "PTRS Configuration (Transform Precoding = Off)"
 on page 97

**CONFigure[:NR5G]:UL[:CC<cc>]:FRAMe<fr>:BWPart<bwp>:SLOT<sl>:
 ALLocation<al>:PTRS:L <Value>**

Defines an offset for the PTRS in the time domain.

Prerequisites for this command

- Turn on PTRS (CONFigure[:NR5G]:UL[:CC<cc>]:FRAMe<fr>:
 BWPart<bwp>:SLOT<sl>:ALLocation<al>:PTRS[:STATe]).

Suffix:

<cc> Component Carrier
 <fr> Frame
 <bwp> Bandwidth part
 <sl> Slot
 <al> Allocation

Parameters:

<Value> 1 | 2 | 4 [OFDM symbols]
 *RST: 1

Example: //Define PTRS offset
 CONF:UL:CC2:FRAM3:BWP2:SLOT4:ALL5:PTRS ON
 CONF:UL:CC2:FRAM3:BWP2:SLOT4:ALL5:PTRS:L 4

Manual operation: See "PTRS Configuration (Transform Precoding = Off)"
 on page 97
 See "PTRS Configuration (Transform Precoding = On)"
 on page 98

**CONFigure[:NR5G]:UL[:CC<cc>]:FRAMe<fr>:BWPart<bwp>:SLOT<sl>:
 ALLocation<al>:PTRS:NGRoups <PTRSGroups>**

Defines the number of PTRS groups.

Prerequisites for this command

- Turn on transform precoding (`CONFigure[:NR5G]:UL[:CC<cc>]:TPRecoding`).
- Turn on PTRS (`CONFigure[:NR5G]:UL[:CC<cc>]:FRAMe<fr>:BWPart<bwp>:SLOT<sl>:ALLocation<al>:PTRS[:STATe]`).

Suffix:

<cc>	Component Carrier
<fr>	Frame
<bwp>	Bandwidth part
<sl>	Slot
<al>	Allocation

Parameters:

<PTRSGroups>	2 4 8
*RST:	2

Example:

```
//Define samples of PTRS group
CONF:UL:CC2:TPR ON
CONF:UL:CC2:FRAM3:BWP2:SLOT4:ALL4:PTRS ON
CONF:UL:CC2:FRAM3:BWP2:SLOT4:ALL4:PTRS:NGR 8
```

Manual operation: See "PTRS Configuration (Transform Precoding = On)" on page 98

CONFigure[:NR5G]:UL[:CC<cc>]:FRAMe<fr>:BWPart<bwp>:SLOT<sl>:ALLocation<al>:PTRS:NID <Method>

Selects the PUSCH PTRS sequence generation method.

Prerequisites for this command

- Turn on transform precoding (`CONFigure[:NR5G]:UL[:CC<cc>]:TPRecoding`).

Suffix:

<cc>	Component Carrier
<fr>	Frame
<bwp>	Bandwidth part
<sl>	Slot
<al>	Allocation

Parameters:

<Method>	NIDCell Sequence generation based on the cell ID.
	NIDPusch Sequence generation based on a pseudo-random seed value.
*RST:	NIDCell

Example: //Define PTRS sequence method
 CONF:UL:CC2:FRAM3:BWP2:SLOT4:ALL5:PTRS:NID NIDP

Manual operation: See "PTRS Configuration (Transform Precoding = On)" on page 98

CONFigure[:NR5G]:UL[:CC<cc>]:FRAMe<fr>:BWPart<bwp>:SLOT<sl>:ALLocation<al>:PTRS:NIID <Value>

Defines the seed value for the PUSCH PTRS sequence generation.

Prerequisites for this command

- Turn on transform precoding (CONFigure[:NR5G]:UL[:CC<cc>]:TPRecoding).
- Select sequence generation method n_ID^PUSCH (CONFigure[:NR5G]:UL[:CC<cc>]:FRAMe<fr>:BWPart<bwp>:SLOT<sl>:ALLocation<al>:PTRS:NID).

Suffix:

<cc> Component Carrier
 <fr> Frame
 <bwp> Bandwidth part
 <sl> Slot
 <al> Allocation

Parameters:

<Value> <numeric value> (integer only)
 *RST: 0

Example: //Define seed value
 CONF:UL:CC2:FRAM3:BWP2:SLOT4:ALL5:PTRS:NID NIDP
 CONF:UL:CC2:FRAM3:BWP2:SLOT4:ALL5:PTRS:NIID 15

Manual operation: See "PTRS Configuration (Transform Precoding = On)" on page 98

CONFigure[:NR5G]:UL[:CC<cc>]:FRAMe<fr>:BWPart<bwp>:SLOT<sl>:ALLocation<al>:PTRS:NSAMples <Samples>

Defines the number of samples allocated to a PTRS group.

Prerequisites for this command

- Turn on transform precoding (CONFigure[:NR5G]:UL[:CC<cc>]:TPRecoding).
- Turn on PTRS (CONFigure[:NR5G]:UL[:CC<cc>]:FRAMe<fr>:BWPart<bwp>:SLOT<sl>:ALLocation<al>:PTRS[:STATe]).

Suffix:

<cc> Component Carrier

<fr> Frame

<bwp> Bandwidth part

<sl> Slot

<al> Allocation

Parameters:

<Samples> 2 | 4

*RST: 2

Example:

```
//Define samples of PTRS group
CONF:UL:CC2:TPR ON
CONF:UL:CC2:FRAM3:BWP2:SLOT4:ALL4:PTRS ON
CONF:UL:CC2:FRAM3:BWP2:SLOT4:ALL4:PTRS:NSAM 2
```

Manual operation: See "[PTRS Configuration \(Transform Precoding = On\)](#)" on page 98

CONFigure[:NR5G]:UL[:CC<cc>]:FRAMe<fr>:BWPART<bwp>:SLOT<sl>:ALLOCATION<al>:PTRS:POWer <Power>

Defines the relative power of the PTRS.

Prerequisites for this command

- Turn on PTRS (`CONFigure[:NR5G]:UL[:CC<cc>]:FRAMe<fr>:BWPART<bwp>:SLOT<sl>:ALLOCATION<al>:PTRS[:STATe]`).

Suffix:

<cc> Component Carrier

<fr> Frame

<bwp> Bandwidth part

<sl> Slot

<al> Allocation

Parameters:

<Power> <numeric value>

*RST: 0

Default unit: dB

Example:

```
//Define PTRS power
CONF:UL:CC2:FRAM3:BWP2:SLOT4:ALL5:PTRS ON
CONF:UL:CC2:FRAM3:BWP2:SLOT4:ALL5:PTRS:POW 1DB
```

Manual operation: See "[PTRS Configuration \(Transform Precoding = Off\)](#)" on page 97
See "[PTRS Configuration \(Transform Precoding = On\)](#)" on page 98

**CONFigure[:NR5G]:UL[:CC<cc>]:FRAMe<fr>:BWPART<bwp>:SLOT<sl>:
ALLOCATION<al>:PTRS:REOffset <Offset>**

Defines the location of the PTRS in the frequency domain relative to the first subcarrier.

Prerequisites for this command

- Turn off transform precoding (`CONFigure[:NR5G]:UL[:CC<cc>]:TPRecoding`).
- Turn on PTRS (`CONFigure[:NR5G]:UL[:CC<cc>]:FRAMe<fr>:BWPART<bwp>:SLOT<sl>:ALLOCATION<al>:PTRS[:STATE]`).

Suffix:

<cc>	Component Carrier
<fr>	Frame
<bwp>	Bandwidth part
<sl>	Slot
<al>	Allocation

Parameters:

<Offset>	OS00 OS01 OS10 OS11 Defines an offset.
	NONE No offset.
	*RST: 00

Example:

```
//Define PTRS offset
CONF:UL:CC2:FRAM3:BWP2:SLOT4:ALL5:PTRS ON
CONF:UL:CC2:FRAM3:BWP2:SLOT4:ALL5:PTRS:REOF
OS10
```

Manual operation: See "PTRS Configuration (Transform Precoding = Off)" on page 97

**CONFigure[:NR5G]:UL[:CC<cc>]:FRAMe<fr>:BWPART<bwp>:SLOT<sl>:
ALLOCATION<al>:PTRS[:STATE] <State>**

Turns the PTRS on and off.

Suffix:

<cc>	Component Carrier
<fr>	Frame
<bwp>	Bandwidth part
<sl>	Slot
<al>	Allocation

Parameters:

<State> ON | OFF | 1 | 0
 *RST: OFF

Example:

```
//Turn on PTRS
CONF:UL:CC2:FRAM3:BWP2:SLOT4:ALL5:PTRS ON
```

Manual operation:

See "PTRS Configuration (Transform Precoding = Off)"
 on page 97
 See "PTRS Configuration (Transform Precoding = On)"
 on page 98

6.10.14 Enhanced PUSCH settings: scrambling / coding

Commands to configure the PTRS described elsewhere.

- `CONFigure[:NR5G]:UL[:CC<cc>]:FRAMe<fr>:BWPart<bwp>:SLOT<sl>:ALLocation<al>:UEID`

<code>CONFigure[:NR5G]:UL[:CC<cc>]:FRAMe<fr>:BWPart<bwp>:SLOT<sl>:ALLocation<al>:CCODing:IMCS</code>	351
<code>CONFigure[:NR5G]:UL[:CC<cc>]:FRAMe<fr>:BWPart<bwp>:SLOT<sl>:ALLocation<al>:CCODing:MCSTable</code>	352
<code>CONFigure[:NR5G]:UL[:CC<cc>]:FRAMe<fr>:BWPart<bwp>:SLOT<sl>:ALLocation<al>:CCODing:RVINdex</code>	352
<code>CONFigure[:NR5G]:UL[:CC<cc>]:FRAMe<fr>:BWPart<bwp>:SLOT<sl>:ALLocation<al>:SCRambling</code>	353
<code>CONFigure[:NR5G]:UL[:CC<cc>]:FRAMe<fr>:BWPart<bwp>:SLOT<sl>:ALLocation<al>:SCRambling:DSID</code>	353

CONFigure[:NR5G]:UL[:CC<cc>]:FRAMe<fr>:BWPart<bwp>:SLOT<sl>:ALLocation<al>:CCODing:IMCS <Value>

Selects the MCS index (I_{MCS}).

Suffix:

<cc> Component Carrier
 <fr> Frame
 <bwp> Bandwidth part
 <sl> Slot
 <al> Allocation

Parameters:

<Value>

The value range depends on:

- The modulation order (`CONFigure[:NR5G]:UL[:CC<cc>]:FRAMe<fr>:BWPart<bwp>:SLOT<sl>:ALLocation<al>:CCODing:MCSTable`).
- The modulation scheme of the PUSCH (`CONFigure[:NR5G]:UL[:CC<cc>]:FRAMe<fr>:BWPart<bwp>:SLOT<sl>:ALLocation<al>:MODulation`).

*RST: 0

Example:

```
//Select MCS index for modulation order 64QAM
CONF:UL:CC2:FRAM3:BWP2:SLOT3:ALL1:MOD QPSK
CONF:UL:CC2:FRAM3:BWP2:SLOT3:ALL1:CCOD:MCST Q64
CONF:UL:CC2:FRAM3:BWP2:SLOT3:ALL1:CCOD:IMCS 2
```

Manual operation: See "Channel Coding" on page 99

**CONFigure[:NR5G]:UL[:CC<cc>]:FRAMe<fr>:BWPart<bwp>:SLOT<sl>:
ALLocation<al>:CCODing:MCSTable <Table>**

Selects the modulation order (MCS table) of the PDSCH.

Suffix:

<cc> Component Carrier
 <fr> Frame
 <bwp> Bandwidth part
 <sl> Slot
 <al> Allocation

Parameters:

<Table>

Q64

Table for 64QAM.

Q64L

Table for 64QAM LowSE.

Q256

Table for 256QAM.

*RST: Q64

Example:

```
//Select modulation order
CONF:UL:CC2:FRAM3:BWP2:SLOT3:ALL1:CCOD:MCST Q64
```

Manual operation: See "Channel Coding" on page 99

**CONFigure[:NR5G]:UL[:CC<cc>]:FRAMe<fr>:BWPart<bwp>:SLOT<sl>:
ALLocation<al>:CCODing:RVIndex <Index>**

Selects the redundancy version index.

Suffix:

<cc>	Component Carrier
<fr>	Frame
<bwp>	Bandwidth part
<sl>	Slot
<al>	Allocation

Parameters:

<Index>	Range: 0 to 3
	*RST: 0

Example: //Select redundancy version index
 CONF:UL:CC2:FRAM3:BWP2:SLOT2:ALL1:CCOD:RVIN 1

Manual operation: See "Channel Coding" on page 99

**CONFigure[:NR5G]:UL[:CC<cc>]:FRAMe<fr>:BWPART<bwp>:SLOT<sl>:
 ALLOCATION<al>:SCRAMBLING <Method>**

Selects the PUSCH scrambling method.

Suffix:

<cc>	Component Carrier
<fr>	Frame
<bwp>	Bandwidth part
<sl>	Slot
<al>	Allocation

Parameters:

<Method>	DSID Sequence generation based on a pseudo-random seed value.
	NIDCell Sequence generation based on the cell ID.
	*RST: NIDCell

Example: //Define PUSCH scrambling method
 CONF:UL:CC2:FRAM3:BWP2:SLOT2:ALL1:SCR NIDC

Manual operation: See "PUSCH Scrambling" on page 100

**CONFigure[:NR5G]:UL[:CC<cc>]:FRAMe<fr>:BWPART<bwp>:SLOT<sl>:
 ALLOCATION<al>:SCRAMBLING:DSID <Value>**

Defines the seed value for the PDSCH scrambling.

Prerequisites for this command

- Select sequence generation method DMRS-Scrambling-ID (`CONFigure[:NR5G]:UL[:CC<cc>]:FRAMe<fr>:BWPart<bw>:SLOT<sl>:ALLocation<al>:SCRambling`).

Suffix:

<cc>	Component Carrier
<fr>	Frame
<bw>	Bandwidth part
<sl>	Slot
<al>	Allocation

Parameters:

<Value>	<numeric value> (integer only)
*RST:	0

Example:

```
//Define seed value
CONF:UL:CC2:FRAM3:BWP2:SLOT3:ALL1:SCR DSID
CONF:UL:CC2:FRAM3:BWP2:SLOT3:ALL1:SCR:DSID 10
```

Manual operation: See "PUSCH Scrambling" on page 100

6.10.15 Antenna port configuration

<code>CONFigure[:NR5G]:UL[:CC<cc>]:PAMapping<cf>:PUSCh:AP<ap></code>	354
<code>CONFigure[:NR5G]:UL[:CC<cc>]:PAMapping<cf>:STATe</code>	355

`CONFigure[:NR5G]:UL[:CC<cc>]:PAMapping<cf>:PUSCh:AP<ap> <State>`

Selects the antenna port(s) that transmits the PUSCH. The selection indirectly also selects the antenna port that transmits the PUSCH DMRS.

Suffix:

<cc>	Component Carrier
<cf>	1...2 Antenna port configuration
<ap>	1...11 Antenna port

Parameters:

<State>	ON OFF 1 0 Turns the transmission on a specific antenna port on and off.
	ALL Turns on the transmission on all antenna ports (1000 to 1011).
	NONE Turns off the transmission on all antenna ports. By default, the transmission is on antenna port 1000 (configuration 1) and 1001 (configuration 2).

Example: //Turn on transmission on antenna port 11 (PUSCH DMRS) and 1011 (PUSCH) in configuration 1
CONF:UL:CC1:PAM1:PDSCH:AP1 ON

Manual operation: See "PUSCH" on page 101

CONFigure[:NR5G]:UL[:CC<cc>]:PAMapping<cf>:STATe <State>

Selects one of the antenna port configurations.

Effects of this command

- If you turn on a configuration, the other antenna port configuration is automatically turned off (and vice versa).

Suffix:

<cc> [Component Carrier](#)
<cf> 1...2
 [Antenna port configuration](#)

Parameters:

<State> ON | OFF | 1 | 0
*RST: ON for configuration 1

Example: //Turn on antenna port configuration 2
CONF:UL:CC2:PAM2:STAT ON

Manual operation: See "State" on page 101

6.10.16 Advanced settings: global

CONFigure[:NR5G]:ORAN:TCASe.....	355
CONFigure[:NR5G]:UL[:CC<cc>]:FNNF.....	356
CONFigure[:NR5G]:UL[:CC<cc>]:IDC.....	356
CONFigure[:NR5G]:UL[:CC<cc>]:PUSCh:FHOPping.....	356
CONFigure[:NR5G]:UL[:CC<cc>]:PUSCh:HOPping.....	357
CONFigure[:NR5G]:UL[:CC<cc>]:RFUC:FZERo:FREQuency.....	357
CONFigure[:NR5G]:UL[:CC<cc>]:RFUC:FZERo:MODE.....	357
CONFigure[:NR5G]:UL[:CC<cc>]:RFUC:STATe.....	358
CONFigure[:NR5G]:UL[:CC<cc>]:SFLatness:ECONditions.....	358
CONFigure[:NR5G]:UL[:CC<cc>]:TPRecoding.....	359

CONFigure[:NR5G]:ORAN:TCASe <Testcase>

Selects an O-RAN test case.

Parameters:

<Testcase> **<string>**
String containing the name of the test case, e.g. "TC 3.2.3.1.1".
The string "NONE" removes a test case.
*RST: NONE

Example: //Select O-RAN test case TC 3.2.3.1.4
CONF:ORAN:TCAS "TC 3.2.3.1.4"

Manual operation: See "[O-RAN Test Case](#)" on page 105

CONFigure[:NR5G]:UL[:CC<cc>]:FNNF <FrameNumber>

Defines the 5G NR system frame number.

Suffix:

<cc> irrelevant

Parameters:

<FrameNumber> *RST: 0

Example: //Define frame number
CONF:UL:FNNF 124

Manual operation: See "[Frame Number n_f](#)" on page 104

CONFigure[:NR5G]:UL[:CC<cc>]:IDC <State>

Turns analysis of the DC carrier on and off.

Suffix:

<cc> [Component Carrier](#)

Parameters:

<State> ON | OFF | 1 | 0
*RST: OFF

Example: //Do not analyze DC carrier
CONF:UL:CC2:IDC ON

Manual operation: See "[Handling of Carrier Leakage](#)" on page 103

CONFigure[:NR5G]:UL[:CC<cc>]:PUSCh:FHOPping <Mode>

Selects the PUSCH frequency hopping mode.

Prerequisites for this command

- Configure exactly one PUSCH allocation.

Suffix:

<cc> [Component Carrier](#)

Parameters:

<Mode> **DISable**
No PUSCH frequency hopping.
INTRa
Intra-slot frequency hopping.
*RST: DISable

Example: //Turn on intra-slot hopping
CONF:UL:PUSC:FHOP INTR

Manual operation: See "PUSCH Frequency Hopping" on page 104

CONFigure[:NR5G]:UL[:CC<cc>]:PUSCh:HOPping <Mode>

Selects a hopping mode for the PUSCH DMRS sequence.

Suffix:

<cc> [Component Carrier](#)

Parameters:

<Mode> **GRoUp**
Selects group hopping.

NONE
Selects no hopping.

SEQuence
Selects sequence hopping.

Manual operation: See "PUSCH Hopping" on page 104

CONFigure[:NR5G]:UL[:CC<cc>]:RFUC:FZERo:FREQuency <Frequency>

Selects a frequency for RF upconversion.

Prerequisites for this command

- Turn on phase compensation ([CONFigure\[:NR5G\]:UL\[:CC<cc>\]:RFUC:STATe](#)).
- Select mode to select custom frequency ([CONFigure\[:NR5G\]:UL\[:CC<cc>\]:RFUC:FZERo:MODE](#)).

Suffix:

<cc> [Component Carrier](#)

Parameters:

<Frequency> <numeric value>

*RST: 0
Default unit: Hz

Example: //Define frequency for RF upconversion
CONF:UL:CC2:RFUC:STAT ON
CONF:UL:CC2:RFUC:FZER:MODE MAN
CONF:UL:CC2:RFUC:FZER:FREQ 800MHZ

Manual operation: See "RF Upconversion" on page 105

CONFigure[:NR5G]:UL[:CC<cc>]:RFUC:FZERo:MODE <Mode>

Selects the frequency selection mode for RF upconversion.

Prerequisites for this command

- Turn on phase compensation (`CONFigure[:NR5G]:UL[:CC<cc>]:RFUC:STATE`).

Suffix:

<cc> [Component Carrier](#)

Parameters:

<Mode>

CF

Converts the signal to the center frequency.

MANual

Converts the signal to another frequency.

You can define the frequency with `CONFigure[:NR5G]:UL[:CC<cc>]:RFUC:FZERo:FREQuency`.

*RST: CF

Example:

```
//Select frequency mode for RF upconversion
CONF:UL:CC2:RFUC:STAT ON
CONF:UL:CC2:RFUC:FZER:MODE CF
```

Manual operation: See "[RF Upconversion](#)" on page 105

CONFigure[:NR5G]:UL[:CC<cc>]:RFUC:STATE <State>

Turns RF upconversion and corresponding phase compensation on and off.

Suffix:

<cc> [Component Carrier](#)

Parameters:

<State>

ON | OFF | 1 | 0

*RST: ON

Example:

```
//Turn on phase compensation
CONF:UL:CC2:RFUC:STAT ON
```

Manual operation: See "[RF Upconversion](#)" on page 105

CONFigure[:NR5G]:UL[:CC<cc>]:SFLatness:ECONditions <State>

Turns extreme conditions for spectrum flatness measurements on and off.

Prerequisites for this command

- Select FR1 deployment (`CONFigure[:NR5G]:UL[:CC<cc>]:DFRange`).

Suffix:

<cc> [Component Carrier](#)

Parameters:

<State>

ON | OFF | 1 | 0

*RST: OFF

Example: //Turn on extreme conditions
 CONF:UL:DFR LOW
 CONF:UL:SFL:ECON ON

Manual operation: See ["Extreme Conditions"](#) on page 105

CONFigure[:NR5G]:UL[:CC<cc>]:TPRecoding <State>

Turns transform precoding on and off.

Effects of this command

- When you turn on transform precoding after a preset, the FSW automatically changes the relative power of the PUSCH DMRS to 3 dB, according to 3GPP 38.214.

Suffix:

<cc> [Component Carrier](#)

Parameters:

<State> ON | OFF | 1 | 0
 *RST: OFF

Example: //Turn on transform precoding
 CONF:UL:CC2:TPR ON

Manual operation: See ["Transform Precoding"](#) on page 104

6.10.17 Advanced settings: reference point A

CONFigure[:NR5G]:UL[:CC<cc>]:RPA:AFRequency?	359
CONFigure[:NR5G]:UL[:CC<cc>]:RPA:KZERo:SCFE	360
CONFigure[:NR5G]:UL[:CC<cc>]:RPA:KZERo:SCFT	360
CONFigure[:NR5G]:UL[:CC<cc>]:RPA:KZERo:SCNS	360
CONFigure[:NR5G]:UL[:CC<cc>]:RPA:KZERo:SCOT	361
CONFigure[:NR5G]:UL[:CC<cc>]:RPA:KZERo:SCST	361
CONFigure[:NR5G]:UL[:CC<cc>]:RPA:KZERo:SCTT	361
CONFigure[:NR5G]:UL[:CC<cc>]:RPA:RTCF	362
CONFigure[:NR5G]:UL[:CC<cc>]:RPA:TBOFset?	362

CONFigure[:NR5G]:UL[:CC<cc>]:RPA:AFRequency?

Queries the absolute frequency of the reference point A.

Suffix:

<cc> [Component Carrier](#)

Return values:

<Frequency> <numeric value>
 Default unit: Hz

Example: //Query location of reference point A
 CONF:UL:CC2:RPA:AFR?

Usage: Query only

Manual operation: See "Reference Point A" on page 106

CONFigure[:NR5G]:UL[:CC<cc>]:RPA:KZERo:SCFE <Offset>

Defines an offset relative to reference point A for bandwidth parts with 480 kHz subcarrier spacing.

Prerequisites for this command

- Bandwidth part with 480 kHz subcarrier spacing is available.

Suffix:

<cc> [Component Carrier](#)

Parameters:

<Offset> -6 | 0 | 6

Example:

```
//Define offset
CONF:UL:CC2:RPA:KZER:SCFE 0
```

Manual operation: See "k_0" on page 106

CONFigure[:NR5G]:UL[:CC<cc>]:RPA:KZERo:SCFT <Offset>

Defines an offset relative to reference point A for bandwidth parts with 15 kHz subcarrier spacing.

Prerequisites for this command

- Bandwidth part with 15 kHz subcarrier spacing is available.

Suffix:

<cc> [Component Carrier](#)

Parameters:

<Offset> -6 | 0 | 6

Example:

```
//Define offset
CONF:UL:CC2:RPA:KZER:SCFT 0
```

Manual operation: See "k_0" on page 106

CONFigure[:NR5G]:UL[:CC<cc>]:RPA:KZERo:SCNS <Offset>

Defines an offset relative to reference point A for bandwidth parts with 960 kHz subcarrier spacing.

Prerequisites for this command

- Bandwidth part with 960 kHz subcarrier spacing is available.

Suffix:

<cc> [Component Carrier](#)

Parameters:

<Offset> -6 | 0 | 6

Example: //Define offset
CONF:DL:CC2:RPA:KZER:SCNS 0

Manual operation: See "[k_0](#)" on page 106

CONFigure[:NR5G]:UL[:CC<cc>]:RPA:KZERo:SCOT <Offset>

Defines an offset relative to reference point A for bandwidth parts with 120 kHz subcarrier spacing.

Prerequisites for this command

- Bandwidth part with 120 kHz subcarrier spacing is available.

Suffix:

<cc> [Component Carrier](#)

Parameters:

<Offset> -6 | 0 | 6

Example: //Define offset
CONF:UL:CC2:RPA:KZER:SCOT 0

Manual operation: See "[k_0](#)" on page 106

CONFigure[:NR5G]:UL[:CC<cc>]:RPA:KZERo:SCST <Offset>

Defines an offset relative to reference point A for bandwidth parts with 60 kHz subcarrier spacing.

Prerequisites for this command

- Bandwidth part with 60 kHz subcarrier spacing is available.

Suffix:

<cc> [Component Carrier](#)

Parameters:

<Offset> -6 | 0 | 6

Example: //Define offset
CONF:UL:CC2:RPA:KZER:SCST 0

Manual operation: See "[k_0](#)" on page 106

CONFigure[:NR5G]:UL[:CC<cc>]:RPA:KZERo:SCTT <Offset>

Defines an offset relative to reference point A for bandwidth parts with 30 kHz subcarrier spacing.

Prerequisites for this command

- Bandwidth part with 30 kHz subcarrier spacing is available.

Suffix:

<cc> [Component Carrier](#)

Parameters:

<Offset> -6 | 0 | 6

Example:

```
//Define offset
CONF:UL:CC2:RPA:KZER:SCTT 0
```

Manual operation: See "[k_0](#)" on page 106

CONFigure[:NR5G]:UL[:CC<cc>]:RPA:RTCF <Frequency>

Defines the frequency of the reference point A relative to the carrier's center frequency.

Suffix:

<cc> [Component Carrier](#)

Parameters:

<Frequency> <numeric value>
Default unit: Hz

Example:

```
//Define location of reference point A
CONF:UL:CC2:RPA:RTCF -54.5MHZ
```

Manual operation: See "[Reference Point A](#)" on page 106

CONFigure[:NR5G]:UL[:CC<cc>]:RPA:TBOffset?

Queries the TxBW offset of the reference point A.

Suffix:

<cc> [Component Carrier](#)

Return values:

<Offset> <numeric value>
Default unit: Hz

Example:

```
//Query TxBW offset
CONF:UL:CC2:RPA:TBOF?
```

Usage:

Query only

Manual operation: See "[Reference Point A](#)" on page 106

6.10.18 Generator control

CONFigure:GENerator:FREQuency:CENTer:SYNC[:STATe]	363
CONFigure:GENerator:IPConnection:ADDRess	363
CONFigure:GENerator:IPConnection:LEDState?	363
CONFigure:GENerator:POWer:LEVel:STATe	364
CONFigure:GENerator:LEVel:DUTGain	364
CONFigure:GENerator:LEVel:DUTLimit	365
CONFigure:GENerator:LEVel:DUTLimit:STATe	365
CONFigure:GENerator:POWer:LEVel	365
CONFigure:SETTings:NR5G	366

CONFigure:SETTings:NR5G:PINTErval.....	366
CONFigure:SETTings:NR5G:SYNC.....	367
CONFigure:SETTings:RF.....	367
CONFigure:GENerator:RFOutput[:STATe].....	367
CONFigure:GENerator:CONTRol[:STATe].....	368
CONFigure:GENerator:SETTings:UPDate:RF.....	368

CONFigure:GENerator:FREQUency:CENTer:SYNC[:STATe] <State>

Turns frequency synchronization between analyzer and generator on and off.

You can define the frequency itself with `[SENSe:]FREQUency:CENTer[:CC<cc>]`.

Prerequisites for this command

- IP connection to a signal generator.
- Generator control state is on (`CONFigure:GENerator:CONTRol[:STATe]`).

Parameters:

<State> ON | OFF | 1 | 0
 *RST: OFF

Example: //Turn on RF output
 CONF:GEN:CONT ON
 CONF:GEN:FREQ:CENT ON

Manual operation: See "[Center Frequency](#)" on page 108

CONFigure:GENerator:IPConnection:ADDRess <IPAddress>

This command defines the IP address of the connected signal generator.

Make sure to synchronize with `*OPC?` or `*WAI` to make sure that the command was successfully applied on the generator before sending the next command.

Parameters:

<IPAddress> String containing the IP address or computer name.

Example: //Connect to the generator with the stated IP address
 CONF:GEN:IPC:ADDR '192.0.2.0';*WAI

Example: //Connect to the generator with a computer name
 CONF:GEN:IPC:ADDR 'MyGenerator';*WAI

Manual operation: See "[Generator IP Address](#)" on page 107

CONFigure:GENerator:IPConnection:LEDState?

This command queries the state of connection to the signal generator.

Return values:

<State> **GREen**
 Connection was successful.

GREY

Unknown connection state.

RED

Connection was not successful.

Example:

```
CONF:GEN:IPC:LEDS?
would return, e.g.:
RED
```

Usage:

Query only

Manual operation: See "[Generator IP Address](#)" on page 107**CONFigure:GENerator:POWer:LEVel:STATe** <State>

Turns level synchronization between analyzer and generator on and off.

Prerequisites for this command

- IP connection to a signal generator.
- Generator control state is on ([CONFigure:GENerator:CONTRol\[:STATe\]](#)).

Parameters:

```
<State>      ON | OFF | 1 | 0
*RST:        OFF
```

Example:

```
//Turn on level synchronization
CONF:GEN:CONT ON
CONF:GEN:POW:LEV:STAT ON
```

Manual operation: See "[Level Control State](#)" on page 109**CONFigure:GENerator:LEVel:DUTGain** <Level>

Defines DUT level gain for generator level control.

Prerequisites for this command

- IP connection to a signal generator.
- Generator control state is on ([CONFigure:GENerator:CONTRol\[:STATe\]](#)).
- Level control is on ([CONFigure:GENerator:POWer:LEVel:STATe](#)).

Parameters:

```
<Level>      *RST:      0
Default unit: dB
```

Example:

```
//Define DUT gain
CONF:GEN:CONT ON
CONF:GEN:LEV:DUTG ON
```

Manual operation: See "[DUT Gain](#)" on page 109

CONFigure:GENerator:LEVel:DUTLimit <Level>

Defines the output power RMS level of the generator.

Prerequisites for this command

- IP connection to a signal generator.
- Generator control state is on (`CONFigure:GENerator:CONTRol[:STATe]`).
- Level control is on (`CONFigure:GENerator:POWer:LEVel:STATe`).
- DUT peak input power limit is on (`CONFigure:GENerator:LEVel:DUTLimit:STATe`).

Parameters:

<Level> *RST: 30
 Default unit: dB

Example:

```
//Define peak input power
CONF:GEN:CONT ON
CONF:GEN:POW:LEV:STAT ON
CONF:GEN:LEV:DUTL:STAT ON
CONF:GEN:LEV:DUTL 10
```

Manual operation: See "[Limit DUT Peak Input Power](#)" on page 109

CONFigure:GENerator:LEVel:DUTLimit:STATe <State>

Turns a limitation of the DUT peak input power on and off.

Define the peak input power with `CONFigure:GENerator:LEVel:DUTLimit`.

Prerequisites for this command

- IP connection to a signal generator.
- Generator control state is on (`CONFigure:GENerator:CONTRol[:STATe]`).
- Level control is on (`CONFigure:GENerator:POWer:LEVel:STATe`).

Parameters:

<State> ON | OFF | 1 | 0
 *RST: OFF

Example:

```
//Turn on DUT input power limitation
CONF:GEN:CONT ON
CONF:GEN:POW:LEV:STAT ON
CONF:GEN:LEV:DUTL:STAT ON
```

Manual operation: See "[Limit DUT Peak Input Power](#)" on page 109

CONFigure:GENerator:POWer:LEVel <Level>

Defines the output power RMS level of the generator.

Prerequisites for this command

- IP connection to a signal generator.

- Generator control state is on ([CONFigure:GENerator:CONTrol\[:STATe\]](#)).
- Level control is on ([CONFigure:GENerator:POWer:LEVel:STATe](#)).

Parameters:

<Level> *RST: 0
 Default unit: dBm

Example:

```
//Define generator output level
CONF:GEN:CONT ON
CONF:GEN:POW:LEV:STAT ON
CONF:GEN:POW:LEV -10
```

Manual operation: See "[Level \(RMS\)](#)" on page 109

CONFigure:SETTings:NR5G

Downloads the NR signal description from the generator to the analyzer.

Prerequisites for this command

- IP connection to a signal generator.
- Generator control state is on ([CONFigure:GENerator:CONTrol\[:STATe\]](#)).

Example:

```
//Synchronize signal description
CONF:GEN:CONT ON
CONF:SETT:NR5G
```

Usage:

Event

Manual operation: See "[Query Settings from Generator](#)" on page 109

CONFigure:SETTings:NR5G:PINTerval <Time>

Defines the polling interval for periodic synchronization between analyzer and generator.

Prerequisites for this command

- IP connection to a signal generator.
- Generator control state is on ([CONFigure:GENerator:CONTrol\[:STATe\]](#)).
- Periodic synchronization is on ([CONFigure:SETTings:NR5G:SYNC](#)).

Parameters:

<Time> Default unit: s

Example:

```
//Define polling interval
CONF:GEN:CONT ON
CONF:SETT:NR5G:SYNC ON
CONF:SETT:NR5G:PINT 30
```

Manual operation: See "[Periodic synchronization of 5G NR settings](#)" on page 110

CONFigure:SETTings:NR5G:SYNC <State>

Turns periodic synchronization of the signal description on the analyzer on and off.

Prerequisites for this command

- IP connection to a signal generator.
- Generator control state is on (`CONFigure:GENerator:CONTrol[:STATe]`).

Parameters:

<State> ON | OFF | 1 | 0
 *RST: OFF

Example: //Define polling interval
 CONF:GEN:CONT ON
 CONF:SETT:NR5G:SYNC ON

Manual operation: See ["Periodic synchronization of 5G NR settings"](#) on page 110

CONFigure:SETTings:RF

Downloads the RF settings (frequency, level) from the generator to the analyzer.

Prerequisites for this command

- IP connection to a signal generator.
- Generator control state is on (`CONFigure:GENerator:CONTrol[:STATe]`).

Example: //Synchronize signal description
 CONF:GEN:CONT ON
 CONF:SETT:RF

Usage: Event

Manual operation: See ["Query Settings from Generator"](#) on page 109

CONFigure:GENerator:RFOutput[:STATe] <State>

Turns the RF output of the generator on and off.

Prerequisites for this command

- IP connection to a signal generator.
- Generator control state is on (`CONFigure:GENerator:CONTrol[:STATe]`).

Parameters:

<State> ON | OFF | 1 | 0
 *RST: OFF

Example: //Turn on RF output
 CONF:GEN:CONT ON
 CONF:GEN:RFO ON

Manual operation: See ["RF Output State"](#) on page 108

CONFigure:GENerator:CONTrol[:STATe] <State>

Turns control over the signal generator on and off.

Prerequisites for this command

- IP connection to a signal generator.

Parameters:

<State> ON | OFF | 1 | 0
*RST: OFF

Example: //Turn on generator control
CONF:GEN:CONT ON

Manual operation: See "[Generator Control State](#)" on page 108

CONFigure:GENerator:SETTings:UPDate:RF

Uploads the RF settings (frequency, level) from analyzer to the generator.

Prerequisites for this command

- IP connection to a signal generator.
- Generator control state is on (`CONFigure:GENerator:CONTrol[:STATe]`).

Example: //Upload RF settings
CONF:GEN:CONT ON
CONF:GEN:SETT:UPD:RF

Usage: Event

Manual operation: See "[Upload RF Settings to Generator](#)" on page 109

6.10.19 Input configuration

Remote commands to configure the input described elsewhere:

- `INPut:COUPling` on page 380
- `INPut:IMPedance` on page 381
- `[SENSe:]SWAPiq` on page 384

<code>CALibration:AIQ:HATiming[:STATe]</code>	369
<code>INPut:CONNector</code>	369
<code>INPut:DIQ:CDEVice</code>	369
<code>INPut:DIQ:RANGe:COUPling</code>	370
<code>INPut:DIQ:RANGe:UPPer</code>	370
<code>INPut:DIQ:RANGe:UPPer:AUTO</code>	370
<code>INPut:DIQ:RANGe:UPPer:UNIT</code>	371
<code>INPut:DIQ:SRATe</code>	371
<code>INPut:DIQ:SRATe:AUTO</code>	371
<code>INPut:DPATH</code>	371
<code>INPut:FILE:PATH</code>	372
<code>INPut:FILTer:HPASs[:STATe]</code>	373

INPut:FiLTeR:YIG[:STATe].....	373
INPut:IQ:BALEnced[:STATe].....	373
INPut:IQ:TYPE.....	374
INPut:SELEct.....	374
INPut:TYPE.....	375
MMEMory:LOAD:IQ:STReam.....	375
MMEMory:LOAD:IQ:STReam:AUTO.....	375
MMEMory:LOAD:IQ:STReam:LIST?.....	376
TRACe:IQ:FILE:REPetition:COUNT.....	376

CALibration:AIQ:HATiming[:STATe] <State>

Activates a mode with enhanced timing accuracy between analog baseband, RF and external trigger signals.

Parameters:

<State> ON | OFF | 0 | 1
 OFF | 0
 Switches the function off
 ON | 1
 Switches the function on

Example: CAL:AIQ:HAT:STAT ON

Manual operation: See "[High Accuracy Timing Trigger - Baseband - RF](#)"
 on page 114

INPut:CONNector <ConnType>

Determines which connector the input for the measurement is taken from.

If an external frontend is active, the connector is automatically set to RF.

Parameters:

<ConnType> **RF**
 RF input connector
 RFProbe
 Active RF probe
 *RST: RF

Example: INP:CONN RF
 Selects input from the RF input connector.

Manual operation: See "[Input Connector](#)" on page 111

INPut:DIQ:CDEvice

Queries the current configuration and the status of the digital I/Q input from the optional "Digital Baseband" interface.

For details see the section "Interface Status Information" for the optional "Digital Baseband" interface in the FSW I/Q Analyzer User Manual.

Return values:

<Value>

Example:

INP:DIQ:CDEV?

Result:1, SMW200A, 101190, BBMM 1 OUT,
100000000, 200000000, Passed, Passed, 1, 1. #QNAN**Manual operation:** See ["Connected Instrument"](#) on page 113**INPut:DIQ:RANGe:COUPling** <State>

If enabled, the reference level for digital input is adjusted to the full scale level automatically if the full scale level changes.

Is only available if the optional "Digital Baseband" interface is installed.

Parameters:

<State> ON | OFF | 1 | 0

*RST: 0

Manual operation: See ["Adjust Reference Level to Full Scale Level"](#) on page 113**INPut:DIQ:RANGe[:UPPer]** <Level>

Defines or queries the "Full Scale Level", i.e. the level that corresponds to an I/Q sample with the magnitude "1".

Is only available if the optional "Digital Baseband" interface is installed.

Parameters:<Level> Range: 1 μ V to 7.071 V

*RST: 1 V

Default unit: DBM

Manual operation: See ["Full Scale Level"](#) on page 113**INPut:DIQ:RANGe[:UPPer]:AUTO** <State>

If enabled, the digital input full scale level is automatically set to the value provided by the connected device (if available).

Is only available if the optional "Digital Baseband" interface is installed.

Parameters:

<State> ON | OFF | 1 | 0

*RST: 0

Manual operation: See ["Full Scale Level"](#) on page 113

INPut:DIQ:RANGe[:UPPer]:UNIT <Level>

Defines the unit of the full scale level. The availability of units depends on the measurement application you are using.

Is only available if the optional "Digital Baseband" interface is installed.

Parameters:

<Level> DBM | DBPW | WATT | DBUV | DBMV | VOLT | DBUA | AMPere
*RST: Volt

Manual operation: See ["Full Scale Level"](#) on page 113

INPut:DIQ:SRATe <SampleRate>

Specifies or queries the sample rate of the input signal from the optional "Digital Baseband" interface.

Parameters:

<SampleRate> Range: 1 Hz to 20 GHz
*RST: 32 MHz
Default unit: HZ

Example: INP:DIQ:SRAT 200 MHz

Manual operation: See ["Input Sample Rate"](#) on page 112

INPut:DIQ:SRATe:AUTO <State>

If enabled, the sample rate of the digital I/Q input signal is set automatically by the connected device.

Is only available if the optional "Digital Baseband" interface is installed.

Parameters:

<State> ON | OFF | 1 | 0
*RST: 0

Manual operation: See ["Input Sample Rate"](#) on page 112

INPut:DPATH <DirectPath>

Enables or disables the use of the direct path for frequencies close to 0 Hz.

If an external frontend is active, the direct path is always used.

Parameters:

<DirectPath> AUTO | OFF
AUTO | 1
(Default) the direct path is used automatically for frequencies close to 0 Hz.
OFF | 0
The analog mixer path is always used.

Example: INP:DPAT OFF

Manual operation: See ["Direct Path"](#) on page 110

INPut:FILE:PATH <FileName>[, <AnalysisBW>]

Selects the I/Q data file to be used as input for further measurements.

The I/Q data file must be in one of the following supported formats:

- .iq.tar
- .iqw
- .csv
- .mat
- .wv
- .aid

Only a single data stream or channel can be used as input, even if multiple streams or channels are stored in the file.

For some file formats that do not provide the sample rate and measurement time or record length, you must define these parameters manually. Otherwise the traces are not visible in the result displays.

Parameters:

<FileName> String containing the path and name of the source file.
The file type is determined by the file extension. If no file extension is provided, the file type is assumed to be .iq.tar.
For .mat files, Matlab® v4 is assumed.

<AnalysisBW> Optionally: The analysis bandwidth to be used by the measurement. The bandwidth must be smaller than or equal to the bandwidth of the data that was stored in the file.
Default unit: HZ

Example: INP:FILE:PATH 'C:\R_S\Instr\user\data.iq.tar'
Uses I/Q data from the specified file as input.

Example:

```
//Load an IQW file
INP:SEL:FIQ
INP:FILE:PATH 'C:\R_S\Instr\user\data.iqw'
//Define the sample rate
TRAC:IQ:SRAT 10MHz
//Define the measurement time
SENSE:SWEep:TIME 0.001001
//Start the measurement
INIT:IMM
```

Manual operation: See ["Select I/Q data file"](#) on page 116
See ["Data import and export"](#) on page 171

INPut:FILTer:HPASs[:STATe] <State>

Activates an additional internal high-pass filter for RF input signals from 1 GHz to 3 GHz. This filter is used to remove the harmonics of the FSW to measure the harmonics for a DUT, for example.

Requires an additional high-pass filter hardware option.

(Note: for RF input signals outside the specified range, the high-pass filter has no effect. For signals with a frequency of approximately 4 GHz upwards, the harmonics are suppressed sufficiently by the YIG-preselector, if available.)

Parameters:

<State> ON | OFF | 0 | 1
OFF | 0
 Switches the function off
ON | 1
 Switches the function on
 *RST: 0

Example: INP:FILT:HPAS ON
 Turns on the filter.

Manual operation: See "[High Pass Filter 1 to 3 GHz](#)" on page 111

INPut:FILTer:YIG[:STATe] <State>

Enables or disables the YIG filter.

Parameters:

<State> ON | OFF | 0 | 1

Example: INP:FILT:YIG OFF
 Deactivates the YIG-preselector.

Manual operation: See "[YIG-Preselector](#)" on page 111

INPut:IQ:BALanced[:STATe] <State>

Defines whether the input is provided as a differential signal via all 4 Analog Baseband connectors or as a plain I/Q signal via 2 single-ended lines.

Parameters:

<State> ON | OFF | 1 | 0
ON | 1
 Differential
OFF | 0
 Single ended
 *RST: 1

Example: INP:IQ:BAL OFF

Manual operation: See "[Input Configuration](#)" on page 114

INPut:IQ:TYPE <DataType>

Defines the format of the input signal.

Parameters:

<DataType>

IQ | I | Q

IQ

The input signal is filtered and resampled to the sample rate of the application.

Two input channels are required for each input signal, one for the in-phase component, and one for the quadrature component.

I

The in-phase component of the input signal is filtered and resampled to the sample rate of the application. If the center frequency is not 0, the in-phase component of the input signal is down-converted first (Low IF I).

Q

The quadrature component of the input signal is filtered and resampled to the sample rate of the application. If the center frequency is not 0, the quadrature component of the input signal is down-converted first (Low IF Q).

*RST: IQ

Example:

INP:IQ:TYPE Q

Manual operation: See "[I/Q Mode](#)" on page 114

INPut:SElect <Source>

Selects the signal source for measurements, i.e. it defines which connector is used to input data to the FSW.

If no additional input options are installed, only RF input or file input is supported.

For FSW85 models with two RF input connectors, you must select the input connector to configure first using [INPut:TYPE](#).

Parameters:

<Source>

RF

Radio Frequency ("RF INPUT" connector)

FIQ

I/Q data file

(selected by [INPut:FILE:PATH](#) on page 372)

Not available for Input2.

AIQ

Analog Baseband signal (only available with optional "Analog Baseband" interface)

Not available for Input2.

*RST: RF

- Example:** `INP:TYPE INP1`
 For FSW85 models with two RF input connectors: selects the 1.00 mm RF input connector for configuration.
`INP:SEL RF`
- Manual operation:** See ["Digital I/Q Input State"](#) on page 112
 See ["Analog Baseband Input State"](#) on page 114
 See ["I/Q Input File State"](#) on page 115

INPut:TYPE <Input>

The command selects the input path.

Parameters:

- <Input>
- INPUT1**
 Selects RF input 1.
 1 mm [RF Input] connector
- INPUT2**
 Selects RF input 2.
 For FSW85 models with two RF input connectors:
 1.85 mm [RF2 Input] connector
 For all other models: not available
- *RST: INPUT1

- Example:** `//Select input path`
`INP:TYPE INPUT1`

MMEMory:LOAD:IQ:STReam <Channel>

Only available for files that contain more than one data stream from multiple channels: selects the data stream to be used as input for the currently selected channel.

Automatic mode (`MMEMory:LOAD:IQ:STReam:AUTO`) is set to OFF.

Parameters:

- <Channel> String containing the channel name.

- Example:** `MMEM:LOAD:IQ:STR?`
`//Result: 'Channel1','Channel2'`
`MMEM:LOAD:IQ:STR 'Channel2'`

- Manual operation:** See ["Selected Channel"](#) on page 116

MMEMory:LOAD:IQ:STReam:AUTO <State>

Only available for files that contain more than one data stream from multiple channels: automatically defines which data stream in the file is used as input for the channel.

Parameters:

- <State> ON | OFF | 0 | 1

OFF | 0

The data stream specified by `MMEMoRY:LOAD:IQ:STReam` is used as input for the channel.

ON | 1

The first data stream in the file is used as input for the channel. Applications that support multiple data streams use the first data stream in the file for the first input stream, the second for the second stream etc.

*RST: 1

Manual operation: See "[Selected Channel](#)" on page 116

MMEMoRY:LOAD:IQ:STReam:LIST?

Returns the available channels in the currently loaded input file.

Example: `MMEM:LOAD:IQ:STR?`
`//Result: 'Channel1','Channel2'`

Usage: Query only

Manual operation: See "[Selected Channel](#)" on page 116

TRACe:IQ:FILE:REPetition:COUNT <RepetitionCount>

Determines how often the data stream is repeatedly copied in the I/Q data memory. If the available memory is not sufficient for the specified number of repetitions, the largest possible number of complete data streams is used.

Parameters:

<RepetitionCount> integer

Example: `TRAC:IQ:FILE:REP:COUN 3`

Manual operation: See "[File Repetitions](#)" on page 116

6.10.20 Frequency configuration

<code>[SENSe:]FREQuency:CENTer[:CC<cc>]</code>	376
<code>[SENSe:]FREQuency:CENTer[:CC<cc>]:OFFSet</code>	377
<code>[SENSe:]FREQuency:CENTer:STEP</code>	378

[SENSe:]FREQuency:CENTer[:CC<cc>] <Frequency>

Sets the center frequency for RF measurements.

Component carrier measurements

- Defining or querying the frequency of the first carrier is possible with `FREQ:CENT:CC1`. The `CC1` part of the syntax is mandatory in that case.
- `FREQ:CENT?` queries the measurement frequency (center of the two carriers).

Suffix:`<cc>` [Component Carrier](#)**Parameters:**

`<Frequency>` `<numeric value>`
 Range: `fmin` to `fmax`
 *RST: `1 GHz`
 Default unit: Hz

Example:

```
//Define frequency for measurement on one carrier:
FREQ:CENt 1GHZ
```

Example:

```
//Define frequency for measurement on aggregated carriers:
FREQ:CENt:CC1 850MHZ
```

Manual operation:

See "[Frequency configuration](#)" on page 65
 See "[Center Frequency](#)" on page 108
 See "[Center Frequency](#)" on page 117

[SENSe:]FREQuency:CENTer[:CC<cc>]:OFFSet <Offset>

Defines the general frequency offset.

For measurements on multiple component carriers, the command defines the frequency offset for a component carrier. The effect of the command depends on the syntax:

- When you omit the `[CC<cc>]` syntax element, the command defines the overall frequency offset.
 In that case, the value is added to the measurement frequency and, in case of measurements with component carriers, the center frequency of the component carriers.
- When you include the `[CC<cc>]` syntax element, the command defines the offset of the component carrier relative the first component carrier.
 In that case, the command is not available for the first component carrier - thus, `...:CC1:...` is not possible.

Prerequisites for this command

- Select the first component carrier (CC1) as the reference point for the frequency offset (`CONFigure[:NR5G]:OREL`).

Suffix:`<cc>` [Component Carrier](#)**Parameters:**

`<Offset>` `<numeric value>`

- General frequency offset: frequency offset in Hz.
- Component carrier offset: frequency offset relative to the first component carrier in Hz.

Default unit: Hz

- Example:** //Add a frequency offset of 50 Hz to the measurement frequency.
//If you are measuring component carriers, the value is also added to the center frequencies of those carriers.
FREQ:CENT:OFFS 50HZ
- Example:** //Define a frequency offset of 15 MHz for the second component carrier relative to the first component carrier.
CONF:OREL CC1
FREQ:CENT:CC2:OFFS 15MHZ
- Manual operation:** See ["Frequency configuration"](#) on page 65
See ["Center Frequency"](#) on page 117

[SENSe:]FREQuency:CENTer:STEP <StepSize>

Defines the center frequency step size.

Parameters:

<StepSize> For f_{max} , refer to the specifications document.
Range: 1 to fMAX
*RST: 0.1 x span
Default unit: Hz

Example: //Set the center frequency to 110 MHz.
FREQ:CENT 100 MHz
FREQ:CENT:STEP 10 MHz
FREQ:CENT UP

Manual operation: See ["Frequency Stepsize"](#) on page 117

6.10.21 Amplitude configuration

DISPlay[:WINDow<n>][:SUBWindow<w>]:TRACe<t>:Y[:SCALe]:RLEVel.....	378
DISPlay[:WINDow<n>][:SUBWindow<w>]:TRACe<t>:Y[:SCALe]:RLEVel:OFFSet.....	379
INPut:ATTenuation<ant>.....	379
INPut:ATTenuation<ant>:AUTO.....	380
INPut:COUPling.....	380
INPut:GAIN:STATe.....	380
INPut:GAIN[:VALue].....	381
INPut:IMPedance.....	381
INPut:EATT<ant>.....	381
INPut:EATT<ant>:AUTO.....	382
INPut:EATT<ant>:STATe.....	382

DISPlay[:WINDow<n>][:SUBWindow<w>]:TRACe<t>:Y[:SCALe]:RLEVel <ReferenceLevel>

Defines the reference level (for all traces in all windows).

With a reference level offset $\neq 0$, the value range of the reference level is modified by the offset.

Suffix:

<n>	irrelevant
<w>	subwindow Not supported by all applications
<t>	irrelevant

Parameters:

<ReferenceLevel>	The unit is variable. Range: see specifications document *RST: 0 dBm Default unit: DBM
------------------	---

Example: `DISP:TRAC:Y:RLEV -60dBm`

Manual operation: See ["Reference Level"](#) on page 118

DISPlay[:WINDow<n>][:SUBWindow<w>]:TRACe<t>:Y[:SCALe]:RLEVel:OFFSet
<Offset>

Defines a reference level offset (for all traces in all windows).

Suffix:

<n>	irrelevant
<w>	subwindow Not supported by all applications
<t>	irrelevant

Parameters:

<Offset>	Range: -200 dB to 200 dB *RST: 0dB Default unit: DB
----------	---

Example: `DISP:TRAC:Y:RLEV:OFFS -10dB`

Manual operation: See ["Reference Level Offset"](#) on page 118

INPut:ATTenuation<ant> <Attenuation>

Defines the RF attenuation level.

Prerequisites for this command

- Decouple attenuation from reference level (`INPut:ATTenuation<ant>:AUTO`).

Suffix:

<ant>	irrelevant
-------	------------

Parameters:

<Attenuation>	*RST: 10 dB Default unit: dB
---------------	---------------------------------

Example: //Define RF attenuation
 INP:ATT:AUTO OFF
 INP:ATT 10

Manual operation: See "[RF Attenuation](#)" on page 119

INPut:ATTenuation<ant>:AUTO <State>

Couples and decouples the RF attenuation to the reference level.

Suffix:
 <ant> irrelevant

Parameters:
 <State> ON | OFF | 1 | 0
 *RST: ON

Example: //Couple attenuation to reference level (auto attenuation)
 INP:ATT:AUTO ON

Manual operation: See "[RF Attenuation](#)" on page 119

INPut:COUPling <CouplingType>

Selects the coupling type of the RF input.

If an external frontend is active, the coupling is automatically set to AC.

Parameters:
 <CouplingType> AC | DC
 AC
 AC coupling
 DC
 DC coupling
 *RST: AC

Example: INP:COUP DC

Manual operation: See "[Input Coupling](#)" on page 120

INPut:GAIN:STATe <State>

Turns the internal preamplifier on and off. It requires the optional preamplifier hardware.

Note that if an optional external preamplifier is activated, the internal preamplifier is automatically disabled, and vice versa.

If option R&S FSW-B22 is installed, the preamplifier is only active below 7 GHz.

If option R&S FSW-B24 is installed, the preamplifier is active for all frequencies.

Parameters:
 <State> ON | OFF | 0 | 1

OFF | 0

Switches the function off

ON | 1

Switches the function on

***RST:** 0**Example:**

INP:GAIN:STAT ON

INP:GAIN:VAL 15

Switches on 15 dB preamplification.

Manual operation: See "[Preamplifier](#)" on page 120**INPut:GAIN[:VALue] <Gain>**Selects the "gain" if the preamplifier is activated (INP:GAIN:STAT ON, see [INPut:GAIN:STATe](#) on page 380).

The command requires the additional preamplifier hardware option.

Parameters:

<Gain>

For all FSW models except for FSW85, the following settings are available:

15 dB and 30 dB

All other values are rounded to the nearest of these two.

For FSW85 models:

FSW43 or higher:

30 dB

Default unit: DB

Example:

INP:GAIN:STAT ON

INP:GAIN:VAL 30

Switches on 30 dB preamplification.

Manual operation: See "[Preamplifier](#)" on page 120**INPut:IMPedance <Impedance>**

Selects the nominal input impedance of the RF input. In some applications, only 50 Ω are supported.

Parameters:

<Impedance>

50 | 75

***RST:** 50 Ω

Default unit: OHM

Example:

INP:IMP 75

Manual operation: See "[Impedance](#)" on page 120**INPut:EATT<ant> <Attenuation>**

Defines the electronic attenuation level.

If the current reference level is not compatible with an attenuation that has been set manually, the command also adjusts the reference level.

Is available with the optional electronic attenuator, but not if you are using the optional digital baseband input.

Suffix:

<ant> Connected instrument

Parameters:

<Attenuation> Attenuation level in dB.
Default unit: dB

Example:

```
//Define signal attenuation
INP:EATT 10
```

Manual operation: See "[Electronic Attenuation](#)" on page 119

INPut:EATT<ant>:AUTO <State>

Turns automatic selection of the electronic attenuation on and off.

If on, electronic attenuation reduces the mechanical attenuation whenever possible.

Is available with the optional electronic attenuator, but not if you are using the optional digital baseband Input.

Suffix:

<ant> 1...4
Connected instrument

Parameters:

<State> ON | OFF | 1 | 0
*RST: OFF

Example:

```
//Turn on automatic selection of electronic attenuation
INP:EATT:AUTO ON
```

Manual operation: See "[Electronic Attenuation](#)" on page 119

INPut:EATT<ant>:STATE <State>

Turns the electronic attenuator on and off.

Is available with the optional electronic attenuator, but not if you are using the optional digital baseband input.

Suffix:

<ant> 1...4
Connected instrument

Parameters:

<State> ON | OFF
*RST: OFF

Example: //Turn on electronic attenuation
INP:EATT:STAT ON

Manual operation: See ["Electronic Attenuation"](#) on page 119

6.10.22 Data capture

[SENSe:]NR5G:FRAMe:COUNt.....	383
[SENSe:]NR5G:FRAMe:COUNt:AUTO.....	383
[SENSe:]NR5G:FRAMe:COUNt:STATe.....	384
[SENSe:]NR5G:FRAMe:SLOT.....	384
[SENSe:]NR5G:FRAMe:SRSLot.....	384
[SENSe:]SWAPiq.....	384
[SENSe:]SWEep:CTMode.....	385
[SENSe:]SWEep:LCAPture.....	385
[SENSe:]SWEep:TIME.....	386
TRACe:IQ:SRATe?.....	386

[SENSe:]NR5G:FRAMe:COUNt <Frames>

Defines the number of frames to analyze.

Prerequisites for this command

- Turn on overall frame count ([SENSe:]NR5G:FRAMe:COUNt:STATe on page 384).
If the overall frame count is off, this command is a query only.

Parameters:

<Frames> <numeric value> (integer only)
*RST: 1

Example: //Define number of frames to analyze manually
NR5G:FRAM:COUN:STAT ON
NR5G:FRAM:COUN 10

Manual operation: See ["Number of Frames to Analyze"](#) on page 123

[SENSe:]NR5G:FRAMe:COUNt:AUTO <State>

Turns automatic selection of the number of frames to analyze on and off.

Parameters:

<State> **ON | 1**
Selects the analyzed number of frames as specified by 3GPP.
OFF | 0
Turns on manual selection of the number of frames.

Example: //Turn on automatic selection of analyzed frames
NR5G:FRAM:COUN:AUTO ON

Manual operation: See ["Auto According to Standard"](#) on page 123

[SENSe:]NR5G:FRAMe:COUNT:STATe <State>

Turns manual definition of number of frames to analyze on and off.

Parameters:

<State> **OFF | 0**
 The FSW analyzes all frames in the capture buffer.

ON | 1
 Define the number of frames to analyze with [SENSe:]NR5G:FRAMe:COUNT.

*RST: ON

Example: //Turn on overall frame count.
 NR5G:FRAM:COUN:STAT ON

Manual operation: See ["Overall Frame Count"](#) on page 123

[SENSe:]NR5G:FRAMe:SLOT <Slots>

Defines the number of slots that are analyzed.

Parameters:

<Slots> **ALL**
 Analyzes all slots in a frame.

<numeric value> (integer only)
 Analyzes a certain number of slots in a frame.

*RST: ALL

Example: //Analyze all slots in a frame
 NR5G:FRAM:SLOT ALL

Manual operation: See ["Maximum Number of Slots per Frame to Analyze"](#) on page 123

[SENSe:]NR5G:FRAMe:SRSLot <State>

Turns analysis of custom signals with repeating slots on and off.

Parameters:

<State> ON | OFF | 1 | 0

*RST: OFF

Example: //Turn on repeated slot analysis
 NR5G:FRAM:SRSL ON

Manual operation: See ["Signal Repeats Max No of Slots to Analyze"](#) on page 124

[SENSe:]SWAPiq <State>

Turns a swap of the I and Q branches on and off.

Parameters:

<State> ON | OFF | 1 | 0
 *RST: OFF

Example:

```
//Swap I and Q branches
SWAP ON
```

Manual operation: See "[Swap I/Q](#)" on page 122

[SENSe:]SWEep:CTMode <Mode>

Selects the capture mode.

Prerequisites for this command

- Select FR2-2 ([CONFigure \[:NR5G\]:UL\[:CC<cc>\]:DFRange](#) on page 284).

Parameters:

<Mode> **AUTO**
 Automatic determination of the capture time.

MANual
 Manual definition of the capture time.
 Define the capture time with [\[SENSe:\]SWEep:TIME](#).

Example:

```
//Select capture time mode
CONF:UL:DFR EHIG
SWE:CTM AUTO
```

Manual operation: See "[Capture Time](#)" on page 122

[SENSe:]SWEep:LCAPture <State>

Turns the long capture on and off.

Prerequisites for this command

- Number of component carriers must be "1" ([CONFigure\[:NR5G\]:NOCC](#)).
- Turn off segmented capture ([\[SENSe:\]SWEep:SCAPture:STATE](#)).
- Multi frame configuration is not supported. Every frame must have the same configuration.

Effects of this command

- Frame count functions become unavailable:
[\[SENSe:\]NR5G:FRAME:COUNT](#)
[\[SENSe:\]NR5G:FRAME:COUNT:AUTO](#)
- [\[SENSe:\]NR5G:FRAME:COUNT:STATE](#)

Parameters:

<State> ON | OFF | 1 | 0
 *RST: OFF

Example:

```
//Turn on long capture
SWE:LCAP ON
```

Manual operation: See "Long Capture" on page 122

[SENSE:]SWEep:TIME <CaptureLength>

Defines the capture time.

Parameters:

<CaptureLength> <numeric value>
 *RST: 20.1 ms
 Default unit: s

Example: //Define capture time
 SWE:TIME 40ms

Manual operation: See "Capture Time" on page 122

TRACe:IQ:SRATe?

Queries the capture sampling rate.

Return values:

<SamplingRate> <numeric value> (integer only)

Example: //Query sample rate
 TRAC:IQ:SRAT?

Usage: Query only

6.10.23 Trigger

TRIGger[:SEquence]:DTIME.....	386
TRIGger[:SEquence]:HOLDoff<ant>[:TIME].....	387
TRIGger[:SEquence]:IFPower:HOLDoff.....	387
TRIGger[:SEquence]:IFPower:HYSteresis.....	387
TRIGger[:SEquence]:LEVel<ant>[:EXternal<tp>].....	388
TRIGger[:SEquence]:LEVel<ant>:IFPower.....	388
TRIGger[:SEquence]:LEVel<ant>:IQPower.....	388
TRIGger[:SEquence]:LEVel<ant>:RFPower.....	389
TRIGger[:SEquence]:PORT<ant>.....	389
TRIGger[:SEquence]:SLOPe.....	390
TRIGger[:SEquence]:SOURce<ant>.....	390

TRIGger[:SEquence]:DTIME <DropoutTime>

Defines the time the input signal must stay below the trigger level before a trigger is detected again.

For input from the "Analog Baseband" interface using the baseband power trigger (BBP), the default drop out time is set to 100 ns to avoid unintentional trigger events (as no hysteresis can be configured in this case).

Parameters:

<DropoutTime> Dropout time of the trigger.
 Range: 0 s to 10.0 s
 *RST: 0 s
 Default unit: S

Manual operation: See ["Trigger Source"](#) on page 125

TRIGger[:SEQuence]:HOLDoff<ant>[:TIME] <Offset>

Defines the trigger offset.

Suffix:

<ant> [Instrument](#)

Parameters:

<Offset> <numeric value>
 *RST: 0 s
 Default unit: s

Example: //Define trigger offset
 TRIG:HOLD 5MS

Manual operation: See ["Trigger Source"](#) on page 125

TRIGger[:SEQuence]:IFPower:HOLDoff <Period>

Defines the holding time before the next trigger event.

Note that this command can be used for **any trigger source**, not just IF Power (despite the legacy keyword).

Parameters:

<Period> Range: 0 s to 10 s
 *RST: 0 s
 Default unit: S

Example: TRIG:SOUR EXT
 Sets an external trigger source.
 TRIG:IFP:HOLD 200 ns
 Sets the holding time to 200 ns.

Manual operation: See ["Trigger Source"](#) on page 125

TRIGger[:SEQuence]:IFPower:HYSteresis <Hysteresis>

Defines the trigger hysteresis, which is only available for "IF Power" trigger sources.

Parameters:

<Hysteresis> Range: 3 dB to 50 dB
 *RST: 3 dB
 Default unit: DB

Example: TRIG:SOUR IFP
Sets the IF power trigger source.
TRIG:IFP:HYST 10DB
Sets the hysteresis limit value.

Manual operation: See "[Trigger Source](#)" on page 125

TRIGger[:SEquence]:LEVel<ant>[:EXternal<tp>] <Level>

Defines the level for an external trigger.

Suffix:

<ant> Instrument

<tp> Trigger port

Parameters:

<Level> Range: 0.5 V to 3.5 V
 *RST: 1.4 V
 Default unit: V

Example: //Define trigger level
TRIG:LEV 2V

Manual operation: See "[Trigger Source](#)" on page 125

TRIGger[:SEquence]:LEVel<ant>:IFPower <Level>

Defines the power level at the third intermediate frequency that must be exceeded to cause a trigger event.

Note that any RF attenuation or preamplification is considered when the trigger level is analyzed. If defined, a reference level offset is also considered.

Suffix:

<ant> Instrument

Parameters:

<Level> <numeric value>
For details on available trigger levels and trigger bandwidths see the specifications document.
 *RST: -10 dBm
 Default unit: dBm

Example: //Define trigger level
TRIG:SOUR IFP
TRIG:LEV:IFP -30dBm

Manual operation: See "[Trigger Source](#)" on page 125

TRIGger[:SEquence]:LEVel<ant>:IQPower <Level>

Defines the magnitude the I/Q data must exceed to cause a trigger event.

Note that any RF attenuation or preamplification is considered when the trigger level is analyzed. If defined, a reference level offset is also considered.

Suffix:

<ant> [Instrument](#)

Parameters:

<Level> <numeric value>
 Range: -130 dBm to 30 dBm
 *RST: -20 dBm
 Default unit: dBm

Example:

```
//Define trigger level
TRIG:SOUR IQP
TRIG:LEV:IQP -30dBm
```

Manual operation: See "[Trigger Source](#)" on page 125

TRIGger[:SEquence]:LEVel<ant>:RFPower <Level>

Defines the power level the RF input must exceed to cause a trigger event. Note that any RF attenuation or preamplification is considered when the trigger level is analyzed. If defined, a reference level offset is also considered.

The input signal must be between 500 MHz and 8 GHz.

Suffix:

<ant> [Instrument](#)

Parameters:

<Level> <numeric value>
 For details on available trigger levels and trigger bandwidths see the specifications document.
 *RST: -20 dBm
 Default unit: dBm

Example:

```
//Define trigger level
TRIG:SOUR RFP
TRIG:LEV:RFP -30dBm
```

Manual operation: See "[Trigger Source](#)" on page 125

TRIGger[:SEquence]:PORT<ant> <port>

Selects the trigger port for measurements with devices that have several trigger ports.

Suffix:

<ant> [Analyzer](#)

Parameters:

<port> **PORT1**
PORT2
PORT3

Example: //Select trigger port 1
 TRIG:PORT PORT1

TRIGger[:SEQuence]:SLOPe <Type>

Selects the trigger slope.

Parameters:

<Type> POSitive | NEGative

POSitive

Triggers when the signal rises to the trigger level (rising edge).

NEGative

Triggers when the signal drops to the trigger level (falling edge).

*RST: POSitive

Example: TRIG:SLOP NEG

Manual operation: See "[Trigger Source](#)" on page 125

TRIGger[:SEQuence]:SOURce<ant> <Source>

Selects the trigger source.

Note on external triggers:

If a measurement is configured to wait for an external trigger signal in a remote control program, remote control is blocked until the trigger is received and the program can continue. Make sure this situation is avoided in your remote control programs.

Suffix:

<ant> [Analyzer](#)

Parameters:

<Source>

IMMediate

Free run (no trigger event to start a measurement).

EXTernal

Measurement starts when the external trigger signal exceeds a certain level.

Trigger signal from the "Trigger In" connector.

EXT2

Trigger signal from the "Trigger Input / Output" connector.

Note: Connector must be configured for "Input".

EXT3

Trigger signal from the "Trigger 3 Input / Output" connector.

Note: Connector must be configured for "Input".

RFPower

Measurement starts when the first intermediate frequency exceeds a certain level.

(Frequency and time domain measurements only.)

Not available for input from the optional Digital Baseband Interface or the optional analog baseband Interface.

IFPower

Measurement starts when the second intermediate frequency exceeds a certain level.

Not available for input from the optional digital baseband interface. For input from the optional analog baseband interface, this parameter is interpreted as `BBPower` for compatibility reasons.

IQPower

Measurement starts when the sampled I/Q data exceeds a certain magnitude.

For applications that process I/Q data, such as the I/Q analyzer or optional applications.

BBPower

Measurement starts when the baseband power exceeds a certain level.

For digital input via the optional digital baseband interface or the optional analog baseband interface.

PSEN

External power sensor

GP0 | GP1 | GP2 | GP3 | GP4 | GP5

For applications that process I/Q data, such as the I/Q analyzer or optional applications, and only if the optional digital baseband interface is available.

Defines triggering of the measurement directly via the LVDS connector. The parameter specifies which general purpose bit (0 to 5) will provide the trigger data.

*RST: IMMEDIATE

Manual operation: See "[Trigger Source](#)" on page 125

6.10.24 Segmented capture

<code>[SENSe:]SWEep:SCAPture:EVENTs</code>	391
<code>[SENSe:]SWEep:SCAPture:LENGth[:TIME]</code>	392
<code>[SENSe:]SWEep:SCAPture:OFFSet[:TIME]</code>	392
<code>[SENSe:]SWEep:SCAPture:STATe</code>	392

`[SENSe:]SWEep:SCAPture:EVENTs` <Events>

Defines the number of segments to capture.

Prerequisites for this command

- Select external of IF power trigger source (`TRIGger[:SEQUence]:SOURCE<ant>`).
- Turn on segmented capture (`[SENSe:]SWEep:SCAPture:STATe`).

Parameters:

<Events> *RST: 2

Example:

```
//Define segment length
TRIG:SOUR EXT
SWE:SCAP:STAT ON
SWE:SCAP:EVEN 5
```

Manual operation: See ["Configuration"](#) on page 127

[SENSe:]SWEep:SCAPture:LENGth[:TIME] <Length>

Defines the length of a segment for segmented data capture.

Prerequisites for this command

- Select external of IF power trigger source ([TRIGger\[:SEquence\]:SOURCE<ant>](#)).
- Turn on segmented capture ([\[SENSe:\]SWEep:SCAPture:STATe](#)).

Parameters:

<Length> *RST: 1.0
 Default unit: s

Example:

```
//Define segment length
TRIG:SOUR EXT
SWE:SCAP:STAT ON
SWE:SCAP:LENG 2MS
```

Manual operation: See ["Configuration"](#) on page 127

[SENSe:]SWEep:SCAPture:OFFSet[:TIME] <Offset>

Defines the offset of a segment for segmented data capture.

Prerequisites for this command

- Select external of IF power trigger source ([TRIGger\[:SEquence\]:SOURCE<ant>](#)).
- Turn on segmented capture ([\[SENSe:\]SWEep:SCAPture:STATe](#)).

Parameters:

<Offset> *RST: 0
 Default unit: s

Example:

```
//Define offset
TRIG:SOUR EXT
SWE:SCAP:STAT ON
SWE:SCAP:OFFS 0.5MS
```

Manual operation: See ["Configuration"](#) on page 127

[SENSe:]SWEep:SCAPture:STATe <State>

Turns segmented capture on and off.

Prerequisites for this command

- Select external of IF power trigger source (`TRIGger[:SEquence]:SOURCE<ant>`).

Parameters:

<State> ON | OFF | 1 | 0
*RST: OFF

Example:

```
//Turn on segmented capture
TRIG:SOUR EXT
SWE:SCAP:STAT ON
```

Manual operation: See "Configuration" on page 127

6.10.25 Optimization

`[SENSe:]ADJust:NCANcel:AVERage[:COUNT]`..... 393

`[SENSe:]ADJust:NCANcel:AVERage[:STATE]`..... 393

`[SENSe:]ADJust:NCANcel:AVERage[:COUNT]` <Length>

Defines the number of measurements that are performed on the captured I/Q data to determine the average noise density due to the spectrum analyzer.

Only available if I/Q noise cancellation is enabled (`[SENSe:]ADJust:NCANcel:AVERage[:STATE] ON`).

Parameters:

<Length> integer
Number of measurements

Example:

```
[SENSe:]ADJust:NCANcel:AVERage[:STATE] ON
[SENSe:]ADJust:NCANcel:AVERage[:COUNT] 8
```

Manual operation: See "Reduce Noise on I/Q Data" on page 128

`[SENSe:]ADJust:NCANcel:AVERage[:STATE]` <State>

Enables and disables I/Q noise cancellation.

Requires the R&S FSW-K575 option and a synchronized, repetitive input signal.

The number of initial measurements performed is defined by `[SENSe:]ADJust:NCANcel:AVERage[:COUNT]` on page 393.

For details on the concept of I/Q noise cancellation, see the FSW I/Q Analyzer and I/Q Input User Manual.

Parameters:

<State> ON | OFF | 0 | 1
OFF | 0
Switches the function off

ON | 1

Switches the function on

If synchronization fails, the noise cancellation process is not started, and an error message is provided. Status bit 7 in the `STATus:QUEStionable:SYNC:CONDition` status register is set (`BIT_K575_FAILED`).

*RST: 0

Example: `[SENSe:]ADJust:NCANcel:AVERage[:STATe] ON`
`[SENSe:]ADJust:NCANcel:AVERage[:COUNT] 8`

Manual operation: See "[Reduce Noise on I/Q Data](#)" on page 128

6.10.26 Tracking

[SENSe:]NR5G:DEMod:CESTimation	394
[SENSe:]NR5G:IQ:GIQE	394
[SENSe:]NR5G:TRACking:LEVel	395
[SENSe:]NR5G:TRACking:PHASe	395
[SENSe:]NR5G:TRACking:TIME	395
[SENSe:]NR5G:TRACking:TPUT:STATe	395

[SENSe:]NR5G:DEMod:CESTimation <State>

Selects the channel estimation method.

Parameters:

<State>

LINT

Channel estimation by interpolating the missing information.

OFF

Turns off channel estimation.

PILPay

Channel estimation by examining both the reference signal and the payload resource elements.

Example: `//Select channel estimation method`
`NR5G:DEM:CEST PILP`

Manual operation: See "[Channel Estimation](#)" on page 129

[SENSe:]NR5G:IQ:GIQE <State>

Turns the calculation of the gain imbalance and the quadrature error in the result summary on and off.

Parameters:

<State>

ON | OFF | 1 | 0

*RST: ON

Example: `//Turn off calculation of results`
`NR5G:IQ:GIQE OFF`

Manual operation: See ["Gain Imbalance / Quadrature Error"](#) on page 130

[SENSe:]NR5G:TRACking:LEVel <State>

Turns level tracking on and off.

Parameters:

<State> ON | OFF | 0 | 1
*RST: OFF

Example: //Turn on level tracking
TRAC:LEV ON

Manual operation: See ["Level Tracking"](#) on page 130

[SENSe:]NR5G:TRACking:PHASe <State>

Turns phase tracking on and off.

Parameters:

<State> **OFF**
Deactivate phase tracking
PIL
Pilot only
Corresponds to ON for PRACH analysis
PILPAY
Pilot and payload
Unavailable for PRACH analysis.
*RST: OFF

Example: //Use pilots and payload for channel estimation
SENS:TRAC:PHAS PILPAY

Manual operation: See ["Phase"](#) on page 129

[SENSe:]NR5G:TRACking:TIME <State>

Turns time tracking on and off.

Parameters:

<State> ON | OFF | 1 | 0
*RST: OFF

Example: //Turn on time tracking
NR5G:TRAC:TIME ON

Manual operation: See ["Time Tracking"](#) on page 130

[SENSe:]NR5G:TRACking:TPUT:STATe <State>

Turns the throuput measurement on and off.

Effects of this command

- Number of analyzed frames is set to manual (`[SENSe:]NR5G:FRAMe:COUNT:AUtO`).

Parameters:

<State> ON | OFF | 1 | 0
*RST: OFF

Example: //Turn on throughput measurement
NR5G:TRAC:TPUT:STAT ON

Manual operation: See "[Throughput Measurement State](#)" on page 130

6.10.27 Demodulation

[SENSe:]NR5G:DEMod:CMETHOD	396
[SENSe:]NR5G:DEMod:DDATA	397
[SENSe:]NR5G:DEMod:EFLRange	397
[SENSe:]NR5G:DEMod:FILTER	397
[SENSe:]NR5G:DEMod:PRData	398
[SENSe:]NR5G:DEMod:SATRansient	398
[SENSe:]NR5G:DEMod:SBTRansient	398
[SENSe:]NR5G:DEMod:TPERiod	399

[SENSe:]NR5G:DEMod:CMETHOD <State>

Selects the EVM calculation method.

Parameters:

<State> **HPOS**
EVM at high timing position
LPOS
EVM at low timing position
OTP
EVM at optimal timing position
TGPP
EVM according to 3GPP definition
*RST: TGPP

Example: //Select EVM calculation method
NR5G:DEM:CMET TGPP

Manual operation: See "[EVM Calculation Method](#)" on page 132

[SENSe:]NR5G:DEMod:DDATa <State>

Selects the point at which the data is demodulated for the bitstream.

Parameters:

<State>

ADEScramble
Demodulates the descrambled data.

BDEScramble
Demodulates the scrambled data.

DPData
Demodulates the decoded data.

*RST: BDEScramble

Example: //Demodulate decoded data
NR5G:DEM:DDAT DPD

Manual operation: See "[Demodulation Data](#)" on page 131

[SENSe:]NR5G:DEMod:EFLRange <State>

Turns the extended frequency lock range on and off.

Parameters:

<State> ON | OFF | 1 | 0

*RST: OFF

Example: Turn on extended frequency lock range
NR5G:DEM:EFLR ON

Manual operation: See "[Extended Frequency Lock Range](#)" on page 133

[SENSe:]NR5G:DEMod:FILTer <Filter>

Selects the filter for suppression of neighboring channels.

Parameters:

<Filter>

MFILter
Multicarrier filter.

NONE
No filter.

PBWP
Bandwidthpart filter.

*RST: NONE

Example: //Select multicarrier filter
NR5G:DEM:FILT MFIL

Manual operation: See "[Filter](#)" on page 131

[SENSe:]NR5G:DEMod:PRData <Reference>

Selects the PUSCH reference data.

Note that when you select an ORAN test case, this setting is automatically adjusted to the ORAN test case.

Parameters:

<Reference>

AUTO

Automatic detection of reference values.

PASLots

Available when the ORAN application is installed.

PDSCH based on NR-TM PN23 (pseudo random sequence 23) with all PUSCH having the same sequence.

If an ORAN test case is selected ([CONFigure\[:NR5G\]:ORAN:TCASe](#)), this parameter selects the ORAN PN23 sequence for all PUSCH.

PN23

Available when the ORAN application is installed.

PDSCH based on NR-TM PN23 (pseudo random sequence 23) with each PUSCH getting its own sequence.

If an ORAN test case is selected ([CONFigure\[:NR5G\]:ORAN:TCASe](#)), this parameter selects the ORAN PN23 sequence.

*RST: AUTO

Example:

```
//Select PDSCH reference data
NR5G:DEMod:PRD AUTO
```

Manual operation: See "[PUSCH Reference Data](#)" on page 133

[SENSe:]NR5G:DEMod:SATRansient <Symbol>

Selects the symbol right after the transient period.

Prerequisites for this command

- Select a transient period $\neq 10 \mu\text{s}$ ([\[SENSe:\]NR5G:DEMod:TPERiod](#)).

Parameters:

<Symbol>

String containing the symbol numbers as a comma separated list.

Example:

```
//Select symbol before transient
NR5G:DEMod:TPER US2
NR5G:DEMod:SATR "1, 5, 9"
```

Manual operation: See "[Transient Period](#)" on page 132

[SENSe:]NR5G:DEMod:SBTRansient <Symbol>

Selects the symbol right before the transient period.

Prerequisites for this command

- Select a transient period $\neq 10 \mu\text{s}$ ([SENSe:]NR5G:DEMod:TPERiod).

Parameters:

<Symbol> String containing the symbol numbers as a comma separated list.

Example: //Select symbol before transient
NR5G:DEMod:TPER US2
NR5G:DEMod:SBTR "1, 5, 9"

Manual operation: See "[Transient Period](#)" on page 132

[SENSe:]NR5G:DEMod:TPERiod <State>

Selects the time period of the transient.

Parameters:

<State> US2 | US4 | US7 | US10
Transient period in μs . Available transient periods depend on the selected subcarrier spacing.

Example: //Select transient period
NR5G:DEMod:TPER US2

Manual operation: See "[Transient Period](#)" on page 132

6.10.28 PRACH analysis

CONFigure[:NR5G]:UL[:CC<cc>]:PRACH:FORMat.....	399
CONFigure[:NR5G]:UL[:CC<cc>]:PRACH:LRA.....	400
CONFigure[:NR5G]:UL[:CC<cc>]:PRACH:POWer.....	400
CONFigure[:NR5G]:UL[:CC<cc>]:PRACH:PREamble.....	400
CONFigure[:NR5G]:UL[:CC<cc>]:PRACH:RBOFfset.....	401
CONFigure[:NR5G]:UL[:CC<cc>]:PRACH:RSEquence.....	401
CONFigure[:NR5G]:UL[:CC<cc>]:PRACH:RSET.....	401
CONFigure[:NR5G]:UL[:CC<cc>]:PRACH:SCS.....	401
CONFigure[:NR5G]:UL[:CC<cc>]:PRACH:ZCZone.....	402

CONFigure[:NR5G]:UL[:CC<cc>]:PRACH:FORMat <Format>

Selects the PRACH format.

Suffix:

<cc> [Component Carrier](#)

Parameters:

<Format> 0 | 1 | 2 | 3 | A1 | A2 | A3 | B1 | B2 | B3 | B4 | C0 | C2
*RST: A1

Example: //Select PRACH format
CONF:UL:CC2:PRACH:FORM B4

Manual operation: See ["Preamble Format"](#) on page 135

CONFigure[:NR5G]:UL[:CC<cc>]:PRACH:LRA <Value>

Selects the PRACH parameter L_{RA} .

Suffix:

<cc> [Component Carrier](#)

Parameters:

<Value> L139 | L571 | L839 | L1151

The availability of the parameters depends on the PRACH format and subcarrier spacing.

• [CONFigure\[:NR5G\]:UL\[:CC<cc>\]:PRACH:FORMat](#)

• [CONFigure\[:NR5G\]:UL\[:CC<cc>\]:PRACH:SCS](#)

*RST: L839

Example:

```
//Select L_RA
CONF:UL:PRAC:FORM A1
CONF:UL:PRAC:SCS SS15
CONF:UL:PRAC:LRA L139
```

Manual operation: See ["L_RA"](#) on page 136

CONFigure[:NR5G]:UL[:CC<cc>]:PRACH:POWer <Power>

Defines the relative power of the PRACH.

Suffix:

<cc> [Component Carrier](#)

Parameters:

<Power> *RST: 0
Default unit: dB

Example:

```
//Select PRACH power
CONF:UL:CC2:PRAC:POW -3
```

Manual operation: See ["Rel. Power"](#) on page 136

CONFigure[:NR5G]:UL[:CC<cc>]:PRACH:PREamble <Index>

Selects the PRACH preamble index.

Suffix:

<cc> [Component Carrier](#)

Parameters:

<Index> *RST: 0

Example:

```
//Select preamble index
CONF:UL:CC2:PRAC:PRE 2
```

Manual operation: See ["Preamble Index"](#) on page 137

CONFigure[:NR5G]:UL[:CC<cc>]:PRACH:RBOffset <Offset>

Defines the resource block offset for the PRACH.

Suffix:

<cc> [Component Carrier](#)

Parameters:

<Offset> *RST: 0

Example:

```
//Select PRACH resource block offset
CONF:UL:CC2:PRAC:RBOF 10
```

Manual operation: See "[RB Offset](#)" on page 136

CONFigure[:NR5G]:UL[:CC<cc>]:PRACH:RSEquence <Index>

Defines the PRACH logical root sequence index.

Suffix:

<cc> [Component Carrier](#)

Parameters:

<Index> *RST: 0

Example:

```
//Select logical root sequence index
CONF:UL:CC2:PRAC:RSEQ 4
```

Manual operation: See "[Logical Root Sequ. Idx](#)" on page 136

CONFigure[:NR5G]:UL[:CC<cc>]:PRACH:RSET <Type>

Selects the restricted set for the PRACH.

Suffix:

<cc> [Component Carrier](#)

Parameters:

<Type> NONE | A | B

Restricted sets Type A and Type B are only supported by PRACH formats 0 to 3 ([CONFigure\[:NR5G\]:UL\[:CC<cc>\]:PRACH:FORMat](#)).

Example:

```
//Select PRACH restricted set
CONF:UL:CC2:PRAC:RBOF A
```

Manual operation: See "[Restricted Set](#)" on page 136

CONFigure[:NR5G]:UL[:CC<cc>]:PRACH:SCS <SubcarrierSpacing>

Select the subcarrier spacing of the PRACH.

Suffix:

<cc> [Component Carrier](#)

Parameters:

<SubcarrierSpacing> SS1_25 | SS5 | SS15 | SS30 | SS60 | SS120 | SS480 | SS960

The availability of subcarrier spacings depends on the selected deployment and PRACH format (`CONFigure[:NR5G]:UL[:CC<cc>]:DFRange` and `CONFigure[:NR5G]:UL[:CC<cc>]:PRACH:FORMat`).

Example:

```
//Select PRACH subcarrier spacing
CONF:UL:CC2:DFR LOW
CONF:UL:CC2:PRAC:FORM 0
CONF:UL:CC2:PRAC:SCS SS1_25
```

Manual operation: See "[Subcarrier Spacing \(PRACH\)](#)" on page 136

CONFigure[:NR5G]:UL[:CC<cc>]:PRACH:ZCZone <Index>

Defines the PRACH zero correlation zone.

Suffix:

<cc> [Component Carrier](#)

Parameters:

<Index> *RST: 0

Example:

```
//Select zero correlation zone
CONF:UL:CC2:PRAC:ZCZ 1
```

Manual operation: See "[Zero Correlation Zone](#)" on page 137

6.10.29 Frequency sweep measurements

Commands to configure frequency sweep measurements described elsewhere.

- [CONFigure\[:NR5G\]:LDIRection](#) on page 283
- [MMEMemory:LOAD:DEModsetting:ALL](#) on page 287
- [MMEMemory:LOAD:DEModsetting\[:CC<cc>\]](#) on page 287
- [MMEMemory:STORE<n>:DEModsetting:ALL](#) on page 287
- [MMEMemory:STORE<n>:DEModsetting\[:CC<cc>\]](#) on page 288
- [CONFigure\[:NR5G\]:UL\[:CC<cc>\]:BW](#) on page 284

Refer also to the user manual of the FSW base unit for a list of commands supported by the frequency sweep measurements that are not specific to the 5G NR application.

[SENSe:]POWer:ACHannel:AACHannel	403
[SENSe:]POWer:PClass	403
[SENSe:]POWer:SEM:IFF	403
[SENSe:]POWer:TID	404
CALCulate<n>:LIMit:ACPower:PMODE	404

[SENSe:]POWer:ACHannel:AACHannel <Channel>

Selects the bandwidth of the adjacent channel for ACLR measurements.

Parameters:

<Channel>	E500 Selects an WCDMA signal with 3.84 MHz bandwidth as assumed adjacent channel carrier.
	NOSBw Selects an 5G NR signal as assumed adjacent channel carrier.
	*RST: NOSBw

Example: //Select assumed adjacent channel
POW:ACH:AACH NOSB

Manual operation: See "[Adjacent Channels](#)" on page 138

[SENSe:]POWer:PCLass <PowerClass>

Selects the power class of a UE for ACLR measurements.

Parameters:

<PowerClass>	PC1 PC1_5 PC2 PC3
	*RST: PC2

Example: //Select power class
POW:PCL PC3

Manual operation: See "[Power Class](#)" on page 138

[SENSe:]POWer:SEM:IFF <Size>

Selects the size of the DUT for the SEM measurement.

Prerequisites for this command

- Select FR2 deployment ([CONFigure\[:NR5G\]:UL\[:CC<cc>\]:DFRange](#)).

Parameters:

<Size>	DUT15 DUT size ≤15 cm
	DUT30 DUT size ≤30 cm
	*RST: DUT15

Example: //Select DUT size
CONF:UL:DFR HIGH
POW:SEM:IFF DUT30

Manual operation: See "[IFF \(Indirect Far Field\)](#)" on page 138

[SENSe:]POWer:TID <ID>

Selects the test ID for ACLR measurements.

Prerequisites for this command

- Select FR2 frequency deployment ([CONFigure\[:NR5G\]:UL\[:CC<cc>\]:DFRange](#) on page 284).

Parameters:

<ID> **NONE**
No test ID.

ID1 | ID2 | ID3 | ID4 | ID5 | ID6 | ID7 | ID8 | ID9 | ID10 | ID11 | ID12 | ID13 | ID14 | ID15
Test ID 1 to 15.

Example: //Select ACLR test ID
CONF:UL:DFR HIGH
POW:TID ID1

Manual operation: See "[Test ID](#)" on page 138

CALCulate<n>:LIMit:ACPoweR:PMODE <Mode>

Selects the limit evaluation mode for ACLR measurements.

Supported for ACLR measurements in the LTE and 5G applications.

Suffix:

<n> irrelevant

 irrelevant

Parameters:

<Mode> **AND**
Overall limit check passes if both absolute and relative limit checks pass.

OR
Overall limit check passes if either absolute or relative limit checks pass.

*RST: AND

Example: //Select evaluation mode
CALC:LIM:ACP:PMOD AND

Manual operation: See "[Total Limit Pass Mode](#)" on page 139

6.10.30 Combined measurements

In addition to the commands otherwise supported for I/Q measurements and frequency sweep measurements, combined mode supports the following commands.

[SENSe:]ESpectrum<sb>:PRESet[:STANdard].....	405
[SENSe:]NR5G:ACPower:ALPMode.....	405
[SENSe:]NR5G:FRAMe:SCAPture.....	406
[SENSe:]NR5G:FRAMe:SALevel.....	406
[SENSe:]SWEep:EGATe:AGATing.....	406
[SENSe:]SWEep:EVENT.....	406
[SENSe:]SWEep:MODE.....	407
CALCulate<n>:MARKer<m>:FUNCTion:POWer<sb>:PRESet.....	407
CONFigure[:NR5G]:ACLR.....	408
CONFigure[:NR5G]:EVM.....	408
CONFigure[:NR5G]:SEM.....	408
MMEMory:LOAD:SETTings.....	408
OUTPut<up>:TRIGger<tp>:PULSe:IMMEDIATE.....	409
TRIGger:TSHelper:DELay.....	409
TRIGger:TSHelper:EDELay.....	409
TRIGger:TSHelper:FTRigger.....	410
TRIGger:TSHelper:RINTerval.....	410
TRIGger:TSHelper:SEQuence.....	411

[SENSe:]ESpectrum<sb>:PRESet[:STANdard] <Standard>

Loads an SEM settings file for combined measurements.

Suffix:

<sb> irrelevant

Parameters:

<Standard> **<string>**
String that contains the path to the settings file (.xml format).

NONE
Removes the settings file.

Example:

```
//Select and subsequently remove settings file
ESP:PRES 'c:\settings.xml'
ESP:PRES NONE
```

Manual operation: See "[Manage User Standards](#)" on page 141

[SENSe:]NR5G:ACPower:ALPMode <Mode>

Selects the limit evaluation mode for ACLR measurements in combined measurement mode.

Parameters:

<Mode> **ABSolute**
Checks against the absolute limits.

RELative
Checks against the relative limits.

OR
Checks against both absolute and relative limits according to 3GPP.

*RST: OR

Example: //Select ACLR limit evaluation mode
NR5G:ACP:ALPM ABS

Manual operation: See "[ACLR Limit Pass Mode](#)" on page 177

[SENSe:]NR5G:FRAMe:SCAPture <State>

Selects the signal capture mode for combined multiple carrier measurements.

Parameters:

<State> **AUTO**
Automatically determines how many carriers are captured.

SINGLE
Captures a single capture buffer for each carrier.

*RST: AUTO

Example: //Turn on single capture mode
NR5G:FRAM:SCAP SING

Manual operation: See "[Signal Capture](#)" on page 143

[SENSe:]NR5G:FRAMe:SALevel <Level>

Turns auto leveling for each event in combined measurement sequence on and off.

Parameters:

<Level> ON | OFF | 1 | 0

*RST: OFF

Example: //Turn on auto leveling sequence
NR5G:FRAM:SAL ON

Manual operation: See "[Sequence Auto Level](#)" on page 143

[SENSe:]SWEep:EGATe:AGATing <State>

Turns auto gating on and off.

Parameters:

<State> ON | OFF | 1 | 0

*RST: ON

Example: //Turn on auto gating

Manual operation: See "[Auto Gating](#)" on page 146

[SENSe:]SWEep:EVENT <Event>

Defines the number of events in a combined measurement sequence.

Parameters:

<Event> *RST: 10

Example:

```
//Define number of events
SWE:EVEN 25
```

Manual operation: See "[# Events](#)" on page 142

[SENSE:]SWEep:MODE <Mode>

Selects the capture mode for combined measurements.

Prerequisites for this command

- Measure the EVM only:
 - `CONFigure[:NR5G]:ACLR = OFF`
 - `CONFigure[:NR5G]:SEM = OFF`
 - `CONFigure[:NR5G]:EVM = ON`

Parameters:

<Mode> **AUTO**
Captures and analyzes the complete signal.

TX
Captures and analyzes the Tx channel only.

*RST: AUTO

Example:

```
//Select capture mode
CONF:ACLR OFF
CONF:SEM OFF
CONF:EVM ON
SWE:MODE TX
```

Manual operation: See "[Capture Mode](#)" on page 142

CALCulate<n>:MARKer<m>:FUNctioN:POWer<sb>:PRESet <Standard>

Loads an ACLR settings file for combined measurements.

Suffix:

<n> irrelevant

<m> irrelevant

<sb> irrelevant

Parameters:

<Standard> **<string>**
String that contains the path to the settings file (.xml format).

NONE
Removes the settings file.

Example: //Select and subsequently remove settings file
CALC:MARK:FUNC:POW:PRES 'c:\settings.xml'
CALC:MARK:FUNC:POW:PRES NONE

Manual operation: See ["Manage User Standards"](#) on page 141

CONFigure[:NR5G]:ACLR <State>

Includes or excludes ACLR measurements from combined measurements.

Parameters:

<State> ON | OFF | 1 | 0
*RST: ON

Example: //Include ACLR measurements
CONF:ACLR ON

Manual operation: See ["EVM / ACLR / SEM"](#) on page 141

CONFigure[:NR5G]:EVM <State>

Includes or excludes EVM measurements from combined measurements.

Parameters:

<State> ON | OFF | 1 | 0
*RST: ON

Example: //Include EVM measurements
CONF:EVM ON

Manual operation: See ["EVM / ACLR / SEM"](#) on page 141

CONFigure[:NR5G]:SEM <State>

Includes or excludes SEM measurements from combined measurements.

Parameters:

<State> ON | OFF | 1 | 0
*RST: ON

Example: //Include SEM measurements
CONF:SEM ON

Manual operation: See ["EVM / ACLR / SEM"](#) on page 141

MMEMory:LOAD:SETTings

Restores the settings of the last measurement sequence in combined mode.

Example: //Restore settings
MMEM:LOAD:SETT

Usage: Event

Manual operation: See ["Restore Settings"](#) on page 141

OUTPut<up>:TRIGger<tp>:PULSe:IMMediate

Sends a trigger signal from the analyzer to the DUT.

For combined measurement, this command is useful to start a closed-loop trigger sequence.

Suffix:

<up>	irrelevant
<tp>	1..3 Trigger port

Example: //Send trigger signal from trigger output 3
OUTP:TRIG3:PULS:IMM

Usage: Event

Manual operation: See ["Send Trigger 3"](#) on page 145

TRIGger:TSHelper:DELay <Time>

Defines a delay between events.

Prerequisites for this command

- Select open-loop sequence ([TRIGger:TSHelper:SEQuence](#)).
- Select frame trigger with delay ([TRIGger:TSHelper:FTRigger](#)).

Parameters:

<Time>	*RST: 0 Default unit: s
--------	----------------------------

Example: //Define a delay between open-loop measurements
TRIG:TSH:SEQ OLO
TRIG:TSH:FTR AED
TRIG:TSH:DEL 1S

Manual operation: See ["Delay"](#) on page 145

TRIGger:TSHelper:EDELay <Time>

Defines the event delay for combined measurements.

Prerequisites for this command

- Select periodic sequence ([TRIGger:TSHelper:SEQuence](#)).

Parameters:

<Time>	*RST: 1.0 Default unit: s
--------	------------------------------

Example: //Define event delay
 TRIG:TSH:SEQ PER
 TRIG:TSH:EDEL 2S

Manual operation: See ["Event Delay"](#) on page 145

TRIGger:TSHelper:FTRigger <Source>

Select the availability of a frame trigger in a combined measurement sequence.

Parameters:

<Source> **AEDelay**
 Frame trigger available (external) trigger with a delay between events.

AVailable
 Frame trigger available (external trigger).

NAVailable
 Time trigger available.

RSLots
 No trigger available.

 *RST: AVailable

Example: //Select trigger source
 TRIG:TSH:FTR RSL

Manual operation: See ["Frame Trigger"](#) on page 144

TRIGger:TSHelper:RINTerval <Interval>

Defines the recalibration interval for combined measurements.

Prerequisites for this command

- Select time trigger ([TRIGger:TSHelper:SEquence](#)).

Parameters:

<Interval> *RST: 1

Example: //Define recalibration interval
 TRIG:TSH:SEQ OLO
 TRIG:TSH:FTR NAV
 TRIG:TSH:RINT 5

Manual operation: See ["Recalibration Interval"](#) on page 145

TRIGger:TSHelper:SEquence <Source>

Select the type of measurement sequence for combined measurement.

Parameters:

<Source>

The selected sequence has an impact on the trigger settings. If you select a certain sequence and change, for example, the trigger source or trigger input / output configuration, the sequence type automatically returns to manual.

CLOop

Closed-loop sequence.

MANual

Custom trigger configuration.

OLOop

Open-loop sequence.

PERiodic

Periodic sequence.

*RST: MANual

Example:

```
//Select sequence type
TRIG:TSH:SEQ OLO
```

Manual operation: See "[Sequence](#)" on page 144

6.11 Analysis

- [General analysis tools](#)..... 411
- [Analysis tools for I/Q measurements](#)..... 424
- [Analysis tools for combined measurements](#).....435

6.11.1 General analysis tools

- [Trace export](#)..... 411
- [Diagram scale](#)..... 413
- [Zoom](#).....414
- [Markers](#)..... 418

6.11.1.1 Trace export

- [FORMat:DEXPort:DSEParator](#)..... 412
- [FORMat:DEXPort:HEADer](#).....412
- [FORMat:DEXPort:TRACes](#)..... 412
- [MMEMory:STORe<n>:TRACe](#).....412

FORMat:DEXPort:DSEParator <Separator>

Selects the decimal separator for data exported in ASCII format.

Parameters:

<Separator> POINT | COMMa

COMMa

Uses a comma as decimal separator, e.g. 4,05.

POINT

Uses a point as decimal separator, e.g. 4.05.

*RST: *RST has no effect on the decimal separator.
Default is POINT.

Example:

FORM:DEXP:DSEP POIN

Sets the decimal point as separator.

FORMat:DEXPort:HEADer <State>

If enabled, additional instrument and measurement settings are included in the header of the export file for result data. If disabled, only the pure result data from the selected traces and tables is exported.

Parameters:

<State> ON | OFF | 0 | 1

*RST: 1

FORMat:DEXPort:TRACes <Selection>

Selects the data to be included in a data export file (see [MMEMory:STORe<n>:TRACe](#) on page 412).

Parameters:

<Selection> SINGle | ALL

SINGle

Only a single trace is selected for export, namely the one specified by the [MMEMory:STORe<n>:TRACe](#) command.

ALL

Selects all active traces and result tables (e.g. "Result Summary", marker peak list etc.) in the current application for export to an ASCII file.

The <trace> parameter for the [MMEMory:STORe<n>:TRACe](#) command is ignored.

*RST: SINGle

MMEMory:STORe<n>:TRACe <Trace>, <FileName>

Exports trace data from the specified window to an ASCII file.

Secure User Mode

In secure user mode, settings that are stored on the instrument are stored to volatile memory, which is restricted to 256 MB. Thus, a "memory limit reached" error can occur although the hard disk indicates that storage space is still available.

To store data permanently, select an external storage location such as a USB memory device.

For details, see "Protecting Data Using the Secure User Mode" in the "Data Management" section of the FSW base unit user manual.

Suffix:

<n> [Window](#)

Parameters:

<Trace> Number of the trace to be stored

<FileName> String containing the path and name of the target file.

Example:

```
M MEM:STOR1:TRAC 1, 'C:\TEST.ASC'
```

Stores trace 1 from window 1 in the file TEST.ASC.

6.11.1.2 Diagram scale

[DISPlay\[:WINDow<n>\]\[:SUBWindow<w>\]:TRACe<t>:Y\[:SCALe\]:AUTO](#)..... 413

[DISPlay\[:WINDow<n>\]\[:SUBWindow<w>\]:TRACe<t>:Y\[:SCALe\]:MAXimum](#)..... 414

[DISPlay\[:WINDow<n>\]\[:SUBWindow<w>\]:TRACe<t>:Y\[:SCALe\]:MINimum](#)..... 414

DISPlay[:WINDow<n>][:SUBWindow<w>]:TRACe<t>:Y[:SCALe]:AUTO <ONCE>

Automatically scales the y-axis of a diagram based on the displayed results.

Suffix:

<n> [Window](#)

<w> [Subwindow](#)

<t> irrelevant

Setting parameters:

<ONCE> **ALL**
Scales the y-axis in all windows for an ideal viewing experience.

DEFault

Restores the default scale of the y-axis.

ONCE

Scales the y-axis in a specific window for an ideal viewing experience.

Example:

```
//Automatically scale the y-axis in subwindow 2 of window 2
```

```
DISP:WIND2:SUBW2:TRAC:Y:AUTO ONCE
```

Usage:

Setting only

Manual operation:

See ["Auto Scale"](#) on page 59

See ["Automatic scaling of the y-axis"](#) on page 172

DISPlay[:WINDow<n>][:SUBWindow<w>]:TRACe<t>:Y[:SCALe]:MAXimum
<Value>

Defines the maximum value displayed on the y-axis of a diagram.

Suffix:

<n> [Window](#)
 <w> [Subwindow](#)
 <t> irrelevant

Parameters:

<Value> Maximum displayed value. The unit and value range depend on the selected diagram.

Example: //Define maximum value on y-axis in subwindow 2 of window 2
 DISP:WIND2:SUBW2:TRAC:Y:MAX 0

Manual operation: See "[Manual scaling of the y-axis](#)" on page 172

DISPlay[:WINDow<n>][:SUBWindow<w>]:TRACe<t>:Y[:SCALe]:MINimum
<Value>

Defines the minimum value displayed on the vertical diagram axis.

Suffix:

<n> [Window](#)
 <w> [Subwindow](#)
 <t> irrelevant

Parameters:

<Value> Minimum displayed value. The unit and value range depend on the selected diagram.

Example: //Define minimum value on y-axis in subwindow 2 of window 2
 DISP:WIND2:SUBW2:TRAC:Y:MIN -50

Manual operation: See "[Manual scaling of the y-axis](#)" on page 172

6.11.1.3 Zoom

[DISPlay\[:WINDow<n>\]\[:SUBWindow<w>\]:ZOOM:AREA](#)..... 414
[DISPlay\[:WINDow<n>\]\[:SUBWindow<w>\]:ZOOM:MULTiple<zn>:AREA](#).....416
[DISPlay\[:WINDow<n>\]\[:SUBWindow<w>\]:ZOOM:MULTiple<zn>\[:STATe\]](#)..... 417
[DISPlay\[:WINDow<n>\]\[:SUBWindow<w>\]:ZOOM\[:STATe\]](#).....417

DISPlay[:WINDow<n>][:SUBWindow<w>]:ZOOM:AREA <x1>,<y1>,<x2>,<y2>

Defines the zoom area.

To define a zoom area, you first have to turn the zoom on.

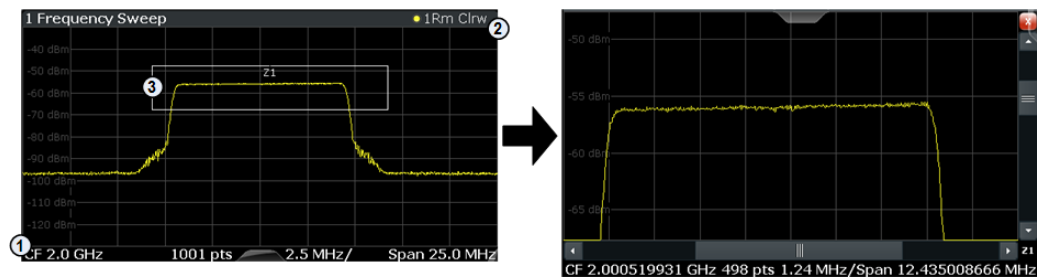

- 1 = origin of coordinate system (x1 = 0, y1 = 0)
 2 = end point of system (x2 = 100, y2 = 100)
 3 = zoom area (e.g. x1 = 60, y1 = 30, x2 = 80, y2 = 75)

Suffix:

- <n> [Window](#)
 <w> subwindow
 Not supported by all applications

Parameters:

- <x1> Diagram coordinates in % of the complete diagram that define the zoom area.
 The lower left corner is the origin of coordinate system. The upper right corner is the end point of the system.
 Range: 0 to 100
 Default unit: PCT
- <y1> Diagram coordinates in % of the complete diagram that define the zoom area.
 The lower left corner is the origin of coordinate system. The upper right corner is the end point of the system.
 Range: 0 to 100
 Default unit: PCT
- <x2> Diagram coordinates in % of the complete diagram that define the zoom area.
 The lower left corner is the origin of coordinate system. The upper right corner is the end point of the system.
 Range: 0 to 100
 Default unit: PCT
- <y2> Diagram coordinates in % of the complete diagram that define the zoom area.
 The lower left corner is the origin of coordinate system. The upper right corner is the end point of the system.
 Range: 0 to 100
 Default unit: PCT

DISPlay[:WINDow<n>][:SUBWindow<w>]:ZOOM:MULTiple<zn>:AREA
 <x1>,<y1>,<x2>,<y2>

Defines the zoom area for a multiple zoom.

To define a zoom area, you first have to turn the zoom on.

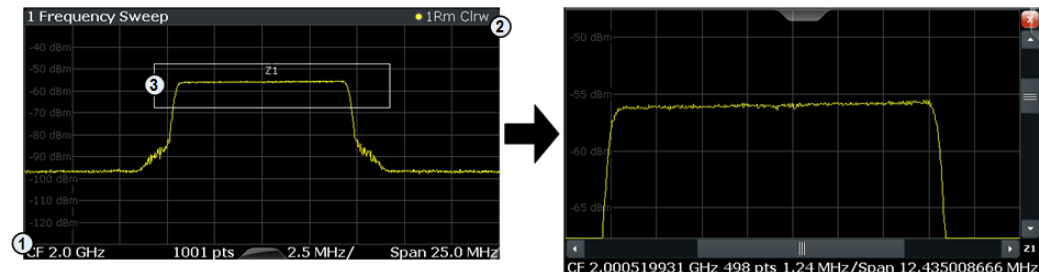

- 1 = origin of coordinate system (x1 = 0, y1 = 0)
- 2 = end point of system (x2 = 100, y2 = 100)
- 3 = zoom area (e.g. x1 = 60, y1 = 30, x2 = 80, y2 = 75)

Suffix:

- <n> [Window](#)
- <w> subwindow
Not supported by all applications
- <zn> Selects the zoom window.

Parameters:

- <x1> Diagram coordinates in % of the complete diagram that define the zoom area.
The lower left corner is the origin of coordinate system. The upper right corner is the end point of the system.
Range: 0 to 100
Default unit: PCT
- <y1> Diagram coordinates in % of the complete diagram that define the zoom area.
The lower left corner is the origin of coordinate system. The upper right corner is the end point of the system.
Range: 0 to 100
Default unit: PCT
- <x2> Diagram coordinates in % of the complete diagram that define the zoom area.
The lower left corner is the origin of coordinate system. The upper right corner is the end point of the system.
Range: 0 to 100
Default unit: PCT

<y2> Diagram coordinates in % of the complete diagram that define the zoom area.
The lower left corner is the origin of coordinate system. The upper right corner is the end point of the system.
Range: 0 to 100
Default unit: PCT

DISPlay[:WINDow<n>][:SUBWindow<w>]:ZOOM:MULTiple<zn>[:STATe] <State>

Turns the multiple zoom on and off.

Suffix:

<n> [Window](#)

<w> subwindow
Not supported by all applications

<zn> Selects the zoom window.
If you turn off one of the zoom windows, all subsequent zoom windows move up one position.

Parameters:

<State> ON | OFF | 0 | 1
OFF | 0
Switches the function off
ON | 1
Switches the function on

DISPlay[:WINDow<n>][:SUBWindow<w>]:ZOOM[:STATe] <State>

Turns the zoom on and off.

Suffix:

<n> [Window](#)

<w> subwindow
Not supported by all applications

Parameters:

<State> ON | OFF | 0 | 1
OFF | 0
Switches the function off
ON | 1
Switches the function on

Example:

DISP:ZOOM ON
Activates the zoom mode.

6.11.1.4 Markers

Commands to configure markers described elsewhere.

- `CALCulate<n>:DELTamarker<m>:X`
- `CALCulate<n>:DELTamarker<m>:Y?`
- `CALCulate<n>:MARKer<m>:X`
- `CALCulate<n>:MARKer<m>:Y`
- `CALCulate<n>:MARKer<m>:Z?`
- `CALCulate<n>:MARKer<m>:Z:ALL?`

<code>CALCulate<n>:DELTamarker<m>:AOFF</code>	418
<code>CALCulate<n>:DELTamarker<m>:MAXimum:LEFT</code>	418
<code>CALCulate<n>:DELTamarker<m>:MAXimum:NEXT</code>	419
<code>CALCulate<n>:DELTamarker<m>:MAXimum:RIGHT</code>	419
<code>CALCulate<n>:DELTamarker<m>:MAXimum[:PEAK]</code>	419
<code>CALCulate<n>:DELTamarker<m>:MINimum:LEFT</code>	419
<code>CALCulate<n>:DELTamarker<m>:MINimum:NEXT</code>	420
<code>CALCulate<n>:DELTamarker<m>:MINimum:RIGHT</code>	420
<code>CALCulate<n>:DELTamarker<m>:MINimum[:PEAK]</code>	420
<code>CALCulate<n>:DELTamarker<m>[:STATE]</code>	420
<code>CALCulate<n>:DELTamarker<m>:TRACe</code>	421
<code>CALCulate<n>:MARKer<m>:AOFF</code>	421
<code>CALCulate<n>:MARKer<m>:MAXimum:LEFT</code>	421
<code>CALCulate<n>:MARKer<m>:MAXimum:NEXT</code>	421
<code>CALCulate<n>:MARKer<m>:MAXimum:RIGHT</code>	421
<code>CALCulate<n>:MARKer<m>:MAXimum[:PEAK]</code>	422
<code>CALCulate<n>:MARKer<m>:MINimum:LEFT</code>	422
<code>CALCulate<n>:MARKer<m>:MINimum:NEXT</code>	422
<code>CALCulate<n>:MARKer<m>:MINimum:RIGHT</code>	422
<code>CALCulate<n>:MARKer<m>[:STATE]</code>	423
<code>CALCulate<n>:MARKer<m>:TRACe</code>	423
<code>DISPlay[:WINDow<n>]:MTABle</code>	423

CALCulate<n>:DELTamarker<m>:AOFF

Turns off *all* delta markers.

Suffix:

<n>	Window
<m>	irrelevant

Example:

`CALC:DELT:AOFF`
Turns off all delta markers.

CALCulate<n>:DELTamarker<m>:MAXimum:LEFT

Moves a delta marker to the next positive peak value.

The search includes only measurement values to the left of the current marker position.

Suffix:

<n> [Window](#)

<m> [Marker](#)

CALCulate<n>:DELTamarker<m>:MAXimum:NEXT

Moves a marker to the next positive peak value.

Suffix:

<n> 1..n
[Window](#)

<m> 1..n
[Marker](#)

CALCulate<n>:DELTamarker<m>:MAXimum:RIGHT

Moves a delta marker to the next positive peak value on the trace.

The search includes only measurement values to the right of the current marker position.

Suffix:

<n> [Window](#)

<m> [Marker](#)

CALCulate<n>:DELTamarker<m>:MAXimum[:PEAK]

Moves a delta marker to the highest level.

If the marker is not yet active, the command first activates the marker.

Suffix:

<n> [Window](#)

<m> [Marker](#)

CALCulate<n>:DELTamarker<m>:MINimum:LEFT

Moves a delta marker to the next minimum peak value.

The search includes only measurement values to the right of the current marker position.

Suffix:

<n> [Window](#)

<m> [Marker](#)

CALCulate<n>:DELTamarker<m>:MINimum:NEXT

Moves a marker to the next minimum peak value.

Suffix:

<n> [Window](#)

<m> [Marker](#)

CALCulate<n>:DELTamarker<m>:MINimum:RIGHT

Moves a delta marker to the next minimum peak value.

The search includes only measurement values to the right of the current marker position.

Suffix:

<n> [Window](#)

<m> [Marker](#)

CALCulate<n>:DELTamarker<m>:MINimum[:PEAK]

Moves a delta marker to the minimum level.

If the marker is not yet active, the command first activates the marker.

Suffix:

<n> [Window](#)

<m> [Marker](#)

CALCulate<n>:DELTamarker<m>[:STATE] <State>

Turns delta markers on and off.

If necessary, the command activates the delta marker first.

No suffix at DELTmarker turns on delta marker 1.

Suffix:

<n> [Window](#)

<m> [Marker](#)

Parameters:

<State> ON | OFF | 0 | 1

OFF | 0

Switches the function off

ON | 1

Switches the function on

Example:

CALC:DELT2 ON

Turns on delta marker 2.

CALCulate<n>:DELTaMarker<m>:TRACe <Trace>

Selects the trace a delta marker is positioned on.

Note that the corresponding trace must have a trace mode other than "Blank".

If necessary, the command activates the marker first.

Suffix:

<n> [Window](#)

<m> [Marker](#)

Parameters:

<Trace> Trace number the marker is assigned to.

Example:

CALC:DELT2:TRAC 2
Positions delta marker 2 on trace 2.

CALCulate<n>:MARKer<m>:AOFF

Turns off all markers.

Suffix:

<n> [Window](#)

<m> [Marker](#)

Example:

CALC:MARK:AOFF
Switches off all markers.

CALCulate<n>:MARKer<m>:MAXimum:LEFT

Moves a marker to the next positive peak.

The search includes only measurement values to the left of the current marker position.

Suffix:

<n> [Window](#)

<m> [Marker](#)

CALCulate<n>:MARKer<m>:MAXimum:NEXT

Moves a marker to the next positive peak.

Suffix:

<n> [Window](#)

<m> [Marker](#)

CALCulate<n>:MARKer<m>:MAXimum:RIGHT

Moves a marker to the next positive peak.

The search includes only measurement values to the right of the current marker position.

Suffix:

<n> [Window](#)

<m> [Marker](#)

CALCulate<n>:MARKer<m>:MAXimum[:PEAK]

Moves a marker to the highest level.

If the marker is not yet active, the command first activates the marker.

Suffix:

<n> [Window](#)

<m> [Marker](#)

CALCulate<n>:MARKer<m>:MINimum:LEFT

Moves a marker to the next minimum peak value.

The search includes only measurement values to the right of the current marker position.

Suffix:

<n> [Window](#)

<m> [Marker](#)

CALCulate<n>:MARKer<m>:MINimum:NEXT

Moves a marker to the next minimum peak value.

Suffix:

<n> [Window](#)

<m> [Marker](#)

CALCulate<n>:MARKer<m>:MINimum:RIGHT

Moves a marker to the next minimum peak value.

The search includes only measurement values to the right of the current marker position.

Suffix:

<n> [Window](#)

<m> [Marker](#)

CALCulate<n>:MARKer<m>[:STATe] <State>

Turns markers on and off. If the corresponding marker number is currently active as a delta marker, it is turned into a normal marker.

Suffix:

<n> [Window](#)

<m> [Marker](#)

Parameters:

<State> ON | OFF | 0 | 1

OFF | 0

Switches the function off

ON | 1

Switches the function on

Example:

```
CALC:MARK3 ON
Switches on marker 3.
```

CALCulate<n>:MARKer<m>:TRACe <Trace>

Selects the trace the marker is positioned on.

Note that the corresponding trace must have a trace mode other than "Blank".

If necessary, the command activates the marker first.

Suffix:

<n> [Window](#)

<m> [Marker](#)

Parameters:

<Trace> **1 to 16**

Trace number (or bandwidth part if the trace represents one) the marker is assigned to.

Example:

```
//Assign marker to trace 1
CALC:MARK3:TRAC 2
```

DISPlay[:WINDow<n>]:MTABle <DisplayMode>

Turns the marker table on and off.

Suffix:

<n> irrelevant

Parameters:

<DisplayMode> **ON | 1**

Turns on the marker table.

OFF | 0

Turns off the marker table.

AUTO

Turns on the marker table if 3 or more markers are active.

*RST: AUTO

Example:

DISP:MTAB ON

Activates the marker table.

6.11.2 Analysis tools for I/Q measurements

- [Result views](#).....424
- [Result settings](#).....425
- [Evaluation range](#).....430

6.11.2.1 Result views

- [DISPlay\[:WINDow<n>\]\[:SUBWindow<w>\]:CCNumber](#).....424
- [DISPlay\[:WINDow<n>\]\[:SUBWindow<w>\]:FNUMber](#).....424

DISPlay[:WINDow<n>][:SUBWindow<w>]:CCNumber <Carrier>

Assigns a specific component carrier to a view.

Prerequisites for this command

- Capture more than one component carrier.

Suffix:

<n> irrelevant

<w> [View](#)

Parameters:

<Carrier> <numeric value> (integer only)

Example:

//Select a component carrier to analyze in view 2

DISP:SUBW2:CCN 2

Manual operation:

See "[Views](#)" on page 65

See "[Component Carrier No](#)" on page 179

DISPlay[:WINDow<n>][:SUBWindow<w>]:FNUMber <Frame>

Assigns a specific frame to a view.

Prerequisites for this command

- Capture more than one frame.

Suffix:

<n> irrelevant

<w> [View](#)

Parameters:

<Frame> <numeric value> (integer only)

Example: //Select a frame to analyze in view 2
DISP:SUBW2:FNUM 2

Manual operation: See ["Effects of capturing multiple frames on results"](#) on page 71
See ["Frame No"](#) on page 179

6.11.2.2 Result settings

DISPlay[:WINDow<n>][:SUBWindow<w>]:COUPling.....	425
DISPlay[:WINDow<n>]:TABLe:ITEM.....	425
[SENSe:]NR5G:CCOLor.....	426
[SENSe:]NR5G:CDRPower.....	426
[SENSe:]NR5G:EMHold.....	426
[SENSe:]NR5G:RSUMmary:CCResult.....	427
[SENSe:]NR5G:RSUMmary:PMODE.....	427
[SENSe:]NR5G:RSUMmary:SHOW.....	428
[SENSe:]NR5G:TDDView.....	428
UNIT:BSTR.....	428
UNIT:CAReference.....	429
UNIT:CAXes.....	429
UNIT:EVM.....	429
UNIT:SAXes.....	430

DISPlay[:WINDow<n>][:SUBWindow<w>]:COUPling <State>

Couples or decouples result display tabs (subwindows).

Subwindow coupling is available for measurements with multiple data streams (like carrier aggregation).

Suffix:

<n> [Window](#)

<w> [Subwindow](#)

Parameters:

<State> ON | OFF | 1 | 0

*RST: OFF

Example: //Turn on subwindow coupling

DISP:COUP ON

Manual operation: See ["Subwindow Coupling"](#) on page 176

DISPlay[:WINDow<n>]:TABLe:ITEM <Result>, <State>

Turns the display of individual results in the numerical result summary on and off.

Suffix:

<n> [Window](#)

Parameters:

<Result> BLER | CRES | DSQP | DSSF | DSST | DSTS | UPRach |
 FSOFset | EVM | EVMPeak | FERRor | GIMBalance | IQOOffset
 | MODulation | NORB | OSTP | RSTP | SSPower | CSIPower |
 PCHannel | POWer | PPRE | PSIGnal | QUADrature | SDPB |
 SDQP | SDSF | SDST | SDTS | SERRor | TPUT | UCCD | UCCH
 | USPB | USQP | USSF | USST | USTS

<State> ON | OFF | 1 | 0

Example:

```
//Display or hide results
DISP:WIND2:TABL:ITEM DSSF,ON
DISP:WIND2:TABL:ITEM DSQP,OFF
```

Manual operation: See "[Result state](#)" on page 178

[SENSe:]NR5G:CCOLor <Type>

Selects the information that the colors of the constellation points in the constellation diagram represent.

Parameters:

<Type> **ALLocation**
 Colors represent allocation types.

MODulation
 Colors represent modulation types.

*RST: MODulation

Example:

```
//Select colors for constellation diagram
NR5G:CCOL MOD
```

Manual operation: See "[Constellation Color](#)" on page 177

[SENSe:]NR5G:CDRPower <State>

Turns the consideration of a boosting factor to calculate the constellation points in the constellation diagram on and off.

Parameters:

<State> ON | OFF | 1 | 0

*RST: OFF

Example:

```
//Turn on boosting factor
NR5G:CDRP ON
```

Manual operation: See "[Constellation Diagram Relative Power](#)" on page 177

[SENSe:]NR5G:EMHold <State>

Turns the EVM max hold function on and off.

Parameters:

<State> ON | OFF | 1 | 0
 *RST: OFF

Example:

//Turn on EVM max hold
 NR5G:EMH ON

Manual operation: See ["EVM Max Hold"](#) on page 176

[SENSe:]NR5G:RSUMmary:CCRResult <Result>

Selects the way multiple carriers are analyzed.

Prerequisites for this command

- Select mutiple carriers ([CONFigure\[:NR5G\]:NOCC](#)).

Parameters:

<Result> **ALL**
 Analyzes all component carriers and shows information about all of them in the result summary.

VIEWed

Analyzes the two component carriers assigned to the two views. The result summary only shows information about those two component carriers.

*RST: VIEWed

Example:

//Analyze all carriers
 CONF:NOCC 4
 NR5G:RSUM:CCR ALL

Manual operation: See ["CC Result"](#) on page 178

[SENSe:]NR5G:RSUMmary:PMODE <Result>

Selects the power averaging mode.

Parameters:

<Result> **AASL**
 Power avergaing over all symbols in a slot.

AASY

Power avergaing over all used symbols in a slot.

*RST: AASL

Example:

//Select power averaging mode
 NR5G:RSUM:PMOD AASY

Manual operation: See ["Power Mode"](#) on page 178

[SENSe:]NR5G:RSUMmary:SHOW <Result>

Selects the way the contents of the result summary are calculated.

Parameters:

<Result>

AVERage

Shows the average over all analyzed frames.

SINGLE

Shows the result for the frame selected with `[SENSe:]NR5G[:CC<cc>]:FRAMe:SElect`.

If only one frame has been captured, the results are the same in both cases.

*RST: AVERage

Example:

```
//Display results for a single frame
DISP:SUBW2:FNUM 2
NR5G:RSUM:SHOW SING
```

[SENSe:]NR5G:TDDView <State>

Turns the 3D view for [selected diagrams](#) on and off.

Parameters:

<State>

ON | OFF | 1 | 0

*RST: OFF

Example:

```
//Turn on 3D view
NR5G:TDD ON
```

Manual operation: See ["3D View"](#) on page 176

UNIT:BSTR <Unit>

Selects the way the bit stream is displayed.

Parameters:

<Unit>

SYMBOLs

Displays the bit stream using symbols

BITs

Displays the bit stream using bits

*RST: SYMBOLs

Example:

```
//Display bit stream as bits
UNIT:BSTR BIT
```

Manual operation: See ["Bit Stream Format"](#) on page 175

UNIT:CAReference <Reference>

Selects the reference for result displays whose x-axis shows frequency characteristics of the signal.

Parameters:

<Reference>

LRB

Frequency values relative to the lowest resource block.

RTCF

Frequency values relative to the center frequency of the carrier.

*RST: LRB

Example:

```
//Select carrier reference
UNIT:CAR RTCF
```

Manual operation: See "[Carrier Axes Reference](#)" on page 175

UNIT:CAXes <Unit>

Selects the scale of the x-axis for result displays that show subcarrier results.

Parameters:

<Unit>

CARR

Shows the number of the subcarriers on the x-axis.

HZ

Shows the frequency of the subcarriers on the x-axis.

Example:

```
//Display frequency on the x-axis
UNIT:CAX HZ
```

Manual operation: See "[Carrier Axes](#)" on page 175

UNIT:EVM <Unit>

Selects the EVM unit.

Parameters:

<Unit>

DB

EVM results returned in dB

PCT

EVM results returned in %

*RST: PCT

Example:

```
//Display EVM results in %
UNIT:EVM PCT
```

Manual operation: See "[EVM Unit](#)" on page 174

UNIT:SAXes <Unit>

Selects the scale of the x-axis for result displays that show symbol results.

Parameters:

<Unit>

SYMBOL

Shows the number of the symbol on the x-axis.

TIME

Shows the time stamp of the symbols on the x-axis.

Example:

```
//Display symbol numbers on the x-axis
UNIT:SAX SYMB
```

Manual operation: See "[Symbol Axes](#)" on page 175

6.11.2.3 Evaluation range

[SENSe:]NR5G[:CC<cc>]:ALlocation:SElect.....	430
[SENSe:]NR5G[:CC<cc>]:ANTenna:SElect.....	431
[SENSe:]NR5G[:CC<cc>]:BWPart:SElect.....	431
[SENSe:]NR5G[:CC<cc>]:CARRier:SElect.....	431
[SENSe:]NR5G[:CC<cc>]:FRAMe:SElect.....	432
[SENSe:]NR5G[:CC<cc>]:LOCation:SElect.....	432
[SENSe:]NR5G[:CC<cc>]:MODulation:SElect.....	432
[SENSe:]NR5G[:CC<cc>]:PREamble:SElect.....	433
[SENSe:]NR5G[:CC<cc>]:SLOT:SElect.....	433
[SENSe:]NR5G[:CC<cc>]:SUBFrame:SElect.....	434
[SENSe:]NR5G[:CC<cc>]:SYMBOL:SElect.....	434
[SENSe:]NR5G:SEGMent:SElect.....	434

[SENSe:]NR5G[:CC<cc>]:ALlocation:SElect <Allocation>

Filters the displayed results in the constellation diagram by a certain allocation.

Suffix:

<cc>

irrelevant

Parameters:

<Allocation>

ALL

Shows the results for all allocations.

<numeric value> (integer only)

Shows the results for a single allocation type.

Allocation types are mapped to numeric values. For the code assignment, see [Chapter 6.9.1.21, "Return value codes"](#), on page 271.

```
*RST: ALL
```

Example:

```
//Display results for all allocations
NR5G:ALL:SEL ALL
```

Manual operation: See "[Evaluation range for the constellation diagram](#)" on page 183

[SENSe:]NR5G[:CC<cc>]:ANTenna:SElect <Antenna>

Filters the constellation points by a certain antenna port.

Prerequisites for this command

- Create the constellation diagram after MIMO decoding (`[SENSe:]NR5G[:CC<cc>]:LOCation:SElect`).

Suffix:

<cc> irrelevant

Parameters:

<Antenna> Number of the antenna port (for example 1001).

Example:

```
//Filter constellation points by antenna port
NR5G:LOC:SEL AMD
NR5G:ANT:SEL 1001
```

[SENSe:]NR5G[:CC<cc>]:BWPart:SElect <BWP>

Filters the displayed results by a certain bandwidth part.

Suffix:

<cc> irrelevant

Parameters:

<BWP> **ALL**
Shows the results for all bandwidth parts, including the SS/PBCH block.

SSBLock

Shows the results for the SS/PBCH block.

<numeric value> (integer only)

Shows the results for a single bandwidth part.

*RST: ALL

Example:

```
//Display results for SS/PBCH block
NR5G:BWP:SEL SSBL
```

Manual operation: See "[BWP/SS Selection](#)" on page 181

[SENSe:]NR5G[:CC<cc>]:CARRier:SElect <Carrier>

Filters the displayed results in the constellation diagram by a certain subcarrier.

Suffix:

<cc> irrelevant

Parameters:

<Carrier> **ALL**
Shows the results for all subcarriers.

<numeric value> (integer only)

Shows the results for a single subcarrier.

*RST: ALL

Example: //Display results for all subcarriers
NR5G:CARR:SEL ALL

Manual operation: See ["Evaluation range for the constellation diagram"](#) on page 183

[SENSe:]NR5G[:CC<cc>]:FRAMe:SElect <Frame>

Filters the displayed results by a specific frame.

Suffix:

<cc> irrelevant

Parameters:

<Frame> *RST: 1

Example: //Display results for frame 2
NR5G:FRAM:SEL 2

Manual operation: See ["Effects of capturing multiple frames on results"](#) on page 71
See ["Frame Selection"](#) on page 180

[SENSe:]NR5G[:CC<cc>]:LOCation:SElect <Location>

Selects the point in the signal processing at which the constellation diagram is created.

Suffix:

<cc> irrelevant

Parameters:

<Location> **AMD**
After MIMO decoding.
BMD
Before MIMO decoding.
*RST: BMD

Example: //Select constellation diagram data source
NR5G:LOC:SEL AMD

[SENSe:]NR5G[:CC<cc>]:MODulation:SElect <Modulation>

Filters the displayed results in the constellation diagram by a certain modulation type.

Suffix:

<cc> irrelevant

Parameters:

<Modulation> **ALL**
Shows the results for all modulation types.

<numeric value> (integer only)

Shows the results for a single modulation type.

Modulation types are mapped to numeric values. For the code assignment, see [Chapter 6.9.1.21, "Return value codes"](#), on page 271.

*RST: ALL

Example: //Display results for all elements with a QPSK modulation
NR5G:MOD:SEL 2

Manual operation: See ["Evaluation range for the constellation diagram"](#) on page 183

[SENSe:]NR5G[:CC<cc>]:PREamble:SElect <Preamble>

Filters the displayed results by a certain preamble.

Suffix:

<cc> irrelevant

Parameters:

<Preamble> **ALL**

Shows the results for all preambles.

<numeric value> (integer only)

Shows the results for a single preamble.

*RST: ALL

Example: //Display result for preamble 2
NR5G:SLOT:SEL 2

Manual operation: See ["Preamble Selection"](#) on page 183

[SENSe:]NR5G[:CC<cc>]:SLOT:SElect <Slot>

Filters the displayed results by a certain slot.

Suffix:

<cc> irrelevant

Parameters:

<Slot> **ALL**

Shows the results for all slots.

<numeric value> (integer only)

Shows the results for a single slot.

*RST: ALL

Example: //Display result for slot 4
NR5G:SLOT:SEL 4

Manual operation: See ["Slot Selection"](#) on page 182

[SENSe:]NR5G:CC<cc>:SUBFrame:SElect <Subframe>

Filters the displayed results by a certain OFDM subframe.

Suffix:

<cc> irrelevant

Parameters:

<Subframe>

ALL

Shows the results for all subframes.

<numeric value> (integer only)

Shows the results for a single subframe.

*RST: ALL

Example:

```
//Display result for subframe 1
NR5G:SUBF:SEL 1
```

Manual operation: See "[Subframe Selection](#)" on page 181

[SENSe:]NR5G:CC<cc>:SYMBOL:SElect <Symbol>

Filters the displayed results in the constellation diagram by a certain OFDM symbol.

Suffix:

<cc> irrelevant

Parameters:

<Symbol>

ALL

Shows the results for all symbols.

<numeric value> (integer only)

Shows the results for a single OFDM symbol.

*RST: ALL

Example:

```
//Display result for OFDM symbol 2
NR5G:SYMB:SEL 2
```

Manual operation: See "[Evaluation range for the constellation diagram](#)" on page 183

[SENSe:]NR5G:SEGMENT:SElect <Segment>

Selects the analyzed segment for a segmented capture.

Prerequisites for this command

- Turn on segmented capture ([\[SENSe:\]SWEep:SCAPture:STATe](#)).

Parameters:

<Segment>

<numeric value> (integer only)

The value range depends on the number of captured segments ([\[SENSe:\]SWEep:SCAPture:EVENTs](#)).

Example: //Select segment to analyze
 SWE:SCAP:STAT ON
 SWE:SCAP:EVEN 3
 NR5G:SEGM:SEL 2

Manual operation: See "[Segment Selection](#)" on page 180

6.11.3 Analysis tools for combined measurements

[SENSe:]NR5G[:CC<cc>]:SMID.....	435
[SENSe:]NR5G:EFILter:FPARameters.....	435
[SENSe:]NR5G:EFILter:FPARameters:STATE.....	436
[SENSe:]NR5G:EFILter:PRESet.....	436
[SENSe:]NR5G:EFILter:STATE.....	437
[SENSe:]NR5G:FEVents:COUNT?.....	437

[SENSe:]NR5G[:CC<cc>]:SMID <Event>

Selects a specific measurement (meas ID) from the measurement sequence in combined measurements.

Suffix:

<cc> irrelevant

Parameters:

<Event> *RST: 1

Example: //Select a measurement
 NR5G:SMID 5

Manual operation: See "[Selected Meas ID](#)" on page 180

[SENSe:]NR5G:EFILter:FPARameters <Result>[, <Condition>, <Value>]

Defines a filter condition for the event filter in combined measurements.

Parameters:

<Result> SSTate | APFail | AAPFail | ARPFail | SPFail | MID | TSTamp |
 TSDelta | EVM | Power | DSQP | DSST | DSSF | DSTS |
 FSOFFset | PCHannel | PSIGnal | FERRor | SERRor | IQOFFset |
 GIMBalance | QUADrature | OSTP | RSTP | RSSI | CSIPower |
 SSPower | CRES t | OVLD | MODulation | NORB | BLER | TPUT
 Selects the result that you want to define a filter for.

<Condition>

FAILED

Filter condition: test failed (for boolean results only).

GTEQual

Filter condition: greater than or equal (for numerical results only).

LTEQual

Filter condition: lower than or equal (for numerical results only).

PASSed

Filter condition: test passed (for boolean results only).

<Value>

For numerical results only.

Example:

```
//Define filter condition: time stamp deltas greater than 0.25 seconds
NR5G:EFIL:FPA R TSD,GTH,0.25S
```

Example:

```
//Define filter condition: signal synchronization pass
NR5G:EFIL:FPA R SST,PASS
```

Manual operation: See "[Filter Parameters](#)" on page 185

[SENSe:]NR5G:EFILter:FPAParameters:STATe <Result>, <State>

Turns an event filter on and off.

Turning on an event filter adds it to the filter list and removes the results from the result summary that do not fulfill the filter conditions.

Turning it off removes it from the list.

Prerequisites for this command

- Define a filter condition ([\[SENSe:\]NR5G:EFILter:FPAParameters](#)).

Parameters:

<Result>

CRESt | DSQP | DSSF | DSST | DSTS | FSOFFset | EVM |
 OVLD | FERRor | GIMBalance | IQOFFset | MODulation |
 NORB | OSTP | RSTP | RSSI | SSPower | CSIpower |
 PCHannel | POWer | PPRE | PSIGnal | QUADrature | SERRor |
 MID | TSTamp | TSDelta | SSTate | APFail | AAPFail | ARPFail |
 SPFail | BLER | TPUT

Selects the result that you want to add a filter for.

<State>

ON | OFF | 1 | 0

*RST: OFF

Example:

```
//Add two filter conditions to the filter list
NR5G:EFIL:FPA R TSD,GTH,0.25S
NR5G:EFIL:FPA R TSD,ON
NR5G:EFIL:FPA R SST,PASS
NR5G:EFIL:FPA R SST,ON
```

Manual operation: See "[Filter Parameters](#)" on page 185

[SENSe:]NR5G:EFILter:PRESet

Removes all event filters.

Example:

```
//Remove all event filters
NR5G:EFIL:PRE S
```

Usage:

Event

Manual operation: See ["Reset Filter Settings"](#) on page 185

[SENSe:]NR5G:EFILter:STATe <State>

Turns an event filter for combined measurement results on and off.

Parameters:

<State> ON | OFF | 0 | 1
*RST: OFF

Example: //Turn on event filter
NR5G:EFIL:STAT ON

Manual operation: See ["State"](#) on page 184

[SENSe:]NR5G:FEVents:COUNT?

Queries the number of filtered events for combined measurements.

Prerequisites for this command

- Define and turn on an event filter.

Return values:

<Count>

Example: //Query filtered events
NR5G:EFIL:STAT ON
NR5G:FEV:COUNT?

Usage: Query only

Manual operation: See ["Filter Parameters"](#) on page 185

6.12 Reading out status register

The following commands are required to read out the `STATus:QUESTIONable:SYNC` status register.

For a full list of commands required to read out the status register, refer to the FSW user manual.

STATus:QUESTIONable:SYNC[:EVENT]?	437
STATus:QUESTIONable:SYNC:CONDition?	438
STATus:QUESTIONable:SYNC:ENABle	438
STATus:QUESTIONable:SYNC:NTRansition	438
STATus:QUESTIONable:SYNC:PTRansition	439

STATus:QUESTIONable:SYNC[:EVENT]? <ChannelName>

Reads out the `EVENT` section of the status register.

The command also deletes the contents of the `EVENT` section.

Query parameters:

<ChannelName> String containing the name of the channel.
The parameter is optional. If you omit it, the command works for the currently active channel.

Usage: Query only

STATus:QUESTionable:SYNC:CONDition? <ChannelName>

Reads out the CONDition section of the status register.

The command does not delete the contents of the EVENT section.

Query parameters:

<ChannelName> String containing the name of the channel.
The parameter is optional. If you omit it, the command works for the currently active channel.

Usage: Query only

STATus:QUESTionable:SYNC:ENABLE <BitDefinition>, <ChannelName>

Controls the ENABLE part of a register.

The ENABLE part allows true conditions in the EVENT part of the status register to be reported in the summary bit. If a bit is 1 in the enable register and its associated event bit transitions to true, a positive transition will occur in the summary bit reported to the next higher level.

Parameters:

<BitDefinition> Range: 0 to 65535

<ChannelName> String containing the name of the channel.
The parameter is optional. If you omit it, the command works for the currently active channel.

STATus:QUESTionable:SYNC:NTRansition <BitDefinition>[,<ChannelName>]

Controls the Negative TRansition part of a register.

Setting a bit causes a 1 to 0 transition in the corresponding bit of the associated register. The transition also writes a 1 into the associated bit of the corresponding EVENT register.

Parameters:

<BitDefinition> Range: 0 to 65535

<ChannelName> String containing the name of the channel.
The parameter is optional. If you omit it, the command works for the currently active channel.

STATus:QUESTionable:SYNC:PTRansition <BitDefinition>[,<ChannelName>]

These commands control the Positive TRansition part of a register.

Setting a bit causes a 0 to 1 transition in the corresponding bit of the associated register. The transition also writes a 1 into the associated bit of the corresponding EVENT register.

Parameters:

<BitDefinition> Range: 0 to 65535

<ChannelName> String containing the name of the channel.
The parameter is optional. If you omit it, the command works for the currently active channel.

List of commands (5G NR uplink)

[SENSe:]ADJust:CONFigure:LEVel:DURation.....	280
[SENSe:]ADJust:CONFigure:LEVel:DURation:MODE.....	281
[SENSe:]ADJust:DEMod.....	281
[SENSe:]ADJust:EVM.....	281
[SENSe:]ADJust:EVM:SLOTs.....	282
[SENSe:]ADJust:LEVel.....	282
[SENSe:]ADJust:NCANcel:AVERage[:COUNT].....	393
[SENSe:]ADJust:NCANcel:AVERage[:STATe].....	393
[SENSe:]ESpectrum<sb>:PRESet[:STANdard].....	405
[SENSe:]FREQuency:CENTer:STEP.....	378
[SENSe:]FREQuency:CENTer[:CC<cc>].....	376
[SENSe:]FREQuency:CENTer[:CC<cc>]:MCOFFset.....	292
[SENSe:]FREQuency:CENTer[:CC<cc>]:OFFSet.....	377
[SENSe:]NR5G:ACPower:ALPMode.....	405
[SENSe:]NR5G:CCOLor.....	426
[SENSe:]NR5G:CDRPower.....	426
[SENSe:]NR5G:DEMod:CESTimation.....	394
[SENSe:]NR5G:DEMod:CMETHod.....	396
[SENSe:]NR5G:DEMod:DDATa.....	397
[SENSe:]NR5G:DEMod:EFLRange.....	397
[SENSe:]NR5G:DEMod:FILTer.....	397
[SENSe:]NR5G:DEMod:PRData.....	398
[SENSe:]NR5G:DEMod:SATRansient.....	398
[SENSe:]NR5G:DEMod:SBTRansient.....	398
[SENSe:]NR5G:DEMod:TPERiod.....	399
[SENSe:]NR5G:EFILter:FPARameters.....	435
[SENSe:]NR5G:EFILter:FPARameters:STATe.....	436
[SENSe:]NR5G:EFILter:PRESet.....	436
[SENSe:]NR5G:EFILter:STATe.....	437
[SENSe:]NR5G:EMHold.....	426
[SENSe:]NR5G:FEVents:COUNT?.....	437
[SENSe:]NR5G:FRAMe:COUNT.....	383
[SENSe:]NR5G:FRAMe:COUNT:AUTO.....	383
[SENSe:]NR5G:FRAMe:COUNT:STATe.....	384
[SENSe:]NR5G:FRAMe:SALevel.....	406
[SENSe:]NR5G:FRAMe:SCAPture.....	406
[SENSe:]NR5G:FRAMe:SLOT.....	384
[SENSe:]NR5G:FRAMe:SRSLot.....	384
[SENSe:]NR5G:IQ:GIQE.....	394
[SENSe:]NR5G:RSUMmary:CCResult.....	427
[SENSe:]NR5G:RSUMmary:PMODE.....	427
[SENSe:]NR5G:RSUMmary:SHOW.....	428
[SENSe:]NR5G:SEGMENT:SElect.....	434
[SENSe:]NR5G:TDView.....	428
[SENSe:]NR5G:TRACking:LEVel.....	395
[SENSe:]NR5G:TRACking:PHASe.....	395
[SENSe:]NR5G:TRACking:TIME.....	395

[SENSe:]NR5G:TRACking:TPUT:STATe.....	395
[SENSe:]NR5G[:CC<cc>]:ALLocation:SElect.....	430
[SENSe:]NR5G[:CC<cc>]:ANTenna:SElect.....	431
[SENSe:]NR5G[:CC<cc>]:BWPart:SElect.....	431
[SENSe:]NR5G[:CC<cc>]:CARRier:SElect.....	431
[SENSe:]NR5G[:CC<cc>]:FRAMe:SElect.....	432
[SENSe:]NR5G[:CC<cc>]:LOCation:SElect.....	432
[SENSe:]NR5G[:CC<cc>]:MODulation:SElect.....	432
[SENSe:]NR5G[:CC<cc>]:PREAmble:SElect.....	433
[SENSe:]NR5G[:CC<cc>]:SLOT:SElect.....	433
[SENSe:]NR5G[:CC<cc>]:SMID.....	435
[SENSe:]NR5G[:CC<cc>]:SUBFrame:SElect.....	434
[SENSe:]NR5G[:CC<cc>]:SYMBol:SElect.....	434
[SENSe:]POWer:ACHannel:AACHannel.....	403
[SENSe:]POWer:PCLass.....	403
[SENSe:]POWer:SEM:IFF.....	403
[SENSe:]POWer:TID.....	404
[SENSe:]SWAPiq.....	384
[SENSe:]SWEep:CTMode.....	385
[SENSe:]SWEep:EGATe:AGATing.....	406
[SENSe:]SWEep:EVENT.....	406
[SENSe:]SWEep:LCAPture.....	385
[SENSe:]SWEep:MODE.....	407
[SENSe:]SWEep:SCAPture:EVENTs.....	391
[SENSe:]SWEep:SCAPture:LENGth[:TIME].....	392
[SENSe:]SWEep:SCAPture:OFFSet[:TIME].....	392
[SENSe:]SWEep:SCAPture:STATe.....	392
[SENSe:]SWEep:TIME.....	386
[SENSe:]SYNC[:CC<cc>][:STATe]?.....	208
ABORT.....	206
CALCulate<n>:DELTamarker<m>:AOFF.....	418
CALCulate<n>:DELTamarker<m>:MAXimum:LEFT.....	418
CALCulate<n>:DELTamarker<m>:MAXimum:NEXT.....	419
CALCulate<n>:DELTamarker<m>:MAXimum:RIGHT.....	419
CALCulate<n>:DELTamarker<m>:MAXimum[:PEAK].....	419
CALCulate<n>:DELTamarker<m>:MINimum:LEFT.....	419
CALCulate<n>:DELTamarker<m>:MINimum:NEXT.....	420
CALCulate<n>:DELTamarker<m>:MINimum:RIGHT.....	420
CALCulate<n>:DELTamarker<m>:MINimum[:PEAK].....	420
CALCulate<n>:DELTamarker<m>:TRACe.....	421
CALCulate<n>:DELTamarker<m>:X.....	237
CALCulate<n>:DELTamarker<m>:Y?.....	238
CALCulate<n>:DELTamarker<m>[:STATe].....	420
CALCulate<n>:LIMit:ACPower:ACHannel:RESult:ABSolute.....	253
CALCulate<n>:LIMit:ACPower:ACHannel:RESult:RELative.....	253
CALCulate<n>:LIMit:ACPower:ACHannel:RESult?.....	252
CALCulate<n>:LIMit:ACPower:ALTerNate<alt>:RESult?.....	254
CALCulate<n>:LIMit:ACPower:GAP<gap>:ACLR:RESult:ABSolute?.....	255
CALCulate<n>:LIMit:ACPower:GAP<gap>:ACLR:RESult:RELative?.....	255
CALCulate<n>:LIMit:ACPower:GAP<gap>:ACLR:RESult?.....	254

CALCulate<n>:LIMit:ACPoweR:GAP<gap>[:CACLR]:RESult:ABSolute?.....	256
CALCulate<n>:LIMit:ACPoweR:GAP<gap>[:CACLR]:RESult:RELative?.....	257
CALCulate<n>:LIMit:ACPoweR:GAP<gap>[:CACLR]:RESult?.....	256
CALCulate<n>:LIMit:ACPoweR:PMODE.....	404
CALCulate<n>:LIMit:FAIL?.....	258
CALCulate<n>:LIMit[:CC<cc>][:ISRC<ant>][:FRAMe<fr>]:SUMMary:ALL:RESult?.....	243
CALCulate<n>:LIMit[:CC<cc>][:ISRC<ant>][:FRAMe<fr>]:SUMMary:EVM:FERRor[:AVERAge]:RESult?.....	243
CALCulate<n>:LIMit[:CC<cc>][:ISRC<ant>][:FRAMe<fr>]:SUMMary:EVM:SD1K:MAXimum:RESult?..	244
CALCulate<n>:LIMit[:CC<cc>][:ISRC<ant>][:FRAMe<fr>]:SUMMary:EVM:SDPB:MAXimum:RESult?..	244
CALCulate<n>:LIMit[:CC<cc>][:ISRC<ant>][:FRAMe<fr>]:SUMMary:EVM:SDQP:MAXimum:RESult?..	245
CALCulate<n>:LIMit[:CC<cc>][:ISRC<ant>][:FRAMe<fr>]:SUMMary:EVM:SDSF:MAXimum:RESult?..	246
CALCulate<n>:LIMit[:CC<cc>][:ISRC<ant>][:FRAMe<fr>]:SUMMary:EVM:SDST:MAXimum:RESult?..	246
CALCulate<n>:LIMit[:CC<cc>][:ISRC<ant>][:FRAMe<fr>]:SUMMary:EVM:SDTS:MAXimum:RESult?..	247
CALCulate<n>:LIMit[:CC<cc>][:ISRC<ant>][:FRAMe<fr>]:SUMMary:EVM:UCCD:MAXimum:RESult?..	247
CALCulate<n>:LIMit[:CC<cc>][:ISRC<ant>][:FRAMe<fr>]:SUMMary:EVM:UCCH:MAXimum:RESult?..	248
CALCulate<n>:LIMit[:CC<cc>][:ISRC<ant>][:FRAMe<fr>]:SUMMary:EVM:US1K:MAXimum:RESult?..	248
CALCulate<n>:LIMit[:CC<cc>][:ISRC<ant>][:FRAMe<fr>]:SUMMary:EVM:USPB:MAXimum:RESult?..	249
CALCulate<n>:LIMit[:CC<cc>][:ISRC<ant>][:FRAMe<fr>]:SUMMary:EVM:USQP:MAXimum:RESult?..	250
CALCulate<n>:LIMit[:CC<cc>][:ISRC<ant>][:FRAMe<fr>]:SUMMary:EVM:USSF:MAXimum:RESult?..	250
CALCulate<n>:LIMit[:CC<cc>][:ISRC<ant>][:FRAMe<fr>]:SUMMary:EVM:USST:MAXimum:RESult?..	251
CALCulate<n>:LIMit[:CC<cc>][:ISRC<ant>][:FRAMe<fr>]:SUMMary:EVM:USTS:MAXimum:RESult?..	251
CALCulate<n>:MARKer<m>:AOFF.....	421
CALCulate<n>:MARKer<m>:FUNction:POWeR<sb>:PRESet.....	407
CALCulate<n>:MARKer<m>:FUNction:POWeR<sb>:RESult:DEtails.....	273
CALCulate<n>:MARKer<m>:FUNction:POWeR<sb>:RESult[:CURRent]?.....	272
CALCulate<n>:MARKer<m>:MAXimum:LEFT.....	421
CALCulate<n>:MARKer<m>:MAXimum:NEXT.....	421
CALCulate<n>:MARKer<m>:MAXimum:RIGHT.....	421
CALCulate<n>:MARKer<m>:MAXimum[:PEAK].....	422
CALCulate<n>:MARKer<m>:MINimum:LEFT.....	422
CALCulate<n>:MARKer<m>:MINimum:NEXT.....	422
CALCulate<n>:MARKer<m>:MINimum:RIGHT.....	422
CALCulate<n>:MARKer<m>:TRACe.....	423
CALCulate<n>:MARKer<m>:X.....	238
CALCulate<n>:MARKer<m>:Y.....	239
CALCulate<n>:MARKer<m>:Z:ALL?.....	240
CALCulate<n>:MARKer<m>:Z?.....	239
CALCulate<n>:MARKer<m>[:STATe].....	423
CALCulate<n>:STATistics:CCDF:X<t>?.....	241
CALCulate<n>:STATistics:RESult<res>?.....	241
CALibration:AIQ:HATiming[:STATe].....	369
CONFigure:GENerator:CONTRol[:STATe].....	368
CONFigure:GENerator:FREQuency:CENTer:SYNC[:STATe].....	363
CONFigure:GENerator:IPConnection:ADDReSS.....	363
CONFigure:GENerator:IPConnection:LEDState?.....	363
CONFigure:GENerator:LEVel:DUTGain.....	364
CONFigure:GENerator:LEVel:DUTLimit.....	365
CONFigure:GENerator:LEVel:DUTLimit:STATe.....	365
CONFigure:GENerator:POWeR:LEVel.....	365

CONFigure:GENerator:POWer:LEVel:STATe.....	364
CONFigure:GENerator:RFOutput[:STATe].....	367
CONFigure:GENerator:SETTings:UPDate:RF.....	368
CONFigure:SETTings:NR5G.....	366
CONFigure:SETTings:NR5G:PINterval.....	366
CONFigure:SETTings:NR5G:SYNC.....	367
CONFigure:SETTings:RF.....	367
CONFigure[:NR5G]:ACLR.....	408
CONFigure[:NR5G]:CENTer.....	289
CONFigure[:NR5G]:CRASter.....	289
CONFigure[:NR5G]:CSCapture.....	290
CONFigure[:NR5G]:CSPacing.....	289
CONFigure[:NR5G]:EVM.....	408
CONFigure[:NR5G]:FCOFset.....	290
CONFigure[:NR5G]:GMCFreq.....	290
CONFigure[:NR5G]:LDIRection.....	283
CONFigure[:NR5G]:MEASurement.....	277
CONFigure[:NR5G]:NCSPacing.....	290
CONFigure[:NR5G]:NOCC.....	291
CONFigure[:NR5G]:OBANd.....	283
CONFigure[:NR5G]:OMODE.....	291
CONFigure[:NR5G]:ORAN:TCASe.....	355
CONFigure[:NR5G]:OREL.....	292
CONFigure[:NR5G]:SEM.....	408
CONFigure[:NR5G]:UL[:CC<cc>]:BW.....	284
CONFigure[:NR5G]:UL[:CC<cc>]:DFRange.....	284
CONFigure[:NR5G]:UL[:CC<cc>]:FNNF.....	356
CONFigure[:NR5G]:UL[:CC<cc>]:FRAME<fr>:BWPpart<bwp>:ADD.....	294
CONFigure[:NR5G]:UL[:CC<cc>]:FRAME<fr>:BWPpart<bwp>:CLEar.....	295
CONFigure[:NR5G]:UL[:CC<cc>]:FRAME<fr>:BWPpart<bwp>:CSLot.....	298
CONFigure[:NR5G]:UL[:CC<cc>]:FRAME<fr>:BWPpart<bwp>:DETection.....	282
CONFigure[:NR5G]:UL[:CC<cc>]:FRAME<fr>:BWPpart<bwp>:DUPLicate.....	295
CONFigure[:NR5G]:UL[:CC<cc>]:FRAME<fr>:BWPpart<bwp>:RBCount.....	295
CONFigure[:NR5G]:UL[:CC<cc>]:FRAME<fr>:BWPpart<bwp>:RBOFset.....	296
CONFigure[:NR5G]:UL[:CC<cc>]:FRAME<fr>:BWPpart<bwp>:REMOve.....	296
CONFigure[:NR5G]:UL[:CC<cc>]:FRAME<fr>:BWPpart<bwp>:SCOunt?.....	298
CONFigure[:NR5G]:UL[:CC<cc>]:FRAME<fr>:BWPpart<bwp>:SLOT<sl>:ALCount.....	320
CONFigure[:NR5G]:UL[:CC<cc>]:FRAME<fr>:BWPpart<bwp>:SLOT<sl>:ALLocation<al>:CCODing:IMCS.351	
CONFigure[:NR5G]:UL[:CC<cc>]:FRAME<fr>:BWPpart<bwp>:SLOT<sl>:ALLocation<al>:CCODing: MCSTable.....	352
CONFigure[:NR5G]:UL[:CC<cc>]:FRAME<fr>:BWPpart<bwp>:SLOT<sl>:ALLocation<al>:CCODing: RVIndex.....	352
CONFigure[:NR5G]:UL[:CC<cc>]:FRAME<fr>:BWPpart<bwp>:SLOT<sl>:ALLocation<al>:CLMapping.....	335
CONFigure[:NR5G]:UL[:CC<cc>]:FRAME<fr>:BWPpart<bwp>:SLOT<sl>:ALLocation<al>:COPY.....	322
CONFigure[:NR5G]:UL[:CC<cc>]:FRAME<fr>:BWPpart<bwp>:SLOT<sl>:ALLocation<al>:COPY:DURation321	
CONFigure[:NR5G]:UL[:CC<cc>]:FRAME<fr>:BWPpart<bwp>:SLOT<sl>:ALLocation<al>:COPY:MODE.....	321
CONFigure[:NR5G]:UL[:CC<cc>]:FRAME<fr>:BWPpart<bwp>:SLOT<sl>:ALLocation<al>:COPY:PERiod... 323	
CONFigure[:NR5G]:UL[:CC<cc>]:FRAME<fr>:BWPpart<bwp>:SLOT<sl>:ALLocation<al>:COPY:SLOT.....	323
CONFigure[:NR5G]:UL[:CC<cc>]:FRAME<fr>:BWPpart<bwp>:SLOT<sl>:ALLocation<al>:DMRS:AP.....	336
CONFigure[:NR5G]:UL[:CC<cc>]:FRAME<fr>:BWPpart<bwp>:SLOT<sl>:ALLocation<al>:DMRS:CGWD... 337	

CONFigure[:NR5G]:UL[:CC<cc>]:FRAME<fr>:BWPart<bwp>:SLOT<sl>:ALLocation<al>:DMRS:CTYPe...	337
CONFigure[:NR5G]:UL[:CC<cc>]:FRAME<fr>:BWPart<bwp>:SLOT<sl>:ALLocation<al>:DMRS: MSYMBOL:APOSition.....	337
CONFigure[:NR5G]:UL[:CC<cc>]:FRAME<fr>:BWPart<bwp>:SLOT<sl>:ALLocation<al>:DMRS: MSYMBOL:LENGth.....	338
CONFigure[:NR5G]:UL[:CC<cc>]:FRAME<fr>:BWPart<bwp>:SLOT<sl>:ALLocation<al>:DMRS:MTYPe...	338
CONFigure[:NR5G]:UL[:CC<cc>]:FRAME<fr>:BWPart<bwp>:SLOT<sl>:ALLocation<al>:DMRS:NID.....	339
CONFigure[:NR5G]:UL[:CC<cc>]:FRAME<fr>:BWPart<bwp>:SLOT<sl>:ALLocation<al>:DMRS:NIONe...	339
CONFigure[:NR5G]:UL[:CC<cc>]:FRAME<fr>:BWPart<bwp>:SLOT<sl>:ALLocation<al>:DMRS:NIRid.....	340
CONFigure[:NR5G]:UL[:CC<cc>]:FRAME<fr>:BWPart<bwp>:SLOT<sl>:ALLocation<al>:DMRS:NIRS.....	341
CONFigure[:NR5G]:UL[:CC<cc>]:FRAME<fr>:BWPart<bwp>:SLOT<sl>:ALLocation<al>:DMRS:NSCid...	342
CONFigure[:NR5G]:UL[:CC<cc>]:FRAME<fr>:BWPart<bwp>:SLOT<sl>:ALLocation<al>:DMRS:POWer...	342
CONFigure[:NR5G]:UL[:CC<cc>]:FRAME<fr>:BWPart<bwp>:SLOT<sl>:ALLocation<al>:DMRS:RST.....	343
CONFigure[:NR5G]:UL[:CC<cc>]:FRAME<fr>:BWPart<bwp>:SLOT<sl>:ALLocation<al>:DMRS: SGENeration.....	343
CONFigure[:NR5G]:UL[:CC<cc>]:FRAME<fr>:BWPart<bwp>:SLOT<sl>:ALLocation<al>:DMRS:TAPos....	344
CONFigure[:NR5G]:UL[:CC<cc>]:FRAME<fr>:BWPart<bwp>:SLOT<sl>:ALLocation<al>:MODulation.....	324
CONFigure[:NR5G]:UL[:CC<cc>]:FRAME<fr>:BWPart<bwp>:SLOT<sl>:ALLocation<al>:POWer.....	325
CONFigure[:NR5G]:UL[:CC<cc>]:FRAME<fr>:BWPart<bwp>:SLOT<sl>:ALLocation<al>:PTRS:K.....	345
CONFigure[:NR5G]:UL[:CC<cc>]:FRAME<fr>:BWPart<bwp>:SLOT<sl>:ALLocation<al>:PTRS:L.....	346
CONFigure[:NR5G]:UL[:CC<cc>]:FRAME<fr>:BWPart<bwp>:SLOT<sl>:ALLocation<al>:PTRS:NGRoups	346
CONFigure[:NR5G]:UL[:CC<cc>]:FRAME<fr>:BWPart<bwp>:SLOT<sl>:ALLocation<al>:PTRS:NID.....	347
CONFigure[:NR5G]:UL[:CC<cc>]:FRAME<fr>:BWPart<bwp>:SLOT<sl>:ALLocation<al>:PTRS:NIID.....	348
CONFigure[:NR5G]:UL[:CC<cc>]:FRAME<fr>:BWPart<bwp>:SLOT<sl>:ALLocation<al>:PTRS: NSAMPles.....	348
CONFigure[:NR5G]:UL[:CC<cc>]:FRAME<fr>:BWPart<bwp>:SLOT<sl>:ALLocation<al>:PTRS:POWer....	349
CONFigure[:NR5G]:UL[:CC<cc>]:FRAME<fr>:BWPart<bwp>:SLOT<sl>:ALLocation<al>:PTRS:REOffset	350
CONFigure[:NR5G]:UL[:CC<cc>]:FRAME<fr>:BWPart<bwp>:SLOT<sl>:ALLocation<al>:PTRS[:STATe]...	350
CONFigure[:NR5G]:UL[:CC<cc>]:FRAME<fr>:BWPart<bwp>:SLOT<sl>:ALLocation<al>:RBCount.....	325
CONFigure[:NR5G]:UL[:CC<cc>]:FRAME<fr>:BWPart<bwp>:SLOT<sl>:ALLocation<al>:RBOffset.....	325
CONFigure[:NR5G]:UL[:CC<cc>]:FRAME<fr>:BWPart<bwp>:SLOT<sl>:ALLocation<al>:SCOUnt.....	326
CONFigure[:NR5G]:UL[:CC<cc>]:FRAME<fr>:BWPart<bwp>:SLOT<sl>:ALLocation<al>:SCRambling.....	353
CONFigure[:NR5G]:UL[:CC<cc>]:FRAME<fr>:BWPart<bwp>:SLOT<sl>:ALLocation<al>: SCRambling:DSID.....	353
CONFigure[:NR5G]:UL[:CC<cc>]:FRAME<fr>:BWPart<bwp>:SLOT<sl>:ALLocation<al>:SOFFset.....	326
CONFigure[:NR5G]:UL[:CC<cc>]:FRAME<fr>:BWPart<bwp>:SLOT<sl>:ALLocation<al>:UEID.....	344
CONFigure[:NR5G]:UL[:CC<cc>]:FRAME<fr>:BWPart<bwp>:SLOT<sl>:ATYPe.....	299
CONFigure[:NR5G]:UL[:CC<cc>]:FRAME<fr>:BWPart<bwp>:SLOT<sl>:COPY.....	299
CONFigure[:NR5G]:UL[:CC<cc>]:FRAME<fr>:BWPart<bwp>:SLOT<sl>:FORMat.....	299
CONFigure[:NR5G]:UL[:CC<cc>]:FRAME<fr>:BWPart<bwp>:SLOT<sl>:PASTe:ALL.....	300
CONFigure[:NR5G]:UL[:CC<cc>]:FRAME<fr>:BWPart<bwp>:SLOT<sl>:PASTe:TO.....	302
CONFigure[:NR5G]:UL[:CC<cc>]:FRAME<fr>:BWPart<bwp>:SLOT<sl>:PASTe:TO:DURation.....	300
CONFigure[:NR5G]:UL[:CC<cc>]:FRAME<fr>:BWPart<bwp>:SLOT<sl>:PASTe:TO:MODE.....	301
CONFigure[:NR5G]:UL[:CC<cc>]:FRAME<fr>:BWPart<bwp>:SLOT<sl>:PASTe:TO:PERiod.....	303
CONFigure[:NR5G]:UL[:CC<cc>]:FRAME<fr>:BWPart<bwp>:SLOT<sl>:PASTe:TO:SLOTs.....	303
CONFigure[:NR5G]:UL[:CC<cc>]:FRAME<fr>:BWPart<bwp>:SLOT<sl>:PASTe[:SLOT].....	304
CONFigure[:NR5G]:UL[:CC<cc>]:FRAME<fr>:BWPart<bwp>:SLOT<sl>:PRESet.....	304
CONFigure[:NR5G]:UL[:CC<cc>]:FRAME<fr>:BWPart<bwp>:SLOT<sl>:PUCCh<cr>:COPY.....	315
CONFigure[:NR5G]:UL[:CC<cc>]:FRAME<fr>:BWPart<bwp>:SLOT<sl>:PUCCh<cr>:COPY:DURation....	314
CONFigure[:NR5G]:UL[:CC<cc>]:FRAME<fr>:BWPart<bwp>:SLOT<sl>:PUCCh<cr>:COPY:MODE.....	314

CONFigure[:NR5G]:UL[:CC<cc>]:FRAMe<fr>:BWPart<bwp>:SLOT<sl>:PUCCh<cr>:COPY:PERiod.....	316
CONFigure[:NR5G]:UL[:CC<cc>]:FRAMe<fr>:BWPart<bwp>:SLOT<sl>:PUCCh<cr>:COPY:SLOT.....	316
CONFigure[:NR5G]:UL[:CC<cc>]:FRAMe<fr>:BWPart<bwp>:SLOT<sl>:PUCCh<cr>:DMRS:ADDITIONal...	327
CONFigure[:NR5G]:UL[:CC<cc>]:FRAMe<fr>:BWPart<bwp>:SLOT<sl>:PUCCh<cr>:DMRS:GHOPping...	328
CONFigure[:NR5G]:UL[:CC<cc>]:FRAMe<fr>:BWPart<bwp>:SLOT<sl>:PUCCh<cr>:DMRS:HID.....	329
CONFigure[:NR5G]:UL[:CC<cc>]:FRAMe<fr>:BWPart<bwp>:SLOT<sl>:PUCCh<cr>:DMRS:ICSHift.....	329
CONFigure[:NR5G]:UL[:CC<cc>]:FRAMe<fr>:BWPart<bwp>:SLOT<sl>:PUCCh<cr>:DMRS:ISFHopping...	330
CONFigure[:NR5G]:UL[:CC<cc>]:FRAMe<fr>:BWPart<bwp>:SLOT<sl>:PUCCh<cr>:DMRS:NID.....	330
CONFigure[:NR5G]:UL[:CC<cc>]:FRAMe<fr>:BWPart<bwp>:SLOT<sl>:PUCCh<cr>:DMRS:OCCLength...	331
CONFigure[:NR5G]:UL[:CC<cc>]:FRAMe<fr>:BWPart<bwp>:SLOT<sl>:PUCCh<cr>:DMRS:POWER.....	332
CONFigure[:NR5G]:UL[:CC<cc>]:FRAMe<fr>:BWPart<bwp>:SLOT<sl>:PUCCh<cr>:DMRS: SGENeration.....	332
CONFigure[:NR5G]:UL[:CC<cc>]:FRAMe<fr>:BWPart<bwp>:SLOT<sl>:PUCCh<cr>:DMRS:SHPRb.....	333
CONFigure[:NR5G]:UL[:CC<cc>]:FRAMe<fr>:BWPart<bwp>:SLOT<sl>:PUCCh<cr>:DMRS:SID.....	333
CONFigure[:NR5G]:UL[:CC<cc>]:FRAMe<fr>:BWPart<bwp>:SLOT<sl>:PUCCh<cr>:DMRS:TDOindex....	334
CONFigure[:NR5G]:UL[:CC<cc>]:FRAMe<fr>:BWPart<bwp>:SLOT<sl>:PUCCh<cr>:FORMat.....	334
CONFigure[:NR5G]:UL[:CC<cc>]:FRAMe<fr>:BWPart<bwp>:SLOT<sl>:PUCCh<cr>:POWER.....	317
CONFigure[:NR5G]:UL[:CC<cc>]:FRAMe<fr>:BWPart<bwp>:SLOT<sl>:PUCCh<cr>:RBCount.....	317
CONFigure[:NR5G]:UL[:CC<cc>]:FRAMe<fr>:BWPart<bwp>:SLOT<sl>:PUCCh<cr>:RBOFFset.....	318
CONFigure[:NR5G]:UL[:CC<cc>]:FRAMe<fr>:BWPart<bwp>:SLOT<sl>:PUCCh<cr>:SCOUNT.....	318
CONFigure[:NR5G]:UL[:CC<cc>]:FRAMe<fr>:BWPart<bwp>:SLOT<sl>:PUCCh<cr>:SOFFset.....	319
CONFigure[:NR5G]:UL[:CC<cc>]:FRAMe<fr>:BWPart<bwp>:SLOT<sl>:UCCCOUNT.....	319
CONFigure[:NR5G]:UL[:CC<cc>]:FRAMe<fr>:BWPart<bwp>:SRS:FHOPping:BHOP.....	305
CONFigure[:NR5G]:UL[:CC<cc>]:FRAMe<fr>:BWPart<bwp>:SRS:FHOPping:BSRS.....	306
CONFigure[:NR5G]:UL[:CC<cc>]:FRAMe<fr>:BWPart<bwp>:SRS:FHOPping:CSRS.....	306
CONFigure[:NR5G]:UL[:CC<cc>]:FRAMe<fr>:BWPart<bwp>:SRS:FPOS.....	306
CONFigure[:NR5G]:UL[:CC<cc>]:FRAMe<fr>:BWPart<bwp>:SRS:FSHift.....	307
CONFigure[:NR5G]:UL[:CC<cc>]:FRAMe<fr>:BWPart<bwp>:SRS:NPORTs.....	307
CONFigure[:NR5G]:UL[:CC<cc>]:FRAMe<fr>:BWPart<bwp>:SRS:NSYMBOLs.....	308
CONFigure[:NR5G]:UL[:CC<cc>]:FRAMe<fr>:BWPart<bwp>:SRS:POWER.....	308
CONFigure[:NR5G]:UL[:CC<cc>]:FRAMe<fr>:BWPart<bwp>:SRS:RFACtor.....	309
CONFigure[:NR5G]:UL[:CC<cc>]:FRAMe<fr>:BWPart<bwp>:SRS:SEQUence:CSHift.....	309
CONFigure[:NR5G]:UL[:CC<cc>]:FRAMe<fr>:BWPart<bwp>:SRS:SEQUence:HOPping.....	310
CONFigure[:NR5G]:UL[:CC<cc>]:FRAMe<fr>:BWPart<bwp>:SRS:SEQUence:ID.....	310
CONFigure[:NR5G]:UL[:CC<cc>]:FRAMe<fr>:BWPart<bwp>:SRS:SLOT:PERiodicity.....	311
CONFigure[:NR5G]:UL[:CC<cc>]:FRAMe<fr>:BWPart<bwp>:SRS:SLOT:POFFset.....	311
CONFigure[:NR5G]:UL[:CC<cc>]:FRAMe<fr>:BWPart<bwp>:SRS:SPOS.....	311
CONFigure[:NR5G]:UL[:CC<cc>]:FRAMe<fr>:BWPart<bwp>:SRS:STATe.....	312
CONFigure[:NR5G]:UL[:CC<cc>]:FRAMe<fr>:BWPart<bwp>:SRS:TComb:OFFSet.....	312
CONFigure[:NR5G]:UL[:CC<cc>]:FRAMe<fr>:BWPart<bwp>:SRS:TComb:VALue].....	313
CONFigure[:NR5G]:UL[:CC<cc>]:FRAMe<fr>:BWPart<bwp>:SSPacing.....	296
CONFigure[:NR5G]:UL[:CC<cc>]:FRAMe<fr>:BWPCount?.....	297
CONFigure[:NR5G]:UL[:CC<cc>]:FRAMe<fr>:COPY.....	293
CONFigure[:NR5G]:UL[:CC<cc>]:FRAMe<fr>:PASTe:ALL.....	293
CONFigure[:NR5G]:UL[:CC<cc>]:FRAMe<fr>:PASTe[:FRAMe].....	293
CONFigure[:NR5G]:UL[:CC<cc>]:FTConfig.....	294
CONFigure[:NR5G]:UL[:CC<cc>]:IDC.....	356
CONFigure[:NR5G]:UL[:CC<cc>]:PAMapping<cf>:PUSCh:AP<ap>.....	354
CONFigure[:NR5G]:UL[:CC<cc>]:PAMapping<cf>:STATe.....	355
CONFigure[:NR5G]:UL[:CC<cc>]:PLC:CID.....	285

CONFigure[:NR5G]:UL[:CC<cc>]:PLC:DETection.....	285
CONFigure[:NR5G]:UL[:CC<cc>]:PLC:PCLass.....	286
CONFigure[:NR5G]:UL[:CC<cc>]:PRACH:FORMat.....	399
CONFigure[:NR5G]:UL[:CC<cc>]:PRACH:LRA.....	400
CONFigure[:NR5G]:UL[:CC<cc>]:PRACH:POWer.....	400
CONFigure[:NR5G]:UL[:CC<cc>]:PRACH:PREamble.....	400
CONFigure[:NR5G]:UL[:CC<cc>]:PRACH:RBOFset.....	401
CONFigure[:NR5G]:UL[:CC<cc>]:PRACH:RSEquence.....	401
CONFigure[:NR5G]:UL[:CC<cc>]:PRACH:RSET.....	401
CONFigure[:NR5G]:UL[:CC<cc>]:PRACH:SCS.....	401
CONFigure[:NR5G]:UL[:CC<cc>]:PRACH:ZCZone.....	402
CONFigure[:NR5G]:UL[:CC<cc>]:PUSCh:FHOpping.....	356
CONFigure[:NR5G]:UL[:CC<cc>]:PUSCh:HOPping.....	357
CONFigure[:NR5G]:UL[:CC<cc>]:RFUC:FZERo:FREquency.....	357
CONFigure[:NR5G]:UL[:CC<cc>]:RFUC:FZERo:MODE.....	357
CONFigure[:NR5G]:UL[:CC<cc>]:RFUC:STATe.....	358
CONFigure[:NR5G]:UL[:CC<cc>]:RPA:AFRequency?.....	359
CONFigure[:NR5G]:UL[:CC<cc>]:RPA:KZERo:SCFE.....	360
CONFigure[:NR5G]:UL[:CC<cc>]:RPA:KZERo:SCFT.....	360
CONFigure[:NR5G]:UL[:CC<cc>]:RPA:KZERo:SCNS.....	360
CONFigure[:NR5G]:UL[:CC<cc>]:RPA:KZERo:SCOT.....	361
CONFigure[:NR5G]:UL[:CC<cc>]:RPA:KZERo:SCST.....	361
CONFigure[:NR5G]:UL[:CC<cc>]:RPA:KZERo:SCTT.....	361
CONFigure[:NR5G]:UL[:CC<cc>]:RPA:RTCF.....	362
CONFigure[:NR5G]:UL[:CC<cc>]:RPA:TBOFset?.....	362
CONFigure[:NR5G]:UL[:CC<cc>]:SFLatness:ECONditions.....	358
CONFigure[:NR5G]:UL[:CC<cc>]:TPReCoding.....	359
DISPlay:FORMat.....	197
DISPlay[:WINDow<n>]:MTABLE.....	423
DISPlay[:WINDow<n>]:SIZE.....	197
DISPlay[:WINDow<n>]:TAB<tab>:SELeCt.....	198
DISPlay[:WINDow<n>]:TABLE:ITEM.....	425
DISPlay[:WINDow<n>][:SUBWIndow<w>]:CCNumber.....	424
DISPlay[:WINDow<n>][:SUBWIndow<w>]:COUPling.....	425
DISPlay[:WINDow<n>][:SUBWIndow<w>]:FNUMber.....	424
DISPlay[:WINDow<n>][:SUBWIndow<w>]:SELeCt.....	198
DISPlay[:WINDow<n>][:SUBWIndow<w>]:TRACe<t>:Y[:SCALe]:AUTO.....	413
DISPlay[:WINDow<n>][:SUBWIndow<w>]:TRACe<t>:Y[:SCALe]:MAXimum.....	414
DISPlay[:WINDow<n>][:SUBWIndow<w>]:TRACe<t>:Y[:SCALe]:MINimum.....	414
DISPlay[:WINDow<n>][:SUBWIndow<w>]:TRACe<t>:Y[:SCALe]:RLEVel.....	378
DISPlay[:WINDow<n>][:SUBWIndow<w>]:TRACe<t>:Y[:SCALe]:RLEVel:OFFSet.....	379
DISPlay[:WINDow<n>][:SUBWIndow<w>]:ZOOM:AREA.....	414
DISPlay[:WINDow<n>][:SUBWIndow<w>]:ZOOM:MULTiple<zn>:AREA.....	416
DISPlay[:WINDow<n>][:SUBWIndow<w>]:ZOOM:MULTiple<zn>:STATe]......	417
DISPlay[:WINDow<n>][:SUBWIndow<w>]:ZOOM[:STATe]......	417
FETCh:ALL:SUMMery:BLER:MAXimum?.....	213
FETCh:ALL:SUMMery:BLER:MINimum?.....	213
FETCh:ALL:SUMMery:EVM:ALL?.....	214
FETCh:ALL:SUMMery:EVM:PCHannel?.....	214
FETCh:ALL:SUMMery:EVM:PEAK?.....	215

FETCh:ALL:SUMMary:EVM:PSIGnal?.....	216
FETCh:ALL:SUMMary:EVM:SD1K?.....	217
FETCh:ALL:SUMMary:EVM:SDPB?.....	218
FETCh:ALL:SUMMary:EVM:SDQP?.....	218
FETCh:ALL:SUMMary:EVM:SDSF?.....	219
FETCh:ALL:SUMMary:EVM:SDST?.....	219
FETCh:ALL:SUMMary:EVM:SDTS?.....	220
FETCh:ALL:SUMMary:EVM:UCCD?.....	221
FETCh:ALL:SUMMary:EVM:UCCH?.....	221
FETCh:ALL:SUMMary:EVM:US1K?.....	222
FETCh:ALL:SUMMary:EVM:USPB?.....	223
FETCh:ALL:SUMMary:EVM:USQP?.....	223
FETCh:ALL:SUMMary:EVM:USSF?.....	224
FETCh:ALL:SUMMary:EVM:USST?.....	224
FETCh:ALL:SUMMary:EVM:USTS?.....	225
FETCh:ALL:SUMMary:POWer?.....	228
FETCh:ALL:SUMMary:TPUT:MAXimum?.....	230
FETCh:ALL:SUMMary:TPUT:MINimum?.....	230
FETCh[:CC<cc>]:PLC:CID?.....	286
FETCh[:CC<cc>][:ISRC<ant>]:SUMMary:CRESt[:AVERAge]?.....	213
FETCh[:CC<cc>][:ISRC<ant>][:FRAMe<fr>]:SUMMary:AAPFail?.....	231
FETCh[:CC<cc>][:ISRC<ant>][:FRAMe<fr>]:SUMMary:ALL?.....	212
FETCh[:CC<cc>][:ISRC<ant>][:FRAMe<fr>]:SUMMary:APFail?.....	232
FETCh[:CC<cc>][:ISRC<ant>][:FRAMe<fr>]:SUMMary:ARPFail?.....	232
FETCh[:CC<cc>][:ISRC<ant>][:FRAMe<fr>]:SUMMary:BLER[:AVERAge]?.....	213
FETCh[:CC<cc>][:ISRC<ant>][:FRAMe<fr>]:SUMMary:CFRequency?.....	233
FETCh[:CC<cc>][:ISRC<ant>][:FRAMe<fr>]:SUMMary:EAACcs?.....	233
FETCh[:CC<cc>][:ISRC<ant>][:FRAMe<fr>]:SUMMary:EVM:PCHannel:MAXimum?.....	214
FETCh[:CC<cc>][:ISRC<ant>][:FRAMe<fr>]:SUMMary:EVM:PCHannel:MINimum?.....	215
FETCh[:CC<cc>][:ISRC<ant>][:FRAMe<fr>]:SUMMary:EVM:PCHannel[:AVERAge]?.....	215
FETCh[:CC<cc>][:ISRC<ant>][:FRAMe<fr>]:SUMMary:EVM:PEAK:MAXimum?.....	215
FETCh[:CC<cc>][:ISRC<ant>][:FRAMe<fr>]:SUMMary:EVM:PEAK:MINimum?.....	215
FETCh[:CC<cc>][:ISRC<ant>][:FRAMe<fr>]:SUMMary:EVM:PEAK[:AVERAge]?.....	215
FETCh[:CC<cc>][:ISRC<ant>][:FRAMe<fr>]:SUMMary:EVM:PRACH:MAXimum?.....	216
FETCh[:CC<cc>][:ISRC<ant>][:FRAMe<fr>]:SUMMary:EVM:PRACH:MINimum?.....	216
FETCh[:CC<cc>][:ISRC<ant>][:FRAMe<fr>]:SUMMary:EVM:PRACH[:AVERAge]?.....	216
FETCh[:CC<cc>][:ISRC<ant>][:FRAMe<fr>]:SUMMary:EVM:PSIGnal:MAXimum?.....	216
FETCh[:CC<cc>][:ISRC<ant>][:FRAMe<fr>]:SUMMary:EVM:PSIGnal:MINimum?.....	216
FETCh[:CC<cc>][:ISRC<ant>][:FRAMe<fr>]:SUMMary:EVM:PSIGnal[:AVERAge]?.....	216
FETCh[:CC<cc>][:ISRC<ant>][:FRAMe<fr>]:SUMMary:EVM:SD1K:MAXimum?.....	217
FETCh[:CC<cc>][:ISRC<ant>][:FRAMe<fr>]:SUMMary:EVM:SD1K:MINimum?.....	217
FETCh[:CC<cc>][:ISRC<ant>][:FRAMe<fr>]:SUMMary:EVM:SD1K[:AVERAge]?.....	217
FETCh[:CC<cc>][:ISRC<ant>][:FRAMe<fr>]:SUMMary:EVM:SDPB:MAXimum?.....	218
FETCh[:CC<cc>][:ISRC<ant>][:FRAMe<fr>]:SUMMary:EVM:SDPB:MINimum?.....	218
FETCh[:CC<cc>][:ISRC<ant>][:FRAMe<fr>]:SUMMary:EVM:SDPB[:AVERAge]?.....	218
FETCh[:CC<cc>][:ISRC<ant>][:FRAMe<fr>]:SUMMary:EVM:SDQP:MAXimum?.....	218
FETCh[:CC<cc>][:ISRC<ant>][:FRAMe<fr>]:SUMMary:EVM:SDQP:MINimum?.....	218
FETCh[:CC<cc>][:ISRC<ant>][:FRAMe<fr>]:SUMMary:EVM:SDQP[:AVERAge]?.....	218
FETCh[:CC<cc>][:ISRC<ant>][:FRAMe<fr>]:SUMMary:EVM:SDSF:MAXimum?.....	219
FETCh[:CC<cc>][:ISRC<ant>][:FRAMe<fr>]:SUMMary:EVM:SDSF:MINimum?.....	219

FETCh[:CC<cc>][:ISRC<ant>][:FRAMe<fr>]:SUMMary:EVM:SDSF[:AVERAge]?	219
FETCh[:CC<cc>][:ISRC<ant>][:FRAMe<fr>]:SUMMary:EVM:SDST:MAXimum?	219
FETCh[:CC<cc>][:ISRC<ant>][:FRAMe<fr>]:SUMMary:EVM:SDST:MINimum?	220
FETCh[:CC<cc>][:ISRC<ant>][:FRAMe<fr>]:SUMMary:EVM:SDST[:AVERAge]?	220
FETCh[:CC<cc>][:ISRC<ant>][:FRAMe<fr>]:SUMMary:EVM:SDTS:MAXimum?	220
FETCh[:CC<cc>][:ISRC<ant>][:FRAMe<fr>]:SUMMary:EVM:SDTS:MINimum?	220
FETCh[:CC<cc>][:ISRC<ant>][:FRAMe<fr>]:SUMMary:EVM:SDTS[:AVERAge]?	220
FETCh[:CC<cc>][:ISRC<ant>][:FRAMe<fr>]:SUMMary:EVM:UCCD:MAXimum?	221
FETCh[:CC<cc>][:ISRC<ant>][:FRAMe<fr>]:SUMMary:EVM:UCCD:MINimum?	221
FETCh[:CC<cc>][:ISRC<ant>][:FRAMe<fr>]:SUMMary:EVM:UCCD[:AVERAge]?	221
FETCh[:CC<cc>][:ISRC<ant>][:FRAMe<fr>]:SUMMary:EVM:UCCH:MAXimum?	221
FETCh[:CC<cc>][:ISRC<ant>][:FRAMe<fr>]:SUMMary:EVM:UCCH:MINimum?	221
FETCh[:CC<cc>][:ISRC<ant>][:FRAMe<fr>]:SUMMary:EVM:UCCH[:AVERAge]?	221
FETCh[:CC<cc>][:ISRC<ant>][:FRAMe<fr>]:SUMMary:EVM:US1K:MAXimum?	222
FETCh[:CC<cc>][:ISRC<ant>][:FRAMe<fr>]:SUMMary:EVM:US1K:MINimum?	222
FETCh[:CC<cc>][:ISRC<ant>][:FRAMe<fr>]:SUMMary:EVM:US1K[:AVERAge]?	222
FETCh[:CC<cc>][:ISRC<ant>][:FRAMe<fr>]:SUMMary:EVM:USPB:MAXimum?	223
FETCh[:CC<cc>][:ISRC<ant>][:FRAMe<fr>]:SUMMary:EVM:USPB:MINimum?	223
FETCh[:CC<cc>][:ISRC<ant>][:FRAMe<fr>]:SUMMary:EVM:USPB[:AVERAge]?	223
FETCh[:CC<cc>][:ISRC<ant>][:FRAMe<fr>]:SUMMary:EVM:USQP:MAXimum?	223
FETCh[:CC<cc>][:ISRC<ant>][:FRAMe<fr>]:SUMMary:EVM:USQP:MINimum?	223
FETCh[:CC<cc>][:ISRC<ant>][:FRAMe<fr>]:SUMMary:EVM:USQP[:AVERAge]?	223
FETCh[:CC<cc>][:ISRC<ant>][:FRAMe<fr>]:SUMMary:EVM:USSF:MAXimum?	224
FETCh[:CC<cc>][:ISRC<ant>][:FRAMe<fr>]:SUMMary:EVM:USSF:MINimum?	224
FETCh[:CC<cc>][:ISRC<ant>][:FRAMe<fr>]:SUMMary:EVM:USSF[:AVERAge]?	224
FETCh[:CC<cc>][:ISRC<ant>][:FRAMe<fr>]:SUMMary:EVM:USST:MAXimum?	224
FETCh[:CC<cc>][:ISRC<ant>][:FRAMe<fr>]:SUMMary:EVM:USST:MINimum?	225
FETCh[:CC<cc>][:ISRC<ant>][:FRAMe<fr>]:SUMMary:EVM:USST[:AVERAge]?	225
FETCh[:CC<cc>][:ISRC<ant>][:FRAMe<fr>]:SUMMary:EVM:USTS:MAXimum?	225
FETCh[:CC<cc>][:ISRC<ant>][:FRAMe<fr>]:SUMMary:EVM:USTS:MINimum?	225
FETCh[:CC<cc>][:ISRC<ant>][:FRAMe<fr>]:SUMMary:EVM:USTS[:AVERAge]?	225
FETCh[:CC<cc>][:ISRC<ant>][:FRAMe<fr>]:SUMMary:EVM[:ALL]:MAXimum?	214
FETCh[:CC<cc>][:ISRC<ant>][:FRAMe<fr>]:SUMMary:EVM[:ALL]:MINimum?	214
FETCh[:CC<cc>][:ISRC<ant>][:FRAMe<fr>]:SUMMary:EVM[:ALL][:AVERAge]?	214
FETCh[:CC<cc>][:ISRC<ant>][:FRAMe<fr>]:SUMMary:FERRor:MAXimum?	226
FETCh[:CC<cc>][:ISRC<ant>][:FRAMe<fr>]:SUMMary:FERRor:MINimum?	226
FETCh[:CC<cc>][:ISRC<ant>][:FRAMe<fr>]:SUMMary:FERRor[:AVERAge]?	226
FETCh[:CC<cc>][:ISRC<ant>][:FRAMe<fr>]:SUMMary:FOFFset?	231
FETCh[:CC<cc>][:ISRC<ant>][:FRAMe<fr>]:SUMMary:GIMBalance:MAXimum?	226
FETCh[:CC<cc>][:ISRC<ant>][:FRAMe<fr>]:SUMMary:GIMBalance:MINimum?	226
FETCh[:CC<cc>][:ISRC<ant>][:FRAMe<fr>]:SUMMary:GIMBalance[:AVERAge]?	226
FETCh[:CC<cc>][:ISRC<ant>][:FRAMe<fr>]:SUMMary:IQOFset:MAXimum?	227
FETCh[:CC<cc>][:ISRC<ant>][:FRAMe<fr>]:SUMMary:IQOFset:MINimum?	227
FETCh[:CC<cc>][:ISRC<ant>][:FRAMe<fr>]:SUMMary:IQOFset[:AVERAge]?	227
FETCh[:CC<cc>][:ISRC<ant>][:FRAMe<fr>]:SUMMary:OSTP:MAXimum?	228
FETCh[:CC<cc>][:ISRC<ant>][:FRAMe<fr>]:SUMMary:OSTP:MINimum?	228
FETCh[:CC<cc>][:ISRC<ant>][:FRAMe<fr>]:SUMMary:OSTP[:AVERAge]?	228
FETCh[:CC<cc>][:ISRC<ant>][:FRAMe<fr>]:SUMMary:OVLd?	234
FETCh[:CC<cc>][:ISRC<ant>][:FRAMe<fr>]:SUMMary:PACCs?	235
FETCh[:CC<cc>][:ISRC<ant>][:FRAMe<fr>]:SUMMary:POWer:MAXimum?	228

FETCh[:CC<cc>][:ISRC<ant>][:FRAMe<fr>]:SUMMary:POWer:MINimum?	228
FETCh[:CC<cc>][:ISRC<ant>][:FRAMe<fr>]:SUMMary:POWer[:AVERAge]?	228
FETCh[:CC<cc>][:ISRC<ant>][:FRAMe<fr>]:SUMMary:QUADerror:MAXimum?	229
FETCh[:CC<cc>][:ISRC<ant>][:FRAMe<fr>]:SUMMary:QUADerror:MINimum?	229
FETCh[:CC<cc>][:ISRC<ant>][:FRAMe<fr>]:SUMMary:QUADerror[:AVERAge]?	229
FETCh[:CC<cc>][:ISRC<ant>][:FRAMe<fr>]:SUMMary:SERRor:MAXimum?	230
FETCh[:CC<cc>][:ISRC<ant>][:FRAMe<fr>]:SUMMary:SERRor:MINimum?	230
FETCh[:CC<cc>][:ISRC<ant>][:FRAMe<fr>]:SUMMary:SERRor[:AVERAge]?	230
FETCh[:CC<cc>][:ISRC<ant>][:FRAMe<fr>]:SUMMary:SPFfail?	235
FETCh[:CC<cc>][:ISRC<ant>][:FRAMe<fr>]:SUMMary:SState?	236
FETCh[:CC<cc>][:ISRC<ant>][:FRAMe<fr>]:SUMMary:TPUT[:AVERAge]?	230
FETCh[:CC<cc>][:ISRC<ant>][:FRAMe<fr>]:SUMMary:TSDelta?	236
FETCh[:CC<cc>][:ISRC<ant>][:FRAMe<fr>]:SUMMary:TSTamp?	237
FORMat:DEXPort:DSEPARATOR	412
FORMat:DEXPort:FORMat	278
FORMat:DEXPort:HEADer	412
FORMat:DEXPort:TRACes	412
FORMat[:DATA]	274
INITiate:SEQuencer:ABORT	208
INITiate:SEQuencer:IMMEDIATE	209
INITiate:SEQuencer:MODE	209
INITiate<n>:CONTinuous	207
INITiate<n>[:IMMEDIATE]	208
INPut:ATTenuation<ant>	379
INPut:ATTenuation<ant>:AUTO	380
INPut:CONNector	369
INPut:COUPling	380
INPut:DIQ:CDEvice	369
INPut:DIQ:RANGe:COUPling	370
INPut:DIQ:RANGe[:UPPer]	370
INPut:DIQ:RANGe[:UPPer]:AUTO	370
INPut:DIQ:RANGe[:UPPer]:UNIT	371
INPut:DIQ:SRATe	371
INPut:DIQ:SRATe:AUTO	371
INPut:DPATH	371
INPut:EATT<ant>	381
INPut:EATT<ant>:AUTO	382
INPut:EATT<ant>:STATe	382
INPut:FILE:PATH	372
INPut:FILTer:HPASS[:STATe]	373
INPut:FILTer:YIG[:STATe]	373
INPut:GAIN:STATe	380
INPut:GAIN[:VALue]	381
INPut:IMPedance	381
INPut:IQ:BALanced[:STATe]	373
INPut:IQ:TYPE	374
INPut:SElect	374
INPut:TYPE	375
INSTrument:CREate:DUPLicate	193
INSTrument:CREate:REPLace	194

INSTRument:CREate[:NEW].....	193
INSTRument:DELeTe.....	194
INSTRument:LIST?.....	194
INSTRument:REName.....	196
INSTRument[:SElect].....	196
LAYout:ADD[:WINDow]?.....	199
LAYout:CATalog[:WINDow]?.....	201
LAYout:IDENtify[:WINDow]?.....	202
LAYout:REMove[:WINDow].....	202
LAYout:REPLace[:WINDow].....	202
LAYout:SPLitter.....	203
LAYout:WINDow<n>:ADD?.....	204
LAYout:WINDow<n>:IDENtify?.....	205
LAYout:WINDow<n>:REMove.....	205
LAYout:WINDow<n>:REPLace.....	205
LAYout:WINDow<n>:TYPE.....	206
MMEMory:LOAD:DEModsetting:ALL.....	287
MMEMory:LOAD:DEModsetting[:CC<cc>].....	287
MMEMory:LOAD:IQ:STATe:ALL.....	278
MMEMory:LOAD:IQ:STReam.....	375
MMEMory:LOAD:IQ:STReam:AUTO.....	375
MMEMory:LOAD:IQ:STReam:LIST?.....	376
MMEMory:LOAD:SETTings.....	408
MMEMory:LOAD:TMODeI[:CC<cc>].....	286
MMEMory:STORe<n>:DEModsetting:ALL.....	287
MMEMory:STORe<n>:DEModsetting[:CC<cc>].....	288
MMEMory:STORe<n>:IQ:STATe.....	278
MMEMory:STORe<n>:IQ:STATe:ALL.....	279
MMEMory:STORe<n>:IQNC:STATe.....	279
MMEMory:STORe<n>:MSERvice.....	279
MMEMory:STORe<n>:TRACe.....	412
OUTPut<up>:TRIGger<tp>:PULSe:IMMediate.....	409
STATus:QUEStionable:SYNC:CONDition?.....	438
STATus:QUEStionable:SYNC:ENABle.....	438
STATus:QUEStionable:SYNC:NTRansition.....	438
STATus:QUEStionable:SYNC:PTRansition.....	439
STATus:QUEStionable:SYNC[:EVENT]?.....	437
SYSTem:PRESet:CHANnel[:EXEC].....	280
SYSTem:SEQuencer.....	209
TRACe:IQ:FILE:REPetition:COUNt.....	376
TRACe:IQ:SRATe?.....	386
TRACe<n>:CATalog?.....	274
TRACe<n>[:DATA]:X?.....	276
TRACe<n>[:DATA]?.....	275
TRIGger:TSHelper:DELay.....	409
TRIGger:TSHelper:EDELay.....	409
TRIGger:TSHelper:FTRigger.....	410
TRIGger:TSHelper:RINTerval.....	410
TRIGger:TSHelper:SEQuence.....	411
TRIGger[:SEQuence]:DTIME.....	386

TRIGger[:SEQuence]:HOLDoff<ant>[:TIME].....	387
TRIGger[:SEQuence]:IFPower:HOLDoff.....	387
TRIGger[:SEQuence]:IFPower:HYSteresis.....	387
TRIGger[:SEQuence]:LEVel<ant>:IFPower.....	388
TRIGger[:SEQuence]:LEVel<ant>:IQPower.....	388
TRIGger[:SEQuence]:LEVel<ant>:RFPower.....	389
TRIGger[:SEQuence]:LEVel<ant>[:EXternal<tp>].....	388
TRIGger[:SEQuence]:PORT<ant>.....	389
TRIGger[:SEQuence]:SLOPe.....	390
TRIGger[:SEQuence]:SOURce<ant>.....	390
UNIT:BSTR.....	428
UNIT:CAReference.....	429
UNIT:CAXes.....	429
UNIT:EVM.....	429
UNIT:SAXes.....	430

Index

A

AC/DC coupling	120
ACLR	47
Allocation	
Filter by	183
Allocation ID vs symbol x carrier	44
Allocation summary	40
Amplitude	118
Analog Baseband	
I/Q mode	114
Input	111
Application cards	11
Application notes	11
Attenuation	119
Auto level	118

B

Bit stream	41
Bitstream format	175
Brochures	10

C

Capture buffer	31
Capture time	122
Carrier	
Filter by	183
Carrier axis scale	175
CCDF	39
Center frequency	117
Channel	
Creating (remote)	194
Deleting (remote)	194
Duplicating (remote)	193
Querying (remote)	194
Renaming (remote)	196
Replacing (remote)	194
Closing	
Channels (remote)	194
Windows (remote)	205
Configuration overview	56
Constellation diagram	40
Configuration	183
Constellation selection	183
Conventions	
SCPI commands	188
Copying	
Channel (remote)	193

D

Data capture	121
Data format	
Remote	412
Data sheets	10
DC offset	
Analog Baseband (B71, remote control)	369
Differential input	
Analog Baseband	114
Digital I/Q	
Input connection information	113

Digital input

Connection information	113
Direct path	
Input configuration	110
Duplexing	60
Duplicating	
Channel (remote)	193

E

Evaluation methods	
Remote	199
EVM calculation method	132
EVM unit	174
EVM vs Carrier	32
EVM vs RB	33
EVM vs symbol	32
EVM vs symbol x carrier	43
External Attenuation	119

F

Files	
I/Q data input	167
Filters	
High-pass (RF input)	111
YIG (remote)	373
Flatness vs carrier	38
Format	
Data (remote)	412
Frequency	
Configuration	117
Frequency error vs subframe	35
Frequency error vs symbol	34
Frequency sweep	46
Full scale level	
Digital I/Q	113

G

Getting started	9
-----------------------	---

H

Hardware settings	
Displayed	16, 140
High-pass filter	
RF input	111

I

I/Q data	
Input file	116
Input files	167
Impedance	
Setting	120
Inband emission	36
Input	
Coupling	120
I/Q data files	115
Input sample rate (ISR)	
Digital I/Q	112

Input sources	
Analog Baseband	114
Digital I/Q	112
I/Q data file	116
I/Q data files	167
Installation	15
Instrument security procedures	10
L	
Level configuration	118
Link direction	60
LO feedthrough	110
M	
Marker table	
Evaluation method	44
Markers	
Table (evaluation method)	44
Maximizing	
Windows (remote)	197
Measurement	
ACLR	47
alloc ID vs sym x carrier	44
allocation summary	40
bit stream	41
Capture buffer	31
CCDF	39
constellation	40
Continuous	21
EVM vs carrier	32
EVM vs RB	33
EVM vs sym x carr	43
EVM vs symbol	32
flatness vs carrier	38
freq err vs subframe	35
freq err vs symbol	34
inband emission	36
power spectrum	36
power vs sym x carr	43
Refresh	21
Result displays	20
Single	21
spectrum mask	48
Measurement time	122
Modulation	
Filter by	183
O	
Offset	
Frequency	117
Reference level	118
Options	
High-pass filter	111
Preamplifier	120
Overview	56
P	
Peak list	
Evaluation method	49
Phase error	129
Physical signal description	60
Power spectrum	36
Power vs symbol x carrier	43
Preamplifier	
Setting	120
Softkey	120
Presetting	
Channels	57
PUSCH reference data	133
R	
Reference level	
Digital I/Q	113
Reference Level	118
Release notes	10
Remote commands	
Basics on syntax	187
Boolean values	191
Capitalization	188
Character data	191
Data blocks	192
Numeric values	190
Optional keywords	189
Parameters	190
Strings	191
Suffixes	189
Restoring	
Channel settings	57
Result displays	20
Marker table	44
Peak list	49
Results	
Data format (remote)	412
RF measurement	46
S	
Safety instructions	10
Sample rate	
Digital I/Q	112
Security procedures	10
Sequencer	
Activating (remote)	209
Remote	207
Sequences	
Aborting (remote)	208
Mode (remote)	209
Service manual	9
Settings	
Bitstream format	175
Capture time	122
Carrier axes	175
Constellation selection	183
EVM calculation method	132
EVM unit	174
Ext Att	119
Frequency	117
Phase tracking	129
PUSCH reference data	133
Ref Level	118
Slot selection	182
Standard	60
Subframe selection	181
Swap I/Q	122
Timing error	130
Signal capture	121
Signal description	60
Slope	
Trigger	390

Slot selection	182
Softkeys	
Preamp	120
Specifications	10
Specifics for	
Configuration	57
Spectrum mask	48
Standard selection	60
Step size	117
Subframe selection	181
Suffixes	
Common	186
Remote commands	189
Swap I/Q	122
Symbol	
Filter by	183
T	
Timing error	130
Tracking	128
Phase	129
Timing	130
Transmission path	60
Trigger	
Slope	390
Trigger configuration	124
Trigger source	125
V	
Videos	11
W	
White papers	11
Window title bar information	17
Windows	
Adding (remote)	199
Closing (remote)	205
Configuring	57
Layout (remote)	203
Maximizing (remote)	197
Querying (remote)	201, 202
Replacing (remote)	202
Splitting (remote)	197
Types (remote)	199
Y	
YIG-preselector	
Activating/Deactivating	111
Activating/Deactivating (remote)	373
Z	
Zoom	
Capture buffer	31
Zooming	
Activating (remote)	417
Area (Multiple mode, remote)	416
Area (remote)	414
Multiple mode (remote)	417