

# R&S®FSW-K14x

## 3GPP 5G NR Downlink Measurement Application User Manual



1178803602  
Version 16

**ROHDE & SCHWARZ**  
Make ideas real



This manual applies to the following FSW models with firmware version 6.00 and later:

- R&S®FSW8 (1331.5003K08 / 1312.8000K08)
- R&S®FSW13 (1331.5003K13 / 1312.8000K13)
- R&S®FSW26 (1331.5003K26 / 1312.8000K26)
- R&S®FSW43 (1331.5003K43 / 1312.8000K43)
- R&S®FSW50 (1331.5003K50 / 1312.8000K50)
- R&S®FSW67 (1331.5003K67 / 1312.8000K67)
- R&S®FSW85 (1331.5003K85 / 1312.8000K85)

The following firmware options are described:

- R&S®FSW-K144 (5G NR R15 Downlink Measurements) (1338.3606.02)
- R&S®FSW-K147 (5G NR Combined EVM / ACLR / SEM Measurements) (1338.6486.02)
- R&S®FSW-K147C (3GPP 5G-NR FAST Multicarrier Measurement Application 1351.1355.02)
- R&S®FSW-K148 (5G NR R16 Downlink / Uplink Measurements) (1338.6624.02)
- R&S®FSW-K171 (5G NR R17 Downlink / Uplink Measurements) (1350.7108.02)
- R&S®FSW-K175 (O-RAN Measurements) (1353.2642.02)

© 2024 Rohde & Schwarz

Muehldorfstr. 15, 81671 Muenchen, Germany

Phone: +49 89 41 29 - 0

Email: [info@rohde-schwarz.com](mailto:info@rohde-schwarz.com)

Internet: [www.rohde-schwarz.com](http://www.rohde-schwarz.com)

Subject to change – data without tolerance limits is not binding.

R&S® is a registered trademark of Rohde & Schwarz GmbH & Co. KG.

Trade names are trademarks of the owners.

1178.8036.02 | Version 16 | R&S®FSW-K14x

Throughout this manual, products from Rohde & Schwarz are indicated without the ® symbol , e.g. R&S®FSW is indicated as R&S FSW.

# Contents

<b>1</b>	<b>Documentation overview.....</b>	<b>9</b>
1.1	Getting started manual.....	9
1.2	User manuals and help.....	9
1.3	Service manual.....	9
1.4	Instrument security procedures.....	10
1.5	Printed safety instructions.....	10
1.6	Specifications and brochures.....	10
1.7	Release notes and open-source acknowledgment (OSA).....	10
1.8	Application notes, application cards, white papers, etc.....	11
1.9	Videos.....	11
<b>2</b>	<b>Welcome to the 5G NR measurement application.....</b>	<b>12</b>
2.1	Overview of the 5G NR applications.....	12
2.2	Installation.....	15
2.3	5G NR measurement application selection.....	15
2.4	Display information.....	15
<b>3</b>	<b>Measurements and result displays.....</b>	<b>19</b>
3.1	Selecting measurements.....	19
3.2	Selecting result displays.....	21
3.3	Performing measurements.....	21
3.4	Selecting the operating mode.....	22
3.5	Result summary.....	23
3.6	I/Q measurements.....	30
3.7	Time alignment error.....	47
3.8	Transmit on / off power measurement.....	50
3.9	Frequency sweep measurements.....	55
3.10	Combined measurements.....	63
3.11	Reference: custom limits.....	67
3.12	Reference: 3GPP test scenarios.....	68
<b>4</b>	<b>Configuration.....</b>	<b>71</b>
4.1	I/Q measurement.....	71

4.1.1	Configuration overview.....	72
4.1.2	Automatic measurement configuration.....	74
4.1.3	Physical signal description.....	77
4.1.4	Test scenarios.....	80
4.1.5	Component carrier configuration.....	81
4.1.6	Radio frame configuration.....	86
4.1.7	Synchronization signal configuration.....	90
4.1.8	Bandwidth part configuration.....	96
4.1.9	Slot configuration.....	101
4.1.10	PDSCH and PDCCH configuration.....	113
4.1.11	Antenna port configuration.....	133
4.1.12	Advanced settings.....	135
4.1.13	Generator control.....	141
4.1.14	Input source configuration.....	145
4.1.15	Frequency configuration.....	151
4.1.16	Amplitude configuration.....	152
4.1.17	Data capture.....	156
4.1.18	Trigger configuration.....	159
4.1.19	Segmented capture.....	161
4.1.20	Data capture optimization.....	162
4.1.21	Tracking.....	163
4.1.22	Demodulation.....	166
<b>4.2</b>	<b>Time alignment error configuration.....</b>	<b>169</b>
<b>4.3</b>	<b>Transmit on / off power configuration.....</b>	<b>170</b>
<b>4.4</b>	<b>Frequency sweep measurement configuration.....</b>	<b>171</b>
<b>4.5</b>	<b>Combined measurement configuration.....</b>	<b>174</b>
4.5.1	Signal description.....	175
4.5.2	Signal capture.....	176
4.5.3	Trigger configuration.....	178
<b>4.6</b>	<b>Combined measurement guide.....</b>	<b>180</b>
4.6.1	General configuration.....	181
4.6.2	Trigger configuration.....	182
<b>4.7</b>	<b>Time trigger measurement guide.....</b>	<b>191</b>

4.8	Microservice export.....	192
4.9	O-RAN measurement guide.....	192
4.10	Reference: structure of .allocation files.....	193
4.11	Basics on input from I/Q data files.....	202
<b>5</b>	<b>Analysis.....</b>	<b>204</b>
5.1	General analysis tools.....	204
5.1.1	Data export.....	204
5.1.2	Diagram scale.....	205
5.1.3	Zoom.....	206
5.1.4	Markers.....	207
5.2	Analysis tools for I/Q measurements.....	207
5.2.1	Layout of numerical results.....	208
5.2.2	Result settings.....	208
5.2.3	Table configuration.....	211
5.2.4	Result views.....	212
5.2.5	Evaluation range.....	214
5.2.6	Beamforming selection.....	217
5.3	Analysis tools for combined measurements.....	218
5.3.1	Event filter.....	218
5.3.2	General analysis tools.....	219
5.4	Analysis tools for frequency sweep measurements.....	219
<b>6</b>	<b>Remote control.....</b>	<b>220</b>
6.1	Common suffixes.....	220
6.2	Introduction.....	221
6.2.1	Conventions used in descriptions.....	222
6.2.2	Long and short form.....	222
6.2.3	Numeric suffixes.....	223
6.2.4	Optional keywords.....	223
6.2.5	Alternative keywords.....	223
6.2.6	SCPI parameters.....	224
6.3	Status register.....	226
6.4	5G NR application selection.....	227
6.5	Screen layout.....	231

6.5.1	General layout.....	231
6.5.2	Layout of a single channel.....	232
<b>6.6</b>	<b>Measurement control.....</b>	<b>241</b>
6.6.1	Measurements.....	241
6.6.2	Measurement sequences.....	243
<b>6.7</b>	<b>Remote commands to retrieve numeric results.....</b>	<b>245</b>
6.7.1	Result summary.....	245
6.7.2	Combined measurements.....	261
6.7.3	Time alignment error.....	271
6.7.4	Marker table.....	271
6.7.5	CCDF table.....	275
<b>6.8</b>	<b>Limit check results.....</b>	<b>276</b>
6.8.1	EVM limits.....	276
6.8.2	Transmit power on / off limits.....	281
6.8.3	Frequency sweep limits.....	282
<b>6.9</b>	<b>Retrieve trace data.....</b>	<b>290</b>
6.9.1	Using the TRACe[:DATA] command.....	290
6.9.2	Read measurement results.....	309
<b>6.10</b>	<b>Configuration.....</b>	<b>313</b>
6.10.1	General configuration.....	314
6.10.2	Automatic configuration.....	317
6.10.3	Physical settings.....	321
6.10.4	Component carrier configuration.....	326
6.10.5	General radio frame configuration.....	330
6.10.6	Synchronization signal configuration.....	332
6.10.7	Bandwidth part configuration.....	339
6.10.8	Slot configuration.....	342
6.10.9	CSI reference signal configuration.....	349
6.10.10	Positioning reference signal.....	358
6.10.11	CORESET allocation configuration.....	362
6.10.12	PDSCH allocation configuration.....	369
6.10.13	Enhanced CORESET allocation configuration.....	376
6.10.14	Enhanced PDSCH settings: DMRS.....	393

6.10.15	Enhanced PDSCH settings: PTRS.....	402
6.10.16	Enhanced PDSCH settings: scrambling / coding.....	406
6.10.17	Antenna port configuration.....	410
6.10.18	Advanced settings: global.....	411
6.10.19	Advanced settings: reference point A.....	415
6.10.20	Advanced settings: LTE-CRS coexistence.....	419
6.10.21	Generator control.....	421
6.10.22	Input configuration.....	427
6.10.23	Frequency configuration.....	435
6.10.24	Amplitude configuration.....	437
6.10.25	Data capture.....	442
6.10.26	Trigger.....	445
6.10.27	Segmented capture.....	450
6.10.28	Optimization.....	452
6.10.29	Tracking.....	453
6.10.30	Demodulation.....	455
6.10.31	Time alignment measurement.....	459
6.10.32	Transmit on/off power measurements.....	459
6.10.33	Frequency sweep measurements.....	462
6.10.34	Combined measurements.....	466
<b>6.11</b>	<b>Analysis.....</b>	<b>472</b>
6.11.1	General analysis tools.....	472
6.11.2	Analysis tools for I/Q measurements.....	484
6.11.3	Analysis tools for combined measurements.....	496
<b>6.12</b>	<b>Reading out status register.....</b>	<b>498</b>
	<b>List of commands (5G NR downlink).....</b>	<b>501</b>
	<b>Index.....</b>	<b>513</b>





# 1 Documentation overview

This section provides an overview of the FSW user documentation. Unless specified otherwise, you find the documents at:

[www.rohde-schwarz.com/manual/FSW](http://www.rohde-schwarz.com/manual/FSW)

Further documents are available at:

[www.rohde-schwarz.com/product/FSW](http://www.rohde-schwarz.com/product/FSW)

## 1.1 Getting started manual

Introduces the FSW and describes how to set up and start working with the product. Includes basic operations, typical measurement examples, and general information, e.g. safety instructions, etc.

A printed version is delivered with the instrument. A PDF version is available for download on the Internet.

## 1.2 User manuals and help

Separate user manuals are provided for the base unit and the firmware applications:

- Base unit manual  
Contains the description of all instrument modes and functions. It also provides an introduction to remote control, a complete description of the remote control commands with programming examples, and information on maintenance, instrument interfaces and error messages. Includes the contents of the getting started manual.
- Firmware application manual  
Contains the description of the specific functions of a firmware application, including remote control commands. Basic information on operating the FSW is not included.

The contents of the user manuals are available as help in the FSW. The help offers quick, context-sensitive access to the complete information for the base unit and the firmware applications.

All user manuals are also available for download or for immediate display on the Internet.

## 1.3 Service manual

Describes the performance test for checking the rated specifications, module replacement and repair, firmware update, troubleshooting and fault elimination, and contains mechanical drawings and spare part lists.

The service manual is available for registered users on the global Rohde & Schwarz information system (GLORIS):

<https://gloris.rohde-schwarz.com>

## 1.4 Instrument security procedures

Deals with security issues when working with the FSW in secure areas. It is available for download on the internet.

## 1.5 Printed safety instructions

Provides safety information in many languages. The printed document is delivered with the product.

## 1.6 Specifications and brochures

The specifications document, also known as the data sheet, contains the technical specifications of the FSW. It also lists the firmware applications and their order numbers, and optional accessories.

The brochure provides an overview of the instrument and deals with the specific characteristics.

See [www.rohde-schwarz.com/brochure-datasheet/FSW](http://www.rohde-schwarz.com/brochure-datasheet/FSW)

## 1.7 Release notes and open-source acknowledgment (OSA)

The release notes list new features, improvements and known issues of the current firmware version, and describe the firmware installation.

The firmware makes use of several valuable open source software packages. An open-source acknowledgment document provides verbatim license texts of the used open source software.

See [www.rohde-schwarz.com/firmware/FSW](http://www.rohde-schwarz.com/firmware/FSW)

## 1.8 Application notes, application cards, white papers, etc.

These documents deal with special applications or background information on particular topics.

See [www.rohde-schwarz.com/application/FSW](http://www.rohde-schwarz.com/application/FSW)

## 1.9 Videos

Find various videos on Rohde & Schwarz products and test and measurement topics on YouTube: <https://www.youtube.com/@RohdeundSchwarz>

## 2 Welcome to the 5G NR measurement application

The 5G NR application is a firmware application that adds functionality to measure signals according to the 3GPP 5G NR (new radio) standard on the downlink to the FSW.



### Bandwidth of 5G NR signals

5G NR signals have a bandwidth between 5 MHz and 400 MHz.

Measuring signals greater than 10 MHz requires an FSW with one of the optional bandwidth extensions (28 MHz or more).

This user manual contains a description of the functionality that the application provides, including remote control operation. Functions that are not discussed in this manual are the same as in the spectrum application and are described in the FSW user manual. The latest versions of the manuals are available for download at the product homepage.

<https://www.rohde-schwarz.com/manual/fsw>

- [Overview of the 5G NR applications](#)..... 12
- [Installation](#)..... 15
- [5G NR measurement application selection](#)..... 15
- [Display information](#)..... 15

### 2.1 Overview of the 5G NR applications

You can equip the FSW with one or more NR 5G applications. Each of the applications provides functionality for specific measurement tasks.

#### R&S FSW-K144

The R&S FSW-K144 is designed to measure NR 5G signals on the downlink.

The application supports features up to 3GPP release 15.

- Basic signal characteristics (like multiple component carriers, frequency ranges and channel bandwidths).
- (Automatic) demodulation and configuration of the PDSCH and synchronization signal (SS/PBCH).
- Configuration and analysis of multiple frames and bandwidth parts (multi-numerology).
- Configuration and analysis of special downlink channels and reference signals (like the PDCCH, the CSI-RS or the PT-RS).
- Configuration and analysis of various demodulation reference signals.
- Mapping of channels to different antenna ports.
- LTE coexistence analysis.

- Synchronization of the configuration with a connected Rohde & Schwarz signal generator.
- Tools to refine and filter the measurement results.
- Various result displays that show the measured signal characteristics in a diagram or a numeric result table.
- Available measurements: EVM, ACLR, SEM, time alignment and on / off power.

### **R&S FSW-K145**

The R&S FSW-K145 is designed to measure NR 5G signals on the uplink.

The application supports features up to 3GPP release 15.

- Basic signal characteristics (like multiple component carriers, frequency ranges and channel bandwidths).
- (Automatic) demodulation and configuration of the PUSCH.
- Configuration and analysis of multiple frames and bandwidth parts (multi-numerology).
- Configuration and analysis of special uplink channels and reference signals (like the PUCCH, the PRACH, the SRS or the PT-RS).
- Configuration and analysis of various demodulation reference signals.
- Mapping of channels to different antenna ports.
- Synchronization of the configuration with a connected Rohde & Schwarz signal generator.
- Tools to refine and filter the measurement results.
- Various result displays that show the measured signal characteristics in a diagram or a numeric result table.
- Available measurements: EVM, ACLR and SEM.

### **R&S FSW-K147**

The R&S FSW-K147 is designed to combine different 5G NR measurements in a single measurement sequence, either on the downlink or on the uplink.

Note that this application requires the R&S FSW-K144 or -K145.

The application supports the following features.

- Combined analysis of EVM, ACLR and SEM in a single application.
- Automatic measurement of multiple, subsequent events with a single analyzer.
- Increased measurement speed due to optimized measurement methods.
- Advanced trigger configuration.
- Extended functionality of the result displays that reflect the measurement sequence.
- R&S FSW-K147C unlocks combined measurements for multi-carrier signals. Requires the R&S FSW-K147 license.

### R&S FSW-K148

The R&S FSW-K148 extends the functionality of the base application with features introduced with 3GPP release 16.

Note that this application requires the R&S FSW-K144 or -K145.

Release 16 features include:

- Configuration of DCI parameters.
- Configuration and analysis of the PRS.
- New operating bands, slot formats (for IAB) and test models introduced with release 16.
- New channel bandwidth introduced with release 16 (70 MHz).
- Increased PDSCH DMRS length.
- Increased number of SS/PBCH blocks to support shared spectrum access.

### R&S FSW-K171

The R&S FSW-K171 extends the functionality of the base application with features introduced with 3GPP release 17.

Note that this application requires the R&S FSW-K144 or -K145 and the R&S FSW-K148.

Release 17 features include:

- New deployment frequency range (FR2-2, up to 71 GHz).
- New channel bandwidths introduced with FR2-2 (800 MHz, 1600 MHz and 2000 MHz).
- New subcarrier spacings for various channels (user allocations, SS/PBCH, PRACH etc.) introduced with FR2-2.
- New channel bandwidths introduced with release 17 (35 MHz and 45 MHz).
- Support of 1024QAM modulation in FR1.
- New operating bands, test models and limits for ACLR and SEM measurements introduced with release 17.

### R&S FSW-K175

The R&S FSW-K175 extends the functionality of the base application with features that allow measurements based on the O-RAN standard.

Note that this application requires the R&S FSW-K144 or -K145.

The application supports the following features.

- Support of O-RAN test cases.
- Extended features in selected result displays that allow evaluation of O-RAN test cases.
- Automatic configuration of the NR 5G application upon selection of an O-RAN test case.

## 2.2 Installation

Find detailed installation instructions in the getting started or the release notes of the FSW.

## 2.3 5G NR measurement application selection

The 5G NR measurement application adds a new application to the FSW.

### Starting the application

1. Press the [MODE] key on the front panel of the FSW.

A dialog box opens that contains all operating modes and applications currently available on your FSW.

2. Select the "5G NR" item.



The FSW opens a new measurement channel for the 5G NR measurement application.

The measurement is started immediately with the default settings. It can be configured in the "Overview" dialog box, which is displayed when you select the "Overview" soft-key from any menu.

## 2.4 Display information

The following figure shows a measurement diagram during analyzer operation. All different information areas are labeled. They are explained in more detail in the following sections.

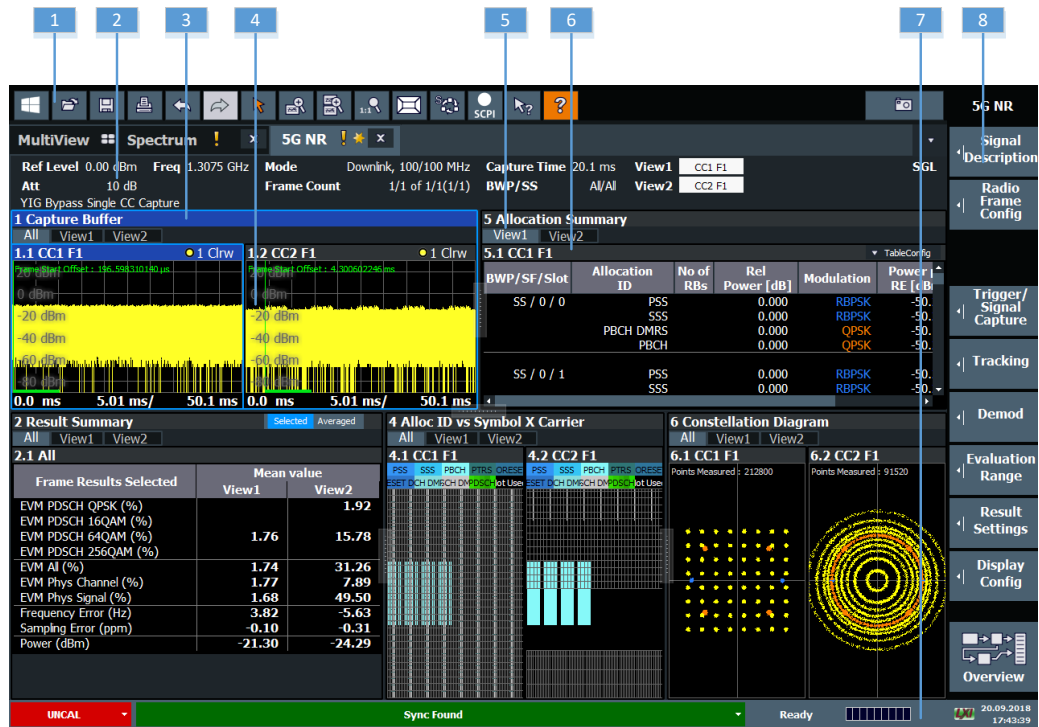

- 1 = Toolbar
- 2 = Channel bar
- 3 = Diagram header
- 4 = Result display
- 5 = Subwindows (Views)
- 6 = Subwindow header
- 7 = Status bar
- 8 = Softkeys



**MSRA operating mode**

In MSRA operating mode, additional tabs and elements are available. A colored background of the screen behind the measurement channel tabs indicates that you are in MSRA operating mode. Frequency sweep measurements are not available in MSRA operating mode.

For details on the MSRA operating mode, see the FSW MSRA user manual.

**Channel bar information**

In the 5G NR measurement application, the FSW shows the following settings:

*Table 2-1: Information displayed in the channel bar in the 5G NR measurement application*

<b>Ref Level</b>	Reference level.
<b>Att</b>	Mechanical and electronic RF attenuation.
<b>Inp: File Freq</b>	Frequency for I/Q file input.
<b>Freq</b>	Frequency for other input sources (RF etc.).
<b>Mode*</b>	5G NR mode (link direction and channel bandwidth).



<b>Frame Count*</b>	<p>The first number represents the number of frames that have already been captured.</p> <p>The second number represents the total number of frames that will be captured.</p> <p>The third number in brackets represents the number of frames currently in the capture buffer.</p>
<b>Capture Time</b>	Signal length that has been captured.
<b>Frame</b>	Selected frame number.
<b>BWP/SS*</b>	<p>Shows the signal part for which results are displayed (evaluation range).</p> <p>SS = synchronization signal</p> <p>BWP = bandwidth part</p>
<b>View&lt;x&gt;</b>	<p>Information about the contents of View 1 and View 2.</p> <p>Select the button for access to the dialog box for view configuration.</p>
<b>SGL</b>	Indicates that single sweep measurement is active.
<b>Auto Demod Once</b>	Select the button to start automatic signal demodulation.
<b>Consecutive CC Meas</b>	<p>Number of component carriers that are measured; the numbers in parentheses indicate the number of component carriers that are analyzed in a single capture.</p> <p>Example: 8 (3 / 3 / 2) means that 8 component carriers are analyzed in three consecutive data captures. The first two data captures analyze the first 6 component carriers (3 CCs each), while the last data capture analyzes the last 2 component carriers.</p>

\*If you capture more than one data stream (for example several component carriers), the FSW shows two values separated by a slash. The first number corresponds to the first analyzed data stream, the second number to the second analyzed data stream.

The channel bar also displays information on instrument settings that affect the measurement results even though this is not immediately apparent from the display of the measured values (for example transducer or trigger settings). This information is displayed only when applicable for the current measurement. For details, see the FSW getting started manual.

### Diagram header

The information in the diagram header depends on the result display.

- All diagrams show the window number and type of result display.
- Most diagrams contain trace information.
- Some diagrams contain controls to customize the diagram contents. The diagram header of the "Allocation Summary", for example, contains a control to select which columns are displayed.
- If you analyze multiple component carriers or frames, the diagram header shows which CC or frame is analyzed.

### Status bar information

Global instrument settings, the instrument status and any irregularities are indicated in the status bar beneath the diagram. Furthermore, the progress of the current operation is displayed in the status bar.

Regarding the synchronization state, the application shows the following labels.

- "Sync OK"  
The synchronization was successful. The status bar is green.
- "Sync Failed"  
The synchronization was not successful. The status bar is red.  
If you are measuring several component carriers, the message also indicates which component carrier could not be synchronized.

## 3 Measurements and result displays

The 5G NR measurement application measures and analyzes various aspects of a 5G NR signal.

The application provides several measurements and result displays.

- Measurements capture and analyze the signal in a different way.
- Result displays are different representations of the measurement results. They are either diagrams that show the results as a graph or tables that show the results as numbers.

Remote command:

Measurement selection: `CONFigure[:NR5G]:MEASurement` on page 314

Result display selection: `LAYout:ADD[:WINDow]?` on page 233

• <a href="#">Selecting measurements</a> .....	19
• <a href="#">Selecting result displays</a> .....	21
• <a href="#">Performing measurements</a> .....	21
• <a href="#">Selecting the operating mode</a> .....	22
• <a href="#">Result summary</a> .....	23
• <a href="#">I/Q measurements</a> .....	30
• <a href="#">Time alignment error</a> .....	47
• <a href="#">Transmit on / off power measurement</a> .....	50
• <a href="#">Frequency sweep measurements</a> .....	55
• <a href="#">Combined measurements</a> .....	63
• <a href="#">Reference: custom limits</a> .....	67
• <a href="#">Reference: 3GPP test scenarios</a> .....	68

### 3.1 Selecting measurements

**Access:** "Overview" > "Select Measurement"

The "Select Measurement" dialog box contains several buttons. Each button represents a measurement. A measurement in turn is a set of result displays that thematically belong together and that have a particular display configuration. If these predefined display configurations do not suit your requirements, you can add or remove result displays as you like. For more information about selecting result displays, see [Chapter 3.2, "Selecting result displays"](#), on page 21.

Depending on the measurement, the FSW changes the way it captures and processes the raw signal data.

#### EVM

EVM measurements record, process and demodulate the signal's I/Q data. The result displays available for EVM measurements show various aspects of the 5G NR signal quality.

For EVM measurements, you can combine the result displays in any way.

For more information on the result displays, see [Chapter 3.6, "I/Q measurements"](#), on page 30.

Remote command:

[CONFigure\[:NR5G\]:MEASurement](#) on page 314

#### **Time alignment error**

Time alignment error (TAE) measurements record, process and demodulate the signal's I/Q data. The result displays available for TAE measurements indicate how well the antennas in a multi-antenna system are aligned.

For TAE measurements, you can combine the result displays in any way.

For more information on the result displays, see [Chapter 3.7, "Time alignment error"](#), on page 47.

Remote command:

[CONFigure\[:NR5G\]:MEASurement](#) on page 314

#### **Transmit on / off power**

Transmit on / off power measurements record and process the signal's I/Q data without demodulating the data. The result displays available for transmit on / off power measurements show various aspects of the transition from on to off power.

For transmit on / off power measurements, you can combine the result displays in any way.

For more information on the result displays, see [Chapter 3.8, "Transmit on / off power measurement"](#), on page 50.

Remote command:

[CONFigure\[:NR5G\]:MEASurement](#) on page 314

#### **Combined EVM / ACLR / SEM**

Combined measurements are a sequence of individual measurements that evaluate the EVM, ACLR and / or SEM of a DUT.

For more information on the result displays, see [Chapter 3.10, "Combined measurements"](#), on page 63.

#### **Channel power ACLR**

(includes multi carrier ACLR and cumulative ACLR measurements)

ACLR measurements sweep the frequency spectrum instead of processing I/Q data.

The ACLR measurements evaluates the leakage ratio of neighboring channels and evaluates if the signal is within the defined limits. The measurement provides several result displays. You can combine the result displays in any way.

For more information on the result displays, see [Chapter 3.9, "Frequency sweep measurements"](#), on page 55.

Remote command:

[CONFigure\[:NR5G\]:MEASurement](#) on page 314

#### **SEM**

(includes multi carrier SEM measurements)

SEM measurements sweep the frequency spectrum instead of processing I/Q data.

The SEM measurements tests the signal against a spectrum emission mask and evaluates if the signal is within the defined limits. The measurement provides several result displays. You can combine the result displays in any way.

For more information on the result displays, see [Chapter 3.9, "Frequency sweep measurements"](#), on page 55.

Remote command:

[CONFigure\[:NR5G\]:MEASurement](#) on page 314

## 3.2 Selecting result displays

**Access:** 

The FSW opens a menu (the SmartGrid) to select result displays. For more information on the SmartGrid functionality, see the FSW Getting Started.

In the default state of the application, it shows several conventional result displays.

- Capture Buffer
- EVM vs Carrier
- Power Spectrum
- Result Summary
- Alloc ID vs Symbol x Carrier
- Constellation Diagram

From that predefined state, add and remove result displays as you like from the Smart-Grid menu.

Remote command: [LAYout:ADD\[:WINDow\]?](#) on page 233

## 3.3 Performing measurements

By default, the application measures the signal continuously. In "Continuous Sweep" mode, the FSW captures and analyzes the data again and again.

- For I/Q measurements, the amount of captured data depends on the [capture time](#).
- For frequency sweep measurement, the amount of captured data depends on the sweep time.

In "Single Sweep" mode, the FSW stops measuring after it has captured the data once. The amount of data again depends on the capture time.

### Refreshing captured data

You can also repeat a measurement based on the data that has already been captured with the "Refresh" function. Repeating a measurement with the same data can be useful, for example, if you want to apply different modulation settings to the same I/Q data.

For more information, see the documentation of the FSW.

## 3.4 Selecting the operating mode

**Access:** [MODE] > "Multi-Standard Radio Analyzer Tab"

The 5G NR application is supported by the Multi Standard Radio Analyzer (MSRA).

In MSRA operating mode, only the MSRA primary actually captures data. The application receives an extract of the captured data for analysis, referred to as the **application data**. The application data range is defined by the same settings used to define the signal capture in "Signal and Spectrum Analyzer" mode. In addition, a capture offset can be defined, i.e. an offset from the start of the captured data to the start of the analysis interval.

If a signal contains multiple data channels for multiple standards, separate applications are used to analyze each data channel. Thus, it is of interest to know which application is analyzing which data channel. The MSRA primary display indicates the data covered by each application by vertical blue lines labeled with the application name. The blue lines correspond to the channel bandwidth.

However, the individual result displays of the application need not analyze the complete data range. The data range that is actually analyzed by the individual result display is referred to as the **analysis interval**.

The analysis interval is automatically determined according to the [Capture Time](#) you have defined. The analysis interval cannot be edited directly in the 5G NR application, but is changed automatically when you change the evaluation range. The currently used analysis interval (in seconds, related to capture buffer start) is indicated in the window header for each result display.

A frequent question when analyzing multi-standard signals is how each data channel is correlated (in time) to others. Thus, an analysis line has been introduced. The analysis line is a common time marker for all MSRA secondary applications. It can be positioned in any MSRA secondary application or the MSRA primary and is then adjusted in all other secondary applications. Thus, you can easily analyze the results at a specific time in the measurement in all secondary applications and determine correlations.

If the analysis interval of the secondary application contains the marked point in time, the line is indicated in all time-based result displays, such as time, symbol, slot or bit diagrams. By default, the analysis line is displayed. However, you can hide it from view manually. In all result displays, the "AL" label in the window title bar indicates whether the analysis line lies within the analysis interval or not:

- **orange "AL"**: the line lies within the interval
- **white "AL"**: the line lies within the interval, but is not displayed (hidden)
- **no "AL"**: the line lies outside the interval

For details on the MSRA operating mode, see the FSW MSRA documentation.

### 3.5 Result summary

In addition to various graphical results, the FSW provides a numerical result summary for I/Q measurements. The result summary shows a multitude of results that indicate the signal quality, combined in one table.

The result summary is split into several parts.

- Frame statistics, which evaluate the metrics of the resource elements in a complete frame.  
Results are averaged over frames.
- Slot and subframe statistics, which evaluate metrics of the resource elements in a single slot or subframe.  
Results are averaged over slots / subframes.

If you are using different [numerologies](#), the FSW first averages all slots with the same numerology, before calculating the overall mean value.

Each row in the table corresponds to a certain metric or result parameter. You can [add](#) or [remove](#) results you want to display as necessary.

By default, the FSW evaluates the results over all captured frames, bandwidth parts, subframes and slots. For most results, the result summary therefore contains a mean (average), maximum and minimum value.

2 Result Summary				
Frame Results Selected	Mean	Limit	Max	Min
EVM PDSCH QPSK (%)	0.00	0.00	0.00	0.00
EVM PDSCH 16QAM (%)	0.00	0.00	0.00	0.00
EVM PDSCH 64QAM (%)	0.00	0.00	0.00	0.00
EVM PDSCH 256QAM (%)	0.00	0.00	0.00	0.00
Results for Selection BWP/SS All, Subframe All, Slot All				
EVM All (%)	0.00		0.00	0.00
EVM Peak (%)	0.00		0.00	0.00
EVM Phys Channel (%)	0.00		0.00	0.00
EVM Phys Signal (%)	0.00		0.00	0.00
Frequency Error (Hz)	0.00		0.00	0.00
Sampling Error (ppm)	0.00		0.00	0.00
I/Q Offset (dB)	0.00		0.00	0.00
I/Q Gain Imbalance (dB)	-		-	-
I/Q Quadrature Error (°)	-		-	-

#### Limit check

The FSW also tests several results against limits, if 3GPP has defined limits for a result. Limits are only evaluated if the signal complies to the 3GPP specification regarding the [number of analyzed frames](#) and the results are averaged over all frames.

Depending on the limit test, the results are highlighted.

- If one of the results passes the limit, the value is highlighted green.
- If one of the results violates the limit, the value is highlighted red.
- Results that are not evaluated are not highlighted in a color.

For some results you can define custom limits. For more information, see [Chapter 3.11, "Reference: custom limits"](#), on page 67.

You can check if a result supports limit evaluation in the result descriptions below. The result descriptions also indicate special behavior of the limit check.

### Evaluation range and multiple frame analysis

The **evaluation range** selects the way the results are evaluated and which values are displayed.

For the **frame statistics**, the evaluation range is irrelevant. However, you can select a specific frame that you want to analyze.

- Select "Frame Averaged" in the result summary header to display the average result over all analyzed frames. The average results relate to all frames, not just those in the capture buffer.  
The table also shows the minimum and maximum values over the analyzed frames.
- Select "Selected Frame" in the result summary header to display the results for a **single frame**.  
If you analyze a single frame, the mean, minimum and maximum values are the same.

## 2 Result Summary

Selected Frame **Frame Averaged**

For the **slot statistics** and subframe statistics, the effects of the evaluation range are as follows.

- Select "Frame Averaged" in the result summary header to display the average results over all analyzed slots in all analyzed frames. The average results relate to all frames, not just those in the capture buffer. The table also shows the minimum and maximum values found in the analyzed frames.  
When you select a specific BWP, subframe or slot while in "Frame Averaged" mode, the FSW automatically selects "Selected Frame" mode.
- Select "Selected Frame" in the result summary header to display the results over all analyzed slots in a single frame. The analyzed frame depends on the frame you have selected. In this case, you can filter the evaluation range as you like.

Examples:

- If you select a specific BWP: the FSW takes the average over all slots in the selected BWP.
- If you select a specific subframe: the FSW takes the average over all slots in the selected subframe.
- If you select a specific slot: the FSW shows the result for that slot.  
Note that selecting a specific slot for the subframe results (frequency and sampling error) will not make a difference, because those results are always calculated over a complete subframe.

The current evaluation range is indicated in the header row of the slot statistics.



### Multiple carrier analysis

For measurements on [multiple carriers](#), the contents of the result summary depend on your configuration, especially the [CC result](#) setting.

- Select "CC Result" = "All" to display information about all component carriers, regardless of the number of component carriers.
  - The "All" tab shows the average results for all component carriers. Each column in the table corresponds to one component carrier.
  - The "View <x>" tabs show the detailed results for the component carriers assigned to the two [views](#).
- Select "CC Result" = "Viewed" to display information about the component carriers assigned to the two views.
  - The "All" tab shows the average results for the two selected component carriers. Depending on your selection in the result summary header, the results are either averaged over all frames, or relate to a single frame.
  - The "View <x>" tabs show the detailed results for the component carriers assigned to the two views. Depending on your selection in the result summary header, the results are either averaged over all frames, or relate to a single, selected frame.
 

If you analyze only one frame, the results are the same in both cases.

Note that analyzing all component carriers is slower compared analyzing the viewed component carriers, because of the post-processing that occurs during the analysis. Thus, if time is an issue, you can select two component carriers to analyze, and, if you are later interested in the characteristics of another component carrier, analyze that component carrier later (the data of the other carriers is available, just not analyzed).

### Units

Most of the units of the results are fixed.

The unit of the EVM results depends on the selected [EVM unit](#).

<a href="#">Remote queries</a> .....	26
<a href="#">EVM PDSCH</a> .....	26
<a href="#">BLER (%)</a> .....	26
<a href="#">TPUT (%)</a> .....	27
<a href="#">Frame Start Offset</a> .....	27
<a href="#">EVM All</a> .....	27
<a href="#">EVM Peak</a> .....	27
<a href="#">EVM Phys Channel</a> .....	28
<a href="#">EVM Phys Signal</a> .....	28
<a href="#">Frequency Error</a> .....	28
<a href="#">Sampling Error</a> .....	28
<a href="#">Power</a> .....	28
<a href="#">I/Q Offset</a> .....	29
<a href="#">I/Q Gain Imbalance</a> .....	29
<a href="#">I/Q Quadrature Error</a> .....	29
<a href="#">Crest Factor</a> .....	29

OSTP.....	29
RSTP.....	29
RSRP.....	30

### Remote queries

The remote commands to query individual results and limit check results are indicated in the description of the respective result.

Alternatively, you can query all results or limit check results at the same time using a single command.

Remote command:

Results: `FETCh[:CC<cc>][:ISRC<ant>][:FRAMe<fr>]:SUMMary:ALL?`  
on page 246

Limit check: `CALCulate<n>:LIMit<li>[:CC<cc>][:ISRC<ant>][:FRAMe<fr>]:SUMMary:ALL:RESult?` on page 277

### EVM PDSCH

Shows the EVM for all PDSCH resource elements with a certain modulation in the analyzed frame (QPSK, 16QAM, 64QAM, 256QAM).

3GPP release 17 adds 1024QAM modulation.

Limit evaluation supported.

Remote command:

QPSK: `FETCh[:CC<cc>][:ISRC<ant>][:FRAMe<fr>]:SUMMary:EVM:DSQP[:AVERage]?` on page 249

16QAM: `FETCh[:CC<cc>][:ISRC<ant>][:FRAMe<fr>]:SUMMary:EVM:DSST[:AVERage]?` on page 251

64QAM: `FETCh[:CC<cc>][:ISRC<ant>][:FRAMe<fr>]:SUMMary:EVM:DSSF[:AVERage]?` on page 250

256QAM: `FETCh[:CC<cc>][:ISRC<ant>][:FRAMe<fr>]:SUMMary:EVM:DSTS[:AVERage]?` on page 251

1024QAM: `FETCh[:CC<cc>][:ISRC<ant>][:FRAMe<fr>]:SUMMary:EVM:DS1K[:AVERage]?` on page 249

Limit check QPSK: `CALCulate<n>:LIMit<li>[:CC<cc>][:ISRC<ant>][:FRAMe<fr>]:SUMMary:EVM:DSQP[:AVERage]:RESult?` on page 278

Limit check 16QAM: `CALCulate<n>:LIMit<li>[:CC<cc>][:ISRC<ant>][:FRAMe<fr>]:SUMMary:EVM:DSST[:AVERage]:RESult?` on page 279

Limit check 64QAM: `CALCulate<n>:LIMit<li>[:CC<cc>][:ISRC<ant>][:FRAMe<fr>]:SUMMary:EVM:DSSF[:AVERage]:RESult?` on page 278

Limit check 256QAM: `CALCulate<n>:LIMit<li>[:CC<cc>][:ISRC<ant>][:FRAMe<fr>]:SUMMary:EVM:DSTS[:AVERage]:RESult?` on page 280

Limit check 1024QAM: `CALCulate<n>:LIMit<li>[:CC<cc>][:ISRC<ant>][:FRAMe<fr>]:SUMMary:EVM:DS1K[:AVERage]:RESult?` on page 277

### BLER (%)

Shows the block error rate (BLER) for all code blocks used by the PDSCH as a percentage. The BLER is the ratio of the number of erroneously transmitted code blocks to all code blocks in the analyzed frame.

Note that the result is only calculated if the number of bits per code block is identical for all allocations.

To see the BLER results, you have turn on the [throughput measurement](#).

Remote command:

`FETCh[:CC<cc>][:ISRC<ant>][:FRAME<fr>]:SUMMARY:BLER[:AVERage]?`  
on page 247

### TPUT (%)

Shows the throughput for all code blocks used by the PDSCH. The BLER is the ratio of the number of successfully transmitted code blocks to all code blocks in the analyzed frame.

Note that the result is only calculated if the number of bits per code block is identical for all allocations.

To see the throughput results, you have turn on the [throughput measurement](#).

Remote command:

`FETCh[:CC<cc>][:ISRC<ant>][:FRAME<fr>]:SUMMARY:TPUT[:AVERage]?`  
on page 260

### Frame Start Offset

Shows the start of the frame relative to the start of the capture buffer.

Unavailable for "Frame Averaged" results, otherwise refers to the selected frame.

Remote command:

`FETCh[:CC<cc>][:ISRC<ant>][:FRAME<fr>]:SUMMARY:FOFFset?`  
on page 260

### EVM All

Shows the EVM for all resource elements in the selected evaluation range.

The result is a weighted average over all resource elements (PDSCH, DMRS etc.). The number of occupied resource blocks and the number of used symbols of each allocation is taken into account in the calculation of the mean EVM. Therefore, a fully loaded PDSCH across multiple symbols gets a much higher weight than a single symbol DMRS.

Remote command:

`FETCh[:CC<cc>][:ISRC<ant>][:FRAME<fr>]:SUMMARY:EVM[:ALL][:AVERage]?` on page 248

### EVM Peak

Shows the EVM of the resource element with the highest EVM value in the selected evaluation range.

Unavailable for combined measurements.

Remote command:

`FETCh[:CC<cc>][:ISRC<ant>][:FRAME<fr>]:SUMMARY:EVM:PEAK[:AVERage]?` on page 253

**EVM Phys Channel**

Shows the EVM for all physical channel resource elements in the selected evaluation range.

A physical channel corresponds to a set of resource elements carrying information from higher layers. PDSCH, PUSCH, PBCH or PDCCH, for example, are physical channels.

Remote command:

`FETCh[:CC<cc>][:ISRC<ant>][:FRAME<fr>]:SUMMARY:EVM:PCChannel[:AVERage]?` on page 252

**EVM Phys Signal**

Shows the EVM for all physical signal resource elements in the selected evaluation range.

The reference signal is a physical signal, for example.

**Frequency Error**

Shows the difference in the measured center frequency and the reference center frequency.

The frequency error is calculated over a subframe.

Limits are evaluated if you [turn on the limit check](#).

The FSW checks the measured frequency error against the limits defined by 3GPP. The values are highlighted green (pass) or red (fail) respectively. The color of the mean value indicates the overall limit check passes or fails. Note that if you evaluate a single subframe only, the minimum, maximum and mean values are the same.

The limit values depend on the [base station category](#).

Remote command:

Result: `FETCh[:CC<cc>][:ISRC<ant>][:FRAME<fr>]:SUMMARY:FERRor[:AVERage]?` on page 254

Limit check: `CALCulate<n>:LIMit<li>[:CC<cc>][:ISRC<ant>][:FRAME<fr>]:SUMMARY:EVM:FERRor[:AVERage]:RESult?` on page 280

**Sampling Error**

Shows the difference in measured symbol clock and reference symbol clock relative to the system sampling rate.

The sampling error is calculated over a subframe.

Remote command:

`FETCh[:CC<cc>][:ISRC<ant>][:FRAME<fr>]:SUMMARY:SERRor[:AVERage]?` on page 259

**Power**

Shows the average time domain power for all resource elements in the selected evaluation range.

Remote command:

`FETCh[:CC<cc>][:ISRC<ant>][:FRAME<fr>]:SUMMARY:POWer[:AVERage]?` on page 256

**I/Q Offset**

Shows the power at spectral line 0 normalized to the total transmitted power.

Not available for multiple BWPs.

Remote command:

`FETCh[:CC<cc>][:ISRC<ant>][:FRAME<fr>]:SUMMARY:IQOffset[:AVERAGE]?` on page 255

**I/Q Gain Imbalance**

Shows the logarithm of the gain ratio between the Q-channel and the I-channel.

Not available for multiple BWPs and only calculated if you [turn on the calculation](#).

Remote command:

`FETCh[:CC<cc>][:ISRC<ant>][:FRAME<fr>]:SUMMARY:GIMBalance[:AVERAGE]?` on page 255

**I/Q Quadrature Error**

Shows the measure of the phase angle between Q-channel and I-channel deviating from the ideal 90 degrees.

Not available for multiple BWPs and only calculated if you [turn on the calculation](#).

**Crest Factor**

Shows the peak-to-average power ratio of the captured signal.

The peak power is determined over multiple frames.

Remote command:

`FETCh[:CC<cc>][:ISRC<ant>]:SUMMARY:CRESt[:AVERAGE]?` on page 247

**OSTP**

Shows the OFDM symbol transmit power.

The result is the average power of all OFDM symbols that carry PDSCH and not containing PDCCH, RS or SSB within a slot.

Not available for multiple BWPs.

Remote command:

`FETCh[:CC<cc>][:ISRC<ant>][:FRAME<fr>]:SUMMARY:OSTP[:AVERAGE]?` on page 256

**RSTP**

Shows the reference signal transmit power.

The result is an average over all PDSCH DMRS within a frame. For the calculation, the FSW first averages all DMRS in each slot, and then averages this value over all slots in a frame.

Not available for multiple BWPs.

Remote command:

`FETCh[:CC<cc>][:ISRC<ant>][:FRAME<fr>]:SUMMARY:RSTP[:AVERAGE]?` on page 259

**RSRP**

Shows the reference signal receive power for the CSI reference signal (CSI-RSRP) and the second synchronization reference signal (SS-RSRP) as defined in 3GPP 38.215.

It is an average power over all resource elements that carry the CSI or SS reference signal.

Not available for multiple BWPs.

Remote command:

CSI-RSRP: `FETCh[:CC<cc>][:ISRC<ant>][:FRAMe<fr>]:SUMMary:RSRP:CSI[:AVERAge]? on page 258`

SS-RSRP: `FETCh[:CC<cc>][:ISRC<ant>][:FRAMe<fr>]:SUMMary:RSRP:SS[:AVERAge]? on page 258`

## 3.6 I/Q measurements

**Access:** [MEAS] > "EVM/Frequency Err/Power"

For I/Q measurements, the FSW captures and then analyzes the demodulated I/Q data. I/Q measurements provide various result displays that show different aspects and characteristics of the captured signal.

You can select the result displays from the evaluation bar and arrange them as you like with the SmartGrid functionality.

Remote command:

Measurement selection: `CONFigure[:NR5G]:MEASurement on page 314`

Result display selection: `LAYout:ADD[:WINDow]? on page 233`

Capture Buffer.....	31
EVM vs Carrier.....	32
EVM vs Symbol.....	32
EVM vs RB.....	33
Frequency Error vs Symbol.....	34
Frequency Error vs Subframe.....	35
Power Spectrum.....	36
Flatness.....	36
CCDF.....	37
Constellation Diagram.....	38
Allocation Summary.....	38
Channel Decoder Results.....	39
Bitstream.....	40
EVM vs Symbol x Carrier.....	42
Power vs Symbol x Carrier.....	42
Allocation ID vs Symbol x Carrier.....	42
RS Magnitude.....	43
RS Phase.....	44

RS Phase Difference.....	45
Beamforming Summary.....	45
Marker Table.....	46

### Capture Buffer

The "Capture Buffer" shows the complete range of captured data for the last data capture.

The x-axis represents time. The maximum value of the x-axis is equal to the [Capture Time](#).

The y-axis represents the amplitude of the captured I/Q data in dBm (for RF input).

The capture buffer uses the auto peak detector to evaluate the measurement data. The auto peak detector determines the maximum and the minimum value of the measured levels for each measurement point and combines both values in one sample point.

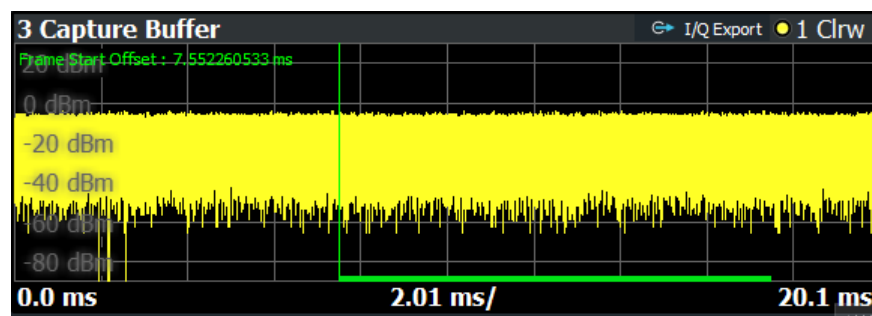

Figure 3-1: Capture buffer without zoom

A green bar at the bottom of the diagram represents the frame that is currently analyzed.

A green vertical line at the beginning of the green bar in the capture buffer represents the frame start. The diagram also contains the "Start Offset" value. This value is the time difference between the frame start and capture buffer start.

If you are using the [segmented capture](#), the capture buffer also contains blue vertical lines to indicate the beginning, the end and the length of a segment. In addition, the footer of the diagram shows the overall measurement time (in brackets) and the time of the displayed data. If the number of segments is > 100, only every other segment is indicated.

The header of the "Capture Buffer" result display contains an "I/Q Export" button that allows you to export I/Q data easily.

Remote command:

Selection: `LAY:ADD ? '1', LEFT, CBUF`

Query (y-axis): `TRACe:DATA?`

Query (x-axis): `TRACe<n> [:DATA] :X?` on page 313

Frame start offset: `FETCh [:CC<cc>] [:ISRC<ant>] [:FRAMe<fr>] :SUMMARY: FOFFset?` on page 260

### EVM vs Carrier

The "EVM vs Carrier" result display shows the error vector magnitude (EVM) of the subcarriers. With the help of a marker, you can use it as a debugging technique to identify any subcarriers whose EVM is too high.

The results are based on an average EVM that is calculated over the resource elements for each subcarrier. This average subcarrier EVM is determined for each analyzed slot in the capture buffer.

The contents of the result display depend on the [evaluation range](#).

- If you analyze all synchronization signals (SS) and bandwidth parts (BWP), the result display contains one trace for the [synchronization signal](#) and a variable number of traces that represent the [bandwidth parts](#). The traces show the average EVM of the corresponding signal part. The diagram header contains a legend that shows the information that each trace carries.
- If you analyze only the synchronization signal, one specific bandwidth part, or a single subframe, the diagram contains three traces. The traces show the following information.
  - The average subcarrier EVM over all slots in the selected signal part.
  - The lowest subcarrier EVM over all slots in the selected signal part.
  - The highest subcarrier EVM over all slots in the selected signal part.
- If you analyze only a single slot, the diagram contains one trace. That trace shows the subcarrier EVM for that slot only. Average, minimum and maximum values in that case are the same.

The x-axis represents the center frequencies of the subcarriers. The y-axis shows the EVM in % or in dB, depending on the [EVM Unit](#).

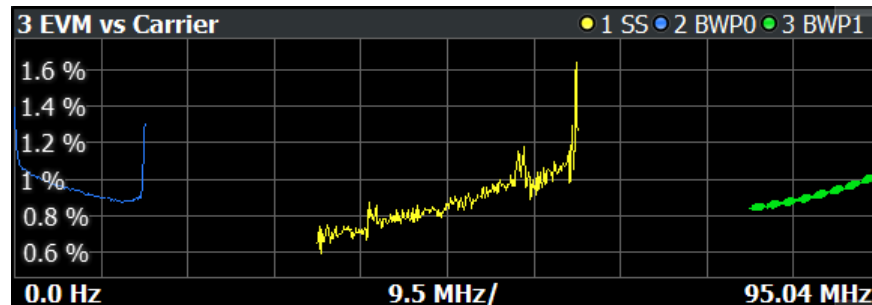

Remote command:

Selection `LAY:ADD ? '1', LEFT, EVCA`

Query (y-axis): `TRACe:DATA?`

Query (x-axis): `TRACe<n>[:DATA]:X?` on page 313

### EVM vs Symbol

The "EVM vs Symbol" result display shows the error vector magnitude (EVM) of the OFDM symbols. You can use it as a debugging technique to identify any symbols whose EVM is too high.

The results are based on an average EVM that is calculated over the resource elements for each subcarrier. This average subcarrier EVM is determined for each analyzed slot in the capture buffer.



The contents of the result display depend on the [evaluation range](#).

- If you analyze all synchronization signals (SS) and bandwidth parts (BWP), the result display contains one trace for the [synchronization signal](#) and a variable number of traces that represent the [bandwidth parts](#). The diagram header contains a legend that shows the information that each trace carries.
- If you analyze only the synchronization signal, one specific bandwidth part, a single subframe or a single slot, the diagram contains one trace. That trace shows the average EVM of the symbols in the selected signal part.

The x-axis represents the OFDM symbols, with each symbol represented by a dot on the line. Any missing connections from one dot to another mean that the FSW could not determine the EVM for that symbol.

On the y-axis, the EVM is plotted either in % or in dB, depending on the [EVM Unit](#).

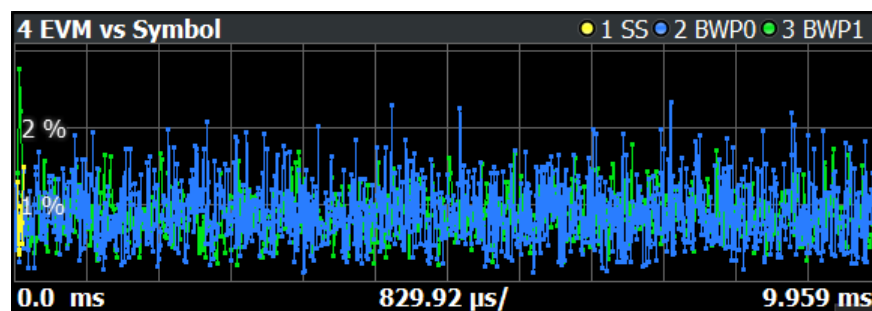

Remote command:

Selection: `LAY:ADD ? '1',LEFT,EVSY`

Query (y-axis): `TRACe:DATA?`

Query (x-axis): `TRACe<n> [:DATA] :X?` on page 313

### EVM vs RB

The "EVM vs RB" result display shows the Error Vector Magnitude (EVM) for all resource blocks that can be occupied by the PDSCH.

The contents of the result display depend on the [evaluation range](#).

- If you analyze all synchronization signals (SS) and bandwidth parts (BWP), the result display contains one trace for the [synchronization signal](#) and a variable number of traces that represent the [bandwidth parts](#). The traces show the average EVM of the corresponding signal part. The diagram header contains a legend that shows the information that each trace carries.
- If you analyze only the synchronization signal, one specific bandwidth part, or a single subframe, the diagram contains three traces. The traces show the following information.
  - The average subcarrier EVM over all slots in the selected signal part.
  - The lowest subcarrier EVM over all slots in the selected signal part.
  - The highest subcarrier EVM over all slots in the selected signal part.
- If you analyze only a single slot, the diagram contains one trace. That trace shows the subcarrier EVM for that slot only. Average, minimum and maximum values in that case are the same.

If you select and analyze one subframe only, the result display contains one trace that shows the resource block EVM for that subframe only. Average, minimum and maximum values in that case are the same. For more information, see "[Subframe Selection](#)" on page 215.

The x-axis represents the PDSCH resource blocks. On the y-axis, the EVM is plotted either in % or in dB, depending on the [EVM Unit](#).

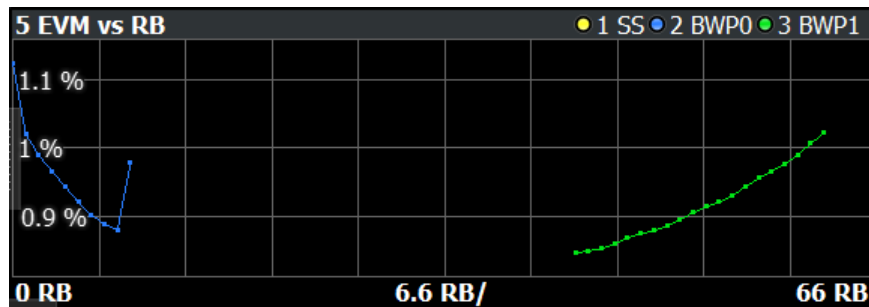

Remote command:

Selection: `LAY:ADD ? '1', LEFT, EVRB`

Query (y-axis): `TRACe:DATA?`

Query (x-axis): `TRACe<n> [:DATA] :X?` on page 313

### Frequency Error vs Symbol

The "Frequency Error vs Symbol" result display shows the frequency error of each symbol. You can use it as a debugging technique to identify any frequency errors within symbols.

The result is an average over all subcarriers in the symbol.

The contents of the result display depend on the [evaluation range](#).

- If you analyze all synchronization signals (SS) and bandwidth parts (BWP), the result display contains one trace for the [synchronization signal](#) and a variable number of traces that represent the [bandwidth parts](#). The diagram header contains a legend that shows the information that each trace carries.
- If you analyze only the synchronization signal, one specific bandwidth part, a single subframe or a single slot, the diagram contains one trace. That trace shows the average frequency error of the symbols in the selected signal part.

The x-axis represents the OFDM symbols, with each symbol represented by a dot on the line. The number of displayed symbols depends on the [subframe selection](#). Any missing connections from one dot to another mean that the FSW could not determine the frequency error for that symbol.

On the y-axis, the frequency error is plotted in Hz.

Note that the variance of the measurement results in this result display can be much higher compared to the frequency error display in the numerical result summary, depending on the PDSCH and control channel configuration. The potential difference is caused by the number of available resource elements for the measurement on symbol level.

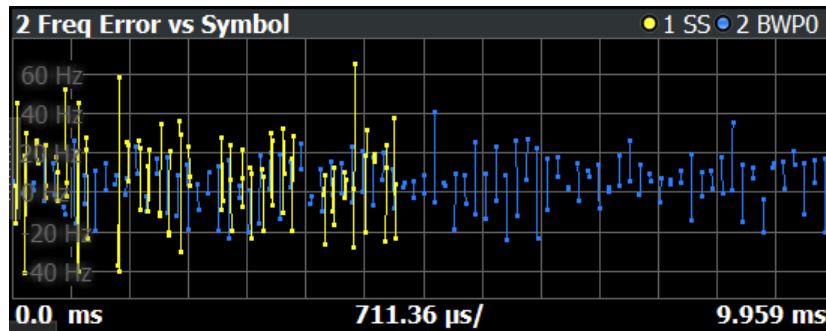

Remote command:

Selection: `LAY:ADD ? '1',LEFT,FEVS`

Query (y-axis): `TRACe:DATA?`

Query (x-axis): `TRACe<n>[:DATA]:X?` on page 313

### Frequency Error vs Subframe

The "Frequency Error vs Subframe" result display shows the frequency error of each subframe. You can use it as a debugging technique to identify any frequency errors among subframes.

The result is an average over all subcarriers and symbols of each subframe.

The contents of the result display depend on the [evaluation range](#).

- If you analyze all synchronization signals (SS) and bandwidth parts (BWP), the result display contains one trace for the [synchronization signal](#) and a variable number of traces that represent the [bandwidth parts](#). The diagram header contains a legend that shows the information that each trace carries.
- If you analyze only the synchronization signal or one specific bandwidth part, the diagram contains one trace. That trace shows the average frequency error of the subframes in the selected signal part. Selecting a specific subframe or slot from the evaluation range has no effects on the contents of the diagram.

The x-axis represents the subframes, with each of the nine subframes represented by a dot on the line.

On the y-axis, the frequency error is plotted in Hz.

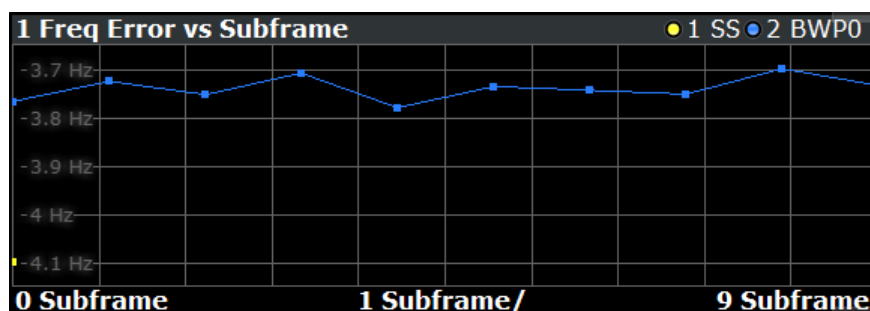

Remote command:

Selection: `LAY:ADD ? '1',LEFT,FEVS`

Query (y-axis): `TRACe:DATA?`

Query (x-axis): `TRACe<n>[:DATA]:X?` on page 313

### Power Spectrum

The "Power Spectrum" shows the power density of the complete capture buffer in dBm/Hz.

The displayed bandwidth depends on the [channel bandwidth](#).

The x-axis represents the frequency. On the y-axis, the power level is plotted.

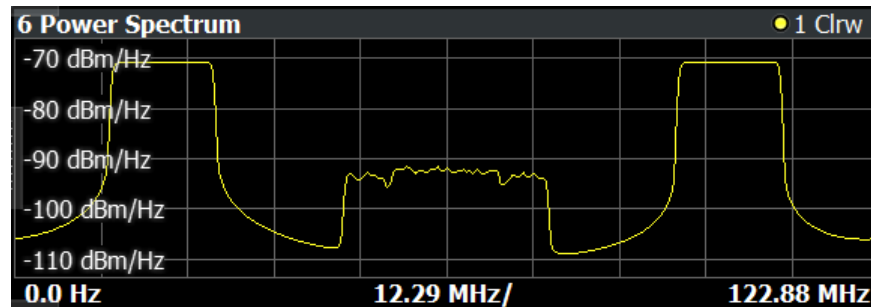

Remote command:

Selection: `LAY:ADD ? '1', LEFT, PSPE`

Query (y-axis): `TRACe:DATA?`

Query (x-axis): `TRACe<n>[:DATA]:X?` on page 313

### Flatness

The "Channel Flatness" result shows the relative power offset caused by the transmit channel for each subcarrier.

The contents of the result display depend on the [evaluation range](#).

- If you analyze all synchronization signals (SS) and bandwidth parts (BWP), the result display contains one trace for the [synchronization signal](#) and a variable number of traces that represent the [bandwidth parts](#). The traces show the average flatness of the corresponding signal part. The diagram header contains a legend that shows the information that each trace carries.
- If you analyze only the synchronization signal, one specific bandwidth part, a specific frame or a single subframe, the diagram contains three traces. The traces show the following information.
  - The average subcarrier flatness over all slots in the selected signal part.
  - The lowest subcarrier flatness over all slots in the selected signal part.
  - The highest subcarrier flatness over all slots in the selected signal part.
- If you analyze only a single slot, the diagram contains one trace. That trace shows the subcarrier flatness for that slot only. Average, minimum and maximum values in that case are the same.

The x-axis represents the frequency. On the y-axis, the channel flatness is plotted in dB.

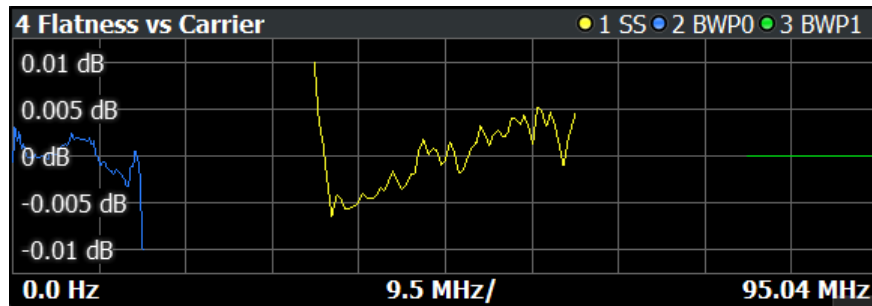

Remote command:

Selecting the result display: `LAY:ADD ? '1',LEFT,FLAT`

Querying results:

`TRACe:DATA?`

`TRACe<n>[:DATA]:X?` on page 313

### CCDF

The "Complementary Cumulative Distribution Function (CCDF)" shows the probability of an amplitude exceeding the mean power. For the measurement, the complete capture buffer is used.

The x-axis represents the power relative to the measured mean power. On the y-axis, the probability is plotted in %.

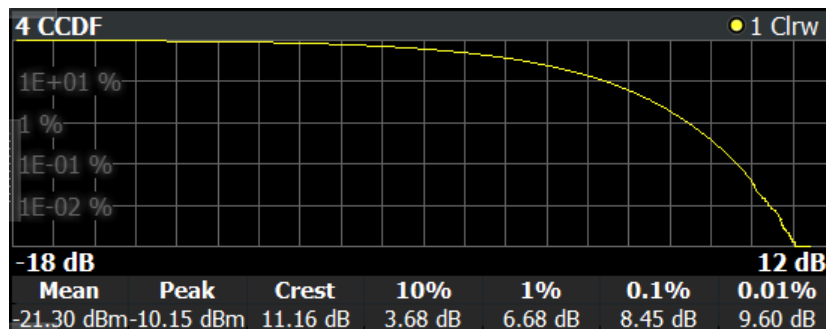

In addition to the diagram, the results for the CCDF measurement are summarized in the CCDF table.

<b>Mean</b>	Mean power
<b>Peak</b>	Peak power
<b>Crest</b>	Crest factor (peak power – mean power)
<b>10 %</b>	10 % probability that the level exceeds mean power + [x] dB
<b>1 %</b>	1 % probability that the level exceeds mean power + [x] dB
<b>0.1 %</b>	0.1 % probability that the level exceeds mean power + [x] dB
<b>0.01 %</b>	0.01 % probability that the level exceeds mean power + [x] dB

Remote command:

Selection: `LAY:ADD ? '1',LEFT,CCDF`

Query (y-axis): `TRACe:DATA?`

Numerical results: [CALCulate<n>:STATistics:CCDF:X<t>?](#) on page 275

Numerical results: [CALCulate<n>:STATistics:RESult<res>?](#) on page 275

### Constellation Diagram

The "Constellation Diagram" shows the in-phase and quadrature phase results and is an indicator of the quality of the modulation of the signal.

In the default state, the result display evaluates the full range of the measured input data.

If you apply a boosting factor to resources as required by 3GPP for certain test models, the constellation diagram excludes that boosting factor to display the constellation diagram points by default. To consider the boosting factor for the calculation of the constellation points, turn on the [corresponding parameter](#).

The color represent either the modulation type or the allocation type, depending on your selection. The color mapping for modulation is as follows. The color mapping for allocations is the same as in the [allocation ID vs symbol vs carrier](#) result display.

- ■ : RBPSK
- ■ : QPSK
- ■ : 16QAM
- ■ : 64QAM
- ■ : 256QAM
- ■ : 1024QAM

You can filter the results by changing the [evaluation range](#).

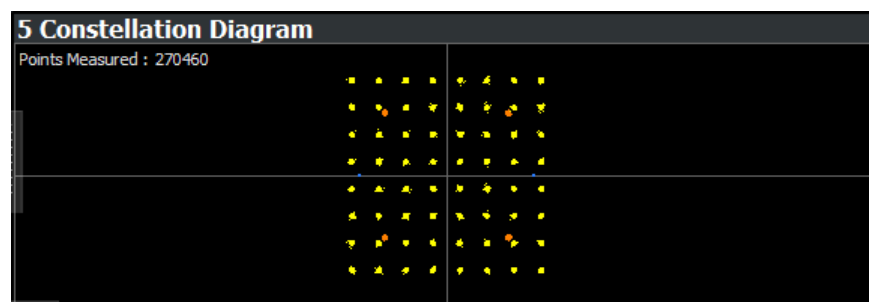

The constellation diagram shows the number of points that are displayed in the diagram.

Remote command:

Selection: [LAY:ADD ? '1', LEFT, CONS](#)

Query: [TRACe:DATA?](#)

### Allocation Summary

The "Allocation Summary" shows various parameters of the measured allocations in a table.

Each row in the allocation table corresponds to an allocation. A set of several allocations make up a slot. A horizontal line indicates the beginning of a new slot. Special allocations summarize the characteristics of all allocations in a bandwidth part ("BWP ALL") and the radio frame ("TOTAL ALL").

The "BWP ALL" and "TOTAL ALL" values are an average of all EVM values in the table. For example: (EVM PDSCH 1 + EVM PDSCH 2 + EVM PDSCH 3 + EVM DMRS) / 4. Each value has the same weight. Therefore, a fully loaded PDSCH across multiple symbols has the same weight as a single symbol DMRS.

1 Allocation Summary						
BWP/SF/Slot	Allocation ID	No of RBs	Rel Power [dB]	Modulation	Power per RE [dBm]	EVM [%]
SS / 1 / 3	PSS 6		0.000	RBPSK	-23.113	0.003
	SSS 6		0.000	RBPSK	-23.113	0.003
	PBCH 6		0.000	QPSK	-23.113	0.003
	PBCH DMRS 6		0.000	QPSK	-23.113	0.003
	PSS 7		0.000	RBPSK	-23.113	0.003
	SSS 7		0.000	RBPSK	-23.113	0.003
	PBCH 7		0.000	QPSK	-23.113	0.003
	PBCH DMRS 7		0.000	QPSK	-23.113	0.003
	BWP ALL	273				0.003
0 / 0 / 0	CORESET 0	270	0.000	QPSK	-23.113	0.003

The columns of the table show the following properties for each allocation.

- The location of the allocation (slot, subframe, bandwidth part number).
- The ID of the allocation (channel type).
- Number of resource blocks used by the allocation.
- The relative power of the allocation in dB.
- The modulation of the allocation.
- The power of each resource element in the allocation in dBm.
- The EVM of the allocation.

The unit depends on the [EVM unit](#)

Select "TableConfig" to open a dialog box that allows you to add and remove columns.

Remote command:

Selection: `LAY:ADD ? '1', LEFT, ASUM`

Query: `TRACe:DATA?`

### Channel Decoder Results

The "Channel Decoder" result display shows the characteristics of various channels in a specific subframe.

The size of the table thus depends on the number of subframes and the number of channels that were decoded.

The FSW can decode the following channels, if they are present.

- Protocol information of the PBCH.

2 Channel Decoder Results					
SUBF / SSB	Allocation ID	Data			
SUBF 0 / SSB 0	PBCH	SSBIndexExplicitFR2	1		
		HalfFrameIndex	secondHalf	systemFrameNumber	922
		sub-carrierOffset	8	dmrs-TypeA-Position	pos3
		cellBarred	not barred	intraFreqReselection	not allowe
SUBF 0 / SSB 1	PBCH	SSBIndexExplicitFR2	0		
		HalfFrameIndex	secondHalf	systemFrameNumber	403
		sub-carrierOffset	6	dmrs-TypeA-Position	pos2

For each channel type, the table contains a different set of values.

- PBCH

Information as defined in 3GPP 38.331, for example:

- The half frame index
- The system frame number
- The [subcarrier spacing](#)
- The [subcarrier offset](#)
- The [DMRS Type A position](#)

If the CRC is not valid, the FSW shows a corresponding message instead of the results.

- PDCCH

Information about the [DCI fields](#) in the signal as defined by 3GPP. This includes the field name and transmitted field values.

To decode the PDCCH, you have to demodulate the [decoded payload data](#).

Remote command:

Selecting the result display: `LAY:ADD ? '1',LEFT,CDEC`

Querying results: `TRACe:DATA?`

### Bitstream

The "Bitstream" shows the demodulated data stream for the data allocations.

Each row in the table corresponds to an allocation (PDSCH or CORESET). A set of several allocations make up a slot.

At the end of the table is a summary of the bitstream for certain configurations.

- Total number of bits or symbols
- Total number of coded bits
- Total number of bit errors
- Bit error rate (BER) in percent
- Bits per second (= coded bits - bit errors)

The totals are calculated over all PDSCH allocations that contribute to the bitstream. If the crc fails for one of the allocations, the FSW returns NAN for the total numbers.

The bitstream summary is displayed under the following conditions.

- Select an ORAN test case.  
The PDSCH [reference data](#) must be "ORAN PN23".
- Outside of ORAN test cases:  
Select PDSCH [reference data](#) = "All 0" or "PN23" or [demodulation data](#) = "Decoded Payload Data".

Depending on the [bitstream format](#), the numbers represent either bits (bit order) or symbols (symbol order).

- For the bit format, each number represents one raw bit.
- For the symbol format, the bits that belong to one symbol are shown as hexadecimal numbers with two digits.  
(1024QAM: hexadecimal number with three digits)

Resource elements that do not contain data or are not part of the transmission are represented by a "-".



BWP/Sf/Slot	Allocation ID	Code-word	Modulation	# Symbols	Bitstream
SS / 0 / 0	PBCH 0	1/1	QPSK	432	02 01 03 00 03 02 00 02 02
SS / 0 / 0	PBCH 1	1/1	QPSK	432	02 01 01 03 03 00 03 03 00
0 / 0 / 0	PDSCH 0	1/1	QPSK	39990	00 02 03 01 00 00 01 00 02
0 / 0 / 1	PDSCH 0	1/1	QPSK	40050	02 03 01 00 02 03 01 00 02

The table contains the following information:

- BWP / Sf / Slot**  
 Number of the bandwidth part, subframe and slot the bits belong to.
- Allocation ID**  
 Channel the bits belong to.  
 This is either a PDSCH, PDCCH or PBCH allocation.  
 If you [bundle PDSCH allocations](#), a row combines the information for all allocations with the same user ID.
- Codeword**  
 Code word of the allocation.
- Modulation**  
 Modulation type of the channels.
- # Symbols / # Bits**  
 Number of symbols in the allocation.
- Bit Stream**  
 The actual bit stream.  
 The table only shows the first few bits for each slot. If you want to see the complete bitstream, you have to select a certain bandwidth part, subframe and slot from the [evaluation range](#). When you have done that, you can select "Extended" bitstream from the header row.

# Symbols	Bitstream [Extended]   [Compact]
3756	00 00 00 00 00 00 00 00 00 00 00 00 00 00 00 00 ...

Symbol Index	Bitstream [Extended]   Compact
0	00 00 00 00 00 00 00 00 00 00 00 00 00 00 00 00
16	00 00 00 00 00 00 00 00 00 00 00 00 00 00 00 00
32	00 00 00 00 00 00 00 00 00 00 00 00 00 00 00 00
48	00 00 00 00 00 00 00 00 00 00 00 00 00 00 00 00
64	00 00 00 00 00 00 00 00 00 00 00 00 00 00 00 03
80	00 00 00 00 00 00 00 00 00 00 00 00 00 00 00 00
96	00 00 00 00 00 00 00 00 00 00 00 00 00 00 00 00

Figure 3-2: Compact vs extended bitstream (symbol format for coded data)

In the extended display, the "# Symbols" / "# Bits" column turns into the "Bit Index" or "Symbol Index" column, which indicates the position of the table row's first bit or symbol within the complete stream.

If you decode the payload data, the FSW shows the number of coded bits (# symbols \* Number of bits per symbol) and the number of bit errors at the end of the bitstream. The number of info bits transmitted by the PDCCH is displayed in a dedicated column ("# Bits").

Remote command:

Selection: `LAY:ADD ? '1',LEFT,BSTR`

Query: `TRACe:DATA?`

### EVM vs Symbol x Carrier

The "EVM vs Symbol x Carrier" result display shows the EVM for each carrier in each symbol.

The x-axis represents the symbols. The y-axis represents the subcarriers. Different colors in the diagram area represent the EVM. A color map in the diagram header indicates the corresponding power levels.

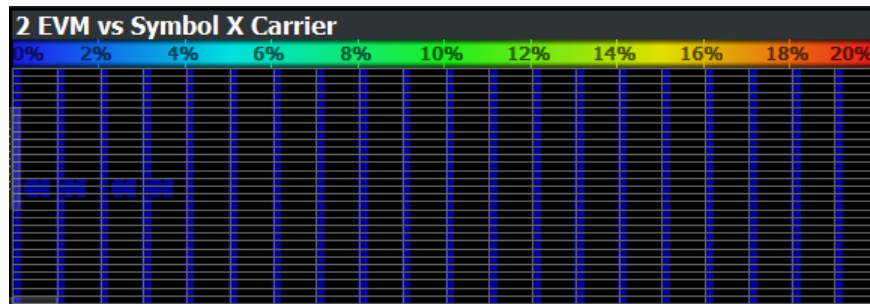

Remote command:

Selection: `LAY:ADD ? '1',LEFT,EVSC`

Query: `TRACe:DATA?`

### Power vs Symbol x Carrier

The "Power vs Symbol x Carrier" result display shows the power for each carrier in each symbol.

The x-axis represents the symbols. The y-axis represents the subcarriers. Different colors in the diagram area represent the power. A color map in the diagram header indicates the corresponding power levels.

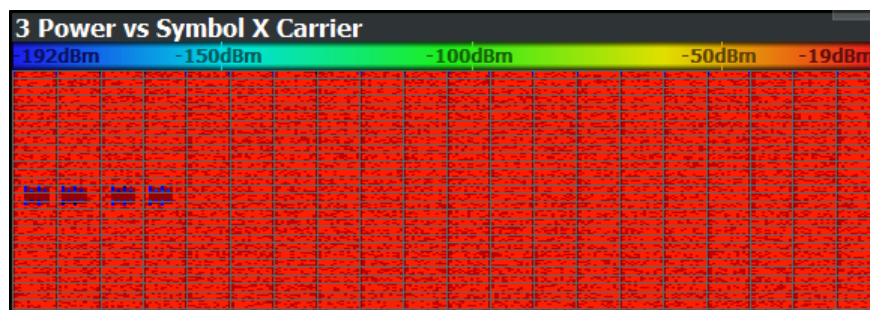

Remote command:

Selection: `LAY:ADD ? '1',LEFT,PVSC`

Query: `TRACe:DATA?`







### Allocation ID vs Symbol x Carrier

The "Allocation ID vs Symbol x Carrier" result display is a graphical representation of the structure of the analyzed frame. It shows the allocation type of each subcarrier in each symbol of the received signal.

The x-axis represents the OFDM symbols. The y-axis represents the subcarriers.

Each type of allocation is represented by a different color. The legend above the diagram indicates the colors used for each allocation. You can also use a marker to get more information about the type of allocation.

The color mapping is as follows.

- : PDSCH allocations
- : CORESET allocations
- : DMRS allocations (PBCH, CORESET, PDSCH)
- : PTRS allocations
- : CSI-RS and PRS allocations
- : Synchronization signal allocations (PSS, SSS, PBCH)

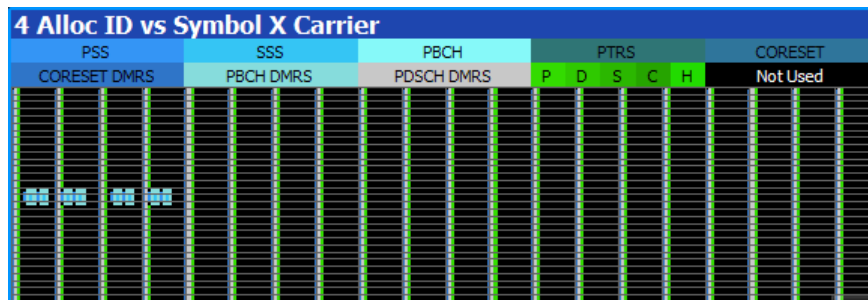

Remote command:

Selection: `LAY:ADD ? '1',LEFT,AISC`

Query: `TRACe:DATA?`

### RS Magnitude

The "RS Magnitude" result display shows the magnitude of the carriers occupied by various reference signals (PDSCH, PDCCH etc.) on different antenna ports (AP).

The contents of the result display depend on the [evaluation range](#).

- If you analyze all antenna ports, the result display contains one trace for each antenna port. The traces show the average magnitude of the corresponding antenna port. The diagram header contains a legend that shows the information that each trace carries.
- If you analyze a specific antenna port, the diagram contains three traces.
  - The average magnitude over all slots on the selected antenna port.
  - The lowest magnitude over all slots on the selected antenna port.
  - The highest magnitude over all slots on the selected antenna port.
- If you analyze only a single slot, the diagram contains one trace. That trace shows the magnitude for that slot only. Average, minimum and maximum values in that case are the same.

The x-axis represents the frequency, with the unit depending on your [selection](#). The y-axis shows the magnitude of each antenna port in dB.

Because the beamforming configuration can change between the slots of one frame, the contents of this result display for [Slot Selection](#) = 'All' might be invalid. Thus, it is recommended to select the precise slot to be evaluated in order to get valid results.

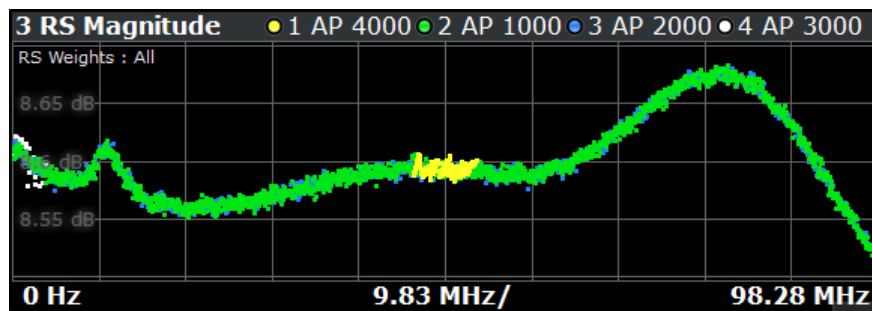

Remote command:

Selection: `LAY:ADD ? '1',LEFT,RSMA`

Query: `TRACe:DATA?`

### RS Phase

The "RS Phase" result display shows the phase of the carriers occupied by various reference signals (PDSCH, PDCCH etc.) on different antenna ports (AP).

The contents of the result display depend on the [evaluation range](#).

- If you analyze all antenna ports, the result display contains one trace for each antenna port. The traces show the average phase of the corresponding antenna port. The diagram header contains a legend that shows the information that each trace carries.
- If you analyze a specific antenna port, the diagram contains three traces.
  - The average phase over all slots on the selected antenna port.
  - The lowest phase over all slots on the selected antenna port.
  - The highest phase over all slots on the selected antenna port.
- If you analyze only a single slot, the diagram contains one trace. That trace shows the phase for that slot only. Average, minimum and maximum values in that case are the same.

The x-axis represents the frequency, with the unit depending on your [selection](#). The y-axis shows the phase of each antenna port in degrees.

Because the beamforming configuration can change between the slots of one frame, the contents of this result display for [Slot Selection](#) = 'All' might be invalid. Thus, it is recommended to select the precise slot to be evaluated in order to get valid results.

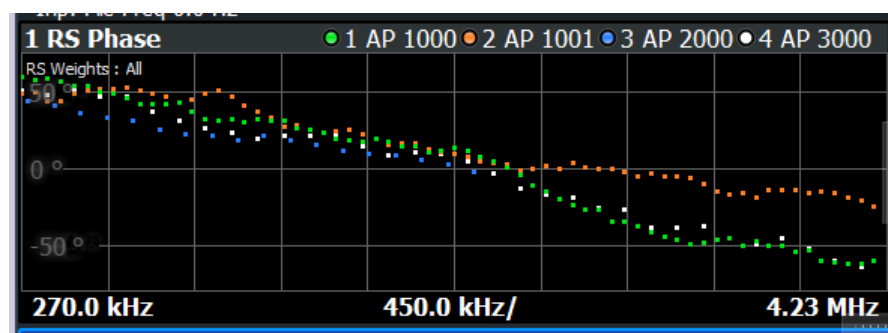

Remote command:

Selection: `LAY:ADD ? '1',LEFT,RSWP`

Query: `TRACe:DATA?`

### RS Phase Difference

The "RS Phase Difference" result display shows the phase difference of different antenna ports (AP) relative to a [reference antenna port](#).

The contents of the result display depend on the [evaluation range](#).

- If you analyze all antenna ports, the result display contains one trace for each antenna port (but not the reference antenna port). The traces show the average phase deviation of the corresponding antenna port to the reference antenna port. The diagram header contains a legend that shows the information that each trace carries.
- If you analyze a specific antenna port, the diagram contains three traces.
  - The average phase deviation over all slots on the selected antenna port.
  - The lowest phase deviation over all slots on the selected antenna port.
  - The highest phase deviation over all slots on the selected antenna port.
- If you analyze only a single slot, the diagram contains one trace. That trace shows the phase deviation for that slot only. Average, minimum and maximum values in that case are the same.

The x-axis represents the frequency, with the unit depending on your [selection](#). The y-axis shows the phase deviation of each evaluated antenna port in degrees.

Because the beamforming configuration can change between the slots of one frame, the contents of this result display for [Slot Selection](#) = 'All' might be invalid. Thus, it is recommended to select the precise slot to be evaluated in order to get valid results.

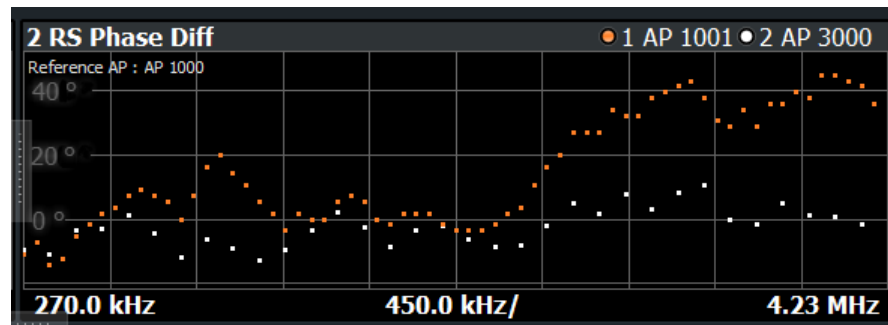

Remote command:

Selection: `LAY:ADD ? '1',LEFT,RSWP`

Query: `TRACe:DATA?`

### Beamforming Summary

The "Beamforming Summary" shows the phase characteristics for each allocation used by the UE-specific reference signals (PDSCH, CORESET, CSI-RS etc.) in numerical form.

2 Beamforming Summary				
BWP/Sf/Slot	Allocation Type	Antenna Port	Phase [°]	Phase Diff [°]
0 / 0 / 0	PDSCH	AP 1000	0.000	
	CORESET	AP 2000	-134.124	-134.124
0 / 0 / 1	PDSCH	AP 1000	-0.000	
	CORESET	AP 2000	59.630	59.630
0 / 1 / 2	PDSCH	AP 1000	0.000	
	CORESET	AP 2000	-1068.054	-708.054

The rows in the table represent the allocation types. A set of allocations forms a slot. The slots are separated by a line. The columns of the table contain the following information:

- **BWP / SF / Slot**  
Shows the location of the allocation (bandwidth part - subframe - slot).
- **Allocation Type**  
Shows the type of the allocation.
- **Antenna Port**  
Shows the antenna port used by the allocation.
- **Phase**  
Shows the phase of the allocation in degrees.
- **Phase Diff(erence)**  
Shows the phase difference of the allocation relative to the [reference antenna port](#).
- **Average RS Weights**  
Shows the average [magnitude](#) of the weighted reference signal carriers in dB.
- **Rel Power**  
Shows the power of each antenna port relative to the [reference AP](#) defined for the corresponding slot.  
The relative power in combination with the phase difference allows you to calculate the beamforming.

Remote command:

Selection: `LAY:ADD ? '1',LEFT,BSUM`

Query: `TRACe:DATA?`

### Marker Table

Displays a table with the current marker values for the active markers.

This table is displayed automatically if configured accordingly.

<b>Wnd</b>	Shows the window the marker is in.
<b>Type</b>	Shows the marker type and number ("M" for a normal marker, "D" for a delta marker).
<b>Trc</b>	Shows the trace that the marker is positioned on.
<b>Ref</b>	Shows the reference marker that a delta marker refers to.

<b>X- / Y-Value</b>	Shows the marker coordinates (usually frequency and level).
<b>Z-EVM</b>	Shows the "EVM", power and allocation type at the marker position. Only in 3D result displays (for example "EVM vs Symbol x Carrier").
<b>Z-Power</b>	
<b>Z-Alloc ID</b>	

5 Marker Table	
<b>2 - M1</b>	
Trace	1
X-value	<b>Symbol 84</b>
Y-value	<b>Carrier 14</b>
Z-EVM	<b>772.99 %</b>
Z-Power	<b>-47.12 dBm</b>
Z-Alloc ID	<b>PHICH</b>
<b>4 - M1</b>	
Trace	1
X-value	<b>-495.000 kHz</b>
Y-value	<b>0.32 dB</b>

**Tip:** To navigate within long marker tables, simply scroll through the entries with your finger on the touchscreen.

Remote command:

LAY:ADD? '1', RIGH, MTAB, see [LAYout:ADD\[:WINDow\]?](#) on page 233

Results:

[CALCulate<n>:MARKer<m>:X](#) on page 273

[CALCulate<n>:MARKer<m>:Y](#) on page 273

[CALCulate<n>:MARKer<m>:Z?](#) on page 274

[CALCulate<n>:MARKer<m>:Z:ALL?](#) on page 274

## 3.7 Time alignment error

**Access:** [MEAS] > "Time Alignment Error"

The time alignment error measurement captures the signal from different antenna ports and calculates the time offset between a reference antenna port and another antenna port(s).

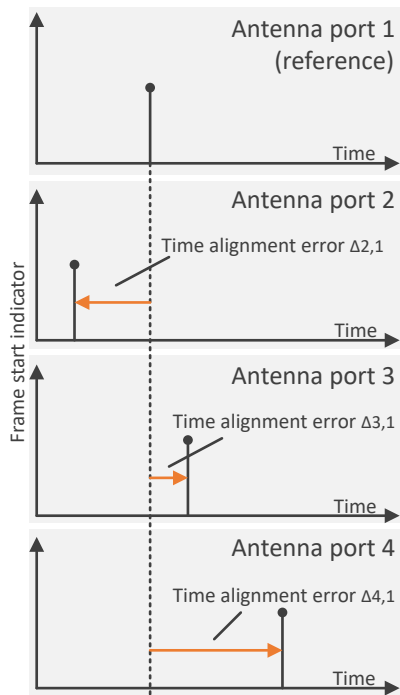

**Figure 3-3: Time alignment error measurement (4 antenna ports)**

Note that the measurement only works if you are analyzing [multiple layers](#) (antenna ports). Therefore, you have to mix the signals into one cable that you can connect to the FSW.

### Test setup

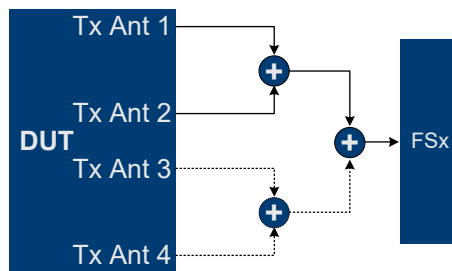

**Figure 3-4: Hardware setup**

The dashed lines are optional connections, and only necessary if you measure more than two antenna ports. For most accurate measurement results, we recommend to use cables of the same length and identical combiners as adders.

In addition to the result displays mentioned in this section, the time alignment error measurement also supports the following result displays described elsewhere.

- ["Capture Buffer"](#) on page 31
- ["Power Spectrum"](#) on page 36
- ["Marker Table"](#) on page 46



In the default layout, the application shows the "Time Alignment Error", "Capture Buffer" and "Power Spectrum" result displays.

The remote commands required to configure the time alignment error measurement are described in [Chapter 6.10.31, "Time alignment measurement"](#), on page 459.

Remote command:

Measurement selection: `CONFigure[:NR5G]:MEASurement` on page 314

Result display selection: `LAYout:ADD[:WINDow]?` on page 233

[Time Alignment Error](#)..... 49

### Time Alignment Error

The time alignment is an indicator of how well the transmission antennas or antenna ports in a MIMO system and between component carriers are synchronized. The time alignment error is the time delay between a reference antenna port and another antenna port. The reference is [antenna port 1000](#). For measurements on multiple carriers, the reference is antenna port 1000 of the first component carrier.

As AP1000 is the reference antenna port, it must be sent. Otherwise result are invalid.

The application shows the results in a table.

- For single carrier MIMO measurements, each row in the table represents one antenna port.
- For multi carrier measurements, each row in the table represents one antenna port for each carrier.

The number of rows therefore depends on the [number of carriers](#) and the [PDSCH antenna port configuration](#).

The reference antenna port is not shown in the table (all results would be "0").

For each antenna, the maximum, minimum and average time delay that has been measured is shown. The minimum and maximum results are calculated only if the measurement covers more than one frame.

In any case, results are only displayed if the transmission power of both antennas ports is within 15 dB of each other. Likewise, if only one antenna transmits a signal, results will not be displayed (for example if the cabling on one antenna is faulty).

The "Limit" value shown in the result display is the maximum time delay that may occur for each antenna (only displayed for systems without carrier aggregation).

You can define a custom limit for the time alignment error. For more information, see [Chapter 3.11, "Reference: custom limits"](#), on page 67.

2 Time Alignment Error			
Limit : 90 ns			
Time Alignment Error to Antenna Port 1000			
Antenna Port	Min	Mean	Max
AP 1001	2.60 ns	2.60 ns	2.60 ns
AP 1002	5.21 ns	5.21 ns	5.21 ns
AP 1003	7.81 ns	7.81 ns	7.81 ns
AP 1006	15.63 ns	15.63 ns	15.63 ns

Remote command:

Measurement selection: `LAY:ADD ? '1',LEFT,TAL`

Result query: `FETCh:TAERror[:CC<cc>]:AP<ap>[:AVERage]?` on page 271

### 3.8 Transmit on / off power measurement

The technical specification in 3GPP 38.141-1 / -2 describes the measurement of the transmitter "off" power and the transmitter transient period of a base transceiver station (BTS) transmitting a TDD signal and operating at its rated output power.

This measurement requires a special hardware setup. During the "off" periods (the interesting parts of the signal for this measurement), the signal power is very low - measuring such low powers requires a low attenuation at the RF input. On the other hand, the signal power is very high during the transmitter "on" periods - in fact the signal power is usually higher than the maximum allowed RF input level. Measuring high signal levels requires an appropriate test setup as described below.

#### NOTICE

##### Risk of instrument damage

The signal power during the "on" periods in this test scenario is usually higher than the maximum power allowed at the RF input of a spectrum analyzer.

Make sure to set up the measurement appropriately. Not doing so can cause severe damage to the spectrum analyzer.

##### Test setup

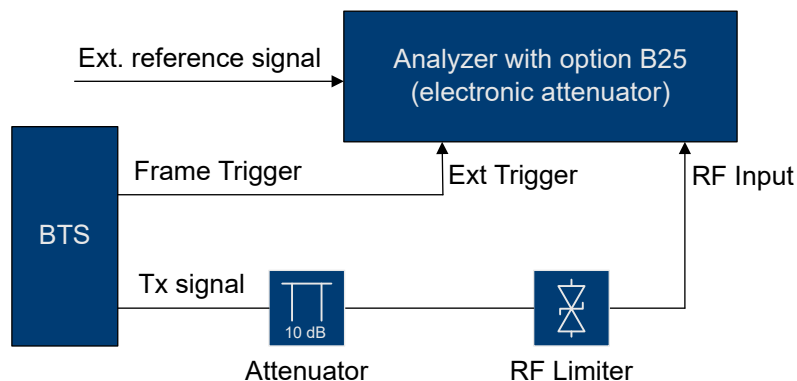

Figure 3-5: Test setup for transmit on / off power measurement

- Connect an RF limiter to the RF input to protect the RF input from damage. [Table 3-1](#) shows the specifications that the limiter has to fulfill.
- Insert an additional 10 dB attenuator in front of the RF limiter to absorb possible reflected waves (because of the high VSWR of the limiter). The maximum allowed CW input power of the attenuator must be higher than the maximum output power of the BTS.

**Table 3-1: Specifications of the RF limiter in the test setup**

Min. acceptable CW input power	BTS output power minus 10 dB
Min. acceptable peak input power	BTS peak output power minus 10 dB
Max. output leakage	20 dBm
Max. response time	1 µs
Max. recovery time	1 µs

### Measuring the on / off power

If you are using an external trigger, you have to [adjust the timing](#) before you can start the actual measurement.

The status message in the diagram header shows if timing adjustment is required or not. After timing was successfully adjusted, you can start the measurement. Note that relevant changes of settings might require another timing adjustment.

If timing adjustment fails for any reason, the application shows a corresponding message in the diagram header. To find out what causes the synchronization failure, we recommend to perform a regular [EVM measurement](#). Then you can use all the measurement results like "EVM vs Carrier" to get more detailed information about the failure. The timing adjustment will succeed if the synchronization state in the header is OK.

Select "Run Single" to start the measurement. The number of measurements that trace averaging is based on depends on the [number of frames](#) you have defined. When all measurements are done, the FSW indicates if the measurement has failed or passed.

The remote commands required to measure the transmit on / off power are described in [Chapter 6.10.32, "Transmit on/off power measurements"](#), on page 459.

Remote command:

Measurement selection: `CONFigure[:NR5G]:MEASurement` on page 314

Result display selection: `LAYout:ADD[:WINDow]?` on page 233

<a href="#">Transmit On / Off Power</a> .....	51
L <a href="#">Numerical results</a> .....	52
L <a href="#">Transmit power on / off diagram</a> .....	53
L <a href="#">Transition diagram</a> .....	54
L <a href="#">Adjust Timing</a> .....	54
L <a href="#">Noise Cancellation</a> .....	54

### Transmit On / Off Power

The transmit on / off power measurement analyzes the transition from transmission ("on" periods) to reception ("off" periods) of an 5G NR TDD signal over time. Because this transition must happen very fast to use resources efficiently, it can be an issue in TDD systems.

During the transmit power on / off measurement, the FSW verifies if the "off" periods (= no signal transmission) comply to the limits defined by 3GPP. Note that you have to apply a signal to the RF input for this measurement, because the FSW has to capture new I/Q data instead of using the data other I/Q measurements are based on.

The results for the transmit on / off power measurement are available in the following displays.

- "Numerical results" on page 52
- "Transmit power on / off diagram" on page 53
- "Transition diagram" on page 54

Remote command:

Selection: `CONFigure[:NR5G]:MEASurement` on page 314

Selection (transition period): `DISPlay[:WINDow<n>]:TPOO:PERiod:SElect` on page 461

Query: `TRACe:DATA?`

Unit: `UNIT:OPower` on page 462

### Numerical results ← Transmit On / Off Power

The result summary shows the measurement results in a table. Each line in the table corresponds to one "off" period.

The result summary shows the following information for each "off" period.

- "Start Off Period Limit"
 

Shows the beginning of the "off" period relative to the frame start (0 seconds).
- "Stop Off Period Limit"
 

Shows the end of the "off" period relative to the frame start (0 seconds).  
The time from the start to the stop of the "off" period is the period over which the limits are checked. It corresponds to the yellow trace in the diagram.
- "Time at  $\Delta$  to Limit"
 

Shows the trace point at which the lowest distance between trace and limit line has been detected. The result is a time relative to the frame start.
- "OFF Power"
 

Shows the absolute power of the signal at the trace point with the lowest distance to the limit line.  
You can display the "OFF Power" either as an absolute value in dBm or a relative value in dBm/MHz. To select the unit, use the "Power Unit (dBm/MHz)" softkey available in the "Meas Config" menu.
- "OFF Power  $\Delta$  to Limit"
 

Shows the distance between the trace and the limit line of the trace point with the lowest distance to the limit line in dB.
- "Falling Transition Period"
 

Shows the length of the falling transient.
- "Rising Transition Period"
 

Shows the length of the rising transient.

Results that comply with the limits are displayed in green. Any results that violate the limits defined by 3GPP are displayed in red.

6 Transmit ON/OFF Power List						
Start OFF Period Limit	Stop OFF Period Limit	Time at $\Delta$ to Limit	OFF Power Abs [dBm]	OFF Power $\Delta$ to Limit	Falling Trans Period	Rising Trans Period
1.267 ms	4.948 ms	4.786523 ms	-92.41 dBm	17.41 dB	2.73 $\mu$ s	2.80 $\mu$ s
6.267 ms	9.948 ms	8.799381 ms	-92.32 dBm	17.32 dB	2.73 $\mu$ s	2.77 $\mu$ s

Note that the beginning and end of a transition period is determined based on the "Off Power Density Limit". This limit is defined in 3GPP 38.141-1 / -2 as the maximum allowed mean power spectral density. The length of the transient from "on" to "off" period is, for example, the distance from the detected end of the subframe to the last time that the signal power is above the measured mean power spectral density.

You can define a custom limit for the off power density. For more information, see [Chapter 3.11, "Reference: custom limits"](#), on page 67.

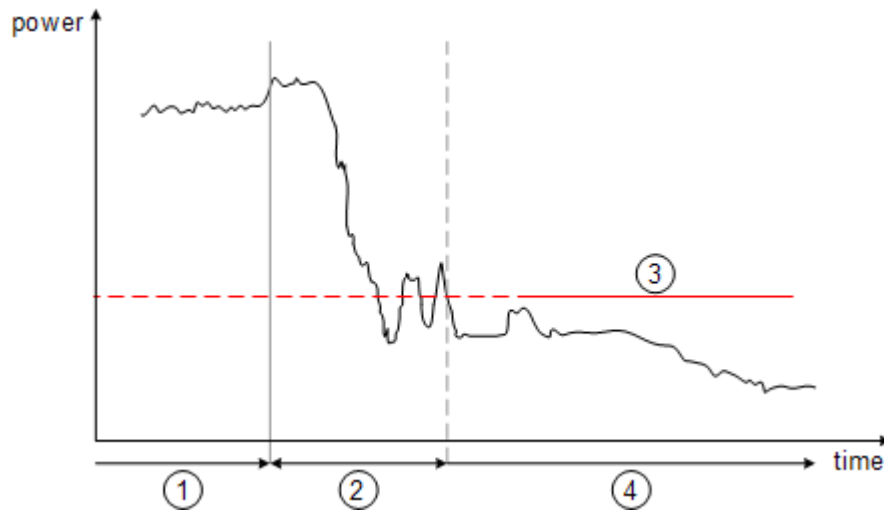

**Figure 3-6: Power profile of a TD-LTE On-to-Off transition. The transition lasts from the end of the ON period until the signal is completely below the off power density limit.**

- 1 = subframe ("on" power period)
- 2 = transient (transition length)
- 3 = "off" power density limit
- 4 = "off" power period

#### Transmit power on / off diagram ← Transmit On / Off Power

The diagram shows all TDD frames that were captured and analyzed and contains several elements.

- Yellow trace
  - The yellow trace represents the signal power during the "off" periods. The calculation of the trace also accounts for filtering as defined in 3GPP 38.141-1 / -2.
- Blue trace
  - The blue trace represents the transition periods (falling and rising).
  - Note that the blue trace might not be visible in the diagram because of its steep flank and small horizontal dimensions. You can see the falling and rising transitions in [separate diagrams](#).
- Blue rectangles
  - The blue rectangles represent the "on" periods. Because of the overload during the "on" periods, the actual signal power is only hinted at, not shown.
- Red lines
  - Limits as defined by 3GPP.
- Other information
  - In addition to these elements, the diagram also shows the overall limit check, the average count and the limit for the mean power spectral density ("Off Power Density Limit").
  - The overall limit check only passes if all "off" periods (including the transients) comply with the limits.

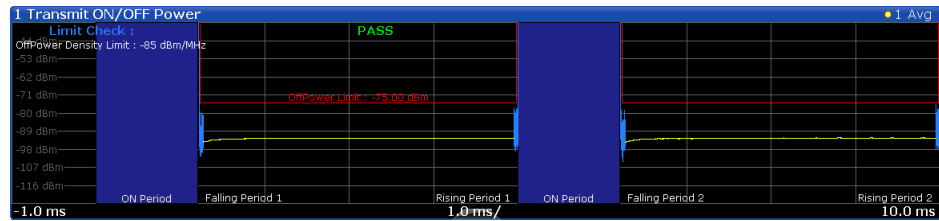

### Transition diagram ← Transmit On / Off Power

The transition diagrams show the rising and falling periods for each TDD frame in more detail.

The maximum number of transitions you can display depends on the slot configuration. When you add a "Falling Period" or "Rising Period" to the diagram area, you can select the period you want to analyze from a dropdown menu in the header of the result display. By default, the FSW shows two periods.

Alternatively, you can configure these diagrams via the "Evaluation Range" dialog box.

The diagrams contain the following elements.

- Blue trace  
The blue trace represents the transition periods (falling and rising).
- Red lines  
Limits as defined by 3GPP.

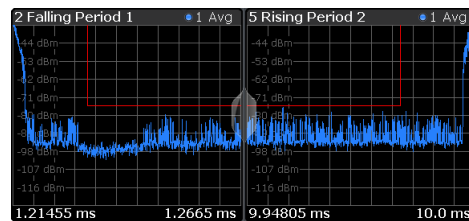

### Adjust Timing ← Transmit On / Off Power

**Access:** [Sweep] > "Adjust Timing"

If you are using an external trigger for the on / off power measurement, you have to determine the offset of the trigger time to the time the 5G NR frame starts. You can do this with the "Adjust Timing" function. When the application has determined the offset, it corrects the results of the on / off power measurement accordingly.

Adjust timing also captures data with a reference level optimized for the "on" period to increase the probability for successful synchronization.

Remote command:

[\[SENSe:\]NR5G:OOPower:ATIMing](#) on page 462

### Noise Cancellation ← Transmit On / Off Power

**Access:** [Meas Config] > "Noise Cancellation"

Noise cancellation corrects the results by removing the inherent noise of the analyzer, which increases the dynamic range. To do this, the FSW measures its inherent noise and subtracts the measured noise power from the power in the channel that is being analyzed.

Noise cancellation is valid for the current measurement configuration. If you change the measurement configuration in any way, you have to repeat noise cancellation.

Remote command:

[\[SENSe:\]NR5G:OOPower:NCORrection](#) on page 462

### 3.9 Frequency sweep measurements

**Access (ACLR):** [MEAS] > "Channel Power ACLR"

**Access (MC ACLR):** [MEAS] > "Multi Carrier ACLR"

**Access (Cumulative ACLR):** [MEAS] > "Cumulative ACLR"

**Access (SEM):** [MEAS] > "Spectrum Emission Mask"

**Access (Multi Carrier SEM):** [MEAS] > "Multi Carrier SEM"

The 5G NR application supports the following frequency sweep measurements.

- Adjacent channel leakage ratio (ACLR)
- Spectrum emission mask (SEM)

Instead of using I/Q data, the frequency sweep measurements sweep the spectrum every time you run a new measurement. Therefore, it is mandatory to feed a signal into the RF input for these measurements. Using previously acquired I/Q data for the frequency sweep measurements is not possible (and vice-versa).

Because each of the frequency sweep measurements uses different settings to obtain signal data it is also not possible to run a frequency sweep measurement and view the results in another frequency sweep measurement.

Make sure to have sufficient bandwidth to be able to capture the whole signal, including neighboring channels.

Features of the frequency sweep measurements:

- SEM measurements use the FFT sweep type by default. For more information, see the FSW user manual.

In addition to the specific diagrams and table (see description below), frequency sweep measurements support the following result displays.

- ["Marker Table"](#) on page 46
- Marker peak list  
Both result displays have the same contents as the spectrum application.

Remote command:

Measurement selection: [CONFigure\[:NR5G\]:MEASurement](#) on page 314

Result display selection: [LAYout:ADD\[:WINDow\]?](#) on page 233

<a href="#">Adjacent Channel Leakage Ratio (ACLR)</a> .....	56
L <a href="#">Result diagram</a> .....	56
L <a href="#">Result summary</a> .....	56
<a href="#">Multi Carrier ACLR (MC ACLR)</a> .....	57
L <a href="#">Result diagram</a> .....	57
L <a href="#">Result summary</a> .....	58
<a href="#">Cumulative ACLR</a> .....	59

L Result diagram.....	59
L Result summary.....	60
Spectrum Emission Mask (SEM).....	61
L Result diagram.....	61
L Result summary.....	62
Marker Peak List.....	62

### Adjacent Channel Leakage Ratio (ACLR)

The adjacent channel leakage ratio (ACLR) measurement is designed to analyze signals that contain multiple signals for different radio standards. Using the ACLR measurement, you can determine the power of the transmit (Tx) channel and the power of the neighboring (adjacent) channels to the left and right of the Tx channel. Thus, the ACLR measurement provides information about the power in the adjacent channels as well as the leakage into these adjacent channels.

When you measure the ACLR in the 5G NR application, the FSW automatically selects appropriate ACLR settings based on the selected channel bandwidth.

For a comprehensive description of the ACLR measurement, refer to the user manual of the FSW.

Remote command:

Selection: [CONFigure \[:NR5G\] :MEASurement](#) on page 314

### Result diagram ← Adjacent Channel Leakage Ratio (ACLR)

The result diagram is a graphic representation of the signals with a trace that shows the measured signal. Individual channels (Tx and adjacent channels) are indicated by vertical lines and corresponding labels.

In addition, the FSW highlights the channels (blue: Tx channel, green: adjacent channels).

The x-axis represents the frequency with a frequency span that relates to the specified 5G NR channel and adjacent channel bandwidths. On the y-axis, the power is plotted in dBm.

The power for the Tx channel is an absolute value in dBm. The power of the adjacent channels is relative to the power of the Tx channel.

In addition, the FSW tests the ACLR measurement results against the limits defined by 3GPP.

Remote command:

Result query: [TRACe:DATA?](#)

### Result summary ← Adjacent Channel Leakage Ratio (ACLR)

The result summary shows the signal characteristics in numerical form. Each row in the table corresponds to a certain channel type (Tx, adjacent channel). The columns contain the channel characteristics.

- **Channel**  
Shows the channel type (Tx, adjacent or alternate channel).
- **Bandwidth**  
Shows the channel bandwidth.
- **Offset**  
Shows the channel spacing.



- **Power**  
Shows the power of the Tx channel.
- **Lower / Upper**  
Shows the relative power of the lower and upper adjacent and alternate channels. The values turn red if the power violates the limits. Depending on the [evaluation logic](#), the FSW shows either the absolute power in dBm, the relative power in dBc or both power values. The overall limit check passes or fails depending on your selected evaluation logic. The end result of the limit check is displayed in the table header.

Remote command:

Result query: `CALCulate<n>:MARKer<m>:FUNction:POWer<sb>:RESult[:CURRent]?`

Result query details: `CALCulate<n>:MARKer<m>:FUNction:POWer<sb>:RESult:DEtails` on page 310

Limit check: `CALCulate<n>:LIMit<li>:FAIL?` on page 289

Limit check absolute: `CALCulate<n>:LIMit<li>:ACPoweR:ACHannel:RESult:ABSolute` on page 283

Limit check relative: `CALCulate<n>:LIMit<li>:ACPoweR:ACHannel:RESult:RELative` on page 283

### Multi Carrier ACLR (MC ACLR)

The MC ACLR measurement is basically the same as the [Adjacent Channel Leakage Ratio \(ACLR\)](#) measurement: it measures the power of the transmission channels and neighboring channels and their effect on each other. Instead of measuring a single carrier, the MC ACLR measures several component carriers and the gaps in between. The component carriers do not necessarily have to be next to each other.

In its default state, the MC ACLR measurement measures two neighboring channels above and below the carrier.

Note that you can configure a different neighboring channel setup with the tools provided by the measurement. These tools are the same as those in the spectrum application. For more information, refer to the documentation of the FSW.

The configuration in its default state complies with the test specifications defined in 38.141-1 / -2.

Remote command:

Selection: `CONF:MEAS MCAC`

### Result diagram ← Multi Carrier ACLR (MC ACLR)

The result diagram is a graphic representation of the signals with a trace that shows the measured signal. Individual channels (Tx and adjacent channels) are indicated by vertical lines and corresponding labels.

In addition, the FSW highlights the channels (blue: Tx channel, green: adjacent channels).

The x-axis represents the frequency with a frequency span that relates to the 5G NR channel characteristics and adjacent channel bandwidths. Note that the application automatically determines the center frequency of the measurement according to the frequencies of the carriers.

On the y-axis, the power is plotted in dBm. The power for the TX channels is an absolute value in dBm. The powers of the adjacent channels are values relative to the power of the TX channel. The power of the channels is automatically tested against the limits defined by 3GPP.

The result display contains several additional elements.

- **Blue and green lines:**  
Represent the bandwidths of the carriers (blue lines) and those of the neighboring channels (green lines). Note that the channels can overlap each other.
- **Blue and green bars:**  
Represent the integrated power of the transmission channels (blue bars) and neighboring channels (green bars).

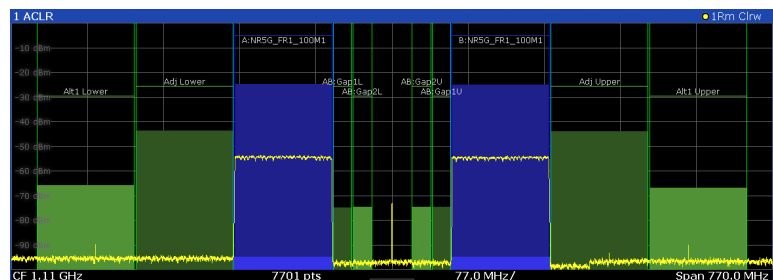

Remote command:

`TRACe:DATA?`

### Result summary ← Multi Carrier ACLR (MC ACLR)

The result summary shows the signal characteristics in numerical form. Each row in the table corresponds to a certain channel type (Tx, adjacent channel). The columns contain the channel characteristics.

A table above the result display contains information about the measurement in numerical form:

- **Channel**  
Shows the type of channel.  
The first rows represent the characteristics of the component carriers. The label also indicates their respective bandwidths (for example: NR5G\_FR1\_100M1 means the first NR channel ("\_100M1") with a 100 MHz bandwidth ("\_100M1")). The information also includes the total power of all component carriers.  
The other rows represent the neighboring channels (Adj Lower / Upper and Alt1 Lower / Upper).
- **Bandwidth**  
Shows the bandwidth of the channel.  
The bandwidth of the carrier is the sum of the two component carriers.
- **Frequency**  
Shows the center frequency of the component carriers.
- **Offset**  
Frequency offset relative to the center frequency of the aggregated carrier.
- **Power / Lower / Upper / Gap**  
Shows the power of the carrier and the power of the lower and upper neighboring channels relative to the power of the aggregated carrier.  
Depending on the [evaluation logic](#), the FSW shows either the absolute power in dBm, the relative power in dBc or both power values. The overall limit check

passes or fails depending on your selected evaluation logic. The end result of the limit check is displayed in the table header.

2 Result Summary		Multi-Standard Radio	
Channel	Bandwidth	Frequency	Power
A:NR5G_FR1_100M1 (Ref)	98.280 MHz	1.000 GHz	-24.79 dBm
Sub Block A Total			-24.79 dBm
Channel	Bandwidth	Frequency	Power
B:NR5G_FR1_100M1	98.280 MHz	1.220 GHz	-25.01 dBm
Sub Block B Total			-25.01 dBm
Adj Channels	Bandwidth	Offset	ACLR Power
Adj Lower*	98.280 MHz	100.000 MHz	-19.01 dBc *
Adj Upper*	98.280 MHz	100.000 MHz	-19.28 dBc *

Note that the font of the results turns red if the signal violates the limits defined by 3GPP.

Remote command:

Result query: `CALCulate<n>:MARKer<m>:FUNction:POWer<sb>:RESult[:CURRent]?` on page 309

Limit check adjacent: `CALCulate<n>:LIMit<li>:ACPowEr:ACHannel:RESult?` on page 282

Limit check adjacent absolute: `CALCulate<n>:LIMit<li>:ACPowEr:ACHannel:RESult:ABSolute` on page 283

Limit check adjacent relative: `CALCulate<n>:LIMit<li>:ACPowEr:ACHannel:RESult:RELative` on page 283

Limit check alternate: `CALCulate<n>:LIMit<li>:ACPowEr:ALTernate<alt>:RESult?` on page 284

Limit check alternate absolute: `CALCulate<n>:LIMit<li>:ACPowEr:ALTernate<ch>:RESult:ABSolute` on page 285

Limit check alternate relative: `CALCulate<n>:LIMit<li>:ACPowEr:ALTernate<ch>:RESult:RELative` on page 285

### Cumulative ACLR

The cumulative ACLR measurement is designed to measure the cumulative ACLR test requirement for non-contiguous spectrum in 38.141-1 / -2. It calculates the cumulative ACLR of the gaps as defined in 3GPP 38.141-1 / -2. Note that this measurement is only useful for two non-contiguous carriers.

The gap channels are labeled "Gap<x>U" or "Gap<x>L", with <x> representing the number of the gap channels and "U" and "L" standing for "Upper" and "Lower". The number of analyzed gap channels depends on the channel spacing between the carriers as defined in the test specification.

Remote command:

Selection: `CONF:MEAS MCAC`

### Result diagram ← Cumulative ACLR

The result diagram is a graphic representation of the signals with a trace that shows the measured signal. Individual channels (Tx and adjacent channels) are indicated by vertical lines and corresponding labels.

In addition, the FSW highlights the channels (blue: Tx channel, green: adjacent channels).

The x-axis represents the frequency. Note that the application automatically determines the center frequency and span of the measurement according to the frequencies of the carriers.

On the y-axis, the power is plotted in dBm. The power for the Tx channels is an absolute value in dBm. The power of the gap channels is an absolute value relative to the cumulative power of the Tx channels. The power of the channels is automatically tested against the limits defined by 3GPP.

The result display contains several additional elements.

- **Blue and green lines:**  
Represent the bandwidths of the carriers (blue lines) and those of the gap channels (green lines). Note that the channels can overlap each other.
- **Blue and green bars:**  
Represent the integrated power of the transmission channels (blue bars) and gap channels (green bars).

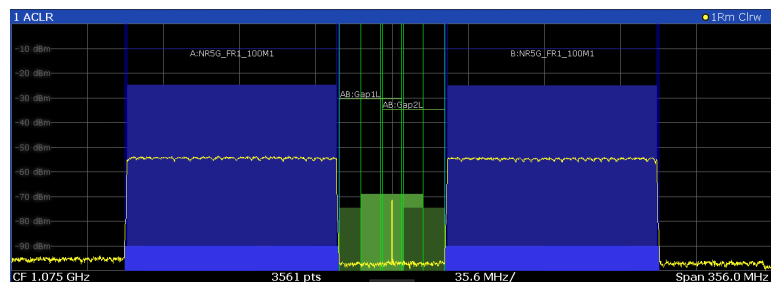

Remote command:

[TRACe:DATA?](#)

### Result summary ← Cumulative ACLR

The result summary shows the signal characteristics in numerical form. Each row in the table corresponds to a certain channel type (Tx, adjacent channel). The columns contain the channel characteristics.

A table in the result display contains information about the measurement in numerical form:

- **Channel**  
Shows the type of channel.  
Channel "A" and "B" represent the component carriers. For each of the channels, the application also shows the "Total", which should be the same as that for the channel.  
The other rows ("AB:Gap") represent the gap channels.
- **Bandwidth**  
Shows the bandwidth of the channel.  
The bandwidth of the carrier is the sum of the two component carriers.
- **Frequency**  
Shows the frequency of the carrier.  
Available for the aggregated carriers.
- **Offset**  
Frequency offset relative to the center frequency of the aggregated carrier.  
Available for the gap channels.
- **Power / Lower / Upper**  
Shows the power of the carrier and the power of the lower and upper gap channels relative to the power of the aggregated carrier.  
Depending on the [evaluation logic](#), the FSW shows either the absolute power in dBm, the relative power in dBc or both power values. The overall limit check

passes or fails depending on your selected evaluation logic. The end result of the limit check is displayed in the table header.

2 Result Summary		Multi-Standard Radio			
Channel	Bandwidth	Frequency	Power		
A:NR5G_FR1_100M1 (Ref)	98.280 MHz	1.000 GHz	<b>-24.77 dBm</b>		
Sub Block A Total			<b>-24.77 dBm</b>		
Channel	Bandwidth	Frequency	Power		
B:NR5G_FR1_100M1	98.280 MHz	1.150 GHz	<b>-25.09 dBm</b>		
Sub Block B Total			<b>-25.09 dBm</b>		
Gap Channels		Bandwidth	Offset	ACLR Power	CACLR Power
AB:Gap1L		19.080 MHz	10.000 MHz	<b>-49.98 dBc</b>	<b>-52.83 dBc</b>
AB:Gap1U		19.080 MHz	10.000 MHz	<b>-49.53 dBc</b>	<b>-52.70 dBc</b>

Remote command:

Result query: `CALCulate<n>:MARKer<m>:FUNction:POWer<sb>:RESult[:CURRent]?` on page 309

Limit check adjacent: `CALCulate<n>:LIMit<li>:ACPowEr:ACHannel:RESult?` on page 282

Limit check adjacent absolute: `CALCulate<n>:LIMit<li>:ACPowEr:ACHannel:RESult:ABSolute` on page 283

Limit check adjacent relative: `CALCulate<n>:LIMit<li>:ACPowEr:ACHannel:RESult:RELative` on page 283

Limit check alternate: `CALCulate<n>:LIMit<li>:ACPowEr:ALTernate<alt>:RESult?` on page 284

Limit check alternate absolute: `CALCulate<n>:LIMit<li>:ACPowEr:ALTernate<ch>:RESult:ABSolute` on page 285

Limit check alternate relative: `CALCulate<n>:LIMit<li>:ACPowEr:ALTernate<ch>:RESult:RELative` on page 285

### Spectrum Emission Mask (SEM)

**Note:** The application also provides multi-SEM measurements as a separate measurement. This measurement is basically the same as the SEM measurement, with the difference that it analyzes several sub blocks. The limits between the carriers are a sum of the individual limits according to 3GPP.38.141-1 / -2 The multi-SEM measurement also supports carrier aggregation.

The "Spectrum Emission Mask" (SEM) measurement shows the quality of the measured signal by comparing the power values in the frequency range near the carrier against a spectral mask that is defined by the 3GPP specifications. In this way, you can test the performance of the DUT and identify the emissions and their distance to the limit.

For a comprehensive description of the SEM measurement, refer to the user manual of the FSW.

Remote command:

Selection: `CONFigure[:NR5G]:MEASurement` on page 314

### Result diagram ← Spectrum Emission Mask (SEM)

The result diagram is a graphic representation of the signal with a trace that shows the measured signal. The SEM is represented by a red line.

If any measured power levels are above that limit line, the test fails. If all power levels are inside the specified limits, the test passes. The application labels the limit line to indicate whether the limit check has passed or failed.

The x-axis represents the frequency with a frequency span that relates to the specified 5G NR channel bandwidths. The y-axis shows the signal power in dBm.

Remote command:

Result query: [TRACe:DATA?](#)

### Result summary ← Spectrum Emission Mask (SEM)

The result summary shows the signal characteristics in numerical form. Each row in the table corresponds to a certain SEM range. The columns contain the range characteristics. If a limit fails, the range characteristics turn red.

- **Start / Stop Freq Rel**  
Shows the start and stop frequency of each section of the spectrum emission mask relative to the center frequency.
- **RBW**  
Shows the resolution bandwidth of each section of the spectrum emission mask.
- **Freq at  $\Delta$  to Limit**  
Shows the absolute frequency whose power measurement being closest to the limit line for the corresponding frequency segment.
- **Power Abs**  
Shows the absolute measured power of the frequency whose power is closest to the limit. The application evaluates this value for each frequency segment.
- **Power Rel**  
Shows the distance from the measured power to the limit line at the frequency whose power is closest to the limit. The application evaluates this value for each frequency segment.
- **$\Delta$  to Limit**  
Shows the minimal distance of the tolerance limit to the SEM trace for the corresponding frequency segment. Negative distances indicate that the trace is below the tolerance limit, positive distances indicate that the trace is above the tolerance limit.

### Marker Peak List

The marker peak list determines the frequencies and levels of peaks in the spectrum or time domain. How many peaks are displayed can be defined, as well as the sort order. In addition, the detected peaks can be indicated in the diagram. The peak list can also be exported to a file for analysis in an external application.

3 Marker Peak List			
Wnd	No	X-Value	Y-Value
2	1	1.086245 ms	-75.810 dBm
2	2	2.172490 ms	-6.797 dBm
2	3	3.258736 ms	-76.448 dBm
2	4	4.831918 ms	-76.676 dBm
2	5	6.255274 ms	-76.482 dBm
2	6	6.798397 ms	-6.800 dBm
2	7	9.233084 ms	-76.519 dBm
2	8	10.075861 ms	-76.172 dBm
2	9	11.405574 ms	-6.801 dBm

**Tip:** To navigate within long marker peak lists, simply scroll through the entries with your finger on the touchscreen.

Remote command:

LAY:ADD? '1',RIGH, PEAK, see LAYout:ADD[:WINDow]? on page 233

Results:

CALCulate<n>:MARKer<m>:X on page 273

CALCulate<n>:MARKer<m>:Y on page 273

## 3.10 Combined measurements

**Access (ACLR):** [MEAS] > "Channel Power ACLR"

For an introduction on combined measurements and their application, see [Chapter 4.6, "Combined measurement guide"](#), on page 180.

The measurements (EVM, ACLR and SEM) themselves are the same as in their respective mode. The combined mode supports all result displays that are available for the corresponding measurements (diagrams, tables etc.).

Note that combined measurements are not available for FR2-2 frequency deployment.

For a comprehensive description of the measurements and their result displays, refer to:

- [EVM measurements](#)
- [ACLR measurements](#) (single carrier measurements)
- [SEM measurements](#) (single carrier measurements)
- [MC ACLR measurements](#) (multi carrier measurements)
- [Cumulative ACLR measurements](#) (multi carrier measurements)
- [MC SEM measurements](#) (multi carrier measurements)

### Using the combined EVM / ACLR / SEM results table

Combined measurements show the results of the measurement sequence in a big numerical result summary. This result summary contains a list of all single measurements ([events](#)) in the measurement sequence.

Each line in the result summary corresponds to an event (aka "Meas ID"). Each column shows a certain aspect about the events. By default, the table contains the results of all measurements.

You have several options to work with the table.

1. Filter the results by certain aspects.
2. Add columns (= other results) to the tables.
3. Select a line to view the results for the captured I/Q data of the corresponding event.

When you select a single event, you can view the usual result displays (tables and diagrams) available for the EVM, ACLR and SEM measurements. By default, the FSW only shows the result summaries, but you can add other result displays as well.

4. Select another line to compare the results of different events.
5. Apply different settings to the captured data.  
You can apply different settings to all events or the selected event only.  
All events: "Sweep" > "Refresh"  
Selected event: "Sweep" > "Refresh Current"  
The result summary displays a yellow star for all events whose settings deviate from the current setting - if you select a measurement, change the signal configuration, all other measurements get a yellow star.  
Yellow stars disappear if you also apply the current signal configuration to other events. To do so, select an event and apply the current configuration.  
You can restore the initial settings with "Restore Settings" available in the "Meas Config" softkey menu.

In addition to the results available for EVM, ACLR and SEM measurements, the combined measurements result summary contains the following events aspects.

#### **Meas ID**

Shows an index number that identifies each measurement in the measurement sequence.

Remote command:

[TRACe:DATA?](#)

#### **CC**

Shows the number of the component carrier that the corresponding measurement refers to.

Available for multi-carrier measurements.

Remote command:

via the suffix at the `CC<cc>` keyword

#### **Time Stamp**

Shows the beginning time of the I/Q data capture for the corresponding measurement (= time when the event has occurred).

The time stamp is a value relative to the first event. The first event has a time stamp = 0 seconds.

Remote command:

[FETCh\[:CC<cc>\]\[:ISRC<ant>\]\[:FRAMe<fr>\]:SUMMary:TSTamp?](#) on page 270  
[TRACe:DATA?](#)

#### **Time Stamp Delta**

Shows the time that has passed between events.

The delta is therefore the difference between the time stamp of two consecutive measurements.

Remote command:

[FETCh\[:CC<cc>\]\[:ISRC<ant>\]\[:FRAMe<fr>\]:SUMMary:TSDelta?](#)  
on page 270



**Center Frequency**

Shows the center frequency of the component carrier.

Available for combined multi-carrier measurements.

Remote command:

`FETCh[:CC<cc>][:ISRC<ant>][:FRAMe<fr>]:SUMMARY:CFRequency?`

on page 263

**Frequency Offset**

Shows the frequency offset of the component carrier relative to the center frequency of the first component carrier.

Available for combined multi-carrier measurements.

Remote command:

`FETCh[:CC<cc>][:ISRC<ant>][:FRAMe<fr>]:SUMMARY:FOffset?`

on page 260

**EVM All CCs**

Shows the average EVM of all resource elements over all CCs in the corresponding measurement of the measurement sequence.

Available for combined multi-carrier measurements.

Remote command:

`FETCh[:CC<cc>][:ISRC<ant>][:FRAMe<fr>]:SUMMARY:EAACcs?` on page 265

**Power All CCs**

Shows the total power over all CCs in the corresponding measurement of the measurement sequence.

Available for combined multi-carrier measurements.

Remote command:

`FETCh[:CC<cc>][:ISRC<ant>][:FRAMe<fr>]:SUMMARY:PACCs?` on page 268

**Sync State**

Shows the synchronization state for the corresponding measurement.

Remote command:

`FETCh[:CC<cc>][:ISRC<ant>][:FRAMe<fr>]:SUMMARY:SState?` on page 269

`TRACe:DATA?`

**ACLR Pass / Fail**

Shows the limit check results for the ACLR of the corresponding measurement.

You can check the ACLR against the [absolute or relative limits](#) defined by 3GPP. The result summary shows the limit check results that you have selected.

For multi-carrier measurements, the application evaluates the limits of the MC ACLR and cumulative ACLR measurements instead.

For multi-carrier measurements, the application does not evaluate the ACLR.

"ACLR Pass / Fail" Shows the overall limit check result.

Fail"

"ACLR Abs Pass / Fail" Shows the absolute limit check result.

"ACLR Rel Pass / Fail" Shows the relative limit check result.

Remote command:

ACLR absolute or relative: `FETCh[:CC<cc>][:ISRC<ant>][:FRAMe<fr>]:SUMMary:APFail?` on page 262

ACLR absolute: `FETCh[:CC<cc>][:ISRC<ant>][:FRAMe<fr>]:SUMMary:AAPFail?` on page 261

ACLR relative: `FETCh[:CC<cc>][:ISRC<ant>][:FRAMe<fr>]:SUMMary:ARPFail?` on page 262

C. ACLR absolute or relative: `FETCh[:CC<cc>][:ISRC<ant>][:FRAMe<fr>]:SUMMary:CPFail?` on page 264

C. ACLR absolute: `FETCh[:CC<cc>][:ISRC<ant>][:FRAMe<fr>]:SUMMary:CAPFail?` on page 263

C. ACLR relative: `FETCh[:CC<cc>][:ISRC<ant>][:FRAMe<fr>]:SUMMary:CRPFail?` on page 264

MC ACLR absolute or relative: `FETCh[:CC<cc>][:ISRC<ant>][:FRAMe<fr>]:SUMMary:MCPFail?` on page 266

MC ACLR absolute: `FETCh[:CC<cc>][:ISRC<ant>][:FRAMe<fr>]:SUMMary:MAPFail?` on page 265

MC ACLR relative: `FETCh[:CC<cc>][:ISRC<ant>][:FRAMe<fr>]:SUMMary:MRPFail?` on page 267

Trace data: `TRACe:DATA?`

### SEM Pass / Fail

Shows the overall limit check result for the SEM of the corresponding measurement.

For multi-carrier measurements, the application evaluates the limits of the MC SEM measurement instead.

Remote command:

SEM: `FETCh[:CC<cc>][:ISRC<ant>][:FRAMe<fr>]:SUMMary:SPFail?` on page 269

MC SEM: `FETCh[:CC<cc>][:ISRC<ant>][:FRAMe<fr>]:SUMMary:MSPFail?` on page 267

Trace data: `TRACe:DATA?`

### OVLD

Shows a message if an overload status was detected (RF overload, RF input overload, IF overload).

For details about the overload states and what to do about them, see the FSW user manual.

Remote command:

`FETCh[:CC<cc>][:ISRC<ant>][:FRAMe<fr>]:SUMMary:OVLD?` on page 268  
`TRACe:DATA?`

## 3.11 Reference: custom limits

The FSW checks various results against the limits defined by 3GPP. For some of those limits, you can define custom limits.

### I/Q measurement [result summary](#)

- EVM PDSCH QPSK / 16QAM / 64QAM / 256QAM
- EVM PUSCH PI/2 BPSK / QPSK / 16QAM / 64QAM
- EVM PUSCH DMRS PI/2 BPSK / QPSK / 16QAM / 64QAM
- EVM PUCCH

### [Time alignment error measurements](#)

- Time alignment error

### [Transmit on / off power](#)

- Off power spectral density

Limit values are stored in an xml file that combines the limits for downlink and uplink. The file name must be `Default.nr5g_limits` and is located in the following directory:

```
C:\R_S\instr\user\NR5G\
```

The FSW automatically applies the custom limits after you have copied the file and restarted the FSW

The structure of the file is as follows. You can omit any xml elements you do not want to define, either by making no entry or by deleting the corresponding element.

```
<Limits>
  <DL>
    <EVM>
      <PDSCHQPSK Mean="0.185"></PDSCHQPSK>
      <!--Unit: linear (1 = 0 dB, 0.1 = -20 dB)-->
      <PDSCH16QAM Mean="0.135"></PDSCH16QAM>
      <!--Unit: linear (1 = 0 dB, 0.1 = -20 dB)-->
      <PDSCH64QAM Mean="0.09"></PDSCH64QAM>
      <!--Unit: linear (1 = 0 dB, 0.1 = -20 dB)-->
      <PDSCH256QAM Mean="0.045"></PDSCH256QAM>
      <!--Unit: linear (1 = 0 dB, 0.1 = -20 dB)-->
    </EVM>
    <TimeAlignmentError Limit="90"></TimeAlignmentError>
    <!--Unit [ns]-->
    <OffPowSpectralDensity Limit="-82.5"></OffPowSpectralDensity>
    <!--Unit: [dBm/MHz]-->
  </DL>
  <UL>
    <EVM>
      <PUSCHPI_2BPSK Max="0.3"></PUSCHPI_2BPSK>
      <!--Unit: linear (1 = 0 dB, 0.1 = -20 dB)-->
      <PUSCHQPSK Max="0.175"></PUSCHQPSK>
      <!--Unit: linear (1 = 0 dB, 0.1 = -20 dB)-->
    </EVM>
  </UL>
</Limits>
```

```

<PUSCH16QAM Max="0.125"></PUSCH16QAM>
<!--Unit: linear (1 = 0 dB, 0.1 = -20 dB)-->
<PUSCH64QAM Max="0.08"></PUSCH64QAM>
<!--Unit: linear (1 = 0 dB, 0.1 = -20 dB)-->
<DMRSPUSCHPI_2BPSK Mean="0.3"></DMRSPUSCHPI_2BPSK>
<!--Unit: linear (1 = 0 dB, 0.1 = -20 dB)-->
<DMRSPUSCHQPSK Mean="0.175"></DMRSPUSCHQPSK>
<!--Unit: linear (1 = 0 dB, 0.1 = -20 dB)-->
<DMRSPUSCH16QAM Mean="0.125"></DMRSPUSCH16QAM>
<!--Unit: linear (1 = 0 dB, 0.1 = -20 dB)-->
<DMRSPUSCH64QAM Mean="0.08"></DMRSPUSCH64QAM>
<!--Unit: linear (1 = 0 dB, 0.1 = -20 dB)-->
<PUCCH Max="0.175"></PUCCH>
<!--Unit: linear (1 = 0 dB, 0.1 = -20 dB)-->
</EVM>
</UL>
</Limits>

```

## 3.12 Reference: 3GPP test scenarios

3GPP defines several test scenarios for measuring base stations. These test scenarios are described in detail in 3GPP TS 38.141-1 (conducted measurements) and 38.141-2 (radiated measurements).

For radiated measurements, 3GPP only supports test models 1.1, 2, and 3.1. Release 16 also supports test models 2a and 3.1a.

The following table provides an overview which measurements available in the 5G NR application are suited to use for the test scenarios in the 3GPP documents.

**Table 3-2: Test scenarios for NR-FR<x>-TMs as defined by 3GPP (38.141-1 / -2)**

Test Model	Test scenario	FR1 test described in	FR2 test described in	Measurement
NR-FR-TM1.1	Radiated transmit power	n/a	chapter 6.2	Transmit on / off power
	Base station output power	chapter 6.2	chapter 6.3	Power (→ "Result Summary")
	Transmit on / off power	chapter 6.4	chapter 6.5	Transmit on / off power
	TAE	chapter 6.5.4	chapter 6.6.4	Time alignment error
	Transmitter intermodulation	chapter 6.7	chapter 6.8	ACLR
	Occupied bandwidth	chapter 6.6.1	chapter 6.7.2	Occupied bandwidth <sup>1</sup>
	ACLR	chapter 6.6.2	chapter 6.7.3	ACLR
	Operating band unwanted emissions	chapter 6.6.3	chapter 6.7.4	Spectrum emission mask

Test Model	Test scenario	FR1 test described in	FR2 test described in	Measurement
	Transmitter spurious emissions	chapter 6.6.4	chapter 6.7.5	Spurious emissions <sup>1</sup>
<b>NR-FR-TM1.2</b>	ACLR	chapter 6.6.2	n/a	ACLR
	Operating band unwanted emissions	chapter 6.6.2	n/a	Spectrum emission mask
<b>NR-FR-TM2</b>	Total power dynamic range	chapter 6.3.2	chapter 6.4.3	OSTP (→ "Result Summary")
	Frequency error	chapter 6.5.1	chapter 6.6.2	Frequency Error (→ "Result Summary")
	Error vector magnitude	chapter 6.5.2	chapter 6.6.3	EVM results
<b>NR-FR-TM2a</b>	Total power dynamic range	chapter 6.3.2	n/a	OSTP (→ "Result Summary")
	Error vector magnitude	chapter 6.5.2	n/a	EVM results
	Frequency error	chapter 6.5.1	n/a	Frequency error (→ "Result Summary")
<b>NR-FR-TM2b</b>	Total power dynamic range	chapter 6.3.2	n/a	OSTP (→ "Result Summary")
	Error vector magnitude	chapter 6.5.2	n/a	EVM results
	Frequency error	chapter 6.5.1	n/a	Frequency error (→ "Result Summary")
<b>NR-FR-TM3.1</b>	Total power dynamic range	chapter 6.3.2	chapter 6.4.3	OSTP (→ "Result Summary")
	Frequency error	chapter 6.5.1	chapter 6.6.2	Frequency error (→ "Result Summary")
	Error vector magnitude	chapter 6.5.2	chapter 6.6.3	EVM results
<b>NR-FR-TM3.1a</b>	Total power dynamic range	chapter 6.3.2	n/a	OSTP (→ "Result Summary")
	Error vector magnitude	chapter 6.5.2	n/a	EVM results
	Frequency error	chapter 6.5.1	n/a	Frequency error (→ "Result Summary")
<b>NR-FR-TM3.1b</b>	Total power dynamic range	chapter 6.3.2	n/a	OSTP (→ "Result Summary")
	Error vector magnitude	chapter 6.5.2	n/a	EVM results
	Frequency error	chapter 6.5.1	n/a	Frequency error (→ "Result Summary")

Test Model	Test scenario	FR1 test described in	FR2 test described in	Measurement
<b>NR-FR-TM3.2</b>	Frequency error	chapter 6.5.1	n/a	Frequency error (→ "Result Summary")
	Error vector magnitude	chapter 6.5.2	n/a	EVM results
<b>NR-FR-TM3.3</b>	Frequency error	chapter 6.5.1	n/a	Frequency error (→ "Result Summary")
	Error vector magnitude	chapter 6.5.2	n/a	EVM results

<sup>1</sup>These measurements are available in the spectrum application of the Rohde & Schwarz signal and spectrum analyzers (for example the R&S FSW)

## 4 Configuration

3GPP 5G NR measurements require a special application on the FSW, which you activate using the [MODE] key on the front panel.

When you start the 5G NR application, the FSW starts to measure the input signal with the default configuration or the configuration of the last measurement (when you have not performed a preset since then). After you have started an instance of the 5G NR application, the application displays the "Meas Config" menu which contains functions to define the characteristics of the signal you are measuring.



### Unavailable hardkeys

Note that the [SPAN], [BW], [TRACE], [LINES] and [MKR FUNC] keys have no contents and no function in the 5G NR application.

• I/Q measurement.....	71
• Time alignment error configuration.....	169
• Transmit on / off power configuration.....	170
• Frequency sweep measurement configuration.....	171
• Combined measurement configuration.....	174
• Combined measurement guide.....	180
• Time trigger measurement guide.....	191
• Microservice export.....	192
• O-RAN measurement guide.....	192
• Reference: structure of .allocation files.....	193
• Basics on input from I/Q data files.....	202

### 4.1 I/Q measurement

• Configuration overview.....	72
• Automatic measurement configuration.....	74
• Physical signal description.....	77
• Test scenarios.....	80
• Component carrier configuration.....	81
• Radio frame configuration.....	86
• Synchronization signal configuration.....	90
• Bandwidth part configuration.....	96
• Slot configuration.....	101
• PDSCH and PDCCH configuration.....	113
• Antenna port configuration.....	133
• Advanced settings.....	135
• Generator control.....	141
• Input source configuration.....	145
• Frequency configuration.....	151
• Amplitude configuration.....	152
• Data capture.....	156
• Trigger configuration.....	159

- [Segmented capture](#)..... 161
- [Data capture optimization](#)..... 162
- [Tracking](#)..... 163
- [Demodulation](#)..... 166

### 4.1.1 Configuration overview

Throughout the measurement channel configuration, an overview of the most important currently defined settings is provided in the "Overview". The "Overview" is displayed when you select the "Overview" menu item from the "Meas Setup" menu.

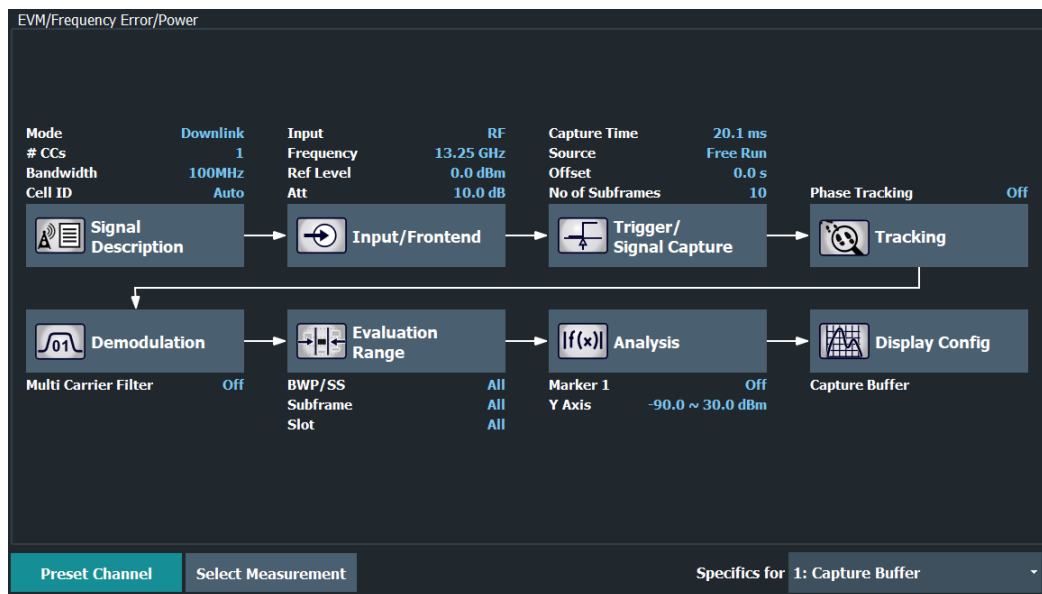

In addition to the main measurement settings, the "Overview" provides quick access to the main settings dialog boxes. The individual configuration steps are displayed in the order of the data flow. Thus, you can easily configure an entire measurement channel from input over processing to output and analysis by stepping through the dialog boxes as indicated in the "Overview".

In particular, the "Overview" provides quick access to the following configuration dialog boxes (listed in the recommended order of processing):

1. [Signal Description](#)  
See [Chapter 4.1.3, "Physical signal description"](#), on page 77.
2. [Input / Frontend](#)  
See [Chapter 4.1.14, "Input source configuration"](#), on page 145.
3. [Trigger / Signal Capture](#)  
See [Chapter 4.1.18, "Trigger configuration"](#), on page 159.  
See [Chapter 4.1.17, "Data capture"](#), on page 156.
4. [Tracking](#)  
See [Chapter 4.1.21, "Tracking"](#), on page 163.



5. Demodulation  
See [Chapter 4.1.22, "Demodulation"](#), on page 166.
6. Analysis  
See [Chapter 5, "Analysis"](#), on page 204.
7. Display Configuration  
See [Chapter 3, "Measurements and result displays"](#), on page 19

In addition, the dialog box provides the "Select Measurement" button that serves as a shortcut to select the measurement type.

### Configuring the measurement

- ▶ Select any button in the "Overview" to open the corresponding dialog box.  
Select a setting in the channel bar (at the top of the measurement channel tab) to change a specific setting.

<a href="#">Preset Channel</a> .....	73
<a href="#">Select Measurement</a> .....	73
<a href="#">Specific Settings for</a> .....	73

#### Preset Channel

Select "Preset Channel" in the lower left-hand corner of the "Overview" to restore all measurement settings *in the current channel* to their default values.

**Note:** Do not confuse "Preset Channel" with the [Preset] key, which restores the entire instrument to its default values and thus closes *all channels* on the FSW (except for the default channel)!

Remote command:

`SYSTem:PRESet:CHANnel[:EXEC]` on page 317

#### Select Measurement

Opens a dialog box to select the type of measurement.

For more information about selecting measurements, see [Chapter 3.1, "Selecting measurements"](#), on page 19.

Remote command:

`CONFigure[:NR5G]:MEASurement` on page 314

#### Specific Settings for

The channel can contain several windows for different results. Thus, the settings indicated in the "Overview" and configured in the dialog boxes vary depending on the selected window.

Select an active window from the "Specific Settings for" selection list that is displayed in the "Overview" and in all window-specific configuration dialog boxes.

The "Overview" and dialog boxes are updated to indicate the settings for the selected window.

## 4.1.2 Automatic measurement configuration

The FSW provides various functions to automatically configure measurements based on the signal you are measuring and thus makes these measurements as easy as possible.

Automatic configuration functions are available in different dialog boxes and softkey menus.

**Access** (auto configuration): [AUTO SET]

**Access** (auto demodulation): "Overview" > "Signal Description" > "Signal Description"

### Automatic measurement configuration

The automatic measurement configuration functions adjust various general measurement settings to achieve the optimal display of the measurement results.

### Automatic signal demodulation

The automatic signal demodulation functions determine the characteristics of the signal you are measuring. Based on the signal characteristics, the FSW is then able to demodulate and analyze the signal.

Signal demodulation is available on several levels.

- Detection of all signal characteristics.
- Detection of the bandwidth part configuration, incl. antenna port configuration.
- Detection of the synchronization signal configuration.

For an automatic signal demodulation, all frames must have the same configuration.

<a href="#">Auto Level</a> .....	74
<a href="#">Auto EVM</a> .....	74
<a href="#">Auto Scale</a> .....	75
<a href="#">Complete Signal Demodulation</a> .....	75
<a href="#">Bandwidth Parts Demodulation</a> .....	76
<a href="#">Synchronization Signal Demodulation</a> .....	77

### Auto Level

You can use the auto leveling routine for a quick determination of preliminary amplitude settings for the current 5G NR input signal.

For additional information, see "[Auto Level](#)" on page 153.

Remote command:

[SENSe:]ADJust:LEVel on page 319

### Auto EVM

Adjusts the amplitude settings to achieve the optimal EVM using the maximum dynamic range.

This routine measures the signal several times at various levels to achieve the best results.

If you measure several component carriers, this routine can take several minutes to finish (depending on the number of component carriers).

You can speed up the auto EVM routine by performing it across a certain number of slots only ("Auto EVM # Of Slots To Analyze").

Select "Auto Set" > "Auto Level Config" > "Meas Time Mode" = "Manual" to access this method.

If you are using this method, make sure to:

- Define an appropriate measurement time that corresponds to the number of selected slots. The minimum measurement time is 1 ms.
- Perform a triggered measurement to reliably capture at least one complete slot.

Remote command:

Run measurement: `[SENSe:]ADJust:EVM` on page 318

Slots used: `[SENSe:]ADJust:EVM:SLOTs` on page 319

### Auto Scale

Scales the y-axis for best viewing results based on the results.

For more information about y-axis scaling, see ["Automatic scaling of the y-axis"](#) on page 206.

Remote command:

`DISPlay[:WINDow<n>][:SUBWindow<w>]:TRACe<t>:Y[:SCALE]:AUTO`  
on page 474

### Complete Signal Demodulation

Automatic signal demodulation determines the complete signal configuration.

Complete signal demodulation includes:

- Detection of the synchronization signal configuration, including the SS/PBCH block state.  
You can still define the relative powers of the PSS, SSS, PBCH and PBCH DMRS.
- Detection of the cell ID.
- Detection of the bandwidth part configuration.
- Detection of the slot configuration.
- Detection of the PDSCH and CORESET configuration, including the enhanced settings.
- Detection of the antenna port configuration.

It is not possible to edit any properties that are automatically detected.

When you turn on complete signal detection, you only have to define the basic signal characteristics like the deployment frequency range, the channel bandwidth or the number of component carriers.

To turn on complete and continuous signal demodulation, select "All On". "All On" automatically turns on automatic demodulation of the synchronization signal, the cell ID and the bandwidth parts.

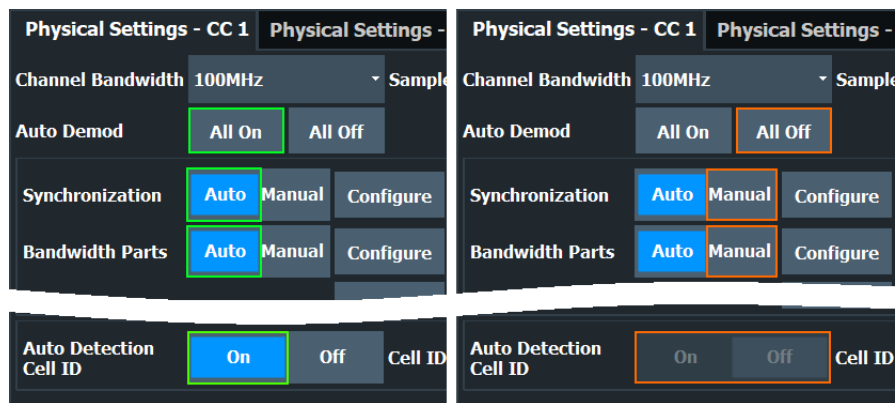

Instead of continuous automatic demodulation, you can demodulate the signal once for a single capture. This method is useful if you want to change individual parameters like the bandwidth part configuration later on without subsequent automatic demodulation. In addition, it increases the measurement speed, because automatic demodulation occurs only once.

To demodulate the signal once, select the corresponding button in the channel bar.

For a one-off demodulation, all properties remain available to edit.

Similarly, you can turn off automatic signal demodulation with a single step with "All Off". All automatic signal demodulation routines are turned off in that case.

Note that if the signal contains no synchronization signal, you have to define the cell ID manually ("Auto Detection Cell ID" = Off).

For FR2-2 frequency deployment, only auto demodulation of the synchronization signal is supported.

Remote command:

State: `CONFigure[:NR5G]:DL[:CC<cc>]:DEMod:AUTO` on page 320

Demodulate once: `[SENSe:]ADJust:DEMod` on page 318

### Bandwidth Parts Demodulation

Determines the configuration of the bandwidth parts.

Bandwidth part demodulation includes:

- Detection of the bandwidth part configuration.
- Detection of the slot configuration.
- Detection of the PDSCH and CORESET configuration, including the enhanced settings.
- Detection of the cell ID in the range of 0 to 10.

If you are using a different cell ID, you have to enter the cell ID manually.

It is not possible to edit any properties that are automatically detected.

When you turn on bandwidth part detection, you only have to define the basic signal characteristics like the deployment, the channel bandwidth or the number of component carriers and the synchronization signal.

Note that auto demodulation is not available for FR2-2 frequency deployment.

Remote command:

`CONFigure[:NR5G]:DL[:CC<cc>]:FRAME<fr>:BWPart<bwp>:DETection`  
on page 320

### Synchronization Signal Demodulation

Determines the configuration of the synchronization signal.

Synchronization signal demodulation includes:

- Detection of the synchronization signal configuration, including the SS/PBCH block state.  
You can still define the relative powers of the PSS, SSS, PBCH and PBCH DMRS.
- Detection of the cell ID.

It is not possible to edit any properties that are automatically detected.

When you turn on synchronization signal detection, you can still define the basic signal characteristics like the deployment or the channel bandwidth and the complete bandwidth part configuration, including the PDSCH and CORESET allocations.

Note that if the signal contains no synchronization signal, you have to define the cell ID manually ("Auto Detection Cell ID" = Off).

Remote command:

CONFigure[:NR5G]:DL[:CC<cc>]:SSBLock<ssb>:DETection on page 321

### 4.1.3 Physical signal description

**Access:** "Overview" > "Signal Description" > "Signal Description"

The "Signal Description" dialog box contains general signal characteristics.

Signal Description	Radio Frame Config	Ant Port Mapping	Advanced Settings
Mode	Downlink	(CC1)User Defined Set: Settings.allocation	
Number of Component Carriers	2	CC Signal Capture	Auto Single
Deploy Frequency Range	FR1 > 3GHz	Operating Band	n1
Physical Settings - CC 1		Physical Settings - CC 2	Carrier Configuration
Channel Bandwidth	100MHz	Sample Rate 122.88 MHz	
Auto Demod	All On	All Off	
Synchronization	Auto Manual	Configure	SCS --- Delta to CF ---
Bandwidth Parts	Auto Manual	Configure	1 BWPs SCS 30kHz
Slot		Configure	Slot Format 0
PDSCH/PDCCH		Configure	QPSK
Auto Detection Cell ID	On Off	Cell ID	1



### Configuring component carriers

When you are doing measurements on [aggregated carriers](#), you can configure each carrier separately.

When available, each carrier in the dialog boxes is represented by an additional tab labeled "CC<x>", with <x> indicating the number of the component carrier.

Note that the additional tabs are only added to the user interface after you have selected more than "1" component carrier.

The remote commands required to configure the physical signal characteristics are described in [Chapter 6.10.3, "Physical settings"](#), on page 321.

The remote commands required to query measurement results are described in:

- [Chapter 6.9, "Retrieve trace data"](#), on page 290
- [Chapter 6.7, "Remote commands to retrieve numeric results"](#), on page 245

<a href="#">Selecting the 5G NR mode</a> .....	78
<a href="#">Deployment Frequency Range</a> .....	78
<a href="#">Operating Band</a> .....	79
<a href="#">Physical settings of the signal</a> .....	79

### Selecting the 5G NR mode

The "Mode" selects the 5G NR link direction you are testing.

The choices you have depend on the set of options you have installed.

- Option FSW-K144 enables testing of 3GPP 5G NR signals on the downlink.
- Option FSW-K145 enables testing of 3GPP 5G NR signals on the uplink.

Downlink (DL) and Uplink (UL) describe the **transmission path**.

- Downlink is the transmission path from the base station to the user equipment.  
The physical layer mode for the downlink is always OFDMA.
- Uplink is the transmission path from the user equipment to the base station.

The application shows the currently selected 5G NR mode (including the bandwidth) in the channel bar.

Remote command:

Link direction: `CONFigure[:NR5G]:LDIRection` on page 323  
not supported

### Deployment Frequency Range

A 5G NR signal can be transmitted in several different frequency ranges ("FR").

3GPP release 17 extends the deployment frequency range (FR2-2).

- "FR1 <= 3 GHz": Deployment in frequency range 1 ≤ 3 GHz.
- "FR1 > 3 GHz": Deployment in frequency range 1 above 3 GHz.
- "FR2-1": Deployment in frequency range 2 (high frequencies up to 52.60 GHz).
- "FR2-2": Deployment in frequency range 2 (extra high frequencies up to 71 GHz).

The frequencies that FR1 and FR2 cover are defined by 3GPP.

The selected frequency range has an effect on the following settings.

- Different [channel bandwidths](#) are available in each frequency range.
- Different [subcarrier spacings](#) are available in each frequency range.
- Different [synchronization signal patterns](#) are available in each frequency range.

Remote command:

[CONFigure\[:NR5G\]:DL\[:CC<cc>\]:DFRange](#) on page 322

### Operating Band

Selects the operating band that the carriers are in. The operating bands are defined in 3GPP 38.104: 5.2 "Operating Bands".

Depending on the operating band you select for the transmission, the FSW automatically adjusts the minimum requirements for channel spacing between component carriers, especially the [frequency offset to CC1](#).

If the center frequency of the carriers is not within the selected operating band, the FSW shows a corresponding message in the [carrier configuration](#) dialog box.

For a selected set of operating bands, you can select the [channel raster](#) within the component carrier.

3GPP release 16 unlocks additional operating bands.

3GPP release 17 unlocks additional operating bands.

Remote command:

[CONFigure\[:NR5G\]:OBANd](#) on page 322

### Physical settings of the signal

Physical settings describe the basic structure of the signal you are measuring.

The "Channel Bandwidth" is variable with fixed values in the range from 5 MHz to 400 MHz. The numbers next to the dropdown box show the sample rate of the signal. The sample rate depends on the selected channel bandwidth.

3GPP release 17 extends the channel bandwidths up to 2000 MHz in FR2 and adds additional bandwidths in FR1 (35 MHz and 45 MHz).

The available channel bandwidths depend on the [frequency range](#) you have selected.

Selecting one of the "Configure" buttons opens the [radio frame configuration](#) tab where you can customize the radio frame structure according to your needs.

- "Synchronization": Configuration of [synchronization signal](#) (SS).  
The numbers next to the button indicate the subcarrier spacing of the SS and the frequency offset relative to the center of the channel bandwidth.
- "Bandwidth Parts": Configuration of [bandwidth parts](#) (BWP).  
The numbers next to the button indicate the number of configured BWPs and their subcarrier spacings.
- "Slot Config": Configuration of individual [slots](#).  
The numbers next to the button indicate the slot format used in the BWPs and if a CSI reference signal is present or not.  
The slot format determines the usage of the OFDM symbols (UL, DL or flexible).  
The slot formats are defined in 3GPP 38.211, table 4.3.2-3.
- "PDSCH / PDCCH Config": Configuration of the [data channel \(PDSCH\)](#) and the control channel (PDCCH)  
The numbers next to the button indicate the modulation types used for the allocations in all slots and if a SMUX or phase-tracking reference signal (PT-RS) is present or not.

The physical layer cell ID is responsible for synchronization between network and user equipment. It identifies a specific radio cell in the 5G NR network. The cell ID is a value between 0 and 503.

For automatic detection of the cell ID, turn on the "Auto" function. However, auto detection only works if at least one [SS/PBCH block](#) is included in the signal.

Remote command:

Channel bandwidth: [CONFigure\[:NR5G\]:DL\[:CC<cc>\]:BW](#) on page 322

Cell ID: [CONFigure\[:NR5G\]:DL\[:CC<cc>\]:PLC:CID](#) on page 323

#### 4.1.4 Test scenarios

**Access:** "Overview" > "Signal Description" > "Test Models"

Test scenarios are descriptions of specific 5G NR signals for standardized testing of DUTs. These test scenarios are stored in `.allocation` files. You can select, manage and create test scenarios in the "Test Models" dialog box.

##### 3GPP test models

Test models are certain signal descriptions defined by 3GPP for various test scenarios. 3GPP calls them NR-TM. These NR-TM are defined in 3GPP 38.141-1 / -2.

There are three main test model groups (NR-TM1, NR-TM2 and NR-TM3). Each of these main groups in turn contain signal descriptions for specific signal configurations (different transmission type, different bandwidth etc.).

Because the complete list of test scenarios is long, you can filter the list by the following criteria.

- "Test Model": Filters by test model group (NR-TM1, NR-TM2 etc.).
- "Transmission": Filters by transmission technology (radiated or conducted).
- "Duplexing": Filters by duplexing mode (FDD or TDD).
- "Bandwidth": Filters by [channel bandwidth](#).
- "Subcarrier Spacing": Filters by [subcarrier spacing](#).

For an overview of the test scenarios, see [Chapter 3.12, "Reference: 3GPP test scenarios"](#), on page 68.

3GPP release 17 adds additional test models.

Remote command:

[MMEMory:LOAD:TMODe1\[:CC<cc>\]](#) on page 324

##### ORAN test cases

In addition to the 3GPP test models, you can also use O-RAN test cases. O-RAN test cases are defined by the O-RAN alliance for standardized measurements.

The test cases comply with O-RAN specification O-RAN.WG4.CONF.0-v08.00.

The O-RAN test cases are based on the 3GPP test models (downlink) and fixed reference channels (uplink) and are customized for the O-RAN applications.

For more information about the test cases themselves, see the O-RAN specifications available on the O-RAN website.

For more information about using O-RAN test cases in measurements with the FSW, see [Chapter 4.9, "O-RAN measurement guide"](#), on page 192.



Remote command:

`MMEMemory:LOAD:TMODe1[:CC<cc>]` on page 324

#### User defined test scenarios

User defined test scenarios are custom signal descriptions for standardized measurements that you can save and restore as you like. To create a custom test scenario, describe a signal as required and then save it with the corresponding button. The FSW stores custom scenarios in `.allocation` files.

If you do not need test scenarios any longer, you can also delete them.

For a description of the `.allocation` files, see [Chapter 4.10, "Reference: structure of .allocation files"](#), on page 193.

Remote command:

Save: `MMEMemory:STORe<n>:DEModsetting[:CC<cc>]` on page 326

Restore: `MMEMemory:LOAD:DEModsetting[:CC<cc>]` on page 325

#### Test scenarios for carrier aggregation

When you measure component carriers, you can describe each component carrier separately and save or restore the scenario for each carrier in the corresponding tab ("CC<x>"). Single carrier scenarios are stored in `.allocation` files.

For easier handling of multiple carriers, however, you can also store the descriptions of all carriers in a single file. To do so, configure all component carriers as required and save the test scenario in "All CCs" tab. Multiple carrier test scenarios are stored in `.ccallocation` files. The advantage of this method is, that you do not have to restore a scenario for each component carrier, but can do so in a single step.

The `.ccallocation` files contain the frequency information of the signal.

Remote command:

Save: `MMEMemory:STORe<n>:DEModsetting:ALL` on page 325

Restore: `MMEMemory:LOAD:DEModsetting:ALL` on page 324

### 4.1.5 Component carrier configuration

**Access:** "Overview" > "Signal Description"

Carrier aggregation has been introduced in the 5G NR standard to increase the bandwidth. In those systems, you can use several carriers to transmit a signal.

The 5G NR measurement application supports up to 16 component carriers for measurements on contiguous and non-contiguous intra-band carrier aggregation (the carriers are in the same frequency band).

Each carrier has one of the [channel bandwidths](#) defined by 3GPP. You can deploy the component carriers in different [frequency ranges](#).

The radio frame can be different for each component carrier. For more information about configuring 5G NR radio frames, see [Chapter 4.1.6, "Radio frame configuration"](#), on page 86.

Several measurements support contiguous and non-contiguous intra-band carrier aggregation (the carriers are in the same frequency band).

- I/Q Based Measurements (EVM, Frequency Error, etc.)
- Frequency sweep measurements (multi-carrier ACLR, cumulative ACLR and multi SEM)

The screenshot shows the 'Carrier Configuration' window. It has three tabs: 'Physical Settings - CC 1', 'Physical Settings - CC 2', and 'Carrier Configuration'. The 'Carrier Configuration' tab is active, showing a table of carrier settings and a frequency diagram.

CC	Center Frequency	Frequency Offset	Bandwidth
1	850 MHz	0 Hz	100MHz
2	1 GHz	150 MHz	100MHz

Below the table, the 'MC Setup' section includes:

- Global MC Frequency: 850.0 MHz (Center)
- Frequency Offset rel. to: CC1
- Frequency Offset Mode: Arbitrary
- Carrier Spacing: 0 Hz
- Fixed CC Offset: On/Off

The frequency diagram at the bottom shows two trapezoidal carriers, CC1 and CC2, on a frequency axis. CC1 has a bandwidth of 100 MHz and is centered at 850 MHz. CC2 has a bandwidth of 100 MHz and is centered at 1 GHz. There is a 30 MHz gap between the two carriers. The total span from the start of CC1 to the end of CC2 is 250 MHz.

The remote commands required to configure component carriers are described in Chapter 6.10.4, "Component carrier configuration", on page 326.

- Number of component carriers..... 82
- Component carrier data capture..... 82
- Views..... 83
- Basic component carrier configuration..... 83
  - └ Frequency configuration..... 83
  - └ Bandwidth configuration..... 84
  - └ Channel Raster..... 84
- Nominal Channel Spacing..... 85
- Additional tools for frequency configuration..... 85
  - └ Center frequency configuration..... 86
  - └ Frequency offset configuration..... 86

**Number of component carriers**

The supported "Number Of Component Carriers" you can measure is in the range from 1 to 16. When you select more than one component carrier, the FSW expands the "Signal Description" dialog box by several tabs.

One tab for each component carrier you can configure and one tab to define [general properties](#) of the component carrier configuration.

Remote command:

CONFigure[:NR5G]:NOCC on page 329

**Component carrier data capture**

Capturing signals with several component carriers can generate big amounts of data.

The 5G NR application thus provides different "CC Signal Capture" modes that allow you to capture even several component carriers with a large bandwidth.

- "Single": Each configured component carrier is captured consecutively by an individual data capture buffer.

- "Auto": The FSW determines how many component carriers it can capture in a single measurement.

If you select "Auto" mode, the FSW captures as many component carriers as it can in a single measurement and captures the rest in subsequent measurements. The maximum number of component carriers the FSW can analyze in a single capture depends on the available bandwidth.

With the optional 500 MHz bandwidth, for example, it can analyze up to 5 100 MHz carriers in a single capture.

When all required measurements are done, the FSW shows the results for all component carriers.

Remote command:

`CONFigure[:NR5G]:CSCapture` on page 328

### Views

Results of component carrier measurements are shown for each component carrier separately. When you measure more than one carrier, each result display shows the information of up to two component carriers. For more than two component carriers, you can select which component carriers are displayed in the [two views](#).

Remote command:

`DISPlay[:WINDow<n>][:SUBWindow<w>]:CCNumber` on page 485

### Basic component carrier configuration

**Access:** "Overview" > "Signal Description" > "Carrier Configuration"

The number of component carriers (CCs) you can select depends on the measurement.

- I/Q based measurements (EVM etc.): up to 16 CCs
- Frequency sweep measurements (ACLR etc.): up to 8 CCs

You can define the characteristics of the CCs in the carrier configuration table.

Depending on the "Number of Component Carriers", the application adjusts the size of the table. Each line corresponds to a component carrier.

The FSW shows a preview of the current carrier configuration in a diagram at the bottom of the dialog.

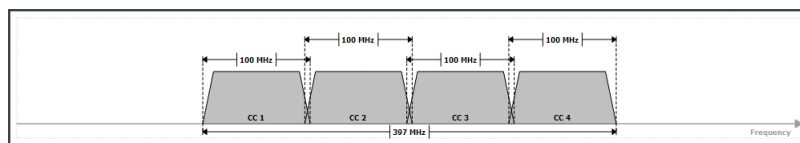

### Frequency configuration ← Basic component carrier configuration

The location of each component carrier in the spectrum is defined by a center frequency. The frequencies of the carriers must be in an ascending order.

The FSW indicates if the location of the carriers is compatible to the selected [operating band](#).

- "Carrier within selected NR band"
- "Carrier outside of selected NR band"

The actual measurement frequency differs from the carrier frequencies: the application calculates that frequency based on the carrier frequencies. It is somewhere in between the carrier frequencies.

Note that the measurement frequency can change during a capture. If the signal bandwidth is larger than the available analysis bandwidth, the captured data consists of several captures with a smaller bandwidth, each with a different measurement frequency.

The FSW indicates the actual measurement frequency in the channel bar.

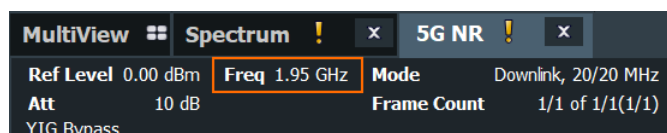

In addition to the carrier's center frequency, you have to define a frequency offset. By default, the frequency offset is an offset relative to the first component carrier and an arbitrary value.

- When you change the offset of a carrier in the table, the FSW adjusts its center frequency.
- When you change the frequency of one of the carriers in the table, the FSW adjusts the offset.

You can use [additional tools](#) to define the frequency characteristics of the component carriers.

Remote command:

Frequency: `[SENSe:]FREQUENCY:CENTer[:CC<cc>]` on page 435

Offset (ref. point = CC1): `[SENSe:]FREQUENCY:CENTer[:CC<cc>]:OFFSet` on page 436

Offset (ref. point = global MC freq.): `[SENSe:]FREQUENCY:CENTer[:CC<cc>]:MCOFFset` on page 330

### Bandwidth configuration ← Basic component carrier configuration

For each carrier, select the "Bandwidth" from the corresponding dropdown menu.

The combination of bandwidths is arbitrary. If the total bandwidth of all component carriers is too large, the FSW displays a corresponding message.

The FSW also shows the "Occupied Bandwidth" of the aggregated carriers and the "Sample Rate" in a read-only field next to the carrier configuration.

Remote command:

`CONFigure[:NR5G]:DL[:CC<cc>]:BW` on page 322

### Channel Raster ← Basic component carrier configuration

**Access:** "Overview" > "Signal Description" > "Carrier Configuration" > "Global"

Shows the distance between the RF reference frequencies in the selected [operating band](#). The distance between frequencies depends on the channel raster the operating band belongs to (channel raster are defined by 3GPP).

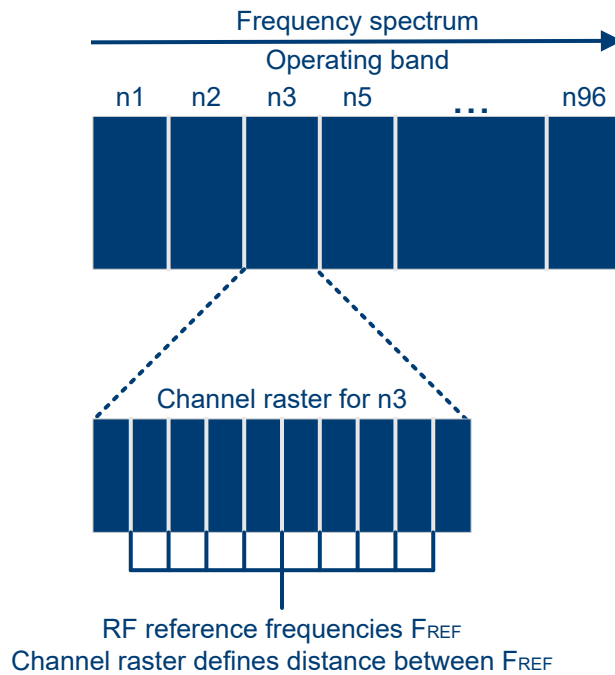

For most operating bands, the channel raster is a fix value of 15 kHz, 60 kHz or 100 kHz.

A few selected operating bands support multiple channel raster.

The channel raster is the basis for the calculation of the channel spacing (distance between component carriers) for intra-band contiguous carrier aggregation.

For details about the channel raster and its effects, see 3GPP 38.104, chapter 5.4.2.

Remote command:

[CONFigure\[:NR5G\]:CRASter](#) on page 327

### Nominal Channel Spacing

Resets the channel spacing between component carriers to its default value according to the channel spacings defined by 3GPP.

This setting has an effect if you change the distance (frequency offset) between the component carriers, for example by changing the frequency of one of the carriers.

Remote command:

[CONFigure\[:NR5G\]:NCSPacing](#) on page 328

### Additional tools for frequency configuration

**Access:** "Overview" > "Signal Description" > "Carrier Configuration" > "MC Setup"

You can either define the frequency characteristics of each component carrier separately in the [component carrier table](#), or use the following tools. These tools allow you to change the frequency characteristics of all component carriers at the same time according to a certain logic.

Note that regardless of the changes you make with these tools, the [carrier bandwidth](#) of each carrier remains the same.

**Center frequency configuration ← Additional tools for frequency configuration**

The global multicarrier frequency is a tool you can use to change the center frequency of all carriers at the same time.

Center frequencies of the component carriers remain the same, as long as you do not change the global MC frequency. When you change the global MC frequency, the center frequencies change and the frequency offset for each carrier remains the same.

You can also synchronize the global MC frequency to the center frequency of all carriers.

Remote command:

Define global MC frequency: [CONFigure\[:NR5G\]:GMCFreq](#) on page 328

Synchronize to center frequency: [CONFigure\[:NR5G\]:CENTer](#) on page 327

**Frequency offset configuration ← Additional tools for frequency configuration**

The frequency offset configuration tools allow you to change the frequency offset between carriers.

By default, the frequency offset of each component carrier is a frequency relative to the first component carrier (CC1). In that case, the offset of the first carrier is always 0 Hz.

Alternatively, you can set a frequency offset that is relative to the [global multicarrier frequency](#). In that case, the offset can take on negative values if a carrier is on a frequency below the global MC frequency.

For both methods, the offsets are arbitrary values - the spacing between carriers is not equidistant.

If you have a setup in which the distance between carriers is the same, you can use the equidistant frequency offset mode. In this mode, you can define a carrier spacing that is applied to all component carriers. Changing the component carrier's offset separately is no longer possible. Center frequencies of the component carriers are automatically adjusted depending on the carrier spacing you enter.

You can change this logic by turning on a fixed CC offset. When you do, the offset becomes a fixed value (but not necessarily equidistant). Changing the frequency of one carrier adjusts the frequencies of the other carriers. The offset remains the same.

Remote command:

Reference point: [CONFigure\[:NR5G\]:OREL](#) on page 330

Offset mode: [CONFigure\[:NR5G\]:OMODE](#) on page 329

Carrier spacing: [CONFigure\[:NR5G\]:CSPacing](#) on page 327

Fixed offset: [CONFigure\[:NR5G\]:FCOFFset](#) on page 328

## 4.1.6 Radio frame configuration

**Access:** "Overview" > "Signal Description" > "Radio Frame Config"

**Basic frame structure**

A radio frame in the 5G NR standard has a length of 10 ms (same as in LTE). It consists of 10 subframes, each with a length of 1 ms.

A subframe contains a variable number of [slots](#), depending on the [subcarrier spacing](#). A subframe can have different subcarrier spacings in different [bandwidth parts](#).

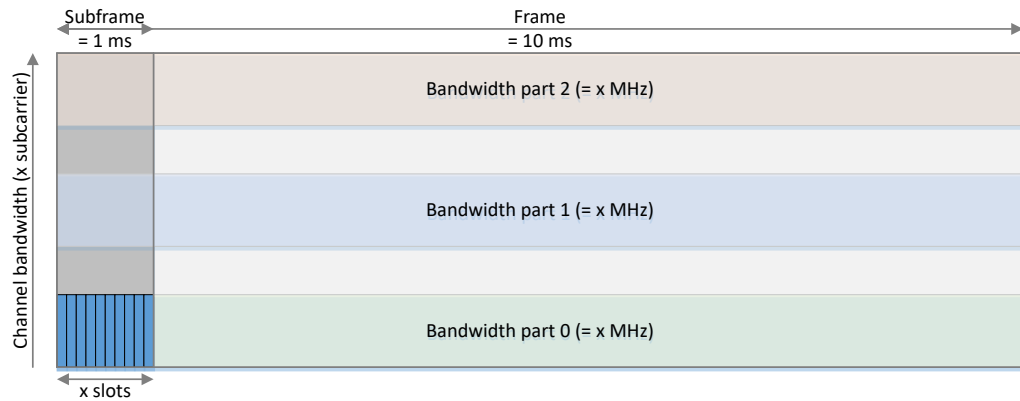

Figure 4-1: Basic frame structure of a 5G NR frame

### Slot structure

A slot contains 14 OFDM symbols and has a bandwidth the size of the bandwidth part it is in. A slot can have one of many slot formats, with each slot format representing a different symbol usage. Most of the symbols are usually used by the PDSCH for transmission of user data (payload).

### Resource blocks

One symbol with a bandwidth of 12 subcarriers makes up a resource block (the size of the subcarrier is variable). One symbol over one subcarrier makes up a resource element, which is the basic quantity in a 5G NR radio frame.

The 5G NR standard differentiates between virtual resource blocks (VRB) and physical resource blocks (PRB). VRBs are all resource blocks that are allocated to the resource grid. PRBs have the same size and number as VRBs, but can be mapped to different subcarriers to according to certain rules defined by 3GPP. Mapping to different subcarriers can be useful to use the resource grid more efficiently.

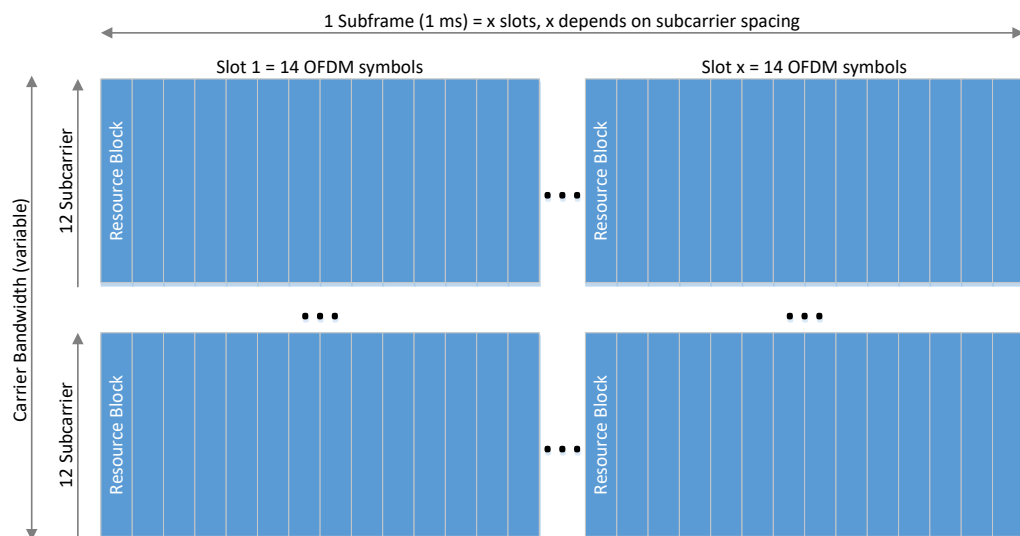

Figure 4-2: Basic slot structure of a 5G NR slot

The radio frame in a 5G NR signal is highly flexible. The location of the synchronization signal is just as variable as the size and number of bandwidth parts and the configuration of each slot in the radio frame.

For more information about configuring the radio frame structure, refer to the following topics.

- [Synchronization Signal](#)
- [Bandwidth parts](#)
- [Slots](#)
- [PDSCH](#)

### Measuring multiple radio frames

You can capture and analyze multiple radio frames. Each radio frame can have a different configuration.



### Configuring component carriers

When you are doing measurements on [aggregated carriers](#), you can configure each carrier separately.

When available, each carrier in the dialog boxes is represented by an additional tab labeled "CC<x>", with <x> indicating the number of the component carrier.

Note that the additional tabs are only added to the user interface after you have selected more than "1" component carrier.

<a href="#">Frame Configuration</a> .....	88
<a href="#">Effects of capturing multiple frames on results</a> .....	89
<a href="#">Frame Configuration Management</a> .....	90

### Frame Configuration

The "# Frames To Configure" input field defines the number of radio frames with a different configuration. If you select more than one frame to configure, you can assign a different slot configuration and PDSCH configuration for the frames. The synchronization signal and bandwidth part configuration is the same for all frames.

To configure a specific frame, enter the corresponding number in the "Selected Frame" field. If you configure only one frame ("# Frames To Configure" = 1), all frames have the same configuration.

After you have configured several frames, you can also select how many frames the FSW actually captures and analyzes with the ["Number of Frames to Analyze"](#) property. If you capture more than the number of configurable frames, the frame configuration is repeated for the surplus frames.

#### Example:

The number of configurable frames is 2. The number of frames you have captured is 5. In that case, the BWP configuration of frame 0 and 1 is repeated for frames 2 to 4.

If you capture less than the number of configurable frames, only the first frame configurations are applied.



**Example:**

The number of configurable frames is 3. The number of frames you have captured is 1. In that case, the BWP configuration of frame 0 is used for analysis.

In addition, if the FSW needs more than one capture to analyze all frames, for example if the capture time is too small, the capture always starts with the configuration of the first frame.

**Example:**

The number of configurable frames is 3. The capture time is 20.1 ms. The number of frames you have captured is 3.

The first capture contains 2 full frames with configuration of frame 0 and 1.

The second capture contains 1 frame, again with configuration of frame 0.

(If you want to capture a frame with the third configuration, you would have to define a capture time of at least 30.1 ms.)

Remote command:

Configurable frames: `CONFigure[:NR5G]:DL[:CC<cc>]:FTConfig` on page 332

Frame selection: via suffix at `FRAMe<fr>`

**Effects of capturing multiple frames on results**

Analyzing multiple frames has the following effects on results.

- Results in the [result summary](#) are either averaged over all frames or refer to a single frame, depending on your selection.
- All graphical results refer to a single frame.  
If there is more than one frame in the capture buffer, you can [select the frame](#) you want to display.
- The FSW can only display graphical results of the last data capture.  
If the [capture time](#) is too small to capture all [frames to analyze](#), the FSW captures the signal in multiple capture buffers.  
Note that this only applies to graphical results like EVM vs Carrier or the constellation diagram. The result summary still averages over all analyzed frames.

**Example:**

The capture time is 20.1 ms. The number of frames to analyze is 3. Two data captures are required to analyze all frames.

In that case, the first data capture analyzes the first two frames. The second data capture analyzes the third frame. However, you can only display the results for the third frame in the graphical result displays.

If you analyze multiple component carriers, you can also display the results for a specific frame by assigning a frame to a [view](#).

Remote command:

Select a frame: `[SENSe:]NR5G[:CC<cc>]:FRAMe:SElect` on page 493

Assign frame to a view: `DISPlay[:WINDow<n>][:SUBWindow<w>]:FNUMber` on page 485

### Frame Configuration Management

The FSW provides some tools to make frame configuration easier.

- "Copy Frame": Copies the bandwidth part configuration of the selected frame. Note that this includes the [slot configuration](#) and [PDSCH/PDCCH configuration](#) of that frame.
- "Paste Frame": Applies the bandwidth part configuration in the cache to the selected frame.
- "Paste To All": Applies the bandwidth part configuration in the cache to all configurable frames.

Remote command:

Copy: `CONFigure[:NR5G]:DL[:CC<cc>]:FRAMe<fr>:COPY` on page 331

Paste: `CONFigure[:NR5G]:DL[:CC<cc>]:FRAMe<fr>:PASTe[:FRAMe]`  
on page 331

Paste to all: `CONFigure[:NR5G]:DL[:CC<cc>]:FRAMe<fr>:PASTe:ALL`  
on page 331

## 4.1.7 Synchronization signal configuration

**Access:** "Overview" > "Signal Description" > "Radio Frame Config" > "Synchronization"

The 3GPP 5G NR standard defines two synchronization signals (SS), the primary synchronization signal (PSS) and the secondary synchronization signal (SSS). They are bundled in a synchronization signal block (SS/PBCH block). Both synchronization signals are used for radio frame synchronization. The UE also uses the synchronization signals to detect the [physical layer cell ID](#).

In addition to the two synchronization signals, the SS/PBCH block also includes the physical broadcast channel (PBCH). The PBCH carries general system information.

An SS/PBCH block is transmitted on a fix schedule. Each half frame contains either 4, 8 or 64 SS/PBCH blocks, depending on the subcarrier spacing and the deploy frequency range.

The synchronization signals are assigned to fix symbols as defined by 3GPP, but you can adjust the subcarriers on which they are transmitted.



**Figure 4-3: Location of synchronization signals in a succession of several slots**

### Detection of synchronization signal

The FSW supports automatic detection of the synchronization signal characteristics. When you select "Auto" detection mode, the FSW detects various synchronization signal properties like the subcarrier spacing, block pattern and the frequency offset (in terms of resource blocks and subcarriers).

When you select "Manual" mode, you can describe the synchronization signals manually with various characteristics.

If you measure a signal with a bad signal-to-noise ratio, for example due to a low signal level, manual configuration of the synchronization signals can increase the synchronization probability.

When you turn on automatic signal detection, the settings in this dialog box are unavailable.

### Synchronization signal in multiple frame analysis

If you measure [multiple frames](#), the configuration of the synchronization signal is the same for all frames. Therefore, the synchronization signal configuration is only available for the first frame.

Signal Description		Radio Frame Config		Ant Port Mapping		Advanced Settings	
CC 1							
Synchronization		BWP Config		Slot Config		PDSCH/PDCCH Config	
Detection		Auto		Manual			
Subcarrier Spacing		30kHz		SS/PBCH Block Pattern		CASE C	
SS/PBCH Block Offset							
Offset rel to		Ref Point A		Delta: SS/PBCH Block Center to CF		-36.54 MHz	
RB Offset (15kHz SCS)		50		Additional Subcarrier Offset (15kHz SCS)		0	
Burst Set Periodicity		10ms		SS/PBCH Block State		Configure	
Half Frame Offset		0		L Selection		4	
PSS Rel Power		0.0 dB		SSS Rel Power		0.0 dB	
PBCH Rel Power		0.0 dB		PBCH DMRS Rel Power (to PBCH)		0.0 dB	



### Configuring component carriers

When you are doing measurements on [aggregated carriers](#), you can configure each carrier separately.

When available, each carrier in the dialog boxes is represented by an additional tab labeled "CC<x>", with <x> indicating the number of the component carrier.

Note that the additional tabs are only added to the user interface after you have selected more than "1" component carrier.

The remote commands required to configure the synchronization signals are described in [Chapter 6.10.6, "Synchronization signal configuration"](#), on page 332.

<a href="#">Subcarrier Spacing (synchronization signal)</a> .....	92
<a href="#">SS/PBCH Block Pattern</a> .....	93
<a href="#">Synchronization Signal Offset</a> .....	93
<a href="#">Burst Set Periodicity</a> .....	95
<a href="#">SS/PBCH Block State</a> .....	95
<a href="#">Half Frame Offset</a> .....	95
<a href="#">Relative Power</a> .....	96

### Subcarrier Spacing (synchronization signal)

The "Subcarrier Spacing" selects the subcarrier spacing for the synchronization signals.

The available subcarrier spacings depend on the [frequency range](#) you have selected.

- FR1: 15 kHz, 30 kHz  
(30 kHz unavailable for a 5 MHz [channel bandwidth](#).)
- FR2-1: 120 kHz, 240 kHz  
(240 kHz unavailable for a 50 MHz [channel bandwidth](#).)
- FR2-2: 120 kHz, 480 kHz, 960 kHz

Note that a 60 kHz subcarrier spacing is only supported for the [user data](#) transmission.

Subcarrier spacings for FR2-2 have been introduced in 3GPP release 17.

Remote command:

[CONFigure\[:NR5G\]:DL\[:CC<cc>\]:SSBLock<ssb>:SSPacing](#) on page 337

### SS/PBCH Block Pattern

The "SS Block Pattern" defines which symbols in a slot carry the synchronization signals.

- "Case A": Used for subcarrier spacing of 15 kHz and a carrier frequency in FR1.
- "Case B": Used for subcarrier spacing of 30 kHz and a carrier frequency in FR1.
- "Case C": Used for subcarrier spacing of 30 kHz and a carrier frequency in FR1.  
The start symbol index for the SS/PBCH blocks is different than "Case B".
- "Case D": Used for subcarrier spacing of 120 kHz and a carrier frequency in FR2.
- "Case E": Used for subcarrier spacing of 240 kHz and a carrier frequency in FR2.
- "Case F": Used for subcarrier spacing of 480 kHz and carrier frequency in FR2-2.
- "Case G": Used for subcarrier spacing of 960 kHz and carrier frequency in FR2-2.

For cases A, B and C, the symbols occupied by the SS further depend on if the carrier frequency is below or above 3 GHz.

For a comprehensive description of the block patterns, refer to 3GPP 38.213, chapter 4.1.

The FSW automatically selects the valid case, depending on the selected [frequency range](#) and [subcarrier spacing](#) - you only have to select the case for a subcarrier spacing of 30 kHz.

Remote command:

[CONFigure\[:NR5G\]:DL\[:CC<cc>\]:SSBLock<ssb>:PATtern](#) on page 335

### Synchronization Signal Offset

The "RB Offset" and "Additional Subcarrier Offset" parameters define the location of the synchronization signals in the frequency domain in terms of resource blocks (RB) and subcarrier.

Both values are either relative to the first subcarrier of the channel or the [reference point A](#), depending on the "Offset Rel To" property.

- If you select "TxBW", the offset refers to a resource grid with the subcarrier spacing of the bandwidth part.
- If you select "Reference Point A", the offset refers to a resource grid with a 15 kHz subcarrier spacing (deployment in FR1) or a 60 kHz subcarrier spacing (deployment in FR2).

Note that an offset relative to the "TxBW" is only supported if one of the [bandwidth parts](#) has the same subcarrier spacing as the synchronization signal. Therefore, for a SS/PBCH subcarrier spacing = 240 kHz, the reference is always the reference point A.

The read-only field next to the input fields indicates the frequency offset of the SS/PBCH block in Hz, relative to the center of the channel bandwidth.

**Example:**

For "Offset Rel To" = "TXBW":

An RB offset = 0 would position the first subcarrier of the SS/PBCH block on the first subcarrier of the channel.

An RB offset = 12 would position the first subcarrier of the SS/PBCH block on the 144th subcarrier of the channel.

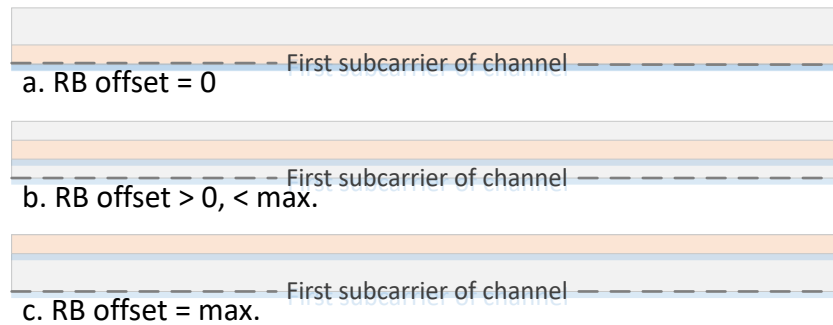

**Figure 4-4: Synchronization signal block offset relative to the first subcarrier**

For "Offset Rel To" = "Ref Point A":

The RB offset must consider the distance between reference point A and the first subcarrier of the channel (min. offset).

The min. offset would position the first subcarrier of the SS/PBCH block on the first subcarrier of the channel.

An RB offset greater than the minimum RB offset would place the SS/PBCH block on the nth subcarrier of the channel.

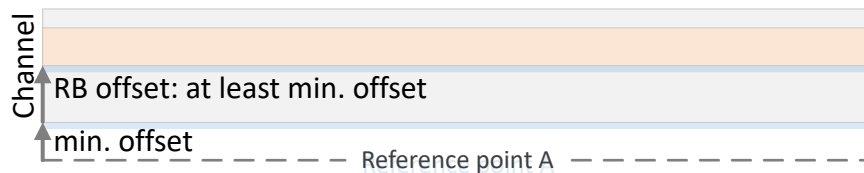

**Figure 4-5: Synchronization signal block offset relative to the reference point A**

You can fine-tune the location by defining an "Additional Subcarrier Offset".

**Example:**

An SS block offset = 12 and an additional subcarrier offset = 6 would position the first subcarrier of the SS/PBCH block on the 150th subcarrier of the channel or above the reference point A (provided that the minimum offset is lower than 150 subcarriers).

Remote command:

Resource blocks: `CONFigure[:NR5G]:DL[:CC<cc>]:SSBLock<ssb>:OFFSet`  
on page 334

Subcarrier: `CONFigure[:NR5G]:DL[:CC<cc>]:SSBLock<ssb>:ASOFFset`  
on page 332

Offset reference: `CONFigure[:NR5G]:DL[:CC<cc>]:SSBLock<ssb>:RTO`  
on page 337

### Burst Set Periodicity

The "Burst Set Periodicity" determines how often a block of synchronization signals is transmitted.

Currently, the FSW supports a burst set periodicity of 10 ms which corresponds to a transmission in every frame.

The following periodicities are supported.

- 5 ms: transmission in every half frame.
- 10 ms: transmission in every frame.
- 20 ms: transmission in every second frame.
- 40 ms: transmission in every fourth frame.

Burst set periodicities greater than 10 ms are useful for the analysis of [multiple frames](#).

Remote command:

`CONFigure[:NR5G]:DL[:CC<cc>]:SSBLock<ssb>:BSPeriod` on page 333

### SS/PBCH Block State

A half frame can contain up to 4, 8 or 64 SS/PBCH blocks, depending on the selected subcarrier spacing and the deploy frequency range. However, you can exclude individual SS/PBCH blocks from the signal description if you measure a signal that contains less than the supported number of SS/PBCH blocks.

When you select the "Configure" button, the FSW opens a dialog box to turn individual SS/PBCH blocks on and off.

The number of SS/PBCH blocks that you can turn on and off (4, 8 or 64) depends on the deployment.

- 4 SS/PBCH blocks for a deployment in FR1  $\leq$  3 GHz.\*
- 8 SS/PBCH blocks for a deployment in FR1 above 3 GHz.
- 64 SS/PBCH blocks for a deployment in FR2.

\*A special scenario also allows you to use 8 SS/PBCH blocks for a deployment < 3 GHz:

- Select a 30 kHz [subcarrier spacing](#).
- Select a "Case C" [block pattern](#).
- The "L Selection" parameter becomes available. Select the number of resource blocks to use (4 or 8).

Remote command:

SS/PBCH block state: `CONFigure[:NR5G]:DL[:CC<cc>]:SSBLock<ssb>[:STATe<ss>]` on page 338

L selection: `CONFigure[:NR5G]:DL[:CC<cc>]:SSBLock<ssb>:L` on page 334

### Half Frame Offset

Selects the half frame in which the synchronization signal is in.

Select "0" if your SSB is in the first half frame, and "1" if it is in the second.

This selection only has an effect for synchronization signals with a [periodicity](#) greater than 5 ms.

Remote command:

[CONFigure\[:NR5G\]:DL\[:CC<cc>\]:SSBLock<ssb>:HFOffset](#) on page 333

### Relative Power

You can define an additional boosting for each synchronization signal.

The "PSS Rel Power" defines the relative power of the PSS.

The "SSS Rel Power" defines the relative power of the SSS.

The "PBCH Rel Power" defines the relative power of the PBCH.

The "PBCH DMRS Power" defines the power of the PBCH demodulation reference signal (DMRS) relative to the PBCH power.

Remote command:

PSS: [CONFigure\[:NR5G\]:DL\[:CC<cc>\]:SSBLock<ssb>:PSS:POWer](#)  
on page 336

SSS: [CONFigure\[:NR5G\]:DL\[:CC<cc>\]:SSBLock<ssb>:SSS:POWer](#)  
on page 338

PBCH: [CONFigure\[:NR5G\]:DL\[:CC<cc>\]:SSBLock<ssb>:PBCH:POWer](#)  
on page 335

PBCH DMRS: [CONFigure\[:NR5G\]:DL\[:CC<cc>\]:SSBLock<ssb>:PDMRs:POWer](#)  
on page 336

## 4.1.8 Bandwidth part configuration

**Access:** "Overview" > "Signal Description" > "Radio Frame Config" > "BWP Config"

One of the defining features of the 5G NR standard is bandwidth parts (BWP). Using bandwidth parts, you can split the complete channel bandwidth into several smaller slices. A bandwidth part is defined as a contiguous set of physical resource blocks that have the same subcarrier spacing (or numerology as the 3GPP standard calls it).

The numerology has several effects on the signal, like the symbol length and the number of slots in a subframe.

**Table 4-1: Numerology in 5G NR**

Numerology	0	1	2	3	4
Subcarrier spacing	15 kHz	30 kHz	60 kHz	120 kHz	240 kHz
Slot length	1 ms	0.5 ms	0.25 ms	0.125 ms	0.0625 ms
Number of slots in subframe	1	2	4	8	16



**Table 4-2: Additional numerology introduced with 3GPP release 17**

Numerology	5	6
Subcarrier spacing	480 kHz	960 kHz
Slot length	0.03125 ms	0.015625 ms
Number of slots in subframe	32	64

The number of bandwidth parts you can configure with the FSW is limited to 12. During transmission, each bandwidth part can be assigned to a specific user equipment (UE). Bandwidth parts can overlap, in which case UEs share the resource elements of a bandwidth part.

For measurements on signals with multiple bandwidth parts, it is sufficient to configure only the active bandwidth part.

You can configure bandwidth parts in the bandwidth part configuration table. This table contains the characteristics of all bandwidth parts in the currently selected frame. You can add or remove bandwidth parts and configure them as you like.

Each row in the table corresponds to a bandwidth part.

#### Detection of bandwidth part configuration

The FSW supports [automatic detection](#) of the bandwidth part configuration. When you select "Auto" detection mode, the FSW detects the bandwidth part configuration, slot configuration and PDSCH and CORESET allocations.

When you select "Manual" mode, you can describe the bandwidth part manually with various characteristics.

If you measure a signal with a bad signal-to-noise ratio, for example due to a low signal level, manual configuration of the bandwidth parts can increase the synchronization probability.

When you turn on automatic signal detection, the settings in this dialog box are unavailable.

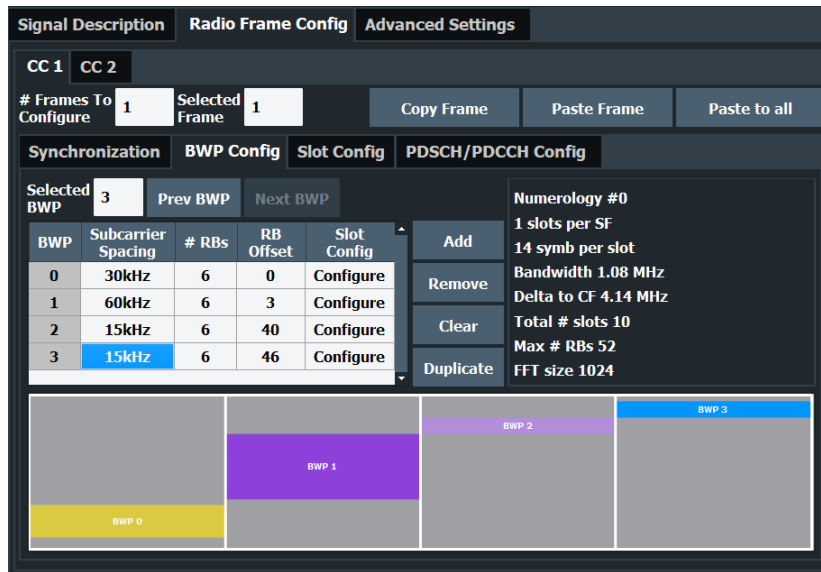

**Configuring component carriers**

When you are doing measurements on [aggregated carriers](#), you can configure each carrier separately.

When available, each carrier in the dialog boxes is represented by an additional tab labeled "CC<x>", with <x> indicating the number of the component carrier.

Note that the additional tabs are only added to the user interface after you have selected more than "1" component carrier.

The remote commands required to configure the bandwidth parts are described in [Chapter 6.10.7, "Bandwidth part configuration"](#), on page 339.

- [BWP configuration table management](#).....98
- [BWP configuration table](#).....99

**4.1.8.1 BWP configuration table management**

The FSW provides several tools to manage the configuration table and make the configuration of bandwidth parts easier.

- [Bandwidth Part Selection](#)..... 98
- [BWP Configuration Tools](#)..... 99

**Bandwidth Part Selection**

You can select the bandwidth part you want to configure by entering its number in the "Selected BWP" input field. In the configuration table, the selected bandwidth part is highlighted blue.

You can also select bandwidth parts with the "Prev BWP" and "Next BWP" buttons.

Note that when you select a bandwidth part, the FSW also selects that bandwidth part in the [Slot Config](#) and [PDSCH / PDCCH Config](#) tabs and vice versa.

Remote command:  
via suffix at `BWPart<bwp>`

### BWP Configuration Tools

The BWP configuration table provides several management tools.

- "Add": Adds a bandwidth part to the table.
- "Remove": Deletes the selected (highlighted) bandwidth part.
- "Clear": Removes all entries from the table.
- "Duplicate": Copies the configuration of the selected bandwidth part to a new bandwidth part.

Note that this includes the [Slot Config](#) and [PDSCH / PDCCH](#).

Remote command:

Add BWP: `CONFigure[:NR5G]:DL[:CC<cc>]:FRAME<fr>:BWPart<bwp>:ADD`  
on page 339

Remove BWP: `CONFigure[:NR5G]:DL[:CC<cc>]:FRAME<fr>:BWPart<bwp>:REMove`  
on page 341

Clear table: `CONFigure[:NR5G]:DL[:CC<cc>]:FRAME<fr>:BWPart<bwp>:CLEar`  
on page 339

Duplicate BWP: `CONFigure[:NR5G]:DL[:CC<cc>]:FRAME<fr>:BWPart<bwp>:DUPLicate`  
on page 340

#### 4.1.8.2 BWP configuration table

The bandwidth part configuration table consists of several rows, each of which corresponds to a bandwidth part. The size of the table therefore depends on the number of bandwidth parts you have added to the table.

#### Preview diagram

The preview diagram shows the distribution and location of the bandwidth parts. The x-axis represents the bandwidth part, the y-axis represent the frequency, with the point of origin of the diagram being the first subcarrier. The color depends on the subcarrier spacing selected for the corresponding bandwidth part.

The width of the bandwidth parts depends on the number of resource blocks it occupies. The location of the bandwidth part on the y-axis depends on the resource block offset.

If two or more bandwidth parts overlap (share the same resource blocks), the corresponding parts of the bandwidth part are highlighted by black lines.

Unused parts of the spectrum remain gray.

#### Numerology

Next to the bandwidth part configuration table, the FSW displays various information about the numerology in the currently selected bandwidth part.

- "Numerology": Shows the [numerology](#) of the bandwidth part as defined by 3GPP.
- "Slots per SF": Shows the number of slots in a subframe in the selected BWP. The number of slots depends on the selected subcarrier spacing.

- "Symbols Per Slot": Shows the number of symbols in a slot in the selected BWP.
- "Bandwidth": Shows the width of the selected BWP in Hz.
- "Delta To CF": Shows the frequency offset of the BWP relative to the center frequency of the complete signal.
- "Total # Slots": Shows the complete number of slots in the BWP over all subframes. The number of slots depends on the selected subcarrier spacing.
- "Max # RBs": Shows the maximum number of resource blocks that the bandwidth part can have.
- "FFT Size": Shows the FFT size in the selected BWP. The FFT size depends on the selected subcarrier spacing.

BWP Number.....	100
Subcarrier Spacing (user data).....	100
# RBs.....	101
RB Offset.....	101
Slot Config.....	101

### BWP Number

The "BWP Number" shows the index number of the corresponding BWP.

The bandwidth part number is a consecutive index number that allows you to identify each bandwidth part. The first bandwidth part has the index number 0.

Remote command:  
not supported

### Subcarrier Spacing (user data)







The "Subcarrier Spacing" selects the subcarrier spacing for the corresponding BWP.

The available subcarrier spacings depend on the [frequency range](#) you have selected.

- FR1: 15 kHz, 30 kHz, 60 kHz  
Note that 15 kHz is only available for channel bandwidths < 60 MHz.
- FR2-1: 60 kHz, 120 kHz
- FR2-2: 120 kHz, 480 kHz, 960 kHz  
The following restrictions apply:
  - Channel bandwidth = 100 MHz: 120 kHz
  - Channel bandwidth = 400 MHz: 120 kHz, 480 kHz and 960 kHz
  - Channel bandwidth = 800 MHz and 1600 MHz: 480 kHz and 960 kHz
  - Channel bandwidth = 2000 MHz: 960 kHz

Note that a 240 kHz subcarrier spacing is only supported for the [synchronization signal](#).

Subcarrier spacings are indicated by different colors in the preview diagram.

- : 15 kHz
- : 30 kHz
- : 60 kHz
- : 120 kHz
- : 480 kHz
- : 960 kHz

For bandwidth parts with a 60 kHz subcarrier spacing, you can select if it has a normal cyclic prefix (NCP) or an extended cyclic prefix (ECP). Note that the diagrams only show results if you select the BWP with the extended cyclic prefix from the [evaluation range](#).

Remote command:

`CONFigure[:NR5G]:DL[:CC<cc>]:FRAMe<fr>:BWPart<bwp>:SSPacing`  
on page 341

### # RBs

The "# RBs" defines the number of physical resource blocks (PRB) the bandwidth part occupies. The number of physical resource blocks also defines the frequency width of the bandwidth part.

The maximum number of physical resource blocks for a bandwidth part depends on the selected [subcarrier spacing](#) and the overall [channel bandwidth](#), which in turn depend on the selected [frequency range](#). For a detailed overview, see 3GPP 38.104, tables 5.3.2-1 and 5.3.2-2.

Bandwidth parts can share resource blocks.

Remote command:

`CONFigure[:NR5G]:DL[:CC<cc>]:FRAMe<fr>:BWPart<bwp>:RBCount`  
on page 340

### RB Offset

The "RB Offset" defines an offset of the first resource block that the bandwidth part uses relative to the first resource block of the channel.

The resource block offset therefore defines the location (frequency) of the bandwidth part in the NR channel.

Remote command:

`CONFigure[:NR5G]:DL[:CC<cc>]:FRAMe<fr>:BWPart<bwp>:RBOffset`  
on page 341

### Slot Config

The "Configure" button opens the dialog box to configure the slots in the corresponding bandwidth part.

For details, see [Slot Config](#).

Remote command:

not supported

## 4.1.9 Slot configuration

**Access:** "Overview" > "Signal Description" > "Radio Frame Config" > "Slot Config"

### Slots

Slots are flexible entities in the 5G NR radio frame, whose characteristics depend on a number of factors.

In the time domain, the length of a slot and the number of slots in a subframe depends on the numerology.

Each slot contains 14 OFDM symbols. Each symbol can have a different scheduling type to make scheduling during transmission as flexible as possible.

### Slot configuration table

The slot configuration table represents the frame structure in the time domain. Each row corresponds to one slot, and each slot can have a different configuration.

When you turn on automatic signal detection, the settings in this dialog box are unavailable.

### Selecting the bandwidth part to configure

- ▶ Enter the number of the bandwidth part you want to configure in the "Bandwidth Part Number" field.

The FSW selects the corresponding bandwidth part.

Note that when you select bandwidth part here, the FSW also selects that bandwidth part in the [BWP Config](#) tab and vice versa.



### Configuring component carriers

When you are doing measurements on [aggregated carriers](#), you can configure each carrier separately.

When available, each carrier in the dialog boxes is represented by an additional tab labeled "CC<x>", with <x> indicating the number of the component carrier.

Note that the additional tabs are only added to the user interface after you have selected more than "1" component carrier.

The remote commands required to configure the slots are described in [Chapter 6.10.8, "Slot configuration"](#), on page 342.

• <a href="#">General slot configuration</a> .....	103
• <a href="#">Slot configuration table</a> .....	104
• <a href="#">CSI reference signal</a> .....	106
• <a href="#">Positioning reference signal</a> .....	110

#### 4.1.9.1 General slot configuration

The slot configuration table contains a variable number of rows, depending on the bandwidth parts configuration.

<a href="#">Selected Slot</a> .....	103
<a href="#">Number of Configurable Slots</a> .....	103
<a href="#">Slot Configuration Tools</a> .....	104

##### Selected Slot

You can select the slot you want to configure by entering its number in the "Selected Slot" input field. In the configuration table, the selected slot is highlighted blue.

You can also select slots with the "Prev Slot" and "Next Slot" buttons.

Note that when you select a slot, the FSW also selects that slot in the [PDSCH / PDCCH Config](#) tab and vice versa.

Remote command:

via suffix at `SLOT<sl>`

##### Number of Configurable Slots

You can configure each slot in the radio frame individually, but when more slots have the same configuration (for example each subframe has the same slot configurations), you can configure just a certain number of slots and repeat this configuration on other slots.

The slots you can edit ("# User Configurable Slots") are always the first slots in the table. For example, if the number of configurable slots is "4", you can edit the first four rows in the table. The cells of slots you can edit are white.

The slot configuration is repeated for all other slots. For example, if you can edit the first four slots, the subsequent four slots have the same configuration and so on. The configuration that a specific slot uses is indicated in the last column of the slot configuration table.

The "Periodicity" shown next to the slot configuration table indicates the length of all customized slots. For example, a periodicity of 1 ms in a BWP with a 30 kHz subcarrier spacing indicates that the first two slots have a custom configuration which is repeated every 1 ms.

Remote command:

[CONFigure\[:NR5G\]:DL\[:CC<cc>\]:FRAME<fr>:BWPart<bwp>:CSLot](#)  
on page 343

### Slot Configuration Tools

The FSW provides some tools to make slot configuration easier.

- "Copy Slot": Copies the slot configuration of the selected slot.  
Note that this includes the [PDSCH/PDCCH configuration](#) of that slot.
- "Paste Slot": Applies the slot configuration in the cache to the selected slot.
- "Paste To": Applies the slot configuration to a set of configurable slots.
  - Paste to "Slots": Paste to specific slots or range of slots (e.g. 1,2,5-8)
  - Paste to "Data": Paste to all data slots.
  - Paste to "Unused": Paste to all unused slots (they will turn into data slots).
  - Paste to "Custom": Paste to selected slots according to a certain [logic](#) (period / duration).
- "Paste To All": Applies the slot configuration in the cache to all configurable slots.
- "Reset Slot Config": Restores the default slot configuration (including the PDSCH/ PDCCH configuration).

Remote command:

Copy: `CONFigure[:NR5G]:DL[:CC<cc>]:FRAMe<fr>:BWPart<bw>:SLOT<sl>:COPY` on page 344

Paste: `CONFigure[:NR5G]:DL[:CC<cc>]:FRAMe<fr>:BWPart<bw>:SLOT<sl>:PASTe[:SLOT]` on page 348

Paste to all: `CONFigure[:NR5G]:DL[:CC<cc>]:FRAMe<fr>:BWPart<bw>:SLOT<sl>:PASTe:ALL` on page 345

Paste to selected: `CONFigure[:NR5G]:DL[:CC<cc>]:FRAMe<fr>:BWPart<bw>:SLOT<sl>:PASTe:TO` on page 347

Reset: `CONFigure[:NR5G]:DL[:CC<cc>]:FRAMe<fr>:BWPart<bw>:SLOT<sl>:PRESet` on page 349

#### 4.1.9.2 Slot configuration table

The slot configuration table contains the configuration of all slots in the currently selected bandwidth part. The number of rows (slots) depends on the [subcarrier spacing](#) in the selected bandwidth part.

The complete number of slots in the selected bandwidth part is indicated next to the table ("n Slots in BWP x").

SF Number	Slot Number	Slot Allocation	Slot Format	PDSCH Allocations	Repeated Slot No	Ref Signals
0	0	Data	0	Configure	User	CSI-RS
	1	Data	0		0	None
1	2	Data	0		0	None
	3	Data	0		0	None
2	4	Data	0		0	CSI-RS
	5	Data	0		0	None
3	6	Data	0		0	None
	7	Data	0		0	None

### Slot preview

The slot preview shows the scheduling of the OFDM symbols in the selected slot.





Figure 4-6: Preview of symbol usage for slot format 38 as defined in 3GPP 38.211, table 4.3.2-3

The scheduling depends on the selected [slot format](#).

Subframe Number.....	105
Slot Number.....	105
Slot Allocation.....	105
Slot Format.....	105
PDSCH Allocations.....	106
Repeated Slot No.....	106
Ref Signals.....	106

### Subframe Number

The "Subframe Number" shows the index number (0 to 9) of the subframe that the slot belongs to.

The number of subframes is always 10, the number of slots in a subframe varies, depending on the subcarrier spacing / [numerology](#). The first subframe always has the index 0.

Remote command:  
not supported

### Slot Number

The "Slot Number" shows the index number (0 to n) of the corresponding slot.

The selected slot is highlighted blue.

The number of slots in the frame varies, depending on the subcarrier spacing / [numerology](#). The first slot always has the index 0.

Remote command:  
not supported

### Slot Allocation

The "Slot Allocation" selects the usage of the corresponding slot.

- "Data": Slot is used for user data transmission.
- "Unused": Slot is not used.

Remote command:

`CONFigure[:NR5G]:DL[:CC<cc>]:FRAME<fr>:BWPart<bwp>:SLOT<sl>:`  
[ATYPe](#) on page 343

### Slot Format

The "Slot Format" selects one of the slot formats defined by 3GPP for the corresponding slot.

The slot format defines the usage of the OFDM symbols in a slot. Possible symbol usages are:

- Uplink: Symbol carries uplink information.
- Downlink: Symbol carries downlink information.
- Flexible: Symbol usage is undefined and can carry uplink or downlink information.

The symbol usage of the selected slot format is indicated in the [slot preview](#).

For a comprehensive list of all supported slot formats, see 3GPP 38.211, table 4.3.2-3: "Slot formats".

3GPP release 16 unlocks additional slot formats.

Remote command:

`CONFigure[:NR5G]:DL[:CC<cc>]:FRAMe<fr>:BWPart<bwp>:SLOT<sl>:  
FORMat` on page 344

### PDSCH Allocations

The "Configure" button opens the dialog box to configure the PDSCH or CORESET allocations in the corresponding slot.

For details, see [Chapter 4.1.10, "PDSCH and PDCCH configuration"](#), on page 113.

Remote command:

not supported

### Repeated Slot No

The "Repeated Slot No" shows the slot number on which the configuration of a slot is based on.

If the table cell says "User", the slot is configured manually.

If the table cell contains a number, the slot configuration is the same as the slot indicated by that number. For example, if the cell contains the number "1", the slot configuration is the same as the slot with the index number 1.

Remote command:

not supported

### Ref Signals

Opens a dialog box to configure reference signals transmitted in the corresponding slot.

For details, see [Chapter 4.1.9.3, "CSI reference signal"](#), on page 106.

Remote command:

not supported

#### 4.1.9.3 CSI reference signal

The channel state information reference signal (CSI-RS) is used to estimate the properties of the signal propagation channel from the base station to the user equipment. This information is quantized and fed back to the base station. The base station makes use of this information for example to calculate the channel quality or to adjust the beamforming parameters.

You can define various parameters to describe the physical attributes and structure of the CSI-RS, for example where it is located in the resource grid or how often it occurs in the signal.

The CSI-RS configuration is specific to a bandwidth part.

Within a bandwidth part, the CSI-RS configuration depends on the number of resources you define. Each resource of the CSI-RS can have a different configuration. You

can allocate the CSI-RS to more than one slot (periodic or aperiodic [transmission method](#)).

Note that the CSI-RS is only analyzed if you assign it to an [antenna port](#).

Channel-State Information RS

State **On** Off Resources 3

Slot Config	Zero Power	Number of RBs	Start RB	Row	Ports	Density	CDM Type	Bitmap	I0	I1	Scrambling ID	Rel. Power / dB
Periodic	Off	273	0	1	1	3	No CDM	1111	9	11	0	0 dB
Periodic	Off	273	0	1	1	3	No CDM	1111	9	11	0	0 dB
Periodic	Off	273	0	1	1	3	No CDM	1111	9	11	0	0 dB

The remote commands required to configure the CSI reference signal are described in [Chapter 6.10.9, "CSI reference signal configuration"](#), on page 349.

State..... 107

Resources..... 107

Slot Config..... 108

    L Periodic transmission..... 108

    L Aperiodic transmission..... 108

Zero Power..... 108

No. RBs..... 109

Start RB..... 109

Row..... 109

Density..... 109

Bitmap..... 110

I0 / I1..... 110

Scrambling ID..... 110

Rel Power..... 110

**State**

Turns the CSI reference signal on and off.

Remote command:

```
CONFigure[:NR5G]:DL[:CC<cc>]:FRAME<fr>:BWPart<bwp>:CSI<csi>:
STATE on page 357
```

**Resources**

Defines the number of CSI-RS resources that make up the CSI-RS. Each resource can have a different configuration

Each line in the CSI-RS configuration table corresponds to a resource. Changing the number of resources adjusts the number of rows accordingly.

Remote command:

```
CONFigure[:NR5G]:DL[:CC<cc>]:FRAME<fr>:BWPart<bwp>:CSI<csi>:
RESources on page 353
```

**Slot Config**

Opens a dialog box to configure in which slots the CSI reference signal appears.

You can select "Periodic" or "Aperiodic" transmission.

Remote command:

Method: `CONFigure[:NR5G]:DL[:CC<cc>]:FRAMe<fr>:BWPart<bwp>:CSI<csi>:SLOT:MODE` on page 355

**Periodic transmission ← Slot Config**

Periodic transmission transmits the CSI-RS every <x> slots ("Periodicity"). You can also define an "Offset" if you do not want the first occurrence of the CSI-RS in the first slot - for an offset of 2, for example, the first slot that carries the CSI-RS is slot 2.

If you configure and analyze multiple frames, the sequence of CSI-RS is applied in subsequent frames. For example, if you define a periodicity of "4" in 2 frames with 10 slots each, the following slots contain a CSI-RS (assuming, there is no offset):

- First frame: 0 - 4 - 8
- Second frame: 2 - 6 - 10

You can check the distribution of CSI-RS in the "Ref Signals" column of the [slot configuration table](#) when you [select different frames](#).

For a correct analysis of the CSI-RS over multiple frames, you have to define the starting frame. You can do this in different ways.

- Trigger on a fixed system frame number (recommended).
- Select the received frame with the [frame number n\\_f](#) parameter. You can find out the system frame n\_f in the [channel decoder results](#) (an SSB must be available for this to work). After you change n\_f, you have to [refresh](#) the results.

Remote command:

Periodicity: `CONFigure[:NR5G]:DL[:CC<cc>]:FRAMe<fr>:BWPart<bwp>:CSI<csi>:SLOT:PERiodicity` on page 356

Offset: `CONFigure[:NR5G]:DL[:CC<cc>]:FRAMe<fr>:BWPart<bwp>:CSI<csi>:SLOT:POFFset` on page 356

**Aperiodic transmission ← Slot Config**

Aperiodic transmission transmits the CSI-RS in arbitrary slots. Enter the slot numbers that should carry the CSI-RS in the "Slots" input field. For example: 1-3,5,7 to transmit the CSI-RS in slots 1,2,3,5 and 7.

Available slots depend on the subcarrier spacing in the bandwidth part.

For aperiodic transmission over multiple frames, you can define the location of the CSI-RS in each frame manually. If you only define the CSI-RS location for one frame, the FSW assumes that the location is the same in all frames.

Remote command:

Slots: `CONFigure[:NR5G]:DL[:CC<cc>]:FRAMe<fr>:BWPart<bwp>:CSI<csi>:SLOT:APERiodic` on page 355

**Zero Power**

Turns zero power transmission of the CSI reference signal on and off.

If you turn on zero power transmission, the resource elements are allocated to the CSI-RS as if it were there, but it is not actually transmitted. Results for the CSI-RS, like the EVM, are also not calculated. You can no longer define a scrambling ID or relative power for the CSI-RS.

Remote command:

`CONFigure[:NR5G]:DL[:CC<cc>]:FRAMe<fr>:BWPart<bwp>:CSI<csi>:ZPOWer` on page 358

### No. RBs

Selects the number of resource blocks the CSI reference signal uses.

Remote command:

`CONFigure[:NR5G]:DL[:CC<cc>]:FRAMe<fr>:BWPart<bwp>:CSI<csi>:NORBs` on page 352

### Start RB

Selects the first resource block in the bandwidth part that the CSI reference signal uses.

Remote command:

`CONFigure[:NR5G]:DL[:CC<cc>]:FRAMe<fr>:BWPart<bwp>:CSI<csi>:SRB` on page 357

### Row

Selects one of the CSI-RS location settings defined in 3GPP 38.211, table 7.4.1.5.3-1. The location settings correspond to the rows in this table.

The selection has an effect on the ranges of the following CSI-RS settings:

- [Density](#)
- [Bitmap](#)  
(Note that the bitmap has a fixed configuration for some rows.)
- [I0 / I1](#)  
(Some location settings reserve two symbols for the CSI-RS transmission.)

The row selection also defines the values for the "Ports" and the "CDM Type" (code domain multiplexing type) parameters. These two values are fixed for each row and therefore read only parameters.

Remote command:

Row selection: `CONFigure[:NR5G]:DL[:CC<cc>]:FRAMe<fr>:BWPart<bwp>:CSI<csi>:ROW` on page 354

Ports (query): `CONFigure[:NR5G]:DL[:CC<cc>]:FRAMe<fr>:BWPart<bwp>:CSI<csi>:PORT?` on page 353

CDM type (query): `CONFigure[:NR5G]:DL[:CC<cc>]:FRAMe<fr>:BWPart<bwp>:CSI<csi>:CTYPe?` on page 350

### Density

Defines how many subcarriers are allocated to the CSI-RS.

The available values depend on the [location settings](#) parameter.

If you select 0.5 density, you can define if the CSI-RS is located on even or odd resource blocks.

Remote command:

CONFigure [:NR5G] :DL[:CC<cc>] :FRAMe<fr>:BWPart<bwp>:CSI<csi>:  
DENSIty on page 351

### Bitmap

Defines the subcarriers on which the CSI-RS is transmitted (location of the CSI-RS in the frequency domain).

For more information about supported bitmap values, see 3GPP 38.211, chapter 7.4.1.5.

Note that the bitmap setting is not available for all [location settings](#).

Remote command:

CONFigure [:NR5G] :DL[:CC<cc>] :FRAMe<fr>:BWPart<bwp>:CSI<csi>:  
BITMap on page 350

### I0 / I1

Parameters  $I_0$  and  $I_1$  define the location of the CSI-RS in the time domain.

"I0" defines the position of the first symbol of the first CSI-RS in the resource grid.

"I1" becomes available for [location settings](#) that support a two-symbol transmission of the CSI-RS. It defines the resource grid position of the second symbol allocated to the CSI-RS.

Note that  $I_0$  must be smaller than  $I_1$ .  $I_0$  is automatically adjusted if this is not the case.

Remote command:

$I_0$ : CONFigure [:NR5G] :DL[:CC<cc>] :FRAMe<fr>:BWPart<bwp>:CSI<csi>:  
LZERo  
 $I_1$ : CONFigure [:NR5G] :DL[:CC<cc>] :FRAMe<fr>:BWPart<bwp>:CSI<csi>:  
LONE on page 351

### Scrambling ID

Defines the pseudo-random seed value for the CSI-RS sequence generation.

Remote command:

CONFigure [:NR5G] :DL[:CC<cc>] :FRAMe<fr>:BWPart<bwp>:CSI<csi>:SID  
on page 354

### Rel Power

Defines the relative power of the CSI-RS in dB.

Remote command:

CONFigure [:NR5G] :DL[:CC<cc>] :FRAMe<fr>:BWPart<bwp>:CSI<csi>:  
POWer on page 353

#### 4.1.9.4 Positioning reference signal

The positioning reference signal (PRS) is used to locate user equipment using timing based methods. Compared to other positioning systems like GPS, using the PRS is highly accurate and provides a greater coverage, even indoors. PRS is useful for any type of location based services, for example emergency calls.

You can define various parameters to describe the physical attributes and structure of the PRS, for example where it is located in the resource grid or how often it occurs in the signal.

The PRS configuration is specific to a bandwidth part.

Within a bandwidth part, you can configure a single PRS. You can allocate the PRS to more than one slot (aperiodic [transmission method](#)).

The positioning reference signal is available with 3GPP release 16.

Positioning RS								
State	On		Off					
Slot Config	Number of RBs	Start RB	l <sup>^</sup> PRS_start	L_PRS	n <sup>^</sup> PRS_ID,Seq	K <sup>^</sup> PRS_comb	k <sup>^</sup> PRS_offset	Rel. Power/dB
Aperiodic	272	0	0	2	0	2	0	0 dB

The remote commands required to configure the positioning reference signal are described in [Chapter 6.10.10, "Positioning reference signal"](#), on page 358.

State.....	111
Slot Config.....	111
No. RBs.....	111
Start RB.....	112
l <sup>^</sup> PRS_Start.....	112
L_PRS.....	112
n <sup>^</sup> PRS_ID,Seq.....	112
K <sup>^</sup> PRS_comb.....	112
K <sup>^</sup> PRS_Offset.....	112
Rel Power.....	113

### State

Turns the positioning reference signal on and off.

Remote command:

```
CONFigure[:NR5G]:DL[:CC<cc>]:FRAME<fr>:BWPart<bw>:PRS:STATE
```

on page 362

### Slot Config

Opens a dialog box to configure in which slots the positioning reference signal appears.

You can assign the PRS to arbitrary slots. Enter the slot numbers that should carry the PRS in the "Slots" input field. For example: 1-3,5,7 to transmit the PRS in slots 1,2,3,5 and 7.

Available slots depend on the subcarrier spacing in the bandwidth part.

Remote command:

```
CONFigure[:NR5G]:DL[:CC<cc>]:FRAME<fr>:BWPart<bw>:PRS:SLOT:APERiodic
```

on page 361

### No. RBs

Selects the number of resource blocks the positioning reference signal uses.

Remote command:

`CONFigure[:NR5G]:DL[:CC<cc>]:FRAMe<fr>:BWPart<bwp>:PRS:NORBs`  
on page 360

### Start RB

Selects the first resource block in the bandwidth part that the positioning reference signal uses.

Remote command:

`CONFigure[:NR5G]:DL[:CC<cc>]:FRAMe<fr>:BWPart<bwp>:PRS:SRB`  
on page 361

### I^PRS\_Start

Defines the first symbol in a slot allocated to the positioning reference signal.

Note that the selection of the start symbol has an effect on the number of symbols [number of symbols](#) the PRS can use. The higher the start symbol, the less symbols the PRS can use.

Remote command:

`CONFigure[:NR5G]:DL[:CC<cc>]:FRAMe<fr>:BWPart<bwp>:PRS:LPStart`  
on page 360

### L\_PRS

Defines the number of symbols allocated to the positioning reference signal.

Note that the selection of the [start symbol](#) has an effect on the number of symbols the PRS can use. The higher the start symbol, the less symbols the PRS can use.

Remote command:

`CONFigure[:NR5G]:DL[:CC<cc>]:FRAMe<fr>:BWPart<bwp>:PRS:LPRS`  
on page 359

### n^PRS\_ID,Seq

Defines the pseudo-random seed value for the PRS sequence generation.

Remote command:

`CONFigure[:NR5G]:DL[:CC<cc>]:FRAMe<fr>:BWPart<bwp>:PRS:NPID`  
on page 360

### K^PRS\_comb

Defines the number of subcarriers allocated to the positioning reference signal.

The number of subcarriers you can use depends on the [size of the PRS](#).

Remote command:

`CONFigure[:NR5G]:DL[:CC<cc>]:FRAMe<fr>:BWPart<bwp>:PRS:KPComb`  
on page 358

### K^PRS\_Offset

Defines an offset for the positioning reference signal in the frequency domain relative to the first subcarrier.

Possible offsets depend on the [number of subcarriers](#) the PRS uses.



Remote command:

`CONFigure [:NR5G] :DL[:CC<cc>] :FRAMe<fr>:BWPart<bwp>:PRS:KPOffset`  
on page 359

### Rel Power

Defines the relative power of the positioning reference signal in dB.

Remote command:

`CONFigure [:NR5G] :DL[:CC<cc>] :FRAMe<fr>:BWPart<bwp>:PRS:POWer`  
on page 361

## 4.1.10 PDSCH and PDCCH configuration

**Access:** "Overview" > "Signal Description" > "Radio Frame Config" > "PDSCH / PDCCH Config"

Each slot assigned to carry user data contains one or more resource allocations. Resource allocations are the physical channels that carry user data or information about it. The size of an allocation in the resource grid is variable. An allocation covers one or more physical resource blocks.

### PDSCH

The physical downlink shared channel (PDSCH) carries the general user data and is therefore the most prominent channel in a radio frame that occupies the most resources. PDSCH allocations have a variable number of resource blocks and OFDM symbols. Each slot can have one or more PDSCHs. The PDSCH has a dedicated demodulation reference signal (DMRS).

Interleaving means that virtual resource block bundles are mapped to different physical resource block bundles in the physical resource grid. If you do not apply interleaving, the physical resource grid is the same as the virtual resource grid.

The RB bundle size in the frequency domain is variable, in the time domain it still consists of a single OFDM symbol.

### CORESET

The physical downlink control channel (PDCCH) carries the downlink control information. The PDCCH is transmitted in a control resource set (CORESET) that has a dedicated demodulation reference signal (DMRS). A CORESET contains the control information for one or more UEs. Each slot can contain one or more CORESETs.

In terms of the resource allocation, a PDCCH consists of several control channel elements (CCEs), depending on the aggregation level. A CCE is a cluster of several REG bundles, which in turn consist of one or more resource element groups (REG). In the resource grid, the REG bundles can be grouped, but can also be distributed over non-contiguous resource blocks (interleaving). A REG corresponds to one resource block (12 resource elements in the frequency domain and one OFDM symbol in the time domain).

The PDCCH also contains the [downlink control information](#) (DCI).

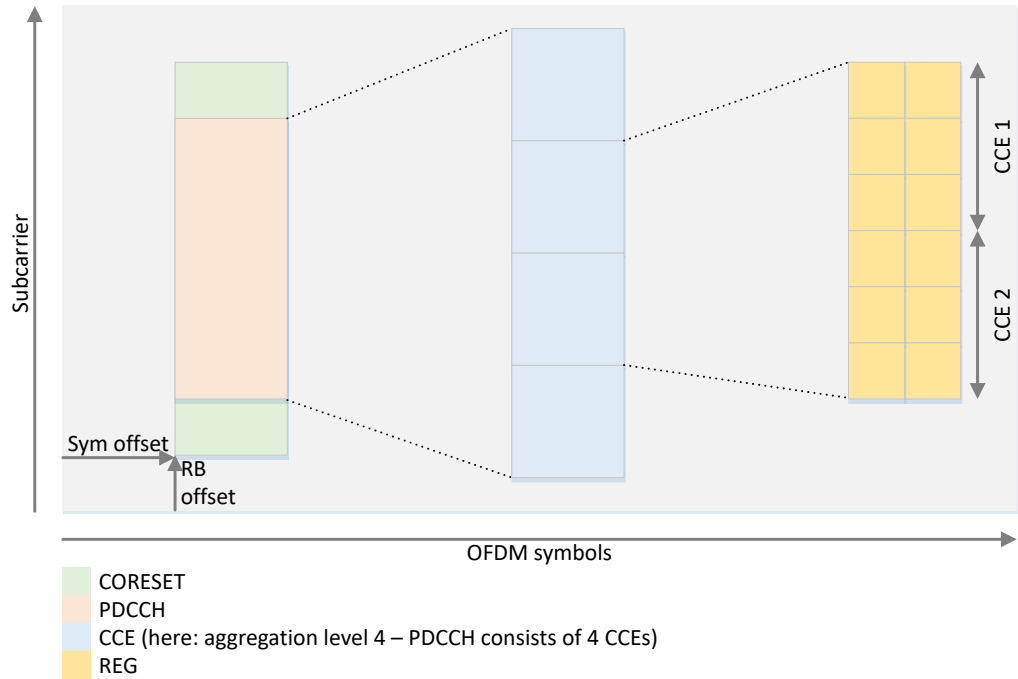

Figure 4-7: PDCCH structure

When you turn on automatic signal detection, the settings in this dialog box are unavailable.

Signal Description Radio Frame Config Ant Port Mapping Advanced Settings

CC 1 CC 2

# Frames To Configure: 1 Selected Frame: 1 Copy Frame Paste Frame Paste to all

Synchronization BWP Config Slot Config PDSCH/PDCCH Config

Bandwidth Part Number: 0 Slot Number: 0

# PDSCH Allocations: 2 # CORESETs: 2

ID	User ID	Allocation	Code Word	Modulation	Enhanced Settings	Number of RBs	Offset RB	Number of Symb	Offset Symb	Rel. Power /dB	Conflict
0		CORESET		QPSK	...	6	0	1	0	0 dB	
1		CORESET		QPSK	...	6	6	1	0	0 dB	
0	0	PDSCH	1/1	QPSK	...	20	20	10	1	0 dB	
1	0	PDSCH	1/1	QPSK	...	20	0	10	1	0 dB	

Combine PDSCH Allocations with Same User ID: On Off



### Configuring component carriers

When you are doing measurements on [aggregated carriers](#), you can configure each carrier separately.

When available, each carrier in the dialog boxes is represented by an additional tab labeled "CC<x>", with <x> indicating the number of the component carrier.

Note that the additional tabs are only added to the user interface after you have selected more than "1" component carrier.

- [General PDSCH / PDCCH configuration](#)..... 115
- [PDSCH / PDCCH configuration table](#)..... 116
- [Enhanced CORESET settings: allocation configuration](#)..... 120
- [Enhanced CORESET settings: PDCCH](#)..... 122
- [Enhanced PDSCH settings: DMRS](#)..... 126
- [Enhanced PDSCH settings: PTRS](#)..... 130
- [Enhanced PDSCH settings: scrambling / coding](#)..... 131

#### 4.1.10.1 General PDSCH / PDCCH configuration

The allocations in the table refer to a specific bandwidth part and slot.

##### Selecting the bandwidth part to configure

- ▶ Enter the number of the bandwidth part you want to configure in the "Bandwidth Part Number" field.

The FSW selects the corresponding bandwidth part.

Note that when you select bandwidth part here, the FSW also selects that bandwidth part in the [BWP Config](#) tab and vice versa.

##### Selecting the slot to configure

- ▶ Enter the number of the slot you want to configure in the "Selected Slot" field.

Note that when you select a slot here, the FSW also selects that slot in the [Slot Config](#) tab and vice versa.

##### Defining the number of PDSCH and CORESET allocations

The FSW allows you to allocate up to 100 individual CORESETs and PDSCH allocations to a slot.

- ▶ Enter the number of allocations in the "# CORESETs" or "# PDSCH Allocations" field.

The FSW expands the PDSCH configuration table accordingly.

When you add a CORESET, the new CORESET is added after the last existing CORESET and before the first PDSCH allocation. New PDSCH allocations are always added at the end of the table.

### Combining PDSCH allocations with the same user ID

Instead of decoding each PDSCH separately, you can bundle PDSCH allocations and decode them as one (PRB bundling), even if they have a different location in the resource grid. You can bundle PDSCH allocations by giving them the same user ID.

1. Assign [user IDs](#) to PDSCH allocations as required.  
You can define the user ID for a specific allocation in the "Enhanced Settings" or in the corresponding column in the allocation table.
2. Turn on "Combine PDSCH Allocations With Same User ID".

When you combine allocations, you can change the allocation settings (modulation, number of symbols, enhanced settings etc.) only for the first allocation in the bundle. Number of resource blocks and the resource block offset remain available for all allocations.

Bundling PDSCH allocations has an effect on result displays that show the decoded signal, like the bit stream. Instead of showing the decoded results for each PDSCH allocation, these result display combine the results for bundled allocations.

# PDSCH Allocations.....	116
# CORESETs.....	116
Combine PDSCH Allocations With Same User ID.....	116

#### # PDSCH Allocations

Defines the [number of PDSCH allocations](#) in the slot.

Remote command:

```
CONFigure[:NR5G]:DL[:CC<cc>]:FRAMe<fr>:BWPart<bwp>:SLOT<sl>:ALCount on page 369
```

#### # CORESETs

Defines the [number of CORESET allocations](#) in the slot.

Remote command:

```
CONFigure[:NR5G]:DL[:CC<cc>]:FRAMe<fr>:BWPart<bwp>:SLOT<sl>:CRSCoUnT on page 368
```

#### Combine PDSCH Allocations With Same User ID

Turns [PRB bundling](#) on and off.

Remote command:

```
CONFigure[:NR5G]:DL[:CC<cc>]:FRAMe<fr>:BWPart<bwp>:SLOT<sl>:CUID on page 376
```

#### 4.1.10.2 PDSCH / PDCCH configuration table

The configuration table contains the PDSCH and PDCCH (CORESET) allocations. Each row corresponds to an allocation. The first part of the table shows the CORESETs, the second part of the table the PDSCH allocations.

## Reusing PDSCH allocations

If you are measuring multiple slots with a different configuration, you can copy allocations to other slots once you have defined them in the first slot.

Prerequisite: [# of configurable slots](#) > 1

1. Select "Copy To" to copy the allocation configuration to the clipboard.  
The FSW opens a dialog to select the target slots.
2. From the "Copy To" menu, select:
  - "Slots" to copy the allocation to a number of selected slots.
  - "Custom" to copy the allocation to slots based on a certain logic.
3. "Copy To": "Slots":  
Select the slots you want to copy the allocation to.
  - Enter a comma-separated list of slots (for example: 1,4,5,7)
  - Enter a range of slots (for example: 3-6)
  - Enter a combination of both (for example: 1,3-5,8)
4. "Copy To": "Custom":  
Select the copy logic.
  - "Period": Copy the allocation to every  $n^{\text{th}}$  slot.  
Example: Period = 3 copies the allocation to every 3rd slot, beginning with slot 0 (if selected slot = 0, the copy appears in slots 3,6,9, etc.).
  - "Duration": Copy the allocation to  $n$  slots in a row.  
Example: Period = 3 and duration = 2 copies the allocation to two slots in a row, every 3rd slot, beginning with slot 0 (if selected slot = 0, the copy appears in slots 1,3,4,6,7,9,10 etc.)

The FSW only copies the allocation to a slot if the slot configuration accepts a [manual configuration](#) (and is not based on the configuration of another slot).



## Allocations in the time alignment measurements

For time alignment measurements, you can only configure PDSCH allocations.

In addition, enhanced settings are only available for the PDSCH DMRS. Because the enhanced PDSCH settings are the same for all PDSCH allocations in the entire frame, you can configure them centrally with the corresponding button in the "Slot" configuration tab.

ID	User ID	Allocation	Code Word	Modulation	Enhanced Settings	Number of RBs	Offset RB	Number of Symb	Offset Symb	Rel. Power /dB	Conflict
0		CORESET		QPSK	...	6	0	1	0	0 dB	
1		CORESET		QPSK	...	6	6	1	0	0 dB	
0	0	PDSCH	1/1	QPSK	...	10	16	13	1	0 dB	
1	0	PDSCH	1/1	QPSK	...	10	0	13	1	0 dB	

The remote commands required to configure the PDSCH and CORESET allocations are described in [Chapter 6.10.11, "CORESET allocation configuration"](#), on page 362 and [Chapter 6.10.12, "PDSCH allocation configuration"](#), on page 369.

ID.....	118
Allocation.....	118
Modulation.....	118
Enhanced Settings.....	118
Number of RBs.....	119
Offset RB.....	119
Number of Symbols.....	119
Offset Symbols.....	119
Rel Power / dB.....	119
Copy to.....	120
Conflicts.....	120

### ID

The "ID" column shows the unique identifier for the corresponding CORESET or PDSCH allocation.

The counter starts at 0.

Remote command:

```
CONFigure[:NR5G]:DL[:CC<cc>]:FRAMe<fr>:BWPart<bwp>:SLOT<sl>:
ALLocation<al>:UEID on page 401
```

### Allocation

The "Allocation" column shows the allocation's channel type (CORESET or PDSCH).

Remote command:

not supported

### Modulation

The "Modulation" selects the modulation type for the corresponding allocation (channel).

"DMRS Only" analyzes the DMRS and ignores the payload data in the allocation.

The CORESET modulation is always QPSK.

The PDSCH modulation is either QPSK, 16QAM, 64QAM, 256QAM.

3GPP release 17 adds 1024QAM modulation.

Remote command:

CORESET: not supported

```
PDSCH allocations: CONFigure[:NR5G]:DL[:CC<cc>]:FRAMe<fr>:
BWPart<bwp>:SLOT<sl>:ALLocation<al>[:CW<cw>]:MODulation
on page 373
```

### Enhanced Settings

Opens the "Enhanced Settings" dialog box.

Enhanced settings for CORESET allocations:

- [CORESET DMRS](#)
- [PDCCH and DCI](#)

Enhanced settings for PDSCH allocations:

- [PDSCH DMRS](#)
- [PTRS](#)
- [Channel coding and PDSCH scrambling](#)

Remote command:  
not supported

### Number of RBs

The "Number of RBs" defines the number of physical resource blocks that the allocation occupies in the resource grid.

Remote command:

CORESET: `CONFigure[:NR5G]:DL[:CC<cc>]:FRAMe<fr>:BWPart<bwp>:SLOT<sl>:COReset<cr>:RBCount` on page 366

PDSCH allocation: `CONFigure[:NR5G]:DL[:CC<cc>]:FRAMe<fr>:BWPart<bwp>:SLOT<sl>:ALLocation<al>:RBCount` on page 374

### Offset RB

The "Offset RB" defines the first physical resource block that the allocation uses. The offset is a value relative to the first resource block used by the bandwidth part the allocation is in.

Remote command:

CORESET: `CONFigure[:NR5G]:DL[:CC<cc>]:FRAMe<fr>:BWPart<bwp>:SLOT<sl>:COReset<cr>:RBOffset` on page 367

PDSCH allocation: `CONFigure[:NR5G]:DL[:CC<cc>]:FRAMe<fr>:BWPart<bwp>:SLOT<sl>:ALLocation<al>:RBOffset` on page 374

### Number of Symbols

The "Number of Symbols" defines the number of symbols that the allocation uses.

The number of symbols a CORESET can use is limited to 3.

3GPP release 16 unlocks additional numbers of symbols a PDSCH can use.

Remote command:

CORESET: `CONFigure[:NR5G]:DL[:CC<cc>]:FRAMe<fr>:BWPart<bwp>:SLOT<sl>:COReset<cr>:SCOunt` on page 367

PDSCH allocation: `CONFigure[:NR5G]:DL[:CC<cc>]:FRAMe<fr>:BWPart<bwp>:SLOT<sl>:ALLocation<al>:SCOunt` on page 375

### Offset Symbols

The "Offset Symbols" defines the first symbol that the allocation uses. The offset is a value relative to the first symbol in the slot.

Remote command:

CORESET: `CONFigure[:NR5G]:DL[:CC<cc>]:FRAMe<fr>:BWPart<bwp>:SLOT<sl>:COReset<cr>:SOFFset` on page 368

PDSCH allocation: `CONFigure[:NR5G]:DL[:CC<cc>]:FRAMe<fr>:BWPart<bwp>:SLOT<sl>:ALLocation<al>:SOFFset` on page 375

### Rel Power / dB

The "Rel Power / dB" defines the relative power of the corresponding allocation.

Remote command:

CORESET: CONFigure [ :NR5G ] :DL [ :CC<cc> ] :FRAMe<fr> :BWPart<bwp> :  
SLOT<sl> :COReset<cr> :POWer on page 366

PDSCH allocation: CONFigure [ :NR5G ] :DL [ :CC<cc> ] :FRAMe<fr> :  
BWPart<bwp> :SLOT<sl> :ALLocation<al> :POWer on page 373

### Copy to

Opens a dialog to copy the allocation configuration to other slots.

For details, see ["Reusing PDSCH allocations"](#) on page 117.

Remote command:

PDSCH: CONFigure [ :NR5G ] :DL [ :CC<cc> ] :FRAMe<fr> :BWPart<bwp> :  
SLOT<sl> :ALLocation<al> :COPY on page 371

CORESET: CONFigure [ :NR5G ] :DL [ :CC<cc> ] :FRAMe<fr> :BWPart<bwp> :  
SLOT<sl> :COReset<cr> :COPY on page 364

### Conflicts

The FSW indicates a conflict in the following cases.

- If the allocation is located in a symbol reserved for uplink.
- If two or more allocations use the same resource blocks (overlapping allocations).
- If the total number of resource blocks over all allocations is greater than 273.

To remove a conflict, try to reduce the total number of resource blocks or change the RB offset.

Remote command:

not supported

#### 4.1.10.3 Enhanced CORESET settings: allocation configuration

The enhanced CORESET settings contain settings to configure the CORESET demodulation reference signal (CORESET DMRS) and the characteristics (like the location and [DCI content](#)) of the PDCCH within the CORESET.

General		CORESET DMRS Config				
Precoder Granularity	REG Bundle	Rel Power (to CORESET)	0.0 dB			
Use DMRS Scrambling ID	On Off 0	Reference Point	Ref Point A			
Allow PDSCH	On Off					
Interleaving						
State	On Off	Bundle Size	6			
Shift Index	n_shift 0	Interleaver Size	2			
PDCCH Config						
Usage	RNTI	DCI Format	Aggregation Level	CCE Index	Pattern Length	Content
C-RNTI	0	0_0	1	0	44	...

The remote commands required to configure CORESET allocations are described in [Chapter 6.10.13, "Enhanced CORESET allocation configuration"](#), on page 376.



Precoder Granularity.....	121
CORESET DMRS Sequence Generation.....	121
Allow PDSCH.....	121
CORESET DMRS Rel Power.....	121
CORESET DMRS Reference Point.....	122
Interleaving.....	122

### Precoder Granularity

Defines which resource elements are used by the PDCCH DMRS.

"All Contiguous PDCCH DMRS expected on all resource blocks of the CORESET RBs"

"REG Bundle" PDCCH DMRS expected on the resource blocks allocated to the PDCCH.

Remote command:

`CONFigure[:NR5G]:DL[:CC<cc>]:FRAMe<fr>:BWPart<bwp>:SLOT<sl>:COREset<cr>:PGRanularity` on page 392

### CORESET DMRS Sequence Generation

3GPP (38.211) defines two methods by which the CORESET DMRS sequence can be calculated. You can select the method with the "Use DMRS Scrambling ID" parameter.

"On":

Calculates the sequence based on a pseudo-random seed value. You can define the seed value in the input field that becomes available when you select this method.

"Off":

Calculates the sequence based on the **cell ID**, if the higher layers provide no value. "n\_ID^Cell" has the same value as the cell ID.

For this method, N\_RNTI is assumed to be 0 as defined by 3GPP.

Remote command:

Method: `CONFigure[:NR5G]:DL[:CC<cc>]:FRAMe<fr>:BWPart<bwp>:SLOT<sl>:COREset<cr>:DMRS:SCRam[:STATe]` on page 379

Seed value: `CONFigure[:NR5G]:DL[:CC<cc>]:FRAMe<fr>:BWPart<bwp>:SLOT<sl>:COREset<cr>:DMRS:SID` on page 378

### Allow PDSCH

Turns usage of CORESET resources for PDSCH transmission on and off.

By default, resource elements allocated to the CORESET are reserved for the CORESET, even if they are unused. When you allow PDSCH resources within a CORESET, unused CORESET resource elements can be allocated to the PDSCH.

Available if CORESET resources are **not contiguous**.

Remote command:

`CONFigure[:NR5G]:DL[:CC<cc>]:FRAMe<fr>:BWPart<bwp>:SLOT<sl>:COREset<cr>:PDSCh:STATe` on page 392

### CORESET DMRS Rel Power

Defines the power of the CORESET DMRS relative to the power of the CORESET resource elements.

Remote command:

```
CONFigure[:NR5G]:DL[:CC<cc>]:FRAME<fr>:BWPart<bwp>:SLOT<sl>:
COReset<cr>:DMRS:POWer on page 377
```

#### CORESET DMRS Reference Point

Defines the reference point for the CORESET DMRS in the resource grid.

The CORESET DMRS position is either relative to the [reference point A](#) or the start of the CORESET.

Select "CORESET Start" if

- the CORESET is configured by the PBCH or
- the CORESET is configured by the controlResourceSetZero field in the PDCCH-ConfigCommon IE.

Remote command:

```
CONFigure[:NR5G]:DL[:CC<cc>]:FRAME<fr>:BWPart<bwp>:SLOT<sl>:
COReset<cr>:DMRS:RPOint on page 378
```

#### Interleaving

Interleaving defines the position of the PDCCH resource elements in the resource grid.

As long as you turn off interleaving, all PDCCH resource elements groups (REGs) use subcarriers next to each other. If you turn on interleaving, you can assign the REGs to non-adjacent subcarriers according to certain rules defined in 3GPP 38.211.

The "Bundle Size" defines the number of REGs in a REG bundle.

The "Shift Index" defines an offset of the REG bundles.

You can select one of two methods to define the offset.

- "N\_ID^Cell": Select an offset based on the cell ID.
- "n\_shift": Select the offset manually.

The "Interleaver Size" defines the distance between individual REG bundles in the frequency domain.

Remote command:

```
State: CONFigure[:NR5G]:DL[:CC<cc>]:FRAME<fr>:BWPart<bwp>:
SLOT<sl>:COReset<cr>:INTerleaving:STATe on page 382
```

```
Bundle size: CONFigure[:NR5G]:DL[:CC<cc>]:FRAME<fr>:BWPart<bwp>:
SLOT<sl>:COReset<cr>:INTerleaving:BSIZE on page 379
```

```
Shift index method: CONFigure[:NR5G]:DL[:CC<cc>]:FRAME<fr>:
BWPart<bwp>:SLOT<sl>:COReset<cr>:INTerleaving:SINDEX on page 381
```

```
Shift index: CONFigure[:NR5G]:DL[:CC<cc>]:FRAME<fr>:BWPart<bwp>:
SLOT<sl>:COReset<cr>:INTerleaving:NSHift on page 380
```

```
Interleaving size: CONFigure[:NR5G]:DL[:CC<cc>]:FRAME<fr>:BWPart<bwp>:
SLOT<sl>:COReset<cr>:INTerleaving:ISIZE
```

#### 4.1.10.4 Enhanced CORESET settings: PDCCH

The enhanced CORESET settings also contains a table to define the downlink control information (DCI) fields (as defined in 38.212) contained in the PDCCH payload.

You can configure one PDCCH in each CORESET.

You can assign an RNTI type to the PDCCH in the CORESET. Each type of RNTI has a certain purpose in the network and the CRC of the information of several DCI formats is scrambled by a RNTI. The DCI format in turn determines the DCI fields that are available.

The base station transmits control information to the user equipment via several DCI formats. The control information can comprise all kinds of information about the transmitted data like resource allocation, bandwidth part usage, modulation type and many others. 3GPP defines various DCI formats, each of which carries different sets of information (DCI fields), depending on the system setup.

You can evaluate the DCI fields in the [channel decoder](#).

The DCI fields you can configure depend on the selected [DCI format](#) and the selected [RNTI type](#).

The DCI fields have a predefined order. This order is represented in the [DCI field configuration table](#), from left to right and top to bottom.

#### Example:

- RNTI type = C-RNTI
- DCI format = 0\_0

	DCI Field	Bit Length		DCI Field	Bit Length
1. field:	Identifier for DCI formats	1	2. field:	Frequency Domain Resource Assignment	Auto
3. field:	Time Domain Resource Assignment	4	4. field:	Frequency Hopping Flag	1
5. field:	Modulation and Coding Scheme (TB1)	5	6. field:	New Data Indicator (TB1)	1
7. field:	Redundancy Version (TB1)	2	8. field:	HARQ Process Number	4
9. field:	UL/DL Command for Scheduled PUSCH	2	10. field:	Padding bits	0
11. field:	UL/SUL indicator	0	12. field:	ChannelAccess-CPeet	0

Figure 4-8: Order of DCI fields in DCI format 0\_0

1 = Name of DCI field

2 = Bit length of DCI fields (grey fields: not editable, white fields: editable)

Order of DCI fields in the PDCCH:

"Identifier For DCI Formats" > "Frequency Domain Resource Assignment" > "Time Domain Resource Assignment" > "Frequency Hopping Flag" etc.

Each DCI field has a certain bit length. The sum of all bits must be the same as the [pattern length](#). The pattern length must be at least 12 bits and must be correct.

The bit lengths for each DCI field are defined in 3GPP 38.212.

- Fix bit lengths are always the same and defined by 3GPP (for example DCI field "X" always uses 1 bit). You cannot edit those values.
- Automatically calculated bit lengths are variable and depend on other parameters. The FSW calculates them according to the conditions defined by 3GPP. You cannot edit those values.
- Variable bit lengths can have different values in a certain value range (for example DCI field "Y" uses either 1, 2 or 4 bits). You can edit those values as required.

Which bit lengths are variable depends on the DCI format and its corresponding RNTIs. Note that in some scenarios all bit lengths are fix.



There are a few test scenarios that allow you to ignore the DCI field bit lengths.

- If you are only interested in the bit stream, it is not necessary to define the bit lengths of each DCI field. The correct pattern length is sufficient in that case and does not have to match the bits of the individual fields.
- If you are only interested in the decoding of certain fields, it is sufficient to define the pattern length and the bit length up to the DCI field you are interested in correctly.  
For example, if you are interested in the 4th DCI field, define the complete pattern length and the bit lengths of the first four DCI fields and ignore the subsequent ones.

For some DCI fields, you can define how often they are transmitted in a single PDCCH. For those DCI fields the total bit length = bit length \* # indicator.

**Example:**

- RNTI type = SFI-RNTI
- DCI format = 2\_0
- Slot format indicator bit length = 4
- # indicators = 4

Total bit length of the slot format indicator = 16 bits

For some DCI formats, you can define how often the complete set of DCI fields are transmitted in a single PDCCH. In that case the total bit length = bit length of all parameters \* # blocks.

**Example:**

- RNTI type = TPC-PUCCH-RNTI
- DCI format = 2\_2
- Closed loop indicator bit length = 4
- TPC commands bit length = 2 (fix value)
- # blocks = 2

Total bit length of the PDCCH = 12 bits

**Configuring DCI fields**

Here's an example for the usual process to define DCI fields.

1. Select the RNTI "Usage".
2. Select the "DCI Format".
3. Define the PDCCH "Pattern Length".
4. Select "Content" to define the details of the DCI.

For a list of available DCI fields, see [Table 6-5](#). For a comprehensive breakdown of availability of DCI fields, their bit lengths and dependencies, refer to 3GPP 38.212. 3GPP release 16 unlocks additional DCI formats and fields.

Usage.....	125
RNTI.....	125
DCI Format.....	125
Aggregation Level.....	125
CCE Index.....	125
Pattern Length.....	126
Content.....	126

### Usage

Selects the type of radio network temporary identifier (RNTI) that the PDCCH uses. It also determines which [DCI formats](#) are available.

Remote command:

```
CONFigure[:NR5G]:DL[:CC<cc>]:FRAMe<fr>:BWPart<bwp>:SLOT<sl>:
COReset<cr>:PDCCh<cf>:USAGe on page 391
```

### RNTI

Selects the radio network identifier.

Remote command:

```
CONFigure[:NR5G]:DL[:CC<cc>]:FRAMe<fr>:BWPart<bwp>:SLOT<sl>:
COReset<cr>:PDCCh<cf>:RNTI on page 391
```

### DCI Format

Selects the DCI format.

The available DCI formats depend on the selected [RNTI type](#).

The selected DCI format in turn defines which information the PDCCH can carry.

3GPP release 16 unlocks additional DCI formats and fields.

Remote command:

```
CONFigure[:NR5G]:DL[:CC<cc>]:FRAMe<fr>:BWPart<bwp>:SLOT<sl>:
COReset<cr>:PDCCh<cf>:DCIFormat on page 383
```

### Aggregation Level

Defines how many [control channel elements](#) (CCEs) the PDCCH uses in the resource grid.

Remote command:

```
CONFigure[:NR5G]:DL[:CC<cc>]:FRAMe<fr>:BWPart<bwp>:SLOT<sl>:
COReset<cr>:PDCCh<cf>:ALEVel on page 382
```

### CCE Index

Defines an offset of the CCE relative to the first subcarrier.

Remote command:

```
CONFigure[:NR5G]:DL[:CC<cc>]:FRAMe<fr>:BWPart<bwp>:SLOT<sl>:
COReset<cr>:PDCCh<cf>:CCEindex on page 382
```

**Pattern Length**

Defines the number of bits the PDCCH uses. The number of bits is a custom value depending on your signal.

Remote command:

CONFigure[:NR5G]:DL[:CC<cc>]:FRAMe<fr>:BWPart<bwp>:SLOT<sl>:COReset<cr>:PDCCh<cf>:PLENgtH on page 390

**Content**

Opens a dialog box to define the information that the PDCCH carries.

The number and type of information depends on the selected [DCI format](#).

You can find an overview of all DCI fields that are available in one or more DCI formats, including the SCPI command you can use to change the bit length of the DCI field in [Table 6-5](#).

Special settings for certain DCI formats:

- DCI format 0\_1: "Scope": Selection defines the DCI fields available in format 0\_1.
- DCI format 1\_0: "Frequency Domain Resource Assignment": Selection defines the DCI fields available in format 1\_0.
- For other special fields, see [Chapter 4.1.10.4, "Enhanced CORESET settings: PDCCH"](#), on page 122.

3GPP release 16 unlocks additional DCI formats and fields.

Remote command:

Query DCI fields: CONFigure[:NR5G]:DL[:CC<cc>]:FRAMe<fr>:BWPart<bwp>:SLOT<sl>:COReset<cr>:PDCCh<cf>:DCISettings:LIST? on page 388

Configure DCI fields: CONFigure[:NR5G]:DL[:CC<cc>]:FRAMe<fr>:BWPart<bwp>:SLOT<sl>:COReset<cr>:PDCCh<cf>:DCISettings:ITEM on page 384

# blocks: CONFigure[:NR5G]:DL[:CC<cc>]:FRAMe<fr>:BWPart<bwp>:SLOT<sl>:COReset<cr>:PDCCh<cf>:DCISettings:NOBLock on page 388

TCP commands: CONFigure[:NR5G]:DL[:CC<cc>]:FRAMe<fr>:BWPart<bwp>:SLOT<sl>:COReset<cr>:PDCCh<cf>:DCISettings:TPCCommand on page 390

Frequency resource assignment: CONFigure[:NR5G]:DL[:CC<cc>]:FRAMe<fr>:BWPart<bwp>:SLOT<sl>:COReset<cr>:PDCCh<cf>:DCISettings:FDRassign on page 384

Scope: CONFigure[:NR5G]:DL[:CC<cc>]:FRAMe<fr>:BWPart<bwp>:SLOT<sl>:COReset<cr>:PDCCh<cf>:DCISettings:SCOPE on page 389

**4.1.10.5 Enhanced PDSCH settings: DMRS**

**Access:** "Overview" > "Signal Description" > "Radio Frame Config" > "PDSCH / PDCCH Config" > "Enhanced Settings" > "PDSCH DMRS Config"

User ID	0	VRB-to-PRB Interleaver	Non-Interleaved
PDSCH DMRS Config			
Config Type	1	Phase-tracking RS Config (PTRS)	Scrambling/Coding
First DMRS Symb Rel to (Mapping Type)	Slot start (A)	Codeword to Layer Mapping	Layers/Codewords 1/1
First DMRS Symb (Type A Pos)	2	Antenna Ports 1000 +	0
DMRS Add Position Index	0	CDM groups w/o data	1
DMRS Length	1	Reference Point	Ref Point A
Sequence Generation	N_ID^Cell	DMRS-Downlink	On Off
n_SCID	0 1		
Rel Power (to PDSCH)	0.0 dB		

The remote commands required to configure the DMRS are described in [Chapter 6.10.14, "Enhanced PDSCH settings: DMRS"](#), on page 393.

User ID.....	127
VRB-to-PRB Interleaver.....	127
PDSCH DMRS Location.....	128
Multi Symbol DMRS.....	128
PDSCH DMRS Sequence Generation.....	128
PDSCH DMRS Rel Power.....	129
Codeword to Layer Mapping.....	129
Antenna Port.....	129
CDM Groups w/o Data.....	130
Reference Point.....	130
DMRS-Downlink.....	130

### User ID

Selects the radio network temporary identifier (RNTI) used to identify different users currently accessing the network. The corresponding allocation and its configuration is assigned specifically to the ID you select in this field.

By default, the RNTI is the same the [bandwidth part index](#).

Remote command:

```
CONFigure[:NR5G]:DL[:CC<cc>]:FRAME<fr>:BWPart<bwp>:SLOT<sl>:
ALLocation<al>:UEID on page 401
```

### VRB-to-PRB Interleaver

Selects the RB bundle size of the interleaver according to 3GPP 38.211, chapter 7.3.1.6. Interleaving means that virtual resource block bundles are mapped to different physical resource blocks in the physical resource grid.

A VRB bundle can consist of 2 or 4 resource blocks. "Non-interleaved" means that no interleaving or bundling is applied.

Remote command:

```
CONFigure[:NR5G]:DL[:CC<cc>]:FRAME<fr>:BWPart<bwp>:SLOT<sl>:
ALLocation<al>:VTPinter on page 402
```

### PDSCH DMRS Location

The "Config Type" defines the mapping of the DMRS to physical resources elements as defined in 3GPP 38.211. You can select from configuration "Type 1" or "Type 2".

The "Mapping Type" defines the position of the first DMRS symbol in the resource grid. Mapping "Type A" is a location relative to the start of the slot. Mapping "Type B" is a location relative to the start of the PDSCH resources.

For mapping type A, you can select an additional parameter "Type A Pos" to select the first symbol that the DMRS uses.

The mapping type also limits the [number of symbols](#) the PDSCH allocations can use.

Remote command:

Configuration type: `CONFigure[:NR5G]:DL[:CC<cc>]:FRAME<fr>:`

`BWPart<bwp>:SLOT<sl>:ALLocation<al>:DMRS:CTYPE` on page 395

Mapping type: `CONFigure[:NR5G]:DL[:CC<cc>]:FRAME<fr>:BWPart<bwp>:`

`SLOT<sl>:ALLocation<al>:DMRS:MTYPE` on page 397

Type A position: `CONFigure[:NR5G]:DL[:CC<cc>]:FRAME<fr>:BWPart<bwp>:`

`SLOT<sl>:ALLocation<al>:DMRS:TAPos` on page 400

### Multi Symbol DMRS

The DMRS can be transmitted on one or two symbols, depending on the "DMRS Length".

You can also add additional DMRS with the "DMRS Add Position Index".

Remote command:

Length: `CONFigure[:NR5G]:DL[:CC<cc>]:FRAME<fr>:BWPart<bwp>:`

`SLOT<sl>:ALLocation<al>:DMRS:MSYMBOL:LENGTH` on page 396

Position index: `CONFigure[:NR5G]:DL[:CC<cc>]:FRAME<fr>:BWPart<bwp>:`

`SLOT<sl>:ALLocation<al>:DMRS:MSYMBOL:APOSITION` on page 396

### PDSCH DMRS Sequence Generation

3GPP (38.211) defines two methods by which the PDSCH DMRS sequence can be calculated. You can select the method with the "Sequence Generation" parameter.

"n\_ID^DMRS":

Calculates the sequence based on a pseudo-random seed value. You can define the seed value in the input field that becomes available when you select this method.

The scrambling ID "N\_ID^1" is for low PAPR DMRS transmission. For other transmission types, use the "N\_ID^0" scrambling ID.

"N\_ID^1" is available if [DMRS-Downlink](#) = "On".

"n\_ID^Cell":

Calculates the sequence based on the [cell ID](#), if the higher layers provide no value.

"n\_ID^Cell" has the same value as the cell ID.

Remote command:

Method: `CONFigure[:NR5G]:DL[:CC<cc>]:FRAME<fr>:BWPart<bwp>:`

`SLOT<sl>:ALLocation<al>:DMRS:SGENERATION` on page 399

Seed value N\_ID^0: `CONFigure[:NR5G]:DL[:CC<cc>]:FRAME<fr>:`

`BWPart<bwp>:SLOT<sl>:ALLocation<al>:DMRS:SID` on page 399



Seed value N\_ID<sup>1</sup>: [CONFigure\[:NR5G\]:DL\[:CC<cc>\]:FRAMe<fr>:BWPart<bwp>:SLOT<sl>:ALLocation<al>:DMRS:SIONe](#) on page 400  
 Scrambling ID: [CONFigure\[:NR5G\]:DL\[:CC<cc>\]:FRAMe<fr>:BWPart<bwp>:SLOT<sl>:ALLocation<al>:DMRS:NSCid](#) on page 397

### PDSCH DMRS Rel Power

Defines the power of the PDSCH DMRS relative to the power of the PDSCH resource elements.

Remote command:

[CONFigure\[:NR5G\]:DL\[:CC<cc>\]:FRAMe<fr>:BWPart<bwp>:SLOT<sl>:ALLocation<al>:DMRS:POWER](#) on page 398

### Codeword to Layer Mapping

Selects the number of layers for a PDSCH allocation and the number of codewords. The combination of layers and number of codewords determines the layer mapping. Each layer is transmitted on a separate [antenna port](#).

The number of supported layers depends on:

- [DMRS configuration type](#)
- [DMRS length](#)

Remote command:

[CONFigure\[:NR5G\]:DL\[:CC<cc>\]:FRAMe<fr>:BWPart<bwp>:SLOT<sl>:ALLocation<al>:CLMapping](#) on page 394

### Antenna Port

Each layer of a PDSCH allocation is mapped to a certain antenna port. The "Antenna Port 1000 +" dropdown menu selects the antenna ports that are used for the transmission of the PDSCH allocation.

Note that the FSW has only one RF input and can therefore measure only one PDSCH. Which PDSCH is measured depends on the [antenna port mapping](#).

### Example:

- [DMRS configuration type](#) = 1
- [DMRS length](#) = 2
- [Codeword to layer mapping](#) = 4/1, which corresponds to 4 layers

For this configuration you can map the layers to antenna ports "1000,1001,1004,1005", "1000,1002,1004,1006" or "1002,1003,1006,1007".

The antenna ports (layers) that are actually analyzed depend on the [antenna port configuration](#).

The contents of result displays that analyze antenna ports depend on the [beamforming selection](#).

Remote command:

[CONFigure\[:NR5G\]:DL\[:CC<cc>\]:FRAMe<fr>:BWPart<bwp>:SLOT<sl>:ALLocation<al>:DMRS:AP](#) on page 394

**CDM Groups w/o Data**

Selects the number of CDM groups that are reserved and contain no data. They are therefore not used by the PDSCH for data transmission. In the resource grid, the resource elements for CDM (between PDSCH DMRS resource elements) remain empty.

Note that the different values for this parameter change the default values of the [relative DMRS power](#) according to 3GPP 38.214, table 4.1-1.

Remote command:

```
CONFigure[:NR5G]:DL[:CC<cc>]:FRAMe<fr>:BWPart<bwp>:SLOT<sl>:
ALLocation<al>:DMRS:CGWD on page 395
```

**Reference Point**

Defines the reference point for the PDSCH DMRS in the resource grid.

The PDSCH DMRS position is either relative to the [reference point A](#) or the first sub-carrier of the [bandwidth part](#) it is in.

You can use the bandwidth part start as the reference point for the PDSCH DMRS to define the reference point according to 3GPP 38.211 chapter 7.4.1.1.2.

Remote command:

```
CONFigure[:NR5G]:DL[:CC<cc>]:FRAMe<fr>:BWPart<bwp>:SLOT<sl>:
ALLocation<al>:RPOint on page 401
```

**DMRS-Downlink**

Turns the higher layer parameter "dmrs-downlink" on and off.

This parameter reduces the peak-to-average power ratio (PAPR) of the PDSCH DMRS as defined 3GPP, release 16. Using the low PAPR also results in a different calculation of the DMRS sequence.

Remote command:

```
CONFigure[:NR5G]:DL[:CC<cc>]:FRAMe<fr>:BWPart<bwp>:SLOT<sl>:
ALLocation<al>:DMRS:RST on page 398
```

**4.1.10.6 Enhanced PDSCH settings: PTRS**

**Access:** "Overview" > "Signal Description" > "Radio Frame Config" > "PDSCH / PDCCH Config" > "Enhanced Settings" > "Phase-Tracking RS Config (PTRS)"

The phase tracking reference signal (PTRS) is a reference signal whose main purpose is to track the phase of the transmitter and the receiver. It thus helps to avoid phase errors which can disturb the signal transmission.

If you assign the PDSCH to [antenna ports](#) whose port number is higher than the maximum port that 3GPP allows for the PTRS, the PTRS settings become unavailable. For an overview of supported antenna ports, see 3GPP 38.211, table 6.4.1.2.2.1-1.

User ID 1	
PDSCH DMRS Config	Phase-tracking RS Config (PTRS)
State	<input checked="" type="radio"/> On <input type="radio"/> Off
Rel Power (to PDSCH)	0.0 dB
L_PTRS	1
K_PTRS	2
DL-PTRS-RE-offset	00

The remote commands required to configure the PTRS are described in [Chapter 6.10.15, "Enhanced PDSCH settings: PTRS"](#), on page 402.

Functions in the "PTRS" dialog box described elsewhere:

- "User ID" on page 127
- "VRB-to-PRB Interleaver" on page 127

[PTRS Configuration](#)..... 131

### PTRS Configuration

The phase tracking reference signal (PTRS) is a UE-specific reference signal that is used to compensate for the phase noise of the oscillator. The PTRS is transmitted in resource blocks used for the PDSCH.

If the PTRS "State" is on, you can define its "Power" relative to the PDSCH and its location in the resource grid.

The "L\_PTRS" defines distance between the PTRS in terms of OFDM symbols (transmission every 1, 2 or 4 OFDM symbols). If the subcarrier used by the PTRS also contains a DMRS, the distance can be larger.

The "K\_PTRS" and "DL-PTRS-RE-Offset" define the location of the PTRS in the frequency domain.  $K_{\text{PTRS}}$  defines the distances between the PTRS in terms of subcarrier. You can also define an additional frequency offset for the PTRS relative to the first subcarrier.

Remote command:

State: `CONFigure[:NR5G]:DL[:CC<cc>]:FRAMe<fr>:BWPART<bwp>:SLOT<sl>:ALLOCATION<al>:PTRS[:STATE]` on page 405

Power: `CONFigure[:NR5G]:DL[:CC<cc>]:FRAMe<fr>:BWPART<bwp>:SLOT<sl>:ALLOCATION<al>:PTRS:POWER` on page 404

L\_PTRS: `CONFigure[:NR5G]:DL[:CC<cc>]:FRAMe<fr>:BWPART<bwp>:SLOT<sl>:ALLOCATION<al>:PTRS:L` on page 403

K\_PTRS: `CONFigure[:NR5G]:DL[:CC<cc>]:FRAMe<fr>:BWPART<bwp>:SLOT<sl>:ALLOCATION<al>:PTRS:K` on page 403

Offset: `CONFigure[:NR5G]:DL[:CC<cc>]:FRAMe<fr>:BWPART<bwp>:SLOT<sl>:ALLOCATION<al>:PTRS:REOFFSET` on page 404

#### 4.1.10.7 Enhanced PDSCH settings: scrambling / coding

**Access:** "Overview" > "Signal Description" > "Radio Frame Config" > "PDSCH / PDCCH Config" > "Enhanced Settings" > "Scrambling / Coding"

User ID  VRB-to-PRB Interleaver Non-Interleaved

PDSCH DMRS Config | Phase-tracking RS Config (PTRS) | **Scrambling/Coding**

Channel Coding

MCS Table 64QAM

I\_MCS

Redundancy Version Index

TB Scaling Factor S 1

TB Size Including Allocation Gaps On Off

Scrambling

Scrambling Data-Scrambling-ID

The remote commands required to configure the channel coding and scrambling are described in [Chapter 6.10.16, "Enhanced PDSCH settings: scrambling / coding"](#), on page 406.

Functions in the "Scrambling / Coding" dialog box described elsewhere:

- ["User ID"](#) on page 127
- ["VRB-to-PRB Interleaver"](#) on page 127

<a href="#">Channel Coding</a> .....	132
<a href="#">PDSCH Scrambling</a> .....	133

### Channel Coding

Channel coding parameters determine the code rate of the PDSCH, which is the ratio between transmitted bits and maximum possible bits in a subframe (or 1 ms transport block). Because the number of bits in a subframe is variable, the target code rate has to be derived from the modulation order in combination with an index  $I_{MCS}$ .

In addition, the target code rate depends on a transport block scaling factor  $S$ .

You can select the modulation order for the PDSCH (one of several tables, one for each modulation type) from the "MCS Table" dropdown menu and select the corresponding index value (defined in the tables) in the "I\_MCS" input field. The target code rates for modulation order and index are defined in 3GPP 38.214, chapter 5.1.3.

The size of a transport block (TB) depends on the "TB Scaling Factor  $S$ ", which in turn affects the code rate. Transport blocks can continue over combined allocations if you turn on "TB Size Including Allocation Gaps". This is only available when you [combine PDSCH allocations](#).

In addition to the modulation order and  $I_{MCS}$ , the number of transmitted bits depends on the "Redundancy Version Index", which is used to re-transmit data in case of transmission errors. Depending on the redundancy version index, the PDSCH contains a different amount of parity bits for error detection: Index 0 adds 1 sequence of parity bits, index 1 adds two sequences of parity bits etc.

Because redundancy version 1 and 2 do not transmit a complete set of data (only new bits that have not been transmitted correctly before), it is not possible to decode such signals, even if the signal-to-noise ratio is perfect. Only redundancy version 3 transmits a complete set of data, and can therefore be decoded without the knowledge of previous data.

Remote command:

Modulation order: `CONFigure[:NR5G]:DL[:CC<cc>]:FRAMe<fr>:`

`BWPart<bwp>:SLOT<sl>:ALLocation<al>:CCODing:MCSTable` on page 407

MCS index: `CONFigure[:NR5G]:DL[:CC<cc>]:FRAMe<fr>:BWPart<bwp>:`  
`SLOT<sl>:ALLocation<al>:CCODing:IMCS` on page 406

Redundancy version: `CONFigure[:NR5G]:DL[:CC<cc>]:FRAMe<fr>:`

`BWPart<bwp>:SLOT<sl>:ALLocation<al>:CCODing:RVIndex` on page 407

Scaling factor: `CONFigure[:NR5G]:DL[:CC<cc>]:FRAMe<fr>:BWPart<bwp>:`  
`SLOT<sl>:ALLocation<al>:CCODing:TBSFs` on page 408

TB size including allocation gaps: `CONFigure[:NR5G]:DL[:CC<cc>]:FRAMe<fr>:`  
`BWPart<bwp>:SLOT<sl>:ALLocation<al>:CCODing:TBSize` on page 408

### PDSCH Scrambling

3GPP (38.211) defines two methods by which the PDSCH scrambling can be calculated. You can select the method with the "Scrambling" parameter.

- "Data-Scrambling-ID"  
Scrambles the PDSCH based on a pseudo-random seed value. You can define the seed value in the input field that becomes available when you select this method.
- "n\_ID^Cell"  
Scrambles the PDSCH based on the [cell ID](#), if the higher layers provide no value for "DMRS-Scrambling-ID". "n\_ID^Cell" has the same value as the cell ID.

Remote command:

Method: `CONFigure[:NR5G]:DL[:CC<cc>]:FRAMe<fr>:BWPart<bwp>:`  
`SLOT<sl>:ALLocation<al>:SCRambling` on page 409

Seed value: `CONFigure[:NR5G]:DL[:CC<cc>]:FRAMe<fr>:BWPart<bwp>:`  
`SLOT<sl>:ALLocation<al>:SCRambling:DSID` on page 409

## 4.1.11 Antenna port configuration

**Access:** "Overview" > "Signal Description" > "Ant Port Mapping"

Antenna ports are not physical antennas, but rather are a logical concept. Each antenna port carries certain signal components (= physical channels) that should be transmitted under the same conditions. Physical channels can be transmitted on a single antenna port, or on several antenna ports. Each antenna port in turn can be mapped to one of the physical antennas. Typically, one physical antenna combines several antenna ports. However, one specific antenna port can also be transmitted on more than one physical antenna.

The dialog is designed as a table with two rows representing the physical antennas ("Config 1" and "Config 2").

Only one of the two configurations can be on.

The columns represent the physical channels.

The "Ant Port Mapping" dialog box allows you to map the antenna ports used by the various physical channels defined by 3GPP to one or two layer configurations.

Signal Description	Radio Frame Config	Ant Port Mapping	Advanced Settings	Generator Control		
<b>CC 1</b>						
Antenna Port to Physical Antenna Mapping						
	State	PSS, SSS, PBCH	PDSCH	PDCCH	CSI-RS	PRS
Config 1	On	4000	1000, 1001, 1002, 1003, 1010, 1011	2000	3000	5000
Config 2	Off	4000	1001	2000	3000	5000

The remote commands required to configure the antenna ports are described in [Chapter 6.10.17, "Antenna port configuration"](#), on page 410.

State.....	134
PSS, SSS, PBCH.....	134
PDSCH.....	134
CORESET.....	135
CSI-RS.....	135

### State

Turns the corresponding antenna port configuration on and off and applies it to the measurement.

Note that you can currently measure only one of the two configurations (physical antenna). If you turn on one configuration, the other is automatically turned off.

Remote command:

`CONFigure[:NR5G]:DL[:CC<cc>]:PAMapping<cf>:STATe` on page 411

### PSS, SSS, PBCH

Shows the antenna ports that transmit the synchronization signals.

The synchronization signals are assumed to be transmitted on antenna port 4000.

Remote command:

not supported

### PDSCH

Selects the antenna ports that transmit the PDSCH. You can assign the PDSCH to multiple antenna ports (1000 to 1011).

When you select the table cell, the FSW opens another dialog box in which you can turn the transmission of the PDSCH on certain antenna ports on and off.

By default, the PDSCH is transmitted on antenna port 1000 (for physical antenna 1) and antenna port 1001 (for physical antenna 2).

Remote command:

`CONFigure[:NR5G]:DL[:CC<cc>]:PAMapping<cf>:PDSCh:AP<ap>`  
on page 410

### CORESET

Shows the antenna ports that transmit the CORESET.

The CORESET is assumed to be transmitted on antenna port 2000.

Remote command:

not supported

### CSI-RS

Selects the antenna ports that transmit the CSI-RS. You can assign the CSI-RS to one or more of several antenna ports (3000 to 3031).

When you select the table cell, the FSW opens another dialog box in which you can turn the transmission of the CSI-RS on a certain antenna port on and off.

By default, the CSI-RS is transmitted on antenna port 3000 (for both physical antennas).

Remote command:

`CONFigure[:NR5G]:DL[:CC<cc>]:PAMapping<cf>:CSIRs:AP<ap>`  
on page 410

## 4.1.12 Advanced settings

**Access:** "Overview" > "Signal Description" > "Advanced Settings"

Advanced settings contain settings that are independent of the radio frame configuration.



### Configuring component carriers

When you are doing measurements on [aggregated carriers](#), you can configure each carrier separately.

When available, each carrier in the dialog boxes is represented by an additional tab labeled "CC<x>", with <x> indicating the number of the component carrier.

Note that the additional tabs are only added to the user interface after you have selected more than "1" component carrier.

- [Global settings](#)..... 135
- [Reference point A](#)..... 138
- [LTE-CRS coexistence](#)..... 139

### 4.1.12.1 Global settings

**Access:** "Overview" > "Signal Description" > "Advanced Settings" > "Global Settings"

The global settings contain various settings that have an effect on how the FSW analyzes the signal.

Signal Description	Radio Frame Config	Ant Port Mapping	Advanced Settings	Generator Control
<div style="display: flex; justify-content: space-between;"> <span>CC 1</span> <span>CC 2</span> </div>				
<b>Global Settings</b>  <b>Reference Point A</b>  <b>LTE-CRS Coexistence</b>	Handling of Carrier Leakage	None		
	Frame Number n <sub>f</sub>	0		
	RF Upconversion			
	Phase Compensation	<input checked="" type="checkbox"/> On <input type="checkbox"/> Off		
	f <sub>0</sub> =	<input type="text" value="CF"/> <input checked="" type="checkbox"/> Manual		
		850.0 MHz		
	Exclude PDSCH Allocations From 3GPP EVM Evaluation			
	Exclude User IDs (e.g. 1,3,5-19)	<input type="text"/>		
	Frequency Error Limit Check			
	State	<input checked="" type="checkbox"/> On <input type="checkbox"/> Off		
Category	Category A			
Shared Spectrum Channel Access	<input type="checkbox"/> On <input checked="" type="checkbox"/> Off			

The remote commands required to configure the global settings are described in [Chapter 6.10.18, "Advanced settings: global"](#), on page 411.

<a href="#">Handling of Carrier Leakage</a> .....	136
<a href="#">Frame Number n<sub>f</sub></a> .....	136
<a href="#">RF Upconversion</a> .....	137
<a href="#">Exclude User IDs</a> .....	137
<a href="#">Frequency Error Limit Check</a> .....	137
<a href="#">Category</a> .....	137
<a href="#">Shared Spectrum Channel Access</a> .....	138
<a href="#">O-RAN Test Case</a> .....	138

### Handling of Carrier Leakage

Controls the way the DC carrier is handled during signal analysis.

You can either leave the DC carrier as it is, remove it from the analysis or compensate for carrier leakage effects.

Removing the DC carrier or compensating leakage effects is useful if the DC carrier is located on a subcarrier, which would have a negative effect on the EVM.

- If you leave the DC carrier as it is, the FSW includes the DC carrier in all results.
- If you ignore the DC carrier, the FSW removes the DC carrier from all results by ignoring the corresponding subcarriers. The DC carrier is assumed to be in the center of the channel bandwidth.
- If you compensate for carrier leakage, the FSW includes the subcarriers used by the DC carrier in the result analysis, but compensates them mathematically.

Remote command:

`CONFigure[:NR5G]:DL[:CC<cc>]:IDC` on page 412

### Frame Number n<sub>f</sub>

Defines the system frame number n<sub>f</sub> in the capture buffer. For multiple frame analysis it defines the system frame number of the first frame you are analyzing.



You can find out the system frame number in the [channel decoder results](#). The system frame number is useful for evaluation of periodic CSI-RS, for example.

Remote command:

[CONFigure\[:NR5G\]:DL\[:CC<cc>\]:FNNE](#) on page 412

### RF Upconversion

It is necessary to upconvert the baseband signal to the radio frequency. The upconversion requires a frequency related phase compensation after each symbol according to 3GPP 38.211: 5.4 "Modulation and Upconversion".

When you turn off "Phase Compensation", the FSW assumes that the applied signal is not phase-compensated and analyzes the signal accordingly.

When you turn on "Phase Compensation", the FSW assumes that the applied signal is already phase-compensated for a specific frequency. This frequency is either the current center frequency ("CF") or an arbitrary frequency ("Manual"). You can define the frequency in the corresponding input field.

Remote command:

State: [CONFigure\[:NR5G\]:DL\[:CC<cc>\]:RFUC:STATe](#) on page 414

Mode: [CONFigure\[:NR5G\]:DL\[:CC<cc>\]:RFUC:FZERo:MODE](#) on page 413

Frequency: [CONFigure\[:NR5G\]:DL\[:CC<cc>\]:RFUC:FZERo:FREQuency](#) on page 413

### Exclude User IDs

Defines certain [user IDs](#) that are excluded from the calculation of modulation-specific EVM results in the result summary.

You can define the numbers as a comma-separated list (1,2,6,7), a certain range with a dash (1-3), or a combination of both (1-3,5,6).

This is required by some test models defined in 38.141.

Remote command:

[CONFigure\[:NR5G\]:DL\[:CC<cc>\]:EUIDs](#) on page 412

### Frequency Error Limit Check

Turns the frequency error limit check on and off.

When you turn on the frequency error limit check, the FSW evaluates the limits of the frequency error and shows the results of the limit check in the [result summary](#).

Remote command:

[CONFigure\[:NR5G\]:FELC:STATe](#) on page 414

### Category

Selects the base station category of the equipment you are testing (base station or user equipment).

The base station category has an effect on the limits of the [frequency error](#) and the [SEM](#) measurement.

You can select one of the following base station categories:

- Wide area base stations (category A and B)
- Local area base stations
- Medium range base stations

**I/Q measurements:** The base station category is relevant for the evaluation of the [frequency error](#).

**SEM measurements only:** For category B base stations, you can select the limit tables from the "Category B Options" dropdown menu.

Remote command:

Category: [\[SENSe:\]POWer:CATegory](#) on page 415

Category B options: [\[SENSe:\]POWer:CATegory:B](#) on page 463

### Shared Spectrum Channel Access

Turns an increased number of available [SS/PBCH blocks](#) on and off.

The setting has an effect for FR1 deployments and [block patterns A and C](#).

Available with 3GPP release 16.

Unavailable for FR2-2 deployments.

Remote command:

[CONFigure\[:NR5G\]:DL\[:CC<cc>\]:SSCA](#) on page 414

### O-RAN Test Case

Selects the O-RAN test case that the DSP uses for signal analysis.

Select "None" when you do not measure O-RAN signals.

See [Chapter 4.9, "O-RAN measurement guide"](#), on page 192 for more information about O-RAN measurements.

Remote command:

[CONFigure\[:NR5G\]:ORAN:TCASe](#) on page 414

## 4.1.12.2 Reference point A

**Access:** "Overview" > "Signal Description" > "Advanced Settings" > "Reference Point A"

Point A, as defined in 3GPP 38.211: 4.4.4.2 "Point A", is a reference point with a fixed frequency. The resource block grid for each subcarrier spacing is defined relative to the reference point A. It is aligned with the center of subcarrier 0 of common resource block 0, independent of the numerology.

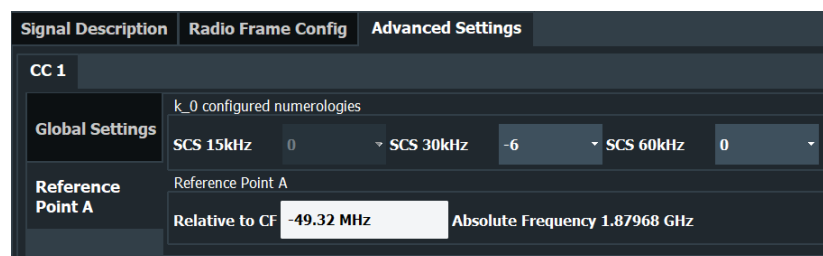

The remote commands required to configure the reference point A are described in [Chapter 6.10.18, "Advanced settings: global"](#), on page 411.

<a href="#">k_0</a> .....	139
<a href="#">Reference Point A</a> .....	139

**k<sub>0</sub>**

The k<sub>0</sub> defines an additional (subcarrier) offset of the resource grid with a specific subcarrier spacing relative to the reference point A.

You can select the offset you require from the "SCS <x> kHz" dropdown menus. Note that the dropdown menus are only available if you are using a bandwidth part with the corresponding subcarrier spacing.

Remote command:

SCS 15 kHz: `CONFigure[:NR5G]:DL[:CC<cc>]:RPA:KZERO:SCFT` on page 416

SCS 30 kHz: `CONFigure[:NR5G]:DL[:CC<cc>]:RPA:KZERO:SCTT` on page 418

SCS 60 kHz: `CONFigure[:NR5G]:DL[:CC<cc>]:RPA:KZERO:SCST` on page 417

SCS 120 kHz: `CONFigure[:NR5G]:DL[:CC<cc>]:RPA:KZERO:SCOT` on page 417

SCS 480 kHz: `CONFigure[:NR5G]:DL[:CC<cc>]:RPA:KZERO:SCFE` on page 416

SCS 960 kHz: `CONFigure[:NR5G]:DL[:CC<cc>]:RPA:KZERO:SCNS` on page 416

**Reference Point A**

You can define the location of the reference point relative to the center frequency of the carrier with the "Relative to CF" parameter.

The value range is limited, depending on various parameters like [channel bandwidth](#) or used [subcarrier spacing](#). You can change it in steps of 12 times the largest subcarrier spacing.

The FSW also displays absolute frequency location of the reference point A and its offset to the first subcarrier of the channel ("TxBW").

Remote command:

Center frequency: `CONFigure[:NR5G]:DL[:CC<cc>]:RPA:RTCF` on page 418

Absolute frequency: `CONFigure[:NR5G]:DL[:CC<cc>]:RPA:AFRequency?`  
on page 415

TxBW: `CONFigure[:NR5G]:DL[:CC<cc>]:RPA:TBOffset?` on page 418

**4.1.12.3 LTE-CRS coexistence**

**Access:** "Overview" > "Signal Description" > "Advanced Settings" > "LTE-CRS Coexistence"

5G NR deployments that are compatible to LTE can share their resources with LTE transmissions, aka dynamic spectrum sharing.

If you deploy such a scenario, the 5G NR are rate matched around the LTE cell specific reference signal (CRS). The reason is that in LTE, the location of the CRS resource elements in the resource grid is fixed, and must not be allocated to the 5G NR allocations. To make sure that this is the case, 5G NR uses rate matching.

Dynamic spectrum sharing is meant for bandwidth parts with 15 kHz subcarrier spacings (the LTE subcarrier spacing). However, you can also measure signals whose 5G resources have different subcarrier spacings than LTE. If you do so, make sure to always turn on spectrum sharing in the 5G application, even if LTE and 5G resources do not overlap. Doing so increases the stability of the synchronization against interferences from the multi-numerology signal configuration.

Note that LTE CRS resources can overlap with the resources used by 5G DMRS symbols. In that case, the 5G DMRS symbols are shifted to a different position according to 38.211.

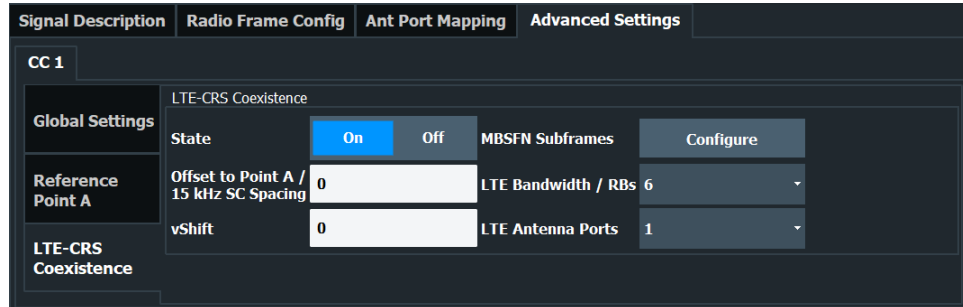

The remote commands required to configure the LTE coexistence are described in [Chapter 6.10.18, "Advanced settings: global"](#), on page 411.

State.....	140
MBSFN Subframes.....	140
Offset to Point A.....	140
LTE Bandwidth.....	141
vShift.....	141
LTE Antenna Ports.....	141

### State

Turns the LTE-CRS coexistence on and off.

The setting is only available for certain 5G NR [signal characteristics](#).

Remote command:

`CONFigure[:NR5G]:DL[:CC<cc>]:LTE:STATe` on page 420

### MBSFN Subframes

Opens a dialog box to define subframes that contain MBSFN resource elements. In MBSFN subframe, no LTE CRS are expected.

Remote command:

`CONFigure[:NR5G]:DL[:CC<cc>]:LTE:MBSFn:SUBFrame<sf>:STATe`  
on page 419

### Offset to Point A

Defines an offset of the LTE carrier in resource blocks relative to [reference point A](#).

The logic here is that an offset of 0 means that the center of the LTE carrier is exactly on the reference point A. This in turn means that one half of the LTE carrier is below the reference point A and parts below this point are not considered by the FSW. Therefore you have to define an offset to reference point A that is at least half the bandwidth of the LTE carrier to align the LTE and 5G NR carriers.

**Example:**

The LTE carrier has a bandwidth of 5 MHz (or 25 resource blocks). 2.5 MHz of the carrier are above the reference point A (within the 5G NR resource grid), the other 2.5 MHz are below the reference point.

To analyze the complete LTE carrier, you have to define an offset of at least 13 resource blocks to analyze the complete LTE carrier.

Remote command:

[CONFigure\[:NR5G\]:DL\[:CC<cc>\]:LTE:POINTa](#) on page 420

**LTE Bandwidth**

Selects the bandwidth of the LTE carrier in number of resource blocks.

<b>Channel bandwidth [MHz]</b>	1.4	3	5	10	15	20
<b>Number of resource blocks</b>	6	15	25	50	75	100

Remote command:

[CONFigure\[:NR5G\]:DL\[:CC<cc>\]:LTE:CBW](#) on page 419

**vShift**

Defines the allocation of resource elements to the CRS.

"vShift" is a function of the cell ID and shifts the CRS patterns in LTE neighbor cells in the range of 0 to 5 subcarriers. The parameter thus prevents CRS pattern overlapping.

Remote command:

[CONFigure\[:NR5G\]:DL\[:CC<cc>\]:LTE:VSHift](#) on page 421

**LTE Antenna Ports**

Selects the number of antenna ports in the LTE configuration. This affects the location of the LTE CRS within the frame.

Remote command:

[CONFigure\[:NR5G\]:DL\[:CC<cc>\]:LTE:NAP](#) on page 420

**4.1.13 Generator control**

**Access:** "Overview" > "Signal Description" > "Generator Control"

Generator control settings provide an easy way to synchronize settings of the analyzer and a connected signal generator that is also equipped with the 5G NR application.

The generator settings become available after a successful connection to the generator.

Signal Description	Radio Frame Config	Ant Port Mapping	Advanced Settings	Generator Control
Generator IP Address <input type="radio"/> <input type="button" value="Configure..."/>				
Generator Control				
State	<input type="button" value="On"/>	<input type="button" value="Off"/>		
RF Output	<input type="button" value="On"/>	<input type="button" value="Off"/>		
<input checked="" type="checkbox"/>	Center Frequency	<input type="text" value="13.25 GHz"/>		
<input type="checkbox"/>	Level			
	Level (RMS)	<input type="text" value="0.0 dBm"/>		
<input type="checkbox"/>	Limit DUT Peak Input Power	<input type="text" value="30.0 dBm"/>		
	DUT Gain	<input type="text" value="0.0 dB"/>		
<input type="button" value="Query RF Settings From Generator"/>		<input type="button" value="Upload RF Settings To Generator"/>		
<input type="button" value="Query 5G NR Settings From Generator"/>				
Sync 5G NR Settings From Generator	<input type="button" value="On"/>	<input type="button" value="Off"/>	Polling Interval	<input type="text" value="10.0"/>

The remote commands required to configure the generator control are described in [Chapter 6.10.21, "Generator control"](#), on page 421.

<a href="#">Generator IP Address</a> .....	142
<a href="#">Generator Control State</a> .....	142
<a href="#">RF Output State</a> .....	143
<a href="#">Center Frequency</a> .....	143
<a href="#">Level Control State</a> .....	143
L <a href="#">Level (RMS)</a> .....	143
L <a href="#">Limit DUT Peak Input Power</a> .....	144
L <a href="#">DUT Gain</a> .....	144
<a href="#">Upload RF Settings to Generator</a> .....	144
<a href="#">Query Settings from Generator</a> .....	144
<a href="#">Periodic synchronization of 5G NR settings</a> .....	144

### Generator IP Address

Opens a dialog box to configure the network properties of the signal generator.

You can connect to the generator either by entering its IP address ("123" button), or its computer name ("ABC" button).

If you are not sure about the IP address or computer name of your generator, check its user interface or kindly ask your IT administrator to provide them.

After you have entered IP address or computer name, use "Connect" to establish the connection. The FSW shows if the connection state, and, if the connection was successful, the connected generator type.

Remote command:

Define IP address: [CONFigure:GENErator:IPConnection:ADDRes](#) on page 422

Query connection state: [CONFigure:GENErator:IPConnection:LEDState?](#) on page 422

### Generator Control State

Activates or disables control of the signal generator by the FSW.

If a connection was defined in another measurement channel, the connection is maintained when you switch to the 5G NR measurement application. However, generator control is disabled to protect the DUT from possibly erroneous or damaging settings. Check the settings, then enable the control state.

**Note:** While generator control is active, you cannot change the connection information. Only one channel can control a generator at any time. If you switch on generator control while it is still active in another channel, for example for parameter coupling with a generator, the control is disabled in the other channel.

Exception: The SCPI Recorder maintains control of the generator even if you switch channels.

Remote command:

[CONFigure:GENErator:CONTrol\[:STATe\]](#) on page 427

### RF Output State

To protect the instrument from possibly erroneous or damaging settings, you must manually activate the RF output on the signal generator to start providing a signal. Check all settings on the signal generator, in particular the level settings, before activating the RF output.

A red LED on the "Generator Control" tab indicates a setting error on the generator.

Remote command:

[CONFigure:GENErator:RFOutput\[:STATe\]](#) on page 426

### Center Frequency

Turns frequency synchronization on and off.

If you change the frequency on the analyzer, the generator automatically adjusts its [frequency](#).

Remote command:

Synchronization state: [CONFigure:GENErator:FREQuency:CENTer:SYNC\[:STATe\]](#) on page 422

Center frequency: [\[SENSe:\]FREQuency:CENTer\[:CC<cc>\]](#) on page 435

### Level Control State

If enabled, the FSW automatically controls the signal level provided by the signal generator as input to the FSW. Initially, the [Level \(RMS\)](#) value is applied. Note that the reference level on the FSW is also affected by the signal level:

$\text{Ref\_level}_{\text{Analyzer}} = \text{<Peak envelope power DUT>} + \text{DUT Gain}$

Where the current peak envelope power (PEP) value of the DUT is determined from the generator.

To protect the signal generator from possibly excess power levels, the level setting control is disabled by default.

Remote command:

[CONFigure:GENErator:POWer:LEVel:STATe](#) on page 423

### Level (RMS) ← Level Control State

(Default:) The specified power level is used for the output power by the connected signal generator.

Remote command:

[CONFigure:GENerator:POWer:LEVel](#) on page 424

#### Limit DUT Peak Input Power ← Level Control State

If enabled, the generator does not exceed the maximum input power (peak envelope power, "PEP") that is currently allowed by the DUT and that is specified on the generator. The defined "PEP" value is indicated.

Remote command:

State: [CONFigure:GENerator:LEVel:DUTLimit:STATe](#) on page 424

Limit: [CONFigure:GENerator:LEVel:DUTLimit](#) on page 423

#### DUT Gain ← Level Control State

The FSW considers a gain due to the DUT when determining the reference level.

During the reference calibration measurement, in which the DUT is removed from the signal path, the generator level is also adjusted according to the DUT gain value.

Remote command:

[CONFigure:GENerator:LEVel:DUTGain](#) on page 423

#### Upload RF Settings to Generator

Uploads the RF settings available in this dialog to the generator.

Useful when you change the level or frequency on the generator itself. In that case, those settings remain the same on the FSW. To restore the original settings defined within the FSW, use that button to restore the generator settings.

Remote command:

[CONFigure:GENerator:SETTings:UPDate:RF](#) on page 427

#### Query Settings from Generator

Downloads the generator settings to the FSW. You can synchronize both, basic RF settings and 5G NR settings.

RF settings include the [frequency](#) and the [level](#) settings.

5G NR settings include the complete signal description.

Remote command:

RF settings: [CONFigure:SETTings:RF](#) on page 426

NR settings: [CONFigure:SETTings:NR5G](#) on page 425

#### Periodic synchronization of 5G NR settings

Instead of downloading the 5G NR settings from the generator once, you can synchronize the settings on a periodic basis. This synchronization makes sure that the analyzer always has the same signal description as the generator.

"Sync 5G NR Settings from Generator" turns the periodic synchronization of the settings on and off. The "Polling Interval" defines how often the synchronization takes place (in seconds).

Polling automatically stops when you change a parameter in the signal description on the analyzer.

Note that this only applies to the 5G NR settings, not the RF settings.



Remote command:

State: [CONFigure:SETTings:NR5G:SYNC](#) on page 426

Interval: [CONFigure:SETTings:NR5G:PINTerval](#) on page 425

#### 4.1.14 Input source configuration

The FSW supports several input sources and outputs.

For a comprehensive description of the supported inputs and outputs, refer to the FSW user manual.

• <a href="#">RF input</a> .....	145
• <a href="#">External Frontends</a> .....	147
• <a href="#">External mixer</a> .....	147
• <a href="#">Digital I/Q input</a> .....	147
• <a href="#">Analog baseband</a> .....	148
• <a href="#">Baseband oscilloscope</a> .....	150
• <a href="#">I/Q file</a> .....	150

##### 4.1.14.1 RF input

**Access:** "Overview" > "Input / Frontend" > "Input Source" > "Radio Frequency"

Functions to configure the RF input described elsewhere:

- ["Input Coupling"](#) on page 155
- ["Impedance"](#) on page 155

<a href="#">Direct Path</a> .....	145
<a href="#">High Pass Filter 1 to 3 GHz</a> .....	146
<a href="#">YIG-Preselector</a> .....	146
<a href="#">Input Connector</a> .....	146

##### Direct Path

Enables or disables the use of the direct path for small frequencies.

In spectrum analyzers, passive analog mixers are used for the first conversion of the input signal. In such mixers, the LO signal is coupled into the IF path due to its limited isolation. The coupled LO signal becomes visible at the RF frequency 0 Hz. This effect is referred to as LO feedthrough.

To avoid the LO feedthrough the spectrum analyzer provides an alternative signal path to the A/D converter, referred to as the *direct path*. By default, the direct path is selected automatically for RF frequencies close to zero. However, this behavior can be disabled. If "Direct Path" is set to "Off", the spectrum analyzer always uses the analog mixer path.

For an active external frontend, the direct path is always used automatically for frequencies close to zero.

"Auto" (Default) The direct path is used automatically for frequencies close to zero.

"Off" The analog mixer path is always used.

Remote command:

[INPut:DPATH](#) on page 430

### High Pass Filter 1 to 3 GHz

Activates an additional internal highpass filter for RF input signals from 1 GHz to 3 GHz. This filter is used to remove the harmonics of the analyzer to measure the harmonics for a DUT, for example.

This function requires an additional hardware option.

**Note:** For RF input signals outside the specified range, the high-pass filter has no effect. For signals with a frequency of approximately 4 GHz upwards, the harmonics are suppressed sufficiently by the YIG-preselector, if available.)

Remote command:

[INPut:FILTer:HPASs\[:STATe\]](#) on page 432

### YIG-Preselector

Enables or disables the YIG-preselector.

This setting requires an additional option on the FSW.

**Note:** Note that the YIG-preselector is active only on frequencies greater than 8 GHz. Therefore, switching the YIG-preselector on or off has no effect if the frequency is below that value.

To use the optional 90 GHz frequency extension (R&S FSW-B90G), the YIG-preselector must be disabled.

The YIG-"Preselector" is off by default.

Remote command:

[INPut:FILTer:YIG\[:STATe\]](#) on page 432

### Input Connector

Determines which connector the input data for the measurement is taken from.

For more information on the optional "Analog Baseband" interface, see the FSW I/Q Analyzer and I/Q Input user manual.

"RF"	(Default:) The "RF Input" connector
"RF Probe"	The "RF Input" connector with an adapter for a modular probe This setting is only available if a probe is connected to the "RF Input" connector. It is not available for an active external frontend.
"Baseband Input I"	The optional "Baseband Input I" connector This setting is only available if the optional "Analog Baseband" interface is installed and active for input. It is not available for the FSW67. For FSW85 models with two input connectors, this setting is only available for "Input 1".

Remote command:

[INPut:CONNector](#) on page 428

#### 4.1.14.2 External Frontends

**Access:** "Overview" > "Input / Frontend" > "Input Source" > "Ext. Frontend"

Controlling external frontends is available with the optional external generator control. The functionality is the same as in the I/Q analyzer application.

For more information about using external frontends, refer to the FSW I/Q analyzer user manual.

#### 4.1.14.3 External mixer

**Access:** "Overview" > "Input / Frontend" > "Input Source" > "External Mixer"

Controlling external generators is available with the optional external generator control. The functionality is the same as in the spectrum application.

For more information about using external generators, refer to the FSW user manual.

#### 4.1.14.4 Digital I/Q input

**Access:** "Overview" > "Input / Frontend" > "Input Source" > "Digital IQ"

Digital I/Q Input State.....	147
Input Sample Rate.....	147
Full Scale Level.....	147
Adjust Reference Level to Full Scale Level.....	148
Connected Instrument.....	148

##### Digital I/Q Input State

Enables or disable the use of the "Digital I/Q" input source for measurements.

"Digital I/Q" is only available if the optional "Digital Baseband" is installed.

Remote command:

[INPut:SElect](#) on page 433

##### Input Sample Rate

Defines the sample rate of the digital I/Q signal source. This sample rate must correspond with the sample rate provided by the connected device, e.g. a generator.

If "Auto" is selected, the sample rate is adjusted automatically by the connected device.

The allowed range is from 100 Hz to 20 GHz.

Remote command:

[INPut:DIQ:SRATe](#) on page 430

[INPut:DIQ:SRATe:AUTO](#) on page 430

##### Full Scale Level

The "Full Scale Level" defines the level and unit that corresponds to an I/Q sample with the magnitude "1".

If "Auto" is selected, the level is automatically set to the value provided by the connected device.

Remote command:

[INPut:DIQ:RANGe\[:UPPer\]](#) on page 429

[INPut:DIQ:RANGe\[:UPPer\]:UNIT](#) on page 430

[INPut:DIQ:RANGe\[:UPPer\]:AUTO](#) on page 429

#### Adjust Reference Level to Full Scale Level

If enabled, the reference level is adjusted to the full scale level automatically if any change occurs.

Remote command:

[INPut:DIQ:RANGe:COUPling](#) on page 429

#### Connected Instrument

Displays the status of the "Digital Baseband" interface connection.

If an instrument is connected, the following information is displayed:

- Name and serial number of the instrument connected to the "Digital Baseband" interface
- Used port
- Sample rate of the data currently being transferred via the "Digital Baseband" interface
- Level and unit that corresponds to an I/Q sample with the magnitude "1" ([Full Scale Level](#)), if provided by connected instrument

Remote command:

[INPut:DIQ:CDEVIce](#) on page 428

#### 4.1.14.5 Analog baseband

**Access:** "Overview" > "Input / Frontend" > "Input Source" > "Analog BB"

[Analog Baseband Input State](#)..... 148

[I/Q Mode](#)..... 148

[Input Configuration](#)..... 149

[High Accuracy Timing Trigger - Baseband - RF](#)..... 149

#### Analog Baseband Input State

Enables or disable the use of the "Analog Baseband" input source for measurements. "Analog Baseband" is only available if the optional "Analog Baseband" is installed.

Remote command:

[INPut:SELEct](#) on page 433

#### I/Q Mode

Defines the format of the input signal.

- |          |  |
|----------|--|
| "I + jQ" | The input signal is filtered and resampled to the sample rate of the application.<br>Two inputs are required for a complex signal, one for the in-phase component, and one for the quadrature component. |
|----------|--|

**"I Only / Low IF I"**

The input signal at the "Baseband Input I" connector is filtered and resampled to the sample rate of the application.  
 If the center frequency is set to 0 Hz, the real baseband signal is displayed without down-conversion (**Real Baseband I**).  
 If a center frequency greater than 0 Hz is set, the input signal is down-converted with the center frequency (**Low IF I**).

**"Q Only / Low IF Q"**

The input signal at the "Baseband Input Q" connector is filtered and resampled to the sample rate of the application.  
 If the center frequency is set to 0 Hz, the real baseband signal is displayed without down-conversion (**Real Baseband Q**).  
 If a center frequency greater than 0 Hz is set, the input signal is down-converted with the center frequency (**Low IF Q**).

Remote command:

`INPut:IQ:TYPE` on page 433

**Input Configuration**

Defines whether the input is provided as a differential signal via all four Analog Baseband connectors or as a plain I/Q signal via two single-ended lines.

**Note:** Both single-ended and differential probes are supported as input; however, since only one connector is occupied by a probe, the "Single-ended" setting must be used for all probes.

"Single-ended" I, Q data only  
 "Differential" I, Q and inverse I,Q data  
 (Not available for FSW85)

Remote command:

`INPut:IQ:BALanced[:STATe]` on page 432

**High Accuracy Timing Trigger - Baseband - RF**

Activates a mode with enhanced timing accuracy between analog baseband, RF and external trigger signals.

**Note:** Prerequisites for previous models of FSW.

For FSW models with a serial number lower than 103000, special prerequisites and restrictions apply for high accuracy timing:

- To obtain this high timing precision, trigger port 1 and port 2 must be connected via the Cable for High Accuracy Timing (order number 1325.3777.00).
- As trigger port 1 and port 2 are connected via the cable, only trigger port 3 can be used to trigger a measurement.
- Trigger port 2 is configured as output if the high accuracy timing option is active. Make sure not to activate this option if you use trigger port 2 in your measurement setup.
- When you first enable this setting, you are prompted to connect the cable for high accuracy timing to trigger ports 1 and 2. If you cancel this prompt, the setting remains disabled. As soon as you confirm this prompt, the cable must be in place - the firmware does not check the connection. (In remote operation, the setting is activated without a prompt.)

Remote command:

[CALibration:AIQ:HATiming\[:STATe\]](#) on page 428

#### 4.1.14.6 Baseband oscilloscope

**Access:** "Overview" > "Input / Frontend" > "Input Source" > "Baseband Oscilloscope"

Capturing I/Q data with an oscilloscope is available with the optional baseband oscilloscope inputs. The functionality is the same as in the spectrum application.

For details, see the user manual of the I/Q analyzer.

#### 4.1.14.7 I/Q file

**Access:** "Overview" > "Input / Frontend" > "Input Source" > "I/Q File"

As an alternative to capturing the measurement (I/Q) data live, you can also load previously recorded I/Q data stored in an `iq.tar` file. The file is then used as the input source for the application.

Available for I/Q based measurements.

For details, see the user manual of the I/Q analyzer.

<a href="#">I/Q Input File State</a> .....	150
<a href="#">Select I/Q data file</a> .....	150
<a href="#">File Repetitions</a> .....	151
<a href="#">Selected Channel</a> .....	151

##### I/Q Input File State

Enables input from the selected I/Q input file.

If enabled, the application performs measurements on the data from this file. Thus, most measurement settings related to data acquisition (attenuation, center frequency, measurement bandwidth, sample rate) cannot be changed. The measurement time can only be decreased to perform measurements on an extract of the available data only.

**Note:** Even when the file input is disabled, the input file remains selected and can be enabled again quickly by changing the state.

Remote command:

[INPut:SElect](#) on page 433

##### Select I/Q data file

Opens a file selection dialog box to select an input file that contains I/Q data.

The default storage location for I/Q data files is `C:\R_S\INSTR\USER`.

Remote command:

[INPut:FILE:PATH](#) on page 431

### File Repetitions

Determines how often the data stream is repeatedly copied in the I/Q data memory to create a longer record. If the available memory is not sufficient for the specified number of repetitions, the largest possible number of complete data streams is used.

Remote command:

[TRACe:IQ:FILE:REPetition:COUNT](#) on page 435

### Selected Channel

Only available for files that contain more than one data stream from multiple channels: selects the data stream to be used as input for the currently selected channel.

In "Auto" mode (default), the first data stream in the file is used as input for the channel. Applications that support multiple data streams use the first data stream in the file for the first input stream, the second for the second stream etc.

Remote command:

[MMEMory:LOAD:IQ:STReam](#) on page 434

[MMEMory:LOAD:IQ:STReam:AUTO](#) on page 434

[MMEMory:LOAD:IQ:STReam:LIST?](#) on page 435

## 4.1.15 Frequency configuration

**Access:** "Overview" > "Input / Frontend" > "Frequency"

Frequency settings define the frequency characteristics of the signal at the RF input. They are part of the "Frequency" tab of the "Signal Characteristics" dialog box.

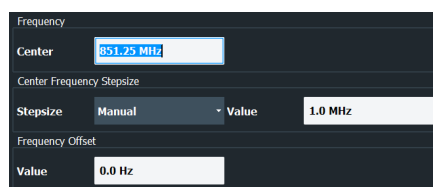

The remote commands required to configure the frequency are described in [Chapter 6.10.23, "Frequency configuration"](#), on page 435.

Signal Frequency.....	151
L Center Frequency.....	151
L Frequency Stepsize.....	152

### Signal Frequency

For measurements with an RF input source, you have to match the **center frequency** of the analyzer to the frequency of the signal.

### Center Frequency ← Signal Frequency

Defines the center frequency of the signal and thus the frequency the FSW tunes to. The frequency range depends on the hardware configuration of the analyzer you are using.

Remote command:

Center frequency: `[SENSe:] FREQuency:CENTer[:CC<cc>]` on page 435

Frequency offset: `[SENSe:] FREQuency:CENTer[:CC<cc>]:OFFSet` on page 436

### Frequency Stepsize ← Signal Frequency

In addition to the frequency itself, you can also define a frequency stepsize. The frequency stepsize defines the extent of a frequency change if you change it, for example with the rotary knob.

You can define the stepsize in two ways.

- = Center  
One frequency step corresponds to the current center frequency.
- Manual  
Define any stepsize you need.

Remote command:

Frequency stepsize: `[SENSe:] FREQuency:CENTer:STEP` on page 437

## 4.1.16 Amplitude configuration

**Access:** "Overview" > "Input / Frontend" > "Amplitude"

Amplitude settings define the expected level characteristics of the signal at the RF input.

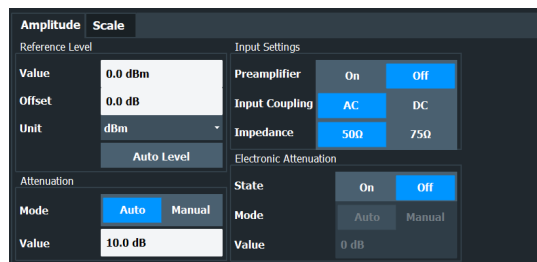

The remote commands required to configure the amplitude are described in [Chapter 6.10.24, "Amplitude configuration"](#), on page 437.

Reference Level.....	152
L Auto Level.....	153
L Reference Level Offset.....	153
Attenuating the Signal.....	153
L RF Attenuation.....	154
L Electronic Attenuation.....	154
Preamplifier.....	155
Input Coupling.....	155
Impedance.....	155

### Reference Level

The reference level is the power level the analyzer expects at the RF input. Keep in mind that the power level at the RF input is the peak envelope power for signals with a high crest factor like 5G NR.



To get the best dynamic range, you have to set the reference level as low as possible. At the same time, make sure that the maximum signal level does not exceed the reference level. If it does, it will overload the A/D converter, regardless of the signal power. Measurement results can deteriorate (e.g. EVM), especially for measurements with more than one active channel near the one you are trying to measure ( $\pm 6$  MHz).

Note that the signal level at the A/D converter can be stronger than the level the application displays, depending on the current resolution bandwidth. This is because the resolution bandwidths are implemented digitally after the A/D converter.

The reference level is a value in dBm.

Remote command:

Reference level: `DISPlay[:WINDow<n>][:SUBWindow<w>]:TRACe<t>:Y[:SCALE]:RLEVel` on page 437

### Auto Level ← Reference Level

Automatically determines the ideal reference level. The automatic leveling process measures the signal and defines the ideal reference signal for the measured signal.

Automatic level detection also optimizes RF attenuation.

Auto leveling slightly increases the measurement time, because of the extra leveling measurement prior to each sweep. By default, the FSW automatically defines the time for auto leveling, but you can also define it manually ([Auto Set] > "Auto Level Config" > "Meas Time").

The application shows the current reference level (including RF and external attenuation) in the channel bar.

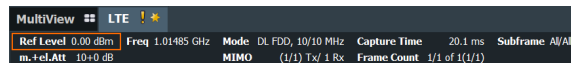

Remote command:

Automatic: `[SENSe:]ADJust:LEVel` on page 319

Auto level mode: `[SENSe:]ADJust:CONFigure:LEVel:DURation:MODE` on page 318

Auto level time: `[SENSe:]ADJust:CONFigure:LEVel:DURation` on page 318

### Reference Level Offset ← Reference Level

The reference level offset is an arithmetic level offset. A level offset is useful if the signal is attenuated or amplified before it is fed into the analyzer. All displayed power level results are shifted by this value. Note however, that the reference value ignores the level offset. Thus, it is still mandatory to define the actual power level that the analyzer has to handle as the reference level.

Remote command:

`DISPlay[:WINDow<n>][:SUBWindow<w>]:TRACe<t>:Y[:SCALE]:RLEVel:OFFSet` on page 438

### Attenuating the Signal

Attenuation of the signal becomes necessary if you have to reduce the power of the signal that you have applied. Power reduction is necessary, for example, to prevent an overload of the input mixer.

For a comprehensive information about signal attenuation, refer to the user manual of the FSW.

The 5G NR measurement application provides several attenuation modes.

### RF Attenuation ← Attenuating the Signal

Controls the RF (or mechanical) attenuator at the RF input.

If you select automatic signal attenuation, the attenuation level is coupled to the reference level.

If you select manual signal attenuation, you can define an arbitrary attenuation (within the supported value range).

Positive values correspond to signal attenuation and negative values correspond to signal gain.

Note that when you are using an external frontend, you can define attenuation for the analyzer and the external frontend separately. For more information about external frontends, refer to the user manual of the I/Q analyzer.

The application shows the attenuation level (mechanical and electronic) in the channel bar.



Remote command:

State: `INPut:ATTenuation<ant>:AUTO` on page 439

Level: `INPut:ATTenuation<ant>` on page 438

### Electronic Attenuation ← Attenuating the Signal

Controls the optional electronic attenuator.

If you select automatic signal attenuation, the attenuation level is coupled to the reference level.

If you select manual signal attenuation, you can define an arbitrary attenuation (within the supported value range).

Positive values correspond to signal attenuation and negative values correspond to signal gain.

Note that the frequency range must not exceed the specification of the electronic attenuator for it to work.

The application shows the attenuation level (mechanical and electronic) in the channel bar.

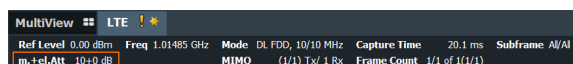

Remote command:

Electronic attenuation: `INPut:EATT<ant>:STATE` on page 441

Electronic attenuation: `INPut:EATT<ant>:AUTO` on page 441

Electronic attenuation: `INPut:EATT<ant>` on page 440

### Preamplifier

If the (optional) internal preamplifier hardware is installed on the FSW, a preamplifier can be activated for the RF input signal.

You can use a preamplifier to analyze signals from DUTs with low output power.

**Note:** If an optional external preamplifier is activated, the internal preamplifier is automatically disabled, and vice versa.

For an active external frontend, a preamplifier is not available.

This function is not available for input from the (optional) "Digital Baseband" interface.

For all FSW models except for FSW85, the following settings are available:

"Off"	Deactivates the preamplifier.
"15 dB"	The RF input signal is amplified by about 15 dB.
"30 dB"	The RF input signal is amplified by about 30 dB.

For FSW85 models, the input signal is amplified by 30 dB if the preamplifier is activated.

Remote command:

[INPut:GAIN:STATe](#) on page 439

[INPut:GAIN\[:VALue\]](#) on page 440

### Input Coupling

The RF input of the FSW can be coupled by alternating current (AC) or direct current (DC).

For an active external frontend, input coupling is always DC.

Not available for input from the optional "Analog Baseband" interface.

Not available for input from the optional "Digital Baseband" interface.

AC coupling blocks any DC voltage from the input signal. AC coupling is activated by default to prevent damage to the instrument. Very low frequencies in the input signal can be distorted.

However, some specifications require DC coupling. In this case, you must protect the instrument from damaging DC input voltages manually. For details, refer to the specifications document.

Remote command:

[INPut:COUPling](#) on page 439

### Impedance

For some measurements, the reference impedance for the measured levels of the FSW can be set to 50  $\Omega$  or 75  $\Omega$ .

For an active external frontend, impedance is always 50  $\Omega$ .

Select 75  $\Omega$  if the 50  $\Omega$  input impedance is transformed to a higher impedance using a 75  $\Omega$  adapter of the RAZ type. (That corresponds to 25 $\Omega$  in series to the input impedance of the instrument.) The correction value in this case is 1.76 dB = 10 log (75 $\Omega$ /50 $\Omega$ ).

Not available for input from the optional "Digital Baseband" interface.

Not available for input from the optional "Analog Baseband" interface. For analog baseband input, an impedance of 50 Ω is always used.

Remote command:

[INPut : IMPedance](#) on page 440

#### 4.1.17 Data capture

**Access:** "Overview" > "Trigger / Signal Capture" > "Signal Capture"

The data capture settings contain settings that control various aspects of the data capture.

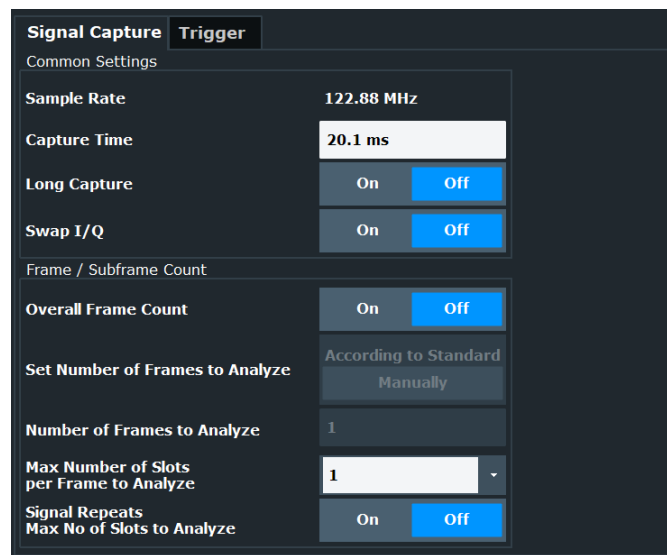

The "Maximum Number of Subframes per Frame to Analyze" setting available in older firmware versions is no longer supported.

The remote commands required to configure the data capture are described in [Chapter 6.10.25, "Data capture"](#), on page 442.

<a href="#">Capture Time</a> .....	156
<a href="#">Long Capture</a> .....	157
<a href="#">Swap I/Q</a> .....	157
<a href="#">Overall Frame Count</a> .....	157
<a href="#">Auto According to Standard</a> .....	158
<a href="#">Number of Frames to Analyze</a> .....	158
<a href="#">Maximum Number of Slots per Frame to Analyze</a> .....	158
<a href="#">Signal Repeats Max No of Slots to Analyze</a> .....	158

##### Capture Time

The "Capture Time" corresponds to the time of one measurement. Therefore, it defines the amount of data the application captures during a single measurement (or sweep).

By default, the application captures 20.1 ms of data to make sure that at least one complete 5G NR frame is captured in the measurement.

The maximum capture time is limited when you are only [measuring slots repeatedly](#).

For measurements in FR2-2, you can let the FSW determine the capture time automatically or enter the capture time manually. For an automatic capture time, the FSW makes the capture as small as possible but also makes sure that the first 80 slots are captured in one piece according to 3GPP specifications. If you are measuring a signals with different subcarrier spacings, the capture time is based on the smallest subcarrier spacing.

The application shows the current capture time in the channel bar.

Note that if you are using the [multi-standard radio analyzer](#), only the MSRA primary channel actually captures the data. The capture time only defines the 5G NR analysis interval.

Remote command:

[\[SENSe:\]SWEep:TIME](#) on page 445

Capture mode (FR2-2): [\[SENSe:\]SWEep:CTMode](#) on page 444

### Long Capture

Turns a limitation of the [capture time](#) on and off.

When you turn off the long capture, the capture time is limited to 50.1 ms (maximum of 5 frames).

To capture more frames, turn on the long capture. The long capture allows you to capture data up to 1 s. However, the long capture has the following limitations.

- The long capture captures several frames, but analyzes only one. The analyzed frame is indicated by a horizontal green bar in the capture buffer. The analyzed frame depends on your [selection](#).
- Multiple frame configurations are not possible, because every frame must have the same configuration.
- The frame count settings (overall frame count etc.) are unavailable.
- Averaging results over several frames is not supported. Therefore, the FSW does not evaluate EVM limits for long captures.
- Segmented capture is not supported.
- Component carrier measurements are not supported.
- Measurements in FR2-2 are not supported.

Remote command:

[\[SENSe:\]SWEep:LCAPture](#) on page 444

### Swap I/Q

Swaps the real (I branch) and the imaginary (Q branch) parts of the signal.

Remote command:

[\[SENSe:\]SWAPiq](#) on page 443

### Overall Frame Count

The "Overall Frame Count" turns the manual selection of the number of frames to capture (and analyze) on and off.

When you turn on the overall frame count, you can define the [number of frames to capture and analyze](#). The measurement runs until all frames have been analyzed, even if it takes more than one capture.

When you turn off the overall frame count, the application analyzes all 5G NR frames found in one capture buffer.

For more information about the effects on the results of capturing more frames than fit in the capture buffer, see [Chapter 4.1.6, "Radio frame configuration"](#), on page 86.

The application shows the current frame count in the channel bar.

Remote command:

[\[SENSe:\]NR5G:FRAMe:COUNT:STATe](#) on page 443

#### Auto According to Standard

Turns automatic selection of the number of frames to capture and analyze on and off.

When you turn on this feature, the FSW captures and evaluates a number of frames the 3GPP standard specifies for EVM tests.

If you want to analyze an arbitrary number of frames, turn off the feature.

This parameter is not available when the overall frame count is inactive.

Remote command:

[\[SENSe:\]NR5G:FRAMe:COUNT:AUTO](#) on page 442

#### Number of Frames to Analyze

Defines the number of frames you want to capture and analyze.

If the number of frames you have set last longer than a [single measurement](#), the application continues the measurement until all frames have been captured.

The parameter is read only in the following cases:

- If you turn off the [overall frame count](#).
- If you capture the data [according to the standard](#).

Remote command:

[\[SENSe:\]NR5G:FRAMe:COUNT](#) on page 442

On / off power measurements: [CONFigure\[:NR5G\]:OOPower:NFRames](#) on page 461

#### Maximum Number of Slots per Frame to Analyze

Selects the number of slots that the application analyzes.

You can select to analyze "All" slots, or a certain number of slots - select the number from the dropdown menu and enter the number of slots to analyze. The maximum number of slots you can analyze depends on the subcarrier spacing.

If you select a certain number of slots, the FSW analyzes the first <x> slots in a frame. By default, the FSW analyzes 80 slots to comply with 3GPP specifications.

Reducing the number of slots to analyze improves measurement speed.

Remote command:

[\[SENSe:\]NR5G:FRAMe:SLOT](#) on page 443

#### Signal Repeats Max No of Slots to Analyze

Turns analysis of custom signals with repeating slots on and off.

You can use this setting to measure custom (shortened) signals that only contain a few slots per frame. This setting is useful to achieve a high measurement and analysis speed without trigger availability. Multiple frame analysis tailored to the custom signal is also possible.

**Example:**

Slot 0 | Slot 0 | Slot 0 etc.

Slot 0 | Slot 1 | Slot 0 | Slot 1 etc.

Note that the slot sequence must start with slot number 0.

Measuring such signals is not possible with the standard signal capture settings without a trigger.

Instead, configure the FSW like this.

- Reduce the capture time based on the number of slots in the repeated signal and the subcarrier spacing. Make sure that the slot sequence is contained at least once in the capture buffer.  
For example to measure 3 slots with a subcarrier spacing of 30 kHz (length of one slot = 500 µs), reduce the capture time to 3.1 ms.  
Capturing repeating slots limits the maximum allowed capture time based on the maximum number of slots you are capturing.
- Select a maximum number of slots to analyze that matches the number of slots in your signal.  
For example: if you have a sequence of three slots being repeated in your signal, select 3 slots to analyze.
- Turn on the "Signal Repeats Max No of Slots to Analyze" setting.

Remote command:

[\[SENSe:\]NR5G:FRAMe:SRSLOt](#) on page 443

#### 4.1.18 Trigger configuration

**Access:** "Overview" > "Trig / Sig Capture" > "Trigger"

A trigger allows you to capture those parts of the signal that you are really interested in.

While the application runs freely and analyzes all signal data in its default state, no matter if the signal contains information or not, a trigger initiates a measurement only under certain circumstances (the trigger event).

Except for the available trigger sources, the functionality is the same as that of the FSW base system.

For a comprehensive description of the available trigger settings not described here, refer to the documentation of the FSW.



#### Gated measurements

In addition to the general trigger functions, the frequency sweep measurements (for example ACLR) also support gated measurements.

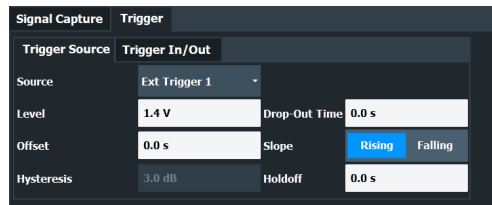

Trigger Source.....160

## Trigger Source

The application supports several trigger modes or sources.

- **Free Run**  
Starts the measurement immediately and measures continuously.
- **External <x>**  
The trigger event is the level of an external trigger signal. The measurement starts when this signal meets or exceeds a specified trigger level at the trigger input. Some measurement devices have several trigger ports. When you use one of these, several external trigger sources are available.
- **I/Q Power**  
The trigger event is the magnitude of the sampled I/Q data. The measurement starts when the magnitude of the I/Q data meets or exceeds the trigger level.
- **IF Power**  
The trigger event is the level of the intermediate frequency (IF). The measurement starts when the level of the IF meets or exceeds the trigger level.
- **RF Power**  
The trigger event is the level measured at the RF input. The measurement starts when the level of the signal meets or exceeds the trigger level.
- **Time**  
The trigger event is a certain time interval (every <x> seconds).

For all trigger sources, except "Free Run", you can define several trigger characteristics.

- The trigger "Level" defines the signal level that initiates the measurement.
- The trigger "Repetition Interval" defines the time interval that initiates a measurement for the time trigger.
- The trigger "Offset" is the time that must pass between the trigger event and the start of the measurement. This can be a negative value (a pretrigger).
- The trigger "Drop-out Time" defines the time the input signal must stay below the trigger level before triggering again.
- The trigger "Slope" defines whether triggering occurs when the signal rises to the trigger level or falls down to it.
- The trigger "Holdoff" defines a time period that must at least pass between one trigger event and the next.
- The trigger "Hysteresis" is available for the IF power trigger. It defines a distance to the trigger level that the input signal must stay below to fulfill the trigger condition.

For a detailed description of the trigger parameters, see the user manual of the I/Q analyzer.



Remote command:

Source: `TRIGger[:SEquence]:SOURce<ant>` on page 449

Level (external): `TRIGger[:SEquence]:LEVel<ant>[:EXternal<tp>]`  
on page 447

Level (I/Q power): `TRIGger[:SEquence]:LEVel<ant>:IQPower` on page 447

Level (IF power): `TRIGger[:SEquence]:LEVel<ant>:IFPower` on page 447

Level (RF power): `TRIGger[:SEquence]:LEVel<ant>:RFPower` on page 448

Offset: `TRIGger[:SEquence]:HOLDoff<ant>[:TIME]` on page 446

Hysteresis: `TRIGger[:SEquence]:IFPower:HYSteresis` on page 446

Drop-out time: `TRIGger[:SEquence]:DTIME` on page 445

Slope: `TRIGger[:SEquence]:SLOPe` on page 449

Holdoff: `TRIGger[:SEquence]:IFPower:HOLDoff` on page 446

### 4.1.19 Segmented capture

**Access:** "Overview" > "Trigger / Signal Capture" > "Trigger" > "Segmented Capture"

Segmented capture is a useful tool for large data captures. For a segmented capture, the FSW measures the signal over the complete measurement time, but only keeps those signal parts in the capture buffer that are of interest for you: the signal itself. This has the advantage that the measurement accumulates less data, and only data that is really relevant. The number of segments you want to capture is arbitrary.

A prerequisite for the segmented data capture is an [external or IF power trigger](#), because the segment characteristics (start, stop and length) are based on a trigger event. You can apply a trigger offset to each segment, thus allowing for post- or pretrigger data to be included in the segment.

#### Effects on result displays

The [capture buffer](#) only shows the information of the captured segments. The signal information between the segments is no longer displayed. A blue vertical line indicates the start and stop of a segment.

For all other result displays, you can select one of the captured segments whose information is evaluated in the [evaluation range](#).

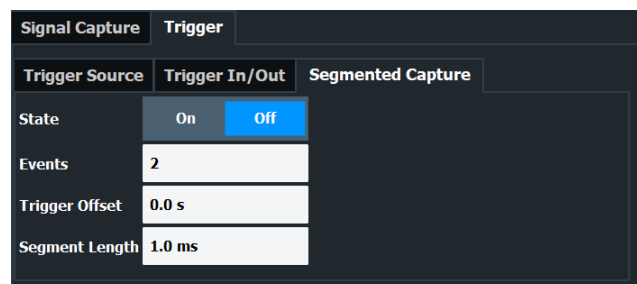

The remote commands required to configure the segmented capture are described in [Chapter 6.10.27, "Segmented capture"](#), on page 450.

[Configuration](#)..... 162

**Configuration**

Turn the segmented capture on and off with "State".

If you turn on the segmented capture, the FSW captures data for a certain time ("Segment Length") when a trigger event occurs. You can define the number of segments that the FSW captures by defining the number of (trigger) "Events" to consider.

The segmented capture is available for the [external or IF power trigger](#).

**Example:**

Number of events: 4, segment length: 2 ms

After you start the measurement, the FSW waits until the first trigger event occurs, then captures data for 2 ms. After that, the FSW waits for the second trigger event before it again captures data. This goes on until all 4 segments have been captured.

If no trigger event occurs during the capture time, the FSW captures nothing.

Note that it is not possible to define a [capture time](#) when segmented capture is on.

The "Trigger Offset" defines a time between the trigger event and the actual start of the measurement. For a negative offset, the data capture starts before the actual trigger event.

**Example:**

Trigger offset: 0.5 ms

The data capture starts 0.5 ms after the trigger event occurs.

Remote command:

State: [\[SENSe:\]SWEep:SCAPture:STATE](#) on page 451

Events: [\[SENSe:\]SWEep:SCAPture:EVENTs](#) on page 450

Length: [\[SENSe:\]SWEep:SCAPture:LENGth\[:TIME\]](#) on page 451

Offset: [\[SENSe:\]SWEep:SCAPture:OFFSet\[:TIME\]](#) on page 451

**4.1.20 Data capture optimization**

**Access:** "Overview" > "Trigger / Signal Capture" > "Optimization"

The optimization settings contain settings that control tools to optimize the data capture and processing.

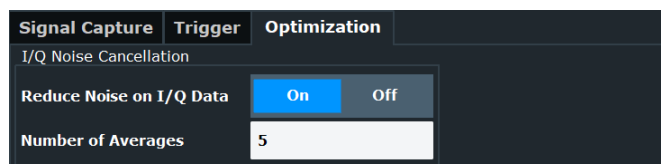

The remote commands required to configure the data capture are described in [Chapter 6.10.25, "Data capture"](#), on page 442.

[Reduce Noise on I/Q Data](#)..... 163

### Reduce Noise on I/Q Data

This function requires the R&S FSW-K575 option and a repetitive input signal.

If enabled, initial measurement steps are performed to remove the receiver noise of the spectrum analyzer. The steps include capturing and synchronizing data, averaging the data to estimate the total noise, and measuring the internal noise. Based on these measurements, the I/Q data is corrected so that it only includes the external noise contributions. The number of captures used for averaging is defined by the "Number of Averages".

Using this function, the residual EVM of the signal analyzer can be improved, even for very low signal levels.

If synchronization fails during the initial measurements, the noise cancellation process is not started, and an error message is displayed in the status bar.

If noise cancellation is enabled, "IQNC" is indicated in the channel bar.

For statistical evaluation, the entire noise cancellation process is counted as one measurement.

For details on the concept of I/Q noise cancellation and for troubleshooting tips, see the FSW I/Q Analyzer and I/Q Input User Manual.

Remote command:

[SENSe:]ADJust:NCANcel:AVERage[:STATe] on page 452

[SENSe:]ADJust:NCANcel:AVERage[:COUNT] on page 452

## 4.1.21 Tracking

**Access:** "Overview" > "Tracking"

Tracking settings contain settings that compensate various errors.

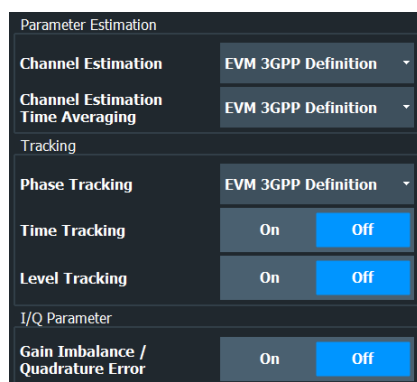

The remote commands required to configure error tracking are described in [Chapter 6.10.29, "Tracking"](#), on page 453.

<a href="#">Channel Estimation</a> .....	164
<a href="#">Channel Estimation Time Averaging</a> .....	164
<a href="#">Phase</a> .....	165
<a href="#">Time Tracking</a> .....	165

Level Tracking.....	165
Gain Imbalance / Quadrature Error.....	165
Throughput Measurement State.....	166

### Channel Estimation

Selects the channel estimation method.

"EVM 3GPP definition"	Estimates the channel according to 3GPP (38.141-1 / -2, annex H.6). Recommended for standard conform measurements.
"Pilot Only (Linear Interpolation)"	Calculates the equalizer coefficients on all available reference signal subcarriers. All missing subcarriers are interpolated (linear interpolation). Uses the selected <a href="#">time averaging</a> . This estimation method is more prone to noise, because it does not apply a frequency domain moving average. However, the estimation can adapt to the individual subcarrier.
"Pilot And Payload"	Calculates equalizer coefficients on all available resource elements of the reference signal and the payload. This implies that payload symbols could have been demodulated without wrong symbol decisions. If this is not the case, the reference signal generated from the payload is wrong and the calculated equalizer is not ideal. Uses the selected <a href="#">time averaging</a> . This estimation method improves the equalizer estimate, because more subcarriers and symbols are used. This is beneficial for noisy signals (low SNR). Further subcarriers without pilots are taken into account
"Off"	Turns off channel estimation. Turning off channel estimation is useful if you want to see the impact of the channel frequency response on the signal quality (EVM).

Remote command:

[\[SENSe:\]NR5G:DEMod:CESTimation](#) on page 453

### Channel Estimation Time Averaging

Select the averaging time interval for channel estimation.

"EVM 3GPP Definition"	Averages equalizer coefficients of DMRS across all symbols according to 38.141-1 / -2, annex H.6. Recommended for standard conform measurements.
"Per Allocation"	Averages equalizer coefficients across one allocation only. Equalizer coefficients between allocations are independent. An allocation is for example a single PDSCH. Because this method does no time averaging, this option is more prone to noise. However, the estimation can adapt better to the individual allocation.

Remote command:

[\[SENSe:\]NR5G:DEMod:CETaverage](#) on page 453

**Phase**

Turns phase tracking on and off.

Phase tracking aims to remove random phase fluctuations between OFDM symbols. The phases of all pilot subcarriers are estimated and averaged per symbol.

When you turn on phase tracking, the application removes the phase difference between consecutive symbols.

"Off"	Phase tracking is not applied. Allows you to evaluate the impact of phase noise and phase drifts on the signal quality.
"Pilot Only"	Uses the reference signal (PTRS) for phase tracking. Symbols without PTRS are interpolated (linear interpolation).
"Pilot and Payload"	Uses available reference signals (PTRS) and the payload resource elements for phase tracking. Allows you to improve tracking results (a better immunity to noise), because of the analysis of the payload. This method does not interpolate symbols without reference signals.
"EVM 3GPP Definition"	Estimation according to the 3GPP definition in 38.141-2, L.6. FR2 uses the PTRS for phase tracking. FR1 does not use phase tracking. Recommended for standard conform measurements.

Remote command:

[\[SENSe:\]NR5G:TRACking:PHASe](#) on page 454

**Time Tracking**

Turns time tracking on and off.

Clock deviations (slower or faster sampling time) lead to a drift of the ideal sampling instant over time, causing a rotating constellation diagram.

When you turn on time tracking, the application compensates measurement results for timing errors on a slot level.

Remote command:

[\[SENSe:\]NR5G:TRACking:TIME](#) on page 455

**Level Tracking**

Turns level tracking on and off.

Gain variations over time, caused for example by temperature drifts in power amplifiers, impact signal quality.

When you turn on level tracking, the FSW corrects a gain value that is constant across frequency on symbol level.

Remote command:

[\[SENSe:\]NR5G:TRACking:LEVel](#) on page 454

**Gain Imbalance / Quadrature Error**

Turns the calculation of the I/Q gain imbalance and the quadrature error ([result summary](#)) on and off.

Remote command:

[SENSe:]NR5G:IQ:GIQE on page 454

### Throughput Measurement State

Turns the throughput and block error rate measurement on and off.

The results of these measurements are displayed in the [result summary](#).

If you turn on the throughput measurement, selecting a [number of frames to analyze](#) according to standard is not supported. If that setting was active when you turn on the throughput measurement, it is automatically set to manual number of frames to analyze.

Remote command:

[SENSe:]NR5G:TRACking:TPUT:STATe on page 455

## 4.1.22 Demodulation

**Access:** "Overview" > "Demodulation"

Demodulation settings contain settings that describe signal processing and the way the signal is measured.

Multicarrier Filter	
Use Multicarrier Filter	<input checked="" type="radio"/> On <input type="radio"/> Off
Demodulation Data	Before Descrambling
CORESET Analysis Mode	<input checked="" type="radio"/> Auto <input type="radio"/> Manual
Calculation Method	Custom
Symbol Time Adjustment	50.0 %
CORESET Reference Data	Auto Detect
PDSCH Reference Data	Auto Detect
Extended Frequency Lock Range	<input type="radio"/> On <input checked="" type="radio"/> Off

The remote commands required to configure the demodulation are described in [Chapter 6.10.30, "Demodulation"](#), on page 455.

<a href="#">Filter</a> .....	166
<a href="#">Demodulation Data</a> .....	167
<a href="#">CORESET Analysis Mode</a> .....	167
<a href="#">EVM Calculation Method</a> .....	167
<a href="#">Symbol Time Adjustment</a> .....	168
<a href="#">PDSCH Reference Data</a> .....	168
<a href="#">CORESET Reference Data</a> .....	169
<a href="#">Extended Frequency Lock Range</a> .....	169

### Filter

Selects the filter to suppress interference of neighboring carriers.

"None"            No suppression of neighboring channels.

"Multicarrier Filter" Suppresses interference for tests on multiradio base stations (LTE, WCDMA, GSM etc.).  
The FSW automatically selects the multicarrier filter when you analyze more than 1 [component carrier](#).

"Per BWP" Suppresses interference for tests on multi BWP signals.

Remote command:

[SENSe:]NR5G:DEMod:FILTer on page 458

### Demodulation Data

For the [bitstream](#) results, you can get the data at various points in the signal processing chain.

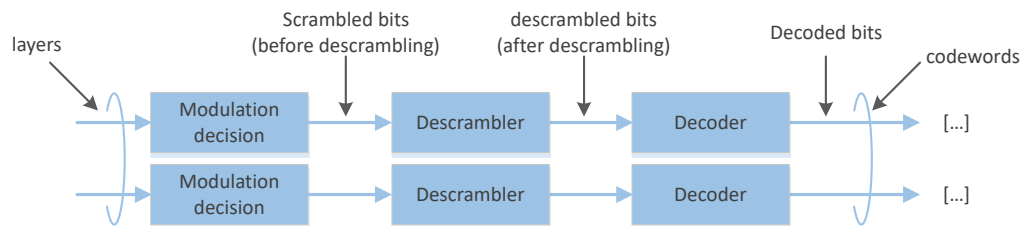

"Before Descrambling" Demodulates the scrambled data.

"After Descrambling" Demodulates the descrambled data.

"Decoded Payload Data" Demodulates the descrambled and decoded PDSCH data.

Remote command:

[SENSe:]NR5G:DEMod:DDATa on page 457

### CORESET Analysis Mode

Selects the way the FSW demodulates the PDCCH.

"Auto" The FSW automatically demodulates the PDCCH by detecting the payload of the CORESET DMRS.

"Manual" The FSW demodulates the PDCCH based on the [PDCCH parameters](#) you have defined.

Remote command:

[SENSe:]NR5G:DEMod:CAMode on page 456

### EVM Calculation Method

Selects the way the EVM is calculated.

"EVM 3GPP Definition" Calculates the EVM according to 3GPP TS 38.141-1 / -2. Evaluates the EVM at two trial timing positions and then uses the higher EVM of the two.

"At Optimal Timing Position" Calculates the EVM using the optimal timing position.

"EVM High Timing Position" Calculates the EVM at the high trial position defined by 3GPP.

"EVM Low Timing Position" Calculates the EVM at the low trial position defined by 3GPP.

Remote command:

[SENSe:]NR5G:DEMod:CMETHod on page 456

### Symbol Time Adjustment

Defines the position of the FFT window within a symbol. The FFT window defines the time over which the FFT is calculated.

The value is a percentage relative to the beginning of the cyclic prefix.

- 0 %: FFT window starts at the beginning of the cyclic prefix.
- 100 %: FFT window starts at the end of the cyclic prefix.

Remote command:

[SENSe:]NR5G:DEMod:STADjust on page 458

### PDSCH Reference Data

Selects the type of reference data to calculate the EVM for the PDSCH.

By default, the FSW automatically detects the PDSCH reference values and maps the measured values to the nearest reference point.

If you expect noisy signals with a high EVM, however, the automatic detection is no longer reliable and can yield EVM values that are too good for the analyzed signal - measured values could be mapped to the wrong reference values by mistake, if they are too far from their original position.

Instead, you can set the PDSCH reference values to a fixed value of 0. This setting calculates the correct EVM, regardless of the signal quality. However, you have to make sure that the DUT transmits an all-zero data vector for the PDSCH.

Another option is to base the PDSCH reference values on the pseudo random sequence 23 (PN23) as defined by 3GPP. This method also yield correct EVM values. Again, the signal must use the NR-TM PN23 for this to work.

"Auto Detect" Automatically detects the PDSCH reference values.

"All 0" Assumes the PDSCH to be all 0's, according to test model definitions.

"NR-TM PN23" Assumes the PDSCH to be based on the pseudo random sequence 23, as defined by 3GPP. Each PDSCH / PDCCH has an individual sequence.

"NR-TM PN23 All Slots" Assumes the PDSCH to be based on the pseudo random sequence 23, as defined by 3GPP. All PDSCH / PDCCH have the same sequence.

"ORAN PN23" Assumes the PDSCH to be based on the pseudo random sequence 23, as defined by the ORAN alliance. Note that this type of reference data is automatically selected when you select an ORAN test case. The FSW assumes that the measured signal actually contains the corresponding ORAN PN23 sequence. For this option, each PDSCH has an individual sequence.



"ORAN PN23 All Slots" Assumes the PDSCH to be based on the pseudo random sequence 23, as defined by the ORAN alliance. Note that this type of reference data is automatically selected when you select an ORAN test case. The FSW assumes that the measured signal actually contains the corresponding ORAN PN23 sequence. For this option, all PDSCH / PDCCH have the same sequence.

Remote command:

[SENSe:]NR5G:DEMod:PRData on page 458

#### CORESET Reference Data

Selects the type of reference data to calculate the EVM for the CORESET.

The logic and type of reference data is the same as that for the [PDSCH](#).

Remote command:

[SENSe:]NR5G:DEMod:CRData on page 456

#### Extended Frequency Lock Range

Selects the frequency error tolerance for successful signal synchronization.

Turn the setting off to have a small tolerance (0.5\*subcarrier spacing).

Turn the setting on to have a large tolerance (10\*subcarrier spacing).

For a large tolerance, we recommend to configure the synchronization signal manually, because the auto demodulation might not work properly depending on the actual frequency error.

Remote command:

[SENSe:]NR5G:DEMod:EFLRange on page 457

## 4.2 Time alignment error configuration

**Access:** [MEAS CONFIG]

The settings for time alignment error measurements are similar to the settings of the I/Q measurements. For a comprehensive description of those, refer to the following chapters.

- [Chapter 4.1.3, "Physical signal description"](#), on page 77
- [Chapter 4.1.5, "Component carrier configuration"](#), on page 81 (intra-band component carriers only - contiguous and non-contiguous)
- [Chapter 4.1.7, "Synchronization signal configuration"](#), on page 90 (note that the time alignment error measurement does not support all synchronization signal settings)
- [Chapter 4.1.9, "Slot configuration"](#), on page 101 (configuring individual slots allows measurements according to TDD NR-TM's)
- [Chapter 4.1.10, "PDSCH and PDCCH configuration"](#), on page 113 (note that the enhanced PDSCH settings are the same for all PDSCH allocations in the entire frame and are available centrally in the "Slot" configuration tab - trying to open the enhanced PDSCH settings from the allocation table shows a corresponding message)

- [Chapter 4.1.14, "Input source configuration"](#), on page 145
- [Chapter 4.1.15, "Frequency configuration"](#), on page 151
- [Chapter 4.1.16, "Amplitude configuration"](#), on page 152
- [Chapter 4.1.17, "Data capture"](#), on page 156
- [Chapter 4.1.18, "Trigger configuration"](#), on page 159
- [Chapter 4.1.22, "Demodulation"](#), on page 166

## 4.3 Transmit on / off power configuration

**Access:** [MEAS CONFIG]

The settings for transmit on / off power measurement are similar to the settings of the I/Q measurements.

Settings for the transmit on / off power measurement described elsewhere (not all settings described in the following chapters are available in the transmit on / off power measurement though):

- [5G NR Mode](#)
- [Signal Description / Test Model](#)
- [Deployment](#)
- [Base station type](#)
- [Channel Bandwidth](#)
- [Synchronization signal](#)
- [Bandwidth part configuration](#)
- [Slot configuration](#)
- [PDSCH configuration](#)
- [Antenna port configuration](#)
- [Advanced settings](#)
- [Signal capture](#)
- [Trigger configuration](#)
- [Demodulation settings](#)

[Base station output power](#).....170

### Base station output power

For transmit on / off power measurements on [2-O type base stations](#), you can define the output power of the base station.

You can define the following rated power values that have an effect on the limits:

- $P_{\text{rated, c, EIRP}}$
- $P_{\text{rated, c, TRP}}$

Remote command:

EIRP: `CONFigure[:NR5G]:DL[:CC<cc>]:PLC:EIRP` on page 460

TRP: `CONFigure[:NR5G]:DL[:CC<cc>]:PLC:TRP` on page 461

## 4.4 Frequency sweep measurement configuration

**Access:** [MEAS CONFIG] > "Signal Description"

The signal description for ACLR and SEM measurements contains settings to describe general physical characteristics of the signal you are measuring.



### Settings for frequency sweep measurements

When you start the frequency sweep measurement from within the 5G NR application, the FSW automatically configures the measurement and limits according to the specification defined by 3GPP.

Therefore, it is sufficient for you to configure the details of the 5G NR signal description.



### Filter type in SEM measurements

The 5G NR application uses a channel filter for SEM measurements by default. The spectrum application on the other hand uses a Gauss filter. If you need a Gauss filter for the SEM measurement in the 5G NR application, change it manually in the sweep list for the corresponding frequency ranges.

Note that ACLR and SEM measurements are currently unavailable for FR2-2 frequency deployment.

Functions in the "Signal Description" dialog box described elsewhere:

- [5G NR Mode](#)
- [Signal Description / Test Model](#)
- [Deployment](#)
- [Channel Bandwidth](#)
- [Subcarrier spacing](#)  
(for FR2 deployments)
- For SEM measurements: [Base station category](#)
- For MC ACLR, Cumulative ACLR and Multi SEM measurements: [Component carriers](#)
  - ACLR measurements support a maximum of 16 component carriers.
  - SEM measurements support a maximum of 8 component carriers.
- [Subcarrier spacing](#)

All other settings available for the ACLR and SEM measurements are the same as in the spectrum application. For more information, refer to the user manual of the FSW.

<a href="#">Base Station Type</a> .....	172
<a href="#">Adjacent Channels</a> .....	172
<a href="#">Tx Power</a> .....	172
<a href="#">Position of SEM and ACLR limits</a> .....	173
<a href="#">Total Limit Pass Mode</a> .....	173

### Base Station Type

3GPP defines several types of base station for the different deployment [frequency ranges](#).

Each base station class sets different requirements for

- [SEM measurements](#) (the SEM limits)
- [ACLR measurements](#) (the power of the adjacent channels)
- [transmit on / off power measurements](#) (the transient limits)

See 3GPP 38.141-1 / -2 for details.

The type you should use for the measurement depends on the base station you are testing.

- "1-C": Base station for conducted transmission requirements in FR1. (Only supported for ACLR and SEM measurements.)
- "1-H": Base station for hybrid transmission requirements (conducted and over-the-air) in FR1. (Only supported for ACLR and SEM measurements.)
- "1-O": Base station for over-the-air transmission requirements in FR1. (Only supported for ACLR and SEM measurements.)
- "2-O": Base station for over-the-air transmission requirements in FR2.

[output power](#).

For SEM measurements on 2-O type base stations, you can also define the [output power](#).

For transmit on / off power measurements on 2-O type base stations, you can also define the [output power](#).

The output power in both cases has an effect on the limits.

Remote command:

Base station type: [CONFigure\[:NR5G\]:BStation](#) on page 465

### Adjacent Channels

#### ACLR measurement only

Selects the assumed adjacent channel carrier for the ACLR measurement.

- "NR of Same BW": the neighboring channel is a 5G NR channel with the same bandwidth.
- "5 MHz E-UTRA": the neighboring channel is a LTE channel with 5 MHz bandwidth.

Remote command:

[\[SENSe:\]POWER:ACHannel:AACHannel](#) on page 463

### Tx Power

#### SEM measurement only

For SEM tests on [medium range base station](#) and [2-O type base stations](#), you can measure or manually enter the "Tx Power" of the carrier.

If you select "Manual", you can define the power in the corresponding input field. Otherwise, the FSW measures the power of the Tx channel automatically.

The exact label of the rated power value depends on the selected base station type as defined in 3GPP 38.141-1 / -2.

- "1-O":  $P_{\text{rated, c, TRP}}$

- "1-C":  $P_{\text{rated}}$ , c, AC
- "1-H":  $P_{\text{rated}}$ , c, cell
- "2-O":  $P_{\text{rated}}$ , t, TRP

The value range depends on the selected base station type.

For 1-H medium range base station, the supported output power value range also depends on the "N\_TXU, countedpercell" and "N\_TABconnectors" parameters.

Remote command:

BS power mode: [SENSE:] POWER:SEM:AMPower:AUTO on page 464

BS power value: [SENSE:] POWER:SEM:AMPower on page 463

### Position of SEM and ACLR limits

For tests on [1-H type base stations](#), you can also define two parameters "N\_TXU, countedpercell" and "# Tab connectors (n)".

For the spectrum emission mask, these two parameters shift the limits according to 3GPP 38.141-1, chapter 6.6.4.5.8. The parameters also select which SEM power class (SEM limits) applies to a given base station [output power](#) ( $P_{\text{rated}}$ ).

For the adjacent channel leakage error, these two parameters define the limits according to 3GPP 38.141-1, chapter 6.6.3.5.4.

Remote command:

N\_TABconnectors: [SENSE:] POWER:SEM:NTAB on page 464

N\_TXU: [SENSE:] POWER:SEM:NTXU on page 465

### Total Limit Pass Mode

Supported only by the LTE and 5G application.

**Access** (ACLR measurement): "Meas Config" > "CP / ACLR Config" > "Channel Settings" > "Limits"

**Access** (multi-carrier ACLR measurement): "Meas Config" > "CP / ACLR Config" > "MSR General Settings"

The "Total Limit Pass Mode" selects the logic the ACLR limits are evaluated with if you define both absolute limits and relative limits.

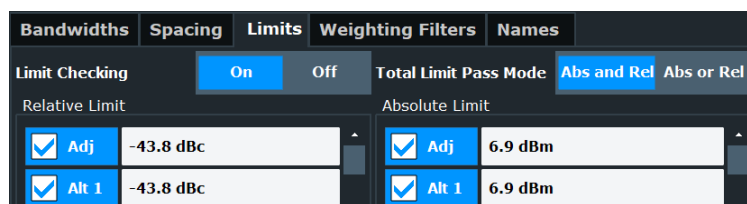

Figure 4-9: Evaluate both absolute and relative limits

If you define only relative or absolute limits, the FSW only evaluates the corresponding limits.

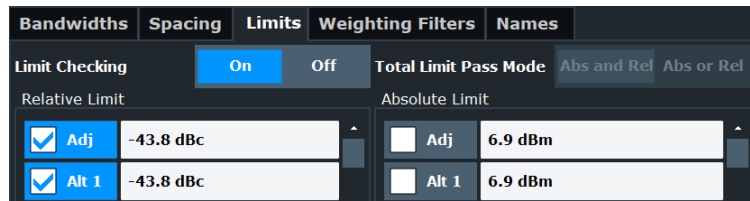

Figure 4-10: Evaluate only relative limits

If you change the limit evaluation method after the measurement, you have to refresh the measurement.

The selected method adjusts the contents of the following result displays.

- ACLR result summary
- MC ACLR result summary
- Cumulative ACLR result summary

The default value is according to 3GPP 38.141-1/2.

"Absolute"	Checks the absolute limits defined for the ACLR. The limit check passes when the signal level is within the absolute limits.
"Relative"	Checks the relative limits defined for the ACLR. The limit check passes when the signal level is within the relative limits.
"Absolute and Relative"	The limit check for both, the absolute and the relative limits, must pass to get an overall pass.
"Absolute or Relative"	The limit check for either the absolute or the relative limits must pass to get an overall pass.

Remote command:

`CALCulate<n>:LIMit<li>:ACPower:PMODE` on page 465

## 4.5 Combined measurement configuration

**Access:** "Overview"

The configuration for combined measurements is a combination of the configuration for I/Q measurements, ACLR measurements and SEM measurements with several special settings.

For an introduction on combined measurements and their application, see [Chapter 4.6, "Combined measurement guide"](#), on page 180.

Note that combined measurements are currently unavailable for the FR2-2 frequency deployment.

### Channel bar

In combined measurement mode, the [channel bar](#) contains additional information.

Table 4-3: Information displayed in the channel bar in the combined measurement mode

Ref Level	Reference level.
Att	Mechanical and electronic RF attenuation.

<b>Freq</b>	Frequency for other input sources (RF etc.).
<b>Mode*</b>	5G NR mode (link direction and channel bandwidth).
<b>Event Count</b>	The first number represents the number of events that have already been captured. The second number represents the total number of events that will be captured.
<b>Filtered Events</b>	Number of events that have been filtered when you have applies an <a href="#">event filter</a> .
<b>Capture Time</b>	Signal length that has been captured.
<b>Selected Meas ID</b>	Selected measurement.
<b>BWP/SS*</b>	Shows the signal part for which results are displayed (evaluation range). SS = synchronization signal BWP = bandwidth part
<b>I/Q</b>	Shows the type of memory used for I/Q data capture (RAM only).

Functions for combined measurements described elsewhere:

- [Input source settings](#)
- [Frequency settings](#)
- [Level settings](#)
- [Signal tracking](#)
- [Signal demodulation](#)
- [Signal description](#)..... 175
- [Signal capture](#)..... 176
- [Trigger configuration](#)..... 178

### 4.5.1 Signal description

**Access:** "Overview" > "Signal Description"

The signal description for combined measurements combines the signal description for I/Q, ACLR and SEM measurements.

Functions in the "Signal Description" dialog box described elsewhere:

- [Auto configuration](#)
- [Signal description](#)
- [Radio frame configuration](#), incl. synchronization signal configuration, bandwidth part configuration, slot configuration and allocation configuration.
- [Antenna port configuration](#)
- [Advanced signal settings](#)
- [Frequency sweep measurement configuration](#) (ACLR and SEM only)  
For single carrier measurements: ACLR and SEM only.  
For multi carrier measurements: Cumulative ACLR, MC ACLR and MC SEM only.

<a href="#">EVM / ACLR / SEM</a> .....	176
<a href="#">Manage User Standards</a> .....	176
<a href="#">Restore Settings</a> .....	176

### EVM / ACLR / SEM

Turns the corresponding measurement on and off (blue = on, otherwise = off).

All selected measurements are part of the combined measurement sequence.

Remote command:

EVM state: [CONFigure\[:NR5G\]:EVM](#) on page 469

ACLR state: [CONFigure\[:NR5G\]:ACLR](#) on page 469

SEM state: [CONFigure\[:NR5G\]:SEM](#) on page 470

### Manage User Standards

Available for ACLR and SEM measurements.

Opens a dialog that allows you to import custom ACLR or SEM settings from a xml file. The FSW applies the ACLR and SEM settings stored in the selected file.

When you load custom ACLR or SEM settings, exporting I/Q data of an ACLR or SEM measurement also exports the custom settings that the corresponding measurement was done with. The settings are stored in a dedicated `settings.xml` file.

Select "Clear" to remove the file based settings.

Remote command:

ACLR: [CALCulate<n>:MARKer<m>:FUNCTION:POWer<sb>:PRESet](#) on page 469

SEM: [\[SENSE:\]ESpectrum<sb>:PRESet\[:STANdard\]](#) on page 466

### Restore Settings

Restores the settings that were active during the last sequence of measurements. This can be a useful feature if you have changed the signal description since the last measurement sequence and want to restore the measurement settings. You can restore settings as long as you do not start a new measurement sequence.

Remote command:

[MMEMory:LOAD:SETTings](#) on page 470

## 4.5.2 Signal capture

**Access:** "Overview" > "Trigger / Signal Capture" > "Signal Capture"

The data capture settings contain settings that control various aspects of the data capture.

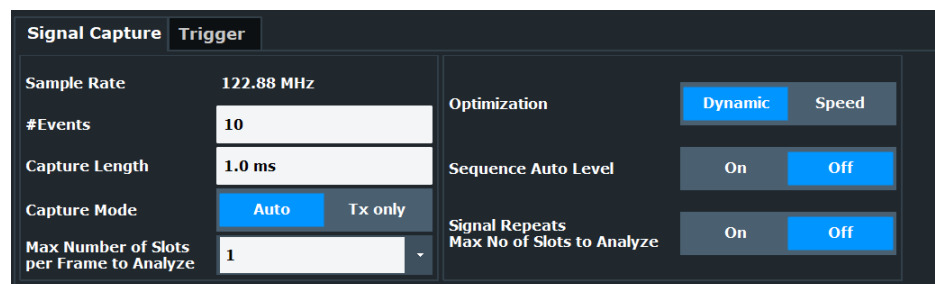



Functions in the "Signal Capture" dialog box described elsewhere:

- [Capture length](#)
- [Max number of slots to analyze](#)
- [Signal repeats max no of slots to analyze](#)

<a href="#"># Events</a> .....	177
<a href="#">Capture Mode</a> .....	177
<a href="#">Optimization</a> .....	177
<a href="#">Sequence Auto Level</a> .....	177

### # Events

Defines the number of measurements in the measurement sequence. Each event corresponds to one combined measurement. A combined measurement consists of one EVM, ACLR and / or SEM measurement.

Remote command:

[\[SENSe:\] SWEep:EVENT](#) on page 468

### Capture Mode

Selects the capture mode for combined measurements. You can define the capture mode if the measurement sequence consists of a series of EVM measurements only ([ACLR and SEM](#) measurements must be inactive).

In "Auto" mode, the FSW captures and analyzes the complete signal, including adjacent and alternate channels. For EVM measurements, these channels can be uninteresting, but their data capture slows down the measurement. To increase the measurement speed for EVM measurements, select "Tx Only". Using this mode, the FSW captures and analyzes only the Tx channel.

Remote command:

[\[SENSe:\] SWEep:MODE](#) on page 468

### Optimization

Selects the data capture method.

"Dynamic"	Captures the carrier and neighboring channels separately, and stitches them together during the data analysis. This method yields a higher dynamic range at the expense of measurement speed.
"Speed"	Captures the complete signal, including all neighboring channels at the same time. This method is faster at the expense of dynamic range and higher noise. Requires FSW with enough bandwidth.

Remote command:

[\[SENSe:\] NR5G:FRAMe:OPTimization](#) on page 467

### Sequence Auto Level

Turns [auto leveling](#) prior to each event in the measurement sequence on and off.

Remote command:

[\[SENSe:\] NR5G:FRAMe:SALevel](#) on page 467

### 4.5.3 Trigger configuration

**Access:** "Overview" > "Trigger / Signal Capture" > "Trigger"

Combined measurement mode provide an assistant that helps you to find a suitable trigger configuration for your test setup. The resulting trigger configuration depends on the combination of a trigger sequence and the availability of a frame trigger.

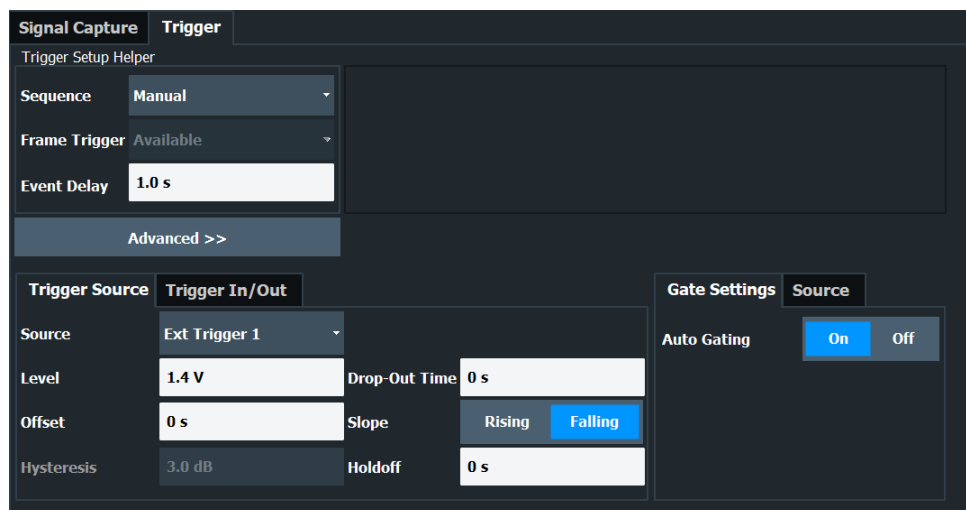

For a comprehensive description of all predefined trigger configurations, refer to the [combined measurement guide](#). This guide also contains a list of the trigger settings associated with each scenario.

If the assistant does not provide a suitable trigger configuration, you can still set up a custom trigger configuration in the "Advanced" trigger settings. These [advanced settings](#) are the same as for all other measurements.

You can change advanced trigger settings like trigger level, slope, drop-out time etc, even if the assistant already provides a scenario that fits your needs. However, if you select a different trigger source, gate source or trigger connector usage, the FSW discards the selected trigger sequence and changes back to the "Manual" sequence.

<a href="#">Sequence</a> .....	178
<a href="#">Frame Trigger</a> .....	179
<a href="#">Event Delay</a> .....	179
<a href="#">Recalibration Interval</a> .....	179
<a href="#">Send Trigger 3</a> .....	180
<a href="#">Auto Gating</a> .....	180

#### Sequence

Selects the general sequence of the measurement, including the type of triggers available in the test setup and the number of trigger signals.

For a comprehensive description of the sequences, see [Chapter 4.6, "Combined measurement guide"](#), on page 180.

"Manual"            Custom trigger configuration.

"Periodic"         Measurement sequence defined by an [event delay](#).

"Open-loop"	Measurement sequence that includes a trigger to indicate that the DUT is ready for testing. Trigger is connected to trigger input 2.
"Closed-loop"	Measurement sequence that includes a trigger to indicate that the DUT is ready for testing and a trigger output that indicates that the I/Q data capture is done. Triggers are connected to trigger input 2 and trigger output 3.

Remote command:

[TRIGger:TSHelper:SEquence](#) on page 471

### Frame Trigger

Selects the availability of a frame trigger. The availability of a frame trigger basically selects the trigger source.

For a comprehensive description on the effects of this setting, see [Chapter 4.6, "Combined measurement guide"](#), on page 180.

"Available"	Frame trigger available as an external trigger.
"n/a - Time Trigger"	Periodic measurement using a time trigger synchronized to the frame as the trigger source. Includes automatic calibration.
"n/a - Repeating Slots"	Free run measurement that captures a certain amount of data. The amount of data corresponds to a number of slots that are repeated in the signal.

Remote command:

[TRIGger:TSHelper:FTRigger](#) on page 471

### Event Delay

Available for periodic and manual measurement sequences.

The "Event Delay" defines a time period between two events (or combined measurements). Therefore, the event delay is the time period spanning the time when an event occurs and the the point in time when a new event can occur.

For a manual [sequence](#), the event delay is available for all trigger sources, except the time trigger.

Remote command:

[TRIGger:TSHelper:EDELay](#) on page 470

### Recalibration Interval

Available for open- and closed-loop scenarios using a time trigger.

Using a time trigger requires a synchronization to the frame start offset. Because the frame start offset drifts over time, you have to recalibrate the time trigger on a regular basis. In combined measurement mode, this is an automatic process, controlled by the "Recalibration Interval" - on each recalibration, the FSW synchronizes the time trigger to the frame start offset.

The recalibration interval is in terms of events (single measurements).

For example, an interval of "5" recalibrates the time trigger after 5 events in the measurement sequence. To find out an appropriate interval, run several measurement, and check after how many measurements synchronization fails. Define an interval that recalibrates a few measurements before synchronization fails.

Increasing the recalibration interval increases the measurement speed for all events in which no recalibration is performed.

For a manual [sequence](#), the recalibration interval is available for the time trigger source.

Remote command:

[TRIGger:TSHelper:RINTerval](#) on page 471

### Send Trigger 3

**Access:** "Trigger" > "Send Trigger 3" (softkey only)

Available for closed-loop [sequences](#).

Sends an initial trigger to start the measurement sequence for setups that use a trigger output to inform the test setup that the FSW is ready for the measurement.

Remote command:

[OUTPut<up>:TRIGger<tp>:PULSe:IMMediate](#) on page 470

### Auto Gating

Turns automated gating on and off.

Turning on the auto gating makes sure that the FSW only measures the ACLR and SEM when the Tx channel is transmitted ("On" state). The gate is open during the on periods of the Tx channels that occur in the analysis range. The analysis range begins with a frame start. When the frame start is known, the FSW can detect the on and off periods.

Note that auto gating is not possible for free run measurements on TDD signals and when the signal capture consists of several captures (for example for [dynamic capture](#) or if the available analysis bandwidth is smaller than the signal bandwidth). The FSW shows a corresponding error message in that case.

Remote command:

[\[SENSe:\]SWEep:EGATe:AGATing](#) on page 468

## 4.6 Combined measurement guide

The combined measurement mode provides functionality to combine several, subsequent EVM, ACLR and (or) SEM measurements in a single sequence of measurement. If you combine the measurements into a sequence, the FSW analyzes the captured data for EVM, ACLR and SEM in parallel (multi-processing) - the data capture itself is processed independent from the analysis. This in turn increases the speed of the measurement evaluation.

These measurements can occur on a single DUT, for example one that changes its position in space. Or they can occur on multiple DUTs, for example as an end test in a production line.

Combined measurements allow you to automate such measurement sequences and to increase the speed of such sequences. The measurement mode also provides tools to evaluate the results. However, combined measurements only work on a DUT whose

signal description and center frequency remain the same over the sequence of measurements.

Each single measurement is also called an event. Several events make up the measurement sequence. The number of events you can define depends on the capture length, bandwidth (or sampling rate) and the available memory (RAM). Events are also processed in parallel, which increases the measurement speed even more.

An event can be, for example, a new position of the DUT, or the next DUT in a production line. When the DUT is ready, some kind of trigger initiates the next measurement.

- [General configuration](#)..... 181
- [Trigger configuration](#)..... 182

### 4.6.1 General configuration

There are some basic settings that you should define for all measurements, regardless of your test setup.

Before you start configuring the application, set up the measurement physically.

#### Setting up the measurement

1. Enter the combined measurement mode.  
("Meas" > "Combined EVM/ACLR/SEM")
2. Select the measurements you want to run.  
("Meas Config" > "Signal Description" > "EVM", "ACLR" and / or "SEM")
3. Define the [signal characteristics](#), select a test model or load an allocation file.  
Note that handling allocation files for combined measurements is [slightly different](#) compared to other measurements.  
("Meas Config" > "Signal Description")
4. Adjust the [amplitude settings](#) to achieve an ideal EVM.  
("Auto" > "Auto EVM" softkey).  
As an alternative, you can optimize the amplitude settings for each event.  
("Meas Config" > "Trigger / Signal Capture" > "Signal Capture" > "Sequence Auto Level")
5. Define the number of [events](#).  
("Meas Config" > "Signal Capture" > "Events")
6. Define the [capture length](#) (slightly more than the amount of data you want to analyze).  
("Meas Config" > "Signal Capture" > "Capture Time")
7. Select the [optimization](#) method.  
("Meas Config" > "Signal Description" > "Optimization")
8. Define the trigger configuration. The trigger configuration that you apply depends on your setup. For details, see [Chapter 4.6.2, "Trigger configuration"](#), on page 182.
9. Run the measurement.

The FSW initiates the sequence of measurement.

When an event that triggers a combined measurement occurs, the FSW adds a line to the combined EVM / ACLR / SEM [result table](#).

The time until all events have happened varies, depending on your setup.

If you want to reevaluate the measurement sequence or a certain event after the sequence has finished, you can do so by [refreshing](#) the results.

("Sweep" > "Refresh" / "Refresh Current")

10. Evaluate the measurement, for example by:

- [Filtering the results](#) to view only certain events.
- [Selecting an event](#) to view the details of that event in graphical result displays.
- Exporting the results for the whole sequence, selected events or a single event.
- [Exporting the I/Q data](#) for later reevaluation.

You can export the I/Q data for a single event, or the I/Q data for the complete measurement sequence.

### Using allocation files in combined measurement mode

[Allocation files](#) are basically the same in combined measurement mode. In combined mode, the allocation files combine the signal description for all selected measurements (EVM, ACLR and SEM). In addition, the allocation file also contains the measurement results for a measurement sequence (only the results, not the I/Q data).

1. Select a file name and location for the allocation file you want to save or load.
2. Select the measurements you want to include.  
"General" settings are always included. Otherwise, you can select if you want to include the settings for EVM, ACLR and (or) SEM measurements.
3. Select if you want to include the measurement results ("Combined Result Table").

## 4.6.2 Trigger configuration

The trigger configuration is a vital part of the combined measurements. The trigger is what makes the automated combined measurements possible in the first place: Wait for the first event to initiate a measurement - run the measurement - wait for the next event - run the measurement and so on.

The FSW provides several [trigger presets](#) for typical combined measurement scenarios. Other than those, you can, of course, use a custom trigger configuration (or even no trigger at all).

The main criteria for the trigger selection are:

- Is a frame trigger available or not?
- Which possibilities do you have to trigger the measurement sequence?



### Advanced trigger settings

If you select one of the trigger presets ("Sequence" or "Frame Trigger" menus), and change something in the [advanced trigger settings](#), the preset becomes obsolete ("Sequence" = "Manual").

### Using the trigger setup helper

The trigger setup helper allows you to select certain trigger configuration presets. These presets are typical trigger setups for certain test scenarios.

Of course it is also possible to apply a custom trigger configuration.

1. Select the trigger "Sequence".
  - "Manual" = custom trigger configuration
  - "Periodic" = measurements in certain interval
  - "Open-Loop" = an external trigger indicates that the DUT is ready
  - "Closed-Loop" = an external trigger indicates that the DUT is ready, plus the analyzer indicates that the data capture is finished
2. Select the frame trigger availability.
3. For periodic trigger, define the event delay.
4. For time trigger instead of dedicated frame trigger, define the recalibration interval.

**Table 4-4: Trigger presets and their trigger configuration\***

Trigger setup helper			Advanced trigger settings			
Sequence	Frame trigger		Trigger source	Source	Trigger 2	Trigger 3
Periodic	n/a	>>	Free run	n/a	n/a	n/a
Periodic	available	>>	Ext. trigger 1	n/a	n/a	n/a
Open-loop	n/a	>>	Free run	Ext. trigger 2	Input	n/a
Open-loop	n/a	>>	Time	Ext. trigger 2	Input	n/a
Open-loop	available	>>	Ext. trigger 1	Ext. trigger 2	Input	n/a
Closed-loop	n/a	>>	Free run	Ext. trigger 2	Input	Output
Closed-loop	n/a	>>	Time	Ext. trigger 2	Input	Output
Closed-loop	available	>>	Ext. trigger 1	Ext. trigger 2	Input	Output

\*Changing one of these settings always returns to trigger sequence = manual; you can still change other trigger settings like level, drop-out time etc.



### DUT reconfiguration

The following procedures use the term "DUT reconfiguration".

The DUT reconfiguration is a process that depends on your test scenario. For example, the term can refer to the DUT moving into another position or the DUT being replaced by another DUT in a production line.

#### Using a periodic sequence: no frame trigger

In this scenario, measurements take place periodically, every <x> seconds. A trigger is not available.

This scenario requires a capture time that is at least double the time of the data you want to capture - for example, if you want to capture a single slot with 30 kHz subcarrier spacing (slot length = 0.5 ms), the capture time must be greater than 1 ms.

Note that the number of slots that the signal repeats have to start with slot 0.

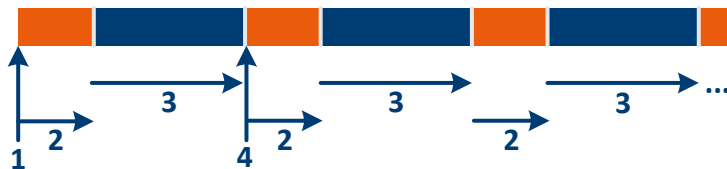

Figure 4-11: Workflow for a periodic measurement without frame trigger

- 1 = Start of measurement
- 2 = I/Q data capture
- 3 = DUT reconfiguration
- 4 = Subsequent I/Q data capture

The time a single measurement event lasts in the sequence is the sum of:

I/Q capture + DUT reconfiguration

Optional auto leveling for each measurement extends the measurement time a little.

The sequence of measurements runs like this:

1. Start of the measurement sequence.
2. The FSW captures the I/Q data.
3. The DUT reconfigures itself.  
Note that the event delay starts with the I/Q capture. Thus, make sure to define an event delay that is long enough to include the data capture and the DUT reconfiguration.
4. The I/Q data capture starts again after the event delay is over.  
Steps 2 through 4 repeat until all events are captured.

#### Using a periodic sequence: frame trigger available

In this scenario, measurements take place periodically, every <x> seconds.



The scenario requires an external trigger, connected to trigger input 1. The external trigger is a frame trigger that initiates the I/Q data capture. The trigger event is the frame start.

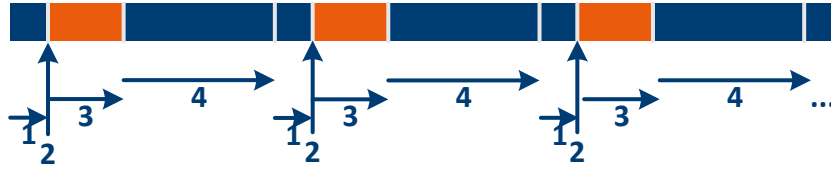

Figure 4-12: Workflow for a periodic measurement with frame trigger

- 1 = Wait for frame start
- 2 = Start of measurement
- 3 = I/Q data capture
- 4 = DUT reconfiguration

The time a single measurement event lasts in the sequence is the sum of:

I/Q capture + DUT reconfiguration + waiting on frame start

Optional auto leveling for each measurement extends the measurement time a little.

The sequence of measurements runs like this:

1. The FSW waits for a frame start.
2. A frame trigger initiates the measurement.
3. The FSW captures the I/Q data.
4. The DUT reconfigures itself.
 

Note that the event delay starts with the I/Q capture. Thus, make sure to define an event delay that is long enough to include the data capture and the DUT reconfiguration.

The end of the event delay also rearms the frame trigger.

Steps 1 through 4 repeat until all events are captured.

#### Using an open-loop sequence: frame trigger available

This scenario needs two trigger sources.

The first is an external frame trigger, connected to trigger input 1, that initiates the I/Q data capture. The trigger event is the frame start.

The second is an external trigger, connected to trigger input 2, that indicates that the DUT is ready for the measurement. This trigger is sent, for example, when the DUT has reached its measurement position.

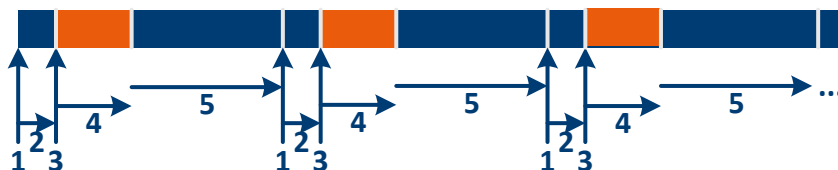

Figure 4-13: Workflow for an open loop measurement with frame trigger

- 1 = DUT ready for measurement
- 2 = Wait for frame start
- 3 = Frame trigger starts measurement
- 4 = I/Q data capture
- 5 = DUT reconfiguration

The time a single measurement event lasts in the sequence is the sum of:

I/Q capture + DUT reconfiguration + waiting on frame start + waiting for DUT ready trigger

Optional auto leveling for each measurement extends the measurement time a little.

The sequence of measurements runs like this:

1. The DUT sends a trigger signal to indicate that it is ready for the measurement.
  2. The FSW waits for a frame start.
  3. A frame trigger initiates the measurement.
  4. The FSW captures the I/Q data.
  5. The DUT reconfigures itself.
- Steps 1 through 5 repeat until all events are captured.

#### Using an open-loop sequence: using time trigger

This scenario needs two trigger sources.

The first is a [time trigger](#) that initiates a periodic I/Q data capture. Because the frame start and time trigger drift from each other over time, using the time trigger requires regular recalibration - in combined measurement mode, this is an automated process, defined by the [recalibration interval](#). The initial synchronization of the time trigger to the frame start is also an automated process.

The second is an external trigger, connected to trigger input 2, that indicates that the DUT is ready for the measurement. This trigger is sent, for example, when the DUT has reached its measurement position.

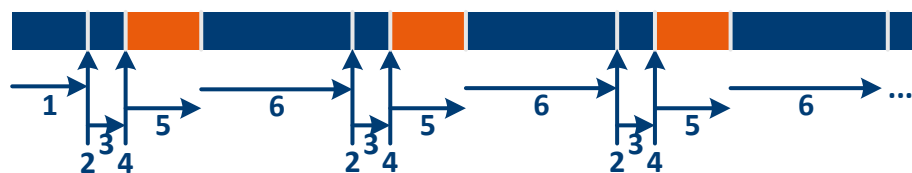

**Figure 4-14: Workflow for an open loop measurement with time trigger**

- 1 = Initial calibration of time trigger
- 2 = DUT ready for measurement
- 3 = Wait for frame start
- 4 = Start of measurement
- 5 = I/Q data capture
- 6 = DUT reconfiguration

The time a single measurement event lasts in the sequence is the sum of:

I/Q capture + DUT reconfiguration + time trigger recalibration + waiting on frame start + waiting for DUT ready trigger

Optional auto leveling for each measurement extends the measurement time a little.

Before you start the measurement sequence, define an appropriate recalibration interval.

The sequence of measurements runs like this:

1. The FSW calibrates the time trigger by defining a trigger offset = frame start offset.
2. The DUT sends a trigger signal to indicate that it is ready for the measurement.
3. The FSW waits for a frame start.
4. A frame synchronized time trigger initiates the measurement.
5. The FSW captures the I/Q data.
6. The DUT reconfigures itself.  
At the same time, the time trigger recalibration occurs.
7. The DUT sends a trigger signal to indicate it is ready for the next measurement.  
Steps 2 through 6 repeat themselves until all events are captured.

#### Using an open-loop sequence: no trigger available (repeating slots)

In this scenario, the DUT uses an external trigger signal to indicate it is ready for a measurement. The trigger signal initiates a (free run) measurement.

This scenario requires a capture time that is at least double the time of the data you want to capture - for example, if you want to capture a single slot with 30 kHz subcarrier spacing (slot length = 0.5 ms), the capture time must be greater than 1 ms.

Note that the number of slots that the signal repeats have to start with slot 0.

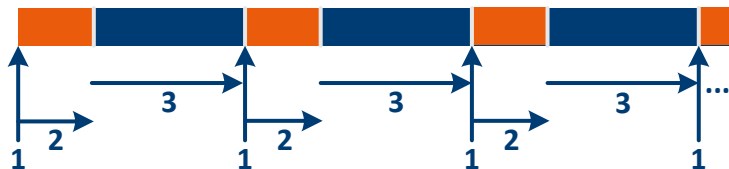

Figure 4-15: Workflow for an open-loop measurement without trigger

- 1 = DUT ready for measurement
- 2 = I/Q data capture
- 3 = DUT reconfiguration

The time a single measurement event lasts in the sequence is the sum of:

I/Q capture + DUT reconfiguration + waiting for DUT ready trigger

Optional auto leveling for each measurement extends the measurement time a little.

The sequence of measurements runs like this:

1. The DUT sends a trigger signal to indicate that it is ready for the measurement.

2. The FSW captures the I/Q data.
3. The DUT reconfigures itself.
4. The DUT sends a trigger signal to indicate it is ready for the next measurement. Steps 1 through 3 repeat themselves until all events are captured.

### Using an closed-loop sequence: frame trigger available

This scenario needs two trigger sources and one trigger output.

The first trigger source is an external frame trigger, connected to trigger input 1, that initiates the I/Q data capture. The trigger event is the frame start.

The second trigger source is an external trigger, connected to trigger input 2, that indicates that the DUT is ready for the measurement. This trigger is sent, for example, when the DUT has reached its measurement position.

The trigger output initiates the DUT reconfiguration after the FSW is done capturing the I/Q data. The DUT must have a corresponding trigger interface. This signal is output on trigger 3, which is defined as a user-defined output.

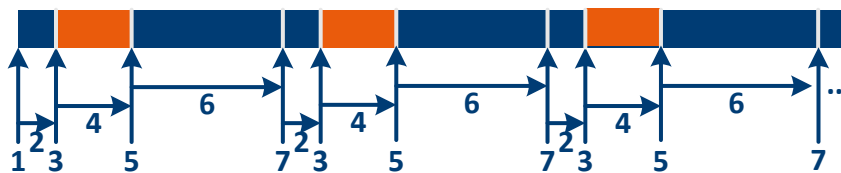

**Figure 4-16: Workflow for a closed loop measurement with frame trigger**

- 1 = Send initial trigger signal
- 2 = Wait for frame start
- 3 = Frame trigger starts measurement
- 4 = I/Q data capture
- 5 = I/Q data capture done - waiting for DUT reconfiguration
- 6 = DUT reconfiguration
- 7 = DUT ready for measurement

The time a single measurement event lasts in the sequence is the sum of:

I/Q capture + DUT reconfiguration + waiting on frame start + waiting for DUT ready trigger

Optional auto leveling for each measurement extends the measurement time a little.

The sequence of measurements runs like this:

1. Send an initial trigger with "Send Trigger 3" (optional).
2. The FSW waits for a frame start.
3. A frame trigger initiates the measurement.
4. The FSW captures the I/Q data.
5. The FSW sends a trigger signal to the DUT to indicate the I/Q data capture is done.
6. The DUT reconfigures itself.

- The DUT sends a trigger signal to indicate that it is ready for the measurement. Steps 2 through 7 repeat until all events are captured.

### Using an closed-loop sequence: using time trigger

This scenario needs two trigger sources and one trigger output.

The first is a **time trigger** that initiates a periodic I/Q data capture. Because the frame start and time trigger drift from each other over time, using the time trigger requires regular recalibration - in combined measurement mode, this is an automated process, defined by the **recalibration interval**. The initial synchronization of the time trigger to the frame start is also an automated process.

The second is an external trigger, connected to trigger input 2, that indicates that the DUT is ready for the measurement. This trigger is sent, for example, when the DUT has reached its measurement position.

The trigger output initiates the DUT reconfiguration after the FSW is done capturing the I/Q data. The DUT must have a corresponding trigger interface. This signal is output on trigger 3, which is defined as a user-defined output.

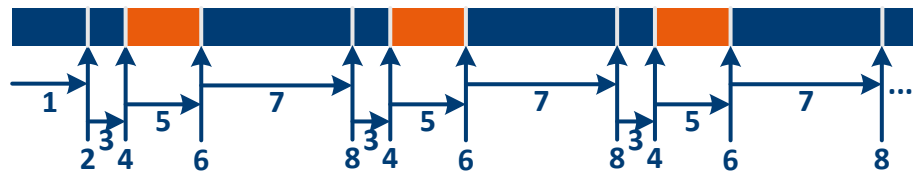

**Figure 4-17: Workflow for a closed loop measurement with time trigger**

- 1 = Initial calibration of time trigger
- 2 = Send initial trigger signal
- 3 = Wait for frame start
- 4 = Start of measurement
- 5 = I/Q data capture
- 6 = I/Q data capture done - waiting for DUT reconfiguration
- 7 = DUT reconfiguration
- 8 = DUT ready for measurement

The time a single measurement event lasts in the sequence is the sum of:

I/Q capture + DUT reconfiguration + time trigger recalibration + waiting on frame start + waiting for DUT ready trigger

Optional auto leveling for each measurement extends the measurement time a little.

Before you start the measurement sequence, define an appropriate recalibration interval.

The sequence of measurements runs like this:

- The FSW calibrates the time trigger by defining a trigger offset = frame start offset.
- Send an initial trigger with "Send Trigger 3" (optional).
- The FSW waits for a frame start.
- A frame synchronized time trigger initiates the measurement

5. The FSW captures the I/Q data.
6. The FSW sends a trigger signal to the DUT to indicate the I/Q data capture is done.
7. The DUT reconfigures itself.  
At the same time, the time trigger recalibration occurs.
8. The DUT sends a trigger signal to indicate it is ready for the next measurement.  
Steps 3 through 8 repeat themselves until all events are captured.

#### Using an closed-loop sequence: no trigger available (repeating slots)

In this scenario, the DUT uses an external trigger signal to indicate it is ready for a measurement. The trigger signal initiates a (free run) measurement.

In addition, the FSW sends a trigger to the DUT to indicate that the I/Q capture is done.

This scenario requires a capture time that is at least double the time of the data you want to capture - for example, if you want to capture a single slot with 30 kHz subcarrier spacing (slot length = 0.5 ms), the capture time must be greater than 1 ms.

Note that the number of slots that the signal repeats have to start with slot 0.

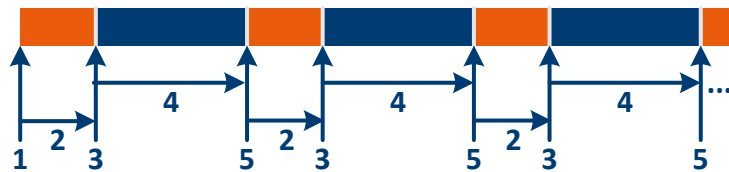

**Figure 4-18: Workflow for an closed-loop measurement without trigger**

- 1 = Send initial trigger signal
- 2 = I/Q data capture
- 3 = I/Q data capture done - waiting for DUT reconfiguration
- 4 = DUT reconfiguration
- 5 = DUT ready for measurement

The time a single measurement event lasts in the sequence is the sum of:

I/Q capture + DUT reconfiguration + waiting for DUT ready trigger

Optional auto leveling for each measurement extends the measurement time a little.

The sequence of measurements runs like this:

1. Send an initial trigger with "Send Trigger 3" (optional).
2. The FSW captures the I/Q data.
3. The FSW sends a trigger signal to the DUT to indicate the I/Q data capture is done.
4. The DUT reconfigures itself.
5. The DUT sends a trigger signal to indicate it is ready for the next measurement.  
Steps 2 through 5 repeat themselves until all events are captured.

## 4.7 Time trigger measurement guide

The time trigger initiates a measurement in certain intervals (every <x> seconds). For the 5G NR application this means that you can use the time trigger to initiate a measurement at the start of each frame (every 10 ms). Therefore, the time trigger is a useful tool when you do not have access to a frame trigger (external trigger source), for example when you test a base station on-site.

Configured correctly, the time trigger also allows you to focus on the analysis of a single slot, which in turn speeds up the measurement. In that case, the idea is to capture only the I/Q data of a single slot (plus a certain tolerance) which increases the measurement speed accordingly.

Since the frequency references of the DUT and the FSW are not necessarily coupled in such a scenario, the frame start and the time trigger may deviate over time. In this case, you can increase the capture time tolerance or readjust the time trigger offset periodically.

### Analyzing signals with a time trigger

1. Connect the FSW to the DUT.
2. Select the time trigger as the trigger source.  
("Overview" > "Trigger / Signal Capture" > "Trigger" > "Trigger Source" = "Time")
3. Define a repetition interval of 10 ms (capture every frame).  
("Overview" > "Trigger / Signal Capture" > "Trigger" > "Repetition Interval" = "10 ms")
4. Run a measurement to get the frame start offset readout in the capture buffer result display.
5. Define a trigger offset with a length that equals the [frame start offset](#) to synchronize the start of the measurement with the first slot in the frame.  
("Overview" > "Trigger / Signal Capture" > "Trigger" > "Offset" = frame start offset)
6. Select one slot to analyze.  
("Overview" > "Trigger / Signal Capture" > "Signal Capture" > "Set Number of Frames to Analyze" = "Manually")  
("Overview" > "Trigger / Signal Capture" > "Signal Capture" > "Number of Frames to Analyze" = "1")
7. Define a capture length that corresponds to one slot (plus tolerance). The slot length depends on the [subcarrier spacing](#).  
("Overview" > "Trigger / Signal Capture" > "Signal Capture" > "Capture Time" = slot length)
8. Run the measurement.  
If synchronization to the signal fails (see message in the status bar), you have to increase the trigger offset slightly (a few  $\mu\text{s}$ ).

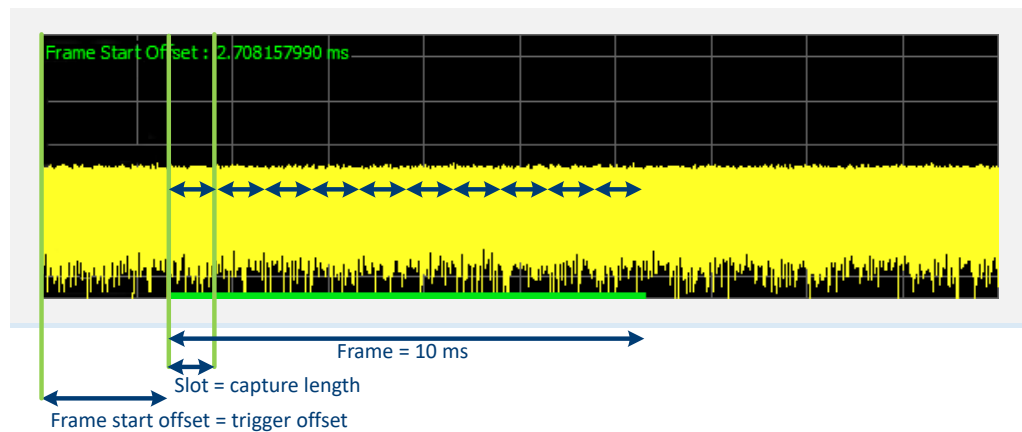

## 4.8 Microservice export

**Access:** / > "Export" > "Microservice Export"

In addition to [exporting the signal configuration](#) locally, you can export the signal configuration in a file format compatible to the cloud-based microservice (.m5g file extension).

Exporting signal configurations with multiple component carriers writes the configuration of each component carrier into a separate file. The number of files depends on the [analysis mode](#):

- If you analyze the viewed CCs only, the FSW exports those two CCs (two files - config\_CC1.m5g, config\_CC2.m5g).
- If you analyze all CCs, the FSW exports all CCs. The number of files depends on the number of component carriers (config\_CC1.m5g, config\_CC2.m5g etc.).

When you change the CC analysis mode (all to viewed or vice versa), you have to either refresh the I/Q data or re-run the sweep to reflect this change in the microservice export.

For a comprehensive description of the microservice, refer to the microservice user manual.

Remote command:

`MMEMoRY:STORe<n>:MSERvice` on page 317

## 4.9 O-RAN measurement guide

The O-RAN alliance specifies specific signal configurations (test cases) for standardized testing of O-RAN equipment. The FSW provides these O-RAN test cases. When you apply one of them, the measurement configuration automatically adjusts to the values of the selected test case.



Basically, you can verify O-RAN based signals by certain bit sequences in the PDSCH and the positions of those sequences. The position of the bit sequence in the PDSCH is unique for each test case.

The [type of bit sequence](#) depends on the test case.

- Some test cases use a bit sequence of all 0's.
- Some test cases use an O-RAN specific PN23 bit sequence.

In addition, the [data demodulation](#) depends on the test case (before or after descrambling).

As pointed out, these settings are automatically selected, depending on the selected test case.

For valid measurement results, it is essential that the measured signal complies with the selected test case and uses the correct bit sequences in the correct locations. If you get unexpected measurement results, check if the signal is configured correctly. You can do a quick check to validate the signal as follows.

- Check if the selected test case in the "Advanced Settings" is the same as the test case in the "Test Models" dialog.
- Use the [Allocation ID vs Symbol x Carrier](#) result display to verify if the correct PDSCH allocations are analyzed. If the signal contains the correct bit sequence, the EVM should be good.
- Use the [Bitstream](#) result display to verify if the bits match the O-RAN specifications. Each test case has a typical bit sequence. Make sure to select the bit sequence as the [bitstream format](#).

## 4.10 Reference: structure of .allocation files

.allocation (and .ccallocation) files are basically xml files that follow a certain structure. The structure of the file is based on the structure of the dialogs in the user interface.

Basically, the structure is as follows:

- Each setting is stored in a dedicated element.  
Example: <ChannelBandwidth>, <CellID>
- The settings are grouped as in the user interface.  
Example: <ChannelBandwidth> and <CellID> belong to the <Physical\_Settings> element.
- Some xml elements can occur multiple times.  
Examples: <Frame\_Config>, <BWP\_Config>, <Slot\_Config>. The number of occurrences depends on the number of frames, BWPs and slots in the signal.
- The values for all elements are the SCPI parameters of the corresponding setting.  
Example: <ChannelBandwidth>BW100</ChannelBandwidth>, <CellID>0</CellID>



Probably the most comfortable way to describe a signal in an xml file is to save an .allocation file after a preset and then change the values within that file.

### Root structure

For structure of child elements, see:

- "[<Information> element](#)" on page 194
- "[<PRACH> element](#)" on page 194
- "[<Signal\\_Description> element](#)" on page 195
- "[<Signal\\_Capture> element](#)" on page 195
- "[<Parameter\\_Estimation> element](#)" on page 195
- "[<CCSettings> element](#)" on page 196
- "[<RF\\_Parameter> element](#)" on page 197
- "[<MultiCarrier> element](#)" on page 197

```
<NR5G>
  <Information/>
  <!-- PRACH settings are relevant in uplink only -->
  <PRACH/>
  <Signal_Description/>
  <Signal_Capture/>
  <Parameter_Estimation/>
  <!-- CCSettings can occur several times -->
  <CCSettings/>
  <RF_Parameter/>
  <!-- MultiCarrier only for multiple carriers -->
  <MultiCarrier/>
</NR5G>
```

### <Information> element

The <Information> element is a child element of the <NR5G> element.

```
<Information>
  <FWVersion/>
  <Device/>
  <Type/>
  <IQFrequency/>
  <Mode/>
  <ExportIssues/>
</Information>
```

### <PRACH> element

The <PRACH> element is a child element of the <NR5G> element.

```
<PRACH>
  <PRACHFormat/>
  <PRACHSCS/>
  <L_RA/>
```

```

    <Restricted/>
    <LogicalRootSequenceIndex/>
    <ZeroCorrelationZone/>
    <PreambleIndex/>
    <RelPower/>
    <RBOffset/>
  </PRACH>

```

### <Signal\_Description> element

The <Signal\_Description> element is a child element of the <NR5G> element.

```

<Signal_Description>
  <Mode/>
  <DeployFrequencyRange/>
  <NumberOfCC/>
  <NumberofInputSource/>
  <ORANTestCase/>
  <FreqErrLimitState/>
  <TestModelName/>
</Signal_Description>

```

### <Signal\_Capture> element

The <Signal\_Capture> element is a child element of the <NR5G> element.

```

<Signal_Capture>
  <SwapIQ/>
  <LongCaptureMode/>
  <CaptureTime/>
  <CaptureTimeAuto/>
  <OverallFrameCount/>
  <SetNumberOfFramesToAnalyze/>
  <NumOfFramesToAnalyze/>
  <MaxOfSlotsPerFrameToAnalyze/>
  <AveragedFrame/>
  <SignalRepeatsMaxNoOfSlotsToAnalyze/>
</Signal_Capture>

```

### <Parameter\_Estimation> element

The <Parameter\_Estimation> element is a child element of the <NR5G> element.

```

<Parameter_Estimation>
  <ChannelEstimation/>
  <ChannelEstimationTimeAveraging/>
  <TrackPhase/>
  <TrackTiming/>
  <TrackLevel/>
  <MultiCarrierFilter/>
  <DemodulatedData/>
  <IQGainImbalance_QuadratureError/>

```

```

<TPUTState/>
<CORESETAnalysisMode/>
<EVMCalculationMethod/>
<CORESETReferenceData/>
<PDSCHReferenceData/>
<ExtendedFrequencyLockRange/>
<SymbolTimingPosition/>
</Parameter_Estimation>

```

### <CCSettings> element

The <CCSettings> element is a child element of the <NR5G> element.

The <CCSettings> element can occur several times, one for each component carrier.

For structure of child elements, see:

- "[<Synchronization> element](#)" on page 198
- "[<Frame\\_Config> element](#)" on page 198

```

<CCSettings>
  <AutoBWPDetection/>
  <CCFrequency/>
  <FreqOffsetToCC0/>
  <PhysicalSettings>
    <ChannelBandwidth/>
    <CellIDAuto/>
    <CellID/>
    <P_rated_c_EIRP/>
    <P_rated_c_TRP/>
  </PhysicalSettings>
  <NumofAntPortMapping/>
  <!-- Ant_Port_Mapping occurs several times, once for each AP configuration -->
  <Ant_Port_Mapping>
    <State/>
    <SyncSignal_AP/>
    <PDSCH_APxxxx/>
    <PDCCH_AP/>
    <CSI_RS_APx/>
  </Ant_Port_Mapping>
  <Advanced_Settings>
    <IgnoreDC/>
    <RFUpconversion_PhaseCompensation/>
    <RFUpconversion_f_0/>
    <RFUpconversion_f_0_Freq/>
    <FrameNumber_n_f/>
    <RefPointA_SCS15kHz/>
    <RefPointA_SCS30kHz/>
    <RefPointA_SCS60kHz/>
    <RefPointA_SCS120kHz/>
    <RefPointA_SCS480kHz/>
    <RefPointA_SCS960kHz/>

```

```

    <RefPointA_RelativeToCF/>
    <ExcludeUserIDs/>
    <SharedSpectrumChannelAccess/>
  </Advanced_Settings>
  <NumofSynchronization/>
  <!-- Contents of synchronization element see below -->
  <Synchronization/>
  <NumofFrame/>
  <!-- Frame_Config can occur several times, contents see below -->
  <Frame_Config/>
  <LTE_CRS_Coexistence/>
  <State/>
  <OffsToPoints/>
  <VShift/>
  <LTEBWRBs/>
  <LTEAntPorts/>
  <!-- The MBSFNsubframeConfiguration occurs once for each MBSFN subframe -->
  <MBSFNsubframeConfiguration/>
  <IndexofSubframe/>
  <Active/>
  </MBSFNsubframeConfiguration>
</LTE_CRS_Coexistence/>
</CCSetting>

```

### <RF\_Parameter> element

The <RF\_Parameter> element is a child element of the <NR5G> element.

```

<RF_Parameter>
  <BaseStationType/>
  <ACLR>
  <AdjacentChannels/>
  <LimitCheckMode/>
</ACLR>
<SEM>
  <Category/>
  <CategoryBOption/>
  <TxPowerAuto/>
  <TxPowerValue/>
  <N_TXUcountedpercell/>
  <N_TABconnectors/>
  <IFF/>
</SEM>
</RF_Parameter>

```

### <MultiCarrier> element

The <MultiCarrier> element is a child element of the <NR5G> element.

```

<MultiCarrier>
  <CCSignalCapture/>

```

```

<OperatingBand/>
<CCResult/>
<View1ComponentCarrierNo/>
<View1FrameNo/>
<View2ComponentCarrierNo/>
<View2FrameNo/>
<FixedCCOffset/>
<GlobalMCCenter/>
<OffsetRelto/>
<OffsetMode/>
<CarrierSpacing/>
</MultiCarrier>

```

### <Synchronization> element

The <Synchronization> element is a child element of the <CCSettings> element.

```

<Synchronization>
  <SSBC_Detection/>
  <SubcarrierSpacing/>
  <Pattern/>
  <OffsetOption/>
  <RBOffset/>
  <AdditionalSubcarrierOffset/>
  <BurstSetPeriodicity/>
  <!-- One entry for each SSB -->
  <SSBStateX/>
  <NRPSSRelPower/>
  <NRSSRelPower/>
  <NRPBCHRelPower/>
  <PBCHDMRSRelPower/>
  <LSelection/>
  <HalfFrameOffset/>
</Synchronization>

```

### <Frame\_Config> element

The <Frame\_Config> element is a child element of the <CCSettings> element.

- The <Frame\_Config> element can occur several times, one for each configurable frame.
- Within the <Frame\_Config> element, the <BWP\_Config> element can occur several times, one for each bandwidth part.
- Within the <BWP\_Config> element, the <Slot\_Config> element can occur several times, one for each slot.
- Within the <Slot\_Config> element, the <PXCCH> and <PXSCH> elements can occur several times, one for each PXCCH or PXSCH allocation.

For structure of child elements, see:

- "[<PXCCH> element](#)" on page 199
- "[<PXSCH> element](#)" on page 200

- "[<CSI\\_Settings> element](#)" on page 201

```

<Frame_Config>
  <NumofBWP/>
  <!-- BWP_Config can occur several times -->
  <BWP_Config>
    <SubcarrierSpacing/>
    <NumofRBs/>
    <RBOffset/>
    <NumberOfUserConfigurableSlots/>
    <NumofSlot/>
    <!-- Slot_Config can occur several times -->
    <Slot_Config>
      <SlotAllocation/>
      <SlotFormat/>
      <CombinePDSCHAllocationsWithSameUserID/>
      <NumofPXCCH/>
      <!-- PXCCH can occur several times, description see below -->
      <PXCCH/>
      <NumofPXSCH/>
      <!-- PXSCH can occur several times, description see below -->
      <PXSCH/>
    </Slot_Config>
    <CSISettingsState/>
    <NumofCSI/>
    <!-- Contents of CS-RS element see below -->
    <CSI_Settings/>
    <PRSSettingsState/>
    <NumofPRS/>
    <!-- Contents of PRS element see below -->
    <PRS_Settings/>
  </BWP_Config>
</Frame_Config>

```

### <PXCCH> element

The <PXCCH> element is a child element of the <Frame\_Config> element.

The <PXCCH> element can occur several times, one for each PXCCH allocation.

```

<PXCCH>
  <NumberOfRBs/>
  <OffsetRB/>
  <NumberOfSymbols/>
  <OffsetSymbol/>
  <RelPower_dB/>
  <DMRS>
    <UseDMRSScramblingID/>
    <ScramblingID/>
    <RelPower/>
    <ReferencePoint/>
  <PrecoderGranularity/>

```

```

<AllowPDSCH/>
<InterleavingState/>
<BundleSize/>
<ShiftIndex/>
<ShiftIndexNID/>
<InterleaverSize/>
<NumofPDCCH/>
<PDCCH/>
  <RNTI/>
  <AggregationLevel/>
  <CCEIndex/>
  <PatternLength/>
  <DCIFormat/>
  <Usage/>
  <Scope/>
  <NumberofBlocks/>
  <NumberofTPCCCommands/>
  <FrequencyDomainResourceAssignment/>
  <!-- DCIBitLength occurs several times, once for each DCI field -->
  <DCIBitLength/>
</PDCCH>
</DMRS>
</PXCCH>

```

### <PXSCH> element

The <PXSCH> element is a child element of the <Slot\_Config> element.

The <PXSCH> element can occur several times, one for each PXSCH allocation.

```

<PXSCH>
  <UserID/>
  <VRBtoPRBInterleaver/>
  <Modulation/>
  <NumberOfRBs/>
  <OffsetRB/>
  <NumberOfSymbols/>
  <OffsetSymbol/>
  <RelPower_dB/>
  <ModulationforCodeword2/>
  <DMRS>
    <ConfigType/>
    <FirstDMRSSymbolRelTo/>
    <FirstDMRSSymbol/>
    <DMRSAddPositionIndex/>
    <DMRSLength/>
    <SequenceGeneration/>
    <ScramblingID/>
    <ScramblingID1/>
    <n_SCID/>
    <RelPowerToPDSCH/>

```



```

    <Layer_Codewords/>
    <AntennaPort/>
    <CDMGroupWOData/>
    <ReferencePoint/>
    <DMRS_R16/>
  </DMRS>
  <PTRS>
    <State/>
    <RelPower/>
    <L_PTRS/>
    <K_PTRS/>
    <RE_Offset/>
  </PTRS>
  <ChannelCoding>
    <MCSTable/>
    <I_MCS/>
    <RedundancyVersionIndex/>
    <TBScalingFactorS/>
    <TBSizeIncAllocGaps/>
  </ChannelCoding>
  <Scrambling>
    <Type/>
    <DataScramblingID/>
  </Scrambling>
</PXSCH>

```

### <CSI\_Settings> element

The <CSI\_Settings> element is a child element of the <BWP\_Config> element.

```

<CSI_Settings>
  <SlotConfig>
    <SlotConfigMode/>
    <Periodicity/>
    <Offset/>
    <Slots/>
  </SlotConfig>
  <ZeroPower/>
  <Row/>
  <Ports/>
  <Density/>
  <CDMType/>
  <Bitmap/>
  <l0/>
  <l1/>
  <ScramblingID/>
  <RelPower_dB/>
  <NumberOfRBs/>
  <StartRB/>
</CSI_Settings>

```

### <PRS\_Settings> element

The <PRS\_Settings> element is a child element of the <BWP\_Config> element.

```
<PRS_Settings>
  <SlotConfig>
    <SlotConfigMode/>
    <Slots/>
  </SlotConfig>
  <NumberofRBs/>
  <StartRB/>
  <l_PRS_start/>
  <L_PRS/>
  <n_PRS_ID/>
  <K_PRS_comb/>
  <k_PRS_offset/>
  <RelPower_dB/>
</CSI_Settings>
```

## 4.11 Basics on input from I/Q data files

The I/Q data to be evaluated in a particular FSW application cannot only be captured by the application itself, it can also be loaded from a file, provided it has the correct format. The file is then used as the input source for the application.

For example, you can capture I/Q data using the I/Q Analyzer application, store it to a file, and then analyze the signal parameters for that data later using the AM/FM/PM Modulation Analysis application.

The I/Q data file must be in one of the following supported formats:

- .iq.tar
- .iqw
- .csv
- .mat
- .wv
- .aid



An application note on converting Rohde & Schwarz I/Q data files is available from the Rohde & Schwarz website:

[1EF85: Converting R&S I/Q data files](#)

When importing data from an I/Q data file using the import functions provided by some FSW applications, the data is only stored temporarily in the capture buffer. It overwrites the current measurement data and is in turn overwritten by a new measurement. If you use an I/Q data file as input, the stored I/Q data remains available for any number of subsequent measurements. Furthermore, the (temporary) data import requires the current measurement settings in the current application to match the settings that were

applied when the measurement results were stored (possibly in a different application). When the data is used as an input source, however, the data acquisition settings in the current application (attenuation, center frequency, measurement bandwidth, sample rate) can be ignored. As a result, these settings cannot be changed in the current application. Only the measurement time can be decreased, to perform measurements on an extract of the available data (from the beginning of the file) only.



For I/Q data which was captured as segmented data, the timing information for the captured segments is also stored during export. It can then be retrieved when the I/Q data file is used as an input source to reproduce results that are consistent with the original measurement.



### 5G NR signal description

When you export I/Q data from the 5G NR application, the `iq.tar` file also contains the signal description (`.allocation` file information). The signal description is included in the I/Q parameter XML file.

Therefore, it is no longer necessary to load the signal description separately before loading the I/Q data.

For input files that contain multiple data streams from different channels, you can define which data stream to be used for the currently selected channel in the input settings. You can define whether the data stream is used only once, or repeatedly, to create a larger amount of input data.

When using input from an I/Q data file, the [RUN SINGLE] function starts a single measurement (i.e. analysis) of the stored I/Q data, while the [RUN CONT] function repeatedly analyzes the same data from the file.



### Sample `iq.tar` files

If you have the optional FSW VSA application (R&S FSW-K70), some sample `iq.tar` files are provided in the `C:\R_S\INSTR\USER\vsa\DemoSignals` directory on the FSW.

### Pre-trigger and post-trigger samples

In applications that use pre-triggers or post-triggers, if no pre-trigger or post-trigger samples are specified in the I/Q data file, or too few trigger samples are provided to satisfy the requirements of the application, the missing pre- or post-trigger values are filled up with zeros. Superfluous samples in the file are dropped, if necessary. For pre-trigger samples, values are filled up or omitted at the beginning of the capture buffer. For post-trigger samples, values are filled up or omitted at the end of the capture buffer.

## 5 Analysis

The FSW provides various tools to analyze the measurement results.

- [General analysis tools](#).....204
- [Analysis tools for I/Q measurements](#)..... 207
- [Analysis tools for combined measurements](#).....218
- [Analysis tools for frequency sweep measurements](#)..... 219

### 5.1 General analysis tools

The general analysis tools are tools available for all measurements.



#### Event-based actions

The 5G NR measurement application supports event-based actions, as described in the FSW User Manual.

When using event based actions, make sure that all frames are included in a single I/Q capture. Event based actions only evaluate the last I/Q capture.

- [Data export](#).....204
- [Diagram scale](#)..... 205
- [Zoom](#).....206
- [Markers](#)..... 207

#### 5.1.1 Data export

**Access:** [TRACE] > "Trace Export Config"

You can export the measurement results to an ASCII file, for example to backup the results or analyze the results with external applications (for example in a Microsoft Excel spreadsheet).

You can also export the I/Q data itself, for example if you want to keep it for later reevaluation.

The data export is available for:

- I/Q measurements
- Time alignment error measurements
- Transmit power on / off measurements
- Combined measurements

#### Exporting trace data

1. Select [TRACE] > "Trace Export Config".
2. Select the data you would like to export.

3. Select the results you would like to export from the "Specifics For" dropdown menu.
4. Export the data with the "Export Trace to ASCII File" feature.
5. Select the location where you would like to save the data (as a .dat file).

Note that the measurement data stored in the file depend on the selected result display ("Specifics For" selection).

### Exporting I/Q data

1. Select the disk icon in the toolbar.
2. Select "Export" > "I/Q Export".
3. Define a file name and location for the I/Q data.  
The default file type is `iq.tar`.
4. Later on, you can import the I/Q data using the [I/Q file input source](#).

Combined measurements have additional features for the I/Q data export and import. You can either

- export I/Q data for specific measurements ("I/Q Export" and import using the I/Q file input source) or
- export and import the I/Q data of all measurements in the sequence ("I/Q Export All" / "I/Q Import All").

If you are using the [I/Q noise cancellation](#) algorithm, you can also export the corrected I/Q data ("IQNC I/Q Export"). Exporting corrected I/Q data is only available in single sweep mode and if I/Q noise cancellation is enabled

### Data import and export

The basic principle for both trace export and I/Q data export and import is the same as in the spectrum application. For a comprehensive description, refer to the FSW user manual.

Exporting and importing "all" measurements is available in combined measurement mode - it selects all measurements in a sequence.

Remote command:

Trace export: `TRACe<n>[:DATA]?` on page 312

I/Q export: `MMEMoRY:STORe<n>:IQ:STATe` on page 316

I/Q export (all): `MMEMoRY:STORe<n>:IQ:STATe:ALL` on page 316

I/Q import: `INPut:FILE:PATH` on page 431

I/Q import (all): `MMEMoRY:LOAD:IQ:STATe:ALL` on page 315

I/Q noise cancellation: `MMEMoRY:STORe<n>:IQNC:STATe` on page 316

## 5.1.2 Diagram scale

**Access:** "Overview" > "Analysis" > "Scale"

You can change the scale of the y-axis in various diagrams. The y-axis scale determines the vertical resolution of the measurement results.

The scale of the x-axis in the diagrams is fix. If you want to get a better resolution of the x-axis, you have to [zoom](#) into the diagram.

The remote commands required to configure the y-axis scale are described in [Chapter 6.11.1.2, "Diagram scale"](#), on page 474.

<a href="#">Manual scaling of the y-axis</a> .....	206
<a href="#">Automatic scaling of the y-axis</a> .....	206

### Manual scaling of the y-axis

The "Y Minimum" and "Y Maximum" properties define a custom scale of the y-axis.

The "Y Minimum" corresponds to the value at the origin. The "Y Maximum" corresponds to the last value on the y-axis. The scale you select applies to the currently active window.

You can restore the original scale anytime with "Restore Scale".

Remote command:

```
DISPlay[:WINDow<n>][:SUBWindow<w>]:TRACe<t>:Y[:SCALe]:MAXimum
```

on page 474

```
DISPlay[:WINDow<n>][:SUBWindow<w>]:TRACe<t>:Y[:SCALe]:MINimum
```

on page 475

### Automatic scaling of the y-axis

Usually, the best way to view the results is if they fit ideally in the diagram area and display the complete trace. The "Auto Scale Once" automatically determines the scale of the y-axis that fits this criteria in the currently active window.

**Tip:** You can also scale the windows in the "Auto Set" menu. In addition to scaling the selected window ("Auto Scale Window"), you can change the scale of all windows at the same time ("Auto Scale All").

You can restore the original scale anytime with "Restore Scale".

Remote command:

```
DISPlay[:WINDow<n>][:SUBWindow<w>]:TRACe<t>:Y[:SCALe]:AUTO
```



on page 474

## 5.1.3 Zoom

The zoom feature allows you to zoom into any graphical result display. This can be a useful tool if you want to analyze certain parts of a diagram in more detail.

The zoom functionality is the same as in the spectrum application.

The following zoom functions are supported.

- : Magnifies the selected diagram area.
- : Magnifies the selected diagram area, but keeps the original diagram in a separate window.
- : Restores the original diagram.

Note that the zoom is a graphical feature that magnifies the data in the capture buffer. Zooming into the diagram does not reevaluate the I/Q data.

For a comprehensive description of the zoom, refer to the FSW user manual.

### 5.1.4 Markers

**Access:** "Overview" > "Analysis" > "Marker"

Markers are a tool that help you to identify measurement results at specific trace points. When you turn on a marker, it gives you the coordinates of its position, for example the frequency and its level value or the symbol and its EVM value.

In general, the marker functionality of setting and positioning markers is similar to the spectrum application.

For I/Q measurement, the FSW supports up to four markers, for frequency sweep measurements there are more. Markers give either absolute values (normal markers) or values relative to the first marker (deltamarkers). If a result display has more than one trace, for example the "EVM vs Symbol" result display, you can position the marker on either trace. By default, all markers are positioned on trace 1.

Note that if you analyze more than one bandwidth part, each bandwidth part is represented by a different trace.

The FSW also supports several automatic positioning mechanisms that allow you to move the marker to the maximum trace value (peak), the minimum trace value or move it from peak to subsequent peak.

The [marker table](#) summarizes the marker characteristics.

For a comprehensive description, refer to the FSW user manual.

#### Markers in result displays with a third quantity

In result displays that show a third quantity, for example the "EVM vs Symbol x Carrier" result, the FSW provides an extended marker functionality.

You can position the marker on a specific resource element, whose position is defined by the following coordinates:

- The "BWP/SS" dropdown menu selects the bandwidth part.
- The "Symbol" input field selects the symbol.
- The "Carrier" input field selects the carrier.

Alternatively, you can define the marker position in the "Marker Configuration" dialog box, which is expanded accordingly.

The marker information shows the EVM, the power and the allocation ID of the resource element you have selected as the marker position.

## 5.2 Analysis tools for I/Q measurements

The following analysis tools are available exclusively for I/Q measurements.

• <a href="#">Layout of numerical results</a> .....	208
• <a href="#">Result settings</a> .....	208
• <a href="#">Table configuration</a> .....	211
• <a href="#">Result views</a> .....	212
• <a href="#">Evaluation range</a> .....	214
• <a href="#">Beamforming selection</a> .....	217

## 5.2.1 Layout of numerical results

You can customize the displayed information of some numerical result displays or tables, for example the [allocation summary](#).

You can identify these result display by the "Table Config" button in the result display header.



When you select the "Table Config" button, the FSW opens a dialog box that allows you to add or remove table columns. Note that some columns are mandatory and cannot be removed.

Alternatively, select some point in the header row of the table to open the dialog box.

## 5.2.2 Result settings

**Access:** "Overview" > "Analysis" > "Result Settings"

The result settings control the way various results are displayed.

<a href="#">EVM Unit</a> .....	208
<a href="#">Bit Stream Format</a> .....	209
<a href="#">Carrier Axes</a> .....	209
<a href="#">Symbol Axes</a> .....	209
<a href="#">Carrier Axes Reference</a> .....	209
<a href="#">EVM Max Hold</a> .....	209
<a href="#">Subwindow Coupling</a> .....	210
<a href="#">3D View</a> .....	210
<a href="#">ACLR Limit Pass Mode</a> .....	210
<a href="#">Constellation Diagram Relative Power</a> .....	211
<a href="#">Constellation Color</a> .....	211

### EVM Unit

The "EVM Unit" selects the unit for the EVM measurement results in diagrams and numerical result displays.

Possible units are dB and %.

Remote command:

`UNIT: EVM` on page 490



**Bit Stream Format**

Selects the way the bit stream is displayed.

The bit stream is either a stream of raw bits or of symbols. In case of the symbol format, the bits that belong to a symbol are shown as hexadecimal numbers with two digits.

Selecting the bit stream format is possible when [data demodulation](#) occurs before or after descrambling.

Remote command:

[UNIT:BSTR](#) on page 489

**Carrier Axes**

The "Carrier Axes" selects the unit of the x-axis in result displays that show results over the subcarriers.

- "Hertz"  
X-axis shows the results in terms of the subcarrier frequency.
- "Subcarrier Number"  
X-axis shows the results in terms of the subcarrier number.

Remote command:

[UNIT:CAXes](#) on page 490

**Symbol Axes**

The "Symbol Axes" selects the unit of the x-axis in result displays that show results over the OFDM symbols.

- "Time"  
X-axis shows the results in terms of time.
- "Symbol Number"  
X-axis shows the results in terms of the symbol number.

Remote command:

[UNIT:SAXes](#) on page 490

**Carrier Axes Reference**

Selects the way the frequency is displayed in result displays that plot (carrier) frequency information on the x-axis. In these result displays, the x-axis covers the whole [channel bandwidth](#).

"Lowest RB"	Frequency values relative to the first resource block in the channel. The origin of the x-axis (0 Hz) corresponds to the first resource block in the channel.
"Relative to CF"	Frequency values relative to the center frequency of the carrier. The center frequency of the carrier corresponds to 0 Hz, which is displayed at the center of the x-axis.

Remote command:

[UNIT:CAReference](#) on page 489

**EVM Max Hold**

The "EVM Max Hold" turns the display of the highest EVM values in graphical result displays on and off.

Depending on the result display and the evaluation range, this means that

- either the maximum trace is displayed
- or the highest value in a data bin is displayed instead of the average.

Remote command:

[\[SENSe:\]NR5G:EMHold](#) on page 487

### Subwindow Coupling

Couples or decouples result display tabs (subwindows).

If the coupling is on and you select another tab in a result display, the application automatically selects the same tab for all result displays.

Subwindow coupling is available for measurements with multiple data streams (for example carrier aggregation).

Remote command:

[DISPlay\[:WINDow<n>\]\[:SUBWindow<w>\]:COUPling](#) on page 486

### 3D View

The "3D View" turns the display of a 3D view of the following result displays on and off.

- "Allocation ID vs Symbol x Carrier" on page 42
- "EVM vs Symbol x Carrier" on page 42
- "Power vs Symbol x Carrier" on page 42

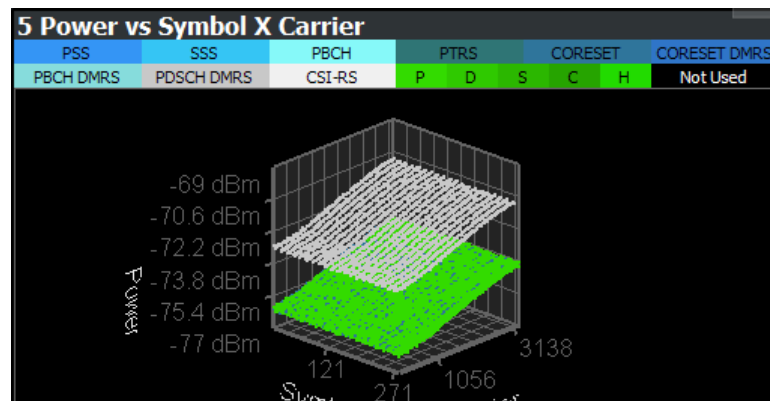

The 3D diagram shows a point cloud of all measurement points in the capture buffer. The information is the same as in the 2D views. The 3D diagram can help you find value distributions more easily, for example.

The 3D view supports the following controls:

- Changing the scale of the axes.
- Turning the diagram in any direction.  
The view from the top corresponds to the 2D views.
- Zooming in and out of the diagram to see more details.

Remote command:

[\[SENSe:\]NR5G:TDView](#) on page 489

### ACLR Limit Pass Mode

Available for combined measurements.

The "ACLR Limit Pass Mode" selects the method the ACLR limits are evaluated with.

By default, the FSW evaluates the relative and absolute limits according to 3GPP. One of the two must pass for an overall pass.

If you want to evaluate only the absolute or relative limits, select the corresponding evaluation method. If you want to change the limit evaluation method after the measurement, you have to [refresh the measurement](#).

The selected method adjusts the contents [combined result summary](#) and the [ACLR result summary](#) accordingly.

"Absolute"	Checks the absolute limits defined for the ACLR. The limit check passes when the signal level is within the absolute limits.
"Relative"	Checks the relative limits defined for the ACLR. The limit check passes when the signal level is within the relative limits.
"Absolute or Relative"	The limit check for either the absolute or the relative limits must pass to get an overall pass.

Remote command:

`[SENSe:]NR5G:ACPower:ALPMode` on page 467

#### Constellation Diagram Relative Power

Turns the consideration of a boosting factor to calculate the constellation points in the [constellation diagram](#) on and off.

Remote command:

`[SENSe:]NR5G:CDRPower` on page 487

#### Constellation Color

Selects the information that the colors of the constellation points in the [constellation diagram](#) represent.

"Modulation"	Colors represent modulation types.
"Allocation"	Colors represent allocation types.

Remote command:

`[SENSe:]NR5G:CCOLor` on page 487

### 5.2.3 Table configuration

**Access:** "Result Settings" > "Table Config"

The result summary and allocation summary contain all sorts of results and information. If you only want to see a selected set of results, you can customize the contents of these result displays by adding or removing individual results.



#### Accessing the "Table Config" tab

Note that the contents of the "Table Config" dialog box are only available after you have selected the "Specifics for: Result Summary" or "Specifics for: Allocation Summary" item from the corresponding dropdown menu at the bottom of the dialog box.

Specifics for 2: Result Summary ▾

**CC Result**

Selects the way the FSW analyzes [multiple carriers](#).

The component carrier analysis method also changes the layout of the [result summary](#).

"All"	Analyzes all component carriers and shows information about all of them in the result summary overview ("All" tab). Note that measuring all component carriers can take a while, depending on the number of component carriers.
"Viewed"	Analyzes the two component carriers assigned to the two <a href="#">views</a> . The result summary overview ("All" tab) only shows information about those two component carriers.

Remote command:

[\[SENSe:\]NR5G:RSUMmary:CCResult](#) on page 487

**Power Mode**

Selects the power averaging mode for the results in the [result summary](#).

Available if the signal only contains a single numerology.

"Average Active Slots"	Averages the power of all OFDM symbols in the slot.
"Average Active Symbols"	Averages the OFDM symbols that are used. If all symbols are occupied, the results are the same as averaging over all symbols. This setting has an effect on TDD signals that combine both downlink and uplink symbols in a slot.

Remote command:

[\[SENSe:\]NR5G:RSUMmary:PMODE](#) on page 488

**Result state**

Turn individual results on and off by selecting or deselecting the corresponding result labels.

Note that some information is always visible, the corresponding checkboxes are greyed out.

Remote command:

Result selection: [DISPlay\[:WINDow<n>\]:TABLE:ITEM](#) on page 486

**5.2.4 Result views**

When you capture multiple data streams, for example [several component carriers](#), the FSW displays the results for each single data stream in a separate diagram. Because this can lead to literally dozens of diagrams in each result display, the FSW only shows two data streams simultaneously.

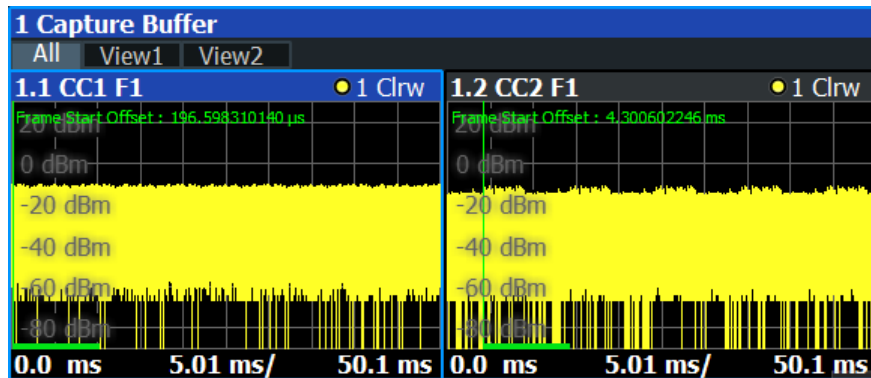

Result displays are made up out of three tabs in such cases.

- The first tab labeled "All" shows the two data streams next to each other, in two subwindows.
- The other two tabs labeled "View <x>" show each of the two data streams in a single window.

There are always just two views, but you can assign the data streams you would like to see to those two views. If you measure more than two data streams, you have to select the data streams you want to display.

If you measure [several frames](#) in addition to multiple data streams, you can also select a specific frame whose information is displayed in the two diagrams.

You can see the currently displayed component carriers in the window title bar and the channel bar.

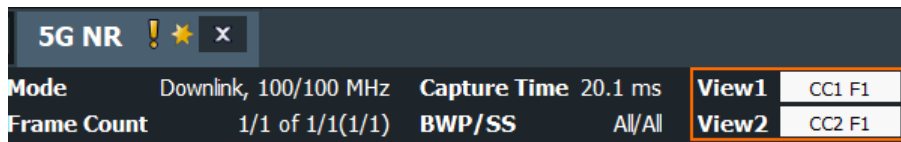

CC = Component carrier number  
F = Frame number

[Component Carrier No.....](#) 213  
[Frame No.....](#) 213

**Component Carrier No**

Selects the number of the component carrier that the FSW displays in the two views.

Remote command:

[DISPlay\[:WINDow<n>\]\[:SUBWindow<w>\]:CCNumber](#) on page 485

**Frame No**

Selects the frame that the FSW displays in the two views.

Note that the frame selection in the "Result View" dialog box and the ["Evaluation Range"](#) dialog box are coupled.

Remote command:

[DISPlay\[:WINDow<n>\]\[:SUBWindow<w>\]:FNUMber](#) on page 485

## 5.2.5 Evaluation range

**Access:** "Overview" > "Evaluation Range" > "Global / Constellation"

You can filter various result displays by the type of information they display.

The remote commands required to configure the results are described in [Chapter 6.11.2.3, "Evaluation range"](#), on page 490.

<a href="#">Segment Selection</a> .....	214
<a href="#">Frame Selection</a> .....	214
<a href="#">Selected Meas ID</a> .....	214
<a href="#">BWP/SS Selection</a> .....	214
<a href="#">Subframe Selection</a> .....	215
<a href="#">Slot Selection</a> .....	216
<a href="#">Evaluation range for the constellation diagram</a> .....	217

### Segment Selection

The "Segment" selection filters the results by a certain segment.

If you apply the filter, only the results for the segment you have selected are displayed. Otherwise, the FSW shows the results for the first segment.

The segment filter is available when you are using [segmented capture](#). For more information about this feature and its effect on results, see [Chapter 4.1.19, "Segmented capture"](#), on page 161.

Remote command:

[\[SENSe:\]NR5G:SEGment:SElect](#) on page 495

### Frame Selection

The "Frame" selection filters the results by a specific frame number.

If you apply the filter, only the results for the frame you have selected are displayed. Otherwise, the FSW shows the results for the first frame.

Note that the frame selection in the "Evaluation Range" dialog box and the ["Result Views"](#) dialog box are coupled.

For more information about the effects on results when you capture multiple frames, see ["Effects of capturing multiple frames on results"](#) on page 89.

Remote command:

[\[SENSe:\]NR5G\[:CC<cc>\]:FRAME:SElect](#) on page 493

### Selected Meas ID

Available for combined measurements.

Selects one of the events in the measurement sequence.

Remote command:

[\[SENSe:\]NR5G\[:CC<cc>\]:SMID](#) on page 496

### BWP/SS Selection

The "BWP/SS" selection filters the results by a specific bandwidth part.

If you apply the filter, only the results for the bandwidth part you have selected are displayed. Otherwise, the FSW shows the results for all bandwidth parts that have been analyzed.

Selecting "SS/PBCH Block" shows only the results for the synchronization signal and PBCH block. Selecting one of the numbers only shows the results for the corresponding bandwidth part.

The FSW shows several traces if the filter is not active, one for each bandwidth part and one for SS/PBCH block.

If you apply the filter, the number of traces depends on the result display. For some result displays, the minimum, maximum and average result are displayed in three traces, for others only one trace.

You can apply the filter to the following result displays.

- EVM vs Carrier
- EVM vs Symbol
- Flatness vs Carrier
- Constellation Diagram
- Allocation Summary
- Alloc ID vs Symbol x Carrier
- EVM vs Symbol x Carrier
- Power vs Symbol x Carrier

Remote command:

`[SENSe:]NR5G[:CC<cc>]:BWPart:SElect` on page 492

### Subframe Selection

The "Subframe" selection filters the results by a specific subframe number.

If you apply the filter, only the results for the subframe you have selected are displayed. Otherwise, the FSW shows the results for all subframes that have been analyzed.

The FSW shows three traces if you display the results for all subframes.

- One trace ("Min") shows the minimum values measured over all analyzed subframes.
- One trace ("Max") shows the maximum values measured over all analyzed subframes.
- One trace ("Avg") shows the average values measured over all subframes.

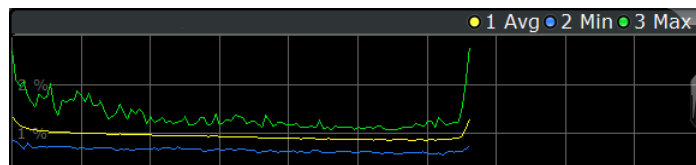

If you filter by a single subframe, the FSW still shows three traces, but with different information.

- One trace ("Min") shows the minimum values measured over all slots in the selected subframe.
- One trace ("Max") shows the maximum values measured over all slots in the selected subframe.
- One trace ("Avg") shows the average values measured over all slots in the selected subframe.

The number of traces is only reduced to one trace if you filter by a single **slot**.

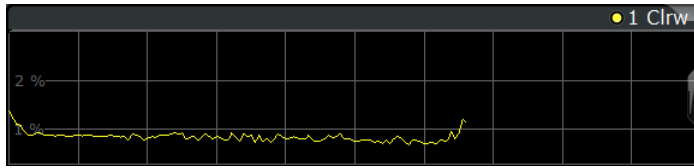

You can apply the filter to the following result displays.

- EVM vs Carrier
- EVM vs Symbol
- Flatness vs Carrier
- Constellation Diagram
- Allocation Summary
- Alloc ID vs Symbol x Carrier
- EVM vs Symbol x Carrier
- Power vs Symbol x Carrier

Remote command:

[\[SENSe:\]NR5G\[:CC<cc>\]:SUBFrame:SElect](#) on page 494

### Slot Selection

The "Slot" selection filters the results by a specific slot number.

If you apply the filter, only the results for the slot you have selected are displayed. Otherwise, the FSW shows the results for all slots.

The FSW shows three traces if you display the results for all slots.

- One trace ("Min") shows the minimum values measured over all slots.
- One trace ("Max") shows the maximum values measured over all slots.
- One trace ("Avg") shows the average values measured over all slots.

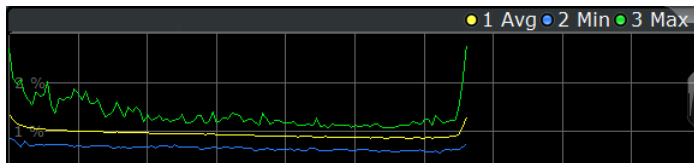

If you filter by a single slot, the FSW shows one trace that represents the values measured for that slot only.

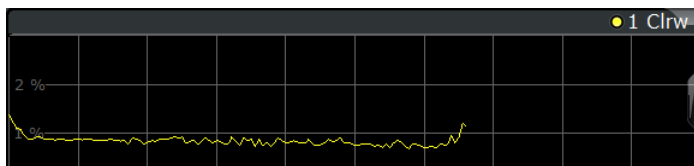

You can apply the filter to the following result displays.

- EVM vs Carrier
- EVM vs Symbol
- Flatness vs Carrier
- Constellation Diagram
- Allocation Summary
- Alloc ID vs Symbol x Carrier
- EVM vs Symbol x Carrier



- Power vs Symbol x Carrier

Remote command:

`[SENSe:]NR5G[:CC<cc>]:SLOT:SElect` on page 494

### Evaluation range for the constellation diagram

The "Evaluation Range" for the constellation diagram selects the information displayed in the [constellation diagram](#).

By default, the constellation diagram contains the constellation points of the complete data that has been analyzed. However, you can filter the results by several aspects.

- Modulation  
Filters the results by the selected type of modulation.
- Allocation  
Filters the results by a certain type of allocation.
- Symbol (OFDM)  
Filters the results by a certain OFDM symbol.
- Carrier  
Filters the results by a certain subcarrier.

Remote command:

Modulation: `[SENSe:]NR5G[:CC<cc>]:MODulation:SElect` on page 493

Allocation: `[SENSe:]NR5G[:CC<cc>]:ALlocation:SElect` on page 491

Symbol: `[SENSe:]NR5G[:CC<cc>]:SYMBOL:SElect` on page 495

Carrier: `[SENSe:]NR5G[:CC<cc>]:CARRier:SElect` on page 492

## 5.2.6 Beamforming selection

**Access:** "Overview" > "Evaluation Range" > "Beamforming"

You can filter various beamforming result displays by the type of information they display.

The remote commands required to configure the results are described in [Chapter 6.11.2.3, "Evaluation range"](#), on page 490.

<a href="#">RS Weights</a> .....	217
<a href="#">Reference AP</a> .....	217

### RS Weights

Filters the displayed results to include only certain antenna port(s).

The availability of antenna ports depends on the number of channels and the number of beamforming layers you are testing.

Remote command:

`CONFigure[:NR5G]:DL[:CC<cc>]:BF:AP[:UERS]` on page 491

### Reference AP

Selects the reference antenna port for relative beamforming results.

Remote command:

`[SENSe:]NR5G[:CC<cc>]:RAP` on page 494

## 5.3 Analysis tools for combined measurements

**Access:** "Overview" > "Analysis"

**Access:** "Overview" > "Evaluation Range"

**Access:** [Meas Config] > "Result Settings"

Combined measurements provide several analysis tools. In addition to the tools available in other measurement modes, combined measurement also provide specific tools.

- [Event filter](#).....218
- [General analysis tools](#).....219

### 5.3.1 Event filter

**Access:** [Meas Config] > "Result Settings" > "Table Config" > "Event Filter"

**Access:** "Table Config" (header of result summary) > "Event Filter"

Depending on your test setup, you can have a lot of measurement events in your measurement sequence. Thus, the result summary for combined measurements can become pretty large. To make the list more manageable, and inspect the results of selected events in detail, you can filter the results by all kinds criteria.

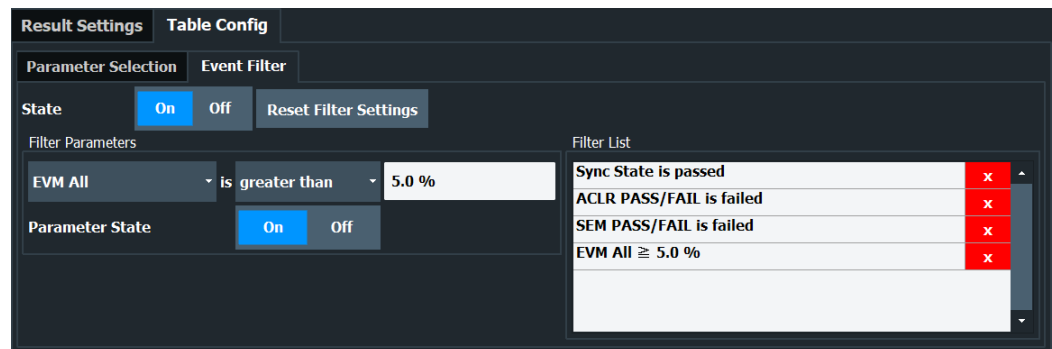

1. Turn on the event filter.
2. Select a filter parameter.  
The filter parameter is usually one of the results from combined measurement [result summary](#).
3. Select a filter condition.
4. Turn on the filter to add it to the filter list.  
You can add as many filter conditions as you like to the filter list.  
You can remove a filter with the x in the filter list or remove all filters with "Reset Filter Settings".

[State](#).....219

[Reset Filter Settings](#).....219

[Filter Parameters](#).....219

**State**

Turns on the event filter.

Remote command:

[\[SENSe:\]NR5G:EFILter:STATe](#) on page 497

**Reset Filter Settings**

Clears the filter list.

Remote command:

[\[SENSe:\]NR5G:EFILter:PRESet](#) on page 497

**Filter Parameters**

Selects the filter conditions.

The filter condition is a combination of a filter parameter and a condition for that parameter, for example "Sync State" = "Passed".

The "Parameter State" adds a filter to the filter list.

Remote command:

Condition: [\[SENSe:\]NR5G:EFILter:FPARameters](#) on page 496

State: [\[SENSe:\]NR5G:EFILter:FPARameters:STATe](#) on page 497

Query number of filtered events: [\[SENSe:\]NR5G:FEVents:COUNT?](#) on page 498

### 5.3.2 General analysis tools

Analysis tools described elsewhere:

- [Data and trace export](#)
- [Diagram scale](#)
- [Zoom](#)
- [Markers](#)  
Note that the markers you set remain on their position when you browse through the measurements in a sequence.
- [Table layout](#)
- [General result setting](#)
- [Evaluation range](#)
- [Beamforming selection](#)

## 5.4 Analysis tools for frequency sweep measurements

**Access:** "Overview" > "Analysis"

**Access:** "Overview" > "Analysis"

The analysis tools available for the frequency sweep measurements are the same as in the spectrum analyzer.

For more information, refer to the FSW user manual.

## 6 Remote control

The following remote control commands are required to configure and perform 5G NR measurements in a remote environment. The FSW must already be set up for remote operation in a network as described in the base unit manual.



### Universal functionality

Note that basic tasks that are also performed in the base unit in the same way are not described here. For a description of such tasks, see the FSW User Manual.

In particular, this includes:

- Managing Settings and Results, i.e. storing and loading settings and result data.
- Basic instrument configuration, e.g. checking the system configuration, customizing the screen layout, or configuring networks and remote operation.
- Using the common status registers.

• <a href="#">Common suffixes</a> .....	220
• <a href="#">Introduction</a> .....	221
• <a href="#">Status register</a> .....	226
• <a href="#">5G NR application selection</a> .....	227
• <a href="#">Screen layout</a> .....	231
• <a href="#">Measurement control</a> .....	241
• <a href="#">Remote commands to retrieve numeric results</a> .....	245
• <a href="#">Limit check results</a> .....	276
• <a href="#">Retrieve trace data</a> .....	290
• <a href="#">Configuration</a> .....	313
• <a href="#">Analysis</a> .....	472
• <a href="#">Reading out status register</a> .....	498

### 6.1 Common suffixes

In the 5G NR measurement application, the following common suffixes are used in remote commands:

**Table 6-1: Common suffixes used in remote commands in the 5G NR measurement application**

Suffix	Value range	Description
<m>	1..4	Marker
<n>	1..16	Window ( <b>in the currently selected channel</b> )
<t>	1..6	Trace
<li>	1 to 8	Limit line
<al>	0..99	Selects a subframe allocation.
<bwp>	1..12	Selects a bandwidth part.

Suffix	Value range	Description
<cc>	1..16	Selects a component carrier. (8 CCs for MC ACLR, cum. ACLR and Multi SEM)
<csi>	1..64	Selects a CSI-RS.
<fr>	1..n	Selects a frame. The maximum value depends on the signal configuration.
<k>	---	Selects a limit line. Irrelevant for the 5G NR application.
<sf>	0..n	Selects a subframe. The maximum value depends on the signal configuration.
<sl>	0..n	Selects a slot. The maximum value depends on the signal configuration.
<ss>	0..64	Selects a synchronization signal block (SSB).
<ssb>	1..4	irrelevant
<sym>	0..13	Selects an OFDM symbol
<w>	1..2	Selects a subwindow (view)

## 6.2 Introduction

Commands are program messages that a controller (e.g. a PC) sends to the instrument or software. They operate its functions ('setting commands' or 'events') and request information ('query commands'). Some commands can only be used in one way, others work in two ways (setting and query). If not indicated otherwise, the commands can be used for settings and queries.

The syntax of a SCPI command consists of a header and, usually, one or more parameters. To use a command as a query, you have to append a question mark after the last header element, even if the command contains a parameter.

A header contains one or more keywords, separated by a colon. Header and parameters are separated by a "white space" (ASCII code 0 to 9, 11 to 32 decimal, e.g. blank). If there is more than one parameter for a command, they are separated by a comma from one another.

Only the most important characteristics that you need to know when working with SCPI commands are described here. For a more complete description, refer to the user manual of the FSW.



### Remote command examples

Note that some remote command examples mentioned in this general introduction are possibly not supported by this particular application.

## 6.2.1 Conventions used in descriptions

The following conventions are used in the remote command descriptions:

- **Command usage**  
If not specified otherwise, commands can be used both for setting and for querying parameters.  
If a command can be used for setting or querying only, or if it initiates an event, the usage is stated explicitly.
- **Parameter usage**  
If not specified otherwise, a parameter can be used to set a value, and it is the result of a query.  
Parameters required only for setting are indicated as **Setting parameters**.  
Parameters required only to refine a query are indicated as **Query parameters**.  
Parameters that are only returned as the result of a query are indicated as **Return values**.
- **Conformity**  
Commands that are taken from the SCPI standard are indicated as **SCPI confirmed**. All commands used by the FSW follow the SCPI syntax rules.
- **Asynchronous commands**  
A command which does not automatically finish executing before the next command starts executing (overlapping command) is indicated as an **Asynchronous command**.
- **Reset values (\*RST)**  
Default parameter values that are used directly after resetting the instrument (\*RST command) are indicated as **\*RST** values, if available.
- **Default unit**  
The default unit is used for numeric values if no other unit is provided with the parameter.
- **Manual operation**  
If the result of a remote command can also be achieved in manual operation, a link to the description is inserted.

## 6.2.2 Long and short form

The keywords have a long and a short form. You can use either the long or the short form, but no other abbreviations of the keywords.

The short form is emphasized in uppercase letters. Note however, that this emphasis only serves the purpose to distinguish the short from the long form in the manual. For the instrument, the case does not matter.

### Example:

SENSe:FREQuency:CENTer is the same as SENS:FREQ:CENT.

### 6.2.3 Numeric suffixes

Some keywords have a numeric suffix if the command can be applied to multiple instances of an object. In that case, the suffix selects a particular instance (e.g. a measurement window).

Numeric suffixes are indicated by angular brackets (<n>) next to the keyword.

If you do not quote a suffix for keywords that support one, a 1 is assumed.

**Example:**

`DISPlay[:WINDow<1...4>]:ZOOM:STATe` enables the zoom in a particular measurement window, selected by the suffix at `WINDow`.

`DISPlay:WINDow4:ZOOM:STATe ON` refers to window 4.

### 6.2.4 Optional keywords

Some keywords are optional and are only part of the syntax because of SCPI compliance. You can include them in the header or not.



If an optional keyword has a numeric suffix and you need to use the suffix, you have to include the optional keyword. Otherwise, the suffix of the missing keyword is assumed to be the value 1.

Optional keywords are emphasized with square brackets.

**Example:**

Without a numeric suffix in the optional keyword:

`[SENSe:]FREQuency:CENTer` is the same as `FREQuency:CENTer`

With a numeric suffix in the optional keyword:

`DISPlay[:WINDow<1...4>]:ZOOM:STATe`

`DISPlay:ZOOM:STATe ON` enables the zoom in window 1 (no suffix).

`DISPlay:WINDow4:ZOOM:STATe ON` enables the zoom in window 4.

### 6.2.5 Alternative keywords

A vertical stroke indicates alternatives for a specific keyword. You can use both keywords to the same effect.

**Example:**

`[SENSe:]BANDwidth|BWIDth[:RESolution]`

In the short form without optional keywords, `BAND 1MHZ` would have the same effect as `BWID 1MHZ`.

## 6.2.6 SCPI parameters

Many commands feature one or more parameters.

If a command supports more than one parameter, they are separated by a comma.

### Example:

```
LAYout:ADD:WINDow Spectrum,LEFT,MTABLE
```

Parameters can have different forms of values.

- [Numeric values](#)..... 224
- [Boolean](#)..... 225
- [Character data](#)..... 225
- [Character strings](#)..... 225
- [Block data](#)..... 226

### 6.2.6.1 Numeric values

Numeric values can be entered in any form, i.e. with sign, decimal point or exponent. For physical quantities, you can also add the unit. If the unit is missing, the command uses the basic unit.

### Example:

With unit: `SENSe:FREQuency:CENTer 1GHZ`

Without unit: `SENSe:FREQuency:CENTer 1E9` would also set a frequency of 1 GHz.

Values exceeding the resolution of the instrument are rounded up or down.

If the number you have entered is not supported (e.g. for discrete steps), the command returns an error.

Instead of a number, you can also set numeric values with a text parameter in special cases.

- MIN/MAX  
Defines the minimum or maximum numeric value that is supported.
- DEF  
Defines the default value.
- UP/DOWN  
Increases or decreases the numeric value by one step. The step size depends on the setting. Sometimes, you can customize the step size with a corresponding command.

### Querying numeric values

When you query numeric values, the system returns a number. For physical quantities, it applies the basic unit (e.g. Hz for frequencies). The number of digits after the decimal point depends on the type of numeric value.



**Example:**

Setting: `SENSe:FREQuency:CENTer 1GHZ`

Query: `SENSe:FREQuency:CENTer?` would return `1E9`

Sometimes, numeric values are returned as text.

- **INF/NINF**  
Infinity or negative infinity. Represents the numeric values `9.9E37` or `-9.9E37`.
- **NAN**  
Not a number. Represents the numeric value `9.91E37`. NAN is returned if errors occur.

### 6.2.6.2 Boolean

Boolean parameters represent two states. The "on" state (logically true) is represented by "ON" or the numeric value 1. The "off" state (logically untrue) is represented by "OFF" or the numeric value 0.

**Querying Boolean parameters**

When you query Boolean parameters, the system returns either the value 1 ("ON") or the value 0 ("OFF").

**Example:**

Setting: `DISPlay:WINDow:ZOOM:STATe ON`

Query: `DISPlay:WINDow:ZOOM:STATe?` would return `1`

### 6.2.6.3 Character data

Character data follows the syntactic rules of keywords. You can enter text using a short or a long form. For more information, see [Chapter 6.2.2, "Long and short form"](#), on page 222.

**Querying text parameters**

When you query text parameters, the system returns its short form.

**Example:**

Setting: `SENSe:BANDwidth:RESolution:TYPE NORMAL`

Query: `SENSe:BANDwidth:RESolution:TYPE?` would return `NORM`

### 6.2.6.4 Character strings

Strings are alphanumeric characters. They have to be in straight quotation marks. You can use a single quotation mark ( ' ) or a double quotation mark ( " ).

**Example:**

```
INSTRument:DELeTe 'Spectrum'
```

**6.2.6.5 Block data**

Block data is a format which is suitable for the transmission of large amounts of data.

The ASCII character # introduces the data block. The next number indicates how many of the following digits describe the length of the data block. The data bytes follow. During the transmission of these data bytes, all end or other control signs are ignored until all bytes are transmitted. #0 specifies a data block of indefinite length. The use of the indefinite format requires an `NL^END` message to terminate the data block. This format is useful when the length of the transmission is not known or if speed or other considerations prevent segmentation of the data into blocks of definite length.

**6.3 Status register**

The 5G NR measurement application uses the standard status registers of the FSW (depending on the measurement type). However, some registers are used differently. Only those differences are described in the following sections.

For details on the common FSW status registers refer to the description of remote control basics in the FSW user manual.



\*RST does not influence the status registers.

**STATUS:QUESTIONABLE:SYNC register**

The `STATUS:QUESTIONABLE:SYNC` register contains application-specific information. If any errors occur in this register, the status bit #11 in the `STATUS:QUESTIONABLE` register is set to 1.



Each active channel uses a separate `STATUS:QUESTIONABLE:SYNC` register. Thus, if the status bit #11 in the `STATUS:QUESTIONABLE` register indicates an error, the error may have occurred in any of the channel-specific `STATUS:QUESTIONABLE:SYNC` registers. In this case, you must check the register of each channel to determine which channel caused the error. By default, querying the status of a register always returns the result for the currently selected channel. However, you can specify any other channel name as a query parameter.

**Table 6-2: Meaning of the bits used in the STATUS:QUESTIONABLE:SYNC register**

Bit No.	Meaning
0	Synchronization status
1 to 5	Unused

Bit No.	Meaning
7	I/Q noise cancellation error
8 to 14	Unused
15	This bit is always 0

## 6.4 5G NR application selection

<a href="#">INSTrument:CREate:DUPLicate</a> .....	227
<a href="#">INSTrument:CREate[:NEW]</a> .....	227
<a href="#">INSTrument:CREate:REPLace</a> .....	228
<a href="#">INSTrument:DELeTe</a> .....	228
<a href="#">INSTrument:LIST?</a> .....	228
<a href="#">INSTrument:REName</a> .....	230
<a href="#">INSTrument[:SELeCt]</a> .....	230

---

### INSTrument:CREate:DUPLicate

Duplicates the currently selected channel, i.e. creates a new channel of the same type and with the identical measurement settings. The name of the new channel is the same as the copied channel, extended by a consecutive number (e.g. "IQAnalyzer" -> "IQAnalyzer 2").

The channel to be duplicated must be selected first using the `INST:SEL` command.

**Example:**

```
INST:SEL 'IQAnalyzer'
```

```
INST:CRE:DUPL
```

Duplicates the channel named 'IQAnalyzer' and creates a new channel named 'IQAnalyzer2'.

**Usage:** Event

---

### INSTrument:CREate[:NEW] <ChannelType>, <ChannelName>

Adds a measurement channel. You can configure up to 10 measurement channels at the same time (depending on available memory).

**Parameters:**

<ChannelType> Channel type of the new channel.  
For a list of available channel types, see [INSTrument:LIST?](#) on page 228.

<ChannelName> String containing the name of the channel.  
Note that you cannot assign an existing channel name to a new channel. If you do, an error occurs.

**Example:**

```
INST:CRE SAN, 'Spectrum 2'
```

Adds a spectrum display named "Spectrum 2".

---

**INSTrument:CREate:REPLace** <ChannelName1>, <ChannelType>,  
<ChannelName2>

Replaces a channel with another one.

**Setting parameters:**

<ChannelName1> String containing the name of the channel you want to replace.

<ChannelType> Channel type of the new channel.  
For a list of available channel types, see [INSTrument:LIST?](#) on page 228.

<ChannelName2> String containing the name of the new channel.  
**Note:** If the specified name for a new channel already exists, the default name, extended by a sequential number, is used for the new channel (see [INSTrument:LIST?](#) on page 228).  
Channel names can have a maximum of 31 characters, and must be compatible with the Windows conventions for file names. In particular, they must not contain special characters such as ":", "\*", "?".

**Example:** `INST:CRE:REPL 'IQAnalyzer2',IQ,'IQAnalyzer'`  
Replaces the channel named "IQAnalyzer2" by a new channel of type "IQ Analyzer" named "IQAnalyzer".

**Usage:** Setting only

---

**INSTrument:DELeTe** <ChannelName>

Deletes a channel.

If you delete the last channel, the default "Spectrum" channel is activated.

**Setting parameters:**

<ChannelName> String containing the name of the channel you want to delete.  
A channel must exist to delete it.

**Example:** `INST:DEL 'IQAnalyzer4'`  
Deletes the channel with the name 'IQAnalyzer4'.

**Usage:** Setting only

---

**INSTrument:LIST?**

Queries all active channels. The query is useful to obtain the names of the existing channels, which are required to replace or delete the channels.

**Return values:**

<ChannelType>,  
<ChannelName> For each channel, the command returns the channel type and channel name (see tables below).

Tip: to change the channel name, use the [INSTrument:REName](#) command.

**Example:**           INST:LIST?  
                   Result for 3 channels:  
                   'ADEM', 'Analog Demod', 'IQ', 'IQ  
                   Analyzer', 'IQ', 'IQ Analyzer2'

**Usage:**            Query only

**Table 6-3: Available channel types and default channel names in Signal and Spectrum Analyzer mode**

Application	<ChannelType> parameter	Default Channel name*)
Spectrum	SANALYZER	Spectrum
1xEV-DO BTS (FSW-K84)	BDO	1xEV-DO BTS
1xEV-DO MS (FSW-K85)	MDO	1xEV-DO MS
3GPP FDD BTS (FSW-K72)	BWCD	3G FDD BTS
3GPP FDD UE (FSW-K73)	MWCD	3G FDD UE
802.11ad (FSW-K95)	WIGIG	802.11ad
802.11ay (FSW-K97)	EDMG	802.11ay EDMG
Amplifier Measurements (FSW-K18)	AMPLifier	Amplifier
AM/FM/PM Modulation Analysis (FSW-K7)	ADEM	Analog Demod
Avionics (FSW-K15)	AVIonics	Avionics
Bluetooth (FSW-K8)	BTO	Bluetooth
cdma2000 BTS (FSW-K82)	BC2K	CDMA2000 BTS
cdma2000 MS (FSW-K83)	MC2K	CDMA2000 MS
DOCSIS 3.1 (FSW-K192/193)	DOCSis	DOCSIS 3.1
Fast Spur Search (FSW-K50)	SPUR	Spurious
GSM (FSW-K10)	GSM	GSM
HRP UWB (FSW-K149)	UWB	HRP UWB
I/Q Analyzer	IQ	IQ Analyzer
LTE (FSW-K10x)	LTE	LTE
Multi-Carrier "Group Delay" (FSW-K17)	MCGD	MC "Group Delay"
NB-IoT (FSW-K106)	NIOT	NB-IoT
Noise (FSW-K30)	NOISE	Noise
5G NR (FSW-K144)	NR5G	5G NR
OFDM VSA (FSW-K96)	OFDMVSA	OFDM VSA
OneWeb (FSW-K201)	OWEB	OneWeb
Phase Noise (FSW-K40)	PNOISE	Phase Noise
*) If the specified name for a new channel already exists, the default name, extended by a sequential number, is used for the new channel.		

Application	<ChannelType> parameter	Default Channel name*)
Pulse (FSW-K6)	PULSE	Pulse
"Real-Time Spectrum"	RTIM	"Real-Time Spectrum"
TD-SCDMA BTS (FSW-K76)	BTDS	TD-SCDMA BTS
TD-SCDMA UE (FSW-K77)	MTDS	TD-SCDMA UE
Transient Analysis (FSW-K60)	TA	Transient Analysis
Verizon 5GTF Measurement Application (V5GTF, FSW-K118)	V5GT	V5GT
VSA (FSW-K70)	DDEM	VSA
WLAN (FSW-K91)	WLAN	WLAN
*) If the specified name for a new channel already exists, the default name, extended by a sequential number, is used for the new channel.		

---

**INSTrument:REName** <ChannelName1>, <ChannelName2>

Renames a channel.

**Setting parameters:**

<ChannelName1> String containing the name of the channel you want to rename.

<ChannelName2> String containing the new channel name.  
 Note that you cannot assign an existing channel name to a new channel. If you do, an error occurs.  
 Channel names can have a maximum of 31 characters, and must be compatible with the Windows conventions for file names. In particular, they must not contain special characters such as ":", "\*", "?".

**Example:** `INST:REN 'IQAnalyzer2', 'IQAnalyzer3'`  
 Renames the channel with the name 'IQAnalyzer2' to 'IQAnalyzer3'.

**Usage:** Setting only

---

**INSTrument[:SElect]** <ChannelType>

Selects a new measurement channel with the defined channel type.

**Parameters:**

<ChannelType> **NR5G**  
 5G NR measurement channel

**Example:** `//Select 5G NR application`  
`INST NR5G`

## 6.5 Screen layout

- [General layout](#).....231
- [Layout of a single channel](#)..... 232

### 6.5.1 General layout

The following commands are required to configure general window layout, independent of the application.

Note that the suffix <n> always refers to the window *in the currently selected measurement channel*.

<a href="#">DISPlay:FORMat</a> .....	231
<a href="#">DISPlay[:WINDow&lt;n&gt;]:SIZE</a> .....	231
<a href="#">DISPlay[:WINDow&lt;n&gt;][:SUBWindow&lt;w&gt;]:SElect</a> .....	232
<a href="#">DISPlay[:WINDow&lt;n&gt;]:TAB&lt;tab&gt;:SElect</a> .....	232

---

#### DISPlay:FORMat <Format>

Determines which tab is displayed.

##### Parameters:

<Format>

##### SPLit

Displays the MultiView tab with an overview of all active channels

##### SINGle

Displays the measurement channel that was previously focused.

\*RST: SING

##### Example:

DISP:FORM SPL

---

#### DISPlay[:WINDow<n>]:SIZE <Size>

Maximizes the size of the selected result display window *temporarily*. To change the size of several windows on the screen permanently, use the `LAY:SPL` command (see [LAYout:SPLitter](#) on page 237).

##### Suffix:

<n>

Window

##### Parameters:

<Size>

##### LARGE

Maximizes the selected window to full screen. Other windows are still active in the background.

##### SMALI

Reduces the size of the selected window to its original size. If more than one measurement window was displayed originally, these are visible again.

\*RST: SMALI

**Example:** `DISP:WIND2:SIZE LARG`

---

### **DISPlay[:WINDow<n>][:SUBWindow<w>]:SElect**

Sets the focus on the selected result display window.

This window is then the active window.

For measurements with multiple results in subwindows, the command also selects the subwindow. Use this command to select the (sub)window before querying trace data.

#### **Suffix:**

<n>	<a href="#">Window</a>
<w>	subwindow Not supported by all applications

**Example:** `//Put the focus on window 1  
DISP:WIND1:SEL`

**Example:** `//Put the focus on subwindow 2 in window 1  
DISP:WIND1:SUBW2:SEL`

---

### **DISPlay[:WINDow<n>]:TAB<tab>:SElect**

Selects a tab in diagrams with multiple subwindows (or views).

Note that selecting a tab does not actually select a subwindow. To select a subwindow, for example to query the results of a subwindow, use `DISPlay[:WINDow<n>][:SUBWindow<w>]:SElect`.

#### **Suffix:**

<n>	<a href="#">Window</a>
<tab>	1..n <a href="#">Tab</a>

**Example:** `//Select a tab  
DISP:WIND2:TAB2:SEL`

## 6.5.2 Layout of a single channel

The following commands are required to change the evaluation type and rearrange the screen layout for a measurement channel as you do using the SmartGrid in manual operation. Since the available evaluation types depend on the selected application, some parameters for the following commands also depend on the selected measurement channel.

Note that the suffix <n> always refers to the window *in the currently selected measurement channel*.

<a href="#">LAYout:ADD[:WINDow]?</a> .....	233
<a href="#">LAYout:CATalog[:WINDow]?</a> .....	235
<a href="#">LAYout:IDENtify[:WINDow]?</a> .....	236



LAYout:REMove[:WINDow].....	236
LAYout:REPLace[:WINDow].....	237
LAYout:SPLitter.....	237
LAYout:WINDow<n>:ADD?.....	239
LAYout:WINDow<n>:IDENtify?.....	239
LAYout:WINDow<n>:REMove.....	240
LAYout:WINDow<n>:REPLace.....	240
LAYout:WINDow<n>:TYPE.....	241

---

### LAYout:ADD[:WINDow]? <WindowName>, <Direction>, <WindowType>

Adds a window to the display in the active channel.

Is always used as a query so that you immediately obtain the name of the new window as a result.

To replace an existing window, use the `LAYout:REPLace[:WINDow]` command.

#### Query parameters:

<WindowName>	String containing the name of the existing window the new window is inserted next to. By default, the name of a window is the same as its index. To determine the name and index of all active windows, use the <code>LAYout:CATalog[:WINDow]? query</code> .
<Direction>	LEFT   RIGHT   ABOVE   BELOW Direction the new window is added relative to the existing window.
<WindowType>	text value Type of result display (evaluation method) you want to add. See the table below for available parameter values.

#### Return values:

<NewWindowName>	When adding a new window, the command returns its name (by default the same as its number) as a result.
-----------------	---

**Usage:** Query only

- Manual operation:**
- See "Capture Buffer" on page 31
  - See "EVM vs Carrier" on page 32
  - See "EVM vs Symbol" on page 32
  - See "EVM vs RB" on page 33
  - See "Frequency Error vs Symbol" on page 34
  - See "Frequency Error vs Subframe" on page 35
  - See "Power Spectrum" on page 36
  - See "Flatness" on page 36
  - See "CCDF" on page 37
  - See "Constellation Diagram" on page 38
  - See "Allocation Summary" on page 38
  - See "Channel Decoder Results" on page 39
  - See "Bitstream" on page 40
  - See "EVM vs Symbol x Carrier" on page 42
  - See "Power vs Symbol x Carrier" on page 42
  - See "Allocation ID vs Symbol x Carrier" on page 42
  - See "RS Magnitude" on page 43
  - See "RS Phase" on page 44
  - See "RS Phase Difference" on page 45
  - See "Beamforming Summary" on page 45
  - See "Marker Table" on page 46
  - See "Time Alignment Error" on page 49
  - See "Marker Peak List" on page 62

**Table 6-4: <WindowType> parameter values for 5G NR measurement application**

Parameter value	Window type
<b>I/Q measurements</b>	
AISC	"Allocation ID vs. Symbol X Carrier"
ASUM	"Allocation Summary"
BSUM	"Beamforming Summary"
BSTR	"Bitstream"
CBUF	"Capture Buffer"
CCDF	"CCDF"
CDEC	"Channel Decoder"
CONS	"Constellation Diagram"
EVCA	"EVM vs. Carrier"
EVRB	"EVM vs. RB"
EVSC	"EVM vs. Symbol X Carrier"
EVSY	"EVM vs. Symbol"
FEVS	"Frequency Error vs Symbol"
FLAT	"Channel Flatness"
FVSU	"Frequency Error vs Subframe"

Parameter value	Window type
MTAB	"Marker Table"
PSPE	"Power Spectrum"
PVSC	"Power vs. Symbol X Carrier"
RSUM	"Result Summary"
RSMA	"RS Magnitude"
RSPD	"RS Phase Difference"
RSWP	"RS Phase"
<b>Time alignment error</b>	
CBUF	"Capture Buffer"
MTAB	"Marker Table"
PSPE	"Power Spectrum"
TAL	"Time Alignment Error"
<b>Transmit on / off power</b>	
DIAG	"Diagram"
FALL	"Falling Period"
OOPL	"On / Off Power List"
RIS	"Rising Period 1"
<b>ACLR and SEM measurements</b>	
DIAG	"Diagram"
PEAK	"Peak List"
MTAB	"Marker Table"
RSUM	"Result Summary"
<b>Combined measurements:</b> same as I/Q measurements, plus:	
ADI	"ACLR Diagram"
ARS	"ACLR Result Summary"
CMS	"Combined EVM / ACLR / SEM Result"
RSUM	"Result Summary EVM"
SDI	"SEM Diagram"
SRS	"SEM Result Summary"

### LAYout:CATalog[:WINDow]?

Queries the name and index of all active windows in the active channel from top left to bottom right. The result is a comma-separated list of values for each window, with the syntax:

<WindowName\_1>,<WindowIndex\_1>..<WindowName\_n>,<WindowIndex\_n>

**Return values:**

<WindowName> string  
Name of the window.  
In the default state, the name of the window is its index.

<WindowIndex> **numeric value**  
Index of the window.

**Example:** LAY:CAT?  
Result:  
'2',2,'1',1  
Two windows are displayed, named '2' (at the top or left), and '1' (at the bottom or right).

**Usage:** Query only

**LAYout:IDENTify[:WINDow]? <WindowName>**

Queries the **index** of a particular display window in the active channel.

**Note:** to query the **name** of a particular window, use the [LAYout:WINDow<n>:IDENTify?](#) query.

**Query parameters:**

<WindowName> String containing the name of a window.

**Return values:**

<WindowIndex> Index number of the window.

**Example:** LAY:IDEN:WIND? '2'  
Queries the index of the result display named '2'.  
Response:  
2

**Usage:** Query only

**LAYout:REMOve[:WINDow] <WindowName>**

Removes a window from the display in the active channel.

**Setting parameters:**

<WindowName> String containing the name of the window. In the default state, the name of the window is its index.

**Example:** LAY:REM '2'  
Removes the result display in the window named '2'.

**Usage:** Setting only

---

**LAYout:REPLace[:WINDow]** <WindowName>, <WindowType>

Replaces the window type (for example from "Diagram" to "Result Summary") of an already existing window in the active channel while keeping its position, index and window name.

To add a new window, use the [LAYout:ADD\[:WINDow\]?](#) command.

**Setting parameters:**

<b>&lt;WindowName&gt;</b>	String containing the name of the existing window. By default, the name of a window is the same as its index. To determine the name and index of all active windows in the active channel, use the <a href="#">LAYout:CATalog[:WINDow]?</a> query.
<b>&lt;WindowType&gt;</b>	Type of result display you want to use in the existing window. See <a href="#">LAYout:ADD[:WINDow]?</a> on page 233 for a list of available window types.

**Example:** `LAY:REPL:WIND '1',MTAB`  
Replaces the result display in window 1 with a marker table.

**Usage:** Setting only

---

**LAYout:SPLitter** <Index1>, <Index2>, <Position>

Changes the position of a splitter and thus controls the size of the windows on each side of the splitter.

Compared to the [DISPlay\[:WINDow<n>\]:SIZE](#) on page 231 command, the `LAYout:SPLitter` changes the size of all windows to either side of the splitter permanently, it does not just maximize a single window temporarily.

Note that windows must have a certain minimum size. If the position you define conflicts with the minimum size of any of the affected windows, the command does not work, but does not return an error.

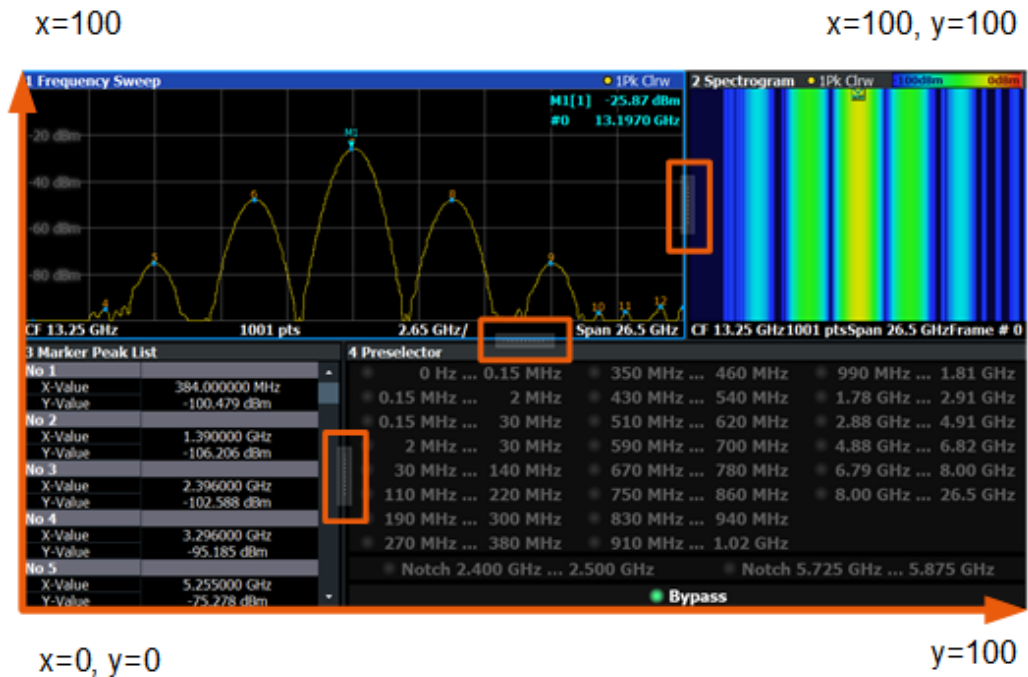

Figure 6-1: SmartGrid coordinates for remote control of the splitters

#### Setting parameters:

- <Index1> The index of one window the splitter controls.
- <Index2> The index of a window on the other side of the splitter.
- <Position> New vertical or horizontal position of the splitter as a fraction of the screen area (without channel and status bar and softkey menu).  
The point of origin ( $x = 0$ ,  $y = 0$ ) is in the lower left corner of the screen. The end point ( $x = 100$ ,  $y = 100$ ) is in the upper right corner of the screen. (See Figure 6-1.)  
The direction in which the splitter is moved depends on the screen layout. If the windows are positioned horizontally, the splitter also moves horizontally. If the windows are positioned vertically, the splitter also moves vertically.

Range: 0 to 100

#### Example:

LAY:SPL 1,3,50

Moves the splitter between window 1 ("Frequency Sweep") and 3 ("Marker Table") to the center (50%) of the screen, i.e. in the figure above, to the left.

**Example:** `LAY:SPL 1,4,70`  
 Moves the splitter between window 1 ('Frequency Sweep') and 3 ('Marker Peak List') towards the top (70%) of the screen. The following commands have the exact same effect, as any combination of windows above and below the splitter moves the splitter vertically.

`LAY:SPL 3,2,70`  
`LAY:SPL 4,1,70`  
`LAY:SPL 2,1,70`

**Usage:** Setting only

### **LAYout:WINDow<n>:ADD? <Direction>,<WindowType>**

Adds a measurement window to the display. Note that with this command, the suffix <n> determines the existing window next to which the new window is added. Unlike [LAYout:ADD\[:WINDow\]?](#), for which the existing window is defined by a parameter.

To replace an existing window, use the [LAYout:WINDow<n>:REPLace](#) command.

Is always used as a query so that you immediately obtain the name of the new window as a result.

#### **Suffix:**

<n> [Window](#)

#### **Query parameters:**

<Direction> LEFT | RIGHT | ABOVE | BELOW

<WindowType> Type of measurement window you want to add.  
 See [LAYout:ADD\[:WINDow\]?](#) on page 233 for a list of available window types.

#### **Return values:**

<NewWindowName> When adding a new window, the command returns its name (by default the same as its number) as a result.

**Example:** `LAY:WIND1:ADD? LEFT,MTAB`  
**Result:**  
`'2'`  
 Adds a new window named '2' with a marker table to the left of window 1.

**Usage:** Query only

### **LAYout:WINDow<n>:IDENTify?**

Queries the **name** of a particular display window (indicated by the <n> suffix) in the active channel.

**Note:** to query the **index** of a particular window, use the [LAYout:IDENTify\[:WINDow\]?](#) command.

<b>Suffix:</b>	
<n>	Window
<b>Return values:</b>	
<WindowName>	String containing the name of a window. In the default state, the name of the window is its index.
<b>Example:</b>	LAY:WIND2:IDEN? Queries the name of the result display in window 2. Response: '2'
<b>Usage:</b>	Query only

---

#### LAYout:WINDow<n>:REMove

Removes the window specified by the suffix <n> from the display in the active channel.  
The result of this command is identical to the [LAYout:REMove\[:WINDow\]](#) command.

<b>Suffix:</b>	
<n>	Window
<b>Example:</b>	LAY:WIND2:REM Removes the result display in window 2.
<b>Usage:</b>	Event

---

#### LAYout:WINDow<n>:REPLace <WindowType>

Changes the window type of an existing window (specified by the suffix <n>) in the active channel.

The effect of this command is identical to the [LAYout:REPLace\[:WINDow\]](#) command.

To add a new window, use the [LAYout:WINDow<n>:ADD?](#) command.

<b>Suffix:</b>	
<n>	Window
<b>Setting parameters:</b>	
<WindowType>	Type of measurement window you want to replace another one with. See <a href="#">LAYout:ADD[:WINDow]?</a> on page 233 for a list of available window types.
<b>Example:</b>	LAY:WIND2:REPL MTAB Replaces the result display in window 2 with a marker table.
<b>Usage:</b>	Setting only



**LAYout:WINDow<n>:TYPE** <WindowType>

Queries or defines the window type of the window specified by the index <n>. The window type determines which results are displayed. For a list of possible window types, see [LAYout:ADD\[:WINDow\]?](#) on page 233.

Note that this command is not available in all applications and measurements.

**Suffix:**

<n> 1..n  
Window

**Parameters:**

<WindowType>

**Example:** LAY:WIND2:TYPE?

## 6.6 Measurement control

### 6.6.1 Measurements

<a href="#">ABORt</a> .....	241
<a href="#">INITiate&lt;n&gt;:CONTinuous</a> .....	242
<a href="#">INITiate&lt;n&gt;[:IMMEDIATE]</a> .....	242
<a href="#">[SENSe:]SYNC[:CC&lt;cc&gt;][:STATe]?</a> .....	243

#### ABORt

Aborts the measurement in the current channel and resets the trigger system.

To prevent overlapping execution of the subsequent command before the measurement has been aborted successfully, use the `*OPC?` or `*WAI` command after `ABOR` and before the next command.

For details on overlapping execution see [Remote control via SCPI](#).

#### Note on blocked remote control programs:

If a sequential command cannot be completed, for example because a triggered sweep never receives a trigger, the remote control program will never finish and the remote channel to the FSW is blocked for further commands. In this case, you must interrupt processing on the remote channel first in order to abort the measurement.

To do so, send a "Device Clear" command from the control instrument to the FSW on a parallel channel to clear all currently active remote channels. Depending on the used interface and protocol, send the following commands:

- **Visa:** `viClear()`
- **GPIB:** `ibclr()`
- **RSIB:** `RSDLLibclr()`

Now you can send the `ABORT` command on the remote channel performing the measurement.

<b>Example:</b>	<code>ABOR; :INIT:IMM</code> Aborts the current measurement and immediately starts a new one.
<b>Example:</b>	<code>ABOR; *WAI</code> <code>INIT:IMM</code> Aborts the current measurement and starts a new one once abortion has been completed.
<b>Usage:</b>	Event

### **INITiate<n>:CONTInuous <State>**

Controls the measurement mode for an individual channel.

Note that in single measurement mode, you can synchronize to the end of the measurement with `*OPC`, `*OPC?` or `*WAI`. In continuous measurement mode, synchronization to the end of the measurement is not possible. Thus, it is not recommended that you use continuous measurement mode in remote control, as results like trace data or markers are only valid after a single measurement end synchronization.

For details on synchronization see [Remote control via SCPI](#).

<b>Suffix:</b>	
<n>	irrelevant
<b>Parameters:</b>	
<State>	<code>ON   OFF   0   1</code> <b>ON   1</b> Continuous measurement <b>OFF   0</b> Single measurement <b>*RST:</b> 1 (some applications can differ)
<b>Example:</b>	<code>INIT:CONT OFF</code> Switches the measurement mode to single measurement. <code>INIT:CONT ON</code> Switches the measurement mode to continuous measurement.

### **INITiate<n>[:IMMEDIATE]**

Starts a (single) new measurement.

You can synchronize to the end of the measurement with `*OPC`, `*OPC?` or `*WAI`.

For details on synchronization see [Remote control via SCPI](#).

<b>Suffix:</b>	
<n>	irrelevant
<b>Usage:</b>	Asynchronous command

**[SENSe:]SYNC[:CC<cc>][:STATe]?**

Queries the current synchronization state.

**Suffix:**

<cc>                      irrelevant

**Return values:**

<State>                      The string contains the following information:  
A zero represents a failure and a one represents a successful synchronization.

**Example:**                      //Query synchronization state  
                                     SYNC:STAT?

**Usage:**                         Query only

## 6.6.2 Measurement sequences

<a href="#">INITiate:SEQuencer:ABORt</a> .....	243
<a href="#">INITiate:SEQuencer:IMMediate</a> .....	243
<a href="#">INITiate:SEQuencer:MODE</a> .....	244
<a href="#">SYSTem:SEQuencer</a> .....	244

**INITiate:SEQuencer:ABORt**

Stops the currently active sequence of measurements.

You can start a new sequence any time using [INITiate:SEQuencer:IMMediate](#) on page 243.

**Usage:**                         Event

**INITiate:SEQuencer:IMMediate**

Starts a new sequence of measurements by the Sequencer.

Its effect is similar to the [INITiate<n>\[:IMMediate\]](#) command used for a single measurement.

Before this command can be executed, the Sequencer must be activated (see [SYSTem:SEQuencer](#) on page 244).

**Example:**                      SYST:SEQ ON  
                                     Activates the Sequencer.  
                                     INIT:SEQ:MODE SING  
                                     Sets single sequence mode so each active measurement is performed once.  
                                     INIT:SEQ:IMM  
                                     Starts the sequential measurements.

**INITiate:SEQuencer:MODE** <Mode>

Defines the capture mode for the entire measurement sequence and all measurement groups and channels it contains.

**Note:** To synchronize to the end of a measurement sequence using \*OPC, \*OPC? or \*WAI, use **SINGle** Sequencer mode.

**Parameters:**

&lt;Mode&gt;

**SINGle**

Each measurement group is started one after the other in the order of definition. All measurement channels in a group are started simultaneously and performed once. After *all* measurements are completed, the next group is started. After the last group, the measurement sequence is finished.

**CONTInuous**

Each measurement group is started one after the other in the order of definition. All measurement channels in a group are started simultaneously and performed once. After *all* measurements are completed, the next group is started. After the last group, the measurement sequence restarts with the first one and continues until it is stopped explicitly.

\*RST:       CONTInuous

**SYSTem:SEQuencer** <State>

Turns the Sequencer on and off. The Sequencer must be active before any other Sequencer commands (**INIT:SEQ...**) are executed, otherwise an error occurs.

**Parameters:**

&lt;State&gt;

ON | OFF | 0 | 1

**ON | 1**

The Sequencer is activated and a sequential measurement is started immediately.

**OFF | 0**

The Sequencer is deactivated. Any running sequential measurements are stopped. Further Sequencer commands (**INIT:SEQ...**) are not available.

\*RST:       0

**Example:**

```
SYST:SEQ ON
```

Activates the Sequencer.

```
INIT:SEQ:MODE SING
```

Sets single Sequencer mode so each active measurement is performed once.

```
INIT:SEQ:IMM
```

Starts the sequential measurements.

```
SYST:SEQ OFF
```

## 6.7 Remote commands to retrieve numeric results

• Result summary.....	245
• Combined measurements.....	261
• Time alignment error.....	271
• Marker table.....	271
• CCDF table.....	275

### 6.7.1 Result summary

FETCh[:CC<cc>][:ISRC<ant>][:FRAMe<fr>]:SUMMary:ALL?	246
FETCh[:CC<cc>][:ISRC<ant>]:SUMMary:CRESt[:AVERage]?	247
FETCh[:CC<cc>][:ISRC<ant>][:FRAMe<fr>]:SUMMary:BLER:MAXimum?	247
FETCh[:CC<cc>][:ISRC<ant>][:FRAMe<fr>]:SUMMary:BLER:MINimum?	247
FETCh[:CC<cc>][:ISRC<ant>][:FRAMe<fr>]:SUMMary:BLER[:AVERage]?	247
FETCh:ALL:SUMMary:EVM:ALL?	248
FETCh[:CC<cc>][:ISRC<ant>][:FRAMe<fr>]:SUMMary:EVM[:ALL]:MAXimum?	248
FETCh[:CC<cc>][:ISRC<ant>][:FRAMe<fr>]:SUMMary:EVM[:ALL]:MINimum?	248
FETCh[:CC<cc>][:ISRC<ant>][:FRAMe<fr>]:SUMMary:EVM[:ALL][:AVERage]?	248
FETCh:ALL:SUMMary:EVM:DS1K?	248
FETCh[:CC<cc>][:ISRC<ant>][:FRAMe<fr>]:SUMMary:EVM:DS1K:MAXimum?	248
FETCh[:CC<cc>][:ISRC<ant>][:FRAMe<fr>]:SUMMary:EVM:DS1K:MINimum?	249
FETCh[:CC<cc>][:ISRC<ant>][:FRAMe<fr>]:SUMMary:EVM:DS1K[:AVERage]?	249
FETCh:ALL:SUMMary:EVM:DSQP?	249
FETCh[:CC<cc>][:ISRC<ant>][:FRAMe<fr>]:SUMMary:EVM:DSQP:MAXimum?	249
FETCh[:CC<cc>][:ISRC<ant>][:FRAMe<fr>]:SUMMary:EVM:DSQP:MINimum?	249
FETCh[:CC<cc>][:ISRC<ant>][:FRAMe<fr>]:SUMMary:EVM:DSQP[:AVERage]?	249
FETCh:ALL:SUMMary:EVM:DSSF?	250
FETCh[:CC<cc>][:ISRC<ant>][:FRAMe<fr>]:SUMMary:EVM:DSSF:MAXimum?	250
FETCh[:CC<cc>][:ISRC<ant>][:FRAMe<fr>]:SUMMary:EVM:DSSF:MINimum?	250
FETCh[:CC<cc>][:ISRC<ant>][:FRAMe<fr>]:SUMMary:EVM:DSSF[:AVERage]?	250
FETCh:ALL:SUMMary:EVM:DSST?	251
FETCh[:CC<cc>][:ISRC<ant>][:FRAMe<fr>]:SUMMary:EVM:DSST:MAXimum?	251
FETCh[:CC<cc>][:ISRC<ant>][:FRAMe<fr>]:SUMMary:EVM:DSST:MINimum?	251
FETCh[:CC<cc>][:ISRC<ant>][:FRAMe<fr>]:SUMMary:EVM:DSST[:AVERage]?	251
FETCh:ALL:SUMMary:EVM:DSTS?	251
FETCh[:CC<cc>][:ISRC<ant>][:FRAMe<fr>]:SUMMary:EVM:DSTS:MAXimum?	251
FETCh[:CC<cc>][:ISRC<ant>][:FRAMe<fr>]:SUMMary:EVM:DSTS:MINimum?	251
FETCh[:CC<cc>][:ISRC<ant>][:FRAMe<fr>]:SUMMary:EVM:DSTS[:AVERage]?	251
FETCh:ALL:SUMMary:EVM:PCHannel?	252
FETCh[:CC<cc>][:ISRC<ant>][:FRAMe<fr>]:SUMMary:EVM:PCHannel:MAXimum?	252
FETCh[:CC<cc>][:ISRC<ant>][:FRAMe<fr>]:SUMMary:EVM:PCHannel:MINimum?	252
FETCh[:CC<cc>][:ISRC<ant>][:FRAMe<fr>]:SUMMary:EVM:PCHannel[:AVERage]?	252
FETCh:ALL:SUMMary:EVM:PEAK?	253
FETCh[:CC<cc>][:ISRC<ant>][:FRAMe<fr>]:SUMMary:EVM:PEAK:MAXimum?	253
FETCh[:CC<cc>][:ISRC<ant>][:FRAMe<fr>]:SUMMary:EVM:PEAK:MINimum?	253
FETCh[:CC<cc>][:ISRC<ant>][:FRAMe<fr>]:SUMMary:EVM:PEAK[:AVERage]?	253
FETCh:ALL:SUMMary:EVM:PSIGnal?	253

## Remote commands to retrieve numeric results

FETCh[:CC<cc>][:ISRC<ant>][:FRAMe<fr>]:SUMMary:EVM:PSIGnal:MAXimum?.....	253
FETCh[:CC<cc>][:ISRC<ant>][:FRAMe<fr>]:SUMMary:EVM:PSIGnal:MINimum?.....	253
FETCh[:CC<cc>][:ISRC<ant>][:FRAMe<fr>]:SUMMary:EVM:PSIGnal[:AVERage]?.....	253
FETCh[:CC<cc>][:ISRC<ant>][:FRAMe<fr>]:SUMMary:FERRor:MAXimum?.....	254
FETCh[:CC<cc>][:ISRC<ant>][:FRAMe<fr>]:SUMMary:FERRor:MINimum?.....	254
FETCh[:CC<cc>][:ISRC<ant>][:FRAMe<fr>]:SUMMary:FERRor[:AVERage]?.....	254
FETCh[:CC<cc>][:ISRC<ant>][:FRAMe<fr>]:SUMMary:GIMBalance:MAXimum?.....	255
FETCh[:CC<cc>][:ISRC<ant>][:FRAMe<fr>]:SUMMary:GIMBalance:MINimum?.....	255
FETCh[:CC<cc>][:ISRC<ant>][:FRAMe<fr>]:SUMMary:GIMBalance[:AVERage]?.....	255
FETCh[:CC<cc>][:ISRC<ant>][:FRAMe<fr>]:SUMMary:IQOFfset:MAXimum?.....	255
FETCh[:CC<cc>][:ISRC<ant>][:FRAMe<fr>]:SUMMary:IQOFfset:MINimum?.....	255
FETCh[:CC<cc>][:ISRC<ant>][:FRAMe<fr>]:SUMMary:IQOFfset[:AVERage]?.....	255
FETCh[:CC<cc>][:ISRC<ant>][:FRAMe<fr>]:SUMMary:OSTP:MAXimum?.....	256
FETCh[:CC<cc>][:ISRC<ant>][:FRAMe<fr>]:SUMMary:OSTP:MINimum?.....	256
FETCh[:CC<cc>][:ISRC<ant>][:FRAMe<fr>]:SUMMary:OSTP[:AVERage]?.....	256
FETCh:ALL:SUMMary:POWer?.....	256
FETCh[:CC<cc>][:ISRC<ant>][:FRAMe<fr>]:SUMMary:POWer:MAXimum?.....	256
FETCh[:CC<cc>][:ISRC<ant>][:FRAMe<fr>]:SUMMary:POWer:MINimum?.....	256
FETCh[:CC<cc>][:ISRC<ant>][:FRAMe<fr>]:SUMMary:POWer[:AVERage]?.....	256
FETCh[:CC<cc>][:ISRC<ant>][:FRAMe<fr>]:SUMMary:QUADerror:MAXimum?.....	257
FETCh[:CC<cc>][:ISRC<ant>][:FRAMe<fr>]:SUMMary:QUADerror:MINimum?.....	257
FETCh[:CC<cc>][:ISRC<ant>][:FRAMe<fr>]:SUMMary:QUADerror[:AVERage]?.....	257
FETCh[:CC<cc>][:ISRC<ant>][:FRAMe<fr>]:SUMMary:RSRP:CSI:MAXimum?.....	258
FETCh[:CC<cc>][:ISRC<ant>][:FRAMe<fr>]:SUMMary:RSRP:CSI:MINimum?.....	258
FETCh[:CC<cc>][:ISRC<ant>][:FRAMe<fr>]:SUMMary:RSRP:CSI[:AVERage]?.....	258
FETCh[:CC<cc>][:ISRC<ant>][:FRAMe<fr>]:SUMMary:RSRP:SS:MAXimum?.....	258
FETCh[:CC<cc>][:ISRC<ant>][:FRAMe<fr>]:SUMMary:RSRP:SS:MINimum?.....	258
FETCh[:CC<cc>][:ISRC<ant>][:FRAMe<fr>]:SUMMary:RSRP:SS[:AVERage]?.....	258
FETCh[:CC<cc>][:ISRC<ant>][:FRAMe<fr>]:SUMMary:RSTP:MAXimum?.....	259
FETCh[:CC<cc>][:ISRC<ant>][:FRAMe<fr>]:SUMMary:RSTP:MINimum?.....	259
FETCh[:CC<cc>][:ISRC<ant>][:FRAMe<fr>]:SUMMary:RSTP[:AVERage]?.....	259
FETCh[:CC<cc>][:ISRC<ant>][:FRAMe<fr>]:SUMMary:SERRor:MAXimum?.....	259
FETCh[:CC<cc>][:ISRC<ant>][:FRAMe<fr>]:SUMMary:SERRor:MINimum?.....	259
FETCh[:CC<cc>][:ISRC<ant>][:FRAMe<fr>]:SUMMary:SERRor[:AVERage]?.....	259
FETCh[:CC<cc>][:ISRC<ant>][:FRAMe<fr>]:SUMMary:TPUT:MAXimum?.....	260
FETCh[:CC<cc>][:ISRC<ant>][:FRAMe<fr>]:SUMMary:TPUT:MINimum?.....	260
FETCh[:CC<cc>][:ISRC<ant>][:FRAMe<fr>]:SUMMary:TPUT[:AVERage]?.....	260
FETCh[:CC<cc>][:ISRC<ant>][:FRAMe<fr>]:SUMMary:FOFFset?.....	260

**FETCh[:CC<cc>][:ISRC<ant>][:FRAMe<fr>]:SUMMary:ALL?**

Queries all results in the numerical result summary.

**Suffix:**

<cc>	Component Carrier
<ant>	irrelevant
<fr>	Frame

**Return values:**

<Result> String containing all results in the following format.  
 <ResultType>, <AverageResult>, <MaximumResult>,  
 <MinimumResult>  
 If a result has not been calculated, the command returns NAN.

**Example:**

```
//Query all numerical results
FETC:SUMM:ALL?
would return, e.g.
EVM PDSCH QPSK,
+2.695721388E-001, +2.695721388E-001,
+2.695721388E-001,
EVM PDSCH 16QAM, NAN, NAN, NAN,
...
```

**Usage:** Query only

**Manual operation:** See "[Remote queries](#)" on page 26

**FETCh[:CC<cc>][:ISRC<ant>]:SUMMary:CRESt[:AVERAge]?**

Queries the average crest factor as shown in the result summary.

**Suffix:**

<cc> [Component Carrier](#)  
 <ant> irrelevant

**Return values:**

<CrestFactor> Default unit: dB

**Example:**

```
//Query crest factor
FETC:SUMM:CRES?
```

**Usage:** Query only

**Manual operation:** See "[Crest Factor](#)" on page 29

**FETCh[:CC<cc>][:ISRC<ant>][:FRAMe<fr>]:SUMMary:BLER:MAXimum?****FETCh[:CC<cc>][:ISRC<ant>][:FRAMe<fr>]:SUMMary:BLER:MINimum?****FETCh[:CC<cc>][:ISRC<ant>][:FRAMe<fr>]:SUMMary:BLER[:AVERAge]?**

Queries the EVM of all resource elements.

Prerequisites for this command

- Turn on throughput measurement ([\[SENSe:\]NR5G:TRACking:TPUT:STATe](#)).
- Turn on BLER measurement ([DISPlay\[:WINDow<n>\]:TABLe:ITEM](#)).

**Suffix:**

<cc> [Component Carrier](#)  
 <ant> irrelevant  
 <fr> [Frame](#)

**Return values:**

<BLER> Default unit: PCT

**Example:**

```
//Query BLER
NR5G:TRAC:TPUT:STAT ON
DISP:TABL:ITEM BLER,ON
FETC:CC2:FRAM3:SUMM:BLER?
```

**Usage:**

Query only

**Manual operation:** See "BLER (%)" on page 26

**FETCh:ALL:SUMMary:EVM:ALL?** <Result>

**FETCh[:CC<cc>][:ISRC<ant>][:FRAMe<fr>]:SUMMary:EVM[:ALL]:MAXimum?**  
[<Result>]

**FETCh[:CC<cc>][:ISRC<ant>][:FRAMe<fr>]:SUMMary:EVM[:ALL]:MINimum?**  
[<Result>]

**FETCh[:CC<cc>][:ISRC<ant>][:FRAMe<fr>]:SUMMary:EVM[:ALL][:AVERage]?**  
[<Result>]

Queries the EVM of all resource elements.

FETCh:ALL:SUMMary:EVM:ALL queries the average result over all carriers. Prerequisites:

- Select to evaluate all carriers ([SENSe:]NR5G:RSUMmary:CCResult).

**Suffix:**

<cc> [Component Carrier](#)

<ant> irrelevant

<fr> [Frame](#)

**Query parameters:**

<Result> ALL

Available for combined measurements.

Queries the EVM of all events (meas IDs).

Omitting this parameter queries the EVM of the selected event.

**Return values:**

<EVM> EVM in % or dB.

**Example:**

```
//Query EVM
FETC:CC2:FRAM3:SUMM:EVM?
```

**Usage:**

Query only

**Manual operation:** See "EVM All" on page 27

**FETCh:ALL:SUMMary:EVM:DS1K?** <Result>

**FETCh[:CC<cc>][:ISRC<ant>][:FRAMe<fr>]:SUMMary:EVM:DS1K:MAXimum?**  
[<Result>]



**FETCh[:CC<cc>][:ISRC<ant>][:FRAMe<fr>]:SUMMary:EVM:DS1K:MINimum?**  
 [<Result>]

**FETCh[:CC<cc>][:ISRC<ant>][:FRAMe<fr>]:SUMMary:EVM:DS1K[:AVERage]?**  
 [<Result>]

Queries the EVM of all PDSCH resource elements with a 1024QAM modulation.

FETCh:ALL:SUMMary:EVM:DS1K queries the average result over all carriers. Prerequisites:

- Select to evaluate all carriers ([\[SENSe:\]NR5G:RSUMmary:CCResult](#)).

**Suffix:**

<cc> [Component Carrier](#)

<ant> irrelevant

<fr> [Frame](#)

**Query parameters:**

<Result> ALL

Available for combined measurements.

Queries the EVM of all events (meas IDs).

Omitting this parameter queries the EVM of the selected event.

**Return values:**

<EVM> EVM in % or dB.

**Example:**

//Query EVM

FETC:CC2:FRAM3:SUMM:EVM:DS1K?

**Usage:**

Query only

**Manual operation:** See "[EVM PDSCH](#)" on page 26

**FETCh:ALL:SUMMary:EVM:DSQP? <Result>**

**FETCh[:CC<cc>][:ISRC<ant>][:FRAMe<fr>]:SUMMary:EVM:DSQP:MAXimum?**  
 [<Result>]

**FETCh[:CC<cc>][:ISRC<ant>][:FRAMe<fr>]:SUMMary:EVM:DSQP:MINimum?**  
 [<Result>]

**FETCh[:CC<cc>][:ISRC<ant>][:FRAMe<fr>]:SUMMary:EVM:DSQP[:AVERage]?**  
 [<Result>]

Queries the EVM of all PDSCH resource elements with a QPSK modulation.

FETCh:ALL:SUMMary:EVM:DSQP queries the average result over all carriers. Prerequisites:

- Select to evaluate all carriers ([\[SENSe:\]NR5G:RSUMmary:CCResult](#)).

**Suffix:**

<cc> [Component Carrier](#)

<ant> irrelevant

<fr> [Frame](#)

**Query parameters:**

<Result> ALL  
 Available for combined measurements.  
 Queries the EVM of all events (meas IDs).  
 Omitting this parameter queries the EVM of the selected event.

**Return values:**

<EVM> EVM in % or dB.

**Example:**

```
//Query EVM
FETC:CC2:FRAM3:SUMM:EVM:DSQP?
```

**Usage:**

Query only

**Manual operation:** See "EVM PDSCH" on page 26

**FETCh:ALL:SUMMary:EVM:DSSF? <Result>**

**FETCh[:CC<cc>][:ISRC<ant>][:FRAMe<fr>]:SUMMary:EVM:DSSF:MAXimum?**  
 [<Result>]

**FETCh[:CC<cc>][:ISRC<ant>][:FRAMe<fr>]:SUMMary:EVM:DSSF:MINimum?**  
 [<Result>]

**FETCh[:CC<cc>][:ISRC<ant>][:FRAMe<fr>]:SUMMary:EVM:DSSF[:AVERage]?**  
 [<Result>]

Queries the EVM of all PDSCH resource elements with a 64QAM modulation.

FETCh:ALL:SUMMary:EVM:DSSF queries the average result over all carriers. Prerequisites:

- Select to evaluate all carriers ([SENSe:]NR5G:RSUMmary:CCResult).

**Suffix:**

<cc> [Component Carrier](#)

<ant> irrelevant

<fr> [Frame](#)

**Query parameters:**

<Result> ALL  
 Available for combined measurements.  
 Queries the EVM of all events (meas IDs).  
 Omitting this parameter queries the EVM of the selected event.

**Return values:**

<EVM> EVM in % or dB.

**Example:**

```
//Query EVM
FETC:CC2:FRAM3:SUMM:EVM:DSSF?
```

**Usage:**

Query only

**Manual operation:** See "EVM PDSCH" on page 26

---

```

FETCh:ALL:SUMMary:EVM:DSST? <Result>
FETCh[:CC<cc>][:ISRC<ant>][:FRAMe<fr>]:SUMMary:EVM:DSST:MAXimum?
  [<Result>]
FETCh[:CC<cc>][:ISRC<ant>][:FRAMe<fr>]:SUMMary:EVM:DSST:MINimum?
  [<Result>]
FETCh[:CC<cc>][:ISRC<ant>][:FRAMe<fr>]:SUMMary:EVM:DSST[:AVERage]?
  [<Result>]

```

Queries the EVM of all PDSCH resource elements with a 16QAM modulation.

FETCh:ALL:SUMMary:EVM:DSST queries the average result over all carriers. Prerequisites:

- Select to evaluate all carriers ( [SENSe:]NR5G:RSUMmary:CCResult).

**Suffix:**

<cc>                    [Component Carrier](#)

<ant>                    irrelevant

<fr>                     [Frame](#)

**Query parameters:**

<Result>                ALL  
 Available for combined measurements.  
 Queries the EVM of all events (meas IDs).  
 Omitting this parameter queries the EVM of the selected event.

**Return values:**

<EVM>                    EVM in % or dB.

**Example:**                //Query EVM  
 FETC:CC2:FRAM3:SUMM:EVM:DSST?

**Usage:**                    Query only

**Manual operation:**    See "[EVM PDSCH](#)" on page 26

---

```

FETCh:ALL:SUMMary:EVM:DSTS? <Result>
FETCh[:CC<cc>][:ISRC<ant>][:FRAMe<fr>]:SUMMary:EVM:DSTS:MAXimum?
  [<Result>]
FETCh[:CC<cc>][:ISRC<ant>][:FRAMe<fr>]:SUMMary:EVM:DSTS:MINimum?
  [<Result>]
FETCh[:CC<cc>][:ISRC<ant>][:FRAMe<fr>]:SUMMary:EVM:DSTS[:AVERage]?
  [<Result>]

```

Queries the EVM of all PDSCH resource elements with a 256QAM modulation.

FETCh:ALL:SUMMary:EVM:DSTS queries the average result over all carriers. Prerequisites:

- Select to evaluate all carriers ( [SENSe:]NR5G:RSUMmary:CCResult).

**Suffix:**

<cc>                    [Component Carrier](#)

<ant>                    irrelevant

<fr> [Frame](#)

**Query parameters:**

<Result> ALL  
Available for combined measurements.  
Queries the EVM of all events (meas IDs).  
Omitting this parameter queries the EVM of the selected event.

**Return values:**

<EVM> EVM in % or dB.

**Example:**

```
//Query EVM
FETC:CC2:FRAM3:SUMM:EVM:DSTS?
```

**Usage:** Query only

**Manual operation:** See "[EVM PDSCH](#)" on page 26

```
FETCh:ALL:SUMMary:EVM:PCHannel? <Result>
FETCh[:CC<cc>][:ISRC<ant>][:FRAMe<fr>]:SUMMary:EVM:PCHannel:
  MAXimum? [<Result>]
FETCh[:CC<cc>][:ISRC<ant>][:FRAMe<fr>]:SUMMary:EVM:PCHannel:MINimum?
  [<Result>]
FETCh[:CC<cc>][:ISRC<ant>][:FRAMe<fr>]:SUMMary:EVM:PCHannel[:
  AVERage]? [<Result>]
```

Queries the EVM of the physical channel.

FETCh:ALL:SUMMary:EVM:PCHannel queries the average result over all carriers.

Prerequisites:

- Select to evaluate all carriers ([\[SENSe:\]NR5G:RSUMmary:CCResult](#)).

**Suffix:**

<cc> [Component Carrier](#)

<ant> irrelevant

<fr> [Frame](#)

**Query parameters:**

<Result> ALL  
Available for combined measurements.  
Queries the EVM of all events (meas IDs).  
Omitting this parameter queries the EVM of the selected event.

**Return values:**

<EVM> EVM in % or dB.

**Example:**

```
//Query EVM
FETC:CC2:FRAM3:SUMM:EVM:PCH?
```

**Usage:** Query only

**Manual operation:** See "[EVM Phys Channel](#)" on page 28

---

```

FETCh:ALL:SUMMary:EVM:PEAK? <Result>
FETCh[:CC<cc>][:ISRC<ant>][:FRAMe<fr>]:SUMMary:EVM:PEAK:MAXimum?
  [<Result>]
FETCh[:CC<cc>][:ISRC<ant>][:FRAMe<fr>]:SUMMary:EVM:PEAK:MINimum?
  [<Result>]
FETCh[:CC<cc>][:ISRC<ant>][:FRAMe<fr>]:SUMMary:EVM:PEAK[:AVERage]?
  [<Result>]

```

Queries the peak EVM.

FETCh:ALL:SUMMary:EVM:PEAK queries the average result over all carriers. Prerequisites:

- Select to evaluate all carriers ( [SENSe:]NR5G:RSUMmary:CCResult).

**Suffix:**

<cc>                      [Component Carrier](#)

<ant>                     irrelevant

<fr>                      [Frame](#)

**Query parameters:**

<Result>                ALL  
 Available for combined measurements.  
 Queries the EVM of all events (meas IDs).  
 Omitting this parameter queries the EVM of the selected event.

**Return values:**

<EVM>                    EVM in % or dB.

**Example:**              //Query peak EVM  
 FETC:CC2:FRAM3:SUMM:EVM:PEAK?

**Usage:**                Query only

**Manual operation:**   See "[EVM Peak](#)" on page 27

---

```

FETCh:ALL:SUMMary:EVM:PSIGnal? <Result>
FETCh[:CC<cc>][:ISRC<ant>][:FRAMe<fr>]:SUMMary:EVM:PSIGnal:MAXimum?
  [<Result>]
FETCh[:CC<cc>][:ISRC<ant>][:FRAMe<fr>]:SUMMary:EVM:PSIGnal:MINimum?
  [<Result>]
FETCh[:CC<cc>][:ISRC<ant>][:FRAMe<fr>]:SUMMary:EVM:PSIGnal[:AVERage]?
  [<Result>]

```

Queries the EVM of the physical signal.

FETCh:ALL:SUMMary:EVM:PSIGnal queries the average result over all carriers. Prerequisites:

- Select to evaluate all carriers ( [SENSe:]NR5G:RSUMmary:CCResult).

**Suffix:**

<cc>                      [Component Carrier](#)

<ant>                     irrelevant

<fr> [Frame](#)

**Query parameters:**

<Result> ALL  
 Available for combined measurements.  
 Queries the EVM of all events (meas IDs).  
 Omitting this parameter queries the EVM of the selected event.

**Return values:**

<EVM> EVM in % or dB.

**Example:**

```
//Query EVM
FETC:CC2:FRAM3:SUMM:EVM:PSIG?
```

**Usage:**

Query only

**FETCh[:CC<cc>][:ISRC<ant>][:FRAMe<fr>]:SUMMary:FERRor:MAXimum?**  
 [<Result>]

**FETCh[:CC<cc>][:ISRC<ant>][:FRAMe<fr>]:SUMMary:FERRor:MINimum?**  
 [<Result>]

**FETCh[:CC<cc>][:ISRC<ant>][:FRAMe<fr>]:SUMMary:FERRor[:AVERage]?**  
 [<Result>]

Queries the frequency error.

**Suffix:**

<cc> [Component Carrier](#)

<ant> irrelevant

<fr> [Frame](#)

**Query parameters:**

<Result> ALL  
 Available for combined measurements.  
 Queries the frequency error of all events (meas IDs).  
 Omitting this parameter queries the frequency error of the selected event.

**Return values:**

<FrequencyError> Default unit: Hz

**Example:**

```
//Query frequency error
FETC:CC2:FRAM3:SUMM:FERR?
```

**Usage:**

Query only

**Manual operation:** See "[Frequency Error](#)" on page 28

---

```
FETCh[:CC<cc>][:ISRC<ant>][:FRAMe<fr>]:SUMMary:GIMBalance:MAXimum?
  [<Result>]
```

```
FETCh[:CC<cc>][:ISRC<ant>][:FRAMe<fr>]:SUMMary:GIMBalance:MINimum?
  [<Result>]
```

```
FETCh[:CC<cc>][:ISRC<ant>][:FRAMe<fr>]:SUMMary:GIMBalance[:AVERage]?
  [<Result>]
```

Queries the gain imbalance.

**Suffix:**

<cc>                    [Component Carrier](#)

<ant>                    irrelevant

<fr>                     [Frame](#)

**Query parameters:**

<Result>                ALL  
 Available for combined measurements.  
 Queries the gain imbalance of all events (meas IDs).  
 Omitting this parameter queries the gain imbalance of the  
 selected event.

**Return values:**

<GainImbalance>        Default unit: dB

**Example:**             //Query gain imbalance  
 FETC:CC2:FRAM3:SUMM:GIMB?

**Usage:**                Query only

**Manual operation:**   See "[I/Q Gain Imbalance](#)" on page 29

---

```
FETCh[:CC<cc>][:ISRC<ant>][:FRAMe<fr>]:SUMMary:IQOFfset:MAXimum?
  [<Result>]
```

```
FETCh[:CC<cc>][:ISRC<ant>][:FRAMe<fr>]:SUMMary:IQOFfset:MINimum?
  [<Result>]
```

```
FETCh[:CC<cc>][:ISRC<ant>][:FRAMe<fr>]:SUMMary:IQOFfset[:AVERage]?
  [<Result>]
```

Queries the I/Q offset.

**Suffix:**

<cc>                    [Component Carrier](#)

<ant>                    irrelevant

<fr>                     [Frame](#)

**Query parameters:**

<Result>                ALL  
 Available for combined measurements.  
 Queries the I/Q offset of all events (meas IDs).  
 Omitting this parameter queries the I/Q offset of the selected  
 event.

**Return values:**

<IQOffset> Default unit: dB

**Example:**

```
//Query I/Q offset
FETC:CC2:FRAM3:SUMM:IQOF?
```

**Usage:**

Query only

**Manual operation:** See "[I/Q Offset](#)" on page 29

```
FETCh[:CC<cc>][:ISRC<ant>][:FRAMe<fr>]:SUMMary:OSTP:MAXimum?
```

[<Result>]

```
FETCh[:CC<cc>][:ISRC<ant>][:FRAMe<fr>]:SUMMary:OSTP:MINimum?
```

[<Result>]

```
FETCh[:CC<cc>][:ISRC<ant>][:FRAMe<fr>]:SUMMary:OSTP[:AVERage]?
```

[<Result>]

Queries the OSTP.

**Suffix:**

<cc> [Component Carrier](#)

<ant> irrelevant

<fr> [Frame](#)

**Query parameters:**

<Result> ALL

Available for combined measurements.

Queries the OSTP of all events (meas IDs).

Omitting this parameter queries the OSTP of the selected event.

**Return values:**

<OSTP> Default unit: dBm

**Example:**

```
//Query OSTP
FETC:CC2:FRAM3:SUMM:OSTP?
```

**Usage:**

Query only

**Manual operation:** See "[OSTP](#)" on page 29

```
FETCh:ALL:SUMMary:POWer? <Result>
```

```
FETCh[:CC<cc>][:ISRC<ant>][:FRAMe<fr>]:SUMMary:POWer:MAXimum?
```

[<Result>]

```
FETCh[:CC<cc>][:ISRC<ant>][:FRAMe<fr>]:SUMMary:POWer:MINimum?
```

[<Result>]

```
FETCh[:CC<cc>][:ISRC<ant>][:FRAMe<fr>]:SUMMary:POWer[:AVERage]?
```

[<Result>]

Queries the total signal power.

FETCh:ALL:SUMMary:POWer queries the average result over all carriers. Prerequisites:

- Select to evaluate all carriers ([\[SENSe:\]NR5G:RSUMmary:CCResult](#)).



**Suffix:**

<cc> [Component Carrier](#)

<ant> irrelevant

<fr> [Frame](#)

**Query parameters:**

<Result> ALL  
Available for combined measurements.  
Queries the total power of all events (meas IDs).  
Omitting this parameter queries the total power of the selected event.

**Return values:**

<Power> Default unit: dBm

**Example:** //Query signal power  
FETC:CC2:FRAM3:SUMM:POW?

**Usage:** Query only

**Manual operation:** See "[Power](#)" on page 28

**FETCh[:CC<cc>][:ISRC<ant>][:FRAMe<fr>]:SUMMary:QUADerror:MAXimum?**  
[<Result>]

**FETCh[:CC<cc>][:ISRC<ant>][:FRAMe<fr>]:SUMMary:QUADerror:MINimum?**  
[<Result>]

**FETCh[:CC<cc>][:ISRC<ant>][:FRAMe<fr>]:SUMMary:QUADerror[:AVERage]?**  
[<Result>]

Queries the quadrature error.

**Suffix:**

<cc> [Component Carrier](#)

<ant> irrelevant

<fr> [Frame](#)

**Query parameters:**

<Result> ALL  
Available for combined measurements.  
Queries the quadrature error of all events (meas IDs).  
Omitting this parameter queries the quadrature error of the selected event.

**Return values:**

<QuadratureError> Default unit: DEG

**Example:** //Query quadrature error  
FETC:CC2:FRAM3:SUMM:QUAD?

**Usage:** Query only

---

**FETCh[:CC<cc>][:ISRC<ant>][:FRAMe<fr>]:SUMMary:RSRP:CSI:MAXimum?**  
[<Result>]

**FETCh[:CC<cc>][:ISRC<ant>][:FRAMe<fr>]:SUMMary:RSRP:CSI:MINimum?**  
[<Result>]

**FETCh[:CC<cc>][:ISRC<ant>][:FRAMe<fr>]:SUMMary:RSRP:CSI[:AVERage]?**  
[<Result>]

Queries the CSI-RSRP.

**Suffix:**

<cc> [Component Carrier](#)

<ant> irrelevant

<fr> [Frame](#)

**Query parameters:**

<Result> ALL  
Available for combined measurements.  
Queries the CSI-RSRP of all events (meas IDs).  
Omitting this parameter queries the CSI-RSRP of the selected event.

**Return values:**

<EVM> Default unit: dBm

**Example:** //Query CSI-RSRP  
FETC:CC2:FRAM3:SUMM:RSRP:CSI?

**Usage:** Query only

**Manual operation:** See "[RSRP](#)" on page 30

---

**FETCh[:CC<cc>][:ISRC<ant>][:FRAMe<fr>]:SUMMary:RSRP:SS:MAXimum?**  
[<Result>]

**FETCh[:CC<cc>][:ISRC<ant>][:FRAMe<fr>]:SUMMary:RSRP:SS:MINimum?**  
[<Result>]

**FETCh[:CC<cc>][:ISRC<ant>][:FRAMe<fr>]:SUMMary:RSRP:SS[:AVERage]?**  
[<Result>]

Queries the SS-RSRP.

**Suffix:**

<cc> [Component Carrier](#)

<ant> irrelevant

<fr> [Frame](#)

**Query parameters:**

<Result> ALL  
Available for combined measurements.  
Queries the SS-RSRP of all events (meas IDs).  
Omitting this parameter queries the SS-RSRP of the selected event.

**Return values:**

<EVM> Default unit: dBm

**Example:**

```
//Query SS-RSRP
FETC:CC2:FRAM3:SUMM:RSRP:SS?
```

**Usage:**

Query only

**Manual operation:** See "[RSRP](#)" on page 30

**FETCh[:CC<cc>][:ISRC<ant>][:FRAMe<fr>]:SUMMary:RSTP:MAXimum?**

[<Result>]

**FETCh[:CC<cc>][:ISRC<ant>][:FRAMe<fr>]:SUMMary:RSTP:MINimum?** [<Result>]

**FETCh[:CC<cc>][:ISRC<ant>][:FRAMe<fr>]:SUMMary:RSTP[:AVERage]?**

[<Result>]

Queries the RSTP.

**Suffix:**

<cc> [Component Carrier](#)

<ant> irrelevant

<fr> [Frame](#)

**Query parameters:**

<Result> ALL

Available for combined measurements.

Queries the RSTP of all events (meas IDs).

Omitting this parameter queries the RSTP of the selected event.

**Return values:**

<RSTP> Default unit: dBm

**Example:**

```
//Query RSTP
FETC:CC2:FRAM3:SUMM:RSTP?
```

**Usage:**

Query only

**Manual operation:** See "[RSTP](#)" on page 29

**FETCh[:CC<cc>][:ISRC<ant>][:FRAMe<fr>]:SUMMary:SERRor:MAXimum?**

[<Result>]

**FETCh[:CC<cc>][:ISRC<ant>][:FRAMe<fr>]:SUMMary:SERRor:MINimum?**

[<Result>]

**FETCh[:CC<cc>][:ISRC<ant>][:FRAMe<fr>]:SUMMary:SERRor[:AVERage]?**

[<Result>]

Queries the sampling error.

**Suffix:**

<cc> [Component Carrier](#)

<ant> irrelevant

<fr> [Frame](#)

**Query parameters:**

<Result> ALL  
 Available for combined measurements.  
 Queries the sampling error of all events (meas IDs).  
 Omitting this parameter queries the sampling error of the selected event.

**Return values:**

<SamplingError> Default unit: ppm

**Example:**

```
//Query sampling error
FETC:CC2:FRAM3:SUMM:SERR?
```

**Usage:**

Query only

**Manual operation:** See "[Sampling Error](#)" on page 28

```
FETCh[:CC<cc>][:ISRC<ant>][:FRAMe<fr>]:SUMMary:TPUT:MAXimum?
FETCh[:CC<cc>][:ISRC<ant>][:FRAMe<fr>]:SUMMary:TPUT:MINimum?
FETCh[:CC<cc>][:ISRC<ant>][:FRAMe<fr>]:SUMMary:TPUT[:AVERage]?
```

Queries the EVM of all resource elements.

Prerequisites for this command

- Turn on throughput measurement ([\[SENSe:\]NR5G:TRACking:TPUT:STATe](#)).

**Suffix:**

<cc> [Component Carrier](#)  
 <ant> irrelevant  
 <fr> [Frame](#)

**Return values:**

<TPUT> Default unit: PCT

**Example:**

```
//Query BLER
NR5G:TRAC:TPUT:STAT ON
FETC:CC2:FRAM3:SUMM:TPUT?
```

**Usage:**

Query only

**Manual operation:** See "[TPUT \(%\)](#)" on page 27

```
FETCh[:CC<cc>][:ISRC<ant>][:FRAMe<fr>]:SUMMary:FOFFset? [<Result>]
```

Queries the frequency offset of a component carrier evaluated during an event.

Available for combined multi-carrier measurements.

**Suffix:**

<cc> [Component Carrier](#)  
 <ant> irrelevant  
 <fr> [Frame](#)

**Query parameters:**

<Result> ALL  
 Available for combined measurements.  
 Queries the frequency offset of component carriers of all events (meas IDs).  
 Omitting this parameter queries the frequency offset of a component carrier in the selected event.

**Return values:**

<Frequency> Default unit: Hz

**Example:**

```
//Query frequency offset of a component carrier
FETC:CC2:FRAM3:SUMM:FOFF?
```

**Usage:**

Query only

**Manual operation:**

See "[Frame Start Offset](#)" on page 27  
 See "[Capture Buffer](#)" on page 31  
 See "[Frequency Offset](#)" on page 65

## 6.7.2 Combined measurements

The following commands are exclusive to combined measurements to query results available in the result summary of combined measurements.

Commands to query combined measurement results described elsewhere.

- [Chapter 6.7.1, "Result summary"](#), on page 245
- [Chapter 6.9, "Retrieve trace data"](#), on page 290
- [Chapter 6.8, "Limit check results"](#), on page 276

---

```
FETCh[:CC<cc>][:ISRC<ant>][:FRAMe<fr>]:SUMMary:AAPFail? [<Result>]
```

Queries the absolute ACLR limit check of an event.

**Suffix:**

<cc> [Component Carrier](#)  
 <ant> irrelevant  
 <fr> [Frame](#)

**Query parameters:**

<Result> ALL  
 Available for combined measurements.  
 Queries the ACLR limit check of all events (meas IDs).  
 Omitting this parameter queries the ACLR limit check of the selected event.

**Return values:**

<State> 0 | 1

**Example:**

```
//Query absolute ACLR limit check
FETC:CC2:FRAM3:SUMM:AAPF?
```

**Usage:** Query only  
**Manual operation:** See "ACLR Pass / Fail" on page 65

---

**FETCh[:CC<cc>][:ISRC<ant>][:FRAMe<fr>]:SUMMary:APFail? [<Result>]**

Queries the overall ACLR limit check of an event (absolute and relative). If one limit check passes (abs. or rel.), the overall limit check passes as well.

**Suffix:**

<cc> [Component Carrier](#)  
 <ant> irrelevant  
 <fr> [Frame](#)

**Query parameters:**

<Result> ALL  
 Available for combined measurements.  
 Queries the ACLR limit check of all events (meas IDs).  
 Omitting this parameter queries the ACLR limit check of the selected event.

**Return values:**

<State> 0 | 1

**Example:** //Query ACLR limit check  
 FETC:CC2:FRAM3:SUMM:APF?

**Usage:** Query only  
**Manual operation:** See "ACLR Pass / Fail" on page 65

---

**FETCh[:CC<cc>][:ISRC<ant>][:FRAMe<fr>]:SUMMary:ARPFail? [<Result>]**

Queries the relative ACLR limit check of an event.

**Suffix:**

<cc> [Component Carrier](#)  
 <ant> irrelevant  
 <fr> [Frame](#)

**Query parameters:**

<Result> ALL  
 Available for combined measurements.  
 Queries the ACLR limit check of all events (meas IDs).  
 Omitting this parameter queries the ACLR limit check of the selected event.

**Return values:**

<State> 0 | 1

**Example:** //Query relative ACLR limit check  
 FETC:CC2:FRAM3:SUMM:ARPF?

**Usage:** Query only  
**Manual operation:** See "ACLR Pass / Fail" on page 65

**FETCh[:CC<cc>][:ISRC<ant>][:FRAMe<fr>]:SUMMary:CAPFail?** [<Result>]

Queries the absolute cumulative ACLR limit check of an event.

Available for combined multi-carrier measurements.

**Suffix:**

<cc> [Component Carrier](#)

<ant> irrelevant

<fr> [Frame](#)

**Query parameters:**

<Result> ALL  
 Available for combined measurements.  
 Queries the cumulative ACLR limit check of all events (meas IDs).  
 Omitting this parameter queries the cumulative ACLR limit check of the selected event.

**Return values:**

<State> 0 | 1

**Example:** //Query absolute cumulative ACLR limit check  
 FETC:CC2:FRAM3:SUMM:CAPF?

**Usage:** Query only

**Manual operation:** See "ACLR Pass / Fail" on page 65

**FETCh[:CC<cc>][:ISRC<ant>][:FRAMe<fr>]:SUMMary:CFRequency?** [<Result>]

Queries the center frequency of a component carrier evaluated during an event.

Available for combined multi-carrier measurements.

**Suffix:**

<cc> [Component Carrier](#)

<ant> irrelevant

<fr> [Frame](#)

**Query parameters:**

<Result> ALL  
 Available for combined measurements.  
 Queries the center frequency of component carriers of all events (meas IDs).  
 Omitting this parameter queries the center frequency of a component carrier in the selected event.

**Return values:**

<State> Default unit: Hz

**Example:**

//Query center frequency of a component carrier  
FETC:CC2:FRAM3:SUMM:FOFF?

**Usage:**

Query only

**Manual operation:** See "[Center Frequency](#)" on page 65

**FETCh[:CC<cc>][:ISRC<ant>][:FRAMe<fr>]:SUMMary:CPFail? [<Result>]**

Queries the overall cumulative ACLR limit check of an event (absolute and relative). If one limit check passes (abs. or rel.), the overall limit check passes as well.

Available for combined multi-carrier measurements.

**Suffix:**

<cc> [Component Carrier](#)

<ant> irrelevant

<fr> [Frame](#)

**Query parameters:**

<Result> ALL

Available for combined measurements.

Queries the cumulative ACLR limit check of all events (meas IDs).

Omitting this parameter queries the cumulative ACLR limit check of the selected event.

**Return values:**

<State> 0 | 1

**Example:**

//Query cumulative ACLR limit check  
FETC:CC2:FRAM3:SUMM:CPF?

**Usage:**

Query only

**Manual operation:** See "[ACLR Pass / Fail](#)" on page 65

**FETCh[:CC<cc>][:ISRC<ant>][:FRAMe<fr>]:SUMMary:CRPFail? [<Result>]**

Queries the relative cumulative ACLR limit check of an event.

Available for combined multi-carrier measurements.

**Suffix:**

<cc> [Component Carrier](#)

<ant> irrelevant

<fr> [Frame](#)



**Query parameters:**

<Result> ALL  
 Available for combined measurements.  
 Queries the cumulative ACLR limit check of all events (meas IDs).  
 Omitting this parameter queries the cumulative ACLR limit check of the selected event.

**Return values:**

<State> 0 | 1

**Example:**

```
//Query relative cumulative ACLR limit check
FETC:CC2:FRAM3:SUMM:CRPF?
```

**Usage:**

Query only

**Manual operation:** See "[ACLR Pass / Fail](#)" on page 65

**FETCh[:CC<cc>][:ISRC<ant>][:FRAMe<fr>]:SUMMary:EAACcs? [<Result>]**

Queries the average EVM of all component carriers evaluated during an event.

Available for combined multi-carrier measurements.

**Suffix:**

<cc> [Component Carrier](#)

<ant> irrelevant

<fr> [Frame](#)

**Query parameters:**

<Result> ALL  
 Available for combined measurements.  
 Queries the EVM of all events (meas IDs).  
 Omitting this parameter queries the average EVM of the selected event.

**Return values:**

<AverageEVM> EVM in % or dB.

**Example:**

```
//Query average EVM over all component carriers analyzed in
an event
FETC:CC2:FRAM3:SUMM:EAAC?
```

**Usage:**

Query only

**Manual operation:** See "[EVM All CCs](#)" on page 65

**FETCh[:CC<cc>][:ISRC<ant>][:FRAMe<fr>]:SUMMary:MAPFail? [<Result>]**

Queries the absolute MC ACLR limit check of an event.

Available for combined multi-carrier measurements.

**Suffix:**

<cc> [Component Carrier](#)

<ant> irrelevant

<fr> [Frame](#)

**Query parameters:**

<Result> ALL  
Available for combined measurements.  
Queries the MC ACLR limit check of all events (meas IDs).  
Omitting this parameter queries the MC ACLR limit check of the selected event.

**Return values:**

<State> 0 | 1

**Example:** //Query absolute MC ACLR limit check  
FETC:CC2:FRAM3:SUMM:MAPF?

**Usage:** Query only

**Manual operation:** See "[ACLR Pass / Fail](#)" on page 65

**FETCh[:CC<cc>][:ISRC<ant>][:FRAMe<fr>]:SUMMary:MCPFail? [<Result>]**

Queries the overall MC ACLR limit check of an event (absolute and relative). If one limit check passes (abs. or rel.), the overall limit check passes as well.

Available for combined multi-carrier measurements.

**Suffix:**

<cc> [Component Carrier](#)

<ant> irrelevant

<fr> [Frame](#)

**Query parameters:**

<Result> ALL  
Available for combined measurements.  
Queries the MC ACLR limit check of all events (meas IDs).  
Omitting this parameter queries the MC ACLR limit check of the selected event.

**Return values:**

<State> 0 | 1

**Example:** //Query MC ACLR limit check  
FETC:CC2:FRAM3:SUMM:MCPF?

**Usage:** Query only

**Manual operation:** See "[ACLR Pass / Fail](#)" on page 65

---

**FETCh[:CC<cc>][:ISRC<ant>][:FRAMe<fr>]:SUMMArY:MRPFail? [<Result>]**

Queries the relative MC ACLR limit check of an event.

Available for combined multi-carrier measurements.

**Suffix:**

<cc> [Component Carrier](#)

<ant> irrelevant

<fr> [Frame](#)

**Query parameters:**

<Result> ALL

Available for combined measurements.

Queries the MC ACLR limit check of all events (meas IDs).

Omitting this parameter queries the MC ACLR limit check of the selected event.

**Return values:**

<State> 0 | 1

**Example:**

```
//Query relative MC ACLR limit check
FETC:CC2:FRAM3:SUMM:MRPF?
```

**Usage:**

Query only

**Manual operation:**

See "[ACLR Pass / Fail](#)" on page 65

---

**FETCh[:CC<cc>][:ISRC<ant>][:FRAMe<fr>]:SUMMArY:MSPFfail? [<Result>]**

Queries the MC SEM limit check of an event.

Available for combined multi-carrier measurements.

**Suffix:**

<cc> [Component Carrier](#)

<ant> irrelevant

<fr> [Frame](#)

**Query parameters:**

<Result> ALL

Available for combined measurements.

Queries the MC SEM limit check of all events (meas IDs).

Omitting this parameter queries the MC SEM limit check of the selected event.

**Return values:**

<State> 0 | 1

**Example:**

```
//Query MC SEM limit check
FETC:CC2:FRAM3:SUMM:MSPF?
```

**Usage:**

Query only

**Manual operation:** See "SEM Pass / Fail" on page 66

---

**FETCh[:CC<cc>][:ISRC<ant>][:FRAMe<fr>]:SUMMary:OVLD? [<Result>]**

Queries the overload state of an event.

**Suffix:**

<cc> [Component Carrier](#)

<ant> irrelevant

<fr> [Frame](#)

**Query parameters:**

<Result> ALL  
 Available for combined measurements.  
 Queries the overload state of all events (meas IDs).  
 Omitting this parameter queries the overload state of the selected event.

**Return values:**

<State> **NAN**  
 no overload situation  
**0**  
 RF OVLD  
**2**  
 OVLD  
**3**  
 INPUT OVLD

**Example:** //Query overload state  
 FETC:CC2:FRAM3:SUMM:OVLD?

**Usage:** Query only

**Manual operation:** See "OVLD" on page 66

---

**FETCh[:CC<cc>][:ISRC<ant>][:FRAMe<fr>]:SUMMary:PACCs? [<Result>]**

Queries the total power of all component carriers evaluated during an event.

Available for combined multi-carrier measurements.

**Suffix:**

<cc> [Component Carrier](#)

<ant> irrelevant

<fr> [Frame](#)

**Query parameters:**

<Result> ALL  
 Available for combined measurements.  
 Queries the power of all events (meas IDs).  
 Omitting this parameter queries the total power of the selected event.

**Return values:**

<Power> Default unit: dBm

**Example:**

//Query total power over all component carriers analyzed in an event  
 FETC:CC2:FRAM3:SUMM:PACC?

**Usage:**

Query only

**Manual operation:** See "[Power All CCs](#)" on page 65

**FETCh[:CC<cc>][:ISRC<ant>][:FRAMe<fr>]:SUMMary:SPFail? [<Result>]**

Queries the SEM limit check of an event.

**Suffix:**

<cc> [Component Carrier](#)

<ant> irrelevant

<fr> [Frame](#)

**Query parameters:**

<Result> ALL  
 Available for combined measurements.  
 Queries the SEM limit check of all events (meas IDs).  
 Omitting this parameter queries the SEM limit check of the selected event.

**Return values:**

<State> 0 | 1

**Example:**

//Query SEM limit check  
 FETC:CC2:FRAM3:SUMM:SPF?

**Usage:**

Query only

**Manual operation:** See "[SEM Pass / Fail](#)" on page 66

**FETCh[:CC<cc>][:ISRC<ant>][:FRAMe<fr>]:SUMMary:SState? [<Result>]**

Queries the synchronization state of an event.

**Suffix:**

<cc> [Component Carrier](#)

<ant> irrelevant

<fr> [Frame](#)

**Query parameters:**

<Result> ALL  
 Available for combined measurements.  
 Queries the synchronization state of all events (meas IDs).  
 Omitting this parameter queries the synchronization state of the selected event.

**Return values:**

<State> 0 | 1

**Example:**

```
//Query synchronization state
FETC:CC2:FRAM3:SUMM:SST?
```

**Usage:**

Query only

**Manual operation:** See "[Sync State](#)" on page 65

**FETCh[:CC<cc>][:ISRC<ant>][:FRAMe<fr>]:SUMMary:TSDelta? [<Result>]**

Queries the time stamp delta of an event.

**Suffix:**

<cc> [Component Carrier](#)

<ant> irrelevant

<fr> [Frame](#)

**Query parameters:**

<Result> ALL  
 Available for combined measurements.  
 Queries the time stamp delta of all events (meas IDs).  
 Omitting this parameter queries the time stamp delta of the selected event.

**Return values:**

<Time> Default unit: s

**Example:**

```
//Query time stamp
FETC:CC2:FRAM3:SUMM:TSD?
```

**Usage:**

Query only

**Manual operation:** See "[Time Stamp Delta](#)" on page 64

**FETCh[:CC<cc>][:ISRC<ant>][:FRAMe<fr>]:SUMMary:TSTamp? [<Result>]**

Queries the time stamp of an event.

**Suffix:**

<cc> [Component Carrier](#)

<ant> irrelevant

<fr> [Frame](#)

**Query parameters:**

<Result> ALL  
 Available for combined measurements.  
 Queries the time stamp of all events (meas IDs).  
 Omitting this parameter queries the time stamp of the selected event.

**Return values:**

<Time> Default unit: s

**Example:**

//Query time stamp  
 FETC:CC2:FRAM3:SUMM:TST?

**Usage:**

Query only

**Manual operation:** See "Time Stamp" on page 64

### 6.7.3 Time alignment error

FETCh:TAERror[:CC<cc>]:AP<ap>:MAXimum?	271
FETCh:TAERror[:CC<cc>]:AP<ap>:MINimum?	271
FETCh:TAERror[:CC<cc>]:AP<ap>[:AVERage]?	271

---

**FETCh:TAERror[:CC<cc>]:AP<ap>:MAXimum?**

**FETCh:TAERror[:CC<cc>]:AP<ap>:MINimum?**

**FETCh:TAERror[:CC<cc>]:AP<ap>[:AVERage]?**

**Suffix:**

<cc> Component Carrier  
 <ap> 1000 ... 1011  
 Antenna port

**Return values:**

<TAE> Minimum, maximum or average time alignment error, depending on the last command syntax element.

**Example:**

//Query average TAE between reference antenna port and antenna port 1006  
 FETC:TAER:AP1001?

**Usage:**

Query only

**Manual operation:** See "Time Alignment Error" on page 49

### 6.7.4 Marker table

CALCulate<n>:DELTaMarker<m>:X	272
CALCulate<n>:DELTaMarker<m>:Y?	272
CALCulate<n>:MARKer<m>:X	273
CALCulate<n>:MARKer<m>:Y	273
CALCulate<n>:MARKer<m>:Z?	274
CALCulate<n>:MARKer<m>:Z:ALL?	274

**CALCulate<n>:DELTaMarker<m>:X <Position>**

Moves a delta marker to a particular coordinate on the x-axis.

If necessary, the command activates the delta marker and positions a reference marker to the peak power.

**Suffix:**

<n> [Window](#)

<m> [Marker](#)

**Parameters:**

<Position> Numeric value that defines the marker position on the x-axis.

Range: The value range and unit depend on the measurement and scale of the x-axis.

**Example:**

`CALC:DELT:X?`

Outputs the absolute x-value of delta marker 1.

**CALCulate<n>:DELTaMarker<m>:Y?**

Queries the position of a deltamarker on the y-axis.

If necessary, the command activates the deltamarker first.

To get a valid result, you have to perform a complete measurement with synchronization to the end of the measurement before reading out the result. This is only possible for single measurement mode.

See also [INITiate<n>:CONTinuous](#) on page 242.

Note that result displays with a third aspect (for example "EVM vs Symbol x Carrier") do not support deltamarkers.

**Suffix:**

<n> [Window](#)

<m> [Marker](#)

**Return values:**

<Result> <numeric value>

Result at the deltamarker position. The return value is a value relative to the position of marker 1.

The type of value and its unit depend on the selected result display.

**Example:**

`//Query coordinates of deltamarker 2 in window 4`

`CALC4:DELT2:X?`

`CALC4:DELT2:Y?`

**Usage:**

Query only



**CALCulate<n>:MARKer<m>:X <Position>**

Moves a marker to a specific coordinate on the x-axis.

If necessary, the command activates the marker.

If the marker has been used as a delta marker, the command turns it into a normal marker.

**Suffix:**

<n> [Window](#)

<m> [Marker](#)

Note that 3D diagrams only support one marker.

**Parameters:**

<Position> Numeric value that defines the marker position on the x-axis.  
The unit depends on the result display.

Range: The range depends on the current x-axis range.  
Default unit: Hz

**Example:**

`CALC:MARK2:X 1.7MHz`

Positions marker 2 to frequency 1.7 MHz.

**Manual operation:** See ["Marker Table"](#) on page 46

See ["Marker Peak List"](#) on page 62

**CALCulate<n>:MARKer<m>:Y <Result>**

Queries the position of a marker on the y-axis.

In result displays with a third aspect (for example "EVM vs Symbol x Carrier"), you can also use the command to define the position of the marker on the y-axis.

If necessary, the command activates the marker first.

To get a valid result, you have to perform a complete measurement with synchronization to the end of the measurement before reading out the result. This is only possible for single measurement mode.

See also [INITiate<n>:CONTinuous](#) on page 242.

**Suffix:**

<n> [Window](#)

<m> [Marker](#)

Note that 3D diagrams only support one marker.

**Parameters:**

<Result> <numeric value>

Result at the marker position.

The type of value and its unit depend on the selected result display.

- Example:** //Query coordinates of marker 2 in window 4  
 CALC4:MARK2:X?  
 CALC4:MARK2:Y?
- Example:** //Define position of marker in 3D diagram  
 CALC:MARK:X 16  
 CALC:MARK:Y 6
- Manual operation:** See "[Marker Table](#)" on page 46  
 See "[Marker Peak List](#)" on page 62

**CALCulate<n>:MARKer<m>:Z?**

Queries the marker position on the z-axis of three-dimensional result displays.

Returns the type of value displayed in the selected result display (EVM, Power or Allocation ID).

**Suffix:**

<n> [Window](#)

<m> [Marker](#)

**Return values:**

<Position> <numeric value>

Default unit: Depends on result display

**Example:** //Query marker position  
 CALC:MARK:Z?

**Usage:** Query only

**Manual operation:** See "[Marker Table](#)" on page 46

**CALCulate<n>:MARKer<m>:Z:ALL?**

Queries the marker position on the z-axis of three-dimensional result displays.

Instead of returning a certain type of value (EVM, Power **or** Allocation ID), which is possible with [CALCulate<n>:MARKer<m>:Z?](#), this command returns all types of values (EVM, Power **and** Allocation ID), regardless of the result display type.

**Suffix:**

<n> [Window](#)

<m> irrelevant

**Return values:**

<Position> <numeric value>

**EVM**

EVM at the marker position.

**Power**

Power at the marker position.

**Allocation ID**

Allocation ID at the marker position.

**Example:** //Query EVM, Power and Allocation ID at the marker position.  
CALC:MARK:Z:ALL?

**Usage:** Query only

**Manual operation:** See "[Marker Table](#)" on page 46

**6.7.5 CCDF table**

CALCulate<n>:STATistics:CCDF:X<t>?.....	275
CALCulate<n>:STATistics:RESult<res>?.....	275

**CALCulate<n>:STATistics:CCDF:X<t>? <Probability>**

Queries the results of the CCDF.

**Suffix:**

<n> [Window](#)

<t> [Trace](#)

**Query parameters:**

<Probability> **P0\_01**  
Level value for 0.01 % probability

**P0\_1**  
Level value for 0.1 % probability

**P1**  
P1: Level value for 1 % probability

**P10**  
Level value for 10 % probability

**Return values:**

&lt;CCDF Result&gt;

**Example:** CALC:STAT:CCDF:X1? P10  
Returns the level values that are over 10 % above the mean value.

**Usage:** Query only

**Manual operation:** See "[CCDF](#)" on page 37

**CALCulate<n>:STATistics:RESult<res>? <ResultType>**

Queries the results of a measurement for a specific trace.

**Suffix:**

<n> [Window](#)

<res> [Trace](#)

**Query parameters:**

<ResultType>

**MEAN**

Average (=RMS) power in dBm measured during the measurement time.

**PEAK**

Peak power in dBm measured during the measurement time.

**CFACTOR**

Determined crest factor (= ratio of peak power to average power) in dB.

**ALL**

Results of all three measurements mentioned before, separated by commas: <mean power>,<peak power>,<crest factor>

**Example:**

CALC:STAT:RES2? ALL

Reads out the three measurement results of trace 2. Example of answer string: 5.56,19.25,13.69 i.e. mean power: 5.56 dBm, peak power 19.25 dBm, crest factor 13.69 dB

**Usage:**

Query only

**Manual operation:** See "CCDF" on page 37

## 6.8 Limit check results

- [EVM limits](#).....276
- [Transmit power on / off limits](#).....281
- [Frequency sweep limits](#).....282

### 6.8.1 EVM limits

CALCulate<n>:LIMit<li>[:CC<cc>][:ISRC<ant>][:FRAMe<fr>]:SUMMARY:ALL:RESult?.....	277
CALCulate<n>:LIMit<li>[:CC<cc>][:ISRC<ant>][:FRAMe<fr>]:SUMMARY:EVM:DS1K[:	
AVERAge]:RESult?.....	277
CALCulate<n>:LIMit<li>[:CC<cc>][:ISRC<ant>][:FRAMe<fr>]:SUMMARY:EVM:DSQP[:	
AVERAge]:RESult?.....	278
CALCulate<n>:LIMit<li>[:CC<cc>][:ISRC<ant>][:FRAMe<fr>]:SUMMARY:EVM:DSSF[:	
AVERAge]:RESult?.....	278
CALCulate<n>:LIMit<li>[:CC<cc>][:ISRC<ant>][:FRAMe<fr>]:SUMMARY:EVM:DSST[:	
AVERAge]:RESult?.....	279
CALCulate<n>:LIMit<li>[:CC<cc>][:ISRC<ant>][:FRAMe<fr>]:SUMMARY:EVM:DSTS[:	
AVERAge]:RESult?.....	280
CALCulate<n>:LIMit<li>[:CC<cc>][:ISRC<ant>][:FRAMe<fr>]:SUMMARY:EVM:FERRor[:	
AVERAge]:RESult?.....	280

---

**CALCulate<n>:LIMit<li>[:CC<cc>][:ISRC<ant>][:FRAMe<fr>]:SUMMary:ALL:RESult?**

Queries the limits and limit check results for all numerical results that evaluate 3GPP limits.

**Suffix:**

<n>	irrelevant
<li>	irrelevant
<cc>	irrelevant
<ant>	irrelevant
<fr>	irrelevant

**Return values:**

<Result> String containing the limit information for all results that evaluate limits.  
 For each limit, the command returns the following information:  
 <ResultType>, <Limit>, <LimitCheckAverage>, <LimitCheckMin>, <LimitCheckMax>  
 For results that are not checked against a limit, the command returns NOTEVALUATED.

**Example:**

```
//Query limit check information
CALC:LIM:SUMM:ALL:RES?
would return, e.g.
EVM PDSCH QPSK,
+1.850000000E+001, PASSED, NOTEVALUATED,
NOTEVALUATED,
EVM PDSCH 16QAM,
+1.350000000E+001, NOTEVALUATED, NOTEVALUATED,
NOTEVALUATED,
...
```

**Usage:** Query only

**Manual operation:** See "[Remote queries](#)" on page 26

---

**CALCulate<n>:LIMit<li>[:CC<cc>][:ISRC<ant>][:FRAMe<fr>]:SUMMary:EVM:DS1K[:AVERAge]:RESult?**

Queries the limit specified by 3GPP for the EVM of all PDSCH resource elements with a 1024QAM modulation.

**Suffix:**

<n>	irrelevant
<li>	irrelevant
<cc>	irrelevant
<ant>	irrelevant

<fr> irrelevant

**Return values:**

<LimitCheck>

**FAILED**

Limit check has failed.

**PASSED**

Limit check has passed.

**NOTEVALUATED**

Limits have not been evaluated.

**Example:**

```
//Query limit check result
CALC:LIM:SUMM:EVM:DS1K:RES?
```

**Usage:**

Query only

**Manual operation:** See "EVM PDSCH" on page 26

**CALCulate<n>:LIMit<li>[:CC<cc>][:ISRC<ant>][:FRAMe<fr>]:SUMMary:EVM:DSQP[:AVERAge]:RESult?**

Queries the limit specified by 3GPP for the EVM of all PDSCH resource elements with a QPSK modulation.

**Suffix:**

<n> irrelevant

<li> irrelevant

<cc> irrelevant

<ant> irrelevant

<fr> irrelevant

**Return values:**

<LimitCheck>

**FAILED**

Limit check has failed.

**PASSED**

Limit check has passed.

**NOTEVALUATED**

Limits have not been evaluated.

**Example:**

```
//Query limit check result
CALC:LIM:SUMM:EVM:DSQP:RES?
```

**Usage:**

Query only

**Manual operation:** See "EVM PDSCH" on page 26

**CALCulate<n>:LIMit<li>[:CC<cc>][:ISRC<ant>][:FRAMe<fr>]:SUMMary:EVM:DSSF[:AVERAge]:RESult?**

Queries the limit specified by 3GPP for the EVM of all PDSCH resource elements with a 64QAM modulation.

**Suffix:**

<n>	irrelevant
<li>	irrelevant
<cc>	irrelevant
<ant>	irrelevant
<fr>	irrelevant

**Return values:**

<LimitCheck>	<b>FAILED</b> Limit check has failed.
	<b>PASSED</b> Limit check has passed.
	<b>NOTEVALUATED</b> Limits have not been evaluated.

**Example:**

```
//Query limit check result
CALC:LIM:SUMM:EVM:DSSF:RES?
```

**Usage:**

Query only

**Manual operation:** See "EVM PDSCH" on page 26

**CALCulate<n>:LIMit<li>[:CC<cc>][:ISRC<ant>][:FRAMe<fr>]:SUMMery:EVM:  
DSST[:AVERAge]:RESult?**

Queries the limit specified by 3GPP for the EVM of all PDSCH resource elements with a 16QAM modulation.

**Suffix:**

<n>	irrelevant
<li>	irrelevant
<cc>	irrelevant
<ant>	irrelevant
<fr>	irrelevant

**Return values:**

<LimitCheck>	<b>FAILED</b> Limit check has failed.
	<b>PASSED</b> Limit check has passed.
	<b>NOTEVALUATED</b> Limits have not been evaluated.

**Example:**

```
//Query limit check result
CALC:LIM:SUMM:EVM:DSST:RES?
```

**Usage:**

Query only

**Manual operation:** See "EVM PDSCH" on page 26

---

**CALCulate<n>:LIMit<li>[:CC<cc>][:ISRC<ant>][:FRAMe<fr>]:SUMMary:EVM:  
DSTS[:AVERAge]:RESult?**

Queries the limit specified by 3GPP for the EVM of all PDSCH resource elements with a 256QAM modulation.

**Suffix:**

<n>	irrelevant
<li>	irrelevant
<cc>	irrelevant
<ant>	irrelevant
<fr>	irrelevant

**Return values:**

<LimitCheck>	<b>FAILED</b> Limit check has failed.
	<b>PASSED</b> Limit check has passed.
	<b>NOTEVALUATED</b> Limits have not been evaluated.

**Example:** //Query limit check result  
CALC:LIM:SUMM:EVM:DSTS:RES?

**Usage:** Query only

**Manual operation:** See "[EVM PDSCH](#)" on page 26

---

**CALCulate<n>:LIMit<li>[:CC<cc>][:ISRC<ant>][:FRAMe<fr>]:SUMMary:EVM:  
FERRor[:AVERAge]:RESult?**

Queries the limit specified by 3GPP for the frequency error.

**Suffix:**

<n>	irrelevant
<li>	irrelevant
<cc>	irrelevant
<ant>	irrelevant
<fr>	irrelevant

**Return values:**

<LimitCheck>	<b>FAILED</b> Limit check has failed.
	<b>PASSED</b> Limit check has passed.
	<b>NOTEVALUATED</b> Limits have not been evaluated.



**Example:** //Query limit check result  
CALC:LIM:SUMM:EVM:FERR:RES?

**Usage:** Query only

**Manual operation:** See "Frequency Error" on page 28

## 6.8.2 Transmit power on / off limits

CALCulate<n>:LIMit<li>:OOPower:OFFPower?..... 281  
CALCulate<n>:LIMit<li>:OOPower:TRANSient?..... 281

---

### CALCulate<n>:LIMit<li>:OOPower:OFFPower?

Queries the results of the limit check in the "Off" periods of On/Off Power measurements.

**Suffix:**

<n> irrelevant

<li> irrelevant

**Return values:**

<Results> Returns one value for every "Off" period.

**PASSED**  
Limit check has passed.

**FAILED**  
Limit check has failed.

**Example:** //Query the results for the limit check during the signal OFF periods  
CALC:LIM:OOP:OFFP?

**Usage:** Query only

---

### CALCulate<n>:LIMit<li>:OOPower:TRANSient? <Result>

Queries the results of the limit check during the transient periods of the On/Off power measurement.

**Suffix:**

<n> irrelevant

<li> irrelevant

**Query parameters:**

<Result> **ALL**  
Queries the overall limit check results.

**FALLing**  
Queries the limit check results of falling transients.

**RISing**

Queries the limit check results of rising transients.

**Return values:**

<LimitCheck> Returns one value for every "Off" period.

**PASSED**

Limit check has passed.

**FAILED**

Limit check has failed.

**Example:**

```
//Query the limit check result of rising transients
CALC:LIM:OOP:TRAN? RIS
```

**Usage:**

Query only

**6.8.3 Frequency sweep limits**

CALCulate<n>:LIMit<li>:ACPpower:ACHannel:RESult?	282
CALCulate<n>:LIMit<li>:ACPpower:ACHannel:RESult:ABSolute	283
CALCulate<n>:LIMit<li>:ACPpower:ACHannel:RESult:RELative	283
CALCulate<n>:LIMit<li>:ACPpower:ALTernate<alt>:RESult?	284
CALCulate<n>:LIMit<li>:ACPpower:ALTernate<ch>:RESult:ABSolute	285
CALCulate<n>:LIMit<li>:ACPpower:ALTernate<ch>:RESult:RELative	285
CALCulate<n>:LIMit<li>:ACPpower:GAP<gap>:ACLR:RESult?	286
CALCulate<n>:LIMit<li>:ACPpower:GAP<gap>:ACLR:RESult:ABSolute?	286
CALCulate<n>:LIMit<li>:ACPpower:GAP<gap>:ACLR:RESult:RELative?	287
CALCulate<n>:LIMit<li>:ACPpower:GAP<gap>[:CACLR]:RESult?	287
CALCulate<n>:LIMit<li>:ACPpower:GAP<gap>[:CACLR]:RESult:ABSolute?	288
CALCulate<n>:LIMit<li>:ACPpower:GAP<gap>[:CACLR]:RESult:RELative?	288
CALCulate<n>:LIMit<li>:FAIL?	289

**CALCulate<n>:LIMit<li>:ACPpower:ACHannel:RESult? [<Result>]**

Queries the limit check results for the adjacent channels during ACLR measurements.

**Suffix:**

<n> irrelevant

<li> irrelevant

**Query parameters:**

<Result> **REL**  
Queries the channel power limit check results.

**ABS**

Queries the distance to the limit line.

**Return values:**

<LimitCheck> Returns two values, one for the upper and one for the lower adjacent channel.

**PASSED**

Limit check has passed.

**FAILED**

Limit check has failed.

- Example:** //Query results of the adjacent channel limit check  
CALC:LIM:ACP:ACH:RES?
- Example:** //Query results of the adjacent channel limit check  
CALC:LIM:ACP:ACH:RES? ABS
- Usage:** Query only
- Manual operation:** See "Result summary" on page 58  
See "Result summary" on page 60

**CALCulate<n>:LIMit<li>:ACPpower:ACHannel:RESult:ABSolute**

Queries the absolute limit check results for adjacent channels (ACLR measurements).

Prerequisites for this command

- Select absolute limit check mode evaluation mode  
ACLR: [CALCulate<n>:LIMit<li>:ACPpower:PMODE.](#)  
Combined measurements: [\[SENSe:\]NR5G:ACPpower:ALPMode](#) on page 467

**Suffix:**

<n> irrelevant

<li> irrelevant

**Return values:**

<LimitCheck> Returns two values, one for the upper and one for the lower adjacent channel.

**PASSED**

Limit check has passed.

**FAILED**

Limit check has failed.

- Example:** //Query results of the adjacent channel limit check  
CALC:LIM:ACP:ACH:RES:ABS?

- Manual operation:** See "Result summary" on page 56  
See "Result summary" on page 58  
See "Result summary" on page 60

**CALCulate<n>:LIMit<li>:ACPpower:ACHannel:RESult:RELative**

Queries the relative limit check results for the adjacent channels (ACLR measurements).

Prerequisites for this command

- Select relative limit check mode  
ACLR: [CALCulate<n>:LIMit<li>:ACPpower:PMODE.](#)  
Combined measurements: [\[SENSe:\]NR5G:ACPpower:ALPMode](#) on page 467

**Suffix:**

<n> irrelevant

<li> irrelevant

**Return values:**

<LimitCheck> Returns two values, one for the upper and one for the lower adjacent channel.

**PASSED**

Limit check has passed.

**FAILED**

Limit check has failed.

**Example:**

//Query results of the adjacent channel limit check

CALC:LIM:ACP:ACH:RES:REL?

**Manual operation:**

See ["Result summary"](#) on page 56

See ["Result summary"](#) on page 58

See ["Result summary"](#) on page 60

**CALCulate**<n>:**LIMit**<li>:**ACP**ower:**ALTErnate**<alt>:**RESult**? [<Result>]

Queries the limit check results for the alternate channels during ACLR measurements.

**Suffix:**

<n> irrelevant

<li> irrelevant

<alt> irrelevant

**Query parameters:**

<Result> **REL**

Queries the channel power limit check results.

**ABS**

Queries the distance to the limit line.

**Return values:**

<LimitCheck> Returns two values, one for the upper and one for the lower alternate channel.

**PASSED**

Limit check has passed.

**FAILED**

Limit check has failed.

**Example:**

//Query results of the alternate channel limit check

CALC:LIM:ACP:ALT:RES?

**Example:**

//Query results of the alternate channel limit check

CALC:LIM:ACP:ACH:RES? ABS

**Usage:**

Query only

**Manual operation:**

See ["Result summary"](#) on page 58

See ["Result summary"](#) on page 60

**CALCulate<n>:LIMit<li>:ACPpower:ALternate<ch>:RESult:ABSolute**

Queries the absolute limit check results for the alternate channels (MC ACLR measurements).

Prerequisites for this command

- Select absolute limit check mode  
ACLR: `CALCulate<n>:LIMit<li>:ACPpower:PMODE.`

**Suffix:**

<n>	irrelevant
<li>	irrelevant
<ch>	irrelevant

**Return values:**

<LimitCheck> Returns two values, one for the upper and one for the lower adjacent channel.

**PASSED**

Limit check has passed.

**FAILED**

Limit check has failed.

**Example:**

```
//Query results of the alternate channel limit check
CALC:LIM:ACP:ALT:RES:ABS?
```

**Manual operation:**

See "[Result summary](#)" on page 58  
See "[Result summary](#)" on page 60

**CALCulate<n>:LIMit<li>:ACPpower:ALternate<ch>:RESult:RELative**

Queries the relative limit check results for the alternate channels (MC ACLR measurements).

Prerequisites for this command

- Select relative limit check mode  
ACLR: `CALCulate<n>:LIMit<li>:ACPpower:PMODE.`

**Suffix:**

<n>	irrelevant
<li>	irrelevant
<ch>	irrelevant

**Return values:**

<LimitCheck> Returns two values, one for the upper and one for the lower adjacent channel.

**PASSED**

Limit check has passed.

**FAILED**

Limit check has failed.

**Example:** //Query results of the alternate channel limit check  
 CALC:LIM:ACP:ALT:RES:REL?

**Manual operation:** See "Result summary" on page 58  
 See "Result summary" on page 60

### CALCulate<n>:LIMit<li>:ACPower:GAP<gap>:ACLR:RESult?

Queries the ACLR power limit check results for the gap channels (MC ACLR measurements).

**Suffix:**

<n> irrelevant  
 <li> irrelevant  
 <gap> irrelevant

**Return values:**

<LimitCheck> Returns two values, one for the upper and one for the lower adjacent channel.

**PASSED**

Limit check has passed.

**FAILED**

Limit check has failed.

**Example:** //Query results of the gap channel limit check  
 CALC:LIM:ACP:GAP:ACLR:RES?

**Usage:** Query only

### CALCulate<n>:LIMit<li>:ACPower:GAP<gap>:ACLR:RESult:ABSolute?

Queries the absolute power limit check results for the gap channels (MC ACLR measurements).

Prerequisites for this command

- Select absolute limit check mode  
 evaluation mode

ACLR: CALCulate<n>:LIMit<li>:ACPower:PMODE.

Combined measurements: [SENSe:]NR5G:ACPower:ALPMode on page 467

**Suffix:**

<n> irrelevant  
 <li> irrelevant  
 <gap> irrelevant

**Return values:**

<LimitCheck> Returns two values, one for the upper and one for the lower adjacent channel.

**PASSED**

Limit check has passed.

**FAILED**

Limit check has failed.

**Example:** //Query results of the gap channel limit check  
 CALC:LIM:ACP:GAP:ACLR:RES:ABS?

**Usage:** Query only

**CALCulate<n>:LIMit<li>:ACPpower:GAP<gap>:ACLR:RESult:RELative?**

Queries the relative power limit check results for the gap channels (MC ACLR measurements).

Prerequisites for this command

- Select relative limit check mode evaluation mode  
 ACLR: [CALCulate<n>:LIMit<li>:ACPpower:PMODE.](#)  
 Combined measurements: [\[SENSe:\]NR5G:ACPpower:ALPMode](#) on page 467

**Suffix:**

<n> irrelevant

<li> irrelevant

<gap> irrelevant

**Return values:**

<LimitCheck> Returns two values, one for the upper and one for the lower adjacent channel.

**PASSED**

Limit check has passed.

**FAILED**

Limit check has failed.

**Example:** //Query results of the gap channel limit check  
 CALC:LIM:ACP:GAP:ACLR:RES:REL?

**Usage:** Query only

**CALCulate<n>:LIMit<li>:ACPpower:GAP<gap>[:CACLR]:RESult?**

Queries the limit check results for the gap channels (MC ACLR measurements).

**Suffix:**

<n> irrelevant

<li> irrelevant

<gap> irrelevant

**Return values:**

<LimitCheck> Returns two values, one for the upper and one for the lower adjacent channel.

**PASSED**

Limit check has passed.

**FAILED**

Limit check has failed.

**Example:** //Query results of the gap channel limit check  
 CALC:LIM:ACP:GAP:RES?

**Usage:** Query only

**CALCulate<n>:LIMit<li>:ACPower:GAP<gap>[:CACLR]:RESult:ABSolute?**

Queries the absolute limit check results for the gap channels (MC ACLR measurements).

Prerequisites for this command

- Select absolute limit check mode evaluation mode

ACLR: [CALCulate<n>:LIMit<li>:ACPower:PMODE](#).

Combined measurements: [\[SENSe:\]NR5G:ACPower:ALPMode](#) on page 467

**Suffix:**

<n> irrelevant

<li> irrelevant

<gap> irrelevant

**Return values:**

<LimitCheck> Returns two values, one for the upper and one for the lower adjacent channel.

**PASSED**

Limit check has passed.

**FAILED**

Limit check has failed.

**Example:** //Query results of the gap channel limit check  
 CALC:LIM:ACP:GAP:RES:ABS?

**Usage:** Query only

**CALCulate<n>:LIMit<li>:ACPower:GAP<gap>[:CACLR]:RESult:RELative?**

Queries the relative limit check results for the gap channels (MC ACLR measurements).

Prerequisites for this command

- Select relative limit check mode evaluation mode

ACLR: [CALCulate<n>:LIMit<li>:ACPower:PMODE](#).

Combined measurements: [\[SENSe:\]NR5G:ACPower:ALPMode](#) on page 467



**Suffix:**

<n>	irrelevant
<li>	irrelevant
<gap>	irrelevant

**Return values:**

<LimitCheck> Returns two values, one for the upper and one for the lower adjacent channel.

**PASSED**

Limit check has passed.

**FAILED**

Limit check has failed.

**Example:**

```
//Query results of the gap channel limit check
CALC:LIM:ACP:GAP:RES:REL?
```

**Usage:**

Query only

**CALCulate<n>:LIMit<li>:FAIL?**

Queries the limit check results for all measurements that feature a limit check.

For ACLR measurements: Returns the result of the overall limit check (absolute and relative limit evaluation).

**Suffix:**

<n>	1..n <a href="#">Window</a>
<li>	irrelevant

**Return values:**

<LimitCheck>	<b>0</b> Limit check has passed.
	<b>1</b> Limit check has failed. For spectrum flatness: Limit out of selected band.
	<b>2</b> For spectrum flatness: Limit out of band.
	<b>3</b> For spectrum flatness: Limit check has failed.

**Example:**

```
//Query the limit check in the active result display
CALC:LIM:FAIL?
```

**Usage:**

Query only

**Manual operation:**

See "[Result summary](#)" on page 56

## 6.9 Retrieve trace data

- [Using the TRACe\[:DATA\] command](#)..... 290
- [Read measurement results](#)..... 309

### 6.9.1 Using the TRACe[:DATA] command

This chapter contains information on the `TRACe:DATA` command and a detailed description of the characteristics of that command.

The `TRACe:DATA` command queries the trace data or results of the currently active measurement or result display. The type, number and structure of the return values are specific for each result display. In case of results that have any kind of unit, the command returns the results in the unit you have currently set for that result display.

For several result displays, the command also supports various SCPI parameters in combination with the query. If available, each SCPI parameter returns a different aspect of the results. If SCPI parameters are supported, you have to quote one in the query.

#### Example:

```
TRAC2:DATA? TRACE1
```

The format of the return values is either in ASCII or binary characters and depends on the format you have set with `FORMat[:DATA]`.

Following this detailed description, you will find a short summary of the most important functions of the command (`TRACe<n>[:DATA]?`).



#### Selecting a measurement window

Before querying results, you have to select the measurement window with the suffix `<n>` at `TRACe`. The range of `<n>` depends on the number of active measurement windows.

For measurements on aggregated carriers, where each measurement window has subwindows, you have to select the subwindow first with `DISPlay[:WINDow<n>][:SUBWindow<w>]:SElect`.

- [Capture buffer](#)..... 291
- [EVM vs carrier](#)..... 291
- [EVM vs symbol](#)..... 292
- [EVM vs RB](#)..... 292
- [Frequency error vs symbol](#)..... 293
- [Frequency error vs subframe](#)..... 294
- [Power spectrum](#)..... 294
- [Flatness vs carrier](#)..... 294
- [CCDF](#)..... 295
- [Constellation diagram](#)..... 296
- [Allocation summary](#)..... 296

• Bitstream.....	298
• Channel decoder results.....	299
• EVM vs symbol x carrier.....	300
• Power vs symbol x carrier.....	300
• Allocation ID vs symbol x carrier.....	301
• RS phase.....	302
• RS magnitude.....	302
• RS phase difference.....	303
• Beamforming summary.....	304
• Adjacent channel leakage ratio.....	304
• Spectrum emission mask.....	305
• On/off power.....	306
• Combined EVM / ACLR / SEM.....	306
• Return value codes.....	307

### 6.9.1.1 Capture buffer

For the capture buffer result display, the command returns one value for each I/Q sample in the capture buffer.

`<absolute power>, ...`

The unit is always dBm.

The following parameters are supported.

- `TRAC:DATA TRACE1`

Note that the command returns positive peak values only.

### 6.9.1.2 EVM vs carrier

For the EVM vs carrier result display, the command returns one value for each subcarrier that has been analyzed.

`<EVM>, ...`

The unit depends on `UNIT:EVM`.

The following parameters are supported.

- `TRAC:DATA TRACE1`

The return values depend on the evaluation range:

- All bandwidth parts: average EVM of the SS/PBCH block over all subframes (or the first bandwidth part if the SS/PBCH block does not exist).
- A specific bandwidth part: average EVM of the selected BWP over all subframes.
- A specific subframe: average EVM of that subframe over all slots.
- A specific slot: EVM of that slot.

- `TRAC:DATA TRACE2`

The return values depend on the evaluation range:

- All bandwidth parts: average EVM of the first BWP over all subframes.

- A specific bandwidth part: minimum EVM of the selected BWP block over all subframes.
- A specific subframe: minimum EVM of that subframe over all slots.
- A specific slot: not supported.
- `TRAC:DATA TRACE3`  
The return values depend on the evaluation range:
  - All bandwidth parts: average EVM of the second BWP over all subframes.
  - A specific bandwidth part: maximum EVM of the selected BWP block over all subframes.
  - A specific subframe: maximum EVM of that subframe over all slots.
  - A specific slot: not supported.
- `TRAC:DATA TRACE4 | TRACE5 | TRACE6 | TRACE7 | TRACE8`  
Only supported for evaluation over all bandwidth parts.  
Returns the average EVM of the corresponding bandwidth part over all subframes (for example TRACE4 for the 4th bandwidth part).

### 6.9.1.3 EVM vs symbol

For the EVM vs symbol result display, the command returns one value for each OFDM symbol that has been analyzed.

<EVM>, ...

The unit depends on [UNIT:EVM](#).

The following parameters are supported.

- `TRAC:DATA TRACE1`  
The return values depend on the evaluation range:
  - All bandwidth parts: EVM of the SS/PBCH block over all subframes (or the first bandwidth part if the SS/PBCH block does not exist).
  - A specific bandwidth part: EVM of the selected BWP over all subframes.
  - A specific subframe: EVM of that subframe over all slots.
  - A specific slot: EVM of that slot.
- `TRAC:DATA TRACE2 to TRACE8`  
Only supported for evaluation over all bandwidth parts.  
Returns the EVM of the corresponding bandwidth part over all subframes (for example TRACE4 for the 4th bandwidth part).

### 6.9.1.4 EVM vs RB

For the EVM vs RB result display, the command returns one value for each resource block that has been analyzed.

<EVM>, ...

The unit depends on [UNIT:EVM](#).

The following parameters are supported.

- TRAC:DATA TRACE1

The return values depend on the evaluation range:

- All bandwidth parts: average EVM of the first bandwidth part if the SS/PBCH block does not exist (if the SS/PBCH block exists, it returns an error).
- A specific bandwidth part: average EVM of the selected BWP over all subframes.
- A specific subframe: average EVM of that subframe over all slots.
- A specific slot: EVM of that slot.

- TRAC:DATA TRACE2

The return values depend on the evaluation range:

- All bandwidth parts: average EVM of the first bandwidth part if the SS/PBCH block does exist. If the SS/PBCH block does not exist, it returns the results of the second bandwidth part).
- A specific bandwidth part: minimum EVM of the selected BWP block over all subframes.
- A specific subframe: minimum EVM of that subframe over all slots.
- A specific slot: not supported.

- TRAC:DATA TRACE3

The return values depend on the evaluation range:

- All bandwidth parts: average EVM of the third BWP over all subframes.
- A specific bandwidth part: maximum EVM of the selected BWP block over all subframes.
- A specific subframe: maximum EVM of that subframe over all slots.
- A specific slot: not supported.

- TRAC:DATA TRACE4 | TRACE5 | TRACE6 | TRACE7 | TRACE8

Only supported for evaluation over all bandwidth parts.

Returns the average EVM of the corresponding bandwidth part over all subframes (for example TRACE4 for the 4th bandwidth part).

### 6.9.1.5 Frequency error vs symbol

For the frequency error vs symbol result display, the command returns one value for each OFDM symbol that has been analyzed.

<frequency error>,...

The unit is always Hz.

The following parameters are supported.

- TRAC:DATA TRACE1

The return values depend on the evaluation range:

- All bandwidth parts: Frequency error of the SS/PBCH block over all subframes (or the first bandwidth part if the SS/PBCH block does not exist).

- A specific bandwidth part: Frequency error of the selected BWP over all subframes.
- A specific subframe: Frequency error of that subframe over all slots.
- A specific slot: Frequency error of that slot.
- `TRAC:DATA TRACE2 to TRACE8`  
Only supported for evaluation over all bandwidth parts.  
Returns the average EVM of the corresponding bandwidth part over all subframes (for example TRACE4 for the 4th bandwidth part).

#### 6.9.1.6 Frequency error vs subframe

For the frequency error vs symbol result display, the command returns one value for each of the nine subframes that have been analyzed.

`<frequency error>, ...`

The unit is always Hz.

The following parameters are supported.

- `TRAC:DATA TRACE1`  
The return values depend on the evaluation range:
  - All bandwidth parts: Frequency error for the subframes of the SS/PBCH block (or the first bandwidth part if the SS/PBCH block does not exist).
  - A specific bandwidth part: Frequency error for the subframes of the selected BWP.
- `TRAC:DATA TRACE2 to TRACE8`  
Only supported for evaluation over all bandwidth parts.  
Returns the frequency error for the subframes of the corresponding bandwidth part (for example TRACE4 for the 4th bandwidth part).

#### 6.9.1.7 Power spectrum

For the power spectrum result display, the command returns one value for each trace point.

`<power>, ...`

The unit is always dBm/Hz.

The following parameters are supported.

- `TRAC:DATA TRACE1`

#### 6.9.1.8 Flatness vs carrier

For the flatness vs carrier result display, the command returns one value for each trace point.

`<relative power>, ...`

The unit is always dB. The number of values depends on the selected 5G NR bandwidth.

The following parameters are supported.

- TRAC:DATA TRACE1

The return values depend on the evaluation range:

- All bandwidth parts: average power of the SS/PBCH block over all subframes.
- A specific bandwidth part: average power of the selected BWP over all subframes.
- A specific subframe: average power of that subframe over all slots.
- A specific slot: power of that slot.

- TRAC:DATA TRACE2

The return values depend on the evaluation range:

- All bandwidth parts: average power of the first BWP over all subframes.
- A specific bandwidth part: minimum power of the selected BWP block over all subframes.
- A specific subframe: minimum power of that subframe over all slots.
- A specific slot: not supported.

- TRAC:DATA TRACE3

The return values depend on the evaluation range:

- All bandwidth parts: average power of the second BWP over all subframes.
- A specific bandwidth part: maximum power of the selected BWP block over all subframes.
- A specific subframe: maximum power of that subframe over all slots.
- A specific slot: not supported.

- TRAC:DATA TRACE4 | TRACE5 | TRACE6 | TRACE7 | TRACE8

Only supported for evaluation over all bandwidth parts.

Returns the average EVM of the corresponding bandwidth part over all subframes (for example TRACE4 for the 4th bandwidth part).

### 6.9.1.9 CCDF

For the CCDF result display, the type of return values depends on the parameter.

- TRAC:DATA TRACE1

Returns the probability values (y-axis).

<# of values>, <probability>, ...

The unit is always %.

The first value that is returned is the number of the following values.

- TRAC:DATA TRACE2

Returns the corresponding power levels (x-axis).

<# of values>, <relative power>, ...

The unit is always dB.

The first value that is returned is the number of the following values.

### 6.9.1.10 Constellation diagram

For the constellation diagram, the command returns two values for each constellation point.

```
<I[SF0][Sym0][Carrier1]>, <Q[SF0][Sym0][Carrier1]>, ..., <I[SF0][Sym0][Carrier(n)]>, <Q[SF0][Sym0][Carrier(n)]>,
<I[SF0][Sym1][Carrier1]>, <Q[SF0][Sym1][Carrier1]>, ..., <I[SF0][Sym1][Carrier(n)]>, <Q[SF0][Sym1][Carrier(n)]>,
<I[SF0][Sym(n)][Carrier1]>, <Q[SF0][Sym(n)][Carrier1]>, ..., <I[SF0][Sym(n)][Carrier(n)]>, <Q[SF0][Sym(n)][Carrier(n)]>,
<I[SF1][Sym0][Carrier1]>, <Q[SF1][Sym0][Carrier1]>, ..., <I[SF1][Sym0][Carrier(n)]>, <Q[SF1][Sym0][Carrier(n)]>,
<I[SF1][Sym1][Carrier1]>, <Q[SF1][Sym1][Carrier1]>, ..., <I[SF1][Sym1][Carrier(n)]>, <Q[SF1][Sym1][Carrier(n)]>,
<I[SF(n)][Sym(n)][Carrier1]>, <Q[SF(n)][Sym(n)][Carrier1]>, ..., <I[SF(n)][Sym(n)][Carrier(n)]>, <Q[SF(n)][Sym(n)][Carrier(n)]>
```

With SF = subframe and Sym = symbol of that subframe.

The I and Q values have no unit.

The number of return values depends on the constellation selection. By default, it returns all resource elements including the DC carrier.

For each bandwidth part, the command returns the values for all resource elements. However, only the resource elements allocated to the corresponding bandwidth part have a value. All others are returned as NAN. If you query the constellation for a signal with SS/PBCH and 2 bandwidth parts, for example, the stream of values would look like this:

- 1st block of values: NAN, NAN, ( . . . ) , RE [SS/PBCH] , RE [SS/PBCH] , ( . . . ) , NAN, NAN, ( . . . )
- 2nd block of values: NAN, NAN, ( . . . ) , RE [BWP0] , RE [BWP0] , ( . . . ) , NAN, NAN, ( . . . )
- 3rd block of values: NAN, NAN, ( . . . ) , RE [BWP1] , RE [BWP1] , ( . . . ) , NAN, NAN, ( . . . )

The following parameters are supported.

- TRAC:DATA TRACE1  
Returns all constellation points included in the selection.

### 6.9.1.11 Allocation summary

For the allocation summary, the command returns several values for each line of the table.

- <bwp>
- <subframe>
- <slot>
- <allocation ID>



- <number of RB>
- <relative power>
- <modulation>
- <absolute power>
- <EVM>

The data format of the return values is always ASCII.

The return values have the following characteristics.

- The <bwp> for bandwidth part containing the synchronization signals is -1. For all other bandwidth parts, the corresponding bandwidth part number, beginning with 0.
- The <allocation ID is encoded.  
For the code assignment, see [Chapter 6.9.1.25, "Return value codes"](#), on page 307.
- The unit for <relative power> is always dB.
- The <modulation> is encoded.  
For the code assignment, see [Chapter 6.9.1.25, "Return value codes"](#), on page 307.
- The unit for <absolute power> is always dBm.
- The unit for <EVM> depends on `UNIT:EVM`.

#### Example:

BWP/SF/Slot	Allocation ID	No of RBs	Rel Power [dB]	Modulation	Power per RE [dBm]	EVM [%]
SS / 0 / 0	PSS		0.000	RBPSK	-16.611	3.781
	SSS		0.000	RBPSK	-17.569	0.219
	PBCH DMRS		0.000	QPSK	-17.117	5.935
	PBCH		0.000	QPSK	-17.229	3.278

TRAC:DATA? TRACE1 would return:

```
-1,0,0,-20,,+0.000000000,1,-1.611724981E+001,+3.781490920E-003,
-1,0,0,-21,,+0.000000000,1,-1.756929651E+001,+0.219507916E-003,
-1,0,0,-11,,+0.000000000,2,-1.711705594E+001,+5.935088581E-003,
-1,0,0,-30,,+0.000000000,2,-1.722917126E+001,+3.278761694E-003,
```

#### Additional information "ALL"

In addition, there is a line at the end of the allocation summary that shows the average EVM over all analyzed subframes. This information is also added as the last return values. The "ALL" information has the subframe ID and allocation ID code "-2".

A query result would thus look like this, for example:

```
//For subframe 0:
0, -40, 10, 2, 2, -84.7431947342849, 2.68723483754626E-06,
0, -41, 0, 0, 6, -84.7431432845264, 2.37549449584568E-06,
(...)
//For subframe 1:
1, -40, 10, 2, 2, -84.7431947342849, 2.68723483754626E-06,
1, -41, 0, 0, 6, -84.7431432845264, 2.37549449584568E-06,
(...)
```

```
//ALL for all subframes
-2,-2,,,,,2.13196434228374E-06
```

### 6.9.1.12 Bitstream

For the bitstream result display, the number of return values depends on the parameter.

- `TRAC:DATA TRACE1`  
Returns several values and the bitstream for each line of the table.  
<bwp>, <subframe>, <slot>, <allocation ID>, <codeword>, <modulation>, <# of decoded bits>, <# of decoded bit errors>, <# of symbols/bits>, <hexadecimal/binary numbers>,...
- `TRAC:DATA TRACE2`  
Returns the CRC status of an allocation, but not the bitstream.  
<bwp>, <subframe>, <slot>, <allocation ID>, <codeword>, <crc status>,...
- `TRAC:DATA TRACE3`  
Returns all informative values of an allocation, but not the bitstream.  
<bwp>, <subframe>, <slot>, <allocation ID>, <codeword>, <crc status>, <modulation>, <# of decoded bits>, <# of decoded bit errors>, <# of symbols/bits>,...
- `TRAC:DATA TRACE4`  
Note that this query is only available under certain circumstances. For more information see the description of the [bitstream](#) result display.  
Returns all informative values of an allocation, including the totals over all PDSCH allocations that contribute to the bitstream, but not the bitstream itself.  
<bwp>, <subframe>, <slot>, <allocation ID>, <codeword>, <crc status>, <modulation>, <# of decoded bits>, <# of decoded bit errors>, <# of symbols/bits>, ..., <total # decoded bits>, <total # bit errors>, <total # bits>, <total bit error rate>
- `TRAC:DATA TRACE5`  
Returns the CRC status of an allocation, including the number of bits in the bitstream.  
<bwp>, <subframe>, <slot>, <allocation ID>, <codeword>, <crc status>, <#Bits>,...
- `TRAC:DATA TRACE6`  
Note that this query is only available under certain circumstances. For more information see the description of the [bitstream](#) result display.  
Returns all informative values of an allocation, including the totals over all PDSCH allocations that contribute to the bitstream, but not the bitstream itself. The difference to `TRACE3` is that this query includes the Bit/s result.  
<bwp>, <subframe>, <slot>, <allocation ID>, <codeword>, <crc status>, <modulation>, <# of decoded bits>, <# of decoded bit errors>, <# of symbols/bits>, ..., <total # decoded bits>, <total # bit errors>, <total # bits>, <total bit error rate>, <bit per second>

All values have no unit. The format of the bitstream depends on the [demodulation data](#) property.

The <allocation ID>, <codeword>, <crc status> and <modulation> are encoded. For the code assignment see [Chapter 6.9.1.25, "Return value codes"](#), on page 307.

For symbols or bits that are not transmitted, the command returns

- "FFFF" if the bitstream is analyzed [before decoding](#)
- "9" if the bitstream is analyzed [after decoding](#).

Note that the data format of the return values is always ASCII.

### Example:

Sub-frame	Allocation ID	Code-word	Modulation	Symbol Index	Bit Stream
0	PBCH	1/1	QPSK	0	01 01 00 02 03 00 01 02 01 02 01 00 03 00 02 02
0	PBCH	1/1	QPSK	16	02 03 02 03 03 03 00 02 00 03 00 02 02 03 01 01
0	PBCH	1/1	QPSK	32	03 02 03 03 03 03 01 03 00 03 00 03 03 00 03 02

TRAC:DATA? TRACE1 would return:

```
-1,0,0,-500200,0,2,0,0,432, 01, 01, 00, 02, 03, 00, 01, 02, 01, 02, 01, ...
<continues like this until the next data block starts or the end of data is reached>
0,0,0,-200000,0,2,0,0,2430,02,03,03,03,01,01, 01, 03, 00, 03, ...
```

### 6.9.1.13 Channel decoder results

For the channel decoder Results, the number and type of return values depend on the parameter.

- TRAC:DATA CORESET
 

Returns the results for DCI decoding. The results are made up out of the following values.

<bwp>, <subframe>, <slot>, <allocationID>, <dci\_info>

The <allocationID> is encoded. For the code assignment see [Chapter 6.9.1.25, "Return value codes"](#), on page 307.

If decoding was not successful, the command returns NAN.

<dci\_info> is a string with information about the DCI field:

<field\_name:bit\_length>
- TRAC:DATA PBCH
 

Returns the results for the PBCH if PBCH decoding (or CRC check) was successful. The results are made up out of the following values.

<subframe>, <ssb>, <ik0\_msb\_fr1>, <ia6a7\_reserved\_fr1>, <ssb\_index>, <half frame>, <system frame>, <subcarrier spacing>, <subcarrier offset>, <dmrs type a position>, <pdccch config>, <cell barred>, <intra frequency reselection>, <spare>

The unit for <subcarrier spacing> is Hz. All other values have no unit.

The <cell barred> and <intra frequency reselection> are encoded.

For the code assignment see [Chapter 6.9.1.25, "Return value codes"](#), on page 307.

If PBCH decoding was not successful, the command returns NAN.

#### 6.9.1.14 EVM vs symbol x carrier

For the EVM vs symbol x carrier, the command returns one value for each resource element.

```
<SS/BWP>,<Subcarrier Spacing>,<Symbol Start Offset>,  
<Freq Start Offset>,<#Symbols>,<#Carriers>,  
<EVM[Symbol(0),Carrier(1)]>, ..., <EVM[Symbol(0),Carrier(n)]>,  
<EVM[Symbol(1),Carrier(1)]>, ..., <EVM[Symbol(1),Carrier(n)]>,  
...  
<EVM[Symbol(n),Carrier(1)]>, ..., <EVM[Symbol(n),Carrier(n)]>
```

The unit depends on [UNIT:EVM](#).

The number of values depends on the [evaluation range](#).

Resource elements that are unused return NAN.

The following parameters are supported.

- TRAC:DATA TRACE1
  - The return values depend on the evaluation range:
    - All bandwidth parts: EVM of the SS/PBCH block (or the first bandwidth part if the SS/PBCH block does not exist).
    - A specific bandwidth part: EVM of the selected BWP.
- TRAC:DATA TRACE2 to TRACE8
  - Only supported for evaluation over all bandwidth parts.
  - Returns the EVM of the corresponding bandwidth part (for example TRACE4 for the 4th bandwidth part).

#### 6.9.1.15 Power vs symbol x carrier

For the power vs symbol x carrier, the command returns one value for each resource element.

```
<SS/BWP>,<Subcarrier Spacing>,<Symbol Start Offset>,  
<Freq Start Offset>,<#Symbols>,<#Carriers>,  
<P[Symbol(0),Carrier(1)]>, ..., <P[Symbol(0),Carrier(n)]>,  
<P[Symbol(1),Carrier(1)]>, ..., <P[Symbol(1),Carrier(n)]>,  
...  
<P[Symbol(n),Carrier(1)]>, ..., <P[Symbol(n),Carrier(n)]>
```

with P = Power of a resource element.

The unit is always dBm.

The number of values depends on the [evaluation range](#).

Resource elements that are unused return NAN.

The following parameters are supported.

- TRAC:DATA TRACE1

The return values depend on the evaluation range:

- All bandwidth parts: EVM of the SS/PBCH block (or the first bandwidth part if the SS/PBCH block does not exist).
- A specific bandwidth part: EVM of the selected BWP.

- TRAC:DATA TRACE2 to TRACE8

Only supported for evaluation over all bandwidth parts.

Returns the EVM of the corresponding bandwidth part (for example TRACE4 for the 4th bandwidth part).

#### 6.9.1.16 Allocation ID vs symbol x carrier

For the allocation ID vs symbol x carrier, the command returns one value for each resource element.

```
<SS/BWP>,<Subcarrier Spacing>,<Symbol Start Offset>,  
<Freq Start Offset>,<#Symbols>,<#Carriers>,  
<ID[Symbol(0),Carrier(1)]>, ..., <ID[Symbol(0),Carrier(n)]>,  
<ID[Symbol(1),Carrier(1)]>, ..., <ID[Symbol(1),Carrier(n)]>,  
...  
<ID[Symbol(n),Carrier(1)]>, ..., <ID[Symbol(n),Carrier(n)]>
```

The <allocation ID> is encoded.

For the code assignment, see [Chapter 6.9.1.25, "Return value codes"](#), on page 307.

The number of values depends on the [evaluation range](#).

The following parameters are supported.

- TRAC:DATA TRACE1

The return values depend on the evaluation range:

- All bandwidth parts: EVM of the SS/PBCH block (or the first bandwidth part if the SS/PBCH block does not exist).
- A specific bandwidth part: EVM of the selected BWP.

- TRAC:DATA TRACE2 to TRACE8

Only supported for evaluation over all bandwidth parts.

Returns the EVM of the corresponding bandwidth part (for example TRACE4 for the 4th bandwidth part).

### 6.9.1.17 RS phase

For the RS phase result display, the command returns one value for each subcarrier that has been analyzed.

<Phase>, ...

The unit is degrees.

The following parameters are supported.

- TRAC:DATA TRACE1

The return values depend on the evaluation range:

- All antenna ports: average phase of the antenna port mapped to trace 1.
- A specific antenna port: average phase of the selected antenna port over all slots.
- A specific bandwidth part or subframe: average phase of the selected antenna port over all slots.
- A specific slot: phase of that slot.

- TRAC:DATA TRACE2

The return values depend on the evaluation range:

- All antenna ports: average phase of the antenna port mapped to trace 1.
- A specific antenna port: minimum phase of the selected antenna port over all slots.
- A specific bandwidth part or subframe: minimum phase of the selected antenna port over all slots.
- A specific slot: not supported.

- TRAC:DATA TRACE3

The return values depend on the evaluation range:

- All antenna ports: average phase of the antenna port mapped to trace 1.
- A specific antenna port: maximum phase of the selected antenna port over all slots.
- A specific bandwidth part or subframe: maximum phase of the selected antenna port over all slots.
- A specific slot: not supported.

- TRAC:DATA TRACE4 | TRACE5 | TRACE6 | TRACE7 | TRACE8

Only supported for evaluation over all antenna ports.

Returns the average phase of the corresponding antenna port over all subcarriers (for example TRACE4 for the antenna port mapped to the 4th trace).

### 6.9.1.18 RS magnitude

For the RS magnitude result display, the command returns one value for each subcarrier that has been analyzed.

<Magnitude>, ...

The unit is dB.

The following parameters are supported.

- `TRAC:DATA TRACE1`

The return values depend on the evaluation range:

- All antenna ports: average magnitude of the antenna port mapped to trace 1.
- A specific antenna port: average magnitude of the selected antenna port over all slots.
- A specific bandwidth part or subframe: average magnitude of the selected antenna port over all slots.
- A specific slot: magnitude of that slot.

- `TRAC:DATA TRACE2`

The return values depend on the evaluation range:

- All antenna ports: average magnitude of the antenna port mapped to trace 1.
- A specific antenna port: minimum magnitude of the selected antenna port over all slots.
- A specific bandwidth part or subframe: minimum magnitude of the selected antenna port over all slots.
- A specific slot: not supported.

- `TRAC:DATA TRACE3`

The return values depend on the evaluation range:

- All antenna ports: average magnitude of the antenna port mapped to trace 1.
- A specific antenna port: maximum magnitude of the selected antenna port over all slots.
- A specific bandwidth part or subframe: maximum magnitude of the selected antenna port over all slots.
- A specific slot: not supported.

- `TRAC:DATA TRACE4 | TRACE5 | TRACE6 | TRACE7 | TRACE8`

Only supported for evaluation over all antenna ports.

Returns the average magnitude of the corresponding antenna port over all subcarriers (for example TRACE4 for the antenna port mapped to the 4th trace).

### 6.9.1.19 RS phase difference

For the RS phase difference result display, the command returns one value for each subcarrier that has been analyzed. The value is the phase deviation to a reference antenna port.

<Phase>, ...

The unit is degrees.

The following parameters are supported.

- `TRAC:DATA TRACE1`

The return values depend on the evaluation range:

- All antenna ports: average phase deviation of the antenna port mapped to trace 1.

- A specific antenna port: average phase deviation of the selected antenna port over all slots.
- A specific bandwidth part or subframe: average phase deviation of the selected antenna port over all slots.
- A specific slot: phase deviation of that slot.
- `TRAC:DATA TRACE2`  
The return values depend on the evaluation range:
  - All antenna ports: average phase deviation of the antenna port mapped to trace 1.
  - A specific antenna port: minimum phase deviation of the selected antenna port over all slots.
  - A specific bandwidth part or subframe: minimum phase deviation of the selected antenna port over all slots.
  - A specific slot: not supported.
- `TRAC:DATA TRACE3`  
The return values depend on the evaluation range:
  - All antenna ports: average phase deviation of the antenna port mapped to trace 1.
  - A specific antenna port: maximum phase deviation of the selected antenna port over all slots.
  - A specific bandwidth part or subframe: maximum phase deviation of the selected antenna port over all slots.
  - A specific slot: not supported.
- `TRAC:DATA TRACE4 | TRACE5 | TRACE6 | TRACE7 | TRACE8`  
Only supported for evaluation over all antenna ports.  
Returns the average phase deviation of the corresponding antenna port over all subcarriers (for example `TRACE4` for the antenna port mapped to the 4th trace).

#### 6.9.1.20 Beamforming summary

For the beamforming summary result display, the command returns four values for each allocation that has been found.

```
<BWP>, <Subframe>, <Slot>, <AllocationType>, <AP>, <Phase>,
<PhaseDifference>, ...
```

The unit for `<Phase>` and `<PhaseDifference>` is always degrees. The other values have no unit.

The `<AllocationType>` is encoded. For the code assignment see [Chapter 6.9.1.25, "Return value codes"](#), on page 307.

#### 6.9.1.21 Adjacent channel leakage ratio

For the ACLR result display, the number and type of returns values depend on the parameter.



- `TRAC:DATA TRACE1`  
Returns one value for each trace point.
- `TRAC:DATA RESult`  
Combined mode only. Returns the results for all ACLR measurements in a measurement sequence.  
For each measurement event, the command returns the following information.  
`<event number>`, `<channel power>`,  
`<abs. power lower adj. ch.>`, `<abs. power upper adj. ch.>`,  
`<rel. power lower adj. ch.>`, `<rel. power upper adj. ch.>`,  
`<abs. power lower alt. ch.>`, `<abs. power upper alt. ch.>`,  
`<rel. power lower alt. ch.>`, `<rel. power upper alt. ch.>`,  
etc.  
The number of values for alternate channels depends on the number of alternate channels in the measurement.
- `TRAC:DATA LIMit`  
Combined mode only. Returns the results for all ACLR limit checks in a measurement sequence.  
For each measurement event, the command returns the following information.  
`<event number>`,  
`<adj. ch. limit check result>`,  
`<abs. limit lower adj. ch.>`, `<abs. limit upper adj. ch.>`,  
`<rel. limit lower adj. ch.>`, `<rel. limit upper adj. ch.>`,  
`<alt. ch. limit check result>`,  
`<abs. power lower alt. ch.>`, `<abs. power upper alt. ch.>`,  
`<rel. power lower alt. ch.>`, `<rel. power upper alt. ch.>`  
etc.  
The limit check results are either `PASSED` or `FAILED`. The number of results for alternate channels depends on the number of alternate channels in the measurement.

#### 6.9.1.22 Spectrum emission mask

For the SEM measurement, the number and type of returns values depend on the parameter.

- `TRAC:DATA TRACE1`  
Returns one value for each trace point.  
`<absolute power>`, ...  
The unit is always dBm.
- `TRAC:DATA LIST`  
Returns the contents of the SEM table. For every frequency in the spectrum emission mask, it returns 11 values.  
`<index>`, `<start frequency in Hz>`, `<stop frequency in Hz>`,  
`<RBW in Hz>`, `<limit fail frequency in Hz>`, `<absolute power in dBm>`,  
`<relative power in dBc>`, `<limit distance in dB>`, `<limit check result>`,  
`<reserved>`, `<reserved>`...  
The `<limit check result>` is either a 0 (for PASS) or a 1 (for FAIL).
- `TRAC:DATA RESult`  
Combined mode only. Returns the results for all SEM measurements in a measurement sequence.

For each measurement event, the command returns the following information.  
 <event number>, <channel power>, <range index>, <start frequency in Hz>, <stop frequency in Hz>, <RBW in Hz>, <frequency>, <absolute power in dBm>, <relative power in dBc>, <limit distance in dB>, <limit check result>, <reserved>, <reserved>, etc.

The number of SEM ranges depend on the SEM configuration.

- TRAC:DATA LIMIt

Combined mode only. Returns the results for all SEM limit checks in a measurement sequence.

For each measurement event, the command returns the following information.  
 <event number>, <limit check result>, etc.

The limit check results are either PASSED or FAILED.

### 6.9.1.23 On/off power

For the on/off power measurement, the number and type of return values depend on the parameter.

- TRAC:DATA TRACE1

Returns the power for the Off power regions.

<absolute power>, ...

The unit is always dBm.

- TRAC:DATA TRACE2

Returns the power for the transient regions.

<absolute power>, ...

The unit is always dBm.

- TRAC:DATA LIST

Returns the contents of the on/off power table. For each line, it returns seven values.

<off period start limit>, <off period stop limit>, <time at delta to limit>, <absolute off power>, <distance to limit>, <falling transient period>, <rising transient period>, ...

The unit for the <absolute off power> is dBm. The unit for the <distance to limit> is dB. All other values have the unit s.

### 6.9.1.24 Combined EVM / ACLR / SEM

For combined EVM / ACLR / SEM result summary, the return values depend on the number of carriers.

#### Single carrier measurements

The command returns the following values for each measurement.

<measID>, <time stamp>, <EVM>, <power>, <sync state>, <ACLR result>, <SEM result>, <OVLD>, ...

### Multi carrier measurements

The command returns the following values for each measurement.

<measID>, <cc>, <time stamp>, <EVM>, <power>, <sync state>, <MCACLR result>, <CACLR result>, <MCSEM result>, <OVLd>, ...

The <SyncState>, <ACLR result> and <SEM result> are encoded:

- 1 for a pass and 0 for a fail.

The <OVLd> state is encoded.

- NAN: no overload
- 0: RF OVLd
- 2: IF OVLd
- 3: INPUT OVLd

The following parameters are supported.

- TRAC:DATA TRACE1  
Returns the results for all events.
- TRAC:DATA TRACE2  
Returns the results for a selected event ([SENSe:]NR5G[:CC<cc>]:SMID).

In addition, you can query individual results (for example the time stamp). To query other results from the combined result summary, use the standard commands to query the results.

For a detailed list, see [Chapter 6.7.1, "Result summary"](#), on page 245.

#### 6.9.1.25 Return value codes

##### <allocation ID>

Represents the allocation ID. The range is as follows.

- 0xxxxx = PDSCH
- -1 = INVALID
- -1xxxxx = PDSCH DMRS
- -2xxxxx = CORESET
- -3xxxxx = CORESET DMRS
- -4xxxxx = PDSCH PTRS
- -5000xx = PSS
- -5001xx = SSS
- -5002xx = PBCH
- -5003xx = PBCH DMRS

Note. xxxxx is a placeholder for the ID of the channel.

If the channel has, for example, the ID 22, the return value would be -100022, -200022 or -300022 (depending on the configuration)

**<AllocationType>**

- 0 = SS/PBCH
- 1 = CORESET
- 2 = PDSCH
- 3 = CSI-RS

**<modulation>**

Represents the modulation scheme.

- 0 = unrecognized
- 1 = RBPSK
- 2 = QPSK
- 3 = 16QAM
- 4 = 64QAM
- 14 = 256QAM
- 15 = 1024QAM

**<crc status>**

The range is {0...1}.

- 0 = fail
- 1 = pass

**<cell barred>**

The range is {0...1}.

- 0 = not barred
- 1 = barred

**<intra frequency reselection>**

The range is {0...1}.

- 0 = not allowed
- 1 = allowed

**<codeword>**

Represents the codeword of an allocation. The range is {0...6}.

- 0 = 1/1
- 1 = 1/2
- 2 = 2/2
- 3 = 1/4
- 4 = 2/4
- 5 = 3/4
- 6 = 4/4

## 6.9.2 Read measurement results

CALCulate<n>:MARKer<m>:FUNCTion:POWer<sb>:RESult[:CURRent]?	309
CALCulate<n>:MARKer<m>:FUNCTion:POWer<sb>:RESult:DEtails	310
FORMat[:DATA]	311
TRACe<n>:CATalog?	311
TRACe<n>[:DATA]?	312
TRACe<n>[:DATA]:X?	313

---

### CALCulate<n>:MARKer<m>:FUNCTion:POWer<sb>:RESult[:CURRent]?

[<Measurement>]

Queries the results of the ACLR measurement or the total signal power level of the SEM measurement.

To get a valid result, you have to perform a complete measurement with synchronization to the end of the measurement before reading out the result. This is only possible for single sweeps.

#### Suffix:

<n>	Window
<m>	Marker
<sb>	irrelevant

#### Query parameters:

<Measurement>	<b>CPOW</b> This parameter queries the channel power of the reference range.
	<b>MCAC</b> Queries the channel powers of the ACLR measurements as shown in the ACLR table. Where available, this parameter also queries the power of the adjacent channels (for example in the ACLR measurement).

#### Return values:

<Result>	<b>Results for the Spectrum Emission Mask measurement:</b> Power level in dBm.
----------	---

**Results for the ACLR measurements:**

Relative power levels of the ACLR channels. The number of return values depends on the number of transmission and adjacent channels. The order of return values is:

- <TXChannelPower> is the power of the transmission channel in dBm
- <LowerAdjChannelPower> is the relative power of the lower adjacent channel in dB
- <UpperAdjChannelPower> is the relative power of the upper adjacent channel in dB
- <1stLowerAltChannelPower> is the relative power of the first lower alternate channel in dB
- <1stUpperAltChannelPower> is the relative power of the first lower alternate channel in dB
- (...)
- <nthLowerAltChannelPower> is the relative power of a subsequent lower alternate channel in dB
- <nthUpperAltChannelPower> is the relative power of a subsequent lower alternate channel in dB

**Example:**

```
CALC1:MARK:FUNC:POW:RES? MCAC
```

Returns the current ACLR measurement results.

**Usage:**

Query only

**Manual operation:**

See ["Result summary"](#) on page 56

See ["Result summary"](#) on page 58

See ["Result summary"](#) on page 60

---

**CALCulate<n>:MARKer<m>:FUNCTION:POWer<sb>:RESult:DEtails**  
 <Measurement>

Queries the results of the ACLR measurement.

To get a valid result, you have to perform a complete measurement with synchronization to the end of the measurement before reading out the result. This is only possible for single sweeps.

Prerequisites for this command

- Available for combined measurements only.

**Suffix:**

<n> [Window](#)

<m> [Marker](#)

<sb> irrelevant

**Parameters:**

<Measurement> [ACPower](#)

**Return values:**

&lt;Result&gt;

**Results for the ACLR measurements:**

Absolute and relative power levels of the ACLR channels. The number of return values depends on the number of transmission and adjacent channels. The order of return values is:

- <TXChannelPower> is the power of the transmission channel in dBm
- <LowerAdjChannelPower> is the relative power of the lower adjacent channel in dB
- <UpperAdjChannelPower> is the relative power of the upper adjacent channel in dB
- <1stLowerAltChannelPower> is the relative power of the first lower alternate channel in dB
- <1stUpperAltChannelPower> is the relative power of the first lower alternate channel in dB
- (...)
- <nthLowerAltChannelPower> is the relative power of a subsequent lower alternate channel in dB
- <nthUpperAltChannelPower> is the relative power of a subsequent lower alternate channel in dB

**Example:**

```
//Query the current ACLR measurement results.
CALC1:MARK:FUNC:POW:RES? ACP
```

**Manual operation:** See "[Result summary](#)" on page 56

**FORMat[:DATA] <Format>**

Selects the data format for the data transmission between the FSW and the remote client.

**Parameters:**

```
<Format>      ASCii | REAL
               *RST:      ASCii
```

**Example:**

```
//Select data format
FORM REAL
```

**TRACe<n>:CATalog?**

Queries the types of traces in a diagram.

Prerequisites for this command

- Query results in a window that contains one or more line traces.

**Suffix:**

```
<n>           Window
```

**Return values:**

```
<TraceType>  CLRW | SSB<x> | BWP<x> | AVG | MIN | MAX
```

**CLRW**

For result displays with a single trace (for example the capture buffer).

**SSB<x> | BWP<x>**

For unfiltered result displays that show all signal parts (for example unfiltered EVM vs Carrier).

(SSB = synchronization signal block, BWP = bandwidth part)

**AVG | MIN | MAX**

For result displays that are filtered by a specific bandwidth part or subframe and show the average, minimum or maximum results of the slots (for example filtered EVM vs Carrier).

**Example:** //Query trace types  
TRAC2:CAT?

**Usage:** Query only

**TRACe<n>[:DATA]? <Result>**

This command queries the trace data for each measurement point (y-axis values).

In combination with [TRACe<n>\[:DATA\]:X?](#), you can thus query the coordinates of each measurement point.

**Suffix:**

<n> [Window](#)

**Parameters:**

**RESult** Combined mode only:  
Queries the results of all ACLR or SEM measurements in a measurement sequence.

**LIMit** Combined mode only:  
Queries the limit check results of all ACLR or SEM measurements in a measurement sequence.

**Query parameters:**

<TraceNumber> **TRACE1 | TRACE2 | TRACE3**  
Queries the trace data of the corresponding trace.

**LIST** Queries the results for the SEM measurement.

**PBCH** Queries the results for the PBCH in the channel decoder.

**CORESET** Queries the results for the PDCCH in the channel decoder.

**Return values:**

<TraceData> For more information about the type of return values in the different result displays, see [Chapter 6.9.1, "Using the TRACe\[:DATA\] command"](#), on page 290.

**Example:** //Query results of the second measurement window. The type of data that is returned by the parameter (TRACE1) depends on the result display shown in measurement window 2.  
TRAC2? TRACE1



<b>Example:</b>	//Query results of the channel decoder result display TRAC2? PBCH TRAC2? CORESET
<b>Usage:</b>	Query only
<b>Manual operation:</b>	See "Data import and export" on page 205

### TRACe<n>[:DATA]:X? <Result>

Queries the horizontal trace data for each measurement point (x-axis values).

In combination with [TRACe<n>\[:DATA\]?](#), you can thus query the coordinates of each measurement point.

**Suffix:**

<n> [Window](#)

**Query parameters:**

<TraceNumber> TRACe1 | TRACe2 | TRACe3 | TRACe4 | TRACe5 | TRACe6

**Return values:**

<TraceData> The type of value depends on the information displayed on the x-axis of the result display whose contents you query.

**Example:** //Query trace data of trace 1 in window 2  
TRAC2? TRACE1  
TRAC2:X? TRACE1

**Usage:** Query only

**Manual operation:** See "Capture Buffer" on page 31  
See "EVM vs Carrier" on page 32  
See "EVM vs Symbol" on page 32  
See "EVM vs RB" on page 33  
See "Frequency Error vs Symbol" on page 34  
See "Frequency Error vs Subframe" on page 35  
See "Power Spectrum" on page 36  
See "Flatness" on page 36

## 6.10 Configuration

• <a href="#">General configuration</a> .....	314
• <a href="#">Automatic configuration</a> .....	317
• <a href="#">Physical settings</a> .....	321
• <a href="#">Component carrier configuration</a> .....	326
• <a href="#">General radio frame configuration</a> .....	330
• <a href="#">Synchronization signal configuration</a> .....	332
• <a href="#">Bandwidth part configuration</a> .....	339
• <a href="#">Slot configuration</a> .....	342
• <a href="#">CSI reference signal configuration</a> .....	349
• <a href="#">Positioning reference signal</a> .....	358

• CORESET allocation configuration.....	362
• PDSCH allocation configuration.....	369
• Enhanced CORESET allocation configuration.....	376
• Enhanced PDSCH settings: DMRS.....	393
• Enhanced PDSCH settings: PTRS.....	402
• Enhanced PDSCH settings: scrambling / coding.....	406
• Antenna port configuration.....	410
• Advanced settings: global.....	411
• Advanced settings: reference point A.....	415
• Advanced settings: LTE-CRS coexistence.....	419
• Generator control.....	421
• Input configuration.....	427
• Frequency configuration.....	435
• Amplitude configuration.....	437
• Data capture.....	442
• Trigger.....	445
• Segmented capture.....	450
• Optimization.....	452
• Tracking.....	453
• Demodulation.....	455
• Time alignment measurement.....	459
• Transmit on/off power measurements.....	459
• Frequency sweep measurements.....	462
• Combined measurements.....	466

### 6.10.1 General configuration

The following remote control command control general configuration of the application.

The remote control commands to select the result displays for I/Q measurements are described in [Chapter 6.5, "Screen layout"](#), on page 231.

CONFigure[:NR5G]:MEASurement.....	314
MMEemory:LOAD:IQ:STATe:ALL.....	315
MMEemory:STORe<n>:IQ:STATe.....	316
MMEemory:STORe<n>:IQ:STATe:ALL.....	316
MMEemory:STORe<n>:IQNC:STATe.....	316
MMEemory:STORe<n>:MSERvice.....	317
SYSTem:PRESet:CHANnel[:EXEC].....	317

---

#### CONFigure[:NR5G]:MEASurement <Measurement>

Selects the measurement type.

##### Parameters:

<Measurement>	<b>ACLR</b> Selects the adjacent channel leakage ratio (ACLR) measurement.
	<b>CACLR</b> Selects the Cumulative ACLR measurement.

**CMEasurement**

Selects combined EVM / ACLR / SEM measurement.

**ESpectrum**

Selects the spectrum emission mask (SEM) measurement.

**EVM**

Selects I/Q measurements.

**MCAClr**

Selects Multi-Carrier ACLR measurement.

**MCESpectrum**

Selects Multi-Carrier SEM measurement.

**TAERor**

Selects the time alignment error measurement.

**TPOO**

Selects the transmit on / off power measurement.

\*RST: EVM

**Example:** //Select a measurement  
CONF:MEAS EVM

**Manual operation:** See ["EVM"](#) on page 19  
See ["Time alignment error"](#) on page 20  
See ["Transmit on / off power"](#) on page 20  
See ["Channel power ACLR"](#) on page 20  
See ["SEM"](#) on page 20  
See ["Transmit On / Off Power"](#) on page 51  
See ["Adjacent Channel Leakage Ratio \(ACLR\)"](#) on page 56  
See ["Multi Carrier ACLR \(MC ACLR\)"](#) on page 57  
See ["Cumulative ACLR"](#) on page 59  
See ["Spectrum Emission Mask \(SEM\)"](#) on page 61  
See ["Select Measurement"](#) on page 73

---

**MMEMory:LOAD:IQ:STATe:ALL 1, <FileName>**

Restores the captured I/Q data of all measurements in a combined measurement sequence to a file.

The file extension is \*.iq.tar.

**Parameters:**

1 Fixed value.

<FileName> String containing the path and name of the target file.

**Example:** //Import I/Q data  
MMEM:LOAD:IQ:STAT:ALL 1, 'C:  
\R\_S\Instr\user\data.iq.tar'

**Manual operation:** See ["Data import and export"](#) on page 205

**MMEMory:STORe<n>:IQ:STATe <Value>,<FileName>**

Saves I/Q data to a file.

**Suffix:**

<n> irrelevant

**Parameters:**

<Value> 1

<FileName> String containing the path and name of the target file.

**Example:**

```
MMEM:STOR:IQ:STAT 'C:
\R_S\Instr\user\data.iq.tar'
Saves I/Q data to the specified file.
```

**Manual operation:** See ["Data import and export"](#) on page 205

**MMEMory:STORe<n>:IQ:STATe:ALL 1, <FileName>**

Writes the captured I/Q data of all measurements in a combined measurement sequence to a file.

The file extension is \*.iq.tar. By default, the contents of the file are in 32-bit floating point format.

**Suffix:**

<n> irrelevant

**Parameters:**

1 Fixed value.

<FileName> String containing the path and name of the target file.

**Example:**

```
//Export I/Q data
MMEM:STOR:IQ:STAT:ALL 1, 'C:
\R_S\Instr\user\data.iq.tar'
```

**Manual operation:** See ["Data import and export"](#) on page 205

**MMEMory:STORe<n>:IQNC:STATe 1, <FileName>**

Exports the I/Q data for a single PPDU with the analyzer noise removed to a file.

Prerequisites for this command:

- Turn on I/Q noise cancellation.  
(See [\[SENSe:\]ADJust:NCANcel:AVERage\[:STATe\]](#)).

**Suffix:**

<n> irrelevant

**Parameters:**

1

<FileName> String containing the path and name of the file.  
The file extension is .iq.tar.

**Example:** //Export corrected I/Q data  
 ADJ:NCAN:AVER ON  
 MMEM:STOR:IQNC:STAT 1, 'c:\corrected\_iqdata'

**Manual operation:** See ["Data import and export"](#) on page 205

#### MMEMory:STORe<n>:MSERvice <FileName>

Exports the signal configuration to the microservice.

#### Suffix:

<n> irrelevant

#### Parameters:

<FileName> String containing the path and name of the file.  
 The file extension is .m5g.

**Example:** //Export to microservice  
 MMEM:STOR:MSER 'signal.xxx'

#### SYSTem:PRESet:CHANnel[:EXEC]

Restores the default instrument settings in the current channel.

Use `INST:SEL` to select the channel.

**Example:** INST:SEL 'Spectrum2'  
 Selects the channel for "Spectrum2".  
 SYST:PRES:CHAN:EXEC  
 Restores the factory default settings to the "Spectrum2" channel.

**Usage:** Event

**Manual operation:** See ["Preset Channel"](#) on page 73

## 6.10.2 Automatic configuration

Commands to automatically configure measurements described elsewhere.

- `DISPlay[:WINDow<n>][:SUBWindow<w>]:TRACe<t>:Y[:SCALE]:AUTO`  
 on page 474

<code>[SENSe:]ADJust:CONFigure:LEVel:DURation</code> .....	318
<code>[SENSe:]ADJust:CONFigure:LEVel:DURation:MODE</code> .....	318
<code>[SENSe:]ADJust:DEMod</code> .....	318
<code>[SENSe:]ADJust:EVM</code> .....	318
<code>[SENSe:]ADJust:EVM:SLOTs</code> .....	319
<code>[SENSe:]ADJust:LEVel</code> .....	319
<code>[SENSe:]ADJust:LEVel&lt;ant&gt;:ALL</code> .....	319
<code>CONFigure[:NR5G]:DL[:CC&lt;cc&gt;]:DEMod:AUTO</code> .....	320
<code>CONFigure[:NR5G]:DL[:CC&lt;cc&gt;]:FRAMe&lt;fr&gt;:BWPart&lt;bwp&gt;:DETection</code> .....	320
<code>CONFigure[:NR5G]:DL[:CC&lt;cc&gt;]:SSBLoCk&lt;ssb&gt;:DETection</code> .....	321

**[SENSe:]ADJust:CONFigure:LEVel:DURation <Duration>**

To determine the ideal reference level, the FSW performs a measurement on the current input data. This command defines the length of the measurement if [\[SENSe:\]ADJust:CONFigure:LEVel:DURation:MODE](#) is set to `MANual`.

**Parameters:**

<Duration>            Numeric value in seconds  
 Range:            0.001 to 16000.0  
 \*RST:            0.001  
 Default unit: s

**Example:**

```
ADJ:CONF:DUR:MODE MAN
Selects manual definition of the measurement length.
ADJ:CONF:LEV:DUR 5ms
Length of the measurement is 5 ms.
```

**Manual operation:** See ["Auto Level"](#) on page 153

**[SENSe:]ADJust:CONFigure:LEVel:DURation:MODE <Mode>**

To determine the ideal reference level, the FSW performs a measurement on the current input data. This command selects the way the FSW determines the length of the measurement .

**Parameters:**

<Mode>            **AUTO**  
 The FSW determines the measurement length automatically according to the current input data.

**MANual**  
 The FSW uses the measurement length defined by [\[SENSe:\]ADJust:CONFigure:LEVel:DURation](#) on page 318.

\*RST:            AUTO

**Manual operation:** See ["Auto Level"](#) on page 153

**[SENSe:]ADJust:DEMod**

Automatically demodulates the signal once.

For continuous automatic demodulation, use [CONFigure\[:NR5G\]:DL\[:CC<cc>\]:DEMod:AUTO](#).

**Usage:**            Event

**Manual operation:** See ["Complete Signal Demodulation"](#) on page 75

**[SENSe:]ADJust:EVM**

Adjusts the amplitude settings, including attenuator and preamplifier, to achieve the optimal EVM using the maximum dynamic range.

Note that this process can up to several minutes, depending on the number of component carriers you are measuring.

For the auto EVM routine, it is sufficient to send this command. It is not necessary to send `INITiate<n>[:IMMEDIATE]`.

**Example:**            //Optimize EVM  
                      ADJ:EVM

**Usage:**             Event

**Manual operation:** See "Auto EVM" on page 74

### `[SENSe:]ADJust:EVM:SLOTs <Slots>`

Selects the number of slots to be used during the auto EVM routine.

Prerequisites for this command

- Select manual automatic measurement time mode (`[SENSe:]ADJust:CONFigure:LEVel:DURation:MODE`).
- Define an appropriate automatic measurement time (`[SENSe:]ADJust:CONFigure:LEVel:DURation` on page 318).

**Parameters:**

<Slots>                \*RST:        1

**Example:**            //Define number of slots for automatic EVM measurement  
                      CONF:LEV:DUR:MODE MAN  
                      ADJ:EVM:SLOT 2

**Manual operation:** See "Auto EVM" on page 74

### `[SENSe:]ADJust:LEVel`

Adjusts the level settings, including attenuator and preamplifier, to achieve the best dynamic range.

Compared to `[SENSe:]ADJust:EVM` on page 318, which achieves the best amplitude settings to optimize the EVM, you can use this command for a quick determination of preliminary amplitude settings.

**Example:**            //Adjust level settings  
                      ADJ:LEV

**Usage:**             Event

**Manual operation:** See "Auto Level" on page 74  
                      See "Auto Level" on page 153

### `[SENSe:]ADJust:LEVel<ant>:ALL`

Determines the ideal reference level based on the current measurement data and settings on all connected input sources.

This ensures that the settings of the RF attenuation and the reference level are optimally adjusted to the signal level without overloading the FSW or limiting the dynamic range by an S/N ratio that is too small.

The command is available for MIMO measurements with more than one input source.

**Suffix:**

<ant> irrelevant

**Example:**

```
//Auto level all connected instruments
ADJ:LEV:ALL
```

**Usage:**

Event

**CONFigure[:NR5G]:DL[:CC<cc>]:DEMod:AUTO <Mode>**

Turns automatic signal demodulation on and off.

**Suffix:**

<cc> [Component Carrier](#)

**Parameters:**

<Mode> ON | OFF | 1 | 0

**ON**

Automatically detects the following signal properties.

- Synchronization signal configuration
- Bandwidth part configuration
- Slot configuration
- PDSCH and CORESET configuration

**OFF**

Lets you configure the signal manually.

\*RST: MANual

**Example:**

```
//Select manual configuration mode
CONF:DL:CC2:DEMod:AUTO OFF
```

**Usage:**

Setting only

**Manual operation:** See "[Complete Signal Demodulation](#)" on page 75

**CONFigure[:NR5G]:DL[:CC<cc>]:FRAMe<fr>:BWPart<bwp>:DETection <State>**

Turns automatic detection of the bandwidth part configuration on and off.

**Suffix:**

<cc> [Component Carrier](#)

<fr> irrelevant



<bwp> irrelevant

**Parameters:**

<State>

**AUTO**

Automatically detects the following signal properties.

- Bandwidth part configuration
- Slot configuration
- PDSCH and CORESET configuration

**MANual**

Lets you configure the bandwidth parts manually.

\*RST:       MANual

**Example:**

```
//Select configuration mode
CONF:DL:CC2:FRAM:BWP:DET AUTO
```

**Manual operation:** See "[Bandwidth Parts Demodulation](#)" on page 76

**CONFigure[:NR5G]:DL[:CC<cc>]:SSBLoCk<ssb>:DETectioN <Mode>**

Turns automatic detection of the synchronization signal configuration on and off.

**Suffix:**

<cc>                   [Component Carrier](#)

<ssb>                  irrelevant

**Parameters:**

<Mode>

**AUTO**

Automatically detects the following synchronization signal properties.

- Subcarrier spacing
- SS/PBCH block pattern
- RB offset
- Additional subcarrier offset
- Cell ID

**MANual**

Lets you configure the SS/PBCH block manually.

\*RST:       AUTO

**Example:**

```
//Select configuration mode
CONF:DL:CC2:SSBL:DET AUTO
```

**Manual operation:** See "[Synchronization Signal Demodulation](#)" on page 77

### 6.10.3 Physical settings

<a href="#">CONFigure[:NR5G]:OBANd.....</a>	322
<a href="#">CONFigure[:NR5G]:DL[:CC&lt;cc&gt;]:BW.....</a>	322
<a href="#">CONFigure[:NR5G]:DL[:CC&lt;cc&gt;]:DFRanGe.....</a>	322
<a href="#">CONFigure[:NR5G]:DL[:CC&lt;cc&gt;]:PLC:CID.....</a>	323
<a href="#">CONFigure[:NR5G]:LDIRectioN.....</a>	323

FETCh[:CC<cc>]:PLC:CID?.....	324
MMEMory:LOAD:TMODeI[:CC<cc>].....	324
MMEMory:LOAD:DEModsetting:ALL.....	324
MMEMory:LOAD:DEModsetting[:CC<cc>].....	325
MMEMory:STORe<n>:DEModsetting:ALL.....	325
MMEMory:STORe<n>:DEModsetting[:CC<cc>].....	326

---

### CONFigure[:NR5G]:OBANd <OperatingBand>

Selects the operating band.

Prerequisites for this command

- Select at least 2 component carriers ([CONFigure\[:NR5G\]:NOCC](#) on page 329).

#### Parameters:

<OperatingBand> N1 | N2 | N3 | N5 | N7 | N8 | N12 | N13 | N14 | N18 | N20 | N24 |  
 N25 | N26 | N28 | N29 | N30 | N34 | N38 | N39 | N40 | N41 |  
 N46 | N48 | N50 | N51 | N53 | N65 | N66 | N67 | N70 | N71 |  
 N74 | N75 | N76 | N77 | N78 | N79 | N80 | N81 | N82 | N83 |  
 N84 | N85 | N86 | N89 | N90 | N91 | N92 | N93 | N94 | N95 |  
 N96 | N97 | N98 | N99 | N100 | N101 | N102 | N257 | N258 |  
 N259 | N260 | N261 | N262 | N263  
 \*RST: n1

**Example:** //Select operating band  
 CONF:NOCC 2  
 CONF:OBAN N20

**Manual operation:** See "[Operating Band](#)" on page 79

---

### CONFigure[:NR5G]:DL[:CC<cc>]:BW <Bandwidth>

Selects the channel bandwidth of the 5G NR carrier.

#### Suffix:

<cc> [Component Carrier](#)

#### Parameters:

<Bandwidth> BW5 | BW10 | BW15 | BW20 | BW25 | BW30 | BW35 | BW40 |  
 BW45 | BW50 | BW60 | BW70 | BW80 | BW90 | BW100 |  
 BW200 | BW400 | BW800 | BW1600 | BW2000  
 \*RST: BW100

**Example:** //Select carrier bandwidth  
 CONF:DL:BW BW20

**Manual operation:** See "[Physical settings of the signal](#)" on page 79  
 See "[Bandwidth configuration](#)" on page 84

---

### CONFigure[:NR5G]:DL[:CC<cc>]:DFRange <Deployment>

Selects the deployment frequency range of the signal.

**Suffix:**`<cc>` [Component Carrier](#)**Parameters:**`<Deployment>`**LOW**

Deployment in FR1 ≤ 3 GHz.

**MIDDLE**

Deployment in FR1 &gt; 3 GHz.

**HIGH**

Deployment in FR2-1.

**EHIGH**

Deployment in FR2-2.

\*RST: MIDDLE

**Example:**

```
//Select frequency range of signal
CONF:DL:DFR LOW
```

**Manual operation:** See ["Deployment Frequency Range"](#) on page 78**CONFigure[:NR5G]:DL[:CC<cc>]:PLC:CID <CellID>**

Defines the cell ID.

**Suffix:**`<cc>` [Component Carrier](#)**Parameters:**`<CellID>`**AUTO**

Automatically determines the cell ID.

**<numeric value> (integer only)**

Number of the cell ID.

Range: 0 to 503

**Example:**

```
//Define cell ID
CONF:DL:CC2:PLC:CID 12
```

**Manual operation:** See ["Physical settings of the signal"](#) on page 79**CONFigure[:NR5G]:LDIRrection <Mode>**

Selects the link direction you want to analyze.

**Parameters:**`<Mode>`**DL**

Selects the downlink application to analyze 5G NR downlink signals.

Requires option FSW-K144.

**UL**

Selects the uplink application to analyze 5G NR uplink signals.

Requires option FSW-K145.

**Example:** //Select uplink application  
CONF:LDIR UL

**Manual operation:** See ["Selecting the 5G NR mode"](#) on page 78

### FETCH[:CC<cc>]:PLC:CID?

Queries the cell ID.

**Suffix:**  
<cc> [Component Carrier](#)

**Return values:**  
<CellID> <numeric value> (integer only)

**Example:** //Query cell ID  
FETC:PLC:CID?

**Usage:** Query only

### MMEMory:LOAD:TMODeI[:CC<cc>] <TestModel>

Loads a test model (NR-FR-TM) as defined by 3GPP (38.141-1 / -2).

You can also select an O-RAN test case with the command.

**Suffix:**  
<cc> [Component Carrier](#)

**Parameters:**  
<TestModel> String containing the name of the test model (file name).  
Alternatively, a string that contains the name of the O-RAN test case, e.g. 'ORAN-FR1-TC32311\_\_FDD\_5MHZ\_15KHZ'.

**Example:** //Select test model  
:MMEM:LOAD:TMOD:CC1  
'NR-FR1-TM1\_1\_\_FDD\_5MHZ\_15KHZ'

**Example:** //Select O-RAN test case  
MMEM:LOAD:TMOD:DL  
'ORAN-FR1-TC32311\_\_FDD\_5MHZ\_15KHZ'

**Manual operation:** See ["3GPP test models"](#) on page 80  
See ["ORAN test cases"](#) on page 80

### MMEMory:LOAD:DEModsetting:ALL <FileName>

Restores the signal description of multiple carriers from a single file.

**Parameters:**  
<FileName> String containing the path and name of the file.  
The file extension is .ccallocation.

**Example:** //Restore signal description for multiple carriers in a single files  
 CONF:NOCC 2  
 MMEM:LOAD:DEM:ALL 'c:\TestSignal.ccallocation'

**Manual operation:** See ["Test scenarios for carrier aggregation"](#) on page 81

**MMEMory:LOAD:DEModsetting[:CC<cc>] <FileName>[, <Item>, <Item>, <Item>, <Item>, <Item>]**

Restores the signal description.

**Suffix:**

<cc> [Component Carrier](#)

**Parameters:**

<FileName> String containing the path and name of the file.  
 The file extension is .allocation.

<Item> Combined measurements only: Selects the allocation data you want to load.

**ACLR**

Loads the allocation data for ACLR measurements.

**ALL**

Loads the allocation data for all measurements (EVM, ACLR, SEM and results).

**CRT**

Loads the allocation data for EVM measurements.

**EVM**

Loads the results of a combined measurement sequence.

**SEM**

Loads the allocation data for SEM measurements.

**Example:** //Restore signal description for a single component carrier  
 MMEM:LOAD:DEM 'c:\TestSignal.allocation'

**Example:** //Restore signal description for multiple carriers in individual files  
 CONF:NOCC 2  
 MMEM:LOAD:DEM:CC1 'c:\TestSignalCC1.allocation'  
 MMEM:LOAD:DEM:CC2 'c:\TestSignalCC2.allocation'

**Example:** //Restore combined measurement allocation  
 MMEM:LOAD:DEM 'c:\TestSignalComb.allocation', EVM, SEM

**Manual operation:** See ["User defined test scenarios"](#) on page 81

**MMEMory:STORe<n>:DEModsetting:ALL <FileName>**

Saves the signal description of multiple carriers in a single file.

**Suffix:**

<n> irrelevant

**Parameters:**

<FileName> String containing the path and name of the file.  
The file extension is .ccallocation.

**Example:**

```
//Save signal description for multiple carriers in a single files
CONF:NOCC 2
MMEM:STOR:DEM:ALL 'c:\TestSignal.ccallocation'
```

**Manual operation:** See ["Test scenarios for carrier aggregation"](#) on page 81

**MMEMory:STORe<n>:DEModsetting[:CC<cc>] <FileName>**

Saves the signal description.

**Suffix:**

<n> irrelevant

<cc> [Component Carrier](#)

**Parameters:**

<FileName> String containing the path and name of the file.  
The file extension is .allocation.

**Example:**

```
//Save signal description for a single component carrier
MMEM:STOR:DEM 'c:\TestSignal.allocation'
```

**Example:**

```
//Save signal description for multiple carriers in individual files
CONF:NOCC 2
MMEM:STOR:DEM:CC1 'c:\TestSignalCC1.allocation'
MMEM:STOR:DEM:CC2 'c:\TestSignalCC2.allocation'
```

**Manual operation:** See ["User defined test scenarios"](#) on page 81

## 6.10.4 Component carrier configuration

Commands to configure component carrier described elsewhere.

- [\[SENSe:\]FREQuency:CENTer\[:CC<cc>\]](#)
- [\[SENSe:\]FREQuency:CENTer\[:CC<cc>\]:OFFSet](#)
- [CONFigure\[:NR5G\]:DL\[:CC<cc>\]:BW](#)

<a href="#">CONFigure[:NR5G]:CENTer</a> .....	327
<a href="#">CONFigure[:NR5G]:CRASter</a> .....	327
<a href="#">CONFigure[:NR5G]:CSPacing</a> .....	327
<a href="#">CONFigure[:NR5G]:CSCapture</a> .....	328
<a href="#">CONFigure[:NR5G]:FCOFFset</a> .....	328
<a href="#">CONFigure[:NR5G]:GMCFreq</a> .....	328
<a href="#">CONFigure[:NR5G]:NCSPacing</a> .....	328
<a href="#">CONFigure[:NR5G]:NOCC</a> .....	329
<a href="#">CONFigure[:NR5G]:OMODE</a> .....	329
<a href="#">CONFigure[:NR5G]:OREL</a> .....	330
<a href="#">[SENSe:]FREQuency:CENTer[:CC&lt;cc&gt;]:MCOFFset</a> .....	330

---

**CONFigure[:NR5G]:CENTer**

Synchronizes the global multicarrier frequency to the current center frequency (= center of all carriers).

Use `CONFigure[:NR5G]:GMCFreq` to query the global multicarrier frequency.

**Example:**

```
//Synchronize global multicarrier frequency
CONF:CENT
//Query global MC frequency
CONF:GMCF?
```

**Usage:** Event

**Manual operation:** See "[Center frequency configuration](#)" on page 86

---

**CONFigure[:NR5G]:CRASter <Bandwidth>**

Selects the channel raster of a component carrier.

Prerequisites for this command

- Select an operating band that supports different channel raster (`CONFigure[:NR5G]:OBANd`).  
For all other operating bands, the command works as a query only.

**Parameters:**

<Bandwidth>

**C15**  
15 kHz channel raster

**C15**  
100 kHz channel raster

**Example:**

```
//Select channel raster
CONF:OBAN N90
CONF:CRAS C100
```

**Manual operation:** See "[Channel Raster](#)" on page 84

---

**CONFigure[:NR5G]:CSPacing <Frequency>**

Defines the carrier spacing for equidistant frequency offsets in a multicarrier setup. This frequency offset applies to all component carriers in the setup.

Prerequisites for this command

- Select equidistant frequency offset (`CONFigure[:NR5G]:OMODe`).

**Parameters:**

<Frequency>

\*RST: 0  
Default unit: Hz

**Example:**

```
//Define carrier spacing
CONF:OMOD EQU
CONF:CSP 500MHZ
```

**Manual operation:** See "[Frequency offset configuration](#)" on page 86

---

**CONFigure[:NR5G]:CSCapture <Mode>**

Selects the capture mode for measurements on multiple component carriers.

**Parameters:**

&lt;Mode&gt;

**AUTO**

Automatically selects the number of component carriers that can be analyzed in a single capture. If there are more carriers than can be analyzed in a single measurement, the other carriers are analyzed in subsequent measurements.

**SINGLE**

Capture each component carrier subsequently in individual measurements.

\*RST: AUTO

**Example:**

```
//Select component carrier capture mode
CONF:CSC AUTO
```

**Manual operation:** See "[Component carrier data capture](#)" on page 82

---

**CONFigure[:NR5G]:FCOOffset <State>**

Turns a fixed frequency offset for component carriers on and off.

**Parameters:**

&lt;State&gt;

ON | OFF | 1 | 0

\*RST: OFF

**Example:**

```
//Turn on fixed frequency offset
CONF:FCOF ON
```

**Manual operation:** See "[Frequency offset configuration](#)" on page 86

---

**CONFigure[:NR5G]:GMCFreq <Frequency>**

Defines the global multicarrier frequency for component carrier setups.

**Parameters:**

&lt;Frequency&gt;

Default unit: Hz

**Example:**

```
//Define global MC frequency
CONF:GMCF 950MHZ
```

**Manual operation:** See "[Center frequency configuration](#)" on page 86

---

**CONFigure[:NR5G]:NCSPacing**

Resets the channel spacing of component carriers to its default value.

**Example:**

```
//Reset channel spacing
CONF:NCSP
```

**Usage:**

Event



**Manual operation:** See "[Nominal Channel Spacing](#)" on page 85

---

### CONFigure[:NR5G]:NOCC <Carrier>

Selects the number of component carriers analyzed in the measurement.

**Parameters:**

<Carrier> Number of the component carriers that you would like to measure. The range depends on the measurement. For more information see [Chapter 4.1.5, "Component carrier configuration"](#), on page 81.

\*RST: 1

**Example:** //Select number of component carriers  
CONF:NOCC 2

**Manual operation:** See "[Number of component carriers](#)" on page 82

---

### CONFigure[:NR5G]:OMODe <Mode>

Selects the frequency offset mode for component carriers in a multicarrier setup.

**Parameters:**

<Mode>

**ARbitrary**

Distance between component carriers is arbitrary. You can define the frequency offsets with [\[SENSe:\]FREQuency:CENTer\[:CC<cc>\]:OFFSet](#).

**EQUidistant**

Component carriers have the same distance between each other.

You can define the spacing between carriers with [CONFigure\[:NR5G\]:CSPacing](#).

\*RST: ARB

**Example:** //Select arbitrary frequency offsets relative to CC1  
CONF:OREL CC1  
CONF:OMOD ARB  
FREQ:CENT:CC2:OFFS 200MHZ  
FREQ:CENT:CC3:OFFS 300MHZ  
FREQ:CENT:CC4:OFFS 800MHZ

**Example:** //Select equidistant frequency offsets relative to CC1  
CONF:OREL CC1  
CONF:OMOD EQU  
CONF:CSP 200MHZ

**Manual operation:** See "[Frequency offset configuration](#)" on page 86

**CONFigure[:NR5G]:OREL** <Reference>

Selects the reference point for frequency offsets of component carriers in a multicarrier setup.

**Parameters:**

<Reference>                    **CC1**  
Reference point is the center frequency of first component carrier.

**GMCFreq**  
Reference point the global multicarrier frequency.

\*RST:            CC1

**Example:**                    //Select reference point for frequency offsets  
CONF:OREL GMCF

**Manual operation:**    See "[Frequency offset configuration](#)" on page 86

**[SENSe:]FREQuency:CENTer[:CC<cc>]:MCOffset** <Offset>

Defines the frequency offset of a component carrier.

Prerequisites for this command

- Select the global MC frequency as the reference point for the frequency offset ([CONFigure\[:NR5G\]:OREL](#)).

**Suffix:**

<cc>                            [Component Carrier](#)

**Parameters:**

<Offset>                    <numeric value>

- Component carrier offset: frequency offset relative to the first component carrier in Hz.

Default unit: Hz

**Example:**                    //Define a frequency offset of 15 MHz for the second component carrier relative to the first component carrier.  
CONF:OREL GMCF  
FREQ:CENT:CC2:OFFS 150MHZ

**Manual operation:**    See "[Frequency configuration](#)" on page 83

## 6.10.5 General radio frame configuration

<a href="#">CONFigure[:NR5G]:DL[:CC&lt;cc&gt;]:FRAME&lt;fr&gt;:COPY</a> .....	331
<a href="#">CONFigure[:NR5G]:DL[:CC&lt;cc&gt;]:FRAME&lt;fr&gt;:PASTE:ALL</a> .....	331
<a href="#">CONFigure[:NR5G]:DL[:CC&lt;cc&gt;]:FRAME&lt;fr&gt;:PASTE[:FRAME]</a> .....	331
<a href="#">CONFigure[:NR5G]:DL[:CC&lt;cc&gt;]:FTConfig</a> .....	332

**CONFigure[:NR5G]:DL[:CC<cc>]:FRAMe<fr>:COPY**

Copies a frame configuration.

**Suffix:**

<cc>                    [Component Carrier](#)  
 <fr>                    [Frame](#)

**Example:**            //Copy configuration of frame 3  
 CONF:DL:CC2:FRAM3:COPY

**Usage:**              Event

**Manual operation:** See "[Frame Configuration Management](#)" on page 90

**CONFigure[:NR5G]:DL[:CC<cc>]:FRAMe<fr>:PASTe:ALL**

Applies an existing frame configuration to all other frames.

Prerequisites for this command

- Copy a frame configuration ([CONFigure\[:NR5G\]:DL\[:CC<cc>\]:FRAMe<fr>:COPY](#) on page 331).

**Suffix:**

<cc>                    [Component Carrier](#)  
 <fr>                    irrelevant

**Example:**            //Copy configuration of frame 3  
 CONF:DL:CC2:FRAM3:COPY  
 //Apply configuration to all other frames  
 CONF:DL:CC2:FRAM:PAST:ALL

**Usage:**              Event

**Manual operation:** See "[Frame Configuration Management](#)" on page 90

**CONFigure[:NR5G]:DL[:CC<cc>]:FRAMe<fr>:PASTe[:FRAMe]**

Applies an existing frame configuration to another one.

Prerequisites for this command

- Copy a frame configuration ([CONFigure\[:NR5G\]:DL\[:CC<cc>\]:FRAMe<fr>:COPY](#) on page 331).

**Suffix:**

<cc>                    [Component Carrier](#)  
 <fr>                    [Frame](#)

**Example:**            //Copy configuration of frame 3  
 CONF:DL:CC2:FRAM3:COPY  
 //Apply configuration to frame 4  
 CONF:DL:CC2:FRAM4:PAST

**Usage:** Event

**Manual operation:** See "Frame Configuration Management" on page 90

---

#### CONFigure[:NR5G]:DL[:CC<cc>]:FTConfig <Frames>

Defines the number of configurable frames.

**Suffix:**

<cc> [Component Carrier](#)

**Parameters:**

<Frames> <numeric value> (integer only)  
\*RST: 1

**Example:** //Define number of configurable frames  
CONF:DL:CC2:FTC 2

**Manual operation:** See "Frame Configuration" on page 88

### 6.10.6 Synchronization signal configuration

CONFigure[:NR5G]:DL[:CC<cc>]:SSBLock<ssb>:ASOFFset.....	332
CONFigure[:NR5G]:DL[:CC<cc>]:SSBLock<ssb>:BSPeriod.....	333
CONFigure[:NR5G]:DL[:CC<cc>]:SSBLock<ssb>:HFOFFset.....	333
CONFigure[:NR5G]:DL[:CC<cc>]:SSBLock<ssb>:L.....	334
CONFigure[:NR5G]:DL[:CC<cc>]:SSBLock<ssb>:OFFSet.....	334
CONFigure[:NR5G]:DL[:CC<cc>]:SSBLock<ssb>:PATtern.....	335
CONFigure[:NR5G]:DL[:CC<cc>]:SSBLock<ssb>:PBCH:POWer.....	335
CONFigure[:NR5G]:DL[:CC<cc>]:SSBLock<ssb>:PDMRs:POWer.....	336
CONFigure[:NR5G]:DL[:CC<cc>]:SSBLock<ssb>:PSS:POWer.....	336
CONFigure[:NR5G]:DL[:CC<cc>]:SSBLock<ssb>:RTO.....	337
CONFigure[:NR5G]:DL[:CC<cc>]:SSBLock<ssb>:SSPacing.....	337
CONFigure[:NR5G]:DL[:CC<cc>]:SSBLock<ssb>:SSS:POWer.....	338
CONFigure[:NR5G]:DL[:CC<cc>]:SSBLock<ssb>[:STATE<ss>].....	338

---

#### CONFigure[:NR5G]:DL[:CC<cc>]:SSBLock<ssb>:ASOFFset <Offset>

Defines a frequency offset for the synchronization signal block.

Prerequisites for this command

- Select manual configuration mode for SS (CONFigure[:NR5G]:DL[:CC<cc>]:SSBLock<ssb>:DETection).

**Suffix:**

<cc> [Component Carrier](#)

<ssb> irrelevant

**Parameters:**

<Offset> <numeric value> (integer only)  
 Offset in terms of subcarrier, relative to the first subcarrier of a resource block.  
 Range: 0 to 11  
 \*RST: 0

**Example:**

```
//Define synchronization signal offset in terms of resource blocks
CONF:DL:CC2:SSBL:DET MAN
CONF:DL:CC2:SSBL:OFFS 50
//Define additional offset in terms of subcarrier
CONF:DL:CC2:SSBL:OFFS 6
```

**Manual operation:** See "[Synchronization Signal Offset](#)" on page 93

**CONFigure[:NR5G]:DL[:CC<cc>]:SSBLock<ssb>:BSPeriod <Periodicity>**

Selects the burst set periodicity of a synchronization signal block.

**Suffix:**

<cc> [Component Carrier](#)  
 <ssb> irrelevant

**Parameters:**

<Periodicity> **AUTO**  
 Determines the burst set periodicity of the signal automatically.  
**MS05 | MS10 | MS20 | MS40**  
 Selects one of the following periodicities:  
 5 ms, 10 ms, 20 ms, 40 ms  
 \*RST: MS10

**Example:**

```
//Select burst set periodicity
CONF:DL:CC2:SSBL:BSP MS05
```

**Manual operation:** See "[Burst Set Periodicity](#)" on page 95

**CONFigure[:NR5G]:DL[:CC<cc>]:SSBLock<ssb>:HFOffset <HalfFrame>**

Selects the half frame that contains the synchronization signal.

Prerequisites for this command

- Select a SSB periodicity > 5 ms ([CONFigure\[:NR5G\]:DL\[:CC<cc>\]:SSBLock<ssb>:BSPeriod](#) on page 333).

**Suffix:**

<cc> [Component Carrier](#)  
 <ssb> irrelevant

**Parameters:**

<HalfFrame> **ZERO**  
 SSB in first half frame.

**ONE**

SSB in second half frame.

\*RST: ZERO

**Example:** //Select half frame that contains SSB  
 CONF:DL:CC2:SSBL:BSP MS10  
 CONF:DL:CC2:SSBL:HFOF ONE

**Manual operation:** See "[Half Frame Offset](#)" on page 95

**CONFigure[:NR5G]:DL[:CC<cc>]:SSBLock<ssb>:L <Blocks>**

Selects the number of SS/PBCH blocks in the deployment range &lt; 3 GHz.

Prerequisites for this command

- Select a deployment < 3 GHz ([CONFigure\[:NR5G\]:DL\[:CC<cc>\]:DFRange](#)).
- Select a 30 kHz subcarrier spacing ([CONFigure\[:NR5G\]:DL\[:CC<cc>\]:SSBLock<ssb>:SSPacing](#)).
- Select the case C block pattern ([CONFigure\[:NR5G\]:DL\[:CC<cc>\]:SSBLock<ssb>:PATTern](#)).

**Suffix:**<cc> [Component Carrier](#)

&lt;ssb&gt; irrelevant

**Parameters:**

&lt;Blocks&gt; 4 | 8

\*RST: 4

**Example:** //Select 8 SS/PBCH blocks  
 CONF:DL:CC2:DFR LOW  
 CONF:DL:CC2:SSBL:SSP SS30  
 CONF:DL:CC2:SSBL:PATT C  
 CONF:DL:CC2:SSBL:L 8

**Manual operation:** See "[SS/PBCH Block State](#)" on page 95

**CONFigure[:NR5G]:DL[:CC<cc>]:SSBLock<ssb>:OFFSet <Offset>**

Defines a frequency offset for the synchronization signal block.

Prerequisites for this command

- Select manual configuration mode for SS ([CONFigure\[:NR5G\]:DL\[:CC<cc>\]:SSBLock<ssb>:DETection](#)).

**Suffix:**<cc> [Component Carrier](#)

&lt;ssb&gt; irrelevant

**Parameters:**

<Offset> <numeric value> (integer only)  
 Offset in terms of resource blocks, relative to the first subcarrier.  
 \*RST: 125

**Example:**

```
//Define synchronization signal offset
CONF:DL:CC2:SSBL:DET MAN
CONF:DL:CC2:SSBL:OFFS 50
```

**Manual operation:** See "[Synchronization Signal Offset](#)" on page 93

**CONFigure[:NR5G]:DL[:CC<cc>]:SSBLoCk<ssb>:PATTern <Pattern>**

Selects the pattern of a synchronization signal block.

Prerequisites for this command

- Select manual configuration mode for SS ([CONFigure\[:NR5G\]:DL\[:CC<cc>\]:SSBLoCk<ssb>:DETectioN](#)).

**Suffix:**

<cc> [Component Carrier](#)  
 <ssb> irrelevant

**Parameters:**

<Pattern> A | B | C | D | E | F | G  
 The SSB patterns are linked to the subcarrier spacing. Patterns A, D, E, F and G cannot be set. They are always selected automatically when you select a subcarrier spacing of 15 kHz (pattern A), 120 kHz (pattern D), 240 kHz (pattern E), 480 kHz (pattern F) or 960 kHz (pattern G). For these subcarrier spacing, the command is a query only. For subcarrier spacing of 30 kHz, you can select pattern B or C.  
 \*RST: B

**Example:**

```
//Query SSB pattern
CONF:DL:CC2:SSBL:SSP SS15
CONF:DL:CC2:SSBL:PATT?
returns
A
//Select SSB pattern
CONF:DL:CC2:DFR LOW
CONF:DL:CC2:SSBL:DET MAN
CONF:DL:CC2:SSBL:SSP SS30
CONF:DL:CC2:SSBL:PATT B
```

**Manual operation:** See "[SS/PBCH Block Pattern](#)" on page 93

**CONFigure[:NR5G]:DL[:CC<cc>]:SSBLoCk<ssb>:PBCH:POWer <Power>**

Defines the relative power of the PBCH.

**Suffix:**

<cc> [Component Carrier](#)

<ssb> irrelevant

**Parameters:**

<Power> <numeric value>

\*RST: 0

Default unit: dB

**Example:**

//Define relative power of the PBCH

CONF:DL:CC2:SSB:PBCH:POW 3

**Manual operation:** See "[Relative Power](#)" on page 96

**CONFigure[:NR5G]:DL[:CC<cc>]:SSBLock<ssb>:PDMRs:POWer <Power>**

Defines the relative power of the PBCH DMRS.

**Suffix:**

<cc> [Component Carrier](#)

<ssb> irrelevant

**Parameters:**

<Power> <numeric value>

\*RST: 0

Default unit: dB

**Example:**

//Define relative power of the PBCH DMRS

CONF:DL:CC2:SSB:PDMR:POW 3

**Manual operation:** See "[Relative Power](#)" on page 96

**CONFigure[:NR5G]:DL[:CC<cc>]:SSBLock<ssb>:PSS:POWer <Power>**

Defines the relative power of the primary synchronization signal (PSS).

**Suffix:**

<cc> [Component Carrier](#)

<ssb> irrelevant

**Parameters:**

<Power> <numeric value>

\*RST: 0

Default unit: dB

**Example:**

//Define relative power of the PSS

CONF:DL:CC2:SSB:PSS:POW 3

**Manual operation:** See "[Relative Power](#)" on page 96



**CONFigure[:NR5G]:DL[:CC<cc>]:SSBLoCk<ssb>:RTO** <Reference>

Selects the reference point for a synchronization signal offset.

Prerequisites for this command

- For selection of TxBW: Use at least one bandwidth part that has the same subcarrier spacing as the synchronization signal.  
For subcarrier spacing = 240 kHz, TxBW is not supported.

**Suffix:**

<cc> [Component Carrier](#)

<ssb> irrelevant

**Parameters:**

<Reference> **RPA**  
Offset relative to the reference point A.

**TXBW**

Offset relative to the the first subcarrier.

\*RST: TXBW

**Example:**

```
//Select reference point for SSB offset
CONF:DL:CC2:SSBL:RTO TXBW
```

**Manual operation:** See "[Synchronization Signal Offset](#)" on page 93

**CONFigure[:NR5G]:DL[:CC<cc>]:SSBLoCk<ssb>:SSPacing** <SubcarrierSpacing>

Selects the subcarrier spacing of a synchronization signal block.

Prerequisites for this command

- Select manual configuration mode for SS ([CONFigure\[:NR5G\]:DL\[:CC<cc>\]:SSBLoCk<ssb>:DETection](#)).

**Suffix:**

<cc> [Component Carrier](#)

<ssb> irrelevant

**Parameters:**

<SubcarrierSpacing> **SS15**  
15 kHz subcarrier spacing.  
Only for signal deployment in FR1.

**SS30**

30 kHz subcarrier spacing.  
Only for signal deployment in FR1.

**SS120**

120 kHz subcarrier spacing.  
Only for signal deployment in FR2.

**SS240**

240 kHz subcarrier spacing.  
Only for signal deployment in FR2.

**SS480**

240 kHz subcarrier spacing.  
Only for signal deployment in FR2-2.

**SS960**

240 kHz subcarrier spacing.  
Only for signal deployment in FR2-2.

\*RST: SS30

**Example:** //Select subcarrier spacing  
CONF:DL:CC2:DFR LOW  
CONF:DL:CC2:SSBL:DET MAN  
CONF:DL:CC2:SSBL:SSP SS30

**Manual operation:** See "[Subcarrier Spacing \(synchronization signal\)](#)" on page 92

**CONFigure[:NR5G]:DL[:CC<cc>]:SSBLock<ssb>:SSS:POWer <Power>**

Defines the relative power of the secondary synchronization signal (SSS).

**Suffix:**

<cc> [Component Carrier](#)

<ssb> irrelevant

**Parameters:**

<Power> <numeric value>

\*RST: 0

Default unit: dB

**Example:** //Define relative power of the SSS  
CONF:DL:CC2:SSB:SSS:POW 3

**Manual operation:** See "[Relative Power](#)" on page 96

**CONFigure[:NR5G]:DL[:CC<cc>]:SSBLock<ssb>[:STATE<ss>] <State>**

Turns an individual SS/PBCH block on and off.

**Suffix:**

<cc> [Component Carrier](#)

<ssb> [SS block](#)

<ss> 1...64  
SS/PBCH block

**Parameters:**

<State> **ALL**  
Turns on all synchronization blocks.  
**NONE**  
Turns off all synchronization blocks.

**ON | 1**

Turns on a single synchronization block (selected by the suffix at STATE).

**ON | 1**

Turns off a single synchronization block (selected by the suffix at STATE).

\*RST: ON

**Example:**

```
//Configure first four SS blocks
CONF:DL:CC2:SSBL:STAT0 ON
CONF:DL:CC2:SSBL:STAT1 ON
CONF:DL:CC2:SSBL:STAT2 OFF
CONF:DL:CC2:SSBL:STAT3 OFF
```

**Manual operation:** See "[SS/PBCH Block State](#)" on page 95

## 6.10.7 Bandwidth part configuration

<a href="#">CONFigure[:NR5G]:DL[:CC&lt;cc&gt;]:FRAME&lt;fr&gt;:BWPpart&lt;bwp&gt;:ADD</a>	339
<a href="#">CONFigure[:NR5G]:DL[:CC&lt;cc&gt;]:FRAME&lt;fr&gt;:BWPpart&lt;bwp&gt;:CLEar</a>	339
<a href="#">CONFigure[:NR5G]:DL[:CC&lt;cc&gt;]:FRAME&lt;fr&gt;:BWPpart&lt;bwp&gt;:DUPLICATE</a>	340
<a href="#">CONFigure[:NR5G]:DL[:CC&lt;cc&gt;]:FRAME&lt;fr&gt;:BWPpart&lt;bwp&gt;:RBCount</a>	340
<a href="#">CONFigure[:NR5G]:DL[:CC&lt;cc&gt;]:FRAME&lt;fr&gt;:BWPpart&lt;bwp&gt;:RBOffset</a>	341
<a href="#">CONFigure[:NR5G]:DL[:CC&lt;cc&gt;]:FRAME&lt;fr&gt;:BWPpart&lt;bwp&gt;:REMove</a>	341
<a href="#">CONFigure[:NR5G]:DL[:CC&lt;cc&gt;]:FRAME&lt;fr&gt;:BWPpart&lt;bwp&gt;:SSPacing</a>	341
<a href="#">CONFigure[:NR5G]:DL[:CC&lt;cc&gt;]:FRAME&lt;fr&gt;:BWPCount?</a>	342

---

### CONFigure[:NR5G]:DL[:CC<cc>]:FRAME<fr>:BWPpart<bwp>:ADD

Adds a bandwidth part to the signal configuration.

The new bandwidth part has the highest index number. Index numbers start at 0. For example, if you already have three bandwidth parts and add a fourth one, the new one has the index number 3.

**Suffix:**

<cc>	<a href="#">Component Carrier</a>
<fr>	irrelevant
<bwp>	irrelevant

**Example:**

```
//Add a bandwidth part
CONF:DL:CC2:FRAM:BWP:ADD
```

**Usage:**

Event

**Manual operation:** See "[BWP Configuration Tools](#)" on page 99

---

### CONFigure[:NR5G]:DL[:CC<cc>]:FRAME<fr>:BWPpart<bwp>:CLEar

Deletes all bandwidth parts.

<b>Suffix:</b>	
<cc>	Component Carrier
<fr>	irrelevant
<bwp>	irrelevant
<b>Example:</b>	//Delete all bandwidth parts CONF:DL:CC2:FRAM:BWP:CLE
<b>Usage:</b>	Event
<b>Manual operation:</b>	See " <a href="#">BWP Configuration Tools</a> " on page 99

---

### CONFigure[:NR5G]:DL[:CC<cc>]:FRAMe<fr>:BWPart<bwp>:DUPLicate

Duplicates an existing bandwidth part.

A duplication of a bandwidth part also duplicates its slot and PDSCH configuration.

<b>Suffix:</b>	
<cc>	irrelevant
<fr>	Frame
<bwp>	Bandwidth part
<b>Example:</b>	//Duplicate a bandwidth part CONF:DL:CC2:FRAM:BWP2:DUPL
<b>Usage:</b>	Event
<b>Manual operation:</b>	See " <a href="#">BWP Configuration Tools</a> " on page 99

---

### CONFigure[:NR5G]:DL[:CC<cc>]:FRAMe<fr>:BWPart<bwp>:RBCCount <ResourceBlocks>

Defines the number of physical resource blocks a bandwidth part occupies.

<b>Suffix:</b>	
<cc>	Component Carrier
<fr>	irrelevant
<bwp>	Bandwidth part
<b>Parameters:</b>	
<ResourceBlocks>	<numeric value> (integer only) *RST: 10
<b>Example:</b>	//Define number of PRB for a BWP CONF:DL:CC2:FRAM:BWP2:RBC 20
<b>Manual operation:</b>	See " <a href="#"># RBs</a> " on page 101

---

**CONFigure[:NR5G]:DL[:CC<cc>]:FRAMe<fr>:BWPart<bwp>:RBOffset <Offset>**

Defines a resource block offset for a bandwidth part.

**Suffix:**

<cc>	<a href="#">Component Carrier</a>
<fr>	irrelevant
<bwp>	<a href="#">Bandwidth part</a>

**Parameters:**

<Offset> <numeric value> (integer only)

\*RST: 0

**Example:**

```
//Define resource block offset for BWP
CONF:DL:CC2:FRAM:BWPart:RBOF 6
```

**Manual operation:** See "[RB Offset](#)" on page 101

---

**CONFigure[:NR5G]:DL[:CC<cc>]:FRAMe<fr>:BWPart<bwp>:REMOve**

Deletes a bandwidth part.

**Suffix:**

<cc>	<a href="#">Component Carrier</a>
<fr>	irrelevant
<bwp>	<a href="#">Bandwidth part</a>

**Example:**

```
//Remove a bandwidth part
CONF:DL:CC2:FRAM:BWPart:REM
```

**Usage:**

Event

**Manual operation:** See "[BWP Configuration Tools](#)" on page 99

---

**CONFigure[:NR5G]:DL[:CC<cc>]:FRAMe<fr>:BWPart<bwp>:SSPacing  
<SubcarrierSpacing>**

Selects the subcarrier spacing of a bandwidth part.

**Suffix:**

<cc>	<a href="#">Component Carrier</a>
<fr>	<a href="#">Frame</a>
<bwp>	<a href="#">Bandwidth part</a>

**Parameters:**

<SubcarrierSpacing> **SS15**  
15 kHz subcarrier spacing.  
Only for signal deployment in FR1.

**SS30**

30 kHz subcarrier spacing.  
Only for signal deployment in FR1.

**SS60**

60 kHz subcarrier spacing with normal cyclic prefix.  
For all signal deployments.

**SS120**

120 kHz subcarrier spacing.  
Only for signal deployment in FR2.

**SS480**

480 kHz subcarrier spacing.  
Only for signal deployment in FR2-2.

**SS960**

960 kHz subcarrier spacing.  
Only for signal deployment in FR2-2 and a 2000 MHz bandwidth.

**X60**

60 kHz subcarrier spacing with extended cyclic prefix.  
For all signal deployments.

**Example:**           //Select BWP subcarrier spacing  
CONF:DL:DFR LOW  
CONF:DL:FRAM:BWP2:SSP SS30

**Manual operation:** See "[Subcarrier Spacing \(user data\)](#)" on page 100

**CONFigure[:NR5G]:DL[:CC<cc>]:FRAMe<fr>:BWPCount?**

Queries the number of analyzed bandwidth parts.

**Suffix:**

<cc>                    [Component Carrier](#)  
<fr>                    irrelevant

**Return values:**

<BWPs>                <numeric value> (integer)

**Example:**           //Query number of bandwidth parts  
CONF:DL:FRAM:BWPC?

**Usage:**             Query only

**6.10.8 Slot configuration**

CONFigure[:NR5G]:DL[:CC<cc>]:FRAMe<fr>:BWPart<bwp>:CSLot.....	343
CONFigure[:NR5G]:DL[:CC<cc>]:FRAMe<fr>:BWPart<bwp>:SCOut?.....	343
CONFigure[:NR5G]:DL[:CC<cc>]:FRAMe<fr>:BWPart<bwp>:SLOT<sl>:ATYPe.....	343
CONFigure[:NR5G]:DL[:CC<cc>]:FRAMe<fr>:BWPart<bwp>:SLOT<sl>:COPY.....	344
CONFigure[:NR5G]:DL[:CC<cc>]:FRAMe<fr>:BWPart<bwp>:SLOT<sl>:FORMat.....	344
CONFigure[:NR5G]:DL[:CC<cc>]:FRAMe<fr>:BWPart<bwp>:SLOT<sl>:PASTE:ALL.....	345

CONFigure[:NR5G]:DL[:CC<cc>]:FRAMe<fr>:BWPart<bwp>:SLOT<sl>:PASTe:TO: DURation.....	345
CONFigure[:NR5G]:DL[:CC<cc>]:FRAMe<fr>:BWPart<bwp>:SLOT<sl>:PASTe:TO:MODE...	346
CONFigure[:NR5G]:DL[:CC<cc>]:FRAMe<fr>:BWPart<bwp>:SLOT<sl>:PASTe:TO.....	347
CONFigure[:NR5G]:DL[:CC<cc>]:FRAMe<fr>:BWPart<bwp>:SLOT<sl>:PASTe:TO:PERiod..	347
CONFigure[:NR5G]:DL[:CC<cc>]:FRAMe<fr>:BWPart<bwp>:SLOT<sl>:PASTe:TO:SLOTs...	348
CONFigure[:NR5G]:DL[:CC<cc>]:FRAMe<fr>:BWPart<bwp>:SLOT<sl>:PASTe[:SLOT].....	348
CONFigure[:NR5G]:DL[:CC<cc>]:FRAMe<fr>:BWPart<bwp>:SLOT<sl>:PRESet.....	349

---

### CONFigure[:NR5G]:DL[:CC<cc>]:FRAMe<fr>:BWPart<bwp>:CSLot <Slots>

Defines the number of slots that you can configure.

#### Suffix:

<cc>	Component Carrier
<fr>	Frame
<bwp>	Bandwidth part

#### Parameters:

<Slots>	<numeric value> (integer only) The maximum number of configurable slots depends on the sub-carrier spacing in the bandwidth part. *RST: 1
---------	---

**Example:** //Select number of custom slots  
CONF:DL:CC2:FRAM3:BWP2:CSL 2

**Manual operation:** See "Number of Configurable Slots" on page 103

---

### CONFigure[:NR5G]:DL[:CC<cc>]:FRAMe<fr>:BWPart<bwp>:SCOunt?

Queries the number of analyzed slots.

#### Suffix:

<cc>	Component Carrier
<fr>	Frame
<bwp>	Bandwidth part

#### Return values:

<Slots>	<numeric value> (integer)
---------	---------------------------

**Example:** //Query number of analyzed slots  
CONF:DL:CC2:FRAM3:BWP2:SCO?

**Usage:** Query only

---

### CONFigure[:NR5G]:DL[:CC<cc>]:FRAMe<fr>:BWPart<bwp>:SLOT<sl>:ATYPe <Type>

Selects the allocation type of a slot.

**Suffix:**

<cc>	Component Carrier
<fr>	Frame
<bwp>	Bandwidth part
<sl>	Bandwidth part

**Parameters:**

<Type>	<b>DATA</b> Slot contains information.
	<b>UNUSed</b> Slot contains no information.
*RST:	DATA

**Example:**

```
//Select slot allocation
CONF:DL:CC2:FRAM3:BWP2:SLOT4:ATYP DATA
```

**Manual operation:** See "[Slot Allocation](#)" on page 105

**CONFigure[:NR5G]:DL[:CC<cc>]:FRAMe<fr>:BWPart<bwp>:SLOT<sl>:COPY**

Copies a slot configuration.

**Suffix:**

<cc>	Component Carrier
<fr>	Frame
<bwp>	Bandwidth part
<sl>	Bandwidth part

**Example:**

```
//Copy configuration of a slot
CONF:DL:CC2:FRAM3:BWP2:SLOT4:COPY
```

**Usage:**

Event

**Manual operation:** See "[Slot Configuration Tools](#)" on page 104

**CONFigure[:NR5G]:DL[:CC<cc>]:FRAMe<fr>:BWPart<bwp>:SLOT<sl>:FORMat  
<SlotFormat>**

Selects the slot format for a slot.

**Suffix:**

<cc>	Component Carrier
<fr>	Frame
<bwp>	Bandwidth part
<sl>	Bandwidth part



**Parameters:**

<SlotFormat> <numeric value> (integer only)

Range: 0 to 61

\*RST: 0

**Example:**

//Select a slot format

CONF:DL:CC2:FRAM3:BWP2:SLOT4:ATYP 6

**Manual operation:** See "Slot Format" on page 105

**CONFigure[:NR5G]:DL[:CC<cc>]:FRAMe<fr>:BWPart<bw>:SLOT<sl>:PASTe:  
ALL**

Applies an existing slot configuration to all other slots.

Prerequisites for this command

- Copy a slot configuration (CONFigure[:NR5G]:DL[:CC<cc>]:FRAMe<fr>:BWPart<bw>:SLOT<sl>:COPY).

**Suffix:**

<cc> Component Carrier

<fr> Frame

<bw> Bandwidth part

<sl> Bandwidth part

**Example:**

//Copy configuration of slot 4

CONF:DL:CC2:FRAM3:BWP2:SLOT4:COPY

//Apply configuration to all other slots

CONF:DL:CC2:FRAM3:BWP2:SLOT:PAST:ALL

**Usage:**

Event

**Manual operation:** See "Slot Configuration Tools" on page 104

**CONFigure[:NR5G]:DL[:CC<cc>]:FRAMe<fr>:BWPart<bw>:SLOT<sl>:PASTe:  
TO:DURation <Value>**

Defines to which slots a slot configuration is copied to.

Prerequisites for this command

- A slot configuration is in the clipboard (CONFigure[:NR5G]:DL[:CC<cc>]:FRAMe<fr>:BWPart<bw>:SLOT<sl>:COPY).
- Number of configurable slots > 1 (CONFigure[:NR5G]:DL[:CC<cc>]:FRAMe<fr>:BWPart<bw>:CSLot).
- Select custom paste mode (CONFigure[:NR5G]:DL[:CC<cc>]:FRAMe<fr>:BWPart<bw>:SLOT<sl>:PASTe:TO:MODE).

**Suffix:**

<cc> Component Carrier

<fr> Frame

<bwp> [Bandwidth part](#)

<sl> [Bandwidth part](#)

**Parameters:**

<Value> The paste duration corresponds to a certain number of slots in a row.

\*RST: 1

**Example:**

//Paste configuration of slot 0 to 2 slots in a row, every 3rd slot (0,1,3,4,6,7,9,10,12)

CONF:DL:CC2:FRAM3:BWP2:CSL 12

CONF:DL:CC2:FRAM3:BWP2:SLOT0:COPY

CONF:DL:CC2:FRAM3:BWP2:SLOT0:PASTE:TO:MODE CUST

CONF:DL:CC2:FRAM3:BWP2:SLOT0:PASTE:TO:PER 3

CONF:DL:CC2:FRAM3:BWP2:SLOT0:PASTE:TO:DUR 2

---

**CONFigure[:NR5G]:DL[:CC<cc>]:FRAMe<fr>:BWPart<bwp>:SLOT<sl>:PASTE:TO:MODE <Mode>**

Selects the paste logic when you copy a slot configuration to other slots.

Prerequisites for this command

- A slot configuration is in the clipboard (`CONFigure[:NR5G]:DL[:CC<cc>]:FRAMe<fr>:BWPart<bwp>:SLOT<sl>:COPY`).
- Number of configurable slots > 1 (`CONFigure[:NR5G]:DL[:CC<cc>]:FRAMe<fr>:BWPart<bwp>:CSLot`).

**Suffix:**

<cc> [Component Carrier](#)

<fr> [Frame](#)

<bwp> [Bandwidth part](#)

<sl> [Bandwidth part](#)

**Parameters:**

<Mode> **CUSTOM**

Copies the slot configuration to specific set of slots according to the logic defined with:

•`CONFigure[:NR5G]:DL[:CC<cc>]:FRAMe<fr>:BWPart<bwp>:SLOT<sl>:PASTE:TO:PERiod`

•`CONFigure[:NR5G]:DL[:CC<cc>]:FRAMe<fr>:BWPart<bwp>:SLOT<sl>:PASTE:TO:DURation`

**DATA**

Copies the slot configuration to all data slots.

**SLOTS**

Copies the slot configuration to a specific set of slots.

**UNUSed**

Copies the slot configuration to all unused slots.

**Example:** //Paste configuration of slot 0 to every DATA slot  
 CONF:DL:CC2:FRAM3:BWP2:CSL 12  
 CONF:DL:CC2:FRAM3:BWP2:SLOT0:COPY  
 CONF:DL:CC2:FRAM3:BWP2:SLOT0:PASTE:TO:MODE DATA

---

### CONFigure[:NR5G]:DL[:CC<cc>]:FRAMe<fr>:BWPart<bwp>:SLOT<sl>:PASTE:TO

Copies a slot configuration to other slots.

Prerequisites for this command

- A slot configuration is in the clipboard (`CONFigure[:NR5G]:DL[:CC<cc>]:FRAMe<fr>:BWPart<bwp>:SLOT<sl>:COPY`).
- Number of configurable slots > 1 (`CONFigure[:NR5G]:DL[:CC<cc>]:FRAMe<fr>:BWPart<bwp>:CSLot`).
- Select custom paste mode (`CONFigure[:NR5G]:DL[:CC<cc>]:FRAMe<fr>:BWPart<bwp>:SLOT<sl>:PASTE:TO:MODE`).

#### Suffix:

<cc>	Component Carrier
<fr>	Frame
<bwp>	Bandwidth part
<sl>	Bandwidth part

**Example:** //Paste configuration of slot 0 to 2 slots in a row, every 3rd slot (0,1,3,4,6,7,9,10,12)  
 CONF:DL:CC2:FRAM3:BWP2:CSL 12  
 CONF:DL:CC2:FRAM3:BWP2:SLOT0:COPY  
 CONF:DL:CC2:FRAM3:BWP2:SLOT0:PASTE:TO:MODE CUST  
 CONF:DL:CC2:FRAM3:BWP2:SLOT0:PASTE:TO:PER 3  
 CONF:DL:CC2:FRAM3:BWP2:SLOT0:PASTE:TO:DUR 2  
 CONF:DL:CC2:FRAM3:BWP2:SLOT0:PASTE:TO

**Usage:** Event

**Manual operation:** See "[Slot Configuration Tools](#)" on page 104

---

### CONFigure[:NR5G]:DL[:CC<cc>]:FRAMe<fr>:BWPart<bwp>:SLOT<sl>:PASTE:TO:PERiod <Period>

Defines to which slots a slot configuration is copied to.

Prerequisites for this command

- A slot configuration is in the clipboard (`CONFigure[:NR5G]:DL[:CC<cc>]:FRAMe<fr>:BWPart<bwp>:SLOT<sl>:COPY`).
- Number of configurable slots > 1 (`CONFigure[:NR5G]:DL[:CC<cc>]:FRAMe<fr>:BWPart<bwp>:CSLot`).
- Select custom paste mode (`CONFigure[:NR5G]:DL[:CC<cc>]:FRAMe<fr>:BWPart<bwp>:SLOT<sl>:PASTE:TO:MODE`).

**Suffix:**

<cc>	Component Carrier
<fr>	Frame
<bwp>	Bandwidth part
<sl>	Bandwidth part

**Parameters:**

<Period>	The paste period corresponds to every n <sup>th</sup> slot. *RST: 1
----------	--

**Example:**

```
//Paste configuration of slot 0 to every 3rd slot (0,3,6,9,12)
CONF:DL:CC2:FRAM3:BWP2:CSL 12
CONF:DL:CC2:FRAM3:BWP2:SLOT0:COPY
CONF:DL:CC2:FRAM3:BWP2:SLOT0:PAST:TO:MODE CUST
CONF:DL:CC2:FRAM3:BWP2:SLOT0:PAST:TO:PER 3
```

---

**CONFigure[:NR5G]:DL[:CC<cc>]:FRAMe<fr>:BWPart<bwp>:SLOT<sl>:PASTe:  
TO:SLOTs <Slot>**

Copies a slot configuration to a specific set of slots.

Prerequisites for this command

- Number of configurable slots > 1 (CONFigure[:NR5G]:DL[:CC<cc>]:FRAMe<fr>:BWPart<bwp>:CSLot).
- Select slot paste mode (CONFigure[:NR5G]:DL[:CC<cc>]:FRAMe<fr>:BWPart<bwp>:SLOT<sl>:PASTe:TO:MODE).

**Suffix:**

<cc>	Component Carrier
<fr>	Frame
<bwp>	Bandwidth part
<sl>	Slot

**Parameters:**

<Slot>	String that contains a list of slots either as comma-separated list ("2,5,8"), a range ("3-5") or a combination of both ("2-5,8,10").
--------	---

**Example:**

```
//Copy allocation configuration to several slots
CONF:DL:CC2:FRAM3:BWP2:CSL 12
CONF:DL:CC2:FRAM3:BWP2:SLOT0:PAST:TO:MODE SLOT
CONF:DL:CC2:FRAM3:BWP2:SLOT0:PAST:TO:SLOT
"3, 6, 9"
```

---

**CONFigure[:NR5G]:DL[:CC<cc>]:FRAMe<fr>:BWPart<bwp>:SLOT<sl>:PASTe[:  
SLOT]**

Applies an existing slot configuration to another one.

Prerequisites for this command

- Copy a slot configuration (`CONFigure[:NR5G]:DL[:CC<cc>]:FRAMe<fr>:BWPart<bwp>:SLOT<sl>:COPY`).

**Suffix:**

<cc>                    [Component Carrier](#)

<fr>                    [Frame](#)

<bwp>                   [Bandwidth part](#)

<sl>                    [Bandwidth part](#)

**Example:**

```
//Copy configuration of slot 4
CONF:DL:CC2:FRAM3:BWP2:SLOT4:COPY
//Apply configuration to slot 3
CONF:DL:CC2:FRAM3:BWP2:SLOT5:PAST
```

**Usage:**              Event

**Manual operation:** See "[Slot Configuration Tools](#)" on page 104

**CONFigure[:NR5G]:DL[:CC<cc>]:FRAMe<fr>:BWPart<bwp>:SLOT<sl>:PRESet**

Resets the slot configuration of a bandwidth part to its default state.

**Suffix:**

<cc>                    [Component Carrier](#)

<fr>                    [Frame](#)

<bwp>                   [Bandwidth part](#)

<sl>                    irrelevant

**Example:**

```
//Reset the slot configuration
CONF:DL:CC2:FRAM3:BWP2:SLOT:PRES
```

**Usage:**              Event

**Manual operation:** See "[Slot Configuration Tools](#)" on page 104

## 6.10.9 CSI reference signal configuration

<a href="#">CONFigure[:NR5G]:DL[:CC&lt;cc&gt;]:FRAMe&lt;fr&gt;:BWPart&lt;bwp&gt;:CSI&lt;csi&gt;:BITMap</a>	350
<a href="#">CONFigure[:NR5G]:DL[:CC&lt;cc&gt;]:FRAMe&lt;fr&gt;:BWPart&lt;bwp&gt;:CSI&lt;csi&gt;:CTYPe?</a>	350
<a href="#">CONFigure[:NR5G]:DL[:CC&lt;cc&gt;]:FRAMe&lt;fr&gt;:BWPart&lt;bwp&gt;:CSI&lt;csi&gt;:DENSity</a>	351
<a href="#">CONFigure[:NR5G]:DL[:CC&lt;cc&gt;]:FRAMe&lt;fr&gt;:BWPart&lt;bwp&gt;:CSI&lt;csi&gt;:LONE</a>	351
<a href="#">CONFigure[:NR5G]:DL[:CC&lt;cc&gt;]:FRAMe&lt;fr&gt;:BWPart&lt;bwp&gt;:CSI&lt;csi&gt;:LZERo</a>	352
<a href="#">CONFigure[:NR5G]:DL[:CC&lt;cc&gt;]:FRAMe&lt;fr&gt;:BWPart&lt;bwp&gt;:CSI&lt;csi&gt;:NORBs</a>	352
<a href="#">CONFigure[:NR5G]:DL[:CC&lt;cc&gt;]:FRAMe&lt;fr&gt;:BWPart&lt;bwp&gt;:CSI&lt;csi&gt;:PORT?</a>	353
<a href="#">CONFigure[:NR5G]:DL[:CC&lt;cc&gt;]:FRAMe&lt;fr&gt;:BWPart&lt;bwp&gt;:CSI&lt;csi&gt;:POWER</a>	353
<a href="#">CONFigure[:NR5G]:DL[:CC&lt;cc&gt;]:FRAMe&lt;fr&gt;:BWPart&lt;bwp&gt;:CSI&lt;csi&gt;:RESources</a>	353
<a href="#">CONFigure[:NR5G]:DL[:CC&lt;cc&gt;]:FRAMe&lt;fr&gt;:BWPart&lt;bwp&gt;:CSI&lt;csi&gt;:ROW</a>	354
<a href="#">CONFigure[:NR5G]:DL[:CC&lt;cc&gt;]:FRAMe&lt;fr&gt;:BWPart&lt;bwp&gt;:CSI&lt;csi&gt;:SID</a>	354

CONFigure[:NR5G]:DL[:CC<cc>]:FRAMe<fr>:BWPart<bwp>:CSI<csi>:SLOT:APERiodic.....	355
CONFigure[:NR5G]:DL[:CC<cc>]:FRAMe<fr>:BWPart<bwp>:CSI<csi>:SLOT:MODE.....	355
CONFigure[:NR5G]:DL[:CC<cc>]:FRAMe<fr>:BWPart<bwp>:CSI<csi>:SLOT:PERiodicity.....	356
CONFigure[:NR5G]:DL[:CC<cc>]:FRAMe<fr>:BWPart<bwp>:CSI<csi>:SLOT:POFFset.....	356
CONFigure[:NR5G]:DL[:CC<cc>]:FRAMe<fr>:BWPart<bwp>:CSI<csi>:SRB.....	357
CONFigure[:NR5G]:DL[:CC<cc>]:FRAMe<fr>:BWPart<bwp>:CSI<csi>:STATe.....	357
CONFigure[:NR5G]:DL[:CC<cc>]:FRAMe<fr>:BWPart<bwp>:CSI<csi>:ZPOWer.....	358

---

### CONFigure[:NR5G]:DL[:CC<cc>]:FRAMe<fr>:BWPart<bwp>:CSI<csi>:BITMap <Value>

Defines the bitmap setting for the CSI-RS.

Note that you cannot change the bitmap value for selected location settings (CONFigure[:NR5G]:DL[:CC<cc>]:FRAMe<fr>:BWPart<bwp>:CSI<csi>:ROW on page 354).

#### Suffix:

<cc>	Component Carrier
<fr>	Frame
<bwp>	Bandwidth part
<csi>	CSI-RS

#### Parameters:

<Value> The value range depends on the selected location setting.

#### Example:

```
//Define bitmap
CONF:DL:CC2:FRAM:BWP2:CSI:ROW 1
CONF:DL:CC2:FRAM:BWP2:CSI:BITM 0011
```

**Manual operation:** See "Bitmap" on page 110

---

### CONFigure[:NR5G]:DL[:CC<cc>]:FRAMe<fr>:BWPart<bwp>:CSI<csi>:CTYPe?

Queries the CDM type of the CSI-RS.

#### Suffix:

<cc>	Component Carrier
<fr>	Frame
<bwp>	Bandwidth part
<csi>	CSI-RS

#### Return values:

<CDMType> NOCDm | FDm2 | CDM4 | CDM8

#### Example:

```
//Query CDM type
CONF:DL:CC2:FRAM:BWP2:CSI:ROW 4
CONF:DL:CC2:FRAM:BWP2:CSI:CTYP?
returns: FDm2
```

**Usage:** Query only

**Manual operation:** See "Row" on page 109

---

**CONFigure[:NR5G]:DL[:CC<cc>]:FRAMe<fr>:BWPart<bwp>:CSI<csi>:DENSity**  
<Configuration>

Selects the density configuration for the CSI-RS.

**Suffix:**

<cc>	Component Carrier
<fr>	Frame
<bwp>	Bandwidth part
<csi>	CSI-RS

**Parameters:**

<Configuration> DEN1 | DEN3 | EVEN | ODD

The availability and default value of the configurations depends on the location setting (`CONFigure[:NR5G]:DL[:CC<cc>]:FRAMe<fr>:BWPart<bwp>:CSI<csi>:ROW`).

**Example:**

```
//Define density
CONF:DL:CC2:FRAM:BWP2:CSI:ROW 4
CONF:DL:CC2:FRAM:BWP2:CSI:DENS DEN1
```

**Manual operation:** See "Density" on page 109

---

**CONFigure[:NR5G]:DL[:CC<cc>]:FRAMe<fr>:BWPart<bwp>:CSI<csi>:LONE**  
<Value>

Defines parameter  $I_1$  of the CSI-RS.

Prerequisites for this command

- Select a location setting that supports  $I_1$  (`CONFigure[:NR5G]:DL[:CC<cc>]:FRAMe<fr>:BWPart<bwp>:CSI<csi>:ROW`).

Effects of this command

- Changing  $I_1$  can have an effect on the value of  $I_0$  (`CONFigure[:NR5G]:DL[:CC<cc>]:FRAMe<fr>:BWPart<bwp>:CSI<csi>:LZERo`).

**Suffix:**

<cc>	Component Carrier
<fr>	Frame
<bwp>	Bandwidth part
<csi>	CSI-RS

**Parameters:**

<Value> The range of values and default value depend on the selected CSI-RS location setting.

**Example:** //Define location of CSI-RS  
 CONF:DL:CC2:FRAM:BWP2:CSI:ROW 16  
 CONF:DL:CC2:FRAM:BWP2:CSI:LZER 10

**Manual operation:** See "I0 / I1" on page 110

**CONFigure[:NR5G]:DL[:CC<cc>]:FRAMe<fr>:BWPart<bwp>:CSI<csi>:LZERo**  
 <Value>

Defines parameter  $I_0$  of the CSI-RS.

Effects of this command

- Changing  $I_0$  can have an effect on the value of  $I_1$  (CONFigure[:NR5G]:DL[:CC<cc>]:FRAMe<fr>:BWPart<bwp>:CSI<csi>:LONE).

**Suffix:**

<cc>                    Component Carrier  
 <fr>                    Frame  
 <bwp>                   Bandwidth part  
 <csi>                   CSI-RS

**Parameters:**

<Value>                The range of values and default value depend on the selected CSI-RS location setting (CONFigure[:NR5G]:DL[:CC<cc>]:FRAMe<fr>:BWPart<bwp>:CSI<csi>:ROW).

**Example:** //Define location of CSI-RS  
 CONF:DL:CC2:FRAM:BWP2:CSI:ROW 1  
 CONF:DL:CC2:FRAM:BWP2:CSI:LZER 5

**Manual operation:** See "I0 / I1" on page 110

**CONFigure[:NR5G]:DL[:CC<cc>]:FRAMe<fr>:BWPart<bwp>:CSI<csi>:NORBs**  
 <ResourceBlocks>

Selects the number of resource blocks occupied by the CSI reference signal.

**Suffix:**

<cc>                    Component Carrier  
 <fr>                    Frame  
 <bwp>                   Bandwidth part  
 <csi>                   CSI-RS

**Parameters:**

<ResourceBlocks>

**Example:** //Select number of resource blocks  
 CONF:DL:CC2:FRAM:BWP2:CSI:NORB 4

**Manual operation:** See "No. RBs" on page 109



**CONFigure[:NR5G]:DL[:CC<cc>]:FRAMe<fr>:BWPart<bwp>:CSI<csi>:PORT?**

Queries the port configuration of the CSI-RS.

**Suffix:**

<cc>	Component Carrier
<fr>	Frame
<bwp>	Bandwidth part
<csi>	CSI-RS

**Return values:**

<Value>

**Example:**

```
//Query ports
CONF:DL:CC2:FRAM:BWP2:CSI:ROW 16
CONF:DL:CC2:FRAM:BWP2:CSI:PORT?
returns: 32
```

**Usage:**

Query only

**Manual operation:** See "[Row](#)" on page 109

**CONFigure[:NR5G]:DL[:CC<cc>]:FRAMe<fr>:BWPart<bwp>:CSI<csi>:POWER  
<Power>**

Defines the relative power of the CSI-RS.

**Suffix:**

<cc>	Component Carrier
<fr>	Frame
<bwp>	Bandwidth part
<csi>	CSI-RS

**Parameters:**

<Power>            \*RST:        0  
                      Default unit: dB

**Example:**

```
//Define relative power
CONF:DL:CC2:FRAM:BWP2:CSI:POW 6
```

**Manual operation:** See "[Rel Power](#)" on page 110

**CONFigure[:NR5G]:DL[:CC<cc>]:FRAMe<fr>:BWPart<bwp>:CSI<csi>:RESources  
<Resource>**

Defines the number of different CSI-RS resources.

**Suffix:**

<cc>	Component Carrier
<fr>	Frame

<bwp>                    [Bandwidth part](#)

<csi>                    [CSI-RS](#)

**Parameters:**

<Resource>            \*RST:            1

**Example:**            //Define number of CSI-RS resources  
CONF:DL:CC2:FRAM:BWP2:CSI:RES 5

**Manual operation:** See "[Resources](#)" on page 107

**CONFigure[:NR5G]:DL[:CC<cc>]:FRAMe<fr>:BWPart<bwp>:CSI<csi>:ROW**  
<Value>

Selects the location setting for the CSI-RS.

Effects of this command

- Selecting a location setting has effects on the range and availability of the other CSI-RS parameters.

**Suffix:**

<cc>                    [Component Carrier](#)

<fr>                    [Frame](#)

<bwp>                   [Bandwidth part](#)

<csi>                   [CSI-RS](#)

**Parameters:**

<Value>                The numeric value corresponds to the number of the row in 3GPP 38.211, table 7.4.1.5.3-1.

Range:                1 to 18

\*RST:                1

**Example:**            //Select row  
CONF:DL:CC2:FRAM:BWP2:CSI:ROW 16

**Manual operation:** See "[Row](#)" on page 109

**CONFigure[:NR5G]:DL[:CC<cc>]:FRAMe<fr>:BWPart<bwp>:CSI<csi>:SID**  
<Value>

Defines the seed value for the CSI-RS sequence generation.

**Suffix:**

<cc>                    [Component Carrier](#)

<fr>                    [Frame](#)

<bwp>                   [Bandwidth part](#)

<csi>                   [CSI-RS](#)

**Parameters:**

<Value>                \*RST:            0

**Example:** //Define seed value  
 CONF:DL:CC2:FRAM:BWP2:CSI:SID 4

**Manual operation:** See "[Scrambling ID](#)" on page 110

**CONFigure[:NR5G]:DL[:CC<cc>]:FRAMe<fr>:BWPart<bwp>:CSI<csi>:SLOT:  
 APERiodic <Slot>**

Defines the slots in which a CSI reference signal is transmitted.

Prerequisites for this command

- Select aperiodic transmission ([CONFigure\[:NR5G\]:DL\[:CC<cc>\]:FRAMe<fr>:BWPart<bwp>:CSI<csi>:SLOT:MODE](#)).

**Suffix:**

<cc>                    [Component Carrier](#)  
 <fr>                    [Frame](#)  
 <bwp>                   [Bandwidth part](#)  
 <csi>                   [CSI-RS](#)

**Parameters:**

<Slot>                   String containing the slot numbers a CSI-RS is allocated to.  
 Example: To transmit the CSI-RS in slots 1,2,3,4,5,7,11, enter the string '1-5,7,11'.

**Example:** //Define CSI-RS transmission  
 CONF:DL:CC2:FRAM:BWP2:CSI:SLOT:MODE APER  
 CONF:DL:CC2:FRAM:BWP2:CSI:SLOT:APER '1,3,5-10'

**Manual operation:** See "[Aperiodic transmission](#)" on page 108

**CONFigure[:NR5G]:DL[:CC<cc>]:FRAMe<fr>:BWPart<bwp>:CSI<csi>:SLOT:  
 MODE <Configuration>**

Selects the transmission method for the CSI reference signal.

**Suffix:**

<cc>                    [Component Carrier](#)  
 <fr>                    [Frame](#)  
 <bwp>                   [Bandwidth part](#)  
 <csi>                   [CSI-RS](#)

**Parameters:**

<Configuration>       **APERiodic**  
 Aperiodic transmission.  
**PERiodic**  
 Periodic transmission every <x> slots.  
 \*RST:                  PERiodic

**Example:** //Select transmission method for CSI-RS  
 CONF:DL:CC2:FRAM:BWP2:CSI:SLOT:MODE PER

**Manual operation:** See "[Slot Config](#)" on page 108

### CONFigure[:NR5G]:DL[:CC<cc>]:FRAMe<fr>:BWPart<bwp>:CSI<csi>:SLOT: PERiodicity <Slot>

Selects the periodicity of CSI-RS transmission in terms of slots.

Prerequisites for this command

- Select periodic transmission (CONFigure[:NR5G]:DL[:CC<cc>]:FRAMe<fr>:BWPart<bwp>:CSI<csi>:SLOT:MODE).

#### Suffix:

<cc>	Component Carrier
<fr>	Frame
<bwp>	Bandwidth part
<csi>	CSI-RS

#### Parameters:

<Slot> SL4 | SL5 | SL8 | SL10 | SL16 | SL20 | SL32 | SL40 | SL64 |  
 SL80 | S160 | S320 | S640

Example: SL4 selects a periodicity of 4 (transmission every four slots).

The availability of parameters depends on the subcarrier spacing in the bandwidth part you are configuring.

\*RST: SL4

**Example:** //Define CSI-RS transmission periodicity  
 CONF:DL:CC2:FRAM:BWP2:CSI:SLOT:MODE PER  
 CONF:DL:CC2:FRAM:BWP2:CSI:SLOT:PER SL8

**Manual operation:** See "[Periodic transmission](#)" on page 108

### CONFigure[:NR5G]:DL[:CC<cc>]:FRAMe<fr>:BWPart<bwp>:CSI<csi>:SLOT: POFFset <Offset>

This command defines an offset for the first CSI-RS relative to the first slot in a bandwidth part.

Prerequisites for this command

- Select periodic transmission (CONFigure[:NR5G]:DL[:CC<cc>]:FRAMe<fr>:BWPart<bwp>:CSI<csi>:SLOT:MODE).

#### Suffix:

<cc>	Component Carrier
<fr>	Frame
<bwp>	Bandwidth part

<csi> [CSI-RS](#)

**Parameters:**

<Offset>

Example: An offset of 2 assigns the first CSI-RS to the second slot.

\*RST: 0

**Example:**

```
//Define CSI-RS transmission periodicity
CONF:DL:CC2:FRAM:BWP2:CSI:SLOT:MODE PER
CONF:DL:CC2:FRAM:BWP2:CSI:SLOT:POFF 2
```

**Manual operation:** See "[Periodic transmission](#)" on page 108

**CONFigure[:NR5G]:DL[:CC<cc>]:FRAMe<fr>:BWPART<bwp>:CSI<csi>:SRB**  
<ResourceBlock>

Select the first resource block occupied by the CSI reference signal.

**Suffix:**

<cc> [Component Carrier](#)

<fr> [Frame](#)

<bwp> [Bandwidth part](#)

<csi> [CSI-RS](#)

**Parameters:**

<ResourceBlock>

**Example:**

```
//Select starting resource block
CONF:DL:CC2:FRAM:BWP2:CSI:NORB 10
```

**Manual operation:** See "[Start RB](#)" on page 109

**CONFigure[:NR5G]:DL[:CC<cc>]:FRAMe<fr>:BWPART<bwp>:CSI<csi>:STATe**  
<State>

Turns the transmission of the CSI reference signal on and off.

**Suffix:**

<cc> [Component Carrier](#)

<fr> [Frame](#)

<bwp> [Bandwidth part](#)

<csi> [CSI-RS](#)

**Parameters:**

<State>

ON | OFF | 1 | 0

\*RST: OFF

**Example:**

```
//Turn on transmission of CSI-RS
CONF:DL:CC2:FRAM:BWP2:CSI:STAT ON
```

**Manual operation:** See "[State](#)" on page 107

---

**CONFigure[:NR5G]:DL[:CC<cc>]:FRAMe<fr>:BWPart<bwp>:CSI<csi>:ZPOWer**  
<State>

Turns zero power transmission of the CSI reference signal on and off.

Effects of this command

- Turning on zero power transmission disables the scrambling ID and relative power parameters (CONFigure[:NR5G]:DL[:CC<cc>]:FRAMe<fr>:BWPart<bwp>:CSI<csi>:SID and CONFigure[:NR5G]:DL[:CC<cc>]:FRAMe<fr>:BWPart<bwp>:CSI<csi>:POWer).

**Suffix:**

<cc>                    Component Carrier

<fr>                    Frame

<bwp>                  Bandwidth part

<csi>                  CSI-RS

**Parameters:**

<State>                ON | OFF | 1 | 0

\*RST:                OFF

**Example:**

//Turn on zero power transmission  
CONF:DL:CC2:FRAM:BWP2:CSI:ZPOW ON

**Manual operation:** See "Zero Power" on page 108

## 6.10.10 Positioning reference signal

CONFigure[:NR5G]:DL[:CC<cc>]:FRAMe<fr>:BWPart<bwp>:PRS:KPComb.....	358
CONFigure[:NR5G]:DL[:CC<cc>]:FRAMe<fr>:BWPart<bwp>:PRS:KPOFset.....	359
CONFigure[:NR5G]:DL[:CC<cc>]:FRAMe<fr>:BWPart<bwp>:PRS:LPRS.....	359
CONFigure[:NR5G]:DL[:CC<cc>]:FRAMe<fr>:BWPart<bwp>:PRS:LPStart.....	360
CONFigure[:NR5G]:DL[:CC<cc>]:FRAMe<fr>:BWPart<bwp>:PRS:NORBs.....	360
CONFigure[:NR5G]:DL[:CC<cc>]:FRAMe<fr>:BWPart<bwp>:PRS:NPID.....	360
CONFigure[:NR5G]:DL[:CC<cc>]:FRAMe<fr>:BWPart<bwp>:PRS:POWer.....	361
CONFigure[:NR5G]:DL[:CC<cc>]:FRAMe<fr>:BWPart<bwp>:PRS:SLOT:APERiodic.....	361
CONFigure[:NR5G]:DL[:CC<cc>]:FRAMe<fr>:BWPart<bwp>:PRS:SRB.....	361
CONFigure[:NR5G]:DL[:CC<cc>]:FRAMe<fr>:BWPart<bwp>:PRS:STATE.....	362

---

**CONFigure[:NR5G]:DL[:CC<cc>]:FRAMe<fr>:BWPart<bwp>:PRS:KPComb**  
<Subcarrier>

Defines the number of subcarriers the positioning reference signal uses.

**Suffix:**

<cc>                    Component Carrier

<fr>                    Frame

<bwp>                  Bandwidth part

**Parameters:**

<Subcarrier> Available values depend on the number of symbols the PRS uses (CONF:DL:CC2:FRAM:BWP2:PRS:LPRS: BWPPart<bwp>:PRS:LPRS).

\*RST: 2

**Example:**

```
//Select number of subcarrier
CONF:DL:CC2:FRAM:BWP2:PRS:LPRS 4
CONF:DL:CC2:FRAM:BWP2:PRS:KPC 4
```

**Manual operation:** See "[K^PRS\\_comb](#)" on page 112

### CONF:DL:NR5G:DL[:CC<cc>]:FRAM<fr>:BWPPart<bwp>:PRS:KPOffset <Offset>

Defines an offset in the frequency domain for the positioning reference signal.

**Suffix:**

<cc> [Component Carrier](#)

<fr> [Frame](#)

<bwp> [Bandwidth part](#)

**Parameters:**

<Offset> \*RST: 0

**Example:**

```
//Define offset in frequency domain
CONF:DL:CC2:FRAM:BWP2:PRS:KPOF 4
```

**Manual operation:** See "[K^PRS\\_Offset](#)" on page 112

### CONF:DL:NR5G:DL[:CC<cc>]:FRAM<fr>:BWPPart<bwp>:PRS:LPRS <Symbols>

Defines the number of symbols the positioning reference signal uses.

**Suffix:**

<cc> [Component Carrier](#)

<fr> [Frame](#)

<bwp> [Bandwidth part](#)

**Parameters:**

<Symbols> \*RST: 2

**Example:**

```
//Select number of symbol for PRS
CONF:DL:CC2:FRAM:BWP2:PRS:LPRS 6
```

**Manual operation:** See "[L\\_PRS](#)" on page 112

---

**CONFigure[:NR5G]:DL[:CC<cc>]:FRAMe<fr>:BWPart<bwp>:PRS:LPStart**  
 <Symbol>

Defines the first symbol the positioning reference signal uses.

**Suffix:**

<cc> [Component Carrier](#)

<fr> [Frame](#)

<bwp> [Bandwidth part](#)

**Parameters:**

<Symbol> \*RST: 0

**Example:**

```
//Select first symbol for PRS
CONF:DL:CC2:FRAM:BWP2:PRS:LPST 4
```

**Manual operation:** See "[I^PRS\\_Start](#)" on page 112

---

**CONFigure[:NR5G]:DL[:CC<cc>]:FRAMe<fr>:BWPart<bwp>:PRS:NORBs**  
 <ResourceBlocks>

Selects the number of resource blocks occupied by the positioning reference signal.

**Suffix:**

<cc> [Component Carrier](#)

<fr> [Frame](#)

<bwp> [Bandwidth part](#)

**Parameters:**

<ResourceBlocks>

**Example:**

```
//Select number of resource blocks
CONF:DL:CC2:FRAM:BWP2:PRS:NORB 4
```

**Manual operation:** See "[No. RBs](#)" on page 111

---

**CONFigure[:NR5G]:DL[:CC<cc>]:FRAMe<fr>:BWPart<bwp>:PRS:NPID <Value>**

Defines the seed value for the positioning reference signal sequence generation.

**Suffix:**

<cc> [Component Carrier](#)

<fr> [Frame](#)

<bwp> [Bandwidth part](#)

**Parameters:**

<Value> \*RST: 0

**Example:**

```
//Define seed value
CONF:DL:CC2:FRAM:BWP2:PRS:SID 4
```

**Manual operation:** See "[n^PRS\\_ID,Seq](#)" on page 112



**CONFigure[:NR5G]:DL[:CC<cc>]:FRAMe<fr>:BWPart<bwp>:PRS:POWer <Power>**

Defines the relative power of the positioning reference signal.

**Suffix:**

<cc>	Component Carrier
<fr>	Frame
<bwp>	Bandwidth part

**Parameters:**

<Power>	*RST: 0 Default unit: dB
---------	-----------------------------

**Example:**

```
//Define relative power
CONF:DL:CC2:FRAM:BWP2:PRS:POW 6
```

**Manual operation:** See "[Rel Power](#)" on page 113

**CONFigure[:NR5G]:DL[:CC<cc>]:FRAMe<fr>:BWPart<bwp>:PRS:SLOT:APERiodic <Slot>**

Defines the slots in which a positioning reference signal is transmitted.

**Suffix:**

<cc>	Component Carrier
<fr>	Frame
<bwp>	Bandwidth part

**Parameters:**

<Slot>	String containing the slot numbers a PRS is allocated to. Example: To transmit the CSI-RS in slots 1,2,3,4,5,7,11, enter the string '1-5,7,11'.
--------	--

**Example:**

```
//Define PRS transmission
CONF:DL:CC2:FRAM:BWP2:CSI:SLOT:APER '1,3,5-10'
```

**Manual operation:** See "[Slot Config](#)" on page 111

**CONFigure[:NR5G]:DL[:CC<cc>]:FRAMe<fr>:BWPart<bwp>:PRS:SRB <ResourceBlock>**

Select the first resource block occupied by the positioning reference signal.

**Suffix:**

<cc>	Component Carrier
<fr>	Frame
<bwp>	Bandwidth part

**Parameters:**

<ResourceBlock>	
-----------------	--

**Example:** //Select starting resource block  
CONF:DL:CC2:FRAM:BWP2:PRS:NORB 10

**Manual operation:** See "Start RB" on page 112

---

**CONFigure[:NR5G]:DL[:CC<cc>]:FRAMe<fr>:BWPart<bwp>:PRs:STATe <State>**

Turns the transmission of the positioning reference signal on and off.

**Suffix:**

<cc> [Component Carrier](#)

<fr> [Frame](#)

<bwp> [Bandwidth part](#)

**Parameters:**

<State> ON | OFF | 1 | 0

\*RST: OFF

**Example:** //Turn on transmission of PRS  
CONF:DL:CC2:FRAM:BWP2:PRS:STAT ON

**Manual operation:** See "State" on page 111

## 6.10.11 CORESET allocation configuration

CONFigure[:NR5G]:DL[:CC<cc>]:FRAMe<fr>:BWPart<bwp>:SLOT<sl>:COReset<cr>: COPY:DURation.....	363
CONFigure[:NR5G]:DL[:CC<cc>]:FRAMe<fr>:BWPart<bwp>:SLOT<sl>:COReset<cr>: COPY:MODE.....	363
CONFigure[:NR5G]:DL[:CC<cc>]:FRAMe<fr>:BWPart<bwp>:SLOT<sl>:COReset<cr>: COPY.....	364
CONFigure[:NR5G]:DL[:CC<cc>]:FRAMe<fr>:BWPart<bwp>:SLOT<sl>:COReset<cr>: COPY:PERiod.....	365
CONFigure[:NR5G]:DL[:CC<cc>]:FRAMe<fr>:BWPart<bwp>:SLOT<sl>:COReset<cr>: COPY:SLOT.....	365
CONFigure[:NR5G]:DL[:CC<cc>]:FRAMe<fr>:BWPart<bwp>:SLOT<sl>:COReset<cr>: POWer.....	366
CONFigure[:NR5G]:DL[:CC<cc>]:FRAMe<fr>:BWPart<bwp>:SLOT<sl>:COReset<cr>: RBCount.....	366
CONFigure[:NR5G]:DL[:CC<cc>]:FRAMe<fr>:BWPart<bwp>:SLOT<sl>:COReset<cr>: RBOFset.....	367
CONFigure[:NR5G]:DL[:CC<cc>]:FRAMe<fr>:BWPart<bwp>:SLOT<sl>:COReset<cr>: SCOnt.....	367
CONFigure[:NR5G]:DL[:CC<cc>]:FRAMe<fr>:BWPart<bwp>:SLOT<sl>:COReset<cr>: SOFFset.....	368
CONFigure[:NR5G]:DL[:CC<cc>]:FRAMe<fr>:BWPart<bwp>:SLOT<sl>:CRSCount.....	368

---

**CONFigure[:NR5G]:DL[:CC<cc>]:FRAMe<fr>:BWPart<bwp>:SLOT<sl>:  
COREset<cr>:COPY:DURation <Value>**

Defines to which slots a CORESET configuration is copied to.

Prerequisites for this command

- Number of configurable slots > 1 (CONFigure[:NR5G]:DL[:CC<cc>]:FRAMe<fr>:BWPart<bwp>:CSLot).
- Select custom paste mode (CONFigure[:NR5G]:DL[:CC<cc>]:FRAMe<fr>:BWPart<bwp>:SLOT<sl>:COREset<cr>:COPY:MODE).

**Suffix:**

<cc>	Component Carrier
<fr>	Frame
<bwp>	Bandwidth part
<sl>	Bandwidth part
<cr>	CORESET

**Parameters:**

<Value> The paste duration corresponds to a certain number of slots in a row.

\*RST: 1

**Example:** //Paste CORESET configuration to 2 slots in a row, every 3rd slot (0,1,3,4,6,7,9,10,12)  
 CONF:DL:CC2:FRAM3:BWP2:CSL 12  
 CONF:DL:CC2:FRAM3:BWP2:SLOT0:COR2:COPY:MODE CUST  
 CONF:DL:CC2:FRAM3:BWP2:SLOT0:COR2:COPY:PER 3  
 CONF:DL:CC2:FRAM3:BWP2:SLOT0:COR2:COPY:DUR 2

---

**CONFigure[:NR5G]:DL[:CC<cc>]:FRAMe<fr>:BWPart<bwp>:SLOT<sl>:  
COREset<cr>:COPY:MODE <Mode>**

Selects the paste logic when you copy a CORESET configuration to other slots.

Prerequisites for this command

- Number of configurable slots > 1 (CONFigure[:NR5G]:DL[:CC<cc>]:FRAMe<fr>:BWPart<bwp>:CSLot).

**Suffix:**

<cc>	Component Carrier
<fr>	Frame
<bwp>	Bandwidth part
<sl>	Bandwidth part

**<cr>** **CORESET**

**Parameters:**

**<Mode>** **CUSTom**  
Copies the slot configuration to specific set of slots according to the logic defined with:

- **CONFigure[:NR5G]:DL[:CC<cc>]:FRAMe<fr>:BWPart<bwp>:SLOT<sl>:COReset<cr>:COPY:PERiod**
- **CONFigure[:NR5G]:DL[:CC<cc>]:FRAMe<fr>:BWPart<bwp>:SLOT<sl>:COReset<cr>:COPY:DURation**

**SLOT**  
Copies the slot configuration to a specific set of slots.  
Select the slots with **CONFigure[:NR5G]:DL[:CC<cc>]:FRAMe<fr>:BWPart<bwp>:SLOT<sl>:COReset<cr>:COPY:SLOT**.

**Example:** `//Select paste mode  
CONF:DL:CC2:FRAM3:BWP2:CSL 12  
CONF:DL:CC2:FRAM3:BWP2:SLOT0:COR2:COPY:MODE  
SLOT`

---

### **CONFigure[:NR5G]:DL[:CC<cc>]:FRAMe<fr>:BWPart<bwp>:SLOT<sl>:COReset<cr>:COPY**

Copies a CORESET configuration to other slots.

Prerequisites for this command

- Number of configurable slots > 1 (**CONFigure[:NR5G]:DL[:CC<cc>]:FRAMe<fr>:BWPart<bwp>:CSLot**).
- Select paste mode (**CONFigure[:NR5G]:DL[:CC<cc>]:FRAMe<fr>:BWPart<bwp>:SLOT<sl>:COReset<cr>:COPY:MODE**).

#### **Suffix:**

**<cc>** **Component Carrier**

**<fr>** **Frame**

**<bwp>** **Bandwidth part**

**<sl>** **Bandwidth part**

**<cr>** **<100  
CORESET**

**Example:** `//Paste CORESET configuration to 2 slots in a row, every 3rd slot (0,1,3,4,6,7,9,10,12)  
CONF:DL:CC2:FRAM3:BWP2:CSL 12  
CONF:DL:CC2:FRAM3:BWP2:SLOT0:COR2:COPY:MODE  
CUST  
CONF:DL:CC2:FRAM3:BWP2:SLOT0:COR2:COPY:PER 3  
CONF:DL:CC2:FRAM3:BWP2:SLOT0:COR2:COPY:DUR 2  
CONF:DL:CC2:FRAM3:BWP2:SLOT0:COR2:COPY`

**Manual operation:** See "Copy to" on page 120

---

**CONFigure[:NR5G]:DL[:CC<cc>]:FRAMe<fr>:BWPart<bwp>:SLOT<sl>:  
COReset<cr>:COPY:PERiod <Period>**

Defines to which slots a CORESET configuration is copied to.

Prerequisites for this command

- Number of configurable slots > 1 (CONFigure[:NR5G]:DL[:CC<cc>]:FRAMe<fr>:BWPart<bwp>:CSLot).
- Select custom paste mode (CONFigure[:NR5G]:DL[:CC<cc>]:FRAMe<fr>:BWPart<bwp>:SLOT<sl>:COReset<cr>:COPY:MODE).

**Suffix:**

<cc>	Component Carrier
<fr>	Frame
<bwp>	Bandwidth part
<sl>	Bandwidth part
<cr>	CORESET

**Parameters:**

<Period> The paste period corresponds to every n<sup>th</sup> slot.  
\*RST: 1

**Example:** //Paste CORESET configuration to every 3rd slot (0,3,6,9,12)  
CONF:DL:CC2:FRAM3:BWP2:CSL 12  
CONF:DL:CC2:FRAM3:BWP2:SLOT0:COR2:COPY:MODE  
CUST  
CONF:DL:CC2:FRAM3:BWP2:SLOT0:COR2:COPY:PER 3

---

**CONFigure[:NR5G]:DL[:CC<cc>]:FRAMe<fr>:BWPart<bwp>:SLOT<sl>:  
COReset<cr>:COPY:SLOT <Slot>**

Copies a CORESET allocation configuration to a specific set of slots.

Prerequisites for this command

- Number of configurable slots > 1 (CONFigure[:NR5G]:DL[:CC<cc>]:FRAMe<fr>:BWPart<bwp>:CSLot).
- Select slot paste mode (CONFigure[:NR5G]:DL[:CC<cc>]:FRAMe<fr>:BWPart<bwp>:SLOT<sl>:COReset<cr>:COPY:MODE).

**Suffix:**

<cc>	Component Carrier
<fr>	Frame
<bwp>	Bandwidth part
<sl>	Slot

<cr> [PUCCH](#)

**Parameters:**

<Slot> List of slots either as comma-separated list (2,5,8), a range (3-5) or a combination of both (2-5,8,10).

**Example:**

```
//Copy allocation configuration to several slots
CONF:DL:CC2:FRAM3:BWP2:CSL 12
CONF:DL:CC2:FRAM3:BWP2:SLOT0:COR2:COPY:MODE
SLOT
CONF:DL:CC2:FRAM3:BWP2:SLOT0:COR2:COPY:SLOT
'3,6,9'
```

**CONFigure[:NR5G]:DL[:CC<cc>]:FRAMe<fr>:BWPart<bwp>:SLOT<sl>:  
COREset<cr>:POWER <Power>**

Defines the relative power of a CORESET.

**Suffix:**

<cc> irrelevant

<fr> irrelevant

<bwp> [Bandwidth part](#)

<sl> [Bandwidth part](#)

<cr> [CORESET](#)

**Parameters:**

<Power> <numeric value>  
\*RST: 0  
Default unit: dB

**Example:**

```
//Define CORESET power
CONF:DL:CC2:FRAM3:BWP2:SLOT4:COR3:POW 3
```

**Manual operation:** See "[Rel Power / dB](#)" on page 119

**CONFigure[:NR5G]:DL[:CC<cc>]:FRAMe<fr>:BWPart<bwp>:SLOT<sl>:  
COREset<cr>:RBCount <ResourceBlocks>**

Selects the number of resource blocks that a CORESET allocation occupies.

**Suffix:**

<cc> [Component Carrier](#)

<fr> [Frame](#)

<bwp> [Bandwidth part](#)

<sl> [Bandwidth part](#)

<cr> [CORESET](#)

**Parameters:**

<ResourceBlocks> <numeric value> (integer only)

\*RST: 270

**Example:**

```
//Define number of CORESET resource blocks
CONF:DL:CC2:FRAM3:BWP2:SLOT4:COR3:RBC 40
```

**Manual operation:** See "Number of RBs" on page 119

**CONFigure[:NR5G]:DL[:CC<cc>]:FRAMe<fr>:BWPart<bwp>:SLOT<sl>:  
COREset<cr>:RBOFset <Offset>**

Defines the resource block offset of a CORESET allocation.

**Suffix:**

<cc> [Component Carrier](#)

<fr> [Frame](#)

<bwp> [Bandwidth part](#)

<sl> [Bandwidth part](#)

<cr> [CORESET](#)

**Parameters:**

<Offset> <numeric value> (integer only)

The offset is a value relative to the first resource block of the slot.

\*RST: 0

**Example:**

```
//Define RB offset of CORESET
CONF:DL:CC2:FRAM3:BWP2:SLOT4:COR3:RBOF 10
```

**Manual operation:** See "Offset RB" on page 119

**CONFigure[:NR5G]:DL[:CC<cc>]:FRAMe<fr>:BWPart<bwp>:SLOT<sl>:  
COREset<cr>:SCOunt <Symbols>**

Selects the number of symbols that a CORESET allocation occupies.

**Suffix:**

<cc> [Component Carrier](#)

<fr> [Frame](#)

<bwp> [Bandwidth part](#)

<sl> [Bandwidth part](#)

<cr> [CORESET](#)

**Parameters:**

<Symbols> <numeric value> (integer only)

\*RST: 14

**Example:** //Define number of CORESET symbols  
 CONF:DL:CC2:FRAM3:BWP2:SLOT4:COR3:SCO 7

**Manual operation:** See "Number of Symbols" on page 119

**CONFigure[:NR5G]:DL[:CC<cc>]:FRAMe<fr>:BWPart<bwp>:SLOT<sl>:  
 COREset<cr>:SOFFset <Offset>**

Defines the symbol offset of a CORESET allocation.

**Suffix:**

<cc>                   Component Carrier  
 <fr>                   Frame  
 <bwp>                  Bandwidth part  
 <sl>                   Bandwidth part  
 <cr>                   CORESET

**Parameters:**

<Offset>              <numeric value> (integer only)  
 The offset is a value relative to the first symbol in the slot.  
 \*RST:                 0

**Example:** //Define CORESET symbol offset  
 CONF:DL:CC2:FRAM3:BWP2:SLOT4:COR3:SOFF 2

**Manual operation:** See "Offset Symbols" on page 119

**CONFigure[:NR5G]:DL[:CC<cc>]:FRAMe<fr>:BWPart<bwp>:SLOT<sl>:  
 CRSCount <CORESETs>**

Defines the number of CORESETs in a slot.

**Suffix:**

<cc>                   Component Carrier  
 <fr>                   Frame  
 <bwp>                  Bandwidth part  
 <sl>                   Bandwidth part

**Parameters:**

<CORESETs>           <numeric value> (integer only)  
 Range:                0 to 100  
 \*RST:                 1

**Example:** //Define number of CORESETs  
 CONF:DL:CC2:FRAM3:BWP2:SLOT4:ALC 10

**Manual operation:** See "# CORESETs" on page 116



## 6.10.12 PDSCH allocation configuration

CONFigure[:NR5G]:DL[:CC<cc>]:FRAMe<fr>:BWPart<bwp>:SLOT<sl>:ALCount.....	369
CONFigure[:NR5G]:DL[:CC<cc>]:FRAMe<fr>:BWPart<bwp>:SLOT<sl>: ALLocation<al>:COPY:DURation.....	370
CONFigure[:NR5G]:DL[:CC<cc>]:FRAMe<fr>:BWPart<bwp>:SLOT<sl>: ALLocation<al>:COPY:MODE.....	370
CONFigure[:NR5G]:DL[:CC<cc>]:FRAMe<fr>:BWPart<bwp>:SLOT<sl>: ALLocation<al>:COPY.....	371
CONFigure[:NR5G]:DL[:CC<cc>]:FRAMe<fr>:BWPart<bwp>:SLOT<sl>: ALLocation<al>:COPY:PERiod.....	372
CONFigure[:NR5G]:DL[:CC<cc>]:FRAMe<fr>:BWPart<bwp>:SLOT<sl>: ALLocation<al>:COPY:SLOT.....	372
CONFigure[:NR5G]:DL[:CC<cc>]:FRAMe<fr>:BWPart<bwp>:SLOT<sl>: ALLocation<al>[:CW<cw>]:MODulation.....	373
CONFigure[:NR5G]:DL[:CC<cc>]:FRAMe<fr>:BWPart<bwp>:SLOT<sl>: ALLocation<al>:POWER.....	373
CONFigure[:NR5G]:DL[:CC<cc>]:FRAMe<fr>:BWPart<bwp>:SLOT<sl>: ALLocation<al>:RBCount.....	374
CONFigure[:NR5G]:DL[:CC<cc>]:FRAMe<fr>:BWPart<bwp>:SLOT<sl>: ALLocation<al>:RBOFFset.....	374
CONFigure[:NR5G]:DL[:CC<cc>]:FRAMe<fr>:BWPart<bwp>:SLOT<sl>: ALLocation<al>:SCOunt.....	375
CONFigure[:NR5G]:DL[:CC<cc>]:FRAMe<fr>:BWPart<bwp>:SLOT<sl>: ALLocation<al>:SOFFset.....	375
CONFigure[:NR5G]:DL[:CC<cc>]:FRAMe<fr>:BWPart<bwp>:SLOT<sl>:CUID.....	376

---

### CONFigure[:NR5G]:DL[:CC<cc>]:FRAMe<fr>:BWPart<bwp>:SLOT<sl>:ALCount <Allocations>

Defines the number of PDSCH allocations in a slot.

#### Suffix:

<cc>	Component Carrier
<fr>	Frame
<bwp>	Bandwidth part
<sl>	Bandwidth part

#### Parameters:

<Allocations>	<numeric value> (integer only)
	Range: 0 to 100
	*RST: 1

#### Example:

```
//Define number of PDSCH allocations
CONF:DL:CC2:FRAM3:BWP2:SLOT4:ALC 10
```

**Manual operation:** See "[# PDSCH Allocations](#)" on page 116

---

**CONFigure[:NR5G]:DL[:CC<cc>]:FRAMe<fr>:BWPart<bwp>:SLOT<sl>:  
ALLocation<al>:COPY:DURation <Value>**

Defines to which slots a PDSCH configuration is copied to.

Prerequisites for this command

- Number of configurable slots > 1 (CONFigure[:NR5G]:DL[:CC<cc>]:FRAMe<fr>:BWPart<bwp>:CSLot).
- Select custom paste mode (CONFigure[:NR5G]:DL[:CC<cc>]:FRAMe<fr>:BWPart<bwp>:SLOT<sl>:ALLocation<al>:COPY:MODE).

**Suffix:**

<cc>	Component Carrier
<fr>	Frame
<bwp>	Bandwidth part
<sl>	Bandwidth part
<al>	Allocation

**Parameters:**

<Value> The paste duration corresponds to a certain number of slots in a row.

\*RST: 1

**Example:** //Paste PDSCH configuration to 2 slots in a row, every 3rd slot (0,1,3,4,6,7,9,10,12)  
CONF:DL:CC2:FRAM3:BWP2:CSL 12  
CONF:DL:CC2:FRAM3:BWP2:SLOT0:ALL2:COPY:MODE  
CUST  
CONF:DL:CC2:FRAM3:BWP2:SLOT0:ALL2:COPY:PER 3  
CONF:DL:CC2:FRAM3:BWP2:SLOT0:ALL2:COPY:DUR 2

---

**CONFigure[:NR5G]:DL[:CC<cc>]:FRAMe<fr>:BWPart<bwp>:SLOT<sl>:  
ALLocation<al>:COPY:MODE <Mode>**

Selects the paste logic when you copy a PDSCH configuration to other slots.

Prerequisites for this command

- Number of configurable slots > 1 (CONFigure[:NR5G]:DL[:CC<cc>]:FRAMe<fr>:BWPart<bwp>:CSLot).

**Suffix:**

<cc>	Component Carrier
<fr>	Frame
<bwp>	Bandwidth part
<sl>	Bandwidth part

<al> Allocation

**Parameters:**

<Mode>

**CUSTOM**

Copies the slot configuration to specific set of slots according to the logic defined with:

- `CONFigure[:NR5G]:DL[:CC<cc>]:FRAME<fr>:BWPart<bwp>:SLOT<sl>:ALLocation<al>:COPY:PERiod`
- `CONFigure[:NR5G]:DL[:CC<cc>]:FRAME<fr>:BWPart<bwp>:SLOT<sl>:ALLocation<al>:COPY:DURation`

**SLOT**

Copies the slot configuration to a specific set of slots.

Select the slots with `CONFigure[:NR5G]:DL[:CC<cc>]:FRAME<fr>:BWPart<bwp>:SLOT<sl>:ALLocation<al>:COPY:SLOT`.

**Example:**

```
//Select paste mode
CONF:DL:CC2:FRAM3:BWP2:CSL 12
CONF:DL:CC2:FRAM3:BWP2:SLOT0:ALL2:COPY:MODE
SLOT
```

---

**CONFigure[:NR5G]:DL[:CC<cc>]:FRAME<fr>:BWPart<bwp>:SLOT<sl>:ALLocation<al>:COPY**

Copies a PDSCH configuration to other slots.

Prerequisites for this command

- Number of configurable slots > 1 (`CONFigure[:NR5G]:DL[:CC<cc>]:FRAME<fr>:BWPart<bwp>:CSLot`).
- Select paste mode (`CONFigure[:NR5G]:DL[:CC<cc>]:FRAME<fr>:BWPart<bwp>:SLOT<sl>:ALLocation<al>:COPY:MODE`).

**Suffix:**

<cc> Component Carrier

<fr> Frame

<bwp> Bandwidth part

<sl> Bandwidth part

<al> <100  
Allocation

**Example:** //Paste PDSCH configuration to 2 slots in a row, every 3rd slot (0,1,3,4,6,7,9,10,12)  
 CONF:DL:CC2:FRAM3:BWP2:CSL 12  
 CONF:DL:CC2:FRAM3:BWP2:SLOT0:ALL2:COPY:MODE  
 CUST  
 CONF:DL:CC2:FRAM3:BWP2:SLOT0:ALL2:COPY:PER 3  
 CONF:DL:CC2:FRAM3:BWP2:SLOT0:ALL2:COPY:DUR 2  
 CONF:DL:CC2:FRAM3:BWP2:SLOT0:ALL2:COPY

**Manual operation:** See "Copy to" on page 120

**CONFigure[:NR5G]:DL[:CC<cc>]:FRAMe<fr>:BWPart<bwp>:SLOT<sl>:  
 ALLocation<al>:COPY:PERiod <Period>**

Defines to which slots a PDSCH configuration is copied to.

Prerequisites for this command

- Number of configurable slots > 1 (CONFigure[:NR5G]:DL[:CC<cc>]:FRAMe<fr>:BWPart<bwp>:CSLot).
- Select custom paste mode (CONFigure[:NR5G]:DL[:CC<cc>]:FRAMe<fr>:BWPart<bwp>:SLOT<sl>:ALLocation<al>:COPY:MODE).

**Suffix:**

<cc>                   Component Carrier  
 <fr>                   Frame  
 <bwp>                  Bandwidth part  
 <sl>                   Bandwidth part  
 <al>                   Allocation

**Parameters:**

<Period>              The paste period corresponds to every n<sup>th</sup> slot.  
 \*RST:                 1

**Example:** //Paste PDSCH configuration to every 3rd slot (0,3,6,9,12)  
 CONF:DL:CC2:FRAM3:BWP2:CSL 12  
 CONF:DL:CC2:FRAM3:BWP2:SLOT0:ALL2:COPY:MODE  
 CUST  
 CONF:DL:CC2:FRAM3:BWP2:SLOT0:ALL2:COPY:PER 3

**CONFigure[:NR5G]:DL[:CC<cc>]:FRAMe<fr>:BWPart<bwp>:SLOT<sl>:  
 ALLocation<al>:COPY:SLOT <Slot>**

Copies a PDSCH allocation configuration to a specific set of slots.

Prerequisites for this command

- Number of configurable slots > 1 (CONFigure[:NR5G]:DL[:CC<cc>]:FRAMe<fr>:BWPart<bwp>:CSLot).

- Select slot paste mode (CONFigure[:NR5G]:DL[:CC<cc>]:FRAMe<fr>:BWPart<bwp>:SLOT<sl>:ALLocation<al>:COPY:MODE).

**Suffix:**

<cc>	Component Carrier
<fr>	Frame
<bwp>	Bandwidth part
<sl>	Slot
<al>	Allocation

**Parameters:**

<Slot> String that contains a list of slots either as comma-separated list ("2,5,8"), a range ("3-5") or a combination of both ("2-5,8,10").

**Example:**

```
//Copy allocation configuration to several slots
CONF:DL:CC2:FRAM3:BWP2:CSL 12
CONF:DL:CC2:FRAM3:BWP2:SLOT0:ALL2:COPY:MODE
SLOT
CONF:DL:CC2:FRAM3:BWP2:SLOT0:ALL2:COPY:SLOT
"3,6,9"
```

---

**CONFigure[:NR5G]:DL[:CC<cc>]:FRAMe<fr>:BWPart<bwp>:SLOT<sl>:  
ALLocation<al>[:CW<cw>]:MODulation <Modulation>**

Selects the modulation of a PDSCH allocation.

**Suffix:**

<cc>	Component Carrier
<fr>	Frame
<bwp>	Bandwidth part
<sl>	Bandwidth part
<al>	Allocation
<cw>	Codeword

**Parameters:**

<Modulation> DMRS | Q1K | QPSK | QAM16 | QAM64 | QAM256  
\*RST: QPSK

**Example:**

```
//Define allocation modulation
CONF:DL:CC2:FRAM3:BWP2:SLOT4:ALL5:MOD QAM16
```

**Manual operation:** See "Modulation" on page 118

---

**CONFigure[:NR5G]:DL[:CC<cc>]:FRAMe<fr>:BWPart<bwp>:SLOT<sl>:  
ALLocation<al>:POWER <Power>**

Defines the relative power of a PDSCH allocation.

**Suffix:**

<cc>	Component Carrier
<fr>	Frame
<bwp>	Bandwidth part
<sl>	Bandwidth part
<al>	Allocation

**Parameters:**

<Power>	<numeric value>
	*RST: 0
	Default unit: dB

**Example:**

```
//Define relative allocation power
CONF:DL:CC2:FRAM3:BWP2:SLOT4:ALL5:POW 6
```

**Manual operation:** See "[Rel Power / dB](#)" on page 119

**CONFigure[[NR5G](#)]:DL[:[CC](#)<cc>]:FRAMe<fr>:BWPart<bwp>:SLOT<sl>:  
ALLocation<al>:RBCount <ResourceBlocks>**

Selects the number of resource blocks that a PDSCH allocation occupies.

**Suffix:**

<cc>	Component Carrier
<fr>	Frame
<bwp>	Bandwidth part
<sl>	Bandwidth part
<al>	Allocation

**Parameters:**

<ResourceBlocks>	<numeric value> (integer only)
	*RST: 273

**Example:**

```
//Define number of PDSCH resource blocks
CONF:DL:CC2:FRAM3:BWP2:SLOT4:ALL5:RBC 40
```

**Manual operation:** See "[Number of RBs](#)" on page 119

**CONFigure[[NR5G](#)]:DL[:[CC](#)<cc>]:FRAMe<fr>:BWPart<bwp>:SLOT<sl>:  
ALLocation<al>:RBOffset <Offset>**

Defines the resource block offset of a PDSCH allocation.

**Suffix:**

<cc>	Component Carrier
<fr>	Frame
<bwp>	Bandwidth part

<sl> [Bandwidth part](#)

<al> [Allocation](#)

**Parameters:**

<Offset> <numeric value> (integer only)

The offset is a value relative to the first resource block of the slot.

\*RST: 0

**Example:**

```
//Define allocation RB offset
CONF:DL:CC2:FRAM3:BWP2:SLOT4:ALL5:RBOF 10
```

**Manual operation:** See "[Offset RB](#)" on page 119

**CONFigure[:NR5G]:DL[:CC<cc>]:FRAMe<fr>:BWPart<bwp>:SLOT<sl>:  
ALLocation<al>:SCOunt <Symbols>**

Selects the number of symbols that a PDSCH allocation occupies.

**Suffix:**

<cc> [Component Carrier](#)

<fr> [Frame](#)

<bwp> [Bandwidth part](#)

<sl> [Bandwidth part](#)

<al> [Allocation](#)

**Parameters:**

<Symbols> <numeric value> (integer only)

\*RST: 14

**Example:**

```
//Define number of allocation symbols
CONF:DL:CC2:FRAM3:BWP2:SLOT4:ALL5:SCO 7
```

**Manual operation:** See "[Number of Symbols](#)" on page 119

**CONFigure[:NR5G]:DL[:CC<cc>]:FRAMe<fr>:BWPart<bwp>:SLOT<sl>:  
ALLocation<al>:SOFFset <Offset>**

Defines the symbol offset of a PDSCH allocation.

**Suffix:**

<cc> [Component Carrier](#)

<fr> [Frame](#)

<bwp> [Bandwidth part](#)

<sl> [Bandwidth part](#)

<al> [Allocation](#)

**Parameters:**

<Offset> <numeric value> (integer only)  
 The offset is a value relative to the first symbol in the slot.  
 \*RST: 0

**Example:**

```
//Define allocation symbol offset
CONF:DL:CC2:FRAM3:BWP2:SLOT4:ALL5:SOFF 2
```

**Manual operation:** See "Offset Symbols" on page 119

**CONFigure[:NR5G]:DL[:CC<cc>]:FRAMe<fr>:BWPart<bwp>:SLOT<sl>:CUID**  
 <State>

Turns PRB bundling for PDSCH allocations on and off.

**Suffix:**

<cc> Component Carrier  
 <fr> Frame  
 <bwp> Bandwidth part  
 <sl> Bandwidth part

**Parameters:**

<State> ON | OFF | 1 | 0  
 \*RST: OFF

**Example:**

```
//Combine PDSCH allocations
CONF:DL:CC2:FRAM3:BWP2:SLOT4:CUID ON
```

**Manual operation:** See "Combine PDSCH Allocations With Same User ID" on page 116

### 6.10.13 Enhanced CORESET allocation configuration

CONFigure[:NR5G]:DL[:CC<cc>]:FRAMe<fr>:BWPart<bwp>:SLOT<sl>:COReset<cr>: DMRS:POWer.....	377
CONFigure[:NR5G]:DL[:CC<cc>]:FRAMe<fr>:BWPart<bwp>:SLOT<sl>:COReset<cr>: DMRS:RPOint.....	378
CONFigure[:NR5G]:DL[:CC<cc>]:FRAMe<fr>:BWPart<bwp>:SLOT<sl>:COReset<cr>: DMRS:SID.....	378
CONFigure[:NR5G]:DL[:CC<cc>]:FRAMe<fr>:BWPart<bwp>:SLOT<sl>:COReset<cr>: DMRS:SCRam[:STATE].....	379
CONFigure[:NR5G]:DL[:CC<cc>]:FRAMe<fr>:BWPart<bwp>:SLOT<sl>:COReset<cr>: INTerleaving:BSIZE.....	379
CONFigure[:NR5G]:DL[:CC<cc>]:FRAMe<fr>:BWPart<bwp>:SLOT<sl>:COReset<cr>: INTerleaving:ISIZE.....	380
CONFigure[:NR5G]:DL[:CC<cc>]:FRAMe<fr>:BWPart<bwp>:SLOT<sl>:COReset<cr>: INTerleaving:NSHift.....	380
CONFigure[:NR5G]:DL[:CC<cc>]:FRAMe<fr>:BWPart<bwp>:SLOT<sl>:COReset<cr>: INTerleaving:SINDEX.....	381



CONFigure[:NR5G]:DL[:CC<cc>]:FRAMe<fr>:BWPart<bwp>:SLOT<sl>:COReset<cr>: INTerleaving:STATe.....	382
CONFigure[:NR5G]:DL[:CC<cc>]:FRAMe<fr>:BWPart<bwp>:SLOT<sl>:COReset<cr>: PDCCh<cf>:ALEVel.....	382
CONFigure[:NR5G]:DL[:CC<cc>]:FRAMe<fr>:BWPart<bwp>:SLOT<sl>:COReset<cr>: PDCCh<cf>:CCEindex.....	382
CONFigure[:NR5G]:DL[:CC<cc>]:FRAMe<fr>:BWPart<bwp>:SLOT<sl>:COReset<cr>: PDCCh<cf>:DCIFormat.....	383
CONFigure[:NR5G]:DL[:CC<cc>]:FRAMe<fr>:BWPart<bwp>:SLOT<sl>:COReset<cr>: PDCCh<cf>:DCISettings:FDRassign.....	384
CONFigure[:NR5G]:DL[:CC<cc>]:FRAMe<fr>:BWPart<bwp>:SLOT<sl>:COReset<cr>: PDCCh<cf>:DCISettings:ITEM.....	384
CONFigure[:NR5G]:DL[:CC<cc>]:FRAMe<fr>:BWPart<bwp>:SLOT<sl>:COReset<cr>: PDCCh<cf>:DCISettings:LIST?.....	388
CONFigure[:NR5G]:DL[:CC<cc>]:FRAMe<fr>:BWPart<bwp>:SLOT<sl>:COReset<cr>: PDCCh<cf>:DCISettings:NOBLock.....	388
CONFigure[:NR5G]:DL[:CC<cc>]:FRAMe<fr>:BWPart<bwp>:SLOT<sl>:COReset<cr>: PDCCh<cf>:DCISettings:SCOPE.....	389
CONFigure[:NR5G]:DL[:CC<cc>]:FRAMe<fr>:BWPart<bwp>:SLOT<sl>:COReset<cr>: PDCCh<cf>:DCISettings:TPCCommand.....	390
CONFigure[:NR5G]:DL[:CC<cc>]:FRAMe<fr>:BWPart<bwp>:SLOT<sl>:COReset<cr>: PDCCh<cf>:PLENght.....	390
CONFigure[:NR5G]:DL[:CC<cc>]:FRAMe<fr>:BWPart<bwp>:SLOT<sl>:COReset<cr>: PDCCh<cf>:RNTI.....	391
CONFigure[:NR5G]:DL[:CC<cc>]:FRAMe<fr>:BWPart<bwp>:SLOT<sl>:COReset<cr>: PDCCh<cf>:USAGe.....	391
CONFigure[:NR5G]:DL[:CC<cc>]:FRAMe<fr>:BWPart<bwp>:SLOT<sl>:COReset<cr>: PDSCh:STATe.....	392
CONFigure[:NR5G]:DL[:CC<cc>]:FRAMe<fr>:BWPart<bwp>:SLOT<sl>:COReset<cr>: PGRanularity.....	392

---

**CONFigure[:NR5G]:DL[:CC<cc>]:FRAMe<fr>:BWPart<bwp>:SLOT<sl>:  
COReset<cr>:DMRS:POWER <Power>**

Defines the power of a CORESET DM-RS relative to the CORESET.

**Suffix:**

<cc>	Component Carrier
<fr>	Frame
<bwp>	Bandwidth part
<sl>	Bandwidth part
<cr>	CORESET

**Parameters:**

<Power>	<numeric value>
	*RST: 0
	Default unit: dB

**Example:** //Define CORESET power  
 CONF:DL:CC2:FRAM3:BWP2:SLOT4:COR3:DMRS:POW 1.5

**Manual operation:** See "CORESET DMRS Rel Power" on page 121

**CONFigure[:NR5G]:DL[:CC<cc>]:FRAMe<fr>:BWPart<bwp>:SLOT<sl>:  
 COREset<cr>:DMRS:RPOint <Reference>**

Defines the reference point of the CORESET DMRS.

**Suffix:**

<cc>                   Component Carrier  
 <fr>                   Frame  
 <bwp>                  Bandwidth part  
 <sl>                   Bandwidth part  
 <cr>                   CORESET

**Parameters:**

<Reference>           **CStart**  
 Reference point is the start of the CORESET.  
**RPA**  
 Reference point is the reference point A.  
 \*RST:           RPA

**Example:** //Select reference point for CORESET DMRS  
 CONF:DL:CC2:FRAM3:BWP2:SLOT4:COR2:DMRS:RPO RPA

**Manual operation:** See "CORESET DMRS Reference Point" on page 122

**CONFigure[:NR5G]:DL[:CC<cc>]:FRAMe<fr>:BWPart<bwp>:SLOT<sl>:  
 COREset<cr>:DMRS:SID <Value>**

Defines the seed value for the CORESET DM-RS sequence generation.

Prerequisites for this command

- Select sequence generation method "n\_ID^DMRS" (CONFigure[:NR5G]:DL[:CC<cc>]:FRAMe<fr>:BWPart<bwp>:SLOT<sl>:COREset<cr>:DMRS:SCRam[:STATE]).

**Suffix:**

<cc>                   Component Carrier  
 <fr>                   Frame  
 <bwp>                  Bandwidth part  
 <sl>                   Bandwidth part  
 <cr>                   CORESET

**Parameters:**

<Value> <numeric value> (integer only)

\*RST: 0

**Example:**

//Define seed value

CONF:DL:CC2:FRAM3:BWP2:SLOT4:COR3:DMRS:SGEN  
DSID

CONF:DL:CC2:FRAM3:BWP2:SLOT4:COR3:DMRS:SID 15

**Manual operation:** See "[CORESET DMRS Sequence Generation](#)" on page 121

**CONFigure[:NR5G]:DL[:CC<cc>]:FRAMe<fr>:BWPART<bwp>:SLOT<sl>:  
COReset<cr>:DMRS:SCRam[:STATe] <State>**

Selects the CORESET DM-RS sequence generation method.

**Suffix:**

<cc> [Component Carrier](#)

<fr> [Frame](#)

<bwp> [Bandwidth part](#)

<sl> [Bandwidth part](#)

<cr> [CORESET](#)

**Parameters:**

<State> **ON**  
Sequence generation based on a pseudo-random seed value.

**OFF**

Sequence generation based on the cell ID.

\*RST: OFF

**Example:**

//Select CORESET sequence generation method

CONF:DL:CC2:FRAM3:BWP2:SLOT4:COR3:DMRS:SCR ON

**Manual operation:** See "[CORESET DMRS Sequence Generation](#)" on page 121

**CONFigure[:NR5G]:DL[:CC<cc>]:FRAMe<fr>:BWPART<bwp>:SLOT<sl>:  
COReset<cr>:INTerleaving:BSIZe <Size>**

Selects the REG bundle size of the PDCCH.

Prerequisites for this command

- Turn on interleaving ([CONFigure\[:NR5G\]:DL\[:CC<cc>\]:FRAMe<fr>:  
BWPART<bwp>:SLOT<sl>:COReset<cr>:INTerleaving:STATe](#)).

**Suffix:**

<cc> [Component Carrier](#)

<fr> [Frame](#)

<bwp> [Bandwidth part](#)

<sl> Bandwidth part

<cr> CORESET

**Parameters:**

<Size> 2 | 6  
\*RST: 6

**Example:** //Define bundle size  
CONF:DL:CC2:FRAM3:BWP2:SLOT4:COR3:INT:STAT ON  
CONF:DL:CC2:FRAM3:BWP2:SLOT4:COR3:INT:BSIZ 2

**Manual operation:** See "[Interleaving](#)" on page 122

**CONFigure[:NR5G]:DL[:CC<cc>]:FRAME<fr>:BWPpart<bwp>:SLOT<sl>:  
COReset<cr>:INTerleaving:ISIZe <Size>**

Selects the interleaving size of the PDCCH.

Prerequisites for this command

- Turn on interleaving (CONFigure[:NR5G]:DL[:CC<cc>]:FRAME<fr>:  
BWPpart<bwp>:SLOT<sl>:COReset<cr>:INTerleaving:STATe).

**Suffix:**

<cc> Component Carrier

<fr> Frame

<bwp> Bandwidth part

<sl> Bandwidth part

<cr> CORESET

**Parameters:**

<Size> 2 | 3 | 6  
\*RST: 2

**Example:** //Define interleaving size  
CONF:DL:CC2:FRAM3:BWP2:SLOT4:COR3:INT:STAT ON  
CONF:DL:CC2:FRAM3:BWP2:SLOT4:COR3:INT:ISIZ 3

**Manual operation:** See "[Interleaving](#)" on page 122

**CONFigure[:NR5G]:DL[:CC<cc>]:FRAME<fr>:BWPpart<bwp>:SLOT<sl>:  
COReset<cr>:INTerleaving:NSHift <Value>**

Defines the shift index of the PDCCH.

Prerequisites for this command

- Turn on interleaving (CONFigure[:NR5G]:DL[:CC<cc>]:FRAME<fr>:  
BWPpart<bwp>:SLOT<sl>:COReset<cr>:INTerleaving:STATe).
- Select manual shift index (CONFigure[:NR5G]:DL[:CC<cc>]:FRAME<fr>:  
BWPpart<bwp>:SLOT<sl>:COReset<cr>:INTerleaving:SINDEX).

**Suffix:**

<cc>	Component Carrier
<fr>	Frame
<bwp>	Bandwidth part
<sl>	Bandwidth part
<cr>	CORESET

**Parameters:**

<Value> \*RST: 0

**Example:**

```
//Define shift index
CONF:DL:CC2:FRAM3:BWP2:SLOT4:COR3:INT:STAT ON
CONF:DL:CC2:FRAM3:BWP2:SLOT4:COR3:INT:SIND NSH
CONF:DL:CC2:FRAM3:BWP2:SLOT4:COR3:INT:NSH 2
```

**Manual operation:** See "Interleaving" on page 122

**CONFigure[:NR5G]:DL[:CC<cc>]:FRAMe<fr>:BWPART<bwp>:SLOT<sl>:  
COREset<cr>:INTerleaving:SINDex <Method>**

Defines the shift index of the PDCCH.

Prerequisites for this command

- Turn on interleaving (CONFigure[:NR5G]:DL[:CC<cc>]:FRAMe<fr>:BWPART<bwp>:SLOT<sl>:COREset<cr>:INTerleaving:STATe).

**Suffix:**

<cc>	Component Carrier
<fr>	Frame
<bwp>	Bandwidth part
<sl>	Bandwidth part
<cr>	CORESET

**Parameters:**

<Method> **NIDCell**  
Shift index based on cell ID.

**NShift**

Manual shift index (CONFigure[:NR5G]:DL[:CC<cc>]:FRAMe<fr>:BWPART<bwp>:SLOT<sl>:COREset<cr>:INTerleaving:NSHift).

**Example:**

```
//Define shift index calculation method
CONF:DL:CC2:FRAM3:BWP2:SLOT4:COR3:INT:STAT ON
CONF:DL:CC2:FRAM3:BWP2:SLOT4:COR3:INT:SIND NIDC
```

**Manual operation:** See "Interleaving" on page 122

---

**CONFigure[:NR5G]:DL[:CC<cc>]:FRAMe<fr>:BWPart<bwp>:SLOT<sl>:  
COReset<cr>:INTerleaving:STATe <State>**

Turns interleaving of the PDCCH on and off.

**Suffix:**

<cc>                    [Component Carrier](#)  
 <fr>                    [Frame](#)  
 <bwp>                  [Bandwidth part](#)  
 <sl>                    [Bandwidth part](#)  
 <cr>                    [CORESET](#)

**Parameters:**

<State>                ON | OFF | 1 | 0

**Example:**

//Turn on interleaving  
 CONF:DL:CC2:FRAM3:BWP2:SLOT4:COR3:INT:STAT ON

**Manual operation:** See "[Interleaving](#)" on page 122

---

**CONFigure[:NR5G]:DL[:CC<cc>]:FRAMe<fr>:BWPart<bwp>:SLOT<sl>:  
COReset<cr>:PDCCh<cf>:ALEVel <Value>**

Selects the aggregation level of the PDCCH.

**Suffix:**

<cc>                    [Component Carrier](#)  
 <fr>                    [Frame](#)  
 <bwp>                  [Bandwidth part](#)  
 <sl>                    [Bandwidth part](#)  
 <cr>                    [CORESET](#)  
 <cf>                    0

**Parameters:**

<Value>                \*RST:        1

**Example:**

//Select aggregation level  
 CONF:DL:CC2:FRAM3:BWP2:SLOT4:COR3:PDCC0:ALEV 2

**Manual operation:** See "[Aggregation Level](#)" on page 125

---

**CONFigure[:NR5G]:DL[:CC<cc>]:FRAMe<fr>:BWPart<bwp>:SLOT<sl>:  
COReset<cr>:PDCCh<cf>:CCEindex <Value>**

Select the CCE index for the PDCCH.

**Suffix:**

<cc>                    [Component Carrier](#)

<fr>	Frame
<bwp>	Bandwidth part
<sl>	Bandwidth part
<cr>	CORESET
<cf>	0

**Parameters:**

<Value> \*RST: 0

**Example:**

```
//Select CCE index
CONF:DL:CC2:FRAM3:BWP2:SLOT4:COR3:PDCC0:CCE 2
```

**Manual operation:** See "[CCE Index](#)" on page 125

**CONFigure[:NR5G]:DL[:CC<cc>]:FRAMe<fr>:BWPART<bwp>:SLOT<sl>:  
COReset<cr>:PDCCh<cf>:DCIFormat <Format>**

Selects the DCI format for a PDCCH.

Prerequisites for this command

- The availability of DCI formats depends on the selected RNTI type (CONFigure[:NR5G]:DL[:CC<cc>]:FRAMe<fr>:BWPART<bwp>:SLOT<sl>:COReset<cr>:PDCCh<cf>:USAGe).

**Suffix:**

<cc>	Component Carrier
<fr>	Frame
<bwp>	Bandwidth part
<sl>	Bandwidth part
<cr>	CORESET
<cf>	0

**Parameters:**

<Format> F00 | F01 | F02 | F10 | F11 | F12 | F20 | F21 | F22 | F23 | F24 |  
F25 | F26  
\*RST: F00

**Example:**

```
//Select DCI format
CONF:DL:CC2:FRAM3:BWP2:SLOT4:COR3:PDCC0:USAG
CRNT
CONF:DL:CC2:FRAM3:BWP2:SLOT4:COR3:PDCC0:DCIF
F00
```

**Manual operation:** See "[DCI Format](#)" on page 125

---

**CONFigure[:NR5G]:DL[:CC<cc>]:FRAMe<fr>:BWPart<bwp>:SLOT<sl>:  
COReset<cr>:PDCCh<cf>:DCISettings:FDRassign <Assignment>**

Defines the frequency domain resource assignment of the DCI fields.

Prerequisites for this command

- Select DCI format 1\_0 (`CONFigure[:NR5G]:DL[:CC<cc>]:FRAMe<fr>:  
BWPart<bwp>:SLOT<sl>:COReset<cr>:PDCCh<cf>:DCIFormat`).

**Suffix:**

<cc>	Component Carrier
<fr>	Frame
<bwp>	Bandwidth part
<sl>	Bandwidth part
<cr>	CORESET
<cf>	0

**Parameters:**

<Assignment>	<b>CUSTom</b> Custom
	<b>ALL</b> All ones
*RST:	CUSTom

**Example:**

```
//Select frequency resource assignment for DCI transmission
CONF:DL:CC2:FRAM3:BWP2:SLOT4:COR3:PDCCH0:USAG
CRNT
CONF:DL:CC2:FRAM3:BWP2:SLOT4:COR3:PDCCH0:DCIF
F10
CONF:DL:CC2:FRAM3:BWP2:SLOT4:COR3:PDCCH0:DCIS:
SCOP ALL
```

**Manual operation:** See "[Content](#)" on page 126

---

**CONFigure[:NR5G]:DL[:CC<cc>]:FRAMe<fr>:BWPart<bwp>:SLOT<sl>:  
COReset<cr>:PDCCh<cf>:DCISettings:ITEM <DCIField>, <BitLength>**

Defines the bit length for DCI fields.

Prerequisites for this command

- Availability of parameters depend on the selected DCI format (`CONFigure[:  
NR5G]:DL[:CC<cc>]:FRAMe<fr>:BWPart<bwp>:SLOT<sl>:COReset<cr>:  
PDCCh<cf>:DCIFormat` on page 383).

Note that, depending on the DCI format, some bit lengths are fix and cannot be changed.

**Suffix:**

<cc>	Component Carrier
------	-------------------



<fr>	Frame
<bwp>	Bandwidth part
<sl>	Bandwidth part
<cr>	CORESET
<cf>	0
<b>Parameters:</b>	
<DCIField>	For an overview of parameters, see <a href="#">Table 6-5</a> .
<BitLength>	*RST: depends on DCI field
<b>Example:</b>	<pre>//Define bit length for "Time Domain Resource Assignment" CONF:DL:CC2:FRAM3:BWP2:SLOT4:COR3:PDCC0:USAG CRNT CONF:DL:CC2:FRAM3:BWP2:SLOT4:COR3:PDCC0:DCIF F01 CONF:DL:CC2:FRAM3:BWP2:SLOT4:COR3:PDCC0:DCIS: ITEM TDR, 2</pre>
<b>Example:</b>	<pre>//Define bit length for "Slot Format Indicator" incl. number of indi- cators CONF:DL:CC2:FRAM3:BWP2:SLOT4:COR3:PDCC0:USAG SFIR CONF:DL:CC2:FRAM3:BWP2:SLOT4:COR3:PDCC0:DCIF F20 CONF:DL:CC2:FRAM3:BWP2:SLOT4:COR3:PDCC0:DCIS: ITEM SFIN, 4 CONF:DL:CC2:FRAM3:BWP2:SLOT4:COR3:PDCC0:DCIS: ITEM N, 2</pre>
<b>Manual operation:</b>	See " <a href="#">Content</a> " on page 126

**Table 6-5: List of DCI fields**

DCI field	SCPI parameter
"Identifier for DCI formats"	IFDFormats
"Frequency Domain Resource Assignment"	FDRassign
"Time Domain Resource Assignment"	TDRassign
"Frequency Hopping Flag"	FHFLag
"Modulation and Coding Scheme (TB1)"	MCS1
"New Data Indicator (TB1)"	NDI1
"Redundancy Version (TB1)"	RV1
"HARQ Process Number"	HPNumber
"TPC Command for Scheduled PUSCH"	TCSPusch
"Padding Bits"	PBITs
"UL/SUL Indicator"	USUL

DCI field	SCPI parameter
"ChannelAccess-Cpext"	CACPext
"Carrier Indicator"	CARRier
"DFI Flag"	DFIFlag
"HARQ-ACK Bitmap"	HABitmap
"Bandwidth Part Indicator"	BPINdicator
"(1st) Downlink Assignment Index"	DAI1
"2nd Downlink Assignment Index"	DAI2
"SRS Resource Indicator"	SRINdicator
"Precoding Information and Number of Layers"	PINLayers
"Antenna Ports"	APORts
"SRS Request"	SRSRequest
"CSI Request"	CSIRequest
"CBG Transmission Information (CBGTI)"	CBGTi
"PTRS-DMRS Association"	PDASso
"beta_offset Indicator"	BOINdicator
"DMRS Sequence Initialization"	DSINit
"UL-SCH Indicator"	USCH
"ChannelAccess-Cpext-CAPC"	CAPC
"Open-loop Power Control Parameter Set Indication"	OPCParam
"Priority Indicator"	PINdicator
"Invalid Symbol Pattern Indicator"	ISPindicator
"Minimum Applicable Scheduling Offset Indicator"	MASoffset
"SCell Dormancy Indication"	SDINdicator
"Random Access Preamble Index"	RAPindex
"SS/PBCH Index"	SPINdex
"PRACH Mask Index"	PMINdex
"Reserved Bits"	RBITs
"VRB-to-PRB Mapping"	VTPMapping
"PUCCH Resource Indicator"	PRINdicator
"PDSCH-to-HARQ Feedback Timing Indicator"	PHFTiming
"Short Message Indicator"	SMINdicator
"Short Message"	SMESsage
"TB Scaling"	TBScaling

DCI field	SCPI parameter
"System Information Indicator"	SIIndicator
"LBSs of SFN"	LOSFn
"PRB Bundling Size Indicator"	PBSindicator
"Rate Matching Indicator"	RMIndicator
"ZP CSI-RS Trigger"	ZCRTrigger
"Modulation and Coding Scheme (TB2)"	MCS2
"New Data Indicator (TB2)"	NDI2
"Redundancy Version (TB2)"	RV2
"One-shot HARQ-ACK Request"	OHARrequest
"PDSCH Group Index"	PGIndex
"New Feedback Indicator"	NFIndicator
"Number of Requested PDSCH Group"	NRPGroup
"Transmission Configuration Indication"	TCIndication
"CBG Flushing out Information (CBGFI)"	CBGFi
"Slot Format Indicator" Indicator index	SFIndicator N
"Available RB Set Indicator" Indicator index	ARBSet N1
"COT Duration Indicator" Indicator index	COTDuration N2
"Monitoring Group Flag" Indicator index	MGFLag M
"Pre-emption Indication" Indicator index	PEIndication N
"Closed Loop Indicator"	CLIndicator
"TPC Command"	TPCCommand
"Cancellation Indication" Indicator index	CIndication N
"Availability Indicator" Indicator index	AIndicator N
"Wake Up Indication"	WUIndication
"SCell Dormancy Indication"	SDIndication

---

**CONFigure[:NR5G]:DL[:CC<cc>]:FRAMe<fr>:BWPart<bwp>:SLOT<sl>:  
COREset<cr>:PDCCh<cf>:DCISettings:LIST?**

Queries the DCI fields available for the currently selected DCI format and the number of bits each DCI field uses.

Prerequisites for this command

- Select a DCI format (.CONFigure[:NR5G]:DL[:CC<cc>]:FRAMe<fr>:BWPart<bwp>:SLOT<sl>:COREset<cr>:PDCCh<cf>:DCIFormat).
- Assign bits to the DCI fields (CONFigure[:NR5G]:DL[:CC<cc>]:FRAMe<fr>:BWPart<bwp>:SLOT<sl>:COREset<cr>:PDCCh<cf>:DCISettings:ITEM).

**Suffix:**

<cc>	Component Carrier
<fr>	Frame
<bwp>	Bandwidth part
<sl>	Bandwidth part
<cr>	CORESET
<cf>	0

**Return values:**

<List> String that contains the names of the DCI fields and the number of bits they use as a comma separated list.

**Example:**

```
//Query DCI field information
CONF:DL:CC2:FRAM3:BWP2:SLOT4:COR3:PDCC0:USAG
TPUC
CONF:DL:CC2:FRAM3:BWP2:SLOT4:COR3:PDCC0:DCIF
F22
CONF:DL:CC2:FRAM3:BWP2:SLOT4:COR3:PDCC0:DCIS:
LIST?
would return:
'Closed Loop Indicator,0,TPC Command,2'
```

**Usage:** Query only

**Manual operation:** See "Content" on page 126

---

**CONFigure[:NR5G]:DL[:CC<cc>]:FRAMe<fr>:BWPart<bwp>:SLOT<sl>:  
COREset<cr>:PDCCh<cf>:DCISettings:NOBLock <Blocks>**

Defines the number of blocks that DCI is transmitted in.

Prerequisites for this command

- Select a DCI format that supports multiple transmission (CONFigure[:NR5G]:DL[:CC<cc>]:FRAMe<fr>:BWPart<bwp>:SLOT<sl>:COREset<cr>:PDCCh<cf>:DCIFormat).

**Suffix:**

<cc>	Component Carrier
------	-------------------

<fr>	Frame
<bwp>	Bandwidth part
<sl>	Bandwidth part
<cr>	CORESET
<cf>	0

**Parameters:**

<Blocks> \*RST: 1

**Example:**

```
//Select number of blocks for DCI transmission
CONF:DL:CC2:FRAM3:BWP2:SLOT4:COR3:PDCCH0:USAG
TPUS
CONF:DL:CC2:FRAM3:BWP2:SLOT4:COR3:PDCCH0:DCIF
F22
CONF:DL:CC2:FRAM3:BWP2:SLOT4:COR3:PDCCH0:DCIS:
NOBL 4
```

**Manual operation:** See "[Content](#)" on page 126

---

**CONFigure[:NR5G]:DL[:CC<cc>]:FRAMe<fr>:BWPPart<bwp>:SLOT<sl>:  
COREset<cr>:PDCCh<cf>:DCISettings:SCOPE <Scope>**

Defines the scope of the DCI fields.

Prerequisites for this command

- Select DCI format 0\_1 (CONFigure[:NR5G]:DL[:CC<cc>]:FRAMe<fr>:  
BWPPart<bwp>:SLOT<sl>:COREset<cr>:PDCCh<cf>:DCIFormat).

**Suffix:**

<cc>	Component Carrier
<fr>	Frame
<bwp>	Bandwidth part
<sl>	Bandwidth part
<cr>	CORESET
<cf>	0

**Parameters:**

<Scope> **ICDF**  
Indicate CG-DFI  
**SPUS**  
Schedule PUSCH  
\*RST: ICDF

**Example:**

```
//Select scope of DCI transmission
CONF:DL:CC2:FRAM3:BWP2:SLOT4:COR3:PDCC0:USAG
SPCR
CONF:DL:CC2:FRAM3:BWP2:SLOT4:COR3:PDCC0:DCIF
F01
CONF:DL:CC2:FRAM3:BWP2:SLOT4:COR3:PDCC0:DCIS:
SCOP SPUS
```

**Manual operation:** See ["Content"](#) on page 126

**CONFigure[:NR5G]:DL[:CC<cc>]:FRAMe<fr>:BWPart<bwp>:SLOT<sl>:  
COReset<cr>:PDCCh<cf>:DCISettings:TPCCommand <Value>**

Defines the number of TCP commands that are transmitted in the DCI.

Prerequisites for this command

- Select a DCI format that supports transmission of multiple TCP commands  
([CONFigure\[:NR5G\]:DL\[:CC<cc>\]:FRAMe<fr>:BWPart<bwp>:SLOT<sl>:  
COReset<cr>:PDCCh<cf>:DCIFormat](#)).

**Suffix:**

<cc>	Component Carrier
<fr>	Frame
<bwp>	Bandwidth part
<sl>	Bandwidth part
<cr>	CORESET
<cf>	0

**Parameters:**

<Value> \*RST: 1

**Example:**

```
//Select number of TCP commands
CONF:DL:CC2:FRAM3:BWP2:SLOT4:COR3:PDCC0:USAG
TSRN
CONF:DL:CC2:FRAM3:BWP2:SLOT4:COR3:PDCC0:DCIF
F23
CONF:DL:CC2:FRAM3:BWP2:SLOT4:COR3:PDCC0:DCIS:
TPCC 2
```

**Manual operation:** See ["Content"](#) on page 126

**CONFigure[:NR5G]:DL[:CC<cc>]:FRAMe<fr>:BWPart<bwp>:SLOT<sl>:  
COReset<cr>:PDCCh<cf>:PLENght <Bits>**

Defines the bit length of the PDCCH.

**Suffix:**

<cc>	Component Carrier
<fr>	Frame

<bwp>            Bandwidth part  
 <sl>            Bandwidth part  
 <cr>            CORESET  
 <cf>            0

**Parameters:**

<Bits>            \*RST:        44

**Example:**

```
//Select PDCCH pattern length
CONF:DL:CC2:FRAM3:BWP2:SLOT4:COR3:PDCC0:PLEN 22
```

**Manual operation:** See "Pattern Length" on page 126

**CONFigure[:NR5G]:DL[:CC<cc>]:FRAME<fr>:BWPart<bwp>:SLOT<sl>:  
 COREset<cr>:PDCCh<cf>:RNTI <Value>**

Selects the CORESET radio network identifier (RNTI).

**Suffix:**

<cc>            Component Carrier  
 <fr>            Frame  
 <bwp>           Bandwidth part  
 <sl>            Bandwidth part  
 <cr>            CORESET  
 <cf>            0

**Parameters:**

<Value>           \*RST:        0

**Example:**

```
//Select RNTI
CONF:DL:CC2:FRAM3:BWP2:SLOT4:COR3:PDCC0:RNTI 2
```

**Manual operation:** See "RNTI" on page 125

**CONFigure[:NR5G]:DL[:CC<cc>]:FRAME<fr>:BWPart<bwp>:SLOT<sl>:  
 COREset<cr>:PDCCh<cf>:USAGe <Usage>**

Selects the RNTI type for a PDCCH.

**Suffix:**

<cc>            Component Carrier  
 <fr>            Frame  
 <bwp>           Bandwidth part  
 <sl>            Bandwidth part  
 <cr>            CORESET  
 <cf>            0

**Parameters:**

<Usage> CRNT | CSRN | MCSC | TCRN | SPCR | PRNT | SIRN | RNRN |  
MSGB | SFIR | INTR | TPUS | TPUC | TSRN | CIRN | AIRN |  
PSRN  
\*RST: CRNT

**Example:**

```
//Select RNTI type
CONF:DL:CC2:FRAM3:BWP2:SLOT4:COR3:PDCC0:USAG
CSRN
```

**Manual operation:** See "[Usage](#)" on page 125

**CONFigure[:NR5G]:DL[:CC<cc>]:FRAMe<fr>:BWPart<bwp>:SLOT<sl>:  
COReset<cr>:PDSCh:STATe <State>**

Turns usage of CORESET allocations for PDSCH transmission on and off.

Prerequisites for this command

- Select precoder granularity = REG bundle ([CONFigure\[:NR5G\]:DL\[:CC<cc>\]:  
FRAMe<fr>:BWPart<bwp>:SLOT<sl>:COReset<cr>:PGRanularity](#)).

**Suffix:**

<cc> [Component Carrier](#)  
<fr> [Frame](#)  
<bwp> [Bandwidth part](#)  
<sl> [Bandwidth part](#)  
<cr> [CORESET](#)

**Parameters:**

<State> ON | OFF | 1 | 0  
\*RST: OFF

**Example:**

```
//Allow PDSCH transmission in CORESET
CONF:DL:CC2:FRAM3:BWP2:SLOT4:COR3:PGR REGB
CONF:DL:CC2:FRAM3:BWP2:SLOT4:COR3:PDSC:STAT ON
```

**Manual operation:** See "[Allow PDSCH](#)" on page 121

**CONFigure[:NR5G]:DL[:CC<cc>]:FRAMe<fr>:BWPart<bwp>:SLOT<sl>:  
COReset<cr>:PGRanularity <Method>**

Selects the precoder granularity for the PDCCH DMRS.

**Suffix:**

<cc> [Component Carrier](#)  
<fr> [Frame](#)  
<bwp> [Bandwidth part](#)  
<sl> [Bandwidth part](#)



<cr>	CORESET
<b>Parameters:</b>	
<Method>	<b>ACRBs</b> All contiguous RBs.
	<b>REGBundle</b> REG bundles only.
<b>Example:</b>	//Define precoder granularity CONF:DL:CC2:FRAM3:BWP2:SLOT4:COR3:PGR ACRB
<b>Manual operation:</b>	See "Precoder Granularity" on page 121

### 6.10.14 Enhanced PDSCH settings: DMRS

CONFigure[:NR5G]:DL[:CC<cc>]:FRAMe<fr>:BWPart<bwp>:SLOT<sl>: ALLocation<al>:CLMapping.....	394
CONFigure[:NR5G]:DL[:CC<cc>]:FRAMe<fr>:BWPart<bwp>:SLOT<sl>: ALLocation<al>:DMRS:AP.....	394
CONFigure[:NR5G]:DL[:CC<cc>]:FRAMe<fr>:BWPart<bwp>:SLOT<sl>: ALLocation<al>:DMRS:CGWD.....	395
CONFigure[:NR5G]:DL[:CC<cc>]:FRAMe<fr>:BWPart<bwp>:SLOT<sl>: ALLocation<al>:DMRS:CTYPe.....	395
CONFigure[:NR5G]:DL[:CC<cc>]:FRAMe<fr>:BWPart<bwp>:SLOT<sl>: ALLocation<al>:DMRS:MSYMBOL:APOSITION.....	396
CONFigure[:NR5G]:DL[:CC<cc>]:FRAMe<fr>:BWPart<bwp>:SLOT<sl>: ALLocation<al>:DMRS:MSYMBOL:LENGTH.....	396
CONFigure[:NR5G]:DL[:CC<cc>]:FRAMe<fr>:BWPart<bwp>:SLOT<sl>: ALLocation<al>:DMRS:MTYPe.....	397
CONFigure[:NR5G]:DL[:CC<cc>]:FRAMe<fr>:BWPart<bwp>:SLOT<sl>: ALLocation<al>:DMRS:NSCID.....	397
CONFigure[:NR5G]:DL[:CC<cc>]:FRAMe<fr>:BWPart<bwp>:SLOT<sl>: ALLocation<al>:DMRS:POWER.....	398
CONFigure[:NR5G]:DL[:CC<cc>]:FRAMe<fr>:BWPart<bwp>:SLOT<sl>: ALLocation<al>:DMRS:RST.....	398
CONFigure[:NR5G]:DL[:CC<cc>]:FRAMe<fr>:BWPart<bwp>:SLOT<sl>: ALLocation<al>:DMRS:SGENERATION.....	399
CONFigure[:NR5G]:DL[:CC<cc>]:FRAMe<fr>:BWPart<bwp>:SLOT<sl>: ALLocation<al>:DMRS:SID.....	399
CONFigure[:NR5G]:DL[:CC<cc>]:FRAMe<fr>:BWPart<bwp>:SLOT<sl>: ALLocation<al>:DMRS:SIONe.....	400
CONFigure[:NR5G]:DL[:CC<cc>]:FRAMe<fr>:BWPart<bwp>:SLOT<sl>: ALLocation<al>:DMRS:TAPos.....	400
CONFigure[:NR5G]:DL[:CC<cc>]:FRAMe<fr>:BWPart<bwp>:SLOT<sl>: ALLocation<al>:RPOINT.....	401
CONFigure[:NR5G]:DL[:CC<cc>]:FRAMe<fr>:BWPart<bwp>:SLOT<sl>: ALLocation<al>:UEID.....	401
CONFigure[:NR5G]:DL[:CC<cc>]:FRAMe<fr>:BWPart<bwp>:SLOT<sl>: ALLocation<al>:VTPINTER.....	402

---

**CONFigure[:NR5G]:DL[:CC<cc>]:FRAMe<fr>:BWPart<bwp>:SLOT<sl>:  
ALLocation<al>:CLMapping <Mapping>**

Selects the codeword to layer mapping.

**Suffix:**

<cc>	Component Carrier
<fr>	Frame
<bwp>	Bandwidth part
<sl>	Slot
<al>	Allocation

**Parameters:**

<Mapping> LC11 | LC21 | LC31 | LC41 | LC51 | LC61 | LC71 | LC81 | LC91 |  
LC101 | LC111 | LC121 | LC22 | LC32 | LC42 | LC52 | LC62 |  
LC72 | LC82

The availability of codeword to layer mappings depends on:

- DM-RS configuration type (CONFigure[:NR5G]:DL[:  
CC<cc>]:FRAMe<fr>:BWPart<bwp>:SLOT<sl>:  
ALLocation<al>:DMRS:CTYPe)
- DM-RS length (CONFigure[:NR5G]:DL[:CC<cc>]:  
FRAMe<fr>:BWPart<bwp>:SLOT<sl>:ALLocation<al>:  
DMRS:MSYMBOL:LENGTH)

\*RST: LC11

**Example:** //Select codeword to layer mapping  
CONF:DL:CC2:FRAM3:BWP2:SLOT4:ALL5:CLM LC21

**Manual operation:** See "Codeword to Layer Mapping" on page 129

---

**CONFigure[:NR5G]:DL[:CC<cc>]:FRAMe<fr>:BWPart<bwp>:SLOT<sl>:  
ALLocation<al>:DMRS:AP <AntennaPorts>...**

Selects the antenna ports for PDSCH transmission.

**Suffix:**

<cc>	Component Carrier
<fr>	Frame
<bwp>	Bandwidth part
<sl>	Slot
<al>	Allocation

**Parameters:**

&lt;AntennaPorts&gt;

The number of numeric values depends on how many layers you have. For a single layer, add one value. For two layers, add two values etc.

The value range depends on the codeword to layer mapping you have selected (`CONFigure[:NR5G]:DL[:CC<cc>]:FRAMe<fr>:BWPart<bwp>:SLOT<sl>:ALLocation<al>:CLMapping`).

**Example:**

```
//Map layers to antenna ports
CONF:DL:CC2:FRAM3:BWP2:SLOT4:ALL5:CLM LC21
CONF:DL:CC2:FRAM3:BWP2:SLOT4:ALL5:DMRS:AP
1000,1001
```

**Manual operation:** See "[Antenna Port](#)" on page 129

**CONFigure[:NR5G]:DL[:CC<cc>]:FRAMe<fr>:BWPart<bwp>:SLOT<sl>:  
ALLocation<al>:DMRS:CGWD <CDMGroups>**

**Suffix:**

<cc>	Component Carrier
<fr>	Frame
<bwp>	Bandwidth part
<sl>	Slot
<al>	Allocation

**Parameters:**

<CDMGroups> \*RST: 0

**Example:**

```
//Select CMD groups without data
CONF:DL:CC2:FRAM3:BWP2:SLOT4:ALL5:DMRS:CGWD 2
```

**Manual operation:** See "[CDM Groups w/o Data](#)" on page 130

**CONFigure[:NR5G]:DL[:CC<cc>]:FRAMe<fr>:BWPart<bwp>:SLOT<sl>:  
ALLocation<al>:DMRS:CTYPe <Configuration>**

Selects the PDSCH DM-RS configuration type.

**Suffix:**

<cc>	Component Carrier
<fr>	Frame
<bwp>	Bandwidth part
<sl>	Bandwidth part
<al>	Allocation

**Parameters:**

<Configuration> 1 | 2  
 \*RST: 1

**Example:**

```
//Define DM-RS configuration
CONF:DL:CC2:FRAM3:BWP2:SLOT4:ALL5:DMRS:CTYP 1
```

**Manual operation:** See "[PDSCH DMRS Location](#)" on page 128

**CONFigure[:NR5G]:DL[:CC<cc>]:FRAME<fr>:BWPpart<bwp>:SLOT<sl>:  
 ALlocation<al>:DMRS:MSYMBOL:APOSition <Symbol>**

Defines the position of additional DM-RS.

**Suffix:**

<cc> [Component Carrier](#)  
 <fr> [Frame](#)  
 <bwp> [Bandwidth part](#)  
 <sl> [Bandwidth part](#)  
 <al> [Allocation](#)

**Parameters:**

<Symbol> 0 | 1 | 2 | 3

**Example:**

```
//Define position of additional DM-RS
CONF:DL:CC2:FRAM3:BWP2:SLOT4:ALL5:DMRS:MSYM:
APOS 3
```

**Manual operation:** See "[Multi Symbol DMRS](#)" on page 128

**CONFigure[:NR5G]:DL[:CC<cc>]:FRAME<fr>:BWPpart<bwp>:SLOT<sl>:  
 ALlocation<al>:DMRS:MSYMBOL:LENGth <Symbols>**

Defines the length of the DM-RS.

**Suffix:**

<cc> [Component Carrier](#)  
 <fr> [Frame](#)  
 <bwp> [Bandwidth part](#)  
 <sl> [Bandwidth part](#)  
 <al> [Allocation](#)

**Parameters:**

<Symbols> 1  
 DM-RS transmitted on 1 symbol.  
 2  
 DM-RS transmitted on 2 symbols.  
 \*RST: 1

**Example:** //Define DM-RS length  
 CONF:DL:CC2:FRAM3:BWP2:SLOT4:ALL5:DMRS:MSYM:  
 LENG 2

**Manual operation:** See "[Multi Symbol DMRS](#)" on page 128

**CONFigure[:NR5G]:DL[:CC<cc>]:FRAME<fr>:BWPpart<bwp>:SLOT<sl>:  
 ALLocation<al>:DMRS:MTYPE <Mapping>**

Selects the mapping type of the PDSCH DM-RS.

**Suffix:**

<cc> [Component Carrier](#)  
 <fr> [Frame](#)  
 <bwp> [Bandwidth part](#)  
 <sl> [Bandwidth part](#)  
 <al> [Allocation](#)

**Parameters:**

<Mapping> **A**  
 Location of DM-RS relative to the start of the slot.  
**B**  
 Location relative to the start of the PDSCH resource elements.  
 \*RST: A

**Example:** //Define DM-RS mapping  
 CONF:DL:CC2:FRAM3:BWP2:SLOT4:ALL5:DMRS:MTYP B

**Manual operation:** See "[PDSCH DMRS Location](#)" on page 128

**CONFigure[:NR5G]:DL[:CC<cc>]:FRAME<fr>:BWPpart<bwp>:SLOT<sl>:  
 ALLocation<al>:DMRS:NSCid <Value>**

Defines the scrambling ID for the PDSCH DM-RS sequence generation.

Prerequisites for this command

- Select sequence generation method "n\_ID^DMRS" ([CONFigure\[:NR5G\]:DL\[:CC<cc>\]:FRAME<fr>:BWPpart<bwp>:SLOT<sl>:ALLocation<al>:DMRS:SGENERation](#)).

**Suffix:**

<cc> [Component Carrier](#)  
 <fr> [Frame](#)  
 <bwp> [Bandwidth part](#)  
 <sl> [Bandwidth part](#)  
 <al> [Allocation](#)

**Parameters:**

<Value> 0 | 1

**Example:**

```
//Define DM-RS scrambling ID
CONF:DL:CC2:FRAM3:BWP2:SLOT4:ALL5:DMRS:SGEN
DSID
CONF:DL:CC2:FRAM3:BWP2:SLOT4:ALL5:DMRS:NSC 1
```

**Manual operation:** See "PDSCH DMRS Sequence Generation" on page 128

**CONFigure[:NR5G]:DL[:CC<cc>]:FRAMe<fr>:BWPart<bwp>:SLOT<sl>:  
ALLocation<al>:DMRS:POWer <Power>**

Defines the PDSCH DM-RS power relative to the PDSCH.

**Suffix:**

<cc> [Component Carrier](#)  
 <fr> [Frame](#)  
 <bwp> [Bandwidth part](#)  
 <sl> [Bandwidth part](#)  
 <al> [Allocation](#)

**Parameters:**

<Power> <numeric value>  
 \*RST: 0  
 Default unit: dB

**Example:**

```
//Define DM-RS power
CONF:DL:CC2:FRAM3:BWP2:SLOT4:ALL5:DMRS:POW 0.5
```

**Manual operation:** See "PDSCH DMRS Rel Power" on page 129

**CONFigure[:NR5G]:DL[:CC<cc>]:FRAMe<fr>:BWPart<bwp>:SLOT<sl>:  
ALLocation<al>:DMRS:RST <State>**

Turns low peak to average power ratio for the PDSCH DMRS on and off.

**Suffix:**

<cc> [Component Carrier](#)  
 <fr> [Frame](#)  
 <bwp> [Bandwidth part](#)  
 <sl> [Slot](#)  
 <al> [Allocation](#)

**Parameters:**

<State> ON | OFF | 1 | 0  
 \*RST: OFF

**Example:** //Turn on dmrs-downlink-r16  
 CONF:DL:CC2:FRAM3:BWP2:SLOT4:ALL5:DMRS:RST ON

**Manual operation:** See "[DMRS-Downlink](#)" on page 130

**CONFigure[:NR5G]:DL[:CC<cc>]:FRAMe<fr>:BWPart<bwp>:SLOT<sl>:  
 ALLocation<al>:DMRS:SGENeration <Method>**

Selects the PDSCH DM-RS sequence generation method.

**Suffix:**

<cc> [Component Carrier](#)  
 <fr> [Frame](#)  
 <bwp> [Bandwidth part](#)  
 <sl> [Bandwidth part](#)  
 <al> [Allocation](#)

**Parameters:**

<Method> **NIDCell**  
 Sequence generation based on the cell ID.  
**NIDDmrs**  
 Sequence generation based on a pseudo-random seed value.  
 \*RST: NIDCell

**Example:** //Define DM-RS sequence type  
 CONF:DL:CC2:FRAM3:BWP2:SLOT4:ALL5:DMRS:SGEN  
 NIDC

**Manual operation:** See "[PDSCH DMRS Sequence Generation](#)" on page 128

**CONFigure[:NR5G]:DL[:CC<cc>]:FRAMe<fr>:BWPart<bwp>:SLOT<sl>:  
 ALLocation<al>:DMRS:SID <Value>**

Defines the seed value ("N\_ID^0") for the PDSCH DM-RS sequence generation.

Prerequisites for this command

- Select sequence generation method DMRS-Scrambling-ID ([CONFigure\[:NR5G\]:DL\[:CC<cc>\]:FRAMe<fr>:BWPart<bwp>:SLOT<sl>:ALLocation<al>:DMRS:SGENeration](#)).

**Suffix:**

<cc> [Component Carrier](#)  
 <fr> [Frame](#)  
 <bwp> [Bandwidth part](#)  
 <sl> [Bandwidth part](#)  
 <al> [Allocation](#)

**Parameters:**

<Value> <numeric value> (integer only)

\*RST: 0

**Example:**

```
//Define seed value
CONF:DL:CC2:FRAM3:BWP2:SLOT4:ALL5:DMRS:SGEN
DSID
CONF:DL:CC2:FRAM3:BWP2:SLOT4:ALL5:DMRS:SID 15
```

**Manual operation:** See ["PDSCH DMRS Sequence Generation"](#) on page 128

**CONFigure[:NR5G]:DL[:CC<cc>]:FRAMe<fr>:BWPart<bwp>:SLOT<sl>:  
ALLocation<al>:DMRS:SIONe <Value>**

Defines the scrambling ID ("N\_ID^1") for the PDSCH DM-RS sequence generation.

Prerequisites for this command

- Select sequence generation method "n\_ID^DMRS" ([CONFigure\[:NR5G\]:DL\[:CC<cc>\]:FRAMe<fr>:BWPart<bwp>:SLOT<sl>:ALLocation<al>:DMRS:SGENeration](#)).
- Turn on "DMRS-Downlink" ([CONFigure\[:NR5G\]:DL\[:CC<cc>\]:FRAMe<fr>:BWPart<bwp>:SLOT<sl>:ALLocation<al>:DMRS:RST](#)).

**Suffix:**

<cc> [Component Carrier](#)

<fr> [Frame](#)

<bwp> [Bandwidth part](#)

<sl> [Bandwidth part](#)

<al> [Allocation](#)

**Parameters:**

<Value> \*RST: 0

**Example:**

```
//Define DM-RS scrambling ID
CONF:DL:CC2:FRAM3:BWP2:SLOT4:ALL5:DMRS:SGEN
DSID
CONF:DL:CC2:FRAM3:BWP2:SLOT4:ALL5:DMRS:RST ON
CONF:DL:CC2:FRAM3:BWP2:SLOT4:ALL5:DMRS:SION 15
```

**Manual operation:** See ["PDSCH DMRS Sequence Generation"](#) on page 128

**CONFigure[:NR5G]:DL[:CC<cc>]:FRAMe<fr>:BWPart<bwp>:SLOT<sl>:  
ALLocation<al>:DMRS:TAPos <Symbol>**

Defines the first symbol that the DM-RS uses.

Prerequisites for this command

- Select DM-RS mapping type A ([CONFigure\[:NR5G\]:DL\[:CC<cc>\]:FRAMe<fr>:BWPart<bwp>:SLOT<sl>:ALLocation<al>:DMRS:MTYPE](#)).



**Suffix:**

<cc>	Component Carrier
<fr>	Frame
<bwp>	Bandwidth part
<sl>	Bandwidth part
<al>	Allocation

**Parameters:**

<Symbol> 2 | 3

**Example:**

```
//Define position of DM-RS
CONF:DL:CC2:FRAM3:BWP2:SLOT4:ALL5:DMRS:MTYP A
CONF:DL:CC2:FRAM3:BWP2:SLOT4:ALL5:DMRS:TAP 3
```

**Manual operation:** See "[PDSCH DMRS Location](#)" on page 128

**CONFigure[:NR5G]:DL[:CC<cc>]:FRAMe<fr>:BWPART<bwp>:SLOT<sl>:  
ALLOCATION<al>:RPOINT <Reference>**

Defines the reference point of the PDSCH DMRS.

**Suffix:**

<cc>	Component Carrier
<fr>	Frame
<bwp>	Bandwidth part
<sl>	Bandwidth part
<al>	Allocation

**Parameters:**

<Reference>

**BWPStart**

Reference point is the first subcarrier of the bandwidth part the PDSCH DMRS is in.

**RPA**

Reference point is the reference point A.

\*RST: RPA

**Example:**

```
//Select reference point for PDSCH DMRS
CONF:DL:CC2:FRAM3:BWP2:SLOT4:ALL5:RPO BWPS
```

**Manual operation:** See "[Reference Point](#)" on page 130

**CONFigure[:NR5G]:DL[:CC<cc>]:FRAMe<fr>:BWPART<bwp>:SLOT<sl>:  
ALLOCATION<al>:UEID <ID>**

Defines the user ID of a PDSCH allocation.

**Suffix:**

<cc>	Component Carrier
------	-------------------

<fr>	Frame
<bw>	Bandwidth part
<sl>	Bandwidth part
<al>	Allocation
<b>Parameters:</b>	
<ID>	<numeric value> (integer only)
<b>Example:</b>	//Define allocation ID CONF:DL:CC2:FRAM3:BWP2:SLOT4:ALL5:UEID 8
<b>Manual operation:</b>	See "ID" on page 118 See "User ID" on page 127

---

**CONFigure[:NR5G]:DL[:CC<cc>]:FRAMe<fr>:BWPart<bw>:SLOT<sl>:  
ALLocation<al>:VTPinter <Type>**

Selects the interleaving size of VRB bundles.

**Suffix:**

<cc>	Component Carrier
<fr>	Frame
<bw>	Bandwidth part
<sl>	Bandwidth part
<al>	Allocation

**Parameters:**

<Type>	<b>NINT</b> No resource block bundling. <b>&lt;numeric_value&gt; (integer only)</b> Size of a VRB bundle (2 or 4 resource blocks). <b>*RST: NINT</b>
--------	--

**Example:** //Select interleaving size  
CONF:DL:CC2:FRAM3:BWP2:SLOT4:ALL5:VTP 4

**Manual operation:** See "VRB-to-PRB Interleaver" on page 127

### 6.10.15 Enhanced PDSCH settings: PTRS

Commands to configure the PTRS described elsewhere.

- **CONFigure[:NR5G]:DL[:CC<cc>]:FRAMe<fr>:BWPart<bw>:SLOT<sl>:  
ALLocation<al>:UEID** on page 401

CONFigure[:NR5G]:DL[:CC<cc>]:FRAMe<fr>:BWPart<bwp>:SLOT<sl>: ALLocation<al>:PTRS:K.....	403
CONFigure[:NR5G]:DL[:CC<cc>]:FRAMe<fr>:BWPart<bwp>:SLOT<sl>: ALLocation<al>:PTRS:L.....	403
CONFigure[:NR5G]:DL[:CC<cc>]:FRAMe<fr>:BWPart<bwp>:SLOT<sl>: ALLocation<al>:PTRS:POWer.....	404
CONFigure[:NR5G]:DL[:CC<cc>]:FRAMe<fr>:BWPart<bwp>:SLOT<sl>: ALLocation<al>:PTRS:REOfset.....	404
CONFigure[:NR5G]:DL[:CC<cc>]:FRAMe<fr>:BWPart<bwp>:SLOT<sl>: ALLocation<al>:PTRS[:STATe].....	405

---

### CONFigure[:NR5G]:DL[:CC<cc>]:FRAMe<fr>:BWPart<bwp>:SLOT<sl>:     ALLocation<al>:PTRS:K <Value>

Defines an offset for the PTRS in the frequency domain.

Prerequisites for this command

- Turn on PTRS (CONFigure[:NR5G]:DL[:CC<cc>]:FRAMe<fr>:  
    BWPart<bwp>:SLOT<sl>:ALLocation<al>:PTRS[:STATe]).

#### Suffix:

<cc>	Component Carrier
<fr>	Frame
<bwp>	Bandwidth part
<sl>	Bandwidth part
<al>	Allocation

#### Parameters:

<Value>	2   4 [subcarrier]
*RST:	1

#### Example:

```
//Define PTRS offset
CONF:DL:CC2:FRAM3:BWP2:SLOT4:ALL5:PTRS ON
CONF:DL:CC2:FRAM3:BWP2:SLOT4:ALL5:PTRS:K 4
```

**Manual operation:** See "PTRS Configuration" on page 131

---

### CONFigure[:NR5G]:DL[:CC<cc>]:FRAMe<fr>:BWPart<bwp>:SLOT<sl>:     ALLocation<al>:PTRS:L <Value>

Defines an offset for the PTRS in the time domain.

Prerequisites for this command

- Turn on PTRS (CONFigure[:NR5G]:DL[:CC<cc>]:FRAMe<fr>:  
    BWPart<bwp>:SLOT<sl>:ALLocation<al>:PTRS[:STATe]).

#### Suffix:

<cc>	Component Carrier
<fr>	Frame

<bwp>                    Bandwidth part

<sl>                     Bandwidth part

<al>                     Allocation

**Parameters:**

<Value>                1 | 2 | 4 [OFDM symbols]

\*RST:                 1

**Example:**

//Define PTRS offset

CONF:DL:CC2:FRAM3:BWP2:SLOT4:ALL5:PTRS ON

CONF:DL:CC2:FRAM3:BWP2:SLOT4:ALL5:PTRS:L 4

**Manual operation:** See "PTRS Configuration" on page 131

**CONFigure[:NR5G]:DL[:CC<cc>]:FRAMe<fr>:BWPart<bwp>:SLOT<sl>:  
ALLocation<al>:PTRS:POWer <Power>**

Defines the relative power of the PTRS.

Prerequisites for this command

- Turn on PTRS (CONFigure[:NR5G]:DL[:CC<cc>]:FRAMe<fr>:  
BWPart<bwp>:SLOT<sl>:ALLocation<al>:PTRS[:STATE]).

**Suffix:**

<cc>                     Component Carrier

<fr>                     Frame

<bwp>                    Bandwidth part

<sl>                     Bandwidth part

<al>                     Allocation

**Parameters:**

<Power>                <numeric value>

\*RST:                 0

Default unit: dB

**Example:**

//Define PTRS power

CONF:DL:CC2:FRAM3:BWP2:SLOT4:ALL5:PTRS ON

CONF:DL:CC2:FRAM3:BWP2:SLOT4:ALL5:PTRS:POW 1DB

**Manual operation:** See "PTRS Configuration" on page 131

**CONFigure[:NR5G]:DL[:CC<cc>]:FRAMe<fr>:BWPart<bwp>:SLOT<sl>:  
ALLocation<al>:PTRS:REOffset <Offset>**

Defines the location of the PTRS in the frequency domain relative to the first subcarrier.

Prerequisites for this command

- Turn on PTRS (`CONFigure[:NR5G]:DL[:CC<cc>]:FRAMe<fr>:BWPart<bwp>:SLOT<sl>:ALLocation<al>:PTRS[:STATE]`).

**Suffix:**

<cc>	Component Carrier
<fr>	Frame
<bwp>	Bandwidth part
<sl>	Bandwidth part
<al>	Allocation

**Parameters:**

<Offset>	<b>OS00   OS01   OS10   OS11</b> Defines an offset.
	<b>NONE</b> No offset.
	*RST: 00

**Example:**

```
//Define PTRS offset
CONF:DL:CC2:FRAM3:BWP2:SLOT4:ALL5:PTRS ON
CONF:DL:CC2:FRAM3:BWP2:SLOT4:ALL5:PTRS:REOF
OS10
```

**Manual operation:** See "[PTRS Configuration](#)" on page 131

**CONFigure[:NR5G]:DL[:CC<cc>]:FRAMe<fr>:BWPart<bwp>:SLOT<sl>:ALLocation<al>:PTRS[:STATE] <State>**

Turns the PTRS on and off.

**Suffix:**

<cc>	Component Carrier
<fr>	Frame
<bwp>	Bandwidth part
<sl>	Bandwidth part
<al>	Allocation

**Parameters:**

<State>	ON   OFF   1   0
	*RST: OFF

**Example:**

```
//Turn on PTRS
CONF:DL:CC2:FRAM3:BWP2:SLOT4:ALL5:PTRS ON
```

**Manual operation:** See "[PTRS Configuration](#)" on page 131

## 6.10.16 Enhanced PDSCH settings: scrambling / coding

Commands to configure the PTRS described elsewhere.

- `CONFigure[:NR5G]:DL[:CC<cc>]:FRAMe<fr>:BWPart<bwp>:SLOT<sl>:ALLocation<al>:UEID` on page 401

<code>CONFigure[:NR5G]:DL[:CC&lt;cc&gt;]:FRAMe&lt;fr&gt;:BWPart&lt;bwp&gt;:SLOT&lt;sl&gt;:ALLocation&lt;al&gt;:CCODing:IMCS</code> .....	406
<code>CONFigure[:NR5G]:DL[:CC&lt;cc&gt;]:FRAMe&lt;fr&gt;:BWPart&lt;bwp&gt;:SLOT&lt;sl&gt;:ALLocation&lt;al&gt;:CCODing:MCSTable</code> .....	407
<code>CONFigure[:NR5G]:DL[:CC&lt;cc&gt;]:FRAMe&lt;fr&gt;:BWPart&lt;bwp&gt;:SLOT&lt;sl&gt;:ALLocation&lt;al&gt;:CCODing:RVIndex</code> .....	407
<code>CONFigure[:NR5G]:DL[:CC&lt;cc&gt;]:FRAMe&lt;fr&gt;:BWPart&lt;bwp&gt;:SLOT&lt;sl&gt;:ALLocation&lt;al&gt;:CCODing:TBSFs</code> .....	408
<code>CONFigure[:NR5G]:DL[:CC&lt;cc&gt;]:FRAMe&lt;fr&gt;:BWPart&lt;bwp&gt;:SLOT&lt;sl&gt;:ALLocation&lt;al&gt;:CCODing:TBSsize</code> .....	408
<code>CONFigure[:NR5G]:DL[:CC&lt;cc&gt;]:FRAMe&lt;fr&gt;:BWPart&lt;bwp&gt;:SLOT&lt;sl&gt;:ALLocation&lt;al&gt;:SCRambling</code> .....	409
<code>CONFigure[:NR5G]:DL[:CC&lt;cc&gt;]:FRAMe&lt;fr&gt;:BWPart&lt;bwp&gt;:SLOT&lt;sl&gt;:ALLocation&lt;al&gt;:SCRambling:DSID</code> .....	409

---

**`CONFigure[:NR5G]:DL[:CC<cc>]:FRAMe<fr>:BWPart<bwp>:SLOT<sl>:ALLocation<al>:CCODing:IMCS` <Value>**

Selects the MCS index ( $I_{MCS}$ ).

**Suffix:**

<cc>	Component Carrier
<fr>	Frame
<bwp>	Bandwidth part
<sl>	Slot
<al>	Allocation

**Parameters:**

<Value>	The value range depends on: <ul style="list-style-type: none"> <li>• The modulation order (<code>CONFigure[:NR5G]:DL[:CC&lt;cc&gt;]:FRAMe&lt;fr&gt;:BWPart&lt;bwp&gt;:SLOT&lt;sl&gt;:ALLocation&lt;al&gt;:CCODing:MCSTable</code>).</li> <li>• The modulation scheme of the PDSCH (<code>CONFigure[:NR5G]:DL[:CC&lt;cc&gt;]:FRAMe&lt;fr&gt;:BWPart&lt;bwp&gt;:SLOT&lt;sl&gt;:ALLocation&lt;al&gt;[:CW&lt;cw&gt;]:MODulation</code>).</li> </ul>
*RST:	0

**Example:**

```
//Select MCS index for modulation order 256QAM
CONF:DL:CC2:FRAM3:BWP2:SLOT4:ALL5:MOD_QAM256
CONF:DL:CC2:FRAM3:BWP2:SLOT4:ALL5:CCOD:MCST
Q256
CONF:DL:CC2:FRAM3:BWP2:SLOT4:ALL5:CCOD:IMCS 2
```

**Manual operation:** See "Channel Coding" on page 132

---

**CONFigure[:NR5G]:DL[:CC<cc>]:FRAMe<fr>:BWPart<bwp>:SLOT<sl>:  
ALLocation<al>:CCODing:MCSTable <Table>**

Selects the modulation order (MCS table) of the PDSCH.

**Suffix:**

<cc>	Component Carrier
<fr>	Frame
<bwp>	Bandwidth part
<sl>	Slot
<al>	Allocation

**Parameters:**

<Table>	<b>Q64</b> Table for 64QAM.
	<b>Q64L</b> Table for 64QAM LowSE.
	<b>Q256</b> Table for 256QAM.
	<b>Q1024</b> Table for 1024QAM.
	*RST: Q64

**Example:** //Select modulation order  
CONF:DL:CC2:FRAM3:BWP2:SLOT4:ALL5:CCOD:MCST Q64

**Manual operation:** See "Channel Coding" on page 132

---

**CONFigure[:NR5G]:DL[:CC<cc>]:FRAMe<fr>:BWPart<bwp>:SLOT<sl>:  
ALLocation<al>:CCODing:RVINdex <Index>**

Selects the redundancy version index.

**Suffix:**

<cc>	Component Carrier
<fr>	Frame
<bwp>	Bandwidth part
<sl>	Slot
<al>	Allocation

**Parameters:**

<Index>	Range: 0 to 3
	*RST: 0

**Example:** //Select redundancy version index  
CONF:DL:CC2:FRAM3:BWP2:SLOT4:ALL5:CCOD:RVIN 1

**Manual operation:** See "Channel Coding" on page 132

**CONFigure[:NR5G]:DL[:CC<cc>]:FRAMe<fr>:BWPart<bwp>:SLOT<sl>:  
ALLOcation<al>:CCODing:TBSFs <Factor>**

Selects the transport block scaling factor S.

**Suffix:**

<cc>                   Component Carrier  
<fr>                   Frame  
<bwp>                  Bandwidth part  
<sl>                   Slot  
<al>                   Allocation

**Parameters:**

<Factor>              **ONE**  
                          S = 1  
                          **HALF**  
                          S = 0.5  
                          **QUAR**  
                          S = 0.25  
\*RST:                 ONE

**Example:** //Select TB scaling factor S  
CONF:DL:CC2:FRAM3:BWP2:SLOT4:ALL5:CCOD:TBSF  
HALF

**Manual operation:** See "Channel Coding" on page 132

**CONFigure[:NR5G]:DL[:CC<cc>]:FRAMe<fr>:BWPart<bwp>:SLOT<sl>:  
ALLOcation<al>:CCODing:TBSiSize <State>**

Turns transport block size calculation including allocation gaps on and off.

Prerequisites for this command

- Combine PDSCH allocations (CONFigure[:NR5G]:DL[:CC<cc>]:FRAMe<fr>:  
BWPart<bwp>:SLOT<sl>:CUID on page 376).

**Suffix:**

<cc>                   Component Carrier  
<fr>                   Frame  
<bwp>                  Bandwidth part  
<sl>                   Slot  
<al>                   Allocation



**Parameters:**

<State> ON | OFF | 1 | 0  
 \*RST: OFF

**Example:**

```
//Calculate transport block size including allocation gaps
CONF:DL:CC2:FRAM3:BWP2:SLOT4:CUID ON
CONF:DL:CC2:FRAM3:BWP2:SLOT4:ALL5:CCOD:TBS ON
```

**Manual operation:** See "[Channel Coding](#)" on page 132

**CONFigure[:NR5G]:DL[:CC<cc>]:FRAMe<fr>:BWPart<bwp>:SLOT<sl>:  
 ALLocation<al>:SCRambling <Method>**

Selects the PDSCH scrambling method.

**Suffix:**

<cc> [Component Carrier](#)  
 <fr> [Frame](#)  
 <bwp> [Bandwidth part](#)  
 <sl> [Slot](#)  
 <al> [Allocation](#)

**Parameters:**

<Method> **DSID**  
 Sequence generation based on a pseudo-random seed value.  
**NIDCell**  
 Sequence generation based on the cell ID.  
 \*RST: NIDCell

**Example:**

```
//Define PDSCH scrambling method
CONF:DL:CC2:FRAM3:BWP2:SLOT4:ALL5:SCR NIDC
```

**Manual operation:** See "[PDSCH Scrambling](#)" on page 133

**CONFigure[:NR5G]:DL[:CC<cc>]:FRAMe<fr>:BWPart<bwp>:SLOT<sl>:  
 ALLocation<al>:SCRambling:DSID <Value>**

Defines the seed value for the PDSCH scrambling.

Prerequisites for this command

- Select sequence generation method DMRS-Scrambling-ID ([CONFigure\[:NR5G\]:DL\[:CC<cc>\]:FRAMe<fr>:BWPart<bwp>:SLOT<sl>:ALLocation<al>:SCRambling](#)).

**Suffix:**

<cc> [Component Carrier](#)  
 <fr> [Frame](#)  
 <bwp> [Bandwidth part](#)

<sl>	Slot
<al>	Allocation
<b>Parameters:</b>	
<Value>	<numeric value> (integer only)
	*RST: 0
<b>Example:</b>	//Define seed value CONF:DL:CC2:FRAM3:BWP2:SLOT4:ALL5:SCR:DSID CONF:DL:CC2:FRAM3:BWP2:SLOT4:ALL5:SCR:DSID 10
<b>Manual operation:</b>	See "PDSCH Scrambling" on page 133

### 6.10.17 Antenna port configuration

CONFigure[:NR5G]:DL[:CC<cc>]:PAMapping<cf>:CSIRs:AP<ap>.....	410
CONFigure[:NR5G]:DL[:CC<cc>]:PAMapping<cf>:PDSCh:AP<ap>.....	410
CONFigure[:NR5G]:DL[:CC<cc>]:PAMapping<cf>:STATE.....	411

---

#### CONFigure[:NR5G]:DL[:CC<cc>]:PAMapping<cf>:CSIRs:AP<ap> <State>

Selects the antenna port(s) on which the CSI reference signal is transmitted.

##### Suffix:

<cc>	Component Carrier
<cf>	1...2 Antenna port configuration
<ap>	3000...3031 Antenna port

##### Parameters:

<State>	<b>ON   OFF   1   0</b> Turns a specific CSI-RS antenna port on and off.
	<b>ALL   NONE</b> Turns all CSI-RS antenna port on and off.
	*RST: AP 3000 = ON

**Example:** //Transmit CSI RS on antenna port 3010 in configuration 2  
CONF:DL:CC2:PAM2:CSIR:AP3010

**Manual operation:** See "CSI-RS" on page 135

---

#### CONFigure[:NR5G]:DL[:CC<cc>]:PAMapping<cf>:PDSCh:AP<ap> <State>

Selects the antenna port(s) on which the PDSCH is transmitted.

##### Suffix:

<cc>	Component Carrier
<cf>	1...2 Antenna port configuration

<ap>	1000...1011 <a href="#">Antenna port</a>
<b>Parameters:</b>	
<State>	<b>ON   OFF   1   0</b> Turns the transmission on a specific antenna port on and off. <b>ALL</b> Turns on the transmission on all antenna ports (1000 to 1011). <b>NONE</b> Turns off the transmission on all antenna ports. By default, the transmission is on antenna port 1000 (configuration 1) and 1001 (configuration 2).
<b>Example:</b>	//Turn on transmission on antenna port 1002 in configuration 1 CONF:DL:CC1:PAM1:PDSCH:AP1002 ON
<b>Manual operation:</b>	See " <a href="#">PDSCH</a> " on page 134

---

#### CONFigure[:NR5G]:DL[:CC<cc>]:PAMapping<cf>:STATe <State>

Selects one of the antenna port configurations.

Effects of this command

- If you turn on a configuration, the other antenna port configuration is automatically turned off (and vice versa).

#### Suffix:

<cc>	<a href="#">Component Carrier</a>
<cf>	1...2 <a href="#">Antenna port configuration</a>

#### Parameters:

<State>	ON   OFF   1   0 *RST: ON for configuration 1
---------	--

**Example:** //Turn on antenna port configuration 2  
CONF:DL:CC2:PAM2:STAT ON

**Manual operation:** See "[State](#)" on page 134

### 6.10.18 Advanced settings: global

CONFigure[:NR5G]:DL[:CC<cc>]:EUIDs.....	412
CONFigure[:NR5G]:DL[:CC<cc>]:FNNF.....	412
CONFigure[:NR5G]:DL[:CC<cc>]:IDC.....	412
CONFigure[:NR5G]:DL[:CC<cc>]:RFUC:FZRo:FREQuency.....	413
CONFigure[:NR5G]:DL[:CC<cc>]:RFUC:FZRo:MODE.....	413
CONFigure[:NR5G]:DL[:CC<cc>]:RFUC:STATe.....	414
CONFigure[:NR5G]:DL[:CC<cc>]:SSCA.....	414

CONFigure[:NR5G]:FELC:STATe.....	414
CONFigure[:NR5G]:ORAN:TCASe.....	414
[SENSe:]POWer:CATegory.....	415

---

### CONFigure[:NR5G]:DL[:CC<cc>]:EUIDs <IDs>

Defines user IDs that are excluded from the calculation of modulation-specific EVM results.

**Suffix:**

<cc> [Component Carrier](#)

**Parameters:**

<IDs> String containing the user IDs to exclude. This is either a comma-separated list (1,2,5,6), a range (1-6) or a combination of both.

**Example:**

```
//Exclude user IDs
CONF:DL:EUID "1, 3, 5-6"
```

**Manual operation:** See ["Exclude User IDs"](#) on page 137

---

### CONFigure[:NR5G]:DL[:CC<cc>]:FNNF <FrameNumber>

Defines the 5G NR system frame number.

**Suffix:**

<cc> irrelevant

**Parameters:**

<FrameNumber> \*RST: 0

**Example:**

```
//Define frame number
CONF:UL:FNNF 432
```

**Manual operation:** See ["Frame Number n<sub>f</sub>"](#) on page 136

---

### CONFigure[:NR5G]:DL[:CC<cc>]:IDC <State>

Turns analysis of the DC carrier on and off.

**Suffix:**

<cc> [Component Carrier](#)

**Parameters:**

<State>

**OFF | 0**  
Includes the DC carrier in the analysis.

**ON | 1**  
Excludes the DC carrier from the analysis.

**COMPensate**  
Compensates the DC carrier.

\*RST: OFF

**Example:**

```
//Do not analyze DC carrier
CONF:DL:CC2:IDC ON
```

**Manual operation:** See "[Handling of Carrier Leakage](#)" on page 136

---

### CONFigure[:NR5G]:DL[:CC<cc>]:RFUC:FZERo:FREQuency <Frequency>

Selects a frequency for RF upconversion.

Prerequisites for this command

- Turn on phase compensation ([CONFigure\[:NR5G\]:DL\[:CC<cc>\]:RFUC:STATe](#)).
- Select mode to select custom frequency ([CONFigure\[:NR5G\]:DL\[:CC<cc>\]:RFUC:FZERo:MODE](#)).

**Suffix:**

<cc>                      [Component Carrier](#)

**Parameters:**

<Frequency>              <numeric value>  
 \*RST:                      0  
 Default unit: Hz

**Example:**

```
//Define frequency for RF upconversion
CONF:DL:CC2:RFUC:STAT ON
CONF:DL:CC2:RFUC:FZER:MODE MAN
CONF:DL:CC2:RFUC:FZER:FREQ 800MHZ
```

**Manual operation:** See "[RF Upconversion](#)" on page 137

---

### CONFigure[:NR5G]:DL[:CC<cc>]:RFUC:FZERo:MODE <Mode>

Selects the frequency selection mode for RF upconversion.

Prerequisites for this command

- Turn on phase compensation ([CONFigure\[:NR5G\]:DL\[:CC<cc>\]:RFUC:STATe](#)).

**Suffix:**

<cc>                      [Component Carrier](#)

**Parameters:**

<Mode>                      **CF**  
 Converts the signal to the center frequency.

**MANual**

Converts the signal to another frequency.

You can define the frequency with [CONFigure\[:NR5G\]:DL\[:CC<cc>\]:RFUC:FZERo:FREQuency](#).

\*RST:                      CF

**Example:**

```
//Select frequency mode for RF upconversion
CONF:DL:CC2:RFUC:STAT ON
CONF:DL:CC2:RFUC:FZER:MODE CF
```

**Manual operation:** See "[RF Upconversion](#)" on page 137

---

**CONFigure[:NR5G]:DL[:CC<cc>]:RFUC:STATe <State>**

Turns RF upconversion and corresponding phase compensation on and off.

**Suffix:**

<cc> [Component Carrier](#)

**Parameters:**

<State> ON | OFF | 1 | 0

\*RST: ON

**Example:**

```
//Turn on phase compensation
CONF:DL:CC2:RFUC:STAT ON
```

**Manual operation:** See "[RF Upconversion](#)" on page 137

---

**CONFigure[:NR5G]:DL[:CC<cc>]:SSCA <State>**

Turn shared spectrum channel access on and off.

**Suffix:**

<cc> [Component Carrier](#)

**Parameters:**

<State> ON | OFF | 1 | 0

\*RST: OFF

**Example:**

```
//Turn on shared spectrum channel acces
CONF:DL:SSCA ON
```

**Manual operation:** See "[Shared Spectrum Channel Access](#)" on page 138

---

**CONFigure[:NR5G]:FELC:STATe <State>**

Turns the frequency error limit check on and off.

**Parameters:**

<State> ON | OFF | 1 | 0

\*RST: ON

**Example:**

```
//Turn on frequency error limit check
CONF:FELC:STAT ON
```

**Manual operation:** See "[Frequency Error Limit Check](#)" on page 137

---

**CONFigure[:NR5G]:ORAN:TCASe <Testcase>**

Selects an O-RAN test case.

**Parameters:**

<Testcase>                    **<string>**  
 String containing the name of the test case, e.g. "TC 3.2.3.1.1".  
 The string "NONE" removes a test case.  
 \*RST:                    NONE

**Example:**                    //Select O-RAN test case TC 3.2.3.1.4  
 CONF:ORAN:TCAS "TC 3.2.3.1.4"

**Manual operation:**    See "[O-RAN Test Case](#)" on page 138

**[SENSe:]POWer:CAteGory <Category>**

Selects the base station category-

**Parameters:**

<Category>                    **A**  
 Category A base station.  
**B**  
 Category B base station.  
**LARE**  
 Large area base station.  
**MED**  
 Medium area base station.  
 \*RST:                    A

**Example:**                    //Select base station category  
 POW:CAT B

**Manual operation:**    See "[Category](#)" on page 137

**6.10.19 Advanced settings: reference point A**

CONFigure[:NR5G]:DL[:CC<cc>]:RPA:AFRequency?	415
CONFigure[:NR5G]:DL[:CC<cc>]:RPA:KZERo:SCFE	416
CONFigure[:NR5G]:DL[:CC<cc>]:RPA:KZERo:SCFT	416
CONFigure[:NR5G]:DL[:CC<cc>]:RPA:KZERo:SCNS	416
CONFigure[:NR5G]:DL[:CC<cc>]:RPA:KZERo:SCOT	417
CONFigure[:NR5G]:DL[:CC<cc>]:RPA:KZERo:SCST	417
CONFigure[:NR5G]:DL[:CC<cc>]:RPA:KZERo:SCTT	418
CONFigure[:NR5G]:DL[:CC<cc>]:RPA:RTCF	418
CONFigure[:NR5G]:DL[:CC<cc>]:RPA:TBOFset?	418

**CONFigure[:NR5G]:DL[:CC<cc>]:RPA:AFRequency?**

Queries the absolute frequency of the reference point A.

**Suffix:**

<cc>                    [Component Carrier](#)

**Return values:**

<Frequency>            <numeric value>  
                               Default unit: Hz

**Example:**                //Query location of reference point A  
                               CONF:DL:CC2:RPA:AFR?

**Usage:**                    Query only

**Manual operation:**    See "[Reference Point A](#)" on page 139

**CONFigure[:NR5G]:DL[:CC<cc>]:RPA:KZERo:SCFE <Offset>**

Defines an offset relative to reference point A for bandwidth parts with 480 kHz subcarrier spacing.

Prerequisites for this command

- Bandwidth part with 480 kHz subcarrier spacing is available.

**Suffix:**

<cc>                        [Component Carrier](#)

**Parameters:**

<Offset>                    -6 | 0 | 6

**Example:**                //Define offset  
                               CONF:DL:CC2:RPA:KZER:SCFE 0

**Manual operation:**    See "[k\\_0](#)" on page 139

**CONFigure[:NR5G]:DL[:CC<cc>]:RPA:KZERo:SCFT <Offset>**

Defines an offset relative to reference point A for bandwidth parts with 15 kHz subcarrier spacing.

Prerequisites for this command

- Bandwidth part with 15 kHz subcarrier spacing is available.

**Suffix:**

<cc>                        [Component Carrier](#)

**Parameters:**

<Offset>                    -6 | 0 | 6

**Example:**                //Define offset  
                               CONF:DL:CC2:RPA:KZER:SCFT 0

**Manual operation:**    See "[k\\_0](#)" on page 139

**CONFigure[:NR5G]:DL[:CC<cc>]:RPA:KZERo:SCNS <Offset>**

Defines an offset relative to reference point A for bandwidth parts with 960 kHz subcarrier spacing.



Prerequisites for this command

- Bandwidth part with 960 kHz subcarrier spacing is available.

**Suffix:**

<cc> [Component Carrier](#)

**Parameters:**

<Offset> -6 | 0 | 6

**Example:**

```
//Define offset
CONF:DL:CC2:RPA:KZER:SCNS 0
```

**Manual operation:** See "[k\\_0](#)" on page 139

**CONFigure[:NR5G]:DL[:CC<cc>]:RPA:KZERo:SCOT <Offset>**

Defines an offset relative to reference point A for bandwidth parts with 120 kHz subcarrier spacing.

Prerequisites for this command

- Bandwidth part with 120 kHz subcarrier spacing is available.

**Suffix:**

<cc> [Component Carrier](#)

**Parameters:**

<Offset> -6 | 0 | 6

**Example:**

```
//Define offset
CONF:DL:CC2:RPA:KZER:SCOT 0
```

**Manual operation:** See "[k\\_0](#)" on page 139

**CONFigure[:NR5G]:DL[:CC<cc>]:RPA:KZERo:SCST <Offset>**

Defines an offset relative to reference point A for bandwidth parts with 60 kHz subcarrier spacing.

Prerequisites for this command

- Bandwidth part with 60 kHz subcarrier spacing is available.

**Suffix:**

<cc> [Component Carrier](#)

**Parameters:**

<Offset> -6 | 0 | 6

**Example:**

```
//Define offset
CONF:DL:CC2:RPA:KZER:SCST 0
```

**Manual operation:** See "[k\\_0](#)" on page 139

**CONFigure[:NR5G]:DL[:CC<cc>]:RPA:KZERo:SCTT <Offset>**

Defines an offset relative to reference point A for bandwidth parts with 30 kHz subcarrier spacing.

Prerequisites for this command

- Bandwidth part with 30 kHz subcarrier spacing is available.

**Suffix:**

<cc> [Component Carrier](#)

**Parameters:**

<Offset> -6 | 0 | 6

**Example:**

```
//Define offset
CONF:DL:CC2:RPA:KZER:SCTT 0
```

**Manual operation:** See "[k\\_0](#)" on page 139

**CONFigure[:NR5G]:DL[:CC<cc>]:RPA:RTCF <Frequency>**

Defines the frequency of the reference point A relative to the carrier's center frequency.

**Suffix:**

<cc> [Component Carrier](#)

**Parameters:**

<Frequency> <numeric value>  
Default unit: Hz

**Example:**

```
//Define location of reference point A
CONF:DL:CC2:RPA:RTCF -54.5MHZ
```

**Manual operation:** See "[Reference Point A](#)" on page 139

**CONFigure[:NR5G]:DL[:CC<cc>]:RPA:TBOFset?**

Queries the TxBW offset of the reference point A.

**Suffix:**

<cc> [Component Carrier](#)

**Return values:**

<Offset> <numeric value>  
Default unit: Hz

**Example:**

```
//Query TxBW offset
CONF:DL:CC2:RPA:TBOF?
```

**Usage:**

Query only

**Manual operation:** See "[Reference Point A](#)" on page 139

## 6.10.20 Advanced settings: LTE-CRS coexistence

CONFigure[:NR5G]:DL[:CC<cc>]:LTE:CBW.....	419
CONFigure[:NR5G]:DL[:CC<cc>]:LTE:MBSFn:SUBFrame<sf>:STATe.....	419
CONFigure[:NR5G]:DL[:CC<cc>]:LTE:NAP.....	420
CONFigure[:NR5G]:DL[:CC<cc>]:LTE:POINta.....	420
CONFigure[:NR5G]:DL[:CC<cc>]:LTE:STATe.....	420
CONFigure[:NR5G]:DL[:CC<cc>]:LTE:VSHift.....	421

---

### CONFigure[:NR5G]:DL[:CC<cc>]:LTE:CBW <ResourceBlocks>

Selects the channel bandwidth of an LTE carrier.

Prerequisites for this command

- Turn on LTE-CRS coexistence (`CONFigure[:NR5G]:DL[:CC<cc>]:LTE:STATe`).

#### Suffix:

<cc>                      [Component Carrier](#)

#### Parameters:

<ResourceBlocks>    N6 | N15 | N25 | N50 | N75 | N100  
\*RST:                  N6

#### Example:

```
//Select LTE channel bandwidth
CONF:DL:CC2:LTE:STAT ON
CONF:DL:CC2:LTE:CBW N25
```

**Manual operation:** See "[LTE Bandwidth](#)" on page 141

---

### CONFigure[:NR5G]:DL[:CC<cc>]:LTE:MBSFn:SUBFrame<sf>:STATe <State>

Turns MBSFN transmission in specific subframes on and off.

Prerequisites for this command

- Turn on LTE-CRS coexistence (`CONFigure[:NR5G]:DL[:CC<cc>]:LTE:STATe`).

#### Suffix:

<cc>                      [Component Carrier](#)

<sf>                      1...9  
                            Subframe

#### Parameters:

<State>                  ON | OFF | 1 | 0  
\*RST:                  OFF (all subframes)

#### Example:

```
//Turn on MBSFN transmission in subframe 2
CONF:DL:LTE:MBSF:SUBF2:STAT ON
```

**Manual operation:** See "[MBSFN Subframes](#)" on page 140

**CONFigure[:NR5G]:DL[:CC<cc>]:LTE:NAP <APs>**

Selects the number of antenna ports for an LTE signal.

Prerequisites for this command

- Turn on LTE-CRS coexistence ([CONFigure\[:NR5G\]:DL\[:CC<cc>\]:LTE:STATE](#)).

**Suffix:**

<cc> [Component Carrier](#)

**Parameters:**

<APs> AP1 | AP2 | AP4  
1-, 2-, or 4 antenna port configurations.  
\*RST: AP1

**Example:**

```
//Select number of LTE antenna ports
CONF:DL:CC2:LTE:STAT ON
CONF:DL:CC2:LTE:NAP AP2
```

**Manual operation:** See "[LTE Antenna Ports](#)" on page 141

**CONFigure[:NR5G]:DL[:CC<cc>]:LTE:POINta <Offset>**

Defines an LTE carrier offset relative to reference point A (in terms of resource blocks).

Prerequisites for this command

- Turn on LTE-CRS coexistence ([CONFigure\[:NR5G\]:DL\[:CC<cc>\]:LTE:STATE](#)).

**Suffix:**

<cc> [Component Carrier](#)

**Parameters:**

<Offset> \*RST: 0

**Example:**

```
//Define carrier offset
CONF:DL:CC2:LTE:STAT ON
CONF:DL:CC2:LTE:POIN 25
```

**Manual operation:** See "[Offset to Point A](#)" on page 140

**CONFigure[:NR5G]:DL[:CC<cc>]:LTE:STATE <State>**

Turns coexistence with LTE resources on and off.

Prerequisites for this command

- Select subcarrier spacing of 15 kHz ([CONFigure\[:NR5G\]:DL\[:CC<cc>\]:FRAME<fr>:BWPart<bwp>:SSPacing](#)).

**Suffix:**

<cc> [Component Carrier](#)

**Parameters:**

<State> ON | OFF | 1 | 0  
 \*RST: OFF

**Example:**

```
//Turn on LTE coexistence
CONF:DL:CC2:FRAM:BWP1:SSP SS15
CONF:DL:CC2:LTE:STAT ON
```

**Manual operation:** See "State" on page 140

**CONFigure[:NR5G]:DL[:CC<cc>]:LTE:VShifT <Value>**

Selects the vShift parameter for an LTE signal.

Prerequisites for this command

- Turn on LTE-CRS coexistence (**CONFigure[:NR5G]:DL[:CC<cc>]:LTE:STATe**).

**Suffix:**

<cc> [Component Carrier](#)

**Parameters:**

<Value> \*RST: 0

**Example:**

```
//Define vShift parameter
CONF:DL:CC2:LTE:STAT ON
CONF:DL:CC2:LTE:VSH 2
```

**Manual operation:** See "vShift" on page 141

## 6.10.21 Generator control

<a href="#">CONFigure:GENerator:FREQuency:CENTer:SYNC[:STATe]</a> .....	422
<a href="#">CONFigure:GENerator:IPConnection:ADDRess</a> .....	422
<a href="#">CONFigure:GENerator:IPConnection:LEDState?</a> .....	422
<a href="#">CONFigure:GENerator:POWer:LEVel:STATe</a> .....	423
<a href="#">CONFigure:GENerator:LEVel:DUTGain</a> .....	423
<a href="#">CONFigure:GENerator:LEVel:DUTLimit</a> .....	423
<a href="#">CONFigure:GENerator:LEVel:DUTLimit:STATe</a> .....	424
<a href="#">CONFigure:GENerator:POWer:LEVel</a> .....	424
<a href="#">CONFigure:GENerator:QERRor?</a> .....	425
<a href="#">CONFigure:SETTings:NR5G</a> .....	425
<a href="#">CONFigure:SETTings:NR5G:PINterval</a> .....	425
<a href="#">CONFigure:SETTings:NR5G:SYNC</a> .....	426
<a href="#">CONFigure:SETTings:RF</a> .....	426
<a href="#">CONFigure:GENerator:RFOutput[:STATe]</a> .....	426
<a href="#">CONFigure:GENerator:CONTRol[:STATe]</a> .....	427
<a href="#">CONFigure:GENerator:SETTings:UPDate:RF</a> .....	427

**CONFigure:GENerator:FREQUENCY:CENTer:SYNC[:STATe]** <State>

Turns frequency synchronization between analyzer and generator on and off.

You can define the frequency itself with [**SENSe:**] **FREQUENCY:CENTer[:CC<cc>]**.

Prerequisites for this command

- IP connection to a signal generator.
- Generator control state is on (**CONFigure:GENerator:CONTrol[:STATe]**).

**Parameters:**

<State>            ON | OFF | 1 | 0  
\*RST:            OFF

**Example:**            //Turn on RF output  
CONF:GEN:CONT ON  
CONF:GEN:FREQ:CENT ON

**Manual operation:** See "[Center Frequency](#)" on page 143

**CONFigure:GENerator:IPConnection:ADDRess** <IPAddress>

This command defines the IP address of the connected signal generator.

Make sure to synchronize with \*OPC? or \*WAI to make sure that the command was successfully applied on the generator before sending the next command.

**Parameters:**

<IPAddress>        String containing the IP address or computer name.

**Example:**            //Connect to the generator with the stated IP address  
CONF:GEN:IPC:ADDR '192.0.2.0';\*WAI

**Example:**            //Connect to the generator with a computer name  
CONF:GEN:IPC:ADDR 'MyGenerator';\*WAI

**Manual operation:** See "[Generator IP Address](#)" on page 142

**CONFigure:GENerator:IPConnection:LEDState?**

This command queries the state of connection to the signal generator.

**Return values:**

<State>            **GREen**  
                         Connection was successful.  
                         **GREY**  
                         Unknown connection state.  
                         **RED**  
                         Connection was not successful.

**Example:**            CONF:GEN:IPC:LEDS?  
                         would return, e.g.:  
                         RED

**Usage:** Query only

**Manual operation:** See "[Generator IP Address](#)" on page 142

#### **CONFigure:GENerator:POWer:LEVel:STATe** <State>

Turns level synchronization between analyzer and generator on and off.

Prerequisites for this command

- IP connection to a signal generator.
- Generator control state is on ([CONFigure:GENerator:CONTRol\[:STATe\]](#)).

**Parameters:**

<State> ON | OFF | 1 | 0  
\*RST: OFF

**Example:** //Turn on level synchronization  
CONF:GEN:CONT ON  
CONF:GEN:POW:LEV:STAT ON

**Manual operation:** See "[Level Control State](#)" on page 143

#### **CONFigure:GENerator:LEVel:DUTGain** <Level>

Defines DUT level gain for generator level control.

Prerequisites for this command

- IP connection to a signal generator.
- Generator control state is on ([CONFigure:GENerator:CONTRol\[:STATe\]](#)).
- Level control is on ([CONFigure:GENerator:POWer:LEVel:STATe](#)).

**Parameters:**

<Level> \*RST: 0  
Default unit: dB

**Example:** //Define DUT gain  
CONF:GEN:CONT ON  
CONF:GEN:LEV:DUTG ON

**Manual operation:** See "[DUT Gain](#)" on page 144

#### **CONFigure:GENerator:LEVel:DUTLimit** <Level>

Defines the output power RMS level of the generator.

Prerequisites for this command

- IP connection to a signal generator.
- Generator control state is on ([CONFigure:GENerator:CONTRol\[:STATe\]](#)).
- Level control is on ([CONFigure:GENerator:POWer:LEVel:STATe](#)).
- DUT peak input power limit is on ([CONFigure:GENerator:LEVel:DUTLimit:STATe](#)).

**Parameters:**

<Level>                    \*RST:        30  
                                   Default unit: dB

**Example:**

```
//Define peak input power
CONF:GEN:CONT ON
CONF:GEN:POW:LEV:STAT ON
CONF:GEN:LEV:DUTL:STAT ON
CONF:GEN:LEV:DUTL 10
```

**Manual operation:** See "[Limit DUT Peak Input Power](#)" on page 144

**CONFigure:GENerator:LEVel:DUTLimit:STATE <State>**

Turns a limitation of the DUT peak input power on and off.

Define the peak input power with [CONFigure:GENerator:LEVel:DUTLimit](#).

Prerequisites for this command

- IP connection to a signal generator.
- Generator control state is on ([CONFigure:GENerator:CONTRol\[:STATE\]](#)).
- Level control is on ([CONFigure:GENerator:POWer:LEVel:STATE](#)).

**Parameters:**

<State>                    ON | OFF | 1 | 0  
                                   \*RST:        OFF

**Example:**

```
//Turn on DUT input power limitation
CONF:GEN:CONT ON
CONF:GEN:POW:LEV:STAT ON
CONF:GEN:LEV:DUTL:STAT ON
```

**Manual operation:** See "[Limit DUT Peak Input Power](#)" on page 144

**CONFigure:GENerator:POWer:LEVel <Level>**

Defines the output power RMS level of the generator.

Prerequisites for this command

- IP connection to a signal generator.
- Generator control state is on ([CONFigure:GENerator:CONTRol\[:STATE\]](#)).
- Level control is on ([CONFigure:GENerator:POWer:LEVel:STATE](#)).

**Parameters:**

<Level>                    \*RST:        0  
                                   Default unit: dBm

**Example:**

```
//Define generator output level
CONF:GEN:CONT ON
CONF:GEN:POW:LEV:STAT ON
CONF:GEN:POW:LEV -10
```



**Manual operation:** See "[Level \(RMS\)](#)" on page 143

---

### CONFigure:GENerator:QERRor?

Queries any errors that might have occurred for the generator control

**Return values:**

<Message> String containing the error messages.

**Example:** //Query error messages  
CONF:GEN:QERR?

**Usage:** Query only

---

### CONFigure:SETTings:NR5G

Downloads the NR signal description from the generator to the analyzer.

Prerequisites for this command

- IP connection to a signal generator.
- Generator control state is on ([CONFigure:GENerator:CONTrol\[:STATE\]](#)).

**Example:** //Synchronize signal description  
CONF:GEN:CONT ON  
CONF:SETT:NR5G

**Usage:** Event

**Manual operation:** See "[Query Settings from Generator](#)" on page 144

---

### CONFigure:SETTings:NR5G:PINTerval <Time>

Defines the polling interval for periodic synchronization between analyzer and generator.

Prerequisites for this command

- IP connection to a signal generator.
- Generator control state is on ([CONFigure:GENerator:CONTrol\[:STATE\]](#)).
- Periodic synchronization is on ([CONFigure:SETTings:NR5G:SYNC](#)).

**Parameters:**

<Time> Default unit: s

**Example:** //Define polling interval  
CONF:GEN:CONT ON  
CONF:SETT:NR5G:SYNC ON  
CONF:SETT:NR5G:PINT 30

**Manual operation:** See "[Periodic synchronization of 5G NR settings](#)" on page 144

**CONFigure:SETTings:NR5G:SYNC <State>**

Turns periodic synchronization of the signal description on the analyzer on and off.

Prerequisites for this command

- IP connection to a signal generator.
- Generator control state is on (`CONFigure:GENerator:CONTrol[:STATe]`).

**Parameters:**

<State>            ON | OFF | 1 | 0  
\*RST:            OFF

**Example:**            //Define polling interval  
CONF:GEN:CONT ON  
CONF:SETT:NR5G:SYNC ON

**Manual operation:** See ["Periodic synchronization of 5G NR settings"](#) on page 144

**CONFigure:SETTings:RF**

Downloads the RF settings (frequency, level) from the generator to the analyzer.

Prerequisites for this command

- IP connection to a signal generator.
- Generator control state is on (`CONFigure:GENerator:CONTrol[:STATe]`).

**Example:**            //Synchronize signal description  
CONF:GEN:CONT ON  
CONF:SETT:RF

**Usage:**            Event

**Manual operation:** See ["Query Settings from Generator"](#) on page 144

**CONFigure:GENerator:RFOutput[:STATe] <State>**

Turns the RF output of the generator on and off.

Prerequisites for this command

- IP connection to a signal generator.
- Generator control state is on (`CONFigure:GENerator:CONTrol[:STATe]`).

**Parameters:**

<State>            ON | OFF | 1 | 0  
\*RST:            OFF

**Example:**            //Turn on RF output  
CONF:GEN:CONT ON  
CONF:GEN:RFO ON

**Manual operation:** See ["RF Output State"](#) on page 143

**CONFigure:GENerator:CONTrol[:STATe] <State>**

Turns control over the signal generator on and off.

Prerequisites for this command

- IP connection to a signal generator.

**Parameters:**

<State>                    ON | OFF | 1 | 0  
\*RST:                    OFF

**Example:**                //Turn on generator control  
CONF:GEN:CONT ON

**Manual operation:**    See "[Generator Control State](#)" on page 142

**CONFigure:GENerator:SETTings:UPDate:RF**

Uploads the RF settings (frequency, level) from analyzer to the generator.

Prerequisites for this command

- IP connection to a signal generator.
- Generator control state is on (`CONFigure:GENerator:CONTrol[:STATe]`).

**Example:**                //Upload RF settings  
CONF:GEN:CONT ON  
CONF:GEN:SETT:UPD:RF

**Usage:**                    Event

**Manual operation:**    See "[Upload RF Settings to Generator](#)" on page 144

**6.10.22 Input configuration**

Remote commands to configure the input described elsewhere:

- `INPut:COUPling` on page 439
- `INPut:IMPedance` on page 440
- `[SENSe:]SWAPiq` on page 443

<code>CALibration:AIQ:HATiming[:STATe]</code> .....	428
<code>INPut:CONNector</code> .....	428
<code>INPut:DIQ:CDEVice</code> .....	428
<code>INPut:DIQ:RANGe:COUPling</code> .....	429
<code>INPut:DIQ:RANGe[:UPPer]</code> .....	429
<code>INPut:DIQ:RANGe[:UPPer]:AUTO</code> .....	429
<code>INPut:DIQ:RANGe[:UPPer]:UNIT</code> .....	430
<code>INPut:DIQ:SRATe</code> .....	430
<code>INPut:DIQ:SRATe:AUTO</code> .....	430
<code>INPut:DPATH</code> .....	430
<code>INPut:FILE:PATH</code> .....	431
<code>INPut:FILTer:HPASs[:STATe]</code> .....	432

INPut:FILTer:YIG[:STATe].....	432
INPut:IQ:BALanced[:STATe].....	432
INPut:IQ:TYPE.....	433
INPut:SElect.....	433
INPut:TYPE.....	434
MMEMory:LOAD:IQ:STReam.....	434
MMEMory:LOAD:IQ:STReam:AUTO.....	434
MMEMory:LOAD:IQ:STReam:LIST?.....	435
TRACe:IQ:FILE:REPetition:COUNT.....	435

---

### CALibration:AIQ:HATiming[:STATe] <State>

Activates a mode with enhanced timing accuracy between analog baseband, RF and external trigger signals.

#### Parameters:

<State>                    ON | OFF | 0 | 1  
                               **OFF | 0**  
                               Switches the function off  
                               **ON | 1**  
                               Switches the function on

**Example:**                CAL:AIQ:HAT:STAT ON

**Manual operation:**    See "[High Accuracy Timing Trigger - Baseband - RF](#)"  
                                   on page 149

---

### INPut:CONNector <ConnType>

Determines which connector the input for the measurement is taken from.

If an external frontend is active, the connector is automatically set to RF.

#### Parameters:

<ConnType>                **RF**  
                                   RF input connector  
                                   **RFProbe**  
                                   Active RF probe  
                                   \*RST:            RF

**Example:**                INP:CONN RF  
                                   Selects input from the RF input connector.

**Manual operation:**    See "[Input Connector](#)" on page 146

---

### INPut:DIQ:CDEvice

Queries the current configuration and the status of the digital I/Q input from the optional "Digital Baseband" interface.

For details see the section "Interface Status Information" for the optional "Digital Baseband" interface in the FSW I/Q Analyzer User Manual.

**Return values:**

&lt;Value&gt;

**Example:**

INP:DIQ:CDEV?

**Result:**1, SMW200A, 101190, BBMM 1 OUT,  
100000000, 200000000, Passed, Passed, 1, 1. #QNAN**Manual operation:** See ["Connected Instrument"](#) on page 148**INPut:DIQ:RANGe:COUPling** <State>

If enabled, the reference level for digital input is adjusted to the full scale level automatically if the full scale level changes.

Is only available if the optional "Digital Baseband" interface is installed.

**Parameters:**

&lt;State&gt; ON | OFF | 1 | 0

\*RST: 0

**Manual operation:** See ["Adjust Reference Level to Full Scale Level"](#) on page 148**INPut:DIQ:RANGe[:UPPer]** <Level>

Defines or queries the "Full Scale Level", i.e. the level that corresponds to an I/Q sample with the magnitude "1".

Is only available if the optional "Digital Baseband" interface is installed.

**Parameters:**<Level> Range: 1  $\mu$ V to 7.071 V

\*RST: 1 V

Default unit: DBM

**Manual operation:** See ["Full Scale Level"](#) on page 147**INPut:DIQ:RANGe[:UPPer]:AUTO** <State>

If enabled, the digital input full scale level is automatically set to the value provided by the connected device (if available).

Is only available if the optional "Digital Baseband" interface is installed.

**Parameters:**

&lt;State&gt; ON | OFF | 1 | 0

\*RST: 0

**Manual operation:** See ["Full Scale Level"](#) on page 147

---

**INPut:DIQ:RANGe[:UPPer]:UNIT** <Level>

Defines the unit of the full scale level. The availability of units depends on the measurement application you are using.

Is only available if the optional "Digital Baseband" interface is installed.

**Parameters:**

<Level> DBM | DBPW | WATT | DBUV | DBMV | VOLT | DBUA | AMPere  
\*RST: Volt

**Manual operation:** See "[Full Scale Level](#)" on page 147

---

**INPut:DIQ:SRATe** <SampleRate>

Specifies or queries the sample rate of the input signal from the optional "Digital Baseband" interface.

**Parameters:**

<SampleRate> Range: 1 Hz to 20 GHz  
\*RST: 32 MHz  
Default unit: HZ

**Example:** INP:DIQ:SRAT 200 MHz

**Manual operation:** See "[Input Sample Rate](#)" on page 147

---

**INPut:DIQ:SRATe:AUTO** <State>

If enabled, the sample rate of the digital I/Q input signal is set automatically by the connected device.

Is only available if the optional "Digital Baseband" interface is installed.

**Parameters:**

<State> ON | OFF | 1 | 0  
\*RST: 0

**Manual operation:** See "[Input Sample Rate](#)" on page 147

---

**INPut:DPATH** <DirectPath>

Enables or disables the use of the direct path for frequencies close to 0 Hz.

If an external frontend is active, the direct path is always used.

**Parameters:**

<DirectPath> AUTO | OFF  
**AUTO | 1**  
(Default) the direct path is used automatically for frequencies close to 0 Hz.  
**OFF | 0**  
The analog mixer path is always used.

**Example:** INP:DPAT OFF

**Manual operation:** See ["Direct Path"](#) on page 145

**INPut:FILE:PATH** <FileName>[, <AnalysisBW>]

Selects the I/Q data file to be used as input for further measurements.

The I/Q data file must be in one of the following supported formats:

- .iq.tar
- .iqw
- .csv
- .mat
- .wv
- .aid

Only a single data stream or channel can be used as input, even if multiple streams or channels are stored in the file.

For some file formats that do not provide the sample rate and measurement time or record length, you must define these parameters manually. Otherwise the traces are not visible in the result displays.

**Parameters:**

<FileName> String containing the path and name of the source file.  
The file type is determined by the file extension. If no file extension is provided, the file type is assumed to be .iq.tar.  
For .mat files, Matlab® v4 is assumed.

<AnalysisBW> Optionally: The analysis bandwidth to be used by the measurement. The bandwidth must be smaller than or equal to the bandwidth of the data that was stored in the file.

Default unit: HZ

**Example:** INP:FILE:PATH 'C:\R\_S\Instr\user\data.iq.tar'  
Uses I/Q data from the specified file as input.

**Example:**

```
//Load an IQW file
INP:SEL:FIQ
INP:FILE:PATH 'C:\R_S\Instr\user\data.iqw'
//Define the sample rate
TRAC:IQ:SRAT 10MHz
//Define the measurement time
SENSE:SWEep:TIME 0.001001
//Start the measurement
INIT:IMM
```

**Manual operation:** See ["Select I/Q data file"](#) on page 150  
See ["Data import and export"](#) on page 205

---

**INPut:FILTer:HPASs[:STATe] <State>**

Activates an additional internal high-pass filter for RF input signals from 1 GHz to 3 GHz. This filter is used to remove the harmonics of the FSW to measure the harmonics for a DUT, for example.

Requires an additional high-pass filter hardware option.

(Note: for RF input signals outside the specified range, the high-pass filter has no effect. For signals with a frequency of approximately 4 GHz upwards, the harmonics are suppressed sufficiently by the YIG-preselector, if available.)

**Parameters:**

<State>            ON | OFF | 0 | 1  
**OFF | 0**  
 Switches the function off  
**ON | 1**  
 Switches the function on  
 \*RST:            0

**Example:**            INP:FILT:HPAS ON  
 Turns on the filter.

**Manual operation:** See "[High Pass Filter 1 to 3 GHz](#)" on page 146

---

**INPut:FILTer:YIG[:STATe] <State>**

Enables or disables the YIG filter.

**Parameters:**

<State>            ON | OFF | 0 | 1

**Example:**            INP:FILT:YIG OFF  
 Deactivates the YIG-preselector.

**Manual operation:** See "[YIG-Preselector](#)" on page 146

---

**INPut:IQ:BALanced[:STATe] <State>**

Defines whether the input is provided as a differential signal via all 4 Analog Baseband connectors or as a plain I/Q signal via 2 single-ended lines.

**Parameters:**

<State>            ON | OFF | 1 | 0  
**ON | 1**  
 Differential  
**OFF | 0**  
 Single ended  
 \*RST:            1

**Example:**            INP:IQ:BAL OFF

**Manual operation:** See "[Input Configuration](#)" on page 149



**INPut:IQ:TYPE** <DataType>

Defines the format of the input signal.

**Parameters:**

&lt;DataType&gt;

IQ | I | Q

**IQ**

The input signal is filtered and resampled to the sample rate of the application.

Two input channels are required for each input signal, one for the in-phase component, and one for the quadrature component.

**I**

The in-phase component of the input signal is filtered and resampled to the sample rate of the application. If the center frequency is not 0, the in-phase component of the input signal is down-converted first (Low IF I).

**Q**

The quadrature component of the input signal is filtered and resampled to the sample rate of the application. If the center frequency is not 0, the quadrature component of the input signal is down-converted first (Low IF Q).

\*RST: IQ

**Example:**

INP:IQ:TYPE Q

**Manual operation:** See "[I/Q Mode](#)" on page 148

**INPut:SElect** <Source>

Selects the signal source for measurements, i.e. it defines which connector is used to input data to the FSW.

If no additional input options are installed, only RF input or file input is supported.

For FSW85 models with two RF input connectors, you must select the input connector to configure first using [INPut:TYPE](#).

**Parameters:**

&lt;Source&gt;

**RF**

Radio Frequency ("RF INPUT" connector)

**FIQ**

I/Q data file

(selected by [INPut:FILE:PATH](#) on page 431)

Not available for Input2.

**AIQ**

Analog Baseband signal (only available with optional "Analog Baseband" interface)

Not available for Input2.

\*RST: RF

- Example:** `INP:TYPE INP1`  
 For FSW85 models with two RF input connectors: selects the 1.00 mm RF input connector for configuration.  
`INP:SEL RF`
- Manual operation:** See ["Digital I/Q Input State"](#) on page 147  
 See ["Analog Baseband Input State"](#) on page 148  
 See ["I/Q Input File State"](#) on page 150

**INPut:TYPE** <Input>

The command selects the input path.

**Parameters:**

- <Input>
- INPUT1**  
 Selects RF input 1.  
 1 mm [RF Input] connector
- INPUT2**  
 Selects RF input 2.  
 For FSW85 models with two RF input connectors:  
 1.85 mm [RF2 Input] connector  
 For all other models: not available
- \*RST: INPUT1

- Example:** `//Select input path`  
`INP:TYPE INPUT1`

**MMEMory:LOAD:IQ:STReam** <Channel>

Only available for files that contain more than one data stream from multiple channels: selects the data stream to be used as input for the currently selected channel.

Automatic mode (`MMEMory:LOAD:IQ:STReam:AUTO`) is set to OFF.

**Parameters:**

- <Channel> String containing the channel name.

- Example:** `MMEM:LOAD:IQ:STR?`  
`//Result: 'Channel1','Channel2'`  
`MMEM:LOAD:IQ:STR 'Channel2'`

- Manual operation:** See ["Selected Channel"](#) on page 151

**MMEMory:LOAD:IQ:STReam:AUTO** <State>

Only available for files that contain more than one data stream from multiple channels: automatically defines which data stream in the file is used as input for the channel.

**Parameters:**

- <State> ON | OFF | 0 | 1

**OFF | 0**

The data stream specified by `MMEMoRY:LOAD:IQ:STReam` is used as input for the channel.

**ON | 1**

The first data stream in the file is used as input for the channel. Applications that support multiple data streams use the first data stream in the file for the first input stream, the second for the second stream etc.

\*RST: 1

**Manual operation:** See "[Selected Channel](#)" on page 151

**MMEMoRY:LOAD:IQ:STReam:LIST?**

Returns the available channels in the currently loaded input file.

**Example:** `MMEM:LOAD:IQ:STR?`  
`//Result: 'Channel1','Channel2'`

**Usage:** Query only

**Manual operation:** See "[Selected Channel](#)" on page 151

**TRACe:IQ:FILE:REPetition:COUNT <RepetitionCount>**

Determines how often the data stream is repeatedly copied in the I/Q data memory. If the available memory is not sufficient for the specified number of repetitions, the largest possible number of complete data streams is used.

**Parameters:**

<RepetitionCount> integer

**Example:** `TRAC:IQ:FILE:REP:COUN 3`

**Manual operation:** See "[File Repetitions](#)" on page 151

## 6.10.23 Frequency configuration

<code>[SENSe:]FREQuency:CENTer[:CC&lt;cc&gt;]</code> .....	435
<code>[SENSe:]FREQuency:CENTer[:CC&lt;cc&gt;]:OFFSet</code> .....	436
<code>[SENSe:]FREQuency:CENTer:STEP</code> .....	437

**[SENSe:]FREQuency:CENTer[:CC<cc>] <Frequency>**

Sets the center frequency for RF measurements.

**Component carrier measurements**

- Defining or querying the frequency of the first carrier is possible with `FREQ:CENT:CC1`. The `CC1` part of the syntax is mandatory in that case.
- `FREQ:CENT?` queries the measurement frequency (center of the two carriers).

**Suffix:**

<cc> [Component Carrier](#)

**Parameters:**

<Frequency> <numeric value>  
 Range: fmin to fmax  
 \*RST: 1 GHz  
 Default unit: Hz

**Example:** //Define frequency for measurement on one carrier:

```
FREQ:CENt 1GHZ
```

**Example:** //Define frequency for measurement on aggregated carriers:

```
FREQ:CENt:CC1 850MHZ
```

**Manual operation:** See "[Frequency configuration](#)" on page 83

See "[Center Frequency](#)" on page 143

See "[Center Frequency](#)" on page 151

**[SENSe:]FREQuency:CENTer[:CC<cc>]:OFFSet <Offset>**

Defines the general frequency offset.

For measurements on multiple component carriers, the command defines the frequency offset for a component carrier. The effect of the command depends on the syntax:

- When you omit the [CC<cc>] syntax element, the command defines the overall frequency offset.  
In that case, the value is added to the measurement frequency and, in case of measurements with component carriers, the center frequency of the component carriers.
- When you include the [CC<cc>] syntax element, the command defines the offset of the component carrier relative the first component carrier.  
In that case, the command is not available for the first component carrier - thus, ...:CC1:... is not possible.

Prerequisites for this command

- Select the first component carrier (CC1) as the reference point for the frequency offset ([CONFigure\[:NR5G\]:OREL](#)).

**Suffix:**

<cc> [Component Carrier](#)

**Parameters:**

<Offset> <numeric value>  
 • General frequency offset: frequency offset in Hz.  
 • Component carrier offset: frequency offset relative to the first component carrier in Hz.  
 Default unit: Hz

- Example:** //Add a frequency offset of 50 Hz to the measurement frequency.  
//If you are measuring component carriers, the value is also added to the center frequencies of those carriers.  
FREQ:CENT:OFFS 50HZ
- Example:** //Define a frequency offset of 15 MHz for the second component carrier relative to the first component carrier.  
CONF:OREL CC1  
FREQ:CENT:CC2:OFFS 15MHZ
- Manual operation:** See ["Frequency configuration"](#) on page 83  
See ["Center Frequency"](#) on page 151

---

#### [SENSe:]FREQuency:CENTer:STEP <StepSize>

Defines the center frequency step size.

##### Parameters:

<StepSize> For  $f_{max}$ , refer to the specifications document.  
Range: 1 to fMAX  
\*RST: 0.1 x span  
Default unit: Hz

**Example:** //Set the center frequency to 110 MHz.  
FREQ:CENT 100 MHz  
FREQ:CENT:STEP 10 MHz  
FREQ:CENT UP

**Manual operation:** See ["Frequency Stepsize"](#) on page 152

## 6.10.24 Amplitude configuration

DISPlay[:WINDow<n>][:SUBWindow<w>]:TRACe<t>:Y[:SCALe]:RLEVel.....	437
DISPlay[:WINDow<n>][:SUBWindow<w>]:TRACe<t>:Y[:SCALe]:RLEVel:OFFSet.....	438
INPut:ATTenuation<ant>.....	438
INPut:ATTenuation<ant>:AUTO.....	439
INPut:COUPling.....	439
INPut:GAIN:STATe.....	439
INPut:GAIN[:VALue].....	440
INPut:IMPedance.....	440
INPut:EATT<ant>.....	440
INPut:EATT<ant>:AUTO.....	441
INPut:EATT<ant>:STATe.....	441

---

#### DISPlay[:WINDow<n>][:SUBWindow<w>]:TRACe<t>:Y[:SCALe]:RLEVel <ReferenceLevel>

Defines the reference level (for all traces in all windows).

With a reference level offset  $\neq 0$ , the value range of the reference level is modified by the offset.

**Suffix:**

<n>	irrelevant
<w>	subwindow Not supported by all applications
<t>	irrelevant

**Parameters:**

<ReferenceLevel>	The unit is variable. Range: see specifications document *RST: 0 dBm Default unit: DBM
------------------	---

**Example:** `DISP:TRAC:Y:RLEV -60dBm`

**Manual operation:** See "[Reference Level](#)" on page 152

**DISPlay[:WINDow<n>][:SUBWindow<w>]:TRACe<t>:Y[:SCALe]:RLEVel:OFFSet**  
<Offset>

Defines a reference level offset (for all traces in all windows).

**Suffix:**

<n>	irrelevant
<w>	subwindow Not supported by all applications
<t>	irrelevant

**Parameters:**

<Offset>	Range: -200 dB to 200 dB *RST: 0dB Default unit: DB
----------	---

**Example:** `DISP:TRAC:Y:RLEV:OFFS -10dB`

**Manual operation:** See "[Reference Level Offset](#)" on page 153

**INPut:ATTenuation<ant>** <Attenuation>

Defines the RF attenuation level.

Prerequisites for this command

- Decouple attenuation from reference level (`INPut:ATTenuation<ant>:AUTO`).

**Suffix:**

<ant>	irrelevant
-------	------------

**Parameters:**

<Attenuation>	*RST: 10 dB Default unit: dB
---------------	---------------------------------

**Example:** //Define RF attenuation  
 INP:ATT:AUTO OFF  
 INP:ATT 10

**Manual operation:** See "[RF Attenuation](#)" on page 154

#### INPut:ATTenuation<ant>:AUTO <State>

Couples and decouples the RF attenuation to the reference level.

**Suffix:**  
 <ant> irrelevant

**Parameters:**  
 <State> ON | OFF | 1 | 0  
 \*RST: ON

**Example:** //Couple attenuation to reference level (auto attenuation)  
 INP:ATT:AUTO ON

**Manual operation:** See "[RF Attenuation](#)" on page 154

#### INPut:COUPling <CouplingType>

Selects the coupling type of the RF input.

If an external frontend is active, the coupling is automatically set to AC.

**Parameters:**  
 <CouplingType> AC | DC  
**AC**  
 AC coupling  
**DC**  
 DC coupling  
 \*RST: AC

**Example:** INP:COUP DC

**Manual operation:** See "[Input Coupling](#)" on page 155

#### INPut:GAIN:STATe <State>

Turns the internal preamplifier on and off. It requires the optional preamplifier hardware.

Note that if an optional external preamplifier is activated, the internal preamplifier is automatically disabled, and vice versa.

If option R&S FSW-B22 is installed, the preamplifier is only active below 7 GHz.

If option R&S FSW-B24 is installed, the preamplifier is active for all frequencies.

**Parameters:**  
 <State> ON | OFF | 0 | 1

**OFF | 0**

Switches the function off

**ON | 1**

Switches the function on

**\*RST:** 0**Example:**

INP:GAIN:STAT ON

INP:GAIN:VAL 15

Switches on 15 dB preamplification.

**Manual operation:** See "[Preamplifier](#)" on page 155**INPut:GAIN[:VALue] <Gain>**Selects the "gain" if the preamplifier is activated (INP:GAIN:STAT ON, see [INPut:GAIN:STATe](#) on page 439).

The command requires the additional preamplifier hardware option.

**Parameters:**

&lt;Gain&gt;

For all FSW models except for FSW85, the following settings are available:

15 dB and 30 dB

All other values are rounded to the nearest of these two.

For FSW85 models:

FSW43 or higher:

30 dB

Default unit: DB

**Example:**

INP:GAIN:STAT ON

INP:GAIN:VAL 30

Switches on 30 dB preamplification.

**Manual operation:** See "[Preamplifier](#)" on page 155**INPut:IMPedance <Impedance>**

Selects the nominal input impedance of the RF input. In some applications, only 50 Ω are supported.

**Parameters:**

&lt;Impedance&gt;

50 | 75

**\*RST:** 50 Ω

Default unit: OHM

**Example:**

INP:IMP 75

**Manual operation:** See "[Impedance](#)" on page 155**INPut:EATT<ant> <Attenuation>**

Defines the electronic attenuation level.



If the current reference level is not compatible with an attenuation that has been set manually, the command also adjusts the reference level.

Is available with the optional electronic attenuator, but not if you are using the optional digital baseband input.

**Suffix:**

<ant> Connected instrument

**Parameters:**

<Attenuation> Attenuation level in dB.  
Default unit: dB

**Example:**

```
//Define signal attenuation
INP:EATT 10
```

**Manual operation:** See "[Electronic Attenuation](#)" on page 154

**INPut:EATT<ant>:AUTO <State>**

Turns automatic selection of the electronic attenuation on and off.

If on, electronic attenuation reduces the mechanical attenuation whenever possible.

Is available with the optional electronic attenuator, but not if you are using the optional digital baseband Input.

**Suffix:**

<ant> 1...4  
Connected instrument

**Parameters:**

<State> ON | OFF | 1 | 0  
\*RST: OFF

**Example:**

```
//Turn on automatic selection of electronic attenuation
INP:EATT:AUTO ON
```

**Manual operation:** See "[Electronic Attenuation](#)" on page 154

**INPut:EATT<ant>:STATE <State>**

Turns the electronic attenuator on and off.

Is available with the optional electronic attenuator, but not if you are using the optional digital baseband input.

**Suffix:**

<ant> 1...4  
Connected instrument

**Parameters:**

<State> ON | OFF  
\*RST: OFF

**Example:** //Turn on electronic attenuation  
INP:EATT:STAT ON

**Manual operation:** See ["Electronic Attenuation"](#) on page 154

## 6.10.25 Data capture

[SENSe:]NR5G:FRAMe:COUNt.....	442
[SENSe:]NR5G:FRAMe:COUNt:AUTO.....	442
[SENSe:]NR5G:FRAMe:COUNt:STATe.....	443
[SENSe:]NR5G:FRAMe:SLOT.....	443
[SENSe:]NR5G:FRAMe:SRSLot.....	443
[SENSe:]SWAPiq.....	443
[SENSe:]SWEep:CTMode.....	444
[SENSe:]SWEep:LCAPture.....	444
[SENSe:]SWEep:TIME.....	445
TRACe:IQ:SRATE?.....	445

---

### [SENSe:]NR5G:FRAMe:COUNt <Frames>

Defines the number of frames to analyze.

Prerequisites for this command

- Turn on overall frame count ( [SENSe:]NR5G:FRAMe:COUNt:STATe on page 443).  
If the overall frame count is off, this command is a query only.

**Parameters:**

<Frames>                    <numeric value> (integer only)  
\*RST:                    1

**Example:** //Define number of frames to analyze manually  
NR5G:FRAM:COUN:STAT ON  
NR5G:FRAM:COUN 10

**Manual operation:** See ["Number of Frames to Analyze"](#) on page 158

---

### [SENSe:]NR5G:FRAMe:COUNt:AUTO <State>

Turns automatic selection of the number of frames to analyze on and off.

**Parameters:**

<State>                    **ON | 1**  
                              Selects the analyzed number of frames as specified by 3GPP.  
                              **OFF | 0**  
                              Turns on manual selection of the number of frames.

**Example:** //Turn on automatic selection of analyzed frames  
NR5G:FRAM:COUN:AUTO ON

**Manual operation:** See ["Auto According to Standard"](#) on page 158

---

**[SENSe:]NR5G:FRAMe:COUNT:STATe** <State>

Turns manual definition of number of frames to analyze on and off.

**Parameters:**

&lt;State&gt;

**OFF | 0**

The FSW analyzes all frames in the capture buffer.

**ON | 1**

Define the number of frames to analyze with `[SENSe:]NR5G:FRAMe:COUNT`.

**\*RST: ON****Example:**

```
//Turn on overall frame count.
NR5G:FRAM:COUN:STAT ON
```

**Manual operation:** See ["Overall Frame Count"](#) on page 157

---

**[SENSe:]NR5G:FRAMe:SLOT** <Slots>

Defines the number of slots that are analyzed.

**Parameters:**

&lt;Slots&gt;

**ALL**

Analyzes all slots in a frame.

**<numeric value> (integer only)**

Analyzes a certain number of slots in a frame.

**\*RST: ALL****Example:**

```
//Analyze all slots in a frame
NR5G:FRAM:SLOT ALL
```

**Manual operation:** See ["Maximum Number of Slots per Frame to Analyze"](#) on page 158

---

**[SENSe:]NR5G:FRAMe:SRSLot** <State>

Turns analysis of custom signals with repeating slots on and off.

**Parameters:**

&lt;State&gt;

**ON | OFF | 1 | 0****\*RST: OFF****Example:**

```
//Turn on repeated slot analysis
NR5G:FRAM:SRSL ON
```

**Manual operation:** See ["Signal Repeats Max No of Slots to Analyze"](#) on page 158

---

**[SENSe:]SWAPiq** <State>

Turns a swap of the I and Q branches on and off.

**Parameters:**

<State> ON | OFF | 1 | 0  
 \*RST: OFF

**Example:**

```
//Swap I and Q branches
SWAP ON
```

**Manual operation:** See ["Swap I/Q"](#) on page 157

**[SENSe:]SWEep:CTMode <Mode>**

Selects the capture mode.

Prerequisites for this command

- Select FR2-2 ([CONFigure \[:NR5G\]:DL\[:CC<cc>\]:DFRange](#)).

**Parameters:**

<Mode> **AUTO**  
 Automatic determination of the capture time.

**MANual**  
 Manual definition of the capture time.  
 Define the capture time with [\[SENSe:\]SWEep:TIME](#).

**Example:**

```
//Select capture time mode
CONF:DL:DFR EHIG
SWE:CTM AUTO
```

**Manual operation:** See ["Capture Time"](#) on page 156

**[SENSe:]SWEep:LCAPture <State>**

Turns the long capture on and off.

Prerequisites for this command

- Number of component carriers must be "1" ([CONFigure \[:NR5G\]:NOCC](#)).
- Turn off segmented capture ([\[SENSe:\]SWEep:SCAPture:STATe](#)).
- Multi frame configuration is not supported. Every frame must have the same configuration.

Effects of this command

- Frame count functions become unavailable:  
[\[SENSe:\]NR5G:FRAME:COUNT](#)  
[\[SENSe:\]NR5G:FRAME:COUNT:AUtO](#)
- [\[SENSe:\]NR5G:FRAME:COUNT:STATe](#)

**Parameters:**

<State> ON | OFF | 1 | 0  
 \*RST: OFF

**Example:**

```
//Turn on long capture
SWE:LCAP ON
```

**Manual operation:** See "Long Capture" on page 157

---

**[SENSe:]SWEep:TIME** <CaptureLength>

Defines the capture time.

**Parameters:**

<CaptureLength> <numeric value>  
 \*RST: 20.1 ms  
 Default unit: s

**Example:** //Define capture time  
 SWE:TIME 40ms

**Manual operation:** See "Capture Time" on page 156

---

**TRACe:IQ:SRATe?**

Queries the capture sampling rate.

**Return values:**

<SamplingRate> <numeric value> (integer only)

**Example:** //Query sample rate  
 TRAC:IQ:SRAT?

**Usage:** Query only

## 6.10.26 Trigger

TRIGger[:SEQuence]:DTIME.....	445
TRIGger[:SEQuence]:HOLDoff<ant>[:TIME].....	446
TRIGger[:SEQuence]:IFPower:HOLDoff.....	446
TRIGger[:SEQuence]:IFPower:HYSteresis.....	446
TRIGger[:SEQuence]:LEVel<ant>[:EXternal<tp>].....	447
TRIGger[:SEQuence]:LEVel<ant>:IFPower.....	447
TRIGger[:SEQuence]:LEVel<ant>:IQPower.....	447
TRIGger[:SEQuence]:LEVel<ant>:RFPower.....	448
TRIGger[:SEQuence]:PORT<ant>.....	448
TRIGger[:SEQuence]:SLOPe.....	449
TRIGger[:SEQuence]:SOURce<ant>.....	449

---

**TRIGger[:SEQuence]:DTIME** <DropoutTime>

Defines the time the input signal must stay below the trigger level before a trigger is detected again.

For input from the "Analog Baseband" interface using the baseband power trigger (BBP), the default drop out time is set to 100 ns to avoid unintentional trigger events (as no hysteresis can be configured in this case).

**Parameters:**

<DropoutTime> Dropout time of the trigger.  
 Range: 0 s to 10.0 s  
 \*RST: 0 s  
 Default unit: S

**Manual operation:** See "[Trigger Source](#)" on page 160

**TRIGger[:SEQuence]:HOLDoff<ant>[:TIME] <Offset>**

Defines the trigger offset.

**Suffix:**

<ant> [Instrument](#)

**Parameters:**

<Offset> <numeric value>  
 \*RST: 0 s  
 Default unit: s

**Example:** //Define trigger offset  
 TRIG:HOLD 5MS

**Manual operation:** See "[Trigger Source](#)" on page 160

**TRIGger[:SEQuence]:IFPower:HOLDoff <Period>**

Defines the holding time before the next trigger event.

Note that this command can be used for **any trigger source**, not just IF Power (despite the legacy keyword).

**Parameters:**

<Period> Range: 0 s to 10 s  
 \*RST: 0 s  
 Default unit: S

**Example:** TRIG:SOUR EXT  
 Sets an external trigger source.  
 TRIG:IFP:HOLD 200 ns  
 Sets the holding time to 200 ns.

**Manual operation:** See "[Trigger Source](#)" on page 160

**TRIGger[:SEQuence]:IFPower:HYSteresis <Hysteresis>**

Defines the trigger hysteresis, which is only available for "IF Power" trigger sources.

**Parameters:**

<Hysteresis> Range: 3 dB to 50 dB  
 \*RST: 3 dB  
 Default unit: DB

**Example:**           TRIG:SOUR IFP  
Sets the IF power trigger source.  
TRIG:IFP:HYST 10DB  
Sets the hysteresis limit value.

**Manual operation:** See "[Trigger Source](#)" on page 160

**TRIGger[:SEQuence]:LEVel<ant>[:EXtErnal<tp>] <Level>**

Defines the level for an external trigger.

**Suffix:**

<ant>                   Instrument

<tp>                    Trigger port

**Parameters:**

<Level>                Range:       0.5 V to 3.5 V  
\*RST:                 1.4 V  
Default unit: V

**Example:**           //Define trigger level  
TRIG:LEV 2V

**Manual operation:** See "[Trigger Source](#)" on page 160

**TRIGger[:SEQuence]:LEVel<ant>:IFPower <Level>**

Defines the power level at the third intermediate frequency that must be exceeded to cause a trigger event.

Note that any RF attenuation or preamplification is considered when the trigger level is analyzed. If defined, a reference level offset is also considered.

**Suffix:**

<ant>                   Instrument

**Parameters:**

<Level>                <numeric value>  
For details on available trigger levels and trigger bandwidths see the specifications document.  
\*RST:                 -10 dBm  
Default unit: dBm

**Example:**           //Define trigger level  
TRIG:SOUR IFP  
TRIG:LEV:IFP -30dBm

**Manual operation:** See "[Trigger Source](#)" on page 160

**TRIGger[:SEQuence]:LEVel<ant>:IQPower <Level>**

Defines the magnitude the I/Q data must exceed to cause a trigger event.

Note that any RF attenuation or preamplification is considered when the trigger level is analyzed. If defined, a reference level offset is also considered.

**Suffix:**

<ant> [Instrument](#)

**Parameters:**

<Level> <numeric value>  
 Range: -130 dBm to 30 dBm  
 \*RST: -20 dBm  
 Default unit: dBm

**Example:**

```
//Define trigger level
TRIG:SOUR IQP
TRIG:LEV:IQP -30dBm
```

**Manual operation:** See "[Trigger Source](#)" on page 160

**TRIGger[:SEQuence]:LEVel<ant>:RFPower <Level>**

Defines the power level the RF input must exceed to cause a trigger event. Note that any RF attenuation or preamplification is considered when the trigger level is analyzed. If defined, a reference level offset is also considered.

The input signal must be between 500 MHz and 8 GHz.

**Suffix:**

<ant> [Instrument](#)

**Parameters:**

<Level> <numeric value>  
 For details on available trigger levels and trigger bandwidths see the specifications document.  
 \*RST: -20 dBm  
 Default unit: dBm

**Example:**

```
//Define trigger level
TRIG:SOUR RFP
TRIG:LEV:RFP -30dBm
```

**Manual operation:** See "[Trigger Source](#)" on page 160

**TRIGger[:SEQuence]:PORT<ant> <port>**

Selects the trigger port for measurements with devices that have several trigger ports.

**Suffix:**

<ant> [Analyzer](#)

**Parameters:**

<port> **PORT1**  
**PORT2**  
**PORT3**



**Example:**           //Select trigger port 1  
                  TRIG:PORT PORT1

---

### TRIGger[:SEQuence]:SLOPe <Type>

Selects the trigger slope.

#### Parameters:

<Type>               POSitive | NEGative

#### **POSitive**

Triggers when the signal rises to the trigger level (rising edge).

#### **NEGative**

Triggers when the signal drops to the trigger level (falling edge).

\*RST:            POSitive

**Example:**           TRIG:SLOP NEG

**Manual operation:** See "[Trigger Source](#)" on page 160

---

### TRIGger[:SEQuence]:SOURce<ant> <Source>

Selects the trigger source.

#### Note on external triggers:

If a measurement is configured to wait for an external trigger signal in a remote control program, remote control is blocked until the trigger is received and the program can continue. Make sure this situation is avoided in your remote control programs.

#### Suffix:

<ant>                [Analyzer](#)

#### Parameters:

<Source>

#### **IMMediate**

Free run (no trigger event to start a measurement).

#### **EXTernal**

Measurement starts when the external trigger signal exceeds a certain level.

Trigger signal from the "Trigger In" connector.

#### **EXT2**

Trigger signal from the "Trigger Input / Output" connector.

Note: Connector must be configured for "Input".

#### **EXT3**

Trigger signal from the "Trigger 3 Input / Output" connector.

Note: Connector must be configured for "Input".

#### **RFPower**

Measurement starts when the first intermediate frequency exceeds a certain level.

(Frequency and time domain measurements only.)

Not available for input from the optional Digital Baseband Interface or the optional analog baseband Interface.

**IFPower**

Measurement starts when the second intermediate frequency exceeds a certain level.

Not available for input from the optional digital baseband interface. For input from the optional analog baseband interface, this parameter is interpreted as `BBPower` for compatibility reasons.

**IQPower**

Measurement starts when the sampled I/Q data exceeds a certain magnitude.

For applications that process I/Q data, such as the I/Q analyzer or optional applications.

**BBPower**

Measurement starts when the baseband power exceeds a certain level.

For digital input via the optional digital baseband interface or the optional analog baseband interface.

**PSEN**

External power sensor

**GP0 | GP1 | GP2 | GP3 | GP4 | GP5**

For applications that process I/Q data, such as the I/Q analyzer or optional applications, and only if the optional digital baseband interface is available.

Defines triggering of the measurement directly via the LVDS connector. The parameter specifies which general purpose bit (0 to 5) will provide the trigger data.

\*RST: IMMEDIATE

**Manual operation:** See "[Trigger Source](#)" on page 160

**6.10.27 Segmented capture**

[SENSe:]SWEep:SCAPture:EVENTs.....	450
[SENSe:]SWEep:SCAPture:LENGth[:TIME].....	451
[SENSe:]SWEep:SCAPture:OFFSet[:TIME].....	451
[SENSe:]SWEep:SCAPture:STATe.....	451

**[SENSe:]SWEep:SCAPture:EVENTs <Events>**

Defines the number of segments to capture.

Prerequisites for this command

- Select external of IF power trigger source (`TRIGger[:SEquence]:SOURCE<ant>`).
- Turn on segmented capture (`[SENSe:]SWEep:SCAPture:STATe`).

**Parameters:**

<Events>                    \*RST:        2

**Example:**

```
//Define segment length
TRIG:SOUR EXT
SWE:SCAP:STAT ON
SWE:SCAP:EVEN 5
```

**Manual operation:** See ["Configuration"](#) on page 162

### [SENSe:]SWEep:SCAPture:LENGth[:TIME] <Length>

Defines the length of a segment for segmented data capture.

Prerequisites for this command

- Select external of IF power trigger source ([TRIGger\[:SEquence\]:SOURCE<ant>](#)).
- Turn on segmented capture ([\[SENSe:\]SWEep:SCAPture:STATe](#)).

#### Parameters:

<Length>            \*RST:        1.0  
                           Default unit: s

**Example:**

```
//Define segment length
TRIG:SOUR EXT
SWE:SCAP:STAT ON
SWE:SCAP:LENG 2MS
```

**Manual operation:** See ["Configuration"](#) on page 162

### [SENSe:]SWEep:SCAPture:OFFSet[:TIME] <Offset>

Defines the offset of a segment for segmented data capture.

Prerequisites for this command

- Select external of IF power trigger source ([TRIGger\[:SEquence\]:SOURCE<ant>](#)).
- Turn on segmented capture ([\[SENSe:\]SWEep:SCAPture:STATe](#)).

#### Parameters:

<Offset>            \*RST:        0  
                           Default unit: s

**Example:**

```
//Define offset
TRIG:SOUR EXT
SWE:SCAP:STAT ON
SWE:SCAP:OFFS 0.5MS
```

**Manual operation:** See ["Configuration"](#) on page 162

### [SENSe:]SWEep:SCAPture:STATe <State>

Turns segmented capture on and off.

Prerequisites for this command

- Select external of IF power trigger source (`TRIGger[:SEquence]:SOURCE<ant>`).

**Parameters:**

<State> ON | OFF | 1 | 0  
\*RST: OFF

**Example:**

```
//Turn on segmented capture
TRIG:SOUR EXT
SWE:SCAP:STAT ON
```

**Manual operation:** See "Configuration" on page 162

## 6.10.28 Optimization

<code>[SENSe:]ADJust:NCANcel:AVERage[:COUNT]</code> .....	452
<code>[SENSe:]ADJust:NCANcel:AVERage[:STATE]</code> .....	452

---

### `[SENSe:]ADJust:NCANcel:AVERage[:COUNT]` <Length>

Defines the number of measurements that are performed on the captured I/Q data to determine the average noise density due to the spectrum analyzer.

Only available if I/Q noise cancellation is enabled (`[SENSe:]ADJust:NCANcel:AVERage[:STATE] ON`).

**Parameters:**

<Length> integer  
Number of measurements

**Example:**

```
[SENSe:]ADJust:NCANcel:AVERage[:STATE] ON
[SENSe:]ADJust:NCANcel:AVERage[:COUNT] 8
```

**Manual operation:** See "Reduce Noise on I/Q Data" on page 163

---

### `[SENSe:]ADJust:NCANcel:AVERage[:STATE]` <State>

Enables and disables I/Q noise cancellation.

Requires the R&S FSW-K575 option and a synchronized, repetitive input signal.

The number of initial measurements performed is defined by `[SENSe:]ADJust:NCANcel:AVERage[:COUNT]` on page 452.

For details on the concept of I/Q noise cancellation, see the FSW I/Q Analyzer and I/Q Input User Manual.

**Parameters:**

<State> ON | OFF | 0 | 1  
**OFF | 0**  
Switches the function off

**ON | 1**

Switches the function on

If synchronization fails, the noise cancellation process is not started, and an error message is provided. Status bit 7 in the `STATUS:QUESTIONABLE:SYNC:CONDITION` status register is set (`BIT_K575_FAILED`).

\*RST: 0

**Example:** `[SENSe:]ADJust:NCANcel:AVERage[:STATE] ON`  
`[SENSe:]ADJust:NCANcel:AVERage[:COUNT] 8`

**Manual operation:** See "[Reduce Noise on I/Q Data](#)" on page 163

## 6.10.29 Tracking

<a href="#">[SENSe:]NR5G:DEMod:CESTimation</a> .....	453
<a href="#">[SENSe:]NR5G:DEMod:CETaverage</a> .....	453
<a href="#">[SENSe:]NR5G:IQ:GIQE</a> .....	454
<a href="#">[SENSe:]NR5G:TRACking:LEVel</a> .....	454
<a href="#">[SENSe:]NR5G:TRACking:PHASe</a> .....	454
<a href="#">[SENSe:]NR5G:TRACking:TIME</a> .....	455
<a href="#">[SENSe:]NR5G:TRACking:TPUT:STATe</a> .....	455

---

### **[SENSe:]NR5G:DEMod:CESTimation <State>**

Selects the channel estimation method.

**Parameters:**

<State>

**LINT**

Channel estimation by interpolating the missing information.

**NORMAL**

Channel estimation according to 3GPP.

**OFF**

Turns off channel estimation.

**PILPay**

Channel estimation by examining both the reference signal and the payload resource elements.

**Example:** `//Select channel estimation method`  
`NR5G:DEM:CEST PILP`

**Manual operation:** See "[Channel Estimation](#)" on page 164

---

### **[SENSe:]NR5G:DEMod:CETaverage <State>**

Select the averaging interval for channel estimation.

**Parameters:**

<State>

**PALL**

Averaging every allocation.

**TGPP**

Averaging according to 3GPP.

\*RST: TGPP

**Example:** //Select time averaging  
NR5G:DEM:CET PALL

**Manual operation:** See ["Channel Estimation Time Averaging"](#) on page 164

**[SENSe:]NR5G:IQ:GIQE <State>**

Turns the calculation of the gain imbalance and the quadrature error in the result summary on and off.

**Parameters:**

&lt;State&gt; ON | OFF | 1 | 0

\*RST: ON

**Example:** //Turn off calculation of results  
NR5G:IQ:GIQE OFF

**Manual operation:** See ["Gain Imbalance / Quadrature Error"](#) on page 165

**[SENSe:]NR5G:TRACking:LEVeL <State>**

Turns level tracking on and off.

**Parameters:**

&lt;State&gt; ON | OFF | 0 | 1

\*RST: OFF

**Example:** //Turn on level tracking  
TRAC:LEV ON

**Manual operation:** See ["Level Tracking"](#) on page 165

**[SENSe:]NR5G:TRACking:PHASe <State>**

Turns phase tracking on and off.

**Parameters:**

&lt;State&gt;

**OFF**

Deactivate phase tracking

**PIL**

Pilot only

**PILPAY**

Pilot and payload

**TGPP**

3GPP EVM

\*RST: OFF

**Example:** //Use pilots and payload for channel estimation  
SENS:TRAC:PHAS PILPAY

**Manual operation:** See ["Phase"](#) on page 165

**[SENSe:]NR5G:TRACking:TIME <State>**

Turns time tracking on and off.

**Parameters:**

<State> ON | OFF | 1 | 0  
\*RST: OFF

**Example:** //Turn on time tracking  
NR5G:TRAC:TIME ON

**Manual operation:** See ["Time Tracking"](#) on page 165

**[SENSe:]NR5G:TRACking:TPUT:STATe <State>**

Turns the throuput measurement on and off.

Effects of this command

- Number of analyzed frames is set to manual ([\[SENSe:\]NR5G:FRAME:COUNT: AUTO](#)).

**Parameters:**

<State> ON | OFF | 1 | 0  
\*RST: OFF

**Example:** //Turn on throughput measurement  
NR5G:TRAC:TPUT:STAT ON

**Manual operation:** See ["Throughput Measurement State"](#) on page 166

### 6.10.30 Demodulation

<a href="#">[SENSe:]NR5G:DEMod:CAMode</a> .....	456
<a href="#">[SENSe:]NR5G:DEMod:CMETHod</a> .....	456
<a href="#">[SENSe:]NR5G:DEMod:CRData</a> .....	456
<a href="#">[SENSe:]NR5G:DEMod:DDATa</a> .....	457
<a href="#">[SENSe:]NR5G:DEMod:EFLRange</a> .....	457
<a href="#">[SENSe:]NR5G:DEMod:FILTer</a> .....	458
<a href="#">[SENSe:]NR5G:DEMod:PRData</a> .....	458
<a href="#">[SENSe:]NR5G:DEMod:STADjust</a> .....	458

---

**[SENSe:]NR5G:DEMod:CAMode <Mode>**

Selects the CORESET analysis mode.

**Parameters:**

<Mode>

**AUTO**  
Automatic demodulation of the PDCCH.

**MANual**  
Demodulation based on the PDCCH configuration.

\*RST:        AUTO

**Example:**        //Select PDCCH demodulation mode  
NR5G:DEM:CAM MAN

**Manual operation:** See "[CORESET Analysis Mode](#)" on page 167

---

**[SENSe:]NR5G:DEMod:CMETHod <State>**

Selects the EVM calculation method.

**Parameters:**

<State>

**HPOS**  
EVM at high timing position

**LPOS**  
EVM at low timing position

**OTP**  
EVM at optimal timing position

**TGPP**  
EVM according to 3GPP definition

\*RST:        TGPP

**Example:**        //Select EVM calculation method  
NR5G:DEM:CMET TGPP

**Manual operation:** See "[EVM Calculation Method](#)" on page 167

---

**[SENSe:]NR5G:DEMod:CRData <Reference>**

Selects the CORESET reference data.

**Parameters:**

<Reference>

**AUTO**  
Automatic detection of reference values.

**ALLO**  
CORESET consists of 0's only.



**PASLots**

CORESET based on NR-TM PN23 (pseudo random sequence 23) with all PDCCH having the same sequence.

If an ORAN test case is selected (`CONFigure[:NR5G]:ORAN:TCASe`), this parameter selects the ORAN PN23 sequence for all PDCCH.

**PN23**

CORESET based on NR-TM PN23 (pseudo random sequence 23).

\*RST: AUTO

**Example:** //Select CORESET reference data  
NR5G:DEM:CRD ALL0

**Manual operation:** See "[CORESET Reference Data](#)" on page 169

**[SENSe:]NR5G:DEMod:DDATa <State>**

Selects the point at which the data is demodulated for the bitstream.

**Parameters:**

<State>

**ADEScramble**

Demodulates the descrambled data.

**BDEScramble**

Demodulates the scrambled data.

**DPData**

Demodulates the decoded data.

\*RST: BDEScramble

**Example:** //Demodulate decoded data  
NR5G:DEM:DDAT DPD

**Manual operation:** See "[Demodulation Data](#)" on page 167

**[SENSe:]NR5G:DEMod:EFLRange <State>**

Turns the extended frequency lock range on and off.

**Parameters:**

<State>

ON | OFF | 1 | 0

\*RST: OFF

**Example:** Turn on extended frequency lock range  
NR5G:DEM:EFLR ON

**Manual operation:** See "[Extended Frequency Lock Range](#)" on page 169

---

**[SENSe:]NR5G:DEMod:FILTer** <Filter>

Selects the filter for suppression of neighboring channels.

**Parameters:**

<Filter>

**MFILter**  
Multicarrier filter.

**NONE**  
No filter.

**PBWP**  
Bandwidthpart filter.

\*RST: NONE

**Example:** //Select multicarrier filter  
NR5G:DEM:FILT MFIL

**Manual operation:** See "[Filter](#)" on page 166

---

**[SENSe:]NR5G:DEMod:PRData** <Reference>

Selects the PDSCH reference data.

Note that when you select an ORAN test case, this setting is automatically adjusted to the ORAN test case.

**Parameters:**

<Reference>

**AUTO**  
Automatic detection of reference values.

**ALLO**  
PDSCH consists of 0's only.

**PASLots**  
PDSCH based on NR-TM PN23 (pseudo random sequence 23) with all PDSCH having the same sequence.  
If an ORAN test case is selected ([CONFigure\[:NR5G\]:ORAN:TCASE](#)), this parameter selects the ORAN PN23 sequence for all PDSCH.

**PN23**  
PDSCH based on NR-TM PN23 (pseudo random sequence 23) with each PDSCH getting its own sequence.  
If an ORAN test case is selected ([CONFigure\[:NR5G\]:ORAN:TCASE](#)), this parameter selects the ORAN PN23 sequence.

\*RST: AUTO

**Example:** //Select PDSCH reference data  
NR5G:DEM:PRD AUTO

**Manual operation:** See "[PDSCH Reference Data](#)" on page 168

---

**[SENSe:]NR5G:DEMod:STADjust** <Value>

Defines the symbol time adjustment.

**Parameters:**

<Value>                    Range:     0 to 100  
                                  \*RST:     50  
                                  Default unit: PCT

**Example:**

```
//Define symbol time adjustment
NR5G:DEM:STAD 75
```

**Manual operation:** See "[Symbol Time Adjustment](#)" on page 168

### 6.10.31 Time alignment measurement

Commands to configure time alignment measurements described elsewhere.

- General configuration: [Chapter 6.10.1, "General configuration"](#), on page 314
- Physical settings: [Chapter 6.10.3, "Physical settings"](#), on page 321  
(Component carrier are not supported in the time alignment measurement.)
- Radio frame configuration: [Chapter 6.10.5, "General radio frame configuration"](#), on page 330
- Synchronization signal: [Chapter 6.10.6, "Synchronization signal configuration"](#), on page 332
- Bandwidth parts: [Chapter 6.10.7, "Bandwidth part configuration"](#), on page 339
- Slot configuration: [Chapter 6.10.8, "Slot configuration"](#), on page 342
- PDSCH allocations: [Chapter 6.10.12, "PDSCH allocation configuration"](#), on page 369  
(Only one PDSCH allocation is supported in the time alignment measurement.)
- PDSCH DMRS: [Chapter 6.10.14, "Enhanced PDSCH settings: DMRS"](#), on page 393
- Advanced signal configuration: [Chapter 6.10.18, "Advanced settings: global"](#), on page 411
- Input: [Chapter 6.10.22, "Input configuration"](#), on page 427
- Frequency: [Chapter 6.10.23, "Frequency configuration"](#), on page 435
- Amplitude: [Chapter 6.10.24, "Amplitude configuration"](#), on page 437
- Data capture: [Chapter 6.10.25, "Data capture"](#), on page 442
- Trigger: [Chapter 6.10.26, "Trigger"](#), on page 445
- Demodulation: [Chapter 6.10.30, "Demodulation"](#), on page 455
- Automatic configuration: [Chapter 6.10.2, "Automatic configuration"](#), on page 317

### 6.10.32 Transmit on/off power measurements

Commands to configure time alignment measurements described elsewhere.

- General configuration: [Chapter 6.10.1, "General configuration"](#), on page 314
- Physical settings: [Chapter 6.10.3, "Physical settings"](#), on page 321  
(Component carrier are not supported in the time alignment measurement.)

- Radio frame configuration: [Chapter 6.10.5, "General radio frame configuration"](#), on page 330
- Synchronization signal: [Chapter 6.10.6, "Synchronization signal configuration"](#), on page 332
- Bandwidth parts: [Chapter 6.10.7, "Bandwidth part configuration"](#), on page 339
- Slot configuration: [Chapter 6.10.8, "Slot configuration"](#), on page 342
- PDSCH / CORESET allocations: [Chapter 6.10.12, "PDSCH allocation configuration"](#), on page 369
- CORESET DMRS: [Chapter 6.10.13, "Enhanced CORESET allocation configuration"](#), on page 376
- PDSCH DMRS: [Chapter 6.10.14, "Enhanced PDSCH settings: DMRS"](#), on page 393
- PTRS: [Chapter 6.10.15, "Enhanced PDSCH settings: PTRS"](#), on page 402
- Scrambling / Coding: [Chapter 6.10.16, "Enhanced PDSCH settings: scrambling / coding"](#), on page 406
- Advanced signal configuration: [Chapter 6.10.18, "Advanced settings: global"](#), on page 411
- Input: [Chapter 6.10.22, "Input configuration"](#), on page 427
- Frequency: [Chapter 6.10.23, "Frequency configuration"](#), on page 435
- Amplitude: [Chapter 6.10.24, "Amplitude configuration"](#), on page 437
- Data capture: [Chapter 6.10.25, "Data capture"](#), on page 442
- Trigger: [Chapter 6.10.26, "Trigger"](#), on page 445
- Demodulation: [Chapter 6.10.30, "Demodulation"](#), on page 455
- Automatic configuration: [Chapter 6.10.2, "Automatic configuration"](#), on page 317

<a href="#">CONFigure[:NR5G]:DL[:CC&lt;cc&gt;]:PLC:EIRP</a> .....	460
<a href="#">CONFigure[:NR5G]:DL[:CC&lt;cc&gt;]:PLC:TRP</a> .....	461
<a href="#">CONFigure[:NR5G]:OOPower:NFRames</a> .....	461
<a href="#">DISPlay[:WINDow&lt;n&gt;]:TPOO:PERiod:SElect</a> .....	461
<a href="#">[SENSe:]NR5G:OOPower:ATIMing</a> .....	462
<a href="#">[SENSe:]NR5G:OOPower:NCORrection</a> .....	462
<a href="#">UNIT:OPOWer</a> .....	462

---

### **CONFigure[:NR5G]:DL[:CC<cc>]:PLC:EIRP** <Power>

Defines the base station output power for limit selection ( $P_{\text{rated}}$ ,  $c$ , EIRP).

Prerequisites for this command

- Select FR2 deployment ([CONFigure\[:NR5G\]:DL\[:CC<cc>\]:DFRange](#)).

#### **Suffix:**

<cc>                      [Component Carrier](#)

#### **Parameters:**

<Power>                      Default unit: dBm

**Example:**           //Define output power  
 CONF:DL:DFR HIGH  
 CONF:DL:PLC:EIRP 0.5

**Manual operation:** See ["Base station output power"](#) on page 170

### CONFigure[:NR5G]:DL[:CC<cc>]:PLC:TRP <Power>

Defines the base station output power for limit selection ( $P_{rated}$ , c, TRP).

Prerequisites for this command

- Select FR2 deployment (`CONFigure[:NR5G]:DL[:CC<cc>]:DFRange`).

**Suffix:**

<cc>                    [Component Carrier](#)

**Parameters:**

<Power>                Default unit: dBm

**Example:**           //Define output power  
 CONF:DL:DFR HIGH  
 CONF:DL:PLC:TRP 0.5

**Manual operation:** See ["Base station output power"](#) on page 170

### CONFigure[:NR5G]:OOPower:NFRames <Frames>

Defines the number of frames to analyze in on / off power measurements.

**Parameters:**

<Frames>                \*RST:        25

**Example:**           //Define number of frames to analyze  
 CONF:OOP:NFR 20

**Manual operation:** See ["Number of Frames to Analyze"](#) on page 158

### DISPlay[:WINDow<n>]:TPOO:PERiod:SELect <Period>

Selects the period to display the rising or falling edge in the on / off power measurement.

**Suffix:**

<n>                      [Window](#)

**Parameters:**

<Period>

**Example:**           //Add diagram for rising edge and view edge for period 2  
 LAY:ADD? '1',BEL,RIS  
 DISP:WIND2:TPOO:PER:SEL 2

**Manual operation:** See ["Transmit On / Off Power"](#) on page 51

**[SENSe:]NR5G:OOPower:ATIMing**

Adjusts the timing for on / off power measurements.

**Example:** //Adjust the on / off power timing  
NR5G:OOP:ATIM

**Usage:** Event

**Manual operation:** See ["Adjust Timing"](#) on page 54

**[SENSe:]NR5G:OOPower:NCORrection <State>**

Turns noise correction for transmit on / off power measurements on and off.

**Parameters:**

<State> ON | OFF | 1 | 0  
\*RST: OFF

**Example:** //Turn on noise cancelling  
NR5G:OOP:NCOR ON

**Manual operation:** See ["Noise Cancellation"](#) on page 54

**UNIT:OPOWer <Unit>**

Selects the unit the off power (transmit on / off power measurements) is displayed in.

**Parameters:**

<Unit> **DBM**  
Displays the power as an absolute value in dBm.  
**DMHZ**  
Displays the power as a relative value in dBm/MHz.  
\*RST: DMHZ

**Example:** //Select the unit dBm.  
UNIT:OPOW DBM

**Manual operation:** See ["Transmit On / Off Power"](#) on page 51

### 6.10.33 Frequency sweep measurements

Commands to configure frequency sweep measurements described elsewhere.

- [CONFigure\[:NR5G\]:LDIRrection](#) on page 323
- [MMEMoRY:LOAD:DEModsetting:ALL](#) on page 324
- [MMEMoRY:LOAD:DEModsetting\[:CC<cc>\]](#) on page 325
- [MMEMoRY:STORe<n>:DEModsetting:ALL](#) on page 325
- [MMEMoRY:STORe<n>:DEModsetting\[:CC<cc>\]](#) on page 326
- [CONFigure\[:NR5G\]:DL\[:CC<cc>\]:BW](#) on page 322
- [\[SENSe:\]POWer:CATegory](#) on page 415

Refer also to the user manual of the FSW base unit for a list of commands supported by the frequency sweep measurements that are not specific to the 5G NR application.

[SENSe:]POWer:ACHannel:AACHannel.....	463
[SENSe:]POWer:CATegory:B.....	463
[SENSe:]POWer:SEM:AMPower.....	463
[SENSe:]POWer:SEM:AMPower:AUTO.....	464
[SENSe:]POWer:SEM:NTAB.....	464
[SENSe:]POWer:SEM:NTXU.....	465
CALCulate<n>:LIMit<li>:ACPower:PMODE.....	465
CONFigure[:NR5G]:BSTation.....	465

---

### [SENSe:]POWer:ACHannel:AACHannel <Channel>

Selects the bandwidth of the adjacent channel for ACLR measurements.

#### Parameters:

<Channel>

#### E500

Selects an LTE signal with 5 MHz bandwidth as assumed adjacent channel carrier.

#### NOSBw

Selects an 5G NR signal as assumed adjacent channel carrier.

\*RST: NOSBw

#### Example:

```
//Select assumed adjacent channel
POW:ACH:AACH NOSB
```

**Manual operation:** See "[Adjacent Channels](#)" on page 172

---

### [SENSe:]POWer:CATegory:B <Category>

Selects the limit table for category B stations.

Prerequisites for this command

- Select category B base station ([SENSe:]POWer:CATegory).

#### Parameters:

<Category>

OPT1 | OPT2

\*RST: OPT1

#### Example:

```
//Select limits for category B base station
POW:CAT B
POW:CAT:B OPT1
```

**Manual operation:** See "[Category](#)" on page 137

---

### [SENSe:]POWer:SEM:AMPower <Power>

Defines the power of a medium range base station.

Prerequisites for this command

- Select a medium range base station ([SENSe:]POWer:CATegory).

- Select manual definition of Tx power (`[SENSe:]POWer:SEM:AMPower:AUTO`).

**Parameters:**

<Power> <numeric value>  
 \*RST: 0  
 Default unit: dBm

**Example:** //Determine power of medium range base station  
 POW:CAT MED  
 POW:SEM:AMP:AUTO OFF  
 POW:SEM:AMP 3

**Manual operation:** See "[Tx Power](#)" on page 172

**[SENSe:]POWer:SEM:AMPower:AUTO <State>**

Selects how the FSW determines the power of a medium range base station.

Prerequisites for this command

- Select a medium range base station (`[SENSe:]POWer:CATegory`).

**Parameters:**

<State> **ON | 1**  
 Automatically determines the Tx power.  
**OFF | 0**  
 Define a Tx power manually with `[SENSe:]POWer:SEM:AMPower`.  
 \*RST: ON

**Example:** //Determine power of medium range base station  
 POW:CAT MED  
 POW:SEM:AMP:AUTO ON

**Manual operation:** See "[Tx Power](#)" on page 172

**[SENSe:]POWer:SEM:NTAB <Value>**

Defines the parameter  $N_{\text{TABconnectors}}$  that defines the position of the spectrum emission mask for 1-H base stations.

Prerequisites for this command

- Select a 1-H base station (`CONFigure[:NR5G]:BSTation`).

**Parameters:**

<Value> \*RST: 1

**Example:** //Define N\_TABconnector  
 CONF:BST FR1H  
 POW:SEM:NTAB 5

**Manual operation:** See "[Position of SEM and ACLR limits](#)" on page 173



---

**[SENSe:]POWer:SEM:NTXU <Value>**

Defines the parameter  $N_{TXU}$  that defines the position of the spectrum emission mask for 1-H base stations.

Prerequisites for this command

- Select a 1-H base station ([CONFigure\[:NR5G\]:BSTation](#)).

**Parameters:**

<Value>                    \*RST:            1

**Example:**                //Define N\_TXU  
CONF:BST FR1H  
POW:SEM:NTXU 5

**Manual operation:**    See "[Position of SEM and ACLR limits](#)" on page 173

---

**CALCulate<n>:LIMit<li>:ACPowe:r:PMODE <Mode>**

Selects the limit evaluation mode for ACLR measurements.

Supported for ACLR measurements in the LTE and 5G applications.

**Suffix:**

<n>                        irrelevant

<li>                        irrelevant

**Parameters:**

<Mode>                    **AND**  
Overall limit check passes if both absolute and relative limit checks pass.

**OR**

Overall limit check passes if either absolute or relative limit checks pass.

\*RST:                    AND

**Example:**                //Select evaluation mode  
CALC:LIM:ACP:PMOD AND

**Manual operation:**    See "[Total Limit Pass Mode](#)" on page 173

---

**CONFigure[:NR5G]:BSTation <BSType>**

Selects the base station type.

**Parameters:**

<BSType>                **FR1C**  
Base station for conducted requirements.

**FR1H**

Base station for hybrid requirements.

**FR10**

Base station for over-the-air requirements in FR1.  
(Only for ACLR and SEM measurements.)

**FR20**

Base station for over-the-air requirements in FR2.  
(Only for ACLR and SEM measurements.)

\*RST: FR10

**Example:** //Select base station type  
CONF:BST FR1H

**Manual operation:** See "[Base Station Type](#)" on page 172

### 6.10.34 Combined measurements

In addition to the commands otherwise supported for I/Q measurements and frequency sweep measurements, combined mode supports the following commands.

[SENSe:]ESpectrum<sb>:PRESet[:STANdard]	466
[SENSe:]NR5G:ACPower:ALPMode	467
[SENSe:]NR5G:FRAMe:OPTimization	467
[SENSe:]NR5G:FRAMe:SALevel	467
[SENSe:]SWEep:EGATe:AGATing	468
[SENSe:]SWEep:EVENT	468
[SENSe:]SWEep:MODE	468
CALCulate<n>:MARKer<m>:FUNCTion:POWER<sb>:PRESet	469
CONFigure[:NR5G]:ACLR	469
CONFigure[:NR5G]:EVM	469
CONFigure[:NR5G]:SEM	470
MMEMory:LOAD:SETTings	470
OUTPut<up>:TRIGger<tp>:PULSe:IMMEDIATE	470
TRIGger:TSHelper:EDELay	470
TRIGger:TSHelper:FTRigger	471
TRIGger:TSHelper:RINterval	471
TRIGger:TSHelper:SEQuence	471

---

#### [SENSe:]ESpectrum<sb>:PRESet[:STANdard] <Standard>

Loads an SEM settings file for combined measurements.

**Suffix:**

<sb> irrelevant

**Parameters:**

<Standard> **<string>**  
String that contains the path to the settings file (.xml format).

**NONE**

Removes the settings file.

**Example:**           //Select and subsequently remove settings file  
ESP:PRES 'c:\settings.xml'  
ESP:PRES NONE

**Manual operation:** See "[Manage User Standards](#)" on page 176

#### [SENSe:]NR5G:ACPower:ALPMode <Mode>

Selects the limit evaluation mode for ACLR measurements in combined measurement mode.

**Parameters:**

<Mode>

**ABSolute**

Checks against the absolute limits.

**RELative**

Checks against the relative limits.

**OR**

Checks against both absolute and relative limits according to 3GPP.

\*RST:       OR

**Example:**           //Select ACLR limit evaluation mode  
NR5G:ACP:ALPM ABS

**Manual operation:** See "[ACLR Limit Pass Mode](#)" on page 210

#### [SENSe:]NR5G:FRAMe:OPTimization <State>

Selects the data capture method for combined measurements.

**Parameters:**

<State>

**DYNamic**

Separate capture of carrier and neighboring channels.

**SPEed**

Capture all channels in one take.

\*RST:       DYNamic

**Example:**           //Select capture method  
NR5G:FRAM:OPT SPE

**Manual operation:** See "[Optimization](#)" on page 177

#### [SENSe:]NR5G:FRAMe:SALevel <Level>

Turns auto leveling for each event in combined measurement sequence on and off.

**Parameters:**

<Level>

ON | OFF | 1 | 0

\*RST:       OFF

**Example:** //Turn on auto leveling sequence  
NR5G:FRAM:SAL ON

**Manual operation:** See "[Sequence Auto Level](#)" on page 177

**[SENSe:]SWEep:EGATe:AGATing <State>**

Turns auto gating on and off.

**Parameters:**

<State> ON | OFF | 1 | 0  
\*RST: ON

**Example:** //Turn on auto gating

**Manual operation:** See "[Auto Gating](#)" on page 180

**[SENSe:]SWEep:EVENT <Event>**

Defines the number of events in a combined measurement sequence.

**Parameters:**

<Event> \*RST: 10

**Example:** //Define number of events  
SWE:EVENT 25

**Manual operation:** See "[# Events](#)" on page 177

**[SENSe:]SWEep:MODE <Mode>**

Selects the capture mode for combined measurements.

Prerequisites for this command

- Measure the EVM only:
  - `CONFigure[:NR5G]:ACLR = OFF`
  - `CONFigure[:NR5G]:SEM = OFF`
  - `CONFigure[:NR5G]:EVM = ON`

**Parameters:**

<Mode> **AUTO**  
Captures and analyzes the complete signal.  
**TX**  
Captures and analyzes the Tx channel only.  
\*RST: AUTO

**Example:** //Select capture mode  
CONF:ACLR OFF  
CONF:SEM OFF  
CONF:EVM ON  
SWE:MODE TX

**Manual operation:** See ["Capture Mode"](#) on page 177

---

### **CALCulate<n>:MARKer<m>:FUNCtion:POWer<sb>:PRESet <Standard>**

Loads an ACLR settings file for combined measurements.

**Suffix:**

<n>	irrelevant
<m>	irrelevant
<sb>	irrelevant

**Parameters:**

<Standard>	<b>&lt;string&gt;</b> String that contains the path to the settings file (.xml format).
	<b>NONE</b> Removes the settings file.

**Example:** //Select and subsequently remove settings file  
 CALC:MARK:FUNC:POW:PRES 'c:\settings.xml'  
 CALC:MARK:FUNC:POW:PRES NONE

**Manual operation:** See ["Manage User Standards"](#) on page 176

---

### **CONFigure[:NR5G]:ACLR <State>**

Includes or excludes ACLR measurements from combined measurements.

**Parameters:**

<State>	ON   OFF   1   0
*RST:	ON

**Example:** //Include ACLR measurements  
 CONF:ACLR ON

**Manual operation:** See ["EVM / ACLR / SEM"](#) on page 176

---

### **CONFigure[:NR5G]:EVM <State>**

Includes or excludes EVM measurements from combined measurements.

**Parameters:**

<State>	ON   OFF   1   0
*RST:	ON

**Example:** //Include EVM measurements  
 CONF:EVM ON

**Manual operation:** See ["EVM / ACLR / SEM"](#) on page 176

---

**CONFigure[:NR5G]:SEM <State>**

Includes or excludes SEM measurements from combined measurements.

**Parameters:**

<State> ON | OFF | 1 | 0  
\*RST: ON

**Example:** //Include SEM measurements  
CONF:SEM ON

**Manual operation:** See "[EVM / ACLR / SEM](#)" on page 176

---

**MMEMory:LOAD:SETTings**

Restores the settings of the last measurement sequence in combined mode.

**Example:** //Restore settings  
MMEM:LOAD:SETT

**Usage:** Event

**Manual operation:** See "[Restore Settings](#)" on page 176

---

**OUTPut<up>:TRIGger<tp>:PULSe:IMMEDIATE**

Sends a trigger signal from the analyzer to the DUT.

For combined measurement, this command is useful to start a closed-loop trigger sequence.

**Suffix:**

<up> irrelevant  
<tp> 1..3  
Trigger port

**Example:** //Send trigger signal from trigger output 3  
OUTP:TRIG3:PULS:IMM

**Usage:** Event

**Manual operation:** See "[Send Trigger 3](#)" on page 180

---

**TRIGger:TSHelper:EDELay <Time>**

Defines the event delay for combined measurements.

Prerequisites for this command

- Select periodic sequence ([TRIGger:TSHelper:SEQuence](#)).

**Parameters:**

<Time> \*RST: 1.0  
Default unit: s

**Example:**           //Define event delay  
 TRIG:TSH:SEQ PER  
 TRIG:TSH:EDEL 2S

**Manual operation:** See ["Event Delay"](#) on page 179

#### TRIGger:TSHelper:FTRigger <Source>

Select the availability of a frame trigger in a combined measurement sequence.

**Parameters:**

<Source>           **AVAILable**  
 Frame trigger available (external trigger).  
**NAVAILable**  
 Time trigger available.  
**RSLots**  
 No trigger available.  
 \*RST:           AVAILable

**Example:**           //Select trigger source  
 TRIG:TSH:FTR RSL

**Manual operation:** See ["Frame Trigger"](#) on page 179

#### TRIGger:TSHelper:RINTerval <Interval>

Defines the recalibration interval for combined measurements.

Prerequisites for this command

- Select time trigger ([TRIGger:TSHelper:SEQuence](#)).

**Parameters:**

<Interval>           \*RST:           1

**Example:**           //Define recalibration interval  
 TRIG:TSH:SEQ OLO  
 TRIG:TSH:FTR NAV  
 TRIG:TSH:RINT 5

**Manual operation:** See ["Recalibration Interval"](#) on page 179

#### TRIGger:TSHelper:SEQuence <Source>

Select the type of measurement sequence for combined measurement.

**Parameters:**

<Source>           The selected sequence has an impact on the trigger settings. If you select a certain sequence and change, for example, the trigger source or trigger input / output configuration, the sequence type automatically returns to manual.

**CLOop**  
 Closed-loop sequence.

**MANual**

Custom trigger configuration.

**OLOop**

Open-loop sequence.

**PERiodic**

Periodic sequence.

\*RST:       MANual

**Example:**       //Select sequence type  
                   TRIG:TSH:SEQ OLO

**Manual operation:** See "Sequence" on page 178

## 6.11 Analysis

- [General analysis tools](#).....472
- [Analysis tools for I/Q measurements](#).....484
- [Analysis tools for combined measurements](#).....496

### 6.11.1 General analysis tools

- [Trace export](#).....472
- [Diagram scale](#).....474
- [Zoom](#).....475
- [Markers](#).....478

#### 6.11.1.1 Trace export

<a href="#">FORMat:DEXPort:DSEParator</a> .....	472
<a href="#">FORMat:DEXPort:HEADer</a> .....	473
<a href="#">FORMat:DEXPort:TRACes</a> .....	473
<a href="#">MMEMory:STORe&lt;n&gt;:TRACe</a> .....	473

---

#### **FORMat:DEXPort:DSEParator** <Separator>

Selects the decimal separator for data exported in ASCII format.

**Parameters:**

<Separator>       POINT | COMMa

**COMMa**

Uses a comma as decimal separator, e.g. *4,05*.

**POINT**

Uses a point as decimal separator, e.g. *4.05*.

\*RST:            \*RST has no effect on the decimal separator.  
                   Default is POINT.



**Example:**                   FORM:DEXP:DSEP POIN  
Sets the decimal point as separator.

#### **FORMat:DEXPort:HEADer** <State>

If enabled, additional instrument and measurement settings are included in the header of the export file for result data. If disabled, only the pure result data from the selected traces and tables is exported.

#### **Parameters:**

<State>                   ON | OFF | 0 | 1  
\*RST:                    1

#### **FORMat:DEXPort:TRACes** <Selection>

Selects the data to be included in a data export file (see [MMEMory:STORe<n>:TRACe](#) on page 473).

#### **Parameters:**

<Selection>             SINGle | ALL

**SINGle**  
Only a single trace is selected for export, namely the one specified by the [MMEMory:STORe<n>:TRACe](#) command.

**ALL**  
Selects all active traces and result tables (e.g. "Result Summary", marker peak list etc.) in the current application for export to an ASCII file.  
The <trace> parameter for the [MMEMory:STORe<n>:TRACe](#) command is ignored.

\*RST:                    SINGle

#### **MMEMory:STORe<n>:TRACe** <Trace>, <FileName>

Exports trace data from the specified window to an ASCII file.

#### **Secure User Mode**

In secure user mode, settings that are stored on the instrument are stored to volatile memory, which is restricted to 256 MB. Thus, a "memory limit reached" error can occur although the hard disk indicates that storage space is still available.

To store data permanently, select an external storage location such as a USB memory device.

For details, see "Protecting Data Using the Secure User Mode" in the "Data Management" section of the FSW base unit user manual.

#### **Suffix:**

<n>                        Window

**Parameters:**

<Trace>	Number of the trace to be stored
<FileName>	String containing the path and name of the target file.

**Example:**

```
MME:STOR1:TRAC 1, 'C:\TEST.ASC'
Stores trace 1 from window 1 in the file TEST.ASC.
```

**6.11.1.2 Diagram scale**

DISPlay[:WINDow<n>][:SUBWindow<w>]:TRACe<t>:Y[:SCALe]:AUTO.....	474
DISPlay[:WINDow<n>][:SUBWindow<w>]:TRACe<t>:Y[:SCALe]:MAXimum.....	474
DISPlay[:WINDow<n>][:SUBWindow<w>]:TRACe<t>:Y[:SCALe]:MINimum.....	475

**DISPlay[:WINDow<n>][:SUBWindow<w>]:TRACe<t>:Y[:SCALe]:AUTO <ONCE>**

Automatically scales the y-axis of a diagram based on the displayed results.

**Suffix:**

<n>	Window
<w>	Subwindow
<t>	irrelevant

**Setting parameters:**

<ONCE>	<b>ALL</b> Scales the y-axis in all windows for an ideal viewing experience.
	<b>DEFault</b> Restores the default scale of the y-axis.
	<b>ONCE</b> Scales the y-axis in a specific window for an ideal viewing experience.

**Example:** //Automatically scale the y-axis in subwindow 2 of window 2  
DISP:WIND2:SUBW2:TRAC:Y:AUTO ONCE

**Usage:** Setting only

**Manual operation:** See "[Auto Scale](#)" on page 75  
See "[Automatic scaling of the y-axis](#)" on page 206

**DISPlay[:WINDow<n>][:SUBWindow<w>]:TRACe<t>:Y[:SCALe]:MAXimum <Value>**

Defines the maximum value displayed on the y-axis of a diagram.

**Suffix:**

<n>	Window
<w>	Subwindow
<t>	irrelevant

**Parameters:**

<Value> Maximum displayed value. The unit and value range depend on the selected diagram.

**Example:**

```
//Define maximum value on y-axis in subwindow 2 of window 2
DISP:WIND2:SUBW2:TRAC:Y:MAX 0
```

**Manual operation:** See ["Manual scaling of the y-axis"](#) on page 206

**DISPlay[:WINDow<n>][:SUBWindow<w>]:TRACe<t>:Y[:SCALe]:MINimum**  
<Value>

Defines the minimum value displayed on the vertical diagram axis.

**Suffix:**

<n> [Window](#)  
<w> [Subwindow](#)  
<t> irrelevant

**Parameters:**

<Value> Minimum displayed value. The unit and value range depend on the selected diagram.

**Example:**

```
//Define minimum value on y-axis in subwindow 2 of window 2
DISP:WIND2:SUBW2:TRAC:Y:MIN -50
```

**Manual operation:** See ["Manual scaling of the y-axis"](#) on page 206

**6.11.1.3 Zoom**

<a href="#">DISPlay[:WINDow&lt;n&gt;][:SUBWindow&lt;w&gt;]:ZOOM:AREA</a> .....	475
<a href="#">DISPlay[:WINDow&lt;n&gt;][:SUBWindow&lt;w&gt;]:ZOOM:MULTiple&lt;zn&gt;:AREA</a> .....	476
<a href="#">DISPlay[:WINDow&lt;n&gt;][:SUBWindow&lt;w&gt;]:ZOOM:MULTiple&lt;zn&gt;[:STATe]</a> .....	478
<a href="#">DISPlay[:WINDow&lt;n&gt;][:SUBWindow&lt;w&gt;]:ZOOM[:STATe]</a> .....	478

**DISPlay[:WINDow<n>][:SUBWindow<w>]:ZOOM:AREA** <x1>,<y1>,<x2>,<y2>

Defines the zoom area.

To define a zoom area, you first have to turn the zoom on.

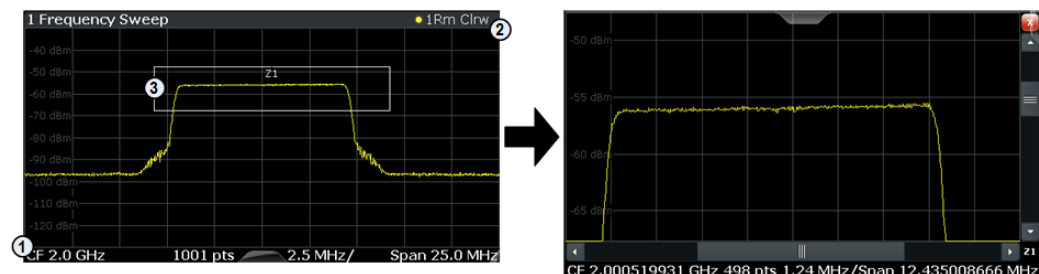

- 1 = origin of coordinate system ( $x1 = 0, y1 = 0$ )  
 2 = end point of system ( $x2 = 100, y2 = 100$ )  
 3 = zoom area (e.g.  $x1 = 60, y1 = 30, x2 = 80, y2 = 75$ )

**Suffix:**

<n>	Window
<w>	subwindow Not supported by all applications

**Parameters:**

<x1>	Diagram coordinates in % of the complete diagram that define the zoom area. The lower left corner is the origin of coordinate system. The upper right corner is the end point of the system. Range: 0 to 100 Default unit: PCT
<y1>	Diagram coordinates in % of the complete diagram that define the zoom area. The lower left corner is the origin of coordinate system. The upper right corner is the end point of the system. Range: 0 to 100 Default unit: PCT
<x2>	Diagram coordinates in % of the complete diagram that define the zoom area. The lower left corner is the origin of coordinate system. The upper right corner is the end point of the system. Range: 0 to 100 Default unit: PCT
<y2>	Diagram coordinates in % of the complete diagram that define the zoom area. The lower left corner is the origin of coordinate system. The upper right corner is the end point of the system. Range: 0 to 100 Default unit: PCT

---

**DISPlay[:WINDow<n>][:SUBWIndow<w>]:ZOOM:MULTiple<zn>:AREA**  
 <x1>,<y1>,<x2>,<y2>

Defines the zoom area for a multiple zoom.

To define a zoom area, you first have to turn the zoom on.

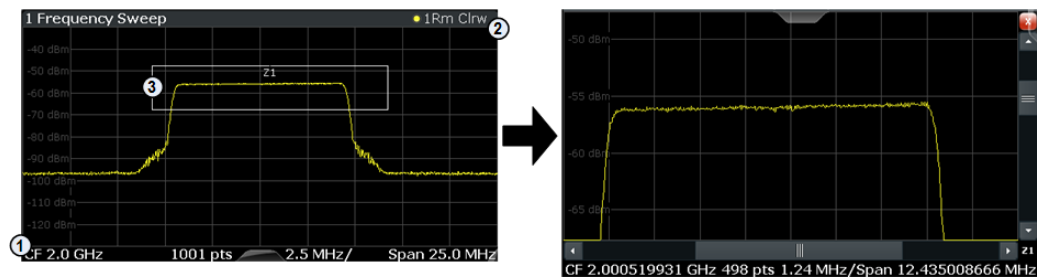

- 1 = origin of coordinate system (x1 = 0, y1 = 0)  
 2 = end point of system (x2 = 100, y2 = 100)  
 3 = zoom area (e.g. x1 = 60, y1 = 30, x2 = 80, y2 = 75)

**Suffix:**

- <n> [Window](#)  
 <w> subwindow  
 Not supported by all applications  
 <zn> Selects the zoom window.

**Parameters:**

- <x1> Diagram coordinates in % of the complete diagram that define the zoom area.  
 The lower left corner is the origin of coordinate system. The upper right corner is the end point of the system.  
 Range: 0 to 100  
 Default unit: PCT
- <y1> Diagram coordinates in % of the complete diagram that define the zoom area.  
 The lower left corner is the origin of coordinate system. The upper right corner is the end point of the system.  
 Range: 0 to 100  
 Default unit: PCT
- <x2> Diagram coordinates in % of the complete diagram that define the zoom area.  
 The lower left corner is the origin of coordinate system. The upper right corner is the end point of the system.  
 Range: 0 to 100  
 Default unit: PCT
- <y2> Diagram coordinates in % of the complete diagram that define the zoom area.  
 The lower left corner is the origin of coordinate system. The upper right corner is the end point of the system.  
 Range: 0 to 100  
 Default unit: PCT

---

**DISPlay[:WINDow<n>][:SUBWindow<w>]:ZOOM:MULTiple<zn>[:STATe] <State>**

Turns the multiple zoom on and off.

**Suffix:**

<n>	Window
<w>	subwindow Not supported by all applications
<zn>	Selects the zoom window. If you turn off one of the zoom windows, all subsequent zoom windows move up one position.

**Parameters:**

<State>	ON   OFF   0   1 <b>OFF   0</b> Switches the function off <b>ON   1</b> Switches the function on
---------	--

---

**DISPlay[:WINDow<n>][:SUBWindow<w>]:ZOOM[:STATe] <State>**

Turns the zoom on and off.

**Suffix:**

<n>	Window
<w>	subwindow Not supported by all applications

**Parameters:**

<State>	ON   OFF   0   1 <b>OFF   0</b> Switches the function off <b>ON   1</b> Switches the function on
---------	--

**Example:**

DISP:ZOOM ON  
Activates the zoom mode.

#### 6.11.1.4 Markers

Commands to configure markers described elsewhere.

- CALCulate<n>:DELTaMarker<m>:X
- CALCulate<n>:DELTaMarker<m>:Y?
- CALCulate<n>:MARKer<m>:X
- CALCulate<n>:MARKer<m>:Y
- CALCulate<n>:MARKer<m>:Z?
- CALCulate<n>:MARKer<m>:Z:ALL?

CALCulate<n>:DELTaMarker<m>:AOFF.....	479
CALCulate<n>:DELTaMarker<m>:MAXimum:LEFT.....	479
CALCulate<n>:DELTaMarker<m>:MAXimum:NEXT.....	479
CALCulate<n>:DELTaMarker<m>:MAXimum:RIGHT.....	480
CALCulate<n>:DELTaMarker<m>:MAXimum[:PEAK].....	480
CALCulate<n>:DELTaMarker<m>:MINimum:LEFT.....	480
CALCulate<n>:DELTaMarker<m>:MINimum:NEXT.....	480
CALCulate<n>:DELTaMarker<m>:MINimum:RIGHT.....	480
CALCulate<n>:DELTaMarker<m>:MINimum[:PEAK].....	481
CALCulate<n>:DELTaMarker<m>[:STATe].....	481
CALCulate<n>:DELTaMarker<m>:TRACe.....	481
CALCulate<n>:MARKer<m>:AOFF.....	482
CALCulate<n>:MARKer<m>:MAXimum:LEFT.....	482
CALCulate<n>:MARKer<m>:MAXimum:NEXT.....	482
CALCulate<n>:MARKer<m>:MAXimum:RIGHT.....	482
CALCulate<n>:MARKer<m>:MAXimum[:PEAK].....	482
CALCulate<n>:MARKer<m>:MINimum:LEFT.....	483
CALCulate<n>:MARKer<m>:MINimum:NEXT.....	483
CALCulate<n>:MARKer<m>:MINimum:RIGHT.....	483
CALCulate<n>:MARKer<m>[:STATe].....	483
CALCulate<n>:MARKer<m>:TRACe.....	484
DISPlay[:WINDow<n>]:MTABLE.....	484

---

#### **CALCulate<n>:DELTaMarker<m>:AOFF**

Turns off *all* delta markers.

##### **Suffix:**

<n>                      Window

<m>                      irrelevant

##### **Example:**

CALC : DELT : AOFF

Turns off all delta markers.

---

#### **CALCulate<n>:DELTaMarker<m>:MAXimum:LEFT**

Moves a delta marker to the next positive peak value.

The search includes only measurement values to the left of the current marker position.

##### **Suffix:**

<n>                      Window

<m>                      Marker

---

#### **CALCulate<n>:DELTaMarker<m>:MAXimum:NEXT**

Moves a marker to the next positive peak value.

**Suffix:**

<n> 1..n  
Window

<m> 1..n  
Marker

**CALCulate<n>:DELTamarker<m>:MAXimum:RIGHT**

Moves a delta marker to the next positive peak value on the trace.

The search includes only measurement values to the right of the current marker position.

**Suffix:**

<n> Window

<m> Marker

**CALCulate<n>:DELTamarker<m>:MAXimum[:PEAK]**

Moves a delta marker to the highest level.

If the marker is not yet active, the command first activates the marker.

**Suffix:**

<n> Window

<m> Marker

**CALCulate<n>:DELTamarker<m>:MINimum:LEFT**

Moves a delta marker to the next minimum peak value.

The search includes only measurement values to the right of the current marker position.

**Suffix:**

<n> Window

<m> Marker

**CALCulate<n>:DELTamarker<m>:MINimum:NEXT**

Moves a marker to the next minimum peak value.

**Suffix:**

<n> Window

<m> Marker

**CALCulate<n>:DELTamarker<m>:MINimum:RIGHT**

Moves a delta marker to the next minimum peak value.



The search includes only measurement values to the right of the current marker position.

**Suffix:**

<n> [Window](#)

<m> [Marker](#)

**CALCulate<n>:DELTamarker<m>:MINimum[:PEAK]**

Moves a delta marker to the minimum level.

If the marker is not yet active, the command first activates the marker.

**Suffix:**

<n> [Window](#)

<m> [Marker](#)

**CALCulate<n>:DELTamarker<m>[:STATE] <State>**

Turns delta markers on and off.

If necessary, the command activates the delta marker first.

No suffix at DELTmarker turns on delta marker 1.

**Suffix:**

<n> [Window](#)

<m> [Marker](#)

**Parameters:**

<State> ON | OFF | 0 | 1

**OFF | 0**

Switches the function off

**ON | 1**

Switches the function on

**Example:**

CALC:DELT2 ON

Turns on delta marker 2.

**CALCulate<n>:DELTamarker<m>:TRACe <Trace>**

Selects the trace a delta marker is positioned on.

Note that the corresponding trace must have a trace mode other than "Blank".

If necessary, the command activates the marker first.

**Suffix:**

<n> [Window](#)

<m> [Marker](#)

**Parameters:**

<Trace> Trace number the marker is assigned to.

**Example:**

CALC:DELT2:TRAC 2  
Positions delta marker 2 on trace 2.

**CALCulate<n>:MARKer<m>:AOFF**

Turns off all markers.

**Suffix:**

<n> [Window](#)

<m> [Marker](#)

**Example:**

CALC:MARK:AOFF  
Switches off all markers.

**CALCulate<n>:MARKer<m>:MAXimum:LEFT**

Moves a marker to the next positive peak.

The search includes only measurement values to the left of the current marker position.

**Suffix:**

<n> [Window](#)

<m> [Marker](#)

**CALCulate<n>:MARKer<m>:MAXimum:NEXT**

Moves a marker to the next positive peak.

**Suffix:**

<n> [Window](#)

<m> [Marker](#)

**CALCulate<n>:MARKer<m>:MAXimum:RIGHT**

Moves a marker to the next positive peak.

The search includes only measurement values to the right of the current marker position.

**Suffix:**

<n> [Window](#)

<m> [Marker](#)

**CALCulate<n>:MARKer<m>:MAXimum[:PEAK]**

Moves a marker to the highest level.

If the marker is not yet active, the command first activates the marker.

**Suffix:**

<n>                    Window  
<m>                    Marker

**CALCulate<n>:MARKer<m>:MINimum:LEFT**

Moves a marker to the next minimum peak value.

The search includes only measurement values to the right of the current marker position.

**Suffix:**

<n>                    Window  
<m>                    Marker

**CALCulate<n>:MARKer<m>:MINimum:NEXT**

Moves a marker to the next minimum peak value.

**Suffix:**

<n>                    Window  
<m>                    Marker

**CALCulate<n>:MARKer<m>:MINimum:RIGHT**

Moves a marker to the next minimum peak value.

The search includes only measurement values to the right of the current marker position.

**Suffix:**

<n>                    Window  
<m>                    Marker

**CALCulate<n>:MARKer<m>[:STATe] <State>**

Turns markers on and off. If the corresponding marker number is currently active as a delta marker, it is turned into a normal marker.

**Suffix:**

<n>                    Window  
<m>                    Marker

**Parameters:**

<State>                ON | OFF | 0 | 1  
                          **OFF | 0**  
                          Switches the function off

**ON | 1**

Switches the function on

**Example:**           `CALC:MARK3 ON`  
Switches on marker 3.

**CALCulate<n>:MARKer<m>:TRACe <Trace>**

Selects the trace the marker is positioned on.

Note that the corresponding trace must have a trace mode other than "Blank".

If necessary, the command activates the marker first.

**Suffix:**

&lt;n&gt;                   Window

&lt;m&gt;                   Marker

**Parameters:**

<Trace>           **1 to 16**  
Trace number (or bandwidth part if the trace represents one) the marker is assigned to.

**Example:**           `//Assign marker to trace 1`  
`CALC:MARK3:TRAC 2`

**DISPlay[:WINDow<n>]:MTABle <DisplayMode>**

Turns the marker table on and off.

**Suffix:**

&lt;n&gt;                   irrelevant

**Parameters:**

<DisplayMode>   **ON | 1**  
Turns on the marker table.  
**OFF | 0**  
Turns off the marker table.  
**AUTO**  
Turns on the marker table if 3 or more markers are active.  
`*RST:        AUTO`

**Example:**           `DISP:MTAB ON`  
Activates the marker table.

## 6.11.2 Analysis tools for I/Q measurements

- [Result views](#).....485
- [Result settings](#).....485
- [Evaluation range](#).....490

### 6.11.2.1 Result views

DISPlay[:WINDow<n>][:SUBWindow<w>]:CCNumber.....	485
DISPlay[:WINDow<n>][:SUBWindow<w>]:FNUMber.....	485

---

#### DISPlay[:WINDow<n>][:SUBWindow<w>]:CCNumber <Carrier>

Assigns a specific component carrier to a view.

Prerequisites for this command

- Capture more than one component carrier.

#### Suffix:

<n> irrelevant

<w> [View](#)

#### Parameters:

<Carrier> <numeric value> (integer only)

**Example:** //Select a component carrier to analyze in view 2  
DISP:SUBW2:CCN 2

**Manual operation:** See "[Views](#)" on page 83  
See "[Component Carrier No](#)" on page 213

---

#### DISPlay[:WINDow<n>][:SUBWindow<w>]:FNUMber <Frame>

Assigns a specific frame to a view.

Prerequisites for this command

- Capture more than one frame.

#### Suffix:

<n> irrelevant

<w> [View](#)

#### Parameters:

<Frame> <numeric value> (integer only)

**Example:** //Select a frame to analyze in view 2  
DISP:SUBW2:FNUM 2

**Manual operation:** See "[Effects of capturing multiple frames on results](#)" on page 89  
See "[Frame No](#)" on page 213

### 6.11.2.2 Result settings

DISPlay[:WINDow<n>][:SUBWindow<w>]:COUPling.....	486
DISPlay[:WINDow<n>]:TABLe:ITEM.....	486
[SENSe:]NR5G:CCOLor.....	487
[SENSe:]NR5G:CDRPower.....	487
[SENSe:]NR5G:EMHold.....	487

[SENSe:]NR5G:RSUMmary:CCResult.....	487
[SENSe:]NR5G:RSUMmary:PMODE.....	488
[SENSe:]NR5G:RSUMmary:SHOW.....	488
[SENSe:]NR5G:TDView.....	489
UNIT:BSTR.....	489
UNIT:CAReference.....	489
UNIT:CAXes.....	490
UNIT:EVM.....	490
UNIT:SAXes.....	490

---

### DISPlay[:WINDow<n>][:SUBWindow<w>]:COUPling <State>

Couples or decouples result display tabs (subwindows).

Subwindow coupling is available for measurements with multiple data streams (like carrier aggregation).

#### Suffix:

<n>	Window
<w>	Subwindow

#### Parameters:

<State>	ON   OFF   1   0
*RST:	OFF

**Example:** //Turn on subwindow coupling  
DISP:COUP ON

**Manual operation:** See "[Subwindow Coupling](#)" on page 210

---

### DISPlay[:WINDow<n>]:TABLe:ITEM <Result>, <State>

Turns the display of individual results in the numerical result summary on and off.

#### Suffix:

<n>	Window
-----	--------

#### Parameters:

<Result>	BLER   CRES   DSQP   DSSF   DSST   DSTS   UPRach   FSOFFset   EVM   EVMPeak   FERRor   GIMBalance   IQOFFset   MODulation   NORB   OSTP   RSTP   SSPower   CSIPower   PCHannel   POWer   PPRE   PSIGnal   QUADRature   SDPB   SDQP   SDSF   SDST   SDTS   SERRor   TPUT   UCCD   UCCH   USPB   USQP   USSF   USST   USTS Combined measurements only: TSTamp   TSDelta   MID   SState   APFail   AAPFail   ARPFail   SPFail
<State>	ON   OFF   1   0

**Example:** //Display or hide results  
DISP:WIND2:TABL:ITEM DSSF,ON  
DISP:WIND2:TABL:ITEM DSQP,OFF

**Manual operation:** See "[Result state](#)" on page 212

---

**[SENSe:]NR5G:CCOLor <Type>**

Selects the information that the colors of the constellation points in the constellation diagram represent.

**Parameters:**

&lt;Type&gt;

**ALLocation**

Colors represent allocation types.

**MODulation**

Colors represent modulation types.

\*RST:       MODulation

**Example:**

```
//Select colors for constellation diagram
NR5G:CCOL MOD
```

**Manual operation:** See "[Constellation Color](#)" on page 211

---

**[SENSe:]NR5G:CDRPower <State>**

Turns the consideration of a boosting factor to calculate the constellation points in the constellation diagram on and off.

**Parameters:**

&lt;State&gt;

ON | OFF | 1 | 0

\*RST:       OFF

**Example:**

```
//Turn on boosting factor
NR5G:CDRP ON
```

**Manual operation:** See "[Constellation Diagram Relative Power](#)" on page 211

---

**[SENSe:]NR5G:EMHold <State>**

Turns the EVM max hold function on and off.

**Parameters:**

&lt;State&gt;

ON | OFF | 1 | 0

\*RST:       OFF

**Example:**

```
//Turn on EVM max hold
NR5G:EMH ON
```

**Manual operation:** See "[EVM Max Hold](#)" on page 209

---

**[SENSe:]NR5G:RSUMmary:CCResult <Result>**

Selects the way multiple carriers are analyzed.

Prerequisites for this command

- Select multiple carriers (`CONFigure[:NR5G]:NOCC`).

**Parameters:**

<Result>

**ALL**

Analyzes all component carriers and shows information about all of them in the result summary.

**VIEWed**

Analyzes the two component carriers assigned to the two views. The result summary only shows information about those two component carriers.

\*RST: VIEWed

**Example:**

```
//Analyze all carriers
CONF:NOCC 4
NR5G:RSUM:CCR ALL
```

**Manual operation:** See "[CC Result](#)" on page 212

**[SENSe:]NR5G:RSUMmary:PMODE <Result>**

Selects the power averaging mode.

**Parameters:**

<Result>

**AASL**

Power averaging over all symbols in a slot.

**AASY**

Power averaging over all used symbols in a slot.

\*RST: AASL

**Example:**

```
//Select power averaging mode
NR5G:RSUM:PMOD AASY
```

**Manual operation:** See "[Power Mode](#)" on page 212

**[SENSe:]NR5G:RSUMmary:SHOW <Result>**

Selects the way the contents of the result summary are calculated.

**Parameters:**

<Result>

**AVERage**

Shows the average over all analyzed frames.

**SINGle**

Shows the result for the frame selected with `[SENSe:]NR5G[:CC<cc>]:FRAME:SElect`.

If only one frame has been captured, the results are the same in both cases.

\*RST: AVERage



**Example:**           //Display results for a single frame  
 DISP:SUBW2:FNUM 2  
 NR5G:RSUM:SHOW SING

#### **[SENSe:]NR5G:TDView <State>**

Turns the 3D view for [selected diagrams](#) on and off.

#### **Parameters:**

<State>           ON | OFF | 1 | 0  
 \*RST:           OFF

**Example:**           //Turn on 3D view  
 NR5G:TDV ON

**Manual operation:** See "[3D View](#)" on page 210

#### **UNIT:BSTR <Unit>**

Selects the way the bit stream is displayed.

#### **Parameters:**

<Unit>           **SYMBOLS**  
 Displays the bit stream using symbols  
**BITS**  
 Displays the bit stream using bits  
 \*RST:           SYMBOLS

**Example:**           //Display bit stream as bits  
 UNIT:BSTR BIT

**Manual operation:** See "[Bit Stream Format](#)" on page 209

#### **UNIT:CAReference <Reference>**

Selects the reference for result displays whose x-axis shows frequency characteristics of the signal.

#### **Parameters:**

<Reference>       **LRB**  
 Frequency values relative to the lowest resource block.  
**RTCF**  
 Frequency values relative to the center frequency of the carrier.  
 \*RST:           LRB

**Example:**           //Select carrier reference  
 UNIT:CAR RTCF

**Manual operation:** See "[Carrier Axes Reference](#)" on page 209

---

**UNIT:CAXes** <Unit>

Selects the scale of the x-axis for result displays that show subcarrier results.

**Parameters:**

<Unit>	<b>CARR</b> Shows the number of the subcarriers on the x-axis.
	<b>HZ</b> Shows the frequency of the subcarriers on the x-axis.

**Example:** //Display frequency on the x-axis  
UNIT:CAX HZ

**Manual operation:** See "Carrier Axes" on page 209

---

**UNIT:EVM** <Unit>

Selects the EVM unit.

**Parameters:**

<Unit>	<b>DB</b> EVM results returned in dB
	<b>PCT</b> EVM results returned in % *RST: PCT

**Example:** //Display EVM results in %  
UNIT:EVM PCT

**Manual operation:** See "EVM Unit" on page 208

---

**UNIT:SAXes** <Unit>

Selects the scale of the x-axis for result displays that show symbol results.

**Parameters:**

<Unit>	<b>SYMBOL</b> Shows the number of the symbol on the x-axis.
	<b>TIME</b> Shows the time stamp of the symbols on the x-axis.

**Example:** //Display symbol numbers on the x-axis  
UNIT:SAX SYMB

**Manual operation:** See "Symbol Axes" on page 209

---

**6.11.2.3 Evaluation range**

CONFigure[:NR5G]:DL[:CC<cc>]:BF:AP[:UERS].....	491
[SENSe:]NR5G[:CC<cc>]:ALLocation:SElect.....	491
[SENSe:]NR5G[:CC<cc>]:ANTenna:SElect.....	492
[SENSe:]NR5G[:CC<cc>]:BWPart:SElect.....	492

[SENSe:]NR5G[:CC<cc>]:CARRier:SElect.....	492
[SENSe:]NR5G[:CC<cc>]:FRAMe:SElect.....	493
[SENSe:]NR5G[:CC<cc>]:LOCation:SElect.....	493
[SENSe:]NR5G[:CC<cc>]:MODulation:SElect.....	493
[SENSe:]NR5G[:CC<cc>]:RAP.....	494
[SENSe:]NR5G[:CC<cc>]:SLOT:SElect.....	494
[SENSe:]NR5G[:CC<cc>]:SUBFrame:SElect.....	494
[SENSe:]NR5G[:CC<cc>]:SYMBol:SElect.....	495
[SENSe:]NR5G:SEGMent:SElect.....	495

---

### CONFigure[:NR5G]:DL[:CC<cc>]:BF:AP[:UERS] <Port>

Selects an antenna port to analyze.

**Suffix:**

<cc>                      [Component Carrier](#)

**Parameters:**

<Port>                      **ALL**  
 Selects all antenna ports.

**<numeric\_value> (integer only)**  
 Selects a specific antenna port. The value corresponds to the antenna port number.

\*RST:                      ALL

**Example:**

```
//Select antenna port
CONF:DL:BF:AP 1002
```

**Manual operation:** See "[RS Weights](#)" on page 217

---

### [SENSe:]NR5G[:CC<cc>]:ALlocation:SElect <Allocation>

Filters the displayed results in the constellation diagram by a certain allocation.

**Suffix:**

<cc>                      irrelevant

**Parameters:**

<Allocation>                      **ALL**  
 Shows the results for all allocations.

**<numeric value> (integer only)**  
 Shows the results for a single allocation type.  
 Allocation types are mapped to numeric values. For the code assignment, see [Chapter 6.9.1.25, "Return value codes"](#), on page 307.

\*RST:                      ALL

**Example:**

```
//Display results for all allocations
NR5G:ALL:SEL ALL
```

**Manual operation:** See "[Evaluation range for the constellation diagram](#)" on page 217

---

**[SENSe:]NR5G[:CC<cc>]:ANTenna:SElect <Antenna>**

Filters the constellation points by a certain antenna port.

Prerequisites for this command

- Create the constellation diagram after MIMO decoding (`[SENSe:]NR5G[:CC<cc>]:LOCation:SElect`).

**Suffix:**

<cc>                      irrelevant

**Parameters:**

<Antenna>                Number of the antenna port (for example 1001).

**Example:**

```
//Filter constellation points by antenna port
NR5G:LOC:SEL AMD
NR5G:ANT:SEL 1001
```

---

**[SENSe:]NR5G[:CC<cc>]:BWPart:SElect <BWP>**

Filters the displayed results by a certain bandwidth part.

**Suffix:**

<cc>                      irrelevant

**Parameters:**

<BWP>                    **ALL**  
Shows the results for all bandwidth parts, including the SS/PBCH block.

**SSBLock**

Shows the results for the SS/PBCH block.

**<numeric value> (integer only)**

Shows the results for a single bandwidth part.

\*RST:            ALL

**Example:**

```
//Display results for SS/PBCH block
NR5G:BWP:SEL SSBL
```

**Manual operation:** See "[BWP/SS Selection](#)" on page 214

---

**[SENSe:]NR5G[:CC<cc>]:CARRier:SElect <Carrier>**

Filters the displayed results in the constellation diagram by a certain subcarrier.

**Suffix:**

<cc>                      irrelevant

**Parameters:**

<Carrier>                **ALL**  
Shows the results for all subcarriers.

**<numeric value> (integer only)**

Shows the results for a single subcarrier.

\*RST: ALL

**Example:** //Display results for all subcarriers  
NR5G:CARR:SEL ALL

**Manual operation:** See ["Evaluation range for the constellation diagram"](#) on page 217

**[SENSe:]NR5G[:CC<cc>]:FRAMe:SElect <Frame>**

Filters the displayed results by a specific frame.

**Suffix:**

<cc> irrelevant

**Parameters:**

<Frame> \*RST: 1

**Example:** //Display results for frame 2  
NR5G:FRAM:SEL 2

**Manual operation:** See ["Effects of capturing multiple frames on results"](#) on page 89  
See ["Frame Selection"](#) on page 214

**[SENSe:]NR5G[:CC<cc>]:LOCation:SElect <Location>**

Selects the point in the signal processing at which the constellation diagram is created.

**Suffix:**

<cc> irrelevant

**Parameters:**

<Location> **AMD**  
After MIMO decoding.  
**BMD**  
Before MIMO decoding.  
\*RST: BMD

**Example:** //Select constellation diagram data source  
NR5G:LOC:SEL AMD

**[SENSe:]NR5G[:CC<cc>]:MODulation:SElect <Modulation>**

Filters the displayed results in the constellation diagram by a certain modulation type.

**Suffix:**

<cc> irrelevant

**Parameters:**

<Modulation> **ALL**  
Shows the results for all modulation types.

**<numeric value> (integer only)**

Shows the results for a single modulation type.

Modulation types are mapped to numeric values. For the code assignment, see [Chapter 6.9.1.25, "Return value codes"](#), on page 307.

\*RST: ALL

**Example:** //Display results for all elements with a QPSK modulation  
NR5G:MOD:SEL 2

**Manual operation:** See ["Evaluation range for the constellation diagram"](#) on page 217

**[SENSe:]NR5G[:CC<cc>]:RAP <Port>**

Selects the reference antenna port for relative beamforming results.

**Suffix:**

<cc> irrelevant

**Parameters:**

<Port> Value corresponds to the antenna port.

\*RST: 1000

**Example:** //Select reference antenna port  
NR5G:RAP 2000

**Manual operation:** See ["Reference AP"](#) on page 217

**[SENSe:]NR5G[:CC<cc>]:SLOT:SElect <Slot>**

Filters the displayed results by a certain slot.

**Suffix:**

<cc> irrelevant

**Parameters:**

<Slot> **ALL**

Shows the results for all slots.

**<numeric value> (integer only)**

Shows the results for a single slot.

\*RST: ALL

**Example:** //Display result for slot 4  
NR5G:SLOT:SEL 4

**Manual operation:** See ["Slot Selection"](#) on page 216

**[SENSe:]NR5G[:CC<cc>]:SUBFrame:SElect <Subframe>**

Filters the displayed results by a certain OFDM subframe.

**Suffix:**

<cc> irrelevant

**Parameters:**

<Subframe>

**ALL**

Shows the results for all subframes.

**<numeric value> (integer only)**

Shows the results for a single subframe.

\*RST: ALL

**Example:**

//Display result for subframe 1

NR5G:SUBF:SEL 1

**Manual operation:** See ["Subframe Selection"](#) on page 215

**[SENSe:]NR5G:CC<cc>]:SYMBOL:SElect <Symbol>**

Filters the displayed results in the constellation diagram by a certain OFDM symbol.

**Suffix:**

<cc> irrelevant

**Parameters:**

<Symbol>

**ALL**

Shows the results for all symbols.

**<numeric value> (integer only)**

Shows the results for a single OFDM symbol.

\*RST: ALL

**Example:**

//Display result for OFDM symbol 2

NR5G:SYMB:SEL 2

**Manual operation:** See ["Evaluation range for the constellation diagram"](#) on page 217

**[SENSe:]NR5G:SEGMENT:SElect <Segment>**

Selects the analyzed segment for a segmented capture.

Prerequisites for this command

- Turn on segmented capture ([\[SENSe:\]SWEp:SCAPture:STATe](#)).

**Parameters:**

<Segment>

<numeric value> (integer only)

The value range depends on the number of captured segments ([\[SENSe:\]SWEp:SCAPture:EVENTs](#)).

**Example:**

//Select segment to analyze

SWE:SCAP:STAT ON

SWE:SCAP:EVEN 3

NR5G:SEGM:SEL 2

**Manual operation:** See ["Segment Selection"](#) on page 214

### 6.11.3 Analysis tools for combined measurements

[SENSe:]NR5G[:CC<cc>]:SMID.....	496
[SENSe:]NR5G:EFILter:FPARameters.....	496
[SENSe:]NR5G:EFILter:FPARameters:STATe.....	497
[SENSe:]NR5G:EFILter:PRESet.....	497
[SENSe:]NR5G:EFILter:STATe.....	497
[SENSe:]NR5G:FEVents:COUNT?.....	498

---

#### [SENSe:]NR5G[:CC<cc>]:SMID <Event>

Selects a specific measurement (meas ID) from the measurement sequence in combined measurements.

##### Suffix:

<cc>                      irrelevant

##### Parameters:

<Event>                      \*RST:            1

**Example:**                      //Select a measurement  
NR5G:SMID 5

**Manual operation:**    See "[Selected Meas ID](#)" on page 214

---

#### [SENSe:]NR5G:EFILter:FPARameters <Result>[, <Condition>, <Value>]

Defines a filter condition for the event filter in combined measurements.

##### Parameters:

<Result>                      SState | APFail | AAPFail | ARPFail | SPFail | MID | TSTamp |  
TSDelta | EVM | Power | DSQP | DSST | DSSF | DSTS |  
FSOFFset | PCHannel | PSIGnal | FERRor | SERRor | IQOFFset |  
GIMBalance | QUADrature | OSTP | RSTP | RSSI | CSIPower |  
SSPower | CRES t | OVLD | MODulation | NORB | BLER | TPUT  
Selects the result that you want to define a filter for.

<Condition>

##### **FAILed**

Filter condition: test failed (for boolean results only).

##### **GTEQual**

Filter condition: greater than or equal (for numerical results only).

##### **LTEQual**

Filter condition: lower than or equal (for numerical results only).

##### **PASSed**

Filter condition: test passed (for boolean results only).

<Value>

For numerical results only.

**Example:**                      //Define filter condition: time stamp deltas greater than 0.25 seconds  
NR5G:EFIL:FPAR TSD,GTH,0.25S



**Example:** //Define filter condition: signal synchronization pass  
NR5G:EFIL:FPA R SST, PASS

**Manual operation:** See "[Filter Parameters](#)" on page 219

**[SENSe:]NR5G:EFILter:FPAParameters:STATe** <Result>, <State>

Turns an event filter on and off.

Turning on an event filter adds it to the filter list and removes the results from the result summary that do not fulfill the filter conditions.

Turning it off removes it from the list.

Prerequisites for this command

- Define a filter condition (`[SENSe:]NR5G:EFILter:FPAParameters`).

**Parameters:**

<Result> CRES t | DSQP | DSSF | DSST | DSTS | FSOFFset | EVM |  
OVL D | FERRor | GIMBalance | IQOFFset | MODulation |  
NORB | OSTP | RSTP | RSSI | SSPower | CSIpower |  
PCHannel | POWer | PPRE | PSIGNal | QUADrature | SERRor |  
MID | TSTamp | TSDelta | SSTate | APFail | AAPFail | ARPFail |  
SPFail | BLER | TPUT

Selects the result that you want to add a filter for.

<State> ON | OFF | 1 | 0  
\*RST: OFF

**Example:** //Add two filter conditions to the filter list  
NR5G:EFIL:FPA R TSD, GTH, 0.25S  
NR5G:EFIL:FPA R TSD, ON  
NR5G:EFIL:FPA R SST, PASS  
NR5G:EFIL:FPA R SST, ON

**Manual operation:** See "[Filter Parameters](#)" on page 219

**[SENSe:]NR5G:EFILter:PRESet**

Removes all event filters.

**Example:** //Remove all event filters  
NR5G:EFIL:PRE S

**Usage:** Event

**Manual operation:** See "[Reset Filter Settings](#)" on page 219

**[SENSe:]NR5G:EFILter:STATe** <State>

Turns an event filter for combined measurement results on and off.

**Parameters:**

<State> ON | OFF | 0 | 1  
 \*RST: OFF

**Example:**

```
//Turn on event filter
NR5G:EFIL:STAT ON
```

**Manual operation:** See "[State](#)" on page 219

**[SENSe:]NR5G:FEVents:COUNT?**

Queries the number of filtered events for combined measurements.

Prerequisites for this command

- Define and turn on an event filter.

**Return values:**

<Count>

**Example:**

```
//Query filtered events
NR5G:EFIL:STAT ON
NR5G:FEV:COUN?
```

**Usage:**

Query only

**Manual operation:** See "[Filter Parameters](#)" on page 219

## 6.12 Reading out status register

The following commands are required to read out the `STATus:QUESTionable:SYNC` status register.

For a full list of commands required to read out the status register, refer to the FSW user manual.

<a href="#">STATus:QUESTionable:SYNC[:EVENT]?</a> .....	498
<a href="#">STATus:QUESTionable:SYNC:CONDition?</a> .....	499
<a href="#">STATus:QUESTionable:SYNC:ENABLE</a> .....	499
<a href="#">STATus:QUESTionable:SYNC:NTRansition</a> .....	499
<a href="#">STATus:QUESTionable:SYNC:PTRansition</a> .....	499

**STATus:QUESTionable:SYNC[:EVENT]? <ChannelName>**

Reads out the `EVENT` section of the status register.

The command also deletes the contents of the `EVENT` section.

**Query parameters:**

<ChannelName> String containing the name of the channel.  
 The parameter is optional. If you omit it, the command works for the currently active channel.

**Usage:**

Query only

---

**STATus:QUESTIONable:SYNC:CONDition?** <ChannelName>

Reads out the CONDition section of the status register.

The command does not delete the contents of the EVENT section.

**Query parameters:**

<ChannelName> String containing the name of the channel.  
The parameter is optional. If you omit it, the command works for the currently active channel.

**Usage:** Query only

---

**STATus:QUESTIONable:SYNC:ENABLE** <BitDefinition>, <ChannelName>

Controls the ENABLE part of a register.

The ENABLE part allows true conditions in the EVENT part of the status register to be reported in the summary bit. If a bit is 1 in the enable register and its associated event bit transitions to true, a positive transition will occur in the summary bit reported to the next higher level.

**Parameters:**

<BitDefinition> Range: 0 to 65535

<ChannelName> String containing the name of the channel.  
The parameter is optional. If you omit it, the command works for the currently active channel.

---

**STATus:QUESTIONable:SYNC:NTRansition** <BitDefinition>[,<ChannelName>]

Controls the Negative TRansition part of a register.

Setting a bit causes a 1 to 0 transition in the corresponding bit of the associated register. The transition also writes a 1 into the associated bit of the corresponding EVENT register.

**Parameters:**

<BitDefinition> Range: 0 to 65535

<ChannelName> String containing the name of the channel.  
The parameter is optional. If you omit it, the command works for the currently active channel.

---

**STATus:QUESTIONable:SYNC:PTRansition** <BitDefinition>[,<ChannelName>]

These commands control the Positive TRansition part of a register.

Setting a bit causes a 0 to 1 transition in the corresponding bit of the associated register. The transition also writes a 1 into the associated bit of the corresponding EVENT register.

**Parameters:**

<BitDefinition> Range: 0 to 65535

<ChannelName> String containing the name of the channel.  
The parameter is optional. If you omit it, the command works for the currently active channel.

## List of commands (5G NR downlink)

[SENSe:]ADJust:CONFigure:LEVel:DURation.....	318
[SENSe:]ADJust:CONFigure:LEVel:DURation:MODE.....	318
[SENSe:]ADJust:DEMod.....	318
[SENSe:]ADJust:EVM.....	318
[SENSe:]ADJust:EVM:SLOTs.....	319
[SENSe:]ADJust:LEVel.....	319
[SENSe:]ADJust:LEVel<ant>:ALL.....	319
[SENSe:]ADJust:NCANcel:AVERAge[:COUNT].....	452
[SENSe:]ADJust:NCANcel:AVERAge[:STATE].....	452
[SENSe:]ESpectrum<sb>:PRESet[:STANdard].....	466
[SENSe:]FREQuency:CENTer:STEP.....	437
[SENSe:]FREQuency:CENTer[:CC<cc>].....	435
[SENSe:]FREQuency:CENTer[:CC<cc>]:MCOFFset.....	330
[SENSe:]FREQuency:CENTer[:CC<cc>]:OFFSet.....	436
[SENSe:]NR5G:ACPower:ALPMode.....	467
[SENSe:]NR5G:CCOLor.....	487
[SENSe:]NR5G:CDRPower.....	487
[SENSe:]NR5G:DEMod:CAMode.....	456
[SENSe:]NR5G:DEMod:CESTimation.....	453
[SENSe:]NR5G:DEMod:CETAverage.....	453
[SENSe:]NR5G:DEMod:CMETHod.....	456
[SENSe:]NR5G:DEMod:CRData.....	456
[SENSe:]NR5G:DEMod:DDATa.....	457
[SENSe:]NR5G:DEMod:EFLRange.....	457
[SENSe:]NR5G:DEMod:FILTer.....	458
[SENSe:]NR5G:DEMod:PRData.....	458
[SENSe:]NR5G:DEMod:STAD]ust.....	458
[SENSe:]NR5G:EFILter:FPARameters.....	496
[SENSe:]NR5G:EFILter:FPARameters:STATE.....	497
[SENSe:]NR5G:EFILter:PRESet.....	497
[SENSe:]NR5G:EFILter:STATE.....	497
[SENSe:]NR5G:EMHold.....	487
[SENSe:]NR5G:FEVents:COUNT?.....	498
[SENSe:]NR5G:FRAMe:COUNT.....	442
[SENSe:]NR5G:FRAMe:COUNT:AUTO.....	442
[SENSe:]NR5G:FRAMe:COUNT:STATE.....	443
[SENSe:]NR5G:FRAMe:OPTimization.....	467
[SENSe:]NR5G:FRAMe:SALevel.....	467
[SENSe:]NR5G:FRAMe:SLOT.....	443
[SENSe:]NR5G:FRAMe:SRSLot.....	443
[SENSe:]NR5G:IQ:GIQE.....	454
[SENSe:]NR5G:OOPower:ATIMing.....	462
[SENSe:]NR5G:OOPower:NCORrection.....	462
[SENSe:]NR5G:RSUMmary:CCResult.....	487
[SENSe:]NR5G:RSUMmary:PMODE.....	488
[SENSe:]NR5G:RSUMmary:SHOW.....	488
[SENSe:]NR5G:SEGMENT:SElect.....	495

[SENSe:]NR5G:TDView.....	489
[SENSe:]NR5G:TRACking:LEVel.....	454
[SENSe:]NR5G:TRACking:PHASe.....	454
[SENSe:]NR5G:TRACking:TIME.....	455
[SENSe:]NR5G:TRACking:TPUT:STATe.....	455
[SENSe:]NR5G[:CC<cc>]:ALLocation:SElect.....	491
[SENSe:]NR5G[:CC<cc>]:ANTenna:SElect.....	492
[SENSe:]NR5G[:CC<cc>]:BWPart:SElect.....	492
[SENSe:]NR5G[:CC<cc>]:CARRier:SElect.....	492
[SENSe:]NR5G[:CC<cc>]:FRAMe:SElect.....	493
[SENSe:]NR5G[:CC<cc>]:LOCation:SElect.....	493
[SENSe:]NR5G[:CC<cc>]:MODulation:SElect.....	493
[SENSe:]NR5G[:CC<cc>]:RAP.....	494
[SENSe:]NR5G[:CC<cc>]:SLOT:SElect.....	494
[SENSe:]NR5G[:CC<cc>]:SMID.....	496
[SENSe:]NR5G[:CC<cc>]:SUBFrame:SElect.....	494
[SENSe:]NR5G[:CC<cc>]:SYMBol:SElect.....	495
[SENSe:]POWer:ACHannel:AACHannel.....	463
[SENSe:]POWer:CATegory.....	415
[SENSe:]POWer:CATegory:B.....	463
[SENSe:]POWer:SEM:AMPower.....	463
[SENSe:]POWer:SEM:AMPower:AUTO.....	464
[SENSe:]POWer:SEM:NTAB.....	464
[SENSe:]POWer:SEM:NTXU.....	465
[SENSe:]SWAPiq.....	443
[SENSe:]SWEep:CTMode.....	444
[SENSe:]SWEep:EGATe:AGATing.....	468
[SENSe:]SWEep:EVENT.....	468
[SENSe:]SWEep:LCAPture.....	444
[SENSe:]SWEep:MODE.....	468
[SENSe:]SWEep:SCAPture:EVENTs.....	450
[SENSe:]SWEep:SCAPture:LENGth[:TIME].....	451
[SENSe:]SWEep:SCAPture:OFFSet[:TIME].....	451
[SENSe:]SWEep:SCAPture:STATe.....	451
[SENSe:]SWEep:TIME.....	445
[SENSe:]SYNC[:CC<cc>][:STATe]?.....	243
ABORT.....	241
CALCulate<n>:DELTamarker<m>:AOFF.....	479
CALCulate<n>:DELTamarker<m>:MAXimum:LEFT.....	479
CALCulate<n>:DELTamarker<m>:MAXimum:NEXT.....	479
CALCulate<n>:DELTamarker<m>:MAXimum:RIGHT.....	480
CALCulate<n>:DELTamarker<m>:MAXimum[:PEAK].....	480
CALCulate<n>:DELTamarker<m>:MINimum:LEFT.....	480
CALCulate<n>:DELTamarker<m>:MINimum:NEXT.....	480
CALCulate<n>:DELTamarker<m>:MINimum:RIGHT.....	480
CALCulate<n>:DELTamarker<m>:MINimum[:PEAK].....	481
CALCulate<n>:DELTamarker<m>:TRACe.....	481
CALCulate<n>:DELTamarker<m>:X.....	272
CALCulate<n>:DELTamarker<m>:Y?.....	272
CALCulate<n>:DELTamarker<m>[:STATe].....	481

CALCulate<n>:LIMit<li>:ACPowEr:ACHannel:RESult:ABSolute.....	283
CALCulate<n>:LIMit<li>:ACPowEr:ACHannel:RESult:RELative.....	283
CALCulate<n>:LIMit<li>:ACPowEr:ACHannel:RESult?.....	282
CALCulate<n>:LIMit<li>:ACPowEr:ALternate<alt>:RESult?.....	284
CALCulate<n>:LIMit<li>:ACPowEr:ALternate<ch>:RESult:ABSolute.....	285
CALCulate<n>:LIMit<li>:ACPowEr:ALternate<ch>:RESult:RELative.....	285
CALCulate<n>:LIMit<li>:ACPowEr:GAP<gap>:ACLR:RESult:ABSolute?.....	286
CALCulate<n>:LIMit<li>:ACPowEr:GAP<gap>:ACLR:RESult:RELative?.....	287
CALCulate<n>:LIMit<li>:ACPowEr:GAP<gap>:ACLR:RESult?.....	286
CALCulate<n>:LIMit<li>:ACPowEr:GAP<gap>[:CACLr]:RESult:ABSolute?.....	288
CALCulate<n>:LIMit<li>:ACPowEr:GAP<gap>[:CACLr]:RESult:RELative?.....	288
CALCulate<n>:LIMit<li>:ACPowEr:GAP<gap>[:CACLr]:RESult?.....	287
CALCulate<n>:LIMit<li>:ACPowEr:PMODE.....	465
CALCulate<n>:LIMit<li>:FAIL?.....	289
CALCulate<n>:LIMit<li>:OOPowEr:OFFPowEr?.....	281
CALCulate<n>:LIMit<li>:OOPowEr:TRANsient?.....	281
CALCulate<n>:LIMit<li>[:CC<cc>][:ISRC<ant>][:FRAMe<fr>]:SUMMary:ALL:RESult?.....	277
CALCulate<n>:LIMit<li>[:CC<cc>][:ISRC<ant>][:FRAMe<fr>]:SUMMary:EVM:DS1K[:AVERAge]:RESult?.....	277
CALCulate<n>:LIMit<li>[:CC<cc>][:ISRC<ant>][:FRAMe<fr>]:SUMMary:EVM:DSQP[:AVERAge]:RESult?.....	278
CALCulate<n>:LIMit<li>[:CC<cc>][:ISRC<ant>][:FRAMe<fr>]:SUMMary:EVM:DSSF[:AVERAge]:RESult?.....	278
CALCulate<n>:LIMit<li>[:CC<cc>][:ISRC<ant>][:FRAMe<fr>]:SUMMary:EVM:DSS[T]:AVERAge]:RESult?.....	279
CALCulate<n>:LIMit<li>[:CC<cc>][:ISRC<ant>][:FRAMe<fr>]:SUMMary:EVM:DSTS[:AVERAge]:RESult?.....	280
CALCulate<n>:LIMit<li>[:CC<cc>][:ISRC<ant>][:FRAMe<fr>]:SUMMary:EVM:FERRor[:AVERAge]:RESult?.....	280
CALCulate<n>:MARKer<m>:AOFF.....	482
CALCulate<n>:MARKer<m>:FUNctIon:POWer<sb>:PRESet.....	469
CALCulate<n>:MARKer<m>:FUNctIon:POWer<sb>:RESult:DEtails.....	310
CALCulate<n>:MARKer<m>:FUNctIon:POWer<sb>:RESult[:CURRent]?.....	309
CALCulate<n>:MARKer<m>:MAXimum:LEFT.....	482
CALCulate<n>:MARKer<m>:MAXimum:NEXT.....	482
CALCulate<n>:MARKer<m>:MAXimum:RIGHT.....	482
CALCulate<n>:MARKer<m>:MAXimum[:PEAK].....	482
CALCulate<n>:MARKer<m>:MINimum:LEFT.....	483
CALCulate<n>:MARKer<m>:MINimum:NEXT.....	483
CALCulate<n>:MARKer<m>:MINimum:RIGHT.....	483
CALCulate<n>:MARKer<m>:TRACe.....	484
CALCulate<n>:MARKer<m>:X.....	273
CALCulate<n>:MARKer<m>:Y.....	273
CALCulate<n>:MARKer<m>:Z:ALL?.....	274
CALCulate<n>:MARKer<m>:Z?.....	274
CALCulate<n>:MARKer<m>[:STATe].....	483
CALCulate<n>:STATistics:CCDF:X<t>?.....	275
CALCulate<n>:STATistics:RESult<res>?.....	275
CALibration:AIQ:HATiming[:STATe].....	428
CONFigure:GENerator:CONTRol[:STATe].....	427
CONFigure:GENerator:FREQuency:CENTer:SYNC[:STATe].....	422
CONFigure:GENerator:IPConnection:ADDResS.....	422
CONFigure:GENerator:IPConnection:LEDState?.....	422
CONFigure:GENerator:LEVel:DUTGain.....	423
CONFigure:GENerator:LEVel:DUTLimit.....	423

CONFigure:GENerator:LEVel:DUTLimit:STATe.....	424
CONFigure:GENerator:POWer:LEVel.....	424
CONFigure:GENerator:POWer:LEVel:STATe.....	423
CONFigure:GENerator:QERRor?.....	425
CONFigure:GENerator:RFOutput[:STATe].....	426
CONFigure:GENerator:SETTings:UPDate:RF.....	427
CONFigure:SETTings:NR5G.....	425
CONFigure:SETTings:NR5G:PINTerval.....	425
CONFigure:SETTings:NR5G:SYNC.....	426
CONFigure:SETTings:RF.....	426
CONFigure[:NR5G]:ACLR.....	469
CONFigure[:NR5G]:BS Tation.....	465
CONFigure[:NR5G]:CENTer.....	327
CONFigure[:NR5G]:CRASter.....	327
CONFigure[:NR5G]:CSCapture.....	328
CONFigure[:NR5G]:CSPacing.....	327
CONFigure[:NR5G]:DL[:CC<cc>]:BF:AP[:UERS].....	491
CONFigure[:NR5G]:DL[:CC<cc>]:BW.....	322
CONFigure[:NR5G]:DL[:CC<cc>]:DEMod:AUTO.....	320
CONFigure[:NR5G]:DL[:CC<cc>]:DFRange.....	322
CONFigure[:NR5G]:DL[:CC<cc>]:EUIDs.....	412
CONFigure[:NR5G]:DL[:CC<cc>]:FNNF.....	412
CONFigure[:NR5G]:DL[:CC<cc>]:FRAME<fr>:BWPpart<bwp>:ADD.....	339
CONFigure[:NR5G]:DL[:CC<cc>]:FRAME<fr>:BWPpart<bwp>:CLEar.....	339
CONFigure[:NR5G]:DL[:CC<cc>]:FRAME<fr>:BWPpart<bwp>:CSI<csi>:BITMap.....	350
CONFigure[:NR5G]:DL[:CC<cc>]:FRAME<fr>:BWPpart<bwp>:CSI<csi>:CTYPe?.....	350
CONFigure[:NR5G]:DL[:CC<cc>]:FRAME<fr>:BWPpart<bwp>:CSI<csi>:DENSity.....	351
CONFigure[:NR5G]:DL[:CC<cc>]:FRAME<fr>:BWPpart<bwp>:CSI<csi>:LONE.....	351
CONFigure[:NR5G]:DL[:CC<cc>]:FRAME<fr>:BWPpart<bwp>:CSI<csi>:LZERo.....	352
CONFigure[:NR5G]:DL[:CC<cc>]:FRAME<fr>:BWPpart<bwp>:CSI<csi>:NORBs.....	352
CONFigure[:NR5G]:DL[:CC<cc>]:FRAME<fr>:BWPpart<bwp>:CSI<csi>:PORT?.....	353
CONFigure[:NR5G]:DL[:CC<cc>]:FRAME<fr>:BWPpart<bwp>:CSI<csi>:POWer.....	353
CONFigure[:NR5G]:DL[:CC<cc>]:FRAME<fr>:BWPpart<bwp>:CSI<csi>:RESources.....	353
CONFigure[:NR5G]:DL[:CC<cc>]:FRAME<fr>:BWPpart<bwp>:CSI<csi>:ROW.....	354
CONFigure[:NR5G]:DL[:CC<cc>]:FRAME<fr>:BWPpart<bwp>:CSI<csi>:SID.....	354
CONFigure[:NR5G]:DL[:CC<cc>]:FRAME<fr>:BWPpart<bwp>:CSI<csi>:SLOT:APERiodic.....	355
CONFigure[:NR5G]:DL[:CC<cc>]:FRAME<fr>:BWPpart<bwp>:CSI<csi>:SLOT:MODE.....	355
CONFigure[:NR5G]:DL[:CC<cc>]:FRAME<fr>:BWPpart<bwp>:CSI<csi>:SLOT:PERiodicity.....	356
CONFigure[:NR5G]:DL[:CC<cc>]:FRAME<fr>:BWPpart<bwp>:CSI<csi>:SLOT:POFFset.....	356
CONFigure[:NR5G]:DL[:CC<cc>]:FRAME<fr>:BWPpart<bwp>:CSI<csi>:SRB.....	357
CONFigure[:NR5G]:DL[:CC<cc>]:FRAME<fr>:BWPpart<bwp>:CSI<csi>:STATe.....	357
CONFigure[:NR5G]:DL[:CC<cc>]:FRAME<fr>:BWPpart<bwp>:CSI<csi>:ZPOWer.....	358
CONFigure[:NR5G]:DL[:CC<cc>]:FRAME<fr>:BWPpart<bwp>:CSLot.....	343
CONFigure[:NR5G]:DL[:CC<cc>]:FRAME<fr>:BWPpart<bwp>:DETection.....	320
CONFigure[:NR5G]:DL[:CC<cc>]:FRAME<fr>:BWPpart<bwp>:DUPLicate.....	340
CONFigure[:NR5G]:DL[:CC<cc>]:FRAME<fr>:BWPpart<bwp>:PRS:KPComb.....	358
CONFigure[:NR5G]:DL[:CC<cc>]:FRAME<fr>:BWPpart<bwp>:PRS:KPOFFset.....	359
CONFigure[:NR5G]:DL[:CC<cc>]:FRAME<fr>:BWPpart<bwp>:PRS:LPRS.....	359
CONFigure[:NR5G]:DL[:CC<cc>]:FRAME<fr>:BWPpart<bwp>:PRS:LPSTart.....	360
CONFigure[:NR5G]:DL[:CC<cc>]:FRAME<fr>:BWPpart<bwp>:PRS:NORBs.....	360



CONFigure[:NR5G]:DL[:CC<cc>]:FRAME<fr>:BWPpart<bwp>:PRS:NPID.....	360
CONFigure[:NR5G]:DL[:CC<cc>]:FRAME<fr>:BWPpart<bwp>:PRS:POWer.....	361
CONFigure[:NR5G]:DL[:CC<cc>]:FRAME<fr>:BWPpart<bwp>:PRS:SLOT:APERiodic.....	361
CONFigure[:NR5G]:DL[:CC<cc>]:FRAME<fr>:BWPpart<bwp>:PRS:SRB.....	361
CONFigure[:NR5G]:DL[:CC<cc>]:FRAME<fr>:BWPpart<bwp>:PRS:STATe.....	362
CONFigure[:NR5G]:DL[:CC<cc>]:FRAME<fr>:BWPpart<bwp>:RBCount.....	340
CONFigure[:NR5G]:DL[:CC<cc>]:FRAME<fr>:BWPpart<bwp>:RBOffset.....	341
CONFigure[:NR5G]:DL[:CC<cc>]:FRAME<fr>:BWPpart<bwp>:REMove.....	341
CONFigure[:NR5G]:DL[:CC<cc>]:FRAME<fr>:BWPpart<bwp>:SCOunt?.....	343
CONFigure[:NR5G]:DL[:CC<cc>]:FRAME<fr>:BWPpart<bwp>:SLOT<sl>:ALCount.....	369
CONFigure[:NR5G]:DL[:CC<cc>]:FRAME<fr>:BWPpart<bwp>:SLOT<sl>:ALLocation<al>:CCODing:IMCS.406	
CONFigure[:NR5G]:DL[:CC<cc>]:FRAME<fr>:BWPpart<bwp>:SLOT<sl>:ALLocation<al>:CCODing: MCSTable.....	407
CONFigure[:NR5G]:DL[:CC<cc>]:FRAME<fr>:BWPpart<bwp>:SLOT<sl>:ALLocation<al>:CCODing: RVINdex.....	407
CONFigure[:NR5G]:DL[:CC<cc>]:FRAME<fr>:BWPpart<bwp>:SLOT<sl>:ALLocation<al>:CCODing: TBSFs.....	408
CONFigure[:NR5G]:DL[:CC<cc>]:FRAME<fr>:BWPpart<bwp>:SLOT<sl>:ALLocation<al>:CCODing: TBSize.....	408
CONFigure[:NR5G]:DL[:CC<cc>]:FRAME<fr>:BWPpart<bwp>:SLOT<sl>:ALLocation<al>:CLMapping.....	394
CONFigure[:NR5G]:DL[:CC<cc>]:FRAME<fr>:BWPpart<bwp>:SLOT<sl>:ALLocation<al>:COPY.....	371
CONFigure[:NR5G]:DL[:CC<cc>]:FRAME<fr>:BWPpart<bwp>:SLOT<sl>:ALLocation<al>:COPY:DURation370	
CONFigure[:NR5G]:DL[:CC<cc>]:FRAME<fr>:BWPpart<bwp>:SLOT<sl>:ALLocation<al>:COPY:MODE.....	370
CONFigure[:NR5G]:DL[:CC<cc>]:FRAME<fr>:BWPpart<bwp>:SLOT<sl>:ALLocation<al>:COPY:PERiod...372	
CONFigure[:NR5G]:DL[:CC<cc>]:FRAME<fr>:BWPpart<bwp>:SLOT<sl>:ALLocation<al>:COPY:SLOT.....	372
CONFigure[:NR5G]:DL[:CC<cc>]:FRAME<fr>:BWPpart<bwp>:SLOT<sl>:ALLocation<al>:DMRS:AP.....	394
CONFigure[:NR5G]:DL[:CC<cc>]:FRAME<fr>:BWPpart<bwp>:SLOT<sl>:ALLocation<al>:DMRS:CGWD...395	
CONFigure[:NR5G]:DL[:CC<cc>]:FRAME<fr>:BWPpart<bwp>:SLOT<sl>:ALLocation<al>:DMRS:CTYPe...395	
CONFigure[:NR5G]:DL[:CC<cc>]:FRAME<fr>:BWPpart<bwp>:SLOT<sl>:ALLocation<al>:DMRS: MSYMBOL:APOsition.....	396
CONFigure[:NR5G]:DL[:CC<cc>]:FRAME<fr>:BWPpart<bwp>:SLOT<sl>:ALLocation<al>:DMRS: MSYMBOL:LENGth.....	396
CONFigure[:NR5G]:DL[:CC<cc>]:FRAME<fr>:BWPpart<bwp>:SLOT<sl>:ALLocation<al>:DMRS:MTYPe...397	
CONFigure[:NR5G]:DL[:CC<cc>]:FRAME<fr>:BWPpart<bwp>:SLOT<sl>:ALLocation<al>:DMRS:NSCid...397	
CONFigure[:NR5G]:DL[:CC<cc>]:FRAME<fr>:BWPpart<bwp>:SLOT<sl>:ALLocation<al>:DMRS:POWer...398	
CONFigure[:NR5G]:DL[:CC<cc>]:FRAME<fr>:BWPpart<bwp>:SLOT<sl>:ALLocation<al>:DMRS:RST.....	398
CONFigure[:NR5G]:DL[:CC<cc>]:FRAME<fr>:BWPpart<bwp>:SLOT<sl>:ALLocation<al>:DMRS: SGENeration.....	399
CONFigure[:NR5G]:DL[:CC<cc>]:FRAME<fr>:BWPpart<bwp>:SLOT<sl>:ALLocation<al>:DMRS:SID.....	399
CONFigure[:NR5G]:DL[:CC<cc>]:FRAME<fr>:BWPpart<bwp>:SLOT<sl>:ALLocation<al>:DMRS:SIONe...400	
CONFigure[:NR5G]:DL[:CC<cc>]:FRAME<fr>:BWPpart<bwp>:SLOT<sl>:ALLocation<al>:DMRS:TAPos...400	
CONFigure[:NR5G]:DL[:CC<cc>]:FRAME<fr>:BWPpart<bwp>:SLOT<sl>:ALLocation<al>:POWer.....	373
CONFigure[:NR5G]:DL[:CC<cc>]:FRAME<fr>:BWPpart<bwp>:SLOT<sl>:ALLocation<al>:PTRS:K.....	403
CONFigure[:NR5G]:DL[:CC<cc>]:FRAME<fr>:BWPpart<bwp>:SLOT<sl>:ALLocation<al>:PTRS:L.....	403
CONFigure[:NR5G]:DL[:CC<cc>]:FRAME<fr>:BWPpart<bwp>:SLOT<sl>:ALLocation<al>:PTRS:POWer...404	
CONFigure[:NR5G]:DL[:CC<cc>]:FRAME<fr>:BWPpart<bwp>:SLOT<sl>:ALLocation<al>:PTRS:REOOffset404	
CONFigure[:NR5G]:DL[:CC<cc>]:FRAME<fr>:BWPpart<bwp>:SLOT<sl>:ALLocation<al>:PTRS[:STATe]...405	
CONFigure[:NR5G]:DL[:CC<cc>]:FRAME<fr>:BWPpart<bwp>:SLOT<sl>:ALLocation<al>:RBCount.....	374
CONFigure[:NR5G]:DL[:CC<cc>]:FRAME<fr>:BWPpart<bwp>:SLOT<sl>:ALLocation<al>:RBOffset.....	374
CONFigure[:NR5G]:DL[:CC<cc>]:FRAME<fr>:BWPpart<bwp>:SLOT<sl>:ALLocation<al>:RPOint.....	401

CONFigure[:NR5G]:DL[:CC<cc>]:FRAMe<fr>:BWPart<bwp>:SLOT<sl>:ALLocation<al>:SCOunt.....	375
CONFigure[:NR5G]:DL[:CC<cc>]:FRAMe<fr>:BWPart<bwp>:SLOT<sl>:ALLocation<al>:SCRambling.....	409
CONFigure[:NR5G]:DL[:CC<cc>]:FRAMe<fr>:BWPart<bwp>:SLOT<sl>:ALLocation<al>: SCRambling:DSID.....	409
CONFigure[:NR5G]:DL[:CC<cc>]:FRAMe<fr>:BWPart<bwp>:SLOT<sl>:ALLocation<al>:SOFFset.....	375
CONFigure[:NR5G]:DL[:CC<cc>]:FRAMe<fr>:BWPart<bwp>:SLOT<sl>:ALLocation<al>:UEID.....	401
CONFigure[:NR5G]:DL[:CC<cc>]:FRAMe<fr>:BWPart<bwp>:SLOT<sl>:ALLocation<al>:VTPinter.....	402
CONFigure[:NR5G]:DL[:CC<cc>]:FRAMe<fr>:BWPart<bwp>:SLOT<sl>:ALLocation<al>[: CW<cw>]:MODulation.....	373
CONFigure[:NR5G]:DL[:CC<cc>]:FRAMe<fr>:BWPart<bwp>:SLOT<sl>:ATYPE.....	343
CONFigure[:NR5G]:DL[:CC<cc>]:FRAMe<fr>:BWPart<bwp>:SLOT<sl>:COPY.....	344
CONFigure[:NR5G]:DL[:CC<cc>]:FRAMe<fr>:BWPart<bwp>:SLOT<sl>:COReset<cr>:COPY.....	364
CONFigure[:NR5G]:DL[:CC<cc>]:FRAMe<fr>:BWPart<bwp>:SLOT<sl>:COReset<cr>:COPY:DURation..	363
CONFigure[:NR5G]:DL[:CC<cc>]:FRAMe<fr>:BWPart<bwp>:SLOT<sl>:COReset<cr>:COPY:MODE.....	363
CONFigure[:NR5G]:DL[:CC<cc>]:FRAMe<fr>:BWPart<bwp>:SLOT<sl>:COReset<cr>:COPY:PERiod.....	365
CONFigure[:NR5G]:DL[:CC<cc>]:FRAMe<fr>:BWPart<bwp>:SLOT<sl>:COReset<cr>:COPY:SLOT.....	365
CONFigure[:NR5G]:DL[:CC<cc>]:FRAMe<fr>:BWPart<bwp>:SLOT<sl>:COReset<cr>:DMRS:POWer.....	377
CONFigure[:NR5G]:DL[:CC<cc>]:FRAMe<fr>:BWPart<bwp>:SLOT<sl>:COReset<cr>:DMRS:RPOint.....	378
CONFigure[:NR5G]:DL[:CC<cc>]:FRAMe<fr>:BWPart<bwp>:SLOT<sl>:COReset<cr>:DMRS: SCRam[:STATe].....	379
CONFigure[:NR5G]:DL[:CC<cc>]:FRAMe<fr>:BWPart<bwp>:SLOT<sl>:COReset<cr>:DMRS:SID.....	378
CONFigure[:NR5G]:DL[:CC<cc>]:FRAMe<fr>:BWPart<bwp>:SLOT<sl>:COReset<cr>: INTerleaving:BSIZe.....	379
CONFigure[:NR5G]:DL[:CC<cc>]:FRAMe<fr>:BWPart<bwp>:SLOT<sl>:COReset<cr>:INTerleaving:ISIZe380	
CONFigure[:NR5G]:DL[:CC<cc>]:FRAMe<fr>:BWPart<bwp>:SLOT<sl>:COReset<cr>: INTerleaving:NSHift.....	380
CONFigure[:NR5G]:DL[:CC<cc>]:FRAMe<fr>:BWPart<bwp>:SLOT<sl>:COReset<cr>: INTerleaving:SINDEX.....	381
CONFigure[:NR5G]:DL[:CC<cc>]:FRAMe<fr>:BWPart<bwp>:SLOT<sl>:COReset<cr>: INTerleaving:STATe.....	382
CONFigure[:NR5G]:DL[:CC<cc>]:FRAMe<fr>:BWPart<bwp>:SLOT<sl>:COReset<cr>:PDCCh<cf>: ALEVel.....	382
CONFigure[:NR5G]:DL[:CC<cc>]:FRAMe<fr>:BWPart<bwp>:SLOT<sl>:COReset<cr>:PDCCh<cf>: CCEindex.....	382
CONFigure[:NR5G]:DL[:CC<cc>]:FRAMe<fr>:BWPart<bwp>:SLOT<sl>:COReset<cr>:PDCCh<cf>: DCIFormat.....	383
CONFigure[:NR5G]:DL[:CC<cc>]:FRAMe<fr>:BWPart<bwp>:SLOT<sl>:COReset<cr>:PDCCh<cf>: DCISettings:FDRAssign.....	384
CONFigure[:NR5G]:DL[:CC<cc>]:FRAMe<fr>:BWPart<bwp>:SLOT<sl>:COReset<cr>:PDCCh<cf>: DCISettings:ITEM.....	384
CONFigure[:NR5G]:DL[:CC<cc>]:FRAMe<fr>:BWPart<bwp>:SLOT<sl>:COReset<cr>:PDCCh<cf>: DCISettings:LIST?.....	388
CONFigure[:NR5G]:DL[:CC<cc>]:FRAMe<fr>:BWPart<bwp>:SLOT<sl>:COReset<cr>:PDCCh<cf>: DCISettings:NOBLock.....	388
CONFigure[:NR5G]:DL[:CC<cc>]:FRAMe<fr>:BWPart<bwp>:SLOT<sl>:COReset<cr>:PDCCh<cf>: DCISettings:SCOPE.....	389
CONFigure[:NR5G]:DL[:CC<cc>]:FRAMe<fr>:BWPart<bwp>:SLOT<sl>:COReset<cr>:PDCCh<cf>: DCISettings:TPCCCommand.....	390
CONFigure[:NR5G]:DL[:CC<cc>]:FRAMe<fr>:BWPart<bwp>:SLOT<sl>:COReset<cr>:PDCCh<cf>: PLENgtH.....	390

CONFigure[:NR5G]:DL[:CC<cc>]:FRAMe<fr>:BWPart<bwp>:SLOT<sl>:COReset<cr>:PDCCh<cf>:RNTI	391
CONFigure[:NR5G]:DL[:CC<cc>]:FRAMe<fr>:BWPart<bwp>:SLOT<sl>:COReset<cr>:PDCCh<cf>: USAGe.....	391
CONFigure[:NR5G]:DL[:CC<cc>]:FRAMe<fr>:BWPart<bwp>:SLOT<sl>:COReset<cr>:PDSCh:STATe.....	392
CONFigure[:NR5G]:DL[:CC<cc>]:FRAMe<fr>:BWPart<bwp>:SLOT<sl>:COReset<cr>:PGRanularity.....	392
CONFigure[:NR5G]:DL[:CC<cc>]:FRAMe<fr>:BWPart<bwp>:SLOT<sl>:COReset<cr>:POWer.....	366
CONFigure[:NR5G]:DL[:CC<cc>]:FRAMe<fr>:BWPart<bwp>:SLOT<sl>:COReset<cr>:RBCount.....	366
CONFigure[:NR5G]:DL[:CC<cc>]:FRAMe<fr>:BWPart<bwp>:SLOT<sl>:COReset<cr>:RBOFFset.....	367
CONFigure[:NR5G]:DL[:CC<cc>]:FRAMe<fr>:BWPart<bwp>:SLOT<sl>:COReset<cr>:SCOUnt.....	367
CONFigure[:NR5G]:DL[:CC<cc>]:FRAMe<fr>:BWPart<bwp>:SLOT<sl>:COReset<cr>:SOFFset.....	368
CONFigure[:NR5G]:DL[:CC<cc>]:FRAMe<fr>:BWPart<bwp>:SLOT<sl>:CRSCount.....	368
CONFigure[:NR5G]:DL[:CC<cc>]:FRAMe<fr>:BWPart<bwp>:SLOT<sl>:CUID.....	376
CONFigure[:NR5G]:DL[:CC<cc>]:FRAMe<fr>:BWPart<bwp>:SLOT<sl>:FORMat.....	344
CONFigure[:NR5G]:DL[:CC<cc>]:FRAMe<fr>:BWPart<bwp>:SLOT<sl>:PASTe:ALL.....	345
CONFigure[:NR5G]:DL[:CC<cc>]:FRAMe<fr>:BWPart<bwp>:SLOT<sl>:PASTe:TO.....	347
CONFigure[:NR5G]:DL[:CC<cc>]:FRAMe<fr>:BWPart<bwp>:SLOT<sl>:PASTe:TO:DURation.....	345
CONFigure[:NR5G]:DL[:CC<cc>]:FRAMe<fr>:BWPart<bwp>:SLOT<sl>:PASTe:TO:MODE.....	346
CONFigure[:NR5G]:DL[:CC<cc>]:FRAMe<fr>:BWPart<bwp>:SLOT<sl>:PASTe:TO:PERiod.....	347
CONFigure[:NR5G]:DL[:CC<cc>]:FRAMe<fr>:BWPart<bwp>:SLOT<sl>:PASTe:TO:SLOTs.....	348
CONFigure[:NR5G]:DL[:CC<cc>]:FRAMe<fr>:BWPart<bwp>:SLOT<sl>:PASTe[:SLOT].....	348
CONFigure[:NR5G]:DL[:CC<cc>]:FRAMe<fr>:BWPart<bwp>:SLOT<sl>:PRESet.....	349
CONFigure[:NR5G]:DL[:CC<cc>]:FRAMe<fr>:BWPart<bwp>:SSPacing.....	341
CONFigure[:NR5G]:DL[:CC<cc>]:FRAMe<fr>:BWPCount?.....	342
CONFigure[:NR5G]:DL[:CC<cc>]:FRAMe<fr>:COPY.....	331
CONFigure[:NR5G]:DL[:CC<cc>]:FRAMe<fr>:PASTe:ALL.....	331
CONFigure[:NR5G]:DL[:CC<cc>]:FRAMe<fr>:PASTe[:FRAMe].....	331
CONFigure[:NR5G]:DL[:CC<cc>]:FTConfig.....	332
CONFigure[:NR5G]:DL[:CC<cc>]:IDC.....	412
CONFigure[:NR5G]:DL[:CC<cc>]:LTE:CBW.....	419
CONFigure[:NR5G]:DL[:CC<cc>]:LTE:MBSFn:SUBFrame<sf>:STATe.....	419
CONFigure[:NR5G]:DL[:CC<cc>]:LTE:NAP.....	420
CONFigure[:NR5G]:DL[:CC<cc>]:LTE:POINta.....	420
CONFigure[:NR5G]:DL[:CC<cc>]:LTE:STATe.....	420
CONFigure[:NR5G]:DL[:CC<cc>]:LTE:VSHift.....	421
CONFigure[:NR5G]:DL[:CC<cc>]:PAMapping<cf>:CSIRs:AP<ap>.....	410
CONFigure[:NR5G]:DL[:CC<cc>]:PAMapping<cf>:PDSCh:AP<ap>.....	410
CONFigure[:NR5G]:DL[:CC<cc>]:PAMapping<cf>:STATe.....	411
CONFigure[:NR5G]:DL[:CC<cc>]:PLC:CID.....	323
CONFigure[:NR5G]:DL[:CC<cc>]:PLC:EIRP.....	460
CONFigure[:NR5G]:DL[:CC<cc>]:PLC:TRP.....	461
CONFigure[:NR5G]:DL[:CC<cc>]:RFUC:FZERo:FREQuency.....	413
CONFigure[:NR5G]:DL[:CC<cc>]:RFUC:FZERo:MODE.....	413
CONFigure[:NR5G]:DL[:CC<cc>]:RFUC:STATe.....	414
CONFigure[:NR5G]:DL[:CC<cc>]:RPA:AFREquency?.....	415
CONFigure[:NR5G]:DL[:CC<cc>]:RPA:KZERo:SCFE.....	416
CONFigure[:NR5G]:DL[:CC<cc>]:RPA:KZERo:SCFT.....	416
CONFigure[:NR5G]:DL[:CC<cc>]:RPA:KZERo:SCNS.....	416
CONFigure[:NR5G]:DL[:CC<cc>]:RPA:KZERo:SCOT.....	417
CONFigure[:NR5G]:DL[:CC<cc>]:RPA:KZERo:SCST.....	417
CONFigure[:NR5G]:DL[:CC<cc>]:RPA:KZERo:SCTT.....	418

CONFigure[:NR5G]:DL[:CC<cc>]:RPA:RTCF.....	418
CONFigure[:NR5G]:DL[:CC<cc>]:RPA:TBOffset?.....	418
CONFigure[:NR5G]:DL[:CC<cc>]:SSBLock<ssb>:ASOFFset.....	332
CONFigure[:NR5G]:DL[:CC<cc>]:SSBLock<ssb>:BSPeriod.....	333
CONFigure[:NR5G]:DL[:CC<cc>]:SSBLock<ssb>:DETection.....	321
CONFigure[:NR5G]:DL[:CC<cc>]:SSBLock<ssb>:HFOFFset.....	333
CONFigure[:NR5G]:DL[:CC<cc>]:SSBLock<ssb>:L.....	334
CONFigure[:NR5G]:DL[:CC<cc>]:SSBLock<ssb>:OFFSet.....	334
CONFigure[:NR5G]:DL[:CC<cc>]:SSBLock<ssb>:PATtern.....	335
CONFigure[:NR5G]:DL[:CC<cc>]:SSBLock<ssb>:PBCH:POWer.....	335
CONFigure[:NR5G]:DL[:CC<cc>]:SSBLock<ssb>:PDMRs:POWer.....	336
CONFigure[:NR5G]:DL[:CC<cc>]:SSBLock<ssb>:PSS:POWer.....	336
CONFigure[:NR5G]:DL[:CC<cc>]:SSBLock<ssb>:RTO.....	337
CONFigure[:NR5G]:DL[:CC<cc>]:SSBLock<ssb>:SSPacing.....	337
CONFigure[:NR5G]:DL[:CC<cc>]:SSBLock<ssb>:SSS:POWer.....	338
CONFigure[:NR5G]:DL[:CC<cc>]:SSBLock<ssb>[:STATe<ss>].....	338
CONFigure[:NR5G]:DL[:CC<cc>]:SSCA.....	414
CONFigure[:NR5G]:EVM.....	469
CONFigure[:NR5G]:FCOFFset.....	328
CONFigure[:NR5G]:FELC:STATe.....	414
CONFigure[:NR5G]:GMCFreq.....	328
CONFigure[:NR5G]:LDIRection.....	323
CONFigure[:NR5G]:MEASurement.....	314
CONFigure[:NR5G]:NCSPacing.....	328
CONFigure[:NR5G]:NOCC.....	329
CONFigure[:NR5G]:OBANd.....	322
CONFigure[:NR5G]:OMODE.....	329
CONFigure[:NR5G]:OOPower:NFRames.....	461
CONFigure[:NR5G]:ORAN:TCASe.....	414
CONFigure[:NR5G]:OREL.....	330
CONFigure[:NR5G]:SEM.....	470
DISPlay:FORMat.....	231
DISPlay[:WINDow<n>]:MTABLE.....	484
DISPlay[:WINDow<n>]:SIZE.....	231
DISPlay[:WINDow<n>]:TAB<tab>:SElect.....	232
DISPlay[:WINDow<n>]:TABLE:ITEM.....	486
DISPlay[:WINDow<n>]:TPOO:PERiod:SElect.....	461
DISPlay[:WINDow<n>][:SUBWindow<w>]:CCNumber.....	485
DISPlay[:WINDow<n>][:SUBWindow<w>]:COUPling.....	486
DISPlay[:WINDow<n>][:SUBWindow<w>]:FNUMber.....	485
DISPlay[:WINDow<n>][:SUBWindow<w>]:SElect.....	232
DISPlay[:WINDow<n>][:SUBWindow<w>]:TRACe<t>:Y[:SCALE]:AUTO.....	474
DISPlay[:WINDow<n>][:SUBWindow<w>]:TRACe<t>:Y[:SCALE]:MAXimum.....	474
DISPlay[:WINDow<n>][:SUBWindow<w>]:TRACe<t>:Y[:SCALE]:MINimum.....	475
DISPlay[:WINDow<n>][:SUBWindow<w>]:TRACe<t>:Y[:SCALE]:RLEVel.....	437
DISPlay[:WINDow<n>][:SUBWindow<w>]:TRACe<t>:Y[:SCALE]:RLEVel:OFFSet.....	438
DISPlay[:WINDow<n>][:SUBWindow<w>]:ZOOM:AREA.....	475
DISPlay[:WINDow<n>][:SUBWindow<w>]:ZOOM:MULTiple<zn>:AREA.....	476
DISPlay[:WINDow<n>][:SUBWindow<w>]:ZOOM:MULTiple<zn>[:STATe].....	478
DISPlay[:WINDow<n>][:SUBWindow<w>]:ZOOM[:STATe].....	478

FETCh:ALL:SUMMary:EVM:ALL?	248
FETCh:ALL:SUMMary:EVM:DS1K?	248
FETCh:ALL:SUMMary:EVM:DSQP?	249
FETCh:ALL:SUMMary:EVM:DSSF?	250
FETCh:ALL:SUMMary:EVM:DSST?	251
FETCh:ALL:SUMMary:EVM:DSTS?	251
FETCh:ALL:SUMMary:EVM:PCHannel?	252
FETCh:ALL:SUMMary:EVM:PEAK?	253
FETCh:ALL:SUMMary:EVM:PSIGnal?	253
FETCh:ALL:SUMMary:POWer?	256
FETCh:TAERror[CC<cc>]:AP<ap>:MAXimum?	271
FETCh:TAERror[CC<cc>]:AP<ap>:MINimum?	271
FETCh:TAERror[CC<cc>]:AP<ap>[:AVERage]?	271
FETCh[CC<cc>]:PLC:CID?	324
FETCh[CC<cc>][:ISRC<ant>]:SUMMary:CRESt[:AVERage]?	247
FETCh[CC<cc>][:ISRC<ant>][:FRAMe<fr>]:SUMMary:AAPFail?	261
FETCh[CC<cc>][:ISRC<ant>][:FRAMe<fr>]:SUMMary:ALL?	246
FETCh[CC<cc>][:ISRC<ant>][:FRAMe<fr>]:SUMMary:APFail?	262
FETCh[CC<cc>][:ISRC<ant>][:FRAMe<fr>]:SUMMary:ARPFail?	262
FETCh[CC<cc>][:ISRC<ant>][:FRAMe<fr>]:SUMMary:BLER:MAXimum?	247
FETCh[CC<cc>][:ISRC<ant>][:FRAMe<fr>]:SUMMary:BLER:MINimum?	247
FETCh[CC<cc>][:ISRC<ant>][:FRAMe<fr>]:SUMMary:BLER[:AVERage]?	247
FETCh[CC<cc>][:ISRC<ant>][:FRAMe<fr>]:SUMMary:CAPFail?	263
FETCh[CC<cc>][:ISRC<ant>][:FRAMe<fr>]:SUMMary:CFRequency?	263
FETCh[CC<cc>][:ISRC<ant>][:FRAMe<fr>]:SUMMary:CPFail?	264
FETCh[CC<cc>][:ISRC<ant>][:FRAMe<fr>]:SUMMary:CRPFail?	264
FETCh[CC<cc>][:ISRC<ant>][:FRAMe<fr>]:SUMMary:EAACcs?	265
FETCh[CC<cc>][:ISRC<ant>][:FRAMe<fr>]:SUMMary:EVM:DS1K:MAXimum?	248
FETCh[CC<cc>][:ISRC<ant>][:FRAMe<fr>]:SUMMary:EVM:DS1K:MINimum?	249
FETCh[CC<cc>][:ISRC<ant>][:FRAMe<fr>]:SUMMary:EVM:DS1K[:AVERage]?	249
FETCh[CC<cc>][:ISRC<ant>][:FRAMe<fr>]:SUMMary:EVM:DSQP:MAXimum?	249
FETCh[CC<cc>][:ISRC<ant>][:FRAMe<fr>]:SUMMary:EVM:DSQP:MINimum?	249
FETCh[CC<cc>][:ISRC<ant>][:FRAMe<fr>]:SUMMary:EVM:DSQP[:AVERage]?	249
FETCh[CC<cc>][:ISRC<ant>][:FRAMe<fr>]:SUMMary:EVM:DSSF:MAXimum?	250
FETCh[CC<cc>][:ISRC<ant>][:FRAMe<fr>]:SUMMary:EVM:DSSF:MINimum?	250
FETCh[CC<cc>][:ISRC<ant>][:FRAMe<fr>]:SUMMary:EVM:DSSF[:AVERage]?	250
FETCh[CC<cc>][:ISRC<ant>][:FRAMe<fr>]:SUMMary:EVM:DSST:MAXimum?	251
FETCh[CC<cc>][:ISRC<ant>][:FRAMe<fr>]:SUMMary:EVM:DSST:MINimum?	251
FETCh[CC<cc>][:ISRC<ant>][:FRAMe<fr>]:SUMMary:EVM:DSST[:AVERage]?	251
FETCh[CC<cc>][:ISRC<ant>][:FRAMe<fr>]:SUMMary:EVM:DSTS:MAXimum?	251
FETCh[CC<cc>][:ISRC<ant>][:FRAMe<fr>]:SUMMary:EVM:DSTS:MINimum?	251
FETCh[CC<cc>][:ISRC<ant>][:FRAMe<fr>]:SUMMary:EVM:DSTS[:AVERage]?	251
FETCh[CC<cc>][:ISRC<ant>][:FRAMe<fr>]:SUMMary:EVM:PCHannel:MAXimum?	252
FETCh[CC<cc>][:ISRC<ant>][:FRAMe<fr>]:SUMMary:EVM:PCHannel:MINimum?	252
FETCh[CC<cc>][:ISRC<ant>][:FRAMe<fr>]:SUMMary:EVM:PCHannel[:AVERage]?	252
FETCh[CC<cc>][:ISRC<ant>][:FRAMe<fr>]:SUMMary:EVM:PEAK:MAXimum?	253
FETCh[CC<cc>][:ISRC<ant>][:FRAMe<fr>]:SUMMary:EVM:PEAK:MINimum?	253
FETCh[CC<cc>][:ISRC<ant>][:FRAMe<fr>]:SUMMary:EVM:PEAK[:AVERage]?	253
FETCh[CC<cc>][:ISRC<ant>][:FRAMe<fr>]:SUMMary:EVM:PSIGnal:MAXimum?	253
FETCh[CC<cc>][:ISRC<ant>][:FRAMe<fr>]:SUMMary:EVM:PSIGnal:MINimum?	253

FETCh[CC<cc>][:ISRC<ant>][:FRAMe<fr>]:SUMMary:EVM:PSIGnal[:AVERAge]?	253
FETCh[CC<cc>][:ISRC<ant>][:FRAMe<fr>]:SUMMary:EVM[:ALL]:MAXimum?	248
FETCh[CC<cc>][:ISRC<ant>][:FRAMe<fr>]:SUMMary:EVM[:ALL]:MINimum?	248
FETCh[CC<cc>][:ISRC<ant>][:FRAMe<fr>]:SUMMary:EVM[:ALL][:AVERAge]?	248
FETCh[CC<cc>][:ISRC<ant>][:FRAMe<fr>]:SUMMary:FERRor:MAXimum?	254
FETCh[CC<cc>][:ISRC<ant>][:FRAMe<fr>]:SUMMary:FERRor:MINimum?	254
FETCh[CC<cc>][:ISRC<ant>][:FRAMe<fr>]:SUMMary:FERRor[:AVERAge]?	254
FETCh[CC<cc>][:ISRC<ant>][:FRAMe<fr>]:SUMMary:FOFFset?	260
FETCh[CC<cc>][:ISRC<ant>][:FRAMe<fr>]:SUMMary:GIMBalance:MAXimum?	255
FETCh[CC<cc>][:ISRC<ant>][:FRAMe<fr>]:SUMMary:GIMBalance:MINimum?	255
FETCh[CC<cc>][:ISRC<ant>][:FRAMe<fr>]:SUMMary:GIMBalance[:AVERAge]?	255
FETCh[CC<cc>][:ISRC<ant>][:FRAMe<fr>]:SUMMary:IQOFset:MAXimum?	255
FETCh[CC<cc>][:ISRC<ant>][:FRAMe<fr>]:SUMMary:IQOFset:MINimum?	255
FETCh[CC<cc>][:ISRC<ant>][:FRAMe<fr>]:SUMMary:IQOFset[:AVERAge]?	255
FETCh[CC<cc>][:ISRC<ant>][:FRAMe<fr>]:SUMMary:MAPFail?	265
FETCh[CC<cc>][:ISRC<ant>][:FRAMe<fr>]:SUMMary:MCPPFail?	266
FETCh[CC<cc>][:ISRC<ant>][:FRAMe<fr>]:SUMMary:MRPFail?	267
FETCh[CC<cc>][:ISRC<ant>][:FRAMe<fr>]:SUMMary:MSPFail?	267
FETCh[CC<cc>][:ISRC<ant>][:FRAMe<fr>]:SUMMary:OSTP:MAXimum?	256
FETCh[CC<cc>][:ISRC<ant>][:FRAMe<fr>]:SUMMary:OSTP:MINimum?	256
FETCh[CC<cc>][:ISRC<ant>][:FRAMe<fr>]:SUMMary:OSTP[:AVERAge]?	256
FETCh[CC<cc>][:ISRC<ant>][:FRAMe<fr>]:SUMMary:OVLD?	268
FETCh[CC<cc>][:ISRC<ant>][:FRAMe<fr>]:SUMMary:PACCs?	268
FETCh[CC<cc>][:ISRC<ant>][:FRAMe<fr>]:SUMMary:POWer:MAXimum?	256
FETCh[CC<cc>][:ISRC<ant>][:FRAMe<fr>]:SUMMary:POWer:MINimum?	256
FETCh[CC<cc>][:ISRC<ant>][:FRAMe<fr>]:SUMMary:POWer[:AVERAge]?	256
FETCh[CC<cc>][:ISRC<ant>][:FRAMe<fr>]:SUMMary:QUADerror:MAXimum?	257
FETCh[CC<cc>][:ISRC<ant>][:FRAMe<fr>]:SUMMary:QUADerror:MINimum?	257
FETCh[CC<cc>][:ISRC<ant>][:FRAMe<fr>]:SUMMary:QUADerror[:AVERAge]?	257
FETCh[CC<cc>][:ISRC<ant>][:FRAMe<fr>]:SUMMary:RSRP:CSI:MAXimum?	258
FETCh[CC<cc>][:ISRC<ant>][:FRAMe<fr>]:SUMMary:RSRP:CSI:MINimum?	258
FETCh[CC<cc>][:ISRC<ant>][:FRAMe<fr>]:SUMMary:RSRP:CSI[:AVERAge]?	258
FETCh[CC<cc>][:ISRC<ant>][:FRAMe<fr>]:SUMMary:RSRP:SS:MAXimum?	258
FETCh[CC<cc>][:ISRC<ant>][:FRAMe<fr>]:SUMMary:RSRP:SS:MINimum?	258
FETCh[CC<cc>][:ISRC<ant>][:FRAMe<fr>]:SUMMary:RSRP:SS[:AVERAge]?	258
FETCh[CC<cc>][:ISRC<ant>][:FRAMe<fr>]:SUMMary:RSTP:MAXimum?	259
FETCh[CC<cc>][:ISRC<ant>][:FRAMe<fr>]:SUMMary:RSTP:MINimum?	259
FETCh[CC<cc>][:ISRC<ant>][:FRAMe<fr>]:SUMMary:RSTP[:AVERAge]?	259
FETCh[CC<cc>][:ISRC<ant>][:FRAMe<fr>]:SUMMary:SERRor:MAXimum?	259
FETCh[CC<cc>][:ISRC<ant>][:FRAMe<fr>]:SUMMary:SERRor:MINimum?	259
FETCh[CC<cc>][:ISRC<ant>][:FRAMe<fr>]:SUMMary:SERRor[:AVERAge]?	259
FETCh[CC<cc>][:ISRC<ant>][:FRAMe<fr>]:SUMMary:SPFail?	269
FETCh[CC<cc>][:ISRC<ant>][:FRAMe<fr>]:SUMMary:SSTate?	269
FETCh[CC<cc>][:ISRC<ant>][:FRAMe<fr>]:SUMMary:TPUT:MAXimum?	260
FETCh[CC<cc>][:ISRC<ant>][:FRAMe<fr>]:SUMMary:TPUT:MINimum?	260
FETCh[CC<cc>][:ISRC<ant>][:FRAMe<fr>]:SUMMary:TPUT[:AVERAge]?	260
FETCh[CC<cc>][:ISRC<ant>][:FRAMe<fr>]:SUMMary:TSDelta?	270
FETCh[CC<cc>][:ISRC<ant>][:FRAMe<fr>]:SUMMary:TSTamp?	270
FORMat:DEXPort:DSEPARATOR	472
FORMat:DEXPort:HEADer	473

FORMat:DEXPort:TRACes.....	473
FORMat[:DATA].....	311
INITiate:SEQuencer:ABORT.....	243
INITiate:SEQuencer:IMMediate.....	243
INITiate:SEQuencer:MODE.....	244
INITiate<n>:CONTinuous.....	242
INITiate<n>[:IMMediate].....	242
INPut:ATTenuation<ant>.....	438
INPut:ATTenuation<ant>:AUTO.....	439
INPut:CONNector.....	428
INPut:COUPling.....	439
INPut:DIQ:CDEvice.....	428
INPut:DIQ:RANGe:COUPling.....	429
INPut:DIQ:RANGe[:UPPer].....	429
INPut:DIQ:RANGe[:UPPer]:AUTO.....	429
INPut:DIQ:RANGe[:UPPer]:UNIT.....	430
INPut:DIQ:SRATe.....	430
INPut:DIQ:SRATe:AUTO.....	430
INPut:DPATH.....	430
INPut:EATT<ant>.....	440
INPut:EATT<ant>:AUTO.....	441
INPut:EATT<ant>:STATe.....	441
INPut:FILE:PATH.....	431
INPut:FILTer:HPASs[:STATe].....	432
INPut:FILTer:YIG[:STATe].....	432
INPut:GAIN:STATe.....	439
INPut:GAIN[:VALue].....	440
INPut:IMPedance.....	440
INPut:IQ:BALanced[:STATe].....	432
INPut:IQ:TYPE.....	433
INPut:SElect.....	433
INPut:TYPE.....	434
INSTrument:CREate:DUPLicate.....	227
INSTrument:CREate:REPLace.....	228
INSTrument:CREate[:NEW].....	227
INSTrument:DELeTe.....	228
INSTrument:LIST?.....	228
INSTrument:REName.....	230
INSTrument[:SElect].....	230
LAYout:ADD[:WINDow]?.....	233
LAYout:CATalog[:WINDow]?.....	235
LAYout:IDENtify[:WINDow]?.....	236
LAYout:REMove[:WINDow].....	236
LAYout:REPLace[:WINDow].....	237
LAYout:SPLitter.....	237
LAYout:WINDow<n>:ADD?.....	239
LAYout:WINDow<n>:IDENtify?.....	239
LAYout:WINDow<n>:REMove.....	240
LAYout:WINDow<n>:REPLace.....	240
LAYout:WINDow<n>:TYPE.....	241

MMEMory:LOAD:DEModsetting:ALL.....	324
MMEMory:LOAD:DEModsetting[:CC<cc>].....	325
MMEMory:LOAD:IQ:STATe:ALL.....	315
MMEMory:LOAD:IQ:STReam.....	434
MMEMory:LOAD:IQ:STReam:AUTO.....	434
MMEMory:LOAD:IQ:STReam:LIST?.....	435
MMEMory:LOAD:SETTings.....	470
MMEMory:LOAD:TMODeI[:CC<cc>].....	324
MMEMory:STORe<n>:DEModsetting:ALL.....	325
MMEMory:STORe<n>:DEModsetting[:CC<cc>].....	326
MMEMory:STORe<n>:IQ:STATe.....	316
MMEMory:STORe<n>:IQ:STATe:ALL.....	316
MMEMory:STORe<n>:IQNC:STATe.....	316
MMEMory:STORe<n>:MSERvice.....	317
MMEMory:STORe<n>:TRACe.....	473
OUTPut<up>:TRIGger<tp>:PULSe:IMMediate.....	470
STATus:QUEStionable:SYNC:CONDition?.....	499
STATus:QUEStionable:SYNC:ENABLe.....	499
STATus:QUEStionable:SYNC:NTRansition.....	499
STATus:QUEStionable:SYNC:PTRansition.....	499
STATus:QUEStionable:SYNC[:EVENT?].	498
SYSTem:PRESet:CHANnel[:EXEC].....	317
SYSTem:SEQuencer.....	244
TRACe:IQ:FILE:REPetition:COUNT.....	435
TRACe:IQ:SRATe?.....	445
TRACe<n>:CATalog?.....	311
TRACe<n>[:DATA]:X?.....	313
TRACe<n>[:DATA]?.....	312
TRIGger:TSHelper:EDELay.....	470
TRIGger:TSHelper:FTRigger.....	471
TRIGger:TSHelper:RINTerval.....	471
TRIGger:TSHelper:SEQuence.....	471
TRIGger[:SEQuence]:DTIME.....	445
TRIGger[:SEQuence]:HOLDoff<ant>[:TIME].....	446
TRIGger[:SEQuence]:IFPower:HOLDoff.....	446
TRIGger[:SEQuence]:IFPower:HYSTeresis.....	446
TRIGger[:SEQuence]:LEVel<ant>:IFPower.....	447
TRIGger[:SEQuence]:LEVel<ant>:IQPower.....	447
TRIGger[:SEQuence]:LEVel<ant>:RFPower.....	448
TRIGger[:SEQuence]:LEVel<ant>[:EXTernal<tp>].....	447
TRIGger[:SEQuence]:PORT<ant>.....	448
TRIGger[:SEQuence]:SLOPe.....	449
TRIGger[:SEQuence]:SOURce<ant>.....	449
UNIT:BSTR.....	489
UNIT:CAReference.....	489
UNIT:CAXes.....	490
UNIT:EVM.....	490
UNIT:OPOWer.....	462
UNIT:SAXes.....	490



# Index

## A

AC/DC coupling .....	155
ACLR .....	56
ACLR (Cumulative) .....	59
Adjust timing .....	54
Allocation	
Filter by .....	217
Allocation ID vs symbol x carrier .....	42
Allocation summary .....	38
Amplitude .....	152
Analog Baseband	
I/Q mode .....	148
Input .....	146
Application cards .....	11
Application notes .....	11
Attenuation .....	153
Auto level .....	152

## B

Beamforming summary .....	45
Bit stream .....	40
Bitstream format .....	209
Brochures .....	10

## C

Capture buffer .....	31
Capture time .....	156
Carrier	
Filter by .....	217
Carrier axis scale .....	209
CCDF .....	37
Center frequency .....	151
Channel	
Creating (remote) .....	228
Deleting (remote) .....	228
Duplicating (remote) .....	227
Querying (remote) .....	228
Renaming (remote) .....	230
Replacing (remote) .....	228
Channel decoder results .....	39
Closing	
Channels (remote) .....	228
Windows (remote) .....	240
Configuration overview .....	72
Constellation diagram .....	38
Configuration .....	217
Constellation selection .....	217
Conventions	
SCPI commands .....	222
Copying	
Channel (remote) .....	227
Cumulative ACLR .....	59

## D

Data capture .....	156
Data format	
Remote .....	473
Data sheets .....	10
DC offset	
Analog Baseband (B71, remote control) .....	428

Differential input	
Analog Baseband .....	149
Digital I/Q	
Input connection information .....	148
Digital input	
Connection information .....	148
Direct path	
Input configuration .....	145
Duplexing .....	78
Duplicating	
Channel (remote) .....	227

## E

Evaluation methods	
Remote .....	233
EVM calculation method .....	167
EVM unit .....	208
EVM vs Carrier .....	32
EVM vs RB .....	33
EVM vs symbol .....	32
EVM vs symbol x carrier .....	42
External Attenuation .....	153

## F

Files	
I/Q data input .....	202
Filters	
High-pass (RF input) .....	146
YIG (remote) .....	432
Flatness vs carrier .....	36
Format	
Data (remote) .....	473
Frequency	
Configuration .....	151
Frequency error vs subframe .....	35
Frequency error vs symbol .....	34
Frequency sweep .....	55
Full scale level	
Digital I/Q .....	147

## G

Getting started .....	9
-----------------------	---

## H

Hardware settings	
Displayed .....	16, 174
High-pass filter	
RF input .....	146

## I

I/Q data	
Input file .....	150
Input files .....	202
I/Q measurement .....	30
Impedance	
Setting .....	155
Input	
Coupling .....	155
I/Q data files .....	150

Input sample rate (ISR)	
Digital I/Q .....	147
Input sources	
Analog Baseband .....	148
Digital I/Q .....	147
I/Q data file .....	150
I/Q data files .....	202
Installation .....	15
Instrument security procedures .....	10
<b>L</b>	
Level configuration .....	152
Link direction .....	78
LO feedthrough .....	145
<b>M</b>	
Marker table	
Evaluation method .....	46
Markers	
Table (evaluation method) .....	46
Maximizing	
Windows (remote) .....	231
MC ACLR .....	57
Measurement .....	19
ACLR .....	56
alloc ID vs sym x carrier .....	42
allocation summary .....	38
Beamforming summary .....	45
bit stream .....	40
Capture buffer .....	31
CCDF .....	37
channel decoder results .....	39
constellation .....	38
Continuous .....	21
Cumulative ACLR .....	59
EVM vs carrier .....	32
EVM vs RB .....	33
EVM vs sym x carr .....	42
EVM vs symbol .....	32
flatness vs carrier .....	36
freq err vs subframe .....	35
freq err vs symbol .....	34
MC ACLR .....	57
on/off power .....	51
power spectrum .....	36
power vs sym x carr .....	42
Refresh .....	21
Result displays .....	21
Single .....	21
spectrum mask .....	61
Measurement time .....	156
Modulation	
Filter by .....	217
<b>N</b>	
Noise cancellation .....	54
<b>O</b>	
Offset	
Frequency .....	151
Reference level .....	152
On/off power .....	51
Options	
High-pass filter .....	146
Preamplifier .....	155
Overview .....	72
<b>P</b>	
PDSCH reference data .....	168
Peak list	
Evaluation method .....	62
Phase error .....	165
Physical signal description .....	77
Power spectrum .....	36
Power vs symbol x carrier .....	42
Preamplifier	
Setting .....	155
Softkey .....	155
Presetting	
Channels .....	73
<b>R</b>	
Reference level	
Digital I/Q .....	148
Reference Level .....	152
Release notes .....	10
Remote commands	
Basics on syntax .....	221
Boolean values .....	225
Capitalization .....	222
Character data .....	225
Data blocks .....	226
Numeric values .....	224
Optional keywords .....	223
Parameters .....	224
Strings .....	225
Suffixes .....	223
Restoring	
Channel settings .....	73
Result displays .....	21
Marker table .....	46
Peak list .....	62
Results	
Data format (remote) .....	473
RF measurement .....	55
<b>S</b>	
Safety instructions .....	10
Sample rate	
Digital I/Q .....	147
Security procedures .....	10
SEM position .....	173
Sequencer	
Activating (remote) .....	243
Remote .....	242
Sequences	
Aborting (remote) .....	243
Mode (remote) .....	244
Service manual .....	9
Settings	
Bitstream format .....	209
Capture time .....	156
Carrier axes .....	209
Constellation selection .....	217
EVM calculation method .....	167
EVM unit .....	208

Ext Att .....	153
Frequency .....	151
PDSCH reference data .....	168
Phase tracking .....	165
Ref Level .....	152
Slot selection .....	216
Standard .....	78
Subframe selection .....	215
Swap I/Q .....	157
Timing error .....	165
Signal capture .....	156
Signal description .....	77
Slope	
Trigger .....	449
Slot selection .....	216
Softkeys	
Preamp .....	155
Specifications .....	10
Specifics for	
Configuration .....	73
Spectrum mask .....	61
Standard selection .....	78
Step size .....	151
Subframe selection .....	215
Suffixes	
Common .....	220
Remote commands .....	223
Swap I/Q .....	157
Symbol	
Filter by .....	217

**T**

Time alignment error .....	47
Timing error .....	165
Tracking .....	163
Phase .....	165
Timing .....	165
Transmission path .....	78
Transmit on / off power .....	50
Trigger	
Slope .....	449
Trigger configuration .....	159
Trigger source .....	160

**V**

Videos .....	11
--------------	----

**W**

White papers .....	11
Window title bar information .....	17
Windows	
Adding (remote) .....	233
Closing (remote) .....	240
Configuring .....	73
Layout (remote) .....	237
Maximizing (remote) .....	231
Querying (remote) .....	235, 236
Replacing (remote) .....	237
Splitting (remote) .....	231
Types (remote) .....	233

**Y**

YIG-preselector	
Activating/Deactivating .....	146
Activating/Deactivating (remote) .....	432

**Z**

Zoom	
Capture buffer .....	31
Zooming	
Activating (remote) .....	478
Area (Multiple mode, remote) .....	476
Area (remote) .....	475
Multiple mode (remote) .....	478