

R&S® FPL1-K30

Noise Figure Measurements User Manual



1178340502
Version 09



This manual applies to the following R&S®FPL1000 models with firmware version 2.10 and later:

- R&S®FPL1003 (1304.0004K03) - FPL1000 with maximum frequency 3 GHz
- R&S®FPL1007 (1304.0004K07) - FPL1000 with maximum frequency 7.5 GHz
- R&S®FPL1014 (1304.0004K14) - FPL1000 with maximum frequency 14 GHz
- R&S®FPL1026 (1304.0004K26) - FPL1000 with maximum frequency 26.5 GHz

The following firmware options are described:

- R&S FPL1-K30 (1323.1760.02)

© 2023 Rohde & Schwarz GmbH & Co. KG
Muehldorfstr. 15, 81671 Muenchen, Germany
Phone: +49 89 41 29 - 0
Email: info@rohde-schwarz.com
Internet: www.rohde-schwarz.com

Subject to change – data without tolerance limits is not binding.

R&S® is a registered trademark of Rohde & Schwarz GmbH & Co. KG.

All other trademarks are the properties of their respective owners.

1178.3405.02 | Version 09 | R&S®FPL1-K30 | COMPANY RESTRICTED

Throughout this manual, products from Rohde & Schwarz are indicated without the ® symbol, e.g. R&S®FPL1000 is indicated as R&S FPL1000.

Contents

1	Preface	7
1.1	Documentation overview	7
1.1.1	Getting started manual.....	7
1.1.2	User manuals and help.....	7
1.1.3	Service manual.....	7
1.1.4	Instrument security procedures.....	8
1.1.5	Printed safety instructions.....	8
1.1.6	Data sheets and brochures.....	8
1.1.7	Release notes and open source acknowledgment (OSA).....	8
1.1.8	Application notes, application cards, white papers, etc.....	8
1.1.9	Video tutorials.....	8
1.1.10	Calibration certificate.....	9
1.2	Conventions used in the documentation	9
1.2.1	Typographical conventions.....	9
1.2.2	Conventions for procedure descriptions.....	9
1.2.3	Notes on screenshots.....	10
2	Welcome to the noise figure measurement application	11
2.1	Starting the noise application	11
2.2	Understanding the display information	12
3	Measurements and result displays	15
4	Measurement basics	24
4.1	Tuning modes	24
4.1.1	Swept measurements.....	25
4.1.2	Frequency table measurements.....	25
4.1.3	Single frequency measurements.....	26
4.2	Measurement modes	26
4.3	DUT types	28
4.3.1	Measurements on linear DUTs (direct measurement).....	28
4.3.2	Measurements on frequency converting DUTs.....	28
4.4	Image frequency rejection	29

4.5	Calibration (2nd stage correction).....	32
4.6	Using smart noise sources.....	35
4.7	Separating signals by selecting an appropriate resolution bandwidth.....	36
4.8	Analyzing several traces - trace mode.....	37
4.9	Using markers.....	37
5	Configuration.....	40
5.1	Configuration overview.....	40
5.2	Defining the measurement frequency.....	42
5.2.1	Defining a frequency set.....	42
5.2.2	Configuring single frequency measurements.....	45
5.2.3	Using a frequency table.....	46
5.3	Selecting DUT characteristics.....	49
5.4	Configuring the noise source.....	50
5.4.1	Defining the noise source characteristics.....	50
5.4.2	Using an ENR or temperature table.....	54
5.5	Configuring additional loss.....	58
5.5.1	Defining loss.....	58
5.5.2	Using a loss table.....	61
5.6	Configuring the analyzer.....	63
5.7	Using the uncertainty calculator.....	67
5.7.1	Configuring noise source characteristics.....	68
5.7.2	Configuring DUT characteristics.....	70
5.7.3	Configuring analyzer characteristics.....	71
5.7.4	Guidelines and results.....	72
5.8	Performing measurements.....	73
5.9	Configuring inputs and outputs of the R&S FPL1000.....	75
5.9.1	Impedance.....	75
6	Analysis.....	76
6.1	Configuring the display.....	76
6.1.1	Configuring graphical results.....	76
6.1.2	Configuring numerical results.....	78
6.2	Working with traces.....	79
6.3	Trace / data export configuration.....	81

6.4	Using markers.....	84
6.4.1	Marker configuration.....	84
6.4.2	Marker positioning.....	87
7	Remote control commands for noise figure measurements.....	90
7.1	Common suffixes.....	91
7.2	Introduction.....	91
7.2.1	Conventions used in descriptions.....	91
7.2.2	Long and short form.....	92
7.2.3	Numeric suffixes.....	92
7.2.4	Optional keywords.....	93
7.2.5	Alternative keywords.....	93
7.2.6	SCPI parameters.....	93
7.2.6.1	Numeric values.....	94
7.2.6.2	Boolean.....	95
7.2.6.3	Character data.....	95
7.2.6.4	Character strings.....	95
7.2.6.5	Block data.....	95
7.3	Controlling the noise figure measurement channel.....	96
7.4	Working with windows in the display.....	99
7.5	General window commands.....	107
7.6	Retrieving measurement results.....	107
7.7	Defining the measurement frequency.....	109
7.8	Selecting DUT characteristics.....	114
7.9	Configuring the noise source.....	115
7.10	Configuring additional loss.....	123
7.11	Configuring the analyzer.....	130
7.12	Using the uncertainty calculator.....	136
7.13	Performing measurements.....	146
7.14	Configuring the inputs and outputs.....	150
7.14.1	Impedance.....	150
7.15	Independant CW source commands.....	151
7.16	Configuring the display.....	152
7.17	Working with traces.....	156

7.18 Working with limit lines.....	161
7.18.1 Defining general characteristics of a limit line.....	162
7.18.2 Defining horizontal data points.....	163
7.18.3 Controlling lower limit lines.....	164
7.18.4 Controlling upper limit lines.....	165
7.18.5 Managing limit lines.....	166
7.18.6 Controlling limit checks.....	167
7.19 Working with markers.....	169
7.19.1 Using markers.....	170
7.19.2 Using delta markers.....	172
7.19.3 Configuring markers.....	175
7.19.4 Positioning markers.....	176
7.19.5 Positioning delta markers.....	178
7.20 Using the status register.....	180
7.20.1 Status registers for noise figure measurements.....	181
7.20.1.1 STATus:OPERation register.....	183
7.20.1.2 STATus:QUESTionable register.....	183
7.20.1.3 STATus:QUESTionable:LIMit register.....	184
7.20.1.4 STATus:QUESTionable:CORRection register.....	184
7.20.1.5 Status register remote commands.....	185
7.21 Deprecated remote commands for noise figure measurements.....	187
7.22 Programming example: measuring a noise figure.....	188
Annex.....	189
A Reference: frequency table file format.....	189
List of commands (Noise figure measurements).....	190
Index.....	195

1 Preface

This chapter provides safety-related information, an overview of the user documentation and the conventions used in the documentation.

1.1 Documentation overview

This section provides an overview of the R&S FPL1000 user documentation. Unless specified otherwise, you find the documents at:

www.rohde-schwarz.com/manual/FPL1000

1.1.1 Getting started manual

Introduces the R&S FPL1000 and describes how to set up and start working with the product. Includes basic operations, typical measurement examples, and general information, e.g. safety instructions, etc.

A printed version is delivered with the instrument. A PDF version is available for download on the Internet.

1.1.2 User manuals and help

Separate user manuals are provided for the base unit and the firmware applications:

- **Base unit manual**
Contains the description of all instrument modes and functions. It also provides an introduction to remote control, a complete description of the remote control commands with programming examples, and information on maintenance, instrument interfaces and error messages. Includes the contents of the getting started manual.
- **Firmware application manual**
Contains the description of the specific functions of a firmware application, including remote control commands. Basic information on operating the R&S FPL1000 is not included.

The contents of the user manuals are available as help in the R&S FPL1000. The help offers quick, context-sensitive access to the complete information for the base unit and the firmware applications.

All user manuals are also available for download or for immediate display on the Internet.

1.1.3 Service manual

Describes the performance test for checking compliance with rated specifications, firmware update, troubleshooting, adjustments, installing options and maintenance.

The service manual is available for registered users on the global Rohde & Schwarz information system (GLORIS):

<https://gloris.rohde-schwarz.com>

1.1.4 Instrument security procedures

Deals with security issues when working with the R&S FPL1000 in secure areas. It is available for download on the internet.

1.1.5 Printed safety instructions

Provides safety information in many languages. The printed document is delivered with the product.

1.1.6 Data sheets and brochures

The data sheet contains the technical specifications of the R&S FPL1000. It also lists the firmware applications and their order numbers, and optional accessories.

The brochure provides an overview of the instrument and deals with the specific characteristics.

See www.rohde-schwarz.com/brochure-datasheet/FPL1000

1.1.7 Release notes and open source acknowledgment (OSA)

The release notes list new features, improvements and known issues of the current firmware version, and describe the firmware installation.

The software makes use of several valuable open source software packages. An open source acknowledgment document provides verbatim license texts of the used open source software.

See www.rohde-schwarz.com/firmware/FPL1000

1.1.8 Application notes, application cards, white papers, etc.

These documents deal with special applications or background information on particular topics.

See www.rohde-schwarz.com/application/FPL1000

1.1.9 Video tutorials

Video tutorials that show you how to get started and perform basic tasks with the R&S FPL1000 are available on the Rohde & Schwarz internet site:

https://www.rohde-schwarz.com/manual/r-s-fpl1000-trying-out-basic-measurement-tasks-manuals_78701-567115.html

1.1.10 Calibration certificate

The document is available on <https://gloris.rohde-schwarz.com/calcert>. You need the device ID of your instrument, which you can find on a label on the rear panel.

1.2 Conventions used in the documentation

1.2.1 Typographical conventions

The following text markers are used throughout this documentation:

Convention	Description
"Graphical user interface elements"	All names of graphical user interface elements on the screen, such as dialog boxes, menus, options, buttons, and softkeys are enclosed by quotation marks.
[Keys]	Key and knob names are enclosed by square brackets.
Filenames, commands, program code	Filenames, commands, coding samples and screen output are distinguished by their font.
<i>Input</i>	Input to be entered by the user is displayed in italics.
Links	Links that you can click are displayed in blue font.
"References"	References to other parts of the documentation are enclosed by quotation marks.

1.2.2 Conventions for procedure descriptions

When operating the instrument, several alternative methods may be available to perform the same task. In this case, the procedure using the touchscreen is described. Any elements that can be activated by touching can also be clicked using an additionally connected mouse. The alternative procedure using the keys on the instrument or the on-screen keyboard is only described if it deviates from the standard operating procedures.

The term "select" may refer to any of the described methods, i.e. using a finger on the touchscreen, a mouse pointer in the display, or a key on the instrument or on a keyboard.

1.2.3 Notes on screenshots

When describing the functions of the product, we use sample screenshots. These screenshots are meant to illustrate as many as possible of the provided functions and possible interdependencies between parameters. The shown values may not represent realistic usage scenarios.

The screenshots usually show a fully equipped product, that is: with all options installed. Thus, some functions shown in the screenshots may not be available in your particular product configuration.

2 Welcome to the noise figure measurement application

The R&S FPL1-K30 is a firmware application that adds functionality to perform "noise figure" measurements to the R&S FPL1000.



Noise Source Control

The Noise Source Control connector on the R&S FPL1000 is a prerequisite for the R&S FPL1 Noise Figure measurements application.

This connector is part of the "Additional Interfaces" hardware option R&S FPL1-B5.

This user manual contains a description of the functionality that the application provides, including remote control operation.

Functions that are not discussed in this manual are the same as in the Spectrum application and are described in the R&S FPL1000 user manual.

The latest versions of the manuals are available for download at the product homepage.

www.rohde-schwarz.com/manual/FPL1000

Installation

Find detailed installing instructions in the getting started or the release notes of the R&S FPL1000.

- [Starting the noise application](#)..... 11
- [Understanding the display information](#)..... 12

2.1 Starting the noise application

The "noise figure" measurement application adds a new type of measurement to the R&S FPL1000.

To activate the R&S FPL1 Noise Figure measurements application

1. Select the [MODE] key.

A dialog box opens that contains all operating modes and applications currently available on your R&S FPL1000.

2. Select the "Noise Figure" item.

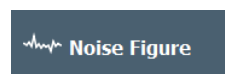

The R&S FPL1000 opens a new measurement channel for the "noise figure" measurement application.

All settings specific to "noise figure" measurements are in their default state.

Multiple Channel setups and Sequencer Function

When you activate an application, a new channel setup is created which determines the measurement settings for that application ("Channel"). The same application can be activated with different measurement settings by creating several "Channel"s for the same application.

The number of channel setups that can be configured at the same time depends on the available memory on the instrument.

Only one measurement can be performed at any time, namely the one in the currently active channel setup. However, to perform the configured measurements consecutively, a Sequencer function is provided.

If activated, the measurements configured in the currently defined "Channel"s are performed one after the other in the order of the tabs. The currently active measurement is indicated by a  symbol in the tab label.

The result displays of the individual channel setups are updated in the tabs (as well as the "MultiView") as the measurements are performed. Sequential operation itself is independent of the currently *displayed* tab.

For details on the Sequencer function, see the R&S FPL1000 user manual.

2.2 Understanding the display information

The following figure shows the display as it looks for "noise figure" measurements. All different information areas are labeled. They are explained in more detail in the following sections.



Figure 2-1: Screen layout of the noise figure measurement application

- 1 = Toolbar
- 2 = Channel setup bar
- 3 = Diagram header
- 4 = Result display
- 5 = Softkey bar
- 6 = Status bar

Channel setup bar information

In the R&S FPL1 Noise Figure measurements application, the R&S FPL1000 shows the following settings:

Ref Level	Reference level of the R&S FPL1000.
Att	Attenuation of the R&S FPL1000.
RBW	Resolution bandwidth
SWT	Sweep time
AVG	Number of averages
ENR	Excess noise ratio For smart noise sources: also the provided temperature
2nd Stage Corr	State of the 2nd stage correction.
Calibration Data	Date and time of the current calibration data.
Mode	Currently selected measurement mode.

Window title bar information

For each diagram, the header provides the following information:



Figure 2-2: Window title bar information for the R&S FPL1 Noise Figure measurements application

- 1 = Window number
- 2 = Window type
- 3 = Trace color and number
- 4 = Trace mode

Status bar information

Global instrument settings, the instrument status and any irregularities are indicated in the status bar beneath the diagram. Furthermore, the progress of the current operation is displayed in the status bar.

NOTICE

Risk of damaging the instrument

Make sure not to overload the input mixer during calibration and the measurement. An overload condition can damage or destroy the input mixer.

If an overload condition occurs, the R&S FPL1000 shows a corresponding message in the status line ("RF OVLD" or "IF OVLD").

To avoid an overload during calibration or measurement, do one or more of the following:

- Check and adjust the DUT "gain" settings
- Check and adjust the ENR settings
- Increase the reference level.

3 Measurements and result displays

The R&S FPL1-K30 measures the "noise figure" of a DUT and displays the results graphically and numerically. Each graphical result display shows the "noise figure" from a different perspective. In the default configuration, the application shows the "noise figure" of the DUT, the "gain" of the DUT and the corresponding "y-factor". In addition, it shows the numerical results of the measurement.

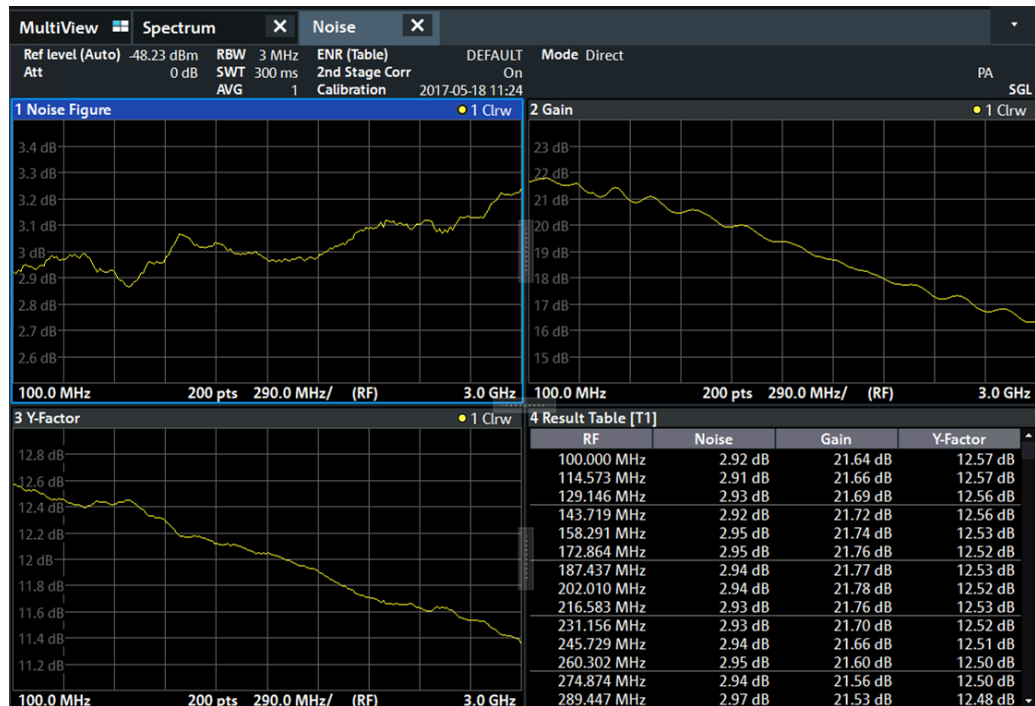

The scale of the horizontal axis depends on the tuning mode.

Frequency list and swept measurements

In all graphical result displays, the horizontal axis represents the frequency. The displayed frequency is either the RF (radio frequency) or the IF (intermediate frequency). The range depends on the frequency set you have currently defined. Because the application only measures selected frequencies, it connects the results to draw a trace.



Negative "noise figure" and "noise temperature"

From a physical point of view, the "noise figure" and the "noise temperature" levels have a positive range (including zero).

Due to the mathematical operations the application performs, the results can be negative. Sometimes this happens due to incorrect calibration or variance of measurement values.

Single frequency measurements

In all graphical result displays, the horizontal axis represents a chronological order of measurement results for the frequency you are testing. The axis has no unit, but is made up out of several index values that represent time. Each index value represents one measurement point and therefore one measurement on the single frequency you are analyzing. The size of the index (and thus number of results) depends on the number of **(Measurement) Points** that you have defined. Because the application only measures at certain points in time, it connects the results to draw a trace.

The right diagram border represents the present (index = 0), values to the left represent past measurement results (index = -<x>). As soon as the application finishes a single measurement, the measurement points are moved to the left, the new result is added on the right. All other measurement points are moved down one position with the most obsolete result falling out of the diagram (like in the roll mode of an oscilloscope).

Selecting the result display

- ▶ Select the  icon in the toolbar or press the [MEAS] key.

The application enters the SmartGrid configuration mode.

For more information on the SmartGrid functionality, see the R&S FPL1000 Getting Started.

Noise Figure.....	16
Gain.....	17
Noise Temperature.....	17
Y-Factor.....	18
ENR Measured.....	19
Power (Hot).....	20
Power (Cold).....	20
Cal Y-Factor.....	21
Cal Power (Hot).....	21
Cal Power (Cold).....	22
Result Table.....	22
Current Values.....	22
Marker Table.....	23

Noise Figure

Shows the "noise figure" of the DUT.

The "noise figure" is the ratio of the signal-to-noise ratio at the DUT input to the signal-to-noise ratio at the DUT output.

$$\text{Noise Figure} = \frac{SNR_{in}}{SNR_{out}}$$

The vertical axis shows the level of the "noise figure" in dB. The scale depends on the settings in the "Display Configuration" dialog box.

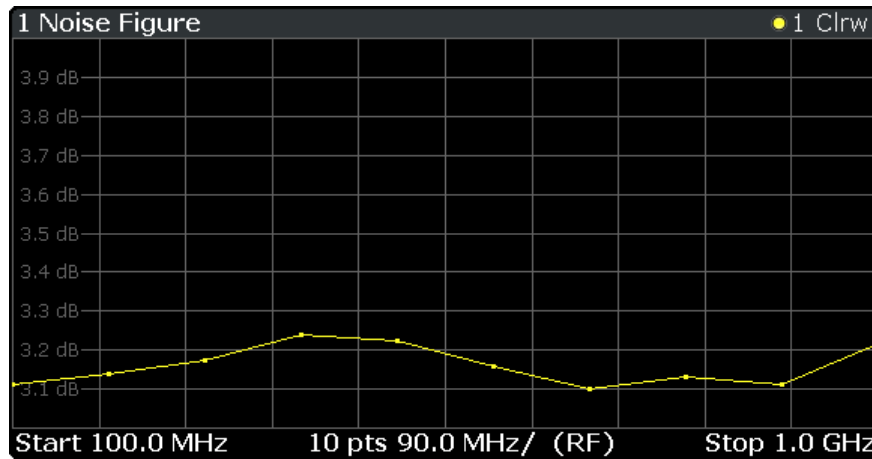

Remote command:

LAY:ADD:WIND? '2',RIGH,NOIS see [LAYout:ADD\[:WINDOW\]?](#) on page 100

Results:TRACe<t>[:DATA]? <Trace>,NOISe

Gain

Shows the "gain" characteristics of the DUT.

The vertical axis shows the level of the "gain" in dB. The scale depends on the settings in the "Display Configuration" dialog box.

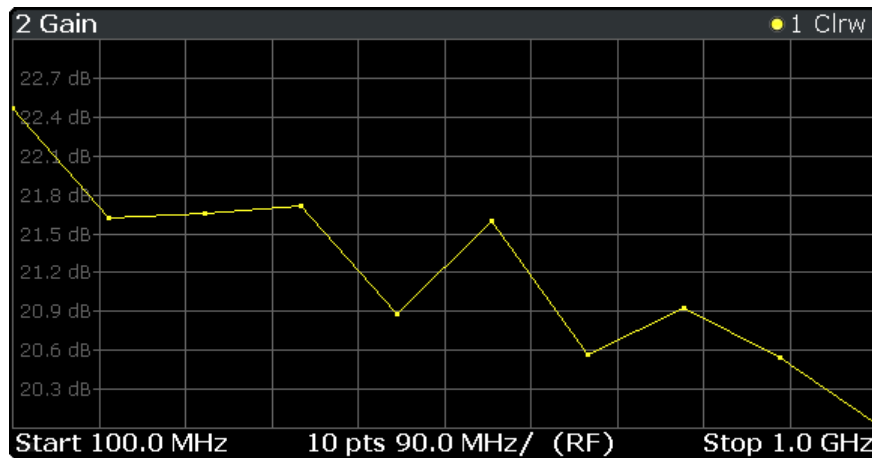

Remote command:

LAY:ADD:WIND? '2',RIGH,GAIN see [LAYout:ADD\[:WINDOW\]?](#) on page 100

Results:TRACe<t>[:DATA]? <Trace>,GAIN

Noise Temperature

Shows the "noise temperature" characteristics of the DUT.

$$\text{Noise Temperature} = \frac{P}{B \cdot k}$$

with

P = Power

B = Bandwidth

k = Boltzmann constant

The vertical axis shows the "noise temperature" in Kelvin. The scale depends on the settings in the "Display Configuration" dialog box.

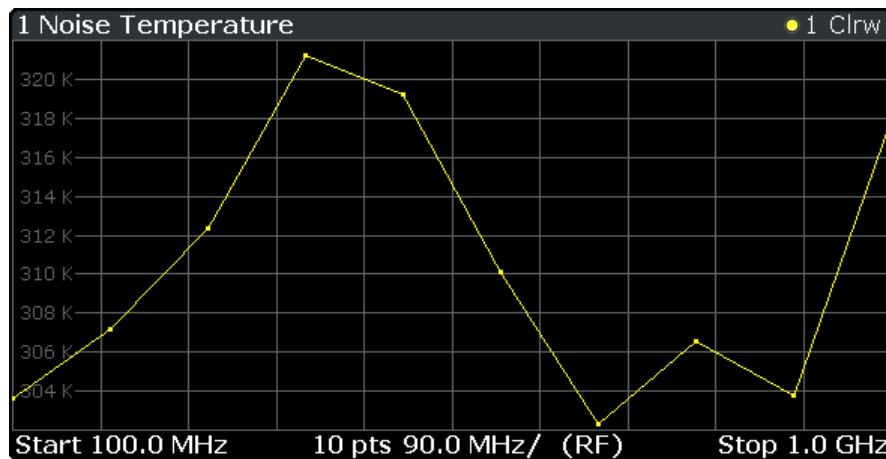

Remote command:

LAY:ADD:WIND? '2', RIGH, TEMP see [LAYout:ADD\[:WINDow\]?](#) on page 100

Results: [TRACe<t>\[:DATA\]? <Trace>, TEMPerature](#)

Y-Factor

Shows the ratio of the hot and the cold power of the DUT.

The "Y-factor" indicates the quality of measurement tolerances and uncertainties. To get the result, the application measures the DUT power with the noise source turned on (hot power) and the noise source turned off (cold power).

$$Y\text{-Factor} = \frac{N_{on}}{N_{off}}$$

with

N_{on} = Noise power [dB] with noise source on

N_{off} = Noise power [dB] with noise source off

The vertical axis shows the linear relation. The scale depends on the settings in the "Display Configuration" dialog box.

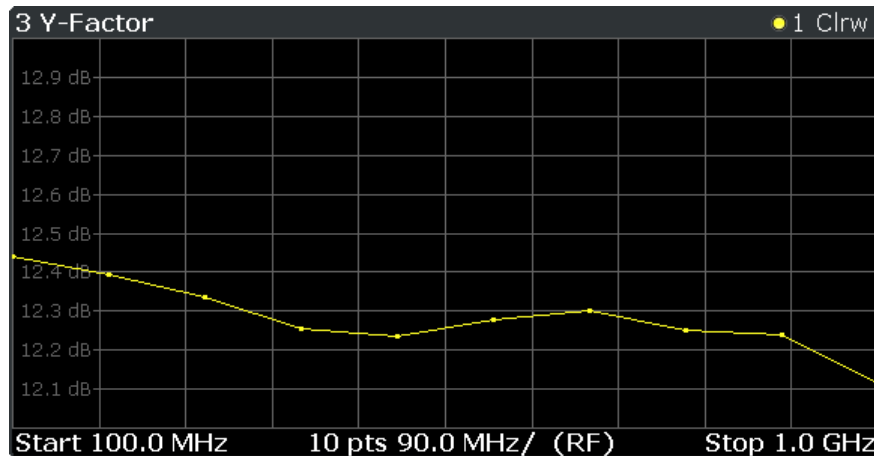

Remote command:

LAY:ADD:WIND? '2',RIGH,YFAC see [LAYout:ADD\[:WINDow\]?](#) on page 100

Results: [TRACe<t>\[:DATA\]? <Trace>,YFACTOR](#)

ENR Measured

Shows the results of the ENR measurement.

To measure the ENR of a noise source, first attach a noise source with known ENR to the device, enter the ENR of this noise source to the calibration ENR table and calibrate using this one. Then, attach the unknown noise source to the device and perform a measurement ("Run Single") with this one. The graph shown in the ENR Measured display and the results for ENR Measured in the Result Summary will be the ENR of the noise source at the measured frequencies. The vertical axis shows the level of the measured ENR in dB. The scale depends on the settings in the "Display Configuration" dialog box.

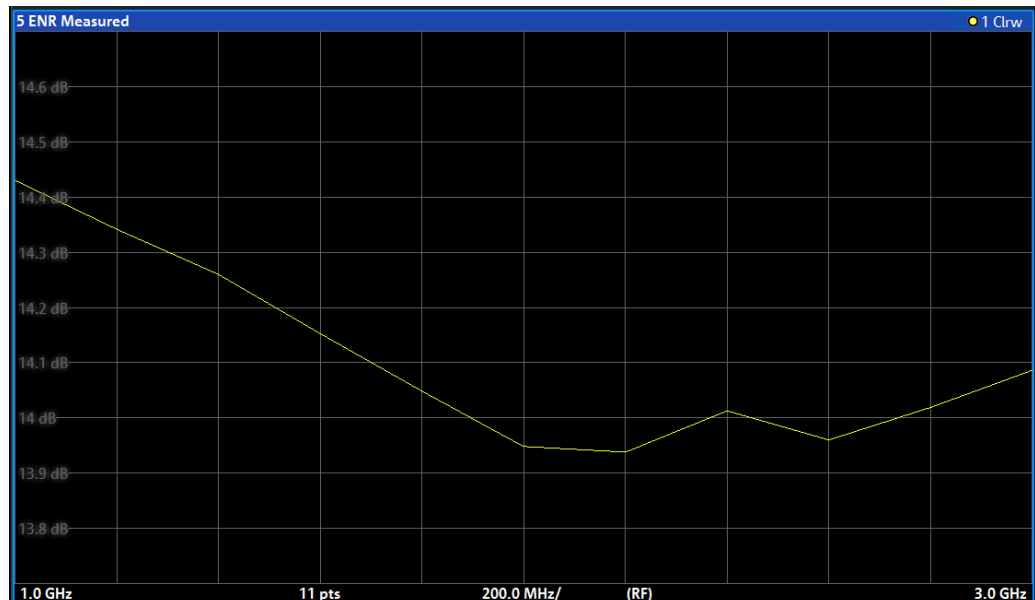

Remote command:

LAY:ADD:WIND? '2',RIGH,ENR see LAYout:ADD[:WINDow]? on page 100

Results: TRACe<t>[:DATA]? <Trace>,ENR

Power (Hot)

Shows the absolute power characteristics at the instrument input. The noise source is turned on.

The vertical axis shows the power in dBm. The scale depends on the settings in the "Display Configuration" dialog box.

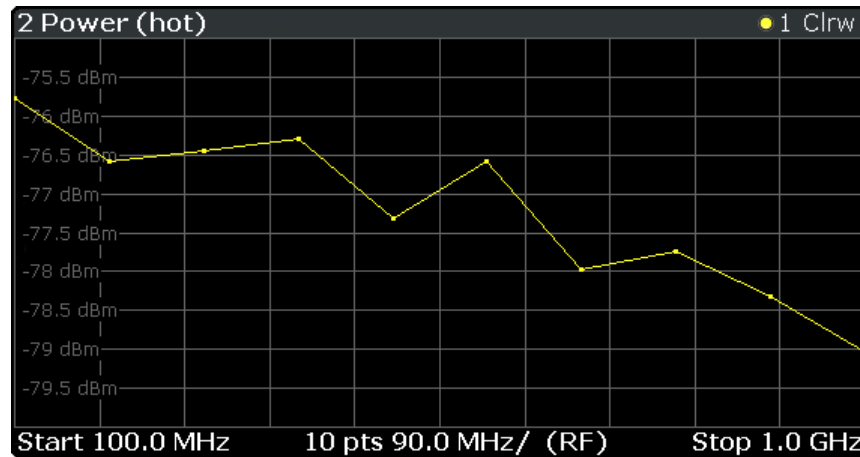

Remote command:

LAY:ADD:WIND? '2',RIGH,PHOT see LAYout:ADD[:WINDow]? on page 100

Results: TRACe<t>[:DATA]? <Trace>,PHOT

Power (Cold)

Shows the absolute power characteristics at the instrument input. The noise source is turned off.

The vertical axis shows the power in dBm. The scale depends on the settings in the "Display Configuration" dialog box.

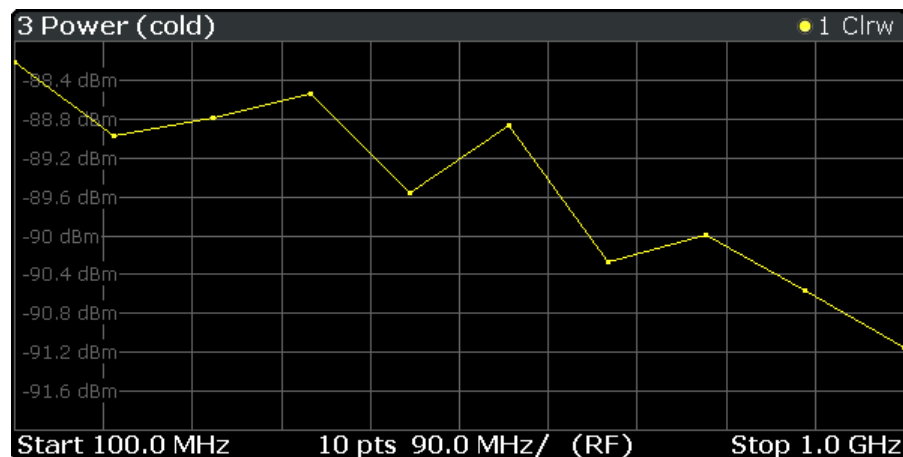

Remote command:

LAY:ADD:WIND? '2', RIGH, PCOL see LAYout:ADD[:WINDow] ? on page 100

Results: TRACe<t>[:DATA] ? <Trace>, PCOLd

Cal Y-Factor

Shows the ratio of the hot and the cold power measured during calibration.

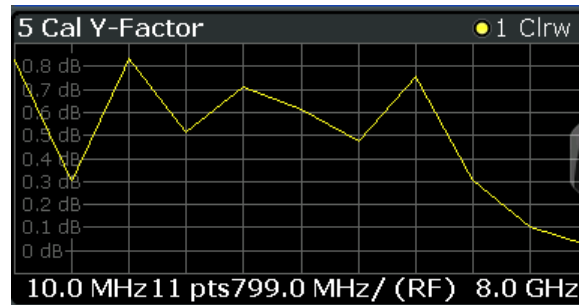

The "Y-factor" indicates the quality of measurement tolerances and uncertainties. To get the result, the application measures the power with the noise source turned on (hot power) and the noise source turned off (cold power), but without the DUT inserted.

$$Y\text{-Factor} = \frac{N_{on}}{N_{off}}$$

with

N_{on} = Noise power [dB] with noise source on

N_{off} = Noise power [dB] with noise source off

The vertical axis shows the linear relation. The scale depends on the settings in the "Display Configuration" dialog box.

Remote command:

LAY:ADD:WIND? '2', RIGH, CYF see LAYout:ADD[:WINDow] ? on page 100

Results: TRACe<t>[:DATA] ? <Trace>, CYFactor

Cal Power (Hot)

Shows the absolute power characteristics at the instrument input during the calibration measurement. The noise source is turned on, the DUT is not inserted.

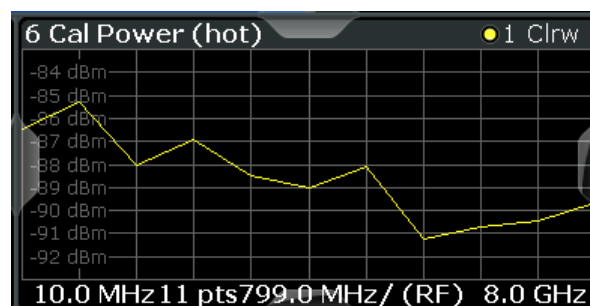

The vertical axis shows the power in dBm. The scale depends on the settings in the "Display Configuration" dialog box.

Remote command:

LAY:ADD:WIND? ' 2 ', RIGH, CPH see [LAYout:ADD\[:WINDow\]?](#) on page 100

Results: [TRACe<t>\[:DATA\]?](#) <Trace>, CPHot

Cal Power (Cold)

Shows the absolute power characteristics at the instrument input during the calibration measurement. The noise source is turned off, the DUT is not inserted.

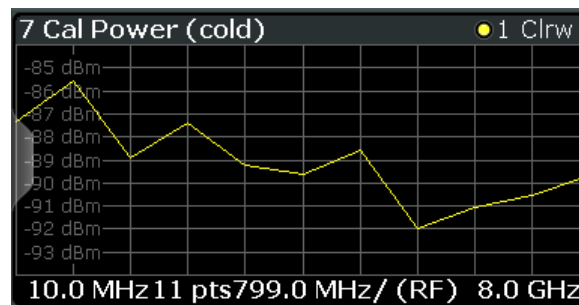

The vertical axis shows the power in dBm. The scale depends on the settings in the "Display Configuration" dialog box.

Remote command:

LAY:ADD:WIND? ' 2 ', RIGH, CPC see [LAYout:ADD\[:WINDow\]?](#) on page 100

Results: [TRACe<t>\[:DATA\]?](#) <Trace>, CPCold

Result Table

Shows the measurement results in numerical form in a table.

The contents of the table depend on the "Display Settings". By default it shows the "noise figure", "gain" and "y-factor" results. Each row represents one measurement point. Each column represents one result type. The first column shows the measurement frequency.

The result table shows either the RF or the IF, depending on your selection.

For more information, see [Chapter 6.1.2, "Configuring numerical results"](#), on page 78.

4 Result Table [T1]					
RF	Noise	Gain	Y-Factor	ENR	
1.000 GHz	0.02 dB	-0.02 dB	10.18 dB	14.43 dB	
1.200 GHz	-0.00 dB	-0.01 dB	9.96 dB	14.34 dB	
1.400 GHz	-0.03 dB	0.01 dB	9.67 dB	14.26 dB	
1.600 GHz	0.00 dB	0.01 dB	9.38 dB	14.15 dB	
1.800 GHz	-0.10 dB	-0.03 dB	9.31 dB	14.05 dB	
2.000 GHz	-0.02 dB	0.01 dB	9.03 dB	13.95 dB	
2.200 GHz	0.11 dB	0.01 dB	8.93 dB	13.94 dB	
2.400 GHz	-0.03 dB	0.03 dB	8.83 dB	14.01 dB	
2.600 GHz	0.11 dB	-0.02 dB	8.67 dB	13.96 dB	
2.800 GHz	0.02 dB	-0.00 dB	8.61 dB	14.02 dB	
3.000 GHz	-0.08 dB	0.02 dB	8.44 dB	14.09 dB	

Remote command:

LAY:ADD:WIND? ' 2 ', RIGH, RES see [LAYout:ADD\[:WINDow\]?](#) on page 100

Results: [TRACe<n>\[:DATA\]?](#) on page 107

Table items: [DISPlay\[:WINDow<n>\]:TABLE:ITEM](#) on page 152

Current Values

Shows the result at the current measurement point.

The contents of the "Current" result display are updated as soon as a new measurement point is analyzed.

The result types shown in the table depend on the "Display Settings". By default it shows the results for the "Noise Figure", "Gain" and "Y-Factor" result type. Each row represents one result type. The first column shows the result type, the second column shows the result.

For more information, see [Chapter 6.1.2, "Configuring numerical results"](#), on page 78.

Marker Table

Shows the marker characteristics in numerical form in a table.

The size of the table depends on the number of active markers and the way you have configured the table in the "Result Config" dialog box. For more information, see [Chapter 6.4, "Using markers"](#), on page 84 and [Chapter 6.1.2, "Configuring numerical results"](#), on page 78.

4 Marker Table					
Type	Ref	Trc	Stimulus	Noise	Gain
N1		1	400.00 MHz	3.24 dB	21.72 dB
D2	N1	1	100.00 MHz	-0.01 dB	-0.84 dB
D3	N1	1	200.00 MHz	-0.08 dB	-0.12 dB

The first four columns of the table are fix.

- Type
Shows the marker type. 'M' represents a normal marker, 'D' represents a delta marker.
- Ref
Shows the reference marker for relative delta markers.
- Trc
Shows the trace that the marker is positioned on.
- X-value
Shows the horizontal position (frequency) of the marker.
For normal markers, the position is an absolute value. The position of delta markers is relative to another marker.
- <Result>
Shows the measurement result at the marker position.
For normal markers, the result is an absolute value. Results for delta markers are relative to another marker.

Remote command:

LAY:ADD:WIND? '2', RIGH, MTAB see [LAYout:ADD\[:WINDow\]?](#) on page 100

Results:

[CALCulate<n>:MARKer<m>:Y?](#) on page 171

[CALCulate<n>:DELTamarker<m>:Y?](#) on page 174

4 Measurement basics

The measurement basics contain background information on the terminology and principles of "noise figure" measurements.

"Noise figure" measurements determine the noise that a device under test (DUT) adds to a signal as that signal passes through the DUT.

- [Tuning modes](#)..... 24
- [Measurement modes](#)..... 26
- [DUT types](#)..... 28
- [Image frequency rejection](#)..... 29
- [Calibration \(2nd stage correction\)](#)..... 32
- [Using smart noise sources](#)..... 35
- [Separating signals by selecting an appropriate resolution bandwidth](#)..... 36
- [Analyzing several traces - trace mode](#)..... 37
- [Using markers](#)..... 37

4.1 Tuning modes

Basically, the application calculates the "noise figure" of a DUT based on the characteristics of the DUT that have been measured and a noise source whose properties are known. Therefore, the Noise Source Control connector on the R&S FPL1000 is a prerequisite for the R&S FPL1 Noise Figure measurements application.

In addition to the noise characteristics of a DUT, the application is also able to determine several more DUT characteristics like its "gain" or its "noise temperature" characteristics.

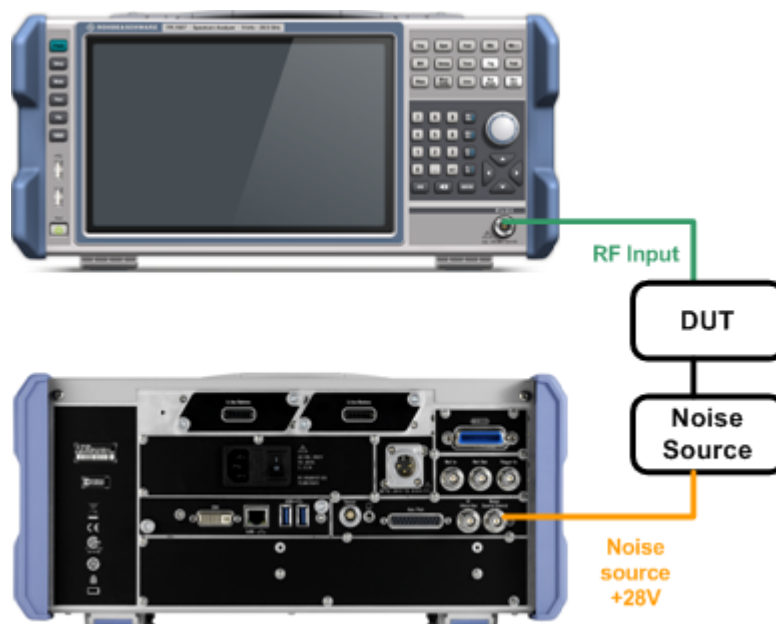

The application provides several measurement modes or **tuning modes**.

- [Swept measurements](#)..... 25
- [Frequency table measurements](#).....25
- [Single frequency measurements](#).....26

4.1.1 Swept measurements

The **sweep** tuning mode performs measurements on a set of discrete frequencies based on the frequency parameters. Each measurement analyzes the noise characteristics of the corresponding frequency or measurement point.

For swept measurements, the application automatically determines the measurement frequencies and combines them in a frequency list.

Such a frequency set is the result of the frequency and span information that you have provided. The frequency and span information is made up out of the center frequency, the span, the start and the stop frequency. In combination with the measurement points or the frequency table step size, the application calculates the contents of the frequency table.

The **center frequency** is the frequency in the center of the frequency band you are measuring. Thus, it is defined either by the span, or the start and stop frequencies.

The **measurement points** is the number of entries in a frequency list and thus the number of measurements that the application performs during a "noise figure" measurement.

The **stepsize** defines the distance between two measurement points. It is constant for all measurement points.



If the stepsize is larger than the distance between start and stop frequency, the frequency table consists of the start and stop frequencies only.

4.1.2 Frequency table measurements

The **frequency table** tuning mode also performs measurements on a set of frequencies based on the contents of a frequency list. Each measurement analyzes the noise characteristics of the corresponding frequency.

Compared to a swept measurement, you can customize the contents of the frequency list. Thus, you can add frequencies that are independent of the frequency stepsize and the number of measurement points.

Frequency tables also allow you to define a variable RBW and sweep time, depending on the current frequency of the sweep point (see "[Variable RBW and sweep time for low-frequency measurements](#)" on page 36 and [Chapter 5.2.3, "Using a frequency table"](#), on page 46).

4.1.3 Single frequency measurements

The **single frequency** tuning mode performs one or several consecutive measurements on a single frequency. You can perform the measurement on any frequency that is supported by the hardware you are using.

Single frequency measurements are a way to facilitate manual adjustments for "noise figure" measurements. They also allow you to get an idea about how the "noise figure" at a particular frequency change over time.

Note that sweep lists or frequency tables are not considered in this measurement mode.

Single frequency measurement results

For single frequency measurements, the same set of graphical result displays is available as for frequency list measurements ("Noise Figure", "Gain" etc.). Note, however, that the x-axis has no unit, but shows a series of results taken for a single frequency. The number of displayed results depends on the number of measurement points you have defined.

For more information, see [Chapter 3, "Measurements and result displays"](#), on page 15.

In addition, you can also view the results in the Result Table in numerical form.

Single frequency measurements are not available when you are using a resistor as a noise source.

4.2 Measurement modes

In some cases, the Power (Hot) and Power (Cold) results require two different noise sources with different temperature characteristics (cold and hot). Measurements with a resistor noise source are such a case.

Usually, noise sources with diode characteristics are used for "Noise Figure" measurements. These noise sources have two states, on and off. When they are supplied with power (state = on), the application measures the hot power, when they are not supplied with power (state = off), it measures the cold power. Turning the noise source on and off is automatically done by the application, so that you can get the hot and cold power characteristics in a single step.

This **automatic measurement mode** is the default measurement mode of the R&S FPL1 Noise Figure measurements application.

A resistor noise source, however, requires two resistors, one hot and one cold. You have to substitute the hot resistor by the cold resistor to measure first the hot and then the cold power. For these cases, the application provides a **manual measurement mode**. This measurement mode is automatically selected when you select a ["Noise Source"](#) on page 52 with resistor characteristics, but is not restricted to those cases.

The manual measurement mode is available for measurements and the calibration stage.

Performing a manual measurement

In manual measurement mode, you have to measure (or calibrate) the hot and cold power characteristics of the DUT separately. When you start the measurement, the application opens a dialog box that allows you to select the type of measurement to perform next.

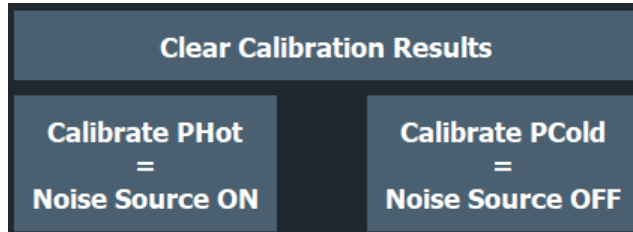

Recommended order of measurements

Note that it is recommended that you begin with the hot power measurement.

Furthermore, calibration always begins with the hot power measurement.

In case the hot power has to be measured first, the cold power measurement is unavailable:

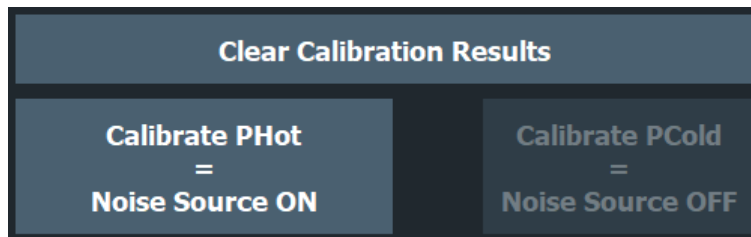

When the first measurement is done, you can change the test setup by connecting the other resistor. Then start the second measurement.

In the dialog box, the measurement stage that is already done is labeled green.

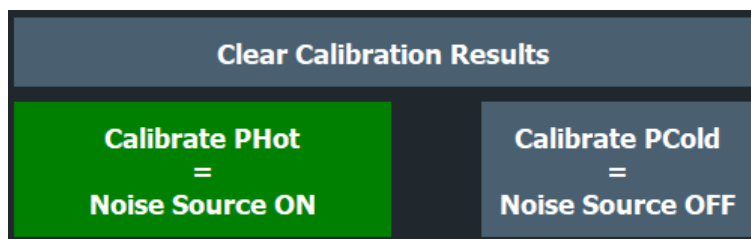

In addition, the application shows the missing calibration and measurement steps in the channel bar.

Noise		X	
ENR (THot, TCold)	296.50 K, 77.00 K	Mode	Direct
2nd Stage Corr	On (No Cal)		
Calibration	PCold required	Meas	PHot & PCold required

Clearing results

To replace the previous calibration or measurement results, clear the currently stored data using the "Clear Calibration Results" or "Clear Measurement Results" function.



Returning to automatic measurement mode

When you are in automatic measurement mode and select a noise source with resistor characteristics, the application automatically selects the manual measurement mode.

When you are in manual measurement mode and select a noise source with diode characteristics, you have to select the automatic measurement mode deliberately in the "Sweep" menu.

4.3 DUT types

"Noise figure" measurements are possible on DUTs with a wide variety of characteristics. The DUT characteristics not only affect the test setup, but also determine the way the application populates the frequency list for swept measurements.

The R&S FPL1 Noise Figure measurements application supports measurements on DUTs that work on a fixed frequency as well as measurements on frequency-converting DUTs.

- [Measurements on linear DUTs \(direct measurement\)](#).....28
- [Measurements on frequency converting DUTs](#)..... 28

4.3.1 Measurements on linear DUTs (direct measurement)

For a linear DUT, the RF frequency remains the same between its input and output. For measurements on such DUTs, it is sufficient to measure the signal's RF frequency without any additional equipment (like a local oscillator). A typical linear DUT is an amplifier, for example.

The test setup for measurements on such DUTs usually consists of the noise source, the DUT and an analyzer. If necessary, the measurement also considers loss that occurs somewhere in the measurement path.

For linear DUTs, the contents and layout of the "Overview" dialog box represents the configuration of a typical test setup.



4.3.2 Measurements on frequency converting DUTs

A frequency converting DUT converts the RF frequency to an intermediate frequency (IF) using the local oscillator (LO). A frequency-converting DUT either converts the RF frequency to a lower IF (down-conversion) or a higher IF (up-conversion).

If you have selected a frequency-converting DUT measurement mode, the layout of the "Overview" dialog box adds the local oscillator to the test setup.

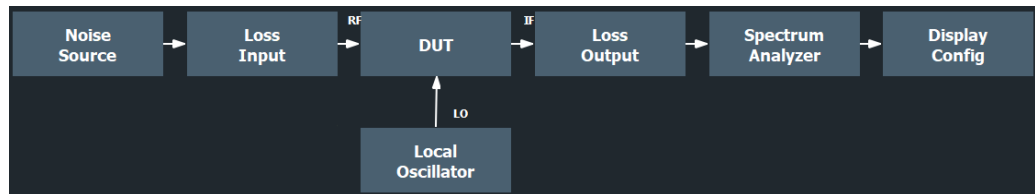

The local oscillator can have a fixed or a variable frequency. If the LO frequency is fixed, the intermediate frequency (IF) resulting from the conversion process is variable (depending on the input signal). If the LO frequency is variable, the IF has to be fixed.

The R&S FPL1 Noise Figure measurements application supports only the fixed LO frequency measurement method.

Fixed LO frequency

If you select one of the fixed LO measurement modes, the LO frequency is the same for all entries in the frequency list. The IF frequency for each entry is variable and is the result of the equation the selected mode is based on.

- $f_{RF} + f_{LO}$ for up-converters
- $f_{RF} - f_{LO}$ for down-converters

The fixed LO measurement modes are, for example, required for measurements on satellite converters.

4.4 Image frequency rejection

Frequency converting DUTs convert a radio frequency (RF) to an intermediate frequency (IF). The IF is lower than the RF for down-converting DUTs, and higher than the RF for up-converting DUTs.

In a basic test setup, the image frequency of the RF signal is also converted to the IF. Depending on the DUT, this effect can be wanted or even necessary, or not. To avoid measurement errors of the "noise figure" and "gain" of up to 3 dB, make sure to use the appropriate measurement configuration.

Basically, you can distinguish between single sideband (SSB) mixers, double sideband (DSB) mixers, and mixers that partly suppress a sideband. If a sideband is not needed or only partly needed, you can reject the image frequency. If you do so, the application activates a filter that suppresses the image frequency to a certain extent.

The following illustrations help you configure the measurement correctly.

For more information on how to configure image rejection, see ["Image Rejection"](#) on page 49.

Double sideband measurements

Double sideband mixers use both sidebands to the same extent. Both RF and image frequency are converted. In that case, turn off image rejection.

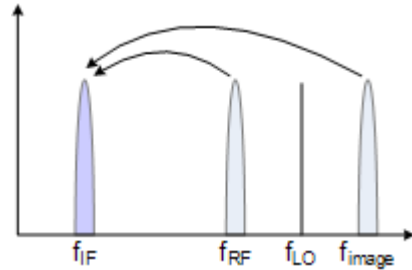

f_{LO} = frequency of the local oscillator
 f_{IF} = intermediate frequency = $f_{RF} \pm f_{LO}$
 f_{RF} = lower sideband = $f_{LO} - f_{IF}$
 f_{image} = upper sideband = $f_{LO} + f_{IF}$

If image rejection is on, the results have a 3 dB error. That means "noise figure" results are 3 dB lower than they should be. "Gain" results are 3 dB higher.

Single sideband measurements

Single sideband mixers use a single sideband only. In that case, you have to suppress the sideband that is not required. If you do so, the measurement is like on an amplifier.

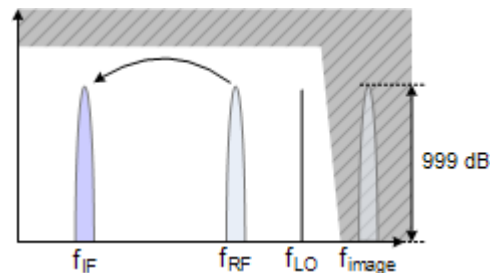

To suppress a sideband completely, it is best to set the image rejection to the maximum amount possible (999.99 dB).

Partial sideband suppression

For measurements on mixers with a low image frequency rejection, there are two test scenarios.

- Mixers whose image rejection is known.
- Mixers whose image rejection is unknown.

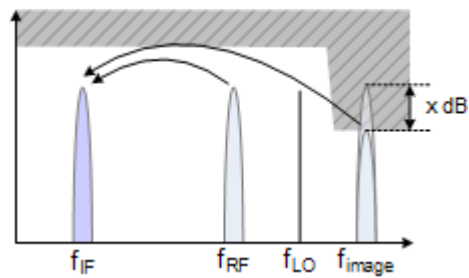

For mixers whose image rejection is known, define the magnitude of image rejection in dB as accurately as possible. Otherwise, measurement results ("noise figure" and "gain") deviate between 0 dB to 3 dB.

If you do not know the image rejection characteristics of a mixer, use a custom test setup including an additional filter. You also have to know the "gain" characteristics of the DUT.

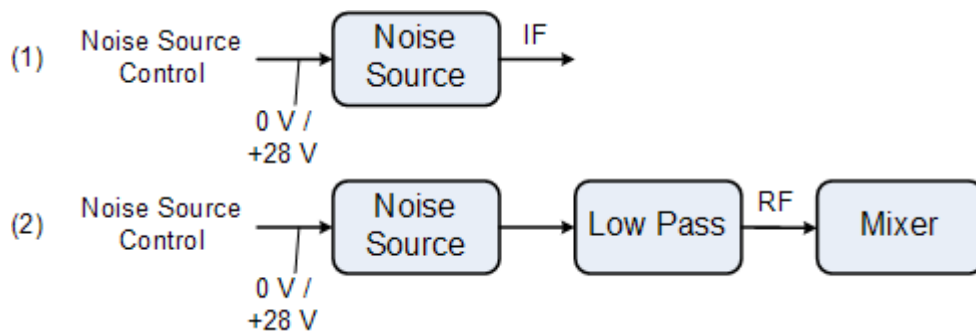

- (1) = Test setup for calibration
 (2) = Test setup for "noise figure" measurement

In the test setup shown above, a lowpass filter prevents unwanted noise from being fed in at the image frequency.

Depending on the position of the frequency bands, you might need a highpass or bandpass filter for the RF frequency instead of the lowpass filter. The important point is that unwanted noise is not converted by a further receive path of the mixer. The unwanted noise at the receive frequency must not be reduced. The insertion loss must be considered, if applicable.

With this test setup, the measurement on a mixer without sideband suppression is the same as SSB measurements.

To take the characteristics of the filter into account, include the insertion loss of the filter at the RF. To consider the actual filter suppression at the image frequency, include the actual attenuation for the image rejection.

Harmonics mixer measurement

For a harmonics mixer, the input signals are not only converted to the IF by the wanted harmonic. The harmonic of the LO signal produced in the mixer is also converted. Often, the mixer even features a lower conversion loss for unwanted harmonics. For measurements on this type of mixer, you have to use a bandpass filter. The filter ensures that there is only noise at the desired frequency at the input of the DUT. This

measurement is similar to measurements on a mixer with an average sideband suppression.

4.5 Calibration (2nd stage correction)

The calibration procedure of the application measures the inherent noise of the R&S FPL1000 you are using. Performing calibration is therefore recommended, as it increases the accuracy of measurement results. The results get more accurate because the application takes the inherent noise of the analyzer into account while it calculates the results.

Calibration for "noise figure" measurements is also known as 2nd stage correction. This term is used because in a typical "noise figure" test setup, the DUT represents the first stage and the analyzer the second stage in the test setup.



The 2nd stage correction is a calibration that is specific to "noise figure" measurements. It is independent of the overall calibration state of the analyzer and does not calibrate the analyzer.

For successful calibration, you need additional equipment.

- Noise source
The noise source is like a calibration standard. It provides a reference with known noise characteristics that allows the application to determine the inherent noise of the analyzer you are using.

During the calibration, the application measures the inherent noise characteristics of the analyzer at the set of measurement frequencies.

Thus, the 2nd stage correction is valid for a particular instrument configuration, the room temperature and the instrument temperature. As long as this configuration stays the same, calibration data remains valid.



Calibrating single frequency measurements

Like for all other measurements of the R&S FPL1 Noise Figure measurements application, perform a calibration before a single frequency measurement for increased accuracy.

There is an easy way to calibrate single frequency measurements, if you already calibrated the application for swept or list measurements. If the single frequency is part of the frequency list, the measurement is already calibrated for that frequency and no further steps are necessary. The application recalls the last calibration values when you switch back to sweep mode or frequency table mode.

Only if you use a single frequency that is not part of the frequency list, you must calibrate this frequency point first.

- Interpolation

If you change the frequency, while the frequency span stays the same or is reduced, the application interpolates the correction data for the new measurement points. A new calibration is not required.

However, measurements based on interpolated data can result in an increased measurement uncertainty. Highly accurate measurements that conform to the values specified in the data sheet are only possible at calibrated measurement points.

Note that useful interpolation is possible only if essential calibration parameters (e.g. impedance or attenuation) change only slightly. This is the case if the distance between the original calibration points is sufficiently small.

If the span increases compared to the span during calibration, a new calibration is necessary.

If the application interpolates the calibration data, it shows a corresponding label in the channel bar and a warning message in the status bar.

- **Invalid calibration**

If you change one of the amplitude parameters (e.g. the attenuation), calibration is labeled invalid. In that case, calibration is not accurate, because the settings are not in line with the settings at the time the R&S FPL1000 has been calibrated. If calibration is invalid, repeat the calibration or restore the settings as they were during the calibration.



Saving calibration data

If you save the current configuration or measurement results to a data set, calibration data is part of that data set.

For more information on saving and restoring data sets, see the "Storing and Recalling Instrument Settings and Measurement Data" chapter in the R&S FPL1000 user manual.

The picture below shows a typical calibration setup that includes a noise source.

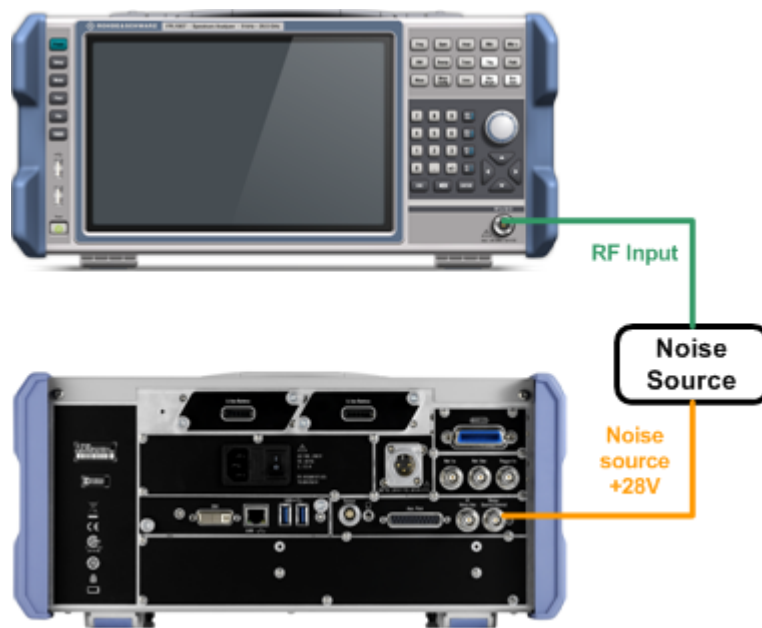

Figure 4-1: Noise figure calibration setup

1. Connect the noise source directly and without a cable to the RF input of the analyzer.
2. Connect the noise source to the +28 V voltage supply (Noise Source Control connector) on the back of the R&S FPL1000.
To connect the noise source to the voltage supply, you need a coaxial cable.

After you have set up calibration, there are several ways to start calibration.

- In the "Noise Overview" dialog box, press the "Calibrate" button.
- In the "Sweep" menu, press the "Calibrate" softkey.

Calibration Save



If the user has performed a valid calibration on the instrument, the calibration results can be saved by using the "Calibration Save" button in the "Export" dialog. This provides the possibility to use once stored calibration results at a later point.

Remote command:

[\[SENSe:\]CORRection:SAVE](#) on page 132

Calibration Recall



Calibration results that have been stored once on the instrument can be recalled by using the "Calibration Recall" button in the "Import" dialog.

To achieve a valid calibration by importing a saved one, all parameters of R&S FPL1000-K30 must match exactly to the ones that have been used for the calibration. At the import of a calibration, a preview dialog is shown which contains all relevant parameters of the calibration to be imported and an indication (green / red) if they match to the current instrument and option settings. Only if the calibration context summary is green, the calibration import can be done. If the calibration context summary is red, importing the calibration results would lead to an invalid calibration status for the current settings. Thus the calibration results cannot be imported in this case. If the calibration context summary is green but some of the individual entries are red (i.e. they differ from the current settings), the calibration results still can be imported. The import will then overwrite the red marked settings with the ones from the stored calibration to ensure the settings match.

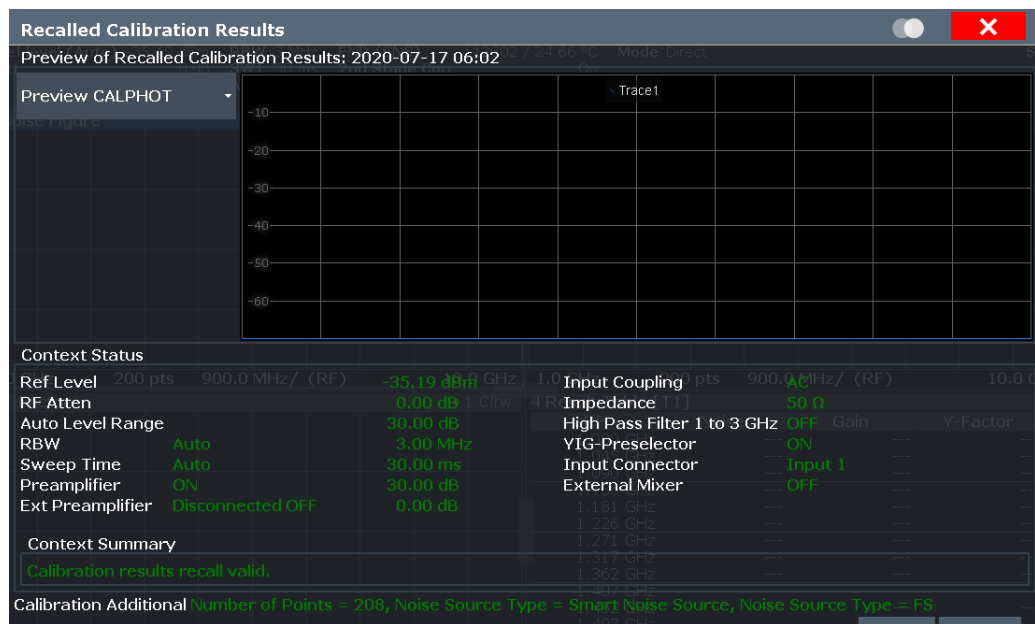

Remote command:

`[SENSe:]CORRection:RECall` on page 132

4.6 Using smart noise sources

A smart noise source (SNS) provides its own ENR and uncertainty tables and a temperature value from an internal measurement. Thus, accuracy is improved and less configuration efforts are required.

When you connect a smart noise source, the R&S FPL1000 automatically loads its ENR table and stores it for future measurements. The ENR table remains stored on the instrument even after the noise source is disconnected. If the table already exists on the R&S FPL1000, the contents are updated, if necessary. The contents of the most recently loaded SNS ENR table are also stored as the "default" ENR table. Thus, they remain available even if the noise source type is changed, for example to "noise diode". The ENR tables for smart noise sources are shown for reference only and can-

not be edited in the R&S FPL1 Noise Figure measurements application. The name of each ENR table contains the serial number of the SNS.

Test Setup

Connect the smart noise source to the Lemos Power Sensor / Noise Source Control connector on the R&S FPL1000. (For models without a Lemos connector, connect the SNS to the BNC Noise source control connector and a USB connector on the R&S FPL1000.) Then connect the SNS output to the DUT or the RF Input connector on the R&S FPL1000. Only one SNS can be active on the R&S FPL1000 at any time.

The identification and setup procedure after connecting the FS-SNS may take up to 10 seconds.

4.7 Separating signals by selecting an appropriate resolution bandwidth

The resolution bandwidth defines the 3 dB bandwidth of the resolution filter to be used. An RF sinusoidal signal is displayed according to the passband characteristic of the resolution filter (RBW), i.e. the signal display reflects the shape of the filter.

The highest sensitivity is obtained at the smallest bandwidth (1 Hz). If the bandwidth is increased, the reduction in sensitivity is proportional to the change in bandwidth. Increasing the bandwidth by a factor of 3 increases the displayed noise by approx. 5 dB (4.77 dB precisely). If the bandwidth is increased by a factor of 10, the displayed noise increases by a factor of 10, i.e. 10 dB.

The higher spectral resolution with smaller bandwidths is won by longer sweep times for the same span. The sweep time has to allow the resolution filters to settle during a sweep at all signal levels and frequencies to be displayed.

If the RBW is too large, signal parts that are very far away (e.g. from a different signal) are considered in the measurement and distort the results. The displayed noise increases.

If the RBW is too small, the measurement time increases.

Variable RBW and sweep time for low-frequency measurements

Usually, a constant RBW and sweep time is used for the entire measurement. However, for low-frequency measurements (under 10 MHz), smaller bandwidths and longer sweep times are required to improve accuracy of the results. Using a small RBW and long sweep time for the entire span would increase measurement time significantly. In this case, a variable RBW and sweep time can be defined for lower frequencies, depending on the current frequency of the sweep point. The variable RBW and sweep times are defined in the frequency table (see [Chapter 5.2.3, "Using a frequency table"](#), on page 46). The defined RBW and sweep times are also included in a table export. In the channel bar, the bandwidth and sweep time range of the variable values is indicated.

4.8 Analyzing several traces - trace mode

The trace mode determines the way the data is processed and displayed. The application provides the following trace modes.

Table 4-1: Overview of available trace modes

Trace Mode	Description
Blank	Hides the selected trace.
Clear Write	Overwrite mode: the trace is overwritten by each sweep. This is the default setting.
View	The current contents of the trace memory are frozen and displayed.



Each time the trace mode is changed, the selected trace memory is cleared.

The default trace mode for the first trace is Clear/Write. For trace 2-4, the default trace mode is "Blank". If you require another mode, you have to set it manually.

As you can have up to four traces simultaneously, you can compare the results with different measurement configurations. For example, freeze a trace and use it as a reference trace.

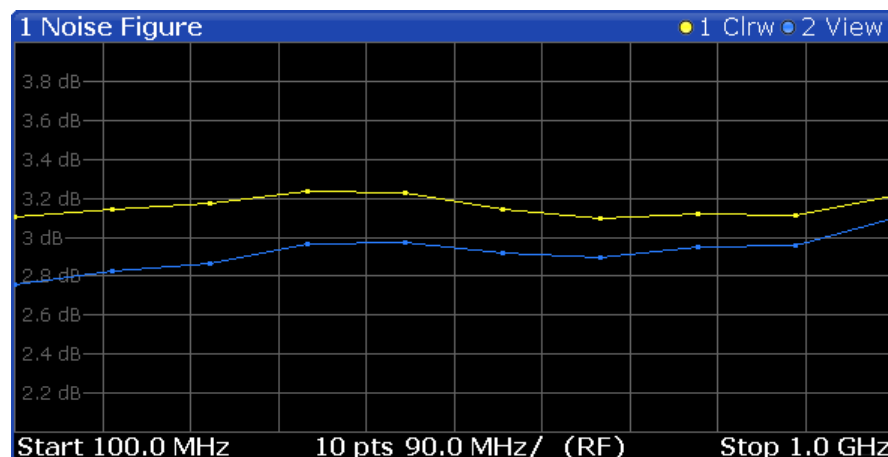

If you change the scaling of the y-axis, the R&S FPL1000 automatically adapts the trace data to the changed display range. Thus, you can perform an amplitude zoom after the measurement to show details of the trace.

4.9 Using markers

Markers are used to mark points on traces, to read out the results of a particular measurement point or compare results of different traces. The noise application provides four markers.

When you activate a marker, the application automatically positions it on the first measurement point (left border of the diagram) of trace 1, regardless of how many traces

are active. A marker is always positioned on the same horizontal position in all active measurement windows. If you change the position of a marker in one window, the application adjusts the position of that marker in all other measurement windows. Thus, the marker results for a specific marker are always for the same frequency, which makes it easier to compare results.



Markers in single frequency mode

When you use a marker for single frequency measurements, the marker is positioned on a particular index value and not a particular measurement point. This means that during continuous measurements, the marker remains on the index value you have put it on. It does not move down the line with the results.

To move a marker, you can use several methods.

- Enter a particular measurement frequency in the input field that opens when you activate a marker.
- Move the marker around with the rotary knob or the cursor keys.
- Drag the marker around using the touchscreen.

All markers can be used either as normal markers or delta markers. A normal marker indicates the absolute signal value at the defined position in the diagram. A delta marker indicates the value of the marker relative to the specified reference marker (by default marker 1).

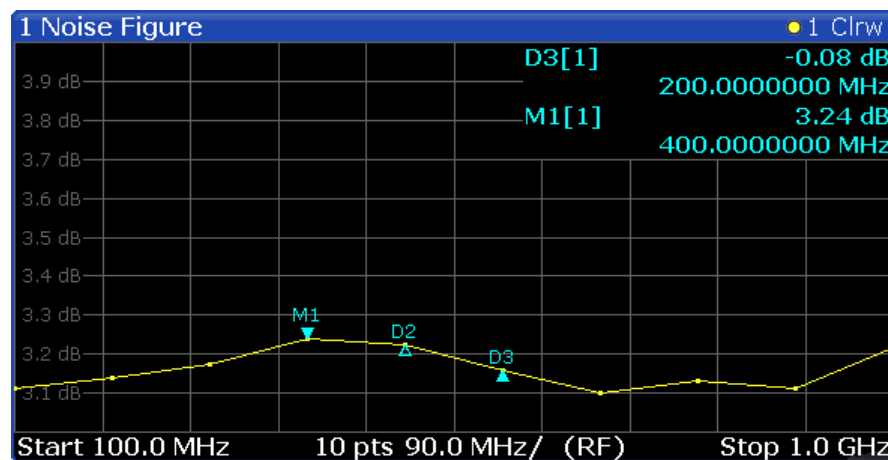

The application always positions the marker on the trace with the lowest number that is in Clear/Write trace mode. To set the marker on another trace, use the "Marker to Trace" function. With this function, you can also position a marker on a trace that is in "View" trace mode, e.g. to compare measurement results. Note that at least one active marker has to be a normal marker.

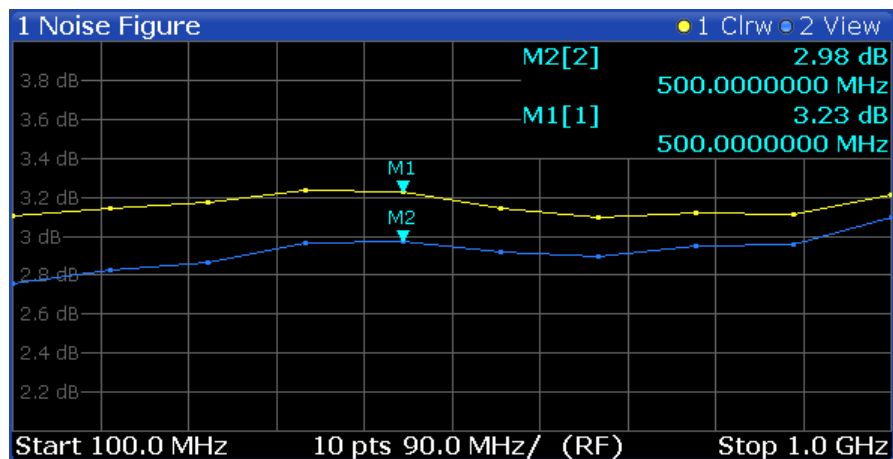

The application shows the results at the marker position directly in the diagram area (up to two markers) or in the marker table (if you use more than two markers).

Marker information in diagram area

By default, the results of the last two markers or delta markers that were activated are displayed in the diagram area.

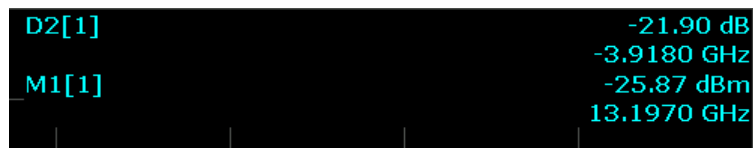

The following information is displayed there:

- The marker type (M for normal, D for delta, or special function name)
- The marker number (1 to 4)
- The assigned trace number in square brackets []
- The marker value on the y-axis
- The marker position on the x-axis

Marker information in marker table

In addition to the marker information displayed within the diagram area, a marker table can be displayed in a separate window. For more information on the contents of the marker table, see ["Marker Table"](#) on page 23.

5 Configuration

"Noise figure" measurements require a special application on the R&S FPL1000, which you activate using the [MODE] key.



The Noise Source Control connector on the R&S FPL1000 is also a prerequisite for the R&S FPL1 Noise Figure measurements application. Without this connector, no measurement can be performed.

This connector is part of the "Additional Interfaces" hardware option R&S FPL1-B5.

When you activate a measurement channel in the R&S FPL1 Noise Figure measurements application, a measurement for the input signal is defined with the default configuration. The "Noise Figure" menu is displayed and provides access to the most important configuration functions.



Unavailable hardkeys

Note that the [AMPT], [BW], and [TRIG] keys have no contents and no function in the R&S FPL1 Noise Figure measurements application.

- [Configuration overview](#).....40
- [Defining the measurement frequency](#).....42
- [Selecting DUT characteristics](#).....49
- [Configuring the noise source](#).....50
- [Configuring additional loss](#).....58
- [Configuring the analyzer](#).....63
- [Using the uncertainty calculator](#).....67
- [Performing measurements](#).....73
- [Configuring inputs and outputs of the R&S FPL1000](#).....75

5.1 Configuration overview



Throughout the measurement channel configuration, an overview of the most important currently defined settings is provided in the "Overview". The "Overview" is displayed when you select the "Overview" icon, which is available at the bottom of all softkey menus.

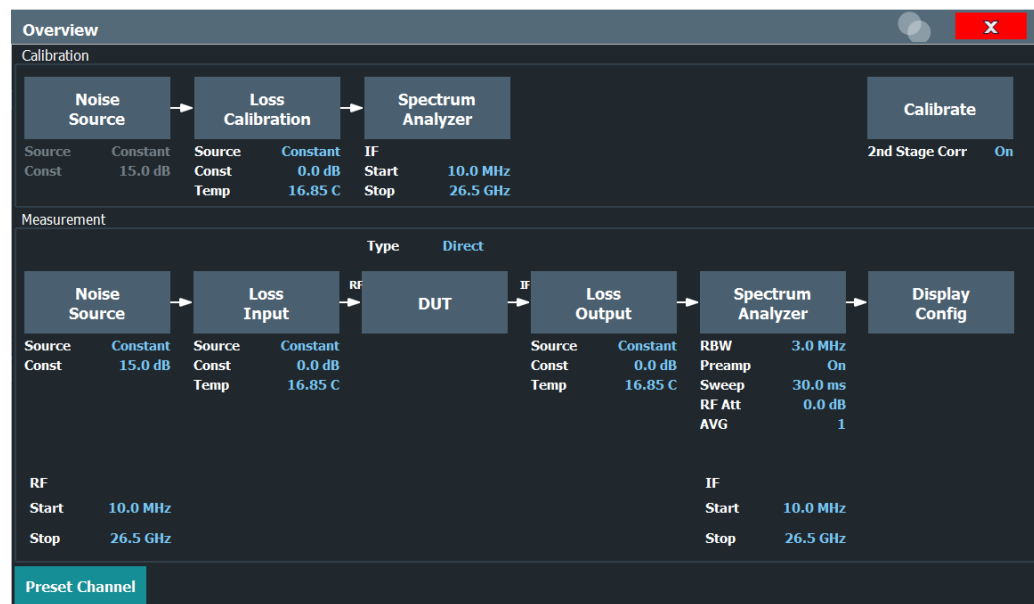

In addition to the main measurement settings, the "Overview" provides quick access to the main settings dialog boxes. The individual configuration steps are displayed in the order of the data flow. Thus, you can easily configure an entire measurement channel from input over processing to output and analysis by stepping through the dialog boxes as indicated in the "Overview".

In particular, the "Overview" provides quick access to the following configuration dialog boxes (listed in the recommended order of processing):

To perform a calibration

1. Noise Source
See [Chapter 5.4, "Configuring the noise source"](#), on page 50.
2. Spectrum Analyzer
See [Chapter 5.6, "Configuring the analyzer"](#), on page 63.
3. Calibration
See ["Calibrate"](#) on page 74

To perform a measurement

1. Noise Source
See [Chapter 5.4, "Configuring the noise source"](#), on page 50.
2. Input and output losses
See [Chapter 5.5, "Configuring additional loss"](#), on page 58.
3. DUT configuration
See [Chapter 5.3, "Selecting DUT characteristics"](#), on page 49
4. Spectrum Analyzer
See [Chapter 5.6, "Configuring the analyzer"](#), on page 63.
5. Display Configuration

See [Chapter 6.1, "Configuring the display"](#), on page 76

To configure settings

- ▶ Select any button in the "Overview" to open the corresponding dialog box. Select a setting in the channel bar (at the top of the measurement channel tab) to change a specific setting.

Preset Channel setup

Select the "Preset Channel" button in the lower left-hand corner of the "Overview" to restore all measurement settings *in the current channel setup* to their default values.

Note: Do not confuse the "Preset Channel" button with the [Preset] key, which restores the entire instrument to its default values and thus closes *all channel setups* on the R&S FPL1000 (except for the default channel setup)!

Remote command:

`SYSTem:PRESet:CHANnel[:EXEC]` on page 99

Specific Settings for

The channel setup can contain several windows for different results. Thus, the settings indicated in the "Overview" and configured in the dialog boxes vary depending on the selected window.

Select an active window from the "Specific Settings for" selection list that is displayed in the "Overview" and in all window-specific configuration dialog boxes.

The "Overview" and dialog boxes are updated to indicate the settings for the selected window.

5.2 Defining the measurement frequency

- [Defining a frequency set](#)..... 42
- [Configuring single frequency measurements](#).....45
- [Using a frequency table](#)..... 46

5.2.1 Defining a frequency set

Access: "Overview" > "DUT" > "Frequency Config"

These settings define the frequency characteristics for the measurement.

The information in this tab is also the basis for an automatic population of the frequency table. All parameters of this dialog are interdependent. If you change one parameter, at least one other parameter is changed by the application.



If you change a frequency set, perform a new calibration to ensure accurate results.

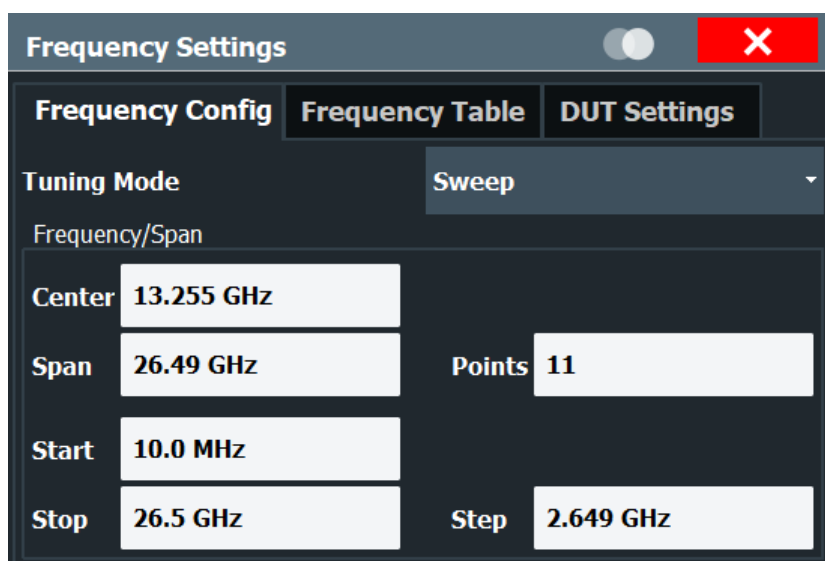

Tuning Mode.....	43
Center.....	44
Span.....	44
Start and Stop Frequency.....	44
(Measurement) Points.....	44
Step.....	45

Tuning Mode

Selects the tuning or measurement mode.

For more information, see [Chapter 4.1, "Tuning modes"](#), on page 24.

Tuning mode selection is also available via softkeys ("Sweep Mode", "Frequency Table Mode", "Single Frequency Mode") in the "Sweep" menu.

Note: A preamplifier can be activated or deactivated individually for different tuning modes. When you switch tuning modes, the defined preamplifier state is adapted.

"Sweep"	The measurement is based on an automatically generated frequency set.
"Frequency Table"	The measurement is based on a customized frequency table. For more information, see Chapter 5.2.3, "Using a frequency table" , on page 46.
"Single Frequency"	The measurement measures a single frequency only. For more information, see Chapter 5.2.2, "Configuring single frequency measurements" , on page 45.

Remote command:

Frequency sweep measurement:

[\[SENSe:\]CONFigure:LIST:CONTInuous](#) on page 110

[\[SENSe:\]CONFigure:LIST:SINGle](#) on page 110

[INITiate<n>\[:IMMediate\]](#) on page 147

Single frequency measurement:

[\[SENSe:\]CONFigure:FREQuency:CONTInuous](#) on page 109

[\[SENSe:\]CONFigure:FREQuency:SINGle](#) on page 110

[INITiate<n>\[:IMMediate\]](#) on page 147

Center

Defines the center of the measurement frequency range.

If you change the center frequency, the application changes the start and stop frequency according to the span you have set.

The "Center" setting is also available via the [FREQ] key.

Remote command:

Frequency list measurement:

[\[SENSe:\]FREQuency:CENTer](#) on page 110

Single frequency measurement:

[\[SENSe:\]FREQuency:SINGle](#) on page 112

Span

Defines the measurement span.

If you change the span, the application changes the start frequency, the stop frequency and the stepsize according to the center frequency and the measurement points.

The "Span" setting is also available via the [SPAN] key.

Remote command:

[\[SENSe:\]FREQuency:SPAN](#) on page 113

Start and Stop Frequency

Defines the start and stop frequencies.

If you change the start or stop frequency, the application changes the center frequency, the span and the measurement points according to the new values and the stepsize.

The "Start" and "Stop" settings are also available via the [FREQ] key.

Remote command:

Start frequency:

[\[SENSe:\]FREQuency:START](#) on page 113

Stop frequency:

[\[SENSe:\]FREQuency:STOP](#) on page 113

(Measurement) Points

Defines the measurement points.

For frequency list measurements, the number of measurement points corresponds to the number of entries in the frequency table. The number of points displayed in the graphical results is also the same.

If you change the measurement points, the application changes the stepsize according to the span.

The "Points" setting is also available via the [SPAN] key.

Remote command:

[\[SENSe:\]FREQuency:POINTs](#) on page 112

Step

Defines the frequency step size in the frequency table.

The stepsize corresponds to the distance between two consecutive measurement points.

If you change the stepsize, the application changes the measurement point according to the span.

The "Stepsize" setting is also available via the [FREQ] key.

Remote command:

[SENSe:] FREQuency: STEP on page 113

5.2.2 Configuring single frequency measurements

Access: "Overview" > "DUT" > "Frequency Config" > "Tuning Mode: Single Frequency"

These settings define the frequency characteristics for the measurement.



If you change the frequency, perform a new calibration to ensure accurate results.

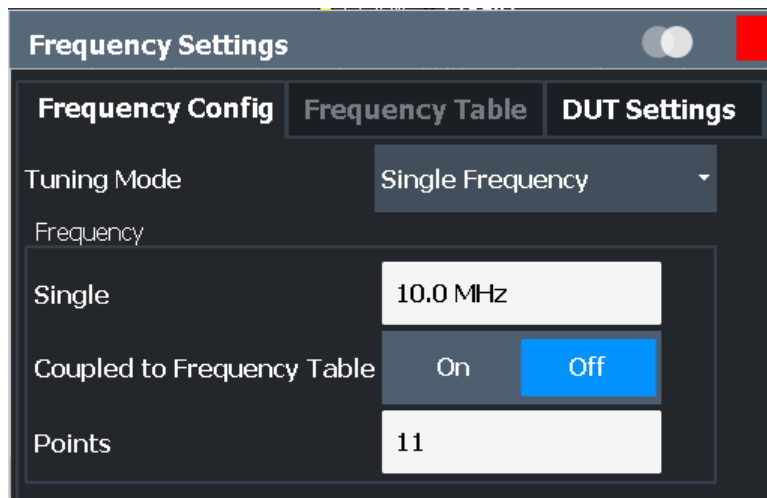

Single (Frequency).....	45
Coupled to Sweep List.....	46
(Measurement) Points.....	46

Single (Frequency)

Defines the frequency that the single frequency measurement is performed on.

The "Single" setting is also available via the [FREQ] key.

Remote command:

[SENSe:] FREQuency: SINGLe on page 112

Coupled to Sweep List

Couples or decouples frequency selection to the contents of a sweep list.

If you couple the frequency to the sweep list, the application allows you to select only the frequencies currently part of the frequency list. If you enter another frequency, the application automatically selects the nearest frequency of the frequency list. If the frequency list has been calibrated previously, calibration remains valid for those frequencies when you change the tuning mode.

If you turn off the coupling, you can define any frequency for single frequency measurements. Note, however, that you have to calibrate the measurement for that frequency.

Remote command:

`[SENSe:]FREQuency:SINGle:COUPled` on page 112

(Measurement) Points

Defines the number of measurement points for single frequency measurements.

For single frequency measurements, the number of measurement points corresponds to the number of measurements (index values) performed on a single frequency.

For more information, see "[Single frequency measurements](#)" on page 16.

The "Points" setting is also available via the [SPAN] key.

Remote command:

`[SENSe:]FREQuency:POINTs` on page 112

5.2.3 Using a frequency table

Access: "Overview" > "DUT" > "Frequency Config" > "Frequency Table"

The "Frequency Table" tab in the "Frequency Settings" dialog box contains functionality to manage the measurement frequencies.

The application populates the table according to the information you entered in the "Frequency Config" tab when you select "Populate Table".

Note that changes to the frequency table take effect only if you select the "Frequency Table" tuning mode.

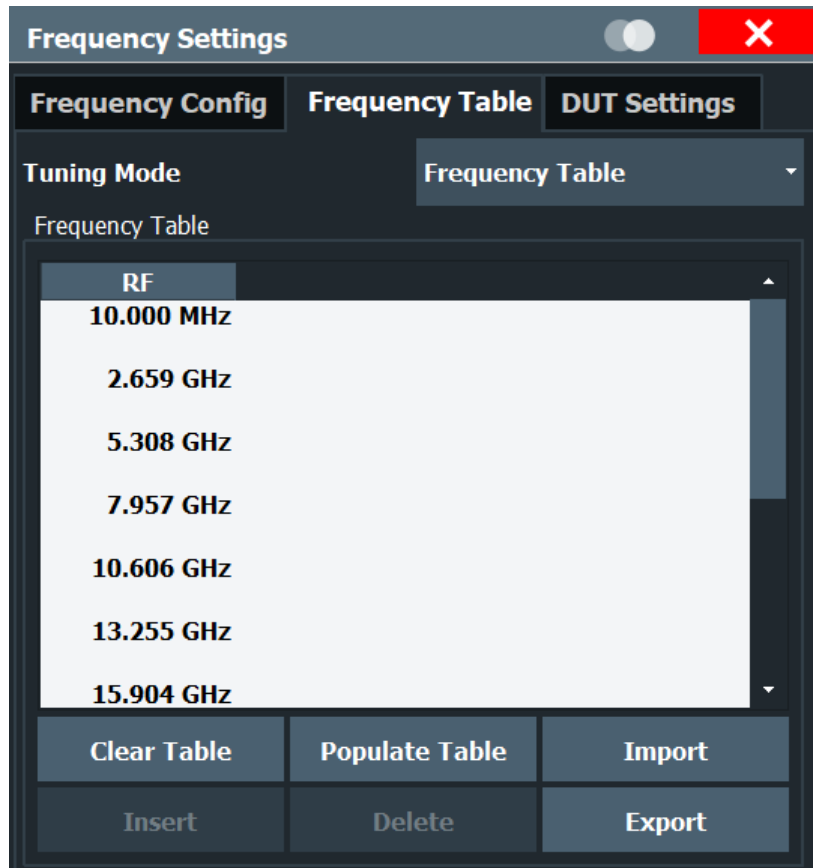

Frequency Table.....	47
Clear Table.....	48
Populate Table.....	48
Insert.....	48
Delete.....	48
Import / Export.....	48

Frequency Table

Shows the current measurement points.

The table is made up of one column that represents the measurement frequency. Each frequency corresponds to one measurement point. The length of the table is variable (up to a maximum of 10001 points).

When you perform measurements in "Sweep" or "Single Frequency" tuning mode, the contents of the table have no effect on the measurement.

When you select a table entry in "Frequency Table" tuning mode, you can edit it or add a new frequency below the selected frequency. A new frequency has to be higher than the last table entry and lower than the next table entry.

If the RBW and sweep time settings are set to "variable" in the measurement settings (see [Resolution Bandwidth \(RBW\)](#) and [Sweep Time](#) on page 64), you can also define those values in the frequency table.

Select [Populate Table](#) to predefine the RBW and sweep times to be used. For each sweep point with a frequency under 10 MHz in the table, suitable settings are defined. For higher frequencies, the values provided in the measurement settings are used (indicated by "--" as they are automatically updated if the measurement settings change.) All predefined values in the table can be overwritten manually.

The defined RBW and sweep times are also included in a table export.

See also "[Variable RBW and sweep time for low-frequency measurements](#)" on page 36.

Clear Table

Deletes the contents of the table.

Populate Table

Populates or restores the measurement frequencies based on the center frequency, the start and stop frequencies, the span, the stepsize and the number of measurement points.

If the RBW and sweep time settings are set to "variable" in the measurement settings (see [Resolution Bandwidth \(RBW\)](#) and "[Sweep Time](#)" on page 64), those values are also predefined. For each sweep point with a frequency under 10 MHz in the table, suitable settings are defined. For higher frequencies, the values provided in the measurement settings are used (indicated by "--" as they are automatically updated if the measurement settings change.) All predefined values in the table can be overwritten manually.

See also "[Variable RBW and sweep time for low-frequency measurements](#)" on page 36.

Remote command:

`[SENSe:] FREQuency:TABLE:DATA` on page 111

`[SENSe:] FREQuency:LIST:DATA` on page 111

RBW and sweep time set to variable: `[SENSe:] BANDwidth:LIST:DATA` on page 111

Insert

Inserts a new measurement point above the one you have selected.

Delete

Deletes the currently selected measurement point.

Import / Export

Opens a dialog box to select a frequency table to import or export.

An import copies the frequency table into the default frequency table directory. An export copies the table to a location outside the default frequency table directory, e.g. a memory stick. The file extension has to be `*.freq`.

If variable RBW and sweep times are enabled, they are also included in a table export (see "[Frequency Table](#)" on page 47).

For details on the required file format, see [Chapter A, "Reference: frequency table file format"](#), on page 189.

5.3 Selecting DUT characteristics

Access: "Overview" > "DUT" > "DUT Settings"

The "DUT" button opens a dialog box to configure the characteristics of the DUT you are testing. The dialog box contains a schematic overview of the DUT input and output characteristics and the way it is integrated into the test setup.

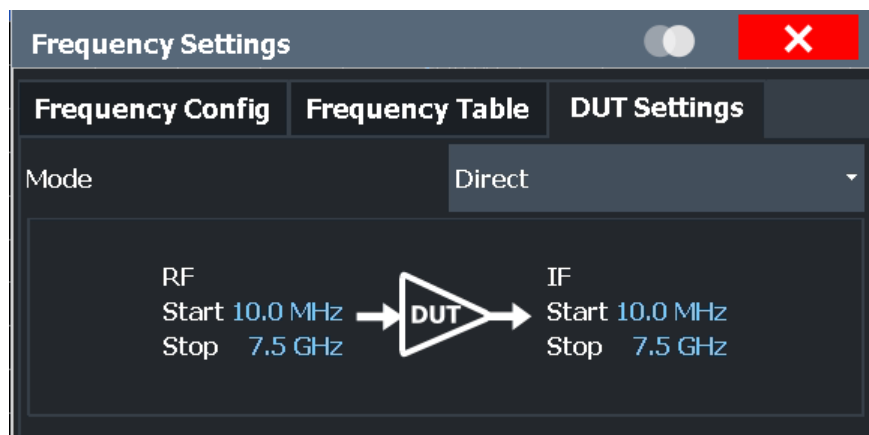

Mode.....	49
LO Fixed.....	49
Image Rejection.....	49

Mode

Selects the measurement mode.

The required measurement mode depends on the type of DUT you are testing. For more information, see [Chapter 4.3, "DUT types"](#), on page 28.

Note: For upconverting measurements, if a preamplifier is used, make sure the upconverted frequencies for the measurement stay below the maximum frequency the preamplifier supports.

Remote command:

DUT type: `[SENSe:]CONFigure:MODE:DUT` on page 115

LO type: `[SENSe:]CONFigure:MODE:SYSTem:LO` on page 114

LO Fixed

Defines a fixed LO frequency for measurements on frequency-converting DUTs with a fixed LO.

After you have defined the LO frequency, the application updates the frequency list accordingly.

The "LO" setting is also available via the [FREQ] key.

Remote command:

`[SENSe:]CONFigure:MODE:SYSTem:LO:FREQuency` on page 114

Image Rejection

Turns image rejection of the DUT on and off.

If you set an image rejection of 0 dB, the image frequency passes completely. If you set a high image rejection (up to 999.99 dB), the image frequency is suppressed completely. For DUTs that have a partial image rejection, define the amount of suppression. For more information, see [Chapter 4.4, "Image frequency rejection"](#), on page 29.

Remote command:

[\[SENSe:\]CORRection:IREJection](#) on page 115

5.4 Configuring the noise source

The noise source characteristics are used to calculate the effective "noise temperature" of the noise source. The more accurate the specified characteristics of the noise source you are using, the more accurate the measurement results. The noise source characteristics must be supplied by its manufacturer.

- [Defining the noise source characteristics](#).....50
- [Using an ENR or temperature table](#).....54

5.4.1 Defining the noise source characteristics

Access: "Overview" > "Noise Source" > "ENR / Temp Settings"

The noise characteristics of noise sources with diode characteristics are usually defined by their ENR (Excess Noise Ratio). The noise characteristics of noise sources with resistor characteristics are defined by their noise (or ambient) temperatures (T_{hot} and T_{cold}). T_{cold} is typically at a very low temperature of liquid nitrogen or liquid helium.

Both noise source types can have different ENR values during the calibration and the measurement stage. You can use either the same type of noise source for both calibration and measurement, or use different types of noise sources for calibration and measurement.

ENR/TEMP Settings	
ENR/TEMP Settings	Table Settings
Auto Select SNS	<input checked="" type="radio"/> On <input type="radio"/> Off
Measurement	
Noise Source	Noise Diode ▾
<input checked="" type="radio"/> Constant	15.0 dB
<input type="radio"/> Table	DEFAULT ▾
Common Noise Source	<input checked="" type="radio"/> On <input type="radio"/> Off
Calibration	
Noise Source	Noise Diode ▾
<input type="radio"/> Constant	15.0 dB
<input type="radio"/> Table	DEFAULT ▾
Temperature	23.35 C

Auto Select SNS.....	51
Noise Source.....	52
Measurement.....	52
Common Noise Source.....	53
Calibration.....	53
Temperature.....	54

Auto Select SNS

If enabled (default), the R&S FPL1 Noise Figure measurements application automatically recognizes a connected smart noise source and uses it for the noise measurement. The provided ENR and uncertainty tables and temperature are loaded and used for the measurement. The recognized serial number of the SNS is indicated in the channel bar and dialogs of the R&S FPL1 Noise Figure measurements application.

If "Auto Select SNS" is ON and a SNS is connected, a green message with information about the connected SNS is displayed:

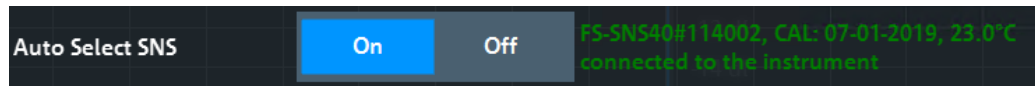

If no SNS is connected, a red "No SNS connected" warning is displayed:



If "Auto Select SNS" is disabled, you must manually change the noise source to SNS and select the required tables, if necessary (see ["Frequency Table"](#) on page 47).

Noise Source

Access: "Overview" > "Noise Source" > "ENR / Temp Settings" > "Noise Source"

You can select the type of noise source and its characteristics independently for the [Calibration](#) and the [Measurement](#).

"Diode"	Selects a noise source with diode characteristics. The frequency characteristics of the noise source are defined by the Excess Noise ratio (ENR).
"Resistor"	Selects a test setup that uses two resistors which act as a noise source. One of the resistors has a low noise or ambient temperature (a cold resistor), the other has a high noise or ambient temperature (a hot resistor). The noise characteristics of the resistor are defined by its "noise temperatures" T_{hot} and T_{cold} . When you select the resistor noise source, the application automatically starts the manual measurement mode, which is indicated in a message at the bottom of the dialog box.
"Smart Noise Source"	Selects a smart noise source, which provides its own ENR and uncertainty tables. The serial number of the connected noise source is automatically recognized and indicated. Otherwise, enter the number of a noise source to continue preconfiguring the measurement.

Remote command:

Measurement: [\[SENSe:\]CORRection:ENR\[:MEASurement\]:TYPE](#) on page 121

[\[SENSe:\]CORRection:ENR\[:MEASurement\]:SNS:SRNumber](#) on page 123

Calibration: [\[SENSe:\]CORRection:ENR:CALibration:TYPE](#) on page 118

[\[SENSe:\]CORRection:ENR:CALibration:SNS:SRNumber](#) on page 123

Measurement

Selects the source of the ENR or temperature values.

The frequency characteristics can be approximated by a constant or be based on an ENR or temperature table.

If the ENR or temperature is a constant, the same values are used for all frequencies in the frequency table. If you have selected a constant ENR, you have to define its magnitude in the input field next to the radio button. If you have selected a constant temperature, you have to define the temperatures of the resistor in the input fields next to the radio button. T_{hot} is the temperature of a resistor with a low noise or ambient temperature; T_{cold} is the temperature of a resistor with a high noise or ambient temperature.

If the noise characteristics are based on a table, the ENR level and temperatures typically depend on the measurement frequency. You can select an existing table from the dropdown menu next to the radio button, if it is active. For more information on ENR and temperature tables, see [Chapter 5.4.2, "Using an ENR or temperature table"](#), on page 54.

When "Common Noise Source" is on, the ENR is used for both measurement and calibration.

Remote command:

ENR mode: `[SENSe:]CORRection:ENR[:MEASurement]:MODE` on page 121

Constant ENR: `[SENSe:]CORRection:ENR[:MEASurement]:SPOT` on page 121

Select table: `[SENSe:]CORRection:ENR[:MEASurement]:TABLE:SElect`
on page 120

Constant temperature: `[SENSe:]CORRection:ENR[:MEASurement]:SPOT:COLD`
on page 122

Constant temperature: `[SENSe:]CORRection:ENR[:MEASurement]:SPOT:HOT`
on page 122

Common Noise Source

Turns the use of a common ENR on and off.

Common ENRs have the same characteristics for the measurement and calibration. If you turn off common ENR, you can define an additional ENR to be used during calibration.

Define additional ENR for measurements on frequency converting DUTs, if one noise source does not cover the frequency range at the DUT input (RF) and for calibration (IF).

Remote command:

`[SENSe:]CORRection:ENR:COMMon` on page 118

Calibration

Selects the source of the ENR or temperature values used during calibration.

The frequency characteristics can be a constant or be based on an ENR or temperature table.

If the ENR or temperature is a constant, the same value is used for all frequencies in the frequency table. If you have selected a constant ENR, you can also define its value in the input field next to the radio button. If you have selected a constant temperature, you have to define the temperatures of the resistor in the input fields next to the radio button. T_{hot} is the temperature of a resistor with a low noise or ambient temperature; T_{cold} is the temperature of a resistor with a high noise or ambient temperature.

If the noise source characteristics are based on a table, the ENR level and temperature depend on the measurement frequency. In that case, the values are interpolated to the measurement points. You can select a table from the dropdown menu next to the radio button, if it is active. For more information on ENR tables, see [Chapter 5.4.2, "Using an ENR or temperature table"](#), on page 54.

The calibration settings are available if the "Common Noise Source" is off.

Remote command:

ENR mode: `[SENSe:]CORRection:ENR:CALibration:MODE` on page 117

Constant ENR: `[SENSe:]CORRection:ENR:CALibration:SPOT` on page 117

Select table: `[SENSe:]CORRection:ENR:CALibration:TABLE:SElect`
on page 117

Constant temperature: `[SENSe:]CORRection:ENR:CALibration:SPOT:COLD`
on page 116

Constant temperature: `[SENSe:]CORRection:ENR:CALibration:SPOT:HOT`
on page 116

Temperature

Defines the absolute room temperature in degree Celsius or Fahrenheit.

The room temperature is required for the calculation of the real ENR of the noise source, because an ENR table is based on a temperature of 290K.

For smart noise sources, the temperature is provided automatically by the connected SNS itself. If no SNS is connected, the most recently loaded value is indicated. The provided temperature is used for all noise sources throughout the measurement.

To change the unit of the temperature from Celsius to Fahrenheit, change the date format from "DE" to "US" in the "General" display settings.

- Press the [SETUP] key.
- Select "Display".
- Select the "General" tab.
- Select "DE" for Celsius or "US" for Fahrenheit.

Note: If you define the temperature via remote control, the unit is degree Kelvin.

Remote command:

`[SENSe:]CORRection:TEMPerature` on page 123

5.4.2 Using an ENR or temperature table

Access: "Overview" > "Noise Source" > "Table Settings"

The "Table Settings" tab in the "ENR/TEMP Settings" dialog box contains the functionality to create and edit ENR or temperature tables.

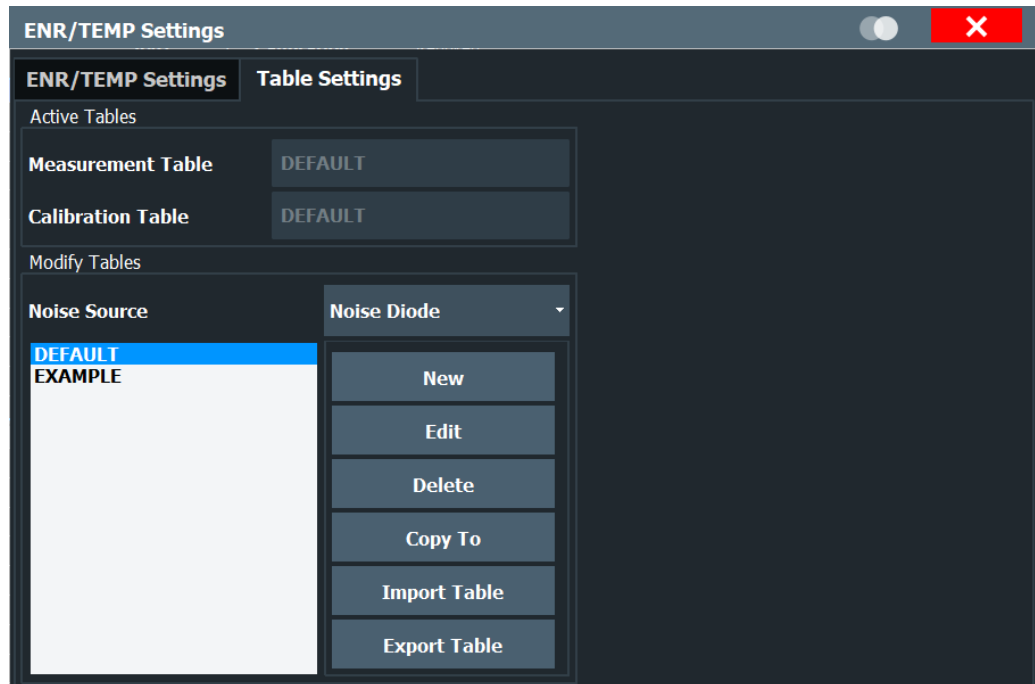

ENR or temperature tables contain the noise source characteristics for particular frequencies. If the table does not contain ENR or temperature values for one of the measurement frequencies, the application interpolates between the values.

The "Table Settings" tab contains a list of ENR and temperature tables currently available on the R&S FPL1000 and shows the table currently in use if the "ENR/TEMP Settings" are enabled.

In addition, the tab contains functionality to create new tables and modify existing ones.

Noise Source.....	55
New.....	56
Edit.....	56
Delete.....	56
Copy To.....	57
Import / Export Table.....	57
Edit Table.....	57

Noise Source

Selects the type of noise source you are using for the measurement. The type of noise source selected in the "ENR/TEMP Settings" > "Noise Source" dialog is adopted automatically.

The noise source type affects the data type that the table contains. For a "Noise Diode", the table contains the ENR values of the noise source you are using. For a "Resistor", the table contains the "noise temperatures" of the resistors (T_{hot} and T_{cold}).

For a smart noise source, the table contains the provided ENR and uncertainty table. The table for the connected noise source is automatically recognized and highlighted. The name of the ENR table contains the serial number of the SNS. The "default" table also contains the data for the most recently connected smart noise source. The tables for all previously connected noise sources, whose ENR tables remain stored on the instrument, are also listed. Smart noise source tables are for reference only and cannot be edited.

For more information on the noise source types, see "Noise Source" on page 52.

Remote command:

`[SENSe:]CORRection:ENR[:MEASurement]:TYPE` on page 121

New

Opens the [Edit Table](#) dialog box to create a new table.

The contents of the dialog box are empty.

Smart noise source tables are shown for reference only and cannot be edited. A message indicates whether the SNS with the selected serial number is currently connected to the R&S FPL1000 or not. If it is connected, the table data reflects the most recent data provided by the SNS.

Remote command:

Table selection: `[SENSe:]CORRection:ENR:CALibration:TABLE:SElect`

on page 117

and: `[SENSe:]CORRection:ENR[:MEASurement]:TABLE:SElect` on page 120

Diode: `[SENSe:]CORRection:ENR[:MEASurement]:TABLE[:DATA]` on page 119

Resistor: `[SENSe:]CORRection:ENR[:MEASurement]:TABLE:TEMPerature[:DATA]` on page 120

Edit

Opens the [Edit Table](#) dialog box to modify the selected table.

Smart noise source tables are for reference only and cannot be edited.

Remote command:

Table selection: `[SENSe:]CORRection:ENR[:MEASurement]:TABLE:SElect`

on page 120

and: `[SENSe:]CORRection:ENR[:MEASurement]:TABLE:SElect` on page 120

Diode: `[SENSe:]CORRection:ENR[:MEASurement]:TABLE[:DATA]` on page 119

Resistor: `[SENSe:]CORRection:ENR[:MEASurement]:TABLE:TEMPerature[:DATA]` on page 120

Delete

Deletes the selected table.

Smart noise source tables cannot be deleted.

Remote command:

Diode: `[SENSe:]CORRection:ENR[:MEASurement]:TABLE:DElete` on page 119

Resistor: `[SENSe:]CORRection:ENR[:MEASurement]:TABLE:TEMPerature:DElete` on page 120

Copy To

Opens the [Edit Table](#) dialog box to modify the selected table and save it under a new name.

Import / Export Table

Opens a dialog box to select a table to import or export.

Smart noise source tables can be exported, but not re-imported. Tables for smart noise sources are always loaded directly from the SNS itself. However, you can edit and use the SNS tables for other noise sources, such as noise diodes.

Edit Table

Defines the noise source characteristics or the loss characteristics of additional measurement equipment.

The noise source and loss tables are made up of up to 10001 data points. A data point consists of a frequency and its corresponding ENR, temperature or loss value. The ENR and temperature values must be supplied by the manufacturer of the noise source or resistor. The loss characteristics of measurement equipment must also be supplied by the manufacturer.

Frequency	Value
1.00000000 MHz	1.00 dB
10.00000000 MHz	10.00 dB

"Name" Name of the ENR, temperature or loss table.

"Comment" Comment for the ENR, temperature or loss table.

"Frequency" Frequency of a particular ENR, temperature or loss value.

"Value"	ENR value or loss in dB. For a resistor, the characteristics of the resistor are defined by the "noise temperatures" T_{hot} and T_{cold} instead of a single value. The unit in that case is Kelvin (degrees).
"Clear Table"	Deletes the contents of the table (frequencies and values) or the loss table.
"Insert"	Inserts a new data point above the selected one.
"Delete"	Deletes the selected data point.
"Save"	Saves the table.
"Cancel"	Exits the "Edit Table" dialog box and returns to the result diagram.
Remote command:	
Edit ENR table: <code>[SENSe:]CORRection:ENR[:MEASurement]:TABLE[:DATA]</code> on page 119	
Edit temperature table: <code>[SENSe:]CORRection:ENR[:MEASurement]:TABLE:TEMPerature[:DATA]</code> on page 120	
Edit input loss table: <code>[SENSe:]CORRection:LOSS:INPut:TABLE[:DATA]</code> on page 127	
Edit output loss table: <code>[SENSe:]CORRection:LOSS:OUTPut:TABLE[:DATA]</code> on page 129	

5.5 Configuring additional loss

These settings configure the loss characteristics of additional equipment in the test setup, such as cables or attenuators at the DUT input or output. The characteristics of such equipment must be supplied by the manufacturer.

Note that loss is only considered during the measurement and not during calibration because the noise source is connected directly to the analyzer input.



Treatment of losses in resistor noise sources

For resistor noise sources, it is not possible to change the loss characteristics.

When you change back to using a diode as a noise source, the previous loss settings are **not** restored. In that case, store loss settings in a loss table for later use.

- [Defining loss](#).....58
- [Using a loss table](#).....61

5.5.1 Defining loss

Access: "Overview" > "Loss Input" / "Loss Output" > "Loss Settings"

The "Loss Settings" tab in the "Loss Settings" dialog box contains settings to define the loss characteristics of miscellaneous equipment in the test setup.

You can define the loss characteristics of the signal path to the DUT input and the signal path from the DUT output to the analyzer.

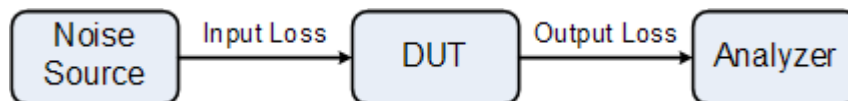

Furthermore, you can define the loss characteristics of the signal path from the noise source directly to the analyzer for the calibration measurement.

Input Loss	59
Output Loss	60
Calibration Loss	60

Input Loss

Defines losses between the noise source and the DUT input.

The input loss is the sum of all losses caused by the measurement equipment. The loss can be constant or based on a loss table.

If the loss is constant, the same loss is used for all frequencies in the frequency table. If you have selected a constant loss, you can also define its value in the input field next to the radio button.

If the loss is based on a table, the loss values are interpolated to the measurement frequencies. You can select a table from the dropdown menu next to the radio button, if it is active. For more information on loss tables, see [Chapter 5.5.2, "Using a loss table"](#), on page 61.

The specified temperature at the time of measurement can be considered in the loss calculation.

Remote command:

Loss mode:

[\[SENSe:\]CORRection:LOSS:INPut:MODE](#) on page 126

Constant loss:

[\[SENSe:\]CORRection:LOSS:INPut:SPOT](#) on page 126

Select loss table:

[\[SENSe:\]CORRection:LOSS:INPut:TABLE:SElect](#) on page 127

Temperature:

[\[SENSe:\]CORRection:LOSS:INPut:TEMPerature](#) on page 128

Output Loss

Selects the loss between the DUT output and the RF input of the analyzer.

The output loss is the sum of all losses caused by the measurement equipment (e.g. connectors, cables or attenuators). The loss can be constant or be based on a loss table.

If the loss is constant, the same loss is used for all frequencies in the frequency table. If you have selected a constant loss, you can also define its value in the input field next to the radio button.

If the loss is based on a table, the loss values are interpolated to the measurement frequencies. You can select a table from the dropdown menu next to the radio button, if it is active. For more information on loss tables, see [Chapter 5.5.2, "Using a loss table"](#), on page 61.

The current temperature at the time of measurement can be considered in the loss calculation.

Remote command:

Loss mode:

[\[SENSe:\]CORRection:LOSS:OUTPut:MODE](#) on page 128

Constant loss:

[\[SENSe:\]CORRection:LOSS:OUTPut:SPOT](#) on page 128

Select loss table:

[\[SENSe:\]CORRection:LOSS:OUTPut:TABLE:SElect](#) on page 129

Temperature:

[\[SENSe:\]CORRection:LOSS:OUTPut:TEMPerature](#) on page 130

Calibration Loss

Selects the loss between the noise source and the RF input of the analyzer for the calibration measurement.

The loss is the sum of all losses caused by the measurement equipment (e.g. connectors, cables or attenuators). The loss can be constant or be based on a loss table.

If the loss is constant, the same loss is used for all frequencies in the frequency table. If you have selected a constant loss, you can also define its value in the input field next to the radio button.

If the loss is based on a table, the loss values are interpolated to the measurement frequencies. You can select a table from the dropdown menu next to the radio button, if it is active. For more information on loss tables, see [Chapter 5.5.2, "Using a loss table"](#), on page 61.

The current temperature at the time of measurement can be considered in the loss calculation.

Remote command:

Loss mode:

`[SENSe:]CORRection:LOSS:CALibration:MODE` on page 124

Constant loss:

`[SENSe:]CORRection:LOSS:CALibration:SPOT` on page 124

Select loss table:

`[SENSe:]CORRection:LOSS:CALibration:TABLE:SElect` on page 125

Temperature:

`[SENSe:]CORRection:LOSS:CALibration:TEMPerature` on page 126

5.5.2 Using a loss table

Access: "Overview" > "Loss Input" / "Loss Output" > "Table Settings"

The "Table Settings" tab in the "Loss Settings" dialog box contains the functionality to create and edit loss tables.

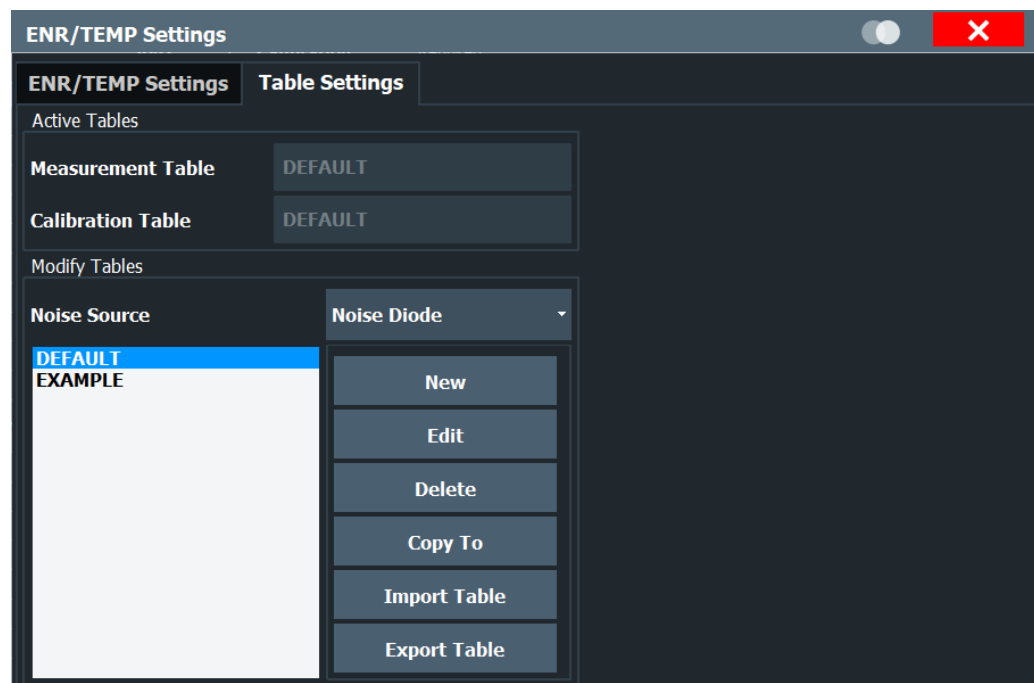

Loss tables contain the loss characteristics of additional frequency-dependent equipment in the test setup. If you are using a loss table, the loss values can be different on

each frequency that is measured. If the table does not contain a loss for one of the measurement frequencies, the application interpolates between values.

The "Table Settings" tab contains a list of loss tables currently available on the R&S FPL1000. It shows the table currently selected in the "Loss Settings" tab.

In addition, the tab contains functionality to create new tables and modify existing ones.

New	62
Edit	62
Delete	62
Copy To	62
Import / Export Table	63

New

Opens the [Edit Table](#) dialog box to create a new loss table.

The contents of the dialog box are empty.

Remote command:

Create input loss table:

[\[SENSe:\]CORRection:LOSS:INPut:TABLE\[:DATA\]](#) on page 127

Create output loss table:

[\[SENSe:\]CORRection:LOSS:OUTPut:TABLE\[:DATA\]](#) on page 129

Create calibration loss table:

[\[SENSe:\]CORRection:LOSS:CALibration:TABLE\[:DATA\]](#) on page 125

Edit

Opens the [Edit Table](#) dialog box to modify the selected table.

Remote command:

Edit input loss table:

[\[SENSe:\]CORRection:LOSS:INPut:TABLE\[:DATA\]](#) on page 127

Edit output loss table:

[\[SENSe:\]CORRection:LOSS:OUTPut:TABLE\[:DATA\]](#) on page 129

Edit calibration loss table:

[\[SENSe:\]CORRection:LOSS:CALibration:TABLE\[:DATA\]](#) on page 125

Delete

Deletes the selected table.

Remote command:

Delete input loss table:

[\[SENSe:\]CORRection:LOSS:INPut:TABLE:DELeTe](#) on page 127

Delete output loss table:

[\[SENSe:\]CORRection:LOSS:OUTPut:TABLE:DELeTe](#) on page 129

Delete calibration loss table:

[\[SENSe:\]CORRection:LOSS:CALibration:TABLE:DELeTe](#) on page 124

Copy To

Opens the [Edit Table](#) dialog box to modify the selected table and save it under a new name.

Import / Export Table

Opens a dialog box to select a loss table to import or export.

An import copies the loss table into the default loss table directory. The file extension can be *.loss or *.s2p. In case the file extension is *.s2p, the S21 vector is parsed out of the *.s2p file. The magnitude of this vector is written to a file with ending *.loss into the default loss directory. This file then can be used like conventional loss files.

An export copies the table to a location outside the default loss table directory, e.g. a memory stick. The file extension will be *.loss.

5.6 Configuring the analyzer

Access: "Overview" > "Spectrum Analyzer"

Or: [MEAS CONFIG] > "Meas Settings"

The measurement settings include parameters related to the second stage correction measurement.

Measurement Settings	
2nd Stage Correction	On

RBW and Sweep Settings		
RBW	Variable	3.0 MHz
Sweep Time	Variable	30.0 ms
Settling Time		50.0 ms
Average		1

Level and Range Settings		
Ref Level	Auto	-35.0 dBm
Auto Level Range		30.0 dB
RF Atten		0.0 dB

Preamplifier	
Preamplifier	On

2nd Stage Correction.....	64
Resolution Bandwidth (RBW).....	64
Sweep Time.....	64
Settling Time.....	65
Average.....	65
Ref Level.....	65

Auto Level Range.....	66
RF Attenuation.....	66
Preamplifier.....	66

2nd Stage Correction

Turns 2nd stage correction on and off.

If enabled, the application uses the calibration data to compensate for the inherent noise of the analyzer when calculating the measurement results.

If disabled, the application does not correct the measurement results, even if a valid calibration has been performed. Note that correction data is not deleted if you turn off the 2nd stage correction.

For more information, see [Chapter 4.5, "Calibration \(2nd stage correction\)"](#), on page 32.

Remote command:

State: `[SENSe:]CORRection[:STATe]` on page 132

Calibration measurement selection: `[SENSe:]CONFigure:CORRection` on page 131

Resolution Bandwidth (RBW)

Defines the resolution bandwidth for the measurement.

For more information on the resolution bandwidth, see [Chapter 4.7, "Separating signals by selecting an appropriate resolution bandwidth"](#), on page 36.

"Constant"	Uses a constant RBW for the entire measurement span
"Variable"	Uses a variable RBW, depending on the current frequency of the sweep point, as defined in the frequency table (see Chapter 5.2.3, "Using a frequency table" , on page 46); In the channel bar, the bandwidth and sweep time range of the variable values is indicated.

Remote command:

`[SENSe:]BANDwidth:RESolution:AUTO` on page 131

`[SENSe:]BANDwidth[:RESolution]` on page 130

Sweep Time

Defines the sweep time for the measurement.

The sweep time is the time it takes the analyzer to perform a measurement at one measurement frequency.

Note that "noise figure" measurements perform two measurements during one sweep. One with the noise source turned on, one with the noise source turned off.

Frequency tables allow you to define a variable RBW and sweep time, depending on the current frequency of the sweep point (see ["Variable RBW and sweep time for low-frequency measurements"](#) on page 36 and [Chapter 5.2.3, "Using a frequency table"](#), on page 46).

"Constant"	Uses a constant sweep time for the entire measurement span
------------	--

"Variable" Uses a variable sweep time, depending on the current frequency of the sweep point, as defined in the frequency table (see [Chapter 5.2.3, "Using a frequency table"](#), on page 46); In the channel bar, the bandwidth and sweep time range of the variable values is indicated.

Remote command:

[\[SENSe:\] SWEep:TIME:AUTO](#) on page 133

[\[SENSe:\] SWEep:TIME](#) on page 133

Settling Time

Defines the settling time of the DUT and the noise source.

Most noise sources need a certain amount of time to settle after you turn them on. Low-frequency DUTs can require a certain time until their coupling capacitors have been charged or discharged. Both are defined as the settling time. For details on the settling time, refer to the datasheet of the noise source.

Remote command:

[SYSTem:CONFigure:DUT:STIME](#) on page 135

Average

Defines the number of measurements that are used to average the results.

The more measurements you include in the averaging, the more accurate and stable the results are. However, accuracy and stability come at the price of measurement speed.

Remote command:

[\[SENSe:\] SWEep:COUNT](#) on page 133

Ref Level

Turns automatic determination of the reference level on and off.

The reference level is the power level the R&S FPL1000 expects at the RF input. Keep in mind that the noise signal has a high crest factor. To avoid an instrument overload, set the reference level to the peak envelope power of the noise signal, not to the mean power.

Set the reference level to approximately 5 dB to 15 dB above the noise display that occurs with the DUT connected and the noise source activated.

To get the best dynamic range, set the reference level as low as possible. At the same time, make sure that the maximum signal level does not exceed the reference level. If it does, it can overload the RF and IF stages of the analyzer, regardless of the signal power. Measurement results can deteriorate.

Note that the signal level at the A/D converter can be stronger than the level the R&S FPL1000 displays because the resolution bandwidths are implemented digitally after the A/D converter.

If automatic detection of the reference level is on, the application performs a measurement to determine the ideal reference level. The time of this measurement depends on the state of the "2nd Stage Correction".

- "2nd Stage Correction" is enabled

The application determines the reference level before the calibration starts. The reference level is based on several test measurements on the start frequency. For more information, see ["Auto Level Range"](#) on page 66.

- "2nd Stage Correction" is disabled
The application determines the reference level before the measurement begins. The reference level is based on the measurement of the first frequency that is measured. After this measurement is done, the application resumes the measurement.

If manual selection of the reference level is on, you can define the reference level in the corresponding input field.

Note: Reference level. Even for DUTs with a high-ripple frequency response it can be useful to define the reference level manually. Determining the reference level automatically does not always result in optimal settings.

Remote command:

Manual reference level:

`DISPlay[:WINDow<n>]:TRACe<t>:Y[:SCALe]:RLEVel` on page 134

Automatic reference level:

`DISPlay[:WINDow<n>]:TRACe<t>:Y[:SCALe]:RLEVel:AUTO` on page 134

Auto Level Range

Defines the maximum expected "gain" of the DUT.

The application uses the auto level range to determine the reference level automatically if the 2nd stage correction is on.

Make sure the range does not exceed the actual "gain" of the DUT by more than 10 dB.

Remote command:

`SYSTem:CONFIgure:DUT:GAIN` on page 135

RF Attenuation

Defines the RF attenuation of the analyzer.

The attenuation is applied to the signal at the RF input.

Attenuation affects the quality of the "noise figure" measurement results. For a low "noise figure" of the analyzer (and thus more accurate measurement results), keep the attenuation as low as possible. No attenuation is best. However, some high-power DUTs require attenuation to avoid an overload of the analyzer. An attenuation of 10 dB provides a better input VSWR of the analyzer, but results in a deteriorating "noise figure".

Remote command:

`INPut<ip>:ATTenuation` on page 134

Preamplifier

If the (optional) internal preamplifier hardware is installed on the R&S FPL1000, a preamplifier can be activated for the RF input signal.

Turn on the preamplifier for a low inherent noise of the analyzer.

Note: If an optional external preamplifier is activated, the internal preamplifier is automatically disabled, and vice versa.

The input signal is amplified by 20 dB if the preamplifier option is activated.

Remote command:

`INPut<ip>:GAIN:STATe` on page 135

5.7 Using the uncertainty calculator

Access: [MEAS CONFIG] > "Uncertainty Calculation"

"Noise figure" measurements are subject to uncertainty. The "noise figure" measurement is meaningless if the measurement uncertainty is too large. Knowing the uncertainty of the "noise figure" measurement adds value especially when comparing measurement results.

Note that the "noise figure" uncertainty is not calculated for frequencies above 67 GHz because input VSWR values are not specified.

The screenshot shows the 'Uncertainty Calculation' configuration window. It is organized into several sections:

- Measurement Noise Source:**
 - Output Match: VSWR 1.15, RL 1.15
 - ENR Uncert: 0.1 dB
 - Same Source for Meas and Cal: On/Off
 - Calibration Noise Source: Output Match (VSWR 1.15, RL 1.15), ENR Uncert 0.1 dB
- DUT:**
 - Input Match: VSWR 1.0, RL 1.0
 - Output Match: VSWR 1.0, RL 1.0
 - Use Meas Values: On/Off
 - DUT NF: 0.0 dB
 - DUT Gain: 0.0 dB
 - Frequency (IF): 1.0 GHz
- Analyzer:**
 - Ext PA Input Match: VSWR 1.5, RL 1.5
 - SA NF Uncert: 0.05 dB
 - SA Gain Uncert: 0.15 dB
 - SA NF: 11.22 dB
 - Ext PA: On/Off
 - PA NF: 5.0 dB
 - PA Gain: 20.0 dB
 - Net SA NF: 5.16 dB
 - NF Uncert +/-: 0.44 dB
 - Meas Offset: -5.17 dB
- Guidelines (repeatability):**
 - ENR - SA NF: [> 3 dB] 9.83 dB
 - ENR - DUT NF: [> 5 dB] 15.0 dB
 - DUT (NF+Gain) - SA NF: [> 1 dB] -5.17 dB



Uncertainty values and systematic error recognition

Note that the uncertainty calculation only takes systematic measurement inaccuracies into account.

The most significant inaccuracies are:

- Uncertainties of the noise source and the analyzer
- Input and output matching
- "Noise figure" and "gain" of the DUT
- "Noise figure" of the analyzer

The accuracy of the measurement can also be affected by insufficient repeatability during calibration or measurement.

The repeatability is mainly affected by:

- Signal-to-noise ratio during calibration and measurement
- Measurement time (if it is too short)
- Environmental conditions (e.g. a change in the temperature between measurements)
- Mechanical stability of the test setup

For more background information on "noise figure" measurement uncertainty, refer to the application note "The "Y-Factor" Technique for "Noise Figure" Measurement" available for download on the Rohde & Schwarz homepage (http://www.rohde-schwarz.com/en/applications/the-y-factor-technique-for-noise-figure-measurements-application-note_56280-15484.html).

In addition to the parameters described here, the application also considers several parameters from the general measurement configuration when calculating the uncertainty.

- [Measurement mode](#)
- [2nd Stage Correction](#)
If 2nd stage correction is on, but no calibration data is available, uncertainty is calculated without the 2nd stage correction data.
- [RF Attenuation](#)
- [Temperature](#)
- [ENR values](#)

5.7.1 Configuring noise source characteristics

Access: [MEAS CONFIG] > "Uncertainty Calculation"

The Uncertainty Calculator supports individual characteristics for a noise source used during calibration and the measurement.

If you are using a Common ENR, the application assumes that the [Output Match](#) and [ENR Uncert\(ainty\)](#) are the same during calibration and measurement. Only the "Measurement Noise Source" parameters are displayed.

If you are using a different noise source during calibration and measurement, the Uncertainty Calculator adds an **Output Match** and **ENR Uncert(ainty)** required for uncertainty calculation during calibration.

Note that you have to turn off the **Common Noise Source** if you have to define the values of the noise source used during calibration.

Common Source for Meas and Cal	69
Use SNS Values	69
Output Match	69
ENR Uncert(ainty)	69
Temperature Uncert(ainty)	70

Common Source for Meas and Cal

Controls the way the application calculates the uncertainty for the noise source.

Turn on the switch when you use the same noise source during calibration and measurement. Only one set of fields to define the noise source characteristics is available. The application calculates the uncertainty according to the values you have entered in there.

Turn the switch off when you use different noise sources during calibration and measurement. The application shows an additional set of fields to define the noise source characteristics. The uncertainty calculation also includes these values.

The switch is available if you have turned on **Common Noise Source**.

Remote command:

`CALCulate<n>:UNCertainty:COMMON` on page 136

Use SNS Values

If enabled, the values from the uncertainty table provided by the (most recently) connected smart noise source are used.

Output Match

Defines the output match of the noise source you are using.

You can define the output match either as the VSWR or as the return loss (RL).

Refer to the datasheet of the noise source for these values.

If a smart noise source is used, the VSWR / RL values defined in the SNS table are used.

Remote command:

`CALCulate<n>:UNCertainty:MATCH:SOURce:CALibration:RL` on page 143

`CALCulate<n>:UNCertainty:MATCH:SOURce:RL` on page 143

`CALCulate<n>:UNCertainty:MATCH:SOURce:CALibration[:VSWR]`
on page 142

`CALCulate<n>:UNCertainty:MATCH:SOURce:CALibration:RL` on page 143

ENR Uncert(ainty)

Defines the uncertainty of the excess noise ratio of the noise source you are using.

Refer to the datasheet of the noise source for this value.

Available for noise sources with diode characteristics.

If a smart noise source is used, the ENR uncertainty values defined in the SNS table are used.

Remote command:

[CALCulate<n>:UNCertainty:ENR:UNCertainty](#) on page 139

[CALCulate<n>:UNCertainty:ENR:CALibration:UNCertainty](#) on page 138

Temperature Uncert(ainty)

Defines the uncertainty of the hot and cold temperatures of the noise source you are using.

Refer to the datasheet of the noise source for these values.

Available for resistor noise sources.

Remote command:

[CALCulate<n>:UNCertainty:ENR:UNCertainty:COLD](#) on page 140

[CALCulate<n>:UNCertainty:ENR:CALibration:UNCertainty:HOT](#)
on page 139

[CALCulate<n>:UNCertainty:ENR:CALibration:UNCertainty:COLD](#)
on page 139

[CALCulate<n>:UNCertainty:ENR:CALibration:UNCertainty:HOT](#)
on page 139

5.7.2 Configuring DUT characteristics

Access: [MEAS CONFIG] > "Uncertainty Calculation"

Input / Output Match	70
Use Measurement Values	70

Input / Output Match

Defines the match at the DUT input and output.

You can define the match either as the VSWR or as the return loss (RL). If you define the VSWR or the return loss, the application automatically calculates the other.

If these values are not defined in the DUT datasheet, determine these values, for example, with a network analyzer.

Remote command:

[CALCulate<n>:UNCertainty:MATCh:DUT:IN\[:VSWR\]](#) on page 141

[CALCulate<n>:UNCertainty:MATCh:DUT:IN:RL](#) on page 141

[CALCulate<n>:UNCertainty:MATCh:DUT:OUT\[:VSWR\]](#) on page 141

[CALCulate<n>:UNCertainty:MATCh:DUT:OUT:RL](#) on page 141

Use Measurement Values

Turns automatic determination of the DUT characteristics used for the uncertainty calculation on and off.

If on, the application calculates the uncertainty with the DUT characteristics ("noise figure", "gain" and frequency) resulting from the "noise figure" measurement. For this method, the application calculates the uncertainty for each measurement point (or frequency) based on the "noise figure" and "gain" results of the last measurement.

If you have selected automatic determination of the DUT characteristics, the application does not show a result in the "NF Uncertainty +/-" field in the dialog box. Instead, to view the uncertainty at all measurement points, use the "Result Table".

If off, define the "gain", "noise figure" and frequency of the DUT manually for a single frequency. With this manual determination of the DUT characteristics, the application only calculates the uncertainty for that frequency and shows the result in the "NF Uncertainty +/-" field in the dialog box.

- "Noise Figure" of the DUT
- "Gain" of the DUT
- Frequency of the DUT

Remote command:

Control automatic DUT characteristics determination:

[CALCulate<n>:UNCertainty\[:RESult\]? on page 145](#)

Manual definition of DUT characteristics:

[CALCulate<n>:UNCertainty:DATA:NOISe on page 138](#)

[CALCulate<n>:UNCertainty:DATA:GAIN on page 137](#)

[CALCulate<n>:UNCertainty:DATA:FREQuency on page 137](#)

5.7.3 Configuring analyzer characteristics

Access: [MEAS CONFIG] > "Uncertainty Calculation"

For the analyzer characteristics, the application always uses the data specified in the datasheet of the R&S FPL1000 model you are using. Thus, it is not possible to change or adjust the analyzer characteristics in any way. The uncertainty calculation takes several analyzer characteristics into account, of which the following are shown as read-only fields in the user interface.

- "SA Input Match:" Input match (VSWR or return loss) of the analyzer
- "SA NF Uncert:" Noise figure uncertainty of the analyzer
- "SA Gain Uncert:" Gain uncertainty of the analyzer
- "SA NF:" Noise figure of the analyzer

However, if you are using an external preamplifier in the test setup, you have to specify its characteristics to get a valid uncertainty result.

Remote commands:

[CALCulate<n>:UNCertainty:SANalyzer:GAIN:UNCertainty? on page 145](#)

[CALCulate<n>:UNCertainty:SANalyzer:NOISe:UNCertainty? on page 145](#)

External Preamplifier (Ext PA).....	71
L Preamplifier noise figure (PA NF).....	72
L Preamplifier Gain (PA Gain).....	72
L Net spectrum analyzer noise figure (Net SA NF).....	72

External Preamplifier (Ext PA)

If enabled, the application automatically calculates and updates the analyzer characteristics based on the characteristics of the external preamplifier defined here.

Refer to the datasheet of the preamplifier you are using for the values you have to enter.

Remote command:

`CALCulate<n>:UNCertainty:PREamp:STATe` on page 144

Preamplifier noise figure (PA NF) ← External Preamplifier (Ext PA)

Defines the "noise figure" of the preamplifier.

Remote command:

`CALCulate<n>:UNCertainty:PREamp:NOISe` on page 144

Preamplifier Gain (PA Gain) ← External Preamplifier (Ext PA)

Defines the "gain" of the preamplifier.

Remote command:

`CALCulate<n>:UNCertainty:PREamp:GAIN` on page 144

Net spectrum analyzer noise figure (Net SA NF) ← External Preamplifier (Ext PA)

Shows the "noise figure" of the analyzer.

If you are using an external preamplifier, the application calculates the "noise figure" of the analyzer including the "noise figure" of the preamplifier and shows the result here.

If you do not use an external preamplifier, this value is the same as the "noise figure" of the analyzer shown in the "SA NF" field.

5.7.4 Guidelines and results

Access: [MEAS CONFIG] > "Uncertainty Calculation"

The lower part of the dialog box contains measurement guidelines that provide information on the quality of measurement and the actual "noise figure" uncertainty.



Guidelines

The guidelines are an indicator of the quality of the measurement and an indicator the repeatability of the measurement.

The three guidelines are:

- Make sure that the "noise figure" of the DUT and the "gain" of the DUT is greater than the "noise figure" of the analyzer plus 1 dB.
- Make sure that the ENR of the noise source is greater than the "noise figure" of the DUT plus 5 dB.
- Make sure that the ENR of the noise source is greater than the "noise figure" of the analyzer plus 3 dB.

A short form of these guidelines is indicated in the "Uncertainty Calculation" dialog box. The dialog box also indicates if the guidelines have been met or not by a colored dot.

- Green light : guideline condition met.
- Yellow light : guideline condition not met, but within 1 dB of being met.
- Red light : guideline condition not met.

Note that the guidelines have no effect on the actual uncertainty that has been calculated and that they are only considered for measurements with 2nd Stage Correction.

Uncertainty

The "Uncertainty" result is shown only if you define the "noise figure" and "gain" characteristics of the DUT manually on a single frequency. In that case, the uncertainty shown in the "Uncertainty Calculation" dialog box is valid only for the DUT frequency you have defined.

The "Measurement Offset" evaluates the internal noise of the R&S FPL1000 that is added to the "noise figure" results. The measurement offset result is displayed when 2nd stage correction is turned off. When you turn on 2nd stage correction, the internal noise is automatically removed from the uncertainty results, so the measurement offset is not shown.

If you are using the "noise figure" and "gain" that has been determined during a measurement, the uncertainty is displayed only in the result table.

For more information, see ["Use Measurement Values"](#) on page 70.

SCPI command:

`CALCulate<n>:UNCertainty[:RESult]?` on page 145

5.8 Performing measurements

Access: [SWEEP]

Access (calibration): "Overview" > "Calibrate"

This chapter contains all functionality necessary to control and perform "noise figure" measurements.

Continuous Sweep / Run Cont	73
Single Sweep / Run Single	74
Calibrate	74
Sweep Time	74
Meas Mode (Auto Manual)	75

Continuous Sweep / Run Cont

After triggering, starts the measurement and repeats it continuously until stopped.

Initiates a measurement and repeats it continuously until stopped. If necessary, the application automatically determines the reference level before starting the actual measurement.

While the measurement is running, the "Continuous Sweep" softkey and the [RUN CONT] key are highlighted. The running measurement can be aborted by selecting the highlighted softkey or key again. The results are not deleted until a new measurement is started.

Note: Sequencer. If the Sequencer is active, the "Continuous Sweep" softkey only controls the sweep mode for the currently selected channel setup. However, the sweep

mode only takes effect the next time the Sequencer activates that channel setup, and only for a channel-defined sequence. In this case, a channel setup in continuous sweep mode is swept repeatedly.

Furthermore, the [RUN CONT] key controls the Sequencer, not individual sweeps. [RUN CONT] starts the Sequencer in continuous mode.

For details on the Sequencer, see the R&S FPL1000 User Manual.

Remote command:

`INITiate<n>:CONTInuous` on page 147

Single Sweep / Run Single

Initiates a single measurement. The measurement is finished after all frequencies in the frequency list have been measured. If necessary, the application automatically determines the reference level before starting the actual measurement.

After triggering, initiates a single measurement. The measurement is finished after all frequencies in the frequency list have been measured. If necessary, the application automatically determines the reference level before starting the actual measurement.

While the measurement is running, the "Single Sweep" softkey and the [RUN SINGLE] key are highlighted. The running measurement can be aborted by selecting the highlighted softkey or key again.

Note: Sequencer. If the Sequencer is active, the "Single Sweep" softkey only controls the sweep mode for the currently selected channel setup. However, the sweep mode only takes effect the next time the Sequencer activates that channel setup, and only for a channel-defined sequence. In this case, the Sequencer sweeps a channel setup in single sweep mode only once.

Furthermore, the [RUN SINGLE] key controls the Sequencer, not individual sweeps. [RUN SINGLE] starts the Sequencer in single mode.

If the Sequencer is off, only the evaluation for the currently displayed channel setup is updated.

For details on the Sequencer, see the R&S FPL1000 User Manual.

Remote command:

`INITiate<n>[:IMMEDIATE]` on page 147

Calibrate

Initiates a calibration measurement.

For interpolation purposes, R&S FPL1000-K30 will internally add additional measurement points at the band switching frequencies. This may increase the time needed to complete the calibration.

For more information see [Chapter 4.5, "Calibration \(2nd stage correction\)"](#), on page 32.

Remote command:

`INITiate<n>[:IMMEDIATE]` on page 147
when `[SENSE:]CONFigure:CORRection` is on.

Sweep Time

Defines the sweep time.

For more information see ["Sweep Time"](#) on page 64.

Meas Mode (Auto Manual)

Selects the measurement mode for the hot and cold power measurements.

For more information about the measurement modes see [Chapter 4.2, "Measurement modes"](#), on page 26.

In manual measurement mode, the application opens a dialog box when you start a measurement. For more information about its contents see ["Performing a manual measurement"](#) on page 27.

Remote command:

[\[SENSe:\]CONFigure:CONTRol](#) on page 149

[\[SENSe:\]CONFigure:MEASurement](#) on page 149

5.9 Configuring inputs and outputs of the R&S FPL1000

The only input setting available for the R&S FPL1 Noise Figure measurements application on the R&S FPL1000 is [Chapter 5.9.1, "Impedance"](#), on page 75.

In addition, the optional independent CW source (R&S FPL1000-K14 option) is supported. See the R&S FPL1000 user manual.

- [Impedance](#)..... 75

5.9.1 Impedance

Access: [MEAS] > "Input Source Config"

Impedance

For some measurements, the reference impedance for the measured levels of the R&S FPL1000 can be set to 50 Ω or 75 Ω .

Select 75 Ω if the 50 Ω input impedance is transformed to a higher impedance using a 75 Ω adapter of the RAZ type. (That corresponds to 25 Ω in series to the input impedance of the instrument.) The correction value in this case is 1.76 dB = 10 log (75 Ω /50 Ω).

Remote command:

[INPut<ip>:IMPedance](#) on page 150

6 Analysis

This chapter contains all settings and parameters that the application provides to analyze and evaluate measurement results.

- [Configuring the display](#).....76
- [Working with traces](#).....79
- [Trace / data export configuration](#)..... 81
- [Using markers](#).....84

6.1 Configuring the display

Access: [MEAS CONFIG] > "Result Config"

Display configuration settings configure the way the results are displayed in the diagram.

The contents depend on whether you want to configure a graphical result display or a numerical result display.

Specifics for

The settings you make apply to the results you have selected in the "Specifics for" dropdown menu. If more than one window is active, "Specifics for" also puts the focus on the corresponding window.

- [Configuring graphical results](#).....76
- [Configuring numerical results](#).....78

6.1.1 Configuring graphical results

Access: [MEAS CONFIG] > "Result Config" > "Graph"

When configuring graphical results, the dialog box contains functionality to scale and set up the diagram axes.

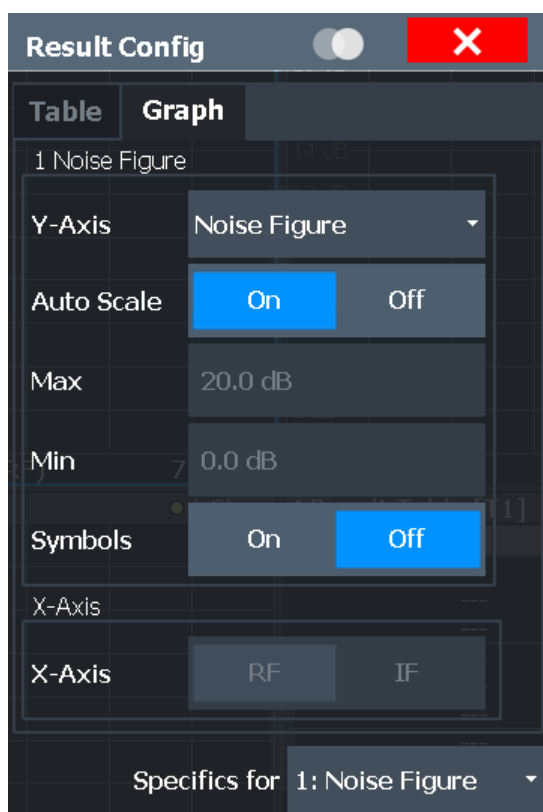

Y-Axis.....	77
Auto Scale / Min / Max.....	77
Symbols.....	78
X-Axis.....	78

Y-Axis

Selects the result display and thus the scaling of the vertical axis.

For more information, see [Chapter 3, "Measurements and result displays"](#), on page 15.

Auto Scale / Min / Max

Turns automatic scaling of the vertical axis on and off.

If on, the application optimizes the scaling of the vertical axis after each measurement for ideal viewing of the results.

If off, you can define the scaling manually. The "Min" and "Max" input fields become available. These two input fields define the values at the top and bottom of the vertical axis.

Remote command:

Automatic scaling:

`DISPlay[:WINDow<n>]:TRACe<t>:Y[:SCALE]:AUTO` on page 155

Manual minimum value:

`DISPlay[:WINDow<n>]:TRACe<t>:Y[:SCALE]:BOTTom` on page 154

Manual maximum value

`DISPlay[:WINDow<n>]:TRACe<t>:Y[:SCALE]:TOP` on page 155

Symbols

Turns symbols that represent a measurement point on the trace on and off.

Remote command:

[DISPlay\[:WINDow<n>\]:TRACe<t>:SYMBOLs](#) on page 153

X-Axis

Selects the frequency data that is displayed on the x-axis.

For measurements on frequency converting DUTs with a variable intermediate frequency, you can display either the RF frequency or the IF frequency.

Note that a change of the x-axis scale applies to all result displays, and also determines which value is output for trace export.

The "Frequency Axis" scale is also available via the [FREQ] key.

Remote command:

[DISPlay\[:WINDow<n>\]:TRACe<t>:X\[:SCALE\]](#) on page 153

6.1.2 Configuring numerical results

When configuring numerical results, the dialog box selects the type of results you want to display in the result table. The results in the table are based on a particular trace that you can select in the corresponding input field.

You can add an aspect of the measurement by placing a checkmark in front of the corresponding result on and remove it by removing the checkmark.

For more information on each result, see [Chapter 3, "Measurements and result displays"](#), on page 15.

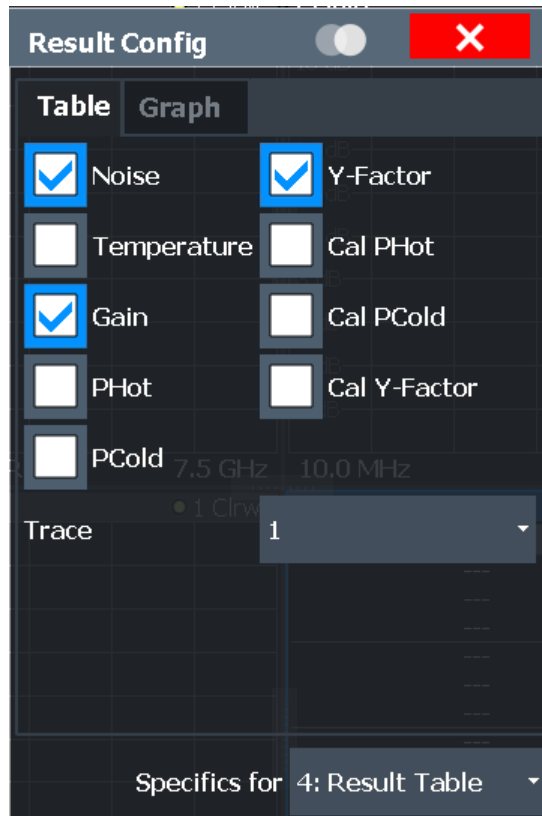

Remote command:

[DISPlay\[:WINDow<n>\]:TABLE:ITEM](#) on page 152

6.2 Working with traces

Access (trace configuration): [TRACE] > "Trace Config" > "Traces"

Access (trace export): [TRACE] > "Trace Config" > "Trace / Data Export"

Access (copy trace): [TRACE] > "Trace Config" > "Trace Copy"

A trace is the graphical representation of a set of measurement results in a diagram. Each measurement window that contains graphical results supports up to four individual traces. Each trace has a different color. Trace settings determine how the measured data is analyzed and displayed on the screen. The trace information, including a color map and trace mode is summarized in the diagram header.

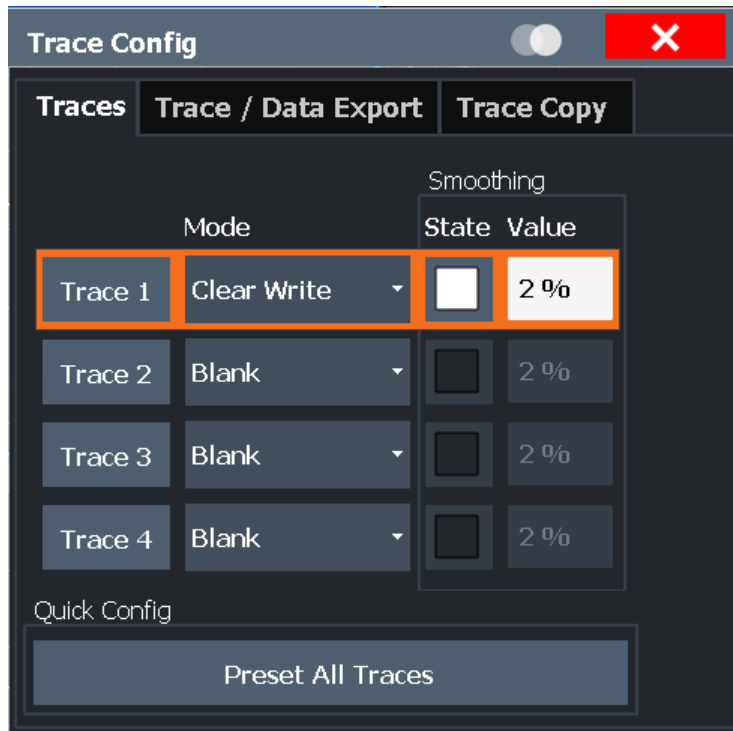

Traces..... 80
 Smoothing..... 80
 Preset Traces..... 81
 Copy Trace..... 81

Traces

The "Trace 1 to 4" softkeys open the "Traces" tab of the "Trace Configuration" dialog box.

The "Traces" tab contains functionality to configure a trace.

"Trace Selection" The "Trace 1" to "Trace 4" buttons select a trace. If a trace is selected, it is highlighted orange.
 Note that you cannot select a trace if its trace mode is "Blank".

"Trace Mode" Selects the trace mode for the corresponding trace.
 For more information, see [Chapter 4, "Measurement basics"](#), on page 24.

Remote command:

Trace mode:

`DISPlay[:WINDow<n>][:SUBWindow<w>]:TRACe<t>:MODE` on page 156

Smoothing

If enabled, the trace is smoothed by the specified value (between 1 % and 50 %). The smoothing value is defined as a percentage of the display width. The larger the smoothing value, the greater the smoothing effect.

Remote command:

`DISPlay[:WINDow<n>][:SUBWindow<w>]:TRACe<t>:SMOothing[:STATe]`
on page 157

`DISPlay[:WINDow<n>][:SUBWindow<w>]:TRACe<t>:SMOothing:APERture`
on page 157

Preset Traces

Restores the default configuration for all traces in a window.

Copy Trace

Access: "Overview" > "Analysis" > "Traces" > "Copy Trace"

Or: [TRACE] > "Copy Trace"

Copies trace data to another trace.

The first group of buttons (labeled "Trace 1" to "Trace 4") selects the source trace. The second group of buttons (labeled "Copy to Trace 1" to "Copy to Trace 4") selects the destination.

Remote command:

`TRACe<n>:COPY` on page 160

6.3 Trace / data export configuration



Access: "Save" > "Export" > "Export Configuration"

Or: [TRACE] > "Trace Config" > "Trace / Data Export"



The standard data management functions (e.g. saving or loading instrument settings) that are available for all R&S FPL1000 applications are not described here.

See the R&S FPL1000 base unit user manual for a description of the standard functions.

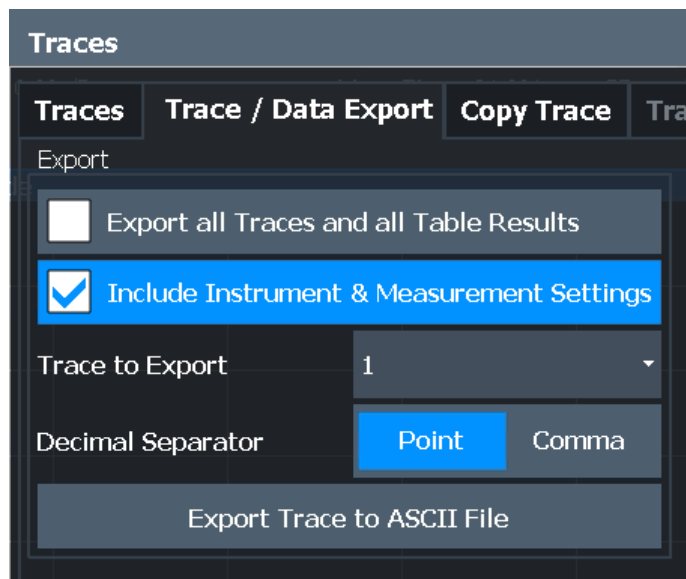

Export all Traces and all Table Results.....	82
Include Instrument & Measurement Settings.....	82
Trace to Export.....	82
Decimal Separator.....	83
Export Trace to ASCII File.....	83
L File Type.....	83
L Decimal Separator.....	84
L File Explorer.....	84
Export Trace to ASCII File.....	84

Export all Traces and all Table Results

Selects all displayed traces and result tables (e.g. "Result Summary", marker table etc.) in the current application for export to an ASCII file.

Alternatively, you can select one specific trace only for export (see [Trace to Export](#)).

The results are output in the same order as they are displayed on the screen: window by window, trace by trace, and table row by table row.

Remote command:

`FORMat:DEXPort:TRACes` on page 159

Include Instrument & Measurement Settings

Includes additional instrument and measurement settings in the header of the export file for result data.

Remote command:

`FORMat:DEXPort:HEADer` on page 159

Trace to Export

Defines an individual trace to be exported to a file.

This setting is not available if [Export all Traces and all Table Results](#) is selected.

Decimal Separator

Defines the decimal separator for floating-point numerals for the data export/import files. Evaluation programs require different separators in different languages.

Remote command:

[FORMat:DEXPort:DSEParator](#) on page 159

Export Trace to ASCII File

Saves the selected trace or all traces in the currently active result display to the specified file and directory in the selected ASCII format.

"File Explorer": Instead of using the file manager of the R&S FPL1000 firmware, you can also use the Microsoft Windows File Explorer to manage files.

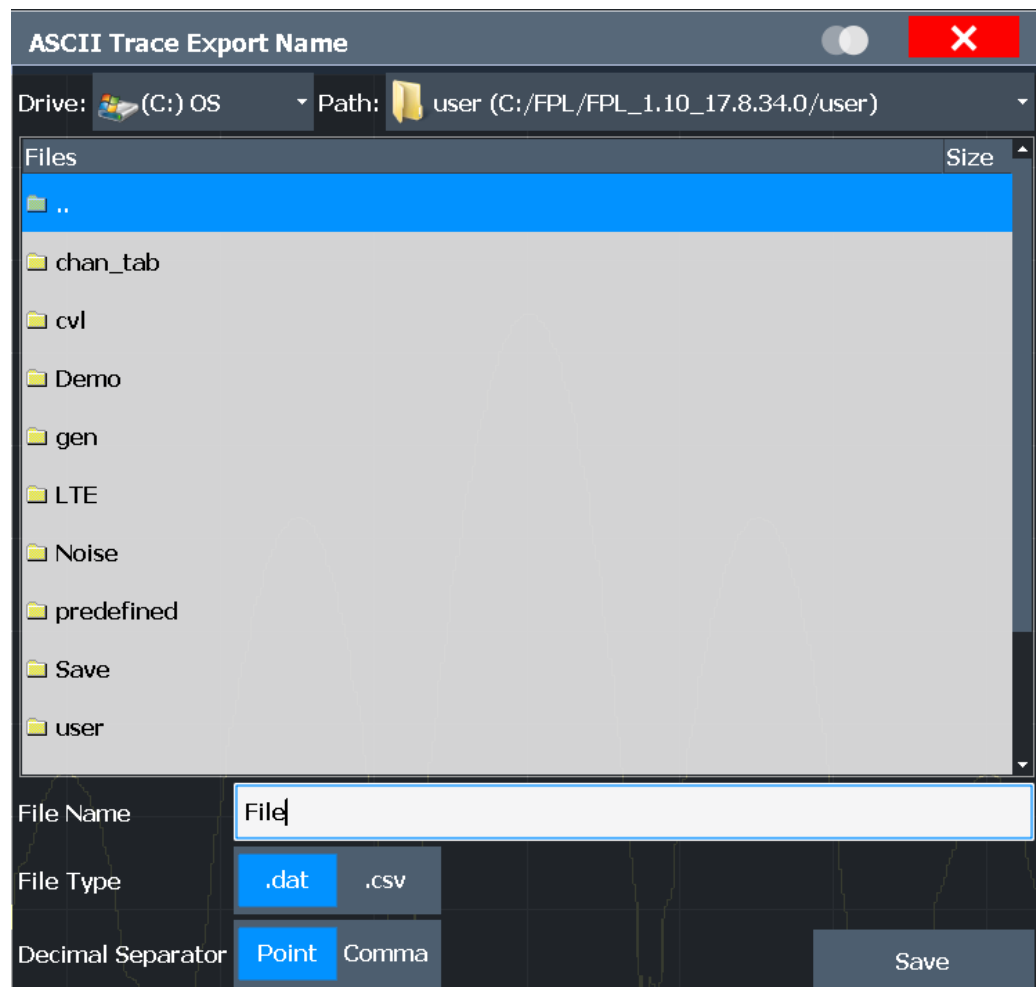

Remote command:

[MMEMory:STORe<n>:TRACe](#) on page 160

File Type ← Export Trace to ASCII File

Determines the format of the ASCII file to be imported or exported.

Depending on the external program in which the data file was created or is evaluated, a comma-separated list (CSV) or a plain data format (DAT) file is required.

Remote command:

[FORMat:DEXPort:FORMat](#) on page 159

Decimal Separator ← Export Trace to ASCII File

Defines the decimal separator for floating-point numerals for the data export/import files. Evaluation programs require different separators in different languages.

Remote command:

[FORMat:DEXPort:DSEParator](#) on page 159

File Explorer ← Export Trace to ASCII File

Opens the Microsoft Windows File Explorer.

Remote command:

not supported

Export Trace to ASCII File

Opens a file selection dialog box and saves the selected trace in ASCII format (.dat) to the specified file and directory.

The results are output in the same order as they are displayed on the screen: window by window, trace by trace, and table row by table row.

The column headers are provided as the first row. Whether the frequency value represents the RF or IF frequency depends on the [X-Axis](#) setting.

Remote command:

[MMEMory:STORe<n>:TRACe](#) on page 160

6.4 Using markers

Markers help you to read out measurement results for particular frequencies or mark a particular point on a trace. The "noise figure" application features four markers. Markers in the "noise figure" application are linked. If you use more than one measurement window and activate a marker in one window, it also appears in all other measurement windows on the same horizontal position.

- [Marker configuration](#)..... 84
- [Marker positioning](#).....87

6.4.1 Marker configuration

Access (marker configuration): [MKR] > "Marker Config" > "Marker"

Access (marker settings): [MKR] > "Marker Config" > "Marker Settings"

The "Marker Configuration" dialog box and the "Marker" menu contain all functionality necessary to control markers.

The "Marker Configuration" dialog box consists of two tabs.

The "Markers" tab contains functionality to define characteristics for each marker.

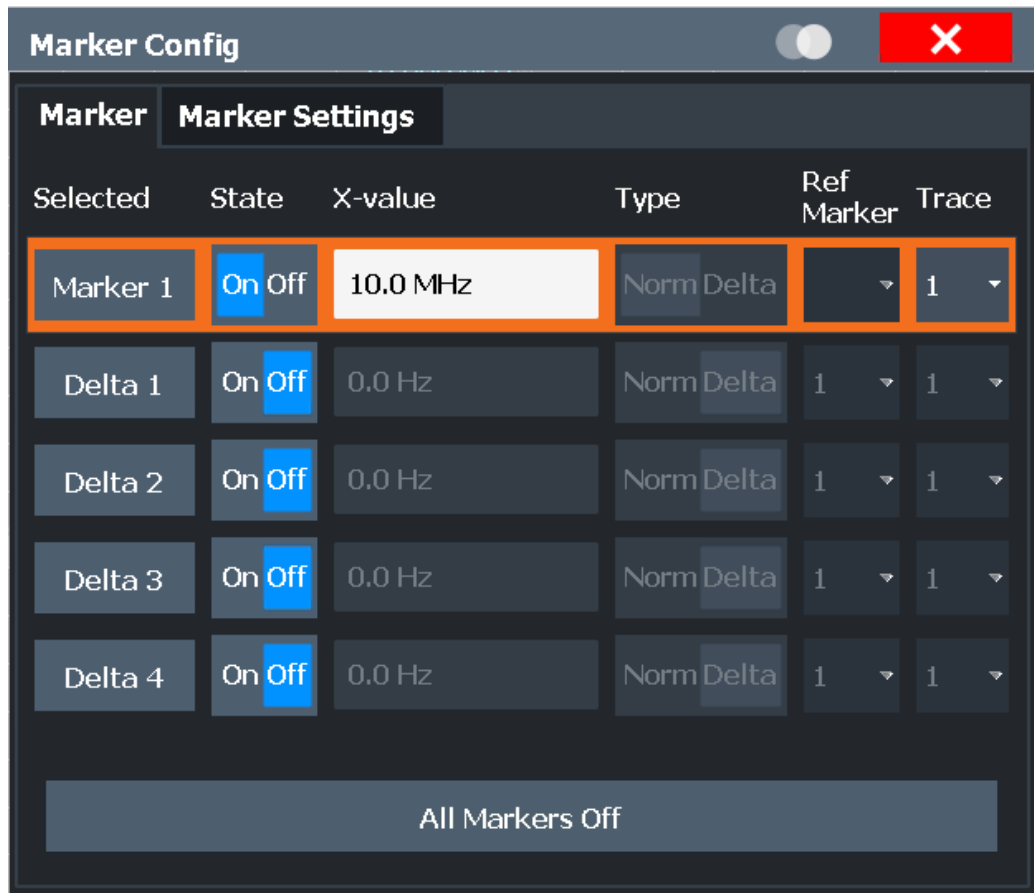

The "Marker Settings" tab contains general marker functionality.

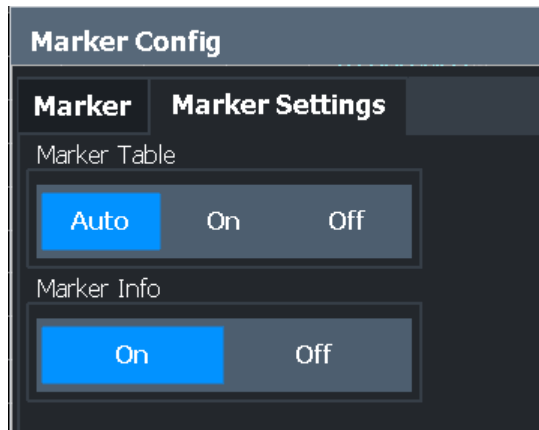

Marker (1...4).....	86
Marker Type.....	86
Marker to Trace.....	86
All Markers Off.....	86
Marker Config.....	86
Marker Table Display.....	86
Marker Info.....	87

Marker (1...4)

Selects or turns the corresponding marker on and off.

Turning on a marker also opens an input field to define the horizontal position of the marker.

By default, the first marker you turn on is a normal marker, all others are delta markers.

Marker Type

Toggles the marker type.

The type for marker 1 is always "Normal", the type for delta marker 1 is always "Delta". These types cannot be changed.

Note: If normal marker 1 is the active marker, switching the "Mkr Type" activates an additional delta marker 1. For any other marker, switching the marker type does not activate an additional marker, it only switches the type of the selected marker.

"Normal" A normal marker indicates the absolute value at the defined position in the diagram.

"Delta" A delta marker defines the value of the marker relative to the specified reference marker (marker 1 by default).

Remote command:

[CALCulate<n>:MARKer<m>\[:STATe\]](#) on page 170

[CALCulate<n>:DELTAmarker<m>\[:STATe\]](#) on page 173

Marker to Trace

Opens an input field to assign the marker to a particular trace if you are using more than one trace.

All Markers Off

Deactivates all markers in one step.

Remote command:

[CALCulate<n>:MARKer<m>:AOFF](#) on page 170

Marker Config

Opens the "Marker Configuration" dialog box.

The "Marker Configuration" dialog box contains all marker functions necessary to set up the four markers supported by the application.

- Selected
Highlights the currently selected marker.
- State
Turns a marker on and off.
- X-value
Defines the marker position on the horizontal axis.
- Type
Selects the marker type. For more information see "[Marker Type](#)" on page 86.
- Trace
Selects the trace the marker is positioned on.

Marker Table Display

Defines how the marker information is displayed.

"On"	Displays the marker information in a table in a separate area beneath the diagram.
"Off"	No separate marker table is displayed. If Marker Info is active, the marker information is displayed within the diagram area.

Remote command:

`DISPlay[:WINDow<n>]:MTABLE` on page 176

Marker Info

Turns the marker information displayed in the diagram on and off.

1AP Clrw	
M1[1]	81.13 dBµV 177.610 MHz
D2[1]	-22.18 dB -28.980 MHz

Remote command:

`DISPlay[:WINDow<n>]:MINFo[:STATe]` on page 175

6.4.2 Marker positioning

If you are using more than one measurement window, the application performs the peak search in the currently selected measurement window. The currently selected measurement window has a blue border. Because the markers are linked in the "noise figure" application, the frequency position of the marker in the other window is updated accordingly, even if it means that the marker is on a peak in one window only.

Select Marker <x>	87
Peak Search	88
Search Next Peak	88
Search Minimum	88
Search Next Minimum	88
Marker to Single Frequency	89

Select Marker <x>

Opens a dialog box to select and activate or deactivate one or more markers.

The number in the softkey label (<x>) shows the number of the currently selected marker.



Remote command:

Marker selected via suffix <m> in remote commands.

Peak Search

Sets the selected marker/delta marker to the maximum of the trace. If no marker is active, marker 1 is activated.

Remote command:

[CALCulate<n>:MARKer<m>:MAXimum\[:PEAK\]](#) on page 177

[CALCulate<n>:DELTAmarker<m>:MAXimum\[:PEAK\]](#) on page 179

Search Next Peak

Sets the selected marker/delta marker to the next (lower) maximum of the assigned trace. If no marker is active, marker 1 is activated.

Remote command:

[CALCulate<n>:MARKer<m>:MAXimum:NEXT](#) on page 177

[CALCulate<n>:MARKer<m>:MAXimum:RIGHT](#) on page 177

[CALCulate<n>:MARKer<m>:MAXimum:LEFT](#) on page 176

[CALCulate<n>:DELTAmarker<m>:MAXimum:NEXT](#) on page 179

[CALCulate<n>:DELTAmarker<m>:MAXimum:RIGHT](#) on page 179

[CALCulate<n>:DELTAmarker<m>:MAXimum:LEFT](#) on page 178

Search Minimum

Sets the selected marker/delta marker to the minimum of the trace. If no marker is active, marker 1 is activated.

Remote command:

[CALCulate<n>:MARKer<m>:MINimum\[:PEAK\]](#) on page 178

[CALCulate<n>:DELTAmarker<m>:MINimum\[:PEAK\]](#) on page 180

Search Next Minimum

Sets the selected marker/delta marker to the next (higher) minimum of the selected trace. If no marker is active, marker 1 is activated.

Remote command:

`CALCulate<n>:MARKer<m>:MINimum:NEXT` on page 177

`CALCulate<n>:MARKer<m>:MINimum:LEFT` on page 177

`CALCulate<n>:MARKer<m>:MINimum:RIGHT` on page 178

`CALCulate<n>:DELTamarker<m>:MINimum:NEXT` on page 180

`CALCulate<n>:DELTamarker<m>:MINimum:LEFT` on page 179

`CALCulate<n>:DELTamarker<m>:MINimum:RIGHT` on page 180

Marker to Single Frequency

Starts a single frequency measurement on the current marker position.

When you use this function, the application changes the tuning mode and automatically adjusts the single frequency to that of the current marker position.

For more information see [Chapter 4.1.3, "Single frequency measurements"](#), on page 26.

7 Remote control commands for noise figure measurements

The following remote control commands are required to configure and perform "noise figure" measurements in a remote environment. The R&S FPL1000 must already be set up for remote operation in a network as described in the base unit manual.



Common functionality

Note that basic tasks that are also performed in the base unit in the same way are not described here. For a description of such tasks, see the R&S FPL1000 User Manual.

In particular, this includes:

- Managing Settings and Results, i.e. storing and loading settings and result data.
- Basic instrument configuration, e.g. checking the system configuration, customizing the screen layout, or configuring networks and remote operation.
- Using the common status registers (specific status registers for Pulse measurements are not used).

Channel setup-specific commands

Apart from a few general commands on the R&S FPL1000, most commands refer to the currently active channel setup. Thus, always remember to activate a "Noise Figure" channel setup before starting a remote program for a "noise figure" measurement.

• Common suffixes	91
• Introduction	91
• Controlling the noise figure measurement channel	96
• Working with windows in the display	99
• General window commands	107
• Retrieving measurement results	107
• Defining the measurement frequency	109
• Selecting DUT characteristics	114
• Configuring the noise source	115
• Configuring additional loss	123
• Configuring the analyzer	130
• Using the uncertainty calculator	136
• Performing measurements	146
• Configuring the inputs and outputs	150
• Independant CW source commands	151
• Configuring the display	152
• Working with traces	156
• Working with limit lines	161
• Working with markers	169
• Using the status register	180
• Deprecated remote commands for noise figure measurements	187
• Programming example: measuring a noise figure	188

7.1 Common suffixes

In the R&S FPL1 Noise Figure measurements application, the following common suffixes are used in remote commands:

Table 7-1: Common suffixes used in remote commands in the R&S FPL1 Noise Figure measurements application

Suffix	Value range	Description
<m>	1 to 4	Marker
<n>	1 to 16	Window (in the currently selected channel setup)
<t>	1 to 4	Trace
	1 to 8	Limit line

7.2 Introduction

Commands are program messages that a controller (e.g. a PC) sends to the instrument or software. They operate its functions ('setting commands' or 'events') and request information ('query commands'). Some commands can only be used in one way, others work in two ways (setting and query). If not indicated otherwise, the commands can be used for settings and queries.

The syntax of a SCPI command consists of a header and, usually, one or more parameters. To use a command as a query, you have to append a question mark after the last header element, even if the command contains a parameter.

A header contains one or more keywords, separated by a colon. Header and parameters are separated by a "white space" (ASCII code 0 to 9, 11 to 32 decimal, e.g. blank). If there is more than one parameter for a command, they are separated by a comma from one another.

Only the most important characteristics that you need to know when working with SCPI commands are described here. For a more complete description, refer to the user manual of the R&S FPL1000.



Remote command examples

Note that some remote command examples mentioned in this general introduction are possibly not supported by this particular application.

7.2.1 Conventions used in descriptions

The following conventions are used in the remote command descriptions:

- **Command usage**
If not specified otherwise, commands can be used both for setting and for querying parameters.

If a command can be used for setting or querying only, or if it initiates an event, the usage is stated explicitly.

- **Parameter usage**

If not specified otherwise, a parameter can be used to set a value and it is the result of a query.

Parameters required only for setting are indicated as **Setting parameters**.

Parameters required only to refine a query are indicated as **Query parameters**.

Parameters that are only returned as the result of a query are indicated as **Return values**.

- **Conformity**

Commands that are taken from the SCPI standard are indicated as **SCPI confirmed**. All commands used by the R&S FPL1000 follow the SCPI syntax rules.

- **Asynchronous commands**

A command which does not automatically finish executing before the next command starts executing (overlapping command) is indicated as an **Asynchronous command**.

- **Reset values (*RST)**

Default parameter values that are used directly after resetting the instrument (*RST command) are indicated as ***RST** values, if available.

- **Default unit**

The default unit is used for numeric values if no other unit is provided with the parameter.

- **Manual operation**

If the result of a remote command can also be achieved in manual operation, a link to the description is inserted.

7.2.2 Long and short form

The keywords have a long and a short form. You can use either the long or the short form, but no other abbreviations of the keywords.

The short form is emphasized in uppercase letters. Note however, that this emphasis only serves the purpose to distinguish the short from the long form in the manual. For the instrument, the case does not matter.

Example:

`SENSe:FREQuency:CENTer` is the same as `SENS:FREQ:CENT`.

7.2.3 Numeric suffixes

Some keywords have a numeric suffix if the command can be applied to multiple instances of an object. In that case, the suffix selects a particular instance (e.g. a measurement window).

Numeric suffixes are indicated by angular brackets (<n>) next to the keyword.

If you do not quote a suffix for keywords that support one, a 1 is assumed.

Example:

`DISPlay[:WINDow<1...4>]:ZOOM:STATe` enables the zoom in a particular measurement window, selected by the suffix at `WINDow`.

`DISPlay:WINDow4:ZOOM:STATe ON` refers to window 4.

7.2.4 Optional keywords

Some keywords are optional and are only part of the syntax because of SCPI compliance. You can include them in the header or not.



If an optional keyword has a numeric suffix and you need to use the suffix, you have to include the optional keyword. Otherwise, the suffix of the missing keyword is assumed to be the value 1.

Optional keywords are emphasized with square brackets.

Example:

Without a numeric suffix in the optional keyword:

`[SENSe:]FREQuency:CENTer` is the same as `FREQuency:CENTer`

With a numeric suffix in the optional keyword:

`DISPlay[:WINDow<1...4>]:ZOOM:STATe`

`DISPlay:ZOOM:STATe ON` enables the zoom in window 1 (no suffix).

`DISPlay:WINDow4:ZOOM:STATe ON` enables the zoom in window 4.

7.2.5 Alternative keywords

A vertical stroke indicates alternatives for a specific keyword. You can use both keywords to the same effect.

Example:

`[SENSe:]BANDwidth|BWIDth[:RESolution]`

In the short form without optional keywords, `BAND 1MHZ` would have the same effect as `BWID 1MHZ`.

7.2.6 SCPI parameters

Many commands feature one or more parameters.

If a command supports more than one parameter, they are separated by a comma.

Example:

`LAYout:ADD:WINDow Spectrum,LEFT,MTABLE`

Parameters can have different forms of values.

• Numeric values	94
• Boolean	95
• Character data	95
• Character strings	95
• Block data	95

7.2.6.1 Numeric values

Numeric values can be entered in any form, i.e. with sign, decimal point or exponent. For physical quantities, you can also add the unit. If the unit is missing, the command uses the basic unit.

Example:

With unit: `SENSe:FREQuency:CENTer 1GHZ`

Without unit: `SENSe:FREQuency:CENTer 1E9` would also set a frequency of 1 GHz.

Values exceeding the resolution of the instrument are rounded up or down.

If the number you have entered is not supported (e.g. for discrete steps), the command returns an error.

Instead of a number, you can also set numeric values with a text parameter in special cases.

- **MIN/MAX**
Defines the minimum or maximum numeric value that is supported.
- **DEF**
Defines the default value.
- **UP/DOWN**
Increases or decreases the numeric value by one step. The step size depends on the setting. Sometimes, you can customize the step size with a corresponding command.

Querying numeric values

When you query numeric values, the system returns a number. For physical quantities, it applies the basic unit (e.g. Hz for frequencies). The number of digits after the decimal point depends on the type of numeric value.

Example:

Setting: `SENSe:FREQuency:CENTer 1GHZ`

Query: `SENSe:FREQuency:CENTer?` would return `1E9`

Sometimes, numeric values are returned as text.

- **INF/NINF**
Infinity or negative infinity. Represents the numeric values 9.9E37 or -9.9E37.
- **NAN**

Not a number. Represents the numeric value 9.91E37. NAN is returned if errors occur.

7.2.6.2 Boolean

Boolean parameters represent two states. The "on" state (logically true) is represented by "ON" or the numeric value 1. The "off" state (logically untrue) is represented by "OFF" or the numeric value 0.

Querying Boolean parameters

When you query Boolean parameters, the system returns either the value 1 ("ON") or the value 0 ("OFF").

Example:

Setting: `DISPlay:WINDow:ZOOM:STATe ON`

Query: `DISPlay:WINDow:ZOOM:STATe?` would return 1

7.2.6.3 Character data

Character data follows the syntactic rules of keywords. You can enter text using a short or a long form. For more information, see [Chapter 7.2.2, "Long and short form"](#), on page 92.

Querying text parameters

When you query text parameters, the system returns its short form.

Example:

Setting: `SENSe:BANDwidth:RESolution:TYPE NORMAL`

Query: `SENSe:BANDwidth:RESolution:TYPE?` would return NORM

7.2.6.4 Character strings

Strings are alphanumeric characters. They have to be in straight quotation marks. You can use a single quotation mark (') or a double quotation mark (").

Example:

`INSTRument:DELeTe 'Spectrum'`

7.2.6.5 Block data

Block data is a format which is suitable for the transmission of large amounts of data.

The ASCII character # introduces the data block. The next number indicates how many of the following digits describe the length of the data block. The data bytes follow. During the transmission of these data bytes, all end or other control signs are ignored until

all bytes are transmitted. #0 specifies a data block of indefinite length. The use of the indefinite format requires an `NL^END` message to terminate the data block. This format is useful when the length of the transmission is not known or if speed or other considerations prevent segmentation of the data into blocks of definite length.

7.3 Controlling the noise figure measurement channel

The following commands are necessary to control the measurement channel.

<code>INSTrument:CREate:DUPLicate</code>	96
<code>INSTrument:CREate[:NEW]</code>	96
<code>INSTrument:CREate:REPLace</code>	97
<code>INSTrument:DELeTe</code>	97
<code>INSTrument:LIST?</code>	97
<code>INSTrument:REName</code>	98
<code>INSTrument[:SELeCt]</code>	98
<code>SYSTem:PRESet:CHANnel[:EXEC]</code>	99

`INSTrument:CREate:DUPLicate`

This command duplicates the currently selected channel setup, i.e. creates a new channel setup of the same type and with the identical measurement settings. The name of the new channel setup is the same as the copied channel setup, extended by a consecutive number (e.g. "IQAnalyzer" -> "IQAnalyzer 2").

The channel setup to be duplicated must be selected first using the `INST:SEL` command.

Example:

```
INST:SEL 'IQAnalyzer'
```

```
INST:CRE:DUPL
```

Duplicates the channel setup named 'IQAnalyzer' and creates a new channel setup named 'IQAnalyzer2'.

Usage: Event

`INSTrument:CREate[:NEW]` <ChannelType>, <ChannelName>

This command adds a measurement channel. You can configure up to 10 measurement channels at the same time (depending on available memory).

Parameters:

<ChannelType> Channel type of the new channel.
For a list of available channel types, see `INSTrument:LIST?` on page 97.

<ChannelName> String containing the name of the channel.
Note that you cannot assign an existing channel name to a new channel. If you do, an error occurs.

Example:

```
INST:CRE SAN, 'Spectrum 2'
```

Adds a spectrum display named "Spectrum 2".

INSTRument:CREate:REPLace <ChannelName1>,<ChannelType>,<ChannelName2>

This command replaces a channel setup with another one.

Setting parameters:

- <ChannelName1> String containing the name of the channel setup you want to replace.
- <ChannelType> Channel type of the new channel setup.
For a list of available channel setup types, see [INSTRument:LIST?](#) on page 97.
- <ChannelName2> String containing the name of the new channel setup.
Note: If the specified name for a new channel setup already exists, the default name, extended by a sequential number, is used for the new channel setup (see [INSTRument:LIST?](#) on page 97).
Channel names can have a maximum of 31 characters, and must be compatible with the Windows conventions for file names. In particular, they must not contain special characters such as ":", "*", "?".

Example: `INST:CRE:REPL 'IQAnalyzer2',IQ,'IQAnalyzer'`
Replaces the channel setup named "IQAnalyzer2" by a new channel setup of type "IQ Analyzer" named "IQAnalyzer".

Usage: Setting only

INSTRument:DELeTe <ChannelName>

This command deletes a channel setup.

Setting parameters:

- <ChannelName> String containing the name of the channel setup you want to delete.
A channel setup must exist to delete it.

Usage: Setting only

INSTRument:LIST?

This command queries all active channel setups. The query is useful to obtain the names of the existing channel setups, which are required to replace or delete the channel setups.

Return values:

- <ChannelType>,
<ChannelName> For each channel setup, the command returns the channel setup type and channel setup name (see tables below).
Tip: to change the channel setup name, use the [INSTRument:REName](#) command.

Example: `INST:LIST?`
 Result for 3 channel setups:
 'ADEM', 'Analog Demod', 'IQ', 'IQ Analyzer', 'IQ', 'IQ Analyzer2'

Usage: Query only

Table 7-2: Available channel setup types and default channel setup names

Application	<ChannelType> Parameter	Default Channel setup Name*)
Spectrum	SANALYZER	Spectrum
AM/FM/PM Modulation Analysis	ADEM	Analog Demod
I/Q Analyzer	IQ	IQ Analyzer
Noise Figure Measurements	NOISE	Noise
Vector Signal Analysis (VSA)	DDEM	VSA

Note: the default channel setup name is also listed in the table. If the specified name for a new channel setup already exists, the default name, extended by a sequential number, is used for the new channel setup.

INSTrument:REName <ChannelName1>, <ChannelName2>

This command renames a channel setup.

Setting parameters:

<ChannelName1> String containing the name of the channel setup you want to rename.

<ChannelName2> String containing the new channel setup name.
 Note that you cannot assign an existing channel setup name to a new channel setup. If you do, an error occurs.
 Channel names can have a maximum of 31 characters, and must be compatible with the Windows conventions for file names. In particular, they must not contain special characters such as ":", "*", "?".

Example: `INST:REN 'IQAnalyzer2', 'IQAnalyzer3'`
 Renames the channel setup with the name 'IQAnalyzer2' to 'IQAnalyzer3'.

Usage: Setting only

INSTrument[:SElect] <ChannelType> | <ChannelName>

This command activates a new channel setup with the defined channel setup type, or selects an existing channel setup with the specified name.

Also see

- [INSTrument:CREate\[:NEW\]](#) on page 96

Parameters:

<ChannelType> Channel type of the new channel setup.
For a list of available channel setup types see [INSTrument:LIST?](#) on page 97.

<ChannelName> String containing the name of the channel setup.

Example:

```
INST IQ
```

```
INST 'MyIQSpectrum'
```

Selects the channel setup named 'MyIQSpectrum' (for example before executing further commands for that channel setup).

SYSTem:PRESet:CHANnel[:EXEC]

This command restores the default instrument settings in the current channel setup.

Use `INST:SEL` to select the channel setup.

Example:

```
INST:SEL 'Spectrum2'
```

Selects the channel setup for "Spectrum2".

```
SYST:PRESet:CHAN:EXEC
```

Restores the factory default settings to the "Spectrum2"channel setup.

Usage:

Event

Manual operation: See "[Preset Channel setup](#)" on page 42

7.4 Working with windows in the display

The following commands are required to change the evaluation type and rearrange the screen layout for a channel setup as you do using the SmartGrid in manual operation. Since the available evaluation types depend on the selected application, some parameters for the following commands also depend on the selected channel setup.

Note that the suffix <n> always refers to the window *in the currently selected channel setup*.

LAYout:ADD[:WINDow]?	100
LAYout:CATalog[:WINDow]?	101
LAYout:IDENtify[:WINDow]?	101
LAYout:MOVE[:WINDow]	102
LAYout:REMove[:WINDow]	102
LAYout:REPLace[:WINDow]	103
LAYout:SPLitter	103
LAYout:WINDow<n>:ADD?	105
LAYout:WINDow<n>:IDENtify?	105
LAYout:WINDow<n>:REMove	106
LAYout:WINDow<n>:REPLace	106

LAYout:ADD[:WINDow]? <WindowName>, <Direction>, <WindowType>

This command adds a window to the display in the active channel setup.

This command is always used as a query so that you immediately obtain the name of the new window as a result.

To replace an existing window, use the `LAYout:REPLace[:WINDow]` command.

Query parameters:

<WindowName>	String containing the name of the existing window the new window is inserted next to. By default, the name of a window is the same as its index. To determine the name and index of all active windows, use the <code>LAYout:CATalog[:WINDow]?</code> query.
<Direction>	LEFT RIGHT ABOVE BELOW Direction the new window is added relative to the existing window.
<WindowType>	text value Type of result display (evaluation method) you want to add. See the table below for available parameter values.

Return values:

<NewWindowName> When adding a new window, the command returns its name (by default the same as its number) as a result.

Example:

LAY:ADD? '1', LEFT, MTAB

Result:

'2'

Adds a new window named '2' with a marker table to the left of window 1.

Usage:

Query only

Manual operation:

See "Noise Figure" on page 16
 See "Gain" on page 17
 See "Noise Temperature" on page 17
 See "Y-Factor" on page 18
 See "ENR Measured" on page 19
 See "Power (Hot)" on page 20
 See "Power (Cold)" on page 20
 See "Cal Y-Factor" on page 21
 See "Cal Power (Hot)" on page 21
 See "Cal Power (Cold)" on page 22
 See "Result Table" on page 22
 See "Marker Table" on page 23

Table 7-3: <WindowType> parameter values for Noise Figure application

Parameter value	Window type
CPCold	Cal Power (Cold)
CPHot	Cal Power (Hot)

Parameter value	Window type
CYFactor	"Cal Y-Factor"
ENR	ENR Measured
GAIN	"Gain" result display
MTABle	Marker table
NOISe	"Noise figure" result display
PCOLd	Power cold result display
PHOT	Power hot result display
RESults	Result table
TEMPerature	"Noise temperature" result display
YFACtor	"Y-Factor" result display

LAYout:CATalog[:WINDow]?

This command queries the name and index of all active windows in the active channel setup from top left to bottom right. The result is a comma-separated list of values for each window, with the syntax:

<WindowName_1>,<WindowIndex_1>..<WindowName_n>,<WindowIndex_n>

Return values:

<WindowName> string
 Name of the window.
 In the default state, the name of the window is its index.

<WindowIndex> **numeric value**
 Index of the window.

Example:

LAY:CAT?

Result:

'2',2,'1',1

Two windows are displayed, named '2' (at the top or left), and '1' (at the bottom or right).

Usage: Query only

LAYout:IDENTify[:WINDow]? <WindowName>

This command queries the **index** of a particular display window in the active channel setup.

Note: to query the **name** of a particular window, use the [LAYout:WINDow<n>:IDENTify?](#) query.

Query parameters:

<WindowName> String containing the name of a window.

Return values:

<WindowIndex> Index number of the window.

Example:

```
LAY:IDEN:WIND? '2'
```

Queries the index of the result display named '2'.

Response:

```
2
```

Usage:

Query only

LAYout:MOVE[:WINDow] <WindowName>, <WindowName>, <Direction>

Setting parameters:

<WindowName> String containing the name of an existing window that is to be moved.

By default, the name of a window is the same as its index. To determine the name and index of all active windows in the active channel setup, use the `LAYout:CATalog[:WINDow]?` query.

<WindowName> String containing the name of an existing window the selected window is placed next to or replaces.

By default, the name of a window is the same as its index. To determine the name and index of all active windows in the active channel setup, use the `LAYout:CATalog[:WINDow]?` query.

<Direction> LEFT | RIGHT | ABOVE | BELOW | REPLACE

Destination the selected window is moved to, relative to the reference window.

Example:

```
LAY:MOVE '4', '1', LEFT
```

Moves the window named '4' to the left of window 1.

Example:

```
LAY:MOVE '1', '3', REPL
```

Replaces the window named '3' by window 1. Window 3 is deleted.

Usage:

Setting only

LAYout:REMOve[:WINDow] <WindowName>

This command removes a window from the display in the active channel.

Setting parameters:

<WindowName> String containing the name of the window. In the default state, the name of the window is its index.

Example:

```
LAY:REM '2'
```

Removes the result display in the window named '2'.

Usage:

Setting only

LAYout:REPLace[:WINDow] <WindowName>, <WindowType>

This command replaces the window type (for example from "Diagram" to "Result Summary") of an already existing window in the active channel setup while keeping its position, index and window name.

To add a new window, use the [LAYout:ADD\[:WINDow\]?](#) command.

Setting parameters:

- <WindowName> String containing the name of the existing window.
By default, the name of a window is the same as its index. To determine the name and index of all active windows in the active channel setup, use the [LAYout:CATalog\[:WINDow\]?](#) query.
- <WindowType> Type of result display you want to use in the existing window.
See [LAYout:ADD\[:WINDow\]?](#) on page 100 for a list of available window types.

Example: `LAY:REPL:WIND '1',MTAB`
Replaces the result display in window 1 with a marker table.

Usage: Setting only

LAYout:SPLitter <Index1>, <Index2>, <Position>

This command changes the position of a splitter and thus controls the size of the windows on each side of the splitter.

Note that windows must have a certain minimum size. If the position you define conflicts with the minimum size of any of the affected windows, the command does not work, but does not return an error.

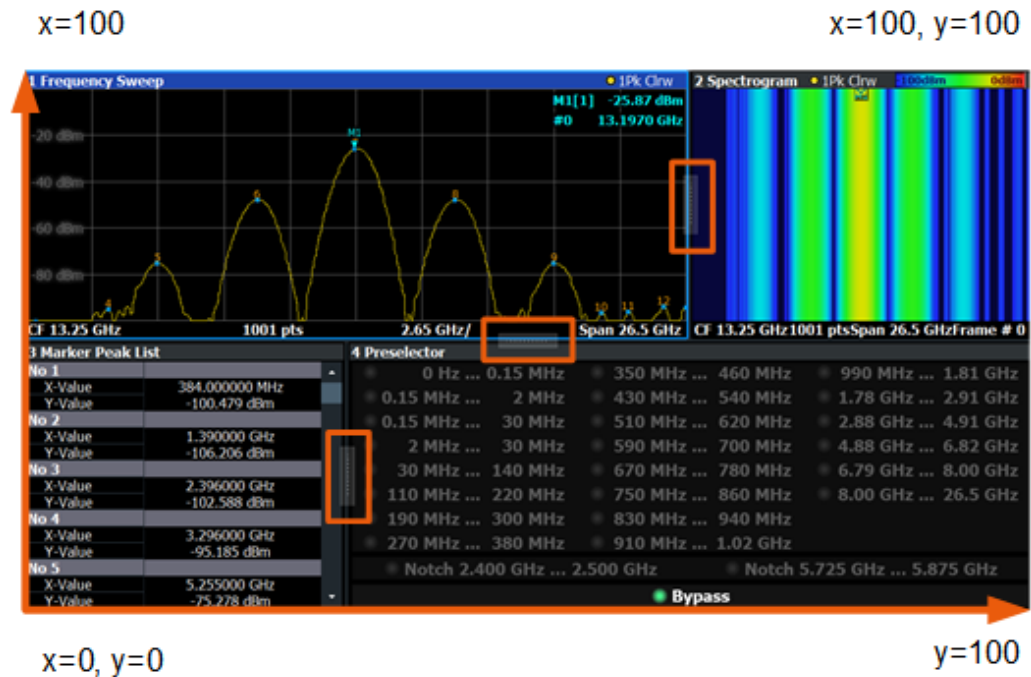

Figure 7-1: SmartGrid coordinates for remote control of the splitters

Setting parameters:

- <Index1> The index of one window the splitter controls.
- <Index2> The index of a window on the other side of the splitter.
- <Position> New vertical or horizontal position of the splitter as a fraction of the screen area (without channel and status bar and softkey menu).
The point of origin ($x = 0$, $y = 0$) is in the lower left corner of the screen. The end point ($x = 100$, $y = 100$) is in the upper right corner of the screen. (See [Figure 7-1](#).)
The direction in which the splitter is moved depends on the screen layout. If the windows are positioned horizontally, the splitter also moves horizontally. If the windows are positioned vertically, the splitter also moves vertically.
- Range: 0 to 100

Example:

LAY:SPL 1,3,50

Moves the splitter between window 1 ("Frequency Sweep") and 3 ("Marker Table") to the center (50%) of the screen, i.e. in the figure above, to the left.

Example: `LAY:SPL 1,4,70`
 Moves the splitter between window 1 ('Frequency Sweep') and 3 ('Marker Peak List') towards the top (70%) of the screen. The following commands have the exact same effect, as any combination of windows above and below the splitter moves the splitter vertically.

`LAY:SPL 3,2,70`
`LAY:SPL 4,1,70`
`LAY:SPL 2,1,70`

Usage: Setting only

LAYout:WINDow<n>:ADD? <Direction>,<WindowType>

This command adds a measurement window to the display. Note that with this command, the suffix <n> determines the existing window next to which the new window is added. Unlike [LAYout:ADD\[:WINDow\]?](#), for which the existing window is defined by a parameter.

To replace an existing window, use the [LAYout:WINDow<n>:REPLace](#) command.

This command is always used as a query so that you immediately obtain the name of the new window as a result.

Suffix:

<n> [Window](#)

Query parameters:

<Direction> LEFT | RIGHT | ABOVE | BELOW

<WindowType> Type of measurement window you want to add.
 See [LAYout:ADD\[:WINDow\]?](#) on page 100 for a list of available window types.

Return values:

<NewWindowName> When adding a new window, the command returns its name (by default the same as its number) as a result.

Example: `LAY:WIND1:ADD? LEFT,MTAB`
Result:
`'2'`
 Adds a new window named '2' with a marker table to the left of window 1.

Usage: Query only

LAYout:WINDow<n>:IDENTify?

This command queries the **name** of a particular display window (indicated by the <n> suffix) in the active channel setup.

Note: to query the **index** of a particular window, use the [LAYout:IDENTify\[:WINDow\]?](#) command.

Suffix:	
<n>	Window
Return values:	
<WindowName>	String containing the name of a window. In the default state, the name of the window is its index.
Example:	LAY:WIND2:IDEN? Queries the name of the result display in window 2. Response: '2'
Usage:	Query only

LAYout:WINDow<n>:REMove

This command removes the window specified by the suffix <n> from the display in the active channel setup.

The result of this command is identical to the [LAYout:REMove\[:WINDow\]](#) command.

Suffix:	
<n>	Window
Example:	LAY:WIND2:REM Removes the result display in window 2.
Usage:	Event

LAYout:WINDow<n>:REPLace <WindowType>

This command changes the window type of an existing window (specified by the suffix <n>) in the active channel setup.

The effect of this command is identical to the [LAYout:REPLace\[:WINDow\]](#) command.

To add a new window, use the [LAYout:WINDow<n>:ADD?](#) command.

Suffix:	
<n>	Window
Setting parameters:	
<WindowType>	Type of measurement window you want to replace another one with. See LAYout:ADD[:WINDow]? on page 100 for a list of available window types.
Example:	LAY:WIND2:REPL MTAB Replaces the result display in window 2 with a marker table.
Usage:	Setting only

7.5 General window commands

The following commands are required to configure general window layout, independent of the application.

[DISPlay\[:WINDow<n>\]:SIZE](#)..... 107

DISPlay[:WINDow<n>]:SIZE <Size>

This command maximizes the size of the selected result display window *temporarily*. To change the size of several windows on the screen permanently, use the [LAY:SPL](#) command (see [LAYout:SPLitter](#) on page 103).

Suffix:

<n> [Window](#)

Parameters:

<Size>

LARGe

Maximizes the selected window to full screen.
Other windows are still active in the background.

SMALl

Reduces the size of the selected window to its original size.
If more than one measurement window was displayed originally, these are visible again.

*RST: SMALl

Example:

DISP:WIND2:SIZE LARG

7.6 Retrieving measurement results

The following commands are necessary to query measurement results.

[TRACe<n>\[:DATA\]?](#)..... 107

TRACe<n>[:DATA]? <Trace>[, <Result>]

This command queries the "noise figure" measurement results.

Suffix:

<n> 1..n
[Window](#)

Query parameters:

<Trace>

TRACe1 | TRACe2 | TRACe3 | TRACe4

Selects the trace to be read out.

TRACE1

TRACE2

TRACE3

	TRACE4
<Result>	NOISe GAIN TEMPerature YFACTOR ENR PHOT PCOLd CYFactor CPHot CPCold NUNCertainty Selects the result display to be read out.
	ALL Queries all available results for the measurement.
	CPCold Queries calibration power (cold) results.
	CPHot Queries calibration power (hot) results.
	CYFactor Queries calibration "y-factor" results.
	ENR Queries ENR measured results.
	GAIN Queries "gain" results.
	NOISe Queries "noise figure" results.
	NUNCertainty Queries "noise figure" uncertainty results.
	PCOLd Queries power (cold) results.
	PHOT Queries power (hot) results.
	TEMPerature Queries "noise temperature" results.
	X Queries the x values (frequency).
	YFACTOR Queries "y-factor" results.
Return values:	
<TraceData>	For any graphical result display, the command returns one result for each measurement point. The unit depends on the result you are querying.
Example:	TRAC? TRACE1, GAIN Queries the "gain" results for the first trace.
Usage:	Query only

- Manual operation:** See "Noise Figure" on page 16
 See "Gain" on page 17
 See "Noise Temperature" on page 17
 See "Y-Factor" on page 18
 See "ENR Measured" on page 19
 See "Power (Hot)" on page 20
 See "Power (Cold)" on page 20
 See "Cal Y-Factor" on page 21
 See "Cal Power (Hot)" on page 21
 See "Cal Power (Cold)" on page 22
 See "Result Table" on page 22

7.7 Defining the measurement frequency

The following commands are necessary to define the frequency characteristics of the "noise figure" measurement.

[SENSe:]CONFigure:FREQuency:CONTInuous.....	109
[SENSe:]CONFigure:FREQuency:SINGle.....	110
[SENSe:]CONFigure:LIST:CONTInuous.....	110
[SENSe:]CONFigure:LIST:SINGle.....	110
[SENSe:]FREQuency:CENTer.....	110
[SENSe:]FREQuency:TABLE:DATA.....	111
[SENSe:]FREQuency:LIST:DATA.....	111
[SENSe:]BANDwidth:LIST:DATA.....	111
[SENSe:]FREQuency:POINts.....	112
[SENSe:]FREQuency:SINGle.....	112
[SENSe:]FREQuency:SINGle:COUPled.....	112
[SENSe:]FREQuency:SPAN.....	113
[SENSe:]FREQuency:STARt.....	113
[SENSe:]FREQuency:STEP.....	113
[SENSe:]FREQuency:STOP.....	113

[SENSe:]CONFigure:FREQuency:CONTInuous

This command configures the software to perform a single frequency measurement in continuous sweep mode.

Example: FREQ:SING 20MHz
 Defines a measurement frequency of 20 MHz.
 CONF:FREQ:CONT
 INIT
 Selects and initiates a single frequency measurement.

Usage: Event

Manual operation: See "Tuning Mode" on page 43

[SENSe:]CONFigure:FREQuency:SINGle

This command configures the software to perform a single frequency measurement in single sweep mode.

Example: FREQ:SING 20MHz
 Defines a measurement frequency of 20 MHz.
 CONF:FREQ:SING
 INIT
 Selects and initiates a single frequency measurement.

Usage: Event

Manual operation: See ["Tuning Mode"](#) on page 43

[SENSe:]CONFigure:LIST:CONTInuous

This command configures the software to perform a frequency list measurement in continuous sweep mode.

Example: CONF:LIST:CONT
 INIT
 Selects and initiates a frequency list measurement.

Usage: Event

Manual operation: See ["Tuning Mode"](#) on page 43

[SENSe:]CONFigure:LIST:SINGle

This command configures the software to perform a measurement in single frequency tuning mode.

Example: CONF:LIST:SING
 INIT
 Selects and initiates a single frequency measurement.

Example: See [Chapter 7.22, "Programming example: measuring a noise figure"](#), on page 188

Usage: Event

Manual operation: See ["Tuning Mode"](#) on page 43

[SENSe:]FREQuency:CENTer <Frequency>

This command defines the center frequency.

Parameters:
 <Frequency> The allowed range and f_{\max} is specified in the data sheet.
 *RST: fmax/2
 Default unit: Hz

Example: FREQ:CENT 100 MHz
 FREQ:CENT:STEP 10 MHz
 FREQ:CENT UP
 Sets the center frequency to 110 MHz.

Manual operation: See "[Center](#)" on page 44

[SENSe:]FREQuency:TABLE:DATA <Frequency>...

This command defines the contents of the frequency table.

The command overwrites the current contents of the frequency table.

Parameters:

<Frequency> Defines a frequency for each entry in the frequency table. A frequency table can contain up to 10001 entries.

Range: 0 Hz to fmax

Default unit: HZ

Example: FREQ:TABL:DATA 100MHZ,200MHZ,300MHZ,400MHZ,
 500MHZ
 Creates a frequency table with five entries.

Manual operation: See "[Populate Table](#)" on page 48

[SENSe:]FREQuency:LIST:DATA {<RFFrequency>, <LOFrequency>, <IFFrequency>}...

Queries the RF, LO and IF frequency.

Parameters:

<RFFrequency> Default unit: Hz

<LOFrequency> Default unit: Hz

<IFFrequency> Default unit: Hz

Example: SENS:FREQ:LIST:DATA?

Manual operation: See "[Populate Table](#)" on page 48

[SENSe:]BANDwidth:LIST:DATA {<Frequency>, <Bandwidth>, <SweepTime>}...

Queries the RF, RBW and sweep time.

Parameters:

<Frequency> <numeric value>
 Default unit: Hz

<Bandwidth> <numeric value>
 Default unit: Hz

<SweepTime> <numeric value>
 Default unit: s

Example: SENS:BAND:LIST:DATA?

Manual operation: See ["Populate Table"](#) on page 48

[SENSe:]FREQUENCY:POINTs <SweepPoints>

This command defines the number of measurement points analyzed during a sweep.

Parameters:

<SweepPoints> Range: 1 to 10001
*RST: 20

Example: SWE:POIN 100
Defines 100 measurement points.

Example: See [Chapter 7.22, "Programming example: measuring a noise figure"](#), on page 188

Manual operation: See ["\(Measurement\) Points"](#) on page 44
See ["\(Measurement\) Points"](#) on page 46

[SENSe:]FREQUENCY:SINGLE <Frequency>

This command defines the frequency for single frequency measurements.

Parameters:

<Frequency> The minimum and maximum frequency depend on the hardware. Refer to the datasheet for details.
*RST: 100 MHz
Default unit: HZ

Example: FREQ:SING 200MHZ
Defines a measurement frequency of 200 MHz.

Manual operation: See ["Center"](#) on page 44
See ["Single \(Frequency\)"](#) on page 45

[SENSe:]FREQUENCY:SINGLE:COUPled <State>

Couples or decouples frequency selection to the contents of a sweep list.

Parameters:

<State> ON | OFF | 0 | 1
OFF | 0
Decouples frequency selection
ON | 1
Couples frequency selection
*RST: 0

Example: SENS:FREQ:SING:COUP ON

Manual operation: See ["Coupled to Sweep List"](#) on page 46

**[SENSe:]FREQuency:SPAN **

This command defines the frequency span.

If you change the span, the application creates a new frequency list.

Parameters:

 Default unit: Hz

Example:

FREQ:SPAN 500MHZ

Defines a span of 500 MHz.

Manual operation: See "[Span](#)" on page 44

[SENSe:]FREQuency:STARt <Frequency>

This command defines the start frequency.

If you change the start frequency, the application creates a new frequency list.

Parameters:

<Frequency> *RST: RST value
Default unit: HZ

Example:

FREQ:STAR 900MHZ

Defines a start frequency of 900 MHz.

Example:

See [Chapter 7.22, "Programming example: measuring a noise figure"](#), on page 188

Manual operation: See "[Start and Stop Frequency](#)" on page 44

[SENSe:]FREQuency:STEP <Stepsize>

This command defines the frequency stepsize in the frequency table.

The stepsize corresponds to the distance from one measurement point to another.

If you change the stepsize, the application creates a new frequency list.

Parameters:

<Stepsize> Range: 0 Hz to span
*RST: 100 MHz
Default unit: HZ

Example:

FREQ:STEP 100MHZ

Defines a stepsize of 100 MHz.

Manual operation: See "[Step](#)" on page 45

[SENSe:]FREQuency:STOP <Frequency>

This command defines the stop frequency.

If you change the stop frequency, the application creates a new frequency list.

Parameters:	
<Frequency>	*RST: RST value Default unit: HZ
Example:	FREQ:STOP 900MHZ Defines a stop frequency of 900 MHz.
Example:	See Chapter 7.22, "Programming example: measuring a noise figure" , on page 188
Manual operation:	See "Start and Stop Frequency" on page 44

7.8 Selecting DUT characteristics

The following commands are necessary to define DUT characteristics.

[SENSe:]CONFigure:MODE:SYSTem:LO.....	114
[SENSe:]CONFigure:MODE:SYSTem:LO:FREQuency.....	114
[SENSe:]CONFigure:MODE:DUT.....	115
[SENSe:]CORRection:IREJection.....	115

[SENSe:]CONFigure:MODE:SYSTem:LO <LOType>

This command selects the type of local oscillator you are using.

The command is available for measurements on frequency converting DUTs [\[SENSe:\]CONFigure:MODE:DUT\(\)](#).

Parameters:	
<LOType>	FIXed VARiable FIXed The local oscillator is used as a fixed frequency source. The IF is variable.
Example:	CONF:MODE:DUT DOWN CONF:MODE:SYST:LO FIX CONF:MODE:SYST:LO:FREQ 1GHZ Selects a fixed LO frequency (= 1 GHz) on a down converting DUT.
Manual operation:	See "Mode" on page 49

[SENSe:]CONFigure:MODE:SYSTem:LO:FREQuency <LOFrequency>

This command defines the frequency for DUTs with a fixed LO.

Parameters:	
<LOFrequency>	Range: 0 Hz to 100 GHz *RST: 10 MHz, if frequency converting mode has been selected Default unit: HZ

Example: `CONF:MODE:SYST:LO:FREQ 1GHZ`
Defines a fixed LO frequency of 1 GHz.

Manual operation: See "[LO Fixed](#)" on page 49

`[SENSe:]CONFigure:MODE:DUT <DUTType>`

This command selects the type of DUT you are testing.

Note that you have to use `[SENSe:]CONFigure:MODE:SYSTem:LO` to select the fixed LO.

Parameters:
<DUTType> `AMPLifier | DDOWnconv | DOWNconv | UPConv`

AMPLifier
Measurements on fixed frequency DUTs.

DOWNconv
Measurements on down-converting DUTs.

UPConv
Measurements on up-converting DUTs.

*RST: `AMPLifier`

Example: `CONF:MODE:DUT DOWN`
Selects the measurement mode for a down-converting DUT.

Manual operation: See "[Mode](#)" on page 49

`[SENSe:]CORRection:IREJection <ImageRejection>`

This command defines the image frequency rejection for the DUT.

Parameters:
<ImageRejection> Range: 0 to 999.99
*RST: 999.99
Default unit: DB

Example: `CORR:IREJ 0`
Turns image rejection off.

Manual operation: See "[Image Rejection](#)" on page 49

7.9 Configuring the noise source

The following commands are necessary to define the noise source characteristics.

<code>[SENSe:]CORRection:ENR:CALibration:SPOT:COLD</code>	116
<code>[SENSe:]CORRection:ENR:CALibration:SPOT:HOT</code>	116
<code>[SENSe:]CORRection:ENR:CALibration:MODE</code>	117
<code>[SENSe:]CORRection:ENR:CALibration:SPOT</code>	117
<code>[SENSe:]CORRection:ENR:CALibration:TABLE:SElect</code>	117

[SENSe:]CORRection:ENR:CALibration:TYPE.....	118
[SENSe:]CORRection:ENR:COMMon.....	118
[SENSe:]CORRection:ENR[:MEASurement]:TABLe[:DATA].....	119
[SENSe:]CORRection:ENR[:MEASurement]:TABLe:DELeTe.....	119
[SENSe:]CORRection:ENR[:MEASurement]:TABLe:LIST?.....	119
[SENSe:]CORRection:ENR[:MEASurement]:TABLe:SELeCt.....	120
[SENSe:]CORRection:ENR[:MEASurement]:TABLe:TEMPerature[:DATA].....	120
[SENSe:]CORRection:ENR[:MEASurement]:TABLe:TEMPerature:DELeTe.....	120
[SENSe:]CORRection:ENR[:MEASurement]:TABLe:TEMPerature:LIST?.....	120
[SENSe:]CORRection:ENR[:MEASurement]:MODE.....	121
[SENSe:]CORRection:ENR[:MEASurement]:SPOT.....	121
[SENSe:]CORRection:ENR[:MEASurement]:TYPE.....	121
[SENSe:]CORRection:ENR[:MEASurement]:SPOT:COLD.....	122
[SENSe:]CORRection:ENR[:MEASurement]:SPOT:HOT.....	122
[SENSe:]CORRection:TEMPerature.....	123
[SENSe:]CORRection:ENR[:MEASurement]:SNS:SRNumber.....	123
[SENSe:]CORRection:ENR:CALibration:SNS:SRNumber.....	123

[SENSe:]CORRection:ENR:CALibration:SPOT:COLD <Temperature>

This command defines a constant temperature of a resistor not supplied with power (T_{cold}) used during calibration.

The command is available when you have selected a noise source with resistor characteristics with [SENSe:]CORRection:ENR:CALibration:TYPE.

Parameters:

<Temperature> Temperature in degrees Kelvin.
 *RST: 77 K
 Default unit: K

Example:

```
CORR:ENR:CAL:TYPE RES
CORR:ENR:CAL:SPOT:COLD 100
```

Defines a cold temperature of 100 K.

Manual operation: See "Calibration" on page 53

[SENSe:]CORRection:ENR:CALibration:SPOT:HOT <Temperature>

This command defines a constant temperature of a resistor supplied with power (T_{hot}) used during calibration.

The command is available when you have selected a noise source with resistor characteristics with [SENSe:]CORRection:ENR:CALibration:TYPE.

Parameters:

<Temperature> Temperature in degrees Kelvin.
 *RST: 77 K
 Default unit: K

Example: CORR:ENR:TYPE RES
 CORR:ENR:CAL:SPOT:HOT 300
 Defines a cold temperature of 300 K.

Manual operation: See "[Calibration](#)" on page 53

[SENSe:]CORRection:ENR:CALibration:MODE <Mode>

This command selects the ENR mode for the calibration.

This command is available when you use different noise sources for calibration and measurement ([SENSe:]CORRection:ENR:COMMON OFF).

Parameters:

<Mode> SPOT | TABLE

SPOT
 Uses a constant ENR value for all measurement points (see [SENSe:]CORRection:ENR:CALibration:SPOT).

TABLE
 Uses the contents of the ENR table.

*RST: SPOT

Example: CORR:ENR:CAL:MODE SPOT
 Uses a constant ENR value for all measurement points.

Manual operation: See "[Calibration](#)" on page 53

[SENSe:]CORRection:ENR:CALibration:SPOT <ENR>

This command defines the constant ENR for all measurement points during calibration.

This command is available when you use different noise sources for calibration and measurement ([SENSe:]CORRection:ENR:COMMON OFF).

Parameters:

<ENR> Range: -999.99 to 999.99
 *RST: 15
 Default unit: DB

Example: CORR:ENR:CAL:MODE SPOT
 CORR:ENR:CAL:SPOT 30
 Selects constant ENR value mode and defines an ENR of 30 dB for all measurement points.

Manual operation: See "[Calibration](#)" on page 53

[SENSe:]CORRection:ENR:CALibration:TABLE:SElect <TableName>

This command selects an ENR or temperature table for calibration.

Note that the contents of the table are independent of whether you use it for calibration or the actual measurement. When you want to edit a table, regardless if you want to use it later for a measurement or for calibration, you have to use `[SENSe:]CORRection:ENR[:MEASurement]:TABLE:SElect`. This command only selects a table for calibration.

This command is available when you use different noise sources for calibration and measurement (`[SENSe:]CORRection:ENR:COMMOn OFF`).

Parameters:

<TableName> String containing the table name.

Example:

```
CORR:ENR:MEAS:TABL:SEL 'ENRTable'
```

Selects a table called 'ENRTable'.

Manual operation:

See "Calibration" on page 53
See "New" on page 56

[SENSe:]CORRection:ENR:CALibration:TYPE <Type>

This command selects the type of noise source you are using for the calibration.

Parameters:

<Type>

DIODE

Selects a noise source with diode characteristics.

RESistor

Selects a noise source with resistor characteristics. When you select this noise source type, the application automatically selects the manual measurement mode (see `[SENSe:]CONFigure:CONTRol`).

SMART

Selects a smart noise source.

*RST: DIODE

Example:

```
CORR:ENR:CAL:TYPE RES
```

Selects a noise source with resistor characteristics.

Manual operation:

See "Noise Source" on page 52

[SENSe:]CORRection:ENR:COMMOn <State>

This command turns the use of a common ENR on or off.

For more information see "Common Noise Source" on page 53.

Parameters:

<State> ON | OFF | 1 | 0

Example:

```
CORR:ENR:COMM ON
```

Turns the use of a common ENR on.

Manual operation:

See "Common Noise Source" on page 53

```
[SENSe:]CORRection:ENR[:MEASurement]:TABLe[:DATA] {<FrequencyENR>,
<ENR>}...
```

This command defines the contents of the currently selected ENR table.

Define an ENR for all measurement points.

Each entry of the ENR table consists of one measurement point and the corresponding ENR. The individual values are separated by commas or spaces. The table can contain up to 10001 entries.

If you create a new table with this command, it overwrites the current entries of the frequency list.

To select the ENR table to edit, use `[SENSe:]CORRection:ENR[:MEASurement]:TABLe[:DATA]`.

Parameters:

<FrequencyENR> Frequency of the measurement point.

Range: 0 Hz to 999.99 GHz

Default unit: HZ

<ENR> Default unit: DB

Example: `CORR:ENR:MEAS:TABL:DATA 1MHZ,10,2MHZ,12`
 Defines a new ENR table with two measurement points.

Example: See [Chapter 7.22, "Programming example: measuring a noise figure"](#), on page 188

Manual operation: See ["New"](#) on page 56
 See ["Edit"](#) on page 56
 See ["Edit Table"](#) on page 57

```
[SENSe:]CORRection:ENR[:MEASurement]:TABLe:DELeTe <TableName>
```

This command deletes a temperature table.

Setting parameters:

<TableName> String containing the name of the table.

Example: `CORR:ENR:MEAS:TABL:TEMP:DEL 'TemperatureTable'`
 Deletes the table with the name 'TemperatureTable'.

Usage: Setting only

Manual operation: See ["Delete"](#) on page 56

```
[SENSe:]CORRection:ENR[:MEASurement]:TABLe:LIST?
```

Return values:

<Tables> <list>

Usage: Query only

[SENSe:]CORRection:ENR[:MEASurement]:TABLe:SElect <TableName>

This command selects an ENR or temperature table for the actual measurement.

When you want to edit a table, regardless if you want to use it later for a measurement or for calibration, you have to use this command. `[SENSe:]CORRection:ENR:CALibration:TABLe:SElect` only selects a table for calibration.

Parameters:

<TableName>

Manual operation: See "Measurement" on page 52
See "New" on page 56
See "Edit" on page 56

[SENSe:]CORRection:ENR[:MEASurement]:TABLe:TEMPerature[:DATA]

{<Frequency>, <Thot>, <Tcold>}...

Parameters:

<Frequency> Default unit: HZ

<Thot> Default unit: K

<Tcold> Default unit: K

Manual operation: See "New" on page 56
See "Edit" on page 56
See "Edit Table" on page 57

[SENSe:]CORRection:ENR[:MEASurement]:TABLe:TEMPerature:DELeTe

<TableName>

This command deletes a temperature table.

Setting parameters:

<TableName> String containing the name of the table.

Example: `CORR:ENR:MEAS:TABL:TEMP:DEL 'TemperatureTable'`
Deletes the table with the name 'TemperatureTable'.

Usage: Setting only

Manual operation: See "Delete" on page 56

[SENSe:]CORRection:ENR[:MEASurement]:TABLe:TEMPerature:LIST?

This command queries all temperature tables available in the application.

Return values:

<Tables> <list>

String containing the names of the tables as a comma separated list.

Example: `CORR:ENR:TABL:TEMP:LIST`
would return, e.g.
'Table1, Table2, Table3'

Usage: Query only

[SENSe:]CORRection:ENR[:MEASurement]:MODE <Mode>

This command selects the ENR mode for the actual measurement.

Parameters:

<Mode> SPOT | TABLE

SPOT

Uses a constant ENR value for all measurement points (see [\[SENSe:\]CORRection:ENR\[:MEASurement\]:SPOT](#)).

TABLE

Uses the contents of the ENR table.

*RST: SPOT

Example: `CORR:ENR:MODE SPOT`
Uses a constant ENR value for all measurement points.

Example: See [Chapter 7.22, "Programming example: measuring a noise figure"](#), on page 188

Manual operation: See "[Measurement](#)" on page 52

[SENSe:]CORRection:ENR[:MEASurement]:SPOT <ENR>

This command defines the constant ENR for all measurement points during the actual measurement.

Parameters:

<ENR> *RST: 15
Default unit: DB

Example: `CORR:ENR:MODE SPOT`
`CORR:ENR:SPOT 30`
Selects constant ENR value mode and defines an ENR of 30 dB for all measurement points.

Manual operation: See "[Measurement](#)" on page 52

[SENSe:]CORRection:ENR[:MEASurement]:TYPE <Type>

This command selects the type of noise source you are using for the measurement.

Parameters:

<Type> **DIODE**
Selects a noise source with diode characteristics.

RESistor

Selects a noise source with resistor characteristics.
When you select this noise source type, the application automatically selects the manual measurement mode (see [SENSe:]CONFigure:CONTRol]).

SMART

Selects a smart noise source.

*RST: DIODE

Example:

CORR:ENR:TYPE RES

Selects a noise source with resistor characteristics.

Manual operation:

See "Noise Source" on page 52

See "Noise Source" on page 55

[SENSe:]CORRection:ENR[:MEASurement]:SPOT:COLD <Temperature>

This command defines a constant temperature of a resistor not supplied with power (T_{cold}) used during measurements.

The command is available when you have selected a noise source with resistor characteristics with [SENSe:]CORRection:ENR[:MEASurement]:TYPE.

Parameters:

<Temperature> Temperature in degrees Kelvin.

*RST: 77 K

Default unit: K

Example:

CORR:ENR:TYPE RES

CORR:ENR:SPOT:COLD 100

Defines a cold temperature of 100 K.

Manual operation:

See "Measurement" on page 52

[SENSe:]CORRection:ENR[:MEASurement]:SPOT:HOT <Temperature>

This command defines a constant temperature of a resistor supplied with power (T_{hot}) used during measurements.

The command is available when you have selected a noise source with resistor characteristics with [SENSe:]CORRection:ENR[:MEASurement]:TYPE .

Parameters:

<Temperature> Temperature in degrees Kelvin.

*RST: 77 K

Default unit: K

Example:

CORR:ENR:TYPE RES

CORR:ENR:SPOT:HOT 300

Defines a cold temperature of 300 K.

Manual operation:

See "Measurement" on page 52

[SENSe:]CORRection:TEMPerature <Temperature>

This command defines the room temperature of the measurement environment. The temperature is taken into account when calculating noise results.

Parameters:

<Temperature> Range: 278.15 to 318.15
 *RST: 293
 Default unit: K

Example:

CORR:TEMP 291.50
 Specifies a room temperature of 291.50 Kelvin (18.5 C).

Manual operation: See "[Temperature](#)" on page 54

[SENSe:]CORRection:ENR[:MEASurement]:SNS:SRNumber <SerialNumber>

This command sets and queries the measurement noise source smart noise source serial number.

Parameters:

<SerialNumber>

Manual operation: See "[Noise Source](#)" on page 52

[SENSe:]CORRection:ENR:CALibration:SNS:SRNumber <SerialNumber>

This command sets and queries the calibration noise source smart noise source serial number.

Parameters:

<SerialNumber>

Manual operation: See "[Noise Source](#)" on page 52

7.10 Configuring additional loss

The following commands are necessary to define loss resulting from equipment in the measurement setup.

[SENSe:]CORRection:LOSS:CALibration:MODE.....	124
[SENSe:]CORRection:LOSS:CALibration:SPOT.....	124
[SENSe:]CORRection:LOSS:CALibration:TABLE:DELeTe.....	124
[SENSe:]CORRection:LOSS:CALibration:TABLE:LIST?.....	125
[SENSe:]CORRection:LOSS:CALibration:TABLE:SELeCt.....	125
[SENSe:]CORRection:LOSS:CALibration:TABLE[:DATA].....	125
[SENSe:]CORRection:LOSS:CALibration:TEMPerature.....	126
[SENSe:]CORRection:LOSS:INPut:MODE.....	126
[SENSe:]CORRection:LOSS:INPut:SPOT.....	126
[SENSe:]CORRection:LOSS:INPut:TABLE[:DATA].....	127
[SENSe:]CORRection:LOSS:INPut:TABLE:DELeTe.....	127

[SENSe:]CORRection:LOSS:INPut:TABLE:LIST?	127
[SENSe:]CORRection:LOSS:INPut:TABLE:SElect	127
[SENSe:]CORRection:LOSS:INPut:TEMPerature	128
[SENSe:]CORRection:LOSS:OUTPut:MODE	128
[SENSe:]CORRection:LOSS:OUTPut:SPOT	128
[SENSe:]CORRection:LOSS:OUTPut:TABLE[:DATA]	129
[SENSe:]CORRection:LOSS:OUTPut:TABLE:DELeTe	129
[SENSe:]CORRection:LOSS:OUTPut:TABLE:LIST?	129
[SENSe:]CORRection:LOSS:OUTPut:TABLE:SElect	129
[SENSe:]CORRection:LOSS:OUTPut:TEMPerature	130

[SENSe:]CORRection:LOSS:CALibration:MODE <Mode>

This command selects the input loss mode.

Parameters:

<Mode> SPOT | TABLE

SPOT

Uses a constant calibration loss value for all measurement points (see [SENSe:]CORRection:LOSS:CALibration:SPOT on page 124).

TABLE

Uses the contents of the calibration loss table.

*RST: SPOT

Example:

```
CORR:LOSS:INP:MODE SPOT
```

```
CORR:LOSS:INP:SPOT 10
```

Selects constant calibration loss mode and defines an input loss of 10 dB for all measurement points.

Manual operation: See "[Calibration Loss](#)" on page 60

[SENSe:]CORRection:LOSS:CALibration:SPOT <Loss>

This command defines a constant calibration loss for all measurement points.

Parameters:

<Loss> Range: -999.99 to 999.99

*RST: 0 dB

Default unit: dB

Example:

```
CORR:LOSS:INP:MODE SPOT
```

```
CORR:LOSS:INP:SPOT 10
```

Selects constant calibration loss mode and defines an input loss of 10 dB for all measurement points.

Manual operation: See "[Calibration Loss](#)" on page 60

[SENSe:]CORRection:LOSS:CALibration:TABLE:DELeTe <TableName>

This command deletes a calibration loss table.

Setting parameters:

<TableName> String containing the name of the table.

Example: `CORR:LOSS:CAL:TABL:DEL 'CalibrationLoss'`
Deletes the table with the name 'CalibrationLoss'.

Usage: Setting only

Manual operation: See "[Delete](#)" on page 62

[SENSe:]CORRection:LOSS:CALibration:TABLE:LIST?

This command queries all calibration loss tables available in the application.

Example: `CORR:LOSS:CAL:TABL:LIST?`
Result:
'Table1, Table2, Table3'

Usage: Query only

[SENSe:]CORRection:LOSS:CALibration:TABLE:SElect <TableName>

This command selects a calibration loss table.

Parameters:

<TableName> String containing the table name.

Example: `CORR:LOSS:CAL:TABL:SEL 'CalibrationLoss'`
Selects a table called CalibrationLoss'.

Manual operation: See "[Calibration Loss](#)" on page 60

[SENSe:]CORRection:LOSS:CALibration:TABLE[:DATA] {<Frequency>, <Loss>}...

This command defines the contents of the currently selected calibration loss table.

Each entry of the loss table consists of one measurement point and the corresponding loss. The table can contain up to 10001 entries.

If you create a new table with this command, it overwrites the current entries of the loss table.

Parameters:

<Frequency> Frequency of the measurement point.
Range: 0 Hz to 999.99 GHz
Default unit: HZ

<Loss> Loss of the measurement point.
Range: -999.99 GHz to 999.99 GHz
Default unit: DB

Example: `CORR:LOSS:CAL:TABL 1MHz,10,2MHz,12`
Defines a new calibration loss table with two measurement points.

Manual operation: See "New" on page 62
See "Edit" on page 62

[SENSe:]CORRection:LOSS:CALibration:TEMPerature <Temperature>

The specified temperature at the time of measurement is considered in the loss calculation.

Parameters:

<Temperature> Default unit: K

Example:

SENS:CORR:LOSS:CAL:TEMP 296.5

Calibration loss is corrected for a temperature of 296.5 K (23.35° C).

Manual operation: See "Calibration Loss" on page 60

[SENSe:]CORRection:LOSS:INPut:MODE <Mode>

This command selects the input loss mode.

Parameters:

<Mode> SPOT | TABLE

SPOT

Uses a constant input loss value for all measurement points (see [SENSe:]CORRection:LOSS:INPut:SPOT on page 126).

TABLE

Uses the contents of the input loss table.

*RST: SPOT

Example:

CORR:LOSS:INP:MODE SPOT

Selects constant input loss.

Manual operation: See "Input Loss" on page 59

[SENSe:]CORRection:LOSS:INPut:SPOT <Loss>

This command defines a constant input loss for all measurement points.

Parameters:

<Loss> Range: -999.99 to 999.99
*RST: 0 dB
Default unit: DB

Example:

CORR:LOSS:INP:MODE SPOT

CORR:LOSS:INP:SPOT 10

Selects constant input loss mode and defines an input loss of 10 dB for all measurement points.

Manual operation: See "Input Loss" on page 59

[SENSe:]CORRection:LOSS:INPut:TABLE[:DATA] {<Frequency>, <Loss>}...

This command defines the contents of the currently selected input loss table.

Each entry of the loss table consists of one measurement point and the corresponding loss. The table can contain up to 10001 entries.

The table should contain an input loss for all measurement points.

If you create a new table with this command, it will overwrite the current entries of the loss table.

Parameters:

<Frequency> Frequency of the measurement point.

Range: 0 dB to 999.99 dB

Default unit: HZ

<Loss> Loss of the measurement point.

Range: -999.99 dB to 999.99 dB

Default unit: DB

Example: `CORR:LOSS:INP:TABL 1MHz,10,2MHz,12`
 Defines a new input loss table with two measurement points.

Manual operation: See ["Edit Table"](#) on page 57
 See ["New"](#) on page 62
 See ["Edit"](#) on page 62

[SENSe:]CORRection:LOSS:INPut:TABLE:DELeTe <TableName>

This command deletes an input loss table.

Setting parameters:

<TableName> String containing the name of the table.

Example: `CORR:LOSS:INP:TABL:DEL 'InputLoss'`
 Deletes the table with the name 'InputLoss'.

Usage: Setting only

Manual operation: See ["Delete"](#) on page 62

[SENSe:]CORRection:LOSS:INPut:TABLE:LIST?

This command queries all input loss tables available in the application.

Example: `CORR:LOSS:INP:TABL:LIST?`
 Result:
 'Table1,Table2,Table3'

Usage: Query only

[SENSe:]CORRection:LOSS:INPut:TABLE:SELeCt <TableName>

This command selects an input loss table.

Parameters:

<TableName> String containing the table name.

Example:

```
CORR:LOSS:INP:TABL:SEL 'InputLoss'
```

Selects a table called 'InputLoss'.

Manual operation: See ["Input Loss"](#) on page 59

[SENSe:]CORRection:LOSS:INPut:TEMPerature <Temperature>

The specified temperature at the time of measurement is considered in the loss calculation.

Parameters:

<Temperature> Default unit: K

Example:

```
SENS:CORR:LOSS:INP:TEMP 296.5
```

Input loss is corrected for a temperature of 296.5 K (23.35° C).

Manual operation: See ["Input Loss"](#) on page 59

[SENSe:]CORRection:LOSS:OUTPut:MODE <Mode>

This command selects the output loss mode.

Parameters:

<Mode> SPOT | TABLE

SPOT

Uses a constant output loss value for all measurement points (see [\[SENSe:\]CORRection:LOSS:OUTPut:SPOT](#) on page 128).

TABLE

Uses the contents of the output loss table.

*RST: SPOT

Example:

```
CORR:LOSS:OUTP:MODE SPOT
```

Selects constant output loss.

Manual operation: See ["Output Loss"](#) on page 60

[SENSe:]CORRection:LOSS:OUTPut:SPOT <Loss>

This command defines a constant output loss for all measurement points.

Parameters:

<Loss> Range: -999.99 to 999.99
*RST: 0 dB
Default unit: DB

Example:

```
CORR:LOSS:OUTP:MODE SPOT
CORR:LOSS:OUTP:SPOT 10
```

Selects constant output loss mode and defines an output loss of 10 dB for all measurement points.

Manual operation: See ["Output Loss"](#) on page 60

[SENSe:]CORRection:LOSS:OUTPut:TABLE[:DATA] {<Frequency>, <Loss>}...

This command defines the contents of the currently selected output loss table.

The table should contain an output loss for all measurement points.

Each entry of the loss table consists of one measurement point and the corresponding loss. The table can contain up to 10001 entries.

If you create a new table with this command, it will overwrite the current entries of the frequency list.

Parameters:

<Frequency> Frequency of the measurement point.

Range: 0 dB to 999.99 dB

Default unit: HZ

<Loss> Loss of the measurement point.

Range: -999.99 dB to 999.99 dB

Default unit: DB

Example:

`CORR:LOSS:OUTP:TABL 1MHz,10,2MHz,12`

Defines a new output loss table with two measurement points.

Manual operation: See ["Edit Table"](#) on page 57

See ["New"](#) on page 62

See ["Edit"](#) on page 62

[SENSe:]CORRection:LOSS:OUTPut:TABLE:DELeTe <TableName>

Setting parameters:

<TableName>

Usage: Setting only

Manual operation: See ["Delete"](#) on page 62

[SENSe:]CORRection:LOSS:OUTPut:TABLE:LIST?

This command queries all output loss tables available in the application.

Example:

`CORR:LOSS:OUTP:TABL:LIST?`

Result:

`'Table1,Table2,Table3'`

Usage: Query only

[SENSe:]CORRection:LOSS:OUTPut:TABLE:SELeCt <TableName>

Parameters:

<TableName>

[SENSe:]BWiDth:RESolution:AUTO <State>

[SENSe:]BANDwidth:RESolution:AUTO <State>

If enabled, the resolution bandwidth is selected automatically, depending on the current frequency of the sweep point, as defined in the frequency table (see [Chapter 5.2.3, "Using a frequency table"](#), on page 46).

If disabled, the RBW defined by `[SENSe:]BANDwidth[:RESolution]` is used.

Parameters:

<State>

ON | OFF | 0 | 1

OFF | 0

Switches the function off

ON | 1

Switches the function on

*RST: 0

Example:

SENS:BAND:RES:AUTO ON

Manual operation: See ["Resolution Bandwidth \(RBW\)"](#) on page 64

[SENSe:]CONFigure:CORRection

This command configures the software to perform calibration measurements.

Using `INITiate<n>[:IMMediate]` then initiates a calibration instead of the actual measurement, until you deliberately select one of the normal measurements again with one of the following commands.

- `[SENSe:]CONFigure:FREQuency:CONTInuous`
- `[SENSe:]CONFigure:FREQuency:SINGLE`
- `[SENSe:]CONFigure:LIST:CONTInuous`
- `[SENSe:]CONFigure:LIST:SINGLE`

Note that calibration data is used only when the second stage correction mode has been turned on with `[SENSe:]CORRection[:STATe]`.

Example:

```
//Turn on second stage correction
CORR ON
//Configure application to run calibration measurement
CONF:CORR
//Initiate calibration with synchronization to end of measurement
INIT;*OPC
//Return to normal measurement (single sweep list mode)
CONF:LIST:SING
//Initiate a calibrated measurement with synchronization to end
of measurement
INIT;*OPC
```

Example:

See [Chapter 7.22, "Programming example: measuring a noise figure"](#), on page 188

Usage:

Event

Manual operation: See ["2nd Stage Correction"](#) on page 64
See ["Calibrate"](#) on page 74

[SENSe:]CORRection[:STATe] <State>

This command includes or excludes calibration data in the actual measurement (see ["2nd Stage Correction"](#) on page 64 for more information).

Parameters:

<State> ON | OFF | 1 | 0
*RST: 0

Example: CORR ON
Includes calibration data in the measurement.

Example: See [Chapter 7.22, "Programming example: measuring a noise figure"](#), on page 188

Manual operation: See ["2nd Stage Correction"](#) on page 64

[SENSe:]CORRection:RECall <recallfilepath>

Sets the calibration results recall filepath and recalls the calibration results.

Setting parameters:

<recallfilepath>

Example: SENS:CORR:REC 'filepath'
This command will recall the calibration results from a selected file with extension .df1.

Usage: Setting only

Manual operation: See ["Calibration Recall"](#) on page 34

[SENSe:]CORRection:SAVE <savefilepath>

Queries and sets the calibration results save filepath and if set saves the calibration results.

Parameters:

<savefilepath>

Example: SENS:CORR:SAVE?
This will report an error -221 if calibration results are not available for saving. If calibration results are available the command will report a suggested filepath which includes the calibration results timestamp.
SENS:CORR:SAVE 'filepath'
This will report an error if calibration results are not available for saving. The command will save the calibration results to a filename with extension .df1.

Manual operation: See ["Calibration Save"](#) on page 34

[SENSe:]SWEep:COUNT <Averages>

This command defines the number of measurements that are used to average the results.

Parameters:

<Averages>

Number of measurements that are performed at a single frequency before average results are displayed.
If you set an average of 0 or 1, the application performs a single measurement at each frequency.

Range: 0 to 32767

*RST: 1

Example:

SWE:COUN 10

The application averages 10 measurements before it displays the results.

Manual operation: See "[Average](#)" on page 65

[SENSe:]SWEep:TIME <Time>

This command defines the sweep time. It automatically decouples the time from any other settings.

Parameters:

<Time>

refer to data sheet

*RST: depends on current settings (determined automatically)

Default unit: S

Manual operation: See "[Sweep Time](#)" on page 64

[SENSe:]SWEep:TIME:AUTO <State>

If enabled, the sweep time is automatically selected, depending on the current frequency of the sweep point, as defined in the frequency table (see [Chapter 5.2.3, "Using a frequency table"](#), on page 46).

If disabled, the value defined by `[SENSe:]SWEep:TIME` is used.

Parameters:

<State>

ON | OFF | 0 | 1

OFF | 0

Switches the function off

ON | 1

Switches the function on

*RST: 0

Manual operation: See "[Sweep Time](#)" on page 64

DISPlay[:WINDow<n>]:TRACe<t>:Y[:SCALe]:RLEVel <ReferenceLevel>

This command defines the reference level (for all traces in all windows).

Suffix:

<n> irrelevant
<t> irrelevant

Parameters:

<ReferenceLevel> Range: see datasheet
 *RST: -30 dBm
 Default unit: DBM

Example: DISP:TRAC:Y:RLEV -60dBm

Manual operation: See "[Ref Level](#)" on page 65

DISPlay[:WINDow<n>]:TRACe<t>:Y[:SCALe]:RLEVel:AUTO <State>

This command turns automatic determination of the reference level on and off.

Suffix:

<n> 1..n
<t> 1..n
 irrelevant

Parameters:

<State> ON | OFF | 1 | 0

Example: DISP:TRAC:Y:RLEV:AUTO ON
 Turns on automatic level detection.

Manual operation: See "[Ref Level](#)" on page 65

INPut<ip>:ATTenuation <Attenuation>

This command defines the total attenuation for RF input.

If you set the attenuation manually, it is no longer coupled to the reference level, but the reference level is coupled to the attenuation. Thus, if the current reference level is not compatible with an attenuation that has been set manually, the command also adjusts the reference level.

Suffix:

<ip> 1 | 2
 irrelevant

Parameters:

<Attenuation> Range: see data sheet
 Increment: 5 dB (with optional electr. attenuator: 1 dB)
 *RST: 10 dB (AUTO is set to ON)
 Default unit: DB

Example: `INP:ATT 30dB`
 Defines a 30 dB attenuation and decouples the attenuation from the reference level.

Manual operation: See "[RF Attenuation](#)" on page 66

INPut<ip>:GAIN:STATe <State>

This command turns the internal preamplifier on and off. It requires the optional preamplifier hardware.

If activated, the input signal is amplified by 20 dB. The preamplifier is only active below 3 GHz (R&S FPL1003) or 7.5 GHz (R&S FPL1007).

Suffix:

<ip> 1 | 2
 irrelevant

Parameters:

<State> ON | OFF | 0 | 1
 OFF | 0
 Switches the function off
 ON | 1
 Switches the function on
 *RST: 0

Example: `INP:GAIN:STAT ON`
 Switches on 20 dB preamplification.

Manual operation: See "[Preamplifier](#)" on page 66

SYSTem:CONFigure:DUT:GAIN <Gain>

This command defines the expected "gain" of the DUT.

The application uses the "gain" for automatic reference level detection.

Parameters:

<Gain> Range: 10 to 1000
 *RST: 30
 Default unit: DB

Example: `SYST:CONF:DUT:GAIN 25`
 Defines "gain" of 25 dB.

Manual operation: See "[Auto Level Range](#)" on page 66

SYSTem:CONFigure:DUT:STIME <SettlingTime>

This command defines the settling time of the noise source.

Parameters:

<SettlingTime> Range: 0 s to 20 s
 *RST: 50 ms
 Default unit: S

Example:

SYST:CONF:DUT:STIM 1 s
 Defines a settling time of 1 second.

Manual operation: See "Settling Time" on page 65

7.12 Using the uncertainty calculator

The following commands are necessary to work with the measurement uncertainty calculator.

CALCulate<n>:UNCertainty:COMMON.....	136
CALCulate<n>:UNCertainty:DATA:FREQUENCY.....	137
CALCulate<n>:UNCertainty:DATA:GAIN.....	137
CALCulate<n>:UNCertainty:DATA:NOISE.....	138
CALCulate<n>:UNCertainty:DATA:RESULTS.....	138
CALCulate<n>:UNCertainty:ENR:CALIBRATION:UNCERTAINTY.....	138
CALCulate<n>:UNCertainty:ENR:CALIBRATION:UNCERTAINTY:COLD.....	139
CALCulate<n>:UNCertainty:ENR:CALIBRATION:UNCERTAINTY:HOT.....	139
CALCulate<n>:UNCertainty:ENR:UNCERTAINTY.....	139
CALCulate<n>:UNCertainty:ENR:UNCERTAINTY:COLD.....	140
CALCulate<n>:UNCertainty:ENR:UNCERTAINTY:HOT.....	140
CALCulate<n>:UNCertainty:MATCH:DUT:IN:RL.....	141
CALCulate<n>:UNCertainty:MATCH:DUT:IN[:VSWR].....	141
CALCulate<n>:UNCertainty:MATCH:DUT:OUT:RL.....	141
CALCulate<n>:UNCertainty:MATCH:DUT:OUT[:VSWR].....	141
CALCulate<n>:UNCertainty:MATCH:PREAMP:RL.....	142
CALCulate<n>:UNCertainty:MATCH:PREAMP[:VSWR].....	142
CALCulate<n>:UNCertainty:MATCH:SOURCE:CALIBRATION[:VSWR].....	142
CALCulate<n>:UNCertainty:MATCH:SOURCE:CALIBRATION:RL.....	143
CALCulate<n>:UNCertainty:MATCH:SOURCE:RL.....	143
CALCulate<n>:UNCertainty:MATCH:SOURCE[:VSWR].....	143
CALCulate<n>:UNCertainty:PREAMP:GAIN.....	144
CALCulate<n>:UNCertainty:PREAMP:NOISE.....	144
CALCulate<n>:UNCertainty:PREAMP:STATE.....	144
CALCulate<n>:UNCertainty[:RESULT]?	145
CALCulate<n>:UNCertainty:SANALYZER:GAIN:UNCERTAINTY?	145
CALCulate<n>:UNCertainty:SANALYZER:NOISE:UNCERTAINTY?	145

CALCulate<n>:UNCertainty:COMMON <State>

This command turns matching of the noise source characteristics used during calibration and measurement on and off.

This command is available when you use different noise sources for calibration and measurement ([SENSe:]CORRection:ENR:COMMON OFF).

Suffix:

<n> 1..n

Parameters:<State> ON | OFF | 1 | 0
*RST: unavailable**Example:**

CALC:UNC:COMM ON

Applies the values of the calibration noise source to those of the measurement noise source.

Manual operation: See ["Common Source for Meas and Cal"](#) on page 69**CALCulate<n>:UNCertainty:DATA:FREQuency <Frequency>**

This command defines the frequency for which the uncertainty should be calculated.

This command is available if you have turned automatic determination of the DUT characteristics off with [CALCulate<n>:UNCertainty:DATA:FREQuency](#).**Suffix:**

<n> 1..n

Parameters:<Frequency> Frequency of the DUT.
*RST: 1 GHz
Default unit: HZ**Example:**

CALC:UNC:DATA:FREQ 100MHZ

Defines a frequency of 100 MHz.

Manual operation: See ["Use Measurement Values"](#) on page 70**CALCulate<n>:UNCertainty:DATA:GAIN <Gain>**

This command defines the "gain" of the DUT.

This command is available if you have turned automatic determination of the DUT characteristics off with [CALCulate<n>:UNCertainty:DATA:GAIN](#).**Suffix:**

<n> 1..n

Parameters:<Gain> "Gain" of the DUT.
*RST: 0 dB
Default unit: DB**Example:**

CALC:UNC:DATA:GAIN -5DB

Defines a DUT "gain" of -5 dB.

Manual operation: See ["Use Measurement Values"](#) on page 70

CALCulate<n>:UNCertainty:DATA:NOISe <NoiseLevel>

This command defines the noise level of the DUT.

This command is available if you have turned automatic determination of the DUT characteristics off with `CALCulate<n>:UNCertainty:DATA:RESults`.

Suffix:

<n> 1..n

Parameters:

<NoiseLevel> Noise level of the DUT.
*RST: 0 dB
Default unit: DB

Example:

`CALC:UNC:DATA:NOIS 10DB`
Defines a DUT noise level of 10 dB.

Manual operation: See ["Use Measurement Values"](#) on page 70

CALCulate<n>:UNCertainty:DATA:RESults <State>

This command turns automatic determination of the DUT characteristics for the calculation of the uncertainty on and off.

Suffix:

<n> 1..n

Parameters:

<State> **ON | 1**
The application calculates the uncertainty with the DUT characteristics ("noise figure", "gain" and frequency) resulting from the "noise figure" measurement.
OFF | 0
The application calculates the uncertainty with the DUT characteristics ("noise figure", "gain" and frequency) based on the values you have defined manually.

Example:

`CALC:UNC:DATA:RES ON`
Includes the uncertainty in the results displays.

CALCulate<n>:UNCertainty:ENR:CALibration:UNCertainty <Uncertainty>

This command defines the uncertainty of a calibration noise source.

This command is available when `[SENSe:]CORRection:ENR:COMMon` and `[SENSe:]CORRection:ENR:COMMon` are off.

If a smart noise source is used for calibration, the uncertainty values defined in the SNS table are used.

Suffix:

<n> 1..n

Parameters:

<Uncertainty> Uncertainty value of the noise source.
 Refer to the data sheet of the noise source to determine its uncertainty.
 *RST: 0.1 dB
 Default unit: DB

Example:

CALC:UNC:ENR:CAL:UNC 0.05
 Defines an uncertainty of 0.05 dB.

Manual operation: See "[ENR Uncert\(ainty\)](#)" on page 69

CALCulate<n>:UNCertainty:ENR:CALibration:UNCertainty:COLD <Uncertainty>

Suffix:

<n> 1..n

Parameters:

<Uncertainty>

Manual operation: See "[Temperature Uncert\(ainty\)](#)" on page 70

CALCulate<n>:UNCertainty:ENR:CALibration:UNCertainty:HOT <Uncertainty>

This command defines the uncertainty of a calibration noise source.

This command is available when [[SENSe:\]CORRection:ENR:COMMon](#) and [CALCulate<n>:UNCertainty:COMMon](#) are off.

Suffix:

<n> 1..n

Parameters:

<Uncertainty> Hot temperature uncertainty value of the noise source.
 Refer to the data sheet of the noise source to determine its uncertainty.
 *RST: 0 K

Example:

CALC:UNC:ENR:CAL:UNC:COLD 5 K
 Defines a high temperature uncertainty of 5 K.

Manual operation: See "[Temperature Uncert\(ainty\)](#)" on page 70

CALCulate<n>:UNCertainty:ENR:UNCertainty <Uncertainty>

This command defines the uncertainty of a noise source.

If the noise sources during calibration and measurement are different, the command defines the uncertainty of the measurement noise source.

If a smart noise source is used, the uncertainty values defined in the SNS table are used.

Suffix:

<n> 1..n

Parameters:

<Uncertainty> Uncertainty value of the noise source.
Refer to the data sheet of the noise source to determine its uncertainty.

*RST: 0.1 dB

Default unit: DB

Example:

CALC:UNC:ENR:UNC 0.05

Defines an uncertainty of 0.05 dB.

Manual operation: See "[ENR Uncert\(ainty\)](#)" on page 69**CALCulate<n>:UNCertainty:ENR:UNCertainty:COLD <Uncertainty>**

This command defines the uncertainty of a resistor.

If the noise sources during calibration and measurement are different, the command defines the uncertainty of the measurement noise source.

Suffix:

<n> 1..n

Parameters:

<Uncertainty> Cold temperature uncertainty value of the noise source.
Refer to the data sheet of the noise source to determine its uncertainty.

*RST: 0 K

Example:

CALC:UNC:ENR:UNC:COLD 10

Defines an low temperature uncertainty of 10 K.

Manual operation: See "[Temperature Uncert\(ainty\)](#)" on page 70**CALCulate<n>:UNCertainty:ENR:UNCertainty:HOT <Uncertainty>**

This command defines the uncertainty of a resistor.

If the noise sources during calibration and measurement are different, the command defines the uncertainty of the measurement noise source.

Suffix:

<n> 1..n

Parameters:

<Uncertainty> Hot temperature uncertainty value of the noise source.
Refer to the data sheet of the noise source to determine its uncertainty.

*RST: 0 K

Example:

CALC:UNC:ENR:UNC:HOT 10

Defines an high temperature uncertainty of 10 K.

CALCulate<n>:UNCertainty:MATCh:DUT:IN:RL <ReturnLoss>

This command defines the return loss at the DUT input.

Suffix:

<n> 1..n

Parameters:

<ReturnLoss> *RST: 50.0 dB
Default unit: DB

Example:

CALC:UNC:MATC:DUT:IN:RL 25DB
Defines a return loss of 25 dB.

Manual operation: See ["Input / Output Match"](#) on page 70

CALCulate<n>:UNCertainty:MATCh:DUT:IN[:VSWR] <VSWR>

This command defines the VSWR at the DUT input.

Suffix:

<n> 1..n

Parameters:

<VSWR> *RST: 1.0

Example:

CALC:UNC:MATC:DUT:IN 1.1
Defines a VSWR of 1.1 at the DUT input.

Manual operation: See ["Input / Output Match"](#) on page 70

CALCulate<n>:UNCertainty:MATCh:DUT:OUT:RL <ReturnLoss>

This command defines the returns loss at the DUT output.

Suffix:

<n> 1..n

Parameters:

<ReturnLoss> *RST: 50.0 dB
Default unit: DB

Example:

CALC:UNC:MATC:DUT:OUT:RL 40DB
Defines a return loss of 40 dB at the DUT output.

Manual operation: See ["Input / Output Match"](#) on page 70

CALCulate<n>:UNCertainty:MATCh:DUT:OUT[:VSWR] <VSWR>

This command defines the VSWR at the DUT output.

Suffix:

<n> 1..n

Parameters:

<VSWR> *RST: 1.0

Example: `CALC:UNC:MATC:DUT:OUT 2.0`
Defines a VSWR of 2.0 at the DUT output.

Manual operation: See ["Input / Output Match"](#) on page 70

CALCulate<n>:UNCertainty:MATCh:PREamp:RL <ReturnLoss>

This command defines the return loss at the input of the preamplifier.

Suffix:

<n> 1..n

Parameters:

<ReturnLoss> *RST: 13.98 dB
Default unit: DB

Example: `CALC:UNC:MATC:PRE:RL 14.5DB`
Defines a return loss of 14.5 dB.

CALCulate<n>:UNCertainty:MATCh:PREamp[:VSWR] <VSWR>

This command defines the VSWR at the input of the preamplifier.

The command is available if you have turned on the preamplifier with [CALCulate<n>:UNCertainty:PREamp:STATe](#) on page 144.

Suffix:

<n> 1..n

Parameters:

<VSWR> *RST: 1.5

Example: `CALC:UNC:MATC:PRE 1.8`
Defines a VSWR of 1.8.

CALCulate<n>:UNCertainty:MATCh:SOURce:CALibration[:VSWR] <VSWR>

This command defines the VSWR at the calibration noise source output.

This command is available when [\[SENSe:\]CORRection:ENR:COMMon](#) and [CALCulate<n>:UNCertainty:COMMon](#) are off.

If a smart noise source is used, the VSWR values defined in the SNS table are used.

Suffix:

<n> 1..n

Parameters:

<VSWR> *RST: 1.15

Example: `CALC:UNC:MATC:SOUR:CAL 1.4`
Defines a VSWR of 1.4.

Manual operation: See ["Output Match"](#) on page 69

CALCulate<n>:UNCertainty:MATCh:SOURce:CALibration:RL <ReturnLoss>

This command defines the return loss at the calibration noise source output.

This command is available when [SENSe:]CORRection:ENR:COMMon and CALCulate<n>:UNCertainty:COMMon are off.

If a smart noise source is used, the return loss values defined in the SNS table are used.

Suffix:

<n> 1..n

Parameters:

<ReturnLoss> *RST: 23.13 dB
Default unit: DB

Example:

CALC:UNC:MATC:SOUR:CAL:RL 20DB
Defines a return loss of 20 dB.

Manual operation: See "Output Match" on page 69

CALCulate<n>:UNCertainty:MATCh:SOURce:RL <ReturnLoss>

This command defines the return loss at the noise source output.

If the noise sources during calibration and measurement are different, the command defines the uncertainty of the measurement noise source.

Suffix:

<n> 1..n

Parameters:

<ReturnLoss> *RST: 23.13 dB
Default unit: DB

Example:

CALC:UNC:MATC:SOUR:RL 20DB
Defines a return loss of 20 dB.

Manual operation: See "Output Match" on page 69

CALCulate<n>:UNCertainty:MATCh:SOURce[:VSWR] <VSWR>

This command defines the VSWR at the noise source output.

If the noise sources during calibration and measurement are different, the command defines the uncertainty of the measurement noise source.

If a smart noise source is used, the VSWR values defined in the SNS table are used.

Suffix:

<n> 1..n

Parameters:

<VSWR> *RST: 1.15

Example: `CALC:UNC:MATC:SOUR 1.4`
Defines a VSWR of 1.4.

CALCulate<n>:UNCertainty:PREamp:GAIN <Gain>

This command define the "gain" of an external preamplifier that may be part of the test setup.

Suffix:
<n> 1..n

Parameters:
<Gain> **Gain of the preamplifier.**
Refer to the data sheet of the preamplifier to determine its "gain".
*RST: 20 dB
Default unit: DB

Example: `CALC:UNC:PRE:GAIN 15DB`
Defines a gain of 15 dB.

Manual operation: See "[Preamplifier Gain \(PA Gain\)](#)" on page 72

CALCulate<n>:UNCertainty:PREamp:NOISe <NoiseLevel>

This command defines the noise level of an external preamplifier that may be part of the test setup.

Suffix:
<n> 1..n

Parameters:
<NoiseLevel> Noise level of the preamplifier.
Refer to the data sheet of the preamplifier to determine its noise level.
*RST: 5 dB
Default unit: DB

Example: `CALC:UNC:PRE:NOIS 10DB`
Defines a noise level of 10 dB.

Manual operation: See "[Preamplifier noise figure \(PA NF\)](#)" on page 72

CALCulate<n>:UNCertainty:PREamp:STATe <State>

This command includes or excludes an external preamplifier from the uncertainty calculation.

If the test setup uses an external preamplifier, you also have to define its "noise figure" and "gain" values.

Suffix:
<n> 1..n

Parameters:

<State> ON | OFF | 1 | 0
 *RST: 0

Example:

CALC:UNC:PRE:STAT ON
 Turns the preamplifier on.

Manual operation: See ["External Preamplifier \(Ext PA\)"](#) on page 71

CALCulate<n>:UNCertainty[:RESult]?

This command queries the uncertainty of "noise figure" results.

Suffix:

<n> 1..n

Return values:

<Uncertainty> Measurement uncertainty in dB.

Example:

CALC:UNC?
 Queries the uncertainty.

Usage:

Query only

Manual operation: See ["Use Measurement Values"](#) on page 70

CALCulate<n>:UNCertainty:SANalyzer:GAIN:UNCertainty? <Uncertainty>

This command queries the uncertainty value of the spectrum analyzer's internal "gain".

Suffix:

<n> 1..n

Query parameters:

<Uncertainty> "Gain" uncertainty of the spectrum analyzer in dB.
 Default unit: DB

Example:

CALC:UNC:SAN:GAIN:UNC?
 Queries the "gain" uncertainty.

CALCulate<n>:UNCertainty:SANalyzer:NOISe:UNCertainty? <Uncertainty>

This command queries the uncertainty value of the spectrum analyzer's internal noise.

Suffix:

<n> 1..n

Query parameters:

<Uncertainty> "Noise figure" uncertainty of the spectrum analyzer in dB.
 Default unit: DB

Example:

CALC:UNC:SAN:NOIS:UNC?
 Queries the "noise figure" uncertainty.

7.13 Performing measurements

The following commands are necessary to perform "noise figure" measurements.

Example: perform calibration and subsequent single sweep measurement

```
//Perform calibration:
CONF:CORR
INIT;*OPC?
//Perform single sweep measurement and use 2nd stage correction:
CORR:STAT ON
CONF:LIST:SING
INIT
```



You can also perform a sequence of measurements using the Sequencer (see "[Multiple Channel setups and Sequencer Function](#)" on page 12).

ABORt.....	146
INITiate<n>:CONTinuous.....	147
INITiate<n>:[IMMediate].....	147
INITiate:SEQuencer:ABORt.....	148
INITiate:SEQuencer:IMMediate.....	148
INITiate:SEQuencer:MODE.....	148
[SENSe:]CONFigure:CONTrol.....	149
[SENSe:]CONFigure:MEASurement.....	149
SYSTem:SEQuencer.....	149

ABORt

This command aborts the measurement in the current channel setup and resets the trigger system.

To prevent overlapping execution of the subsequent command before the measurement has been aborted successfully, use the *OPC? or *WAI command after ABOR and before the next command.

For details on overlapping execution see [Remote control via SCPI](#).

Note on blocked remote control programs:

If a sequential command cannot be completed, for example because a triggered sweep never receives a trigger, the remote control program will never finish and the remote channel to the R&S FPL1000 is blocked for further commands. In this case, you must interrupt processing on the remote channel first in order to abort the measurement.

To do so, send a "Device Clear" command from the control instrument to the R&S FPL1000 on a parallel channel to clear all currently active remote channels. Depending on the used interface and protocol, send the following commands:

- **Visa:** viClear()

Now you can send the `ABORT` command on the remote channel performing the measurement.

Example: `ABOR; :INIT:IMM`
Aborts the current measurement and immediately starts a new one.

Example: `ABOR; *WAI`
`INIT:IMM`
Aborts the current measurement and starts a new one once abortion has been completed.

Usage: Event

INITiate<n>:CONTInuous <State>

This command controls the sweep mode for an individual channel setup.

Note that in single sweep mode, you can synchronize to the end of the measurement with `*OPC`, `*OPC?` or `*WAI`. In continuous sweep mode, synchronization to the end of the measurement is not possible. Thus, it is not recommended that you use continuous sweep mode in remote control, as results like trace data or markers are only valid after a single sweep end synchronization.

For details on synchronization see [Remote control via SCPI](#).

Suffix:
<n> irrelevant

Parameters:
<State> `ON | OFF | 0 | 1`
ON | 1
Continuous sweep
OFF | 0
Single sweep
`*RST: 1` (some applications can differ)

Example: `INIT:CONT OFF`
Switches the sweep mode to single sweep.
`INIT:CONT ON`
Switches the sweep mode to continuous sweep.

Manual operation: See "[Continuous Sweep / Run Cont](#)" on page 73

INITiate<n>[:IMMEDIATE]

This command starts a (single) new measurement.

You can synchronize to the end of the measurement with `*OPC`, `*OPC?` or `*WAI`.

For details on synchronization see [Remote control via SCPI](#).

Suffix:
<n> irrelevant

Manual operation: See "Tuning Mode" on page 43
 See "Single Sweep / Run Single" on page 74
 See "Calibrate" on page 74

INITiate:SEQuencer:ABORt

This command stops the currently active sequence of measurements.

You can start a new sequence any time using `INITiate:SEQuencer:IMMediate` on page 148.

Usage: Event

INITiate:SEQuencer:IMMediate

This command starts a new sequence of measurements by the Sequencer.

Before this command can be executed, the Sequencer must be activated (see `SYSTem:SEQuencer` on page 149).

Example:

```
SYST:SEQ ON
  Activates the Sequencer.
INIT:SEQ:MODE SING
  Sets single sequence mode so each active measurement is per-
  formed once.
INIT:SEQ:IMM
  Starts the sequential measurements.
```

INITiate:SEQuencer:MODE <Mode>

Defines the capture mode for the entire measurement sequence and all measurement groups and channels it contains.

Note: To synchronize to the end of a measurement sequence using `*OPC`, `*OPC?` or `*WAI`, use `SINGle` Sequencer mode.

Parameters:

<Mode>

SINGle

Each measurement group is started one after the other in the order of definition. All measurement channels in a group are started simultaneously and performed once. After *all* measurements are completed, the next group is started. After the last group, the measurement sequence is finished.

CONTInuous

Each measurement group is started one after the other in the order of definition. All measurement channels in a group are started simultaneously and performed once. After *all* measurements are completed, the next group is started. After the last group, the measurement sequence restarts with the first one and continues until it is stopped explicitly.

*RST: CONTInuous

[SENSe:]CONFigure:CONTRol <Mode>

This command selects the measurement mode for the hot and cold power measurements.

Note that selecting a noise source with resistor characteristics with `[SENSe:]CORRection:ENR:CALibration:TYPE` or `[SENSe:]CORRection:ENR[:MEASurement]:TYPE` automatically selects manual measurement mode.

Parameters:

<Mode> AUTO | MANual

AUTO

Performs the Power (Hot) and Power (Cold) measurement in one step.

MANual

Performs the Power (Hot) and Power (Cold) measurement in two separate steps.

Example:

```
CONF:CONT AUTO
```

Selects the automatic measurement mode.

Manual operation: See "[Meas Mode \(Auto Manual\)](#)" on page 75

[SENSe:]CONFigure:MEASurement <Measurement>

This command selects the type of power measurement to perform next.

The command is available for manual measurements (see `[SENSe:]CONFigure:CONTRol`).

Parameters:

<Measurement> HOT | COLD

COLD

Performs the Power (Cold) measurement next.

HOT

Performs the Power (Hot) measurement next.

Example:

```
CONF:CONT MAN
```

```
CONF:MEAS HOT
```

Performs the hot power measurement.

Manual operation: See "[Meas Mode \(Auto Manual\)](#)" on page 75

SYSTem:SEQuencer <State>

This command turns the Sequencer on and off. The Sequencer must be active before any other Sequencer commands (`INIT:SEQ...`) are executed, otherwise an error occurs.

A detailed programming example is provided in the "Operating Modes" chapter in the R&S FPL1000 User Manual.

Parameters:

<State> ON | OFF | 0 | 1

ON | 1

The Sequencer is activated and a sequential measurement is started immediately.

OFF | 0

The Sequencer is deactivated. Any running sequential measurements are stopped. Further Sequencer commands (INIT:SEQ...) are not available.

*RST: 0

Example:

SYST:SEQ ON

Activates the Sequencer.

INIT:SEQ:MODE SING

Sets single Sequencer mode so each active measurement is performed once.

INIT:SEQ:IMM

Starts the sequential measurements.

SYST:SEQ OFF

7.14 Configuring the inputs and outputs

- [Impedance](#)..... 150

7.14.1 Impedance

INPut<ip>:IMPedance <Impedance>

This command selects the nominal input impedance of the RF input. In some applications, only 50 Ω are supported.

Suffix:

<ip> 1 | 2
irrelevant

Parameters:

<Impedance> 50 | 75
*RST: 50 Ω
Default unit: OHM

Example: INP:IMP 75

Manual operation: See "[Impedance](#)" on page 75

7.15 Independant CW source commands

The following commands are required to configure an internal generator as an independant CW source.

OUTPut<up>[:STATe].....	151
SOURce<si>:INTernal:FREQUency.....	151
SOURce<si>:POWer[:LEVel][:IMMediate][:AMPLitude].....	151
SOURce<si>:POWer[:LEVel][:IMMediate]:OFFSet.....	152

OUTPut<up>[:STATe] <State>

Enables or disables the internal generator. The generator signal is output at the GEN Output 50 Ω connector on the front panel.

Suffix:

<up>

Parameters:

<State> ON | OFF | 0 | 1
OFF | 0
 Switches the function off
ON | 1
 Switches the function on
 *RST: 0

Example: OUTP ON

SOURce<si>:INTernal:FREQUency <Frequency>

Defines the frequency of the internal generator signal.

Suffix:

<si> irrelevant

Parameters:

<Frequency> Range: 5 kHz to 3 GHz
 Increment: 0.1 Hz
 *RST: 1 GHz
 Default unit: HZ

Example: SOUR:INT:FREQ 2 GHz

SOURce<si>:POWer[:LEVel][:IMMediate][:AMPLitude] <Amplitude>

Defines the output power of the internal generator.

Suffix:

<si> irrelevant

Parameters:

<Amplitude> Range: -60 dBm to +10 dBm
 Increment: 0.1 dB
 *RST: -20 dBm
 Default unit: DBM

Example:

SOUR:POW -30dBm

SOURce<si>:POWer[:LEVel][:IMMediate]:OFFSet <Offset>

This command defines a level offset for the internal generator level. Thus, for example, attenuators or amplifiers at the output of the internal generator can be considered for the setting.

Suffix:

<si> irrelevant

Parameters:

<Offset> Range: -200 dB to +200 dB
 *RST: 0dB
 Default unit: DB

Example:

SOUR:POW:OFFS -10dB

7.16 Configuring the display

The following commands are necessary to configure and scale the result displays.

DISPlay[:WINDow<n>]:TABLe:ITEM.....	152
DISPlay[:WINDow<n>]:TRACe<t>:SYMBols.....	153
DISPlay[:WINDow<n>]:TRACe<t>:UNCertainty.....	153
DISPlay[:WINDow<n>]:TRACe<t>:X[:SCALE].....	153
DISPlay[:WINDow<n>]:TRACe<t>:Y[:SCALE]:BOTTom.....	154
DISPlay[:WINDow<n>]:TRACe<t>:Y[:SCALE]:AUTO.....	155
DISPlay[:WINDow<n>]:TRACe<t>:Y[:SCALE]:TOP.....	155

DISPlay[:WINDow<n>]:TABLe:ITEM <Items>, <State>

This command selects the items displayed in the Result Table.

Suffix:

<n> 1..n
 Window

Parameters:

<Items> NOISe | GAIN | TEMPerature | YFACtor | ENR | PHOT |
 PCOLd | CYFactor | CPHot | CPCold | NUNCertainty
 For a list of possible parameter values (table items) see the
 parameter description of the TRACe<n>[:DATA]? command.

<State> ON | OFF | 1 | 0

Example: `DISP:WIND2:TABL:ITEM NOIS,OFF`
Removes the Noise result from the Result Table.

Manual operation: See ["Result Table"](#) on page 22

DISPlay[:WINDow<n>]:TRACe<t>:SYMBols <State>

This command turns symbols that represent the measurement points on a trace on and off.

Suffix:

<n> 1..n
[Window](#)

<t> 1..n

Parameters:

<State> ON | OFF | 1 | 0
*RST: 0

Example: `DISP:WIND2:TRAC:SYMB ON`
Switches on the display of symbols in window 2..

Manual operation: See ["Symbols"](#) on page 78

DISPlay[:WINDow<n>]:TRACe<t>:UNCertainty <State>

If enabled, an additional trace is displayed indicating the measured trace values \pm the uncertainty values determined by the uncertainty calculator. This result is only useful for "noise figure" measurements.

Suffix:

<n> 1..n
[Window](#)

<t> 1..n
[Trace](#)

Parameters:

<State> ON | OFF | 0 | 1
OFF | 0
Switches the function off
ON | 1
Switches the function on
*RST: 0

Example: `DISP:WIND:TRAC:UNC ON`

DISPlay[:WINDow<n>]:TRACe<t>:X[:SCALe] <Frequency>

This command selects the type of frequency displayed on the x-axis.

Suffix:

<n> 1..n
Window

<t> 1..n

Parameters:

<Frequency> RF | IF | LO
IF
Intermediary frequency, e.g. for measurements on frequency converting DUTs.

RF
Radio frequency.

*RST: RF

Example:

CONF:MODE:DUT DOWN

The DUT converts the input frequency to a lower output frequency.

DISP:TRAC:X RF

Shows the RF frequency on the x-axis.

Manual operation: See "X-Axis" on page 78

DISPlay[:WINDow<n>]:TRACe<t>:Y[:SCALe]:BOTTom <Level>

This command defines the bottom value of the y-axis.

Suffix:

<n> 1..n
Window

<t> 1..n
Trace

Parameters:

<Level> The value ranges depend on the result display.

Noise figure

-75 dB to 75 dB

Noise temperature

-999990000 K to 999990000 K

Y-factor

-200 dB to 200 dB

Gain

-75 dB to 75 dB

Power (hot)

-200 dBm to 200 dBm

Power (cold)

-200 dBm to 200 dBm

Default unit: DB

Example: `DISP:WIND2:TRAC:Y:SCAL:AUTO OFF`
 `DISP:WIND2:TRAC:Y:BOTT`

Manual operation: See ["Auto Scale / Min / Max"](#) on page 77

DISPlay[:WINDow<n>]:TRACe<t>:Y[:SCALe]:AUTO <State>

This command turns automatic scaling of the y-axis on and off.

Suffix:

<n> 1..n
 [Window](#)

<t> 1..n

Parameters:

<State> ON | OFF | 1 | 0
 *RST: 1

Example: `DISP:WIND2:TRAC:Y:AUTO ON`
 Turns on automatic scaling for measurement window 2.

Manual operation: See ["Auto Scale / Min / Max"](#) on page 77

DISPlay[:WINDow<n>]:TRACe<t>:Y[:SCALe]:TOP <Level>

This command defines the top value of the y-axis.

Suffix:

<n> 1..n
 [Window](#)

<t> 1..n
 [Trace](#)

Parameters:

<Level> The value ranges depend on the result display.

Noise figure

-75 dB to 75 dB

Noise temperature

-999990000 K to 999990000 K

Y-factor

-200 dB to 200 dB

Gain

-75 dB to 75 dB

Power (hot)

-200 dBm to 200 dBm

Power (cold)

-200 dBm to 200 dBm

Default unit: DB

Example: `DISP:WIND2:TRAC:Y:SCAL:AUTO OFF`
 `DISP:WIND2:TRAC:Y:TOP`

Manual operation: See "[Auto Scale / Min / Max](#)" on page 77

7.17 Working with traces

The following commands are necessary to define trace characteristics.

<code>DISPlay[:WINDow<n>][:SUBWindow<w>]:TRACe<t>:MODE</code>	156
<code>DISPlay[:WINDow<n>][:SUBWindow<w>]:TRACe<t>[:STATe]</code>	157
<code>DISPlay[:WINDow<n>][:SUBWindow<w>]:TRACe<t>:SMOothing:APERture</code>	157
<code>DISPlay[:WINDow<n>][:SUBWindow<w>]:TRACe<t>:SMOothing[:STATe]</code>	157
<code>FORMat[:DATA]</code>	158
<code>FORMat:DEXPort:DSEParator</code>	159
<code>FORMat:DEXPort:FORMat</code>	159
<code>FORMat:DEXPort:HEADer</code>	159
<code>FORMat:DEXPort:TRACes</code>	159
<code>MMEMory:STORe<n>:TRACe</code>	160
<code>TRACe<n>:COPY</code>	160

`DISPlay[:WINDow<n>][:SUBWindow<w>]:TRACe<t>:MODE <Mode>`

This command selects the trace mode. If necessary, the selected trace is also activated.

Suffix:

<code><n></code>	Window
<code><w></code>	subwindow Not supported by all applications
<code><t></code>	Trace

Parameters:

<code><Mode</code>	BLANK VIEW WRITe *RST: Trace 1: WRITe, Trace 2-4: BLANK
-----------------------	---

Example:

```
INIT:CONT OFF
Switching to single sweep mode.
SWE:COUN 16
Sets the number of measurements to 16.
DISP:TRAC3:MODE WRIT
Selects clear/write mode for trace 3.
INIT;*WAI
Starts the measurement and waits for the end of the measurement.
```

Manual operation: See "[Traces](#)" on page 80

DISPlay[:WINDow<n>][:SUBWindow<w>]:TRACe<t>[:STATe] <State>

This command turns a trace on and off.

The measurement continues in the background.

Suffix:

<n> [Window](#)

<w> subwindow
Not supported by all applications

<t> [Trace](#)

Parameters:

<State> ON | OFF | 0 | 1

OFF | 0
Switches the function off

ON | 1
Switches the function on

Example: DISP:TRAC3 ON

DISPlay[:WINDow<n>][:SUBWindow<w>]:TRACe<t>:SMOothing:APERture <Aperture>

This command defines the degree (aperture) of the trace smoothing, if [DISPlay\[:WINDow<n>\]\[:SUBWindow<w>\]:TRACe<t>:SMOothing\[:STATe\]](#) TRUE.

Suffix:

<n> [Window](#)

<w> subwindow

<t> [Trace](#)

Parameters:

<Aperture> Range: 1 to 50
 *RST: 2
 Default unit: PCT

Example: DISP3:TRAC2:SMO:APER 5
 Defines an aperture of 5% for trace 2 in window 3

Manual operation: See "[Smoothing](#)" on page 80

DISPlay[:WINDow<n>][:SUBWindow<w>]:TRACe<t>:SMOothing[:STATe] <State>

This command turns trace smoothing for a particular trace on and off.

If enabled, the trace is smoothed by the value specified using [DISPlay\[:WINDow<n>\]\[:SUBWindow<w>\]:TRACe<t>:SMOothing:APERture](#) on page 157.

Suffix:

<n> [Window](#)

<w> subwindow

<t> [Trace](#)

Parameters:

<State> ON | OFF | 0 | 1
OFF | 0
 Switches the function off
ON | 1
 Switches the function on

Example: DISP3:TRAC2:SMO ON
 Turns on trace smoothing for trace 2 in window 3

Manual operation: See "[Smoothing](#)" on page 80

FORMat[:DATA] <Format>[, <BitLength>]

This command selects the data format that is used for transmission of trace data from the R&S FPL1000 to the controlling computer.

Note that the command has no effect for data that you send to the R&S FPL1000. The R&S FPL1000 automatically recognizes the data it receives, regardless of the format.

Parameters:

<Format> **AScii**
 Ascii format, separated by commas.
 This format is almost always suitable, regardless of the actual data format. However, the data is not as compact as other formats can be.

REAL
 Floating-point numbers (according to IEEE 754) in the "definite length block format".
 In the Spectrum application, the format setting `REAL` is used for the binary transmission of trace data.

<BitLength> Length in bits for floating-point results

16
 16-bit floating-point numbers.
 Compared to `REAL, 32` format, half as many numbers are returned.

32
 32-bit floating-point numbers
 For I/Q data, 8 bytes per sample are returned for this format setting.

64
 64-bit floating-point numbers
 Compared to `REAL, 32` format, twice as many numbers are returned.

Example: FORM REAL, 32

FORMat:DEXPort:DSEParator <Separator>

This command selects the decimal separator for data exported in ASCII format.

Parameters:

<Separator> POINT | COMMa

COMMa

Uses a comma as decimal separator, e.g. *4,05*.

POINT

Uses a point as decimal separator, e.g. *4.05*.

*RST: *RST has no effect on the decimal separator.
Default is POINT.

Example:

FORM:DEXP:DSEP POIN

Sets the decimal point as separator.

Manual operation: See "[Decimal Separator](#)" on page 83

FORMat:DEXPort:FORMat <FileFormat>

Determines the format of the ASCII file to be imported or exported. Depending on the external program that creates the data file or evaluates it, a comma-separated list (CSV) or a plain data format (DAT) file is required.

Parameters:

<FileFormat> CSV | DAT

*RST: DAT

Example:

FORM:DEXP:FORM CSV

Manual operation: See "[File Type](#)" on page 83

FORMat:DEXPort:HEADer <State>

If enabled, additional instrument and measurement settings are included in the header of the export file for result data. If disabled, only the pure result data from the selected traces and tables is exported.

Parameters:

<State> ON | OFF | 0 | 1

*RST: 1

Manual operation: See "[Include Instrument & Measurement Settings](#)" on page 82

FORMat:DEXPort:TRACes <Selection>

This command selects the data to be included in a data export file (see [MMEMory:STORe<n>:TRACe](#) on page 160).

Parameters:

<Selection> SINGle | ALL

SINGLE

Only a single trace is selected for export, namely the one specified by the `MMEMoRY:STORe<n>:TRACe` command.

ALL

Selects all active traces and result tables (e.g. "Result Summary", marker peak list etc.) in the current application for export to an ASCII file.

The `<trace>` parameter for the `MMEMoRY:STORe<n>:TRACe` command is ignored.

*RST: SINGLE

Manual operation: See ["Export all Traces and all Table Results"](#) on page 82

MMEMoRY:STORe<n>:TRACe <Trace>, <FileName>

This command exports trace data from the specified window to an ASCII file.

Suffix:

<n> [Window](#)

Parameters:

<Trace> Number of the trace to be stored

<FileName> String containing the path and name of the target file.

Example:

`MME:STOR1:TRAC 1, 'C:\TEST.ASC'`

Stores trace 1 from window 1 in the file `TEST.ASC`.

Manual operation: See ["Export Trace to ASCII File"](#) on page 83
See ["Export Trace to ASCII File"](#) on page 84

TRACe<n>:COPY <TraceNumber>, <TraceNumber>

This command copies data from one trace to another.

Suffix:

<n> [Window](#)

Parameters:

<TraceNumber> **TRACE1 | TRACE2 | TRACE3 | TRACE4**

The first parameter is the destination trace, the second parameter is the source.

(Note the 'e' in the parameter is required!)

Example:

`TRAC:COPY TRACE1, TRACE2`

Copies the data from trace 2 to trace 1.

Manual operation: See ["Copy Trace"](#) on page 81

7.18 Working with limit lines

The following commands are necessary to set up limit lines and checks.

When configuring limit lines for the "noise figure" application via remote control, you have to send some commands in a defined order.

1. Select the limit line you want to configure by name or create a new limit line name.
2. Select the result type you want to apply the limit line to.
The application automatically selects the unit and scale to make the line compatible to the result type.
3. Define the horizontal data points of the limit line.
4. Define the vertical data points of the limit line. Depending on the command syntax you are using, the shape also defines if the limit line is an upper or lower limit line (CALCulate:LIMit:UPPer:... or CALCulate:LIMit:LOWer:...).

Example: Configure an upper limit line for the Noise Figure result type

```
//Select or create the limit line by name.
CALC:LIM:NAME 'NoiseFigure'
//Comment on the limit line.
CALC:LIM:COMM 'Limit line to test noise figure results'
//Select the result type (here: Noise Figure) to apply the limit line to.
CALC:LIM:TYPE NOIS
//Define the horizontal data points of the limit line.
CALC:LIM:CONT 100MHZ,850MHZ
//Shift the limit line 50 MHz to the left.
CALC:LIM:CONT:SHIF -50MHZ
//Define the vertical data points of an (upper) limit line.
//The unit is fix according to the result type you have selected.
CALC:LIM:UPP 10,10
//Shift the limit line 5 dB down.
CALC:LIM:UPP:SHIF -5
//Turn the limit line on.
CALC:LIM:UPP:STAT ON
//Select the trace to check.
CALC:LIM:TRAC 1
//Turn on the limit check.
CALC:LIM:STAT ON
//Query the limit check results.
CALC:LIM:FAIL?
```

- [Defining general characteristics of a limit line](#)..... 162
- [Defining horizontal data points](#)..... 163
- [Controlling lower limit lines](#)..... 164
- [Controlling upper limit lines](#)..... 165
- [Managing limit lines](#)..... 166
- [Controlling limit checks](#)..... 167

7.18.1 Defining general characteristics of a limit line

CALCulate<n>:LIMit:COMMeNt.....	162
CALCulate<n>:LIMit:NAME.....	162
CALCulate<n>:LIMit:TYPE.....	162

CALCulate<n>:LIMit:COMMeNt <Comment>

This command defines a comment for a limit line.

Suffix:

<n> irrelevant

 [Limit line](#)

Parameters:

<Comment> String containing the description of the limit line.

CALCulate<n>:LIMit:NAME <Name>

This command selects a limit line that already exists or defines a name for a new limit line.

Suffix:

<n> [Window](#)

 [Limit line](#)

Parameters:

<Name> String containing the limit line name.

*RST: REM1 to REM8 for lines 1 to 8

CALCulate<n>:LIMit:TYPE <Result>

This command configures a limit line for a particular result type.

Suffix:

<n> 1..n

 1..n
[Limit line](#)

Parameters:

<Result> NOISe | GAIN | TEMPerature | YFACTOR | ENR | PHOT | PCOLd

GAIN

Assigns the limit line to "gain" results.

NOISe

Assigns the limit line to "noise figure" results.

PCOLd

Assigns the limit line to power (cold) results.

PHOT

Assigns the limit line to power (hot) results.

TEMPerature

Assigns the limit line to "noise temperature" results.

YFACTOR

Assigns the limit line to "y-factor" results.

Example:

```
CALC:LIM2:TYPE GAIN
```

Assigns limit line 2 to the "gain" result display.

7.18.2 Defining horizontal data points

Note that the number of data points on the horizontal axis should be the same as the number of data points on the vertical axis. Otherwise the limit line may take on an unintended shape.

Example: Number of vertical data points < number of horizontal data points

```
CALC:LIM:CONT 100MHZ,200MHZ,300MHZ,400MHZ,500MHZ
```

```
CALC:LIM:UPP 0,5,0
```

⇒ the application dumps 400 and 500 MHz.

Example: Number of vertical data points > number of horizontal data points

```
CALC:LIM:CONT 100MHZ,200MHZ,300MHZ,400MHZ,500MHZ
```

```
CALC:LIM:UPP 0,5,0,5,0,5,0
```

⇒ the application adds new horizontal data points (500.00000100 MHz and 500.00000200 MHz).

[CALCulate<n>:LIMit:CONTrol\[:DATA\]](#)..... 163

[CALCulate<n>:LIMit:CONTrol:SHIFT](#)..... 164

CALCulate<n>:LIMit:CONTrol[:DATA] <LimitLinePoints>

This command defines the horizontal definition points of a limit line.

Suffix:

<n> irrelevant

 [Limit line](#)

Parameters:

<LimitLinePoints> Variable number of x-axis values.

Note that the number of horizontal values has to be the same as the number of vertical values set with [CALCulate<n>:LIMit:LOWer\[:DATA\]](#) or [CALCulate<n>:LIMit:UPPer\[:DATA\]](#).

If not, the R&S FPL1000 either adds missing values or ignores surplus values.

*RST: -

Default unit: HZ

CALCulate<n>:LIMit:CONTrol:SHIFt <Distance>

This command moves a complete limit line horizontally.

Compared to defining an offset, this command actually changes the limit line definition points by the value you define.

Suffix:

<n> irrelevant

 [Limit line](#)

Parameters:

<Distance> Numeric value.
The unit depends on the scale of the x-axis.
Default unit: HZ

7.18.3 Controlling lower limit lines

[CALCulate<n>:LIMit:LOWer\[:DATA\]](#)..... 164

[CALCulate<n>:LIMit:LOWer:SHIFt](#)..... 164

[CALCulate<n>:LIMit:LOWer:STATe](#)..... 165

CALCulate<n>:LIMit:LOWer[:DATA] <LimitLinePoints>

This command defines the vertical definition points of a lower limit line.

Suffix:

<n> irrelevant

 [Limit line](#)

Parameters:

<LimitLinePoints> Variable number of level values.
Note that the number of vertical values has to be the same as the number of horizontal values set with [CALCulate<n>:LIMit:CONTrol\[:DATA\]](#). If not, the R&S FPL1000 either adds missing values or ignores surplus values.
*RST: Limit line state is OFF
Default unit: DBM

CALCulate<n>:LIMit:LOWer:SHIFt <Distance>

This command moves a complete lower limit line vertically.

Compared to defining an offset, this command actually changes the limit line definition points by the value you define.

Suffix:

<n> [Window](#)

 [Limit line](#)

Parameters:

<Distance> Defines the distance that the limit line moves.
Default unit: DB

CALCulate<n>:LIMit:LOWer:STATe <State>

This command turns a lower limit line on and off.

Before you can use the command, you have to select a limit line with [CALCulate<n>:LIMit:NAME](#) on page 162.

Suffix:

<n> irrelevant
 [Limit line](#)

Parameters:

<State> ON | OFF | 0 | 1
OFF | 0
Switches the function off
ON | 1
Switches the function on

7.18.4 Controlling upper limit lines

CALCulate<n>:LIMit:UPPer[:DATA]	165
CALCulate<n>:LIMit:UPPer:SHIFt	165
CALCulate<n>:LIMit:UPPer:STATe	166

CALCulate<n>:LIMit:UPPer[:DATA] <LimitLinePoints>

This command defines the vertical definition points of an upper limit line.

Suffix:

<n> irrelevant
 [Limit line](#)

Parameters:

<LimitLinePoints> Variable number of level values.
Note that the number of vertical values has to be the same as the number of horizontal values set with [CALCulate<n>:LIMit:CONTRol\[:DATA\]](#). If not, the R&S FPL1000 either adds missing values or ignores surplus values.
*RST: Limit line state is OFF
Default unit: DBM

CALCulate<n>:LIMit:UPPer:SHIFt <Distance>

This command moves a complete upper limit line vertically.

Compared to defining an offset, this command actually changes the limit line definition points by the value you define.

Suffix:

<n> irrelevant

 [Limit line](#)

Parameters:

<Distance> Defines the distance that the limit line moves.

CALCulate<n>:LIMit:UPPer:STATe <State>

This command turns an upper limit line on and off.

Before you can use the command, you have to select a limit line with [CALCulate<n>:LIMit:NAME](#) on page 162.

Suffix:

<n> irrelevant

 [Limit line](#)

Parameters:

<State> ON | OFF | 0 | 1

OFF | 0

Switches the function off

ON | 1

Switches the function on

7.18.5 Managing limit lines

CALCulate<n>:LIMit:ACTive?	166
CALCulate<n>:LIMit:COPY	167
CALCulate<n>:LIMit:DELete	167

CALCulate<n>:LIMit:ACTive?

This command queries the names of *all* active limit lines.

Suffix:

<n> irrelevant

 irrelevant

Return values:

<LimitLines> String containing the names of all active limit lines in alphabetical order.

Example:

CALC:LIM:ACT?

Queries the names of all active limit lines.

Usage:

Query only

CALCulate<n>:LIMit:COPY <Line>

This command copies a limit line.

Suffix:

<n> [Window](#)

 [Limit line](#)

Parameters:

<Line> **1 to 8**
number of the new limit line

<name>

String containing the name of the limit line.

Example:

```
CALC:LIM1:COPY 2
```

Copies limit line 1 to line 2.

```
CALC:LIM1:COPY 'FM2'
```

Copies limit line 1 to a new line named FM2.

CALCulate<n>:LIMit:DELEte

This command deletes a limit line.

Suffix:

<n> [Window](#)

 [Limit line](#)

7.18.6 Controlling limit checks

CALCulate<n>:LIMit:CLEar[:IMMEDIATE]	167
CALCulate<n>:LIMit:FAIL?	168
CALCulate<n>:LIMit:STATe	168
CALCulate<n>:LIMit:TRACe<t>	169
CALCulate<n>:LIMit:TRACe<t>:CHECK	169

CALCulate<n>:LIMit:CLEar[:IMMEDIATE]

This command deletes the result of the current limit check.

The command works on *all* limit lines in *all* measurement windows at the same time.

Suffix:

<n> [Window](#)

 irrelevant

Example:

```
CALC:LIM:CLE
```

Deletes the result of the limit check.

CALCulate<n>:LIMit:FAIL?

This command queries the result of a limit check in the specified window.

To get a valid result, you have to perform a complete measurement with synchronization to the end of the measurement before reading out the result. This is only possible for single sweep mode.

See also [INITiate<n>:CONTinuous](#) on page 147.

Suffix:

<n> [Window](#)

 [Limit line](#)

Return values:

<Result> **0**
 PASS
 1
 FAIL

Example:

```
INIT;*WAI
Starts a new sweep and waits for its end.
CALC2:LIM3:FAIL?
Queries the result of the check for limit line 3 in window 2.
```

Usage:

Query only

CALCulate<n>:LIMit:STATe <State>

This command turns the limit check for a specific limit line on and off.

To query the limit check result, use [CALCulate<n>:LIMit:FAIL?](#).

Note that a new command exists to activate the limit check and define the trace to be checked in one step (see [CALCulate<n>:LIMit:TRACe<t>:CHECK](#) on page 169).

Suffix:

<n> irrelevant

 [Limit line](#)

Parameters:

<State> ON | OFF | 0 | 1
 OFF | 0
 Switches the function off
 ON | 1
 Switches the function on

Example:

```
CALC:LIM:STAT ON
Switches on the limit check for limit line 1.
```

CALCulate<n>:LIMit:TRACe<t> <TraceNumber>

This command links a limit line to one or more traces.

Note that this command is maintained for compatibility reasons only. Limit lines no longer need to be assigned to a trace explicitly. The trace to be checked can be defined directly (as a suffix) in the new command to activate the limit check (see [CALCulate<n>:LIMit:TRACe<t>:CHECK](#) on page 169).

Suffix:

<n>	Window
	Limit line
<t>	irrelevant

Parameters:

<TraceNumber>	1 to 4
*RST:	1

Example:

```
CALC:LIM2:TRAC 3
Assigns limit line 2 to trace 3.
```

CALCulate<n>:LIMit:TRACe<t>:CHECK <State>

This command turns the limit check for a specific trace on and off.

To query the limit check result, use [CALCulate<n>:LIMit:FAIL?](#).

Suffix:

<n>	Window
	Limit line
<t>	Trace

Parameters:

<State>	ON OFF 0 1
	OFF 0
	Switches the function off
	ON 1
	Switches the function on

Example:

```
CALC:LIM3:TRAC2:CHEC ON
Switches on the limit check for limit line 3 on trace 2.
```

7.19 Working with markers

The following commands are necessary to work with markers.

- [Using markers](#)..... 170
- [Using delta markers](#)..... 172
- [Configuring markers](#)..... 175
- [Positioning markers](#)..... 176
- [Positioning delta markers](#)..... 178

7.19.1 Using markers

Note that the suffix at `CALCulate` has an effect only if you query the characteristics of a marker. If you set a marker, you can ignore the suffix because the markers are linked to each other over all measurement windows and will always be on the same frequency.

CALCulate<n>:MARKer<m>:AOFF	170
CALCulate<n>:MARKer<m>[:STATe]	170
CALCulate<n>:MARKer<m>:TRACe	171
CALCulate<n>:MARKer<m>:X	171
CALCulate<n>:MARKer<m>:Y?	171

CALCulate<n>:MARKer<m>:AOFF

This command turns off all markers.

Suffix:

<n> [Window](#)

<m> [Marker](#)

Example:

`CALC:MARK:AOFF`
Switches off all markers.

Manual operation: See "[All Markers Off](#)" on page 86

CALCulate<n>:MARKer<m>[:STATe] <State>

This command turns markers on and off. If the corresponding marker number is currently active as a delta marker, it is turned into a normal marker.

Suffix:

<n> [Window](#)

<m> [Marker](#)

Parameters:

<State> `ON | OFF | 0 | 1`
OFF | 0
Switches the function off
ON | 1
Switches the function on

Example:

`CALC:MARK3 ON`
Switches on marker 3.

Manual operation: See "Marker Type" on page 86

CALCulate<n>:MARKer<m>:TRACe <Trace>

This command selects the trace the marker is positioned on.

Note that the corresponding trace must have a trace mode other than "Blank".

If necessary, the command activates the marker first.

Suffix:

<n> Window

<m> Marker

Parameters:

<Trace> **1 to 4**
Trace number the marker is assigned to.

Example: //Assign marker to trace 1
CALC:MARK3:TRAC 2

CALCulate<n>:MARKer<m>:X <Position>

This command moves a marker to a specific coordinate on the x-axis.

If necessary, the command activates the marker.

If the marker has been used as a delta marker, the command turns it into a normal marker.

Note that markers have to be positioned on a discrete frequency that is part of the frequency list. If you set the marker on a frequency not included in the frequency list, the application positions the marker to the nearest frequency in the list (rounding up or down).

Suffix:

<n> Window

<m> Marker

Parameters:

<Position> Numeric value that defines the marker position on the x-axis.
The unit depends on the result display.

Range: The range depends on the current x-axis range.

Default unit: Hz

Example: CALC:MARK2:X 1.7MHz
Positions marker 2 to frequency 1.7 MHz.

CALCulate<n>:MARKer<m>:Y? <Result>

Queries the result at the position of the specified marker.

Suffix:

<n> 1..n

<m> 1..n

Query parameters:

<Result> Selects the result.

CPCold

Queries calibration power (cold) results.

CPHot

Queries calibration power (hot) results.

CYFactor

Queries calibration "y-factor" results.

GAIN

Queries "gain" results.

NOISe

Queries "noise figure" results.

NUNCertainty

Queries the "noise figure" uncertainty results.

PCOLd

Queries power (cold) results.

PHOT

Queries power (hot) results.

TEMPerature

Queries "noise temperature" results.

YFACtor

Queries "y-factor" results.

Return values:

<Result> Default unit: DBM

Usage: Query only**Manual operation:** See "[Marker Table](#)" on page 23

7.19.2 Using delta markers

Note that the suffix at `CALCulate` has an effect only if you query the characteristics of a marker. If you set a marker, you can ignore the suffix because the markers are linked to each other over all measurement windows and will always be on the same frequency.

<code>CALCulate<n>:DELTamarker<m>:AOFF</code>	173
<code>CALCulate<n>:DELTamarker<m>:MREFerence</code>	173
<code>CALCulate<n>:DELTamarker<m>[:STATe]</code>	173
<code>CALCulate<n>:DELTamarker<m>:TRACe</code>	174
<code>CALCulate<n>:DELTamarker<m>:X</code>	174
<code>CALCulate<n>:DELTamarker<m>:Y?</code>	174

CALCulate<n>:DELTamarker<m>:AOFF

This command turns off *all* delta markers.

Suffix:

<n> [Window](#)

<m> irrelevant

Example:

`CALC:DELT:AOFF`

Turns off all delta markers.

CALCulate<n>:DELTamarker<m>:MREFerence <Reference>

This command selects a reference marker for a delta marker other than marker 1.

The reference may be another marker or the fixed reference.

Suffix:

<n> [Window](#)

<m> [Marker](#)

Parameters:

<Reference> **1 to 16**

Selects markers 1 to 16 as the reference.

FIXed

Selects the fixed reference as the reference.

Example:

`CALC:DELT3:MREF 2`

Specifies that the values of delta marker 3 are relative to marker 2.

CALCulate<n>:DELTamarker<m>[:STATe] <State>

This command turns delta markers on and off.

If necessary, the command activates the delta marker first.

No suffix at DELTmarker turns on delta marker 1.

Suffix:

<n> [Window](#)

<m> [Marker](#)

Parameters:

<State> **ON | OFF | 0 | 1**

OFF | 0

Switches the function off

ON | 1

Switches the function on

Example:

`CALC:DELT2 ON`

Turns on delta marker 2.

Manual operation: See "Marker Type" on page 86

CALCulate<n>:DELTamarker<m>:TRACe <Trace>

This command selects the trace a delta marker is positioned on.

Note that the corresponding trace must have a trace mode other than "Blank".

If necessary, the command activates the marker first.

Suffix:

<n> [Window](#)

<m> [Marker](#)

Parameters:

<Trace> Trace number the marker is assigned to.

Example:

CALC:DELT2:TRAC 2
Positions delta marker 2 on trace 2.

CALCulate<n>:DELTamarker<m>:X <Position>

This command moves a delta marker to a particular coordinate on the x-axis.

If necessary, the command activates the delta marker and positions a reference marker to the peak power.

Suffix:

<n> [Window](#)

<m> [Marker](#)

Parameters:

<Position> Numeric value that defines the marker position on the x-axis.

Range: The value range and unit depend on the measurement and scale of the x-axis.

Example:

CALC:DELT:X?
Outputs the absolute x-value of delta marker 1.

CALCulate<n>:DELTamarker<m>:Y? <Trace>

Queries the result at the position of the specified delta marker.

Suffix:

<n> 1..n

<m> 1..n

Parameters:

<Trace> **CPCold**
Queries calibration power (cold) results.

CPHot
Queries calibration power (hot) results.

CYFactor

Queries calibration "y-factor" results.

GAIN

Queries "gain" results.

NOISe

Queries "noise figure" results.

PCOLd

Queries power (cold) results.

PHOT

Queries power (hot) results.

TEMPerature

Queries "noise temperature" results.

YFACTOR

Queries "y-factor" results.

Return values:

<Result>

Result at the position of the delta marker.

The unit is variable and depends on the one you have currently set.

Default unit: DBM

Usage:

Query only

Manual operation:

See "[Marker Table](#)" on page 23

7.19.3 Configuring markers

DISPlay[:WINDow<n>]:MINFo[:STATe].....	175
DISPlay[:WINDow<n>]:MTABLE.....	176

DISPlay[:WINDow<n>]:MINFo[:STATe] <State>

This command turns the marker information in all diagrams on and off.

Suffix:

<n> irrelevant

Parameters:

<State>

ON | 1

Displays the marker information in the diagrams.

OFF | 0

Hides the marker information in the diagrams.

*RST: 1

Example:

DISP:MINF OFF

Hides the marker information.

Manual operation:

See "[Marker Info](#)" on page 87

DISPlay[:WINDow<n>]:MTABle <DisplayMode>

This command turns the marker table on and off.

Suffix:

<n> irrelevant

Parameters:

<DisplayMode>

ON | 1

Turns on the marker table.

OFF | 0

Turns off the marker table.

AUTO

Turns on the marker table if 3 or more markers are active.

*RST: AUTO

Example:

DISP:MTAB ON

Activates the marker table.

Manual operation: See "[Marker Table Display](#)" on page 86

7.19.4 Positioning markers

If you are using more than one window, the application performs the peak search in the window that you have selected with the suffix at `CALCulate` only. Because the markers are linked, the frequency position of the marker in the other windows is adjusted accordingly, even if it means that the marker is on a peak in the selected window only.

<code>CALCulate<n>:MARKer<m>:MAXimum:LEFT</code>	176
<code>CALCulate<n>:MARKer<m>:MAXimum:NEXT</code>	177
<code>CALCulate<n>:MARKer<m>:MAXimum[:PEAK]</code>	177
<code>CALCulate<n>:MARKer<m>:MAXimum:RIGHT</code>	177
<code>CALCulate<n>:MARKer<m>:MINimum:NEXT</code>	177
<code>CALCulate<n>:MARKer<m>:MINimum:LEFT</code>	177
<code>CALCulate<n>:MARKer<m>:MINimum[:PEAK]</code>	178
<code>CALCulate<n>:MARKer<m>:MINimum:RIGHT</code>	178

CALCulate<n>:MARKer<m>:MAXimum:LEFT

This command moves a marker to the next positive peak.

The search includes only measurement values to the left of the current marker position.

Suffix:

<n> [Window](#)

<m> [Marker](#)

Manual operation: See "[Search Next Peak](#)" on page 88

CALCulate<n>:MARKer<m>:MAXimum:NEXT

This command moves a marker to the next positive peak.

Suffix:

<n> [Window](#)

<m> [Marker](#)

Manual operation: See ["Search Next Peak"](#) on page 88

CALCulate<n>:MARKer<m>:MAXimum[:PEAK]

This command moves a marker to the highest level.

If the marker is not yet active, the command first activates the marker.

Suffix:

<n> [Window](#)

<m> [Marker](#)

Manual operation: See ["Peak Search"](#) on page 88

CALCulate<n>:MARKer<m>:MAXimum:RIGHT

This command moves a marker to the next positive peak.

The search includes only measurement values to the right of the current marker position.

Suffix:

<n> [Window](#)

<m> [Marker](#)

Manual operation: See ["Search Next Peak"](#) on page 88

CALCulate<n>:MARKer<m>:MINimum:NEXT

This command moves a marker to the next minimum peak value.

Suffix:

<n> [Window](#)

<m> [Marker](#)

Manual operation: See ["Search Next Minimum"](#) on page 88

CALCulate<n>:MARKer<m>:MINimum:LEFT

This command moves a marker to the next minimum peak value.

The search includes only measurement values to the right of the current marker position.

Suffix:

<n> Window

<m> Marker

Manual operation: See "Search Next Minimum" on page 88**CALCulate<n>:MARKer<m>:MINimum[:PEAK]**

This command moves a marker to the minimum level.

If the marker is not yet active, the command first activates the marker.

Suffix:

<n> Window

<m> Marker

Manual operation: See "Search Minimum" on page 88**CALCulate<n>:MARKer<m>:MINimum:RIGHT**

This command moves a marker to the next minimum peak value.

The search includes only measurement values to the right of the current marker position.

Suffix:

<n> Window

<m> Marker

Manual operation: See "Search Next Minimum" on page 88

7.19.5 Positioning delta markers

If you are using more than one window, the application performs the peak search in the window that you have selected with the suffix at `CALCulate` only. Because the markers are linked, the frequency position of the marker in the other windows is adjusted accordingly, even if it means that the marker is on a peak in the selected window only.

<code>CALCulate<n>:DELTamarker<m>:MAXimum:LEFT</code>	178
<code>CALCulate<n>:DELTamarker<m>:MAXimum:NEXT</code>	179
<code>CALCulate<n>:DELTamarker<m>:MAXimum[:PEAK]</code>	179
<code>CALCulate<n>:DELTamarker<m>:MAXimum:RIGHT</code>	179
<code>CALCulate<n>:DELTamarker<m>:MINimum:LEFT</code>	179
<code>CALCulate<n>:DELTamarker<m>:MINimum:NEXT</code>	180
<code>CALCulate<n>:DELTamarker<m>:MINimum[:PEAK]</code>	180
<code>CALCulate<n>:DELTamarker<m>:MINimum:RIGHT</code>	180

CALCulate<n>:DELTamarker<m>:MAXimum:LEFT

This command moves a delta marker to the next positive peak value.

The search includes only measurement values to the left of the current marker position.

Suffix:

<n> [Window](#)

<m> [Marker](#)

Manual operation: See ["Search Next Peak"](#) on page 88

CALCulate<n>:DELTamarker<m>:MAXimum:NEXT

This command moves a marker to the next positive peak value.

Suffix:

<n> 1..n
[Window](#)

<m> 1..n
[Marker](#)

Manual operation: See ["Search Next Peak"](#) on page 88

CALCulate<n>:DELTamarker<m>:MAXimum[:PEAK]

This command moves a delta marker to the highest level.

If the marker is not yet active, the command first activates the marker.

Suffix:

<n> [Window](#)

<m> [Marker](#)

Manual operation: See ["Peak Search"](#) on page 88

CALCulate<n>:DELTamarker<m>:MAXimum:RIGHT

This command moves a delta marker to the next positive peak value on the trace.

The search includes only measurement values to the right of the current marker position.

Suffix:

<n> [Window](#)

<m> [Marker](#)

Manual operation: See ["Search Next Peak"](#) on page 88

CALCulate<n>:DELTamarker<m>:MINimum:LEFT

This command moves a delta marker to the next minimum peak value.

The search includes only measurement values to the right of the current marker position.

Suffix:

<n> [Window](#)

<m> [Marker](#)

Manual operation: See "[Search Next Minimum](#)" on page 88

CALCulate<n>:DELTamarker<m>:MINimum:NEXT

This command moves a marker to the next minimum peak value.

Suffix:

<n> [Window](#)

<m> [Marker](#)

Manual operation: See "[Search Next Minimum](#)" on page 88

CALCulate<n>:DELTamarker<m>:MINimum[:PEAK]

This command moves a delta marker to the minimum level.

If the marker is not yet active, the command first activates the marker.

Suffix:

<n> [Window](#)

<m> [Marker](#)

Manual operation: See "[Search Minimum](#)" on page 88

CALCulate<n>:DELTamarker<m>:MINimum:RIGHT

This command moves a delta marker to the next minimum peak value.

The search includes only measurement values to the right of the current marker position.

Suffix:

<n> [Window](#)

<m> [Marker](#)

Manual operation: See "[Search Next Minimum](#)" on page 88

7.20 Using the status register

The status reporting system stores information about the current state of the R&S FPL1000. This includes, for example, information about errors during operation or information about limit checks. The R&S FPL1000 stores this information in the status

registers and in the error queue. You can query the status register and error queue via IEC bus.

The R&S FPL1-K30 features several status registers that are specific to "noise figure" measurements. This chapter describes the application-specific registers, including the corresponding remote commands.

- [Status registers for noise figure measurements](#).....181

7.20.1 Status registers for noise figure measurements

The figure below shows the status registers of the "noise figure" application.

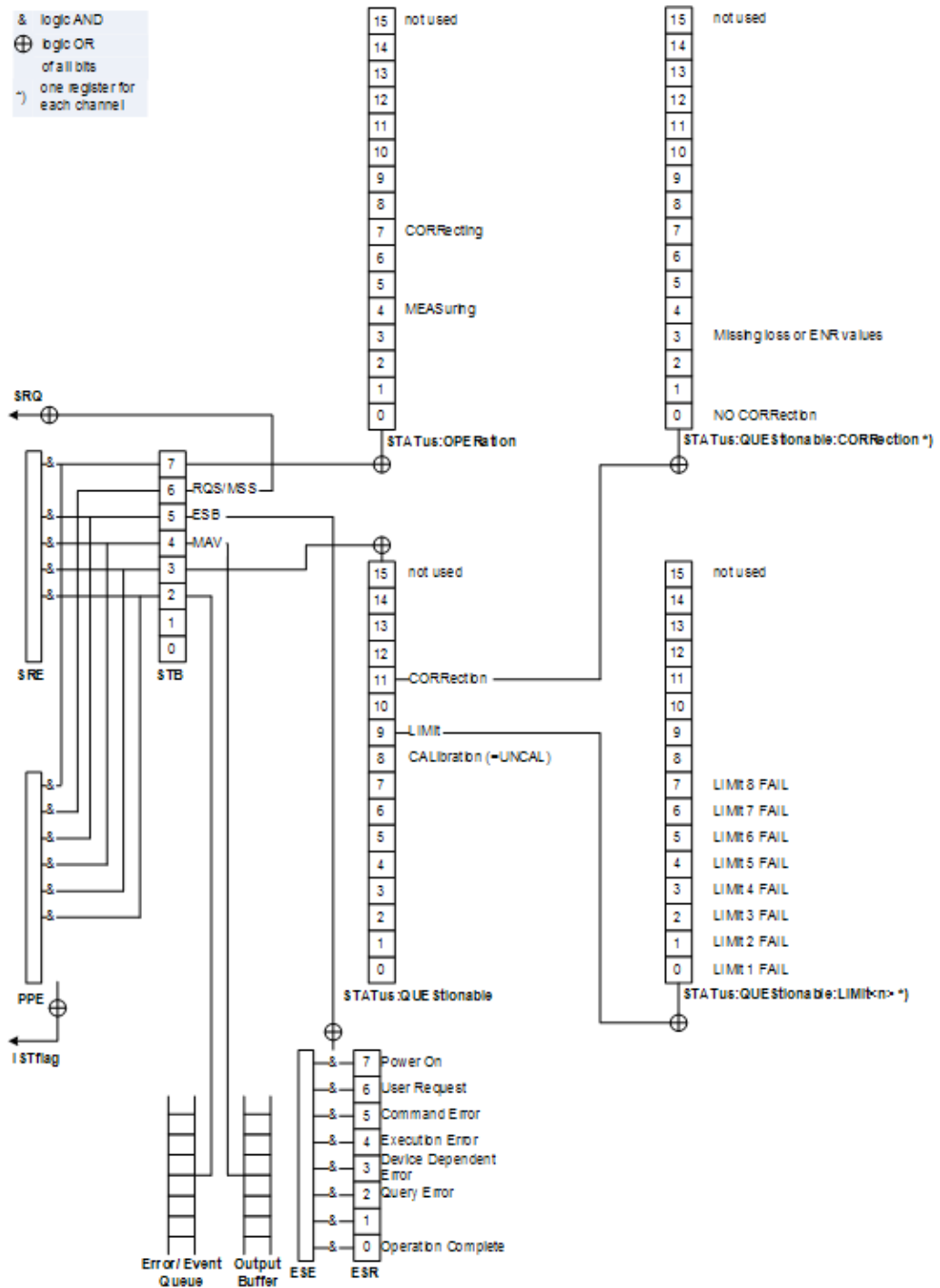

Figure 7-2: Status registers for noise figure measurements

The R&S FPL1000 structures the information hierarchically, with the Status Byte register (STB) and the Service Request Enable mask register (SRE) being on the highest level. The STB gets its information from the standard Event Status Register (ESR) and the Event Status Enable mask register (ESE). The STB and ESR are both defined by IEEE 488.2. In addition to the ESR, the STB also gets information from the Status:OPERation and Status:QUESTIONable registers. These registers are the link to

the lower levels of the status register and are defined by SCPI. They contain information about the state of the instrument.

For a more comprehensive description of the status registers not mentioned here, and status register functionality in general, see the manual of the base unit.

7.20.1.1 STATus:OPERation register

The STATus:OPERation register contains information on current activities of the R&S FPL1000. It also contains information on activities that have been executed since the last read out.

Bit no	Meaning
0 to 3	Unavailable for "noise figure" measurements.
4	MEASuring This bit is set if a measurement is in progress.
5 to 6	Unavailable for "noise figure" measurements.
7	CORReCting This bit is set if a 2nd stage correction is in progress.
8	HCOPy This bit is set if a hardcopy is created.
9 - 14	Unavailable for "noise figure" measurements.
15	This bit is always 0.

7.20.1.2 STATus:QUEStionable register

The STATus:QUEStionable register contains information about indefinite states which can occur if the unit is operated without meeting the specifications.

Bit no	Meaning
0 to 7	Unavailable for "noise figure" measurements.
8	CALibration This bit is set if the R&S FPL1000 is not calibrated.
9	LIMit This bit is set if a limit line is violated.
10	Unavailable for "noise figure" measurements.
11	CORRection This bit is set if the "noise figure" calibration is questionable.
14	Unavailable for "noise figure" measurements.
15	This bit is always 0.

7.20.1.3 STATUS:QUESTIONABLE:LIMIT register

The STATUS:QUESTIONABLE:LIMIT register contains information about limit lines and the results of a limit checks.

The number of LIMIT registers depends on the number of measurement windows available in any application.

Bit no	Meaning
0	LIMIT 1 FAIL This bit is set if limit line 1 is violated.
1	LIMIT 2 FAIL This bit is set if limit line 2 is violated.
2	LIMIT 3 FAIL This bit is set if limit line 3 is violated.
3	LIMIT 4 FAIL This bit is set if limit line 4 is violated.
4	LIMIT 5 FAIL This bit is set if limit line 5 is violated.
5	LIMIT 6 FAIL This bit is set if limit line 6 is violated.
6	LIMIT 7 FAIL This bit is set if limit line 7 is violated.
7	LIMIT 8 FAIL This bit is set if limit line 8 is violated.
8 to 14	Unavailable for "noise figure" measurements.
15	This bit is always 0.

7.20.1.4 STATUS:QUESTIONABLE:CORRECTION register

The STATUS:QUESTIONABLE:CORRECTION register contains information about the calibration status of "noise figure" measurements.

Bit no	Meaning
0	NO CORRECTION This bit is set if calibration is required.
1 to 2	Unavailable for "noise figure" measurements.
3	Missing Loss or ENR values This bit is set if loss or ENR values are missing for one or more measurement frequencies.

Bit no	Meaning
4 to 14	Unavailable for "noise figure" measurements.
15	This bit is always 0.

7.20.1.5 Status register remote commands

STATus:OPERation[:EVENT]?.....	185
STATus:QUESTionable[:EVENT]?.....	185
STATus:QUESTionable:CORRection[:EVENT]?.....	185
STATus:QUESTionable:LIMit[:EVENT]?.....	185
STATus:OPERation:CONDition?.....	185
STATus:QUESTionable:CONDition?.....	185
STATus:QUESTionable:CORRection:CONDition?.....	185
STATus:QUESTionable:LIMit:CONDition?.....	185
STATus:OPERation:ENABle.....	186
STATus:QUESTionable:ENABle.....	186
STATus:QUESTionable:CORRection:ENABle.....	186
STATus:QUESTionable:LIMit:ENABle.....	186
STATus:OPERation:NTRansition.....	186
STATus:QUESTionable:NTRansition.....	186
STATus:QUESTionable:CORRection:NTRansition.....	186
STATus:QUESTionable:LIMit:NTRansition.....	186
STATus:OPERation:PTRansition.....	186
STATus:QUESTionable:PTRansition.....	186
STATus:QUESTionable:CORRection:PTRansition.....	186
STATus:QUESTionable:LIMit:PTRansition.....	186

STATus:OPERation[:EVENT]?

STATus:QUESTionable[:EVENT]?

STATus:QUESTionable:CORRection[:EVENT]? <ChannelName>

STATus:QUESTionable:LIMit[:EVENT]? <ChannelName>

These commands read out the EVENT section of the status register.

The commands at the same time delete the contents of the EVENT section.

Query parameters:

<ChannelName> String containing the name of the channel.
The parameter is optional. If you omit it, the command works for the currently active channel.

Usage: Query only

STATus:OPERation:CONDition?

STATus:QUESTionable:CONDition?

STATus:QUESTionable:CORRection:CONDition? <ChannelName>

STATus:QUESTionable:LIMit:CONDition? <ChannelName>

These commands read out the CONDition section of the status register.

The commands do not delete the contents of the EVENT section.

Query parameters:

<ChannelName> String containing the name of the channel.
The parameter is optional. If you omit it, the command works for the currently active channel.

Usage: Query only

STATus:OPERation:ENABLE <SumBit>,<ChannelName>

STATus:QUESTionable:ENABLE <SumBit>,<ChannelName>

STATus:QUESTionable:CORRection:ENABLE <SumBit>,<ChannelName>

STATus:QUESTionable:LIMit:ENABLE <SumBit>,<ChannelName>

These commands control the ENABLE part of a register.

The ENABLE part allows true conditions in the EVENT part of the status register to be reported in the summary bit. If a bit is 1 in the enable register and its associated event bit transitions to true, a positive transition occurs in the summary bit reported to the next higher level.

Parameters:

<SumBit> Range: 0 to 65535

<ChannelName> String containing the name of the channel.
The parameter is optional. If you omit it, the command works for the currently active channel.

STATus:OPERation:NTRansition <SumBit>,<ChannelName>

STATus:QUESTionable:NTRansition <SumBit>,<ChannelName>

STATus:QUESTionable:CORRection:NTRansition <SumBit>,<ChannelName>

STATus:QUESTionable:LIMit:NTRansition <SumBit>,<ChannelName>

These commands control the Negative TRansition part of a register.

Setting a bit causes a 1 to 0 transition in the corresponding bit of the associated register. The transition also writes a 1 into the associated bit of the corresponding EVENT register.

Parameters:

<SumBit> Range: 0 to 65535

<ChannelName> String containing the name of the channel.
The parameter is optional. If you omit it, the command works for the currently active channel.

STATus:OPERation:PTRansition <SumBit>,<ChannelName>

STATus:QUESTionable:PTRansition <SumBit>,<ChannelName>

STATus:QUESTionable:CORRection:PTRansition <SumBit>,<ChannelName>

STATus:QUESTionable:LIMit:PTRansition <SumBit>,<ChannelName>

These commands control the Positive TRansition part of a register.

Deprecated remote commands for noise figure measurements

Setting a bit causes a 0 to 1 transition in the corresponding bit of the associated register. The transition also writes a 1 into the associated bit of the corresponding EVENT register.

Parameters:

<SumBit> Range: 0 to 65535

<ChannelName> String containing the name of the channel.
The parameter is optional. If you omit it, the command works for the currently active channel.

7.21 Deprecated remote commands for noise figure measurements

Following is a list of deprecated remote commands. The remote commands are still supported to maintain compatibility to previous versions of "noise figure" measurements (like the R&S FSV-K30), but it is strongly recommended to use the command system in the way it is meant to be used in the R&S FPL1-K30.

Legacy command	Replaced by	Comment
CALCulate:LIMit:TRACe	CALCulate:LIMit:TYPE	Parameters NFIGure, TEFFective and GAIN were supported to assign a limit line to a result and thus the trace because trace and result type were fix. CALCulate:LIMit:TRACe now assigns the limit line to a trace (1 to 4).
CALCulate:MARKer:TRACe CALCulate:DELTaMarker:TRACe		The parameters NOISe, GAIN, NMEM1-3 and GMEM1-3 have been replaced by 1 2 3 4 because no distinction is made between memory and live trace.
CONFigure:ARRay:MEMory	TRACe:COPI	No more distinction between memory and live traces.
CONFigure:SINGle	CONFigure:FREQuency:SINGle	
DISPlay:ARRay:MEMory:STATe DISPlay:CURREnt:DATA:STATe	DISPlay:WINDow:TRACe:STATe	No more distinction between memory and live traces.
DISPlay:DATA:TRACe	LAYout system	
DISPlay:FORMat	---	Functionality not supported any more.
DISPlay:WINDow:TABLe	LAYout:WINDow:REPLace / LAYout:REPLace:WINDow	
FETCH: command system	TRACe:DATA	
SENSe:SWEp:POINTs	SENSe:FREQuency:POINTs	
SENSe:FREQuency:CW:FIXed	SENSe:FREQuency:SINGle	
SENSe:FREQuency:LIST:DATA	SENSe:FREQuency:TABLe:DATA	Frequency table only requires RF frequencies on R&S FPL1000.

Legacy command	Replaced by	Comment
SENSe:CONFigure:MODE:SYSTem: LOSCillator	SENSe:CONFigure:MODE: SYSTem:LO	
SENSe:CONFigure:MODE:SYSTem: LOSCillator:FREQuency	SENSe:CONFigure:MODE: SYSTem:LO:FREQuency	

7.22 Programming example: measuring a noise figure

```

// Preset and start option K30
*RST
INSTRument:SElect NOISE

// Set frequencies
SENSe:FREQuency:START 100000
SENSe:FREQuency:STOP 3000000000
SENSe:FREQuency:POINTs 201

// ENR settings
SENSe:CORRection:ENR:MODE TABLE
// Set the ENR values of your noise source here
SENSe:CORRection:ENR:MEASurement:TABLE:DATA 100e3, 15.77, 10e6, 15.77, 100e6, 15.35,
1e9, 15.12, 2e9, 14.70, 3e9, 14.57

// Set meas time
SENSe:SWEep:TIME 300ms

// Configure and start calibration
SENSe:CONFigure:CORRection
INITiate:IMMEDIATE
*OPC
SENSe:CORRection:STATe ON

// Configure and start measurement
// --> don't forget to add the DUT to the signal path here
// Configure a frequency list measurement with the settings above in single sweep
SENSe:CONFigure:LIST:SINGLE
INITiate:IMMEDIATE
*OPC

```

Annex

A Reference: frequency table file format

Frequency tables can be exported to a file in xml format for further evaluation in other applications. Transducer factors stored in the specified xml format can also be imported to the R&S FPL1000 for other measurements (see ["Import / Export"](#) on page 48). This reference describes in detail the format of the export/import files for frequency tables.

```
<?xml version="1.0" encoding="UTF-8"?>
<TableAttributes>
  <Header comment=""/>
  <Data freq="" value=""/>
  ...
</TableAttributes>
```

Example: Import file for a frequency table

```
<?xml version="1.0" encoding="UTF-8"?>
<TableAttributes>
  <Header comment="Frequency values for NC364B (example)"/>
  <Data freq="10000000" value="13.14"/>
  <Data freq="100000000" value="13.21"/>
  <Data freq="1000000000" value="13.22"/>
  <Data freq="2000000000" value="13.17"/>
  <Data freq="3000000000" value="13.26"/>
  <Data freq="4000000000" value="13.38"/>
  <Data freq="5000000000" value="13.53"/>
  <Data freq="6000000000" value="13.63"/>
  <Data freq="7000000000" value="13.81"/>
</TableAttributes>
```

List of commands (Noise figure measurements)

[SENSe:]BANDwidth:LIST:DATA.....	111
[SENSe:]BANDwidth:RESolution:AUTO.....	131
[SENSe:]BANDwidth[:RESolution].....	130
[SENSe:]BWIDth:RESolution:AUTO.....	131
[SENSe:]BWIDth[:RESolution].....	130
[SENSe:]CONFigure:CONTRol.....	149
[SENSe:]CONFigure:CORRection.....	131
[SENSe:]CONFigure:FREQuency:CONTInuous.....	109
[SENSe:]CONFigure:FREQuency:SINGle.....	110
[SENSe:]CONFigure:LIST:CONTInuous.....	110
[SENSe:]CONFigure:LIST:SINGle.....	110
[SENSe:]CONFigure:MEASurement.....	149
[SENSe:]CONFigure:MODE:DUT.....	115
[SENSe:]CONFigure:MODE:SYSTem:LO.....	114
[SENSe:]CONFigure:MODE:SYSTem:LO:FREQuency.....	114
[SENSe:]CORRection:ENR:CALibration:MODE.....	117
[SENSe:]CORRection:ENR:CALibration:SNS:SRNumber.....	123
[SENSe:]CORRection:ENR:CALibration:SPOT.....	117
[SENSe:]CORRection:ENR:CALibration:SPOT:COLD.....	116
[SENSe:]CORRection:ENR:CALibration:SPOT:HOT.....	116
[SENSe:]CORRection:ENR:CALibration:TABLE:SElect.....	117
[SENSe:]CORRection:ENR:CALibration:TYPE.....	118
[SENSe:]CORRection:ENR:COMMon.....	118
[SENSe:]CORRection:ENR[:MEASurement]:MODE.....	121
[SENSe:]CORRection:ENR[:MEASurement]:SNS:SRNumber.....	123
[SENSe:]CORRection:ENR[:MEASurement]:SPOT.....	121
[SENSe:]CORRection:ENR[:MEASurement]:SPOT:COLD.....	122
[SENSe:]CORRection:ENR[:MEASurement]:SPOT:HOT.....	122
[SENSe:]CORRection:ENR[:MEASurement]:TABLE:DELeTe.....	119
[SENSe:]CORRection:ENR[:MEASurement]:TABLE:LIST?.....	119
[SENSe:]CORRection:ENR[:MEASurement]:TABLE:SElect.....	120
[SENSe:]CORRection:ENR[:MEASurement]:TABLE:TEMPerature:DELeTe.....	120
[SENSe:]CORRection:ENR[:MEASurement]:TABLE:TEMPerature:LIST?.....	120
[SENSe:]CORRection:ENR[:MEASurement]:TABLE:TEMPerature[:DATA].....	120
[SENSe:]CORRection:ENR[:MEASurement]:TABLE[:DATA].....	119
[SENSe:]CORRection:ENR[:MEASurement]:TYPE.....	121
[SENSe:]CORRection:IREJection.....	115
[SENSe:]CORRection:LOSS:CALibration:MODE.....	124
[SENSe:]CORRection:LOSS:CALibration:SPOT.....	124
[SENSe:]CORRection:LOSS:CALibration:TABLE:DELeTe.....	124
[SENSe:]CORRection:LOSS:CALibration:TABLE:LIST?.....	125
[SENSe:]CORRection:LOSS:CALibration:TABLE:SElect.....	125
[SENSe:]CORRection:LOSS:CALibration:TABLE[:DATA].....	125
[SENSe:]CORRection:LOSS:CALibration:TEMPerature.....	126
[SENSe:]CORRection:LOSS:INPut:MODE.....	126

[SENSe:]CORRection:LOSS:INPut:SPOT.....	126
[SENSe:]CORRection:LOSS:INPut:TABLE:DELeTe.....	127
[SENSe:]CORRection:LOSS:INPut:TABLE:LIST?.....	127
[SENSe:]CORRection:LOSS:INPut:TABLE:SELeCt.....	127
[SENSe:]CORRection:LOSS:INPut:TABLE[:DATA].....	127
[SENSe:]CORRection:LOSS:INPut:TEMPeRature.....	128
[SENSe:]CORRection:LOSS:OUTPut:MODE.....	128
[SENSe:]CORRection:LOSS:OUTPut:SPOT.....	128
[SENSe:]CORRection:LOSS:OUTPut:TABLE:DELeTe.....	129
[SENSe:]CORRection:LOSS:OUTPut:TABLE:LIST?.....	129
[SENSe:]CORRection:LOSS:OUTPut:TABLE:SELeCt.....	129
[SENSe:]CORRection:LOSS:OUTPut:TABLE[:DATA].....	129
[SENSe:]CORRection:LOSS:OUTPut:TEMPeRature.....	130
[SENSe:]CORRection:RECall.....	132
[SENSe:]CORRection:SAVE.....	132
[SENSe:]CORRection:TEMPeRature.....	123
[SENSe:]CORRection[:STATe].....	132
[SENSe:]FREQUency:CENTer.....	110
[SENSe:]FREQUency:LIST:DATA.....	111
[SENSe:]FREQUency:POINts.....	112
[SENSe:]FREQUency:SINGle.....	112
[SENSe:]FREQUency:SINGle:COUPlEd.....	112
[SENSe:]FREQUency:SPAN.....	113
[SENSe:]FREQUency:STARt.....	113
[SENSe:]FREQUency:STEP.....	113
[SENSe:]FREQUency:STOP.....	113
[SENSe:]FREQUency:TABLE:DATA.....	111
[SENSe:]SWEep:COUNT.....	133
[SENSe:]SWEep:TIME.....	133
[SENSe:]SWEep:TIME:AUTO.....	133
ABORt.....	146
CALCulate<n>:DELTAmarker<m>:AOFF.....	173
CALCulate<n>:DELTAmarker<m>:MAXimum:LEFT.....	178
CALCulate<n>:DELTAmarker<m>:MAXimum:NEXT.....	179
CALCulate<n>:DELTAmarker<m>:MAXimum:RIGHT.....	179
CALCulate<n>:DELTAmarker<m>:MAXimum[:PEAK].....	179
CALCulate<n>:DELTAmarker<m>:MINimum:LEFT.....	179
CALCulate<n>:DELTAmarker<m>:MINimum:NEXT.....	180
CALCulate<n>:DELTAmarker<m>:MINimum:RIGHT.....	180
CALCulate<n>:DELTAmarker<m>:MINimum[:PEAK].....	180
CALCulate<n>:DELTAmarker<m>:MREFerence.....	173
CALCulate<n>:DELTAmarker<m>:TRACe.....	174
CALCulate<n>:DELTAmarker<m>:X.....	174
CALCulate<n>:DELTAmarker<m>:Y?.....	174
CALCulate<n>:DELTAmarker<m>[:STATe].....	173
CALCulate<n>:LIMit:ACTive?.....	166
CALCulate<n>:LIMit:CLEAr[:IMMediate].....	167
CALCulate<n>:LIMit:COMMENT.....	162
CALCulate<n>:LIMit:CONTRol:SHIFt.....	164
CALCulate<n>:LIMit:CONTRol[:DATA].....	163

CALCulate<n>:LIMit:COPY.....	167
CALCulate<n>:LIMit:DELeTe.....	167
CALCulate<n>:LIMit:FAIL?.....	168
CALCulate<n>:LIMit:LOWer:SHIFt.....	164
CALCulate<n>:LIMit:LOWer:STATe.....	165
CALCulate<n>:LIMit:LOWer[:DATA].....	164
CALCulate<n>:LIMit:NAME.....	162
CALCulate<n>:LIMit:STATe.....	168
CALCulate<n>:LIMit:TRACe<t>.....	169
CALCulate<n>:LIMit:TRACe<t>:CHECK.....	169
CALCulate<n>:LIMit:TYPE.....	162
CALCulate<n>:LIMit:UPPer:SHIFt.....	165
CALCulate<n>:LIMit:UPPer:STATe.....	166
CALCulate<n>:LIMit:UPPer[:DATA].....	165
CALCulate<n>:MARKer<m>:AOFF.....	170
CALCulate<n>:MARKer<m>:MAXimum:LEFT.....	176
CALCulate<n>:MARKer<m>:MAXimum:NEXT.....	177
CALCulate<n>:MARKer<m>:MAXimum:RIGHT.....	177
CALCulate<n>:MARKer<m>:MAXimum[:PEAK].....	177
CALCulate<n>:MARKer<m>:MINimum:LEFT.....	177
CALCulate<n>:MARKer<m>:MINimum:NEXT.....	177
CALCulate<n>:MARKer<m>:MINimum:RIGHT.....	178
CALCulate<n>:MARKer<m>:MINimum[:PEAK].....	178
CALCulate<n>:MARKer<m>:TRACe.....	171
CALCulate<n>:MARKer<m>:X.....	171
CALCulate<n>:MARKer<m>:Y?.....	171
CALCulate<n>:MARKer<m>[:STATe].....	170
CALCulate<n>:UNCertainty:COMMon.....	136
CALCulate<n>:UNCertainty:DATA:FREQuency.....	137
CALCulate<n>:UNCertainty:DATA:GAIN.....	137
CALCulate<n>:UNCertainty:DATA:NOISe.....	138
CALCulate<n>:UNCertainty:DATA:RESuLts.....	138
CALCulate<n>:UNCertainty:ENR:CALibration:UNCertainty.....	138
CALCulate<n>:UNCertainty:ENR:CALibration:UNCertainty:COLD.....	139
CALCulate<n>:UNCertainty:ENR:CALibration:UNCertainty:HOT.....	139
CALCulate<n>:UNCertainty:ENR:UNCertainty.....	139
CALCulate<n>:UNCertainty:ENR:UNCertainty:COLD.....	140
CALCulate<n>:UNCertainty:ENR:UNCertainty:HOT.....	140
CALCulate<n>:UNCertainty:MATCH:DUT:IN:RL.....	141
CALCulate<n>:UNCertainty:MATCH:DUT:IN[:VSWR].....	141
CALCulate<n>:UNCertainty:MATCH:DUT:OUT:RL.....	141
CALCulate<n>:UNCertainty:MATCH:DUT:OUT[:VSWR].....	141
CALCulate<n>:UNCertainty:MATCH:PREamp:RL.....	142
CALCulate<n>:UNCertainty:MATCH:PREamp[:VSWR].....	142
CALCulate<n>:UNCertainty:MATCH:SOURce:CALibration:RL.....	143
CALCulate<n>:UNCertainty:MATCH:SOURce:CALibration[:VSWR].....	142
CALCulate<n>:UNCertainty:MATCH:SOURce:RL.....	143
CALCulate<n>:UNCertainty:MATCH:SOURce[:VSWR].....	143
CALCulate<n>:UNCertainty:PREamp:GAIN.....	144
CALCulate<n>:UNCertainty:PREamp:NOISe.....	144

CALCulate<n>:UNCertainty:PREamp:STATe.....	144
CALCulate<n>:UNCertainty:SANalyzer:GAIN:UNCertainty?.....	145
CALCulate<n>:UNCertainty:SANalyzer:NOISe:UNCertainty?.....	145
CALCulate<n>:UNCertainty[:RESult]?.....	145
DISPlay[:WINDow<n>]:MINFo[:STATe].....	175
DISPlay[:WINDow<n>]:MTABLe.....	176
DISPlay[:WINDow<n>]:SIZE.....	107
DISPlay[:WINDow<n>]:TABLe:ITEM.....	152
DISPlay[:WINDow<n>]:TRACe<t>:SYMBols.....	153
DISPlay[:WINDow<n>]:TRACe<t>:UNCertainty.....	153
DISPlay[:WINDow<n>]:TRACe<t>:X[:SCALe].....	153
DISPlay[:WINDow<n>]:TRACe<t>:Y[:SCALe]:AUTO.....	155
DISPlay[:WINDow<n>]:TRACe<t>:Y[:SCALe]:BOTTom.....	154
DISPlay[:WINDow<n>]:TRACe<t>:Y[:SCALe]:RLEVel.....	134
DISPlay[:WINDow<n>]:TRACe<t>:Y[:SCALe]:RLEVel:AUTO.....	134
DISPlay[:WINDow<n>]:TRACe<t>:Y[:SCALe]:TOP.....	155
DISPlay[:WINDow<n>][:SUBWindow<w>]:TRACe<t>:MODE.....	156
DISPlay[:WINDow<n>][:SUBWindow<w>]:TRACe<t>:SMOothing:APERture.....	157
DISPlay[:WINDow<n>][:SUBWindow<w>]:TRACe<t>:SMOothing[:STATe].....	157
DISPlay[:WINDow<n>][:SUBWindow<w>]:TRACe<t>[:STATe].....	157
FORMat:DEXPort:DSEParator.....	159
FORMat:DEXPort:FORMat.....	159
FORMat:DEXPort:HEADer.....	159
FORMat:DEXPort:TRACes.....	159
FORMat[:DATA].....	158
INITiate:SEQuencer:ABORT.....	148
INITiate:SEQuencer:IMMediate.....	148
INITiate:SEQuencer:MODE.....	148
INITiate<n>:CONTinuous.....	147
INITiate<n>[:IMMediate].....	147
INPut<ip>:ATTenuation.....	134
INPut<ip>:GAIN:STATe.....	135
INPut<ip>:IMPedance.....	150
INSTrument:CREate:DUPLicate.....	96
INSTrument:CREate:REPLace.....	97
INSTrument:CREate[:NEW].....	96
INSTrument:DELeTe.....	97
INSTrument:LIST?.....	97
INSTrument:REName.....	98
INSTrument[:SElect].....	98
LAYout:ADD[:WINDow]?.....	100
LAYout:CATalog[:WINDow]?.....	101
LAYout:IDENtify[:WINDow]?.....	101
LAYout:MOVE[:WINDow].....	102
LAYout:REMOve[:WINDow].....	102
LAYout:REPLace[:WINDow].....	103
LAYout:SPLitter.....	103
LAYout:WINDow<n>:ADD?.....	105
LAYout:WINDow<n>:IDENtify?.....	105
LAYout:WINDow<n>:REMOve.....	106

LAYout:WINDow<n>:REPLace.....	106
MMEMory:STORe<n>:TRACe.....	160
OUTPut<up>[:STATe].....	151
SOURce<si>:INTernal:FREQUency.....	151
SOURce<si>:POWer[:LEVel][:IMMediate]:OFFSet.....	152
SOURce<si>:POWer[:LEVel][:IMMediate][:AMPLitude].....	151
STATus:OPERation:CONDition?.....	185
STATus:OPERation:ENABle.....	186
STATus:OPERation:NTRansition.....	186
STATus:OPERation:PTRansition.....	186
STATus:OPERation[:EVENT]?.....	185
STATus:QUEStionable:CONDition?.....	185
STATus:QUEStionable:CORRection:CONDition?.....	185
STATus:QUEStionable:CORRection:ENABle.....	186
STATus:QUEStionable:CORRection:NTRansition.....	186
STATus:QUEStionable:CORRection:PTRansition.....	186
STATus:QUEStionable:CORRection[:EVENT]?.....	185
STATus:QUEStionable:ENABle.....	186
STATus:QUEStionable:LIMit:CONDition?.....	185
STATus:QUEStionable:LIMit:ENABle.....	186
STATus:QUEStionable:LIMit:NTRansition.....	186
STATus:QUEStionable:LIMit:PTRansition.....	186
STATus:QUEStionable:LIMit[:EVENT]?.....	185
STATus:QUEStionable:NTRansition.....	186
STATus:QUEStionable:PTRansition.....	186
STATus:QUEStionable[:EVENT]?.....	185
SYSTem:CONFIgure:DUT:GAIN.....	135
SYSTem:CONFIgure:DUT:STIME.....	135
SYSTem:PRESet:CHANnel[:EXEC].....	99
SYSTem:SEQuencer.....	149
TRACe<n>:COPY.....	160
TRACe<n>[:DATA]?.....	107

Index

Symbols

2nd stage correction 32, 64

A

Aborting
 Sweep 73, 74
 Application cards 8
 Application notes 8
 Attenuation 66
 Auto level range 66
 Averaging 65

B

Bandwidth
 Resolution 36, 64
 Basic Measurement Examples
 see User Manual 7
 Brochures 8

C

Calibration 32, 64, 74
 Recall 34
 Save 34
 Calibration certificate 9
 Capture time
 see also Measurement time 133
 Center frequency 44
 Channel setup
 Creating (remote) 97, 98
 Deleting (remote) 97
 Duplicating (remote) 96
 Querying (remote) 97
 Renaming (remote) 98
 Replacing (remote) 97
 Selecting (remote) 98
 Clear 48
 Closing
 Channel setups (remote) 97
 Windows (remote) 106
 Continuous sweep
 Softkey 73
 Conventions
 SCPI commands 91
 Copying
 Channel setup (remote) 96
 Traces 81

D

Data format
 Remote 159
 Data sheets 8
 Decimal separator
 Trace export 83, 84
 Delta markers
 Defining 86
 Direct measurement 49
 Direct measurements 28
 Duplicating
 Channel setup (remote) 96

DUT characteristics 49

E

ENR 50
 ENR source 52
 ENR table 54
 Delete 56
 Edit 56, 57
 Evaluation methods
 Remote 100
 Excess noise ratio (ENR) 50
 Exporting
 Measurement settings 82
 Traces 81, 83, 84

F

Filters
 RBW 36
 Fixed LO 49
 Format
 Data (remote) 159
 Frequency
 Center 44
 Span 44
 Start 44
 Stepsize 45
 Stop 44
 Frequency conversion 49
 Frequency conversion measurements 28
 Frequency list 25, 47
 Frequency set 42
 Frequency table 47, 48

G

Getting started 7
 Group delay
 Smoothing 80

H

Hardware settings
 Displayed 13

I

Image rejection 49
 Impedance
 Setting 75
 Input loss 58
 Installation 11
 Instrument security procedures 8

K

Keys
 Peak Search 88
 RUN CONT 73
 RUN SINGLE 74

L	
Loss	
Input	58
Output	58
Loss table	61
Delete	62
Edit	62
Losses	58
M	
Marker	37
Markers	
Deactivating	86
Delta markers	86
Minimum	88
Next minimum	88
Next peak	88
Peak	88
Table	86
Type	86
Maximizing	
Windows (remote)	107
Measurement	
Frequency list	25
Performing	73
Measurement point	
Delete	48
Insert	48
Measurement points	44
Measurement time	
Remote	133
Minimum	88
Marker positioning	88
Next	88
Multiple	
Measurement channels	12
N	
Next Minimum	88
Marker positioning	88
Next Peak	88
Marker positioning	88
Noise source	32
Noise source characteristics	50
Noise Source Control	11
O	
Options	
Preamplifier	66
Output loss	58
Overview	
Configuration	40
P	
Peak search	
Key	88
Peaks	
Marker positioning	88
Next	88
Softkey	88
Populate	48
Preamplifier	
Setting	66
Softkey	66
Presetting	
Channels	42
R	
RBW	64
see Resolution Bandwidth	36
Reference level	65
Release notes	8
Remote commands	
Basics on syntax	91
Boolean values	95
Capitalization	92
Character data	95
Data blocks	95
Numeric values	94
Optional keywords	93
Parameters	93
Strings	95
Suffixes	92
Resolution bandwidth	64
Impact	36
Restoring	
Channel settings	42
Results	
Data format (remote)	159
Exporting	82
RF attenuation	66
Room temperature	54
RUN CONT	
Key	73
RUN SINGLE	
Key	74
S	
Safety instructions	8
Security procedures	8
Sensitivity	
RBW	36
Sequencer	12
Activating (remote)	148
Remote	147
Sequences	
Aborting (remote)	148
Mode (remote)	148
Service manual	7
Settling time	65
Signal capturing	
Duration (remote)	133
Single sweep	
Softkey	74
Smoothing	
Traces (group delay)	80
Softkeys	
Continuous Sweep	73
Min	88
Next Min	88
Next Peak	88
Norm/Delta	86
Peak	88
Preamp	66
Single Sweep	74
Span	44

Specifics for	
Configuration	42
Start frequency	44
Step(size)	45
Stop frequency	44
Suffixes	
Common	91
Remote commands	92
Sweep	
Aborting	73, 74
Time (remote)	133
Sweep time	64

T

Temperature	54
Trace	79
Mode	37
Preset	81
Selection	80
Traces	
Copying	81
Copying (remote control)	160
Export format	83, 84
Exporting	81, 82, 83, 84
Mode (remote)	156
Tuning mode	24, 43

W

White papers	8
Window title bar information	13
Windows	
Adding (remote)	100
Closing (remote)	106
Configuring	42
Layout (remote)	103
Maximizing (remote)	107
Querying (remote)	101
Replacing (remote)	103
Splitting (remote)	107
Types (remote)	100