

R&S®FSWP-B1

Multi-Standard Radio Analyzer

User Manual

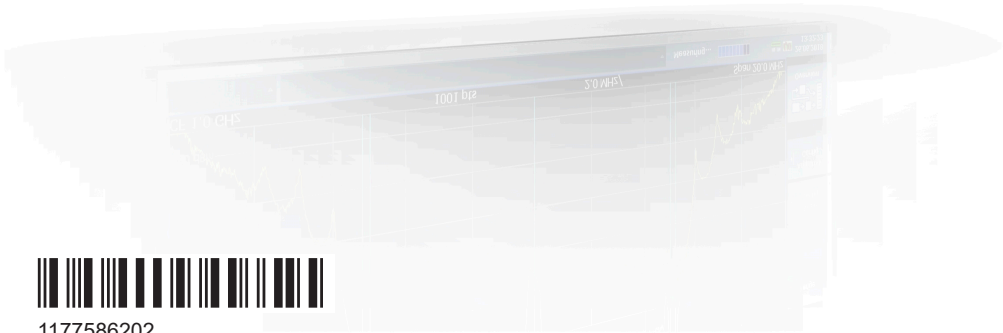

1177586202
Version 11



This manual describes the following R&S®FSWP models with firmware version 4.10 or higher:

- R&S®FSWP8 (1322.8003K08)
- R&S®FSWP8 (1322.8003K09)
- R&S®FSWP26 (1322.8003K26)
- R&S®FSWP26 (1322.8003K27)
- R&S®FSWP50 (1322.8003K50)
- R&S®FSWP50 (1322.8003K51)

The MSRA mode is an integral part of the following options:

- R&S FSWP-B1 (1322.9997.08)
- R&S FSWP-B1 (1322.9997.26)
- R&S FSWP-B1 (1322.9997.50)

© 2025 Rohde & Schwarz

Muehldorfstr. 15, 81671 Muenchen, Germany

Phone: +49 89 41 29 - 0

Email: info@rohde-schwarz.com

Internet: www.rohde-schwarz.com

Subject to change – data without tolerance limits is not binding.

R&S® is a registered trademark of Rohde & Schwarz GmbH & Co. KG.

Trade names are trademarks of the owners.

1177.5862.02 | Version 11 | R&S®FSWP-B1

Throughout this manual, products from Rohde & Schwarz are indicated without the ® symbol , e.g. R&S®FSWP is indicated as R&S FSWP.

Contents

1	Preface	7
1.1	About this manual.....	7
1.2	Documentation overview.....	8
1.2.1	Getting started manual.....	8
1.2.2	User manuals and help.....	8
1.2.3	Service manual.....	8
1.2.4	Instrument security procedures.....	8
1.2.5	Printed safety instructions.....	9
1.2.6	Specifications and brochures.....	9
1.2.7	Release notes and open source acknowledgment (OSA).....	9
1.2.8	Application notes, application cards, white papers, etc.....	9
1.2.9	Videos.....	9
1.3	Conventions used in the documentation.....	9
1.3.1	Typographical conventions.....	9
1.3.2	Conventions for procedure descriptions.....	10
1.3.3	Notes on screenshots.....	10
2	Welcome to the MSRA operating mode	11
2.1	Starting the MSRA operating mode.....	11
2.2	Understanding the display information.....	12
2.2.1	MSRA view.....	14
2.2.2	MSRA primary.....	15
2.2.3	MSRA secondary applications.....	16
3	Measurements and result displays	18
4	Applications and operating modes	20
4.1	Available secondary applications.....	21
4.2	Selecting the operating mode and secondary applications.....	22
4.3	Using the sequencer in MSRA mode.....	23
5	MSRA basics	26
5.1	Configuration.....	26
5.2	Data acquisition.....	27

5.3	Multi-standard analysis.....	28
5.4	Restrictions for secondary applications.....	30
5.5	Measurements in the time and frequency domain.....	30
6	MSRA configuration.....	32
6.1	Configuration overview.....	33
6.2	Input source settings.....	35
6.2.1	Radio frequency input.....	35
6.2.2	Settings for input from I/Q data files.....	38
6.3	Amplitude.....	39
6.3.1	Scaling the y-axis.....	39
6.4	Frequency settings.....	40
6.5	Trigger settings.....	42
6.6	Data acquisition and bandwidth settings.....	47
6.6.1	Data acquisition.....	47
6.6.2	Sweep settings.....	52
6.7	Output settings.....	54
6.8	Display configuration.....	55
6.9	Automatic settings.....	55
7	Analysis.....	58
7.1	Configuring the analysis line.....	58
8	How to perform measurements in MSRA mode.....	60
9	Remote commands to perform measurements in MSRA mode.....	63
9.1	Introduction.....	63
9.1.1	Conventions used in descriptions.....	64
9.1.2	Long and short form.....	65
9.1.3	Numeric suffixes.....	65
9.1.4	Optional keywords.....	65
9.1.5	Alternative keywords.....	66
9.1.6	SCPI parameters.....	66
9.1.6.1	Numeric values.....	66
9.1.6.2	Boolean.....	67
9.1.6.3	Character data.....	68

9.1.6.4	Character strings.....	68
9.1.6.5	Block data.....	68
9.2	Common suffixes.....	68
9.3	Activating MSRA measurements.....	69
9.4	Configuring MSRA measurements.....	74
9.4.1	Configuring input/output and frontend settings.....	74
9.4.1.1	RF input.....	75
9.4.1.2	Configuring file input.....	78
9.4.1.3	Using external mixers.....	79
	Basic settings.....	80
	Mixer settings.....	81
	Conversion loss table settings.....	86
	Programming example: working with an external mixer.....	90
9.4.1.4	Setting up probes.....	92
9.4.1.5	Configuring the vertical axis (amplitude, scaling).....	97
	Amplitude settings.....	98
	Configuring the attenuation.....	99
	Configuring a preamplifier.....	100
	Scaling the Y-axis.....	101
9.4.1.6	Frequency.....	103
9.4.1.7	Configuring the outputs.....	104
9.4.2	Triggering.....	105
9.4.2.1	Configuring the triggering conditions.....	105
9.4.2.2	Configuring the trigger output.....	109
9.4.3	Configuring data acquisition.....	111
9.4.4	Adjusting settings automatically.....	117
9.5	Capturing data and performing sweeps.....	119
9.6	Retrieving results.....	124
9.7	Querying the status registers.....	128
9.7.1	STATus:OPERation register.....	129
9.7.2	Commands to query the STATus:OPERation register.....	129
9.8	Analyzing MSRA measurements.....	131
9.9	Commands specific to MSRA secondary applications.....	131

Annex.....	135
A Reference: format description for I/Q data files.....	135
B Formats for returned values: ASCII format and binary format.....	137
C Sample rate and maximum usable I/Q bandwidth for RF input.....	138
C.1 Bandwidth extension options.....	139
C.2 Relationship between sample rate, record length and usable I/Q bandwidth.....	139
C.3 R&S FSWP without additional bandwidth extension options.....	139
C.4 R&S FSWP with I/Q bandwidth extension option B80.....	139
C.5 R&S FSWP with activated I/Q bandwidth extension option B320.....	140
List of Remote Commands (MSRA).....	142
Index.....	145

1 Preface

1.1 About this manual

This R&S FSWP MSRA User Manual provides all the information **specific to the operating mode**. All general instrument functions and settings common to all applications and operating modes are described in the main R&S FSWP User Manual.

The main focus in this manual is on the measurement results and the tasks required to obtain them. The following topics are included:

- **Welcome to the MSRA Operating Mode**
Introduction to and getting familiar with the operating mode
- **Typical Applications**
Example measurement scenarios in which the operating mode is frequently used
- **Measurements and Result Displays**
Details on supported measurements and their result types
- **MSRA Basics**
Background information on basic terms and principles in the context of the MSRA operating mode
- **MSRA Configuration**
A concise description of all functions and settings available to configure an MSRA measurement with their corresponding remote control command
- **How to Perform Measurements in MSRA Mode**
The basic procedure to perform an MSRA measurement with step-by-step instructions
- **Measurement Examples**
Detailed measurement examples to guide you through typical measurement scenarios and allow you to try out the operating mode immediately
- **Optimizing and Troubleshooting the Measurement**
Hints and tips on how to handle errors and optimize the test setup
- **Remote Commands for MSRA Measurements**
Remote commands required to configure and perform MSRA measurements in a remote environment, sorted by tasks
(Commands required to set up the environment or to perform common tasks on the instrument are provided in the main R&S FSWP User Manual)
Programming examples demonstrate the use of many commands and can usually be executed directly for test purposes
- **Annex**
Reference material
- **List of remote commands**
Alphabetical list of all remote commands described in the manual
- **Index**

1.2 Documentation overview

This section provides an overview of the R&S FSWP user documentation. Unless specified otherwise, you find the documents at:

www.rohde-schwarz.com/manual/FSWP

1.2.1 Getting started manual

Introduces the R&S FSWP and describes how to set up and start working with the product. Includes basic operations, typical measurement examples, and general information, e.g. safety instructions, etc.

A printed version is delivered with the instrument. A PDF version is available for download on the Internet.

1.2.2 User manuals and help

The user manual contains the description of all instrument modes and functions. It also provides an introduction to remote control, a complete description of the remote control commands with programming examples, and information on maintenance, instrument interfaces and error messages. Includes the contents of the getting started manual.

The contents of the user manual are available as help in the R&S FSWP. The help offers quick, context-sensitive access to the complete information for the instrument and its firmware.

The user manual is also available for download or for immediate display on the Internet.

1.2.3 Service manual

Describes the performance test for checking the rated specifications, module replacement and repair, firmware update, troubleshooting and fault elimination, and contains mechanical drawings and spare part lists.

The service manual is available for registered users on the global Rohde & Schwarz information system (GLORIS):

<https://gloris.rohde-schwarz.com>

1.2.4 Instrument security procedures

Deals with security issues when working with the R&S FSWP in secure areas. It is available for download on the internet.

1.2.5 Printed safety instructions

Provides safety information in many languages. The printed document is delivered with the product.

1.2.6 Specifications and brochures

The specifications document, also known as the data sheet, contains the technical specifications of the R&S FSWP. It also lists the firmware applications and their order numbers, and optional accessories.

The brochure provides an overview of the instrument and deals with the specific characteristics.

See www.rohde-schwarz.com/brochure-datasheet/FSWP

1.2.7 Release notes and open source acknowledgment (OSA)

The release notes list new features, improvements and known issues of the current software version, and describe the software installation.

The software uses several valuable open source software packages. An open source acknowledgment document provides verbatim license texts of the used open source software.

See www.rohde-schwarz.com/firmware/FSWP

1.2.8 Application notes, application cards, white papers, etc.

These documents deal with special applications or background information on particular topics.

See www.rohde-schwarz.com/application/FSWP

1.2.9 Videos

Find various videos on Rohde & Schwarz products and test and measurement topics on YouTube: <https://www.youtube.com/@Rohde-Schwarz>

1.3 Conventions used in the documentation

1.3.1 Typographical conventions

The following text markers are used throughout this documentation:

Convention	Description
"Graphical user interface elements"	All names of graphical user interface elements on the screen, such as dialog boxes, menus, options, buttons, and softkeys are enclosed by quotation marks.
[Keys]	Key and knob names are enclosed by square brackets.
Filenames, commands, program code	Filenames, commands, coding samples and screen output are distinguished by their font.
<i>Input</i>	Input to be entered by the user is displayed in italics.
Links	Links that you can click are displayed in blue font.
"References"	References to other parts of the documentation are enclosed by quotation marks.

1.3.2 Conventions for procedure descriptions

When operating the instrument, several alternative methods may be available to perform the same task. In this case, the procedure using the touchscreen is described. Any elements that can be activated by touching can also be clicked using an additionally connected mouse. The alternative procedure using the keys on the instrument or the on-screen keyboard is only described if it deviates from the standard operating procedures.

The term "select" may refer to any of the described methods, i.e. using a finger on the touchscreen, a mouse pointer in the display, or a key on the instrument or on a keyboard.

1.3.3 Notes on screenshots

When describing the functions of the product, we use sample screenshots. These screenshots are meant to illustrate as many as possible of the provided functions and possible interdependencies between parameters. The shown values may not represent realistic usage scenarios.

The screenshots usually show a fully equipped product, that is: with all options installed. Thus, some functions shown in the screenshots may not be available in your particular product configuration.

2 Welcome to the MSRA operating mode

The MSRA operating mode is part of the standard R&S FSWP firmware and adds functionality to perform multi-standard radio analysis.

The R&S FSWP MSRA operating mode features:

- Analysis of the same I/Q data in more than one application
- Analysis of correlated effects due to multiple standards
- Configuration of data acquisition settings only required once for all applications
- Overview of all results in one screen in addition to large display of individual results
- Common analysis line (time marker) across all applications
- Performing measurements in the frequency and time domain (such as channel power measurements) on I/Q data



Availability of the Multi-Standard Radio Analyzer

The Multi-Standard Radio Analyzer becomes available when you equip the R&S FSWP with the optional Spectrum Analyzer hardware (R&S FSWP-B1).

Note that the MSRA does not support all applications (for example, the Phase Noise application is not supported by MSRA).

This user manual contains a description of the functionality specific to the MSRA operating mode, including remote control operation.

All functions not discussed in this manual are the same as in Signal and Spectrum Analyzer mode and are described in the R&S FSWP User Manual. The latest version is available for download at the product homepage

<http://www.rohde-schwarz.com/product/fswp.html>.

Additional information

An application note discussing efficient measurements using the MSRA mode is available from the Rohde & Schwarz website:

[1EF83: Using the R&S®FSW for Efficient Measurements on Multi- Standard Radio Base Stations \(MSRA\)](#)

2.1 Starting the MSRA operating mode

MSRA is a new operating mode on the R&S FSWP.

To activate the MSRA operating mode

1. Select [MODE].

A dialog box opens that contains all operating modes and applications currently available on your R&S FSWP.

2. Select the "Multi Standard Radio Analyzer" tab.

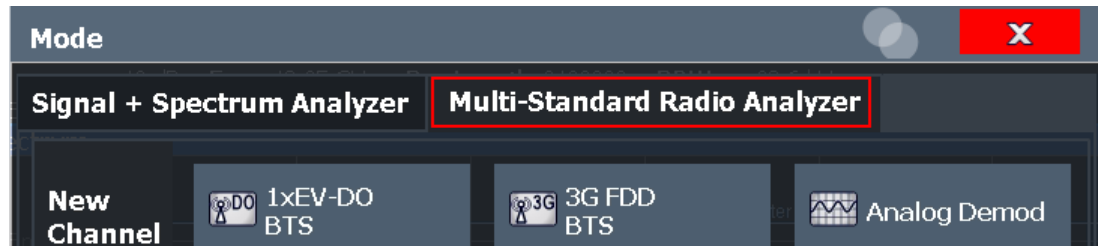

3. Confirm the message informing you that you are changing operating modes.

The R&S FSWP closes all active measurement channels in the current operating mode, then opens a new measurement channel for the MSRA operating mode.

Note: when you return to the Phase Noise Analyzer mode, the R&S FSWP opens a Spectrum channel.

In addition to the "MSRA View", an "MSRA Primary" tab is displayed.

The Sequencer is automatically activated in continuous mode (see [Section 4.3, "Using the sequencer in MSRA mode"](#), on page 23), starting an I/Q Analyzer data acquisition with the default settings (but with a "Spectrum" result display). It can be configured in the MSRA "Overview" dialog box, which is displayed when you select "Overview" from any menu (see [Section 6.1, "Configuration overview"](#), on page 33).



Remote command:

INST:MODE MSR, see [INSTrument:MODE](#) on page 72

2.2 Understanding the display information

The following figure shows a screen display during MSRA operation. All different information areas are labeled. They are explained in more detail in the following sections.



- The orange background of the screen behind the measurement channel tabs indicates that you are in MSRA operating mode.
- The  icon on the tab label indicates that the displayed trace (e.g. in an MSRA secondary application) no longer matches the currently captured data. This may be the case, for example, if a data acquisition was performed in another secondary application. As soon as the result display is refreshed, the icon disappears.
- The  icon indicates that an error or warning is available for that measurement channel. This is particularly useful if the MSRA View tab is displayed.

An orange "IQ" indicates that the results displayed in the MSRA secondary application(s) no longer match the data captured by the MSRA primary. The "IQ" disappears after the results in the secondary application(s) are refreshed.

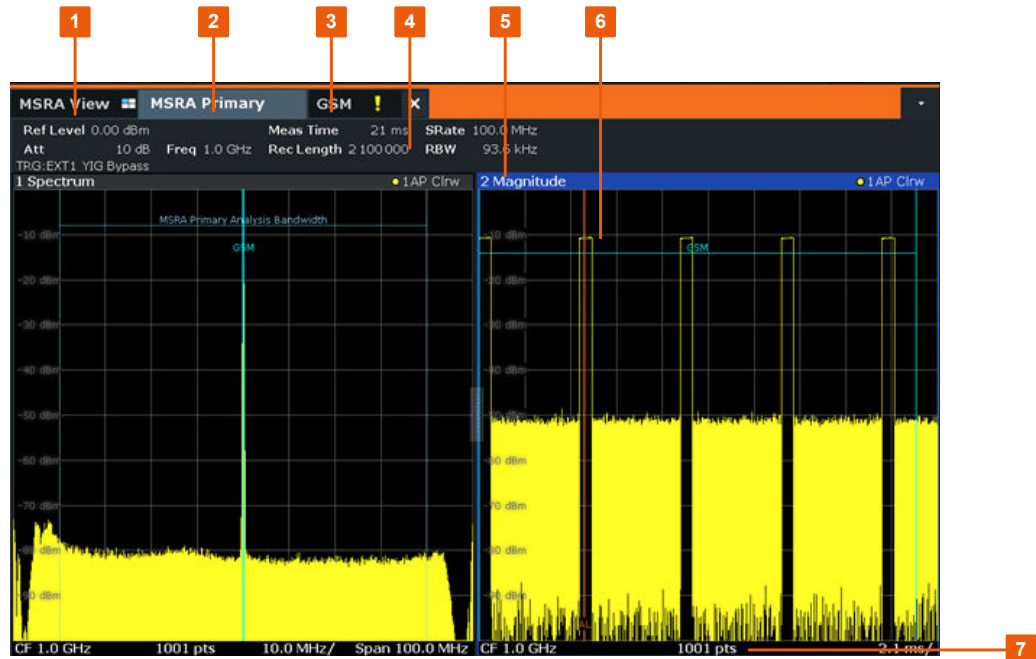

- 1 = MSRA View (overview of all active channels in MSRA mode)
- 2 = MSRA Primary (data acquisition channel with global configuration settings)
- 3 = Measurement channel tab for individual MSRA secondary application
- 4 = Channel bar with firmware and measurement settings for selected channel
- 5 = Window title bar with diagram-specific (trace) information and analysis interval
- 6 = Diagram area
- 7 = Diagram footer with diagram-specific information, depending on evaluation

The diagram area varies depending on the type of measurement channel, as described in detail in the following topics.

Window title bar information

For each diagram, the header provides the following information:

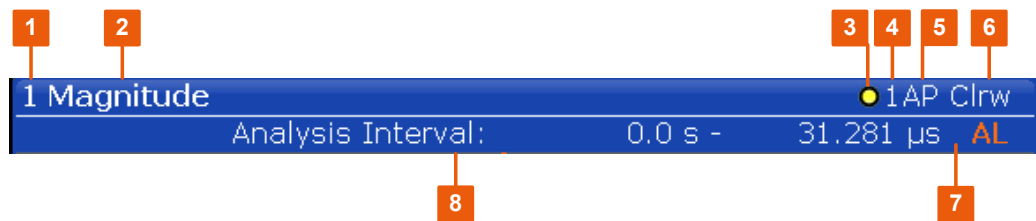

Figure 2-1: Window title bar information in MSRA mode

- 1 = Window number
- 2 = Window type
- 3 = Trace color
- 4 = Trace number
- 5 = Detector
- 6 = Trace mode
- 7 = Analysis line indication
- 8 = Analysis interval

Diagram footer information

The information in the diagram footer (beneath the diagram) depends on the evaluation:

- Center frequency
- Number of sweep points
- Range per division (x-axis)
- Span (Spectrum)

Status bar information

Global instrument settings, the instrument status and any irregularities are indicated in the status bar beneath the diagram. Furthermore, the progress of the current operation is displayed in the status bar.



If an error or warning is available for a measurement channel, the  icon is displayed next to the tab label in the channel bar.

2.2.1 MSRA view

The MSRA View is an overview of all active channels in MSRA mode, similar to the MultiView tab in Signal and Spectrum Analyzer mode. At the top of the screen the MSRA Primary is displayed, i.e. the application that captures data. Beneath the MSRA Primary, all active secondary applications are displayed in individual windows. Each secondary application has its own channel bar with the current settings as well as a button in order to switch to that secondary application tab directly.

The MSRA View displays the following basic elements:

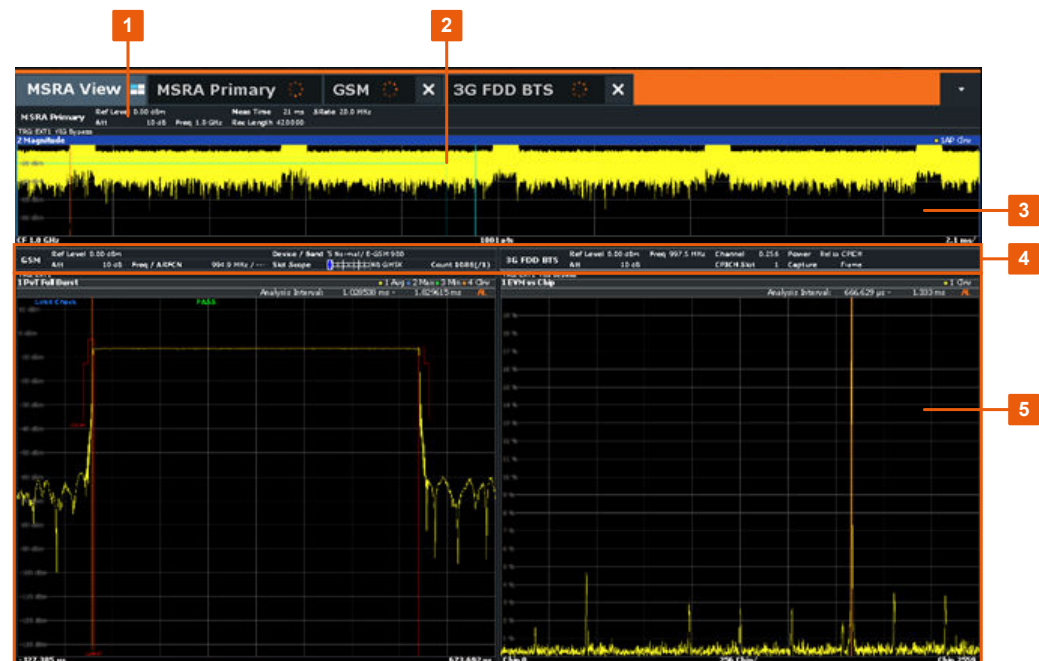

- 1 = Channel information bar for the MSRA Primary
- 2 = Secondary application data coverage for each active secondary application
- 3 = Result display for MSRA Primary (for entire capture buffer)
- 4 = Channel information bar for secondary application with button to switch to secondary application tab
- 5 = Result display for secondary application (for analysis interval)

2.2.2 MSRA primary

The MSRA primary is the only channel that captures data. It also controls global configuration settings for all secondary applications. The MSRA primary channel itself is implemented as an I/Q Analyzer secondary application. The MSRA primary measurement channel cannot be deleted or replaced.

The following figure shows the screen elements specific to the MSRA primary.

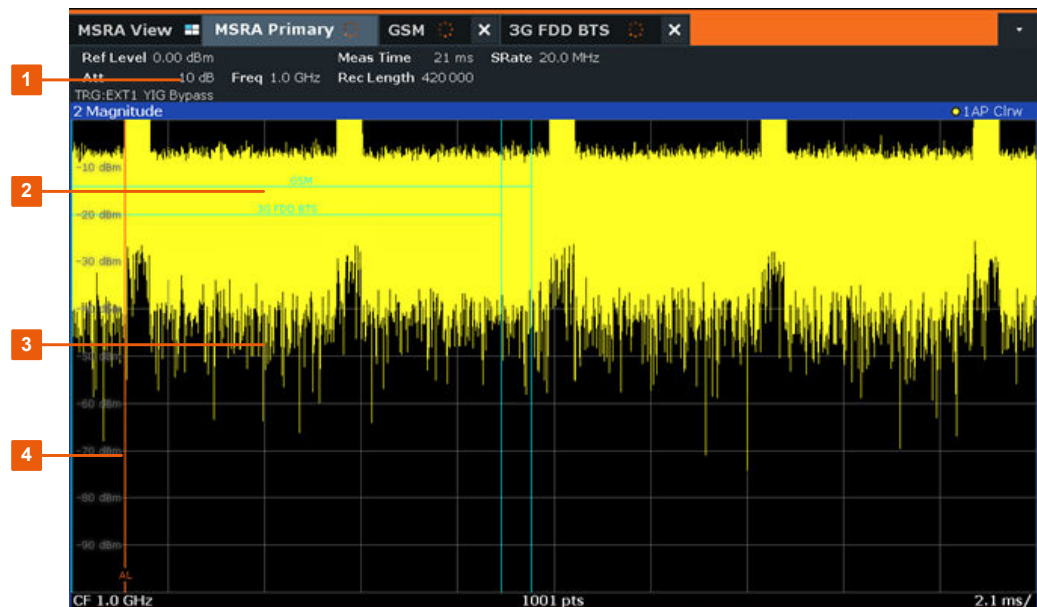

- 1 = Channel information bar for the MSRA Primary
- 2 = Data coverage for each active secondary application
- 3 = Result display for MSRA Primary (for entire capture buffer)
- 4 = Analysis line

Channel bar information

The channel bar shows the firmware and measurement information for data acquisition and global configuration.

Table 2-1: Information displayed in the channel bar for the MSRA Primary

Ref Level	Reference level
Att	RF attenuation
Ref Offset	Reference level offset
Freq	Center frequency

AQT	Defined measurement time, i.e. the duration of data acquisition to the capture buffer
Rec Length	Defined record length (number of samples to capture)
SRate	Defined sample rate for data acquisition
RBW	(Spectrum evaluation only) Resolution bandwidth calculated from the sample rate and record length

In addition, the channel bar also displays information on instrument settings that affect the measurement results even though this is not immediately apparent from the display of the measured values (e.g. transducer or trigger settings). This information is displayed only when applicable for the current measurement. For details see the R&S FSWP Getting Started manual.

Data coverage for each active secondary application

Each secondary application obtains an extract of the data captured by the MSRA primary (see also [Section 5.3, "Multi-standard analysis"](#), on page 28). Generally, if a signal contains data channels for multiple standards, the individual secondary applications are used to analyze the channel for the corresponding standard. Thus, it is of interest to know which secondary application is analyzing which part of the captured data, or more precisely, which data channel. The MSRA Primary display indicates the data covered by each secondary application, restricted to the channel bandwidth used by the corresponding standard, by vertical blue lines labeled with the secondary application name. For secondary applications that support several standards (e.g. VSA, LTE) an estimated or user-defined bandwidth is indicated.

2.2.3 MSRA secondary applications

The data captured by the MSRA primary measurement (or only parts of it) can be evaluated by various secondary applications. The measurement channel for each secondary application contains the settings and results for the secondary application data extract from the capture buffer.

The following figure shows the screen elements specific to the MSRA secondary application tabs.

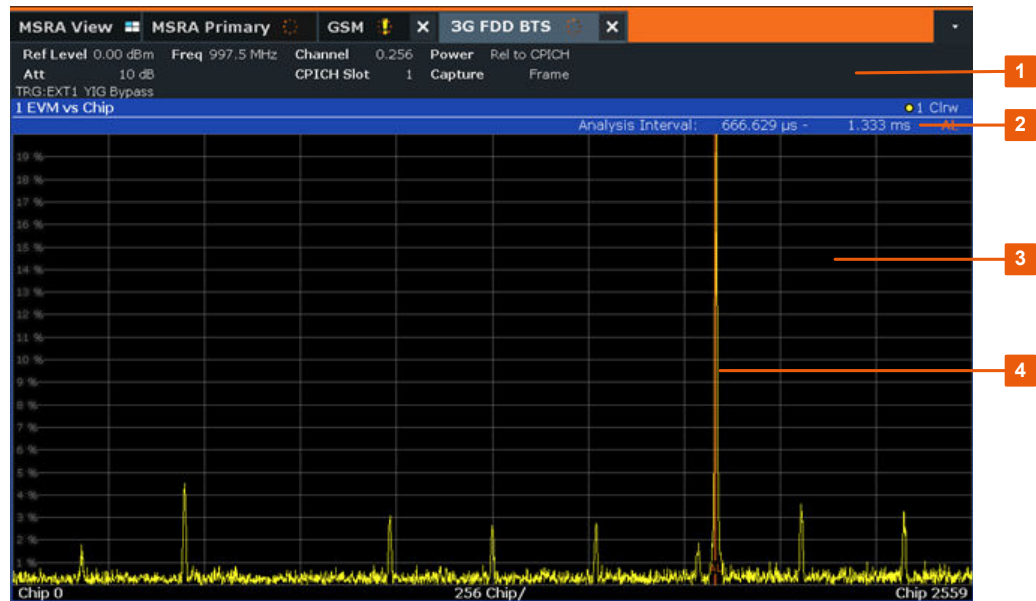

- 1 = Channel information bar for secondary application
- 2 = Analysis interval for current evaluation
- 3 = Result display for analysis interval
- 4 = Analysis line

The display for the individual MSRA secondary applications is identical to the display in Signal and Spectrum Analyzer mode except for the following differences:

- The analysis interval indicates which part of the capture buffer is being evaluated and displayed in each window.
- The acquisition time indicated in the channel bar (Meas Time) indicates the *analyzed* measurement time, not the captured time.
- Any bandwidth or sample rate values refer to the secondary application data, not to the actual data acquisition from the input signal.
- The analysis line for time-based displays is only available in MSRA mode. It represents a common time marker in all secondary applications whose analysis interval includes that time (see "[Analysis line](#)" on page 29).

For details on the individual secondary application displays see the corresponding User Manuals for those applications.

3 Measurements and result displays

MSRA measurement

The only true measurement in MSRA mode in which I/Q data from the input signal is captured and stored is performed by the MSRA primary application. This data acquisition is performed as in the I/Q Analyzer application, i.e. a specified frequency span of the input signal is swept for a specified measurement time. The captured I/Q data can then be analyzed in various different applications.

Result displays

The data that was captured by the MSRA primary can be evaluated in various different applications. All evaluation modes available for the MSRA applications are displayed in the selection bar in SmartGrid mode.



For details on working with the SmartGrid see the R&S FSWP Getting Started manual.

The result displays available in MSRA mode are those described for the individual applications. The MSRA primary is implemented as an I/Q Analyzer application and has the same result displays.

See the R&S FSWP I/Q Analyzer User Manual for a description of the result displays available for the I/Q Analyzer and thus the MSRA primary.

Measurements in the time and frequency domain

The I/Q Analyzer secondary application (*not primary*) in MSRA mode can also perform measurements on the captured I/Q data in the time and frequency domain (see also [Section 5.5, "Measurements in the time and frequency domain"](#), on page 30).

This allows you to perform standard-specific and general power measurements (such as ACLR or SEM) or statistical evaluations, as well as analyzing the EVM or modulation accuracy, on the same captured I/Q data.

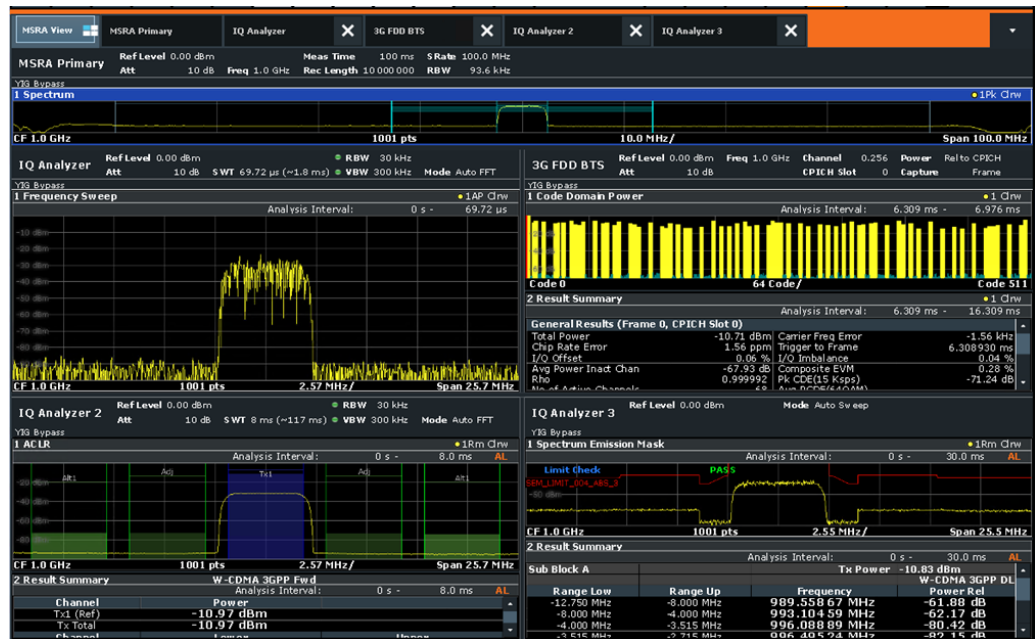

Time and frequency-based measurements are configured using the same settings and provide similar results as in the Spectrum application. In addition, the analysis interval used for the measurement is indicated as in all MSRA applications.

The time and frequency domain measurements and the available results are described in detail in the R&S FSWP User Manual.

4 Applications and operating modes

The R&S FSWP provides several applications for different analysis tasks and different types of signals, e.g. WCDMA, I/Q analysis or basic spectrum analysis. When you activate an application, a new measurement channel is created which determines the measurement settings for that application. The same application can be activated with different measurement settings by creating several channels for the same application. Each channel is displayed in a separate tab on the screen.



The maximum number can be limited further by the available memory on the instrument.

Measurements

Depending on the task, the application can provide different measurement functions. The measurement function determines which settings, functions and evaluation methods are available in the R&S FSWP. Only one measurement can be performed at the same time within the same application instance. You select the measurement for an application via the [MEAS] key.

In the Spectrum application, for example, the R&S FSWP provides a variety of different measurement functions, including:

- Frequency sweep or zero span measurement
- **Basic measurements** - measure the spectrum of your signal or watch your signal in time domain
- **Power measurements** - calculate the powers involved in modulated carrier signals
- **Emission measurements** - detect unwanted signal emission
- **Statistic measurements** - evaluate the spectral distribution of the signal
- **Further measurements** - provide characteristic values of the signal

The individual functions are described in detail in the R&S FSWP User Manual.

Independent vs correlating measurements

With the **conventional R&S FSWP signal and spectrum analyzer**, you can perform several different measurements almost simultaneously. However, the individual measurements are independent of each other - **each application captures and evaluates its own set of data**, regardless of what the other applications do.

Sometimes, it can be useful to **analyze the exact same input data using different applications**. For example, imagine capturing data from a base station and analyzing the RF spectrum in the Modulation Analysis application. If a spur or an unexpected peak occurs, possibly you want to analyze the same data in the I/Q Analyzer. There, you see the real and imaginary components of the signal and can thus detect the reason for the irregular signal. Normally, when you switch to a different application, evaluation is performed on the data that was captured by that application, and not the previous one. In our example, the irregular signal is lost. Therefore, a second operating mode is available in the R&S FSWP: Multistandard radio analyzer (MSRA) mode.

Multistandard radio analyzer mode

In **multistandard radio analyzer (MSRA) mode**, data acquisition is performed once as an I/Q measurement by a primary application. The captured data is then evaluated by any number of secondary applications for different radio standards. Data acquisition and global configuration settings are controlled globally, while the evaluation and display settings can be configured individually for each secondary application. Using the multistandard radio analyzer, unwanted correlations between different signal components using different transmission standards can be detected. Thus, for example, an irregularity in a GSM burst can be examined closer in the R&S FSWP 3G FDD BTS (WCDMA) secondary application. There you can analyze dependencies like a change in the EVM value.

Distinct operating modes

Although the applications themselves are identical in all operating modes, the handling of the data between applications is not. Thus, the operating mode determines which secondary applications are available and active. Whenever you change the operating mode, the currently active measurement channels are closed. The default operating mode is "Signal and Spectrum Analyzer" mode; however, the presetting can be changed.

Remote command:

`INST:MODE MSR`, see `INSTrument:MODE` on page 72

Switching between applications

When you switch to a new application, a set of parameters is passed on from the current application to the new one:

- Center frequency and frequency offset
- Reference level and reference level offset
- Attenuation

After initial setup, the parameters for the measurement channel are stored upon exiting and restored upon re-entering the channel. Thus, you can switch between applications quickly and easily.

4.1 Available secondary applications

Not all options available for the R&S FSWP are supported as secondary applications in the MSRA mode. The supported secondary applications are listed here. Note that some of the applications are provided with the base unit, while others are available only if the corresponding firmware options are installed.

Currently, only applications for **base-station** tests and applications that process I/Q data are supported in MSRA mode, in particular:

AM/FM/PM Modulation Analysis.....	22
I/Q Analyzer.....	22
Pulse Measurements.....	22
Vector Signal Analysis (VSA).....	22

AM/FM/PM Modulation Analysis

The AM/FM/PM Modulation Analysis secondary application requires an instrument equipped with the corresponding optional software. This secondary application provides measurement functions for demodulating AM, FM, or PM signals.

For details, see the R&S FSWP AM/FM/PM Modulation Analysis user manual.

Remote command:

INST:SEL ADEM, see [INSTrument\[:SElect\]](#) on page 73

I/Q Analyzer

The I/Q Analyzer secondary application provides measurement and display functions for I/Q signals. Evaluation of the captured I/Q data in the frequency and time domain is also possible.

For details, see the R&S FSWP I/Q Analyzer user manual.

Remote command:

INST:SEL IQ, see [INSTrument\[:SElect\]](#) on page 73

Pulse Measurements

The Pulse measurements secondary application requires an instrument equipped with the pulse measurements option, R&S FSWP-K6. This secondary application provides measurement functions for pulsed signals.

For details, see the R&S FSWP-K6 user manual.

Remote command:

INST:SEL PULSE, see [INSTrument\[:SElect\]](#) on page 73

Vector Signal Analysis (VSA)

The VSA secondary application requires an instrument equipped with the Vector Signal Analysis option, R&S FSWP-K70. This secondary application provides measurements and evaluations for single-carrier digitally modulated signals.

For details, see the R&S FSWP VSA user manual.

Remote command:

INST:SEL DDEM, see [INSTrument\[:SElect\]](#) on page 73

4.2 Selecting the operating mode and secondary applications

Access: [MODE]

The default operating mode is "Signal and Spectrum Analyzer" mode, however, the presetting can be changed.

(See the "Instrument Setup" section in the R&S FSWP user manual).

Switching the operating mode.....	23
Selecting an MSRA secondary application.....	23
L New Channel.....	23
L Replace Current Channel.....	23
Closing an application.....	23

Switching the operating mode

To switch the operating mode, select the corresponding tab (see [Section 2.1, "Starting the MSRA operating mode"](#), on page 11).

Remote command:

`INSTrument:MODE` on page 72

Selecting an MSRA secondary application

To start a new or replace an existing secondary application, select the corresponding button in the correct tab.

Remote command:

`INSTrument[:SELEct]` on page 73

New Channel ← Selecting an MSRA secondary application

The secondary application selected on this tab is started in a new channel, i.e. a new tab in the display.

Remote command:

`INSTrument:CREate[:NEW]` on page 70

`INSTrument[:SELEct]` on page 73

Replace Current Channel ← Selecting an MSRA secondary application

The secondary application selected on this tab is started in the currently displayed channel, replacing the current secondary application.

Remote command:

`INSTrument:CREate:REPLace` on page 70

Closing an application

To close an application, simply close the corresponding tab by selecting the "x" next to the channel name.

Remote command:

`INSTrument:DELEte` on page 71

4.3 Using the sequencer in MSRA mode

When you switch to MSRA mode, the Sequencer is automatically activated in continuous mode. Unless it is stopped or you select a different Sequencer mode, the R&S FSWP continuously performs the following tasks:

1. The MSRA primary application acquires data.

2. The active secondary applications evaluate the data one after the other.
3. The display in the tab is updated.

This behavior is identical to "Signal and Spectrum Analyzer" mode (also for single sequence or channel-defined Sequencer modes).

However, if you switch the Sequencer off, the behavior of the sweep functions is slightly different to "Signal and Spectrum Analyzer" mode (see also "[Performing sweeps](#)" on page 27):

- If continuous sweep is active (default) and you switch to a different secondary application, continuous sweep is aborted. Thus, the same data is evaluated in different secondary applications without overwriting the data in the capture buffer. You can start continuous sweep again as usual.
- Only the secondary application that is currently displayed when a measurement is performed is updated automatically. A new "Refresh" function is available to update the display in one or all other secondary applications.

For details on the Sequencer function, see the R&S FSWP user manual.



The "Sequencer" menu is available from the toolbar.

Sequencer State

Activates or deactivates the Sequencer. If activated, sequential operation according to the selected Sequencer mode is started immediately.

Remote command:

[SYSTem:SEQuencer](#) on page 124

[INITiate:SEQuencer:IMMediate](#) on page 122

[INITiate:SEQuencer:ABORT](#) on page 122

Sequencer Mode

Defines how often which measurements are performed. The currently selected mode softkey is highlighted blue. During an active Sequencer process, the selected mode softkey is highlighted orange.

"Single Sequence"

Each measurement is performed once, until all measurements in all active channels have been performed.

"Continuous Sequence"

The measurements in each active channel are performed one after the other, repeatedly, in the same order, until sequential operation is stopped.

This is the default Sequencer mode.

"Channel Defined Sequence"

First, a single sequence is performed. Then, only channels in continuous sweep mode are repeated.

Remote command:

[INITiate:SEQuencer:MODE](#) on page 122

Refresh All

This function is only available if the Sequencer is deactivated, no sweep is currently running, and only in MSRA mode.

The data in the capture buffer is re-evaluated by all active secondary applications, for example after a new sweep was performed while the Sequencer was off.

Note: To update only the displays in the currently active secondary application, use the "Refresh" function in the "Sweep" menu for that secondary application (see ["Refresh \(MSRA only\)"](#) on page 53).

Remote command:

`INITiate:SEQuencer:REFresh[:ALL]` on page 123

5 MSRA basics

Some background knowledge on basic terms and principles used in MSRA operating mode is provided here for a better understanding of the required configuration settings.

5.1 Configuration

Primary parameters

In MSRA mode, only the MSRA primary performs a data acquisition. Thus, all parameters that determine how the I/Q data is captured from the I/Q channel can only be configured in the "MSRA Primary" tab. In all secondary application tabs, these settings are deactivated (or have a different meaning).

Typical primary parameters include:

- Sample rate
- Record length
- Bandwidth
- Center frequency
- Reference level
- Trigger settings
- External reference
- Impedance, preamplification, attenuation

Channel-specific parameters

Each secondary application, however, can define all parameters concerning analysis individually.

Typical channel-specific parameters include:

- Center frequency, duration and number of trace points for the secondary application data extract
- Offset of the secondary application data extract from the trigger event
- Evaluation methods
- Range and scaling
- Trace mode
- Marker positions

Conflicting parameters

Primary and channel-specific parameters can be configured independently of one another, in any order that is convenient to you. However, there are dependencies between the parameters, as the secondary applications can only evaluate data that has been captured by the MSRA primary previously. Thus, configuring parameters is

not restricted, but you are informed about the violation of possible restrictions by error messages in the status bar of the secondary applications where necessary.

5.2 Data acquisition

As mentioned before, only the MSRA primary performs a data acquisition. Thus, the MSRA primary defines the center frequency, sample rate and record length of the captured I/Q data. It also defines the trigger event, thus all secondary applications have the same trigger. However, an offset from the trigger can be defined by the individual secondary applications (see "[Trigger offset vs. capture offset](#)" on page 29).

Performing sweeps

When you switch to MSRA mode, the Sequencer is automatically activated in continuous mode. The MSRA primary continuously performs a data acquisition. If any secondary applications are activated, then after each measurement, the data in the active secondary applications is evaluated one after the other. The MSRA primary will then repeat the data acquisition and evaluate the new data etc. The channel displays are updated after each measurement or evaluation.

Alternatively, you can perform measurements manually. You can start a single or continuous sweep from any secondary application, which updates the data in the capture buffer and the results in the current secondary application. The results in the other secondary applications, however, remain unchanged. You must refresh them manually, either individually or all at once, using a "**Refresh**" function.

Note that in **continuous sweep mode**, sweeping is aborted when you switch to a different secondary application. You can then continue sweeping from there. This is necessary in order to evaluate the same data in different secondary applications without overwriting the data in the capture buffer.

In **single sweep mode**, only one sweep is performed; a sweep count is not available - neither for the MSRA primary, nor for the secondary applications. However, depending on the secondary application, a statistics count may be available for statistics based on a single data acquisition. Trace averaging is performed as usual for sweep count = 0, the current trace is averaged with the previously stored averaged trace.

Data availability

The secondary applications can only receive data that is available in the capture buffer. As soon as data has been stored to the capture buffer successfully, a status bit (#9) in the `STAT:OPER` register is set. If the required secondary application data is not available, an error message is displayed. Details on restrictions are described in [Section 5.4, "Restrictions for secondary applications"](#), on page 30.

5.3 Multi-standard analysis

Secondary application data

The secondary applications receive data for analysis from the capture buffer, if necessary resampled or with filters applied. The secondary applications can define their own center frequency, sample rate and record length for their **secondary application data**, which is an **extract of the capture buffer data**. The secondary applications may not request more sample points than the captured data contains, or samples from a frequency outside the range of the capture buffer, for example.

Generally, if a signal contains data channels for multiple standards, the individual secondary applications are used to analyze the channel for the corresponding standard. Thus, it is of interest to know which secondary application, or more precisely: which data channel is analyzing which part of the captured data and how each data channel is correlated (in time) to others.

The MSRA primary display indicates the data covered by each secondary application, restricted to the channel bandwidth used by the corresponding standard, by vertical blue lines labeled with the secondary application name. For secondary applications that support several standards (e.g. VSA, LTE) an estimated or user-defined bandwidth is indicated.

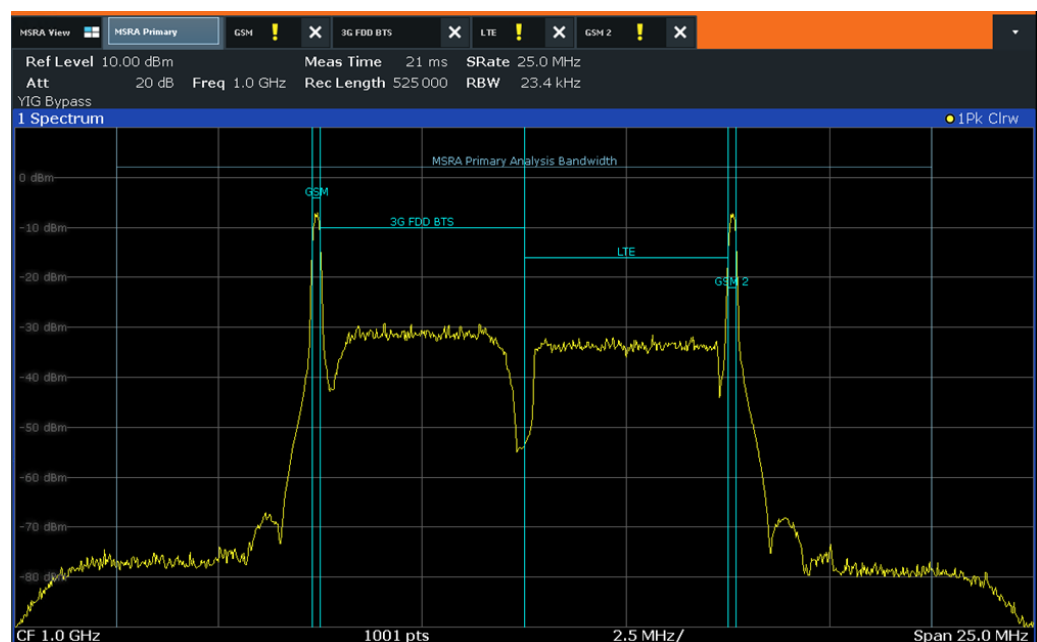

Figure 5-1: MSRA primary indicating covered bandwidth for 4 secondary applications

Analysis interval

Each secondary application receives an extract of the data from the capture buffer. However, the individual evaluation methods of the secondary application need not analyze the complete data range. Some secondary applications allow you to select a specific part of the data for analysis, e.g. an individual frame, burst or pulse, or to use an

offline trigger that defines an additional offset to the capture offset. The data range that is actually analyzed is referred to as the **analysis interval**.

The analysis interval is indicated in the window title bar for each evaluation, and can be queried via remote control.



For secondary applications that do not allow you to restrict the evaluation range (e.g. I/Q Analyzer, Modulation Analysis), the analysis interval is identical to the secondary application data extract.

Trigger offset vs. capture offset

The beginning of the capture buffer is defined by the trigger event and the trigger offset. The trigger source is defined by the MSRA primary, which means that all channels use the same trigger. However, each secondary application might need a different trigger offset or a different number of pretrigger samples. Instead of a trigger offset, the secondary applications define a **capture offset**. The capture offset is defined as an **offset to the beginning of the capture buffer**.

Thus, the beginning of the secondary application data extract is calculated as:

[time of trigger event] + [trigger offset] + [capture offset]

Note that while the trigger offset value may be negative, thus starting before the trigger event, the capture offset may not. A negative capture offset would mean the secondary application data would start before the first sample of the capture buffer. The (pre-)trigger offset in the MSRA primary must be configured such that the required number of pre-trigger samples for the secondary applications are available.

Analysis line

A frequent question when analyzing multi-standard radio signals is how each data channel is correlated (in time) to others. Thus, an analysis line has been introduced. The analysis line is a common time marker for all MSRA secondary applications. It can be positioned in any MSRA secondary application or the MSRA primary and is then adjusted in all other secondary applications. Thus, you can easily analyze the results at a specific time in the measurement in all secondary applications and determine correlations (e.g. cross-talk).

If the marked point in time is contained in the analysis interval of the secondary application, the line is indicated in all time-based result displays, such as time, symbol, slot or bit diagrams. By default, the analysis line is displayed, however, it can be hidden from view manually. In all result displays, the "AL" label in the window title bar indicates whether or not the analysis line lies within the analysis interval or not:

- **orange "AL"**: the line lies within the interval
- **white "AL"**: the line lies within the interval, but is not displayed (hidden)
- **no "AL"**: the line lies outside the interval

5.4 Restrictions for secondary applications

As mentioned in various contexts before, the MSRA secondary applications themselves are identical to Signal and Spectrum operating mode, however, the correlation between secondary applications and the MSRA primary require some restrictions. Principally, you are not restricted in setting parameters. However, if any contradictions occur between the configured capture settings and the analysis settings, error messages are displayed in the status bar of the secondary application and an icon (🚫) is displayed next to the channel label. However, it does not matter in which order you configure the settings - you will not be prevented from doing so.

In particular, the following restrictions apply to secondary applications in MSRA mode:

- **Data acquisition:** parameters related to data acquisition can only be configured by the MSRA primary
- **Secondary application data:** only data contained in the capture buffer can be analyzed by the secondary application; this implies the following restrictions:
 - **Center frequency:** must lie within the captured data bandwidth
 - **Measurement time/Record length:** must be smaller than or equal to the values of the MSRA primary
 - **Capture offset:** must be smaller than the record length of the MSRA primary
 - **Trace averaging:** only for sweep count = 0
- **AUTO SET functions:** in secondary applications, only the frequency can be adjusted automatically; all other adjustment functions require a new data acquisition

5.5 Measurements in the time and frequency domain

The I/Q Analyzer secondary application (*not Primary*) in **multistandard mode** can also perform measurements on the captured I/Q data in the time and frequency domain. In order to do so, the I/Q Analyzer performs an FFT sweep on the captured I/Q data, providing power vs frequency results, or uses the RBW filter to obtain power vs time (zero span) results. This data is then used for the common frequency or time domain measurements provided by the R&S FSWP Spectrum application, such as ACLR, SEM or CCDF.

Configuration

Apart from the data capturing process, the measurements are identical in the Spectrum and I/Q Analyzer secondary applications. They are configured using the same settings and provide the same results. The "Magnitude" result display in the I/Q Analyzer, for instance, will principally show the same results as the zero span measurement for the same data. However, while the "Magnitude" evaluation is configured by the I/Q analysis bandwidth and the measurement time, the zero span measurement is configured by the center frequency, RBW and sweep time settings. Internally, these "time domain" settings are converted to the required I/Q settings by the I/Q Analyzer.

The time and frequency domain measurements and the required settings are described in detail in the R&S FSWP User Manual.

Limitations

However, since the data in the I/Q Analyzer secondary application is captured by the Primary, independently of the specific time or frequency measurement requirements concerning the RBW, filter type and number of sweep points in the secondary application, some restrictions may apply to these measurements in the I/Q Analyzer. If not enough samples are available in the captured and converted I/Q data, for example, an error message is displayed in the secondary application.

The **maximum span** for a frequency sweep on I/Q-based data corresponds to the maximum I/Q bandwidth.

The **maximum resolution bandwidth (RBW)** is 1 MHz.

Furthermore, the following **functions** are not available for time and frequency domain measurements in multistandard mode:

- Marker demodulation
- Frequency counter marker
- Gated measurement
- Video trigger

6 MSRA configuration

Access: [MODE] > "Multi Standard Radio Analyzer" tab

MSRA is a special operating mode on the R&S FSWP.

When you switch the operating mode of a measurement channel to MSRA mode the first time, the Sequencer is automatically activated in continuous mode (see [Section 4.3, "Using the sequencer in MSRA mode"](#), on page 23), starting an I/Q Analyzer data acquisition with the default settings (but with a "Spectrum" result display). The "I/Q Analyzer" menu is displayed, providing access to the most important configuration functions.

Configuring the MSRA primary

The MSRA primary is the only channel that captures data. It also controls global configuration settings for all secondary applications. Thus, all settings that refer to data acquisition can only be configured in the MSRA primary tab. These settings are deactivated in the configuration overviews and dialog boxes for all secondary application channels. All other settings, e.g. concerning the evaluated data range, the display configuration or analysis, can be configured individually for each secondary application and the primary application.



Restrictions

Note that although some restrictions apply to parameters that affect both the MSRA primary and secondary applications (see [Section 5.4, "Restrictions for secondary applications"](#), on page 30), it does not matter in which order you configure them. If any contradictions occur between the captured data and the data to be evaluated, error messages are displayed in the status bar of the secondary application and an icon (✖ or !) is displayed next to the channel label. However, you will not be prevented from configuring contradictory settings.



Importing and Exporting I/Q Data

The I/Q data to be evaluated in the I/Q Analyzer application can not only be captured by the MSRA primary itself, it can also be imported to the R&S FSWP, provided it has the correct format. Furthermore, the captured I/Q data from the MSRA primary can be exported for further analysis in external applications.

For details see the R&S FSWP I/Q Analyzer and I/Q Input User Manual.

Configuring an I/Q Analyzer as an MSRA secondary application

Access: [MODE] > "Multi Standard Radio Analyzer" tab > "Select Meas"

In principle, the I/Q Analyzer in MSRA mode is configured as in Signal and Spectrum Analyzer mode.

However, the I/Q Analyzer secondary application (*not primary*) in MSRA mode can also perform measurements on the captured I/Q data in the time and frequency domain (see also [Section 5.5, "Measurements in the time and frequency domain"](#), on page 30).

You can select which type of measurement is to be performed: conventional I/Q data analysis or a time or frequency domain measurement.

The common measurements as in the Spectrum application are available. In addition, "IQ Analyzer" is provided under "Basic Measurements" to return to the default I/Q Analysis functions.

The time and frequency domain measurements and the required settings are described in detail in the R&S FSWP Spectrum Analyzer User Manual. Further configuration of the I/Q Analyzer secondary application is described in the R&S FSWP I/Q Analyzer and I/Q Input User Manual.

The following chapters describe configuration for the MSRA primary.

- [Configuration overview](#).....33
- [Input source settings](#).....35
- [Amplitude](#).....39
- [Frequency settings](#).....40
- [Trigger settings](#).....42
- [Data acquisition and bandwidth settings](#).....47
- [Output settings](#).....54
- [Display configuration](#).....55
- [Automatic settings](#).....55

6.1 Configuration overview



Access: all menus

Throughout the measurement channel configuration, an overview of the most important currently defined settings is provided in the "Overview"

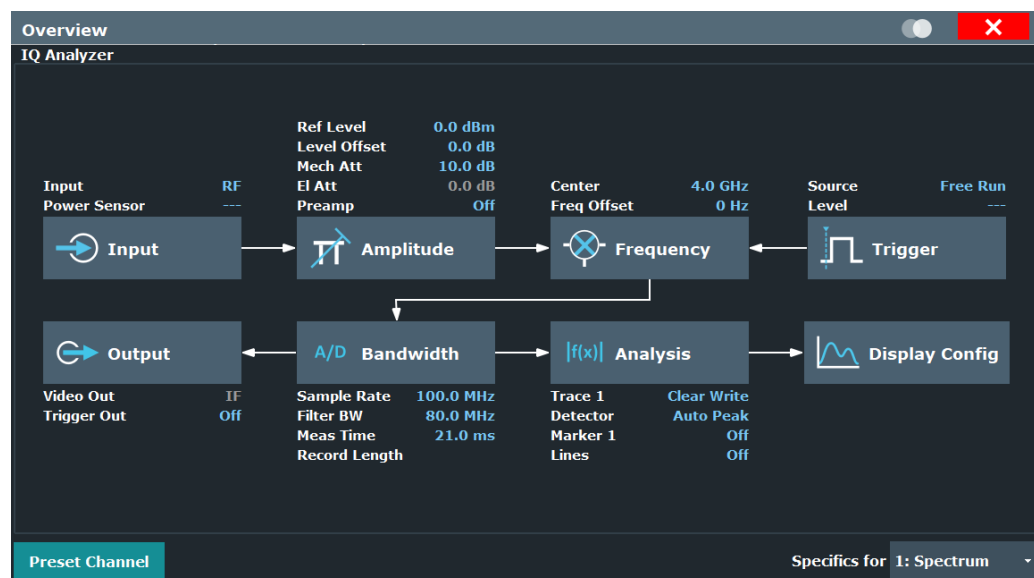

Figure 6-1: Configuration Overview for MSRA primary

In addition to the main measurement settings, the "Overview" provides quick access to the main settings dialog boxes. The individual configuration steps are displayed in the order of the data flow. Thus, you can easily configure an entire measurement channel from input over processing to output and analysis by stepping through the dialog boxes as indicated in the "Overview".



The "Overview" varies depending on the secondary application; for detailed descriptions see the corresponding application User Manual.

If the I/Q Analyzer is used as an MSRA secondary application, the "Overview" also provides a measurement selection button in order to perform measurements in the frequency and time domain. See the R&S FSWP I/Q Analyzer and I/Q Input User Manual for details.

The "Overview" for the MSRA primary provides quick access to the following configuration dialog boxes (listed in the recommended order of processing):

1. Input settings
See [Section 6.2, "Input source settings"](#), on page 35
2. Amplitude settings
See [Section 6.3, "Amplitude"](#), on page 39
3. Frequency settings
See [Section 6.4, "Frequency settings"](#), on page 40
4. Optionally, trigger settings
See [Section 6.5, "Trigger settings"](#), on page 42
5. Bandwidth settings
See [Section 6.6, "Data acquisition and bandwidth settings"](#), on page 47
6. Optionally, output settings
See [Section 6.7, "Output settings"](#), on page 54
7. Display configuration
See [Section 6.8, "Display configuration"](#), on page 55
8. Analysis settings and functions
See [Section 7, "Analysis"](#), on page 58

To configure settings

- ▶ Select any button to open the corresponding dialog box.

For step-by-step instructions on configuring MSRA measurements, see [Section 8, "How to perform measurements in MSRA mode"](#), on page 60.

Preset Channel

Select "Preset Channel" in the lower left-hand corner of the "Overview" to restore all measurement settings *in the current channel* to their default values.

Note: Do not confuse "Preset Channel" with the [Preset] key, which restores the entire instrument to its default values and thus closes *all channels* on the R&S FSWP (except for the default channel)!

Remote command:

`SYSTEM:PRESet:CHANnel [:EXEC]` on page 74

Specific Settings for

The channel can contain several windows for different results. Thus, the settings indicated in the "Overview" and configured in the dialog boxes vary depending on the selected window.

Select an active window from the "Specific Settings for" selection list that is displayed in the "Overview" and in all window-specific configuration dialog boxes.

The "Overview" and dialog boxes are updated to indicate the settings for the selected window.

6.2 Input source settings

Access: "Overview" > "Input/Frontend" > "Input Source"

The input source determines which data the R&S FSWP analyzes.

The default input source for the R&S FSWP is "Radio Frequency", i.e. the signal at the "RF Input" connector of the R&S FSWP. If no additional options are installed, this is the only available input source.



Input from other sources

The MSRA mode application can also process input from the following sources:

- External mixer

For details, see the R&S FSWP User Manual.

Since the Digital I/Q input and the Analog Baseband input use the same digital signal path, both cannot be used simultaneously. When one is activated, established connections for the other are disconnected. When the second input is deactivated, connections to the first are re-established. Reconnecting can cause a short delay in data transfer after switching the input source.

- [Radio frequency input](#)..... 35
- [Settings for input from I/Q data files](#).....38

6.2.1 Radio frequency input

Access: "Overview" > "Input/Frontend" > "Input Source" > "Radio Frequency"

Input/Frontend		Signal	Reference I/Q	Input Source	Frequency	Amplitude	Output	Probes
Radio Frequency	On		Off					
External Mixer	Input Coupling	AC		DC				
	Impedance	50Ω		75Ω				
Baseband	High Pass Filter 1 to 3 GHz	On		Off				
	YIG-Preselector	On		Off				
I/Q File	Input Connector	RF						

Radio Frequency State.....	36
Input Coupling.....	36
Impedance.....	36
Direct Path.....	37
High Pass Filter 1 to 3 GHz.....	37
YIG-Preselector.....	37
Input Connector.....	38

Radio Frequency State

Activates input from the "RF Input" connector.

Remote command:

[INPut:SElect](#) on page 77

Input Coupling

The RF input of the R&S FSWP can be coupled by alternating current (AC) or direct current (DC).

AC coupling blocks any DC voltage from the input signal. AC coupling is activated by default to prevent damage to the instrument. Very low frequencies in the input signal can be distorted.

However, some specifications require DC coupling. In this case, you must protect the instrument from damaging DC input voltages manually. For details, refer to the specifications document.

Remote command:

[INPut:COUpling](#) on page 75

Impedance

For some measurements, the reference impedance for the measured levels of the R&S FSWP can be set to 50 Ω or 75 Ω.

Select 75 Ω if the 50 Ω input impedance is transformed to a higher impedance using a 75 Ω adapter of the RAZ type. (That corresponds to 25Ω in series to the input impedance of the instrument.) The correction value in this case is 1.76 dB = 10 log (75Ω/50Ω).

This value also affects the unit conversion.

Remote command:

[INPut:IMPedance](#) on page 77

Direct Path

Enables or disables the use of the direct path for small frequencies.

In spectrum analyzers, passive analog mixers are used for the first conversion of the input signal. In such mixers, the LO signal is coupled into the IF path due to its limited isolation. The coupled LO signal becomes visible at the RF frequency 0 Hz. This effect is referred to as LO feedthrough.

To avoid the LO feedthrough the spectrum analyzer provides an alternative signal path to the A/D converter, referred to as the *direct path*. By default, the direct path is selected automatically for RF frequencies close to zero. However, this behavior can be disabled. If "Direct Path" is set to "Off", the spectrum analyzer always uses the analog mixer path.

"Auto" (Default) The direct path is used automatically for frequencies close to zero.

"Off" The analog mixer path is always used.

Remote command:

[INPut:DPATH](#) on page 76

High Pass Filter 1 to 3 GHz

Activates an additional internal highpass filter for RF input signals from 1 GHz to 3 GHz. This filter is used to remove the harmonics of the analyzer to measure the harmonics for a DUT, for example.

This function requires an additional hardware option.

Note: For RF input signals outside the specified range, the high-pass filter has no effect. For signals with a frequency of approximately 4 GHz upwards, the harmonics are suppressed sufficiently by the YIG-preselector, if available.)

Remote command:

[INPut:FILTer:HPASs\[:STATe\]](#) on page 76

YIG-Preselector

Enables or disables the YIG-preselector.

This setting requires an additional option on the R&S FSWP.

An internal YIG-preselector at the input of the R&S FSWP ensures that image frequencies are rejected. However, image rejection is only possible for a restricted bandwidth. To use the maximum bandwidth for signal analysis you can disable the YIG-preselector at the input of the R&S FSWP, which can lead to image-frequency display.

Note: Note that the YIG-preselector is active only on frequencies greater than 8 GHz. Therefore, switching the YIG-preselector on or off has no effect if the frequency is below that value.

Note:

For the following measurements, the YIG-"Preselector" is off by default (if available).

- VSA

Remote command:

`INPut:FILTer:YIG[:STATe]` on page 76

Input Connector

Determines which connector the input data for the measurement is taken from.

"RF" (Default:) The "RF Input" connector

Remote command:

`INPut:CONNector` on page 75

6.2.2 Settings for input from I/Q data files

Access: "Overview" > "Input/Frontend" > "Input Source" > "I/Q File"

Or: [INPUT/OUTPUT] > "Input Source Config" > "Input Source" > "I/Q File"

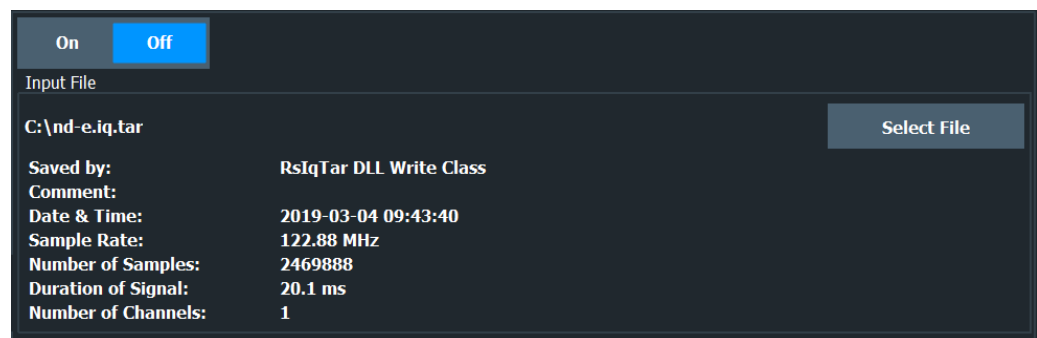

I/Q Input File State.....	38
Select I/Q data file.....	38

I/Q Input File State

Enables input from the selected I/Q input file.

If enabled, the application performs measurements on the data from this file. Thus, most measurement settings related to data acquisition (attenuation, center frequency, measurement bandwidth, sample rate) cannot be changed. The measurement time can only be decreased to perform measurements on an extract of the available data only.

Note: Even when the file input is disabled, the input file remains selected and can be enabled again quickly by changing the state.

Remote command:

`INPut:SElect` on page 77

Select I/Q data file

Opens a file selection dialog box to select an input file that contains I/Q data.

The I/Q data must have a specific format (.iq.tar) as described in R&S FSWP I/Q Analyzer and I/Q Input user manual.

The default storage location for I/Q data files is `C:\R_S\INSTR\USER`.

Remote command:

`INPut:FILE:PATH` on page 78

6.3 Amplitude

Access: [AMPT]

Amplitude settings are identical to the Signal and Spectrum Analyzer mode.

For background information on amplitude settings see the R&S FSWP User Manual.

6.3.1 Scaling the y-axis

The individual scaling settings that affect the vertical axis are described here.

Access: "Overview" > "Amplitude" > "Scale" tab

Or: [AMPT] > "Scale Config"

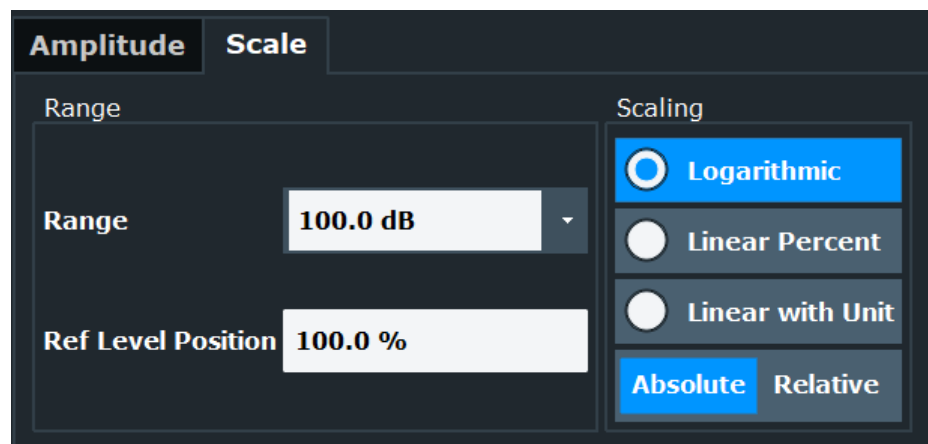

Range.....	39
Ref Level Position.....	39
Scaling.....	40
Y-Axis Max.....	40

Range

Defines the displayed y-axis range in dB.

The default value is 100 dB.

Remote command:

`DISPlay[:WINDow<n>][:SUBWindow<w>]:TRACe<t>:Y[:SCALE]` on page 101

Ref Level Position

Defines the reference level position, i.e. the position of the maximum AD converter value on the level axis in %.

0 % corresponds to the lower and 100 % to the upper limit of the diagram.

Values from -120 % to +280 % are available.

Larger values are useful for small scales, such as a power range of 10 dB or 20 dB, and low signal levels, for example 60 dB below the reference level. In this case, large reference level position values allow you to see the trace again.

Remote command:

`DISPlay[:WINDow<n>][:SUBWindow<w>]:TRACe<t>:Y[:SCALe]:RPOSition`
on page 102

Scaling

Defines the scaling method for the y-axis.

"Logarithmic"	Logarithmic scaling (only available for logarithmic units - dB..., and A, V, Watt)
"Linear with Unit"	Linear scaling in the unit of the measured signal
"Linear Percent"	Linear scaling in percentages from 0 to 100
"Absolute"	The labeling of the level lines refers to the absolute value of the reference level (not available for "Linear Percent")
"Relative"	The scaling is in dB, relative to the reference level (only available for logarithmic units - dB...). The upper line of the grid (reference level) is always at 0 dB.

Remote command:

`DISPlay[:WINDow<n>][:SUBWindow<w>]:TRACe<t>:Y:SPACing` on page 103
`DISPlay[:WINDow<n>][:SUBWindow<w>]:TRACe<t>:Y[:SCALe]:MODE`
on page 101

Y-Axis Max

Defines the maximum value of the y-axis in the currently selected diagram in either direction (in Volts). Thus, the y-axis scale starts at $-<Y\text{-Axis Max}>$ and ends at $+<Y\text{-Axis Max}>$.

The maximum y-axis value depends on the current reference level. If the reference level is changed, the "Y-Axis Max" value is automatically set to the new reference level (in V).

This command is only available if the evaluation mode for the I/Q Analyzer is set to "I/Q-Vector" or "Real/Imag (I/Q)".

Remote command:

`DISPlay[:WINDow<n>][:SUBWindow<w>]:TRACe<t>:Y[:SCALe]` on page 101

6.4 Frequency settings

Access: "Overview" > "Frequency"

The screenshot shows a 'Frequency' configuration window. It contains three main sections: 'Center' with a text input field set to '4.0 GHz'; 'Center Frequency Stepsize' with a dropdown menu set to 'Manual' and a 'Value' text input field set to '1.0 MHz'; and 'Frequency Offset' with a 'Value' text input field set to '0 Hz'. The window has a dark grey background and a red close button in the top right corner.

Center Frequency.....	41
Center Frequency Stepsize.....	41
Frequency Offset.....	41

Center Frequency

Defines the center frequency of the signal in Hertz.

Remote command:

[\[SENSe:\] FREQuency: CENTer](#) on page 103

Center Frequency Stepsize

Defines the step size by which the center frequency is increased or decreased using the arrow keys.

When you use the rotary knob the center frequency changes in steps of only 1/10 of the span.

The step size can be coupled to another value or it can be manually set to a fixed value.

"= Center" Sets the step size to the value of the center frequency. The used value is indicated in the "Value" field.

"Manual" Defines a fixed step size for the center frequency. Enter the step size in the "Value" field.

Remote command:

[\[SENSe:\] FREQuency: CENTer: STEP](#) on page 104

Frequency Offset

Shifts the displayed frequency range along the x-axis by the defined offset.

This parameter has no effect on the instrument's hardware, on the captured data, or on data processing. It is simply a manipulation of the final results in which absolute frequency values are displayed. Thus, the x-axis of a spectrum display is shifted by a constant offset if it shows absolute frequencies. However, if it shows frequencies relative to the signal's center frequency, it is not shifted.

A frequency offset can be used to correct the display of a signal that is slightly distorted by the measurement setup, for example.

The allowed values range from -1 THz to 1 THz. The default setting is 0 Hz.

Note: In MSRA mode, this function is only available for the MSRA primary.

Remote command:

[SENSe:] FREQuency: OFFSet on page 104

6.5 Trigger settings

Access: "Overview" > "Trigger"

or: [TRIG] > "Trigger Config"

Trigger settings determine when the input signal is measured. These settings are only available for the MSRA primary.



The "Capture Offset", which has a similar function to the trigger offset but is available for MSRA secondary applications only, is described in "Capture Offset" on page 52 [Section 6.6, "Data acquisition and bandwidth settings"](#), on page 47.

Trigger Source		Trigger In/Out	
Source	IF Power		
Level	-20.0 dBm	Drop-Out Time	0.0 s
Offset	0.0 s	Slope	Rising Falling
Hysteresis	3.0 dB	Holdoff	0.0 s

External triggers from one of the [TRIGGER INPUT/OUTPUT] connectors on the R&S FSWP are configured in a separate tab of the dialog box.

For step-by-step instructions on configuring triggered measurements, see the R&S FSWP User Manual.

Trigger Source.....	43
L Trigger Source.....	43
L Free Run.....	43
L Ext. Trigger 1/2.....	43
L IF Power.....	43
L RF Power.....	44
L I/Q Power.....	44
L Trigger Level.....	44
L Drop-Out Time.....	45
L Trigger Offset.....	45
L Hysteresis.....	45

L Trigger Holdoff.....	45
L Slope.....	45
Trigger 1/2.....	46
L Output Type.....	46
L Level.....	46
L Pulse Length.....	47
L Send Trigger.....	47

Trigger Source

The trigger settings define the beginning of a measurement.

Trigger Source ← Trigger Source

Defines the trigger source. If a trigger source other than "Free Run" is set, "TRG" is displayed in the channel bar and the trigger source is indicated.

Remote command:

[TRIGger \[:SEquence \] :SOURce](#) on page 108

Free Run ← Trigger Source ← Trigger Source

No trigger source is considered. Data acquisition is started manually or automatically and continues until stopped explicitly.

Remote command:

[TRIG:SOUR IMM](#), see [TRIGger \[:SEquence \] :SOURce](#) on page 108

Ext. Trigger 1/2 ← Trigger Source ← Trigger Source

Data acquisition starts when the TTL signal fed into the specified input connector meets or exceeds the specified trigger level.

Note: "External Trigger 1" automatically selects the trigger signal from the "Trigger Input / Output" connector on the front panel.

For details, see the "Instrument Tour" section in the R&S FSWP Getting Started manual.

"External Trigger 1"

Trigger signal from the "Trigger Input / Output" connector.
(front panel)

"External Trigger 2"

Trigger signal from the "Sync Trigger Input / Output" connector.
(rear panel)

Remote command:

[TRIG:SOUR EXT](#), [TRIG:SOUR EXT2](#)

See [TRIGger \[:SEquence \] :SOURce](#) on page 108

IF Power ← Trigger Source ← Trigger Source

The R&S FSWP starts capturing data as soon as the trigger level is exceeded around the third intermediate frequency.

For frequency sweeps, the third IF represents the start frequency. The trigger threshold depends on the defined trigger level, as well as on the RF attenuation and preamplification. A reference level offset, if defined, is also considered. The trigger bandwidth at the intermediate frequency depends on the RBW and sweep type. For details on available trigger levels and trigger bandwidths, see the instrument specifications document. For measurements on a fixed frequency (e.g. zero span or I/Q measurements), the third IF represents the center frequency.

This trigger source is only available for RF input.

The available trigger levels depend on the RF attenuation and preamplification. A reference level offset, if defined, is also considered.

For details on available trigger levels and trigger bandwidths, see the specifications document.

Remote command:

TRIG:SOUR IFP, see [TRIGger\[:SEquence\]:SOURce](#) on page 108

RF Power ← Trigger Source ← Trigger Source

Defines triggering of the measurement via signals which are outside the displayed measurement range.

For this purpose, the instrument uses a level detector at the first intermediate frequency.

The input signal must be in the frequency range between 500 MHz and 8 GHz.

The resulting trigger level at the RF input depends on the RF attenuation and preamplification. For details on available trigger levels, see the instrument's specifications document.

Note: If the input signal contains frequencies outside of this range (e.g. for fullspan measurements), the measurement can be aborted. A message indicating the allowed input frequencies is displayed in the status bar.

A "Trigger Offset", "Trigger Polarity" and "Trigger Holdoff" (to improve the trigger stability) can be defined for the RF trigger, but no "Hysteresis".

Remote command:

TRIG:SOUR RFP, see [TRIGger\[:SEquence\]:SOURce](#) on page 108

I/Q Power ← Trigger Source ← Trigger Source

Triggers the measurement when the magnitude of the sampled I/Q data exceeds the trigger threshold.

Remote command:

TRIG:SOUR IQP, see [TRIGger\[:SEquence\]:SOURce](#) on page 108

Trigger Level ← Trigger Source

Defines the trigger level for the specified trigger source.

For details on supported trigger levels, see the instrument specifications document.

Remote command:

[TRIGger\[:SEquence\]:LEVel\[:EXTernal<port>\]](#) on page 107

Drop-Out Time ← Trigger Source

Defines the time that the input signal must stay below the trigger level before triggering again.

Remote command:

`TRIGger [:SEquence] :DTIME` on page 106

Trigger Offset ← Trigger Source

Defines the time offset between the trigger event and the start of the sweep for the MSRA primary.

This setting is not available in MSRA secondary application measurement channels. For secondary applications, use the "[Capture Offset](#)" on page 52 instead.

offset > 0:	Start of the sweep is delayed
offset < 0:	Sweep starts earlier (pre-trigger) Maximum allowed range limited by the sweep time: $\text{pretrigger}_{\text{max}} = \text{sweep time}$

Remote command:

`TRIGger [:SEquence] :HOLDoff [:TIME]` on page 106

Hysteresis ← Trigger Source

Defines the distance in dB to the trigger level that the trigger source must exceed before a trigger event occurs. Setting a hysteresis avoids unwanted trigger events caused by noise oscillation around the trigger level.

This setting is only available for "IF Power" trigger sources. The range of the value is between 3 dB and 50 dB with a step width of 1 dB.

Remote command:

`TRIGger [:SEquence] :IFPower:HYSteresis` on page 106

Trigger Holdoff ← Trigger Source

Defines the minimum time (in seconds) that must pass between two trigger events. Trigger events that occur during the holdoff time are ignored.

Remote command:

`TRIGger [:SEquence] :IFPower:HOLDoff` on page 106

Slope ← Trigger Source

For all trigger sources except time, you can define whether triggering occurs when the signal rises to the trigger level or falls down to it.

Remote command:

`TRIGger [:SEquence] :SLOPe` on page 108

Trigger 1/2

Trigger Source	Trigger In/Out	
Trigger 2	<input checked="" type="radio"/> Input	<input type="radio"/> Output
Trigger 3	<input type="radio"/> Input	<input checked="" type="radio"/> Output
Output Type	User Defined	Level <input checked="" type="radio"/> Low <input type="radio"/> High
Pulse Length	100.0 μ s	Send Trigger 

The trigger input and output functionality depends on how the variable "Trigger Input/Output" connectors are used.

Note: Providing trigger signals as output is described in detail in the R&S FSWP base unit user manual.

"Trigger 1"	"Trigger 1": "Trigger Input/Output" connector on the front panel
"Trigger 2"	Defines the usage of the variable "Trigger Input/Output" connector on the rear panel.
"Input"	The signal at the connector is used as an external trigger source by the R&S FSWP. Trigger input parameters are available in the "Trigger" dialog box.
"Output"	The R&S FSWP sends a trigger signal to the output connector to be used by connected devices. Further trigger parameters are available for the connector.

Remote command:

[OUTPut:TRIGger<tp>:DIRection](#) on page 109

Output Type ← **Trigger 1/2**

Type of signal to be sent to the output

"Device Triggered"	(Default) Sends a trigger when the R&S FSWP triggers.
"Trigger Armed"	Sends a (high level) trigger when the R&S FSWP is in "Ready for trigger" state. This state is indicated by a status bit in the <code>STATUS:OPERation</code> register (bit 5), as well as by a low-level signal at the "AUX" port (pin 9).
"User Defined"	Sends a trigger when you select "Send Trigger". In this case, further parameters are available for the output signal.

Remote command:

[OUTPut:TRIGger<tp>:OTYPe](#) on page 110

Level ← **Output Type** ← **Trigger 1/2**

Defines whether a high (1) or low (0) constant signal is sent to the trigger output connector (for "Output Type": "User Defined").

The trigger pulse level is always opposite to the constant signal level defined here. For example, for "Level" = "High", a constant high signal is output to the connector until you select the [Send Trigger](#) function. Then, a low pulse is provided.

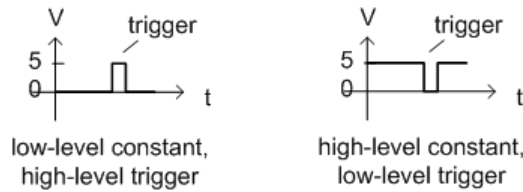

Remote command:

[OUTPut:TRIGger<tp>:LEVel](#) on page 109

Pulse Length ← **Output Type** ← **Trigger 1/2**

Defines the duration of the pulse (pulse width) sent as a trigger to the output connector.

Remote command:

[OUTPut:TRIGger<tp>:PULSe:LENGth](#) on page 111

Send Trigger ← **Output Type** ← **Trigger 1/2**

Sends a user-defined trigger to the output connector immediately.

Note that the trigger pulse level is always opposite to the constant signal level defined by the output [Level](#) setting. For example, for "Level" = "High", a constant high signal is output to the connector until you select the "Send Trigger" function. Then, a low pulse is sent.

Which pulse level is sent is indicated by a graphic on the button.

Remote command:

[OUTPut:TRIGger<tp>:PULSe:IMMediate](#) on page 110

6.6 Data acquisition and bandwidth settings

How data is to be acquired is configured in the "Bandwidth" dialog box.

- [Data acquisition](#).....47
- [Sweep settings](#).....52

6.6.1 Data acquisition

Access: "Overview" > "Bandwidth"

or: [MEAS CONFIG] > "Data Acquisition"

The data acquisition settings define which parts of the input signal are captured for further evaluation in the applications. They are configured in the "Data Acquisition" tab of the "Bandwidth" dialog box.

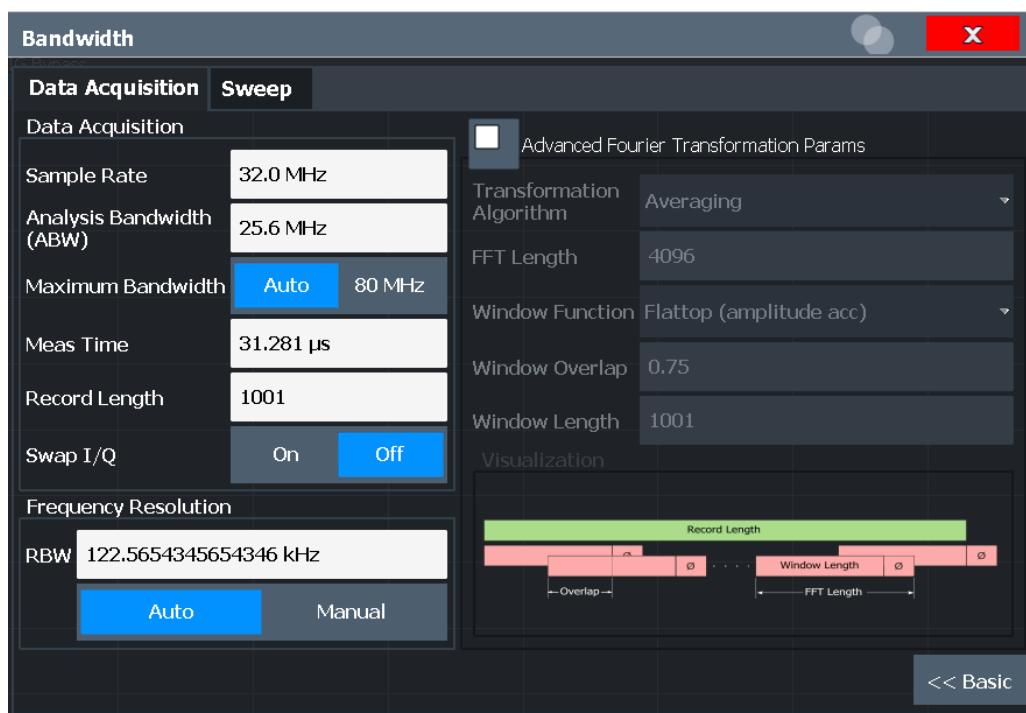

Figure 6-2: Data acquisition settings with advanced FFT parameters



Configuring data acquisition is only possible for the MSRA primary channel. In I/Q Analyzer application channels, these settings define the analysis interval (see [Section 5.3, "Multi-standard analysis"](#), on page 28). Be sure to select the correct measurement channel before changing these settings.

Remote command to query the current analysis interval:

CALCulate<n>:MSRA:WINDow<n>:IVAL on page 133

Sample Rate.....	48
Analysis Bandwidth.....	49
Maximum Bandwidth.....	49
Meas Time.....	49
Record Length.....	50
RBW.....	50
Advanced FFT mode / Basic settings.....	50
L Transformation Algorithm.....	51
L FFT Length.....	51
L Window Function.....	51
L Window Overlap.....	51
L Window Length.....	51
Capture Offset.....	52

Sample Rate

Defines the I/Q data sample rate of the R&S FSWP. This value depends on the defined [Analysis Bandwidth](#).

Note: The Spectrum Monitor is limited to a maximum sample rate of 25 MHz.

The following rule applies:

$$\text{sample rate} = \text{analysis bandwidth} / 0.8$$

For details on the dependencies see [Section C, "Sample rate and maximum usable I/Q bandwidth for RF input"](#), on page 138.

Remote command:

[TRACe: IQ:SRATe](#) on page 115

Analysis Bandwidth

Defines the flat, usable bandwidth of the final I/Q data. This value depends on the defined [Sample Rate](#).

Note: The Spectrum Monitor is limited to a maximum analysis bandwidth of 20 MHz.

The following rule applies:

$$\text{analysis bandwidth} = 0.8 * \text{sample rate}$$

Remote command:

[TRACe: IQ:BWIDth](#) on page 114

Maximum Bandwidth

Defines the maximum bandwidth to be used by the R&S FSWP for I/Q data acquisition. Which options are available depends on which bandwidth extension options are installed.

This setting is only available if the 320 MHz bandwidth extension option is installed on the R&S FSWP. Otherwise the maximum bandwidth is determined automatically.

"Auto"	(Default:) All installed bandwidth extension options are enabled. The currently available maximum bandwidth is allowed. Note that the 320 MHz bandwidth extension may cause more spurious effects.
"80 MHz"	Restricts the analysis bandwidth to a maximum of 80 MHz.
"160 MHz"	Restricts the analysis bandwidth to a maximum of 160 MHz. The bandwidth extension option for 320 MHz is disabled.

Remote command:

[TRACe: IQ:WBANd\[:STATe\]](#) on page 116

[TRACe: IQ:WBANd:MBwidth](#) on page 116

Meas Time

Defines the I/Q acquisition time. By default, the measurement time is calculated as the number of I/Q samples ("Record Length") divided by the sample rate. If you change the measurement time, the [Record Length](#) is automatically changed, as well.

For details on the maximum number of samples see also [Section C, "Sample rate and maximum usable I/Q bandwidth for RF input"](#), on page 138.

Remote command:

[\[SENSe:\] SWEep:TIME](#) on page 124

Record Length

Defines the number of I/Q samples to record. By default, the number of measurement points is used. The record length is calculated as the measurement time multiplied by the sample rate. If you change the record length, the [Meas Time](#) is automatically changed, as well.

Note: For the I/Q vector result display, the number of I/Q samples to record ("Record Length") must be identical to the number of trace points to be displayed ("Sweep Points"). Thus, the measurement points are not editable for this result display. If the "Record Length" is edited, the measurement points are adapted automatically. For record lengths outside the valid range of measurement points, i.e. fewer than 101 points or more than 100001 points, the diagram does not show valid results.

Remote command:

[TRACe: IQ: RLENgth](#) on page 114

RBW

Defines the resolution bandwidth. The maximum RBW corresponds to the [Analysis Bandwidth](#). The minimum RBW depends on the sample rate.

Depending on the selected RBW mode, the value is either determined automatically or can be defined manually. As soon as you enter a value in the input field, the RBW mode is changed to "Manual".

If the "Advanced Fourier Transformation Params" option is enabled, advanced FFT mode is selected and the RBW cannot be defined directly.

Note that the RBW is correlated with the [Sample Rate](#) and [Record Length](#) (and possibly the "[Window Function](#)" on page 51 and "[Window Length](#)" on page 51). Changing any one of these parameters may cause a change to one or more of the other parameters.

For more information see the "Basics on FFT" section of the R&S FSWP I/Q Analyzer and I/Q Input User Manual.

- | | |
|---------------------|---|
| "Auto mode" | (Default) The RBW is determined automatically depending on the Sample Rate and Record Length . |
| "Manual mode" | The RBW can be defined by the user. The maximum RBW corresponds to the Analysis Bandwidth . The minimum RBW depends on the sample rate.
The user-defined RBW is used and the " Window Length " on page 51 (and possibly Sample Rate) are adapted accordingly. |
| "Advanced FFT mode" | This mode is used if the "Advanced Fourier Transformation Params" option is enabled.
The RBW is determined by the advanced FFT parameters . |

Remote command:

[\[SENSe:\] IQ: BWIDth: MODE](#) on page 111

[\[SENSe:\] IQ: BWIDth: RESolution](#) on page 112

Advanced FFT mode / Basic settings

Shows or hides the "Advanced Fourier Transformation" parameters in the "Data Acquisition" dialog box. These parameters are only available and required for the advanced FFT mode.

Transformation Algorithm ← Advanced FFT mode / Basic settings

Defines the FFT calculation method.

- | | |
|-------------|--|
| "Single" | One FFT is calculated for the entire record length; if the "FFT Length" on page 51 is larger than the record length, zeros are appended to the captured data. |
| "Averaging" | Several overlapping FFTs are calculated for each record; the results are combined to determine the final FFT result for the record. The number of FFTs to be averaged is determined by the "Window Overlap" on page 51 and the "Window Length" on page 51. |

Remote command:

[SENSe:] IQ:FFT:ALGORITHM on page 112

FFT Length ← Advanced FFT mode / Basic settings

Defines the number of frequency points determined by each FFT calculation. The more points are used, the higher the resolution in the spectrum becomes, but the longer the calculation takes.

In advanced FFT mode, the number of sweep points is set to the FFT length automatically.

Note: If you use the arrow keys or the rotary knob to change the FFT length, the value is incremented or decremented by powers of 2.

If you enter the value manually, any integer value from 3 to 524288 is available.

Remote command:

[SENSe:] IQ:FFT:LENGTH on page 113

Window Function ← Advanced FFT mode / Basic settings

In the I/Q analyzer you can select one of several FFT window types.

The following window types are available:

- Blackman-Harris
- Flattop
- Gauss
- Rectangular
- 5-Term

Remote command:

[SENSe:] IQ:FFT:WINDOW:TYPE on page 114

Window Overlap ← Advanced FFT mode / Basic settings

Defines the part of a single FFT window that is re-calculated by the next FFT calculation when using multiple FFT windows.

Remote command:

[SENSe:] IQ:FFT:WINDOW:OVERLAP on page 113

Window Length ← Advanced FFT mode / Basic settings

Defines the number of samples to be included in a single FFT window in averaging mode. (In single mode, the window length corresponds to the "Record Length" on page 50.)

Values from 3 to 4096 are available in "Manual" mode; in "Advanced" FFT mode, values from 3 to 524288 are available.

However, the window length may not be longer than the "FFT Length" on page 51.

Remote command:

[SENSe:] IQ:FFT:WINDow:LENGth on page 113

Capture Offset

This setting is only available for secondary applications in **MSRA operating mode**. It has a similar effect as the trigger offset in other measurements: it defines the time offset between the capture buffer start and the start of the extracted secondary application data.

In MSRA mode, the offset must be a positive value, as the capture buffer starts at the trigger time = 0.

For more information, see "Trigger offset vs. capture offset" on page 29.

Remote command:

[SENSe:] MSRA:CAPTure:OFFSet on page 134

6.6.2 Sweep settings

Access: "Overview" > "Bandwidth" > "Sweep" tab

or: [SWEEP]

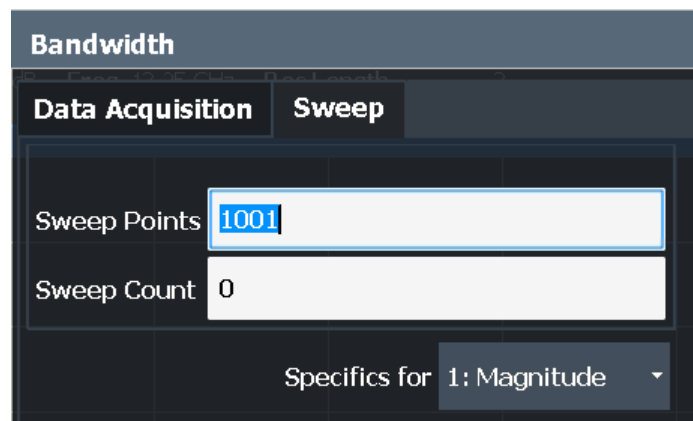

For background information on performing sweeps in MSRA mode see [Section 5.2, "Data acquisition"](#), on page 27.

Sweep Points.....	53
Refresh (MSRA only).....	53
Continuous Sweep/RUN CONT.....	53
Single Sweep/ RUN SINGLE.....	54
Continue Single Sweep.....	54

Sweep Points

In the I/Q Analyzer application, a specific frequency bandwidth is swept for a specified measurement time. During this time, a defined number of samples (= "Record Length") are captured. These samples are then evaluated by the applications. Therefore, in this case the number of sweep points does not define the amount of data to be acquired, but rather the number of trace points that are evaluated and displayed in the result diagrams.

Note: As opposed to previous versions of the I/Q Analyzer, the sweep settings are now window-specific. For some result displays, the sweep points may not be editable as they are determined automatically, or restrictions may apply.

For the I/Q vector result display, the number of I/Q samples to record ("Record Length") must be identical to the number of trace points to be displayed ("Sweep Points"). Thus, the sweep points are not editable for this result display. If the "Record Length" is edited, the sweep points are adapted automatically. For record lengths outside the valid range of sweep points, i.e. less than 101 points or more than 100001 points, the diagram does not show valid results.

Using fewer than 4096 sweep points with a detector other than Auto Peak may lead to wrong level results.

Remote command:

[\[SENSe:\] SWEep\[:WINDow<n>\]: POINTs](#) on page 123

Refresh (MSRA only)

This function is only available if the Sequencer is deactivated and only for **MSRA secondary applications**.

The data in the capture buffer is re-evaluated by the currently active secondary application only. The results for any other secondary applications remain unchanged.

This is useful, for example, after evaluation changes have been made or if a new sweep was performed from another secondary application. In this case, only that secondary application is updated automatically after data acquisition.

Note: To update all active secondary applications at once, use the "Refresh All" function in the "Sequencer" menu.

Remote command:

[INITiate<n>:REFresh](#) on page 133

Continuous Sweep/RUN CONT

After triggering, initiates data acquisition continuously until stopped. If the Sequencer is off, only the evaluation for the currently displayed measurement channel is updated.

While the measurement is running, "Continuous Sweep" and [RUN CONT] are highlighted. The running measurement can be aborted by selecting the highlighted softkey or key again. The results are not deleted until a new measurement is started.

Note: Sequencer. If the Sequencer is active, "Continuous Sweep" only controls the sweep mode for the currently selected channel; however, the sweep mode only has an effect the next time the Sequencer activates that channel, and only for a channel-defined sequence. In this case, a channel in continuous sweep mode is swept repeatedly.

Furthermore, [RUN CONT] controls the Sequencer, not individual sweeps. [RUN CONT] starts the Sequencer in continuous mode.

For details on the Sequencer, see the R&S FSWP User Manual.

Remote command:

`INITiate<n>:CONTinuous` on page 121

Single Sweep/ RUN SINGLE

After triggering, starts a single data acquisition. If the Sequencer is off, only the evaluation for the currently displayed measurement channel is updated.

While the measurement is running, "Single Sweep" and [RUN SINGLE] are highlighted. The running measurement can be aborted by selecting the highlighted softkey or key again.

Note: Sequencer. If the Sequencer is active, "Single Sweep" only controls the sweep mode for the currently selected channel; however, the sweep mode only has an effect the next time the Sequencer activates that channel, and only for a channel-defined sequence. In this case, a channel in single sweep mode is swept only once by the Sequencer.

Furthermore, [RUN SINGLE] controls the Sequencer, not individual sweeps. [RUN SINGLE] starts the Sequencer in single mode.

If the Sequencer is off, only the evaluation for the currently displayed measurement channel is updated.

For details on the Sequencer, see the R&S FSWP User Manual.

Remote command:

`INITiate<n>[:IMMediate]` on page 122

Continue Single Sweep

After triggering, repeats data acquisition without deleting the trace of the last measurement. If the Sequencer is off, only the evaluation for the currently displayed measurement channel is updated.

While the measurement is running, "Continue Single Sweep" and [RUN SINGLE] are highlighted. The running measurement can be aborted by selecting the highlighted softkey or key again.

Remote command:

`INITiate<n>:CONMeas` on page 121

6.7 Output settings

Access: [Input/Output] > "Output"

The R&S FSWP can provide output to special connectors for other devices.

For details on connectors, refer to the R&S FSWP Getting Started manual, "Front / Rear Panel View" sections.



Providing trigger signals as output is described in "Trigger 1/2" on page 46.

How to provide trigger signals as output is described in detail in the R&S FSWP base unit user manual.

[Noise Source Control](#)..... 55

Noise Source Control

Enables or disables the 28 V voltage supply for an external noise source connected to the "Noise source control / Power sensor") connector. By switching the supply voltage for an external noise source on or off in the firmware, you can enable or disable the device as required.

External noise sources are useful when you are measuring power levels that fall below the noise floor of the R&S FSWP itself, for example when measuring the noise level of an amplifier.

In this case, you can first connect an external noise source (whose noise power level is known in advance) to the R&S FSWP and measure the total noise power. From this value, you can determine the noise power of the R&S FSWP. Then when you measure the power level of the actual DUT, you can deduct the known noise level from the total power to obtain the power level of the DUT.

Remote command:

[DIAGnostic:SERVice:NSOurce](#) on page 105

6.8 Display configuration



Access: "Overview" > "Display Config"

or: [MEAS]

The captured signal can be displayed using various evaluation methods. All evaluation methods available for the current application are displayed in the evaluation bar in SmartGrid mode when you do one of the following:

Up to 6 evaluations can be displayed in the I/Q Analyzer and thus in the MSRA primary at any time, including several graphical diagrams, marker tables or peak lists.

For a description of the available evaluation methods see the "Measurements and Result Displays" topic of the corresponding application User Manual.

6.9 Automatic settings

Access: [AUTO SET]

Some settings can be adjusted by the R&S FSWP automatically according to the current measurement settings.



Settings related to data acquisition (measurement time, hysteresis) can only be adjusted in the MSRA primary, not in the applications.

Adjusting all Determinable Settings Automatically (Auto All).....	56
Adjusting the Center Frequency Automatically (Auto Frequency).....	56
Setting the Reference Level Automatically (Auto Level).....	56
Resetting the Automatic Measurement Time (Meas Time Auto).....	56
(Meas Time Manual).....	57
Upper Level Hysteresis.....	57
Lower Level Hysteresis.....	57

Adjusting all Determinable Settings Automatically (Auto All)

Activates all automatic adjustment functions for the current measurement settings, including:

- [Auto Level](#)

Note: MSRA operating modes. In MSRA operating mode, this function is only available for the MSRA primary, not the secondary applications.

Remote command:

`[SENSe:]ADJust:ALL` on page 117

Adjusting the Center Frequency Automatically (Auto Frequency)

The R&S FSWP adjusts the center frequency automatically.

The optimum center frequency is the frequency with the highest S/N ratio in the frequency span. As this function uses the signal counter, it is intended for use with sinusoidal signals.

Remote command:

`[SENSe:]ADJust:FREQuency` on page 118

Setting the Reference Level Automatically (Auto Level)

Automatically determines a reference level which ensures that no overload occurs at the R&S FSWP for the current input data. At the same time, the internal attenuators are adjusted. As a result, the signal-to-noise ratio is optimized, while signal compression and clipping are minimized.

To determine the required reference level, a level measurement is performed on the R&S FSWP.

If necessary, you can optimize the reference level further. Decrease the attenuation level manually to the lowest possible value before an overload occurs, then decrease the reference level in the same way.

You can change the measurement time for the level measurement if necessary (see "[\(Meas Time Manual\)](#)" on page 57).

Remote command:

`[SENSe:]ADJust:LEVel` on page 119

Resetting the Automatic Measurement Time (Meas Time Auto)

Resets the measurement duration for automatic settings to the default value.

Remote command:

[\[SENSe:\]ADJust:CONFigure:LEVel:DURation:MODE](#) on page 118

(Meas Time Manual)

This function allows you to change the measurement duration for automatic setting adjustments. Enter the value in seconds.

Note: The maximum measurement duration depends on the currently selected measurement and the installed (optional) hardware. Thus, the measurement duration actually used to determine the automatic settings can be shorter than the value you define here.

Remote command:

[\[SENSe:\]ADJust:CONFigure:LEVel:DURation:MODE](#) on page 118

[\[SENSe:\]ADJust:CONFigure:LEVel:DURation](#) on page 117

Upper Level Hysteresis

When the reference level is adjusted automatically using the [Auto Level](#) function, the internal attenuators and the preamplifier are also adjusted. To avoid frequent adaptation due to small changes in the input signal, you can define a hysteresis. This setting defines an upper threshold that the signal must exceed (compared to the last measurement) before the reference level is adapted automatically.

Remote command:

[\[SENSe:\]ADJust:CONFigure:HYSTeresis:UPPer](#) on page 119

Lower Level Hysteresis

When the reference level is adjusted automatically using the [Auto Level](#) function, the internal attenuators and the preamplifier are also adjusted. To avoid frequent adaptation due to small changes in the input signal, you can define a hysteresis. This setting defines a lower threshold that the signal must fall below (compared to the last measurement) before the reference level is adapted automatically.

Remote command:

[\[SENSe:\]ADJust:CONFigure:HYSTeresis:LOWer](#) on page 118

7 Analysis

The data that was captured by the MSRA primary can be analyzed in various different secondary applications.

The analysis settings and functions available in MSRA mode are those described for the individual secondary applications. The MSRA primary is in effect an I/Q Analyzer application and has the same analysis functions and settings.

See the R&S FSWP I/Q Analyzer User Manual for a description of the analysis functions and settings available for the I/Q Analyzer and thus the MSRA primary.

Configuring the secondary application data extract and analysis interval

The settings required to configure the secondary application data extract or analysis intervals vary depending on the secondary application. See the corresponding application manuals for details.

For the I/Q Analyzer, the settings are the same as those used to define the actual data acquisition (see [Section 6.6.1, "Data acquisition"](#), on page 47). In MSRA secondary application channels, they define the analysis interval. Be sure to select the correct measurement channel before executing these commands.



Exporting I/Q Data

Access : "Save"/"Recall" > "Export"

The captured I/Q data from the MSRA primary can be exported for further analysis in external applications.

For details on exporting I/Q data see the R&S FSWP I/Q Analyzer User Manual.

7.1 Configuring the analysis line

AL 10.0 ms

Access: toolbar

The analysis line is a common time marker across all secondary applications (only available in MSRA mode). You can hide or show and change the position of the analysis line in each secondary application. The current position of the analysis line is indicated on the icon.

Position.....	59
Show Line.....	59

Position

Defines the position of the analysis line in the time domain. The position must lie within the measurement time of the multistandard measurement.

Remote command:

`CALCulate<n>:MSRA:ALINe[:VALue]` on page 133

Show Line

Hides or displays the analysis line in the time-based windows. By default, the line is displayed.

Note: The window title bar always shows whether the currently defined line position lies within the analysis interval of the active secondary application, even if the analysis line display is disabled.



Remote command:

`CALCulate<n>:MSRA:ALINe:SHOW` on page 132

8 How to perform measurements in MSRA mode

The following step-by-step instructions demonstrate how to perform a measurement in MSRA mode.

How to capture I/Q data in MSRA mode

1. Press [MODE] and select the "MSRA" operating mode.
Confirm the message.
2. Select "Overview" to display the "Overview" for an MSRA measurement.
3. Select "Input" to select the input signal source.
4. Select "Amplitude" to define the attenuation, reference level or other settings that affect the input signal's amplitude and scaling.
5. Select "Frequency" to define the input signal's center frequency.
6. Optionally, select "Trigger" and define a trigger for data acquisition, for example an IQ Power trigger to start capturing data only when a specific power is exceeded.
7. Select "Bandwidth" and define the bandwidth parameters for data acquisition:
 - "Sample rate" or "Analysis Bandwidth:" the span of the input signal to be captured for analysis, or the rate at which samples are captured (both values are correlated)
 - Optionally, if a bandwidth extension (> 160 MHz) is installed, the "Maximum Bandwidth", depending on whether you require a larger bandwidth or fewer spurious emissions.
 - "Measurement Time:" how long the data is to be captured
 - "Record Length": the number of samples to be captured (also defined by sample rate and measurement time)
8. If necessary, select "Display Config" and select other displays (up to a total of 6) required to control the acquired data.
Arrange them on the display to suit your preferences.
9. Exit the SmartGrid mode.
10. Optionally, stop continuous measurement mode by the Sequencer and perform a single data acquisition:
 - a) Select the Sequencer icon () from the toolbar.
 - b) Set the Sequencer state to "OFF".
 - c) Press [RUN SINGLE].
11. Optionally, export the captured or analyzed I/Q data (depending on the active channel) to a file.
 - a) Select the  "Save" icon in the toolbar.

- b) Select "I/Q Export".
- c) Define a file name and storage location and select "Save".

The captured data is stored to a file with the extension `.iq.tar`.

Now you can analyze the captured I/Q data in various MSRA secondary applications at the same time.

How to analyze the captured I/Q data in MSRA secondary applications

1. Press [MODE] and select an MSRA secondary application.
2. Select "Overview" to display the "Overview" for the MSRA secondary application.
3. Define the secondary application data extract, i.e. the range of the capture buffer you want to analyze in this secondary application.
4. Define the analysis interval, i.e. the frame number or similar within the secondary application data you want to analyze in this secondary application (not necessary for I/Q Analyzer or Analog Demodulation secondary applications).
5. Select "Frequency" and define the center frequency for the analysis interval.
6. Select "Display Config" and select other displays (up to a total of 6) to analyze the data in the configured interval.
Arrange them on the display to suit your preferences.
7. Exit the SmartGrid mode.
Repeat these steps for any other secondary applications.

How to perform multi-standard analysis of the I/Q data

1. Perform a single I/Q data acquisition measurement as described in ["How to capture I/Q data in MSRA mode"](#) on page 60.
2. Activate measurement channels for the MSRA secondary applications you require as described in ["How to analyze the captured I/Q data in MSRA secondary applications"](#) on page 61.
3. Select the MSRA View to get an overview of the captured data and the configured secondary applications.
Determine the individual data ranges that are relevant for a specific standard. If necessary, adapt the secondary application data and analysis interval settings for the secondary applications to reflect the relevant data ranges.
4. If the results indicate that dependencies between different standards in the signal may exist:
 - a) Select the secondary application in which unusual data occurs.
 - b) If necessary, perform a new data acquisition.
 - c) Determine the bandwidth or measurement time of the unusual data.

- d) Select the MSRA View to compare the data with the other standard secondary applications.
If a specific event (e.g. a burst, spur etc.) occurs in another standard at the same time as the unusual data in the first secondary application, the two effects may be correlated.
- e) Select the possibly dependant standard secondary application.
- f) Define an analysis interval for the conspicuous data range (as described in ["How to analyze the captured I/Q data in MSRA secondary applications"](#) on page 61).
- g) Refresh the result display for the changed analysis interval ("Sweep" menu).

Now you can analyze the data in detail to determine the cause of the unusual signal behavior.

How to perform a measurement in the time or frequency domain in MSRA mode

1. Capture I/Q data with the MSRA primary application as described in ["How to capture I/Q data in MSRA mode"](#) on page 60.
2. Activate an "I/Q Analyzer" channel as an MSRA secondary application as described in ["How to analyze the captured I/Q data in MSRA secondary applications"](#) on page 61.
3. In the I/Q Analyzer secondary application, press [MEAS].
4. From the "Select Measurement" dialog box, select the required measurement in the time or frequency domain.
5. Configure the measurement as described in the R&S FSWP User Manual.
The I/Q data captured by the MSRA primary application is analyzed in the time or frequency domain, according to the selected measurement and result displays.
6. To switch back to a conventional I/Q analysis, press [MEAS] and select the "IQ Analyzer" measurement.

9 Remote commands to perform measurements in MSRA mode

The following commands are specific to performing measurements in MSRA mode in a remote environment. Generally, the remote commands are identical to those used in Spectrum mode as described in the R&S FSWP User Manual. However, some restrictions or conditions may apply to specific commands (see also [Section 5, "MSRA basics"](#), on page 26).



You must always switch to MSRA mode before executing any MSRA-specific commands (using `INST:MODE MSR`).

It is assumed that the R&S FSWP has already been set up for remote control in a network as described in the R&S FSWP User Manual.



Note that basic tasks that are also performed in the base unit in the same way are not described here. For a description of such tasks, see the R&S FSWP User Manual.

In particular, this includes:

- Managing Settings and Results, i.e. storing and loading settings and result data
- Basic instrument configuration, e.g. checking the system configuration, customizing the screen layout, or configuring networks and remote operation
- Using the common status registers

The following tasks specific to MSRA mode are described here:

• Introduction	63
• Common suffixes	68
• Activating MSRA measurements	69
• Configuring MSRA measurements	74
• Capturing data and performing sweeps	119
• Retrieving results	124
• Querying the status registers	128
• Analyzing MSRA measurements	131
• Commands specific to MSRA secondary applications	131

9.1 Introduction

Commands are program messages that a controller (e.g. a PC) sends to the instrument or software. They operate its functions ('setting commands' or 'events') and request information ('query commands'). Some commands can only be used in one way, others work in two ways (setting and query). If not indicated otherwise, the commands can be used for settings and queries.

The syntax of a SCPI command consists of a header and, usually, one or more parameters. To use a command as a query, you have to append a question mark after the last header element, even if the command contains a parameter.

A header contains one or more keywords, separated by a colon. Header and parameters are separated by a "white space" (ASCII code 0 to 9, 11 to 32 decimal, e.g. blank). If there is more than one parameter for a command, they are separated by a comma from one another.

Only the most important characteristics that you need to know when working with SCPI commands are described here. For a more complete description, refer to the user manual of the R&S FSWP.



Remote command examples

Note that some remote command examples mentioned in this general introduction are possibly not supported by this particular application.

9.1.1 Conventions used in descriptions

The following conventions are used in the remote command descriptions:

- *Command usage*
If not specified otherwise, commands can be used both for setting and for querying parameters.
If a command can be used for setting or querying only, or if it initiates an event, the usage is stated explicitly.
- *Parameter usage*
If not specified otherwise, a parameter can be used to set a value, and it is the result of a query.
Parameters required only for setting are indicated as "Setting parameters".
Parameters required only to refine a query are indicated as "Query parameters".
Parameters that are only returned as the result of a query are indicated as "Return values".
- *Conformity*
Commands that are taken from the SCPI standard are indicated as "SCPI confirmed". All commands used by the R&S FSWP follow the SCPI syntax rules.
- *Asynchronous commands*
A command which does not automatically finish executing before the next command starts executing (overlapping command) is indicated as an "Asynchronous command".
- *Reset values (*RST)*
Default parameter values that are used directly after resetting the instrument (*RST command) are indicated as "*RST" values, if available.
- *Default unit*
The default unit is used for numeric values if no other unit is provided with the parameter.
- *Manual operation*

If the result of a remote command can also be achieved in manual operation, a link to the description is inserted.

9.1.2 Long and short form

The keywords have a long and a short form. You can use either the long or the short form, but no other abbreviations of the keywords.

The short form is emphasized in uppercase letters. Note however, that this emphasis only serves the purpose to distinguish the short from the long form in the manual. For the instrument, the case does not matter.

Example:

`SENSe:FREQUency:CENTer` is the same as `SENS:FREQ:CENT`.

9.1.3 Numeric suffixes

Some keywords have a numeric suffix if the command can be applied to multiple instances of an object. In that case, the suffix selects a particular instance (e.g. a measurement window).

Numeric suffixes are indicated by angular brackets (<n>) next to the keyword.

If you do not quote a suffix for keywords that support one, a 1 is assumed.

Example:

`DISPlay[:WINDow<1...4>]:ZOOM:STATe` enables the zoom in a particular measurement window, selected by the suffix at `WINDow`.

`DISPlay:WINDow4:ZOOM:STATe ON` refers to window 4.

9.1.4 Optional keywords

Some keywords are optional and are only part of the syntax because of SCPI compliance. You can include them in the header or not.



If an optional keyword has a numeric suffix and you need to use the suffix, you have to include the optional keyword. Otherwise, the suffix of the missing keyword is assumed to be the value 1.

Optional keywords are emphasized with square brackets.

Example:

Without a numeric suffix in the optional keyword:

```
[SENSe:]FREQuency:CENTer is the same as FREQuency:CENTer
```

With a numeric suffix in the optional keyword:

```
DISPlay[:WINDow<1...4>]:ZOOM:STATe
```

DISPlay:ZOOM:STATe ON enables the zoom in window 1 (no suffix).

DISPlay:WINDow4:ZOOM:STATe ON enables the zoom in window 4.

9.1.5 Alternative keywords

A vertical stroke indicates alternatives for a specific keyword. You can use both keywords to the same effect.

Example:

```
[SENSe:]BANDwidth|BWIDth[:RESolution]
```

In the short form without optional keywords, BAND 1MHZ would have the same effect as BWID 1MHZ.

9.1.6 SCPI parameters

Many commands feature one or more parameters.

If a command supports more than one parameter, they are separated by a comma.

Example:

```
LAYout:ADD:WINDow Spectrum,LEFT,MTABLE
```

Parameters can have different forms of values.

- [Numeric values](#)..... 66
- [Boolean](#)..... 67
- [Character data](#)..... 68
- [Character strings](#)..... 68
- [Block data](#)..... 68

9.1.6.1 Numeric values

Numeric values can be entered in any form, i.e. with sign, decimal point or exponent. For physical quantities, you can also add the unit. If the unit is missing, the command uses the basic unit.

Example:

With unit: SENSe:FREQuency:CENTer 1GHZ

Without unit: SENSe:FREQuency:CENTer 1E9 would also set a frequency of 1 GHz.

Values exceeding the resolution of the instrument are rounded up or down.

If the number you have entered is not supported (e.g. for discrete steps), the command returns an error.

Instead of a number, you can also set numeric values with a text parameter in special cases.

- **MIN/MAX**
Defines the minimum or maximum numeric value that is supported.
- **DEF**
Defines the default value.
- **UP/DOWN**
Increases or decreases the numeric value by one step. The step size depends on the setting. Sometimes, you can customize the step size with a corresponding command.

Querying numeric values

When you query numeric values, the system returns a number. For physical quantities, it applies the basic unit (e.g. Hz for frequencies). The number of digits after the decimal point depends on the type of numeric value.

Example:

Setting: `SENSe:FREQuency:CENTer 1GHZ`

Query: `SENSe:FREQuency:CENTer?` would return `1E9`

Sometimes, numeric values are returned as text.

- **INF/NINF**
Infinity or negative infinity. Represents the numeric values `9.9E37` or `-9.9E37`.
- **NAN**
Not a number. Represents the numeric value `9.91E37`. NAN is returned if errors occur.

9.1.6.2 Boolean

Boolean parameters represent two states. The "on" state (logically true) is represented by "ON" or the numeric value 1. The "off" state (logically untrue) is represented by "OFF" or the numeric value 0.

Querying Boolean parameters

When you query Boolean parameters, the system returns either the value 1 ("ON") or the value 0 ("OFF").

Example:

Setting: `DISPlay:WINDow:ZOOM:STATe ON`

Query: `DISPlay:WINDow:ZOOM:STATe?` would return `1`

9.1.6.3 Character data

Character data follows the syntactic rules of keywords. You can enter text using a short or a long form. For more information, see [Section 9.1.2, "Long and short form"](#), on page 65.

Querying text parameters

When you query text parameters, the system returns its short form.

Example:

Setting: `SENSe:BANDwidth:RESolution:TYPE NORMAl`

Query: `SENSe:BANDwidth:RESolution:TYPE?` would return `NORM`

9.1.6.4 Character strings

Strings are alphanumeric characters. They have to be in straight quotation marks. You can use a single quotation mark (') or a double quotation mark (").

Example:

`INSTRument:DELeTe 'Spectrum'`

9.1.6.5 Block data

Block data is a format which is suitable for the transmission of large amounts of data.

The ASCII character # introduces the data block. The next number indicates how many of the following digits describe the length of the data block. The data bytes follow. During the transmission of these data bytes, all end or other control signs are ignored until all bytes are transmitted. #0 specifies a data block of indefinite length. The use of the indefinite format requires an `NL^END` message to terminate the data block. This format is useful when the length of the transmission is not known or if speed or other considerations prevent segmentation of the data into blocks of definite length.

9.2 Common suffixes

In the MSRA mode, the following common suffixes are used in remote commands:

Table 9-1: Common suffixes used in remote commands in the MSRA mode

Suffix	Value range	Description
<m>	1..16	Marker (or spot noise marker)
<n>	1..16 (depends on application)	Window (in the currently selected channel)

Suffix	Value range	Description
<t>	1..6	Trace
	1 to 8	Limit line By default, the suffixes 1 to 8 correspond to the lines REM1 to REM8. If they are used but do not yet exist, they are created automatically. If a name has been set via <code>CALCulate:LIMit:NAME</code> , you can access the corresponding line using its index.



Selecting windows in multiple channels

Note that the suffix <n> always refers to a window in the currently selected channel.

<j>	1..10	Selects an integrated measurement range.
<k>	1..8 (Limit line) 1 2 (Display line)	Selects a limit or display line.
<r>	1..x	Selects a half decade. The value range depends on the number of half decades. The first half decade in the measurement always has the value "1". For subsequent half decades, add "1" to get the value "x" (the fourth half decade, for example, would have the value "4").
<s>	1..6	Selects a (user defined) spot noise marker.
<x>	1..2	Selects a mixer in the test setup.



Selecting windows in multiple channels

Note that the suffix <n> always refers to a window in the currently selected channel.

9.3 Activating MSRA measurements

MSRA measurements requires a special operating mode on the R&S FSWP. A measurement is started immediately with the default settings.



The special MSRA primary measurement channel is of the channel type "IQ" and is referred to by the channel name "MSRA Primary". This channel cannot be replaced, deleted, or renamed.

<code>INSTrument:CREate:DUPLicate</code>	70
<code>INSTrument:CREate[:NEW]</code>	70
<code>INSTrument:CREate:REPLace</code>	70

INSTrument:DELeTe	71
INSTrument:LIST?	71
INSTrument:MODE	72
INSTrument:REName	73
INSTrument[:SELeCt]	73
SYSTem:PRESet:COMPAtible	73
SYSTem:PRESet:CHANnel[:EXEC]	74

INSTrument:CREate:DUPLicate

Duplicates the currently selected channel, i.e. creates a new channel of the same type and with the identical measurement settings. The name of the new channel is the same as the copied channel, extended by a consecutive number (e.g. "IQAnalyzer" -> "IQAnalyzer 2").

The channel to be duplicated must be selected first using the `INST:SEL` command.

Is not available if the MSRA primary channel is selected.

Example:

```
INST:SEL 'PhaseNoise'
```

```
INST:CRE:DUPL
```

Duplicates the channel named 'PhaseNoise' and creates a new channel named 'PhaseNoise 2'.

Usage: Event

INSTrument:CREate[:NEW] <ChannelType>, <ChannelName>

Adds a measurement channel. You can configure up to 10 measurement channels at the same time (depending on available memory).

Parameters:

<ChannelType> Channel type of the new channel.
For a list of available channel types, see [INSTrument:LIST?](#) on page 71.

<ChannelName> String containing the name of the channel.
Note that you cannot assign an existing channel name to a new channel. If you do, an error occurs.
Channel names can have a maximum of 31 characters, and must be compatible with the Windows conventions for file names. In particular, they must not contain special characters such as ":", "*", "?".

Example:

```
INST:CRE SAN, 'Spectrum 2'
```

Adds a spectrum display named "Spectrum 2".

Manual operation: See "[New Channel](#)" on page 23

INSTrument:CREate:REPLace <ChannelName1>, <ChannelType>, <ChannelName2>

Replaces a channel with another one.

Setting parameters:

<ChannelName1> String containing the name of the channel you want to replace.

<ChannelType> Channel type of the new channel.
For a list of available channel types, see [INSTrument:LIST?](#) on page 71.

<ChannelName2> String containing the name of the new channel.
Note: If the specified name for a new channel already exists, the default name, extended by a sequential number, is used for the new channel (see [INSTrument:LIST?](#) on page 71).
Channel names can have a maximum of 31 characters, and must be compatible with the Windows conventions for file names. In particular, they must not contain special characters such as ":", "*", "?".

Example: `INST:CRE:REPL 'PhaseNoise',PNO,'PNO2'`
Replaces the channel named "PhaseNoise" by a new channel of type "Phase Noise" named "PNO2".

Usage: Setting only

Manual operation: See "[Replace Current Channel](#)" on page 23

INSTrument:DELeTe <ChannelName>

Deletes a channel.

If you delete the last channel, the default "Phase Noise" channel is activated.

Setting parameters:

<ChannelName> String containing the name of the channel you want to delete.
A channel must exist to delete it.

Example: `INST:DEL 'PhaseNoise'`
Deletes the channel with the name 'PhaseNoise'.

Usage: Setting only

Manual operation: See "[Closing an application](#)" on page 23

INSTrument:LIST?

Queries all active channels. The query is useful to obtain the names of the existing channels, which are required to replace or delete the channels.

Return values:

<ChannelType>, <ChannelName> For each channel, the command returns the channel type and channel name (see tables below).
Tip: to change the channel name, use the [INSTrument:REName](#) command.

Example: `INST:LIST?`
Result for 2 channels:
'PNO','PhaseNoise','PNO','Phase Noise 2'

Usage: Query only

Table 9-2: Available channel types and default channel names

Application	<ChannelType> Parameter	Default Channel Name*)
Phase Noise	PNOise	Phase Noise
Spectrum Monitor	SMONitor	Spectrum Monitor
Spectrum (R&S FSWP-B1)	SANalyzer	Spectrum
I/Q Analyzer (R&S FSWP-B1)	IQ	IQ Analyzer
Pulse Measurements (R&S FSWP-K6)	PULSe	Pulse
Analog Modulation Analysis (R&S FSWP-K7)	ADEMod	Analog Demod
Noise Figure Measurements (R&S FSWP-K30)	NOISe	Noise
Fast Spur Search (R&S FSWP-K50)	SPUR	Spurious
Transient Analysis (R&S FSWP-K60)	TA	Transient Analysis
Vector Signal Analysis (R&S FSWP-K70)	DDEM	VSA

Note: the default channel name is also listed in the table. If the specified name for a new channel already exists, the default name, extended by a sequential number, is used for the new channel.

INSTrument:MODE <OpMode>

The operating mode of the R&S FSWP determines which applications are available and active. Whenever you change the operating mode, the currently active channels are closed. The default operating mode is Signal and Spectrum Analyzer mode, however, the presetting can be changed.

(See the "Instrument Setup" section in the R&S FSWP User Manual).

Parameters:

<OpMode>

SANalyzer

Signal and Spectrum Analyzer mode

MSRanalyzer

Multi-Standard Radio Analysis (MSRA) mode

*RST: SAN

Example:

```
INST:MODE MSR
```

Switches to Multi-Standard Radio Analysis (MSRA) mode.

Manual operation: See "[Switching the operating mode](#)" on page 23

INSTrument:REName <ChannelName1>, <ChannelName2>

Renames a channel.

Setting parameters:

<ChannelName1> String containing the name of the channel you want to rename.

<ChannelName2> String containing the new channel name.

Note that you cannot assign an existing channel name to a new channel. If you do, an error occurs.

Channel names can have a maximum of 31 characters, and must be compatible with the Windows conventions for file names. In particular, they must not contain special characters such as ":", "*", "?".

Example: `INST:REN 'PhaseNoise', 'PNO'`

Renames the channel with the name 'PhaseNoise' to 'PNO'.

Usage: Setting only

INSTrument[:SElect] <ChannelType> | <ChannelName>

Activates a new channel with the defined channel type, or selects an existing channel with the specified name.

Also see

- [INSTrument:CREate\[:NEW\]](#) on page 70

Parameters:

<ChannelType> Channel type of the new channel.
For a list of available channel types see [INSTrument:LIST?](#) on page 71.

<ChannelName> String containing the name of the channel.

Example: `INST IQ`
Activates a channel for the I/Q Analyzer application (evaluation mode).

`INST 'MyIQSpectrum'`
Selects the channel named 'MyIQSpectrum' (for example before executing further commands for that channel).

Manual operation: See ["AM/FM/PM Modulation Analysis"](#) on page 22
See ["I/Q Analyzer"](#) on page 22
See ["Pulse Measurements"](#) on page 22
See ["Vector Signal Analysis \(VSA\)"](#) on page 22
See ["Selecting an MSRA secondary application"](#) on page 23
See ["New Channel"](#) on page 23

SYSTem:PRESet:COMPAtible <OpMode>

Defines the operating mode that is activated when you switch on the R&S FSWP or press [PRESET].

For details on operating modes see [Section 4, "Applications and operating modes"](#), on page 20.

Parameters:

<OpMode>	SANalyzer Defines Signal and Spectrum Analyzer operating mode as the presetting.
	OFF Selects the phase noise application as the default application (default value).

SYSTem:PRESet:CHANnel[:EXEC]

Restores the default instrument settings in the current channel.

Use `INST:SEL` to select the channel.

Example:

```
INST:SEL 'Spectrum2'
```

Selects the channel for "Spectrum2".

```
SYST:PRESet:CHAN:EXEC
```

Restores the factory default settings to the "Spectrum2" channel.

Usage: Event

Manual operation: See ["Preset Channel"](#) on page 34

9.4 Configuring MSRA measurements

- [Configuring input/output and frontend settings](#)..... 74
- [Triggering](#)..... 105
- [Configuring data acquisition](#)..... 111
- [Adjusting settings automatically](#)..... 117

9.4.1 Configuring input/output and frontend settings

The following commands are required to define input, output and frontend settings. Any settings related to data acquisition or data output are only available for the MSRA primary application.

- [RF input](#).....75
- [Configuring file input](#)..... 78
- [Using external mixers](#).....79
- [Setting up probes](#).....92
- [Configuring the vertical axis \(amplitude, scaling\)](#).....97
- [Frequency](#)..... 103
- [Configuring the outputs](#)..... 104

9.4.1.1 RF input

INPut:ATTenuation:PROTection:RESet.....	75
INPut:CONNector.....	75
INPut:COUPling.....	75
INPut:DPATH.....	76
INPut:FILTer:HPASs[:STATe].....	76
INPut:FILTer:YIG[:STATe].....	76
INPut:IMPedance.....	77
INPut:IMPedance:PTYPe.....	77
INPut:SELEct.....	77
INPut:TYPE.....	78

INPut:ATTenuation:PROTection:RESet

Resets the attenuator and reconnects the RF input with the input mixer for the R&S FSWP after an overload condition occurred and the protection mechanism intervened. The error status bit (bit 3 in the `STAT:QUES:POW` status register) and the `INPUT OVLD` message in the status bar are cleared.

The command works only if the overload condition has been eliminated first.

Example: `INP:ATT:PROT:RES`

INPut:CONNector <ConnType>

Determines which connector the input for the measurement is taken from.

Parameters:

<ConnType> **RF**
 RF input connector
 *RST: RF

Example: `INP:CONN RF`
 Selects input from the RF input connector.

Manual operation: See "[Input Connector](#)" on page 38

INPut:COUPling <CouplingType>

Selects the coupling type of the RF input.

Parameters:

<CouplingType> AC | DC
AC
 AC coupling
DC
 DC coupling
 *RST: AC

Example: `INP:COUP DC`

Manual operation: See ["Input Coupling"](#) on page 36

INPut:DPATH <DirectPath>

Enables or disables the use of the direct path for frequencies close to 0 Hz.

Parameters:

<DirectPath>

AUTO | OFF

AUTO | 1

(Default) the direct path is used automatically for frequencies close to 0 Hz.

OFF | 0

The analog mixer path is always used.

Example:

INP:DPATH OFF

Manual operation: See ["Direct Path"](#) on page 37

INPut:FILTer:HPASs[:STATe] <State>

Activates an additional internal high-pass filter for RF input signals from 1 GHz to 3 GHz. This filter is used to remove the harmonics of the R&S FSWP to measure the harmonics for a DUT, for example.

Requires an additional high-pass filter hardware option.

(Note: for RF input signals outside the specified range, the high-pass filter has no effect. For signals with a frequency of approximately 4 GHz upwards, the harmonics are suppressed sufficiently by the YIG-preselector, if available.)

Parameters:

<State>

ON | OFF | 0 | 1

OFF | 0

Switches the function off

ON | 1

Switches the function on

*RST: 0

Example:

INP:FILT:HPAS ON

Turns on the filter.

Manual operation: See ["High Pass Filter 1 to 3 GHz"](#) on page 37

INPut:FILTer:YIG[:STATe] <State>

Enables or disables the YIG filter.

Parameters:

<State>

ON | OFF | 0 | 1

*RST: 0

Example: `INP:FILT:YIG OFF`
Deactivates the YIG-preselector.

Manual operation: See "[YIG-Preselector](#)" on page 37

INPut:IMPedance <Impedance>

Selects the nominal input impedance of the RF input. In some applications, only 50 Ω are supported.

Parameters:

<Impedance> 50 | 75

numeric value

User-defined impedance from 50 Ohm to 100000000 Ohm (=100 MOhm)

User-defined values are only available for the Spectrum application, the I/Q Analyzer, and some optional applications.

*RST: 50 Ω

Default unit: OHM

Example: `INP:IMP 75`

Manual operation: See "[Impedance](#)" on page 36

INPut:IMPedance:PTYPe <PadType>

Defines the type of matching pad used for impedance conversion for RF input.

Parameters:

<PadType> SRESistor | MLPad

SRESistor

Series-R

MLPad

Minimum Loss Pad

*RST: SRESistor

Example: `INP:IMP 100`

`INP:IMP:PTYP MLP`

INPut:SElect <Source>

Selects the signal source for measurements, i.e. it defines which connector is used to input data to the R&S FSWP.

Parameters:

<Source> **RF**
Radio Frequency ("RF INPUT" connector)

FIQ

I/Q data file

*RST: RF

Manual operation: See "Radio Frequency State" on page 36
See "I/Q Input File State" on page 38

INPut:TYPE <Input>

The command selects the input path.

Parameters:

<Input> **INPUT1**
 Selects RF input 1.

INPUT2
 Selects RF input 2.

***RST: INPUT1**

Example: //Select input path
 INP:TYPE INPUT1

9.4.1.2 Configuring file input

The following commands are required to define input from a file.

Useful commands for configuring file input described elsewhere:

- [INPut:SElect](#) on page 77

Remote commands exclusive to configuring input from files:

INPut:FILE:PATH	78
TRACe:IQ:FILE:REPetition:COUNT	79

INPut:FILE:PATH <FileName>[, <AnalysisBW>]

Selects the I/Q data file to be used as input for further measurements.

The I/Q data file must be in one of the following supported formats:

- .iq.tar
- .iqw
- .csv
- .mat
- .wv
- .aid

Only a single data stream or channel can be used as input, even if multiple streams or channels are stored in the file.

For some file formats that do not provide the sample rate and measurement time or record length, you must define these parameters manually. Otherwise the traces are not visible in the result displays.

Parameters:

<FileName>	String containing the path and name of the source file. The file type is determined by the file extension. If no file extension is provided, the file type is assumed to be <code>.iq.tar</code> . For <code>.mat</code> files, Matlab® v4 is assumed.
<AnalysisBW>	Optionally: The analysis bandwidth to be used by the measurement. The bandwidth must be smaller than or equal to the bandwidth of the data that was stored in the file. Default unit: HZ

Example:

```
INP:FILE:PATH 'C:\R_S\Instr\user\data.iq.tar'
```

Uses I/Q data from the specified file as input.

Example:

```
//Load an IQW file
INP:SEL:FIQ
INP:FILE:PATH 'C:\R_S\Instr\user\data.iqw'
//Define the sample rate
TRAC:IQ:SRAT 10MHz
//Define the measurement time
SENSe:SWEp:TIME 0.001001
//Start the measurement
INIT:IMM
```

Manual operation: See ["Select I/Q data file"](#) on page 38

TRACe:IQ:FILE:REPetition:COUNt <RepetitionCount>

Determines how often the data stream is repeatedly copied in the I/Q data memory. If the available memory is not sufficient for the specified number of repetitions, the largest possible number of complete data streams is used.

Parameters:

<RepetitionCount> integer

Example:

```
TRAC:IQ:FILE:REP:COUN 3
```

9.4.1.3 Using external mixers

The commands required to work with external mixers in a remote environment are described here. Note that these commands require the R&S FSWP to have an external mixer option installed and an external mixer to be connected to the R&S FSWP.

In MSRA mode, external mixers are not supported.

- [Basic settings](#).....80
- [Mixer settings](#).....81
- [Conversion loss table settings](#).....86
- [Programming example: working with an external mixer](#).....90

Basic settings

The basic settings concern general usage of an external mixer.

[SENSe:]MIXer<x>[:STATe].....	80
[SENSe:]MIXer<x>:BIAS:HIGH.....	80
[SENSe:]MIXer<x>:BIAS[:LOW].....	80
[SENSe:]MIXer<x>:LOPower.....	81

[SENSe:]MIXer<x>[:STATe] <State>

Activates or deactivates the use of a connected external mixer as input for the measurement. This command is only available if the optional External Mixer is installed and an external mixer is connected.

Suffix:

<x> 1..n
 irrelevant

Parameters:

<State> ON | OFF | 1 | 0
 *RST: 0

Example: MIX ON

[SENSe:]MIXer<x>:BIAS:HIGH <BiasSetting>

Defines the bias current for the high (last) range.

Is only available if the external mixer is active (see [SENSe:]MIXer<x>[:STATe] on page 80).

Suffix:

<x> 1..n
 irrelevant

Parameters:

<BiasSetting> *RST: 0.0 A
 Default unit: A

[SENSe:]MIXer<x>:BIAS[:LOW] <BiasSetting>

Defines the bias current for the low (first) range.

Is only available if the external mixer is active (see [SENSe:]MIXer<x>[:STATe] on page 80).

Suffix:

<x> 1..n
 irrelevant

Parameters:

<BiasSetting> *RST: 0.0 A
 Default unit: A

[SENSe:]MIXer<x>:LOPower <Level>

Specifies the LO level of the external mixer's LO port.

Suffix:

<x> 1..n
 irrelevant

Parameters:

<Level> Range: 13.0 dBm to 17.0 dBm
 Increment: 0.1 dB
 *RST: 15.5 dBm
 Default unit: DBM

Example: MIX:LOP 16.0dBm

Mixer settings

The following commands are required to configure the band and specific mixer settings.

[SENSe:]MIXer<x>:FREQUENCY:HANdOver.....	81
[SENSe:]MIXer<x>:FREQUENCY:STARt.....	82
[SENSe:]MIXer<x>:FREQUENCY:STOP.....	82
[SENSe:]MIXer<x>:HARMonic:BAND:PRESet.....	82
[SENSe:]MIXer<x>:HARMonic:BAND.....	82
[SENSe:]MIXer<x>:HARMonic:HIGH:STATe.....	83
[SENSe:]MIXer<x>:HARMonic:HIGH[:VALue].....	83
[SENSe:]MIXer<x>:HARMonic:TYPE.....	84
[SENSe:]MIXer<x>:HARMonic[:LOW].....	84
[SENSe:]MIXer<x>:IF?.....	84
[SENSe:]MIXer<x>:LOSS:HIGH.....	85
[SENSe:]MIXer<x>:LOSS:TABLE:HIGH.....	85
[SENSe:]MIXer<x>:LOSS:TABLE[:LOW].....	85
[SENSe:]MIXer<x>:LOSS[:LOW].....	86
[SENSe:]MIXer<x>:PORTs.....	86
[SENSe:]MIXer<x>:RFOVerrange[:STATe].....	86

[SENSe:]MIXer<x>:FREQUENCY:HANdOver <Frequency>

Defines the frequency at which the mixer switches from one range to the next (if two different ranges are selected). The handover frequency for each band can be selected freely within the overlapping frequency range.

Is only available if the external mixer is active (see [SENSe:]MIXer<x>[:STATe] on page 80).

Suffix:

<x> 1..n
 irrelevant

Parameters:

<Frequency> Default unit: HZ

Example: MIX ON
 Activates the external mixer.
 MIX:FREQ:HAND 78.0299GHz
 Sets the handover frequency to 78.0299 GHz.

[SENSe:]MIXer<x>:FREQuency:STARt

Sets or queries the frequency at which the external mixer band starts.

Suffix:

<x> 1..n
 irrelevant

Example: MIX:FREQ:STAR?
 Queries the start frequency of the band.

[SENSe:]MIXer<x>:FREQuency:STOP

Sets or queries the frequency at which the external mixer band stops.

Suffix:

<x> 1..n
 irrelevant

Example: MIX:FREQ:STOP?
 Queries the stop frequency of the band.

[SENSe:]MIXer<x>:HARMonic:BAND:PRESet

Restores the preset frequency ranges for the selected standard waveguide band.

Note: Changes to the band and mixer settings are maintained even after using the [PRESET] function. Use this command to restore the predefined band ranges.

Suffix:

<x> 1..n
 irrelevant

Example: MIX:HARM:BAND:PRES
 Presets the selected waveguide band.

[SENSe:]MIXer<x>:HARMonic:BAND <Band>

Selects the external mixer band. The query returns the currently selected band.

Is only available if the external mixer is active (see [SENSe:]MIXer<x>[:STATe] on page 80).

Suffix:

<x> 1..n
 irrelevant

Parameters:

<Band> KA | Q | U | V | E | W | F | D | G | Y | J | USER
 Standard waveguide band or user-defined band.

Table 9-3: Frequency ranges for pre-defined bands

Band	Frequency start [GHz]	Frequency stop [GHz]
KA (A) *)	26.5	40.0
Q	33.0	50.0
U	40.0	60.0
V	50.0	75.0
E	60.0	90.0
W	75.0	110.0
F	90.0	140.0
D	110.0	170.0
G	140.0	220.0
J	220.0	325.0
Y	325.0	500.0
USER	32.18 (default)	68.22 (default)

*) The band formerly referred to as "A" is now named "KA".

[SENSe:]MIXer<x>:HARMonic:HIGH:STATe <State>

Specifies whether a second (high) harmonic is to be used to cover the band's frequency range.

Suffix:

<x> 1..n

Parameters:

<State> ON | OFF
 *RST: ON

Example: MIX:HARM:HIGH:STAT ON

[SENSe:]MIXer<x>:HARMonic:HIGH[:VALue] <HarmOrder>

Specifies the harmonic order to be used for the high (second) range.

Suffix:

<x> 1..n
 irrelevant

Parameters:

<HarmOrder> Range: 2 to 61 (USER band); for other bands: see band definition

Example:

```
MIX:HARM:HIGH:STAT ON
MIX:HARM:HIGH 3
```

[SENSe:]MIXer<x>:HARMonic:TYPE <OddEven>

Specifies whether the harmonic order to be used should be odd, even, or both.

Which harmonics are supported depends on the mixer type.

Suffix:

<x> 1..n
 irrelevant

Parameters:

<OddEven> ODD | EVEN | EODD
 ODD | EVEN | EODD
*RST: EVEN

Example:

```
MIX:HARM:TYPE ODD
```

[SENSe:]MIXer<x>:HARMonic[:LOW] <HarmOrder>

Specifies the harmonic order to be used for the low (first) range.

Suffix:

<x> 1..n
 irrelevant

Parameters:

<HarmOrder> Range: 2 to 61 (USER band); for other bands: see band definition
 *RST: 2 (for band F)

Example:

```
MIX:HARM 3
```

[SENSe:]MIXer<x>:IF?

Queries the intermediate frequency currently used by the external mixer.

Suffix:

<x> 1..n
 irrelevant

Example:

```
MIX:IF?
```

Example:

See "[Programming example: working with an external mixer](#)" on page 90.

Usage:

Query only

[SENSe:]MIXer<x>:LOSS:HIGH <Average>

Defines the average conversion loss to be used for the entire high (second) range.

Suffix:

<x> 1..n
Mixer

Parameters:

<Average> Range: 0 to 100
*RST: 24.0 dB
Default unit: dB

Example: MIX:LOSS:HIGH 20dB

[SENSe:]MIXer<x>:LOSS:TABLE:HIGH <FileName>

Defines the conversion loss table to be used for the high (second) range.

Suffix:

<x> 1..n
Mixer

Parameters:

<FileName> String containing the path and name of the file, or the serial number of the external mixer whose file is required. The R&S FSWP automatically selects the correct cvl file for the current IF. As an alternative, you can also select a user-defined conversion loss table (.acl file).

[SENSe:]MIXer<x>:LOSS:TABLE[:LOW] <FileName>

Defines the file name of the conversion loss table to be used for the low (first) range.

Suffix:

<x> 1..n
Mixer

Parameters:

<FileName> String containing the path and name of the file, or the serial number of the external mixer whose file is required. The R&S FSWP automatically selects the correct cvl file for the current IF. As an alternative, you can also select a user-defined conversion loss table (.acl file).

Example:
MIX:LOSS:TABL '101567'
MIX:LOSS:TABL?
//Result:
'101567_MAG_6_B5000_3G5.B5G'

[SENSe:]MIXer<x>:LOSS[:LOW] <Average>

Defines the average conversion loss to be used for the entire low (first) range.

Suffix:

<x> 1..n
Mixer

Parameters:

<Average> Range: 0 to 100
*RST: 24.0 dB
Default unit: dB

Example: MIX:LOSS 20dB

[SENSe:]MIXer<x>:PORTs <PortType>

Selects the mixer type.

Suffix:

<x> 1..n
irrelevant

Parameters:

<PortType> 2 | 3
2
Two-port mixer.
3
Three-port mixer.
*RST: 2

Example: MIX:PORT 3

[SENSe:]MIXer<x>:RFOVerrange[:STATe] <State>

If enabled, the band limits are extended beyond "RF Start" and "RF Stop" due to the capabilities of the used harmonics.

Suffix:

<x> 1..n
irrelevant

Parameters:

<State> ON | OFF | 1 | 0
*RST: 0

Conversion loss table settings

The following settings are required to configure and manage conversion loss tables.

[SENSe:]CORRection:CVL:BAND.....	87
[SENSe:]CORRection:CVL:BIAS.....	87
[SENSe:]CORRection:CVL:CATalog?.....	88
[SENSe:]CORRection:CVL:CLEar.....	88
[SENSe:]CORRection:CVL:COMMent.....	88
[SENSe:]CORRection:CVL:DATA.....	88
[SENSe:]CORRection:CVL:HARMonic.....	89
[SENSe:]CORRection:CVL:MIXer.....	89
[SENSe:]CORRection:CVL:PORTs.....	89
[SENSe:]CORRection:CVL:SElect.....	90
[SENSe:]CORRection:CVL:SNUMber.....	90

[SENSe:]CORRection:CVL:BAND <Band>

Defines the waveguide band for which the conversion loss table is to be used. This setting is checked against the current mixer setting before the table can be assigned to the range.

Before this command can be performed, the conversion loss table must be selected (see [SENSe:]CORRection:CVL:SElect on page 90).

Is only available with option B21 (External Mixer) installed.

Parameters:

<Band> K | KA | Q | U | V | E | W | F | D | G | Y | J | USER
 Standard waveguide band or user-defined band.
 For a definition of the frequency range for the pre-defined bands, see [Table 9-3](#).
 *RST: F (90 GHz - 140 GHz)

Example:

```
CORR:CVL:SEL 'LOSS_TAB_4'
Selects the conversion loss table.
CORR:CVL:BAND KA
Sets the band to KA (26.5 GHz - 40 GHz).
```

[SENSe:]CORRection:CVL:BIAS <BiasSetting>

Defines the bias setting to be used with the conversion loss table.

Before this command can be performed, the conversion loss table must be selected (see [SENSe:]CORRection:CVL:SElect on page 90).

Is only available with option B21 (External Mixer) installed.

Parameters:

<BiasSetting> *RST: 0.0 A
 Default unit: A

Example:

```
CORR:CVL:SEL 'LOSS_TAB_4'
Selects the conversion loss table.
CORR:CVL:BIAS 3A
```

[SENSe:]CORRection:CVL:CATalog?

Queries all available conversion loss tables saved in the C:\R_S\INSTR\USER\cvl\ directory on the instrument.

Is only available with option B21 (External Mixer) installed.

Return values:

<Files> 'string'
Comma-separated list of strings containing the file names.

Example: CORR:CVL:CAT?

Usage: Query only

[SENSe:]CORRection:CVL:CLEar

Deletes the selected conversion loss table. Before this command can be performed, the conversion loss table must be selected (see [\[SENSe:\]CORRection:CVL:SELEct](#) on page 90).

Is only available with option B21 (External Mixer) installed.

Example: CORR:CVL:SEL 'LOSS_TAB_4'
Selects the conversion loss table.
CORR:CVL:CLE

[SENSe:]CORRection:CVL:COMment <Text>

Defines a comment for the conversion loss table. Before this command can be performed, the conversion loss table must be selected (see [\[SENSe:\]CORRection:CVL:SELEct](#) on page 90).

Is only available with option B21 (External Mixer) installed.

Parameters:

<Text>

Example: CORR:CVL:SEL 'LOSS_TAB_4'
Selects the conversion loss table.
CORR:CVL:COMM 'Conversion loss table for
FS_Z60'

[SENSe:]CORRection:CVL:DATA {<Freq>, <Level>}...

Defines the reference values of the selected conversion loss tables. The values are entered as a set of frequency/level pairs. You can define a maximum of 500 frequency/level pairs. Before this command can be performed, you must select the conversion loss table (see [\[SENSe:\]CORRection:CVL:SELEct](#) on page 90).

Is only available with option B21 (External Mixer) installed.

Parameters:

<Freq> The frequencies have to be sent in ascending order.
Default unit: HZ

<Level> Default unit: DB

Example:

```
CORR:CVL:SEL 'LOSS_TAB_4'
Selects the conversion loss table.
CORR:CVL:DATA 1MHZ,-30DB,2MHZ,-40DB
```

[SENSe:]CORRection:CVL:HARMonic <HarmOrder>

Defines the harmonic order for which the conversion loss table is to be used. This setting is checked against the current mixer setting before the table can be assigned to the range.

Before this command can be performed, the conversion loss table must be selected (see [\[SENSe:\]CORRection:CVL:SElect](#) on page 90).

Is only available with option B21 (External Mixer) installed.

Parameters:

<HarmOrder> Range: 2 to 65

Example:

```
CORR:CVL:SEL 'LOSS_TAB_4'
Selects the conversion loss table.
CORR:CVL:HARM 3
```

[SENSe:]CORRection:CVL:MIXer <Type>

Defines the mixer name in the conversion loss table. This setting is checked against the current mixer setting before the table can be assigned to the range.

Before this command can be performed, the conversion loss table must be selected (see [\[SENSe:\]CORRection:CVL:SElect](#) on page 90).

Is only available with option B21 (External Mixer) installed.

Parameters:

<Type> string
Name of mixer with a maximum of 16 characters

Example:

```
CORR:CVL:SEL 'LOSS_TAB_4'
Selects the conversion loss table.
CORR:CVL:MIX 'FS_Z60'
```

[SENSe:]CORRection:CVL:PORTs <PortType>

Defines the mixer type in the conversion loss table. This setting is checked against the current mixer setting before the table can be assigned to the range.

Before this command can be performed, the conversion loss table must be selected (see [\[SENSe:\]CORRection:CVL:SElect](#) on page 90).

Is only available with option B21 (External Mixer) installed.

Parameters:

<PortType> 2 | 3
 *RST: 2

Example:

```
CORR:CVL:SEL 'LOSS_TAB_4'
Selects the conversion loss table.
CORR:CVL:PORT 3
```

[SENSe:]CORRection:CVL:SElect <FileName>

Selects the conversion loss table with the specified file name. If <file_name> is not available, a new conversion loss table is created.

Is only available with option B21 (External Mixer) installed.

Parameters:

<FileName> String containing the path and name of the file.

Example:

```
CORR:CVL:SEL 'LOSS_TAB_4'
```

[SENSe:]CORRection:CVL:SNUMber <SerialNo>

Defines the serial number of the mixer for which the conversion loss table is to be used. This setting is checked against the current mixer setting before the table can be assigned to the range.

Before this command can be performed, the conversion loss table must be selected (see [\[SENSe:\]CORRection:CVL:SElect](#) on page 90).

Is only available with option B21 (External Mixer) installed.

Parameters:

<SerialNo> Serial number with a maximum of 16 characters

Example:

```
CORR:CVL:SEL 'LOSS_TAB_4'
Selects the conversion loss table.
CORR:CVL:MIX '123.4567'
```

Programming example: working with an external mixer

This example demonstrates how to work with an external mixer in a remote environment. It is performed in the Spectrum application in the default layout configuration. Note that without a real input signal and connected mixer, this measurement will not return useful results.

```
//-----Preparing the instrument -----
//Reset the instrument
*RST
//Activate the use of the connected external mixer.
SENS:MIX ON
//----- Configuring basic mixer behavior -----
//Set the LO level of the mixer's LO port to 15 dBm.
```

```

SENS:MIX:LOP 15dBm
//Set the bias current to -1 mA .
SENS:MIX:BIAS:LOW -1mA
//----- Configuring the mixer and band settings -----
//Use band "V" to full possible range extent for assigned harmonic (6).
SENS:MIX:HARM:BAND V
SENS:MIX:RFOV ON
//Query the possible range
SENS:MIX:FREQ:STAR?
//Result: 4748000000 (47.48 GHz)
SENS:MIX:FREQ:STOP?
//Result: 13802000000 (138.02 GHz)
//Use a 3-port mixer type
SENS:MIX:PORT 3
//Split the frequency range into two ranges;
//range 1 covers 47.48 GHz GHz to 80 GHz; harmonic 6, average conv. loss of 20 dB
//range 2 covers 80 GHz to 138.02 GHz; harmonic 8, average conv.loss of 30 dB
SENS:MIX:HARM:TYPE EVEN
SENS:MIX:HARM:HIGH:STAT ON
SENS:MIX:FREQ:HAND 80GHz
SENS:MIX:HARM:LOW 6
SENS:MIX:LOSS:LOW 20dB
SENS:MIX:HARM:HIGH 8
SENS:MIX:LOSS:HIGH 30dB
//----- Activating automatic signal identification functions -----
//Activate both automatic signal identification functions.
SENS:MIX:SIGN ALL
//Use auto ID threshold of 8 dB.
SENS:MIX:THR 8dB

//-----Performing the Measurement-----
//Select single sweep mode.
INIT:CONT OFF
//Initiate a basic frequency sweep and wait until the sweep has finished.
INIT;*WAI
//-----Retrieving Results-----
//Return the trace data for the input signal without distortions
//(default screen configuration)
TRAC:DATA? TRACE3

```

Configuring a conversion loss table for a user-defined band

```

//-----Preparing the instrument -----
//Reset the instrument
*RST
//Activate the use of the connected external mixer.
SENS:MIX ON
//-----Configuring a new conversion loss table -----
//Define cvl table for range 1 of band as described in previous example

```

```

// (extended V band)
SENS:CORR:CVL:SEL 'UserTable'
SENS:CORR:CVL:COMM 'User-defined conversion loss table for USER band'
SENS:CORR:CVL:BAND USER
SENS:CORR:CVL:HARM 6
SENS:CORR:CVL:BIAS -1mA
SENS:CORR:CVL:MIX 'FS_Z60'
SENS:CORR:CVL:SNUM '123.4567'
SENS:CORR:CVL:PORT 3
//Conversion loss is linear from 55 GHz to 75 GHz
SENS:CORR:CVL:DATA 55GHZ,-20DB,75GHZ,-30DB
//----- Configuring the mixer and band settings -----
//Use user-defined band and assign new cvl table.
SENS:MIX:HARM:BAND USER
//Define band by two ranges;
//range 1 covers 47.48 GHz to 80 GHz; harmonic 6, cvl table 'UserTable'
//range 2 covers 80 GHz to 138.02 GHz; harmonic 8, average conv.loss of 30 dB
SENS:MIX:HARM:TYPE EVEN
SENS:MIX:HARM:HIGH:STAT ON
SENS:MIX:FREQ:HAND 80GHz
SENS:MIX:HARM:LOW 6
SENS:MIX:LOSS:TABL:LOW 'UserTable'
SENS:MIX:HARM:HIGH 8

SENS:MIX:LOSS:HIGH 30dB
//Query the possible range
SENS:MIX:FREQ:STAR?
//Result: 47480000000 (47.48 GHz)
SENS:MIX:FREQ:STOP?
//Result: 138020000000 (138.02 GHz)

//-----Performing the Measurement-----
//Select single sweep mode.
INIT:CONT OFF
//Initiate a basic frequency sweep and wait until the sweep has finished.
INIT;*WAI
//-----Retrieving Results-----
//Return the trace data (default screen configuration)
TRAC:DATA? TRACe1

```

9.4.1.4 Setting up probes

Modular probes can be connected to the RF input connector of the R&S FSWP.

For details see the R&S FSWP User Manual.

[SENSe:]PROBe<pb>:ID:PARTnumber?	93
[SENSe:]PROBe<pb>:ID:SRNumber?	93
[SENSe:]PROBe<pb>:SETup:ATTRatio	93
[SENSe:]PROBe<pb>:SETup:CMOffset	94

[SENSe:]PROBe<pb>:SETup:DMOOffset.....	94
[SENSe:]PROBe<pb>:SETup:MODE.....	95
[SENSe:]PROBe<pb>:SETup:NAME?.....	95
[SENSe:]PROBe<pb>:SETup:NMOOffset.....	95
[SENSe:]PROBe<pb>:SETup:PMODE.....	96
[SENSe:]PROBe<pb>:SETup:PMOOffset.....	96
[SENSe:]PROBe<pb>:SETup:STATe?.....	97
[SENSe:]PROBe<pb>:SETup:TYPE?.....	97

[SENSe:]PROBe<pb>:ID:PARTnumber?

Queries the R&S part number of the probe.

Suffix:

<pb> 1..n
 Selects the connector:
 3 = RF

Return values:

<PartNumber>

Example: //Query part number
 PROB3:ID:PART?

Usage: Query only

[SENSe:]PROBe<pb>:ID:SRNumber?

Queries the serial number of the probe.

Suffix:

<pb> 1..n
 Selects the connector:
 3 = RF

Return values:

<SerialNo>

Example: //Query serial number
 PROB3:ID:SRN?

Usage: Query only

[SENSe:]PROBe<pb>:SETup:ATTRatio <AttenuationRatio>

Defines the attenuation applied to the input at the probe. This setting is only available for modular probes.

Suffix:

<pb> 1..n
 Selects the connector:
 3 = RF

Parameters:

<AttenuationRatio> **10**
 Attenuation by 20 dB (ratio= 10:1)
2
 Attenuation by 6 dB (ratio= 2:1)
 *RST: 10
 Default unit: DB

[SENSe:]PROBe<pb>:SETup:CMOffset <CMOffset>

Sets the common mode offset. The setting is only available if a differential probe in CM-mode is connected to the R&S FSWP.

If the probe is disconnected, the common mode offset of the probe is reset to 0.0 V.

Note that if the offset for DM-mode or CM-mode is changed, the offsets for the P-mode and N-mode are adapted accordingly, and vice versa.

For details see the R&S FSWP User Manual.

Suffix:

<pb> 1..n
 Selects the connector:
 3 = RF

Parameters:

<CMOffset> Offset of the mean voltage between the positive and negative input terminal vs. ground
 Range: -16 V to +16 V
 Default unit: V

[SENSe:]PROBe<pb>:SETup:DMOffset <DMOffset>

Sets the DM-mode offset. The setting is only available if a modular probe in DM-mode is connected to the R&S FSWP.

If the probe is disconnected, the DM-mode offset of the probe is reset to 0.0 V.

Note that if the offset for DM-mode or CM-mode is changed, the offsets for the P-mode and N-mode are adapted accordingly, and vice versa.

For details see the R&S FSWP User Manual.

Suffix:

<pb> 1..n
 Selects the connector:
 3 = RF

Parameters:

<DMOffset> Voltage offset between the positive and negative input terminal
Default unit: V

[SENSe:]PROBe<pb>:SETup:MODE <Mode>**Suffix:**

<pb> 1..n
Selects the connector:
3 = RF

Parameters:

<Mode> RSINgle | NOACtion
RSINgle
Run single: starts one data acquisition.
NOACtion
Nothing is started on pressing the micro button.

[SENSe:]PROBe<pb>:SETup:NAME?

Queries the name of the probe.

Suffix:

<pb> 1..n
Selects the connector:
3 = RF

Return values:

<Name> String containing the name of the probe.

Example:

```
//Query name of the probe
PROB3:SET:NAME?
```

Usage:

Query only

[SENSe:]PROBe<pb>:SETup:NMOffset <NMOffset>

Sets the N-mode offset. The setting is only available if a modular probe in N-mode is connected to the R&S FSWP. The maximum voltage difference between the positive and negative input terminals is 16 V.

If the probe is disconnected, the N-mode offset of the probe is reset to 0.0 V.

Note that if the offset for DM-mode or CM-mode is changed, the offsets for the P-mode and N-mode are adapted accordingly, and vice versa.

For details see the R&S FSWP User Manual.

Suffix:

<pb> 1..n
Selects the connector:
3 = RF

Parameters:

<NMOffset> The voltage offset between the negative input terminal and ground.
Default unit: V

[SENSe:]PROBe<pb>:SETup:PMODE <Mode>

Determines the mode of a multi-mode modular probe.

For details see the R&S FSWP User Manual.

Suffix:

<pb> 1..n
Selects the connector:
3 = RF

Parameters:

<Mode> CM | DM | PM | NM

DM
Voltage between the positive and negative input terminal

CM
Mean voltage between the positive and negative input terminal vs. ground

PM
Voltage between the positive input terminal and ground

NM
Voltage between the negative input terminal and ground

Example:

SENS:PROB:SETU:PMOD PM
Sets the probe to P-mode.

[SENSe:]PROBe<pb>:SETup:PMOffset <PMOffset>

Sets the P-mode offset. The setting is only available if a modular probe in P-mode is connected to the R&S FSWP. The maximum voltage difference between the positive and negative input terminals is 16 V.

If the probe is disconnected, the P-mode offset of the probe is reset to 0.0 V.

Note that if the offset for DM-mode or CM-mode is changed, the offsets for the P-mode and N-mode are adapted accordingly, and vice versa.

For details see the R&S FSWP User Manual.

Suffix:

<pb> 1..n
Selects the connector:
3 = RF

Amplitude settings

Remote commands exclusive to amplitude configuration:

CALCulate<n>:MARKer<m>:FUNction:REFerence.....	98
DISPlay[:WINDow<n>][:SUBWindow<w>]:TRACe<t>:Y[:SCALe]:RLEVel.....	98
DISPlay[:WINDow<n>][:SUBWindow<w>]:TRACe<t>:Y[:SCALe]:RLEVel:OFFSet.....	98

CALCulate<n>:MARKer<m>:FUNction:REFerence

Matches the reference level to the power level of a marker.

If you use the command in combination with a delta marker, that delta marker is turned into a normal marker.

Suffix:

<n> Window

<m> Marker

Example:

CALC:MARK2:FUNC:REF

Sets the reference level to the level of marker 2.

DISPlay[:WINDow<n>][:SUBWindow<w>]:TRACe<t>:Y[:SCALe]:RLEVel <ReferenceLevel>

Defines the reference level (for all traces in all windows).

With a reference level offset ≠ 0, the value range of the reference level is modified by the offset.

Suffix:

<n> irrelevant

<w> subwindow
Not supported by all applications

<t> irrelevant

Parameters:

<ReferenceLevel> The unit is variable.

Range: see specifications document

*RST: 0 dBm

Default unit: DBM

Example:

DISP:TRAC:Y:RLEV -60dBm

DISPlay[:WINDow<n>][:SUBWindow<w>]:TRACe<t>:Y[:SCALe]:RLEVel:OFFSet <Offset>

Defines a reference level offset (for all traces in all windows).

Suffix:

<n> irrelevant

<w> subwindow
Not supported by all applications

<t> irrelevant

Parameters:

<Offset> Range: -200 dB to 200 dB
*RST: 0dB
Default unit: DB

Example: DISP:TRAC:Y:RLEV:OFFS -10dB

Configuring the attenuation

INPut:ATTenuation.....	99
INPut:ATTenuation:AUTO.....	99
INPut:EATT:AUTO.....	99

INPut:ATTenuation <Attenuation>

Defines the total attenuation for RF input.

If you set the attenuation manually, it is no longer coupled to the reference level, but the reference level is coupled to the attenuation. Thus, if the current reference level is not compatible with an attenuation that has been set manually, the command also adjusts the reference level.

Parameters:

<Attenuation> Range: see specifications document
Increment: 5 dB (with optional electr. attenuator: 1 dB)
*RST: 10 dB (AUTO is set to ON)
Default unit: DB

Example: INP:ATT 30dB
Defines a 30 dB attenuation and decouples the attenuation from the reference level.

INPut:ATTenuation:AUTO <State>

Couples or decouples the attenuation to the reference level. Thus, when the reference level is changed, the R&S FSWP determines the signal level for optimal internal data processing and sets the required attenuation accordingly.

Parameters:

<State> ON | OFF | 0 | 1
*RST: 1

Example: INP:ATT:AUTO ON
Couples the attenuation to the reference level.

INPut:EATT:AUTO <State>

Turns automatic selection of the electronic attenuation on and off.

If on, electronic attenuation reduces the mechanical attenuation whenever possible.

Parameters:

<State> ON | OFF | 0 | 1
 OFF | 0
 Switches the function off
 ON | 1
 Switches the function on
 *RST: 1

Example: INP:EATT:AUTO OFF

Configuring a preamplifier

INPut:GAIN:STATe..... 100
 INPut:GAIN[:VALue]..... 100

INPut:GAIN:STATe <State>

Turns the internal preamplifier on and off. It requires the optional preamplifier hardware.

The preamplification value is defined using the [INPut:GAIN\[:VALue\]](#) on page 100.

Parameters:

<State> ON | OFF | 0 | 1
 OFF | 0
 Switches the function off
 ON | 1
 Switches the function on
 *RST: 0

Example: INP:GAIN:STAT ON
 INP:GAIN:VAL 15
 Switches on 15 dB preamplification.

INPut:GAIN[:VALue] <Gain>

Selects the "gain" if the preamplifier is activated (INP:GAIN:STAT ON, see [INPut:GAIN:STATe](#) on page 100).

The command requires the additional preamplifier hardware option.

Parameters:

<Gain> For R&S FSWP models 1322.8003K08, 1322.8003K09, 1322.8003K27 and 1322.8003K51, the following settings are available:
 15 dB and 30 dB
 All other values are rounded to the nearest of these two.
 For R&S FSWP models 1322.8003K26 and 1322.8003K50:
 30 dB

Default unit: DB

Example: INP:GAIN:STAT ON
INP:GAIN:VAL 30
Switches on 30 dB preamplification.

Scaling the Y-axis

DISPlay[:WINDow<n>][:SUBWindow<w>]:TRACe<t>:Y[:SCALe].....	101
DISPlay[:WINDow<n>][:SUBWindow<w>]:TRACe<t>:Y[:SCALe]:AUTO ONCE.....	101
DISPlay[:WINDow<n>][:SUBWindow<w>]:TRACe<t>:Y[:SCALe]:MODE.....	101
DISPlay[:WINDow<n>][:SUBWindow<w>]:TRACe<t>:Y[:SCALe]:PDIVision.....	102
DISPlay[:WINDow<n>][:SUBWindow<w>]:TRACe<t>:Y[:SCALe]:RPOStion.....	102
DISPlay[:WINDow<n>][:SUBWindow<w>]:TRACe<t>:Y:SPACing.....	103

DISPlay[:WINDow<n>][:SUBWindow<w>]:TRACe<t>:Y[:SCALe] <Range>

Defines the display range of the y-axis (for all traces).

Suffix:

<n>	Window
<w>	subwindow Not supported by all applications
<t>	irrelevant

Example: DISP:TRAC:Y 110dB

Manual operation: See "Range" on page 39
See "Y-Axis Max" on page 40

DISPlay[:WINDow<n>][:SUBWindow<w>]:TRACe<t>:Y[:SCALe]:AUTO ONCE

Automatic scaling of the y-axis is performed once, then switched off again (for all traces).

Suffix:

<n>	Window
<t>	irrelevant

DISPlay[:WINDow<n>][:SUBWindow<w>]:TRACe<t>:Y[:SCALe]:MODE <Mode>

Selects the type of scaling of the y-axis (for all traces).

When the display update during remote control is off, this command has no immediate effect.

Suffix:

<n>	Window
<w>	subwindow

<t> irrelevant

Parameters:

<Mode> **ABSolute**
absolute scaling of the y-axis

RELative
relative scaling of the y-axis

*RST: ABSolute

Example: DISP:TRAC:Y:MODE REL

Manual operation: See "Scaling" on page 40

DISPlay[:WINDow<n>][:SUBWindow<w>]:TRACe<t>:Y[:SCALe]:PDIVision
<Value>

This remote command determines the grid spacing on the Y-axis for all diagrams, where possible.

In spectrum displays, for example, this command is not available.

Suffix:

<n> [Window](#)

<w> subwindow
Not supported by all applications

<t> irrelevant

Parameters:

<Value> numeric value WITHOUT UNIT (unit according to the result display)
Defines the range per division (total range = 10*<Value>)

*RST: depends on the result display
Default unit: DBM

Example: DISP:TRAC:Y:PDIV 10
Sets the grid spacing to 10 units (e.g. dB) per division

DISPlay[:WINDow<n>][:SUBWindow<w>]:TRACe<t>:Y[:SCALe]:RPOSition
<Position>

Defines the vertical position of the reference level on the display grid (for all traces).

The R&S FSWP adjusts the scaling of the y-axis accordingly.

Suffix:

<n> [Window](#)

<w> subwindow
Not supported by all applications

<t> irrelevant

Example: DISP:TRAC:Y:RPOS 50PCT

Manual operation: See "Ref Level Position" on page 39

DISPlay[:WINDow<n>][:SUBWindow<w>]:TRACe<t>:Y:SPACing <ScalingType>

Selects the scaling of the y-axis (for all traces, <t> is irrelevant).

Suffix:

<n> [Window](#)
 <w> subwindow
 <t> [Trace](#)

Parameters:

<ScalingType> **LOGarithmic**
 Logarithmic scaling.
 LINear
 Linear scaling in %.
 LDB
 Linear scaling in the specified unit.
 PERCent
 Linear scaling in %.
 *RST: LOGarithmic

Example: DISP:TRAC:Y:SPAC LIN
 Selects linear scaling in %.

Manual operation: See "Scaling" on page 40

9.4.1.6 Frequency

[\[SENSe:\]FREQuency:CENTer](#)..... 103
[\[SENSe:\]FREQuency:CENTer:STEP](#)..... 104
[\[SENSe:\]FREQuency:OFFSet](#)..... 104

[SENSe:]FREQuency:CENTer <Frequency>

Defines the center frequency.

CW, pulsed and VCO measurements:

This command defines or queries (in case of automatic frequency search) the current signal frequency.

Transient measurement:

This command defines the center frequency of the transient measurement.

Parameters:

<Frequency> For the allowed range and f_{max} , refer to the specifications document.
 *RST: fmax/2
 Default unit: Hz

Example: FREQ:CENT 100 MHz
 FREQ:CENT:STEP 10 MHz
 FREQ:CENT UP
 Sets the center frequency to 110 MHz.

Manual operation: See "[Center Frequency](#)" on page 41

[SENSe:]FREQuency:CENTer:STEP <StepSize>

Defines the center frequency step size.

You can increase or decrease the center frequency quickly in fixed steps using the SENS:FREQ UP AND SENS:FREQ DOWN commands, see [[SENSe:\]FREQuency:CENTer](#) on page 103.

Parameters:

<StepSize> For f_{max} , refer to the specifications document.
 Range: 1 to fMAX
 *RST: 0.1 x span
 Default unit: Hz

Example: //Set the center frequency to 110 MHz.
 FREQ:CENT 100 MHz
 FREQ:CENT:STEP 10 MHz
 FREQ:CENT UP

Manual operation: See "[Center Frequency Stepsize](#)" on page 41

[SENSe:]FREQuency:OFFSet <Offset>

Defines a frequency offset.

If this value is not 0 Hz, the application assumes that the input signal was frequency shifted outside the application. All results of type "frequency" will be corrected for this shift numerically by the application.

See also "[Frequency Offset](#)" on page 41.

Note: In MSRA mode, the setting command is only available for the MSRA primary application. For MSRA secondary applications, only the query command is available.

Parameters:

<Offset> Range: -1 THz to 1 THz
 *RST: 0 Hz
 Default unit: HZ

Example: FREQ:OFFS 1GHZ

Manual operation: See "[Frequency Offset](#)" on page 41

9.4.1.7 Configuring the outputs

The following commands are required to provide output from the R&S FSWP.



Configuring trigger input/output is described in [Section 9.4.2.2, "Configuring the trigger output"](#), on page 109.

[DIAGnostic:SERVice:NSOource](#)..... 105

DIAGnostic:SERVice:NSOource <State>

Turns the 28 V supply of the BNC connector labeled [noise source control] on the R&S F5WP on and off.

Parameters:

<State> ON | OFF | 0 | 1
 OFF | 0
 Switches the function off
 ON | 1
 Switches the function on

Example: DIAG:SERV:NSO ON

Manual operation: See ["Noise Source Control"](#) on page 55

9.4.2 Triggering

The following remote commands are required to configure a triggered measurement in a remote environment. These commands are only available for the MSRA primary channel. More details are described for manual operation in [Section 6.5, "Trigger settings"](#), on page 42.



*OPC should be used after requesting data. This will hold off any subsequent changes to the selected trigger source, until after the sweep is completed and the data is returned.

- [Configuring the triggering conditions](#).....105
- [Configuring the trigger output](#).....109

9.4.2.1 Configuring the triggering conditions

The following commands are required to configure a triggered measurement.

[TRIGger\[:SEQuence\]:DTIME](#)..... 106
[TRIGger\[:SEQuence\]:HOLDoff\[:TIME\]](#)..... 106
[TRIGger\[:SEQuence\]:IFPower:HOLDoff](#)..... 106
[TRIGger\[:SEQuence\]:IFPower:HYSTeresis](#)..... 106
[TRIGger\[:SEQuence\]:LEVel\[:EXTernal<port>\]](#)..... 107
[TRIGger\[:SEQuence\]:LEVel:IFPower](#)..... 107
[TRIGger\[:SEQuence\]:LEVel:RFPower](#)..... 107
[TRIGger\[:SEQuence\]:SLOPe](#)..... 108
[TRIGger\[:SEQuence\]:SOURce](#)..... 108

TRIGger[:SEQuence]:DTIME <DropoutTime>

Defines the time the input signal must stay below the trigger level before a trigger is detected again.

Parameters:

<DropoutTime> Dropout time of the trigger.
 Range: 0 s to 10.0 s
 *RST: 0 s
 Default unit: S

Manual operation: See "[Drop-Out Time](#)" on page 45

TRIGger[:SEQuence]:HOLDoff[:TIME] <Offset>

Defines the time offset between the trigger event and the start of the measurement.

Parameters:

<Offset> *RST: 0 s
 Default unit: S

Example: TRIG:HOLD 500us

Manual operation: See "[Trigger Offset](#)" on page 45

TRIGger[:SEQuence]:IFPower:HOLDoff <Period>

Defines the holding time before the next trigger event.

Note that this command can be used for **any trigger source**, not just IF Power (despite the legacy keyword).

Parameters:

<Period> Range: 0 s to 10 s
 *RST: 0 s
 Default unit: S

Example: TRIG:SOUR EXT
 Sets an external trigger source.
 TRIG:IFP:HOLD 200 ns
 Sets the holding time to 200 ns.

Manual operation: See "[Trigger Holdoff](#)" on page 45

TRIGger[:SEQuence]:IFPower:HYSTeresis <Hysteresis>

Defines the trigger hysteresis, which is only available for "IF Power" trigger sources.

Parameters:

<Hysteresis> Range: 3 dB to 50 dB
 *RST: 3 dB
 Default unit: DB

Example: TRIG:SOUR IFP
Sets the IF power trigger source.
TRIG:IFP:HYST 10DB
Sets the hysteresis limit value.

Manual operation: See "[Hysteresis](#)" on page 45

TRIGger[:SEQuence]:LEVel[:EXTeRnal<port>] <TriggerLevel>

Defines the level the external signal must exceed to cause a trigger event.

Suffix:

<port> Selects the trigger port.
1 = trigger port 1 (TRIGGER INPUT connector on front panel)
2 = trigger port 2 (TRIGGER INPUT/OUTPUT connector on rear panel)

Parameters:

<TriggerLevel> Range: 0.5 V to 3.5 V
*RST: 1.4 V
Default unit: V

Example: TRIG:LEV 2V

Manual operation: See "[Trigger Level](#)" on page 44

TRIGger[:SEQuence]:LEVel:IFPower <TriggerLevel>

Defines the power level at the third intermediate frequency that must be exceeded to cause a trigger event.

Note that any RF attenuation or preamplification is considered when the trigger level is analyzed. If defined, a reference level offset is also considered.

Parameters:

<TriggerLevel> For details on available trigger levels and trigger bandwidths, see the specifications document.
*RST: -20 dBm
Default unit: DBM

Example: TRIG:LEV:IFP -30DBM

TRIGger[:SEQuence]:LEVel:RFPower <TriggerLevel>

Defines the power level the RF input must exceed to cause a trigger event. Note that any RF attenuation or preamplification is considered when the trigger level is analyzed. If defined, a reference level offset is also considered.

The input signal must be between 500 MHz and 8 GHz.

Parameters:

<TriggerLevel> For details on available trigger levels and trigger bandwidths, see the specifications document.

*RST: -20 dBm

Default unit: DBM

Example:

TRIG:LEV:RFP -30dBm

TRIGger[:SEQUence]:SLOPe <Type>

Selects the trigger slope.

Parameters:

<Type> POSitive | NEGative

POSitive

Triggers when the signal rises to the trigger level (rising edge).

NEGative

Triggers when the signal drops to the trigger level (falling edge).

*RST: POSitive

Example:

TRIG:SLOP NEG

Manual operation: See ["Slope"](#) on page 45

TRIGger[:SEQUence]:SOURce <Source>

Selects the trigger source.

Note on external triggers:

If a measurement is configured to wait for an external trigger signal in a remote control program, remote control is blocked until the trigger is received and the program can continue. Make sure that this situation is avoided in your remote control programs.

Parameters:

<Source>

IMMediate

Free Run

EXT | EXT2

Trigger signal from one of the "Trigger Input/Output" connectors.

Note: Connector must be configured for "Input".

RFPower

First intermediate frequency

(Frequency and time domain measurements only.)

IFPower

Second intermediate frequency

IQPower

Magnitude of sampled I/Q data

For applications that process I/Q data, such as the I/Q Analyzer or optional applications.

*RST: IMMediate

- Example:** TRIG:SOUR EXT
Selects the external trigger input as source of the trigger signal
- Manual operation:** See "Trigger Source" on page 43
See "Free Run" on page 43
See "Ext. Trigger 1/2" on page 43
See "IF Power" on page 43
See "RF Power" on page 44
See "I/Q Power" on page 44

9.4.2.2 Configuring the trigger output

The following commands are required to send the trigger signal to one of the variable "TRIGGER INPUT/OUTPUT" connectors on the R&S FSWP.

OUTPut:TRIGger<tp>:DIRection.....	109
OUTPut:TRIGger<tp>:LEVel.....	109
OUTPut:TRIGger<tp>:OTYPe.....	110
OUTPut:TRIGger<tp>:PULSe:IMMEDIATE.....	110
OUTPut:TRIGger<tp>:PULSe:LENGth.....	111

OUTPut:TRIGger<tp>:DIRection <Direction>

Selects the trigger direction for trigger ports that serve as an input as well as an output.

Suffix:

<tp> Selects the used trigger port.
<2>: selects trigger port 2 (on the rear panel).

Parameters:

<Direction> INPut | OUTPut

INPut
Port works as an input.

OUTPut
Port works as an output.

*RST: INPut

Manual operation: See "Trigger 1/2" on page 46

OUTPut:TRIGger<tp>:LEVel <Level>

Defines the level of the (TTL compatible) signal generated at the trigger output.

Works only if you have selected a user-defined output with `OUTPut:TRIGger<tp>:OTYPe`.

Suffix:

<tp> 1..n
 Selects the trigger port to which the output is sent.
 2 = trigger port 2 (rear)

Parameters:

<Level> **HIGH**
 5 V
LOW
 0 V
 *RST: LOW

Example: OUTP:TRIG2:LEV HIGH

Manual operation: See "[Level](#)" on page 46

OUTPut:TRIGger<tp>:OTYPe <OutputType>

Selects the type of signal generated at the trigger output.

Suffix:

<tp> 1..n
 Selects the trigger port to which the output is sent.
 2 = trigger port 2 (rear)

Parameters:

<OutputType> **DEvice**
 Sends a trigger signal when the R&S FSWP has triggered internally.

TARMed
 Sends a trigger signal when the trigger is armed and ready for an external trigger event.

UDEFineD
 Sends a user-defined trigger signal. For more information, see [OUTPut:TRIGger<tp>:LEVel](#).

*RST: DEvice

Manual operation: See "[Output Type](#)" on page 46

OUTPut:TRIGger<tp>:PULSe:IMMediate

Generates a pulse at the trigger output.

Suffix:

<tp> 1..n
 Selects the trigger port to which the output is sent.
 2 = trigger port 2 (rear)

Manual operation: See "[Send Trigger](#)" on page 47

OUTPut:TRIGger<tp>:PULSe:LENGth <Length>

Defines the length of the pulse generated at the trigger output.

Suffix:

<tp> Selects the trigger port to which the output is sent.
2 = trigger port 2 (rear)

Parameters:

<Length> Pulse length in seconds.
Default unit: S

Example: OUTP:TRIG2:PULS:LENG 0.02

Manual operation: See "Pulse Length" on page 47

9.4.3 Configuring data acquisition

The following commands are required to configure the actual data acquisition.

Configuring data acquisition is only possible for the MSRA primary channel. In MSRA secondary application channels, these commands define the analysis interval (see [Section 9.9, "Commands specific to MSRA secondary applications"](#), on page 131). Be sure to select the correct measurement channel before executing these commands.

[SENSe:]IQ:BWIDth:MODE.....	111
[SENSe:]IQ:BWIDth:RESolution.....	112
[SENSe:]IQ:FFT:ALGorithm.....	112
[SENSe:]IQ:FFT:LENGth.....	113
[SENSe:]IQ:FFT:WINDow:LENGth.....	113
[SENSe:]IQ:FFT:WINDow:OVERlap.....	113
[SENSe:]IQ:FFT:WINDow:TYPE.....	114
TRACe:IQ:BWIDth.....	114
TRACe:IQ:RLENGth.....	114
TRACe:IQ:SRATe.....	115
TRACe:IQ:TPISample?.....	115
TRACe:IQ:WBANd[:STATe].....	116
TRACe:IQ:WBANd:MBWIDth.....	116

[SENSe:]IQ:BWIDth:MODE <Mode>

Defines how the resolution bandwidth is determined.

Parameters:

<Mode> AUTO | MANual | FFT

AUTO

(Default) The RBW is determined automatically depending on the sample rate and record length.

MANual

The user-defined RBW is used and the (FFT) window length (and possibly the sample rate) are adapted accordingly. The RBW is defined using the `[SENSe:]IQ:BWIDth:RESolution` command.

FFT

The RBW is determined by the FFT parameters.

*RST: AUTO

Example:

```
IQ:BAND:MODE MAN
Switches to manual RBW mode.
IQ:BAND:RES 120000
Sets the RBW to 120 kHz.
```

Manual operation: See "RBW" on page 50

[SENSe:]IQ:BWIDth:RESolution <Bandwidth>

Defines the resolution bandwidth manually if `[SENSe:]IQ:BWIDth:MODE` is set to MAN.

Defines the resolution bandwidth. The available RBW values depend on the sample rate and record length.

Parameters:

<Bandwidth> refer to specifications document
 *RST: RBW: AUTO mode is used
 Default unit: HZ

Example:

```
IQ:BAND:MODE MAN
Switches to manual RBW mode.
IQ:BAND:RES 120000
Sets the RBW to 120 kHz.
```

Manual operation: See "RBW" on page 50

[SENSe:]IQ:FFT:ALGORITHM <Method>

Defines the FFT calculation method.

Parameters:

<Method> **SINGLE**
 One FFT is calculated for the entire record length; if the FFT length is larger than the record length (see `[SENSe:]IQ:FFT:LENGth` and `TRACe:IQ:RLENGth`), zeros are appended to the captured data.

AVERage

Several overlapping FFTs are calculated for each record; the results are averaged to determine the final FFT result for the record.

The user-defined window length and window overlap are used. See [\[SENSe:\] IQ:FFT:WINDow:LENGth](#) and [\[SENSe:\] IQ:FFT:WINDow:OVERlap](#).

*RST: AVER

Example: IQ:FFT:ALG SING

Manual operation: See ["Transformation Algorithm"](#) on page 51

[SENSe:]IQ:FFT:LENGth <NoOfBins>

Defines the number of frequency points determined by each FFT calculation. The more points are used, the higher the resolution in the spectrum becomes, but the longer the calculation takes.

Parameters:

<NoOfBins> integer value
 Range: 3 to 524288
 *RST: 4096

Example: IQ:FFT:LENG 2048

Manual operation: See ["FFT Length"](#) on page 51

[SENSe:]IQ:FFT:WINDow:LENGth <NoOfFFT>

Defines the number of samples to be included in a single FFT window when multiple FFT windows are used.

Parameters:

<NoOfFFT> integer value
 Range: 3 to 4096
 *RST: record length

Example: IQ:FFT:WIND:LENG 500

Manual operation: See ["Window Length"](#) on page 51

[SENSe:]IQ:FFT:WINDow:OVERlap <Rate>

Defines the part of a single FFT window that is re-calculated by the next FFT calculation.

Parameters:

<Rate> double value
 Percentage rate
 Range: 0 to 1
 *RST: 0.75

Example: `IQ:FFT:WIND:OVER 0.5`
Half of each window overlaps the previous window in FFT calculation.

Manual operation: See "[Window Overlap](#)" on page 51

[SENSe:]IQ:FFT:WINDow:TYPE <Function>

In the I/Q Analyzer you can select one of several FFT window types.

Parameters:

<Function>

- BLACkharris**
Blackman-Harris
- FLATtop**
Flattop
- GAUSSian**
Gauss
- RECTangular**
Rectangular
- P5**
5-Term

*RST: FLAT

Example: `IQ:FFT:WIND:TYPE GAUS`

Manual operation: See "[Window Function](#)" on page 51

TRACe:IQ:BWIDth

Defines or queries the bandwidth of the resampling filter.

The bandwidth of the resampling filter depends on the sample rate.

Parameters:

<Bandwidth> Default unit: HZ

Manual operation: See "[Analysis Bandwidth](#)" on page 49

TRACe:IQ:RLENgth <NoOfSamples>

Sets the record length for the acquired I/Q data.

Increasing the record length also increases the measurement time.

Note: Alternatively, you can define the measurement time using the `SENS:SWE:TIME` command.

Parameters:

<NoOfSamples> Number of samples to record.
*RST: 1001

Example: `TRAC:IQ:RLEN 256`

Manual operation: See ["Record Length"](#) on page 50

TRACe:IQ:SRATe <SampleRate>

Sets the final user sample rate for the acquired I/Q data. Thus, the user sample rate can be modified without affecting the actual data capturing settings on the R&S FSWP.

Note: The smaller the user sample rate, the smaller the usable I/Q bandwidth, see [Section C, "Sample rate and maximum usable I/Q bandwidth for RF input"](#), on page 138.

Parameters:

<SampleRate> The valid sample rates are described in [Section C, "Sample rate and maximum usable I/Q bandwidth for RF input"](#), on page 138.
 *RST: 32 MHz
 Default unit: HZ

Manual operation: See ["Sample Rate"](#) on page 48

TRACe:IQ:TPISample?

Queries the time offset from the sample start to the trigger event (trigger point in sample = TPIS). Since the R&S FSWP usually samples with a much higher sample rate than the specific application actually requires, the trigger point determined internally is much more precise than the one determined from the (downsampled) data in the application. Thus, the TPIS indicates the offset from the sample start to the actual trigger event.

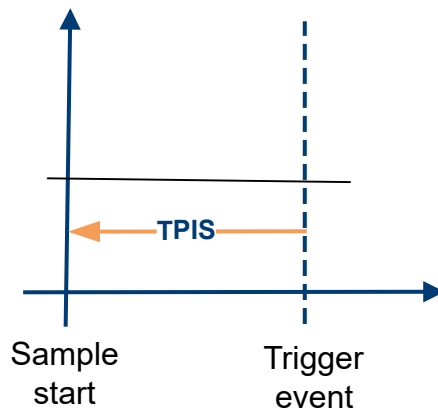

This value can only be determined in triggered measurements using external or IFPower triggers, otherwise the value is 0.

Return values:

<TPIS> numeric value
 Default unit: s

Example: TRAC:IQ:TPIS?
Result for a sample rate of 1 MHz: between 0 and 1/1 MHz, i.e. between 0 and 1 μ s (the duration of 1 sample).

Usage: Query only

TRACe:IQ:WBAND[:STATe] <State>

Determines whether the wideband provided by bandwidth extension options is used or not (if installed).

Parameters:

<State> ON | OFF | 0 | 1
OFF | 0
Switches the function off
ON | 1
Switches the function on

Manual operation: See "[Maximum Bandwidth](#)" on page 49

TRACe:IQ:WBAND:MBWidth <Limit>

Defines the maximum analysis bandwidth. Any value can be specified; the next higher fixed bandwidth is used.

Parameters:

<Limit> **80 MHz**
Restricts the analysis bandwidth to a maximum of 80 MHz. The bandwidth extension option R&S FSWP-B320 is deactivated.
`TRACe:IQ:WBAND[:STATe]` is set to OFF.
160 MHz
Restricts the analysis bandwidth to a maximum of 160 MHz. The bandwidth extension option R&S FSWP-B320 is deactivated.
`TRACe:IQ:WBAND[:STATe]` is set to ON.
160 MHz | MAX
The bandwidth extension option is activated. The currently available maximum bandwidth is allowed.
`TRACe:IQ:WBAND[:STATe]` is set to ON.
*RST: maximum available
Default unit: Hz

Example: TRAC:IQ:WBAN:MBW 82 MHZ
TRAC:IQ:WBAN:MBW?
160000000

Manual operation: See "[Maximum Bandwidth](#)" on page 49

9.4.4 Adjusting settings automatically

The following remote commands are required to adjust settings automatically in a remote environment. These commands are only available for the MSRA primary channel. The tasks for manual operation are described in [Section 6.9, "Automatic settings"](#), on page 55.



Settings related to data acquisition (measurement time, hysteresis) can only be adjusted in the MSRA primary application, not in the secondary applications.

[SENSe:]ADJust:ALL.....	117
[SENSe:]ADJust:CONFigure:LEVel:DURation.....	117
[SENSe:]ADJust:CONFigure:LEVel:DURation:MODE.....	118
[SENSe:]ADJust:FREQuency.....	118
[SENSe:]ADJust:CONFigure:HYSTeresis:LOWer.....	118
[SENSe:]ADJust:CONFigure:HYSTeresis:UPPer.....	119
[SENSe:]ADJust:LEVel.....	119

[SENSe:]ADJust:ALL

Initiates a measurement to determine and set the ideal settings for the current task automatically (only once for the current measurement).

This includes:

- Reference level

Example: ADJ:ALL

Manual operation: See "[Adjusting all Determinable Settings Automatically \(Auto All\)](#)" on page 56

[SENSe:]ADJust:CONFigure:LEVel:DURation <Duration>

To determine the ideal reference level, the R&S FSWP performs a measurement on the current input data. This command defines the length of the measurement if [SENSe:]ADJust:CONFigure:LEVel:DURation:MODE is set to MANual.

Parameters:

<Duration> Numeric value in seconds
 Range: 0.001 to 16000.0
 *RST: 0.001
 Default unit: s

Example: ADJ:CONF:DUR:MODE MAN
 Selects manual definition of the measurement length.
 ADJ:CONF:LEV:DUR 5ms
 Length of the measurement is 5 ms.

Manual operation: See "[\(Meas Time Manual\)](#)" on page 57

[SENSe:]ADJJust:CONFigure:LEVel:DURation:MODE <Mode>

To determine the ideal reference level, the R&S FSWP performs a measurement on the current input data. This command selects the way the R&S FSWP determines the length of the measurement .

Parameters:

<Mode>

AUTO

The R&S FSWP determines the measurement length automatically according to the current input data.

MANual

The R&S FSWP uses the measurement length defined by [\[SENSe:\]ADJJust:CONFigure:LEVel:DURation](#) on page 117.

*RST: AUTO

Manual operation: See "[Resetting the Automatic Measurement Time \(Meas Time Auto\)](#)" on page 56

See "[\(Meas Time Manual\)](#)" on page 57

[SENSe:]ADJJust:FREQuency

Sets the center frequency to the frequency with the highest signal level in the current frequency range.

Example: ADJ:FREQ

Manual operation: See "[Adjusting the Center Frequency Automatically \(Auto Frequency\)](#)" on page 56

[SENSe:]ADJJust:CONFigure:HYSTeresis:LOWer <Threshold>

When the reference level is adjusted automatically using the [\[SENSe:\]ADJJust:LEVel](#) on page 119 command, the internal attenuators and the preamplifier are also adjusted. To avoid frequent adaptation due to small changes in the input signal, you can define a hysteresis. This setting defines a lower threshold the signal must fall below (compared to the last measurement) before the reference level is adapted automatically.

This setting can only be adjusted in the MSRA primary application, not in the secondary applications.

Parameters:

<Threshold>

Range: 0 dB to 200 dB

*RST: +1 dB

Default unit: dB

Example: SENS:ADJ:CONF:HYST:LOW 2

For an input signal level of currently 20 dBm, the reference level is only adjusted when the signal level falls below 18 dBm.

Manual operation: See "[Lower Level Hysteresis](#)" on page 57

[SENSe:]ADJ:CONF:HYSteresis:UPPer <Threshold>

When the reference level is adjusted automatically using the [\[SENSe:\]ADJ:LEVEL](#) on page 119 command, the internal attenuators and the preamplifier are also adjusted. To avoid frequent adaptation due to small changes in the input signal, you can define a hysteresis. This setting defines an upper threshold the signal must exceed (compared to the last measurement) before the reference level is adapted automatically.

This setting can only be adjusted in the MSRA primary application, not in the secondary applications.

Parameters:

<Threshold> Range: 0 dB to 200 dB
 *RST: +1 dB
 Default unit: dB

Example: SENS:ADJ:CONF:HYS:UPP 2

Example: For an input signal level of currently 20 dBm, the reference level is only adjusted when the signal level rises above 22 dBm.

Manual operation: See "[Upper Level Hysteresis](#)" on page 57

[SENSe:]ADJ:LEVel

Initiates a single (internal) measurement that evaluates and sets the ideal reference level for the current input data and measurement settings. Thus, the settings of the RF attenuation and the reference level are optimized for the signal level. The R&S FSWP is not overloaded and the dynamic range is not limited by an S/N ratio that is too small.

Example: ADJ:LEV

Manual operation: See "[Setting the Reference Level Automatically \(Auto Level\)](#)" on page 56

9.5 Capturing data and performing sweeps

The only true measurement in MSRA mode in which I/Q data from the input signal is captured and stored is performed by the MSRA primary application. This data acquisition is performed as in the I/Q Analyzer application, i.e. a specified frequency span of the input signal is swept for a specified measurement time.



As soon as data has been stored to the capture buffer successfully, a status bit (#9) in the `STAT:OPER` register is set (see [Section 9.7.1, "STATus:OPERation register"](#), on page 129). Once the bit has been set, the device under test can already be reconfigured while the R&S FSWP performs analysis on the captured data. For measurements that require long measurement times and comprehensive analysis tasks, using the "capture finished" information can reduce the overall measurement time significantly.

See also:

- [INITiate<n>:REFresh](#) on page 133

ABORt	120
INITiate<n>:CONMeas	121
INITiate<n>:CONTinuous	121
INITiate<n>[:IMMEDIATE]	122
INITiate:SEQuencer:ABORt	122
INITiate:SEQuencer:IMMEDIATE	122
INITiate:SEQuencer:MODE	122
INITiate:SEQuencer:REFresh[:ALL]	123
[SENSe:]SWEep[:WINDow<n>]:POINts	123
[SENSe:]SWEep:TIME	124
SYSTem:SEQuencer	124

ABORt

Aborts the measurement in the current channel and resets the trigger system.

To prevent overlapping execution of the subsequent command before the measurement has been aborted successfully, use the `*OPC?` or `*WAI` command after `ABOR` and before the next command.

For details on overlapping execution see [Remote control via SCPI](#).

To abort a sequence of measurements by the Sequencer, use the `INITiate:SEQuencer:ABORt` command.

Note on blocked remote control programs:

If a sequential command cannot be completed, for example because a triggered sweep never receives a trigger, the remote control program will never finish and the remote channel to the R&S FSWP is blocked for further commands. In this case, you must interrupt processing on the remote channel first in order to abort the measurement.

To do so, send a "Device Clear" command from the control instrument to the R&S FSWP on a parallel channel to clear all currently active remote channels. Depending on the used interface and protocol, send the following commands:

- **Visa:** `viClear()`
- **GPIB:** `ibclr()`
- **RSIB:** `RSDLLibclr()`

Now you can send the `ABORt` command on the remote channel performing the measurement.

Example: `ABOR; :INIT:IMM`
Aborts the current measurement and immediately starts a new one.

Example: `ABOR; *WAI`
`INIT:IMM`
Aborts the current measurement and starts a new one once abortion has been completed.

Usage: Event

INITiate<n>:CONMeas

Restarts a (single) measurement that has been stopped (using `ABORT`) or finished in single measurement mode.

The measurement is restarted at the beginning, not where the previous measurement was stopped.

As opposed to `INITiate<n>[:IMMEDIATE]`, this command does not reset traces in maxhold, minhold or average mode. Therefore it can be used to continue measurements using maxhold or averaging functions.

Suffix:

<n> irrelevant

Usage: Asynchronous command

Manual operation: See "[Continue Single Sweep](#)" on page 54

INITiate<n>:CONTinuous <State>

Controls the measurement mode for an individual channel.

Note that in single measurement mode, you can synchronize to the end of the measurement with `*OPC`, `*OPC?` or `*WAI`. In continuous measurement mode, synchronization to the end of the measurement is not possible. Thus, it is not recommended that you use continuous measurement mode in remote control, as results like trace data or markers are only valid after a single measurement end synchronization.

For details on synchronization see [Remote control via SCPI](#).

If the measurement mode is changed for a channel while the Sequencer is active, the mode is only considered the next time the measurement in that channel is activated by the Sequencer.

Suffix:

<n> irrelevant

Parameters:

<State> ON | OFF | 0 | 1

ON | 1

Continuous measurement

OFF | 0

Single measurement

*RST: 1 (some applications can differ)

Example:

`INIT:CONT OFF`

Switches the measurement mode to single measurement.

`INIT:CONT ON`

Switches the measurement mode to continuous measurement.

Manual operation: See "[Continuous Sweep/RUN CONT](#)" on page 53

INITiate<n>[:IMMEDIATE]

Starts a (single) new measurement.

You can synchronize to the end of the measurement with *OPC, *OPC? or *WAI.

For details on synchronization see [Remote control via SCPI](#).

Suffix:

<n> irrelevant

Usage: Asynchronous command

Manual operation: See "[Single Sweep/ RUN SINGLE](#)" on page 54

INITiate:SEQuencer:ABORt

Stops the currently active sequence of measurements.

You can start a new sequence any time using [INITiate:SEQuencer:IMMEDIATE](#) on page 122.

Usage: Event

Manual operation: See "[Sequencer State](#)" on page 24

INITiate:SEQuencer:IMMEDIATE

Starts a new sequence of measurements by the Sequencer.

Its effect is similar to the [INITiate<n>\[:IMMEDIATE\]](#) command used for a single measurement.

Before this command can be executed, the Sequencer must be activated (see [SYSTem:SEQuencer](#) on page 124).

Example:

```
SYST:SEQ ON
```

Activates the Sequencer.

```
INIT:SEQ:MODE SING
```

Sets single sequence mode so each active measurement is performed once.

```
INIT:SEQ:IMM
```

Starts the sequential measurements.

Manual operation: See "[Sequencer State](#)" on page 24

INITiate:SEQuencer:MODE <Mode>

Defines the capture mode for the entire measurement sequence and all measurement groups and channels it contains.

Note: To synchronize to the end of a measurement sequence using *OPE, *OPE? or *WAI, use SINGLe Sequencer mode.

Parameters:

<Mode>

SINGLe

Each measurement group is started one after the other in the order of definition. All measurement channels in a group are started simultaneously and performed once. After *all* measurements are completed, the next group is started. After the last group, the measurement sequence is finished.

CONTInuous

Each measurement group is started one after the other in the order of definition. All measurement channels in a group are started simultaneously and performed once. After *all* measurements are completed, the next group is started. After the last group, the measurement sequence restarts with the first one and continues until it is stopped explicitly.

*RST: CONTInuous

Manual operation: See "[Sequencer Mode](#)" on page 24

INITiate:SEQuencer:REFResh[:ALL]

Is only available if the Sequencer is deactivated (`SYSTem:SEQuencer` `SYST:SEQ:OFF`) and only in MSRA mode.

The data in the capture buffer is re-evaluated by all active MSRA secondary applications.

Example:

`SYST:SEQ:OFF`

Deactivates the scheduler

`INIT:CONT OFF`

Switches to single sweep mode.

`INIT;*WAI`

Starts a new data measurement and waits for the end of the sweep.

`INIT:SEQ:REFR`

Refreshes the display for all channels.

Manual operation: See "[Refresh All](#)" on page 25

[SENSe:]SWEep[:WINDow<n>]:POINts <SweepPoints>

This command defines the number of measurement points to analyze after a measurement.

Suffix:

<n>

Example:

`SWE:POIN 251`

Manual operation: See "[Sweep Points](#)" on page 53

[SENSe:]SWEep:TIME <Time>

Defines the measurement time. It automatically decouples the time from any other settings.

Parameters:

<Time> refer to specifications document
 *RST: depends on current settings (determined automatically)
 Default unit: S

Manual operation: See "[Meas Time](#)" on page 49

SYSTem:SEQuencer <State>

Turns the Sequencer on and off. The Sequencer must be active before any other Sequencer commands (`INIT:SEQ...`) are executed, otherwise an error occurs.

A detailed programming example is provided in the "Operating Modes" section in the R&S FSWP User Manual.

Parameters:

<State> ON | OFF | 0 | 1
ON | 1
 The Sequencer is activated and a sequential measurement is started immediately.
OFF | 0
 The Sequencer is deactivated. Any running sequential measurements are stopped. Further Sequencer commands (`INIT:SEQ...`) are not available.
 *RST: 0

Example:

```
SYST:SEQ ON
Activates the Sequencer.
INIT:SEQ:MODE SING
Sets single Sequencer mode so each active measurement is
performed once.
INIT:SEQ:IMM
Starts the sequential measurements.
SYST:SEQ OFF
```

Manual operation: See "[Sequencer State](#)" on page 24

9.6 Retrieving results

The measurement results are output in the form of a list, three different formats can be selected for this list (see [TRACe:IQ:DATA:FORMat](#) on page 126).

For details on formats refer to [Section A, "Reference: format description for I/Q data files"](#), on page 135.



The applications can only receive data that is available in the capture buffer. As soon as data has been stored to the capture buffer successfully, a status bit (#9) in the `STAT:OPER` register is set (see [Section 9.7.1, "STATus:OPERation register"](#), on page 129).

<code>FORMat[:DATA]</code>	125
<code>TRACe:IQ:DATA?</code>	126
<code>TRACe:IQ:DATA:FORMat</code>	126
<code>TRACe:IQ:DATA:MEMory?</code>	127

FORMat[:DATA] <Format>[, <BitLength>]

Selects the data format that is used for transmission of trace data from the R&S FSWP to the controlling computer.

Note that the command has no effect for data that you send to the R&S FSWP. The R&S FSWP automatically recognizes the data it receives, regardless of the format.

Parameters:

<Format>

ASCIi

ASCIi format, separated by commas.

This format is almost always suitable, regardless of the actual data format. However, the data is not as compact as other formats can be.

REAL

Floating-point numbers (according to IEEE 754) in the "definite length block format".

The format setting `REAL` is used for the binary transmission of trace data.

<BitLength>

Length in bits for floating-point results

16

16-bit floating-point numbers.

Compared to `REAL, 32` format, half as many numbers are returned.

32

32-bit floating-point numbers

For I/Q data, 8 bytes per sample are returned for this format setting.

64

64-bit floating-point numbers

Compared to `REAL, 32` format, twice as many numbers are returned.

Example:

`FORM REAL, 32`

TRACe:IQ:DATA?

Initiates a measurement with the current settings and returns the captured data from I/Q measurements.

Corresponds to:

```
INIT:IMM;*WAI;:TRACe:IQ:DATA:MEMory?
```

However, the TRACe:IQ:DATA? command is quicker in comparison.

Return values:

<Results> Measured voltage for I and Q component for each sample that has been captured during the measurement.
Default unit: V

Example:

```
TRAC:IQ:STAT ON
Enables acquisition of I/Q data
TRAC:IQ:SET NORM,10MHz,32MHz,EXT,POS,0,4096
Measurement configuration:
Sample Rate = 32 MHz
Trigger Source = External
Trigger Slope = Positive
Pretrigger Samples = 0
Number of Samples = 4096
FORMat REAL,32
Selects format of response data
TRAC:IQ:DATA?
Starts measurement and reads results
```

Usage: Query only

TRACe:IQ:DATA:FORMat <Format>

Selects the order of the I/Q data.

For details see [Section A, "Reference: format description for I/Q data files"](#), on page 135.

Parameters:

<Format> COMPatible | IQBLock | IQPair

COMPatible

I and Q values are separated and collected in blocks: A block (512k) of I values is followed by a block (512k) of Q values, followed by a block of I values, followed by a block of Q values etc.
(I,I,I,I,Q,Q,Q,Q,I,I,I,I,Q,Q,Q,Q...)

IQBLock

First all I-values are listed, then the Q-values
(I,I,I,I,I,I,...Q,Q,Q,Q,Q,Q)

IQPair

One pair of I/Q values after the other is listed
(I,Q,I,Q,I,Q...).

*RST: IQBL

TRACe:IQ:DATA:MEMory? [<OffsetSamples>,<NoOfSamples>]

Queries the I/Q data currently stored in the capture buffer of the R&S FSWP.

By default, the command returns all I/Q data in the memory. You can, however, narrow down the amount of data that the command returns using the optional parameters.

If no parameters are specified with the command, the entire trace data is retrieved.

In this case, the command returns the same results as [TRACe:IQ:DATA?](#). (Note, however, that the [TRACe:IQ:DATA?](#) command initiates a new measurement before returning the captured values, rather than returning the existing data in the memory.)

The command returns a comma-separated list of the measured values in floating point format (comma-separated values = CSV). The number of values returned is 2 * the number of complex samples.

The total number of complex samples is displayed in the channel bar in manual operation and can be calculated as:

$\text{<SampleRate> * <CaptureTime>}$

Query parameters:

- <OffsetSamples>** Selects an offset at which the output of data should start in relation to the first data. If omitted, all captured samples are output, starting with the first sample.
- Range: 0 to <# of samples> – 1, with <# of samples> being the maximum number of captured values
- *RST: 0
- <NoOfSamples>** Number of samples you want to query, beginning at the offset you have defined. If omitted, all captured samples (starting at offset) are output.
- Range: 1 to <# of samples> - <offset samples> with <# of samples> maximum number of captured values
- *RST: <# of samples>

Return values:

- <IQData>** Measured value pair (I,Q) for each sample that has been recorded.
- By default, the first half of the list contains the I values, the second half the Q values. The order can be configured using [TRACe:IQ:DATA:FORMat](#).
- The data format of the individual values depends on [FORMat \[: DATA \]](#) on page 125.
- Default unit: V

Example:

```
TRAC:IQ:STAT ON
```

Enables acquisition of I/Q data

```
TRAC:IQ:SET NORM,10MHz,32MHz,EXT,POS,100,4096
```

Measurement configuration:

Sample Rate = 32 MHz

Trigger Source = External

Trigger Slope = Positive

Pretrigger Samples = 100

Number of Samples = 4096

```
INIT;*WAI
```

Starts measurement and wait for sync

```
FORMat REAL,32
```

Determines output format

To read the results:

```
TRAC:IQ:DATA:MEM?
```

Reads all 4096 I/Q data

```
TRAC:IQ:DATA:MEM? 0,2048
```

Reads 2048 I/Q data starting at the beginning of data acquisition

```
TRAC:IQ:DATA:MEM? 2048,1024
```

Reads 1024 I/Q data from half of the recorded data

```
TRAC:IQ:DATA:MEM? 100,512
```

Reads 512 I/Q data starting at the trigger point (<Pretrigger Samples> was 100)

Example:

```
// Perform a single I/Q capture.
```

```
INIT;*WAI
```

```
// Determine output format (binary float32)
```

```
FORMat REAL,32
```

```
// Read 1024 I/Q samples starting at sample 2048.
```

```
TRAC:IQ:DATA:MEM? 2048,1024
```

Usage:

Query only

9.7 Querying the status registers

The R&S FSWP-I/Q Analyzer uses the standard status registers of the R&S FSWP.

The MSRA operating mode uses an additional bit in the `STATus:OPERation` register.

This register and the commands required to query its contents are described here.

For details on the common R&S FSWP status registers refer to the description of remote control basics in the R&S FSWP User Manual.



*RST does not influence the status registers.

- [STATus:OPERation register](#)..... 129
- [Commands to query the STATus:OPERation register](#)..... 129

9.7.1 STATUS:OPERation register

The `STATUS:OPERation` register contains information on current activities of the R&S FSWP. It also contains information on activities that have been executed since the last read out.

You can read out the register with `STATUS:OPERation:CONDition?` on page 130 or `STATUS:OPERation[:EVENT]?` on page 130.

Table 9-4: Meaning of the bits used in the STATUS:OPERation register

Bit No.	Meaning
0	<code>CALibrating</code> This bit is set as long as the instrument is performing a calibration.
1-2	Not used
3	<code>SWEeping</code> Sweep is being performed in base unit (applications are not considered); identical to bit 4 Available in the optional Spectrum application.
4	<code>MEASuring</code> Measurement is being performed in base unit (applications are not considered); identical to bit 3 Available in the optional Spectrum application.
5	<code>Waiting for TRigger</code> Instrument is ready to trigger and waiting for trigger signal. Available in the optional Spectrum application.
6-7	Not used
8	<code>HardCOpy in progress</code> This bit is set while the instrument is printing a hardcopy.
9	Not used
10	<code>Range completed</code> This bit is set when a range in the sweep list has been completed if "Stop after Range" has been activated. Available in the optional Spectrum application.
11-14	Not used
15	This bit is always 0.

9.7.2 Commands to query the STATUS:OPERation register

The following commands are required to query the contents of the `STATUS:OPERation` register.

<code>STATUS:OPERation:CONDition?</code>	130
<code>STATUS:OPERation:ENABLE</code>	130
<code>STATUS:OPERation:NTRansition</code>	130
<code>STATUS:OPERation:PTRansition</code>	130
<code>STATUS:OPERation[:EVENT]?</code>	130

STATus:OPERation:CONDition? <ChannelName>

This comand reads out the CONDition section of the status register.

The command does not delete the contents of the EVENT section.

Query parameters:

<ChannelName> String containing the name of the channel.
The parameter is optional. If you omit it, the command works for the currently active channel.

Usage: Query only

STATus:OPERation:ENABLE <SumBit>,<ChannelName>**Parameters:**

<SumBit>

Query parameters:

<ChannelName> String containing the name of the channel.
The parameter is optional. If you omit it, the command works for the currently active channel.

STATus:OPERation:NTRansition <SumBit>,<ChannelName>**Parameters:**

<SumBit>

Query parameters:

<ChannelName> String containing the name of the channel.
The parameter is optional. If you omit it, the command works for the currently active channel.

STATus:OPERation:PTRansition <SumBit>,<ChannelName>**Parameters:**

<SumBit>

Query parameters:

<ChannelName> String containing the name of the channel.
The parameter is optional. If you omit it, the command works for the currently active channel.

STATus:OPERation[:EVENT]? <ChannelName>

Queries the contents of the EVENT section of the status register.

A query deletes the contents of the EVENT section.

Query parameters:

<ChannelName> String containing the name of the channel.
The parameter is optional. If you omit it, the command works for the currently active channel.

Return values:

<RegisterContents> Range: 0 to 32767

Usage: Query only

9.8 Analyzing MSRA measurements

The data that was captured by the MSRA primary application can be analyzed in various different applications.

The analysis settings and functions available in MSRA mode are those described for the individual applications. The MSRA primary application is in effect an I/Q Analyzer application and has the same analysis functions and settings.

See the R&S FSWP I/Q Analyzer User Manual for a description of the analysis functions and settings available for the I/Q Analyzer and thus the MSRA primary application.



The commands required to configure the MSRA-specific analysis line are described in [Section 9.9, "Commands specific to MSRA secondary applications"](#), on page 131.

9.9 Commands specific to MSRA secondary applications

Most commands for the MSRA secondary applications are identical to those described for the individual secondary applications. However, some specific commands are available for the MSRA secondary applications only.

Configuring the analysis interval

The commands required to configure the secondary application data extracts and analysis intervals vary depending on the secondary application. See the corresponding application manuals for details.

For the I/Q Analyzer, the commands are the same as those used to define the actual data acquisition (see [Section 9.4.3, "Configuring data acquisition"](#), on page 111). In MSRA secondary application channels, these commands define the analysis interval. Be sure to select the correct measurement channel before executing these commands.

Useful commands for configuring the analysis interval described elsewhere:

- [TRACe:IQ:SRATe](#) on page 115
- [TRACe:IQ:BWIDth](#) on page 114
- [TRACe:IQ:RLENgth](#) on page 114

- [\[SENSe:\]SWEep:TIME](#) on page 124

Remote commands exclusive to MSRA secondary applications

The following commands are only available for MSRA secondary application channels:

CALCulate<n>:IQ:MODE	132
CALCulate<n>:MSRA:ALINe:SHOW	132
CALCulate<n>:MSRA:ALINe[:VALue]	133
CALCulate<n>:MSRA:WINDow<n>:IVAL	133
INITiate<n>:REFResh	133
[SENSe:]MSRA:CAPTure:OFFSet	134

CALCulate<n>:IQ:MODE <EvalMode>

This command defines whether the captured I/Q data is evaluated directly, or if it is converted (via FFT) to spectral or time data first.

It is currently only available for I/Q Analyzer secondary applications in multistandard mode (not the MSRA primary application).

Suffix:

<n> irrelevant

Parameters:

<EvalMode>

TDOMain
Evaluation in time domain (zero span).

FDOMain
Evaluation in frequency domain.

IQ
Evaluation using I/Q data.

CALCulate<n>:MSRA:ALINe:SHOW

Defines whether or not the analysis line is displayed in all time-based windows in all MSRA secondary applications and the MSRA primary application.

Note: even if the analysis line display is off, the indication whether or not the currently defined line position lies within the analysis interval of the active secondary application remains in the window title bars.

Suffix:

<n> irrelevant

Parameters:

<State>

ON | OFF | 0 | 1

OFF | 0
Switches the function off

ON | 1
Switches the function on

Manual operation: See ["Show Line"](#) on page 59

CALCulate<n>:MSRA:ALINe[:VALue] <Position>

Defines the position of the analysis line for all time-based windows in all MSRA secondary applications and the MSRA primary application.

Suffix:

<n> irrelevant

Parameters:

<Position> Position of the analysis line in seconds. The position must lie within the measurement time of the MSRA measurement.
Default unit: s

Manual operation: See "[Position](#)" on page 59

CALCulate<n>:MSRA:WINDow<n>:IVAL

Returns the current analysis interval for applications in MSRA operating mode.

Suffix:

<n> irrelevant

<n> 1..n
[Window](#)

Return values:

<IntStart> Analysis start = Capture offset time
Default unit: s

<IntStop> Analysis end = capture offset + capture time
Default unit: s

INITiate<n>:REFResh

Updates the current measurement results to reflect the current measurement settings.

No new I/Q data is captured. Thus, measurement settings apply to the I/Q data currently in the capture buffer.

The command applies exclusively to I/Q measurements. It requires I/Q data.

Suffix:

<n> irrelevant

Example:

INIT:REFR
Updates the IQ measurement results.

Usage:

Asynchronous command

Manual operation: See "[Refresh \(MSRA only\)](#)" on page 53

[SENSe:]MSRA:CAPTure:OFFSet <Offset>

This setting is only available for secondary applications in MSRA mode, not for the MSRA primary application. It has a similar effect as the trigger offset in other measurements.

Parameters:

<Offset>

This parameter defines the time offset between the capture buffer start and the start of the extracted secondary application data. The offset must be a positive value, as the secondary application can only analyze data that is contained in the capture buffer.

Range: 0 to <Record length>

*RST: 0

Default unit: S

Manual operation: See "[Capture Offset](#)" on page 52

Annex

A Reference: format description for I/Q data files

This section describes how I/Q data is transferred to the memory during remote control (see `TRACe: IQ: DATA: FORMat` command).

For details on the format of the individual values, see [Section B, "Formats for returned values: ASCII format and binary format"](#), on page 137.

For details on the format of I/Q export files (using the "I/Q Export" function), see the R&S FSWP User Manual.

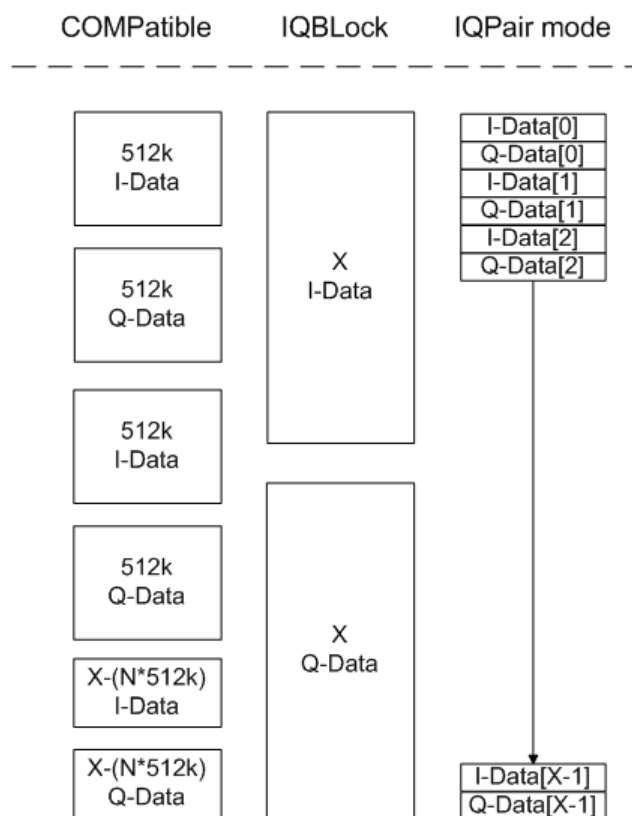

Figure A-1: I/Q data formats

Note: 512k corresponds to 524288 samples

For maximum performance, the formats "Compatible" or "IQPair" should be used. Furthermore, for large amounts of data, the data should be in binary format to improve performance.

In binary format, the number of I- and Q-data can be calculated as follows:

$$\# \text{ of } I\text{-Data} = \# \text{ of } Q\text{-Data} = \frac{\# \text{ of } DataBytes}{8}$$

For the format "QBlock", the offset of Q-data in the output buffer can be calculated as follows:

$$Q\text{-Data-Offset} = \frac{(\# \text{ of } DataBytes)}{2} + LengthIndicatorDigits$$

with "LengthIndicatorDigits" being the number of digits of the length indicator including the #. In the example above (#41024...), this results in a value of 6 for "LengthIndicatorDigits" and the offset for the Q-data results in $512 + 6 = 518$.

B Formats for returned values: ASCII format and binary format

When trace data is retrieved using the `TRAC:DATA` or `TRAC:IQ:DATA` command, the data is returned in the format defined using the `FORMat[:DATA]` on page 125. The possible formats are described here.

- **ASCII Format (FORMat ASCII):**
The data is stored as a list of comma-separated values (CSV) of the measured values in floating point format.
- **Binary Format (FORMat REAL,16/32/64):**
The data is stored as binary data (definite length block data according to IEEE 488.2), each measurement value being formatted in 16-bit/32-bit/64-bit IEEE 754 floating-point-format.
The schema of the result string is as follows:
`#<Length of length><Length of data><value1><value2>...<value n>`
with:

<Length of length>	Number of digits of the following number of data bytes
<Length of data>	Number of following data bytes
<Value>	2-byte/4-byte/8-byte floating point value

Example: `#41024<Data>...` contains 1024 data bytes

Data blocks larger than 999,999,999 bytes

According to SCPI, the header of the block data format allows for a maximum of 9 characters to describe the data length. Thus, the maximum REAL 32 data that can be represented is 999,999,999 bytes. However, the R&S FSWP is able to send larger data blocks. In this case, the length of the data block is placed in brackets, e.g.
`#(1234567890)<value1><value2>...`



Reading out data in binary format is quicker than in ASCII format. Thus, binary format is recommended for large amounts of data.

C Sample rate and maximum usable I/Q bandwidth for RF input

Definitions

- **Input sample rate (ISR):** the sample rate of the useful data provided by the device connected to the input of the R&S FSWP
- (User, Output) **Sample rate (SR):** the user-defined sample rate (e.g. in the "Data Acquisition" dialog box in the "I/Q Analyzer" application) which is used as the basis for analysis or output
- **Usable I/Q (Analysis) bandwidth:** the bandwidth range in which the signal remains undistorted in regard to amplitude characteristic and group delay; this range can be used for accurate analysis by the R&S FSWP
- **Record length:** Number of I/Q samples to capture during the specified measurement time; calculated as the measurement time multiplied by the sample rate

For the I/Q data acquisition, digital decimation filters are used internally in the R&S FSWP. The passband of these digital filters determines the *maximum usable I/Q bandwidth*. In consequence, signals within the usable I/Q bandwidth (passband) remain unchanged, while signals outside the usable I/Q bandwidth (passband) are suppressed. Usually, the suppressed signals are noise, artifacts, and the second IF side band. If frequencies of interest to you are also suppressed, try to increase the output sample rate, which increases the maximum usable I/Q bandwidth.



Bandwidth extension options

You can extend the maximum usable I/Q bandwidth provided by the R&S FSWP in the basic installation by adding options. The maximum bandwidth provided by the individual option is indicated by its number, for example, B40 extends the bandwidth to 40 MHz.

As a rule, the usable I/Q bandwidth is proportional to the output sample rate. Yet, when the I/Q bandwidth reaches the bandwidth of the analog IF filter (at very high output sample rates), the curve breaks.

- [Bandwidth extension options](#)..... 139
- [Relationship between sample rate, record length and usable I/Q bandwidth](#)..... 139
- [R&S FSWP without additional bandwidth extension options](#)..... 139
- [R&S FSWP with I/Q bandwidth extension option B80](#)..... 139
- [R&S FSWP with activated I/Q bandwidth extension option B320](#)..... 140

C.1 Bandwidth extension options

Max. usable I/Q BW	Required B-option
80 MHz	B80
320 MHz	B320

C.2 Relationship between sample rate, record length and usable I/Q bandwidth

Up to the maximum bandwidth, the following rule applies:

$$\text{Usable I/Q bandwidth} = 0.8 * \text{Output sample rate}$$

Regarding the record length, the following rule applies:

$$\text{Record length} = \text{Measurement time} * \text{sample rate}$$

Maximum record length for RF input

The maximum record length, that is, the maximum number of samples that can be captured, depends on the sample rate.

Table C-1: Maximum record length (without I/Q bandwidth extension options)

Sample rate	Maximum record length
100 Hz to 200 MHz	440 Msamples
200 MHz to 600 MHz	220 Msamples

C.3 R&S FSWP without additional bandwidth extension options

Sample rate: 100 Hz - 600 MHz

Maximum I/Q bandwidth: 10 MHz

Table C-2: Maximum I/Q bandwidth

Sample rate	Maximum I/Q bandwidth
100 Hz to 10 MHz	Proportional up to maximum 10 MHz
10 MHz to 600 MHz	10 MHz

C.4 R&S FSWP with I/Q bandwidth extension option B80

Sample rate: 100 Hz - 600 MHz

Maximum bandwidth: 80 MHz

Sample rate	Maximum I/Q bandwidth
100 Hz to 100 MHz	Proportional up to maximum 80 MHz
100 MHz to 600 MHz	80 MHz

C.5 R&S FSWP with activated I/Q bandwidth extension option B320

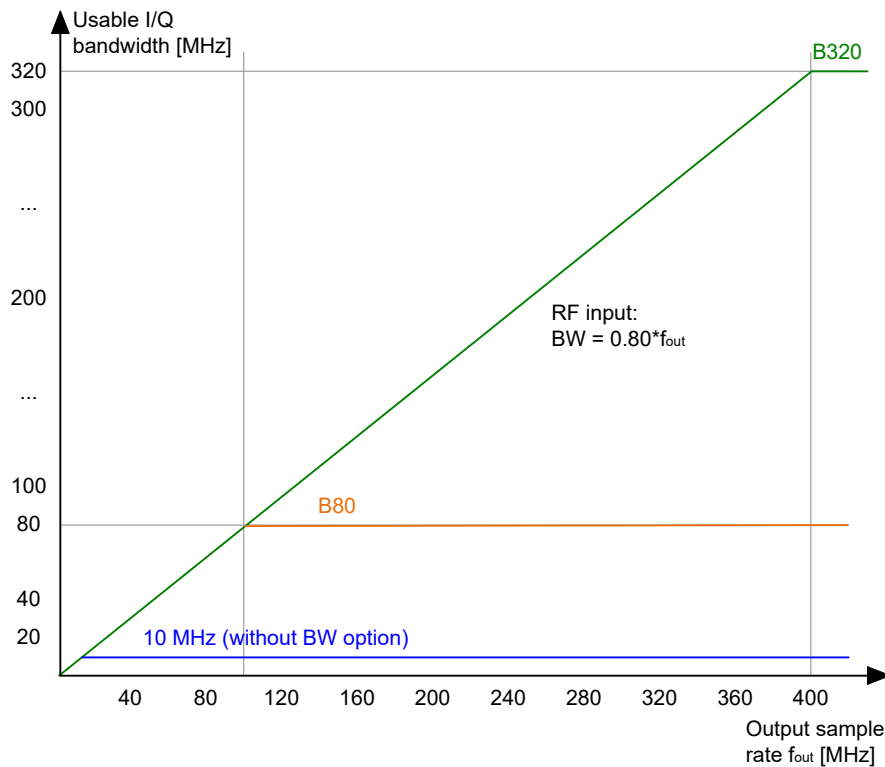

Figure C-1: Relationship between maximum usable I/Q bandwidth and output sample rate with and without bandwidth extensions

Sample rate	Maximum I/Q bandwidth
100 Hz to 400 MHz	Proportional up to maximum 320 MHz
400 MHz to 20 GHz MSRA primary: 400 MHz to 600 MHz	320 MHz

Table C-3: Maximum record length with activated I/Q bandwidth extension option B320

Sample rate	Maximum record length
100 Hz to 200 MHz*)	440 Msamples
200 MHz to 468 MHz	470 Msamples * sample rate / 1GHz
468 MHz to 20 GHz MSRA primary: 468 MHz to 600 MHz	220 Msamples
*) for sample rates up to 200 MHz the I/Q Bandwidth Extension B320 is not used	

List of Remote Commands (MSRA)

[SENSe:]ADJust:ALL.....	117
[SENSe:]ADJust:CONFigure:HYSTeresis:LOWer.....	118
[SENSe:]ADJust:CONFigure:HYSTeresis:UPPer.....	119
[SENSe:]ADJust:CONFigure:LEVel:DURation.....	117
[SENSe:]ADJust:CONFigure:LEVel:DURation:MODE.....	118
[SENSe:]ADJust:FREQuency.....	118
[SENSe:]ADJust:LEVel.....	119
[SENSe:]CORRection:CVL:BAND.....	87
[SENSe:]CORRection:CVL:BIAS.....	87
[SENSe:]CORRection:CVL:CATalog?.....	88
[SENSe:]CORRection:CVL:CLEar.....	88
[SENSe:]CORRection:CVL:COMMeNt.....	88
[SENSe:]CORRection:CVL:DATA.....	88
[SENSe:]CORRection:CVL:HARMonic.....	89
[SENSe:]CORRection:CVL:MIXer.....	89
[SENSe:]CORRection:CVL:PORTs.....	89
[SENSe:]CORRection:CVL:SELEct.....	90
[SENSe:]CORRection:CVL:SNUMber.....	90
[SENSe:]FREQuency:CENTer.....	103
[SENSe:]FREQuency:CENTer:STEP.....	104
[SENSe:]FREQuency:OFFSet.....	104
[SENSe:]IQ:BWIDth:MODE.....	111
[SENSe:]IQ:BWIDth:RESolution.....	112
[SENSe:]IQ:FFT:ALGorithm.....	112
[SENSe:]IQ:FFT:LENGth.....	113
[SENSe:]IQ:FFT:WINDow:LENGth.....	113
[SENSe:]IQ:FFT:WINDow:OVERlap.....	113
[SENSe:]IQ:FFT:WINDow:TYPE.....	114
[SENSe:]MIXer<x>:BIAS:HIGH.....	80
[SENSe:]MIXer<x>:BIAS[:LOW].....	80
[SENSe:]MIXer<x>:FREQuency:HANDover.....	81
[SENSe:]MIXer<x>:FREQuency:STARt.....	82
[SENSe:]MIXer<x>:FREQuency:STOP.....	82
[SENSe:]MIXer<x>:HARMonic:BAND.....	82
[SENSe:]MIXer<x>:HARMonic:BAND:PRESet.....	82
[SENSe:]MIXer<x>:HARMonic:HIGH:STATE.....	83
[SENSe:]MIXer<x>:HARMonic:HIGH[:VALue].....	83
[SENSe:]MIXer<x>:HARMonic:TYPE.....	84
[SENSe:]MIXer<x>:HARMonic[:LOW].....	84
[SENSe:]MIXer<x>:IF?.....	84
[SENSe:]MIXer<x>:LOPower.....	81
[SENSe:]MIXer<x>:LOSS:HIGH.....	85
[SENSe:]MIXer<x>:LOSS:TABLE:HIGH.....	85
[SENSe:]MIXer<x>:LOSS:TABLE[:LOW].....	85
[SENSe:]MIXer<x>:LOSS[:LOW].....	86
[SENSe:]MIXer<x>:PORTs.....	86
[SENSe:]MIXer<x>:RFOVerrange[:STATE].....	86

[SENSe:]MIXer<x>[:STATe].....	80
[SENSe:]MSRA:CAPTure:OFFSet.....	134
[SENSe:]PROBe<pb>:ID:PARTnumber?.....	93
[SENSe:]PROBe<pb>:ID:SRNumber?.....	93
[SENSe:]PROBe<pb>:SETup:ATTRatio.....	93
[SENSe:]PROBe<pb>:SETup:CMOFFset.....	94
[SENSe:]PROBe<pb>:SETup:DMOFFset.....	94
[SENSe:]PROBe<pb>:SETup:MODE.....	95
[SENSe:]PROBe<pb>:SETup:NAME?.....	95
[SENSe:]PROBe<pb>:SETup:NMOFFset.....	95
[SENSe:]PROBe<pb>:SETup:PMODE.....	96
[SENSe:]PROBe<pb>:SETup:PMOFFset.....	96
[SENSe:]PROBe<pb>:SETup:STATe?.....	97
[SENSe:]PROBe<pb>:SETup:TYPE?.....	97
[SENSe:]SWEep:TIME.....	124
[SENSe:]SWEep[:WINDow<n>]:POINts.....	123
ABORT.....	120
CALCulate<n>:IQ:MODE.....	132
CALCulate<n>:MARKer<m>:FUNCTion:REFerence.....	98
CALCulate<n>:MSRA:ALINe:SHOW.....	132
CALCulate<n>:MSRA:ALINe[:VALue].....	133
CALCulate<n>:MSRA:WINDow<n>:IVAL.....	133
DIAGnostic:SERVice:NSource.....	105
DISPlay[:WINDow<n>][:SUBWIndow<w>]:TRACe<t>:Y:SPACing.....	103
DISPlay[:WINDow<n>][:SUBWIndow<w>]:TRACe<t>:Y[:SCALE].....	101
DISPlay[:WINDow<n>][:SUBWIndow<w>]:TRACe<t>:Y[:SCALE]:AUTO ONCE.....	101
DISPlay[:WINDow<n>][:SUBWIndow<w>]:TRACe<t>:Y[:SCALE]:MODE.....	101
DISPlay[:WINDow<n>][:SUBWIndow<w>]:TRACe<t>:Y[:SCALE]:PDIVision.....	102
DISPlay[:WINDow<n>][:SUBWIndow<w>]:TRACe<t>:Y[:SCALE]:RLEVel.....	98
DISPlay[:WINDow<n>][:SUBWIndow<w>]:TRACe<t>:Y[:SCALE]:RLEVel:OFFSet.....	98
DISPlay[:WINDow<n>][:SUBWIndow<w>]:TRACe<t>:Y[:SCALE]:RPOsition.....	102
FORMat[:DATA].....	125
INITiate:SEQuencer:ABORT.....	122
INITiate:SEQuencer:IMMEdiate.....	122
INITiate:SEQuencer:MODE.....	122
INITiate:SEQuencer:REFResh[:ALL].....	123
INITiate<n>:CONMeas.....	121
INITiate<n>:CONTInuous.....	121
INITiate<n>:REFResh.....	133
INITiate<n>[:IMMEdiate].....	122
INPut:ATTenuation.....	99
INPut:ATTenuation:AUTO.....	99
INPut:ATTenuation:PROTection:RESet.....	75
INPut:CONNector.....	75
INPut:COUPLing.....	75
INPut:DPATH.....	76
INPut:EATT:AUTO.....	99
INPut:FILE:PATH.....	78
INPut:FILTer:HPASs[:STATe].....	76
INPut:FILTer:YIG[:STATe].....	76

INPut:GAIN:STATe.....	100
INPut:GAIN[:VALue].....	100
INPut:IMPedance.....	77
INPut:IMPedance:PTYPe.....	77
INPut:SElect.....	77
INPut:TYPE.....	78
INSTRument:CREate:DUPLicate.....	70
INSTRument:CREate:REPLace.....	70
INSTRument:CREate[:NEW].....	70
INSTRument:DELeTe.....	71
INSTRument:LIST?.....	71
INSTRument:MODE.....	72
INSTRument:REName.....	73
INSTRument[:SElect].....	73
OUTPut:TRIGger<tp>:DIRection.....	109
OUTPut:TRIGger<tp>:LEVel.....	109
OUTPut:TRIGger<tp>:OTYPe.....	110
OUTPut:TRIGger<tp>:PULSe:IMMEDIATE.....	110
OUTPut:TRIGger<tp>:PULSe:LENGth.....	111
STATus:OPERation:CONDition?.....	130
STATus:OPERation:ENABLe.....	130
STATus:OPERation:NTRansition.....	130
STATus:OPERation:PTRansition.....	130
STATus:OPERation[:EVENT]?.....	130
SYSTem:PRESet:CHANnel[:EXEC].....	74
SYSTem:PRESet:COMPATible.....	73
SYSTem:SEQuencer.....	124
TRACe:IQ:BWIDth.....	114
TRACe:IQ:DATA:FORMat.....	126
TRACe:IQ:DATA:MEMory?.....	127
TRACe:IQ:DATA?.....	126
TRACe:IQ:FILE:REPetition:COUNT.....	79
TRACe:IQ:RLENGth.....	114
TRACe:IQ:SRATe.....	115
TRACe:IQ:TPIsample?.....	115
TRACe:IQ:WBAND:MBWIDth.....	116
TRACe:IQ:WBAND[:STATe].....	116
TRIGger[:SEQuence]:DTIME.....	106
TRIGger[:SEQuence]:HOLDoff[:TIME].....	106
TRIGger[:SEQuence]:IFPower:HOLDoff.....	106
TRIGger[:SEQuence]:IFPower:HYSteresis.....	106
TRIGger[:SEQuence]:LEVel:IFPower.....	107
TRIGger[:SEQuence]:LEVel:RFPower.....	107
TRIGger[:SEQuence]:LEVel[:EXTernal<port>].....	107
TRIGger[:SEQuence]:SLOPe.....	108
TRIGger[:SEQuence]:SOURce.....	108

Index

Symbols

*OPC 105

A

Aborting
Sweep 53, 54
AC/DC coupling 36
Activating
MSRA (remote) 69
AM/FM/PM Modulation Analysis
MSRA secondary application 22
Amplitude
Scaling 40
Settings 39
Analysis
Bandwidth 49
Bandwidth, definition 138
Settings 58
Analysis interval 28
Configuration 58
Configuration (remote) 131
I/Q Analyzer 48, 58
Start 29
Analysis line 29
Configuration 58
Application cards 9
Application notes 9
Applications
see MSRA secondary applications 20
AQT
Displayed 16
Attenuation
Displayed 15
Protective (remote) 75
Auto all 56
Auto frequency 56
Auto level
Hysteresis 57
Reference level 56
Softkey 56
Auto settings
Meastime Auto 56
Meastime Manual 57
MSRA primary 55
Remote 117

B

Band
External Mixer (remote) 82
Bandwidth
Analysis 49
Extension options 49, 138, 139
Maximum usable 49, 138
Relationship to sample rate 139
Settings 47
Bias
External Mixer (remote) 80
Brochures 9

C

Capture buffer 28
Capture finished
Status bit 128
Capture offset 29
MSRA secondary applications 52
Remote 134
Softkey 52
Capture time
see also Measurement time 124
Center frequency 41
Automatic configuration 56
Softkey 41
Step size 41
Channel
Creating (remote) 70, 72, 73
Deleting (remote) 71
Duplicating (remote) 70
Querying (remote) 71
Renaming (remote) 73
Replacing (remote) 70
Selecting (remote) 72, 73
Channel-defined Sequencer
Softkey 24
Channels
New 23
Operating modes 20
Replacing 23
Closing
Channels (remote) 71
Configuration
MSRA mode 32
Continue single sweep
Softkey 54
Continuous Sequencer
Softkey 24
Continuous sweep
Softkey 53
Conventions
SCPI commands 64
Conversion loss
External Mixer (remote) 85, 86
Conversion loss tables
Available (remote) 88
Band (remote) 87
Bias (remote) 87
Deleting (remote) 88
External Mixer (remote) 85
Harmonic order (remote) 89
Mixer type (remote) 89
Selecting (remote) 90
Copying
Channel (remote) 70

D

Data acquisition 18
Analysis interval 48
Basics 27
Performing (remote) 119
Procedure 60
Settings 47

- Settings (remote) 111
 - Softkey 47
 - Status bit 128
 - Data format
 - ASCII 137
 - Binary 137
 - Data sheets 9
 - Diagram area
 - Displayed 15
 - Diagram footer information 14
 - Direct path
 - Input configuration 37
 - Display configuration
 - Softkey 55
 - Display elements
 - MSRA 12
 - Drop-out time
 - Trigger 45
 - Duplicating
 - Channel (remote) 70
- E**
- Exporting
 - I/Q data 32, 58
 - External Mixer
 - Activating (remote) 80
 - Band 82
 - Programming example 90
 - RF overrange 86
 - Type 86
 - External trigger 43
 - Level (remote) 107
- F**
- FFT
 - Window functions 51
 - Files
 - I/Q data input 38
 - Filters
 - Bandwidth, I/Q data 49
 - High-pass (RF input) 37
 - YIG (remote) 76
 - Format
 - Data 137
 - I/Q data files 135
 - Free Run
 - Trigger 43
 - Frequency
 - Configuration 40
 - Configuration (remote) 103
 - Offset 41
 - Frontend settings
 - Remote 74
- G**
- Getting started 8
- H**
- Handover frequency
 - External Mixer (remote) 81
 - Hardware settings
 - Display 15
 - Displayed 15
 - Harmonics
 - External Mixer (remote) 84
 - High-pass filter
 - RF input 37
 - Hysteresis
 - Lower (Auto level) 57
 - Trigger 45
 - Upper (Auto level) 57
- I**
- I/Q Analyzer
 - Analysis interval 58
 - MSRA primary 18
 - MSRA primary application 131
 - MSRA secondary application 22
 - I/Q data
 - Analyzing 61
 - Availability 27
 - Capturing 60
 - Exporting 32, 58
 - File format description 135
 - Importing 32
 - Input file 38
 - Input files 38
 - Maximum bandwidth 138
 - Measurements in time and frequency domain 30
 - Sample rate 138
 - Trigger point in sample (TPIS) 115
 - I/Q Power
 - Trigger 44
 - I/Q Vector
 - Y-axis scaling 40
 - IF Power
 - Trigger 43
 - Trigger level (remote) 107
 - IF WIDE OUTPUT
 - Connector 49
 - Impedance
 - Setting 36
 - Importing
 - I/Q data 32
 - Input
 - Coupling 36
 - I/Q data files 38
 - Overload (remote) 75
 - RF 36
 - Settings 35
 - Source Configuration (softkey) 35
 - Source, Radio frequency (RF) 35
 - Input sample rate (ISR)
 - Definition 138
 - Input settings
 - Remote 74
 - Input sources
 - I/Q data file 38
 - I/Q data files 38
 - Instrument security procedures 8
 - IQBlock
 - I/Q data files 135
 - IQPair
 - I/Q data files 135

K

Keys	
LINES (not used)	32
RUN CONT	53
RUN SINGLE	54

L

LO feedthrough	37
Lower Level Hysteresis	57

M

Measurement time	
Auto settings	56, 57
I/Q data	49
Remote	124
Measurements	
Activating (remote)	69
Analyzing	131
Configuring (remote)	74
Correlating	20
Result displays	18
Modes	
see Operating mode	20
MSRA primary	
Analyzing	58
Configuring	32
Data acquisition	47
Data acquisition (basics)	27
Data acquisition (remote)	111
Display elements	15
Parameters	26
Results display	18
Tab	15
Trigger offset	45
Trigger settings	42
MSRA primary application	
Capturing data	60
Selecting (remote)	69
MSRA secondary applications	
AM/FM/PM Modulation Analysis	22
Analysis interval (remote)	131
Analyzing I/Q data	61
Available	21
Capture offset	52
Capture offset (remote)	134
Display elements	16
I/Q Analyzer	22
Parameters	26
Pulse	22
Restrictions	30
Selecting	22
Specific commands (remote)	131
Vector signal analysis (VSA)	22
MSRA View	61
Display elements	14
Tab	14
Multi-standard	
Analysis	61

N

Noise	
Source	55

O

Offset	
Analysis interval	52
Frequency	41
Reference level, displayed	15
Operating mode	20
Changing	21
MSRA (remote)	69
Selecting	22
Starting	11
Options	
Bandwidth extension	49, 138, 139
High-pass filter	37
Output	
Configuration	54
Configuration (remote)	104
Noise source	55
Sample rate, definition	138
Settings	54
Settings (remote)	74
Trigger	46
Overload	
RF input (remote)	75
Overview	
Configuration	33

P

Parameters	
Conflicting	26
MSRA primary	26
MSRA secondary applications	26
Passing between applications	21
Performing	
MSRA measurement	60
Ports	
External Mixer (remote)	86
Pre-trigger	45
Preset	
Bands (External Mixer, remote)	82
Presetting	
Channels	34
Programming examples	
External Mixer	90
Protection	
RF input (remote)	75
Pulse	
MSRA secondary application	22

R

Range	39
RBW	
Displayed	16
Ready for trigger	
Status register	129
Record length	
Definition	138
Displayed	16
I/Q data	50
Relationship to sample rate	139
Reference level	
Auto level	56
Displayed	15
Position	39

- Refreshing 25
 - All secondary applications (softkey) 25
 - MSRA secondary applications 53
 - Result display 27
 - Softkey 53
- Release notes 9
- Remote commands
 - Basics on syntax 63
 - Boolean values 67
 - Capitalization 65
 - Character data 68
 - Data blocks 68
 - Numeric values 66
 - Optional keywords 65
 - Parameters 66
 - Strings 68
 - Suffixes 65
- Resetting
 - RF input protection 75
- Restoring
 - Channel settings 34
- Restrictions
 - MSRA secondary applications 30
- Results
 - Analyzing 58
 - Display, MSRA primary 18
 - Retrieving (remote) 124
 - Updating the display 53
- RF input 35
 - Overload protection (remote) 75
 - Remote 75
- RF overrange
 - External Mixer 86
- RF Power
 - Trigger 44
 - Trigger level (remote) 107
- RUN CONT
 - Key 53
- RUN SINGLE
 - Key 54
- S**
- Safety instructions 9
- Sample rate
 - Definition 138
 - Displayed 16
 - I/Q data 48
 - Maximum 138
 - Relationship to bandwidth 139
 - Remote 115
- Scaling
 - Configuration 39
 - Y-axis 40
 - Y-axis (remote control) 103
- Secondary application data 28
 - Availability 27
 - Configuration (remote) 131
 - Coverage 14, 16
 - Results 16
 - Settings 26
 - Start 29
- Secondarysecondary application data
 - Restrictions 30
- Security procedures 8
- Sequencer
 - Activating (remote) 122
 - Continuous sweep 24
 - Mode 24
 - MSRA mode 11, 23
 - Remote 121
 - Result display 24
 - Softkey 24
 - State 24
- Sequences
 - Aborting (remote) 122
 - Mode (remote) 122
- Service manual 8
- Signal capturing
 - Duration (remote) 124
- Single Sequencer
 - Softkey 24
- Single sweep
 - Softkey 54
- Slope
 - Trigger 45, 108
- Softkeys
 - Auto All 56
 - Auto Level 56
 - Capture Offset 52
 - Center 41
 - Channel-defined Sequencer 24
 - Continue Single Sweep 54
 - Continuous Sequencer 24
 - Continuous Sweep 53
 - Data Acquisition 47
 - Display Config 55
 - External 43
 - Free Run 43
 - IF Power 43
 - Input Source Config 35
 - Lower Level Hysteresis 57
 - Meastime Auto 56
 - Meastime Manual 57
 - Refresh 53
 - Refresh All 25
 - RF Power 44
 - Sequencer 24
 - Single Sequencer 24
 - Single Sweep 54
 - Trigger Config 42
 - Trigger Offset 45
 - Upper Level Hysteresis 57
- Specifics for
 - Configuration 35
- SRate
 - see Sample rate 16
- Status
 - Capture finished 128
- Status bar 14
- Status registers
 - Querying (remote) 128
 - STAT:QUES:POW 75
 - STATus:OPERation 128, 129
 - STATUS:OPERation 27
- Suffixes
 - Common 68
 - Remote commands 65
- Sweep
 - Aborting 53, 54
 - MSRA 27
 - Performing (remote) 119

Points (I/Q Analyzer)	53
Settings	52
Time (remote)	124
Sweep status	
Status register	129

T

Tabs	
Channels	20
MSRA primary	15
MSRA View	14
TPIS	
I/Q data	115
Traces	
Retrieving data (remote)	124
Trigger	
Configuration (softkey)	42
Drop-out time	45
External (remote)	108
Holdoff	45
Hysteresis	45
Offset	29
Offset (softkey)	45
Output	46
Remote control	105
Slope	45, 108
Source	43
Status register	129
Trigger level	44
External trigger (remote)	107
IF Power (remote)	107
RF Power (remote)	107
Trigger source	43
External	43
Free Run	43
I/Q Power	44
IF Power	43
RF Power	44
Troubleshooting	
Input overload	75

U

Updating	
Result display	53
Upper Level Hysteresis	57
Usable I/Q bandwidth	
Definition	138
User sample rate	
Definition	138

V

Videos	9
VSA (vector signal analysis)	
MSRA secondary application	22

W

Waiting for trigger	
Status register	129
White papers	9
Window title bar information	13
Windows	
Configuring	35

Y

Y-axis	
Scaling	40
Scaling (I/Q Vector)	40
Settings	39
YIG-preselector	
Activating/Deactivating	37
Activating/Deactivating (remote)	76