

R&S®FSWP-K7

Analog Modulation Analysis

User Manual

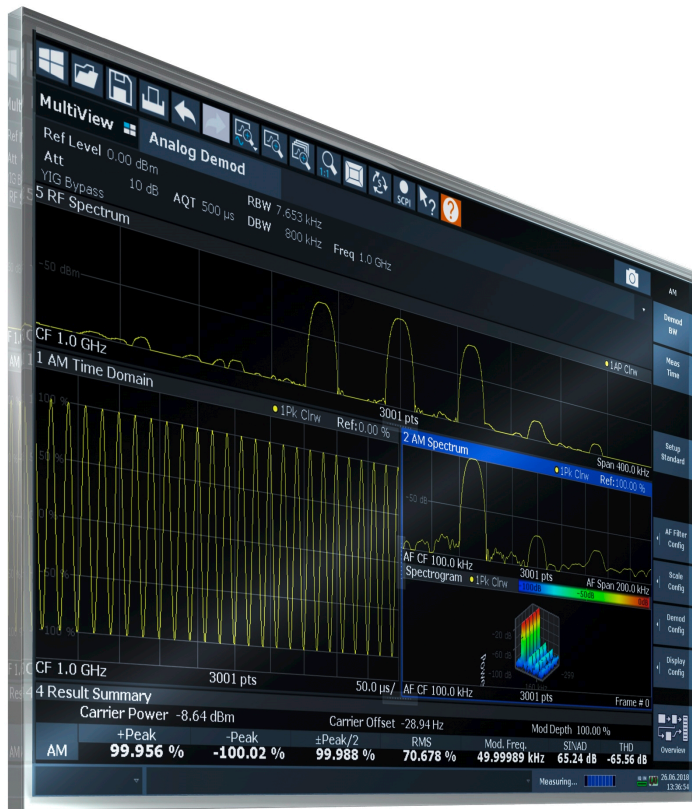

1177569102
Version 11



This manual describes the following R&S®FSWP models with firmware version 4.10 or higher:

- R&S®FSWP8 (1322.8003K08)
- R&S®FSWP8 (1322.8003K09)
- R&S®FSWP26 (1322.8003K26)
- R&S®FSWP26 (1322.8003K27)
- R&S®FSWP50 (1322.8003K50)
- R&S®FSWP50 (1322.8003K51)

The following firmware options are described:

- R&S FSWP-K7 (1325.4238.02) (requires R&S FSWP-B1)

© 2025 Rohde & Schwarz

Muehldorfstr. 15, 81671 Muenchen, Germany

Phone: +49 89 41 29 - 0

Email: info@rohde-schwarz.com

Internet: www.rohde-schwarz.com

Subject to change – data without tolerance limits is not binding.

R&S® is a registered trademark of Rohde & Schwarz GmbH & Co. KG.

Trade names are trademarks of the owners.

1177.5691.02 | Version 11 | R&S®FSWP-K7

Throughout this manual, products from Rohde & Schwarz are indicated without the ® symbol , e.g. R&S®FSWP is indicated as R&S FSWP.

Contents

1	Preface	9
1.1	About this manual.....	9
1.2	Documentation overview.....	10
1.2.1	Getting started manual.....	10
1.2.2	User manuals and help.....	10
1.2.3	Service manual.....	10
1.2.4	Instrument security procedures.....	10
1.2.5	Printed safety instructions.....	11
1.2.6	Specifications and brochures.....	11
1.2.7	Release notes and open source acknowledgment (OSA).....	11
1.2.8	Application notes, application cards, white papers, etc.....	11
1.2.9	Videos.....	11
1.3	Conventions used in the documentation.....	11
1.3.1	Typographical conventions.....	11
1.3.2	Conventions for procedure descriptions.....	12
1.3.3	Notes on screenshots.....	12
2	Welcome to the R&S FSWP Analog Modulation Analysis applica- tion	13
2.1	Starting analog modulation analysis.....	13
2.2	Understanding the display information.....	14
3	Measurements and result displays	18
4	Measurement basics	30
4.1	Demodulation process.....	30
4.2	Demodulation bandwidth.....	32
4.3	Sample rate and demodulation bandwidth.....	33
4.4	AF triggers.....	34
4.5	AF filters.....	34
4.6	Time domain zoom.....	34
4.7	Analog modulation analysis in MSRA operating mode.....	36
5	Configuration	38

5.1	Configuration according to digital standards.....	38
5.2	Configuration overview.....	40
5.3	Data input and output.....	41
5.3.1	RF input.....	42
5.3.2	Power sensors.....	43
5.3.3	External generators.....	43
5.3.4	Probes.....	44
5.3.5	External mixers.....	44
5.3.6	Configuring additional outputs.....	44
5.3.7	Analog demod output settings.....	46
5.3.8	DC power output.....	48
5.3.9	Signal source output.....	48
5.4	Amplitude.....	48
5.5	Frequency.....	51
5.6	Trigger configuration.....	52
5.6.1	Trigger source settings.....	52
5.6.2	Trigger input and output settings.....	56
5.7	Data acquisition.....	58
5.7.1	Bandwidth settings.....	59
5.7.2	Sweep settings.....	61
5.8	Demodulation.....	63
5.8.1	Basic demodulation measurement parameters (Demod).....	63
5.8.2	Demodulation spectrum.....	67
5.8.2.1	AF evaluation.....	67
5.8.2.2	RF evaluation.....	68
5.8.3	AF filter.....	70
5.8.4	Scaling.....	73
5.8.4.1	AF evaluation.....	73
5.8.4.2	RF evaluation.....	75
5.8.5	Units.....	77
5.8.6	Result table settings.....	78
5.8.7	Settling time.....	81
5.9	Demodulation display.....	83

5.10	Automatic settings.....	83
6	Analysis.....	86
6.1	Trace configuration.....	86
6.2	Marker settings.....	87
6.3	Display lines and limit lines.....	87
7	I/Q data import and export.....	88
8	How to perform measurements in the R&S FSWP Analog Modulation Analysis application.....	89
8.1	How to export trace data and numerical results.....	90
9	Measurement example: demodulating an FM signal.....	91
10	Optimizing and troubleshooting the measurement.....	96
11	Remote commands for analog modulation analysis.....	97
11.1	Introduction.....	97
11.1.1	Conventions used in descriptions.....	97
11.1.2	Long and short form.....	98
11.1.3	Numeric suffixes.....	98
11.1.4	Optional keywords.....	99
11.1.5	Alternative keywords.....	99
11.1.6	SCPI parameters.....	99
11.1.6.1	Numeric values.....	100
11.1.6.2	Boolean.....	101
11.1.6.3	Character data.....	101
11.1.6.4	Character strings.....	101
11.1.6.5	Block data.....	101
11.2	Common suffixes.....	102
11.3	Remote commands to select the application.....	103
11.4	Remote commands to configure analog modulation analysis.....	106
11.4.1	Configuring standards.....	107
11.4.2	Configuring inputs and outputs.....	107
11.4.2.1	Configuring the input.....	108
11.4.2.2	Configuring external generators.....	110
11.4.2.3	Configuring outputs.....	110

11.4.3	Configuring level characteristics.....	114
11.4.4	Defining frequency characteristics.....	117
11.4.5	Configuring trigger.....	119
11.4.6	Settling time.....	126
11.4.7	Defining settings automatically.....	127
11.4.8	Configuring data acquisition.....	130
11.4.9	Configuring demodulation.....	139
11.4.9.1	Basic demodulation settings.....	140
11.4.9.2	Time domain zoom settings.....	141
11.4.9.3	Configuring the demodulation spectrum.....	143
	AF evaluation.....	143
	RF evaluation.....	146
11.4.9.4	(Post-processing) AF filters.....	147
11.4.9.5	Defining the scaling and units.....	153
11.4.9.6	Scaling for AF evaluation.....	153
11.4.9.7	Scaling for RF evaluation.....	153
11.4.9.8	Units.....	155
11.4.9.9	Relative demodulation results.....	155
11.5	Configuring the result display.....	159
11.5.1	General window commands.....	159
11.5.2	Working with windows in the display.....	160
11.6	Working with measurement results.....	167
11.6.1	Retrieving trace results.....	167
11.6.2	Exporting trace results.....	170
11.7	Retrieving result summary values.....	172
11.8	Analyzing results.....	176
11.9	Importing and exporting data.....	180
11.10	Programming example.....	181
	Annex.....	184
	A Reference.....	184
A.1	Predefined standards and settings.....	184
A.2	Formats for returned values: ASCII format and binary format.....	186
A.3	Reference: ASCII file export format.....	187

A.4 I/Q data file format (iq-tar)	187
A.4.1 I/Q parameter XML file specification.....	188
A.4.1.1 Minimum data elements.....	189
A.4.1.2 Example.....	191
A.4.2 I/Q data binary file.....	193
List of commands	196
Index	200

1 Preface

1.1 About this manual

This Analog Modulation Analysis User Manual provides all the information **specific to the application**. All general instrument functions and settings common to all applications and operating modes are described in the main R&S FSWP User Manual.

The main focus in this manual is on the measurement results and the tasks required to obtain them. The following topics are included:

- **Welcome to the Analog Modulation Analysis Application**
Introduction to and getting familiar with the application
- **Measurements and Result Displays**
Details on supported measurements and their result types
- **Measurement Basics**
Background information on basic terms and principles in the context of the measurement
- **Configuration + Analysis**
A concise description of all functions and settings available to configure measurements and analyze results with their corresponding remote control command
- **I/Q Data Import and Export**
Description of general functions to import and export raw I/Q (measurement) data
- **How to Perform Measurements in the Analog Modulation Analysis Application**
The basic procedure to perform each measurement and step-by-step instructions for more complex tasks or alternative methods
- **Measurement Examples**
Detailed measurement examples to guide you through typical measurement scenarios and allow you to try out the application immediately
- **Optimizing and Troubleshooting the Measurement**
Hints and tips on how to handle errors and optimize the measurement configuration
- **Remote Commands for Analog Modulation Analysis Measurements**
Remote commands required to configure and perform Analog Modulation Analysis measurements in a remote environment, sorted by tasks
(Commands required to set up the environment or to perform common tasks on the instrument are provided in the main R&S FSWP User Manual)
Programming examples demonstrate the use of many commands and can usually be executed directly for test purposes
- **List of remote commands**
Alphabetical list of all remote commands described in the manual
- **Index**

1.2 Documentation overview

This section provides an overview of the R&S FSWP user documentation. Unless specified otherwise, you find the documents at:

www.rohde-schwarz.com/manual/FSWP

1.2.1 Getting started manual

Introduces the R&S FSWP and describes how to set up and start working with the product. Includes basic operations, typical measurement examples, and general information, e.g. safety instructions, etc.

A printed version is delivered with the instrument. A PDF version is available for download on the Internet.

1.2.2 User manuals and help

The user manual contains the description of all instrument modes and functions. It also provides an introduction to remote control, a complete description of the remote control commands with programming examples, and information on maintenance, instrument interfaces and error messages. Includes the contents of the getting started manual.

The contents of the user manual are available as help in the R&S FSWP. The help offers quick, context-sensitive access to the complete information for the instrument and its firmware.

The user manual is also available for download or for immediate display on the Internet.

1.2.3 Service manual

Describes the performance test for checking the rated specifications, module replacement and repair, firmware update, troubleshooting and fault elimination, and contains mechanical drawings and spare part lists.

The service manual is available for registered users on the global Rohde & Schwarz information system (GLORIS):

<https://gloris.rohde-schwarz.com>

1.2.4 Instrument security procedures

Deals with security issues when working with the R&S FSWP in secure areas. It is available for download on the internet.

1.2.5 Printed safety instructions

Provides safety information in many languages. The printed document is delivered with the product.

1.2.6 Specifications and brochures

The specifications document, also known as the data sheet, contains the technical specifications of the R&S FSWP. It also lists the firmware applications and their order numbers, and optional accessories.

The brochure provides an overview of the instrument and deals with the specific characteristics.

See www.rohde-schwarz.com/brochure-datasheet/FSWP

1.2.7 Release notes and open source acknowledgment (OSA)

The release notes list new features, improvements and known issues of the current software version, and describe the software installation.

The software uses several valuable open source software packages. An open source acknowledgment document provides verbatim license texts of the used open source software.

See www.rohde-schwarz.com/firmware/FSWP

1.2.8 Application notes, application cards, white papers, etc.

These documents deal with special applications or background information on particular topics.

See www.rohde-schwarz.com/application/FSWP

1.2.9 Videos

Find various videos on Rohde & Schwarz products and test and measurement topics on YouTube: <https://www.youtube.com/@Rohde-Schwarz>

1.3 Conventions used in the documentation

1.3.1 Typographical conventions

The following text markers are used throughout this documentation:

Convention	Description
"Graphical user interface elements"	All names of graphical user interface elements on the screen, such as dialog boxes, menus, options, buttons, and softkeys are enclosed by quotation marks.
[Keys]	Key and knob names are enclosed by square brackets.
Filenames, commands, program code	Filenames, commands, coding samples and screen output are distinguished by their font.
<i>Input</i>	Input to be entered by the user is displayed in italics.
Links	Links that you can click are displayed in blue font.
"References"	References to other parts of the documentation are enclosed by quotation marks.

1.3.2 Conventions for procedure descriptions

When operating the instrument, several alternative methods may be available to perform the same task. In this case, the procedure using the touchscreen is described. Any elements that can be activated by touching can also be clicked using an additionally connected mouse. The alternative procedure using the keys on the instrument or the on-screen keyboard is only described if it deviates from the standard operating procedures.

The term "select" may refer to any of the described methods, i.e. using a finger on the touchscreen, a mouse pointer in the display, or a key on the instrument or on a keyboard.

1.3.3 Notes on screenshots

When describing the functions of the product, we use sample screenshots. These screenshots are meant to illustrate as many as possible of the provided functions and possible interdependencies between parameters. The shown values may not represent realistic usage scenarios.

The screenshots usually show a fully equipped product, that is: with all options installed. Thus, some functions shown in the screenshots may not be available in your particular product configuration.

2 Welcome to the R&S FSWP Analog Modulation Analysis application

The R&S FSWP Analog Modulation Analysis application converts the R&S FSWP into an analog modulation analyzer for amplitude-, frequency- or phase-modulated signals. It measures not only characteristics of the useful modulation, but also factors such as residual FM or synchronous modulation.

The digital signal processing in the R&S FSWP, used in the Spectrum application for digital IF filters, is also ideally suited for demodulating AM, FM, or PM signals.

The R&S FSWP Analog Modulation Analysis application features:

- AM, FM, and PM demodulation, with various result displays:
 - Modulation signal versus time
 - Spectrum of the modulation signal (FFT)
 - RF signal power versus time
 - Spectrum of the RF signal
- Determining maximum, minimum and average or current values in parallel over a selected number of measurements
- Maximum accuracy and temperature stability due to sampling (digitization) already at the IF and digital down-conversion to the baseband (I/Q)
- Error-free AM to FM conversion and vice versa, without deviation errors, frequency response or frequency drift at DC coupling
- Relative demodulation, in relation to a user-defined or measured reference value



Availability of the R&S FSWP Analog Modulation Analysis application

Analog modulation analysis requires the optional spectrum analyzer hardware (R&S FSWP-B1).

This user manual contains a description of the functionality that the application provides, including remote control operation.

All functions not discussed in this manual are the same as in the base unit and are described in the R&S FSWP User Manual. The latest version is available for download at the product homepage <http://www.rohde-schwarz.com/product/fswp>.

Installation

You can find detailed installation instructions in the R&S FSWP Getting Started manual or in the Release Notes.

2.1 Starting analog modulation analysis

analog modulation analysis is a separate application on the R&S FSWP.

To activate analog modulation analysis

1. Select [MODE].

A dialog box opens that contains all operating modes and applications currently available on your R&S FSWP.

2. Select the "AM FM PM Analog Demod" item.



The R&S FSWP opens a new channel for the application for analog modulation analysis.

The measurement is started immediately with the default settings. It can be configured in the analog modulation analysis [Configuration overview](#) dialog box, which is displayed when you select "Overview" from any menu.

Multiple Channels and Sequencer Function

When you activate an application, a new channel is created which determines the measurement settings for that application ("Channel"). The same application can be activated with different measurement settings by creating several "Channel"s for the same application.

The number of channels that can be configured at the same time depends on the available memory on the instrument.

Only one measurement can be performed at any time, namely the one in the currently active channel. However, to perform the configured measurements consecutively, a Sequencer function is provided.

If activated, the measurements configured in the currently defined "Channel"s are performed one after the other in the order of the tabs. The currently active measurement is indicated by a  symbol in the tab label.

The result displays of the individual channels are updated in the tabs (as well as the "MultiView") as the measurements are performed. Sequential operation itself is independent of the currently *displayed* tab.

For details on the Sequencer function, see the R&S FSWP User Manual.

2.2 Understanding the display information

The following figure shows a measurement diagram during analog modulation analysis. All different information areas are labeled. They are explained in more detail in the following sections.



- 1 = Channel bar for firmware and measurement settings
- 2 = Window title bar with diagram-specific (trace) information
- 3 = Diagram area
- 4 = Diagram footer with diagram-specific information, depending on result display
- 5 = Instrument status bar with error messages and date/time display



MSRA operating mode

In MSRA operating mode, additional tabs and elements are available. A colored background of the screen behind the channel tabs indicates that you are in MSRA operating mode.

For details on the MSRA operating mode, see the R&S FSWP MSRA User Manual.

Channel bar information

In the Analog Modulation Analysis application, the R&S FSWP shows the following settings:

Table 2-1: Information displayed in the channel bar in the application for analog modulation analysis

Ref Level	Reference level
m.+el.Att	Mechanical and electronic RF attenuation
Offset	Reference level offset
AQT	Measurement time for data acquisition.
RBW	Resolution bandwidth
DBW	Demodulation bandwidth
Freq	Center frequency for the RF signal

Window title bar information

For each diagram, the header provides the following information:



Figure 2-1: Window title bar information in the application for analog modulation analysis

- 1 = Window number
- 2 = Window type
- 3 = Trace color
- 4 = Trace number
- 5 = Detector
- 6 = Trace mode
- 7 = Reference value (at the defined reference position)
- 8 = AF coupling (AC/DC), only in AF time domains, if applicable
- 9 = Results are selected for demodulation output

Diagram footer information

The diagram footer (beneath the diagram) contains the following information, depending on the evaluation:

"RF Spectrum"		
CF: Center frequency of input signal	Sweep points	Span: measured span

RF Time domain		
CF: Center frequency of input signal	Sweep points	Time per division

AF Spectrum		
AF CF: center frequency of demodulated signal	Sweep points	AF Span: evaluated span

AF Time domain		
CF: Center frequency of input signal	Sweep points	Time per division

For most modes, the number of sweep points shown in the display are indicated in the diagram footer. In zoom mode, the (rounded) number of currently displayed points are indicated.

Status bar information

Global instrument settings, the instrument status and any irregularities are indicated in the status bar beneath the diagram.

Furthermore, the progress of the current operation is displayed in the status bar.

3 Measurements and result displays

Access: "Overview" > "Display Config"

Or: [MEAS] > "Display Config"

The data that was measured by the R&S FSWP can be evaluated using various different methods. In the Analog Modulation Analysis application, up to six evaluation methods can be displayed simultaneously in separate windows. The results can be displayed as absolute deviations or relative to a reference value or level.



The abbreviation "AF" (for Audio Frequency) refers to the demodulated AM, FM or PM signal.

Basis for evaluation

All evaluations are based on the I/Q data set acquired during the measurement. The spectrum of the modulated signal to be evaluated is determined by the demodulation bandwidth. However, it can be restricted to a limited span ("AF Span") if only part of the signal is of interest. Furthermore, the time base for evaluations in the time domain can be restricted to analyze a smaller extract in more detail, see [Section 4.6, "Time domain zoom"](#), on page 34.

AM Time Domain	18
FM Time Domain	19
PM Time Domain	20
AM Spectrum	21
FM Spectrum	22
PM Spectrum	23
RF Time Domain	24
RF Spectrum	25
Result Summary	26
Marker Table	28
Marker Peak List	28

AM Time Domain

Displays the modulation depth of the demodulated AM signal (in %) versus time.

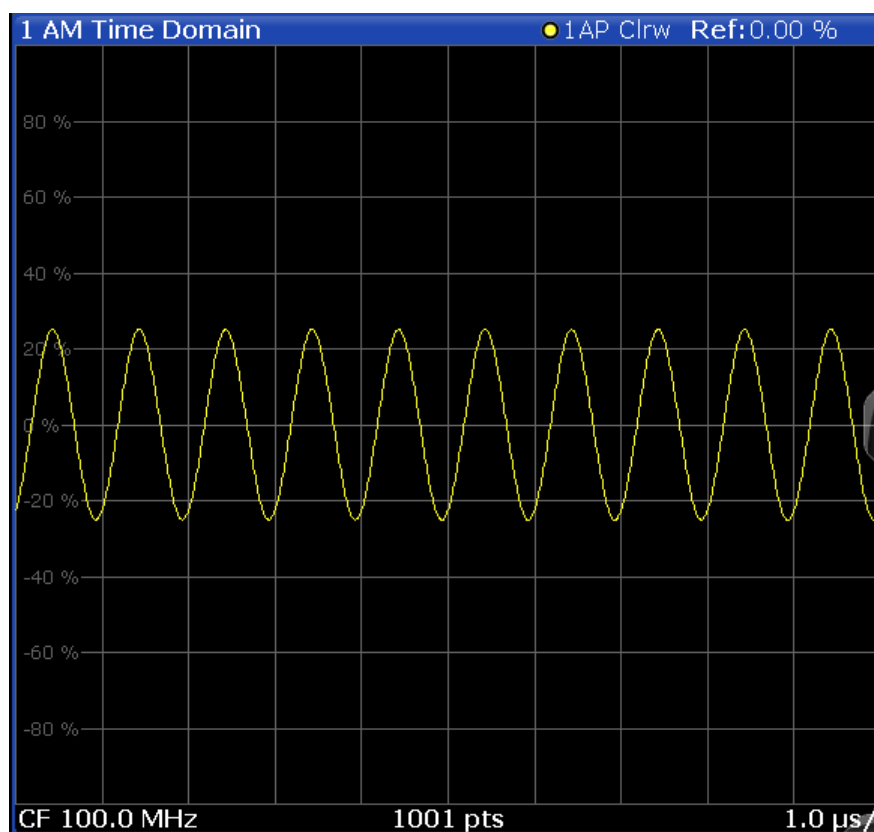

Optionally, the settling time can be evaluated and displayed, see [Section 5.8.7, "Settling time"](#), on page 81.

Remote command:

```
LAY:ADD? '1',RIGHT,'XTIM:AM:REL'
```

(See [LAYout:ADD\[:WINDow\]?](#) on page 160)

FM Time Domain

Displays the frequency spectrum of the demodulated FM signal versus time.

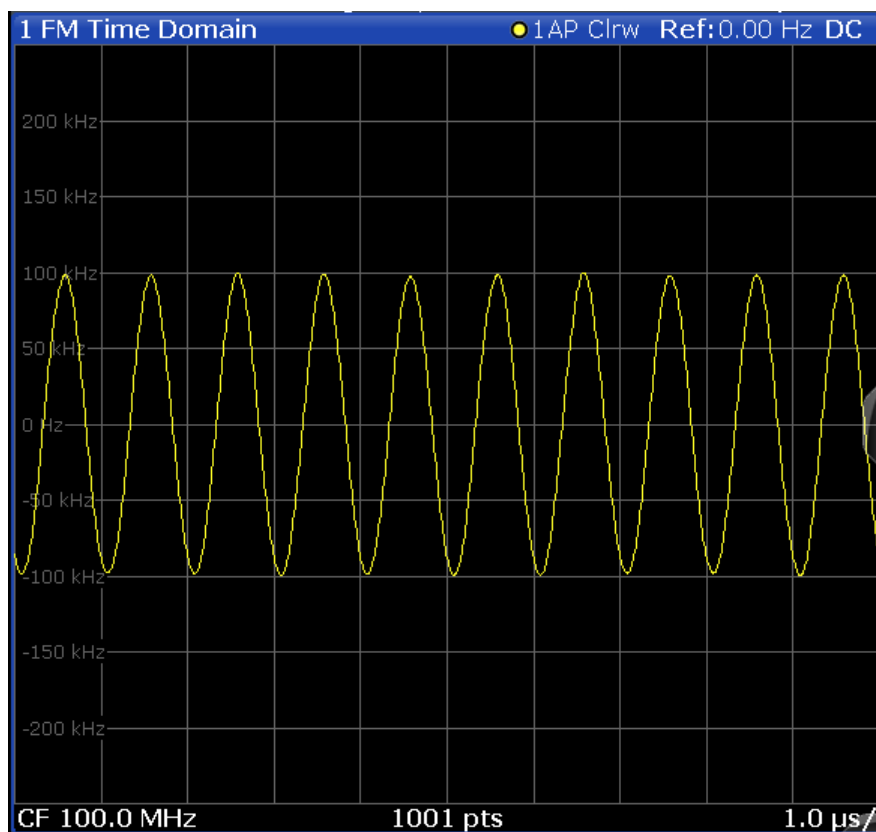

Optionally, the settling time can be evaluated and displayed, see [Section 5.8.7, "Settling time"](#), on page 81.

Remote command:

```
LAY:ADD? '1',RIGH,'XTIM:FM'
```

(See [LAYout:ADD\[:WINDow\]?](#) on page 160)

PM Time Domain

Displays the phase deviations of the demodulated PM signal (in rad or °) versus time.

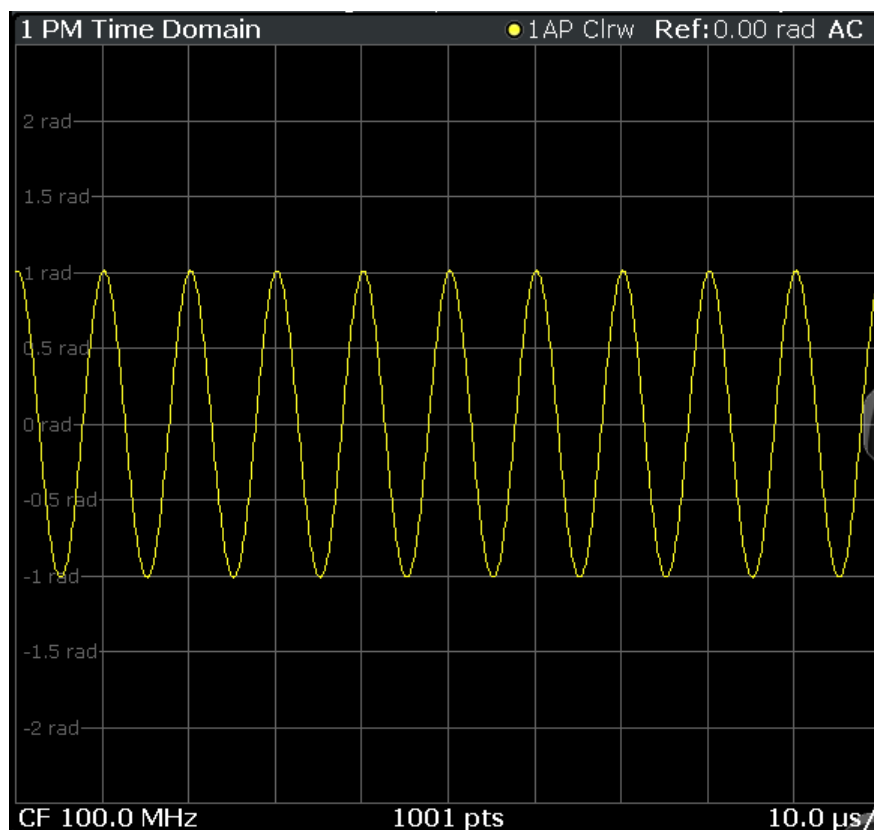

Optionally, the settling time can be evaluated and displayed, see [Section 5.8.7, "Settling time"](#), on page 81.

Remote command:

```
LAY:ADD? '1', RIGH, 'XTIM:PM'
```

(See [LAYout:ADD\[:WINDow\]?](#) on page 160)

AM Spectrum

Displays the modulation depth of the demodulated AM signal (in % or dB) versus AF span. The spectrum is calculated from the demodulated AM signal in the time domain via FFT.

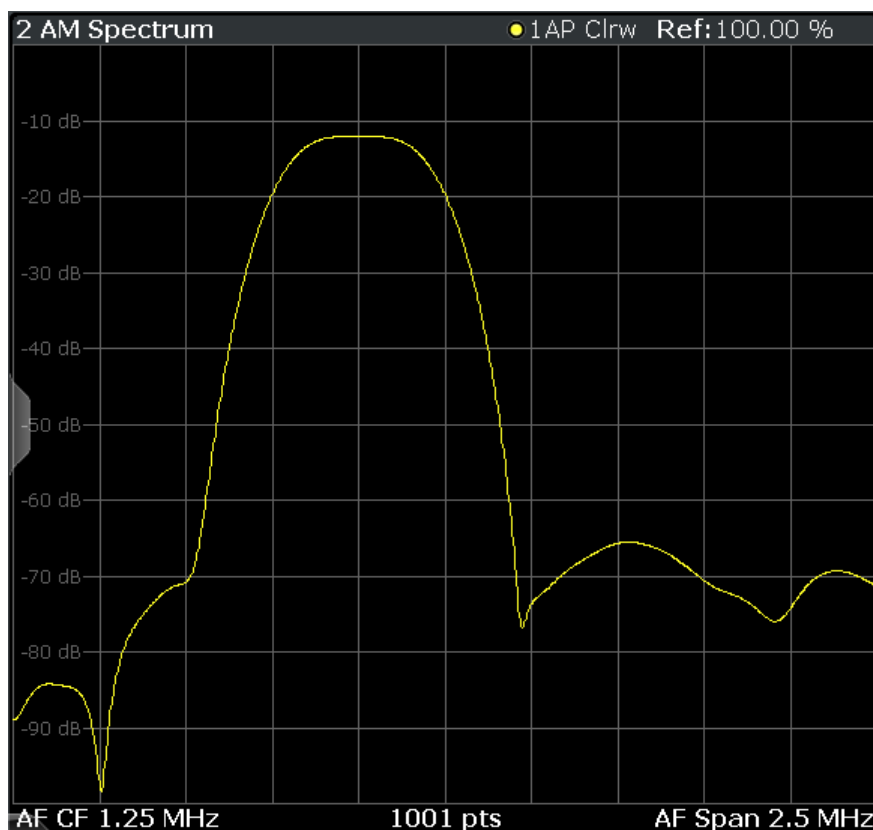

Note: If a high pass or low pass AF filter is defined, the filter is indicated by a vertical red line in the spectrum display.

Remote command:

```
LAY:ADD? '1',RIGH,'XTIME:AM:REL:AFSPpectrum1'
```

(see [LAYout:ADD\[:WINDow\]?](#) on page 160)

FM Spectrum

Displays the frequency deviations of the demodulated FM signal (in Hz or dB) versus AF span. The spectrum is calculated from the demodulated AM signal in the time domain via FFT.

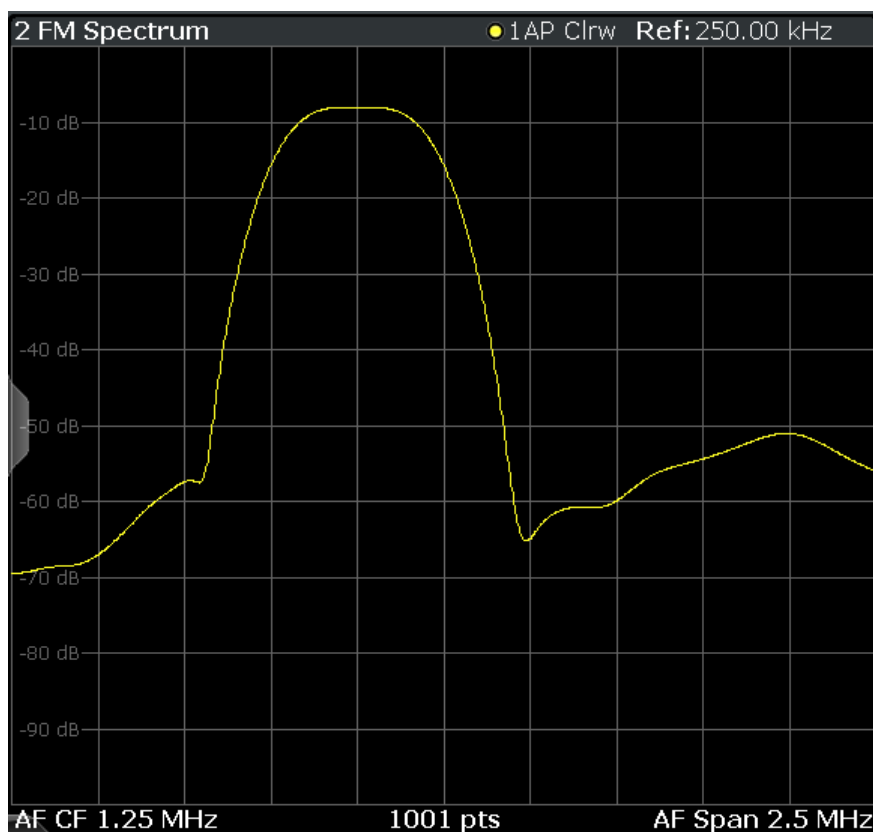

Note: If a high pass or low pass AF filter is defined, the filter is indicated by a vertical red line in the spectrum display.

Remote command:

```
LAY:ADD? '1',RIGH,'XTIME:FM:AFSPpectrum1'
```

(see [LAYout:ADD\[:WINDow\]?](#) on page 160)

PM Spectrum

Displays the phase deviations of the demodulated PM signal (in rad, ° or dB) versus AF span. The spectrum is calculated from the demodulated AM signal in the time domain via FFT.

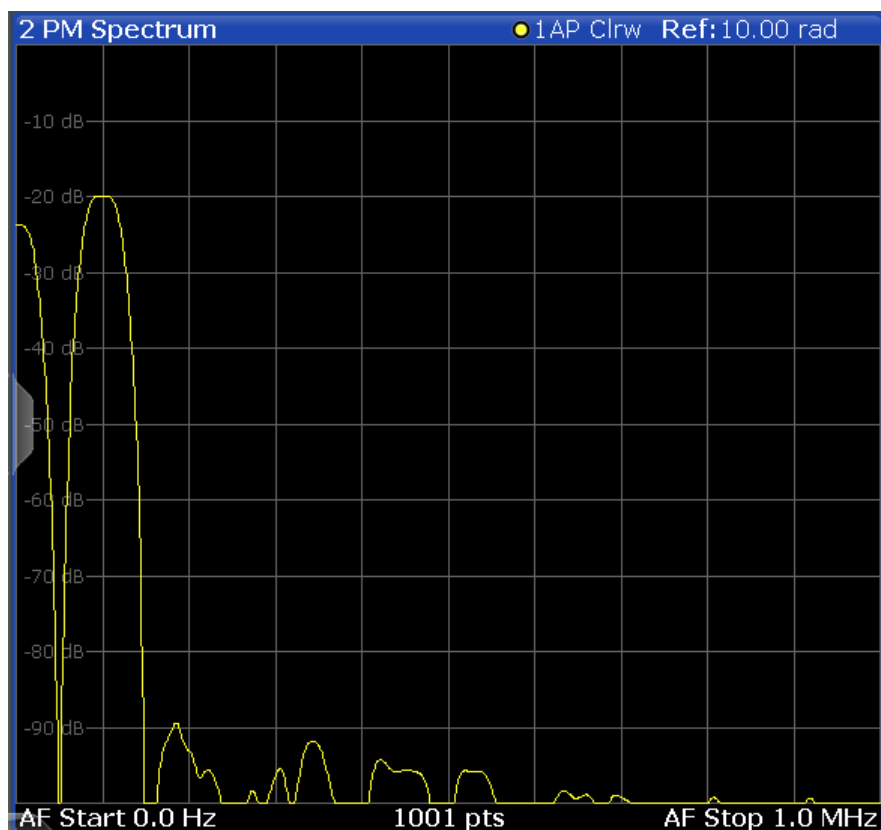

Note: If a high pass or low pass AF filter is defined, the filter is indicated by a vertical red line in the spectrum display.

Remote command:

```
LAY:ADD? '1',RIGH,'XTIME:PM:AFSPpectrum1'
```

(see [LAYout:ADD\[:WINDow\]?](#) on page 160)

RF Time Domain

Displays the RF power of the input signal versus time. The level values represent the magnitude of the I/Q data set.

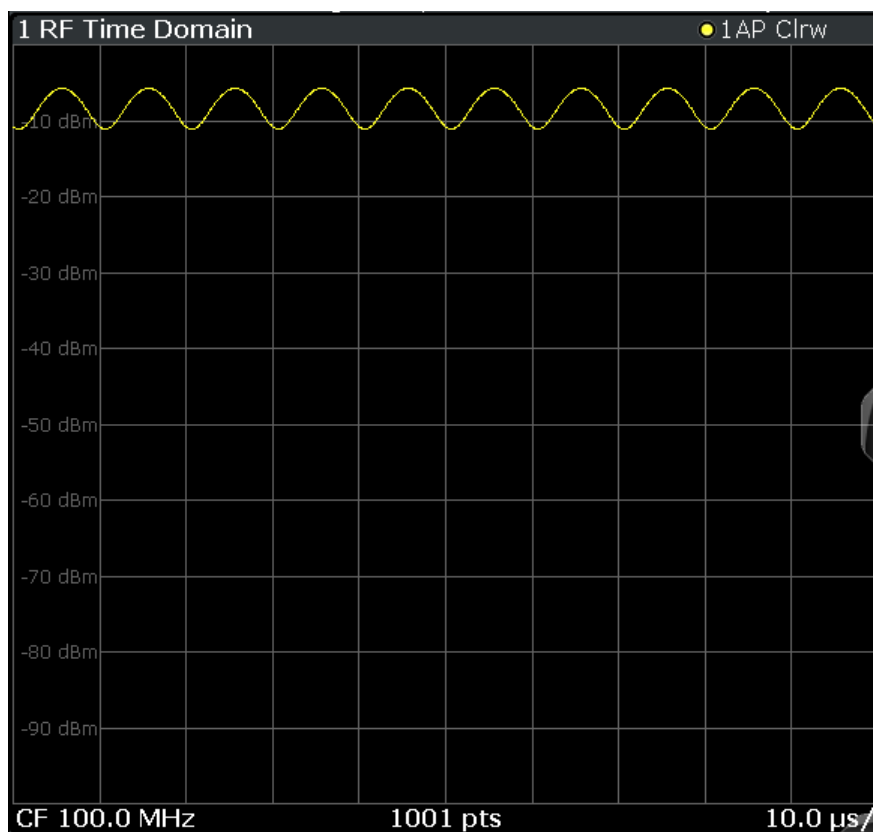

Optionally, the settling time can be evaluated and displayed, see [Section 5.8.7, "Settling time"](#), on page 81.

Remote command:

```
LAY:ADD? '1',RIGH,'XTIM:AM'
```

(see [LAYout:ADD\[:WINDow\]?](#) on page 160)

RF Spectrum

Displays the spectrum of the input signal. In contrast to the Spectrum application, the frequency values are determined using FFT from the recorded I/Q data set.

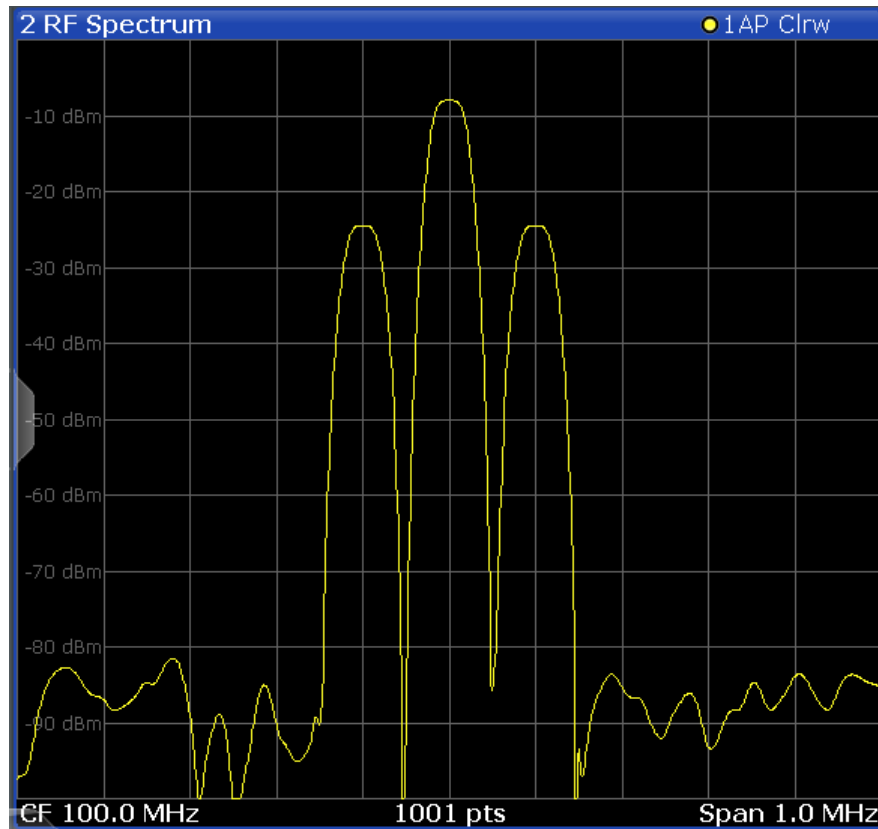

Remote command:

```
LAY:ADD? '1',RIGH,'XTIM:SPECTRUM'
```

(see [LAYout:ADD\[:WINDow\]?](#) on page 160)

Result Summary

The "result summary" displays the results of the demodulation functions for all windows in a table.

4 Result Summary									
	Carrier Power -20.69 dBm				Carrier Offset 390.56 Hz				
	Settling Time	+Peak	-Peak	±Peak/2	RMS	Mod. Freq.	SINAD	DISTORT	THD
FM	1.022 µs	4.8423 MHz	-1.8343 MHz	3.3383 MHz	1.1283 MHz	---	---	---	---

The following general results are provided:

For each demodulation, the following results are provided:

Label	Description
"Carr Power"	Measured carrier power
"Carr Offset"	Carrier offset to nominal center frequency
"Mod. Depth"	Modulation depth

Table 3-1: Result summary description

Label	Description
"Settling Time"	Time after which signal remains in a specified value range. Only evaluated and displayed if enabled, see Section 5.8.7, "Settling time" , on page 81.
"Peak"	Positive peak (maximum)
"-Peak"	Negative peak (minimum)
"Peak/2"	Average of positive and negative peaks
"RMS"	Root Mean Square value
"Mod Freq"	Modulation frequency
"SINAD"	Signal-to-noise-and-distortion (Calculated only if AF Spectrum is displayed) Measures the ratio of the total power to the power of noise and harmonic distortions. The noise and harmonic power is calculated inside the AF spectrum span. The DC offset is removed before the calculation. $SINAD[dB] = 20 \cdot \log \left[\frac{P_{total}}{P_{Noise} + P_{distortion}} \right]$
"DISTORT"	Modulation distortion in % (Calculated only if "SINAD" is also calculated) Measures the distortion of the modulation in relation to the total power of the signal inside the AF spectrum span. Indicates the quality of the modulation. $Modulation\ distortion = \frac{\sqrt{P_{total} - P_{signal}}}{\sqrt{P_{total}}} * 100\%$
"THD"	Total harmonic distortion The ratio of the harmonics to the fundamental and harmonics. All harmonics inside the AF spectrum span are considered up to the tenth harmonic. (Calculated only if AF Spectrum is displayed) $THD[dB] = 20 \cdot \log \left[\frac{\sqrt{\sum_{i=2}^{\infty} U_i^2}}{\sqrt{\sum_{i=1}^{\infty} U_i^2}} \right]$

Note: Relative demodulation results. Optionally, the demodulation results in relation to user-defined or measured reference values are determined. See [Section 5.8.6, "Result table settings"](#), on page 78.

In addition, the following general information for the input signal is provided:

- "Carrier Power": the power of the carrier without modulation
- "Carrier Offset": the deviation of the calculated carrier frequency to the ideal carrier frequency
- "Modulation Depth" (AM or "RF Time Domain" only): the difference in amplitude the carrier signal is modulated with

Remote command:

LAY:ADD? '1', RIGH, RSUM, see [LAYout:ADD\[:WINDow\]?](#) on page 160

Results:

[Section 11.7, "Retrieving result summary values"](#), on page 172

Marker Table

Displays a table with the current marker values for the active markers.

This table is displayed automatically if configured accordingly.

Type	Shows the marker type and number ("M" for a normal marker, "D" for a delta marker).
Ref	Shows the reference marker that a delta marker refers to.
Trace	Shows the trace that the marker is positioned on.
X- / Y-Value	Shows the marker coordinates (usually frequency and level).

1 Marker Table							
Wnd	Type	Ref	Trc	X-Value	Y-Value	Function	Function Result
2	M1		1	2.1725 ms	-6.80 dBm		
2	D2	M1	1	13.859 ms	-0.00 dB		
2	D3	M1	1	4.6259 ms	-0.00 dB		
2	D4	M1	1	9.2531 ms	-0.00 dB		

Tip: To navigate within long marker tables, simply scroll through the entries with your finger on the touchscreen.

Remote command:

LAY:ADD? '1', RIGH, MTAB, see [LAYout:ADD\[:WINDow\]?](#) on page 160

Results:

[CALCulate<n>:MARKer<m>:X](#) on page 176

[CALCulate<n>:MARKer<m>:Y?](#) on page 177

Marker Peak List

The marker peak list determines the frequencies and levels of peaks in the spectrum or time domain. How many peaks are displayed can be defined, as well as the sort order. In addition, the detected peaks can be indicated in the diagram. The peak list can also be exported to a file for analysis in an external application.

3 Marker Peak List				
Wnd	No	X-Value	Y-Value	
2	1	1.086245 ms	-75.810 dBm	
2	2	2.172490 ms	-6.797 dBm	
2	3	3.258736 ms	-76.448 dBm	
2	4	4.831918 ms	-76.676 dBm	
2	5	6.255274 ms	-76.482 dBm	
2	6	6.798397 ms	-6.800 dBm	
2	7	9.233084 ms	-76.519 dBm	
2	8	10.075861 ms	-76.172 dBm	
2	9	11.405574 ms	-6.801 dBm	

Tip: To navigate within long marker peak lists, simply scroll through the entries with your finger on the touchscreen.

Remote command:

LAY:ADD? '1',RIGH, PEAK, see [LAYout:ADD\[:WINDow\]?](#) on page 160

Results:

[CALCulate<n>:MARKer<m>:X](#) on page 176

[CALCulate<n>:MARKer<m>:Y?](#) on page 177

4 Measurement basics

Some background knowledge on basic terms and principles used in Analog Modulation Analysis measurements is provided here for a better understanding of the required configuration settings.

- [Demodulation process](#)..... 30
- [Demodulation bandwidth](#).....32
- [Sample rate and demodulation bandwidth](#).....33
- [AF triggers](#).....34
- [AF filters](#).....34
- [Time domain zoom](#).....34
- [Analog modulation analysis in MSRA operating mode](#)..... 36

4.1 Demodulation process

The demodulation process is shown in [Figure 4-1](#). All calculations are performed simultaneously with the same I/Q data set. Magnitude (= amplitude) and phase of the complex I/Q pairs are determined. The frequency result is obtained from the differential phase.

For details on general I/Q data processing in the R&S FSWP, refer to the reference part of the I/Q Analysis remote control description in the R&S FSWP User Manual.

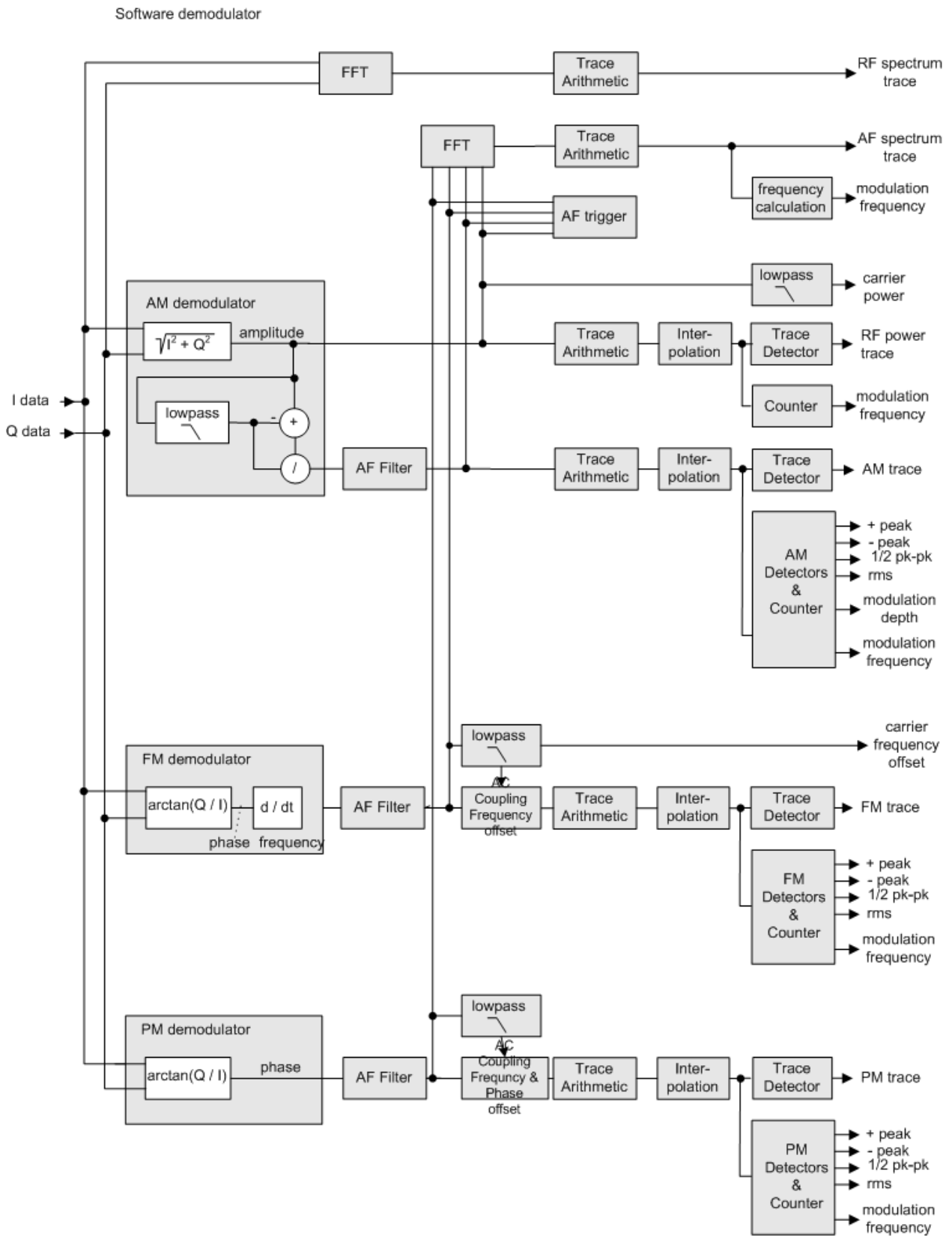

Figure 4-1: Block diagram of software demodulator

The AM DC, FM DC and PM DC raw data of the demodulators is fed into the "Trace Arithmetic" block that combines consecutive data sets. Possible trace modes are: Clear Write, Max Hold, Min Hold and Average. The output data of the "Trace Arithmetic" block can be read via remote control ([SENS:]ADEM:<evaluation>:RES?, see [SENSe:]ADEMod:AM[:ABSolute] [:TDOMain]:RESult? on page 167.

The collected measured values are evaluated by the selected detector. The result is displayed on the screen and can be read out via remote control.

In addition, important parameters are calculated:

- A counter determines the modulation frequency for AM, FM, and PM.
- average power = carrier power (RF power)
- average frequency = carrier frequency offset (FM)
- The modulation depth or the frequency or phase deviation; the deviations are determined from the trace data

AC coupling is possible with FM and PM display.

4.2 Demodulation bandwidth

The demodulation bandwidth determines the span of the signal that is demodulated. It is not the 3-dB bandwidth of the filter, but the useful bandwidth which is distortion-free regarding phase and amplitude.

Therefore the following formulas apply:

- AM: demodulation bandwidth $\geq 2 \times$ modulation frequency
- FM: demodulation bandwidth $\geq 2 \times$ (frequency deviation + modulation frequency)
- PM: demodulation bandwidth $\geq 2 \times$ modulation frequency \times (1 + phase deviation)



If the center frequency of the analyzer is not set exactly to the signal frequency, the demodulation bandwidth must be increased by the carrier offset, in addition to the requirement described above. The bandwidth must also be increased if FM or PM AC coupling is selected.

In general, select the demodulation bandwidth as narrow as possible to improve the S/N ratio. The residual FM caused by noise floor and phase noise increases dramatically with the bandwidth, especially with FM.

For help on determining the adequate demodulation bandwidth, see "[Determining the demodulation bandwidth](#)" on page 96.

A practical example is described in [Section 9, "Measurement example: demodulating an FM signal"](#), on page 91.

4.3 Sample rate and demodulation bandwidth

The maximum demodulation bandwidths that can be obtained during the measurement, depending on the sample rate, are listed in the tables below for different demodulation filter types. The allowed value range of the measurement time and trigger offset depends on the selected demodulation bandwidth and demodulation filter. If the AF filter or the AF trigger are not active, the measurement time increases by 20 %.



A maximum of 24 million samples can be captured, assuming sufficient memory is available; thus the maximum measurement time can be determined according to the following formula:

$$\text{Meas.time}_{\text{max}} = \text{Sample count}_{\text{max}} / \text{sample rate}$$

The minimum trigger offset is $(-\text{Meas.time}_{\text{max}})$

Table 4-1: Available demodulation bandwidths and corresponding sample rates

Demodulation BW	Sample Rate (Flat Top)	Sample Rate (Gaussian Top)
100 Hz	122.0703125 Hz	400 Hz
200 Hz	244.140625 Hz	800 Hz
400 Hz	488.28125 Hz	1.6 kHz
800 Hz	976.5625 Hz	3.2 kHz
1.6 kHz	1.953125 kHz	6.4 kHz
3.2 kHz	3.90625 kHz	12.8 kHz
6.4 kHz	7.8125 kHz	25.6 kHz
12.5 kHz	15.625 kHz	50 kHz
25 kHz	31.25 kHz	100 kHz
50 kHz	62.5 kHz	200 kHz
100 kHz	125 kHz	400 kHz
200 kHz	250 kHz	800 kHz
400 kHz	500 kHz	1.6 MHz
800 kHz	1 MHz	3.2 MHz
1.6 MHz	2 MHz	6.4 MHz
3 MHz	4 MHz	12 MHz
5 MHz	8 MHz	20 MHz
8 MHz	16 MHz	32 MHz
10 MHz	32 MHz	40 MHz
80 MHz ¹⁾	128 MHz	320 MHz
160 MHz ²⁾	200 MHz	640 MHz

Demodulation BW	Sample Rate (Flat Top)	Sample Rate (Gaussian Top)
320 MHz ²⁾	400 MHz	1280 MHz
¹⁾ only available with option B80 ²⁾ only available with option B320		

Large numbers of samples

Principally, the R&S FSWP can handle up to 24 million samples. However, when 480001 samples are exceeded, all traces that are not currently being displayed in a window are deactivated to improve performance. The traces can only be activated again when the samples are reduced.



Effects of measurement time on the stability of measurement results

Despite amplitude and frequency modulation, the display of carrier power and carrier frequency offset is stable.

Stability is achieved by a digital filter which sufficiently suppresses the modulation. As a prerequisite, the measurement time must be $\geq 3 \times 1 / \text{modulation frequency}$, i.e. at least three periods of the AF signal are recorded.

The mean carrier power for calculating the AM is also calculated with a digital filter. The filter returns stable results after a measurement time of $\geq 3 \times 1 / \text{modulation frequency}$, i.e. at least three cycles of the AF signal must be recorded before a stable AM can be shown.

4.4 AF triggers

The Analog Modulation Analysis application allows triggering to the demodulated signal. The display is stable if a minimum of five modulation periods are within the recording time.

Triggering is always DC-coupled. Therefore triggering is possible directly to the point where a specific carrier level, phase or frequency is exceeded or not attained.

4.5 AF filters

Additional filters applied after demodulation help filter out unwanted signals, or correct pre-emphasized input signals. A CCITT filter allows you to evaluate the signal by simulating the characteristics of human hearing.

4.6 Time domain zoom

For evaluations in the time domain, the demodulated data for a particular time span can be extracted and displayed in more detail using the "Time Domain Zoom" function.

Zooming is useful if the measurement time is very large and thus each sweep point represents a large time span. The time domain zoom function distributes the available sweep points only among the time span defined by the zoom area length. The time span displayed per division of the diagram is decreased. Thus, the display of the extracted time span becomes more precise.

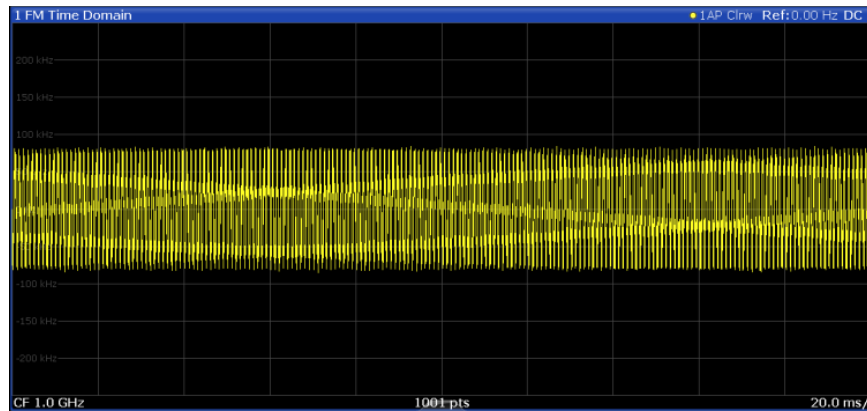

Figure 4-2: FM time domain measurement with a very long measurement time (200 ms)



Figure 4-3: FM time domain measurement with time domain zoom (2.0 ms per division)

The time domain zoom area affects not only the diagram display, but the entire evaluation for the current window.

In contrast to the time domain zoom, the graphical zoom is available for all diagram evaluations. However, the graphical zoom is useful only if more measured values than trace points are available. The (time) span represented by each measurement point remains the same.

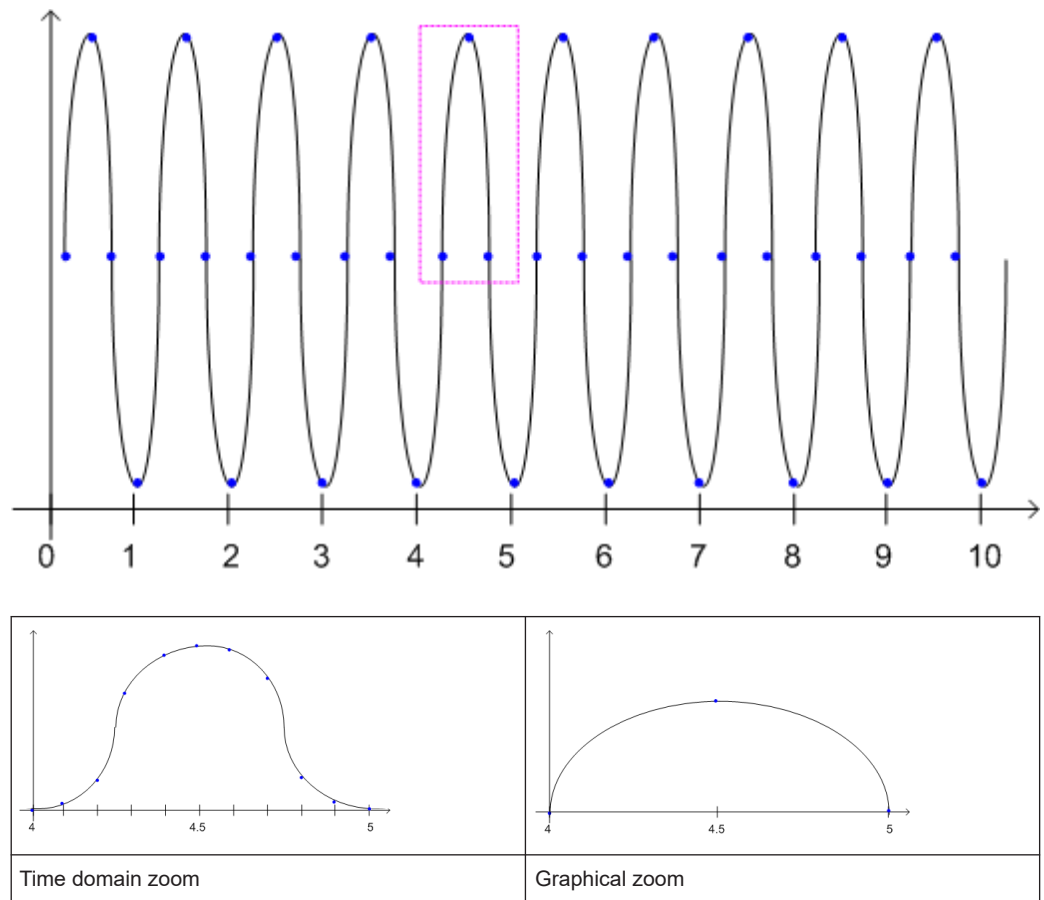

4.7 Analog modulation analysis in MSRA operating mode

The Analog Modulation Analysis application can also be used to analyze data in MSRA operating mode.

In MSRA operating mode, only the MSRA primary actually captures data. The data acquisition settings for an analog modulation analysis application channel in MSRA mode configure the **analysis interval**, not an actual data capture from the input signal.

In addition, a capture offset can be defined, i.e. an offset from the start of the captured data to the start of the analysis interval for analog modulation analysis.

The currently used analysis interval (in seconds, related to measurement start) is indicated in the window header for each result display.

Analysis line

A frequent question when analyzing multi-standard signals is how each data channel is correlated (in time) to others. Thus, an analysis line has been introduced. The analysis line is a common time marker for all MSRA secondary applications. It can be positioned in any MSRA secondary application or the MSRA primary and is then adjusted in all other secondary applications. Thus, you can easily analyze the results at a specific time in the measurement in all secondary applications and determine correlations.

If the analysis interval of the secondary application contains the marked point in time, the line is indicated in all time-based result displays, such as time, symbol, slot or bit diagrams. By default, the analysis line is displayed. However, you can hide it from view manually. In all result displays, the "AL" label in the window title bar indicates whether the analysis line lies within the analysis interval or not:

- **orange "AL"**: the line lies within the interval
- **white "AL"**: the line lies within the interval, but is not displayed (hidden)
- **no "AL"**: the line lies outside the interval



For details on the MSRA operating mode, see the R&S FSWP MSRA User Manual.

5 Configuration

The optional application for analog modulation analysis is an application, which you activate using the [MODE] key on the front panel. The Analog Modulation Analysis application requires the optional Spectrum application.

When you activate the Analog Modulation Analysis application, a Analog Modulation Analysis measurement for the input signal is started automatically with the default configuration. It can be configured in the Analog Modulation Analysis "Overview" dialog box, which is displayed when you select the "Overview" softkey from any menu.



The main configuration settings and dialog boxes are also available via the "Analog Demod" menu which is displayed when you press the [MEAS CONFIG] key.

Predefined settings

For commonly performed measurements, standard setup files are provided for quick and easy configuration. Simply load an existing standard settings file and, if necessary, adapt the measurement settings to your specific requirements.

For an overview of predefined standards and settings see [Section A.1, "Predefined standards and settings"](#), on page 184.

• Configuration according to digital standards	38
• Configuration overview	40
• Data input and output	41
• Amplitude	48
• Frequency	51
• Trigger configuration	52
• Data acquisition	58
• Demodulation	63
• Demodulation display	83
• Automatic settings	83

5.1 Configuration according to digital standards

Various predefined settings files for common digital standards are provided for use with the Analog Modulation Analysis application. In addition, you can create your own settings files for user-specific measurements.

For details on which settings are defined and an overview of predefined standards see [Section A.1, "Predefined standards and settings"](#), on page 184.

Digital standard settings are available via the "Digital Standards" softkey in the [MEAS] menu or the "Overview".

Setup Standard	39
L Selecting Storage Location - Drive/ Path/ Files	39
L File Name	39
L Load Standard	39

L Save Standard	39
L Delete Standard	39
L Restore Standard Files	40

Setup Standard

Opens a file selection dialog box to select a predefined setup file. The predefined settings are configured in the R&S FSWP Analog Modulation Analysis application, which allows for quick and easy configuration for commonly performed measurements.

Selecting Storage Location - Drive/ Path/ Files ← Setup Standard

Select the storage location of the file on the instrument or an external drive.

The default storage location for the settings files is:

C:\R_S\INSTR\USER\predefined\AdemodPredefined.

Note: Saving instrument settings in secure user mode.

In secure user mode, settings that are stored on the instrument are stored to volatile memory, which is restricted to 256 MB. Thus, a "memory limit reached" error can occur although the hard disk indicates that storage space is still available.

To store data permanently, select an external storage location such as a USB memory device.

For details, see "Protecting Data Using the Secure User Mode" in the "Data Management" section of the R&S FSWP base unit user manual.

File Name ← Setup Standard

Contains the name of the data file without the path or extension.

File names must be compatible with the Windows conventions for file names. In particular, they must not contain special characters such as ":", "*", "?".

For details on the filename and location, see the "Data Management" topic in the R&S FSWP User Manual.

Load Standard ← Setup Standard

Loads the selected measurement settings file.

Remote command:

[\[SENSe:\]ADEMod:PRESet\[:STANdard\]](#) on page 107

Save Standard ← Setup Standard

Saves the current measurement settings for a specific standard as a file with the defined name.

Remote command:

[\[SENSe:\]ADEMod:PRESet:STORE](#) on page 107

Delete Standard ← Setup Standard

Deletes the selected standard. Standards predefined by Rohde & Schwarz can also be deleted. A confirmation query is displayed to avoid unintentional deletion of the standard.

Note: Restoring predefined standard files. The standards predefined by Rohde & Schwarz available at the time of delivery can be restored using the "Restore Standard Files" function (see ["Restore Standard Files"](#) on page 40).

Restore Standard Files ← Setup Standard

Restores the standards predefined by Rohde & Schwarz available at the time of delivery.

Note that this function overwrites customized standards that have the same name as predefined standards.

Remote command:

[SENSe:]ADEMod:PRESet:REStore on page 107

5.2 Configuration overview



Using the R&S FSWP Analog Modulation Analysis application you can perform analog modulation analysis using predefined standard setting files, or independently of standards using user-defined measurement settings. Such settings can be stored for recurrent use.

Thus, configuring analog modulation analysis measurements requires one of the following tasks:

- Selecting an existing standard settings file and, if necessary, adapting the measurement settings to your specific requirements.
- Configuring the measurement settings and, if necessary, storing the settings in a file.

"Overview" window

Throughout the channel configuration, an overview of the most important currently defined settings is provided in the "Overview".

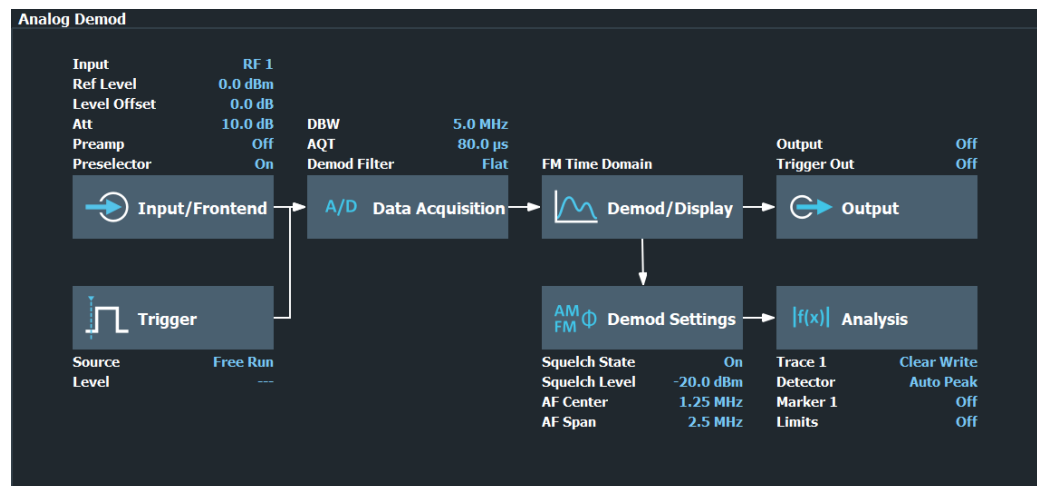

In addition to the main measurement settings, the "Overview" provides quick access to the main settings dialog boxes. Thus, you can easily configure an entire Analog Modulation Analysis measurement channel from input over processing to output and analysis by stepping through the dialog boxes as indicated in the "Overview".

To configure settings

- ▶ Select any button in the "Overview" to open the corresponding dialog box. Select a setting in the channel bar (at the top of the measurement channel tab) to change a specific setting.

Preset Channel	41
Setup Standard	41
Specific Settings for	41

Preset Channel

Select "Preset Channel" in the lower left-hand corner of the "Overview" to restore all measurement settings *in the current channel* to their default values.

Note: Do not confuse "Preset Channel" with the [Preset] key, which restores the entire instrument to its default values and thus closes *all channels* on the R&S FSWP (except for the default channel)!

Remote command:

`SYSTem:PRESet:CHANnel [:EXEC]` on page 106

Setup Standard

Opens a file selection dialog box to select a predefined setup file. See "[Setup Standard](#)" on page 39.

Specific Settings for

The channel can contain several windows for different results. Thus, the settings indicated in the "Overview" and configured in the dialog boxes vary depending on the selected window.

Select an active window from the "Specific Settings for" selection list that is displayed in the "Overview" and in all window-specific configuration dialog boxes.

The "Overview" and dialog boxes are updated to indicate the settings for the selected window.

5.3 Data input and output

The R&S FSWP can analyze signals from different input sources and provide various types of output (such as video or trigger signals).

• RF input	42
• Power sensors	43
• External generators	43
• Probes	44
• External mixers	44
• Configuring additional outputs	44
• Analog demod output settings	46
• DC power output	48
• Signal source output	48

5.3.1 RF input

Access: "Overview" > "Input / Frontend" > "Input Source" > "Radio Frequency"

These settings control the characteristics of the RF input connector at the front panel of the R&S FSWP.

Input Coupling	42
Impedance	42
Direct Path	42
YIG-Preselector	43
High Pass Filter 1 to 3 GHz	43

Input Coupling

The RF input of the R&S FSWP can be coupled by alternating current (AC) or direct current (DC).

AC coupling blocks any DC voltage from the input signal. AC coupling is activated by default to prevent damage to the instrument. Very low frequencies in the input signal can be distorted.

However, some specifications require DC coupling. In this case, you must protect the instrument from damaging DC input voltages manually. For details, refer to the specifications document.

Remote command:

[INPut:COUPling](#) on page 108

Impedance

For some measurements, the reference impedance for the measured levels of the R&S FSWP can be set to 50 Ω or 75 Ω .

Select 75 Ω if the 50 Ω input impedance is transformed to a higher impedance using a 75 Ω adapter of the RAZ type. (That corresponds to 25 Ω in series to the input impedance of the instrument.) The correction value in this case is 1.76 dB = 10 log (75 Ω /50 Ω).

This value also affects the unit conversion.

Remote command:

[INPut:IMPedance](#) on page 109

Direct Path

Enables or disables the use of the direct path for small frequencies.

In spectrum analyzers, passive analog mixers are used for the first conversion of the input signal. In such mixers, the LO signal is coupled into the IF path due to its limited isolation. The coupled LO signal becomes visible at the RF frequency 0 Hz. This effect is referred to as LO feedthrough.

To avoid the LO feedthrough the spectrum analyzer provides an alternative signal path to the A/D converter, referred to as the *direct path*. By default, the direct path is selected automatically for RF frequencies close to zero. However, this behavior can be disabled. If "Direct Path" is set to "Off", the spectrum analyzer always uses the analog mixer path.

"Auto" (Default) The direct path is used automatically for frequencies close to zero.

"Off" The analog mixer path is always used.

Remote command:

[INPut:DPATh](#) on page 108

YIG-Preselector

Enables or disables the YIG-preselector.

This setting requires an additional option on the R&S FSWP.

An internal YIG-preselector at the input of the R&S FSWP ensures that image frequencies are rejected. However, image rejection is only possible for a restricted bandwidth. To use the maximum bandwidth for signal analysis you can disable the YIG-preselector at the input of the R&S FSWP, which can lead to image-frequency display.

Note: Note that the YIG-preselector is active only on frequencies greater than 8 GHz. Therefore, switching the YIG-preselector on or off has no effect if the frequency is below that value.

Remote command:

[INPut:FILTer:YIG\[:STATe\]](#) on page 109

High Pass Filter 1 to 3 GHz

Activates an additional internal highpass filter for RF input signals from 1 GHz to 3 GHz. This filter is used to remove the harmonics of the analyzer to measure the harmonics for a DUT, for example.

This function requires an additional hardware option.

Note: For RF input signals outside the specified range, the high-pass filter has no effect. For signals with a frequency of approximately 4 GHz upwards, the harmonics are suppressed sufficiently by the YIG-preselector, if available.)

Remote command:

[INPut:FILTer:HPASs\[:STATe\]](#) on page 109

5.3.2 Power sensors

Access: "Overview" > "Input / Frontend" > "Power Sensors"

The functionality to use power sensors is the same as in the optional spectrum application.

For a comprehensive description, refer to the user manual of the optional R&S FSWP spectrum application.

5.3.3 External generators

Access: "Overview" > "Input / Frontend" > "External Generator"

Controlling external generators is available with the optional external generator control. The functionality is the same as in the optional spectrum application.

For a comprehensive description, refer to the user manual of the optional R&S FSWP spectrum application.

5.3.4 Probes

Access: "Overview" > "Input / Frontend" > "Probes"

The functionality to use probes (via the RF input) is the same as in the optional spectrum application.

For a comprehensive description, refer to the user manual of the optional R&S FSWP spectrum application.

5.3.5 External mixers

Access: "Overview" > "Input / Frontend" > "Input Source" > "External Mixer"

Input through external mixers is available with the optional external mixer control hardware.

The features are the same as in the phase noise application. For a comprehensive description, refer to the R&S FSWP user manual.

5.3.6 Configuring additional outputs

Access: "Overview" > "Output Config" > "Output"

The R&S FSWP provides additional outputs that you can use for various tasks.

The remote commands required to configure the outputs are described in [Section 11.4.2.3, "Configuring outputs"](#), on page 110.

Noise Source Control.....	44
Trigger 1/2.....	45
L Output Type.....	45
L Level.....	46
L Pulse Length.....	46
L Send Trigger.....	46

Noise Source Control

Enables or disables the 28 V voltage supply for an external noise source connected to the "Noise source control / Power sensor") connector. By switching the supply voltage for an external noise source on or off in the firmware, you can enable or disable the device as required.

External noise sources are useful when you are measuring power levels that fall below the noise floor of the R&S FSWP itself, for example when measuring the noise level of an amplifier.

In this case, you can first connect an external noise source (whose noise power level is known in advance) to the R&S FSWP and measure the total noise power. From this value, you can determine the noise power of the R&S FSWP. Then when you measure the power level of the actual DUT, you can deduct the known noise level from the total power to obtain the power level of the DUT.

Remote command:

[DIAGnostic:SERVice:NSource](#) on page 110

Trigger 1/2

Trigger Source	Trigger In/Out	
Trigger 2	<input checked="" type="checkbox"/> Input	<input type="checkbox"/> Output
Trigger 3	<input type="checkbox"/> Input	<input checked="" type="checkbox"/> Output
Output Type	User Defined	Level <input checked="" type="checkbox"/> Low <input type="checkbox"/> High
Pulse Length	100.0 µs	Send Trigger 

The trigger input and output functionality depends on how the variable "Trigger Input/Output" connectors are used.

Note: Providing trigger signals as output is described in detail in the R&S FSWP base unit user manual.

"Trigger 1"	"Trigger 1": "Trigger Input/Output" connector on the front panel
"Trigger 2"	Defines the usage of the variable "Trigger Input/Output" connector on the rear panel.
"Input"	The signal at the connector is used as an external trigger source by the R&S FSWP. Trigger input parameters are available in the "Trigger" dialog box.
"Output"	The R&S FSWP sends a trigger signal to the output connector to be used by connected devices. Further trigger parameters are available for the connector. Note: For offline AF or RF triggers, no output signal is provided.

Remote command:

[OUTPut:TRIGger<tp>:DIRection](#) on page 112

Output Type ← Trigger 1/2

Type of signal to be sent to the output

"Device Triggered"	(Default) Sends a trigger when the R&S FSWP triggers.
"Trigger Armed"	Sends a (high level) trigger when the R&S FSWP is in "Ready for trigger" state. This state is indicated by a status bit in the <code>STATUS:OPERation</code> register (bit 5), as well as by a low-level signal at the "AUX" port (pin 9).

"User Defined" Sends a trigger when you select "Send Trigger".
In this case, further parameters are available for the output signal.

Remote command:

`OUTPut:TRIGger<tp>:OTYPe` on page 113

Level ← Output Type ← Trigger 1/2

Defines whether a high (1) or low (0) constant signal is sent to the trigger output connector (for "Output Type": "User Defined").

The trigger pulse level is always opposite to the constant signal level defined here. For example, for "Level" = "High", a constant high signal is output to the connector until you select the [Send Trigger](#) function. Then, a low pulse is provided.

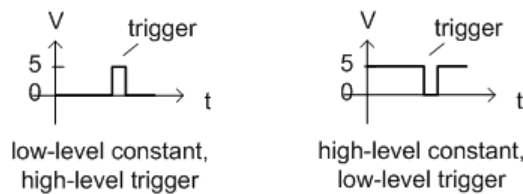

Remote command:

`OUTPut:TRIGger<tp>:LEVel` on page 113

Pulse Length ← Output Type ← Trigger 1/2

Defines the duration of the pulse (pulse width) sent as a trigger to the output connector.

Remote command:

`OUTPut:TRIGger<tp>:PULSe:LENGth` on page 114

Send Trigger ← Output Type ← Trigger 1/2

Sends a user-defined trigger to the output connector immediately.

Note that the trigger pulse level is always opposite to the constant signal level defined by the output [Level](#) setting. For example, for "Level" = "High", a constant high signal is output to the connector until you select the "Send Trigger" function. Then, a low pulse is sent.

Which pulse level is sent is indicated by a graphic on the button.

Remote command:

`OUTPut:TRIGger<tp>:PULSe:IMMediate` on page 113

5.3.7 Analog demod output settings

Access: "Overview" ≥ "Output" > "Analog Demod"

The demodulated signal in time domain results can be output to the IF/VIDEO/DEMODO output connector on the R&S FSWP.

The following settings and functions are available to configure the output in the R&S FSWP Analog Modulation Analysis application.

Note that the audio frequency (AF) filter settings used for demodulation also apply to the online output. However, a maximum of two high pass, low pass or deemphasis filters can be active at the same time if "Analog Demod" output is active.

(See [Section 5.8.3, "AF filter"](#), on page 70)

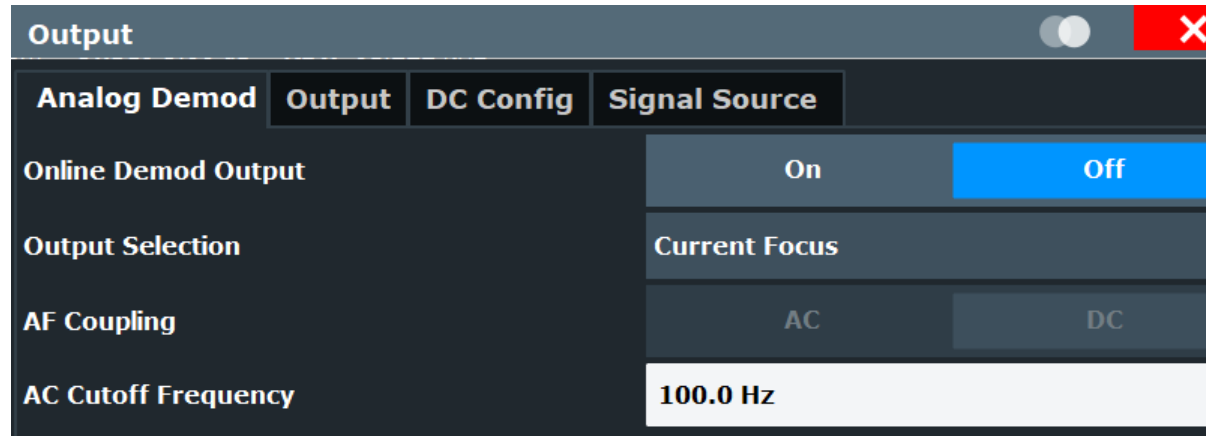

Online Demodulation Output State	47
Output Selection	47
AF Coupling	47
AC Cutoff Frequency	48

Online Demodulation Output State

Enables or disables online demodulation output. If enabled, the demodulated audio frequencies are output to the IF/VIDEO/DEMODO output connector on the R&S FSWP.

Remote command:

`OUTPut:ADEMod[:ONLine][:STATe]` on page 111

Output Selection

Selects the result display whose results are output. Only time domain results can be selected. All currently active time domain result displays are listed.

"Current Focus" dynamically switches to the currently selected window. Thus you can easily change the output signal simply by selecting the windows in the display. If a window is selected that does not contain a time-domain result display, the selection is ignored and the previous setting is maintained.

The result display currently used for output is indicated by a "Demod Out" label in the window title bar.

Remote command:

`OUTPut:ADEMod[:ONLine]:SOURCE` on page 111

AF Coupling

Controls the automatic correction of the frequency offset and phase offset of the input signal:

This function is only available for FM or PM time domain evaluations.

- FM time evaluation

If DC is selected, the absolute frequency is displayed. That means, an input signal with an offset relative to the center frequency is not displayed symmetrically to the zero line.

If AC is selected, the frequency offset is automatically corrected, i.e. the trace is always symmetric to the zero line.

- PM time evaluation

If DC is selected, the phase runs according to the existing frequency offset. In addition, the DC signal contains a phase offset of $\pm \pi$.

If AC is selected, the frequency offset and phase offset are automatically corrected, i.e. the trace is always symmetric to the zero line.

Remote command:

[\[SENSe:\]ADEMod<n>:AF:COUPling](#) on page 140

AC Cutoff Frequency

Defines the cutoff frequency for the AC highpass filter (for AC coupling only, see [AF Coupling](#)).

Note that the audio frequency (AF) filter settings used for demodulation also apply to the online output.

(See [Section 5.8.3, "AF filter"](#), on page 70)

Remote command:

[OUTPut:ADEMod\[:ONLine\]:AF\[:CFrequency\]](#) on page 110

5.3.8 DC power output

Access: "Overview" > "Output Config" > "DC Config"

The configuration of the DC power supply is the same as in the phase noise application.

For a comprehensive description, refer to the R&S FSWP user manual.

5.3.9 Signal source output

Access: "Overview" > "Output Config" > "Signal Source"

The configuration of the optional signal source is the same as in the phase noise application.

For a comprehensive description, refer to the R&S FSWP user manual.

5.4 Amplitude

Access: "Overview" > "Input / Frontend" > "Amplitude"

The amplitude is configured in the "Amplitude" tab of the "Input" dialog box.

For background information on amplitude settings see the R&S FSWP user manual.

The remote commands required to define these settings are described in [Section 11.4.3, "Configuring level characteristics"](#), on page 114.

Functions to configure level characteristics described elsewhere:

- "Input Coupling" on page 42
- "Impedance" on page 42

Reference Level.....	49
L Shifting the Display (Offset).....	49
L Unit.....	49
L Setting the Reference Level Automatically (Auto Level).....	50
Attenuation Mode / Value.....	50
Preamplifier.....	50

Reference Level

Defines the expected maximum reference level. Signal levels above this value are possibly not measured correctly. Signals above the reference level are indicated by an "IF Overload" or "OVLd" status display.

The reference level can also be used to scale power diagrams; the reference level is then used for the calculation of the maximum on the y-axis.

Since the hardware of the R&S FSWP is adapted according to this value, it is recommended that you set the reference level close above the expected maximum signal level. Thus you ensure an optimal measurement (no compression, good signal-to-noise ratio).

Note that for input from the External Mixer (R&S FSWP-B21) the maximum reference level also depends on the conversion loss; see the R&S FSWP base unit user manual for details.

Remote command:

```
DISPlay[:WINDow<n>][:SUBWindow<w>]:TRACe<t>:Y[:SCALe]:RLEVel
```

on page 115

Shifting the Display (Offset) ← Reference Level

Defines an arithmetic level offset. This offset is added to the measured level. In some result displays, the scaling of the y-axis is changed accordingly.

Define an offset if the signal is attenuated or amplified before it is fed into the R&S FSWP so the application shows correct power results. All displayed power level results are shifted by this value.

The setting range is ± 200 dB in 0.01 dB steps.

Note, however, that the *internal* reference level (used to adjust the hardware settings to the expected signal) ignores any "Reference Level Offset". Thus, it is important to keep in mind the actual power level the R&S FSWP must handle. Do not rely on the displayed reference level (internal reference level = displayed reference level - offset).

Remote command:

```
DISPlay[:WINDow<n>][:SUBWindow<w>]:TRACe<t>:Y[:SCALe]:RLEVel:OFFSet
```

on page 115

Unit ← Reference Level

The R&S FSWP measures the signal voltage at the RF input.

In the default state, the level is displayed at a power level of 1 mW (= dBm). Via the known input impedance (50 Ω or 75 Ω, see "[Impedance](#)" on page 42), conversion to other units is possible.

Remote command:

[INPut:IMPedance](#) on page 109

[CALCulate<n>:UNIT:POWer](#) on page 114

Setting the Reference Level Automatically (Auto Level) ← Reference Level

Automatically determines a reference level which ensures that no overload occurs at the R&S FSWP for the current input data. At the same time, the internal attenuators are adjusted. As a result, the signal-to-noise ratio is optimized, while signal compression and clipping are minimized.

To determine the required reference level, a level measurement is performed on the R&S FSWP.

If necessary, you can optimize the reference level further. Decrease the attenuation level manually to the lowest possible value before an overload occurs, then decrease the reference level in the same way.

You can change the measurement time for the level measurement if necessary (see "[\(Meas Time Manual\)](#)" on page 85).

Remote command:

[\[SENSe:\]ADJust:LEVel](#) on page 117

Attenuation Mode / Value

Defines the attenuation applied to the RF input of the R&S FSWP.

The RF attenuation can be set automatically as a function of the selected reference level (Auto mode). Automatic attenuation ensures that no overload occurs at the RF Input connector for the current reference level. It is the default setting.

In "Manual" mode, you can set the RF attenuation in 1 dB steps (down to 0 dB). Other entries are rounded to the next integer value. The range is specified in the specifications document. If the defined reference level cannot be set for the defined RF attenuation, the reference level is adjusted accordingly and the warning "limit reached" is displayed.

NOTICE! Risk of hardware damage due to high power levels. When decreasing the attenuation manually, ensure that the power level does not exceed the maximum level allowed at the RF input, as an overload can lead to hardware damage.

Remote command:

[INPut:ATTenuation](#) on page 116

[INPut:ATTenuation:AUTO](#) on page 116

Preamplifier

If the (optional) internal preamplifier hardware is installed on the R&S FSWP, a preamplifier can be activated for the RF input signal.

You can use a preamplifier to analyze signals from DUTs with low output power.

The preamplifier amplifies the signal by 15 dB or 30 dB and is only available for frequencies above 8 GHz for the phase noise measurement. In the spectrum analyzer, the preamplifier is available for the whole frequency range.

Note that the preamplifier is located before the point where the signal is split into two paths. Consequently, the influence of cross-correlation is limited in this configuration.

Note: The preamplifier is useful for signals with power levels of -20 dBm or less, particularly when large offsets are important.

"Off" Deactivates the preamplifier.

"On" The RF input signal is amplified.

Remote command:

`INPut:GAIN:STATe` on page 116

`INPut:GAIN[:VALue]` on page 117

5.5 Frequency

Access: "Overview" > "Input / Frontend" > "Frequency"

The center frequency of the input signal is configured in the "Frequency" tab of the "Input/Frontend" dialog box.

Input				
Input Source	Power Sensor	External Generator	Amplitude	Frequency
Frequency				
Center	4.0 GHz			
Center Frequency Stepsize				
Stepsize	Manual	Value	1.0 MHz	

The remote commands required to configure the frequency are described in [Section 11.4.4, "Defining frequency characteristics"](#), on page 117.

Center Frequency	51
Center Frequency Stepsize	51

Center Frequency

Defines the center frequency of the signal in Hertz.

The allowed range of values for the center frequency depends on the frequency span.

$$\text{span} > 0: \text{span}_{\min}/2 \leq f_{\text{center}} \leq f_{\text{max}} - \text{span}_{\min}/2$$

f_{max} and span_{\min} depend on the instrument and are specified in the specifications document.

Remote command:

`[SENSe:] FREQuency:CENTer` on page 117

Center Frequency Stepsize

Defines the step size of the center frequency. The step size can be coupled to the demodulation bandwidth, or you can set it to a fixed value manually.

"0.1 * Demod BW"	(default:) Sets the step size for the center frequency to 10 % of the demodulation bandwidth.
"0.5 * Demod BW"	Sets the step size for the center frequency to 50 % of the demodulation bandwidth.
"X * Demod BW"	Sets the step size for the center frequency to a manually defined factor of the demodulation bandwidth. The "X-Factor" defines the percentage of the demodulation bandwidth. Values between 1 % and 100 % in steps of 1 % are allowed. The default setting is 10 %.
"= Center"	Sets the step size to the value of the center frequency and removes the coupling of the step size to the demodulation bandwidth. The used value is indicated in the "Value" field.
"Manual"	Defines a fixed step size for the center frequency. Enter the step size in the "Value" field.

Remote command:

[SENSe:] FREQuency:CENTer:STEP:LINK on page 118

[SENSe:] FREQuency:CENTer:STEP:LINK:FACTor on page 119

[SENSe:] FREQuency:CENTer:STEP on page 118

5.6 Trigger configuration

Access: "Overview" > "Trigger"

Triggering means to capture the interesting part of the signal. Choosing the right trigger type and configuring all trigger settings correctly allows you to detect various incidents in your demodulated signals.

Optionally, the trigger signal used by the R&S FSWP can be output to a connected device, and an external trigger signal from a connected device can be used by the R&S FSWP.

For a comprehensive description, refer to the user manual of the optional spectrum application.

- [Trigger source settings](#).....52
- [Trigger input and output settings](#).....56

5.6.1 Trigger source settings

Access: "Overview" > "Trigger" > "Trigger Source"

The trigger source settings contain parameter to configure triggered measurements.

Trigger			
Trigger Source	Trigger In/Out		
Source	Ext Trigger 1		
Level	1.4 V	Drop-Out Time	0 s
Offset	0 s	Slope	Rising Falling
Hysteresis	3.0 dB	Holdoff	0 s

The remote commands required to configure the trigger source are described in [Section 11.4.5, "Configuring trigger"](#), on page 119.

Trigger Source.....	53
L Free Run.....	53
L Ext. Trigger 1/2.....	53
L I/Q Power.....	54
L IF Power.....	54
L FM / AM / PM / RF (Offline).....	54
L Time.....	55
L RF Power.....	55
Trigger Level.....	55
Trigger Offset.....	55
Hysteresis.....	56
Drop-Out Time.....	56
Slope.....	56
Trigger Holdoff.....	56
Repetition Interval.....	56

Trigger Source

In the Analog Modulation Analysis application, the next measurement can be triggered if the selected input signal exceeds the threshold specified using the "Trigger Level" setting (see ["Trigger Level"](#) on page 55). Thus, a periodic signal modulated onto the carrier frequency can be displayed. It is recommended that the measurement time covers at least five periods of the audio signal.

Remote command:

[TRIGger \[:SEquence \] :SOURce](#) on page 124

Free Run ← Trigger Source

No trigger source is considered. Data acquisition is started manually or automatically and continues until stopped explicitly.

Remote command:

TRIG:SOUR IMM, see [TRIGger \[:SEquence \] :SOURce](#) on page 124

Ext. Trigger 1/2 ← Trigger Source

Data acquisition starts when the TTL signal fed into the specified input connector meets or exceeds the specified trigger level.

Note: "External Trigger 1" automatically selects the trigger signal from the "Trigger Input / Output" connector on the front panel.

For details, see the "Instrument Tour" section in the R&S FSWP Getting Started manual.

"External Trigger 1"

Trigger signal from the "Trigger Input / Output" connector.
(front panel)

"External Trigger 2"

Trigger signal from the "Sync Trigger Input / Output" connector.
(rear panel)

Note: Connector must be configured for "Input" in the "Output" configuration

(See the R&S FSWP base unit user manual).

Remote command:

TRIG:SOUR EXT, TRIG:SOUR EXT2

See [TRIGger\[:SEquence\]:SOURce](#) on page 124

I/Q Power ← Trigger Source

Triggers the measurement when the magnitude of the sampled I/Q data exceeds the trigger threshold.

The trigger bandwidth corresponds to the resolution bandwidth setting for data acquisition (see ["Resolution Bandwidth"](#) on page 60).

Remote command:

TRIG:SOUR IQP, see [TRIGger\[:SEquence\]:SOURce](#) on page 124

IF Power ← Trigger Source

The R&S FSWP starts capturing data as soon as the trigger level is exceeded around the third intermediate frequency.

For frequency sweeps, the third IF represents the start frequency. The trigger threshold depends on the defined trigger level, as well as on the RF attenuation and preamplification. A reference level offset, if defined, is also considered. The trigger bandwidth at the intermediate frequency depends on the RBW and sweep type. For details on available trigger levels and trigger bandwidths, see the instrument specifications document.

For measurements on a fixed frequency (e.g. zero span or I/Q measurements), the third IF represents the center frequency.

This trigger source is only available for RF input.

The available trigger levels depend on the RF attenuation and preamplification. A reference level offset, if defined, is also considered.

For details on available trigger levels and trigger bandwidths, see the specifications document.

Remote command:

TRIG:SOUR IFP, see [TRIGger\[:SEquence\]:SOURce](#) on page 124

FM / AM / PM / RF (Offline) ← Trigger Source

Triggers when the demodulated input signal exceeds the trigger level.

Remote command:

[TRIGger\[:SEquence\]:SOURce](#) on page 124

Time ← Trigger Source

Triggers in a specified repetition interval.

See "[Repetition Interval](#)" on page 56.

Remote command:

TRIG:SOUR TIME, see [TRIGger\[:SEquence\]:SOURce](#) on page 124

RF Power ← Trigger Source

Defines triggering of the measurement via signals which are outside the displayed measurement range.

For this purpose, the instrument uses a level detector at the first intermediate frequency.

The input signal must be in the frequency range between 500 MHz and 8 GHz.

The resulting trigger level at the RF input depends on the RF attenuation and preamplification. For details on available trigger levels, see the instrument's specifications document.

Note: If the input signal contains frequencies outside of this range (e.g. for fullspan measurements), the measurement can be aborted. A message indicating the allowed input frequencies is displayed in the status bar.

A "Trigger Offset", "Trigger Polarity" and "Trigger Holdoff" (to improve the trigger stability) can be defined for the RF trigger, but no "Hysteresis".

Remote command:

TRIG:SOUR RFP, see [TRIGger\[:SEquence\]:SOURce](#) on page 124

Trigger Level

Defines the trigger level for the specified trigger source.

For details on supported trigger levels, see the instrument specifications document.

Remote command:

[TRIGger\[:SEquence\]:LEVel:IFPower](#) on page 123

[TRIGger\[:SEquence\]:LEVel:IQPower](#) on page 123

[TRIGger\[:SEquence\]:LEVel\[:EXTernal<port>\]](#) on page 122

[TRIGger\[:SEquence\]:LEVel:RFPower](#) on page 124

[TRIGger\[:SEquence\]:LEVel:AM:RELative](#) on page 122

[TRIGger\[:SEquence\]:LEVel:AM\[:ABSolute\]](#) on page 121

[TRIGger\[:SEquence\]:LEVel:FM](#) on page 122

[TRIGger\[:SEquence\]:LEVel:PM](#) on page 123

Trigger Offset

Defines the time offset between the trigger event and the start of the measurement.

Offset > 0:	Start of the measurement is delayed
Offset < 0:	Measurement starts earlier (pretrigger)

For the "Time" trigger source in swept measurements, this function is not available.

Remote command:

[TRIGger\[:SEquence\]:HOLDoFF\[:TIME\]](#) on page 121

Hysteresis

Defines the distance in dB to the trigger level that the trigger source must exceed before a trigger event occurs. Setting a hysteresis avoids unwanted trigger events caused by noise oscillation around the trigger level.

This setting is only available for "IF Power" trigger sources. The range of the value is between 3 dB and 50 dB with a step width of 1 dB.

Remote command:

[TRIGger\[:SEquence\]:IFPower:HYSTeresis](#) on page 121

Drop-Out Time

Defines the time that the input signal must stay below the trigger level before triggering again.

Remote command:

[TRIGger\[:SEquence\]:DTIME](#) on page 120

Slope

For all trigger sources except time, you can define whether triggering occurs when the signal rises to the trigger level or falls down to it.

Remote command:

[TRIGger\[:SEquence\]:SLOPe](#) on page 124

Trigger Holdoff

Defines the minimum time (in seconds) that must pass between two trigger events. Trigger events that occur during the holdoff time are ignored.

Remote command:

[TRIGger\[:SEquence\]:IFPower:HOLDoFF](#) on page 120

Repetition Interval

Defines the repetition interval for a time trigger.

The shortest interval is 2 ms.

Set the repetition interval to the exact pulse period, burst length, frame length or other repetitive signal characteristic. If the required interval cannot be set with the available granularity, configure a multiple of the interval that can be set. Thus, the trigger remains synchronized to the signal.

Remote command:

[TRIGger\[:SEquence\]:TIME:RINTerval](#) on page 125

5.6.2 Trigger input and output settings

Access: "Overview" > "Trigger" > "Trigger In / Out"

The trigger input and output settings control usage of the trigger connectors available on the R&S FSWP.

The remote commands required to configure the trigger input and output are described in [Section 11.4.2.3, "Configuring outputs"](#), on page 110.

Trigger 1/2.....57

- L Output Type.....57
 - L Level.....58
 - L Pulse Length.....58
 - L Send Trigger.....58

Trigger 1/2

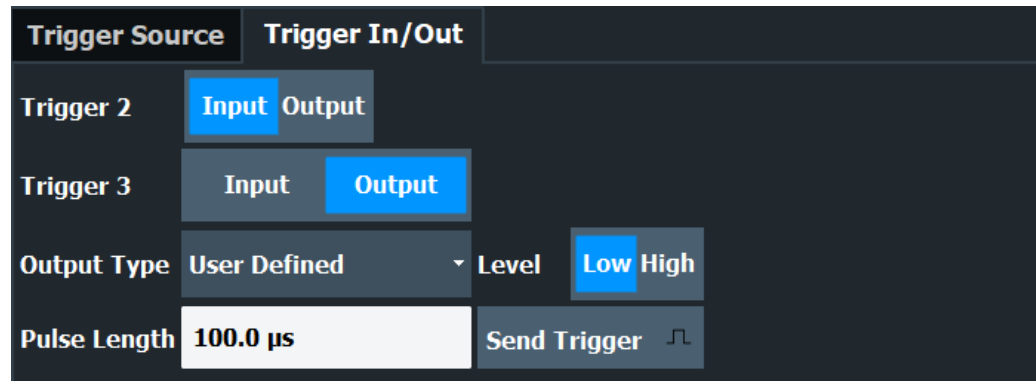

The trigger input and output functionality depends on how the variable "Trigger Input/Output" connectors are used.

Note: Providing trigger signals as output is described in detail in the R&S FSWP base unit user manual.

- "Trigger 1" "Trigger 1": "Trigger Input/Output" connector on the front panel
- "Trigger 2" Defines the usage of the variable "Trigger Input/Output" connector on the rear panel.
- "Input" The signal at the connector is used as an external trigger source by the R&S FSWP. Trigger input parameters are available in the "Trigger" dialog box.
- "Output" The R&S FSWP sends a trigger signal to the output connector to be used by connected devices. Further trigger parameters are available for the connector.
Note: For offline AF or RF triggers, no output signal is provided.

Remote command:

[OUTPut:TRIGger<tp>:DIRection](#) on page 112

Output Type ← Trigger 1/2

Type of signal to be sent to the output

- "Device Triggered" (Default) Sends a trigger when the R&S FSWP triggers.
- "Trigger Armed" Sends a (high level) trigger when the R&S FSWP is in "Ready for trigger" state. This state is indicated by a status bit in the `STATUS:OPERation` register (bit 5), as well as by a low-level signal at the "AUX" port (pin 9).

"User Defined" Sends a trigger when you select "Send Trigger".
In this case, further parameters are available for the output signal.

Remote command:

[OUTPut:TRIGger<tp>:OTYPe](#) on page 113

Level ← Output Type ← Trigger 1/2

Defines whether a high (1) or low (0) constant signal is sent to the trigger output connector (for "Output Type": "User Defined").

The trigger pulse level is always opposite to the constant signal level defined here. For example, for "Level" = "High", a constant high signal is output to the connector until you select the [Send Trigger](#) function. Then, a low pulse is provided.

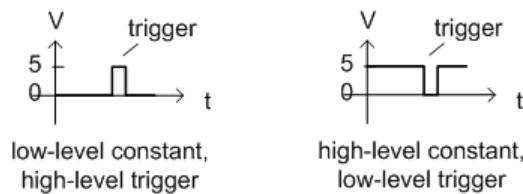

Remote command:

[OUTPut:TRIGger<tp>:LEVel](#) on page 113

Pulse Length ← Output Type ← Trigger 1/2

Defines the duration of the pulse (pulse width) sent as a trigger to the output connector.

Remote command:

[OUTPut:TRIGger<tp>:PULSe:LENGth](#) on page 114

Send Trigger ← Output Type ← Trigger 1/2

Sends a user-defined trigger to the output connector immediately.

Note that the trigger pulse level is always opposite to the constant signal level defined by the output [Level](#) setting. For example, for "Level" = "High", a constant high signal is output to the connector until you select the "Send Trigger" function. Then, a low pulse is sent.

Which pulse level is sent is indicated by a graphic on the button.

Remote command:

[OUTPut:TRIGger<tp>:PULSe:IMMediate](#) on page 113

5.7 Data acquisition

Access: "Overview" > "Data Acquisition"

How data is to be acquired and then demodulated is configured in the "Data Acquisition" dialog box.



MSRA operating mode

In MSRA operating mode, only the MSRA Master channel actually captures data from the input signal. The data acquisition settings for the Analog Modulation Analysis application in MSRA mode define the analysis interval.

For details on the MSRA operating mode see the R&S FSWP MSRA User Manual.

- [Bandwidth settings](#).....59
- [Sweep settings](#).....61

5.7.1 Bandwidth settings

Access: "Overview" > "Data Acquisition" > "Bandwidth"

The bandwidth settings define which parts of the input signal are acquired and then demodulated.

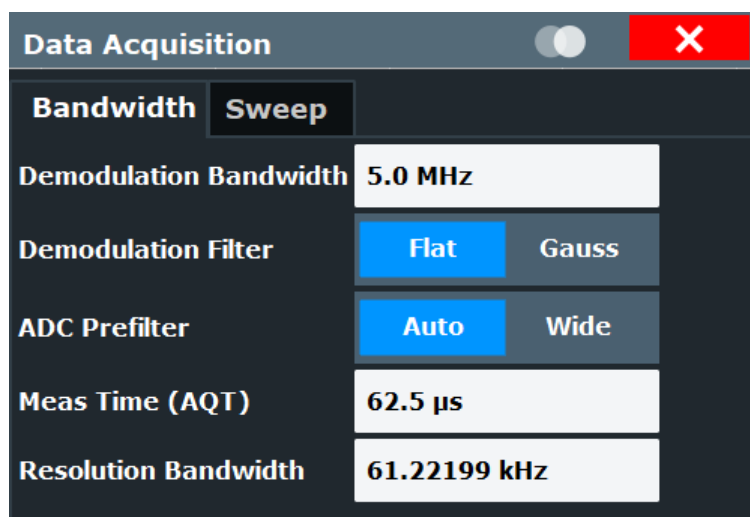

The remote commands required to configure the bandwidth are described in [Section 11.4.8, "Configuring data acquisition"](#), on page 130.

Demodulation Bandwidth	59
Demodulation Filter	60
Measurement Time (AQT)	60
ADC Prefilter	60
Capture Offset	60
Resolution Bandwidth	60

Demodulation Bandwidth

Defines the demodulation bandwidth of the measurement. The demodulation bandwidth determines the sample rate with which the input signal is captured and analyzed.

For recommendations on finding the correct demodulation bandwidth, see [Section 4.2, "Demodulation bandwidth"](#), on page 32.

For details on the relation between demodulation bandwidth and sample rate, refer to [Section 4.3, "Sample rate and demodulation bandwidth"](#), on page 33.

Remote command:

[SENSe:] BWIDth:DEMod on page 137

Demodulation Filter

Defines the filter to be used for demodulation.

For details on sample rates, measurement times and trigger offsets for various demodulation bandwidths when using a Gaussian filter, see [Section 4.3, "Sample rate and demodulation bandwidth"](#), on page 33.

"Flat" Default

"Gauss" Optimizes the settling behavior of the filter

Remote command:

[SENSe:] BWIDth:DEMod:TYPE on page 137

Measurement Time (AQT)

Defines how long data is acquired for demodulation.

Remote command:

[SENSe:] ADEMod:MTIME on page 135

ADC Prefilter

Selects the IF filter bandwidth mode.

- "Auto"
The bandwidth of the IF filter is selected automatically, depending on the demodulation bandwidth.
- "Wide"
Selects the largest possible bandwidth of the IF filter.

Remote command:

[SENSe:] ADEMod:ADCPrefilter on page 134

Capture Offset

This setting is only available for secondary applications in **MSRA operating mode**. It has a similar effect as the trigger offset in other measurements: it defines the time offset between the capture buffer start and the start of the extracted secondary application data.

In MSRA mode, the offset must be a positive value, as the capture buffer starts at the trigger time = 0.

For details on the MSRA operating mode, see the R&S FSWP MSRA User Manual.

Remote command:

[SENSe:] MSRA:CAPTure:OFFSet on page 138

Resolution Bandwidth

Defines the resolution bandwidth for data acquisition. The available range is defined in the specifications document.

Remote command:

[SENSe:] BANDwidth[:RESolution] on page 137

5.7.2 Sweep settings

Access: "Overview" > "Data Acquisition" > "Sweep" tab

The sweep settings define how often data from the input signal is acquired and then demodulated.

Bandwidth	Sweep
Meas Time (AQT)	80.0 µs
Sweep Points	1001
Sweep Count	0
Specifics for	1: FM Time Domain

For more information on the spectrogram settings that become available when you turn on a spectrogram, refer to the R&S FSWP user manual.

The remote commands required to configure the sweep are described in [Section 11.4.8, "Configuring data acquisition"](#), on page 130.

Continuous Sweep / Run Cont	61
Single Sweep / Run Single	62
Continue Single Sweep	62
Refresh (MSRA only)	62
Measurement Time (AQT)	62
Sweep Points	63
Sweep/Average Count	63

Continuous Sweep / Run Cont

After triggering, starts the sweep and repeats it continuously until stopped. This is the default setting.

While the measurement is running, "Continuous Sweep" and [RUN CONT] are highlighted. The running measurement can be aborted by selecting the highlighted softkey or key again. The results are not deleted until a new measurement is started.

Note: Sequencer. If the Sequencer is active, "Continuous Sweep" only controls the sweep mode for the currently selected channel. However, the sweep mode only takes effect the next time the Sequencer activates that channel, and only for a channel-defined sequence. In this case, a channel in continuous sweep mode is swept repeatedly.

Furthermore, [RUN CONT] controls the Sequencer, not individual sweeps. [RUN CONT] starts the Sequencer in continuous mode.

For details on the Sequencer, see the R&S FSWP base unit user manual.

Remote command:

`INITiate<n>:CONTInuous` on page 132

Single Sweep / Run Single

After triggering, starts the number of sweeps set in "Sweep Count". The measurement stops after the defined number of sweeps has been performed.

While the measurement is running, "Single Sweep" and [RUN SINGLE] are highlighted. The running measurement can be aborted by selecting the highlighted softkey or key again.

Note: Sequencer. If the Sequencer is active, "Single Sweep" only controls the sweep mode for the currently selected channel. However, the sweep mode only takes effect the next time the Sequencer activates that channel, and only for a channel-defined sequence. In this case, the Sequencer sweeps a channel in single sweep mode only once.

Furthermore, [RUN SINGLE] controls the Sequencer, not individual sweeps. [RUN SINGLE] starts the Sequencer in single mode.

If the Sequencer is off, only the evaluation for the currently displayed channel is updated.

For details on the Sequencer, see the R&S FSWP base unit user manual.

Remote command:

`INITiate<n>[:IMMEDIATE]` on page 134

Continue Single Sweep

After triggering, repeats the number of sweeps set in "Sweep Count", without deleting the trace of the last measurement.

While the measurement is running, "Continue Single Sweep" and [RUN SINGLE] are highlighted. The running measurement can be aborted by selecting the highlighted softkey or key again.

Remote command:

`INITiate<n>:CONMeas` on page 132

Refresh (MSRA only)

This function is only available if the Sequencer is deactivated and only for **MSRA secondary applications**.

The data in the capture buffer is re-evaluated by the currently active secondary application only. The results for any other secondary applications remain unchanged.

This is useful, for example, after evaluation changes have been made or if a new sweep was performed from another secondary application. In this case, only that secondary application is updated automatically after data acquisition.

Note: To update all active secondary applications at once, use the "Refresh All" function in the "Sequencer" menu.

Remote command:

`INITiate<n>:REFresh` on page 133

Measurement Time (AQT)

Defines how long data is acquired for demodulation.

Remote command:

`[SENSe:]ADEMod:MTIME` on page 135

Sweep Points

Defines the number of measured values to be collected during one sweep.

All values from 101 to 100001 can be set. The default value is 1001 sweep points.

Remote command:

[\[SENSe:\] SWEep\[:WINDow<n>\]: POINTs](#) on page 139

Sweep/Average Count

Defines the number of measurements to be performed in the single sweep mode. Values from 0 to 200000 are allowed. If the values 0 or 1 are set, one measurement is performed.

The sweep count is applied to all the traces in all diagrams.

If the trace modes "Average", "Max Hold" or "Min Hold" are set, this value also determines the number of averaging or maximum search procedures.

In continuous sweep mode, if "Sweep Count" = 0 (default), averaging is performed over 10 measurements. For "Sweep Count" = 1, no averaging, maxhold or minhold operations are performed.

Remote command:

[\[SENSe:\] SWEep:COUNT](#) on page 138

5.8 Demodulation

Access: "Overview" > "Demod Settings"

Or: "Meas Setup" > "Demod"

- [Basic demodulation measurement parameters \(Demod\)](#).....63
- [Demodulation spectrum](#).....67
- [AF filter](#).....70
- [Scaling](#).....73
- [Units](#).....77
- [Result table settings](#).....78
- [Settling time](#).....81

5.8.1 Basic demodulation measurement parameters (Demod)

Access: "Overview" > "Demod Settings" > "Demod"

Or: "Meas Setup" > "Demod" > "Demod" tab

The basic demodulation measurement parameters define how the measurement is performed.

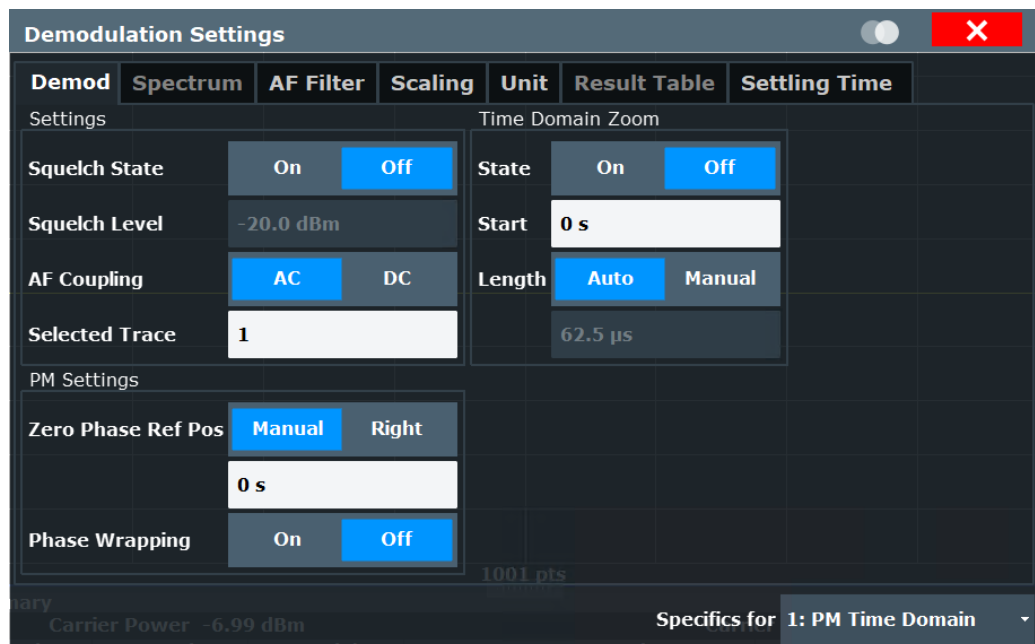

Squelch State.....	64
Squelch Level.....	64
AF Coupling.....	64
Selected Trace.....	65
Time Domain Zoom.....	65
L State.....	65
L Start.....	65
L Length.....	66
L Time per Division.....	66
Zero Phase Reference Position (PM Time Domain only).....	66
Phase Wrap On/Off (PM Time Domain only).....	66

Squelch State

Activates the squelch function, that is: if the signal falls below a defined threshold, the demodulated data is automatically set to 0. This is useful, for example, to avoid demodulation noise during transmission breaks.

This function is only available for FM demodulation.

Remote command:

`[SENSe:]ADEMod:SQUelch[:STATe]` on page 141

Squelch Level

Defines the level threshold below which the demodulated data is set to 0 if squelching is enabled. The squelch level is an absolute value.

Remote command:

`[SENSe:]ADEMod:SQUelch:LEVel` on page 141

AF Coupling

Controls the automatic correction of the frequency offset and phase offset of the input signal:

This function is only available for FM or PM time domain evaluations.

- FM time evaluation
If DC is selected, the absolute frequency is displayed. That means, an input signal with an offset relative to the center frequency is not displayed symmetrically to the zero line.
If AC is selected, the frequency offset is automatically corrected, i.e. the trace is always symmetric to the zero line.
- PM time evaluation
If DC is selected, the phase runs according to the existing frequency offset. In addition, the DC signal contains a phase offset of $\pm \pi$.
If AC is selected, the frequency offset and phase offset are automatically corrected, i.e. the trace is always symmetric to the zero line.

Remote command:

[\[SENSe:\]ADEMod<n>:AF:COUPLing](#) on page 140

Selected Trace

Defines the trace used to determine the results in the "Result Summary".

Time Domain Zoom

Using the time domain zoom, the demodulated data for a particular time span is extracted and displayed in more detail. Time domain zoom is useful if the measurement time is very large and thus each sweep point represents a large time span. The time domain zoom function distributes the available sweep points only among the time span defined by the zoom area length. The time span displayed per division of the diagram is decreased. Thus, the display of the extracted time span becomes more precise. Note that the time domain zoom area affects not only the diagram display, but the entire evaluation for the current window.

This function is only available for evaluations in the time domain.

Tip: In addition to the Time Domain Zoom, a graphical zoom is available for all diagram evaluations. However, the graphical zoom is useful only if more measured values than trace points are available. The (time) span represented by each measurement point remains the same.

State ← Time Domain Zoom

Activates or deactivates the time domain zoom mode.

- | | |
|-------|--|
| "On" | Activates the time domain zoom. |
| "Off" | Deactivates the time domain zoom and restores the original display. If more measured values than measurement points are available, several measured values are combined in one measurement point according to the method of the selected trace detector. |

Remote command:

[\[SENSe:\]ADEMod<n>:ZOOM\[:STATe\]](#) on page 143

Start ← Time Domain Zoom

Defines the start time for the time domain zoom area. For spectrum evaluations, the start time is always 0.

Remote command:

[SENSe:]ADEMod<n>:ZOOM:START on page 142

Length ← Time Domain Zoom

Defines the length of the time domain zoom area. Enter the length as a time value manually, or use the "Auto" setting to set the length to the current number of sweep points automatically.

Remote command:

[SENSe:]ADEMod<n>:ZOOM:LENGTH on page 141

[SENSe:]ADEMod<n>:ZOOM:LENGTH:MODE on page 142

Time per Division ← Time Domain Zoom

Enables the "Time Domain Zoom" function and defines the zoom area length in one step. The width of the zoom display is divided into 10 divisions; thus, by entering the time that is displayed in each division, you indirectly define the zoom area length ("Time per Division" * 10). The starting point of the zoom area is determined automatically. To specify the starting point manually, use the [Start](#) setting.

"Time per Division" is available from the main "AM FM PM Analog Demod" menu.

Zero Phase Reference Position (PM Time Domain only)

Defines the position in time at which the phase of the PM-demodulated signal is set to 0 rad.

In the default setting, the time of the first measured value is set to 0 rad. You can define a different position manually, or select the time of the last measured value (i.e. the furthest to the right in the diagram) as the reference position. The time of the last measured value corresponds to the total acquisition time, considering the trigger event and trigger offset, if applicable. If the acquisition time or the trigger values are changed, the reference position is automatically adapted.

This setting is only available for PM time domain displays with DC coupling.

Remote command:

[SENSe:]ADEMod:PM:RPOINT[:X] on page 140

[SENSe:]ADEMod:PM:RPOINT[:X]:MODE on page 179

Phase Wrap On/Off (PM Time Domain only)

Activates/deactivates the phase wrap.

On	The phase is displayed in the range $\pm 180^\circ$ ($\pm \Pi$). For example, if the phase exceeds $+180^\circ$, 360° is subtracted from the phase value, with the display thus showing $>-180^\circ$.
Off	The phase is not wrapped.

This setting is only available for PM time domain displays with DC coupling.

Remote command:

CALC:FORM PHAS/CALC:FORM UPH, see [CALCulate<n>:FORMat](#) on page 158

5.8.2 Demodulation spectrum

Access: "Overview" > "Demod Settings" > "Spectrum"

Or: "Meas Setup" > "Demod" > "Spectrum" tab

The demodulation spectrum defines which span of the demodulated data is evaluated.

Depending on the evaluation (AF or RF display), the settings vary.

- [AF evaluation](#)..... 67
- [RF evaluation](#)..... 68

5.8.2.1 AF evaluation

Access: "Overview" > "Demod Settings" > "Spectrum"

Or: "Meas Setup" > "Demod" > "Spectrum" tab

These settings are only available for AF Spectrum evaluations, not in the time domain.

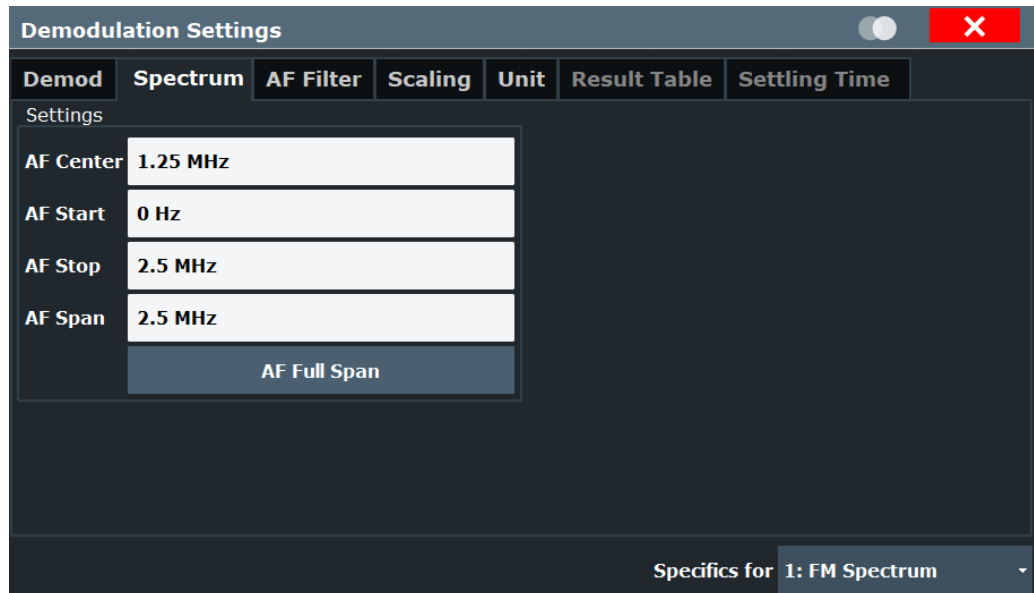

- [AF Center](#)..... 67
- [AF Start](#)..... 67
- [AF Stop](#)..... 68
- [AF Span](#)..... 68
- [AF Full Span](#)..... 68

AF Center

Defines the center frequency of the demodulated data to evaluate.

Remote command:

[SENSe:]ADEMod:AF:CENTer on page 145

AF Start

Defines the start frequency of the demodulated data to evaluate.

Remote command:

[SENSe:] ADEMod:AF:START on page 146

AF Stop

Defines the stop frequency of the demodulated data to evaluate.

The maximum AF stop frequency corresponds to half the demodulation bandwidth.

Remote command:

[SENSe:] ADEMod:AF:STOP on page 146

AF Span

Defines the span (around the center frequency) of the demodulated data to evaluate.

The maximum span is DBW/2.

Remote command:

[SENSe:] ADEMod:AF:SPAN on page 145

AF Full Span

Sets the span (around the center frequency) of the demodulated data to the maximum of DBW/2.

Remote command:

[SENSe:] ADEMod:AF:SPAN:FULL on page 146

5.8.2.2 RF evaluation

Access: "Overview" > "Demod Settings" > "Spectrum"

Or: "Meas Setup" > "Demod" > "Spectrum" tab

These settings are only available for RF evaluation, both in time and frequency domain. Note that for RF data the center frequency and demodulation bandwidth correspond to the settings defined in the "Input" and "Data Acquisition" configuration.

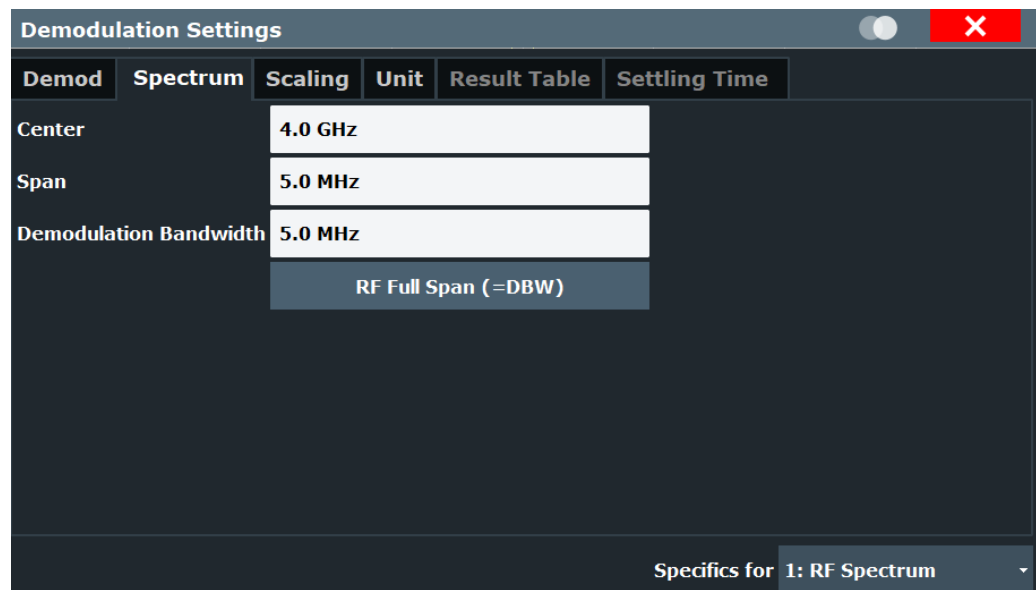

Center Frequency.....	69
Span.....	69
Demodulation Bandwidth.....	69
RF Full Span.....	69

Center Frequency

Defines the center frequency of the signal in Hertz.

The allowed range of values for the center frequency depends on the frequency span.

$$\text{span} > 0: \text{span}_{\min}/2 \leq f_{\text{center}} \leq f_{\text{max}} - \text{span}_{\min}/2$$

f_{max} and span_{\min} depend on the instrument and are specified in the specifications document.

Remote command:

[SENSe:] FREQuency:CENTer on page 117

Span

Defines the frequency span. The center frequency is kept constant. The following range is allowed:

$$\text{span} = 0: 0 \text{ Hz}$$

$$\text{span} > 0:$$

$$\text{span}_{\min} \leq f_{\text{span}} \leq f_{\text{max}}$$

$$\text{and } f_{\text{max}} = \text{DBW}/2$$

f_{max} and span_{\min} are specified in the specifications document.

Remote command:

[SENSe:] ADEMod:SPECTrum:SPAN[:MAXimum] on page 147

[SENSe:] ADEMod:SPECTrum:SPAN:ZOOM on page 147

Demodulation Bandwidth

Defines the demodulation bandwidth of the measurement. The demodulation bandwidth determines the sample rate with which the input signal is captured and analyzed.

For recommendations on finding the correct demodulation bandwidth, see [Section 4.2, "Demodulation bandwidth"](#), on page 32.

For details on the relation between demodulation bandwidth and sample rate, refer to [Section 4.3, "Sample rate and demodulation bandwidth"](#), on page 33.

Remote command:

[SENSe:] BWIDth:DEMod on page 137

RF Full Span

Sets the span (around the center frequency) of the RF data to be evaluated to the demodulation bandwidth.

Remote command:

[SENSe:] ADEMod:SPECTrum:SPAN[:MAXimum] on page 147

5.8.3 AF filter

Access: "Overview" > "Demod Settings" > "AF Filter"

Or: "Meas Setup" > "Demod" > "AF Filter" tab

The AF filter reduces the evaluated bandwidth of the demodulated signal and can define a weighting function.



AF filters are only available for AF evaluations, not for RF evaluation.

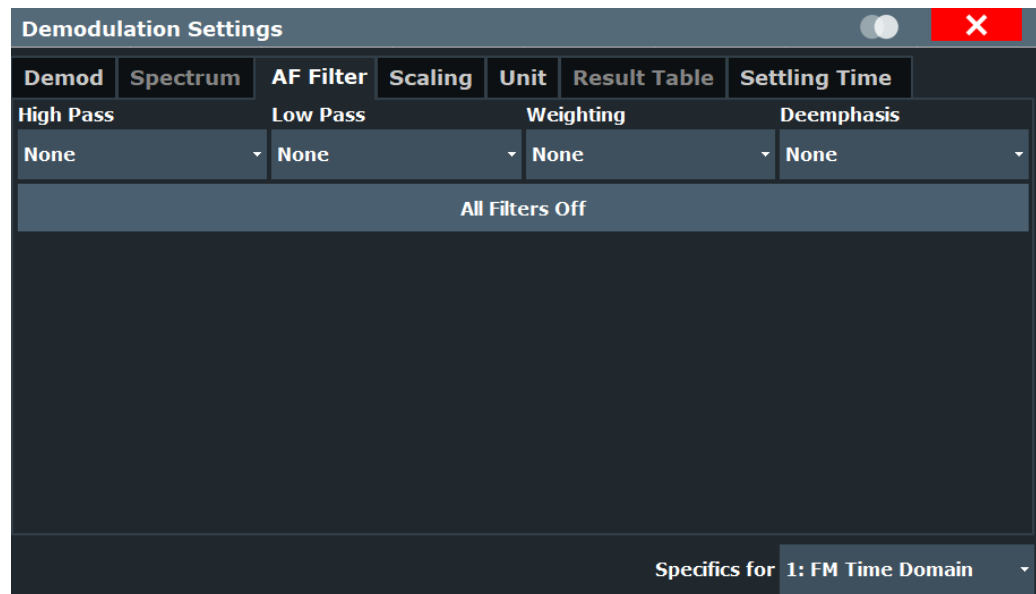

If a high pass or low pass AF filter is defined, the filter is indicated by a vertical red line in the spectrum display.

High Pass.....	70
Low Pass.....	71
Weighting.....	72
Deemphasis.....	72
Deactivating all AF Filters.....	73

High Pass

Defines a high pass filter with the given limit to separate the DC component. The filters are indicated by the 3 dB cutoff frequency. The 50 Hz and 300 Hz filters are designed as 2nd-order Butterworth filter (12 dB/octave). The 20 Hz filter is designed as 3rd-order Butterworth filter (18 dB/octave).

The high pass filters are active in the following demodulation bandwidth range:

None	No AF Filter used (default)
20 Hz	100 Hz ≤ demodulation bandwidth ≤ 1.6 MHz

50 Hz:	200 Hz ≤ demodulation bandwidth ≤ 3 MHz
300 Hz:	800 Hz ≤ demodulation bandwidth ≤ 8 MHz
Manual:	A high pass filter with the manually defined frequency is used.

Note: If online demodulation output is active, the predefined (fixed) filters are not available. In this case, you must define the frequency for the high pass filter manually. (See also [Section 5.3.7, "Analog demod output settings"](#), on page 46).

If a filter was already configured when online demodulation output is activated, it is replaced by a manual filter that provides corresponding results, if possible.

Remote command:

[SENSe:] FILTer<n>:HPASs [:STATe] on page 151

[SENSe:] FILTer<n>:HPASs:FREQuency [:ABSolute] on page 150

[SENSe:] FILTer<n>:HPASs:FREQuency:MANual on page 150

Low Pass

Defines a low pass filter type. Relative and absolute low pass filter are available.

- Absolute low pass filters:
Absolute filters are indicated by the 3 dB cutoff frequency. The 3 kHz, 15 kHz and 23 kHz filters are designed as 5th-order Butterworth filters (30 dB/octave). The 150 kHz filter is designed as 8th-order Butterworth filter (48 dB/octave).
The absolute low pass filters are active in the following demodulation bandwidth range:

Filter type	Demodulation bandwidth
3 kHz:	6.4 kHz ≤ demodulation bandwidth ≤ 3 MHz
15 kHz:	50 kHz ≤ demodulation bandwidth ≤ 8 MHz
23 kHz:	50 kHz ≤ demodulation bandwidth ≤ 18 MHz
150 kHz:	400 kHz ≤ demodulation bandwidth ≤ 8 MHz
Manual:	A low pass filter with the manually defined frequency is used.

Note: If online demodulation output is active, the predefined (fixed) filters are not available. In this case, you must define the frequency for the low pass filter manually (see also ["AC Cutoff Frequency"](#) on page 48).

If a filter was already configured when online demodulation output is activated, it is replaced by a manual filter that provides corresponding results, if possible.

- Relative low pass filters:
Relative filters (3 dB) can be selected in % of the demodulation bandwidth. The filters are designed as 5th-order Butterworth filter (30 dB/octave) and active for all demodulation bandwidths.
- "NONE" deactivates the AF low pass filter (default).

Remote command:

[SENSe:] FILTer<n>:LPASs [:STATe] on page 152

[SENSe:] FILTer<n>:LPASs:FREQuency [:ABSolute] on page 151

[\[SENSe:\] FILTER<n>:LPASs:FREQuency:RELative](#) on page 152

[\[SENSe:\] FILTER<n>:LPASs:FREQuency:MANual](#) on page 151

Weighting

Selects a weighting AF filter. By default, no weighting filter is active.

"A weighted"	Switches on the A weighted filter. The weighting filter is active in the following demodulation bandwidth range: 100 kHz ≤ demodulation bandwidth ≤ 800 kHz
"CCITT"	Switches on a CCITT P.53 weighting filter. The weighting filter is active in the following demodulation bandwidth range: 20 kHz ≤ demodulation bandwidth ≤ 3 MHz
"CCIR weighed"	Switches on the CCIR weighted filter. The weighting filter is active in the following demodulation bandwidth range: 100 kHz ≤ demodulation bandwidth ≤ 3.0 MHz
"CCIR unweighted"	Switches on the CCIR unweighted filter, which is the combination of the 20 Hz highpass and 23 kHz low pass filter. The weighting filter is active in the following demodulation bandwidth range: 50 kHz ≤ demodulation bandwidth ≤ 1.6 MHz

Remote command:

[\[SENSe:\] FILTER<n>:CCITt\[:STATe\]](#) on page 149

[\[SENSe:\] FILTER<n>:CCIR\[:UNWeighted\]\[:STATe\]](#) on page 149

[\[SENSe:\] FILTER<n>:CCIR:WEIGHTed\[:STATe\]](#) on page 148

[\[SENSe:\] FILTER<n>:AWEighted\[:STATe\]](#) on page 148

Deemphasis

Activates a deemphasis filter with the given time constant.

Sometimes a modulated signal is extorted by a pre-emphasis filter before transmission, for example to eliminate frequencies that are more prone to interferences. In this case, the emphasis function must be reversed after demodulation, which is done by the deemphasis filter.

The deemphasis filter is active in the following demodulation bandwidth range:

25 μs:	25 kHz ≤ demodulation bandwidth ≤ 40 MHz
50 μs:	6.4 kHz ≤ demodulation bandwidth ≤ 18 MHz
75 μs:	6.4 kHz ≤ demodulation bandwidth ≤ 18 MHz
750 μs:	800 Hz ≤ demodulation bandwidth ≤ 3 MHz

Depending on the deemphasis filter, a minimum demodulation bandwidth is required for an error less than 0.5 dB, up to a maximum AF frequency. The following table shows the dependencies.

Deemphasis [us]	25 μs	50 μs	75 μs	750 μs
Max. AF frequency	25 kHz	12 kHz	8 kHz	800 Hz
Required demodulation bandwidth	≥ 200 kHz	≥ 100 kHz	≥ 50 kHz	≥ 6.4 kHz

For higher AF frequencies, you must increase the demodulation bandwidth.

Remote command:

[SENSe:]FILTer<n>:DEMPHasis[:STATe] on page 149

[SENSe:]FILTer<n>:DEMPHasis:TCONstant on page 149

Deactivating all AF Filters

"All Filter Off" deactivates all AF filters for the selected evaluation.

Remote command:

[SENSe:]FILTer<n>:AOFF on page 148

5.8.4 Scaling

Access: "Overview" > "Demod Settings" > "Scaling"

Or: "Meas Setup" > "Demod" > "Scaling" tab

The scaling parameters define the range of the demodulated data to be displayed.

- [AF evaluation](#)..... 73
- [RF evaluation](#)..... 75

5.8.4.1 AF evaluation

Access: "Overview" > "Demod Settings" > "Scaling"

Or: "Meas Setup" > "Demod" > "Scaling" tab

These settings are only available for AF evaluations.

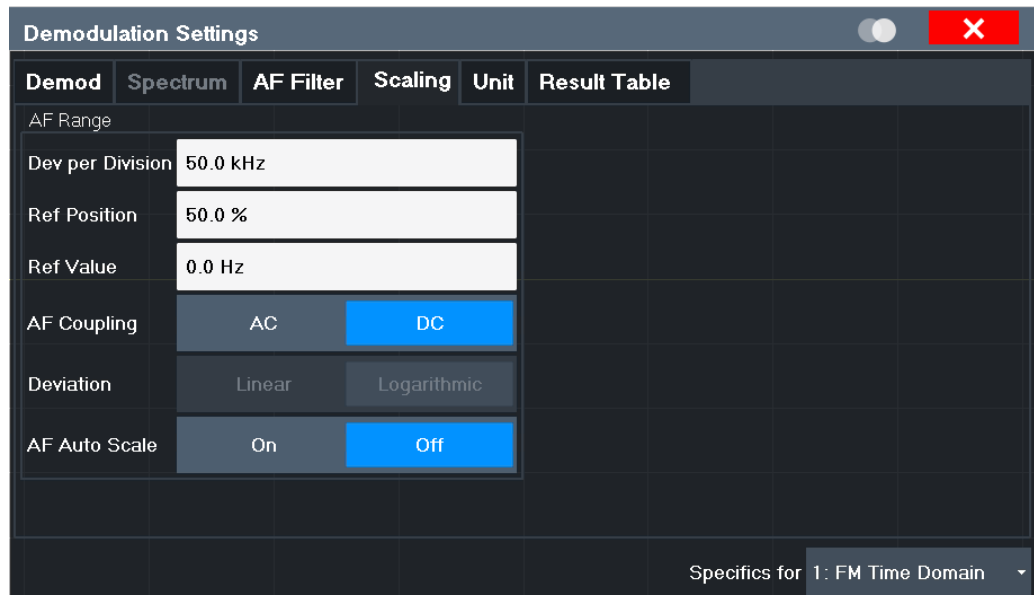

- [Dev per Division/ dB per Division](#)..... 74
- [Reference Value Position](#)..... 74
- [Reference Value](#)..... 74

AF Coupling.....	75
Deviation.....	75
AF Auto Scale.....	75

Dev per Division/ dB per Division

Defines the modulation depth or the phase deviation or frequency deviation per division (logarithmic: 0.1 dB to 20 dB):

AM display:	0.0001 % to 1000 %
FM display:	10 mHz/div to 500 MHz/div
PM display:	0.0001 rad/div to 1000 rad/div

Note: The value defined per division refers to the default display of 10 divisions on the y-axis. If fewer divisions are displayed (e.g. because the window is reduced in height), the range per division is increased. Thus, the same result range is displayed in the smaller window. In this case, the per division value does not correspond to the actual display.

Remote command:

`DISPlay[:WINDow<n>][:SUBWindow<w>]:TRACe<t>:Y[:SCALe]:PDIVision`
on page 144

Reference Value Position

Determines the position of the reference value for the modulation depth or the phase deviation or frequency deviation on the y-axis of the diagram.

The position is entered as a percentage of the diagram height with 100 % corresponding to the upper diagram border. The default setting is 50 % (diagram center) for the AF time evaluations and 100 % (upper diagram border) for the AF spectrum evaluations.

Remote command:

`DISPlay[:WINDow<n>][:SUBWindow<w>]:TRACe<t>:Y[:SCALe]:RPOSition`
on page 144

Reference Value

Determines the modulation depth or the phase deviation or the frequency deviation at the reference line of the y-axis. The reference value can be set specifically for each evaluation.

- AF time display
The trace display takes individual frequency/phase offsets into account (in contrast, the **AF Coupling** setting permits automatic correction by the average frequency/phase offset of the signal, and therefore cannot be activated simultaneously).
- AF spectrum display
In the default setting, the reference value defines the modulation depth or the FM/PM deviation at the upper diagram border.

Possible values:

- AM: 0 and ± 10000 %
- FM: 0 and ± 10 MHz
- PM: 0 and ± 10000 rad

Note: The reference value for the AF range in the **window title bar** is displayed with respect to the defined reference *position*. The position can vary for different windows. For time domain and frequency domain windows, for example, a different reference value can be displayed, although the same reference is actually used (but the positions vary).

Remote command:

`DISPlay[:WINDow<n>][:SUBWindow<w>]:TRACe<t>:Y[:SCALe]:RVALue`
on page 153

AF Coupling

Controls the automatic correction of the frequency offset and phase offset of the input signal:

This function is only available for FM or PM time domain evaluations.

- FM time evaluation
If DC is selected, the absolute frequency is displayed. That means, an input signal with an offset relative to the center frequency is not displayed symmetrically to the zero line.
If AC is selected, the frequency offset is automatically corrected, i.e. the trace is always symmetric to the zero line.
- PM time evaluation
If DC is selected, the phase runs according to the existing frequency offset. In addition, the DC signal contains a phase offset of $\pm \pi$.
If AC is selected, the frequency offset and phase offset are automatically corrected, i.e. the trace is always symmetric to the zero line.

Remote command:

`[SENSe:]ADEMod<n>:AF:COUPling` on page 140

Deviation

Switches between logarithmic and linear display of the modulation depth or the phase deviation or the frequency deviation.

Remote command:

`DISPlay[:WINDow<n>][:SUBWindow<w>]:TRACe<t>:Y:SPACing` on page 145

AF Auto Scale

Activates automatic scaling of the y-axis for AF measurements. RF power and RF spectrum measurements are not affected by the auto-scaling.

Remote command:

`[SENSe:]ADJust:SCALe[:Y]:AUTO[:CONTinuous]` on page 130

5.8.4.2 RF evaluation

Access: "Overview" > "Demod Settings" > "Scaling"

Or: "Meas Setup" > "Demod" > "Scaling" tab

These settings are only available for RF evaluations and the "result summary".

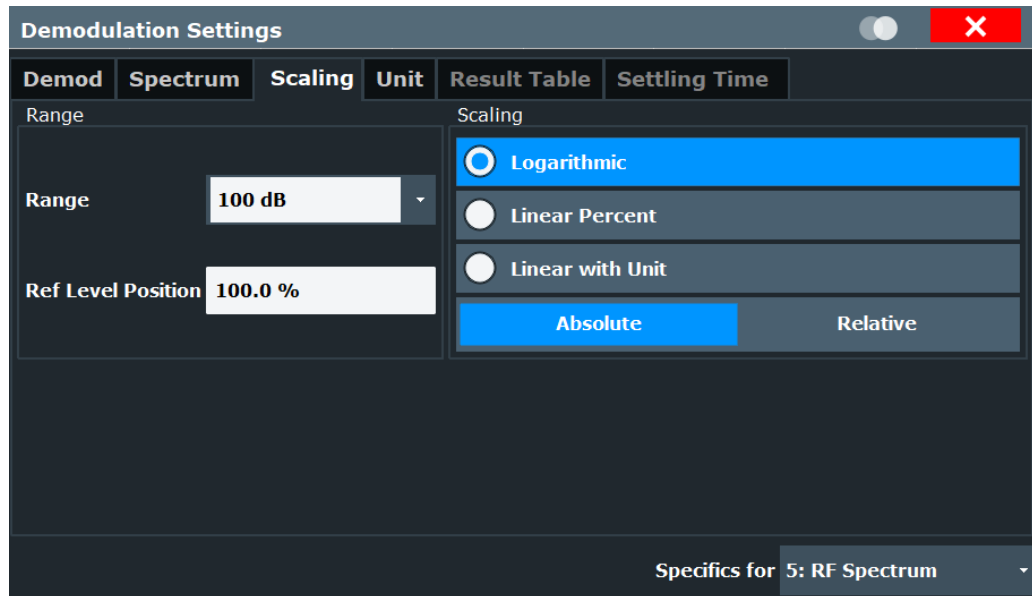

Range.....	76
Ref Level Position.....	76
Auto Scale Once.....	76
Scaling.....	77

Range

Defines the displayed y-axis range in dB.

The default value is 100 dB.

For Analog Modulation Analysis measurements, time domain scaling is defined in Hz (default: 500 kHz).

Remote command:

`DISPlay[:WINDow<n>][:SUBWindow<w>]:TRACe<t>:Y[:SCALE]` on page 154

Ref Level Position

Defines the reference level position, i.e. the position of the maximum AD converter value on the level axis in %.

0 % corresponds to the lower and 100 % to the upper limit of the diagram.

Values from -120 % to +280 % are available.

Larger values are useful for small scales, such as a power range of 10 dB or 20 dB, and low signal levels, for example 60 dB below the reference level. In this case, large reference level position values allow you to see the trace again.

Only available for RF measurements.

Remote command:

`DISPlay[:WINDow<n>][:SUBWindow<w>]:TRACe<t>:Y[:SCALE]:RPOsition` on page 144

Auto Scale Once

Automatically determines the optimal range and reference level position to be displayed for the current measurement settings.

The display is only set once; it is not adapted further if the measurement settings are changed again.

Remote command:

`DISPlay[:WINDow<n>][:SUBWindow<w>]:TRACe<t>:Y[:SCALe]:AUTO ONCE`
on page 154

Scaling

Defines the scaling method for the y-axis.

"Logarithmic"	Logarithmic scaling (only available for logarithmic units - dB..., and A, V, Watt)
"Linear with Unit"	Linear scaling in the unit of the measured signal
"Linear Percent"	Linear scaling in percentages from 0 to 100
"Absolute"	The labeling of the level lines refers to the absolute value of the reference level (not available for "Linear Percent")
"Relative"	The scaling is in dB, relative to the reference level (only available for logarithmic units - dB...). The upper line of the grid (reference level) is always at 0 dB.

Remote command:

`DISPlay[:WINDow<n>][:SUBWindow<w>]:TRACe<t>:Y:SPACing` on page 145
`DISPlay[:WINDow<n>][:SUBWindow<w>]:TRACe<t>:Y[:SCALe]:MODE`
on page 154

5.8.5 Units

Access: "Overview" > "Demod Settings" > "Unit"

Or: "Meas Setup" > "Demod" > "Unit" tab

The units define how the demodulated data is displayed.

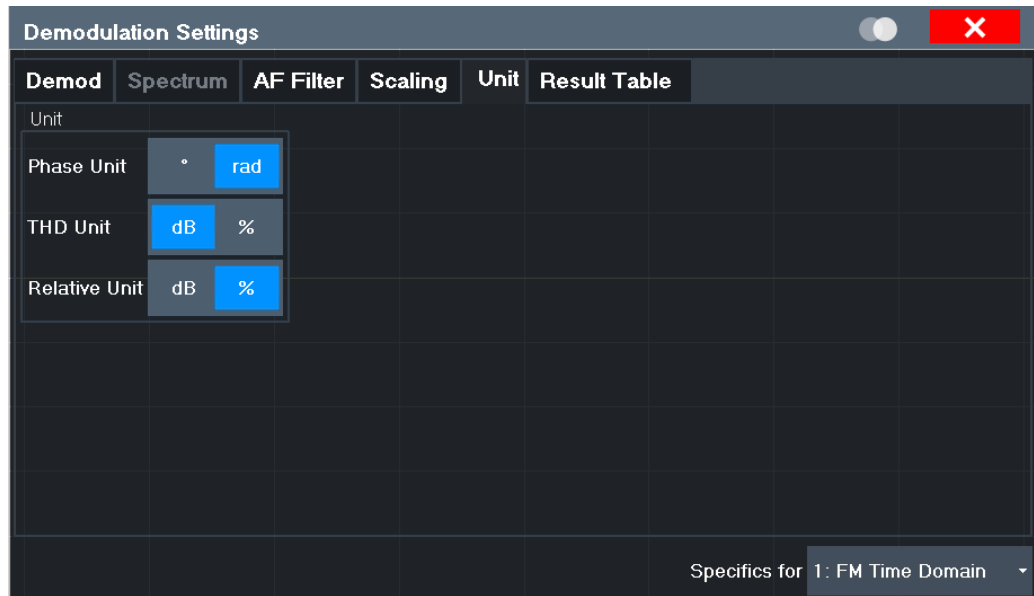

Phase Unit (Rad/Deg).....	78
THD Unit (%/ DB).....	78
Relative Unit.....	78

Phase Unit (Rad/Deg)

Sets the phase unit to rad or deg for displaying PM signals.

Remote command:

`UNIT<n>:ANGLE` on page 155

THD Unit (%/ DB)

Sets the unit to percent or DB for the calculation of the THD (in the "Result Summary").

Remote command:

`UNIT<n>:THD` on page 155

Relative Unit

Defines the unit for relative demodulation results (see [Section 5.8.6, "Result table settings"](#), on page 78).

Remote command:

`CONFigure:ADEMod:RESults:UNIT` on page 158

5.8.6 Result table settings

Access: "Overview" > "Demod Settings" > "Result Table"

Or: "Meas Setup" > "Demod" > "Result Table" tab

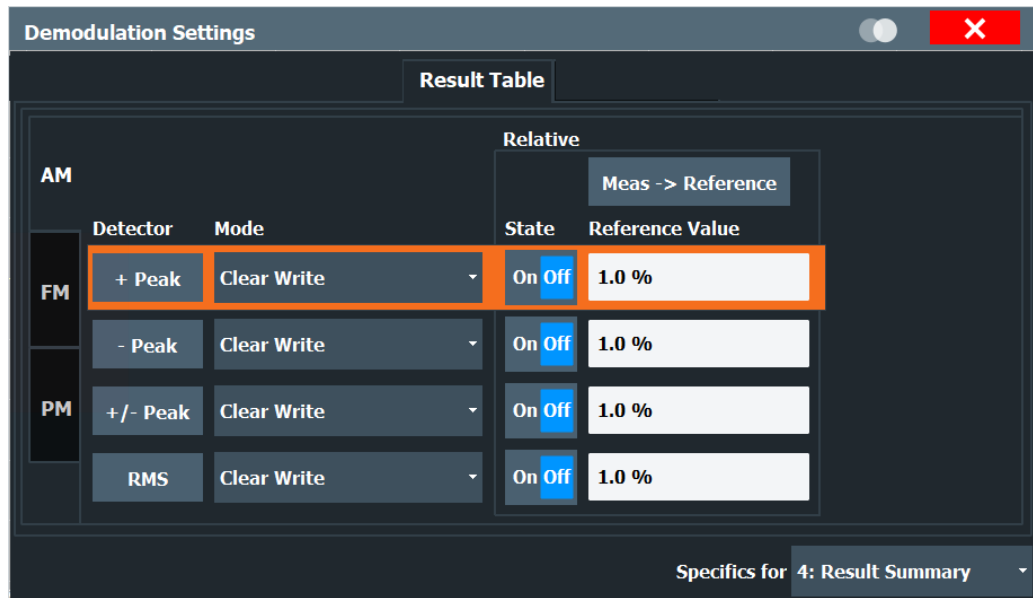

The demodulation results are displayed in the "Result Summary" table (see also "Result Summary" on page 26). The detectors used to determine the results can be configured.

In addition to common absolute demodulation, the R&S FSWP Analog Modulation Analysis application also provides demodulation results relative to user-defined or measured reference values in the "Result Summary".

The settings for the "Result Summary" can be defined individually for the different modulation types (FM, AM, PM). For each modulation type, a separate tab is provided in the dialog box.

Detector.....79
 Mode.....79
 State.....80
 Reference Value.....80
 Meas -> Reference.....80

Detector

Detector type for demodulation results

- "+ Peak" Positive peak
- "- Peak" Negative peak
- "+/- Peak" Autopeak
- "RMS" Root mean square

Remote command:

The detector is specified by the DETector<det> suffix in CONFIGure:RELative:AM|FM|PM:DETector<det>... commands.

Mode

Defines the mode with which the demodulation result is determined.

- "Clear Write" Overwrite mode: the detector value is overwritten by each sweep. This is the default setting.
- "Max Hold" The maximum value is determined over several sweeps and displayed. The R&S FSWP saves each result only if the new value is greater than the previous one.
- "Average" The average result is determined over all sweeps.

Remote command:

[CONFigure:ADEMod:RESults:AM:DETEctor<det>:MODE](#) on page 158

[CONFigure:ADEMod:RESults:FM:DETEctor<det>:MODE](#) on page 158

[CONFigure:ADEMod:RESults:PM:DETEctor<det>:MODE](#) on page 158

State

Activates relative demodulation for the selected detector. If activated, the demodulated result is set in relation to the [Reference Value](#).

Remote command:

[CONFigure:ADEMod:RESults:AM:DETEctor<det>:STATE](#) on page 156

[CONFigure:ADEMod:RESults:FM:DETEctor<det>:STATE](#) on page 156

[CONFigure:ADEMod:RESults:PM:DETEctor<det>:STATE](#) on page 156

Reference Value

Defines the reference value to be used for relative demodulation results and recalculates the results. If necessary, the detector is activated.

Note: A reference value 0 would provide infinite results and is thus automatically corrected to 0.1.

Remote command:

[CONFigure:ADEMod:RESults:AM:DETEctor<det>:REFerence](#) on page 156

[CONFigure:ADEMod:RESults:FM:DETEctor<det>:REFerence](#) on page 156

[CONFigure:ADEMod:RESults:PM:DETEctor<det>:REFerence](#) on page 156

Meas -> Reference

Sets the [Reference Value](#) to be used for relative demodulation results to the currently measured value *for all relative detectors*.

Note: A reference value 0 would provide infinite results and is thus automatically corrected to 0.1.

If necessary, the detectors are activated.

Remote command:

[CONFigure:ADEMod:RESults:AM:DETEctor<det>:REFerence:MEASref<t>](#)
on page 157

[CONFigure:ADEMod:RESults:FM:DETEctor<det>:REFerence:MEASref<t>](#)
on page 157

[CONFigure:ADEMod:RESults:PM:DETEctor<det>:REFerence:MEASref<t>](#)
on page 157

5.8.7 Settling time

Access: "Overview" > "Demod Settings" > "Settling Time"

Or: "Meas Setup" > "Demod" > "Settling Time" tab

The settling time defines when the signal remains within a specified target corridor. The corridor is defined by the upper and lower settling limit. The function is available for all time domain displays.

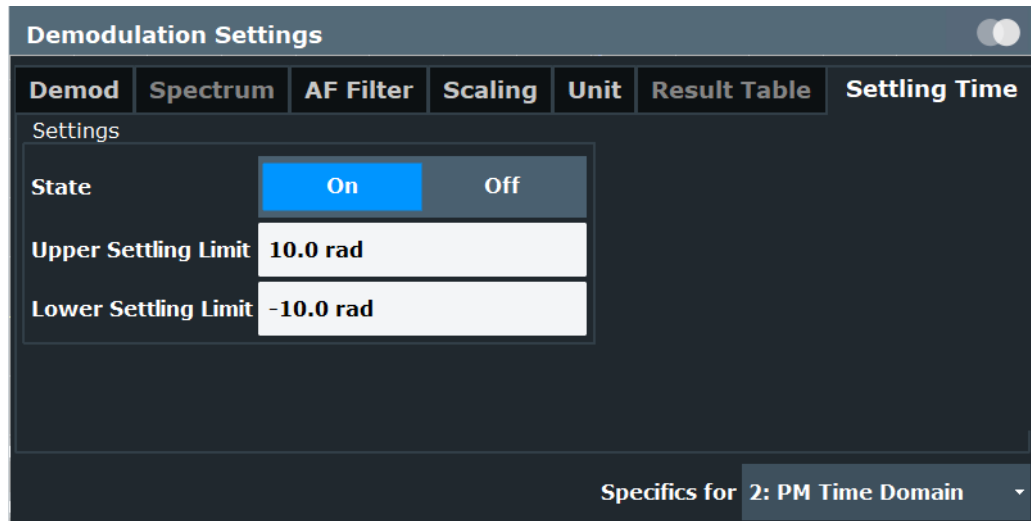

If enabled, the time is determined by evaluating the signal values from the end of the measurement. The last position at which the signal exceeds the corridor is the settling time. The settling time is defined with reference to the start of the data acquisition or the trigger event (including the trigger offset, if applicable). The trigger event, including a defined trigger offset, is indicated by a vertical red line, if applicable.

The upper and lower settling limits are indicated by horizontal red lines in the time domain diagrams. The settling time is indicated by a temporary marker labeled "ST". The result is also indicated in the "Result Summary". The settling time is evaluated for each time domain window for the selected trace (see "[Selected Trace](#)" on page 65).

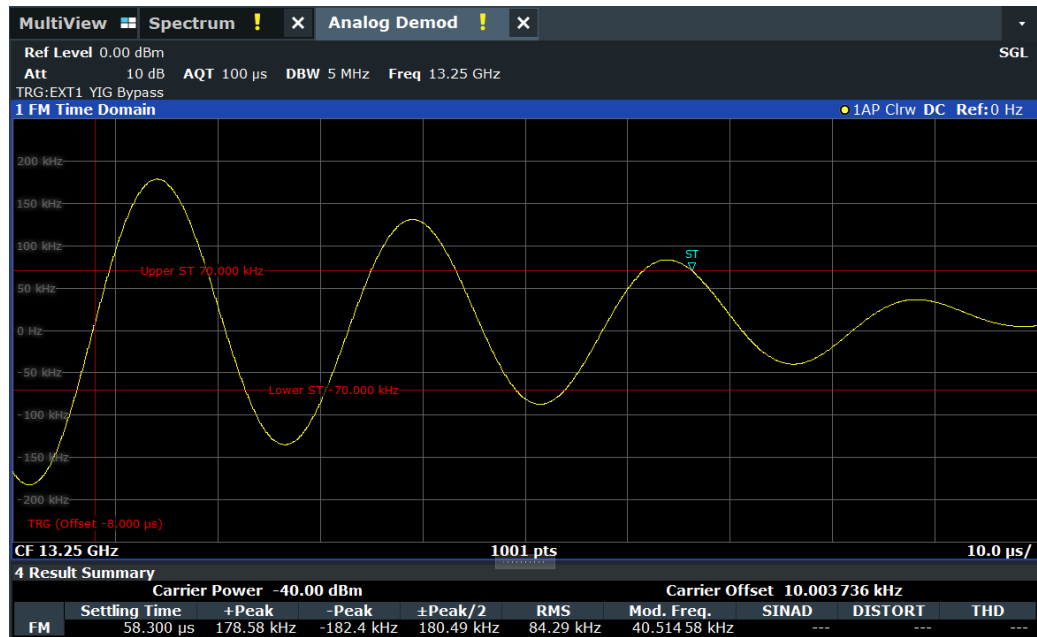

State.....	82
Upper Settling Limit.....	82
Lower Settling Limit.....	82

State

Enables or disables the calculation and display of the settling time.

Remote command:

[SENSe:]ADEMod:SETTling:TIME:STATE on page 126

Result: [SENSe:]ADEMod:SETTling:TIME:RESult<t>? on page 176

Upper Settling Limit

Defines the upper limit of the settling time corridor. The value is defined with reference to the reference value, see also "Reference Value" on page 74 and "Zero Phase Reference Position (PM Time Domain only)" on page 66.

Remote command:

[SENSe:]ADEMod:SETTling:TIME:LIMit:UPPer on page 126

Lower Settling Limit

Defines the lower limit of the settling time corridor. The value is defined with reference to the reference value, see also "Reference Value" on page 74 and "Zero Phase Reference Position (PM Time Domain only)" on page 66.

Remote command:

[SENSe:]ADEMod:SETTling:TIME:LIMit:LOWer on page 126

5.9 Demodulation display



Access: "Overview" > "Demod/Display"

The demodulated signal can be displayed using various evaluation methods. All evaluation methods available for the Analog Modulation Analysis application are displayed in the evaluation bar in SmartGrid mode when you do one of the following:

Up to six evaluation methods can be displayed simultaneously in separate windows. The Analog Modulation Analysis evaluation methods are described in [Section 3, "Measurements and result displays"](#), on page 18.



For details on working with the SmartGrid, see the R&S FSWP Getting Started manual.

5.10 Automatic settings

Access: "AUTO SET"

Some settings can be adjusted by the R&S FSWP automatically according to the current measurement settings.



MSRA operating mode

In MSRA operating mode, settings related to data acquisition can only be adjusted automatically for the MSRA Master, not the applications.



Adjusting settings automatically during triggered measurements

When you select an auto adjust function a measurement is performed to determine the optimal settings. If you select an auto adjust function for a triggered measurement, you are asked how the R&S FSWP should behave:

- (default:) The measurement for adjustment waits for the next trigger
- The measurement for adjustment is performed without waiting for a trigger. The trigger source is temporarily set to "Free Run". After the measurement is completed, the original trigger source is restored. The trigger level is adjusted as follows:
 - For IF Power and RF Power triggers:
Trigger Level = Reference Level - 15 dB
 - For Video trigger:
Trigger Level = 85 %

Remote command:

`[SENSe:]ADJust:CONFigure:TRIGger` on page 129

Adjusting all Determinable Settings Automatically (Auto All).....	84
Adjusting the Center Frequency Automatically (Auto Frequency).....	84
AF Auto Scale.....	84
Setting the Reference Level Automatically (Auto Level).....	84
Resetting the Automatic Measurement Time (Meas Time Auto).....	85
(Meas Time Manual).....	85
Upper Level Hysteresis.....	85
Lower Level Hysteresis.....	85

Adjusting all Determinable Settings Automatically (Auto All)

Activates all automatic adjustment functions for the current measurement settings, including:

- [Auto Frequency](#)
- [Auto Level](#)
- "[AF Auto Scale](#)" on page 75

Note: MSRA operating modes. In MSRA operating mode, this function is only available for the MSRA primary, not the secondary applications.

Remote command:

[\[SENSe:\]ADJust:ALL](#) on page 127

Adjusting the Center Frequency Automatically (Auto Frequency)

The R&S FSWP adjusts the center frequency automatically.

The optimum center frequency is the frequency with the highest S/N ratio in the frequency span. As this function uses the signal counter, it is intended for use with sinusoidal signals.

Remote command:

[\[SENSe:\]ADJust:FREQuency](#) on page 130

AF Auto Scale

Activates automatic scaling of the y-axis for AF measurements. RF power and RF spectrum measurements are not affected by the auto-scaling.

Remote command:

[\[SENSe:\]ADJust:SCALe\[:Y\]:AUTO\[:CONTInuous\]](#) on page 130

Setting the Reference Level Automatically (Auto Level)

Automatically determines a reference level which ensures that no overload occurs at the R&S FSWP for the current input data. At the same time, the internal attenuators are adjusted. As a result, the signal-to-noise ratio is optimized, while signal compression and clipping are minimized.

To determine the required reference level, a level measurement is performed on the R&S FSWP.

If necessary, you can optimize the reference level further. Decrease the attenuation level manually to the lowest possible value before an overload occurs, then decrease the reference level in the same way.

You can change the measurement time for the level measurement if necessary (see "[\(Meas Time Manual\)](#)" on page 85).

Remote command:

[\[SENSe:\]ADJust:LEVel](#) on page 117

Resetting the Automatic Measurement Time (Meas Time Auto)

Resets the measurement duration for automatic settings to the default value.

(Spectrum and AM/FM/PM modulation analysis application: 1 ms)

Remote command:

[\[SENSe:\]ADJust:CONFigure:LEVel:DURation:MODE](#) on page 128

(Meas Time Manual)

This function allows you to change the measurement duration for automatic setting adjustments. Enter the value in seconds.

Note: The maximum measurement duration depends on the currently selected measurement and the installed (optional) hardware. Thus, the measurement duration actually used to determine the automatic settings can be shorter than the value you define here.

Remote command:

[\[SENSe:\]ADJust:CONFigure:LEVel:DURation:MODE](#) on page 128

[\[SENSe:\]ADJust:CONFigure:LEVel:DURation](#) on page 128

Upper Level Hysteresis

When the reference level is adjusted automatically using the [Auto Level](#) function, the internal attenuators and the preamplifier are also adjusted. To avoid frequent adaptation due to small changes in the input signal, you can define a hysteresis. This setting defines an upper threshold that the signal must exceed (compared to the last measurement) before the reference level is adapted automatically.

Remote command:

[\[SENSe:\]ADJust:CONFigure:HYSTeresis:UPPer](#) on page 129

Lower Level Hysteresis

When the reference level is adjusted automatically using the [Auto Level](#) function, the internal attenuators and the preamplifier are also adjusted. To avoid frequent adaptation due to small changes in the input signal, you can define a hysteresis. This setting defines a lower threshold that the signal must fall below (compared to the last measurement) before the reference level is adapted automatically.

Remote command:

[\[SENSe:\]ADJust:CONFigure:HYSTeresis:LOWer](#) on page 129

6 Analysis

Access: "Overview" > "Analysis"

General result analysis settings concerning the trace, markers, lines etc. are similar to the analysis functions in the spectrum application, except for the features described here.

For more information, refer to the user manual of the R&S FSWP spectrum application.

- [Trace configuration](#)..... 86
- [Marker settings](#)..... 87
- [Display lines and limit lines](#)..... 87

6.1 Trace configuration

Access

- "Overview" > "Analysis" > "Trace"

For more information, refer to the R&S FSWP user manual.

Spectrograms in the analog modulation analysis application

Basically, spectrograms work the same as in the spectrum application (including the 3D spectrogram).

However, in the analog demodulator, they have the following distinctive features.

- Not all result displays support spectrograms.
- Compared to the spectrum application, a spectrogram can not be added as an independent result display. Instead, spectrograms relate to a certain measurement window (or result display). Result diagram and spectrogram are a single entity in that case and can not be divided.
- You can assign a specific trace to the spectrogram.

To view results in a spectrogram, select a window (indicated by a blue frame), then select [TRACE] > "Spectrogram Config".

Spectrograms are either displayed in "Split" mode (spectrogram is displayed below the trace diagram), in "Full" mode (trace diagram is not displayed), or not displayed at all ("Off").

When the "Spectrogram Config" softkey is greyed out, spectrograms are not supported by the selected result display.

State	86
Trace	87

State

Activates and deactivates a Spectrogram subwindow.

"Split"	Displays the Spectrogram as a subwindow in the original result display.
"Full"	Displays the Spectrogram in a subwindow in the full size of the original result display.
"Off"	Closes the Spectrogram subwindow.

Remote command:

[CALCulate<n>:SPECTrogram:LAYout](#) on page 179

Trace

Selects the diagram trace on which the spectrogram is based.

Remote command:

[CALCulate<n>:SGRam:TRACe](#) on page 180

6.2 Marker settings

Access

- "Overview" > "Analysis" > "Marker"
- "Overview" > "Analysis" > "Marker Function"

For more information, refer to the R&S FSWP user manual.

Link AF Spectrum Marker	87
Link Time Marker	87

Link AF Spectrum Marker

Links the markers in all AF spectrum displays.

Remote command:

[CALCulate<n>:MARKer<m>:LINK](#) on page 177

Link Time Marker

Links the markers in all time domain diagrams.

Remote command:

[CALCulate<n>:MARKer<m>:LINK](#) on page 177

6.3 Display lines and limit lines

Access (limit lines): "Overview" > "Analysis" > "Lines" > "Limit Lines"

Access (display lines): "Overview" > "Analysis" > "Lines" > "Display Lines"

For more information, refer to the R&S FSWP user manual.

7 I/Q data import and export

Baseband signals mostly occur as so-called complex baseband signals, i.e. a signal representation that consists of two channels; the inphase (I) and the quadrature (Q) channel. Such signals are referred to as I/Q signals. The complete modulation information and even distortion that originates from the RF, IF or baseband domains can be analyzed in the I/Q baseband.

Importing and exporting I/Q signals is useful for various applications:



- Generating and saving I/Q signals in an RF or baseband signal generator or in external software tools to analyze them with the R&S FSWP later.
The R&S FSWP supports various I/Q data formats for import.
For details on formats, see the R&S FSWP I/Q Analyzer and I/Q Input user manual.
- Capturing and saving I/Q signals with the R&S FSWP to analyze them with the R&S FSWP or an external software tool later
As opposed to storing trace data, which can be averaged or restricted to peak values, I/Q data is stored as it was captured, without further processing. Multi-channel data is not supported.
The data is stored as complex values in 32-bit floating-point format.
The file type is determined by the file extension. If no file extension is provided, the file type is assumed to be `.iq.tar`. For `.mat` files, Matlab® v4 is assumed.
For a detailed description, see the R&S FSWP I/Q Analyzer and I/Q Input User Manual.

For example, you can capture I/Q data using the I/Q Analyzer application, if available, and then analyze that data later using the R&S FSWP Analog Modulation Analysis application.



An application note on converting Rohde & Schwarz I/Q data files is available from the Rohde & Schwarz website:

[1EF85: Converting R&S I/Q data files](#)

The import and export functions are available in the "Save/Recall" menu which is displayed when you select the  "Save" or  "Open" icon in the toolbar.

See the R&S FSWP I/Q Analyzer and I/Q Input User Manual.



Export only in MSRA mode

In MSRA mode, I/Q data can only be exported to other applications; I/Q data cannot be imported to the MSRA primary or any MSRA secondary applications.

8 How to perform measurements in the R&S FSWP Analog Modulation Analysis application

The following step-by-step instructions demonstrate how to perform analog modulation analysis with the optional R&S FSWP Analog Modulation Analysis application.

1. Press [MODE].
2. Select the "analog modulation analysis" application.
3. Select "Overview" to display the "Overview" for analog modulation analysis.
4. Select "Input/Frontend" > "Frequency" tab to define the input signal's center frequency.
5. Select "Data Acquisition" and define the bandwidth parameters for the input signal: (Note: in MSRA mode, define the analysis interval using the same settings.)
 - "Demodulation Bandwidth": the span of the input signal to demodulate
 - "Measurement Time": how long the input signal is measured
 - "Resolution Bandwidth": how precise the signal is demodulated
 - "Capture Offset" (multistandard mode only): the offset of the analysis interval from the start of the capture buffer
6. Optionally, select "Trigger" and define a trigger for data acquisition, for example an offline demodulation trigger to start capturing data only when a useful signal is transmitted.
7. Select "Demod/Display" and select the demodulation displays that are of interest to you (up to 6).
Arrange them on the display to suit your preferences.
8. Exit the SmartGrid mode and select "Overview" to display the "Overview" again.
9. Select "Demodulation Settings" to define demodulation parameters for each evaluation:
 - Configure the "Squelch" function (on the "Demod" tab) to suppress noise during demodulation.
 - For time domain evaluations, zoom into the areas of interest by defining a zoom area (on the "Demod" tab).
 - For AF evaluations, use special filters to eliminate certain effects of demodulation or to correct pre-emphasized modulated signals (on the "AF Filters" tab).
 - Adapt the diagram scaling to the displayed data (on the "Scaling" tab).
10. Select "Overview" > "Analysis" to use the advanced analysis functions in the demodulation displays.

- Configure a trace to display the average over a series of sweeps (on the "Trace" tab. If necessary, increase the "Sweep Count" in the "Data Acquisition" settings).
 - Configure markers and delta markers to determine deviations and offsets within the demodulated signal (on the "Marker" tab).
 - Use special marker functions to calculate phase noise or an n-dB-down bandwidth (on the "Marker Config" tab).
 - Configure a limit check to detect excessive deviations (on the "Lines" tab).
11. Start a new sweep with the defined settings.
In multistandard mode, to stop the continuous measurement mode by the Sequencer and perform a single data acquisition:
 - a) Select the Sequencer () from the toolbar.
 - b) Set the Sequencer state to "Off".
 - c) Press [RUN SINGLE].
 12. Optionally, export the trace data of the demodulated signal to a file.
 - a) In the "Traces" tab of the "Analysis" dialog box, switch to the "Trace Export" tab.
 - b) Select "Export Trace to ASCII File".
 - c) Define a file name and storage location and select "OK".

8.1 How to export trace data and numerical results

The measured trace data and numerical measurement results in tables can be exported to an ASCII file. For each measurement point, the measured trace position and value are output.

The file is stored with a `.DAT` or `.CSV` extension. For details on the storage format, see [Section A.3, "Reference: ASCII file export format"](#), on page 187.

To export trace data and table results

1. Select [TRACE] > "Trace Config" > "Trace / Data Export" tab.
2. Select "Export all Traces and all Table Results" to export all available measurement result data for the current application, or select a specific "Trace to Export".
3. Optionally, select "Include Instrument & Measurement Settings" to insert additional information in the export file header.
4. If necessary, change the decimal separator for the ASCII export file.
5. Select "Export Trace to ASCII File".
6. In the file selection dialog box, select the storage location and file name for the export file.
7. Select "Save" to close the dialog box and export the data to the file.

9 Measurement example: demodulating an FM signal

A practical example for a basic Analog Modulation Analysis measurement is provided here. It demonstrates how operating and measurement errors can be avoided using correct configuration settings.

The measurement is performed using the following devices:

- An R&S FSWP with the optional Spectrum application and the optional Analog Modulation Analysis application
- A vector signal generator, e.g. R&S SMW



Figure 9-1: Test setup

Signal generator settings (e.g. R&S SMW):

Frequency:	500 MHz
Level:	-10 dBm
Modulation:	FM
Modulation frequency:	10 kHz
Frequency deviation:	50 kHz

Procedure:

1. Preset the R&S FSWP.
2. Set the center frequency to *500 MHz*.
3. Set the reference level to *0 dBm*.
4. Select [MODE] and then "AM FM PM Analog Demod".

By default, the "FM Time Domain" result display and a "Result Summary" are shown.

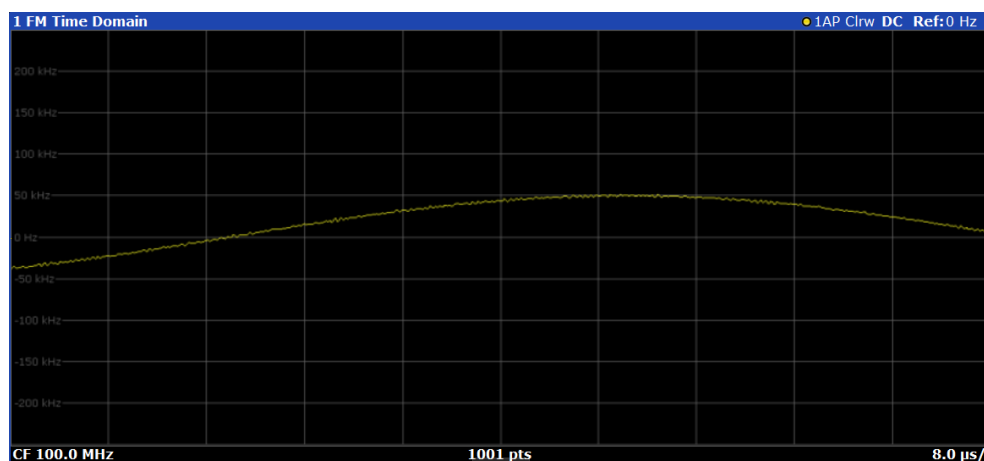

Figure 9-2: Default Analog Modulation Analysis measurement result display

5. Set the measurement time (AQT) to 1 ms to measure 10 periods of the signal.
6. Adjust the y-axis scaling to the measured frequency deviation automatically by selecting "Scale Config" > "Scaling" tab > "AF Auto Scale": "On".

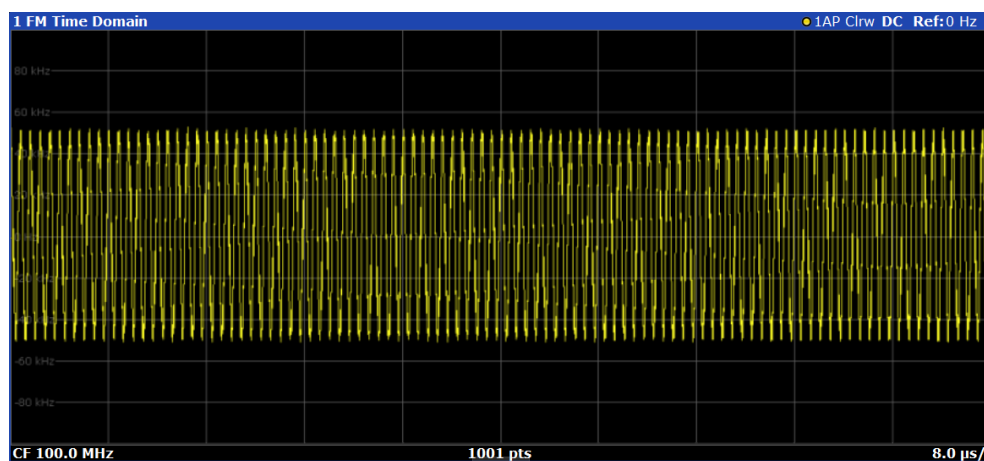

Figure 9-3: Auto-scaled measurement of 10 signal periods (continuous)

7. Display the RF spectrum of the measured signal to determine the required demodulation bandwidth. Select "Display Config" and add an "RF Spectrum" window to the display.

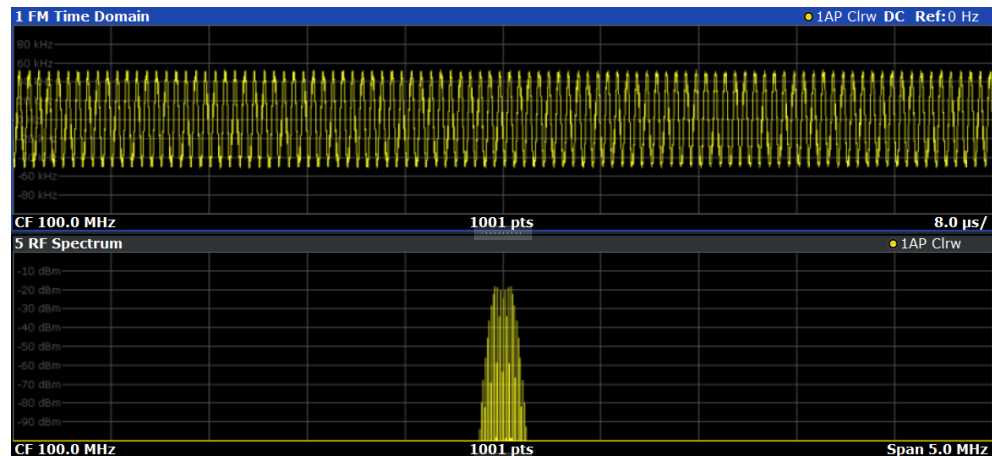

Figure 9-4: RF spectrum of FM signal with default demodulation bandwidth = 5 MHz

8. As you can see in Figure 9-4, the default demodulation bandwidth of 5 MHz is much too large - the actual signal takes up only a small part of the displayed range. That means that any noise or additional signals apart from the FM signal of interest may be included in the measured results. Select "Demod BW" and reduce the value to 200 kHz.

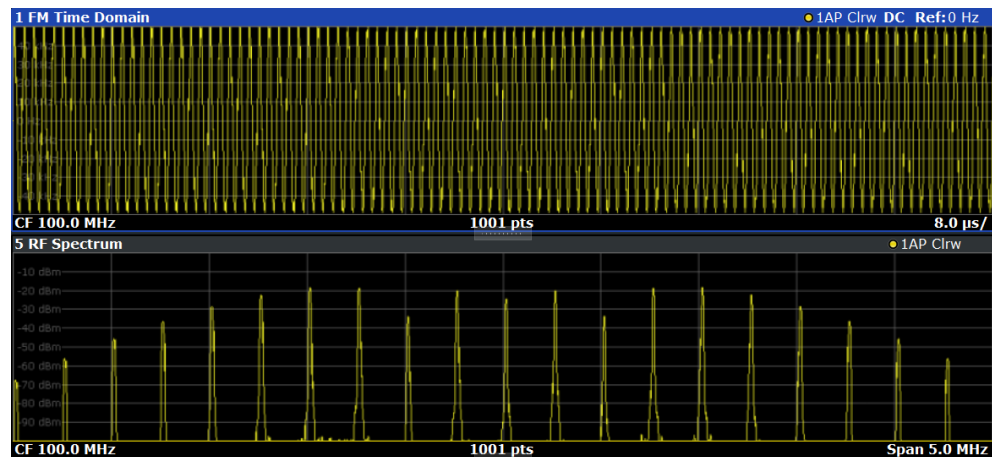

Figure 9-5: RF spectrum with demodulation bandwidth = 200 kHz

The span is automatically reduced to 200 kHz as well, as only the demodulated range can be displayed.

9. Now the RF spectrum shows that part of the FM signal is cut off. The missing signal parts are not included in the calculated results. Increase the demodulation bandwidth to 400 kHz to include the entire signal, but no interfering frequencies.

The span is not automatically increased for the wider DBW since it may be useful to display only a small range from the demodulated bandwidth. However, this means the RF spectrum will still not show the entire signal.

10. Increase the span manually to show the entire demodulated bandwidth:
- Select the "RF Spectrum" window.

- b) Press [SPAN].
- c) Select "Full Span".

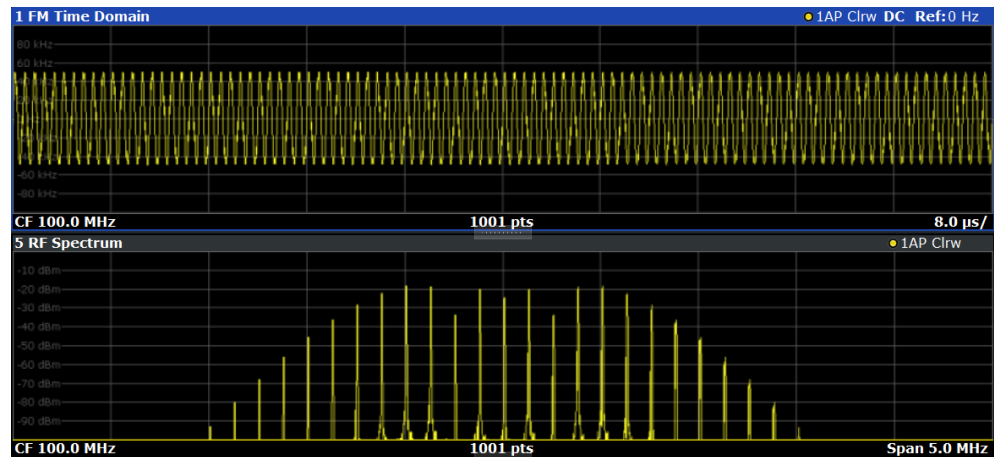

Figure 9-6: RF spectrum with demodulation bandwidth = 400 kHz

11. Once the correct DBW has been determined, you can replace the RF spectrum by the FM spectrum result display to analyze the spectrum of the FM signal. Select "Display Config" and move an "FM Spectrum" window over the "RF Spectrum" window in the display.

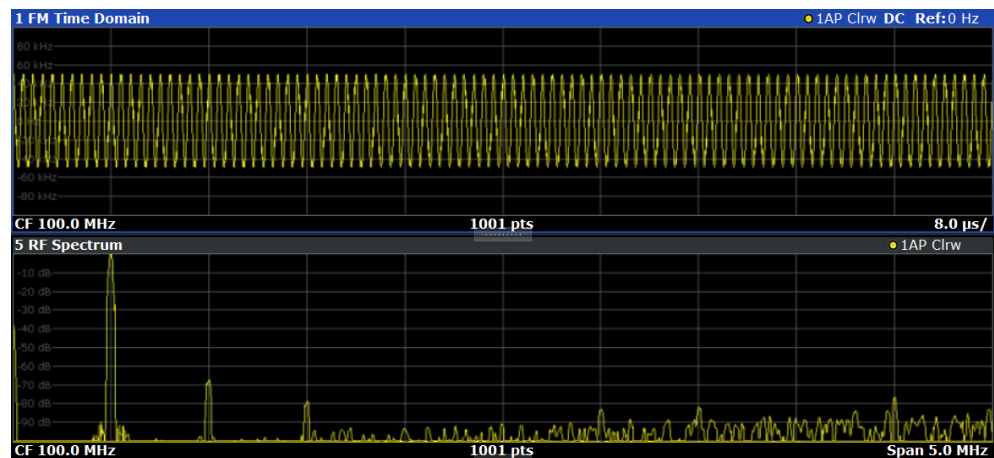
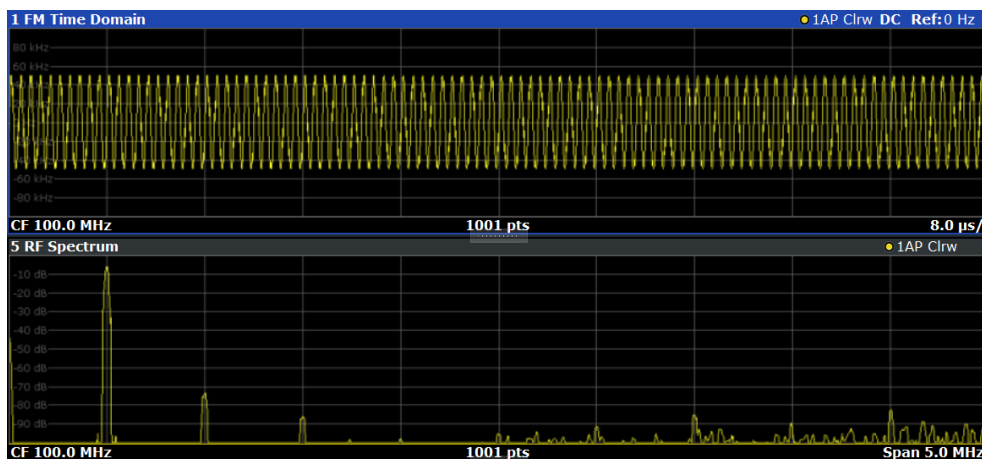

Figure 9-7: FM spectrum and Result Summary including SINAD and THD values

From the FM spectrum, the SINAD and THD are also calculated and displayed in the "Result Summary".

12. Since the "AF Auto Scale" function is enabled, the "FM Spectrum" diagram is scaled according to the current measurement automatically. Each diagram is scaled individually, so that the reference values at the top of the two diagrams can differ (100 kHz in the "FM Time Domain" versus 50 kHz in the "FM Spectrum"). However, you can adjust the values manually.
 - a) Select the "FM Spectrum" window to set the focus in it.
 - b) Press [AMPT].

- c) Select "Scale Config".
- d) Disable the "AF Auto Scale" function.
- e) Define the new reference value (at 100% = top of the diagram) as *100 kHz*.



Note that while the reference values at the top of both y-axes are now identical, the reference values indicated in the window title bars are not. This is due to the fact that, by default, in AF time domain displays the reference value is defined at the reference position 50 % (=center of diagram), while in AF frequency domains it is defined at the position 100 % (= top of diagram).

10 Optimizing and troubleshooting the measurement

If the results do not meet your expectations, consider the following notes and tips to optimize the measurement.

Determining the demodulation bandwidth

A frequent cause for measurement errors and false results is an **incorrectly defined demodulation bandwidth (DBW)**.

If the DBW is too large, the actual signal takes up only a small part of the demodulated range. That means that any noise or additional signal parts can be included in the measured results, which are then false.

On the other hand, if the DBW is too small, part of the signal is cut off and thus not included in the calculation of the results.

An easy way to determine the required DBW is to display the RF spectrum of the input signal. If the entire signal is displayed there and takes up most of the diagram width, the DBW is probably appropriate.

This procedure is demonstrated in the measurement example described in [Section 9, "Measurement example: demodulating an FM signal"](#), on page 91.

For further recommendations on finding the correct demodulation bandwidth, see [Section 4.2, "Demodulation bandwidth"](#), on page 32.

Adjusting the displayed span

Be aware that the span of the "RF Spectrum" display is not automatically increased for a wider DBW. Sometimes, it can be useful to display only a small range from the demodulated bandwidth. Thus, if the RF spectrum does not show the entire demodulated bandwidth, you must increase the span manually to show the entire signal.

Determining the SINAD and THD

The signal-to-noise-and-distortion ratio (SINAD) and the total harmonic distortion (THD) of the demodulated signal are a good indicator of the signal quality sent by the DUT. Both values are calculated inside the AF spectrum span and thus only if an AF spectrum window is displayed. If either value deviates strongly from the expected result, make sure that the demodulation bandwidth is defined correctly (see [Determining the demodulation bandwidth](#)).

11 Remote commands for analog modulation analysis

• Introduction	97
• Common suffixes	102
• Remote commands to select the application	103
• Remote commands to configure analog modulation analysis	106
• Configuring the result display	159
• Working with measurement results	167
• Retrieving result summary values	172
• Analyzing results	176
• Importing and exporting data	180
• Programming example	181

11.1 Introduction

Commands are program messages that a controller (e.g. a PC) sends to the instrument or software. They operate its functions ('setting commands' or 'events') and request information ('query commands'). Some commands can only be used in one way, others work in two ways (setting and query). If not indicated otherwise, the commands can be used for settings and queries.

The syntax of a SCPI command consists of a header and, usually, one or more parameters. To use a command as a query, you have to append a question mark after the last header element, even if the command contains a parameter.

A header contains one or more keywords, separated by a colon. Header and parameters are separated by a "white space" (ASCII code 0 to 9, 11 to 32 decimal, e.g. blank). If there is more than one parameter for a command, they are separated by a comma from one another.

Only the most important characteristics that you need to know when working with SCPI commands are described here. For a more complete description, refer to the user manual of the R&S FSWP.



Remote command examples

Note that some remote command examples mentioned in this general introduction are possibly not supported by this particular application.

11.1.1 Conventions used in descriptions

The following conventions are used in the remote command descriptions:

- *Command usage*
If not specified otherwise, commands can be used both for setting and for querying parameters.

If a command can be used for setting or querying only, or if it initiates an event, the usage is stated explicitly.

- *Parameter usage*

If not specified otherwise, a parameter can be used to set a value, and it is the result of a query.

Parameters required only for setting are indicated as "Setting parameters".

Parameters required only to refine a query are indicated as "Query parameters".

Parameters that are only returned as the result of a query are indicated as "Return values".

- *Conformity*

Commands that are taken from the SCPI standard are indicated as "SCPI confirmed". All commands used by the R&S FSWP follow the SCPI syntax rules.

- *Asynchronous commands*

A command which does not automatically finish executing before the next command starts executing (overlapping command) is indicated as an "Asynchronous command".

- *Reset values (*RST)*

Default parameter values that are used directly after resetting the instrument (*RST command) are indicated as "*RST" values, if available.

- *Default unit*

The default unit is used for numeric values if no other unit is provided with the parameter.

- *Manual operation*

If the result of a remote command can also be achieved in manual operation, a link to the description is inserted.

11.1.2 Long and short form

The keywords have a long and a short form. You can use either the long or the short form, but no other abbreviations of the keywords.

The short form is emphasized in uppercase letters. Note however, that this emphasis only serves the purpose to distinguish the short from the long form in the manual. For the instrument, the case does not matter.

Example:

SENSE:FREQUENCY:CENTer is the same as SENS:FREQ:CENT.

11.1.3 Numeric suffixes

Some keywords have a numeric suffix if the command can be applied to multiple instances of an object. In that case, the suffix selects a particular instance (e.g. a measurement window).

Numeric suffixes are indicated by angular brackets (<n>) next to the keyword.

If you do not quote a suffix for keywords that support one, a 1 is assumed.

Example:

`DISPlay[:WINDow<1...4>]:ZOOM:STATe` enables the zoom in a particular measurement window, selected by the suffix at `WINDow`.

`DISPlay:WINDow4:ZOOM:STATe ON` refers to window 4.

11.1.4 Optional keywords

Some keywords are optional and are only part of the syntax because of SCPI compliance. You can include them in the header or not.



If an optional keyword has a numeric suffix and you need to use the suffix, you have to include the optional keyword. Otherwise, the suffix of the missing keyword is assumed to be the value 1.

Optional keywords are emphasized with square brackets.

Example:

Without a numeric suffix in the optional keyword:

`[SENSe:]FREQuency:CENTer` is the same as `FREQuency:CENTer`

With a numeric suffix in the optional keyword:

`DISPlay[:WINDow<1...4>]:ZOOM:STATe`

`DISPlay:ZOOM:STATe ON` enables the zoom in window 1 (no suffix).

`DISPlay:WINDow4:ZOOM:STATe ON` enables the zoom in window 4.

11.1.5 Alternative keywords

A vertical stroke indicates alternatives for a specific keyword. You can use both keywords to the same effect.

Example:

`[SENSe:]BANDwidth|BWIDth[:RESolution]`

In the short form without optional keywords, `BAND 1MHZ` would have the same effect as `BWID 1MHZ`.

11.1.6 SCPI parameters

Many commands feature one or more parameters.

If a command supports more than one parameter, they are separated by a comma.

Example:

`LAYout:ADD:WINDow Spectrum,LEFT,MTABLE`

Parameters can have different forms of values.

- [Numeric values](#)..... 100
- [Boolean](#)..... 101
- [Character data](#)..... 101
- [Character strings](#)..... 101
- [Block data](#)..... 101

11.1.6.1 Numeric values

Numeric values can be entered in any form, i.e. with sign, decimal point or exponent. For physical quantities, you can also add the unit. If the unit is missing, the command uses the basic unit.

Example:

With unit: `SENSe:FREQuency:CENTer 1GHZ`

Without unit: `SENSe:FREQuency:CENTer 1E9` would also set a frequency of 1 GHz.

Values exceeding the resolution of the instrument are rounded up or down.

If the number you have entered is not supported (e.g. for discrete steps), the command returns an error.

Instead of a number, you can also set numeric values with a text parameter in special cases.

- `MIN/MAX`
Defines the minimum or maximum numeric value that is supported.
- `DEF`
Defines the default value.
- `UP/DOWN`
Increases or decreases the numeric value by one step. The step size depends on the setting. Sometimes, you can customize the step size with a corresponding command.

Querying numeric values

When you query numeric values, the system returns a number. For physical quantities, it applies the basic unit (e.g. Hz for frequencies). The number of digits after the decimal point depends on the type of numeric value.

Example:

Setting: `SENSe:FREQuency:CENTer 1GHZ`

Query: `SENSe:FREQuency:CENTer?` would return `1E9`

Sometimes, numeric values are returned as text.

- `INF/NINF`
Infinity or negative infinity. Represents the numeric values `9.9E37` or `-9.9E37`.
- `NAN`

Not a number. Represents the numeric value 9.91E37. NAN is returned if errors occur.

11.1.6.2 Boolean

Boolean parameters represent two states. The "on" state (logically true) is represented by "ON" or the numeric value 1. The "off" state (logically untrue) is represented by "OFF" or the numeric value 0.

Querying Boolean parameters

When you query Boolean parameters, the system returns either the value 1 ("ON") or the value 0 ("OFF").

Example:

Setting: `DISPlay:WINDow:ZOOM:STATe ON`

Query: `DISPlay:WINDow:ZOOM:STATe?` would return 1

11.1.6.3 Character data

Character data follows the syntactic rules of keywords. You can enter text using a short or a long form. For more information, see [Section 11.1.2, "Long and short form"](#), on page 98.

Querying text parameters

When you query text parameters, the system returns its short form.

Example:

Setting: `SENSe:BANDwidth:RESolution:TYPE NORMAL`

Query: `SENSe:BANDwidth:RESolution:TYPE?` would return NORM

11.1.6.4 Character strings

Strings are alphanumeric characters. They have to be in straight quotation marks. You can use a single quotation mark (') or a double quotation mark (").

Example:

`INSTRument:DELeTe 'Spectrum'`

11.1.6.5 Block data

Block data is a format which is suitable for the transmission of large amounts of data.

The ASCII character # introduces the data block. The next number indicates how many of the following digits describe the length of the data block. The data bytes follow. During the transmission of these data bytes, all end or other control signs are ignored until

all bytes are transmitted. #0 specifies a data block of indefinite length. The use of the indefinite format requires an `NL^END` message to terminate the data block. This format is useful when the length of the transmission is not known or if speed or other considerations prevent segmentation of the data into blocks of definite length.

11.2 Common suffixes

In the R&S FSWP Analog Modulation Analysis application, the following common suffixes are used in remote commands:

Table 11-1: Common suffixes used in remote commands in the R&S FSWP Analog Modulation Analysis application

Suffix	Value range	Description
<m>	1 to 16	Marker (or spot noise marker)
<n>	1 to 6	Window (in the currently selected channel)
<t>	1 to 6	Trace
	1 to 8	Limit line By default, the suffixes 1 to 8 correspond to the lines REM1 to REM8. If they are used but do not yet exist, they are created automatically. If a name has been set via <code>CALCulate:LIMit:NAME</code> , you can access the corresponding line using its index.



Selecting windows in multiple channels

Note that the suffix <n> always refers to a window in the currently selected channel.

<m>	1 to 16	Marker (or spot noise marker)
<j>	1..10	Selects an integrated measurement range.
<k>	1..8 (Limit line) 1 2 (Display line)	Selects a limit or display line.
<r>	1..x	Selects a half decade. The value range depends on the number of half decades. The first half decade in the measurement always has the value "1". For subsequent half decades, add "1" to get the value "x" (the fourth half decade, for example, would have the value "4").

<s>	1..6	Selects a (user defined) spot noise marker.
<x>	1..2	Selects a mixer in the test setup.

11.3 Remote commands to select the application

INSTrument:CREate:DUPLicate	103
INSTrument:CREate[:NEW]	103
INSTrument:CREate:REPLace	104
INSTrument:DELeTe	104
INSTrument:LIST?	104
INSTrument:REName	105
INSTrument[:SELeCt]	106
SYSTem:PRESet:CHANnel[:EXEC]	106

INSTrument:CREate:DUPLicate

Duplicates the currently selected channel, i.e creates a new channel of the same type and with the identical measurement settings. The name of the new channel is the same as the copied channel, extended by a consecutive number (e.g. "IQAnalyzer" -> "IQAnalyzer 2").

The channel to be duplicated must be selected first using the `INST:SEL` command.

Example:

```
INST:SEL 'PhaseNoise'
```

```
INST:CRE:DUPL
```

Duplicates the channel named 'PhaseNoise' and creates a new channel named 'PhaseNoise 2'.

Usage: Event

INSTrument:CREate[:NEW] <ChannelType>, <ChannelName>

Adds a measurement channel. You can configure up to 10 measurement channels at the same time (depending on available memory).

Parameters:

- <ChannelType> Channel type of the new channel.
For a list of available channel types, see [INSTrument:LIST?](#) on page 104.
- <ChannelName> String containing the name of the channel.
Note that you cannot assign an existing channel name to a new channel. If you do, an error occurs.
Channel names can have a maximum of 31 characters, and must be compatible with the Windows conventions for file names. In particular, they must not contain special characters such as ":", "*", "?".

Example: `INST:CRE SAN, 'Spectrum 2'`
Adds a spectrum display named "Spectrum 2".

INSTrument:CREate:REPLace <ChannelName1>, <ChannelType>, <ChannelName2>

Replaces a channel with another one.

Setting parameters:

<ChannelName1> String containing the name of the channel you want to replace.

<ChannelType> Channel type of the new channel.
For a list of available channel types, see [INSTrument:LIST?](#) on page 104.

<ChannelName2> String containing the name of the new channel.
Note: If the specified name for a new channel already exists, the default name, extended by a sequential number, is used for the new channel (see [INSTrument:LIST?](#) on page 104).
Channel names can have a maximum of 31 characters, and must be compatible with the Windows conventions for file names. In particular, they must not contain special characters such as ":", "*", "?".

Example: `INST:CRE:REPL 'PhaseNoise', PNO, 'PNO2'`
Replaces the channel named "PhaseNoise" by a new channel of type "Phase Noise" named "PNO2".

Usage: Setting only

INSTrument:DELeTe <ChannelName>

Deletes a channel.

If you delete the last channel, the default "Phase Noise" channel is activated.

Setting parameters:

<ChannelName> String containing the name of the channel you want to delete.
A channel must exist to delete it.

Example: `INST:DEL 'PhaseNoise'`
Deletes the channel with the name 'PhaseNoise'.

Usage: Setting only

INSTrument:LIST?

Queries all active channels. The query is useful to obtain the names of the existing channels, which are required to replace or delete the channels.

Return values:

<ChannelType>
<ChannelName>

For each channel, the command returns the channel type and channel name (see tables below).

Tip: to change the channel name, use the [INSTrument:REName](#) command.

Example:

INST:LIST?

Result for 2 channels:

'PNO', 'PhaseNoise', 'PNO', 'Phase Noise 2'

Usage:

Query only

Table 11-2: Available channel types and default channel names

Application	<ChannelType> Parameter	Default Channel Name*)
Phase Noise	PNOise	Phase Noise
Spectrum Monitor	SMONitor	Spectrum Monitor
Spectrum (R&S FSWP-B1)	SANalyzer	Spectrum
I/Q Analyzer (R&S FSWP-B1)	IQ	IQ Analyzer
Pulse Measurements (R&S FSWP-K6)	PULSe	Pulse
Analog Modulation Analysis (R&S FSWP-K7)	ADEMod	Analog Demod
Noise Figure Measurements (R&S FSWP-K30)	NOISe	Noise
Fast Spur Search (R&S FSWP-K50)	SPUR	Spurious
Transient Analysis (R&S FSWP-K60)	TA	Transient Analysis
Vector Signal Analysis (R&S FSWP-K70)	DDEM	VSA

Note: the default channel name is also listed in the table. If the specified name for a new channel already exists, the default name, extended by a sequential number, is used for the new channel.

INSTrument:REName <ChannelName1>, <ChannelName2>

Renames a channel.

Setting parameters:

<ChannelName1> String containing the name of the channel you want to rename.

<ChannelName2> String containing the new channel name.

Note that you cannot assign an existing channel name to a new channel. If you do, an error occurs.

Channel names can have a maximum of 31 characters, and must be compatible with the Windows conventions for file names. In particular, they must not contain special characters such as ":", "*", "?".

Remote commands to configure analog modulation analysis

Example: `INST:REN 'PhaseNoise', 'PNO'`
Renames the channel with the name 'PhaseNoise' to 'PNO'.

Usage: Setting only

INSTrument[:SElect] <ChannelType>

Selects the channel type for the current channel.

See also `INSTrument:CREate[:NEW]` on page 103.

For a list of available channel types, see `INSTrument:LIST?` on page 104.

Parameters:

<ChannelType> **ADEMod**
Optional Analog Modulation Analysis application.

SYSTem:PRESet:CHANnel[:EXEC]

Restores the default instrument settings in the current channel.

Use `INST:SEL` to select the channel.

Example: `INST:SEL 'Spectrum2'`
Selects the channel for "Spectrum2".
`SYST:PRESet:CHAN:EXEC`
Restores the factory default settings to the "Spectrum2" channel.

Usage: Event

Manual operation: See "Preset Channel" on page 41

11.4 Remote commands to configure analog modulation analysis

- [Configuring standards](#)..... 107
- [Configuring inputs and outputs](#)..... 107
- [Configuring level characteristics](#)..... 114
- [Defining frequency characteristics](#)..... 117
- [Configuring trigger](#)..... 119
- [Settling time](#)..... 126
- [Defining settings automatically](#)..... 127
- [Configuring data acquisition](#)..... 130
- [Configuring demodulation](#)..... 139

11.4.1 Configuring standards

[SENSe:]ADEMod:PRESet[:STANdard].....	107
[SENSe:]ADEMod:PRESet:RESTore.....	107
[SENSe:]ADEMod:PRESet:STORe.....	107

[SENSe:]ADEMod:PRESet[:STANdard] <Standard>

Loads a measurement configuration.

Standard definitions are stored in an xml file. The default directory for Analog Modulation Analysis standards is C :

\R_S\INSTR\USER\predefined\AdemodPredefined.

Parameters:

<Standard> String containing the file name.
 If you have stored the file in a subdirectory of the directory mentioned above, you have to include the relative path to the file.

Manual operation: See "[Load Standard](#)" on page 39

[SENSe:]ADEMod:PRESet:RESTore

Manual operation: See "[Restore Standard Files](#)" on page 40

[SENSe:]ADEMod:PRESet:STORe <Standard>

Saves the current Analog Modulation Analysis measurement configuration.

Standard definitions are stored in an XML file. The default directory for Analog Modulation Analysis standards is C :

\R_S\INSTR\USER\predefined\AdemodPredefined.

Parameters:

<Standard> String containing the file name.
 You can save the file in a subdirectory of the directory mentioned above. In that case, you have to include the relative path to the file.

Manual operation: See "[Save Standard](#)" on page 39

11.4.2 Configuring inputs and outputs

• Configuring the input	108
• Configuring external generators	110
• Configuring outputs	110

11.4.2.1 Configuring the input

INPut:ATTenuation:PROTection:RESet.....	108
INPut:COUPling.....	108
INPut:DPATH.....	108
INPut:FILTer:HPASs[:STATe].....	109
INPut:FILTer:YIG[:STATe].....	109
INPut:IMPedance.....	109

INPut:ATTenuation:PROTection:RESet

Resets the attenuator and reconnects the RF input with the input mixer for the R&S FSWP after an overload condition occurred and the protection mechanism intervened. The error status bit (bit 3 in the `STAT:QUES:POW` status register) and the `INPUT OVLD` message in the status bar are cleared.

(For details on the status register see the R&S FSWP base unit user manual).

The command works only if the overload condition has been eliminated first.

Example: `INP:ATT:PROT:RES`

INPut:COUPling <CouplingType>

Selects the coupling type of the RF input.

Parameters:

<CouplingType> AC | DC
AC
 AC coupling
DC
 DC coupling
 *RST: AC

Example: `INP:COUP DC`

Manual operation: See "[Input Coupling](#)" on page 42

INPut:DPATH <DirectPath>

Enables or disables the use of the direct path for frequencies close to 0 Hz.

Parameters:

<DirectPath> AUTO | OFF
AUTO | 1
 (Default) the direct path is used automatically for frequencies close to 0 Hz.
OFF | 0
 The analog mixer path is always used.

Example: `INP:DPAT OFF`

Manual operation: See ["Direct Path"](#) on page 42

INPut:FILTer:HPASs[:STATe] <State>

Activates an additional internal high-pass filter for RF input signals from 1 GHz to 3 GHz. This filter is used to remove the harmonics of the R&S FSWP to measure the harmonics for a DUT, for example.

Requires an additional high-pass filter hardware option.

(Note: for RF input signals outside the specified range, the high-pass filter has no effect. For signals with a frequency of approximately 4 GHz upwards, the harmonics are suppressed sufficiently by the YIG-preselector, if available.)

Parameters:

<State> ON | OFF | 0 | 1
 OFF | 0
 Switches the function off
 ON | 1
 Switches the function on
 *RST: 0

Example: INP:FILT:HPAS ON
 Turns on the filter.

Manual operation: See ["High Pass Filter 1 to 3 GHz"](#) on page 43

INPut:FILTer:YIG[:STATe] <State>

Enables or disables the YIG filter.

Parameters:

<State> ON | OFF | 0 | 1
 *RST: 0

Example: INP:FILT:YIG OFF
 Deactivates the YIG-preselector.

Manual operation: See ["YIG-Preselector"](#) on page 43

INPut:IMPedance <Impedance>

Selects the nominal input impedance of the RF input. In some applications, only 50 Ω are supported.

Parameters:

<Impedance> 50 | 75
 *RST: 50 Ω
 Default unit: OHM

Example: INP:IMP 75

Manual operation: See "[Impedance](#)" on page 42
See "[Unit](#)" on page 49

11.4.2.2 Configuring external generators

The External Generator Control is available as an option.

Please refer to the User Manual of the R&S FSWP for a comprehensive list and description of remote commands necessary to control external generators.

11.4.2.3 Configuring outputs

DIAGnostic:SERVice:NSource.....	110
OUTPut:ADEMod[:ONLine]:AF[:CFRequency].....	110
OUTPut:ADEMod[:ONLine]:SOURce.....	111
OUTPut:ADEMod[:ONLine][:STATe].....	111
OUTPut:IF:IFFRequency.....	112
OUTPut:IF[:SOURce].....	112
OUTPut:TRIGger<tp>:DIRection.....	112
OUTPut:TRIGger<tp>:LEVel.....	113
OUTPut:TRIGger<tp>:OTYPe.....	113
OUTPut:TRIGger<tp>:PULSe:IMMediate.....	113
OUTPut:TRIGger<tp>:PULSe:LENGth.....	114

DIAGnostic:SERVice:NSource <State>

Turns the 28 V supply of the BNC connector labeled [noise source control] on the R&S FSWP on and off.

Parameters:

<State> ON | OFF | 0 | 1
 OFF | 0
 Switches the function off
 ON | 1
 Switches the function on

Example: DIAG:SERV:NSO ON

Manual operation: See "[Noise Source Control](#)" on page 44

OUTPut:ADEMod[:ONLine]:AF[:CFRequency] <Frequency>

Defines the cutoff frequency for the AC highpass filter (for AC coupling only, see [[SENSe:\]ADEMod<n>:AF:COUPLing](#) on page 140).

Remote commands to configure analog modulation analysis

Parameters:

<Frequency> numeric value
 Range: 10 Hz to DemodBW/10 (= 300 kHz for active demodulation output)
 *RST: 100 Hz
 Default unit: HZ

Example: `OUTP:ADEM:ONL:AF:CFR 100Hz`

Manual operation: See "[AC Cutoff Frequency](#)" on page 48

OUTPut:ADEMod[:ONLine]:SOURce <WindowName>

Selects the result display whose results are output. Only active time domain results can be selected.

Parameters:

<WindowName> **<string>**
 String containing the name of the window.
 By default, the name of a window is the same as its index. To determine the name and index of all active windows, use the [LAYout:CATalog\[:WINDow\] ?](#) query.

FOCUS

Dynamically switches to the currently selected window. If a window is selected that does not contain a time-domain result display, the selection is ignored and the previous setting is maintained.

Example: `OUTP:ADEM:ONL:SOUR 'AnalogDemod'`
OR:
`DISP:WIND1:SEL`
`OUTP:ADEM:SOUR FOC`

Manual operation: See "[Output Selection](#)" on page 47

OUTPut:ADEMod[:ONLine][:STATE] <State>

Enables or disables online demodulation output to the IF/VIDEO/DEMODO output connector on the rear panel of the R&S FSWP.

Parameters:

<State> ON | OFF | 0 | 1
OFF | 0
 Switches the function off
ON | 1
 Switches the function on

Example: `OUTP:ADEM ON`

Manual operation: See "[Online Demodulation Output State](#)" on page 47

OUTPut:IF:IFFRequency <Frequency>

Defines the frequency for the IF output of the R&S FSWP. The IF frequency of the signal is converted accordingly.

Is available in the time domain and if the IF/VIDEO/DEMODO output is configured for IF.

Parameters:

<Frequency> *RST: 50.0 MHz
 Default unit: HZ

OUTPut:IF[:SOURce] <Source>

Defines the type of signal available at one of the output connectors of the R&S FSWP.

Note that you can use the audio frequency output only if the IF output source is "Video".

Parameters:

<Source> **IF**
 The measured IF value is available at the IF/VIDEO/DEMODO output connector.

VIDeo
 The displayed video signal (i.e. the filtered and detected IF signal, 200mV) is available at the IF/VIDEO/DEMODO output connector.
 This setting is required to provide demodulated audio frequencies at the output.

 *RST: IF

Example:

OUTP:IF VID
Selects the video signal for the IF/VIDEO/DEMODO output connector.

OUTPut:TRIGger<tp>:DIRection <Direction>

Selects the trigger direction for trigger ports that serve as an input as well as an output.

Suffix:

<tp> Selects the used trigger port.
 <2>: selects trigger port 2 (on the rear panel).

Parameters:

<Direction> INPut | OUTPut

INPut
 Port works as an input.

OUTPut
 Port works as an output.

 *RST: INPut

Manual operation: See "[Trigger 1/2](#)" on page 45

OUTPut:TRIGger<tp>:LEVel <Level>

Defines the level of the (TTL compatible) signal generated at the trigger output.

Works only if you have selected a user-defined output with [OUTPut:TRIGger<tp>:OTYPe](#).

Suffix:

<tp> 1..n
Selects the trigger port to which the output is sent.
2 = trigger port 2 (rear)

Parameters:

<Level> **HIGH**
5 V
LOW
0 V
*RST: LOW

Example: OUTP:TRIG2:LEV HIGH

Manual operation: See "[Level](#)" on page 46

OUTPut:TRIGger<tp>:OTYPe <OutputType>

Selects the type of signal generated at the trigger output.

Note: For offline AF or RF triggers, no output signal is provided.

Suffix:

<tp> 1..n
Selects the trigger port to which the output is sent.
2 = trigger port 2 (rear)

Parameters:

<OutputType> **DEVICE**
Sends a trigger signal when the R&S FSWP has triggered internally.
TARMed
Sends a trigger signal when the trigger is armed and ready for an external trigger event.
UDEFined
Sends a user-defined trigger signal. For more information, see [OUTPut:TRIGger<tp>:LEVel](#).
*RST: DEVICE

Manual operation: See "[Output Type](#)" on page 45

OUTPut:TRIGger<tp>:PULSe:IMMediate

Generates a pulse at the trigger output.

Suffix:

<tp> 1..n
 Selects the trigger port to which the output is sent.
 2 = trigger port 2 (rear)

Manual operation: See "Send Trigger" on page 46

OUTPut:TRIGger<tp>:PULSe:LENGth <Length>

Defines the length of the pulse generated at the trigger output.

Suffix:

<tp> Selects the trigger port to which the output is sent.
 2 = trigger port 2 (rear)

Parameters:

<Length> Pulse length in seconds.
 Default unit: S

Example: OUTP:TRIG2:PULS:LENG 0.02

Manual operation: See "Pulse Length" on page 46

11.4.3 Configuring level characteristics

Commands useful to configure level characteristics described elsewhere:

- [INPut:COUPling](#) on page 108
- [INPut:IMPedance](#) on page 109

CALCulate<n>:UNIT:POWer	114
DISPlay[:WINDow<n>][:SUBWindow<w>]:TRACe<t>:Y[:SCALe]:RLEVel	115
DISPlay[:WINDow<n>][:SUBWindow<w>]:TRACe<t>:Y[:SCALe]:RLEVel:OFFSet	115
INPut:ATTenuation	116
INPut:ATTenuation:AUTO	116
INPut:GAIN:STATe	116
INPut:GAIN[:VALue]	117
[SENSe:]ADJust:LEVel	117

CALCulate<n>:UNIT:POWer <Unit>

Selects the power unit.

The unit applies to all power-based measurement windows with absolute values.

In addition, the unit of the reference level is adapted to the same unit.

Suffix:

<n> irrelevant

Remote commands to configure analog modulation analysis

Parameters:

<Unit> DBM | V | A | W | DBPW | WATT | DBUV | DBMV | VOLT |
 DBUA | AMPere
 *RST: dBm

Example:

CALC:UNIT:POW DBM
 Sets the power unit to dBm.

Manual operation: See "[Unit](#)" on page 49

DISPlay[:WINDow<n>][:SUBWindow<w>]:TRACe<t>:Y[:SCALe]:RLEVel
 <ReferenceLevel>

Defines the reference level (for all traces in all windows).

With a reference level offset $\neq 0$, the value range of the reference level is modified by the offset.

Suffix:

<n> irrelevant
 <w> subwindow
 Not supported by all applications
 <t> irrelevant

Parameters:

<ReferenceLevel> The unit is variable.
 Range: see specifications document
 *RST: 0 dBm
 Default unit: DBM

Example: DISP:TRAC:Y:RLEV -60dBm

Manual operation: See "[Reference Level](#)" on page 49

DISPlay[:WINDow<n>][:SUBWindow<w>]:TRACe<t>:Y[:SCALe]:RLEVel:OFFSet
 <Offset>

Defines a reference level offset (for all traces in all windows).

Suffix:

<n> irrelevant
 <w> subwindow
 Not supported by all applications
 <t> irrelevant

Parameters:

<Offset> Range: -200 dB to 200 dB
 *RST: 0dB
 Default unit: DB

Example: DISP:TRAC:Y:RLEV:OFFS -10dB

Manual operation: See ["Shifting the Display \(Offset\)"](#) on page 49

INPut:ATTenuation <Attenuation>

Defines the total attenuation for RF input.

If you set the attenuation manually, it is no longer coupled to the reference level, but the reference level is coupled to the attenuation. Thus, if the current reference level is not compatible with an attenuation that has been set manually, the command also adjusts the reference level.

Parameters:

<Attenuation> Range: see specifications document
 Increment: 5 dB (with optional electr. attenuator: 1 dB)
 *RST: 10 dB (AUTO is set to ON)
 Default unit: DB

Example:

`INP:ATT 30dB`

Defines a 30 dB attenuation and decouples the attenuation from the reference level.

Manual operation: See ["Attenuation Mode / Value"](#) on page 50

INPut:ATTenuation:AUTO <State>

Couples or decouples the attenuation to the reference level. Thus, when the reference level is changed, the R&S FSWP determines the signal level for optimal internal data processing and sets the required attenuation accordingly.

Parameters:

<State> ON | OFF | 0 | 1
 *RST: 1

Example:

`INP:ATT:AUTO ON`

Couples the attenuation to the reference level.

Manual operation: See ["Attenuation Mode / Value"](#) on page 50

INPut:GAIN:STATe <State>

Turns the internal preamplifier on and off. It requires the optional preamplifier hardware.

The preamplification value is defined using the `INPut:GAIN[:VALue]` on page 117.

Parameters:

<State> ON | OFF | 0 | 1
 OFF | 0
 Switches the function off
 ON | 1
 Switches the function on
 *RST: 0

Remote commands to configure analog modulation analysis

Example: INP:GAIN:STAT ON
 INP:GAIN:VAL 15
 Switches on 15 dB preamplification.

Manual operation: See "[Preamplifier](#)" on page 50

INPut:GAIN[:VALue] <Gain>

Selects the "gain" if the preamplifier is activated (INP:GAIN:STAT ON, see [INPut:GAIN:STATe](#) on page 116).

The command requires the additional preamplifier hardware option.

Parameters:

<Gain> For R&S FSWP models 1322.8003K08, 1322.8003K09, 1322.8003K27 and 1322.8003K51, the following settings are available:
 15 dB and 30 dB
 All other values are rounded to the nearest of these two.
 For R&S FSWP models 1322.8003K26 and 1322.8003K50:
 30 dB
 Default unit: DB

Example: INP:GAIN:STAT ON
 INP:GAIN:VAL 30
 Switches on 30 dB preamplification.

Manual operation: See "[Preamplifier](#)" on page 50

[SENSe:]ADJJust:LEVel

Initiates a single (internal) measurement that evaluates and sets the ideal reference level for the current input data and measurement settings. Thus, the settings of the RF attenuation and the reference level are optimized for the signal level. The R&S FSWP is not overloaded and the dynamic range is not limited by an S/N ratio that is too small.

Example: ADJ:LEV

Manual operation: See "[Setting the Reference Level Automatically \(Auto Level\)](#)" on page 50

11.4.4 Defining frequency characteristics

[SENSe:]FREQuency:CENTer	117
[SENSe:]FREQuency:CENTer:STEP	118
[SENSe:]FREQuency:CENTer:STEP:LINK	118
[SENSe:]FREQuency:CENTer:STEP:LINK:FACTor	119

[SENSe:]FREQuency:CENTer <Frequency>

Defines the center frequency.

CW, pulsed and VCO measurements:

This command defines or queries (in case of automatic frequency search) the current signal frequency.

Transient measurement:

This command defines the center frequency of the transient measurement.

Parameters:

<Frequency> For the allowed range and f_{max} , refer to the specifications document.

*RST: $f_{max}/2$

Default unit: Hz

Example:

```
FREQ:CENT 100 MHz
```

```
FREQ:CENT:STEP 10 MHz
```

```
FREQ:CENT UP
```

Sets the center frequency to 110 MHz.

Manual operation: See "[Center Frequency](#)" on page 51

[SENSe:]FREQuency:CENTer:STEP <StepSize>

Defines the center frequency step size.

You can increase or decrease the center frequency quickly in fixed steps using the `SENS:FREQ UP` AND `SENS:FREQ DOWN` commands, see [[SENSe: \] FREQuency: CENTer](#) on page 117.

Parameters:

<StepSize> For f_{max} , refer to the specifications document.

Range: 1 to f_{MAX}

*RST: 0.1 x span

Default unit: Hz

Example:

```
//Set the center frequency to 110 MHz.
```

```
FREQ:CENT 100 MHz
```

```
FREQ:CENT:STEP 10 MHz
```

```
FREQ:CENT UP
```

Manual operation: See "[Center Frequency Stepsize](#)" on page 51

[SENSe:]FREQuency:CENTer:STEP:LINK <CouplingType>

Couples and decouples the center frequency step size to the span or the resolution bandwidth.

Parameters:

<CouplingType> SPAN | RBW | OFF

Remote commands to configure analog modulation analysis

SPAN

Couples the step size to the span. Available for measurements in the frequency domain.
(for RF spectrum result display)

RBW

Couples the step size to the resolution bandwidth. Available for measurements in the time domain.
(for all result displays except RF spectrum)

OFF

Decouples the step size.

*RST: SPAN

Example: //Couple step size to span
FREQ:CENT:STEP:LINK SPAN

Manual operation: See "[Center Frequency Stepsize](#)" on page 51

[SENSe:]FREQuency:CENTer:STEP:LINK:FACTor <Factor>

Defines a step size factor if the center frequency step size is coupled to the span or the resolution bandwidth.

Parameters:

<Factor> 1 to 100 PCT
*RST: 10
Default unit: PCT

Example: //Couple frequency step size to span and define a step size factor
FREQ:CENT:STEP:LINK SPAN
FREQ:CENT:STEP:LINK:FACT 20PCT

Manual operation: See "[Center Frequency Stepsize](#)" on page 51

11.4.5 Configuring trigger

Useful commands to configure triggered measurements described elsewhere:

- [OUTPut:TRIGger<tp>:DIRection](#) on page 112
- [OUTPut:TRIGger<tp>:LEVel](#) on page 113
- [OUTPut:TRIGger<tp>:OTYPe](#) on page 113
- [OUTPut:TRIGger<tp>:PULSe:IMMediate](#) on page 113
- [OUTPut:TRIGger<tp>:PULSe:LENGth](#) on page 114

TRIGger[:SEQuence]:BBPower:HOLDoff	120
TRIGger[:SEQuence]:DTIME	120
TRIGger[:SEQuence]:IFPower:HOLDoff	120
TRIGger[:SEQuence]:HOLDoff[:TIME]	121
TRIGger[:SEQuence]:IFPower:HYSTeresis	121
TRIGger[:SEQuence]:LEVel:AM[:ABSolute]	121

Remote commands to configure analog modulation analysis

TRIGger[:SEquence]:LEVel:AM:RELative.....	122
TRIGger[:SEquence]:LEVel[:EXternal<port>].....	122
TRIGger[:SEquence]:LEVel:FM.....	122
TRIGger[:SEquence]:LEVel:IFPower.....	123
TRIGger[:SEquence]:LEVel:IQPower.....	123
TRIGger[:SEquence]:LEVel:PM.....	123
TRIGger[:SEquence]:LEVel:RFPower.....	124
TRIGger[:SEquence]:SLOPe.....	124
TRIGger[:SEquence]:SOURce.....	124
TRIGger[:SEquence]:TIME:RINTerval.....	125

TRIGger[:SEquence]:BBPower:HOLDoff <Period>

Defines the holding time before the baseband power trigger event.

Note that this command is maintained for compatibility reasons only. Use the [TRIGger\[:SEquence\]:IFPower:HOLDoff](#) on page 120 command for new remote control programs.

Parameters:

<Period> Range: 150 ns to 1000 s
 *RST: 150 ns
 Default unit: S

Example:

```
TRIG:SOUR BBP
Sets the baseband power trigger source.
TRIG:BBP:HOLD 200 ns
Sets the holding time to 200 ns.
```

TRIGger[:SEquence]:DTIME <DropoutTime>

Defines the time the input signal must stay below the trigger level before a trigger is detected again.

Parameters:

<DropoutTime> Dropout time of the trigger.
 Range: 0 s to 10.0 s
 *RST: 0 s
 Default unit: S

Manual operation: See "[Drop-Out Time](#)" on page 56

TRIGger[:SEquence]:IFPower:HOLDoff <Period>

Defines the holding time before the next trigger event.

Note that this command can be used for **any trigger source**, not just IF Power (despite the legacy keyword).

Note: If you perform gated measurements in combination with the IF Power trigger, the R&S FSWP ignores the holding time for frequency sweep, FFT sweep, zero span and I/Q data measurements.

Remote commands to configure analog modulation analysis

Parameters:

<Period> Range: 0 s to 10 s
 *RST: 0 s
 Default unit: S

Example:

TRIG:SOUR EXT
 Sets an external trigger source.
 TRIG:IFP:HOLD 200 ns
 Sets the holding time to 200 ns.

Manual operation: See "[Trigger Holdoff](#)" on page 56

TRIGger[:SEQuence]:HOLDoff[:TIME] <Offset>

Defines the time offset between the trigger event and the start of the measurement.

Parameters:

<Offset> *RST: 0 s
 Default unit: S

Example:

TRIG:HOLD 500us

Manual operation: See "[Trigger Offset](#)" on page 55

TRIGger[:SEQuence]:IFPower:HYSTeresis <Hysteresis>

Defines the trigger hysteresis, which is only available for "IF Power" trigger sources.

Parameters:

<Hysteresis> Range: 3 dB to 50 dB
 *RST: 3 dB
 Default unit: DB

Example:

TRIG:SOUR IFP
 Sets the IF power trigger source.
 TRIG:IFP:HYST 10DB
 Sets the hysteresis limit value.

Manual operation: See "[Hysteresis](#)" on page 56

TRIGger[:SEQuence]:LEVel:AM[:ABSolute] <Level>

The command sets the level when RF power signals are used as trigger source.

For triggering to be successful, the measurement time must cover at least 5 periods of the audio signal.

Parameters:

<Level> Range: -100 to +30
 *RST: -20 dBm
 Default unit: dBm

Example:

TRIG:LEV:AM -30 dBm
 Sets the RF power signal trigger threshold to -30 dBm

Manual operation: See ["Trigger Level"](#) on page 55

TRIGger[:SEQuence]:LEVel:AM:RELative <Level>

The command sets the level when AM-modulated signals are used as trigger source.

For triggering to be successful, the measurement time must cover at least 5 periods of the audio signal.

Parameters:

<Level> Range: -100 to +100
 *RST: 0 %
 Default unit: %

Example:

TRIG:LEV:AM:REL -20 %
 Sets the AM trigger threshold to -20 %

Manual operation: See ["Trigger Level"](#) on page 55

TRIGger[:SEQuence]:LEVel[:EXTernal<port>] <TriggerLevel>

Defines the level the external signal must exceed to cause a trigger event.

Suffix:

<port> Selects the trigger port.
 1 = trigger port 1 (TRIGGER INPUT connector on front panel)
 2 = trigger port 2 (TRIGGER INPUT/OUTPUT connector on rear panel)

Parameters:

<TriggerLevel> Range: 0.5 V to 3.5 V
 *RST: 1.4 V
 Default unit: V

Example:

TRIG:LEV 2V

Manual operation: See ["Trigger Level"](#) on page 55

TRIGger[:SEQuence]:LEVel:FM <Level>

The command sets the level when FM-modulated signals are used as trigger source.

For triggering to be successful, the measurement time must cover at least 5 periods of the audio signal.

Parameters:

<Level> Range: -10 to +10
 *RST: 0 Hz
 Default unit: MHz

Example:

TRIG:LEV:FM 10 kHz
 Sets the FM trigger threshold to 10 kHz

Manual operation: See ["Trigger Level"](#) on page 55

TRIGger[:SEQuence]:LEVel:IFPower <TriggerLevel>

Defines the power level at the third intermediate frequency that must be exceeded to cause a trigger event.

Note that any RF attenuation or preamplification is considered when the trigger level is analyzed. If defined, a reference level offset is also considered.

Parameters:

<TriggerLevel> For details on available trigger levels and trigger bandwidths, see the specifications document.

*RST: -20 dBm

Default unit: DBM

Example: TRIG:LEV:IFP -30DBM

Manual operation: See "[Trigger Level](#)" on page 55

TRIGger[:SEQuence]:LEVel:IQPower <TriggerLevel>

Defines the magnitude the I/Q data must exceed to cause a trigger event.

Note that any RF attenuation or preamplification is considered when the trigger level is analyzed. If defined, a reference level offset is also considered.

Parameters:

<TriggerLevel> Range: -130 dBm to 30 dBm

*RST: -20 dBm

Default unit: DBM

Example: TRIG:LEV:IQP -30DBM

Manual operation: See "[Trigger Level](#)" on page 55

TRIGger[:SEQuence]:LEVel:PM <Level>

The command sets the level when PM-modulated signals are used as trigger source.

For triggering to be successful, the measurement time must cover at least 5 periods of the audio signal.

Parameters:

<Level> Range: -1000 to +1000

*RST: 0 RAD

Default unit: RAD | DEG

Example: TRIG:LEV:PM 1.2 RAD
Sets the PM trigger threshold to 1.2 rad

Manual operation: See "[Trigger Level](#)" on page 55

TRIGger[:SEQuence]:LEVel:RFPower <TriggerLevel>

Defines the power level the RF input must exceed to cause a trigger event. Note that any RF attenuation or preamplification is considered when the trigger level is analyzed. If defined, a reference level offset is also considered.

The input signal must be between 500 MHz and 8 GHz.

Parameters:

<TriggerLevel> For details on available trigger levels and trigger bandwidths, see the specifications document.

*RST: -20 dBm

Default unit: DBM

Example: TRIG:LEV:RFP -30dBm

Manual operation: See "[Trigger Level](#)" on page 55

TRIGger[:SEQuence]:SLOPe <Type>

Selects the trigger slope.

Parameters:

<Type> POSitive | NEGative

POSitive

Triggers when the signal rises to the trigger level (rising edge).

NEGative

Triggers when the signal drops to the trigger level (falling edge).

*RST: POSitive

Example: TRIG:SLOP NEG

Manual operation: See "[Slope](#)" on page 56

TRIGger[:SEQuence]:SOURce <Source>

Selects the trigger source.

Note on external triggers:

If a measurement is configured to wait for an external trigger signal in a remote control program, remote control is blocked until the trigger is received and the program can continue. Make sure that this situation is avoided in your remote control programs.

Parameters:

<Source> **IMMEDIATE**

Free Run

EXT | EXT2

Trigger signal from one of the "Trigger Input/Output" connectors.

Note: Connector must be configured for "Input".

Remote commands to configure analog modulation analysis

RFPower

First intermediate frequency
(Frequency and time domain measurements only.)

IFPower

Second intermediate frequency

IQPower

Magnitude of sampled I/Q data
For applications that process I/Q data, such as the I/Q Analyzer or optional applications.

AF

AF power signal

FM

FM power signal

AM

corresponds to the RF power signal

AMRelative

corresponds to the AM signal

PM

PM power signal

*RST: IMMEDIATE

Example:

TRIG:SOUR EXT

Selects the external trigger input as source of the trigger signal

Manual operation:

See ["Trigger Source"](#) on page 53

See ["Free Run"](#) on page 53

See ["Ext. Trigger 1/2"](#) on page 53

See ["I/Q Power"](#) on page 54

See ["IF Power"](#) on page 54

See ["FM / AM / PM / RF \(Offline\)"](#) on page 54

See ["Time"](#) on page 55

See ["RF Power"](#) on page 55

TRIGger[:SEquence]:TIME:RINTerval <Interval>

Defines the repetition interval for the time trigger.

Parameters:

<Interval>

numeric value

Range: 2 ms to 5000 s

*RST: 1.0 s

Default unit: S

Example:

TRIG:SOUR TIME

Selects the time trigger input for triggering.

TRIG:TIME:RINT 5

The measurement starts every 5 s.

Manual operation:

See ["Repetition Interval"](#) on page 56

11.4.6 Settling time

Optionally, the settling time can be evaluated for time domain measurements.

Useful commands for the settling time described elsewhere:

- [\[SENSe:\]ADEMod:SETTLing:TIME:RESult<t>?](#) on page 176

Remote commands exclusive to configuring the settling time:

[SENSe:]ADEMod:SETTLing:TIME:LIMit:LOWer	126
[SENSe:]ADEMod:SETTLing:TIME:LIMit:UPPer	126
[SENSe:]ADEMod:SETTLing:TIME:STATe	126

[SENSe:]ADEMod:SETTLing:TIME:LIMit:LOWer <Position>

Defines the upper limit of the settling time corridor. The value is defined with reference to the reference value, see also [DISPlay\[:WINDow<n>\]\[:SUBWindow<w>\]:TRACe<t>:Y\[:SCALE\]:RVALue](#) on page 153 and [\[SENSe:\]ADEMod:PM:RPOint\[:X\]](#) on page 140.

For details, see [Section 5.8.7, "Settling time"](#), on page 81.

Parameters:

<Position> Default unit: depends on result type

Example:

ADEM:SETT:TIME:LIM:LOW -10 RAD

Manual operation: See "[Lower Settling Limit](#)" on page 82

[SENSe:]ADEMod:SETTLing:TIME:LIMit:UPPer <Position>

Defines the upper limit of the settling time corridor. The value is defined with reference to the reference value, see also [DISPlay\[:WINDow<n>\]\[:SUBWindow<w>\]:TRACe<t>:Y\[:SCALE\]:RVALue](#) on page 153 and [\[SENSe:\]ADEMod:PM:RPOint\[:X\]](#) on page 140.

For details, see [Section 5.8.7, "Settling time"](#), on page 81.

Parameters:

<Position> Default unit: depends on result type

Example:

ADEM:SETT:TIME:LIM:UPP 10 RAD

Manual operation: See "[Upper Settling Limit](#)" on page 82

[SENSe:]ADEMod:SETTLing:TIME:STATe <State>

Enables or disables the calculation and display of the settling time. The function is available for all time domain displays.

For details, see [Section 5.8.7, "Settling time"](#), on page 81.

Parameters:

<State> ON | OFF | 0 | 1

Remote commands to configure analog modulation analysis

OFF | 0

Switches the function off

ON | 1

Switches the function on

***RST:** 0**Example:**

```
//Define a PM time domain result display
LAY:ADD? '1',RIGH,'XTIM:PM'
//Define a second maxhold trace
DISP:WIND2:TRAC2:MODE MAXH
//Enable settling time calculation
ADEM:SETT:TIME:STAT ON
//Define the settling limit corridor as +/-10 RAD
ADEM:SETT:TIME:LIM:UPP 10 RAD
ADEM:SETT:TIME:LIM:LOW -10 RAD
//Set the zero RAD reference to the last measurement value
ADEM:PM:RPO:MODE LAST
//Perform the measurement
INIT;*WAI
//Query the settling time
ADEM:SETT:TIME:RES2?
//Result: 29.950000us
//After 29.95 us the signal is settled.
```

Manual operation: See "State" on page 82

11.4.7 Defining settings automatically

Commands useful for automatic configuration described elsewhere:

- [SENSe:]ADJust:LEVel on page 117

[SENSe:]ADJust:ALL.....	127
[SENSe:]ADJust:CONFigure:LEVel:DURation.....	128
[SENSe:]ADJust:CONFigure:LEVel:DURation:MODE.....	128
[SENSe:]ADJust:CONFigure:HYSteresis:LOWer.....	129
[SENSe:]ADJust:CONFigure:HYSteresis:UPPer.....	129
[SENSe:]ADJust:CONFigure:TRIGger.....	129
[SENSe:]ADJust:FREQuency.....	130
[SENSe:]ADJust:SCALe[:Y]:AUTO[:CONTinuous].....	130

[SENSe:]ADJust:ALL

Initiates a measurement to determine and set the ideal settings for the current task automatically (only once for the current measurement).

This includes:

- Center frequency
- Reference level
- Scaling

Example: ADJ:ALL

Manual operation: See "[Adjusting all Determinable Settings Automatically \(Auto All\)](#)" on page 84

[SENSe:]ADJust:CONFigure:LEVel:DURation <Duration>

To determine the ideal reference level, the R&S FSWP performs a measurement on the current input data. This command defines the length of the measurement if [SENSe:]ADJust:CONFigure:LEVel:DURation:MODE is set to MANual.

Parameters:

<Duration> Numeric value in seconds
 Range: 0.001 to 16000.0
 *RST: 0.001
 Default unit: s

Example: ADJ:CONF:DUR:MODE MAN
 Selects manual definition of the measurement length.
 ADJ:CONF:LEV:DUR 5ms
 Length of the measurement is 5 ms.

Manual operation: See "[\(Meas Time Manual\)](#)" on page 85

[SENSe:]ADJust:CONFigure:LEVel:DURation:MODE <Mode>

To determine the ideal reference level, the R&S FSWP performs a measurement on the current input data. This command selects the way the R&S FSWP determines the length of the measurement .

Parameters:

<Mode> **AUTO**
 The R&S FSWP determines the measurement length automatically according to the current input data.

MANual
 The R&S FSWP uses the measurement length defined by [SENSe:]ADJust:CONFigure:LEVel:DURation on page 128.

*RST: AUTO

Manual operation: See "[Resetting the Automatic Measurement Time \(Meas Time Auto\)](#)" on page 85
 See "[\(Meas Time Manual\)](#)" on page 85

[SENSe:]ADJust:CONFigure:HYSTeresis:LOWer <Threshold>

When the reference level is adjusted automatically using the [\[SENSe:\]ADJust:LEVe1](#) on page 117 command, the internal attenuators and the preamplifier are also adjusted. To avoid frequent adaptation due to small changes in the input signal, you can define a hysteresis. This setting defines a lower threshold the signal must fall below (compared to the last measurement) before the reference level is adapted automatically.

Parameters:

<Threshold> Range: 0 dB to 200 dB
 *RST: +1 dB
 Default unit: dB

Example:

SENS:ADJ:CONF:HYST:LOW 2

For an input signal level of currently 20 dBm, the reference level is only adjusted when the signal level falls below 18 dBm.

Manual operation: See "[Lower Level Hysteresis](#)" on page 85

[SENSe:]ADJust:CONFigure:HYSTeresis:UPPer <Threshold>

When the reference level is adjusted automatically using the [\[SENSe:\]ADJust:LEVe1](#) on page 117 command, the internal attenuators and the preamplifier are also adjusted. To avoid frequent adaptation due to small changes in the input signal, you can define a hysteresis. This setting defines an upper threshold the signal must exceed (compared to the last measurement) before the reference level is adapted automatically.

Parameters:

<Threshold> Range: 0 dB to 200 dB
 *RST: +1 dB
 Default unit: dB

Example:

SENS:ADJ:CONF:HYST:UPP 2

Example:

For an input signal level of currently 20 dBm, the reference level is only adjusted when the signal level rises above 22 dBm.

Manual operation: See "[Upper Level Hysteresis](#)" on page 85

[SENSe:]ADJust:CONFigure:TRIGger <State>

Defines the behavior of a triggered measurement when adjusting a setting automatically (using `SENS:ADJ:LEV ON`, for example).

Parameters:

<State> ON | OFF | 0 | 1
 ON | 1
 (default:) The measurement for adjustment waits for the next trigger.

Remote commands to configure analog modulation analysis

OFF | 0

The measurement for adjustment is performed without waiting for a trigger (corresponds to "Continue" in manual operation).

*RST: 0

Example:

```
//Use default ref level at 0.00 dBm.
//Define an RF power trigger at -20 dBm
:TRIG:SEQ:SOUR RFP
:TRIG:SEQ:LEV:RFP -20
//Perform adjustment measurement without waiting for trigger
SENS:ADJ:CONF:TRIG OFF
//Perform auto level adjustment
:SENS:ADJ:LEV;*WAI
```

[SENSe:]ADJust:FREQuency

Sets the center frequency to the frequency with the highest signal level in the current frequency range.

Example: ADJ:FREQ

Manual operation: See ["Adjusting the Center Frequency Automatically \(Auto Frequency\)"](#) on page 84

[SENSe:]ADJust:SCALe[:Y]:AUTO[:CONTInuous] <State>

Activates automatic scaling of the y-axis in all diagrams according to the current measurement results. Currently auto-scaling is only available for AF measurements. RF power and RF spectrum measurements are not affected by the auto-scaling.

Parameters:

<State> ON | OFF | 0 | 1

OFF | 0

Switches the function off

ON | 1

Switches the function on

Example: SENS:ADJ:SCAL:Y:AUTO ON

Manual operation: See ["AF Auto Scale"](#) on page 75

11.4.8 Configuring data acquisition

ABORT.....	131
INITiate<n>:CONMeas.....	132
INITiate<n>:CONTInuous.....	132
INITiate<n>:REFResh.....	133
INITiate:SEQuencer:ABORT.....	133
INITiate:SEQuencer:IMMediate.....	133
INITiate:SEQuencer:MODE.....	134

Remote commands to configure analog modulation analysis

INITiate<n>[:IMMEDIATE]	134
[SENSe:]ADEMod:ADCPrefilter	134
[SENSe:]ADEMod:MTIME	135
[SENSe:]ADEMod:RLENgth	135
[SENSe:]ADEMod:SET	135
[SENSe:]ADEMod:SPECtrum:BWIDth[:RESolution]	136
[SENSe:]ADEMod:SRATE	136
[SENSe:]AVERage<n>:COUNT	136
[SENSe:]BWIDth:DEMod	137
[SENSe:]BWIDth:DEMod:TYPE	137
[SENSe:]BANDwidth[:RESolution]	137
[SENSe:]MSRA:CAPture:OFFSet	138
[SENSe:]SWEep:COUNT	138
[SENSe:]SWEep[:WINDow<n>]:POINTs	139
SYSTem:SEQuencer	139

ABORt

Aborts the measurement in the current channel and resets the trigger system.

To prevent overlapping execution of the subsequent command before the measurement has been aborted successfully, use the *OPC? or *WAI command after ABOR and before the next command.

For details on overlapping execution see [Remote control via SCPI](#).

To abort a sequence of measurements by the Sequencer, use the [INITiate:SEQuencer:ABORt](#) command.

Note on blocked remote control programs:

If a sequential command cannot be completed, for example because a triggered sweep never receives a trigger, the remote control program will never finish and the remote channel to the R&S FSWP is blocked for further commands. In this case, you must interrupt processing on the remote channel first in order to abort the measurement.

To do so, send a "Device Clear" command from the control instrument to the R&S FSWP on a parallel channel to clear all currently active remote channels. Depending on the used interface and protocol, send the following commands:

- **Visa:** viClear()
- **GPIB:** ibclr()
- **RSIB:** RSDLLibclr()

Now you can send the ABORt command on the remote channel performing the measurement.

Example:

```
ABOR; :INIT:IMM
```

Aborts the current measurement and immediately starts a new one.

Example: ABOR; *WAI
 INIT: IMM
 Aborts the current measurement and starts a new one once
 abortion has been completed.

Usage: Event

INITiate<n>:CONMeas

Restarts a (single) measurement that has been stopped (using `ABORT`) or finished in single measurement mode.

The measurement is restarted at the beginning, not where the previous measurement was stopped.

As opposed to `INITiate<n>[:IMMEDIATE]`, this command does not reset traces in maxhold, minhold or average mode. Therefore it can be used to continue measurements using maxhold or averaging functions.

Suffix:

<n> irrelevant

Usage: Asynchronous command

Manual operation: See "[Continue Single Sweep](#)" on page 62

INITiate<n>:CONTinuous <State>

Controls the measurement mode for an individual channel.

Note that in single measurement mode, you can synchronize to the end of the measurement with `*OPC`, `*OPC?` or `*WAI`. In continuous measurement mode, synchronization to the end of the measurement is not possible. Thus, it is not recommended that you use continuous measurement mode in remote control, as results like trace data or markers are only valid after a single measurement end synchronization.

For details on synchronization see [Remote control via SCPI](#).

If the measurement mode is changed for a channel while the Sequencer is active, the mode is only considered the next time the measurement in that channel is activated by the Sequencer.

Suffix:

<n> irrelevant

Parameters:

<State> ON | OFF | 0 | 1

ON | 1

Continuous measurement

OFF | 0

Single measurement

*RST: 1 (some applications can differ)

Example: `INIT:CONT OFF`
Switches the measurement mode to single measurement.
 `INIT:CONT ON`
Switches the measurement mode to continuous measurement.

Manual operation: See "[Continuous Sweep / Run Cont](#)" on page 61

INITiate<n>:REFResh

Updates the current measurement results to reflect the current measurement settings.

No new I/Q data is captured. Thus, measurement settings apply to the I/Q data currently in the capture buffer.

The command applies exclusively to I/Q measurements. It requires I/Q data.

Suffix:
<n> irrelevant

Example: `INIT:REFR`
Updates the IQ measurement results.

Usage: Asynchronous command

Manual operation: See "[Refresh \(MSRA only\)](#)" on page 62

INITiate:SEQuencer:ABORt

Stops the currently active sequence of measurements.

You can start a new sequence any time using [INITiate:SEQuencer:IMMediate](#) on page 133.

Usage: Event

INITiate:SEQuencer:IMMediate

Starts a new sequence of measurements by the Sequencer.

Its effect is similar to the [INITiate<n>\[:IMMediate\]](#) command used for a single measurement.

Before this command can be executed, the Sequencer must be activated (see [SYSTem:SEQuencer](#) on page 139).

Example: `SYST:SEQ ON`
Activates the Sequencer.
 `INIT:SEQ:MODE SING`
Sets single sequence mode so each active measurement is performed once.
 `INIT:SEQ:IMM`
Starts the sequential measurements.

INITiate:SEQuencer:MODE <Mode>

Defines the capture mode for the entire measurement sequence and all measurement groups and channels it contains.

Note: To synchronize to the end of a measurement sequence using *OPC, *OPC? or *WAI, use **SINGLe** Sequencer mode.

Parameters:

<Mode>

SINGLe

Each measurement group is started one after the other in the order of definition. All measurement channels in a group are started simultaneously and performed once. After *all* measurements are completed, the next group is started. After the last group, the measurement sequence is finished.

CONTInuous

Each measurement group is started one after the other in the order of definition. All measurement channels in a group are started simultaneously and performed once. After *all* measurements are completed, the next group is started. After the last group, the measurement sequence restarts with the first one and continues until it is stopped explicitly.

*RST: CONTInuous

INITiate<n>[:IMMediate]

Starts a (single) new measurement.

With measurement count or average count > 0, this means a restart of the corresponding number of measurements. With trace mode MAXHold, MINHold and AVERage, the previous results are reset on restarting the measurement.

You can synchronize to the end of the measurement with *OPC, *OPC? or *WAI.

For details on synchronization see [Remote control via SCPI](#).

Suffix:

<n> irrelevant

Usage:

Asynchronous command

Manual operation:See "[Single Sweep / Run Single](#)" on page 62**[SENSe:]ADEMod:ADCPrefilter** <Mode>

This command selects the bandwidth selection mode for the ADC prefilter.

Parameters:

<Mode>

AUTO

Selects the analog bandwidth based on the demodulation bandwidth.

WIDE

Selects the largest possible analog bandwidth.

Remote commands to configure analog modulation analysis

*RST: AUTO

Example: //Select bandwidth selection mode
ADEM:ADCP AUTO

Manual operation: See "[ADC Prefilter](#)" on page 60

[SENSe:]ADEMod:MTIME <Time>

Defines the measurement time for Analog Modulation Analysis.

Parameters:

<Time> *RST: 62.5us
Default unit: S

Example: ADEM:MTIM 62.5us
Sets the measurement time to 62.5 μ s.

Manual operation: See "[Measurement Time \(AQT\)](#)" on page 60

[SENSe:]ADEMod:RLENgth**[SENSe:]ADEMod:SET <SampleRate>, <RecordLength>, <TriggerSource>, <TriggerSlope>, <OffsetSamples>, <NoOfMeas>**

Configures the analog demodulator of the instrument.

Parameters:

<SampleRate> **numeric value**
The frequency at which measurement values are taken from the A/D-converter and stored in I/Q memory.
*RST: 8 MHz
Default unit: HZ

<RecordLength> Number of samples to be stored in I/Q memory.
Range: 1 to 400001 with AF filter or AF trigger active, 1 to 480001 with both AF filter and AF trigger deactive
*RST: 501)

<TriggerSource> **Note:** After selecting IF Power, the trigger threshold can be set with the [TRIGger\[:SEquence\]:LEVel:IFPower](#) command.
*RST: IMMEDIATE

<TriggerSlope> POSitive | NEGative
Used slope of the trigger signal.
The value indicated here will be ignored for <trigger source> = IMMEDIATE.
*RST: POSitive

Remote commands to configure analog modulation analysis

<OffsetSamples> Number of samples to be used as an offset to the trigger signal. The value indicated here is ignored for <trigger source> = "IMMEDIATE".

*RST: 0

<NoOfMeas> Number of repetitions of the measurement to be executed. The value indicated here is especially necessary for the average/maxhold/minhold function.

Range: 0 to 32767

*RST: 0

Example:

```
ADEM:SET 8MHz,32000,EXT,POS,-500,30
```

Performs a measurement at:

sample rate = 8 MHz

record length = 32000

trigger source = EXTERNAL

trigger slope = POSITIVE

offset samples = -500 (500 samples before trigger occurred)

of meas = 30

[SENSe:]ADEMod:SPECTrum:BWIDth[:RESolution] <Bandwidth>

Defines the resolution bandwidth for data acquisition.

From the specified RBW and the demodulation span set by [\[SENSe:\]ADEMod:SPECTrum:SPAN\[:MAXimum\]](#) on page 147 or [\[SENSe:\]BWIDth:DEMod](#) on page 137, the required measurement time is calculated. If the available measurement time is not sufficient for the given bandwidth, the measurement time is set to its maximum and the resolution bandwidth is increased to the resulting bandwidth.

Is identical to `SENS:BAND:RES`, see the R&S FSWP User Manual.

Parameters:

<Bandwidth> Refer to specifications document.

*RST: 61.2 kHz

Default unit: HZ

Example:

```
ADEM:SPEC:BAND 61.2kHz
```

Sets the resolution bandwidth to 61.2 kHz.

[SENSe:]ADEMod:SRATe**[SENSe:]AVERAge<n>:COUNT <AverageCount>**

Defines the number of measurements that the application uses to average traces.

In case of continuous sweep mode, the application calculates the moving average over the average count.

In case of single sweep mode, the application stops the measurement and calculates the average after the average count has been reached.

Remote commands to configure analog modulation analysis

Suffix:

<n> irrelevant

Parameters:

<AverageCount> If you set an average count of 0 or 1, the application performs one single measurement in single sweep mode. In continuous sweep mode, if the average count is set to 0, a moving average over 10 measurements is performed.

Range: 0 to 200000
*RST: 0

[SENSe:]BWIDth:DEMod <Bandwidth>

Sets the bandwidth for Analog Modulation Analysis. Depending on the selected demodulation bandwidth, the instrument selects the required sample rate.

Is identical to `SENS:ADEM:BAND:DEM`.

Parameters:

<Bandwidth> *RST: 5 MHz
Default unit: HZ

Example:

`BAND:DEM 1MHz`
Sets demodulation bandwidth to 1 MHz

Manual operation: See "[Demodulation Bandwidth](#)" on page 59

[SENSe:]BWIDth:DEMod:TYPE <FilterType>

Defines the type of demodulation filter to be used.

Is identical to `SENS:ADEM:BAND:DEM:TYPE`.

Parameters:

<FilterType> **FLAT**
Standard flat demodulation filter

GAUSs
Gaussian filter for optimized settling behavior

*RST: FLAT

Manual operation: See "[Demodulation Filter](#)" on page 60

[SENSe:]BANDwidth[:RESolution] <Bandwidth>

Defines the resolution bandwidth and decouples the resolution bandwidth from the span.

For statistics measurements, this command defines the **demodulation** bandwidth.

Remote commands to configure analog modulation analysis

Parameters:

<Bandwidth>

refer to specifications document

*RST: RBW: AUTO is set to ON; DBW: 3MHz

Default unit: Hz

Example:

BAND 1 MHz

Sets the resolution bandwidth to 1 MHz

Manual operation: See "[Resolution Bandwidth](#)" on page 60**[SENSe:]MSRA:CAPTure:OFFSet <Offset>**

This setting is only available for secondary applications in MSRA mode, not for the MSRA primary application. It has a similar effect as the trigger offset in other measurements.

Parameters:

<Offset>

This parameter defines the time offset between the capture buffer start and the start of the extracted secondary application data. The offset must be a positive value, as the secondary application can only analyze data that is contained in the capture buffer.

Range: 0 to <Record length>

*RST: 0

Default unit: S

Manual operation: See "[Capture Offset](#)" on page 60**[SENSe:]SWEep:COUNT <SweepCount>**

Defines the number of measurements that the application uses to average traces.

In continuous measurement mode, the application calculates the moving average over the average count.

In single measurement mode, the application stops the measurement and calculates the average after the average count has been reached.

Parameters:

<SweepCount>

When you set a sweep count of 0 or 1, the R&S FSWP performs one single measurement in single measurement mode.

In continuous measurement mode, if the sweep count is set to 0, a moving average over 10 measurements is performed.

Range: 0 to 200000

*RST: 0

Example:

SWE:COUN 64

Sets the number of measurements to 64.

INIT:CONT OFF

Switches to single measurement mode.

INIT;*WAI

Starts a measurement and waits for its end.

Manual operation: See "[Sweep/Average Count](#)" on page 63

[SENSe:]SWEep[:WINDow<n>]:POINts <SweepPoints>

This command defines the number of measurement points to analyze after a measurement.

Suffix:

<n>

Example: `SWE:POIN 251`

Manual operation: See "[Sweep Points](#)" on page 63

SYSTem:SEQuencer <State>

Turns the Sequencer on and off. The Sequencer must be active before any other Sequencer commands (`INIT:SEQ...`) are executed, otherwise an error occurs.

A detailed programming example is provided in the "Operating Modes" section in the R&S FSWP User Manual.

Parameters:

<State> `ON | OFF | 0 | 1`

ON | 1

The Sequencer is activated and a sequential measurement is started immediately.

OFF | 0

The Sequencer is deactivated. Any running sequential measurements are stopped. Further Sequencer commands (`INIT:SEQ...`) are not available.

*RST: `0`

Example:

`SYST:SEQ ON`

Activates the Sequencer.

`INIT:SEQ:MODE SING`

Sets single Sequencer mode so each active measurement is performed once.

`INIT:SEQ:IMM`

Starts the sequential measurements.

`SYST:SEQ OFF`

11.4.9 Configuring demodulation

- [Basic demodulation settings](#)..... 140
- [Time domain zoom settings](#)..... 141
- [Configuring the demodulation spectrum](#)..... 143
- [\(Post-processing\) AF filters](#)..... 147
- [Defining the scaling and units](#)..... 153
- [Scaling for AF evaluation](#)..... 153

- [Scaling for RF evaluation](#)..... 153
- [Units](#)..... 155
- [Relative demodulation results](#)..... 155

11.4.9.1 Basic demodulation settings

The basic demodulation measurement parameters define how the measurement is performed.

Useful commands described elsewhere:

- [Section 11.4.9.2, "Time domain zoom settings"](#), on page 141

Basic demodulation commands:

[SENSe:]ADEMod<n>:AF:COUPling	140
[SENSe:]ADEMod:PM:RPOint[:X]	140
[SENSe:]ADEMod:SQUelch[:STATe]	141
[SENSe:]ADEMod:SQUelch:LEVel	141

[SENSe:]ADEMod<n>:AF:COUPling <Coupling>

Selects the coupling of the AF path of the analyzer in the specified window.

Suffix:

<n> irrelevant

Parameters:

<Coupling> AC | DC
 *RST: AC (PM); DC (FM)

Example:

ADEM:AF:COUP DC
 Switches on DC coupling.

Manual operation: See "[AF Coupling](#)" on page 47

[SENSe:]ADEMod:PM:RPOint[:X] <Time>

Determines the position where the phase of the PM-demodulated signal is set to 0 rad. The maximum value depends on the measurement time selected in the instrument; this value is output in response to the query `ADEM:PM:RPO:X? MAX.`

Parameters:

<Time> 0 s to measurement time
 *RST: 0 s
 Default unit: S

Example:

ADEM:PM:RPO 500us
 Sets the position where the phase to 0 rad setting to 500 μ s.

Manual operation: See "[Zero Phase Reference Position \(PM Time Domain only\)](#)" on page 66

[SENSe:]ADEMod:SQUelch[:STATe] <State>

Activates the squelch function, i.e. if the signal falls below a defined threshold (see [\[SENSe:\]ADEMod:SQUelch:LEVel](#) on page 141), the demodulated data is automatically set to 0.

Parameters:

<State> ON | OFF | 0 | 1
OFF | 0
 Switches the function off
ON | 1
 Switches the function on

Example:

DEM:SQU ON
 Signals below the level threshold are squelched.

Manual operation: See "[Squelch State](#)" on page 64

[SENSe:]ADEMod:SQUelch:LEVel <Threshold>

Defines the level threshold below which the demodulated data is set to 0 if squelching is enabled (see [\[SENSe:\]ADEMod:SQUelch\[:STATe\]](#) on page 141).

Parameters:

<Threshold> numeric value
 The absolute threshold level
 Range: -150 dBm to 30 dBm
 *RST: -40 dBm

Example:

DEM:SQU:LEV -80
 If the signal drops below -80 dBm, the demodulated data is set to 0.

Manual operation: See "[Squelch Level](#)" on page 64

11.4.9.2 Time domain zoom settings

Using the time domain zoom, the demodulated data for a particular time span is extracted and displayed in more detail.

[SENSe:]ADEMod<n>:ZOOM:LENGth	141
[SENSe:]ADEMod<n>:ZOOM:LENGth:MODE	142
[SENSe:]ADEMod<n>:ZOOM:STARt	142
[SENSe:]ADEMod<n>:ZOOM[:STATe]	143

[SENSe:]ADEMod<n>:ZOOM:LENGth <Length>

The command allows you to define the length of the time domain zoom area for the analog-demodulated measurement data in the specified window manually. If the length is defined manually using this command, the zoom mode is also set to manual.

Remote commands to configure analog modulation analysis

Suffix:<n> [Window](#)**Parameters:**

<Length> *RST: sweep time
 Default unit: S
 Length of the zoom area in seconds.

Example:

ADEM:ZOOM:LENG 2s
 Zoom mode is set to manual and the zoom length to 2 seconds.

Manual operation: See "[Length](#)" on page 66

[SENSe:]ADEMod<n>:ZOOM:LENGth:MODE <Mode>

The command defines whether the length of the zoom area for the analog-demodulated measurement data is defined automatically or manually in the specified window.

Suffix:<n> [Window](#)**Parameters:**

<Mode> AUTO | MAN
AUTO
 (Default:) The number of sweep points is used as the zoom length.
MAN
 The zoom length is defined manually using [\[SENSe:\]ADEMod<n>:ZOOM:LENGth](#).
 *RST: AUTO

Example:

ADEM:ZOOM:LENG:MODE MAN
 Zoom function uses the length defined manually.

Manual operation: See "[Length](#)" on page 66

[SENSe:]ADEMod<n>:ZOOM:STARt <Time>

The command selects the start time for the zoomed display of analog-demodulated measurements in the specified window. The maximum value depends on the measurement time, which is set and can be queried with the [\[SENSe:\]ADEMod:MTIME](#) command.

If the zoom function is enabled, the defined number of sweep points are displayed from the start time specified with this command.

Suffix:<n> [Window](#)**Parameters:**

<Time> Range: 0 s to (measurement time – zoom length)
 *RST: 0 s
 Default unit: S

Remote commands to configure analog modulation analysis

Example: ADEM:ZOOM:STAT ON
Switches on the zoom function
ADEM:ZOOM:STAR 500us
Sets the starting point of the display to 500 µs.

Manual operation: See "[Start](#)" on page 65

[SENSe:]ADEMod<n>:ZOOM[:STATe] <State>

The command enables or disables the time domain zoom function for the analog-demodulated measurement data in the specified window.

If the zoom function is enabled, the defined number of sweep points are displayed from the start time specified with [\[SENSe:\]ADEMod<n>:ZOOM:STARt](#) on page 142.

If the zoom function is disabled, data reduction is used to adapt the measurement points to the number of points available on the display.

Suffix:

<n> [Window](#)

Parameters:

<State> ON | OFF | 0 | 1
OFF | 0
Switches the function off
ON | 1
Switches the function on

Example: ADEM:ZOOM ON
Switches on the zoom function

Manual operation: See "[State](#)" on page 65

11.4.9.3 Configuring the demodulation spectrum

The demodulation spectrum defines which span of the demodulated data is evaluated.

- [AF evaluation](#)..... 143
- [RF evaluation](#)..... 146

AF evaluation

These settings are only available for AF Spectrum evaluations, not in the time domain.

DISPlay[:WINDow<n>][:SUBWindow<w>]:TRACe<t>:Y[:SCALe]:PDIVision	144
DISPlay[:WINDow<n>][:SUBWindow<w>]:TRACe<t>:Y[:SCALe]:RPOSition	144
DISPlay[:WINDow<n>][:SUBWindow<w>]:TRACe<t>:Y:SPACing	145
[SENSe:]ADEMod:AF:CENTer	145
[SENSe:]ADEMod:AF:SPAN	145
[SENSe:]ADEMod:AF:SPAN:FULL	146
[SENSe:]ADEMod:AF:STARt	146
[SENSe:]ADEMod:AF:STOP	146

DISPlay[:WINDow<n>][:SUBWindow<w>]:TRACe<t>:Y[:SCALe]:PDIVision
<Value>

This remote command determines the grid spacing on the Y-axis for all diagrams, where possible.

In spectrum displays, for example, this command is not available.

Suffix:

<n>	Window
<w>	subwindow Not supported by all applications
<t>	irrelevant

Parameters:

<Value>	numeric value WITHOUT UNIT (unit according to the result display) Defines the range per division (total range = 10*<Value>) *RST: depends on the result display Default unit: DBM
---------	--

Example: `DISP:TRAC:Y:PDIV 10`
Sets the grid spacing to 10 units (e.g. dB) per division

Manual operation: See "[Dev per Division/ dB per Division](#)" on page 74

DISPlay[:WINDow<n>][:SUBWindow<w>]:TRACe<t>:Y[:SCALe]:RPOSition
<Position>

Defines the vertical position of the reference level on the display grid (for all traces).

The R&S FSWP adjusts the scaling of the y-axis accordingly.

For measurements with the optional external generator control, the command defines the position of the reference value.

Suffix:

<n>	Window
<w>	subwindow Not supported by all applications
<t>	irrelevant

Parameters:

<Position>	*RST: 100 PCT = AF spectrum display; 50 PCT = time display
------------	--

Example: `DISP:TRAC:Y:RPOS 50PCT`

Manual operation: See "[Reference Value Position](#)" on page 74
See "[Ref Level Position](#)" on page 76

DISPlay[:WINDow<n>][:SUBWindow<w>]:TRACe<t>:Y:SPACing <ScalingType>

Selects the scaling of the y-axis (for all traces, <t> is irrelevant).

For AF spectrum displays, only the parameters "LINear" and "LOGarithmic" are permitted.

Suffix:

<n> [Window](#)

<w> subwindow

<t> [Trace](#)

Parameters:

<ScalingType> **LOGarithmic**
Logarithmic scaling.

LINear
Linear scaling in %.

LDB
Linear scaling in the specified unit.

PERCent
Linear scaling in %.

*RST: LOGarithmic

Example: `DISP:TRAC:Y:SPAC LIN`
Selects linear scaling in %.

Manual operation: See "[Deviation](#)" on page 75
See "[Scaling](#)" on page 77

[SENSe:]ADEMod:AF:CENTer <Frequency>

Sets the center frequency for AF spectrum result display.

Parameters:

<Frequency> *RST: 1.25 MHz
Default unit: HZ

Manual operation: See "[AF Center](#)" on page 67

**[SENSe:]ADEMod:AF:SPAN **

Sets the span (around the center frequency) for AF spectrum result display.

The span is limited to DBW/2 (see [\[SENSe:\]BWIDth:DEMod](#) on page 137).

Parameters:

 *RST: 9 MHz
Default unit: HZ

Example: `ADEM:AF:SPAN 200 kHz`
Sets the AF span to 200 kHz

Manual operation: See "AF Span" on page 68

[SENSe:]ADEMod:AF:SPAN:FULL

Sets the maximum span for AF spectrum result display.

The maximum span corresponds to DBW/2 (see [SENSe:]BWIDth:DEMod on page 137).

Example:

```
ADEM:BAND 5 MHz
Sets the demodulation bandwidth to 5 MHz
ADEM:AF:SPAN:FULL
Sets the AF span to 2.5 MHz
```

Manual operation: See "AF Full Span" on page 68

[SENSe:]ADEMod:AF:STARt <Frequency>

Sets the start frequency for AF spectrum result display.

Parameters:

<Frequency> *RST: 0 MHz
 Default unit: HZ

Example:

```
ADEM:AF:STAR 0 kHz
Sets the AF start frequency to 0 kHz
ADEM:AF:STOP 500 kHz
Sets the AF stop frequency to 500 kHz
```

Manual operation: See "AF Start" on page 67

[SENSe:]ADEMod:AF:STOP <Frequency>

Sets the stop frequency for AF spectrum result display.

Parameters:

<Frequency> *RST: 9 MHz
 Default unit: HZ

Example:

```
ADEM:AF:STAR 0 kHz
Sets the AF start frequency to 0 kHz
ADEM:AF:STOP 500 kHz
Sets the AF stop frequency to 500 kHz
```

Manual operation: See "AF Stop" on page 68

RF evaluation

These settings are only available for RF evaluation, both in time and frequency domain.

Useful commands described elsewhere

- [SENSe:]FREQuency:CENTer on page 117

- [SENSe:]BWIDth:DEMod on page 137

Specific commands:

[SENSe:]ADEMod:SPECtrum:SPAN:ZOOM.....	147
[SENSe:]ADEMod:SPECtrum:SPAN[:MAXimum].....	147

[SENSe:]ADEMod:SPECtrum:SPAN:ZOOM

Sets the span (around the center frequency) for RF spectrum result display.

The span is limited to the demodulation bandwidth (see [SENSe:]BWIDth:DEMod on page 137).

Parameters:

 *RST: 5 MHz
 Default unit: HZ

Example:

ADEM:SPEC:SPAN:ZOOM 200 kHz
 Sets the rF span to 200 kHz

Manual operation: See "Span" on page 69

[SENSe:]ADEMod:SPECtrum:SPAN[:MAXimum] <FreqRange>

Sets the DBW to the specified value and the span (around the center frequency) of the RF data to be evaluated to its new maximum (the demodulation bandwidth).

Parameters:

<FreqRange> *RST: 5 MHz
 Default unit: Hz

Manual operation: See "Span" on page 69
 See "RF Full Span" on page 69

11.4.9.4 (Post-processing) AF filters

The AF filter reduces the evaluated bandwidth of the demodulated signal and can define a weighting function. AF filters are only available for AM or FM time domain evaluations.

[SENSe:]FILTer<n>:AWEighted[:STATE].....	148
[SENSe:]FILTer<n>:AOFF.....	148
[SENSe:]FILTer<n>:CCIR:WEIGhted[:STATE].....	148
[SENSe:]FILTer<n>:CCIR[:UNWeighted][:STATE].....	149
[SENSe:]FILTer<n>:CCIT[:STATE].....	149
[SENSe:]FILTer<n>:DEMPHasis:TCONstant.....	149
[SENSe:]FILTer<n>:DEMPHasis[:STATE].....	149
[SENSe:]FILTer<n>:HPASs:FREQUency[:ABSolute].....	150
[SENSe:]FILTer<n>:HPASs:FREQUency:MANual.....	150
[SENSe:]FILTer<n>:HPASs[:STATE].....	151
[SENSe:]FILTer<n>:LPASs:FREQUency[:ABSolute].....	151

[SENSe:]FILTer<n>:LPASs:FREQUency:MANual.....	151
[SENSe:]FILTer<n>:LPASs:FREQUency:RELative.....	152
[SENSe:]FILTer<n>:LPASs[:STATe].....	152

[SENSe:]FILTer<n>:AWEighted[:STATe] <State>

Activates/deactivates the "A" weighting filter for the specified evaluation.

For details on weighting filters, see ["Weighting"](#) on page 72.

Suffix:

<n> [Window](#)

Parameters:

<State> ON | OFF | 0 | 1
OFF | 0
 Switches the function off
ON | 1
 Switches the function on

Example: `FILT:AWE ON`
 Activates the A weighting filter.

Manual operation: See ["Weighting"](#) on page 72

[SENSe:]FILTer<n>:AOFF

Suffix:

<n> 1..n

Manual operation: See ["Deactivating all AF Filters"](#) on page 73

[SENSe:]FILTer<n>:CCIR:WEIGhted[:STATe] <State>

Activates/deactivates the weighted CCIR filter for the specified evaluation.

For details on weighting filters, see ["Weighting"](#) on page 72.

Suffix:

<n> [Window](#)

Parameters:

<State> ON | OFF | 0 | 1
OFF | 0
 Switches the function off
ON | 1
 Switches the function on

Example: `FILT:CCIR:WEIG ON`
 Activates the weighted CCIR filter.

Manual operation: See ["Weighting"](#) on page 72

[SENSe:]FILTer<n>:CCIR[:UNWeighted][:STATe] <State>

Activates/deactivates the unweighted CCIR filter in the specified window.

For details on weighting filters, see "[Weighting](#)" on page 72.

Suffix:

<n> [Window](#)

Parameters:

<State> ON | OFF | 0 | 1
OFF | 0
 Switches the function off
ON | 1
 Switches the function on

Example: `FILT:CCIR:UNW ON`
 Activates the unweighted CCIR filter.

Manual operation: See "[Weighting](#)" on page 72

[SENSe:]FILTer<n>:CCITt[:STATe] <State>

Suffix:

<n> 1..n

Parameters:

<State>

Manual operation: See "[Weighting](#)" on page 72

[SENSe:]FILTer<n>:DEMPHasis:TCONstant <Value>

Selects the deemphasis for the specified evaluation.

For details on deemphasis refer to "[Deemphasis](#)" on page 72.

Suffix:

<n> [Window](#)

Parameters:

<Value> 25 us | 50 us | 75 us | 750 us
 *RST: 50 us
 Default unit: S

Example: `FILT:DEMP:TCON 750us`
 Selects the deemphasis for the demodulation bandwidth range from 800 Hz to 4 MHz with a time constant of 750 µs.

Manual operation: See "[Deemphasis](#)" on page 72

[SENSe:]FILTer<n>:DEMPHasis[:STATe] <State>

Activates/deactivates the selected deemphasis for the specified evaluation.

For details about deemphasis refer to "[Deemphasis](#)" on page 72.

Suffix:

<n> [Window](#)

Parameters:

<State> ON | OFF | 0 | 1
OFF | 0
 Switches the function off
ON | 1
 Switches the function on

Example:

FILT:DEMP ON
 Activates the selected deemphasis.

Manual operation: See "[Deemphasis](#)" on page 72

[SENSe:]FILTer<n>:HPASs:FREQuency[:ABSolute] <Frequency>

Selects the high pass filter type for the specified evaluation.

For details on the high pass filters, refer to "[High Pass](#)" on page 70.

Suffix:

<n> [Window](#)

Parameters:

<Frequency> 20 Hz | 50 Hz | 300 Hz
 *RST: 300Hz
 Default unit: Hz

Example:

FILT:HPAS:FREQ 300Hz
 Selects the high pass filter for the demodulation bandwidth range from 800 Hz to 8 MHz.

Manual operation: See "[High Pass](#)" on page 70

[SENSe:]FILTer<n>:HPASs:FREQuency:MANual <Frequency>

Selects the cutoff frequency of the high pass filter for the specified evaluation.

For details on the high pass filters, refer to "[High Pass](#)" on page 70.

Suffix:

<n> [Window](#)

Parameters:

<Frequency> numeric value
 Range: 0 to 3 MHz
 *RST: 15kHz
 Default unit: HZ

Example:

FILT:HPAS:FREQ:MAN 3MHz
 The AF results are restricted to frequencies lower than 3 MHz.

Manual operation: See "High Pass" on page 70

[SENSe:]FILTer<n>:HPASs[:STATe] <State>

Activates/deactivates the selected high pass filter for the specified evaluation.

For details on the high pass filter, refer to "High Pass" on page 70.

Suffix:

<n> [Window](#)

Parameters:

<State> ON | OFF | 0 | 1

OFF | 0

Switches the function off

ON | 1

Switches the function on

Example:

FILT:HPAS ON

Activates the selected high pass filter.

Manual operation: See "High Pass" on page 70

[SENSe:]FILTer<n>:LPASs:FREQuency[:ABSolute] <Frequency>

Selects the absolute low pass filter type for the specified evaluation

For details on the low pass filter, refer to "Low Pass" on page 71.

Suffix:

<n> [Window](#)

Parameters:

<Frequency> 3kHz | 15kHz | 150kHz

*RST: 15kHz

Default unit: HZ

Example:

FILT:LPAS:FREQ 150kHz

Selects the low pass filter for the demodulation bandwidth range from 400 kHz to 16 MHz.

Manual operation: See "Low Pass" on page 71

[SENSe:]FILTer<n>:LPASs:FREQuency:MANual <Frequency>

Selects the cutoff frequency of the low pass filter for the specified evaluation.

For details on the low pass filter, refer to "Low Pass" on page 71.

Suffix:

<n> [Window](#)

Remote commands to configure analog modulation analysis

Parameters:

<Frequency> numeric value
 Range: 0 to 3 MHz
 *RST: 15kHz
 Default unit: HZ

Example:

```
FILT:LPAS:FREQ:MAN 150kHz
```

The AF results are restricted to frequencies lower than 150 kHz.

Manual operation: See "[Low Pass](#)" on page 71

[SENSe:]FILTer<n>:LPASs:FREQuency:RELative <Frequency>

Selects the relative low pass filter type for the specified evaluation

For details on the low pass filter, refer to "[Low Pass](#)" on page 71.

Suffix:

<n> [Window](#)

Parameters:

<Frequency> 5PCT | 10PCT | 25PCT
 *RST: 25PCT
 Default unit: PCT

Example:

```
FILT:LPAS:FREQ:REL 25PCT
```

Selects the low pass filter as 25 % of the demodulation bandwidth.

Manual operation: See "[Low Pass](#)" on page 71

[SENSe:]FILTer<n>:LPASs[:STATe] <State>

Activates/deactivates the selected low pass filter for the specified evaluation.

For details on the low pass filter, refer to "[Low Pass](#)" on page 71.

Suffix:

<n> [Window](#)

Parameters:

<State> ON | OFF | 0 | 1
OFF | 0
 Switches the function off
ON | 1
 Switches the function on

Example:

```
FILT:LPAS ON
```

Activates the selected low pass filter.

Manual operation: See "[Low Pass](#)" on page 71

11.4.9.5 Defining the scaling and units

The scaling parameters define the range of the demodulated data to be displayed.

11.4.9.6 Scaling for AF evaluation

These settings are only available for AF evaluations.

Useful commands described elsewhere:

- `[SENSe:]ADJust:SCALe[:Y]:AUTO[:CONTinuous]` on page 130
- `[SENSe:]ADEMod<n>:AF:COUPling` on page 140
- `DISPlay[:WINDow<n>][:SUBWindow<w>]:TRACe<t>:Y[:SCALe]:RPOSition` on page 144
- `DISPlay[:WINDow<n>][:SUBWindow<w>]:TRACe<t>:Y:SPACing` on page 145

Specific commands:

`DISPlay[:WINDow<n>][:SUBWindow<w>]:TRACe<t>:Y[:SCALe]:RVALue`.....153

DISPlay[:WINDow<n>][:SUBWindow<w>]:TRACe<t>:Y[:SCALe]:RVALue <Value>

Defines the reference value assigned to the reference position in the specified window. Separate reference values are maintained for the various displays.

Suffix:

<n>	Window
<w>	subwindow
<t>	irrelevant

Parameters:

<Value> Default unit: DB

Example:

`DISP:TRAC:Y:RVAL 0`

Sets the value assigned to the reference position to 0 Hz

Manual operation: See "Reference Value" on page 74

11.4.9.7 Scaling for RF evaluation

These commands are required for RF evaluations and the result summary.

- `DISPlay[:WINDow<n>][:SUBWindow<w>]:TRACe<t>:Y[:SCALe]:RPOSition` on page 144
- `DISPlay[:WINDow<n>][:SUBWindow<w>]:TRACe<t>:Y:SPACing` on page 145
- `DISPlay[:WINDow<n>][:SUBWindow<w>]:TRACe<t>:Y[:SCALe]:MODE` on page 154

Remote commands to configure analog modulation analysis

DISPlay[:WINDow<n>][:SUBWindow<w>]:TRACe<t>:Y[:SCALe].....	154
DISPlay[:WINDow<n>][:SUBWindow<w>]:TRACe<t>:Y[:SCALe]:AUTO ONCE.....	154
DISPlay[:WINDow<n>][:SUBWindow<w>]:TRACe<t>:Y[:SCALe]:MODE.....	154

DISPlay[:WINDow<n>][:SUBWindow<w>]:TRACe<t>:Y[:SCALe] <Range>

Defines the display range of the y-axis (for all traces).

Suffix:

<n>	Window
<w>	subwindow Not supported by all applications
<t>	irrelevant

Parameters:

<Range>	If the y-axis shows the power, the unit is dB with a range from 10 dB to 200 dB. If the y-axis shows the frequency, the unit is Hz with a variable range. *RST: 100 dB (frequency domain), 500 kHz (time domain)
---------	--

Example: DISP:TRAC:Y 110dB

Manual operation: See "Range" on page 76

DISPlay[:WINDow<n>][:SUBWindow<w>]:TRACe<t>:Y[:SCALe]:AUTO ONCE

Automatic scaling of the y-axis is performed once, then switched off again (for all traces).

Suffix:

<n>	Window
<t>	irrelevant

Manual operation: See "Auto Scale Once" on page 76

DISPlay[:WINDow<n>][:SUBWindow<w>]:TRACe<t>:Y[:SCALe]:MODE <Mode>

Selects the type of scaling of the y-axis (for all traces).

When the display update during remote control is off, this command has no immediate effect.

Suffix:

<n>	Window
<w>	subwindow
<t>	irrelevant

Parameters:

<Mode>	ABSolute absolute scaling of the y-axis
--------	---

RELative

relative scaling of the y-axis

*RST: ABSolute

Example: DISP:TRAC:Y:MODE REL**Manual operation:** See "Scaling" on page 77**11.4.9.8 Units**

The units define how the demodulated data is displayed.

UNIT<n>:ANGLE.....	155
UNIT<n>:THD.....	155

UNIT<n>:ANGLE <Unit>

Selects the unit for angles (for PM display, <n> is irrelevant).

Is identical to CALC:UNIT:ANGL

Suffix:

<n> Window

Parameters:

<Unit> DEG | RAD

*RST: RAD

Example: UNIT:ANGL DEG**Manual operation:** See "Phase Unit (Rad/Deg)" on page 78**UNIT<n>:THD <Mode>**

Selects the unit for THD measurements (<n> is irrelevant).

Is identical to CALC:UNIT:THD

Suffix:

<n> Window

Parameters:

<Mode> DB | PCT

*RST: DB

Example: UNIT:THD PCT**Manual operation:** See "THD Unit (%/ DB)" on page 78**11.4.9.9 Relative demodulation results**

The following commands are required to obtain relative demodulation results.

Remote commands to configure analog modulation analysis

CONFigure:ADEMod:RESults:AM:DETEctor<det>:REFerence.....	156
CONFigure:ADEMod:RESults:FM:DETEctor<det>:REFerence.....	156
CONFigure:ADEMod:RESults:PM:DETEctor<det>:REFerence.....	156
CONFigure:ADEMod:RESults:AM:DETEctor<det>:STATe.....	156
CONFigure:ADEMod:RESults:FM:DETEctor<det>:STATe.....	156
CONFigure:ADEMod:RESults:PM:DETEctor<det>:STATe.....	156
CONFigure:ADEMod:RESults:AM:DETEctor<det>:REFerence:MEAStoref<t>.....	157
CONFigure:ADEMod:RESults:FM:DETEctor<det>:REFerence:MEAStoref<t>.....	157
CONFigure:ADEMod:RESults:PM:DETEctor<det>:REFerence:MEAStoref<t>.....	157
CONFigure:ADEMod:RESults:AM:DETEctor<det>:MODE.....	158
CONFigure:ADEMod:RESults:FM:DETEctor<det>:MODE.....	158
CONFigure:ADEMod:RESults:PM:DETEctor<det>:MODE.....	158
CONFigure:ADEMod:RESults:UNIT.....	158
CALCulate<n>:FORMat.....	158

CONFigure:ADEMod:RESults:AM:DETEctor<det>:REFerence <RefValue>

CONFigure:ADEMod:RESults:FM:DETEctor<det>:REFerence <RefValue>

CONFigure:ADEMod:RESults:PM:DETEctor<det>:REFerence <RefValue>

Defines the reference value to be used for relative demodulation results and recalculates the results. If necessary, the detector is activated.

A reference value 0 would provide infinite results and is thus automatically corrected to 0.1.

Suffix:

<det> Detector function used for relative demodulation

Parameters:

<RefValue> double value
 The unit depends on the demodulation type:
 ACV: V
 AM: %
 FM: Hz
 PM: depends on [UNIT<n>:ANGLE](#) setting
 *RST: 1.0
 Default unit: RAD

Example: See [CONFigure:ADEMod:RESults:PM:DETEctor<det>:STATe](#) on page 156

Manual operation: See "[Reference Value](#)" on page 80

CONFigure:ADEMod:RESults:AM:DETEctor<det>:STATe <State>

CONFigure:ADEMod:RESults:FM:DETEctor<det>:STATe <State>

CONFigure:ADEMod:RESults:PM:DETEctor<det>:STATe <State>

Activates relative demodulation for the selected detector. If activated, the demodulated result is set in relation to the reference value defined by [CONFigure:ADEMod:RESults:PM:DETEctor<det>:REFerence](#).

Remote commands to configure analog modulation analysis

Suffix:

<det> Detector function used for relative demodulation

Parameters:

<State> ON | OFF | 0 | 1
OFF | 0
 Switches the function off
ON | 1
 Switches the function on

Example:

```
CONF:ADEM:RES:PM:DET2:STAT ON
```

Activates relative demodulation for the negative peak detector.

```
CONF:ADEM:RES:UNIT PCT
```

Defines the unit for relative values as percent.

```
CONF:ADEM:RES:PM:DET2:REF 1.415%
```

Sets the reference value for the negative peak detector to 1.415 %.

```
CONF:ADEM:RES:PM:DET2:MODE AVER
```

Sets the negative peak detector to average mode.

```
CONF:ADEM:RES:PM:DET2:REF:MEAS2
```

Sets the reference value for the negative peak detector to the average of the currently calculated value and the previous reference value on trace 2.

Manual operation: See "State" on page 80

CONFigure:ADEMod:RESults:AM:DETEctor<det>:REFerence:MEASStoref<t>

CONFigure:ADEMod:RESults:FM:DETEctor<det>:REFerence:MEASStoref<t>

CONFigure:ADEMod:RESults:PM:DETEctor<det>:REFerence:MEASStoref<t>

Sets the reference value to be used for relative demodulation results to the currently measured value on the specified trace *for all relative detectors*.

If necessary, the detectors are activated.

A reference value 0 would provide infinite results and is thus automatically corrected to 0.1.

Suffix:

<det> irrelevant

<t> 1..n
[Trace](#)

Example:

See [CONFigure:ADEMod:RESults:PM:DETEctor<det>:STATE](#) on page 156

Manual operation: See "Meas -> Reference" on page 80

CONFigure:ADEMod:RESults:AM:DETEctor<det>:MODE <Mode>

CONFigure:ADEMod:RESults:FM:DETEctor<det>:MODE <Mode>

CONFigure:ADEMod:RESults:PM:DETEctor<det>:MODE <Mode>

Defines the mode with which the demodulation result is determined.

Suffix:

<det> Detector function used for relative demodulation

Parameters:

<Mode>

WRITe

Overwrite mode: the detector value is overwritten by each sweep. This is the default setting.

AVERage

The average result is determined over all sweeps.

MAXHold

The maximum value is determined over several sweeps and displayed. The R&S FSWP saves each result only if the new value is greater than the previous one.

*RST: WRITe

Example:

See [CONFigure:ADEMod:RESults:PM:DETEctor<det>:STATe](#) on page 156

Manual operation: See "[Mode](#)" on page 79

CONFigure:ADEMod:RESults:UNIT <Unit>

Selects the unit for relative demodulation results.

Parameters:

<Unit>

PCT | DB

*RST: PCT

Example:

CONF:ADEM:RES:AM:DET2:STAT ON

Activates relative demodulation for the negative peak detector.

CONF:ADEM:RES:AM:DET2:MODE AVER

Sets the negative peak detector to average mode.

CONF:ADEM:RES:UNIT PCT

Defines the unit for relative values as percent.

CONF:ADEM:RES:AM:DET2:REF 1.415%

Sets the reference value for relative results to 1.415 %.

Manual operation: See "[Relative Unit](#)" on page 78

CALCulate<n>:FORMat <Evaluation>

This command activates/deactivates the phase wrap for the specified PM time domain display with DC coupling.

Suffix:

<n> 1..n

Parameters:

<Evaluation>

PHAS

The phase is wrapped.

UPH

The phase is not wrapped.

*RST: UPH

Example:

LAY:ADD? '1',BEL,'XTIM:PM'

Activates PM time domain display. Result: window '2'

INP:COUP DC

Selects DC coupling.

CALC2:FORM PHAS

Selects a wrapped phase display in the PM time domain window.

Manual operation: See "Phase Wrap On/Off (PM Time Domain only)" on page 66

11.5 Configuring the result display

- [General window commands](#)..... 159
- [Working with windows in the display](#)..... 160

11.5.1 General window commands

Note that the suffix <n> always refers to the window in the **currently selected measurement channel**.

DISPlay:FORMat..... 159

DISPlay[:WINDow<n>]:SIZE..... 160

DISPlay:FORMat <Format>

Determines which tab is displayed.

Parameters:

<Format>

SPLit

Displays the MultiView tab with an overview of all active channels

SINGle

Displays the measurement channel that was previously focused.

*RST: SING

Example:

DISP:FORM SPL

DISPlay[:WINDow<n>]:SIZE <Size>

Maximizes the size of the selected result display window *temporarily*. To change the size of several windows on the screen permanently, use the `LAY:SPL` command (see [LAYout:SPLitter](#) on page 163).

Suffix:

<n> [Window](#)

Parameters:

<Size>

LARGE

Maximizes the selected window to full screen.
Other windows are still active in the background.

SMALI

Reduces the size of the selected window to its original size.
If more than one measurement window was displayed originally, these are visible again.

*RST: SMALI

Example:

DISP:WIND2:SIZE LARG

11.5.2 Working with windows in the display

The following commands are required to change the evaluation type and rearrange the screen layout for a measurement channel as you do using the SmartGrid in manual operation. Since the available evaluation types depend on the selected application, some parameters for the following commands also depend on the selected measurement channel.

Note that the suffix <n> always refers to the window in the **currently selected measurement channel**.

LAYout:ADD[:WINDow]?	160
LAYout:CATalog[:WINDow]?	162
LAYout:IDENtify[:WINDow]?	162
LAYout:REMOve[:WINDow]	162
LAYout:REPLace[:WINDow]	163
LAYout:SPLitter	163
LAYout:WINDow<n>:ADD?	165
LAYout:WINDow<n>:IDENtify?	165
LAYout:WINDow<n>:REMOve	166
LAYout:WINDow<n>:REPLace	166

LAYout:ADD[:WINDow]? <WindowName>, <Direction>, <WindowType>

Adds a window to the display in the active channel.

Is always used as a query so that you immediately obtain the name of the new window as a result.

To replace an existing window, use the [LAYout:REPLace\[:WINDow\]](#) command.

Query parameters:

<WindowName>	String containing the name of the existing window the new window is inserted next to. By default, the name of a window is the same as its index. To determine the name and index of all active windows, use the LAYout:CATalog[:WINDow]? query .
<Direction>	LEFT RIGHT ABOVE BELOW Direction the new window is added relative to the existing window.
<WindowType>	text value Type of result display (evaluation method) you want to add. See the table below for available parameter values.

Return values:

<NewWindowName>	When adding a new window, the command returns its name (by default the same as its number) as a result.
-----------------	---

Example:

LAY:ADD? '1',BEL,'XTIM:AM:RElative[:TDOMain] '
Adds an "AM Time Domain" display below window 1.

Usage:

Query only

Manual operation:

See ["AM Time Domain"](#) on page 18
 See ["FM Time Domain"](#) on page 19
 See ["PM Time Domain"](#) on page 20
 See ["AM Spectrum"](#) on page 21
 See ["FM Spectrum"](#) on page 22
 See ["PM Spectrum"](#) on page 23
 See ["RF Time Domain"](#) on page 24
 See ["RF Spectrum"](#) on page 25
 See ["Result Summary"](#) on page 26
 See ["Marker Table"](#) on page 28
 See ["Marker Peak List"](#) on page 28

Table 11-3: <WindowType> parameter values for AnalogDemod application

Parameter value	Window type
MTABle	"Marker table"
PEAKlist	"Marker peak list"
RSUMmary	"Result summary"
'XTIM:AM'	"RF Time Domain" (= RF power)
'XTIM:AM:RElative'	"AM Time Domain"
'XTIM:AM:RElative:AFSPec-trum'	"AM Spectrum"
'XTIM:FM'	"FM Time Domain"
'XTIM:FM:AFSPpectrum'	"FM Spectrum"

Parameter value	Window type
'XTIM:PM'	"PM Time Domain"
'XTIM:PM:AFSPpectrum'	"PM Spectrum"
'XTIM:SPECTrum'	"RF Spectrum"

LAYout:CATalog[:WINDow]?

Queries the name and index of all active windows in the active channel from top left to bottom right. The result is a comma-separated list of values for each window, with the syntax:

<WindowName_1>,<WindowIndex_1>..<WindowName_n>,<WindowIndex_n>

Return values:

<WindowName> string
Name of the window.
In the default state, the name of the window is its index.

<WindowIndex> **numeric value**
Index of the window.

Example:

LAY:CAT?

Result:

'2',2,'1',1

Two windows are displayed, named '2' (at the top or left), and '1' (at the bottom or right).

Usage: Query only

LAYout:IDENTify[:WINDow]? <WindowName>

Queries the **index** of a particular display window in the active channel.

Query parameters:

<WindowName> String containing the name of a window.

Return values:

<WindowIndex> Index number of the window.

Example:

LAY:IDEN:WIND? '2'

Queries the index of the result display named '2'.

Response:

2

Usage: Query only

LAYout:REMOve[:WINDow] <WindowName>

Removes a window from the display in the active channel.

Setting parameters:

<WindowName> String containing the name of the window. In the default state, the name of the window is its index.

Example:

```
LAY:REM '2'
```

Removes the result display in the window named '2'.

Usage:

Setting only

LAYout:REPLace[:WINDow] <WindowName>, <WindowType>

Replaces the window type (for example from "Diagram" to "Result Summary") of an already existing window in the active channel while keeping its position, index and window name.

To add a new window, use the [LAYout:ADD\[:WINDow\]?](#) command.

Setting parameters:

<WindowName> String containing the name of the existing window.
By default, the name of a window is the same as its index. To determine the name and index of all active windows in the active channel, use the [LAYout:CATalog\[:WINDow\]?](#) query.

<WindowType> Type of result display you want to use in the existing window.
See [LAYout:ADD\[:WINDow\]?](#) on page 160 for a list of available window types.

Example:

```
LAY:REPL:WIND '1',MTAB
```

Replaces the result display in window 1 with a marker table.

Usage:

Setting only

LAYout:SPLitter <Index1>, <Index2>, <Position>

Changes the position of a splitter and thus controls the size of the windows on each side of the splitter.

Compared to the [DISPlay\[:WINDow<n>\]:SIZE](#) on page 160 command, the [LAYout:SPLitter](#) changes the size of all windows to either side of the splitter permanently, it does not just maximize a single window temporarily.

Note that windows must have a certain minimum size. If the position you define conflicts with the minimum size of any of the affected windows, the command does not work, but does not return an error.

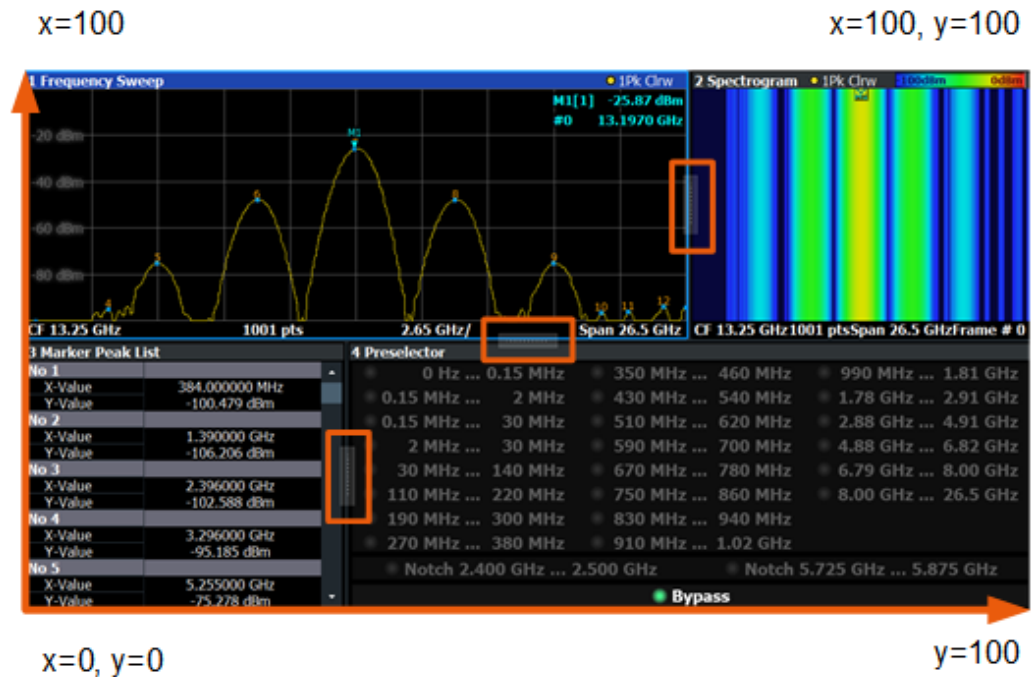

Figure 11-1: SmartGrid coordinates for remote control of the splitters

Setting parameters:

- <Index1> The index of one window the splitter controls.
- <Index2> The index of a window on the other side of the splitter.
- <Position> New vertical or horizontal position of the splitter as a fraction of the screen area (without channel and status bar and softkey menu).
The point of origin (x = 0, y = 0) is in the lower left corner of the screen. The end point (x = 100, y = 100) is in the upper right corner of the screen. (See Figure 11-1.)
The direction in which the splitter is moved depends on the screen layout. If the windows are positioned horizontally, the splitter also moves horizontally. If the windows are positioned vertically, the splitter also moves vertically.

Range: 0 to 100

Example:

LAY:SPL 1,3,50

Moves the splitter between window 1 ("Frequency Sweep") and 3 ("Marker Table") to the center (50%) of the screen, i.e. in the figure above, to the left.

Example: `LAY:SPL 1,4,70`
 Moves the splitter between window 1 ('Frequency Sweep') and 3 ('Marker Peak List') towards the top (70%) of the screen. The following commands have the exact same effect, as any combination of windows above and below the splitter moves the splitter vertically.
`LAY:SPL 3,2,70`
`LAY:SPL 4,1,70`
`LAY:SPL 2,1,70`

Usage: Setting only

LAYout:WINDow<n>:ADD? <Direction>,<WindowType>

Adds a measurement window to the display. Note that with this command, the suffix <n> determines the existing window next to which the new window is added. Unlike [LAYout:ADD\[:WINDow\]?](#), for which the existing window is defined by a parameter.

To replace an existing window, use the [LAYout:WINDow<n>:REPLace](#) command.

Is always used as a query so that you immediately obtain the name of the new window as a result.

Suffix:

<n> [Window](#)

Query parameters:

<Direction> LEFT | RIGHT | ABOVE | BELOW

<WindowType> Type of measurement window you want to add.
 See [LAYout:ADD\[:WINDow\]?](#) on page 160 for a list of available window types.

Return values:

<NewWindowName> When adding a new window, the command returns its name (by default the same as its number) as a result.

Example: `LAY:WIND1:ADD? LEFT,MTAB`
Result:
 '2'
 Adds a new window named '2' with a marker table to the left of window 1.

Usage: Query only

LAYout:WINDow<n>:IDENTify?

Queries the **name** of a particular display window (indicated by the <n> suffix) in the active channel.

Note: to query the **index** of a particular window, use the [LAYout:IDENTify\[:WINDow\]?](#) command.

Suffix:	
<n>	Window
Return values:	
<WindowName>	String containing the name of a window. In the default state, the name of the window is its index.
Example:	LAY:WIND2:IDEN? Queries the name of the result display in window 2. Response: '2'
Usage:	Query only

LAYout:WINDow<n>:REMove

Removes the window specified by the suffix <n> from the display in the active channel.
The result of this command is identical to the [LAYout:REMove\[:WINDow\]](#) command.

Suffix:	
<n>	Window
Example:	LAY:WIND2:REM Removes the result display in window 2.
Usage:	Event

LAYout:WINDow<n>:REPLace <WindowType>

Changes the window type of an existing window (specified by the suffix <n>) in the active channel.

The effect of this command is identical to the [LAYout:REPLace\[:WINDow\]](#) command.

To add a new window, use the [LAYout:WINDow<n>:ADD?](#) command.

Suffix:	
<n>	Window
Setting parameters:	
<WindowType>	Type of measurement window you want to replace another one with. See LAYout:ADD[:WINDow]? on page 160 for a list of available window types.
Example:	LAY:WIND2:REPL MTAB Replaces the result display in window 2 with a marker table.
Usage:	Setting only

11.6 Working with measurement results

- [Retrieving trace results](#)..... 167
- [Exporting trace results](#)..... 170

11.6.1 Retrieving trace results

The following remote commands are required to retrieve the trace results in a remote environment.

[SENSe:]ADEMod:ACV:AFSPpectrum:RESult?	167
[SENSe:]ADEMod:ACV[:TDOMain]:RESult?	167
[SENSe:]ADEMod:AM[:ABSolute]:AFSPpectrum:RESult?	167
[SENSe:]ADEMod:AM[:ABSolute][:TDOMain]:RESult?	167
[SENSe:]ADEMod:AM:RELative:AFSPpectrum:RESult?	167
[SENSe:]ADEMod:AM:RELative[:TDOMain]:RESult?	167
[SENSe:]ADEMod:FM:AFSPpectrum:RESult?	167
[SENSe:]ADEMod:FM[:TDOMain]:RESult?	167
[SENSe:]ADEMod:PM:AFSPpectrum:RESult?	167
[SENSe:]ADEMod:PM[:TDOMain]:RESult?	167
[SENSe:]ADEMod:SPECtrum:RESult?	167
FORMat[:DATA]	168
FORMat:DEXPort:FORMat	169
TRACe<n>[:DATA]	169

```

[SENSe:]ADEMod:ACV:AFSPpectrum:RESult? <TraceMode>
[SENSe:]ADEMod:ACV[:TDOMain]:RESult? <TraceMode>
[SENSe:]ADEMod:AM[:ABSolute]:AFSPpectrum:RESult? <TraceMode>
[SENSe:]ADEMod:AM[:ABSolute][:TDOMain]:RESult? <TraceMode>
[SENSe:]ADEMod:AM:RELative:AFSPpectrum:RESult? <TraceMode>
[SENSe:]ADEMod:AM:RELative[:TDOMain]:RESult? <TraceMode>
[SENSe:]ADEMod:FM:AFSPpectrum:RESult? <TraceMode>
[SENSe:]ADEMod:FM[:TDOMain]:RESult? <TraceMode>
[SENSe:]ADEMod:PM:AFSPpectrum:RESult? <TraceMode>
[SENSe:]ADEMod:PM[:TDOMain]:RESult? <TraceMode>
[SENSe:]ADEMod:SPECtrum:RESult? <TraceMode>

```

Reads the result data of the evaluated signal in the specified trace mode. The data format of the output data block is defined by the FORMat command (see [FORMat \[: DATA\]](#) on page 168).

The trace results are configured for a specific evaluation. The following table indicates which command syntax refers to which evaluation method, as well as the output unit of the results.

Command syntax	Evaluation method	Output unit
ACV[:TDOMain]	AC-Video time domain	V
ACV:AFSPpectrum	AC-Video spectrum	V

Command syntax	Evaluation method	Output unit
AM[:ABSolute][:TDOMain]	RF time domain	dBm
AM:RELative[:TDOMain]	AM time domain	%
AM:RELative:AFSPepectrum	AM spectrum	%
FM[:TDOMain]	FM time domain	kHz
FM:AFSPepectrum	FM spectrum	kHz
PM[:TDOMain]	PM time domain	rad or °
PM:AFSPepectrum	PM spectrum	rad or °
SPEctrum	RF spectrum	dBm (logarithmic display) or V (linear display).

Query parameters:

<TraceMode> WRITe | AVERage | MAXHold | MINHold

Return values:

<TraceModeResult> The specified trace mode must be one of those configured by SENS:ADEM:<Evaluation>:TYPE, see [SENSe:]ADEMod:SPEctrum[:TYPE] on page 178. Otherwise a query error is generated.

Example:

```

ADEM:AM AVER,MAXH,MINH
Sets up RF time domain results to be measured
INIT; *WAI
Starts measurement and waits for sync
FORM ASC
Selects output format
ADEM:AM:RES? AVER
Reads RF time domain average results
ADEM:AM:RES? MAXH
Reads RF time domain max hold results
ADEM:AM:RES? MINH
Reads RF time domain min hold results

```

Usage: Query only

FORMat[:DATA] <Format>[, <BitLength>]

Selects the data format that is used for transmission of trace data from the R&S FSWP to the controlling computer.

Note that the command has no effect for data that you send to the R&S FSWP. The R&S FSWP automatically recognizes the data it receives, regardless of the format.

Parameters:

<Format>

AScii

AScii format, separated by commas.

This format is almost always suitable, regardless of the actual data format. However, the data is not as compact as other formats can be.

REAL

Floating-point numbers (according to IEEE 754) in the "definite length block format".

The format setting `REAL` is used for the binary transmission of trace data.

<BitLength>

Length in bits for floating-point results

16

16-bit floating-point numbers.

Compared to `REAL, 32` format, half as many numbers are returned.

32

32-bit floating-point numbers

For I/Q data, 8 bytes per sample are returned for this format setting.

64

64-bit floating-point numbers

Compared to `REAL, 32` format, twice as many numbers are returned.

Example:

```
FORM REAL, 32
```

FORMat:DEXPort:FORMat <FileFormat>

Determines the format of the ASCII file to be imported or exported. Depending on the external program that creates the data file or evaluates it, a comma-separated list (CSV) or a plain data format (DAT) file is required.

Parameters:

<FileFormat>

CSV | DAT

*RST: DAT

Example:

```
FORM:DEXP:FORM CSV
```

TRACe<n>[:DATA]

This command queries current trace data and measurement results.

The data format depends on [FORMat \[:DATA\]](#) on page 168.

Suffix:

<n>

[Window](#)

Query parameters:

<ResultType>	Selects the type of result to be returned.
	TRACE1 ... TRACE6
	Returns the trace data for the corresponding trace.
	The trace data consists of a list of measured power levels. The number of power levels in the list depends on the currently selected number of sweep points. The unit depends on the measurement and on the configured unit.
	For the auto peak detector, the command returns positive peak values only. (To retrieve negative peak values, define a second trace with a negative peak detector.)

Example:

```
TRAC? TRACE3
Queries the data of trace 3.
```

11.6.2 Exporting trace results

Trace results can be exported to a file.

For more commands concerning data and results storage see the R&S FSWP User Manual.

MMEMory:STORe<n>:TRACe	170
FORMat:DEXPort:DSEParator	171
FORMat:DEXPort:HEADer	171
FORMat:DEXPort:TRACes	171

MMEMory:STORe<n>:TRACe <Trace>, <FileName>

Exports trace data from the specified window to an ASCII file.

Secure User Mode

In secure user mode, settings that are stored on the instrument are stored to volatile memory, which is restricted to 256 MB. Thus, a "memory limit reached" error can occur although the hard disk indicates that storage space is still available.

To store data permanently, select an external storage location such as a USB memory device.

For details, see "Protecting Data Using the Secure User Mode" in the "Data Management" section of the R&S FSWP base unit user manual.

Suffix:

<n> [Window](#)

Parameters:

<Trace>	Number of the trace to be stored (This parameter is ignored if the option "Export all Traces and all Table Results" is activated in the Export configuration settings, see FORMat:DEXPort:TRACes on page 171).
<FileName>	String containing the path and name of the target file.

Example: `MMEM:STOR1:TRAC 1, 'C:\TEST.ASC'`
Stores trace 1 from window 1 in the file TEST.ASC.

FORMat:DEXPort:DSEParator <Separator>

Selects the decimal separator for data exported in ASCII format.

Parameters:

<Separator>

POINT | COMMa

COMMa

Uses a comma as decimal separator, e.g. 4,05.

POINT

Uses a point as decimal separator, e.g. 4.05.

*RST: *RST has no effect on the decimal separator.
Default is POINT.

Example: `FORM:DEXP:DSEP POIN`
Sets the decimal point as separator.

FORMat:DEXPort:HEADer <State>

If enabled, additional instrument and measurement settings are included in the header of the export file for result data. If disabled, only the pure result data from the selected traces and tables is exported.

See [Section A.3, "Reference: ASCII file export format"](#), on page 187 for details.

Parameters:

<State>

ON | OFF | 0 | 1

*RST: 1

FORMat:DEXPort:TRACes <Selection>

Selects the data to be included in a data export file (see [MMEMory:STORe<n>:TRACe](#) on page 170).

Parameters:

<Selection>

SINGle | ALL

SINGle

Only a single trace is selected for export, namely the one specified by the [MMEMory:STORe<n>:TRACe](#) command.

ALL

Selects all active traces and result tables (e.g. "Result Summary", marker peak list etc.) in the current application for export to an ASCII file.

The <trace> parameter for the [MMEMory:STORe<n>:TRACe](#) command is ignored.

*RST: SINGle

11.7 Retrieving result summary values

The result summary contains measurement values that are calculated from the trace data.

For details see "Result Summary" on page 26.

CALCulate<n>:MARKer<m>:FUNction:ADEMod:AFRequency[:RESult<t>]?	172
CALCulate<n>:MARKer<m>:FUNction:ADEMod:AM[:RESult<t>]?	172
CALCulate<n>:MARKer<m>:FUNction:ADEMod:FM[:RESult<t>]?	172
CALCulate<n>:MARKer<m>:FUNction:ADEMod:PM[:RESult<t>]?	172
CALCulate<n>:MARKer<m>:FUNction:ADEMod:AM[:RESult<t>]:RELative?	173
CALCulate<n>:MARKer<m>:FUNction:ADEMod:FM[:RESult<t>]:RELative?	173
CALCulate<n>:MARKer<m>:FUNction:ADEMod:PM[:RESult<t>]:RELative?	173
CALCulate<n>:MARKer<m>:FUNction:ADEMod:CARRier[:RESult<t>]?	174
CALCulate<n>:MARKer<m>:FUNction:ADEMod:DISTortion[:WRITe]:RESult<t>?	174
CALCulate<n>:MARKer<m>:FUNction:ADEMod:FERRor[:RESult<t>]?	175
CALCulate<n>:MARKer<m>:FUNction:ADEMod:SINad:RESult<t>?	175
CALCulate<n>:MARKer<m>:FUNction:ADEMod:THD:RESult<t>?	175
[SENSe:]ADEMod:SETTling:TIME:RESult<t>?	176

CALCulate<n>:MARKer<m>:FUNction:ADEMod:AFRequency[:RESult<t>]?

Queries the modulation (audio) frequency for the demodulation method in the specified window.

Suffix:

<n>	Window
<m>	irrelevant
<t>	Trace

Return values:

<ModFreq>	Modulation frequency in Hz.
-----------	-----------------------------

Usage: Query only

CALCulate<n>:MARKer<m>:FUNction:ADEMod:AM[:RESult<t>]?

CALCulate<n>:MARKer<m>:FUNction:ADEMod:FM[:RESult<t>]?

CALCulate<n>:MARKer<m>:FUNction:ADEMod:PM[:RESult<t>]?

Queries the current value of the demodulated signal for the specified trace (as displayed in the "Result Summary" in manual operation).

Note that all windows with the same evaluation method have the same traces, thus the window is irrelevant.

Suffix:

<n>	Window
<m>	irrelevant

<t> [Trace](#)

Query parameters:

<MeasType> PPEak | MPEak | MIDDLE | RMS

PPEak

Positive peak (+PK)

MPEak | NPEak

Negative peak (-PK)

MIDDLE

Average of positive and negative peaks $\pm PK/2$

RMS

Root mean square value

Return values:

<MeasTypeResult>

Example:

```
CALC:FEED 'XTIM:PM:TDOM'
```

Switches on the PM time domain result display.

```
DISP:TRAC ON
```

Switches on the trace.

```
CALC:MARK:FUNC:ADEM:PM? PPE
```

Queries the peak value of the demodulated PM trace.

Usage:

Query only

CALCulate<n>:MARKer<m>:FUNCTION:ADEMod:AM[:RESult<t>]:RELative?
<MeasType>

CALCulate<n>:MARKer<m>:FUNCTION:ADEMod:FM[:RESult<t>]:RELative?
<MeasType>

CALCulate<n>:MARKer<m>:FUNCTION:ADEMod:PM[:RESult<t>]:RELative?
<MeasType>

Queries the current *relative* value of the demodulated signal for the specified trace (as displayed in the "Result Summary" in manual operation).

Note that all windows with the same evaluation method have the same traces.

The unit of the results depends on the [CONFIGure:ADEMod:RESults:UNIT](#) setting.

Suffix:

<n> irrelevant

<m> irrelevant

<t> [Trace](#)

Query parameters:

<MeasType>

PPEak

Positive peak (+PK)

MPEak | NPEak

Negative peak (-PK)

MIDDLE

Average of positive and negative peaks $\pm PK/2$

RMS

Root mean square value

Return values:

<MeasTypeResult>

Example:

CALC:FEED 'XTIM:PM:TDOM'

Switches on the PM time domain result display.

DISP:TRAC ON

Switches on the trace.

CALC:MARK:FUNC:ADEM:PM? PPE

Queries the peak value of the demodulated PM trace.

Usage:

Query only

CALCulate<n>:MARKer<m>:FUNCTION:ADEMod:CARRier[:RESult<t>]?

Queries the carrier power, which is determined from the Clr/Write data.

Suffix:<n> [Window](#)

<m> irrelevant

<t> [Trace](#)**Return values:**

<CPower> Power of the carrier without modulation in dBm.

Usage:

Query only

CALCulate<n>:MARKer<m>:FUNCTION:ADEMod:DISTortion[:WRITe]:RESult<t>?

Queries the result of the modulation distortion measurement in the specified window for the specified trace.

Note that this value is only calculated if an AF Spectrum window is displayed.

Suffix:<n> [Window](#)

<m> irrelevant

<t> [Trace](#)**Return values:**

<DISTORT> numeric value
 Modulation distortion in percent.
 Default unit: %

Usage:

Query only

CALCulate<n>:MARKer<m>:FUNction:ADEMod:FERRor[:RESult<t>]?

Queries the carrier offset (= frequency error) for FM and PM demodulation. The carrier offset is determined from the current measurement data (CLR/WRITE). The modulation is removed using low pass filtering.

Suffix:

<n>	Window
<m>	irrelevant
<t>	Trace

Return values:

<CarrOffset> The deviation of the calculated carrier frequency to the ideal carrier frequency in Hz.

Usage: Query only

CALCulate<n>:MARKer<m>:FUNction:ADEMod:SINad:RESult<t>?

Queries the result of the signal-to-noise-and-distortion (SINAD) measurement in the specified window for the specified trace.

Note that this value is only calculated if an AF Spectrum window is displayed.

Suffix:

<n>	Window
<m>	irrelevant
<t>	Trace

Return values:

<SINAD> The signal-to-noise-and-distortion ratio in dB.

Usage: Query only

CALCulate<n>:MARKer<m>:FUNction:ADEMod:THD:RESult<t>?

Queries the result of the total harmonic distortion (THD) measurement in the specified window.

Note that this value is only calculated if an AF Spectrum window is displayed.

Suffix:

<n>	Window
<m>	irrelevant
<t>	Trace

Return values:

<THD> Total harmonic distortion of the demodulated signal in dB.

Usage: Query only

[SENSe:]ADEMod:SETTling:TIME:RESult<t>?

Returns the settling time after which the signal remains within a specified target corridor. The settling time is evaluated for the selected trace in each time domain window. The value is only determined for [SENSe:]ADEMod:SETTling:TIME:STATeON.

For details, see [Section 5.8.7, "Settling time"](#), on page 81.

Suffix:

<t> 1..n
Trace

Return values:

<Time> Default unit: s

Example:

```
ADEMod:SETT:TIME:RES2?
//Result: 29.950000us
After 29.95 us, the signal is settled.
```

Usage:

Query only

Manual operation: See ["State"](#) on page 82

11.8 Analyzing results

Except for the commands listed below, the functionality to analyze measurement results is the same as that of the spectrum application.

For a comprehensive list and description of remote commands, refer to the corresponding topics in the R&S FSWP user manual.

CALCulate<n>:MARKer<m>:X	176
CALCulate<n>:MARKer<m>:Y?	177
CALCulate<n>:MARKer<m>:LINK	177
[SENSe:]ADEMod:SPECTrum[:TYPE]	178
[SENSe:]ADEMod:PM:RPOint[:X]:MODE	179
CALCulate<n>:SGRam:LAYout	179
CALCulate<n>:SPECTrogram:LAYout	179
CALCulate<n>:SPECTrogram:TRACe	180
CALCulate<n>:SGRam:TRACe	180

CALCulate<n>:MARKer<m>:X <Position>

Moves a marker to a specific coordinate on the x-axis.

If necessary, the command activates the marker.

If the marker has been used as a delta marker, the command turns it into a normal marker.

Suffix:

<n> Window
<m> Marker

Parameters:

<Position> Numeric value that defines the marker position on the x-axis.
The unit depends on the result display.

Range: The range depends on the current x-axis range.
Default unit: Hz

Example:

CALC:MARK2:X 1.7MHz

Positions marker 2 to frequency 1.7 MHz.

Manual operation:

See "[Marker Table](#)" on page 28

See "[Marker Peak List](#)" on page 28

CALCulate<n>:MARKer<m>:Y?

Queries the result at the position of the specified marker.

Suffix:

<n> 1..n

<m> 1..n

Return values:

<Result> Default unit: DBM

Usage:

Query only

Manual operation:

See "[Marker Table](#)" on page 28

See "[Marker Peak List](#)" on page 28

CALCulate<n>:MARKer<m>:LINK <DisplayType>

Links the specified marker in all displays of the specified type.

Suffix:

<n> irrelevant

<m> [Marker](#)

Parameters:

<DisplayType> TIME | SPECTrum | BOTH | NONE

TIME

Links the markers in all time domain diagrams

SPECTrum

Links the markers in all AF Spectrum displays

BOTH

Links the markers both in the time domain diagrams and in the AF Spectrum displays

NONE

Markers are not linked.

*RST: NONE

Manual operation:

See "[Link AF Spectrum Marker](#)" on page 87

See "[Link Time Marker](#)" on page 87

[SENSe:]ADEMod:SPECTrum[:TYPE] <TraceMode>...

Selects the trace modes of the evaluated signal to be measured simultaneously. For each of the six available traces a mode can be defined.

The trace modes are configured identically for all windows with a specific evaluation. The following table indicates which command syntax refers to which evaluation method.

Command syntax	Evaluation method
AM[:ABSolute][:TDOMain]	RF time domain
AM:RELative[:TDOMain]	AM time domain
AM:RELative:AFSPepectrum	AM spectrum (relative)
FM[:TDOMain]	FM time domain
FM:AFSPepectrum	FM spectrum
PM[:TDOMain]	PM time domain
PM:AFSPepectrum	PM spectrum
SPECTrum	RF spectrum

Parameters:

<TraceMode>

WRITE | AVERage | MAXHold | MINHold | VIEW | OFF

WRITE

Overwrite mode: the trace is overwritten by each sweep. This is the default setting.

AVERage

The average is formed over several sweeps.

MAXHold

The maximum value is determined over several sweeps and displayed. The R&S FSWP saves the sweep result in the trace memory only if the new value is greater than the previous one.

MINHold

The minimum value is determined from several measurements and displayed. The R&S FSWP saves the sweep result in the trace memory only if the new value is lower than the previous one.

VIEW

The current contents of the trace memory are frozen and displayed.

OFF

Hides the selected trace.

*RST: WRITE,OFF,OFF,OFF,OFF,OFF

Example: ADEM:AM AVER,MAXH,MINH,OFF,OFF,OFF
 Determines average, max hold and min hold values simultaneously for the traces 1-3 of the RF time domain evaluation.
 ADEM:AM WRIT,OFF,OFF,OFF,OFF,OFF
 Determines only the current measurement values for trace 1.
 ADEM:AM OFF,OFF,OFF,OFF,OFF,OFF
 Switches AM demodulation off.

[SENSe:]ADEMod:PM:RPOint[:X]:MODE <Mode>

Defines how the reference position in time for 0 rad is determined.

Parameters:

<Mode> MANual | RIGHT

MANual

The time is defined using [SENSe:]ADEMod:PM:RPOint[:X] on page 140.

RIGHT

The time of the last measured value is used as the reference position. The time of the last measured value corresponds to the acquisition time, regarding the trigger event and trigger offset, if applicable. If the acquisition time or the trigger values are changed, the reference position is automatically adapted.

*RST: MANual

Example: ADEM:MTIM 500us
 ADEM:PM:RPO:MODE RIGHT
 Sets the position of the 0 rad phase setting to 500 µs.

Manual operation: See "Zero Phase Reference Position (PM Time Domain only)" on page 66

CALCulate<n>:SGRam:LAYout <State>

CALCulate<n>:SPECtrogram:LAYout <State>

This command selects the state and size of spectrograms.

The command is available for result displays that support spectrograms.

Suffix:

<n> Window

Parameters:

<State>

FULL

Only the spectrogram is displayed, the trace diagram is not.

SPLIT

Spectrogram and trace diagram share a window.

OFF

Only the trace diagram is displayed, the spectrogram is not.

*RST: OFF

Example: `CALC4:SPEC:LAY FULL`
Shows the spectrogram in window 4. The corresponding trace diagram is hidden.

Manual operation: See "State" on page 86

CALCulate<n>:SPECtrogram:TRACe <Trace>

CALCulate<n>:SGRam:TRACe <Trace>

Suffix:

<n> [Window](#)

Parameters:

<Trace> TRACe1 | TRACe2 | TRACe3 | TRACe4 | TRACe5 | TRACe6

Manual operation: See "Trace" on page 87

11.9 Importing and exporting data

[MMEMory:LOAD:IQ:STATe](#)..... 180

[MMEMory:STORe<n>:IQ:COMMeNt](#)..... 180

[MMEMory:STORe<n>:IQ:STATe](#)..... 181

MMEMory:LOAD:IQ:STATe 1, <FileName>

Restores I/Q data from a file.

Setting parameters:

<FileName> string

String containing the path and name of the source file.
The file type is determined by the file extension. If no file extension is provided, the file type is assumed to be `.iq.tar`.
For `.mat` files, Matlab® v4 is assumed.

Example: Loads IQ data from the specified file.

Usage: Setting only

MMEMory:STORe<n>:IQ:COMMeNt <Comment>

Adds a comment to a file that contains I/Q data.

Suffix:

<n> irrelevant

Parameters:

<Comment> String containing the comment.

Example: MMEM:STOR:IQ:COMM 'Device test 1b'
Creates a description for the export file.
MMEM:STOR:IQ:STAT 1, 'C:
\R_S\Instr\user\data.iq.tar'
Stores I/Q data and the comment to the specified file.

MMEMory:STORe<n>:IQ:STATe <1>, <FileName>

Writes the captured I/Q data to a file.

By default, the contents of the file are in 32-bit floating point format.

Suffix:

<n> 1..n

Parameters:

<1>

<FileName>

String containing the path and name of the target file.
The file type is determined by the file extension. If no file extension is provided, the file type is assumed to be .iq.tar.
For .mat files, Matlab® v4 is assumed.

Example:

MMEM:STOR:IQ:STAT 1, 'C:
\R_S\Instr\user\data.iq.tar'
Stores the captured I/Q data to the specified file.

Usage:

Asynchronous command

11.10 Programming example

In this example we will configure and perform an Analog Modulation Analysis measurement to demonstrate the remote control commands.

Signal generator settings (e.g. R&S SMW):

Frequency:	500 MHz
Level:	-10 dBm
Modulation:	FM
Modulation frequency:	10 kHz
Frequency deviation:	50 kHz

```
//-----Preparing the measurement -----
//Reset the instrument
*RST

//Set the center frequency to 500 MHz
FREQ:CENT 500 MHz
//Set the reference level to 0 dBm
```

```

DISP:TRAC:Y:SCAL:RLEV 0

//----- Activating an Analog Modulation Analysis measurement channel -----
//Activate an Analog Modulation Analysis measurement channel named "FMDemodulation"
INST:CRE:NEW ADEM, 'FMDemodulation'

//----- Configuring data acquisition -----
//Set the measurement time to 1 ms (=10 periods)
ADEM:MTIM 1ms
//Optimize the scaling of the y-axis for the current measurement (continuously)
SENS:ADJ:SCAL:Y:AUTO ON
//Set the demodulation bandwidth to 400 kHz
BAND:DEM 400 kHz
//Trigger when magnitude of I/Q data reaches -50dBm
TRIG:SOUR IQP
TRIG:LEV:IQP -50

//----- Configuring the result display -----

//Add an FM Spectrum result display below FM Time Domain
LAY:ADD:WIND? '1',BEL, 'XTIM:FM:AFSP'
//Define two traces in the FM Spectrum: 1: Clear/write, 2: average
ADEM:FM:AFSP WRIT,AVER,OFF,OFF,OFF,OFF
//Set analog demodulator to execute 30 sweeps with 32000 samples each
//at a sample rate of 8 MHz; use IQ trigger, trigger on positive slope
//with a pretrigger offset of 500 samples
ADEM:SET 8MHz,32000,IQP,POS,-500,30

//-----Performing the Measurement-----

//Stop continuous sweep
INIT:CONT OFF

//Start a new measurement with 30 sweeps and wait for the end
INIT;*WAI

//-----Retrieving Results-----
//Query the carrier power
CALC:MARK:FUNC:ADEM:CARR?
//Result: -10.37 [dBm]

//Query the signal-to-noise-and-distortion ratio from the FM Spectrum
CALC2:MARK:FUNC:ADEM:SIN:RES?
//Result: 65.026 [dB]

```

```
//Query the total harmonic distortion of the demodulated signal
//from the FM Spectrum
CALC2:MARK:FUNC:ADEM:THD:RES?
//Result: -66.413 [dB]

//Query the FM carrier offset (=frequency error) for the most recent
//measurement (trace 1)
CALC:MARK:FUNC:ADEM:FERR?
//Result: 649.07 [Hz]

//Query FM carrier offset averaged over 30 measurements
ADEM:FM:OFFS? AVER
//Result: 600 [Hz]

//Retrieve the trace data of the most recent measurement (trace 1)
TRAC:DATA? TRACE1
//Result: -1.201362252,-1.173495054,-1.187217355,-1.186594367,-1.171583891,
//-1.188250422,-1.204138160,-1.181404829,-1.186317205,-1.197872400, [...]

//Retrieve the averaged trace data for all 30 measurements (trace 2)
TRAC:DATA? TRACE2//Result: -1.201362252,-1.173495054,-1.187217355,-1.186594367,-1.171583891,
//-1.188250422,-1.204138160,-1.181404829,-1.186317205,-1.197872400, [...]
```

Annex

A Reference

A.1 Predefined standards and settings

You can configure the Analog Modulation Analysis application using predefined standard settings. This allows for quick and easy configuration for commonly performed measurements.

For details see [Section 5, "Configuration"](#), on page 38.

Provided standard files

The instrument comes prepared with the following standard settings:

- AM Broadcast
- FM Narrowband
- FM Broadcast
- Frequency Settling
- None (default settings)

The default storage location for the settings files is:

C:\R_S\INSTR\USER\predefined\AdemodPredefined.

Predefined settings

The following parameters can be stored in a standard settings file. Any parameters that are not included in the xml file are set to their default values when the standard is loaded.

Measurement settings:

- DBW
- AQT
- Demod Filter
- Sweep Points
- Squelch (State, Level)
- Units (Phase, THD)
- RF Span
- Settling Time (Time domain only)

Window display settings:

- Position
- State
- Window number

Predefined standards and settings

- Window type (all evaluation methods supported by the Analog Modulation Analysis application; see [Section 3, "Measurements and result displays"](#), on page 18)
- Scaling (Ref Position, Dev per Division)
- Time Domain Zoom (State, Start, Length)

AF specific settings:

- AF Center
- AF Span
- AF Filters (Lowpass, Highpass, Deemphasis, Weighting)
- Scaling for Spectrum (Ref Value, Deviation)
- Scaling for Time Domain (Ref Value, AF Coupling (FM/PM only))

Table A-1: List of predefined standards and settings

Setting	AM Broadcast	FM Narrowband	FM Broadcast	Frequency Settling *)	None (Default)
Demod. bandwidth	100 kHz	100 kHz	400 kHz	5 MHz	5 MHz
Aquisition time	100 ms	100 ms	100 ms	10 ms	62.5 µs
Input coupling	AC	AC	AC		AC
Squelch level				-30 dBm	-20 dBm
Windows	"RF Spectrum" "AM Time Domain" "AM Spectrum" "Result Summary"	"RF Spectrum" "FM Time Domain" "FM Spectrum" "Result Summary"	"RF Spectrum" "FM Time Domain" "FM Spectrum" "Result Summary"	"FM Time Domain" "RF Time Domain" "Result Summary"	"FM Time Domain" "Result Summary"
AF filter - High-pass	20 kHz	50 Hz			-
AF filter - Low-pass	15 kHz	3 kHz	150 kHz		-
RF Spectrum					
Span	50 kHz	25 kHz	400 kHz		
AM/FM Time Domain					
Time domain zoom	10 ms	10 ms	10 ms		-
Dev per division		1 kHz	20 kHz	100 kHz	50 kHz
Time domain					
Settling Time State				ON	
AM/FM Spectrum					
Start freq.	0 Hz	0 Hz	0 Hz		
*) The Frequency Settling scenario requires a manually defined trigger					

Formats for returned values: ASCII format and binary format

Setting	AM Broadcast	FM Narrowband	FM Broadcast	Frequency Settling *)	None (Default)
Stop freq.	15 kHz	5 kHz	63.33 kHz		
Ref. value		5 kHz	75 kHz		

*) The Frequency Settling scenario requires a manually defined trigger

A.2 Formats for returned values: ASCII format and binary format

When trace data is retrieved using the `TRAC:DATA` or `TRAC:IQ:DATA` command, the data is returned in the format defined using the `FORMat[:DATA]` on page 168. The possible formats are described here.

- **ASCII Format (FORMat ASCII):**
The data is stored as a list of comma-separated values (CSV) of the measured values in floating point format.
- **Binary Format (FORMat REAL,16/32/64):**
The data is stored as binary data (definite length block data according to IEEE 488.2), each measurement value being formatted in 16-bit/32-bit/64-bit IEEE 754 floating-point-format.
The schema of the result string is as follows:
#<Length of length><Length of data><value1><value2>...<value n>
with:

<Length of length>	Number of digits of the following number of data bytes
<Length of data>	Number of following data bytes
<Value>	2-byte/4-byte/8-byte floating point value

Example: #41024<Data>... contains 1024 data bytes

Data blocks larger than 999,999,999 bytes

According to SCPI, the header of the block data format allows for a maximum of 9 characters to describe the data length. Thus, the maximum REAL 32 data that can be represented is 999,999,999 bytes. However, the R&S FSWP is able to send larger data blocks. In this case, the length of the data block is placed in brackets, e.g.

#(1234567890) <value1><value2>...



Reading out data in binary format is quicker than in ASCII format. Thus, binary format is recommended for large amounts of data.

A.3 Reference: ASCII file export format

Trace data can be exported to a file in ASCII format for further evaluation in other applications. This reference describes in detail the format of the export files for result data.

The file consists of the header information (general configuration of the measurement) and the measurement results. Optionally, the header can be excluded from the file.

The file of the Phase Noise application contains several sections, each section containing related data as shown in the tables below. Each section can contain header information and / or result information (header information is represented by a blue font in the tables below).

The data of the file header consist of three columns, each separated by a semicolon: parameter name; numeric value; basic unit. The data section starts with the keyword "Trace <n>" (<n> = number of stored trace). The measured data follows in one or several columns (depending on the measurement), which are also separated by a semicolon.

The results are output in the same order as they are displayed on the screen: window by window, trace by trace, and table row by table row.

Generally, the format of this ASCII file can be processed by spreadsheet calculation programs, e.g. MS Excel. Different language versions of evaluation programs can require a different handling of the decimal point. Thus, you can define the decimal separator to use (decimal point or comma).

A.4 I/Q data file format (iq-tar)

I/Q data is packed in a file with the extension `.iq.tar`. An `iq-tar` file contains I/Q data in binary format together with meta information that describes the nature and the source of data, e.g. the sample rate. The objective of the `iq-tar` file format is to separate I/Q data from the meta information while still having both inside one file. In addition, the file format allows you to include user-specific data and to preview the I/Q data in a web browser (not supported by all web browsers).

The `iq-tar` container packs several files into a single `.tar` archive file. Files in `.tar` format can be unpacked using standard archive tools (see http://en.wikipedia.org/wiki/Comparison_of_file_archivers) available for most operating systems. The advantage of `.tar` files is that the archived files inside the `.tar` file are not changed (not compressed) and thus it is possible to read the I/Q data directly within the archive without the need to unpack (untar) the `.tar` file first.



Sample iq-tar files

Some sample `iq-tar` files are provided in the `C:\R_S\INSTR\USER\Demo/` directory on the R&S FSWP.



An application note on converting Rohde & Schwarz I/Q data files is available from the Rohde & Schwarz website:

[1EF85: Converting R&S I/Q data files](#)

Contained files

An iq-tar file must contain the following files:

- **I/Q parameter XML file**, e.g. xyz.xml
Contains meta information about the I/Q data (e.g. sample rate). The filename can be defined freely, but there must be only one single I/Q parameter XML file inside an iq-tar file.
- **I/Q data binary file**, e.g. xyz.complex.float32
Contains the binary I/Q data of all channels. There must be only one single I/Q data binary file inside an iq-tar file.

Optionally, an iq-tar file can contain the following file:

- **I/Q preview XSLT file**, e.g. open_IqTar_xml_file_in_web_browser.xslt
Contains a stylesheet to display the I/Q parameter XML file and a preview of the I/Q data in a web browser (not supported by all web browsers).
A sample stylesheet is available at http://www.rohde-schwarz.com/file/open_IqTar_xml_file_in_web_browser.xslt.
- [I/Q parameter XML file specification](#)..... 188
- [I/Q data binary file](#)..... 193

A.4.1 I/Q parameter XML file specification



The content of the I/Q parameter XML file must comply with the XML schema RsIqTar.xsd available at: <http://www.rohde-schwarz.com/file/RsIqTar.xsd>.

In particular, the order of the XML elements must be respected, i.e. iq-tar uses an "ordered XML schema". For your own implementation of the iq-tar file format make sure to validate your XML file against the given schema.

The following example shows an I/Q parameter XML file. The XML elements and attributes are explained in the following sections.

Sample I/Q parameter XML file: xyz.xml

```
<?xml version="1.0" encoding="UTF-8"?>
<?xml-stylesheet type="text/xsl"
href="open_IqTar_xml_file_in_web_browser.xslt"?>
<RS_IQ_TAR_FileFormat fileFormatVersion="1"
xsi:noNamespaceSchemaLocation="RsIqTar.xsd"
xmlns:xsi="http://www.w3.org/2001/XMLSchema-instance">
  <Name>R&S FSWP</Name>
  <Comment>Here is a comment</Comment>
  <DateTime>2011-01-24T14:02:49</DateTime>
```

```

<Samples>68751</Samples>
<Clock unit="Hz">6.5e+006</Clock>
<Format>complex</Format>
<DataType>float32</DataType>
<ScalingFactor unit="V">1</ScalingFactor>
<NumberOfChannels>1</NumberOfChannels>
<DataFilename>xyz.complex.float32</DataFilename>
<UserData>
  <UserDefinedElement>Example</UserDefinedElement>
</UserData>
  <PreviewData>...</PreviewData>
</RS_IQ_TAR_FileFormat>

```

A.4.1.1 Minimum data elements

The following data elements are the minimum required for a valid *iq-tar* file. They are always provided by an *iq-tar* file export from a Rohde & Schwarz product. If not specified otherwise, it must be available in all *iq-tar* files used to import data to a Rohde & Schwarz product.

Element	Possible Values	Description
<RS_IQ_TAR_FileFormat>	-	The root element of the XML file. It must contain the attribute <code>fileFormatVersion</code> that contains the number of the file format definition.
<Name>	string	Optional: describes the device or application that created the file.
<Comment>	string	Optional: contains text that further describes the contents of the file.
<DateTime>	yyyy-mm-ddThh:mm:ss	Contains the date and time of the creation of the file. Its type is <code>xs:dateTime</code> (see <code>RsIqTar.xsd</code>).
<Samples>	integer	Contains the number of samples of the I/Q data. For multi-channel signals all channels have the same number of samples. One sample can be: <ul style="list-style-type: none"> • A complex number represented as a pair of I and Q values • A complex number represented as a pair of magnitude and phase values • A real number represented as a single real value See also <Format> element.
<Clock>	double	Contains the clock frequency in Hz, i.e. the sample rate of the I/Q data. A signal generator typically outputs the I/Q data at a rate that equals the clock frequency. If the I/Q data was captured with a signal analyzer, the signal analyzer used the clock frequency as the sample rate. The attribute <code>unit</code> must be set to "Hz".

I/Q data file format (iq-tar)

Element	Possible Values	Description
<Format>	complex real polar	Specifies how the binary data is saved in the I/Q data binary file (see <DataFilename> element). Every sample must be in the same format. The format can be one of the following: <ul style="list-style-type: none"> • <code>complex</code>: Complex number in cartesian format, i.e. I and Q values interleaved. I and Q are unitless • <code>real</code>: Real number (unitless) • <code>polar</code>: Complex number in polar format, i.e. magnitude (unitless) and phase (rad) values interleaved. Requires <code>DataType = float32 or float64</code>
<DataType>	int8 int16 int32 float32 float64	Specifies the binary format used for samples in the I/Q data binary file (see <DataFilename> element and Section A.4.2, "I/Q data binary file" , on page 193). The following data types are allowed: <ul style="list-style-type: none"> • <code>int8</code>: 8 bit signed integer data • <code>int16</code>: 16 bit signed integer data • <code>int32</code>: 32 bit signed integer data • <code>float32</code>: 32 bit floating point data (IEEE 754) • <code>float64</code>: 64 bit floating point data (IEEE 754)
<ScalingFactor>	double	Optional: describes how the binary data can be transformed into values in the unit Volt. The binary I/Q data itself has no unit. To get an I/Q sample in the unit Volt the saved samples have to be multiplied by the value of the <ScalingFactor>. For polar data only the magnitude value has to be multiplied. For multi-channel signals the <ScalingFactor> must be applied to all channels. The attribute <code>unit</code> must be set to "v". The <ScalingFactor> must be > 0. If the <ScalingFactor> element is not defined, a value of 1 V is assumed.
<NumberOfChannels>	integer	Optional: specifies the number of channels, e.g. of a MIMO signal, contained in the I/Q data binary file. For multi-channels, the I/Q samples of the channels are expected to be interleaved within the I/Q data file (see Section A.4.2, "I/Q data binary file" , on page 193). If the <NumberOfChannels> element is not defined, one channel is assumed.
<DataFilename>		Contains the filename of the I/Q data binary file that is part of the <code>iq-tar</code> file. It is recommended that the filename uses the following convention: <xyz>.<Format>.<Channels>ch.<Type> <ul style="list-style-type: none"> • <xyz> = a valid Windows file name • <Format> = complex, polar or real (see <code>Format</code> element) • <Channels> = Number of channels (see <code>NumberOfChannels</code> element) • <Type> = float32, float64, int8, int16, int32 or int64 (see <code>DataType</code> element) Examples: <ul style="list-style-type: none"> • <code>xyz.complex.1ch.float32</code> • <code>xyz.polar.1ch.float64</code> • <code>xyz.real.1ch.int16</code> • <code>xyz.complex.16ch.int8</code>

Element	Possible Values	Description
<UserData>	xml	Optional: contains user, application or device-specific XML data which is not part of the iq-tar specification. This element can be used to store additional information, e.g. the hardware configuration. User data must be valid XML content.
<PreviewData>	xml	Optional: contains further XML elements that provide a preview of the I/Q data. The preview data is determined by the routine that saves an iq-tar file (e.g. R&S FSWP). For the definition of this element refer to the RsIqTar.xsd schema. Note that the preview can be only displayed by current web browsers that have JavaScript enabled and if the XSLT stylesheet open_IqTar_xml_file_in_web_browser.xslt is available.

A.4.1.2 Example

The following example demonstrates the XML description inside the iq-tar file. Note that this preview is not supported by all web browsers.

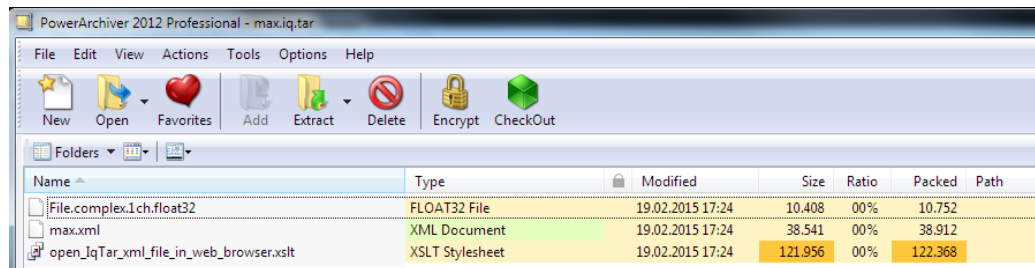

Open the xml file in a web browser. If the stylesheet open_IqTar_xml_file_in_web_browser.xslt is in the same directory, the web browser displays the xml file in a readable format.

max.xml (of .iq.tar file)

Description	
Saved by	VSE_1.10
Date & Time	2014-11-24 14:34:06
Sample rate	32 MHz
Number of samples	3200300
Duration of signal	100.009 ms
Data format	complex, float32
Data filename	File.complex.1ch.float32
Scaling factor	1 V

IQ Analyzer

Power vs time
y-axis: 10 dB /div
x-axis: 10 ms /div

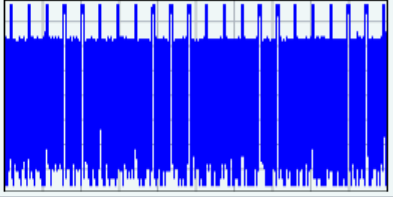

Spectrum
y-axis: 10 dB /div
x-axis: 5 MHz /div

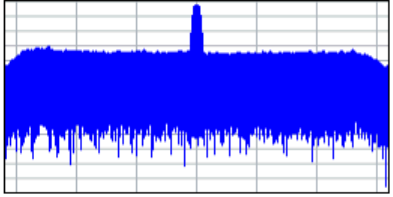

I/Q

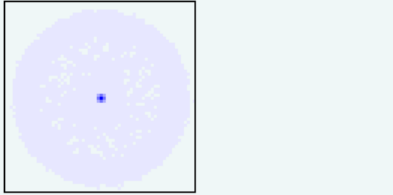

```
<?xml version="1.0" encoding="UTF-8"?>
<?xml-stylesheet type="text/xsl" href="open_IqTar_xml_file_in_web_browser.xslt"?>
<RS_IQ_TAR_FileFormat fileFormatVersion="1" xsi:noNamespaceSchemaLocation=
"http://www.rohde-schwarz.com/file/RsIqTar.xsd" xmlns:xsi=
"http://www.w3.org/2001/XMLSchema-instance">
  <Name>VSE_1.10a 29 Beta</Name>
  <Comment></Comment>
  <DateTime>2015-02-19T15:24:58</DateTime>
  <Samples>1301</Samples>
  <Clock unit="Hz">32000000</Clock>
  <Format>complex</Format>
  <DataType>float32</DataType>
```

```

<ScalingFactor unit="V">1</ScalingFactor>
<NumberOfChannels>1</NumberOfChannels>
<DataFilename>File.complex.1ch.float32</DataFilename>

<UserData>
  <RohdeSchwarz>
    <DataImportExport_MandatoryData>
      <ChannelNames>
        <ChannelName>IQ Analyzer</ChannelName>
      </ChannelNames>
      <CenterFrequency unit="Hz">0</CenterFrequency>
    </DataImportExport_MandatoryData>
    <DataImportExport_OptionalData>
      <Key name="Ch1_NumberOfPostSamples">150</Key>
      <Key name="Ch1_NumberOfPreSamples">150</Key>
    </DataImportExport_OptionalData>
  </RohdeSchwarz>
</UserData>

</RS_IQ_TAR_FileFormat>

```

Example: ScalingFactor

Data stored as int16 and a desired full scale voltage of 1 V

ScalingFactor = 1 V / maximum int16 value = 1 V / 2¹⁵ = 3.0517578125e-5 V

Scaling Factor	Numerical value	Numerical value x ScalingFactor
Minimum (negative) int16 value	- 2 ¹⁵ = - 32768	-1 V
Maximum (positive) int16 value	2 ¹⁵ -1= 32767	0.999969482421875 V

A.4.2 I/Q data binary file

The I/Q data is saved in binary format according to the format and data type specified in the XML file (see <Format> element and <DataType> element). To allow reading and writing of streamed I/Q data, all data is interleaved, i.e. complex values are interleaved pairs of I and Q values and multi-channel signals contain interleaved (complex) samples for channel 0, channel 1, channel 2 etc. If the <NumberOfChannels> element is not defined, one channel is presumed.

Example: Element order for real data (1 channel)

```

I[0],           // Real sample 0
I[1],           // Real sample 1
I[2],           // Real sample 2
...

```

Example: Element order for complex cartesian data (1 channel)

```
I[0], Q[0],           // Real and imaginary part of complex sample 0
I[1], Q[1],           // Real and imaginary part of complex sample 1
I[2], Q[2],           // Real and imaginary part of complex sample 2
...
```

Example: Element order for complex polar data (1 channel)

```
Mag[0], Phi[0],      // Magnitude and phase part of complex sample 0
Mag[1], Phi[1],      // Magnitude and phase part of complex sample 1
Mag[2], Phi[2],      // Magnitude and phase part of complex sample 2
...
```

Example: Element order for complex cartesian data (3 channels)

Complex data: I[channel no][time index], Q[channel no][time index]

```
I[0][0], Q[0][0],    // Channel 0, Complex sample 0
I[1][0], Q[1][0],    // Channel 1, Complex sample 0
I[2][0], Q[2][0],    // Channel 2, Complex sample 0

I[0][1], Q[0][1],    // Channel 0, Complex sample 1
I[1][1], Q[1][1],    // Channel 1, Complex sample 1
I[2][1], Q[2][1],    // Channel 2, Complex sample 1

I[0][2], Q[0][2],    // Channel 0, Complex sample 2
I[1][2], Q[1][2],    // Channel 1, Complex sample 2
I[2][2], Q[2][2],    // Channel 2, Complex sample 2
...
```

Example: Element order for complex cartesian data (1 channel)

This example demonstrates how to store complex cartesian data in float32 format using MATLAB®.

```
% Save vector of complex cartesian I/Q data, i.e. iqiqiq...
N = 100
iq = randn(1,N)+1j*randn(1,N)
fid = fopen('xyz.complex.float32','w');
for k=1:length(iq)
    fwrite(fid, single(real(iq(k))), 'float32');
    fwrite(fid, single(imag(iq(k))), 'float32');
end
fclose(fid)
```

Example: PreviewData in XML

```
<PreviewData>
  <ArrayOfChannel length="1">
    <Channel>
      <PowerVsTime>
        <Min>
```

```

        <ArrayOfFloat length="256">
            <float>-134</float>
            <float>-142</float>
            ...
            <float>-140</float>
        </ArrayOfFloat>
    </Min>
    <Max>
        <ArrayOfFloat length="256">
            <float>-70</float>
            <float>-71</float>
            ...
            <float>-69</float>
        </ArrayOfFloat>
    </Max>
</PowerVsTime>
<Spectrum>
    <Min>
        <ArrayOfFloat length="256">
            <float>-133</float>
            <float>-111</float>
            ...
            <float>-111</float>
        </ArrayOfFloat>
    </Min>
    <Max>
        <ArrayOfFloat length="256">
            <float>-67</float>
            <float>-69</float>
            ...
            <float>-70</float>
            <float>-69</float>
        </ArrayOfFloat>
    </Max>
</Spectrum>
<IQ>
    <Histogram width="64" height="64">0123456789...0</Histogram>
</IQ>
</Channel>
</ArrayOfChannel>
</PreviewData>

```

List of commands

[SENSe:]ADEMod:ACV:AFSPectrum:RESult?	167
[SENSe:]ADEMod:ACV[:TDOMain]:RESult?	167
[SENSe:]ADEMod:ADCPrefilter	134
[SENSe:]ADEMod:AF:CENTer	145
[SENSe:]ADEMod:AF:SPAN	145
[SENSe:]ADEMod:AF:SPAN:FULL	146
[SENSe:]ADEMod:AF:START	146
[SENSe:]ADEMod:AF:STOP	146
[SENSe:]ADEMod:AM:RELative:AFSPectrum:RESult?	167
[SENSe:]ADEMod:AM:RELative[:TDOMain]:RESult?	167
[SENSe:]ADEMod:AM[:ABSolute]:AFSPectrum:RESult?	167
[SENSe:]ADEMod:AM[:ABSolute][:TDOMain]:RESult?	167
[SENSe:]ADEMod:FM:AFSPectrum:RESult?	167
[SENSe:]ADEMod:FM[:TDOMain]:RESult?	167
[SENSe:]ADEMod:MTIME	135
[SENSe:]ADEMod:PM:AFSPectrum:RESult?	167
[SENSe:]ADEMod:PM:RPOint[:X]	140
[SENSe:]ADEMod:PM:RPOint[:X]:MODE	179
[SENSe:]ADEMod:PM[:TDOMain]:RESult?	167
[SENSe:]ADEMod:PRESet:RESTore	107
[SENSe:]ADEMod:PRESet:STORe	107
[SENSe:]ADEMod:PRESet[:STANdard]	107
[SENSe:]ADEMod:RELEngth	135
[SENSe:]ADEMod:SET	135
[SENSe:]ADEMod:SETTling:TIME:LIMit:LOWer	126
[SENSe:]ADEMod:SETTling:TIME:LIMit:UPPer	126
[SENSe:]ADEMod:SETTling:TIME:RESult<t>?	176
[SENSe:]ADEMod:SETTling:TIME:STATe	126
[SENSe:]ADEMod:SPECTrum:BWIDth[:RESolution]	136
[SENSe:]ADEMod:SPECTrum:RESult?	167
[SENSe:]ADEMod:SPECTrum:SPAN:ZOOM	147
[SENSe:]ADEMod:SPECTrum:SPAN[:MAXimum]	147
[SENSe:]ADEMod:SPECTrum[:TYPE]	178
[SENSe:]ADEMod:SQUelch:LEVel	141
[SENSe:]ADEMod:SQUelch[:STATe]	141
[SENSe:]ADEMod:SRATe	136
[SENSe:]ADEMod<n>:AF:COUPling	140
[SENSe:]ADEMod<n>:ZOOM:LENGth	141
[SENSe:]ADEMod<n>:ZOOM:LENGth:MODE	142
[SENSe:]ADEMod<n>:ZOOM:START	142
[SENSe:]ADEMod<n>:ZOOM[:STATe]	143
[SENSe:]ADJust:ALL	127
[SENSe:]ADJust:CONFigure:HYSTeresis:LOWer	129
[SENSe:]ADJust:CONFigure:HYSTeresis:UPPer	129
[SENSe:]ADJust:CONFigure:LEVel:DURation	128
[SENSe:]ADJust:CONFigure:LEVel:DURation:MODE	128
[SENSe:]ADJust:CONFigure:TRIGger	129

[SENSe:]ADJust:FREQuency.....	130
[SENSe:]ADJust:LEVel.....	117
[SENSe:]ADJust:SCALe[:Y]:AUTO[:CONTinuous].....	130
[SENSe:]AVERAge<n>:COUNT.....	136
[SENSe:]BANDwidth[:RESolution].....	137
[SENSe:]BWIDth:DEMod.....	137
[SENSe:]BWIDth:DEMod:TYPE.....	137
[SENSe:]FILTer<n>:AOFF.....	148
[SENSe:]FILTer<n>:AWEighted[:STATe].....	148
[SENSe:]FILTer<n>:CCIR:WEIGhted[:STATe].....	148
[SENSe:]FILTer<n>:CCIR[:UNWeighted][:STATe].....	149
[SENSe:]FILTer<n>:CCITt[:STATe].....	149
[SENSe:]FILTer<n>:DEMPhasis:TCONstant.....	149
[SENSe:]FILTer<n>:DEMPhasis[:STATe].....	149
[SENSe:]FILTer<n>:HPASs:FREQuency:MANual.....	150
[SENSe:]FILTer<n>:HPASs:FREQuency[:ABSolute].....	150
[SENSe:]FILTer<n>:HPASs[:STATe].....	151
[SENSe:]FILTer<n>:LPASs:FREQuency:MANual.....	151
[SENSe:]FILTer<n>:LPASs:FREQuency:RELative.....	152
[SENSe:]FILTer<n>:LPASs:FREQuency[:ABSolute].....	151
[SENSe:]FILTer<n>:LPASs[:STATe].....	152
[SENSe:]FREQuency:CENTer.....	117
[SENSe:]FREQuency:CENTer:STEP.....	118
[SENSe:]FREQuency:CENTer:STEP:LINK.....	118
[SENSe:]FREQuency:CENTer:STEP:LINK:FACTor.....	119
[SENSe:]MSRA:CAPTure:OFFSet.....	138
[SENSe:]SWEep:COUNT.....	138
[SENSe:]SWEep[:WINDow<n>]:POINTs.....	139
ABORT.....	131
CALCulate<n>:FORMat.....	158
CALCulate<n>:MARKer<m>:FUNCTion:ADEMod:AFREquency[:RESult<t>]?.....	172
CALCulate<n>:MARKer<m>:FUNCTion:ADEMod:AM[:RESult<t>]:RELative?.....	173
CALCulate<n>:MARKer<m>:FUNCTion:ADEMod:AM[:RESult<t>]?.....	172
CALCulate<n>:MARKer<m>:FUNCTion:ADEMod:CARRier[:RESult<t>]?.....	174
CALCulate<n>:MARKer<m>:FUNCTion:ADEMod:DISTortion[:WRITe]:RESult<t>?.....	174
CALCulate<n>:MARKer<m>:FUNCTion:ADEMod:FERRor[:RESult<t>]?.....	175
CALCulate<n>:MARKer<m>:FUNCTion:ADEMod:FM[:RESult<t>]:RELative?.....	173
CALCulate<n>:MARKer<m>:FUNCTion:ADEMod:FM[:RESult<t>]?.....	172
CALCulate<n>:MARKer<m>:FUNCTion:ADEMod:PM[:RESult<t>]:RELative?.....	173
CALCulate<n>:MARKer<m>:FUNCTion:ADEMod:PM[:RESult<t>]?.....	172
CALCulate<n>:MARKer<m>:FUNCTion:ADEMod:SINad:RESult<t>?.....	175
CALCulate<n>:MARKer<m>:FUNCTion:ADEMod:THD:RESult<t>?.....	175
CALCulate<n>:MARKer<m>:LINK.....	177
CALCulate<n>:MARKer<m>:X.....	176
CALCulate<n>:MARKer<m>:Y?.....	177
CALCulate<n>:SGRam:LAYout.....	179
CALCulate<n>:SGRam:TRACe.....	180
CALCulate<n>:SPECTrogram:LAYout.....	179
CALCulate<n>:SPECTrogram:TRACe.....	180
CALCulate<n>:UNIT:POWER.....	114

CONFigure:ADEMod:RESults:AM:DETEctor<det>:MODE.....	158
CONFigure:ADEMod:RESults:AM:DETEctor<det>:REFERence.....	156
CONFigure:ADEMod:RESults:AM:DETEctor<det>:REFERence:MEASStoref<t>.....	157
CONFigure:ADEMod:RESults:AM:DETEctor<det>:STATe.....	156
CONFigure:ADEMod:RESults:FM:DETEctor<det>:MODE.....	158
CONFigure:ADEMod:RESults:FM:DETEctor<det>:REFERence.....	156
CONFigure:ADEMod:RESults:FM:DETEctor<det>:REFERence:MEASStoref<t>.....	157
CONFigure:ADEMod:RESults:FM:DETEctor<det>:STATe.....	156
CONFigure:ADEMod:RESults:PM:DETEctor<det>:MODE.....	158
CONFigure:ADEMod:RESults:PM:DETEctor<det>:REFERence.....	156
CONFigure:ADEMod:RESults:PM:DETEctor<det>:REFERence:MEASStoref<t>.....	157
CONFigure:ADEMod:RESults:PM:DETEctor<det>:STATe.....	156
CONFigure:ADEMod:RESults:UNIT.....	158
DIAGnostic:SERVice:NSource.....	110
DISPlay:FORMat.....	159
DISPlay[:WINDow<n>]:SIZE.....	160
DISPlay[:WINDow<n>][:SUBWindow<w>]:TRACe<t>:Y:SPACing.....	145
DISPlay[:WINDow<n>][:SUBWindow<w>]:TRACe<t>:Y[:SCALe].....	154
DISPlay[:WINDow<n>][:SUBWindow<w>]:TRACe<t>:Y[:SCALe]:AUTO ONCE.....	154
DISPlay[:WINDow<n>][:SUBWindow<w>]:TRACe<t>:Y[:SCALe]:MODE.....	154
DISPlay[:WINDow<n>][:SUBWindow<w>]:TRACe<t>:Y[:SCALe]:PDIVision.....	144
DISPlay[:WINDow<n>][:SUBWindow<w>]:TRACe<t>:Y[:SCALe]:RLEVel.....	115
DISPlay[:WINDow<n>][:SUBWindow<w>]:TRACe<t>:Y[:SCALe]:RLEVel:OFFSet.....	115
DISPlay[:WINDow<n>][:SUBWindow<w>]:TRACe<t>:Y[:SCALe]:RPOSition.....	144
DISPlay[:WINDow<n>][:SUBWindow<w>]:TRACe<t>:Y[:SCALe]:RVALue.....	153
FORMat:DEXPort:DSEParator.....	171
FORMat:DEXPort:FORMat.....	169
FORMat:DEXPort:HEADer.....	171
FORMat:DEXPort:TRACes.....	171
FORMat[:DATA].....	168
INITiate:SEQuencer:ABORT.....	133
INITiate:SEQuencer:IMMediate.....	133
INITiate:SEQuencer:MODE.....	134
INITiate<n>:CONMeas.....	132
INITiate<n>:CONTinuous.....	132
INITiate<n>:REFResh.....	133
INITiate<n>[:IMMediate].....	134
INPut:ATTenuation.....	116
INPut:ATTenuation:AUTO.....	116
INPut:ATTenuation:PROTEction:RESet.....	108
INPut:COUPling.....	108
INPut:DPAth.....	108
INPut:FILTer:HPASs[:STATe].....	109
INPut:FILTer:YIG[:STATe].....	109
INPut:GAIN:STATe.....	116
INPut:GAIN[:VALue].....	117
INPut:IMPedance.....	109
INSTrument:CREate:DUPLicate.....	103
INSTrument:CREate:REPLace.....	104
INSTrument:CREate[:NEW].....	103

INSTRument:DELeTe.....	104
INSTRument:LIST?.....	104
INSTRument:REName.....	105
INSTRument[:SELeCt].....	106
LAYout:ADD[:WINDow]?.....	160
LAYout:CATalog[:WINDow]?.....	162
LAYout:IDENtify[:WINDow]?.....	162
LAYout:REMove[:WINDow].....	162
LAYout:REPLace[:WINDow].....	163
LAYout:SPLitter.....	163
LAYout:WINDow<n>:ADD?.....	165
LAYout:WINDow<n>:IDENtify?.....	165
LAYout:WINDow<n>:REMove.....	166
LAYout:WINDow<n>:REPLace.....	166
MMEMory:LOAD:IQ:STATe.....	180
MMEMory:STORe<n>:IQ:COMMeNt.....	180
MMEMory:STORe<n>:IQ:STATe.....	181
MMEMory:STORe<n>:TRACe.....	170
OUTPut:ADEMod[:ONLine]:AF[:CFRequency].....	110
OUTPut:ADEMod[:ONLine]:SOURce.....	111
OUTPut:ADEMod[:ONLine][:STATe].....	111
OUTPut:IF:IFFRequency.....	112
OUTPut:IF[:SOURce].....	112
OUTPut:TRIGger<tp>:DIReCtion.....	112
OUTPut:TRIGger<tp>:LEVel.....	113
OUTPut:TRIGger<tp>:OTYPe.....	113
OUTPut:TRIGger<tp>:PULSe:IMMeDiate.....	113
OUTPut:TRIGger<tp>:PULSe:LENGth.....	114
SYSTem:PRESet:CHANnel[:EXEC].....	106
SYSTem:SEQuencer.....	139
TRACe<n>[:DATA].....	169
TRIGger[:SEQuence]:BBPower:HOLDoff.....	120
TRIGger[:SEQuence]:DTIME.....	120
TRIGger[:SEQuence]:HOLDoff[:TIME].....	121
TRIGger[:SEQuence]:IFPower:HOLDoff.....	120
TRIGger[:SEQuence]:IFPower:HYSterEsis.....	121
TRIGger[:SEQuence]:LEVel:AM:RELative.....	122
TRIGger[:SEQuence]:LEVel:AM[:ABSolute].....	121
TRIGger[:SEQuence]:LEVel:FM.....	122
TRIGger[:SEQuence]:LEVel:IFPower.....	123
TRIGger[:SEQuence]:LEVel:IQPower.....	123
TRIGger[:SEQuence]:LEVel:PM.....	123
TRIGger[:SEQuence]:LEVel:RFPower.....	124
TRIGger[:SEQuence]:LEVel[:EXtERnal<port>].....	122
TRIGger[:SEQuence]:SLOPe.....	124
TRIGger[:SEQuence]:SOURce.....	124
TRIGger[:SEQuence]:TIME:RINteRval.....	125
UNIT<n>:ANGLE.....	155
UNIT<n>:THD.....	155

Index

A

A weighted filter
 AF filters 72

Aborting
 Sweep 61, 62

AC/DC coupling 32, 42, 47, 64, 75

AF 18

AF Auto Scale
 Y-axis 75, 84

AF center
 Demodulation spectrum 67

AF CF 16

AF coupling 47, 64, 75

AF filters 33
 A weighted 72
 CCIR 72
 CCITT 72
 Configuration 70
 Deactivating 73
 Deemphasis 72
 High pass 70
 Low pass 71
 Weighting 72

AF full span
 Demodulation spectrum 68

AF span
 Demodulation spectrum 68
 Displayed 16
 Remote control 145

AF spectrum 67

AF start
 Demodulation spectrum 67

AF stop
 Demodulation spectrum 68

AF trigger 33, 34

AM (Offline)
 Softkey 54

AM Spectrum
 Evaluation method 21

AM Time Domain
 Evaluation method 18

Amplitude
 Scaling 77
 Settings 48

Analog Modulation Analysis
 Measurement examples 91
 Output 47
 Output settings 46

Analysis
 Settings 86

Analysis interval
 MSRA 59

Analysis line 37

Application cards 11

Application notes 11

AQT
 see Measurement time 15

ASCII trace export 187

Attenuation
 Auto 50
 Displayed 15

Manual 50
 Protective (remote) 108

Audio frequency
 see AF 18

Audio signals
 Output (remote) 112

Auto adjustment
 Triggered measurement 129

Auto all 84

Auto frequency 84

Auto level
 Hysteresis 85
 Reference level 50, 84
 Softkey 50, 84

Auto scaling 75, 76, 84

Auto settings 83
 MeasTime Auto 85
 MeasTime Manual 85

Average count 63

B

Bandwidth settings 59

Brochures 11

C

Capture offset
 MSRA secondary applications 60
 Remote 138
 Softkey 60

Carrier
 Offset 27, 32
 Power 27

CCIR filter
 AF filters 72

CCITT filter
 AF filters 72

Center frequency 51, 69
 Automatic configuration 84
 Displayed 15, 16
 Softkey 51, 69
 Step size 51

Channel
 Creating (remote) 104
 Deleting (remote) 104
 Duplicating (remote) 103
 Querying (remote) 104
 Renaming (remote) 105
 Replacing (remote) 104

Closing
 Channels (remote) 104
 Windows (remote) 166

Conditions
 Measurement 30

Continue single sweep
 Softkey 62

Continuous sweep
 Softkey 61

Conventions
 SCPI commands 97

Copying
 Channel (remote) 103

D

Data acquisition	
MSRA	59
Settings	58
Data format	
ASCII	186
Binary	186
Remote	171
Data sheets	11
DB per division	
Scaling	74
DBW	
see Demodulation bandwidth	15
Deemphasis filter	
AF filters	72
Remote control	149
Deleting	
Settings files	39
Standards	39
Demodulation	
AF spectrum	67
Configuration	63
Display	83
Filter types	33, 60
Process	30
Relative (remote control)	158
Relative (remote)	156
RF spectrum	68
Scaling	70, 73
Settings	63
Spectrum	67
Spectrum (Result Summary)	68
Units	77
Demodulation bandwidth	59, 69
Conditions	32
Deemphasis filter	72
Displayed	15
Maximum	33
Remote control	137
Troubleshooting	96
Detectors	
Relative demodulation	158
Relative demodulation (remote)	156
Remote control	156
Dev per division	
Scaling	74
Deviation	
Scaling	75
Diagram footer information	16
Digital standards	
Configuration	38
Direct path	
Input configuration	42
Display configuration	
Softkey	83
Drop-out time	
Trigger	56
Duplicating	
Channel (remote)	103
E	
Errors	
IF OVL	49

Evaluation	
Data basis	18
Methods	18
Evaluation methods	
Remote	160
Examples	
Remote control	181
Export format	
Traces	187
Exporting	
I/Q data	88, 187, 193
Trace data	90
External trigger	53
Level (remote)	122

F

File format	
Export Files	187
Trace export	187
filename	
Settings	39
Files	
Format, I/Q data	187
I/Q data binary XML	193
I/Q parameter XML	188
Filters	
A weighted (AF)	72
AF	70
CCIR (AF)	72
CCITT (AF)	72
Demodulation	32, 33, 60
High pass (AF)	70
High-pass (RF input)	43
Low pass (AF)	71
Weighting (AF)	72
YIG (remote)	109
FM (Offline)	
Softkey	54
FM Spectrum	
Evaluation method	22
FM Time Domain	
Evaluation method	19
Format	
Data	186
Data (remote)	171
see also File format	187
Free Run	
Trigger	53
Frequency	
Configuration	67
Deemphasis filter	72
Deviation	32
Deviation, scaling	74
Settings	51
Span	69
Frontend settings	41
G	
Getting started	10
H	
Hardware settings	
Displayed	15

High pass filter		
AF filters	70	
High-pass filter		
RF input	43	
Hysteresis		
Lower (Auto level)	85	
Trigger	56	
Upper (Auto level)	85	
I		
I/Q data		
Export file binary data description	193	
Export file parameter description	188	
Importing/Exporting	88	
I/Q Power		
Trigger	54	
Trigger level (remote)	123	
IF frequency		
Output (remote)	112	
IF output		
Remote	112	
IF Power		
Trigger	54	
Trigger level (remote)	123	
Impedance		
Setting	42	
Importing		
I/Q data	88, 188	
Input		
Coupling	42	
Overload (remote)	108	
Settings	41	
Input sources	41	
Installation	13	
Instrument security procedures	10	
iq-tar		
Example file	191	
Mandatory data elements	189	
K		
Keys		
RUN CONT	61	
RUN SINGLE	62	
L		
Linking		
Markers	87	
LO feedthrough	42	
Loading		
Settings files	39	
Low pass filter		
AF filters	71	
Lower Level Hysteresis	85	
M		
Marker table		
Evaluation method	28	
Markers		
Linked in AF spectrum display	87	
Linked in time domain	87	
Table (evaluation method)	28	
Maximizing		
Windows (remote)	160	
Measurement examples		
Analog Modulation Analysis	91	
Measurement time	60, 62	
Auto settings	85	
Displayed	15	
Effects	34	
Value range	33	
Modulation		
Depth	27	
Depth, scaling	74	
Frequency	27, 32	
MSRA		
Analysis interval	59	
Operating mode	36	
MSRA secondary applications		
Capture offset (remote)	138	
Multiple		
Channels	14	
N		
Noise		
Source	44	
O		
Offset		
Analysis interval	60	
Reference level	49	
Options		
High-pass filter	43	
Output		
Analog Modulation Analysis	46, 47	
Analog Modulation Analysis (remote)	110, 111	
Audio	112	
IF frequency (remote)	112	
IF source (remote)	112	
Noise source	44	
Probe power	44	
Trigger	44, 45, 57	
Video	112	
Overload		
RF input (remote)	108	
Overview		
Softkey	40	
P		
Peak list		
Evaluation method	28	
Performance		
Improving	34	
Performing		
analog modulation analysis	89	
Phase		
Deviation	32	
Deviation, scaling	74	
Unit	78	
Phase Wrap		
Activating	66	
PM (Offline)		
Softkey	54	
PM Spectrum		
Evaluation method	23	
PM Time Domain		
Evaluation method	20	

Presetting		
Channels	41
Pretrigger	55
Probe power supply	44
Protection		
RF input (remote)	108
R		
Range	76
Scaling	76
RBW	60
Displayed	15
Remote control	136
Reference level	49
Auto level	50, 84
Displayed	15
Offset	49
Offset, displayed	15
Position	76
Unit	49
Value	49
Reference value	74
Position	74
Refreshing		
MSRA secondary applications	62
Softkey	62
Release notes	11
Remote commands		
Basics on syntax	97
Boolean values	101
Capitalization	98
Character data	101
Data blocks	101
Numeric values	100
Optional keywords	99
Parameters	99
Strings	101
Suffixes	98
Repetition interval	56
Res BW		
see RBW	60
Resetting		
RF input protection	108
Residual FM	32
Resolution bandwidth		
see RBW	60
Restoring		
Channel settings	41
Standard files	40
Result Display	14
Result displays		
Marker table	28
Peak list	28
Result Summary		
Demodulation spectrum	68
Evaluation method	26
Retrieving values (remote)	172
Results	18
Analyzing	86
Data format (remote)	171
Stability	34
Updating the display	62
RF (Offline)		
Softkey	54
RF attenuation		
Auto	50
Manual	50
RF full span	69
RF input		
Overload protection (remote)	108
RF Power		
Trigger	55
Trigger level (remote)	124
RF Spectrum		
Evaluation method	25
Troubleshooting	96
RF Time Domain		
Evaluation method	24
RUN CONT		
Key	61
RUN SINGLE		
Key	62
S		
Safety instructions	11
Sample rate	33
Samples		
Performance	34
Saving		
Settings	39
Scaling		
AF	73
Amplitude range, automatically	76
Automatic	75, 84
Configuration	73
Result Summary	75
RF	75
Y-axis	77
Y-axis (remote control)	145
Screen layout	14
Secure user mode		
Storage location	39
Security procedures	10
Sequencer	14
Activating (remote)	133
Remote	132
Sequences		
Aborting (remote)	133
Mode (remote)	134
Service manual	10
Settings		
Displayed	40
filename	39
Restoring files	40
Storage location	39
Settings files		
Deleting	39
Loading	39
Predefined	184
Saving	39
Signal-to-noise ratio	32
Signal-to-noise-and-distortion		
see SINAD	27
SINAD	27
Querying (remote)	175
Troubleshooting	96
Single sweep		
Softkey	62
Slope		
Trigger	56, 124

- Softkeys
 - AF Auto Scale 75, 84
 - AF Center 67
 - AF Filter Config 70
 - AF Full Span 68
 - AF Span Manual 68
 - AF Start 67
 - AF Stop 68
 - AM (Offline) 54
 - Auto All 84
 - Auto Level 50, 84
 - Capture Offset 60
 - Center 51, 69
 - Continue Single Sweep 62
 - Continuous Sweep 61
 - Demod BW 59, 69
 - Demod Config 63
 - Display Config 83
 - External 53
 - FM (Offline) 54
 - Free Run 53
 - Frequency Config 67
 - IF Power 54
 - Lower Level Hysteresis 85
 - Meastime Auto 85
 - Meastime Manual 85
 - Overview 40
 - PM (Offline) 54
 - Ref Level 49
 - Ref Level Offset 49
 - Refresh 62
 - Res BW 60
 - RF (Offline) 54
 - RF Atten Auto 50
 - RF Atten Manual 50
 - RF Power 55
 - Scale Config 73
 - Single Sweep 62
 - Span Manual 69
 - Sweep Count 63
 - Time 55
 - Trigger Offset 55
 - Upper Level Hysteresis 85
- Span 69
 - Displayed 16
 - Manual 69
- Specifics for
 - Configuration 41
- Spectrograms
 - Activating/Deactivating 86
 - Size 86
- Spectrum
 - Demodulation 67
- Squelch
 - AF 64
 - Level 64
 - Remote control 141
 - State 64
- Standards
 - Predefined 184
 - Presetting 39
 - see Digital standards 38
- Status registers
 - STAT:QUES:POW 108
- Storage location
 - Secure user mode 39
 - Settings 39
- Subwindows
 - Spectrogram 86
- Suffixes
 - Common 102
 - Remote commands 98
- Sweep
 - Aborting 61, 62
 - Settings 61
- Sweep Count 63
- Sweep points
 - Displayed 16
- Sweep Points 63
- T**
- THD 27
 - Querying (remote) 175
 - Troubleshooting 96
 - Unit 78
- Time domain zoom 34, 65
 - Length 66
 - Start 65
 - State 65
 - Time per division 66
- Time per division
 - Displayed 16
 - Time domain zoom 66
- Time trigger
 - Repetition interval 56
 - Softkey 55
- Total harmonic distortion
 - see THD 27
- Traces
 - Detector (remote control) 156
 - Exporting 90
 - Retrieving results (remote) 167
- Trigger
 - Drop-out time 56
 - External (remote) 124
 - Holdoff 56
 - Hysteresis 56
 - Offset 55
 - Offset, value range 33
 - Output 45, 57
 - Settings 52
 - Slope 56, 124
- Trigger level 55
 - External trigger (remote) 122
 - I/Q Power (remote) 123
 - IF Power (remote) 123
 - RF Power (remote) 124
- Trigger output 44
- Trigger source 53
 - AF 34
 - AM (Offline) 54
 - External 53
 - FM (Offline) 54
 - Free Run 53
 - I/Q Power 54
 - IF Power 54
 - PM (Offline) 54
 - RF (Offline) 54
 - RF Power 55
 - Settings 52
 - Time 55

Troubleshooting	96
Demodulation bandwidth	96
Input overload	108
RF Spectrum	96
SINAD	96
THD	96

U

Units	77
Reference level	49
Updating	
Result display	62
Upper Level Hysteresis	85

V

Video output	112
Videos	11

W

Weighting filter	
AF filters	72
White papers	11
Window title bar information	16
Windows	
Adding (remote)	160
Closing (remote)	166
Configuring	41
Layout (remote)	163
Maximizing (remote)	160
Querying (remote)	162
Replacing (remote)	163
Splitting (remote)	160
Types (remote)	160

Y

Y-axis	
Scaling	77
YIG-preselector	
Activating/Deactivating	43
Activating/Deactivating (remote)	109

Z

Zero Phase	
Reference Position	66
Reference Position (remote)	140
Zooming	
Time domain	34, 65