

R&S®FSWP-K30

Noise Figure Measurements

User Manual



1177567902
Version 09



This manual describes the following R&S®FSWP models with firmware version 3.00 or higher:

- R&S®FSWP8 (1322.8003K08)
- R&S®FSWP8 (1322.8003K09)
- R&S®FSWP26 (1322.8003K26)
- R&S®FSWP26 (1322.8003K27)
- R&S®FSWP50 (1322.8003K50)
- R&S®FSWP50 (1322.8003K51)

The following firmware applications are described:

- R&S FSWP-K30 (1325.4244.02) (requires R&S FSWP-B1)

© 2022 Rohde & Schwarz GmbH & Co. KG
Muehldorfstr. 15, 81671 Muenchen, Germany
Phone: +49 89 41 29 - 0
Email: info@rohde-schwarz.com
Internet: www.rohde-schwarz.com

Subject to change – data without tolerance limits is not binding.

R&S® is a registered trademark of Rohde & Schwarz GmbH & Co. KG.

Trade names are trademarks of the owners.

1177.5679.02 | Version 09 | R&S®FSWP-K30

Throughout this manual, products from Rohde & Schwarz are indicated without the ® symbol , e.g. R&S®FSWP is indicated as R&S FSWP.

Contents

1	Preface	9
1.1	About this manual	9
1.2	Documentation overview	10
1.2.1	Getting started manual.....	10
1.2.2	User manuals and help.....	10
1.2.3	Service manual.....	10
1.2.4	Instrument security procedures.....	10
1.2.5	Printed safety instructions.....	11
1.2.6	Data sheets and brochures.....	11
1.2.7	Release notes and open source acknowledgment (OSA).....	11
1.2.8	Application notes, application cards, white papers, etc.....	11
1.3	Conventions used in the documentation	11
1.3.1	Typographical conventions.....	11
1.3.2	Conventions for procedure descriptions.....	12
1.3.3	Notes on screenshots.....	12
2	Welcome to the noise figure measurement application	13
2.1	Starting the noise application	13
2.2	Understanding the display information	14
3	Measurements and result displays	17
4	Measurement basics	26
4.1	Tuning modes	26
4.1.1	Swept measurements.....	27
4.1.2	Frequency table measurements.....	27
4.1.3	Single frequency measurements.....	27
4.2	Measurement modes	28
4.3	DUT types	30
4.3.1	Measurements on linear DUTs (direct measurement).....	30
4.3.2	Measurements on frequency converting DUTs.....	30
4.4	External generator control	31
4.5	Image frequency rejection	33

4.6	Calibration (2nd stage correction).....	35
4.7	Separating signals by selecting an appropriate resolution bandwidth.....	38
4.8	Analyzing several traces - trace mode.....	39
4.9	Using markers.....	40
5	Configuration.....	43
5.1	Configuration overview.....	43
5.2	Defining the measurement frequency.....	45
5.2.1	Defining a frequency set.....	45
5.2.2	Configuring single frequency measurements.....	48
5.2.3	Using a frequency table.....	49
5.3	Selecting DUT characteristics.....	52
5.4	Configuring the noise source.....	53
5.4.1	Defining the noise source characteristics.....	53
5.4.2	Using an ENR or temperature table.....	57
5.5	Configuring additional loss.....	61
5.5.1	Defining loss.....	61
5.5.2	Using a loss table.....	64
5.6	Configuring the analyzer.....	66
5.7	Using the uncertainty calculator.....	70
5.7.1	Configuring noise source characteristics.....	71
5.7.2	Configuring DUT characteristics.....	73
5.7.3	Configuring analyzer characteristics.....	74
5.7.4	Guidelines and results.....	75
5.8	Trigger and gate configuration.....	76
5.8.1	Trigger settings.....	76
5.8.2	Gate settings.....	80
5.8.3	Continuous gate settings.....	81
5.9	Performing measurements.....	82
5.10	Configuring inputs and outputs of the R&S FSWP.....	84
5.10.1	Radio frequency (RF) input.....	84
5.10.2	External generator.....	86
5.10.2.1	Interface configuration settings.....	86
5.10.2.2	Measurement configuration.....	87

5.10.3	DC power output configuration.....	90
5.10.4	Signal source output configuration.....	90
6	Analysis.....	91
6.1	Configuring the display.....	91
6.1.1	Configuring graphical results.....	91
6.1.2	Configuring numerical results.....	93
6.2	Working with traces.....	94
6.3	Using markers.....	97
6.3.1	Marker configuration.....	97
6.3.2	Marker positioning.....	100
6.4	Limit line settings and functions.....	102
6.4.1	Limit line management.....	102
6.4.2	Limit line details.....	104
7	Remote control commands for noise figure measurements.....	107
7.1	Common suffixes.....	108
7.2	Introduction.....	108
7.2.1	Conventions used in descriptions.....	109
7.2.2	Long and short form.....	109
7.2.3	Numeric suffixes.....	110
7.2.4	Optional keywords.....	110
7.2.5	Alternative keywords.....	110
7.2.6	SCPI parameters.....	111
7.2.6.1	Numeric values.....	111
7.2.6.2	Boolean.....	112
7.2.6.3	Character data.....	112
7.2.6.4	Character strings.....	113
7.2.6.5	Block data.....	113
7.3	Controlling the noise figure measurement channel.....	113
7.4	Working with windows in the display.....	117
7.5	General window commands.....	123
7.6	Retrieving measurement results.....	124
7.7	Defining the measurement frequency.....	125
7.8	Selecting DUT characteristics.....	130

7.9	Configuring the noise source.....	132
7.10	Configuring additional loss.....	140
7.11	Configuring the analyzer.....	147
7.12	Configuring triggered and gated measurements.....	153
7.12.1	Configuring the triggering conditions.....	154
7.12.2	Configuring gated measurements.....	157
7.12.3	Configuring the trigger output.....	160
7.13	Using the uncertainty calculator.....	162
7.14	Performing measurements.....	172
7.15	Configuring the inputs and outputs.....	177
7.15.1	Radio frequency (RF) input.....	177
7.15.2	External mixer.....	179
7.15.3	External generator.....	190
7.16	Configuring the display.....	194
7.17	Working with traces.....	197
7.18	Working with limit lines.....	202
7.18.1	Defining general characteristics of a limit line.....	203
7.18.2	Defining horizontal data points.....	204
7.18.3	Controlling lower limit lines.....	206
7.18.4	Controlling upper limit lines.....	207
7.18.5	Managing limit lines.....	208
7.18.6	Controlling limit checks.....	209
7.19	Working with markers.....	211
7.19.1	Using markers.....	212
7.19.2	Using delta markers.....	214
7.19.3	Configuring markers.....	217
7.19.4	Positioning markers.....	218
7.19.5	Positioning delta markers.....	220
7.20	Using the status register.....	222
7.20.1	Status registers for noise figure measurements.....	223
7.20.1.1	STATus:OPERation register.....	225
7.20.1.2	STATus:QUEStionable register.....	225
7.20.1.3	STATus:QUEStionable:LIMit register.....	226

7.20.1.4	STATus:QUEStionable:CORRection register.....	226
7.20.1.5	Status register remote commands.....	227
7.21	Deprecated remote commands for noise figure measurements.....	229
7.22	Programming example: measuring a noise figure.....	230
	Annex.....	231
A	Reference: frequency table file format.....	231
	List of Remote Commands (Noise Figure).....	232
	Index.....	238

1 Preface

1.1 About this manual

This Spurious Measurements User Manual provides all the information **specific to the application**. All general instrument functions and settings common to all applications and operating modes are described in the main R&S FSWP User Manual.

The main focus in this manual is on the measurement results and the tasks required to obtain them. The following topics are included:

- **Welcome to the noise measurement application**
Introduction to and getting familiar with the application
- **About the measurement**
General concept of the noise measurement and typical applications
- **Measurements and Result Displays**
Details on supported measurements and their result types
- **Measurement Basics**
Background information on basic terms and principles in the context of the measurement
- **Configuration + Analysis**
A concise description of all functions and settings available to configure measurements and analyze results with their corresponding remote control command
- **How to Perform Measurements in the noise measurement application**
Step-by-step instructions to perform a basic noise measurement
- **Measurement Examples**
Detailed measurement examples to guide you through typical measurement scenarios and allow you to try out the application immediately
- **Optimizing and Troubleshooting the Measurement**
Hints and tips on how to handle errors and optimize the test setup
- **Remote Commands for noise Measurements**
Remote commands required to configure and perform noise measurements in a remote environment, sorted by tasks
(Commands required to set up the environment or to perform common tasks on the instrument are provided in the main R&S FSWP User Manual)
Programming examples demonstrate the use of many commands and can usually be executed directly for test purposes
- **Annex**
Reference material
- **List of remote commands**
Alphabetical list of all remote commands described in the manual
- **Index**

1.2 Documentation overview

This section provides an overview of the R&S FSWP user documentation. Unless specified otherwise, you find the documents at:

www.rohde-schwarz.com/manual/FSWP

1.2.1 Getting started manual

Introduces the R&S FSWP and describes how to set up and start working with the product. Includes basic operations, typical measurement examples, and general information, e.g. safety instructions, etc.

A printed version is delivered with the instrument. A PDF version is available for download on the Internet.

1.2.2 User manuals and help

The user manual contains the description of all instrument modes and functions. It also provides an introduction to remote control, a complete description of the remote control commands with programming examples, and information on maintenance, instrument interfaces and error messages. Includes the contents of the getting started manual.

The contents of the user manual are available as help in the R&S FSWP. The help offers quick, context-sensitive access to the complete information for the instrument and its firmware.

The user manual is also available for download or for immediate display on the Internet.

1.2.3 Service manual

Describes the performance test for checking the rated specifications, module replacement and repair, firmware update, troubleshooting and fault elimination, and contains mechanical drawings and spare part lists.

The service manual is available for registered users on the global Rohde & Schwarz information system (GLORIS):

<https://gloris.rohde-schwarz.com>

1.2.4 Instrument security procedures

Deals with security issues when working with the R&S FSWP in secure areas. It is available for download on the Internet.

1.2.5 Printed safety instructions

Provides safety information in many languages. The printed document is delivered with the product.

1.2.6 Data sheets and brochures

The data sheet contains the technical specifications of the R&S FSWP. It also lists the firmware applications and their order numbers, and optional accessories.

The brochure provides an overview of the instrument and deals with the specific characteristics.

See www.rohde-schwarz.com/brochure-datasheet/FSWP

1.2.7 Release notes and open source acknowledgment (OSA)

The release notes list new features, improvements and known issues of the current firmware version, and describe the firmware installation.

The software makes use of several valuable open source software packages. An open-source acknowledgment document provides verbatim license texts of the used open source software.

See www.rohde-schwarz.com/firmware/FSWP

1.2.8 Application notes, application cards, white papers, etc.

These documents deal with special applications or background information on particular topics.

See www.rohde-schwarz.com/application/FSWP

1.3 Conventions used in the documentation

1.3.1 Typographical conventions

The following text markers are used throughout this documentation:

Convention	Description
"Graphical user interface elements"	All names of graphical user interface elements on the screen, such as dialog boxes, menus, options, buttons, and softkeys are enclosed by quotation marks.
[Keys]	Key and knob names are enclosed by square brackets.

Convention	Description
Filenames, commands, program code	Filenames, commands, coding samples and screen output are distinguished by their font.
<i>Input</i>	Input to be entered by the user is displayed in italics.
Links	Links that you can click are displayed in blue font.
"References"	References to other parts of the documentation are enclosed by quotation marks.

1.3.2 Conventions for procedure descriptions

When operating the instrument, several alternative methods may be available to perform the same task. In this case, the procedure using the touchscreen is described. Any elements that can be activated by touching can also be clicked using an additionally connected mouse. The alternative procedure using the keys on the instrument or the on-screen keyboard is only described if it deviates from the standard operating procedures.

The term "select" may refer to any of the described methods, i.e. using a finger on the touchscreen, a mouse pointer in the display, or a key on the instrument or on a keyboard.

1.3.3 Notes on screenshots

When describing the functions of the product, we use sample screenshots. These screenshots are meant to illustrate as many as possible of the provided functions and possible interdependencies between parameters. The shown values may not represent realistic usage scenarios.

The screenshots usually show a fully equipped product, that is: with all options installed. Thus, some functions shown in the screenshots may not be available in your particular product configuration.

2 Welcome to the noise figure measurement application

The R&S FSWP-K30 is a firmware application that adds functionality to perform "noise figure" measurements to the R&S FSWP.



Availability of "Noise Figure" measurements

The "Noise Figure" measurements application becomes available when you equip the R&S FSWP with the optional Spectrum Analyzer hardware (R&S FSWP-B1) and firmware application R&S FSWP-K30.

The Noise Source Control connector on the R&S FSWP is a prerequisite for the noise measurement application. This connector is part of the "Additional Interfaces" hardware option R&S FSWP-B5.

This user manual contains a description of the functionality that the application provides, including remote control operation.

Functions that are not discussed in this manual are the same as in the Spectrum application and are described in the R&S FSWP user manual.

The latest versions of the manuals are available for download at the product homepage.

<http://www.rohde-schwarz.com/product/FSWP.html>.

Installation

Find detailed installing instructions in the getting started or the release notes of the R&S FSWP.

- [Starting the noise application](#)..... 13
- [Understanding the display information](#)..... 14

2.1 Starting the noise application

The "noise figure" measurement application adds a new type of measurement to the R&S FSWP.

To activate the noise measurement application

1. Select the [MODE] key.
A dialog box opens that contains all operating modes and applications currently available on your R&S FSWP.
2. Select the "Noise Figure" item.

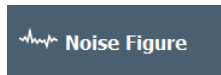

The R&S FSWP opens a new measurement channel for the "noise figure" measurement application.

All settings specific to "noise figure" measurements are in their default state.

Multiple Channels and Sequencer Function

When you activate an application, a new channel is created which determines the measurement settings for that application ("Channel"). The same application can be activated with different measurement settings by creating several "Channel"s for the same application.

The number of channels that can be configured at the same time depends on the available memory on the instrument.

Only one measurement can be performed at any time, namely the one in the currently active channel. However, to perform the configured measurements consecutively, a Sequencer function is provided.

If activated, the measurements configured in the currently defined "Channel"s are performed one after the other in the order of the tabs. The currently active measurement is indicated by a  symbol in the tab label.

The result displays of the individual channels are updated in the tabs (as well as the "MultiView") as the measurements are performed. Sequential operation itself is independent of the currently *displayed* tab.

For details on the Sequencer function, see the R&S FSWP user manual.

2.2 Understanding the display information

The following figure shows the display as it looks for "noise figure" measurements. All different information areas are labeled. They are explained in more detail in the following sections.



Figure 2-1: Screen layout of the noise figure measurement application

- 1 = Toolbar
- 2 = Channel bar
- 3 = Diagram header
- 4 = Result display
- 5 = Softkey bar
- 6 = Status bar

Channel bar information

In the noise measurement application, the R&S FSWP shows the following settings:

Ref Level	Reference level of the R&S FSWP.
Att	Attenuation of the R&S FSWP.
RBW	Resolution bandwidth
SWT	Sweep time
AVG	Number of averages
ENR	Excess noise ratio
2nd Stage Corr	State of the 2nd stage correction.
Calibration Data	Date and time of the current calibration data.
Mode	Currently selected measurement mode.

Window title bar information

For each diagram, the header provides the following information:



Figure 2-2: Window title bar information for the noise measurement application

- 1 = Window number
- 2 = Window type
- 3 = Trace color and number
- 4 = Trace mode

Status bar information

Global instrument settings, the instrument status and any irregularities are indicated in the status bar beneath the diagram. Furthermore, the progress of the current operation is displayed in the status bar.

NOTICE

Risk of damaging the instrument

Make sure not to overload the input mixer during calibration and the measurement. An overload condition can damage or destroy the input mixer.

If an overload condition occurs, the R&S FSWP shows a corresponding message in the status line ("RF OVLD" or "IF OVLD").

To avoid an overload during calibration or measurement, do one or more of the following:

- Check and adjust the DUT "gain" settings
 - Check and adjust the ENR settings
 - Increase the reference level.
-

3 Measurements and result displays

The R&S FSWP-K30 measures the "noise figure" of a DUT and displays the results graphically and numerically. Each graphical result display shows the "noise figure" from a different perspective. In the default configuration, the application shows the "noise figure" of the DUT, the "gain" of the DUT and the corresponding "y-factor". In addition, it shows the numerical results of the measurement.

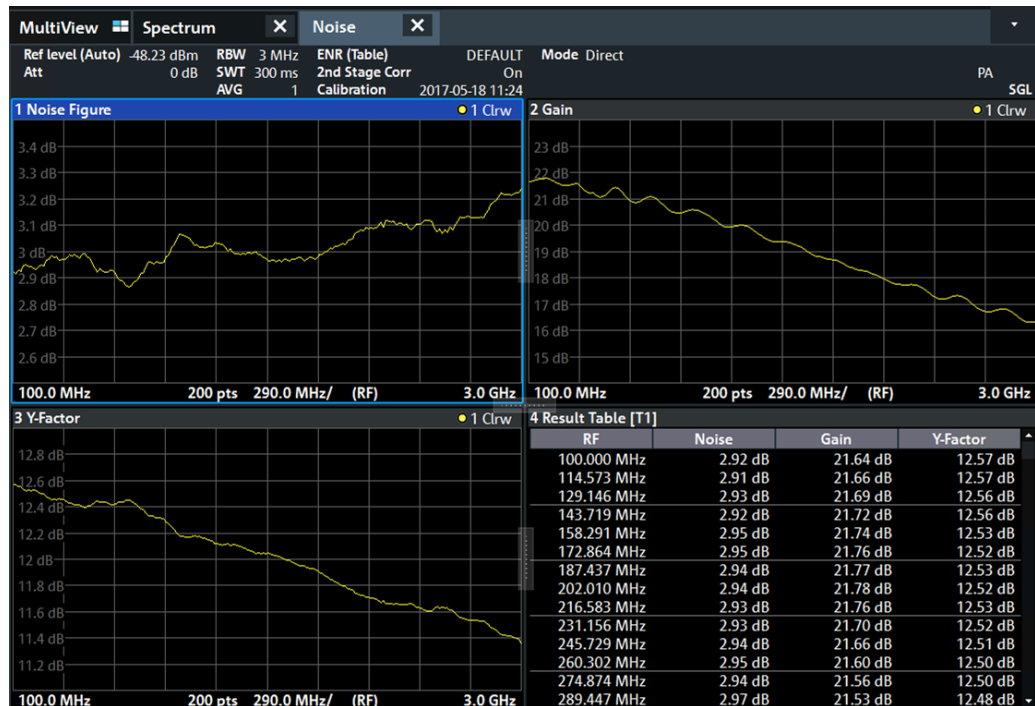

The scale of the horizontal axis depends on the tuning mode.

Frequency list and swept measurements

In all graphical result displays, the horizontal axis represents the frequency. The displayed frequency is either the RF (radio frequency) or the IF (intermediate frequency). The range depends on the frequency set you have currently defined. Because the application only measures selected frequencies, it connects the results to draw a trace.



Negative "noise figure" and "noise temperature"

From a physical point of view, the "noise figure" and the "noise temperature" levels have a positive range (including zero).

Due to the mathematical operations the application performs, the results can be negative. Sometimes this happens due to incorrect calibration or variance of measurement values.

Single frequency measurements

In all graphical result displays, the horizontal axis represents a chronological order of measurement results for the frequency you are testing. The axis has no unit, but is made up out of several index values that represent time. Each index value represents one measurement point and therefore one measurement on the single frequency you are analyzing. The size of the index (and thus number of results) depends on the number of **(Measurement) Points** that you have defined. Because the application only measures at certain points in time, it connects the results to draw a trace.

The right diagram border represents the present (index = 0), values to the left represent past measurement results (index = -<x>). As soon as the application finishes a single measurement, the measurement points are moved to the left, the new result is added on the right. All other measurement points are moved down one position with the most obsolete result falling out of the diagram (like in the roll mode of an oscilloscope).

Selecting the result display

- ▶ Select the  icon in the toolbar or press the [MEAS] key.

The application enters the SmartGrid configuration mode.

Noise Figure.....	18
Gain.....	19
Noise Temperature.....	19
Y-Factor.....	20
ENR Measured.....	21
Power (Hot).....	22
Power (Cold).....	22
Cal Y-Factor.....	23
Cal Power (Hot).....	23
Cal Power (Cold).....	24
Result Table.....	24
Current Values.....	25
Marker Table.....	25

Noise Figure

Shows the "noise figure" of the DUT.

The "noise figure" is the ratio of the signal-to-noise ratio at the DUT input to the signal-to-noise ratio at the DUT output.

$$\text{Noise Figure} = \frac{SNR_{in}}{SNR_{out}}$$

The vertical axis shows the level of the "noise figure" in dB. The scale depends on the settings in the "Display Configuration" dialog box.

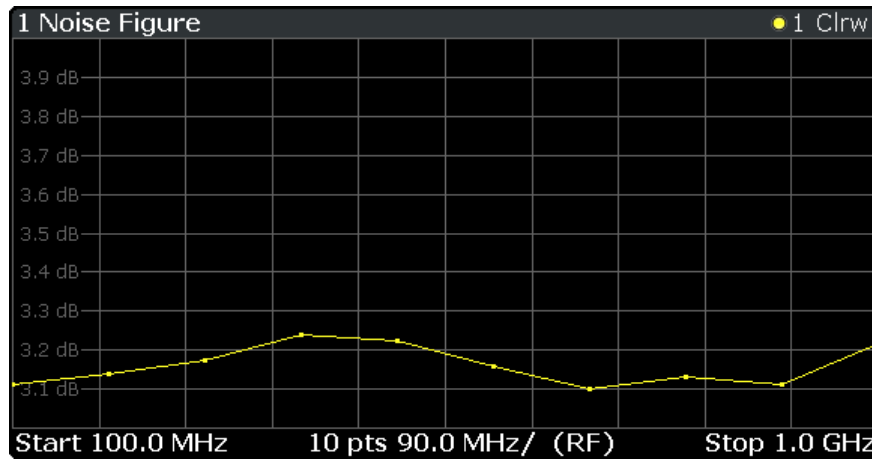

Remote command:

LAY:ADD:WIND? '2',RIGH,NOIS see [LAYout:ADD\[:WINDOW\]?](#) on page 117

Results:TRACe<t>[:DATA]? <Trace>,NOISe

Gain

Shows the "gain" characteristics of the DUT.

The vertical axis shows the level of the "gain" in dB. The scale depends on the settings in the "Display Configuration" dialog box.

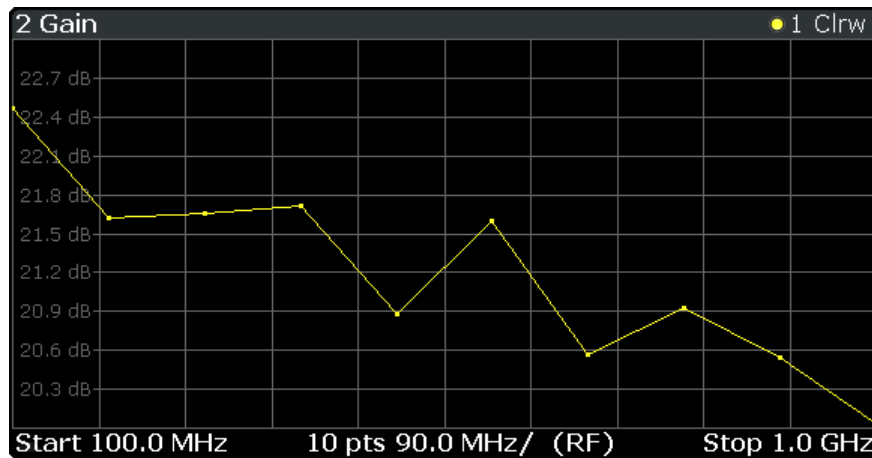

Remote command:

LAY:ADD:WIND? '2',RIGH,GAIN see [LAYout:ADD\[:WINDOW\]?](#) on page 117

Results:TRACe<t>[:DATA]? <Trace>,GAIN

Noise Temperature

Shows the "noise temperature" characteristics of the DUT.

$$\text{Noise Temperature} = \frac{P}{B \cdot k}$$

with

P = Power

B = Bandwidth

k = Boltzmann constant

The vertical axis shows the "noise temperature" in Kelvin. The scale depends on the settings in the "Display Configuration" dialog box.

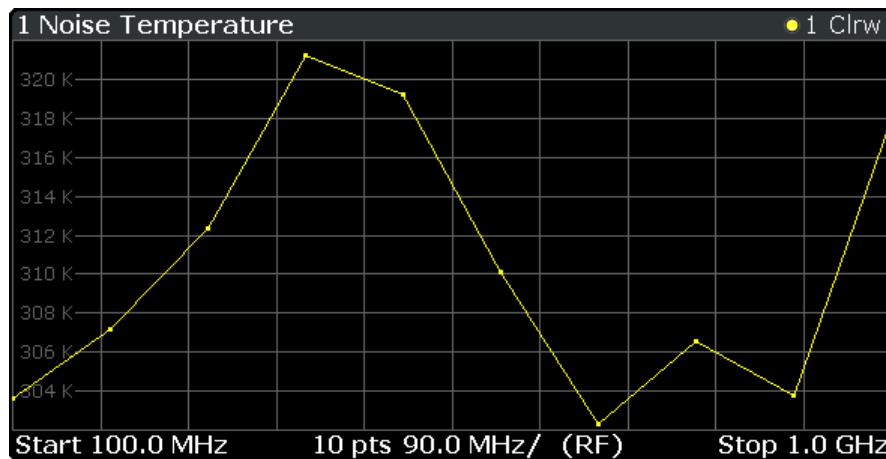

Remote command:

LAY:ADD:WIND? '2', RIGH, TEMP see [LAYout:ADD\[:WINDow\]?](#) on page 117

Results: [TRACe<t>\[:DATA\]?](#) <Trace>, TEMPerature

Y-Factor

Shows the ratio of the hot and the cold power of the DUT.

The "Y-factor" indicates the quality of measurement tolerances and uncertainties. To get the result, the application measures the DUT power with the noise source turned on (hot power) and the noise source turned off (cold power).

$$\text{Y-Factor} = \frac{N_{on}}{N_{off}}$$

with

N_{on} = Noise power [dB] with noise source on

N_{off} = Noise power [dB] with noise source off

The vertical axis shows the linear relation. The scale depends on the settings in the "Display Configuration" dialog box.

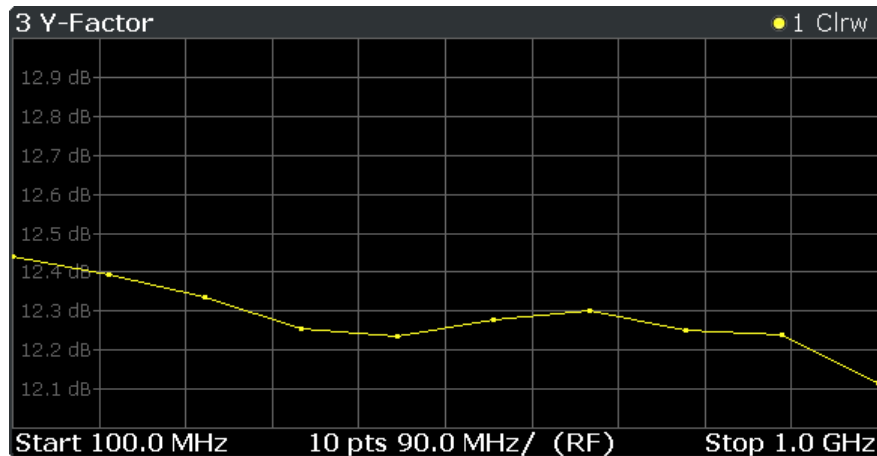

Remote command:

LAY:ADD:WIND? '2',RIGH,YFAC see [LAYout:ADD\[:WINDow\]?](#) on page 117

Results: [TRACe<t>\[:DATA\]?](#) <Trace>,YFACTOR

ENR Measured

Shows the results of the ENR measurement.

To measure the ENR of a noise source, first attach a noise source with known ENR to the device, enter the ENR of this noise source to the calibration ENR table and calibrate using this one. Then, attach the unknown noise source to the device and perform a measurement ("Run Single") with this one. The graph shown in the ENR Measured display and the results for ENR Measured in the Result Summary will be the ENR of the noise source at the measured frequencies. The vertical axis shows the level of the measured ENR in dB. The scale depends on the settings in the "Display Configuration" dialog box.

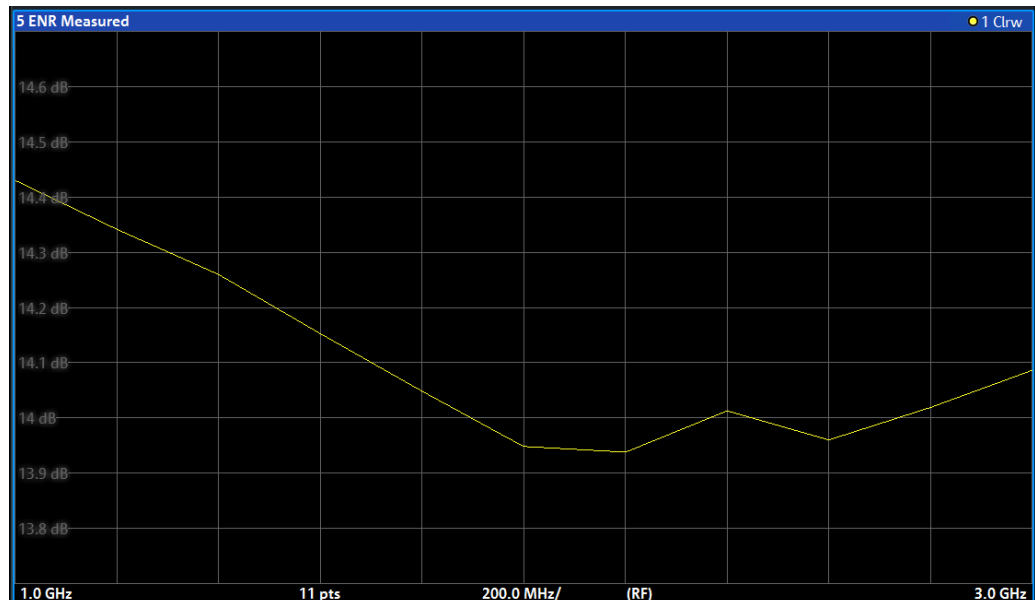

Remote command:

LAY:ADD:WIND? '2',RIGH,ENR see LAYout:ADD[:WINDow]? on page 117

Results: TRACe<t>[:DATA]? <Trace>,ENR

Power (Hot)

Shows the absolute power characteristics at the instrument input. The noise source is turned on.

The vertical axis shows the power in dBm. The scale depends on the settings in the "Display Configuration" dialog box.

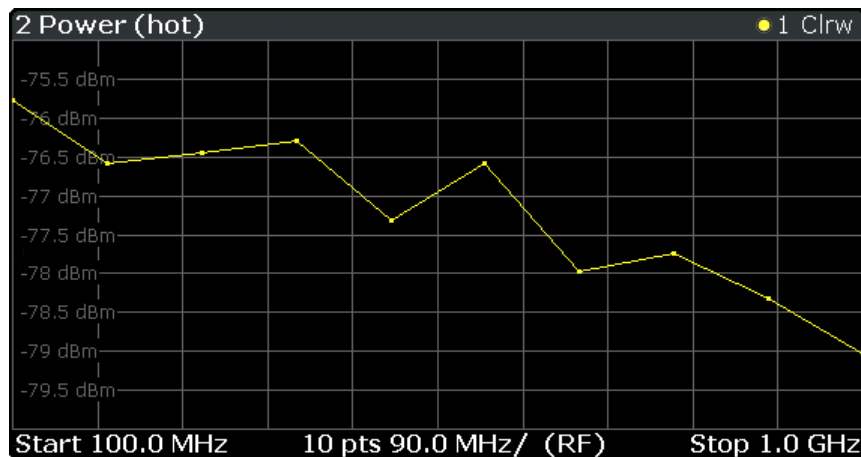

Remote command:

LAY:ADD:WIND? '2',RIGH,PHOT see LAYout:ADD[:WINDow]? on page 117

Results: TRACe<t>[:DATA]? <Trace>,PHOT

Power (Cold)

Shows the absolute power characteristics at the instrument input. The noise source is turned off.

The vertical axis shows the power in dBm. The scale depends on the settings in the "Display Configuration" dialog box.

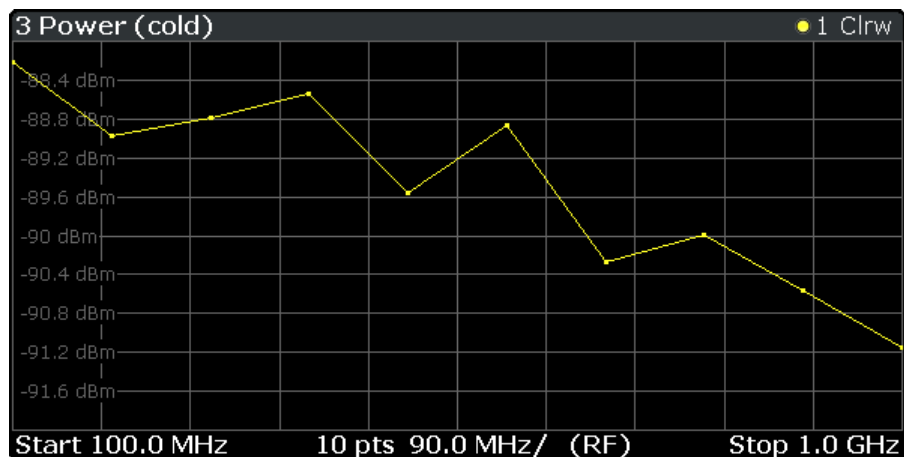

Remote command:

LAY:ADD:WIND? '2',RIGH,PCOL see LAYout:ADD[:WINDow]? on page 117

Results: TRACe<t>[:DATA]? <Trace>,PCOLd

Cal Y-Factor

Shows the ratio of the hot and the cold power measured during calibration.

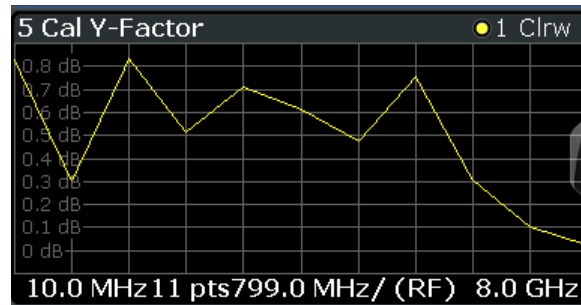

The "Y-factor" indicates the quality of measurement tolerances and uncertainties. To get the result, the application measures the power with the noise source turned on (hot power) and the noise source turned off (cold power), but without the DUT inserted.

$$Y\text{-Factor} = \frac{N_{on}}{N_{off}}$$

with

N_{on} = Noise power [dB] with noise source on

N_{off} = Noise power [dB] with noise source off

The vertical axis shows the linear relation. The scale depends on the settings in the "Display Configuration" dialog box.

Remote command:

LAY:ADD:WIND? '2',RIGH,CYF see LAYout:ADD[:WINDow]? on page 117

Results: TRACe<t>[:DATA]? <Trace>,CYFactor

Cal Power (Hot)

Shows the absolute power characteristics at the instrument input during the calibration measurement. The noise source is turned on, the DUT is not inserted.

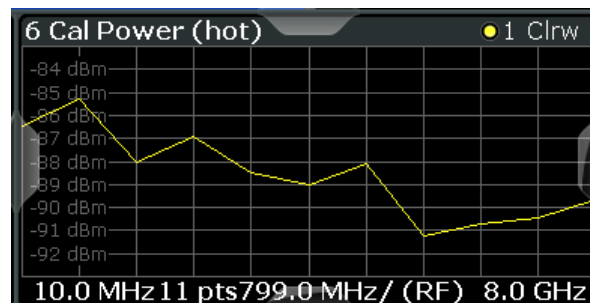

The vertical axis shows the power in dBm. The scale depends on the settings in the "Display Configuration" dialog box.

Remote command:

LAY:ADD:WIND? ' 2 ', RIGH, CPH see LAYout:ADD[:WINDow] ? on page 117

Results: TRACe<t>[:DATA] ? <Trace>, CPHot

Cal Power (Cold)

Shows the absolute power characteristics at the instrument input during the calibration measurement. The noise source is turned off, the DUT is not inserted.

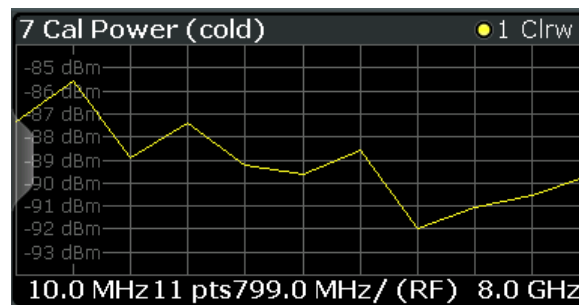

The vertical axis shows the power in dBm. The scale depends on the settings in the "Display Configuration" dialog box.

Remote command:

LAY:ADD:WIND? ' 2 ', RIGH, CPC see LAYout:ADD[:WINDow] ? on page 117

Results: TRACe<t>[:DATA] ? <Trace>, CPCold

Result Table

Shows the measurement results in numerical form in a table.

The contents of the table depend on the "Display Settings". By default it shows the "noise figure", "gain" and "y-factor" results. Each row represents one measurement point. Each column represents one result type. The first column shows the measurement frequency.

If you display the uncertainty result, it is displayed in the "Noise" column next to the "Noise Figure" result. Note that the uncertainty is displayed only after you have turned on the uncertainty calculation and also include the result in the display.

The result table shows either the RF or the IF, depending on your selection.

For more information, see [Chapter 6.1.2, "Configuring numerical results"](#), on page 93.

RF	Noise	Gain	Y-Factor	ENR
1.000 GHz	0.02 dB	-0.02 dB	10.18 dB	14.43 dB
1.200 GHz	-0.00 dB	-0.01 dB	9.96 dB	14.34 dB
1.400 GHz	-0.03 dB	0.01 dB	9.67 dB	14.26 dB
1.600 GHz	0.00 dB	0.01 dB	9.38 dB	14.15 dB
1.800 GHz	-0.10 dB	-0.03 dB	9.31 dB	14.05 dB
2.000 GHz	-0.02 dB	0.01 dB	9.03 dB	13.95 dB
2.200 GHz	0.11 dB	0.01 dB	8.93 dB	13.94 dB
2.400 GHz	-0.03 dB	0.03 dB	8.83 dB	14.01 dB
2.600 GHz	0.11 dB	-0.02 dB	8.67 dB	13.96 dB
2.800 GHz	0.02 dB	-0.00 dB	8.61 dB	14.02 dB
3.000 GHz	-0.08 dB	0.02 dB	8.44 dB	14.09 dB

Remote command:

LAY:ADD:WIND? ' 2 ', RIGH, RES see LAYout:ADD[:WINDow] ? on page 117

Results: TRACe<n>[:DATA] ? on page 124

Table items: DISPlay[:WINDow<n>]:TABLE:ITEM on page 194

Current Values

Shows the result at the current measurement point.

The contents of the "Current" result display are updated as soon as a new measurement point is analyzed.

The result types shown in the table depend on the "Display Settings". By default it shows the results for the "Noise Figure", "Gain" and "Y-Factor" result type. Each row represents one result type. The first column shows the result type, the second column shows the result.

For more information, see [Chapter 6.1.2, "Configuring numerical results"](#), on page 93.

Marker Table

Shows the marker characteristics in numerical form in a table.

The size of the table depends on the number of active markers and the way you have configured the table in the "Result Config" dialog box. For more information, see [Chapter 6.3, "Using markers"](#), on page 97 and [Chapter 6.1.2, "Configuring numerical results"](#), on page 93.

Type	Ref	Trc	Stimulus	Noise	Gain
N1		1	400.00 MHz	3.24 dB	21.72 dB
D2	N1	1	100.00 MHz	-0.01 dB	-0.84 dB
D3	N1	1	200.00 MHz	-0.08 dB	-0.12 dB

The first four columns of the table are fixed.

- **Type**
Shows the marker type. 'M' represents a normal marker, 'D' represents a delta marker.
- **Ref**
Shows the reference marker for relative delta markers.
- **Trc**
Shows the trace that the marker is positioned on.
- **X-value**
Shows the horizontal position (frequency) of the marker.
For normal markers, the position is an absolute value. The position of delta markers is relative to another marker.
- **<Result>**
Shows the measurement result at the marker position.
For normal markers, the result is an absolute value. Results for delta markers are relative to another marker.

Remote command:

LAY:ADD:WIND? '2', RIGH, MTAB see [LAYout:ADD\[:WINDow\]?](#) on page 117

Results:

[CALCulate<n>:MARKer<m>:Y?](#) on page 213

[CALCulate<n>:DELTamarker<m>:Y?](#) on page 216

4 Measurement basics

The measurement basics contain background information on the terminology and principles of "noise figure" measurements.

"Noise figure" measurements determine the noise that a device under test (DUT) adds to a signal as that signal passes through the DUT.

- [Tuning modes](#)..... 26
- [Measurement modes](#)..... 28
- [DUT types](#)..... 30
- [External generator control](#)..... 31
- [Image frequency rejection](#)..... 33
- [Calibration \(2nd stage correction\)](#)..... 35
- [Separating signals by selecting an appropriate resolution bandwidth](#)..... 38
- [Analyzing several traces - trace mode](#)..... 39
- [Using markers](#)..... 40

4.1 Tuning modes

Basically, the application calculates the "noise figure" of a DUT based on the characteristics of the DUT that have been measured and a noise source whose properties are known. Therefore, the Noise Source Control connector on the R&S FSWP is a prerequisite for the noise measurement application.

In addition to the noise characteristics of a DUT, the application is also able to determine several more DUT characteristics like its "gain" or its "noise temperature" characteristics.

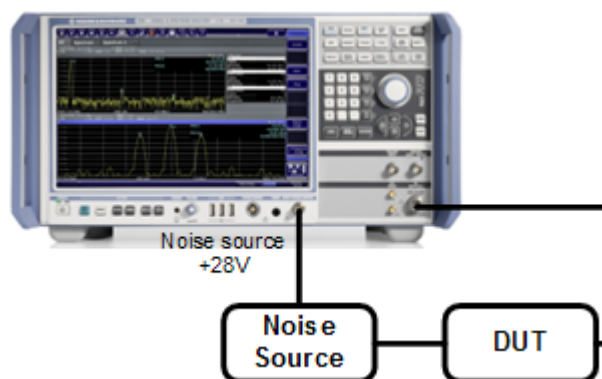

The application provides several measurement modes or **tuning modes**.

- [Swept measurements](#)..... 27
- [Frequency table measurements](#)..... 27
- [Single frequency measurements](#)..... 27

4.1.1 Swept measurements

The **sweep** tuning mode performs measurements on a set of discrete frequencies based on the frequency parameters. Each measurement analyzes the noise characteristics of the corresponding frequency or measurement point.

For swept measurements, the application automatically determines the measurement frequencies and combines them in a frequency list.

Such a frequency set is the result of the frequency and span information that you have provided. The frequency and span information is made up out of the center frequency, the span, the start and the stop frequency. In combination with the measurement points or the frequency table step size, the application calculates the contents of the frequency table.

The **center frequency** is the frequency in the center of the frequency band you are measuring. Thus, it is defined either by the span, or the start and stop frequencies.

The **measurement points** is the number of entries in a frequency list and thus the number of measurements that the application performs during a "noise figure" measurement.

The **stepsize** defines the distance between two measurement points. It is constant for all measurement points.



If the stepsize is larger than the distance between start and stop frequency, the frequency table consists of the start and stop frequencies only.

4.1.2 Frequency table measurements

The **frequency table** tuning mode also performs measurements on a set of frequencies based on the contents of a frequency list. Each measurement analyzes the noise characteristics of the corresponding frequency.

Compared to a swept measurement, you can customize the contents of the frequency list. Thus, you can add frequencies that are independent of the frequency stepsize and the number of measurement points.

Frequency tables also allow you to define a variable RBW and sweep time, depending on the current frequency of the sweep point (see ["Variable RBW and sweep time for low-frequency measurements"](#) on page 39 and [Chapter 5.2.3, "Using a frequency table"](#), on page 49).

4.1.3 Single frequency measurements

The **single frequency** tuning mode performs one or several consecutive measurements on a single frequency. You can perform the measurement on any frequency that is supported by the hardware you are using.

Single frequency measurements are a way to facilitate manual adjustments for "noise figure" measurements. They also allow you to get an idea about how the "noise figure" at a particular frequency change over time.

Note that sweep lists or frequency tables are not considered in this measurement mode.

Single frequency measurement results

For single frequency measurements, the same set of graphical result displays is available as for frequency list measurements ("Noise Figure", "Gain" etc.). Note, however, that the x-axis has no unit, but shows a series of results taken for a single frequency. The number of displayed results depends on the number of measurement points you have defined.

For more information, see [Chapter 3, "Measurements and result displays"](#), on page 17.

In addition, you can also view the results in the Result Table in numerical form.

Single frequency measurements are not available when you are using a resistor as a noise source.

4.2 Measurement modes

In some cases, the Power (Hot) and Power (Cold) results require two different noise sources with different temperature characteristics (cold and hot). Measurements with a resistor noise source are such a case.

Usually, noise sources with diode characteristics are used for "Noise Figure" measurements. These noise sources have two states, on and off. When they are supplied with power (state = on), the application measures the hot power, when they are not supplied with power (state = off), it measures the cold power. Turning the noise source on and off is automatically done by the application, so that you can get the hot and cold power characteristics in a single step.

This **automatic measurement mode** is the default measurement mode of the noise measurement application.

A resistor noise source, however, requires two resistors, one hot and one cold. You have to substitute the hot resistor by the cold resistor to measure first the hot and then the cold power. For these cases, the application provides a **manual measurement mode**. This measurement mode is automatically selected when you select a ["Noise Source"](#) on page 55 with resistor characteristics, but is not restricted to those cases.

The manual measurement mode is available for measurements and the calibration stage.

Performing a manual measurement

In manual measurement mode, you have to measure (or calibrate) the hot and cold power characteristics of the DUT separately. When you start the measurement, the application opens a dialog box that allows you to select the type of measurement to perform next.

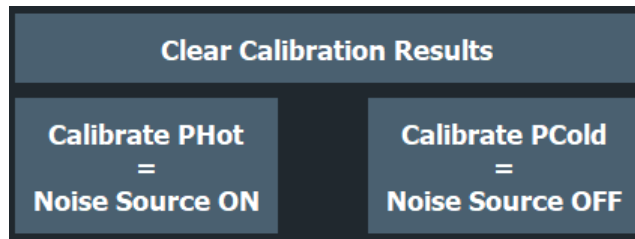

Recommended order of measurements

Note that it is recommended that you begin with the hot power measurement.

Furthermore, calibration always begins with the hot power measurement.

In case the hot power has to be measured first, the cold power measurement is unavailable:

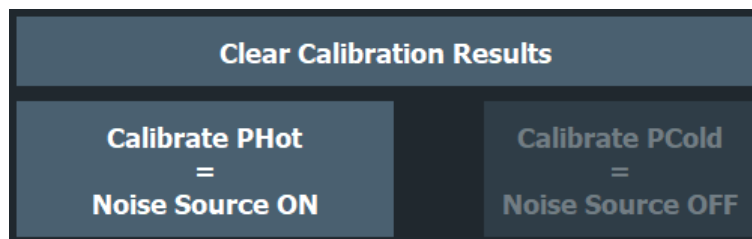

When the first measurement is done, you can change the test setup by connecting the other resistor. Then start the second measurement.

In the dialog box, the measurement stage that is already done is labeled green.

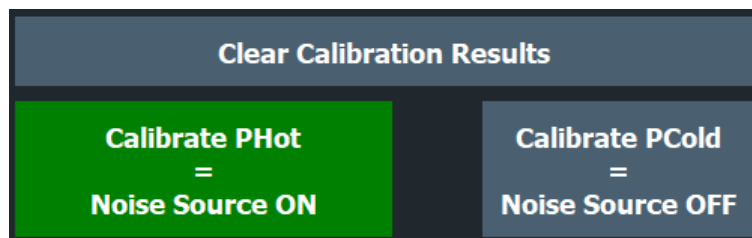

In addition, the application shows the missing calibration and measurement steps in the channel bar.

Noise		X	
ENR (THot, TCold)	296.50 K, 77.00 K	Mode	Direct
2nd Stage Corr	On (No Cal)		
Calibration	PCold required	Meas	PHot & PCold required

Clearing results

To replace the previous calibration or measurement results, clear the currently stored data using the "Clear Calibration Results" or "Clear Measurement Results" function.



Returning to automatic measurement mode

When you are in automatic measurement mode and select a noise source with resistor characteristics, the application automatically selects the manual measurement mode.

When you are in manual measurement mode and select a noise source with diode characteristics, you have to select the automatic measurement mode deliberately in the "Sweep" menu.

4.3 DUT types

"Noise figure" measurements are possible on DUTs with a wide variety of characteristics. The DUT characteristics not only affect the test setup, but also determine the way the application populates the frequency list for swept measurements.

The noise measurement application supports measurements on DUTs that work on a fixed frequency as well as measurements on frequency-converting DUTs.

- [Measurements on linear DUTs \(direct measurement\)](#).....30
- [Measurements on frequency converting DUTs](#)..... 30

4.3.1 Measurements on linear DUTs (direct measurement)

For a linear DUT, the RF frequency remains the same between its input and output. For measurements on such DUTs, it is sufficient to measure the signal's RF frequency without any additional equipment (like a local oscillator). A typical linear DUT is an amplifier, for example.

The test setup for measurements on such DUTs usually consists of the noise source, the DUT and an analyzer. If necessary, the measurement also considers loss that occurs somewhere in the measurement path.

For linear DUTs, the contents and layout of the "Overview" dialog box represents the configuration of a typical test setup.



4.3.2 Measurements on frequency converting DUTs

A frequency converting DUT converts the RF frequency to an intermediate frequency (IF) using the local oscillator (LO). A frequency-converting DUT either converts the RF frequency to a lower IF (down-conversion) or a higher IF (up-conversion).

The conversion process requires a local oscillator in the test setup. You can generate the LO signal in two ways.

- An external generator controlled by the analyzer via IEC bus.
- A VCO controlled by a voltage source.

If you have selected a frequency-converting DUT measurement mode, the layout of the "Overview" dialog box adds the local oscillator to the test setup.

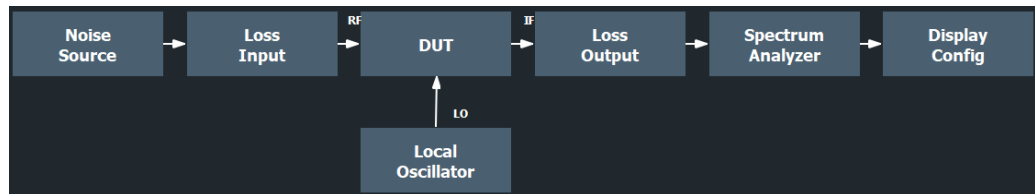

The local oscillator can have a fixed or a variable frequency. If the LO frequency is fixed, the intermediate frequency (IF) resulting from the conversion process is variable (depending on the input signal). If the LO frequency is variable, the IF has to be fixed.

The noise measurement application provides measurement for both measurement scenarios.

Fixed intermediate frequency

If you select one of the fixed IF measurement modes, the IF is the same for all entries in the frequency list. The LO frequency for each entry is variable and is the result of the equation the selected mode is based on.

- $f_{RF} - f_{IF}$ for up-converters
- $f_{RF} + f_{IF}$ for down-converters

The fixed IF measurement modes are, for example, useful for measurements on mixers.

Note that fixed IF measurements are only possible if the R&S FSWP is equipped with the optional External Generator Control hardware. For more information, see [Chapter 4.4, "External generator control"](#), on page 31.

Fixed LO frequency

If you select one of the fixed LO measurement modes, the LO frequency is the same for all entries in the frequency list. The IF frequency for each entry is variable and is the result of the equation the selected mode is based on.

- $f_{RF} + f_{LO}$ for up-converters
- $f_{RF} - f_{LO}$ for down-converters

The fixed LO measurement modes are, for example, required for measurements on satellite converters.

4.4 External generator control

To perform fixed IF measurements with the noise measurement application, you have to install the optional External Generator Control hardware. This option allows you to control an external generator and the type of signal it generates.

The typical measurement setup for such measurements includes the R&S FSWP equipped with the optional noise measurement application, a signal generator and the DUT. The signal generator is controlled either via the LAN connection or the GPIB interface. The GPIB interface is part of the optional External Generator Control hardware.

To enhance the measurement accuracy, it is recommended to use a common reference frequency for both R&S FSWP and signal generator in the measurement setup.

If you have no 10 MHz reference frequency on hand, you can use the internal reference signal of the R&S FSWP or signal generator. For more information, see the documentation of the R&S FSWP or the signal generator.

Signal generator support

The R&S FSWP-B10 supports various signal generators. A list is available in the user interface (see [Generator Type](#)) and in the documentation of the R&S FSWP.

Note that you have to select the generator specifically for the noise measurement application. It does not inherit the generator settings from other applications.

It is also possible to add new signal generators to that list. To do so, you have to copy a custom signal generator setup file with the file extension `.gen` to the R&S FSWP. The setup file defines the frequency and power ranges supported by the generator, as well as information required for communication. You can use a setup file of the signal generators already supported as a template. After you copy it to the R&S FSWP, the new generator model is added to the dropdown menu.

The existing setup files can be displayed in an editor in read-only mode directly from the [Interface Configuration](#) dialog box.

Make sure to adhere to the required syntax and commands and only change the values of the parameters. Errors are only detected and displayed when you try to use the custom generator.

Error and status messages

The following status and error messages can occur during external generator control.

Message	Description
"Ext. Generator GPIB Handshake Error!" / "Ext. Generator TCPIP Handshake Error!" / "Ext. Generator TTL Handshake Error!"	Connection to the generator is not possible, e.g. due to a cable damage or loose connection or wrong address.
"Ext. Generator Limits Exceeded!"	The allowed frequency or power ranges for the generator were exceeded.
"Reverse Sweep via min. Ext. Generator Frequency!"	Reverse sweep is performed; frequencies are reduced to the minimum frequency, then increased again.
"Ext. Generator File Syntax Error!"	Syntax error in the generator setup file.
"Ext. Generator Command Error!"	Missing or wrong command in the generator setup file.
"Ext. Generator Visa Error!!"	Error with Visa driver provided with installation (very unlikely).

NOTICE**Risk of damage to the instrument**

To allow for highest sensitivity during the measurement, the noise measurement application automatically sets the input attenuation to 0 dB.

Because this configuration minimizes the overrange reserve, make sure that the signal you apply does not cause an overload condition. In particular, consider the LO feedthrough. An overload condition can damage or destroy the input mixer.

The R&S FSWP shows a corresponding message in the status line if an overload occurs ("RF OVLD" or "IF OVLD").

To avoid an overload, do one of the following:

- Reduce the LO feedthrough of the mixer device.
- Increase the reference level.

4.5 Image frequency rejection

Frequency converting DUTs convert a radio frequency (RF) to an intermediate frequency (IF). The IF is lower than the RF for down-converting DUTs, and higher than the RF for up-converting DUTs.

In a basic test setup, the image frequency of the RF signal is also converted to the IF. Depending on the DUT, this effect can be wanted or even necessary, or not. To avoid measurement errors of the "noise figure" and "gain" of up to 3 dB, make sure to use the appropriate measurement configuration.

Basically, you can distinguish between single sideband (SSB) mixers, double sideband (DSB) mixers, and mixers that partly suppress a sideband. If a sideband is not needed or only partly needed, you can reject the image frequency. If you do so, the application activates a filter that suppresses the image frequency to a certain extent.

The following illustrations help you configure the measurement correctly.

For more information on how to configure image rejection, see ["Image Rejection"](#) on page 53.

Double sideband measurements

Double sideband mixers use both sidebands to the same extent. Both RF and image frequency are converted. In that case, turn off image rejection.

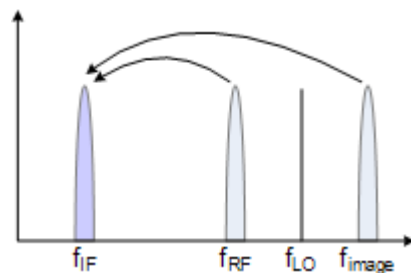

f_{LO} = frequency of the local oscillator
 f_{IF} = intermediate frequency = $f_{RF} \pm f_{LO}$
 f_{RF} = lower sideband = $f_{LO} - f_{IF}$
 f_{image} = upper sideband = $f_{LO} + f_{IF}$

If image rejection is on, the results have a 3 dB error. That means "noise figure" results are 3 dB lower than they should be. "Gain" results are 3 dB higher.

Single sideband measurements

Single sideband mixers use a single sideband only. In that case, you have to suppress the sideband that is not required. If you do so, the measurement is like on an amplifier.

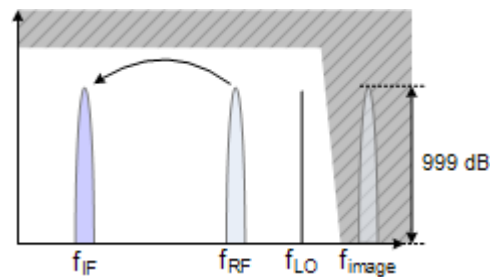

To suppress a sideband completely, it is best to set the image rejection to the maximum amount possible (999.99 dB).

Partial sideband suppression

For measurements on mixers with a low image frequency rejection, there are two test scenarios.

- Mixers whose image rejection is known.
- Mixers whose image rejection is unknown.

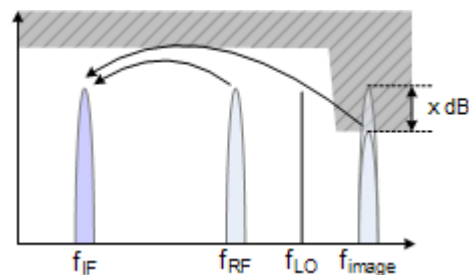

For mixers whose image rejection is known, define the magnitude of image rejection in dB as accurately as possible. Otherwise, measurement results ("noise figure" and "gain") deviate between 0 dB to 3 dB.

If you do not know the image rejection characteristics of a mixer, use a custom test setup including an additional filter. You also have to know the "gain" characteristics of the DUT.

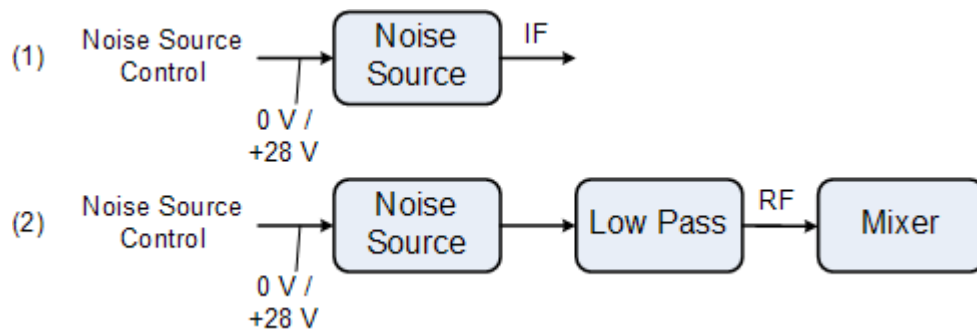

- (1) = Test setup for calibration
 (2) = Test setup for "noise figure" measurement

In the test setup shown above, a lowpass filter prevents unwanted noise from being fed in at the image frequency.

Depending on the position of the frequency bands, you might need a highpass or bandpass filter for the RF frequency instead of the lowpass filter. The important point is that unwanted noise is not converted by a further receive path of the mixer. The unwanted noise at the receive frequency must not be reduced. The insertion loss must be considered, if applicable.

With this test setup, the measurement on a mixer without sideband suppression is the same as SSB measurements.

To take the characteristics of the filter into account, include the insertion loss of the filter at the RF. To consider the actual filter suppression at the image frequency, include the actual attenuation for the image rejection.

Harmonics mixer measurement

For a harmonics mixer, the input signals are not only converted to the IF by the wanted harmonic. The harmonic of the LO signal produced in the mixer is also converted. Often, the mixer even features a lower conversion loss for unwanted harmonics. For measurements on this type of mixer, you have to use a bandpass filter. The filter ensures that there is only noise at the desired frequency at the input of the DUT. This measurement is similar to measurements on a mixer with an average sideband suppression.

4.6 Calibration (2nd stage correction)

The calibration procedure of the application measures the inherent noise of the R&S FSWP you are using. Performing calibration is therefore recommended, as it increases the accuracy of measurement results. The results get more accurate because the application takes the inherent noise of the analyzer into account while it calculates the results.

Calibration for "noise figure" measurements is also known as 2nd stage correction. This term is used because in a typical "noise figure" test setup, the DUT represents the first stage and the analyzer the second stage in the test setup.



The 2nd stage correction is a calibration that is specific to "noise figure" measurements. It is independent of the overall calibration state of the analyzer and does not calibrate the analyzer.

For successful calibration, you need additional equipment.

- Noise source
The noise source is like a calibration standard. It provides a reference with known noise characteristics that allows the application to determine the inherent noise of the analyzer you are using.

During the calibration, the application measures the inherent noise characteristics of the analyzer at the set of measurement frequencies.

Thus, the 2nd stage correction is valid for a particular instrument configuration, the room temperature and the instrument temperature. As long as this configuration stays the same, calibration data remains valid.



Calibrating single frequency measurements

Like for all other measurements of the noise measurement application, perform a calibration before a single frequency measurement for increased accuracy.

There is an easy way to calibrate single frequency measurements, if you already calibrated the application for swept or list measurements. If the single frequency is part of the frequency list, the measurement is already calibrated for that frequency and no further steps are necessary. The application recalls the last calibration values when you switch back to sweep mode or frequency table mode.

Only if you use a single frequency that is not part of the frequency list, you must calibrate this frequency point first.

- Interpolation
If you change the frequency, while the frequency span stays the same or is reduced, the application interpolates the correction data for the new measurement points. A new calibration is not required.
However, measurements based on interpolated data can result in an increased measurement uncertainty. Highly accurate measurements that conform to the values specified in the data sheet are only possible at calibrated measurement points.
Note that useful interpolation is possible only if essential calibration parameters (e.g. impedance or attenuation) change only slightly. This is the case if the distance between the original calibration points is sufficiently small.
If the span increases compared to the span during calibration, a new calibration is necessary.
If the application interpolates the calibration data, it shows a corresponding label in the channel bar and a warning message in the status bar.
- Invalid calibration
If you change one of the amplitude parameters (e.g. the attenuation), calibration is labeled invalid. In that case, calibration is not accurate, because the settings are not in line with the settings at the time the R&S FSWP has been calibrated. If cali-

bration is invalid, repeat the calibration or restore the settings as they were during the calibration.



Saving calibration data

If you save the current configuration or measurement results to a data set, calibration data is part of that data set.

For more information on saving and restoring data sets, see the "Storing and Recalling Instrument Settings and Measurement Data" chapter in the R&S FSWP user manual.

The picture below shows a typical calibration setup that includes a noise source.

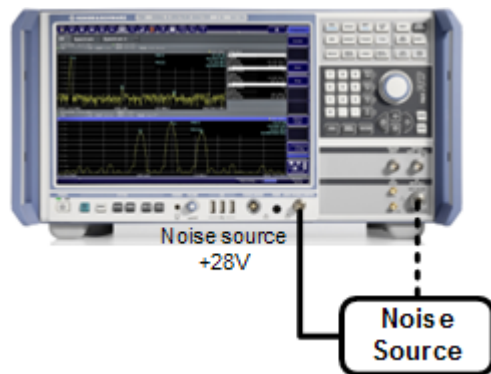

Figure 4-1: Noise figure calibration setup

1. Connect the noise source directly and without a cable to the RF input of the analyzer.
2. Connect the noise source to the +28 V voltage supply (Noise Source Control connector) on the back of the R&S FSWP.
To connect the noise source to the voltage supply, you need a coaxial cable.

After you have set up calibration, there are several ways to start calibration.

- In the "Noise Overview" dialog box, press the "Calibrate" button.
- In the "Sweep" menu, press the "Calibrate" softkey.

Calibration Save



If the user has performed a valid calibration on the instrument, the calibration results can be saved by using the "Calibration Save" button in the "Export" dialog. This provides the possibility to use once stored calibration results at a later point.

Remote command:

`[SENSe:]CORRection:SAVE` on page 149

Calibration Recall



Calibration results that have been stored once on the instrument can be recalled by using the "Calibration Recall" button in the "Import" dialog.

To achieve a valid calibration by importing a saved one, all parameters of R&S FSWP-K30 must match exactly to the ones that have been used for the calibration. At the import of a calibration, a preview dialog is shown which contains all relevant parameters of the calibration to be imported and an indication (green / red) if they match to the current instrument and option settings. Only if the calibration context summary is green, the calibration import can be done. If the calibration context summary is red, importing the calibration results would lead to an invalid calibration status for the current settings. Thus the calibration results cannot be imported in this case. If the calibration context summary is green but some of the individual entries are red (i.e. they differ from the current settings), the calibration results still can be imported. The import will then overwrite the red marked settings with the ones from the stored calibration to ensure the settings match.

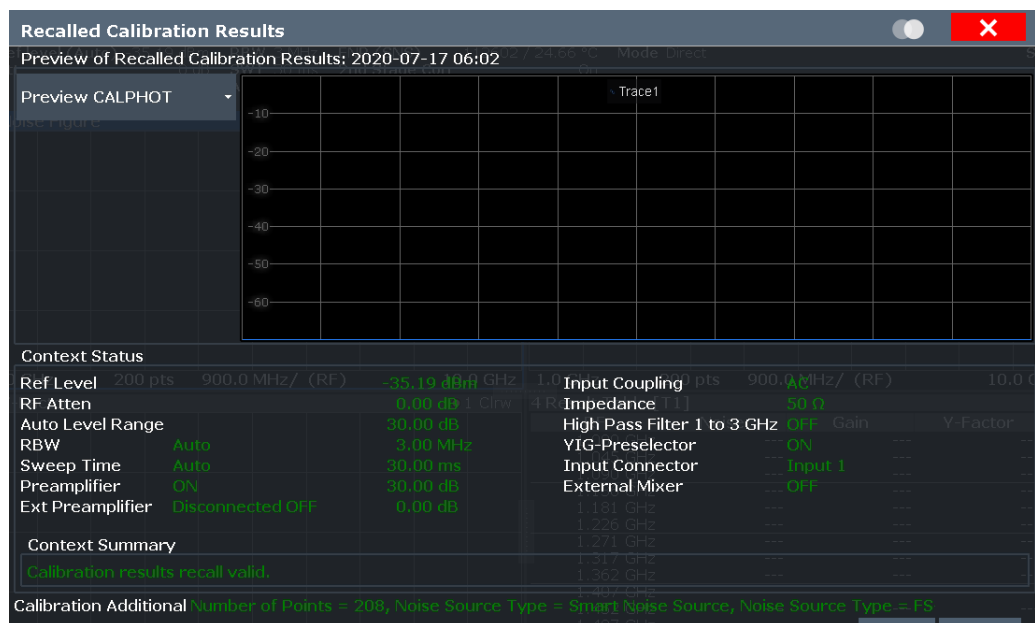

Remote command:

`[SENSe:]CORRection:RECall` on page 149

4.7 Separating signals by selecting an appropriate resolution bandwidth

The resolution bandwidth defines the 3 dB bandwidth of the resolution filter to be used. An RF sinusoidal signal is displayed according to the passband characteristic of the resolution filter (RBW), i.e. the signal display reflects the shape of the filter.

The highest sensitivity is obtained at the smallest bandwidth (1 Hz). If the bandwidth is increased, the reduction in sensitivity is proportional to the change in bandwidth. Increasing the bandwidth by a factor of 3 increases the displayed noise by approx. 5 dB (4.77 dB precisely). If the bandwidth is increased by a factor of 10, the displayed noise increases by a factor of 10, i.e. 10 dB.

The higher spectral resolution with smaller bandwidths is won by longer sweep times for the same span. The sweep time has to allow the resolution filters to settle during a sweep at all signal levels and frequencies to be displayed.

If the RBW is too large, signal parts that are very far away (e.g. from a different signal) are considered in the measurement and distort the results. The displayed noise increases.

If the RBW is too small, the measurement time increases.

Variable RBW and sweep time for low-frequency measurements

Usually, a constant RBW and sweep time is used for the entire measurement. However, for low-frequency measurements (under 10 MHz), smaller bandwidths and longer sweep times are required to improve accuracy of the results. Using a small RBW and long sweep time for the entire span would increase measurement time significantly. In this case, a variable RBW and sweep time can be defined for lower frequencies, depending on the current frequency of the sweep point. The variable RBW and sweep times are defined in the frequency table (see [Chapter 5.2.3, "Using a frequency table"](#), on page 49). The defined RBW and sweep times are also included in a table export. In the channel bar, the bandwidth and sweep time range of the variable values is indicated.

4.8 Analyzing several traces - trace mode

The trace mode determines the way the data is processed and displayed. The application provides the following trace modes.

Table 4-1: Overview of available trace modes

Trace Mode	Description
Blank	Hides the selected trace.
Clear Write	Overwrite mode: the trace is overwritten by each sweep. This is the default setting.
View	The current contents of the trace memory are frozen and displayed.



Each time the trace mode is changed, the selected trace memory is cleared.

The default trace mode for the first trace is Clear/Write. For trace 2-4, the default trace mode is "Blank". If you require another mode, you have to set it manually.

As you can have up to four traces simultaneously, you can compare the results with different measurement configurations. For example, freeze a trace and use it as a reference trace.

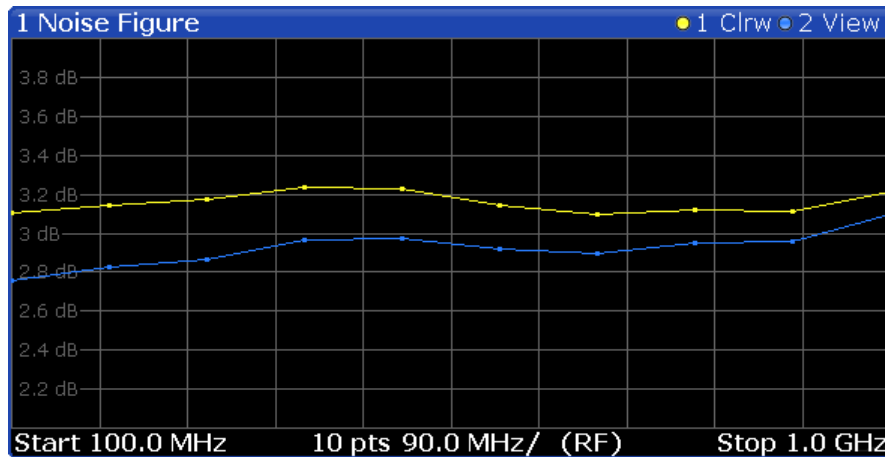

If you change the scaling of the y-axis, the R&S FSWP automatically adapts the trace data to the changed display range. Thus, you can perform an amplitude zoom after the measurement to show details of the trace.

4.9 Using markers

Markers are used to mark points on traces, to read out the results of a particular measurement point or compare results of different traces. The noise application provides four markers.

When you activate a marker, the application automatically positions it on the first measurement point (left border of the diagram) of trace 1, regardless of how many traces are active. A marker is always positioned on the same horizontal position in all active measurement windows. If you change the position of a marker in one window, the application adjusts the position of that marker in all other measurement windows. Thus, the marker results for a specific marker are always for the same frequency, which makes it easier to compare results.



Markers in single frequency mode

When you use a marker for single frequency measurements, the marker is positioned on a particular index value and not a particular measurement point. This means that during continuous measurements, the marker remains on the index value you have put it on. It does not move down the line with the results.

To move a marker, you can use several methods.

- Enter a particular measurement frequency in the input field that opens when you activate a marker.
- Move the marker around with the rotary knob or the cursor keys.
- Drag the marker around using the touchscreen.

All markers can be used either as normal markers or delta markers. A normal marker indicates the absolute signal value at the defined position in the diagram. A delta marker indicates the value of the marker relative to the specified reference marker (by default marker 1).

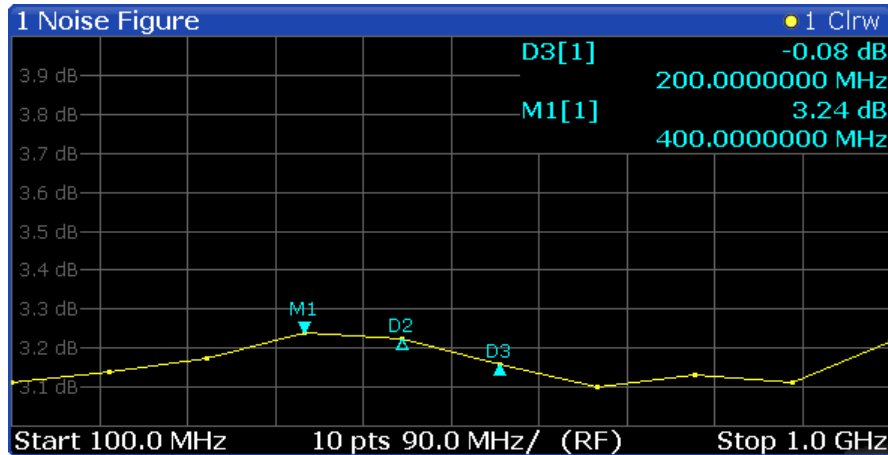

The application always positions the marker on the trace with the lowest number that is in Clear/Write trace mode. To set the marker on another trace, use the "Marker to Trace" function. With this function, you can also position a marker on a trace that is in "View" trace mode, e.g. to compare measurement results. Note that at least one active marker has to be a normal marker.

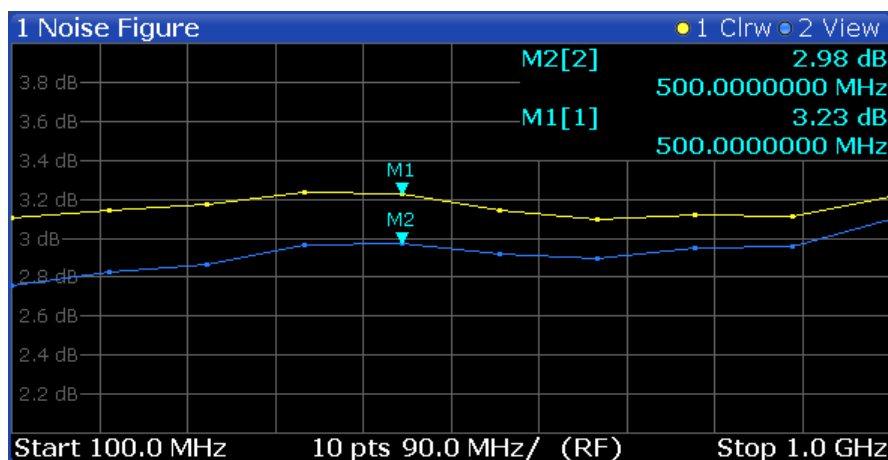

The application shows the results at the marker position directly in the diagram area (up to two markers) or in the marker table (if you use more than two markers).

Marker information in diagram area

By default, the results of the last two markers or delta markers that were activated are displayed in the diagram area.



The following information is displayed there:

- The marker type (M for normal, D for delta, or special function name)
- The marker number (1 to 4)
- The assigned trace number in square brackets []
- The marker value on the y-axis
- The marker position on the x-axis

Marker information in marker table

In addition to the marker information displayed within the diagram area, a marker table can be displayed in a separate window. For more information on the contents of the marker table, see "[Marker Table](#)" on page 25.

5 Configuration

"Noise figure" measurements require a special application on the R&S FSWP, which you activate using the [MODE] key.



The Noise Source Control connector on the R&S FSWP is also a prerequisite for the noise measurement application. Without this connector, no measurement can be performed.

When you activate a measurement channel in the noise measurement application, a measurement for the input signal is defined with the default configuration. The "Noise Figure" menu is displayed and provides access to the most important configuration functions.



Unavailable hardkeys

Note that the [AMPT], [AUTO SET], [BW], [TRIG] and [MKR FUNC] keys have no contents and no function in the noise measurement application.

• Configuration overview	43
• Defining the measurement frequency	45
• Selecting DUT characteristics	52
• Configuring the noise source	53
• Configuring additional loss	61
• Configuring the analyzer	66
• Using the uncertainty calculator	70
• Trigger and gate configuration	76
• Performing measurements	82
• Configuring inputs and outputs of the R&S FSWP	84

5.1 Configuration overview



Throughout the measurement channel configuration, an overview of the most important currently defined settings is provided in the "Overview". The "Overview" is displayed when you select the "Overview" icon, which is available at the bottom of all softkey menus.

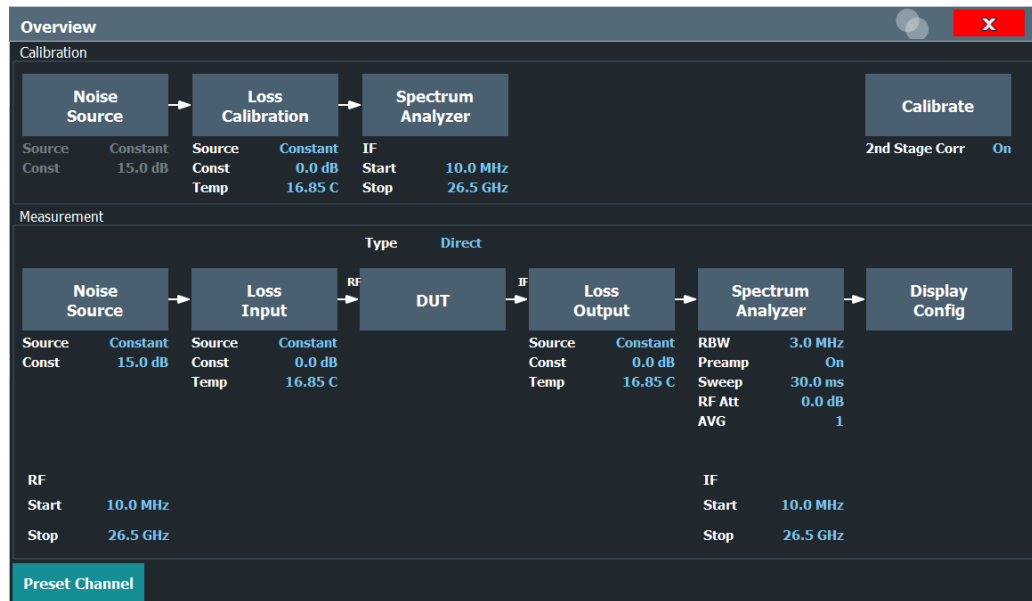

In addition to the main measurement settings, the "Overview" provides quick access to the main settings dialog boxes. The individual configuration steps are displayed in the order of the data flow. Thus, you can easily configure an entire measurement channel from input over processing to output and analysis by stepping through the dialog boxes as indicated in the "Overview".

In particular, the "Overview" provides quick access to the following configuration dialog boxes (listed in the recommended order of processing):

To perform a calibration

1. Noise Source
See [Chapter 5.4, "Configuring the noise source"](#), on page 53.
2. Spectrum Analyzer
See [Chapter 5.6, "Configuring the analyzer"](#), on page 66.
3. Calibration
See ["Calibrate"](#) on page 83

To perform a measurement

1. Noise Source
See [Chapter 5.4, "Configuring the noise source"](#), on page 53.
2. Input and output losses
See [Chapter 5.5, "Configuring additional loss"](#), on page 61.
3. DUT configuration
See [Chapter 5.3, "Selecting DUT characteristics"](#), on page 52
4. Spectrum Analyzer
See [Chapter 5.6, "Configuring the analyzer"](#), on page 66.
5. Display Configuration

See [Chapter 6.1, "Configuring the display"](#), on page 91

To configure settings

- ▶ Select any button in the "Overview" to open the corresponding dialog box.
Select a setting in the channel bar (at the top of the measurement channel tab) to change a specific setting.

Preset Channel

Select the "Preset Channel" button in the lower left-hand corner of the "Overview" to restore all measurement settings *in the current channel* to their default values.

Note: Do not confuse the "Preset Channel" button with the [Preset] key, which restores the entire instrument to its default values and thus closes *all channels* on the R&S FSWP (except for the default channel)!

Remote command:

`SYSTem:PRESet:CHANnel[:EXEC]` on page 116

Specific Settings for

The channel can contain several windows for different results. Thus, the settings indicated in the "Overview" and configured in the dialog boxes vary depending on the selected window.

Select an active window from the "Specific Settings for" selection list that is displayed in the "Overview" and in all window-specific configuration dialog boxes.

The "Overview" and dialog boxes are updated to indicate the settings for the selected window.

5.2 Defining the measurement frequency

- [Defining a frequency set](#)..... 45
- [Configuring single frequency measurements](#).....48
- [Using a frequency table](#)..... 49

5.2.1 Defining a frequency set

Access: "Overview" > "DUT" > "Frequency Config"

These settings define the frequency characteristics for the measurement.

The information in this tab is also the basis for an automatic population of the frequency table. All parameters of this dialog are interdependent. If you change one parameter, at least one other parameter is changed by the application.



If you change a frequency set, perform a new calibration to ensure accurate results.



Pre-amplifier

If a preamplifier is used, make sure the defined (and possibly upconverted) IF frequencies for the measurement stay below the maximum frequency the preamplifier supports. For the R&S FSWP-B22 option, the maximum frequency is 7 GHz. However, the preamplifier can be activated or deactivated individually for different tuning modes. For example, for a sweep mode which requires a span above 7 GHz it is deactivated, while for a single frequency measurement at 1 GHz it can be activated.

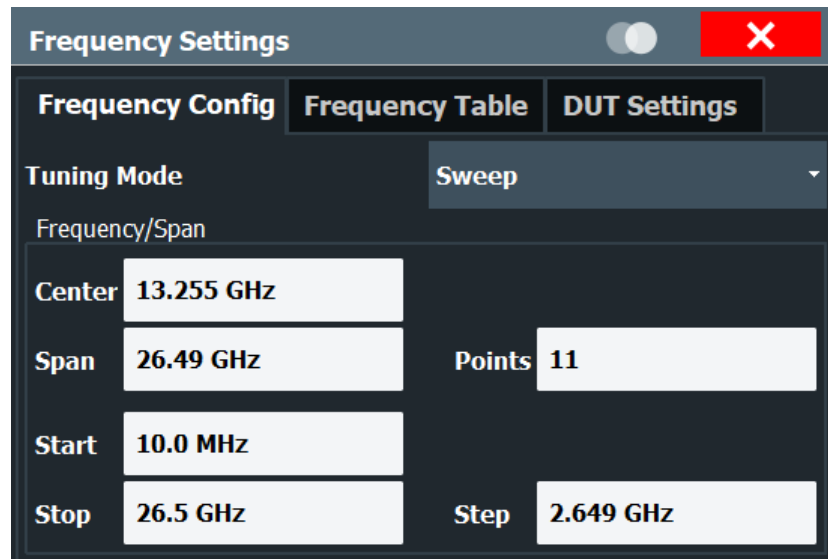

Tuning Mode.....	46
Center.....	47
Span.....	47
Start and Stop Frequency.....	47
(Measurement) Points.....	47
Step.....	48

Tuning Mode

Selects the tuning or measurement mode.

For more information, see [Chapter 4.1, "Tuning modes"](#), on page 26.

Tuning mode selection is also available via softkeys ("Sweep Mode", "Frequency Table Mode", "Single Frequency Mode") in the "Sweep" menu.

Note: A preamplifier can be activated or deactivated individually for different tuning modes. When you switch tuning modes, the defined preamplifier state is adapted.

"Sweep"	The measurement is based on an automatically generated frequency set.
"Frequency Table"	The measurement is based on a customized frequency table. For more information, see Chapter 5.2.3, "Using a frequency table" , on page 49.
"Single Frequency"	The measurement measures a single frequency only. For more information, see Chapter 5.2.2, "Configuring single frequency measurements" , on page 48.

Remote command:

Frequency sweep measurement:

[\[SENSe:\] CONFIGure:LIST:CONTinuous](#) on page 126

[\[SENSe:\] CONFIGure:LIST:SINGle](#) on page 127

[INITiate<n>\[:IMMediate\]](#) on page 174

Single frequency measurement:

[\[SENSe:\] CONFIGure:FREQuency:CONTinuous](#) on page 126

[\[SENSe:\] CONFIGure:FREQuency:SINGle](#) on page 126

[INITiate<n>\[:IMMediate\]](#) on page 174

Center

Defines the center of the measurement frequency range.

If you change the center frequency, the application changes the start and stop frequency according to the span you have set.

The "Center" setting is also available via the [FREQ] key.

Remote command:

Frequency list measurement:

[\[SENSe:\] FREQuency:CENTer](#) on page 127

Single frequency measurement:

[\[SENSe:\] FREQuency:SINGle](#) on page 128

Span

Defines the measurement span.

If you change the span, the application changes the start frequency, the stop frequency and the stepsize according to the center frequency and the measurement points.

The "Span" setting is also available via the [SPAN] key.

Remote command:

[\[SENSe:\] FREQuency:SPAN](#) on page 129

Start and Stop Frequency

Defines the start and stop frequencies.

If you change the start or stop frequency, the application changes the center frequency, the span and the measurement points according to the new values and the stepsize.

The "Start" and "Stop" settings are also available via the [FREQ] key.

Remote command:

Start frequency:

[\[SENSe:\] FREQuency:START](#) on page 129

Stop frequency:

[\[SENSe:\] FREQuency:STOP](#) on page 130

(Measurement) Points

Defines the measurement points.

For frequency list measurements, the number of measurement points corresponds to the number of entries in the frequency table. The number of points displayed in the graphical results is also the same.

If you change the measurement points, the application changes the stepsize according to the span.

The "Points" setting is also available via the [SPAN] key.

Remote command:

[SENSe:] FREQuency: POINTs on page 128

Step

Defines the frequency step size in the frequency table.

The stepsize corresponds to the distance between two consecutive measurement points.

If you change the stepsize, the application changes the measurement point according to the span.

The "Stepsize" setting is also available via the [FREQ] key.

Remote command:

[SENSe:] FREQuency: STEP on page 130

5.2.2 Configuring single frequency measurements

Access: "Overview" > "DUT" > "Frequency Config" > "Tuning Mode: Single Frequency"

These settings define the frequency characteristics for the measurement.



If you change the frequency, perform a new calibration to ensure accurate results.

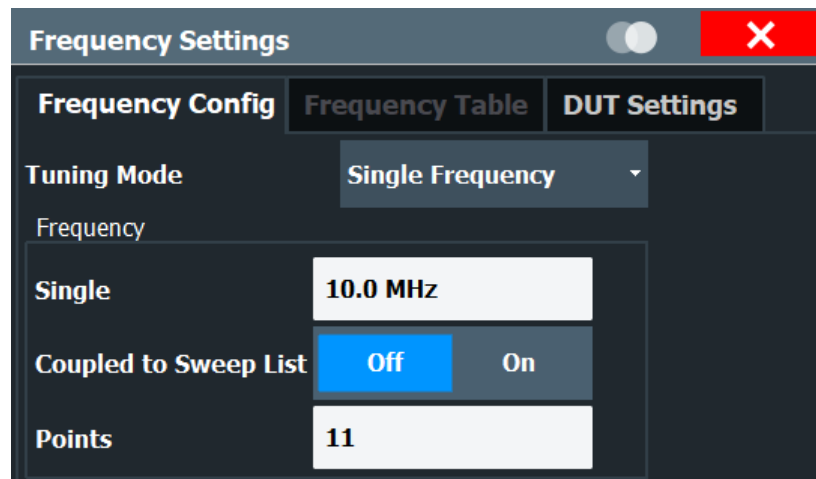

Single (Frequency).....	48
Coupled to Sweep List.....	49
(Measurement) Points.....	49

Single (Frequency)

Defines the frequency that the single frequency measurement is performed on.

The "Single" setting is also available via the [FREQ] key.

Remote command:

[\[SENSe:\]FREQuency:SINGle](#) on page 128

Coupled to Sweep List

Couples or decouples frequency selection to the contents of a sweep list.

If you couple the frequency to the sweep list, the application allows you to select only the frequencies currently part of the frequency list. If you enter another frequency, the application automatically selects the nearest frequency of the frequency list. If the frequency list has been calibrated previously, calibration remains valid for those frequencies when you change the tuning mode.

If you turn off the coupling, you can define any frequency for single frequency measurements. Note, however, that you have to calibrate the measurement for that frequency.

Remote command:

[\[SENSe:\]FREQuency:SINGle:COUPled](#) on page 129

(Measurement) Points

Defines the number of measurement points for single frequency measurements.

For single frequency measurements, the number of measurement points corresponds to the number of measurements (index values) performed on a single frequency.

For more information, see "[Single frequency measurements](#)" on page 18.

The "Points" setting is also available via the [SPAN] key.

Remote command:

[\[SENSe:\]FREQuency:POINTs](#) on page 128

5.2.3 Using a frequency table

Access: "Overview" > "DUT" > "Frequency Config" > "Frequency Table"

The "Frequency Table" tab in the "Frequency Settings" dialog box contains functionality to manage the measurement frequencies.

The application populates the table according to the information you entered in the "Frequency Config" tab when you select "Populate Table".

Note that changes to the frequency table take effect only if you select the "Frequency Table" tuning mode.

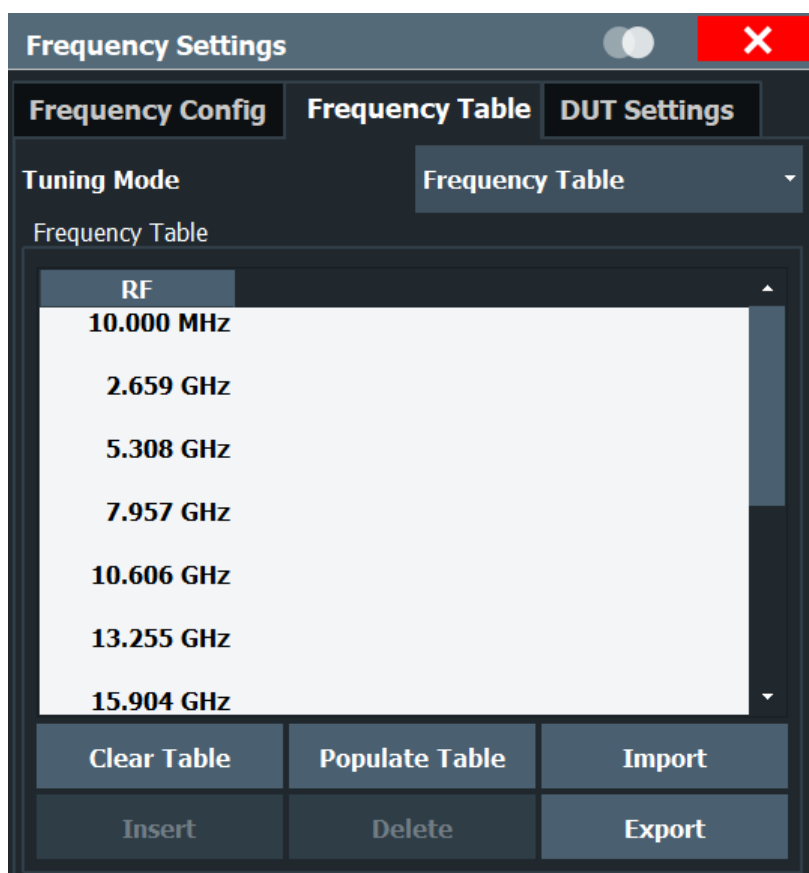

Frequency Table.....	50
Clear Table.....	51
Populate Table.....	51
Insert.....	51
Delete.....	51
Import / Export.....	51

Frequency Table

Shows the current measurement points.

The table is made up of one column that represents the measurement frequency. Each frequency corresponds to one measurement point. The length of the table is variable (up to a maximum of 10001 points).

When you perform measurements in "Sweep" or "Single Frequency" tuning mode, the contents of the table have no effect on the measurement.

When you select a table entry in "Frequency Table" tuning mode, you can edit it or add a new frequency below the selected frequency. A new frequency has to be higher than the last table entry and lower than the next table entry.

If the RBW and sweep time settings are set to "variable" in the measurement settings (see [Resolution Bandwidth \(RBW\)](#) and ["Sweep Time"](#) on page 67), you can also define those values in the frequency table.

Select [Populate Table](#) to predefine the RBW and sweep times to be used. For each sweep point with a frequency under 10 MHz in the table, suitable settings are defined. For higher frequencies, the values provided in the measurement settings are used (indicated by "--" as they are automatically updated if the measurement settings change.) All predefined values in the table can be overwritten manually.

The defined RBW and sweep times are also included in a table export.

See also "[Variable RBW and sweep time for low-frequency measurements](#)" on page 39.

Clear Table

Deletes the contents of the table.

Populate Table

Populates or restores the measurement frequencies based on the center frequency, the start and stop frequencies, the span, the stepsize and the number of measurement points.

If the RBW and sweep time settings are set to "variable" in the measurement settings (see [Resolution Bandwidth \(RBW\)](#) and "[Sweep Time](#)" on page 67), those values are also predefined. For each sweep point with a frequency under 10 MHz in the table, suitable settings are defined. For higher frequencies, the values provided in the measurement settings are used (indicated by "--" as they are automatically updated if the measurement settings change.) All predefined values in the table can be overwritten manually.

See also "[Variable RBW and sweep time for low-frequency measurements](#)" on page 39.

Remote command:

[\[SENSe:\] FREQuency: TABLE: DATA](#) on page 127

[\[SENSe:\] FREQuency: LIST: DATA](#) on page 128

RBW and sweep time set to variable: [\[SENSe:\] BANDwidth: LIST: DATA](#) on page 128

Insert

Inserts a new measurement point above the one you have selected.

Delete

Deletes the currently selected measurement point.

Import / Export

Opens a dialog box to select a frequency table to import or export.

An import copies the frequency table into the default frequency table directory. An export copies the table to a location outside the default frequency table directory, e.g. a memory stick. The file extension has to be *.freq.

If variable RBW and sweep times are enabled, they are also included in a table export (see "[Frequency Table](#)" on page 50).

For details on the required file format, see [Chapter A, "Reference: frequency table file format"](#), on page 231.

5.3 Selecting DUT characteristics

Access: "Overview" > "DUT" > "DUT Settings"

The "DUT" button opens a dialog box to configure the characteristics of the DUT you are testing. The dialog box contains a schematic overview of the DUT input and output characteristics and the way it is integrated into the test setup.

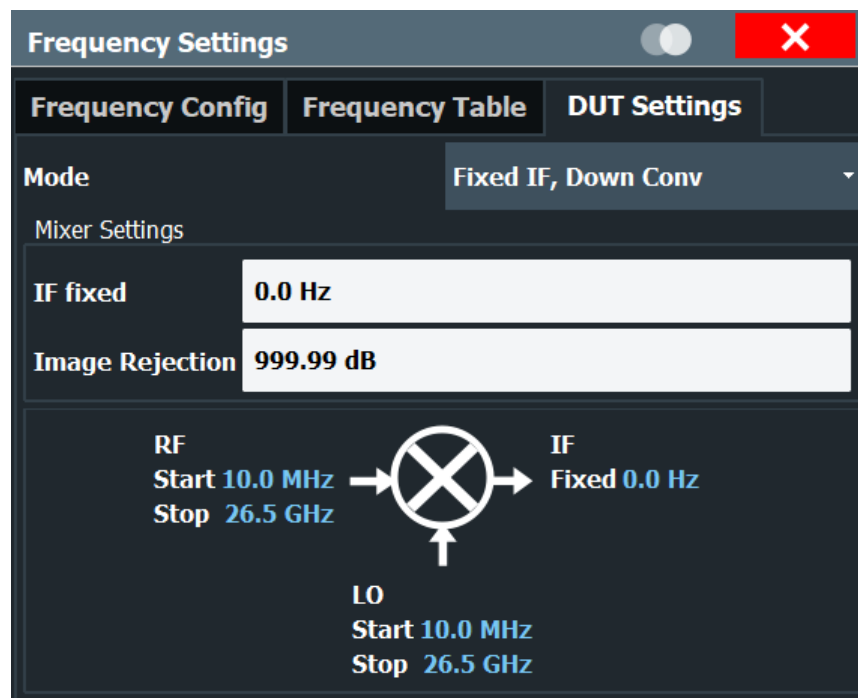

Mode.....	52
LO Fixed.....	52
IF Fixed.....	53
Image Rejection.....	53

Mode

Selects the measurement mode.

The required measurement mode depends on the type of DUT you are testing. For more information, see [Chapter 4.3, "DUT types"](#), on page 30.

Note: For upconverting measurements, if a preamplifier is used, make sure the upconverted frequencies for the measurement stay below the maximum frequency the preamplifier supports.

Remote command:

DUT type: `[SENSe:]CONFigure:MODE:DUT` on page 132

LO type: `[SENSe:]CONFigure:MODE:SYSTem:LO` on page 131

LO Fixed

Defines a fixed LO frequency for measurements on frequency-converting DUTs with a fixed LO.

After you have defined the LO frequency, the application updates the frequency list accordingly.

The "LO" setting is also available via the [FREQ] key.

Remote command:

[\[SENSe:\]CONFigure:MODE:SYSTem:LO:FREQuency](#) on page 131

IF Fixed

Defines a fixed intermediary frequency (IF) for measurements on frequency-converting DUTs with a fixed IF.

After you have defined the intermediary frequency, the application updates the frequency list accordingly.

The "IF" setting is also available via the [FREQ] key.

Remote command:

[\[SENSe:\]CONFigure:MODE:SYSTem:IF:FREQuency](#) on page 131

Image Rejection

Turns image rejection of the DUT on and off.

If you set an image rejection of 0 dB, the image frequency passes completely. If you set a high image rejection (up to 999.99 dB), the image frequency is suppressed completely. For DUTs that have a partial image rejection, define the amount of suppression.

For more information, see [Chapter 4.5, "Image frequency rejection"](#), on page 33.

Remote command:

[\[SENSe:\]CORRection:IREJection](#) on page 132

5.4 Configuring the noise source

The noise source characteristics are used to calculate the effective "noise temperature" of the noise source. The more accurate the specified characteristics of the noise source you are using, the more accurate the measurement results. The noise source characteristics must be supplied by its manufacturer.

- [Defining the noise source characteristics](#).....53
- [Using an ENR or temperature table](#).....57

5.4.1 Defining the noise source characteristics

Access: "Overview" > "Noise Source" > "ENR / Temp Settings"

The noise characteristics of noise sources with diode characteristics are usually defined by their ENR (Excess Noise Ratio). The noise characteristics of noise sources with resistor characteristics are defined by their noise (or ambient) temperatures (T_{hot} and T_{cold}). T_{cold} is typically at a very low temperature of liquid nitrogen or liquid helium.

Both noise source types can have different ENR values during the calibration and the measurement stage. You can use either the same type of noise source for both calibra-

tion and measurement, or use different types of noise sources for calibration and measurement.

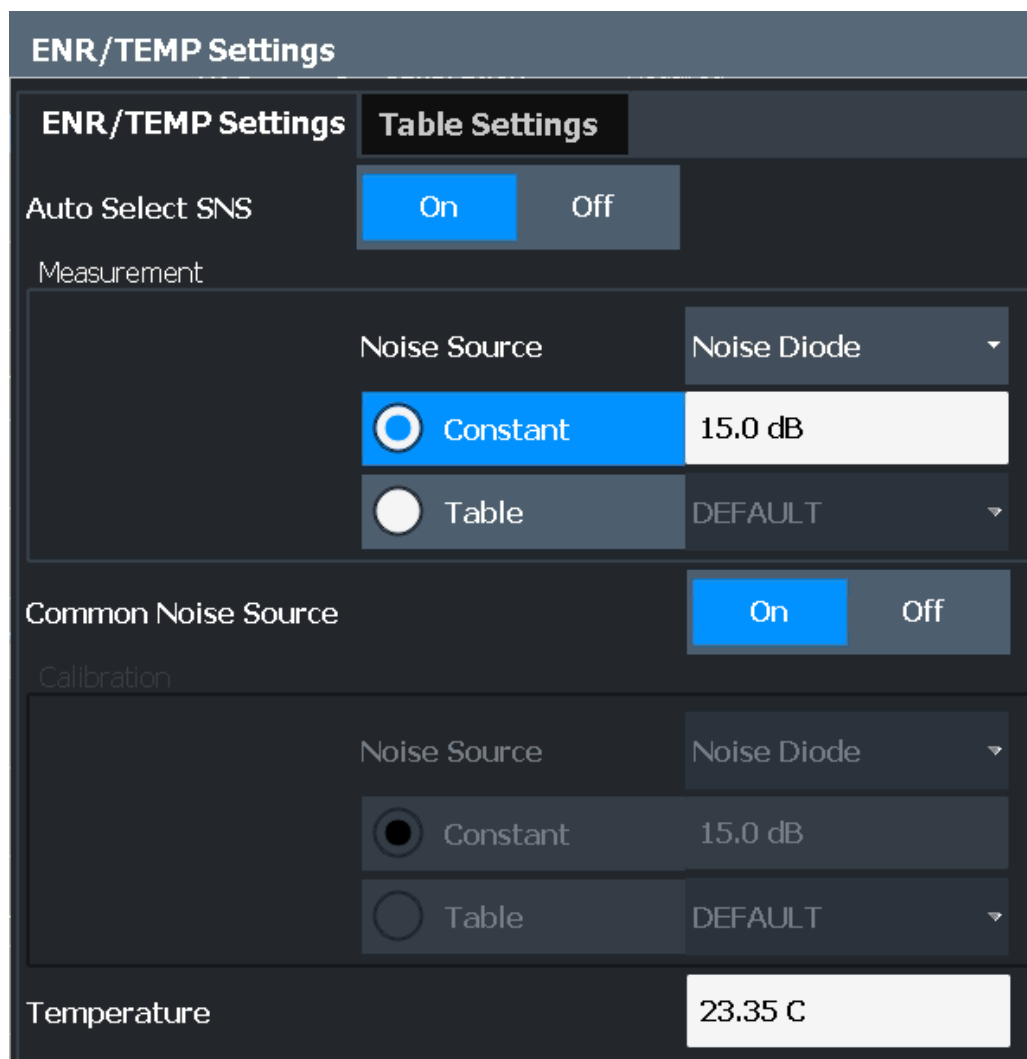

Auto Select SNS..... 54
 Noise Source.....55
 Measurement..... 55
 Common Noise Source..... 56
 Calibration..... 56
 Temperature..... 57

Auto Select SNS

If enabled (default), the noise measurement application automatically recognizes a connected smart noise source and uses it for the noise measurement. The provided ENR and uncertainty tables and temperature are loaded and used for the measurement. The recognized serial number of the SNS is indicated in the channel bar and dialogs of the noise measurement application.

If "Auto Select SNS" is ON and a SNS is connected, a green message with information about the connected SNS is displayed:

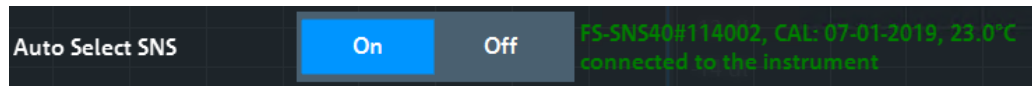

If no SNS is connected, a red "No SNS connected" warning is displayed:



If "Auto Select SNS" is disabled, you must manually change the noise source to SNS and select the required tables, if necessary (see ["Frequency Table"](#) on page 50).

Noise Source

Access: "Overview" > "Noise Source" > "ENR / Temp Settings" > "Noise Source"

You can select the type of noise source and its characteristics independently for the [Calibration](#) and the [Measurement](#).

"Diode"	Selects a noise source with diode characteristics. The frequency characteristics of the noise source are defined by the Excess Noise ratio (ENR).
"Resistor"	Selects a test setup that uses two resistors which act as a noise source. One of the resistors has a low noise or ambient temperature (a cold resistor), the other has a high noise or ambient temperature (a hot resistor). The noise characteristics of the resistor are defined by its "noise temperatures" T_{hot} and T_{cold} . When you select the resistor noise source, the application automatically starts the manual measurement mode, which is indicated in a message at the bottom of the dialog box.
"Smart Noise Source"	Selects a smart noise source, which provides its own ENR and uncertainty tables. The serial number of the connected noise source is automatically recognized and indicated. Otherwise, enter the number of a noise source to continue preconfiguring the measurement.

Remote command:

Measurement: `[SENSe:]CORRection:ENR[:MEASurement]:TYPE` on page 138

`[SENSe:]CORRection:ENR[:MEASurement]:SNS:SRNumber` on page 140

Calibration: `[SENSe:]CORRection:ENR:CALibration:TYPE` on page 135

`[SENSe:]CORRection:ENR:CALibration:SNS:SRNumber` on page 140

Measurement

Selects the source of the ENR or temperature values.

The frequency characteristics can be approximated by a constant or be based on an ENR or temperature table.

If the ENR or temperature is a constant, the same values are used for all frequencies in the frequency table. If you have selected a constant ENR, you have to define its magnitude in the input field next to the radio button. If you have selected a constant temperature, you have to define the temperatures of the resistor in the input fields next to the radio button. T_{hot} is the temperature of a resistor with a low noise or ambient temperature; T_{cold} is the temperature of a resistor with a high noise or ambient temperature.

If the noise characteristics are based on a table, the ENR level and temperatures typically depend on the measurement frequency. You can select an existing table from the dropdown menu next to the radio button, if it is active. For more information on ENR and temperature tables, see [Chapter 5.4.2, "Using an ENR or temperature table"](#), on page 57.

When "Common Noise Source" is on, the ENR is used for both measurement and calibration.

Remote command:

ENR mode: `[SENSe:]CORRection:ENR[:MEASurement]:MODE` on page 138

Constant ENR: `[SENSe:]CORRection:ENR[:MEASurement]:SPOT` on page 138

Select table: `[SENSe:]CORRection:ENR[:MEASurement]:TABLE:SElect`
on page 136

Constant temperature: `[SENSe:]CORRection:ENR[:MEASurement]:SPOT:COLD`
on page 139

Constant temperature: `[SENSe:]CORRection:ENR[:MEASurement]:SPOT:HOT`
on page 139

Common Noise Source

Turns the use of a common ENR on and off.

Common ENRs have the same characteristics for the measurement and calibration. If you turn off common ENR, you can define an additional ENR to be used during calibration.

Define additional ENR for measurements on frequency converting DUTs, if one noise source does not cover the frequency range at the DUT input (RF) and for calibration (IF).

Remote command:

`[SENSe:]CORRection:ENR:COMMon` on page 135

Calibration

Selects the source of the ENR or temperature values used during calibration.

The frequency characteristics can be a constant or be based on an ENR or temperature table.

If the ENR or temperature is a constant, the same value is used for all frequencies in the frequency table. If you have selected a constant ENR, you can also define its value in the input field next to the radio button. If you have selected a constant temperature, you have to define the temperatures of the resistor in the input fields next to the radio button. T_{hot} is the temperature of a resistor with a low noise or ambient temperature; T_{cold} is the temperature of a resistor with a high noise or ambient temperature.

If the noise source characteristics are based on a table, the ENR level and temperature depend on the measurement frequency. In that case, the values are interpolated to the measurement points. You can select a table from the dropdown menu next to the radio button, if it is active. For more information on ENR tables, see [Chapter 5.4.2, "Using an ENR or temperature table"](#), on page 57.

The calibration settings are available if the "Common Noise Source" is off.

Remote command:

ENR mode: `[SENSe:]CORRection:ENR:CALibration:MODE` on page 134

Constant ENR: `[SENSe:]CORRection:ENR:CALibration:SPOT` on page 134

Select table: `[SENSe:]CORRection:ENR:CALibration:TABLE:SElect`
on page 134

Constant temperature: `[SENSe:]CORRection:ENR:CALibration:SPOT:COLD`
on page 133

Constant temperature: `[SENSe:]CORRection:ENR:CALibration:SPOT:HOT`
on page 133

Temperature

Defines the absolute room temperature in degree Celsius or Fahrenheit.

The room temperature is required for the calculation of the real ENR of the noise source, because an ENR table is based on a temperature of 290K.

For smart noise sources, the temperature is provided automatically by the connected SNS itself. If no SNS is connected, the most recently loaded value is indicated. The provided temperature is used for all noise sources throughout the measurement.

To change the unit of the temperature from Celsius to Fahrenheit, change the date format from "DE" to "US" in the "General" display settings.

- Press the [SETUP] key.
- Select "Display".
- Select the "General" tab.
- Select "DE" for Celsius or "US" for Fahrenheit.

Note: If you define the temperature via remote control, the unit is degree Kelvin.

Remote command:

`[SENSe:]CORRection:TEMPerature` on page 139

5.4.2 Using an ENR or temperature table

Access: "Overview" > "Noise Source" > "Table Settings"

The "Table Settings" tab in the "ENR/TEMP Settings" dialog box contains the functionality to create and edit ENR or temperature tables.

ENR or temperature tables contain the noise source characteristics for particular frequencies. If the table does not contain ENR or temperature values for one of the measurement frequencies, the application interpolates between the values.

The "Table Settings" tab contains a list of ENR and temperature tables currently available on the R&S FSWP and shows the table currently in use if the "ENR/TEMP Settings" are enabled.

In addition, the tab contains functionality to create new tables and modify existing ones.

Noise Source.....	58
New.....	58
Edit.....	58
Delete.....	59

Copy To.....	59
Import / Export Table.....	59
Edit Table.....	59

Noise Source

Selects the type of noise source you are using for the measurement. The type of noise source selected in the "ENR/TEMP Settings" > "Noise Source" dialog is adopted automatically.

The noise source type affects the data type that the table contains. For a "Noise Diode", the table contains the ENR values of the noise source you are using. For a "Resistor", the table contains the "noise temperatures" of the resistors (T_{hot} and T_{cold}).

For a smart noise source, the table contains the provided ENR and uncertainty table. The table for the connected noise source is automatically recognized and highlighted. The name of the ENR table contains the serial number of the SNS. The "default" table also contains the data for the most recently connected smart noise source. The tables for all previously connected noise sources, whose ENR tables remain stored on the instrument, are also listed. Smart noise source tables are for reference only and cannot be edited.

For more information on the noise source types, see "Noise Source" on page 55.

Remote command:

`[SENSe:]CORRection:ENR[:MEASurement]:TYPE` on page 138

New

Opens the [Edit Table](#) dialog box to create a new table.

The contents of the dialog box are empty.

Smart noise source tables are shown for reference only and cannot be edited. A message indicates whether the SNS with the selected serial number is currently connected to the R&S FSWP or not. If it is connected, the table data reflects the most recent data provided by the SNS.

Remote command:

Table selection: `[SENSe:]CORRection:ENR:CALibration:TABLE:SElect`
on page 134

and: `[SENSe:]CORRection:ENR[:MEASurement]:TABLE:SElect` on page 136

Diode: `[SENSe:]CORRection:ENR[:MEASurement]:TABLE[:DATA]` on page 135

Resistor: `[SENSe:]CORRection:ENR[:MEASurement]:TABLE:TEMPerature[:DATA]`
on page 137

Edit

Opens the [Edit Table](#) dialog box to modify the selected table.

Smart noise source tables are for reference only and cannot be edited.

Remote command:

Table selection: `[SENSe:]CORRection:ENR[:MEASurement]:TABLE:SElect`
on page 136

and: `[SENSe:]CORRection:ENR[:MEASurement]:TABLE:SElect` on page 136

Diode: [\[SENSe:\]CORRection:ENR\[:MEASurement\]:TABLE\[:DATA\]](#) on page 135

Resistor: [\[SENSe:\]CORRection:ENR\[:MEASurement\]:TABLE:TEMPerature\[:DATA\]](#) on page 137

Delete

Deletes the selected table.

Smart noise source tables cannot be deleted.

Remote command:

Diode: [\[SENSe:\]CORRection:ENR\[:MEASurement\]:TABLE:DELeTe](#) on page 136

Resistor: [\[SENSe:\]CORRection:ENR\[:MEASurement\]:TABLE:TEMPerature:DELeTe](#) on page 137

Copy To

Opens the [Edit Table](#) dialog box to modify the selected table and save it under a new name.

Import / Export Table

Opens a dialog box to select a table to import or export.

Smart noise source tables can be exported, but not re-imported. Tables for smart noise sources are always loaded directly from the SNS itself. However, you can edit and use the SNS tables for other noise sources, such as noise diodes.

Edit Table

Defines the noise source characteristics or the loss characteristics of additional measurement equipment.

The noise source and loss tables are made up of up to 10001 data points. A data point consists of a frequency and its corresponding ENR, temperature or loss value. The ENR and temperature values must be supplied by the manufacturer of the noise source or resistor. The loss characteristics of measurement equipment must also be supplied by the manufacturer.

Frequency	Value
1.00000000 MHz	1.00 dB
10.00000000 MHz	10.00 dB

"Name"	Name of the ENR, temperature or loss table.
"Comment"	Comment for the ENR, temperature or loss table.
"Frequency"	Frequency of a particular ENR, temperature or loss value.
"Value"	ENR value or loss in dB. For a resistor, the characteristics of the resistor are defined by the "noise temperatures" T_{hot} and T_{cold} instead of a single value. The unit in that case is Kelvin (degrees).
"Clear Table"	Deletes the contents of the table (frequencies and values) or the loss table.
"Insert"	Inserts a new data point above the selected one.
"Delete"	Deletes the selected data point.
"Save"	Saves the table.
"Cancel"	Exits the "Edit Table" dialog box and returns to the result diagram.

Remote command:

Edit ENR table: `[SENSe:]CORRection:ENR[:MEASurement]:TABLE[:DATA]`
on page 135

Edit temperature table: `[SENSe:]CORRection:ENR[:MEASurement]:TABLE:TEMPerature[:DATA]`
on page 137

Edit input loss table: [\[SENSe:\]CORRection:LOSS:INPut:TABLE\[:DATA\]](#)
on page 143

Edit output loss table: [\[SENSe:\]CORRection:LOSS:OUTPut:TABLE\[:DATA\]](#)
on page 146

5.5 Configuring additional loss

These settings configure the loss characteristics of additional equipment in the test setup, such as cables or attenuators at the DUT input or output. The characteristics of such equipment must be supplied by the manufacturer.

Note that loss is only considered during the measurement and not during calibration because the noise source is connected directly to the analyzer input.



Treatment of losses in resistor noise sources

For resistor noise sources, it is not possible to change the loss characteristics.

When you change back to using a diode as a noise source, the previous loss settings are **not** restored. In that case, store loss settings in a loss table for later use.

- [Defining loss](#).....61
- [Using a loss table](#).....64

5.5.1 Defining loss

Access: "Overview" > "Loss Input" / "Loss Output" > "Loss Settings"

The "Loss Settings" tab in the "Loss Settings" dialog box contains settings to define the loss characteristics of miscellaneous equipment in the test setup.

You can define the loss characteristics of the signal path to the DUT input and the signal path from the DUT output to the analyzer.

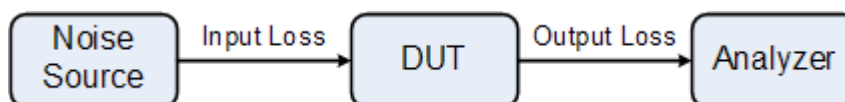

Furthermore, you can define the loss characteristics of the signal path from the noise source directly to the analyzer for the calibration measurement.

Input Loss	62
Output Loss	63
Calibration Loss	63

Input Loss

Defines losses between the noise source and the DUT input.

The input loss is the sum of all losses caused by the measurement equipment. The loss can be constant or based on a loss table.

If the loss is constant, the same loss is used for all frequencies in the frequency table. If you have selected a constant loss, you can also define its value in the input field next to the radio button.

If the loss is based on a table, the loss values are interpolated to the measurement frequencies. You can select a table from the dropdown menu next to the radio button, if it is active. For more information on loss tables, see [Chapter 5.5.2, "Using a loss table"](#), on page 64.

The specified temperature at the time of measurement can be considered in the loss calculation.

Remote command:

Loss mode:

[\[SENSe:\]CORRection:LOSS:INPut:MODE](#) on page 143

Constant loss:

[\[SENSe:\]CORRection:LOSS:INPut:SPOT](#) on page 143

Select loss table:

[\[SENSe:\]CORRection:LOSS:INPut:TABLE:SElect](#) on page 144

Temperature:

[\[SENSe:\]CORRection:LOSS:INPut:TEMPerature](#) on page 145

Output Loss

Selects the loss between the DUT output and the RF input of the analyzer.

The output loss is the sum of all losses caused by the measurement equipment (e.g. connectors, cables or attenuators). The loss can be constant or be based on a loss table.

If the loss is constant, the same loss is used for all frequencies in the frequency table.

If you have selected a constant loss, you can also define its value in the input field next to the radio button.

If the loss is based on a table, the loss values are interpolated to the measurement frequencies. You can select a table from the dropdown menu next to the radio button, if it is active. For more information on loss tables, see [Chapter 5.5.2, "Using a loss table"](#), on page 64.

The current temperature at the time of measurement can be considered in the loss calculation.

Remote command:

Loss mode:

[\[SENSe:\]CORRection:LOSS:OUTPut:MODE](#) on page 145

Constant loss:

[\[SENSe:\]CORRection:LOSS:OUTPut:SPOT](#) on page 145

Select loss table:

[\[SENSe:\]CORRection:LOSS:OUTPut:TABLE:SElect](#) on page 146

Temperature:

[\[SENSe:\]CORRection:LOSS:OUTPut:TEMPerature](#) on page 147

Calibration Loss

Selects the loss between the noise source and the RF input of the analyzer for the calibration measurement.

The loss is the sum of all losses caused by the measurement equipment (e.g. connectors, cables or attenuators). The loss can be constant or be based on a loss table.

If the loss is constant, the same loss is used for all frequencies in the frequency table. If you have selected a constant loss, you can also define its value in the input field next to the radio button.

If the loss is based on a table, the loss values are interpolated to the measurement frequencies. You can select a table from the dropdown menu next to the radio button, if it is active. For more information on loss tables, see [Chapter 5.5.2, "Using a loss table"](#), on page 64.

The current temperature at the time of measurement can be considered in the loss calculation.

Remote command:

Loss mode:

[\[SENSe:\]CORRection:LOSS:CALibration:MODE](#) on page 141

Constant loss:

[\[SENSe:\]CORRection:LOSS:CALibration:SPOT](#) on page 141

Select loss table:

[\[SENSe:\]CORRection:LOSS:CALibration:TABLE:SElect](#) on page 142

Temperature:

[\[SENSe:\]CORRection:LOSS:CALibration:TEMPerature](#) on page 143

5.5.2 Using a loss table

Access: "Overview" > "Loss Input" / "Loss Output" > "Table Settings"

The "Table Settings" tab in the "Loss Settings" dialog box contains the functionality to create and edit loss tables.

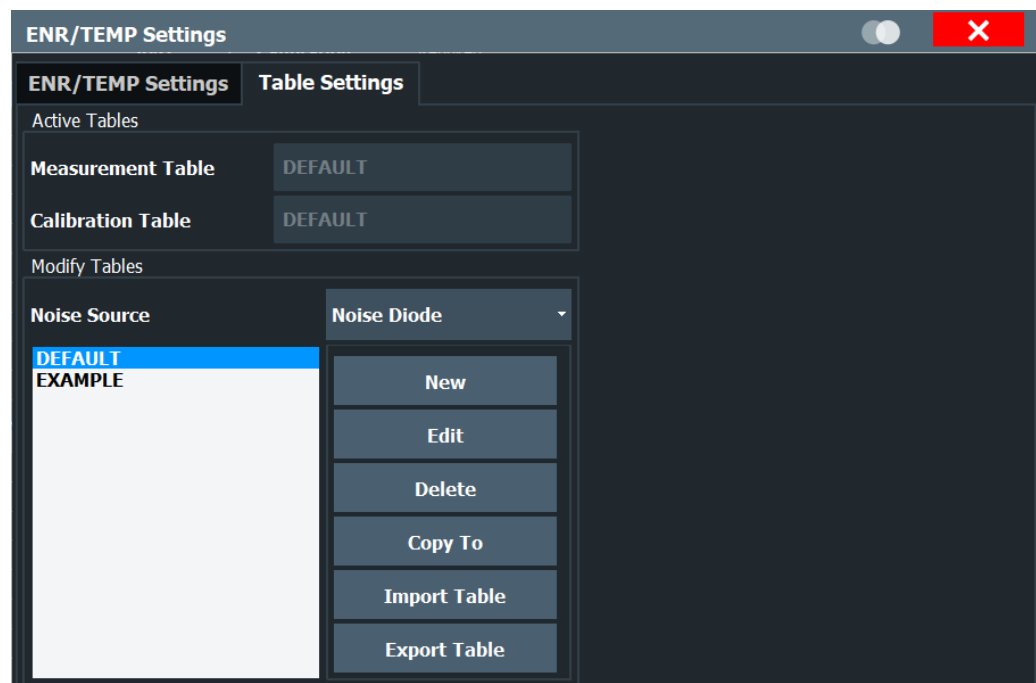

Loss tables contain the loss characteristics of additional frequency-dependent equipment in the test setup. If you are using a loss table, the loss values can be different on

each frequency that is measured. If the table does not contain a loss for one of the measurement frequencies, the application interpolates between values.

The "Table Settings" tab contains a list of loss tables currently available on the R&S FSWP. It shows the table currently selected in the "Loss Settings" tab.

In addition, the tab contains functionality to create new tables and modify existing ones.

New	65
Edit	65
Delete	65
Copy To	65
Import / Export Table	66

New

Opens the [Edit Table](#) dialog box to create a new loss table.

The contents of the dialog box are empty.

Remote command:

Create input loss table:

[\[SENSe:\]CORRection:LOSS:INPut:TABLE\[:DATA\]](#) on page 143

Create output loss table:

[\[SENSe:\]CORRection:LOSS:OUTPut:TABLE\[:DATA\]](#) on page 146

Create calibration loss table:

[\[SENSe:\]CORRection:LOSS:CALibration:TABLE\[:DATA\]](#) on page 142

Edit

Opens the [Edit Table](#) dialog box to modify the selected table.

Remote command:

Edit input loss table:

[\[SENSe:\]CORRection:LOSS:INPut:TABLE\[:DATA\]](#) on page 143

Edit output loss table:

[\[SENSe:\]CORRection:LOSS:OUTPut:TABLE\[:DATA\]](#) on page 146

Edit calibration loss table:

[\[SENSe:\]CORRection:LOSS:CALibration:TABLE\[:DATA\]](#) on page 142

Delete

Deletes the selected table.

Remote command:

Delete input loss table:

[\[SENSe:\]CORRection:LOSS:INPut:TABLE:DELeTe](#) on page 144

Delete output loss table:

[\[SENSe:\]CORRection:LOSS:OUTPut:TABLE:DELeTe](#) on page 146

Delete calibration loss table:

[\[SENSe:\]CORRection:LOSS:CALibration:TABLE:DELeTe](#) on page 141

Copy To

Opens the [Edit Table](#) dialog box to modify the selected table and save it under a new name.

Import / Export Table

Opens a dialog box to select a loss table to import or export.

An import copies the loss table into the default loss table directory. The file extension can be *.loss or *.s2p. In case the file extension is *.s2p, the S21 vector is parsed out of the *.s2p file. The magnitude of this vector is written to a file with ending *.loss into the default loss directory. This file then can be used like conventional loss files.

An export copies the table to a location outside the default loss table directory, e.g. a memory stick. The file extension will be *.loss.

5.6 Configuring the analyzer

Access: "Overview" > "Spectrum Analyzer"

Or: [MEAS CONFIG] > "Meas Settings"

The measurement settings include parameters related to the second stage correction measurement.

Meas Settings

Measurement Settings

2nd Stage Correction On Off

RBW and Sweep Settings

RBW Variable Constant RBW 3.0 MHz

Sweep Time Variable Constant Sweep Time 30.0 ms

The RBW and Sweep Time 'Variable' selections are used to improve measurements at frequency < 10MHz

Settling Time 50.0 ms

Average 1

Level and Range Settings

Ref Level Auto Manual Ref Level -30.0 dBm

Auto Level Range 30.0 dB

RF Atten 0.0 dB

Preamplifier On Off

2nd Stage Correction.....	67
Resolution Bandwidth (RBW).....	67
Sweep Time.....	67
Settling Time.....	68
Average.....	68
Ref Level.....	68

Auto Level Range.....	69
RF Attenuation.....	69
Preamplifier.....	69

2nd Stage Correction

Turns 2nd stage correction on and off.

If enabled, the application uses the calibration data to compensate for the inherent noise of the analyzer when calculating the measurement results.

If disabled, the application does not correct the measurement results, even if a valid calibration has been performed. Note that correction data is not deleted if you turn off the 2nd stage correction.

For more information, see [Chapter 4.6, "Calibration \(2nd stage correction\)"](#), on page 35.

Remote command:

State: `[SENSe:]CORRection[:STATe]` on page 149

Calibration measurement selection: `[SENSe:]CONFigure:CORRection` on page 148

Resolution Bandwidth (RBW)

Defines the resolution bandwidth for the measurement.

For more information on the resolution bandwidth, see [Chapter 4.7, "Separating signals by selecting an appropriate resolution bandwidth"](#), on page 38.

"Constant"	Uses a constant RBW for the entire measurement span
"Variable"	Uses a variable RBW, depending on the current frequency of the sweep point, as defined in the frequency table (see Chapter 5.2.3, "Using a frequency table" , on page 49); In the channel bar, the bandwidth and sweep time range of the variable values is indicated.

Remote command:

`[SENSe:]BANDwidth:RESolution:AUTO` on page 148

`[SENSe:]BANDwidth[:RESolution]` on page 147

Sweep Time

Defines the sweep time for the measurement.

The sweep time is the time it takes the analyzer to perform a measurement at one measurement frequency.

Note that "noise figure" measurements perform two measurements during one sweep. One with the noise source turned on, one with the noise source turned off.

Frequency tables allow you to define a variable RBW and sweep time, depending on the current frequency of the sweep point (see ["Variable RBW and sweep time for low-frequency measurements"](#) on page 39 and [Chapter 5.2.3, "Using a frequency table"](#), on page 49).

"Constant"	Uses a constant sweep time for the entire measurement span
------------	--

"Variable" Uses a variable sweep time, depending on the current frequency of the sweep point, as defined in the frequency table (see [Chapter 5.2.3, "Using a frequency table"](#), on page 49); In the channel bar, the bandwidth and sweep time range of the variable values is indicated.

Remote command:

[\[SENSe:\] SWEEp:TIME:AUTO](#) on page 150

[\[SENSe:\] SWEEp:TIME](#) on page 150

Settling Time

Defines the settling time of the DUT and the noise source.

Most noise sources need a certain amount of time to settle after you turn them on. Low-frequency DUTs can require a certain time until their coupling capacitors have been charged or discharged. Both are defined as the settling time. For details on the settling time, refer to the datasheet of the noise source.

Remote command:

[SYSTem:CONFIgure:DUT:STIME](#) on page 153

Average

Defines the number of measurements that are used to average the results.

The more measurements you include in the averaging, the more accurate and stable the results are. However, accuracy and stability come at the price of measurement speed.

Remote command:

[\[SENSe:\] SWEEp:COUNT](#) on page 150

Ref Level

Turns automatic determination of the reference level on and off.

The reference level is the power level the R&S FSWP expects at the RF input. Keep in mind that the noise signal has a high crest factor. To avoid an instrument overload, set the reference level to the peak envelope power of the noise signal, not to the mean power.

Set the reference level to approximately 5 dB to 15 dB above the noise display that occurs with the DUT connected and the noise source activated.

To get the best dynamic range, set the reference level as low as possible. At the same time, make sure that the maximum signal level does not exceed the reference level. If it does, it can overload the RF and IF stages of the analyzer, regardless of the signal power. Measurement results can deteriorate.

Note that the signal level at the A/D converter can be stronger than the level the R&S FSWP displays because the resolution bandwidths are implemented digitally after the A/D converter.

If automatic detection of the reference level is on, the application performs a measurement to determine the ideal reference level. The time of this measurement depends on the state of the "2nd Stage Correction".

- "2nd Stage Correction" is enabled

The application determines the reference level before the calibration starts. The reference level is based on several test measurements on the start frequency. For more information, see ["Auto Level Range"](#) on page 69.

- "2nd Stage Correction" is disabled
The application determines the reference level before the measurement begins. The reference level is based on the measurement of the first frequency that is measured. After this measurement is done, the application resumes the measurement.

If manual selection of the reference level is on, you can define the reference level in the corresponding input field.

Note: Reference level. Even for DUTs with a high-ripple frequency response it can be useful to define the reference level manually. Determining the reference level automatically does not always result in optimal settings.

Remote command:

Manual reference level:

`DISPlay[:WINDow<n>]:TRACe<t>:Y[:SCALe]:RLEVel` on page 151

Automatic reference level:

`DISPlay[:WINDow<n>]:TRACe<t>:Y[:SCALe]:RLEVel:AUTO` on page 151

Auto Level Range

Defines the maximum expected "gain" of the DUT.

The application uses the auto level range to determine the reference level automatically if the 2nd stage correction is on.

Make sure the range does not exceed the actual "gain" of the DUT by more than 10 dB.

Remote command:

`SYSTem:CONFIgure:DUT:GAIN` on page 153

RF Attenuation

Defines the RF attenuation of the analyzer.

The attenuation is applied to the signal at the RF input.

Attenuation affects the quality of the "noise figure" measurement results. For a low "noise figure" of the analyzer (and thus more accurate measurement results), keep the attenuation as low as possible. No attenuation is best. However, some high-power DUTs require attenuation to avoid an overload of the analyzer. An attenuation of 10 dB provides a better input VSWR of the analyzer, but results in a deteriorating "noise figure".

Remote command:

`INPut<ip>:ATTenuation` on page 151

Preamplifier

If the (optional) internal preamplifier hardware is installed on the R&S FSWP, a preamplifier can be activated for the RF input signal.

Turn on the preamplifier for a low inherent noise of the analyzer.

For R&S FSWP, the following settings are available:

"Off" Deactivates the preamplifier.

"15 dB" The RF input signal is amplified by about 15 dB.

"30 dB" The RF input signal is amplified by about 30 dB.

For R&S FSWP models 1322.8003K09, 1322.8003K27 and 1322.8003K51, 15 dB or 30 dB preamplification is available.

For R&S FSWP models 1322.8003K08, 1322.8003K26 and 1322.8003K50, only 30 dB preamplification is available.

Remote command:

`INPut<ip>:GAIN:STATe` on page 152

`INPut<ip>:GAIN[:VALue]` on page 152

5.7 Using the uncertainty calculator

Access: [MEAS CONFIG] > "Uncertainty Calculation"

"Noise figure" measurements are subject to uncertainty. The "noise figure" measurement is meaningless if the measurement uncertainty is too large. Knowing the uncertainty of the "noise figure" measurement adds value especially when comparing measurement results.

Note that the "noise figure" uncertainty is not calculated for frequencies above 67 GHz because input VSWR values are not specified.

Uncertainty Calculation				Analyzer	
Measurement Noise Source		DUT		Analyzer	
Output Match		Input Match		SA Input Match (Typical)	
Use SNS Values	On Off	VSWR RL	1.0	VSWR RL	1.87
VSWR RL	1.15	Use Meas Values	On Off	SA NF Uncert	0.05 dB
ENR Uncert	0.1 dB	DUT NF	0.0 dB	SA Gain Uncert	0.15 dB
		DUT Gain	0.0 dB	SA NF	11.22 dB
		Frequency (IF)	1.0 GHz	Ext PA	On Off
				PA NF	5.0 dB
				PA Gain	20.0 dB
				Net SA NF	11.22 dB
Guidelines (repeatability)		ENR - SA NF	[> 3 dB] ● 3.78 dB	NF Uncert +/-	1.91 dB
		ENR - DUT NF	[> 5 dB] ● 15.0 dB	Meas Offset	
		DUT (NF+Gain) - SA NF	[> 1 dB] ● -11.22 dB		



Uncertainty values and systematic error recognition

Note that the uncertainty calculation only takes systematic measurement inaccuracies into account.

The most significant inaccuracies are:

- Uncertainties of the noise source and the analyzer
- Input and output matching
- "Noise figure" and "gain" of the DUT
- "Noise figure" of the analyzer

The accuracy of the measurement can also be affected by insufficient repeatability during calibration or measurement.

The repeatability is mainly affected by:

- Signal-to-noise ratio during calibration and measurement
- Measurement time (if it is too short)
- Environmental conditions (e.g. a change in the temperature between measurements)
- Mechanical stability of the test setup

For more background information on "noise figure" measurement uncertainty, refer to the application note "The "Y-Factor" Technique for "Noise Figure" Measurement" available for download on the Rohde & Schwarz homepage (http://www.rohde-schwarz.com/en/applications/the-y-factor-technique-for-noise-figure-measurements-application-note_56280-15484.html).

In addition to the parameters described here, the application also considers several parameters from the general measurement configuration when calculating the uncertainty.

- [Measurement mode](#)
- [2nd Stage Correction](#)
If 2nd stage correction is on, but no calibration data is available, uncertainty is calculated without the 2nd stage correction data.
- [Internal preamplification](#)
- [RF Attenuation](#)
- [Temperature](#)
- [ENR values](#)

5.7.1 Configuring noise source characteristics

Access: [MEAS CONFIG] > "Uncertainty Calculation"

The Uncertainty Calculator supports individual characteristics for a noise source used during calibration and the measurement.

If you are using a Common ENR, the application assumes that the [Output Match](#) and [ENR Uncert\(ainty\)](#) are the same during calibration and measurement. Only the "Measurement Noise Source" parameters are displayed.

If you are using a different noise source during calibration and measurement, the Uncertainty Calculator adds an **Output Match** and **ENR Uncert(ainty)** required for uncertainty calculation during calibration.

Note that you have to turn off the **Common Noise Source** if you have to define the values of the noise source used during calibration.

Common Source for Meas and Cal	72
Output Match	72
ENR Uncert(ainty)	72
Temperature Uncert(ainty)	72

Common Source for Meas and Cal

Controls the way the application calculates the uncertainty for the noise source.

Turn on the switch when you use the same noise source during calibration and measurement. Only one set of fields to define the noise source characteristics is available. The application calculates the uncertainty according to the values you have entered in there.

Turn the switch off when you use different noise sources during calibration and measurement. The application shows an additional set of fields to define the noise source characteristics. The uncertainty calculation also includes these values.

The switch is available if you have turned on **Common Noise Source**.

Remote command:

`CALCulate<n>:UNCertainty:COMMon` on page 163

Output Match

Defines the output match of the noise source you are using.

You can define the output match either as the VSWR or as the return loss (RL).

Refer to the datasheet of the noise source for these values.

Remote command:

`CALCulate<n>:UNCertainty:MATCH:SOURce:CALibration:RL` on page 169

`CALCulate<n>:UNCertainty:MATCH:SOURce:RL` on page 170

`CALCulate<n>:UNCertainty:MATCH:SOURce:CALibration[:VSWR]`
on page 169

`CALCulate<n>:UNCertainty:MATCH:SOURce:CALibration:RL` on page 169

ENR Uncert(ainty)

Defines the uncertainty of the excess noise ratio of the noise source you are using.

Refer to the datasheet of the noise source for this value.

Available for noise sources with diode characteristics.

Remote command:

`CALCulate<n>:UNCertainty:ENR:UNCertainty` on page 166

`CALCulate<n>:UNCertainty:ENR:CALibration:UNCertainty` on page 165

Temperature Uncert(ainty)

Defines the uncertainty of the hot and cold temperatures of the noise source you are using.

Refer to the datasheet of the noise source for these values.

Available for resistor noise sources.

Remote command:

`CALCulate<n>:UNCertainty:ENR:UNCertainty:COLD` on page 166

`CALCulate<n>:UNCertainty:ENR:CALibration:UNCertainty:HOT`
on page 166

`CALCulate<n>:UNCertainty:ENR:CALibration:UNCertainty:COLD`
on page 165

`CALCulate<n>:UNCertainty:ENR:CALibration:UNCertainty:HOT`
on page 166

5.7.2 Configuring DUT characteristics

Access: [MEAS CONFIG] > "Uncertainty Calculation"

Input / Output Match	73
Use Measurement Values	73

Input / Output Match

Defines the match at the DUT input and output.

You can define the match either as the VSWR or as the return loss (RL). If you define the VSWR or the return loss, the application automatically calculates the other.

If these values are not defined in the DUT datasheet, determine these values, for example, with a network analyzer.

Remote command:

`CALCulate<n>:UNCertainty:MATCH:DUT:IN[:VSWR]` on page 167

`CALCulate<n>:UNCertainty:MATCH:DUT:IN:RL` on page 167

`CALCulate<n>:UNCertainty:MATCH:DUT:OUT[:VSWR]` on page 168

`CALCulate<n>:UNCertainty:MATCH:DUT:OUT:RL` on page 168

Use Measurement Values

Turns automatic determination of the DUT characteristics used for the uncertainty calculation on and off.

If on, the application calculates the uncertainty with the DUT characteristics ("noise figure", "gain" and frequency) resulting from the "noise figure" measurement. For this method, the application calculates the uncertainty for each measurement point (or frequency) based on the "noise figure" and "gain" results of the last measurement.

If you have selected automatic determination of the DUT characteristics, the application does not show a result in the "NF Uncertainty +/-" field in the dialog box. Instead, to view the uncertainty at all measurement points, use the "Result Table".

If off, define the "gain", "noise figure" and frequency of the DUT manually for a single frequency. With this manual determination of the DUT characteristics, the application only calculates the uncertainty for that frequency and shows the result in the "NF Uncertainty +/-" field in the dialog box.

- "Noise Figure" of the DUT
- "Gain" of the DUT

- Frequency of the DUT

Remote command:

Control automatic DUT characteristics determination:

[CALCulate<n>:UNCertainty\[:RESult\]? on page 171](#)

Manual definition of DUT characteristics:

[CALCulate<n>:UNCertainty:DATA:NOISe on page 164](#)

[CALCulate<n>:UNCertainty:DATA:GAIN on page 164](#)

[CALCulate<n>:UNCertainty:DATA:FREQuency on page 163](#)

5.7.3 Configuring analyzer characteristics

Access: [MEAS CONFIG] > "Uncertainty Calculation"

For the analyzer characteristics, the application always uses the data specified in the datasheet of the R&S FSWP model you are using. Thus, it is not possible to change or adjust the analyzer characteristics in any way. The uncertainty calculation takes several analyzer characteristics into account, of which the following are shown as read-only fields in the user interface.

- **SA Input Match:** Input match (VSWR or return loss) of the analyzer
- **SA NF Uncert:** "Noise figure" uncertainty of the analyzer
- **SA "Gain" Uncert:** "Gain" uncertainty of the analyzer
- **SA NF:** "Noise figure" of the analyzer

However, if you are using an external preamplifier in the test setup, you have to specify its characteristics to get a valid uncertainty result.

Remote commands:

[CALCulate<n>:UNCertainty:SANalyzer:GAIN:UNCertainty? on page 172](#)

[CALCulate<n>:UNCertainty:SANalyzer:NOISe:UNCertainty? on page 172](#)

External Preamplifier (Ext PA).....	74
L Preamplifier noise figure (PA NF).....	74
L Preamplifier Gain (PA Gain).....	75
L Net spectrum analyzer noise figure (Net SA NF).....	75

External Preamplifier (Ext PA)

If enabled, the application automatically calculates and updates the analyzer characteristics based on the characteristics of the external preamplifier defined here.

Refer to the datasheet of the preamplifier you are using for the values you have to enter.

Remote command:

[CALCulate<n>:UNCertainty:PREamp:STATe on page 171](#)

Preamplifier noise figure (PA NF) ← External Preamplifier (Ext PA)

Defines the "noise figure" of the preamplifier.

Remote command:

`CALCulate<n>:UNCertainty:PREamp:NOISe` on page 171

Preamplifier Gain (PA Gain) ← External Preamplifier (Ext PA)

Defines the "gain" of the preamplifier.

Remote command:

`CALCulate<n>:UNCertainty:PREamp:GAIN` on page 170

Net spectrum analyzer noise figure (Net SA NF) ← External Preamplifier (Ext PA)

Shows the "noise figure" of the analyzer.

If you are using an external preamplifier, the application calculates the "noise figure" of the analyzer including the "noise figure" of the preamplifier and shows the result here.

If you do not use an external preamplifier, this value is the same as the "noise figure" of the analyzer shown in the "SA NF" field.

5.7.4 Guidelines and results

Access: [MEAS CONFIG] > "Uncertainty Calculation"

The lower part of the dialog box contains measurement guidelines that provide information on the quality of measurement and the actual "noise figure" uncertainty.



Guidelines

The guidelines are an indicator of the quality of the measurement and an indicator the repeatability of the measurement.

The three guidelines are:

- Make sure that the "noise figure" of the DUT and the "gain" of the DUT is greater than the "noise figure" of the analyzer plus 1 dB.
- Make sure that the ENR of the noise source is greater than the "noise figure" of the DUT plus 5 dB.
- Make sure that the ENR of the noise source is greater than the "noise figure" of the analyzer plus 3 dB.

A short form of these guidelines is indicated in the "Uncertainty Calculation" dialog box. The dialog box also indicates if the guidelines have been met or not by a colored dot.

- Green light : guideline condition met.
- Yellow light : guideline condition not met, but within 1 dB of being met.
- Red light : guideline condition not met.

Note that the guidelines have no effect on the actual uncertainty that has been calculated and that they are only considered for measurements with 2nd Stage Correction.

Uncertainty

The "Uncertainty" result is shown only if you define the "noise figure" and "gain" characteristics of the DUT manually on a single frequency. In that case, the uncertainty

shown in the "Uncertainty Calculation" dialog box is valid only for the DUT frequency you have defined.

The "Measurement Offset" evaluates the internal noise of the R&S FSWP that is added to the "noise figure" results. The measurement offset result is displayed when 2nd stage correction is turned off. When you turn on 2nd stage correction, the internal noise is automatically removed from the uncertainty results, so the measurement offset is not shown.

If you are using the "noise figure" and "gain" that has been determined during a measurement, the uncertainty is displayed only in the result table.

For more information, see ["Use Measurement Values"](#) on page 73.

SCPI command:

`CALCulate<n>:UNCertainty[:RESult]?` on page 171

5.8 Trigger and gate configuration

Triggering means to capture the interesting part of the signal. Choosing the right trigger type and configuring all trigger settings correctly allows you to detect various incidents in your signals.

Gating allows you to restrict measurement analysis to the important part or parts of the signal, for example bursts.



Noise source for trigger preview

As long as the trigger and gate preview is displayed, a "Noise Source State" function is available in the "Trigger" menu. This function turns on the noise source temporarily so that you can see the effects of the trigger and gate settings with the noise source on. See ["Noise Source State"](#) on page 80.

- [Trigger settings](#)..... 76
- [Gate settings](#).....80
- [Continuous gate settings](#).....81

5.8.1 Trigger settings

Access: "Overview" > "Trigger/Gate"

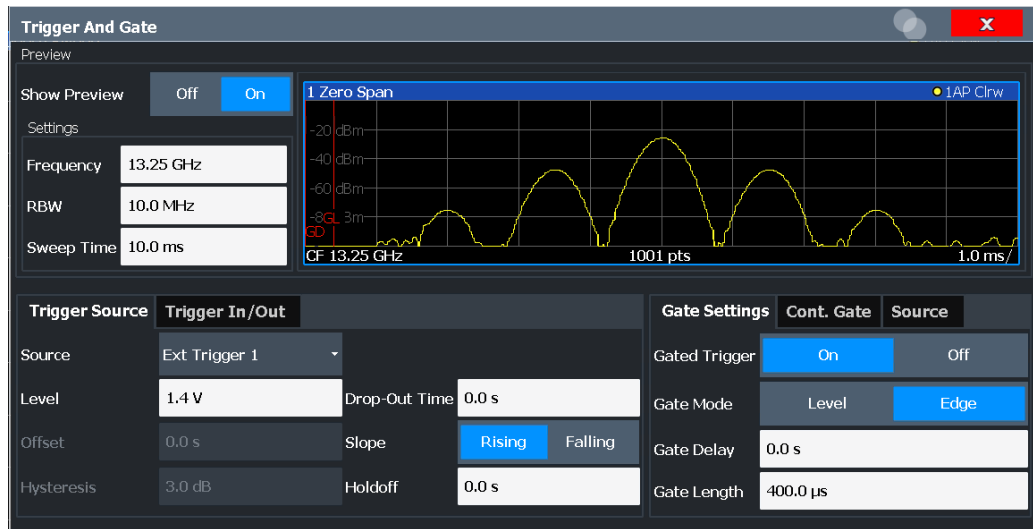

External triggers from one of the trigger connectors on the R&S FSWP are configured in a separate tab of the dialog box.

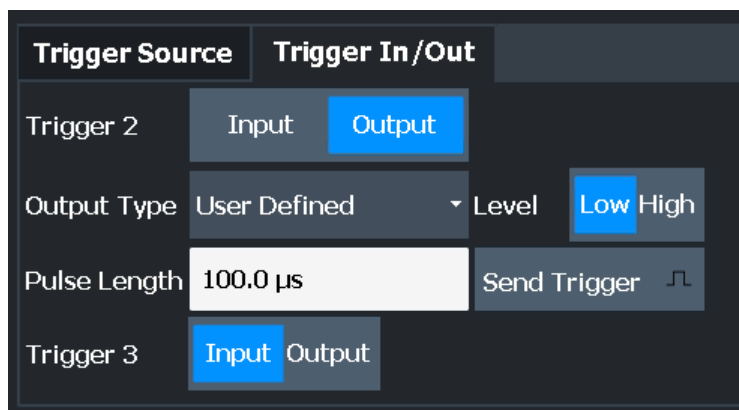

- Preview..... 77
 - └ Frequency..... 78
 - └ RBW..... 78
 - └ Sweep Time..... 78
- Trigger Source..... 78
 - └ Free Run..... 78
 - └ Ext. Trigger 1/2..... 78
- Trigger Level..... 79
- Drop-Out Time..... 79
- Trigger Offset..... 79
- Hysteresis..... 79
- Trigger Holdoff..... 80
- Slope..... 80
- Noise Source State..... 80

Preview

The preview mode allows you to try out trigger and gate settings before actually applying them to the current measurement.

The preview diagram displays a zero span measurement at the center frequency with the defined RBW and sweep time. This is useful when analyzing bursts, for example, to determine the required gate settings.

The trigger and gate settings are applied to the measurement when the dialog box is closed.

Note: The zero span settings refer only to the preview diagram. The main diagram remains unchanged.

If preview mode is switched off, any changes to the settings in this dialog box are applied to the measurement diagram directly. In this case, the zero span settings for the preview diagram are not displayed.

Frequency ← Preview

Defines the center frequency.

Remote command:

[\[SENSe:\] FREQuency:CENTer](#) on page 127

RBW ← Preview

Defines the bandwidth value. The available resolution bandwidths are specified in the data sheet. Numeric input is always rounded to the nearest possible bandwidth.

Remote command:

[\[SENSe:\] BANDwidth\[:RESolution\]](#) on page 147

Sweep Time ← Preview

Defines the sweep time. Allowed values depend on the ratio of span to RBW and RBW to VBW. For details refer to the data sheet. Numeric input is always rounded to the nearest possible sweep time.

Remote command:

[\[SENSe:\] SWEEp:TIME](#) on page 150

Trigger Source

Selects the trigger source. If a trigger source other than "Free Run" is set, "TRG" is displayed in the channel bar and the trigger source is indicated.

Remote command:

[TRIGger\[:SEQuence\]:SOURce](#) on page 157

Free Run ← Trigger Source

No trigger source is considered. Data acquisition is started manually or automatically and continues until stopped explicitly.

Remote command:

[TRIG:SOUR IMM](#), see [TRIGger\[:SEQuence\]:SOURce](#) on page 157

Ext. Trigger 1/2 ← Trigger Source

Data acquisition starts when the TTL signal fed into the specified input connector meets or exceeds the specified trigger level.

Note: The "External Trigger 1" softkey automatically selects the trigger signal from the "Trigger Input / Output" connector on the front panel.

For details, see the "Instrument Tour" chapter in the R&S FSWP Getting Started manual.

"External Trigger 1"

Trigger signal from the "Trigger Input / Output" connector.
(front panel)

"External Trigger 2"

Trigger signal from the "Sync Trigger Input / Output" connector.
(rear panel)

Note: Connector must be configured for "Input" in the "Output" configuration
(See the R&S FSWP user manual).

Remote command:

TRIG:SOUR EXT, TRIG:SOUR EXT2

See [TRIGger\[:SEQuence\]:SOURce](#) on page 157

Trigger Level

Defines the trigger level for the specified trigger source.

For details on supported trigger levels, see the instrument data sheet.

Remote command:

[TRIGger\[:SEQuence\]:LEVel\[:EXternal<port>\]](#) on page 155

Drop-Out Time

Defines the time that the input signal must stay below the trigger level before triggering again.

Remote command:

[TRIGger\[:SEQuence\]:DTIME](#) on page 154

Trigger Offset

Defines the time offset between the trigger event and the start of the measurement.

Offset > 0:	Start of the measurement is delayed
Offset < 0:	Measurement starts earlier (pretrigger)

Remote command:

[TRIGger\[:SEQuence\]:HOLDoff\[:TIME\]](#) on page 154

Hysteresis

Defines the distance in dB to the trigger level that the trigger source must exceed before a trigger event occurs. Setting a hysteresis avoids unwanted trigger events caused by noise oscillation around the trigger level.

This setting is only available for "IF Power" trigger sources. The range of the value is between 3 dB and 50 dB with a step width of 1 dB.

Remote command:

[TRIGger\[:SEQuence\]:IFPower:HYSteresis](#) on page 155

Trigger Holdoff

Defines the minimum time (in seconds) that must pass between two trigger events. Trigger events that occur during the holdoff time are ignored.

Remote command:

[TRIGger \[:SEquence\] :IFPower:HOLDoFF](#) on page 154

Slope

For all trigger sources except time, you can define whether triggering occurs when the signal rises to the trigger level or falls down to it.

Remote command:

[TRIGger \[:SEquence\] :SLOPe](#) on page 156

Noise Source State

Access: [TRIG]

Temporarily turns on the noise source so that you can see the effects of the trigger and gate settings with the noise source on.

This function is only available as long as the trigger and gate preview is displayed.

5.8.2 Gate settings

Access: "Overview" > "Trigger" > "Trigger / Gate Config." > "Gate Settings"

Gate settings define one or more extracts of the signal to be measured.

Gate Settings	Cont. Gate	Source
Gated Trigger	On	Off
Gate Mode	Level	Edge
Gate Delay	0.0 s	
Gate Length	400.0 μ s	



Gating is not available for measurements on I/Q-based data.

Gated Trigger	81
Gate Mode	81
Gate Delay	81
Gate Length	81

Gated Trigger

Switches gated triggering on or off.

If the gate is switched on, a gate signal applied to one of the TRIGGER INPUT connectors or the internal IF power detector controls the measurement.

Remote command:

[\[SENSe:\] SWEEp:EGATe](#) on page 157

Gate Mode

Sets the gate mode.

- | | |
|---------|--|
| "Edge" | The trigger event for the gate to open is the detection of the signal edge.
After the gate signal has been detected, the gate remains open until the gate length is over. |
| "Level" | The trigger event for the gate to open is a particular power level.
After the gate signal has been detected, the gate remains open until the signal disappears. |

Remote command:

[\[SENSe:\] SWEEp:EGATe:TYPE](#) on page 160

Gate Delay

Defines the delay time between the gate signal and the continuation of the measurement.

In the Spectrum application, the delay position on the time axis in relation to the measurement is indicated by a line labeled "GD".

Remote command:

[\[SENSe:\] SWEEp:EGATe:HOLDoff](#) on page 159

Gate Length

Defines how long the gate is open when it is triggered.

The gate length can only be set in the edge-triggered gate mode. In the level-triggered mode the gate length depends on the level of the gate signal.

In the Spectrum application, the gate length in relation to the measurement is indicated by a line labeled "GL".

Remote command:

[\[SENSe:\] SWEEp:EGATe:LENGth](#) on page 159

5.8.3 Continuous gate settings

Access: "Overview" > "Trigger" > "Trigger / Gate Config." > "Cont. Gate" tab

Continuous gating allows you to perform a continuous gated sweep after a single external trigger is received.

Gate Settings	Cont. Gate
Continuous Gate	<input checked="" type="radio"/> On <input type="radio"/> Off
Gate Period Length	5.0 ms
Gate Period Count	100

Continuous Gate.....	82
Gate Period Length.....	82
Gate Period Count.....	82

Continuous Gate

Activates or deactivates continuous gating.

This setting is only available if **Gated Trigger** is "On".

Remote command:

[\[SENSe:\]SWEep:EGATe:CONTInuous\[:STATe\]](#) on page 158

Gate Period Length

Defines the length in seconds of a single gate period in continuous gating. The length is determined from the beginning of one gate measurement to the beginning of the next one.

Remote command:

[\[SENSe:\]SWEep:EGATe:CONTInuous:PLENgtH](#) on page 158

Gate Period Count

Defines the number of gate periods to be measured after a single trigger event in continuous gating.

Remote command:

[\[SENSe:\]SWEep:EGATe:CONTInuous:PCOunt](#) on page 158

5.9 Performing measurements

Access: [SWEEP]

Access (calibration): "Overview" > "Calibrate"

This chapter contains all functionality necessary to control and perform "noise figure" measurements.

Continuous Sweep / Run Cont.....	83
Single Sweep / Run Single.....	83
Calibrate.....	83
Sweep Time.....	84
Meas Mode (Auto Manual).....	84

Continuous Sweep / Run Cont

Initiates a measurement and repeats it continuously until stopped. If necessary, the application automatically determines the reference level before starting the actual measurement.

While the measurement is running, the "Continuous Sweep" softkey and the [RUN CONT] key are highlighted. The running measurement can be aborted by selecting the highlighted softkey or key again. The results are not deleted until a new measurement is started.

Note: Sequencer. Furthermore, the [RUN CONT] key controls the Sequencer, not individual sweeps. [RUN CONT] starts the Sequencer in continuous mode. For details on the Sequencer, see the R&S FSWP User Manual.

Remote command:

`INITiate<n>:CONTInuous` on page 173

Single Sweep / Run Single

Initiates a single measurement. The measurement is finished after all frequencies in the frequency list have been measured. If necessary, the application automatically determines the reference level before starting the actual measurement.

After triggering, initiates a single measurement. The measurement is finished after all frequencies in the frequency list have been measured. If necessary, the application automatically determines the reference level before starting the actual measurement.

While the measurement is running, the "Single Sweep" softkey and the [RUN SINGLE] key are highlighted. The running measurement can be aborted by selecting the highlighted softkey or key again.

Note: Sequencer. Furthermore, the [RUN SINGLE] key controls the Sequencer, not individual sweeps. [RUN SINGLE] starts the Sequencer in single mode. If the Sequencer is off, only the evaluation for the currently displayed channel is updated.

For details on the Sequencer, see the R&S FSWP User Manual.

Remote command:

`INITiate<n>[:IMMEDIATE]` on page 174

Calibrate

Initiates a calibration measurement.

For interpolation purposes, R&S FSWP-K30 will internally add additional measurement points at the band switching frequencies. This may increase the time needed to complete the calibration.

For more information see [Chapter 4.6, "Calibration \(2nd stage correction\)"](#), on page 35.

Remote command:

`INITiate<n>[:IMMediate]` on page 174

when `[SENSe:]CONFigure:CORRection` is on.

Sweep Time

Defines the sweep time.

For more information see "Sweep Time" on page 67.

Meas Mode (Auto Manual)

Selects the measurement mode for the hot and cold power measurements.

For more information about the measurement modes see Chapter 4.2, "Measurement modes", on page 28.

In manual measurement mode, the application opens a dialog box when you start a measurement. For more information about its contents see "Performing a manual measurement" on page 28.

Remote command:

`[SENSe:]CONFigure:CONTRol` on page 175

`[SENSe:]CONFigure:MEASurement` on page 176

5.10 Configuring inputs and outputs of the R&S FSWP



Further input sources

The noise measurement application application can also process input from the following optional sources:

- External mixer
- External generator
- Active modular probes

For details, see the R&S FSWP I/Q Analyzer and I/Q Input User Manual.

• Radio frequency (RF) input	84
• External generator	86
• DC power output configuration	90
• Signal source output configuration	90

5.10.1 Radio frequency (RF) input

Access: `[INPUT/OUTPUT] > "Input Source Config" > "Input Source" > "Radio Frequency"`

The RF input is the default input of the R&S FSWP.

Input Coupling.....	85
Impedance.....	85
High Pass Filter 1 to 3 GHz.....	85
YIG-Preselector.....	85

Input Coupling

The RF input of the R&S FSWP can be coupled by alternating current (AC) or direct current (DC).

AC coupling blocks any DC voltage from the input signal. AC coupling is activated by default to prevent damage to the instrument. Very low frequencies in the input signal can be distorted.

However, some specifications require DC coupling. In this case, you must protect the instrument from damaging DC input voltages manually. For details, refer to the data sheet.

Remote command:

`INPut<ip>:COUPling` on page 177

Impedance

For some measurements, the reference impedance for the measured levels of the R&S FSWP can be set to 50 Ω or 75 Ω.

Select 75 Ω if the 50 Ω input impedance is transformed to a higher impedance using a 75 Ω adapter of the RAZ type. (That corresponds to 25Ω in series to the input impedance of the instrument.) The correction value in this case is 1.76 dB = 10 log (75Ω/50Ω).

This value also affects the unit conversion.

Remote command:

`INPut<ip>:IMPedance` on page 178

High Pass Filter 1 to 3 GHz

Activates an additional internal highpass filter for RF input signals from 1 GHz to 3 GHz. This filter is used to remove the harmonics of the analyzer to measure the harmonics for a DUT, for example.

This function requires an additional hardware option.

Note: For RF input signals outside the specified range, the high-pass filter has no effect. For signals with a frequency of approximately 4 GHz upwards, the harmonics are suppressed sufficiently by the YIG-preselector, if available.)

Remote command:

`INPut<ip>:FILTer:HPASs[:STATe]` on page 178

YIG-Preselector

Enables or disables the YIG-preselector.

This setting requires an additional option on the R&S FSWP.

An internal YIG-preselector at the input of the R&S FSWP ensures that image frequencies are rejected. However, image rejection is only possible for a restricted bandwidth. To use the maximum bandwidth for signal analysis you can disable the YIG-preselector at the input of the R&S FSWP, which can lead to image-frequency display.

Note: Note that the YIG-preselector is active only on frequencies greater than 8 GHz. Therefore, switching the YIG-preselector on or off has no effect if the frequency is below that value.

Remote command:

`INPut<ip>:FILTer:YIG[:STATe]` on page 178

5.10.2 External generator

Access: [INPUT/OUTPUT] > "Input Source Config" > "External Generator"

- [Interface configuration settings](#)..... 86
- [Measurement configuration](#).....87

5.10.2.1 Interface configuration settings

Access: "Overview" > "Local Oscillator" > "External Generator" > "Measurement Configuration"

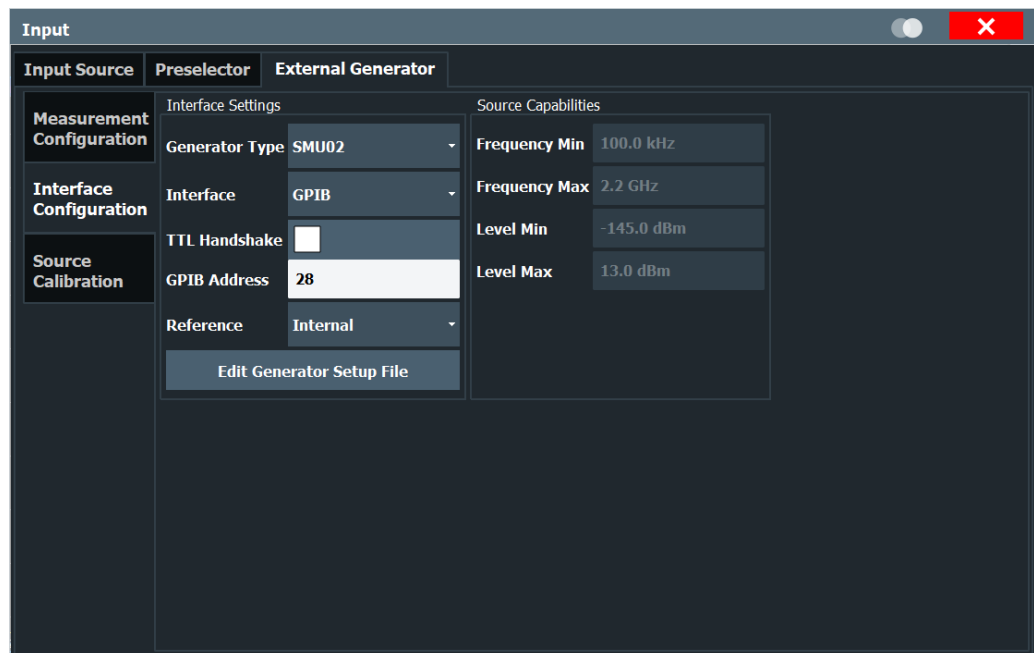

Generator Type	86
Interface	87
TTL Handshake	87
GPIB Address/TCPIP Address / Computer Name	87
Reference	87
Edit Generator Setup File	87
Frequency Min/ Frequency Max	87
Level Min/ Level Max	87

Generator Type

Selects the generator type and thus defines the generator setup file to use.

Remote command:

[SYSTem:COMMunicate:RDEvice:GENerator<gen>:TYPE](#) on page 192

Interface

Type of interface connection used.

For details on which signal generators support which interfaces, see the documentation of the corresponding signal generator.

- GPIB
- TCP/IP

Remote command:

[SYSTem:COMMunicate:RDEvice:GENerator<gen>:INTerface](#) on page 191

TTL Handshake

Turning the TTL handshake on and off has no effect for "Noise Figure" measurements.

GPIB Address/TCP/IP Address / Computer Name

For LAN connections: TCP/IP address of the signal generator

For GPIB connections: GPIB address of the signal generator.

Remote command:

[SYSTem:COMMunicate:GPIB:RDEvice:GENerator<gen>:ADDRess](#) on page 192

[SYSTem:COMMunicate:TCPIP:RDEvice:GENerator<gen>:ADDRess](#)

on page 192

Reference

Selects the internal R&S FSWP or an external frequency reference to synchronize the R&S FSWP with the generator (default: internal).

Remote command:

[SOURce<si>:EXTernal<gen>:ROSCillator\[:SOURce\]](#) on page 191

Edit Generator Setup File

Displays the setup file for the currently selected [Generator Type](#) in read-only mode in an editor.

Although the existing setup files are displayed in read-only mode in the editor, they can be saved under a different name (using "File > SaveAs").

For more information, see [Chapter 4.4, "External generator control"](#), on page 31.

Frequency Min/ Frequency Max

For reference only: Lower and upper frequency limit for the generator.

Level Min/ Level Max

For reference only: Lower and upper power limit for the generator.

5.10.2.2 Measurement configuration

Access: "Overview" > "Local Oscillator" > "External Generator" > "Measurement Configuration"

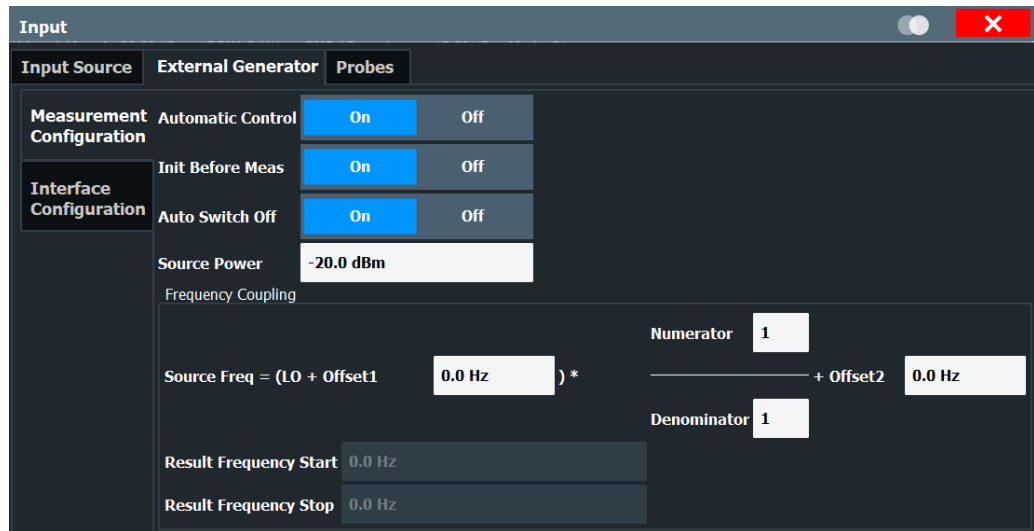

Automatic Control.....88
 Init Before Meas..... 88
 Auto Switch Off.....89
 Source Power.....89
 Frequency Coupling.....89
 Init External Generator..... 90

Automatic Control

Turns automatic control of the external generator on and off.

If on, the application controls the configuration of the external generator during measurements by transmitting the required remote commands. The connection is established automatically before a measurement if **Init Before Meas** is on. To establish the connection manually at any time, use the **Init External Generator** function.

Otherwise, you have to control the generator manually. The application assumes that the generator is configured correctly for the measurement. The remote connection to the generator is automatically terminated.

Turn on automatic control to perform Fixed IF measurements with the LO frequency tuned to the current measurement (RF) frequency. Manual control is recommended only for measurements whose generator settings remain the same during the measurement.

Remote command:

[SYSTem:CONFigure:GENerator:CONTRol:STATe](#) on page 193

Init Before Meas

Turns automatic transmission of the external generator configuration on and off.

If enabled, the application transmits a sequence of remote commands that configures the generator and turns on its RF output before each measurement. Thus, the generator runs with the required configuration and can still receive remote control commands during a measurement. Automatic initialization requires a slightly longer measurement time because of the time required to transmit the commands and configure the generator.

If disabled, you have to initialize the generator manually with [Init External Generator](#).

Note that you have to establish the connection before you can perform a measurement with the external generator.

Remote command:

[SYSTem:CONFIgure:GENerator:INITialise:AUTO](#) on page 193

Auto Switch Off

Turns automatic deactivation of the generator's RF output on and off.

If enabled, the application transmits a sequence of remote commands to turn off the RF output of the generator when a measurement is over. A measurement is over after a single sweep or if the measurement is aborted. The sequence of commands also ends the remote control session.

If disabled, you have to turn off the RF output and remote control session manually.

Note that when you close the noise measurement application, the generator's RF output is turned off and the remote session is terminated.

Remote command:

[SYSTem:CONFIgure:GENerator:SWITCh:AUTO](#) on page 193

Source Power

Defines the output power of the external generator.

The range depends on the generator you are using and is defined in its data sheet.

Remote command:

[SOURce<si>:EXTernal<gen>:POWER\[:LEVel\]](#) on page 191

Frequency Coupling

Defines frequency correction characteristics.

The generator frequency is calculated as follows.

$$f_{\text{Generator}} = \left[(f_{\text{LO}} + \text{Offset} < 1 >) * \frac{\text{Numerator}}{\text{Denominator}} \right] + \text{Offset} < 2 >$$

With:

- $f_{\text{Generator}}$ = generator frequency
- f_{LO} = frequency of the analyzer's LO
- $f_{\text{offset}<1>}$ = offset frequency of the analyzer
- $f_{\text{offset}<2>}$ = offset frequency of other components

Use the factors and offsets to compensate one or more components in the test setup which change the frequency between the generator and the DUT. Make sure, however, that the result does not exceed the frequency range of the generator.

The application calculates the resulting start and stop frequency based on the values you apply and displays them below the equation.

Remote command:

[SOURce:EXTernal:FREQuency\[:FACTor\]:DENominator](#) on page 190

[SOURce:EXTernal:FREQuency\[:FACTor\]:NUMerator](#) on page 190

[SOURce:EXTernal:FREQuency:OFFSet<of>](#) on page 190

Init External Generator

Establishes a connection to generator and turns on its RF output.

You can establish the connection automatically before a measurement if [Init Before Meas](#) is on.

Note that you have to establish the connection before you can perform a measurement with the external generator.

Remote command:

`SYSTem:CONFigure:GENerator:INITialise[:IMMediate]` on page 193

5.10.3 DC power output configuration

The configuration of the DC Power supply is the same as in the Phase Noise application.

For a comprehensive description, please refer to the R&S FSWP user manual.

5.10.4 Signal source output configuration

The configuration of the optional signal source is the same as in the Phase Noise application.

For a comprehensive description, please refer to the R&S FSWP user manual.

6 Analysis

This chapter contains all settings and parameters that the application provides to analyze and evaluate measurement results.

- [Configuring the display](#).....91
- [Working with traces](#).....94
- [Using markers](#).....97
- [Limit line settings and functions](#)..... 102

6.1 Configuring the display

Access: [MEAS CONFIG] > "Result Config"

Display configuration settings configure the way the results are displayed in the diagram.

The contents depend on whether you want to configure a graphical result display or a numerical result display.

Specifics for

The settings you make apply to the results you have selected in the "Specifics for" dropdown menu. If more than one window is active, "Specifics for" also puts the focus on the corresponding window.

- [Configuring graphical results](#).....91
- [Configuring numerical results](#).....93

6.1.1 Configuring graphical results

Access: [MEAS CONFIG] > "Result Config" > "Graph"

When configuring graphical results, the dialog box contains functionality to scale and set up the diagram axes.

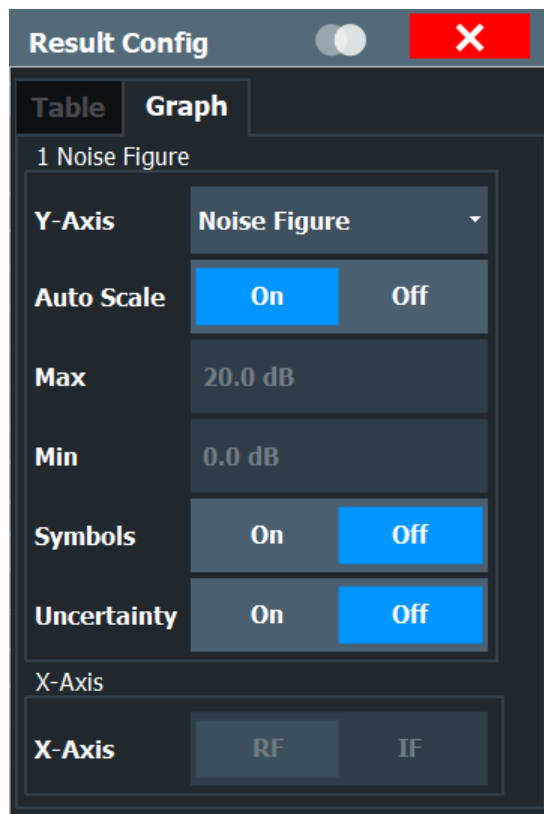

Y-Axis.....	92
Auto Scale / Min / Max.....	92
Symbols.....	93
Uncertainty.....	93
X-Axis.....	93

Y-Axis

Selects the result display and thus the scaling of the vertical axis.

For more information, see [Chapter 3, "Measurements and result displays"](#), on page 17.

Auto Scale / Min / Max

Turns automatic scaling of the vertical axis on and off.

If on, the application optimizes the scaling of the vertical axis after each measurement for ideal viewing of the results.

If off, you can define the scaling manually. The "Min" and "Max" input fields become available. These two input fields define the values at the top and bottom of the vertical axis.

Remote command:

Automatic scaling:

`DISPlay[:WINDow<n>]:TRACe<t>:Y[:SCALE]:AUTO` on page 196

Manual minimum value:

`DISPlay[:WINDow<n>]:TRACe<t>:Y[:SCALE]:BOTTom` on page 196

Manual maximum value

`DISPlay[:WINDow<n>]:TRACe<t>:Y[:SCALE]:TOP` on page 197

Symbols

Turns symbols that represent a measurement point on the trace on and off.

Remote command:

`DISPlay[:WINDow<n>]:TRACe<t>:SYMBOLs` on page 194

Uncertainty

Displays an additional trace indicating the measured trace values \pm the uncertainty values determined by the uncertainty calculator. Thus, you obtain a range of minimum and maximum result values. This trace is only useful for "noise figure" measurements.

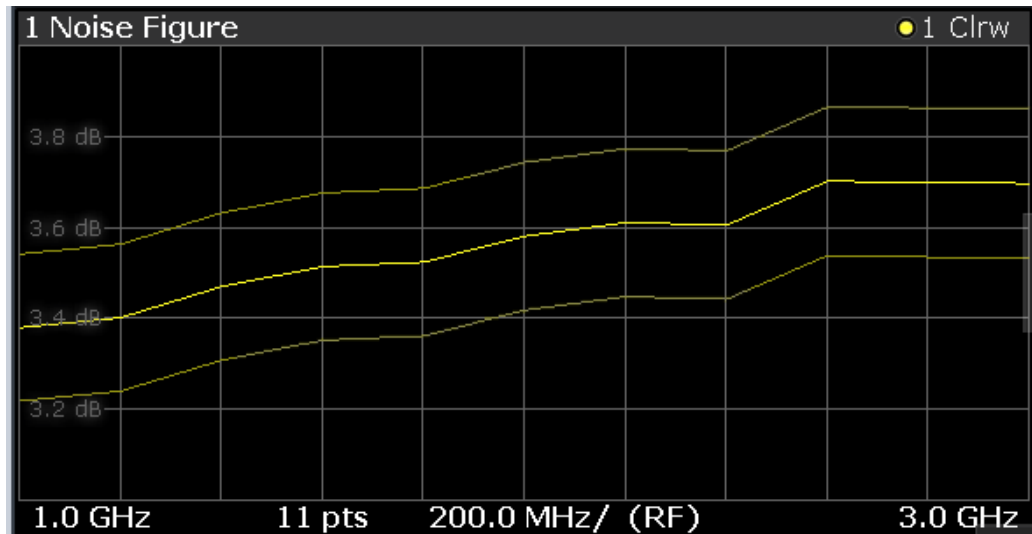

Remote command:

`DISPlay[:WINDow<n>]:TRACe<t>:UNCertainty` on page 195

X-Axis

Selects the frequency data that is displayed on the x-axis.

For measurements on frequency converting DUTs with a variable intermediate frequency, you can display either the RF frequency or the IF frequency.

Note that a change of the x-axis scale applies to all result displays, and also determines which value is output for trace export.

The "Frequency Axis" scale is also available via the [FREQ] key.

Remote command:

`DISPlay[:WINDow<n>]:TRACe<t>:X[:SCALE]` on page 195

6.1.2 Configuring numerical results

When configuring numerical results, the dialog box selects the type of results you want to display in the result table. The results in the table are based on a particular trace that you can select in the corresponding input field.

You can add an aspect of the measurement by placing a checkmark in front of the corresponding result on and remove it by removing the checkmark.

For more information on each result, see [Chapter 3, "Measurements and result displays"](#), on page 17.

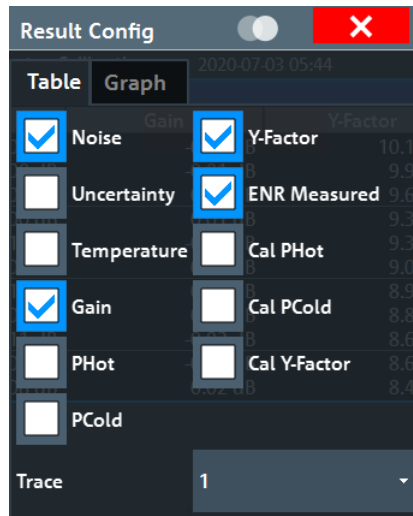

Remote command:

`DISPlay[:WINDow<n>]:TABLE:ITEM` on page 194

6.2 Working with traces

Access (trace configuration): [TRACE] > "Trace Config" > "Traces"

Access (trace export): [TRACE] > "Trace Config" > "Trace / Data Export"

Access (copy trace): [TRACE] > "Trace Config" > "Trace Copy"

A trace is the graphical representation of a set of measurement results in a diagram. Each measurement window that contains graphical results supports up to four individual traces. Each trace has a different color. Trace settings determine how the measured data is analyzed and displayed on the screen. The trace information, including a color map and trace mode is summarized in the diagram header.

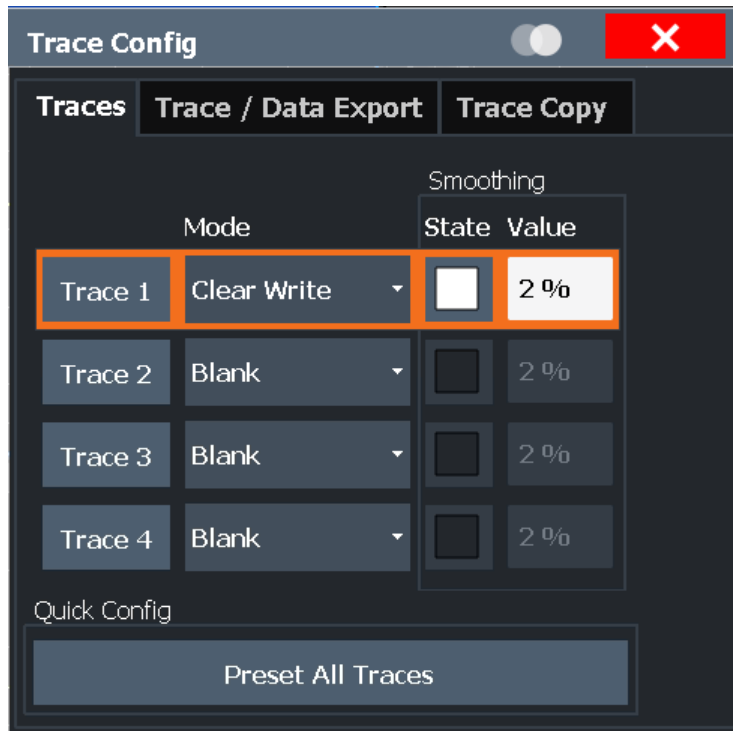

Traces..... 95

Smoothing..... 96

Preset Traces..... 96

Trace Export..... 96

- └ Export all Traces and all Table Results..... 96
- └ Include Instrument & Measurement Settings..... 96
- └ Trace to Export..... 96
- └ Decimal Separator..... 96
- └ Export Trace to ASCII File..... 96

Copy Trace..... 97

Traces

The "Trace 1 to 4" softkeys open the "Traces" tab of the "Trace Configuration" dialog box.

The "Traces" tab contains functionality to configure a trace.

"Trace Selection" The "Trace 1" to "Trace 4" buttons select a trace. If a trace is selected, it is highlighted orange.
Note that you cannot select a trace if its trace mode is "Blank".

"Trace Mode" Selects the trace mode for the corresponding trace.
For more information, see [Chapter 4, "Measurement basics"](#), on page 26.

Remote command:

Trace mode:

`DISPlay[:WINDow<n>] [:SUBWindow<w>]:TRACe<t>:MODE` on page 198

Smoothing

If enabled, the trace is smoothed by the specified value (between 1 % and 50 %). The smoothing value is defined as a percentage of the display width. The larger the smoothing value, the greater the smoothing effect.

Remote command:

`DISPlay[:WINDow<n>][:SUBWindow<w>]:TRACe<t>:SMOothing[:STATe]`

on page 199

`DISPlay[:WINDow<n>][:SUBWindow<w>]:TRACe<t>:SMOothing:APERture`

on page 199

Preset Traces

Restores the default configuration for all traces in a window.

Trace Export

The "Trace Export" tab contains functionality to export trace data.

Export all Traces and all Table Results ← Trace Export

Selects all displayed traces and result tables (e.g. "Result Summary", marker table etc.) in the current application for export to an ASCII file.

Alternatively, you can select one specific trace only for export (see [Trace to Export](#)).

The results are output in the same order as they are displayed on the screen: window by window, trace by trace, and table row by table row.

Remote command:

`FORMat:DEXPort:TRACes` on page 201

Include Instrument & Measurement Settings ← Trace Export

Includes additional instrument and measurement settings in the header of the export file for result data.

Remote command:

`FORMat:DEXPort:HEADer` on page 201

Trace to Export ← Trace Export

Defines an individual trace to be exported to a file.

This setting is not available if [Export all Traces and all Table Results](#) is selected.

Decimal Separator ← Trace Export

Defines the decimal separator for floating-point numerals for the data export/import files. Evaluation programs require different separators in different languages.

Remote command:

`FORMat:DEXPort:DSEParator` on page 200

Export Trace to ASCII File ← Trace Export

Opens a file selection dialog box and saves the selected trace in ASCII format (`.dat`) to the specified file and directory.

The results are output in the same order as they are displayed on the screen: window by window, trace by trace, and table row by table row.

The column headers are provided as the first row. Whether the frequency value represents the RF or IF frequency depends on the [X-Axis](#) setting.

Note: Secure user mode.

In secure user mode, settings that are stored on the instrument are stored to volatile memory, which is restricted to 256 MB. Thus, a "memory limit reached" error can occur although the hard disk indicates that storage space is still available.

To store data permanently, select an external storage location such as a USB memory device.

For details, see "Protecting Data Using the Secure User Mode" in the "Data Management" section of the R&S FSWP base unit user manual.

Remote command:

[MMEMory:STORe<n>:TRACe](#) on page 201

Copy Trace

Access: "Overview" > "Analysis" > "Traces" > "Copy Trace"

Or: [TRACE] > "Copy Trace"

Copies trace data to another trace.

The first group of buttons (labeled "Trace 1" to "Trace 4") selects the source trace. The second group of buttons (labeled "Copy to Trace 1" to "Copy to Trace 4") selects the destination.

Remote command:

[TRACe<n>:COPY](#) on page 202

6.3 Using markers

Markers help you to read out measurement results for particular frequencies or mark a particular point on a trace. The "noise figure" application features four markers. Markers in the "noise figure" application are linked. If you use more than one measurement window and activate a marker in one window, it also appears in all other measurement windows on the same horizontal position.

- [Marker configuration](#)..... 97
- [Marker positioning](#)..... 100

6.3.1 Marker configuration

Access (marker configuration): [MKR] > "Marker Config" > "Marker"

Access (marker settings): [MKR] > "Marker Config" > "Marker Settings"

The "Marker Configuration" dialog box and the "Marker" menu contain all functionality necessary to control markers.

The "Marker Configuration" dialog box consists of two tabs.

The "Markers" tab contains functionality to define characteristics for each marker.

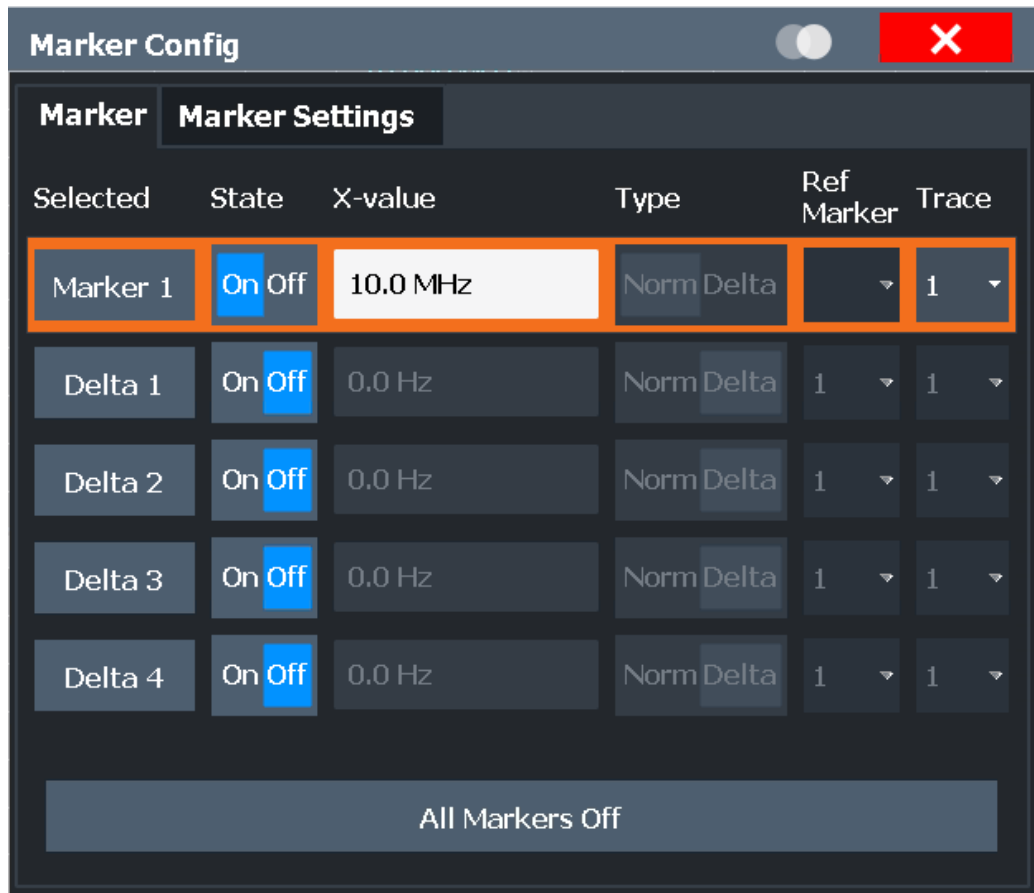

The "Marker Settings" tab contains general marker functionality.

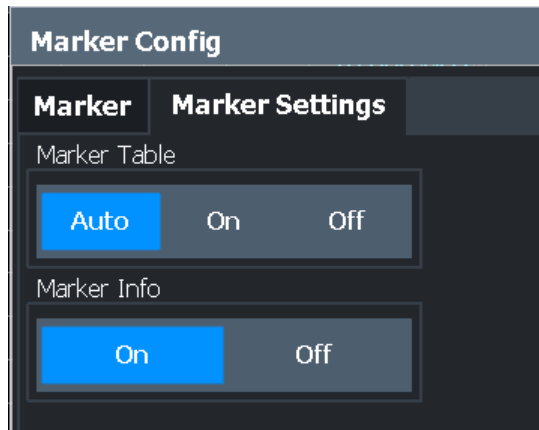

Marker (1...4)..... 99

Marker Type..... 99

Marker to Trace..... 99

All Markers Off..... 99

Marker Config..... 99

Marker Table Display..... 99

Marker Info..... 100

Marker (1...4)

Selects or turns the corresponding marker on and off.

Turning on a marker also opens an input field to define the horizontal position of the marker.

By default, the first marker you turn on is a normal marker, all others are delta markers.

Marker Type

Toggles the marker type.

The type for marker 1 is always "Normal", the type for delta marker 1 is always "Delta". These types cannot be changed.

Note: If normal marker 1 is the active marker, switching the "Mkr Type" activates an additional delta marker 1. For any other marker, switching the marker type does not activate an additional marker, it only switches the type of the selected marker.

"Normal" A normal marker indicates the absolute value at the defined position in the diagram.

"Delta" A delta marker defines the value of the marker relative to the specified reference marker (marker 1 by default).

Remote command:

[CALCulate<n>:MARKer<m>\[:STATe\]](#) on page 212

[CALCulate<n>:DELTAmarker<m>\[:STATe\]](#) on page 215

Marker to Trace

Opens an input field to assign the marker to a particular trace if you are using more than one trace.

All Markers Off

Deactivates all markers in one step.

Remote command:

[CALCulate<n>:MARKer<m>:AOFF](#) on page 212

Marker Config

Opens the "Marker Configuration" dialog box.

The "Marker Configuration" dialog box contains all marker functions necessary to set up the four markers supported by the application.

- Selected
Highlights the currently selected marker.
- State
Turns a marker on and off.
- X-value
Defines the marker position on the horizontal axis.
- Type
Selects the marker type. For more information see "[Marker Type](#)" on page 99.
- Trace
Selects the trace the marker is positioned on.

Marker Table Display

Defines how the marker information is displayed.

"On"	Displays the marker information in a table in a separate area beneath the diagram.
"Off"	No separate marker table is displayed. If Marker Info is active, the marker information is displayed within the diagram area.

Remote command:

`DISPlay[:WINDow<n>]:MTABLE` on page 218

Marker Info

Turns the marker information displayed in the diagram on and off.

1AP Clrw	
M1[1]	81.13 dBµV 177.610 MHz
D2[1]	-22.18 dB -28.980 MHz

Remote command:

`DISPlay[:WINDow<n>]:MINFo[:STATe]` on page 217

6.3.2 Marker positioning

If you are using more than one measurement window, the application performs the peak search in the currently selected measurement window. The currently selected measurement window has a blue border. Because the markers are linked in the "noise figure" application, the frequency position of the marker in the other window is updated accordingly, even if it means that the marker is on a peak in one window only.

Select Marker <x>.....	100
Peak Search.....	101
Search Next Peak.....	101
Search Minimum.....	101
Search Next Minimum.....	101
Marker to Single Frequency.....	102

Select Marker <x>

Opens a dialog box to select and activate or deactivate one or more markers.

The number in the softkey label (<x>) shows the number of the currently selected marker.



Remote command:

Marker selected via suffix <m> in remote commands.

Peak Search

Sets the selected marker/delta marker to the maximum of the trace. If no marker is active, marker 1 is activated.

Remote command:

[CALCulate<n>:MARKer<m>:MAXimum\[:PEAK\]](#) on page 219

[CALCulate<n>:DELTAmarker<m>:MAXimum\[:PEAK\]](#) on page 221

Search Next Peak

Sets the selected marker/delta marker to the next (lower) maximum of the assigned trace. If no marker is active, marker 1 is activated.

Remote command:

[CALCulate<n>:MARKer<m>:MAXimum:NEXT](#) on page 219

[CALCulate<n>:MARKer<m>:MAXimum:RIGHT](#) on page 219

[CALCulate<n>:MARKer<m>:MAXimum:LEFT](#) on page 218

[CALCulate<n>:DELTAmarker<m>:MAXimum:NEXT](#) on page 221

[CALCulate<n>:DELTAmarker<m>:MAXimum:RIGHT](#) on page 221

[CALCulate<n>:DELTAmarker<m>:MAXimum:LEFT](#) on page 220

Search Minimum

Sets the selected marker/delta marker to the minimum of the trace. If no marker is active, marker 1 is activated.

Remote command:

[CALCulate<n>:MARKer<m>:MINimum\[:PEAK\]](#) on page 220

[CALCulate<n>:DELTAmarker<m>:MINimum\[:PEAK\]](#) on page 222

Search Next Minimum

Sets the selected marker/delta marker to the next (higher) minimum of the selected trace. If no marker is active, marker 1 is activated.

Remote command:

[CALCulate<n>:MARKer<m>:MINimum:NEXT](#) on page 219

[CALCulate<n>:MARKer<m>:MINimum:LEFT](#) on page 219

[CALCulate<n>:MARKer<m>:MINimum:RIGHT](#) on page 220

[CALCulate<n>:DELTamarker<m>:MINimum:NEXT](#) on page 222

[CALCulate<n>:DELTamarker<m>:MINimum:LEFT](#) on page 221

[CALCulate<n>:DELTamarker<m>:MINimum:RIGHT](#) on page 222

Marker to Single Frequency

Starts a single frequency measurement on the current marker position.

When you use this function, the application changes the tuning mode and automatically adjusts the single frequency to that of the current marker position.

For more information see [Chapter 4.1.3, "Single frequency measurements"](#), on page 27.

6.4 Limit line settings and functions

Access: [LINES]

The "noise figure" measurement application supports up to eight active limit lines in each active measurement window.



Stored limit line settings

When storing and recalling limit line settings, consider the information provided in the Data Management chapter of the R&S FSWP User Manual.

- [Limit line management](#)..... 102
- [Limit line details](#)..... 104

6.4.1 Limit line management

Access: "Overview" > "Analysis" > "Lines" > "Limit Lines"

or: [LINES] > "Line Config" > "Limit Lines"

For the limit line overview, the R&S FSWP searches for all stored limit lines with the file extension `.LIN` in the `limits` subfolder of the main installation folder. The overview allows you to determine which limit lines are available and can be used for the current measurement.

For details on settings for individual lines see [Chapter 6.4.2, "Limit line details"](#), on page 104.

Name	103
Unit	103
Compatibility	103
Visibility	103

Traces to be Checked.....	103
Comment.....	103
Show Compatible Limit Lines.....	103
Show Lines for Noise.....	103
Create New Line.....	104
Edit Line.....	104
Copy Line.....	104
Delete Line.....	104
Disable All Lines.....	104

Name

The name of the stored limit line.

Unit

The unit in which the y-values of the data points of the limit line are defined.

Compatibility

Indicates whether the limit line definition is compatible with the current measurement settings.

Visibility

Displays or hides the limit line in the diagram. Up to 8 limit lines can be visible at the same time. Inactive limit lines can also be displayed in the diagram.

Remote command:

[CALCulate<n>:LIMit:LOWer:STATe](#) on page 206

[CALCulate<n>:LIMit:UPPer:STATe](#) on page 208

[CALCulate<n>:LIMit:ACTive?](#) on page 208

Traces to be Checked

Defines which traces are automatically checked for conformance with the limit lines. As soon as a trace to be checked is defined, the assigned limit line is active. One limit line can be activated for several traces simultaneously. If any of the "Traces to be Checked" violate any of the active limit lines, a message is indicated in the diagram.

Remote command:

[CALCulate<n>:LIMit:TRACe<t>:CHECK](#) on page 211

Comment

An optional description of the limit line.

Show Compatible Limit Lines

Defines which of the stored limit lines are included in the overview.

If active, only limit lines that are compatible to the result display currently in focus are displayed.

Show Lines for Noise

If activated (default), only limit lines created for "noise figure" measurements are displayed. Otherwise, all limit lines are displayed.

Create New Line

Creates a new limit line.

Edit Line

Edit an existing limit line configuration.

Copy Line

Copy the selected limit line configuration to create a new line.

Remote command:

`CALCulate<n>:LIMit:COPY` on page 208

Delete Line

Delete the selected limit line configuration.

Remote command:

`CALCulate<n>:LIMit:DELeTe` on page 209

Disable All Lines

Disable all limit lines in one step.

Remote command:

`CALCulate<n>:LIMit:STATe` on page 210

6.4.2 Limit line details

Access: "Overview" > "Analysis" > "Lines" > "Limit Lines" > "New" / "Edit" / "Copy To"

or: [LINES] > "Line Config" > "Limit Lines" > "New" / "Edit" / "Copy To"

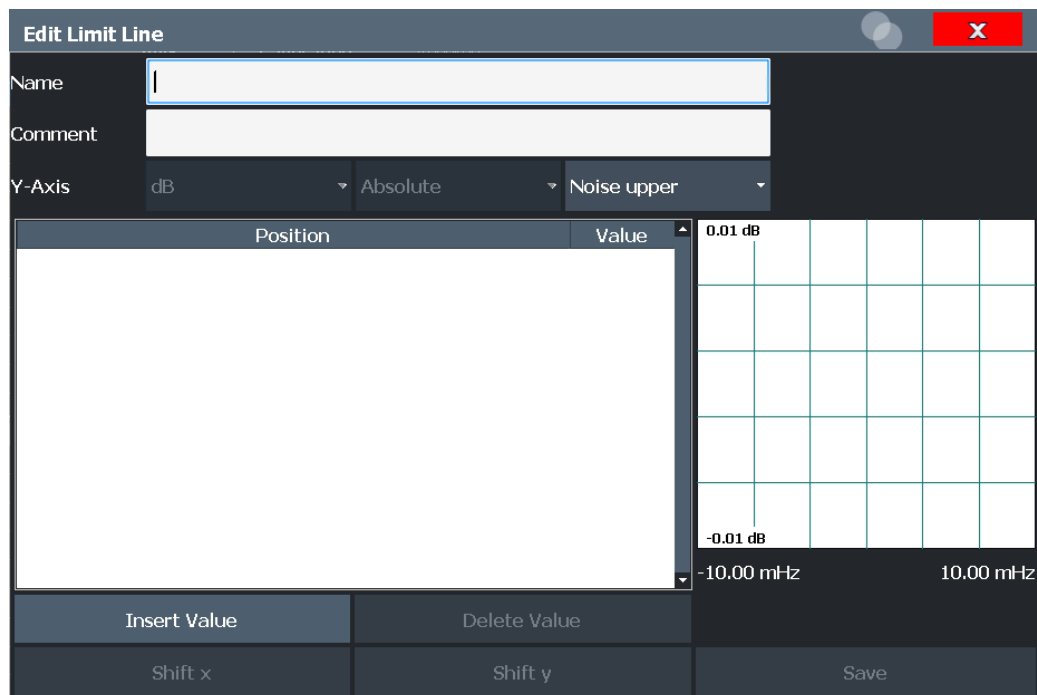

Name.....	105
Comment.....	105
Y-Axis.....	105
Data Points.....	105
Insert Value.....	105
Delete Value.....	105
Shift x.....	105
Shift y.....	106
Save.....	106

Name

Defines the limit line name. All names must be compatible with Windows conventions for file names. The limit line data is stored under this name (with a `.LIN` extension).

Remote command:

`CALCulate<n>:LIMit:NAME` on page 203

Comment

Defines an optional comment for the limit line.

Remote command:

`CALCulate<n>:LIMit:COMMeNt` on page 203

Y-Axis

Describes the vertical axis on which the data points of the limit line are defined.

You can select the type of limit line (upper or lower) for each type of result. From that information, the application sets the level unit and y-axis scaling. Both are then fix parameters because the unit depends on the result and the scaling is always absolute in case of "noise figure" measurements.

Data Points

Each limit line is defined by a minimum of 2 and a maximum of 200 data points. Each data point is defined by its position (x-axis) and value (y-value). Data points must be defined in ascending order. The same position can have two different values.

Remote command:

`CALCulate<n>:LIMit:CONTRol[:DATA]` on page 205

`CALCulate<n>:LIMit:LOWer[:DATA]` on page 206

`CALCulate<n>:LIMit:UPPer[:DATA]` on page 207

Insert Value

Inserts a data point in the limit line above the selected one in the "Edit Limit Line" dialog box.

Delete Value

Deletes the selected data point in the "Edit Limit Line" dialog box.

Shift x

Shifts the x-value of each data point horizontally by the defined shift width.

Remote command:

`CALCulate<n>:LIMit:CONTRol:SHIFt` on page 205

Shift y

Shifts the y-value of each data point vertically by the defined shift width.

Remote command:

[CALCulate<n>:LIMIT:LOWer:SHIFt](#) on page 206

[CALCulate<n>:LIMIT:UPPer:SHIFt](#) on page 207

Save

Saves the currently edited limit line under the name defined in the "Name" field.

7 Remote control commands for noise figure measurements

The following remote control commands are required to configure and perform "noise figure" measurements in a remote environment. The R&S FSWP must already be set up for remote operation in a network as described in the base unit manual.



Common functionality

Note that basic tasks that are also performed in the base unit in the same way are not described here. For a description of such tasks, see the R&S FSWP User Manual.

In particular, this includes:

- Managing Settings and Results, i.e. storing and loading settings and result data.
- Basic instrument configuration, e.g. checking the system configuration, customizing the screen layout, or configuring networks and remote operation.
- Using the common status registers (specific status registers for Pulse measurements are not used).

Channel-specific commands

Apart from a few general commands on the R&S FSWP, most commands refer to the currently active channel. Thus, always remember to activate a "Noise Figure" channel before starting a remote program for a "noise figure" measurement.

• Common suffixes	108
• Introduction	108
• Controlling the noise figure measurement channel	113
• Working with windows in the display	117
• General window commands	123
• Retrieving measurement results	124
• Defining the measurement frequency	125
• Selecting DUT characteristics	130
• Configuring the noise source	132
• Configuring additional loss	140
• Configuring the analyzer	147
• Configuring triggered and gated measurements	153
• Using the uncertainty calculator	162
• Performing measurements	172
• Configuring the inputs and outputs	177
• Configuring the display	194
• Working with traces	197
• Working with limit lines	202
• Working with markers	211
• Using the status register	222
• Deprecated remote commands for noise figure measurements	229
• Programming example: measuring a noise figure	230

7.1 Common suffixes

In the noise measurement application, the following common suffixes are used in remote commands:

Table 7-1: Common suffixes used in remote commands in the noise measurement application

Suffix	Value range	Description
<m>	1 to 4	Marker (or spot noise marker)
<n>	1 to 16	Window (in the currently selected channel)
<t>	1 to 4	Trace
	1 to 8	Limit line
<j>	1..10	Selects an integrated measurement range.
<k>	1..8 (Limit line) 1 2 (Display line)	Selects a limit or display line.
<r>	1..x	Selects a half decade. The value range depends on the number of half decades. The first half decade in the measurement always has the value "1". For subsequent half decades, add "1" to get the value "x" (the fourth half decade, for example, would have the value "4").
<s>	1..6	Selects a (user defined) spot noise marker.
<x>	1..2	Selects a mixer in the test setup.



Selecting windows in multiple channels

Note that the suffix <n> always refers to a window in the currently selected channel.

7.2 Introduction

Commands are program messages that a controller (e.g. a PC) sends to the instrument or software. They operate its functions ('setting commands' or 'events') and request information ('query commands'). Some commands can only be used in one way, others work in two ways (setting and query). If not indicated otherwise, the commands can be used for settings and queries.

The syntax of a SCPI command consists of a header and, usually, one or more parameters. To use a command as a query, you have to append a question mark after the last header element, even if the command contains a parameter.

A header contains one or more keywords, separated by a colon. Header and parameters are separated by a "white space" (ASCII code 0 to 9, 11 to 32 decimal, e.g. blank). If there is more than one parameter for a command, they are separated by a comma from one another.

Only the most important characteristics that you need to know when working with SCPI commands are described here. For a more complete description, refer to the user manual of the R&S FSWP.



Remote command examples

Note that some remote command examples mentioned in this general introduction are possibly not supported by this particular application.

7.2.1 Conventions used in descriptions

The following conventions are used in the remote command descriptions:

- **Command usage**
If not specified otherwise, commands can be used both for setting and for querying parameters.
If a command can be used for setting or querying only, or if it initiates an event, the usage is stated explicitly.
- **Parameter usage**
If not specified otherwise, a parameter can be used to set a value and it is the result of a query.
Parameters required only for setting are indicated as **Setting parameters**.
Parameters required only to refine a query are indicated as **Query parameters**.
Parameters that are only returned as the result of a query are indicated as **Return values**.
- **Conformity**
Commands that are taken from the SCPI standard are indicated as **SCPI confirmed**. All commands used by the R&S FSWP follow the SCPI syntax rules.
- **Asynchronous commands**
A command which does not automatically finish executing before the next command starts executing (overlapping command) is indicated as an **Asynchronous command**.
- **Reset values (*RST)**
Default parameter values that are used directly after resetting the instrument (*RST command) are indicated as ***RST** values, if available.
- **Default unit**
The default unit is used for numeric values if no other unit is provided with the parameter.
- **Manual operation**
If the result of a remote command can also be achieved in manual operation, a link to the description is inserted.

7.2.2 Long and short form

The keywords have a long and a short form. You can use either the long or the short form, but no other abbreviations of the keywords.

The short form is emphasized in uppercase letters. Note however, that this emphasis only serves the purpose to distinguish the short from the long form in the manual. For the instrument, the case does not matter.

Example:

`SENSe:FREQuency:CENTer` is the same as `SENS:FREQ:CENT`.

7.2.3 Numeric suffixes

Some keywords have a numeric suffix if the command can be applied to multiple instances of an object. In that case, the suffix selects a particular instance (e.g. a measurement window).

Numeric suffixes are indicated by angular brackets (<n>) next to the keyword.

If you do not quote a suffix for keywords that support one, a 1 is assumed.

Example:

`DISPlay[:WINDow<1...4>]:ZOOM:STATe` enables the zoom in a particular measurement window, selected by the suffix at `WINDow`.

`DISPlay:WINDow4:ZOOM:STATe ON` refers to window 4.

7.2.4 Optional keywords

Some keywords are optional and are only part of the syntax because of SCPI compliance. You can include them in the header or not.



If an optional keyword has a numeric suffix and you need to use the suffix, you have to include the optional keyword. Otherwise, the suffix of the missing keyword is assumed to be the value 1.

Optional keywords are emphasized with square brackets.

Example:

Without a numeric suffix in the optional keyword:

`[SENSe:]FREQuency:CENTer` is the same as `FREQuency:CENTer`

With a numeric suffix in the optional keyword:

`DISPlay[:WINDow<1...4>]:ZOOM:STATe`

`DISPlay:ZOOM:STATe ON` enables the zoom in window 1 (no suffix).

`DISPlay:WINDow4:ZOOM:STATe ON` enables the zoom in window 4.

7.2.5 Alternative keywords

A vertical stroke indicates alternatives for a specific keyword. You can use both keywords to the same effect.

Example:

```
[SENSe:]BANDwidth|BWIDth[:RESolution]
```

In the short form without optional keywords, `BAND 1MHZ` would have the same effect as `BWID 1MHZ`.

7.2.6 SCPI parameters

Many commands feature one or more parameters.

If a command supports more than one parameter, they are separated by a comma.

Example:

```
LAYout:ADD:WINDow Spectrum,LEFT,MTABLE
```

Parameters can have different forms of values.

- [Numeric values](#)..... 111
- [Boolean](#)..... 112
- [Character data](#)..... 112
- [Character strings](#)..... 113
- [Block data](#)..... 113

7.2.6.1 Numeric values

Numeric values can be entered in any form, i.e. with sign, decimal point or exponent. For physical quantities, you can also add the unit. If the unit is missing, the command uses the basic unit.

Example:

With unit: `SENSe:FREQuency:CENTer 1GHZ`

Without unit: `SENSe:FREQuency:CENTer 1E9` would also set a frequency of 1 GHz.

Values exceeding the resolution of the instrument are rounded up or down.

If the number you have entered is not supported (e.g. for discrete steps), the command returns an error.

Instead of a number, you can also set numeric values with a text parameter in special cases.

- **MIN/MAX**
Defines the minimum or maximum numeric value that is supported.
- **DEF**
Defines the default value.
- **UP/DOWN**
Increases or decreases the numeric value by one step. The step size depends on the setting. Sometimes, you can customize the step size with a corresponding command.

Querying numeric values

When you query numeric values, the system returns a number. For physical quantities, it applies the basic unit (e.g. Hz for frequencies). The number of digits after the decimal point depends on the type of numeric value.

Example:

Setting: `SENSe:FREQuency:CENTer 1GHZ`

Query: `SENSe:FREQuency:CENTer?` would return `1E9`

Sometimes, numeric values are returned as text.

- `INF/NINF`
Infinity or negative infinity. Represents the numeric values `9.9E37` or `-9.9E37`.
- `NAN`
Not a number. Represents the numeric value `9.91E37`. `NAN` is returned if errors occur.

7.2.6.2 Boolean

Boolean parameters represent two states. The "on" state (logically true) is represented by `"ON"` or the numeric value `1`. The "off" state (logically untrue) is represented by `"OFF"` or the numeric value `0`.

Querying Boolean parameters

When you query Boolean parameters, the system returns either the value `1` (`"ON"`) or the value `0` (`"OFF"`).

Example:

Setting: `DISPlay:WINDow:ZOOM:STATe ON`

Query: `DISPlay:WINDow:ZOOM:STATe?` would return `1`

7.2.6.3 Character data

Character data follows the syntactic rules of keywords. You can enter text using a short or a long form. For more information, see [Chapter 7.2.2, "Long and short form"](#), on page 109.

Querying text parameters

When you query text parameters, the system returns its short form.

Example:

Setting: `SENSe:BANDwidth:RESolution:TYPE NORMal`

Query: `SENSe:BANDwidth:RESolution:TYPE?` would return `NORM`

7.2.6.4 Character strings

Strings are alphanumeric characters. They have to be in straight quotation marks. You can use a single quotation mark (') or a double quotation mark (").

Example:

```
INSTRument:DELeTe 'Spectrum'
```

7.2.6.5 Block data

Block data is a format which is suitable for the transmission of large amounts of data.

The ASCII character # introduces the data block. The next number indicates how many of the following digits describe the length of the data block. The data bytes follow. During the transmission of these data bytes, all end or other control signs are ignored until all bytes are transmitted. #0 specifies a data block of indefinite length. The use of the indefinite format requires an NL^END message to terminate the data block. This format is useful when the length of the transmission is not known or if speed or other considerations prevent segmentation of the data into blocks of definite length.

7.3 Controlling the noise figure measurement channel

The following commands are necessary to control the measurement channel.

INSTRument:CREate:DUPLicate.....	113
INSTRument:CREate[:NEW].....	114
INSTRument:CREate:REPLace.....	114
INSTRument:DELeTe.....	114
INSTRument:LIST?.....	115
INSTRument:REName.....	115
INSTRument[:SELeCt].....	116
SYSTem:PRESet:CHANnel[:EXEC].....	116

INSTRument:CREate:DUPLicate

This command duplicates the currently selected channel, i.e creates a new channel of the same type and with the identical measurement settings. The name of the new channel is the same as the copied channel, extended by a consecutive number (e.g. "IQAnalyzer" -> "IQAnalyzer 2").

The channel to be duplicated must be selected first using the `INST:SEL` command.

Example:

```
INST:SEL 'PhaseNoise'
INST:CRE:DUPL
```

Duplicates the channel named 'PhaseNoise' and creates a new channel named 'PhaseNoise 2'.

Usage:

Event

INSTrument:CREate[:NEW] <ChannelType>, <ChannelName>

This command adds a measurement channel. You can configure up to 10 measurement channels at the same time (depending on available memory).

Parameters:

- <ChannelType> Channel type of the new channel.
For a list of available channel types, see [INSTrument:LIST?](#) on page 115.
- <ChannelName> String containing the name of the channel.
Note that you cannot assign an existing channel name to a new channel. If you do, an error occurs.

Example: `INST:CRE SAN, 'Spectrum 2'`
Adds a spectrum display named "Spectrum 2".

INSTrument:CREate:REPLace <ChannelName1>,<ChannelType>,<ChannelName2>

This command replaces a channel with another one.

Setting parameters:

- <ChannelName1> String containing the name of the channel you want to replace.
- <ChannelType> Channel type of the new channel.
For a list of available channel types, see [INSTrument:LIST?](#) on page 115.
- <ChannelName2> String containing the name of the new channel.
Note: If the specified name for a new channel already exists, the default name, extended by a sequential number, is used for the new channel (see [INSTrument:LIST?](#) on page 115).
Channel names can have a maximum of 31 characters, and must be compatible with the Windows conventions for file names. In particular, they must not contain special characters such as ":", "*", "?".

Example: `INST:CRE:REPL 'PhaseNoise', PNO, 'PNO2'`
Replaces the channel named "PhaseNoise" by a new channel of type "Phase Noise" named "PNO2".

Usage: Setting only

INSTrument:DELeTe <ChannelName>

This command deletes a channel.

If you delete the last channel, the default "Phase Noise" channel is activated.

Setting parameters:

- <ChannelName> String containing the name of the channel you want to delete.
A channel must exist to delete it.

Example: `INST:DEL 'PhaseNoise'`
Deletes the channel with the name 'PhaseNoise'.

Usage: Setting only

INSTrument:LIST?

This command queries all active channels. The query is useful to obtain the names of the existing channels, which are required to replace or delete the channels.

Return values:

<ChannelType>, For each channel, the command returns the channel type and
<ChannelName> channel name (see tables below).

Tip: to change the channel name, use the [INSTrument:REName](#) command.

Example: `INST:LIST?`
Result for 2 channels:
'PNO', 'PhaseNoise', 'PNO', 'Phase Noise 2'

Usage: Query only

Table 7-2: Available channel types and default channel names

Application	<ChannelType> Parameter	Default Channel Name*)
Phase Noise	PNOise	Phase Noise
Spectrum Monitor	SMONitor	Spectrum Monitor
Spectrum (R&S FSWP-B1)	SANalyzer	Spectrum
I/Q Analyzer (R&S FSWP-B1)	IQ	IQ Analyzer
Pulse Measurements (R&S FSWP-K6)	PULSe	Pulse
Analog Modulation Analysis (R&S FSWP-K7)	ADEMod	Analog Demod
Noise Figure Measurements (R&S FSWP-K30)	NOISe	Noise
Fast Spur Search (R&S FSWP-K50)	SPUR	Spurious
Transient Analysis (R&S FSWP-K60)	TA	Transient Analysis
Vector Signal Analysis (R&S FSWP-K70)	DDEM	VSA

Note: the default channel name is also listed in the table. If the specified name for a new channel already exists, the default name, extended by a sequential number, is used for the new channel.

INSTrument:REName <ChannelName1>, <ChannelName2>

This command renames a channel.

Setting parameters:

<ChannelName1> String containing the name of the channel you want to rename.

<ChannelName2> String containing the new channel name.

Note that you cannot assign an existing channel name to a new channel. If you do, an error occurs.

Channel names can have a maximum of 31 characters, and must be compatible with the Windows conventions for file names. In particular, they must not contain special characters such as ":", "*", "?".

Example:

```
INST:REN 'PhaseNoise', 'PNO'
```

Renames the channel with the name 'PhaseNoise' to 'PNO'.

Usage:

Setting only

INSTrument[:SElect] <ChannelType> | <ChannelName>

This command activates a new channel with the defined channel type, or selects an existing channel with the specified name.

Also see

- [INSTrument:CREate\[:NEW\]](#) on page 114

Parameters:

<ChannelType> Channel type of the new channel.

For a list of available channel types see [INSTrument:LIST?](#) on page 115.

<ChannelName> String containing the name of the channel.

Example:

```
INST IQ
```

Activates a channel for the I/Q Analyzer application (evaluation mode).

```
INST 'MyIQSpectrum'
```

Selects the channel named 'MyIQSpectrum' (for example before executing further commands for that channel).

SYSTem:PRESet:CHANnel[:EXEC]

This command restores the default instrument settings in the current channel.

Use `INST:SEL` to select the channel.

Example:

```
INST:SEL 'Spectrum2'
```

Selects the channel for "Spectrum2".

```
SYST:PRESet:CHAN:EXEC
```

Restores the factory default settings to the "Spectrum2" channel.

Usage:

Event

Manual operation: See ["Preset Channel"](#) on page 45

7.4 Working with windows in the display

The following commands are required to change the evaluation type and rearrange the screen layout for a channel as you do using the SmartGrid in manual operation. Since the available evaluation types depend on the selected application, some parameters for the following commands also depend on the selected channel.

Note that the suffix <n> always refers to the window *in the currently selected channel*.

LAYout:ADD[:WINDow]?	117
LAYout:CATalog[:WINDow]?	118
LAYout:IDENtify[:WINDow]?	119
LAYout:REMOve[:WINDow]	119
LAYout:REPLace[:WINDow]	119
LAYout:SPLitter	120
LAYout:WINDow<n>:ADD?	121
LAYout:WINDow<n>:IDENtify?	122
LAYout:WINDow<n>:REMOve	122
LAYout:WINDow<n>:REPLace	122

LAYout:ADD[:WINDow]? <WindowName>, <Direction>, <WindowType>

This command adds a window to the display in the active channel.

This command is always used as a query so that you immediately obtain the name of the new window as a result.

To replace an existing window, use the `LAYout:REPLace[:WINDow]` command.

Query parameters:

<WindowName>	String containing the name of the existing window the new window is inserted next to. By default, the name of a window is the same as its index. To determine the name and index of all active windows, use the <code>LAYout:CATalog[:WINDow]?</code> query.
<Direction>	LEFT RIGHT ABOVE BELOW Direction the new window is added relative to the existing window.
<WindowType>	text value Type of result display (evaluation method) you want to add. See the table below for available parameter values.

Return values:

<NewWindowName>	When adding a new window, the command returns its name (by default the same as its number) as a result.
-----------------	---

Example:

```
LAY:ADD? '1', LEFT, MTAB
```

Result:

```
'2'
```

Adds a new window named '2' with a marker table to the left of window 1.

Usage:	Query only
Manual operation:	See "Noise Figure" on page 18
	See "Gain" on page 19
	See "Noise Temperature" on page 19
	See "Y-Factor" on page 20
	See "ENR Measured" on page 21
	See "Power (Hot)" on page 22
	See "Power (Cold)" on page 22
	See "Cal Y-Factor" on page 23
	See "Cal Power (Hot)" on page 23
	See "Cal Power (Cold)" on page 24
	See "Result Table" on page 24
	See "Marker Table" on page 25

Table 7-3: <WindowType> parameter values for Noise Figure application

Parameter value	Window type
CPCold	Cal Power (Cold)
CPHot	Cal Power (Hot)
CYFactor	"Cal Y-Factor"
ENR	ENR Measured
GAIN	"Gain" result display
MTABLE	Marker table
NOISe	"Noise figure" result display
PCOLD	Power cold result display
PHOT	Power hot result display
RESults	Result table
TEMPerature	"Noise temperature" result display
YFACtor	"Y-Factor" result display

LAYout:CATalog[:WINDow]?

This command queries the name and index of all active windows in the active channel from top left to bottom right. The result is a comma-separated list of values for each window, with the syntax:

<WindowName_1>,<WindowIndex_1>..<WindowName_n>,<WindowIndex_n>

Return values:

<WindowName>	string Name of the window. In the default state, the name of the window is its index.
<WindowIndex>	numeric value Index of the window.

Example: LAY:CAT?
 Result:
 '2',2,'1',1
 Two windows are displayed, named '2' (at the top or left), and '1' (at the bottom or right).

Usage: Query only

LAYout:IDENtify[:WINDow]? <WindowName>

This command queries the **index** of a particular display window in the active channel.

Note: to query the **name** of a particular window, use the [LAYout:WINDow<n>:IDENtify?](#) query.

Query parameters:

<WindowName> String containing the name of a window.

Return values:

<WindowIndex> Index number of the window.

Example: LAY:IDEN:WIND? '2'
 Queries the index of the result display named '2'.
 Response:
 2

Usage: Query only

LAYout:REMOve[:WINDow] <WindowName>

This command removes a window from the display in the active channel.

Setting parameters:

<WindowName> String containing the name of the window. In the default state, the name of the window is its index.

Example: LAY:REM '2'
 Removes the result display in the window named '2'.

Usage: Setting only

LAYout:REPLace[:WINDow] <WindowName>,<WindowType>

This command replaces the window type (for example from "Diagram" to "Result Summary") of an already existing window in the active channel while keeping its position, index and window name.

To add a new window, use the [LAYout:ADD\[:WINDow\]?](#) command.

Setting parameters:

<WindowName> String containing the name of the existing window.
 By default, the name of a window is the same as its index. To determine the name and index of all active windows in the active channel, use the [LAYout:CATalog\[:WINDow\]?](#) query.

<WindowType> Type of result display you want to use in the existing window. See [LAYout:ADD\[:WINDow\]?](#) on page 117 for a list of available window types.

Example: `LAY:REPL:WIND '1',MTAB`
Replaces the result display in window 1 with a marker table.

Usage: Setting only

LAYout:SPLitter <Index1>, <Index2>, <Position>

This command changes the position of a splitter and thus controls the size of the windows on each side of the splitter.

Compared to the [DISPlay\[:WINDow<n>\]:SIZE](#) on page 123 command, the `LAYout:SPLitter` changes the size of all windows to either side of the splitter permanently, it does not just maximize a single window temporarily.

Note that windows must have a certain minimum size. If the position you define conflicts with the minimum size of any of the affected windows, the command does not work, but does not return an error.

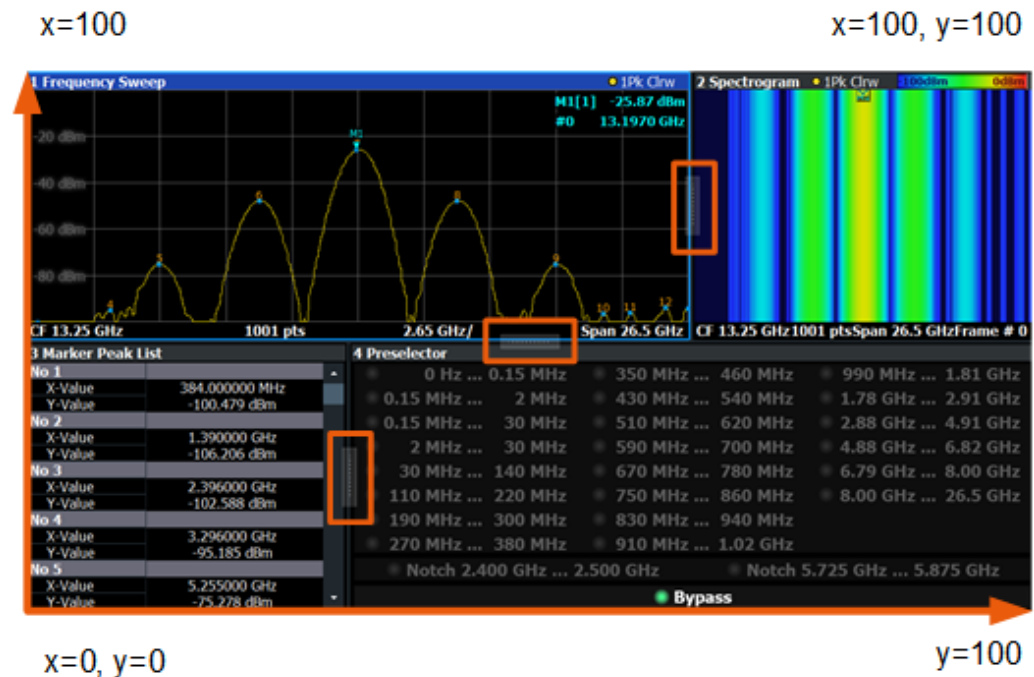

Figure 7-1: SmartGrid coordinates for remote control of the splitters

Setting parameters:

<Index1> The index of one window the splitter controls.
<Index2> The index of a window on the other side of the splitter.

<Position>	<p>New vertical or horizontal position of the splitter as a fraction of the screen area (without channel and status bar and softkey menu).</p> <p>The point of origin (x = 0, y = 0) is in the lower left corner of the screen. The end point (x = 100, y = 100) is in the upper right corner of the screen. (See Figure 7-1.)</p> <p>The direction in which the splitter is moved depends on the screen layout. If the windows are positioned horizontally, the splitter also moves horizontally. If the windows are positioned vertically, the splitter also moves vertically.</p> <p>Range: 0 to 100</p>
Example:	<pre>LAY:SPL 1,3,50</pre> <p>Moves the splitter between window 1 ('Frequency Sweep') and 3 ('Marker Table') to the center (50%) of the screen, i.e. in the figure above, to the left.</p>
Example:	<pre>LAY:SPL 1,4,70</pre> <p>Moves the splitter between window 1 ('Frequency Sweep') and 3 ('Marker Peak List') towards the top (70%) of the screen. The following commands have the exact same effect, as any combination of windows above and below the splitter moves the splitter vertically.</p> <pre>LAY:SPL 3,2,70 LAY:SPL 4,1,70 LAY:SPL 2,1,70</pre>
Usage:	Setting only

LAYout:WINDow<n>:ADD? <Direction>,<WindowType>

This command adds a measurement window to the display. Note that with this command, the suffix <n> determines the existing window next to which the new window is added. Unlike [LAYout:ADD\[:WINDow\]?](#), for which the existing window is defined by a parameter.

To replace an existing window, use the [LAYout:WINDow<n>:REPLace](#) command.

This command is always used as a query so that you immediately obtain the name of the new window as a result.

Suffix:

<n> [Window](#)

Query parameters:

<Direction> LEFT | RIGHT | ABOVE | BELOW

<WindowType> Type of measurement window you want to add.
See [LAYout:ADD\[:WINDow\]?](#) on page 117 for a list of available window types.

Return values:

<NewWindowName> When adding a new window, the command returns its name (by default the same as its number) as a result.

Example: `LAY:WIND1:ADD? LEFT,MTAB`
Result:
 '2'
 Adds a new window named '2' with a marker table to the left of window 1.

Usage: Query only

LAYout:WINDow<n>:IDENtify?

This command queries the **name** of a particular display window (indicated by the <n> suffix) in the active channel.

Note: to query the **index** of a particular window, use the `LAYout:IDENtify[:WINDow]?` command.

Suffix:
 <n> [Window](#)

Return values:
 <WindowName> String containing the name of a window.
 In the default state, the name of the window is its index.

Example: `LAY:WIND2:IDEN?`
 Queries the name of the result display in window 2.
Response:
 '2'

Usage: Query only

LAYout:WINDow<n>:REMOve

This command removes the window specified by the suffix <n> from the display in the active channel.

The result of this command is identical to the `LAYout:REMOve[:WINDow]` command.

Suffix:
 <n> [Window](#)

Example: `LAY:WIND2:REM`
 Removes the result display in window 2.

Usage: Event

LAYout:WINDow<n>:REPLace <WindowType>

This command changes the window type of an existing window (specified by the suffix <n>) in the active channel.

The effect of this command is identical to the `LAYout:REPLace[:WINDow]` command.

To add a new window, use the `LAYout:WINDow<n>:ADD?` command.

Suffix:	
<n>	Window
Setting parameters:	
<WindowType>	Type of measurement window you want to replace another one with. See LAYout:ADD[:WINDow]? on page 117 for a list of available window types.
Example:	LAY:WIND2:REPL MTAB Replaces the result display in window 2 with a marker table.
Usage:	Setting only

7.5 General window commands

The following commands are required to configure general window layout, independent of the application.

DISPlay:FORMat	123
DISPlay[:WINDow<n>]:SIZE	123

DISPlay:FORMat <Format>

This command determines which tab is displayed.

Parameters:

<Format>	SPLit Displays the MultiView tab with an overview of all active channels
	SINGle Displays the measurement channel that was previously focused.
*RST:	SING

Example: DISP:FORM SPL

DISPlay[:WINDow<n>]:SIZE <Size>

This command maximizes the size of the selected result display window *temporarily*. To change the size of several windows on the screen permanently, use the [LAY:SPL](#) command (see [LAYout:SPLitter](#) on page 120).

Suffix:

<n> [Window](#)

Parameters:

<Size>	LARGe Maximizes the selected window to full screen. Other windows are still active in the background.
--------	--

SMALI

Reduces the size of the selected window to its original size.
If more than one measurement window was displayed originally,
these are visible again.

*RST: SMALI

Example:

DISP:WIND2:SIZE LARG

7.6 Retrieving measurement results

The following commands are necessary to query measurement results.

TRACe<n>[:DATA]?..... 124

TRACe<n>[:DATA]? <Trace>[, <Result>]

This command queries the "noise figure" measurement results.

Suffix:

<n> 1..n
Window

Query parameters:

<Trace> TRACe1 | TRACe2 | TRACe3 | TRACe4
Selects the trace to be read out.

TRACE1

TRACE2

TRACE3

TRACE4

<Result> NOISe | GAIN | TEMPerature | YFACTor | ENR | PHOT |
PCOLd | CYFactor | CPHot | CPCold | NUNCertainty
Selects the result display to be read out.

ALL

Queries all available results for the measurement.

CPCold

Queries calibration power (cold) results.

CPHot

Queries calibration power (hot) results.

CYFactor

Queries calibration "y-factor" results.

ENR

Queries ENR measured results.

GAIN

Queries "gain" results.

NOISe

Queries "noise figure" results.

NUNCertainty

Queries "noise figure" uncertainty results.

PCOLd

Queries power (cold) results.

PHOT

Queries power (hot) results.

TEMPerature

Queries "noise temperature" results.

X

Queries the x values (frequency).

YFACTOR

Queries "y-factor" results.

Return values:

<TraceData>

For any graphical result display, the command returns one result for each measurement point.

The unit depends on the result you are querying.

Example:

```
TRAC? TRACE1, GAIN
```

Queries the "gain" results for the first trace.

Usage:

Query only

Manual operation:

See ["Noise Figure"](#) on page 18

See ["Gain"](#) on page 19

See ["Noise Temperature"](#) on page 19

See ["Y-Factor"](#) on page 20

See ["ENR Measured"](#) on page 21

See ["Power \(Hot\)"](#) on page 22

See ["Power \(Cold\)"](#) on page 22

See ["Cal Y-Factor"](#) on page 23

See ["Cal Power \(Hot\)"](#) on page 23

See ["Cal Power \(Cold\)"](#) on page 24

See ["Result Table"](#) on page 24

7.7 Defining the measurement frequency

The following commands are necessary to define the frequency characteristics of the "noise figure" measurement.

[SENSe:]CONFigure:FREQuency:CONTInuous	126
[SENSe:]CONFigure:FREQuency:SINGle	126
[SENSe:]CONFigure:LIST:CONTInuous	126
[SENSe:]CONFigure:LIST:SINGle	127
[SENSe:]FREQuency:CENTer	127
[SENSe:]FREQuency:TABLE:DATA	127
[SENSe:]FREQuency:LIST:DATA	128
[SENSe:]BANDwidth:LIST:DATA	128
[SENSe:]FREQuency:POINts	128

[SENSe:]FREQuency:SINGle.....	128
[SENSe:]FREQuency:SINGle:COUPled.....	129
[SENSe:]FREQuency:SPAN.....	129
[SENSe:]FREQuency:STARt.....	129
[SENSe:]FREQuency:STEP.....	130
[SENSe:]FREQuency:STOP.....	130

[SENSe:]CONFigure:FREQuency:CONTInuous

This command configures the software to perform a single frequency measurement in continuous sweep mode.

Example:

```
FREQ:SING 20MHz
Defines a measurement frequency of 20 MHz.
CONF:FREQ:CONT
INIT
Selects and initiates a single frequency measurement.
```

Usage: Event

Manual operation: See "[Tuning Mode](#)" on page 46

[SENSe:]CONFigure:FREQuency:SINGle

This command configures the software to perform a single frequency measurement in single sweep mode.

Example:

```
FREQ:SING 20MHz
Defines a measurement frequency of 20 MHz.
CONF:FREQ:SING
INIT
Selects and initiates a single frequency measurement.
```

Usage: Event

Manual operation: See "[Tuning Mode](#)" on page 46

[SENSe:]CONFigure:LIST:CONTInuous

This command configures the software to perform a frequency list measurement in continuous sweep mode.

Example:

```
CONF:LIST:CONT
INIT
Selects and initiates a frequency list measurement.
```

Usage: Event

Manual operation: See "[Tuning Mode](#)" on page 46

[SENSe:]CONFigure:LIST:SINGle

This command configures the software to perform a measurement in single frequency tuning mode.

Example: CONF:LIST:SING
 INIT
 Selects and initiates a single frequency measurement.

Example: See [Chapter 7.22, "Programming example: measuring a noise figure"](#), on page 230

Usage: Event

Manual operation: See ["Tuning Mode"](#) on page 46

[SENSe:]FREQuency:CENTer <Frequency>

This command defines the center frequency.

Parameters:
<Frequency> The allowed range and f_{\max} is specified in the data sheet.
 *RST: fmax/2
 Default unit: Hz

Example: FREQ:CENT 100 MHz
 FREQ:CENT:STEP 10 MHz
 FREQ:CENT UP
 Sets the center frequency to 110 MHz.

Manual operation: See ["Center"](#) on page 47
 See ["Frequency"](#) on page 78

[SENSe:]FREQuency:TABLE:DATA <Frequency>...

This command defines the contents of the frequency table.

The command overwrites the current contents of the frequency table.

Parameters:
<Frequency> Defines a frequency for each entry in the frequency table. A frequency table can contain up to 10001 entries.
 Range: 0 Hz to fmax
 Default unit: HZ

Example: FREQ:TABL:DATA 100MHZ,200MHZ,300MHZ,400MHZ,
 500MHZ
 Creates a frequency table with five entries.

Manual operation: See ["Populate Table"](#) on page 51

[SENSe:]FREQuency:LIST:DATA {<RFFrequency>, <LOFrequency>, <IFFrequency>}...

Queries the RF, LO and IF frequency.

Parameters:

<RFFrequency> Default unit: Hz
 <LOFrequency> Default unit: Hz
 <IFFrequency> Default unit: Hz

Example: SENS:FREQ:LIST:DATA?

Manual operation: See "[Populate Table](#)" on page 51

[SENSe:]BANDwidth:LIST:DATA {<Frequency>, <Bandwidth>, <SweepTime>}...

Queries the RF, RBW and sweep time.

Parameters:

<Frequency> <numeric value>
 Default unit: Hz
 <Bandwidth> <numeric value>
 Default unit: Hz
 <SweepTime> <numeric value>
 Default unit: s

Example: SENS:BAND:LIST:DATA?

Manual operation: See "[Populate Table](#)" on page 51

[SENSe:]FREQuency:POINts <SweepPoints>

This command defines the number of measurement points analyzed during a sweep.

Parameters:

<SweepPoints> Range: 1 to 10001
 *RST: 20

Example: SWE:POIN 100
 Defines 100 measurement points.

Example: See [Chapter 7.22, "Programming example: measuring a noise figure"](#), on page 230

Manual operation: See "[\(Measurement\) Points](#)" on page 47
 See "[\(Measurement\) Points](#)" on page 49

[SENSe:]FREQuency:SINGle <Frequency>

This command defines the frequency for single frequency measurements.

Parameters:

<Frequency>

The minimum and maximum frequency depend on the hardware. Refer to the datasheet for details.

*RST: 100 MHz

Default unit: HZ

Example:

FREQ: SING 200MHZ

Defines a measurement frequency of 200 MHz.

Manual operation:See "[Center](#)" on page 47See "[Single \(Frequency\)](#)" on page 48**[SENSe:]FREQuency:SINGle:COUPlEd <State>**

Couples or decouples frequency selection to the contents of a sweep list.

Parameters:

<State>

ON | OFF | 0 | 1

OFF | 0

Decouples frequency selection

ON | 1

Couples frequency selection

*RST: 0

Example:

SENS:FREQ:SING:COUP ON

Manual operation:See "[Coupled to Sweep List](#)" on page 49**[SENSe:]FREQuency:SPAN **

This command defines the frequency span.

If you change the span, the application creates a new frequency list.

Parameters:

Default unit: Hz

Example:

FREQ:SPAN 500MHZ

Defines a span of 500 MHz.

Manual operation:See "[Span](#)" on page 47**[SENSe:]FREQuency:STARt <Frequency>**

This command defines the start frequency.

If you change the start frequency, the application creates a new frequency list.

Parameters:

<Frequency>

*RST: RST value

Default unit: HZ

- Example:** `FREQ:STAR 900MHZ`
Defines a start frequency of 900 MHz.
- Example:** See [Chapter 7.22, "Programming example: measuring a noise figure"](#), on page 230
- Manual operation:** See ["Start and Stop Frequency"](#) on page 47

[SENSe:]FREQuency:STEP <Stepsize>

This command defines the frequency stepsize in the frequency table.

The stepsize corresponds to the distance from one measurement point to another.

If you change the stepsize, the application creates a new frequency list.

Parameters:

<Stepsize> Range: 0 Hz to span
 *RST: 100 MHz
 Default unit: HZ

Example: `FREQ:STEP 100MHZ`
Defines a stepsize of 100 MHz.

Manual operation: See ["Step"](#) on page 48

[SENSe:]FREQuency:STOP <Frequency>

This command defines the stop frequency.

If you change the stop frequency, the application creates a new frequency list.

Parameters:

<Frequency> *RST: RST value
 Default unit: HZ

Example: `FREQ:STOP 900MHZ`
Defines a stop frequency of 900 MHz.

Example: See [Chapter 7.22, "Programming example: measuring a noise figure"](#), on page 230

Manual operation: See ["Start and Stop Frequency"](#) on page 47

7.8 Selecting DUT characteristics

The following commands are necessary to define DUT characteristics.

[SENSe:]CONFigure:MODE:SYSTem:IF:FREQuency	131
[SENSe:]CONFigure:MODE:SYSTem:LO	131
[SENSe:]CONFigure:MODE:SYSTem:LO:FREQuency	131
[SENSe:]CONFigure:MODE:DUT	132
[SENSe:]CORRection:IREJection	132

[SENSe:]CONFigure:MODE:SYSTem:IF:FREQuency <Frequency>

This command defines the frequency for DUTs with a fixed IF.

Parameters:

<Frequency>	Range:	0 Hz to 100 GHz
	*RST:	10 MHz, if frequency converting mode has been selected
	Default unit:	HZ

Example:

```
CONF:MODE:SYST:IF:FREQ 1GHZ
```

Defines a fixed IF of 1 GHz.

Manual operation: See "[IF Fixed](#)" on page 53

[SENSe:]CONFigure:MODE:SYSTem:LO <LOType>

This command selects the type of local oscillator you are using.

The command is available for measurements on frequency converting DUTs [[SENSe:\]CONFigure:MODE:DUT\(\)](#)].

Parameters:

<LOType>	FIXed VARiable
----------	------------------

FIXed
The local oscillator is used as a fixed frequency source.
The IF is variable.

VARiable
The local oscillator is used as a variable frequency source.
The IF is fixed.

Example:

```
CONF:MODE:DUT DOWN
CONF:MODE:SYST:LO FIX
CONF:MODE:SYST:LO:FREQ 1GHZ
```

Selects a fixed LO frequency (= 1 GHz) on a down converting DUT.

Manual operation: See "[Mode](#)" on page 52

[SENSe:]CONFigure:MODE:SYSTem:LO:FREQuency <LOFrequency>

This command defines the frequency for DUTs with a fixed LO.

Parameters:

<LOFrequency>	Range:	0 Hz to 100 GHz
	*RST:	10 MHz, if frequency converting mode has been selected
	Default unit:	HZ

Example:

```
CONF:MODE:SYST:LO:FREQ 1GHZ
```

Defines a fixed LO frequency of 1 GHz.

Manual operation: See "[LO Fixed](#)" on page 52

[SENSe:]CONFigure:MODE:DUT <DUTType>

This command selects the type of DUT you are testing.

Note that you have to use `[SENSe:]CONFigure:MODE:SYSTem:LO` to select if the LO or IF are fixed.

Parameters:

<DUTType> AMPLifier | DDOWnconv | DOWNconv | UPConv

AMPLifier

Measurements on fixed frequency DUTs.

DOWNconv

Measurements on down-converting DUTs.

UPConv

Measurements on up-converting DUTs.

*RST: AMPLifier

Example:

`CONF:MODE:DUT DOWN`

Selects the measurement mode for a down-converting DUT.

Manual operation: See "[Mode](#)" on page 52

[SENSe:]CORRection:IREJection <ImageRejection>

This command defines the image frequency rejection for the DUT.

Parameters:

<ImageRejection> Range: 0 to 999.99
*RST: 999.99
Default unit: DB

Example:

`CORR:IREJ 0`

Turns image rejection off.

Manual operation: See "[Image Rejection](#)" on page 53

7.9 Configuring the noise source

The following commands are necessary to define the noise source characteristics.

<code>[SENSe:]CORRection:ENR:CALibration:SPOT:COLD</code>	133
<code>[SENSe:]CORRection:ENR:CALibration:SPOT:HOT</code>	133
<code>[SENSe:]CORRection:ENR:CALibration:MODE</code>	134
<code>[SENSe:]CORRection:ENR:CALibration:SPOT</code>	134
<code>[SENSe:]CORRection:ENR:CALibration:TABLE:SElect</code>	134
<code>[SENSe:]CORRection:ENR:CALibration:TYPE</code>	135
<code>[SENSe:]CORRection:ENR:COMMon</code>	135
<code>[SENSe:]CORRection:ENR[:MEASurement]:TABLE[:DATA]</code>	135
<code>[SENSe:]CORRection:ENR[:MEASurement]:TABLE:DElete</code>	136
<code>[SENSe:]CORRection:ENR[:MEASurement]:TABLE:LIST?</code>	136

[SENSe:]CORRection:ENR[:MEASurement]:TABLe:SElect.....	136
[SENSe:]CORRection:ENR[:MEASurement]:TABLe:TEMPerature[:DATA].....	137
[SENSe:]CORRection:ENR[:MEASurement]:TABLe:TEMPerature:DELeTe.....	137
[SENSe:]CORRection:ENR[:MEASurement]:TABLe:TEMPerature:LIST?.....	137
[SENSe:]CORRection:ENR[:MEASurement]:MODE.....	138
[SENSe:]CORRection:ENR[:MEASurement]:SPOT.....	138
[SENSe:]CORRection:ENR[:MEASurement]:TYPE.....	138
[SENSe:]CORRection:ENR[:MEASurement]:SPOT:COLD.....	139
[SENSe:]CORRection:ENR[:MEASurement]:SPOT:HOT.....	139
[SENSe:]CORRection:TEMPerature.....	139
[SENSe:]CORRection:ENR[:MEASurement]:SNS:SRNumber.....	140
[SENSe:]CORRection:ENR:CALibration:SNS:SRNumber.....	140

[SENSe:]CORRection:ENR:CALibration:SPOT:COLD <Temperature>

This command defines a constant temperature of a resistor not supplied with power (T_{cold}) used during calibration.

The command is available when you have selected a noise source with resistor characteristics with [SENSe:]CORRection:ENR:CALibration:TYPE.

Parameters:

<Temperature> Temperature in degrees Kelvin.
 *RST: 77 K
 Default unit: K

Example:

```
CORR:ENR:CAL:TYPE RES
CORR:ENR:CAL:SPOT:COLD 100
Defines a cold temperature of 100 K.
```

Manual operation: See "Calibration" on page 56

[SENSe:]CORRection:ENR:CALibration:SPOT:HOT <Temperature>

This command defines a constant temperature of a resistor supplied with power (T_{hot}) used during calibration.

The command is available when you have selected a noise source with resistor characteristics with [SENSe:]CORRection:ENR:CALibration:TYPE.

Parameters:

<Temperature> Temperature in degrees Kelvin.
 *RST: 77 K
 Default unit: K

Example:

```
CORR:ENR:TYPE RES
CORR:ENR:CAL:SPOT:HOT 300
Defines a cold temperature of 300 K.
```

Manual operation: See "Calibration" on page 56

[SENSe:]CORRection:ENR:CALibration:MODE <Mode>

This command selects the ENR mode for the calibration.

This command is available when you use different noise sources for calibration and measurement (`[SENSe:]CORRection:ENR:COMMON OFF`).

Parameters:

<Mode>

SPOT | TABLE

SPOT

Uses a constant ENR value for all measurement points (see `[SENSe:]CORRection:ENR:CALibration:SPOT`).

TABLE

Uses the contents of the ENR table.

*RST: SPOT

Example:

CORR:ENR:CAL:MODE SPOT

Uses a constant ENR value for all measurement points.

Manual operation: See "[Calibration](#)" on page 56

[SENSe:]CORRection:ENR:CALibration:SPOT <ENR>

This command defines the constant ENR for all measurement points during calibration.

This command is available when you use different noise sources for calibration and measurement (`[SENSe:]CORRection:ENR:COMMON OFF`).

Parameters:

<ENR>

Range: -999.99 to 999.99

*RST: 15

Default unit: DB

Example:

CORR:ENR:CAL:MODE SPOT

CORR:ENR:CAL:SPOT 30

Selects constant ENR value mode and defines an ENR of 30 dB for all measurement points.

Manual operation: See "[Calibration](#)" on page 56

[SENSe:]CORRection:ENR:CALibration:TABLE:SElect <TableName>

This command selects an ENR or temperature table for calibration.

Note that the contents of the table are independent of whether you use it for calibration or the actual measurement. When you want to edit a table, regardless if you want to use it later for a measurement or for calibration, you have to use `[SENSe:]CORRection:ENR[:MEASurement]:TABLE:SElect`. This command only selects a table for calibration.

This command is available when you use different noise sources for calibration and measurement (`[SENSe:]CORRection:ENR:COMMON OFF`).

Parameters:

<TableName> String containing the table name.

Example:

```
CORR:ENR:MEAS:TABL:SEL 'ENRTable'
```

Selects a table called 'ENRTable'.

Manual operation:

See ["Calibration"](#) on page 56
See ["New"](#) on page 58

[SENSe:]CORRection:ENR:CALibration:TYPE <Type>

This command selects the type of noise source you are using for the calibration.

Parameters:

<Type>

DIODe

Selects a noise source with diode characteristics.

RESistor

Selects a noise source with resistor characteristics.

When you select this noise source type, the application automatically selects the manual measurement mode (see [\[SENSe:\]CONFigure:CONTRol](#)).

SMART

Selects a smart noise source.

```
*RST: DIODe
```

Example:

```
CORR:ENR:CAL:TYPE RES
```

Selects a noise source with resistor characteristics.

Manual operation:

See ["Noise Source"](#) on page 55

[SENSe:]CORRection:ENR:COMMOn <State>

This command turns the use of a common ENR on or off.

For more information see ["Common Noise Source"](#) on page 56.

Parameters:

<State>

ON | OFF | 1 | 0

Example:

```
CORR:ENR:COMM ON
```

Turns the use of a common ENR on.

Manual operation:

See ["Common Noise Source"](#) on page 56

[SENSe:]CORRection:ENR[:MEASurement]:TABLe[:DATA] {<FrequencyENR>, <ENR>}...

This command defines the contents of the currently selected ENR table.

Define an ENR for all measurement points.

Each entry of the ENR table consists of one measurement point and the corresponding ENR. The individual values are separated by commas or spaces. The table can contain up to 10001 entries.

If you create a new table with this command, it overwrites the current entries of the frequency list.

To select the ENR table to edit, use `[SENSe:]CORRection:ENR[:MEASurement]:TABLE[:DATA]`.

Parameters:

<FrequencyENR> Frequency of the measurement point.

Range: 0 Hz to 999.99 GHz

Default unit: HZ

<ENR> Default unit: DB

Example: `CORR:ENR:MEAS:TABL:DATA 1MHZ,10,2MHZ,12`
Defines a new ENR table with two measurement points.

Example: See [Chapter 7.22, "Programming example: measuring a noise figure"](#), on page 230

Manual operation: See "New" on page 58
See "Edit" on page 58
See "Edit Table" on page 59

`[SENSe:]CORRection:ENR[:MEASurement]:TABLE:DELeTe <TableName>`

This command deletes a temperature table.

Setting parameters:

<TableName> String containing the name of the table.

Example: `CORR:ENR:MEAS:TABL:TEMP:DEL 'TemperatureTable'`
Deletes the table with the name 'TemperatureTable'.

Usage: Setting only

Manual operation: See "Delete" on page 59

`[SENSe:]CORRection:ENR[:MEASurement]:TABLE:LIST?`

Return values:

<Tables> <list>

Usage: Query only

`[SENSe:]CORRection:ENR[:MEASurement]:TABLE:SELeCt <TableName>`

This command selects an ENR or temperature table for the actual measurement.

When you want to edit a table, regardless if you want to use it later for a measurement or for calibration, you have to use this command. `[SENSe:]CORRection:ENR:CALibration:TABLE:SElect` only selects a table for calibration.

Parameters:

<TableName>

Manual operation: See "Measurement" on page 55
 See "New" on page 58
 See "Edit" on page 58

`[SENSe:]CORRection:ENR[:MEASurement]:TABLE:TEMPerature[:DATA]
 {<Frequency>, <Thot>, <Tcold>}...`

Parameters:

<Frequency> Default unit: HZ

<Thot> Default unit: K

<Tcold> Default unit: K

Manual operation: See "New" on page 58
 See "Edit" on page 58
 See "Edit Table" on page 59

`[SENSe:]CORRection:ENR[:MEASurement]:TABLE:TEMPerature:DElete
 <TableName>`

This command deletes a temperature table.

Setting parameters:

<TableName> String containing the name of the table.

Example: `CORR:ENR:MEAS:TABL:TEMP:DEL 'TemperatureTable'`
 Deletes the table with the name 'TemperatureTable'.

Usage: Setting only

Manual operation: See "Delete" on page 59

`[SENSe:]CORRection:ENR[:MEASurement]:TABLE:TEMPerature:LIST?`

This command queries all temperature tables available in the application.

Return values:

<Tables> <list>
 String containing the names of the tables as a comma separated list.

Example: `CORR:ENR:TABL:TEMP:LIST`
 would return, e.g.
 'Table1,Table2,Table3'

Usage: Query only

[SENSe:]CORRection:ENR[:MEASurement]:MODE <Mode>

This command selects the ENR mode for the actual measurement.

Parameters:

<Mode> SPOT | TABLE

SPOT

Uses a constant ENR value for all measurement points (see [\[SENSe:\]CORRection:ENR\[:MEASurement\]:SPOT](#)).

TABLE

Uses the contents of the ENR table.

*RST: SPOT

Example: CORR:ENR:MODE SPOT

Uses a constant ENR value for all measurement points.

Example: See [Chapter 7.22, "Programming example: measuring a noise figure"](#), on page 230

Manual operation: See ["Measurement"](#) on page 55

[SENSe:]CORRection:ENR[:MEASurement]:SPOT <ENR>

This command defines the constant ENR for all measurement points during the actual measurement.

Parameters:

<ENR> *RST: 15
Default unit: DB

Example: CORR:ENR:MODE SPOT
CORR:ENR:SPOT 30

Selects constant ENR value mode and defines an ENR of 30 dB for all measurement points.

Manual operation: See ["Measurement"](#) on page 55

[SENSe:]CORRection:ENR[:MEASurement]:TYPE <Type>

This command selects the type of noise source you are using for the measurement.

Parameters:

<Type>

DIODe

Selects a noise source with diode characteristics.

RESistor

Selects a noise source with resistor characteristics.

When you select this noise source type, the application automatically selects the manual measurement mode (see [\[SENSe:\]CONFigure:CONTRol](#)).

SMART

Selects a smart noise source.

*RST: DIODe

Example:

CORR:ENR:TYPE RES

Selects a noise source with resistor characteristics.

Manual operation:

See "Noise Source" on page 55

See "Noise Source" on page 58

[SENSe:]CORRection:ENR[:MEASurement]:SPOT:COLD <Temperature>

This command defines a constant temperature of a resistor not supplied with power (T_{cold}) used during measurements.

The command is available when you have selected a noise source with resistor characteristics with `[SENSe:]CORRection:ENR[:MEASurement]:TYPE`.

Parameters:

<Temperature>

Temperature in degrees Kelvin.

*RST: 77 K

Default unit: K

Example:

CORR:ENR:TYPE RES

CORR:ENR:SPOT:COLD 100

Defines a cold temperature of 100 K.

Manual operation:

See "Measurement" on page 55

[SENSe:]CORRection:ENR[:MEASurement]:SPOT:HOT <Temperature>

This command defines a constant temperature of a resistor supplied with power (T_{hot}) used during measurements.

The command is available when you have selected a noise source with resistor characteristics with `[SENSe:]CORRection:ENR[:MEASurement]:TYPE`.

Parameters:

<Temperature>

Temperature in degrees Kelvin.

*RST: 77 K

Default unit: K

Example:

CORR:ENR:TYPE RES

CORR:ENR:SPOT:HOT 300

Defines a cold temperature of 300 K.

Manual operation:

See "Measurement" on page 55

[SENSe:]CORRection:TEMPerature <Temperature>

This command defines the room temperature of the measurement environment. The temperature is taken into account when calculating noise results.

Parameters:

<Temperature> Range: 278.15 to 318.15
 *RST: 293
 Default unit: K

Example:

CORR:TEMP 291.50
 Specifies a room temperature of 291.50 Kelvin (18.5 C).

Manual operation: See "[Temperature](#)" on page 57

[SENSe:]CORRection:ENR[:MEASurement]:SNS:SRNumber <SerialNumber>

This command sets and queries the measurement noise source smart noise source serial number.

Parameters:

<SerialNumber>

Manual operation: See "[Noise Source](#)" on page 55

[SENSe:]CORRection:ENR:CALibration:SNS:SRNumber <SerialNumber>

This command sets and queries the calibration noise source smart noise source serial number.

Parameters:

<SerialNumber>

Manual operation: See "[Noise Source](#)" on page 55

7.10 Configuring additional loss

The following commands are necessary to define loss resulting from equipment in the measurement setup.

[SENSe:]CORRection:LOSS:CALibration:MODE.....	141
[SENSe:]CORRection:LOSS:CALibration:SPOT.....	141
[SENSe:]CORRection:LOSS:CALibration:TABLE:DElete.....	141
[SENSe:]CORRection:LOSS:CALibration:TABLE:LIST?.....	142
[SENSe:]CORRection:LOSS:CALibration:TABLE:SElect.....	142
[SENSe:]CORRection:LOSS:CALibration:TABLE[:DATA].....	142
[SENSe:]CORRection:LOSS:CALibration:TEMPerature.....	143
[SENSe:]CORRection:LOSS:INPut:MODE.....	143
[SENSe:]CORRection:LOSS:INPut:SPOT.....	143
[SENSe:]CORRection:LOSS:INPut:TABLE[:DATA].....	143
[SENSe:]CORRection:LOSS:INPut:TABLE:DElete.....	144
[SENSe:]CORRection:LOSS:INPut:TABLE:LIST?.....	144
[SENSe:]CORRection:LOSS:INPut:TABLE:SElect.....	144
[SENSe:]CORRection:LOSS:INPut:TEMPerature.....	145
[SENSe:]CORRection:LOSS:OUTPut:MODE.....	145

[SENSe:]CORRection:LOSS:OUTPut:SPOT.....	145
[SENSe:]CORRection:LOSS:OUTPut:TABLE[:DATA].....	146
[SENSe:]CORRection:LOSS:OUTPut:TABLE:DELeTe.....	146
[SENSe:]CORRection:LOSS:OUTPut:TABLE:LIST?.....	146
[SENSe:]CORRection:LOSS:OUTPut:TABLE:SELeCt.....	146
[SENSe:]CORRection:LOSS:OUTPut:TEMPeRature.....	147

[SENSe:]CORRection:LOSS:CALibration:MODE <Mode>

This command selects the input loss mode.

Parameters:

<Mode> SPOT | TABLE

SPOT

Uses a constant calibration loss value for all measurement points (see [SENSe:]CORRection:LOSS:CALibration:SPOT on page 141).

TABLE

Uses the contents of the calibration loss table.

*RST: SPOT

Example:

```
CORR:LOSS:INP:MODE SPOT
```

```
CORR:LOSS:INP:SPOT 10
```

Selects constant calibration loss mode and defines an input loss of 10 dB for all measurement points.

Manual operation: See "[Calibration Loss](#)" on page 63

[SENSe:]CORRection:LOSS:CALibration:SPOT <Loss>

This command defines a constant calibration loss for all measurement points.

Parameters:

<Loss> Range: -999.99 to 999.99

*RST: 0 dB

Default unit: dB

Example:

```
CORR:LOSS:INP:MODE SPOT
```

```
CORR:LOSS:INP:SPOT 10
```

Selects constant calibration loss mode and defines an input loss of 10 dB for all measurement points.

Manual operation: See "[Calibration Loss](#)" on page 63

[SENSe:]CORRection:LOSS:CALibration:TABLE:DELeTe <TableName>

This command deletes a calibration loss table.

Setting parameters:

<TableName> String containing the name of the table.

Example: `CORR:LOSS:CAL:TABL:DEL 'CalibrationLoss'`
Deletes the table with the name 'CalibrationLoss'.

Usage: Setting only

Manual operation: See "[Delete](#)" on page 65

[SENSe:]CORRection:LOSS:CALibration:TABLE:LIST?

This command queries all calibration loss tables available in the application.

Example: `CORR:LOSS:CAL:TABL:LIST?`
Result:
'Table1, Table2, Table3'

Usage: Query only

[SENSe:]CORRection:LOSS:CALibration:TABLE:SElect <TableName>

This command selects a calibration loss table.

Parameters:
<TableName> String containing the table name.

Example: `CORR:LOSS:CAL:TABL:SEL 'CalibrationLoss'`
Selects a table called CalibrationLoss'.

Manual operation: See "[Calibration Loss](#)" on page 63

[SENSe:]CORRection:LOSS:CALibration:TABLE[:DATA] {<Frequency>, <Loss>}...

This command defines the contents of the currently selected calibration loss table.

Each entry of the loss table consists of one measurement point and the corresponding loss. The table can contain up to 10001 entries.

If you create a new table with this command, it overwrites the current entries of the loss table.

Parameters:

<Frequency> Frequency of the measurement point.
Range: 0 Hz to 999.99 GHz
Default unit: HZ

<Loss> Loss of the measurement point.
Range: -999.99 GHz to 999.99 GHz
Default unit: DB

Example: `CORR:LOSS:CAL:TABL 1MHz, 10, 2MHz, 12`
Defines a new calibration loss table with two measurement points.

Manual operation: See "[New](#)" on page 65
See "[Edit](#)" on page 65

[SENSe:]CORRection:LOSS:CALibration:TEMPerature <Temperature>

The specified temperature at the time of measurement is considered in the loss calculation.

Parameters:

<Temperature> Default unit: K

Example:

SENS:CORR:LOSS:CAL:TEMP 296.5

Calibration loss is corrected for a temperature of 296.5 K (23.35° C).

Manual operation: See "[Calibration Loss](#)" on page 63

[SENSe:]CORRection:LOSS:INPut:MODE <Mode>

This command selects the input loss mode.

Parameters:

<Mode> SPOT | TABLE

SPOT

Uses a constant input loss value for all measurement points (see [\[SENSe:\]CORRection:LOSS:INPut:SPOT](#) on page 143).

TABLE

Uses the contents of the input loss table.

*RST: SPOT

Example:

CORR:LOSS:INP:MODE SPOT

Selects constant input loss.

Manual operation: See "[Input Loss](#)" on page 62

[SENSe:]CORRection:LOSS:INPut:SPOT <Loss>

This command defines a constant input loss for all measurement points.

Parameters:

<Loss> Range: -999.99 to 999.99

*RST: 0 dB

Default unit: DB

Example:

CORR:LOSS:INP:MODE SPOT

CORR:LOSS:INP:SPOT 10

Selects constant input loss mode and defines an input loss of 10 dB for all measurement points.

Manual operation: See "[Input Loss](#)" on page 62

[SENSe:]CORRection:LOSS:INPut:TABLE[:DATA] {<Frequency>, <Loss>}...

This command defines the contents of the currently selected input loss table.

Each entry of the loss table consists of one measurement point and the corresponding loss. The table can contain up to 10001 entries.

The table should contain an input loss for all measurement points.

If you create a new table with this command, it will overwrite the current entries of the loss table.

Parameters:

<Frequency> Frequency of the measurement point.

Range: 0 dB to 999.99 dB

Default unit: HZ

<Loss> Loss of the measurement point.

Range: -999.99 dB to 999.99 dB

Default unit: DB

Example:

`CORR:LOSS:INP:TABL 1MHz,10,2MHz,12`

Defines a new input loss table with two measurement points.

Manual operation:

See ["Edit Table"](#) on page 59

See ["New"](#) on page 65

See ["Edit"](#) on page 65

[SENSe:]CORRection:LOSS:INPut:TABLE:DELEte <TableName>

This command deletes an input loss table.

Setting parameters:

<TableName> String containing the name of the table.

Example:

`CORR:LOSS:INP:TABL:DEL 'InputLoss'`

Deletes the table with the name 'InputLoss'.

Usage:

Setting only

Manual operation:

See ["Delete"](#) on page 65

[SENSe:]CORRection:LOSS:INPut:TABLE:LIST?

This command queries all input loss tables available in the application.

Example:

`CORR:LOSS:INP:TABL:LIST?`

Result:

`'Table1, Table2, Table3'`

Usage:

Query only

[SENSe:]CORRection:LOSS:INPut:TABLE:SELEct <TableName>

This command selects an input loss table.

Parameters:

<TableName> String containing the table name.

Example: `CORR:LOSS:INP:TABL:SEL 'InputLoss'`
Selects a table called 'InputLoss'.

Manual operation: See ["Input Loss"](#) on page 62

[SENSe:]CORRection:LOSS:INPut:TEMPerature <Temperature>

The specified temperature at the time of measurement is considered in the loss calculation.

Parameters:
<Temperature> Default unit: K

Example: `SENS:CORR:LOSS:INP:TEMP 296.5`
Input loss is corrected for a temperature of 296.5 K (23.35° C).

Manual operation: See ["Input Loss"](#) on page 62

[SENSe:]CORRection:LOSS:OUTPut:MODE <Mode>

This command selects the output loss mode.

Parameters:
<Mode> SPOT | TABLE

SPOT
Uses a constant output loss value for all measurement points (see [\[SENSe:\]CORRection:LOSS:OUTPut:SPOT](#) on page 145).

TABLE
Uses the contents of the output loss table.

*RST: SPOT

Example: `CORR:LOSS:OUTP:MODE SPOT`
Selects constant output loss.

Manual operation: See ["Output Loss"](#) on page 63

[SENSe:]CORRection:LOSS:OUTPut:SPOT <Loss>

This command defines a constant output loss for all measurement points.

Parameters:
<Loss> Range: -999.99 to 999.99
*RST: 0 dB
Default unit: DB

Example: `CORR:LOSS:OUTP:MODE SPOT`
`CORR:LOSS:OUTP:SPOT 10`
Selects constant output loss mode and defines an output loss of 10 dB for all measurement points.

Manual operation: See ["Output Loss"](#) on page 63

[SENSe:]CORRection:LOSS:OUTPut:TABLE[:DATA] {<Frequency>, <Loss>}...

This command defines the contents of the currently selected output loss table.

The table should contain an output loss for all measurement points.

Each entry of the loss table consists of one measurement point and the corresponding loss. The table can contain up to 10001 entries.

If you create a new table with this command, it will overwrite the current entries of the frequency list.

Parameters:

<Frequency> Frequency of the measurement point.

Range: 0 dB to 999.99 dB

Default unit: HZ

<Loss> Loss of the measurement point.

Range: -999.99 dB to 999.99 dB

Default unit: DB

Example: CORR:LOSS:OUTP:TABL 1MHz,10,2MHz,12
 Defines a new output loss table with two measurement points.

Manual operation: See ["Edit Table"](#) on page 59
 See ["New"](#) on page 65
 See ["Edit"](#) on page 65

[SENSe:]CORRection:LOSS:OUTPut:TABLE:DELeTe <TableName>

Setting parameters:

<TableName>

Usage: Setting only

Manual operation: See ["Delete"](#) on page 65

[SENSe:]CORRection:LOSS:OUTPut:TABLE:LIST?

This command queries all output loss tables available in the application.

Example: CORR:LOSS:OUTP:TABL:LIST?
 Result:
 'Table1,Table2,Table3'

Usage: Query only

[SENSe:]CORRection:LOSS:OUTPut:TABLE:SELeCt <TableName>

Parameters:

<TableName>

Manual operation: See ["Output Loss"](#) on page 63

[SENSe:]CORRection:LOSS:OUTPut:TEMPerature <Temperature>

The specified temperature at the time of measurement is considered in the loss calculation.

Parameters:

<Temperature> numeric value
Default unit: K

Example:

SENS:CORR:LOSS:OUTP:TEMP 296.5
Output loss is corrected for a temperature of 296.5 K (23.35° C).

Manual operation: See "Output Loss" on page 63

7.11 Configuring the analyzer

The following commands are necessary to configure the analyzer.

[SENSe:]BWIDth[:RESolution].....	147
[SENSe:]BANDwidth[:RESolution].....	147
[SENSe:]BWIDth:RESolution:AUTO.....	148
[SENSe:]BANDwidth:RESolution:AUTO.....	148
[SENSe:]CONFigure:CORRection.....	148
[SENSe:]CORRection[:STATe].....	149
[SENSe:]CORRection:RECall.....	149
[SENSe:]CORRection:SAVE.....	149
[SENSe:]SWEep:COUNT.....	150
[SENSe:]SWEep:TIME.....	150
[SENSe:]SWEep:TIME:AUTO.....	150
DISPlay[:WINDow<n>]:TRACe<t>:Y[:SCALe]:RLEVel.....	151
DISPlay[:WINDow<n>]:TRACe<t>:Y[:SCALe]:RLEVel:AUTO.....	151
INPut<ip>:ATTenuation.....	151
INPut<ip>:GAIN:STATe.....	152
INPut<ip>:GAIN[:VALue].....	152
SYSTem:CONFigure:DUT:GAIN.....	153
SYSTem:CONFigure:DUT:STIME.....	153

[SENSe:]BWIDth[:RESolution] <Bandwidth>

[SENSe:]BANDwidth[:RESolution] <Bandwidth>

This command defines the resolution bandwidth and decouples the resolution bandwidth from the span.

Example:

BAND 1 MHz
Sets the resolution bandwidth to 1 MHz

Manual operation:

See "Resolution Bandwidth (RBW)" on page 67
See "RBW" on page 78

[SENSe:]BWIDth:RESolution:AUTO <State>

[SENSe:]BANDwidth:RESolution:AUTO <State>

If enabled, the resolution bandwidth is selected automatically, depending on the current frequency of the sweep point, as defined in the frequency table (see [Chapter 5.2.3, "Using a frequency table"](#), on page 49).

If disabled, the RBW defined by `[SENSe:]BANDwidth[:RESolution]` is used.

Parameters:

<State>

ON | OFF | 0 | 1

OFF | 0

Switches the function off

ON | 1

Switches the function on

*RST: 0

Example:

SENS:BAND:RES:AUTO ON

Manual operation: See ["Resolution Bandwidth \(RBW\)"](#) on page 67

[SENSe:]CONFigure:CORRection

This command configures the software to perform calibration measurements.

Using `INITiate<n>[:IMMediate]` then initiates a calibration instead of the actual measurement, until you deliberately select one of the normal measurements again with one of the following commands.

- `[SENSe:]CONFigure:FREQuency:CONTInuous`
- `[SENSe:]CONFigure:FREQuency:SINGLE`
- `[SENSe:]CONFigure:LIST:CONTInuous`
- `[SENSe:]CONFigure:LIST:SINGLE`

Note that calibration data is used only when the second stage correction mode has been turned on with `[SENSe:]CORRection[:STATe]`.

Example:

```
//Turn on second stage correction
CORR ON
//Configure application to run calibration measurement
CONF:CORR
//Initiate calibration with synchronization to end of measurement
INIT;*OPC
//Return to normal measurement (single sweep list mode)
CONF:LIST:SING
//Initiate a calibrated measurement with synchronization to end
of measurement
INIT;*OPC
```

Example:

See [Chapter 7.22, "Programming example: measuring a noise figure"](#), on page 230

Usage:

Event

Manual operation: See ["2nd Stage Correction"](#) on page 67
See ["Calibrate"](#) on page 83

[SENSe:]CORRection[:STATe] <State>

This command includes or excludes calibration data in the actual measurement (see ["2nd Stage Correction"](#) on page 67 for more information).

Parameters:

<State> ON | OFF | 1 | 0
*RST: 0

Example: CORR ON
Includes calibration data in the measurement.

Example: See [Chapter 7.22, "Programming example: measuring a noise figure"](#), on page 230

Manual operation: See ["2nd Stage Correction"](#) on page 67

[SENSe:]CORRection:RECall <recallfilepath>

Sets the calibration results recall filepath and recalls the calibration results.

Setting parameters:

<recallfilepath>

Example: SENS:CORR:REC 'filepath'
This command will recall the calibration results from a selected file with extension .df1.

Usage: Setting only

Manual operation: See ["Calibration Recall"](#) on page 38

[SENSe:]CORRection:SAVE <savefilepath>

Queries and sets the calibration results save filepath and if set saves the calibration results.

Parameters:

<savefilepath>

Example: SENS:CORR:SAVE?
This will report an error -221 if calibration results are not available for saving. If calibration results are available the command will report a suggested filepath which includes the calibration results timestamp.
SENS:CORR:SAVE 'filepath'
This will report an error if calibration results are not available for saving. The command will save the calibration results to a filename with extension .df1.

Manual operation: See ["Calibration Save"](#) on page 37

[SENSe:]SWEep:COUNT <Averages>

This command defines the number of measurements that are used to average the results.

Parameters:

<Averages>

Number of measurements that are performed at a single frequency before average results are displayed.
If you set an average of 0 or 1, the application performs a single measurement at each frequency.

Range: 0 to 32767

*RST: 1

Example:

SWE:COUN 10

The application averages 10 measurements before it displays the results.

Manual operation: See ["Average"](#) on page 68

[SENSe:]SWEep:TIME <Time>

This command defines the measurement time. It automatically decouples the time from any other settings.

Parameters:

<Time>

refer to data sheet

*RST: depends on current settings (determined automatically)

Default unit: S

Manual operation: See ["Sweep Time"](#) on page 67
See ["Sweep Time"](#) on page 78

[SENSe:]SWEep:TIME:AUTO <State>

If enabled, the sweep time is automatically selected, depending on the current frequency of the sweep point, as defined in the frequency table (see [Chapter 5.2.3, "Using a frequency table"](#), on page 49).

If disabled, the value defined by `[SENSe:]SWEep:TIME` is used.

Parameters:

<State>

ON | OFF | 0 | 1

OFF | 0

Switches the function off

ON | 1

Switches the function on

*RST: 0

Manual operation: See ["Sweep Time"](#) on page 67

DISPlay[:WINDow<n>]:TRACe<t>:Y[:SCALe]:RLEVel <ReferenceLevel>

This command defines the reference level (for all traces in all windows).

Suffix:

<n> irrelevant
<t> irrelevant

Parameters:

<ReferenceLevel> Range: see datasheet
 *RST: -30 dBm
 Default unit: DBM

Example: DISP:TRAC:Y:RLEV -60dBm

Manual operation: See "[Ref Level](#)" on page 68

DISPlay[:WINDow<n>]:TRACe<t>:Y[:SCALe]:RLEVel:AUTO <State>

This command turns automatic determination of the reference level on and off.

Suffix:

<n> 1..n
<t> 1..n
 irrelevant

Parameters:

<State> ON | OFF | 1 | 0

Example: DISP:TRAC:Y:RLEV:AUTO ON
 Turns on automatic level detection.

Manual operation: See "[Ref Level](#)" on page 68

INPut<ip>:ATTenuation <Attenuation>

This command defines the total attenuation for RF input.

If you set the attenuation manually, it is no longer coupled to the reference level, but the reference level is coupled to the attenuation. Thus, if the current reference level is not compatible with an attenuation that has been set manually, the command also adjusts the reference level.

Suffix:

<ip> 1 | 2
 irrelevant

Parameters:

<Attenuation> Range: see data sheet
 Increment: 5 dB (with optional electr. attenuator: 1 dB)
 *RST: 10 dB (AUTO is set to ON)
 Default unit: DB

Example: `INP:ATT 30dB`
 Defines a 30 dB attenuation and decouples the attenuation from the reference level.

Manual operation: See "[RF Attenuation](#)" on page 69

INPut<ip>:GAIN:STATe <State>

This command turns the internal preamplifier on and off. It requires the optional preamplifier hardware.

The preamplification value is defined using the `INPut<ip>:GAIN[:VALue]` on page 152.

Suffix:

<ip> 1 | 2
 irrelevant

Parameters:

<State> ON | OFF | 0 | 1
OFF | 0
 Switches the function off
ON | 1
 Switches the function on
 *RST: 0

Example: `INP:GAIN:STAT ON`
`INP:GAIN:VAL 15`
 Switches on 15 dB preamplification.

Manual operation: See "[Preamplifier](#)" on page 69

INPut<ip>:GAIN[:VALue] <Gain>

This command selects the "gain" if the preamplifier is activated (`INP:GAIN:STAT ON`, see `INPut<ip>:GAIN:STATe` on page 152).

The command requires the additional preamplifier hardware option.

Suffix:

<ip> 1 | 2
 irrelevant

Parameters:

<Gain> For R&S FSWP8 and R&S FSWP26, the following settings are available:
 15 dB and 30 dB
 All other values are rounded to the nearest of these two.
 R&S FSWP50:
 30 dB
 Default unit: DB

Example: `INP:GAIN:STAT ON`
 `INP:GAIN:VAL 30`
 Switches on 30 dB preamplification.

Manual operation: See "[Preamplifier](#)" on page 69

SYSTem:CONFigure:DUT:GAIN <Gain>

This command defines the expected "gain" of the DUT.

The application uses the "gain" for automatic reference level detection.

Parameters:

<Gain> Range: 10 to 1000
 *RST: 30
 Default unit: DB

Example: `SYST:CONF:DUT:GAIN 25`
 Defines "gain" of 25 dB.

Manual operation: See "[Auto Level Range](#)" on page 69

SYSTem:CONFigure:DUT:STIME <SettlingTime>

This command defines the settling time of the noise source.

Parameters:

<SettlingTime> Range: 0 s to 20 s
 *RST: 50 ms
 Default unit: S

Example: `SYST:CONF:DUT:STIM 1 s`
 Defines a settling time of 1 second.

Manual operation: See "[Settling Time](#)" on page 68

7.12 Configuring triggered and gated measurements

The commands required to configure a triggered or gated measurement in a remote environment are described here.

The commands required for trigger input or output are described in [Chapter 7.12.3, "Configuring the trigger output"](#), on page 160.



*OPC should be used after requesting data. This will hold off any subsequent changes to the selected trigger source, until after the sweep is completed and the data is returned.

- [Configuring the triggering conditions](#).....154
- [Configuring gated measurements](#)..... 157
- [Configuring the trigger output](#).....160

7.12.1 Configuring the triggering conditions

The following commands are required to configure a triggered measurement.

TRIGger[:SEQuence]:DTIME.....	154
TRIGger[:SEQuence]:HOLDoff[:TIME].....	154
TRIGger[:SEQuence]:IFPower:HOLDoff.....	154
TRIGger[:SEQuence]:IFPower:HYSteresis.....	155
TRIGger[:SEQuence]:LEVel[:EXternal<port>].....	155
TRIGger[:SEQuence]:LEVel:IFPower.....	155
TRIGger[:SEQuence]:LEVel:IQPower.....	156
TRIGger[:SEQuence]:LEVel:RFPower.....	156
TRIGger[:SEQuence]:SLOPe.....	156
TRIGger[:SEQuence]:SOURce.....	157

TRIGger[:SEQuence]:DTIME <DropoutTime>

Defines the time the input signal must stay below the trigger level before a trigger is detected again.

Parameters:

<DropoutTime> Dropout time of the trigger.
 Range: 0 s to 10.0 s
 *RST: 0 s
 Default unit: S

Manual operation: See "[Drop-Out Time](#)" on page 79

TRIGger[:SEQuence]:HOLDoff[:TIME] <Offset>

Defines the time offset between the trigger event and the start of the measurement.

Parameters:

<Offset> *RST: 0 s
 Default unit: S

Example: TRIG:HOLD 500us

Manual operation: See "[Trigger Offset](#)" on page 79

TRIGger[:SEQuence]:IFPower:HOLDoff <Period>

This command defines the holding time before the next trigger event.

Note that this command can be used for **any trigger source**, not just IF Power (despite the legacy keyword).

Parameters:

<Period> Range: 0 s to 10 s
 *RST: 0 s
 Default unit: S

Example: TRIG:SOUR EXT
Sets an external trigger source.
TRIG:IFP:HOLD 200 ns
Sets the holding time to 200 ns.

Manual operation: See "[Trigger Holdoff](#)" on page 80

TRIGger[:SEQuence]:IFPower:HYSTeresis <Hysteresis>

This command defines the trigger hysteresis, which is only available for "IF Power" trigger sources.

Parameters:
<Hysteresis> Range: 3 dB to 50 dB
 *RST: 3 dB
 Default unit: DB

Example: TRIG:SOUR IFP
Sets the IF power trigger source.
TRIG:IFP:HYST 10DB
Sets the hysteresis limit value.

Manual operation: See "[Hysteresis](#)" on page 79

TRIGger[:SEQuence]:LEVel[:EXTernal<port>] <TriggerLevel>

This command defines the level the external signal must exceed to cause a trigger event.

Suffix:
<port> Selects the trigger port.
 1 = trigger port 1 (TRIGGER INPUT connector on front panel)
 2 = trigger port 2 (TRIGGER INPUT/OUTPUT connector on rear panel)

Parameters:
<TriggerLevel> Range: 0.5 V to 3.5 V
 *RST: 1.4 V
 Default unit: V

Example: TRIG:LEV 2V

Manual operation: See "[Trigger Level](#)" on page 79

TRIGger[:SEQuence]:LEVel:IFPower <TriggerLevel>

This command defines the power level at the third intermediate frequency that must be exceeded to cause a trigger event.

Note that any RF attenuation or preamplification is considered when the trigger level is analyzed. If defined, a reference level offset is also considered.

Parameters:

<TriggerLevel> For details on available trigger levels and trigger bandwidths, see the data sheet.

*RST: -20 dBm

Default unit: DBM

Example:

TRIG:LEV:IFP -30DBM

TRIGger[:SEQUence]:LEVEL:IQPower <TriggerLevel>

This command defines the magnitude the I/Q data must exceed to cause a trigger event.

Note that any RF attenuation or preamplification is considered when the trigger level is analyzed. If defined, a reference level offset is also considered.

Parameters:

<TriggerLevel>

Range: -130 dBm to 30 dBm

*RST: -20 dBm

Default unit: DBM

Example:

TRIG:LEV:IQP -30DBM

TRIGger[:SEQUence]:LEVEL:RFPower <TriggerLevel>

This command defines the power level the RF input must exceed to cause a trigger event. Note that any RF attenuation or preamplification is considered when the trigger level is analyzed. If defined, a reference level offset is also considered.

The input signal must be between 500 MHz and 8 GHz.

Parameters:

<TriggerLevel>

For details on available trigger levels and trigger bandwidths, see the data sheet.

*RST: -20 dBm

Default unit: DBM

Example:

TRIG:LEV:RFP -30dBm

TRIGger[:SEQUence]:SLOPe <Type>

This command selects the trigger slope.

Parameters:

<Type>

POSitive | NEGative

POSitive

Triggers when the signal rises to the trigger level (rising edge).

NEGative

Triggers when the signal drops to the trigger level (falling edge).

*RST: POSitive

Example:

TRIG:SLOP NEG

Manual operation: See ["Slope"](#) on page 80

TRIGger[:SEQUence]:SOURce <Source>

This command selects the trigger source.

Note on external triggers:

If a measurement is configured to wait for an external trigger signal in a remote control program, remote control is blocked until the trigger is received and the program can continue. Make sure that this situation is avoided in your remote control programs.

Parameters:

<Source> **IMMediate**
 Free Run

EXT | EXT2
 Trigger signal from one of the "Trigger Input/Output" connectors.
 Note: Connector must be configured for "Input".

*RST: IMMediate

Example:

TRIG:SOUR EXT
 Selects the external trigger input as source of the trigger signal

Manual operation: See ["Trigger Source"](#) on page 78
 See ["Free Run"](#) on page 78
 See ["Ext. Trigger 1/2"](#) on page 78

7.12.2 Configuring gated measurements

[SENSe:]SWEep:EGATe.....	157
[SENSe:]SWEep:EGATe:CONTinuous:PCOunt.....	158
[SENSe:]SWEep:EGATe:CONTinuous:PLENgtH.....	158
[SENSe:]SWEep:EGATe:CONTinuous[:STATe].....	158
[SENSe:]SWEep:EGATe:HOLDoff.....	159
[SENSe:]SWEep:EGATe:LENGth.....	159
[SENSe:]SWEep:EGATe:POLarity.....	159
[SENSe:]SWEep:EGATe:SOURce.....	160
[SENSe:]SWEep:EGATe:TYPE.....	160

[SENSe:]SWEep:EGATe <State>

This command turns gated measurements on and off.

See ["\(Measurement\) Points"](#) on page 47.

Parameters:

<State> ON | OFF | 0 | 1

OFF | 0
 Switches the function off

ON | 1
 Switches the function on

Example:

```
SWE:EGAT ON
Switches on the gate mode.
SWE:EGAT:TYPE EDGE
Switches on the edge-triggered mode.
SWE:EGAT:HOLD 100US
Sets the gate delay to 100 µs.
SWE:EGAT:LEN 500US
Sets the gate opening time to 500 µs.
INIT;*WAI
Starts a sweep and waits for its end.
```

Manual operation: See "[Gated Trigger](#)" on page 81

[SENSe:]SWEep:EGATe:CONTinuous:PCOunt <Amount>

Defines the number of gate periods to be measured after a single trigger event.

Parameters:

<Amount> integer
 Range: 1 to 65535
 Increment: 1
 *RST: 100

Example: SWE:EGAT:CONT:PCO 50

Manual operation: See "[Gate Period Count](#)" on page 82

[SENSe:]SWEep:EGATe:CONTinuous:PLENght <Time>

Defines the length in seconds of a single gate period in continuous gating. The length is determined from the beginning of one gate measurement to the beginning of the next one.

Parameters:

<Time> Range: 125 ns to 30 s
 *RST: 5 ms
 Default unit: S

Example: SWE:EGAT:CONT:PLEN 10

Manual operation: See "[Gate Period Length](#)" on page 82

[SENSe:]SWEep:EGATe:CONTinuous[:STATe] <State>

Activates or deactivates continuous gating.

This setting is only available if [SENSe:]SWEep:EGATe is "On".

Parameters:

<State> ON | OFF | 0 | 1
OFF | 0
 Switches the function off

ON | 1

Switches the function on

*RST: 0

Example:

SWE:EGAT ON

Activate gating

SWE:EGAT:CONT:STAT ON

Activate continuous gating

Manual operation: See "[Continuous Gate](#)" on page 82**[SENSe:]SWEep:EGATe:HOLDoff <DelayTime>**

This command defines the delay time between the gate signal and the continuation of the measurement.

Parameters:

<DelayTime> Range: 0 s to 30 s
 *RST: 0 s
 Default unit: S

Example:

SWE:EGAT:HOLD 100us

Manual operation: See "[Gate Delay](#)" on page 81**[SENSe:]SWEep:EGATe:LENGth <GateLength>**

This command defines the gate length.

Parameters:

<GateLength> Range: 125 ns to 30 s
 *RST: 400µs
 Default unit: S

Example:

SWE:EGAT:LENG 10ms

Manual operation: See "[Gate Length](#)" on page 81**[SENSe:]SWEep:EGATe:POLarity <Polarity>**

This command selects the polarity of an external gate signal.

The setting applies both to the edge of an edge-triggered signal and the level of a level-triggered signal.

Parameters:

<Polarity> POSitive | NEGative
 *RST: POSitive

Example:

SWE:EGAT:POL POS

[SENSe:]SWEep:EGATe:SOURce <Source>

This command selects the signal source for gated measurements.

If an IF power signal is used, the gate is opened as soon as a signal at > -20 dBm is detected within the IF path bandwidth (10 MHz).

For more information see "[Trigger Source](#)" on page 78.

Parameters:

<Source> EXTernal | EXT2 | EXT3 | IFPower | IQPower | VIDeo |
 RFPower | PSEN
 *RST: IFPower

Example:

SWE:EGAT:SOUR IFP
 Switches the gate source to IF power.

[SENSe:]SWEep:EGATe:TYPE <Type>

This command selects the way gated measurements are triggered.

Parameters:

<Type> **LEVel**
 The trigger event for the gate to open is a particular power level.
 After the gate signal has been detected, the gate remains open
 until the signal disappears.

EDGE
 The trigger event for the gate to open is the detection of the sig-
 nal edge.
 After the gate signal has been detected, the gate remains open
 until the gate length is over.

*RST: EDGE

Example:

SWE:EGAT:TYPE EDGE

Manual operation: See "[Gate Mode](#)" on page 81

7.12.3 Configuring the trigger output

The following commands are required to send the trigger signal to one of the variable "TRIGGER INPUT/OUTPUT" connectors on the R&S FSWP.

OUTPut<up>:TRIGger<tp>:DIRection	160
OUTPut<up>:TRIGger<tp>:LEVel	161
OUTPut<up>:TRIGger<tp>:OTYPe	161
OUTPut<up>:TRIGger<tp>:PULSe:IMMediate	162
OUTPut<up>:TRIGger<tp>:PULSe:LENGth	162

OUTPut<up>:TRIGger<tp>:DIRection <Direction>

This command selects the trigger direction for trigger ports that serve as an input as well as an output.

Suffix:

<up>	irrelevant
<tp>	Selects the used trigger port. <2>: selects trigger port 2 (on the rear panel).

Parameters:

<Direction>	INPut OUTPut
	INPut Port works as an input.
	OUTPut Port works as an output.
*RST:	INPut

OUTPut<up>:TRIGger<tp>:LEVel <Level>

This command defines the level of the (TTL compatible) signal generated at the trigger output.

This command works only if you have selected a user-defined output with [OUTPut<up>:TRIGger<tp>:OTYPe](#).

Suffix:

<up>	1..n
<tp>	Selects the trigger port to which the output is sent. 2 = trigger port 2 (rear)

Parameters:

<Level>	HIGH 5 V
	LOW 0 V
*RST:	LOW

Example: OUTP:TRIG2:LEV HIGH

OUTPut<up>:TRIGger<tp>:OTYPe <OutputType>

This command selects the type of signal generated at the trigger output.

Suffix:

<up>	1..n
<tp>	Selects the trigger port to which the output is sent. 2 = trigger port 2 (rear panel)

Parameters:

<OutputType>	DEVice Sends a trigger signal when the R&S FSWP has triggered internally.
--------------	---

TARMed

Sends a trigger signal when the trigger is armed and ready for an external trigger event.

UDEFined

Sends a user-defined trigger signal. For more information, see [OUTPut<up>:TRIGger<tp>:LEVel](#).

*RST: DEVice

OUTPut<up>:TRIGger<tp>:PULSe:IMMediate

This command generates a pulse at the trigger output.

Suffix:

<up> Selects the trigger port to which the output is sent.
2 = trigger port 2 (rear)

<tp> 1..n

OUTPut<up>:TRIGger<tp>:PULSe:LENGth <Length>

This command defines the length of the pulse generated at the trigger output.

Suffix:

<up> 1..n

<tp> Selects the trigger port to which the output is sent.
2 = trigger port 2 (rear)

Parameters:

<Length> Pulse length in seconds.
Default unit: S

Example: `OUTP:TRIG2:PULS:LENG 0.02`

7.13 Using the uncertainty calculator

The following commands are necessary to work with the measurement uncertainty calculator.

CALCulate<n>:UNCertainty:COMMon	163
CALCulate<n>:UNCertainty:DATA:FREQuency	163
CALCulate<n>:UNCertainty:DATA:GAIN	164
CALCulate<n>:UNCertainty:DATA:NOISe	164
CALCulate<n>:UNCertainty:DATA:RESults	164
CALCulate<n>:UNCertainty:ENR:CALibration:UNCertainty	165
CALCulate<n>:UNCertainty:ENR:CALibration:UNCertainty:COLD	165
CALCulate<n>:UNCertainty:ENR:CALibration:UNCertainty:HOT	166
CALCulate<n>:UNCertainty:ENR:UNCertainty	166
CALCulate<n>:UNCertainty:ENR:UNCertainty:COLD	166
CALCulate<n>:UNCertainty:ENR:UNCertainty:HOT	167

CALCulate<n>:UNCertainty:MATCh:DUT:IN:RL.....	167
CALCulate<n>:UNCertainty:MATCh:DUT:IN[:VSWR].....	167
CALCulate<n>:UNCertainty:MATCh:DUT:OUT:RL.....	168
CALCulate<n>:UNCertainty:MATCh:DUT:OUT[:VSWR].....	168
CALCulate<n>:UNCertainty:MATCh:PREamp:RL.....	168
CALCulate<n>:UNCertainty:MATCh:PREamp[:VSWR].....	169
CALCulate<n>:UNCertainty:MATCh:SOURce:CALibration[:VSWR].....	169
CALCulate<n>:UNCertainty:MATCh:SOURce:CALibration:RL.....	169
CALCulate<n>:UNCertainty:MATCh:SOURce:RL.....	170
CALCulate<n>:UNCertainty:MATCh:SOURce[:VSWR].....	170
CALCulate<n>:UNCertainty:PREamp:GAIN.....	170
CALCulate<n>:UNCertainty:PREamp:NOISe.....	171
CALCulate<n>:UNCertainty:PREamp:STATe.....	171
CALCulate<n>:UNCertainty[:RESult]?	171
CALCulate<n>:UNCertainty:SANalyzer:GAIN:UNCertainty?	172
CALCulate<n>:UNCertainty:SANalyzer:NOISe:UNCertainty?	172

CALCulate<n>:UNCertainty:COMMON <State>

This command turns matching of the noise source characteristics used during calibration and measurement on and off.

This command is available when you use different noise sources for calibration and measurement (`[SENSe:]CORRection:ENR:COMMON OFF`).

Suffix:

<n> 1..n

Parameters:

<State> ON | OFF | 1 | 0
*RST: unavailable

Example:

`CALC:UNC:COMM ON`
Applies the values of the calibration noise source to those of the measurement noise source.

Manual operation: See "[Common Source for Meas and Cal](#)" on page 72

CALCulate<n>:UNCertainty:DATA:FREQUENCY <Frequency>

This command defines the frequency for which the uncertainty should be calculated.

This command is available if you have turned automatic determination of the DUT characteristics off with `CALCulate<n>:UNCertainty:DATA:FREQUENCY`.

Suffix:

<n> 1..n

Parameters:

<Frequency> Frequency of the DUT.
*RST: 1 GHz
Default unit: HZ

Example: `CALC:UNC:DATA:FREQ 100MHZ`
 Defines a frequency of 100 MHz.

Manual operation: See ["Use Measurement Values"](#) on page 73

CALCulate<n>:UNCertainty:DATA:GAIN <Gain>

This command defines the "gain" of the DUT.

This command is available if you have turned automatic determination of the DUT characteristics off with `CALCulate<n>:UNCertainty:DATA:GAIN`.

Suffix:

<n> 1..n

Parameters:

<Gain> "Gain" of the DUT.
 *RST: 0 dB
 Default unit: DB

Example: `CALC:UNC:DATA:GAIN -5DB`
 Defines a DUT "gain" of -5 dB.

Manual operation: See ["Use Measurement Values"](#) on page 73

CALCulate<n>:UNCertainty:DATA:NOISe <NoiseLevel>

This command defines the noise level of the DUT.

This command is available if you have turned automatic determination of the DUT characteristics off with `CALCulate<n>:UNCertainty:DATA:RESults`.

Suffix:

<n> 1..n

Parameters:

<NoiseLevel> Noise level of the DUT.
 *RST: 0 dB
 Default unit: DB

Example: `CALC:UNC:DATA:NOIS 10DB`
 Defines a DUT noise level of 10 dB.

Manual operation: See ["Use Measurement Values"](#) on page 73

CALCulate<n>:UNCertainty:DATA:RESults <State>

This command turns automatic determination of the DUT characteristics for the calculation of the uncertainty on and off.

Suffix:

<n> 1..n

Parameters:

<State>

ON | 1

The application calculates the uncertainty with the DUT characteristics ("noise figure", "gain" and frequency) resulting from the "noise figure" measurement.

OFF | 0

The application calculates the uncertainty with the DUT characteristics ("noise figure", "gain" and frequency) based on the values you have defined manually.

Example:

```
CALC:UNC:DATA:RES ON
```

Includes the uncertainty in the results displays.

CALCulate<n>:UNCertainty:ENR:CALibration:UNCertainty <Uncertainty>

This command defines the uncertainty of a calibration noise source.

This command is available when `[SENSe:]CORRection:ENR:COMMon` and `[SENSe:]CORRection:ENR:COMMon` are off.

If a smart noise source is used for calibration, the uncertainty values defined in the SNS table are used.

Suffix:

<n> 1..n

Parameters:

<Uncertainty>

Uncertainty value of the noise source.

Refer to the data sheet of the noise source to determine its uncertainty.

*RST: 0.1 dB

Default unit: DB

Example:

```
CALC:UNC:ENR:CAL:UNC 0.05
```

Defines an uncertainty of 0.05 dB.

Manual operation: See "[ENR Uncert\(ainty\)](#)" on page 72

CALCulate<n>:UNCertainty:ENR:CALibration:UNCertainty:COLD <Uncertainty>**Suffix:**

<n> 1..n

Parameters:

<Uncertainty>

Manual operation: See "[Temperature Uncert\(ainty\)](#)" on page 72

CALCulate<n>:UNCertainty:ENR:CALibration:UNCertainty:HOT <Uncertainty>

This command defines the uncertainty of a calibration noise source.

This command is available when `[SENSe:]CORRection:ENR:COMMON` and `CALCulate<n>:UNCertainty:COMMON` are off.

Suffix:

<n> 1..n

Parameters:

<Uncertainty> Hot temperature uncertainty value of the noise source. Refer to the data sheet of the noise source to determine its uncertainty.

*RST: 0 K

Example:

`CALC:UNC:ENR:CAL:UNC:COLD 5 K`

Defines a high temperature uncertainty of 5 K.

Manual operation: See "[Temperature Uncert\(ainty\)](#)" on page 72

CALCulate<n>:UNCertainty:ENR:UNCertainty <Uncertainty>

This command defines the uncertainty of a noise source.

If the noise sources during calibration and measurement are different, the command defines the uncertainty of the measurement noise source.

If a smart noise source is used, the uncertainty values defined in the SNS table are used.

Suffix:

<n> 1..n

Parameters:

<Uncertainty> Uncertainty value of the noise source. Refer to the data sheet of the noise source to determine its uncertainty.

*RST: 0.1 dB

Default unit: DB

Example:

`CALC:UNC:ENR:UNC 0.05`

Defines an uncertainty of 0.05 dB.

Manual operation: See "[ENR Uncert\(ainty\)](#)" on page 72

CALCulate<n>:UNCertainty:ENR:UNCertainty:COLD <Uncertainty>

This command defines the uncertainty of a resistor.

If the noise sources during calibration and measurement are different, the command defines the uncertainty of the measurement noise source.

Suffix:

<n> 1..n

Parameters:

<Uncertainty> Cold temperature uncertainty value of the noise source.
Refer to the data sheet of the noise source to determine its uncertainty.

*RST: 0 K

Example:

CALC:UNC:ENR:UNC:COLD 10

Defines an low temperature uncertainty of 10 K.

Manual operation: See "[Temperature Uncert\(ainty\)](#)" on page 72

CALCulate<n>:UNCertainty:ENR:UNCertainty:HOT <Uncertainty>

This command defines the uncertainty of a resistor.

If the noise sources during calibration and measurement are different, the command defines the uncertainty of the measurement noise source.

Suffix:

<n> 1..n

Parameters:

<Uncertainty> Hot temperature uncertainty value of the noise source.
Refer to the data sheet of the noise source to determine its uncertainty.

*RST: 0 K

Example:

CALC:UNC:ENR:UNC:HOT 10

Defines an high temperature uncertainty of 10 K.

CALCulate<n>:UNCertainty:MATCH:DUT:IN:RL <ReturnLoss>

This command defines the return loss at the DUT input.

Suffix:

<n> 1..n

Parameters:

<ReturnLoss> *RST: 50.0 dB
Default unit: DB

Example:

CALC:UNC:MATC:DUT:IN:RL 25DB

Defines a return loss of 25 dB.

Manual operation: See "[Input / Output Match](#)" on page 73

CALCulate<n>:UNCertainty:MATCH:DUT:IN[:VSWR] <VSWR>

This command defines the VSWR at the DUT input.

Suffix:

<n> 1..n

Parameters:

<VSWR> *RST: 1.0

Example:

CALC:UNC:MATC:DUT:IN 1.1

Defines a VSWR of 1.1 at the DUT input.

Manual operation: See ["Input / Output Match"](#) on page 73

CALCulate<n>:UNCertainty:MATCh:DUT:OUT:RL <ReturnLoss>

This command defines the returns loss at the DUT output.

Suffix:

<n> 1..n

Parameters:

<ReturnLoss> *RST: 50.0 dB
Default unit: DB

Example:

CALC:UNC:MATC:DUT:OUT:RL 40DB

Defines a return loss of 40 dB at the DUT output.

Manual operation: See ["Input / Output Match"](#) on page 73

CALCulate<n>:UNCertainty:MATCh:DUT:OUT[:VSWR] <VSWR>

This command defines the VSWR at the DUT output.

Suffix:

<n> 1..n

Parameters:

<VSWR> *RST: 1.0

Example:

CALC:UNC:MATC:DUT:OUT 2.0

Defines a VSWR of 2.0 at the DUT output.

Manual operation: See ["Input / Output Match"](#) on page 73

CALCulate<n>:UNCertainty:MATCh:PREamp:RL <ReturnLoss>

This command defines the return loss at the input of the preamplifier.

Suffix:

<n> 1..n

Parameters:

<ReturnLoss> *RST: 13.98 dB
Default unit: DB

Example:

CALC:UNC:MATC:PRE:RL 14.5DB

Defines a return loss of 14.5 dB.

CALCulate<n>:UNCertainty:MATCh:PREamp[:VSWR] <VSWR>

This command defines the VSWR at the input of the preamplifier.

The command is available if you have turned on the preamplifier with [CALCulate<n>:UNCertainty:PREamp:STaTe](#) on page 171.

Suffix:

<n> 1..n

Parameters:

<VSWR> *RST: 1.5

Example:

CALC:UNC:MATC:PRE 1.8
Defines a VSWR of 1.8.

CALCulate<n>:UNCertainty:MATCh:SOURce:CALibration[:VSWR] <VSWR>

This command defines the VSWR at the calibration noise source output.

This command is available when [\[SENSe:\]CORRection:ENR:COMMon](#) and [CALCulate<n>:UNCertainty:COMMon](#) are off.

If a smart noise source is used, the VSWR values defined in the SNS table are used.

Suffix:

<n> 1..n

Parameters:

<VSWR> *RST: 1.15

Example:

CALC:UNC:MATC:SOUR:CAL 1.4
Defines a VSWR of 1.4.

Manual operation: See ["Output Match"](#) on page 72

CALCulate<n>:UNCertainty:MATCh:SOURce:CALibration:RL <ReturnLoss>

This command defines the return loss at the calibration noise source output.

This command is available when [\[SENSe:\]CORRection:ENR:COMMon](#) and [CALCulate<n>:UNCertainty:COMMon](#) are off.

If a smart noise source is used, the return loss values defined in the SNS table are used.

Suffix:

<n> 1..n

Parameters:

<ReturnLoss> *RST: 23.13 dB
Default unit: DB

Example:

CALC:UNC:MATC:SOUR:CAL:RL 20DB
Defines a return loss of 20 dB.

Manual operation: See ["Output Match"](#) on page 72

CALCulate<n>:UNCertainty:MATCh:SOURce:RL <ReturnLoss>

This command defines the return loss at the noise source output.

If the noise sources during calibration and measurement are different, the command defines the uncertainty of the measurement noise source.

Suffix:

<n> 1..n

Parameters:

<ReturnLoss> *RST: 23.13 dB
Default unit: DB

Example: CALC:UNC:MATC:SOUR:RL 20DB
Defines a return loss of 20 dB.

Manual operation: See "[Output Match](#)" on page 72

CALCulate<n>:UNCertainty:MATCh:SOURce[:VSWR] <VSWR>

This command defines the VSWR at the noise source output.

If the noise sources during calibration and measurement are different, the command defines the uncertainty of the measurement noise source.

If a smart noise source is used, the VSWR values defined in the SNS table are used.

Suffix:

<n> 1..n

Parameters:

<VSWR> *RST: 1.15

Example: CALC:UNC:MATC:SOUR 1.4
Defines a VSWR of 1.4.

CALCulate<n>:UNCertainty:PREamp:GAIN <Gain>

This command define the "gain" of an external preamplifier that may be part of the test setup.

Suffix:

<n> 1..n

Parameters:

<Gain> **Gain of the preamplifier.**
Refer to the data sheet of the preamplifier to determine its "gain".
*RST: 20 dB
Default unit: DB

Example: CALC:UNC:PRE:GAIN 15DB
Defines a gain of 15 dB.

Manual operation: See "[Preamplifier Gain \(PA Gain\)](#)" on page 75

CALCulate<n>:UNCertainty:PREamp:NOISe <NoiseLevel>

This command defines the noise level of an external preamplifier that may be part of the test setup.

Suffix:

<n> 1..n

Parameters:

<NoiseLevel> Noise level of the preamplifier.
Refer to the data sheet of the preamplifier to determine its noise level.

*RST: 5 dB

Default unit: DB

Example:

CALC:UNC:PRE:NOIS 10DB

Defines a noise level of 10 dB.

Manual operation: See "[Preamplifier noise figure \(PA NF\)](#)" on page 74

CALCulate<n>:UNCertainty:PREamp:STATE <State>

This command includes or excludes an external preamplifier from the uncertainty calculation.

If the test setup uses an external preamplifier, you also have to define its "noise figure" and "gain" values.

Suffix:

<n> 1..n

Parameters:

<State> ON | OFF | 1 | 0

*RST: 0

Example:

CALC:UNC:PRE:STAT ON

Turns the preamplifier on.

Manual operation: See "[External Preamplifier \(Ext PA\)](#)" on page 74

CALCulate<n>:UNCertainty[:RESult]?

This command queries the uncertainty of "noise figure" results.

Suffix:

<n> 1..n

Return values:

<Uncertainty> Measurement uncertainty in dB.

Example:

CALC:UNC?

Queries the uncertainty.

Usage:

Query only

Manual operation: See ["Use Measurement Values"](#) on page 73

CALCulate<n>:UNCertainty:SANalyzer:GAIN:UNCertainty? <Uncertainty>

This command queries the uncertainty value of the spectrum analyzer's internal "gain".

Suffix:

<n> 1..n

Query parameters:

<Uncertainty> "Gain" uncertainty of the spectrum analyzer in dB.
Default unit: DB

Example: CALC:UNC:SAN:GAIN:UNC?
Queries the "gain" uncertainty.

CALCulate<n>:UNCertainty:SANalyzer:NOISe:UNCertainty? <Uncertainty>

This command queries the uncertainty value of the spectrum analyzer's internal noise.

Suffix:

<n> 1..n

Query parameters:

<Uncertainty> "Noise figure" uncertainty of the spectrum analyzer in dB.
Default unit: DB

Example: CALC:UNC:SAN:NOIS:UNC?
Queries the "noise figure" uncertainty.

7.14 Performing measurements

The following commands are necessary to perform "noise figure" measurements.

Example: perform calibration and subsequent single sweep measurement

```
//Perform calibration:
CONF:CORR
INIT;*OPC?
//Perform single sweep measurement and use 2nd stage correction:
CORR:STAT ON
CONF:LIST:SING
INIT
```



You can also perform a sequence of measurements using the Sequencer (see ["Multiple Channels and Sequencer Function"](#) on page 14).

ABORt.....	173
INITiate<n>:CONTinuous.....	173
INITiate<n>[:IMMEDIATE].....	174
INITiate:SEQuencer:ABORt.....	174
INITiate:SEQuencer:IMMEDIATE.....	175
INITiate:SEQuencer:MODE.....	175
[SENSe:]CONFigure:CONTRol.....	175
[SENSe:]CONFigure:MEASurement.....	176
SYSTem:SEQuencer.....	176

ABORt

This command aborts the measurement in the current channel and resets the trigger system.

To prevent overlapping execution of the subsequent command before the measurement has been aborted successfully, use the *OPC? or *WAI command after ABOR and before the next command.

For details on overlapping execution see [Remote control via SCPI](#).

Note on blocked remote control programs:

If a sequential command cannot be completed, for example because a triggered sweep never receives a trigger, the remote control program will never finish and the remote channel to the R&S FSWP is blocked for further commands. In this case, you must interrupt processing on the remote channel first in order to abort the measurement.

To do so, send a "Device Clear" command from the control instrument to the R&S FSWP on a parallel channel to clear all currently active remote channels. Depending on the used interface and protocol, send the following commands:

- **Visa:** viClear()
- **GPIB:** ibclr()
- **RSIB:** RSDLLibclr()

Now you can send the ABORt command on the remote channel performing the measurement.

Example: ABOR; :INIT:IMM
Aborts the current measurement and immediately starts a new one.

Example: ABOR; *WAI
 INIT:IMM
Aborts the current measurement and starts a new one once abortion has been completed.

Usage: Event

INITiate<n>:CONTinuous <State>

This command controls the measurement mode for an individual channel.

Note that in single measurement mode, you can synchronize to the end of the measurement with *OPC, *OPC? or *WAI. In continuous measurement mode, synchronization to the end of the measurement is not possible. Thus, it is not recommended that you use continuous measurement mode in remote control, as results like trace data or markers are only valid after a single measurement end synchronization.

For details on synchronization see [Remote control via SCPI](#).

If the measurement mode is changed for a channel while the Sequencer is active the mode is only considered the next time the measurement in that channel is activated by the Sequencer.

Suffix:

<n> irrelevant

Parameters:

<State> ON | OFF | 0 | 1
ON | 1
 Continuous measurement
OFF | 0
 Single measurement
 *RST: 1

Example:

```
INIT:CONT OFF
Switches the measurement mode to single measurement.
INIT:CONT ON
Switches the measurement mode to continuous measurement.
```

Manual operation: See "[Continuous Sweep / Run Cont](#)" on page 83

INITiate<n>[:IMMediate]

This command starts a (single) new measurement.

You can synchronize to the end of the measurement with *OPC, *OPC? or *WAI.

For details on synchronization see [Remote control via SCPI](#).

Suffix:

<n> irrelevant

Manual operation: See "[Tuning Mode](#)" on page 46
 See "[Single Sweep / Run Single](#)" on page 83
 See "[Calibrate](#)" on page 83

INITiate:SEQuencer:ABORT

This command stops the currently active sequence of measurements.

You can start a new sequence any time using [INITiate:SEQuencer:IMMediate](#) on page 175.

Usage: Event

INITiate:SEQuencer:IMMEDIATE

This command starts a new sequence of measurements by the Sequencer.

Its effect is similar to the `INITiate<n>[:IMMEDIATE]` command used for a single measurement.

Before this command can be executed, the Sequencer must be activated (see `SYSTem:SEQuencer` on page 176).

Example:

```
SYST:SEQ ON
```

Activates the Sequencer.

```
INIT:SEQ:MODE SING
```

Sets single sequence mode so each active measurement is performed once.

```
INIT:SEQ:IMM
```

Starts the sequential measurements.

INITiate:SEQuencer:MODE <Mode>

Defines the capture mode for the entire measurement sequence and all measurement groups and channels it contains.

Note: To synchronize to the end of a measurement sequence using `*OPC`, `*OPC?` or `*WAI`, use `SINGLE` Sequencer mode.

Parameters:

<Mode>

SINGLE

Each measurement group is started one after the other in the order of definition. All measurement channels in a group are started simultaneously and performed once. After *all* measurements are completed, the next group is started. After the last group, the measurement sequence is finished.

CONTInuous

Each measurement group is started one after the other in the order of definition. All measurement channels in a group are started simultaneously and performed once. After *all* measurements are completed, the next group is started. After the last group, the measurement sequence restarts with the first one and continues until it is stopped explicitly.

```
*RST: CONTInuous
```

[SENSe:]CONFigure:CONTRol <Mode>

This command selects the measurement mode for the hot and cold power measurements.

Note that selecting a noise source with resistor characteristics with `[SENSe:]CORRection:ENR:CALibration:TYPE` or `[SENSe:]CORRection:ENR[:MEASurement]:TYPE` automatically selects manual measurement mode.

Parameters:

<Mode> AUTO | MANual

AUTO

Performs the Power (Hot) and Power (Cold) measurement in one step.

MANual

Performs the Power (Hot) and Power (Cold) measurement in two separate steps.

Example:

```
CONF:CONT AUTO
```

Selects the automatic measurement mode.

Manual operation: See "[Meas Mode \(Auto Manual\)](#)" on page 84

[SENSe:]CONFigure:MEASurement <Measurement>

This command selects the type of power measurement to perform next.

The command is available for manual measurements (see `[SENSe:]CONFigure:CONTRol`).

Parameters:

<Measurement> HOT | COLD

COLD

Performs the Power (Cold) measurement next.

HOT

Performs the Power (Hot) measurement next.

Example:

```
CONF:CONT MAN
```

```
CONF:MEAS HOT
```

Performs the hot power measurement.

Manual operation: See "[Meas Mode \(Auto Manual\)](#)" on page 84

SYSTem:SEQuencer <State>

This command turns the Sequencer on and off. The Sequencer must be active before any other Sequencer commands (`INIT:SEQ...`) are executed, otherwise an error occurs.

A detailed programming example is provided in the "Operating Modes" chapter in the R&S FSWP User Manual.

Parameters:

<State> ON | OFF | 0 | 1

ON | 1

The Sequencer is activated and a sequential measurement is started immediately.

OFF | 0

The Sequencer is deactivated. Any running sequential measurements are stopped. Further Sequencer commands (INIT:SEQ...) are not available.

*RST: 0

Example:

SYST:SEQ ON

Activates the Sequencer.

INIT:SEQ:MODE SING

Sets single Sequencer mode so each active measurement is performed once.

INIT:SEQ:IMM

Starts the sequential measurements.

SYST:SEQ OFF

7.15 Configuring the inputs and outputs

- [Radio frequency \(RF\) input](#)..... 177
- [External mixer](#)..... 179
- [External generator](#)..... 190

7.15.1 Radio frequency (RF) input

INPut<ip>:COUPling	177
INPut<ip>:IMPedance	178
INPut<ip>:FILTer:HPASs[:STATe]	178
INPut<ip>:FILTer:YIG[:STATe]	178

INPut<ip>:COUPling <CouplingType>

This command selects the coupling type of the RF input.

Suffix:

<ip> 1 | 2
irrelevant

Parameters:

<CouplingType> AC | DC
AC
AC coupling
DC
DC coupling
*RST: AC

Example: INP:COUP DC

Manual operation: See "[Input Coupling](#)" on page 85

INPut<ip>:IMPedance <Impedance>

This command selects the nominal input impedance of the RF input. In some applications, only 50 Ω are supported.

Suffix:

<ip> 1 | 2
irrelevant

Parameters:

<Impedance> 50 | 75
*RST: 50 Ω
Default unit: OHM

Example: INP:IMP 75

Manual operation: See "[Impedance](#)" on page 85

INPut<ip>:FILTer:HPASs[:STATe] <State>

Activates an additional internal high-pass filter for RF input signals from 1 GHz to 3 GHz. This filter is used to remove the harmonics of the R&S FSWP to measure the harmonics for a DUT, for example.

This function requires an additional high-pass filter hardware option.

(Note: for RF input signals outside the specified range, the high-pass filter has no effect. For signals with a frequency of approximately 4 GHz upwards, the harmonics are suppressed sufficiently by the YIG-preselector, if available.)

Suffix:

<ip> 1 | 2
irrelevant

Parameters:

<State> ON | OFF | 0 | 1
OFF | 0
Switches the function off
ON | 1
Switches the function on
*RST: 0

Example: INP:FILT:HPAS ON
Turns on the filter.

Manual operation: See "[High Pass Filter 1 to 3 GHz](#)" on page 85

INPut<ip>:FILTer:YIG[:STATe] <State>

Enables or disables the YIG filter.

Suffix:	
<ip>	1 2 irrelevant
Parameters:	
<State>	ON OFF 0 1 *RST: 0
Example:	INP:FILT:YIG OFF Deactivates the YIG-preselector.
Manual operation:	See "YIG-Preselector" on page 85

7.15.2 External mixer

[SENSe:]CORRection:CVL:BAND.....	180
[SENSe:]CORRection:CVL:BIAS.....	180
[SENSe:]CORRection:CVL:CATalog?.....	180
[SENSe:]CORRection:CVL:CLEar.....	181
[SENSe:]CORRection:CVL:COMMeNt.....	181
[SENSe:]CORRection:CVL:DATA.....	181
[SENSe:]CORRection:CVL:HARMonic.....	181
[SENSe:]CORRection:CVL:MIXer.....	182
[SENSe:]CORRection:CVL:PORTs.....	182
[SENSe:]CORRection:CVL:SElect.....	183
[SENSe:]CORRection:CVL:SNUMber.....	183
[SENSe:]MIXer<x>:BIAS:HIGH.....	183
[SENSe:]MIXer<x>:BIAS[:LOW].....	183
[SENSe:]MIXer<x>:FREQUency:HANDOver.....	184
[SENSe:]MIXer<x>:FREQUency:STARt.....	184
[SENSe:]MIXer<x>:FREQUency:STOP.....	184
[SENSe:]MIXer<x>:HARMonic:BAND:PRESet.....	185
[SENSe:]MIXer<x>:HARMonic:BAND.....	185
[SENSe:]MIXer<x>:HARMonic:HIGH[:VALue].....	186
[SENSe:]MIXer<x>:HARMonic:TYPE.....	186
[SENSe:]MIXer<x>:HARMonic[:LOW].....	186
[SENSe:]MIXer<x>:LOPower.....	187
[SENSe:]MIXer<x>:SIGNal.....	187
[SENSe:]MIXer<x>:LOSS:HIGH.....	187
[SENSe:]MIXer<x>:LOSS:TABLE:HIGH.....	188
[SENSe:]MIXer<x>:LOSS:TABLE[:LOW].....	188
[SENSe:]MIXer<x>:LOSS[:LOW].....	188
[SENSe:]MIXer<x>:PORTs.....	189
[SENSe:]MIXer<x>:RFOVerrange[:STATe].....	189
[SENSe:]MIXer<x>:THReshold.....	189
[SENSe:]MIXer<x>[:STATe].....	190

[SENSe:]CORRection:CVL:BAND <Band>

This command defines the waveguide band for which the conversion loss table is to be used. This setting is checked against the current mixer setting before the table can be assigned to the range.

Before this command can be performed, the conversion loss table must be selected (see [SENSe:]CORRection:CVL:SElect on page 183).

This command is only available with option B21 (External Mixer) installed.

Parameters:

<Band> K | KA | Q | U | V | E | W | F | D | G | Y | J | USER
 Standard waveguide band or user-defined band.
 For a definition of the frequency range for the pre-defined bands, see Table 7-4).
 *RST: F (90 GHz - 140 GHz)

Example:

```
CORR:CVL:SEL 'LOSS_TAB_4'
Selects the conversion loss table.
CORR:CVL:BAND KA
Sets the band to KA (26.5 GHz - 40 GHz).
```

[SENSe:]CORRection:CVL:BIAS <BiasSetting>

This command defines the bias setting to be used with the conversion loss table.

Before this command can be performed, the conversion loss table must be selected (see [SENSe:]CORRection:CVL:SElect on page 183).

This command is only available with option B21 (External Mixer) installed.

Parameters:

<BiasSetting> *RST: 0.0 A
 Default unit: A

Example:

```
CORR:CVL:SEL 'LOSS_TAB_4'
Selects the conversion loss table.
CORR:CVL:BIAS 3A
```

[SENSe:]CORRection:CVL:CATalog?

This command queries all available conversion loss tables saved in the C:\R_S\INSTR\USER\cvl\ directory on the instrument.

This command is only available with option B21 (External Mixer) installed.

Return values:

<Files> 'string'
 Comma-separated list of strings containing the file names.

Example: CORR:CVL:CAT?

Usage: Query only

[SENSe:]CORRection:CVL:CLEAr

This command deletes the selected conversion loss table. Before this command can be performed, the conversion loss table must be selected (see [SENSe:]CORRection:CVL:SELEct on page 183).

This command is only available with option B21 (External Mixer) installed.

Example:

```
CORR:CVL:SEL 'LOSS_TAB_4'
Selects the conversion loss table.
CORR:CVL:CLE
```

[SENSe:]CORRection:CVL:COMMeNt <Text>

This command defines a comment for the conversion loss table. Before this command can be performed, the conversion loss table must be selected (see [SENSe:]CORRection:CVL:SELEct on page 183).

This command is only available with option B21 (External Mixer) installed.

Parameters:

<Text>

Example:

```
CORR:CVL:SEL 'LOSS_TAB_4'
Selects the conversion loss table.
CORR:CVL:COMM 'Conversion loss table for
FS_Z60'
```

[SENSe:]CORRection:CVL:DATA {<Freq>, <Level>}...

This command defines the reference values of the selected conversion loss tables. The values are entered as a set of frequency/level pairs. A maximum of 50 frequency/level pairs may be entered. Before this command can be performed, the conversion loss table must be selected (see [SENSe:]CORRection:CVL:SELEct on page 183).

This command is only available with option B21 (External Mixer) installed.

Parameters:

<Freq> The frequencies have to be sent in ascending order.

Default unit: HZ

<Level> Default unit: DB

Example:

```
CORR:CVL:SEL 'LOSS_TAB_4'
Selects the conversion loss table.
CORR:CVL:DATA 1MHZ,-30DB,2MHZ,-40DB
```

[SENSe:]CORRection:CVL:HARMOnic <HarmOrder>

This command defines the harmonic order for which the conversion loss table is to be used. This setting is checked against the current mixer setting before the table can be assigned to the range.

Before this command can be performed, the conversion loss table must be selected (see [SENSe:]CORRection:CVL:SElect on page 183).

This command is only available with option B21 (External Mixer) installed.

Parameters:

<HarmOrder> Range: 2 to 65

Example:

```
CORR:CVL:SEL 'LOSS_TAB_4'
Selects the conversion loss table.
CORR:CVL:HARM 3
```

[SENSe:]CORRection:CVL:MIXer <Type>

This command defines the mixer name in the conversion loss table. This setting is checked against the current mixer setting before the table can be assigned to the range.

Before this command can be performed, the conversion loss table must be selected (see [SENSe:]CORRection:CVL:SElect on page 183).

This command is only available with option B21 (External Mixer) installed.

Parameters:

<Type> string
Name of mixer with a maximum of 16 characters

Example:

```
CORR:CVL:SEL 'LOSS_TAB_4'
Selects the conversion loss table.
CORR:CVL:MIX 'FS_Z60'
```

[SENSe:]CORRection:CVL:PORTs <PortType>

This command defines the mixer type in the conversion loss table. This setting is checked against the current mixer setting before the table can be assigned to the range.

Before this command can be performed, the conversion loss table must be selected (see [SENSe:]CORRection:CVL:SElect on page 183).

This command is only available with option B21 (External Mixer) installed.

Parameters:

<PortType> 2 | 3
*RST: 2

Example:

```
CORR:CVL:SEL 'LOSS_TAB_4'
Selects the conversion loss table.
CORR:CVL:PORT 3
```

[SENSe:]CORRection:CVL:SElect <FileName>

This command selects the conversion loss table with the specified file name. If <file_name> is not available, a new conversion loss table is created.

This command is only available with option B21 (External Mixer) installed.

Parameters:

<FileName> String containing the path and name of the file.

Example:

```
CORR:CVL:SEL 'LOSS_TAB_4'
```

[SENSe:]CORRection:CVL:SNUMber <SerialNo>

This command defines the serial number of the mixer for which the conversion loss table is to be used. This setting is checked against the current mixer setting before the table can be assigned to the range.

Before this command can be performed, the conversion loss table must be selected (see [\[SENSe:\]CORRection:CVL:SElect](#) on page 183).

This command is only available with option B21 (External Mixer) installed.

Parameters:

<SerialNo> Serial number with a maximum of 16 characters

Example:

```
CORR:CVL:SEL 'LOSS_TAB_4'
Selects the conversion loss table.
CORR:CVL:MIX '123.4567'
```

[SENSe:]MIXer<x>:BIAS:HIGH <BiasSetting>

This command defines the bias current for the high (last) range.

This command is only available if the external mixer is active (see [\[SENSe:\]MIXer<x>\[:STATe\]](#) on page 190).

Suffix:

<x> 1..n
irrelevant

Parameters:

<BiasSetting> *RST: 0.0 A
Default unit: A

[SENSe:]MIXer<x>:BIAS[:LOW] <BiasSetting>

This command defines the bias current for the low (first) range.

This command is only available if the external mixer is active (see [\[SENSe:\]MIXer<x>\[:STATe\]](#) on page 190).

Suffix:

<x> 1..n
irrelevant

Parameters:

<BiasSetting> *RST: 0.0 A
Default unit: A

[SENSe:]MIXer<x>:FREQuency:HANdOver <Frequency>

This command defines the frequency at which the mixer switches from one range to the next (if two different ranges are selected). The handover frequency for each band can be selected freely within the overlapping frequency range.

This command is only available if the external mixer is active (see [SENSe:]MIXer<x>[:STATe] on page 190).

Suffix:

<x> 1..n
irrelevant

Parameters:

<Frequency> Default unit: HZ

Example:

```
MIX ON
Activates the external mixer.
MIX:FREQ:HAND 78.0299GHz
Sets the handover frequency to 78.0299 GHz.
```

[SENSe:]MIXer<x>:FREQuency:STARt

This command sets or queries the frequency at which the external mixer band starts.

Suffix:

<x> 1..n
irrelevant

Example:

```
MIX:FREQ:STAR?
Queries the start frequency of the band.
```

[SENSe:]MIXer<x>:FREQuency:STOP

This command sets or queries the frequency at which the external mixer band stops.

Suffix:

<x> 1..n
irrelevant

Example:

```
MIX:FREQ:STOP?
Queries the stop frequency of the band.
```

[SENSe:]MIXer<x>:HARMonic:BAND:PRESet

This command restores the preset frequency ranges for the selected standard waveguide band.

Note: Changes to the band and mixer settings are maintained even after using the [PRESET] function. Use this command to restore the predefined band ranges.

Suffix:

<x> 1..n
 irrelevant

Example:

MIX:HARM:BAND:PRESet
Presents the selected waveguide band.

[SENSe:]MIXer<x>:HARMonic:BAND <Band>

This command selects the external mixer band. The query returns the currently selected band.

This command is only available if the external mixer is active (see [SENSe:]MIXer<x>[:STATe] on page 190).

Suffix:

<x> 1..n
 irrelevant

Parameters:

<Band> KA|Q|U|V|E|W|F|D|G|Y|J|USER
 Standard waveguide band or user-defined band.

Table 7-4: Frequency ranges for pre-defined bands

Band	Frequency start [GHz]	Frequency stop [GHz]
KA (A) *)	26.5	40.0
Q	33.0	50.0
U	40.0	60.0
V	50.0	75.0
E	60.0	90.0
W	75.0	110.0
F	90.0	140.0
D	110.0	170.0
G	140.0	220.0
J	220.0	325.0

*) The band formerly referred to as "A" is now named "KA".

Band	Frequency start [GHz]	Frequency stop [GHz]
Y	325.0	500.0
USER	32.18 (default)	68.22 (default)
*) The band formerly referred to as "A" is now named "KA".		

[SENSe:]MIXer<x>:HARMonic:HIGH[:VALue] <HarmOrder>

This command specifies the harmonic order to be used for the high (second) range.

Suffix:

<x> 1..n
 irrelevant

Parameters:

<HarmOrder> Range: 2 to 61 (USER band); for other bands: see band definition

Example:

```
MIX:HARM:HIGH:STAT ON
MIX:HARM:HIGH 3
```

[SENSe:]MIXer<x>:HARMonic:TYPE <OddEven>

This command specifies whether the harmonic order to be used should be odd, even, or both.

Which harmonics are supported depends on the mixer type.

Suffix:

<x> 1..n
 irrelevant

Parameters:

<OddEven> ODD | EVEN | EODD
 ODD | EVEN | EODD
 *RST: EVEN

Example:

```
MIX:HARM:TYPE ODD
```

[SENSe:]MIXer<x>:HARMonic[:LOW] <HarmOrder>

This command specifies the harmonic order to be used for the low (first) range.

Suffix:

<x> 1..n
 irrelevant

Parameters:

<HarmOrder> Range: 2 to 61 (USER band); for other bands: see band definition
 *RST: 2 (for band F)

Example: MIX:HARM 3

[SENSe:]MIXer<x>:LOPower <Level>

This command specifies the LO level of the external mixer's LO port.

Suffix:

<x> irrelevant

Parameters:

<Level> numeric value
 Range: 13.0 dBm to 17.0 dBm
 Increment: 0.1 dB
 *RST: 15.5 dBm

Example: MIX:LOP 16.0dBm

[SENSe:]MIXer<x>:SIGNal <State>

This command specifies whether automatic signal detection is active or not.

Note that automatic signal identification is only available for measurements that perform frequency sweeps (not in vector signal analysis or the I/Q Analyzer, for instance).

Suffix:

<x> 1..n
 irrelevant

Parameters:

<State> OFF | ON | AUTO | ALL
OFF | ON | AUTO | ALL
OFF
 No automatic signal detection is active.
ON
 Automatic signal detection (Signal ID) is active.
AUTO
 Automatic signal detection (Auto ID) is active.
ALL
 Both automatic signal detection functions (Signal ID+Auto ID) are active.
 *RST: OFF

[SENSe:]MIXer<x>:LOSS:HIGH <Average>

This command defines the average conversion loss to be used for the entire high (second) range.

Suffix:

<x> 1..n
 Mixer

Parameters:

<Average> Range: 0 to 100
 *RST: 24.0 dB
 Default unit: dB

Example: MIX:LOSS:HIGH 20dB

[SENSe:]MIXer<x>:LOSS:TABLE:HIGH <FileName>

This command defines the conversion loss table to be used for the high (second) range.

Suffix:

<x> 1..n
 Mixer

Parameters:

<FileName> String containing the path and name of the file, or the serial number of the external mixer whose file is required. The R&S FSWP automatically selects the correct cvl file for the current IF. As an alternative, you can also select a user-defined conversion loss table (.ac1 file).

[SENSe:]MIXer<x>:LOSS:TABLE[:LOW] <FileName>

This command defines the file name of the conversion loss table to be used for the low (first) range.

Suffix:

<x> 1..n
 Mixer

Parameters:

<FileName> String containing the path and name of the file, or the serial number of the external mixer whose file is required. The R&S FSWP automatically selects the correct cvl file for the current IF. As an alternative, you can also select a user-defined conversion loss table (.ac1 file).

Example: MIX:LOSS:TABL '101567'
 MIX:LOSS:TABL?
 //Result:
 '101567_MAG_6_B5000_3G5.B5G'

[SENSe:]MIXer<x>:LOSS[:LOW] <Average>

This command defines the average conversion loss to be used for the entire low (first) range.

Suffix:

<x> 1..n
 Mixer

Parameters:

<Average> Range: 0 to 100
 *RST: 24.0 dB
 Default unit: dB

Example: MIX:LOSS 20dB

[SENSe:]MIXer<x>:PORTs <PortType>

This command selects the mixer type.

Suffix:

<x> 1..n
 irrelevant

Parameters:

<PortType> **2 | 3**
 2
 Two-port mixer.
 3
 Three-port mixer.
 *RST: 2

Example: MIX:PORT 3

[SENSe:]MIXer<x>:RFOVerrange[:STATe] <State>

If enabled, the band limits are extended beyond "RF Start" and "RF Stop" due to the capabilities of the used harmonics.

Suffix:

<x> 1..n
 irrelevant

Parameters:

<State> ON | OFF | 1 | 0
 *RST: 0

[SENSe:]MIXer<x>:THReshold <Value>

This command defines the maximum permissible level difference between test sweep and reference sweep to be corrected during automatic comparison (see [\[SENSe:\]MIXer<x>:SIGNal](#) on page 187).

Suffix:

<x> 1..n
 irrelevant

Parameters:

<Value> <numeric value>
 Range: 0.1 dB to 100 dB
 *RST: 10 dB
 Default unit: DB

Example: MIX:PORT 3

[SENSe:]MIXer<x>[:STATe] <State>

Activates or deactivates the use of a connected external mixer as input for the measurement. This command is only available if the optional External Mixer is installed and an external mixer is connected.

Suffix:

<x> 1..n
 irrelevant

Parameters:

<State> ON | OFF | 1 | 0
 *RST: 0

Example: MIX ON

7.15.3 External generator

SOURce:EXTernal:FREQUency[:FACTor]:DENominator.....	190
SOURce:EXTernal:FREQUency[:FACTor]:NUMerator.....	190
SOURce:EXTernal:FREQUency:OFFSet<of>.....	190
SOURce<si>:EXTernal<gen>:POWER[:LEVel].....	191
SOURce<si>:EXTernal<gen>:ROSCillator[:SOURce].....	191
SYSTem:COMMunicate:RDEvice:GENerator<gen>:INTerface.....	191
SYSTem:COMMunicate:GPIB:RDEvice:GENerator<gen>:ADDRes.....	192
SYSTem:COMMunicate:RDEvice:GENerator<gen>:TYPE.....	192
SYSTem:COMMunicate:TCPip:RDEvice:GENerator<gen>:ADDRes.....	192
SYSTem:CONFigure:GENerator:CONtrol:STATe.....	193
SYSTem:CONFigure:GENerator:INITialise:AUTO.....	193
SYSTem:CONFigure:GENerator:INITialise[:IMMediate].....	193
SYSTem:CONFigure:GENerator:SWITCh:AUTO.....	193

SOURce:EXTernal:FREQUency[:FACTor]:DENominator <Denominator>

SOURce:EXTernal:FREQUency[:FACTor]:NUMerator <Numerator>

SOURce:EXTernal:FREQUency:OFFSet<of> <Denominator>

Suffix:

<of> 1..n

Parameters:

<Denominator> Default unit: HZ

Manual operation: See "Frequency Coupling" on page 89

SOURce<si>:EXTernal<gen>:POWer[:LEVel] <Level>

This command sets the output power of the selected generator.

Suffix:

<si> irrelevant

<gen>

Parameters:

<Level> <numeric value>

*RST: -20 dBm

Default unit: DBM

Example:

//Define generator output level

SOUR:EXT:POW -30dBm

Manual operation: See "[Source Power](#)" on page 89

SOURce<si>:EXTernal<gen>:ROSCillator[:SOURce] <Source>

This command controls selection of the reference oscillator for the external generator.

If the external reference oscillator is selected, the reference signal must be connected to the rear panel of the instrument.

Suffix:

<si> irrelevant

<gen> irrelevant

Parameters:

<Source>

INTERNAL

Uses the internal reference.

EXTERNAL

Uses the external reference; if none is available, an error flag is displayed in the status bar.

*RST: INT

Example:

//Select an external reference oscillator

SOUR:EXT:ROSC EXT

Manual operation: See "[Reference](#)" on page 87

SYSTem:COMMunicate:RDEvice:GENerator<gen>:INTerface <Type>

Defines the interface used for the connection to the external generator.

Suffix:

<gen>

Parameters:

<Type>

GPIB

TCPip

Example: `SYST:COMM:RDEV:GEN:INT TCP`

Manual operation: See ["Interface"](#) on page 87

SYSTem:COMMunicate:GPIB:RDEvice:GENerator<gen>:ADDRess <Number>

Changes the IEC/IEEE-bus address of the external generator.

Suffix:

<gen> 1..n

Parameters:

<Number> Range: 0 to 30
*RST: 28

Example: `SYST:COMM:GPIB:RDEV:GEN:ADDR 15`

Manual operation: See ["GPIB Address/TCPIP Address / Computer Name"](#) on page 87

SYSTem:COMMunicate:RDEvice:GENerator<gen>:TYPE <Type>

This command selects the type of external generator.

Suffix:

<gen>

Parameters:

<Name> <Generator name as string value>
*RST: SMU02

Example: //Select an external generator
`SYST:COMM:RDEV:GEN:TYPE 'SMW06'`

Manual operation: See ["Generator Type"](#) on page 86

SYSTem:COMMunicate:TCPIP:RDEvice:GENerator<gen>:ADDRess <Address>

Configures the TCP/IP address for the external generator.

Suffix:

<gen>

Parameters:

<Address> TCP/IP address between 0.0.0.0 and 0.255.255.255
*RST: 0.0.0.0

Example: `SYST:COMM:TCP:RDEV:GEN:ADDR 130.094.122.195`

Manual operation: See ["GPIB Address/TCPIP Address / Computer Name"](#) on page 87

SYSTem:CONFigure:GENerator:CONTRol:STATe <State>

This command turns automatic control of an external generator on and off.

The command is available with option R&S FSWP-B10.

Parameters:

<State> ON | OFF | 1 | 0
*RST: 0

Example:

SYST:CONF:GEN:CONT:STAT ON
Turns on automatic generator control.

Manual operation: See "[Automatic Control](#)" on page 88

SYSTem:CONFigure:GENerator:INITialise:AUTO <State>

This command turns automatic connection to the generator on and off.

If on, the application automatically configures the generator before each measurement and turns on its RF output. Note that you have to establish a connection to the generator before you can perform the measurement.

The command is available with option R&S FSWP-B10.

Parameters:

<State> ON | OFF | 1 | 0
*RST: 0

Example:

SYST:CONF:GEN:INIT:AUTO ON
Turns automatic generator configuration on.

Manual operation: See "[Init Before Meas](#)" on page 88

SYSTem:CONFigure:GENerator:INITialise[:IMMEDIATE]

This command establishes a connection to the external generator.

When you send the command, the application configures the generator once and turns on its RF output. Note that you have to establish a connection to the generator before you can perform the measurement.

The command is available with option R&S FSWP-B10.

Usage: Event

Manual operation: See "[Init External Generator](#)" on page 90

SYSTem:CONFigure:GENerator:SWITCh:AUTO <State>**Parameters:**

<State>

Manual operation: See "[Auto Switch Off](#)" on page 89

7.16 Configuring the display

The following commands are necessary to configure and scale the result displays.

DISPlay[:WINDow<n>]:TABLe:ITEM.....	194
DISPlay[:WINDow<n>]:TRACe<t>:SYMBols.....	194
DISPlay[:WINDow<n>]:TRACe<t>:UNCertainty.....	195
DISPlay[:WINDow<n>]:TRACe<t>:X[:SCALE].....	195
DISPlay[:WINDow<n>]:TRACe<t>:Y[:SCALE]:BOTTom.....	196
DISPlay[:WINDow<n>]:TRACe<t>:Y[:SCALE]:AUTO.....	196
DISPlay[:WINDow<n>]:TRACe<t>:Y[:SCALE]:TOP.....	197

DISPlay[:WINDow<n>]:TABLe:ITEM <Items>, <State>

This command selects the items displayed in the Result Table.

Suffix:

<n> 1..n
Window

Parameters:

<Items> NOISe | GAIN | TEMPerature | YFACTOR | ENR | PHOT |
PCOLd | CYFactor | CPHot | CPCold | NUNCertainty
For a list of possible parameter values (table items) see the
parameter description of the TRACe<n>[:DATA]? command.

<State> ON | OFF | 1 | 0

Example: DISP:WIND2:TABL:ITEM NOIS,OFF
Removes the Noise result from the Result Table.

Manual operation: See "Result Table" on page 24

DISPlay[:WINDow<n>]:TRACe<t>:SYMBols <State>

This command turns symbols that represent the measurement points on a trace on and off.

Suffix:

<n> 1..n
Window

<t> 1..n

Parameters:

<State> ON | OFF | 1 | 0
*RST: 0

Example: DISP:WIND2:TRAC:SYMB ON
Switches on the display of symbols in window 2..

Manual operation: See "Symbols" on page 93

DISPlay[:WINDow<n>]:TRACe<t>:UNCertainty <State>

If enabled, an additional trace is displayed indicating the measured trace values \pm the uncertainty values determined by the uncertainty calculator. This result is only useful for "noise figure" measurements.

Suffix:

<n> 1..n
Window

<t> 1..n
Trace

Parameters:

<State> ON | OFF | 0 | 1
OFF | 0
Switches the function off
ON | 1
Switches the function on
*RST: 0

Example: DISP:WIND:TRAC:UNC ON

Manual operation: See "Uncertainty" on page 93

DISPlay[:WINDow<n>]:TRACe<t>:X[:SCALe] <Frequency>

This command selects the type of frequency displayed on the x-axis.

Suffix:

<n> 1..n
Window

<t> 1..n

Parameters:

<Frequency> RF | IF | LO
IF
Intermediary frequency, e.g. for measurements on frequency converting DUTs.
RF
Radio frequency.
*RST: RF

Example: CONF:MODE:DUT DOWN
The DUT converts the input frequency to a lower output frequency.
DISP:TRAC:X RF
Shows the RF frequency on the x-axis.

Manual operation: See "X-Axis" on page 93

DISPlay[:WINDow<n>]:TRACe<t>:Y[:SCALe]:BOTTom <Level>

This command defines the bottom value of the y-axis.

Suffix:

<n>	1..n Window
<t>	1..n Trace

Parameters:

<Level> The value ranges depend on the result display.

Noise figure

-75 dB to 75 dB

Noise temperature

-999990000 K to 999990000 K

Y-factor

-200 dB to 200 dB

Gain

-75 dB to 75 dB

Power (hot)

-200 dBm to 200 dBm

Power (cold)

-200 dBm to 200 dBm

Default unit: DB

Example:

```
DISP:WIND2:TRAC:Y:SCAL:AUTO OFF
DISP:WIND2:TRAC:Y:BOT
```

Manual operation: See "[Auto Scale / Min / Max](#)" on page 92

DISPlay[:WINDow<n>]:TRACe<t>:Y[:SCALe]:AUTO <State>

This command turns automatic scaling of the y-axis on and off.

Suffix:

<n>	1..n Window
<t>	1..n

Parameters:

<State>	ON OFF 1 0
*RST:	1

Example:

```
DISP:WIND2:TRAC:Y:AUTO ON
```

Turns on automatic scaling for measurement window 2.

Manual operation: See "[Auto Scale / Min / Max](#)" on page 92

DISPlay[:WINDow<n>]:TRACe<t>:Y[:SCALe]:TOP <Level>

This command defines the top value of the y-axis.

Suffix:

<n> 1..n
Window

<t> 1..n
Trace

Parameters:

<Level> The value ranges depend on the result display.

Noise figure

-75 dB to 75 dB

Noise temperature

-999990000 K to 999990000 K

Y-factor

-200 dB to 200 dB

Gain

-75 dB to 75 dB

Power (hot)

-200 dBm to 200 dBm

Power (cold)

-200 dBm to 200 dBm

Default unit: DB

Example:

```
DISP:WIND2:TRAC:Y:SCAL:AUTO OFF
DISP:WIND2:TRAC:Y:TOP
```

Manual operation: See "[Auto Scale / Min / Max](#)" on page 92

7.17 Working with traces

The following commands are necessary to define trace characteristics.

DISPlay[:WINDow<n>][:SUBWindow<w>]:TRACe<t>:MODE.....	198
DISPlay[:WINDow<n>][:SUBWindow<w>]:TRACe<t>[:STATe].....	198
DISPlay[:WINDow<n>][:SUBWindow<w>]:TRACe<t>:SMOothing:APERture.....	199
DISPlay[:WINDow<n>][:SUBWindow<w>]:TRACe<t>:SMOothing[:STATe].....	199
FORMat[:DATA].....	199
FORMat:DEXPort:DSEParator.....	200
FORMat:DEXPort:HEADer.....	201
FORMat:DEXPort:TRACes.....	201
MMEMory:STORe<n>:TRACe.....	201
TRACe<n>:COPY.....	202

DISPlay[:WINDow<n>][:SUBWindow<w>]:TRACe<t>:MODE <Mode>

This command selects the trace mode. If necessary, the selected trace is also activated.

Suffix:

<n>	Window
<w>	subwindow Not supported by all applications
<t>	Trace

Parameters:

<Mode>	BLANK VIEW WRITe *RST: Trace 1: WRITe, Trace 2-4: BLANK
--------	--

Example:

```
INIT:CONT OFF
Switching to single sweep mode.
SWE:COUN 16
Sets the number of measurements to 16.
DISP:TRAC3:MODE WRIT
Selects clear/write mode for trace 3.
INIT;*WAI
Starts the measurement and waits for the end of the measurement.
```

Manual operation: See "[Traces](#)" on page 95

DISPlay[:WINDow<n>][:SUBWindow<w>]:TRACe<t>[:STATe] <State>

This command turns a trace on and off.

The measurement continues in the background.

Suffix:

<n>	Window
<w>	subwindow Not supported by all applications
<t>	Trace

Parameters:

<State>	ON OFF 0 1 OFF 0 Switches the function off ON 1 Switches the function on
---------	--

Example: DISP:TRAC3 ON

DISPlay[:WINDow<n>][:SUBWindow<w>]:TRACe<t>:SMOothing:APERture
 <Aperture>

This command defines the degree (aperture) of the trace smoothing, if [DISPlay\[:WINDow<n>\]\[:SUBWindow<w>\]:TRACe<t>:SMOothing\[:STATe\]](#) TRUE.

Suffix:

<n> [Window](#)
 <w> subwindow
 <t> [Trace](#)

Parameters:

<Aperture> Range: 1 to 50
 *RST: 2
 Default unit: PCT

Example:

DISP3:TRAC2:SMO:APER 5
 Defines an aperture of 5% for trace 2 in window 3

Manual operation: See "[Smoothing](#)" on page 96

DISPlay[:WINDow<n>][:SUBWindow<w>]:TRACe<t>:SMOothing[:STATe] <State>

This command turns trace smoothing for a particular trace on and off.

If enabled, the trace is smoothed by the value specified using [DISPlay\[:WINDow<n>\]\[:SUBWindow<w>\]:TRACe<t>:SMOothing:APERture](#) on page 199.

Suffix:

<n> [Window](#)
 <w> subwindow
 <t> [Trace](#)

Parameters:

<State> ON | OFF | 0 | 1
 OFF | 0
 Switches the function off
 ON | 1
 Switches the function on

Example:

DISP3:TRAC2:SMO ON
 Turns on trace smoothing for trace 2 in window 3

Manual operation: See "[Smoothing](#)" on page 96

FORMat[:DATA] <Format>[, <BitLength>]

This command selects the data format that is used for transmission of trace data from the R&S FSWP to the controlling computer.

Note that the command has no effect for data that you send to the R&S FSWP. The R&S FSWP automatically recognizes the data it receives, regardless of the format.

Parameters:

<Format>

ASCIi

ASCIi format, separated by commas.

This format is almost always suitable, regardless of the actual data format. However, the data is not as compact as other formats can be.

REAL

Floating-point numbers (according to IEEE 754) in the "definite length block format".

The format setting `REAL` is used for the binary transmission of trace data.

<BitLength>

Length in bits for floating-point results

16

16-bit floating-point numbers.

Compared to `REAL, 32` format, half as many numbers are returned.

32

32-bit floating-point numbers

For I/Q data, 8 bytes per sample are returned for this format setting.

64

64-bit floating-point numbers

Compared to `REAL, 32` format, twice as many numbers are returned.

Example:

```
FORM REAL, 32
```

FORMat:DEXPort:DSEParator <Separator>

This command selects the decimal separator for data exported in ASCII format.

Parameters:

<Separator>

POINT | COMMa

COMMa

Uses a comma as decimal separator, e.g. `4,05`.

POINT

Uses a point as decimal separator, e.g. `4.05`.

*RST: *RST has no effect on the decimal separator.
Default is POINT.

Example:

```
FORM:DEXP:DSEP POIN
```

Sets the decimal point as separator.

Manual operation:

See "[Decimal Separator](#)" on page 96

FORMat:DEXPort:HEADer <State>

If enabled, additional instrument and measurement settings are included in the header of the export file for result data. If disabled, only the pure result data from the selected traces and tables is exported.

Parameters:

<State> ON | OFF | 0 | 1
*RST: 1

Manual operation: See ["Include Instrument & Measurement Settings"](#) on page 96

FORMat:DEXPort:TRACes <Selection>

This command selects the data to be included in a data export file (see [MMEMory:STORe<n>:TRACe](#) on page 201).

Parameters:

<Selection> SINGle | ALL

SINGle

Only a single trace is selected for export, namely the one specified by the [MMEMory:STORe<n>:TRACe](#) command.

ALL

Selects all active traces and result tables (e.g. "Result Summary", marker peak list etc.) in the current application for export to an ASCII file.

The <trace> parameter for the [MMEMory:STORe<n>:TRACe](#) command is ignored.

*RST: SINGle

Manual operation: See ["Export all Traces and all Table Results"](#) on page 96

MMEMory:STORe<n>:TRACe <Trace>, <FileName>

This command exports trace data from the specified window to an ASCII file.

Secure User Mode

In secure user mode, settings that are stored on the instrument are stored to volatile memory, which is restricted to 256 MB. Thus, a "memory limit reached" error can occur although the hard disk indicates that storage space is still available.

To store data permanently, select an external storage location such as a USB memory device.

For details, see "Protecting Data Using the Secure User Mode" in the "Data Management" section of the R&S FSWP base unit user manual.

Suffix:

<n> [Window](#)

Parameters:

<Trace> Number of the trace to be stored

<FileName> String containing the path and name of the target file.

Example: MMEM:STOR1:TRAC 1, 'C:\TEST.ASC'
Stores trace 1 from window 1 in the file TEST.ASC.

Manual operation: See ["Export Trace to ASCII File"](#) on page 96

TRACe<n>:COPY <TraceNumber>, <TraceNumber>

This command copies data from one trace to another.

Suffix:

<n> [Window](#)

Parameters:

<TraceNumber> **TRACE1 | TRACE2 | TRACE3 | TRACE4**
The first parameter is the destination trace, the second parameter is the source.
(Note the 'e' in the parameter is required!)

Example: TRAC:COPY TRACE1, TRACE2
Copies the data from trace 2 to trace 1.

Manual operation: See ["Copy Trace"](#) on page 97

7.18 Working with limit lines

The following commands are necessary to set up limit lines and checks.

When configuring limit lines for the "noise figure" application via remote control, you have to send some commands in a defined order.

1. Select the limit line you want to configure by name or create a new limit line name.
2. Select the result type you want to apply the limit line to.
The application automatically selects the unit and scale to make the line compatible to the result type.
3. Define the horizontal data points of the limit line.
4. Define the vertical data points of the limit line. Depending on the command syntax you are using, the shape also defines if the limit line is an upper or lower limit line (CALCulate:LIMit:UPPer:... or CALCulate:LIMit:LOWer:...).

Example: Configure an upper limit line for the Noise Figure result type

```
//Select or create the limit line by name.
CALC:LIM:NAME 'NoiseFigure'
//Comment on the limit line.
CALC:LIM:COMM 'Limit line to test noise figure results'
//Select the result type (here: Noise Figure) to apply the limit line to.
CALC:LIM:TYPE NOIS
```

```

//Define the horizontal data points of the limit line.
CALC:LIM:CONT 100MHZ,850MHZ
//Shift the limit line 50 MHz to the left.
CALC:LIM:CONT:SHIF -50MHZ
//Define the vertical data points of an (upper) limit line.
//The unit is fix according to the result type you have selected.
CALC:LIM:UPP 10,10
//Shift the limit line 5 dB down.
CALC:LIM:UPP:SHIF -5
//Turn the limit line on.
CALC:LIM:UPP:STAT ON
//Select the trace to check.
CALC:LIM:TRAC 1
//Turn on the limit check.
CALC:LIM:STAT ON
//Query the limit check results.
CALC:LIM:FAIL?

```

- [Defining general characteristics of a limit line](#).....203
- [Defining horizontal data points](#).....204
- [Controlling lower limit lines](#).....206
- [Controlling upper limit lines](#).....207
- [Managing limit lines](#).....208
- [Controlling limit checks](#).....209

7.18.1 Defining general characteristics of a limit line

CALCulate<n>:LIMit:COMMENT	203
CALCulate<n>:LIMit:NAME	203
CALCulate<n>:LIMit:TYPE	204

CALCulate<n>:LIMit:COMMENT <Comment>

This command defines a comment for a limit line.

Suffix:

<n> irrelevant

 [Limit line](#)

Parameters:

<Comment> String containing the description of the limit line.

Manual operation: See "[Comment](#)" on page 105

CALCulate<n>:LIMit:NAME <Name>

This command selects a limit line that already exists or defines a name for a new limit line.

Suffix:<n> [Window](#) [Limit line](#)**Parameters:**

<Name> String containing the limit line name.

*RST: REM1 to REM8 for lines 1 to 8

Manual operation: See "[Name](#)" on page 105**CALCulate<n>:LIMit:TYPE <Result>**

This command configures a limit line for a particular result type.

Suffix:

<n> 1..n

 1..n
[Limit line](#)**Parameters:**

<Result> NOISe | GAIN | TEMPerature | YFACTOR | ENR | PHOT | PCOLd

GAIN

Assigns the limit line to "gain" results.

NOISe

Assigns the limit line to "noise figure" results.

PCOLd

Assigns the limit line to power (cold) results.

PHOT

Assigns the limit line to power (hot) results.

TEMPerature

Assigns the limit line to "noise temperature" results.

YFACTOR

Assigns the limit line to "y-factor" results.

Example:

CALC:LIM2:TYPE GAIN

Assigns limit line 2 to the "gain" result display.

7.18.2 Defining horizontal data points

Note that the number of data points on the horizontal axis should be the same as the number of data points on the vertical axis. Otherwise the limit line may take on an unintended shape.

Example: Number of vertical data points < number of horizontal data points

CALC:LIM:CONT 100MHZ,200MHZ,300MHZ,400MHZ,500MHZ

CALC:LIM:UPP 0,5,0

⇒ the application dumps 400 and 500 MHz.

Example: Number of vertical data points > number of horizontal data points

```
CALC:LIM:CONT 100MHZ,200MHZ,300MHZ,400MHZ,500MHZ
```

```
CALC:LIM:UPP 0,5,0,5,0,5,0
```

⇒ the application adds new horizontal data points (500.00000100 MHz and 500.00000200 MHz).

CALCulate<n>:LIMit:CONTrol[:DATA].....	205
CALCulate<n>:LIMit:CONTrol:SHIFt.....	205

CALCulate<n>:LIMit:CONTrol[:DATA] <LimitLinePoints>

This command defines the horizontal definition points of a limit line.

Suffix:

<n> irrelevant

 [Limit line](#)

Parameters:

<LimitLinePoints> Variable number of x-axis values.
Note that the number of horizontal values has to be the same as the number of vertical values set with [CALCulate<n>:LIMit:LOWer\[:DATA\]](#) or [CALCulate<n>:LIMit:UPPer\[:DATA\]](#). If not, the R&S FSWP either adds missing values or ignores surplus values.

*RST: -

Default unit: HZ

Manual operation: See "[Data Points](#)" on page 105

CALCulate<n>:LIMit:CONTrol:SHIFt <Distance>

This command moves a complete limit line horizontally.

Compared to defining an offset, this command actually changes the limit line definition points by the value you define.

Suffix:

<n> irrelevant

 [Limit line](#)

Parameters:

<Distance> Numeric value.
The unit depends on the scale of the x-axis.
Default unit: HZ

Manual operation: See "[Shift x](#)" on page 105

7.18.3 Controlling lower limit lines

CALCulate<n>:LIMit:LOWer[:DATA]	206
CALCulate<n>:LIMit:LOWer:SHIFt	206
CALCulate<n>:LIMit:LOWer:STATe	206

CALCulate<n>:LIMit:LOWer[:DATA] <LimitLinePoints>

This command defines the vertical definition points of a lower limit line.

Suffix:

<n>	irrelevant
	Limit line

Parameters:

<LimitLinePoints>	Variable number of level values. Note that the number of vertical values has to be the same as the number of horizontal values set with CALCulate<n>:LIMit:CONTRol[:DATA] . If not, the R&S FSWP either adds missing values or ignores surplus values.
*RST:	Limit line state is OFF
	Default unit: DBM

Manual operation: See "[Data Points](#)" on page 105

CALCulate<n>:LIMit:LOWer:SHIFt <Distance>

This command moves a complete lower limit line vertically.

Compared to defining an offset, this command actually changes the limit line definition points by the value you define.

Suffix:

<n>	Window
	Limit line

Parameters:

<Distance>	Defines the distance that the limit line moves. Default unit: DB
------------	---

Manual operation: See "[Shift y](#)" on page 106

CALCulate<n>:LIMit:LOWer:STATe <State>

This command turns a lower limit line on and off.

Before you can use the command, you have to select a limit line with [CALCulate<n>:LIMit:NAME](#) on page 203.

Suffix:

<n>	irrelevant
-----	------------

	Limit line
Parameters:	
<State>	ON OFF 0 1
	OFF 0 Switches the function off
	ON 1 Switches the function on
Manual operation:	See "Visibility" on page 103

7.18.4 Controlling upper limit lines

CALCulate<n>:LIMit:UPPer[:DATA]	207
CALCulate<n>:LIMit:UPPer:SHIFt	207
CALCulate<n>:LIMit:UPPer:STATe	208

CALCulate<n>:LIMit:UPPer[:DATA] <LimitLinePoints>

This command defines the vertical definition points of an upper limit line.

Suffix:

<n>	irrelevant
	Limit line

Parameters:

<LimitLinePoints>	Variable number of level values. Note that the number of vertical values has to be the same as the number of horizontal values set with <code>CALCulate<n>:LIMit:CONTRol[:DATA]</code> . If not, the R&S FSWP either adds missing values or ignores surplus values.
	*RST: Limit line state is OFF
	Default unit: DBM

Manual operation: See "Data Points" on page 105

CALCulate<n>:LIMit:UPPer:SHIFt <Distance>

This command moves a complete upper limit line vertically.

Compared to defining an offset, this command actually changes the limit line definition points by the value you define.

Suffix:

<n>	irrelevant
	Limit line

Parameters:

<Distance>	Defines the distance that the limit line moves.
------------	---

Manual operation: See "Shift y" on page 106

CALCulate<n>:LIMit:UPPer:STATe <State>

This command turns an upper limit line on and off.

Before you can use the command, you have to select a limit line with **CALCulate<n>:LIMit:NAME** on page 203.

Suffix:

<n> irrelevant

 [Limit line](#)

Parameters:

<State> ON | OFF | 0 | 1

OFF | 0

Switches the function off

ON | 1

Switches the function on

Manual operation: See "[Visibility](#)" on page 103

7.18.5 Managing limit lines

[CALCulate<n>:LIMit:ACTive?](#).....208

[CALCulate<n>:LIMit:COPY](#).....208

[CALCulate<n>:LIMit:DELe](#)..... 209

CALCulate<n>:LIMit:ACTive?

This command queries the names of *all* active limit lines.

Suffix:

<n> irrelevant

 irrelevant

Return values:

<LimitLines> String containing the names of all active limit lines in alphabetical order.

Example:

CALC:LIM:ACT?

Queries the names of all active limit lines.

Usage:

Query only

Manual operation: See "[Visibility](#)" on page 103

CALCulate<n>:LIMit:COPY <Line>

This command copies a limit line.

Suffix:

<n> [Window](#)

 [Limit line](#)

Parameters:

<Line> **1 to 8**
number of the new limit line

<name>

String containing the name of the limit line.

Example:

CALC:LIM1:COPY 2

Copies limit line 1 to line 2.

CALC:LIM1:COPY 'FM2'

Copies limit line 1 to a new line named FM2.

Manual operation: See "[Copy Line](#)" on page 104

CALCulate<n>:LIMit:DELeTe

This command deletes a limit line.

Suffix:

<n> [Window](#)

 [Limit line](#)

Manual operation: See "[Delete Line](#)" on page 104

7.18.6 Controlling limit checks

CALCulate<n>:LIMit:CLEar[:IMMEDIATE]	209
CALCulate<n>:LIMit:FAIL?	209
CALCulate<n>:LIMit:STATe	210
CALCulate<n>:LIMit:TRACe<t>	210
CALCulate<n>:LIMit:TRACe<t>:CHECK	211

CALCulate<n>:LIMit:CLEar[:IMMEDIATE]

This command deletes the result of the current limit check.

The command works on *all* limit lines in *all* measurement windows at the same time.

Suffix:

<n> [Window](#)

 irrelevant

Example:

CALC:LIM:CLE

Deletes the result of the limit check.

CALCulate<n>:LIMit:FAIL?

This command queries the result of a limit check in the specified window.

To get a valid result, you have to perform a complete measurement with synchronization to the end of the measurement before reading out the result. This is only possible for single measurement mode.

Suffix:

<n> [Window](#)
 [Limit line](#)

Return values:

<Result> **0**
 PASS
1
 FAIL

Example:

```
INIT; *WAI
Starts a new sweep and waits for its end.
CALC2:LIM3:FAIL?
Queries the result of the check for limit line 3 in window 2.
```

Usage:

Query only

CALCulate<n>:LIMit:STATe <State>

This command turns the limit check for a specific limit line on and off.

To query the limit check result, use [CALCulate<n>:LIMit:FAIL?](#).

Note that a new command exists to activate the limit check and define the trace to be checked in one step (see [CALCulate<n>:LIMit:TRACe<t>:CHECK](#) on page 211).

Suffix:

<n> irrelevant
 [Limit line](#)

Parameters:

<State> ON | OFF | 0 | 1
OFF | 0
 Switches the function off
ON | 1
 Switches the function on

Example:

```
CALC:LIM:STAT ON
Switches on the limit check for limit line 1.
```

Manual operation: See "[Disable All Lines](#)" on page 104

CALCulate<n>:LIMit:TRACe<t> <TraceNumber>

This command links a limit line to one or more traces.

Note that this command is maintained for compatibility reasons only. Limit lines no longer need to be assigned to a trace explicitly. The trace to be checked can be defined directly (as a suffix) in the new command to activate the limit check (see [CALCulate<n>:LIMit:TRACe<t>:CHECK](#) on page 211).

Suffix:

<n>	Window
	Limit line
<t>	irrelevant

Parameters:

<TraceNumber>	1 to 4
*RST:	1

Example:

```
CALC:LIM2:TRAC 3
Assigns limit line 2 to trace 3.
```

CALCulate<n>:LIMit:TRACe<t>:CHECK <State>

This command turns the limit check for a specific trace on and off.

To query the limit check result, use [CALCulate<n>:LIMit:FAIL?](#).

Note that this command replaces the two commands from previous signal and spectrum analyzers (which are still supported, however):

- [CALCulate<n>:LIMit:TRACe<t>](#) on page 210
- [CALCulate<n>:LIMit:STATE](#) on page 210

Suffix:

<n>	Window
	Limit line
<t>	Trace

Parameters:

<State>	ON OFF 0 1
	OFF 0
	Switches the function off
	ON 1
	Switches the function on

Example:

```
CALC:LIM3:TRAC2:CHEC ON
Switches on the limit check for limit line 3 on trace 2.
```

Manual operation: See "[Traces to be Checked](#)" on page 103

7.19 Working with markers

The following commands are necessary to work with markers.

- [Using markers](#).....212
- [Using delta markers](#).....214
- [Configuring markers](#).....217
- [Positioning markers](#).....218
- [Positioning delta markers](#).....220

7.19.1 Using markers

Note that the suffix at `CALCulate` has an effect only if you query the characteristics of a marker. If you set a marker, you can ignore the suffix because the markers are linked to each other over all measurement windows and will always be on the same frequency.

CALCulate<n>:MARKer<m>:AOFF	212
CALCulate<n>:MARKer<m>[:STATe]	212
CALCulate<n>:MARKer<m>:TRACe	213
CALCulate<n>:MARKer<m>:X	213
CALCulate<n>:MARKer<m>:Y?	213

CALCulate<n>:MARKer<m>:AOFF

This command turns off all markers.

Suffix:

<n> [Window](#)

<m> [Marker](#)

Example: `CALC:MARK:AOFF`
Switches off all markers.

Manual operation: See "[All Markers Off](#)" on page 99

CALCulate<n>:MARKer<m>[:STATe] <State>

This command turns markers on and off. If the corresponding marker number is currently active as a delta marker, it is turned into a normal marker.

Suffix:

<n> [Window](#)

<m> [Marker](#)

Parameters:

<State> ON | OFF | 0 | 1

OFF | 0

Switches the function off

ON | 1

Switches the function on

Example: `CALC:MARK3 ON`
Switches on marker 3.

Manual operation: See "Marker Type" on page 99

CALCulate<n>:MARKer<m>:TRACe <Trace>

This command selects the trace the marker is positioned on.

Note that the corresponding trace must have a trace mode other than "Blank".

If necessary, the command activates the marker first.

Suffix:

<n> [Window](#)

<m> [Marker](#)

Parameters:

<Trace> **1 to 4**
Trace number the marker is assigned to.

Example: //Assign marker to trace 1
CALC:MARK3:TRAC 2

CALCulate<n>:MARKer<m>:X <Position>

This command moves a marker to a specific coordinate on the x-axis.

If necessary, the command activates the marker.

If the marker has been used as a delta marker, the command turns it into a normal marker.

Note that markers have to be positioned on a discrete frequency that is part of the frequency list. If you set the marker on a frequency not included in the frequency list, the application positions the marker to the nearest frequency in the list (rounding up or down).

Suffix:

<n> [Window](#)

<m> [Marker](#)

Parameters:

<Position> Numeric value that defines the marker position on the x-axis.
The unit depends on the result display.

Range: The range depends on the current x-axis range.

Default unit: Hz

Example: CALC:MARK2:X 1.7MHz
Positions marker 2 to frequency 1.7 MHz.

CALCulate<n>:MARKer<m>:Y? <Result>

Queries the result at the position of the specified marker.

Suffix:

<n> 1..n

<m> 1..n

Query parameters:

<Result> Selects the result.

CPCold

Queries calibration power (cold) results.

CPHot

Queries calibration power (hot) results.

CYFactor

Queries calibration "y-factor" results.

GAIN

Queries "gain" results.

NOISe

Queries "noise figure" results.

NUNCertainty

Queries the "noise figure" uncertainty results.

PCOLd

Queries power (cold) results.

PHOT

Queries power (hot) results.

TEMPerature

Queries "noise temperature" results.

YFACtor

Queries "y-factor" results.

Return values:

<Result> Default unit: DBM

Usage: Query only**Manual operation:** See "[Marker Table](#)" on page 25

7.19.2 Using delta markers

Note that the suffix at `CALCulate` has an effect only if you query the characteristics of a marker. If you set a marker, you can ignore the suffix because the markers are linked to each other over all measurement windows and will always be on the same frequency.

<code>CALCulate<n>:DELTamarker<m>:AOFF</code>	215
<code>CALCulate<n>:DELTamarker<m>:MREFerence</code>	215
<code>CALCulate<n>:DELTamarker<m>[:STATe]</code>	215
<code>CALCulate<n>:DELTamarker<m>:TRACe</code>	216
<code>CALCulate<n>:DELTamarker<m>:X</code>	216
<code>CALCulate<n>:DELTamarker<m>:Y?</code>	216

CALCulate<n>:DELTamarker<m>:AOFF

This command turns off *all* delta markers.

Suffix:

<n> [Window](#)

<m> irrelevant

Example:

`CALC:DELT:AOff`

Turns off all delta markers.

CALCulate<n>:DELTamarker<m>:MREFerence <Reference>

This command selects a reference marker for a delta marker other than marker 1.

The reference may be another marker or the fixed reference.

Suffix:

<n> [Window](#)

<m> [Marker](#)

Parameters:

<Reference> **1 to 16**

Selects markers 1 to 16 as the reference.

FIXed

Selects the fixed reference as the reference.

Example:

`CALC:DELT3:MREF 2`

Specifies that the values of delta marker 3 are relative to marker 2.

CALCulate<n>:DELTamarker<m>[:STATe] <State>

This command turns delta markers on and off.

If necessary, the command activates the delta marker first.

No suffix at DELTmarker turns on delta marker 1.

Suffix:

<n> [Window](#)

<m> [Marker](#)

Parameters:

<State> **ON | OFF | 0 | 1**

OFF | 0

Switches the function off

ON | 1

Switches the function on

Example:

`CALC:DELT2 ON`

Turns on delta marker 2.

Manual operation: See "Marker Type" on page 99

CALCulate<n>:DELTamarker<m>:TRACe <Trace>

This command selects the trace a delta marker is positioned on.

Note that the corresponding trace must have a trace mode other than "Blank".

If necessary, the command activates the marker first.

Suffix:

<n> [Window](#)

<m> [Marker](#)

Parameters:

<Trace> Trace number the marker is assigned to.

Example:

CALC:DELT2:TRAC 2
Positions delta marker 2 on trace 2.

CALCulate<n>:DELTamarker<m>:X <Position>

This command moves a delta marker to a particular coordinate on the x-axis.

If necessary, the command activates the delta marker and positions a reference marker to the peak power.

Suffix:

<n> [Window](#)

<m> [Marker](#)

Parameters:

<Position> Numeric value that defines the marker position on the x-axis.

Range: The value range and unit depend on the measurement and scale of the x-axis.

Example:

CALC:DELT:X?
Outputs the absolute x-value of delta marker 1.

CALCulate<n>:DELTamarker<m>:Y? <Trace>

Queries the result at the position of the specified delta marker.

Suffix:

<n> 1..n

<m> 1..n

Parameters:

<Trace> **CPCold**
Queries calibration power (cold) results.

CPHot
Queries calibration power (hot) results.

CYFactor

Queries calibration "y-factor" results.

GAIN

Queries "gain" results.

NOISe

Queries "noise figure" results.

PCOLd

Queries power (cold) results.

PHOT

Queries power (hot) results.

TEMPerature

Queries "noise temperature" results.

YFACTOR

Queries "y-factor" results.

Return values:

<Result>

Result at the position of the delta marker.

The unit is variable and depends on the one you have currently set.

Default unit: DBM

Usage:

Query only

Manual operation:

See "[Marker Table](#)" on page 25

7.19.3 Configuring markers

DISPlay[:WINDow<n>]:MINFo[:STATe].....	217
DISPlay[:WINDow<n>]:MTABLE.....	218

DISPlay[:WINDow<n>]:MINFo[:STATe] <State>

This command turns the marker information in all diagrams on and off.

Suffix:

<n> irrelevant

Parameters:

<State>

ON | 1

Displays the marker information in the diagrams.

OFF | 0

Hides the marker information in the diagrams.

*RST: 1

Example:

DISP:MINF OFF

Hides the marker information.

Manual operation:

See "[Marker Info](#)" on page 100

DISPlay[:WINDow<n>]:MTABle <DisplayMode>

This command turns the marker table on and off.

Suffix:

<n> irrelevant

Parameters:

<DisplayMode>

ON | 1

Turns on the marker table.

OFF | 0

Turns off the marker table.

AUTO

Turns on the marker table if 3 or more markers are active.

*RST: AUTO

Example:

DISP:MTAB ON

Activates the marker table.

Manual operation: See "[Marker Table Display](#)" on page 99

7.19.4 Positioning markers

If you are using more than one window, the application performs the peak search in the window that you have selected with the suffix at `CALCulate` only. Because the markers are linked, the frequency position of the marker in the other windows is adjusted accordingly, even if it means that the marker is on a peak in the selected window only.

<code>CALCulate<n>:MARKer<m>:MAXimum:LEFT</code>	218
<code>CALCulate<n>:MARKer<m>:MAXimum:NEXT</code>	219
<code>CALCulate<n>:MARKer<m>:MAXimum[:PEAK]</code>	219
<code>CALCulate<n>:MARKer<m>:MAXimum:RIGHT</code>	219
<code>CALCulate<n>:MARKer<m>:MINimum:NEXT</code>	219
<code>CALCulate<n>:MARKer<m>:MINimum:LEFT</code>	219
<code>CALCulate<n>:MARKer<m>:MINimum[:PEAK]</code>	220
<code>CALCulate<n>:MARKer<m>:MINimum:RIGHT</code>	220

CALCulate<n>:MARKer<m>:MAXimum:LEFT

This command moves a marker to the next positive peak.

The search includes only measurement values to the left of the current marker position.

Suffix:

<n> [Window](#)

<m> [Marker](#)

Manual operation: See "[Search Next Peak](#)" on page 101

CALCulate<n>:MARKer<m>:MAXimum:NEXT

This command moves a marker to the next positive peak.

Suffix:

<n> [Window](#)

<m> [Marker](#)

Manual operation: See "[Search Next Peak](#)" on page 101

CALCulate<n>:MARKer<m>:MAXimum[:PEAK]

This command moves a marker to the highest level.

If the marker is not yet active, the command first activates the marker.

Suffix:

<n> [Window](#)

<m> [Marker](#)

Manual operation: See "[Peak Search](#)" on page 101

CALCulate<n>:MARKer<m>:MAXimum:RIGHT

This command moves a marker to the next positive peak.

The search includes only measurement values to the right of the current marker position.

Suffix:

<n> [Window](#)

<m> [Marker](#)

Manual operation: See "[Search Next Peak](#)" on page 101

CALCulate<n>:MARKer<m>:MINimum:NEXT

This command moves a marker to the next minimum peak value.

Suffix:

<n> [Window](#)

<m> [Marker](#)

Manual operation: See "[Search Next Minimum](#)" on page 101

CALCulate<n>:MARKer<m>:MINimum:LEFT

This command moves a marker to the next minimum peak value.

The search includes only measurement values to the right of the current marker position.

Suffix:

<n> Window

<m> Marker

Manual operation: See "Search Next Minimum" on page 101**CALCulate<n>:MARKer<m>:MINimum[:PEAK]**

This command moves a marker to the minimum level.

If the marker is not yet active, the command first activates the marker.

Suffix:

<n> Window

<m> Marker

Manual operation: See "Search Minimum" on page 101**CALCulate<n>:MARKer<m>:MINimum:RIGHT**

This command moves a marker to the next minimum peak value.

The search includes only measurement values to the right of the current marker position.

Suffix:

<n> Window

<m> Marker

Manual operation: See "Search Next Minimum" on page 101

7.19.5 Positioning delta markers

If you are using more than one window, the application performs the peak search in the window that you have selected with the suffix at `CALCulate` only. Because the markers are linked, the frequency position of the marker in the other windows is adjusted accordingly, even if it means that the marker is on a peak in the selected window only.

<code>CALCulate<n>:DELTamarker<m>:MAXimum:LEFT</code>	220
<code>CALCulate<n>:DELTamarker<m>:MAXimum:NEXT</code>	221
<code>CALCulate<n>:DELTamarker<m>:MAXimum[:PEAK]</code>	221
<code>CALCulate<n>:DELTamarker<m>:MAXimum:RIGHT</code>	221
<code>CALCulate<n>:DELTamarker<m>:MINimum:LEFT</code>	221
<code>CALCulate<n>:DELTamarker<m>:MINimum:NEXT</code>	222
<code>CALCulate<n>:DELTamarker<m>:MINimum[:PEAK]</code>	222
<code>CALCulate<n>:DELTamarker<m>:MINimum:RIGHT</code>	222

CALCulate<n>:DELTamarker<m>:MAXimum:LEFT

This command moves a delta marker to the next positive peak value.

The search includes only measurement values to the left of the current marker position.

Suffix:

<n> [Window](#)

<m> [Marker](#)

Manual operation: See ["Search Next Peak"](#) on page 101

CALCulate<n>:DELTamarker<m>:MAXimum:NEXT

This command moves a marker to the next positive peak value.

Suffix:

<n> 1..n
[Window](#)

<m> 1..n
[Marker](#)

Manual operation: See ["Search Next Peak"](#) on page 101

CALCulate<n>:DELTamarker<m>:MAXimum[:PEAK]

This command moves a delta marker to the highest level.

If the marker is not yet active, the command first activates the marker.

Suffix:

<n> [Window](#)

<m> [Marker](#)

Manual operation: See ["Peak Search"](#) on page 101

CALCulate<n>:DELTamarker<m>:MAXimum:RIGHT

This command moves a delta marker to the next positive peak value on the trace.

The search includes only measurement values to the right of the current marker position.

Suffix:

<n> [Window](#)

<m> [Marker](#)

Manual operation: See ["Search Next Peak"](#) on page 101

CALCulate<n>:DELTamarker<m>:MINimum:LEFT

This command moves a delta marker to the next minimum peak value.

The search includes only measurement values to the right of the current marker position.

Suffix:

<n> [Window](#)

<m> [Marker](#)

Manual operation: See "[Search Next Minimum](#)" on page 101

CALCulate<n>:DELTaMarker<m>:MINimum:NEXT

This command moves a marker to the next minimum peak value.

Suffix:

<n> [Window](#)

<m> [Marker](#)

Manual operation: See "[Search Next Minimum](#)" on page 101

CALCulate<n>:DELTaMarker<m>:MINimum[:PEAK]

This command moves a delta marker to the minimum level.

If the marker is not yet active, the command first activates the marker.

Suffix:

<n> [Window](#)

<m> [Marker](#)

Manual operation: See "[Search Minimum](#)" on page 101

CALCulate<n>:DELTaMarker<m>:MINimum:RIGHT

This command moves a delta marker to the next minimum peak value.

The search includes only measurement values to the right of the current marker position.

Suffix:

<n> [Window](#)

<m> [Marker](#)

Manual operation: See "[Search Next Minimum](#)" on page 101

7.20 Using the status register

The status reporting system stores information about the current state of the R&S FSWP. This includes, for example, information about errors during operation or information about limit checks. The R&S FSWP stores this information in the status

registers and in the error queue. You can query the status register and error queue via IEC bus.

The R&S FSWP-K30 features several status registers that are specific to "noise figure" measurements. This chapter describes the application-specific registers, including the corresponding remote commands.

- [Status registers for noise figure measurements](#).....223

7.20.1 Status registers for noise figure measurements

The figure below shows the status registers of the "noise figure" application.

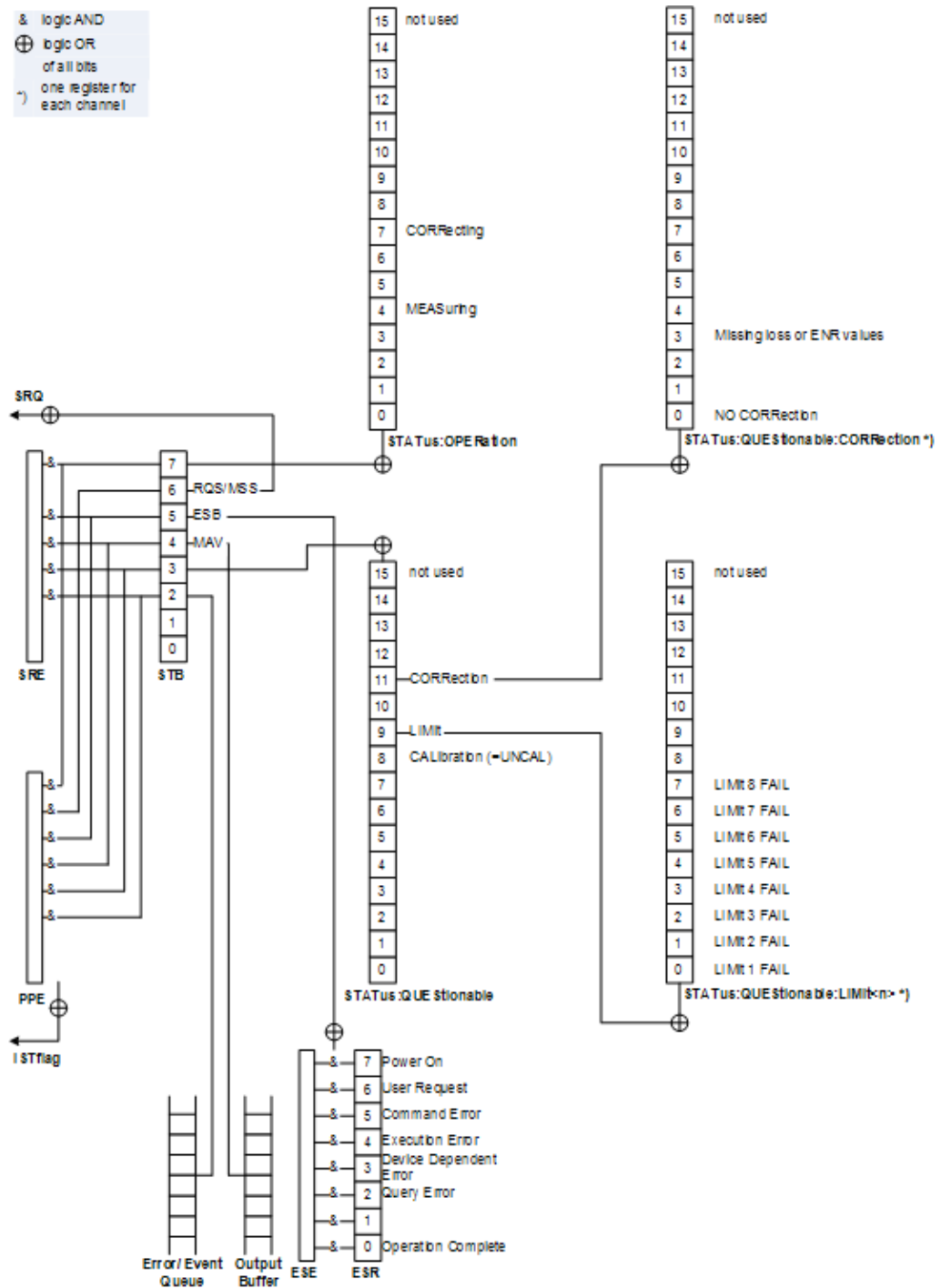

Figure 7-2: Status registers for noise figure measurements

The R&S FSWP structures the information hierarchically, with the Status Byte register (STB) and the Service Request Enable mask register (SRE) being on the highest level. The STB gets its information from the standard Event Status Register (ESR) and the Event Status Enable mask register (ESE). The STB and ESR are both defined by IEEE 488.2. In addition to the ESR, the STB also gets information from the STATUS:OPERation and STATUS:QUESTIONable registers. These registers are the link to the lower lev-

els of the status register and are defined by SCPI. They contain information about the state of the instrument.

For a more comprehensive description of the status registers not mentioned here, and status register functionality in general, see the manual of the base unit.

7.20.1.1 STATus:OPERation register

The STATus:OPERation register contains information on current activities of the R&S FSWP. It also contains information on activities that have been executed since the last read out.

Bit no	Meaning
0 to 3	Unavailable for "noise figure" measurements.
4	MEASuring This bit is set if a measurement is in progress.
5 to 6	Unavailable for "noise figure" measurements.
7	CORReCting This bit is set if a 2nd stage correction is in progress.
8	HCOPy This bit is set if a hardcopy is created.
9 - 14	Unavailable for "noise figure" measurements.
15	This bit is always 0.

7.20.1.2 STATus:QUEStionable register

The STATus:QUEStionable register contains information about indefinite states which can occur if the unit is operated without meeting the specifications.

Bit no	Meaning
0 to 7	Unavailable for "noise figure" measurements.
8	CALibration This bit is set if the R&S FSWP is not calibrated.
9	LIMit This bit is set if a limit line is violated.
10	Unavailable for "noise figure" measurements.
11	CORRection This bit is set if the "noise figure" calibration is questionable.
14	Unavailable for "noise figure" measurements.
15	This bit is always 0.

7.20.1.3 STATus:QUEStionable:LIMit register

The `STATus:QUEStionable:LIMit` register contains information about limit lines and the results of a limit checks.

The number of LIMit registers depends on the number of measurement windows available in any application.

Bit no	Meaning
0	LIMit 1 FAIL This bit is set if limit line 1 is violated.
1	LIMit 2 FAIL This bit is set if limit line 2 is violated.
2	LIMit 3 FAIL This bit is set if limit line 3 is violated.
3	LIMit 4 FAIL This bit is set if limit line 4 is violated.
4	LIMit 5 FAIL This bit is set if limit line 5 is violated.
5	LIMit 6 FAIL This bit is set if limit line 6 is violated.
6	LIMit 7 FAIL This bit is set if limit line 7 is violated.
7	LIMit 8 FAIL This bit is set if limit line 8 is violated.
8 to 14	Unavailable for "noise figure" measurements.
15	This bit is always 0.

7.20.1.4 STATus:QUEStionable:CORRection register

The `STATus:QUEStionable:CORRection` register contains information about the calibration status of "noise figure" measurements.

Bit no	Meaning
0	NO CORRection This bit is set if calibration is required.
1 to 2	Unavailable for "noise figure" measurements.
3	Missing Loss or ENR values This bit is set if loss or ENR values are missing for one or more measurement frequencies.

Bit no	Meaning
4 to 14	Unavailable for "noise figure" measurements.
15	This bit is always 0.

7.20.1.5 Status register remote commands

STATus:OPERation[:EVENT]?.....	227
STATus:QUESTionable[:EVENT]?.....	227
STATus:QUESTionable:CORRection[:EVENT]?.....	227
STATus:QUESTionable:LIMit[:EVENT]?.....	227
STATus:OPERation:CONDition?.....	227
STATus:QUESTionable:CONDition?.....	227
STATus:QUESTionable:CORRection:CONDition?.....	227
STATus:QUESTionable:LIMit:CONDition?.....	227
STATus:OPERation:ENABle.....	228
STATus:QUESTionable:ENABle.....	228
STATus:QUESTionable:CORRection:ENABle.....	228
STATus:QUESTionable:LIMit:ENABle.....	228
STATus:OPERation:NTRansition.....	228
STATus:QUESTionable:NTRansition.....	228
STATus:QUESTionable:CORRection:NTRansition.....	228
STATus:QUESTionable:LIMit:NTRansition.....	228
STATus:OPERation:PTRansition.....	228
STATus:QUESTionable:PTRansition.....	228
STATus:QUESTionable:CORRection:PTRansition.....	228
STATus:QUESTionable:LIMit:PTRansition.....	228

STATus:OPERation[:EVENT]?

STATus:QUESTionable[:EVENT]?

STATus:QUESTionable:CORRection[:EVENT]? <ChannelName>

STATus:QUESTionable:LIMit[:EVENT]? <ChannelName>

These commands read out the EVENT section of the status register.

The commands at the same time delete the contents of the EVENT section.

Query parameters:

<ChannelName> String containing the name of the channel.
The parameter is optional. If you omit it, the command works for the currently active channel.

Usage: Query only

STATus:OPERation:CONDition?

STATus:QUESTionable:CONDition?

STATus:QUESTionable:CORRection:CONDition? <ChannelName>

STATus:QUESTionable:LIMit:CONDition? <ChannelName>

These commands read out the CONDition section of the status register.

The commands do not delete the contents of the EVENT section.

Query parameters:

<ChannelName> String containing the name of the channel.
The parameter is optional. If you omit it, the command works for the currently active channel.

Usage: Query only

STATus:OPERation:ENABLE <SumBit>,<ChannelName>

STATus:QUESTionable:ENABLE <SumBit>,<ChannelName>

STATus:QUESTionable:CORRection:ENABLE <SumBit>,<ChannelName>

STATus:QUESTionable:LIMit:ENABLE <SumBit>,<ChannelName>

These commands control the ENABLE part of a register.

The ENABLE part allows true conditions in the EVENT part of the status register to be reported in the summary bit. If a bit is 1 in the enable register and its associated event bit transitions to true, a positive transition occurs in the summary bit reported to the next higher level.

Parameters:

<SumBit> Range: 0 to 65535

<ChannelName> String containing the name of the channel.
The parameter is optional. If you omit it, the command works for the currently active channel.

STATus:OPERation:NTRansition <SumBit>,<ChannelName>

STATus:QUESTionable:NTRansition <SumBit>,<ChannelName>

STATus:QUESTionable:CORRection:NTRansition <SumBit>,<ChannelName>

STATus:QUESTionable:LIMit:NTRansition <SumBit>,<ChannelName>

These commands control the Negative TRansition part of a register.

Setting a bit causes a 1 to 0 transition in the corresponding bit of the associated register. The transition also writes a 1 into the associated bit of the corresponding EVENT register.

Parameters:

<SumBit> Range: 0 to 65535

<ChannelName> String containing the name of the channel.
The parameter is optional. If you omit it, the command works for the currently active channel.

STATus:OPERation:PTRansition <SumBit>,<ChannelName>

STATus:QUESTionable:PTRansition <SumBit>,<ChannelName>

STATus:QUESTionable:CORRection:PTRansition <SumBit>,<ChannelName>

STATus:QUESTionable:LIMit:PTRansition <SumBit>,<ChannelName>

These commands control the Positive TRansition part of a register.

Deprecated remote commands for noise figure measurements

Setting a bit causes a 0 to 1 transition in the corresponding bit of the associated register. The transition also writes a 1 into the associated bit of the corresponding EVENT register.

Parameters:

<SumBit> Range: 0 to 65535

<ChannelName> String containing the name of the channel.
The parameter is optional. If you omit it, the command works for the currently active channel.

7.21 Deprecated remote commands for noise figure measurements

Following is a list of deprecated remote commands. The remote commands are still supported to maintain compatibility to previous versions of "noise figure" measurements (like the R&S FSV-K30), but it is strongly recommended to use the command system in the way it is meant to be used in the R&S FSWP-K30.

Legacy command	Replaced by	Comment
CALCulate:LIMit:TRACe	CALCulate:LIMit:TYPE	Parameters NFIGure, TEFFective and GAIN were supported to assign a limit line to a result and thus the trace because trace and result type were fix. CALCulate:LIMit:TRACe now assigns the limit line to a trace (1 to 4).
CALCulate:MARKer:TRACe CALCulate:DELTaMarker:TRACe		The parameters NOISe, GAIN, NMEM1-3 and GMEM1-3 have been replaced by 1 2 3 4 because no distinction is made between memory and live trace.
CONFigure:ARRay:MEMory	TRACe:COPI	No more distinction between memory and live traces.
CONFigure:SINGle	CONFigure:FREQuency:SINGle	
DISPlay:ARRay:MEMory:STATe DISPlay:CURREnt:DATA:STATe	DISPlay:WINDow:TRACe:STATe	No more distinction between memory and live traces.
DISPlay:DATA:TRACe	LAYout system	
DISPlay:FORMat	---	Functionality not supported any more.
DISPlay:WINDow:TABLe	LAYout:WINDow:REPLace / LAYout:REPLace:WINDow	
FETCH: command system	TRACe:DATA	
SENSe:SWEep:POINTs	SENSe:FREQuency:POINTs	
SENSe:FREQuency:CW:FIXed	SENSe:FREQuency:SINGle	
SENSe:FREQuency:LIST:DATA	SENSe:FREQuency:TABLe:DATA	Frequency table only requires RF frequencies on R&S FSWP.

Legacy command	Replaced by	Comment
SENSe:CONFigure:MODE:SYSTem: LOSCillator	SENSe:CONFigure:MODE: SYSTem:LO	
SENSe:CONFigure:MODE:SYSTem: LOSCillator:FREQuency	SENSe:CONFigure:MODE: SYSTem:LO:FREQuency	

7.22 Programming example: measuring a noise figure

```

// Preset and start option K30
*RST
INSTRument:SElect NOISE

// Set frequencies
SENSe:FREQuency:START 100000
SENSe:FREQuency:STOP 3000000000
SENSe:FREQuency:POINTs 201

// ENR settings
SENSe:CORRection:ENR:MODE TABLE
// Set the ENR values of your noise source here
SENSe:CORRection:ENR:MEASurement:TABLE:DATA 100e3, 15.77, 10e6, 15.77, 100e6, 15.35,
1e9, 15.12, 2e9, 14.70, 3e9, 14.57

// Set meas time
SENSe:SWEep:TIME 300ms

// Configure and start calibration
SENSe:CONFigure:CORRection
INITiate:IMMEDIATE
*OPC
SENSe:CORRection:STATe ON

// Configure and start measurement
// --> don't forget to add the DUT to the signal path here
// Configure a frequency list measurement with the settings above in single sweep
SENSe:CONFigure:LIST:SINGLE
INITiate:IMMEDIATE
*OPC

```

Annex

A Reference: frequency table file format

Frequency tables can be exported to a file in xml format for further evaluation in other applications. Transducer factors stored in the specified xml format can also be imported to the R&S FSWP for other measurements (see ["Import / Export"](#) on page 51). This reference describes in detail the format of the export/import files for frequency tables.

```
<?xml version="1.0" encoding="UTF-8"?>
<TableAttributes>
  <Header comment=""/>
  <Data freq="" value=""/>
  ...
</TableAttributes>
```

Example: Import file for a frequency table

```
<?xml version="1.0" encoding="UTF-8"?>
<TableAttributes>
  <Header comment="Frequency values for NC364B (example)"/>
  <Data freq="10000000" value="13.14"/>
  <Data freq="100000000" value="13.21"/>
  <Data freq="1000000000" value="13.22"/>
  <Data freq="2000000000" value="13.17"/>
  <Data freq="3000000000" value="13.26"/>
  <Data freq="4000000000" value="13.38"/>
  <Data freq="5000000000" value="13.53"/>
  <Data freq="6000000000" value="13.63"/>
  <Data freq="7000000000" value="13.81"/>
</TableAttributes>
```

List of Remote Commands (Noise Figure)

[SENSe:]BANDwidth:LIST:DATA.....	128
[SENSe:]BANDwidth:RESolution:AUTO.....	148
[SENSe:]BANDwidth[:RESolution].....	147
[SENSe:]BWIDth:RESolution:AUTO.....	148
[SENSe:]BWIDth[:RESolution].....	147
[SENSe:]CONFigure:CONTRol.....	175
[SENSe:]CONFigure:CORRection.....	148
[SENSe:]CONFigure:FREQuency:CONTInuous.....	126
[SENSe:]CONFigure:FREQuency:SINGle.....	126
[SENSe:]CONFigure:LIST:CONTInuous.....	126
[SENSe:]CONFigure:LIST:SINGle.....	127
[SENSe:]CONFigure:MEASurement.....	176
[SENSe:]CONFigure:MODE:DUT.....	132
[SENSe:]CONFigure:MODE:SYSTem:IF:FREQuency.....	131
[SENSe:]CONFigure:MODE:SYSTem:LO.....	131
[SENSe:]CONFigure:MODE:SYSTem:LO:FREQuency.....	131
[SENSe:]CORRection:CVL:BAND.....	180
[SENSe:]CORRection:CVL:BIAS.....	180
[SENSe:]CORRection:CVL:CATalog?.....	180
[SENSe:]CORRection:CVL:CLEar.....	181
[SENSe:]CORRection:CVL:COMMeNt.....	181
[SENSe:]CORRection:CVL:DATA.....	181
[SENSe:]CORRection:CVL:HARMonic.....	181
[SENSe:]CORRection:CVL:MIXer.....	182
[SENSe:]CORRection:CVL:PORTs.....	182
[SENSe:]CORRection:CVL:SELeCt.....	183
[SENSe:]CORRection:CVL:SNUMber.....	183
[SENSe:]CORRection:ENR:CALibration:MODE.....	134
[SENSe:]CORRection:ENR:CALibration:SNS:SRNumber.....	140
[SENSe:]CORRection:ENR:CALibration:SPOT.....	134
[SENSe:]CORRection:ENR:CALibration:SPOT:COLD.....	133
[SENSe:]CORRection:ENR:CALibration:SPOT:HOT.....	133
[SENSe:]CORRection:ENR:CALibration:TABLE:SELeCt.....	134
[SENSe:]CORRection:ENR:CALibration:TYPE.....	135
[SENSe:]CORRection:ENR:COMMon.....	135
[SENSe:]CORRection:ENR[:MEASurement]:MODE.....	138
[SENSe:]CORRection:ENR[:MEASurement]:SNS:SRNumber.....	140
[SENSe:]CORRection:ENR[:MEASurement]:SPOT.....	138
[SENSe:]CORRection:ENR[:MEASurement]:SPOT:COLD.....	139
[SENSe:]CORRection:ENR[:MEASurement]:SPOT:HOT.....	139
[SENSe:]CORRection:ENR[:MEASurement]:TABLE:DELeTe.....	136
[SENSe:]CORRection:ENR[:MEASurement]:TABLE:LIST?.....	136
[SENSe:]CORRection:ENR[:MEASurement]:TABLE:SELeCt.....	136
[SENSe:]CORRection:ENR[:MEASurement]:TABLE:TEMPerature:DELeTe.....	137
[SENSe:]CORRection:ENR[:MEASurement]:TABLE:TEMPerature:LIST?.....	137
[SENSe:]CORRection:ENR[:MEASurement]:TABLE:TEMPerature[:DATA].....	137
[SENSe:]CORRection:ENR[:MEASurement]:TABLE[:DATA].....	135

[SENSe:]CORRection:ENR[:MEASurement]:TYPE.....	138
[SENSe:]CORRection:IREJection.....	132
[SENSe:]CORRection:LOSS:CALibration:MODE.....	141
[SENSe:]CORRection:LOSS:CALibration:SPOT.....	141
[SENSe:]CORRection:LOSS:CALibration:TABLE:DELeTe.....	141
[SENSe:]CORRection:LOSS:CALibration:TABLE:LIST?.....	142
[SENSe:]CORRection:LOSS:CALibration:TABLE:SELeCt.....	142
[SENSe:]CORRection:LOSS:CALibration:TABLE[:DATA].....	142
[SENSe:]CORRection:LOSS:CALibration:TEMPerature.....	143
[SENSe:]CORRection:LOSS:INPut:MODE.....	143
[SENSe:]CORRection:LOSS:INPut:SPOT.....	143
[SENSe:]CORRection:LOSS:INPut:TABLE:DELeTe.....	144
[SENSe:]CORRection:LOSS:INPut:TABLE:LIST?.....	144
[SENSe:]CORRection:LOSS:INPut:TABLE:SELeCt.....	144
[SENSe:]CORRection:LOSS:INPut:TABLE[:DATA].....	143
[SENSe:]CORRection:LOSS:INPut:TEMPerature.....	145
[SENSe:]CORRection:LOSS:OUTPut:MODE.....	145
[SENSe:]CORRection:LOSS:OUTPut:SPOT.....	145
[SENSe:]CORRection:LOSS:OUTPut:TABLE:DELeTe.....	146
[SENSe:]CORRection:LOSS:OUTPut:TABLE:LIST?.....	146
[SENSe:]CORRection:LOSS:OUTPut:TABLE:SELeCt.....	146
[SENSe:]CORRection:LOSS:OUTPut:TABLE[:DATA].....	146
[SENSe:]CORRection:LOSS:OUTPut:TEMPerature.....	147
[SENSe:]CORRection:RECall.....	149
[SENSe:]CORRection:SAVE.....	149
[SENSe:]CORRection:TEMPerature.....	139
[SENSe:]CORRection[:STATe].....	149
[SENSe:]FREQuency:CENTer.....	127
[SENSe:]FREQuency:LIST:DATA.....	128
[SENSe:]FREQuency:POINts.....	128
[SENSe:]FREQuency:SINGle.....	128
[SENSe:]FREQuency:SINGle:COUPled.....	129
[SENSe:]FREQuency:SPAN.....	129
[SENSe:]FREQuency:STARt.....	129
[SENSe:]FREQuency:STEP.....	130
[SENSe:]FREQuency:STOP.....	130
[SENSe:]FREQuency:TABLE:DATA.....	127
[SENSe:]MIXer<x>:BIAS:HIGH.....	183
[SENSe:]MIXer<x>:BIAS[:LOW].....	183
[SENSe:]MIXer<x>:FREQuency:HANdOver.....	184
[SENSe:]MIXer<x>:FREQuency:STARt.....	184
[SENSe:]MIXer<x>:FREQuency:STOP.....	184
[SENSe:]MIXer<x>:HARMonic:BAND.....	185
[SENSe:]MIXer<x>:HARMonic:BAND:PRESet.....	185
[SENSe:]MIXer<x>:HARMonic:HIGH[:VALue].....	186
[SENSe:]MIXer<x>:HARMonic:TYPE.....	186
[SENSe:]MIXer<x>:HARMonic[:LOW].....	186
[SENSe:]MIXer<x>:LOPower.....	187
[SENSe:]MIXer<x>:LOSS:HIGH.....	187
[SENSe:]MIXer<x>:LOSS:TABLE:HIGH.....	188

[SENSe:]MIXer<x>:LOSS:TABLE[:LOW].....	188
[SENSe:]MIXer<x>:LOSS[:LOW].....	188
[SENSe:]MIXer<x>:PORTs.....	189
[SENSe:]MIXer<x>:RFOVerrange[:STATe].....	189
[SENSe:]MIXer<x>:SIGNal.....	187
[SENSe:]MIXer<x>:THReshold.....	189
[SENSe:]MIXer<x>[:STATe].....	190
[SENSe:]SWEep:COUNT.....	150
[SENSe:]SWEep:EGATe.....	157
[SENSe:]SWEep:EGATe:CONTInuous:PCOunt.....	158
[SENSe:]SWEep:EGATe:CONTInuous:PLENgtH.....	158
[SENSe:]SWEep:EGATe:CONTInuous[:STATe].....	158
[SENSe:]SWEep:EGATe:HOLDoff.....	159
[SENSe:]SWEep:EGATe:LENGth.....	159
[SENSe:]SWEep:EGATe:POLarity.....	159
[SENSe:]SWEep:EGATe:SOURce.....	160
[SENSe:]SWEep:EGATe:TYPE.....	160
[SENSe:]SWEep:TIME.....	150
[SENSe:]SWEep:TIME:AUTO.....	150
ABORT.....	173
CALCulate<n>:DELTAmarker<m>:AOFF.....	215
CALCulate<n>:DELTAmarker<m>:MAXimum:LEFT.....	220
CALCulate<n>:DELTAmarker<m>:MAXimum:NEXT.....	221
CALCulate<n>:DELTAmarker<m>:MAXimum:RIGHT.....	221
CALCulate<n>:DELTAmarker<m>:MAXimum[:PEAK].....	221
CALCulate<n>:DELTAmarker<m>:MINimum:LEFT.....	221
CALCulate<n>:DELTAmarker<m>:MINimum:NEXT.....	222
CALCulate<n>:DELTAmarker<m>:MINimum:RIGHT.....	222
CALCulate<n>:DELTAmarker<m>:MINimum[:PEAK].....	222
CALCulate<n>:DELTAmarker<m>:MREFerence.....	215
CALCulate<n>:DELTAmarker<m>:TRACe.....	216
CALCulate<n>:DELTAmarker<m>:X.....	216
CALCulate<n>:DELTAmarker<m>:Y?.....	216
CALCulate<n>:DELTAmarker<m>[:STATe].....	215
CALCulate<n>:LIMit:ACTive?.....	208
CALCulate<n>:LIMit:CLEar[:IMMediate].....	209
CALCulate<n>:LIMit:COMMeNt.....	203
CALCulate<n>:LIMit:CONTRol:SHIFt.....	205
CALCulate<n>:LIMit:CONTRol[:DATA].....	205
CALCulate<n>:LIMit:COPY.....	208
CALCulate<n>:LIMit:DELeTe.....	209
CALCulate<n>:LIMit:FAIL?.....	209
CALCulate<n>:LIMit:LOWer:SHIFt.....	206
CALCulate<n>:LIMit:LOWer:STATe.....	206
CALCulate<n>:LIMit:LOWer[:DATA].....	206
CALCulate<n>:LIMit:NAME.....	203
CALCulate<n>:LIMit:STATe.....	210
CALCulate<n>:LIMit:TRACe<t>.....	210
CALCulate<n>:LIMit:TRACe<t>:CHECK.....	211
CALCulate<n>:LIMit:TYPE.....	204

CALCulate<n>:LIMit:UPPer:SHIFt.....	207
CALCulate<n>:LIMit:UPPer:STATe.....	208
CALCulate<n>:LIMit:UPPer[:DATA].....	207
CALCulate<n>:MARKer<m>:AOFF.....	212
CALCulate<n>:MARKer<m>:MAXimum:LEFT.....	218
CALCulate<n>:MARKer<m>:MAXimum:NEXT.....	219
CALCulate<n>:MARKer<m>:MAXimum:RIGHT.....	219
CALCulate<n>:MARKer<m>:MAXimum[:PEAK].....	219
CALCulate<n>:MARKer<m>:MINimum:LEFT.....	219
CALCulate<n>:MARKer<m>:MINimum:NEXT.....	219
CALCulate<n>:MARKer<m>:MINimum:RIGHT.....	220
CALCulate<n>:MARKer<m>:MINimum[:PEAK].....	220
CALCulate<n>:MARKer<m>:TRACe.....	213
CALCulate<n>:MARKer<m>:X.....	213
CALCulate<n>:MARKer<m>:Y?.....	213
CALCulate<n>:MARKer<m>[:STATe].....	212
CALCulate<n>:UNCertainty:COMMon.....	163
CALCulate<n>:UNCertainty:DATA:FREQuency.....	163
CALCulate<n>:UNCertainty:DATA:GAIN.....	164
CALCulate<n>:UNCertainty:DATA:NOISe.....	164
CALCulate<n>:UNCertainty:DATA:RESuLts.....	164
CALCulate<n>:UNCertainty:ENR:CALibratiOn:UNCertainty.....	165
CALCulate<n>:UNCertainty:ENR:CALibratiOn:UNCertainty:COLD.....	165
CALCulate<n>:UNCertainty:ENR:CALibratiOn:UNCertainty:HOT.....	166
CALCulate<n>:UNCertainty:ENR:UNCertainty.....	166
CALCulate<n>:UNCertainty:ENR:UNCertainty:COLD.....	166
CALCulate<n>:UNCertainty:ENR:UNCertainty:HOT.....	167
CALCulate<n>:UNCertainty:MATCH:DUT:IN:RL.....	167
CALCulate<n>:UNCertainty:MATCH:DUT:IN[:VSWR].....	167
CALCulate<n>:UNCertainty:MATCH:DUT:OUT:RL.....	168
CALCulate<n>:UNCertainty:MATCH:DUT:OUT[:VSWR].....	168
CALCulate<n>:UNCertainty:MATCH:PREamp:RL.....	168
CALCulate<n>:UNCertainty:MATCH:PREamp[:VSWR].....	169
CALCulate<n>:UNCertainty:MATCH:SOURce:CALibratiOn:RL.....	169
CALCulate<n>:UNCertainty:MATCH:SOURce:CALibratiOn[:VSWR].....	169
CALCulate<n>:UNCertainty:MATCH:SOURce:RL.....	170
CALCulate<n>:UNCertainty:MATCH:SOURce[:VSWR].....	170
CALCulate<n>:UNCertainty:PREamp:GAIN.....	170
CALCulate<n>:UNCertainty:PREamp:NOISe.....	171
CALCulate<n>:UNCertainty:PREamp:STATe.....	171
CALCulate<n>:UNCertainty:SANalyzer:GAIN:UNCertainty?.....	172
CALCulate<n>:UNCertainty:SANalyzer:NOISe:UNCertainty?.....	172
CALCulate<n>:UNCertainty[:RESuLt]?.....	171
DISPlay:FORMat.....	123
DISPlay[:WINDow<n>]:MINFo[:STATe].....	217
DISPlay[:WINDow<n>]:MTABLE.....	218
DISPlay[:WINDow<n>]:SIZE.....	123
DISPlay[:WINDow<n>]:TABLE:ITEM.....	194
DISPlay[:WINDow<n>]:TRACe<t>:SYMBols.....	194
DISPlay[:WINDow<n>]:TRACe<t>:UNCertainty.....	195

DISPlay[:WINDow<n>]:TRACe<t>:X[:SCALe].....	195
DISPlay[:WINDow<n>]:TRACe<t>:Y[:SCALe]:AUTO.....	196
DISPlay[:WINDow<n>]:TRACe<t>:Y[:SCALe]:BOTTom.....	196
DISPlay[:WINDow<n>]:TRACe<t>:Y[:SCALe]:RLEVel.....	151
DISPlay[:WINDow<n>]:TRACe<t>:Y[:SCALe]:RLEVel:AUTO.....	151
DISPlay[:WINDow<n>]:TRACe<t>:Y[:SCALe]:TOP.....	197
DISPlay[:WINDow<n>][:SUBWindow<w>]:TRACe<t>:MODE.....	198
DISPlay[:WINDow<n>][:SUBWindow<w>]:TRACe<t>:SMOothing:APERture.....	199
DISPlay[:WINDow<n>][:SUBWindow<w>]:TRACe<t>:SMOothing[:STATE].....	199
DISPlay[:WINDow<n>][:SUBWindow<w>]:TRACe<t>[:STATE].....	198
FORMat:DEXPort:DSEParator.....	200
FORMat:DEXPort:HEADer.....	201
FORMat:DEXPort:TRACes.....	201
FORMat[:DATA].....	199
INITiate:SEQuencer:ABORt.....	174
INITiate:SEQuencer:IMMediate.....	175
INITiate:SEQuencer:MODE.....	175
INITiate<n>:CONTinuous.....	173
INITiate<n>[:IMMediate].....	174
INPut<ip>:ATTenuation.....	151
INPut<ip>:COUPLing.....	177
INPut<ip>:FILTer:HPASs[:STATE].....	178
INPut<ip>:FILTer:YIG[:STATE].....	178
INPut<ip>:GAIN:STATE.....	152
INPut<ip>:GAIN[:VALue].....	152
INPut<ip>:IMPedance.....	178
INSTrument:CREate:DUPLicate.....	113
INSTrument:CREate:REPLace.....	114
INSTrument:CREate[:NEW].....	114
INSTrument:DELeTe.....	114
INSTrument:LIST?.....	115
INSTrument:REName.....	115
INSTrument[:SElect].....	116
LAYout:ADD[:WINDow]?.....	117
LAYout:CATalog[:WINDow]?.....	118
LAYout:IDENtify[:WINDow]?.....	119
LAYout:REMOve[:WINDow].....	119
LAYout:REPLace[:WINDow].....	119
LAYout:SPLitter.....	120
LAYout:WINDow<n>:ADD?.....	121
LAYout:WINDow<n>:IDENtify?.....	122
LAYout:WINDow<n>:REMOve.....	122
LAYout:WINDow<n>:REPLace.....	122
MMEMory:STORe<n>:TRACe.....	201
OUTPut<up>:TRIGger<tp>:DIRection.....	160
OUTPut<up>:TRIGger<tp>:LEVel.....	161
OUTPut<up>:TRIGger<tp>:OTYPe.....	161
OUTPut<up>:TRIGger<tp>:PULSe:IMMediate.....	162
OUTPut<up>:TRIGger<tp>:PULSe:LENGth.....	162
SOURce:EXTernal:FREQUency:OFFSet<of>.....	190

SOURce:EXternal:FREQUENCY[:FACTOR]:DENominator.....	190
SOURce:EXternal:FREQUENCY[:FACTOR]:NUMerator.....	190
SOURce<si>:EXternal<gen>:POWer[:LEVel].....	191
SOURce<si>:EXternal<gen>:ROSCillator[:SOURce].....	191
STATus:OPERation:CONDition?.....	227
STATus:OPERation:ENABle.....	228
STATus:OPERation:NTRansition.....	228
STATus:OPERation:PTRansition.....	228
STATus:OPERation[:EVENT]?.....	227
STATus:QUEStionable:CONDition?.....	227
STATus:QUEStionable:CORRection:CONDition?.....	227
STATus:QUEStionable:CORRection:ENABle.....	228
STATus:QUEStionable:CORRection:NTRansition.....	228
STATus:QUEStionable:CORRection:PTRansition.....	228
STATus:QUEStionable:CORRection[:EVENT]?.....	227
STATus:QUEStionable:ENABle.....	228
STATus:QUEStionable:LIMit:CONDition?.....	227
STATus:QUEStionable:LIMit:ENABle.....	228
STATus:QUEStionable:LIMit:NTRansition.....	228
STATus:QUEStionable:LIMit:PTRansition.....	228
STATus:QUEStionable:LIMit[:EVENT]?.....	227
STATus:QUEStionable:NTRansition.....	228
STATus:QUEStionable:PTRansition.....	228
STATus:QUEStionable[:EVENT]?.....	227
SYSTem:COMMunicate:GPIB:RDEvice:GENerator<gen>:ADDReSS.....	192
SYSTem:COMMunicate:RDEvice:GENerator<gen>:INTerface.....	191
SYSTem:COMMunicate:RDEvice:GENerator<gen>:TYPE.....	192
SYSTem:COMMunicate:TCPip:RDEvice:GENerator<gen>:ADDReSS.....	192
SYSTem:CONFIgure:DUT:GAIN.....	153
SYSTem:CONFIgure:DUT:STIME.....	153
SYSTem:CONFIgure:GENerator:CONTRol:STATe.....	193
SYSTem:CONFIgure:GENerator:INITialise:AUTO.....	193
SYSTem:CONFIgure:GENerator:INITialise[:IMMEDIATE].....	193
SYSTem:CONFIgure:GENerator:SWITCh:AUTO.....	193
SYSTem:PRESet:CHANnel[:EXEC].....	116
SYSTem:SEQuencer.....	176
TRACe<n>:COPY.....	202
TRACe<n>[:DATA]?.....	124
TRIGger[:SEQuence]:DTIME.....	154
TRIGger[:SEQuence]:HOLDoff[:TIME].....	154
TRIGger[:SEQuence]:IFPower:HOLDoff.....	154
TRIGger[:SEQuence]:IFPower:HYSteresis.....	155
TRIGger[:SEQuence]:LEVel:IFPower.....	155
TRIGger[:SEQuence]:LEVel:IQPower.....	156
TRIGger[:SEQuence]:LEVel:RFPower.....	156
TRIGger[:SEQuence]:LEVel[:EXternal<port>].....	155
TRIGger[:SEQuence]:SLOPe.....	156
TRIGger[:SEQuence]:SOURce.....	157

Index

Symbols

2nd stage correction 35, 67

A

Aborting
 Sweep 83
 AC/DC coupling 85
 Application cards 11
 Application notes 11
 Attenuation 69
 Auto ID
 External Mixer (remote) 187
 Threshold (External Mixer, remote control) 189
 Auto level range 69
 Averaging 68

B

Band
 External Mixer (remote) 185
 Bandwidth
 Resolution 38, 67
 Bias
 External Mixer (remote) 183
 Brochures 11

C

Calibration 35, 67, 83
 Recall 38
 Save 37
 Capture time
 see also Measurement time 150
 Center frequency 47
 Channel
 Creating (remote) 114, 116
 Deleting (remote) 114
 Duplicating (remote) 113
 Querying (remote) 115
 Renaming (remote) 115
 Replacing (remote) 114
 Selecting (remote) 116
 Clear 51
 Closing
 Channels (remote) 114
 Windows (remote) 122
 Comment
 Limit lines 105
 Compatibility
 Limit lines 103
 Continuous sweep
 Softkey 83
 Conventions
 SCPI commands 109
 Conversion loss
 External Mixer (remote) 187, 188
 Conversion loss tables
 Available (remote) 180
 Band (remote) 180
 Bias (remote) 180
 Deleting (remote) 181
 External Mixer (remote) 188

Harmonic order (remote) 181
 Mixer type (remote) 182
 Selecting (remote) 183

Copying

Channel (remote) 113
 Traces 97

D

Data format
 Remote 201
 Data sheets 11
 Decimal separator
 Trace export 96
 Deleting
 Limit line values 105
 Delta markers
 Defining 99
 Direct measurement 52
 Direct measurements 30
 Drop-out time
 Trigger 79
 Duplicating
 Channel (remote) 113
 DUT characteristics 52

E

ENR 53
 ENR source 55
 ENR table 57
 Delete 59
 Edit 58, 59
 Evaluation methods
 Remote 117
 Excess noise ratio (ENR) 53
 Exporting
 Measurement settings 96
 Traces 96
 External generator
 Interface 87
 Interface settings 86
 External Mixer
 Activating (remote) 190
 Band 184
 RF overrange 189
 Type 189
 External reference
 External generator control 87
 External trigger 78
 Level (remote) 155

F

Filters
 High-pass (RF input) 85
 RBW 38
 YIG (remote) 178
 Fixed LO 52, 53
 Format
 Data (remote) 201
 Free Run
 Trigger 78

- Frequency
 - Center 47
 - Span 47
 - Start 47
 - Stepsize 48
 - Stop 47
- Frequency conversion 52
- Frequency conversion measurements 30
- Frequency list 27, 50
- Frequency set 45
- Frequency table 50, 51
- G**
- Gate
 - Delay 81
 - Length 81
 - Mode 81
 - Settings 80
- Gated trigger
 - Activating 81
 - Delay 81
 - Length 81
 - Mode 81
- Gating
 - Source 78
- Generator type
 - External generator 86
- Generators
 - Frequency range, external generator 87
 - Power range, external generator 87
 - Setup files, external generator 86, 87
- Getting started 10
- GPIO
 - Address, External generator 87
 - External generator 87
 - TTL synchronization, External generator 87
- Group delay
 - Smoothing 96
- H**
- Handover frequency
 - External Mixer (remote) 184
- Hardware settings
 - Displayed 15
- Harmonics
 - External Mixer (remote) 186
- High-pass filter
 - RF input 85
- Hysteresis
 - Trigger 79
- I**
- I/Q Power
 - Trigger level (remote) 156
- IF Power
 - Trigger level (remote) 155
- Image rejection 53
- Impedance
 - Setting 85
- Input
 - Coupling 85
- Input loss 61
- Inserting
 - Limit line values 105
- Installation 13
- Instrument security procedures 10
- K**
- Keys
 - Peak Search 101
 - RUN CONT 83
 - RUN SINGLE 83
- L**
- Limit lines 102
 - Activating/Deactivating 103
 - Comment 105
 - Compatibility 103
 - Copying 104
 - Creating 104
 - Data points 105
 - Deactivating 104
 - Deleting 104
 - Deleting values 105
 - Details 104
 - Editing 104
 - Inserting values 105
 - Managing 102
 - Name 105
 - Saving 106
 - Selecting 103
 - Shifting 105, 106
 - Traces 103
 - View filter 103
 - Visibility 103
 - Y-axis 105
- Lines
 - Configuration 102
 - Limit, see Limit lines 102
- LO
 - Level (External Mixer, remote control) 187
- Loss
 - Input 61
 - Output 61
- Loss table 64
 - Delete 65
 - Edit 65
- Losses 61
- M**
- Marker 40
- Markers
 - Deactivating 99
 - Delta markers 99
 - Minimum 101
 - Next minimum 101
 - Next peak 101
 - Peak 101
 - Table 99
 - Type 99
- Maximizing
 - Windows (remote) 123
- Measurement
 - Frequency list 27
 - Performing 82
- Measurement point
 - Delete 51
 - Insert 51

- Measurement points 47
- Measurement time
 - Remote 150
- Minimum 101
 - Marker positioning 101
 - Next 101
- Multiple
 - Measurement channels 14
- N**
- Name
 - Limit lines 105
- Next Minimum 101
 - Marker positioning 101
- Next Peak 101
 - Marker positioning 101
- Noise source 35
- Noise source characteristics 53
- O**
- Options
 - High-pass filter 85
 - Preamplifier 69
- Output loss 61
- Overview
 - Configuration 43
- P**
- Peak search
 - Key 101
- Peaks
 - Marker positioning 101
 - Next 101
 - Softkey 101
- Populate 51
- Ports
 - External Mixer (remote) 189
- Position
 - Limit line values 105
- Preamplifier
 - Setting 69
 - Softkey 69
- Preset
 - Bands (External Mixer, remote) 185
- Presetting
 - Channels 45
- Pretrigger 79
- Preview
 - Trigger/Gate settings 77
- R**
- RBW 67
 - see Resolution Bandwidth 38
- Reference frequency
 - External generator 87
- Reference level 68
- Release notes 11
- Remote commands
 - Basics on syntax 108
 - Boolean values 112
 - Capitalization 109
 - Character data 112
 - Data blocks 113
 - Numeric values 111
 - Optional keywords 110
 - Parameters 111
 - Strings 113
 - Suffixes 110
- Resolution bandwidth 67
 - Impact 38
- Restoring
 - Channel settings 45
- Results
 - Data format (remote) 201
 - Exporting 96
- RF attenuation 69
- RF overrange
 - External Mixer 189
- RF Power
 - Trigger level (remote) 156
- Room temperature 57
- RUN CONT
 - Key 83
- RUN SINGLE
 - Key 83
- S**
- Safety instructions 11
- Saving
 - Limit lines 106
- Security procedures 10
- Sensitivity
 - RBW 38
- Sequencer 14
 - Activating (remote) 175
 - Remote 173
- Sequences
 - Aborting (remote) 174
 - Mode (remote) 175
- Service manual 10
- Settling time 68
- Setup files
 - External generator 86, 87
- Shift x
 - Limit lines 105
- Shift y
 - Limit lines 106
- Signal capturing
 - Duration (remote) 150
- Signal ID
 - External Mixer (remote) 187
- Single sweep
 - Softkey 83
- Slope
 - Trigger 80, 156
- Smoothing
 - Traces (group delay) 96
- Softkeys
 - Continuous Sweep 83
 - External 78
 - Free Run 78
 - Line Config 102
 - Min 101
 - Next Min 101
 - Next Peak 101
 - Norm/Delta 99
 - Peak 101
 - Preamp 69
 - Single Sweep 83

Trigger Offset	79
Trigger/Gate Config	76
Span	47
Specifics for	
Configuration	45
Start frequency	47
Step(size)	48
Stop frequency	47
Suffixes	
Common	108
Remote commands	110
Sweep	
Aborting	83
Time (remote)	150
Sweep time	67
T	
TCP/IP	
Address, External generator	87
External generator	87
Temperature	57
Trace	94
Mode	39
Preset	96
Selection	95
Trace export	96
Traces	
Copying	97
Copying (remote control)	202
Export format	96
Exporting	96
Mode (remote)	198
Traces to be Checked	
Limit lines	103
Trigger	
Configuration preview	77
Drop-out time	79
External (remote)	157
Holdoff	80
Hysteresis	79
Offset	79
Slope	80, 156
Trigger level	79
External trigger (remote)	155
I/Q Power (remote)	156
IF Power (remote)	155
RF Power (remote)	156
Trigger source	78
External	78
Free Run	78
Trigger/Gate	
Configuration (Softkey)	76
TTL handshake	
see TTL synchronization	87
TTL synchronization	
External generator	87
Tuning mode	26, 46
V	
View filter	
Limit lines	103
Visible	
Limit lines	103

W

White papers	11
Window title bar information	15
Windows	
Adding (remote)	117
Closing (remote)	122
Configuring	45
Layout (remote)	120
Maximizing (remote)	123
Querying (remote)	118, 119
Replacing (remote)	119
Splitting (remote)	123
Types (remote)	117

Y

Y-axis	
Limit lines	105
YIG-preselector	
Activating/Deactivating	85
Activating/Deactivating (remote)	178